

# United States of America

United States Patent and Trademark Office

## WONDERPEDIA

**Reg. No. 4,196,223**

DHX MEDIA LTD. (CANADA CORPORATION)  
1478 QUEEN STREET

**Registered Aug. 28, 2012**

HALIFAX, NOVA SCOTIA, CANADA B3J2H7

**Int. Cl.: 41**

FOR: ENTERTAINMENT SERVICES, NAMELY, THE PROVISION OF INFORMATION RESOURCES IN THE FIELD OF EDUCATION FOR CHILDREN AND PARENTS, VIA THE GLOBAL COMPUTER NETWORK, WIRELESS NETWORKS OR INTERACTIVE TELEVISION, IN CLASS 41 (U.S. CLS. 100, 101 AND 107).

**SERVICE MARK**

**PRINCIPAL REGISTER**

THE MARK CONSISTS OF STANDARD CHARACTERS WITHOUT CLAIM TO ANY PARTICULAR FONT, STYLE, SIZE, OR COLOR.

PRIORITY CLAIMED UNDER SEC. 44(D) ON CANADA APPLICATION NO. 1333663, FILED 2-2-2007, REG. NO. 817391, DATED 2-10-2012, EXPIRES 2-10-2027.

SER. NO. 76-672,397, FILED 2-6-2007.

BRIAN NEVILLE, EXAMINING ATTORNEY



*David J. Kyffers*

Director of the United States Patent and Trademark Office



# United States of America

United States Patent and Trademark Office

**Time**Keeping  
Systems, Incorporated

**Reg. No. 4,196,224**

TIMEKEEPING SYSTEMS, INC. (OHIO CORPORATION)

**Registered Aug. 28, 2012**

30700 BAINBRIDGE ROAD  
SOLON, OH 44139

**Int. Cl.: 9**

FOR: SECURITY GUARD TOUR DATA COLLECTION SYSTEMS COMPRISING HARDWARE, ELECTRONIC DATA COLLECTORS IN THE NATURE OF PORTABLE DATA COLLECTION DEVICES FOR READING AND RECORDING SECURITY DATA, COMPUTER HARDWARE FOR DOWNLOAD AND TRANSMISSION OF DATA COLLECTED BY THE ELECTRONIC DATA COLLECTORS, SPECIALTY HOLSTERS FOR CARRYING THE ELECTRONIC DATA COLLECTORS, TOUCH BUTTONS, NAMELY, ELECTRONIC BUTTONS CONTAINING ELECTRICAL CIRCUITRY IN THE NATURE OF A MICROCHIP RESPONSIVE TO THE ELECTRONIC DATA COLLECTORS AND USED FOR THE PURPOSE OF IDENTIFYING CHECKPOINTS AND/OR CONDITIONS TO BE NOTED DURING A GUARD TOUR, TOUCH BUTTONS AND MOUNTS THEREFOR SOLD AS A UNIT, AND COMPUTER SOFTWARE FOR USE IN DOWNLOADING, MONITORING, ANALYZING AND REPORTING THE DATA COLLECTED BY THE ELECTRONIC DATA COLLECTORS AND FOR PROVIDING FOR THE ANALYSES THEREOF; METALLIC AND NON-METALLIC MOUNTS SPECIALLY DESIGNED FOR TOUCH BUTTONS, NAMELY, ELECTRONIC BUTTONS CONTAINING ELECTRICAL CIRCUITRY IN THE NATURE OF A MICROCHIP RESPONSIVE TO THE ELECTRONIC DATA COLLECTORS, IN CLASS 9 (U.S. CLS. 21, 23, 26, 36 AND 38).

**TRADEMARK**

**PRINCIPAL REGISTER**

FIRST USE 4-1-2000; IN COMMERCE 4-1-2000.

NO CLAIM IS MADE TO THE EXCLUSIVE RIGHT TO USE "SYSTEMS INCORPORATED", APART FROM THE MARK AS SHOWN.

THE COLOR(S) RED AND BLACK IS/ARE CLAIMED AS A FEATURE OF THE MARK.

THE MARK CONSISTS OF THE WORD "TIMEKEEPING" ABOVE THE WORDS "SYSTEMS, INCORPORATED", WHEREIN THE TIME PORTION OF THE WORD "TIMEKEEPING" IS IN RED, THE "KEEPING" PORTION OF THE WORD "TIMEKEEPING" IS IN BLACK AND THE WORDS "SYSTEMS, INCORPORATED" ARE IN BLACK.



*David J. Kyjars*

SEC. 2(F).

SER. NO. 76-702,266, FILED 3-29-2010.

**Reg. No. 4,196,224** AMY ALFIERI, EXAMINING ATTORNEY

United States of America  
United States Patent and Trademark Office

PIXCEN

**Reg. No. 4,196,225**

**Registered Aug. 28, 2012**

**Int. Cls.: 41 and 42**

**SERVICE MARK**

**PRINCIPAL REGISTER**

VISUAL INTELLIGENCE LP (DELAWARE LIMITED LIABILITY COMPANY)  
510 BERING DRIVE  
SUITE 310  
HOUSTON, TX 77057

FOR: ORTHO IMAGING SERVICES, NAMELY, DIGITAL IMAGE PROCESSING SERVICES,  
IN CLASS 41 (U.S. CLS. 100, 101 AND 107).

FIRST USE 12-0-2006; IN COMMERCE 12-0-2006.

FOR: ORTHO IMAGING SERVICES, NAMELY, PHOTOGRAMMETRY SERVICES, IN CLASS  
42 (U.S. CLS. 100 AND 101).

FIRST USE 12-0-2006; IN COMMERCE 12-0-2006.

THE MARK CONSISTS OF STANDARD CHARACTERS WITHOUT CLAIM TO ANY PAR-  
TICULAR FONT, STYLE, SIZE, OR COLOR.

SER. NO. 76-705,693, FILED 12-15-2010.

NANCY CLARKE, EXAMINING ATTORNEY



*David J. Kybas*

Director of the United States Patent and Trademark Office

# United States of America

United States Patent and Trademark Office

# GRIP ZONE

**Reg. No. 4,196,226**

**Registered Aug. 28, 2012**

**Int. Cl.: 28**

**TRADEMARK**

**PRINCIPAL REGISTER**

SASSAK, MARK S. (UNITED STATES INDIVIDUAL)  
1340 LINDEN  
PLYMOTH, MI 48170

FOR: SPORTS BALLS, NAMELY, FOOTBALLS, BASKETBALLS, BASEBALLS, SOFTBALLS, BOWLING BALLS, SOCCER BALLS, VOLLEYBALLS, PADDLE BALLS, JUGGLE BALLS, WATER POLO BALLS, LACROSSE BALLS, PLAYGROUND BALLS, TENNIS AND FOOTBALL THROWING MACHINES AND BASEBALL AND SOFTBALL BATTING PRACTICE SCREENS AND CAGES; BASKETBALL GOAL SETS; BASKETBALL GOALS; BASKETBALL HOOPS; BASKETBALL NETS; BASKETBALLS; BODY LIMB COMPRESSION SLEEVES FOR USE IN SOCCER AND OTHER SPORTS; FOOTBALL AND SOCCER GOALS; HOCKEY GOALS; SOCCER BALL GOAL NETS; SOCCER BALL KNEE PADS; SOCCER GOALS; TROLLEY BAGS SPECIALLY ADAPTED FOR SOCCER EQUIPMENT, BAGS SPECIALLY ADAPTED FOR SPORTS EQUIPMENT; SPORTING GOODS, NAMELY, BASEBALL GLOVES AND BASEBALL BATS, CARRIERS SPECIALLY ADAPTED FOR SPORTS BALL AND SHIN PADS FOR USE IN SOCCER, LACROSSE SETS COMPRISING LACROSSE STICKS AND BALLS AND GOAL NET, JAI ALAI SET COMPRISED OF BALLS AND BASKETS; EQUIPMENT DESIGNED FOR ATHLETIC USE FOR PROTECTION FROM SPORTS INJURY, NAMELY, ELBOW GUARDS AND PADS, KNEE GUARDS AND PADS, HIP-GUARDS, ABDOMINAL GUARDS AND PADS, BACK GUARDS AND PADS, MOUTH GUARDS, SHIN GUARDS, AND BASEBALL, BASEBALL BATTING, BOWLING, FOOTBALL, GOLF, HOCKEY, AND HANDBALL GLOVES; DISC TOSS TOYS AND FLYING DISCS; AND BOWLING SETS COMPRISING, BOWLING PINS, TOY ALLEYS, AND BALLS, IN CLASS 28 (U.S. CLS. 22, 23, 38 AND 50).

FIRST USE 2-28-2008; IN COMMERCE 2-28-2008.

THE MARK CONSISTS OF STANDARD CHARACTERS WITHOUT CLAIM TO ANY PARTICULAR FONT, STYLE, SIZE, OR COLOR.

NO CLAIM IS MADE TO THE EXCLUSIVE RIGHT TO USE "GRIP", APART FROM THE MARK AS SHOWN.

SER. NO. 76-707,493, FILED 5-3-2011.

CHRISTINE MARTIN, EXAMINING ATTORNEY



*David J. Kyros*

Director of the United States Patent and Trademark Office

# United States of America

United States Patent and Trademark Office

# SOFTOUCH

**Reg. No. 4,196,227**

**Registered Aug. 28, 2012**

**Int. Cl.: 24**

**TRADEMARK**

**PRINCIPAL REGISTER**

GLIPTONE MANUFACTURING, INC. (NEW YORK CORPORATION)  
1740 JULIA GOLDBACH AVENUE  
RONKONKOMA, NY 11779

FOR: MICROFIBER TOWEL FOR USE IN MOTOR VEHICLE CLEANING, WAXING, POLISHING, AND MAINTENANCE OF VEHICLE EXTERIORS AND INTERIORS, IN CLASS 24 (U.S. CLS. 42 AND 50).

FIRST USE 2-15-2003; IN COMMERCE 2-15-2003.

THE MARK CONSISTS OF STANDARD CHARACTERS WITHOUT CLAIM TO ANY PARTICULAR FONT, STYLE, SIZE, OR COLOR.

SER. NO. 76-707,836, FILED 6-3-2011.

ROSELLE HERRERA, EXAMINING ATTORNEY



*David J. Kyffers*

Director of the United States Patent and Trademark Office

# United States of America

United States Patent and Trademark Office

## MILLS COFFEE

**Reg. No. 4,196,228**

**Registered Aug. 28, 2012**

**Int. Cl.: 30**

**TRADEMARK**

**PRINCIPAL REGISTER**

MILLS COFFEE ROASTING CO., INC. (RHODE ISLAND CORPORATION)  
1058 BROAD ST.  
PROVIDENCE, RI 02905

FOR: COFFEE, IN CLASS 30 (U.S. CL. 46).

FIRST USE 1-1-1900; IN COMMERCE 1-1-1900.

THE MARK CONSISTS OF STANDARD CHARACTERS WITHOUT CLAIM TO ANY PARTICULAR FONT, STYLE, SIZE, OR COLOR.

NO CLAIM IS MADE TO THE EXCLUSIVE RIGHT TO USE "COFFEE", APART FROM THE MARK AS SHOWN.

SER. NO. 76-707,840, FILED 6-6-2011.

PATRICIA EVANKO, EXAMINING ATTORNEY



*David J. Kybas*

Director of the United States Patent and Trademark Office

United States of America  
United States Patent and Trademark Office

# HYBRIO

**Reg. No. 4,196,229**

ESAB AB (SWEDEN CORPORATION)  
POST BOX 8004  
GÖTEBORG, SWEDEN SE-40277

**Registered Aug. 28, 2012**

**Int. Cls.: 6, 7 and 9**

FOR: WELDING METAL, NAMELY, WIRE, STRIPS AND RODS MADE OF METAL FOR WELDING; FLUX CORED WELDING WIRES; FLUX COATED RODS FOR WELDING; METALLIC POWDER FOR WELDING; WINDING SPOOLS OF METAL FOR HOLDING WELDING WIRE, IN CLASS 6 (U.S. CLS. 2, 12, 13, 14, 23, 25 AND 50).

**TRADEMARK**

**PRINCIPAL REGISTER**

FOR: LASER WELDING MACHINES, IN CLASS 7 (U.S. CLS. 13, 19, 21, 23, 31, 34 AND 35).

FOR: WELDING ELECTRODES, IN CLASS 9 (U.S. CLS. 21, 23, 26, 36 AND 38).

THE MARK CONSISTS OF STANDARD CHARACTERS WITHOUT CLAIM TO ANY PARTICULAR FONT, STYLE, SIZE, OR COLOR.

OWNER OF ERPN CMNTY TM OFC REG. NO. 009493404, DATED 4-19-2011, EXPIRES 11-3-2020.

SER. NO. 76-707,997, FILED 6-15-2011.

GENE MACIOL, EXAMINING ATTORNEY



*David J. Kyffers*

Director of the United States Patent and Trademark Office

# United States of America

United States Patent and Trademark Office

# WINGFLYER

**Reg. No. 4,196,230**

**Registered Aug. 28, 2012**

**Int. Cl.: 28**

**TRADEMARK**

**PRINCIPAL REGISTER**

HSIN LUNG ACCESSORIES CO., LTD. (TAIWAN CORPORATION)  
NO.18, KUANGFU N. RD.  
HSINCHU ENLARGED INDUSTRIAL PARK, HUKOU  
HSINCHU HSIEN, TAIWAN 303

FOR: STATIONARY EXERCISE BICYCLES AND ROLLERS THEREFOR; BODY-TRAINING APPARATUS; TOY MOBILES; EXERCISE EQUIPMENT NOT FOR PHYSICAL THERAPY PURPOSES, NAMELY, EXERCISE BANDS, TRAINING BARS AND ROWING MACHINES; BODY-BUILDING APPARATUS; RECREATIONAL EQUIPMENT, NAMELY, SKATEBOARDS, IN CLASS 28 (U.S. CLS. 22, 23, 38 AND 50).

FIRST USE 11-1-2010; IN COMMERCE 11-1-2010.

THE MARK CONSISTS OF THE STYLIZED WORDING "WINGFLYER".

SER. NO. 76-708,043, FILED 6-20-2011.

BRENDAN MCCAULEY, EXAMINING ATTORNEY



*David J. Kybas*

Director of the United States Patent and Trademark Office



# United States of America

United States Patent and Trademark Office

## Point of Return

**Reg. No. 4,196,231**

**Registered Aug. 28, 2012**

**Int. Cls.: 5, 16 and 44**

**TRADEMARK**

**SERVICE MARK**

**PRINCIPAL REGISTER**

POINT OF RETURN (CALIFORNIA CORPORATION)  
2630 TOWNSGATE ROAD, UNIT F  
WESTLAKE VILLAGE, CA 91361

FOR: NUTRACEUTICALS FOR USE AS A DIETARY SUPPLEMENT; NUTRACEUTICALS FOR TREATMENT OF SYMPTOMS OF PRESCRIPTION DRUG WITHDRAWAL, IN CLASS 5 (U.S. CLS. 6, 18, 44, 46, 51 AND 52).

FIRST USE 4-1-2006; IN COMMERCE 4-1-2006.

FOR: EDUCATIONAL PUBLICATIONS, NAMELY, WORKBOOKS, GUIDEBOOKS AND EDUCATIONAL BOOKLETS RELATED TO WITHDRAWAL FROM THE USE OF PRESCRIPTION DRUGS, IN CLASS 16 (U.S. CLS. 2, 5, 22, 23, 29, 37, 38 AND 50).

FIRST USE 4-1-2006; IN COMMERCE 4-1-2006.

FOR: PRESCRIPTION DRUGS WITHDRAWAL PROGRAM, NAMELY, ADDICTION TREATMENT SERVICES, IN CLASS 44 (U.S. CLS. 100 AND 101).

FIRST USE 4-1-2006; IN COMMERCE 4-1-2006.

THE MARK CONSISTS OF STANDARD CHARACTERS WITHOUT CLAIM TO ANY PARTICULAR FONT, STYLE, SIZE, OR COLOR.

SER. NO. 76-708,094, FILED 6-23-2011.

JOHN DWYER, EXAMINING ATTORNEY



*David J. Kyros*

Director of the United States Patent and Trademark Office

# United States of America

United States Patent and Trademark Office

## POP-TOP Biscuits

**Reg. No. 4,196,232**

LONE STAR BAKERY, INC. (TEXAS CORPORATION)

**Registered Aug. 28, 2012**

P.O. BOX 201960  
SAN ANTONIO, TX 78220

**Int. Cl.: 30**

FOR: BISCUITS, IN CLASS 30 (U.S. CL. 46).

**TRADEMARK**

FIRST USE 2-9-2011; IN COMMERCE 2-9-2011.

**PRINCIPAL REGISTER**

THE MARK CONSISTS OF STANDARD CHARACTERS WITHOUT CLAIM TO ANY PARTICULAR FONT, STYLE, SIZE, OR COLOR.

NO CLAIM IS MADE TO THE EXCLUSIVE RIGHT TO USE "BISCUITS", APART FROM THE MARK AS SHOWN.

SER. NO. 76-708,108, FILED 6-23-2011.

DEBORAH LOBO, EXAMINING ATTORNEY



*David J. Kyffers*

Director of the United States Patent and Trademark Office

# United States of America

United States Patent and Trademark Office

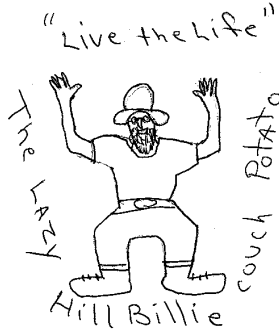

**Reg. No. 4,196,233**

**Registered Aug. 28, 2012**

**Int. Cl.: 9**

**TRADEMARK**

**PRINCIPAL REGISTER**

RUSSELL, PAUL J (UNITED STATES INDIVIDUAL)  
56 PECKS RUN RD  
BUCKHANNON, WV 26201

FOR: PRE-RECORDED CD'S AND DVD'S FEATURING LIVE MUSIC PERFORMANCES BY A MUSICIAN, IN CLASS 9 (U.S. CLS. 21, 23, 26, 36 AND 38).

FIRST USE 5-11-2011; IN COMMERCE 5-11-2011.

THE MARK CONSISTS OF THE WORDING "THE LAZY HILLBILLIE COUCH POTATO" SURROUNDING THE DESIGN OF A MAN WITH A HAT AND BEARD, AND HIS HANDS RAISED ABOVE HIS HEAD. THE WORDING ""LIVE THE LIFE"" APPEARS ABOVE THE DESIGN.

SER. NO. 76-708,302, FILED 7-11-2011.

DAVID HOFFMAN, EXAMINING ATTORNEY



*David J. Kyffers*

Director of the United States Patent and Trademark Office

# United States of America

United States Patent and Trademark Office

## TREE TOONS

**Reg. No. 4,196,234**

**Registered Aug. 28, 2012**

**Int. Cl.: 16**

**TRADEMARK**

**PRINCIPAL REGISTER**

W. PHILLIPS BERWICK (UNITED STATES INDIVIDUAL)  
P.O. BOX 2220  
HILLSBORO, MO 63050

FOR: CARTOONS PERIODICALLY PRINTED IN PUBLICATIONS, NAMELY, NEWSPAPERS AND MAGAZINES IN THE FIELD OF ARBORICULTURE, IN CLASS 16 (U.S. CLS. 2, 5, 22, 23, 29, 37, 38 AND 50).

FIRST USE 7-0-2008; IN COMMERCE 7-0-2008.

NO CLAIM IS MADE TO THE EXCLUSIVE RIGHT TO USE "TOONS", APART FROM THE MARK AS SHOWN.

SER. NO. 76-708,316, FILED 7-13-2011.

GIANCARLO CASTRO, EXAMINING ATTORNEY



*David J. Kyffers*

Director of the United States Patent and Trademark Office

# United States of America

United States Patent and Trademark Office

## UMPQUA PRIVATE BANK

**Reg. No. 4,196,235**

**Registered Aug. 28, 2012**

**Int. Cl.: 36**

**SERVICE MARK**

**PRINCIPAL REGISTER**

UMPQUA BANK (OREGON OREGON STATE CHARTERED BANK)  
P.O. BOX 1560  
EUGENE, OR 97401

FOR: PERSONAL AND COMMERCIAL BANKING SERVICES, NAMELY, SAVINGS AND CHECKING ACCOUNT SERVICES, CONSUMER AND COMMERCIAL LENDING SERVICES, ONLINE BANKING, MORTGAGE BANKING, FINANCIAL SERVICES, NAMELY, FINANCIAL CONSULTATIONS, INVESTMENT CONSULTATIONS, FINANCIAL INVESTMENT SERVICES IN THE FIELD OF SECURITIES, ANNUITIES, BONDS, CERTIFICATES OF DEPOSIT, DEFINED PORTFOLIOS, FUTURES, COMMODITIES, INSURANCE, MUTUAL FUNDS, STOCKS, OPTIONS, AND OTHER SECURITIES, AND FINANCIAL BROKERAGE SERVICES IN THE NATURE OF MUTUAL FUND, SECURITY AND STOCK BROKERAGE SERVICES, IN CLASS 36 (U.S. CLS. 100, 101 AND 102).

FIRST USE 8-0-2009; IN COMMERCE 8-0-2009.

THE MARK CONSISTS OF STANDARD CHARACTERS WITHOUT CLAIM TO ANY PARTICULAR FONT, STYLE, SIZE, OR COLOR.

OWNER OF U.S. REG. NOS. 2,571,638, 2,991,368, AND 3,078,369.

NO CLAIM IS MADE TO THE EXCLUSIVE RIGHT TO USE "PRIVATE BANK", APART FROM THE MARK AS SHOWN.

SEC. 2(F) AS TO "UMPQUA".

SER. NO. 76-709,507, FILED 10-25-2011.

REBECCA GILBERT, EXAMINING ATTORNEY



*David J. Kyffers*

Director of the United States Patent and Trademark Office

# United States of America

United States Patent and Trademark Office

## MY BOWL OF CHERRIES

**Reg. No. 4,196,236**

**Registered Aug. 28, 2012**

**Int. Cl.: 35**

**SERVICE MARK**

**PRINCIPAL REGISTER**

JULIET ROSE LLC (CALIFORNIA LIMITED LIABILITY COMPANY)  
31441 SANTA MARGARITA PKWY SUITE A-196  
RANCHO SANTA MARGARITA, CA 92688

FOR: GIFT REGISTRY SERVICE, IN CLASS 35 (U.S. CLS. 100, 101 AND 102).

FIRST USE 10-1-2011; IN COMMERCE 10-1-2011.

THE MARK CONSISTS OF STANDARD CHARACTERS WITHOUT CLAIM TO ANY PARTICULAR FONT, STYLE, SIZE, OR COLOR.

SER. NO. 76-709,712, FILED 11-14-2011.

MICHAEL TANNER, EXAMINING ATTORNEY



*David J. Kyffers*

Director of the United States Patent and Trademark Office

# United States of America

United States Patent and Trademark Office



**Reg. No. 4,196,237**

VIBES BASE GROUP CORP. (CALIFORNIA CORPORATION)  
9328 TELSTAR AVENUE  
EL MONTE, CA 91731

**Registered Aug. 28, 2012**

**Int. Cl.: 25**

FOR: MEN'S AND WOMEN'S WEARING APPAREL, NAMELY, JEANS, PANTS, SLACKS, AND TROUSERS, IN CLASS 25 (U.S. CLS. 22 AND 39).

**TRADEMARK**

FIRST USE 9-1-2003; IN COMMERCE 9-1-2003.

**PRINCIPAL REGISTER**

THE MARK CONSISTS OF A SHADED RECTANGLE WITH THE TERM "VIBES" IN STYLIZED FORM AND THE LETTER "V" INSIDE THE RECTANGLE; TO THE RIGHT OF THE STYLIZED "VIBES" APPEARS THE LETTER "V" WITH COMB-LIKE NOTCHES ON THE LEFT-SIDE AND SMALL CIRCLE TOWARDS THE TOP OF THE RIGHT-SIDE; AND THE LETTER "V" IS SHADED IN A LIGHTER TONE THAN THE REST OF THE MARK.

SER. NO. 76-709,717, FILED 11-15-2011.

ALEXANDER L. POWERS, EXAMINING ATTORNEY



*David J. Kyffers*

Director of the United States Patent and Trademark Office

# United States of America

United States Patent and Trademark Office

## SHIPBUILDING

**Reg. No. 4,196,238**

DUBOW, BRAD (UNITED STATES INDIVIDUAL)  
608 PUNTO REYES  
EL PASO, TX 79912

**Registered Aug. 28, 2012**

**Int. Cl.: 35**

FOR: MARKETING AND ADVERTISING CONSULTING SERVICES, IN CLASS 35 (U.S. CLS. 100, 101 AND 102).

**SERVICE MARK**

FIRST USE 11-4-2011; IN COMMERCE 11-4-2011.

**PRINCIPAL REGISTER**

THE MARK CONSISTS OF STANDARD CHARACTERS WITHOUT CLAIM TO ANY PARTICULAR FONT, STYLE, SIZE, OR COLOR.

SER. NO. 76-709,728, FILED 11-15-2011.

HAI-LY LAM, EXAMINING ATTORNEY



*David J. Kybas*

Director of the United States Patent and Trademark Office



# United States of America

United States Patent and Trademark Office

## GAS STATIONS USA

**Reg. No. 4,196,239**

**Registered Aug. 28, 2012**

**Int. Cl.: 36**

**SERVICE MARK**

**PRINCIPAL REGISTER**

GAS STATIONS, USA REALTY, INC. (FLORIDA CORPORATION)  
1898 SOUTH CLYDE MORRIS BLVD., SUITE 500  
DAYTONA BEACH, FL 32119

FOR: REAL ESTATE BROKERAGE SERVICES, IN CLASS 36 (U.S. CLS. 100, 101 AND 102).

FIRST USE 3-22-1993; IN COMMERCE 6-0-1998.

THE MARK CONSISTS OF STANDARD CHARACTERS WITHOUT CLAIM TO ANY PARTICULAR FONT, STYLE, SIZE, OR COLOR.

OWNER OF U.S. REG. NO. 2,568,588.

SEC. 2(F).

SER. NO. 76-709,751, FILED 11-16-2011.

ALICE BENMAMAN, EXAMINING ATTORNEY



*David J. Kybas*

Director of the United States Patent and Trademark Office

United States of America  
United States Patent and Trademark Office

**DAWABI**

**Reg. No. 4,196,240**

DAWABI, INC. (COLORADO CORPORATION)  
12121 S. GRASS RIVER TRAIL  
PARKER, CO 80134

**Registered Aug. 28, 2012**

**Int. Cl.: 35**

FOR: INFORMATION TECHNOLOGY SERVICES, NAMELY, BUSINESS MANAGEMENT DATA ANALYSIS FOR DECISION MAKING BY CONSUMERS AND BUSINESS DATA ANALYSIS FOR DECISION MAKING BY CONSUMERS; PREPARING BUSINESS DATA REPORTS, IN CLASS 35 (U.S. CLS. 100, 101 AND 102).

**SERVICE MARK**

**PRINCIPAL REGISTER**

FIRST USE 11-30-2009; IN COMMERCE 11-30-2009.

THE MARK CONSISTS OF STANDARD CHARACTERS WITHOUT CLAIM TO ANY PARTICULAR FONT, STYLE, SIZE, OR COLOR.

SER. NO. 76-709,953, FILED 12-12-2011.

BRENDAN MCCAULEY, EXAMINING ATTORNEY



*David J. Kyffers*

Director of the United States Patent and Trademark Office

# United States of America

United States Patent and Trademark Office



**Q**  
**CLUB**

**Reg. No. 4,196,241**

**Registered Aug. 28, 2012**

**Int. Cl.: 32**

**TRADEMARK**

**PRINCIPAL REGISTER**

Q TONIC, LLC (DELAWARE LIMITED LIABILITY COMPANY)  
45 MAIN STREET  
SUITE 850  
BROOKLYN, NY 11201

FOR: CARBONATED, NON-ALCOHOLIC BEVERAGES, IN CLASS 32 (U.S. CLS. 45, 46 AND 48).

FIRST USE 10-12-2011; IN COMMERCE 10-12-2011.

OWNER OF U.S. REG. NOS. 3,385,908, 3,421,169, AND 4,057,891.

NO CLAIM IS MADE TO THE EXCLUSIVE RIGHT TO USE "CLUB" APART FROM THE MARK AS SHOWN., APART FROM THE MARK AS SHOWN.

THE MARK CONSISTS OF THE LETTER "Q" IN A STYLIZED FONT, ABOVE THE WORDING "CLUB" ALSO IN A STYLIZED FONT.

SER. NO. 76-710,006, FILED 12-14-2011.

LINDA MICKLEBURGH, EXAMINING ATTORNEY



*David J. Kyffers*

Director of the United States Patent and Trademark Office

# United States of America

United States Patent and Trademark Office

we   
feedback

**Reg. No. 4,196,242**

**Registered Aug. 28, 2012**

**Int. Cl.: 35**

**SERVICE MARK**

**PRINCIPAL REGISTER**

ISUGGEST (CALIFORNIA LIMITED LIABILITY COMPANY)  
1931 H ST.  
#42  
SACRAMENTO, CA 95819

FOR: SUGGESTION AND FEEDBACK COLLECTION FROM CONSUMERS ON BEHALF OF BUSINESSES, IN CLASS 35 (U.S. CLS. 100, 101 AND 102).

FIRST USE 6-4-2011; IN COMMERCE 6-4-2011.

NO CLAIM IS MADE TO THE EXCLUSIVE RIGHT TO USE "FEEDBACK", APART FROM THE MARK AS SHOWN.

THE MARK CONSISTS OF THE WORDING "WE" AND "FEEDBACK", WITH THE REPRESENTATION OF A HEART.

SER. NO. 76-710,045, FILED 12-19-2011.

BRIAN NEVILLE, EXAMINING ATTORNEY



*David J. Kybas*

Director of the United States Patent and Trademark Office

# United States of America

United States Patent and Trademark Office

## ASSAEL, CASUAL ELEGANCE

**Reg. No. 4,196,243**

ASSAEL INTERNATIONAL INC. (NEW YORK CORPORATION)  
580 FIFTH AVENUE  
NEW YORK, NY 10036

**Registered Aug. 28, 2012**

**Int. Cl.: 14**

FOR: RINGS, EARRINGS, NECKLACES, BRACELETS AND PENDANTS SET WITH PEARLS,  
IN CLASS 14 (U.S. CLS. 2, 27, 28 AND 50).

**TRADEMARK**

FIRST USE 11-4-2011; IN COMMERCE 11-4-2011.

**PRINCIPAL REGISTER**

THE MARK CONSISTS OF STANDARD CHARACTERS WITHOUT CLAIM TO ANY PAR-  
TICULAR FONT, STYLE, SIZE, OR COLOR.

OWNER OF U.S. REG. NO. 4,032,995.

THE NAME "ASSAEL" DOES NOT IDENTIFY A LIVING INDIVIDUAL.

SER. NO. 76-710,161, FILED 1-3-2012.

SUSAN BILLHEIMER, EXAMINING ATTORNEY



*David J. Kyffers*

Director of the United States Patent and Trademark Office

# United States of America

United States Patent and Trademark Office

## MAKING DATA-DRIVEN DECISIONS POSSIBLE

**Reg. No. 4,196,244**

DAWABI, INC. (COLORADO CORPORATION)  
12121 S. GRASS RIVER TRAIL  
PARKER, CO 80134

**Registered Aug. 28, 2012**

**Int. Cl.: 35**

FOR: INFORMATION TECHNOLOGY SERVICES, NAMELY, BUSINESS MANAGEMENT DATA ANALYSIS FOR DECISION MAKING BY CONSUMERS AND BUSINESS DATA ANALYSIS FOR DECISION MAKING BY CONSUMERS; PREPARING BUSINESS DATA REPORTS, IN CLASS 35 (U.S. CLS. 100, 101 AND 102).

**SERVICE MARK**

**PRINCIPAL REGISTER**

FIRST USE 11-30-2009; IN COMMERCE 11-30-2009.

THE MARK CONSISTS OF STANDARD CHARACTERS WITHOUT CLAIM TO ANY PARTICULAR FONT, STYLE, SIZE, OR COLOR.

SER. NO. 76-710,176, FILED 1-5-2012.

BRENDAN MCCAULEY, EXAMINING ATTORNEY



*David J. Kyffers*

Director of the United States Patent and Trademark Office

# United States of America

United States Patent and Trademark Office



**Reg. No. 4,196,245**

**Registered Aug. 28, 2012**

**Int. Cl.: 34**

**TRADEMARK**

**PRINCIPAL REGISTER**

P.T. DJARUM (INDONESIA LIMITED LIABILITY COMPANY)  
JL. JEND. A. YANI NO. 28  
KUDUS, 59317, INDONESIA

FOR: CIGARS CONTAINING NATURAL LEAF TOBACCO AND CLOVES, IN CLASS 34  
(U.S. CLS. 2, 8, 9 AND 17).

FIRST USE 7-18-2011; IN COMMERCE 7-18-2011.

OWNER OF U.S. REG. NO. 3,482,860 AND OTHERS.

THE COLORS WHITE, GOLD, YELLOW, RED AND BROWN ARE CLAIMED AS A FEATURE  
OF THE MARK.

NO CLAIM IS MADE TO THE EXCLUSIVE RIGHT TO USE "WOOD TIP" (WHEREVER IT  
APPEARS IN THE MARK) AND "NATURAL LEAF" AND "CLASSIC" AND THE IMAGE OF  
THE TOBACCO LEAF, APART FROM THE MARK AS SHOWN.

THE MARK CONSISTS OF THE WORD "DJARUM" IN A STYLIZED WHITE FONT ABOVE  
THE WORDS "NATURAL LEAF" IN A STYLIZED GOLD FONT. A WINDOW TRIMMED IN  
YELLOW IS POSITIONED DIRECTLY BELOW THE WORD "DJARUM". BELOW THIS IS  
THE WORD "CLASSIC" IN A DIFFERENT STYLIZED WHITE FONT. BELOW THIS ARE  
THE WORDS "WOOD TIP" IN A STYLIZED YELLOW FONT. THE WORDS "CLASSIC WOOD  
TIP" ARE SITUATED IN A RED BANNER TRIMMED IN GOLD WITH A SCALLOPED  
BOTTOM. A BROWN LEAF IS POSITIONED IN THE UPPER RIGHT HAND CORNER OF  
THE BANNER. THERE IS A YELLOW TRIANGLE POSITIONED AT THE TOP LEFT CORNER  
WITH THE WORDS "WOOD TIP" IN A STYLIZED BLACK FONT. ALL OF THE AFOREMEN-  
TIONED ARE ON A BLACK BACKGROUND. ABOVE THE AFOREMENTIONED WORD  
"DJARUM" IS A CIRCLE WHICH CONTAINS A NEEDLE DESIGN. THE CIRCLE AND THE  
NEEDLE DESIGN ARE IN WHITE.

THE ENGLISH TRANSLATION OF "DJARUM" IN THE MARK IS "NEEDLE".

SER. NO. 76-710,190, FILED 1-6-2012.

RICHARD WHITE, EXAMINING ATTORNEY



*David J. Kybas*

Director of the United States Patent and Trademark Office

# United States of America

United States Patent and Trademark Office



**Reg. No. 4,196,246**

**Registered Aug. 28, 2012**

**Int. Cl.: 34**

**TRADEMARK**

**PRINCIPAL REGISTER**

P.T. DJARUM (INDONESIA LIMITED LIABILITY COMPANY)  
JL. JEND. A. YANI NO. 28  
KUDUS, 59317, INDONESIA

FOR: CIGARS CONTAINING NATURAL LEAF TOBACCO AND CLOVES, IN CLASS 34  
(U.S. CLS. 2, 8, 9 AND 17).

FIRST USE 7-18-2011; IN COMMERCE 7-18-2011.

OWNER OF U.S. REG. NO. 3,482,860 AND OTHERS.

THE COLORS BLACK, BROWN, WHITE, YELLOW, GOLD, AND BEIGE ARE CLAIMED  
AS A FEATURE OF THE MARK.

NO CLAIM IS MADE TO THE EXCLUSIVE RIGHT TO USE "WOOD TIP" (WHEREVER IT  
APPEARS IN THE MARK) AND "NATURAL LEAF" AND "VANILLA" AND THE IMAGE  
OF THE TOBACCO LEAF, APART FROM THE MARK AS SHOWN.

THE MARK CONSISTS OF THE WORD "DJARUM" IN A STYLIZED BLACK FONT ABOVE  
THE WORDS "NATURAL LEAF" IN A STYLIZED BROWN FONT. A WINDOW TRIMMED  
IN BROWN IS POSITIONED DIRECTLY BELOW THE WORD "DJARUM". BELOW THIS IS  
THE WORD "VANILLA" IN A DIFFERENT STYLIZED WHITE FONT. BELOW THIS ARE  
THE WORDS "WOOD TIP" IN A YELLOW STYLIZED FONT. THE WORDS "VANILLA  
WOOD TIP" ARE SITUATED IN A YELLOW BANNER TRIMMED IN GOLD WITH A  
SCALLOPED BOTTOM. A BROWN LEAF IS POSITIONED IN THE UPPER RIGHT HAND  
CORNER OF THE BANNER. THERE IS A BROWN TRIANGLE POSITIONED AT THE TOP  
LEFT CORNER WITH THE WORDS "WOOD TIP" IN A STYLIZED YELLOW FONT. ALL  
OF THE AFOREMENTIONED ARE ON A BEIGE BACKGROUND. ABOVE THE AFOREMEN-  
TIONED WORD "DJARUM" IS A CIRCLE WHICH CONTAINS A NEEDLE DESIGN. THE  
CIRCLE AND THE NEEDLE DESIGN ARE IN BLACK.

THE ENGLISH TRANSLATION OF "DJARUM" IN THE MARK IS "NEEDLE".

SER. NO. 76-710,192, FILED 1-6-2012.

RICHARD WHITE, EXAMINING ATTORNEY



*David J. Kyros*

Director of the United States Patent and Trademark Office



# United States of America

United States Patent and Trademark Office



**Reg. No. 4,196,247**

**Registered Aug. 28, 2012**

**Int. Cl.: 34**

**TRADEMARK**

**PRINCIPAL REGISTER**

P.T. DJARUM (INDONESIA LIMITED LIABILITY COMPANY)  
JL. JEND. A. YANI NO. 28  
KUDUS, 59317, INDONESIA

FOR: CIGARS CONTAINING NATURAL LEAF TOBACCO AND CLOVES, IN CLASS 34  
(U.S. CLS. 2, 8, 9 AND 17).

FIRST USE 7-18-2011; IN COMMERCE 7-18-2011.

OWNER OF U.S. REG. NO. 3,482,860 AND OTHERS.

THE COLORS WHITE, GOLD, YELLOW, ORANGE, BROWN AND BLACK ARE CLAIMED  
AS A FEATURE OF THE MARK.

NO CLAIM IS MADE TO THE EXCLUSIVE RIGHT TO USE "WOOD TIP (WHEREVER IT  
APPEARS IN THE MARK)" AND "NATURAL LEAF" AND "RUM" AND "THE IMAGE OF  
THE TOBACCO LEAF", APART FROM THE MARK AS SHOWN.

THE MARK CONSISTS OF THE WORD "DJARUM" IN A STYLIZED WHITE FONT ABOVE  
THE WORDS "NATURAL LEAF" IN A STYLIZED GOLD FONT. A WINDOW TRIMMED IN  
YELLOW IS POSITIONED DIRECTLY BELOW THE WORD "DJARUM". BELOW THIS IS  
THE WORD "RUM" IN A DIFFERENT STYLIZED WHITE FONT. BELOW THIS ARE THE  
WORDS "WOOD TIP" IN A YELLOW STYLIZED FONT. THE WORDS "RUM WOOD TIP"  
ARE SITUATED IN AN ORANGE BANNER TRIMMED IN GOLD WITH A SCALLOPED  
BOTTOM. A BROWN LEAF IS POSITIONED IN THE UPPER RIGHT HAND CORNER OF  
THE BANNER. THERE IS A YELLOW TRIANGLE POSITIONED AT THE TOP LEFT CORNER  
WITH THE WORDS "WOOD TIP" IN A STYLIZED BLACK FONT. ALL OF THE AFOREMEN-  
TIONED ARE ON A BROWN BACKGROUND. ABOVE THE AFOREMENTIONED WORD  
"DJARUM" IS A CIRCLE WHICH CONTAINS A NEEDLE DESIGN. THE CIRCLE AND THE  
NEEDLE DESIGN ARE IN WHITE.

THE ENGLISH TRANSLATION OF "DJARUM" IN THE MARK IS "NEEDLE".

SER. NO. 76-710,195, FILED 1-6-2012.

RICHARD WHITE, EXAMINING ATTORNEY



*David J. Kybas*

Director of the United States Patent and Trademark Office

# United States of America

United States Patent and Trademark Office



**Reg. No. 4,196,248**

**Registered Aug. 28, 2012**

**Int. Cl.: 34**

**TRADEMARK**

**PRINCIPAL REGISTER**

P.T. DJARUM (INDONESIA LIMITED LIABILITY COMPANY)  
JL. JEND. A. YANI NO. 28  
KUDUS, 59317, INDONESIA

FOR: CIGARS CONTAINING NATURAL LEAF TOBACCO AND CLOVES, IN CLASS 34  
(U.S. CLS. 2, 8, 9 AND 17).

FIRST USE 7-18-2011; IN COMMERCE 7-18-2011.

OWNER OF U.S. REG. NO. 3,482,860 AND OTHERS.

THE COLORS WHITE, YELLOW, BLACK, GOLD, BROWN AND RED ARE CLAIMED AS  
A FEATURE OF THE MARK.

NO CLAIM IS MADE TO THE EXCLUSIVE RIGHT TO USE "WOOD TIP (WHEREVER IT  
APPEARS IN THE MARK)" AND "NATURAL LEAF" AND "CHERRY" AND "THE IMAGE  
OF THE TOBACCO LEAF", APART FROM THE MARK AS SHOWN.

THE MARK CONSISTS OF THE WORD "DJARUM" IN A STYLIZED WHITE FONT ABOVE  
THE WORDS "NATURAL LEAF" IN A STYLIZED GOLD FONT. A WINDOW TRIMMED IN  
YELLOW IS POSITIONED DIRECTLY BELOW THE WORD "DJARUM". BELOW THIS IS  
THE WORD "CHERRY" IN A DIFFERENT STYLIZED WHITE FONT. BELOW THIS ARE  
THE WORDS "WOOD TIP" IN A STYLIZED YELLOW FONT. THE WORDS "CHERRY WOOD  
TIP" ARE SITUATED IN A BLACK BANNER TRIMMED IN GOLD WITH A SCALLOPED  
BOTTOM. A BROWN LEAF IS POSITIONED IN THE UPPER RIGHT HAND CORNER OF  
THE BANNER. THERE IS A YELLOW TRIANGLE POSITIONED AT THE TOP LEFT CORNER  
WITH THE WORDS "WOOD TIP" IN A STYLIZED BLACK FONT. ALL OF THE AFOREMEN-  
TIONED ARE ON A RED BACKGROUND. ABOVE THE AFOREMENTIONED WORD  
"DJARUM" IS A CIRCLE WHICH CONTAINS A NEEDLE DESIGN. THE CIRCLE AND THE  
NEEDLE DESIGN ARE IN WHITE.

THE ENGLISH TRANSLATION OF "DJARUM" IN THE MARK IS "NEEDLE".

SER. NO. 76-710,196, FILED 1-6-2012.

RICHARD WHITE, EXAMINING ATTORNEY



*David J. Kybas*

Director of the United States Patent and Trademark Office

# United States of America

United States Patent and Trademark Office



**Reg. No. 4,196,249**

TRAVEL SERVICES INC. (NEW YORK CORPORATION)  
57 NORTH BROADWAY, SUITE 208  
HICKSVILLE, NY 11801

**Registered Aug. 28, 2012**

**Int. Cl.: 39**

FOR: TRAVEL AGENCY SERVICES, NAMELY, MAKING RESERVATIONS AND BOOKINGS FOR AIRLINE TICKETS, IN CLASS 39 (U.S. CLS. 100 AND 105).

**SERVICE MARK**

FIRST USE 3-22-2010; IN COMMERCE 3-22-2010.

**PRINCIPAL REGISTER**

NO CLAIM IS MADE TO THE EXCLUSIVE RIGHT TO USE "TRAVEL CENTRE NY", APART FROM THE MARK AS SHOWN.

THE MARK CONSISTS OF A HALF CIRCLE ABOVE A TWO BLADED PROPELLER REPRESENTING THE MOTION OF A ROTATING PROPELLER ON THE RIGHT HAND CORNER ABOVE THE WORDS "TRAVEL CENTRE NY".

SER. NO. 76-710,322, FILED 1-23-2012.

JIM RINGLE, EXAMINING ATTORNEY



*David J. Kybas*

Director of the United States Patent and Trademark Office

# United States of America

United States Patent and Trademark Office

## CUT 'EM

**Reg. No. 4,196,250**

**Registered Aug. 28, 2012**

**Int. Cls.: 9 and 25**

**TRADEMARK**

**PRINCIPAL REGISTER**

DUCK COMMANDER, INC. (LOUISIANA CORPORATION)  
117 KINGS LANE  
WEST MONROE, LA 71292

FOR: PRERECORDED AUDIO AND VIDEO CASSETTES, AUDIO AND VIDEO TAPES, COMPACT DISKS, LASER DISKS AND DVDS FEATURING HUNTING ACTIVITIES , IN CLASS 9 (U.S. CLS. 21, 23, 26, 36 AND 38).

FIRST USE 8-1-1988; IN COMMERCE 8-1-1988.

FOR: APPAREL, NAMELY, SHIRTS AND CAPS; T-SHIRTS, IN CLASS 25 (U.S. CLS. 22 AND 39).

FIRST USE 7-23-2001; IN COMMERCE 7-23-2001.

THE MARK CONSISTS OF STANDARD CHARACTERS WITHOUT CLAIM TO ANY PARTICULAR FONT, STYLE, SIZE, OR COLOR.

SER. NO. 76-710,325, FILED 1-23-2012.

WILLIAM ROSSMAN, EXAMINING ATTORNEY



*David J. Kyfos*

Director of the United States Patent and Trademark Office

# United States of America

United States Patent and Trademark Office

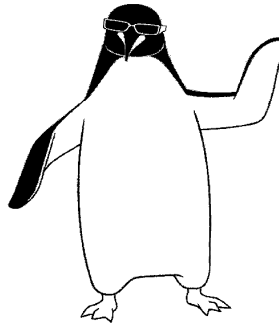

**Reg. No. 4,196,251**

**Registered Aug. 28, 2012**

**Int. Cl.: 36**

**SERVICE MARK**

**PRINCIPAL REGISTER**

PGA SERVICE CORPORATION (TENNESSEE CORPORATION)  
2636 ELM HILL PIKE  
NASHVILLE, TN 37214

FOR: UNDERWRITING AUTOMOBILE INSURANCE; INSURANCE AGENCY AND INSURANCE BROKERAGE SERVICES IN THE FIELDS OF AUTOMOBILE INSURANCE, IN CLASS 36 (U.S. CLS. 100, 101 AND 102).

FIRST USE 4-1-2010; IN COMMERCE 4-1-2010.

THE MARK CONSISTS OF THE IMAGE OF A PENGUIN WITH SUNGLASSES. THE COLOR GREEN FOR THE SUNGLASSES AS SHOWN IN THE ATTACHED SPECIMEN IS NOT CLAIMED AS A PART OF THE MARK.

SER. NO. 76-710,343, FILED 1-24-2012.

TASHIA BUNCH, EXAMINING ATTORNEY



*David J. Kyffers*

Director of the United States Patent and Trademark Office

# United States of America

United States Patent and Trademark Office

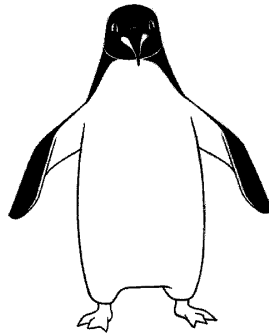

**Reg. No. 4,196,252**

**Registered Aug. 28, 2012**

**Int. Cl.: 36**

**SERVICE MARK**

**PRINCIPAL REGISTER**

PGA SERVICE CORPORATION (TENNESSEE CORPORATION)  
2636 ELM HILL PIKE  
NASHVILLE, TN 37214

FOR: UNDERWRITING AUTOMOBILE INSURANCE; INSURANCE AGENCY AND INSURANCE BROKERAGE SERVICES IN THE FIELDS OF AUTOMOBILE INSURANCE, IN CLASS 36 (U.S. CLS. 100, 101 AND 102).

FIRST USE 3-30-2009; IN COMMERCE 3-30-2009.

THE MARK CONSISTS OF THE IMAGE OF A PENGUIN.

SER. NO. 76-710,347, FILED 1-24-2012.

TASHIA BUNCH, EXAMINING ATTORNEY



*David J. Kyros*

Director of the United States Patent and Trademark Office

# United States of America

United States Patent and Trademark Office

## MARIO RUSSO

**Reg. No. 4,196,253**

**Registered Aug. 28, 2012**

**Int. Cl.: 44**

**SERVICE MARK**

**PRINCIPAL REGISTER**

MARIO RUSSO, INC. (MASSACHUSETTS CORPORATION)  
9 NEWBURY STREET  
BOSTON, MA 02116

FOR: HAIR CUTTING, HAIR STYLING, HAIRDRESSING, BEAUTY SALON, HAIR COLORING, MAKE-UP APPLICATION, MANICURE AND PEDICURE, AND COSMETICIAN SERVICES, IN CLASS 44 (U.S. CLS. 100 AND 101).

FIRST USE 6-0-1991; IN COMMERCE 6-0-1991.

THE MARK CONSISTS OF STANDARD CHARACTERS WITHOUT CLAIM TO ANY PARTICULAR FONT, STYLE, SIZE, OR COLOR.

OWNER OF U.S. REG. NOS. 3,032,674, 3,071,539, AND 3,113,424.

THE NAME "MARIO RUSSO" IDENTIFIES A LIVING INDIVIDUAL WHOSE CONSENT IS OF RECORD.

SER. NO. 76-710,377, FILED 1-26-2012.

COLLEEN DOMBROW, EXAMINING ATTORNEY



*David J. Kyros*

Director of the United States Patent and Trademark Office

**United States of America**  
**United States Patent and Trademark Office**

**MCM**

**Reg. No. 4,196,254**

MUSIC CITY METALS CO., INC. (TENNESSEE CORPORATION)  
2633 GRANDVIEW AVENUE  
NASHVILLE, TN 37211

**Registered Aug. 28, 2012**

**Int. Cl.: 35**

FOR: DISTRIBUTORSHIP SERVICES IN THE FIELD OF GAS GRILL PARTS; NAMELY, VALVES, CONTROL KNOBS, HEAT INDICATORS, IGNITOR COMPONENTS, LID HANDLES, ACCESSORIES, ROTISSERIE HOUSINGS, REGULATORS, HOSES, GRILL PLUMBING, NATURAL GAS GRILL POSTS, WARMING RACKS, GASLIGHT PARTS AND SUPPLIES, HOT PLATES, BURNERS AND VENTURIS, COOKING GRIDS, AND ROCK GRATES/HEAT PLATES, IN CLASS 35 (U.S. CLS. 100, 101 AND 102).

**SERVICE MARK**

**PRINCIPAL REGISTER**

FIRST USE 1-1-2005; IN COMMERCE 1-1-2005.

THE MARK CONSISTS OF STANDARD CHARACTERS WITHOUT CLAIM TO ANY PARTICULAR FONT, STYLE, SIZE, OR COLOR.

SER. NO. 76-710,415, FILED 1-31-2012.

LOURDES AYALA, EXAMINING ATTORNEY



*David J. Kyffers*

Director of the United States Patent and Trademark Office



# United States of America

United States Patent and Trademark Office

## COMMIT TO A HIGHER STANDARD

**Reg. No. 4,196,255**

HUMAN RESOURCE CERTIFICATION INSTITUTE (D.C. CORPORATION)  
1800 DUKE STREET  
ALEXANDRIA, VA 22314

**Registered Aug. 28, 2012**

**Int. Cl.: 9**

FOR: DOWNLOADABLE WEBINARS IN THE FIELD OF HUMAN RESOURCES CREDENTIALING, IN CLASS 9 (U.S. CLS. 21, 23, 26, 36 AND 38).

**TRADEMARK**

FIRST USE 6-1-2008; IN COMMERCE 6-1-2008.

**PRINCIPAL REGISTER**

THE MARK CONSISTS OF STANDARD CHARACTERS WITHOUT CLAIM TO ANY PARTICULAR FONT, STYLE, SIZE, OR COLOR.

SER. NO. 76-710,438, FILED 1-31-2012.

MARGERY A. TIERNEY, EXAMINING ATTORNEY



*David J. Kyffers*

Director of the United States Patent and Trademark Office

# United States of America

United States Patent and Trademark Office

## COMMIT TO A HIGHER STANDARD

**Reg. No. 4,196,256**

**Registered Aug. 28, 2012**

**Int. Cl.: 41**

**SERVICE MARK**

**PRINCIPAL REGISTER**

HUMAN RESOURCE CERTIFICATION INSTITUTE (D.C. CORPORATION)  
1800 DUKE STREET  
ALEXANDRIA, VA 22314

FOR: PROVIDING ON-LINE JOURNALS, NAMELY, BLOGS IN THE FIELD OF HUMAN RESOURCES; PROVIDING ON-LINE PUBLICATIONS, NAMELY, ARTICLES, HANDBOOKS, WHITE PAPERS, STUDY GUIDES AND BROCHURES IN THE FIELD OF HUMAN RESOURCES CREDENTIALING; PROVIDING EDUCATIONAL EXAMINATION SERVICES IN THE FIELD OF HUMAN RESOURCES CREDENTIALING, IN CLASS 41 (U.S. CLS. 100, 101 AND 107).

FIRST USE 6-1-2008; IN COMMERCE 6-1-2008.

THE MARK CONSISTS OF STANDARD CHARACTERS WITHOUT CLAIM TO ANY PARTICULAR FONT, STYLE, SIZE, OR COLOR.

SER. NO. 76-710,442, FILED 1-31-2012.

MARGERY A. TIERNEY, EXAMINING ATTORNEY



*David J. Kyffers*

Director of the United States Patent and Trademark Office

# United States of America

United States Patent and Trademark Office

## COMMIT TO A HIGHER STANDARD

**Reg. No. 4,196,257**

HUMAN RESOURCE CERTIFICATION INSTITUTE (D.C. CORPORATION)

**Registered Aug. 28, 2012**

1800 DUKE STREET  
ALEXANDRIA, VA 22314

**Int. Cl.: 42**

FOR: ACCREDITATION SERVICES IN CONNECTION WITH DEVELOPING AND ADMINISTERING STANDARDS AND PROCEDURES FOR CREDENTIALING PROFESSIONALS IN THE HUMAN RESOURCE MANAGEMENT FIELD; COMPUTER SERVICES, NAMELY, PROVIDING SEARCH ENGINE SERVICES FOR OBTAINING DATA AND CONTENT VIA A GLOBAL COMPUTER NETWORK IN THE FIELD OF HUMAN RESOURCES CREDENTIALING, IN CLASS 42 (U.S. CLS. 100 AND 101).

**SERVICE MARK**

**PRINCIPAL REGISTER**

FIRST USE 6-1-2008; IN COMMERCE 6-1-2008.

THE MARK CONSISTS OF STANDARD CHARACTERS WITHOUT CLAIM TO ANY PARTICULAR FONT, STYLE, SIZE, OR COLOR.

SER. NO. 76-710,443, FILED 1-31-2012.

MARGERY A. TIERNEY, EXAMINING ATTORNEY



*David J. Kybas*

Director of the United States Patent and Trademark Office

# United States of America

United States Patent and Trademark Office

# SEACRETS

**Reg. No. 4,196,258**

**Registered Aug. 28, 2012**

**Int. Cls.: 25, 35, 38 and 41**

O.C. SEACRETS, INC. (MARYLAND CORPORATION)  
117 WEST 49TH STREET  
OCEAN CITY, MD 21842

FOR: CLOTHING, NAMELY, GOLF SHIRTS, HATS, T-SHIRTS, SHORTS, SWEATSHIRTS, WINDSHIRTS, TANK TOPS, FOOTBALL JERSEYS, IN CLASS 25 (U.S. CLS. 22 AND 39).

**TRADEMARK**

FIRST USE 6-30-1988; IN COMMERCE 6-30-1988.

**SERVICE MARK**

**PRINCIPAL REGISTER**

FOR: PROVIDING CONSUMER INFORMATION SERVICES AND MAKING REFERRALS IN THE FIELD OF ENTERTAINMENT SERVICES FOR PRODUCTS, SERVICES, EVENTS, ACTIVITIES, FACILITIES AND LOCATIONS; RETAIL CLOTHING BOUTIQUES; ON-LINE RETAIL GIFT SHOPS; RETAIL GIFT SHOPS; RETAIL STORE AND ON-LINE RETAIL STORES SERVICES FEATURING GOLF SHIRTS, HATS, T-SHIRTS, SHORTS, SWEATSHIRTS, WINDSHIRTS, TANKS, FOOTBALL JERSEYS, GOLF TOWELS, SHOT GLASSES, COMPACT DISCS, CUPS, HOLIDAY ORNAMENTS, HIP KLIPPOCKETS, GOLF BALLS, POSTCARDS, GLASSWARES, BOTTLE OPENERS, BEACH TOWELS AND GIFT CARDS, IN CLASS 35 (U.S. CLS. 100, 101 AND 102).

FIRST USE 6-30-1988; IN COMMERCE 6-30-1988.

FOR: BROADCASTING OF RADIO PROGRAMS; INTERNET RADIO BROADCASTING SERVICES; INTERNET RADIO SERVICES, NAMELY, TRANSMISSION OF AUDIO MATERIAL VIA THE INTERNET, RADIO BROADCASTING; RADIO BROADCASTING OF INFORMATION AND OTHER PROGRAMS, IN CLASS 38 (U.S. CLS. 100, 101 AND 104).

FIRST USE 1-31-2003; IN COMMERCE 1-31-2003.

FOR: ENTERTAINMENT SERVICES, NAMELY, PROVIDING A WEBSITE THAT DISPLAYS VARIOUS REQUESTS, REVIEWS, RECOMMENDATIONS, RANKINGS, TRACKINGS, VOTES, AND INFORMATION RELATING TO NEW, SPECIAL, POPULAR SERVICES, AND EVENTS IN THE FIELDS OF POP CULTURE ENTERTAINMENT AND SPORTS, ALL EXCLUSIVELY FOR NONBUSINESS AND NON-COMMERCIAL TRANSACTIONS AND PURPOSES; PERSONAL APPEARANCES BY CELEBRITIES AND NATIONAL BAND ACTS; PROVIDING RADIO PROGRAMS IN THE FIELD OF MUSIC, ENTERTAINMENT AND COMMENTARY VIA GLOBAL COMPUTER NETWORK; FIREWORKS DISPLAYS; ARRAN-



*David J. Kyros*

Director of the United States Patent and Trademark Office

**Reg. No. 4,196,258** GING OF CONTESTS; CONDUCTING PARTIES; PROVIDING NON DOWNLOADABLE PRERECORDED MUSIC, INFORMATION IN THE FIELD OF MUSIC, AND COMMENTARY AND ARTICLES ABOUT MUSIC, ALL ON-LINE VIA A GLOBAL COMPUTER NETWORK; ENTERTAINMENT SERVICES IN THE NATURE OF LIVE MUSICAL PERFORMANCES; COMEDY SHOWS; PROVIDING NON-DOWNLOADABLE PLAYBACK OF MUSIC VIA GLOBAL COMMUNICATIONS NETWORKS; ENTERTAINMENT SERVICES, NAMELY, THE PROVISION OF CONTINUING PROGRAMS, SEGMENTS, AND SHOWS FEATURING NEWS, COMEDY, AND COMMENTARY DELIVERED VIA RADIO, THE INTERNET, OR LIVE; ENTERTAINMENT SERVICES, NAMELY, PROVIDING INFORMATION BY MEANS OF A GLOBAL COMPUTER NETWORK IN THE FIELDS OF CELEBRITIES, ENTERTAINMENT, AND POPULAR CULTURE; PRESENTING LIVE MUSICAL PERFORMANCES; ENTERTAINMENT TICKET AGENCY SERVICES AND ON-LINE ENTERTAINMENT TICKET AGENCY SERVICES FOR ENTERTAINMENT EVENTS; PRODUCTION AND DISTRIBUTION OF RADIO PROGRAMS; RADIO ENTERTAINMENT SERVICES, NAMELY, RADIO PROGRAMS FEATURING PERFORMANCES BY A RADIO PERSONALITY; NIGHT CLUBS; ON-LINE ELECTRONIC NEWSLETTERS DELIVERED BY E-MAIL IN THE FIELD OF MUSIC AND ENTERTAINMENT, IN CLASS 41 (U.S. CLS. 100, 101 AND 107).

FIRST USE 6-30-1988; IN COMMERCE 6-30-1988.

OWNER OF U.S. REG. NOS. 2,102,604, 3,767,755 AND OTHERS.

SER. NO. 76-979,206, FILED 10-27-2010.

CHRISTINE MARTIN, EXAMINING ATTORNEY

# United States of America

United States Patent and Trademark Office



**Reg. No. 4,196,259**

SABADOS GROUP INC. (CANADA COMPANY)  
401 LOGAN AVENUE  
TORONTO, CANADA M4M2P2

**Registered Aug. 28, 2012**

**Int. Cls.: 11, 20, 24 and  
27**

FOR: LIGHTING FIXTURES AND LAMPS, IN CLASS 11 (U.S. CLS. 13, 21, 23, 31 AND 34).

FOR: HOME, KITCHEN, DECORATIVE AND BATH FURNISHINGS, NAMELY, FURNITURE, DINING ROOM FURNITURE, LIVING ROOM FURNITURE, AND BEDROOM FURNITURE, IN CLASS 20 (U.S. CLS. 2, 13, 22, 25, 32 AND 50).

**TRADEMARK**

**PRINCIPAL REGISTER**

FOR: LINENS, NAMELY, BEDROOM LINENS, KITCHEN LINENS AND BATHROOM LINENS; DRAPERIES; BEDDING, NAMELY, DUVETS, PILLOWS, BED COMFORTERS, BED SHEETS, BED BLANKETS, BED SKIRTS, MATTRESS AND PILLOW PROTECTORS AND PADS, IN CLASS 24 (U.S. CLS. 42 AND 50).

FOR: RUGS, BROADLOOM RUGS, CARPETS, IN CLASS 27 (U.S. CLS. 19, 20, 37, 42 AND 50).

PRIORITY CLAIMED UNDER SEC. 44(D) ON CANADA APPLICATION NO. 1312839, FILED 8-14-2006, REG. NO. TMA819030, DATED 3-5-2012, EXPIRES 3-5-2027.

SER. NO. 77-102,506, FILED 2-8-2007.

MARK SPARACINO, EXAMINING ATTORNEY



*David J. Kybas*

Director of the United States Patent and Trademark Office

# United States of America

United States Patent and Trademark Office



**Reg. No. 4,196,260**

**Registered Aug. 28, 2012**

**Int. Cls.: 9, 38 and 42**

**TRADEMARK**

**SERVICE MARK**

**PRINCIPAL REGISTER**

PARLINGO LIMITED (UNITED KINGDOM PRIVATE LIMITED COMPANY)  
NELSON ROAD  
UNIT 4, ARCOT COURT  
CRAMLINGTON, UNITED KINGDOM NE231BB

FOR: DOWNLOADABLE APPLICATIONS THAT ENABLES INDIVIDUAL USERS AND GROUPS OF USERS TO MONITOR THE STATUS, AVAILABILITY AND LOCATION OF THEIR CONTACTS AND COMMUNICATE WITH THOSE CONTACTS VIA REAL TIME MESSAGES THAT CONTAIN DIGITAL FILES, INCLUDING AUDIO, VIDEO, TEXT, BINARY, STILL IMAGES, GRAPHICS AND MULTIMEDIA FILES, FOR MOBILE PHONES; COMPUTER SOFTWARE THAT ENABLES INDIVIDUAL USERS AND GROUPS OF USERS TO MONITOR THE STATUS, AVAILABILITY AND LOCATION OF THEIR CONTACTS AND COMMUNICATE WITH THOSE CONTACTS VIA REAL TIME MESSAGES THAT CONTAIN DIGITAL FILES, INCLUDING AUDIO, VIDEO, TEXT, BINARY, STILL IMAGES, GRAPHICS AND MULTIMEDIA FILES; COMPUTER SOFTWARE THAT ENABLES INDIVIDUAL USERS AND GROUPS OF USERS TO MONITOR THE STATUS, AVAILABILITY AND LOCATION OF THEIR CONTACTS AND COMMUNICATE WITH THOSE CONTACTS VIA REAL TIME MESSAGES THAT CONTAIN DIGITAL FILES, INCLUDING AUDIO, VIDEO, TEXT, BINARY, STILL IMAGES, GRAPHICS AND MULTIMEDIA FILES, FOR MOBILE PHONES, IN CLASS 9 (U.S. CLS. 21, 23, 26, 36 AND 38).

FOR: MOBILE TELEPHONE COMMUNICATION SERVICES, IN CLASS 38 (U.S. CLS. 100, 101 AND 104).

FOR: PROVIDING ONLINE NON-DOWNLOADABLE SOFTWARE THAT ENABLES INDIVIDUAL USERS AND GROUPS OF USERS TO MONITOR THE STATUS, AVAILABILITY AND LOCATION OF THEIR CONTACTS AND COMMUNICATE WITH THOSE CONTACTS VIA REAL TIME MESSAGES THAT CONTAIN DIGITAL FILES, INCLUDING AUDIO, VIDEO, TEXT, BINARY, STILL IMAGES, GRAPHICS AND MULTIMEDIA FILES, IN CLASS 42 (U.S. CLS. 100 AND 101).

PRIORITY CLAIMED UNDER SEC. 44(D) ON ERPN CMNTY TM OFC APPLICATION NO. 005737151, FILED 3-6-2007, REG. NO. 005737151, DATED 2-12-2008, EXPIRES 6-3-2017.

THE MARK CONSISTS OF A LARGE LETTER "P" AND THE WORD "PALRINGO" DIRECTLY UNDERNEATH IT.



*David J. Kybas*

Director of the United States Patent and Trademark Office

**Reg. No. 4,196,260** SER. NO. 77-125,175, FILED 3-8-2007.

BRIDGETT SMITH, EXAMINING ATTORNEY



# United States of America

United States Patent and Trademark Office

# VITERRA

**Reg. No. 4,196,261**

**Registered Aug. 28, 2012**

**Int. Cls.: 5, 29, 31, 35  
and 40**

**TRADEMARK**

**SERVICE MARK**

**PRINCIPAL REGISTER**

VITERRA INC. (CANADA CORPORATION)  
2625 VICTORIA AVENUE  
REGINA, CANADA S4T7T9

FOR: NON-MEDICATED ADDITIVES FOR ANIMAL FEED FOR USE AS NUTRITIONAL PROTEIN SUPPLEMENTS, IN CLASS 5 (U.S. CLS. 6, 18, 44, 46, 51 AND 52).

FOR: PULSES, IN CLASS 29 (U.S. CL. 46).

FOR: LIVESTOCK SUPPLIES, NAMELY, ANIMAL FEED, GRAIN SCREENING PELLETS IN THE NATURE OF UNPROCESSED GRAIN, MILL ANIMAL FEEDS; AGRICULTURAL SEED AND UNPROCESSED GRAIN, NAMELY, REGISTERED, COMMERCIAL OILSEEDS AND UNPROCESSED CEREALS, IN CLASS 31 (U.S. CLS. 1 AND 46).

FOR: WHOLESALE DISTRIBUTORSHIPS AND RETAIL STORE SERVICES ALL FEATURING AGRICULTURAL PRODUCTS, NAMELY, GRAINS, OILSEEDS, LEGUMES AND FORAGES, AND SEEDS OF AGRICULTURAL PRODUCTS AND PRIMARY BY-PRODUCTS OF AGRICULTURAL PRODUCTS; WHOLESALE DISTRIBUTORSHIPS AND RETAIL STORE SERVICES ALL FEATURING ANIMAL FEEDS, NAMELY, COMPLETE FEEDS, CONCENTRATED VITAMIN PREMIX FEEDS, MINERAL PREMIX FEEDS, CONCENTRATED VITAMIN AND MINERAL PREMIX FEEDS, SUPPLEMENT FEEDS AND FEED CONCENTRATES; WHOLESALE DISTRIBUTORSHIPS AND RETAIL STORE SERVICES ALL FEATURING ANIMAL FEED NUTRIENTS AND ADDITIVES; WHOLESALE DISTRIBUTORSHIPS AND RETAIL STORE SERVICES ALL FEATURING ANIMAL FEED MEDICATIONS AND INJECTABLES TO TREAT AND PREVENT DISEASE IN ANIMALS; MERCHANDISING SERVICES, NAMELY, STRATEGIC DEVELOPMENT, ADVERTISEMENT AND MARKETING RELATING TO THE PRODUCTION, PURCHASE AND SALE OF THE FOLLOWING PRODUCTS OF OTHERS -- AGRICULTURAL PRODUCTS, NAMELY, GRAINS, OILSEEDS, LEGUMES AND FORAGES, AND SEEDS OF AGRICULTURAL PRODUCTS AND PRIMARY BY-PRODUCTS OF AGRICULTURAL PRODUCTS, IN CLASS 35 (U.S. CLS. 100, 101 AND 102).

FOR: CONTRACT MANUFACTURING IN THE FIELD OF AGRICULTURAL PRODUCTS, NAMELY, GRAINS, OILSEEDS, LEGUMES AND FORAGES, AND SEEDS OF AGRICULTURAL PRODUCTS AND PRIMARY BY-PRODUCTS OF AGRICULTURAL PRODUCTS, ANIMAL FEEDS, NAMELY, COMPLETE FEEDS, CONCENTRATED VITAMIN PREMIX FEEDS, MINERAL PREMIX FEEDS, CONCENTRATED VITAMIN AND MINERAL PREMIX FEEDS, SUPPLEMENT FEEDS AND FEED CONCENTRATES, ANIMAL FEED NUTRIENTS



*David J. Kyros*

Director of the United States Patent and Trademark Office

**Reg. No. 4,196,261** AND ADDITIVES, ANIMAL FEED MEDICATIONS AND INJECTABLES TO TREAT AND PREVENT DISEASE IN ANIMALS, IN CLASS 40 (U.S. CLS. 100, 103 AND 106).

THE MARK CONSISTS OF STANDARD CHARACTERS WITHOUT CLAIM TO ANY PARTICULAR FONT, STYLE, SIZE, OR COLOR.

PRIORITY CLAIMED UNDER SEC. 44(D) ON CANADA APPLICATION NO. 1353684, FILED 6-28-2007, REG. NO. TMA810,087, DATED 10-25-2011, EXPIRES 10-25-2026.

OWNER OF U.S. REG. NOS. 999,467 AND 1,642,507.

SER. NO. 77-218,556, FILED 6-28-2007.

LINDA ESTRADA, EXAMINING ATTORNEY

# United States of America

United States Patent and Trademark Office



**Reg. No. 4,196,262**

RED ROCK DEVELOPMENTS, LLC (SOUTH CAROLINA LIMITED LIABILITY COMPANY)  
1901 MAIN STREET, SUITE 1150  
COLUMBIA, SC 29201

**Registered Aug. 28, 2012**

**Int. Cls.: 36 and 37**

FOR: ASSESSMENT AND MANAGEMENT OF REAL ESTATE, NAMELY, PROCUREMENT AND MANAGEMENT FOR OTHERS OF COMMERCIAL REAL PROPERTY PURCHASED FOR INVESTMENT PURPOSES AND THAT IS OCCUPIED BY A SINGLE CORPORATE TENANT ON A LONG TERM, NET LEASE BASIS; REAL ESTATE ACQUISITION SERVICES, NAMELY, AS LONG-TERM HOLDERS OF COMMERCIAL REAL PROPERTY PURCHASED FOR INVESTMENT PURPOSES THAT ARE OCCUPIED BY A SINGLE CORPORATE TENANT ON A LONG TERM, NET LEASE BASIS, IN CLASS 36 (U.S. CLS. 100, 101 AND 102).

**SERVICE MARK**

**PRINCIPAL REGISTER**

FIRST USE 5-1-2007; IN COMMERCE 7-15-2007.

FOR: BUILDING CONSTRUCTION SERVICES, NAMELY, PROJECT MANAGEMENT OF BUILD-TO-SUIT OR THE UP-FIT OF PROPERTIES FOR SPECIFIC BUSINESS ENTITIES OCCUPYING COMMERCIAL, SINGLE TENANT, LONG TERM, NET LEASED PROPERTIES; REAL ESTATE DEVELOPMENT, NAMELY, THE DEVELOPMENT AND UP-FIT OF COMMERCIAL PROPERTIES FOR SPECIFIC BUSINESS ENTITIES OCCUPYING COMMERCIAL, SINGLE TENANT, LONG TERM, NET LEASED PROPERTIES, IN CLASS 37 (U.S. CLS. 100, 103 AND 106).

FIRST USE 5-1-2007; IN COMMERCE 7-15-2007.

NO CLAIM IS MADE TO THE EXCLUSIVE RIGHT TO USE "DEVELOPMENTS", APART FROM THE MARK AS SHOWN.

THE COLOR(S) RED, BLACK, AND WHITE IS/ARE CLAIMED AS A FEATURE OF THE MARK.

THE MARK CONSISTS OF "RED ROCK" APPEARS IN BOLD, RED, CAPITAL LETTERS THAT ARE EQUAL SIZE. "DEVELOPMENTS" APPEARS IN THINNER, BLACK CAPITAL LETTERS THAT ARE APPROXIMATELY ONE-THIRD THE SIZE OF "RED ROCK" AND ARE SPACED APART FROM EACH OTHER. "DEVELOPMENTS" IS PLACED BELOW "RED ROCK". STARTING ABOVE THE "O" IN "ROCK", A BLACK, JAGGED LINE MAKES AN APPROXIMATE 45 DEGREE ANGLE TO THE RIGHT AND FORMS A MOUNTAIN PEAK ABOVE THE LETTER "K". THE BLACK, JAGGED LINE THEN DESCENDS IN A SLOPE-



*David J. Kyffers*

Director of the United States Patent and Trademark Office

**Reg. No. 4,196,262** LIKE MANNER, ENDING AT A POINT ABOVE THE END OF THE WORD "DEVELOPMENTS". THE BLACK LINE THEN EXTENDS IN A STRAIGHT MANNER UNTIL IT ALMOST MEETS THE LETTER "K" IN "ROCK". THE BLACK LINE FORMS THE OUTLINE OF A MOUNTAIN. THE INTERIOR OF THE MOUNTAIN IS WHITE.

SER. NO. 77-251,787, FILED 8-9-2007.

HEATHER BIDDULPH, EXAMINING ATTORNEY

# United States of America

United States Patent and Trademark Office



**GUNNERSAURUS**

**Reg. No. 4,196,263**

**Registered Aug. 28, 2012**

**Int. Cls.: 9, 16, 18, 20, 21,  
25, 28, 29, 30, 32, 41 and  
43**

**TRADEMARK**

**SERVICE MARK**

**PRINCIPAL REGISTER**

THE ARSENAL FOOTBALL CLUB PUBLIC LIMITED COMPANY (UNITED KINGDOM COMPANY)  
HIGHBURY HOUSE  
75 DRAYTON PARK  
LONDON, UNITED KINGDOM N51BU

FOR: AUTOMATIC VENDING MACHINES AND MECHANISMS FOR COIN OPERATED APPARATUS; CASH REGISTER, TALKING MACHINES; CALCULATING MACHINES, DATA PROCESSING EQUIPMENT AND COMPUTERS; FIRE-EXTINGUISHING APPARATUS; HANDHELD CALCULATORS, RADIOS, CAMERAS, MOUSE PADS, AUDIO CASSETTE PLAYERS, DVD PLAYERS, CASES FOR COMPACT DISCS, VIDEO GAME CARTRIDGES; SPECTACLES, SUN GLASSES, SPECTACLE CASES, SPECTACLE FRAMES, DECORATIVE MAGNETS; AUDIO AND VISUAL RECORDINGS IN THE FIELD OF SPORTS; PRERECORDED AUDIO AND VIDEO TAPES, COMPACT DISCS, AUDIO AND VIDEO CASSETTES, AND GRAMOPHONE RECORDS IN THE FIELD OF SPORTS; PRERECORDED AUDIO AND VIDEO RECORDINGS FEATURING SPORTS INFORMATION AND SPORTS GAMES; PRERECORDED INSTRUCTIONAL VIDEO RECORDINGS AND HIGHLIGHT VIDEO RECORDINGS TEACHING AND ILLUSTRATING SOCCER AND FOOTBALL TECHNIQUES; MUSICAL VIDEO AND SOUND RECORDINGS IN THE FIELD OF SPORTS; DIGITAL AUDIO TAPES FEATURING SPORTS INFORMATION AND SPORTS GAMES; VIDEO GAME SOFTWARE; COMPUTER GAME SOFTWARE; VIDEOGAME MACHINES FOR USE WITH TELEVISIONS; COMPUTER PROGRAMS FOR PLAYING GAMES; CAMERA CASES; COMPUTER GAME SOFTWARE FOR CHILDREN; VIDEO DISKS AND VIDEO TAPES WITH RECORDED ANIMATED CARTOONS; EDUCATIONAL COMPUTER SOFTWARE FOR CHILDREN; WATER WING SWIM AIDS FOR SAFETY PURPOSES; DOWNLOADABLE ELECTRONIC NEWSLETTERS AND MAGAZINES IN THE FIELD OF SPORTS, IN CLASS 9 (U.S. CLS. 21, 23, 26, 36 AND 38).

FOR: STATIONERY; FOLDERS; BINDERS; DIARIES AND PERSONAL ORGANIZERS; WRITING INSTRUMENTS; POSTERS; PHOTOGRAPHS; ALBUMS, NAMELY, PHOTOGRAPH AND COLLECTOR CARD ALBUMS; PHILATELIC STAMPS; STICKERS; DECALCOMANIAS; MAPS; WRITING PAPER; DRAWING PAPER; NOTE BOOKS; COASTERS OF PAPER; TABLE MATS OF PAPER; FLAGS AND PENNANTS OF PAPER; ARTISTS' PENCILS; ARTS AND CRAFTS PAINT KITS; PRINTED INSTRUCTIONAL AND TEACHING MATERIAL IN THE FIELD OF SPORTS (EXCEPT APPARATUS); PRINTED BOOKS, MAGAZINES, AND NEWSLETTERS IN THE FIELD OF SPORTS; EVENT PROGRAMS FOR SOCCER MATCHES; EVENT PROGRAMS; STORY BOOKS, NEWSPAPERS; STATIONERY, NOTEPADS, NOTE-



*David J. Kappas*

Director of the United States Patent and Trademark Office

**Reg. No. 4,196,263** BOOKS, BLANK JOURNALS; DOCUMENT FILES; WRITING PADS AND PAPER; DRAWING BOOKS, PADS, PENS; MODELLING CLAY; MODELLING MATERIALS AND COMPOUNDS FOR USE BY CHILDREN; PAINT BOXES; PAINT BRUSHES, PASTELS; PENS, PENCILS, CRAYONS, COLOURED PENCILS, AND CASES THEREFOR; ERASERS, MARKERS, STENCILS, FELT-TIPPED PENS, PENCIL SHARPENERS, DRAWING RULERS, PAINTING SETS FOR CHILDREN, CHALK AND CHALKBOARDS; GLUE FOR STATIONERY OR HOUSEHOLD USE, WRITING INK; HOLDERS AND STANDS FOR PENS, PENCILS, PASTELS AND CRAYONS; DECALS, HEAT TRANSFERS, NON-PERMANENT SKIN DECALS; BOOK COVERS, BOOK MARKS, SCRAP BOOKS; PRINTED CERTIFICATES; PHOTO ALBUMS; EVENT ALBUMS; ADDRESS BOOKS, AUTOGRAPH BOOKS, PAPER FOR WRAPPINGS AND PACKAGING MATERIAL; PAPER GIFT BAGS SOLD EMPTY, PAPER GIFT BOWS, PAPER HANDKERCHIEFS, PAPER PLACE MATS, PAPER TABLECLOTHS, PAPER PARTY DECORATIONS, CALENDARS, DISPOSABLE DIAPERS, POSTERS, PRINTED PICTURES, PHOTOGRAPHS, STICKERS AND TRANSFERS, PRINTED CHARTS; BLANK NOTE CARDS, GREETING CARDS, BIRTHDAY CARDS, HOLIDAY CARDS, OCCASION CARDS, POST CARDS, TRADING CARDS; PAPER NAPKINS, BANNERS MADE FROM PAPER OR CARDBOARD AND PRINTED PARTY INVITATIONS, PRINTED PATTERNS FOR COSTUMES; ADHESIVES FOR STATIONERY AND HOUSEHOLD PURPOSES; BOOKBINDING MATERIAL; TYPE WRITERS; PRINTERS' TYPE; PRINTING BLOCKS; SYNTHETIC FABRIC LUNCH BAGS; PRINTED BOOKS, BOOKLETS, AND PERIODICALS IN THE FIELD OF SOCCER; PASSPORT CASES; PLASTIC AND PAPER BAGS FOR MERCHANDISE PACKAGING CONSISTING OF ENVELOPES AND POUCHES, IN CLASS 16 (U.S. CLS. 2, 5, 22, 23, 29, 37, 38 AND 50).

FOR: CASES, NAMELY, ATTACHÉ CASES, BUSINESS CARD CASES, CREDIT CARD CASES, CALLING CARD CASES, DOCUMENT CASES, KEY CASES, OVERNIGHT CASES, COSMETIC CASES SOLD EMPTY, TOILETRY CASES SOLD EMPTY, VANITY CASES SOLD EMPTY; SUITCASES; UMBRELLAS; BAGS, NAMELY, SCHOOL BOOK BAGS, BARREL BAGS, BEACH BAGS, BOOK BAGS, CARRY-ON BAGS, CLUTCH BAGS, DIAPER BAGS, DUFFEL BAGS, GYM BAGS, LEATHER SHOPPING BAGS, OVERNIGHT BAGS, SCHOOL BAGS, SHOULDER BAGS, TOTE BAGS, TRAVEL BAGS, GARMENT BAGS FOR TRAVEL; SHOE BAGS FOR TRAVEL, HOLDALLS; WALLETS; PURSES; ALL PURPOSE SPORTS BAGS, ATHLETIC BAGS, COIN PURSES, FANNY PACKS, HANDBAGS, BACK PACKS, LUGGAGE, IN CLASS 18 (U.S. CLS. 1, 2, 3, 22 AND 41).

FOR: SLEEPING BAGS, PILLOWS; DECORATING KITS CONSISTING OF PLASTIC CAKE DECORATIONS AND CANDLES SOLD AS A UNIT; DRINKING STRAWS; PLASTIC TISSUE BOX COVERS, IN CLASS 20 (U.S. CLS. 2, 13, 22, 25, 32 AND 50).

FOR: HOUSEHOLD AND KITCHEN CONTAINERS NOT OF PRECIOUS METAL OR COATED THEREWITH; HOUSEHOLD UTENSILS NOT OF PRECIOUS METAL OR COATED THEREWITH, NAMELY WIRE BASKETS, GRATERS, SIEVES, SPATULAS, DRAINERS, TURNERS, CHOPPING BLOCKS; BEVERAGE GLASSWARE; DINNERWARE MADE OF PORCELAIN AND EARTHENWARE; BOWLS, CUPS AND PLATES; BOTTLES SOLD EMPTY; DRINKING GLASSES; LUNCH BOXES; THERMAL INSULATED CONTAINERS FOR FOOD AND BEVERAGE, INFANT CUPS; BATHROOM ACCESSORIES, NAMELY, TOOTHBRUSHES, WASTE BASKETS, HOLDERS FOR FACIAL TISSUES, NAMELY CERAMIC TISSUE BOX COVERS, HOLDERS FOR TOOTHBRUSHES AND PUMP-BOTTLE DISPENSERS FOR LIQUIDS, SOAP AND SIMILAR HOUSEHOLD PRODUCTS; METAL CAKE PANS, COOKIE CUTTERS; HAIRBRUSHES, HAIR COMBS, IN CLASS 21 (U.S. CLS. 2, 13, 23, 29, 30, 33, 40 AND 50).

FOR: ARTICLES OF OUTER CLOTHING, NAMELY, SWEATSHIRTS; SHORTS, RAIN JACKETS, POLO SHIRTS, HOODED TOPS, T-SHIRTS, JACKETS, SWIM SUITS, BIKINIS, SWIM SHORTS, BATH ROBES, BOXER SHORTS, OVERSHIRTS, SWEATERS, PULLOVERS, JUMPERS, JEANS, TIES, HATS, FOOTWEAR, HEADWEAR AND BELTS; LEATHER OR IMITATION LEATHER BELTS; SWIMWEAR; MASQUERADE AND HALLOWEEN COS-

**Reg. No. 4,196,263** TUMES AND MASKS SOLD IN CONNECTION THEREWITH; BABIES' CLOTH DIAPERS, IN CLASS 25 (U.S. CLS. 22 AND 39).

FOR: BOARD GAMES; CARD GAMES; BATH TOYS; INFANT TOYS; FOOTBALLS AND SOCCER BALLS; BAGS FOR CARRYING SOCCER EQUIPMENT; MECHANICAL TOYS AND PARTS THEREFOR; TOY MODEL HOBBY CRAFT KITS AND PARTS THEREFOR, SPORTS GLOVES, NAMELY, SOCCER GLOVES; GOAL KEEPER'S GLOVES; HAND HELD VIDEO GAMES AND STAND ALONE VIDEO GAME MACHINES; BALLOONS, DOLLS, DOLL ACCESSORIES, DOLL'S PRAMS, HAND PUPPETS, PLUSH TOYS, JIGSAW PUZZLES, MANIPULATIVE PUZZLES, INFANT RATTLES, SOFT SCULPTED TOY FIGURES; SPORTS BALLS; CARD GAMES, BATTERY-OPERATED ACTION TOYS, RIDE-ON TOYS, TOY VEHICLES, TOY MODEL VEHICLES; CHRISTMAS TREE ORNAMENTS AND DECORATION; PARTY FAVORS IN THE NATURE OF SMALL TOYS; SKATEBOARDS, ICE SKATES, SNOW SKIS, FLYING DISCS, HOCKEY STICKS, SNOW SLEDS FOR RECREATIONAL USE, PLAYGROUND EQUIPMENT, NAMELY, SANDBOXES AND SLIDES, POOL RINGS, INFLATABLE SWIMMING POOLS, BATH TOYS, POOL TOYS, NAMELY, SOCCER BALLS, SOCCER NETS, AND SOCCER GOALS; WATER WING SWIM AIDS FOR RECREATIONAL USE, WATER SQUIRTING TOYS, INFANT ACTION CRIB TOYS, KITES, BUBBLE-MAKING WAND AND SOLUTION SETS, TOY FIGURES, ACTION FIGURES, ACTION FIGURE ACCESSORIES AND ENVIRONMENTS IN THE NATURE OF PLAYSETS FOR ACTION FIGURES, TOY BAKE WARE, TOY COOKWARE, TOY BUILDING BLOCKS, BUILDING GAMES, TOY MOBILES, TOY MASKS, PUPPETS, CLOTHES FOR DOLLS OR SOFT TOYS, TOY BANKS, TOY TOOLS, TOY TOOL BELTS, TOY HARD HATS, PLAYING CARDS; PAPER PARTY HATS; TOY BOXES; TOY MODELLING DOUGH AND PLAYSETS FOR USE WITH TOY MODELLING DOUGH; AMUSEMENT GAME MACHINES, IN CLASS 28 (U.S. CLS. 22, 23, 38 AND 50).

FOR: CANDIED FRUIT SNACKS, JAMS, JELLIES; PROCESSED NUTS; MILK PRODUCTS EXCLUDING ICE CREAM, ICE MILK AND FROZEN YOGURTS; MILK PRODUCTS NAMELY, YOGURT AND CHEESE; MEAT, FISH, FRUIT AND VEGETABLE PRESERVES, DRIED, COOKED AND CANNED FRUITS AND VEGETABLES; EDIBLE OILS AND FATS; FRUIT TOPPING; SALADS EXCEPT MACARONI, RICE AND PASTA SALAD, FISH, MEAT, POULTRY AND GAME; MEAT EXTRACTS; PROCESSED BEANS; FOOD PRODUCTS MADE FROM FISH, NAMELY, CANNED FISH; FISH CAKES; FISH CROQUETTES, FISH FILLETS, FISH MOUSSE, FISH PRESERVES, FISH SAUSAGE, PICKLED FISH, SMOKED FISH; POTATO CRISPS; RAISINS; SOUPS; POTATO CHIPS; PICKLES; APPLE SAUCE, IN CLASS 29 (U.S. CL. 46).

FOR: FOOD PRODUCTS, NAMELY, CEREAL BASED SNACK FOODS; SUGAR, RICE, TAPIOCA, ARTIFICIAL COFFEE; FLOUR, PREPARATIONS MADE FROM CEREALS, NAMELY, READY TO EAT, CEREAL DERIVED FOOD BARS; BREAD; TREACLE; SALT; MUSTARD; VINEGAR; SAUCES; SPICES; GINGERBREAD; GOLDEN TABLE SYRUP; COCOA-BASED BEVERAGES, AND CHOCOLATE BASED BEVERAGES NOT BEING DAIRY OR VEGETABLE BASED; BREAKFAST CEREALS; AND CEREAL BASED ENERGY BARS NOT FOR USE AS A MEAL REPLACEMENT; MUESLI, CORNFLAKES, PROCESSED CEREALS; PASTRIES, CANDY, CANDY MINTS AND CHEWING GUM; CHOCOLATE, CANDIES, CANDY BARS, BISCUITS, COOKIES, CAKES, CRACKERS, RUSKS, CHOCOLATE SYRUPS AND CHOCOLATE TOPPING; ICE CREAM AND FROZEN CONFECTIONS, FROZEN YOGURT; HONEY, MARSHMALLOWS; SNACK MIX CONSISTING PRIMARILY OF CRACKERS, PRETZELS, NUTS AND/OR POPCORN; KETCHUP; MAYONNAISE; PIES; PANCAKES; PIZZA; SANDWICHES; ICE; FRUIT SAUCES EXCLUDING CRANBERRY SAUCES AND APPLE SAUCE; SALAD DRESSINGS; SWEETENED POWDERED DRINK MIXES USED TO MAKE TEA BEVERAGES; FRUIT JELLIES; EXCLUDING DINNERS COMPRISED PRIMARILY OF PASTA OR RICE , IN CLASS 30 (U.S. CL. 46).

FOR: MINERAL AND AERATED WATERS AND OTHER NON-ALCOHOLIC DRINKS NAMELY CARBONATED BEVERAGES; FRUIT DRINKS AND FRUIT JUICES; FROZEN FRUIT DRINK, FRUIT JUICE CONCENTRATES, SWEETENED POWDERED DRINK MIXES

**Reg. No. 4,196,263** USED TO MAKE SOFT DRINKS, FRUIT DRINKS, ISOTONIC SPORTS BEVERAGES, AND SPORTS BEVERAGES, IN CLASS 32 (U.S. CLS. 45, 46 AND 48).

FOR: ARRANGING AND CONDUCTING ATHLETIC, SOCCER, AND FOOTBALL COMPETITIONS; PROVIDING FACILITIES FOR GYMNASIAC AND RECREATION ACTIVITIES; PROVIDING FACILITIES FOR SOCCER MATCHES; PROVIDING FACILITIES FOR ATHLETIC TOURNAMENTS, PROVIDING FACILITIES FOR EDUCATIONAL TRAINING IN THE NATURE OF SEMINAR PRESENTATIONS; ENTERTAINMENT IN THE NATURE OF SOCCER MATCHES; TRAINING IN THE FIELD OF SOCCER; PROVIDING INFORMATION IN THE FIELD OF SPORTS VIA THE INTERNET; PROVIDING ON-LINE ELECTRONIC MAGAZINES AND NEWSLETTERS IN THE FIELD OF SPORTS; PRODUCTION AND DISTRIBUTION OF RADIO AND TELEVISION PROGRAMMES, AND FILMS; PRODUCTION AND DISTRIBUTION OF RADIO AND TELEVISION PROGRAMS AND MOTION PICTURE FILMS; RENTAL OF AUDIO TAPES AND VIDEO TAPES FEATURING RECORDINGS OF RADIO AND TELEVISION PROGRAMS; PROVISION OF INFORMATION RELATING TO ENTERTAINMENT AND EDUCATION, ALSO ONLINE; PROVIDING ONLINE COMPUTER GAMES THROUGH THE INTERNET AND ENTERTAINMENT SERVICES, NAMELY, PROVIDING A WEB SITE FEATURING PHOTOGRAPHIC, AUDIO, VIDEO AND PROSE PRESENTATIONS IN THE FIELD OF SOCCER; PRESENTATION OF LIVE STAGE SHOW PERFORMANCES, FAN CLUBS, AMUSEMENT PARKS; LIVE PERFORMANCES AND PERSONAL APPEARANCES BY A COSTUMED CHARACTER; NURSERY SCHOOLS, IN CLASS 41 (U.S. CLS. 100, 101 AND 107).

FOR: NURSERIES AND DAY CARE CENTERS, IN CLASS 43 (U.S. CLS. 100 AND 101).

PRIORITY CLAIMED UNDER SEC. 44(D) ON ERPN CMNTY TM OFC APPLICATION NO. 006299655, FILED 9-13-2007, REG. NO. 006299655, DATED 10-20-2008, EXPIRES 9-13-2017.

THE COLOR(S) RED, GREEN, BLACK, WHITE, PINK, BLUE, GRAY AND GOLD IS/ARE CLAIMED AS A FEATURE OF THE MARK.

OWNER OF U.S. REG. NO. 2,653,015.

THE MARK CONSISTS OF A DINOSAUR DESIGN WITH THE WORDING "GUNNERSAUR-US" UNDERNEATH IT. THE WORDING "GUNNERSAURUS" IS IN RED OUTLINED IN WHITE AND BLUE. THE DINOSAUR IS GREEN WITH THE DINOSAUR AND HIS CLOTHING AND DETAILS OUTLINED IN BLACK. THE DINOSAUR'S HAT IS RED WITH BLACK LINES. THE DINOSAUR HAS WHITE TEETH, A PINK TONGUE, WHITE NAILS, AND A BLACK AND GRAY NECKLACE. THE DINOSAUR'S SHIRT IS RED AND WHITE, WITH A GOLD STRIPE OUTLINED IN BLACK ON THE SIDE OF THE SHIRT AND A SMALL RED, WHITE, GOLD AND BLUE CREST ON THE CHEST OF THE SHIRT. THE DINOSAUR'S PANTS AND BELT ARE WHITE WITH A TINY TRIANGLE OF RED AT THE BOTTOM OF THE PANTS ON THE FORWARD LEG. THE DINOSAUR'S SOCKS ARE RED AND ITS LEG IS GREEN. THE DINOSAUR'S SHOES ARE BLACK, GRAY, AND BLUE, WITH WHITE ON THE SIDE OF THE SHOE ON THE FORWARD FOOT. THE INSIDE OF THE HANGING SLEEVE AND PANT LEG ARE BLUE. THERE IS BLUE SHADING ON THE WHITE PART OF THE SHIRT AND PANTS AND GRAY SHADING ON THE RED PART OF THE SHIRT ON THE SAME SIDE AS THE GOLD STRIPE. THE WHITE INSIDE THE WORDING AND DINOSAUR IS PART OF THE MARK, BUT THE WHITE OUTSIDE THE WORDING AND DINOSAUR IS NOT PART OF THE MARK AND REPRESENTS TRANSPARENT AREA.

SER. NO. 77-280,238, FILED 9-14-2007.

ELLEN B. AWRICH, EXAMINING ATTORNEY



**United States of America**  
United States Patent and Trademark Office

**ELEFUNK**

**Reg. No. 4,196,264**

**Registered Aug. 28, 2012**

**Int. Cl.: 9**

**TRADEMARK**

**PRINCIPAL REGISTER**

SONY COMPUTER ENTERTAINMENT EUROPE LIMITED (UNITED KINGDOM LIMITED COMPANY (LTD.))  
10 GREAT MARLBOROUGH STREET  
LONDON, UNITED KINGDOM W1F7LP

FOR: COMPUTER GAMES SOFTWARE DOWNLOADED VIA THE INTERNET, IN CLASS 9 (U.S. CLS. 21, 23, 26, 36 AND 38).

THE MARK CONSISTS OF STANDARD CHARACTERS WITHOUT CLAIM TO ANY PARTICULAR FONT, STYLE, SIZE, OR COLOR.

OWNER OF UNITED KINGDOM REG. NO. 2452517, DATED 4-8-2011, EXPIRES 4-13-2017.

SER. NO. 77-302,955, FILED 10-12-2007.

JOHN E. MICHOS, EXAMINING ATTORNEY



*David J. Kyffers*

Director of the United States Patent and Trademark Office

# United States of America

United States Patent and Trademark Office

## Eastern Energy Solutions

**Reg. No. 4,196,265**

EASTERN ENERGY SOLUTIONS, LLC (NEW YORK LIMITED LIABILITY COMPANY)  
20 PLEASANT AVENUE  
AFTON, NY 13730

**Registered Aug. 28, 2012**

**Int. Cls.: 35, 37 and 42**

FOR: ENERGY AUDITING; CONSULTATION SERVICES IN THE FIELD OF ENERGY EFFICIENCY; TECHNICAL PLANNING SERVICES IN THE FIELD OF OPTIMIZING FACILITIES ENERGY USAGE, IN CLASS 35 (U.S. CLS. 100, 101 AND 102).

**SERVICE MARK**

FIRST USE 4-30-2001; IN COMMERCE 4-30-2001.

**PRINCIPAL REGISTER**

FOR: CONSTRUCTION, INSTALLATION AND MAINTENANCE OF ENERGY-EFFICIENT LIGHTING, HEATING VENTILATING AND AIR CONDITIONING, REFRIGERATION, VOLTAGE SURGE PROTECTION, SOLAR PHOTOVOLTAIC AND SOLAR ENERGY SYSTEMS, IN CLASS 37 (U.S. CLS. 100, 103 AND 106).

FIRST USE 4-30-2001; IN COMMERCE 4-30-2001.

FOR: ENGINEERING SERVICES IN THE FIELD OF OPTIMIZATION OF FACILITIES ENERGY CONSUMPTION, IN CLASS 42 (U.S. CLS. 100 AND 101).

FIRST USE 4-30-2001; IN COMMERCE 4-30-2001.

THE MARK CONSISTS OF STANDARD CHARACTERS WITHOUT CLAIM TO ANY PARTICULAR FONT, STYLE, SIZE, OR COLOR.

NO CLAIM IS MADE TO THE EXCLUSIVE RIGHT TO USE "ENERGY", APART FROM THE MARK AS SHOWN.

SER. NO. 77-303,962, FILED 10-15-2007.

MICHAEL WIENER, EXAMINING ATTORNEY



*David J. Kybas*

Director of the United States Patent and Trademark Office

# United States of America

United States Patent and Trademark Office

# IDLE

**Reg. No. 4,196,266**

**Registered Aug. 28, 2012**

**Int. Cls.: 16 and 41**

**TRADEMARK**

**SERVICE MARK**

**PRINCIPAL REGISTER**

DKRT INVESTMENTS CORP. (CANADA COMPANY)  
SUITE 2400  
65 QUEEN STREET WEST  
TORONTO, ONTARIO, CANADA M5H2M8

FOR: A SERIES OF FICTION BOOKS, BLANK JOURNAL BOOKS, NON-FICTION BOOKS, NAMELY, ART BOOKS, PHOTOGRAPHY BOOKS, COFFEE TABLE BOOKS FEATURING ART AND PHOTOGRAPHY, IN CLASS 16 (U.S. CLS. 2, 5, 22, 23, 29, 37, 38 AND 50).

FOR: PUBLISHING OF BOOKS, IN CLASS 41 (U.S. CLS. 100, 101 AND 107).

THE MARK CONSISTS OF STANDARD CHARACTERS WITHOUT CLAIM TO ANY PARTICULAR FONT, STYLE, SIZE, OR COLOR.

PRIORITY CLAIMED UNDER SEC. 44(D) ON CANADA APPLICATION NO. 1366822, FILED 10-9-2007, REG. NO. TMA808028, DATED 9-29-2011, EXPIRES 9-29-2026.

SER. NO. 77-305,808, FILED 10-17-2007.

ROBERT C. CLARK JR., EXAMINING ATTORNEY



*David J. Kybas*

Director of the United States Patent and Trademark Office

# United States of America

United States Patent and Trademark Office

## Hawk Helmets

**Reg. No. 4,196,267**

HELMET VENTURE INC (CALIFORNIA CORPORATION)  
955 VENICE BLVD  
LOS ANGELES, CA 90015

**Registered Aug. 28, 2012**

**Int. Cl.: 9**

FOR: HELMETS FOR MOTORCYCLISTS; MOTORCYCLE HELMETS; MOTORCYCLE RIDING HELMETS, IN CLASS 9 (U.S. CLS. 21, 23, 26, 36 AND 38).

**TRADEMARK**

FIRST USE 1-15-2007; IN COMMERCE 1-15-2007.

**PRINCIPAL REGISTER**

THE MARK CONSISTS OF STANDARD CHARACTERS WITHOUT CLAIM TO ANY PARTICULAR FONT, STYLE, SIZE, OR COLOR.

NO CLAIM IS MADE TO THE EXCLUSIVE RIGHT TO USE "HELMETS", APART FROM THE MARK AS SHOWN.

SER. NO. 77-324,148, FILED 11-7-2007.

ANGELA M. MICHELI, EXAMINING ATTORNEY



*David J. Kybas*

Director of the United States Patent and Trademark Office

# United States of America

United States Patent and Trademark Office



NORTHWEST  
TERRITORIES  
ARTS

**Reg. No. 4,196,268**

**Registered Aug. 28, 2012**

**Int. Cls.: 6, 8, 9, 14, 15,  
16, 18, 19, 20, 21, 24, 25,  
28, 35 and 41**

GOVERNMENT OF THE NORTHWEST TERRITORIES (CANADA TERRITORIAL  
GOVERNMENT)  
5102 50TH AVENUE 6TH FLOOR SCOTIA CENTRE  
YELLOWKNIFE, CANADA X1A2L9

FOR: ART, NAMELY, CARVINGS AND SCULPTURES MADE OF METAL; PLAQUES MADE  
OF METAL; SOUVENIRS, NAMELY, METAL KEYCHAINS, IN CLASS 6 (U.S. CLS. 2, 12,  
13, 14, 23, 25 AND 50).

**TRADEMARK**

FOR: HANDMADE KNIVES, IN CLASS 8 (U.S. CLS. 23, 28 AND 44).

**SERVICE MARK**

FOR: AUDIO RECORDINGS FEATURING MUSIC, STORYTELLING, SPOKEN WORD IN  
THE FIELD OF THE NORTHWEST TERRITORIES OF CANADA, PEOPLE AND CULTURE  
OF THE NORTHWEST TERRITORIES OF CANADA, HOMELESSNESS; VIDEO RECORDINGS  
FEATURING DOCUMENTARY FILMS, SHORT-LENGTH FILMS, FULL-LENGTH FILMS,  
AND COMMERCIALY TELEVISED DOCUMENTARY FILMS ABOUT THE NORTHWEST  
TERRITORIES OF CANADA, PEOPLE AND CULTURE OF THE NORTHWEST TERRITORIES  
OF CANADA, HOMELESSNESS; PRE-RECORDED CDS FEATURING MUSIC,  
STORYTELLING, SPOKEN WORD IN THE FIELD OF THE NORTHWEST TERRITORIES  
OF CANADA, PEOPLE AND CULTURE OF THE NORTHWEST TERRITORIES OF CANADA,  
HOMELESSNESS; PRE-RECORDED DVDS FEATURING DOCUMENTARY FILMS, SHORT-  
LENGTH FILMS, FULL-LENGTH FILMS, AND COMMERCIALY TELEVISED DOCUMENT-  
ARY FILMS ABOUT THE NORTHWEST TERRITORIES OF CANADA, PEOPLE AND CULT-  
TURE OF THE NORTHWEST TERRITORIES OF CANADA, HOMELESSNESS; SOUVENIRS,  
NAMELY, DECORATIVE MAGNETS, IN CLASS 9 (U.S. CLS. 21, 23, 26, 36 AND 38).

**PRINCIPAL REGISTER**



FOR: JEWELRY; ORNAMENTAL PINS; LAPEL PINS, IN CLASS 14 (U.S. CLS. 2, 27, 28 AND  
50).

FOR: SOUVENIRS, NAMELY, HANDMADE HIDE DRUMS, IN CLASS 15 (U.S. CLS. 2, 21  
AND 36).

FOR: ART, NAMELY, MURALS, LITHOGRAPHS, STENCILS, DRAWINGS, NOVELS, PO-  
ETRY BOOKS; PHOTOGRAPHS; PAINTINGS; SOUVENIRS, NAMELY, STATIONERY-TYPE  
PORTFOLIO CASES, ART AND PHOTOGRAPH PORTFOLIO CASES, AND BOOKS, NAMELY,  
NON-FICTION BOOKS IN THE FIELD OF THE NORTHWEST TERRITORIES OF CANADA,

*David J. Kybas*

Director of the United States Patent and Trademark Office

**Reg. No. 4,196,268** COOK BOOKS, PICTURE BOOKS, STORY BOOKS, TRAVEL BOOKS, SONG BOOKS, IN CLASS 16 (U.S. CLS. 2, 5, 22, 23, 29, 37, 38 AND 50).

FOR: HANDBAGS, HANDMADE PURSES AND WALLETS; SOUVENIRS, NAMELY, BUSINESS CARD HOLDERS IN THE NATURE OF CARD CASES AND WALLETS; WORKS OF ART MADE FROM ANIMAL HIDE, IN CLASS 18 (U.S. CLS. 1, 2, 3, 22 AND 41).

FOR: ART, NAMELY, SCULPTURES AND CARVINGS OF STONE, IN CLASS 19 (U.S. CLS. 1, 12, 33 AND 50).

FOR: CRAFTS, NAMELY, PICTURE FRAMES, LOG FURNITURE; SOUVENIRS, NAMELY, KEY CHAINS MADE OF PLASTIC AND WOOD; ART, NAMELY, CARVINGS AND SCULPTURES OF PLASTER, WAX, IVORY, BONE AND WOOD; PLAQUES MADE OF PLASTIC AND WOOD; WORKS OF ART MADE FROM ANIMAL HAIR BEING TUFTING, QUILLS OR FISH SCALES, IN CLASS 20 (U.S. CLS. 2, 13, 22, 25, 32 AND 50).

FOR: BASKETRY, NAMELY, BASKETS OF WICKER, STRAW, WOOD, BARK, CLOTH; DECORATIVE GLASS, NAMELY, STAINED GLASS, ETCHED GLASS, DECORATED PAINTED GLASS NOT FOR BUILDING; SCULPTURES OF GLASS; FIGURINES OF GLASS; BLOWN GLASS BOTTLES SOLD EMPTY, ETCHED BLOWN GLASS BOTTLES SOLD EMPTY; WORKS OF ART IN THE NATURE OF SCULPTURES OF CERAMICS, POTTERY, EARTHENWARE, CHINA, CRYSTAL, TERRA COTTA AND PORCELAIN; INSTALLATION ART, NAMELY, WORKS OF ART OF MULTIPLE MATERIALS AND MEDIUMS AND PRIMARILY OF CERAMICS AND EARTHENWARE; ART, NAMELY, CARVINGS AND SCULPTURES OF GLASS, IN CLASS 21 (U.S. CLS. 2, 13, 23, 29, 30, 33, 40 AND 50).

FOR: HANDMADE ITEMS, NAMELY, WOVEN TAPESTRIES OF TEXTILES, NAMELY, QUILTS, CHILDREN'S BLANKETS, LAP BLANKETS, TABLE CLOTHS, TABLE RUNNERS, AND PLACE MATS, IN CLASS 24 (U.S. CLS. 42 AND 50).

FOR: CLOTHING, NAMELY, HANDMADE MOCCASINS, SLIPPERS, SWEATERS, SHIRTS, JACKETS, VESTS, DRESSES, BELTS; SNOW ACCESSORIES, NAMELY, HANDMADE GLOVES, MITTENS, SCARVES; TAPESTRY APRONS; SOUVENIRS, NAMELY, HATS, IN CLASS 25 (U.S. CLS. 22 AND 39).

FOR: SNOW ACCESSORIES, NAMELY, SNOW SHOES, IN CLASS 28 (U.S. CLS. 22, 23, 38 AND 50).

FOR: MARKETING AND PROMOTING THE GOODS AND SERVICES OF OTHERS, NAMELY, ARTS, CRAFTS, SOUVENIRS, PHOTOGRAPHS, ARTWORK, PAINTINGS, HANDMADE ITEMS, AUDIO RECORDINGS, VIDEO RECORDINGS, LIVE PERFORMANCES, PRE-RECORDED CDS, PRE-RECORDED DVDS, NAMELY, ARRANGING FOR THE DISTRIBUTION OF THE PRODUCTS OF OTHERS, PROVIDING MARKETING STRATEGIES AND CONSULTING SERVICES, EVALUATING MARKETS FOR EXISTING PRODUCTS AND SERVICES OF OTHERS, TELEMARKETING SERVICES, PRINT MEDIA ADVERTISING SERVICES FOR OTHERS, AND ADVERTISING THE PRODUCTS AND SERVICES OF OTHERS, IN CLASS 35 (U.S. CLS. 100, 101 AND 102).

FOR: LIVE PERFORMANCES BY THEATER GROUPS, ACTORS, MUSICIANS, BANDS, MUSICAL GROUPS, SPOKEN WORD ARTISTS, DANCERS AND STORYTELLERS OF MUSIC, SPOKEN WORD, DANCE, PLAYS AND STORYTELLING, IN CLASS 41 (U.S. CLS. 100, 101 AND 107).

PRIORITY CLAIMED UNDER SEC. 44(D) ON CANADA APPLICATION NO. 1355695, FILED 7-16-2007, REG. NO. TMA784246, DATED 12-6-2010, EXPIRES 12-6-2025.

NO CLAIM IS MADE TO THE EXCLUSIVE RIGHT TO USE "NORTHWEST TERRITORIES ARTS", APART FROM THE MARK AS SHOWN.

**Reg. No. 4,196,268** THE MARK CONSISTS OF WAVY LINES OVER A STAR OVER A HAND IN A BOX NEXT TO THE WORDS "NORTHWEST TERRITORIES ARTS".

SER. NO. 77-373,547, FILED 1-16-2008.

MARK RADEMACHER, EXAMINING ATTORNEY

# United States of America

United States Patent and Trademark Office

# you walk away

**Reg. No. 4,196,269**

**Registered Aug. 28, 2012**

**Int. Cl.: 36**

**SERVICE MARK**

**PRINCIPAL REGISTER**

BEACH & CLAREMONT, LLC (TEXAS LIMITED LIABILITY COMPANY)  
122 WEST CARPENTER FREEWAY  
SIXTH FLOOR  
IRVING, TX 75039

FOR: FORECLOSURE INFORMATION AND CONSULTATION, IN CLASS 36 (U.S. CLS. 100, 101 AND 102).

FIRST USE 1-1-2008; IN COMMERCE 1-1-2008.

THE MARK CONSISTS OF STANDARD CHARACTERS WITHOUT CLAIM TO ANY PARTICULAR FONT, STYLE, SIZE, OR COLOR.

SER. NO. 77-384,074, FILED 1-30-2008.

SUE LAWRENCE, EXAMINING ATTORNEY



*David J. Kyffers*

Director of the United States Patent and Trademark Office



**United States of America**  
United States Patent and Trademark Office

# PLAYFOOT

**Reg. No. 4,196,270**

**Registered Aug. 28, 2012**

**Int. Cl.: 27**

**TRADEMARK**

**PRINCIPAL REGISTER**

FIELDTURF TARKETT INC. (CANADA CORPORATION)  
8088 MONTVIEW ROAD  
TMR-MONTREAL, CANADA H4P2L7

FOR: ARTIFICIAL TURF FOR THE PLAYING OF ATHLETIC ACTIVITIES, IN CLASS 27  
(U.S. CLS. 19, 20, 37, 42 AND 50).

THE MARK CONSISTS OF STANDARD CHARACTERS WITHOUT CLAIM TO ANY PARTICULAR FONT, STYLE, SIZE, OR COLOR.

PRIORITY CLAIMED UNDER SEC. 44(D) ON CANADA APPLICATION NO. 1382548, FILED 2-7-2008, REG. NO. TMA817956, DATED 2-21-2012, EXPIRES 2-12-2027.

SER. NO. 77-399,366, FILED 2-18-2008.

LEIGH CAROLINE CASE, EXAMINING ATTORNEY



*David J. Kybas*

Director of the United States Patent and Trademark Office

# United States of America

United States Patent and Trademark Office

# Z.U.D.

**Reg. No. 4,196,271**

LIFESOURCE (UTAH NON-PROFIT ORGANIZATION)  
3838 SOUTH 700 EAST, STE. 200  
SALT LAKE CITY, UT 84106

**Registered Aug. 28, 2012**

**Int. Cl.: 41**

FOR: PROVIDING CONTINUING MEDICAL EDUCATION COURSES, IN CLASS 41 (U.S. CLS. 100, 101 AND 107).

**SERVICE MARK**

FIRST USE 3-15-2006; IN COMMERCE 6-1-2008.

**PRINCIPAL REGISTER**

THE MARK CONSISTS OF STANDARD CHARACTERS WITHOUT CLAIM TO ANY PARTICULAR FONT, STYLE, SIZE, OR COLOR.

SER. NO. 77-517,478, FILED 7-8-2008.

NICHOLAS COLEMAN, EXAMINING ATTORNEY



*David J. Kybas*

Director of the United States Patent and Trademark Office

# United States of America

United States Patent and Trademark Office



**Reg. No. 4,196,272**

BBRX2 LLC (NEW YORK LIMITED LIABILITY COMPANY)  
523 HUDSON STREET  
NEW YORK, CA 10014

**Registered Aug. 28, 2012**

**Int. Cls.: 35 and 44**

**SERVICE MARK**

**PRINCIPAL REGISTER**

FOR: COMPUTERIZED ON-LINE ORDERING FEATURING GENERAL MERCHANDISE AND GENERAL CONSUMER GOODS; ONLINE ORDERING SERVICES FEATURING CONSUMER MERCHANDISE AND SERVICES IN THE FIELD OF HEALTH, NUTRITION AND LIFESTYLE WELLNESS; RETAIL APOTHECARY STORE SERVICES; RETAIL BOOKSTORE SERVICES; RETAIL DRUG STORE SERVICES; RETAIL PHARMACY SERVICES, RETAIL STORE AND ONLINE RETAIL STORE SERVICES FEATURING GENERAL MERCHANDISE DIRECTED TOWARD AND AVAILABLE TO CONSUMER OF ALL AGES, NAMELY, COSMETICS, PERSONAL CARE AND PERSONAL HYGIENE PRODUCTS, SANITARY AND PHARMACEUTICAL PREPARATIONS, SPECIAL PURPOSE PHARMACEUTICALS AND COMPOUNDS, VITAMINS, NUTRITIONAL AND DIETARY SUPPLEMENTS, SOAP PET CARE PRODUCTS, BOOKS COMPACT DISCS, PRERECORDED VIDEO AND AUDIO TAPES; RETAIL STORE SERVICES FEATURING A WIDE VARIETY OF CONSUMER GOODS OF OTHERS; SPECIALITY COMPOUNDING PHARMACY SERVICES, IN CLASS 35 (U.S. CLS. 100, 101 AND 102).

FIRST USE 12-5-2005; IN COMMERCE 3-3-2006.



*David J. Kyros*

Director of the United States Patent and Trademark Office

FOR: CONSULTING SERVICES IN THE FIELD OF HEALTH, MENTAL HEALTH AND WELLNESS AND WOMEN'S HEALTH; CONSULTING SERVICES IN THE FIELDS OF HEALTH, HERBALISM, AND LIFESTYLE WELLNESS; DIETARY AND NUTRITIONAL GUIDANCE; DISPENSING OF PHARMACEUTICALS; INFORMATION IN THE FIELD OF PARENTING CONCERNING THE HEALTH OF CHILDREN; INTERACTIVE MEDICAL MONITORING AND ALERT SERVICE FOR REMINDING CLIENTS OF MEDICAL INFORMATION, NAMELY, MEDICINAL DOSAGE, ALLERGIC SENSITIVITY, AND PRESCRIPTION REFILLS; MEDICAL AND PHARMACEUTICAL CONSULTATION; PREPARATION AND DISPENSING OF MEDICATIONS; PRESCRIPTION REFILL REMINDER SERVICES; PROVIDING A WEB SITE FEATURING INFORMATION ON HEALTH AND NUTRITION; PROVIDING A WEB SITE THAT FEATURES INFORMATION ON CHILDREN'S NUTRITION; PROVIDING AN ON-LINE COMPUTER DATABASE FEATURING INFORMATION REGARDING HEALTH AND NUTRITION; PROVIDING HEALTHCARE INFORMATION BY TELEPHONE AND THE INTERNET; PROVIDING HEALTH INFORMATION; PROVIDING INFORMATION ABOUT DIETARY SUPPLEMENTS AND NUTRITION, IN CLASS 44 (U.S. CLS. 100 AND 101).

**Reg. No. 4,196,272** FIRST USE 12-5-2005; IN COMMERCE 3-3-2006.

OWNER OF U.S. REG. NOS. 3,575,701 AND 4,127,270.

THE MARK CONSISTS OF THE STYLIZED LETTERS "K", "I", "D", "S", "R" AND "X"  
WITHIN CONTIGUOUS SQUARES.

SEC. 2(F) AS TO "KIDSRX".

SER. NO. 77-554,697, FILED 8-25-2008.

KATHERINE STOIDES, EXAMINING ATTORNEY

# United States of America

United States Patent and Trademark Office

## THE OXFORD HOTEL

**Reg. No. 4,196,273**

**Registered Aug. 28, 2012**

**Int. Cl.: 43**

**SERVICE MARK**

**PRINCIPAL REGISTER**

OXFORD 2005 HOLDINGS, LLC (COLORADO LIMITED LIABILITY COMPANY)  
1575 WELTON  
SUITE 300  
DENVER, CO 80202

FOR: HOTEL SERVICES, IN CLASS 43 (U.S. CLS. 100 AND 101).

FIRST USE 10-3-1891; IN COMMERCE 10-3-1891.

THE MARK CONSISTS OF STANDARD CHARACTERS WITHOUT CLAIM TO ANY PARTICULAR FONT, STYLE, SIZE, OR COLOR.

NO CLAIM IS MADE TO THE EXCLUSIVE RIGHT TO USE "HOTEL", APART FROM THE MARK AS SHOWN.

SER. NO. 77-558,889, FILED 8-29-2008.

CHARLOTTE CORWIN, EXAMINING ATTORNEY



*David J. Kyffers*

Director of the United States Patent and Trademark Office

# United States of America

United States Patent and Trademark Office



**Reg. No. 4,196,274**

**Registered Aug. 28, 2012**

**Int. Cl.: 33**

**TRADEMARK**

**PRINCIPAL REGISTER**

GINUINE LIMITED (UNITED KINGDOM COMPANY)  
50 BROADWAY  
LONDON, ENGLAND

FOR: GIN, IN CLASS 33 (U.S. CLS. 47 AND 49).

OWNER OF UNITED KINGDOM REG. NO. 2606500, DATED 1-9-2012, EXPIRES 1-9-2022.

THE COLOR(S) RED, WHITE, GREY AND BLACK IS/ARE CLAIMED AS A FEATURE OF THE MARK.

OWNER OF U.S. REG. NO. 3,529,422.

NO CLAIM IS MADE TO THE EXCLUSIVE RIGHT TO USE "SMOOTH PREMIUM GIN", APART FROM THE MARK AS SHOWN.

THE MARK CONSISTS OF THE WORDING "BROCKMANS INTENSELY SMOOTH PREMIUM GIN" AND DESIGN. THE COLOR RED OUTLINES THE WORD "BROCKMANS" AND APPEARS IN THE WORDING "PREMIUM GIN" AND IN THE DESIGN ELEMENTS OF THE MARK CONSISTING OF LEAVES AND BERRIES. THE COLOR WHITE APPEARS IN THE WORD "BROCKMANS", IN THE WORDING "INTENSELY SMOOTH", IN THE DESIGN ELEMENTS OF THE MARK CONSISTING OF LEAVES AND BERRIES, AND IN THE DESIGN ELEMENTS OF THE MARK CONSISTING OF TWO PARALLEL LINES, BANDS OR BARS. THE COLOR GREY APPEARS IN THE LEAF DESIGN ELEMENTS OF THE MARK WHICH STAND BEHIND THE WORD "BROCKMANS INTENSELY SMOOTH PREMIUM GIN" AND AS SHADING IN THE DESIGN ELEMENTS OF THE MARK CONSISTING OF TWO PARALLEL LINES, BANDS OR BARS. THE COLOR BLACK APPEARS IN THE BACKGROUND OF THE FOREGOING ELEMENTS OF THE MARK.

SER. NO. 77-579,496, FILED 9-26-2008.

ROBIN MITTLER, EXAMINING ATTORNEY



*David J. Kyros*

Director of the United States Patent and Trademark Office

# United States of America

United States Patent and Trademark Office

# VEREDUS

**Reg. No. 4,196,275**

**Registered Aug. 28, 2012**

**Int. Cls.: 9, 10, 16 and 42**

**TRADEMARK**

**SERVICE MARK**

**PRINCIPAL REGISTER**

VEREDUS LABORATORIES PTE LTD (SINGAPORE PRIVATE LIMITED COMPANY)  
83 SCIENCE PARK DRIVE, #03-02A THE CURIE  
SINGAPORE SCIENCE PARK 1  
SINGAPORE, SINGAPORE 118258

FOR: LABORATORY AND SCIENTIFIC EQUIPMENT FOR GENETIC SAMPLING AND ANALYSIS, NAMELY, DIAGNOSTIC TESTING EQUIPMENT FEATURING MICROCHIPS AND DIAGNOSTIC TEST KITS COMPRISING MICROCHIPS FOR SCREENING SAMPLES, DETECTING THE PRESENCE OF ANALYTES IN SAMPLES AND IDENTIFYING SAMPLE TYPE; MICROFLUIDIC MICROCHIPS FOR LABORATORY GENETIC SAMPLING ANALYSIS; LAB-ON-A-CHIP ANALYZERS, NAMELY, MICROCHIPS FOR LABORATORY GENETIC SAMPLING ANALYSIS; GEL-BASED DETECTION KITS COMPRISING MICROCHIPS FOR LABORATORY GENETIC SAMPLING ANALYSIS; COMPUTER SOFTWARE FOR THE ANALYSIS OF GENETIC SAMPLES; ELECTRONIC PUBLICATIONS, NAMELY, BOOKS, BOOKLETS, GUIDES, PAMPHLETS, USER MANUALS, BROCHURES AND DATA AND TECHNICAL INFORMATIONAL SHEETS ALL IN THE FIELD OF MEDICAL AND LABORATORY EQUIPMENT FOR GENETIC SAMPLING AND ANALYSIS RECORDED ON COMPUTER MEDIA, IN CLASS 9 (U.S. CLS. 21, 23, 26, 36 AND 38).

FOR: MEDICAL AND VETERINARY APPARATUS AND INSTRUMENTATION, NAMELY, MEDICAL APPARATUS AND INSTRUMENTS FEATURING MICROCHIPS FOR GENETIC SAMPLING AND ANALYSIS; MEDICAL AND VETERINARY APPARATUS AND INSTRUMENTATION, NAMELY, MEDICAL DIAGNOSTIC APPARATUS AND INSTRUMENTS FOR DETECTION OF TISSUE AND CELL-BASED SAMPLES IN THE GENETIC SAMPLING AND ANALYSIS PROCESS; MEDICAL AND VETERINARY DIAGNOSTIC TEST EQUIPMENT FOR USE WITH CHEMICAL AND BIOCHEMICAL REAGENTS IN THE GENETIC SAMPLING AND ANALYSIS PROCESS, IN CLASS 10 (U.S. CLS. 26, 39 AND 44).

FOR: PRINTED MATTER, NAMELY, BOOKS, MAGAZINES, BOOKLETS, GUIDES, PAMPHLETS, BROCHURES, FOLDERS, INFORMATIONAL FLYERS, PROSPECTUS, PLACARDS OF PAPER OR CARDBOARD, POSTERS, STATIONERY, INSTRUCTIONAL AND TEACHING MATERIALS, DATA AND TECHNICAL INFORMATIONAL SHEETS AND USER MANUALS IN THE FIELD OF GENETIC SAMPLING AND ANALYSIS; STICKERS; BALLPOINT PENS; CORRUGATED BOXES; PHOTOGRAPHS; PLASTIC BAGS AND BUBBLE PACKS FOR PACKAGING, IN CLASS 16 (U.S. CLS. 2, 5, 22, 23, 29, 37, 38 AND 50).



*David J. Kyjars*

Director of the United States Patent and Trademark Office

**Reg. No. 4,196,275** FOR: SCIENTIFIC RESEARCH AND DEVELOPMENT SERVICES IN THE FIELD OF DIAGNOSTIC APPARATUS FOR GENETIC SAMPLING AND ANALYSIS; SERVICES PROVIDED BY SCIENTISTS, NAMELY, RESEARCH AND DEVELOPMENT FOR NEW PRODUCTS FOR OTHERS IN THE FIELD OF LABORATORY AND MEDICAL PREPARATION, ANALYSES AND RESEARCH PRODUCTS FOR GENETIC SAMPLING AND ANALYSIS; SCIENTIFIC SERVICES, NAMELY, DEVELOPMENT AND ESTABLISHMENT OF TESTING SPECIFICATIONS AND PROCEDURES FOR RESEARCHING AND ESTABLISHING NEW PRODUCTS IN THE FIELDS OF DIAGNOSTIC CHEMICALS, MEDICAL LABORATORY RESEARCH AND DIAGNOSTIC APPARATUS AND INSTRUMENTS ALL FOR GENETIC SAMPLING AND ANALYSIS; SCIENTIFIC SERVICES, NAMELY, NEW PRODUCT DEVELOPMENT FOR OTHERS IN THE FIELD OF CHEMICAL REAGENTS AND BIOCHEMICAL ASSAYS FOR GENETIC SAMPLING AND ANALYSIS; SCIENTIFIC RESEARCH SERVICES IN THE FIELD OF FORENSIC SCIENCE, NAMELY, GENETIC ANALYSIS OF BIOLOGICAL SUBSTANCES IN FORENSIC SAMPLES FOR THIRD PARTIES IN THE FIELDS OF HEALTH CARE; MEDICAL AND CHEMICAL LABORATORIES THAT COLLECT BIOLOGICAL GENETIC SAMPLES FOR THIRD PARTIES IN THE FIELDS OF FORENSIC MEDICINE AND HEALTH CARE; CHEMICAL AND BIOCHEMICAL GENETIC ANALYSIS FOR OTHERS THROUGH THE USE OF MICROCHIPS IN THE FIELD OF HUMAN DISEASE; SCIENTIFIC ANALYSIS, NAMELY, CHEMICAL AND BIOCHEMICAL GENETIC ANALYSIS THROUGH THE USE OF MICROCHIPS IN THE FIELD OF HUMAN DISEASE; SCIENTIFIC RESEARCH, NAMELY, DEVELOPING AND ESTABLISHING TESTING SPECIFICATIONS AND PROCEDURES BASED ON MICROFLUIDICS FOR RESEARCHING AND ESTABLISHING NEW PRODUCTS IN THE FIELD OF MEDICAL LABORATORY RESEARCH FOR GENETIC SAMPLING AND ANALYSIS, IN CLASS 42 (U.S. CLS. 100 AND 101).

THE MARK CONSISTS OF STANDARD CHARACTERS WITHOUT CLAIM TO ANY PARTICULAR FONT, STYLE, SIZE, OR COLOR.

PRIORITY CLAIMED UNDER SEC. 44(D) ON SINGAPORE APPLICATION NO. T0812646F, FILED 9-16-2008, REG. NO. T0812646F, DATED 9-16-2008, EXPIRES 9-16-2018.

SER. NO. 77-602,275, FILED 10-28-2008.

DAVID YONTEF, EXAMINING ATTORNEY



# United States of America

United States Patent and Trademark Office



**Reg. No. 4,196,276**

**Registered Aug. 28, 2012**

**Int. Cls.: 25, 35, 36, 38,  
41, 42, 43, 44 and 45**

**TRADEMARK**

**SERVICE MARK**

**PRINCIPAL REGISTER**

CSOSZ, GABOR (HUNGARY INDIVIDUAL)  
PERENYI ZSIGMOND U. 57  
BUDAPEST, HUNGARY H-1047

FOR: CLOTHING, NAMELY, SHORTS, PANTS, HATS, UNDERWEAR FOR CHILDREN AND MEN, LINGERIE, TIGHTS, BODY STOCKINGS, GARTERS, SUSPENDERS, VESTS, SOCKS, CORSETS, GIRDLES, BRAS, SLIPS, SHIRTS, EVENING DRESSES, MASQUERADE COSTUMES, DANCE COSTUMES, HALLOWEEN COSTUMES, BLAZERS, UNIFORMS, SUITS, OVERCOATS, POLO SHIRTS, PULLOVERS, DRESSING GOWNS, MORNING DRESSES, HOUSECOATS, APRONS, DRESSES, PAJAMAS, BATHING SUITS, BATHING TRUNKS, OVERCOATS WITH FUR LINING AND FUR TRIM, TIES, SCARVES, MEN'S HATS AND CAPS, GLOVES, HEAD SHAWLS, VEILS, SWEATERS, WAISTCOATS, FOOTWEAR, SPORT SHOES, SKI BOOTS, OVERALLS LINED AND UNLINED, SLIPPERS, SANDALS, SHOES, LACED BOOTS, BOOTS, AND HIGH BOOTS; LEATHER CLOTHING, NAMELY, FOOTWEAR, SHIRTS, SHORTS, PANTS, JACKETS, HATS; WATERPROOF CLOTHING, NAMELY, FOOTWEAR, NAMELY, RUBBERS AND RUBBER BOOTS, SHIRTS, SHORTS, PANTS, JACKETS, HATS; WORK CLOTHING, NAMELY, FOOTWEAR, NAMELY, WORK BOOTS, SHIRTS, PANTS, JACKETS, HATS; KNITWEAR, NAMELY, SHIRTS, PANTS, SWEATERS, JACKETS, HATS, SCARVES; BICYCLE CLOTHING, NAMELY, FOOTWEAR, JACKETS, GLOVES, SHIRTS, SHORTS, HATS; ARTIFICIAL LEATHER CLOTHING, NAMELY, FOOTWEAR, SHIRTS, PANTS, JACKETS, HATS; CLOTHING FOR AQUATIC SPORTS, NAMELY, THONGS, FLIP FLOPS, BATHING SUITS, SETS FOR BATHING COMPOSED OF TOPS AND BOTTOMS; SPORT CLOTHING, NAMELY, FOOTWEAR, SHIRTS, PANTS, JACKETS, HATS, IN CLASS 25 (U.S. CLS. 22 AND 39).



*David J. Kybas*

Director of the United States Patent and Trademark Office

FOR: RENTAL OF ADVERTISING DISPLAY SPACES; DESIGN OF ADVERTISING MATERIALS FOR OTHERS, NAMELY, MAKING ADVERTISING PAGES; DATABASE MANAGEMENT, NAMELY, ARRANGING AND EDITING INFORMATION IN COMPUTER DATABASES; ORGANIZING EXHIBITIONS AND FAIRS FOR COMMERCIAL OR ADVERTISING PURPOSES; ADVERTISING SERVICES, NAMELY, RENTING MANNEQUINS AND PROVIDING LIVE MODELS FOR PRODUCT DISPLAY PURPOSES; ON-LINE ADVERTISING ON COMPUTER NETWORKS; MARKET STUDIES; MARKET RESEARCH; ADVERTISING VIA THE RADIO, TELEVISION, AND INTERNET; ADVERTISING AGENCIES; PROVIDING OFFICE SUPPORT STAFF SERVICES, NAMELY, PROVIDING SUPPORT IN COMMERCIAL OR CORPORATE CONTROL AND ADMINISTRATION; OUTDOOR ADVERTISING, NAMELY, PREPARING AND PLACING OUTDOOR ADVERTISEMENTS FOR OTHERS;

**Reg. No. 4,196,276** HOTEL MANAGEMENT; PRODUCT DEMONSTRATIONS; MARKET RESEARCH, IN CLASS 35 (U.S. CLS. 100, 101 AND 102).

FOR: INSURANCE ADMINISTRATION; INSURANCE AGENCY AND BROKERAGE; INSURANCE INFORMATION AND CONSULTANCY; INSURANCE UNDERWRITING SERVICES FOR ALL TYPES OF INSURANCE; GLOBAL FINANCIAL SERVICES, NAMELY, INVESTMENT AND PRIVATE BANKING SERVICES; DIRECT CAPITAL INVESTMENTS; FINANCING OF INTELLECTUAL PROPERTIES; FACTORING AGENCIES; BUSINESS LIQUIDATION SERVICES; FINANCING SERVICES; CREDIT CARD SERVICES; CREDIT CARD ISSUING; MORTGAGE SERVICES, NAMELY, PROCESSING AND LENDING; LEASING OF REAL ESTATE; AGRICULTURAL ESTATE LEASING; BROKERAGE OF BONDS; ISSUANCE OF TRAVELERS CHECKS; BROKERAGE OF SHARES AND OTHER SECURITIES; ELECTRONIC TRANSFER OF MONEY FUNDS; MONETARY EXCHANGE; SAFE DEPOSIT BOX SERVICES; SAVINGS BANKS; ONLINE AND TELEPHONIC BANKING, NAMELY, TELEBANKING; CHARGE CARD SERVICES; BANK CARD SERVICES; DEBT RECOVERY SERVICES, NAMELY, DEBT COLLECTION AND DEBT SETTLEMENT; MORTGAGE LENDING, NAMELY, RESERVATION OF PROPERTY ON CREDIT FOR PURCHASE ON INSTALLMENTS; INFORMATION SERVICES, NAMELY, STOCK EXCHANGE INFORMATION SERVICES; CREDIT REPORTING SERVICES, IN CLASS 36 (U.S. CLS. 100, 101 AND 102).

FOR: TELECOMMUNICATIONS CALL DIVERTING AND CONNECTING SERVICES, NAMELY, CALL HUNTING; INTERNET SERVICE PROVIDER SERVICES, NAMELY, ESTABLISHING TELECOMMUNICATION CONNECTIONS WITH A GLOBAL COMPUTER NETWORK; TELEPHONE COMMUNICATION SERVICES, NAMELY, PROVIDING TELEPHONE CONNECTIONS; TELEPHONE COMMUNICATION SERVICES, NAMELY, PROVIDING TELEPHONE SERVICES; TELEVISION BROADCASTING; INTERNET BROADCASTING SERVICES; TWO-WAY TELETYPE WRITER SERVICES; INFORMATION SERVICES, NAMELY, INFORMATION ABOUT TELECOMMUNICATION; RADIO BROADCASTING; SATELLITE RADIO AND TELEVISION BROADCASTING; CABLE RADIO AND TELEVISION BROADCASTING, IN CLASS 38 (U.S. CLS. 100, 101 AND 104).

FOR: DANCE EVENTS, NAMELY, BALLS; NIGHTCLUBS, NAMELY, DISCOS; HEALTH CLUBS, NAMELY, PROVIDING INSTRUCTION AND EQUIPMENT IN THE FIELD OF PHYSICAL EXERCISE; RENTAL OF STAGE SCENERY; ARRANGING AND CONDUCTING EDUCATIONAL CONFERENCES; SUBTITLING FILMS; PHOTOGRAPHY; FILM PRODUCTION; OPERATING FILM STUDIOS; MOVIE THEATERS; PRODUCTION AND RENTAL OF SOUND RECORDINGS; SOUND RECORDING STUDIO SERVICES; ARRANGING TICKETS AND RESERVATIONS FOR SHOWS; TIMING OF SPORT EVENTS; CASINO SERVICES; BOARDING SCHOOLS; LENDING LIBRARY; ORGANIZING CULTURAL OR EDUCATIONAL EXHIBITIONS; INFORMATION ABOUT EDUCATION; EDUCATIONAL EXAMINATION; ON-LINE COMPUTER GAME SERVICES; NURSERY SCHOOLS; ENTERTAINMENT SERVICES, NAMELY, PROVIDING AN ON-GOING NEWS RADIO SHOW; ORGANIZING LOTTERY GAMES PROVIDING SPORTS FACILITIES; ARRANGING SEMINARS; THEATER PRODUCTIONS; GAMBLING SERVICES; ARRANGING BEAUTY CONTESTS; TELEVISION ENTERTAINMENT, NAMELY, TV NEWS SHOWS; PHYSICAL EDUCATION; VIDEO FILM PRODUCTION; RENTAL OF LIGHTING EQUIPMENT FOR THEATERS; FILM STUDIOS; MUSIC GROUP SERVICES, NAMELY, LIVE PERFORMANCES BY A MUSICAL BAND; MUSICAL CABARETS; PRESENTATION OF LIVE VARIETY SHOWS; NIGHT CLUBS; PRESENTING LIVE SHOW PERFORMANCES; LEASING OF CASINO GAMES; INFORMATION SERVICES, NAMELY, ENTERTAINMENT INFORMATION, IN CLASS 41 (U.S. CLS. 100, 101 AND 107).

FOR: BACTERIOLOGICAL RESEARCH; INTERIOR ARCHITECTURAL DESIGN; BIOLOGICAL RESEARCH; PHYSICS RESEARCH; GEOLOGICAL SURVEY; ZOOLOGICAL RESEARCH; INDUSTRIAL DESIGN; ANALYZING THE EXPLOITATION OF MINERAL OIL FIELDS; SCIENTIFIC RESEARCH; MECHANICAL RESEARCH; ARCHITECTURAL DESIGN; DRAFTING BUILDING PLANS; TOWN PLANNING; ARCHITECTURAL CONSULTING;

**Reg. No. 4,196,276** GIVING PROFESSIONAL OPINIONS ON OIL FIELD ANALYSIS, OIL FIELD SURVEYING AND OIL FIELD EXPLORATION; COMPUTER CODE CONVERSION FOR OTHERS; REPAIR OF COMPUTER DATA; COMPUTER SOFTWARE MAINTENANCE, IN CLASS 42 (U.S. CLS. 100 AND 101).

FOR: CATERING SERVICES, IN CLASS 43 (U.S. CLS. 100 AND 101).

FOR: DETOXIFICATION TREATMENT OF ALCOHOLICS AND PATIENTS SUFFERING FROM ADDICTIONS; NURSING SERVICES; HEALTH CARE SERVICES; PHYSICAL THERAPY; DENTISTRY; PHARMACEUTICAL CONSULTING; PHYSICAL THERAPY, NAMELY, CURATIVE GYMNASTICS; CONVALESCENT HOMES, NAMELY, AFTER-TREATMENT OF CONVALESCING PATIENTS; MEDICAL CLINICS; HOSPITALS; SURGERY SERVICES; ARTIFICIAL INSEMINATION SERVICES; OPTICIAN SERVICES; PLASTIC SURGERY; PSYCHOLOGICAL COUNSELING AND TESTING; MENTAL HEALTH INSTITUTION SERVICES, NAMELY, SANATORIUM SERVICES; BLOOD, SPERM, AND EMBRYONIC CELL BANK SERVICES; VETERINARY SERVICES; COSMETIC SURGERY FOR PETS; PET NURSING, IN CLASS 44 (U.S. CLS. 100 AND 101).

FOR: LICENSING OF INTELLECTUAL PROPERTIES; STOCK PHOTOGRAPHY SERVICES, NAMELY, LEASING REPRODUCTION RIGHTS OF PHOTOGRAPHS AND TRANSPARENCIES TO OTHERS; INDUSTRIAL COPYRIGHT PROTECTION MONITORING SERVICES; INDUSTRIAL COPYRIGHT PROTECTION CONSULTING; GRANTING INTELLECTUAL PROPERTY LICENSES; COPYRIGHT MANAGEMENT, IN CLASS 45 (U.S. CLS. 100 AND 101).

OWNER OF HUNGARY REG. NO. 980948, DATED 9-2-2008, EXPIRES 9-2-2018.

THE MARK CONSISTS OF A STYLIZED DESIGN OF A RECLINING MAN OVER A RECTANGLE CONTAINING THE WORDS "PRIV & EX".

SER. NO. 77-603,803, FILED 10-30-2008.

KHANH LE, EXAMINING ATTORNEY

# United States of America

United States Patent and Trademark Office

# PUMPWELL

**Reg. No. 4,196,277**

**Registered Aug. 28, 2012**

**Int. Cls.: 9 and 42**

**TRADEMARK**

**SERVICE MARK**

**PRINCIPAL REGISTER**

PUMPWELL SOLUTIONS LTD. (CANADA CORPORATION)  
4720-14TH STREET N.E.  
CALGARY, AB T2E 6L7, CANADA

FOR: OIL WELL CONTROLLERS, NAMELY, AN ELECTRICAL CONTROLLER WITH CURRENT MICROPROCESSOR TECHNOLOGY INCLUDING ALGORITHMS TO PROVIDE PROTECTION TO PRODUCING OIL WELL COMPONENTS, AUTOMATION COMPONENTS SUCH AS VARIABLE FREQUENCY DRIVE OR SOFT-STARTER TO ENHANCE WELL PERFORMANCE BY CONTROLLING WELL OPERATION THROUGH CONTROL OF THE WELL'S ELECTRICAL MOTOR AND DATA LOGGING ALGORITHMS TO RECORD AND RELAY INFORMATION FROM VARIOUS SENSORS ATTACHED TO OIL PRODUCING WELL, IN CLASS 9 (U.S. CLS. 21, 23, 26, 36 AND 38).

FOR: OIL WELL MONITORING SERVICES, NAMELY, REMOTE MONITORING OF OIL WELL PERFORMANCE AND CONDITION OF THE OIL WELL IN REAL TIME WITH USE OF WIRELESS INTERNET TECHNOLOGY AND CURRENT MICROPROCESSOR TECHNOLOGY TO ENSURE EFFICIENT AND UNINTERRUPTED OIL WELL OPERATION; OIL WELL OPTIMIZATION SERVICES, NAMELY, USE OF PROPRIETARY AND PATENT PENDING ALGORITHMS TO DESIGN OIL WELL COMPONENTS AND TO CONTROL OIL WELL OPERATION FOR THE PURPOSE OF MAXIMIZING OIL WELL PRODUCTIVITY AND MINIMIZING OIL WELL COMPONENT BREAK-DOWNS AND LOADING OF OIL WELLS, IN CLASS 42 (U.S. CLS. 100 AND 101).

THE MARK CONSISTS OF STANDARD CHARACTERS WITHOUT CLAIM TO ANY PARTICULAR FONT, STYLE, SIZE, OR COLOR.

PRIORITY CLAIMED UNDER SEC. 44(D) ON CANADA APPLICATION NO. 1412117, FILED 9-24-2008, REG. NO. TMA758114, DATED 1-27-2010, EXPIRES 1-27-2025.

SER. NO. 77-637,092, FILED 12-19-2008.

WILLIAM ROSSMAN, EXAMINING ATTORNEY



*David J. Kypos*

Director of the United States Patent and Trademark Office

# United States of America

United States Patent and Trademark Office

## Pro-longevity Factors

**Reg. No. 4,196,278**

YOUTHFORIA, INC. (FLORIDA CORPORATION), DBA RESERVEAGE  
5745 SW 75TH ST., STE. 337  
GAINESVILLE, FL 32608

**Registered Aug. 28, 2012**

**Int. Cl.: 5**

FOR: DIETARY AND NUTRITIONAL SUPPLEMENTS, IN CLASS 5 (U.S. CLS. 6, 18, 44, 46, 51 AND 52).

**TRADEMARK**

FIRST USE 1-1-2009; IN COMMERCE 1-1-2009.

**PRINCIPAL REGISTER**

THE MARK CONSISTS OF STANDARD CHARACTERS WITHOUT CLAIM TO ANY PARTICULAR FONT, STYLE, SIZE, OR COLOR.

SER. NO. 77-655,128, FILED 1-23-2009.

KATHERINE E. HALMEN, EXAMINING ATTORNEY



*David J. Kyffers*

Director of the United States Patent and Trademark Office

# United States of America

United States Patent and Trademark Office

## DURA SLOPE

**Reg. No. 4,196,279**

**Registered Aug. 28, 2012**

**Int. Cl.: 11**

**TRADEMARK**

**PRINCIPAL REGISTER**

NATIONAL DIVERSIFIED SALES, INC. (CALIFORNIA CORPORATION)  
851 N. HARVARD AVENUE  
LINDSAY, CA 93247

FOR: PLUMBING FITTINGS, NAMELY, PLASTIC TRENCH DRAINS FOR USE IN SURFACE AND SUBSURFACE LANDSCAPE AND HARDSCAPE DRAINAGE APPLICATIONS; PLASTIC TRENCH DRAINS FEATURING PLASTIC CHANNEL SEGMENTS AND PLASTIC COUPLINGS CONNECTING THE SEGMENTS TO PROVIDE DRAINAGE SYSTEMS WITH CONTINUOUS BENDS AND CURVES FOR USE IN SURFACE AND SUBSURFACE LANDSCAPE AND HARDSCAPE DRAINAGE APPLICATIONS, IN CLASS 11 (U.S. CLS. 13, 21, 23, 31 AND 34).

FIRST USE 3-3-2006; IN COMMERCE 3-3-2006.

THE MARK CONSISTS OF STANDARD CHARACTERS WITHOUT CLAIM TO ANY PARTICULAR FONT, STYLE, SIZE, OR COLOR.

NO CLAIM IS MADE TO THE EXCLUSIVE RIGHT TO USE "SLOPE" , APART FROM THE MARK AS SHOWN.

SER. NO. 77-672,316, FILED 2-17-2009.

INGA ERVIN, EXAMINING ATTORNEY



*David J. Kyros*

Director of the United States Patent and Trademark Office

# United States of America

United States Patent and Trademark Office

# Tater Dog

**Reg. No. 4,196,280**

MCCLUNG, BENJAMIN L (UNITED STATES INDIVIDUAL)  
13115 VIA ROMA COURT  
JACKSONVILLE, FL 32224

**Registered Aug. 28, 2012**

**Int. Cl.: 30**

FOR: FRESHLY PREPARED SANDWICH CONSISTING OF MEAT WITH OR WITHOUT  
CONDIMENTS INSERTED INTO THE HOLLOWED CAVITY OF AN EDIBLE BREAD ROLL,  
IN CLASS 30 (U.S. CL. 46).

**TRADEMARK**

FIRST USE 3-17-2009; IN COMMERCE 3-17-2009.

**PRINCIPAL REGISTER**

THE MARK CONSISTS OF STANDARD CHARACTERS WITHOUT CLAIM TO ANY PAR-  
TICULAR FONT, STYLE, SIZE, OR COLOR.

NO CLAIM IS MADE TO THE EXCLUSIVE RIGHT TO USE "DOG", APART FROM THE  
MARK AS SHOWN.

SER. NO. 77-723,599, FILED 4-28-2009.

WILLIAM VERHOSEK, EXAMINING ATTORNEY



*David J. Kybas*

Director of the United States Patent and Trademark Office

# United States of America

United States Patent and Trademark Office

# BAYSWATER

**Reg. No. 4,196,281**

**Registered Aug. 28, 2012**

**Int. Cl.: 42**

**SERVICE MARK**

**PRINCIPAL REGISTER**

BAYSWATER URANIUM CORPORATION (CANADA CORPORATION)  
SUITE 510  
510 BURRARD STREET  
VANCOUVER, BC, CANADA V6C3A8

FOR: EXPLORATION SERVICES IN THE FIELD OF NATURAL RESOURCES INCLUDING URANIUM, IN CLASS 42 (U.S. CLS. 100 AND 101).

FIRST USE 3-0-2003; IN COMMERCE 3-0-2003.

THE MARK CONSISTS OF STANDARD CHARACTERS WITHOUT CLAIM TO ANY PARTICULAR FONT, STYLE, SIZE, OR COLOR.

PRIORITY CLAIMED UNDER SEC. 44(D) ON CANADA APPLICATION NO. 1435191, FILED 4-20-2009.

SER. NO. 77-736,683, FILED 5-14-2009.

JOHN WILKE, EXAMINING ATTORNEY



*David J. Kybas*

Director of the United States Patent and Trademark Office



# United States of America

United States Patent and Trademark Office

# SolutionIP

*flex*

**Reg. No. 4,196,282**

**Registered Aug. 28, 2012**

**Int. Cl.: 9**

**TRADEMARK**

**PRINCIPAL REGISTER**

SOLUTIONINC LIMITED (CANADA CORPORATION)  
5692 BLOOMFIELD STREET  
HALIFAX, NOVA SCOTIA, CANADA B3K1T2

FOR: COMPUTER SOFTWARE FOR PROVIDING ACCESS TO THE INTERNET, IN CLASS 9 (U.S. CLS. 21, 23, 26, 36 AND 38).

PRIORITY CLAIMED UNDER SEC. 44(D) ON CANADA APPLICATION NO. 1437432, FILED 5-7-2009, REG. NO. TMA820332, DATED 3-21-2012, EXPIRES 3-21-2027.

OWNER OF U.S. REG. NO. 2,777,122.

THE MARK CONSISTS OF "SOLUTIONIP" ABOVE "FLEX" AND A BAR ABOVE THE LETTER "LUTION".

SER. NO. 77-737,037, FILED 5-14-2009.

MICHELLE DUBOIS, EXAMINING ATTORNEY



*David J. Kybas*

Director of the United States Patent and Trademark Office

# United States of America

United States Patent and Trademark Office

# INOLATE

**Reg. No. 4,196,283**

FERROPEM (FRANCE SOCIÉTÉ PAR ACTIONS SIMPLIFIÉE (SAS))  
517 AVENUE DE LA BOISSE  
CHAMBERY, FRANCE 73000

**Registered Aug. 28, 2012**

**Int. Cl.: 6**

FOR: COMMON METALS AND THEIR ALLOYS; UNWROUGHT AND SEMI-WROUGHT COMMON METALS AND THEIR ALLOYS, IN PARTICULAR FERRO-ALLOYS FOR INOCULATION AND/OR NODULISATION, DEOXIDATION, DESULPHURIZATION, DENITRATION OF CAST IRON; INOCULANTS, NAMELY, SUBSTANCES CONSISTING OF A MIXTURE OF DIFFERENT ALLOYS BASED ON IRON SILICIDE, FOR THE TREATMENT OF LAMELLAR AND DUCTILE CAST IRON; FERRO-SILICIUM INGOTS, FERRO-SILICIUM ALLOYS INGOTS, FERRO-SILICIUM AND ITS ALLOYS FOR THE PACKAGING, AUTOMOBILE, AERONAUTICAL, MARINE, BUILDING, MECHANICAL, BOILERMAKING, ELECTRONICS, DOMESTIC EQUIPMENT, DECORATING, SPORTS AND LEISURE, COOKING EQUIPMENT INDUSTRIES; FOUNDRY MOULDS, OF METAL, IN CLASS 6 (U.S. CLS. 2, 12, 13, 14, 23, 25 AND 50).

**TRADEMARK**

**PRINCIPAL REGISTER**

FIRST USE 1-0-1996; IN COMMERCE 1-0-1996.

THE MARK CONSISTS OF STANDARD CHARACTERS WITHOUT CLAIM TO ANY PARTICULAR FONT, STYLE, SIZE, OR COLOR.

SER. NO. 77-744,383, FILED 5-26-2009.

ANDREA BUTLER, EXAMINING ATTORNEY



*David J. Kybas*

Director of the United States Patent and Trademark Office

# United States of America

United States Patent and Trademark Office

## MJ'S CHILDREN'S GLIOMA CANCER FOUNDATION

**Reg. No. 4,196,284**

**Registered Aug. 28, 2012**

**Int. Cl.: 44**

**SERVICE MARK**

**PRINCIPAL REGISTER**

MARC APODACA JR. CHILDREN'S GLIOMA CANCER FOUNDATION (COLORADO  
NON-PROFIT CORPORATION)  
4422 E. 117TH CT.  
THORNTON, CO 80233

FOR: PROVIDING INFORMATION IN THE FIELD OF GLIOMA AND THE CARE AND  
TREATMENT OF GLIOMA, IN CLASS 44 (U.S. CLS. 100 AND 101).

FIRST USE 0-0-2008; IN COMMERCE 0-0-2008.

THE MARK CONSISTS OF STANDARD CHARACTERS WITHOUT CLAIM TO ANY PAR-  
TICULAR FONT, STYLE, SIZE, OR COLOR.

NO CLAIM IS MADE TO THE EXCLUSIVE RIGHT TO USE "CHILDREN'S GLIOMA CANCER  
FOUNDATION", APART FROM THE MARK AS SHOWN.

SER. NO. 77-746,837, FILED 5-28-2009.

THOMAS MANOR, EXAMINING ATTORNEY



*David J. Kyffers*

Director of the United States Patent and Trademark Office

# United States of America

United States Patent and Trademark Office



**Reg. No. 4,196,285**

**Registered Aug. 28, 2012**

**CERTIFICATION MARK**

**PRINCIPAL REGISTER**

CONSUMERS DIGEST COMMUNICATIONS, LLC (DELAWARE LIMITED LIABILITY COMPANY)  
520 LAKE COOK ROAD, SUITE 500  
DEERFIELD, IL 600155633

FOR: APPLIANCES, AUDIO-VISUAL DEVICES AND COMPONENTS THEREFOR, COMPUTERS AND COMPONENTS THEREFOR, BABY GEAR, EXERCISE DEVICES, LAWN AND GARDEN DEVICES, CELLULAR TELEPHONES AND RELATED ELECTRONIC DEVICES, POWER TOOLS, HEAT AND AIR CONDITIONERS, PORTABLE SPAS, MATTRESSES, CAMERAS, CAMCORDERS, CONSUMER ELECTRONICS, COSMETICS, AUTOMOBILES AND PARTS THEREFOR, TRUCKS AND PARTS THEREFOR, VANS AND PARTS THEREFOR, DRINKING WATER DEVICES, WATER FILTERS, HOME SECURITY SYSTEMS, IN CLASS A (U.S. CL. A).

FIRST USE 4-10-1988; IN COMMERCE 4-10-1988.

NO CLAIM IS MADE TO THE EXCLUSIVE RIGHT TO USE BEST BUY, APART FROM THE MARK AS SHOWN.

THE MARK CONSISTS OF THE STYLIZED WORDING "CONSUMERS DIGEST BEST BUY" WITH "CONSUMERS DIGEST", WITH LEAVES ON EITHER SIDE OF "DIGEST" AND THE WORDING ARRANGED IN BETWEEN CONCENTRIC CIRCLES WITH A JAGGED OUTER EDGE, AND "BEST BUY" ARRANGED ON A BANNER ACROSS THE CENTER OF THE CIRCLE.

THE CERTIFICATION MARK, AS USED (OR INTENDED TO BE USED) BY AUTHORIZED PERSONS, CERTIFIES (OR IS INTENDED TO CERTIFY) CERTIFIER'S DETERMINATION THAT A SUBJECT PRODUCT CONSTITUTES AN EXCEPTIONAL VALUE COMPARED TO OTHER COMPETITIVE PRODUCTS.

SEC. 2(F) AS TO "CONSUMERS DIGEST BEST BUY".

SER. NO. 77-760,812, FILED 6-16-2009.

HOWARD B. LEVINE, EXAMINING ATTORNEY



*David J. Kyros*

Director of the United States Patent and Trademark Office

# United States of America

United States Patent and Trademark Office

# VITALS

**Reg. No. 4,196,286**

**Registered Aug. 28, 2012**

**Int. Cl.: 41**

**SERVICE MARK**

**PRINCIPAL REGISTER**

BILLIAN PUBLISHING, INC. (GEORGIA CORPORATION)  
2100 RIVEREDGE PARKWAY  
SUITE 1200  
ATLANTA, GA 30328

FOR: PROVIDING ONLINE NON-DOWNLOADABLE NEWSLETTERS RELATING TO NEWS AND DEVELOPMENTS IN THE FIELD OF HEALTHCARE BUSINESS TO VENDORS OF HOSPITAL/HEALTHCARE PRODUCTS AND SERVICES, IN CLASS 41 (U.S. CLS. 100, 101 AND 107).

FIRST USE 4-0-2001; IN COMMERCE 4-0-2001.

THE MARK CONSISTS OF STANDARD CHARACTERS WITHOUT CLAIM TO ANY PARTICULAR FONT, STYLE, SIZE, OR COLOR.

SER. NO. 77-763,406, FILED 6-18-2009.

ANDREA HACK, EXAMINING ATTORNEY



*David J. Kyffers*

Director of the United States Patent and Trademark Office

# United States of America

United States Patent and Trademark Office

# ONEDRUM

**Reg. No. 4,196,287**

**Registered Aug. 28, 2012**

**Int. Cls.: 9, 35, 36, 37, 38  
and 42**

**TRADEMARK**

**SERVICE MARK**

**PRINCIPAL REGISTER**

QUOLOS LIMITED (UNITED KINGDOM A LIMITED COMPANY UNDER THE LAWS OF ENGLAND AND WALES)  
46A ENGLEFIELD ROAD  
LONDON, ENGLAND N14HA

FOR: APPARATUS FOR RECORDING, TRANSMISSION OR REPRODUCTION OF SOUND OR IMAGES; MAGNETIC DATA CARRIERS, NAMELY, DISCS PRERECORDED WITH SOFTWARE TO ENABLE FILE COLLABORATION AND THE SHARING AND SYNCHRONIZATION OF FILES; CALCULATING MACHINES, DATA PROCESSING EQUIPMENT AND COMPUTERS; PRERECORDED MEDIA, NAMELY, DISCS FEATURING SOFTWARE FOR USE IN FILE COLLABORATION AND THE SHARING AND SYNCHRONIZATION OF FILES; COMPUTER HARDWARE; COMPUTER FIRMWARE FOR USE IN DOCUMENT COLLABORATION AND THE SHARING AND SYNCHRONIZATION OF FILES; COMPUTER SOFTWARE FOR USE IN FILE COLLABORATION AND THE SHARING AND SYNCHRONIZATION OF FILES; SOFTWARE DOWNLOADABLE FROM THE INTERNET FOR USE IN FILE COLLABORATION AND THE SHARING AND SYNCHRONIZATION OF FILES; DOWNLOADABLE ELECTRONIC PUBLICATIONS, NAMELY, BLOGS AND JOURNALS IN THE FIELDS OF FILE SHARING AND ONLINE COLLABORATION; COMPACT DISCS FEATURING SOFTWARE FOR USE IN FILE COLLABORATION AND THE SHARING AND SYNCHRONIZATION OF FILES; DIGITAL MUSIC DOWNLOADABLE FROM THE INTERNET; TELECOMMUNICATIONS APPARATUS, NAMELY, TELEPHONES AND DIGITAL AND COMPUTERIZED MEANS OF COMMUNICATION, NAMELY, HANDHELD MOBILE DEVICES, MOBILE TELEPHONES, TABLET COMPUTERS, ALL WITH WIRELESS TELECOMMUNICATIONS FEATURES; ADD-ON CIRCUIT BOARDS FOR CONNECTING COMPUTERS TO NETWORKING SOFTWARE; COMPUTER NETWORKING APPARATUS, NAMELY, ROUTERS, TRANSMITTERS AND SWITCHES; COMPUTER NETWORKING INSTALLATIONS, NAMELY, SWITCHES AND OPERATING SYSTEMS; DEVICES FOR USE IN THE NETWORKING OF COMPUTERS, NAMELY, ADAPTERS, CABLES AND CABLE MODEMS; COMPUTER SOFTWARE ENABLING REAL-TIME COLLABORATION BETWEEN MULTIPLE USERS; COMPUTER SERVER SOFTWARE, NAMELY, NETWORK ACCESS SERVER OPERATING SOFTWARE; COMPUTER NETWORK MANAGEMENT SOFTWARE; COMPUTER UTILITY PROGRAMS; COMPUTER SOFTWARE DEVELOPMENT PROGRAMS; BROWSER SOFTWARE FOR COMPUTER NETWORKS, WIRELESS NETWORKS AND GLOBAL COMMUNICATIONS NETWORKS; COMPUTER PROGRAMS FOR MANAGING COMMUNICATIONS AND DATA AND INFORMATION EXCHANGE OVER COMPUTER NETWORKS, WIRELESS NETWORKS AND GLOBAL COMMUNICATIONS NETWORKS; COMPUTER SOFTWARE FOR USE IN ACCESSING WEBSITES AND EXCHANGING IN-



*David J. Kappas*

Director of the United States Patent and Trademark Office

**Reg. No. 4,196,287** FORMATION AND DATA AND OBTAINING SERVICES FROM WEBSITES; COMPUTER SOFTWARE FOR RECORDING, ORGANIZING, EDITING AND TRANSMITTING INFORMATION IN TYPED AND VOICE FORMAT; COMPUTER SOFTWARE FOR ACCESSING WEB MESSAGING AND SHARED DOCUMENTS; COMPUTER SOFTWARE ENABLING THE SHARING OF COMPUTER DATA FILES; COMPUTER SOFTWARE FOR THE PURPOSES OF ENABLING THE SIMULTANEOUS EDITING OF DOCUMENTS BY MULTIPLE USERS; PARTS AND FITTINGS FOR ALL OF THE AFORESAID GOODS, IN CLASS 9 (U.S. CLS. 21, 23, 26, 36 AND 38).

FOR: ONLINE BUSINESS AND PROFESSIONAL NETWORKING SERVICES; PROVIDING BUSINESS INFORMATION; PROVIDING BUSINESS INFORMATION THROUGH THE MEDIUM OF AN INTERNET WEBSITE; COMPILATION OF INFORMATION INTO COMPUTER DATABASES FOR THE USE OF SUBSCRIBERS; PROVIDING DATABASES FEATURING BUSINESS INFORMATION FOR THE USE OF SUBSCRIBERS; OPERATING AN ONLINE MARKETPLACE FEATURING COLLABORATIVE SOFTWARE APPLICATIONS; BUSINESS INFORMATION, ADVISORY AND CONSULTANCY SERVICES RELATING TO ALL THE AFORESAID SERVICES, IN CLASS 35 (U.S. CLS. 100, 101 AND 102).

FOR: PROVIDING OF FINANCIAL PROFESSIONAL INFORMATION IN THE NATURE OF RESEARCH REPORTS RELATING TO THE FINANCIAL SECTOR, IN CLASS 36 (U.S. CLS. 100, 101 AND 102).

FOR: COMPUTER SERVICES, NAMELY, MAINTENANCE OF COMPUTER HARDWARE SYSTEMS, IN CLASS 37 (U.S. CLS. 100, 103 AND 106).

FOR: TELECOMMUNICATIONS SERVICES, NAMELY, INTERNET SERVICE PROVIDERS (ISPS); PROVISION OF ON-LINE COMMUNICATIONS SERVICES, NAMELY, PROVIDING ONLINE COMMUNICATIONS LINKS THAT TRANSFER WEB SITE USERS TO OTHER LOCAL AND GLOBAL WEB PAGES AND PROVIDING ACCESS BETWEEN USERS; PROVISION OF PRIVATE AND SECURE REAL TIME ON-LINE COMMUNICATION OVER A COMPUTER NETWORK; COMMUNICATIONS VIA A GLOBAL COMPUTER NETWORK OR THE INTERNET; ELECTRONIC MAIL, MESSAGE SENDING AND RECEIVING SERVICES; PROVISION OF ACCESS TO WEB PAGES; TRANSMISSION AND DISTRIBUTION OF DATA OR AUDIO VISUAL IMAGES VIA A GLOBAL COMPUTER NETWORK OR THE INTERNET; PROVIDING ONLINE CHAT ROOMS AND FORUMS FOR THE TRANSMISSION OF MESSAGES AMONG COMPUTER USERS; PROVIDING ACCESS FOR OTHERS TO THE INTERNET; VIDEOCONFERENCING AND TELECONFERENCING SERVICES; NETWORK CONFERENCING SERVICES; PROVIDING INFORMATION ABOUT TELECOMMUNICATIONS; TELECOMMUNICATIONS CONSULTANCY SERVICES, IN CLASS 38 (U.S. CLS. 100, 101 AND 104).

FOR: UPDATING OF DATABASES FOR THE USE OF SUBSCRIBERS; COMPUTER SERVICES, NAMELY, COMPUTER PROGRAMMING SERVICES; INFORMATION TECHNOLOGY SERVICES, NAMELY, PROVIDING TEMPORARY USE OF NON-DOWNLOADABLE SOFTWARE FOR USE IN FILE COLLABORATION AND THE SHARING AND SYNCHRONIZATION OF FILES; CREATING, MAINTAINING AND HOSTING ONLINE WEB FACILITIES FOR OTHERS; HOSTING CONTENT OF OTHERS ON A WEBSITE OR WEBSITES; HOSTING ONLINE WEB FACILITIES FOR OTHERS FOR ORGANIZING AND CONDUCTING ONLINE MEETINGS, GATHERINGS, AND INTERACTIVE DISCUSSIONS; HOSTING ONLINE WEB FACILITIES FOR OTHERS FOR PROFESSIONAL NETWORKING PURPOSES; COMPUTER SERVICES IN THE NATURE OF CUSTOMIZED WEB PAGES FEATURING MULTIMEDIA, VIDEOS, PHOTOGRAPHS, INFORMATION, BUSINESS INFORMATION AND BUSINESS PROFILES, PERSONAL INFORMATION AND PERSONAL PROFILES; PROVIDING A WEBSITE THAT GIVES USERS THE ABILITY TO CREATE CUSTOMIZED WEB PAGES FEATURING PROFESSIONAL INFORMATION AND PROFESSIONAL PROFILES; RENTAL AND LEASE OF COMPUTER SOFTWARE; PROVIDING AN INTERNET SEARCH ENGINE; COMPUTER CONSULTANCY SERVICES; PROVIDING INFORMATION IN THE FIELD OF COMPUTER, IN CLASS 42 (U.S. CLS. 100 AND 101).

**Reg. No. 4,196,287** THE MARK CONSISTS OF STANDARD CHARACTERS WITHOUT CLAIM TO ANY PARTICULAR FONT, STYLE, SIZE, OR COLOR.

PRIORITY CLAIMED UNDER SEC. 44(D) ON ERPN CMNTY TM OFC APPLICATION NO. 008383036, FILED 6-23-2009, REG. NO. 008383036, DATED 6-18-2010, EXPIRES 6-23-2019.

SER. NO. 77-769,967, FILED 6-29-2009.

NICHOLAS ALTREE, EXAMINING ATTORNEY



# United States of America

United States Patent and Trademark Office

# ClearVision

**Reg. No. 4,196,288**

TANDBERG TELECOM AS (NORWAY AKSJESELSKAP (AS))

**Registered Aug. 28, 2012**

PHILIP PEDERSENSV. 22  
LYSAKER, NORWAY 1366

**Int. Cl.: 9**

FOR: VIDEOCONFERENCING EQUIPMENT, NAMELY, COMPUTER SOFTWARE FOR ENHANCING THE RESOLUTION OF STREAMING VIDEO, IN CLASS 9 (U.S. CLS. 21, 23, 26, 36 AND 38).

**TRADEMARK**

THE MARK CONSISTS OF STANDARD CHARACTERS WITHOUT CLAIM TO ANY PARTICULAR FONT, STYLE, SIZE, OR COLOR.

**PRINCIPAL REGISTER**

PRIORITY CLAIMED UNDER SEC. 44(D) ON NORWAY APPLICATION NO. 200901259, FILED 2-5-2009, REG. NO. 250724, DATED 4-28-2009, EXPIRES 4-28-2019.

SER. NO. 77-775,641, FILED 7-7-2009.

MEGHAN REINHART, EXAMINING ATTORNEY



*David J. Kyjars*

Director of the United States Patent and Trademark Office

# United States of America

United States Patent and Trademark Office

## HORIZON SERVICES

**Reg. No. 4,196,289**

**Registered Aug. 28, 2012**

**Int. Cl.: 37**

**SERVICE MARK**

**PRINCIPAL REGISTER**

HORIZON SERVICES, INC. (DELAWARE CORPORATION)  
320 CENTURY BOULEVARD  
WILMINGTON, DE 19808

FOR: PROVIDING HEATING, AIR CONDITIONING, PLUMBING, DRAIN CLEANING AND SEWER AND WATER LINE REPAIR AND REPLACEMENT SERVICES, IN CLASS 37 (U.S. CLS. 100, 103 AND 106).

FIRST USE 5-0-1999; IN COMMERCE 5-0-1999.

THE MARK CONSISTS OF STANDARD CHARACTERS WITHOUT CLAIM TO ANY PARTICULAR FONT, STYLE, SIZE, OR COLOR.

NO CLAIM IS MADE TO THE EXCLUSIVE RIGHT TO USE "SERVICES", APART FROM THE MARK AS SHOWN.

SER. NO. 77-783,341, FILED 7-17-2009.

ELLEN PERKINS, EXAMINING ATTORNEY



*David J. Kyffers*

Director of the United States Patent and Trademark Office

# United States of America

United States Patent and Trademark Office

# Dan Eldon

**Reg. No. 4,196,290**

**Registered Aug. 28, 2012**

**Int. Cl.: 25**

**TRADEMARK**

**PRINCIPAL REGISTER**

ELDON, KATHLEEN M. (UNITED STATES INDIVIDUAL)  
18814 TOPANGA BEACH DRIVE  
MALIBU, CA 90265 AND

TURTELTaub, AMY ELDON (UNITED STATES INDIVIDUAL)  
18814 TOPANGA BEACH DRIVE  
MALIBU, CA 90265

FOR: WEARING APPAREL, NAMELY, SHIRTS, SHORT-SLEEVED SHIRTS, LONG-SLEEVED SHIRTS, SPORT SHIRTS, POLO SHIRTS, KNIT SHIRTS, T-SHIRTS, SHORT-SLEEVED T-SHIRTS, LONG-SLEEVED T-SHIRTS, JACKETS, SWEAT SHIRTS, SWEAT SUITS, SHORTS, BERMUDA SHORTS, WALKING SHORTS, SWEAT SHORTS, BLOUSES, TOPS FOR WOMEN, PANTS, JEANS, SWEAT PANTS, SWIMSUITS, HATS, CAPS, CAPS WITH VISORS, VISORS, BASEBALL CAPS, FOOTWEAR, ATHLETIC FOOTWEAR, SHOES, ATHLETIC SHOES, BOOTS, CANVAS SHOES, SANDALS, SOCKS, SWEAT BANDS, BERETS, GLOVES, WAIST BELTS, IN CLASS 25 (U.S. CLS. 22 AND 39).

FIRST USE 3-13-1993; IN COMMERCE 3-13-1993.

THE MARK CONSISTS OF STANDARD CHARACTERS WITHOUT CLAIM TO ANY PARTICULAR FONT, STYLE, SIZE, OR COLOR.

THE NAME "DAN ELDON" DOES NOT IDENTIFY A LIVING INDIVIDUAL.

SER. NO. 77-824,946, FILED 9-11-2009.

JESSICA FATHY, EXAMINING ATTORNEY



*David J. Kyros*

Director of the United States Patent and Trademark Office

# United States of America

United States Patent and Trademark Office

## Aerobic Infusion

**Reg. No. 4,196,291**

ZONE, GUL CELEBI (UNITED STATES INDIVIDUAL)

**Registered Aug. 28, 2012**

5200 SENAC DRIVE  
METAIRIE, LA 70003

**Int. Cl.: 3**

FOR: SKIN CARE PREPARATIONS, NAMELY, SERUMS, MASKS, CREAMS, LOTIONS, GELS, CORRECTIVE NON-MEDICATED SKIN TREATMENTS, IN CLASS 3 (U.S. CLS. 1, 4, 6, 50, 51 AND 52).

**TRADEMARK**

FIRST USE 9-1-1995; IN COMMERCE 12-13-1995.

**PRINCIPAL REGISTER**

THE MARK CONSISTS OF STANDARD CHARACTERS WITHOUT CLAIM TO ANY PARTICULAR FONT, STYLE, SIZE, OR COLOR.

SER. NO. 77-834,162, FILED 9-24-2009.

THOMAS MANOR, EXAMINING ATTORNEY



*David J. Kyfos*

Director of the United States Patent and Trademark Office

# United States of America

United States Patent and Trademark Office

# Screenplay

**Reg. No. 4,196,292**

GUL CELEBI ZONE (UNITED STATES INDIVIDUAL)  
5200 SENAC DRIVE  
METAIRIE, LA 70003

**Registered Aug. 28, 2012**

**Int. Cl.: 3**

FOR: SKIN CARE AND BODY CARE PREPARATIONS, NAMELY, SUNSCREENS, NON-MEDICATED SUN CARE LOTIONS, SKIN MOISTURIZERS, BEAUTY SERUMS, NON-MEDICATED CORRECTIVE SKIN CREAMS, GELS, PEELS AND LOTIONS, EYE CREAMS AND GELS AND LIP CREAM, IN CLASS 3 (U.S. CLS. 1, 4, 6, 50, 51 AND 52).

**TRADEMARK**

**PRINCIPAL REGISTER**

FIRST USE 8-8-1997; IN COMMERCE 8-8-1997.

THE MARK CONSISTS OF STANDARD CHARACTERS WITHOUT CLAIM TO ANY PARTICULAR FONT, STYLE, SIZE, OR COLOR.

SER. NO. 77-840,313, FILED 10-2-2009.

COLLEEN KEARNEY, EXAMINING ATTORNEY



*David J. Kyffers*

Director of the United States Patent and Trademark Office

# United States of America

United States Patent and Trademark Office



**Reg. No. 4,196,293**

**Registered Aug. 28, 2012**

**CERTIFICATION MARK**

**PRINCIPAL REGISTER**

UNITED STATES DEPARTMENT OF HOMELAND SECURITY (UNITED STATES AGENCY OF THE UNITED STATES GOVERNMENT)  
MAIL STOP 0205, S&T OGC  
245 MURRAY LANE  
WASHINGTON, DC 205280205

FOR: ANTITERRORISM TECHNOLOGIES, NAMELY, MILITARY ARMOR, BLAST-RESISTANT BUILDING MATERIALS, BLAST-RESISTANT ARCHITECTURAL FEATURES AND BARRICADES, ELECTRONIC DEVICE PROTECTION SYSTEMS, SECURITY STATIONS, AND SAFE ROOMS, IN CLASS A (U.S. CL. A).

FIRST USE 8-25-2009; IN COMMERCE 8-25-2009.

FOR: SUPPORT, MAINTENANCE, INTEGRATION, AND DESIGN SERVICES IN THE NATURE OF THREAT AND VULNERABILITY ASSESSMENT SERVICES, SECURITY SCREENING SERVICES, SENSOR INTEGRATION SERVICES AND ANTI-TERRORISM SECURITY SERVICES THAT SATISFY CRITERIA, IN CLASS B (U.S. CL. B).

FIRST USE 8-25-2009; IN COMMERCE 8-25-2009.

OWNER OF U.S. REG. NO. 3,912,822.

THE COLOR(S) TURQUOISE, BLUE, GREY AND RED IS/ARE CLAIMED AS A FEATURE OF THE MARK.

NO CLAIM IS MADE TO THE EXCLUSIVE RIGHT TO USE "U.S. DEPARTMENT OF HOMELAND SECURITY", "CERTIFIED", "SCIENCE & TECHNOLOGY" AND "SAFETY ACT", APART FROM THE MARK AS SHOWN.

THE MARK CONSISTS OF TWO GREY CONCENTRIC CIRCLES. THE OUTERMOST CIRCLE IS THE SMALLEST IN DIAMETER, AND INCLUDES THE WORDS "U.S. DEPARTMENT OF HOMELAND SECURITY" AND "SCIENCE AND TECHNOLOGY" IN A CIRCULAR LAYOUT. THE INNERMOST CIRCLE (I.E. CENTER CIRCLE) IS THE LARGEST IN DIAMETER, AND INCLUDES (1) THE WORDS "SAFETY ACT CERTIFIED" AND (2) THE "WWW.SAFETYACT.GOV" WEBSITE ADDRESS. THE OUTERMOST CIRCLE HAS A GROOVED BORDER, WHILE THE INNERMOST CIRCLE IS CHARACTERIZED BY A RED DOTTED BORDER. WITH THE EXCEPTION OF THE WEBSITE ADDRESS, WHICH IS IN



*David J. Kyffers*

Director of the United States Patent and Trademark Office

**Reg. No. 4,196,293** TURQUOISE FONT, ALL THE WORDS IN THE MARK ARE CAPITALIZED AND ARE IN BLUE FONT.

THE CERTIFICATION MARK, AS INTENDED TO BE USED BY AUTHORIZED PERSONS, IS INTENDED TO CERTIFY THAT THE ENTITY SATISFIES CRITERIA ARTICULATED IN THE SUPPORT ANTI-TERRORISM BY FOSTERING EFFECTIVE TECHNOLOGIES ACT OF 2002 (SAFETY ACT) AND IMPLEMENTING REGULATIONS.

SER. NO. 77-840,584, FILED 10-2-2009.

CHRIS WELLS, EXAMINING ATTORNEY

# United States of America

## United States Patent and Trademark Office



**Reg. No. 4,196,294**

ITM POWER PLC (UNITED KINGDOM CORPORATION)  
22 ATLAS WAY

**Registered Aug. 28, 2012**

SHEFFIELD, UNITED KINGDOM S47QQ

**Int. Cls.: 1, 6, 7, 9, 11, 12,  
20, 37, 39, 41 and 42**

FOR: CHEMICALS USED IN INDUSTRY AND SCIENCE; UNPROCESSED ARTIFICIAL RESINS, UNPROCESSED PLASTICS; ADHESIVES USED IN INDUSTRY; UNPROCESSED PLASTICS IN THE FORM OF LIQUIDS, CHIPS OR GRANULES; HYDROGEN; OXYGEN; CHEMICAL COMPOUNDS IN THE NATURE OF HYDROCARBONS; REPLACEMENT PARTS FOR FUEL CELL OR ELECTROLYSER, NAMELY, IONIC POLYMER ACIDIC MEMBRANES IN CHEMICAL FORM, IONIC POLYMER ALKALINE MEMBRANES IN CHEMICAL FORM, AND IONIC POLYMER HYDROPHILIC MEMBRANES IN CHEMICAL FORM; ELECTRO-CHEMICAL CATALYSTS FOR USE IN CONNECTION WITH FUEL CELLS AND ELECTROLYSERS, IN CLASS 1 (U.S. CLS. 1, 5, 6, 10, 26 AND 46).

**TRADEMARK**

**SERVICE MARK**

**PRINCIPAL REGISTER**

FOR: COMMON METALS AND THEIR ALLOYS; NON-ELECTRIC CABLES AND WIRES OF COMMON METAL; SMALL ITEMS OF METAL HARDWARE, NAMELY, WASHERS, NUTS, BOLTS, SCREWS, NAILS, METAL PIPES; METAL PIPE CONNECTORS; METAL TUBES; BOXES AND PRODUCT CASINGS OF COMMON METAL; EMPTY GAS STORAGE MODULES, NAMELY, STAND ALONE UNITS, OF METAL, FOR THE PURPOSE OF STORING GASES CREATED AS A PRODUCT OF CHEMICAL PROCESSES; TANKS, CYLINDERS AND RECEPTACLES OF METAL FOR USE IN THE STORAGE OF GASES, LIQUEFIED GASES AND COMPRESSED GASES, SOLD EMPTY; REPLACEMENT PARTS FOR FUEL CELLS OR ELECTROLYSER, NAMELY, METAL MANIFOLDS; STRUCTURAL PARTS AND FITTINGS FOR ALL OF THE AFORESAID GOODS, IN CLASS 6 (U.S. CLS. 2, 12, 13, 14, 23, 25 AND 50).



FOR: MOTORS AND ENGINES, EXCEPT FOR LAND VEHICLES, NAMELY, INTERNAL COMBUSTION ENGINES, STEAM ENGINES, ELECTRIC ENGINES, PETROL ENGINES, PETROL/ELECTRIC HYBRID ENGINES, PETROL/HYDROGEN HYBRID ENGINES, DIESEL ENGINES, DIESEL/ELECTRIC HYBRID ENGINES, DIESEL/HYDROGEN HYBRID ENGINES, ALL FOR THE PURPOSE OF PRODUCING A DRIVE MEANS BY CONVERTING FUEL ENERGY INTO MECHANICAL WORK; CLEANING MACHINE FOR COMBUSTION ENGINES COMPRISING IONIC POLYMER ACIDIC MEMBRANES, IONIC POLYMER ALKALINE MEMBRANES, AND IONIC POLYMER HYDROPHILIC MEMBRANES, ELECTRO-CHEMICAL CATALYSTS, SOLID POLYMER ELECTROLYTES AND MEMBRANE ELECTRODE ASSEMBLIES, MANIFOLDS, SEPARATING VESSELS AND PUMPS, UTILIZING HYDROGEN FOR THE PURPOSES OF CONVERTING WASTE GASES THAT ARE THE BY-PRODUCTS

*David J. Kybas*

Director of the United States Patent and Trademark Office



**Reg. No. 4,196,294** OF THE INTERNAL COMBUSTION PROCESS INTO HYDROGEN TO REDUCE ENGINE EMISSIONS AND IMPROVE ENGINE EFFICIENCY; CLEANING MACHINE FOR COMBUSTION ENGINES COMPRISING IONIC POLYMER ACIDIC MEMBRANES, IONIC POLYMER ALKALINE MEMBRANES, AND IONIC POLYMER HYDROPHILIC MEMBRANES, ELECTRO-CHEMICAL CATALYSTS, SOLID POLYMER ELECTROLYTES AND MEMBRANE ELECTRODE ASSEMBLIES, MANIFOLDS, SEPARATING VESSELS AND PUMPS, UTILIZING OXYGEN FOR THE PURPOSES OF CONVERTING WASTE GASES THAT ARE THE BY-PRODUCTS OF THE INTERNAL COMBUSTION PROCESS INTO OXYGEN TO REDUCE ENGINE EMISSIONS AND IMPROVE ENGINE EFFICIENCY; EXHAUST APPARATUS FOR COMBUSTION ENGINES, NAMELY, A SYSTEM FOR THE PURPOSE OF GUIDING EXHAUST GASES AWAY FROM A COMBUSTION ENGINE, COMPRISING A CYLINDER HEAD, EXHAUST MANIFOLD, EXHAUST PIPE, EXHAUST PORT, EXHAUST STROKE, EXHAUST VALVE, CATALYTIC CONVERTER, TURBO CHARGER AND SILENCER; EXHAUST SYSTEMS FOR VEHICLES, NAMELY, A SYSTEM FOR REMOVING EXHAUST GASES FROM THE ENGINE OF A VEHICLE, COMPRISING A CYLINDER HEAD, EXHAUST MANIFOLD, EXHAUST PIPE, EXHAUST PORT, EXHAUST STROKE, EXHAUST VALVE, CATALYTIC CONVERTER, TURBO CHARGER AND SILENCER; EXHAUST CLEANING MACHINE FOR COMBUSTION ENGINES COMPRISING IONIC POLYMER ACIDIC MEMBRANES, IONIC POLYMER ALKALINE MEMBRANES, AND IONIC POLYMER HYDROPHILIC MEMBRANES, ELECTRO-CHEMICAL CATALYSTS, SOLID POLYMER ELECTROLYTES AND MEMBRANE ELECTRODE ASSEMBLIES, MANIFOLDS, SEPARATING VESSELS AND PUMPS, UTILIZING HYDROGEN FOR USE IN AN EXHAUST SYSTEM FOR THE PURPOSES OF CONVERTING WASTE GASES THAT ARE THE BY-PRODUCT OF THE INTERNAL COMBUSTION PROCESS INTO HYDROGEN TO REDUCE ENGINE EMISSIONS AND IMPROVE ENGINE EFFICIENCY; EXHAUST CLEANING MACHINE FOR COMBUSTION ENGINES COMPRISING IONIC POLYMER ACIDIC MEMBRANES, IONIC POLYMER ALKALINE MEMBRANES, AND IONIC POLYMER HYDROPHILIC MEMBRANES, ELECTRO-CHEMICAL CATALYSTS, SOLID POLYMER ELECTROLYTES AND MEMBRANE ELECTRODE ASSEMBLIES, MANIFOLDS, SEPARATING VESSELS AND PUMPS, UTILIZING OXYGEN FOR USE IN AN EXHAUST SYSTEM FOR THE PURPOSES OF CONVERTING WASTE GASES THAT ARE THE BY-PRODUCTS OF THE INTERNAL COMBUSTION PROCESS INTO OXYGEN TO REDUCE ENGINE EMISSIONS AND IMPROVE ENGINE EFFICIENCY; HYDROGEN BURNING POWER GENERATORS; GENERATORS UTILIZING HYDROGEN FOR THE PRODUCTION OF ELECTRICITY; REPLACEMENT PARTS FOR FUEL CELL OR ELECTROLYSER, NAMELY, CHARGING MANIFOLDS; WATER PUMPS FOR USE IN THE GENERATION AND SUPPLY OF HYDROGEN AND ELECTRICITY FOR VEHICLES, HOMES, COMMERCIAL AND EDUCATIONAL ESTABLISHMENTS; STRUCTURAL PARTS AND FITTINGS FOR ALL OF THE AFORESAID GOODS, IN CLASS 7 (U.S. CLS. 13, 19, 21, 23, 31, 34 AND 35).

FOR: SCIENTIFIC APPARATUS AND INSTRUMENTS, NAMELY, GAS PRODUCTION AND STORAGE MODULES TO BE USED IN ENERGY CONVERSION DEVICES, COMPRISING POWER CONVERTERS, POWER SUPPLY, ELECTRIC SWITCHES, POWER LINE CONDITIONERS, STEP-UP AND STEP-DOWN TRANSFORMERS, CANISTERS, BOTTLES, CYLINDERS, TANKS, GENERATORS AND VOLTAGE STABILIZING POWER SUPPLY, POWER CONDITIONING MODULES, POWER CONVERSION MODULES, POWER SUPPLY MODULES, SWITCHING ELECTRONICS MODULES, STEP-UP BOOST ELECTRONIC MODULES, STEP-DOWN BUCK ELECTRONIC MODULES, SWITCH MODE POWER SUPPLY MODULES, GENERATORS, POWER SUPPLY MATCHING MODULES; APPARATUS FOR CONDUCTING, STORING, SWITCHING, TRANSFORMING, ACCUMULATING, REGULATING AND/OR CONTROLLING ELECTRICITY, NAMELY, DC/DC CONVERTERS, AC/DC CONVERTERS, AC/AC CONVERTERS, DC/AC CONVERTERS, ELECTRODES, ELECTRICAL CONNECTORS; ELECTRONIC INSTRUMENTS WHICH MONITOR AND CONTROL THE PERFORMANCE OF DC/DC CONVERTERS, AC/DC CONVERTERS, AC/AC CONVERTERS, DC/AC CONVERTERS; APPARATUS FOR THE CONTROL AND MONITORING OF FUEL CELLS AND ELECTROLYSERS, NAMELY, ELECTRONIC MODULES FOR DETECTING GAS FLOW RATE, ELECTRONIC MODULES FOR DETECTING WATER FLOW RATE, AND ELECTRONIC MODULES FOR DETECTING LIQUID FLOW RATE; CONDENSERS; ELECTROCHEMICAL

**Reg. No. 4,196,294** CELLS FOR THE PURPOSES OF SEQUESTING CARBON FROM THE ATMOSPHERE; PHOTOELECTROLYSERS; COMPUTER SOFTWARE FOR MONITORING, REGULATING AND CONTROLLING DC/DC CONVERTERS, AC/DC CONVERTERS, AC/AC CONVERTERS, DC/AC CONVERTERS, FUEL CELLS, ELECTROLYSERS, CARBON SEQUESTRATORS, AND APPARATUS WHICH CONVERT CARBON DIOXIDE INTO FUEL AND PHOTOELECTROLYSERS; ELECTRONIC EQUIPMENT FOR USE IN SYNTHETIC FUEL PRODUCTION, NAMELY, LIGHT GUIDES IN THE NATURE OF MEMBRANE ELECTRODE ASSEMBLIES USED FOR FOCUSING, CONCENTRATING AND DIRECTING LIGHT; ELECTROLYSERS; APPARATUS FOR CONVERTING ELECTROMAGNETIC RADIATION TO ELECTRICAL ENERGY, NAMELY, PHOTOVOLTAIC SOLAR MODULES; FUEL CELLS; BATTERY AND FUEL CELL POWER MONITORING INSTRUMENTS, NAMELY, ELECTRONIC MODULES FOR DETECTING GAS FLOW RATE, ELECTRONIC MODULES FOR DETECTING WATER FLOW RATE, AND ELECTRONIC MODULES FOR DETECTING LIQUID FLOW RATE; ELECTRO CHEMICAL CELLS AND BATTERIES; BATTERIES; ELECTRICAL AND CHEMICAL DEVICES FOR USE IN TESTING BATTERIES, FUEL CELLS, ELECTROLYSERS, NAMELY, DC/DC CONVERTER MODULES, AC/DC CONVERTER MODULES, AC/AC CONVERTER MODULES, DC/AC CONVERTER MODULES, FUEL CELL MODULES, ELECTROLYSER MODULES, CARBON SEQUESTRATORS; VOLTAGE, AMPAGE, INPUT, OUTPUT, INSULATION, RESISTANCE AND CURRENT TESTING APPARATUS AND INSTRUMENTS FOR USE IN CONNECTION WITH DC/DC CONVERTERS, AC/DC CONVERTERS, AC/AC CONVERTERS AND DC/AC CONVERTERS, FUEL CELLS AND ELECTROLYSERS; TESTING APPARATUS AND INSTRUMENTS FOR THE PURPOSES OF MEASURING THE AMOUNT OF CARBON DIOXIDE REMOVED FROM THE ATMOSPHERE FOR USE IN CONNECTION WITH CARBON SEQUESTRATORS; TESTING APPARATUS AND INSTRUMENTS FOR THE PURPOSES OF MEASURING THE AMOUNT OF HYDROGEN AND OXYGEN PRODUCED BY THE PROCESS OF PHOTOELECTROLYSIS FOR USE IN CONNECTION WITH APPARATUS FOR PHOTOELECTROLYSIS; TESTING APPARATUS AND INSTRUMENTS FOR THE PURPOSES OF MEASURING THE AMOUNT OF FUEL PRODUCED FOR USE IN CONNECTION WITH APPARATUS FOR CONVERTING CARBON DIOXIDE INTO FUEL; SOLAR CELLS; GAS DIFFUSION LAYERS FOR USE IN CONNECTION WITH ELECTROLYSERS AND CATALYSTS; SOLAR CELLS FOR USE IN HEATING; THERMOSTATS; RHEOSTATS; TEMPERATURE CONTROLLERS FOR USE IN CENTRAL HEATING INSTALLATIONS AND HOT WATER INSTALLATIONS, IN CLASS 9 (U.S. CLS. 21, 23, 26, 36 AND 38).

FOR: APPARATUS FOR LIGHTING, NAMELY, ELECTRIC LIGHTING FIXTURES; APPARATUS FOR HEATING, NAMELY, RADIATORS AND GAS BURNERS; APPARATUS FOR STEAM GENERATING, NAMELY, STEAM GENERATORS; APPARATUS FOR COOKING, NAMELY, COOKING RANGES, GAS RING BURNERS AND GAS OVENS; APPARATUS FOR REFRIGERATING, NAMELY, REFRIGERATING DISPLAY CABINETS; APPARATUS FOR VENTILATING, NAMELY, VENTILATING EXHAUST FANS; REGULATING ACCESSORIES FOR WATER SUPPLY, NAMELY, METERED AND UN-METERED VALVES; AIR CONDITIONING APPARATUS; GAS COOKERS; ELECTRIC COOKERS WHICH USE ELECTRICITY GENERATED FROM HYDROGEN; GAS PRODUCTION MODULES, NAMELY, STAND ALONE UNITS FOR THE PRODUCTION OF VARIOUS GASES; FISCHER-TROPSCH REACTORS; HYDROGEN GENERATORS; HYDROGEN AND OXYGEN GENERATORS FOR THE PURPOSES OF GENERATING HYDROGEN AND OXYGEN FROM WATER AND/OR RENEWABLE ELECTRICITY; REFRIGERATORS; REFRIGERATORS POWERED BY HYDROGEN; HEATING BOILERS; ELECTRICAL BOILERS; HEAT EXCHANGERS; STEAM GENERATORS; INDUSTRIAL, RESIDENTIAL AND COMMERCIAL BOILERS POWERED BY HYDROGEN; STEAM GENERATORS POWERED BY HYDROGEN; INSTALLATIONS COMBINING BOILERS AND STEAM GENERATORS FOR HEATING; INSTALLATIONS COMBINING BOILERS AND STEAM GENERATORS FOR PRODUCING HOT WATER; HEAT EXCHANGERS; INDUCTION, CONVECTION AND GAS BURNING OVENS; INDUCTION, CONVECTION AND GAS BURNING OVENS UTILIZING HYDROGEN; HYDROGEN HOBBS, NAMELY, COOK TOPS; SOLAR PANELS FOR USE IN HEATING; THERMOSTATIC VALVES; VALVES FOR CONTROLLING TEMPERATURE IN CENTRAL HEATING RADIATORS; EXPANSION TANKS FOR CENTRAL HEATING INSTALLATIONS AND HOT

**Reg. No. 4,196,294** WATER INSTALLATIONS; MODULAR HYDROGEN REFUELING STATIONS THAT MAY BE CONTAINERIZED AND TRANSPORTABLE OR STATIC WITHIN A BUILDING, CONSISTING OF HYDROGEN GENERATORS, GAS STORAGE CONTAINERS, GAS PURIFICATION EQUIPMENT, ELECTROLYSERS, WATER FILTERS AND A REFUELING NOZZLE; OXY-HYDROGEN FLAME GENERATORS USED FOR THE HEATING, BRAZING, SOLDERING, CUTTING OR POLISHING OF METAL, PLASTICS, GLASS OR QUARTZ, IN CLASS 11 (U.S. CLS. 13, 21, 23, 31 AND 34).

FOR: VEHICLES, NAMELY, SCOOTERS, MOTORCYCLES, QUADRICYCLES, MOTOR CARS, KIT CARS, VANS, BUSES, COACHES, TRAINS, TRAMS, BOATS, MOTOR BOATS, YACHTS, SHIPS, HOVERCRAFT, HELICOPTERS, GYRODYNES, HOT AIR BALLOONS, GLIDERS AND AIRPLANES; MOTORS AND ENGINES FOR LAND VEHICLES, NAMELY, INTERNAL COMBUSTION ENGINES, STEAM ENGINES, ELECTRIC ENGINES, PETROL ENGINES, PETROL/ELECTRIC HYBRID ENGINES, PETROL/HYDROGEN HYBRID ENGINES, DIESEL ENGINES, DIESEL/ELECTRIC HYBRID ENGINES, DIESEL/HYDROGEN HYBRID ENGINES, ALL FOR THE PURPOSE OF PRODUCING A DRIVE MEANS BY CONVERTING FUEL ENERGY INTO MECHANICAL WORK; COMBUSTION ENGINES FOR LAND VEHICLES FOR THE PURPOSE OF VEHICLE PROPULSION; LAND VEHICLE ENGINES INCORPORATING AND SOLD TOGETHER WITH A CLEANER SYSTEM COMPRISING IONIC POLYMER ACIDIC MEMBRANES, IONIC POLYMER ALKALINE MEMBRANES, AND IONIC POLYMER HYDROPHILIC MEMBRANES, ELECTRO-CHEMICAL CATALYSTS, SOLID POLYMER ELECTROLYTES AND MEMBRANE ELECTRODE ASSEMBLIES, MANIFOLDS, SEPARATING VESSELS AND PUMPS, UTILIZING HYDROGEN FOR USE IN COMBUSTION ENGINES FOR THE PURPOSES OF CONVERTING WASTE GASES THAT ARE THE BY-PRODUCTS OF THE INTERNAL COMBUSTION PROCESS INTO HYDROGEN TO REDUCE ENGINE EMISSIONS AND IMPROVE ENGINE EFFICIENCY; LAND VEHICLE ENGINES INCORPORATING AND SOLD TOGETHER WITH A CLEANER SYSTEM COMPRISING IONIC POLYMER ACIDIC MEMBRANES, IONIC POLYMER ALKALINE MEMBRANES, AND IONIC POLYMER HYDROPHILIC MEMBRANES, ELECTRO-CHEMICAL CATALYSTS, SOLID POLYMER ELECTROLYTES AND MEMBRANE ELECTRODE ASSEMBLIES, MANIFOLDS, SEPARATING VESSELS AND PUMPS, UTILIZING OXYGEN FOR USE IN COMBUSTION ENGINES FOR THE PURPOSES OF CONVERTING WASTE GASES THAT ARE THE BY-PRODUCTS OF THE INTERNAL COMBUSTION PROCESS INTO OXYGEN TO REDUCE ENGINE EMISSIONS AND IMPROVE ENGINE EFFICIENCY; EXHAUST CLEANING SYSTEMS, NAMELY, LAND VEHICLE ENGINES INCORPORATING AND SOLD TOGETHER WITH A CLEANING SYSTEM COMPRISING IONIC POLYMER ACIDIC MEMBRANES, IONIC POLYMER ALKALINE MEMBRANES, AND IONIC POLYMER HYDROPHILIC MEMBRANES, ELECTRO-CHEMICAL CATALYSTS, SOLID POLYMER ELECTROLYTES AND MEMBRANE ELECTRODE ASSEMBLIES, MANIFOLDS, SEPARATING VESSELS AND PUMPS, UTILIZING HYDROGEN FOR USE IN AN EXHAUST SYSTEM FOR THE PURPOSES OF CONVERTING WASTE GASES THAT ARE THE BY-PRODUCTS OF THE INTERNAL COMBUSTION PROCESS INTO HYDROGEN TO REDUCE ENGINE EMISSIONS AND IMPROVE ENGINE EFFICIENCY; EXHAUST CLEANING SYSTEMS, NAMELY, LAND VEHICLE ENGINES INCORPORATING AND SOLD TOGETHER WITH A CLEANING SYSTEM COMPRISING IONIC POLYMER ACIDIC MEMBRANES, IONIC POLYMER ALKALINE MEMBRANES, AND IONIC POLYMER HYDROPHILIC MEMBRANES, ELECTRO-CHEMICAL CATALYSTS, SOLID POLYMER ELECTROLYTES AND MEMBRANE ELECTRODE ASSEMBLIES, MANIFOLDS, SEPARATING VESSELS AND PUMPS, UTILIZING OXYGEN FOR USE IN AN EXHAUST SYSTEM FOR THE PURPOSES OF CONVERTING WASTE GASES THAT ARE THE BY-PRODUCTS OF THE INTERNAL COMBUSTION PROCESS INTO OXYGEN TO REDUCE ENGINE EMISSIONS AND IMPROVE ENGINE EFFICIENCY; STRUCTURAL PARTS AND FITTINGS FOR ALL OF THE AFORESAID GOODS, IN CLASS 12 (U.S. CLS. 19, 21, 23, 31, 35 AND 44).

FOR: GAS STORAGE MODULES, NAMELY, STAND ALONE CONTAINERS NOT OF METAL AND NOT OF PAPER, FOR THE PURPOSE OF STORING GASES CREATED AS A PRODUCT OF CHEMICAL PROCESSES FOR COMMERCIAL AND DOMESTIC USE; TANKS, CYLINDERS AND NON PAPER CONTAINERS NOT OF METAL FOR USE IN THE STORAGE

**Reg. No. 4,196,294** OF GASES, LIQUEFIED GASES AND COMPRESSED GASES FOR COMMERCIAL AND DOMESTIC USE, IN CLASS 20 (U.S. CLS. 2, 13, 22, 25, 32 AND 50).

FOR: CONSULTATION AND ADVISORY SERVICES REGARDING INSTALLATION AND MAINTENANCE OF ELECTROLYSERS AND FUEL CELLS, IN CLASS 37 (U.S. CLS. 100, 103 AND 106).

FOR: CONSULTATION AND ADVISORY SERVICES IN RELATION TO GAS STORAGE, IN CLASS 39 (U.S. CLS. 100 AND 105).

FOR: CONSULTATION AND ADVISORY SERVICES, NAMELY, TRAINING OTHERS IN THE FIELD OF HOW TO USE ELECTROLYSERS AND FUEL CELLS, IN CLASS 41 (U.S. CLS. 100, 101 AND 107).

FOR: ENGINEERING SERVICES RELATING TO FUEL CELLS AND ELECTROLYSERS, THE GENERATION OF ELECTRICITY, SUSTAINABLE ENERGY SOLUTIONS, HYDROGEN ENERGY SYSTEMS, RENEWABLE ENERGY, NAMELY, WIND, SOLAR AND WAVE ENERGY, HYDROGEN COMBUSTION VEHICLES AND THE REFUELING OF SUCH, FUEL CELL VEHICLES AND THE REFUELING OF SUCH, HYDROGEN GENERATION, OXYGEN GENERATION, OXYGEN PURIFICATION, HYDROGEN PURIFICATION, GAS STORAGE, ENERGY LOGISTICS, THE USE OF HYDROGEN FUEL IN INDUSTRIAL APPLICATIONS AND THE USE OF HYDROGEN FUEL IN DOMESTIC APPLICATIONS; RESEARCH AND DEVELOPMENT OF NEW PRODUCTS RELATING TO FUEL CELLS AND ELECTROLYSERS, THE GENERATION OF ELECTRICITY, SUSTAINABLE ENERGY SOLUTIONS, HYDROGEN ENERGY SYSTEMS, RENEWABLE ENERGY, NAMELY, WIND, SOLAR AND WAVE ENERGY, HYDROGEN COMBUSTION VEHICLES AND THE REFUELING OF SUCH, FUEL CELL VEHICLES AND THE REFUELING OF SUCH, HYDROGEN GENERATION, OXYGEN GENERATION, OXYGEN PURIFICATION, HYDROGEN PURIFICATION, GAS STORAGE, ENERGY LOGISTICS, THE USE OF HYDROGEN FUEL IN INDUSTRIAL APPLICATIONS AND THE USE OF HYDROGEN FUEL IN DOMESTIC APPLICATIONS; DESIGN OF NEW PRODUCTS IN THE FIELD OF FUEL CELLS AND ELECTROLYSERS, THE GENERATION OF ELECTRICITY, SUSTAINABLE ENERGY SOLUTIONS, HYDROGEN ENERGY SYSTEMS, RENEWABLE ENERGY, NAMELY, WIND, SOLAR AND WAVE ENERGY, HYDROGEN COMBUSTION VEHICLES AND THE REFUELING OF SUCH, FUEL CELL VEHICLES AND THE REFUELING OF SUCH, HYDROGEN GENERATION, OXYGEN GENERATION, OXYGEN PURIFICATION, HYDROGEN PURIFICATION, GAS STORAGE, ENERGY LOGISTICS, THE USE OF HYDROGEN FUEL IN INDUSTRIAL APPLICATIONS AND THE USE OF HYDROGEN FUEL IN DOMESTIC APPLICATIONS; CONSULTATION AND ADVISORY SERVICES IN THE FIELD OF ENERGY EFFICIENCY, NAMELY, TECHNOLOGY CONSULTATION REGARDING THE USE OF ENERGY SMOOTHING IN DEVELOPING RENEWABLE ENERGY SYSTEMS, IN CLASS 42 (U.S. CLS. 100 AND 101).

PRIORITY CLAIMED UNDER SEC. 44(D) ON ERPN CMNTY TM OFC APPLICATION NO. 008642803, FILED 10-27-2009, REG. NO. 008642803, DATED 7-5-2010, EXPIRES 10-27-2019.

THE MARK CONSISTS OF CIRCLE DEVICE WITH AN ORBITING SMALLER CIRCLE.

SER. NO. 77-859,641, FILED 10-28-2009.

MICHELLE DUBOIS, EXAMINING ATTORNEY

# United States of America

United States Patent and Trademark Office

## ZENITH FLEX

**Reg. No. 4,196,295**

FUTUREMED HEALTH CARE PRODUCTS LP (CANADA LIMITED PARTNERSHIP)  
277 BASALTIC ROAD

**Registered Aug. 28, 2012**

CONCORD, ONTARIO, CANADA L4K5V3

**Int. Cl.: 10**

FOR: MATTRESSES FOR THERAPEUTIC USE BY THE ELDERLY AND IN LONG TERM CARE FACILITIES, IN CLASS 10 (U.S. CLS. 26, 39 AND 44).

**TRADEMARK**

THE MARK CONSISTS OF STANDARD CHARACTERS WITHOUT CLAIM TO ANY PARTICULAR FONT, STYLE, SIZE, OR COLOR.

**PRINCIPAL REGISTER**

PRIORITY CLAIMED UNDER SEC. 44(D) ON CANADA APPLICATION NO. 1440220, FILED 6-3-2009, REG. NO. TMA805858, DATED 9-1-2011, EXPIRES 9-1-2026.

SER. NO. 77-881,920, FILED 11-30-2009.

BRIAN NEVILLE, EXAMINING ATTORNEY



*David J. Kyffers*

Director of the United States Patent and Trademark Office

# United States of America

United States Patent and Trademark Office



FAVRE-LEUBA

**Reg. No. 4,196,296**

**Registered Aug. 28, 2012**

**Int. Cl.: 14**

**TRADEMARK**

**PRINCIPAL REGISTER**

FAVRE LEUBA AG (SWITZERLAND CORPORATION)  
GOTTHARDSTRASSE 3  
ZUG, SWITZERLAND CH-6300

FOR: JEWELLERY; PRECIOUS STONES; HOROLOGICAL AND CHRONOMETRIC INSTRUMENTS AND CASES AND PARTS THEREFOR, IN CLASS 14 (U.S. CLS. 2, 27, 28 AND 50).

OWNER OF ERPN CMNTY TM OFC REG. NO. 004818671, DATED 11-10-2006, EXPIRES 12-19-2015.

OWNER OF U.S. REG. NOS. 767,158 AND 3,120,945.

THE MARK CONSISTS OF A HOUR GLASS FIGURE IN THE MIDDLE OF A CIRCLE ABOVE THE WORDS "FAVRE-LEUBA".

SER. NO. 77-882,478, FILED 11-30-2009.

TEJBIR SINGH, EXAMINING ATTORNEY



*David J. Kybas*

Director of the United States Patent and Trademark Office

# United States of America

United States Patent and Trademark Office

# E-TABLE

**Reg. No. 4,196,297**

**Registered Aug. 28, 2012**

**Int. Cls.: 9, 35, 41, 42  
and 43**

**TRADEMARK**

**SERVICE MARK**

**PRINCIPAL REGISTER**

COMPURANTS LTD. (GREAT BRITAIN CORPORATION)  
10 PARK CRESCENT  
LONDON W1B1PQ, GREAT BRITAIN

FOR: COMPUTER HARDWARE, EXCLUDING HARDWARE USED IN CONNECTION WITH GAMING OR GAMBLING OR ANY OTHER FORMS OF WAGERING OF MONEY; PROJECTORS, NAMELY, FILM PROJECTORS, MOTION PICTURE PROJECTORS, VIDEO PROJECTORS, LARGE SCREEN VIDEO PROJECTORS, OVERHEAD PROJECTORS, IMAGE PROJECTORS, PHOTOGRAPHIC PROJECTORS, PHOTOGRAPHIC PROJECTORS FOR CINEMATOGRAPHIC FILMS, PHOTOGRAPHIC PROJECTORS FOR SLIDES, SLIDES PROJECTORS, EXCLUDING PROJECTORS USED IN CONNECTION WITH GAMING OR GAMBLING OR ANY OTHER FORMS OF WAGERING OF MONEY; TOUCH SCREEN BASED SYSTEMS NOT USED IN CONNECTION WITH GAMING OR GAMBLING OR ANY OTHER FORMS OF WAGERING OF MONEY, NAMELY, TOUCH SCREEN BASED SYSTEMS COMPRISING A SCREEN THAT A USER INTERACTS WITH BY TOUCHING AN INTERFACE DEVICE, TOUCH SCREEN BASED SYSTEMS COMPRISING A DISPLAY PANEL THAT A USER INTERACTS WITH BY TOUCHING AN INTERFACE DEVICE, TOUCH SCREEN BASED SYSTEMS COMPRISING A PROJECTOR SURFACE THAT A USER INTERACTS WITH BY TOUCHING AN INTERFACE DEVICE, TOUCH BASED SYSTEMS COMPRISING A MOUSE AND TOUCH BASED SYSTEMS COMPRISING A TOUCH PAD; COMPUTER SOFTWARE FOR USE IN A RESTAURANT, NAMELY, SOFTWARE FOR ORDERING FOOD AND DRINKS, ORDERING YOUR BILL, SEEING YOUR BILL, ORDERING A CAB, LOOKING FOR LOCAL VENUES, LOOKING FOR LOCAL EVENTS; COMPUTER SOFTWARE NOT USED IN CONNECTION WITH GAMING OR GAMBLING OR ANY OTHER FORMS OF WAGERING OF MONEY, NAMELY, COMPUTER SOFTWARE FOR CONTROLLING VISUAL PROJECTION SYSTEMS, COMPUTER SOFTWARE FOR CONTROLLING TOUCH BASED SYSTEMS AND TOUCH SCREEN BASED SYSTEMS, ELECTRONIC POINT OF SALE SOFTWARE FOR PROCESSING AND MANAGEMENT OF PAYMENTS AND RECEIPTS, AND COMPUTER GAMES ENTERTAINMENT SOFTWARE, IN CLASS 9 (U.S. CLS. 21, 23, 26, 36 AND 38).

FOR: BUSINESS ADMINISTRATION SERVICES RELATING TO FRANCHISING, NAMELY, PROVIDING ASSISTANCE IN THE ESTABLISHMENT AND/OR OPERATION OF RESTAURANTS, CAFES, CAFETERIAS, SNACK-BARS, COFFEE SHOPS, SELF-SERVICE RESTAURANTS, AND CATERING SERVICES, IN CLASS 35 (U.S. CLS. 100, 101 AND 102).

FOR: ENTERTAINMENT SERVICES PROVIDED AT A RESTAURANT, NAMELY, MULTIMEDIA PRODUCTION SERVICES, CABARETS, COMEDY SHOWS, DINNER THEATERS,



*David J. Kappas*

Director of the United States Patent and Trademark Office

**Reg. No. 4,196,297** LIVE VISUAL AND AUDIO PERFORMANCES, NAMELY, MUSICAL BAND, ROCK GROUP, GYMNAS TIC, DANCE, AND BALLET PERFORMANCES; NON-GAMBLING RELATED GAMES SERVICES FOR ENTERTAINMENT PURPOSES, NAMELY, PROVIDING TEMPORARY USE OF NON-DOWNLOADABLE INTERACTIVE GAMES, ELECTRONIC GAMES, COMPUTER GAMES AND VIDEO GAMES, CONDUCTING ALTERNATE REALITY GAMES VIA THE INTERNET; PROVISION OF GAMES BY MEANS OF A COMPUTER BASED SYSTEM, NAMELY, PROVIDING ON-LINE COMPUTER GAMES, EXCLUDING GAMES RELATING TO GAMING OR GAMBLING OR ANY OTHER FORMS OF WAGERING OF MONEY, IN CLASS 41 (U.S. CLS. 100, 101 AND 107).

FOR: TECHNICAL CONSULTING SERVICES RELATING TO THE DESIGN AND PROVISION OF: COMPUTER BASED RESTAURANT SERVICES, NAMELY, FOOD AND DRINKS ORDERING SYSTEM, ORDERING YOUR BILL, SEEING YOUR BILL, ORDERING A CAB, LOOKING FOR LOCAL VENUES, LOOKING FOR LOCAL EVENTS; TECHNICAL CONSULTING SERVICES RELATING TO THE DESIGN AND PROVISION OF COMPUTER SOFTWARE FOR CONTROLLING VISUAL PROJECTION SYSTEMS, EXCLUDING SOFTWARE RELATING TO GAMING OR GAMBLING OR ANY OTHER FORMS OF WAGERING OF MONEY; TECHNICAL CONSULTING SERVICES RELATING TO THE DESIGN AND PROVISION OF COMPUTER SOFTWARE FOR CONTROLLING TOUCH BASED SYSTEMS AND TOUCH SCREEN BASED SYSTEMS, EXCLUDING SOFTWARE RELATING TO GAMING OR GAMBLING OR ANY OTHER FORMS OF WAGERING OF MONEY; TECHNICAL CONSULTING SERVICES RELATING TO THE DESIGN AND PROVISION OF ELECTRONIC POINT OF SALE SOFTWARE, EXCLUDING SOFTWARE RELATING TO GAMING OR GAMBLING OR ANY OTHER FORMS OF WAGERING OF MONEY, IN CLASS 42 (U.S. CLS. 100 AND 101).

FOR: PROVIDING OF FOOD AND DRINK; CAFÉ, CAFETERIA, SNACK-BAR, COFFEE SHOP, RESTAURANT, SELF-SERVICE RESTAURANT AND CATERING SERVICES; CATERING SERVICES FOR THE PROVISION OF FOOD AND DRINK; CONSULTING IN THE FIELD OF PREPARING, COOKING AND/OR SERVING FOOD AND DRINK; CONSULTING IN THE FIELD OF CAFÉ, CAFETERIA, SNACK-BAR, COFFEE SHOP, RESTAURANT, SELF-SERVICE RESTAURANT AND CATERING SERVICE; AND CONSULTING IN THE FIELD OF CATERING SERVICES FOR THE PROVISION OF FOOD AND DRINK, IN CLASS 43 (U.S. CLS. 100 AND 101).

THE MARK CONSISTS OF STANDARD CHARACTERS WITHOUT CLAIM TO ANY PARTICULAR FONT, STYLE, SIZE, OR COLOR.

PRIORITY CLAIMED UNDER SEC. 44(D) ON ERPN CMNTY TM OFC APPLICATION NO. 008338972, FILED 6-3-2009, REG. NO. 008338972, DATED 12-24-2009, EXPIRES 6-3-2019.

SER. NO. 77-885,040, FILED 12-3-2009.

RAUL CORDOVA, EXAMINING ATTORNEY



# United States of America

United States Patent and Trademark Office

## MY VACATION

**Reg. No. 4,196,298**

NP IP HOLDINGS LLC (NEVADA LIMITED LIABILITY COMPANY)  
1505 SOUTH PAVILION CENTER DRIVE  
LAS VEGAS, NV 89135

**Registered Aug. 28, 2012**

**Int. Cl.: 43**

FOR: BAR AND RESTAURANT SERVICES; HOTEL SERVICES; RESERVATION OF HOTEL ROOMS FOR TRAVELERS; RESORT LODGING SERVICES; TRAVEL AGENCY SERVICES, NAMELY, MAKING RESERVATIONS AND BOOKING FOR TEMPORARY LODGING, IN CLASS 43 (U.S. CLS. 100 AND 101).

**SERVICE MARK**

**PRINCIPAL REGISTER**

FIRST USE 5-22-2008; IN COMMERCE 5-22-2008.

THE MARK CONSISTS OF STANDARD CHARACTERS WITHOUT CLAIM TO ANY PARTICULAR FONT, STYLE, SIZE, OR COLOR.

NO CLAIM IS MADE TO THE EXCLUSIVE RIGHT TO USE "VACATION", APART FROM THE MARK AS SHOWN.

SER. NO. 77-918,713, FILED 1-23-2010.

SETH A. RAPPAPORT, EXAMINING ATTORNEY



*David J. Kyffers*

Director of the United States Patent and Trademark Office

# United States of America

United States Patent and Trademark Office

## Fusion HVAC

**Reg. No. 4,196,299**

**Registered Aug. 28, 2012**

**Int. Cls.: 11 and 42**

**TRADEMARK**

**SERVICE MARK**

**PRINCIPAL REGISTER**

FUSION HVAC PTY LIMITED (AUSTRALIA COMPANY)  
281 MONTAGUE ROAD  
WEST END, QUEENSLAND, AUSTRALIA 4101

FOR: APPARATUS AND INSTALLATIONS FOR HEATING, VENTILATION AND AIR CONDITIONING, NAMELY, REVERSE CYCLE HEATING INSTALLATIONS, VENTILATING EXHAUST FANS, AIR CONDITIONING INSTALLATIONS, AIR DIFFUSERS, AIR JET NOZZLES, AND AIR JET OUTLETS, ALL FOR COMMERCIAL USE, EXCLUDING SOLAR POWERED HEATING APPARATUS AND INSTALLATIONS AND APPARATUS AND INSTALLATIONS USING WOOD AND BIOMASS FUELS, IN CLASS 11 (U.S. CLS. 13, 21, 23, 31 AND 34).

FOR: ENGINEERING AND DESIGN SERVICES, NAMELY, ENGINEERING AND DESIGN FOR OTHERS IN THE FIELD OF HEATING, VENTILATION AND AIR CONDITIONING APPARATUS AND INSTALLATIONS, ALL FOR COMMERCIAL USE, EXCLUDING APPARATUS AND INSTALLATIONS USING WOOD AND BIOMASS FUELS, IN CLASS 42 (U.S. CLS. 100 AND 101).

THE MARK CONSISTS OF STANDARD CHARACTERS WITHOUT CLAIM TO ANY PARTICULAR FONT, STYLE, SIZE, OR COLOR.

OWNER OF AUSTRALIA REG. NO. 1269985, DATED 1-11-2010, EXPIRES 10-30-2018.

NO CLAIM IS MADE TO THE EXCLUSIVE RIGHT TO USE "HVAC", APART FROM THE MARK AS SHOWN.

SER. NO. 77-926,641, FILED 2-3-2010.

ELLEN PERKINS, EXAMINING ATTORNEY



*David J. Kypos*

Director of the United States Patent and Trademark Office

# United States of America

United States Patent and Trademark Office

## VENTURI ANTARCTICA

**Reg. No. 4,196,300**

**Registered Aug. 28, 2012**

**Int. Cls.: 9 and 12**

**TRADEMARK**

**PRINCIPAL REGISTER**

VENTURI AUTOMOBILES (MONACO CORPORATION)  
7, RUE DU GABIAN  
MONACO, MONACO 98000

FOR: APPARATUS AND INSTRUMENTS FOR THE SUPPLY, DISTRIBUTION, TRANSFORMATION, ACCUMULATION, REGULATION AND CONTROL OF ELECTRIC CURRENT; APPARATUS FOR RECORDING, TRANSMISSION AND REPRODUCTION OF SOUND OR IMAGES FOR USE WITH ELECTRIC CARS; BATTERIES; BLANK MAGNETIC DATA CARRIERS AND RECORDING DISCS; PRERECORDED MAGNETIC DATA CARRIERS AND RECORDING DISCS FEATURING AUTOMOBILES; PRERECORDED MAGNETIC DATA CARRIERS AND RECORDING DISCS FEATURING INFORMATION IN THE FIELD OF AUTOMOBILES; COMPUTER SOFTWARE FOR CONTROLLING AUTOMOBILE FUNCTIONS, COMPUTER SOFTWARE FOR CONTROLLING BATTERIES; COMPUTER PROGRAMS FOR USE IN AUTOMOBILES, NAMELY, COMPUTER PROGRAMS FOR PROVIDING MOVIES, MUSIC, TRAFFIC INFORMATION AND NEWS; COMPUTER PROGRAMS FOR USE IN AUTOMOBILES, NAMELY, COMPUTER PROGRAMS FOR MONITORING AUTOMOBILE PERFORMANCE, DIAGNOSING PROBLEMS WITH THE AUTOMOBILES SYSTEMS AND BATTERIES, CONTROLLING AUTOMOTIVE SYSTEMS, OPERATING AUTOMOTIVE SYSTEMS, MAPPING AND NAVIGATION, MAINTAINING PERSONAL DIRECTORIES, CONTACT LISTS, ADDRESSES AND PHONE NUMBER LISTS, IN CLASS 9 (U.S. CLS. 21, 23, 26, 36 AND 38).

FOR: VEHICLES, NAMELY, AUTOMOBILES, MOTORCYCLES, ELECTRIC VEHICLES, NAMELY, CARS, LAND VEHICLES; APPARATUS FOR LOCOMOTION BY LAND, AIR OR WATER, NAMELY, LAND VEHICLES, AIRPLANES, IN CLASS 12 (U.S. CLS. 19, 21, 23, 31, 35 AND 44).

THE MARK CONSISTS OF STANDARD CHARACTERS WITHOUT CLAIM TO ANY PARTICULAR FONT, STYLE, SIZE, OR COLOR.

OWNER OF ERPN CMNTY TM OFC REG. NO. 008799934, DATED 8-18-2010, EXPIRES 1-8-2020.

OWNER OF U.S. REG. NO. 3,419,708.

SER. NO. 77-937,497, FILED 2-17-2010.



*David J. Kypos*

Director of the United States Patent and Trademark Office

**Reg. No. 4,196,300** BARNEY CHARLON, EXAMINING ATTORNEY

# United States of America

United States Patent and Trademark Office

# SmartTaxi

**Reg. No. 4,196,301**

**Registered Aug. 28, 2012**

**Int. Cl.: 9**

**TRADEMARK**

**PRINCIPAL REGISTER**

HILTON SOFTWARE LLC (CALIFORNIA LIMITED LIABILITY COMPANY)  
6205 BALDERSTONE DRIVE  
SAN JOSE, CA 95120

FOR: COMPUTER SOFTWARE AND COMPUTER HARDWARE FOR USE IN THE FIELD OF AVIONICS, WHICH SHOWS A SYMBOL ON AN AIRPORT CHART OR DIAGRAM CORRESPONDING TO THE LOCATION OF THE VEHICLE USING THE GPS COORDINATES OR OTHER LOCATION INFORMATION, WHICH MAY OPTIONALLY INCLUDE A WARNING THAT ALERTS PILOTS OF BEING ON A RUNWAY, ABOUT TO ENTER A RUNWAY, AND DISTANCE INFORMATION BASED ON POSITION ON OR NEAR THE RUNWAY, IN CLASS 9 (U.S. CLS. 21, 23, 26, 36 AND 38).

FIRST USE 9-14-2006; IN COMMERCE 9-14-2006.

THE MARK CONSISTS OF STANDARD CHARACTERS WITHOUT CLAIM TO ANY PARTICULAR FONT, STYLE, SIZE, OR COLOR.

SER. NO. 77-954,504, FILED 3-9-2010.

GINA FINK, EXAMINING ATTORNEY



*David J. Kyffers*

Director of the United States Patent and Trademark Office

# United States of America

United States Patent and Trademark Office

## Surface Improvement

**Reg. No. 4,196,302**

BIOPELLE, INC. (MICHIGAN CORPORATION)  
780 WEST 8 MILE ROAD  
FERNDALE, MI 48220

**Registered Aug. 28, 2012**

**Int. Cl.: 3**

FOR: EXFOLIANT CREAMS; EXFOLIANTS FOR SKIN, IN CLASS 3 (U.S. CLS. 1, 4, 6, 50, 51 AND 52).

**TRADEMARK**

FIRST USE 8-6-2009; IN COMMERCE 8-6-2009.

**PRINCIPAL REGISTER**

THE MARK CONSISTS OF STANDARD CHARACTERS WITHOUT CLAIM TO ANY PARTICULAR FONT, STYLE, SIZE, OR COLOR.

SER. NO. 77-962,269, FILED 3-18-2010.

GILBERT SWIFT, EXAMINING ATTORNEY



*David J. Kybas*

Director of the United States Patent and Trademark Office

# United States of America

United States Patent and Trademark Office

## ADULTFINDER.COM

**Reg. No. 4,196,303**

**Registered Aug. 28, 2012**

**Int. Cl.: 42**

**SERVICE MARK**

**PRINCIPAL REGISTER**

E-NETAINMENT VENTURES, INC. (MARYLAND CORPORATION)  
100 EAST MAIN STREET  
SUITE 1  
WESTMINSTER, MD 21157

FOR: COMPUTER SERVICES, NAMELY, PROVIDING SEARCH ENGINES FOR OBTAINING DATA ON A GLOBAL COMPUTER NETWORK, IN CLASS 42 (U.S. CLS. 100 AND 101).

FIRST USE 11-1-1997; IN COMMERCE 11-3-1997.

THE MARK CONSISTS OF STANDARD CHARACTERS WITHOUT CLAIM TO ANY PARTICULAR FONT, STYLE, SIZE, OR COLOR.

SEC. 2(F).

SER. NO. 77-975,661, FILED 8-29-2007.

INGA ERVIN, EXAMINING ATTORNEY



*David J. Kyffers*

Director of the United States Patent and Trademark Office

# United States of America

United States Patent and Trademark Office

## SPRING TRAINING

**Reg. No. 4,196,304**

MAJOR LEAGUE BASEBALL PROPERTIES, INC. (NEW YORK CORPORATION)  
245 PARK AVENUE

**Registered Aug. 28, 2012**

NEW YORK, NY 10167

**Int. Cl.: 41**

FOR: PRODUCTION AND PROVISION OF ON-GOING TELEVISION, INTERNET AND RADIO PROGRAMS IN THE FIELD OF BASEBALL; PROVIDING NEWS AND INFORMATION IN THE FIELD OF BASEBALL; PROVIDING FACILITIES FOR BASEBALL AND ENTERTAINMENT, IN CLASS 41 (U.S. CLS. 100, 101 AND 107).

**SERVICE MARK**

**PRINCIPAL REGISTER**

FIRST USE 2-28-1925; IN COMMERCE 2-28-1925.

THE MARK CONSISTS OF STANDARD CHARACTERS WITHOUT CLAIM TO ANY PARTICULAR FONT, STYLE, SIZE, OR COLOR.

SEC. 2(F).

SER. NO. 77-982,433, FILED 7-2-2009.

KARANENDRA S. CHHINA, EXAMINING ATTORNEY



*David J. Kybas*

Director of the United States Patent and Trademark Office



# United States of America

United States Patent and Trademark Office



**Reg. No. 4,196,305**

**Registered Aug. 28, 2012**

**Int. Cl.: 33**

**TRADEMARK**

**PRINCIPAL REGISTER**

MACHAT, MICHAEL (UNITED STATES INDIVIDUAL)  
9107 WILSHIRE BLVD., STE. 425  
BEVERLY HILLS, CA 90210

FOR: WINES AND DISTILLED SPIRITS, IN CLASS 33 (U.S. CLS. 47 AND 49).

FIRST USE 2-5-1998; IN COMMERCE 2-5-1998.

OWNER OF U.S. REG. NOS. 2,263,907 AND 3,082,097.

THE COLOR(S) RED AND BLACK IS/ARE CLAIMED AS A FEATURE OF THE MARK.

THE MARK CONSISTS OF A BLACK LETTER "V" WITH A RED DROP OF BLOOD DRIPPING OFF THE "V".

SER. NO. 78-605,786, FILED 4-11-2005.

PAUL E. FAHRENKOPF, EXAMINING ATTORNEY



*David J. Kybas*

Director of the United States Patent and Trademark Office

# United States of America

United States Patent and Trademark Office

## WOODBURY CPA ALLIANCE

**Reg. No. 4,196,306**

**Registered Aug. 28, 2012**

**Int. Cl.: 36**

**SERVICE MARK**

**PRINCIPAL REGISTER**

WOODBURY FINANCIAL SERVICES, INC. (MINNESOTA CORPORATION)  
500 BIELENBERG DRIVE  
WOODBURY, MN 55125

FOR: BROKERAGE IN THE FIELD OF RETIREMENT PLANNING, SMALL BUSINESS PLANNING AND EXECUTIVE BENEFITS FOR CERTIFIED PUBLIC ACCOUNTANTS , IN CLASS 36 (U.S. CLS. 100, 101 AND 102).

FIRST USE 10-11-2005; IN COMMERCE 10-11-2005.

THE MARK CONSISTS OF STANDARD CHARACTERS WITHOUT CLAIM TO ANY PARTICULAR FONT, STYLE, SIZE, OR COLOR.

OWNER OF U.S. REG. NO. 2,597,868.

NO CLAIM IS MADE TO THE EXCLUSIVE RIGHT TO USE "CPA ALLIANCE", APART FROM THE MARK AS SHOWN.

SEC. 2(F).

SER. NO. 78-749,979, FILED 11-9-2005.

JAY BESCH, EXAMINING ATTORNEY



*David J. Kyffers*

Director of the United States Patent and Trademark Office

# United States of America

United States Patent and Trademark Office



**Reg. No. 4,196,307**

**Registered Aug. 28, 2012**

**Int. Cl.: 36**

**SERVICE MARK**

**PRINCIPAL REGISTER**

WOODBURY FINANCIAL SERVICES, INC. (MINNESOTA CORPORATION)  
CORP. LAW DEPT. - TRADEMARK UNIT  
500 BIELENBERG DRIVE  
WOODBURY, MN 55125

FOR: FINANCIAL SERVICES, NAMELY, A RETAIL BROKER/DEALER THAT PROVIDES BROKERAGE SERVICES, LIFE UNDERWRITING INSURANCE SERVICES, AND RETIREMENT PLANNING SERVICES TO ITS CUSTOMERS THROUGH INDEPENDENT REGISTERED REPRESENTATIVES, IN CLASS 36 (U.S. CLS. 100, 101 AND 102).

FIRST USE 4-1-2001; IN COMMERCE 4-1-2001.

OWNER OF U.S. REG. NO. 2,597,868.

NO CLAIM IS MADE TO THE EXCLUSIVE RIGHT TO USE "FINANCIAL SERVICES", APART FROM THE MARK AS SHOWN.

THE MARK CONSISTS OF THE STYLIZED WORDING "WOODBURY FINANCIAL SERVICES" ABOVE THE DESIGN OF A RECTANGLE WITH AN S-SHAPED LINE REPRESENTING AN UPHILL ROAD, WHICH IS ABOVE THE STYLIZED WORDING "ASPIRE. ACHIEVE.".

SEC. 2(F) AS TO "WOODBURY".

SER. NO. 78-786,122, FILED 1-6-2006.

JAY BESCH, EXAMINING ATTORNEY



*David J. Kybas*

Director of the United States Patent and Trademark Office

# United States of America

United States Patent and Trademark Office

# ONE DROP

**Reg. No. 4,196,308**

**Registered Aug. 28, 2012**

**Int. Cls.: 14, 20 and 25**

**TRADEMARK**

**PRINCIPAL REGISTER**

FONDATION ONE DROP (CANADA CORPORATION)  
8400 SECOND AVENUE  
MONTREAL, QUEBEC, CANADA H1Z 4M6

FOR: FINE AND COSTUME JEWELRY, NAMELY, JEWELRY PINS, BROOCHES, EARRINGS, BRACELETS, NECKLACES, RINGS, CHARMS, TIE CLIPS, ORNAMENTAL PINS; CANDLE-STICKS MADE OF PRECIOUS METAL, CANDLE HOLDERS MADE OF PRECIOUS METAL, DECORATIVE BOXES MADE OF PRECIOUS METAL, KEY RINGS MADE OF PRECIOUS METAL, KEY CHAINS, AND LIGHTERS MADE OF PRECIOUS METAL, LETTER OPENERS MADE OF PRECIOUS METAL, SCULPTURES MADE OF PRECIOUS METAL; CLOCKS AND WATCHES, IN CLASS 14 (U.S. CLS. 2, 27, 28 AND 50).

FOR: MIRROR FRAMES MADE OF PRECIOUS METAL, PICTURE FRAMES MADE OF PRECIOUS METAL, FRAMES FOR PAINTINGS MADE OF PRECIOUS METAL, FRAMES FOR DIPLOMAS AND CERTIFICATES MADE OF PRECIOUS METAL, IN CLASS 20 (U.S. CLS. 2, 13, 22, 25, 32 AND 50).

FOR: CLOTHING, WEARING APPAREL AND ACCESSORIES, NAMELY, SHIRTS, SWEATSHIRTS, T-SHIRTS, JERSEYS, SWEATERS, TANKS TOPS, PANTS, SWEAT PANTS, SHORTS, BOXER SHORTS, BATHROBES, NIGHT SHIRTS, PAJAMAS, COATS, JACKETS, WIND-RESISTANT JACKETS, VESTS, DRESSES, SKIRTS, BLOUSES, ROMPERS, SWIMWEAR; RAINWEAR, NAMELY, RAINCOATS, RAIN BONNETS, RAIN BOOTS AND RAIN CAPES; TIES, ASCOTS, BELTS, SCARVES, FOOTWEAR, NAMELY, SHOES, BOOTS AND SOCKS; HEADGEAR, NAMELY, HATS, CAPS AND BEANIES; APRONS; MASQUERADE COSTUMES, IN CLASS 25 (U.S. CLS. 22 AND 39).



THE MARK CONSISTS OF STANDARD CHARACTERS WITHOUT CLAIM TO ANY PARTICULAR FONT, STYLE, SIZE, OR COLOR.

PRIORITY CLAIMED UNDER SEC. 44(D) ON CANADA APPLICATION NO. 1300383, FILED 5-4-2006, REG. NO. TMA821671, DATED 4-5-2012, EXPIRES 4-5-2027.

SER. NO. 78-877,692, FILED 5-5-2006.

JAMES A. RAUEN, EXAMINING ATTORNEY

*David J. Kyffers*

Director of the United States Patent and Trademark Office

# United States of America

United States Patent and Trademark Office

## BENCHMARK RELIANCE

**Reg. No. 4,196,309**

AMERICAN NATIONAL INSURANCE COMPANY (TEXAS INSURANCE COMPANY)  
ONE MOODY PLAZA  
GALVESTON, TX 77550

**Registered Aug. 28, 2012**

**Int. Cl.: 36**

FOR: ISSUANCE AND ADMINISTRATION OF ANNUITIES, IN CLASS 36 (U.S. CLS. 100, 101 AND 102).

**SERVICE MARK**

FIRST USE 8-25-2003; IN COMMERCE 8-25-2003.

**PRINCIPAL REGISTER**

THE MARK CONSISTS OF STANDARD CHARACTERS WITHOUT CLAIM TO ANY PARTICULAR FONT, STYLE, SIZE, OR COLOR.

SER. NO. 78-895,793, FILED 5-30-2006.

JEAN IM, EXAMINING ATTORNEY



*David J. Kyffers*

Director of the United States Patent and Trademark Office

# United States of America

United States Patent and Trademark Office

# SEATWAVE

**Reg. No. 4,196,310**

**Registered Aug. 28, 2012**

**Int. Cls.: 39, 41 and 43**

**SERVICE MARK**

**PRINCIPAL REGISTER**

SEATWAVE LIMITED (UNITED KINGDOM CORPORATION)  
120 MOORGATE  
6TH FLOOR  
LONDON, UNITED KINGDOM EC2M6UR

FOR: TRAVEL ARRANGEMENTS; SERVICES OF A TRAVEL AGENCY, NAMELY, MAKING RESERVATIONS AND BOOKINGS FOR TRANSPORTATION; RESERVATION SERVICES FOR TRAVEL, NAMELY, MAKING RESERVATIONS AND BOOKINGS FOR TRANSPORTATION; TRAVEL BOOKING AGENCIES; ORGANIZATION, BOOKING AND ARRANGEMENT OF EXCURSIONS, DAY TRIPS AND SIGHTSEEING TOURS; MAKING RESERVATIONS AND BOOKINGS FOR HIRE CARS; PROVIDING INFORMATION IN THE FIELD OF MAKING RESERVATIONS AND BOOKINGS FOR TRANSPORTATION, IN CLASS 39 (U.S. CLS. 100 AND 105).

FOR: ENTERTAINMENT IN THE NATURE OF SPORTING EVENTS, MUSICAL CONCERTS AND OTHER ENTERTAINMENT AND CULTURAL EVENTS; ORGANIZING COMMUNITY SPORTING AND CULTURAL EVENTS; BOOKING OF SEATS FOR SHOWS AND BOOKING OF THEATRE TICKETS; TICKET RESERVATION AND BOOKING SERVICES FOR SPORTING EVENTS, MUSICAL CONCERTS AND OTHER ENTERTAINMENT AND CULTURAL EVENTS; TICKET AGENCY SERVICES FOR SPORTING EVENTS, MUSICAL CONCERTS AND OTHER ENTERTAINMENT AND CULTURAL EVENTS, RENDERED ONLINE, THROUGH PHONE ORDERS AND THROUGH TICKET OUTLETS; BOOKING AGENCY AND RESERVATION SERVICES FOR CINEMA TICKETS, THEATRE TICKETS AND CONCERT TICKETS; TICKET INFORMATION SERVICES FOR ENTERTAINMENT EVENTS, SHOWS AND SPORTING EVENTS; TICKET PROCUREMENT SERVICES, NAMELY, ARRANGING FOR TICKET RESERVATIONS FOR ENTERTAINMENT EVENTS, SHOWS AND SPORTING EVENTS; PROVIDING INFORMATION IN THE FIELD OF ENTERTAINMENT, SPORTING AND CULTURAL ACTIVITIES, IN CLASS 41 (U.S. CLS. 100, 101 AND 107).

FOR: SERVING FOOD AND DRINK; PROVIDING TEMPORARY ACCOMMODATION; BOOKING AGENCY SERVICES FOR HOTEL ACCOMMODATION AND RESTAURANTS, NAMELY, MAKING RESERVATIONS OF ROOMS AND RESTAURANTS; SERVICES FOR THE BOOKING OF ACCOMMODATION FOR TRAVELLERS; RESERVATION SERVICES FOR ACCOMMODATION AND RESTAURANTS; PROVIDING INFORMATION AND ADVICE ON ACCOMMODATION AND RESTAURANTS, IN CLASS 43 (U.S. CLS. 100 AND 101).



*David J. Kybas*

Director of the United States Patent and Trademark Office

**Reg. No. 4,196,310** THE MARK CONSISTS OF STANDARD CHARACTERS WITHOUT CLAIM TO ANY PARTICULAR FONT, STYLE, SIZE, OR COLOR.

PRIORITY CLAIMED UNDER SEC. 44(D) ON ERPN CMNTY TM OFC APPLICATION NO. 005186481, FILED 7-7-2006, REG. NO. 005186481, DATED 11-23-2010, EXPIRES 7-7-2016.

SER. NO. 78-929,037, FILED 7-13-2006.

GINA HAYES, EXAMINING ATTORNEY

# United States of America

United States Patent and Trademark Office



**Reg. No. 4,196,311**

**Registered Aug. 28, 2012**

**Int. Cls.: 4 and 39**

**TRADEMARK**

**SERVICE MARK**

**PRINCIPAL REGISTER**

REPSOL-GAS NATURAL LNG, S.L. (SPAIN SOCIEDAD LIMITADA)  
AVDA. DE AMÉRICA, 38  
E-28080 MADRID  
SPAIN

FOR: FUELS, NAMELY, NATURAL GAS AND LIQUEFIED GAS, IN CLASS 4 (U.S. CLS. 1, 6 AND 15).

FOR: WHOLESALE DISTRIBUTION, TRANSPORT AND STORAGE OF ENERGY, FUEL COMPOUNDS, NATURAL GAS AND LIQUEFIED GAS, IN CLASS 39 (U.S. CLS. 100 AND 105).

NO CLAIM IS MADE TO THE EXCLUSIVE RIGHT TO USE "NATURAL LNG", APART FROM THE MARK AS SHOWN.

PRIORITY DATE OF 10-25-2006 IS CLAIMED.

OWNER OF INTERNATIONAL REGISTRATION 0919708 DATED 2-16-2007, EXPIRES 2-16-2017.

THE COLOR(S) BLUE, RED AND YELLOW IS/ARE CLAIMED AS A FEATURE OF THE MARK.

THE COLORS RED AND YELLOW APPEAR IN THE FLAME-LIKE DESIGN THAT APPEARS ABOVE THE WORDING "STREAM" IN THE MARK. THE COLOR BLUE APPEARS IN THE WORDING OF THE MARK.

SER. NO. 79-036,767, FILED 2-16-2007.

DEZMONA MIZELLE, EXAMINING ATTORNEY



*David J. Kyffers*

Director of the United States Patent and Trademark Office



# United States of America

United States Patent and Trademark Office

# NET

**Reg. No. 4,196,312**

**Registered Aug. 28, 2012**

**Int. Cl.: 25**

**TRADEMARK**

**PRINCIPAL REGISTER**

GEOX S.P.A. (ITALY JOINT STOCK COMPANY)  
VIA FELTRINA CENTRO 16  
I-31044 MONTEBELLUNA FRAZIONE BIADENE  
(TREVISO), ITALY

FOR: SHOES, SPORT AND ATHLETIC SHOES, SKI AND SNOWBOARD BOOTS, INFANTS' SHOES AND BOOTS; BOOTS, SANDALS, THONGS BEING FOOTWEAR, SLIPPERS; CLOGS; TIPS, VAMPS, WELTS, INSOLES, SOLES AND HEEL PIECES ALL FOR FOOTWEAR; SHOE DOWELS, SHOE STRAPS, SHOE UPPERS; METAL FITTINGS AND NON SLIPPING DEVICES FOR SHOES AND BOOTS, NAMELY, PROTECTIVE METAL MEMBERS FOR SHOES AND BOOTS, CLEATS FOR ATTACHMENT TO SPORTS SHOES; FOOTWEAR, WORK SHOES AND BOOTS, HALF SOLES FOR FOOTWEAR, BLOUSONS, SWEAT PANTS, GYM SUITS, KNICKERS, LOUNGEWEAR, UNDERWEAR, BEACHWEAR, SLEEPWEAR, HOSIERY, FOULARDS, HEADWEAR, BERETS, CYCLISTS' JERSEYS; SPORT JACKETS; JERSEYS AND BREECHES FOR SPORTS; BRASSIERES, SINGLETS, CORSETS, PETTICOATS, SUSPENDERS, LEGGINGS, NIGHTGOWNS, PAJAMAS, DRESSING GOWNS, PULLOVERS, BATH ROBES, BATHING SUITS, BATHING CAPS, GLOVES AND MUFFS FOR CLOTHING, CARDIGANS, JERSEYS, TANK TOPS, NECKTIES, NECKERCHIEFS AND BANDANAS, SCARVES, SWEATERS, SOCKS, STOCKINGS, TIGHTS, SKIRTS, JACKETS, JERKINS, SHIRTS, BLOUSES, WAISTCOATS, VESTS, JUMPERS, TRACK SUITS, JEANS, TROUSERS, PANTS, PANTIES, UNDERPANTS, BERMUDA SHORTS, T-SHIRTS, SWEATSHIRTS, SUITS AND DRESSES, OVERCOATS, COATS, ANORAKS AND PARKAS, RAINCOATS, PAREUS, BABIES PANTS, DANCE COSTUMES, BELTS AND SASHES FOR CLOTHING; HOODS FOR CLOTHING, HATS, CAPS, IN CLASS 25 (U.S. CLS. 22 AND 39).



OWNER OF INTERNATIONAL REGISTRATION 1009122 DATED 5-22-2009, EXPIRES 5-22-2019.

SER. NO. 79-071,430, FILED 5-22-2009.

HAI-LY LAM, EXAMINING ATTORNEY

*David J. Kybas*

Director of the United States Patent and Trademark Office

# United States of America

United States Patent and Trademark Office



**Reg. No. 4,196,313**

**Registered Aug. 28, 2012**

**Int. Cls.: 7, 9, 11, 12, 19,  
20 and 42**

AIRLIGHT ENERGY IP SA (SWITZERLAND SOCIÉTÉ ANONYME)  
VIA CROCE 1  
CH-6710 BIASCA  
SWITZERLAND

FOR: WIND TURBINES, IN CLASS 7 (U.S. CLS. 13, 19, 21, 23, 31, 34 AND 35).

**TRADEMARK**

**SERVICE MARK**

**PRINCIPAL REGISTER**

FOR: SYSTEMS FOR THE CONVERSION AND USE OF SOLAR ENERGY, NAMELY, SOLAR COLLECTORS, CONCENTRATORS, RECEIVERS, SOLAR CELLS, PRESSURE CELLS, CHASSIS FOR CONCENTRATORS, CHASSIS FOR SOLAR TROUGHS, CHASSIS FOR DISH CONCENTRATORS CHASSIS FOR THE PIPING OF SOLAR COLLECTORS, PIPING OF SOLAR COLLECTORS, AND PIPING OF SOLAR POWER PLANTS, AND THESE COMPONENTS SOLD SEPARATELY; PHOTOVOLTAIC SOLAR COLLECTORS FOR THE SUPPLY OF LIGHT GENERATING ELECTRIC CURRENT AND COMPONENTS OF SOLAR COLLECTORS FOR THE PROVISION OF LIGHT, NAMELY, CONCENTRATORS, COMPONENTS OF CONCENTRATORS, ABSORBER PIPES AND CHASSIS DESIGNED FOR SUCH COLLECTORS; ELECTRONIC CONTROLS FOR OPERATING SOLAR COLLECTORS AND THEIR COMPONENTS, IN CLASS 9 (U.S. CLS. 21, 23, 26, 36 AND 38).

FOR: INSTALLATIONS FOR THE CONVERSION AND USE OF SOLAR ENERGY, NAMELY, SOLAR COLLECTORS, CONCENTRATORS, PRESSURE CELLS, RECEIVERS, ABSORBER PIPES, CHASSIS FOR CONCENTRATORS, CHASSIS FOR SOLAR TROUGHS, CHASSIS FOR DISH CONCENTRATORS, PIPING OF SOLAR COLLECTORS AND PIPING OF SOLAR POWER PLANTS, HEAT STORAGE TANKS, ROCK BIN TANKS AND THESE COMPONENTS SOLD SEPARATELY; SOLAR COLLECTORS FOR PROVIDING HEAT, PARTICULARLY INTENDED FOR USE IN THERMAL POWER STATIONS, FOR HEATING AND FOR GENERATING ELECTRIC CURRENT; AND PARTS OF SOLAR COLLECTORS FOR SUPPLYING HEAT, NAMELY, CONCENTRATORS, PARTS OF CONCENTRATORS, ABSORBER PIPES AND CHASSIS DESIGNED FOR SUCH COLLECTORS ALL OF WHICH IS SOLD INDIVIDUALLY OR COLLECTIVELY AS AN INTEGRAL COMPONENT OF SOLAR COLLECTORS, IN CLASS 11 (U.S. CLS. 13, 21, 23, 31 AND 34).



*David J. Kybas*

Director of the United States Patent and Trademark Office

FOR: AIRCRAFT WITH PNEUMATIC STRUCTURES AND COMPONENTS, ESPECIALLY AEROPLANES, SEAPLANES, VEHICULAR HOT AIR AND GAS CAPTIVE BALLOONS, AND AIRSHIPS; COMPONENT PARTS OF AIRCRAFT, NAMELY, PARTS HAVING PNEUMATIC STRUCTURES; BOATS MADE OF PNEUMATIC STRUCTURES AND ELEMENTS; PNEUMATIC PARTS OF VEHICLES, NAMELY, SPOILERS, CONVERTIBLE TOPS FOR

**Reg. No. 4,196,313** VEHICLES; LATERAL ROCKER PANELS FOR LAND VEHICLES; ROOF PANELS FOR LAND VEHICLES , IN CLASS 12 (U.S. CLS. 19, 21, 23, 31, 35 AND 44).

FOR: NON-METAL TRANSPORTABLE AND NON-METAL STATIONARY CONSTRUCTIONS, NAMELY, NON-METAL ROOF COVERINGS, NON-METAL BUILDINGS, NAMELY, STRUCTURES FOR HOUSING OF PEOPLE; AND NON-METAL BRIDGES COMPRISING PNEUMATIC STRUCTURES, IN CLASS 19 (U.S. CLS. 1, 12, 33 AND 50).

FOR: ARTICLES FOR INTERIOR DESIGN AND UTILITY ITEMS COMPRISING AND HAVING PNEUMATIC STRUCTURES AND COMPONENTS, NAMELY, TABLES, SEATS, CHILD SEATS, BENCHES, ARMCHAIRS, BEDS, HOSPITAL BEDS, TRESTLE TABLES, CUSHIONS, MATTRESSES, AND SCREENS, IN CLASS 20 (U.S. CLS. 2, 13, 22, 25, 32 AND 50).

FOR: PROVIDING ENGINEERING SERVICES FOR BUILDING AND OPERATING SOLAR THERMAL INSTALLATIONS; SCIENTIFIC RESEARCH AND DEVELOPMENT OF DESIGNING OF SOLAR COLLECTORS FEATURING ABSORBER ELEMENTS OR PHOTOVOLTAIC CELLS FOR THE PROVISION OF HEAT OR LIGHT, ESPECIALLY INTENDED FOR USE IN THERMAL POWER STATIONS, FOR HEATING AND FOR GENERATING ELECTRIC CURRENT AND COMPONENTS OF SUCH COLLECTORS SUCH AS CONCENTRATORS, ABSORBER PIPES, CHASSIS INTENDED FOR SUCH COLLECTORS AND CONTROL DEVICES FOR OPERATING SUCH COLLECTORS AND THEIR COMPONENTS; PROVIDING ENGINEERING SERVICES IN THE FIELD OF PNEUMATIC SUPPORTS, GENERAL PURPOSE PNEUMATIC UTILITY OBJECTS AND PNEUMATIC ELEMENTS RELATED TO SOLAR THERMAL INSTALLATIONS; SCIENTIFIC RESEARCH AND DEVELOPMENT OF PROJECTS AND DESIGNS AND CONSTRUCTIONS IN THE FIELD OF TRANSPORTABLE AND STATIONARY CONSTRUCTIONS SUCH AS ROOFING, HANGARS AND BRIDGES , IN CLASS 42 (U.S. CLS. 100 AND 101).

THE MARK CONSISTS OF A CURVED BAND LOOKING LIKE A MOUNTAIN. BELOW THIS IS AN OVAL SHAPE DESIGN.

PRIORITY DATE OF 7-14-2009 IS CLAIMED.

OWNER OF INTERNATIONAL REGISTRATION 1036308 DATED 1-14-2010, EXPIRES 1-14-2020.

SER. NO. 79-081,707, FILED 1-14-2010.

SIMON TENG, EXAMINING ATTORNEY

# United States of America

United States Patent and Trademark Office

# SmartMotion

**Reg. No. 4,196,314**

**Registered Aug. 28, 2012**

**Int. Cls.: 9, 10, 41 and 42**

**TRADEMARK**

**SERVICE MARK**

**PRINCIPAL REGISTER**

MOVEA (FRANCE SOCIÉTÉ ANONYME)  
4 AVENUE DU DOYEN LOUIS WEIL,  
LE PULSAR 5ÈME ÉTAGEF-38000 GRENOBLE  
FRANCE

FOR: DATA PROCESSING EQUIPMENT; DATA PROCESSORS; COMPUTER PERIPHERAL DEVICES, NAMELY, COMPUTER KEYBOARDS; DISTRIBUTED OR COMPACT ELECTRONIC DEVICE(S) TO MEASURE INTERPRET, REGISTER AND SAVE PARAMETERS OR DATA, NAMELY, MOVEMENT, DISPLACEMENT OR ORIENTATION DATA, ADAPTED IN PARTICULAR TO ESTIMATE KINETIC OR DYNAMIC DATA, PHYSICAL OR PHYSIOLOGICAL ACTIVITIES, THE DEVICES BEING PORTABLE FOR USE WITH BIOMECHANICAL ANALYSIS AND EMBEDDED IN OTHER ELECTRONIC DEVICES THAT ARE MOVED BY HUMAN MOTION OR GESTURE; ELECTRONIC DEVICES FOR MOTION ANALYSIS AND MONITORING, QUANTIFYING AND ESTIMATING THE PERFORMANCE OF MOVEMENTS; ELECTRONIC DETECTORS CONCERNING EVENTS RELATED TO MOVEMENTS; COMPUTER PERIPHERAL DEVICES AND COMPUTER GAME DEVICES FOR USE WITH AN EXTERNAL DISPLAY OR MONITOR ALLOWING INTERACTION WITH MULTIMEDIA CONTENT IN THE NATURE OF IMAGES, SOUND AND THREE-DIMENSIONAL DATA VIA MOVEMENT OF THE BODY OR PARTS OF THE BODY; MOTION OR PHYSICAL ACTIVITY MONITORING AND ANALYZING SOFTWARE; SOFTWARE EMBEDDED IN PORTABLE DEVICES, NAMELY, MOBILE PHONES OR PERSONAL ELECTRONIC ASSISTANTS AND ELECTRONIC NAVIGATION ASSISTANTS IN THE NATURE OF GPS TYPE SOFTWARE; SOFTWARE FOR PROVIDING ACCESS TO A GLOBAL COMMUNICATIONS NETWORK IN THE NATURE OF INTERNET AND A PRIVATE OR RESTRICTED ACCESS NETWORK IN THE NATURE OF AN INTRANET; DATA TRANSMISSION SOFTWARE; DIAGNOSIS EQUIPMENT, NAMELY, MOTION SENSORS AND ANALYSIS SOFTWARE FOR NON-MEDICAL USE; RECEIVERS USED FOR CAPTURING ELECTRONIC FITNESS AND SPORTS DATA FROM AN ELECTRONIC SENSOR WHICH SENSES THE FITNESS DATA, NAMELY, DATA REGARDING TIME, DISTANCE, PACE, MOVEMENT-RELATED DATA, BALANCE, COORDINATION, MOTION, HEART RATE, ENERGY EXPENDITURE, SPORTS AND EXERCISE, FOR NON-MEDICAL USE, IN CLASS 9 (U.S. CLS. 21, 23, 26, 36 AND 38).



*David J. Kybas*

Director of the United States Patent and Trademark Office

FOR: MEDICAL AND BIOMECHANICAL ELECTRONIC DEVICES AND INSTRUMENTS FOR MEDICAL USE THAT CAN BE STRAPPED, FIXED OR ATTACHED TO ANY PLACE ON THE HUMAN BODY, FOR ACCURATE ANGLE AND ORIENTATION MEASUREMENT IN 3 DIMENSIONS; APPARATUS FOR MEDICAL USE, NAMELY, PHYSIOLOGICAL

**Reg. No. 4,196,314** MEASUREMENT APPARATUS FOR BODY CONDITION EVALUATION, NAMELY, HEART RATE SENSORS FOR CALORIE EXPENDITURE, BUT ALSO FOR MOTION ALLOWING ASSISTANCE IN MEDICAL DIAGNOSIS, PREVENTION OF HEALTH RISKS AND PHYSICAL REHABILITATION, GONIOMETRIC MEASUREMENT APPARATUS INTENDED TO EVALUATE JOINT FUNCTION BY MEASURING AND RECORDING RANGES AND QUALITY OF MOTION FOR ORTHOPEDIC CHIROPRACTIC THERAPEUTIC JOINT ASSESSMENT, SPORTS MEDICINE, IN/OUTPATIENT REHABILITATION IN PARTICULAR FOR A GLOBAL VIEW OF ARTICULAR EXTENSIONS; ELECTRONIC MOTION MEASUREMENT DEVICES FOR NEUROREHABILITATION, NAMELY, INNER EAR DISORDER REHABILITATION, STROKE REHABILITATION, AND FOR PHYSICAL MOTRICITY EXERCISE APPLIANCES FOR MEDICAL USE; ELECTRONIC MEASUREMENT DEVICES FOR BALANCING DISORDER REHABILITATION POSTUROLOGY AND POSTUROGRAPHY, FOR MEDICAL USE; ELECTRONIC MOTION MEASUREMENT PATCHES FOR MEDICAL USE, NAMELY, FOR TREATMENT OF CHRONIC DISEASES, SLEEP DISORDERS, OBESITY, EPILEPSY, AND USE IN ASSISTED DAILY LIVING, MOTION ANALYSIS, DAY OR NIGHT ACTIVITY MEASUREMENT, NAMELY, ACTIVITY MONITORING, AND DETECTION OF DEGRADATION IN MEDICAL CONDITION AND EARLY SYMPTOM DETECTION, IN CLASS 10 (U.S. CLS. 26, 39 AND 44).

FOR: ENTERTAINMENT SERVICES, NAMELY, PROVISION OF NONDOWNLOADABLE ONLINE GAMES VIA A COMPUTER NETWORK; ENTERTAINMENT SERVICES, NAMELY, GAMES SERVICES PROVIDED ON THE INTERNET IN THE NATURE OF PROVIDING NONDOWNLOADABLE GAME PROGRAMS; GAMES SERVICES PROVIDED VIA A GLOBAL COMMUNICATION NETWORK, NAMELY PROVIDING NONDOWNLOADABLE GAMES VIA A GLOBAL COMMUNICATION NETWORK; PROVIDING A SUPPLY OF NONDOWNLOADABLE PROGRAMS FOR CONSUMER VIDEO GAMES VIA A GLOBAL COMMUNICATIONS NETWORK; PROVIDING A SUPPLY OF NONDOWNLOADABLE GAME PROGRAMS VIA A GLOBAL COMMUNICATIONS NETWORK; ENTERTAINMENT SERVICES, NAMELY, LIVE MUSICAL PERFORMANCES; PROVIDING ENTERTAINMENT INFORMATION AND RECREATION INFORMATION; ENTERTAINMENT SERVICES IN THE NATURE OF DANCE EVENTS BY A RECORDING ARTIST, ORGANIZATION OF GAMES; ENTERTAINMENT SERVICES, NAMELY, PROVIDING A SUPPLY OF NONDOWNLOADABLE RECORDED SOUNDS AND IMAGES VIA A GLOBAL COMMUNICATIONS NETWORK FOR USE ON CONSUMER VIDEO GAME APPARATUS AND PROVIDING A SUPPLY OF NONDOWNLOADABLE SOUNDS AND IMAGES BY COMMUNICATION MEANS VIA PORTABLE LIQUID-CRYSTAL DISPLAY GAMES APPARATUS; PROVIDING A SUPPLY OF NONDOWNLOADABLE PROGRAMS BY COMMUNICATION MEANS VIA CONSUMER VIDEO GAME APPARATUS, NAMELY TELEVISION PROGRAMS FEATURING SPORT AND EDUCATION ; PROVIDING A SUPPLY OF PROGRAMS BY COMMUNICATION MEANS VIA PORTABLE LIQUID-CRYSTAL DISPLAY GAMES APPARATUS, NAMELY GAME PROGRAMS FEATURING SPORTS; PROVIDING A SUPPLY OF NONDOWNLOADABLE GAME PROGRAMS BY COMMUNICATION VIA ARCADE VIDEO GAME MACHINES; PROVIDING CLASSES FOR INSTRUCTION IN GYMNASTICS, PHYSICAL EDUCATION; PRACTICAL TRAINING IN THE FIELD OF SPORT BY MEANS OF PROVIDING DEMONSTRATIONS; EDUCATIONAL SERVICES, NAMELY, PROVISION OF AN INTERNET SITE OFFERING INFORMATION ON EXERCISE PROGRAMS AND PROGRAMS FOR GETTING FIT AGAIN AIMED AT IMPROVING HEALTH-RELATED PROBLEMS; RUNNING INFORMAL NONDOWNLOADABLE EDUCATIONAL TELEVISION PROGRAMS ONLINE IN THE FIELDS OF EXERCISE AND GETTING FIT AGAIN; PERSONAL TRAINING SERVICES, NAMELY, STRENGTH TRAINING AND CONDITIONING, IN CLASS 41 (U.S. CLS. 100, 101 AND 107).

FOR: CONDUCTING TECHNICAL FEASIBILITY STUDIES; RESEARCH AND DEVELOPMENT IN THE FIELD OF MOTION MEASUREMENT AND ANALYSIS APPARATUS; ENGINEERING FEASIBILITY STUDIES; RESEARCH AND DEVELOPMENT IN THE FIELD OF SOFTWARE AND CONCERNING MOTION MONITORING; MATERIALS EVALUATION AND APPRAISAL IN THE NATURE OF TESTING AND RESEARCH CARRIED OUT IN THE SCIENTIFIC AND TECHNOLOGICAL FIELDS BY ENGINEERS IN THE FIELD OF MOTION

**Reg. No. 4,196,314** CAPTURE, MEASUREMENT AND ANALYSIS; DESIGN AND DEVELOPMENT OF COMPUTERS AND SOFTWARE IN THE FIELD OF MOTION CAPTURE, MEASUREMENT AND ANALYSIS; RESEARCH AND DEVELOPMENT OF NEW PRODUCTS IN THE FIELD OF MOTION CAPTURE, MEASUREMENT AND ANALYSIS; SCIENTIFIC STUDY AND TECHNICAL ASSISTANCE SERVICES IN CONNECTION WITH THE USE OF MOTION MEASUREMENT DEVICES; TECHNICAL PROJECT STUDIES IN THE FIELD OF MOTION CAPTURE, MEASUREMENT AND ANALYSIS; DEVELOPMENT OF ELECTRONIC DATA CENTER ARCHITECTURE SYSTEMS; SOFTWARE DEVELOPMENT, INSTALLATION, MAINTENANCE, UPDATING AND RENTAL; COMPUTER PROGRAMMING; DATA CONVERSION OF ELECTRONIC INFORMATION; SOFTWARE SERVICES, NAMELY, SOFTWARE CONSULTING SERVICES; SOFTWARE CREATION, MANAGING, UPDATING AND DATABASE DEVELOPMENT IN THE FIELD OF MOTION ANALYSIS AND MONITORING, IN CLASS 42 (U.S. CLS. 100 AND 101).

THE MARK CONSISTS OF STANDARD CHARACTERS WITHOUT CLAIM TO ANY PARTICULAR FONT, STYLE, SIZE, OR COLOR.

PRIORITY DATE OF 10-30-2009 IS CLAIMED.

OWNER OF INTERNATIONAL REGISTRATION 1037135 DATED 3-2-2010, EXPIRES 3-2-2020.

SER. NO. 79-082,016, FILED 3-2-2010.

SUZANNE BLANE, EXAMINING ATTORNEY

# United States of America

United States Patent and Trademark Office



**Reg. No. 4,196,315**

**Registered Aug. 28, 2012**

**Int. Cls.: 19 and 27**

**TRADEMARK**

**PRINCIPAL REGISTER**

IVC LUXEMBOURG SA (LUXEMBOURG S.A.)  
ROUTE DE WINSELER, 26  
L-9577 WILTZ  
LUXEMBOURG

FOR: WOODEN FLOORS; PARQUET FLOORING AND PARQUET FLOORING BOARDS; LAMINATED PARQUET FLOORING AND PARQUET FLOORING BOARDS; PARQUET FLOORING VENEERED WITH WOOD; SHEET MATERIAL COMPRISING LAYERS OF WOOD VENEER PRESSED AND GLUED TOGETHER, IN CLASS 19 (U.S. CLS. 1, 12, 33 AND 50).

FOR: VINYL FLOOR COVERINGS, CARPETS, RUGS, MATS AND MATTING, LINOLEUM, IN CLASS 27 (U.S. CLS. 19, 20, 37, 42 AND 50).

THE MARK CONSISTS OF THE BLACK WORDING "ITEC" SITUATED NEXT TO A CIRCLE THAT INCLUDES THE BLACK WORDING "IVC" INSIDE AND IS NEXT TO A SQUARE DESIGN THAT INCLUDES A LIGHT BLUE SQUARE AND PARTIAL DARK BLUE SQUARE. NO CLAIM IS MADE TO THE WHITE BACKGROUND.

PRIORITY DATE OF 10-2-2009 IS CLAIMED.

OWNER OF INTERNATIONAL REGISTRATION 1038510 DATED 4-1-2010, EXPIRES 4-1-2020.

THE COLOR(S) LIGHT BLUE (PMS 5435 C), DARK BLUE (PMS 5405 C), BLACK (PMS PROCESS BLACK) IS/ARE CLAIMED AS A FEATURE OF THE MARK.

THE WORDING "IVC" HAS NO MEANING IN A FOREIGN LANGUAGE.

SER. NO. 79-082,509, FILED 4-1-2010.

NAKIA HENRY, EXAMINING ATTORNEY



*David J. Kyffers*

Director of the United States Patent and Trademark Office

United States of America  
United States Patent and Trademark Office

# WALDLÄUFER

**Reg. No. 4,196,316**

**Registered Aug. 28, 2012**

**Int. Cl.: 25**

**TRADEMARK**

**PRINCIPAL REGISTER**

LUGINA-SCHUHFABRIK GMBH (FED REP GERMANY GMBH)  
WASGAUSTRASSE 2A  
76848 SCHWANHEIM  
FED REP GERMANY

FOR: FOOTWEAR AND THEIR PARTS, AS WELL AS INNER SOLES, IN CLASS 25 (U.S. CLS. 22 AND 39).

OWNER OF U.S. REG. NO. 3,580,691.

OWNER OF INTERNATIONAL REGISTRATION 0367823 DATED 4-24-1970, EXPIRES 4-24-2020.

THE ENGLISH TRANSLATION OF "WALDLÄUFER" IN THE MARK IS "FOREST WALKER".

SER. NO. 79-082,975, FILED 4-26-2010.

PAUL MORENO, EXAMINING ATTORNEY



*David J. Kyffers*

Director of the United States Patent and Trademark Office



# United States of America

United States Patent and Trademark Office



**Reg. No. 4,196,317**

**Registered Aug. 28, 2012**

**Int. Cls.: 35, 37, 39, 41  
and 42**

**SERVICE MARK**

**PRINCIPAL REGISTER**

SUPERJET INTERNATIONAL S.P.A. (ITALY JOINT STOCK COMPANY)  
VIA TRIESTINA 214  
LOCALITA' TESSERA; VENEZIA  
ITALY

FOR: RETAIL STORE SERVICES FEATURING SPARE PARTS FOR AIRCRAFT; PERSONNEL MANAGEMENT; PERSONNEL PLACEMENT AND RECRUITING, IN CLASS 35 (U.S. CLS. 100, 101 AND 102).

FOR: AIRPLANE MAINTENANCE AND REPAIR; CONSTRUCTION, MAINTENANCE AND REPAIR SERVICES RELATING TO THE AIR TRANSPORT INDUSTRY, NAMELY, AIRCRAFTS; PROVIDING INFORMATION ON REPAIR SERVICES IN THE AVIATION SECTOR, IN CLASS 37 (U.S. CLS. 100, 103 AND 106).

FOR: AIR TRANSPORT AND STORAGE OF GOODS; SUPPLY CHAIN LOGISTICS AND REVERSE LOGISTICS SERVICES, NAMELY, STORAGE, TRANSPORTATION AND DELIVERY OF GOODS FOR OTHERS BY AIR, SHIP, RAIL OR TRUCK, IN CLASS 39 (U.S. CLS. 100 AND 105).

FOR: AIRPLANE PILOT AND CABIN CREW TRAINING; TRAINING SERVICES, NAMELY, CONDUCTING CLASSES, SEMINARS, WORKSHOPS IN THE FIELD OF AIRPLANE MAINTENANCE, AIRPLANE MECHANICS AND AIRPLANE ENGINEERING; AIRPLANE FLIGHT INSTRUCTION, IN CLASS 41 (U.S. CLS. 100, 101 AND 107).

FOR: SCIENTIFIC AND TECHNOLOGICAL SERVICES IN THE FIELD OF AVIATION, NAMELY, DESIGN OF COMPUTER PROGRAMS AND SOFTWARE RELATING TO AIRCRAFT; AIRCRAFT DESIGN; DESIGN OF STRUCTURAL INTERIOR OF AIRCRAFTS, IN CLASS 42 (U.S. CLS. 100 AND 101).

THE TRADEMARK CONSISTS IN THE STYLIZED REPRESENTATION OF A QUADRANGULAR SHAPE; THE FIGURE IS COMPOSED OF TWO UPSIDE-DOWN "L"-SHAPED SEGMENTS ARRANGED OPPOSITE EACH OTHER, RECIPROCALLY INVERTED AND SPACED FROM ONE ANOTHER.

OWNER OF INTERNATIONAL REGISTRATION 1045093 DATED 5-5-2010, EXPIRES 5-5-2020.



*David J. Kyjars*

Director of the United States Patent and Trademark Office

**Reg. No. 4,196,317** SER. NO. 79-085,032, FILED 5-5-2010.

PAUL MORENO, EXAMINING ATTORNEY

# United States of America

United States Patent and Trademark Office

# KASOMEL

**Reg. No. 4,196,318**

**Registered Aug. 28, 2012**

**Int. Cl.: 1**

**TRADEMARK**

**PRINCIPAL REGISTER**

PRAYON, SOCIÉTÉ ANONYME (BELGIUM JOINT STOCK COMPANY)  
RUE JOSEPH WAUTERS 144  
B-4480 ENGIS, BELGIUM

FOR: CHEMICALS USED IN INDUSTRY, SCIENCE, PHOTOGRAPHY, AS WELL AS IN AGRICULTURE, HORTICULTURE AND FORESTRY EXCEPT FUNGICIDES, HERBICIDES, INSECTICIDES AND PARASITICIDES, NAMELY, CHEMICALS FOR PRESERVING FOODSTUFFS AND CHEMICALS FOR USE IN THE MANUFACTURE OF FOOD AND FEED, IN CLASS 1 (U.S. CLS. 1, 5, 6, 10, 26 AND 46).

OWNER OF U.S. REG. NOS. 2,666,944 AND 2,685,348.

OWNER OF INTERNATIONAL REGISTRATION 0553392 DATED 3-30-1990, EXPIRES 3-30-2020.

THE MARK CONSISTS OF THE STYLIZED WORDING "KASOMEL" WITH THE LETTER "O" FORMED BY A CIRCLE WITH A PARTIALLY REMOVED TRIANGLE SLICE.

SER. NO. 79-085,652, FILED 3-31-2010.

BERNICE MIDDLETON, EXAMINING ATTORNEY



*David J. Kyffers*

Director of the United States Patent and Trademark Office

# United States of America

United States Patent and Trademark Office

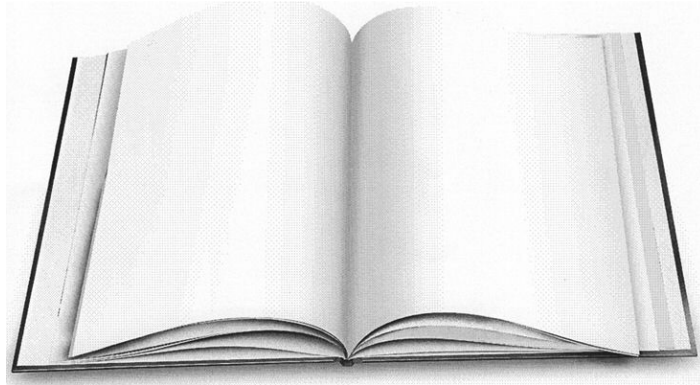

**Reg. No. 4,196,319**

**Registered Aug. 28, 2012**

**Int. Cls.: 9 and 40**

**TRADEMARK**

**SERVICE MARK**

**PRINCIPAL REGISTER**

CEWE COLOR AG & CO. OHG (FED REP GERMANY GENERAL PARTNERSHIP (OFFENE  
HANDELSGESELLSCHAFT))  
MEERWEG 30-32  
OLDENBURG, FED REP GERMANY 26133

FOR: COMPUTER SOFTWARE FOR THE CREATION OF PHOTO BOOKS , IN CLASS 9 (U.S.  
CLS. 21, 23, 26, 36 AND 38).

FOR: PRINTING OF PHOTOGRAPHS, IN CLASS 40 (U.S. CLS. 100, 103 AND 106).

THE MARK CONSISTS OF A STYLIZED OPENED BLANK BOOK.

PRIORITY DATE OF 12-9-2009 IS CLAIMED.

OWNER OF INTERNATIONAL REGISTRATION 1046663 DATED 5-6-2010, EXPIRES 5-6-  
2020.

SER. NO. 79-085,720, FILED 5-6-2010.

JOSETTE BEVERLY, EXAMINING ATTORNEY



*David J. Kybas*

Director of the United States Patent and Trademark Office

# United States of America

United States Patent and Trademark Office

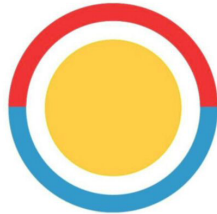

**RIPASSO ENERGY**

**Reg. No. 4,196,320**

**Registered Aug. 28, 2012**

**Int. Cl.: 9**

**TRADEMARK**

**PRINCIPAL REGISTER**

RIPASSO ENERGY AB (SWEDEN JOINT STOCK COMPANY)  
ADELGATAN 21  
SE-211 22 MALMÖ  
SWEDEN

FOR: SOLAR COLLECTOR FOR ELECTRICITY GENERATION; SOLAR BATTERY CHARGERS; APPARATUS AND INSTRUMENTS FOR CONDUCTING, SWITCHING, TRANSFORMING, ACCUMULATING, REGULATING OR CONTROLLING ELECTRICITY, PRODUCTION AND DISTRIBUTION OF ELECTRICITY, NAMELY, ELECTRICITY DISTRIBUTION NETS IN THE NATURE OF ELECTRICAL POWER DISTRIBUTION UNITS; APPARATUS AND INSTRUMENTS FOR SUPERVISION, REMOTE CONTROL, CONTROL AND MEASUREMENT OF ELECTRICITY AND ENERGY CONSUMPTION AND FOR OPERATING POWER STATIONS, NAMELY, SOFTWARE FOR MONITORING AND MEASURING OUTPUT OF POWER STATIONS, ELECTRICAL CURRENT AND VOLTAGE SENSORS, THERMAL AND PRESSURE SENSORS; ELECTRICITY CABLES, ELECTRIC CONNECTORS AND ELECTRIC TRANSFORMERS FOR DISTRIBUTION OF ELECTRICITY AND ENERGY FOR OPERATING POWER PLANTS, IN CLASS 9 (U.S. CLS. 21, 23, 26, 36 AND 38).

NO CLAIM IS MADE TO THE EXCLUSIVE RIGHT TO USE "ENERGY", APART FROM THE MARK AS SHOWN.

OWNER OF INTERNATIONAL REGISTRATION 1047833 DATED 5-27-2010, EXPIRES 5-27-2020.

THE COLOR(S) RED, BLUE, WHITE, YELLOW AND BLACK IS/ARE CLAIMED AS A FEATURE OF THE MARK.

THE MARK CONSISTS OF THE WORDING "RIPASSO ENERGY" IN BLACK STYLIZED LETTERING APPEARING BELOW A DESIGN ELEMENT CONSISTING OF A RED AND BLUE CIRCLE OUTLINING A WHITE CIRCLE ON A YELLOW CIRCULAR CENTER.

THE WORDING "RIPASSO" HAS NO MEANING IN A FOREIGN LANGUAGE.

SER. NO. 79-086,139, FILED 5-27-2010.

JULIE VEPPUMTHARA, EXAMINING ATTORNEY



*David J. Kypos*

Director of the United States Patent and Trademark Office

# United States of America

United States Patent and Trademark Office

# VASEMA

**Reg. No. 4,196,321**

**Registered Aug. 28, 2012**

**Int. Cls.: 9 and 10**

**TRADEMARK**

**PRINCIPAL REGISTER**

PETER HAGL (AUSTRIA INDIVIDUAL)  
HETZENDORFER STRASSE 49  
A-1120 WIEN  
AUSTRIA

FOR: ELECTRIC IMPEDANCE SENSORS TO DETECT STRUCTURAL DAMAGE IN CELLS FOR SCIENTIFIC AND LABORATORY USE; POLYMER-BASED SENSORS FOR HUMIDITY MEASUREMENT; CHEMICAL, BIOCHEMICAL, ELECTRIC, MAGNETIC, OPTIC, AND RADIATION BASED MONITORING SENSORS FOR THE DETECTION OF QUALITATIVE AND QUANTITATIVE CAPTURE OF GASES, FUMES OF HUMIDITY OR OF HUMIDITY FROM SOURCES OF WATER VAPOR NOT FOR MEDICAL USE, IN CLASS 9 (U.S. CLS. 21, 23, 26, 36 AND 38).

FOR: SURFACE-CHARACTERIZING IMPEDANCE MONITORS TO MONITOR CELLULAR STRUCTURAL DAMAGE IN PATIENTS FOR MEDICAL USE; MOISTURE METERS FOR MEASURING MOISTURE CONTENT IN GASES FOR MEDICAL USE; BIOFEEDBACK MEDICAL SENSORS; ELECTRIC IMPEDANCE SENSORS TO DETECT STRUCTURAL DAMAGE IN CELLS FOR MEDICAL USE; MEDICAL AND BIOMEDICAL SENSORS FOR THE DETECTION OF QUALITATIVE AND QUANTITATIVE CAPTURE OF GASES, FUMES OF HUMIDITY OR OF HUMIDITY FROM SOURCES OF WATER VAPOR; CHEMICAL, BIOCHEMICAL, ELECTRIC, MAGNETIC, OPTIC, AND RADIATION BASED MEDICAL, AND BIOMEDICAL PATIENT MONITORING SENSORS FOR THE DETECTION OF QUALITATIVE AND QUANTITATIVE CAPTURE OF GASES, FUMES OF HUMIDITY OR OF HUMIDITY FROM SOURCES OF WATER VAPOR, IN CLASS 10 (U.S. CLS. 26, 39 AND 44).

THE MARK CONSISTS OF STANDARD CHARACTERS WITHOUT CLAIM TO ANY PARTICULAR FONT, STYLE, SIZE, OR COLOR.

PRIORITY DATE OF 9-11-2009 IS CLAIMED.

OWNER OF INTERNATIONAL REGISTRATION 1050135 DATED 3-11-2010, EXPIRES 3-11-2020.

SER. NO. 79-086,997, FILED 3-11-2010.

AMY HELLA, EXAMINING ATTORNEY



*David J. Kyffers*

Director of the United States Patent and Trademark Office

# United States of America

United States Patent and Trademark Office

**arrownet** 

**Reg. No. 4,196,322**

**Registered Aug. 28, 2012**

**Int. Cls.: 36, 38 and 42**

KABUSHIKI KAISHA TOKYO SHOKEN TORIHIKISHO (TOKYO STOCK EXCHANGE, INC.) (JAPAN COMPANY LIMITED BY SHARES)  
2-1 NIHOMBASHI KABUTOCHO,  
CHUO-KU; TOKYO 103-8220  
JAPAN

**SERVICE MARK**

**PRINCIPAL REGISTER**

FOR: ACCEPTANCE OF DEPOSITS INCLUDING SUBSTITUTE BOND ISSUANCE AND ACCEPTANCE OF FIXED INTERVAL INSTALLMENT DEPOSITS, NAMELY, SECURITIES DEPOSIT SERVICES AND SAVINGS BANKS; LOAN FINANCING AND DISCOUNT OF BILLS; DOMESTIC EXCHANGE SETTLEMENT, NAMELY, DEBT SETTLEMENT SERVICES; LIABILITY GUARANTEE AND ACCEPTANCE OF BILLS, NAMELY, FINANCIAL GUARANTEE AND SURETY; SECURITIES LENDING, NAMELY, COMMERCIAL LENDING SERVICES; ACQUISITION AND TRANSFER OF MONETARY CLAIMS; SAFEKEEPING OF VALUABLES INCLUDING SECURITIES AND PRECIOUS METALS, NAMELY, SAFE DEPOSIT BOX SERVICES; MONEY EXCHANGE; TRUSTEESHIP OF FINANCIAL FUTURES CONTRACTS, NAMELY, TRUSTEE SERVICES; TRUSTEESHIP OF MONEY, SECURITIES, MONETARY CLAIMS, PERSONAL PROPERTY, LAND, RIGHTS ON LAND FIXTURES, SURFACE RIGHTS OR LEASE ON LAND, NAMELY, TRUSTEE SERVICES; AGENCIES FOR BOND SUBSCRIPTIONS, NAMELY, BROKERAGE OF BONDS; FOREIGN EXCHANGE TRANSACTIONS; LETTER-OF-CREDIT RELATING SERVICES, NAMELY, ISSUING OF LETTERS OF CREDIT; BROKERAGE FOR HIRE-PURCHASE; ISSUE OF TOKENS OF VALUE; AGENCIES FOR COLLECTING GAS OR ELECTRIC POWER UTILITY PAYMENTS, NAMELY, ELECTRONIC PAYMENT SERVICES BY WHICH UTILITY CUSTOMERS MAY APPLY MONEY FROM VARIOUS SOURCES FOR PAYMENT OF ENERGY COSTS; CONSIGNED COLLECTION OF PAYMENT FOR GOODS, NAMELY, COLLECTION AGENCIES; TRADING IN SECURITIES IN THE NATURE OF BUYING AND SELLING OF SECURITIES; TRADING IN SECURITIES IN THE NATURE OF TRADING OF SECURITIES INDEX FUTURES; TRADING IN SECURITIES IN THE NATURE OF TRADING OF SECURITIES OPTIONS; TRADING IN SECURITIES IN THE NATURE OF TRADING OF OVERSEAS MARKET SECURITIES FUTURES; AGENCIES OR BROKERAGE FOR TRADING OF SECURITIES, SECURITIES INDEX FUTURES, SECURITIES OPTIONS, AND OVERSEAS MARKET SECURITIES FUTURES; SECURITIES BROKERAGE SERVICES IN THE NATURE OF AGENCIES OR BROKERAGE FOR ENTRUSTING AGENTS WITH ON-COMMISSION TRADING IN DOMESTIC MARKETS OF SECURITIES, SECURITIES INDEX FUTURES AND SECURITIES OPTIONS; SECURITIES BROKERAGE SERVICES IN THE NATURE OF AGENCIES OR BROKERAGE FOR ENTRUSTING AGENTS WITH ON-COMMISSION TRADING IN OVERSEAS MARKETS OF SECURITIES, AND SECURITIES INDEX FUTURES; SECURITIES



*David J. Kybas*

Director of the United States Patent and Trademark Office

**Reg. No. 4,196,322** BROKERAGE SERVICES IN THE NATURE OF AGENCIES OR BROKERAGE FOR FORWARD AGREEMENT OF SECURITIES, FOR FORWARD AGREEMENT OF SECURITIES INDEX FUTURES, FOR FORWARD AGREEMENT OF SECURITIES OPTIONS, SPOT AND FORWARD TRANSACTION OF SECURITIES INDEX FUTURES; BROKERAGE FOR SECURITIES LIQUIDATION; SECURITIES BROKERAGE SERVICES IN THE NATURE OF FINANCIAL SECURITIES UNDERWRITING AND DISTRIBUTION OF SECURITIES; SECURITIES BROKERAGE SERVICES IN THE NATURE OF SECURITIES OFFERING; SECURITIES BROKERAGE SERVICES IN THE NATURE OF TRANSACTION OF SECURITIES SUBSCRIPTION OR OFFERING; PROVIDING STOCK MARKET INFORMATION; AGENCIES FOR COMMODITY FUTURES TRADING; SECURITIES BROKERAGE SERVICES IN THE NATURE OF ESTABLISHING FINANCIAL INSTRUMENTS MARKETS WHERE TRADING OF SECURITIES OR MARKET TRADING OF DERIVATIVES ARE CONDUCTED; SECURITIES BROKERAGE SERVICES IN THE NATURE OF ESTABLISHING MARKETS FOR COMMODITY DERIVATIVES OR COMMODITY INDEX DERIVATIVES; SECURITIES BROKERAGE SERVICES IN THE NATURE OF ESTABLISHING MARKETS FOR EMISSIONS TRADING OR DERIVATIVES TRADING BASED ON THEM; SECURITIES BROKERAGE SERVICES IN THE NATURE OF ESTABLISHING MARKETS FOR EMISSIONS TRADING IN THE FIELD OF GREENHOUSE GASES OR DERIVATIVES TRADING BASED ON THEM; PROVIDING FACILITIES AND MANAGEMENT OF FACILITIES FOR FINANCIAL INSTRUMENTS MARKETS WHERE TRADING OF SECURITIES OR MARKET TRADING OF DERIVATIVES ARE CONDUCTED, NAMELY, ORGANIZATION AND FINANCIAL ADMINISTRATION IN THE NATURE OF STOCK EXCHANGES AND FINANCIAL EXCHANGES FEATURING TRADING OF DERIVATIVE TRANSACTIONS, NAMELY, FINANCIAL SERVICES IN THE NATURE OF CONDUCTING A SECURITIES AND DERIVATIVES EXCHANGE; PROVIDING FACILITIES AND MANAGEMENT OF FACILITIES FOR MARKETS OF COMMODITY DERIVATIVES OR COMMODITY INDEX DERIVATIVES, NAMELY, ORGANIZATION AND FINANCIAL ADMINISTRATION IN THE NATURE OF FINANCIAL EXCHANGES FEATURING TRADING OF COMMODITY DERIVATIVE TRANSACTIONS OR COMMODITY INDEX DERIVATIVE TRANSACTIONS, NAMELY, FINANCIAL SERVICES IN THE NATURE OF CONDUCTING A SECURITIES AND DERIVATIVES EXCHANGE; PROVIDING FACILITIES AND MANAGEMENT OF FACILITIES FOR MARKETS OF EMISSIONS TRADING OR DERIVATIVES TRADING BASED ON THEM, NAMELY, ORGANIZATION AND FINANCIAL ADMINISTRATION IN THE NATURE OF FINANCIAL EXCHANGES FEATURING TRADING OF EMISSION TRADINGS OR DERIVATIVE TRANSACTIONS, NAMELY, FINANCIAL SERVICES IN THE NATURE OF CONDUCTING A SECURITIES AND DERIVATIVES EXCHANGE; PROVIDING FACILITIES AND MANAGEMENT OF FACILITIES FOR MARKETS OF EMISSIONS TRADING IN THE FIELD OF GREENHOUSE GASES OR DERIVATIVES TRADING BASED ON THEM, NAMELY, ORGANIZATION AND FINANCIAL ADMINISTRATION IN THE NATURE OF FINANCIAL EXCHANGES FEATURING TRADING OF EMISSION TRADINGS IN THE FIELD OF GREENHOUSE GASES OR DERIVATIVE TRANSACTIONS, NAMELY, FINANCIAL SERVICES IN THE NATURE OF CONDUCTING A SECURITIES AND DERIVATIVES EXCHANGE; PROVIDING MANAGEMENT SERVICES FOR TRADING FOR SECURITIES OR MARKET TRADING OF DERIVATIVES, NAMELY, FINANCIAL MANAGEMENT; PROVIDING MANAGEMENT SERVICES FOR TRADING FOR COMMODITY DERIVATIVES OR COMMODITY INDEX DERIVATIVES, NAMELY, FINANCIAL MANAGEMENT; PROVIDING MANAGEMENT SERVICES FOR EMISSIONS TRADING OR DERIVATIVES TRADING BASED ON THEM, NAMELY, FINANCIAL MANAGEMENT; PROVIDING MANAGEMENT SERVICES FOR EMISSIONS TRADING IN THE FIELD OF GREENHOUSE GASES OR DERIVATIVES TRADING BASED ON THEM, NAMELY, FINANCIAL MANAGEMENT; PROVIDING SERVICES OF SUPERVISION AND ADMINISTRATION FOR TRADING OF SECURITIES OR MARKET TRADING OF DERIVATIVES, NAMELY, FINANCIAL MANAGEMENT; PROVIDING SERVICES OF SUPERVISION AND ADMINISTRATION FOR TRADING OF COMMODITY DERIVATIVES OR COMMODITY INDEX DERIVATIVES, NAMELY, FINANCIAL MANAGEMENT; PROVIDING SERVICES OF SUPERVISION AND ADMINISTRATION FOR EMISSIONS TRADING OR DERIVATIVES TRADING BASED ON THEM, NAMELY, FINANCIAL MANAGEMENT; PROVIDING SERVICES OF SUPERVISION AND ADMINISTRATION FOR EMISSIONS TRADING IN THE FIELD OF GREENHOUSE GASES OR DERIVATIVES TRADING BASED ON THEM,



**Reg. No. 4,196,322** NAMELY, FINANCIAL MANAGEMENT; FINANCIAL SERVICES IN THE NATURE OF THE ESTABLISHMENT AND PROVISION OF INVESTMENT PRODUCTS REGARDING SECURITIES, CLAIMS BASED ON MONETARY CONTRACTS, CURRENCIES OR OTHER FINANCIAL INSTRUMENTS, NAMELY, FINANCIAL SERVICES IN THE NATURE OF CONDUCTING A SECURITIES AND DERIVATIVES EXCHANGE; FINANCIAL SERVICES IN THE NATURE OF THE ESTABLISHMENT AND PROVISION OF INVESTMENT PRODUCTS WHOSE REFERENCE NUMERICAL VALUES ARE PRICES OR INTEREST RATES OF FINANCIAL INSTRUMENTS, WEATHER OBSERVATION NUMERICAL VALUES, SECURITIES INDEX, COMMODITY PRICES, COMMODITY INDEX OR OTHER FINANCIAL INDICATORS, NAMELY, FINANCIAL SERVICES IN THE NATURE OF CONDUCTING A SECURITIES AND DERIVATIVES EXCHANGE; FINANCIAL SERVICES IN THE NATURE OF THE ESTABLISHMENT AND PROVISION OF INVESTMENT OUTLETS, NAMELY, FINANCIAL SERVICES IN THE NATURE OF CONDUCTING A SECURITIES AND DERIVATIVES EXCHANGE; FINANCIAL SERVICES IN THE NATURE OF THE ESTABLISHMENT AND PROVISION OF INVESTMENT PRODUCTS REGARDING COMMODITY DERIVATIVES OR COMMODITY INDEX DERIVATIVES, NAMELY, FINANCIAL SERVICES IN THE NATURE OF CONDUCTING A SECURITIES AND DERIVATIVES EXCHANGE; FINANCIAL SERVICES IN THE NATURE OF THE ESTABLISHMENT AND PROVISION OF INVESTMENT PRODUCTS REGARDING EMISSIONS TRADING OR DERIVATIVES TRADING BASED ON THEM, NAMELY, FINANCIAL SERVICES IN THE NATURE OF CONDUCTING A SECURITIES AND DERIVATIVES EXCHANGE; FINANCIAL SERVICES IN THE NATURE OF THE ESTABLISHMENT AND PROVISION OF INVESTMENT PRODUCTS REGARDING EMISSIONS TRADING IN THE FIELD OF GREENHOUSE GASES OR DERIVATIVES TRADING BASED ON THEM, NAMELY, FINANCIAL SERVICES IN THE NATURE OF CONDUCTING A SECURITIES AND DERIVATIVES EXCHANGE; FINANCIAL SERVICES IN THE NATURE OF MANAGING AND CONDUCTING OF LISTED SECURITIES, LISTED CLAIMS BASED ON MONETARY CONTRACTS, LISTED CURRENCIES, OTHER LISTED FINANCIAL INSTRUMENTS OR FINANCIAL INSTRUMENTS DERIVATIVES, NAMELY, FINANCIAL SERVICES IN THE NATURE OF CONDUCTING A SECURITIES AND DERIVATIVES EXCHANGE; FINANCIAL SERVICES IN THE NATURE OF MANAGING AND CONDUCTING OF LISTED PRICES OR INTEREST RATES OF FINANCIAL INSTRUMENTS, LISTED WEATHER OBSERVATION NUMERICAL VALUES, LISTED SECURITIES INDEX, LISTED COMMODITY PRICES, OTHER LISTED FINANCIAL INDICATORS OR FINANCIAL INDICATOR DERIVATIVES, NAMELY, FINANCIAL SERVICES IN THE NATURE OF CONDUCTING A SECURITIES AND DERIVATIVES EXCHANGE; FINANCIAL SERVICES IN THE NATURE OF MANAGING AND CONDUCTING OF LISTED COMMODITY DERIVATIVES OR LISTED COMMODITY INDEX DERIVATIVES, NAMELY, FINANCIAL SERVICES IN THE NATURE OF CONDUCTING A SECURITIES AND DERIVATIVES EXCHANGE; FINANCIAL SERVICES IN THE NATURE OF MANAGING AND CONDUCTING OF LISTED EMISSIONS TRADING OR LISTED DERIVATIVES TRADING BASED ON THEM, NAMELY, FINANCIAL SERVICES IN THE NATURE OF CONDUCTING A SECURITIES AND DERIVATIVES EXCHANGE; FINANCIAL SERVICES IN THE NATURE OF MANAGING AND CONDUCTING OF LISTED EMISSIONS TRADING IN THE FIELD OF GREENHOUSE GASES OR DERIVATIVES TRADING BASED ON THEM, NAMELY, FINANCIAL SERVICES IN THE NATURE OF CONDUCTING A SECURITIES AND DERIVATIVES EXCHANGE; FINANCIAL SERVICES IN THE NATURE OF PLANNING, PROVISION AND OPERATION OF FINANCIAL SYSTEMS IN THE FIELD OF FINANCIAL INSTRUMENTS MARKETS WHERE TRADING OF SECURITIES OR MARKET TRADING OF DERIVATIVES ARE CONDUCTED, NAMELY, FINANCIAL SERVICES IN THE NATURE OF CONDUCTING A SECURITIES AND DERIVATIVES EXCHANGE; FINANCIAL SERVICES IN THE NATURE OF PLANNING, PROVISION AND OPERATION OF MARKETS REGARDING COMMODITY DERIVATIVES AND COMMODITY INDEX DERIVATIVES, NAMELY, FINANCIAL SERVICES IN THE NATURE OF CONDUCTING A SECURITIES AND DERIVATIVES EXCHANGE; FINANCIAL SERVICES IN THE NATURE OF PLANNING, PROVISION AND OPERATION OF MARKETS REGARDING EMISSIONS TRADING OR DERIVATIVES TRADING BASED ON THEM, NAMELY, FINANCIAL SERVICES IN THE NATURE OF CONDUCTING A SECURITIES AND DERIVATIVES EXCHANGE; FINANCIAL SERVICES IN THE NATURE OF PLANNING, PROVISION AND OPERATION OF MARKETS REGARD-

**Reg. No. 4,196,322** ING EMISSIONS TRADING IN THE FIELD OF GREENHOUSE GASES OR DERIVATIVES TRADING BASED ON THEM, NAMELY, FINANCIAL SERVICES IN THE NATURE OF CONDUCTING A SECURITIES AND DERIVATIVES EXCHANGE; RESEARCH AND COMPILING OF STATISTICS OF FINANCIAL INSTRUMENTS MARKETS WHERE TRADING OF SECURITIES OR MARKET TRADING OF DERIVATIVES ARE CONDUCTED, NAMELY, FINANCIAL RESEARCH AND INFORMATION SERVICES; RESEARCH AND COMPILING OF STATISTICS OF MARKETS REGARDING TRADING OF COMMODITY DERIVATIVES OR COMMODITY INDEX DERIVATIVES, NAMELY, FINANCIAL RESEARCH AND INFORMATION SERVICES; RESEARCH AND COMPILING OF STATISTICS OF MARKETS REGARDING EMISSIONS TRADING OR DERIVATIVES TRADING BASED ON THEM, NAMELY, FINANCIAL RESEARCH AND INFORMATION SERVICES; RESEARCH AND COMPILING OF STATISTICS OF MARKETS REGARDING EMISSIONS TRADING IN THE FIELD OF GREENHOUSE GASES OR DERIVATIVES TRADING BASED ON THEM, NAMELY, FINANCIAL INFORMATION SERVICES; PROVIDING INFORMATION ON TRADING OF SECURITIES OR MARKET TRADING OF DERIVATIVES, NAMELY, FINANCIAL INFORMATION SERVICES; PROVIDING INFORMATION ON TRADING OF COMMODITY DERIVATIVES OR COMMODITY INDEX DERIVATIVES, NAMELY, FINANCIAL INFORMATION SERVICES; PROVIDING INFORMATION ON EMISSIONS TRADING OR DERIVATIVES TRADING BASED ON THEM, NAMELY, FINANCIAL INFORMATION SERVICES; PROVIDING INFORMATION ON EMISSIONS TRADING IN THE FIELD OF GREENHOUSE GASES OR DERIVATIVES TRADING BASED ON THEM, NAMELY, FINANCIAL INFORMATION SERVICES; PROVIDING INFORMATION ON FINANCIAL INSTRUMENTS MARKETS WHERE TRADING OF SECURITIES OR MARKET TRADING OF DERIVATIVES ARE CONDUCTED, NAMELY, FINANCIAL INFORMATION SERVICES; PROVIDING INFORMATION ON OVERSEAS FINANCIAL INSTRUMENTS MARKETS WHERE TRADING OF SECURITIES OR MARKET TRADING OF DERIVATIVES ARE CONDUCTED, NAMELY, FINANCIAL INFORMATION SERVICES; PROVIDING INFORMATION ON MARKETS REGARDING COMMODITY DERIVATIVES OR COMMODITY INDEX DERIVATIVES, NAMELY, FINANCIAL INFORMATION SERVICES; PROVIDING INFORMATION ON MARKETS REGARDING EMISSIONS TRADING OR DERIVATIVES TRADING BASED ON THEM, NAMELY, FINANCIAL INFORMATION SERVICES; PROVIDING INFORMATION ON MARKETS REGARDING EMISSIONS TRADING IN THE FIELD OF GREENHOUSE GASES OR DERIVATIVES TRADING BASED ON THEM, NAMELY, FINANCIAL INFORMATION SERVICES; PROVIDING INFORMATION REGARDING CREDIT AND FINANCE OF INVESTMENT COMPANIES TO INVESTORS, NAMELY, FINANCIAL INFORMATION SERVICES; STOCK BROKING SERVICES FOR CLEARING REGARDING TRADING OF SECURITIES OR MARKET TRADING OF DERIVATIVES; STOCK BROKING SERVICES FOR CLEARING REGARDING TRADING OF COMMODITY DERIVATIVES AND COMMODITY INDEX DERIVATIVES; STOCK BROKING SERVICES FOR CLEARING REGARDING EMISSIONS TRADING OR DERIVATIVES TRADING BASED ON THEM; STOCK BROKING SERVICES FOR CLEARING REGARDING EMISSIONS TRADING IN THE FIELD OF GREENHOUSE GASES OR DERIVATIVES TRADING BASED ON THEM; AGENCIES OR BROKERAGE FOR TRADING OF TRADING OF SECURITIES OR MARKET TRADING OF DERIVATIVES; SECURITIES BROKERAGE SERVICES IN THE NATURE OF AGENCIES OR BROKERAGE FOR TRADING OF COMMODITY DERIVATIVES OR COMMODITY INDEX DERIVATIVES; SECURITIES BROKERAGE SERVICES IN THE NATURE OF AGENCIES OR BROKERAGE FOR TRADING OF EMISSIONS TRADING OR DERIVATIVES TRADING BASED ON THEM; SECURITIES BROKERAGE SERVICES IN THE NATURE OF AGENCIES OR BROKERAGE FOR TRADING OF EMISSIONS TRADING IN THE FIELD OF GREENHOUSE GASES OR DERIVATIVES TRADING BASED ON THEM; SECURITIES BROKERAGE SERVICES IN THE NATURE OF ACCOUNT MANAGEMENT REGARDING EMISSIONS TRADING; SECURITIES BROKERAGE SERVICES IN THE NATURE OF ACCOUNT MANAGEMENT REGARDING EMISSIONS TRADING IN THE FIELD OF GREENHOUSE GASES, IN CLASS 36 (U.S. CLS. 100, 101 AND 102).

FOR: TELECOMMUNICATION OTHER THAN BROADCASTING, NAMELY, TELECOMMUNICATION ACCESS SERVICES; PROVIDING ACCESS TO COMMUNICATIONS NETWORKS, NAMELY, GLOBAL COMPUTER NETWORKS; BROADCASTING, NAMELY, RADIO

**Reg. No. 4,196,322** BROADCASTING, TELEVISION BROADCASTING, CABLE TELEVISION BROADCASTING AND BROADCASTING OF VIDEO AND AUDIO PROGRAMMING OVER THE INTERNET; NEWS AGENCIES, NAMELY, THE TRANSMISSION OF NEWS ITEMS TO NEWS REPORTING ORGANIZATIONS; RENTAL OF TELECOMMUNICATION EQUIPMENT INCLUDING TELEPHONES AND FACSIMILE APPARATUS; RENTAL OF ACCESS TIME TO COMPUTER DATABASES, IN CLASS 38 (U.S. CLS. 100, 101 AND 104).

FOR: COMPUTER SOFTWARE DESIGN, COMPUTER PROGRAMMING, OR MAINTENANCE OF COMPUTER SOFTWARE; COMPUTER SOFTWARE DESIGN FOR TRADING OF FINANCIAL INSTRUMENTS, COMPUTER PROGRAMMING FOR TRADING OF FINANCIAL INSTRUMENTS, OR MAINTENANCE OF COMPUTER SOFTWARE FOR TRADING OF FINANCIAL INSTRUMENTS; DESIGN AND COMPUTER SOFTWARE PROGRAMMING OF A COMPUTER NETWORK FOR TRADING OF FINANCIAL INSTRUMENTS, ALL FOR OTHERS; MAINTENANCE OF A COMPUTER NETWORK FOR TRADING OF FINANCIAL INSTRUMENTS, NAMELY, COMPUTER SERVICES, NAMELY, MAINTAINING WEB SITES FOR OTHERS ON A COMPUTER SERVER FOR A GLOBAL COMPUTER NETWORK; DESIGN, BUILDING, OR MAINTENANCE OF COMMUNICATION NETWORK SYSTEM, AND CONSULTATION ON THESE, NAMELY, DESIGN AND DEVELOPMENT OF COMMUNICATION NETWORK SYSTEM FOR TRADING OF FINANCIAL INSTRUMENTS, COMMODITY FEATURES, COMMODITY DERIVATIVES AND COMMODITY INDEX DERIVATIVES, AND CONSULTATION ON SUCH SYSTEMS, ALL FOR OTHERS, AND MAINTENANCE OF COMMUNICATION NETWORK SYSTEM AND CONSULTATION ON THIS, NAMELY, COMPUTER SERVICES, NAMELY, MAINTAINING WEB SITES FOR OTHERS ON A COMPUTER SERVER FOR A GLOBAL COMPUTER NETWORK AND CONSULTATION ON SUCH SYSTEMS; TECHNICAL ADVICE RELATING TO USABILITY, OPERATION, OF COMPUTERS AND OTHER MACHINES, NAMELY, COMPUTER HARDWARE, THAT REQUIRE HIGH LEVELS OF PERSONAL KNOWLEDGE, SKILL OR EXPERIENCE OF THE OPERATORS TO MEET THE REQUIRED ACCURACY IN OPERATING THEM; PROVIDING COMPUTER PROGRAMS, NAMELY, PROVIDING ON-LINE NON-DOWNLOADABLE SOFTWARE FOR USE IN DATABASE MANAGEMENT; RENTAL OF COMPUTERS; RENTAL OF COMPUTER PROGRAMS; PROVIDING COMPUTER PROGRAMS FOR TRADING OF FINANCIAL INSTRUMENTS, NAMELY, PROVIDING ON-LINE NON-DOWNLOADABLE SOFTWARE FOR THE TRADING OF FINANCIAL INSTRUMENTS; RENTAL OF COMPUTER PROGRAMS FOR TRADING OF FINANCIAL INSTRUMENTS; RENTAL OF COMPUTERS FOR TRADING OF FINANCIAL INSTRUMENTS; RENTAL OF STORAGE AREA OF WEB SERVERS ON WEBSITES, IN CLASS 42 (U.S. CLS. 100 AND 101).

THE MARK CONSISTS OF THE WORD "ARROWNET" IN BLACK AND AN ARROW HEAD-SHAPED DESIGN CONSISTING OF TWO ARROW SHAPES POINTING TO THE RIGHT OF THE WORD "ARROWNET"; THE LEFT SHAPE IS RED AND THE RIGHT SHAPE IS BLACK.

PRIORITY DATE OF 2-1-2010 IS CLAIMED.

OWNER OF INTERNATIONAL REGISTRATION 1051214 DATED 4-30-2010, EXPIRES 4-30-2020.

THE COLOR(S) BLACK AND RED IS/ARE CLAIMED AS A FEATURE OF THE MARK.

SER. NO. 79-087,391, FILED 4-30-2010.

JAMES STEIN, EXAMINING ATTORNEY

United States of America  
United States Patent and Trademark Office

# FIGHTBOX

**Reg. No. 4,196,323**

**Registered Aug. 28, 2012**

**Int. Cl.: 38**

**SERVICE MARK**

**PRINCIPAL REGISTER**

SPI INTERNATIONAL B.V. (NETHERLANDS B.V.)  
LAAN COPES VAN CATTENBURCH 52  
NL-2585 GB 'S-GRAVENHAGE, NETHERLANDS

FOR: BROADCASTING OF RADIO AND TELEVISION PROGRAMMES, IN CLASS 38 (U.S. CLS. 100, 101 AND 104).

THE MARK CONSISTS OF STANDARD CHARACTERS WITHOUT CLAIM TO ANY PARTICULAR FONT, STYLE, SIZE, OR COLOR.

PRIORITY DATE OF 5-20-2010 IS CLAIMED.

OWNER OF INTERNATIONAL REGISTRATION 1051966 DATED 8-26-2010, EXPIRES 8-26-2020.

OWNER OF U.S. REG. NO. 3,113,589.

SER. NO. 79-087,650, FILED 8-26-2010.

GEOFFREY FOSDICK, EXAMINING ATTORNEY



*David J. Kyffers*

Director of the United States Patent and Trademark Office

# United States of America

United States Patent and Trademark Office

# DOOGITS

**Reg. No. 4,196,324**

**Registered Aug. 28, 2012**

**Int. Cls.: 9, 16, 25, 28, 38  
and 41**

**TRADEMARK**

**SERVICE MARK**

**PRINCIPAL REGISTER**

SARL DOOTOONS INTERNATIONAL (FRANCE LIMITED LIABILITY COMPANY)  
36 RUE HOCHÉ  
F-85000  
LA ROCHE-SUR-YON, FRANCE

FOR: MAGNETIC RECORDING MEDIA AND ACOUSTIC OR OPTICAL DISKS, NAMELY, PRERECORDED OPTICAL AND COMPACT DISK FEATURING MUSICAL SOUND RECORDINGS; FLOPPY DISKS, NAMELY, PRERECORDED AUDIO DISKS FEATURING MUSICAL SOUND RECORDINGS; COMPUTER GAME PROGRAMS, IN CLASS 9 (U.S. CLS. 21, 23, 26, 36 AND 38).

FOR: PRINTED MATTER, NAMELY, PRINTED PAPER LABELS; BOOKBINDING MATERIAL; PHOTOGRAPHS; STATIONERY; ADHESIVES GLUES FOR STATIONERY OR HOUSEHOLD PURPOSES; PAINTBRUSHES; PRINTING TYPE; PRINTING BLOCKS; PAPER; CARDBOARD; BOXES OF CARDBOARD OR PAPER; POSTERS; ALBUMS, NAMELY, PHOTOGRAPHS ALBUMS, SELF-ADHESIVE PHOTO ALBUMS; CARDS, NAMELY, GREETING CARDS, BLANK NOTE CARDS, INDEX CARDS; BOOKS, NAMELY, COMIC BOOKS, A SERIES OF FICTION BOOKS FEATURING A CARTOON CHARACTER, CHILDREN'S BOOKS; NEWSPAPERS; PRINTED PROSPECTUSES FEATURING INFORMATION ABOUT CHILDREN'S FANTASY CHARACTERS; PAMPHLETS FEATURING INFORMATION ABOUT CHILDREN'S FANTASY CHARACTERS; CALENDARS; WRITING INSTRUMENTS; ENGRAVED OR LITHOGRAPHED WORKS OF ART, NAMELY, ENGRAVED PAINTINGS, ENGRAVED PHOTOGRAPHS; PAINTINGS; PICTURES, FRAMED OR UNFRAMED; AQUARELLES; GRAPHIC PRINTS; DRAWING INSTRUMENTS, IN CLASS 16 (U.S. CLS. 2, 5, 22, 23, 29, 37, 38 AND 50).

FOR: CLOTHING, NAMELY, SHIRTS, PANTS, SHORTS, HATS, SKIRTS, DRESSES, TEE-SHIRTS; FOOTWEAR, HEADGEAR, NAMELY, HATS, CAPS, BANDANNAS; SHIRTS; LEATHER OR IMITATION LEATHER CLOTHING, NAMELY, LEATHER JACKETS, LEATHER GLOVES, LEATHER SHIRTS, LEATHER VESTS, LEATHER PANTS; CLOTHING, NAMELY, BELTS; CLOTHING, NAMELY, GLOVES; SCARVES; NECKTIES; HOSIERY; SOCKS; SLIPPERS; BEACH, SKI OR SPORTS FOOTWEAR, NAMELY, RUNNING SHOES; BABIES' DIAPERS OF TEXTILE; UNDERWEAR, IN CLASS 25 (U.S. CLS. 22 AND 39).

FOR: GAMES AND PLAYTHINGS, NAMELY, BOARD GAMES, PLAY FIGURES, PLAY HOUSES, PLAYGROUND BALLS, GARDEN GAMES, NAMELY, GAMES OF BOWLING;



*David J. Kyros*

Director of the United States Patent and Trademark Office

**Reg. No. 4,196,324** BALLS FOR GAMES AND PLAY BALLOONS; CARD OR BOARD GAMES; ICE OR ROLLER SKATES, IN CLASS 28 (U.S. CLS. 22, 23, 38 AND 50).

FOR: COMMUNICATIONS BY COMPUTER TERMINALS OR VIA FIBER-OPTIC NETWORKS, IN CLASS 38 (U.S. CLS. 100, 101 AND 104).

FOR: INFORMATION ON ENTERTAINMENT OR EDUCATION, NAMELY, PROVIDING A WEBSITE FEATURING ENTERTAINMENT INFORMATION; PUBLICATION OF BOOKS; LENDING LIBRARIES; VIDEOTAPE FILM PRODUCTION; RENTAL OF MOTION PICTURES; RENTAL OF SOUND RECORDINGS; VIDEOTAPE EDITING; PHOTOGRAPHY; GAME SERVICES PROVIDED ON-LINE FROM A COMPUTER NETWORK, NAMELY, PROVIDING ON-LINE CARD GAMES, CONDUCTING ALTERNATE REALITY GAMES VIA THE INTERNET; PUBLICATION OF ELECTRONIC BOOKS AND JOURNALS ON-LINE; ELECTRONIC DESKTOP PUBLISHING; CARTOON OR ANIMATED FILM PRODUCTION, NAMELY, PRODUCTION OF ANIMATED CARTOON FILMS, IN CLASS 41 (U.S. CLS. 100, 101 AND 107).

THE MARK CONSISTS OF STANDARD CHARACTERS WITHOUT CLAIM TO ANY PARTICULAR FONT, STYLE, SIZE, OR COLOR.

OWNER OF INTERNATIONAL REGISTRATION 1051998 DATED 8-6-2010, EXPIRES 8-6-2020.

SER. NO. 79-087,660, FILED 8-6-2010.

MICHAEL TANNER, EXAMINING ATTORNEY

# United States of America

United States Patent and Trademark Office



**Reg. No. 4,196,325**

**Registered Aug. 28, 2012**

**Int. Cls.: 16, 24, 25, 28,  
29, 30, 32, 41 and 43**

**TRADEMARK**

**SERVICE MARK**

**PRINCIPAL REGISTER**

ATLANTYCA SPA (ITALY JOINT STOCK COMPANY)  
VIA GIACOMO LEOPARDI, 8  
I-20123 MILANO  
ITALY

FOR: PAPER, CARDBOARD AND GOODS MADE FROM THESE MATERIALS, NAMELY, ADDRESS BOOKS, PAPER LABELS, PAPER AND CARDBOARD; PRINTED MATTER, NAMELY, PRINTED AWARDS, PRINTED INVITATIONS, GREETING CARDS, SCRAP-BOOKS; BAGS, ENVELOPES AND/OR POUCHES OF PAPER OR PLASTICS FOR PACKAGING, BOOKMARKERS, DISPOSABLE BABIES' DIAPERS OF PAPER AND CELLULOSE, TOWELS OF PAPER, NAPKINS OF PAPER, MODELLING CLAY; PRINTED MATTER, NAMELY, NEWSPAPERS, PHOTOGRAPHS, MAGAZINES, BOOKS, PRINTED PERIODICALS, SONG BOOKS, ALMANACS, BOOKLETS, NEWSLETTERS, AND BROCHURES ALL IN THE FIELDS OF SECURITIES, STOCK OPTIONS AND OTHER FINANCIAL INSTRUMENTS; PRINTED MATTER, NAMELY, TEACHING MATERIALS IN THE FIELD OF MATHEMATICS, GEOGRAPHY, HISTORY, ORGANIC AND INORGANIC SCIENCE, COMPUTING, LANGUAGE; BOOKBINDING MATERIAL; PHOTOGRAPHS; STATIONERY; ADHESIVES FOR STATIONERY OR HOUSEHOLD PURPOSES; ARTISTS' MATERIALS, NAMELY, BRUSHES, PASTELS; PAINT BRUSHES, DRAWING BOARDS, DRAWING INSTRUMENTS, NAMELY, PADS, PENS AND PINS; TYPEWRITERS AND OFFICE REQUISITES EXCEPT FURNITURE, NAMELY, STAPLERS, RUBBER BANDS, PENCILS, PENS, RUBBER ERASERS; PRINTED INSTRUCTIONAL AND TEACHING MATERIAL IN THE FIELD OF PUBLICATION OF TEXTS, BOOKS, MAGAZINES AND OTHER PRINTED MATTER; PLASTIC MATERIALS FOR PACKAGING, NAMELY, AN ALL-IN-ONE PORTABLE CARDBOARD BOX THAT DISPENSES BOTH CUPS MADE OF PAPER, PLASTIC OR OTHER MATERIAL AND LIQUIDS, NAMELY, FOR DOMESTIC USE; PRINTERS' TYPE; PRINTING BLOCKS; PHOTOGRAPHIC ALBUMS, PHOTOGRAPHIC PRINTS, POSTAGE STAMPS, IN CLASS 16 (U.S. CLS. 2, 5, 22, 23, 29, 37, 38 AND 50).



*David J. Kybas*

Director of the United States Patent and Trademark Office

FOR: TEXTILES AND TEXTILE GOODS, NAMELY, PLACE MATS, HANDKERCHIEFS, ADHESIVE FABRIC FOR APPLICATION BY HEAT, BATH LINEN, COVERS FOR CUSHIONS, HOUSEHOLD LINEN, LABELS OF CLOTH, MATTRESS COVERS, SHOWER CURTAINS OF TEXTILE OR PLASTIC, TABLE RUNNERS, BED BLANKETS AND TEXTILE TABLE COVERS, IN CLASS 24 (U.S. CLS. 42 AND 50).

FOR: CLOTHING, NAMELY, PANTS, SHIRTS, BELT, BOTTOMS, BABIES' DIAPERS OF TEXTILE, TEXTILE BABIES' NAPPIES, BABIES' PANTS, BANDANAS, BATH ROBES,

**Reg. No. 4,196,325** BATHING SUITS, BEACHWEAR, CAMISOLES, CLOTHING FOR GYMNASTICS, NAMELY, LEOTARDS, GYMNASTIC SHOES, ATHLETIC TIGHTS, ATHLETIC UNIFORMS, PADDED SHORTS, PADDED PANTS, PADDED SHIRTS, GYM BOOTS; MASQUERADE COSTUMES, BATHING TRUNKS, GLOVES, JUMPERS, LEGGINGS, PANTS, PAPER CLOTHING IN THE NATURE OF SHIRTS, SKIRTS, PANTS, BELTS, TIES, BOTTOMS, TROUSERS, JACKETS, PULLOVERS, PYJAMAS, SANDALS, SCARVES, SHIRTS, SKIRTS, SLIPS, SOCKS, SWEATERS, TROUSERS, UNDERWEAR, WATERPROOF CLOTHING IN THE NATURE OF SHIRTS, SKIRTS, PANTS, BELTS, TIES, BOTTOMS, TROUSERS, JACKETS; FOOTWEAR, NAMELY, BATH SANDALS, BATH SLIPPERS, BEACH SHOES, BOOTS, FOOTBALL BOOTS, FOOTBALL SHOES, GYMNASTIC SHOES, INNER SOLES; HEADGEAR, NAMELY, HATS, CAPS, BATHING CAPS, BERETS, IN CLASS 25 (U.S. CLS. 22 AND 39).

FOR: GAMES AND PLAYTHINGS, NAMELY, DICE GAMES, CRIB TOYS, AIR PISTOLS, AMUSEMENT GAME MACHINES, AUTOMATIC AND COIN-OPERATED, ARTIFICIAL FISHING BAIT, BALLOONS, BALLS FOR GAMES, BASEBALL GLOVES, BATS FOR GAME, BATTING GLOVES, BILLIARD BALLS, BILLIARD CUE TIPS, BILLIARD CUES, BILLIARD MARKERS, BILLIARD TABLE CUSHIONS, BILLIARD TABLES, COIN-OPERATED BILLIARD TABLES, BINGO CARDS, FISHING TACKLE, BUILDING BLOCKS, BOARD GAMES, BOB-SLEIGHS, BODY BOARDS, SKATING BOOTS WITH SKATES ATTACHED, BOWLING APPARATUS AND MACHINERY, BOXING GLOVES, BUILDING GAMES, BUTTERFLY NETS, PLAYING CARDS, CHECKERBOARDS, CHECKERS, CHESS GAMES, CHESSBOARDS, GOLF CLUBS, CRICKET BAGS, CUPS FOR DICE, DARTS, DICE, DOLLS, DOLLS' BEDS, DOLLS' CLOTHES, DOLLS' FEEDING BOTTLES, DOLLS' HOUSES, DOLLS' ROOMS, DOMINOES, DRAUGHTBOARDS, DRAUGHTS, DUMB-BELLS, ELECTRONIC TARGETS FOR GAMES AND SPORTS, FLIPPERS FOR SWIMMING, FLYING DISCS, TABLES FOR INDOOR FOOTBALL GAMES, MARBLES FOR GAMES, GOLF BAGS WITH OR WITHOUT WHEELS, ICE SKATES, IN-LINE ROLLER SKATES, JIGSAW PUZZLES, PRACTICAL JOKES IN THE NATURE OF FAKE TEETH, FAKE FLOWERS SQUIRTING WATER, FAKE FINGERS, FAKE HANDS, FAKE FEET, FAKE PISTOLS SQUIRTING WATER, FAKE CIGARS, KALIDOSCOPES, MAH-JONG, MARIONETTES, SCALE MODEL VEHICLES, PIÑATAS, TOY SWIMMING POOLS, PUPPETS, RACKETS, RADIO-CONTROLLED TOY VEHICLES, RING GAMES, ROLLER SKATES, TOY SCOOTERS, SKATEBOARD, ICE SKATES, SNOW GLOBES, TOY SOAP BUBBLES, TABLES FOR TABLE TENNIS, TEDDY BEARS, THEATRICAL MASKS, TOY MASKS, TOY VEHICLES, TOYS FOR DOMESTIC PETS; GYMNASTIC AND SPORTING ARTICLES NOT INCLUDED IN OTHER CLASSES, NAMELY, BALANCE BEAMS, TENNIS BALLS; DECORATIONS FOR CHRISTMAS TREES, IN CLASS 28 (U.S. CLS. 22, 23, 38 AND 50).

FOR: MEAT, FISH, NON-LIVING MOLLUSCS AND CRUSTACEANS, POULTRY AND GAME, MEAT EXTRACTS, TINNED MEAT, PRESERVED, DRIED AND COOKED FRUITS AND VEGETABLES, JELLIES, JAMS, EGGS, EDIBLE OILS AND FATS, PICKLES, FRUIT PRESERVES, FRUIT JELLIES, FRUIT CHIPS, FRUIT PULP, FRUIT-BASED SNACK FOOD, VEGETABLE PRESERVES, MEAT PRESERVES, FISH PRESERVES, POTATO CHIPS, PORK, SAUSAGES, ANCHOVY PASTE, PROCESSED ANCHOVIES, BACON, FISH FILLETS, HAM, MARMALADE, IN CLASS 29 (U.S. CL. 46).

FOR: COFFEE, TEA, COCOA, SUGAR, RICE, TAPIOCA, SAGO, ARTIFICIAL COFFEE; FLOUR AND PREPARATIONS MADE FROM CEREALS, NAMELY, CEREAL-BASED SNACK FOODS, BISCUITS MADE WITH CEREALS, BREAD, PASTRY AND CONFECTIONERY, NAMELY, FROZEN CONFECTIONERY, CRYSTAL SUGAR PIECES, ICES; HONEY, TREACLE; YEAST, BAKING-POWDER; SALT, MUSTARD; VINEGAR, SAUCES; SPICES; ICE; ALMOND CONFECTIONERY, ALMOND PASTE, ANISEED FOR USE AS A FLAVORING IN FOOD AND DRINKS, AROMATIC PREPARATIONS FOR FOOD IN THE NATURE OF SPICES, ARTIFICIAL COFFEE, BEER VINEGAR, COCOA-BASED BEVERAGES, COFFEE-BASED BEVERAGES, TEA-BASED BEVERAGES, GINGER BREAD, BREAD ROLLS, CAKE PASTE FLAVOURED WITH CHOCOLATE, ALMOND, VANILLA, CITRUS, PISTACHIO, NUT, CAKE POWDER FLAVOURED WITH CHOCOLATE, ALMOND, VANILLA, CITRUS, PISTACHIO, NUT, CAKES, EDIBLE DECORATIONS FOR CAKES, CANDY FOR FOOD,



**Reg. No. 4,196,325** CANDY CARAMELS, CEREAL PREPARATIONS, NAMELY, GRAIN-BASED ITEMS IN THE NATURE OF TACO SHELLS, BREAD, BISCUITS, TOASTED BREAD SLICES, BREADSTICKS, CEREAL-BASED SNACK FOOD, CHEWING GUM NOT FOR MEDICAL PURPOSES, CHOCOLATE, COFFEE, COFFEE-BASED BEVERAGES, CORN FLAKES, CORN MEAL, CRACKERS, EDIBLE ICES, FARINACEOUS FOODS, NAMELY, FARINACEOUS FOOD PASTES FOR HUMAN CONSUMPTION, ROLLED OATS AND WHEAT, HONEY, ICED TEA, KETCHUP, MACARONI, PASTRY MACAROONS, MARZIPAN, MUESLI, NOODLES, PANCAKES, PASTA, PETIT-BEURRE BISCUITS, PIES, PIZZAS, RAVIOLI, RICE, RICE CAKES, RICE-BASED SNACK FOOD, SANDWICHES, SPAGHETTI, SUGAR, CEREAL OR GRAIN BASED TACO SHELLS, TAPIOCA, TARTS, TEA, ICED TEA, TORTILLAS, IN CLASS 30 (U.S. CL. 46).

FOR: BEER, NON-ALCOHOLIC BEVERAGES IN THE NATURE OF CARBONATED AND NON-CARBONATED BEVERAGES, NAMELY, FRUIT JUICES, NON CARBONATED SOFT DRINKS, NON-ALCOHOLIC HONEY-BASED BEVERAGES, NON-ALCOHOLIC CIDER, NON-ALCOHOLIC COCKTAILS, NON-ALCOHOLIC FRUIT EXTRACTS, NON-ALCOHOLIC FRUIT JUICE BEVERAGES, FRUIT JUICES, GINGER ALE, LEMONADES, MINERAL WATER, NON-ALCOHOLIC BEVERAGES, NAMELY, LOW CALORIE SOFT DRINKS, SODA WATER, SYRUPS FOR BEVERAGES, SYRUPS FOR LEMONADE, PREPARATIONS FOR MAKING AERATED WATER, MILK OF ALMONDS, NON-ALCOHOLIC APERITIFS , IN CLASS 32 (U.S. CLS. 45, 46 AND 48).

FOR: SERVICES FOR EDUCATION AND ENTERTAINMENT, NAMELY, PROVIDING CLASSES IN THE FIELD OF SCIENCE, LIVE MUSIC CONCERTS; ORGANIZATION OF EDUCATIONAL, TRAINING AND REFRESHER COURSES IN THE FIELD OF SCIENCE, MATH, COLLOQUIUMS, SEMINARS, EXHIBITIONS, SHOWS, EVENTS, COMPETITIONS, ALL IN THE FIELD OF SCIENCE, MATH, CULTURAL AND SPORTING ACTIVITIES ALL FOR ENTERTAINMENT AND/OR EDUCATIONAL PURPOSES, ON-LINE PUBLICATION OF BOOKS AND TEXTS, FILM PRODUCTION, THEATRE PRODUCTIONS, PRODUCTION AND SHOWING OF TELEVISION AND RADIO EVENTS AND SHOWS, IN CLASS 41 (U.S. CLS. 100, 101 AND 107).

FOR: PROVIDING OF FOOD AND DRINK; TEMPORARY ACCOMMODATION, IN CLASS 43 (U.S. CLS. 100 AND 101).

NO CLAIM IS MADE TO THE EXCLUSIVE RIGHT TO USE "STILTON" IN CLASSES 029 AND 043, APART FROM THE MARK AS SHOWN.

PRIORITY DATE OF 3-24-2010 IS CLAIMED.

OWNER OF INTERNATIONAL REGISTRATION 1053576 DATED 7-26-2010, EXPIRES 7-26-2020.

THE NAME(S), PORTRAIT(S), AND/OR SIGNATURE(S) SHOWN IN THE MARK DOES NOT IDENTIFY A PARTICULAR LIVING INDIVIDUAL.

THE MARK CONSISTS OF A STYLIZED MOUSE WEARING A SUIT AND GLASSES WITHIN A CONCENTRIC CIRCULAR DESIGN THAT CONTAINS THE WORDING "GERONIMO STILTON" AND A BACKGROUND PATTERN MEANT TO REPRESENT CHEESE HOLES.

SER. NO. 79-088,240, FILED 7-26-2010.

TOBY BULLOFF, EXAMINING ATTORNEY

# United States of America

United States Patent and Trademark Office

# SARAMED

**Reg. No. 4,196,326**

**Registered Aug. 28, 2012**

**Int. Cls.: 1 and 5**

**TRADEMARK**

**PRINCIPAL REGISTER**

BLÜCHER GMBH (FED REP GERMANY PRIVATE LIMITED COMPANY (LTD.))  
METTMANNER STRAÙE 25  
40699 ERKRATH  
FED REP GERMANY

FOR: CHEMICALS USED IN INDUSTRY, SCIENCE AND PHOTOGRAPHY, AS WELL AS IN AGRICULTURE, HORTICULTURE AND FORESTRY, IN PARTICULAR ACTIVATED CARBON, IN CLASS 1 (U.S. CLS. 1, 5, 6, 10, 26 AND 46).

FOR: PHARMACEUTICAL PREPARATIONS FOR THE TREATMENT OF WOUNDS AND ULCERS OF THE SKIN; NAMELY, WOUND PLASTERS, WOUND DRESSINGS, WOUND BANDAGES AND WOUND COVERINGS, EACH COMPRISING ACTIVATED CARBON; PHARMACEUTICAL PREPARATIONS FOR THE TREATMENT OF DIGESTIVE DISEASES; NAMELY, MEDICINE FOR ORAL INTAKE COMPRISING ACTIVATED CARBON FOR THE TREATMENT OF DISEASES OF THE INTESTINES AND BOWELS, ESPECIALLY FOR DIARRHEA, FOOD POISONING AND DETOXIFICATION; AND PHARMACEUTICAL PREPARATIONS FOR THE TREATMENT OF URINARY AND KIDNEY DISEASES; NAMELY, MEDICINE FOR ORAL INTAKE COMPRISING ACTIVATED CARBON FOR THE TREATMENT OF KIDNEY DISEASES, ESPECIALLY FOR DETOXIFICATION; VETERINARY PREPARATIONS FOR PETS, NAMELY, SMALL DOMESTIC ANIMALS TO TREAT WOUNDS AND ULCERS OF THE SKIN, URINARY DISEASES AND KIDNEY DISEASES; HYGIENIC PREPARATIONS FOR MEDICAL PURPOSES, NAMELY, DISINFECTANTS FOR HYGIENIC PURPOSES; DIETETIC SUBSTANCES ADAPTED FOR MEDICAL USE, NAMELY, NUTRITIVE SUBSTANCES, FOOD FOR BABIES, MEDICAL PLASTERS, MEDICAL DRESSINGS; TEETH FILLING MATERIAL AND DENTAL WAX; DISINFECTANTS FOR HYGIENE PURPOSES; PREPARATIONS FOR DESTROYING VERMIN; FUNGICIDES, HERBICIDES, IN CLASS 5 (U.S. CLS. 6, 18, 44, 46, 51 AND 52).



THE MARK CONSISTS OF STANDARD CHARACTERS WITHOUT CLAIM TO ANY PARTICULAR FONT, STYLE, SIZE, OR COLOR.

PRIORITY DATE OF 12-21-2009 IS CLAIMED.

*David J. Kappas*

OWNER OF INTERNATIONAL REGISTRATION 1054455 DATED 6-21-2010, EXPIRES 6-21-2020.

SER. NO. 79-088,531, FILED 6-21-2010.

**Reg. No. 4,196,326** ROSELLE HERRERA, EXAMINING ATTORNEY

# United States of America

United States Patent and Trademark Office



**FUTURE  
NETWORK  
CERT**

**Reg. No. 4,196,327**

**Registered Aug. 28, 2012**

**Int. Cls.: 41 and 42**

**SERVICE MARK**

**PRINCIPAL REGISTER**

CON.ECT EVENTMANAGEMENT GES.M.B.H. (AUSTRIA LIMITED LIABILITY COMPANY)  
KAISERSTRASSE 14/2  
A-1070 WIEN  
AUSTRIA

FOR: CONDUCTING OF SEMINARS FOR FURTHER EDUCATION, NAMELY, THE CONDUCTING OF PEDAGOGIC EXAMS FOR THE PURPOSE OF AWARDING CERTIFICATES FOR PROFESSIONAL CONTINUING EDUCATION IN THE FIELD OF INFORMATION TECHNOLOGY, CONDUCTING OF SYMPOSIA IN THE FIELD OF INFORMATION TECHNOLOGY, PUBLICATION OF MAGAZINES, IN CLASS 41 (U.S. CLS. 100, 101 AND 107).

FOR: SCIENTIFIC STUDIES AND ANALYSES IN THE FIELD OF INFORMATION TECHNOLOGY, CONDUCTING OF SCIENTIFIC RESEARCH, IN CLASS 42 (U.S. CLS. 100 AND 101).

NO CLAIM IS MADE TO THE EXCLUSIVE RIGHT TO USE "NETWORK CERT", APART FROM THE MARK AS SHOWN.

PRIORITY DATE OF 5-6-2010 IS CLAIMED.

OWNER OF INTERNATIONAL REGISTRATION 1054825 DATED 8-10-2010, EXPIRES 8-10-2020.

THE COLOR(S) BLUE, BLACK AND WHITE IS/ARE CLAIMED AS A FEATURE OF THE MARK.

THE MARK CONSISTS OF "FUTURE NETWORK" IN BLACK, "CERT" IN BLUE AND A BLUE AND WHITE SQUARE DESIGN TO THE LEFT OF THE WORDING.

SER. NO. 79-088,683, FILED 8-10-2010.

WILLIAM BRECKENFELD, EXAMINING ATTORNEY



*David J. Kybas*

Director of the United States Patent and Trademark Office

# United States of America

United States Patent and Trademark Office

## АЛЕКСЕЙ КОРОЛЁВ

**Reg. No. 4,196,328**

**Registered Aug. 28, 2012**

**Int. Cls.: 35, 38 and 42**

LIMITED LIABILITY COMPANY "MIND LABS." (RUSSIAN FED. OBSHESTVO S OGRANICHENNOY OTVESTSTVENNOSTYU (OOO))  
STR. 8, D. 34, UL. B. POCHTOVAYA  
RU-105082 MOSCOW  
RUSSIAN FED.

**SERVICE MARK**

FOR: ADVERTISING; BUSINESS MANAGEMENT; BUSINESS ADMINISTRATION; OFFICE FUNCTIONS, IN CLASS 35 (U.S. CLS. 100, 101 AND 102).

**PRINCIPAL REGISTER**

FOR: TELECOMMUNICATION SERVICES, NAMELY, TRANSMISSION OF VOICE, DATA, GRAPHICS, IMAGES, AUDIO AND VIDEO BY MEANS OF TELECOMMUNICATIONS NETWORKS, WIRELESS COMMUNICATION NETWORKS, AND THE INTERNET, IN CLASS 38 (U.S. CLS. 100, 101 AND 104).

FOR: SCIENTIFIC RESEARCH AND DEVELOPMENT; DESIGN AND TESTING FOR NEW PRODUCT DEVELOPMENT; INDUSTRIAL RESEARCH IN THE FIELD OF SOFTWARE FOR TELECONFERENCING AND TELEPRESENCE CONFERENCING SERVICES; DESIGN AND DEVELOPMENT OF COMPUTER HARDWARE AND SOFTWARE, IN CLASS 42 (U.S. CLS. 100 AND 101).

THE NAME(S), PORTRAIT(S), AND/OR SIGNATURE(S) SHOWN IN THE MARK IDENTIFIES ALEKSEY KOROLYOV, WHOSE CONSENT(S) TO REGISTER IS MADE OF RECORD.

PRIORITY DATE OF 4-28-2010 IS CLAIMED.

OWNER OF INTERNATIONAL REGISTRATION 1057972 DATED 9-16-2010, EXPIRES 9-16-2020.

THE TRANSLITERATION OF THE NON-LATIN CHARACTERS IN THE MARK IS: ALEKSEY KOROLYOV.

THE MARK CONSISTS OF THE WORDING "ALEKSEY KOROLYOV" IN STYLIZED CYRILLIC FONT.

SER. NO. 79-089,850, FILED 9-16-2010.

STEVEN PEREZ, EXAMINING ATTORNEY



*David J. Kyros*

Director of the United States Patent and Trademark Office

# United States of America

United States Patent and Trademark Office

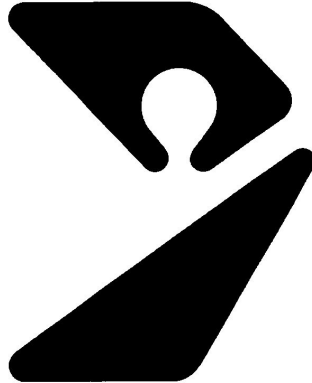

**Reg. No. 4,196,329**

**Registered Aug. 28, 2012**

**Int. Cls.: 6, 19 and 37**

**TRADEMARK**

**SERVICE MARK**

**PRINCIPAL REGISTER**

LEMMINKÄINEN OYJ (FINLAND CORPORATION)  
SALMISAARENAUKIO 2  
HELSINKI, FINLAND FI00180

FOR: COMMON METALS AND THEIR ALLOYS; METAL BUILDING MATERIALS, NAMELY, PROFILES, TUBES, SCAFFOLDS, BUILDING FLASHINGS, CHIMNEYS, CLADDINGS FOR BUILDING AND CONSTRUCTION, METAL ROOFS AND ROOFINGS, STAIR CASES, PREFABRICATED PLATFORMS, PREFABRICATED METAL BRIDGES, METAL WALL FRAMES AND PANELS, METAL GATES, METAL DOORS, METAL WINDOWS AND WINDOW CASEMENTS, METAL PILES AND ARMOUR STEEL; TRANSPORTABLE BUILDINGS OF METAL; MATERIALS OF METAL FOR RAILWAY TRACKS; NON-ELECTRIC CABLES AND WIRES OF COMMON METAL; IRONMONGERY IN THE NATURE OF SMALL ITEMS OF METAL HARDWARE, NAMELY, METAL SASH FASTENERS FOR WINDOWS, BOLTS, NAILS, RIVETS, SCREWS, BRADS, CLAMPS, COTTER PINS, BALL LOCK PINS, WHITE METAL PINS, NUTS; PIPES AND TUBES OF METAL; METAL SAFES; METAL ORES; METAL WIRE FENCES, GATES AND LATCH BARS; METAL STANDS FOR AUDIENCE, NAMELY, METAL BLEACHERS, AND METAL GRATING; METAL GUTTERS; METAL ROOFINGS, IN CLASS 6 (U.S. CLS. 2, 12, 13, 14, 23, 25 AND 50).

FOR: NON-METALLIC BUILDING MATERIALS, NAMELY, SAWN TIMBER, CONSTRUCTION TIMBER, AND PARTLY PROCESSED TIMBER FOR USE IN CONSTRUCTION INDUSTRIES; NON-METALLIC RIGID PIPES FOR BUILDING; ASPHALT, PITCH AND BITUMEN; NON-METALLIC TRANSPORTABLE BUILDINGS; MONUMENTS, NOT OF METAL; BITUMINOUS ROOFING MATERIALS AND WATERPROOFING PRODUCTS, NAMELY, BITUMEN ROOFING MEMBRANES, BITUMEN SHINGLES, BITUMEN ROOFING SEALANTS AND FIXATIVES; CONCRETE COVERING STONES, CERAMIC AND CONCRETE TILES, CERAMIC AND CONCRETE EDGING BLOCKS, CERAMIC AND CONCRETE EDGING TILES, NON-METAL FENCES, CONCRETE WALLS, CONCRETE RETAINING WALLS, AND WALL STONES, CONCRETE BREEZE-BLOCKS, NON-METAL WATER CHANNELS IN THE NATURE OF NON-METAL GUTTERS FOR ROOFS, BALCONIES, STREETS AND YARDS; AND NON-METAL CONSTRUCTION MATERIALS, NAMELY, CUPS FOR COLLECTING RAIN WATER, GOUGE SLABS OF CONCRETE, NON-METAL EXTERIOR STAIRS, CONCRETE DRIVING HINDRANCES, NAMELY, CRASH BARRIERS AND PORTABLE TRAFFIC BARRIERS, AND CONCRETE BOLLARDS, STAIRCASE UNITS OF MOSAIC CONCRETE, NATURAL STONE OR CONCRETE, STEPS IN THE NATURE OF NON-METAL STAIRS; AND CEMENT CHAIR SLABS; BUILDING MATERIALS, NAMELY, ASPHALT



*David J. Kyjars*

Director of the United States Patent and Trademark Office

**Reg. No. 4,196,329** AND BITUMEN ROOF COATING; NON-METALLIC FENCES, GATES AND LATCH BARS, IN CLASS 19 (U.S. CLS. 1, 12, 33 AND 50).

FOR: BUILDING CONSTRUCTION; BUILDING REPAIR; INSTALLATION SERVICES IN THE FIELD OF RESIDENTIAL CONSTRUCTION, COMMERCIAL AND OFFICE CONSTRUCTION, INDUSTRIAL AND LOGISTICS CONSTRUCTION, SPORTS AND RECREATIONAL CONSTRUCTION, AND INFRASTRUCTURE CONSTRUCTION RELATING TO UPKEEP OF ROADS, STREETS AND RAIL NETWORKS, NAMELY, INSTALLATION OF ELECTRICAL SYSTEMS, HVAC SYSTEMS, PLUMBING SYSTEMS, FIRE PROTECTION SYSTEMS, ALARM SYSTEMS, LIGHTING SYSTEMS, COOLING SYSTEMS, HEATING SYSTEMS, TELECOMMUNICATION SYSTEMS, DATA NETWORK SYSTEMS, SECURITY SYSTEMS, AUTOMATION SYSTEMS, IRRIGATION SYSTEMS, AND STRUCTURAL AND DECORATIVE BUILDING ELEMENTS AND COMPONENTS, NAMELY, BUILDING TIMBER, BUILDING STONES, BUILDING GLASS, CONCRETE BLOCKS, BRICKS, PAVERS, POSTS, SLABS, PANELS, BEAMS, GIRDERS, DRYWALL, COLUMNS, PAVING STONES, TILES, WALLS, WALL FORMS, FACADES, FLOOR SLABS, FLOORING, SHUTTERS, SHINGLES, SIDING, PIPES, PANELING, GUTTERS, WINDOWS AND WINDOW FRAMES, DOORS AND DOOR FRAMES, FIREPLACES, CHIMNEYS, STAIRS AND STAIRCASES, CEILINGS, AND ROOFING; RESIDENTIAL BUILDING CONSTRUCTION SERVICES AND INFRASTRUCTURE CONSTRUCTION SERVICES, NAMELY, MUNICIPAL INFRASTRUCTURE CONSTRUCTION SERVICES, WATER SUPPLY INFRASTRUCTURE CONSTRUCTION SERVICES, SEWER INFRASTRUCTURE CONSTRUCTION SERVICES, PUBLIC TRANSPORTATION INFRASTRUCTURE CONSTRUCTION SERVICES, BRIDGE INFRASTRUCTURE CONSTRUCTION SERVICES, AIRPORT INFRASTRUCTURE CONSTRUCTION SERVICES, PEDESTRIAN TUNNELS INFRASTRUCTURE CONSTRUCTION SERVICES, NOISE BARRIER INFRASTRUCTURE CONSTRUCTION SERVICES, ROAD INFRASTRUCTURE CONSTRUCTION SERVICES, AND RAIL NETWORK INFRASTRUCTURE CONSTRUCTION SERVICE; INFRASTRUCTURE BUILDING CONSTRUCTION SERVICES; INSTALLATION, REPAIR AND MAINTENANCE SERVICES RELATED TO TECHNICAL BUILDING SERVICES; CONSULTING SERVICES RELATED TO RESIDENTIAL CONSTRUCTION, INFRASTRUCTURE CONSTRUCTION AND INSTALLATION, REPAIR AND MAINTENANCE OF TECHNICAL BUILDING SERVICES; REPAIR AND MAINTENANCE SERVICES OF REAL ESTATE; QUARRYING, CRUSHING AND SCREENING OF MINERALS AGGREGATE; CONSTRUCTION SERVICES, NAMELY, ASPHALT PAVING AND FOUNDATION STRUCTURING; INSTALLATIONS, MAINTENANCE AND REPAIR OF AUTOMATION SYSTEMS; METAL AND STEEL STRUCTURES CONSTRUCTION; BUILDING OF TELECOMMUNICATIONS NETWORKS, IN CLASS 37 (U.S. CLS. 100, 103 AND 106).

OWNER OF U.S. REG. NO. 1,052,070.

PRIORITY DATE OF 10-29-2009 IS CLAIMED.

OWNER OF INTERNATIONAL REGISTRATION 1058800 DATED 3-17-2010, EXPIRES 3-17-2020.

THE MARK CONSISTS OF AN ABSTRACT DESIGN AND A TRIANGLE WITH ROUNDED EDGES. THE TRANSPARENT AREA IN THE MIDDLE REPRESENTS A MAN.

SER. NO. 79-090,159, FILED 3-17-2010.

BERNICE MIDDLETON, EXAMINING ATTORNEY

# United States of America

United States Patent and Trademark Office

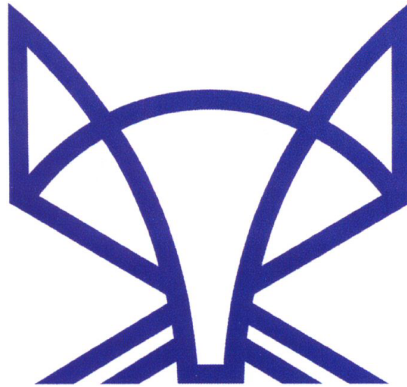

**Reg. No. 4,196,330**

**Registered Aug. 28, 2012**

**Int. Cls.: 6, 7, 12 and 40**

**TRADEMARK**

**SERVICE MARK**

**PRINCIPAL REGISTER**

OTTO FUCHS KG (FED REP GERMANY KG)  
DERSCHLAGER STRAÙE 26  
58540 MEINERZHAGEN, FED REP GERMANY

FOR: COMMON METALS AND THEIR ALLOYS; BUILDING MATERIALS MADE OF METAL, NAMELY, SUPPORT PROFILES, SOLAR SUPPORT PROFILES, FRAME PROFILES, SUN BARRIERS, DOOR PROFILES, WATER AND FLOOD BARRIERS, BALCONY FLOORING, BRIDGE COVER PROFILES, CATWALKS, FORM WORK TABLES, SCAFFOLDING, SIDE BEAMS, SCAFFOLDING FRAMES, LIGHT MASTS, MAST FITTINGS, HINGED LIDS; GOODS OF METAL, IN PARTICULAR PRODUCTS MANUFACTURED BY EXTRUSION, CASTING AND FORGING, NAMELY, SUPPORT PROFILES, SOLAR SUPPORT PROFILES, FRAME PROFILES, SUN BARRIERS, RACK PROFILES, GUIDE BARS, DOOR PROFILES, WATER AND FLOOD BARRIERS, BALCONY FLOORING, BRIDGE COVER PROFILES, CATWALKS, FORM WORK TABLES, SCAFFOLDING, SIDE BEAMS, SCAFFOLDING FRAMES, LIGHT MASTS, MAST FITTINGS, HINGED LIDS; METAL SCAFFOLDING AND COMPONENTS THEREOF; RAMPS FOR CARS MADE OF METAL, IN CLASS 6 (U.S. CLS. 2, 12, 13, 14, 23, 25 AND 50).

FOR: PARTS OF ENGINES OR MOTORS, NAMELY, SUPPORT PLATES FOR TRANSMISSION APPLICATIONS, BEING PARTS OF MACHINES; IMPELLERS, NAMELY, PUMP IMPELLERS AND AXIAL BEARINGS FOR TURBO CHARGERS, OTHER THAN FOR LAND VEHICLES; POWERED LOADING RAMPS; POWERED LOADING BRIDGES IN THE NATURE OF GANTRY CRANES, IN CLASS 7 (U.S. CLS. 13, 19, 21, 23, 31, 34 AND 35).

FOR: VEHICLE PARTS MANUFACTURED FROM COMMON METALS OR THEIR ALLOYS, NAMELY, WHEELS, IN PARTICULAR FORGED WHEELS; PARTS FOR WHEEL SUSPENSION SYSTEMS FOR LAND VEHICLES IN THE NATURE OF LOWER CONTROL ARMS, TRANSVERSAL LINKS, LINK ASSEMBLIES, TRACTION LINKS, JOINTS, PIVOTS, HOMOCINETICAL HINGES, HOUSING, FLANGES, SPLINE HOUSINGS; PARTS FOR POWER TRANSMISSION IN THE NATURE OF SUPPORT PLATES FOR LAND VEHICLES; PARTS FOR VEHICLE HYDRAULIC SYSTEMS IN THE NATURE OF ANTI-LOCK BRAKING SYSTEM HOUSINGS; RIPS AND PROFILES FOR AIRCRAFT CONSTRUCTIONS AS STRUCTURAL PARTS; PARTS OF LAND VEHICLES, NAMELY, SIDE IMPACT BEAMS, CROSS CAR BEAMS, IN CLASS 12 (U.S. CLS. 19, 21, 23, 31, 35 AND 44).

FOR: TREATMENT OF NON-FERROUS METALS; MANUFACTURING OF PARTS AND COMPONENTS OF AUTOMOBILES, PARTS AND COMPONENTS OF AIRPLANES, PARTS



*David J. Kybas*

Director of the United States Patent and Trademark Office



**Reg. No. 4,196,330** AND COMPONENTS OF SHIPS, PARTS AND COMPONENTS OF MACHINES AND CONSTRUCTIONAL PARTS OF NON-FERROUS METAL TO THE ORDER AND SPECIFICATION OF OTHERS; TREATMENT OF MATERIALS, NAMELY, FORGING, EXTRUDING, RING ROLLING, ALL TO THE ORDER AND SPECIFICATION OF OTHERS, IN CLASS 40 (U.S. CLS. 100, 103 AND 106).

THE MARK CONSISTS OF A STYLIZED DESIGN OF A HEAD OF A FOX IN BLUE.

PRIORITY DATE OF 6-23-2010 IS CLAIMED.

OWNER OF INTERNATIONAL REGISTRATION 1058832 DATED 9-6-2010, EXPIRES 9-6-2020.

THE COLOR(S) BLUE IS/ARE CLAIMED AS A FEATURE OF THE MARK.

SER. NO. 79-090,172, FILED 9-6-2010.

BERNICE MIDDLETON, EXAMINING ATTORNEY

# United States of America

United States Patent and Trademark Office

# Green Shoots

**Reg. No. 4,196,331**

**Registered Aug. 28, 2012**

**Int. Cls.: 35 and 36**

SEBASTIAN SCHAEFER C/O GREEN SHOOTS CAPITAL LLC (SWITZERLAND LIMITED LIABILITY COMPANY)  
RATHAUSSTRASSE 14  
CH-6341 BAAR  
SWITZERLAND

**SERVICE MARK**

FOR: ADVERTISING AND MARKETING, BUSINESS MANAGEMENT, BUSINESS ADMINISTRATION AND OFFICE FUNCTIONS, IN CLASS 35 (U.S. CLS. 100, 101 AND 102).

**PRINCIPAL REGISTER**

FOR: FINANCIAL AFFAIRS AND MONETARY AFFAIRS, NAMELY, FINANCIAL INFORMATION, MANAGEMENT AND ANALYSIS SERVICES, IN CLASS 36 (U.S. CLS. 100, 101 AND 102).

THE MARK CONSISTS OF STANDARD CHARACTERS WITHOUT CLAIM TO ANY PARTICULAR FONT, STYLE, SIZE, OR COLOR.

PRIORITY DATE OF 6-25-2010 IS CLAIMED.

OWNER OF INTERNATIONAL REGISTRATION 1059322 DATED 10-20-2010, EXPIRES 10-20-2020.

SER. NO. 79-090,309, FILED 10-20-2010.

SUSAN LESLIE DUBOIS, EXAMINING ATTORNEY



*David J. Kyffers*

Director of the United States Patent and Trademark Office

# United States of America

United States Patent and Trademark Office

# iBuildNet

**Reg. No. 4,196,332**

**Registered Aug. 28, 2012**

**Int. Cl.: 38**

**SERVICE MARK**

**PRINCIPAL REGISTER**

RANPLAN WIRELESS NETWORK DESIGN LTD. (UNITED KINGDOM LIMITED COMPANY)  
15 FAIRFORD AVENUE  
LUTON, BEDFORDSHIRE, LU2 7ER  
UNITED KINGDOM

FOR: TELECOMMUNICATIONS CONSULTATION IN THE NATURE OF TECHNICAL CONSULTING IN THE FIELD OF WIRELESS AUDIO, TEXT AND VISUAL DATA TRANSMISSION AND COMMUNICATION WITHIN COMMERCIAL OFFICE BUILDINGS; PROVIDING AN ON-LINE FORUM FOR TELECOMMUNICATION SCIENTISTS AND OPERATORS CONCERNING THE DESIGN AND DEVELOPMENT OF WIRELESS TELECOMMUNICATIONS NETWORKS WITHIN COMMERCIAL OFFICE BUILDINGS, IN CLASS 38 (U.S. CLS. 100, 101 AND 104).

THE MARK CONSISTS OF STANDARD CHARACTERS WITHOUT CLAIM TO ANY PARTICULAR FONT, STYLE, SIZE, OR COLOR.

OWNER OF INTERNATIONAL REGISTRATION 1063804 DATED 11-10-2010, EXPIRES 11-10-2020.

SER. NO. 79-092,089, FILED 11-10-2010.

LOURDES AYALA, EXAMINING ATTORNEY



*David J. Kyffers*

Director of the United States Patent and Trademark Office

# United States of America

United States Patent and Trademark Office

# TF Est. 1968

**Reg. No. 4,196,333**

FREDDY D. TSCHUMI (SWITZERLAND INDIVIDUAL)  
HIRTENHOFSTRASSE 40

**Registered Aug. 28, 2012**

LUCERNE, SWITZERLAND CH6005

**Int. Cls.: 14 and 18**

FOR: PRECIOUS METALS AND THEIR ALLOYS AND GOODS MADE OF OR COATED WITH THESE MATERIALS, NAMELY, JEWELRY, WATCHES, CUFFLINKS, KEY HOLDERS, AND TIE CLIPS; PRECIOUS STONES, JEWELRY; WRISTWATCHES AND CHRONOMETRIC INSTRUMENTS, IN CLASS 14 (U.S. CLS. 2, 27, 28 AND 50).

**TRADEMARK**

**PRINCIPAL REGISTER**

FOR: LEATHER AND IMITATIONS OF LEATHER, AND GOODS MADE OF THESE MATERIALS, NAMELY, LEATHER WALLET, BAGS, CREDIT CARD HOLDERS, SUITCASES, BRIEFCASE-TYPE PORTFOLIOS, AND PURSES; TRUNKS AND TRAVELLING BAGS, UMBRELLAS, IN CLASS 18 (U.S. CLS. 1, 2, 3, 22 AND 41).

THE MARK CONSISTS OF STANDARD CHARACTERS WITHOUT CLAIM TO ANY PARTICULAR FONT, STYLE, SIZE, OR COLOR.

PRIORITY DATE OF 10-1-2010 IS CLAIMED.

OWNER OF INTERNATIONAL REGISTRATION 1064046 DATED 12-3-2010, EXPIRES 12-3-2020.

NO CLAIM IS MADE TO THE EXCLUSIVE RIGHT TO USE "EST.1968", APART FROM THE MARK AS SHOWN.

SER. NO. 79-092,185, FILED 12-3-2010.

TASNEEM HUSSAIN, EXAMINING ATTORNEY



*David J. Kybas*

Director of the United States Patent and Trademark Office

# United States of America

United States Patent and Trademark Office

BY®K

**Reg. No. 4,196,334**

**Registered Aug. 28, 2012**

**Int. Cls.: 9, 12 and 25**

**TRADEMARK**

**PRINCIPAL REGISTER**

KIDS BIKE CO PTY LTD (AUSTRALIA COMPANY)  
37 QUEENS PARADE  
CLIFTON HILL VIC 3068  
AUSTRALIA

FOR: PROTECTIVE CLOTHING FOR CYCLING, NAMELY, SHIRTS, VESTS, SHORTS AND PANTS WITH PROTECTIVE INSERTS OR MADE FROM PROTECTIVE MATERIALS FOR PROTECTION AGAINST ACCIDENTS; CYCLING HELMETS; SUNGLASSES; PROTECTIVE EYEWEAR; PROTECTIVE DEVICES FOR PERSONAL USE AGAINST ACCIDENTS, NAMELY, LIGHTED AND REFLECTIVE VESTS, ARM BANDS, AND ANKLE BANDS; PROTECTIVE GLOVES FOR PROTECTION AGAINST ACCIDENTS; ALL THE AFORESAID BEING FOR BICYCLE RIDERS, IN CLASS 9 (U.S. CLS. 21, 23, 26, 36 AND 38).

FOR: APPARATUS FOR LOCOMOTION BY LAND, NAMELY, BICYCLES, CHILDREN'S BICYCLES, TRICYCLES, TANDEM BICYCLES, MOUNTAIN BICYCLES, ROAD BICYCLES; PARTS AND ACCESSORIES FOR BICYCLES IN THIS CLASS, NAMELY, PEDALS, FORKS, BRAKES, SHOCK ABSORBERS, BICYCLE RACKS FOR VEHICLES, HANDLEBARS, MIRRORS, BELLS, BEARINGS, BIKE FRAMES AND WHEELS, IN CLASS 12 (U.S. CLS. 19, 21, 23, 31, 35 AND 44).

FOR: CLOTHING, NAMELY, SHIRTS, GLOVES, JACKETS AND PANTS; FOOTWEAR; HEADGEAR, NAMELY, HATS, CAPS, HEADBANDS; CYCLISTS' CLOTHING, NAMELY, SHIRTS, GLOVES, JACKETS AND PANTS FOR CYCLING, AND CYCLE SHOES; ALL THE AFORESAID BEING FOR BICYCLE RIDERS, IN CLASS 25 (U.S. CLS. 22 AND 39).

THE MARK CONSISTS OF THE LETTERS "BY" FOLLOWED BY THE LETTER "K", WITH A CIRCLE AROUND THE LETTER "K".

PRIORITY DATE OF 9-6-2010 IS CLAIMED.

OWNER OF INTERNATIONAL REGISTRATION 1064912 DATED 10-7-2010, EXPIRES 10-7-2020.

SER. NO. 79-092,495, FILED 10-7-2010.

LINDA LAVACHE, EXAMINING ATTORNEY



*David J. Kyros*

Director of the United States Patent and Trademark Office

# United States of America

United States Patent and Trademark Office



**Reg. No. 4,196,335**

**Registered Aug. 28, 2012**

**Int. Cls.: 9, 16, 35, 36, 37, 38, 39, 41, 42 and 45**

NATURAL SECURITY (FRANCE SOCIÉTÉ PAR ACTIONS SIMPLIFIÉE, IMMATRICULÉE AU RCS SOUS LE N°507 967 933)  
165 AVENUE DE BRETAGNE -  
EURATECHNOLOGIES LILLE; F-59000 LILLE CEDEX  
FRANCE

**TRADEMARK**

**SERVICE MARK**

**PRINCIPAL REGISTER**

FOR: COMPUTER SOFTWARE FOR BIOMETRIC AUTHENTICATION; COMPUTER SOFTWARE WITH OR WITHOUT CONTACT BETWEEN THE INDIVIDUAL AND THE COMPUTER DEVICE RECORDED ON DATA MEDIA OR THAT MAY BE DOWNLOADED FROM ANY KIND OF COMMUNICATION NETWORK; COMPUTER DEVICES FOR BIOMETRIC AUTHENTICATION WITH OR WITHOUT CONTACT, NAMELY, COMPUTER SYSTEMS COMPRISING COMPUTER SOFTWARE AND DATA PROCESSORS USED TO AUTHENTICATE AN INDIVIDUAL BIOMETRICALLY WITH OR WITHOUT CONTACT BETWEEN THE INDIVIDUAL AND THE COMPUTER DEVICE; COMPUTER STORAGE MEDIA, NAMELY, CD-ROMS, HARD DRIVES, SMART CARDS AND MEMORY CARDS ON WHICH COMPUTER PROGRAMS FOR BIOMETRIC AUTHENTICATION WITH OR WITHOUT CONTACT ARE RECORDED; MAGNETICALLY ENCODED BANK CARDS; MAGNETICALLY ENCODED PAYMENT CARDS; MAGNETICALLY ENCODED DEBIT CARDS; MAGNETICALLY ENCODED CREDIT CARDS; DATA PROCESSORS; COMPUTER PERIPHERAL DEVICES; ELECTRONIC PAYMENT TERMINALS; MULTIFUNCTION AUTOMATA FOR BANKING, NAMELY, INTERACTIVE ELECTRONIC TERMINALS FOR BIOMETRIC AUTHENTICATION WITH OR WITHOUT PHYSICAL CONTACT BETWEEN THE INDIVIDUAL AND THE AUTHENTICATION DEVICE IN THE FIELDS OF BANKING, SECURED MANAGEMENT OF IDENTITIES AND PASSWORDS, SECURED ACCESS TO ONLINE GAMES SITES, SECURED ONLINE SUBSCRIPTIONS TO PRODUCTS AND SERVICES AND SECURED SIGNATURE OF MESSAGES AND DOCUMENTS; ELECTRIC PAYMENT TERMINALS; AUTOMATIC TELLER MACHINES (ATM) USED FOR WITHDRAWING MONEY, FOR CONSULTING BANK AND FINANCIAL ACCOUNTS AND FOR DEPOSITING MONEY; INTERACTIVE MULTIFUNCTIONAL ELECTRONIC PAYMENT TERMINAL; INTERACTIVE ELECTRONIC PAYMENT TERMINALS FOR ALL TYPES OF GOODS AND SERVICES; INTERNET ACCESS DEVICES, NAMELY, NETWORK ACCESS SERVER HARDWARE; MOBILE INTERNET CONSULTATION TERMINALS, NAMELY, MOBILE COMPUTERS AND CELL PHONES; TELEVISION NETWORK CONNECTION BOXES, NAMELY, NETWORK ACCESS SERVER HARDWARE; DOWNLOADABLE ELECTRONIC PUBLICATIONS, NAMELY, WRITTEN ARTICLES, BOOKS, MAGAZINES, FASCICLES, USER MANUALS AND INSTRUCTION MANUALS IN THE FIELD OF COMPUTER SYSTEMS FOR BIOMETRIC AUTHENTICATION



*David J. Kappas*

Director of the United States Patent and Trademark Office

**Reg. No. 4,196,335** WITH OR WITHOUT PHYSICAL CONTACT BETWEEN THE INDIVIDUAL AND THE AUTHENTICATION DEVICE, IN CLASS 9 (U.S. CLS. 21, 23, 26, 36 AND 38).

FOR: PRINTED MATTER, NAMELY, BOOKS, MAGAZINES, PAMPHLETS, FASCICLES, USER MANUALS AND INSTRUCTION MANUALS, ALL IN THE FIELD OF BIOMETRIC AUTHENTICATION, IN CLASS 16 (U.S. CLS. 2, 5, 22, 23, 29, 37, 38 AND 50).

FOR: BUSINESS CONSULTING IN THE FIELDS OF PROFESSIONAL AND COMMERCIAL ADVICE RELATING TO BIOMETRIC AUTHENTICATION SOFTWARE AND IN THE FIELDS OF COMPUTER SOFTWARE FOR BIOMETRIC AUTHENTICATION WITH OR WITHOUT PHYSICAL CONTACT BETWEEN THE INDIVIDUAL AND THE AUTHENTICATION DEVICE, COMPUTER DEVICES FOR BIOMETRIC AUTHENTICATION WITH OR WITHOUT CONTACT, COMPUTER STORAGE MEDIA ON WHICH COMPUTER PROGRAMS FOR BIOMETRIC AUTHENTICATION WITH OR WITHOUT CONTACT ARE RECORDED, COMPUTER BANK CARDS, COMPUTER PAYMENT CARDS, COMPUTER DEBIT CARDS, COMPUTER CREDIT CARDS, DATA PROCESSING EQUIPMENT AND COMPUTER PERIPHERALS; COMPILATION AND MANAGEMENT OF COMPUTER DATABASES; BUSINESS MANAGEMENT SERVICES, NAMELY, ADMINISTRATION OF BUSINESS ENGAGED IN SECURE PAYMENT SERVICES CARRIED OUT USING COMPUTER MEANS OF BIOMETRIC AUTHENTICATION WITH OR WITHOUT PHYSICAL CONTACT BETWEEN THE INDIVIDUAL AND THE AUTHENTICATION DEVICE; ADMINISTRATIVE MANAGEMENT OF COMPUTER SYSTEMS FOR ACCESSING SERVICES OF ALL KINDS OR FOR SECURE PAYMENT CARRIED OUT BY COMPUTER MEANS FOR BIOMETRIC AUTHENTICATION WITH OR WITHOUT CONTACT; BUSINESS MANAGEMENT SERVICES, NAMELY, ADMINISTRATION OF BUSINESS ENGAGED IN THE COORDINATION OF THE PREVENTION OF FRAUDS IN CONNECTION WITH OPERATIONS TO ACCESS SERVICES OF ALL KINDS OR SECURE PAYMENT SERVICES CARRIED OUT BY COMPUTER MEANS FOR BIOMETRIC AUTHENTICATION WITH OR WITHOUT PHYSICAL CONTACT BETWEEN THE INDIVIDUAL AND THE AUTHENTICATION DEVICE, IN CLASS 35 (U.S. CLS. 100, 101 AND 102).

FOR: INFORMATION AND CONSULTING REGARDING BANKING SERVICES, BILL PAYMENT VIA COMPUTER SYSTEMS, BANK CARDS, PAYMENT CARDS, DEBIT CARDS, CREDIT CARDS; ISSUANCE OF CREDIT CARDS; BANK CARD, PAYMENT CARDS, DEBIT CARDS SERVICES; FINANCIAL MANAGEMENT OF PAYMENT OPERATIONS AND OF COMPUTER PAYMENT SYSTEMS; PROVIDING INFORMATION IN CONNECTION WITH BILL PAYMENT SERVICES; FINANCIAL RESEARCH WITH A VIEW TO DETECTING FRAUDS CONCERNING PAYMENT OPERATIONS AND COMPUTER PAYMENT SYSTEMS, IN CLASS 36 (U.S. CLS. 100, 101 AND 102).

FOR: INSTALLATION AND MAINTENANCE OF COMPUTER HARDWARE DEVICES FOR BIOMETRIC AUTHENTICATION WITH OR WITHOUT PHYSICAL CONTACT BETWEEN THE INDIVIDUAL AND THE AUTHENTICATION DEVICE; TECHNICAL SUPPORT SERVICES, NAMELY, SOLVING SOFTWARE AND COMPUTER PROGRAM PROBLEMS; REPAIR OF COMPUTER HARDWARE DEVICES, IN CLASS 37 (U.S. CLS. 100, 103 AND 106).

FOR: TELECOMMUNICATION SERVICES, NAMELY, ELECTRONIC DATA TRANSMISSION SERVICES ON SECURE COMMUNICATION NETWORKS; RENTAL OF ACCESS TIME TO A DATABASE SERVER CENTER; RENTAL OF ACCESS TIME TO A SECURE COMMUNICATION NETWORK, IN CLASS 38 (U.S. CLS. 100, 101 AND 104).

FOR: ELECTRONIC STORAGE OF DATA ON SECURE COMPUTER SERVERS, IN CLASS 39 (U.S. CLS. 100 AND 105).

FOR: EDITING OF ELECTRONIC PUBLICATIONS, DOWNLOADABLE OR NOT, IN CONNECTION WITH COMPUTER SYSTEMS FOR BIOMETRIC AUTHENTICATION WITH OR WITHOUT PHYSICAL CONTACT BETWEEN THE INDIVIDUAL AND THE AUTHENTICATION DEVICE; PUBLICATION OF PRINTED MATTER, BOOKS, MAGAZINES, PAMPHLETS,

**Reg. No. 4,196,335** FASCICLES, USER MANUALS AND INSTRUCTION MANUALS; PUBLICATION OF PRINTED REPORTS AND STUDIES IN THE FIELD OF BIOMETRIC CONTROL AND AUTHENTICATION WITH OR WITHOUT CONTACT, IN CLASS 41 (U.S. CLS. 100, 101 AND 107).

FOR: DESIGN AND DEVELOPMENT OF SOFTWARE AND OF APPLICATION PROGRAMMING INTERFACES (API); PROVIDING INFORMATION IN THE FIELD OF THE INSTALLATION, MAINTENANCE AND REPAIR OF COMPUTER SOFTWARE FOR BIOMETRIC AUTHENTICATION WITH OR WITHOUT PHYSICAL CONTACT BETWEEN THE INDIVIDUAL AND THE AUTHENTICATION DEVICE STORED ON DATA MEDIA OR DOWNLOADABLE FROM ANY TYPE OF COMMUNICATION NETWORK; PROVIDING INFORMATION IN THE FIELD OF THE INSTALLATION, MAINTENANCE AND REPAIR OF COMPUTER HARDWARE DEVICES FOR BIOMETRIC AUTHENTICATION WITH OR WITHOUT CONTACT, NAMELY, COMPUTER SYSTEMS COMBINING COMPUTER SOFTWARE AND DATA PROCESSING EQUIPMENT USED TO AUTHENTICATE AN INDIVIDUAL BIOMETRICALLY WITH OR WITHOUT CONTACT BETWEEN THE INDIVIDUAL AND THE COMPUTER DEVICE; INFORMATION SERVICES IN THE FIELD OF THE DESIGN AND DEVELOPMENT OF COMPUTER STORAGE MEDIA ON WHICH COMPUTER PROGRAMS FOR BIOMETRIC AUTHENTICATION WITH OR WITHOUT CONTACT ARE STORED, DATA PROCESSING EQUIPMENT AND COMPUTER PERIPHERAL DEVICES; DEVELOPING QUALITY CONTROL STANDARDS AND PROVIDING TESTING, MONITORING AND INSPECTION SERVICES, ALL IN THE FIELDS OF COMPUTER SOFTWARE AND HARDWARE USED TO ACCESS SERVICES OF ALL KINDS AND PAYMENT OPERATIONS, CARRIED OUT BY COMPUTER MEANS FOR BIOMETRIC AUTHENTICATION WITH OR WITHOUT PHYSICAL CONTACT BETWEEN THE INDIVIDUAL AND THE AUTHENTICATION DEVICE; RESEARCH AND DEVELOPMENT IN THE FIELD OF COMPUTER SOFTWARE FOR BIOMETRIC AUTHENTICATION WITH OR WITHOUT PHYSICAL CONTACT BETWEEN THE INDIVIDUAL AND THE AUTHENTICATION DEVICE; RESEARCH AND DEVELOPMENT IN THE FIELD OF COMPUTER DEVICES FOR BIOMETRIC AUTHENTICATION WITH OR WITHOUT CONTACT, NAMELY, COMPUTER SYSTEMS COMBINING COMPUTER SOFTWARE AND DATA PROCESSING EQUIPMENT USED TO AUTHENTICATE AN INDIVIDUAL BIOMETRICALLY WITH OR WITHOUT CONTACT BETWEEN THE INDIVIDUAL AND THE COMPUTER DEVICE; RESEARCH AND DEVELOPMENT IN THE FIELD OF BIOMETRIC CONTROL AND AUTHENTICATION WITH OR WITHOUT PHYSICAL CONTACT BETWEEN THE INDIVIDUAL AND THE AUTHENTICATION DEVICE; PUBLISHING OF COMPUTER SOFTWARE, OF COMPUTER SOFTWARE FOR BIOMETRIC AUTHENTICATION WITH OR WITHOUT CONTACT STORED ON DATA MEDIA OR DOWNLOADABLE FROM ANY TYPE OF COMMUNICATION NETWORK; COMPUTER SECURITY CONSULTANCY IN THE FIELD OF SECURE ACCESS TO SERVICES OF ALL KINDS AND TO SECURE PAYMENT SERVICES PROVIDED BY COMPUTER MEANS FOR BIOMETRIC AUTHENTICATION WITH OR WITHOUT PHYSICAL CONTACT BETWEEN THE INDIVIDUAL AND THE AUTHENTICATION DEVICE; INSTALLATION AND MAINTENANCE OF COMPUTER SOFTWARE, OF COMPUTER SOFTWARE FOR BIOMETRIC AUTHENTICATION WITH OR WITHOUT CONTACT, OF RECORDED COMPUTER PROGRAMS, OF COMPUTER PROGRAMS FOR BIOMETRIC AUTHENTICATION WITH OR WITHOUT CONTACT, IN CLASS 42 (U.S. CLS. 100 AND 101).

FOR: LICENSING OF COMPUTER SOFTWARE FOR BIOMETRIC AUTHENTICATION WITH OR WITHOUT PHYSICAL CONTACT BETWEEN THE INDIVIDUAL AND THE AUTHENTICATION DEVICE; LICENSING OF COMPUTER DEVICES FOR BIOMETRIC AUTHENTICATION WITH OR WITHOUT CONTACT, NAMELY, COMPUTER SYSTEMS COMBINING COMPUTER SOFTWARE AND DATA PROCESSING EQUIPMENT USED TO AUTHENTICATE AN INDIVIDUAL BIOMETRICALLY WITH OR WITHOUT CONTACT BETWEEN THE INDIVIDUAL AND THE COMPUTER DEVICE; PROVIDING ADVICE IN THE FIELD OF LICENSING COMPUTER SOFTWARE FOR BIOMETRIC AUTHENTICATION WITH OR WITHOUT PHYSICAL CONTACT BETWEEN THE INDIVIDUAL AND THE AUTHENTICATION DEVICE; PROVIDING ADVICE IN THE FIELD OF LICENSING COMPUTER DEVICES FOR BIOMETRIC AUTHENTICATION WITH OR WITHOUT CONTACT, NAMELY, COM-



**Reg. No. 4,196,335** PUTER SYSTEMS COMBINING COMPUTER SOFTWARE AND DATA PROCESSING EQUIPMENT USED TO AUTHENTICATE AN INDIVIDUAL BIOMETRICALLY WITH OR WITHOUT CONTACT BETWEEN THE INDIVIDUAL AND THE COMPUTER DEVICE, IN CLASS 45 (U.S. CLS. 100 AND 101).

THE MARK CONSISTS OF A DESIGN OF A HAND IN THE COLOR GREEN WITH A CONCENTRIC CIRCLE DESIGN IN THE PALM OF THE HAND. THE COLOR WHITE REPRESENTS BACKGROUND OR TRANSPARENT AREAS AND IS NOT CLAIMED AS A FEATURE OF THE MARK.

PRIORITY DATE OF 3-9-2010 IS CLAIMED.

OWNER OF INTERNATIONAL REGISTRATION 1064990 DATED 8-23-2010, EXPIRES 8-23-2020.

THE COLOR(S) GREEN IS/ARE CLAIMED AS A FEATURE OF THE MARK.

SER. NO. 79-092,524, FILED 8-23-2010.

JOHN GARTNER, EXAMINING ATTORNEY

# United States of America

United States Patent and Trademark Office

# MEDICALMATE

**Reg. No. 4,196,336**

**Registered Aug. 28, 2012**

**Int. Cl.: 10**

**TRADEMARK**

**PRINCIPAL REGISTER**

LOGGIA B.V (NETHERLANDS PRIVATE LIMITED LIABILITY COMPANY)  
C. RAAYMAKERSLAAN 10  
NL-4731 EV OUDENBOSCH  
NETHERLANDS

FOR: MEDICAL AND DENTAL APPARATUS AND INSTRUMENTS, NAMELY, MEDICAL AND DENTAL HAND TOOLS, NAMELY, PORTABLE DENTAL SYSTEMS COMPRISED OF AIR/WATER SYRINGES, DRILLS, ELECTRONIC OR PNEUMATIC MOTORS, PUMPS, A WATER SUPPLY, WATER TANK, AIR COMPRESSORS, EVACUATORS, FOOT SWITCHES, LIGHTS, RELATED CARRYING AND SUPPORT STRUCTURES, AND X-RAY MACHINES; FURNITURE FOR MEDICAL, PARAMEDICAL, DENTAL AND PHYSIOTHERAPIST PURPOSES, NAMELY, DENTISTS' CHAIRS, MEDICAL PATIENT TREATMENT CHAIRS, TABLES FOR PATIENT EXAMINATION AND TREATMENT, STOOLS AND MASSAGE TABLES, MOBILE AND COLLAPSIBLE MEDICAL PATIENT TREATMENT CHAIRS, MOBILE AND COLLAPSIBLE TABLES FOR PATIENT EXAMINATION AND TREATMENT, AND MEDICAL, PARAMEDICAL, DENTAL AND PHYSIOTHERAPIST TRAINING CHAIRS AND TABLES, IN CLASS 10 (U.S. CLS. 26, 39 AND 44).

THE MARK CONSISTS OF STANDARD CHARACTERS WITHOUT CLAIM TO ANY PARTICULAR FONT, STYLE, SIZE, OR COLOR.

PRIORITY DATE OF 3-23-2010 IS CLAIMED.

OWNER OF INTERNATIONAL REGISTRATION 1065799 DATED 9-20-2010, EXPIRES 9-20-2020.

SER. NO. 79-092,817, FILED 9-20-2010.

ASMAT KHAN, EXAMINING ATTORNEY



*David J. Kypos*

Director of the United States Patent and Trademark Office

United States of America  
United States Patent and Trademark Office

# CITYTOUCH

**Reg. No. 4,196,337**

**Registered Aug. 28, 2012**

**Int. Cls.: 35, 39 and 42**

KONINKLIJKE PHILIPS ELECTRONICS N.V. (NETHERLANDS A PUBLIC LIMITED LIABILITY COMPANY)  
GROENEWOUDSEWEG 1  
NL-5621 BA EINDHOVEN  
NETHERLANDS

**SERVICE MARK**

FOR: COLLECTION AND COMPILATION OF DATA INTO COMPUTER DATABASES IN THE FIELD OF ENERGY CONSUMPTION , IN CLASS 35 (U.S. CLS. 100, 101 AND 102).

**PRINCIPAL REGISTER**

FOR: DISTRIBUTION AND STORAGE OF ELECTRICITY, IN CLASS 39 (U.S. CLS. 100 AND 105).

FOR: CONSULTANCY AND PROFESSIONAL ADVICE IN THE FIELD OF ENERGY-SAVING, IN CLASS 42 (U.S. CLS. 100 AND 101).

THE MARK CONSISTS OF STANDARD CHARACTERS WITHOUT CLAIM TO ANY PARTICULAR FONT, STYLE, SIZE, OR COLOR.

PRIORITY DATE OF 6-10-2010 IS CLAIMED.

OWNER OF INTERNATIONAL REGISTRATION 1066334 DATED 12-9-2010, EXPIRES 12-9-2020.

SER. NO. 79-093,001, FILED 12-9-2010.

JENNIFER VASQUEZ, EXAMINING ATTORNEY



*David J. Kyjars*

Director of the United States Patent and Trademark Office

# United States of America

United States Patent and Trademark Office

# Z-PUSH

**Reg. No. 4,196,338**

**Registered Aug. 28, 2012**

**Int. Cls.: 9, 38 and 42**

ZARAF A B.V. (NETHERLANDS BESLOTEN VENNOOTSCHAP MET BEP.  
AANSPRAKELIJKHEID)  
ELEKTRONICAWEG 20  
NL-2628 XG DELFT  
NETHERLANDS

**TRADEMARK**

**SERVICE MARK**

**PRINCIPAL REGISTER**

FOR: COMPUTER SOFTWARE FOR USE IN WORD PROCESSING; SOFTWARE TO BE USED FOR AND WITH E-MAILING AND E-MAIL SERVER FUNCTIONS, NAMELY, FOR USE IN TRANSMITTING ELECTRONIC MESSAGES, CONTROLLING AND MANAGING E-MAIL ACCESS SERVER APPLICATIONS; COMMUNICATION SOFTWARE FOR ELECTRONIC TRANSMISSION OF DATA AND DOCUMENTS AMONG USERS OF COMPUTERS; SOFTWARE FOR COMMUNICATION WITHIN AND OUTSIDE COMPANIES AND BETWEEN INDIVIDUALS AND GROUPS OF INDIVIDUALS, NAMELY, SOFTWARE FOR TRANSMITTING E-MAILS, CALENDARING, SHARING AND COLLABORATING ON DOCUMENTS, STORING CONTACTS, STORING TASKS, TAKING NOTES, RECORDING TASK REMINDERS, ACCESSING PUBLIC FILES, NAMELY, SETTING UPLOAD AND/OR DOWNLOAD SHARED DATA AVAILABLE WITHIN A COMPANY, CREATING A SHARED WORKING SPACE FOR COLLABORATION, TRANSMITTING DIRECT MESSAGING AND SHORT MESSAGE SERVICE (SMS), FILING OF MESSAGES, CALLING, RETRIEVING OF VOICE-MAILS, COMPLETE OR PARTIAL DATA WIPING, RETRIEVING OF FAX MESSAGES AND FOR MOBILE ACCESS TO ELECTRONIC MESSAGES AND CONTACTS; COMMUNICATION SERVERS AND CENTRAL STORAGE, NAMELY, COMPUTER STORAGE DEVICES IN THE NATURE OF HIGH-SPEED STORAGE SUBSYSTEMS FOR STORAGE AND BACKUP OF ELECTRONIC DATA EITHER LOCALLY OR VIA A TELECOMMUNICATIONS NETWORK; SOFTWARE FOR CONFIGURING ADMINISTRATIVE PROGRAM CONTROLS; ADMINISTRATION INTERFACES FOR COMPUTERS, COMPUTER NETWORK SERVERS; SOFTWARE FOR COMPUTER OPERATING SYSTEMS; SERVER SOFTWARE, NAMELY, NETWORK ACCESS SERVER OPERATING SOFTWARE; SOFTWARE FOR NETWORK MANAGEMENT; SOFTWARE FOR SECURITY MATTERS, NAMELY, SOFTWARE FOR ENSURING THE SECURITY OF ELECTRONIC MAIL; SOFTWARE FOR DISTRIBUTION OF SECURITY CERTIFICATES OR ENCRYPTED KEYS; BROWSER SOFTWARE FOR COMPUTER NETWORKS; COMPUTER PROGRAMS FOR THE MANAGEMENT OF THE TECHNOLOGICAL EXCHANGE OF COMMUNICATIONS, DATA AND INFORMATION VIA COMPUTER NETWORKS, WIRELESS AND WORLD-WIDE COMMUNICATION NETWORKS; ELECTRONIC MAGAZINES AND PUBLICATIONS, NAMELY, MEDIA FEATURING SOFTWARE BENEFITS OR FUNCTIONALITY, NAMELY, BOOKS, WHITEPAPERS, MANUALS FEATURING FUNCTIONALITIES OF THE PRODUCT, INSTRUCTIONS ON ARCHITECTURE, IN-



*David J. Kappas*

Director of the United States Patent and Trademark Office

**Reg. No. 4,196,338** STALLATION AND CONFIGURATION RECORDED ON COMPUTER MEDIA AND DOWNLOADABLE, IN CLASS 9 (U.S. CLS. 21, 23, 26, 36 AND 38).

FOR: TELECOMMUNICATION SERVICES, NAMELY, TRANSMITTING INFORMATION TO CENTRAL DATA SERVERS; PROVISION OF ON-LINE COMMUNICATION SERVICES, NAMELY, TRANSMITTING E-MAILS, PROVIDING ACCESS TO TELECOMMUNICATION NETWORKS FOR PURPOSES OF CALENDARING, SHARING AND COLLABORATING ON DOCUMENTS, STORING CONTACTS, STORING TASKS, TAKING NOTES, RECORDING TASK REMINDERS, ACCESSING PUBLIC FILES, NAMELY, SETTING UPLOAD AND/OR DOWNLOAD SHARED DATA AVAILABLE WITHIN A COMPANY, CREATING A SHARED WORKING SPACE FOR COLLABORATION, TRANSMITTING DIRECT MESSAGING AND SHORT MESSAGE SERVICE (SMS), FILING OF MESSAGES, TRANSMITTING CALLS, RETRIEVING OF VOICEMAILS, RETRIEVING OF FAX MESSAGES AND FOR MOBILE ACCESS TO ELECTRONIC MESSAGES AND CONTACTS; PROVISION OF ON-LINE CHAT ROOMS FOR THE MAILING OF MESSAGES AMONG COMPUTER USERS; PROVISION OF ACCESS FOR THIRD PARTIES TO ONLINE COMMUNICATION SERVICES SUCH AS EMAIL ACCESS, COMPUTER NETWORKS, WIRELESS NETWORKS AND WORLD-WIDE COMMUNICATION NETWORKS; PROVISION OF DATA AND INFORMATION IN THE FIELDS OF MOBILE PHONE NETWORKS AND WIRELESS COMMUNICATION NETWORKS; PROVISION OF INFORMATION IN THE FIELD OF TELECOMMUNICATIONS VIA COMPUTER NETWORKS, WIRELESS NETWORKS AND WORLD-WIDE COMMUNICATION NETWORKS; PROVIDING ACCESS TO AN ON-LINE COMPUTER DATABASE AND CONSULTANCY IN THE FIELD OF ELECTRONIC MAIL, ELECTRONIC MAIL CONTACTS AND TASK COMMUNICATIONS; PROVISION OF INFORMATION ON TELECOMMUNICATIONS, IN CLASS 38 (U.S. CLS. 100, 101 AND 104).

FOR: SCIENTIFIC AND TECHNOLOGICAL SERVICES, NAMELY, SCIENTIFIC RESEARCH, ANALYSIS, TESTING, IN THE FIELD OF EMAIL, CALENDARING, TASK, CONTACTS AND CORRESPONDING RESEARCH AND DESIGN SERVICES; TECHNOLOGICAL RESEARCH SERVICES IN THE FIELD OF BANDWIDTH REDUCTION, NAMELY, SECURITY AND COLLABORATION RESEARCH IN THE FIELD OF COLLABORATIVE EDITING, MOBILE SECURITY, MOBILE ENCRYPTION; DESIGN AND DEVELOPMENT OF COMPUTERS AND SOFTWARE, AND E-MAIL SYSTEMS; SERVICES IN THE FIELD OF INFORMATION AND COMMUNICATIONS TECHNOLOGIES (ICT), NAMELY, PROVIDING ON-LINE NON-DOWNLOADABLE SOFTWARE FOR USE IN DATABASE MANAGEMENT, FOR USE AS TASK STORAGE, CONTACTS STORAGE, CALENDARING, EMAIL TRANSMISSION; HOSTING OF WEBSITES, APPLICATION SERVICE PROVIDERS (ASP), NAMELY, HOSTING OF SOFTWARE APPLICATIONS FOR THIRD PARTIES; CONSULTANCY IN THE FIELDS OF COMPUTERS AND SOFTWARE; SOFTWARE DESIGN VIA COMPUTER NETWORKS, WIRELESS NETWORKS AND WORLD-WIDE COMMUNICATION NETWORKS; PROVISION OF INFORMATION IN THE FIELD OF TELECOMMUNICATION SOFTWARE DESIGN AND DEVELOPMENT VIA COMPUTER NETWORKS, WIRELESS NETWORKS AND WORLD-WIDE COMMUNICATION NETWORKS, IN CLASS 42 (U.S. CLS. 100 AND 101).

THE MARK CONSISTS OF STANDARD CHARACTERS WITHOUT CLAIM TO ANY PARTICULAR FONT, STYLE, SIZE, OR COLOR.

PRIORITY DATE OF 7-21-2010 IS CLAIMED.

OWNER OF INTERNATIONAL REGISTRATION 1068603 DATED 1-18-2011, EXPIRES 1-18-2021.

SER. NO. 79-094,126, FILED 1-18-2011.

SUNG IN, EXAMINING ATTORNEY

# United States of America

United States Patent and Trademark Office

# fairplanet TV

**Reg. No. 4,196,339**

**Registered Aug. 28, 2012**

**Int. Cl.: 41**

**SERVICE MARK**

**PRINCIPAL REGISTER**

JOSEF REICH (FED REP GERMANY INDIVIDUAL)  
HOLZHAUSENSTR. 22  
60322 FRANKFURT AM MAIN  
FED REP GERMANY

FOR: EDUCATIONAL AND TRAINING SERVICES, NAMELY, ARRANGING AND CONDUCTING OF CONFERENCES, CONGRESSES, SYMPOSIUMS, WORKSHOPS, SEMINARS, CLASSES AND COURSES IN THE FIELD OF POLITICAL, ETHICAL, SOCIAL, ENVIRONMENTAL, ECONOMIC, AND NEWS TOPICS AND CURRENT EVENTS; ENTERTAINMENT SERVICES, NAMELY, THE PROVISION OF CONTINUING PROGRAMS FEATURING NEWS AND POLITICAL, ETHICAL, SOCIAL, ENVIRONMENTAL AND ECONOMIC ISSUES AND CURRENT EVENTS DELIVERED BY TELEVISION, RADIO, SATELLITE, THE INTERNET AND/OR LIVE; ENTERTAINMENT SERVICES, NAMELY, PROVIDING A WEB SITE FEATURING BLOGS AND NON DOWNLOADABLE MULTIMEDIA MATERIALS FEATURING NEWS AND POLITICAL, ETHICAL, SOCIAL, ENVIRONMENTAL AND ECONOMIC THEMES AND CURRENT EVENTS; ENTERTAINMENT SERVICES, NAMELY, PROVIDING AN INTERNET NEWS PORTAL FEATURING LINKS TO NEWS STORIES AND ARTICLES IN THE FIELD OF NEWS, AND POLITICAL, ETHICAL, SOCIAL, ENVIRONMENTAL, ECONOMIC THEMES AND CURRENT EVENTS; ENTERTAINMENT SERVICES, NAMELY, PROVIDING VIDEO AND ELECTRONIC GAMES ONLINE VIA A COMPUTER NETWORK; PUBLISHING OF MAGAZINE, NEWSPAPER, JOURNALS, SOFTWARE, GAMES, MUSIC, AND ELECTRONIC PUBLICATIONS; MULTIMEDIA PUBLISHING OF MAGAZINES, NEWSPAPERS, JOURNALS, SOFTWARE, GAMES, MUSIC, AND ELECTRONIC PUBLICATIONS IN THE FIELD OF POLITICAL, ETHICAL, ENVIRONMENTAL AND ECONOMIC ISSUES NEWS TOPICS AND CURRENT EVENTS; EDITING OF WRITTEN TEXTS EXCEPT FOR PUBLICITY TEXTS, IN CLASS 41 (U.S. CLS. 100, 101 AND 107).



THE MARK CONSISTS OF STANDARD CHARACTERS WITHOUT CLAIM TO ANY PARTICULAR FONT, STYLE, SIZE, OR COLOR.

PRIORITY DATE OF 2-16-2010 IS CLAIMED.

OWNER OF INTERNATIONAL REGISTRATION 1068768 DATED 8-13-2010, EXPIRES 8-13-2020.

NO CLAIM IS MADE TO THE EXCLUSIVE RIGHT TO USE "TV", APART FROM THE MARK AS SHOWN.

*David J. Kyffers*

Director of the United States Patent and Trademark Office

**Reg. No. 4,196,339** SER. NO. 79-094,189, FILED 8-13-2010.

JEFFREY LOOK, EXAMINING ATTORNEY

# United States of America

United States Patent and Trademark Office

# ASTRALPOOL

**Reg. No. 4,196,340**

**Registered Aug. 28, 2012**

**Int. Cls.: 1, 6, 11 and 37**

**TRADEMARK**

**SERVICE MARK**

**PRINCIPAL REGISTER**

FLUIDRA COMMERCIAL, S.A.U. (SPAIN SOCIEDAD ANÓNIMA UNIPERSONAL)  
AV. FRANCESC MACIÀ, 38, PLANTA 15ª  
E-08208 SABADELL (BARCELONA)  
SPAIN

FOR: INDUSTRIAL CHEMICALS; CHEMICALS FOR THE TREATMENT, PURIFICATION AND SOFTENING OF WATER AND FOR MAINTAINING FILTERS AND LINES FOR WATER, IN CLASS 1 (U.S. CLS. 1, 5, 6, 10, 26 AND 46).

FOR: SWIMMING POOLS OF METAL; METAL TUBES; METAL RESERVOIRS AND PIPES OF METAL FOR WATER, IN CLASS 6 (U.S. CLS. 2, 12, 13, 14, 23, 25 AND 50).

FOR: WATER FILTERING APPARATUS FOR STERILIZATION OF WATER, NAMELY, WATER STERILIZERS; WATER PURIFYING APPARATUS AND MACHINES; WATER SOFTENING APPARATUS AND INSTALLATIONS; INSTALLATIONS FOR CONDUCTING AND SUPPLYING WATER, NAMELY, HYDRANTS AND IRRIGATION SPRINKLERS; WATER HEATING AND COOLING APPARATUS, NAMELY, WATER HEATERS AND COOLERS; PRESSURE WATER TANKS, NAMELY, HOT WATER TANKS, BATHTUBS; FITTED BATH LININGS; WHIRLPOOLS, SPA BATHS IN THE NATURE OF HEATED POOLS; INSTALLATIONS FOR SPA BATHS, NAMELY, WHIRLPOOL BATHS FOR SPAS; APPARATUS FOR WATER JETS FOR SWIMMING POOLS WITH WHIRLPOOL AND NOZZLES FOR GENERATING CURRENTS FOR MASSAGE IN BATHTUBS FOR SPAS, NAMELY, WHIRLPOOLS, IN CLASS 11 (U.S. CLS. 13, 21, 23, 31 AND 34).

FOR: CONSTRUCTION, REPAIR AND INSTALLATION SERVICES OF SWIMMING POOLS; ADVICE SERVICES ON CONSTRUCTION OF SWIMMING POOLS, WELL, SPAS; CONSTRUCTION CONSULTATION REGARDING SWIMMING POOLS, IN CLASS 37 (U.S. CLS. 100, 103 AND 106).

THE MARK CONSISTS OF STANDARD CHARACTERS WITHOUT CLAIM TO ANY PARTICULAR FONT, STYLE, SIZE, OR COLOR.

PRIORITY DATE OF 7-27-2010 IS CLAIMED.

OWNER OF INTERNATIONAL REGISTRATION 1069180 DATED 1-10-2011, EXPIRES 1-10-2021.



*David J. Kybas*

Director of the United States Patent and Trademark Office



**Reg. No. 4,196,340** OWNER OF U.S. REG. NO. 2,784,569.

SER. NO. 79-094,369, FILED 1-10-2011.

RUDY R. SINGLETON, EXAMINING ATTORNEY

# United States of America

United States Patent and Trademark Office



## THE ROYAL PARKS

**Reg. No. 4,196,341**

**Registered Aug. 28, 2012**

**Int. Cls.: 3, 8, 9, 14, 16,  
18, 20, 21, 24 and 28**

**TRADEMARK**

**PRINCIPAL REGISTER**

THE ROYAL PARKS (UNITED KINGDOM A LIMITED COMPANY INCORPORATED IN THE UK)

THE OLD POLICE HOUSE  
HYDE PARK, LONDON W2 2UH  
UNITED KINGDOM

FOR: NON-MEDICATED TOILET PREPARATIONS, NAMELY, TOILET WATER, TOILET SOAP; SOAPS FOR PERSONAL USE; HAIR CARE PREPARATIONS; SHAMPOOS; PERFUMERY; ESSENTIAL OILS; COSMETICS; COSMETIC PREPARATIONS FOR BODY CARE AND BEAUTY CARE PREPARATIONS, NAMELY, HAND CREAM, FACE CREAM, LIP BALM, BODY LOTION; BATH AND ROOM FRAGRANCES; POTPOURRI, IN CLASS 3 (U.S. CLS. 1, 4, 6, 50, 51 AND 52).

FOR: AGRICULTURAL AND HORTICULTURAL HAND TOOLS AND IMPLEMENTS, NAMELY, GARDEN SPADES, GARDEN FORKS, SECATEURS, PRUNING IMPLEMENTS, NAMELY, PRUNING SCISSORS, PRUNING KNIVES, PRUNING SAWS AND PRUNING SHEARS, HAND SAWS, RAKES; ARTICLES OF CUTLERY, NAMELY, KNIVES, FORKS, SPOONS, CAKE CUTTERS; MANICURE SETS; PENKNIVES; SCISSORS, IN CLASS 8 (U.S. CLS. 23, 28 AND 44).

FOR: SCIENTIFIC, NAUTICAL, SURVEYING, ELECTRIC, PHOTOGRAPHIC, CINEMATOGRAPHIC, OPTICAL, WEIGHING, MEASURING, SIGNALLING, CHECKING IN THE NATURE OF SUPERVISION, LIFE-SAVING AND TEACHING APPARATUS, INSTRUMENTS AND EQUIPMENT, NAMELY, CALCULATORS, BINOCULARS, TELESCOPES; PRE-RECORDED MEDIA, NAMELY, DVDS AND CDS FEATURING MOTION PICTURE FILMS; PRE-RECORDED VIDEO CASSETTES FEATURING SPOKEN WORD PERFORMANCE IN THE FIELD OF CULTURE, MUSIC, ARTS, FOOD, HERITAGE, HORTICULTURE, SPORT, HEALTH, WILDLIFE, LEISURE, ROYALTY, FICTION, ENTERTAINMENT, ARBORICULTURE, PLAY, EDUCATION, PETS, HISTORY, ARCHITECTURE, AGRICULTURE, ENVIRONMENTAL AND SUSTAINABILITY STUDIES, SPORTS, EDUCATIONAL PERFORMANCES IN THE FIELD OF CULTURE, MUSIC, ARTS, FOOD, HERITAGE, HORTICULTURE, SPORT, HEALTH, WILDLIFE, LEISURE, ROYALTY, FICTION, ENTERTAINMENT, ARBORICULTURE, HISTORY, ARCHITECTURE, AGRICULTURE, ENVIRONMENTAL AND SUSTAINABILITY STUDIES AND MUSICAL PERFORMANCES; PRE-RECORDED VIDEO TAPES FEATURING SPOKEN WORD PERFORMANCES IN THE FIELD OF CULTURE, MUSIC, ARTS, FOOD, HERITAGE, HORTICULTURE, SPORT, HEALTH, WILDLIFE, LEISURE, ROYALTY, FICTION, ENTERTAINMENT, ARBORICULTURE, PLAY, EDUCATION, PETS, HISTORY, ARCHITEC-



*David J. Kybas*

Director of the United States Patent and Trademark Office

**Reg. No. 4,196,341** TURE, AGRICULTURE, ENVIRONMENTAL AND SUSTAINABILITY STUDIES, SPORTS, EDUCATIONAL PERFORMANCES IN THE FIELD OF CULTURE, MUSIC, ARTS, FOOD, HERITAGE, HORTICULTURE, SPORT, HEALTH, WILDLIFE, LEISURE, ROYALTY, FICTION, ENTERTAINMENT, ARBORICULTURE, HISTORY, ARCHITECTURE, AGRICULTURE, ENVIRONMENTAL AND SUSTAINABILITY STUDIES AND MUSIC PERFORMANCES; DVDS FEATURING SPOKEN WORD PERFORMANCES IN THE FIELD OF CULTURE, MUSIC, ARTS, FOOD, HERITAGE, HORTICULTURE, SPORT, HEALTH, WILDLIFE, LEISURE, ROYALTY, FICTION, ENTERTAINMENT, ARBORICULTURE, PLAY, EDUCATION, PETS, HISTORY, ARCHITECTURE, AGRICULTURE, ENVIRONMENTAL AND SUSTAINABILITY STUDIES, SPORTS, EDUCATIONAL PERFORMANCES IN THE FIELD OF CULTURE, MUSIC, ARTS, FOOD, HERITAGE, HORTICULTURE, SPORT, HEALTH, WILDLIFE, LEISURE, ROYALTY, FICTION, ENTERTAINMENT, ARBORICULTURE, HISTORY, ARCHITECTURE, AGRICULTURE, ENVIRONMENTAL AND SUSTAINABILITY STUDIES AND MUSICAL PERFORMANCES; BLANK CD-ROMS FOR SOUND AND VIDEO RECORDING; PRE-RECORDED AUDIO CASSETTE TAPES FEATURING SPOKEN WORD PERFORMANCES IN THE FIELD OF CULTURE, MUSIC, ARTS, FOOD, HERITAGE, HORTICULTURE, SPORT, HEALTH, WILDLIFE, LEISURE, ROYALTY, FICTION, ENTERTAINMENT, ARBORICULTURE, PLAY, EDUCATION, PETS, HISTORY, ARCHITECTURE, AGRICULTURE, ENVIRONMENTAL AND SUSTAINABILITY STUDIES, SPORTS, EDUCATIONAL PERFORMANCES IN THE FIELD OF CULTURE, MUSIC, ARTS, FOOD, HERITAGE, HORTICULTURE, SPORT, HEALTH, WILDLIFE, LEISURE, ROYALTY, FICTION, ENTERTAINMENT, ARBORICULTURE, HISTORY, ARCHITECTURE, AGRICULTURE, ENVIRONMENTAL AND SUSTAINABILITY STUDIES AND MUSIC PERFORMANCES; PHONOGRAPH RECORDS FEATURING SPOKEN WORD PERFORMANCES IN THE FIELD OF CULTURE, MUSIC, ARTS, FOOD, HERITAGE, HORTICULTURE, SPORT, HEALTH, WILDLIFE, LEISURE, ROYALTY, FICTION, ENTERTAINMENT, ARBORICULTURE, PLAY, EDUCATION, PETS, HISTORY, ARCHITECTURE, AGRICULTURE, ENVIRONMENTAL AND SUSTAINABILITY STUDIES, SPORTS, EDUCATIONAL PERFORMANCES IN THE FIELD OF CULTURE, MUSIC, ARTS, FOOD, HERITAGE, HORTICULTURE, SPORT, HEALTH, WILDLIFE, LEISURE, ROYALTY, FICTION, ENTERTAINMENT, ARBORICULTURE, HISTORY, ARCHITECTURE, AGRICULTURE, ENVIRONMENTAL AND SUSTAINABILITY STUDIES AND MUSIC PERFORMANCES; PRE-RECORDED VIDEO DISCS FEATURING SPOKEN WORD PERFORMANCES IN THE FIELD OF CULTURE, MUSIC, ARTS, FOOD, HERITAGE, HORTICULTURE, SPORT, HEALTH, WILDLIFE, LEISURE, ROYALTY, FICTION, ENTERTAINMENT, ARBORICULTURE, PLAY, EDUCATION, PETS, HISTORY, ARCHITECTURE, AGRICULTURE, ENVIRONMENTAL AND SUSTAINABILITY STUDIES, SPORTS, EDUCATIONAL PERFORMANCES IN THE FIELD OF CULTURE, MUSIC, ARTS, FOOD, HERITAGE, HORTICULTURE, SPORT, HEALTH, WILDLIFE, LEISURE, ROYALTY, FICTION, ENTERTAINMENT, ARBORICULTURE, HISTORY, ARCHITECTURE, AGRICULTURE, ENVIRONMENTAL AND SUSTAINABILITY STUDIES AND MUSIC PERFORMANCES, PRE-RECORDED LASER DISCS FEATURING SPOKEN WORD PERFORMANCES IN THE FIELD OF CULTURE, MUSIC, ARTS, FOOD, HERITAGE, HORTICULTURE, SPORT, HEALTH, WILDLIFE, LEISURE, ROYALTY, FICTION, ENTERTAINMENT, ARBORICULTURE, PLAY, EDUCATION, PETS, HISTORY, ARCHITECTURE, AGRICULTURE, ENVIRONMENTAL AND SUSTAINABILITY STUDIES AND MUSIC, SPORTS, EDUCATIONAL PERFORMANCES IN THE FIELD OF CULTURE, MUSIC, ARTS, FOOD, HERITAGE, HORTICULTURE, SPORT, HEALTH, WILDLIFE, LEISURE, ROYALTY, FICTION, ENTERTAINMENT, ARBORICULTURE, HISTORY, ARCHITECTURE, AGRICULTURE, ENVIRONMENTAL AND SUSTAINABILITY STUDIES; APPARATUS FOR TRANSMISSION OR REPRODUCTION OF SOUND OR IMAGE; COMPUTER AND VIDEO GAME SOFTWARE; COMPUTER SOFTWARE FOR WORD PROCESSING, FOR DATABASE MANAGEMENT, AND FOR ACCESSING OUTDOOR LIFESTYLE AND WILDLIFE INFORMATION; DOWNLOADABLE ELECTRONIC PUBLICATIONS IN THE NATURE OF NEWSLETTER AND MAGAZINE PUBLICATIONS IN THE FIELD OF FICTION, NATURE AND OUTDOOR LIFESTYLE; MOBILE TELEPHONES; BLANK MAGNETIC DATA CARRIERS, RECORDING DISCS, NAMELY, BLANK RECORDABLE CD-RS AND DVD-RS; AUTOMATIC VENDING MACHINES, TICKET VENDING MACHINES AND MECHANISMS FOR COIN-OPERATED APPARATUS; CASH REGISTERS, CALCULATING MACHINES, DATA PROCESSING EQUIPMENT AND COMPUTERS; COMPUTER MOUSE PADS AND COMPUTER

**Reg. No. 4,196,341** SCREEN SAVER SOFTWARE; SPECTACLES AND SPECTACLE FRAMES; COMPUTER MOUSE PADS IN THE NATURE OF MOUSE MATS; TIMERS; STRUCTURAL PARTS AND STRUCTURAL FITTINGS FOR ALL THE AFORESAID GOODS, IN CLASS 9 (U.S. CLS. 21, 23, 26, 36 AND 38).

FOR: WATCHES, CLOCKS, WATCH STRAPS, WATCH BRACELETS, HOROLOGICAL AND CHRONOMETRIC APPARATUS AND INSTRUMENTS, HOROLOGICAL AND CHRONOMETRIC APPARATUS, NAMELY, CLOCKS, WATCHES; STRUCTURAL PARTS AND STRUCTURAL FITTINGS FOR ALL THE AFORESAID GOODS; GOLD; SILVER; PLATINUM; PRECIOUS METALS AND THEIR ALLOYS; GOODS MADE OF PRECIOUS METALS OR COATED THEREWITH, NOT INCLUDED IN OTHER CLASSES, NAMELY, RINGS, EARRINGS, NECKLACES AND BRACELETS; JEWELLERY, IMITATION JEWELLERY, PRECIOUS STONES, PEARLS AND IMITATIONS THEREOF; EAR AND DRESS ORNAMENTS OF PRECIOUS METAL, ALL BEING IN THE NATURE OF JEWELLERY; KEYRINGS OF PRECIOUS METAL AND THEIR ALLOYS OR COATED THEREWITH; ARTICLES OF PRECIOUS METALS OR COATED THEREWITH, NAMELY, RINGS, EARRINGS, NECKLACES AND BRACELETS, IN CLASS 14 (U.S. CLS. 2, 27, 28 AND 50).

FOR: PRINTED PUBLICATIONS AND PRINTED MATTERS, NAMELY, BOOKS AND MAGAZINES IN THE FIELD OF FICTION, NATURE AND OUTDOOR LIFESTYLE AND TRADE JOURNALS IN THE FIELD OF PARK MANAGEMENT; PAPER, CARDBOARD AND GOODS MADE FROM THESE MATERIALS, NAMELY, COASTERS, POSTCARDS, POSTERS, PHOTOGRAPHIC PRINTS, BLANK JOURNALS, NOTEBOOKS AND SONG BOOKS; APPOINTMENT BOOKS, ADDRESS BOOKS, MEMORANDUM BOOKS, PERSONAL ORGANISERS; CALENDARS; DIARIES; BOOK BINDING MATERIAL; PRINTED CERTIFICATES; CHARTS FOR DISPLAYING DATA, FRAMED AND MATTED ART PICTURES FEATURING GRAPHIC IMAGES AND PRINTED TICKETS; ENVELOPES, BAGS OF PAPER OR PLASTICS FOR PACKAGING, STICKERS, PAPER LABELS, PAPER TAGS; STATIONERY; WRITING IMPLEMENTS, PENS AND PENCILS; WRITING PAPER AND ENVELOPES; PAPER CLIPS, PAPERWEIGHTS; COASTERS OF PAPER; BLANK CARDS; GREETING CARDS; MAPS, POSTERS, PHOTOGRAPHS, PHOTOGRAPHIC PRINTS; PHOTOGRAPHS AND PHOTOGRAPH ALBUMS; ARTISTS' MATERIALS, NAMELY, ARTISTS' BRUSHES, PENCILS, PENCILS AND CRAYONS; PAINT BRUSHES; ADHESIVES FOR STATIONERY AND HOUSEHOLD PURPOSES; PRINTERS' TYPE AND PRINTING BLOCKS; PRINTED CHARTS; BROCHURES ABOUT OUTDOOR LIFESTYLE AND WILDLIFE, CATALOGUES IN THE FIELD OF PARK MANAGEMENT, TOURIST GIFTS, CATERING, AND WILDLIFE AND ADVERTISING MATERIAL, NAMELY, ADVERTISING PAMPHLETS AND ADVERTISING SIGNS OF PAPER; TOWELS OF PAPER; FLAGS OF PAPER; PRINTED INSTRUCTIONAL AND TEACHING MATERIAL IN THE FIELD OF WILDLIFE AND PARK MANAGEMENT; PLASTIC MATERIALS FOR PACKAGING, NAMELY, PLASTIC BAGS FOR PACKAGING; SEALING STAMPS AND SEALING WAX; STRUCTURAL PARTS AND STRUCTURAL FITTINGS FOR ALL THE AFORESAID GOODS, IN CLASS 16 (U.S. CLS. 2, 5, 22, 23, 29, 37, 38 AND 50).

FOR: ARTICLES OF LEATHER AND IMITATION LEATHER, NAMELY, LEATHER CASES, LEATHER SUITCASES, LEATHER ATTACHÉ CASES, LEATHER BRIEF CASES, LEATHER POUCHES, LEATHER BOXES; BAGS, NAMELY, BEACH BAGS, GARDEN CARRY-ALL BAGS, HAND BAGS; ARTICLE OF LUGGAGE; PARASOLS, UMBRELLAS, WALKING STICKS; TRUNKS AND TRAVELLING BAGS, IN CLASS 18 (U.S. CLS. 1, 2, 3, 22 AND 41).

FOR: MIRRORS; FURNITURE AND STRUCTURAL PARTS AND STRUCTURAL FITTINGS FOR FURNITURE; GARDEN FURNITURE, BENCHES, CHAIRS; DECK CHAIRS; SLEEPING BAGS; PICTURE FRAMES; DRESSMAKERS' DUMMIES; GOODS MADE FROM WOOD, NAMELY, DECORATIVE BOXES MADE OF WOOD, STORAGE BOXES MADE OF WOOD, FURNITURE MADE OF WOOD, SOUVENIRS MADE OF WOOD, NAMELY, WOOD CARVINGS AND WOOD ORNAMENTS, BOTTLE RACKS AND FIREGUARDS; BOTTLE RACKS AND FIREGUARDS; CRADLES; GOODS OF CORK, REED, CANE, WICKER, HORN, BONE, IVORY, WHALEBONE, SHELL, AMBER, MOTHER-OF-PEARL, MEERSCHAUM AND SUBSTITUTES FOR ALL THESE MATERIALS, OR OF PLASTICS, NAMELY, DOOR

**Reg. No. 4,196,341** AND DRAWER HANDLES OF PLASTIC, CLOTHES FASTENINGS OF PLASTIC, NAMELY, PLASTIC CLIPS FOR FASTENING PAIRS OF SOCKS FOR LAUNDERING, FURNITURE PARTS, NAMELY, FURNITURE FASTENINGS OF PLASTIC, SOUVENIRS OF PLASTIC, NAMELY, HOLIDAY ORNAMENTS OF PLASTIC, INFLATABLE PLASTIC SIGNS; BAKERS' BREAD BINS AND BREAD BASKETS; PLASTIC FOOD DECORATIONS, NAMELY, IMITATION FOODS FOR DISPLAY MADE OF PLASTIC MATERIALS, NAMELY, IMITATION DESSERTS, IMITATION CANDY, AND IMITATION CAKES; PET FURNITURE, NAMELY, PET BOXES; NON-METAL KEY HOLDERS IN THE NATURE OF KEYBOARDS FOR HANGING KEYS; WAX FIGURES; HAMPERS; LETTER BOXES NOT OF METAL; CLOTHES HANGERS IN THE NATURE OF CLOTHES STANDS; CLOTHES HANGERS; COAT HANGERS; NAMEPLATES NOT OF METAL; MAGAZINE RACKS; NON-METAL LADDERS, IN CLASS 20 (U.S. CLS. 2, 13, 22, 25, 32 AND 50).

FOR: HOUSEHOLD OR KITCHEN UTENSILS AND CONTAINERS, NAMELY, SPLATTER SCREENS, KITCHEN TONGS, PLASTIC STORAGE CONTAINERS FOR HOUSEHOLD USE; CROCKERY, NAMELY, POTS, DISHES, DRINKING CUPS AND SAUCERS, SERVING BOWLS AND TRAYS; CORKSCREWS; CAGES FOR HOUSEHOLD PETS; BIRD CAGES AND BIRD BATHS; COMBS AND SPONGES FOR HOUSEHOLD PURPOSES; BRUSHES, NAMELY, CRUMB BRUSHES, DUSTING BRUSHES; ARTICLES FOR CLEANING PURPOSES, NAMELY, CLEANING CLOTHS, CLEANING PADS; SHOE BRUSHES AND SHOE HORNS; BEVERAGE GLASSWARE, PORCELAIN GOODS, NAMELY, PORCELAIN MUGS, BOWLS AND PLATES CERAMIC GOODS, NAMELY, CERAMIC FIGURINES, MUGS, BOWLS AND PLATES, STONEWARE GOODS, NAMELY, PIZZA STONES, STONE MUGS, STONE BOWLS AND STONE PLATES, POTTERY GOODS, NAMELY, POTTERY MUGS, POTTERY BOWLS AND POTTERY PLATES AND EARTHENWARE GOODS, NAMELY, EARTHENWARE FIGURINES, EARTHENWARE MUGS, EARTHENWARE BOWLS AND EARTHENWARE PLATES; CLOTHES PEGS; SIEVES FOR HOUSEHOLD PURPOSES; SERVING SPOONS, IN CLASS 21 (U.S. CLS. 2, 13, 23, 29, 30, 33, 40 AND 50).

FOR: TEXTILES AND TEXTILE GOODS NOT INCLUDED IN OTHER CLASSES, NAMELY, GIFT WRAP OF TEXTILE, HAND TOWELS OF TEXTILE, HANDKERCHIEFS OF TEXTILE; TOWELS AND FACE CLOTHS; BATHROOM FURNISHING FABRICS; BATH LINEN; KITCHEN FURNISHING FABRICS; COTTON CLOTHS; TABLE CLOTHS OF TEXTILE, TEXTILE NAPKINS AND PLACEMATS OF TEXTILE; FABRICS, NAMELY, DENIM FABRIC, COTTON FABRIC, LINEN FABRIC, WOOL FABRIC, SILK FABRIC, POLYESTER FABRIC, SYNTHETIC FIBER FABRIC FOR USE IN THE MANUFACTURE OF PROTECTIVE CLOTHING, ACRYLIC FABRIC, NYLON FABRIC, SPANDEX FABRIC FOR USE IN THE MANUFACTURE OF CLOTHING, OLEFIN FABRIC FOR THE MANUFACTURE AND REPAIR OF FURNITURE, SYNTHETIC FIBER FABRIC FOR TEXTILE USE; UPHOLSTERY FABRICS; LINEN AND DAMASK; BEDCLOTHES AND BEDDING, NAMELY, BED SHEETS, PILLOW CASES, DUVET COVERS AND FABRIC VALANCES ; BEDCOVERS; BED LINEN; BEDSPREADS; BEDDING, NAMELY, BED SHEETS, PILLOW CASES, DUVET COVERS AND FABRIC VALANCES; BED SHEETS; BED BLANKETS; QUILTS; TAPESTRIES OF TEXTILE; TRACED CLOTHS FOR TAPESTRY AND EMBROIDERY , IN CLASS 24 (U.S. CLS. 42 AND 50).

FOR: GAMES, PLAYTHINGS AND TOYS, NAMELY, ACTION FIGURES AND ACCESSORIES THEREFORE AND BOARD GAMES, BALL GAME SETS, NAMELY, SKITTLE SETS PRIMARILY COMPRISED OF SKITTLES, MARBLES SETS PRIMARILY COMPRISED OF MARBLES AND CRICKET SETS PRIMARILY COMPRISED OF CRICKET BALLS AND CRICKET BATS, RACKET GAME SETS, NAMELY, PADDLE BALL GAMES; PLUSH TOYS, TEDDY BEARS, CUDDLY PLUSH TOYS; BALLOONS; BATHTUB TOYS; PLAYING CARDS; TOY VEHICLES; DOLLS; TOY MODEL HOBBYCRAFT KITS; MODELED PLASTIC FIGURINES BEING TOYS; ELECTRONIC TOYS, NAMELY, ELECTRONIC ACTION TOYS AND STAND-ALONE VIDEO GAME MACHINES, BATTERY-POWERED COMPUTER GAME WITH LCD SCREEN; SOUVENIR TOYS, NAMELY, ACTION FIGURES, PLUSH TOYS; NOVELTY ITEMS, NAMELY, TOY AND NOVELTY FACE MASKS; COMMEMORATIVE MODELS, NAMELY, TOY MODEL GUITARS, TOY MODEL CARS, TOY MODEL COACHES, TOY MODEL SOLDIERS AND TOY MODEL ANIMALS; TOY MODELS FOR COLLECTORS,

**Reg. No. 4,196,341** NAMELY, TOY MODEL CARS, SCALE MODEL AIRPLANES, TOY MODEL SOLDIERS AND TOY MODEL ANIMALS; JIGSAW PUZZLES; BOARD GAMES; SPORTING ARTICLES, NAMELY, BASKETBALLS, SOCCER BALLS, TENNIS BALLS AND RUGBY BALLS; SYNTHETIC CHRISTMAS TREES; DECORATIONS FOR CHRISTMAS TREES; CHILDREN'S TOYS MADE OF WOOD, NAMELY, WOODEN TRAIN SETS, WOODEN TOY SWORDS, POSITIONABLE WOODEN FIGURES FOR USE IN WOODEN PUZZLES, WOODEN TOY FOOD, WOODEN OUTDOOR PLAYHOUSES AND WENDY HOUSES, WOODEN CLIMBING FRAMES, WOODEN DOLLS' HOUSES, WOODEN TOY CASTLES, WOODEN TOY FARM BUILDINGS, WOODEN TOY GARDEN TOOLS ; STRUCTURAL PARTS AND STRUCTURAL FITTINGS FOR ALL THE AFORESAID GOODS, IN CLASS 28 (U.S. CLS. 22, 23, 38 AND 50).

NO CLAIM IS MADE TO THE EXCLUSIVE RIGHT TO USE "PARKS", APART FROM THE MARK AS SHOWN.

OWNER OF INTERNATIONAL REGISTRATION 1069631 DATED 4-29-2010, EXPIRES 4-29-2020.

THE MARK CONSISTS OF A DESIGN OF A CROWN THAT IS MADE UP OF LEAVES. THE WORDING "THE ROYAL PARKS" APPEARS BELOW THE DESIGN ELEMENT.

SER. NO. 79-094,552, FILED 4-29-2010.

EMILY CARLSEN, EXAMINING ATTORNEY

# United States of America

United States Patent and Trademark Office

# TRIBOSINT

**Reg. No. 4,196,342**

**Registered Aug. 28, 2012**

**Int. Cls.: 7 and 12**

**TRADEMARK**

**PRINCIPAL REGISTER**

MIBA SINTER AUSTRIA GMBH (AUSTRIA GESELLSCHAFT MIT BESCHRÄNKTER HAFTUNG (GMBH))  
DR.-MITTERBAUER-STRASSE 3  
LAAKIRCHEN, AUSTRIA A4663

FOR: PARTS OF MOTORS AND ENGINES, NAMELY, COMPONENTS FOR HOUSING, NAMELY, HOUSINGS FOR OIL PUMPS AND FOR FUEL INJECTION PUMPS, GEARS, SPROCKETS, COMPONENTS FOR VARIABLE VALVE TIMING SYSTEMS, NAMELY, ROTORS, STATORS, FLANGES, GEARS, SPROCKETS, CAMS, CAMSHAFT AND CRANK-SHAFT, BEARING CAPS, PULLEYS; MACHINE COUPLING AND TRANSMISSION COMPONENTS EXCEPT FOR LAND VEHICLES, NAMELY, SINTERED PARTS FOR THE POWER TRAIN, FOR FUEL INJECTION PUMPS AND FOR DIESEL INJECTION PUMPS, IN CLASS 7 (U.S. CLS. 13, 19, 21, 23, 31, 34 AND 35).

FOR: PARTS OF VEHICLES AND APPARATUS FOR LOCOMOTION BY LAND, AIR OR WATER EXCEPT BRAKES, NAMELY, SINTERED PARTS FOR THE VEHICLE POWER TRAIN MECHANISM COMPRISED OF CLUTCH, TRANSMISSION, DRIVE SHAFT AND DIFFERENTIAL, FOR FUEL INJECTION PUMPS AND FOR DIESEL INJECTION PUMPS, IN CLASS 12 (U.S. CLS. 19, 21, 23, 31, 35 AND 44).

THE MARK CONSISTS OF STANDARD CHARACTERS WITHOUT CLAIM TO ANY PARTICULAR FONT, STYLE, SIZE, OR COLOR.

PRIORITY DATE OF 6-30-2010 IS CLAIMED.

OWNER OF INTERNATIONAL REGISTRATION 1072061 DATED 12-15-2010, EXPIRES 12-15-2020.

THE WORDING "TRIBOSINT" HAS NO MEANING IN A FOREIGN LANGUAGE.

SER. NO. 79-095,425, FILED 12-15-2010.

MELISSA VALLILLO, EXAMINING ATTORNEY



*David J. Kyffers*

Director of the United States Patent and Trademark Office

# United States of America

United States Patent and Trademark Office

# INREKOR

**Reg. No. 4,196,343**

**Registered Aug. 28, 2012**

**Int. Cls.: 6, 12 and 19**

**TRADEMARK**

**PRINCIPAL REGISTER**

JSP INTERNATIONAL SARL (FRANCE SOCIÉTÉ À RESPONSABILITÉ LIMITÉE)  
LE BOIS CHEVALIER  
F-60190 ESTRÉES-SAINT-DENIS  
FRANCE

FOR: COMPOSITE MATERIALS CONSISTING PRIMARILY OF METAL AND PARTIALLY OF EXPANDED POLYPROPYLENE FOR USE IN AUTOMOTIVE, AVIATION, RAILWAY, TRANSPORTATION, HOUSING, MEDICAL, AND INDUSTRIAL MANUFACTURING AND CONSTRUCTION; CONSTRUCTION ELEMENTS MADE PRINCIPALLY OF METAL AND PARTIALLY OF EXPANDED POLYPROPYLENE FOR BUILDING PURPOSES, NAMELY, FABRICATED METAL COMPONENTS FOR BUILDING FOUNDATIONS; FRAMEWORKS AND STRUCTURES FOR CONSTRUCTIONS MADE PRINCIPALLY OF METAL AND PARTIALLY OF EXPANDED POLYPROPYLENE NAMELY, SHORES, SUPPORTS, BRACES, PARTITIONS, PILES, SUPPORTS, PANELS, BUILDING COMPONENTS, NAMELY, COMPOSITE PANELS COMPOSED PRIMARILY OF METAL MATERIALS FOR USE IN BUILDING CONSTRUCTION, AND FOUNDATION COMPONENTS, NAMELY, FABRICATED METAL COMPONENTS FOR BUILDING FOUNDATIONS; DOORS; PANELS, NAMELY, DOOR PANELS MADE FROM A COMPOSITE MATERIAL CONSISTING PRIMARILY OF METAL AND PARTIALLY OF EXPANDED POLYPROPYLENE; LININGS NAMELY, LININGS CONSISTING PRIMARILY OF METAL AND PARTIALLY OF POLYPROPYLENE FOR USE IN THE AUTOMOTIVE, AVIATION, RAILWAY, TRANSPORTATION, HOUSING, MEDICAL, AND INDUSTRIAL INDUSTRIES; FLOOR AND CEILING COVERINGS MADE PRINCIPALLY OF METAL AND PARTIALLY OF EXPANDED POLYPROPYLENE, NAMELY, TILES, PANELS, SECTIONS, SHEETS, STRIPS, AND MATS; FLOATING DOCKS FOR MOORING BOATS MADE PRINCIPALLY OF METAL AND PARTIALLY OF EXPANDED POLYPROPYLENE; PREFABRICATED PORTABLE HELICOPTER LANDING PADS MADE PRINCIPALLY OF METAL AND PARTIALLY OF EXPANDED POLYPROPYLENE, BUILDING MATERIALS NAMELY, ROOF COVERINGS AND WALL LININGS MADE PRINCIPALLY OF METAL AND PARTIALLY OF EXPANDED POLYPROPYLENE; PORTABLE PARTITIONS AND CONSTRUCTION PANELS MADE PRINCIPALLY OF METAL AND PARTIALLY OF EXPANDED POLYPROPYLENE; MOLDINGS FOR BUILDING MADE PRINCIPALLY OF METAL AND PARTIALLY OF EXPANDED POLYPROPYLENE, IN CLASS 6 (U.S. CLS. 2, 12, 13, 14, 23, 25 AND 50).



*David J. Kappas*

Director of the United States Patent and Trademark Office

FOR: VEHICLES FOR LOCOMOTION BY LAND, AIR, WATER OR RAIL, NAMELY, AIRPLANES, HELICOPTERS, BOATS, SUBMERSIBLES, TRAINS, LIGHT RAIL, MONORAIL, AUTOMOBILES, TRUCKS, MOTORCYCLES, BICYCLES, AND FEATURING ACCESSORIES



**Reg. No. 4,196,343** AND COMPONENT PARTS THEREOF; CHASSIS AND BODIES FOR VEHICLES INCLUDING AUTOMOBILES AND CARAVANS; SPARE PARTS FOR VEHICLES, NAMELY, VEHICLE BODIES, CHAINS, CHASSIS, BUMPERS FOR AUTOMOBILES, GEARBOXES FOR LAND VEHICLES, HOODS FOR VEHICLES, HOODS FOR VEHICLE ENGINES, VEHICLE BRAKES, VEHICLE WHEEL RIMS, ENGINES FOR LAND VEHICLES, REAR-VIEW MIRRORS, VEHICLE WHEELS, VEHICLE SEATS, VEHICLE COVERS, STEERING WHEELS, VEHICLE DOORS; HULLS FOR SHIPS AND YACHTS; CABINS FOR SHIPS AND YACHTS, IN CLASS 12 (U.S. CLS. 19, 21, 23, 31, 35 AND 44).

FOR: CONSTRUCTION MATERIALS MADE PRINCIPALLY OF NON-METALLIC MATERIALS AND IN PARTICULAR EXPANDED POLYPROPYLENE, NAMELY, SHORES, SUPPORTS, BRACES, PANELS, BOARDS, SHEATHING PARTITIONS, SLABS, FLOORING MATERIALS, CEILING MATERIALS, AND PILES FOR USE IN THE CONSTRUCTION AND BUILDING INDUSTRY; WINDOW FRAMES AND DOOR FRAMES FOR CONSTRUCTIONS; DOORS; CONSTRUCTION PANELS; FLOOR AND CEILING PANELS; TRANSPORTABLE CONSTRUCTIONS, NAMELY, FLOATING DOCKS FOR MOORING BOATS, TRANSPORTABLE PREFABRICATED PORTABLE HELICOPTER LANDING; BUILDING MATERIALS, NAMELY, ROOF COVERINGS AND WALL LININGS, PORTABLE PARTITIONS AND BUILDING PANELS, TRANSPORTABLE MOLDINGS FOR CONSTRUCTIONS, ALL MADE PRINCIPALLY OF NON-METALLIC MATERIALS AND IN PARTICULAR EXPANDED POLYPROPYLENE, IN CLASS 19 (U.S. CLS. 1, 12, 33 AND 50).

THE MARK CONSISTS OF STANDARD CHARACTERS WITHOUT CLAIM TO ANY PARTICULAR FONT, STYLE, SIZE, OR COLOR.

PRIORITY DATE OF 6-28-2010 IS CLAIMED.

OWNER OF INTERNATIONAL REGISTRATION 1073482 DATED 12-22-2010, EXPIRES 12-22-2020.

THE WORDING "INREKOR" HAS NO MEANING IN A FOREIGN LANGUAGE.

SER. NO. 79-095,966, FILED 12-22-2010.

FLORENTINA BLANDU, EXAMINING ATTORNEY

# United States of America

United States Patent and Trademark Office

# GRAAL

**Reg. No. 4,196,344**

**Registered Aug. 28, 2012**

**Int. Cls.: 14, 18 and 35**

**TRADEMARK**

**SERVICE MARK**

**PRINCIPAL REGISTER**

PEARL LUXURY GROUP S.A. (LUXEMBOURG SOCIÉTÉ ANONYME)  
102B, RUE DE MARNER  
L-8081 BERTRANGE  
LUXEMBOURG

FOR: PRECIOUS METALS AND THEIR ALLOYS AND GOODS IN PRECIOUS METALS OR COATED THEREWITH, NAMELY, JEWELRY; JEWELRY, PRECIOUS STONES: TIMEPIECES AND CHRONOMETRIC INSTRUMENTS; JEWELRY ARTICLES, NAMELY, BRACELETS, EARRINGS, COLLARS, LONG COLLARS, SAUTOIRS, WEDDING RING, RINGS, BROOCHES AND CHAINS; NECKLACES; BRACELETS; RINGS; CHARMS; JEWEL PENDANTS; EARRINGS; CUFF LINKS; MEDALLIONS; WATCHES; WATCH BANDS; TIE PINS; ORNAMENTAL PINS; JEWELRY CASES; JEWELRY CASKETS; DIAMONDS; PRECIOUS GEMSTONES; KEY RINGS IN THE NATURE OF TRINKET AND FOBS OF PRECIOUS METAL AND STATUES AND FIGURINES IN THE NATURE OF STATUETTES OF PRECIOUS METAL; CASES OR PRESENTATION CASES FOR TIMEPIECES AND JEWELRY; MEDALS, IN CLASS 14 (U.S. CLS. 2, 27, 28 AND 50).

FOR: LEATHER AND IMITATIONS OF LEATHER, AND GOODS MADE OF THESE MATERIALS, NAMELY, TANNED LEATHER, SUITCASES, WALLETS, ALL-PURPOSE CARRYING BAGS, BANDS OF LEATHER, LEATHER FOR FURNITURE, LEATHER AND IMITATION OF LEATHER FOR SHOES, FOR CLOTHES AND LEATHER FOR BAGS AND SUITCASES; ANIMAL SKINS; TRUNKS AND TRAVELING BAGS, UMBRELLAS, PARASOLS AND WALKING STICKS; WHIPS, HARNESS AND SADDLERY; UNFITTED VANITY CASES; LEATHERWARE, NAMELY, HAND BAGS, TRAVEL BAGS, BACKPACKS, SHOPPING BAGS, MAKE-UP BAGS SOLD EMPTY, ROLL BAGS, SPORT BAGS, SUITCASES, TOILETRY BAGS SOLD EMPTY, PURSES AND WALLETS, TRUNKS, ATTACHÉ-CASES, GENERAL PURPOSE TROLLEY BAGS; BAGS, NAMELY, HANDBAGS, CARRY-ALL BAGS, TRAVEL BAGS, BACKPACKS, SHOPPING BAGS OF LEATHER AND CANVAS, MAKE-UP BAGS SOLD EMPTY, ROLL BAGS, SPORT BAGS, TOILETRY BAGS SOLD EMPTY, SCHOOL BAGS; SADDLEBAGS; SCHOOL BAGS; SUITCASES; TRUNKS; VALISES; TRAVELING TRUNKS; KEY CASES; TRAVELING SETS, NAMELY, LUGGAGE OF VARIOUS SIZE; WALLETS; BRIEFCASES; PURSES; BUSINESS CARD CASES; BANDS OF LEATHER; SHOULDER BELTS AND STRAPS OF LEATHER, IN CLASS 18 (U.S. CLS. 1, 2, 3, 22 AND 41).



*David J. Kyffers*

Director of the United States Patent and Trademark Office

FOR: ADVERTISING; BUSINESS MANAGEMENT; BUSINESS ADMINISTRATION; PROVIDING OFFICE FUNCTIONS; PRESENTATION OF GOODS ON COMMUNICATION

**Reg. No. 4,196,344** MEDIA, FOR RETAIL PURPOSES; COMMERCIAL ADMINISTRATION OF THE LICENSING OF THE GOODS AND SERVICES OF OTHERS; ORGANIZATION OF EXHIBITIONS FOR COMMERCIAL OR ADVERTISING PURPOSES; ADMINISTRATIVE AND COMMERCIAL MANAGEMENT OF THE RETAIL SALE OF JEWELRY PRODUCTS, JEWELRY AND LEATHERWARE; WHOLESALE STORE SERVICES FEATURING JEWELRY PRODUCTS, JEWELRY AND LEATHERWARE; RETAIL STORE SERVICES FEATURING JEWELRY PRODUCTS, JEWELRY AND LEATHERWARE, IN CLASS 35 (U.S. CLS. 100, 101 AND 102).

THE MARK CONSISTS OF STANDARD CHARACTERS WITHOUT CLAIM TO ANY PARTICULAR FONT, STYLE, SIZE, OR COLOR.

PRIORITY DATE OF 10-4-2010 IS CLAIMED.

OWNER OF INTERNATIONAL REGISTRATION 1074262 DATED 4-4-2011, EXPIRES 4-4-2021.

THE ENGLISH TRANSLATION OF "GRAAL" IN THE MARK IS GRAIL.

SER. NO. 79-096,317, FILED 4-4-2011.

SUE LAWRENCE, EXAMINING ATTORNEY

# United States of America

United States Patent and Trademark Office

# MEDFIELD

**Reg. No. 4,196,345**

**Registered Aug. 28, 2012**

**Int. Cl.: 10**

**TRADEMARK**

**PRINCIPAL REGISTER**

MEDFIELD DIAGNOSTICS AKTIEBOLAG (SWEDEN JOINT STOCK COMPANY)  
MEDICINAREGATAN 8A  
SE-413 90 GÖTEBORG  
SWEDEN

FOR: MEDICAL APPARATUS AND INSTRUMENTS, NAMELY, APPARATUS AND INSTRUMENTS FOR DIAGNOSIS OF DISEASES AND ILLNESSES OF HUMAN BRAINS, IN CLASS 10 (U.S. CLS. 26, 39 AND 44).

THE MARK CONSISTS OF STANDARD CHARACTERS WITHOUT CLAIM TO ANY PARTICULAR FONT, STYLE, SIZE, OR COLOR.

PRIORITY DATE OF 9-30-2010 IS CLAIMED.

OWNER OF INTERNATIONAL REGISTRATION 1074293 DATED 3-15-2011, EXPIRES 3-15-2021.

SER. NO. 79-096,324, FILED 3-15-2011.

LINDA M. KING, EXAMINING ATTORNEY



*David J. Kyffers*

Director of the United States Patent and Trademark Office

# United States of America

United States Patent and Trademark Office

## Diamond Dash

**Reg. No. 4,196,346**

**Registered Aug. 28, 2012**

**Int. Cls.: 9, 25, 28, 35, 38  
and 41**

**TRADEMARK**

**SERVICE MARK**

**PRINCIPAL REGISTER**

WOOGA GMBH (FED REP GERMANY LIMITED LIABILITY COMPANY)  
SAARBRÜCKER STR. 38  
10405 BERLIN  
FED REP GERMANY

FOR: COMPUTERS, COMPUTER PROGRAMS RECORDED AND DOWNLOADABLE, IN PARTICULAR COMPUTER, VIDEO, ONLINE AND BROWSER GAMES AND COMPUTER GAME PROGRAMS FOR MOBILE PHONES, IN CLASS 9 (U.S. CLS. 21, 23, 26, 36 AND 38).

FOR: CLOTHING, NAMELY, OUTERWEAR, NAMELY, JACKETS, T-SHIRTS; HEADGEAR, NAMELY, HATS, CAPS, IN CLASS 25 (U.S. CLS. 22 AND 39).

FOR: ELECTRONIC GAME MACHINES WITH DISPLAYS, NOT FOR CONNECTING TO AN EXTERNAL DISPLAY SCREEN OR MONITOR, IN PARTICULAR COMPUTER, VIDEO, ONLINE AND BROWSER GAME MACHINES, IN EACH CASE OTHERS THAN THOSE ADAPTED FOR USE WITH AN EXTERNAL DISPLAY SCREEN OR MONITOR, AS FAR AS INCLUDED IN THIS CLASS, IN CLASS 28 (U.S. CLS. 22, 23, 38 AND 50).

FOR: ADVERTISING, ONLINE ADVERTISING IN A COMPUTER NETWORK, DISSEMINATION OF ADVERTISEMENTS, DISTRIBUTION OF ADVERTISING MATERIAL, NAMELY, FLYERS, LEAFLETS, PRINTED MATTER AND SAMPLES, IN CLASS 35 (U.S. CLS. 100, 101 AND 102).

FOR: PROVIDING ACCESS TO AN INTERNET PAGE AND ELECTRONIC TRANSMISSION OF INFORMATION IN THE FORM OF TEXT, IMAGES, SPEECH AND SOUNDS VIA AN INTERNET PAGE; ARRANGING AND RENTING OF ACCESS RIGHTS TO AN INTERNET PAGE; PROVIDING ACCESS TO A SOFTWARE IN DATA NETWORKS FOR INTERNET ACCESS; BROADCASTING OF MOVIE, TELEVISION, RADIO, BTX, VIDEO TEXT, TELE-TEXT PROGRAMS OR BROADCASTS, IN PARTICULAR ADVERTISING SPOTS; PROVIDING ACCESS TO DATABASES; PROVIDING ACCESS TO INFORMATION FROM A DATABASE OR FROM THE INTERNET, IN CLASS 38 (U.S. CLS. 100, 101 AND 104).

FOR: ORGANIZING OF GAMES IN THE INTERNET; ENTERTAINMENT, NAMELY, PROVIDING ONLINE COMPUTER, VIDEO, AND BROWSER GAMES, COMPUTER GAME PROGRAMS FOR MOBILE PHONES AND PROVIDING ENTERTAINMENT INFORMATION ON THE INTERNET; PROVIDING GAME SERVICES OFFERED ONLINE, IN CLASS 41 (U.S. CLS. 100, 101 AND 107).



*David J. Kybas*

Director of the United States Patent and Trademark Office

**Reg. No. 4,196,346** THE MARK CONSISTS OF STANDARD CHARACTERS WITHOUT CLAIM TO ANY PARTICULAR FONT, STYLE, SIZE, OR COLOR.

PRIORITY DATE OF 11-15-2010 IS CLAIMED.

OWNER OF INTERNATIONAL REGISTRATION 1075333 DATED 3-16-2011, EXPIRES 3-16-2021.

SER. NO. 79-096,762, FILED 3-16-2011.

SANI KHOURI, EXAMINING ATTORNEY

# United States of America

United States Patent and Trademark Office

# HYPE & REBEL

*Your freedom stops where mine begins!*

**Reg. No. 4,196,347**

JULIE ALVES DA CUNHA (FRANCE INDIVIDUAL)

**Registered Aug. 28, 2012**

95 RUE DE LA POMPE  
PARIS, FRANCE F75116

**Int. Cls.: 16, 25, 35, 38  
and 41**

FOR: PRINTED MATTER, NAMELY, NEWSPAPERS, PROSPECTUSES, PERIODICALS, PRESS RELEASES, BOOKS AND MAGAZINES IN THE FIELD OF FASHION AND ENTERTAINMENT; PHOTOGRAPHS; POSTERS; ALBUMS FOR PHOTOGRAPHS; FLASH AND FILE CARDS; AND WRITING INSTRUMENTS, IN CLASS 16 (U.S. CLS. 2, 5, 22, 23, 29, 37, 38 AND 50).

**TRADEMARK**

**SERVICE MARK**

FOR: CLOTHING, NAMELY, COATS, JACKETS, DRESSES, RAINCOATS, SKIRTS, SUITS, TIES, TROUSERS, PANTS, SHORTS, SHIRTS, FOOTWEAR, HEADGEAR, NAMELY, HATS, CAPS, SUN HATS AND BONNETS; LEATHER OR IMITATION LEATHER CLOTHING, NAMELY, COATS, JACKETS, DRESSES, RAINCOATS, SKIRTS, SUITS, TIES, TROUSERS, PANTS, SHORTS, SHIRTS, BELTS; FURS, NAMELY, FUR COATS, FUR JACKETS, FUR SCARVES, FUR GLOVES; GLOVES; SCARVES; NECKTIES; HOSIERY; SOCKS; SLIPPERS; BEACH, SKI AND SPORTS FOOTWEAR; BABIES TEXTILE DIAPERS; AND UNDERWEAR, IN CLASS 25 (U.S. CLS. 22 AND 39).

**PRINCIPAL REGISTER**

FOR: ADVERTISING SERVICES; DIRECT MAIL ADVERTISING SERVICES; ARRANGING NEWSPAPER SUBSCRIPTIONS FOR OTHERS; BUSINESS MANAGEMENT AND ORGANIZATION CONSULTANCY; DOCUMENT REPRODUCTION; COMPUTERIZED FILE MANAGEMENT; ORGANIZING EXHIBITIONS FOR COMMERCIAL OR ADVERTISING PURPOSES; ON-LINE ADVERTISING ON A COMPUTER NETWORK; RENTAL OF ADVERTISING TIME ON COMMUNICATION MEDIA; PUBLICATION OF PUBLICITY TEXTS; RENTAL OF ADVERTISING SPACE; DISSEMINATION OF ADVERTISING MATTER; AND PUBLIC RELATIONS SERVICES, IN CLASS 35 (U.S. CLS. 100, 101 AND 102).



*David J. Kyffers*

Director of the United States Patent and Trademark Office

FOR: TELECOMMUNICATIONS SERVICES, NAMELY, TRANSMISSION OF PODCASTS, PROVIDING INTERNET ACCESS VIA BROADBAND OPTICAL OR WIRELESS NETWORKS; PROVIDING INFORMATION ABOUT TELECOMMUNICATIONS; COMMUNICATIONS VIA COMPUTER TERMINALS OR VIA FIBER-OPTIC NETWORKS; RADIO OR TELEPHONE COMMUNICATIONS; MOBILE RADIO TELEPHONE SERVICES; PROVIDING USER ACCESS TO A GLOBAL COMPUTER NETWORK; ELECTRONIC BULLETIN BOARD SERVICES; PROVIDING TELECOMMUNICATIONS CONNECTIONS TO A GLOBAL COMPUTER NETWORK; NEWS AGENCIES SERVICES FOR ELECTRONIC TRANSMISSION; RENTAL OF TELECOMMUNICATION EQUIPMENT, NAMELY, TELEPHONES, MOBILE PHONES,

**Reg. No. 4,196,347** FACSIMILE PHONES, RADIOS, COMPUTERS, LAPTOP COMPUTERS, MP3 PLAYERS, TABLET COMPUTERS; RADIO AND TELEVISION BROADCASTING; TELECONFERENCING SERVICES; ELECTRONIC MESSAGING; RENTAL OF ACCESS TIME TO GLOBAL COMPUTER NETWORKS, IN CLASS 38 (U.S. CLS. 100, 101 AND 104).

FOR: PROVIDING INFORMATION CONCERNING ENTERTAINMENT OR EDUCATION; PUBLICATION OF BOOKS; LENDING LIBRARIES; VIDEO TAPE FILM PRODUCTION; RENTAL OF MOTION PICTURES; RENTAL OF SOUND RECORDINGS; ORGANIZING COMPETITIONS IN THE NATURE OF FASHION SHOW COMPETITIONS; ARRANGING AND CONDUCTING FASHION AND EDUCATIONAL COLLOQUIUMS, CONFERENCES AND CONGRESSES; ORGANIZING EXHIBITIONS FOR CULTURAL OR EDUCATIONAL PURPOSES; ELECTRONIC GAME SERVICES PROVIDED ONLINE FROM A COMPUTER NETWORK; GAMBLING SERVICES; PUBLICATION OF ELECTRONIC BOOKS AND JOURNALS ONLINE; AND ELECTRONIC DESKTOP PUBLISHING, IN CLASS 41 (U.S. CLS. 100, 101 AND 107).

THE MARK CONSISTS OF THE STYLIZED WORDING "HYPE & REBEL". THE LETTER "H" IN THE WORD "HYPE" IS SHOWN IN RED WITH A BLACK BORDER. THE LETTER "R" IN THE WORD "REBEL" IS SHOWN IN RED WITH A BLACK BORDER. THE REMAINING LETTERS AND "&" ARE SHOWN IN BLACK. THE STYLIZED WORDING "YOUR FREEDOM STOPS WHERE MINE BEGINS" APPEARS BELOW IN BLACK, ALL ON A WHITE BACKGROUND.

PRIORITY DATE OF 9-17-2010 IS CLAIMED.

OWNER OF INTERNATIONAL REGISTRATION 1076239 DATED 3-17-2011, EXPIRES 3-17-2021.

THE COLOR(S) RED, BLACK AND WHITE IS/ARE CLAIMED AS A FEATURE OF THE MARK.

SER. NO. 79-097,057, FILED 3-17-2011.

JESSICA FATHY, EXAMINING ATTORNEY



United States of America  
United States Patent and Trademark Office

**Flove**

**Reg. No. 4,196,348**

**Registered Aug. 28, 2012**

**Int. Cl.: 25**

**TRADEMARK**

**PRINCIPAL REGISTER**

BIAN CAIFENG (CHINA INDIVIDUAL)  
NIUZHUGOU GROUP  
LAOCHANGZI VILLAGE,; GOUMENZI TOWN,; LINGYUAN CITY; LIAONING PROVINCE  
CHINA

FOR: CLOTHING, NAMELY, SHIRTS, PANTS, DRESSES, JACKETS; SHOES; HATS; GLOVES;  
GIRDLES; NECKTIES; SCARVES, IN CLASS 25 (U.S. CLS. 22 AND 39).

THE MARK CONSISTS OF THE STYLIZED WORDING "F LOVE".

OWNER OF INTERNATIONAL REGISTRATION 1077628 DATED 5-12-2011, EXPIRES 5-12-  
2021.

SER. NO. 79-097,556, FILED 5-12-2011.

COURTNEY ALVAREZ, EXAMINING ATTORNEY



*David J. Kybas*

Director of the United States Patent and Trademark Office

# United States of America

United States Patent and Trademark Office



**Reg. No. 4,196,349**

**Registered Aug. 28, 2012**

**Int. Cl.: 12**

**TRADEMARK**

**PRINCIPAL REGISTER**

JIANGSU FEICHI CO., LTD. (CHINA CORPORATION)  
NO. 45, RENMIN SOUTH ROAD  
YANCHENG CITY  
JIANGSU PROVINCE, CHINA

FOR: INNER TUBES FOR PNEUMATIC TIRES; TIRES FOR VEHICLE WHEELS; BICYCLE TIRES; CASINGS FOR PNEUMATIC TIRES; TIRES, SOLID, FOR VEHICLE WHEELS; INNER TUBES FOR BICYCLES, CYCLES; VEHICLE WHEEL TIRES; AUTOMOBILE TIRES; TYRES FOR VEHICLE WHEELS; CYCLE TIRES, IN CLASS 12 (U.S. CLS. 19, 21, 23, 31, 35 AND 44).

THE MARK CONSISTS OF THE WORD "FEICHI" IN STYLIZED FONT, WITH EACH LETTER CONTAINING DIAGONAL LINING WHICH IS A FEATURE OF THE MARK. TO THE LEFT OF THE WORDING IS AN ABSTRACT CIRCULAR DESIGN SUGGESTING A COMBINATION OF A WHEEL OR TIRE AND THE LETTER "F".

OWNER OF INTERNATIONAL REGISTRATION 1078545 DATED 5-17-2011, EXPIRES 5-17-2021.

THE WORD(S) "FEICHI" HAS NO MEANING IN A FOREIGN LANGUAGE.

SER. NO. 79-097,839, FILED 5-17-2011.

STEVEN PEREZ, EXAMINING ATTORNEY



*David J. Kyffers*

Director of the United States Patent and Trademark Office

# United States of America

United States Patent and Trademark Office

## GEL POWERBALL

**Reg. No. 4,196,350**

**Registered Aug. 28, 2012**

**Int. Cl.: 3**

**TRADEMARK**

**PRINCIPAL REGISTER**

RECKITT BENCKISER N.V. (NETHERLANDS COMPANY)  
SIRIUSDREEF 14  
NL-2132 WT HOOFDDORP, NETHERLANDS

FOR: BLEACHING PREPARATIONS AND OTHER SUBSTANCES FOR LAUNDRY USE AND DISHWASHING; DISHWASHING PREPARATIONS; DISHWASHER CLEANER, FRESHENER AND DEODORIZER; RINSE AGENTS FOR MACHINE DISHWASHERS; POLISHING PREPARATIONS FOR KITCHEN AND GLASSWARE; CLEANING, POLISHING, SCOURING AND ABRASIVE PREPARATIONS; DECALCIFYING AND DESCALING PREPARATIONS FOR DOMESTIC USE; ALL AFOREMENTIONED GOODS WITH OR WITHOUT A DISINFECTIVE COMPONENT, IN CLASS 3 (U.S. CLS. 1, 4, 6, 50, 51 AND 52).

THE MARK CONSISTS OF STANDARD CHARACTERS WITHOUT CLAIM TO ANY PARTICULAR FONT, STYLE, SIZE, OR COLOR.

PRIORITY DATE OF 11-3-2010 IS CLAIMED.

OWNER OF INTERNATIONAL REGISTRATION 1079374 DATED 5-3-2011, EXPIRES 5-3-2021.

OWNER OF U.S. REG. NOS. 3,206,391 AND 3,761,279.

NO CLAIM IS MADE TO THE EXCLUSIVE RIGHT TO USE "GEL", APART FROM THE MARK AS SHOWN.

SER. NO. 79-098,156, FILED 5-3-2011.

ALLISON SCHRODY, EXAMINING ATTORNEY



*David J. Kybas*

Director of the United States Patent and Trademark Office

# United States of America

United States Patent and Trademark Office



**Reg. No. 4,196,351**

**Registered Aug. 28, 2012**

**Int. Cls.: 35 and 36**

**SERVICE MARK**

**PRINCIPAL REGISTER**

BI-INVEST HOLDINGS S.A. (LUXEMBOURG CORPORATION)  
51, AVENUE J-F KENNEDY  
L-1855 LUXEMBOURG  
LUXEMBOURG

FOR: BUSINESS ADVISORY SERVICES, NAMELY, FOR BUSINESS MANAGEMENT, RELATING TO BUSINESS ACQUISITIONS AND RELATING TO BUSINESS ORGANIZATION; BUSINESS MANAGEMENT; BUSINESS MANAGEMENT CONSULTING, INCLUDING MANAGEMENT BUYOUT ADVICE; BUSINESS ORGANISATION CONSULTING; BUSINESS RESEARCH; BUSINESS APPRAISALS; BUSINESS PLANNING; BUSINESS INFORMATION SERVICES, NAMELY, PROVISION OF INFORMATION AND EVALUATION OF BUSINESS OPPORTUNITIES AND BUSINESS ORGANIZATION; ACQUISITION AND MERGER CONSULTATION; PERSONNEL RECRUITMENT AND MANAGEMENT, IN CLASS 35 (U.S. CLS. 100, 101 AND 102).

FOR: FINANCIAL ADVISORY AND CONSULTANCY SERVICES; FINANCIAL MANAGEMENT; MANAGEMENT OF CAPITAL INVESTMENT FUNDS; FINANCIAL INFORMATION, NAMELY, PROVIDING INFORMATION AND ADVICE IN THE FIELD OF FINANCE, FINANCIAL INVESTMENTS AND FINANCIAL EVALUATIONS; FINANCIAL SERVICES, NAMELY, MANAGEMENT AND BROKERAGE IN THE FIELD OF MONEY LENDING, STOCKS, BONDS, OPTIONS, COMMODITIES, FUTURES AND OTHER SECURITIES; INVESTMENT CONSULTATION; INVESTMENT MANAGEMENT; INVESTMENT AND TRUST COMPANY SERVICES; FINANCIAL GUARANTEE AND SURETY; FUND RAISING FOR OTHERS FOR THE PURPOSE OF PURCHASING COMPANIES; INVESTMENT ADVISORY SERVICES RELATING TO VENTURE AND CORPORATE CAPITAL, IN CLASS 36 (U.S. CLS. 100, 101 AND 102).

OWNER OF U.S. REG. NOS. 3,785,287 AND 3,923,530.

OWNER OF INTERNATIONAL REGISTRATION 1079717 DATED 4-15-2011, EXPIRES 4-15-2021.

THE MARK CONSISTS OF A DIAMOND THAT CONTAINS HORIZONTAL LINES ON THE LEFT-HAND SIDE. TO THE RIGHT OF THE DIAMOND IS THE LANGUAGE "INVESTINDUSTRIAL".

SEC. 2(F) AS TO "INVESTINDUSTRIAL".



*David J. Kyffers*

Director of the United States Patent and Trademark Office

**Reg. No. 4,196,351** SER. NO. 79-098,288, FILED 4-15-2011.

MICHELLE DUBOIS, EXAMINING ATTORNEY

# United States of America

United States Patent and Trademark Office

lol 

**Reg. No. 4,196,352**

**Registered Aug. 28, 2012**

**Int. Cl.: 3**

**TRADEMARK**

**PRINCIPAL REGISTER**

GFA (AUST) PTY LTD (AUSTRALIA AUSTRALIAN PROPRIETARY COMPANY, LIMITED  
BY SHARES)  
61 SUNMORE CLOSE  
HEATHERTON VIC 3202  
AUSTRALIA

FOR: COSMETICS, IN CLASS 3 (U.S. CLS. 1, 4, 6, 50, 51 AND 52).

THE MARK CONSISTS OF "LOL", WITH A HEART APPEARING TO THE RIGHT AND ABOVE THE "LOL".

PRIORITY DATE OF 1-11-2011 IS CLAIMED.

OWNER OF INTERNATIONAL REGISTRATION 1079887 DATED 4-15-2011, EXPIRES 4-15-2021.

SER. NO. 79-098,354, FILED 4-15-2011.

DAVID HOFFMAN, EXAMINING ATTORNEY



*David J. Kyfos*

Director of the United States Patent and Trademark Office

United States of America  
United States Patent and Trademark Office

UNIRAM

**Reg. No. 4,196,353**

**Registered Aug. 28, 2012**

**Int. Cl.: 17**

**TRADEMARK**

**PRINCIPAL REGISTER**

NETAFIM LTD. (ISRAEL LIMITED COMPANY)  
10 DERECH HASHALOM  
67892 TEL AVIV  
ISRAEL

FOR: FLEXIBLE TUBES FOR USE IN DRIP IRRIGATION; HOSES ADAPTED FOR DRIP IRRIGATION PURPOSES; PARTS AND FITTINGS FOR ALL THE AFOREMENTIONED GOODS, NAMELY, PLASTIC CONNECTORS, START AND ENDLINE CONNECTORS, IN CLASS 17 (U.S. CLS. 1, 5, 12, 13, 35 AND 50).

THE MARK CONSISTS OF STANDARD CHARACTERS WITHOUT CLAIM TO ANY PARTICULAR FONT, STYLE, SIZE, OR COLOR.

PRIORITY DATE OF 2-21-2011 IS CLAIMED.

OWNER OF INTERNATIONAL REGISTRATION 1080028 DATED 2-27-2011, EXPIRES 2-27-2021.

SER. NO. 79-098,419, FILED 2-27-2011.

MARK SPARACINO, EXAMINING ATTORNEY



*David J. Kyffers*

Director of the United States Patent and Trademark Office

# United States of America

United States Patent and Trademark Office

# öko skin

**Reg. No. 4,196,354**

WOLFGANG RIEDER (AUSTRIA INDIVIDUAL)  
PAILREITHSTR. 1

**Registered Aug. 28, 2012**

MAISHOFEN, AUSTRIA A5751

**Int. Cls.: 1, 7, 19 and 20**

FOR: AGGLUTINANTS FOR CONCRETE, IN CLASS 1 (U.S. CLS. 1, 5, 6, 10, 26 AND 46).

**TRADEMARK**

FOR: MACHINES FOR THE MANUFACTURE OF CONCRETE BUILDING PANELS, GLASS-FIBRE REINFORCED CONCRETE BUILDING PANELS, TRANSLUCENT CONCRETE BUILDING PANELS, AND THREE-DIMENSIONAL CONCRETE COMPONENTS, IN CLASS 7 (U.S. CLS. 13, 19, 21, 23, 31, 34 AND 35).

**PRINCIPAL REGISTER**

FOR: CONCRETE BUILDING ELEMENTS, NAMELY, GLASS-FIBRE REINFORCED CONCRETE BUILDING PANELS, TRANSLUCENT CONCRETE BUILDING PANELS, AND THREE-DIMENSIONAL CONCRETE BUILDING PANELS, IN CLASS 19 (U.S. CLS. 1, 12, 33 AND 50).

FOR: FURNITURE OF CONCRETE; FURNITURE OF FIBREGLASS-REINFORCED CONCRETE; FURNITURE OF TRANSLUCENT CONCRETE, IN CLASS 20 (U.S. CLS. 2, 13, 22, 25, 32 AND 50).

THE MARK CONSISTS OF STANDARD CHARACTERS WITHOUT CLAIM TO ANY PARTICULAR FONT, STYLE, SIZE, OR COLOR.

OWNER OF INTERNATIONAL REGISTRATION 1081342 DATED 3-4-2011, EXPIRES 3-4-2021.

THE WORD(S) "ÖKO" HAS NO MEANING IN A FOREIGN LANGUAGE.

SER. NO. 79-098,884, FILED 3-4-2011.

KRISTIN DAHLING, EXAMINING ATTORNEY



*David J. Kyffers*

Director of the United States Patent and Trademark Office



# United States of America

United States Patent and Trademark Office

## CB CERATIZIT

**Reg. No. 4,196,355**

**Registered Aug. 28, 2012**

**Int. Cls.: 1, 6, 7, 8, 35, 40,  
41 and 42**

**TRADEMARK**

**SERVICE MARK**

**PRINCIPAL REGISTER**

CB CERATIZIT LUXEMBOURG S.A. (LUXEMBOURG SOCIÉTÉ ANONYME)  
101, ROUTE DE HOLZEM  
L-8232 MAMER  
LUXEMBOURG

FOR: CHEMICALS USED IN INDUSTRY, PHOTOGRAPHY AND SCIENCE, AS WELL AS IN AGRICULTURE, HORTICULTURE AND FORESTRY; ARTIFICIAL RESINS, UNPROCESSED; PLASTICS, UNPROCESSED; FERTILIZERS; FIRE EXTINGUISHING COMPOSITIONS; TEMPERING AND CHEMICAL SOLDERING PREPARATIONS; CHEMICAL COMPOSITIONS FOR PRESERVING FOODSTUFFS; TANNING SUBSTANCES, NAMELY, TANNING AGENTS FOR USE IN THE MANUFACTURE OF LEATHER IN THE NATURE OF OILS FOR TANNING LEATHER; ADHESIVES FOR INDUSTRIAL PURPOSES; COMPOSITIONS, NAMELY, CHEMICALS USED IN INDUSTRY FOR THE MANUFACTURE OF TECHNICAL CERAMICS, IN CLASS 1 (U.S. CLS. 1, 5, 6, 10, 26 AND 46).

FOR: COMMON METALS AND THEIR ALLOYS; BUILDING MATERIALS OF METAL, NAMELY, COMPOSITE PANELS COMPOSED PRIMARILY OF METAL, METAL BUILDING FLASHING, METAL CLADDING FOR CONSTRUCTION AND BUILDING; TRANSPORTABLE METAL BUILDINGS; RAILWAY MATERIAL OF METAL, NAMELY, MATERIALS OF METAL FOR RAILWAY CONSTRUCTION, METALLIC MATERIALS FOR RAILWAY TRACKS, METAL RAILWAY CROSSOVERS; NON-ELECTRIC CABLES AND WIRES OF COMMON METAL; IRONMONGERY, NAMELY, SMALL ITEMS OF METAL HARDWARE IN THE NATURE OF METAL SCREWS, METAL BOLTS, METAL NAILS; PIPES OF METAL; METAL SAFES; GOODS OF COMMON METAL, NAMELY, COMMON METAL DRAWER PULLS, COMMON METAL BASKETS, COMMON METAL BOXES; ORES OF METAL; CERMETS; ANCHOR PARTS, NAMELY, EXTRUDED HARD METAL RODS; COMMON HARD METALS; LAMINATED COMPOSITE MATERIALS PRODUCED FROM SUPERIMPOSING LAYERS OF COMMON METAL OR COMMON METAL ALLOYS; VERY HARD COMMON METALS AND COMMON METAL ALLOYS; SEMI-WORKED PRODUCTS OF COMMON METAL OR OF COMMON METAL ALLOYS FOR FURTHER MANUFACTURE, IN CLASS 6 (U.S. CLS. 2, 12, 13, 14, 23, 25 AND 50).

FOR: MACHINES AND MACHINE TOOLS FOR THE CUTTING AND FORMING OF MATERIALS; MOTORS, OTHER THAN FOR LAND VEHICLES; MACHINE COUPLING AND TRANSMISSION COMPONENTS NOT BEING FOR LAND VEHICLES; AGRICULTURAL IMPLEMENTS OTHER THAN HAND-OPERATED, NAMELY, INCORPORATORS, SEED DRILLS, HAY BALERS; INCUBATORS FOR EGGS; TOOLS IN THE NATURE OF MACHINE



*David J. Kyffers*

Director of the United States Patent and Trademark Office

**Reg. No. 4,196,355** PARTS FOR CUTTING, TURNING, MILLING AND DRILLING, NAMELY, DIAMOND POINTED METAL-CUTTING TOOLS, CEMENTED CARBIDE CUTTING TOOLS, CUTTING MACHINES; TOOLS FOR WOODWORKING, CRUSHING TECHNOLOGY, FASTENING TECHNOLOGY AND FOR STONE WORKING IN THE NATURE OF MACHINE PARTS, NAMELY, WOOD PLANING MACHINES, CRUSHING MACHINES FOR INDUSTRIAL PURPOSES, POWER OPERATED POLISHERS; DRILLING MACHINES FOR THE PRINTING INDUSTRY IN THE NATURE OF MACHINES; STAMPING TOOLS IN THE NATURE OF MACHINE PARTS, NAMELY, AUTOMATIC STAMPING MACHINES, DIE-STAMPING MACHINES, STAMPING PRESSES; MACHINE PARTS, NAMELY, SAW TEETH BLADES; PAPER CUTTING MACHINES AND PAPER MAKING MACHINES; MOLDS IN THE NATURE OF MACHINE PARTS USED FOR PROCESSING METALS; MACHINE PARTS THAT WEAR DOWN FOR THE AFORESAID MACHINES AND MACHINE-TOOLS, MADE OF HARD METALS, CERMET, CERAMICS OR VERY HARD MATERIALS; TOOLS IN THE NATURE OF MACHINE PARTS, IN CLASS 7 (U.S. CLS. 13, 19, 21, 23, 31, 34 AND 35).

FOR: HAND TOOLS AND HAND-OPERATED IMPLEMENTS, NAMELY, DRILLS, CLAMPS, HAMMERS; CUTLERY, NAMELY, FORKS AND SPOONS; SIDEARMS, OTHER THAN FIREARMS, NAMELY, HUNTING KNIVES, SWORDS; RAZORS, IN CLASS 8 (U.S. CLS. 23, 28 AND 44).

FOR: ADVERTISING; BUSINESS MANAGEMENT; BUSINESS ADMINISTRATION; OFFICE FUNCTIONS; WRITING PUBLICITY COLUMNS; DISSEMINATION OF ADVERTISING MATERIALS INCLUDING IN THE NATURE OF LEAFLETS, PROSPECTUSES, PRINTED MATTER AND SAMPLES; DOCUMENT REPRODUCTION; BUSINESS ORGANIZATION CONSULTANCY; UPDATING OF ADVERTISING MATERIAL; DISSEMINATION OF ADVERTISING MATTER; PUBLICATION OF PUBLICITY TEXTS; ON-LINE ADVERTISING ON A COMPUTER NETWORK; ADVERTISING BY MAIL ORDER; RADIO ADVERTISING; BUSINESS MANAGEMENT ASSISTANCE; BUSINESS MANAGEMENT ASSISTANCE; PUBLIC RELATIONS; BUSINESS INQUIRIES; TELEVISION ADVERTISING; BILLPOSTING, NAMELY, BILL STICKING; DEMONSTRATION OF GOODS; ORGANIZATION OF EXHIBITIONS FOR COMMERCIAL OR ADVERTISING PURPOSES; ORGANIZATION OF TRADE FAIRS FOR COMMERCIAL OR ADVERTISING PURPOSES; PRESENTATION OF GOODS ON COMMUNICATION MEDIA, FOR RETAIL PURPOSES, IN CLASS 35 (U.S. CLS. 100, 101 AND 102).

FOR: TECHNICAL CONSULTING IN CONNECTION WITH TREATMENT OF MATERIALS RELATED TO THE USE OF CUTTING MACHINE-TOOLS FOR THE PROCESSING OF METALS AND SYNTHETIC MATERIALS, ESPECIALLY FOR USING TURNING, DE-BURRING AND TAPPING TOOLS, DRILLING MACHINES, MILLING CUTTERS, SIDE-AND-FACE MILLING CUTTERS, SAWS, REAMING AND COUNTERSINKING TOOLS; TECHNICAL CONSULTING IN CONNECTION WITH TREATMENT OF MATERIALS RELATED TO THE USE OF COMPONENTS OF THE AFOREMENTIONED TOOLS, ESPECIALLY IN THE USE OF INTERCHANGEABLE CUTTING PARTS MADE OF HIGH SPEED STEEL, HARD METAL, CERMET, CERAMICS OR EXTRA HARD MATERIALS AND OTHER CUTTING MATERIALS, SAW TOOTH AND EXTRUDED HARD-METAL MANDREL MACHINE TOOLS, GUILLOTINES FOR PROCESSING PAPER, MECHANICAL FORMING TOOLS, TOOLS FOR CUTTING FOR USE IN THE TREATMENT OF METALS AND SYNTHETIC MATERIALS, MECHANICAL CLAMPING APPARATUS FOR TOOLS AND WORK PIECES DESIGNED TO BE USED WITH MACHINE TOOLS, WITH TOOL CRIB AUTO MATS FOR STORING AND DISPENSING MACHINE TOOLS, WITH WEARING PARTS FOR MACHINES MADE OF HARD METAL, CERMET, CERAMICS OR SYNTHETIC MATERIALS, IN CLASS 40 (U.S. CLS. 100, 103 AND 106).

FOR: TEACHING CLASSES AND SEMINARS IN THE FIELD OF METALWORKING, THE USE OF MACHINES, ESPECIALLY CUTTING TOOLS AND MACHINES, AS WELL AS IN THE FIELDS OF HARD MATERIALS; PROVIDING TRAINING IN THE FIELD OF METALWORKING, THE USE OF MACHINES, ESPECIALLY CUTTING TOOLS AND MACHINES, AS WELL AS IN THE FIELDS OF HARD MATERIALS; ENTERTAINMENT SERVICES,

**Reg. No. 4,196,355** NAMELY, IN THE FIELD OF METALWORKING, THE USE OF MACHINES, ESPECIALLY CUTTING TOOLS AND MACHINES, AS WELL AS IN THE FIELDS OF HARD MATERIALS; ORGANIZING COMMUNITY SPORTING AND CULTURAL EVENTS; ARRANGING AND CONDUCTING OF COLLOQUIUMS IN THE NATURE OF CONFERENCES IN THE FIELD OF METALWORKING, THE USE OF MACHINES, ESPECIALLY CUTTING TOOLS AND MACHINES, AS WELL AS IN THE FIELDS OF HARD MATERIALS; ARRANGING AND CONDUCTING OF CONFERENCES IN THE FIELD OF METALWORKING, THE USE OF MACHINES, ESPECIALLY CUTTING TOOLS AND MACHINES, AS WELL AS IN THE FIELDS OF HARD MATERIALS; ARRANGING AND CONDUCTING OF CONGRESSES IN THE NATURE OF MEETINGS IN THE FIELD OF METALWORKING, THE USE OF MACHINES, ESPECIALLY CUTTING TOOLS AND MACHINES, AS WELL AS IN THE FIELDS OF HARD MATERIALS; CORRESPONDENCE COURSES IN THE FIELD OF METALWORKING, THE USE OF MACHINES, ESPECIALLY CUTTING TOOLS AND MACHINES, AS WELL AS IN THE FIELDS OF HARD MATERIALS; ENTERTAINMENT INFORMATION; PROVIDING ONLINE ELECTRONIC PUBLICATIONS, NOT DOWNLOADABLE IN THE NATURE OF E-ZINES, TEXT BOOKS AND NEWSLETTERS IN THE FIELD OF METALWORKING, THE USE OF MACHINES, ESPECIALLY CUTTING TOOLS AND MACHINES, AS WELL AS IN THE FIELDS OF HARD MATERIALS; FILM PRODUCTION; EDUCATION INFORMATION; ELECTRONIC DESKTOP PUBLISHING; VIDEOTAPE EDITING; EDUCATION AND ENTERTAINMENT SERVICES, NAMELY, ORGANIZATION OF SPORTS COMPETITIONS; ORGANIZATION OF EXHIBITIONS FOR CULTURAL OR EDUCATIONAL PURPOSES; ARRANGING AND CONDUCTING OF WORKSHOPS IN THE FIELD OF METALWORKING, THE USE OF MACHINES, ESPECIALLY CUTTING TOOLS AND MACHINES, AS WELL AS IN THE FIELDS OF HARD MATERIALS; PUBLICATION OF BOOKS; ARRANGING AND CONDUCTING OF SEMINARS IN THE FIELD OF METALWORKING, THE USE OF MACHINES, ESPECIALLY CUTTING TOOLS AND MACHINES, AS WELL AS IN THE FIELDS OF HARD MATERIALS; PRESENTATION OF LIVE PERFORMANCES, NAMELY, PLAYS, MUSICAL CONCERTS AND COMEDY SHOWS; ARRANGING AND CONDUCTING OF SYMPOSIUMS; PRODUCTION OF RADIO AND TELEVISION PROGRAMS; PUBLICATION OF TEXTS, OTHER THAN PUBLICITY TEXTS; EDUCATION SERVICES, NAMELY, PROVIDING ACADEMIES SERVICES AT THE COLLEGE AND POST-GRADUATE LEVEL; PRACTICAL TRAINING IN THE FIELD OF METALWORKING, THE USE OF MACHINES, ESPECIALLY CUTTING TOOLS AND MACHINES, AS WELL AS IN THE FIELDS OF HARD MATERIALS; VIDEOTAPE FILM PRODUCTION, IN CLASS 41 (U.S. CLS. 100, 101 AND 107).

FOR: SCIENTIFIC AND TECHNOLOGICAL SERVICES, NAMELY, SCIENTIFIC RESEARCH, ANALYSIS, TESTING IN THE FIELD OF METALWORKING, THE USE OF MACHINES, ESPECIALLY CUTTING TOOLS AND MACHINES, AS WELL AS IN THE FIELDS OF HARD MATERIALS; RESEARCH AND DESIGN, NAMELY, SCIENTIFIC RESEARCH, NEW PRODUCT DESIGN SERVICES, PRODUCT DEVELOPMENT IN THE FIELD OF METALWORKING, THE USE OF MACHINES, ESPECIALLY CUTTING TOOLS AND MACHINES, AS WELL AS IN THE FIELDS OF HARD MATERIALS; INDUSTRIAL ANALYSIS AND RESEARCH SERVICES IN THE FIELD OF METALWORKING, THE USE OF MACHINES, ESPECIALLY CUTTING TOOLS AND MACHINES, AS WELL AS IN THE FIELDS OF HARD MATERIALS; PRODUCT DESIGN AND DEVELOPMENT IN THE FIELD OF COMPUTERS AND SOFTWARE; TECHNICAL CONSULTING IN CONNECTION WITH PRODUCT DESIGN AND DEVELOPMENT OF CUTTING MACHINE-TOOLS FOR THE PROCESSING OF METALS AND SYNTHETIC MATERIALS, ESPECIALLY TURNING, DEBURRING AND TAPPING TOOLS, DRILLING MACHINES, MILLING CUTTERS, SIDE-AND-FACE MILLING CUTTERS, SAWS, REAMING AND COUNTERSINKING TOOLS; TECHNICAL CONSULTING IN CONNECTION WITH PRODUCT DESIGN AND DEVELOPMENT OF COMPONENTS OF THE AFOREMENTIONED TOOLS, ESPECIALLY TURNING INTERCHANGEABLE CUTTING PARTS MADE OF HIGH SPEED STEEL, HARD METAL, CERMET, CERAMICS OR EXTRA HARD MATERIALS AND OTHER CUTTING MATERIALS, SAW TOOTH AND EXTRUDED HARD-METAL MANDREL MACHINE TOOLS, GUILLOTINES FOR PROCESSING PAPER, MECHANICAL FORMING TOOLS, TOOLS FOR CUTTING FOR USE IN THE TREATMENT OF METALS AND SYNTHETIC MATERIALS, MECHANICAL CLAMPING APPARATUS

**Reg. No. 4,196,355** FOR TOOLS AND WORK PIECES DESIGNED TO BE USED WITH MACHINE TOOLS, TOOL CRIB AUTO MATS FOR STORING AND DISPENSING MACHINE TOOLS AND WITH WEARING PARTS FOR MACHINES MADE OF HARD METAL, CERMET, CERAMICS OR SYNTHETIC MATERIALS; PRODUCT DESIGN AND DEVELOPMENT IN THE FIELD OF TOOL MANAGEMENT SYSTEMS IN THE NATURE OF COMPUTER PROGRAMS AND COMPUTER SOFTWARE FOR USE IN LOGISTICS, FOR USE IN CONTROLLING AUTOMATED MACHINERY, FOR ECOMMERCE, AND FOR ALL FUNCTIONAL AND OPERATIONAL SECTORS OF A COMPANY ACTIVE IN THE FIELD OF METALWORKING, THE USE OF MACHINES, ESPECIALLY CUTTING TOOLS AND MACHINES, AS WELL AS IN THE FIELDS OF HARD MATERIALS; TECHNICAL CONSULTING IN THE FIELD OF INFORMATION TECHNOLOGY, IN CLASS 42 (U.S. CLS. 100 AND 101).

THE MARK CONSISTS OF STANDARD CHARACTERS WITHOUT CLAIM TO ANY PARTICULAR FONT, STYLE, SIZE, OR COLOR.

PRIORITY DATE OF 10-19-2010 IS CLAIMED.

OWNER OF INTERNATIONAL REGISTRATION 1081344 DATED 3-9-2011, EXPIRES 3-9-2021.

THE WORDING "CERATIZIT" HAS NO MEANING IN A FOREIGN LANGUAGE.

SER. NO. 79-098,885, FILED 3-9-2011.

JOHN DALIER, EXAMINING ATTORNEY

# United States of America

United States Patent and Trademark Office



**Reg. No. 4,196,356**

**Registered Aug. 28, 2012**

**Int. Cls.: 16, 18 and 25**

**TRADEMARK**

**PRINCIPAL REGISTER**

FABBRICA PELLETERIE MILANO SPA (ITALY JOINT STOCK COMPANY)  
PIAZZA DEL CARMINE, 4  
I-20121 MILANO  
ITALY

FOR: DIARIES; CALENDARS AND ORGANIZATIONAL DAILY PLANNERS; ORGANIZATIONAL DAY PLANNERS; ORGANIZATIONAL DESKTOP PLANNERS; OFFICE REQUISITES, NAMELY, PUNCHES, RUBBER BANDS; PEN STANDS; DESKTOP ORGANIZERS, PERSONAL ORGANIZERS, IN CLASS 16 (U.S. CLS. 2, 5, 22, 23, 29, 37, 38 AND 50).

FOR: LEATHER AND IMITATIONS OF LEATHER AND GOODS MADE OF THESE MATERIALS, NAMELY, LEATHER WALLETS; ANIMAL SKINS, HIDES; TRUNKS; UMBRELLAS, PARASOLS AND WALKING STICKS; TRAVELLING BAGS, PARTICULARLY TRAVELLING BAGS OF TEXTILE AND OF LEATHER INCLUDING HARD AND SOFT TYPES; BAGS, NAMELY, HARD AND SOFT TEXTILE SHOPPING BAGS, HARD AND SOFT LEATHER BAGS; KEY HOLDERS OF LEATHER AND IMITATIONS OF LEATHER; KEY CASES; BRIEFCASES; POCKET WALLETS, PARTICULARLY POCKET WALLETS OF TEXTILE AND OF LEATHER; PURSES, PARTICULARLY PURSES OF TEXTILE AND OF LEATHER, IN CLASS 18 (U.S. CLS. 1, 2, 3, 22 AND 41).

FOR: CLOTHING, NAMELY, SHIRTS, PANTS, T-SHIRTS, SHORTS, HOSIERY, SOCKS, TOPS, BLOUSES, DRESSES, JACKETS, SWEATERS; FOOTWEAR; HEADGEAR, NAMELY, HATS, CAPS; BELTS, IN CLASS 25 (U.S. CLS. 22 AND 39).

THE MARK CONSISTS OF FOUR OPPOSING, NON-INTERLOCKING "FPM" MONOGRAMS.

PRIORITY DATE OF 10-19-2010 IS CLAIMED.

OWNER OF INTERNATIONAL REGISTRATION 1081364 DATED 4-14-2011, EXPIRES 4-14-2021.

SER. NO. 79-098,892, FILED 4-14-2011.

SEAN CROWLEY, EXAMINING ATTORNEY



*David J. Kybas*

Director of the United States Patent and Trademark Office

# United States of America

United States Patent and Trademark Office



**Reg. No. 4,196,357**

**Registered Aug. 28, 2012**

**Int. Cl.: 30**

FIAT GROUP MARKETING & CORPORATE COMMUNICATION S.P.A. (ITALY CORPORATION)  
VIA NIZZA, 250  
I-10126 TORINO  
ITALY

**TRADEMARK**

**PRINCIPAL REGISTER**

FOR: COFFEE, TEA, COCOA, SUGAR, RICE, TAPIOCA, SAGO, ARTIFICIAL COFFEE; FLOUR AND PREPARATIONS MADE FROM CEREALS, NAMELY, BREAKFAST CEREALS; BREAD, PASTRY; CONFECTIONERY, NAMELY, SNACK FOODS, NAMELY, CHOCOLATE-BASED SNACK FOODS, CHOCOLATE, CHIPS FOR BAKING; EDIBLE ICES; HONEY, TREACLE; YEAST, BAKING-POWDER; SALT, MUSTARD; VINEGAR, SAUCES AS CONDIMENTS; SPICES; ICE, IN CLASS 30 (U.S. CL. 46).

THE MARK CONSISTS OF THE WORD "LANCIA" ON A SHIELD DESIGN.

PRIORITY DATE OF 5-9-2011 IS CLAIMED.

OWNER OF INTERNATIONAL REGISTRATION 1081443 DATED 5-11-2011, EXPIRES 5-11-2021.

THE ENGLISH TRANSLATION OF "LANCIA" IN THE MARK IS "SPEAR".

SER. NO. 79-098,915, FILED 5-11-2011.

REBECCA POVARCHUK, EXAMINING ATTORNEY



*David J. Kybas*

Director of the United States Patent and Trademark Office

# United States of America

United States Patent and Trademark Office

# EPIPHANY

**Reg. No. 4,196,358**

**Registered Aug. 28, 2012**

**Int. Cl.: 3**

**TRADEMARK**

**PRINCIPAL REGISTER**

COTY GERMANY GMBH (FED REP GERMANY GMBH)  
FORT MALAKOFF PARK,  
RHEINSTRASSE 4E; 55116 MAINZ  
FED REP GERMANY

FOR: SOAP; PERFUMERY; ESSENTIAL OILS; COSMETICS; HAIR LOTIONS, IN CLASS 3  
(U.S. CLS. 1, 4, 6, 50, 51 AND 52).

THE MARK CONSISTS OF STANDARD CHARACTERS WITHOUT CLAIM TO ANY PAR-  
TICULAR FONT, STYLE, SIZE, OR COLOR.

PRIORITY DATE OF 1-28-2011 IS CLAIMED.

OWNER OF INTERNATIONAL REGISTRATION 1081444 DATED 6-15-2011, EXPIRES 6-15-  
2021.

SER. NO. 79-098,916, FILED 6-15-2011.

ANDREA K. NADELMAN, EXAMINING ATTORNEY



*David J. Kyffers*

Director of the United States Patent and Trademark Office

# United States of America

United States Patent and Trademark Office

# undustrial

**Reg. No. 4,196,359**

**Registered Aug. 28, 2012**

**Int. Cls.: 9, 14 and 25**

**TRADEMARK**

**PRINCIPAL REGISTER**

UNDOSTRIAL (FRANCE EURL)  
12 RUE POPINCOURT  
F-75011 PARIS  
FRANCE

FOR: SPECTACLES, SUNGLASSES, OPTICAL FRAMES, OPTICAL GLASSES, OPTICAL LENSES, SPECTACLE CASES, IN CLASS 9 (U.S. CLS. 21, 23, 26, 36 AND 38).

FOR: JEWELRY; TIMEPIECES AND CHRONOMETRIC INSTRUMENTS; WATCH BANDS, CHAINS, SPRINGS OR GLASSES, IN CLASS 14 (U.S. CLS. 2, 27, 28 AND 50).

FOR: PANTS; SOCKS; FOOTWEAR; HEADWEAR; SHIRTS; BELTS; FUR COATS, FUR JACKETS, FUR HATS, FUR STOLES; GLOVES; SCARVES; NECKTIES; HOSIERY; SLIPPERS; BEACH, SKI OR SPORTS FOOTWEAR; BABIES' DIAPERS OF TEXTILE; UNDERWEAR, IN CLASS 25 (U.S. CLS. 22 AND 39).

OWNER OF INTERNATIONAL REGISTRATION 1042965 DATED 4-21-2010, EXPIRES 4-21-2020.

SER. NO. 79-098,934, FILED 5-17-2011.

ELIZABETH HUGHITT, EXAMINING ATTORNEY



*David J. Kyffers*

Director of the United States Patent and Trademark Office



United States of America  
United States Patent and Trademark Office

# EISOFFEN

**Reg. No. 4,196,360**

EISOFFEN PTY LTD (AUSTRALIA A COMPANY)  
12 COGLIN STREET  
BROMPTON SA 5007, AUSTRALIA

**Registered Aug. 28, 2012**

**Int. Cl.: 3**

FOR: CLEANING PRODUCTS IN THIS CLASS, NAMELY, CHEMICAL CLEANING PREPARATIONS FOR CLEANING FOOD AND BEVERAGE PREPARATION AND DISPENSING APPARATUS, NAMELY, OVENS, GRILLERS, MICROWAVES, ICE CREAM DISPENSERS, ICE MACHINES, HOT AND COLD BEVERAGE DISPENSERS, IN CLASS 3 (U.S. CLS. 1, 4, 6, 50, 51 AND 52).

**TRADEMARK**

**PRINCIPAL REGISTER**

THE MARK CONSISTS OF STANDARD CHARACTERS WITHOUT CLAIM TO ANY PARTICULAR FONT, STYLE, SIZE, OR COLOR.

PRIORITY DATE OF 12-3-2010 IS CLAIMED.

OWNER OF INTERNATIONAL REGISTRATION 1081729 DATED 6-3-2011, EXPIRES 6-3-2021.

SER. NO. 79-099,031, FILED 6-3-2011.

PAUL E. FAHRENKOPF, EXAMINING ATTORNEY



*David J. Kyffers*

Director of the United States Patent and Trademark Office

# United States of America

United States Patent and Trademark Office

帕斯奥蒂  
POSIOIT

**Reg. No. 4,196,361**

**Registered Aug. 28, 2012**

**Int. Cl.: 25**

**TRADEMARK**

**PRINCIPAL REGISTER**

XIAO TIHOU (CHINA INDIVIDUAL)

NO.18, 10TH FLOOR,

TIANYA CLOTHING MARKET,NO.2 YABAO ROAD,, CHAOYANG DISTRICT, BEIJING  
CHINA

FOR: FOOTBALL SHOES; SHOES; HATS; HOSIERY; NECKTIES; BOOTS; BATHING SUITS,  
IN CLASS 25 (U.S. CLS. 22 AND 39).

THE MARK CONSISTS OF FOUR CHINESE CHARACTERS, FOLLOWED BELOW BY THE  
WORD "POSIOIT" IN STYLIZED LETTERS OF THE ENGLISH ALPHABET

OWNER OF INTERNATIONAL REGISTRATION 1081773 DATED 6-15-2011, EXPIRES 6-15-  
2021.

THE NON-LATIN CHARACTERS IN THE MARK TRANSLITERATE TO "POSIOIT" AND  
THIS HAS NO MEANING IN A FOREIGN LANGUAGE.

THE WORDING "POSIOIT" HAS NO MEANING IN A FOREIGN LANGUAGE.

SER. NO. 79-099,047, FILED 6-15-2011.

ERNEST SHOSHO, EXAMINING ATTORNEY



*David J. Kyros*

Director of the United States Patent and Trademark Office

# United States of America

United States Patent and Trademark Office

## Treasure Chest

**Reg. No. 4,196,362**

**Registered Aug. 28, 2012**

**Int. Cls.: 16 and 32**

**TRADEMARK**

**PRINCIPAL REGISTER**

KONTOR N GMBH & CO. KG (FED REP GERMANY GMBH & CO. KG)  
GREIFSWALDER CHAUSSEE 84-85  
18439 STRALSUND  
FED REP GERMANY

FOR: PAPER, CARDBOARD AND GOODS MADE FROM THESE MATERIALS, NAMELY, OPEN AND CLOSED BASKETS FOR THE TRANSPORT OF DRINKING BOTTLES; BOOK-BINDING MATERIAL; PHOTOGRAPHS; STATIONERY; ADHESIVES FOR STATIONERY OR HOUSEHOLD PURPOSES; PAINT BRUSHES; TYPEWRITERS; PLASTIC MATERIALS FOR PACKAGING; PRINTERS' TYPE; PRINTING BLOCKS; GARBAGE BAGS OF PAPER OR PLASTIC; TEAR OFF CALENDARS; TISSUES OF PAPER FOR REMOVING MAKE-UP; TRANSFERS (DECALCOMANIAS); ADDRESS PLATES FOR ADDRESSING MACHINES; ADDRESS STAMPS; ADDRESSING MACHINES; JACKETS FOR PAPERS; LOOSE-LEAF BINDERS FOR OFFICE USE; PHOTO ALBUMS; ALMANACS; OFFICE REQUISITES, NAMELY, FINGER MOISTENERS; ANNOUNCEMENT CARDS; DOCUMENT LAMINATING APPARATUS FOR OFFICE; WATER-COLOUR PAINTINGS; ARCHITECTS' MODELS; ARITHMETICAL TABLES; WRISTBANDS FOR THE RETENTION OF WRITING INSTRUMENTS; ATLASES; STICKERS; DISPOSABLE BABIES' PANTS MADE OF PAPER OR CELLULOSE; DISPOSABLE BABIES' DIAPERS OF PAPER AND CELLULOSE; DISPOSABLE BABIES' NAPKINS OF PAPER AND CELLULOSE CLIPS FOR BANKNOTES; OFFICE REQUISITES, NAMELY, HUMIDIFIERS; OFFICE REQUISITES, NAMELY, CABINETS FOR STATIONERY; BEER MATS; PICTURES; PAINTINGS; PICTURES, FRAMED OR UNFRAMED; TEACHING MATERIAL, NAMELY, BIOLOGICAL SAMPLES FOR USE IN MICROSCOPY; BLUEPRINTS; PENCILS; PENCIL HOLDERS; PENCIL LEADS; PENCIL SHARPENERS, ELECTRIC OR NON ELECTRIC; PENCIL SHARPENING MACHINES, ELECTRIC OR NOT ELECTRIC; STATIONERY PADS; BOOKLETS, NAMELY, BOOKLETS FOR ADVERTISING PURPOSES; PAPERWEIGHTS; LETTER TRAYS; POSTAGE STAMPS; STATIONERY PAPER; ITEMS FOR BOOKBINDING MATERIALS; BOOKBINDING CORDS; OFFICE EQUIPMENT, NAMELY, BOOKBINDING APPARATUS AND MACHINES; BOOKBINDING CLOTH; FABRICS FOR BOOKBINDING; BOOKBINDINGS; BOOKENDS; PAPER CLIPS; CHROMOLITHOGRAPHS (CHROMOS); COMIC BOOKLETS; PRINTERS' REGLETS; ELECTROTYPES; PRINTING BLOCKS; INKING SHEETS FOR DOCUMENT REPRODUCING MACHINES; INKING SHEETS FOR DUPLICATORS; PRINTERS' BLANKETS, NOT OF TEXTILE; FONTS; TYPE NUMERALS AND LETTERS; COVERS STATIONERY; LABELS, NOT OF TEXTILE; STENCIL CASES; FLAGS AND PENNANTS OF PAPER; STATIONERY FOLDERS; BINDING STRIPS FOR BOOKBINDING; INKING RIBBONS; INKING RIBBONS FOR COMPUTER PRINTERS; TYPEWRITER RIBBONS; SPOOLS FOR INKING RIBBONS; CHROMOS; ARTISTS'



*David J. Kappas*

Director of the United States Patent and Trademark Office

**Reg. No. 4,196,362** WATER-COLOUR SAUCERS; PAINT BOXES AND BRUSHES FOR USE IN SCHOOL; PEN-HOLDERS; PEN CLIPS; PENCIL BOXES; PENS; PEN WIPERS; FIGURINES (STATUETTES) OF PAPIER MÂCHÉ; FILTER PAPER; FINGER-STALLS; ISINGLASS FOR STATIONERY OR HOUSEHOLD PURPOSES; BOTTLE SLEEVES MADE OF CARDBOARD OR PAPER; BOTTLE WRAPPINGS MADE OF CARDBOARD OR PAPER; CORRECTING FLUIDS; FOILS FROM PLASTIC FOR PACKAGING PURPOSES; SHEETS OF RECYCLED CELLULOSE FOR WRAPPING; MOULDS FOR MODELLING CLAY; PRINTED FORMS; PHOTOGRAPHS; PHOTOENGRAVINGS; FRANKING MACHINES; FOUNTAIN PENS; TRAYS FOR SORTING AND COUNTING MONEY; SONG BOOKS; TERRESTRIAL GLOBES; GREETING CARDS; GRAPHIC ART REPRESENTATIONS; GRAPHIC ART REPRODUCTIONS; ETCHING NEEDLES; ENGRAVING PLATES; ENGRAVINGS; ADHESIVES, NAMELY, GUMS FOR STATIONERY OR HOUSEHOLD PURPOSES; ELASTIC BANDS FOR OFFICES; GUMMED TAPE; GUMMED CLOTH FOR STATIONERY PURPOSES; STANDS FOR PENS AND PENCILS; MANUALS; HAND LABELING APPLIANCES; HAND-RESTS FOR PAINTERS; STAPLING PRESSES; REPRODUCTION APPARATUS, NAMELY, HECTOGRAPHS; HISTOLOGICAL SECTIONS FOR TEACHING PURPOSES; WOOD PULP PAPER; WOOD-PULP BOARD; ENVELOPES; HAT BOXES OF CARDBOARD; PAPER COFFEE FILTERS; CALENDARS; COASTERS OF PAPER; INDEX CARDS; CARDS; TAGS FOR INDEX CARDS; CARDBOARD; PAPERBOARD; CARDBOARD TUBES; ADHESIVE TAPES FOR STATIONERY AND/OR HOUSEHOLD PURPOSES; GLUTEN GLUE FOR STATIONERY OR HOUSEHOLD PURPOSES; ADHESIVE BANDS FOR STATIONERY OR HOUSEHOLD PURPOSES; ADHESIVE TAPE DISPENSERS; CLIP BOARDS; BAGS FOR MICROWAVE COOKING; CARBON PAPER; COPIER PAPER STATIONERY; CORRECTING INK FOR HELIOGRAPHY; CREDIT CARD IMPRINT APPARATUS, NOT ELECTRIC; CHALK FOR LITHOGRAPHY; CHALK HOLDERS; BALLS FOR BALL-POINT PENS; FRENCH CURVES; MAPS; BIBS OF PAPER; ADHESIVES FOR STATIONERY OR HOUSEHOLD PURPOSES; BOOKMARKS; STEEL LETTERS; LUMINOUS PAPER; LITHOGRAPHS; LITHOGRAPHIC WORKS OF ART; LITHOGRAPHIC STONES; HOLE PUNCHES; PERFORATED CARDS FOR JACQUARD LOOMS; BLOTTERS; LOOSE-LEAF BINDERS; PLASTIC BUBBLE PACKS FOR WRAPPING OR PACKAGING; PAINTERS BRUSHES; CANVAS FOR PAINTING; PALETTES FOR PAINTERS; HOUSE PAINTERS' ROLLERS; PAINTING TEMPLATES; PAINT BOXES FOR USE IN SCHOOL; PAINTING BRUSHES; PAINT EASELS; MARKING CHALK; GRAINING COMBS; STENCILS; PENCIL LEAD HOLDERS; NOTE BOOKS; JOTTERS; PAPER-CLIPS; FILES; OLEOGRAPHS; DRAWING INSTRUMENTS, NAMELY, PANTOGRAPHS; PAPER; ELECTROCARDIOGRAPH PAPER; PAPER FOR RECORDING MACHINES; STATIONERY; PAPER TAPES AND CARDS FOR RECORDING COMPUTER PROGRAMS; PAPER RIBBONS; PAPER SHEETS; PAPIER-MÂCHÉ; FACE TOWELS OF PAPER; PAPER TOWELS; PAPIER MÂCHÉ; PAPER FLOWER POT COVERS; PAPER CUTTERS; PAPER BOWS; PAPER NAPKINS; PAPER HANDKERCHIEFS; PAPER BAGS; PASTELS; TRACING PATTERNS; TRACING CLOTH; TRACING PAPER; PARCHMENT PAPER; SEALS STAMPS; POSTERS; PLACARDS OF PAPER OR CARDBOARD; ADVERTISEMENT BOARDS OF PAPER OR CARDBOARD; PLASTIC CLING FILM, EXTENSIBLE, FOR PALLETIZATION; PLACE MATS OF PAPER; PORTRAITS; POSTCARDS; PROSPECTUSES; ERASING PRODUCTS NAMELY, ERASERS; SCRAPERS FOR OFFICES; ERASING SHIELDS; ETCHINGS; PAPER FOR RADIOGRAMS; ARITHMETICAL TABLES; LEDGERS; DRAWING BOARDS; PASSPORT HOLDERS; DRAWING PENS; TRACING NEEDLES FOR DRAWING PURPOSES; THUMB TACKS; DRAWING T-SQUARES; ROSARIES; CIRCULARS; INDEXES; CREAM CONTAINERS OF PAPER; STENCILS; BOXES OF CARDBOARD OR PAPER; CHEQUE BOOK HOLDERS; SLATE PENCILS; WRITING SLATES; SIGNS OF PAPER OR CARDBOARD; SHIELDS; PAPER SEALS; TAILOR'S CHALK; STATIONERY MANIFOLDS; PATTERNS FOR DRESSMAKING; PATTERNS FOR MAKING CLOTHES; DRAWER LINER PAPER PERFUMED OR NOT; PEN CASES; NIBS; GOLD NIBS; INKSTANDS; WRITING INSTRUMENTS; WRITING BOOKS; WRITING CHALK; WRITING CASES; TYPEWRITERS, ELECTRIC OR NON-ELECTRIC; TYPEWRITER KEYS; ROLLERS FOR TYPEWRITERS; WRITING MATERIALS NAMELY, WRITING CASES SETS AND WRITING BRUSHES; DESK PADS; STENCIL PLATES; HANDWRITING SPECIMENS FOR COPYING; SELF-ADHESIVE TAPES FOR STATIONERY OR HOUSEHOLD PURPOSES; COMPOSING FRAMES PRINTING; GALLEY RACKS; SEALS; SEALING WAX; SEALING

**Reg. No. 4,196,362** MACHINES FOR OFFICES; SEALING COMPOUNDS FOR STATIONERY PURPOSES; SEALING WAFERS; SEALING STAMPS; SILVER PAPER; STEEL PENS; PHOTOGRAPH STANDS; STARCH ADHESIVE PASTE FOR STATIONERY OR HOUSEHOLD PURPOSES; STEATITE TAILOR'S CHALK; STAMPS; STAMP HOLDERS; CASES FOR STAMPS; STAMP PADS; STAMP PADS; STAMP STAND; PRINTS ENGRAVINGS; EMBROIDERY PATTERNS; TICKETS; INKS; INKWELLS; INK STONES OPEN INK WELLS; INK STICKS; PAPER TABLE COVERS; TABLE CLOTHS OF PAPER; TABLE LINEN OF PAPER; TOILET PAPER; PRINTING SETS, PORTABLE OFFICE REQUISITES; TRANSPARENCIES; INDIAN INKS; ENVELOPE SEALING MACHINES; COASTERS OF PAPER; BAGS, ENVELOPES, POUCHES OF PAPER OR PLASTICS, FOR PACKAGING; STARCH MATERIALS FOR PACKAGING; WRAPPING PAPER; DUPLICATORS; MIMEOGRAPH APPARATUS AND MACHINES; SQUARE RULERS; VIGNETTING APPARATUS; VISCOSE SHEETS FOR WRAPPING; WAXED PAPER; BLACKBOARDS; OBLITERATING STAMPS; WRITING BOARD ERASERS; XUAN PAPER (FOR CHINESE PAINTING AND CALLIGRAPHY); DRAWING MATERIALS FOR BLACKBOARDS; DRAWING PADS; DRAWING BOARDS; DRAWING SETS; DRAWING INSTRUMENTS; CHARCOAL PENCILS; DRAWING RULERS; DRAWING SQUARES; DRAWINGS; POINTERS, NON-ELECTRONIC; PRINTED TIMETABLES; NEWSPAPERS; PAPER SHREDDERS FOR OFFICE USE; PAPER DRAWING, IN CLASS 16 (U.S. CLS. 2, 5, 22, 23, 29, 37, 38 AND 50).

FOR: BEERS; MINERAL AND AERATED WATERS; FRUIT DRINKS AND FRUIT JUICES; SYRUPS AND OTHER PREPARATIONS FOR MAKING BEVERAGES; NON-ALCOHOLIC FRUIT EXTRACTS USED IN THE PREPARATION OF BEVERAGES; NON-ALCOHOLIC FRUIT DRINKS; NON ALCOHOLIC HONEY BASED BEVERAGES; NON-ALCOHOLIC APERITIFS; SWEETENED FRUIT JUICE, NAMELY, APPLE JUICE; BEER WORT; POWDERS FOR EFFERVESCING BEVERAGES; PASTILLES FOR EFFERVESCING BEVERAGES; NON-ALCOHOLIC COCKTAILS; SOFT DRINKS, NAMELY, PEANUT MILK; PREPARATIONS FOR MAKING MINERAL WATER; PREPARATIONS FOR MAKING AERATED WATER; ESSENCES FOR MAKING NON-ALCOHOLIC BEVERAGES; NON-ALCOHOLIC FRUIT NECTARS; FRUIT JUICES; VEGETABLE JUICE; EXTRACTS OF HOPS FOR MAKING BEER; GINGER BEER; ISOTONIC BEVERAGES; AERATED WATERS; KVASS; LEMONADES; SYRUPS FOR LEMONADE; LITHIA WATER; MALT BEER; MALT WORT; MILK OF ALMONDS; ORGEAT; MINERAL WATER; WHEY BEVERAGES; MUST; PREPARATIONS FOR MAKING LIQUEURS; SARSAPARILLA; SELTZER WATER; SYRUPS FOR BEVERAGES; SODA WATER; BEVERAGE SHERBETS; TABLE WATERS; TOMATO JUICE; UNFERMENTED GRAPE MUST; WATERS, NAMELY, STILL AND SPARKING WATER, IN CLASS 32 (U.S. CLS. 45, 46 AND 48).

THE MARK CONSISTS OF STANDARD CHARACTERS WITHOUT CLAIM TO ANY PARTICULAR FONT, STYLE, SIZE, OR COLOR.

OWNER OF INTERNATIONAL REGISTRATION 1082022 DATED 2-14-2011, EXPIRES 2-14-2021.

SER. NO. 79-099,133, FILED 2-14-2011.

CAROLYN CATALDO, EXAMINING ATTORNEY

# United States of America

United States Patent and Trademark Office

# UNIPEKTIN

**Reg. No. 4,196,363**

**Registered Aug. 28, 2012**

**Int. Cls.: 6, 7, 11, 37, 41  
and 42**

**TRADEMARK**

**SERVICE MARK**

**PRINCIPAL REGISTER**

BUCHER INDUSTRIES AG (SWITZERLAND JOINT STOCK COMPANY)  
MURZLENSTRASSE 80  
CH-8166 NIEDERWENINGEN  
SWITZERLAND

FOR: TANKS IN THE NATURE OF METAL STORAGE TANKS; CONTAINERS OF METAL FOR THE STORAGE AND TRANSPORTATION OF GOODS; METAL RECEIVING CONTAINERS FOR AGRICULTURAL PRODUCTS; SILOS OF METAL; PIPEWORK OF METAL; NON-MECHANICAL HOPPERS OF METAL, IN CLASS 6 (U.S. CLS. 2, 12, 13, 14, 23, 25 AND 50).

FOR: MACHINES AND INSTALLATIONS CONSISTING THEREOF FOR THE RECEIVING, TREATMENT AND PROCESSING OF FRUITS AND COMPONENT PARTS THEREOF; MECHANICAL EXTRACTORS IN THE NATURE OF JUICE EXTRACTORS; MECHANICAL APPARATUS AND MACHINES AND PARTS THEREFOR FOR THE PRODUCTION AND PREPARATION OF FRUIT JUICES AND FRUIT JUICE CONCENTRATES; MECHANICAL DISCHARGING HOPPERS; CLEANING MACHINES, ELECTRIC APPARATUS AND INSTALLATIONS, NAMELY, COMPRESSOR AND EXTRACTOR CLEANING MACHINES; WASHING APPARATUS, NAMELY, WASHING MACHINES FOR INDUSTRIAL FRUIT PROCESSING LINES; SORTING MACHINES; FRUIT PRESSES BEING MACHINES FOR INDUSTRIAL USE; MILLING MACHINES; FILTERS FOR FRUIT PROCESSING MACHINES; FILTERING MACHINES AND INSTALLATIONS CONSISTING THEREOF, NAMELY, INDUSTRIAL MACHINES FOR FILTERING FRUIT JUICES; FILTER PRESSES BEING MACHINES FOR PRESSING AND FILTERING FRUIT; MEMBRANE FILTERS FOR MACHINES FOR PRESSING AND FILTERING FRUIT; PUMPS BEING MACHINES, NAMELY, PUMPS FOR FRUIT PROCESSING LINES; BELTS FOR CONVEYORS; CONCENTRATORS BEING MACHINES, NAMELY, MACHINES FOR USE IN THE MANUFACTURE OF FRUIT JUICE CONCENTRATE; ADSORBERS BEING MACHINES IN THE NATURE OF FRUIT PROCESSORS; ION EXCHANGERS BEING MACHINES IN THE NATURE OF FRUIT PROCESSORS; MACHINE PARTS, NAMELY, COOLERS FOR MACHINES; MACHINE PARTS FOR GAUGING QUANTITIES OF PRODUCT IN A FRUIT PROCESSING LINE; PUMP DIAPHRAGMS BEING PARTS OF MACHINES; FILLING MACHINES, IN CLASS 7 (U.S. CLS. 13, 19, 21, 23, 31, 34 AND 35).



*David J. Kyros*

Director of the United States Patent and Trademark Office

FOR: HEAT EXCHANGERS; EVAPORATORS; AIR FILTERS AND FILTER MEMBRANES BEING PARTS FOR INDUSTRIAL INSTALLATIONS FOR THE PRODUCTION, TREATMENT AND PROCESSING OF FRUIT JUICES AND FRUIT JUICE CONCENTRATES; PASTEURIZERS FOR USE IN PROCESSING OF FRUIT JUICES AND FRUIT JUICE CONCENTRATES;

**Reg. No. 4,196,363** COOLING APPLIANCES AND INSTALLATIONS, NAMELY, FRUIT JUICE AND FRUIT CONCENTRATE COOLING APPARATUS AND REFRIGERATORS, IN CLASS 11 (U.S. CLS. 13, 21, 23, 31 AND 34).

FOR: MACHINERY INSTALLATION; MAINTENANCE AND REPAIR FOR MACHINERY OF A FRUIT AND FRUIT JUICE PROCESSING LINE; CLEANING OF FRUIT PROCESSING MACHINES AND PARTS THEREOF, IN CLASS 37 (U.S. CLS. 100, 103 AND 106).

FOR: PROVIDING OF TRAINING AND FURTHER TRAINING WITH REGARD TO THE ASSEMBLY, COMMISSIONING, CLEANING, MAINTENANCE AND REPAIR OF TANKS AND CONTAINERS OF METAL, RECEIVING CONTAINERS FOR AGRICULTURAL PRODUCTS OF METAL, SILOS OF METAL, PIPEWORK OF METAL, HOPPERS OF METAL, NON-MECHANICAL, MECHANICAL APPARATUS, MACHINES AND INSTALLATIONS CONSISTING THEREOF, AND PARTS THEREFOR, FOR THE RECEIVING, TREATMENT AND PROCESSING OF FRUITS AND COMPONENTS THEREOF, MECHANICAL EXTRACTORS, MECHANICAL APPARATUS AND MACHINES AND PARTS THEREFOR FOR THE PRODUCTION AND PREPARATION OF FRUIT JUICES AND FRUIT JUICE CONCENTRATES, MECHANICAL DISCHARGING HOPPERS, CLEANING MACHINES, ELECTRIC APPARATUS AND INSTALLATIONS, WASHING APPARATUS, SORTING MACHINES, FRUIT PRESSES BEING MACHINES, MILLS BEING MACHINES, FILTERS BEING PARTS OF MACHINES, MOTORS OR ENGINES, FILTERING MACHINES AND INSTALLATIONS CONSISTING THEREOF, FILTER PRESSES BEING MACHINES, MEMBRANE FILTERS, PUMPS BEING MACHINES, BELTS FOR CONVEYORS, CONCENTRATORS BEING MACHINES, ADSORBERS, ION EXCHANGERS BEING MACHINES, COOLERS FOR MACHINES, PUMP DIAPHRAGMS, DOSING MACHINES, FILLING MACHINES, HEAT EXCHANGERS, EVAPORATORS, CONCENTRATORS BEING EVAPORATING INSTALLATIONS, FILTERS AND FILTER MEMBRANES BEING PARTS FOR INDUSTRIAL INSTALLATIONS FOR THE PRODUCTION, TREATMENT AND PROCESSING OF FRUIT JUICES AND FRUIT JUICE CONCENTRATES, PASTEURIZERS, REFRIGERATING APPARATUS AND INSTALLATIONS, IN CLASS 41 (U.S. CLS. 100, 101 AND 107).

FOR: TECHNOLOGICAL PLANNING OF INSTALLATIONS AND LINES FOR THE FRUIT PROCESSING INDUSTRY; CONSTRUCTION DRAFTING; PRODUCT TESTING INCLUDING TECHNICAL MEASURING OF PRODUCTS; CHEMISTS SERVICES; COMPUTER PROGRAMMING; UPDATING AND MAINTENANCE OF COMPUTER SOFTWARE; RENTAL OF COMPUTER SOFTWARE; TECHNOLOGICAL CONSULTANCY IN THE FIELD OF PROCESSING AGRICULTURAL GOODS; MATERIALS TESTING; QUALITY CONTROL; RENTAL OF MEASURING INSTRUMENTS, INFORMATION TECHNOLOGY CONSULTATION, IN CLASS 42 (U.S. CLS. 100 AND 101).

THE MARK CONSISTS OF STANDARD CHARACTERS WITHOUT CLAIM TO ANY PARTICULAR FONT, STYLE, SIZE, OR COLOR.

PRIORITY DATE OF 9-6-2010 IS CLAIMED.

OWNER OF INTERNATIONAL REGISTRATION 1082035 DATED 3-4-2011, EXPIRES 3-4-2021.

SER. NO. 79-099,138, FILED 3-4-2011.

KRISTINA MORRIS, EXAMINING ATTORNEY

# United States of America

United States Patent and Trademark Office

# EQUISTRO

**Reg. No. 4,196,364**

**Registered Aug. 28, 2012**

**Int. Cls.: 1, 3, 5 and 10**

**TRADEMARK**

**PRINCIPAL REGISTER**

VÉTOQUINOL GMBH (FED REP GERMANY GMBH)  
PARKSTRASSE 10  
88212 RAVENSBURG  
FED REP GERMANY

FOR: DIAGNOSTIC PRODUCTS FOR LABORATORY USE, NAMELY, DIAGNOSTIC PREPARATIONS FOR CLINICAL OR MEDICAL LABORATORY USE FOR DIAGNOSING THE PREGNANCY OF AN ANIMAL AND FOR DETECTING THE SEX AT THE EMBRYONIC STATE, ALL OF THE ABOVE FOR HORSES AND OTHER HOOVED ANIMALS, IN CLASS 1 (U.S. CLS. 1, 5, 6, 10, 26 AND 46).

FOR: WASHING PRODUCTS, NAMELY, SHAMPOO, HAIR RINSE, HAIR RELAXER, DEMATTING RINSE, NAMELY, HAIR RINSES, BATH CREAM, DEODORANT, DEODORIZING SHAMPOO, MOISTURIZING SPRAYS FOR HAIR AND SKIN, SOAPS, NAMELY, MEDICATED SOAP AND ANTISEPTICS, COSMETICS, DENTAL HYGIENE PRODUCTS, NAMELY, DENTAL TABLETS FOR DISCLOSING PLAQUE AND TARTAR ON THE TEETH, AND TOOTHPASTE, ALL OF THE ABOVE FOR HORSES AND OTHER HOOVED ANIMALS, IN CLASS 3 (U.S. CLS. 1, 4, 6, 50, 51 AND 52).

FOR: DIAGNOSTIC PRODUCT PREPARATIONS FOR VETERINARY USE FOR HORSES AND OTHER HOOVED ANIMALS; VETERINARY PREPARATIONS, NAMELY, VETERINARY PREPARATIONS FOR HORSES AND OTHER HOOVED ANIMALS, FOR TREATING LOCOMOTION SYSTEM TO IMPROVE THE QUALITY OF THE JOINT MOBILITY PRONE TO TRAUMATIC INJURY AND DISEASE; FOR HELPING MAINTAIN CARTILAGE QUALITY AND TREATING CHRONIC JOINT PROBLEMS, FOR TREATING JOINT RECOVERY AFTER EFFORT, FOR RELAXING THE LOCOMOTOR SYSTEM AFTER EXERTION, FOR RECOVERY OF MUSCLES, TENDONS AND LIGAMENTS, FOR PREVENTING ACCIDENTS CAUSED BY EXERCISING WHEN COLD; MEDICINES FOR YOUNG ANIMALS, ANIMALS IN GESTATION AND SICK ANIMALS, NAMELY, FOR IMPROVING RESPIRATORY COMFORT, FOR THE MAINTENANCE AND INTEGRITY OF THE PULMONARY CAPILLARIES, FOR HELPING WITH ACUTE RESPIRATORY, FOR SKIN PROBLEMS CARING FOR EXTERNAL USE PROMOTES NATURAL HEALING OF CUTS AND WOUNDS, FOR HEALTHY HOOF GROWTH, FOR THE TREATMENT OF FRAGILE HOOVES, FOR ENSURING A BALANCED DIET FOR FOALS, PREGNANT MARES AND WORKING HORSES, FOR DEALING WITH STRESS AND RESISTING INFECTIONS, FOR CALMING, FOR IMPROVING REACTIONS TO STRESS, FOR TREATMENT FROM EXERTION, FOR IMPROVING THE RESISTANCE DURING EXERCISE OF THE CELLS AND JOINT MECHANISM, FOR



*David J. Kybas*

Director of the United States Patent and Trademark Office



**Reg. No. 4,196,364** HELPING RE-ESTABLISH THE INTEGRITY OF THE DIGESTIVE WALL AND RESTORING THE EQUILIBRIUM OF INTESTINAL FLORA, FOR PREPARING BREEDING HORSES FOR THE COVERING PERIOD AND MEETING THE PRE-WEANING REQUIREMENTS OF YOUNG FOALS, FOR A BALANCED DIET IN HORSES GIVEN A TRADITIONAL FODDER-BASED FEED AND ENSURING HEALTHY BONE GROWTH IN THE UNBORN FOAL, FOR OPTIMAL DEVELOPMENT OF THE SKELETON, FOR OPTIMIZING SPORTING PERFORMANCE AND AVOIDING DIETARY DEFICIENCIES;. DIETETIC PRODUCTS FOR YOUNG ANIMALS, ANIMALS IN GESTATION AND SICK ANIMALS, NAMELY, DIETETIC FOODS ADAPTED FOR MEDICAL USE; PLASTERS FOR MEDICAL PURPOSES, DRESSINGS FOR WOUNDS, BURNS, SURGERY; DISINFECTANTS FOR HYGIENIC PURPOSES; AND PREPARATIONS FOR DESTROYING VERMIN, ALL OF THE ABOVE FOR HORSES AND OTHER HOOVED ANIMALS, IN CLASS 5 (U.S. CLS. 6, 18, 44, 46, 51 AND 52).

FOR: VETERINARY INSTRUMENTS, NAMELY, ORTHOPEDIC SUPPORT BANDAGES; GAITERS FOR HEAT THERAPY AND COLD THERAPY, NAMELY, NON-MEDICATED COMPRESSES; SYNTHETIC MONOFILAMENT FOR USE IN SURGICAL PROCEDURES, ALL OF THE ABOVE GOODS FOR HORSES AND OTHER HOOVED ANIMALS, IN CLASS 10 (U.S. CLS. 26, 39 AND 44).

THE WORDING "EQUISTRO" HAS NO MEANING IN A FOREIGN LANGUAGE.

OWNER OF INTERNATIONAL REGISTRATION 0527980 DATED 9-6-1988, EXPIRES 9-6-2018.

SER. NO. 79-099,214, FILED 5-24-2011.

RUDY R. SINGLETON, EXAMINING ATTORNEY

# United States of America

United States Patent and Trademark Office



**Reg. No. 4,196,365**

**Registered Aug. 28, 2012**

**Int. Cls.: 7, 8, 9, 11, 12,  
13, 14, 18, 20, 21, 22, 24,  
25, 27 and 28**

LIDL STIFTUNG & CO. KG (FED REP GERMANY KOMMANDITGESELLSCHAFT)  
STIFTSBERGSTR. 1  
74167 NECKARSULM  
FED REP GERMANY

FOR: NET HAULING MACHINES, IN CLASS 7 (U.S. CLS. 13, 19, 21, 23, 31, 34 AND 35).

FOR: CUTLERY, IN PARTICULAR FISH CLEANING AND FISH FILLETING KNIVES FOR ANGLERS; LARGE HARPOONS FOR COMMERCIAL FISHING; HARPOONS FOR COMMERCIAL FISHING, IN CLASS 8 (U.S. CLS. 23, 28 AND 44).

**TRADEMARK**

**PRINCIPAL REGISTER**

FOR: PROTECTIVE MOTORCYCLE CLOTHING, NAMELY, CLOTHING FOR WEAR BY MOTORCYCLISTS FOR PROTECTION AGAINST ACCIDENT OR INJURY, MOTORCYCLE CRASH HELMETS, PROTECTIVE GLOVES FOR MOTORCYCLISTS, SUNGLASSES; NAUTICAL APPARATUS AND INSTRUMENTS, NAMELY, SIGNALING LIGHTS AND BUOYS, MARINE RADIO COMMUNICATION MACHINES AND APPARATUS; DIVING REQUISITES, IN PARTICULAR WET SUITS, DIVING MASKS, LIFE JACKETS AND INFLATABLE AND NON-INFLATABLE SWIM VESTS, SNORKELS, WEIGHTS, WEIGHT BELTS, BREATHING APPARATUS, AIR TANKS, REGULATORS, DEPTH GAUGES, MANOMETERS, COMPASSES AND THERMOMETERS, EAR PLUGS, NOSE CLIPS; CLOTHING FOR DIVING, NAMELY, DIVING SUITS, GLOVES, PROTECTIVE DIVING SHOES, AND HEADGEAR; EQUIPMENT FOR UNDERWATER HUNTING, NAMELY, UNDERWATER HUNTING BINOCULARS; UNDERWATER CAMERAS; PHOTOGRAPHIC, CINEMATOGRAPHIC, OPTICAL, WEIGHING, MEASURING, SIGNALING, CHECKING, LIFE-SAVING AND TEACHING APPARATUS AND INSTRUMENTS, NAMELY, SCALES, DIRECTIONAL COMPASSES AND PROTECTION AND SAFETY APPARATUS, NAMELY, INFLATABLE FLOATATION DEVICES; SPECTACLES, SUNGLASSES, SKI GLASSES, GOGGLES, ANTI-GLARE GLASSES; FRAMES FOR GLASSES, LENSES FOR GLASSES; SPECTACLE CASES, BICYCLE HELMETS; TACHOMETERS; FLASHING SAFETY LIGHTS, GROUND SCANNERS, LIGHT EMITTING DIODES, SNAP-ON SAFETY LIGHTS, MARINE DEPTH FINDERS, IN CLASS 9 (U.S. CLS. 21, 23, 26, 36 AND 38).



FOR: ELECTRIC TORCHES FOR LIGHTING, FLASH LIGHTS, LAMPS, IN CLASS 11 (U.S. CLS. 13, 21, 23, 31 AND 34).

*David J. Kybas*

Director of the United States Patent and Trademark Office

FOR: ACCESSORIES AND PARTS FOR VEHICLES OF ALL KINDS, IN PARTICULAR FOR MOTORCYCLES AND TRICYCLES, INCLUDED IN THIS CLASS, NAMELY, BICYCLE AND

**Reg. No. 4,196,365** MOTORCYCLE WHEEL RIMS, HANDLEBARS, BICYCLE FRAMES, MOTORCYCLE FRAMES, HANDLE BAR ENDS BEING BICYCLE OR MOTORCYCLE PARTS, BICYCLE AND MOTORCYCLE SEATS, SADDLE COVERS FOR BICYCLES AND MOTORCYCLES, BICYCLE SADDLES, MOTORCYCLE SADDLES, BICYCLE BELLS, SAFETY PADS FOR BICYCLES AND WATER BOTTLE HOLDERS FOR BICYCLES, WATER BOTTLE HOLDERS FOR MOTORCYCLES, PANNIER BAGS FOR BICYCLES; BASKETS ADAPTED FOR BICYCLES; BICYCLE PUMPS; DIRECTIONAL SIGNALS FOR BICYCLES, GAS TANK AND RADIATOR SHROUDS, FRONT AND SIDE PLATES FOR MOTORCYCLES, MOTORCYCLE SADDLE BAGS AND MOTORCYCLE KICKSTANDS; GOLF EQUIPMENT, NAMELY, GOLF TROLLEYS; BICYCLE ACCESSORIES, IN PARTICULAR BICYCLE BAGS; BOATS AND BOAT ACCESSORIES, NAMELY, BOAT BUMPERS, BOAT CHAFE GUARDS, BOAT CHOCKS, BOAT CLEATS, BOAT FENDERS, BOAT HOOKS, BOAT HALTS, BOAT LAUNCHING TROLLEYS, BOAT RUDDERS, BOAT SHELLS, BOAT TILLERS, IN CLASS 12 (U.S. CLS. 19, 21, 23, 31, 35 AND 44).

FOR: RIFLES, IN CLASS 13 (U.S. CLS. 2 AND 9).

FOR: CLOCKS, IN CLASS 14 (U.S. CLS. 2, 27, 28 AND 50).

FOR: ALL-PURPOSE SPORT BAGS; BAGS, POUCHES, SACKS, IN PARTICULAR SPORTS BAGS, CARRIER BAGS AND SHOULDER BAGS; CARRIER BAGS AND PACKING BAGS; RUCKSACKS AND BACKPACKS, DAY PACKS; DRAWSTRING POUCHES TO BE WORN ON THE CHEST; WALKING STICKS, ALPENSTOCKS, TREKKING STICKS, SADDLERY, RUCKSACKS, DUFFEL BAGS AND TRANSPORT BAGS FOR LUGGAGE, PANNIERS, PANNIER BAGS, NAMELY, SADDLE BAGS, UMBRELLAS AND PARASOLS, IN CLASS 18 (U.S. CLS. 1, 2, 3, 22 AND 41).

FOR: CHAIRS AND BEDS; BASKETS FOR TRANSPORTING GOODS FOR COMMERCIAL PURPOSES; FISHING BASKETS FOR TRANSPORTING GOODS FOR COMMERCIAL PURPOSES; CHAIRS SPECIFICALLY DESIGNED FOR FISHING THAT IS FITTED WITH A BOX FOR STORAGE, IN CLASS 20 (U.S. CLS. 2, 13, 22, 25, 32 AND 50).

FOR: DRINKING BOTTLES, SOLD EMPTY; CONTAINERS FOR ICE AND FOR HOUSEHOLD USE, IN CLASS 21 (U.S. CLS. 2, 13, 23, 29, 30, 33, 40 AND 50).

FOR: TENTS, AWNINGS, IN CLASS 22 (U.S. CLS. 1, 2, 7, 19, 22, 42 AND 50).

FOR: TEXTILES AND TEXTILE GOODS, NAMELY, TEXTILE FABRICS FOR MANUFACTURING OF CLOTHING, BED SHEETS, BED AND TABLE LINEN; COTTON FABRICS, WOOLLEN FABRICS, FINISHED TEXTILE LININGS FOR GARMENTS, NONWOVEN FABRICS; BATH LINEN; TOWELS OF TEXTILE, IN CLASS 24 (U.S. CLS. 42 AND 50).

FOR: CLOTHING, NAMELY, SHIRTS, PANTS, JOGGING SUITS, YOGA PANTS, EXERCISE SHORTS, SHORTS, SOCKS, BLOUSES, DRESSES AND UNDERWEAR; FOOTWEAR, GLOVES, HEADWEAR, ALL THE AFORESAID GOODS EXCLUSIVELY FOR THE SPORTS SECTOR; MOTORCYCLE BOOTS, RAINWEAR, IN PARTICULAR RAINWEAR FOR MOTORCYCLISTS, MOTORCYCLE CLOTHING, NAMELY, JACKETS, GLOVES AND RAIN SUITS; CLOTHING, NAMELY, SHIRTS, VESTS, WADERS, SLACKS, JACKETS, FOOTWEAR AND HEADWEAR FOR FISHING; FISHING GLOVES, IN CLASS 25 (U.S. CLS. 22 AND 39).

FOR: MATS, IN PARTICULAR FOR GYMNASTICS, SPORTS, TRAVELLING, TREKKING AND CAMPING, IN CLASS 27 (U.S. CLS. 19, 20, 37, 42 AND 50).

FOR: GYMNASTIC AND SPORTING ARTICLES, NAMELY, PARALLEL BARS, POMMEL HORSES, GYMNASTIC APPARATUS, GYMNASTIC HORIZONTAL BARS; GYMNASTIC TRAINING STOOLS; GYMNASTIC VAULTING HORSES; GOLF EQUIPMENT, NAMELY, GOLF BALLS, GOLF CLUBS AND GOLF CLUB COVERS, WOODS, BALL MARKERS, DIVOT TOOLS, SPECIFICALLY, PITCHFORKS, CHIPPING NETS, SCORER TAGS, GOLF

**Reg. No. 4,196,365** BAGS; TENNIS EQUIPMENT, NAMELY, TENNIS BALLS, TENNIS RACQUETS AND TENNIS RACQUET COVERS, TENNIS NETS AND POLES THEREFOR; TABLE TENNIS EQUIPMENT, NAMELY, TABLE TENNIS BALLS, TABLE TENNIS BATS AND TABLE TENNIS BAT COVERS, TABLE TENNIS NETS AND POLES THEREFOR; BADMINTON EQUIPMENT, NAMELY, SHUTTLECOCKS, BADMINTON RACQUETS AND BADMINTON RACQUET COVERS, BADMINTON NETS AND POLES THEREFOR; SQUASH EQUIPMENT, NAMELY, SQUASH BALLS, SQUASH RACQUETS AND SQUASH RACQUET COVERS; LINES FOR FISHING, FISHING TACKLE, RODS FOR FISHING AND PARTS THEREOF, REELS FOR FISHING, GUT FOR FISHING, FISH HOOKS, FISHING LEAD, FLOATS FOR FISHING, CLIPS FOR FISHING, SPOONS FOR FISHING, WOBBLERS AND SPINNERS, ARTIFICIAL FLIES, BAIT JARS, ROD RESTS, SPIKES FOR FISHING RODS; FISHING PLUMBS, FISH TRAPS, FISHING TACKLE, NAMELY, BITE INDICATORS, LANDING NETS, NETS FOR FISHING, DECOYS FOR FISHING, ARTIFICIAL LURES FOR USE IN FISHING, CREELS, GAFFS FOR FISHING, FITTINGS FOR LIFTING AND LOWERING NETS, HAND-HELD FISHING NETS, TENSION REELS FOR FISHING, ARTIFICIAL BAIT AND FISHING LURES, BAIT MIXING BOWLS, POLES, IN PARTICULAR FOR FISHING, HOOK LOOSENERS, BAIT NEEDLES, WORM NEEDLES, STOPPER BEADS, FLOAT RINGS FOR FISHING, SPRING RINGS FOR FISHING, LEADS FOR FISHING LINES, PROTECTORS FOR FISHING RODS, ARTICLES FOR SPORTS FISHING, NAMELY, FISHING BUOYS, FISHING LURES, CLAMPS FOR SECURING FISHING EQUIPMENT ON BODY, FISHING LURE RETRIEVERS, FISHING POLE HOLDERS WORN ON THE BODY, FISHING LINES, SPECIAL HIP GUARDS FOR ANGLERS, SPLIT RINGS FOR FISHING, SLIDING VALVES FOR FISHING, UNHOOKING APPARATUS FOR FISHING, FIXING BANDS AND BINDINGS FOR FISHING, GUIDES FOR FISHING, REEL MOUNTS FOR FISHING, WATER BALLS, FLASHERS, FISHING LURE SPINNERS AND SPOONS OF METAL, CONTAINERS FOR FISHING TACKLE AND BAGS FOR FISHING AND FISHING ACCESSORIES; SWIMMING FLIPPERS; GAMES AND PLAYTHINGS, NAMELY, CARD GAMES, BOARD GAMES, DICE GAMES, PARLOR GAMES, PARTY GAMES, MAH JONG GAMES, DART GAMES, ACTION SKILL GAMES, BACKGAMMON GAMES; PLAYTHINGS, NAMELY, BALLOONS, BILLIARD TABLES, PUPPET THEATRES, PUPPETS; PLAY BALLS, PLAY BALLOONS, PLAY MONEY, CHILDREN'S PLAY COSMETICS, PLAY TENTS, PLAY TUNNELS, PLAY WANDS, PLAY HOUSES, PLAY FIGURES, PLAY SWIMMING POOLS, STUFFED TOY BEARS, STUFFED TOY ANIMALS AND PLAY MOTOR CARS, KALEIDOSCOPIES; AUTOMATIC AMUSEMENT GAME MACHINES; TOY SCALE MODEL VEHICLES; GYMNASIUM AND SPORTING EQUIPMENT, NAMELY, BODY-BUILDING AND BODY-TRAINING APPARATUS, NAMELY, WEIGHT LIFTING BENCHES AND BENCH ACCESSORIES, NAMELY, EXERCISE WEIGHT CUFFS AND BAR-BELLS, CHEST EXPANDERS, EXERCISE TREADMILLS, EXERCISE TABLES, EXERCISE BARS, EXERCISE BENCHES, STATIONARY EXERCISE BICYCLES, EXERCISE DOORWAY GYM BARS, MANUALLY OPERATED EXERCISE EQUIPMENT, EXERCISE EQUIPMENT FOR LATERAL MOVEMENT IN A SKATING MOTION, EXERCISE EQUIPMENT, NAMELY, STAIR-STEPPING MACHINES, EXERCISE MACHINES, POWERED TREADMILLS FOR RUNNING, ROWING MACHINES; EXERCISE EQUIPMENT, NAMELY, WEIGHT LIFTING MACHINES, EXERCISING PULLEYS AND MANUALLY OPERATED JOGGING MACHINES; EXERCISE PLATFORMS; EXERCISE TRAMPOLINES, EXERCISE WEIGHT CUFFS, EXERCISE WEIGHTS, MANUAL LEG EXERCISERS, WEIGHT LIFTING BELTS, WEIGHT LIFTING GLOVES, EXERCISE WEIGHTS, LEG WEIGHTS, ANKLE AND WRIST WEIGHTS FOR EXERCISE; BOWS FOR ARCHERY; BOXING GLOVES; TROLLEY BAGS SPECIALLY ADAPTED FOR USE WITH SPORTING EQUIPMENT SKIS AND SKI FITTINGS, IN CLASS 28 (U.S. CLS. 22, 23, 38 AND 50).

THE MARK CONSISTS OF TWO BLACK FLAGS SUPERIMPOSED UPON ONE ANOTHER.

OWNER OF INTERNATIONAL REGISTRATION 1039782 DATED 1-8-2010, EXPIRES 1-8-2020.

SER. NO. 79-099,236, FILED 5-23-2011.

PAM WILLIS, EXAMINING ATTORNEY

# United States of America

United States Patent and Trademark Office

# OZITUDE

**Reg. No. 4,196,366**

**Registered Aug. 28, 2012**

**Int. Cls.: 18, 25 and 35**

**TRADEMARK**

**SERVICE MARK**

**PRINCIPAL REGISTER**

J & V COLLECTIONS PTY LTD (AUSTRALIA AUSTRALIAN PROPRIETARY COMPANY,  
LIMITED BY SHARES)  
1/2 HOUSTON STREET  
MENTONE VIC 3194, AUSTRALIA

FOR: UN-WORKED OR SEMI-WORKED LEATHER; IMITATION LEATHER; AIRLINE TRAVEL BAGS; ALARM EQUIPPED BRIEFCASES; ANIMAL HIDES; ANIMAL SKINS; ART PORTFOLIO CASES; ARTICLES OF CLOTHING FOR ANIMALS; ARTICLES OF LUGGAGE; ARTICLES OF LUGGAGE BEING BAGS; ATHLETICS BAGS; ATTACHE CASES; BABY CARRIERS BEING SLINGS OR HARNESES WORN ON THE BODY; BABY SLINGS BEING BABY CARRIERS WORN ON THE BODY; BACKPACKS; BADGES MADE OF LEATHER; TRAVEL BAGGAGE; LEATHER BAGS FOR MERCHANDISE PACKAGING IN THE NATURE OF ENVELOPES AND POUCHES; BAGS FOR SHAVING KITS, NAMELY, SHAVING BAGS SOLD EMPTY; BAGS FOR TOILETRY KITS, NAMELY, TOILETRY BAGS SOLD EMPTY; BAGS FOR USE IN SPORTS FOR CARRYING SPORTS CLOTHING; BAGS MADE OF IMITATION LEATHER; BAGS MADE OF LEATHER; BANDS OF LEATHER; BEACH BAGS; PORTABLE BEACH UMBRELLAS; BEAUTY CASES NOT FITTED, NAMELY, COSMETIC CASES SOLD EMPTY; BELT BAGS; BELT POUCHES; BILLFOLDS; BOSTON BAGS; BOXES MADE OF LEATHER; BOXES MADE OF LEATHER BOARDS; BOXES OF LEATHER OR LEATHER BOARD; BRIEFCASES; BRIEFCASES MADE OF LEATHER; BRIEFCASE-TYPE PORTFOLIOS; CARD CASES FOR CALLING CARDS, BUSINESS CARDS, CREDIT CARDS, AND NAME CARDS; ALL-PURPOSE CARRYING BAGS; CASES FOR COSMETIC ARTICLES, NAMELY, COSMETIC CASES SOLD EMPTY; CASES FOR HOLDING KEYS; CASES FOR KEYS; CASES FOR SPORTING ARTICLES BUT NOT FITTED OR SHAPED FOR ANY PARTICULAR SPORTING ARTICLE, NAMELY, CARRY CASES; CASES FOR TRAVEL KITS NOT FITTED, NAMELY, TRAVEL CASES SOLD EMPTY; CASES FOR TRAVEL SETS NOT FITTED, NAMELY, TRAVEL CASES SOLD EMPTY; CASES, OF LEATHER OR LEATHER BOARD; CATTLE SKINS; CHAIN MESH PURSES; CHANGE PURSES; CLOTHES FOR ANIMALS; CLUTCH BAGS; CLUTCH PURSES; COIN HOLDERS IN THE NATURE OF WALLETS; COIN PURSES; COLLARS FOR ANIMALS; COSMETIC BAGS NOT FITTED, NAMELY, COSMETIC BAGS SOLD EMPTY; COSMETIC CASES NOT FITTED, NAMELY, COSMETIC CASES SOLD EMPTY; COSMETIC HOLDALLS NOT FITTED, NAMELY, COSMETIC HOLDALLS SOLD EMPTY; COSMETIC PURSES; COSMETICS BAGS NOT FITTED, NAMELY, COSMETICS BAGS SOLD EMPTY; COSMETICS CONTAINERS NOT FITTED, NAMELY, COSMETICS CASES SOLD EMPTY; COVERS, NOT SHAPED, FOR BADMINTON RACKETS, NAMELY, SPORTS BAGS; COVERS, NOT SHAPED, FOR GOLF CLUBS, NAMELY, SPORTS BAGS; COVERS, NOT SHAPED, FOR MUSICAL INSTRUMENTS,



*David J. Kybas*

Director of the United States Patent and Trademark Office

**Reg. No. 4,196,366** NAMELY, CARRY-ALL BAGS; COVERS, NOT SHAPED, FOR SKIS, NAMELY, SPORTS BAGS; COVERS, NOT SHAPED, FOR SPORTING ARTICLES, NAMELY, SPORTS BAGS; COVERS, NOT SHAPED, FOR SQUASH RACQUETS, NAMELY, SPORTS BAGS; COVERS, NOT SHAPED, FOR TENNIS RACQUETS, NAMELY, SPORTS BAGS; COVERS FOR UMBRELLAS; CREDIT CARD CASES MADE OF LEATHER; CREDIT CARD HOLDERS MADE OF IMITATION LEATHER; CREDIT CARD HOLDERS MADE OF LEATHER; CRICKET BAGS, OTHER THAN ADAPTED, NAMELY, SPORTS BAGS; DEVICES FOR CARRYING BABIES UPON ADULTS' SHOULDERS, NAMELY, BABY CARRIERS WORN ON THE BODY; DEVICES FOR CARRYING YOUNG CHILDREN UPON ADULTS' SHOULDERS, NAMELY, BABY CARRIERS WORN ON THE BODY; DIAPER BAGS; DIARY COVERS, NOT ADAPTED; DISPATCH CASES BEING DOCUMENT CASES; DOG COATS; DRIVING LICENSE CASES; DUFFEL BAGS; ELASTICIZED CORDS FOR LUGGAGE, NAMELY, STRAPS FOR LUGGAGE; ELASTICIZED SIDE REINS; ELASTICIZED STRAPS FOR LUGGAGE; ENVELOPES, OF LEATHER, FOR PACKAGING; EVENING BAGS; EVENING PURSES; FLIGHT BAGS; FOLIO CASES, NAMELY, ART AND PHOTOGRAPH PORTFOLIO CASES; FRAMED CARRYING APPARATUS IN THE NATURE OF RUCKSACKS FOR CARRYING BABIES; FRAMED CARRYING APPLIANCES FOR THE PORTERAGE OF INFANTS, NAMELY, BABY CARRIERS WORN ON THE BODY; FURNITURE COVERINGS OF LEATHER; FURS SOLD IN BULK, NAMELY, ANIMAL SKINS; FUR-SKINS, NAMELY, FURS BEING ANIMAL SKINS SOLD IN BULK; GARDEN UMBRELLAS; GARDENING BAGS, NAMELY, ALL-PURPOSE CARRYING BAGS; GARMENT BAGS; GARMENT BAGS FOR TRAVEL; GYM BAGS; HANDBAG FRAMES; HANDBAGS; HANDBAGS MADE OF IMITATIONS LEATHER; HANDBAGS MADE OF LEATHER; HAT BAGS; HAT BOXES OF LEATHER; HAVERSACKS; HEAD COLLARS FOR ANIMALS; ANIMAL HIDES; IMITATION ANIMAL HIDES; IMITATION LEATHER; JEWELLERY BAGS SOLD EMPTY, NAMELY, JEWELRY POUCHES; LEATHER KEY CASES; KEY HOLDERS MADE OF IMITATION LEATHER, NAMELY, IMITATION LEATHER KEY CHAINS; KEY HOLDERS MADE OF LEATHER, NAMELY, LEATHER KEY CHAINS; KEY HOLDERS NOT OF METAL, NAMELY, LEATHER KEY CHAINS; KEY POUCHES; KNAPSACKS; KNITTING BAGS; LADIES HANDBAGS; LEATHER SOLD IN BULK; LEATHER BAGS; LEATHER SHOULDER BELTS; LEATHER BOXES; LEATHER BRIEFCASES; LEATHER CASES; LEATHER CLOTH BEING SEMI-WORKED LEATHER; LEATHER ENVELOPES FOR PACKAGING; LEATHER LACES BEING LEATHER STRAPS; LEATHER LEADS; LEATHER LEASHES; LEATHER NOTECASES, NAMELY, LEATHER CASES; LEATHER BRIEFCASE-STYLE PORTFOLIOS; LEATHER PURSES; LEATHER SHOULDER STRAPS; LEATHER STRAPS; LEATHER THONGS; LEATHER THREAD; LEATHER TRAVELLING SUITCASES; LEATHER TWIST, NAMELY, TWISTED LEATHER STRAPS; LEATHER WALLETS; LEATHER, UNWORKED OR SEMI-WORKED; LEATHER BOARD, NAMELY, SEMI-WORKED LEATHER; LUGGAGE; LUGGAGE BAGS; LUGGAGE FOR USE BY CYCLISTS, NAMELY, BUT ONLY BEING LUGGAGE, NOT LUGGAGE SPECIFICALLY ADAPTED FOR USE ON BICYCLES; LUGGAGE FOR USE WITH MOTORCYCLES, BUT ONLY BEING LUGGAGE, NOT LUGGAGE SPECIFICALLY ADAPTED FOR USE ON MOTORCYCLES; LUGGAGE LABEL HOLDERS; LUGGAGE LABELS BEING LUGGAGE TAGS OF LEATHER OR IMITATION LEATHER; LUGGAGE STRAPS; LUGGAGE TAGS; MAKE-UP BAGS, SOLD EMPTY; MAKE-UP CASES SOLD EMPTY; PORTABLE MARKET UMBRELLAS; MOLESKIN BEING IMITATION OF LEATHER NOT FOR MEDICAL PURPOSES; MUSIC CASES, NAMELY, CARRYING CASES; NAPPY BAGS OTHER THAN BAGS FOR THE DISPOSAL OF NAPPIES, NAMELY, DIAPER BAGS; NET BAGS FOR SHOPPING, NAMELY, MESH SHOPPING BAGS; NIGHTWEAR CASES, NAMELY, OVERNIGHT CASES; NOTE CASES, NAMELY, BRIEFCASES; NURSES BAGS, NAMELY, CARRY-ALL BAGS; OVERNIGHT BAGS; OVERNIGHT CASES; PACK SACKS, NAMELY, FANNY PACKS; PANNIERS BEING TRAVELLING CASES NOT FOR BICYCLES OR MOTORCYCLES; PARASOLS; PELTRY, NAMELY, FUR PELTS; PELTS; PILOTS' BAGS, NAMELY, WHEELED TRAVEL BAGS; POCHETTES; POCKET WALLETS; PORTABLE BAGS, NAMELY, LUGGAGE; PORTABLE BOXES, NAMELY, LUGGAGE; PORTFOLIO CASES, NAMELY, BRIEFCASES; PORTFOLIOS, NAMELY, BRIEFCASES; PORTFOLIOS OTHER THAN STATIONERY, NAMELY, BRIEFCASE-TYPE PORTFOLIOS; POUCHES BEING BAGS, NAMELY, DRAWSTRING POUCHES; POUCHES, OF LEATHER, FOR PACKAGING; PURSES; RUCKSACKS; RUGS FOR ANIMALS, NAMELY, HORSE

**Reg. No. 4,196,366** RUGS; SACHELS; SCHOOL BAGS; SCHOOL SACHELS; PORTABLE SHADE UMBRELLAS; SHAVER BAGS NOT SHAPED, NAMELY, SHAVING BAGS SOLD EMPTY; SHEETS OF IMITATION LEATHER FOR USE IN MANUFACTURE; SHEETS OF LEATHER FOR USE IN MANUFACTURE; SHOE BAGS FOR TRAVEL; SHOPPING BAGS OF LEATHER, CANVAS, MESH AND TEXTILE; SHOPPING CARTS, NAMELY, WHEELED SHOPPING BAGS; SHOULDER BAGS; SHOULDER BAGS FOR USE BY CHILDREN; SHOULDER BELTS OF LEATHER; SHOULDER BELTS BEING STRAPS OF LEATHER; SPORTS BAGS WHICH MAY BE USED TO CARRY SKI BOOTS BUT WHICH ARE NOT FITTED OR SHAPED OR SPECIFICALLY ADAPTED FOR CARRYING SKI BOOTS; CARRYING CASES WHICH MAY BE USED TO CARRY SKI BOOT BUT WHICH ARE NOT FITTED OR SHAPED OR SPECIFICALLY ADAPTED TO CARRY SKI BOOTS; SKINS OF CHAMOIS, OTHER THAN FOR CLEANING PURPOSES, NAMELY, WORKED OR SEMI-WORKED LEATHER; SLING BAGS; SLING BAGS FOR CARRYING ANIMALS; SLING BAGS FOR CARRYING CHILDREN; SLINGS FOR CARRYING BABIES, NAMELY, BABY CARRIERS WORN ON THE BODY; SLINGS FOR CARRYING INFANTS, NAMELY, BABY CARRIERS WORN ON THE BODY; SPORRANS, NAMELY, SMALL WAIST PACKS; SPORT BAGS, OTHER THAN ADAPTED OR SHAPED TO CONTAIN SPECIFIC SPORTS APPARATUS; SUIT CARRIERS; SUIT CARRIERS BEING TRAVELLING BAGS; SUITCASE HANDLES; SUITCASES; SUITERS WHICH ARE SUITCASES DESIGNED FOR CARRYING SUITS; SUNSHADES BEING PORTABLE SUNSHADE PARASOLS; SUNSHADES IN THE NATURE OF PARASOLS; SUNSHADES IN THE NATURE OF UMBRELLAS; SYNTHETIC LEATHER, NAMELY, IMITATION LEATHER; TABLE TENNIS RACKET COVERS NOT SHAPED; TENNIS BAGS, OTHER THAN ADAPTED SHAPED TO CONTAIN A RACKET, NAMELY, SPORTS BAGS; TENNIS RACKET BAGS OTHER THAN ADAPTED OR SHAPED TO CONTAIN A RACKET, NAMELY, SPORTS BAGS; TICKET HOLDERS, NAMELY, TICKET POUCHES; TOILET BAGS, NAMELY, TOILETRY BAGS SOLD EMPTY; TOILETRY BAGS SOLD EMPTY; TOTE BAGS; HARNESS TRACES; TRAVEL BAGGAGE; TRAVEL BAGS; TRAVEL BAGS MADE OF PLASTIC MATERIALS; TRAVEL LUGGAGE; TRAVELLING BAGS; TRAVELLING CASES; TRAVELLING HANDBAGS; TRAVELLING SACKS; LEATHER TRAVELLING BAGS; UMBRELLA BAGS; UMBRELLA COVERS, NAMELY, BAGS FOR UMBRELLAS; UMBRELLAS; UNWORKED LEATHER; VALISES; UNFITTED VANITY CASES; WAIST BAGS; WAIST POUCHES; WALLET HOLDERS INCORPORATING SHOULDER STRAPS; WALLETS FOR ATTACHMENT TO BELTS; WASH BAGS FOR CARRYING TOILETRIES; WEEKEND BAGS, NAMELY, OVERNIGHT BAGS; WHEELED SHOPPING BAGS; WRISTLET BAGS; KEY CASES MADE OF LEATHER , IN CLASS 18 (U.S. CLS. 1, 2, 3, 22 AND 41).

FOR: FOOTWEAR; HEADGEAR, NAMELY, HATS, CAPS; ANKLE BOOTS; ANKLE WARMERS, NAMELY, LEG WARMERS; ANORAKS; SWEAT ABSORBENT UNDERWEAR; APRONS; BOOTS; ARM WARMERS; ARMBANDS; ARMY BOOTS; ARTICLES OF CLOTHING FOR THEATRICAL USE, NAMELY, COSTUMES FOR USE IN THE AMUSEMENT INDUSTRY; ASCOTS; ATHLETICS FOOTWEAR; ATHLETICS HOSIERY; ATHLETICS SHOES; ATHLETICS SHORTS; ATHLETICS VESTS; BABIES' ABSORBENT PANTS; BABIES' BIBS OTHER THAN OF PAPER; BABIES' DIAPERS OF TEXTILE; BABIES' NAPKINS OF TEXTILE; BABIES' NAPPIES OF TEXTILE; BABIES' PANTS; BABIES' UNDERGARMENTS; BABIES' VESTS; BABUSHKAS; BALACLAVAS; BALLET SHOES; BALLET SUITS; BANDANAS; BASEBALL CAPS; BASEBALL SHIRTS; BASKETBALL SHOES, BATH ROBES; BATH SANDALS; BATH SHOES; BATH SLIPPERS; BATH SUITS; BATH WRAPS; BATH GOWNS; BATHING CAPS; BATHING COSTUMES; BATHING DRAWERS; BATHING GOWNS; BATHING JACKETS; BATHING SHOES; BATHING SLIPPERS; BATHING SUIT COVER-UPS; BATHING SUITS; BATHING TRUNKS; BATHING WRAPS; BEACH CAPS; BEACH DRESSES, BEACH HATS; BEACH SHOES; BEACH SHOES; SWIMMING SUITS, BATHING SUITS; BEACH WRAPS; BEACHWEAR; BED JACKETS; BED SOCKS; BELTS; BERETS; BERMUDA SHORTS; BIBS MADE OF TEXTILE MATERIALS; BIBS, NOT OF PAPER; BIKE PANTS; BIKINIS; BLAZERS; BLINDFOLDS FOR WEAR; BLOOMERS; BLOUSES; BLOUSONS; BOAS; BOBBLE HATS; BODICES; BODICES BEING LINGERIE; BODY DRESSES; BODY LINEN; BODY STOCKINGS; BODY SUITS; BOILER SUITS; BOLEROS; BONNETS; BOOT UPPERS; BOOTIES; BOOTS; BOOTS FOR SPORTS; BOW

**Reg. No. 4,196,366** TIES; BOXER SHORTS; BRACES FOR CLOTHING, NAMELY, SUSPENDERS; BRAS; BRASSIERES; BREECHES; BRIDAL GOWNS; BRIDAL HEAD WEAR; BRIDESMAIDS' GOWNS; BRIEFS; BURNOOSES, NAMELY, HOODED CLOAKS; BUSH JACKETS; BUSINESS SUITS; CAFTANS; CAGOULES, CAMIKNICKERS, NAMELY, BODY SUITS; CAMISOLES, CANOEING JACKETS; CANOEING PANTS; CANVAS SHOES; CAP PEAKS; CAPES; CAPS; CAR COATS; CARDIGANS; CASHMERE GLOVES; CASHMERE SCARVES; CASHMERE SHOULDER WRAPS; CASHMERE SKIRTS; CASHMERE SWEATERS; CASHMERE TROUSERS; CASHMERE WAIST COATS; CASUAL FOOTWEAR; CASUAL JACKETS; CASUAL SHIRTS; CASUAL TROUSERS; CHASUBLES; CHEMISE TOPS; CHEMISES; CHEMISETTES; CHRISTENING GOWNS; CHRISTENING ROBES; CLIMBING BOOTS; CLIMBING SUITS; CLOAKS; CLOGS; CLOTH DIAPERS, NAMELY, NAPPIES; CLOTH NAPKINS FOR BABIES, NAMELY, CLOTH DIAPERS; COATS; COCKTAIL DRESSES; COLLAR PROTECTORS; COLLARS; COMBINATIONS; CONFIRMATION DRESSES; COORDINATE SUITS; CORDUROY TROUSERS; CORSELETS; CORSETRY, NAMELY, CORSETS NOT FOR SURGICAL PURPOSES; CORSETS OTHER THAN FOR SURGICAL PURPOSES; CORSETS BEING UNDERCLOTHING; COVERALLS; COVER-UPS; COWLS; CRAVATS; CRINOLINES; CUFFS; CULOTTES; CUMMERBUNDS; DANCE FOOTWEAR; DANCE SHOES; DECK SHOES; DENIM JACKETS; DENIM JEANS; DENIM SHIRTS; DENIM SHORTS; DENIM SKIRTS; DESERT BOOTS; DESERT CAPS; DETACHABLE COLLARS; DETACHABLE HOODS; DETACHABLE SLEEVES; DICKEYS; DINNER JACKETS; DINNER SUITS; DRAWERS; DRESS SHIELDS; DRESS SHIRTS; DRESS SHOES; DRESSES; DRESSING COATS; DRESSING GOWNS; DRIVING GLOVES; DUFFEL COATS; DUNGAREES; EAR MUFFS; ESPADRILLES; ESPARTO SHOES OR SANDALS; EVENING COATS; EVENING DRESSES; EVENING GOWNS; EVENING SUITS; EYE MASKS, NAMELY, BLIND FOLDS WORN OVER THE EYES; EYE SHIELDS, NAMELY, BLIND FOLDS WORN OVER THE EYES; FABRIC BELTS FOR WEAR; FANCY DRESS COSTUMES, NAMELY, COSTUMES FOR USE IN CHILDREN'S DRESS UP PLAY; FEATHER BOAS; FISHING BOOTS; FISHING JACKETS; FISHING VESTS; FLAT CAPS; FLAT SHOES; FLIP-FLOPS; FLYING SUITS; FOOTBALL BOOTS; FOOTBALL JERSEYS; FOOTBALL SHIRTS; FOOTBALL SHOES; FOOTLESS SOCKS, NAMELY, LEG WARMERS; FOOTLESS TIGHTS; FOOT MUFFS, NOT ELECTRICALLY HEATED; FOOTWEAR FOR BABIES; FOOTWEAR FOR CHILDREN; FOOTWEAR FOR DANCING; FOOTWEAR FOR MEN; FOOTWEAR FOR SPORT; FOOTWEAR FOR WOMEN; FOOTWEAR UPPERS; FOOTWEAR LINED WITH WOOLLEN FLEECE OR ARTIFICIAL FLEECE; FORMAL SHIRTS; FOUNDATION GARMENTS; FROCKS; FUR COATS; FUR GLOVES; FUR HATS; FUR JACKETS; FUR STOLE; GABARDINES; GAITER STRAPS; GAITERS; GALOSHES; GARTER BELTS; GARTERS; GIRDLES; GLOVES; GLOVES FOR CYCLISTS; GLOVES FOR SKIERS; GOLF SHOES; GALOSHES, NAMELY, GALOSHES; GOWNS; GREATCOATS; GUERNSEYS, NAMELY, CLOSE-FITTING KNITTED WOOLLEN SHIRTS; GYM SHORTS; GYM SUITS; GYMNASTIC SHOES; GYMNASTIC SUITS; HALF LENGTH TIGHTS; HALF-BOOTS; HALF-COATS; HALF-HOSE; HALLOWEEN COSTUMES; HALTER TOPS; HALTERS; HAND WARMERS; HAT FRAMES; HATS; HEADBANDS; HEADDRESSES BEING VEILS; HEADGEAR FOR WEAR, NAMELY, HATS, CAPS; HEAD SCARVES; HEAD SHAWLS; HEAD SQUARES, NAMELY, HEAD SCARVES; HEEL PROTECTORS FOR BOOTS AND SHOES, NAMELY, HEEL PIECES; HEEL WEDGES; HEEL PIECES FOR BOOTS; HEEL PIECES FOR BOOTS AND SHOES; HEEL PIECES FOR STOCKINGS; HEELS; HEELS FOR SHOES; HIKING SHOES; HOCKEY SHOES; HOCKEY SHORTS; HOODED SWEATSHIRTS; HOODS; HOSE; HOSIERY; HOUSE COATS; HOUSE DRESSES; HOUSE JACKETS; HOUSE ROBES; HUNTING BOOTS; INFANTS' CLOTHING, NAMELY, INFANT ONE PIECE CLOTHING; INFANTS' FOOTWEAR; INFANTS' NAPPIES, NAMELY, DIAPERS OF TEXTILE; INNER BOOTS FOR SKI BOOTS; INNER SOLES; INSERTS FOR FOOTWEAR OTHER THAN ORTHOPAEDIC; INSOLES OTHER THAN ORTHOPAEDIC; INTERLININGS FOR CLOTHING; INTERLININGS FOR HEADGEAR, NAMELY, FOR HATS, CAPS; INTERMEDIATE SOLES; IRON FITTINGS FOR BOOTS; JACKETS; JACKETS FOR CASUAL WEAR; JACKETS FOR MEN; JACKETS FOR WOMEN; JAPANESE KIMONOS; JEANS; JERKINS; JERSEYS; JOCKSTRAP-LIKE UNDERWEAR; JODHPURS; JUMP SUITS; JUMPER SUITS; JUMPERS BEING SHIRT FRONTS; JUMPERS BEING SWEATERS; KAF-TANS; KERCHIEFS; KILTS; KIMONOS; KNEE-HIGH STOCKINGS; KNICKERBOCKERS; LABORATORY COATS NOT BEING PROTECTIVE CLOTHING; LACE BOOTS; LAYETTES;



**Reg. No. 4,196,366** LEATHER BELTS; LEATHER COATS; LEATHER SHOES; LEGGINGS; LEG WARMERS; LEOTARDS; LINGERIE; LIVERIES; LONG PANTS; LOUNGE WEAR; MACKINTOSHES, NAMELY, RAINCOATS MADE OF RUBBERIZED MATERIAL; MAKE-UP CAPES, FOR WEAR; MANIPLES; MANTILLAS; MANTLES; MASQUERADE COSTUMES; MEN'S SHOES; MID SOLES FOR BOOTS AND SHOES; MILLINERY, NAMELY, FASCINATORS; MITERS BEING HATS; MITERS BEING HATS; MITTENS; MITTENS FOR SKIERS; MITTS, NAMELY, MITTENS; MONEY BELTS; MOTORCYCLE RIDING SUITS; MOUNTAINEERING BOOTS; MUFFS; MULES; NAPPY PANTS, NAMELY, NAPPIES; NECK SCARVES; NECKERCHIEFS; NECKTIES; NECK-WEAR; NEGLIGEEES; NIGHTGOWNS; NIGHTIES; NIGHTSHIRTS; NIGHTWEAR; NON-SLIPPING DEVICES FOR BOOTS, NAMELY, NON-SLIP SOLES FOR FOOTWEAR; NON-SLIPPING DEVICES FOR BOOTS AND SHOES, NAMELY, NO-SLIP SOLES FOR FOOTWEAR; NON-SLIPPING DEVICES FOR SHOES, NAMELY, NON-SLIP SOLES FOR FOOTWEAR; NURSES' UNIFORMS; ONE-PIECE SUITS; OPEN-NECKED SHIRTS; OUTDOOR BOOTS OTHER THAN FOR PROTECTION AGAINST ACCIDENT OR INJURY; OUT SOLES, NAMELY, SOLES FOR FOOTWEAR; OVER PANTS, NAMELY, OVERALLS; OVERALLS; OVER BOOTS, NAMELY, BOOTS WHICH FIT OVER OTHER SHOES; OVERCOATS; PADS FOR SHOES OTHER THAN ORTHOPAEDIC, NAMELY, RUNNING PADS THAT STRAP ONTO SHOES; PAJAMAS; PANTALOONS; PANTIES-GIRDLES; PANTIES OTHER THAN SANITARY; PANTYHOSE; PANTS; PANTSUITS; PANTY STOCKINGS; PANTYHOSE; PAPER HATS FOR USE AS CLOTHING ITEMS; PAPER LINERS FOR BABIES' NAPPIES; PAREOS; PARKAS; PARTS OF FOOTWEAR, NAMELY, INNER-SOLES, SOLES, UPPERS, INNERS, HEEL SUPPORTS, BACK SUPPORTS; PEAKED HEAD WEAR; PELERINES; PELISSES; PETTICOATS; PINAFORES; PIRATE PANTS; PLASTIC PANTS FOR USE AS CLOTHING ITEMS; PLAY SUITS; PLIMSOLLS; POCKET SQUARES; POCKETS FOR CLOTHING; POLO BOOTS; POLO NECK JUMPERS; POLO SHIRTS; POLO SWEATERS; POLO TOPS; PONCHOS; PRINTED T-SHIRTS; PULLOVERS; PUMPS; PYJAMAS; QUILTED JACKETS; RAIN BOOTS; RAINCOATS; RAIN HATS; RAINPROOF CLOTHING, NAMELY, RAINCOATS; RAINWEAR; RASH VESTS, NAMELY, RASH GUARDS; READY-MADE POCKETS BEING PARTS OF CLOTHING; RIDING BOOTS; RIDING COATS; RIDING GLOVES; RIDING JACKETS; RIDING WAISTCOATS; ROBES; ROMPER SUITS; ROMPERS; RUBBER SHOES OTHER THAN FOR PROTECTION AGAINST ACCIDENT OR INJURY; RUGBY BOOTS; RUGBY JERSEYS; RUGBY SHIRTS; RUGBY SHOES; RUGBY SHORTS; RUGBY TOPS; RUNNING SHOES; SABOTS; SAFETY BOOTS, NOT BEING PROTECTIVE CLOTHING, NAMELY, NON-SLIP BOOTS; SAFETY FOOTWEAR, NOT BEING PROTECTIVE CLOTHING, NAMELY, NON-SLIP FOOTWEAR; SAFETY GLOVES OTHER THAN FOR PROTECTION AGAINST ACCIDENT OR INJURY; SAFETY SHOES, NOT BEING PROTECTIVE CLOTHING, NAMELY, NON-SLIP SHOES; SALOPETTES; SANDALS; SARIS; SARONGS; SASHES FOR WEAR; SCARFS; SCARVES; SCHOOL UNIFORMS; SERAPES; SHAWLS; SHEEPSKIN COATS; SHELL SUITS; SHIFT DRESSES; SHIRT FRONTS; SHIRT JACKETS; SHIRT WAISTS; SHIRT YOKES; SHIRTS; SHOE INSOLES, OTHER THAN FOR ORTHOPAEDIC USE; SHOE PADS, OTHER THAN FOR ORTHOPAEDIC USE; SHOE SOLE REPAIR BLANKS; SHOE SOLES; SHOES; SHOES FOR CASUAL WEAR; SHOES FOR INFANTS; SHOES FOR LEISURE WEAR; SHOES FOR SPORTS WEAR; SHORT PANTS; SHORTS; SHORT-SLEEVED SHIRTS; SHOULDER WRAPS; SHOWER BOOTS; SHOWER CAPS; SHOWER SHOES; SHOWER SLIPPERS; SILK SCARVES; SINGLETs; SKI BOOTS; SKI GAITERS; SKI JACKETS; SKI PANTS; SKI SUITS; SKI TROUSERS; SKI WEAR; SKIRTS; SKORTS; SKULL CAPS; SLACKS; SLEEP MASKS; SLEEPING GARMENTS; SLEEP WEAR; SLEEVELESS TOPS; SLIP-ON SHOES; SLIPPER SOCKS; SLIPPERS; SLIPS; SLIPS BEING UNDERGARMENTS; SLUMBER CAPS; SMOCKS; SNEAKERS; SNOW BOOTS; SNOW BOARD BOOTS; SNOW BOARD SHOES; SNOWSUITS; SOCCER SHOES; SOCK SUSPENDERS; SOCKS; SOFT INSOLES OTHER THAN ORTHOPAEDIC; SOLES FOR FOOTWEAR; SPATS; SPORTING FOOTWEAR; SPORTING SHOES; SPORTS CAPS; SPORTS FOOTWEAR; SPORTS HOSIERY; SPORTS JACKETS; SPORTS JERSEYS; SPORTS JUMPERS; SPORTS SHIRTS; SPORTS SHOES; SPORTS SOCKS; SPORTS SWEATERS; SPORTS UNIFORMS OTHER THAN GOLF GLOVES OR HELMETS; SQUASH SHOES; STOCKING SUSPENDERS; STOCKINGS; STOKES; STUDS FOR FOOTBALL BOOTS; STUDS FOR SPORTS FOOTWEAR; STUFF JACKETS; SUIT COATS; SUITS; SUITS MADE OF LEATHER FOR WEAR BY MOTORCYCLISTS; SUN HATS; SUN VISORS; SUPPORT PANTY HOSE, OTHER THAN FOR

**Reg. No. 4,196,366** MEDICAL OR SURGICAL USE; SUPPORT STOCKINGS, OTHER THAN FOR MEDICAL OR SURGICAL USE; SURF SHORTS; SURFING SHORTS; SUSPENDER BELTS; SUSPENDERS; SWEAT BANDS; SWEAT PANTS; SWEAT-ABSORBENT STOCKINGS; SWEAT-ABSORBENT UNDERWEAR; SWEATERS; SWEAT PANTS; SWEATSHIRTS; SWIM BRIEFS; SWIMMING CAPS; SWIMMING COSTUMES; SWIMMING ROBES; SWIMMING SHORTS; SWIMMING SUITS; SWIMMING TRUNKS; SWIMSUITS; SWIM WEAR; TABARDS; TAIL COATS; TAM O'SHANTERS, NAMELY, TAMS; TANK TOPS; TARTAN KILTS; TEDDIES; TEE-SHIRTS; TENNIS SHOES; TEXTILE LINERS FOR BABIES' NAPPIES; TEXTILE NAPKINS FOR BABIES FOR USE AS TEXTILE DIAPERS; THEATRICAL COSTUMES, NAMELY, COSTUMES FOR USE IN THE AMUSEMENT INDUSTRY; THONGS BEING CLOTHING; THONGS BEING FOOTWEAR; THREE PIECE SUITS; TIES FOR WEAR; TIGHTS; TIPS FOR FOOTWEAR; TOE INSERTS FOR FOOTWEAR OTHER THAN ORTHOPAEDIC; TOE SHOES; SHOE INSERTS, NAMELY, TOE STIFFENINGS FOR PRIMARILY NON-ORTHOPEDIC PURPOSES; TOGAS; TOP HATS; TOPCOATS; TOQUES; TRACK PANTS; TRACK TOPS; TRACK SUITS; TRAINERS BEING FOOTWEAR; TRAINING SHOES; TREKKING BOOTS; TRENCH COATS; TREWS; TRIANGULAR-SHAPED NAPPIES OF TEXTILE FOR BABIES; TROUSER STRAPS; TROUSERS; TROUSERS SHORTS; T-SHIRTS; TUNICS; TURBANS; TURTLENECK SWEATERS; TURTLENECKS; TUXEDOS; UNDERCLOTHES; UNDERCLOTHING, NAMELY, UNDERCLOTHES; UNDERCLOTHING FOR BABIES, NAMELY, UNDERCLOTHES FOR BABIES; UNDERCLOTHING FOR BOYS, NAMELY, UNDERCLOTHES FOR BOYS; UNDERCLOTHING FOR CHILDREN, NAMELY, UNDERCLOTHES FOR CHILDREN; UNDERCLOTHING FOR GIRLS, NAMELY, UNDERCLOTHES FOR GIRLS; UNDERCLOTHING FOR MEN, NAMELY, UNDERCLOTHES FOR MEN; UNDERCLOTHING FOR WOMEN, NAMELY, UNDERCLOTHES FOR WOMEN; UNDERPANTS; UNDERSHIRTS; UNDERWEAR; UNIFORMS; UNIFORMS FOR ATHLETES; UNIFORMS FOR COMMERCIAL USE; UNLINED JACKETS; VEILS BEING CLOTHING; VEST TOPS; VESTS; VISORS FOR HATS; VISORS BEING HATS; WAISTBANDS; WAISTCOATS; WALKING SHOES; WATER REPELLENT GLOVES FOR USE BY MOTOR CYCLISTS; WATER POLO CAPS; WATERPROOF BABIES' PANTS; WATERPROOF BOOTS; WATERPROOF DIAPER COVERS, NAMELY, INFANT DIAPER COVERS; WATERPROOF SUITS FOR MOTORCYCLISTS; WATER SKIING SUITS; WAX JACKETS, FOR USE AS ITEMS OF CLOTHING; WEATHER COATS; WEATHERPROOF COATS; WEATHERPROOF JACKETS; WEBBED BELTS; WEDDING GOWNS; WELLINGTON BOOTS; WELTS FOR BOOTS; WELTS FOR BOOTS AND SHOES; WELTS FOR SHOES; WET SUITS BOOTS; WET SUITS FOR WATER-SKIING; WET SUITS FOR WINDSURFING; WET SUITS FOR SURFACE WATER SPORTS; WET SUITS FOR SURFING; WHITE COATS FOR HOSPITAL USE BUT BEING PROTECTIVE CLOTHING; WIMPLES; WIND JACKETS; WIND RESISTANT TOPS; WINDPROOF JACKETS; WOODEN SHOES; WOOLLEN CLOTHING, NAMELY, COATS, JACKETS, JUMPERS, PULLOVERS; WORKING SHOES; WOVEN SHIRTS; WRAPAROUNDS; WRAPS BEING CLOTHING; WRIST WARMERS BEING WRISTBANDS; WRISTLETS BEING CLOTHING, NAMELY, WRISTBANDS; YASHMAKS, NAMELY, FACE VEILS; ZORI, IN CLASS 25 (U.S. CLS. 22 AND 39).

FOR: RETAIL STORE SERVICES AND WHOLESALE STORE SERVICES FEATURING CLOTHING, FOOTWEAR, HEADGEAR, AND PERSONAL BAGS INCLUDING HANDBAGS, BACKPACKS, TRAVEL BAGS, WALLETS AND OTHER SUCH PERSONAL BAGS; MARKETING OF GOODS, NAMELY, RETAIL STORE SERVICES FEATURING CLOTHING, FOOTWEAR, HEADGEAR, AND PERSONAL BAGS INCLUDING HANDBAGS, BACKPACKS, TRAVEL BAGS, WALLETS AND OTHER SUCH PERSONAL BAGS; IMPORT AGENCY SERVICES IN THE FIELD OF CLOTHING, FOOTWEAR, HEADGEAR, AND PERSONAL BAGS INCLUDING HANDBAGS, BACKPACKS, TRAVEL BAGS, WALLETS AND OTHER SUCH PERSONAL BAGS; ADVERTISING AND MARKETING SERVICES; RETAIL STORE SERVICES FEATURING CLOTHING, FOOTWEAR, HEADGEAR, AND PERSONAL BAGS INCLUDING HANDBAGS, BACKPACKS, TRAVEL BAGS, WALLETS AND OTHER SUCH PERSONAL BAGS, THE STORE SERVICES BEING ACCESSIBLE ONLINE, AND BY TELEPHONE AND MAIL ORDER; BUSINESS ADVICE AND INFORMATION; PRODUCT DEMONSTRATION; ONLINE AUCTION SERVICES; MAIL ORDER AND CATALOG ORDERING SERVICES FEATURING CLOTHING, FOOTWEAR, HEADGEAR, AND PERSONAL BAGS INCLUDING HANDBAGS, BACKPACKS, TRAVEL BAGS, WALLETS AND OTHER

**Reg. No. 4,196,366** SUCH PERSONAL BAGS; COMPUTERIZED ONLINE RETAIL STORE SERVICES AND WEB-BASED CATALOG SERVICES FEATURING CLOTHING, FOOTWEAR, HEADGEAR, AND PERSONAL BAGS INCLUDING HANDBAGS, BACKPACKS, TRAVEL BAGS, WALLETS AND OTHER SUCH PERSONAL BAGS; COMPILATION OF INFORMATION INTO COMPUTER DATABASES; ON-LINE ADVERTISING ON A COMPUTER NETWORK; ONLINE MARKETING AND ADVERTISING SERVICES; PROMOTING THE GOODS AND SERVICES OF OTHERS BY OPERATING AN ONLINE SHOPPING MALL WITH LINKS TO THE RETAIL WEB SITES OF OTHERS; CREATING AND UPDATING ADVERTISING MATERIAL; MARKET ANALYSIS; MARKET RESEARCH; ELECTRONIC COMMERCE SERVICES, NAMELY, PROVIDING INFORMATION ABOUT PRODUCTS VIA TELECOMMUNICATIONS NETWORKS FOR ADVERTISING AND SALES PURPOSES; BUSINESS ADVISORY, CONSULTANCY AND INFORMATION SERVICES; BUSINESS INFORMATION MANAGEMENT AND PROVISION OF BUSINESS INFORMATION; ADVERTISING AGENCIES, NAMELY, PROMOTING THE GOODS AND SERVICES OF OTHERS; BUSINESS MANAGEMENT; BUSINESS ADMINISTRATION ASSISTANCE; PROVIDING OFFICE FUNCTIONS; DISTRIBUTION OF SAMPLES FOR PUBLICITY PURPOSES; THE BRINGING TOGETHER FOR THE BENEFIT OF OTHERS OF A VARIETY OF GOODS ENABLING CUSTOMERS TO CONVENIENTLY VIEW AND PURCHASE THOSE GOODS IN THE FIELD OF CLOTHING, FOOTWEAR, HEADGEAR, IN CLASS 35 (U.S. CLS. 100, 101 AND 102).

THE MARK CONSISTS OF STANDARD CHARACTERS WITHOUT CLAIM TO ANY PARTICULAR FONT, STYLE, SIZE, OR COLOR.

PRIORITY DATE OF 6-23-2010 IS CLAIMED.

OWNER OF INTERNATIONAL REGISTRATION 1082516 DATED 12-21-2010, EXPIRES 12-21-2020.

SER. NO. 79-099,350, FILED 12-21-2010.

JOHN DWYER, EXAMINING ATTORNEY

# United States of America

United States Patent and Trademark Office

**MAX'S**  
**Life's too short to be small**

**Reg. No. 4,196,367**

**Registered Aug. 28, 2012**

**Int. Cls.: 5, 29 and 30**

**TRADEMARK**

**PRINCIPAL REGISTER**

HI-PERFORMANCE HEALTH PTY LTD (AUSTRALIA LIMITED LIABILITY COMPANY)  
17 TRADE PLACE  
VERMONT VIC 3133  
AUSTRALIA

FOR: DIETETIC FOODS AND BEVERAGES ADAPTED FOR MEDICAL USE AND MEAL REPLACEMENT SUBSTANCES, NAMELY, COOKIES, BARS AND DRINKS; SPORTS NUTRITION PRODUCTS, NAMELY, DIETARY AND NUTRITIONAL SUPPLEMENTS FOR ENDURANCE SPORTS, AND ELECTROLYTE REPLACEMENT SOLUTIONS; FOOD SUPPLEMENTS; MEDICATED AND PHARMACEUTICAL SWEETS; FOOD AND NUTRITIONAL SUPPLEMENTS BEING MUSCLE-BUILDING FOOD SUPPLEMENTS; PROTEIN, VITAMIN AND MINERAL SUPPLEMENTS IN POWDER OR LIQUID FORM; DIETETIC PREPARATIONS FOR MUSCLE-BUILDING, NAMELY, DIETETIC FOODS AND BEVERAGES ADAPTED FOR MEDICAL USE, IN CLASS 5 (U.S. CLS. 6, 18, 44, 46, 51 AND 52).

FOR: MILK; SOYA MILK, IN CLASS 29 (U.S. CL. 46).

FOR: COOKIES; GRANOLA-BASED SNACK BARS, IN CLASS 30 (U.S. CL. 46).

THE MARK CONSISTS OF THE GOLD WORDING "MAX'S" WITH A BORDER OUTLINED IN BLACK. THE COLOR WHITE IN THE BORDER REPRESENTS A TRANSPARENT AREA AND IS NOT CLAIMED AS A FEATURE OF THE MARK. THE BLACK WORDING "LIFE'S TOO SHORT TO BE SMALL" IS UNDERNEATH.

PRIORITY DATE OF 3-18-2011 IS CLAIMED.

OWNER OF INTERNATIONAL REGISTRATION 1082835 DATED 4-1-2011, EXPIRES 4-1-2021.

THE COLOR(S) BLACK AND GOLD IS/ARE CLAIMED AS A FEATURE OF THE MARK.

SER. NO. 79-099,454, FILED 4-1-2011.

TOBY BULLOFF, EXAMINING ATTORNEY



*David J. Kyros*

Director of the United States Patent and Trademark Office

# United States of America

United States Patent and Trademark Office

## COMMON SENSE HAS A FUTURE

**Reg. No. 4,196,368**

**Registered Aug. 28, 2012**

**Int. Cl.: 36**

**SERVICE MARK**

**PRINCIPAL REGISTER**

CREDIT AGRICOLE SA (FRANCE SOCIÉTÉ ANONYME)  
91/93, BOULEVARD PASTEUR  
F-75015 PARIS  
FRANCE

FOR: CAPITAL INVESTMENT, FINANCIAL CONSULTING, STOCK EXCHANGE QUOTATIONS, STOCKS AND BONDS BROKERAGE, ISSUANCE OF TRAVELLERS' CHEQUES AND LETTERS OF CREDIT, ISSUANCE OF CREDIT CARDS, SAVINGS BANKS, FINANCIAL ANALYSES, FISCAL ASSESSMENTS, FINANCING SERVICES, CAPITAL INVESTMENT AND MANAGEMENT, ACTUARIAL SERVICES, CREDIT BUREAU, REAL ESTATE APPRAISALS, REAL ESTATE MANAGEMENT, CREDIT AND DEBIT CARD SERVICES, EXCHANGING MONEY, CHEQUE VERIFICATION, ELECTRONIC FUNDS TRANSFER, IN CLASS 36 (U.S. CLS. 100, 101 AND 102).

THE MARK CONSISTS OF STANDARD CHARACTERS WITHOUT CLAIM TO ANY PARTICULAR FONT, STYLE, SIZE, OR COLOR.

PRIORITY DATE OF 12-30-2010 IS CLAIMED.

OWNER OF INTERNATIONAL REGISTRATION 1082892 DATED 5-24-2011, EXPIRES 5-24-2021.

SER. NO. 79-099,483, FILED 5-24-2011.

JASON TURNER, EXAMINING ATTORNEY



*David J. Kyffers*

Director of the United States Patent and Trademark Office

# United States of America

United States Patent and Trademark Office

## ECHO BARRIER

**Reg. No. 4,196,369**

**Registered Aug. 28, 2012**

**Int. Cls.: 6, 17 and 19**

**TRADEMARK**

**PRINCIPAL REGISTER**

ECHO BARRIER LIMITED (UNITED KINGDOM LIMITED COMPANY)  
DLC HOUSE 64 UPPER MULGRAVE ROAD  
CHEAM, SURREY SM2 7AJ  
UNITED KINGDOM

FOR: SOUND INSULATING STRUCTURES OF METAL, NAMELY, METAL FENCING, AND METAL FENCING PANELS; AND PARTS AND FITTINGS FOR ALL THE AFORESAID GOODS, IN CLASS 6 (U.S. CLS. 2, 12, 13, 14, 23, 25 AND 50).

FOR: INSULATING MATERIALS, NAMELY, ACOUSTIC INSULATING MATERIALS OF PLASTIC; ACOUSTIC INSULATING PANELS; ACOUSTIC INSULATING PANELS MADE FROM NON-METALLIC MATERIALS; ACOUSTIC SCREENS FOR INSULATION; ACOUSTIC SHEETS, NAMELY, INSULATING MATERIALS IN THE FORM OF ACOUSTIC SHEETS; ACOUSTIC SHEETS FOR INSULATION; ACOUSTIC NOISE REDUCTION BARRIERS; AND PARTS AND FITTINGS FOR ALL THE AFORESAID GOODS, IN CLASS 17 (U.S. CLS. 1, 5, 12, 13, 35 AND 50).

FOR: NON-METALLIC SOUND INSULATING STRUCTURES, NAMELY, NON-METAL FENCE PANELS, WALL PANELS NOT OF METAL, AND PLASTIC REINFORCED WALL PANELS USED TO ABSORB NOISE; AND PARTS AND FITTINGS FOR ALL THE AFORESAID GOODS, IN CLASS 19 (U.S. CLS. 1, 12, 33 AND 50).

THE MARK CONSISTS OF STANDARD CHARACTERS WITHOUT CLAIM TO ANY PARTICULAR FONT, STYLE, SIZE, OR COLOR.

PRIORITY DATE OF 12-23-2010 IS CLAIMED.

OWNER OF INTERNATIONAL REGISTRATION 1083473 DATED 5-25-2011, EXPIRES 5-25-2021.

NO CLAIM IS MADE TO THE EXCLUSIVE RIGHT TO USE "BARRIER", APART FROM THE MARK AS SHOWN.

SER. NO. 79-099,761, FILED 5-25-2011.

PAULA MAHONEY, EXAMINING ATTORNEY



*David J. Kyffers*

Director of the United States Patent and Trademark Office

# United States of America

United States Patent and Trademark Office

## VIÑA ALBERDI

**Reg. No. 4,196,370**

**Registered Aug. 28, 2012**

**Int. Cl.: 33**

**TRADEMARK**

**PRINCIPAL REGISTER**

LA RIOJA ALTA, S.A. (SPAIN SOCIEDAD ANÓNIMA)  
AVDA. VIZCAYA, 8  
E-26200 HARO (LA RIOJA)  
SPAIN

FOR: WINE, IN CLASS 33 (U.S. CLS. 47 AND 49).

NO CLAIM IS MADE TO THE EXCLUSIVE RIGHT TO USE "VIÑA", APART FROM THE MARK AS SHOWN.

OWNER OF INTERNATIONAL REGISTRATION 1083654 DATED 6-16-2011, EXPIRES 6-16-2021.

THE ENGLISH TRANSLATION OF THE WORD "VIÑA" IN THE MARK IS "VINEYARD".

SEC. 2(F).

SER. NO. 79-099,822, FILED 6-16-2011.

CYNTHIA TRIPI, EXAMINING ATTORNEY



*David J. Kyffers*

Director of the United States Patent and Trademark Office

# United States of America

United States Patent and Trademark Office

# S P E O S

**Reg. No. 4,196,371**

**Registered Aug. 28, 2012**

**Int. Cl.: 7**

**TRADEMARK**

**PRINCIPAL REGISTER**

JP STEEL PLANTECH CO. (JAPAN CORPORATION)  
3-1 KINKO-CHO  
KANAGAWA-KU.; YOKOHAMA-SHI; KANAGAWA 221-0056  
JAPAN

FOR: CONTINUOUS METAL CASTING MACHINES, CONTINUOUS METAL CASTING APPARATUS, CONTINUOUS METAL CASTING INSTALLATIONS, CONVERTERS FOR STEEL WORKS, MANUFACTURING METAL PRODUCT MACHINES (NOT FURNACES), METAL WORKING AND PROCESSING MACHINES, RECYCLING MACHINES, METAL CUTTING MACHINES, ROLLING MACHINES (FOR METALWORKING), PALATE LEVELERS (MACHINES), TENSION LEVELERS (MACHINES), TUBING MILLS (FOR METALWORKING), IN CLASS 7 (U.S. CLS. 13, 19, 21, 23, 31, 34 AND 35).

OWNER OF INTERNATIONAL REGISTRATION 1083720 DATED 6-1-2011, EXPIRES 6-1-2021.

SER. NO. 79-099,846, FILED 6-1-2011.

GINA FINK, EXAMINING ATTORNEY



*David J. Kyffers*

Director of the United States Patent and Trademark Office



# United States of America

United States Patent and Trademark Office



## SALEWA

**Reg. No. 4,196,372**

**Registered Aug. 28, 2012**

**Int. Cls.: 6, 8, 18, 20, 22,  
25, 28 and 35**

**TRADEMARK**

**SERVICE MARK**

**PRINCIPAL REGISTER**

SALEWA SPORTGERÄTE GMBH (FED REP GERMANY LIMITED LIABILITY COMPANY)  
SATURNSTRASSE 63  
85609 ASCHHEIM  
FED REP GERMANY

FOR: COMMON METALS AND THEIR ALLOYS AS WELL AS GOODS MADE OF THESE MATERIALS, NAMELY, PITONS MADE OF METAL, ICE SCREWS MADE OF METAL, CARABINERS MADE OF METAL, METAL CLAMPS, WEDGES AND CHOCKS MADE OF METAL USED FOR PLACING BETWEEN ROCKS WHEN MOUNTAIN CLIMBING, ANCHOR BOLTS MADE OF METAL, BOLTS MADE OF METAL, CLIMBING ANCHORS, HAND OPERATED PULLEYS OF METAL FOR MOUNTAIN CLIMBING; BOTTLE CLOSURE CAPS MADE OF METAL, AVALANCHE PROBES MADE OF METAL; ROPES OF METAL, IN CLASS 6 (U.S. CLS. 2, 12, 13, 14, 23, 25 AND 50).

FOR: HAND TOOLS, INCLUDED IN THIS CLASS, NAMELY, SAWS, SCRAPERS, SCREW-DRIVERS; ICE PICKS; ICE AXES; ROCK HAMMERS; SHOVELS; KNIVES, NAMELY, SPORTS KNIVES, FOLDING KNIVES, MOUNTAINEERING KNIVES, POCKET KNIVES; TABLE CUTLERY, NAMELY, KNIVES, FORKS, SPOONS; HAMMERS; CUTTING TOOLS; BELTS FOR TOOLS; CHISELS; DITCHERS; MANICURE SETS, IN CLASS 8 (U.S. CLS. 23, 28 AND 44).

FOR: BAGS, NAMELY, ALL PURPOSE SPORTS BAGS, DUFFEL BAGS, MESSENGER BAGS, SHOULDER BAGS, TRAVELLING BAGS, GRIP-SACKS, CARRY-ON BAGS, OVERNIGHTERS, NECK POUCHES, ROPE BAGS, BAGS FOR CRAMPONS, CARRYING AND RETAINING STRAPS FOR THE ABOVE GOODS, WASH BAGS; RUCKSACKS; HIP BAGS AND BELT BAGS; SUITCASES; FITTED RAIN COVERS FOR RUCKSACKS AND BAGS; LEATHER SHOULDER BELTS; RUCKSACKS CONTAINING A HYDRATION SYSTEMS COMPRISED OF A DRINKING RESERVOIR, A DRINKING TUBE AND A MOUTH-PIECE; SCHOOL BAGS; MOUNTAINEERING STICKS AND HIKING STICKS; UMBRELLAS; PARASOLS; TREKKING STICKS; SPORTS BAGS; HANDBAGS; PURSES; CAMPING BAGS, NAMELY, BAGS AND RUCKSACKS FOR CARRYING CAMPING EQUIPMENT; LEATHER AND IMITATIONS OF LEATHER AS WELL AS GOODS MADE OF THESE MATERIALS, NAMELY, LEATHER BELTS, LEATHER STRAPS, LEATHER COVERS FOR MOBILE COMPUTERS; SMALL LEATHER GOODS, NAMELY, SMALL LEATHER BAGS, LEATHER KEY CHAINS, LEATHER WALLETS, LEATHER CREDIT CARD WALLETS, LEATHER COVERS FOR MOBILE PHONES, IN CLASS 18 (U.S. CLS. 1, 2, 3, 22 AND 41).



*David J. Kybas*

Director of the United States Patent and Trademark Office

**Reg. No. 4,196,372** FOR: SLEEPING BAGS FOR CAMPING PURPOSES; COVERS FOR SLEEPING BAGS FOR CAMPING PURPOSES; AIR MATTRESSES FOR CAMPING PURPOSES; MATTRESSES; TENT POLES AND TENT PEGS, NOT OF METAL; BOLSTERS; CAMPING FURNITURE; CUSHIONS; DECK CHAIRS, IN CLASS 20 (U.S. CLS. 2, 13, 22, 25, 32 AND 50).

FOR: ROPES; BELTS NOT OF METAL FOR HANDLING LOADS AND FOR MOUNTAINEERING; INSECT PROTECTION NETS; UNDERLAYS, NAMELY, PADDING MATERIALS NOT OF RUBBER, PAPER OR PLASTIC; TENTS AND ACCESSORIES FOR TENTS, NAMELY, FLIES, RAIN FLIES, BELL ENDS FOR TENTS; TARPAULINS; BAGS, NAMELY, BAGS FOR TENTS, BAGS FOR SECURING VALUABLES; TENT BAGS; SACKS AND BAGS FOR PACKAGING MADE OUT OF TEXTILE MATERIAL; DOWN, NAMELY, DOWN FEATHERS, COMFORTERS MADE OF DOWN; TEXTILE AND PLASTIC FIBERS FOR TEXTILE PURPOSES, IN CLASS 22 (U.S. CLS. 1, 2, 7, 19, 22, 42 AND 50).

FOR: CLOTHING, NAMELY, JACKETS, VESTS, T-SHIRTS, LONG SLEEVE T-SHIRTS, SHIRTS, NECKTIES, BLOUSES, FLEECE JACKETS, PANTS, SKIRTS, GLOVES, UNDERWEAR, FUNCTIONAL UNDERWEAR, SWEATERS, JERSEYS, PULLOVERS, CASUAL SHORTS, SPORTS SHORTS, COATS, HOODED SWEATSHIRTS; FOOTWEAR; HEADGEAR, NAMELY, FACE MASKS, SKI MASKS, BALACLAVAS, CAPS, BASEBALL CAPS, SKULL CAPS, CADET STYLE CAPS, BERETS, HATS, BEANIES, HEADBANDS WITH AND WITHOUT VISORS, TUBE SCARVES; HOSIERY; UNDERWEAR; WEATHERPROOF OUTDOOR CLOTHING, NAMELY, JACKETS, SOFTSHELL JACKETS, VESTS, SHIRTS, BLOUSES, PANTS, SKIRTS, GLOVES, SKIING GLOVES, SWEATERS, SPORTS SHORTS, COATS, HOODED SWEATSHIRTS, ATHLETIC SHOES, RUNNING SHOES, TRAIL RUNNING SHOES, ALPINE BOOTS, MOUNTAIN BOOTS, MOUNTAINEERING BOOTS, HIKING BOOTS, WALKING BOOTS, TREKKING BOOTS, GAITERS, FACE MASKS, SKI MASKS, BALACLAVAS, CAPS, BASEBALL CAPS, SKULL CAPS, CADET STYLE CAPS, BERETS, HATS, BEANIES, HEADBANDS WITH AND WITHOUT VISORS, TUBE SCARVES; SPORT CLOTHING, NAMELY, JACKETS, SOFTSHELL JACKETS, VESTS, SHIRTS, PANTS, GLOVES, SKIING GLOVES, CLIMBING GLOVES, BELAY GLOVES, SWEATERS, SPORTS SHORTS, COATS, HOODED SWEATSHIRTS, GAITERS; HIP-BELTS, AS CLOTHING; BELTS; GLOVES; SCARVES, IN CLASS 25 (U.S. CLS. 22 AND 39).

FOR: SPORTS ARTICLES, NAMELY, MOUNTAINEERING EQUIPMENT IN THE NATURE OF ICE HATCHETS, ICE HAMMERS, ICE HOOKS, ICE PICKS, ICE SCREWS, ROCK HOOKS, ROCK HAMMERS, SPADES, CRAMPONS, CRAMPON BINDINGS, MOUNTAIN CLIMBING ROPES, CLIMBING BELTS, RESTRAINING CORDS, BELAY BRAKES; CLIMBING HARNESSES AS SPORTS ARTICLES; CLIMBING CHALK; CHALK BAGS; RUBBER-CLAD PROTECTIVE COVERING FOR PICK SHAFTS, AVALANCHE PROBES NOT MADE OF METAL; SKIS, SNOW SHOES, SKI SKINS, FIRN GLIDERS, NAMELY, COMPACT SHORT SKIS, SKI BINDINGS, SKI POLES, COVERINGS FOR SKIS IN THE NATURE OF SKI BAGS; SLEIGHS AND SLEDS, NAMELY, TOBOGGANS, STEEL RUNNER SLEDS, INFLATABLE SLEDS, SNOWBOARDS; SNOWBOARD BINDINGS; SNOWBOARD ACCESSORIES, NAMELY, BAGS DESIGNED FOR SNOWBOARDS, IN CLASS 28 (U.S. CLS. 22, 23, 38 AND 50).

FOR: RETAIL STORE, ONLINE RETAIL STORE, AND MAIL-ORDER SERVICES IN THE FIELD OF SPORTS ARTICLES AND CLOTHING, ALSO VIA THE INTERNET; PRESENTATION OF GOODS ON COMMUNICATION MEDIA, FOR RETAIL PURPOSES; ADVERTISING BY MAIL ORDER, NAMELY, DIRECT MAIL ADVERTISING SERVICES; ADVERTISING SERVICES; MARKETING, NAMELY, MARKETING MANAGEMENT, DIRECT MARKETING; PUBLIC RELATIONS; ARRANGING TRADE AND ECONOMIC CONTACTS, ALSO VIA THE INTERNET, NAMELY, PROVIDING AN ON-LINE SEARCHABLE DATABASE FEATURING BUSINESS INFORMATION, NAMELY, TRADE AND ECONOMIC BUSINESS CONTACTS, IN CLASS 35 (U.S. CLS. 100, 101 AND 102).

OWNER OF U.S. REG. NOS. 1,871,115, 3,329,646 AND OTHERS.

**Reg. No. 4,196,372** PRIORITY DATE OF 12-24-2010 IS CLAIMED.

OWNER OF INTERNATIONAL REGISTRATION 1083759 DATED 2-15-2011, EXPIRES 2-15-2021.

THE MARK CONSISTS OF THE WORDING "SALEWA" BELOW THE DESIGN OF AN EAGLE.

SER. NO. 79-099,858, FILED 2-15-2011.

BERNICE MIDDLETON, EXAMINING ATTORNEY

# United States of America

United States Patent and Trademark Office

## charm up your life

**Reg. No. 4,196,373**

**Registered Aug. 28, 2012**

**Int. Cl.: 14**

**TRADEMARK**

**PRINCIPAL REGISTER**

THOMAS SABO GMBH & CO. SCHMUCKHANDEL KG (FED REP GERMANY  
KOMMANDITGESELLSCHAFT)  
MARTIN-LUTHER-STRASSE 20  
LAUF, FED REP GERMANY 91207

FOR: JEWELRY, BIJOUTERIE, RINGS, EARRINGS, EAR CLIPS, BROOCHES; NECKLACES, IN PARTICULAR, JEWELRY AND BIJOUTERIE COLLIER NECKLACES; NECKLACE CHAINS, NECKLACES, PENDANTS, JEWELRY CHAINS, BRACELETS; GOLD JEWELRY, SILVER JEWELRY, PEARL JEWELRY, PLATINUM JEWELRY, JEWELRY OF RHINESTONE AND COLOURED STONE, WEDDING RINGS, MEN'S JEWELRY, PRECIOUS STONES, PEARLS; HOROLOGICAL AND CHRONOMETRIC INSTRUMENTS, IN PARTICULAR SMALL CLOCKS, WRIST WATCHES, PARTS FOR CLOCKS AND WATCHES, STRAPS FOR WRIST WATCHES, CLOCKWORKS, PARTS FOR CLOCKWORKS; PARTS FOR CLOCKS AND WATCHES, NAMELY, FACES AND CASINGS FOR CLOCKS AND WATCHES; PARTS AND FITTINGS FOR ALL THE AFORESAID GOODS, INCLUDED IN THIS CLASS, IN CLASS 14 (U.S. CLS. 2, 27, 28 AND 50).

THE MARK CONSISTS OF STANDARD CHARACTERS WITHOUT CLAIM TO ANY PARTICULAR FONT, STYLE, SIZE, OR COLOR.

PRIORITY DATE OF 3-22-2010 IS CLAIMED.

OWNER OF INTERNATIONAL REGISTRATION 1083833 DATED 9-22-2010, EXPIRES 9-22-2020.

NO CLAIM IS MADE TO THE EXCLUSIVE RIGHT TO USE "CHARM", APART FROM THE MARK AS SHOWN.

SER. NO. 79-099,878, FILED 9-22-2010.

MAUREEN DALL, EXAMINING ATTORNEY



*David J. Kypos*

Director of the United States Patent and Trademark Office

**United States of America**  
United States Patent and Trademark Office

# Wizzdraft

**Reg. No. 4,196,374**

LEGAL360 B.V. (NETHERLANDS BESLOTEN VENNOOTSCHAP)  
OVERGOO 15

**Registered Aug. 28, 2012**

NL-2266 JZ LEIDSCHENDAM, NETHERLANDS

**Int. Cls.: 35 and 42**

FOR: BUSINESS ADMINISTRATION, IN CLASS 35 (U.S. CLS. 100, 101 AND 102).

**SERVICE MARK**

FOR: DESIGN AND DEVELOPMENT OF COMPUTERS AND SOFTWARE , IN CLASS 42  
(U.S. CLS. 100 AND 101).

**PRINCIPAL REGISTER**

THE MARK CONSISTS OF STANDARD CHARACTERS WITHOUT CLAIM TO ANY PARTICULAR FONT, STYLE, SIZE, OR COLOR.

PRIORITY DATE OF 1-26-2011 IS CLAIMED.

OWNER OF INTERNATIONAL REGISTRATION 1083881 DATED 6-14-2011, EXPIRES 6-14-2021.

SER. NO. 79-099,897, FILED 6-14-2011.

BERNICE MIDDLETON, EXAMINING ATTORNEY



*David J. Kybas*

Director of the United States Patent and Trademark Office

# United States of America

United States Patent and Trademark Office

aRMour

**Reg. No. 4,196,375**

**Registered Aug. 28, 2012**

**Int. Cls.: 6 and 14**

**TRADEMARK**

**PRINCIPAL REGISTER**

THE ROYAL MINT LIMITED (UNITED KINGDOM PRIVATE LIMITED COMPANY)  
LLANTRISANT  
PONTYCLUN, MID GLAMORGAN CF72 8YT, UNITED KINGDOM

FOR: METAL COIN BLANKS AND MEDAL BLANKS, IN CLASS 6 (U.S. CLS. 2, 12, 13, 14, 23, 25 AND 50).

FOR: COLLECTIBLE COINS; MEDALS, IN CLASS 14 (U.S. CLS. 2, 27, 28 AND 50).

THE MARK CONSISTS OF THE LITERAL ELEMENT "ARMOUR" IN A STYLIZED FONT, WITH THE "R" AND "M" IN UPPERCASE WITH HORIZONTAL LINES AND THE REMAINING LETTERS IN LOWERCASE.

PRIORITY DATE OF 1-18-2010 IS CLAIMED.

OWNER OF INTERNATIONAL REGISTRATION 1084016 DATED 7-15-2010, EXPIRES 7-15-2020.

SER. NO. 79-099,958, FILED 7-15-2010.

SHANNON TWOHIG, EXAMINING ATTORNEY



*David J. Kyffers*

Director of the United States Patent and Trademark Office

# United States of America

United States Patent and Trademark Office

## CHATEAU DE FERRAND

**Reg. No. 4,196,376**

**Registered Aug. 28, 2012**

**Int. Cl.: 33**

**TRADEMARK**

**PRINCIPAL REGISTER**

FERRAND (FRANCE SOCIÉTÉ PAR ACTIONS SIMPLIFIÉE (SAS) UNIPERSONNELLE)  
CHÂTEAU DE FERRAND  
F-33330 SAINT-HIPPOLYTE  
FRANCE

FOR: WINES, NAMELY, WINES WITH PROTECTED APPELLATION OF ORIGIN FROM THE FERRAND S.A. CHATEAU DE FERRAND WINE ESTATE, IN CLASS 33 (U.S. CLS. 47 AND 49).

THE MARK CONSISTS OF STANDARD CHARACTERS WITHOUT CLAIM TO ANY PARTICULAR FONT, STYLE, SIZE, OR COLOR.

OWNER OF INTERNATIONAL REGISTRATION 1084065 DATED 6-16-2011, EXPIRES 6-16-2021.

NO CLAIM IS MADE TO THE EXCLUSIVE RIGHT TO USE "CHATEAU", APART FROM THE MARK AS SHOWN.

THE ENGLISH TRANSLATION OF "CHATEAU DE" IN THE MARK IS "CASTLE OF" OR "FRENCH VINEYARD ESTATE OF". THE WORD "FERRAND" HAS NO MEANING IN A FOREIGN LANGUAGE.

SER. NO. 79-099,971, FILED 6-16-2011.

JOHN DWYER, EXAMINING ATTORNEY



*David J. Kyros*

Director of the United States Patent and Trademark Office

# United States of America

United States Patent and Trademark Office

 passionflower

**Reg. No. 4,196,377**

KITTYHAWK GROUP PTY LTD (AUSTRALIA CORPORATION)  
PO BOX K177

**Registered Aug. 28, 2012**

HAYMARKET NSW 1240, AUSTRALIA

**Int. Cl.: 30**

FOR: ICE CREAM, ICE CREAM DESSERTS, COFFEE, TEA, COCOA, SUGAR, RICE, TAPIOCA, SAGO, FLOUR, BREAD, PASTRY, HONEY AND SPICES, IN CLASS 30 (U.S. CL. 46).

**TRADEMARK**

OWNER OF INTERNATIONAL REGISTRATION 1084217 DATED 4-21-2011, EXPIRES 4-21-2021.

**PRINCIPAL REGISTER**

SER. NO. 79-100,034, FILED 4-21-2011.

TRACY FLETCHER, EXAMINING ATTORNEY



*David J. Kyffers*

Director of the United States Patent and Trademark Office



United States of America  
United States Patent and Trademark Office

# Junkyard

**Reg. No. 4,196,378**

**Registered Aug. 28, 2012**

**Int. Cls.: 9, 18, 25, 28  
and 35**

**TRADEMARK**

**SERVICE MARK**

**PRINCIPAL REGISTER**

JUNKYARD AB (SWEDEN LIMITED LIABILITY COMPANY)  
GODHEM, ÖVERBY  
SE-461 70 TROLLHÄTTAN  
SWEDEN

FOR: PRERECORDED MAGNETIC DATA CARRIERS AND RECORDING DISCS FEATURING COMPUTER SOFTWARE FOR DATABASE MANAGEMENT IN THE FIELD OF INFORMATION TECHNOLOGY RESOURCES, IN CLASS 9 (U.S. CLS. 21, 23, 26, 36 AND 38).

FOR: LEATHER AND IMITATIONS OF LEATHER, AND GOODS MADE OF THESE MATERIALS AND NOT INCLUDED IN OTHER CLASSES, NAMELY, HANDBAGS, TOTE BAGS, AND BACKPACKS, IN CLASS 18 (U.S. CLS. 1, 2, 3, 22 AND 41).

FOR: CLOTHING, NAMELY, T-SHIRTS, SHIRTS, SHORTS, PANTS, DRESSES, COATS, SNOWBOARD PANTS, SNOWBOARD JACKETS, GLOVES, SCARVES, SWIMWEAR; FOOTWEAR; LEATHER AND IMITATION LEATHER BELTS; HEADGEAR, NAMELY, HATS, CAPS, BEANIES AND BANDANAS, IN CLASS 25 (U.S. CLS. 22 AND 39).

FOR: GAMES AND PLAYTHINGS, NAMELY, BOARD GAMES; SPORTING ARTICLES NOT INCLUDED IN OTHER CLASSES, NAMELY, SKATEBOARDS, SNOWBOARDS, SURFBOARDS, EQUIPMENT FOR SNOWBOARDING, SKATING AND SURFING, NAMELY, BINDINGS, WETSUITS, STRAPS, BACK PROTECTORS AND ANKLE PROTECTORS, IN CLASS 28 (U.S. CLS. 22, 23, 38 AND 50).

FOR: BUSINESS MANAGEMENT AND ADVERTISING FOR THE SKATEBOARDING, SNOWBOARDING AND SURFING COMMUNITY, IN CLASS 35 (U.S. CLS. 100, 101 AND 102).

THE MARK CONSISTS OF STANDARD CHARACTERS WITHOUT CLAIM TO ANY PARTICULAR FONT, STYLE, SIZE, OR COLOR.

PRIORITY DATE OF 1-5-2011 IS CLAIMED.

OWNER OF INTERNATIONAL REGISTRATION 1084220 DATED 6-3-2011, EXPIRES 6-3-2021.

SER. NO. 79-100,036, FILED 6-3-2011.



*David J. Kyffers*

Director of the United States Patent and Trademark Office

**Reg. No. 4,196,378** HEATHER THOMPSON, EXAMINING ATTORNEY

# United States of America

United States Patent and Trademark Office

# LIVE FREE

**Reg. No. 4,196,379**

**Registered Aug. 28, 2012**

**Int. Cls.: 9, 38, 41, 42  
and 45**

**TRADEMARK**

**SERVICE MARK**

**PRINCIPAL REGISTER**

TJARK AUERBACH (FED REP GERMANY INDIVIDUAL)  
LINDAUER STRASSE 21  
88069 TETTANANG  
FED REP GERMANY

FOR: COMPUTER PROGRAMS FOR THE SECURITY OF COMPUTER SYSTEMS, ANTI-VIRUS COMPUTER PROGRAMS, ANTI-SPYWARE COMPUTER PROGRAMS; PARTS AND FITTINGS FOR COMPUTER PROGRAMS, NAMELY, COMPUTER SUBPROGRAMS FOR THE SECURITY OF COMPUTER SYSTEMS, COMPUTER PROGRAM MODULES FOR THE SECURITY OF COMPUTER SYSTEMS, COMPUTER PROGRAMS FOR GENERATING COMPUTER PROGRAMS, SUPPORT SOFTWARE FOR THE SECURITY OF COMPUTER SYSTEMS, AND INTERFACES FOR COMPUTERS; PRERECORDED MAGNETIC AND OPTICAL DATA CARRIERS FEATURING DATA ABOUT COMPUTER VIRUSES, SPYWARE, AND OTHER DATA ABOUT THE SECURITY OF COMPUTER SYSTEMS, IN CLASS 9 (U.S. CLS. 21, 23, 26, 36 AND 38).

FOR: NEWS AGENCIES, NAMELY, TRANSMISSION OF NEWS; ELECTRONIC TRANSMISSION OF DATA; OPERATING AN ELECTRONIC INFORMATION AND COMMUNICATIONS SYSTEM, NAMELY, PROVIDING ACCESS TO A GLOBAL COMPUTER NETWORK, PROVIDING ACCESS TO COMPUTER PROGRAMS ON COMPUTER NETWORKS, PROVIDING USER ACCESS TO A GLOBAL COMPUTER INFORMATION NETWORK, PROVIDING INTERNET CHATROOMS, COMPUTER-AIDED TRANSMISSION OF MESSAGES AND IMAGES, TELECOMMUNICATION BY MEANS OF PLATFORMS AND PORTALS ON THE INTERNET, NAMELY, PROVIDING TELECOMMUNICATIONS CONNECTIONS TO A GLOBAL COMPUTER NETWORK VIA PLATFORMS AND PORTALS, ELECTRONIC SENDING OF MESSAGES, PROVIDING ACCESS TO COMPUTER DATABASES, WEB-MESSAGING; PROVIDING SERVICES IN CONNECTION WITH ONLINE SERVICES AND THE INTERNET, NAMELY, THE TRANSMISSION OF INFORMATION OF ALL KINDS VIA ELECTRONIC COMMUNICATIONS NETWORKS, IN CLASS 38 (U.S. CLS. 100, 101 AND 104).

FOR: EDUCATION SERVICES, NAMELY, PROVIDING CLASSES, SEMINARS, AND WORKSHOPS IN THE FIELD OF COMPUTER SYSTEM SECURITY; TRAINING SERVICES IN THE FIELD OF COMPUTER SYSTEM SECURITY; WRITING OF TEXTS AND PUBLISHING OF BOOKS, REVIEWS, MAGAZINES, AND ELECTRONIC PUBLICATIONS OTHER THAN PUBLICITY TEXTS USING MEDIA OF ALL KINDS, IN CLASS 41 (U.S. CLS. 100, 101 AND 107).



*David J. Kybas*

Director of the United States Patent and Trademark Office

**Reg. No. 4,196,379** FOR: COMPUTER PROGRAMMING; COMPUTER SOFTWARE CONSULTANCY WITH REGARD TO THE USE AND APPLICATION OF SOFTWARE, INSTALLATION AND MAINTENANCE OF SOFTWARE; SERVICES OF A SOFTWARE COMPANY, NAMELY, THE DESIGN OF COMPUTER SOFTWARE, DEVELOPMENT OF COMPUTER SOFTWARE, COMPUTER PROGRAMMING, UPDATING OF COMPUTER SOFTWARE, MAINTENANCE AND INSTALLATION OF SOFTWARE; COMPUTER SYSTEMS ANALYSIS; COMPUTER SOFTWARE APPLICATION CONSULTANCY WITH REGARD TO SOFTWARE; COMPUTER CONSULTANCY; TECHNOLOGICAL SERVICES TO SUPPORT AND IMPLEMENT THE LOCALISATION OF DATA STRUCTURES AND THE AMENDMENT THEREOF, NAMELY, SOFTWARE APPLICATIONS CONSULTANCY AND TECHNICAL SUPPORT IN THE NATURE OF TROUBLESHOOTING COMPUTER SOFTWARE PROBLEMS; INTERNET SERVICES, NAMELY, CREATING AND MAINTENANCE OF COMPUTER PROGRAMS FOR USE ON THE INTERNET AND/OR FOR THE USE OF THE INTERNET, AND COMPUTER SOFTWARE CONSULTANCY WITH REGARD TO THE APPLICATION AND FURTHER DEVELOPMENT OF SUCH PROGRAMS, IN CLASS 42 (U.S. CLS. 100 AND 101).

FOR: SECURITY SERVICES FOR THE PROTECTION OF PROPERTY AND INDIVIDUALS, NAMELY, PERSONAL SECURITY CONSULTATION FOR THE PROTECTION OF INDIVIDUALS AND PERSONAL SECURITY CONSULTATION FOR THE MONITORING OF COMPUTER SYSTEMS FOR SECURITY PURPOSES , IN CLASS 45 (U.S. CLS. 100 AND 101).

THE MARK CONSISTS OF STANDARD CHARACTERS WITHOUT CLAIM TO ANY PARTICULAR FONT, STYLE, SIZE, OR COLOR.

PRIORITY DATE OF 12-14-2010 IS CLAIMED.

OWNER OF INTERNATIONAL REGISTRATION 1084237 DATED 6-6-2011, EXPIRES 6-6-2021.

SER. NO. 79-100,045, FILED 6-6-2011.

COLLEEN DOMBROW, EXAMINING ATTORNEY

# United States of America

United States Patent and Trademark Office

## Delta Q MILQ

**Reg. No. 4,196,380**

**Registered Aug. 28, 2012**

**Int. Cl.: 11**

**TRADEMARK**

**PRINCIPAL REGISTER**

NOVADELTA - COMÉRCIO E INDÚSTRIA DE CAFÉS, S.A. (PORTUGAL PUBLIC LIMITED LIABILITY COMPANY)  
AV. INFANTE D. HENRIQUE, 151-A  
P-1950-406 LISBOA, PORTUGAL

FOR: APPARATUS FOR HEATING AND COOKING, NAMELY, FOOD STEAMERS, ELECTRIC HEATERS; APPARATUS FOR HEATING MILK AND FOR FROTHING MILK, NAMELY, ELECTRIC MILK HEATING AND FROTHING MACHINES; APPARATUS FOR MAKING COFFEE OR TEA, NAMELY, ELECTRIC COFFEE MACHINES, ELECTRIC COFFEE POTS, ELECTRIC COFFEE PERCOLATORS AND ELECTRIC TEA POTS, IN CLASS 11 (U.S. CLS. 13, 21, 23, 31 AND 34).

THE MARK CONSISTS OF STANDARD CHARACTERS WITHOUT CLAIM TO ANY PARTICULAR FONT, STYLE, SIZE, OR COLOR.

PRIORITY DATE OF 5-10-2011 IS CLAIMED.

OWNER OF INTERNATIONAL REGISTRATION 1084336 DATED 6-21-2011, EXPIRES 6-21-2021.

NO CLAIM IS MADE TO THE EXCLUSIVE RIGHT TO USE "MILQ", APART FROM THE MARK AS SHOWN.

SER. NO. 79-100,078, FILED 6-21-2011.

REGINA DRUMMOND, EXAMINING ATTORNEY



*David J. Kybas*

Director of the United States Patent and Trademark Office

# United States of America

United States Patent and Trademark Office

# SD'LOG

**Reg. No. 4,196,381**

**Registered Aug. 28, 2012**

**Int. Cls.: 36 and 39**

**SERVICE MARK**

**PRINCIPAL REGISTER**

ENTREPÔTS ET TRANSPORTS BARBE (FRANCE SOCIÉTÉ ANONYME)  
9, RUE DU PONT VI  
F-76600 LE HAVRE  
FRANCE

FOR: CUSTOMS BROKERAGE SERVICES; CUSTOMS AGENT SERVICES, NAMELY, ACTING AS AN AGENT FOR PAYMENT OF CUSTOMS DUTIES ON GOODS SHIPPED OR RECEIVED BY FOREIGN OR DOMESTIC SHIPPERS AND RECEIVERS, PROVIDING TAX PAYMENT PROCESSING SERVICES, PROVIDING RECLAMATION OF IMPORT DUTIES FOR OTHERS, AND PROVIDING FINANCIAL SPONSORSHIP OF TRANSPORTATION OF MERCHANDISE, IN CLASS 36 (U.S. CLS. 100, 101 AND 102).

FOR: TRANSPORTATION, PARTICULARLY TRANSPORTATION OF MERCHANDISE AND GOODS BY MOTOR VEHICLES, CARS, TRUCKS, RAIL, BOATS OR AIRCRAFT; STORAGE OF GOODS; PACKAGING, NAMELY, PACKING AND WAREHOUSING SERVICES; PACKAGING, SAFEKEEPING, STORAGE AND WAREHOUSING OF GOODS FOR TRANSPORTATION FOR OTHERS; TRANSPORTATION INFORMATION; FREIGHT BROKERAGE; UNLOADING OF CARGO; STORAGE INFORMATION; LOGISTICAL SERVICES IN THE FIELD OF TRANSPORTATION, NAMELY, ADVICE PERTAINING TO PACKAGING, STORAGE AND TRANSPORT OF GOODS; TRANSPORTATION OF GOODS, DELIVERY OF GOODS, PICK UP, TRANSPORTATION AND DELIVERY OF FOOD; LOADING OF SHIPS, AIRPLANES, RAILWAY CARS, CARS, MOTORIZED VEHICLES AND LORRIES; MARKING AND LOCALIZATION SERVICES, NAMELY, STORAGE OF ELECTRONIC DATA USED IN THE TRACKING OF GOODS AND CONTAINERS SERVICES; WAREHOUSING SERVICES; RENTAL OF WAREHOUSES; ORGANIZATION AND PROCESSING OF RETURNED DISPATCHES VIA ELECTRONIC STORAGE OF DATA RELATING THE MANAGEMENT OF REFUSED DISPATCHES OF GOODS; RENTAL OF STORAGE CONTAINERS; CONSULTING IN THE CONTEXT OF LOGISTICAL ACTIVITIES IN THE FIELD OF TRANSPORTATION; ELECTRONIC STORAGE OF DATA FOR PROCESSING AND EXECUTION OF DISPATCHES OF GOODS; SUPPLY OF INFORMATION AND DATA VIA DATABASES AND/OR THE INTERNET, IN THE FIELD OF TRANSPORTATION SERVICES AND PARTICULARLY THE TRANSPORTATION OF GOODS; REFRIGERATOR RENTAL, BOAT STORAGE; STORAGE OF GOODS, DELIVERY OF GOODS; PRIMARY AND SECONDARY PACKAGING OF GOODS FOR STORAGE AND TRANSPORTATION; FREIGHT BROKERAGE, TRANSPORT BROKERAGE; SHIP BROKERAGE; TRANSPORTATION COMMISSION SERVICES IN THE NATURE OF FREIGHT TRANSPORTATION BROKERAGE; FREIGHT FORWARDING, IN CLASS 39 (U.S. CLS. 100 AND 105).



*David J. Kyros*

Director of the United States Patent and Trademark Office

**Reg. No. 4,196,381** THE MARK CONSISTS OF STANDARD CHARACTERS WITHOUT CLAIM TO ANY PARTICULAR FONT, STYLE, SIZE, OR COLOR.

PRIORITY DATE OF 3-29-2011 IS CLAIMED.

OWNER OF INTERNATIONAL REGISTRATION 1084367 DATED 6-8-2011, EXPIRES 6-8-2021.

SER. NO. 79-100,089, FILED 6-8-2011.

BARBARA BROWN, EXAMINING ATTORNEY

# United States of America

United States Patent and Trademark Office

## Intrex Professional

**Reg. No. 4,196,382**

**Registered Aug. 28, 2012**

**Int. Cl.: 9**

**TRADEMARK**

**PRINCIPAL REGISTER**

UNITED PLANET GMBH (FED REP GERMANY GMBH)  
SCHNEWLINSTR. 2  
79098 FREIBURG  
FED REP GERMANY

FOR: COMPUTER SOFTWARE, RECORDED, FOR CREATING AND OPERATING WEB-BASED APPLICATIONS, MOBILE APPLICATIONS, PORTALS, INTRANETS, EXTRANETS, WEBSITES AND ELECTRONIC WORKFLOWS, AND FOR INTEGRATING AND MANAGING CONTENT, DOCUMENTS, INFORMATION, DATA AND BUSINESS PROCESSES, IN CLASS 9 (U.S. CLS. 21, 23, 26, 36 AND 38).

THE MARK CONSISTS OF STANDARD CHARACTERS WITHOUT CLAIM TO ANY PARTICULAR FONT, STYLE, SIZE, OR COLOR.

OWNER OF INTERNATIONAL REGISTRATION 1084400 DATED 6-29-2011, EXPIRES 6-29-2021.

NO CLAIM IS MADE TO THE EXCLUSIVE RIGHT TO USE "PROFESSIONELL", APART FROM THE MARK AS SHOWN.

SER. NO. 79-100,109, FILED 6-29-2011.

WILLIAM ROSSMAN, EXAMINING ATTORNEY



*David J. Kyros*

Director of the United States Patent and Trademark Office



# United States of America

United States Patent and Trademark Office



**Reg. No. 4,196,383**

**Registered Aug. 28, 2012**

**Int. Cl.: 30**

**TRADEMARK**

**PRINCIPAL REGISTER**

PASTA JULIA S.P.A. (ITALY CORPORATION)  
VIA DEL PASTIFICIO NO. 1  
I-06038 SPELLO - PERUGIA  
ITALY

FOR: STUFFED PASTA; PASTA; FLOUR FOR FOOD; FLOUR AND PREPARATIONS MADE FROM CEREALS, NAMELY, LASAGNA, PASTA, FRESH PASTA, DRIED PASTA, DEEP FROZEN PASTA, FILLED PASTA, PASTA CONTAINING FILLINGS, PASTA CONTAINING STUFFINGS, PASTA FOR SOUPS, PREPARED PASTA, FROZEN, PREPARED OR PACKAGED MEALS CONSISTING PRIMARILY OF PASTA, IN CLASS 30 (U.S. CL. 46).

NO CLAIM IS MADE TO THE EXCLUSIVE RIGHT TO USE "PASTA", APART FROM THE MARK AS SHOWN.

OWNER OF INTERNATIONAL REGISTRATION 1084402 DATED 6-23-2011, EXPIRES 6-23-2021.

THE MARK CONSISTS OF A SMALL INNER OVAL WITH A MISSION-STYLE CHURCH AND WHEAT PLANTS INSIDE A LARGER OUTER OVAL WITH THE WORDING "UNA STORIA FATTA DI TRADIZIONI PASTA JULIA" WRITTEN AROUND THE OVAL.

THE ENGLISH TRANSLATION OF "UNA STORIA FATTA DI TRADIZIONI" IN THE MARK IS "A HISTORY OF TRADITIONS".

SER. NO. 79-100,110, FILED 6-23-2011.

JAMES GRIFFIN, EXAMINING ATTORNEY



*David J. Kybas*

Director of the United States Patent and Trademark Office

# United States of America

United States Patent and Trademark Office

# EMPRO

**Reg. No. 4,196,384**

**Registered Aug. 28, 2012**

**Int. Cls.: 9, 16 and 42**

PHOENIX CONTACT GMBH & CO. KG (FED REP GERMANY LIMITED PARTNERSHIPS  
WITH A LIMITED COMPANY AS GENERAL PARTNER)  
FLACHSMARKTSTR. 8  
32825 BLOMBERG  
FED REP GERMANY

**TRADEMARK**

**SERVICE MARK**

**PRINCIPAL REGISTER**

FOR: ELECTRIC METERS, ELECTRIC PRECISION MEASURING APPARATUS, NAMELY, FOR MEASURING VOLTAGE, CURRENT, FREQUENCY, POWER, POWER FACTOR, HARMONICS, NETWORK ASYMMETRY, CAPACITY, AND/OR OSCILLATION, AND FOR ACQUIRING, MONITORING AND DISPLAYING ELECTRICAL SYSTEM AND MACHINE PARAMETERS LOCALLY, WITH THE ABILITY TO BE INTEGRATED INTO NETWORK STRUCTURES IN A MODULAR MANNER, AND WITH THE ABILITY TO COMMUNICATE THE MEASURED VALUES TO THE RELEVANT CONTROL CENTER, VOLTAGE METERS, AMMETERS, FREQUENCY METERS, VOLTMETERS, MEASURING INSTRUMENTS AND APPARATUS FOR SIGNAL CONVERSION AND TRANSFORMATION, ALL IN PARTICULAR FOR THE MEASURING, STORAGE, INPUT, OUTPUT AND/OR ANALYSIS OF VOLTAGE, CURRENT, CAPACITY, FREQUENCY, HARMONICS, NETWORK ASYMMETRY, AND ALL IN PARTICULAR MODULARLY EXPANDABLE VIA INTERFACES, AND CONNECTABLE VIA DATA NETWORKS, NETWORKS (LOCAL AND GLOBAL) AND NETWORK COMPONENTS; ELECTROMECHANICAL AND ELECTRONIC APPLIANCES, DEVICES AND INSTRUMENTS, ALL IN THE FIELD OF ELECTRIC MEASURING TECHNOLOGY, NAMELY, VOLTAGE METERS, AMMETERS, FREQUENCY METERS, VOLTMETERS, CAPACITY METERS, POWER METERS, OSCILLATION METERS, ENERGY METERS, ENERGY MEASUREMENT DEVICES, COMMUNICATION MODULES USED IN CONNECTION WITH ENERGY MEASURING DEVICES, SPECIAL FUNCTION MODULES FOR USE IN CONNECTION WITH ENERGY MEASURING DEVICES, NAMELY, STORAGE MODULES, FUNCTIONAL MODULES WITH DIGITAL INPUTS AND OUTPUTS, FUNCTIONAL MODULES WITH ANALOG OUTPUTS, APPARATUS FOR POWER ANALYSIS; COMMUNICATION INTERFACES FOR USE IN INTERFACING TO DATA NETWORKS, AND DISPLAYS FOR INDICATING ENERGY MEASUREMENTS; HOUSINGS FOR INDUSTRIAL APPLICATIONS, IN PARTICULAR FOR THE HOLDING AND HOUSING OF ELECTRONICS AND ELECTRIC INSTALLATIONS AND APPARATUS; DOWNLOADABLE ELECTRONIC PUBLICATIONS, NAMELY, BOOKS, MAGAZINES, ELECTRONIC IMAGE AND AUDIO FILES, ALL IN THE FIELD OF ELECTRIC MEASURING TECHNOLOGY, IN CLASS 9 (U.S. CLS. 21, 23, 26, 36 AND 38).



*David J. Kyjars*

Director of the United States Patent and Trademark Office

**Reg. No. 4,196,384** FOR: PRINTED MATTER FOR ADVERTISING AND PRESENTATION PURPOSES, NAMELY, PRINTED ADVERTISING BOARDS OF PAPER OR CARDBOARD, PRESENTATION FOLDERS; PRINTED SLEEVES FOR PAPERS OR DOCUMENTS AND PACKAGING, NAMELY, PAPER OR CARDBOARD; CARTONS AND CARDBOARD ARTICLES IN THE NATURE OF BOXES AND/OR CONTAINERS; FLYERS AND HANDBOOKS, ALL IN THE FIELD OF ELECTRIC MEASURING TECHNOLOGY, IN CLASS 16 (U.S. CLS. 2, 5, 22, 23, 29, 37, 38 AND 50).

FOR: TECHNICAL CONSULTANCY SERVICES RELATING TO ELECTRIC MEASURING TECHNOLOGY; TECHNICAL PROJECT PLANNING IN THE FIELD OF ELECTRIC MEASURING TECHNOLOGY; INSTALLATION, MAINTENANCE, REPAIR, DESIGN AND CREATION OF COMPUTER PROGRAMS; ALL OF THE FOREGOING SERVICES IN THE FIELD OF ELECTRIC MEASURING TECHNOLOGY, IN CLASS 42 (U.S. CLS. 100 AND 101).

THE MARK CONSISTS OF STANDARD CHARACTERS WITHOUT CLAIM TO ANY PARTICULAR FONT, STYLE, SIZE, OR COLOR.

PRIORITY DATE OF 8-19-2010 IS CLAIMED.

OWNER OF INTERNATIONAL REGISTRATION 1084409 DATED 2-18-2011, EXPIRES 2-18-2021.

SER. NO. 79-100,113, FILED 2-18-2011.

TOBY BULLOFF, EXAMINING ATTORNEY

# United States of America

United States Patent and Trademark Office

# PASSONI



**Reg. No. 4,196,385**

GRAVI SILVIA (ITALY INDIVIDUAL)  
VIA TURATI 11

**Registered Aug. 28, 2012**

I-20091 BRESSO (MILANO), ITALY

**Int. Cl.: 12**

FOR: BOATS; PARTS AND FITTINGS OF BOATS; RAILWAY VEHICLES, PARTS AND FITTINGS OF RAILWAY VEHICLES; AUTOMOBILES, PARTS AND FITTINGS OF AUTOMOBILE; MOTORCYCLES, PARTS AND FITTINGS OF MOTORCYCLES; BICYCLES, PARTS AND FITTINGS OF BICYCLES, IN CLASS 12 (U.S. CLS. 19, 21, 23, 31, 35 AND 44).

**TRADEMARK**

**PRINCIPAL REGISTER**

THE MARK CONSISTS OF THE WORD, WRITTEN IN SPECIAL CHARACTERS, "PASSONI". BELOW SUCH WORD THERE IS A SHIELD HAVING INSIDE THE STYLIZED REPRESENTATION OF TWO BICYCLE WHEELS CONTAINED IN A RECTANGLE AND, AGAIN, THE WORD "PASSONI", UNDER WHICH THERE IS THE STYLIZED REPRESENTATION OF A BICYCLE SADDLE.

PRIORITY DATE OF 12-20-2010 IS CLAIMED.

OWNER OF INTERNATIONAL REGISTRATION 1084483 DATED 6-20-2011, EXPIRES 6-20-2021.

THE WORDING "PASSONI" HAS NO MEANING IN A FOREIGN LANGUAGE.

SER. NO. 79-100,144, FILED 6-20-2011.

LINDA MICKLEBURGH, EXAMINING ATTORNEY



*David J. Kyffers*

Director of the United States Patent and Trademark Office

# United States of America

United States Patent and Trademark Office

## BioTechniques

**Reg. No. 4,196,386**

**Registered Aug. 28, 2012**

**Int. Cls.: 9, 16 and 41**

**TRADEMARK**

**SERVICE MARK**

**PRINCIPAL REGISTER**

INFORMA UK LIMITED (UNITED KINGDOM LIMITED COMPANY)  
MORTIMER HOUSE  
37-41 MORTIMER STREET; LONDON W1T 3JH  
UNITED KINGDOM

FOR: APPARATUS FOR RECORDING, TRANSMISSION OR REPRODUCTION OF SOUND OR IMAGES; BLANK MAGNETIC DATA CARRIERS, PRERECORDED MAGNETIC DATA CARRIERS FEATURING INFORMATION AND DATA IN THE FIELDS OF LABORATORY TECHNIQUES AND BIOTECHNOLOGY; BLANK RECORDING OPTICAL DISCS; PRE-RECORDED CDS, VIDEO TAPES, LASER DISKS AND DVDS FEATURING INFORMATION IN THE FIELDS OF LABORATORY TECHNIQUES AND BIOTECHNOLOGY; COMPUTER SOFTWARE FOR USE IN DATABASE MANAGEMENT IN THE FIELDS OF LABORATORY TECHNIQUES AND BIOTECHNOLOGY AND MANUALS IN ELECTRONIC FORMAT SOLD AS A UNIT; DOWNLOADABLE ELECTRONIC PUBLICATIONS IN THE NATURE OF NEWSLETTERS, REPORTS, DIRECTORIES AND BULLETINS IN THE FIELDS OF LABORATORY TECHNIQUES AND BIOTECHNOLOGY FROM DATABASES OR THE INTERNET; COMPUTERS; PRERECORDED MAGNETIC, ELECTRONIC OR OPTICAL DATA CARRIERS FEATURING INFORMATION ON LABORATORY TECHNIQUES AND BIOTECHNOLOGY; ELECTRONIC PUBLICATIONS, NAMELY, INSTRUCTION MANUALS RECORDED ON COMPUTER MEDIA RELATING TO USE OF COMPUTERS AND TO DATA, ALL RECORDED MAGNETICALLY, OPTICALLY OR ELECTRONICALLY; MAGNETIC, OPTICAL AND ELECTRONIC DATA RECORDING APPARATUS FOR RECORDING OF SOUND, IMAGES OR DATA, IN CLASS 9 (U.S. CLS. 21, 23, 26, 36 AND 38).



FOR: PAPER AND CARDBOARD; GOODS MADE FROM PAPER OR CARDBOARD NOT INCLUDED IN OTHER CLASSES, NAMELY, BOXES, CARTONS, STORAGE CONTAINERS, AND PACKAGING CONTAINERS; PRINTED MATERIALS, NAMELY, JOURNALS, NEWSLETTERS, REPORTS, AND DIRECTORIES FEATURING INFORMATION ON LABORATORY TECHNIQUES AND BIOTECHNOLOGY; PRINTED INSTRUCTIONAL MATERIALS IN THE FIELD OF COMPUTER SOFTWARE AND PROGRAMMES; PRINTED INSTRUCTIONAL, EDUCATIONAL, AND TEACHING MATERIALS IN THE FIELDS OF LABORATORY TECHNIQUES AND BIOTECHNOLOGY, IN CLASS 16 (U.S. CLS. 2, 5, 22, 23, 29, 37, 38 AND 50).

*David J. Kyjars*

Director of the United States Patent and Trademark Office

FOR: EDUCATION SERVICES, NAMELY, PROVIDING EDUCATIONAL SEMINARS, CONFERENCES, CLASSES AND WORKSHOPS IN THE FIELDS OF LABORATORY TECHNIQUES AND BIOTECHNOLOGY; TRAINING SERVICES IN THE FIELDS OF

**Reg. No. 4,196,386** LABORATORY TECHNIQUES AND BIOTECHNOLOGY; ARRANGING AND CONDUCTING OF RECREATION, ENTERTAINMENT, CULTURAL, TRAINING AND EDUCATIONAL CONFERENCES, COURSES, SEMINARS AND EXHIBITIONS IN THE FIELDS OF LABORATORY TECHNIQUES AND BIOTECHNOLOGY; PUBLISHING AND ISSUING OF SCIENTIFIC PAPERS IN THE FIELDS OF LABORATORY TECHNIQUES AND BIOTECHNOLOGY; ELECTRONIC PUBLISHING SERVICES, NAMELY, PUBLICATION OF TEXT AND GRAPHIC WORKS OF OTHERS ONLINE FEATURING INFORMATION ON LABORATORY TECHNIQUES AND BIOTECHNOLOGY; THE PROVISION OF NEWS ONLINE IN THE NATURE OF NEWS AGENCIES, NAMELY, GATHERING AND DISSEMINATION OF NEWS; NON-DOWNLOADABLE ELECTRONIC PUBLICATIONS IN THE NATURE OF JOURNALS, NEWSLETTERS, REPORTS, AND DIRECTORIES IN THE FIELDS OF LABORATORY TECHNIQUES AND BIOTECHNOLOGY VIA THE INTERNET; PROVIDING INFORMATION AND CONSULTATION SERVICES IN CONNECTION WITH THE ABOVE-MENTIONED SERVICES, IN CLASS 41 (U.S. CLS. 100, 101 AND 107).

THE MARK CONSISTS OF THE TERM "BIOTECHNIQUES" ALL IN RED.

PRIORITY DATE OF 4-28-2011 IS CLAIMED.

OWNER OF INTERNATIONAL REGISTRATION 1084493 DATED 5-12-2011, EXPIRES 5-12-2021.

THE COLOR(S) RED IS/ARE CLAIMED AS A FEATURE OF THE MARK.

SER. NO. 79-100,145, FILED 5-12-2011.

BENJAMIN OKEKE, EXAMINING ATTORNEY

# United States of America

United States Patent and Trademark Office

## GASPARD YURKIEVICH

**Reg. No. 4,196,387**

**Registered Aug. 28, 2012**

**Int. Cl.: 25**

**TRADEMARK**

**PRINCIPAL REGISTER**

GASPARD YURKIEVICH (FRANCE INDIVIDUAL)  
52 RUE PERNETY  
F-75014 PARIS  
FRANCE

FOR: CLOTHING, NAMELY, SKIRTS, DRESSES, KNICKERS, SHIRTS, SHORT-SLEEVE SHIRTS, SUITS, TROUSERS, PULLOVER, WAISTCOATS, JACKETS, COATS; FOOTWEAR AND HEADWEAR; BANDANAS; HEADBANDS; CAPS; STOCKINGS; BERETS; OVERALLS; BOAS; TEDDIES; HOSIERY; SHOWER CAPS; BOOTS; BOOT UPPERS; HALF-BOOTS; BRACES; LACE BOOTS; COLLAR PROTECTORS; CAMISOLES; PANTS; BATHING TRUNKS; BODICES; HOODS; HAT FRAMES; BELTS; MONEY BELTS; SHAWLS; BATHROBES; SWEATERS; HATS; PAPER HATS; CHASUBLES; SOCKS; SOCK SUSPENDERS; SOCK SUPPORTS; INDOOR SLIPPERS; BEACH SHOES; BOOTS FOR SPORTS; SHIRTS; SHIRT YOKES; SHIRT FRONTS; CHEMISETTES; TIGHTS; COLLARS; DETACHABLE COLLARS; SLIPS; COMBINATIONS; READY-MADE CLOTHING, NAMELY, SKIRTS, DRESSES, TROUSERS, JACKETS, SUITS; UNDERGARMENTS; CORSELETS; CORSETS; SUITS; MASQUERADE COSTUMES; EAR MUFFS; NECKTIES; CLOTHING OF LEATHER, NAMELY, TROUSERS, SHIRTS, JACKETS, COATS; CLOTHING OF IMITATION LEATHER, NAMELY, TROUSERS, SHIRTS, JACKETS, COATS; BREECHES; UNDERWEAR; OUTER JACKETS; FINISHED TEXTILE LININGS FOR GARMENTS; SASHES; FOOTWEAR UPPERS; ESPARTO SHOES AND SANDALS; FUR STOLE; FURS COATS AND JACKETS; GABARDINES; GIRDLES; GALOSHES; GLOVES; VESTS; BRASSIERES; SPATS; WIMPLES; GARMENTS, NAMELY, COATS, SKIRTS, DRESSES, KNICKERS, SHIRTS, SHORT-SLEEVE SHIRTS, SUITS, TROUSERS, PULLOVER, WAISTCOATS, JACKETS; TOP HATS; WATERPROOF CLOTHING, NAMELY, HOODED COATS, PARKAS; LEGGINGS; STOCKING SUSPENDERS; GARTERS; JERSEYS; SKIRTS; PETTICOATS; LEOTARDS; LAYETTES; LIVERIES; SINGLET; CUFFS; MUFFS; COATS; MANTILLAS; MITTENS; TOPCOATS; TROUSERS; SLIPPERS; OVERCOATS; PARKAS; DRESSING GOWNS; PELERINES; PELISSES; POCKET KERCHIEFS; POCKET SQUARES; PULLOVERS; PAJAMAS; DRESSES; WOODEN SHOES; SANDALS; SARIS; UNDERPANTS; SHOES; APRONS; TEE-SHIRTS; TOGAS; KNITWEAR, NAMELY, PULLOVER, CARDIGAN, SHIRTS, WAISTCOATS; TURBANS; UNIFORMS; STUFF JACKETS; JACKETS; FISHING VESTS; PAPER CLOTHING, NAMELY, DRESSES, SKIRTS, SHIRTS, TROUSERS; CAP PEAKS; VEILS, IN CLASS 25 (U.S. CLS. 22 AND 39).



*David J. Kyros*

Director of the United States Patent and Trademark Office

THE MARK CONSISTS OF STANDARD CHARACTERS WITHOUT CLAIM TO ANY PARTICULAR FONT, STYLE, SIZE, OR COLOR.

**Reg. No. 4,196,387** PRIORITY DATE OF 12-24-2010 IS CLAIMED.

OWNER OF INTERNATIONAL REGISTRATION 1084794 DATED 6-23-2011, EXPIRES 6-23-2021.

THE NAME(S), PORTRAIT(S), AND/OR SIGNATURE(S) SHOWN IN THE MARK IDENTIFIES "GASPARD YURKIEVICH", WHOSE CONSENT(S) TO REGISTER IS MADE OF RECORD.

SER. NO. 79-100,255, FILED 6-23-2011.

JAMES GRIFFIN, EXAMINING ATTORNEY



# United States of America

United States Patent and Trademark Office

# GENIDUNN

**Reg. No. 4,196,388**

**Registered Aug. 28, 2012**

**Int. Cls.: 3, 5 and 30**

**TRADEMARK**

**PRINCIPAL REGISTER**

YUNNAN HERBESSENCES BIOTECHNOLOGY CO., LTD. (CHINA CORPORATION)  
NO.161 YONGAN ROAD  
CHUXIONG; YUNNAN  
CHINA

FOR: HAIR LOTIONS; CLEANSING MILK FOR TOILET PURPOSES; SHAMPOOS; CAKES OF SOAP; HAIR CONDITIONER; FACIAL WASHING MILK; BATH LOTION; BEAUTY MASKS; COSMETICS; HAIR-BLACKENING CREAM; MEDICATED SOAP; BATH SALTS; FRAGRANT ESSENTIAL OILS; ANTI-WRINKLE CREAM; SKIN WHITENING CREAM; NON-MEDICATED ACNE TREATMENT CREAMS; MACULE-REMOVING SKIN CREAM; HAIR TONIC; SKIN WHITENING CREAMS, IN CLASS 3 (U.S. CLS. 1, 4, 6, 50, 51 AND 52).

FOR: ANTIALLERGIC MEDICINES; MEDICINES FOR THE TREATMENT OF GASTROINTESTINAL DISEASES; PRESCRIPTION AND NON-PRESCRIPTION MEDICINES, NAMELY, PILLS, TABLETS, CAPSULES, CAPLETS, LIQUID DROPS, SACHETS AND PREPARATIONS FOR THE TREATMENT OF CARDIOVASCULAR DISORDERS; PHARMACEUTICAL PREPARATIONS FOR THE TREATMENT OF INFECTIOUS DISEASES; PHARMACEUTICAL PREPARATIONS FOR THE TREATMENT OF EYE DISEASES AND CONDITIONS; PHARMACEUTICAL PREPARATIONS FOR THE PREVENTION AND TREATMENT OF OCULAR DISORDERS OR DISEASES, FOR THE TREATMENT OF BACTERIA-BASED DISEASES, AND FOR THE TREATMENT OF DIABETES, AND ANTI - INFECTIVE PREPARATIONS, ANTIVIRAL PREPARATIONS, ANTIBIOTICS, ANTIFUNGAL PREPARATIONS AND VACCINES; PHARMACEUTICAL PREPARATIONS AND SUBSTANCES FOR THE TREATMENT OF INFECTIOUS DISEASES, BLOOD DISORDERS, PAIN, INFLAMMATION, SEPSIS, ALOPECIA, OBESITY AND COGNITIVE DISORDERS; PHARMACEUTICAL PREPARATIONS AND SUBSTANCES FOR THE TREATMENT OF VIRAL, METABOLIC, ENDOCRINE, MUSCULOSKELETAL, CARDIOVASCULAR, CARDIOPULMONARY, GENITOURINARY, ONCOLOGICAL, HEPATOLOGICAL, OPHTHALMIC, RESPIRATORY, NEUROLOGICAL, GASTROINTESTINAL, HORMONAL, DERMATOLOGICAL, PSYCHIATRIC AND IMMUNE SYSTEM RELATED DISEASES AND DISORDERS; GINSENG ELECTUARY, NAMELY, CONFECTIONERY FOR MEDICINAL PURPOSES; GINSENG FOR MEDICAL USE; CAPSULES SOLD EMPTY FOR PHARMACEUTICALS; MEDICINAL HERBS; HERBS TEAS FOR MEDICINAL PURPOSES; BY-PRODUCTS OF THE PROCESSING OF CEREALS FOR MEDICAL PURPOSES; PREPARATIONS OF TRACE ELEMENTS FOR HUMAN AND ANIMAL USE, NAMELY, DIETARY SUPPLEMENTS; AMINO ACIDS FOR MEDICAL PURPOSES; AQUEOUS FORMULATION, NAMELY, CLEANSING SOLUTIONS FOR MEDICAL USE; ENCAPSULATED PILLS FOR DELIVERY OF PHARMACEUTICALS SOLD



*David J. Kyros*

Director of the United States Patent and Trademark Office

**Reg. No. 4,196,388** WITHOUT THE PHARMACEUTICAL INGREDIENT; MEDICINAL ALCOHOL; PHARMACEUTICAL PREPARATIONS FOR SKIN CARE; BATH PREPARATIONS, MEDICATED; DIETETIC FOODS ADAPTED FOR MEDICAL PURPOSES; FOOD FOR BABIES; DIETETIC BEVERAGES ADAPTED FOR MEDICAL PURPOSES; DIETETIC SUGAR ADAPTED FOR MEDICAL USE; MINERAL FOOD-SUPPLEMENTS; NUTRITIONAL ADDITIVES FOR MEDICAL PURPOSES USED IN FOODS AND DIETARY SUPPLEMENTS FOR HUMAN CONSUMPTION; BAG FILLED WITH CHINESE MEDICINE, NAMELY, A MEDICINE KIT CONSISTING OF MEDICINAL HERBS; VITAMIN PREPARATIONS; MEDICATED SUNBURN OINTMENTS; MEDICINAL HAIR GROWTH PREPARATIONS; DIETARY AND NUTRITIONAL SUPPLEMENTS; DIETARY AND NUTRITIONAL SUPPLEMENTS CONTAINING NUT OIL, FISH OIL; DIETARY AND NUTRITIONAL SUPPLEMENTS FOR ENDURANCE SPORTS; DIETARY AND NUTRITIONAL SUPPLEMENTS USED FOR WEIGHT LOSS; LIQUID NUTRITIONAL SUPPLEMENT; MINERAL NUTRITIONAL SUPPLEMENTS; NUTRITIONAL FOOD ADDITIVES FOR MEDICAL PURPOSES IN THE NATURE OF NATURAL FOOD EXTRACTS DERIVED FROM FISH, MEAT, VEGETABLES; NUTRITIONAL SUPPLEMENTS; NUTRITIONAL SUPPLEMENTS FOR BOOSTING ENERGY, PROMOTING HEALTHY SKIN; NUTRITIONAL SUPPLEMENTS IN THE FORM OF CAPSULES, TABLETS, CAPLETS, POWDER, SYRUPS, GUMMIES AND GELS, IN CLASS 5 (U.S. CLS. 6, 18, 44, 46, 51 AND 52).

FOR: TEA SUBSTITUTE; NUTRITIONAL SUPPLEMENT IN THE FORM OF SOLUTION, CREAM, POWDER OR CAPSULE, NAMELY, WHEAT GERM AND CURRY PASTES; CONDIMENTS, NAMELY, MUSTARD; FLAVORINGS, OTHER THAN ESSENTIAL OILS; RELISH; AROMATIC PREPARATIONS FOR FOOD, NAMELY, FLAVORING; CEREAL PREPARATIONS, NAMELY, PROCESSED CEREALS, IN CLASS 30 (U.S. CL. 46).

THE MARK CONSISTS OF THE LETTERS "GENIDUNN".

OWNER OF INTERNATIONAL REGISTRATION 1084795 DATED 2-11-2011, EXPIRES 2-11-2021.

SER. NO. 79-100,256, FILED 2-11-2011.

JOHN GARTNER, EXAMINING ATTORNEY

# United States of America

United States Patent and Trademark Office



**Reg. No. 4,196,389**

**Registered Aug. 28, 2012**

**Int. Cl.: 30**

**TRADEMARK**

**PRINCIPAL REGISTER**

RIENK RENSE DE VOS (NETHERLANDS INDIVIDUAL)  
DRIETROMPETTERSTRAAT 2  
NL-5256 BE HEUSDEN  
NETHERLANDS

FOR: TEA, IN CLASS 30 (U.S. CL. 46).

NO CLAIM IS MADE TO THE EXCLUSIVE RIGHT TO USE "ORIGINAL" OR "TEA", APART FROM THE MARK AS SHOWN.

OWNER OF INTERNATIONAL REGISTRATION 1084930 DATED 6-22-2011, EXPIRES 6-22-2021.

THE COLOR(S) DARK GRAY, LIGHT GRAY AND TAN IS/ARE CLAIMED AS A FEATURE OF THE MARK.

THE MARK CONSISTS OF THE WORDING "ORIGINAL FIRST TEA" WITH "ORIGINAL" AND "TEA" APPEARING IN TAN, "FIRST" APPEARING IN DARK GRAY, AND THE STYLIZED DESIGN OF TWO TEA LEAVES ONE IN LIGHT GRAY AND ONE IN DARK GRAY. THE MARK ALSO CONTAINS TWO HORIZONTAL LINES IN LIGHT GRAY.

SER. NO. 79-100,353, FILED 6-22-2011.

SEAN CROWLEY, EXAMINING ATTORNEY



*David J. Kybas*

Director of the United States Patent and Trademark Office

United States of America  
United States Patent and Trademark Office

kanopeo

**Reg. No. 4,196,390**

**Registered Aug. 28, 2012**

**Int. Cls.: 6, 28 and 37**

**TRADEMARK**

**SERVICE MARK**

**PRINCIPAL REGISTER**

KANOPEO GMBH (SWITZERLAND SOCIÉTÉ À RESPONSABILITÉ LIMITÉE (SARL))  
WIEDENWEG 8  
CH-4153 REINACH  
SWITZERLAND

FOR: COMMON METALS AND THEIR ALLOYS; BUILDING MATERIALS OF METAL, NAMELY, METAL REINFORCEMENT MATERIALS FOR BUILDING, METAL TRIM, METAL SOFFITS, METAL FASCIA, METAL CEILING BOARDS, AND METAL FLOOR BOARDS; NON-ELECTRIC CABLES AND WIRES OF COMMON METAL; IRON METAL BRACKETS FOR GENERAL USE; IRON CRAMPONS FOR CLIMBING; SMALL ITEMS OF METAL HARDWARE, NAMELY, PULLEYS, SPRINGS, NUTS, WASHERS, CARABINERS, DOUBLE-END SWIVELS, THIMBLES, AND METAL HARDWARE FOR USE IN DESCENDING ROPES, NAMELY, BELAY DEVICES; COMMON METAL GOODS, NAMELY, BEAMS, BOLTS, AND SCREWS; METAL GOODS FOR MOUNTAIN SPORTS, NAMELY, CARABINERS AND PULLEYS; METAL GOODS FOR LIFTING, LIFE-SAVING AND PROTECTIVE PURPOSES, NAMELY, METAL SHACKLES AND HOOKS FOR LIFTING AND RIGGING, CHAIN BLOCKS AND CHAIN HOISTS USED FOR LIFTING AND RIGGING, WIRE ROPES USED FOR LIFTING AND RIGGING; METAL PULLEYS, METAL CABLE SUPPORT BRACKETS, METAL CARABINERS, METAL ANTIRUN-BACK DEVICES, AND METAL SNUBBERS FOR CABLE SUPPORTS, USED IN CONNECTION WITH PERSONAL SAFETY EQUIPMENT FOR ADVENTURE PARKS SYSTEMS, IN CLASS 6 (U.S. CLS. 2, 12, 13, 14, 23, 25 AND 50).

FOR: SPORTING ARTICLES, NAMELY, MOUNTAINEERING HOOKS; PROTECTIVE PADDING USED FOR ZIP LINE ADVENTURE SPORTS; CLIMBERS' HARNESSSES; PERSONAL SAFETY HARNESSSES FOR ADVENTURE PARK SPORTS, NAMELY, CLIMBERS' HARNESSSES WORN FOR ZIP LINE ADVENTURE SPORTS, IN CLASS 28 (U.S. CLS. 22, 23, 38 AND 50).

FOR: CONSULTING IN SETTING-UP AND MAINTAINING SAFETY EQUIPMENT IN CONNECTION WITH ADVENTURE PARKS; CONSULTING IN SETTING-UP AND MAINTAINING PERSONAL SAFETY EQUIPMENT FOR WORK OR SPORTS INVOLVING HEIGHTS, IN CLASS 37 (U.S. CLS. 100, 103 AND 106).

THE MARK CONSISTS OF STANDARD CHARACTERS WITHOUT CLAIM TO ANY PARTICULAR FONT, STYLE, SIZE, OR COLOR.

PRIORITY DATE OF 1-10-2011 IS CLAIMED.



*David J. Kyffers*

Director of the United States Patent and Trademark Office

**Reg. No. 4,196,390** OWNER OF INTERNATIONAL REGISTRATION 1085054 DATED 6-24-2011, EXPIRES 6-24-2021.

THE ENGLISH TRANSLATION OF "KANOPEO" IN THE MARK IS CANOPY.

SER. NO. 79-100,400, FILED 6-24-2011.

ELLEN B. AWRICH, EXAMINING ATTORNEY

# United States of America

United States Patent and Trademark Office

TESSUTI DI PHARMA

**Reg. No. 4,196,391**

**Registered Aug. 28, 2012**

**Int. Cls.: 10, 24 and 25**

**TRADEMARK**

**PRINCIPAL REGISTER**

GOLDEN LADY COMPANY S.P.A. (ITALY JOINT STOCK COMPANY)  
VIA G. LEOPARDI, 3/5  
I-46043 CASTIGLIONE DELLE STIVIERE (MN)  
ITALY

FOR: ORTHOPEDIC SUPPORT BANDAGES; ELASTIC STOCKINGS; ORTHOPEDIC AND THERAPEUTIC BRACES FOR ANKLES AND KNEES; SUSPENSORY BANDAGES FOR AESTHETIC, ANTI-CELLULITE, SLIMMING AND MASSAGING PURPOSES; ELASTIC BRIEFS FOR ORTHOPEDIC PURPOSES; CORSETS FOR THERAPEUTIC USE; CORSETS FOR MEN AND WOMEN FOR THERAPEUTIC USE; ELASTIC BANDAGES AND CORSETS FOR THERAPEUTIC USE, IN CLASS 10 (U.S. CLS. 26, 39 AND 44).

FOR: FABRICS FOR THE MANUFACTURE OF CLOTHING AND FURNISHING, CURTAINS, PILLOW CASES, IN CLASS 24 (U.S. CLS. 42 AND 50).

FOR: CLOTHING, NAMELY, COATS, MANTLES, RAINCOATS, DUSTERS, DRESSES, SUITS, SKIRTS, JACKETS, TROUSERS, SHORT SETS, BERMUDAS SHORTS, JEANS, WAISTCOATS, SHIRTS, T-SHIRTS, TOPS, BLOUSES, JERSEYS, SWEATERS, BLAZERS, CARDIGANS, STOCKINGS, SOCKS, UNDERWEAR, CORSETS, BRASSIERE, UNDERPANTS, NIGHT-GOWNS, SHIFTS, PAJAMAS, BATHROBES, BATHING SUITS, BEACH-WRAPPS, SUNSUITS, SPORT JACKETS, WIND-RESISTANT JACKETS, ANORAKS, SWEATSUITS, TIES, NECKTIES, SCARVES, SHAWLS, MUFFLERS, FOULARDS, CAPS, HATS, HOODS, GLOVES, SASHES, BELTS; KNITWEAR, NAMELY, KNITWEAR PULLOVERS, KNITWEAR SCARVES, KNITWEAR JACKETS; FOOTWEAR, BEACH FOOTWEAR, ATHLETIC FOOTWEAR, BOOTS, SHOES AND SLIPPERS, IN CLASS 25 (U.S. CLS. 22 AND 39).



NO CLAIM IS MADE TO THE EXCLUSIVE RIGHT TO USE "TESSUTI", APART FROM THE MARK AS SHOWN.

PRIORITY DATE OF 3-23-2011 IS CLAIMED.

OWNER OF INTERNATIONAL REGISTRATION 1085256 DATED 3-29-2011, EXPIRES 3-29-2021.

*David J. Kyros*

THE TRADEMARK CONSISTS OF "TESSUTI DI PHARMA" WORDING WHICH SUPERIMPOSES A SERIES OF ELLIPTICAL DESIGN ELEMENTS.

**Reg. No. 4,196,391** THE ENGLISH TRANSLATION OF THE WORD "TESSUTI DI" IN THE MARK IS "FABRICS OF " OR "TEXTILES OF".

SER. NO. 79-100,470, FILED 3-29-2011.

ESTHER A. BORSUK, EXAMINING ATTORNEY

United States of America  
United States Patent and Trademark Office

# XEPHILIO

**Reg. No. 4,196,392**

**Registered Aug. 28, 2012**

**Int. Cl.: 10**

**TRADEMARK**

**PRINCIPAL REGISTER**

CANON KABUSHIKI KAISHA (JAPAN CORPORATION)  
30-2, SHIMOMARUKO 3-CHOME  
OHTA-KU; TOKYO 146-8501  
JAPAN

FOR: MEDICAL MACHINES AND APPARATUS, NAMELY, DIGITAL RADIOGRAPHY SYSTEMS FOR MEDICAL IMAGING; PARTS AND ACCESSORIES FOR DIGITAL RADIOGRAPHY SYSTEMS FOR MEDICAL IMAGING, NAMELY, MOBILE UNITS AND MONITOR WORKSTATIONS FOR IMAGE RECORDING, REPRODUCTION, PROCESSING, STORAGE AND DISPLAY, X-RAY TUBES AND DETECTORS, APPARATUS FOR FASTENING X-RAY TUBES AND DETECTORS, AND REMOTE CONTROLLERS FOR SUCH SYSTEMS, IN CLASS 10 (U.S. CLS. 26, 39 AND 44).

PRIORITY DATE OF 3-16-2011 IS CLAIMED.

OWNER OF INTERNATIONAL REGISTRATION 1085520 DATED 6-28-2011, EXPIRES 6-28-2021.

SER. NO. 79-100,559, FILED 6-28-2011.

BERNICE MIDDLETON, EXAMINING ATTORNEY



*David J. Kyffers*

Director of the United States Patent and Trademark Office



# United States of America

United States Patent and Trademark Office



**Reg. No. 4,196,393**

**Registered Aug. 28, 2012**

**Int. Cls.: 18 and 25**

**TRADEMARK**

**PRINCIPAL REGISTER**

KANTUKAN CO., LTD. (REPUBLIC OF KOREA CORPORATION)  
SUITE 4, DASEONG BLDG.  
GEOJE-DONG YEONJE-GU; BUSAN 611-070  
REPUBLIC OF KOREA

FOR: RUCKSACKS FOR MOUNTAINEERS; BACKPACKS; ALPENSTOCKS; CANES;  
WALKING STICK HANDLES, IN CLASS 18 (U.S. CLS. 1, 2, 3, 22 AND 41).

FOR: MOUNTAINEERING BOOTS; WINTER BOOTS; INNER SOLES; SOLES FOR FOOT-  
WEAR; NON-SLIPPING DEVICES FOR BOOTS, NAMELY, STUDS FOR BOOTS; JUMPERS;  
PARKAS; UNDERWEAR UNDERCLOTHING; UNDERSHIRTS; EAR MUFFS; WINTER  
GLOVES; SOCKS; HOODS; CLIMBING TROUSERS; CLIMBING SOCKS; CLIMBING  
JACKET; CLIMBING VESTS; CLIMBING CAPS; ATHLETIC FOOTWEAR; RAIN COATS;  
SPORT SHIRTS, IN CLASS 25 (U.S. CLS. 22 AND 39).

THE MARK CONSISTS OF FLAMES INSIDE OF A HEXAGON.

PRIORITY DATE OF 12-10-2010 IS CLAIMED.

OWNER OF INTERNATIONAL REGISTRATION 1085564 DATED 6-7-2011, EXPIRES 6-7-  
2021.

SER. NO. 79-100,585, FILED 6-7-2011.

JESSICA FATHY, EXAMINING ATTORNEY



*David J. Kybas*

Director of the United States Patent and Trademark Office

# United States of America

United States Patent and Trademark Office

# ULTRAFLEX

**Reg. No. 4,196,394**

MAPEI S.P.A. (ITALY SOCIÉTÉ PAR ACTION)

**Registered Aug. 28, 2012**

VIA CAFIERO, 22  
I-20158 MILANO, ITALY

**Int. Cls.: 1 and 17**

FOR: CHEMICALS FOR USE IN THE BUILDING CHEMICAL INDUSTRY; ADHESIVES FOR INDUSTRIAL PURPOSES; ADHESIVES FOR FLOORS AND FLOORS WITH COATINGS OF CERAMICS OR OTHER MATERIALS; ADHESIVES FOR THE BUILDING INDUSTRY; ADHESIVES FOR CEMENT MANUFACTURED PRODUCTS; ANTIFREEZE; CHEMICAL ADDITIVES FOR USE IN THE MANUFACTURE OF CEMENT AND CONCRETE; WATERPROOF MATERIALS, NAMELY, WATERPROOF GLAZIERS' PUTTY, FOR PUTTYING CERAMIC SLABS, IN CLASS 1 (U.S. CLS. 1, 5, 6, 10, 26 AND 46).

**TRADEMARK**

**PRINCIPAL REGISTER**

FOR: INSULATING PRODUCTS, NAMELY, INSULATING PAINT, INSULATING GLOVES, INJECTABLE INSULATING PRODUCTS FOR WATERPROOFING GALLERIES, NAMELY, INSULATING PAINT, INSULATING GLOVES; PITCHED INSULATING WATER PROOFING MEMBRANES FOR WATERPROOFING WALLS, PACKING AND INSULATING MATERIALS, AND STOPPING MATERIALS FOR INSULATION; MATERIALS FOR STOPPING LEAKS, NAMELY, INSULATING MATERIALS, FOAM INSULATION FOR USE IN BUILDING AND CONSTRUCTION; INSULATING WATER PROOFING MEMBRANES; INSULATING WATERPROOFING MEMBRANES CONTAINING A MIXTURE OF PITCH, POLYMERS AND OTHER MINERAL INGREDIENTS; PACKAGING MATERIALS MADE OF PLASTIC, NAMELY, FLEXIBLE PLASTIC SHEATHS; LATEX FOR INDUSTRIAL USE TO BE MIXED WITH CEMENT AND SAND AND USED IN BUILDING, IN CLASS 17 (U.S. CLS. 1, 5, 12, 13, 35 AND 50).



THE MARK CONSISTS OF STANDARD CHARACTERS WITHOUT CLAIM TO ANY PARTICULAR FONT, STYLE, SIZE, OR COLOR.

PRIORITY DATE OF 3-11-2011 IS CLAIMED.

OWNER OF INTERNATIONAL REGISTRATION 1085698 DATED 4-1-2011, EXPIRES 4-1-2021.

SER. NO. 79-100,664, FILED 4-1-2011.

SETH A. RAPPAPORT, EXAMINING ATTORNEY

*David J. Kyffers*

Director of the United States Patent and Trademark Office

# United States of America

United States Patent and Trademark Office



**Reg. No. 4,196,395**

**Registered Aug. 28, 2012**

**Int. Cls.: 9, 38 and 42**

BUREAU VERITAS, REGISTRE INTERNATIONAL DE CLASSIFICATION DE NAVIRES ET D'AÉRONEFS (FRANCE SOCIÉTÉ ANONYME)  
67/71 BOULEVARD DU CHÂTEAU  
F-92200 NEUILLY SUR SEINE  
FRANCE

**TRADEMARK**

FOR: SOFTWARE FOR USE IN SETTING UP A WEBSITE DESIGNED FOR MANAGEMENT IN THE FIELD OF THE CERTIFICATION AND CLASSIFICATION OF VARIOUS ACTIVITIES, IN CLASS 9 (U.S. CLS. 21, 23, 26, 36 AND 38).

**SERVICE MARK**

**PRINCIPAL REGISTER**

FOR: TRANSMISSION OF DATA AND INFORMATION VIA INTERNET AND INTRANET NETWORKS; COMPUTER AIDED TRANSMISSION OF IMAGES AND MESSAGES, IN CLASS 38 (U.S. CLS. 100, 101 AND 104).

FOR: INSPECTION, SUPERVISION, AND TECHNICAL TESTING SERVICES, ALL WITH THE AIM OF CLASSIFYING AND CERTIFYING GOODS AND SERVICES AND PROVIDING QUALITY ASSESSMENT OF ALL KINDS OF GOODS AND SERVICES, FACILITIES, EQUIPMENT, MATERIALS, AND APPARATUS FOR OTHERS, NAMELY, INSPECTION, SUPERVISION AND TESTING OF VEHICLES, ELECTRIC-, THERMAL-, HYDRO- OR NUCLEAR POWER PLANTS, COMPUTER INSTALLATIONS, AND DATA PROCESSING EQUIPMENT; PROVIDING NON-DOWNLOADABLE SOFTWARE FOR USE IN THE FIELD OF BUSINESS ADMINISTRATION AND E-COMMERCE; COMPUTER SOFTWARE DESIGN AND DEVELOPMENT IN THE AFOREMENTIONED FIELDS, IN CLASS 42 (U.S. CLS. 100 AND 101).



THE MARK CONSISTS OF THE FOLLOWING: THE LETTERS "BV" IN RED, THE WORD "NET" IN BLACK, AND A TERRESTRIAL GLOBE DESIGN IN BLACK.

PRIORITY DATE OF 12-1-2010 IS CLAIMED.

OWNER OF INTERNATIONAL REGISTRATION 1085920 DATED 6-1-2011, EXPIRES 6-1-2021.

THE COLOR(S) RED AND BLACK IS/ARE CLAIMED AS A FEATURE OF THE MARK.

SER. NO. 79-100,744, FILED 6-1-2011.

*David J. Kyros*

Director of the United States Patent and Trademark Office

**Reg. No. 4,196,395** GINA FINK, EXAMINING ATTORNEY

United States of America  
United States Patent and Trademark Office

MISCHIEF

**Reg. No. 4,196,396**

**Registered Aug. 28, 2012**

**Int. Cls.: 3 and 4**

**TRADEMARK**

**PRINCIPAL REGISTER**

RDPR LIMITED (UNITED KINGDOM LIMITED COMPANY)  
26 CLIFTON TERRACE  
BRIGHTON, EAST SUSSEX BN1 3HB  
UNITED KINGDOM

FOR: PERFUMERY, PERFUMES AND PERFUMERY PRODUCTS, NAMELY, COLOGNE, AFTERSHAVE AND FRAGRANCES; AROMATIC SUBSTANCES FOR USE IN THE MANUFACTURE OF PERFUMES, NAMELY, AROMATIC OILS AND AROMATIC ESSENTIAL OILS; FINE FRAGRANCE, IN CLASS 3 (U.S. CLS. 1, 4, 6, 50, 51 AND 52).

FOR: PERFUMED CANDLES, IN CLASS 4 (U.S. CLS. 1, 6 AND 15).

THE MARK CONSISTS OF STANDARD CHARACTERS WITHOUT CLAIM TO ANY PARTICULAR FONT, STYLE, SIZE, OR COLOR.

PRIORITY DATE OF 4-4-2011 IS CLAIMED.

OWNER OF INTERNATIONAL REGISTRATION 1085937 DATED 6-16-2011, EXPIRES 6-16-2021.

SER. NO. 79-100,750, FILED 6-16-2011.

LEIGH LOWRY, EXAMINING ATTORNEY



*David J. Kyfos*

Director of the United States Patent and Trademark Office

United States of America  
United States Patent and Trademark Office

# Hutbook

**Reg. No. 4,196,397**

**Registered Aug. 28, 2012**

**Int. Cls.: 35 and 36**

**SERVICE MARK**

**PRINCIPAL REGISTER**

ALBERT COHEN (AUSTRALIA INDIVIDUAL)  
4A GARDEN ROAD  
BENTLEIGH EAST VIC 3165  
AUSTRALIA

FOR: COMPILING REAL ESTATE BROKERAGE LISTINGS INTO COMPUTER DATABASES, IN CLASS 35 (U.S. CLS. 100, 101 AND 102).

FOR: REAL ESTATE MANAGEMENT; PROVIDING INFORMATION AND ONLINE INFORMATION IN THE FIELD OF REAL ESTATE; PROVIDING FINANCIAL AND INSURANCE INFORMATION; PROVIDING ONLINE FINANCIAL AND INSURANCE INFORMATION; REAL ESTATE ADMINISTRATION, NAMELY, REAL ESTATE MANAGEMENT; REAL ESTATE SERVICES, NAMELY, RENTAL OF SHORT-TERM FURNISHED APARTMENTS, LONG-TERM FURNISHED APARTMENTS, APARTMENTS, HOUSES, VACATION HOMES, COMMERCIAL PROPERTY, OFFICES AND OFFICE SPACE, IN CLASS 36 (U.S. CLS. 100, 101 AND 102).

THE MARK CONSISTS OF STANDARD CHARACTERS WITHOUT CLAIM TO ANY PARTICULAR FONT, STYLE, SIZE, OR COLOR.

PRIORITY DATE OF 1-22-2011 IS CLAIMED.

OWNER OF INTERNATIONAL REGISTRATION 1086095 DATED 5-31-2011, EXPIRES 5-31-2021.

SER. NO. 79-100,802, FILED 5-31-2011.

CHRISIE B. KING, EXAMINING ATTORNEY



*David J. Kybas*

Director of the United States Patent and Trademark Office

United States of America  
United States Patent and Trademark Office

FETISH

**Reg. No. 4,196,398**

**Registered Aug. 28, 2012**

**Int. Cls.: 3 and 4**

**TRADEMARK**

**PRINCIPAL REGISTER**

RDPR LIMITED (UNITED KINGDOM LIMITED COMPANY)  
26 CLIFTON TERRACE  
BRIGHTON, EAST SUSSEX BN1 3HB  
UNITED KINGDOM

FOR: PERFUMERY, PERFUMES AND PERFUMERY PRODUCTS, NAMELY, COLOGNE, AFTERSHAVE AND FRAGRANCES; AROMATIC SUBSTANCES FOR USE IN THE MANUFACTURE OF PERFUMES, NAMELY, AROMATIC OILS AND AROMATIC ESSENTIAL OILS; FINE FRAGRANCE, IN CLASS 3 (U.S. CLS. 1, 4, 6, 50, 51 AND 52).

FOR: PERFUMED CANDLES, IN CLASS 4 (U.S. CLS. 1, 6 AND 15).

THE MARK CONSISTS OF STANDARD CHARACTERS WITHOUT CLAIM TO ANY PARTICULAR FONT, STYLE, SIZE, OR COLOR.

PRIORITY DATE OF 1-26-2011 IS CLAIMED.

OWNER OF INTERNATIONAL REGISTRATION 1086200 DATED 6-18-2011, EXPIRES 6-18-2021.

SER. NO. 79-100,840, FILED 6-18-2011.

LEIGH LOWRY, EXAMINING ATTORNEY



*David J. Kyros*

Director of the United States Patent and Trademark Office

# United States of America

United States Patent and Trademark Office

# Lise Baccara

**Reg. No. 4,196,399**

**Registered Aug. 28, 2012**

**Int. Cl.: 33**

**TRADEMARK**

**PRINCIPAL REGISTER**

GIE LISE BACCARA (FRANCE GIE (GROUPEMENT D'INTÉRÊT ECONOMIQUE))  
PINTHIERS,  
RUE DES POTIRONS; F-17800 PONS  
FRANCE

FOR: ALCOHOLIC BEVERAGES EXCEPT BEERS; PREPARED ALCOHOLIC COCKTAILS CONTAINING COGNAC; COGNAC LIQUEUR; APERITIFS BASED ON HIGH WINE; COGNAC; PINEAU DES CHARENTES; ALCOHOLIC FRUIT AND COGNAC COCKTAIL DRINK, IN CLASS 33 (U.S. CLS. 47 AND 49).

THE NAME(S), PORTRAIT(S), AND/OR SIGNATURE(S) SHOWN IN THE MARK DOES NOT IDENTIFY A PARTICULAR LIVING INDIVIDUAL.

OWNER OF INTERNATIONAL REGISTRATION 1086544 DATED 6-27-2011, EXPIRES 6-27-2021.

THE WORDING "BACCARA" HAS NO MEANING IN A FOREIGN LANGUAGE.

SER. NO. 79-100,964, FILED 6-27-2011.

SANDRA BUJA, EXAMINING ATTORNEY



*David J. Kyros*

Director of the United States Patent and Trademark Office



# United States of America

United States Patent and Trademark Office

## GLOBE AIR CARGO

**Reg. No. 4,196,400**

**Registered Aug. 28, 2012**

**Int. Cls.: 35 and 39**

**SERVICE MARK**

**PRINCIPAL REGISTER**

EUROPEAN CARGO SERVICES (SOCIÉTÉ ANONYME) (FRANCE SOCIÉTÉ ANONYME)  
LE DÔME ROISSY PÔLE -  
5 RUE DE LA HAYE -; ROISSY CDG CEDEX; F-93290 TREMBLAY EN FRANCE  
FRANCE

FOR: BROKERAGE AND COMMERCIAL AGENT SERVICES RELATING TO FREIGHT AND AIR TRANSPORT OF GOODS, NAMELY, PURCHASING, SELLING, AND ORGANIZING FREIGHT AND AIR TRANSPORTATION FOR GOODS ON BEHALF OF AND FOR OTHERS; PROCUREMENT SERVICES IN THE FIELDS OF FREIGHT AND AIR TRANSPORT, NAMELY, PURCHASING FREIGHT AND AIR TRANSPORT SPACE FOR OTHERS, IN CLASS 35 (U.S. CLS. 100, 101 AND 102).

FOR: BROKERAGE SERVICES FOR FREIGHT AND AIR TRANSPORT OF GOODS; PROFESSIONAL CONSULTANCY SERVICES IN THE AREA OF AIR TRANSPORT AND AIR FREIGHT SHIPPING; AND LOGISTIC SERVICES IN THE AIR TRANSPORT SECTOR, PARTICULARLY, INFORMATION RELATING TO THE DELIVERY OF GOODS, IN CLASS 39 (U.S. CLS. 100 AND 105).

NO CLAIM IS MADE TO THE EXCLUSIVE RIGHT TO USE "AIR CARGO", APART FROM THE MARK AS SHOWN.

PRIORITY DATE OF 12-23-2010 IS CLAIMED.

OWNER OF INTERNATIONAL REGISTRATION 1086641 DATED 6-17-2011, EXPIRES 6-17-2021.

THE COLOR(S) BLUE AND BLACK IS/ARE CLAIMED AS A FEATURE OF THE MARK.

THE MARK CONSISTS OF THE WORDING "GLOBE AIR CARGO" IN STYLIZED CAPITAL LETTERS. THE WORDS "GLOBE AIR" APPEAR IN BLUE LETTERING, AND THE WORD "CARGO" APPEARS IN BLACK LETTERING. THE LETTER "O" IN THE WORD "GLOBE", IS FORMED BY A DESIGN OF BLUE HORIZONTAL BANDS. A BLUE AIRPLANE DESIGN APPEARS ABOVE THE LETTER "O" IN THE WORD "GLOBE", AND A BLUE LINE EXTENDS FROM THE AIRPLANE AROUND THE LEFT SIDE OF THE LETTER "O". THE COLOR GRAY REPRESENTS BACKGROUND AND/OR TRANSPARENT AREAS AND IS NOT PART OF THE MARK.



*David J. Kyffers*

Director of the United States Patent and Trademark Office

**Reg. No. 4,196,400** SER. NO. 79-100,999, FILED 6-17-2011.

JENNIFER MARTIN, EXAMINING ATTORNEY

# United States of America

## United States Patent and Trademark Office

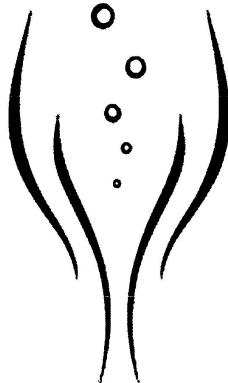

**Reg. No. 4,196,401**

**Registered Aug. 28, 2012**

**Int. Cls.: 16, 33, 35, 38  
and 41**

COMITÉ INTERPROFESSIONNEL DU VIN DE CHAMPAGNE (FRANCE ORGANISATION  
LOI 1941)  
5 RUE HENRI MARTIN  
F-51200 EPERNAY  
FRANCE

**TRADEMARK**

**SERVICE MARK**

**PRINCIPAL REGISTER**

FOR: PRINTED MATTER, NAMELY, BOOKS, BOOKLETS, PRINTED REPORTS, RESEARCH REPORTS, BRIEFS, PAMPHLETS, BROCHURES, MANUALS, LEAFLETS, FLYERS, PROSPECTUSES, INFORMATIONAL SHEETS, NEWSLETTERS, SOUVENIR EVENT PROGRAMS, AND PERIODICAL PUBLICATIONS IN THE FIELDS OF WINE AND THE WINE INDUSTRY; BOOKBINDING MATERIAL; PHOTOGRAPHS; STATIONERY; ADHESIVE GLUES FOR STATIONERY OR HOUSEHOLD PURPOSES; ARTISTS' MATERIALS, NAMELY, PENS, ARTISTS' PENS, PENCILS, ARTISTS' PENCILS; PAINTBRUSHES; TYPEWRITERS; PRINTED INSTRUCTIONAL AND TEACHING MATERIAL EXCEPT APPARATUS IN THE FIELDS OF WINE AND THE WINE INDUSTRY; PRINTING TYPE; PRINTING BLOCKS; PAPER; CARDBOARD; BOXES OF CARDBOARD OR PAPER; POSTERS; ALBUMS, NAMELY, PHOTOGRAPH ALBUMS, STICKER ALBUMS, EVENT ALBUMS; CARDS, NAMELY, POSTCARDS, NOTE CARDS, GREETING CARDS; NEWSPAPERS; CALENDARS; WRITING INSTRUMENTS; LITHOGRAPHIC WORKS OF ART; ENGRAVED WORKS OF ART, NAMELY, ART ETCHINGS; FRAMED AND UNFRAMED PAINTINGS; FRAMED AND UNFRAMED PICTURES; AQUARELLES; PATTERNS FOR DRESSMAKING; GRAPHIC PRINTS; DRAWING INSTRUMENTS; HANDKERCHIEFS OF PAPER; FACE TOWELS OF PAPER; TABLE LINEN OF PAPER; PAPER BAGS FOR PACKAGING PURPOSES; PLASTIC BAGS FOR PACKAGING PURPOSES; PAPER SACHETS IN THE NATURE OF ENVELOPES AND POUCHES FOR PACKAGING PURPOSES; PLASTIC SACHETS IN THE NATURE OF ENVELOPES AND POUCHES FOR PACKAGING PURPOSES, IN CLASS 16 (U.S. CLS. 2, 5, 22, 23, 29, 37, 38 AND 50).

FOR: ALCOHOLIC BEVERAGES, EXCEPT BEER; HARD CIDER; LIQUEURS AND SPIRITS, NAMELY, DIGESTERS; WINE; SPIRITS; ALCOHOLIC EXTRACTS AND ESSENCES, IN CLASS 33 (U.S. CLS. 47 AND 49).

FOR: ADVERTISING; BUSINESS MANAGEMENT; BUSINESS ADMINISTRATION IN THE WINE INDUSTRY; PROVIDING OFFICE FUNCTIONS; DIRECT MAIL ADVERTISING; ARRANGING NEWSPAPER SUBSCRIPTIONS FOR OTHERS; BUSINESS MANAGEMENT AND ORGANIZATION CONSULTANCY; BOOK-KEEPING; DOCUMENT REPRODUCTION; EMPLOYMENT AGENCIES; COMPUTERIZED FILE MANAGEMENT; ORGANIZATION OF



*David J. Kybas*

Director of the United States Patent and Trademark Office

**Reg. No. 4,196,401** EXHIBITIONS FOR COMMERCIAL OR ADVERTISING PURPOSES; ONLINE ADVERTISING ON A COMPUTER NETWORK; RENTAL OF ADVERTISING TIME ON COMMUNICATION MEDIA; PUBLICATION OF PUBLICITY TEXTS; RENTAL OF ADVERTISING SPACE; DISSEMINATION OF ADVERTISING MATTER; PUBLIC RELATIONS, IN CLASS 35 (U.S. CLS. 100, 101 AND 102).

FOR: TELECOMMUNICATIONS, NAMELY, TRANSMISSION OF VOICE, DATA, GRAPHICS, IMAGES, AUDIO AND VIDEO BY MEANS OF TELECOMMUNICATIONS NETWORKS, WIRELESS COMMUNICATION NETWORKS, AND THE INTERNET; PROVIDING ON-LINE CHAT ROOMS FOR SOCIAL NETWORKING; INFORMATION ABOUT TELECOMMUNICATION; COMMUNICATIONS VIA COMPUTER TERMINALS OR VIA FIBER-OPTIC NETWORKS; RADIO OR TELEPHONE COMMUNICATIONS; MOBILE RADIO TELEPHONE SERVICES; PROVIDING USER ACCESS TO A GLOBAL COMPUTER NETWORK; ELECTRONIC BULLETIN BOARD SERVICES; PROVIDING TELECOMMUNICATIONS CONNECTIONS TO A GLOBAL COMPUTER NETWORK; NEWS AGENCIES, NAMELY, THE TRANSMISSION OF NEWS ITEMS TO NEWS REPORTING ORGANIZATIONS; RENTAL OF TELECOMMUNICATION EQUIPMENT; RADIO OR TELEVISION BROADCASTING; TELECONFERENCING SERVICES; ELECTRONIC MESSAGING; RENTAL OF ACCESS TIME TO GLOBAL COMPUTER NETWORKS, IN CLASS 38 (U.S. CLS. 100, 101 AND 104).

FOR: TEACHING IN THE FIELDS OF WINE AND THE WINE INDUSTRY; PROVIDING OF TRAINING IN THE FIELDS OF WINE AND THE WINE INDUSTRY; ENTERTAINMENT IN THE NATURE OF COMPETITIONS IN THE FIELDS OF WINE AND THE WINE INDUSTRY; ORGANIZING SPORTING AND CULTURAL EVENTS; ENTERTAINMENT INFORMATION; PROVIDING INFORMATION ABOUT EDUCATION; PROVIDING RECREATION FACILITIES; PUBLICATION OF BOOKS; LENDING LIBRARIES; VIDEOTAPE FILM PRODUCTION; RENTAL OF MOTION PICTURES; RENTAL OF SOUND RECORDINGS; RENTAL OF VIDEO CASSETTE RECORDERS OR OF RADIO AND TELEVISION SETS; RENTAL OF SHOW SCENERY; VIDEOTAPE EDITING; PHOTOGRAPHY; ORGANIZATION OF EDUCATION AND ENTERTAINMENT COMPETITIONS IN THE FIELDS OF WINE AND THE WINE INDUSTRY; ARRANGING AND CONDUCTING OF COLLOQUIUMS, CONFERENCES AND CONGRESSES IN THE FIELDS OF WINE AND THE WINE INDUSTRY; ORGANIZATION OF EXHIBITIONS FOR CULTURAL OR EDUCATIONAL PURPOSES; BOOKING OF SEATS FOR SHOWS; ELECTRONIC GAME SERVICES PROVIDED ON-LINE FROM A COMPUTER NETWORK; ELECTRONIC PUBLISHING SERVICES, NAMELY, PUBLICATION OF ELECTRONIC BOOKS AND JOURNALS OF OTHERS ON-LINE; ELECTRONIC DESKTOP PUBLISHING, IN CLASS 41 (U.S. CLS. 100, 101 AND 107).

THE MARK CONSISTS OF AN ABSTRACT DESIGN THAT CONSISTS OF FOUR CURVED LINES AND FIVE CIRCLES. THE CURVED LINES ARE ARRANGED TO DEPICT THE OUTLINE OF A STEM AND GOBLET OF A CHAMPAGNE FLUTE WITH THE CIRCLES ARRANGED AS BUBBLES EMANATING FROM THE CENTER OF THE GLASS.

PRIORITY DATE OF 12-27-2010 IS CLAIMED.

OWNER OF INTERNATIONAL REGISTRATION 1086769 DATED 6-20-2011, EXPIRES 6-20-2021.

SER. NO. 79-101,049, FILED 6-20-2011.

JENNIFER WILLISTON, EXAMINING ATTORNEY

# United States of America

United States Patent and Trademark Office

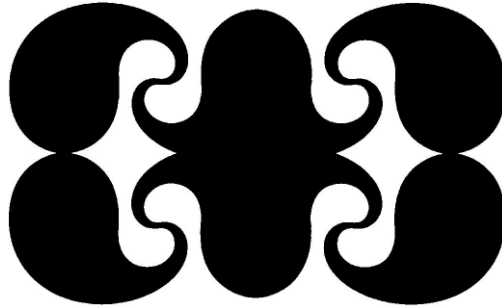

**M/M (Paris)**

**Reg. No. 4,196,402**

**Registered Aug. 28, 2012**

**Int. Cls.: 3, 16, 20, 25, 41  
and 42**

M/M (FRANCE SOCIÉTÉ À RESPONSABILITÉ LIMITÉE)  
5/7 RUE RECOLLETS  
F-75010 PARIS  
FRANCE

FOR: PERFUMES, COSMETICS, IN CLASS 3 (U.S. CLS. 1, 4, 6, 50, 51 AND 52).

**TRADEMARK**

**SERVICE MARK**

**PRINCIPAL REGISTER**

FOR: PRINTED MATTER, NAMELY, BOOKS IN THE FIELD OF ART; BOOKBINDING MATERIAL; PHOTOGRAPHS; STATIONERY; PAPER; POSTERS; ALBUMS; CARDS, NAMELY, GREETING AND BUSINESS CARDS; BOOKS IN THE FIELD OF ART; NEWSPAPERS; PRINTED PROSPECTUSES, NAMELY, INFORMATIONAL SHEETS ABOUT CULTURAL EVENTS; PRINTED PAMPHLETS IN THE FIELD OF ART; CALENDARS; WRITING INSTRUMENTS; LITHOGRAPHIC OR ENGRAVED WORKS OF ART MADE FROM CUSTOM MANUFACTURED PAPER; PAINTING BEING PICTURES, FRAMED OR UNFRAMED; AQUARELLES; PATTERNS FOR DRESSMAKING; GRAPHIC ART PRINTS; DRAWING INSTRUMENTS; TABLE LINEN OF PAPER; BAGS AND SACHET, NAMELY, ENVELOPES AND POUCHES OF PAPER OR PLASTIC FOR PACKAGING PURPOSES, IN CLASS 16 (U.S. CLS. 2, 5, 22, 23, 29, 37, 38 AND 50).

FOR: FURNITURE, MIRRORS, PICTURE FRAMES; WORKS OF ART MADE OF WOOD, WAX, PLASTER, CORK, REED, CANE, WICKER, BONE, IVORY, WHALEBONE, SHELL, AMBER, MOTHER-OF-PEARL, MEERSHAUM, SUBSTITUTES FOR ALL THESE MATERIALS OR PLASTIC; COAT HANGERS; CHEST OF DRAWERS; CUSHIONS; RACKS, NAMELY, CLOTHES BARS AS CLOSET ACCESSORIES AND STORAGE RACKS; PACKAGING CONTAINERS OF PLASTIC; ARMCHAIRS; SEATS; MATTRESSES; PLATE RACKS; WICKERWORK, NAMELY, WICKER FURNITURE; BOXES OF WOOD AND PLASTIC, IN CLASS 20 (U.S. CLS. 2, 13, 22, 25, 32 AND 50).

FOR: CLOTHING AND WEARABLE GARMENTS, NAMELY, T-SHIRTS, SWEATERS, JEANS, SHIRTS, SHORT SLEEVED T-SHIRTS, LONG SLEEVED T-SHIRTS, POLO SHIRTS, SWEAT SHIRTS, DRESS SHIRTS, SHIRTS, RUGBY SHIRTS, CARDIGANS, SWEATERS, PULLOVER JACKETS, FUR JACKETS, WATERPROOF JACKETS, WIND RESISTANT JACKETS, SMOKING JACKETS, SUITS, DENIM JACKETS, SHORTS, SHORT SLEEVED SHIRTS, LONG SLEEVED SHIRTS, SWEAT SHORTS, BERMUDA SHORTS, PANTS, LEATHER PANTS, LOUNGE PANTS, JOGGING PANTS, DENIMS, SWEAT PANTS, DRESSES, SKIRTS AND DRESSES, EVENING DRESSES, DRESS SUITS, TENNIS DRESSES, LEATHER CLOTHING IN THE NATURE OF JACKETS, PANTS, DRESSES, SKIRTS, GLOVES, FUR CLOTHING IN



*David J. Kyros*

Director of the United States Patent and Trademark Office

**Reg. No. 4,196,402** THE NATURE OF JACKETS, GLOVES INCLUDING THOSE MADE OF LEATHER OR FUR, KNITTED GLOVES, SCARVES, SOCKS, BELTS, TIES, SHOES, BOOTS, TENNIS SHOES, CANVAS SHOES, LEATHER SHOES, SWIM WEAR, UNDERWEAR; FOOTWEAR; HEADWEAR, IN CLASS 25 (U.S. CLS. 22 AND 39).

FOR: TEACHING IN THE FIELD OF GRAPHIC DESIGN, CREATIVE DIRECTION, AND ART; PROVIDING OF TRAINING IN THE FIELD OF GRAPHIC DESIGN, CREATIVE DIRECTION, AND ART; ENTERTAINMENT, NAMELY, PROVIDING INSTRUCTION IN THE FIELD OF GRAPHIC DESIGN, CREATIVE DIRECTION, AND ART; SPORTING AND CULTURAL ACTIVITIES, NAMELY, ORGANIZING CULTURAL EVENTS; PUBLICATION OF BOOKS; VIDEOTAPE FILM PRODUCTION; PHOTOGRAPHY; ORGANIZATION OF COMPETITIONS FOR EDUCATION AND ENTERTAINMENT, NAMELY, GRAPHIC DESIGN COMPETITIONS; ARRANGING AND CONDUCTING OF CONFERENCES, ORGANIZATIONS OF EXHIBITIONS FOR CULTURAL OR EDUCATIONAL PURPOSES; PUBLICATION OF ELECTRONIC BOOKS AND JOURNAL ON-LINE, NAMELY, ON-LINE PUBLICATION OF ELECTRONIC BOOKS AND JOURNALS; ELECTRONIC DESKTOP PUBLISHING, IN CLASS 41 (U.S. CLS. 100, 101 AND 107).

FOR: ARCHITECTURE SERVICES; DESIGN OF INTERIOR DECOR; GRAPHIC ARTS DESIGNING; STYLING BEING AN INDUSTRIAL ART DESIGN, IN CLASS 42 (U.S. CLS. 100 AND 101).

NO CLAIM IS MADE TO THE EXCLUSIVE RIGHT TO USE "PARIS", APART FROM THE MARK AS SHOWN.

OWNER OF INTERNATIONAL REGISTRATION 1086807 DATED 7-1-2011, EXPIRES 7-1-2021.

THE MARK CONSISTS OF AN ABSTRACT REPRESENTATION OF THE LETTER "M" ABOVE THE WORDING "M/M (PARIS)".

SER. NO. 79-101,064, FILED 7-1-2011.

BERNICE MIDDLETON, EXAMINING ATTORNEY

# United States of America

United States Patent and Trademark Office

## WHITE-DOCTOR

**Reg. No. 4,196,403**

**Registered Aug. 28, 2012**

**Int. Cls.: 16, 25 and 28**

**TRADEMARK**

**PRINCIPAL REGISTER**

SNOWIDE SA (SWITZERLAND SOCIÉTÉ ANONYME (SA))  
3 RUE DU MONT-BLANC, CASE POSTALE 1363  
CH-1211 GENÈVE 1  
SWITZERLAND

FOR: PAPER; CARDBOARD; BOOKBINDING MATERIAL; PHOTOGRAPHS; STATIONERY;  
PAINTBRUSHES; TYPEWRITERS; PRINTING TYPE; PRINTING BLOCKS, IN CLASS 16  
(U.S. CLS. 2, 5, 22, 23, 29, 37, 38 AND 50).

FOR: FOOTWEAR, IN CLASS 25 (U.S. CLS. 22 AND 39).

FOR: DECORATIONS FOR CHRISTMAS TREES, IN CLASS 28 (U.S. CLS. 22, 23, 38 AND  
50).

THE MARK CONSISTS OF STANDARD CHARACTERS WITHOUT CLAIM TO ANY PAR-  
TICULAR FONT, STYLE, SIZE, OR COLOR.

PRIORITY DATE OF 12-24-2010 IS CLAIMED.

OWNER OF INTERNATIONAL REGISTRATION 1086837 DATED 6-9-2011, EXPIRES 6-9-  
2021.

SER. NO. 79-101,078, FILED 6-9-2011.

SHARON MEIER, EXAMINING ATTORNEY



*David J. Kybas*

Director of the United States Patent and Trademark Office

# United States of America

United States Patent and Trademark Office

# miScript

**Reg. No. 4,196,404**

**Registered Aug. 28, 2012**

**Int. Cls.: 1, 5 and 42**

**TRADEMARK**

**SERVICE MARK**

**PRINCIPAL REGISTER**

QIAGEN GMBH (FED REP GERMANY GMBH)  
QIAGEN STR. 1  
40724 HILDEN  
FED REP GERMANY

FOR: CHEMICAL PREPARATIONS FOR SCIENTIFIC PURPOSES AND FOR USE IN RELATION TO THE ANALYSIS, DETECTION, TRANSCRIPTION, AMPLIFICATION AND/OR TRANSFECTION OF BIOLOGICAL MOLECULES, ESPECIALLY OF NUCLEIC ACIDS; KIT COMPRISING CHEMICAL PREPARATIONS FOR SCIENTIFIC PURPOSES AND FOR USE IN RELATION TO THE ANALYSIS, DETECTION, TRANSCRIPTION, AMPLIFICATION AND/OR TRANSFECTION OF BIOLOGICAL MOLECULES, ESPECIALLY OF NUCLEIC ACIDS, IN CLASS 1 (U.S. CLS. 1, 5, 6, 10, 26 AND 46).

FOR: HUMAN OR VETERINARY DIAGNOSTIC PREPARATIONS FOR MEDICAL PURPOSES AND FOR USE IN RELATION TO THE ANALYSIS, DETECTION, TRANSCRIPTION, AMPLIFICATION AND/OR TRANSFECTION OF BIOLOGICAL MOLECULES, ESPECIALLY OF NUCLEIC ACIDS; KIT COMPRISING HUMAN OR VETERINARY DIAGNOSTIC PREPARATIONS FOR MEDICAL PURPOSES AND FOR USE IN RELATION TO THE ANALYSIS, DETECTION, TRANSCRIPTION, AMPLIFICATION AND/OR TRANSFECTION OF BIOLOGICAL MOLECULES, ESPECIALLY OF NUCLEIC ACIDS, IN CLASS 5 (U.S. CLS. 6, 18, 44, 46, 51 AND 52).

FOR: SCIENTIFIC RESEARCH SERVICES IN RELATION TO THE ANALYSIS, DETECTION, TRANSCRIPTION, AMPLIFICATION AND/OR TRANSFECTION OF BIOLOGICAL MOLECULES, ESPECIALLY OF NUCLEIC ACIDS; SCIENTIFIC RESEARCH SERVICES IN RELATION TO THE SYNTHESIS OF BIOLOGICAL MOLECULES, ESPECIALLY OF NUCLEIC ACIDS, IN CLASS 42 (U.S. CLS. 100 AND 101).

THE MARK CONSISTS OF STANDARD CHARACTERS WITHOUT CLAIM TO ANY PARTICULAR FONT, STYLE, SIZE, OR COLOR.

PRIORITY DATE OF 4-13-2011 IS CLAIMED.

OWNER OF INTERNATIONAL REGISTRATION 1086882 DATED 7-1-2011, EXPIRES 7-1-2021.

SER. NO. 79-101,092, FILED 7-1-2011.



*David J. Kyjars*

Director of the United States Patent and Trademark Office



**Reg. No. 4,196,404** KHANH LE, EXAMINING ATTORNEY

# United States of America

United States Patent and Trademark Office



**Reg. No. 4,196,405**

**Registered Aug. 28, 2012**

**Int. Cls.: 10, 11, 21 and 25**

**TRADEMARK**

**PRINCIPAL REGISTER**

FLORIAN ENGHARD (FED REP GERMANY INDIVIDUAL)  
WIESENSTRASSE 17  
65843 SULZBACH  
FED REP GERMANY

FOR: BABY BOTTLES; FEEDING BOTTLES; CLOSURES FOR FEEDING BOTTLES; PACIFIERS FOR BABIES; TEETHING RINGS TO FACILITATE DENTITION, IN CLASS 10 (U.S. CLS. 26, 39 AND 44).

FOR: ELECTRICAL HEATERS FOR BABY BOTTLES; ELECTRICAL BABY BOTTLE HEATERS, IN CLASS 11 (U.S. CLS. 13, 21, 23, 31 AND 34).

FOR: NON-ELECTRIC BABY BOTTLE HEATERS; INSULATED CONTAINERS FOR BEVERAGES FOR DOMESTIC USE; BINS IN THE NATURE OF INSULATED COOLERS FOR BEVERAGES; VACUUM FLASKS, IN CLASS 21 (U.S. CLS. 2, 13, 23, 29, 30, 33, 40 AND 50).

FOR: BABY LINEN, NAMELY, BABY TOPS, BABY BOTTOMS, AND INFANT AND TODDLER ONE-PIECE CLOTHING, IN CLASS 25 (U.S. CLS. 22 AND 39).

THE MARK CONSISTS OF THE WORD "FLORI" IN STYLIZED LOWERCASE LETTERS, WITH A STYLIZED HUMMINGBIRD SHOWN TO THE RIGHT OF THE WORD.

PRIORITY DATE OF 1-11-2011 IS CLAIMED.

OWNER OF INTERNATIONAL REGISTRATION 1087021 DATED 6-21-2011, EXPIRES 6-21-2021.

THE ENGLISH TRANSLATION OF "FLORI" IN THE MARK IS FLOWERS.

SER. NO. 79-101,146, FILED 6-21-2011.

ESTHER BELENKER, EXAMINING ATTORNEY



*David J. Kybas*

Director of the United States Patent and Trademark Office

# United States of America

United States Patent and Trademark Office

## FURNISH YOUR CASTLE

**Reg. No. 4,196,406**

**Registered Aug. 28, 2012**

**Int. Cl.: 35**

**SERVICE MARK**

**PRINCIPAL REGISTER**

GILET EMMANUEL (FRANCE INDIVIDUAL)  
LA CHEVALINIÈRE  
SAINT MARTIN DES BOIS, FRANCE F41800

FOR: ADVERTISING SERVICES; BUSINESS MANAGEMENT; BUSINESS ADMINISTRATION; PROVIDING OFFICE FUNCTIONS; DIRECT MAIL ADVERTISING SERVICES; ARRANGING NEWSPAPER SUBSCRIPTIONS FOR OTHERS; BUSINESS MANAGEMENT AND ORGANIZATION CONSULTANCY; BOOK-KEEPING; DOCUMENT REPRODUCTION; EMPLOYMENT AGENCIES; COMPUTERIZED FILE MANAGEMENT; ORGANIZATION OF EXHIBITIONS FOR COMMERCIAL OR ADVERTISING PURPOSES; ON-LINE ADVERTISING ON A COMPUTER NETWORK; RENTAL OF ADVERTISING TIME ON COMMUNICATION MEDIA; PUBLICATION OF PUBLICITY TEXTS; RENTAL OF ADVERTISING SPACE; DISSEMINATION OF ADVERTISING MATTER; PUBLIC RELATIONS; DISPLAY OF ALL ANTIQUES AND WORKS OF ART FOR SELLING AND ON ALL MEANS OF COMMUNICATION, IN CLASS 35 (U.S. CLS. 100, 101 AND 102).

THE MARK CONSISTS OF STANDARD CHARACTERS WITHOUT CLAIM TO ANY PARTICULAR FONT, STYLE, SIZE, OR COLOR.

PRIORITY DATE OF 3-22-2011 IS CLAIMED.

OWNER OF INTERNATIONAL REGISTRATION 1087060 DATED 7-6-2011, EXPIRES 7-6-2021.

SER. NO. 79-101,154, FILED 7-6-2011.

ZACHARY BELLO, EXAMINING ATTORNEY



*David J. Kypos*

Director of the United States Patent and Trademark Office

# United States of America

United States Patent and Trademark Office



**Reg. No. 4,196,407**

**Registered Aug. 28, 2012**

**Int. Cl.: 25**

**TRADEMARK**

**PRINCIPAL REGISTER**

VF INTERNATIONAL SAGL (SWITZERLAND LIMITED LIABILITY COMPANY)  
VIA SENAGO  
42/E CENTRO OPEN SPACE 01,; STABILE C;  
CH-6912 PAZZALLO, LUGANO, SWITZERLAND

FOR: CLOTHING, NAMELY, SHIRTS, PANTS, COATS, DRESSES, JACKETS, WAIST JACKETS, SHORTS, T-SHIRTS, TROUSERS, CARDIGANS, PULLOVERS, SWEATERS; FOOTWEAR; HEADGEAR, NAMELY, HATS, CAPS, IN CLASS 25 (U.S. CLS. 22 AND 39).

OWNER OF U.S. REG. NOS. 2,058,049, 2,959,524, AND 3,324,821.

OWNER OF INTERNATIONAL REGISTRATION 0582109 DATED 3-5-1992, EXPIRES 3-5-2022.

THE MARK CONSISTS OF "NAPAPIJRI" IN STYLIZED FONT, THE UPPER PART OF WHICH IS IN SOLID LETTERING ON A TRANSPARENT BACKGROUND AND THE LOWER PART OF WHICH IS IN TRANSPARENT LETTERING ON A SOLID BACKGROUND, WRITTEN INSIDE A RECTANGLE WITH LONGER HORIZONTAL SIDES AND WITH A SOLID OUTLINE.

THE ENGLISH TRANSLATION OF "NAPAPIJRI" IN THE MARK IS "ARCTIC CIRCLE".

SER. NO. 79-101,163, FILED 7-13-2011.

APRIL HESIK, EXAMINING ATTORNEY



*David J. Kybas*

Director of the United States Patent and Trademark Office

# United States of America

United States Patent and Trademark Office

# Smartguard

**Reg. No. 4,196,408**

**Registered Aug. 28, 2012**

**Int. Cls.: 6, 9, 11, 14 and  
20**

**TRADEMARK**

**PRINCIPAL REGISTER**

T-INVESTMENT LTD. (MALAYSIA LIMITED CORPORATION)  
BRUBY HOUSE  
JALAN BAHASA, BOX 80148  
LABUAN, MALAYSIA F.T.87011

FOR: NON-ELECTRIC CABLES AND WIRES OF COMMON METAL; IRONMONGERY, NAMELY, NUTS, BOLTS, NAILS, SCREWS AND RIVETS; SMALL ITEMS OF METAL HARDWARE, NAMELY, WINDOW, DOOR AND FURNITURE FITTINGS; GOODS OF COMMON METAL NOT INCLUDED IN OTHER CLASSES, NAMELY, NON-ELECTRIC CABLES AND WIRES OF COMMON METAL; LOCKS OF METAL, METAL PADLOCKS, METAL FOLDING LOCKS, REINFORCED METAL CABLE LOCKS, METAL CABLE LOCKS, METAL SPIRAL CABLE LOCKS, CABLE LOCKS, METAL U-LOCKS, METAL SPOKE LOCKS, METAL FRAME LOCKS, METAL LOCKS INCORPORATING STRAPS, METAL CHAIN LOCKS, METAL LOCK DEVICES WITH CLAMP SOCKETS FOR CHAINS, CABLES AND ROPES WITH CLAMPING BLOCKS IN THE NATURE OF A LOCKING SYSTEM FOR BICYCLES AND MOTORCYCLES, STATIONARY ANTI-THEFT DEVICES FOR BICYCLES IN THE NATURE OF METAL BICYCLE LOCKS, ANTI-THEFT DEVICES FOR MOBILE AND STATIONARY OBJECTS, NAMELY, METAL LOCKS FOR BICYCLES AND MOTORCYCLES, BICYCLE PARKING INSTALLATIONS OF METAL, FASTENERS OF METAL COMPRISING NUTS, BOLTS AND SCREWS FOR SECURING BAGS AND CARRIERS TO BICYCLES AND MOTORCYCLES, WIRE CLOTH, WIRE ROPE, HANDCUFFS, METAL WHEEL CLAMPS, METAL BOLTS, METAL BOLTS FOR LOCKS, METAL KEYS FOR LOCKS, METAL SPRING LOCKS, SECURITY CHAINS OF METAL, IN CLASS 6 (U.S. CLS. 2, 12, 13, 14, 23, 25 AND 50).



*David J. Kyffers*

Director of the United States Patent and Trademark Office

FOR: COMPUTERS FOR BICYCLES, DISTANCE RECORDING APPARATUS, SENSORS FOR BICYCLES, NAMELY, TOUCH INPUT SENSORS, OPTICAL SENSORS, ELECTRIC SENSORS, ACCELERATION SENSORS, SENSORS FOR DETERMINING POSITION, VELOCITY, ACCELERATION, AND TEMPERATURE, SENSORS FOR DETERMINING TEMPERATURE, POSITIONS AND DISTANCES, GPS SENSORS MOUNTED ON A BICYCLE FOR DETERMINING THE RATE OF MOTION OF THE BICYCLE AND ELECTRIC ACTUATORS FOR COMPUTERS FOR BICYCLES, ELECTRIC LOCKS, SPEED CHECKING APPARATUS FOR VEHICLES, SATELLITE NAVIGATION SYSTEM IN THE NATURE OF A GLOBAL POSITIONING SYSTEM, GOGGLES FOR SPORTS, LIGHT EMITTING DIODES, IN CLASS 9 (U.S. CLS. 21, 23, 26, 36 AND 38).

**Reg. No. 4,196,408** FOR: LIGHTING APPARATUS, NAMELY, LIGHTING INSTALLATIONS, LIGHTING APPARATUS FOR VEHICLES, LAMPS, ELECTRIC TORCHES FOR LIGHTING, BICYCLE LIGHTS, VEHICLE REFLECTORS, VEHICLE HEADLIGHTS, LAMPS FOR VEHICLE DIRECTION INDICATORS, LAMPS FOR DIRECTIONAL SIGNALS OF AUTOMOBILES, ELECTRIC LAMPS, LAMP GLASSES, LIGHTS FOR VEHICLES, LIGHTS FOR AUTOMOBILES, LAMP REFLECTORS, HEADLIGHTS FOR AUTOMOBILES, SAFETY LAMPS FOR VEHICLE BREAKDOWN, ELECTRIC POCKET TORCHES, BICYCLE AND MOTORCYCLE LIGHTS, IN CLASS 11 (U.S. CLS. 13, 21, 23, 31 AND 34).

FOR: HOROLOGICAL AND CHRONOMETRIC INSTRUMENTS, WRISTWATCHES, CHRONOMETERS, ELECTRIC CLOCKS AND WATCHES, KEY RINGS OF PRECIOUS METAL, STOP WATCHES, POCKET WATCHES, WATCH BANDS, CLOCK CASES, CHRONOMETRIC APPARATUS FOR SPORTING AND LEISURE PURPOSES, NAMELY, SPORTS WATCHES, EQUESTRIAN WATCHES, WATCHES FOR OUTDOOR USE, IN CLASS 14 (U.S. CLS. 2, 27, 28 AND 50).

FOR: LOCKS OF PLASTIC, LOCKS OF FIBRE-REINFORCED PLASTIC, NON-METAL VEHICLE LOCKS, NON-METAL PADLOCKS, NON-METAL FOLDING LOCKS, NON-METAL REINFORCED CABLE LOCKS, NON-METAL SPIRAL CABLE LOCKS, NON-METAL CABLE LOCKS, NON-METAL U-LOCKS, NON-METAL SPOKE LOCKS, NON-METAL FRAME LOCKS, NON-METAL LOCKS INCORPORATING STRAPS, NON-METAL CHAIN LOCKS, NON-METAL LOCKS WITH CLAMP SOCKETS FOR CHAINS, NON-METAL CABLES AND NON-METAL ROPES WITH CLAMPING BLOCKS FOR USE AS A NON-METAL LOCKING SYSTEM FOR BICYCLES AND MOTORCYCLES, STATIONARY ANTI-THEFT DEVICES FOR BICYCLES IN THE NATURE OF NON-METAL BICYCLE LOCKS, NON-METAL ANTI-THEFT DEVICES FOR MOBILE AND STATIONARY OBJECTS IN THE NATURE OF NON-METAL BICYCLE LOCKS AND NON-METAL MOTORCYCLE LOCKS, IN CLASS 20 (U.S. CLS. 2, 13, 22, 25, 32 AND 50).

THE MARK CONSISTS OF STANDARD CHARACTERS WITHOUT CLAIM TO ANY PARTICULAR FONT, STYLE, SIZE, OR COLOR.

OWNER OF INTERNATIONAL REGISTRATION 1087137 DATED 5-9-2011, EXPIRES 5-9-2021.

SER. NO. 79-101,208, FILED 5-9-2011.

MICHAEL WIENER, EXAMINING ATTORNEY

# United States of America

United States Patent and Trademark Office

## MUSICAL FREEDOM

**Reg. No. 4,196,409**

**Registered Aug. 28, 2012**

**Int. Cls.: 9, 16, 25 and 41**

**TRADEMARK**

**SERVICE MARK**

**PRINCIPAL REGISTER**

TIJS M. VERWEST (NETHERLANDS INDIVIDUAL)

C/O GELFAND RENNERT & FELDMAN

LLP 360 HAMILTON AVENUE,; SUITE 100 WHITE PLAINS; NEW YORK NY

NEW YORK, UNITED STATES 10601

FOR: APPARATUS FOR RECORDING, TRANSMISSION OR REPRODUCTION OF SOUND OR IMAGES; PRERECORDED MAGNETIC DATA CARRIERS FEATURING MUSIC, MUSICAL SHOWS AND EVENTS; PRERECORDED VIDEO DISCS FEATURING MUSIC, MUSICAL SHOWS AND EVENTS; PRERECORDED DIGITAL VIDEO DISCS FEATURING MUSIC, MUSICAL SHOWS AND EVENTS; COMPACT DISCS FEATURING MUSIC; SUPER AUDIO COMPACT DISCS FEATURING MUSIC; PRERECORDED DVDS AND CD-ROMS FEATURING MUSIC, MUSICAL SHOWS AND EVENTS; DIGITAL MUSIC DOWNLOADABLE FROM THE INTERNET; MP3 PLAYERS; PERSONAL DIGITAL ASSISTANTS AND ELECTRONIC HANDHELD UNITS FOR THE WIRELESS RECEIPT AND/OR TRANSMISSION OF SOUND; DIGITAL DOWNLOADABLE MUSIC PROVIDED FROM MP3 INTERNET WEBSITES, IN CLASS 9 (U.S. CLS. 21, 23, 26, 36 AND 38).

FOR: PAPER, CARDBOARD AND GOODS MADE FROM THESE MATERIALS, NOT INCLUDED IN OTHER CLASSES, NAMELY, BOXES OF PAPER OR CARDBOARD, AND BANNERS OF PAPER; PRINTED MATTER, NAMELY, POSTERS, CALENDARS, STICKERS, AND DECALS; PRINTED MATTER, NAMELY, NEWSPAPERS, MAGAZINES, BOOKS, NEWSLETTERS AND BROCHURES IN THE FIELD OF MUSICAL EVENTS AND SHOWS; BOOKBINDING MATERIAL; PHOTOGRAPHS; STATIONERY; PRINTED INSTRUCTIONAL AND TEACHING MATERIALS IN THE FIELD OF MUSIC; PLASTIC MATERIALS FOR PACKAGING, NOT INCLUDED IN OTHER CLASSES, NAMELY, PLASTIC BAGS FOR PACKAGING, IN CLASS 16 (U.S. CLS. 2, 5, 22, 23, 29, 37, 38 AND 50).

FOR: CLOTHING, FOOTWEAR, AND HEADGEAR, NAMELY, SHIRTS, LONG-SLEEVED SHIRTS, T-SHIRTS, UNDER SHIRTS, NIGHT SHIRTS, RUGBY SHIRTS, POLO SHIRTS, CARDIGANS, JERSEYS, UNIFORMS, SCRUBS NOT FOR MEDICAL PURPOSES, SMOCKS, DRESS SHIRTS, BOTTOMS, PANTS, JEANS, CULOTTES, CARGO PANTS, STRETCH PANTS, DENIM JEANS, OVERALLS, COVERALLS, JUMPERS, JUMP SUITS, SHORTS, BOXER SHORTS, TOPS, STRETCH TOPS, TUBE TOPS, CROP TOPS, TANK TOPS, TANKINIS, HALTER TOPS, SWEAT SHIRTS, HOODED SWEAT SHIRTS, SWEAT JACKETS, SWEAT SHORTS, SWEAT PANTS, WRAPS, WARM-UP SUITS, JOGGING SUITS, TRACK SUITS, TRACK PANTS, PLAY SUITS, BLOUSES, SKIRTS, DRESSES, GOWNS, SWEATERS, VESTS, FLEECE VESTS, PULLOVERS, SNOW SUITS, PARKAS, CAPES, ANORAKS, PONCHOS,



*David J. Kybas*

Director of the United States Patent and Trademark Office

**Reg. No. 4,196,409** CLOAKS, SHRUGS, SHAWLS, PASHMINAS, JACKETS, DINNER JACKETS, REVERSIBLE JACKETS, WIND-RESISTANT JACKETS, SHELL JACKETS, SPORTS JACKETS, GOLF AND SKI JACKETS, JEAN JACKETS, COATS, HEAVY COATS, OVER COATS, TOP COATS, PETTICOATS, BLAZERS, SUITS, TUXEDOS, CUMMERBUNDS, CUFFS, COLLARS, REMOVABLE COLLARS, COLLAR PROTECTORS, TURTLENECKS, CLOTH SKI BIBS, SWIMWEAR, BEACHWEAR, TENNIS WEAR, SURF WEAR, SKI WEAR, LAYETTES, INFANTWEAR, INFANTS SLEEPERS, BOOTIES, BABY BIBS NOT OF PAPER, CAPS, SWIM CAPS, BERETS, BEANIES, HATS, VISORS, HEADBANDS, WRIST BANDS, SWEAT BANDS, HEADWEAR, EAR MUFFS, APRONS, SCARVES, BANDANAS, BELTS, SUSPENDERS, NECKWEAR, TIES, NECKERCHIEFS, POCKET SQUARES, ASCOTS, UNDERWEAR, THERMAL UNDERWEAR, LONG UNDERWEAR, BRIEFS, SWIM AND BATHING TRUNKS, BRAS, SPORTS BRAS, BRASSIERES, BUSTIERS, CORSETS, PANTIES, THONGS, G-STRINGS, GARTERS AND GARTER BELTS, TEDDIES, GIRDLES, FOUNDATION GARMENTS, SINGLET, SOCKS, LOUNGEWEAR, ROBES, UNDERCLOTHES, PAJAMAS, SLEEPWEAR, NIGHT GOWNS, NIGHTIES, LINGERIE, CAMISOLES, NEGLIGEEES, CHEMISES, CHEMISETTES, SLIPS, SARONGS, LEG WARMERS, HOSIERY, PANTYHOSE, BODY STOCKINGS, KNEE HIGHS, LEGGINGS, TIGHTS, LEOTARDS, BODY SUITS, UNITARDS, BODY SHAPERS, GLOVES, MITTENS, RAIN SLICKERS, RAINWEAR, FOOTWEAR, SHOES, MULES, SNEAKERS, BOOTS, GALOSHES, SANDALS, FLIP-FLOPS, AND SLIPPERS, IN CLASS 25 (U.S. CLS. 22 AND 39).

FOR: ORGANIZING COMMUNITY SPORTING AND CULTURAL EVENTS; DISC JOCKEY SERVICES; ENTERTAINMENT IN THE NATURE OF VISUAL AND AUDIO PERFORMANCES BY DISC JOCKEYS, ARTISTS AND DANCERS; RECORDING STUDIO SERVICES; ENTERTAINMENT IMPRESARIO SERVICES, NAMELY, ORGANIZING, ARRANGING AND CONDUCTING LIVE MUSICAL AND DANCE PERFORMANCES AND EVENTS; PRESENTATION OF LIVE SHOW PERFORMANCES, IN CLASS 41 (U.S. CLS. 100, 101 AND 107).

THE MARK CONSISTS OF STANDARD CHARACTERS WITHOUT CLAIM TO ANY PARTICULAR FONT, STYLE, SIZE, OR COLOR.

PRIORITY DATE OF 12-21-2010 IS CLAIMED.

OWNER OF INTERNATIONAL REGISTRATION 1087143 DATED 6-20-2011, EXPIRES 6-20-2021.

SER. NO. 79-101,209, FILED 6-20-2011.

TINA BROWN, EXAMINING ATTORNEY



# United States of America

United States Patent and Trademark Office



**Reg. No. 4,196,410**

**Registered Aug. 28, 2012**

**Int. Cls.: 9 and 42**

**TRADEMARK**

**SERVICE MARK**

**PRINCIPAL REGISTER**

SCHNEIDER ELECTRIC INDUSTRIES SAS (FRANCE SOCIÉTÉ PAR ACTIONS SIMPLIFIÉE)  
35 RUE JOSEPH MONIER  
F-92500 RUEIL-MALMAISON  
FRANCE

FOR: ELECTRIC PLUGS, ELECTRIC SOCKETS FOR PLUGS AND ELECTRIC CORDS, ALL FOR RECHARGING ELECTRIC VEHICLES, HYBRID ELECTRIC VEHICLES OR RECHARGEABLE ELECTRIC BATTERIES, IN CLASS 9 (U.S. CLS. 21, 23, 26, 36 AND 38).

FOR: RUNNING COMPATIBILITY TESTS FOR PLUGS FOR RECHARGING ELECTRIC VEHICLES AND RECHARGEABLE VEHICLES FOR THE PURPOSE OF CERTIFICATION, IN CLASS 42 (U.S. CLS. 100 AND 101).

NO CLAIM IS MADE TO THE EXCLUSIVE RIGHT TO USE "EV PLUG ALLIANCE" , APART FROM THE MARK AS SHOWN.

PRIORITY DATE OF 2-15-2011 IS CLAIMED.

OWNER OF INTERNATIONAL REGISTRATION 1087266 DATED 7-11-2011, EXPIRES 7-11-2021.

THE MARK CONSISTS OF A DESIGN OF A DIVIDED HIGHWAY MORPHING INTO AN ELECTRICAL PLUG; BELOW THAT ARE THE WORDS "EV PLUG ALLIANCE".

SER. NO. 79-101,256, FILED 7-11-2011.

LINDA MICKLEBURGH, EXAMINING ATTORNEY



*David J. Kybas*

Director of the United States Patent and Trademark Office

# United States of America

United States Patent and Trademark Office

# MALTOFER

**Reg. No. 4,196,411**

**Registered Aug. 28, 2012**

**Int. Cl.: 5**

VIFOR (INTERNATIONAL) AG (VIFOR (INTERNATIONAL) LTD.) (VIFOR  
(INTERNATIONAL) INC.) (SWITZERLAND CORPORATION)  
RECHENSTRASSE 37  
CH-9014 ST. GALLEN  
SWITZERLAND

**TRADEMARK**

FOR: PHARMACEUTICAL PREPARATIONS FOR THE TREATMENT OF IRON DEFICIENCY  
AND IRON DEFICIENCY ANEMIA , IN CLASS 5 (U.S. CLS. 6, 18, 44, 46, 51 AND 52).

**PRINCIPAL REGISTER**

THE MARK CONSISTS OF STANDARD CHARACTERS WITHOUT CLAIM TO ANY PAR-  
TICULAR FONT, STYLE, SIZE, OR COLOR.

OWNER OF INTERNATIONAL REGISTRATION 1087330 DATED 7-14-2011, EXPIRES 7-14-  
2021.

OWNER OF U.S. REG. NO. 3,154,270.

SER. NO. 79-101,280, FILED 7-14-2011.

MATTHEW EINSTEIN, EXAMINING ATTORNEY



*David J. Kyffers*

Director of the United States Patent and Trademark Office

# United States of America

United States Patent and Trademark Office



**Reg. No. 4,196,412**

**Registered Aug. 28, 2012**

**Int. Cls.: 29, 35, 38 and 41**

BLUEYOU CONSULTING AG (SWITZERLAND AKTIENGESELLSCHAFT)  
ZENTRALSTRASSE 156  
CH-8003 CH-ZÜRICH  
SWITZERLAND

FOR: FISH, NOT LIVE; FISH FILLETS, CANNED FISH, PRESERVED FISH; PRAWNS, NOT LIVE; SHRIMPS, NOT LIVE; CRUSTACEANS, NOT LIVE; TUNA FISH; SHELLFISH, NOT LIVE; ALL OF THE FOREGOING GOODS BEING FROM ENVIRONMENTALLY RESPONSIBLE SOURCES, IN CLASS 29 (U.S. CL. 46).

**TRADEMARK**

**SERVICE MARK**

**PRINCIPAL REGISTER**

FOR: PROVIDING AN ON-LINE COMPUTER DATABASE IN THE FIELD OF BUSINESS CONTACTS; ELECTRONIC COMMERCE SERVICES, NAMELY, PROVIDING INFORMATION ABOUT SUSTAINABLE PRODUCTION OF FISH AND SEAFOOD PRODUCTS VIA TELECOMMUNICATION NETWORKS FOR ADVERTISING AND SALES PURPOSES; COMMERCIAL PLATFORMS FOR FISH AND SEAFOOD PRODUCTS, NAMELY, INTEGRATED TRACKING AND MANAGEMENT OF COMMERCIAL TRANSACTIONS ON A GLOBAL COMPUTER NETWORK AND PROVIDING COMMERCIAL INFORMATION IN THE FIELD OF FISH AND SEAFOOD PRODUCTS, IN CLASS 35 (U.S. CLS. 100, 101 AND 102).

FOR: PROVIDING ACCESS TO DATABASES; PROVIDING ACCESS TO TELECOMMUNICATION NETWORKS; PROVIDING MULTIPLE USER ACCESS TO PROPRIETARY COLLECTIONS OF INFORMATION BY MEANS OF GLOBAL COMPUTER INFORMATION NETWORKS, IN CLASS 38 (U.S. CLS. 100, 101 AND 104).

FOR: PROVIDING TRAINING IN THE FIELDS OF SUSTAINABLE PRODUCTION OF FISH AND SEAFOOD PRODUCTS AND THE USE AND INTEGRATION OF CUSTOMER INFORMATION, IN CLASS 41 (U.S. CLS. 100, 101 AND 107).

NO CLAIM IS MADE TO THE EXCLUSIVE RIGHT TO USE "CYCLE SHRIMP" AND "ENVIRONMENTALLY PREFERABLE SHRIMP FROM CLOSED FARMING SYSTEMS", APART FROM THE MARK AS SHOWN.

PRIORITY DATE OF 5-24-2011 IS CLAIMED.

OWNER OF INTERNATIONAL REGISTRATION 1087531 DATED 6-15-2011, EXPIRES 6-15-2021.



*David J. Kybas*

Director of the United States Patent and Trademark Office

**Reg. No. 4,196,412** THE MARK CONSISTS OF THE DESIGN OF THE TERM "CYCLE" TO THE LEFT OF A CIRCULAR ARROW DESIGN; TO ITS RIGHT IS THE TERM "SHRIMP". BELOW THIS ARE THE WORDS "ENVIRONMENTALLY PREFERABLE SHRIMP FROM CLOSED FARMING SYSTEMS".

SER. NO. 79-101,355, FILED 6-15-2011.

LINDA MICKLEBURGH, EXAMINING ATTORNEY

# United States of America

United States Patent and Trademark Office

## DORIN INNOVATION

**Reg. No. 4,196,413**

**Registered Aug. 28, 2012**

**Int. Cls.: 7, 9 and 11**

**TRADEMARK**

**PRINCIPAL REGISTER**

OFFICINE MARIO DORIN S.P.A. (ITALY JOINT STOCK COMPANY)  
VIA ARETINA, 388  
I-50061 COMPIOBBI-FIESOLE (FI)  
ITALY

FOR: AIR COOLED CONDENSERS, WATER COOLED CONDENSERS, REMOTE AIR COOLED CONDENSERS, REMOTE WATER COOLED CONDENSORS, IN CLASS 7 (U.S. CLS. 13, 19, 21, 23, 31, 34 AND 35).

FOR: ELECTRIC CONDENSERS, IN CLASS 9 (U.S. CLS. 21, 23, 26, 36 AND 38).

FOR: GAS CONDENSERS, AIR-CONDITIONING INSTALLATIONS AND REFRIGERATORS, IN CLASS 11 (U.S. CLS. 13, 21, 23, 31 AND 34).

THE MARK CONSISTS OF STANDARD CHARACTERS WITHOUT CLAIM TO ANY PARTICULAR FONT, STYLE, SIZE, OR COLOR.

PRIORITY DATE OF 12-17-2010 IS CLAIMED.

OWNER OF INTERNATIONAL REGISTRATION 1087540 DATED 6-15-2011, EXPIRES 6-15-2021.

SER. NO. 79-101,357, FILED 6-15-2011.

GENE MACIOL, EXAMINING ATTORNEY



*David J. Kyffers*

Director of the United States Patent and Trademark Office

# United States of America

## United States Patent and Trademark Office

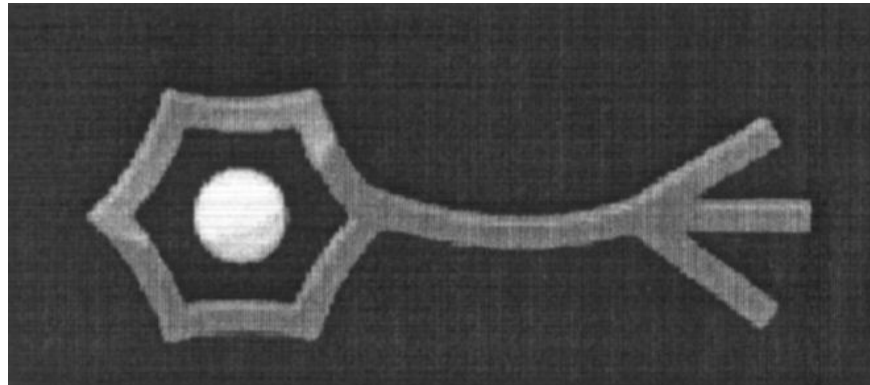

**Reg. No. 4,196,414**

**Registered Aug. 28, 2012**

**Int. Cls.: 1 and 5**

**TRADEMARK**

**PRINCIPAL REGISTER**

SIGMA-TAU INDUSTRIE FARMACEUTICHE RIUNITE S.P.A. (ITALY CORPORATION)  
VIALE SHAKESPEARE, 47  
I-00144 ROMA  
ITALY

FOR: CHEMICAL PRODUCTS FOR THE PHARMACEUTICAL, NUTRITIONAL AND FOOD INDUSTRY; CHEMICAL SUBSTANCES FOR THE MANUFACTURE OF PHARMACEUTICAL, DIETETIC AND NUTRITIONAL PRODUCTS, IN CLASS 1 (U.S. CLS. 1, 5, 6, 10, 26 AND 46).

FOR: DIETETIC SUBSTANCES ADAPTED FOR MEDICAL USE, NAMELY, NUTRITIONAL SUPPLEMENTS, IN CLASS 5 (U.S. CLS. 6, 18, 44, 46, 51 AND 52).

THE MARK CONSISTS OF A DESIGN OF A POLYGON WITH A CIRCLE IN THE CENTER AND A CURVED HORIZONTAL LINE EXTENDING FROM THE RIGHT SIDE. THE CURVED HORIZONTAL LINE BRANCHES OUT INTO THREE LINES. THE TOP LINE EXTENDS UPWARD DIAGONALLY, THE MIDDLE LINE EXTENDS STRAIGHT HORIZONTALLY AND THE BOTTOM LINE EXTENDS DOWNWARD DIAGONALLY. THE RECTANGULAR BACKGROUND IS NOT PART OF THE MARK.

PRIORITY DATE OF 2-28-2011 IS CLAIMED.

OWNER OF INTERNATIONAL REGISTRATION 1087762 DATED 6-20-2011, EXPIRES 6-20-2021.

SER. NO. 79-101,435, FILED 6-20-2011.

TINA BROWN, EXAMINING ATTORNEY



*David J. Kybas*

Director of the United States Patent and Trademark Office

# United States of America

United States Patent and Trademark Office

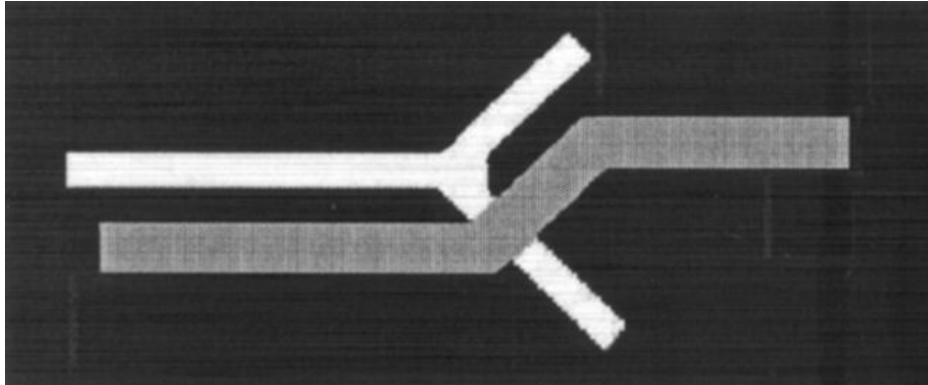

**Reg. No. 4,196,415**

**Registered Aug. 28, 2012**

**Int. Cls.: 1 and 5**

**TRADEMARK**

**PRINCIPAL REGISTER**

SIGMA-TAU INDUSTRIE FARMACEUTICHE RIUNITE S.P.A. (ITALY CORPORATION)  
VIALE SHAKESPEARE, 47  
I-00144 ROMA  
ITALY

FOR: CHEMICAL PRODUCTS FOR THE PHARMACEUTICAL, NUTRITIONAL AND FOOD INDUSTRY; CHEMICAL SUBSTANCES FOR THE MANUFACTURE OF PHARMACEUTICAL, DIETETIC AND NUTRITIONAL PRODUCTS, IN CLASS 1 (U.S. CLS. 1, 5, 6, 10, 26 AND 46).

FOR: DIETETIC SUBSTANCES ADAPTED FOR MEDICAL USE, NAMELY, NUTRITIONAL SUPPLEMENTS, IN CLASS 5 (U.S. CLS. 6, 18, 44, 46, 51 AND 52).

THE MARK CONSISTS OF TWO OVERLAPPING LINES IN THE CENTER. THE TOP LINE BEGINS AS A HORIZONTAL LINE EXTENDING FROM THE LEFT SIDE AND BRANCHES OUT INTO TWO DIAGONAL LINES TOWARDS THE RIGHT SIDE. ONE DIAGONAL LINE EXTENDS UPWARD AND ONE EXTENDS DOWNWARD. THE BOTTOM LINE BEGINS AS A HORIZONTAL LINE THAT IS PARALLEL WITH THE TOP LINE FROM THE LEFT SIDE, EXTENDS UPWARD DIAGONALLY TO OVERLAP THE BOTTOM DIAGONAL OF THE TOP LINE AND THEN EXTENDS HORIZONTALLY TOWARD THE RIGHT SIDE. THE RECTANGULAR BACKGROUND IS NOT PART OF THE MARK.

PRIORITY DATE OF 2-28-2011 IS CLAIMED.

OWNER OF INTERNATIONAL REGISTRATION 1087763 DATED 6-20-2011, EXPIRES 6-20-2021.

SER. NO. 79-101,436, FILED 6-20-2011.

TINA BROWN, EXAMINING ATTORNEY



*David J. Kybas*

Director of the United States Patent and Trademark Office

United States of America  
United States Patent and Trademark Office

# Linero

**Reg. No. 4,196,416**

**Registered Aug. 28, 2012**

**Int. Cls.: 6, 20 and 21**

**TRADEMARK**

**PRINCIPAL REGISTER**

KESSEBÖHMER HOLDING OHG (FED REP GERMANY OHG)  
MINDENER STR. 208  
49152 BAD ESSEN  
FED REP GERMANY

FOR: METAL RAIL-TYPE DEVICES FOR HOLDING ITEMS, INCLUDING PROFILE STRIPS OF METAL AND METAL PRODUCTS, NAMELY, METAL HOLDERS FOR COFFEE FILTERS, SPICES, HOOKS FOR HANGING KITCHEN UTENSILS, COOKBOOKS, KNIVES, BLENDERS, PAPER TOWEL ROLLS, WRITING SETS, WASHING UP UTENSILS, NAMELY, DISH WASHING BRUSHES AND SPONGES, IN CLASS 6 (U.S. CLS. 2, 12, 13, 14, 23, 25 AND 50).

FOR: GOODS OF WOOD AND PLASTIC, NAMELY, FURNITURE AND PICTURE FRAMES, IN CLASS 20 (U.S. CLS. 2, 13, 22, 25, 32 AND 50).

FOR: HOUSEHOLD KITCHEN UTENSILS, NAMELY, SPICE RACKS, WHISKS AND CONTAINERS, IN CLASS 21 (U.S. CLS. 2, 13, 23, 29, 30, 33, 40 AND 50).

THE MARK CONSISTS OF STANDARD CHARACTERS WITHOUT CLAIM TO ANY PARTICULAR FONT, STYLE, SIZE, OR COLOR.

PRIORITY DATE OF 2-21-2011 IS CLAIMED.

OWNER OF INTERNATIONAL REGISTRATION 1087786 DATED 6-28-2011, EXPIRES 6-28-2021.

THE WORDING "LINERO" HAS NO MEANING IN A FOREIGN LANGUAGE.

SER. NO. 79-101,463, FILED 6-28-2011.

RENEE MCCRAY, EXAMINING ATTORNEY



*David J. Kyros*

Director of the United States Patent and Trademark Office



United States of America  
United States Patent and Trademark Office

**Eligo**

**Reg. No. 4,196,417**

**Registered Aug. 28, 2012**

**Int. Cls.: 6 and 11**

**TRADEMARK**

**PRINCIPAL REGISTER**

ZEHNDER VERKAUFS- UND VERWALTUNGS AG (SWITZERLAND AG)  
MOORTALSTR. 1  
CH-5722 GRÄNICHEN  
SWITZERLAND

FOR: DUCTS OF METAL FOR VENTILATING AND AIR-CONDITIONING INSTALLATIONS,  
IN CLASS 6 (U.S. CLS. 2, 12, 13, 14, 23, 25 AND 50).

FOR: RADIATORS, AIR-CONDITIONING SYSTEMS CONSISTING OF AIR CONDITIONING  
UNITS, AIR-CONDITIONING APPARATUS, AIR FILTERS FOR AIR CONDITIONING AP-  
PARATUS, VENTILATION INSTALLATIONS, NAMELY, VENTILATION UNITS FOR IN-  
DOOR VENTILATION WITH HEAT RECOVERY FOR A HEALTHY, ENERGY-EFFICIENT  
INDOOR CLIMATE, VENTILATION APPARATUS, NAMELY, AIR CONDITIONING UNITS,  
HEAT PUMPS, HEATING SYSTEMS CONSISTING OF HEAT PUMPS; VENTILATING  
SYSTEMS CONSISTING OF VENTILATING FANS FOR COMMERCIAL AND INDUSTRIAL  
USE; AIR-CONDITIONING SYSTEMS CONSISTING OF AIR CONDITIONING UNITS, IN  
CLASS 11 (U.S. CLS. 13, 21, 23, 31 AND 34).

THE MARK CONSISTS OF STANDARD CHARACTERS WITHOUT CLAIM TO ANY PAR-  
TICULAR FONT, STYLE, SIZE, OR COLOR.

OWNER OF INTERNATIONAL REGISTRATION 1087793 DATED 7-18-2011, EXPIRES 7-18-  
2021.

SER. NO. 79-101,467, FILED 7-18-2011.

DOUGLAS LEE, EXAMINING ATTORNEY



*David J. Kyros*

Director of the United States Patent and Trademark Office

# United States of America

United States Patent and Trademark Office

# CIMA

**Reg. No. 4,196,418**

**Registered Aug. 28, 2012**

**Int. Cls.: 9, 16, 35, 36, 41,  
42 and 45**

THE CHARTERED INSTITUTE OF MANAGEMENT ACCOUNTANTS (UNITED KINGDOM COMPANY)  
26 CHAPTER STREET  
LONDON SW1P 4NP  
UNITED KINGDOM

**TRADEMARK**

**SERVICE MARK**

**PRINCIPAL REGISTER**

FOR: COMPUTER SOFTWARE FOR DATA PROCESSING IN THE FIELD OF ACCOUNTANCY; DOWNLOADABLE COMPUTER SOFTWARE FOR DATA PROCESSING IN THE FIELD OF ACCOUNTANCY; COMPUTER SOFTWARE FOR COLLATING INFORMATION INTO DATABASES; ELECTRONIC DATABASES IN THE FIELD OF ACCOUNTANCY RECORDED ON COMPUTER MEDIA; BLANK MAGNETIC DATA CARRIERS; MAGNETICALLY ENCODED KEY CARDS; CALCULATORS; DOWNLOADABLE ELECTRONIC BOOKS, HANDBOOKS, MANUALS, PERIODICALS, MAGAZINES, GUIDES, NEWSLETTERS, WORKBOOKS, STUDY TEXT BOOKS, INSTRUCTIONAL AND TEACHING MATERIALS, EDUCATIONAL AND TRAINING COURSE MATERIALS FEATURING BUSINESS AND ACCOUNTANCY INFORMATION; APPARATUS FOR RECORDING, TRANSMISSION AND REPRODUCTION OF SOUND AND/OR IMAGES; BLANK COMPUTER DISCS FOR RECEIVING AND RECORDING SOUND AND IMAGES; DIGITAL MEDIA, NAMELY, MP3S, JPEGS, MPEGS, CD'S AND DVD'S FEATURING ACCOUNTANCY RELATED SOUND, IMAGE AND TEXT FILES; DOWNLOADABLE DIGITAL OR ANALOGUE SOUND AND IMAGE FILES FEATURING BUSINESS AND ACCOUNTANCY INFORMATION; MOUSE PADS, IN CLASS 9 (U.S. CLS. 21, 23, 26, 36 AND 38).

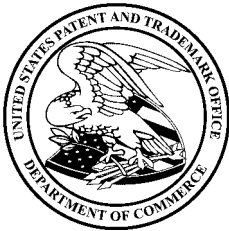

FOR: PRINTED MATTER AND PUBLICATIONS, NAMELY, BOOKS, HANDBOOKS, MANUALS, PERIODICALS, JOURNALS, MAGAZINES, GUIDES, NEWSLETTERS, WORKBOOKS, STUDY TEXTBOOKS, INSTRUCTIONAL AND TEACHING MATERIALS, AND EDUCATIONAL AND TRAINING COURSE MATERIALS ALL IN THE FIELDS OF BUSINESS AND ACCOUNTANCY; PRINTED EDUCATIONAL AND TRAINING COURSE MATERIALS IN THE FIELD OF MANAGEMENT ACCOUNTANCY AND BUSINESS SERVICES; PRINTED BUSINESS REPORTS; PRINTED GUIDELINES IN THE FIELDS OF BUSINESS AND ACCOUNTANCY; STATIONERY; WRITING AND DRAWING INSTRUMENTS; PENS, PENCILS; FOLDERS; DIARIES, CALENDARS AND ADDRESS BOOKS, IN CLASS 16 (U.S. CLS. 2, 5, 22, 23, 29, 37, 38 AND 50).

*David J. Kappas*

Director of the United States Patent and Trademark Office

FOR: ACCOUNTING SERVICES IN THE NATURE OF ADVISORY SERVICES PROVIDING INFORMATION IN THE FIELD OF ACCOUNTING; ACCOUNT AUDITING IN THE NATURE OF ADVISORY SERVICES PROVIDING INFORMATION IN THE FIELD OF ACCOUNT

**Reg. No. 4,196,418** AUDITING; ADVERTISING SERVICES, NAMELY, PROMOTING GOODS AND SERVICES IN THE FIELDS OF BUSINESS AND ACCOUNTANCY; BUSINESS RESEARCH SERVICES IN THE NATURE OF ADVISORY SERVICES PROVIDING INFORMATION IN THE FIELD OF BUSINESS RESEARCH; BUSINESS CONSULTANCY SERVICES; BUSINESS INFORMATION SERVICES; BUSINESS MANAGEMENT AND ADVICE IN THE NATURE OF BUSINESS POLICY REVIEW, DEVELOPMENT AND IMPLEMENTATION, BUSINESS PROBLEM IDENTIFICATION, ANALYSIS AND RESOLUTION AND BUSINESS PRIORITY IDENTIFICATION AND ANALYSIS; EMPLOYMENT STAFFING AND RECRUITMENT SERVICES IN THE NATURE OF EMPLOYMENT CONSULTATION, INFORMATION AND CAREER PLANNING SERVICES; MARKET RESEARCH SERVICES IN THE FIELDS OF ACCOUNTANCY AND FINANCE; COMPILATION OF INFORMATION INTO COMPUTER DATABASES; DATABASE MANAGEMENT SERVICES; PROMOTIONAL SERVICES BEING THE PROMOTION OF INTERESTS OF THE MEMBERS OF AN ASSOCIATION AND THE PROVISION OF BUSINESS SUPPORT STAFF SERVICES AND BUSINESS ADVICE RELATED THERETO; BUSINESS DEVELOPMENT SERVICES IN THE NATURE OF RESEARCH, ANALYSIS AND DEVELOPMENT OF NEW AND EXISTING ORGANIZATIONAL BUSINESS MODELS, STRUCTURES, PRACTICES AND STRATEGIES , IN CLASS 35 (U.S. CLS. 100, 101 AND 102).

FOR: FINANCIAL SERVICES IN THE NATURE OF ADVISORY SERVICES PROVIDING INFORMATION IN THE FIELD OF FINANCIAL ADVICE; MONETARY SERVICES IN THE NATURE OF ADVISORY SERVICES PROVIDING INFORMATION IN THE FIELD OF MONETARY ADVICE; FINANCIAL SPONSORSHIP OF EDUCATION AND TRAINING ACTIVITIES AND CONFERENCES; ADVISORY, CONSULTANCY AND INFORMATION SERVICES RELATING TO ALL THE AFORESAID, IN CLASS 36 (U.S. CLS. 100, 101 AND 102).

FOR: EDUCATIONAL COURSES IN THE FIELDS OF ACCOUNTANCY, MANAGEMENT AND FINANCE; TRAINING SERVICES IN THE FIELDS OF ACCOUNTANCY MANAGEMENT AND FINANCE; TRAINING SERVICES IN THE FIELDS OF ACCOUNTANCY MANAGEMENT AND FINANCE; EDUCATIONAL COURSES IN THE FIELD OF CONTINUAL PROFESSIONAL DEVELOPMENT, NAMELY, ACCOUNTANCY, MANAGEMENT AND FINANCE; EDUCATIONAL SERVICES IN THE NATURE OF STUDY ASSISTANCE IN THE FIELDS OF ACCOUNTANCY AND FINANCE; EDUCATIONAL SERVICES, NAMELY, ORGANIZING AND CONDUCTING EDUCATIONAL CLASSES, WORKSHOPS, TRAINING COURSES, CORRESPONDENCE COURSES, LECTURES, SEMINARS, SYMPOSIUMS, CONFERENCES AND EXHIBITIONS ALL IN THE FIELDS OF ACCOUNTANCY, MANAGEMENT AND FINANCE; EDUCATIONAL SERVICES, NAMELY, EDUCATIONAL EXAMINATION SERVICES, ORGANIZING, ARRANGING AND CONDUCTING EDUCATIONAL EXAMINATIONS BY PAPER AND ELECTRONICALLY, AND EDUCATIONAL SERVICES IN THE NATURE OF PROVIDING EDUCATIONAL SKILLS ASSESSMENT AND PROVIDING EDUCATIONAL INSTRUCTION COURSES ON TEST ADMINISTRATION; ORGANIZATION OF EDUCATIONAL EXHIBITIONS IN THE FIELDS OF ACCOUNTANCY, MANAGEMENT AND FINANCE; PROVIDING FACILITIES FOR EDUCATIONAL PURPOSES, NAMELY FOR CLASSES, WORKSHOPS, SEMINARS, SYMPOSIUMS, CONFERENCES, EXAMINATIONS AND EDUCATIONAL EXHIBITIONS; PROVISION OF EDUCATIONAL EXAMINATION FACILITIES; PROVIDING FACILITIES FOR EDUCATIONAL SERVICES AND EDUCATIONAL TRAINING; LIBRARY SERVICES; PRODUCTION AND RENTAL OF EDUCATIONAL AUDIO TAPE, FILM, VIDEO, MP3S, JPEGS, MPEGs, CD'S, DVD'S; MEMBERSHIP CLUB SERVICES, NAMELY, PROVIDING TRAINING TO MEMBERS IN THE FIELDS OF ACCOUNTANCY, MANAGEMENT AND FINANCE; NEWSPAPER, MAGAZINE, BOOK AND TRAINING COURSE MATERIAL PUBLISHING; ELECTRONIC PUBLISHING OF NEWSPAPERS, MAGAZINES, BOOKS AND TRAINING COURSE MATERIALS; VOCATIONAL GUIDANCE; TESTING, ANALYSIS AND EVALUATION OF EDUCATORS' KNOWLEDGE, SKILLS AND ABILITIES FOR THE PURPOSE OF CERTIFICATION; CAREER COUNSELING, NAMELY, PROVIDING ADVICE CONCERNING EDUCATION AND TRAINING OPTIONS TO PURSUE CAREER OPPORTUNITIES; EDUCATIONAL SERVICES, NAMELY, DEVELOPING CURRICULUMS FOR EDUCATION INCLUDING SYLLABUSES, EXAMINATION SCHEDULES

**Reg. No. 4,196,418** AND TESTS; ORGANIZATION AND CONDUCTING EVENTS IN THE NATURE OF EXHIBITIONS IN THE NATURE OF CLASSES, WORKSHOPS, SEMINARS, SYMPOSIUMS AND CONFERENCES, IN CLASS 41 (U.S. CLS. 100, 101 AND 107).

FOR: QUALITY CONTROL SERVICES BEING THE CERTIFICATION OF SERVICES PROVIDED BY MEMBERS OF AN ASSOCIATION IN THE FIELD OF ACCOUNTANCY AND FINANCE; ACCREDITATION SERVICES, NAMELY, SETTING AND PROVIDING QUALITY STANDARDS IN THE FIELD OF ACCOUNTING FOR THE PURPOSE OF ACCREDITATION OF ACCOUNTANTS; SERVICES IN THE NATURE OF ADVICE PROVIDED BY A PROFESSIONAL INSTITUTE ON BEHALF OF ITS MEMBERS IN THE FIELDS OF ACCOUNTANCY, MANAGEMENT AND FINANCE; PROVIDING QUALITY ASSURANCE SERVICES IN THE FIELDS OF ACCOUNTANCY AND MANAGEMENT; INDUSTRIAL RESEARCH IN THE FIELDS OF ACCOUNTANCY AND MANAGEMENT, IN CLASS 42 (U.S. CLS. 100 AND 101).

FOR: LOBBYING SERVICES IN THE NATURE OF REPRESENTATION OF INDIVIDUALS IN THE FIELD OF ACCOUNTANCY; LEGAL SERVICES IN THE NATURE OF REPRESENTATION OF INDIVIDUALS IN THE FIELD OF ACCOUNTANCY, IN CLASS 45 (U.S. CLS. 100 AND 101).

THE MARK CONSISTS OF STANDARD CHARACTERS WITHOUT CLAIM TO ANY PARTICULAR FONT, STYLE, SIZE, OR COLOR.

PRIORITY DATE OF 4-18-2011 IS CLAIMED.

OWNER OF INTERNATIONAL REGISTRATION 1087795 DATED 5-4-2011, EXPIRES 5-4-2021.

OWNER OF U.S. REG. NO. 4,014,444.

THE ENGLISH TRANSLATION OF "CIMA" IN THE MARK IS "TOP" OR "PEAK".

SER. NO. 79-101,468, FILED 5-4-2011.

COLLEEN KEARNEY, EXAMINING ATTORNEY

# United States of America

United States Patent and Trademark Office

# FIRSTGATE

**Reg. No. 4,196,419**

**Registered Aug. 28, 2012**

**Int. Cls.: 35, 36 and 38**

**SERVICE MARK**

**PRINCIPAL REGISTER**

CBS GMBH (FED REP GERMANY LIMITED LIABILITY COMPANY)  
IM MEDIAPARK 5  
50670 KÖLN  
FED REP GERMANY

FOR: ADMINISTRATIVE PROCESSING OF PURCHASE ORDERS MADE ELECTRONICALLY, NAMELY, PROCESSING OF ORDER PLACEMENT, ORDER DELIVERY AND MANAGING INVOICES, IN CLASS 35 (U.S. CLS. 100, 101 AND 102).

FOR: MONETARY AFFAIRS IN THE NATURE OF ELECTRONIC PROCESSING AND TRANSMISSION OF BILL PAYMENT DATA OVER THE INTERNET, IN CLASS 36 (U.S. CLS. 100, 101 AND 102).

FOR: FEE BASED ELECTRONIC TRANSMISSION OF DATA VIA THE INTERNET, MOBILE AND FIXED NETWORK TELEPHONES, IN CLASS 38 (U.S. CLS. 100, 101 AND 104).

THE MARK CONSISTS OF STANDARD CHARACTERS WITHOUT CLAIM TO ANY PARTICULAR FONT, STYLE, SIZE, OR COLOR.

OWNER OF INTERNATIONAL REGISTRATION 1087802 DATED 5-10-2011, EXPIRES 5-10-2021.

SER. NO. 79-101,470, FILED 5-10-2011.

COLLEEN KEARNEY, EXAMINING ATTORNEY



*David J. Kybas*

Director of the United States Patent and Trademark Office

# United States of America

United States Patent and Trademark Office



**Reg. No. 4,196,420**

**Registered Aug. 28, 2012**

**Int. Cls.: 29 and 43**

**TRADEMARK**

**SERVICE MARK**

**PRINCIPAL REGISTER**

CHARLES FARAUD (FRANCE SOCIÉTÉ PAR ACTIONS SIMPLIFIÉE)  
AVENUE DE GLADENBACH -  
ZI LA TAPY; F-84170 MONTEUX  
FRANCE

FOR: PRESERVED, DRIED AND COOKED FRUITS; CANNED OR BOTTLED FRUIT; JELLIES, JAMS, COMPOTES AND MARMALADES; FRUIT DESSERTS, NAMELY, CANDIED FRUIT, CRYSTALLIZED FRUITS, APPLE SAUCE; FRUIT PUREES, FRUIT PULP; FROZEN FRUITS; FRUIT SALADS; FRUIT CHIPS; FRUIT PEEL; FRUIT-BASED SNACK FOOD; MILK BASED BEVERAGES CONTAINING FRUIT JUICE, IN CLASS 29 (U.S. CL. 46).

FOR: SERVICES FOR PROVIDING FOOD AND DRINK, NAMELY, SNACK BARS, JUICE BARS, RESTAURANTS, COFFEE SHOPS, TEA ROOMS, CANTEN SERVICES, CAFETERIAS, BARS AND TAKE-OUT RESTAURANT SERVICES; FOOD AND DRINK CATERING SERVICES; INSTITUTIONAL CATERING SERVICES, IN CLASS 43 (U.S. CLS. 100 AND 101).

THE MARK CONSISTS OF THE WORDS "CHARLES & ALICE" WITHIN A PARTIALLY BORDERED RECTANGLE WITH ROUNDED CORNERS WITH DESIGNS OF A LEAF, HEART, DOTS, AND OPEN CIRCLES. THE COLOR DARK PLUM APPEARS IN THE BACKGROUND OF THE RECTANGLE; THE COLOR WHITE APPEARS IN THE TEXT "CHARLES" AND "ALICE"; THE COLOR ORANGE APPEARS IN THE &, SOME OF THE DESIGN DOTS AND OPEN CIRCLES, AND THE PARTIAL BORDER OF THE RECTANGLE; THE COLOR PINK APPEARS IN THE HEART AND ONE CIRCLE; THE COLOR GREEN APPEARS IN THE LEAF; AND THE COLOR YELLOW APPEARS IN A CIRCLE AND THE SWIRL OVER THE LETTER "I" IN "ALICE".

PRIORITY DATE OF 1-19-2011 IS CLAIMED.

OWNER OF INTERNATIONAL REGISTRATION 1087934 DATED 7-7-2011, EXPIRES 7-7-2021.

THE COLOR(S) DARK PLUM, WHITE, ORANGE, PINK, GREEN, AND YELLOW IS/ARE CLAIMED AS A FEATURE OF THE MARK.

SER. NO. 79-101,512, FILED 7-7-2011.



*David J. Kyjars*

Director of the United States Patent and Trademark Office

**Reg. No. 4,196,420** CARYN GLASSER, EXAMINING ATTORNEY

# United States of America

United States Patent and Trademark Office

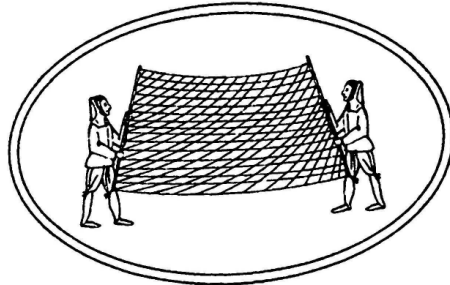

LE RAGNAIE

**Reg. No. 4,196,421**

**Registered Aug. 28, 2012**

**Int. Cl.: 33**

AZIENDA AGRICOLA LE RAGNAIE DI CAMPINOTI RICCARDO (ITALY SOLE PROPRIETORSHIP)  
LOCALITÀ LE RAGNAIE  
MONTALCINO (SI), ITALY I53024

FOR: WINES, IN CLASS 33 (U.S. CLS. 47 AND 49).

**TRADEMARK**

THE MARK CONSISTS OF THE WORDING "LE RAGNAIE" BELOW TWO CONCENTRIC OVALS INSIDE OF WHICH APPEARS A DESIGN OF TWO MEN DRESSED IN HISTORICAL COSTUME AND HOLDING THE SIDES OF A STRETCHED OUT NET.

**PRINCIPAL REGISTER**

PRIORITY DATE OF 6-29-2011 IS CLAIMED.

OWNER OF INTERNATIONAL REGISTRATION 1087978 DATED 7-22-2011, EXPIRES 7-22-2021.

THE WORDING "LE RAGNAIE" HAS NO MEANING IN A FOREIGN LANGUAGE.

SER. NO. 79-101,534, FILED 7-22-2011.

KRISTIN CARLSON, EXAMINING ATTORNEY



*David J. Kybas*

Director of the United States Patent and Trademark Office



# United States of America

United States Patent and Trademark Office

# LIVINGTILES

**Reg. No. 4,196,422**

**Registered Aug. 28, 2012**

**Int. Cls.: 6, 9, 11 and 19**

KONINKLIJKE PHILIPS ELECTRONICS N.V. (NETHERLANDS A PUBLIC LIMITED LIABILITY COMPANY)  
GROENEWOUDSEWEG 1  
NL-5621 BA EINDHOVEN  
NETHERLANDS

**TRADEMARK**

**PRINCIPAL REGISTER**

FOR: BUILDING MATERIALS, NAMELY, METAL COUNTERTOPS FOR FURTHER INSTALLATION AND COMPOSITE PANELS COMPOSED PRIMARILY OF METAL; BUILDING WALL FRAMING MADE PRIMARILY OF METAL, METAL BUILDING MATERIALS, NAMELY, CEILING BOARDS AND FLOOR BOARDS; PIPES AND TUBES OF METAL, IN CLASS 6 (U.S. CLS. 2, 12, 13, 14, 23, 25 AND 50).

FOR: CONTROL APPARATUS FOR LIGHTING SYSTEMS, NAMELY, ELECTRIC LIGHT SWITCHES; SOFTWARE PROGRAMS FOR USE IN CONTROLLING LIGHTING SYSTEMS; LIGHTING BALLASTS; LIGHT EMITTING DIODES (LEDS), LASER DIODES AND ZENER LIGHT DIODES; SOLID-STATE DEVICE AND COMPONENTS THEREOF, NAMELY, LED CIRCUIT BOARDS CONSISTING OF INTEGRATED LEDES, ORGANIC LIGHT EMITTING DIODES AND LIGHT EMITTING DIODES; OPTICAL AND THERMIC CONTROL APPARATUS, NAMELY, OPTICAL AND THERMAL SENSORS; ELECTRONIC CIRCUITS FOR LIGHTING CONTROL SYSTEMS AND LIGHTING MANAGEMENT SYSTEMS, IN CLASS 9 (U.S. CLS. 21, 23, 26, 36 AND 38).

FOR: APPARATUS FOR LIGHTING, NAMELY, ELECTRIC LAMPS, LIGHTING FIXTURES AND LIGHTING INSTALLATIONS; LIGHTING FIXTURES AND LIGHTING INSTALLATIONS, FITTED WITH LED LIGHT SOURCES; PARTS OF THE AFORESAID GOODS, NAMELY, LAMPS SHADES AND LIGHT BULBS, IN CLASS 11 (U.S. CLS. 13, 21, 23, 31 AND 34).

FOR: NON-METAL BUILDING MATERIALS, NAMELY, COMPOSITE PANELS COMPOSED PRIMARILY OF NON-METAL MATERIALS AND MULTILAYER PANELS OF PLASTIC FOR USE IN BUILDING; NON-METALLIC RIGID PIPES FOR BUILDING, IN CLASS 19 (U.S. CLS. 1, 12, 33 AND 50).

THE MARK CONSISTS OF STANDARD CHARACTERS WITHOUT CLAIM TO ANY PARTICULAR FONT, STYLE, SIZE, OR COLOR.

PRIORITY DATE OF 8-20-2010 IS CLAIMED.



*David J. Kyros*

Director of the United States Patent and Trademark Office

**Reg. No. 4,196,422** OWNER OF INTERNATIONAL REGISTRATION 1088411 DATED 2-16-2011, EXPIRES 2-16-2021.

OWNER OF U.S. REG. NO. 3,512,886.

SER. NO. 79-101,710, FILED 2-16-2011.

MARTHA FROMM, EXAMINING ATTORNEY

# United States of America

United States Patent and Trademark Office

**inside**  
SECURE

**Reg. No. 4,196,423**

**Registered Aug. 28, 2012**

**Int. Cls.: 9, 35, 38 and 42**

**TRADEMARK**

**SERVICE MARK**

**PRINCIPAL REGISTER**

INSIDE SECURE (FRANCE CORPORATION)  
41 PARC DU CLUB DU GOLF  
F-13856 AIX EN PROVENCE CEDEX 3  
FRANCE

FOR: CENTRAL PROCESSING UNITS, NAMELY, COMPUTERS, COMPUTER HARDWARE, NAMELY, MICROPROCESSORS; ELECTRONIC COMPONENTS IN THE NATURE OF DISK DRIVES, NAMELY, COMPUTER DISK DRIVES, DIGITAL DISK DRIVES, OPTICAL DISK DRIVES; DATA CONVERTERS, NAMELY, ENCODERS AND TELEVISION DECODERS; ELECTRONIC DEVICES FOR CONNECTING A COMPUTER AND A COMMUNICATION NETWORK, NAMELY, MODEMS; PROGRAMS FOR COMPUTERS FOR READING OF CHIPS AND THE MODIFICATION FOR SAFETY OF DATA IN THE FIELD OF PAYMENTS, FINANCE, TELEPHONY, TRANSPORT, ACCESS CONTROL, ELECTRONIC IDENTIFICATION, RETAIL AND GIFT CARD, ALL TO FACILITATE COMMUNICATION BETWEEN HANDHELD ELECTRONIC DEVICES; ENCRYPTION AND DECRYPTION PROGRAMS FOR COMPUTER DATA; COMPUTER SOFTWARE FOR THE MANAGEMENT OF DATABASE; COMMUNICATION INTERFACE CARDS FOR DATA PROCESSING EQUIPMENT IN THE FORM OF PRINTED CIRCUITS; INTERFACES FOR COMPUTERS BEING COMMUNICATION INTERFACE MODULES FOR THE EXCHANGE OF DATA; ELECTRONIC DATA CONVERTERS FOR DATA RECORDED ON COMPUTER MEDIA; CHIPS, NAMELY, INTEGRATED CIRCUITS; ELECTRONIC COMPUTER CHIPS, NAMELY, CONTACTLESS INTERFACE CHIPS, SEMICONDUCTOR CHIPS, AND SILICON CHIPS; MICROCIRCUITS FOR CODING AND DECODING DATA; PRINTED CIRCUITS; SEMICONDUCTORS; CENTRAL PROCESSING UNITS; MICROPROCESSORS; MICROCONTROLLERS; ELECTRONIC TAGS, NAMELY, TAGS FOR CONTROLLING ACCESS, MANAGEMENT OF STOCK, TRACEABILITY OF GOODS, AND PROTECTION AGAINST THEFT; CHIP CARDS, NAMELY, BLANK ELECTRONIC CHIP CARDS; ENCODED ELECTRONIC CHIP CARDS CONTAINING PROGRAMMING FOR READING, WRITING, CONTROLLING, EXCHANGING AND MODIFICATION OF DATA FOR USE IN THE FIELD OF PAYMENT, FINANCE, ACCESS, CONTROL, TRANSPORT, TICKETING, ELECTRONIC IDENTIFICATION, RETAIL AND GIFT CARD AND MOBILE COMMUNICATION FIELDS FOR USE WITH SMART CARDS, KEY FOBS, MOBILE PHONES, HANDHELD CONSUMER ELECTRONIC DEVICES, POINT OF SALE DISPLAYS AND PC PERIPHERALS; MEMORY CARDS FOR ELECTRONIC AUDIO AND VIDEO DEVICES, MOBILE PHONES, COMPUTERS, PLAYERS, AND MOVIE AND STILL CAMERAS; ELECTRIC AND ELECTRONIC LOCKS, IN CLASS 9 (U.S. CLS. 21, 23, 26, 36 AND 38).



*David J. Kyros*

Director of the United States Patent and Trademark Office

**Reg. No. 4,196,423** FOR: RETAIL STORE SERVICES, WHOLESALE STORES, AND MAIL ORDER SERVICES FEATURING COMPUTER HARDWARE, COMPUTER PROGRAMS, SOFTWARE, COMMUNICATION INTERFACES, COMMUNICATION INTERFACE MODULES, COMMUNICATION INTERFACE CARDS, INTEGRATED CIRCUITS, MICROCIRCUITS, PRINTED CIRCUITS, SEMI-CONDUCTORS, PROCESSORS, MICROPROCESSORS, MICROCONTROLLERS, ELECTRONIC TAGS, ESPECIALLY RADIOFREQUENCY TAGS USED FOR ACCESS CONTROL, STOCK MANAGEMENT, TRACEABILITY OF GOODS, COMBATING THEFT, ELECTRONIC CHIPS, ELECTRONIC CHIP CARDS, ESPECIALLY BLANK CARDS, CODED CHIP CARDS CONTAINING ESPECIALLY PROGRAMS USED IN THE SPHERES OF MONEY, TRANSPORT, COMMUNICATIONS, TELEPHONY, IDENTIFICATION, SECURITY ON COMPUTERS, AND MEMORY CARDS, ESPECIALLY FOR ELECTRONIC AUDIO AND VIDEO DEVICES, MOBILE PHONES, COMPUTERS, PLAYERS, MOVIE AND STILL CAMERAS, ELECTRIC AND ELECTRONIC LOCKS, TELEPHONE SETS, IN CLASS 35 (U.S. CLS. 100, 101 AND 102).

FOR: COMMUNICATION SERVICES USING COMPUTER, TELECOMMUNICATION AND DATA TRANSMISSION NETWORKS, NAMELY, COMMUNICATIONS BY COMPUTER TERMINALS; SERVICES FOR SUPPLYING TELECOMMUNICATION NETWORKS, NAMELY, PROVIDING THIRD PARTY USERS WITH ACCESS TO TELECOMMUNICATION INFRASTRUCTURE; DATA TRACEABILITY SERVICES, NAMELY, CO-LOCATION SERVICES FOR VOICE, VIDEO AND DATA COMMUNICATIONS APPLICATIONS; PROVIDING INFORMATION REGARDING ELECTRONIC DATA TRANSMISSION AND TELECOMMUNICATION; CONSULTING SERVICES IN THE FIELD OF ELECTRONIC DATA TRANSMISSION AND TELECOMMUNICATION; RENTAL OF TELECOMMUNICATIONS EQUIPMENT IN THE NATURE OF MESSAGE AND DATA TRANSMISSION APPARATUS, IN CLASS 38 (U.S. CLS. 100, 101 AND 104).

FOR: ENGINEERING SERVICES; DESIGN OF COMPUTER PROGRAMS FOR COMPUTERS AND MICROPROCESSORS FOR OTHERS, COMPUTER SYSTEM DESIGN AND DEVELOPMENT; TECHNICAL DEVELOPMENT AND RESEARCH STUDY FOR DATA EXCHANGE SYSTEMS AND DEVICES, NAMELY, CONDUCTING SCIENTIFIC RESEARCH, CONDUCTING TECHNICAL FEASIBILITY STUDIES AND NEW PRODUCT DEVELOPMENT FOR OTHERS, PERSONALIZED STUDY AND PROGRAMMING SERVICE FOR CHIP CARDS AND ELECTRONIC CARDS, NAMELY, CUSTOMIZATION OF COMPUTER CHIPS CARDS AND ELECTRONIC CARDS WITH INTEGRATED CIRCUITS FOR OTHERS, IN CLASS 42 (U.S. CLS. 100 AND 101).

OWNER OF U.S. REG. NOS. 2,987,974, 3,835,157, AND 3,835,158.

PRIORITY DATE OF 10-25-2010 IS CLAIMED.

OWNER OF INTERNATIONAL REGISTRATION 1088520 DATED 3-1-2011, EXPIRES 3-1-2021.

THE COLOR(S) GRAY, ORANGE AND BLACK IS/ARE CLAIMED AS A FEATURE OF THE MARK.

NO CLAIM IS MADE TO THE EXCLUSIVE RIGHT TO USE "SECURE", APART FROM THE MARK AS SHOWN.

THE MARK CONSISTS OF THE WORD "INSIDE" SHOWN IN DARK GRAY, ABOVE THE WORD "SECURE" SHOWN IN BLACK; THE DOT OVER THE SECOND "I" IS ORANGE, AS IS THE DOT BEFORE THE WORD "SECURE".

SER. NO. 79-101,741, FILED 3-1-2011.

JENNIFER DIXON, EXAMINING ATTORNEY

# United States of America

United States Patent and Trademark Office

## CONSUMERLENZ

**Reg. No. 4,196,424**

**Registered Aug. 28, 2012**

**Int. Cls.: 16, 35, 38 and  
42**

**TRADEMARK**

**SERVICE MARK**

**PRINCIPAL REGISTER**

FIRMENICH S.A. (SWITZERLAND SOCIÉTÉ ANONYME)  
1, ROUTE DES JEUNES  
CASE POSTALE 239.; CH-1211 GENÈVE 8  
SWITZERLAND

FOR: PRINTED MATTER, NAMELY, LEAFLETS, BROCHURES, NEWSLETTERS, PROSPECTUSES IN THE FIELDS OF FLAVORS AND FLAVORING COMPOSITIONS; PRINTED PUBLICATIONS, NAMELY, PERIODICALS, MAGAZINES, NEWSPAPERS, REVIEWS, IN THE FIELDS OF FLAVORS AND FLAVORING COMPOSITIONS; PRINTED INSTRUCTIONAL OR TEACHING MATERIAL IN THE FIELD OF FLAVORS AND FLAVORING COMPOSITIONS; PRINTED INSTRUCTIONAL OR TEACHING MATERIAL IN THE FIELD OF FLAVOR CLASSIFICATION, IN CLASS 16 (U.S. CLS. 2, 5, 22, 23, 29, 37, 38 AND 50).

FOR: CARRYING OUT OF MARKETING STUDIES RELATING TO CONSUMERS' PREFERENCES IN TASTE AND FOOD FLAVORINGS; MARKETING ADVICE IN THE FIELD OF FLAVORS AND FOOD FLAVORING; DISTRIBUTION OF SAMPLES; ELECTRONIC COMMERCE SERVICE (E-COMMERCE), NAMELY, PROVIDING CONSUMER INFORMATION ABOUT FLAVORS AND THEIR USE IN CONSUMER PRODUCTS AND ABOUT FOODS AND BEVERAGES, THROUGH TELECOMMUNICATION NETWORKS FOR ADVERTISING AND SALE PURPOSES, IN CLASS 35 (U.S. CLS. 100, 101 AND 102).

FOR: IN-LINE DATA TRANSMISSION SERVICES, NAMELY, ELECTRONIC DATA TRANSMISSION; COMMUNICATIONS BY COMPUTER TERMINALS; TELECOMMUNICATION SERVICES, NAMELY, PROVIDING TELECOMMUNICATIONS CONNECTIONS TO A GLOBAL COMPUTER NETWORKS; ELECTRONIC MESSAGING THROUGH THE INTERNET; TRANSMISSION OF COMMERCIAL AND ADVERTISING DATA THROUGH INTERNET NETWORKS; DATA TRANSMISSION OF ELECTRONIC CATALOGS VIA INTERNET NETWORKS, IN CLASS 38 (U.S. CLS. 100, 101 AND 104).

FOR: TECHNICAL CONSULTING AND SERVICES FOR THIRD PARTIES IN CONNECTION WITH THE USE OF FLAVORS FOR THE FLAVORING OF FOODS AND BEVERAGES, NAMELY, TECHNICAL CONSULTANCY AND RESEARCH SERVICES REGARDING DEVELOPMENT OF TECHNOLOGIES AND TECHNICAL COMPONENTS OF FOOD AND BEVERAGE FLAVORINGS FOR THE FOODS INDUSTRY; SCIENTIFIC SERVICES, RESEARCH SERVICES AND TECHNOLOGICAL SERVICES, NAMELY, PRODUCT RESEARCH AND DEVELOPMENT SERVICES FOR OTHERS IN THE FOOD INDUSTRY, IN CLASS 42 (U.S. CLS. 100 AND 101).



*David J. Kyffers*

Director of the United States Patent and Trademark Office

**Reg. No. 4,196,424** THE MARK CONSISTS OF STANDARD CHARACTERS WITHOUT CLAIM TO ANY PARTICULAR FONT, STYLE, SIZE, OR COLOR.

PRIORITY DATE OF 2-11-2011 IS CLAIMED.

OWNER OF INTERNATIONAL REGISTRATION 1088714 DATED 7-13-2011, EXPIRES 7-13-2021.

SER. NO. 79-101,824, FILED 7-13-2011.

APRIL HESIK, EXAMINING ATTORNEY

# United States of America

United States Patent and Trademark Office

# abled

**Reg. No. 4,196,425**

**Registered Aug. 28, 2012**

**Int. Cls.: 9, 41 and 45**

**TRADEMARK**

**SERVICE MARK**

**PRINCIPAL REGISTER**

THE LAURA AND WAGNER FOUNDATION (CURACAO NON PROFIT FOUNDATION)  
BRAKKEPUT ARIBA K-19  
CURAÇAO  
CURACAO

FOR: OPTICAL DISC PLAYERS; SIGNALING APPARATUS FOR PERSONAL ALARM ADAPTED FOR ACCESSIBLE USE BY PERSONS WITH DISABILITIES; APPARATUS FOR RECORDING, TRANSMISSION OR REPRODUCTION OF SOUND OR IMAGES MODIFIED FOR ACCESSIBLE USE BY PERSONS WITH DISABILITIES; BLANK MAGNETIC CARRIERS ADAPTED FOR USE BY PERSONS WITH DISABILITIES WITH BRAILLE DOTS AND AUDIBLE PROMPTS FOR BLIND USERS; BLANK RECORDING DISCS ADAPTED FOR USE BY PERSONS WITH DISABILITIES WITH BRAILLE DOTS AND AUDIBLE PROMPTS FOR BLIND USERS; PRE-RECORDED MAGNETIC DATA CARRIERS WITH BRAILLE DOTS AND AUDIBLE PROMPTS FOR BLIND USERS FEATURING ACCESSIBLE CONTENT, PRODUCTS AND SERVICES OF GENERAL AND SPECIFIC INTEREST TO, AND RELEVANT TO THE LIFESTYLE OF, PERSONS WITH DISABILITIES, SUCH AS MOTION PICTURES OR TELEVISION PROGRAMS WITH DESCRIPTIVE AUDIO CHANNELS FOR BLIND USERS AND SUB-TITLES FOR DEAF USERS, AUDIBLE MAPS AND AUDIBLE BOOKS, AND ACCESSIBILITY-ENHANCED E-BOOKS; PRE-RECORDED RECORDING DISCS WITH BRAILLE DOTS AND AUDIBLE PROMPTS FOR BLIND USERS FEATURING ACCESSIBLE CONTENT, PRODUCTS AND SERVICES OF GENERAL AND SPECIFIC INTEREST TO, AND RELEVANT TO THE LIFESTYLE OF, PERSONS WITH DISABILITIES, SUCH AS MOTION PICTURES OR TELEVISION PROGRAMS WITH DESCRIPTIVE AUDIO CHANNELS FOR BLIND USERS AND SUB-TITLES FOR DEAF USERS, AUDIBLE MAPS AND AUDIBLE BOOKS, AND ACCESSIBILITY-ENHANCED E-BOOKS; OTHER DIGITAL RECORDING MEDIA, NAMELY, RFID OR RADIO FREQUENCY IDENTIFICATION RECORDING DEVICES THAT ALLOW BLIND USERS TO RECORD AUDIO DESCRIPTIVE LABELS FOR THE PURPOSES OF RECALLED IDENTIFICATION OF VARIOUS ITEMS; DOWNLOADABLE ELECTRONIC PUBLICATIONS IN THE NATURE OF ACCESSIBLE PAMPHLETS, BROCHURES, NEWSLETTERS, JOURNALS, MAGAZINES, NEWSPAPERS AND E-BOOKS THAT HAVE BEEN ADAPTED WITH DESCRIPTIVE AUDIO CHANNELS FOR BLIND USERS AND SUB-TITLES FOR DEAF USERS IN THE FIELD OF GENERAL-INTEREST AND TOPIC-SPECIFIC CONTENT, PRODUCTS AND SERVICES OF INTEREST TO, AND RELEVANT TO THE LIFESTYLE OF, PERSONS WITH DISABILITIES; COMPUTERS THAT HAVE BEEN ADAPTED FOR ACCESSIBLE USE BY PERSONS WITH DISABILITIES INCLUDING TEXT TO SPEECH CAPABILITIES FOR BLIND USERS AND SPEECH TO TEXT CAPABILITIES FOR DEAF USERS; COMPUTER SOFTWARE FOR PROVIDING ACCESSIBLE ONLINE AND



*David J. Kappas*

Director of the United States Patent and Trademark Office

**Reg. No. 4,196,425** OFFLINE COMMUNICATION, NAVIGATION, ADMINISTRATION, CONTENT CREATION, PRODUCTION, RECORDING, PLAYBACK AND TRANSACTIONAL FUNCTIONS FOR PERSONS WITH DISABILITIES USING A COMPUTER OR APPARATUS FOR RECORDING, TRANSMISSION OR REPRODUCTION OF SOUND OR IMAGES, IN CLASS 9 (U.S. CLS. 21, 23, 26, 36 AND 38).

FOR: EDUCATIONAL SERVICES, NAMELY, CLASSES AND SEMINARS SPECIALLY ADAPTED FOR PERSONS WITH DISABILITIES IN THE FIELD OF CONTENT AND APPLICATION CREATION, DEVELOPMENT AND PRODUCTION FOR VARIOUS MEDIA PLATFORMS AND FORMATS; TRAINING SERVICES SPECIALLY ADAPTED FOR PERSONS WITH DISABILITIES IN THE FIELD OF CONTENT AND COMPUTER SOFTWARE APPLICATION CREATION, DEVELOPMENT AND PRODUCTION FOR VARIOUS MEDIA PLATFORMS AND FORMATS; ARRANGING AND CONDUCTING SPECIAL EVENTS FOR PERSONS WITH DISABILITIES FOR SOCIAL ENTERTAINMENT PURPOSES; ENTERTAINMENT IN THE NATURE OF EDUCATIONAL SEMINARS AND CONFERENCES RELEVANT TO DAILY LIVING ISSUES FACED BY PERSONS WITH DISABILITIES, AS WELL AS CONCERTS, DANCES, THEATER PERFORMANCES, TELEVISION SHOWS AND MOVIE PRESENTATIONS PROVIDED WITH ASSISTIVE TECHNOLOGY THAT PROVIDES DESCRIPTIVE AUDIO ACCESSIBILITY FOR BLIND PARTICIPANTS AND CLOSED-CAPTIONING/SUB-TITLING FOR DEAF PARTICIPANTS; ENTERTAINMENT SERVICES, NAMELY, FILM PRODUCTION, RADIO AND TELEVISION PROGRAMS AND PROVIDING WEBCASTS IN THE FIELD OF TOPICS RELATED TO DAILY LIVING ISSUES FACED BY PERSONS WITH DISABILITIES, SUCH AS INFORMATION ABOUT SPECIFIC CONDITIONS, MEDICAL RESEARCH, ACCESSIBILITY, MOBILITY, FINANCES, TRAVEL, ENTERTAINMENT, TECHNOLOGY, POLITICS, ART, SOCIAL MEDIA, NUTRITION, AND ADAPTIVE SERVICES; PROVIDING ONLINE NON-DOWNLOADABLE PUBLICATIONS, NAMELY, ACCESSIBLE PAMPHLETS, BROCHURES, NEWSLETTERS, JOURNALS, MAGAZINES, NEWSPAPERS AND E-BOOKS THAT HAVE BEEN ADAPTED FOR ONLINE ACCESS OR STREAMING WITH DESCRIPTIVE AUDIO CHANNELS FOR BLIND USERS AND SUB-TITLES FOR DEAF USERS IN THE FIELD OF GENERAL-INTEREST AND TOPIC-SPECIFIC CONTENT, PRODUCTS AND SERVICES OF INTEREST TO, AND RELEVANT TO THE LIFESTYLE OF, PERSONS WITH DISABILITIES; ORGANIZING COMMUNITY SPORTING AND CULTURAL EVENTS FOR PERSONS WITH DISABILITIES, IN CLASS 41 (U.S. CLS. 100, 101 AND 107).

FOR: PROVIDING CASE MANAGEMENT SERVICES, NAMELY, COORDINATING LEGAL, PHYSICAL, SOCIAL AND PSYCHOLOGICAL SERVICES FOR PERSONS WITH DISABILITIES; SOCIAL SERVICE, NAMELY, OUT-OF-HOUSE SOCIAL ESCORT SERVICES, AND IN-HOUSE COMPANIONSHIP SERVICES FOR PERSONS WITH DISABILITIES; SECURITY AND SURVEILLANCE SERVICES, NAMELY, PROVISION OF, AND MONITORING OF, PERSONAL SAFETY ALARM APPARATUS FOR PERSONS WITH DISABILITIES; PROVIDING PERSONAL SUPPORT SERVICES FOR PERSONS WITH DISABILITIES, AND FAMILIES OF PERSONS WITH DISABILITIES, NAMELY, EMOTIONAL COUNSELING AND EMOTIONAL SUPPORT, IN CLASS 45 (U.S. CLS. 100 AND 101).

THE MARK CONSISTS OF STANDARD CHARACTERS WITHOUT CLAIM TO ANY PARTICULAR FONT, STYLE, SIZE, OR COLOR.

PRIORITY DATE OF 8-13-2010 IS CLAIMED.

OWNER OF INTERNATIONAL REGISTRATION 1088784 DATED 1-27-2011, EXPIRES 1-27-2021.

SER. NO. 79-101,848, FILED 1-27-2011.

MARIA-VICTORIA SUAREZ, EXAMINING ATTORNEY



# United States of America

United States Patent and Trademark Office

# COCOLICIOUS

**Reg. No. 4,196,426**

**Registered Aug. 28, 2012**

**Int. Cls.: 3, 29 and 30**

**TRADEMARK**

**PRINCIPAL REGISTER**

COCOLICIOUS PURE PTY LTD (AUSTRALIA COMPANY)  
LEVEL 13  
63 EXHIBITION ROAD; MELBOURNE VIC 3000  
AUSTRALIA

FOR: COSMETICS; BEAUTY CARE COSMETIC PREPARATIONS; ESSENTIAL OILS; SKIN CARE PRODUCTS, NAMELY, COSMETICS; NON-MEDICATED BALMS; NON-MEDICATED LOTIONS; COSMETIC CREAMS; COSMETIC COCOA BUTTER IN THE FORM OF COSMETIC CREAMS; EXTRACTS OF PLANTS FOR COSMETIC PURPOSES; FACIAL AND BODY SOAPS; ALL OF THE AFOREMENTIONED BEING DERIVED FROM COCONUTS AND/OR COCO BEANS AND ALL EXCLUDING PERFUMES, FRAGRANCES AND MAKEUP, IN CLASS 3 (U.S. CLS. 1, 4, 6, 50, 51 AND 52).

FOR: PRESERVED FRUITS; PRESERVED VEGETABLES; DRIED FRUIT; DRIED VEGETABLES; COOKED FRUITS; COOKED VEGETABLES; JELLIES; JAMS; COMPOTES; DAIRY PRODUCTS EXCLUDING ICE CREAM, ICE MILK AND FROZEN YOGHURT, IN CLASS 29 (U.S. CL. 46).

FOR: COCOA; COCOA POWDER; PREPARATIONS MADE FROM SUGAR; SAUCES, NAMELY, CONDIMENTS; SPICES; EDIBLE ICES; COFFEE; TEA; COCOA BEVERAGES; COFFEE BEVERAGES; HERBAL FOOD BEVERAGES OTHER THAN FOR MEDICINAL USE; NON-MEDICATED TEA BEVERAGES, IN CLASS 30 (U.S. CL. 46).

THE MARK CONSISTS OF STANDARD CHARACTERS WITHOUT CLAIM TO ANY PARTICULAR FONT, STYLE, SIZE, OR COLOR.

PRIORITY DATE OF 4-19-2011 IS CLAIMED.

OWNER OF INTERNATIONAL REGISTRATION 1088880 DATED 6-27-2011, EXPIRES 6-27-2021.

SER. NO. 79-101,878, FILED 6-27-2011.

ZACHARY BELLO, EXAMINING ATTORNEY



*David J. Kyffers*

Director of the United States Patent and Trademark Office

# United States of America

United States Patent and Trademark Office

# LUTATHERA

**Reg. No. 4,196,427**

**Registered Aug. 28, 2012**

**Int. Cl.: 5**

**TRADEMARK**

**PRINCIPAL REGISTER**

ADVANCED ACCELERATOR APPLICATIONS (FRANCE SOCIÉTÉ ANONYME)  
20, RUE DIESEL  
F-01630 SAINT-GENIS-POUILLY  
FRANCE

FOR: RADIOPHARMACEUTICAL PRODUCTS FOR THE TREATMENT OF CANCER, IN CLASS 5 (U.S. CLS. 6, 18, 44, 46, 51 AND 52).

THE MARK CONSISTS OF STANDARD CHARACTERS WITHOUT CLAIM TO ANY PARTICULAR FONT, STYLE, SIZE, OR COLOR.

PRIORITY DATE OF 3-11-2011 IS CLAIMED.

OWNER OF INTERNATIONAL REGISTRATION 1089014 DATED 7-28-2011, EXPIRES 7-28-2021.

SER. NO. 79-101,923, FILED 7-28-2011.

CURTIS FRENCH, EXAMINING ATTORNEY



*David J. Kybas*

Director of the United States Patent and Trademark Office

# United States of America

United States Patent and Trademark Office



**Reg. No. 4,196,428**

GÉNIE NUMÉRIQUE (FRANCE SOCIÉTÉ ANONYME (SA))

**Registered Aug. 28, 2012**

5 ALLÉE DE LA CRÉATIVITÉ  
VILLENEUVE D'ASCQ, FRANCE F59650

**Int. Cls.: 35, 41 and 42**

FOR: BUSINESS MANAGEMENT; BUSINESS ORGANIZATION AND MANAGEMENT  
ADVICE; COMPUTER FILE MANAGEMENT, IN CLASS 35 (U.S. CLS. 100, 101 AND 102).

**SERVICE MARK**

FOR: COMPUTER TRAINING, IN CLASS 41 (U.S. CLS. 100, 101 AND 107).

**PRINCIPAL REGISTER**

FOR: DESIGN AND DEVELOPMENT OF COMPUTERS AND SOFTWARE; RESEARCH AND  
DEVELOPMENT OF NEW PRODUCTS FOR THIRD PARTIES; TECHNICAL PROJECT  
STUDY, NAMELY, MANAGEMENT OF INFORMATION'S SYSTEM BY CARRYING OUT  
SPECIFICATIONS, MODELING, DEVELOPMENT AND TESTS; DEVELOPMENT AND  
DESIGN, INSTALLATION, MAINTENANCE, UPDATING AND RENTAL OF SOFTWARE;  
COMPUTER PROGRAMMING; CONVERSION OF COMPUTER CODE OR INFORMATION,  
CONVERSION OF COMPUTER DATA AND PROGRAMS OTHER THAN PHYSICAL CON-  
VERSION; CONVERSION OF DOCUMENTS FROM A PHYSICAL TO AN ELECTRONIC  
MEDIUM, IN CLASS 42 (U.S. CLS. 100 AND 101).

THE MARK CONSISTS OF LETTERS "CC" IN BLACK COLOR; ONE OF THE "C"'S IS FACING  
UPWARD; AND THE WORDING "CARE AND COMFORT POWERED BY SCOTLER" IN  
BLACK COLOR.



PRIORITY DATE OF 6-1-2011 IS CLAIMED.

OWNER OF INTERNATIONAL REGISTRATION 1089057 DATED 6-27-2011, EXPIRES 6-27-  
2021.

SER. NO. 79-101,937, FILED 6-27-2011.

ZACHARY BELLO, EXAMINING ATTORNEY

*David J. Kypos*

Director of the United States Patent and Trademark Office

# United States of America

United States Patent and Trademark Office

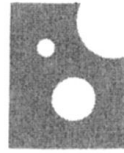

# DEGUST

Käse-Kunst · Formaggi d'artista

**Reg. No. 4,196,429**

**Registered Aug. 28, 2012**

**Int. Cl.: 29**

DEGUST KG S.A.S. DES/DI BAUMGARTNER JOHANN & CO (ITALY LIMITED  
PARTNERSHIP)  
BSACKERAU 1  
I-39040 VARNA (BZ)  
ITALY

**TRADEMARK**

**PRINCIPAL REGISTER**

FOR: FOOD PRODUCTS CONSISTING OF OR INCLUDING CHEESE AS THE PREDOMINANT INGREDIENT, NAMELY, CHEESE AND CHEESE SPREADS, IN CLASS 29, IN CLASS 29 (U.S. CL. 46).

NO CLAIM IS MADE TO THE EXCLUSIVE RIGHT TO USE "FORMAGGI" AND "KASE", APART FROM THE MARK AS SHOWN.

OWNER OF INTERNATIONAL REGISTRATION 1089150 DATED 3-8-2011, EXPIRES 3-8-2021.

THE MARK CONSISTS OF A GRAPHIC IN RECTANGULAR FORM, VERTICAL, WITH A SEMI CIRCLE NOTCH AT THE RIGHT TOP; INSIDE THE RECTANGLE THERE ARE 2 CIRCLES, THE BIG ONE AT THE RIGHT BOTTOM, AND THE SMALL ONE AT THE LEFT TOP; UNDERNEATH THE RECTANGLE IS WRITTEN IN 6 BLOCK LETTERS "DEGUST" AND THE WORDS: "KÄSE-KUNST FORMAGGI D'ARTISTA".

THE ENGLISH TRANSLATION OF "KASE-KUNST" IS "CHEESE ART". THE ENGLISH TRANSLATION OF THE TERM "FORMAGGI D'ARTISTA" IS "CHEESE FROM THE ARTIST".

SER. NO. 79-102,003, FILED 3-8-2011.

ERNEST SHOSHO, EXAMINING ATTORNEY



*David J. Kyros*

Director of the United States Patent and Trademark Office

# United States of America

United States Patent and Trademark Office

# ROSA PEPE

**Reg. No. 4,196,430**

**Registered Aug. 28, 2012**

**Int. Cl.: 14**

**TRADEMARK**

**PRINCIPAL REGISTER**

BORGOGNI RAFFAELE (ITALY INDIVIDUAL)  
VIA F. CORADINI, 13  
AREZZO  
ITALY

FOR: RINGS, BEING JEWELRY AND IMITATION JEWELRY; BRACELETS, BEING JEWELRY AND IMITATION JEWELRY; NECKLACES, BEING JEWELRY AND IMITATION JEWELRY; CHAINS, BEING JEWELRY AND IMITATION JEWELRY; BROOCHES, BEING JEWELRY AND IMITATION JEWELRY; CHARMS, BEING JEWELRY AND IMITATION JEWELRY; PENDANTS, BEING JEWELRY AND IMITATION JEWELRY; TIE CLIPS; EARRINGS; CLOCKS AND WATCHES, IN CLASS 14 (U.S. CLS. 2, 27, 28 AND 50).

THE NAME(S), PORTRAIT(S), AND/OR SIGNATURE(S) SHOWN IN THE MARK DOES NOT IDENTIFY A PARTICULAR LIVING INDIVIDUAL.

OWNER OF INTERNATIONAL REGISTRATION 1089361 DATED 6-29-2011, EXPIRES 6-29-2021.

THE MARK IS COMPOSED OF THE WORDING "ROSA PEPE" IN FANCY CHARACTERS, THE LETTER "O" OF THE WORD "ROSA" BEING COMPOSED OF A CIRCLE, PLACED INSIDE WHICH IS A LINE FORMING A STYLIZED HEART, ALL RESEMBLING A STYLIZED ROSE.

THE ENGLISH TRANSLATION OF THE FOREIGN WORD(S) IN THE MARK IS "ROSE PEPPER".

SER. NO. 79-102,046, FILED 6-29-2011.

REBECCA SMITH, EXAMINING ATTORNEY



*David J. Kyros*

Director of the United States Patent and Trademark Office

# United States of America

United States Patent and Trademark Office

# Tideum

**Reg. No. 4,196,431**

**Registered Aug. 28, 2012**

**Int. Cls.: 9, 35, 41 and 42**

**TRADEMARK**

**SERVICE MARK**

**PRINCIPAL REGISTER**

TIDEUM AG (SWITZERLAND LIMITED LIABILITY COMPANY)  
SUMPFSTRASSE 26  
POSTFACH 947; CH-6301 ZUG  
SWITZERLAND

FOR: DATA PROCESSING COMPUTER PROGRAMS INCLUDED IN THIS CLASS; COMPUTER SOFTWARE FOR USE IN DATABASE MANAGEMENT AND IN THE FIELD OF PROCESS-MANAGING AND OPTIMIZATION, BUSINESS CONTROLLING AND BUSINESS ANALYTICS; ELECTRONIC DATABASE IN THE FIELD OF PROCESS-MANAGING AND OPTIMIZATION, BUSINESS CONTROLLING AND BUSINESS ANALYTICS RECORDED ON COMPUTER MEDIA INCLUDED IN THIS CLASS, IN CLASS 9 (U.S. CLS. 21, 23, 26, 36 AND 38).

FOR: BUSINESS CONSULTING FOR COMPANIES; PROFESSIONAL BUSINESS CONSULTANCY; BUSINESS ORGANIZATION AND MANAGEMENT CONSULTING; BUSINESS MANAGEMENT CONSULTANCY; BUSINESS CONSULTING SERVICES IN THE FIELD OF ORGANIZATIONAL CHANGE MANAGEMENT; COMMERCIAL OR INDUSTRIAL MANAGEMENT ASSISTANCE; BUSINESS MANAGEMENT; MANAGEMENT OF BUSINESS PROJECTS; OFFICE FUNCTIONS; BUSINESS ADMINISTRATION CONSULTANCY OF COMPANIES; MARKET RESEARCH AND MARKET ANALYSIS; COMPILATION OF STATISTICS; PERSONNEL CONSULTING; PUBLIC OPINION POLLING; DIGITAL PROCESSING, PREPARATION AND REPRODUCTION OF DATA; COMPILING AND SYSTEMATIZING DATA IN COMPUTER DATA BANKS, IN CLASS 35 (U.S. CLS. 100, 101 AND 102).

FOR: TRAINING SERVICES IN THE FIELD OF BUSINESS MANAGEMENT, BUSINESS OPERATIONS, LEADERSHIP AND HUMAN RESOURCES MANAGEMENT; TRAINING IN THE USE AND OPERATION OF COMPUTERS, DATA PROCESSORS; ARRANGING OF SEMINARS; DIGITAL IMAGE PROCESSING, IN CLASS 41 (U.S. CLS. 100, 101 AND 107).

FOR: DESIGNING, DEVELOPING, UPDATING AND MAINTAINING DATA PROCESSING PROGRAMS; DESIGNING GRAPHICS FOR OTHERS; INSTALLATION OF COMPUTER SOFTWARE; DESIGN AND DEVELOPMENT OF WEB SITES; COMPUTER SOFTWARE DESIGN SERVICES; PROVIDING TEMPORARY USE OF ON-LINE NON-DOWNLOADABLE SOFTWARE FOR COMPUTER AIDED ARCHITECTURAL DESIGN; CONSULTING IN THE FIELD OF COMPUTER SOFTWARE DESIGN, COMPUTER SOFTWARE ARCHITECTURE AND COMPUTER SOFTWARE DEVELOPMENT; CONSULTING IN THE FIELD OF COMPUTER SOFTWARE FOR THE PURPOSE OF QUALITY ASSURANCE; DESIGN OF COM-



*David J. Kybas*

Director of the United States Patent and Trademark Office

**Reg. No. 4,196,431** PUTER DATABASES; PROVIDING INFORMATION TECHNOLOGY CONSULTING, IN CLASS 42 (U.S. CLS. 100 AND 101).

THE MARK CONSISTS OF STANDARD CHARACTERS WITHOUT CLAIM TO ANY PARTICULAR FONT, STYLE, SIZE, OR COLOR.

OWNER OF INTERNATIONAL REGISTRATION 1089522 DATED 6-6-2011, EXPIRES 6-6-2021.

THE WORDING "TIDEUM" HAS NO MEANING IN A FOREIGN LANGUAGE.

SER. NO. 79-102,087, FILED 6-6-2011.

WARREN L. OLANDRIA, EXAMINING ATTORNEY

# United States of America

United States Patent and Trademark Office



**Reg. No. 4,196,432**

**Registered Aug. 28, 2012**

**Int. Cl.: 14**

**TRADEMARK**

**PRINCIPAL REGISTER**

ADRIEN CHOUX (FRANCE INDIVIDUAL)  
59-63 WAN CHAI ROAD  
WAN CHAI, HONG KONG  
CHINA

FOR: JEWELRY; JEWELRY PRODUCTS, NAMELY, RINGS, BRACELETS, NECKLACES, EARRINGS, AND BROACHES; PRECIOUS STONES; TIMEPIECES AND CHRONOMETRIC INSTRUMENTS; PRECIOUS METALS AND THEIR ALLOYS; COINS, NAMELY, COLLECTIBLE COINS, COMMEMORATIVE COINS, NON-MONETARY COINS, AND SOUVENIR PRESSED COINS; WORKS OF ART OF PRECIOUS METAL; JEWELRY CASES; BOXES OF PRECIOUS METAL; WATCH CASES, BANDS, CHAINS, SPRINGS OR GLASSES; KEY RINGS, NAMELY, TRINKETS OR FOBS OF PRECIOUS METALS; STATUES, FIGURINES, AND STATUETTES OF PRECIOUS METAL; CASES OR PRESENTATION CASES FOR TIMEPIECES; MEDALS, IN CLASS 14 (U.S. CLS. 2, 27, 28 AND 50).

NO CLAIM IS MADE TO THE EXCLUSIVE RIGHT TO USE "CHINESE TIMEKEEPER" AND THE NON-LATIN CHARACTERS THAT TRANSLITERATE TO "ZHANG, HUA, SHI, JI, JI-ANG", APART FROM THE MARK AS SHOWN.

PRIORITY DATE OF 12-6-2010 IS CLAIMED.

OWNER OF INTERNATIONAL REGISTRATION 1089531 DATED 5-9-2011, EXPIRES 5-9-2021.

THE COLOR(S) YELLOW AND BLACK IS/ARE CLAIMED AS A FEATURE OF THE MARK.

THE NON-LATIN CHARACTERS IN THE MARK TRANSLITERATE TO ZHANG, HUA, SHI, JI, JIANG AND THIS MEANS THE CHINESE TIMEKEEPER IN ENGLISH.

THE MARK CONSISTS OF THE WORDING "THE CHINESE TIMEKEEPER CTK" REPRESENTED IN STYLIZED FONT IN THE COLOR YELLOW, FIVE NON-LATIN CHARACTERS IN THE COLOR YELLOW, WITH A STYLIZED DESIGN OF A CHINESE MAN WEARING A ROBE WALKING ON TOP OF A STYLIZED DESIGN OF AN OUTLINE OF A COG WHEEL IN THE COLOR YELLOW, AND ALL WITHIN A BLACK SQUARE.

SER. NO. 79-102,092, FILED 5-9-2011.



*David J. Kybas*

Director of the United States Patent and Trademark Office



**Reg. No. 4,196,432** WARREN L. OLANDRIA, EXAMINING ATTORNEY

# United States of America

United States Patent and Trademark Office



**Reg. No. 4,196,433**

**Registered Aug. 28, 2012**

**Int. Cl.: 43**

**SERVICE MARK**

**PRINCIPAL REGISTER**

ET&ZEUS INC. (REPUBLIC OF KOREA CORPORATION)  
#430, SEOUL AUTO GALLERY KEUM KWAN  
#217 YANGJAE-DONG, SEOCHO-GUSEOUL 137-130  
REPUBLIC OF KOREA

FOR: CANTEEN SERVICES; RESTAURANT SERVICES, ESPECIALLY FOR TOURISTS; BAR SERVICES PROVIDED AT A THEATER; BAR SERVICES PROVIDED AT A DANCE HALL; TEA ROOMS; RESTAURANTS; BUFFET RESTAURANTS; WESTERN STYLE RESTAURANTS; SELF-SERVICE RESTAURANTS; SNACK-BARS; CATERING; BAR SERVICES; JAPANESE RESTAURANTS; CHINESE RESTAURANTS; CAFE SERVICES; CAFETERIAS; COCKTAIL LOUNGE SERVICES; KOREAN BAR SERVICES; KOREAN RESTAURANTS, IN CLASS 43 (U.S. CLS. 100 AND 101).

NO CLAIM IS MADE TO THE EXCLUSIVE RIGHT TO USE THE NON-LATIN CHARACTERS THAT TRANSLITERATE TO BULGOGI, APART FROM THE MARK AS SHOWN.

PRIORITY DATE OF 4-28-2011 IS CLAIMED.

OWNER OF INTERNATIONAL REGISTRATION 1089536 DATED 5-4-2011, EXPIRES 5-4-2021.

THE COLOR(S) RED, YELLOW, WHITE AND BROWN IS/ARE CLAIMED AS A FEATURE OF THE MARK.

THE COLOR BROWN APPEARS IN THE WORDING "BULGOGI BROTHERS" IN KOREAN CHARACTERS, THE COLOR WHITE APPEARS IN THE WORDING "BB" INSIDE A CIRCLE IN RED; THE COLOR YELLOW APPEARS IN THE DESIGN OF THE FIRE FLAME INSIDE THE CIRCLE.

THE NON-LATIN CHARACTERS IN THE MARK TRANSLITERATE TO BULGOGI BROTHERS AND THIS MEANS "BARBECUED BEEF BROTHERS" IN ENGLISH.

SER. NO. 79-102,095, FILED 5-4-2011.

WARREN L. OLANDRIA, EXAMINING ATTORNEY



*David J. Kyffers*

Director of the United States Patent and Trademark Office

# United States of America

United States Patent and Trademark Office

## POEM EXPRESS

**Reg. No. 4,196,434**

**Registered Aug. 28, 2012**

**Int. Cl.: 41**

**SERVICE MARK**

**PRINCIPAL REGISTER**

STICHTING AUTOPED (NETHERLANDS NON PROFIT FOUNDATION (STICHTING))  
SCHIEHAVENKADE 166  
NL-3024 EZ ROTTERDAM  
NETHERLANDS

FOR: TEACHING IN THE FIELD OF POETRY, POEMS AND LITERATURE; ENTERTAINMENT SERVICES IN THE NATURE OF POETRY READINGS AND POETRY AND POEM COMPETITIONS; PROVIDING TRAINING IN THE FIELD OF POETRY, POEMS AND LITERATURE; ARRANGING AND CONDUCTING OF TRAINING, CLASSES AND TRAINING WORKSHOPS IN THE FIELD OF POETRY, POEMS AND LITERATURE; ARRANGING SPORTING AND CULTURAL ACTIVITIES, NAMELY, POETRY READINGS, POETRY AND POEM COMPETITIONS; ENTERTAINMENT IN THE NATURE OF DANCE PERFORMANCES, THEATRICAL PRODUCTIONS AND LIVE MUSICAL PERFORMANCES; ENTERTAINMENT IN THE NATURE OF LIVE CONCERTS; COMPOSING, PRODUCING, STAGING AND PERFORMING OF RADIO AND TELEVISION PROGRAMS; ARRANGING PARTIES AND EVENING SOCIAL EVENTS FOR ENTERTAINMENT PURPOSES; SERVICES OF A PUBLISHING HOUSE, NAMELY, PUBLISHING OF BOOK, MAGAZINES, POETRY AND POEMS; ARRANGING TRADE FAIRS AND EXHIBITIONS, OTHER THAN FOR COMMERCIAL OR ADVERTISING PURPOSES; ENTERTAINMENT SERVICES, NAMELY, ORGANIZING OF SPORTS AND CULTURAL COMPETITIONS AND PRIZE-GIVING CEREMONIES FOR SAID COMPETITIONS; PUBLISHING AND EDITING OF BOOKS, MAGAZINES AND OTHER PUBLICATIONS, NAMELY, BROCHURES, PAMPHLETS IN ELECTRONIC AND PRINTED FORM, IN CLASS 41 (U.S. CLS. 100, 101 AND 107).



THE MARK CONSISTS OF STANDARD CHARACTERS WITHOUT CLAIM TO ANY PARTICULAR FONT, STYLE, SIZE, OR COLOR.

PRIORITY DATE OF 3-17-2011 IS CLAIMED.

OWNER OF INTERNATIONAL REGISTRATION 1089597 DATED 6-29-2011, EXPIRES 6-29-2021.

NO CLAIM IS MADE TO THE EXCLUSIVE RIGHT TO USE "POEM", APART FROM THE MARK AS SHOWN.

SER. NO. 79-102,117, FILED 6-29-2011.

*David J. Kybas*

Director of the United States Patent and Trademark Office

**Reg. No. 4,196,434** LINDA E. BLOHM, EXAMINING ATTORNEY

# United States of America

United States Patent and Trademark Office

## MUGLER FOLLIES

**Reg. No. 4,196,435**

**Registered Aug. 28, 2012**

**Int. Cl.: 41**

**SERVICE MARK**

**PRINCIPAL REGISTER**

MUGLER MANFRED THIERRY C/O AKLEA SOCIÉTÉ D'AVOCATS (FRANCE INDIVIDUAL)  
71-73 AVENUE DES CHAMPS-ÉLYSÉES  
F-75008 PARIS  
FRANCE

FOR: EDUCATION NAMELY PROVIDING SEMINARS AND WORKSHOPS IN THE FIELD OF VISUAL ARTS, FILM PRODUCTION, STAGE PRODUCTION AND SCRIPTWRITING AT A UNIVERSITY AND POSTGRADUATE LEVEL; ENTERTAINMENT IN THE NATURE OF LIVE STAGE PRODUCTIONS, DANCE PERFORMANCES, LIVE PERFORMANCES BY MUSIC GROUPS, MAGIC SHOWS, THEATRICAL AND MUSICAL FLOOR SHOWS PROVIDED AT PERFORMANCE VENUES; RECORDING SERVICES FOR SOUNDS AND IMAGES IN THE NATURE OF FILMING, NAMELY AUDIO AND VIDEO RECORDING SERVICES, MULTIMEDIA ENTERTAINMENT SERVICES IN THE NATURE OF RECORDING, PRODUCTION AND POST-SERVICES IN THE FIELDS OF VIDEO, MUSIC AND FILMS, FILM PRODUCTION; SPORTING AND CULTURAL ACTIVITIES, NAMELY ENTERTAINMENT IN THE NATURE OF DANCE TRAINING AND PERFORMANCES, MUSICAL PERFORMANCES, THEATRE PRODUCTIONS, GYMNASTIC PERFORMANCES, IN CLASS 41 (U.S. CLS. 100, 101 AND 107).

THE MARK CONSISTS OF STANDARD CHARACTERS WITHOUT CLAIM TO ANY PARTICULAR FONT, STYLE, SIZE, OR COLOR.

PRIORITY DATE OF 10-20-2010 IS CLAIMED.

OWNER OF INTERNATIONAL REGISTRATION 1089659 DATED 4-8-2011, EXPIRES 4-8-2021.

NO CLAIM IS MADE TO THE EXCLUSIVE RIGHT TO USE "FOLLIES" , APART FROM THE MARK AS SHOWN.

SER. NO. 79-102,134, FILED 4-8-2011.

MICHAEL TANNER, EXAMINING ATTORNEY



*David J. Kyros*

Director of the United States Patent and Trademark Office

# United States of America

United States Patent and Trademark Office

# LEANPOWER

**Reg. No. 4,196,436**

LEANERGY SAS (FRANCE SOCIÉTÉ PAR ACTIONS SIMPLIFIÉE (SAS))

**Registered Aug. 28, 2012**

33 AVENUE DU MAINE  
F-75015 PARIS, FRANCE

**Int. Cl.: 9**

FOR: APPARATUS AND INSTRUMENTS FOR SWITCHING, REGULATING OR CONTROLLING ELECTRICITY, NAMELY, ELECTRIC SWITCHES, ELECTRIC CURRENT SWITCHES, VOLTAGE REGULATOR FOR ELECTRICAL CONTROLLERS, ELECTRIC BOXES ALLOWING TO REDUCE COST AND INCREASE QUALITY THROUGH BETTER ENERGY MANAGEMENT IN INDUSTRIAL POWER PLANT; COMPUTER SOFTWARE, RECORDED FOR USE IN REDUCING COST AND INCREASING QUALITY THROUGH BETTER ENERGY MANAGEMENT IN INDUSTRIAL POWER PLANT; MEASURING APPARATUS AND INSTRUMENTS, NAMELY, INSTRUMENTS FOR MEASURING LENGTH, VOLTAGE, CURRENT, TEMPERATURE, FORCE, TORQUE, PRESSURE, RADIATION, SPEED, POSITION, LIGHT, WEIGHT, DENSITY, VISCOSITY; CHECKING APPARATUS AND INSTRUMENTS, NAMELY, GRADUATION CHECKERS, IN CLASS 9 (U.S. CLS. 21, 23, 26, 36 AND 38).

**TRADEMARK**

**PRINCIPAL REGISTER**

PRIORITY DATE OF 1-28-2011 IS CLAIMED.

OWNER OF INTERNATIONAL REGISTRATION 1089726 DATED 7-27-2011, EXPIRES 7-27-2021.

SER. NO. 79-102,156, FILED 7-27-2011.

RON FAIRBANKS, EXAMINING ATTORNEY



*David J. Kyffers*

Director of the United States Patent and Trademark Office

# United States of America

United States Patent and Trademark Office

# DAILEE

**Reg. No. 4,196,437**

**Registered Aug. 28, 2012**

**Int. Cls.: 3, 5 and 16**

**TRADEMARK**

**PRINCIPAL REGISTER**

VYNKA BVBA (BELGIUM LIMITED LIABILITY COMPANY)  
BURGEMEESTER ETIENNE DEMUNTERLAAN 5  
B-1090 BRUSSEL, BELGIUM

FOR: SOAPS FOR BABY CARE AND FOR FEMININE HYGIENE; HAIR LOTIONS, HAIR BALSAM, HAIR CONDITIONERS, HAIR SHAMPOOS, HAIR GELS; SKIN CARE AND BODY CARE PRODUCTS, NAMELY, PRE-MOISTENED TOWELETTES FOR NON-MEDICAL HYGIENE PURPOSES; HAND CREAMS; SKIN CREAMS FOR BABY CARE; CREAMS FOR FEMININE HYGIENE AND FOR INDIVIDUALS WITH INCONTINENCE; FEMININE DEODORANT SPRAYS, FEMININE DEODORANT SUPPOSITORIES, FEMININE HYGIENE CLEANSING TOWELETTES, NON-MEDICATED FOOT LOTIONS, CLEANSING WIPES FOR BABY CARE; CLEANSING FOR FEMININE HYGIENE AND FOR INDIVIDUALS WITH INCONTINENCE; WIPES IMPREGNATED WITH CLEANSERS AND LOTIONS FOR THE SKIN; COTTON WOOL AND COTTON SWABS FOR PERSONAL HYGIENE; BODY LOTIONS FOR BABY CARE; BODY LOTIONS FOR FEMININE HYGIENE AND FOR INDIVIDUALS WITH INCONTINENCE; BODY SHAMPOOS FOR BABY CARE; BODY SHAMPOOS FOR FEMININE HYGIENE AND FOR INDIVIDUALS WITH INCONTINENCE; HAND LOTIONS FOR BABY CARE; TALCUM POWDER, BUBBLE BATH; DENTIFRICES, IN CLASS 3 (U.S. CLS. 1, 4, 6, 50, 51 AND 52).

FOR: PHARMACEUTICAL AND VETERINARY PREPARATIONS, NAMELY, MENSTRUAL SYMPTOM TREATMENT PREPARATIONS; SANITARY PREPARATIONS FOR MEDICAL PURPOSES, INCLUDING PREPARATIONS AND PRODUCTS FOR HEALTH CARE OR FOR HEALTH AND PERSONAL HYGIENE, NAMELY, VAGINAL MOISTURIZERS, VAGINAL ANTIFUNGAL PREPARATIONS, VAGINAL WASHES, BREAST PADS AND BREAST-NURSING PADS; SANITARY TOWELS, PANTY LINERS, TAMPONS, SANITARY PANTIES FOR MENSTRUATION; MEDICATED PRE-MOISTENED TOWELETTES FOR HYGIENE PURPOSES; DIAPERS FOR INCONTINENCE; INCONTINENCE PANTS; MEDICATED COTTON WOOL AND STICKS FOR BABY CARE, FOR FEMININE HYGIENE AND FOR INDIVIDUALS WITH INCONTINENCE; ABSORBENT COTTON FOR MEDICAL PURPOSES; FOOD FOR BABIES; MEDICAL PLASTERS, MATERIALS FOR DRESSINGS; DISINFECTANTS FOR HYGIENE PURPOSES, IN CLASS 5 (U.S. CLS. 6, 18, 44, 46, 51 AND 52).

FOR: PAPER AND CELLULOSE GOODS, NAMELY, FACE TOWELS AND HAND TOWELS OF PAPER, TOWELETTES AND DRYING TOWELS FOR ABSORBING BODILY FLUIDS OF PAPER, WIPES NOT IMPREGNATED WITH CHEMICALS OR COMPOUNDS FOR USE WITHIN THE FIELD OF INCONTINENCE, FEMININE HYGIENE AND BABY CARE; PAPER



*David J. Kyros*

Director of the United States Patent and Trademark Office

**Reg. No. 4,196,437** DRYING TOWELS FOR USE WITHIN THE FIELD OF INCONTINENCE, FEMININE HYGIENE AND BABY CARE; BABIES' DISPOSABLE DIAPERS; DISPOSABLE PADS FOR DIAPER CHANGING, DISPOSABLE PANTS OF PAPER AND CELLULOSE FOR ABSORBING BODILY FLUIDS; MOIST TOWELETTES OF PAPER AND OF CELLULOSE, IN CLASS 16 (U.S. CLS. 2, 5, 22, 23, 29, 37, 38 AND 50).

THE MARK CONSISTS OF STANDARD CHARACTERS WITHOUT CLAIM TO ANY PARTICULAR FONT, STYLE, SIZE, OR COLOR.

PRIORITY DATE OF 3-30-2011 IS CLAIMED.

OWNER OF INTERNATIONAL REGISTRATION 1077304 DATED 4-4-2011, EXPIRES 4-4-2021.

THE WORDING "DAILEE" HAS NO MEANING IN A FOREIGN LANGUAGE.

SER. NO. 79-102,211, FILED 8-4-2011.

LINDA MICKLEBURGH, EXAMINING ATTORNEY



# United States of America

United States Patent and Trademark Office

# TRACPAK

**Reg. No. 4,196,438**

**Registered Aug. 28, 2012**

**Int. Cl.: 7**

**TRADEMARK**

**PRINCIPAL REGISTER**

DENSO MARSTON LTD. (UNITED KINGDOM LIMITED LIABILITY COMPANY)  
OTLEY ROAD  
SHIPLEY;  
WEST YORKSHIRE BD17 7JR, UNITED KINGDOM

FOR: COOLING APPARATUS FOR MACHINES AND MOTORS, NAMELY, RADIATORS FOR ENGINE COOLING IN AGRICULTURAL AND CONSTRUCTION VEHICLES; CHARGE AIR COOLERS, NAMELY, INTERCOOLERS FOR TURBO-CHARGED AIR IN ENGINES, OIL COOLERS, FUEL COOLERS, HYDRAULIC OIL COOLERS AND TRANSMISSION OIL COOLERS; CONDENSERS FOR COOLING REFRIGERANT IN AIR-CONDITIONING CIRCUITS IN AGRICULTURAL AND CONSTRUCTION VEHICLES, NAMELY, AIR CONDENSERS AND AXIAL FAN CONDENSERS; COOLING FINS FOR RADIATORS, CHARGE AIR COOLERS, OIL COOLERS AND CONDENSERS, ALL BEING PARTS OF MACHINES OR MOTORS; PARTS AND FITTINGS FOR ALL THE AFORESAID GOODS, IN CLASS 7 (U.S. CLS. 13, 19, 21, 23, 31, 34 AND 35).

THE MARK CONSISTS OF STANDARD CHARACTERS WITHOUT CLAIM TO ANY PARTICULAR FONT, STYLE, SIZE, OR COLOR.

OWNER OF INTERNATIONAL REGISTRATION 1090000 DATED 8-9-2011, EXPIRES 8-9-2021.

SER. NO. 79-102,286, FILED 8-9-2011.

SAIMA MAKHDOOM, EXAMINING ATTORNEY



*David J. Kyros*

Director of the United States Patent and Trademark Office

# United States of America

## United States Patent and Trademark Office



**Reg. No. 4,196,439**

**Registered Aug. 28, 2012**

**Int. Cls.: 35 and 38**

**SERVICE MARK**

**PRINCIPAL REGISTER**

GRUPE FRANCOIS BERNARD, SAS (FRANCE SOCIÉTÉ PAR ACTIONS SIMPLIFIÉE)  
27 RUE DE LA COUDRAIE  
F-79004 NIORT CEDEX  
FRANCE

FOR: ADVERTISING SERVICES; ONLINE ADVERTISING ON A COMPUTER NETWORK; RENTAL OF ADVERTISING TIME ON COMMUNICATION MEDIA; PUBLICATION OF PUBLICITY TEXTS; DISSEMINATION OF ADVERTISING MATTER, IN CLASS 35 (U.S. CLS. 100, 101 AND 102).

FOR: TELECOMMUNICATION SERVICES, NAMELY, PROVIDING USER ACCESS TO GLOBAL COMPUTER NETWORKS, COMMUNICATIONS BY COMPUTER TERMINALS OR SMART PHONES; ELECTRONIC MAIL; TRANSMISSION OF DATA, GRAPHIC AND VIDEO BY MEANS OF BROADBAND FIBER-OPTIC OR WIRELESS NETWORKS, IN CLASS 38 (U.S. CLS. 100, 101 AND 104).

NO CLAIM IS MADE TO THE EXCLUSIVE RIGHT TO USE "SPORT", APART FROM THE MARK AS SHOWN.

PRIORITY DATE OF 5-10-2011 IS CLAIMED.

OWNER OF INTERNATIONAL REGISTRATION 1090175 DATED 7-25-2011, EXPIRES 7-25-2021.

THE MARK CONSISTS OF THE STYLIZED WORDING "DEEP' ON SPORT CRÉEZ L'ÉVÈNEMENT" AND A DESIGN COMPRISING AN IMPLoding GOLF BALL, A SPORTS NET, AND A FLATTENED DEPICTION OF THE CONTINENTS.

THE ENGLISH TRANSLATION OF "CRÉEZ L'ÉVÈNEMENT" IN THE MARK IS "CREATE THE EVENT".

SER. NO. 79-102,354, FILED 7-25-2011.

PATRICIA EVANKO, EXAMINING ATTORNEY



*David J. Kappas*

Director of the United States Patent and Trademark Office

# United States of America

United States Patent and Trademark Office

# LFT

**Reg. No. 4,196,440**

**Registered Aug. 28, 2012**

**Int. Cls.: 18 and 25**

**TRADEMARK**

**PRINCIPAL REGISTER**

INDUSTRIA DE DISEÑO TEXTIL, S.A. (INDITEX, S.A.) (SPAIN SOCIEDAD ANÓNIMA)  
AVENIDA DE LA DIPUTACIÓN,  
EDIFICIO INDITEX.; E-15142 ARTEIXO (A CORUÑA)  
SPAIN

FOR: LEATHER AND IMITATIONS OF LEATHER, GOODS MADE OF THESE MATERIALS NOT INCLUDED IN OTHER CLASSES, NAMELY, ANIMAL SKINS, HIDES, LUGGAGE TRUNKS AND TRAVELLING BAGS; UMBRELLAS, PARASOLS AND WALKING STICKS; WHIPS, HARNESSES AND SADDLERY; BEACH BAGS; BACKPACKS AND DUFFLE BAGS; HANDBAG FRAMES; FRAMES FOR UMBRELLAS OR PARASOLS; MOUNTAINEERING STICKS; ALL-PURPOSE CARRYING BAGS, SPORT BAGS AND ATHLETIC BAGS; HANDBAGS; LEATHER CRAFTED TRAVEL AND KEY CASES; BRIEFCASES; PURSES NOT MADE OF PRECIOUS METAL; SCHOOL SACHELS; HAT BOXES OF LEATHER; SLING BAGS FOR CARRYING INFANTS; WHEELED SHOPPING BAGS; CONTAINERS AND BOXES OF LEATHER OR LEATHER BOARD, NAMELY, LEATHER OR LEATHER-BOARD BOXES; BOXES OF VULCANIZED FIBER, NAMELY, CASES OF IMITATION LEATHER; SCHOOL BAGS; POCKET WALLETS; BRIEFCASES; UNFITTED VANITY CASES; ANIMAL COLLARS; LEATHER LEASHES; LEATHER LACES; UMBRELLA COVERS; SADDLE CLOTHS FOR HORSES; RUCKSACKS; HORSE BLANKETS; HAVERSACKS; HORSE HALTERS; ENVELOPE AND POUCH BAGS, NAMELY, LEATHER POUCHES AND BAGS FOR PACKAGING; RIDING SADDLES; PADS FOR HORSE SADDLES; UMBRELLA RINGS; HARNESS, NAMELY, BLINKERS FOR HORSES; HARNESS FITTINGS OF IRON; HARNESSES FOR ANIMALS; WALKING STICK SEATS; STRAPS, NAMELY, LEATHER SHOULDER BELTS; UNFITTED LEATHER TOOL BAGS SOLD EMPTY; CHAIN MESH PURSES NOT OF PRECIOUS METAL; MUZZLES; HARNESSING BRIDLES; HEAD-STALLS; LEATHER STRAPS; TRAVELLING TRUNKS; SHOPPING BAGS; STRAPS FOR SOLDIERS' EQUIPMENT, NAMELY, DUFFLE BAGS; HARNESS TRACES; LEATHER THONGS; STRAPS FOR SKATES, NAMELY, LEATHER STRAPS; LEATHER STRAPS; BUTTS, NAMELY, ANIMAL HIDES; CURRIED SKINS, NAMELY, ANIMAL SKINS; GARMENT BAGS FOR TRAVEL; LEATHER STIRRUPS; HARNESS, NAMELY, BITS FOR ANIMALS; REINS; SMALL SUITCASES; IMITATION LEATHER, NAMELY, MOLESKIN; FUR SOLD IN BULK; SKINS OF CHAMOIS, OTHER THAN FOR CLEANING PURPOSES, NAMELY, RAW SKINS; FEED BAGS FOR ANIMALS; MESH SHOPPING BAGS; HORSE TACK, NAMELY, CASINGS OF LEATHER FOR SPRINGS, KNEE-PADS FOR HORSES, AND FASTENINGS GIRTHS AND SADDLES; CASES FOR BUSINESS CARDS; HARNESS STRAPS; LEATHER VALVES, NAMELY, UNWORKED LEATHER; STIRRUPS, IN CLASS 18 (U.S. CLS. 1, 2, 3, 22 AND 41).



*David J. Kappas*

Director of the United States Patent and Trademark Office

**Reg. No. 4,196,440** FOR: READY-TO-WEAR CLOTHING FOR MEN, WOMEN AND CHILDREN, NAMELY, BLOUSES, TROUSERS, JEANS, TIGHTS, BELTS AND JEGGINGS; FOOTWEAR EXCEPT ORTHOPEDIC FOOTWEAR; HEADWEAR; CLOTHING FOR MOTORISTS AND CYCLISTS, NAMELY, JACKETS, FOOTWEAR, PANTS AND GLOVES; BIBS, NOT OF PAPER; HEADBANDS; DRESSING GOWNS; SWIMSUITS; BATHING CAPS AND SANDALS; BOAS; LINGERIE; BABIES PANTS; SCARVES; SPORTS AND BEACH FOOTWEAR; HOODS; SHAWLS; MONEY BELTS; WETSUITS FOR WATER SKIING; NECKTIES; CORSETS; SASHES FOR WEAR; FUR STOLES; LINGERIE GIRDLES; FOULARDS; HEADGEAR, NAMELY, CAPS AND STIFF CAPS; GLOVES; WATERPROOF CLOTHING, NAMELY, FOOTWEAR, JACKETS AND PANTS; UNDERCLOTHING, NAMELY, BRAS, UNDERPANTS AND PANTIES; HEAD SCARVES; STOCKINGS; SOCKS; NECKERCHIEFS; CLOTH DIAPERS; POCKET KERCHIEFS; FURS, NAMELY, FUR COATS, JACKETS, STOLES, HATS AND MUFFS; PAJAMAS; SOLES; HEELS; VEILS; SUSPENDERS; PAPER CLOTHING, NAMELY, PAPER HATS FOR USE AS CLOTHING ITEMS AND PAPER SHOES WORN TO PASS THROUGH METAL DETECTORS; GYMNASTIC AND SPORTS OUTFITS, NAMELY, UNIFORMS; LAYETTES; COLLARS; JERSEYS; MITTENS; EAR MUFFS; INNER SOLES; BOW TIES; PAREUS; CUFFS FOR CLOTHING; DRESS SHIELDS; MASQUERADE COSTUMES; BEACH CLOTHES, NAMELY, BATHING SUITS; HEADWEAR, NAMELY, CAP VISORS; DRESSING GOWNS; POCKETS FOR CLOTHING, NAMELY, POCKET SQUARES; SOCK SUSPENDERS; PETTICOATS; COMPLETE STOCKINGS OR LEOTARDS, NAMELY, TIGHTS; APRONS; HEADDRESSES, NAMELY, HEADWEAR; WOODEN SHOES; HEAD COVERINGS, NAMELY, HATS; GARTERS; COATS; ESPADRILLES; NON SLIPPING DEVICES FOR BOOTS, NAMELY, NON-SLIP SOLES FOR FOOTWEAR; BATH ROBES; BATH SLIPPERS; TOQUES; OVERALLS; BERETS; NON ELECTRICALLY HEATED MUFFS FOR FEET; HEAVY DUTY BOOTS; BOOTS; BOOT UPPERS, NAMELY, BOOTS SOLD WITHOUT SOLES; STUDS FOR FOOTBALL SHOES; HALF-BOOTS, NAMELY, ANKLE BOOTS; IRON FITTINGS FOR SHOES, NAMELY, CLEATS FOR ATTACHMENT TO SPORTS SHOES; TIPS FOR FOOTWEAR; WELTS FOR BOOTS; HEEL REINFORCEMENTS, NAMELY, HEEL PIECES FOR SHOES; BRIEFS AND PANTS; SHIRTS; SHIRT YOKES; SHIRT FRONTS; SHORT-SLEEVED SHIRTS; CAMISOLES; VESTS; JACKETS; FISHING JACKETS; HEAVY JACKETS; COMBINATIONS AND COMBINATION UNDERWEAR; DETACHABLE COLLARS; COLLARS; LEATHER CLOTHING AND IMITATION LEATHER CLOTHING, NAMELY, JACKETS, PANTS, BOOTS, BELTS, GLOVES, COATS, SKIRTS AND VESTS; SHOWER CAPS; SLIPPERS; SKIRTS; READY-MADE LININGS, NAMELY, FINISHED TEXTILE LININGS FOR GARMENTS; OVERCOATS; GABARDINES; GYMNASTIC SHOES; JERSEYS; PULLOVERS; SWEATERS; LIVERIES; MUFFS; PARKAS; PELERINES; PELISSES; LEGGINGS; LEG PROTECTORS, NAMELY, LEG WARMERS; KNITWEAR AND KNITTED CLOTHING, NAMELY, SWEATERS, DRESSES, JACKETS, GLOVES, SCARVES, CAPS, TIGHTS AND SOCKS; GYMNASTIC CLOTHING, NAMELY, SHORTS, LEOTARDS, SHOES, TIGHTS AND CARDIGANS; OUTER CLOTHING, NAMELY, JACKETS, COATS, GABARDINES, PONCHOS, CAPES, PARKAS AND RAINCOATS; SANDALS; SARIS; PANTIES AND UNDERPANTS; HATS; BRASSIERES; WIMPLES FOR CLOTHING; TOGAS; TROUSER STRAPS; SUITS; TURBANS; DRESSES; SLIPPERS; SPORT SHOES; PANTS , IN CLASS 25 (U.S. CLS. 22 AND 39).

THE MARK CONSISTS OF STANDARD CHARACTERS WITHOUT CLAIM TO ANY PARTICULAR FONT, STYLE, SIZE, OR COLOR.

OWNER OF INTERNATIONAL REGISTRATION 1090326 DATED 3-25-2011, EXPIRES 3-25-2021.

SER. NO. 79-102,408, FILED 3-25-2011.

ESTHER BELENKER, EXAMINING ATTORNEY

# United States of America

United States Patent and Trademark Office



**Reg. No. 4,196,441**

**Registered Aug. 28, 2012**

**Int. Cl.: 32**

**TRADEMARK**

**PRINCIPAL REGISTER**

KINGS DRINK GMBH (AUSTRIA PRIVATE LIMITED COMPANY)  
GOLDSCHMIEDGASSE 6/6-8  
A-1010 WIEN, AUSTRIA

FOR: AERATED WATERS, NON-ALCOHOLIC DRINKS, NAMELY, FLAVORED SOFT DRINKS; SYRUPS FOR BEVERAGES, FRUIT DRINKS, IN CLASS 32 (U.S. CLS. 45, 46 AND 48).

NO CLAIM IS MADE TO THE EXCLUSIVE RIGHT TO USE "DRINK", APART FROM THE MARK AS SHOWN.

PRIORITY DATE OF 6-22-2011 IS CLAIMED.

OWNER OF INTERNATIONAL REGISTRATION 1090376 DATED 6-22-2011, EXPIRES 6-22-2021.

THE COLOR(S) BLACK, WHITE, ORANGE, GOLD, YELLOW, RED AND DARK RED IS/ARE CLAIMED AS A FEATURE OF THE MARK.

THE MARK CONSISTS OF A DESIGN OF A CROWN IN THE COLORS GOLD, ORANGE, RED AND DARK RED WITH WHITE AND YELLOW HIGHLIGHTING. UNDERNEATH OF THE CROWN DESIGN IS THE WORDING "KINGS" IN ORANGE, YELLOW AND WHITE FOLLOWED BY THE WORDING "DRINK" IMMEDIATELY UNDERNEATH IN ORANGE, YELLOW AND WHITE. ALL OF WHICH ARE SUPERIMPOSED ON A BLACK RECTANGLE.

SER. NO. 79-102,423, FILED 6-22-2011.

HAI-LY LAM, EXAMINING ATTORNEY



*David J. Kybas*

Director of the United States Patent and Trademark Office

# United States of America

United States Patent and Trademark Office

# 3B

**Reg. No. 4,196,442**

**Registered Aug. 28, 2012**

**Int. Cls.: 29, 30, 31, 32,  
33 and 43**

**TRADEMARK**

**SERVICE MARK**

**PRINCIPAL REGISTER**

3 BRASSEURS INTERNATIONAL (FRANCE SOCIÉTÉ PAR ACTIONS SIMPLIFIÉE)  
RUE VAN GOGH -  
IMMEUBLE PÉRICNETREF-59650 VILLENEUVE D'ASCQ  
FRANCE

FOR: MEAT, FISH, POULTRY AND GAME; MEAT EXTRACTS; CHARCUTERIE; PRESERVED, DRIED AND COOKED FRUITS AND VEGETABLES; TINNED VEGETABLES; JELLIES, JAMS, COMPOTES; EGGS; EDIBLE OILS AND FATS; BUTTER; CHEESE; DAIRY PRODUCTS, NAMELY, CREAM; YOGHURTS; FRUIT PULP AND GARDEN SALADS; JELLIES FOR FOOD; HAM; SAUSAGES, PREPARED, FROZEN AND PACKAGED ENTREES CONSISTING PRIMARILY OF FISH, POULTRY, OR MEAT; COOKED DISHES PREPARED CONSISTING PRIMARILY OF FISH, POULTRY OR MEAT, IN CLASS 29 (U.S. CL. 46).

FOR: COFFEE, TEA, COCOA, SUGAR, RICE, TAPIOCA, SAGO; ARTIFICIAL COFFEE; FLOURS, READY TO EAT CEREALS; BREAD; PASTRY; EDIBLE ICES; HONEY, TREACLE; YEAST, BAKING-POWDER; SALT, MUSTARD; VINEGAR; CONDIMENTS, NAMELY, SAUCES; SPICES; ICE FOR REFRESHMENT; COCOA BASED BEVERAGES; BEVERAGES MADE WITH COFFEE; BEVERAGES MADE WITH A CHOCOLATE BASE; BISCUITS; BUNS; CHOCOLATE; PANCAKES; KETCHUP; MAYONNAISE; PIZZAS; SANDWICHES; COOKED DISHES PREPARED CONSISTING PRIMARILY OF CHOCOLATE, COCOA, COFFEE, IN CLASS 30 (U.S. CL. 46).

FOR: NATURAL PLANTS AND FLOWERS; MALT FOR BREWING AND DISTILLING, IN CLASS 31 (U.S. CLS. 1 AND 46).

FOR: BEER; MINERAL AND AERATED WATERS; NON-ALCOHOLIC BEER; FRUIT DRINKS AND FRUIT JUICES; SYRUPS FOR MAKING BEVERAGES; NON ALCOHOLIC COCKTAILS; LEMONADES; MALT BEER; MALT WORT, IN CLASS 32 (U.S. CLS. 45, 46 AND 48).

FOR: ALCOHOLIC BEVERAGES, EXCEPT BEER; ALCOHOLIC BEVERAGES CONTAINING FRUIT; DISTILLED BEVERAGES, NAMELY, SPIRITS; SPIRITS; WINE, IN CLASS 33 (U.S. CLS. 47 AND 49).

FOR: BAR SERVICES; CAFÉS; CAFETERIAS; SELF-SERVICE RESTAURANTS; HOTELS; FOOD AND DRINK CATERING; SNACK-BARS, NAMELY, FAST-FOOD RESTAURANTS AND SNACK BARS, IN CLASS 43 (U.S. CLS. 100 AND 101).



*David J. Kybas*

Director of the United States Patent and Trademark Office

**Reg. No. 4,196,442** THE MARK CONSISTS OF THE WORDING "3B" IN A STYLIZED FONT.

PRIORITY DATE OF 2-7-2011 IS CLAIMED.

OWNER OF INTERNATIONAL REGISTRATION 1090401 DATED 7-29-2011, EXPIRES 7-29-2021.

SER. NO. 79-102,432, FILED 7-29-2011.

DANIEL CAPSHAW, EXAMINING ATTORNEY

# United States of America

United States Patent and Trademark Office



**Reg. No. 4,196,443**

**Registered Aug. 28, 2012**

**Int. Cl.: 11**

SHANGHAI SANDEN BEHR AUTOMOTIVE AIR CONDITIONING CO., LTD. (CHINA  
LIMITED LIABILITY COMPANY)  
347 MA DANG RD  
200025 SHANGHAI  
CHINA

**TRADEMARK**

**PRINCIPAL REGISTER**

FOR: AUTOMOTIVE AIR CONDITIONING APPARATUS; AUTOMOTIVE AIR WARMERS, NAMELY, ELECTRIC HEATING FANS; COOLING SYSTEMS, NAMELY, COOLING RADIATORS FOR MOTORS AND ENGINES; COOLING MACHINES, NAMELY, REFRIGERATING MACHINES; RADIATOR COVERS; AUTOMOTIVE AIR CONDITIONING FILTERS; AUTOMOTIVE AIR CONDITIONING DRIERS; AUTOMOTIVE AIR CONDITIONING FANS FOR ADJUSTING AIR; AUTOMOTIVE AIR CONDITIONING CONDENSERS, NAMELY, GAS CONDENSERS, OTHER THAN PARTS OF MACHINES, IN CLASS 11 (U.S. CLS. 13, 21, 23, 31 AND 34).

THE MARK CONSISTS OF THE STYLIZED LETTERS "SSB" ON A LIGHT BACKGROUND WITHIN A DARK HORIZONTAL OVAL WHICH IN TURN IS SUPERIMPOSED OVER A LIGHT CIRCLE WHICH IN TURN IS SUPERIMPOSED OVER A DARK SQUARE.

OWNER OF INTERNATIONAL REGISTRATION 1090597 DATED 8-16-2011, EXPIRES 8-16-2021.

SER. NO. 79-102,491, FILED 8-16-2011.

TASNEEM HUSSAIN, EXAMINING ATTORNEY



*David J. Kybas*

Director of the United States Patent and Trademark Office



United States of America  
United States Patent and Trademark Office

**ENSITU**

**Reg. No. 4,196,444**

**Registered Aug. 28, 2012**

**Int. Cl.: 9**

ENOTEC GMBH PROZESS- UND UMWELTMESSTECHNIK (FED REP GERMANY  
GESELLSCHAFT MIT BESCHRÄNKTER HAFTUNG)  
HÖHER BIRKEN 6  
51709 MARIENHEIDE  
FED REP GERMANY

**TRADEMARK**

FOR: MEASURING APPARATUS AND INSTRUMENTS, NAMELY, GAS SENSORS, IN  
CLASS 9 (U.S. CLS. 21, 23, 26, 36 AND 38).

**PRINCIPAL REGISTER**

THE MARK CONSISTS OF STANDARD CHARACTERS WITHOUT CLAIM TO ANY PAR-  
TICULAR FONT, STYLE, SIZE, OR COLOR.

PRIORITY DATE OF 2-24-2011 IS CLAIMED.

OWNER OF INTERNATIONAL REGISTRATION 1090601 DATED 8-15-2011, EXPIRES 8-15-  
2021.

SER. NO. 79-102,494, FILED 8-15-2011.

EMILY CARLSEN, EXAMINING ATTORNEY



*David J. Kyffers*

Director of the United States Patent and Trademark Office

# United States of America

United States Patent and Trademark Office



## WHYWIN

**Reg. No. 4,196,445**

**Registered Aug. 28, 2012**

**Int. Cls.: 24 and 25**

**TRADEMARK**

**PRINCIPAL REGISTER**

ANHUI WHYWIN INTERNATIONAL CO., LTD. (CHINA LIMITED COMPANY)  
NO.1 YUE JIN ROAD,  
HEFEI; ANHUI PROVINCE  
CHINA

FOR: CLOTH, NAMELY, SILK CLOTH, WOOL YARN FABRICS, COTTON FABRICS, TOWELS OF TEXTILE, BED COVERS, QUILT, BED BLANKET, TABLE CLOTHS NOT OF PAPER, FURNITURE COVERINGS MADE OF PLASTIC MATERIALS, IN CLASS 24 (U.S. CLS. 42 AND 50).

FOR: CLOTHES, NAMELY, SHIRT, SWEATER, DUST COAT, PANTS AND SPORT COAT, A FULL SET OF BABY CLOTHES, NAMELY, PANTS AND SHIRTS, SHOES, HEADGEAR, NAMELY, HATS AND CAPS, SOCKS, GLOVES AS CLOTHING, SHAWL, SCARF, TIE, WEDDING DRESS, IN CLASS 25 (U.S. CLS. 22 AND 39).

THE MARK CONSISTS OF WORDING "WHYWIN" IN STYLIZED FONT WITH THE DESIGN OF A CIRCLE AND SPIRAL IN THE SHAPE OF A "W".

OWNER OF INTERNATIONAL REGISTRATION 1090643 DATED 8-2-2011, EXPIRES 8-2-2021.

SER. NO. 79-102,505, FILED 8-2-2011.

WILLIAM ROSSMAN, EXAMINING ATTORNEY



*David J. Kyffers*

Director of the United States Patent and Trademark Office

# United States of America

United States Patent and Trademark Office

# TROTEC

**Reg. No. 4,196,446**

**Registered Aug. 28, 2012**

**Int. Cls.: 10, 17, 37 and  
40**

**TRADEMARK**

**SERVICE MARK**

**PRINCIPAL REGISTER**

TRODAT GMBH (AUSTRIA LIMITED LIABILITY COMPANY)  
LINZER STRASSE 156  
A-4600 WELS  
AUSTRIA

FOR: LASERS FOR SURGICAL AND MEDICAL PURPOSES; COMPUTER CONTROLLED LASERS FOR SURGICAL AND MEDICAL PURPOSES; LASERS FOR SURGICAL AND MEDICAL USE; COMPUTER CONTROLLED LASERS FOR SURGICAL AND MEDICAL USE; LASERS FOR THE COSMETIC TREATMENT OF THE FACE AND SKIN; PARTS OF THE AFOREMENTIONED LASERS, IN CLASS 10 (U.S. CLS. 26, 39 AND 44).

FOR: PLATES AND LAMINATED PLATES OF RUBBER, GUTTA-PERCHA, GUM; GOODS MADE FROM RUBBER, GUTTA-PERCHA OR GUM USED FOR INSCRIBING, ENGRAVING AND MARKING, IN PARTICULAR LASER ENGRAVING AND LASER MARKING, NAMELY, UNVULCANIZED LASER ENGRAVING RUBBER COMPOUND AND TEXT PLATES FOR STAMPS; PLASTIC IN EXTRUDED FORM FOR GENERAL INDUSTRIAL USE; PLATES OF SYNTHETIC PLASTIC AS SEMI-FINISHED PRODUCTS; PLASTIC LAMINATED SHEETS AND PANELS USED FOR LASER ENGRAVING AND LASER MARKING, IN CLASS 17 (U.S. CLS. 1, 5, 12, 13, 35 AND 50).

FOR: INSTALLATION, MAINTENANCE AND REPAIR OF ENGRAVING MACHINES AND OF LASERS FOR THE TREATMENT OF MATERIALS; INSTALLATION, MAINTENANCE AND REPAIR OF SURGICAL, MEDICAL AND COSMETIC LASERS; INSTALLATION, MAINTENANCE AND REPAIR OF CONTROL DEVICES FOR THE AFOREMENTIONED GOODS, IN CLASS 37 (U.S. CLS. 100, 103 AND 106).

FOR: TREATMENT OF MATERIALS, NAMELY, LASER TREATMENT OF MATERIALS, NAMELY, THE STAMPING SURFACE OF STAMP PLATES; LASER INSCRIBING, CUTTING, ENGRAVING AND MARKING OF MATERIALS, NAMELY, RUBBER, GUTTA-PERCHA, GUM, WOOD, GLASS, LEATHER, PLASTIC OR PLASTIC LAMINATES, IN CLASS 40 (U.S. CLS. 100, 103 AND 106).

THE MARK CONSISTS OF STANDARD CHARACTERS WITHOUT CLAIM TO ANY PARTICULAR FONT, STYLE, SIZE, OR COLOR.

PRIORITY DATE OF 7-30-2010 IS CLAIMED.



*David J. Kyjars*

Director of the United States Patent and Trademark Office

**Reg. No. 4,196,446** OWNER OF INTERNATIONAL REGISTRATION 1090853 DATED 12-21-2010, EXPIRES 12-21-2020.

OWNER OF U.S. REG. NO. 2,356,500.

SER. NO. 79-102,610, FILED 12-21-2010.

TINA MAI, EXAMINING ATTORNEY

# United States of America

United States Patent and Trademark Office



**Reg. No. 4,196,447**

**Registered Aug. 28, 2012**

**Int. Cl.: 9**

**TRADEMARK**

**PRINCIPAL REGISTER**

BITDEFENDER IPR MANAGEMENT LTD (CYPRUS LIMITED COMPANY)  
KREONTOS 12  
CY-1076 NICOSIA  
CYPRUS

FOR: ANTI-MALWARE SOFTWARE APPLICATIONS, COMPUTER SOFTWARE FOR PROVIDING NETWORK, INTERNET, AND COMPUTER SECURITY, COMPUTER SOFTWARE FOR PROVIDING ONLINE IDENTITY PROTECTION AND PARENTAL CONTROL, COMPUTER SOFTWARE FOR SCANNING, DETECTING, AND REMOVING VIRUSES, WORMS, TROJAN HORSES, ADWARE, SPYWARE, AND OTHER MALWARE; INTERNET SECURITY SOFTWARE, NAMELY, COMPUTER SOFTWARE FOR USE IN THE MONITORING AND CONTROL OF COMPUTER AND ONLINE ACTIVITY, FRAUD PROTECTION SOFTWARE, COMPUTER OPTIMIZATION SOFTWARE, COMPUTER SOFTWARE TO PREVENT, DIAGNOSE, AND REPAIR COMPUTER PROBLEMS, COMPUTER SOFTWARE FOR THE BACK-UP, STORAGE, RESTORATION AND RECOVERY OF DATA, FOLDERS, AND FILES, ENTERPRISE SECURITY SOFTWARE; FIRE WALL SOFTWARE; PRIVACY CONTROL SOFTWARE; CONTENT FILTERING SOFTWARE, COMPUTER SOFTWARE FOR THE CREATION OF VIRTUAL PRIVATE NETWORK, UTILITY SOFTWARE FOR FACILITATING COMPUTER USE AT REMOTE LOCATIONS AND FOR FACILITATING COMMUNICATIONS AMONG MOBILE USERS OVER NETWORKS, COMPUTER SOFTWARE FOR USE IN UP-DATING OTHER COMPUTER SOFTWARE, COMPUTER SOFTWARE FOR CONNECTING REMOTE COMPUTERS AND FOR PROVIDING ANTI-MALWARE PROTECTION FOR NETWORKING APPLICATIONS, COMPUTER SOFTWARE FOR SYNCHRONIZATION OF FILES THROUGH E-MAIL, COMPUTER SOFTWARE FOR PROVIDING SECURITY TO REMOTE COMPUTER USERS; COMPUTER SOFTWARE FOR IMPLEMENTING COMPUTER SOFTWARE NETWORK SECURITY MEASURES FOR REMOTE COMPUTER USERS, COMPUTER SOFTWARE FOR FILE MANAGEMENT AND TRANSFER, COMPUTER SOFTWARE FOR PROVIDING FIREWALLS, CONTENT FILTERING, INTRUSION ALERT, VIRUS PROTECTION, VIRTUAL PRIVATE NETWORKING AND OTHER SECURITY FUNCTIONS, COMPUTER SOFTWARE FOR FILE SERVER STORAGE MANAGEMENT, COMPUTER SOFTWARE FOR USE IN FILE, DISK AND SYSTEMS MANAGEMENT; COMPUTER SOFTWARE FOR DATA STORAGE MANAGEMENT IN STORAGE AREA NETWORKS; COMPUTER SOFTWARE FOR USE IN DATA STORAGE MANAGEMENT AND STORAGE AREA NETWORKS; COMPUTER SOFTWARE FOR BACKING UP AND RESTORING COMPUTER DATA; COMPUTER SOFTWARE FOR MONITORING, IDENTIFYING, AND RECTIFYING FILE, DISK, SYSTEM, AND COMPUTER NETWORK PROBLEMS AND ERRORS; COMPUTER SOFTWARE FOR GENERATING REPORTS FROM DATABASES,



*David J. Kybas*

Director of the United States Patent and Trademark Office

**Reg. No. 4,196,447** COMPUTER SOFTWARE FOR SCHEDULING AUTOMATED PROCESSES; COMPUTER PROGRAMS FOR CENTRAL MANAGEMENT OF COMPUTERS ATTACHED TO A COMPUTER NETWORK; COMPUTER SOFTWARE FOR REPLICATING AND ARCHIVING FILES FROM ONE DATA STORE TO ANOTHER; COMPUTER PROGRAMS FOR ENCRYPTION AND AUTHENTICATION OF ELECTRONIC INFORMATION FOR USE IN DATA COMMUNICATIONS APPLICATIONS, COMPUTER PROGRAMS FOR USE IN THE FIELD OF COMPUTER SYSTEM ADMINISTRATION, NAMELY, PROGRAMS FOR THE ADMINISTRATION AND MANAGEMENT OF COMPUTER PROGRAMS AND ELECTRONIC DATA ABOUT COMPUTER SYSTEMS, COMPUTER PROGRAMS FOR MANAGING THE SOFTWARE CONFIGURATIONS OF COMPUTER SYSTEMS AND COMPUTER NETWORKS; COMPUTER PROGRAMS FOR THE SENDING AND RECEIVING OF COMPUTER SOFTWARE ACROSS A COMPUTER NETWORK TO ACCOMPLISH SOFTWARE DISTRIBUTION AND COMPUTER PROGRAMS FOR INSTALLING AND UPGRADING OTHER COMPUTER SOFTWARE WITHOUT MANUAL USER INTERVENTION; COMPUTER PROGRAMS FOR COPYING DATA FROM ONE ELECTRONIC STORAGE MEDIUM TO ANOTHER ELECTRONIC STORAGE MEDIUM; EMBEDDED SOFTWARE FOR NETWORK MONITORING AND SECURITY, IN CLASS 9 (U.S. CLS. 21, 23, 26, 36 AND 38).

THE MARK CONSISTS OF A THREE DIMENSIONAL DEVICE IN THE FORM OF A STYLIZED MYTHOLOGICAL ANIMAL CONSISTING OF A WOLF HEAD WITH SILVER EYES AND A SNAKE TAIL HAVING THREE SEGMENTS, ALL MADE OF SHINY BLACK MATERIAL; ON ITS SIDES; IT HAS A RED MATERIAL WITH HOLES, RESEMBLING TO A NET.

PRIORITY DATE OF 5-23-2011 IS CLAIMED.

OWNER OF INTERNATIONAL REGISTRATION 1090871 DATED 6-17-2011, EXPIRES 6-17-2021.

THE COLOR(S) BLACK, RED AND SILVER IS/ARE CLAIMED AS A FEATURE OF THE MARK.

THE THREE-DIMENSIONAL TRADEMARK IS A STYLIZED MYTHOLOGICAL ANIMAL CONSISTING OF A WOLF HAND, WITH A SNAKE TAIL HAVING THREE SEGMENTS, ALL MADE OF A SHINY BLACK MATERIAL; ON ITS SIDES IT HAS A RED MATERIAL WITH HOLES, RESEMBLING TO A NET.

SER. NO. 79-102,622, FILED 6-17-2011.

SALLY SHIH, EXAMINING ATTORNEY

# United States of America

United States Patent and Trademark Office



**Reg. No. 4,196,448**

**Registered Aug. 28, 2012**

**Int. Cl.: 1**

**TRADEMARK**

**PRINCIPAL REGISTER**

BIOCENTRAL LABORATORIES LIMITED (AUSTRALIA LIMITED COMPANY)  
22 PHILLIPS STREET  
THEBARTON SA 5031  
AUSTRALIA

FOR: CHEMICAL PREPARATIONS FOR USE IN THE CONTROL OF FIRES; CHEMICALS FOR USE IN FIRE EXTINGUISHING; FIRE EXTINGUISHING CHEMICALS; FIRE EXTINGUISHING COMPOSITIONS; FIRE EXTINGUISHING FOAM COMPOSITIONS; FIRE RETARDANT COMPOSITIONS; FIRE RETARDANT PREPARATIONS, IN CLASS 1 (U.S. CLS. 1, 5, 6, 10, 26 AND 46).

OWNER OF U.S. REG. NO. 3,006,427.

OWNER OF INTERNATIONAL REGISTRATION 1090889 DATED 7-11-2011, EXPIRES 7-11-2021.

THE COLOR(S) ORANGE, BLACK AND GREY IS/ARE CLAIMED AS A FEATURE OF THE MARK.

NO CLAIM IS MADE TO THE EXCLUSIVE RIGHT TO USE "FIRE SUPPRESSANT & RETARDANT TECHNOLOGY", APART FROM THE MARK AS SHOWN.

THE MARK CONSISTS OF AN ORANGE AND GRAY FLAME DESIGN TO THE LEFT, THE TERMS "BLAZETAMER" IN ORANGE WITH BLACK OUTLINES, AND THE TERMS "FIRE SUPPRESSANT & RETARDANT TECHNOLOGY" IN ORANGE AT THE BOTTOM OF THE MARK.

SER. NO. 79-102,632, FILED 7-11-2011.

TEJBIR SINGH, EXAMINING ATTORNEY



*David J. Kybas*

Director of the United States Patent and Trademark Office

# United States of America

United States Patent and Trademark Office



**Reg. No. 4,196,449**

**Registered Aug. 28, 2012**

**Int. Cl.: 6**

GUANGDONG AURICAN ARCHITECTURAL HARDWARE CO., LTD. (CHINA CORPORATION)  
NO.06B3 BLOCK  
SHENGPING 2ND INDUSTRIAL AREA., SHANTOU;GUANGDONG  
CHINA

**TRADEMARK**

**PRINCIPAL REGISTER**

FOR: CHAINS OF METAL; HINGES OF METAL; DOOR BOLTS; RUNNERS OF METAL FOR SLIDING DOORS; METAL WINDOW PULLEYS; FITTINGS OF METAL FOR WINDOWS; HARDWARE OF METAL, NAMELY, BUCKLES; FITTINGS OF METAL FOR DOORS; METAL WINDOW HOOKS, IN CLASS 6 (U.S. CLS. 2, 12, 13, 14, 23, 25 AND 50).

OWNER OF U.S. REG. NO. 3,220,256.

OWNER OF INTERNATIONAL REGISTRATION 1090899 DATED 8-2-2011, EXPIRES 8-2-2021.

THE MARK CONSISTS OF TWO STYLIZED LETTERS "A" AND "R" ON THE UPPER PART AND A COINED WORD "AURICAN" IN STANDARD STYLE BELOW.

THE WORDING "AURICAN" HAS NO MEANING IN A FOREIGN LANGUAGE.

SER. NO. 79-102,637, FILED 8-2-2011.

WILLIAM ROSSMAN, EXAMINING ATTORNEY



*David J. Kyffers*

Director of the United States Patent and Trademark Office



# United States of America

United States Patent and Trademark Office



**Reg. No. 4,196,450**

**Registered Aug. 28, 2012**

**Int. Cl.: 30**

**TRADEMARK**

**PRINCIPAL REGISTER**

LITTLEPOD LIMITED (UNITED KINGDOM LIMITED LIABILITY COMPANY)  
WHYTE HOUSE  
FARRINGTON, EXETER EX5 2HY  
UNITED KINGDOM

FOR: VANILLA FLAVORING; NATURAL VANILLA EXTRACT; NATURAL CHOCOLATE EXTRACT; NATURAL VANILLA PASTE; VANILLA BEANS, IN CLASS 30 (U.S. CL. 46).

THE MARK CONSISTS OF THE TERM "LITTLEPOD" AND A STYLIZED REPRESENTATION OF A VANILLA PLANT.

PRIORITY DATE OF 1-25-2011 IS CLAIMED.

OWNER OF INTERNATIONAL REGISTRATION 1090905 DATED 7-23-2011, EXPIRES 7-23-2021.

SER. NO. 79-102,640, FILED 7-23-2011.

AMY ALFIERI, EXAMINING ATTORNEY



*David J. Kybas*

Director of the United States Patent and Trademark Office

# United States of America

United States Patent and Trademark Office



**Reg. No. 4,196,451**

**Registered Aug. 28, 2012**

**Int. Cls.: 7 and 11**

**TRADEMARK**

**PRINCIPAL REGISTER**

POOLRITE RESEARCH PTY LTD (AUSTRALIA COMPANY)  
415 CREEK ROAD  
MOUNT GRAVATT QLD 4122, AUSTRALIA

FOR: SWIMMING POOL AND SPA CLEANING AND MAINTENANCE MACHINES AND EQUIPMENT, NAMELY, VACUUM CLEANERS, AUTOMATIC SWIMMING POOL CLEANERS AND PARTS THEREOF; SWEEPING MACHINES AND POWER-OPERATED SWEEPING APPARATUS FOR USE IN POOLS AND SPAS; POWER-OPERATED SKIMMERS FOR CLEANING POOLS AND SPAS; PUMPS FOR MACHINES; ELECTRIC GENERATORS, IN CLASS 7 (U.S. CLS. 13, 19, 21, 23, 31, 34 AND 35).

FOR: WATER TREATMENT AND PURIFICATION APPARATUS, MACHINES AND INSTALLATIONS BEING WATER FILTERS, WATER FILTERING AND WATER PURIFICATION UNITS, WATER STERILIZING AND DECONTAMINATION UNITS FOR PURIFYING, STERILIZING AND DECONTAMINATING, SANITIZING AND CHLORINATING WATER IN SWIMMING POOLS, SPAS AND SPA BATHS; GENERATORS FOR SWIMMING POOLS AND SPAS IN THE NATURE OF HEAT GENERATORS; WATER PURIFYING AND FILTRATION APPARATUS FOR SWIMMING POOLS AND SPAS, NAMELY, WATER FILTERS, IN CLASS 11 (U.S. CLS. 13, 21, 23, 31 AND 34).

THE MARK CONSISTS OF A RECTANGLE DESIGN WITH ROUNDED CORNERS AND THE STYLIZED WORDING "TEKNOPOOL" INSIDE THE RECTANGLE. THE LETTER "O" HAS A DROP OF WATER INSIDE.

PRIORITY DATE OF 4-20-2011 IS CLAIMED.

OWNER OF INTERNATIONAL REGISTRATION 1090998 DATED 6-21-2011, EXPIRES 6-21-2021.

SER. NO. 79-102,673, FILED 6-21-2011.

JENNIFER MARTIN, EXAMINING ATTORNEY



*David J. Kyros*

Director of the United States Patent and Trademark Office

# United States of America

United States Patent and Trademark Office

# PULZIT

**Reg. No. 4,196,452**

**Registered Aug. 28, 2012**

**Int. Cl.: 9**

**TRADEMARK**

**PRINCIPAL REGISTER**

IS INTERNATIONAL AB (SWEDEN JOINT STOCK COMPANY)  
BOX 3174  
SE-903 04 UMEÅ  
SWEDEN

FOR: EYEWEAR; SPORTS EYEWEAR; SPECTACLE GLASSES; SUNGLASSES; SPECTACLE FRAMES; EYEWEAR CASES; STRAPS FOR EYEWEAR; PULSE METERS FOR SPORTING PURPOSES; GPS NAVIGATION DEVICES; MOBILE DATA RECEIVERS; SATELLITE RECEIVERS; WIRELESS COMMUNICATION DEVICES FOR RECEIVING ELECTRONIC TEXT MESSAGES; EYEWEAR EQUIPPED WITH APPARATUS FOR THE RECEIPT OF TEXT MESSAGES, AND FOR MEASURING AND DISPLAYING INFORMATION REGARDING PULSE, TIME AND GEOGRAPHICAL LOCATION, IN CLASS 9 (U.S. CLS. 21, 23, 26, 36 AND 38).

THE MARK CONSISTS OF STANDARD CHARACTERS WITHOUT CLAIM TO ANY PARTICULAR FONT, STYLE, SIZE, OR COLOR.

PRIORITY DATE OF 5-25-2011 IS CLAIMED.

OWNER OF INTERNATIONAL REGISTRATION 1091306 DATED 7-6-2011, EXPIRES 7-6-2021.

SER. NO. 79-102,770, FILED 7-6-2011.

STEVEN PEREZ, EXAMINING ATTORNEY



*David J. Kyffers*

Director of the United States Patent and Trademark Office

United States of America  
United States Patent and Trademark Office

# KAMBLY

**Reg. No. 4,196,453**

**Registered Aug. 28, 2012**

**Int. Cl.: 30**

**TRADEMARK**

**PRINCIPAL REGISTER**

KAMBLY SA SPÉCIALITÉS DE BISCUITS SUISSES (SWITZERLAND SOCIÉTÉ ANONYME)  
MÜHLESTRASSE 4  
CH-3555 TRUBSCHACHEN  
SWITZERLAND

FOR: PASTRY; CONFECTIONERY, NAMELY, CHOCOLATE CONFECTIONS, CHOCOLATE, CONFECTIONERY CHIPS FOR BAKING, CONFECTIONERY MADE OF SUGAR, FONDANTS; CHOCOLATES; CONFECTIONERY PRODUCTS, NAMELY, CHOCOLATE CONFECTIONS, CHOCOLATE, CONFECTIONERY CHIPS FOR BAKING, CONFECTIONERY MADE OF SUGAR, FONDANTS; COOKIES; SWEET AND SAVORY BISCUITS; SNACK PRODUCTS, NAMELY, CEREAL BASED SNACK FOODS, CHEESE FLAVORED PUFFED CORN SNACKS, WHEAT-BASED SNACK FOODS, SNACK CAKES, RICE-BASED SNACK FOODS, GRANOLA SNACKS, CORN-BASED SNACK FOODS, MULTIGRAIN BASED SNACK FOODS; CEREAL-BASED SNACK FOOD; BISCUITS, IN CLASS 30 (U.S. CL. 46).

OWNER OF U.S. REG. NOS. 997,802, 1,310,316, AND 3,133,230.

OWNER OF INTERNATIONAL REGISTRATION 0216657 DATED 1-26-1959, EXPIRES 1-26-2019.

THE MARK CONSISTS OF THE STYLIZED WORDING "KAMBLY".

SER. NO. 79-102,838, FILED 11-17-2010.

JAY BESCH, EXAMINING ATTORNEY



*David J. Kyffers*

Director of the United States Patent and Trademark Office

United States of America  
United States Patent and Trademark Office

NOEMIA

**Reg. No. 4,196,454**

**Registered Aug. 28, 2012**

**Int. Cl.: 14**

**TRADEMARK**

**PRINCIPAL REGISTER**

RAYMOND WEIL SA (SWITZERLAND SOCIÉTÉ ANONYME)  
AVENUE EUGÈNE-LANCE 36-38  
GRAND LANCY;  
CH-1212 LANCY, SWITZERLAND

FOR: PRECIOUS METALS AND THEIR ALLOYS; CUFF LINKS, TIE PINS, TIE CLIPS;  
JEWELRY, PRECIOUS STONES; HOROLOGICAL AND CHRONOMETRIC INSTRUMENTS  
AND PARTS THEREOF, IN CLASS 14 (U.S. CLS. 2, 27, 28 AND 50).

THE MARK CONSISTS OF STANDARD CHARACTERS WITHOUT CLAIM TO ANY PAR-  
TICULAR FONT, STYLE, SIZE, OR COLOR.

OWNER OF INTERNATIONAL REGISTRATION 0993945 DATED 2-5-2009, EXPIRES 2-5-  
2019.

THE NAME(S), PORTRAIT(S), AND/OR SIGNATURE(S) SHOWN IN THE MARK DOES NOT  
IDENTIFY A PARTICULAR LIVING INDIVIDUAL.

SER. NO. 79-102,856, FILED 2-11-2011.

JAY BESCH, EXAMINING ATTORNEY



*David J. Kybas*

Director of the United States Patent and Trademark Office

# United States of America

United States Patent and Trademark Office



**Reg. No. 4,196,455**

**Registered Aug. 28, 2012**

**Int. Cl.: 33**

CENTRE VINICOLE CHAMPAGNE NICOLAS FEULLATTE, UNION DE COOPERATIVES  
AGRICOLES (FRANCE UNION DE COOPÉRATIVES AGRICOLES)  
CD 40 A, PLUMECOQ  
F-51530 CHOUILLY  
FRANCE

**TRADEMARK**

FOR: WINES, SPARKLING WINES, CHAMPAGNE WINES, CIDERS, EAU-DE-VIE BRANDY,  
LIQUEURS AND SPIRITS , IN CLASS 33 (U.S. CLS. 47 AND 49).

**PRINCIPAL REGISTER**

OWNER OF U.S. REG. NOS. 1,364,813 AND 3,441,097.

OWNER OF INTERNATIONAL REGISTRATION 1091807 DATED 8-25-2011, EXPIRES 8-25-  
2021.

THE NAME(S), PORTRAIT(S), AND/OR SIGNATURE(S) SHOWN IN THE MARK IDENTIFIES  
NICOLAS FEULLATTE, WHOSE CONSENT(S) TO REGISTER IS MADE OF RECORD.

SER. NO. 79-102,966, FILED 8-25-2011.

JACLYN KIDWELL WALKER, EXAMINING ATTORNEY



*David J. Kyffers*

Director of the United States Patent and Trademark Office

# United States of America

United States Patent and Trademark Office

# LOBSTER

**Reg. No. 4,196,456**

**Registered Aug. 28, 2012**

**Int. Cls.: 18 and 28**

**TRADEMARK**

**PRINCIPAL REGISTER**

HITURN AS (NORWAY AS (UK: LTD; US: CORP))  
SAGVOLLVEIEN 1  
N-2830 RAUFOSS  
NORWAY

FOR: SUITCASES AND TRAVEL BAGS, IN CLASS 18 (U.S. CLS. 1, 2, 3, 22 AND 41).

FOR: SPORTING ARTICLES, NAMELY, SKIS, SNOWBOARDS, SNOW SLEDS FOR RECREATIONAL USE, SKATEBOARDS FOR RECREATIONAL USE, SKI BINDINGS AND PARTS THEREFOR, SNOWBOARD BINDINGS AND PARTS THEREFOR, IN CLASS 28 (U.S. CLS. 22, 23, 38 AND 50).

THE MARK CONSISTS OF STANDARD CHARACTERS WITHOUT CLAIM TO ANY PARTICULAR FONT, STYLE, SIZE, OR COLOR.

PRIORITY DATE OF 1-25-2011 IS CLAIMED.

OWNER OF INTERNATIONAL REGISTRATION 1091933 DATED 7-25-2011, EXPIRES 7-25-2021.

SER. NO. 79-103,012, FILED 7-25-2011.

PATRICIA EVANKO, EXAMINING ATTORNEY



*David J. Kyffers*

Director of the United States Patent and Trademark Office

# United States of America

United States Patent and Trademark Office

## Clark & Marron

**Reg. No. 4,196,457**

**Registered Aug. 28, 2012**

**Int. Cl.: 35**

CLARK & MARRON PTY LTD (AUSTRALIA AUSTRALIAN PROPRIETARY COMPANY,  
LIMITED BY SHARES)  
SUITE 3  
226 UPPER HEIDELBERG ROAD  
IVANHOE VIC 3079, AUSTRALIA

**SERVICE MARK**

**PRINCIPAL REGISTER**

FOR: ECONOMIC FORECASTING ANALYSIS FOR BUSINESS PURPOSES; COMMODITY, RESOURCE INDUSTRY AND CORPORATE ANALYSIS, NAMELY, BUSINESS AND CORPORATE MANAGEMENT ANALYSIS FOR THE COMMODITY AND RESOURCE INDUSTRIES, BUSINESS INDUSTRY RESEARCH; COMMODITY RESEARCH, NAMELY, BUSINESS RESEARCH IN THE FIELD OF COMMODITIES; STRATEGIC ANALYSIS, NAMELY, STRATEGIC BUSINESS MANAGEMENT ANALYSIS, ALL OF THE FOREGOING BEING BUSINESS SERVICES, IN CLASS 35 (U.S. CLS. 100, 101 AND 102).

THE MARK CONSISTS OF STANDARD CHARACTERS WITHOUT CLAIM TO ANY PARTICULAR FONT, STYLE, SIZE, OR COLOR.

OWNER OF INTERNATIONAL REGISTRATION 1092170 DATED 5-4-2011, EXPIRES 5-4-2021.

SER. NO. 79-103,090, FILED 5-4-2011.

APRIL ROACH, EXAMINING ATTORNEY



*David J. Kyffers*

Director of the United States Patent and Trademark Office



# United States of America

United States Patent and Trademark Office

# RAMIRA

**Reg. No. 4,196,458**

**Registered Aug. 28, 2012**

**Int. Cls.: 9, 16 and 41**

**TRADEMARK**

**SERVICE MARK**

**PRINCIPAL REGISTER**

MARTINA OBERMEYER (FED REP GERMANY INDIVIDUAL)  
KOCHELER STR. 1  
82444 SCHLEHDORF  
FED REP GERMANY

FOR: AUDIO AND VIDEO PRODUCTS FOR TEACHING, LEARNING AND EDUCATIONAL PURPOSES, NAMELY, RECORDED CDS, VIDEO TAPES, LASERDISCS AND DVDS WITH INFORMATION ON THE STRUCTURAL COMPOSITION AND STRUCTURAL CONDITION OF THE EYE AND PEDIGREE DYNAMICS, IN CLASS 9 (U.S. CLS. 21, 23, 26, 36 AND 38).

FOR: BOOKS IN THE FIELD OF THE STRUCTURAL COMPOSITION AND STRUCTURAL CONDITION OF THE IRIS AND PEDIGREE DYNAMICS; PRINTED REPRESENTATIONS, NAMELY, PAMPHLETS, BROCHURES, NEWSLETTERS, JOURNALS, MAGAZINES AND BOOKS FOR TEACHING, LEARNING AND EDUCATIONAL PURPOSES IN THE FIELD OF THE STRUCTURAL COMPOSITION AND STRUCTURAL CONDITION OF THE IRIS AND PEDIGREE DYNAMICS, FACE READING, SYSTEMIC FAMILY COUNSELING IN CHILD THERAPY, RESOLUTION OF CONFLICT AND RECURRING UNWANTED PATTERNS OF BEHAVIOR, RELATIONSHIPS AND PARTNERSHIP BOTH ON A PERSONAL AND PROFESSIONAL LEVEL, BLENDED FAMILIES, IN CLASS 16 (U.S. CLS. 2, 5, 22, 23, 29, 37, 38 AND 50).

FOR: ARRANGING AND CONDUCTING SEMINARS, IN PARTICULAR IN THE FIELD OF HOLISTIC MEDICINE; AND CONSULTANCY FOR PRACTICES, NAMELY, PRACTICE COACHING IN THE NATURE OF PROFESSIONAL COACHING FOR MEDICAL PRACTICES; SERVICES FOR TEACHING, LEARNING AND EDUCATIONAL PURPOSES, NAMELY, CONDUCTING OF EDUCATIONAL PROGRAMMES, LECTURES, AND CLOSED MEETINGS IN THE FIELD OF STRUCTURAL COMPOSITION AND STRUCTURAL CONDITION OF THE EYE AND PEDIGREE DYNAMICS; AND DIAGNOSTICS IN THE FIELD OF THE STRUCTURAL COMPOSITION AND STRUCTURAL CONDITION OF THE EYE AND PEDIGREE DYNAMICS, NAMELY, EDUCATIONAL TESTING SERVICES, IN CLASS 41 (U.S. CLS. 100, 101 AND 107).

THE MARK CONSISTS OF STANDARD CHARACTERS WITHOUT CLAIM TO ANY PARTICULAR FONT, STYLE, SIZE, OR COLOR.

PRIORITY DATE OF 6-9-2011 IS CLAIMED.



*David J. Kappas*

Director of the United States Patent and Trademark Office

**Reg. No. 4,196,458** OWNER OF INTERNATIONAL REGISTRATION 1092183 DATED 6-14-2011, EXPIRES 6-14-2021.

SER. NO. 79-103,097, FILED 6-14-2011.

APRIL ROACH, EXAMINING ATTORNEY

# United States of America

United States Patent and Trademark Office

## SELF-STEMCELLS

**Reg. No. 4,196,459**

**Registered Aug. 28, 2012**

**Int. Cls.: 3, 5 and 10**

**TRADEMARK**

**PRINCIPAL REGISTER**

REGEN LAB SA (SWITZERLAND SOCIÉTÉ ANONYME (SA))  
EN BUDRON B2  
CH-1052 MONT-SUR-LAUSANNE  
SWITZERLAND

FOR: COSMETICS CONTAINING STEM CELLS; BEAUTY MASKS CONTAINING STEM CELLS; COSMETIC KITS COMPRISED PRIMARILY OF LOTIONS, CREAMS, AND PREPARATIONS FOR SKIN CARE CONTAINING STEM CELLS; COSMETIC CREAMS CONTAINING STEM CELLS; LOTIONS FOR COSMETIC PURPOSES CONTAINING STEM CELLS; COSMETIC LOTIONS CONTAINING STEM CELLS; COSMETIC PREPARATIONS FOR SKIN CARE CONTAINING STEM CELLS; POMADES FOR COSMETIC PURPOSES CONTAINING STEM CELLS; TISSUES IMPREGNATED WITH COSMETIC LOTIONS; COTTON STICKS FOR COSMETIC PURPOSES; COSMETIC KITS FOR SKIN CARE CONTAINING STEM CELLS COMPRISED PRIMARILY OF LOTIONS, CREAMS, AND PREPARATIONS FOR SKIN CARE; NON-MEDICATED SKIN CARE PREPARATIONS CONTAINING STEM CELLS; SKIN CARE PREPARATIONS, NAMELY, NON-MEDICATED SKIN SERUM CONTAINING STEM CELLS; NON-MEDICATED STIMULATING LOTIONS FOR THE SKIN CONTAINING STEM CELLS; ANTI-WRINKLE PREPARATIONS FOR SKIN CARE CONTAINING STEM CELLS; NON-MEDICATED ANTI-AGING SERUMS CONTAINING STEM CELLS; DISINFECTANT SOAP CONTAINING STEM CELLS, IN CLASS 3 (U.S. CLS. 1, 4, 6, 50, 51 AND 52).



*David J. Kyffers*

Director of the United States Patent and Trademark Office

FOR: PHARMACEUTICAL AND VETERINARY PREPARATIONS, NAMELY, SOLUTIONS CONTAINING STEM CELLS FOR APPLICATION ON AND UNDER TISSUE AND ORGAN; SANITARY PREPARATIONS CONTAINING STEM CELLS FOR MEDICAL PURPOSES; ADJUVANTS CONTAINING STEM CELLS FOR MEDICAL PURPOSES; BIOLOGICAL PREPARATIONS CONTAINING STEM CELLS FOR MEDICAL USE, NAMELY, PLATELET CONCENTRATE, PLATELET RICH PLASMA, PLATELET POOR PLASMA, FIBRIN GEL, PLATELET RICH FIBRIN, CELL EXTRACTS, CELL CONCENTRATES, STEM CELLS, HYALURONIC ACID OR ANY COMBINATIONS THEREOF; SKIN LOTIONS CONTAINING STEM CELLS FOR PHARMACEUTICAL PURPOSES; TISSUES IMPREGNATED WITH PHARMACEUTICAL LOTIONS CONTAINING STEM CELLS FOR THE TREATMENT OF DAMAGED SKIN AND TISSUE; MEDICAL DRESSINGS, SURGICAL TISSUES; MEDICATED SKIN CARE PREPARATIONS CONTAINING STEM CELLS; PHARMACEUTICAL PREPARATIONS AND SUBSTANCES CONTAINING STEM CELLS FOR THE TREATMENT OF THE SKIN AND OF DAMAGED TISSUES; PRODUCTS AND PREPARATIONS FOR MEDICAL PURPOSES FOR CLEANING THE SKIN; KITS CONTAINING SOLUTIONS CONTAINING

**Reg. No. 4,196,459** STEM CELLS FOR RECONSTITUTION OF ALLOGRAFT TISSUE; CELLS FOR MEDICAL OR CLINICAL PURPOSES, DISINFECTANTS FOR SANITARY PURPOSES; DISINFECTANTS FOR HYGIENE PURPOSES; KITS CONTAINING CHEMICAL REAGENTS USED FOR MEDICAL DIAGNOSES; HUMAN, PLANT AND ANIMAL CELLS AND TISSUES AS WELL AS NATURAL DNA FOR MEDICAL AND VETERINARY PURPOSES, IN CLASS 5 (U.S. CLS. 6, 18, 44, 46, 51 AND 52).

FOR: SURGICAL APPARATUS AND INSTRUMENTS FOR MEDICAL, DENTAL AND VETERINARY USE; SURGICAL APPARATUS AND INSTRUMENTS; MEDICAL APPARATUS AND INSTRUMENTS FOR USE IN GENERAL SURGERY, DENTAL SURGERY, ORTHOPEDIC SURGERY, COSMETIC SURGERY, ESTHETIC SURGERY, OPHTHALMIC SURGERY, CARDIOVASCULAR SURGERY, CARDIAC SURGERY, THORACIC SURGERY, TRANSPLANTATION SURGERY, HEAD AND NECK SURGERY, ORAL SURGERY, BONE SURGERY, CARTILAGE SURGERY, TENDON SURGERY, IMPLANT SURGERY, GASTROINTESTINAL SURGERY, NEUROSURGICAL SURGERY, FACIAL SURGERY, FACE-LIFT SURGERY, AND PLASTIC SURGERY; SUTURE MATERIALS; SYRINGES FOR INJECTIONS; CASES FITTED FOR MEDICAL INSTRUMENTS; RECEPTACLES FOR APPLYING MEDICINES, NAMELY, MEDICAL TUBES, VIALS, JARS, BAGS, POUCHES, CARTRIDGES, BOTTLES, CYLINDERS, PODS; SYRINGES FOR MEDICAL PURPOSES; CASES FITTED FOR USE BY SURGEONS AND DOCTORS; RECEPTACLES, NOT OF METAL, FOR STORING MEDICINES, AND TRANSPORTING AND STORING BIOLOGICAL SAMPLES, ORGANS, TISSUES AND CELLS FOR MEDICAL PURPOSES; INSTRUMENTS FOR MEDICAL INJECTIONS, WITH NEEDLES AND WITHOUT NEEDLES; MEDICAL INSTRUMENTS, NAMELY, SURGICAL INSTRUMENTS FOR IDENTIFYING, SEPARATING OR ABLATING BIOLOGICAL TISSUES; MEDICAL AND SURGICAL APPARATUS AND INSTRUMENTS FOR USE IN GENERAL SURGERY; MEDICAL APPARATUS FOR TAKING BLOOD; MEDICAL APPARATUS FOR TAKING BLOOD SAMPLES; APPARATUS FOR SEPARATING BLOOD COMPONENTS FOR MEDICAL PURPOSES; MEDICAL INSTRUMENTS FOR FILTERING BLOOD AND BLOOD COMPONENTS; MEDICAL APPARATUS FOR INTRODUCING PHARMACEUTICAL PREPARATIONS INTO THE HUMAN BODY; MEDICAL INSTRUMENTS, NAMELY, SURGICAL INSTRUMENTS FOR BIOLOGICAL TISSUE; MEDICAL DEVICES, NAMELY, KITS INTENDED FOR THE PREPARATION OF PLATELET RICH PLASMA, PLASMA CONCENTRATE, PLATELET POOR PLASMA, FIBRIN GEL, PLATELET RICH FIBRIN, CELL EXTRACTS, CELL CONCENTRATES OR ANY COMBINATIONS THEREOF, KITS INTENDED FOR TISSUE AND/OR CELLULAR REGENERATION/REJUVENATION/HEALING/REPAIR COMPRISED OF RECEPTACLES, NAMELY, MEDICAL TUBES, VIALS, JARS, BAGS, POUCHES, CARTRIDGES, BOTTLES, CYLINDERS OR PODS, SYRINGES AND NEEDLES FOR REGENERATIVE MEDICINE, ISOLATION AND/OR APPLICATION OF PLATELETS AND/OR CELLS, FOR EXAMPLE FROM BLOOD, FAT (ADIPOCYTES), BONE MARROW, STEM CELLS AND/OR OTHER TISSUE, AND KITS COMPRISING MEDICAL TUBES, SYRINGES AND NEEDLES, IN CLASS 10 (U.S. CLS. 26, 39 AND 44).

THE MARK CONSISTS OF STANDARD CHARACTERS WITHOUT CLAIM TO ANY PARTICULAR FONT, STYLE, SIZE, OR COLOR.

OWNER OF INTERNATIONAL REGISTRATION 1092272 DATED 8-23-2011, EXPIRES 8-23-2021.

SER. NO. 79-103,126, FILED 8-23-2011.

TOBY BULLOFF, EXAMINING ATTORNEY

# United States of America

United States Patent and Trademark Office

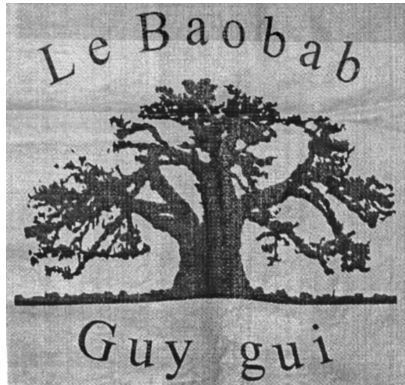

**Reg. No. 4,196,460**

**Registered Aug. 28, 2012**

**Int. Cls.: 29 and 30**

**TRADEMARK**

**PRINCIPAL REGISTER**

CAPEZZANA SHIPPING AND TRADING S.A. (SWITZERLAND SOCIÉTÉ ANONYME (SA))  
18, RUE DU MARCHÉ  
CH-1204 GENEVA  
SWITZERLAND

FOR: PULSES, IN CLASS 29 (U.S. CL. 46).

FOR: COFFEE, TEA, COCOA, SUGAR, RICE, MILLED LONG GRAIN RICE 100% BROKEN,  
ARTIFICIAL COFFEE; HONEY, YEAST, BAKING POWDER, FLOUR, SPICES, MOLASSES  
FOR FOOD, IN CLASS 30 (U.S. CL. 46).

THE MARK CONSISTS OF A DESIGN OF A TREE. BELOW THE TREE APPEARS THE  
WORDING "GUY GUI" AND ABOVE THE TREE APPEARS THE WORDING "LE BAOBAB".

OWNER OF INTERNATIONAL REGISTRATION 0906735 DATED 10-19-2006, EXPIRES 10-  
19-2016.

SER. NO. 79-103,179, FILED 2-7-2011.

KATHERINE E. HALMEN, EXAMINING ATTORNEY



*David J. Kybas*

Director of the United States Patent and Trademark Office

# United States of America

United States Patent and Trademark Office

# Bal D'Afrique

**Reg. No. 4,196,461**

**Registered Aug. 28, 2012**

**Int. Cl.: 3**

**TRADEMARK**

**PRINCIPAL REGISTER**

BYREDO AB (SWEDEN LIMITED COMPANY)  
MÄSTER SAMUELSGATAN 42  
SE-111 57 STOCKHOLM  
SWEDEN

FOR: SOAPS; PERFUMERY, ESSENTIAL OILS, COSMETICS, IN CLASS 3 (U.S. CLS. 1, 4, 6, 50, 51 AND 52).

THE MARK CONSISTS OF STANDARD CHARACTERS WITHOUT CLAIM TO ANY PARTICULAR FONT, STYLE, SIZE, OR COLOR.

PRIORITY DATE OF 3-30-2011 IS CLAIMED.

OWNER OF INTERNATIONAL REGISTRATION 1092498 DATED 9-26-2011, EXPIRES 9-26-2021.

THE ENGLISH TRANSLATION OF "BAL D'AFRIQUE" IN THE MARK IS "AFRICAN DANCE".

SER. NO. 79-103,234, FILED 9-26-2011.

SEAN CROWLEY, EXAMINING ATTORNEY



*David J. Kyffers*

Director of the United States Patent and Trademark Office

# United States of America

United States Patent and Trademark Office



**Reg. No. 4,196,462**

**Registered Aug. 28, 2012**

**Int. Cls.: 5, 10 and 34**

**TRADEMARK**

**PRINCIPAL REGISTER**

OLIVER KLEINJOHANN (FED REP GERMANY INDIVIDUAL)  
UNTER DEN ULMEN 41  
50968 KÖLN  
FED REP GERMANY

FOR: TOBACCO-FREE CIGARETTES FOR MEDICAL PURPOSES, IN CLASS 5 (U.S. CLS. 6, 18, 44, 46, 51 AND 52).

FOR: ELECTRONIC CIGARETTES FOR MEDICAL PURPOSES, IN CLASS 10 (U.S. CLS. 26, 39 AND 44).

FOR: CIGARETTES; TOBACCO; LIGHTERS FOR SMOKERS; MATCHES; ELECTRONIC CIGARETTES, NOT FOR MEDICAL PURPOSES; CIGARETTE CASES, IN CLASS 34 (U.S. CLS. 2, 8, 9 AND 17).

NO CLAIM IS MADE TO THE EXCLUSIVE RIGHT TO USE "SMOKE-FREE", APART FROM THE MARK AS SHOWN.

OWNER OF INTERNATIONAL REGISTRATION 1092529 DATED 7-6-2011, EXPIRES 7-6-2021.

THE COLOR(S) BLACK AND RED IS/ARE CLAIMED AS A FEATURE OF THE MARK.

THE MARK CONSISTS OF THE WORD "SNOKE" IN BLACK WITH THE UPRIGHT BAR OF THE LETTER "K" IN RED. THE WORDING "SENSUAL, STYLISH, SMOKE-FREE" APPEARS IN RED.

SER. NO. 79-103,246, FILED 7-6-2011.

DORITT L. CARROLL, EXAMINING ATTORNEY



*David J. Kyffers*

Director of the United States Patent and Trademark Office

# United States of America

United States Patent and Trademark Office

 **Airolux**

**Reg. No. 4,196,463**

**Registered Aug. 28, 2012**

**Int. Cls.: 20, 21 and 42**

**TRADEMARK**

**SERVICE MARK**

**PRINCIPAL REGISTER**

AIROLUX AG (SWITZERLAND AKTIENGESELLSCHAFT)  
INDUSTRIE OST  
CH-8865 BILTEN  
SWITZERLAND

FOR: PACKAGING CONTAINERS MADE OF PLASTIC MATERIALS, IN CLASS 20 (U.S. CLS. 2, 13, 22, 25, 32 AND 50).

FOR: BOTTLES, SOLD EMPTY; SOAP DISPENSERS; AEROSOL DISPENSERS, NOT FOR MEDICAL PURPOSES; ATOMIZERS FOR HOUSEHOLD USE, HAND-OPERATED VAPORIZERS FOR HOUSEHOLD USE, PERFUME SPRAYERS SOLD EMPTY; VAPORIZERS OPERATED MANUALLY FOR PERFUME, SOLD EMPTY; PORTABLE BEVERAGE DISPENSERS; PERFUME ATOMIZERS, SOLD EMPTY, IN CLASS 21 (U.S. CLS. 2, 13, 23, 29, 30, 33, 40 AND 50).

FOR: SCIENTIFIC AND TECHNOLOGICAL SERVICES, NAMELY, SCIENTIFIC RESEARCH AND DEVELOPMENT AND INDUSTRIAL DESIGN RELATING TO PACKAGING CONTAINERS MADE OF PLASTIC MATERIALS; INDUSTRIAL ANALYSIS AND RESEARCH SERVICES IN THE FIELD OF PACKAGING CONTAINERS MADE OF PLASTIC MATERIALS, IN CLASS 42 (U.S. CLS. 100 AND 101).

THE MARK CONSISTS OF A DESIGN OF CIRCLES AND LINES AND THE STYLIZED WORDING OF "AIROLUX".

PRIORITY DATE OF 6-28-2011 IS CLAIMED.

OWNER OF INTERNATIONAL REGISTRATION 1092544 DATED 8-18-2011, EXPIRES 8-18-2021.

SER. NO. 79-103,249, FILED 8-18-2011.

ROBERT STRUCK, EXAMINING ATTORNEY



*David J. Kybas*

Director of the United States Patent and Trademark Office



# United States of America

United States Patent and Trademark Office

# FIAT

**Reg. No. 4,196,464**

**Registered Aug. 28, 2012**

**Int. Cls.: 1, 4, 6, 7, 9, 12,  
16, 18, 25, 28, 35, 36, 37,  
39 and 41**

**TRADEMARK**

**SERVICE MARK**

**PRINCIPAL REGISTER**

FIAT GROUP MARKETING & CORPORATE COMMUNICATION S.P.A. (ITALY CORPORATION)

VIA NIZZA, 250

I-10126 TORINO

ITALY

FOR: CHEMICALS, NAMELY, LIQUID COOLANTS FOR USE WITH INTERNAL COMBUSTION ENGINES, ANTI-FREEZE PREPARATIONS FOR ENGINES AND FOR HYDRAULIC EQUIPMENT, HYDRAULIC FLUID, ARTIFICIAL AND NATURAL MANURES, FIRE EXTINGUISHING COMPOSITIONS, CHEMICAL TEMPERING AND SOLDERING PREPARATIONS FOR USE IN METALWORKING; CHEMICAL SUBSTANCES FOR PRESERVING FOODSTUFFS; TANNING AGENTS FOR USE IN THE MANUFACTURE OF LEATHER; ADHESIVES FOR GENERAL INDUSTRIAL USE, IN CLASS 1 (U.S. CLS. 1, 5, 6, 10, 26 AND 46).

FOR: GENERAL PURPOSE INDUSTRIAL AND AUTOMOTIVE OILS AND GREASES AND LUBRICANTS; CANDLES, WICKS FOR OIL LAMPS, IN CLASS 4 (U.S. CLS. 1, 6 AND 15).

FOR: METAL ALLOYS FOR FURTHER MANUFACTURING SOLD IN FOIL AND POWDER FORM; MARINE ANCHORS, ANVILS, METAL BELLS, ROLLED AND CAST BUILDING MATERIALS OF METAL, NAMELY, FASCIA AND SOFFITS; CAST IRON BUILDING MATERIALS FOR RAILROAD TRACKS; METAL RAILWAY TRACKS, METAL CHAINS; TRANSPORTABLE METAL BUILDINGS; NON ELECTRIC METAL CABLES AND METAL WIRES; METAL DOOR FRAMES; METAL TUBES AND PIPES; METAL SAFES; STEEL IN THE FORM OF BALLS; METAL NAILS AND SCREWS; SEMI-PROCESSED IRON AND LEAD ORES FOR USE IN FURTHER MANUFACTURING; RINGS OF COMMON METAL FOR KEYS, IN CLASS 6 (U.S. CLS. 2, 12, 13, 14, 23, 25 AND 50).

FOR: DYNAMOS, MOTORS AND ENGINES, NOT FOR LAND VEHICLES, AND STRUCTURAL PARTS AND STRUCTURAL FITTINGS THEREOF; INDUSTRIAL ENGINES, MOTORS AND ENGINES USED IN INDUSTRIAL APPLICATIONS, ALTERNATORS; MACHINE TOOLS, NAMELY LATHES, MACHINE FOR DRILLING, MILLING, BORING, CUTTING, SHEARING, FORGING, SEWING AND STITCHING MACHINES; TRUCK MILLS FOR MINING PURPOSES, ELEVATORS; EARTH MOVING MACHINES; EXCAVATORS, NAMELY EARTH MOVING MACHINES, NAMELY, EXCAVATORS; LOADERS, NAMELY EARTH MOVING MACHINES, NAMELY, LOADERS; CONSTRUCTION MACHINERY, NAMELY CONCRETE CONSTRUCTION MACHINES; SKID-STEER LOADERS; AGRICULTURAL MACHINERY, NAMELY, HARVESTERS; BALE MACHINES FOR AGRICULTURAL USE,



*David J. Kappas*

Director of the United States Patent and Trademark Office

**Reg. No. 4,196,464** NAMELY, STRAW BALE TIGHTENING MACHINES, TRACTOR-TOWED AGRICULTURAL INSTRUMENTS, NAMELY, BALE SPLITTERS, BALE SPIKES, BALE FORKS, TRACTOR-TOWED AGRICULTURAL INSTRUMENT ATTACHMENTS, NAMELY, MECHANICAL AND HYDRAULIC ARMS FOR USE AS BALE CARRIERS; AVIATION ENGINES, NAMELY, AIRCRAFT ENGINES; GAS TURBINE ENGINES NOT FOR LAND VEHICLES; MARINE ENGINES; INCUBATORS FOR EGGS, IN CLASS 7 (U.S. CLS. 13, 19, 21, 23, 31, 34 AND 35).

FOR: CONVERTERS, TRANSFORMERS AND STRUCTURAL PARTS THEREFOR, ELECTRIC STORAGE BATTERIES AND STRUCTURAL PARTS THEREOF, DRY BATTERIES, AUTOMATIC SWITCHBOARDS, ELECTRIC SWITCHES, COMMUTATORS AND CIRCUIT BREAKERS, RHEOSTATS AND ELECTRIC TRANSFORMERS, ELECTRIC FUSES; ELECTRONIC SIGNALING MECHANISM IN THE NATURE OF A TRAIN CONTROL SYSTEM USED IN THE RAILWAY INDUSTRY FOR DETECTING AND CONTROLLING TRAINS, GROUND FAULTS, BROKEN RAILS, POWER FAILURES, TRACK SWITCHES AND LIGHTS; ELECTRIC TRANSMITTER AND RECEIVERS FOR WIRELESS TELEVISION AND RADIO SIGNALS; ELECTRIC WIRES AND CABLES, NAVIGATION APPARATUS FOR VEHICLES IN THE NATURE OF ON-BOARD COMPUTERS; HAND HELD JOYSTICK AND INTERACTIVE REMOTE FOR PLAYING VIDEO GAMES; MAGNETICALLY CODED KEY CARDS AND CREDIT CARDS; NOTEBOOK COMPUTERS, LAPTOP COMPUTERS, COMPUTER MOUSE, MICROPROCESSORS, SCANNERS, WORD PROCESSORS, COMPUTER DOCKING STATIONS, BLANK MAGNETIC COMPUTER DISCS, ELECTRONIC POCKET PERSONAL DIGITAL ASSISTANTS; AUTOMATIC TELLER MACHINES, NAMELY, ELECTRIC DISTRIBUTION MACHINES; PRINTERS FOR USE WITH COMPUTERS; COMPUTER ELECTRONIC AMUSEMENT APPARATUS, NAMELY, VIDEO OUTPUT GAME MACHINES FOR USE WITH EXTERNAL DISPLAY SCREEN OR MONITOR; COMPUTER KEYBOARDS, ELECTRIC CONTROL PANELS, ELECTRONIC POCKET CALCULATORS, ELECTRONIC POCKET TRANSLATORS, COMPACT DISCS FEATURING MUSIC, MOVIES AND GAMES, MOUSE PADS; RECORDED COMPUTER PROGRAMS FOR EDITING IMAGES, SOUND AND VIDEO FOR USE IN DATABASE MANAGEMENT, FOR ROUTE PLANNING; AUTOMATIC VENDING MACHINES; CASH REGISTERS; FIRE EXTINGUISHERS; MOBILE PHONES; PROTECTIVE HELMETS, BLANK USB FLASH DRIVES; HOLDERS FOR COMPUTER, MOBILE PHONES AND USB FLASH DRIVES, NAMELY, CARRYING CASES FOR COMPUTERS, MOBILE PHONES, AND USB FLASH DRIVES, IN CLASS 9 (U.S. CLS. 21, 23, 26, 36 AND 38).

FOR: AIRPLANES, HYDROPLANES, AIRCRAFT, HELICOPTERS; AUTOMOBILES, SPORTS CARS, MOTOR BUSES; OMNIBUSES, MOTOR HOMES, TRUCKS, TRAILERS; TRACTORS; ELECTRIC LOCOMOTIVES; BICYCLES; MOTORCYCLES; PASSENGER SHIPS AND BOATS, MOTORBOATS, SAILING SHIPS, YACHTS; VEHICLE BODIES, ENGINES, CLUTCHES, BRAKES, SAFETY BELTS, ALL FOR MOTOR LAND VEHICLES; STRUCTURAL PARTS FOR MOTOR LAND VEHICLES; DUMP TRUCKS, IN CLASS 12 (U.S. CLS. 19, 21, 23, 31, 35 AND 44).

FOR: PAPER, CARDBOARD, PAPER CUTTERS, PENS, FOUNTAIN PENS, FELT PENS, BALLPOINT PENS, PEN HOLDERS, WRITING IMPLEMENTS, FOLDERS, DOCUMENT HOLDERS, PHOTOGRAPHS, STATIONERY, ADHESIVES FOR STATIONERY OR HOUSEHOLD PURPOSES; SCRAPBOOK ALBUMS, CARDBOARD HAT BOXES; PHOTO ALBUMS; PRINTING PAPER, PAPERWEIGHTS; PAINTBRUSHES; TYPEWRITERS; WRAPPING PAPER, PLASTIC FILMS FOR WRAPPING, NAMELY, FOOD WRAPPING PLASTIC FOR HOUSEHOLD USE; PLASTIC SHEETS FOR WRITING, PRINTING AND MARKING, PLASTIC BAGS FOR PACKAGING; PRINTING TYPE; PRINTING BLOCKS, IN CLASS 16 (U.S. CLS. 2, 5, 22, 23, 29, 37, 38 AND 50).

FOR: LEATHER AND IMITATION OF LEATHER; LEATHER KEY CASES, LEATHER KEY HOLDERS, ATTACHE CASES, BRIEFCASES, LEATHER SUIT BAGS, HANDBAGS, TRAVELLING BAGS, ATHLETIC BAGS, ALL PURPOSE SPORT BAGS, VANITY CASES SOLD EMPTY, WALLETS, PURSES, BUSINESS CARD HOLDERS, NAMELY, CARD CASES, GREETING CARD HOLDERS AND DOCUMENT CASES ALL OF LEATHER AND IMITATION

**Reg. No. 4,196,464** OF LEATHER; ANIMAL SKINS AND HIDES; TRUNKS AND SUITCASES; UMBRELLAS, PARASOLS AND WALKING STICKS; WHIPS, HARNESS AND SADDLERY, IN CLASS 18 (U.S. CLS. 1, 2, 3, 22 AND 41).

FOR: T-SHIRTS, SWEAT SHIRTS, POLO-SHIRTS, TIES, CAPS, OVERALLS, WIND RESISTANT JACKETS, WATERPROOF JACKETS, BLAZERS, PULLOVERS, COATS, ROBES, SCARVES, SWEATERS, SHIRTS, TROUSERS, BELTS, RAINCOATS, TRACK SUITS, SHORTS, GLOVES, PAJAMAS, SLIPPERS, SWIMWEAR, OVERALL COATS, FOULARDS CLOTHING ARTICLES, FOOTWEAR, IN CLASS 25 (U.S. CLS. 22 AND 39).

FOR: TOY AND PLAYTHINGS, NAMELY, TOY MODEL CARS IN AN ASSEMBLY KIT FORM, TOY MODEL VEHICLES, TOY COLLECTION MODELS REPRODUCING AUTOMOBILES AND OTHER VEHICLES, TOY BUILDING STRUCTURES; DOLLS, DOLL CLOTHING, ACCESSORIES FOR DOLLS, SOFT SCULPTURE FELT TOYS, TOY VEHICLE TRAIN TRACKS, REAL SIZE NON OPERATING TOY REPLICAS OF AUTOMOBILES FOR ORNAMENTATION, ENTERTAINMENT AND EXHIBITION PURPOSES; PUZZLES, VIDEO GAMES, NAMELY, STAND ALONE VIDEO GAME MACHINES; AMUSEMENT APPARATUS, NAMELY, PINBALL MACHINES; TENNIS RACKET BAGS, GOLF BAGS, GOLF ACCESSORY POUCHES, GOLF CLUBS, PLAYING CARDS; DECORATIONS FOR CHRISTMAS TREES, IN CLASS 28 (U.S. CLS. 22, 23, 38 AND 50).

FOR: RETAIL STORES SERVICES FEATURING AIRPLANES, HYDROPLANES, AIRCRAFT, HELICOPTERS, AUTOMOBILES, SPORTS CARS, MOTOR BUSES; OMNIBUSES, MOTOR HOMES, TRUCKS, TRAILERS, TRACTORS, ELECTRIC LOCOMOTIVES, BICYCLES, MOTORCYCLES, PASSENGER SHIPS AND BOATS, MOTORBOATS, SAILING SHIPS, YACHTS, VEHICLE BODIES, ENGINES, CLUTCHES, BRAKES, SAFETY BELTS, ALL FOR MOTOR LAND VEHICLES, STRUCTURAL PARTS FOR MOTOR LAND VEHICLES, PAPER, CARDBOARD, PAPER CUTTERS, PENS, FOUNTAIN PENS, FELT PENS, BALLPOINT PENS, PEN HOLDERS, WRITING IMPLEMENTS, FOLDERS, DOCUMENT HOLDERS, PHOTOGRAPHS, STATIONERY, ADHESIVES FOR STATIONERY OR HOUSEHOLD PURPOSES, SCRAPBOOK ALBUMS, CARDBOARD HAT BOXES, PHOTO ALBUMS, PRINTING PAPER, PAPER-WEIGHTS, PAINTBRUSHES, TYPEWRITERS, WRAPPING PAPER, PLASTIC FILMS NOT FOR COMMERCIAL OR INDUSTRIAL PURPOSES, PLASTIC SHEETS FOR WRITING, PRINTING AND MARKING, PLASTIC BAGS FOR PACKAGING, PRINTING TYPE, PRINTING BLOCKS, LEATHER AND IMITATION LEATHER, LEATHER KEY CASES, LEATHER KEY RINGS, ATTACH CASES, BRIEFCASES, LEATHER SUIT BAGS, HANDBAGS, TRAVELLING BAGS, SUITCASES, ATHLETIC BAGS, ALL PURPOSE SPORT BAGS EXCLUDING BAGS RELATING TO GOLF AND GOLF LIFESTYLE, VANITY CASES SOLD EMPTY, WALLETS, PURSES, BUSINESS AND GREETING CARD HOLDERS AND DOCUMENT CASES ALL OF LEATHER AND IMITATION OF LEATHER, ANIMAL SKINS AND HIDES, TRUNKS AND SUITCASES, UMBRELLAS, PARASOLS AND WALKING STICKS, WHIPS, HARNESS AND SADDLER, T-SHIRTS, SWEAT SHIRTS, POLO-SHIRTS, TIES, CAPS, OVERALLS, WIND RESISTANT JACKETS, WATERPROOF JACKETS, BLAZERS, PULLOVERS, COATS, ROBES, SCARVES, SWEATERS, SHIRTS, TROUSERS, BELTS, RAINCOATS, TRACK SUITS, SHORTS, GLOVES, PAJAMAS, SLIPPERS, SWIMWEAR, OVERALL COATS, FOULARDS, FOOTWEAR, TOY AND PLAYTHINGS, NAMELY, TOY MODEL CARS IN AN ASSEMBLY KIT FORM, TOY MODEL VEHICLES, TOY COLLECTION MODELS REPRODUCING AUTOMOBILES AND OTHER VEHICLES, TOY BUILDING STRUCTURES, DOLLS, DOLL CLOTHING, ACCESSORIES FOR DOLLS, SOFT SCULPTURE FELT TOYS, TOY VEHICLE TRAIN TRACKS, REAL SIZE NON OPERATING TOY REPLICAS OF AUTOMOBILES FOR ORNAMENTATION, ENTERTAINMENT AND EXHIBITION PURPOSES, PUZZLES, VIDEO GAMES, NAMELY, STAND ALONE VIDEO GAME MACHINES, AMUSEMENT APPARATUS, NAMELY, PINBALL MACHINES, TENNIS RACKET BAGS, GOLF BAGS, GOLF ACCESSORY POUCHES, GOLF CLUBS, PLAYING CARDS, DECORATIONS FOR CHRISTMAS TREES, METAL KEY RINGS, MOBILE PHONES, PROTECTIVE HELMETS, USB FLASH DRIVES, HOLDERS FOR COMPUTER, MOBILE PHONES AND USB FLASH DRIVES, IN CLASS 35 (U.S. CLS. 100, 101 AND 102).

**Reg. No. 4,196,464** FOR: INSURANCE UNDERWRITING, NAMELY, AUTOMOBILE INSURANCE UNDERWRITING AND INSURANCE AGENCIES; FINANCING SERVICES; REAL ESTATE AGENCIES, MANAGEMENT, AND BROKERAGE; FINANCIAL GUARANTEES, CHARITABLE FUND RAISING; FACTORING AGENCIES, CREDIT CARD FACTORING SERVICES, PAWN SHOP , IN CLASS 36 (U.S. CLS. 100, 101 AND 102).

FOR: BUILDING CONSTRUCTION; REPAIR, MAINTENANCE AND LUBRICATION OF VEHICLES; VEHICLE SERVICE STATIONS, IN CLASS 37 (U.S. CLS. 100, 103 AND 106).

FOR: TRANSPORT OF PEOPLE AND GOODS; PACKING ARTICLES FOR TRANSPORTATION AND STORAGE OF GOODS; RENTAL OF VEHICLES; TRAVEL GUIDE SERVICES AND ORGANIZATION OF EXCURSIONS AND SIGHTSEEING TOURS; TRAVEL AGENCY SERVICES, NAMELY MAKING RESERVATIONS AND BOOKING FOR TRANSPORTATION, ORGANIZATION OF TRAVEL AND HOLIDAYS, IN CLASS 39 (U.S. CLS. 100 AND 105).

FOR: EDUCATION SERVICES, NAMELY, CONDUCTING SEMINARS, LECTURES, WORKSHOPS IN THE FIELD OF AUTOMOBILE MANUFACTURING; TRAINING IN THE FIELD OF AUTOMOBILE MANUFACTURING; ENTERTAINMENT, NAMELY, ORGANIZING COMMUNITY SPORTING AND CULTURAL ACTIVITIES, IN CLASS 41 (U.S. CLS. 100, 101 AND 107).

OWNER OF U.S. REG. NOS. 2,924,679, 3,776,578 AND OTHERS.

PRIORITY DATE OF 11-19-2010 IS CLAIMED.

OWNER OF INTERNATIONAL REGISTRATION 1092723 DATED 5-4-2011, EXPIRES 5-4-2021.

SER. NO. 79-103,310, FILED 5-4-2011.

LINDSEY RUBIN, EXAMINING ATTORNEY

# United States of America

United States Patent and Trademark Office



**Reg. No. 4,196,465**

**Registered Aug. 28, 2012**

**Int. Cls.: 9 and 37**

**TRADEMARK**

**SERVICE MARK**

**PRINCIPAL REGISTER**

COMELIT GROUP S.P.A. (ITALY JOINT STOCK COMPANY)  
VIA DON B. ARRIGONI, 5  
ROVETTA,; I-24020 FRAZIONE LOC. SAN LORENZO (BG)  
ITALY

FOR: PHOTOGRAPHIC APPARATUS AND INSTRUMENTS, NAMELY, PHOTOGRAPHIC CAMERAS AND PHOTOGRAPHIC FILTERS; CHECKING AND SUPERVISION APPARATUS AND INSTRUMENTS, NAMELY, CLOSED CIRCUIT TV SYSTEMS FOR SECURITY AND SURVEILLANCE, COMPRISING CAMERAS, SWITCHERS, MONITORS, MICROPHONES AND RECORDERS; APPARATUS AND INSTRUMENTS FOR CONDUCTING, SWITCHING, TRANSFORMING, ACCUMULATING, REGULATING OR CONTROLLING ELECTRICITY, NAMELY, ELECTRIC CONDUCTORS; APPARATUS FOR RECORDING, TRANSMISSION OR REPRODUCTION OF SOUND OR IMAGES, NAMELY, PHONE SYSTEMS COMPRISING ENTRY PHONES, VIDEO ENTRY PHONES, VIDEO SURVEILLANCE INTERCOMS, HOUSEHOLD AUTOMATION SYSTEMS COMPRISING WIRELESS AND WIRED CONTROLLERS AND SOFTWARE FOR LIGHTING, HVAC, SECURITY, SAFETY AND OTHER HOME MONITORING APPLICATIONS; ANTI-INTRUSION SYSTEMS COMPRISING ANTI-INTRUSION ALARMS, ACCESS CONTROL AND ALARM MONITORING SYSTEMS, AND CLOSED-CIRCUIT TELEVISIONS; COMPUTER SOFTWARE FOR USE IN MONITORING, RESTRICTING AND CONTROLLING ACCESS TO BUILDINGS OR OTHER PHYSICAL LOCATIONS, HAND PROGRAMMERS, NAMELY, HAND-HELD PROGRAMMERS; KEYBOARDS; POWER SUPPLIES, TRANSFORMERS, AND SOUND MIXERS, TELEVISION CAMERAS; PORTABLE MEDIA PLAYERS, IN CLASS 9 (U.S. CLS. 21, 23, 26, 36 AND 38).

FOR: INSTALLATION, MAINTENANCE, REPAIR AND TECHNICAL SUPPORT SERVICES, NAMELY, TECHNICAL ADVICE RELATED TO REPAIR, ALL RELATING TO SYSTEMS AND APPARATUSES FEATURING ENTRY PHONES, IN CLASS 37 (U.S. CLS. 100, 103 AND 106).

OWNER OF U.S. REG. NO. 3,429,403.

OWNER OF INTERNATIONAL REGISTRATION 1093154 DATED 4-29-2011, EXPIRES 4-29-2021.

THE MARK CONSISTS OF THE WORDING "COMELIT" WITH A STYLIZED ARROW, PLACED ON THE LEFT SIDE OF THE SAID WORDING.



*David J. Kyjars*

Director of the United States Patent and Trademark Office

**Reg. No. 4,196,465** SER. NO. 79-103,505, FILED 4-29-2011.

PATRICIA EVANKO, EXAMINING ATTORNEY

# United States of America

United States Patent and Trademark Office

# TISI

**Reg. No. 4,196,466**

**Registered Aug. 28, 2012**

**Int. Cl.: 36**

**SERVICE MARK**

**PRINCIPAL REGISTER**

STEEL BUSINESS BRIEFING LIMITED (UNITED KINGDOM LIMITED COMPANY)  
HAZLEMS FENTON CHARTERED ACCOUNTANTS  
PALLADIUM HOUSE; 1-4 ARGYLL STREET  
LONDON W1F 7LD, UNITED KINGDOM

FOR: PROVISION OF PRICING INFORMATION ABOUT COMMODITIES; COMMODITIES INVESTMENT ADVICE, INFORMATION AND CONSULTANCY SERVICES; COMMODITY QUOTATIONS; FINANCIAL INFORMATION SERVICES PROVIDED ONLINE FROM A COMPUTER DATABASE OR A GLOBAL COMPUTER NETWORK, NAMELY, PROVIDING INVESTMENT AND PRICING INFORMATION IN THE FIELD OF COMMODITIES; FINANCIAL INFORMATION SERVICES RELATING TO FINANCIAL STOCK MARKETS AND COMMODITIES; FINANCIAL INFORMATION SERVICES RELATING TO THE BUYING AND TRADING OF COMMODITIES; PREPARATION OF FINANCIAL ANALYSES RELATING TO COMMODITIES; PROVISION OF COMPUTERIZED INFORMATION RELATING TO COMMODITIES; PROVISION OF FINANCIAL INFORMATION RELATING TO PRICE INDEXES, STEEL, IRON ORE AND METAL PRICE INDEXES AND STOCK EXCHANGE PRICE QUOTATIONS, IN CLASS 36 (U.S. CLS. 100, 101 AND 102).

THE MARK CONSISTS OF STANDARD CHARACTERS WITHOUT CLAIM TO ANY PARTICULAR FONT, STYLE, SIZE, OR COLOR.

PRIORITY DATE OF 12-30-2010 IS CLAIMED.

OWNER OF INTERNATIONAL REGISTRATION 1093263 DATED 6-30-2011, EXPIRES 6-30-2021.

SER. NO. 79-103,552, FILED 6-30-2011.

COLLEEN KEARNEY, EXAMINING ATTORNEY



*David J. Kyjars*

Director of the United States Patent and Trademark Office

# United States of America

United States Patent and Trademark Office

## DIAMOND TWINS

**Reg. No. 4,196,467**

**Registered Aug. 28, 2012**

**Int. Cls.: 10 and 16**

**TRADEMARK**

**PRINCIPAL REGISTER**

KARL STORZ GMBH & CO. KG (FED REP GERMANY GMBH & CO. KG)  
MITTELSTRASSE 8  
78532 TUTTLINGEN  
FED REP GERMANY

FOR: SURGICAL AND MEDICAL APPARATUS MADE IN PART WITH DIAMONDS FOR USE IN GENERAL AND ENDOSCOPIC SURGERY , IN CLASS 10 (U.S. CLS. 26, 39 AND 44).

FOR: PRINTED MATERIAL, NAMELY, CATALOGUES, MAGAZINES, JOURNALS, BROCHURES AND INFORMATIONAL FLYERS, LETTERS AND SHEETS IN THE FIELD OF MEDICAL TECHNOLOGY; BINDERS; PRINTED TEACHING AND INSTRUCTIONAL MANUALS IN THE FIELD OF MEDICAL TECHNOLOGY; PHOTOGRAPHS, IN CLASS 16 (U.S. CLS. 2, 5, 22, 23, 29, 37, 38 AND 50).

THE MARK CONSISTS OF STANDARD CHARACTERS WITHOUT CLAIM TO ANY PARTICULAR FONT, STYLE, SIZE, OR COLOR.

PRIORITY DATE OF 2-15-2011 IS CLAIMED.

OWNER OF INTERNATIONAL REGISTRATION 1093276 DATED 8-2-2011, EXPIRES 8-2-2021.

NO CLAIM IS MADE TO THE EXCLUSIVE RIGHT TO USE "DIAMOND", APART FROM THE MARK AS SHOWN.

SER. NO. 79-103,557, FILED 8-2-2011.

JOHN DWYER, EXAMINING ATTORNEY



*David J. Kypos*

Director of the United States Patent and Trademark Office



# United States of America

United States Patent and Trademark Office



**Reg. No. 4,196,468**

**Registered Aug. 28, 2012**

**Int. Cl.: 14**

**TRADEMARK**

**PRINCIPAL REGISTER**

CALMELL IBAÑEZ, M. DE LOS ANGELES (SPAIN INDIVIDUAL)  
CALLE FIGUERES, 8  
E-08022 BARCELONA  
SPAIN

FOR: PRECIOUS METALS AND THEIR ALLOYS AND GOODS IN THESE MATERIALS OR COATED THEREWITH, NAMELY, RINGS, EARRINGS, BRACELETS, PENDANTS, NECKLACES, BROOCHES, TIE PINS, PINS BEING JEWELRY, CHAINS, TRAYS FOR HOLDING JEWELRY, RECOGNITION AND WALL PLAQUES, PACIFIER FIGURINES FOR USE AS KEEPSAKES, KEY RINGS, JEWELRY BOXES, WATCHES AND OTHER HOROLOGICAL AND CHRONOMETRIC INSTRUMENTS, JEWELRY; PRECIOUS STONES, IN CLASS 14 (U.S. CLS. 2, 27, 28 AND 50).

THE MARK CONSISTS OF THE WORD "ONA" IN STYLIZED TEXT WHEREIN A CIRCLE APPEARS WITHIN THE LETTER "O" AND A CIRCLE APPEARS AFTER THE "N".

OWNER OF INTERNATIONAL REGISTRATION 1093446 DATED 8-17-2011, EXPIRES 8-17-2021.

THE ENGLISH TRANSLATION OF "ONA" IN THE MARK IS WAIVE.

SER. NO. 79-103,620, FILED 8-17-2011.

SHANNON TWOHIG, EXAMINING ATTORNEY



*David J. Kyros*

Director of the United States Patent and Trademark Office

# United States of America

United States Patent and Trademark Office

# AWI

**Reg. No. 4,196,469**

**Registered Aug. 28, 2012**

**Int. Cls.: 6 and 37**

**TRADEMARK**

**SERVICE MARK**

**PRINCIPAL REGISTER**

AWI OUTSOURCING LIMITED (UNITED KINGDOM LIMITED COMPANY)  
SUITE 13, BROOK HOUSE  
BROOK STREET; DRIFFIELD, EAST YORKSHIREYO25 6AP  
UNITED KINGDOM

FOR: METAL BUILDING MATERIALS, NAMELY, FRAMES, GIRDERS, TILES, WALL PANELS, CEILING PANELS, GENERAL PURPOSE WALL, FLOOR, AND CEILING PANELS, ALSO HAVING ACOUSTIC REFLECTING PROPERTIES, AND WALLS OF METAL; MODULAR, TRANSPORTABLE BUILDINGS OF METAL OR PREDOMINANTLY OF METAL; PRE-FABRICATED METAL ELEMENTS FOR BUILDINGS, NAMELY, BEAMS, TRUSSES, TOWERS, FIXED NON-MECHANICAL WALKWAYS, STAIRS, HANDRAILS, PLATFORMS, LANDINGS FOR STAIRWAYS, CANOPIES, MEZZANINES, LOUVRE DOORS, PARTITIONS, VENTILATION DUCTS, GRATINGS, CHIMNEYS, AND CLADDING; METAL SILOS, MODULAR METAL BUILDINGS WITH LOCKING DOORS, MOVEABLE METAL OFFICES, AND METAL RESIDENTIAL UNITS, ALL FOR LATER INSTALLATION AS FIXED METAL STRUCTURES; PARTS AND FITTINGS FOR ALL THE AFORESAID GOODS, IN CLASS 6 (U.S. CLS. 2, 12, 13, 14, 23, 25 AND 50).

FOR: BUILDING SERVICES, NAMELY, BUILDING CONSTRUCTION, PLANNING, LAYING OUT, AND CUSTOM CONSTRUCTION OF COMMERCIAL BUILDINGS; MAINTENANCE AND REPAIR SERVICES, NAMELY, MAINTENANCE AND REPAIR OF BUILDINGS; CONSTRUCTION OF BUILDINGS; BUILDING CONSTRUCTION SUPERVISION SERVICES FOR BUILDING PROJECTS; INSTALLATION, MAINTENANCE AND REPAIR OF METALLIC MODULAR BUILDINGS, IN CLASS 37 (U.S. CLS. 100, 103 AND 106).

THE MARK CONSISTS OF STANDARD CHARACTERS WITHOUT CLAIM TO ANY PARTICULAR FONT, STYLE, SIZE, OR COLOR.

PRIORITY DATE OF 1-20-2011 IS CLAIMED.

OWNER OF INTERNATIONAL REGISTRATION 1093828 DATED 5-28-2011, EXPIRES 5-28-2021.

SER. NO. 79-103,765, FILED 5-28-2011.

LIEF MARTIN, EXAMINING ATTORNEY



*David J. Kyros*

Director of the United States Patent and Trademark Office

# United States of America

United States Patent and Trademark Office

# КИС-КИС

**Reg. No. 4,196,470**

**Registered Aug. 28, 2012**

**Int. Cl.: 30**

JOINT-STOCK COMPANY "KRASNYJ OCTYABR" (RUSSIAN FED. OPEN-TYPE JOINT STOCK COMPANY)  
UL. MALAYA KRASNOSCLSKAYA  
D. 7, STR. 24; RU-107140 MOSCOW  
RUSSIAN FED.

**TRADEMARK**

**PRINCIPAL REGISTER**

FOR: CONFECTIONERY MADE OF SUGAR, WAFFLES; CAKES; PASTRIES; PEANUT AND/OR ALMOND CONFECTIONERY IN THE FORM OF CHIPS; COCOA; COCOA PRODUCTS, NAMELY COCOA POWDER, COCOA MIXES, COCOA SPREADS, COCOA-BASED BEVERAGES; CARAMELS; SWEETMEATS; PEPPERMINT SWEETS; CRACKERS; CANDY FOR FOOD; FRUIT JELLY CANDIES; MARZIPAN; COCOA BEVERAGES WITH MILK; CHOCOLATE BEVERAGES WITH MILK; CHOCOLATE-BASED BEVERAGES; BISCUITS; FONDANTS; PRALINES; GINGERBREAD; CONFECTIONERY, NAMELY TOFFEE, PASTILLA, MARSHMALLOW, WAFFLE CAKES, SWEET SPREADS MADE FROM FRUIT, CHOCOLATE OR CHOCOLATE WITH NUTS; RUSKS; TARTS; HALVAH; CHOCOLATE, IN CLASS 30 (U.S. CL. 46).

THE MARK CONSISTS OF KIS-KIS IN CYRILLIC (RUSSIAN) CHARACTERS.

OWNER OF INTERNATIONAL REGISTRATION 0969821 DATED 5-29-2008, EXPIRES 5-29-2018.

THE TRANSLITERATION OF THE NON-LATIN CHARACTERS IN THE MARK IS: "KIS-KIS".

THE ENGLISH TRANSLATION OF CYRILLIC (RUSSIAN) CHARACTERS IN THE MARK IS "KITTY, KITTY".

SER. NO. 79-103,792, FILED 9-20-2011.

MARTHA SANTOMARTINO, EXAMINING ATTORNEY



*David J. Kyffers*

Director of the United States Patent and Trademark Office

# United States of America

United States Patent and Trademark Office

# FOAMSTREAM

**Reg. No. 4,196,471**

**Registered Aug. 28, 2012**

**Int. Cls.: 1, 7 and 37**

**TRADEMARK**

**SERVICE MARK**

**PRINCIPAL REGISTER**

WEEDING TECHNOLOGIES LIMITED (UNITED KINGDOM LIMITED COMPANY)  
2 FITZHARDINGE STREET  
LONDON W1H 6EE  
UNITED KINGDOM

FOR: CHEMICALS FOR USE IN AGRICULTURE, GARDENING AND FACILITIES MANAGEMENT, NAMELY, SURFACTANTS FOR USE IN AGRICULTURAL SPRAYS EXCLUDING AGRICULTURAL FUNGICIDES, HERBICIDES, INSECTICIDES AND PARASITICIDES, IN CLASS 1 (U.S. CLS. 1, 5, 6, 10, 26 AND 46).

FOR: MACHINES FOR USE IN AGRICULTURE, GARDENING AND FACILITIES MANAGEMENT, NAMELY, LAWN AND GARDEN TILLING MACHINES, POWER OPERATED LAWN AND GARDEN STRING TRIMMERS, POWER OPERATED LAWN AND GARDEN EDGERS; MACHINES FOR USE IN AGRICULTURE, GARDENING AND FACILITIES MANAGEMENT, NAMELY, POWER OPERATED SPRAYERS THAT GENERATE STEAM AND FOAM USED TO SPRAY WEEDS AND STRUCTURAL PARTS AND FITTINGS THEREFOR, IN CLASS 7 (U.S. CLS. 13, 19, 21, 23, 31, 34 AND 35).

FOR: MAINTENANCE AND SERVICING OF MACHINES FOR USE IN AGRICULTURE, GARDENING AND FACILITIES MANAGEMENT; MAINTENANCE AND SERVICING OF MACHINES FOR USE IN KILLING WEEDS, IN CLASS 37 (U.S. CLS. 100, 103 AND 106).

THE MARK CONSISTS OF STANDARD CHARACTERS WITHOUT CLAIM TO ANY PARTICULAR FONT, STYLE, SIZE, OR COLOR.

PRIORITY DATE OF 2-24-2011 IS CLAIMED.

OWNER OF INTERNATIONAL REGISTRATION 1094018 DATED 8-12-2011, EXPIRES 8-12-2021.

SER. NO. 79-103,849, FILED 8-12-2011.

MICHAEL TANNER, EXAMINING ATTORNEY



*David J. Kypos*

Director of the United States Patent and Trademark Office

# United States of America

United States Patent and Trademark Office

# FreeBase

**Reg. No. 4,196,472**

**Registered Aug. 28, 2012**

**Int. Cls.: 5 and 10**

**TRADEMARK**

**PRINCIPAL REGISTER**

FRIADENT GMBH (FED REP GERMANY LIMITED LIABILITY COMPANY)  
STEINZEUGSTRASSE 50  
68229 MANNHEIM  
FED REP GERMANY

FOR: LIVING TISSUE IMPLANTS FOR TISSUES OF HUMAN OR ANIMAL BODIES; BONE IMPLANT MATERIALS COMPRISED OF LIVING TISSUES; REPLACEMENT MATERIALS FOR HUMAN AND ANIMAL BODY TISSUE MADE OF MARITIME ALGAE AND OTHER LIVING TISSUES; MEMBRANES COMPRISING LIVING TISSUE TO COVER BONE DEFECTS; ALL THE AFORESAID GOODS IN THE FORM OF GRANULES, POWDER, FORMED PARTS, PASTES, JELLIES, LIQUIDS OR MIXTURES OF THESE; IMPLANT MATERIALS, REPLACEMENT MATERIALS AND SUBSTITUTES FOR TISSUES OF HUMAN OR ANIMAL BODIES, ALL COMPRISING LIVING TISSUES, PARTICULARLY MARITIME ALGAE; BIOLOGICAL LIVING TISSUE BONE IMPLANT MATERIALS; MEMBRANES TO COVER BONE DEFECTS COMPRISED OF LIVING NATURAL TISSUES, IN CLASS 5 (U.S. CLS. 6, 18, 44, 46, 51 AND 52).

FOR: DENTAL IMPLANTS AND THEIR ACCESSORIES, NAMELY, ABUTMENTS AND INSTRUMENTS; DENTAL IMPLANT SURFACES MADE OF TITAN; COMPONENTS OF DENTAL PROSTHESIS, NAMELY, GINGIVAL FORMER, TRANSFER COPING, ABUTMENTS, MEDICAL SCREW CONNECTIONS, DENTAL BRIDGES; TOOLS FOR SURGICAL AND DENTAL PURPOSES, NAMELY, DRILLS, DRIVERS, SCREWS, AND DENTAL TOOLS FOR HANDLING DENTAL IMPLANTS AND SURGICAL INSTRUMENTS; MEDICAL DEVICES, NAMELY, MEMBRANES TO COVER BONE DEFECTS MADE OF TITAN AND OTHER ARTIFICIAL MATERIALS; IMPLANTS COMPRISING ARTIFICIAL MATERIAL FOR USE IN DENTISTRY, FOR FACIAL SURGERY AND MAXILLOFACIAL SURGERY; MEDICAL INSTRUMENTS FOR IMPLANT AND SURGICAL PURPOSES; DENTAL IMPLANTS COMPRISING ARTIFICIAL MATERIAL FOR SINGLE AND MULTIPLE DENTAL PROSTHESIS AND PARTS THEREOF; AUXILIARY PARTS FOR THE CONNECTION OF PROSTHODONTICS AND DENTAL IMPLANTS; DENTAL INSTRUMENTS AND APPARATUS TO INSERT AND SUPPORT DENTAL IMPLANTS; SEPARATE COMPONENT PARTS FOR DENTAL PROSTHESIS SUPPORTED BY BAR-JOINT DENTURE; MEDICAL AND SURGICAL APPARATUS, NAMELY, APPARATUS TO SUPPORT MEDICAL TREATMENT, NAMELY, PLANNING SUPPORT FOR IMPLANT PROSTHESIS; DENTAL SUPRACONSTRUCTIONS, NAMELY, DENTAL CROWNS, DENTAL BRIDGES, DENTAL PROSTHESES, PARTS THEREOF; APPARATUS, INSTRUMENTS AND TOOLS FOR SURGICAL AND DENTAL PURPOSES AND FOR USE IN DENTAL LABORATORIES, NAMELY, MECHANICALLY



*David J. Kyffers*

Director of the United States Patent and Trademark Office

**Reg. No. 4,196,472** OPERATED DENTAL UNITS AS WELL AS INSTRUMENTS AND TOOLS FOR IMPLANTS AND PROSTHESES; COMPONENT AND REPLACEMENT PARTS OF THE AFORESAID APPARATUS, INSTRUMENTS AND TOOLS; SPECIAL CASES, BAGS AND BOXES FOR MEDICAL AND DENTAL PURPOSES AND FOR USE IN DENTAL LABORATORIES, PARTICULARLY FOR THE STORAGE AND FOR THE STERILIZATION OF THE AFORESAID APPARATUS, INSTRUMENTS AND TOOLS, IMPLANTS AND DENTAL SUPRACONSTRUCTIONS; SURGICAL HAND INSTRUMENTS; SURGICAL INSTRUMENTS MECHANICALLY OPERATED; ARTIFICIAL IMPLANT TISSUE IN THE NATURE OF MEMBRANES TO COVER BONE DEFECTS AS WELL AS SCREWS AND PINS FOR THE FIXING OF THESE MEMBRANES ON THE BONE; IMPLANT MATERIALS AND SUBSTITUTE MATERIALS FOR TISSUES OF HUMAN OR ANIMAL BODIES MADE OF ARTIFICIAL MATERIALS, NAMELY, OF BIOCERAMICS, PLASTIC AND/OR METAL; REPLACEMENT MATERIALS MADE OF BIOCERAMIC MATERIALS AND/OR PLASTIC AND/OR METAL FOR TISSUES OF THE HUMAN BODY IN FORM OF GRANULES, POWDER, FORMED PARTS, PASTES, JELLIES, LIQUIDS OR MIXTURES OF THESE, IN CLASS 10 (U.S. CLS. 26, 39 AND 44).

THE MARK CONSISTS OF STANDARD CHARACTERS WITHOUT CLAIM TO ANY PARTICULAR FONT, STYLE, SIZE, OR COLOR.

PRIORITY DATE OF 11-29-2010 IS CLAIMED.

OWNER OF INTERNATIONAL REGISTRATION 1094124 DATED 5-26-2011, EXPIRES 5-26-2021.

SER. NO. 79-103,884, FILED 5-26-2011.

REBECCA POVARCHUK, EXAMINING ATTORNEY

# United States of America

United States Patent and Trademark Office

## WINXCLUBADVENTURE

**Reg. No. 4,196,473**

**Registered Aug. 28, 2012**

**Int. Cls.: 9, 35, 38, 41  
and 42**

**TRADEMARK**

**SERVICE MARK**

**PRINCIPAL REGISTER**

RAINBOW S.R.L. (ITALY LIMITED LIABILITY COMPANY)  
SNC, VIA BRECCIE  
I-60025 LORETO (AN)  
ITALY

FOR: GAME SOFTWARE FOR USE ON COMPUTERS OR VIDEO GAME PLAYERS; COMPUTER GAME SOFTWARE; AMUSEMENT APPARATUS AND GAMES ADAPTED FOR USE WITH VIDEO, NAMELY, VIDEO GAME JOYSTICKS, VIDEO GAME DISCS; COMPUTER GAME SOFTWARE FOR PERSONAL COMPUTERS AND HOME VIDEO GAME CONSOLES; COMPUTER PROGRAMS FOR VIDEO AND COMPUTER GAMES; PRERECORDED CD-ROMS FEATURING COMPUTER GAMES; COMPUTER PROGRAM MEMORY HARDWARE IN THE FORM OF CARTRIDGES; PRERECORDED VIDEO DISCS, TAPES, CASSETTES, AND TRANSMISSION OF WEBCASTS COMPACT DISCS FEATURING COMPUTER GAMES; PRERECORDED MAGNETIC DATA CARRIERS FEATURING GAMES FOR COMPUTERS OR VIDEO GAME CONSOLES; AUDIO AND VIDEO RECORDINGS FEATURING ELECTRONIC GAMES, IN CLASS 9 (U.S. CLS. 21, 23, 26, 36 AND 38).

FOR: RETAIL STORE SERVICES FEATURING VIDEO GAMES, COMPUTER GAMES AND SOFTWARE FOR COMPUTER GAMES, IN CLASS 35 (U.S. CLS. 100, 101 AND 102).

FOR: TELECOMMUNICATIONS SERVICES, NAMELY, TRANSMISSION OF WEBCASTS; TELECOMMUNICATIONS SERVICES, NAMELY, ELECTRONIC TRANSMISSION OF DOWNLOADABLE AUDIO AND VIDEO FILES BY MEANS OF GLOBAL COMPUTER NETWORKS; PROVIDING THIRD-PARTY USERS WITH ACCESS TO TELECOMMUNICATION INFRASTRUCTURE, NAMELY, PROVISION OF ACCESS TO REMOTE USERS OF ENTERTAINMENT, AND DOWNLOADABLE EDUCATIONAL AND GAME APPLICATIONS AND SOFTWARE PROGRAMS VIA THE INTERNET, CABLE OR SATELLITE COMMUNICATION SERVICES; PROVISION OF E-MAIL SERVICES; PROVIDING USER ACCESS TO THE INTERNET; PROVIDING TELECOMMUNICATIONS CONNECTIONS TO THE INTERNET OR DATABASES, IN CLASS 38 (U.S. CLS. 100, 101 AND 104).

FOR: ENTERTAINMENT, NAMELY, A CONTINUING VARIETY, NEWS, MUSIC OR COMEDY SHOW BROADCAST OVER THE INTERNET; PROVIDING TEMPORARY USE OF NON-DOWNLOADABLE COMPUTER GAMES BY MEANS OF TELECOMMUNICATION NETWORKS; PROVIDING NON-DOWNLOADABLE ELECTRONIC PUBLICATIONS, NAMELY, NEWSLETTERS IN THE FIELD OF COMPUTER GAMES AND TECHNOLOGY; PROVIDING ON-LINE NON-DOWNLOADABLE FILMS VIA A VIDEO-ON-DEMAND SER-



*David J. Kyffers*

Director of the United States Patent and Trademark Office

**Reg. No. 4,196,473** VICE; PROVIDING COMPUTER GAMES VIA COMMUNICATION NETWORKS FOR USE NETWORK-WIDE BY NETWORK USERS; PROVIDING INFORMATION AND CONSULTANCY IN THE FIELD OF ON-LINE COMPUTER GAMES; PROVIDING CINEMA PRESENTATIONS, NAMELY, ARRANGING FOR THE SHOWING OF MOVIES; PRODUCTION OF CINEMATOGRAPHIC FILMS; DISTRIBUTION OF CINEMATOGRAPHIC FILMS, IN CLASS 41 (U.S. CLS. 100, 101 AND 107).

FOR: DESIGN, DEVELOPMENT, PROGRAMMING, AND MAINTENANCE OF COMPUTER GAME SOFTWARE; DESIGN OF COMPUTER HARDWARE FOR USE WITH COMPUTER GAME SOFTWARE; PROVISION OF TECHNICAL SUPPORT IN THE NATURE OF DIAGNOSING PROBLEMS IN THE FIELD OF COMPUTER GAMES SOFTWARE; PROVIDING ADVISORY SERVICES AND INFORMATION IN THE FIELD OF DESIGN, PROGRAMMING, AND MAINTENANCE OF VIDEO GAMES SOFTWARE, IN CLASS 42 (U.S. CLS. 100 AND 101).

THE MARK CONSISTS OF STANDARD CHARACTERS WITHOUT CLAIM TO ANY PARTICULAR FONT, STYLE, SIZE, OR COLOR.

PRIORITY DATE OF 4-18-2011 IS CLAIMED.

OWNER OF INTERNATIONAL REGISTRATION 1094531 DATED 7-19-2011, EXPIRES 7-19-2021.

OWNER OF U.S. REG. NOS. 3,258,932, 3,376,208 AND OTHERS.

SER. NO. 79-104,039, FILED 7-19-2011.

ALYSSA STEEL, EXAMINING ATTORNEY



# United States of America

United States Patent and Trademark Office

## JP CONVEYORS

**Reg. No. 4,196,474**

**Registered Aug. 28, 2012**

**Int. Cls.: 7 and 37**

**TRADEMARK**

**SERVICE MARK**

**PRINCIPAL REGISTER**

ASHWORTH EUROPE B.V. (NETHERLANDS BESLOTEN VENNOOTSCHAP)  
INDUSTRIESTRAAT 6 B  
NL-7622 AV BORNE  
NETHERLANDS

FOR: MACHINES, NAMELY, CONVEYING BELT MACHINES, AND MACHINE PARTS FOR CONVEYING BELT MACHINES, SUCH AS RODS, FRAMES, SPIRALS AND DRIVES; CONVEYORS; BELTS FOR CONVEYORS MADE OF METAL, PLASTIC OR COMBINATIONS OF THESE MATERIALS, IN CLASS 7 (U.S. CLS. 13, 19, 21, 23, 31, 34 AND 35).

FOR: REPAIR, INSTALLATION AND MAINTENANCE OF MACHINES AND MACHINE TOOLS, CONVEYORS AND BELTS FOR CONVEYORS MADE OF METAL, PLASTIC OR COMBINATIONS OF THESE MATERIALS, IN CLASS 37 (U.S. CLS. 100, 103 AND 106).

THE MARK CONSISTS OF STANDARD CHARACTERS WITHOUT CLAIM TO ANY PARTICULAR FONT, STYLE, SIZE, OR COLOR.

PRIORITY DATE OF 4-22-2011 IS CLAIMED.

OWNER OF INTERNATIONAL REGISTRATION 1094542 DATED 9-20-2011, EXPIRES 9-20-2021.

NO CLAIM IS MADE TO THE EXCLUSIVE RIGHT TO USE "CONVEYORS", APART FROM THE MARK AS SHOWN.

SER. NO. 79-104,044, FILED 9-20-2011.

WILLIAM ROSSMAN, EXAMINING ATTORNEY



*David J. Kypos*

Director of the United States Patent and Trademark Office

# United States of America

United States Patent and Trademark Office

# GO-SYCO

**Reg. No. 4,196,475**

**Registered Aug. 28, 2012**

**Int. Cl.: 28**

**TRADEMARK**

**PRINCIPAL REGISTER**

SYCO INDUSTRIES PTY LTD (AUSTRALIA INCORPORATED COMPANY)  
7 CAYMAN CRESCENT  
ORMISTON QLD 4160  
AUSTRALIA

FOR: APPARATUS FOR PLAYING SPORTS, NAMELY, RIDE-ON APPARATUS WHICH SIMULATES THE MOVEMENT OF A SURFBOARD, SNOWBOARD, SKATEBOARD OR KITEBOARD; SPORTS TRAINING APPARATUS, NAMELY, RIDE-ON APPARATUS WHICH SIMULATES THE MOVEMENT OF A SURFBOARD, SNOWBOARD, SKATEBOARD OR KITEBOARD; TRAINING APPLIANCES FOR SPORTSMEN AND SPORTSWOMEN, NAMELY, RIDE-ON APPARATUS WHICH SIMULATES THE MOVEMENT OF A SURFBOARD, SNOWBOARD, SKATEBOARD OR KITEBOARD; FITNESS AND PHYSICAL EXERCISE APPARATUS, NAMELY, RIDE-ON APPARATUS WHICH SIMULATES THE MOVEMENT OF A SURFBOARD, SNOWBOARD, SKATEBOARD OR KITEBOARD; APPARATUS FOR GAMES, NAMELY, MECHANICAL GAME APPARATUS WHICH SIMULATES THE MOVEMENT OF A SURFBOARD, SNOWBOARD, SKATEBOARD OR KITEBOARD; EQUIPMENT SOLD AS A UNIT FOR PLAYING BOARD GAMES; ELECTRONIC GAMES, NAMELY, ELECTRONIC GAMES AND AUTOMATIC HAND HELD COMPUTER GAMES OTHER THAN THOSE ADAPTED FOR USE WITH AN EXTERNAL DISPLAY SCREEN OR MONITOR; GAMES, NAMELY, INDOOR AND OUTDOOR GAMES IN THE NATURE OF ACTION SKILL GAMES; SKATEBOARDS; SURFBOARDS; SNOWBOARDS; KITEBOARDS; BODYBOARDS; WAKEBOARDS; WINDSURFING BOARDS, IN CLASS 28 (U.S. CLS. 22, 23, 38 AND 50).



OWNER OF U.S. REG. NO. 3,873,019.

PRIORITY DATE OF 10-19-2010 IS CLAIMED.

OWNER OF INTERNATIONAL REGISTRATION 1094691 DATED 4-19-2011, EXPIRES 4-19-2021.

SER. NO. 79-104,118, FILED 4-19-2011.

DOMINIC FATHY, EXAMINING ATTORNEY

*David J. Kyros*

Director of the United States Patent and Trademark Office

# United States of America

United States Patent and Trademark Office



**Reg. No. 4,196,476**

**Registered Aug. 28, 2012**

**Int. Cl.: 14**

**TRADEMARK**

**PRINCIPAL REGISTER**

TOD'S S.P.A. (ITALY CORPORATION)  
VIA FILIPPO DELLA VALLE, 1  
I-63811 SANT'ELPIDIO A MARE (FM)  
ITALY

FOR: WATCHES AND CLOCKS, PENDULUM CLOCKS, CHRONOGRAPHS AS WATCHES AND CHRONOMETERS, ROUGH GEMSTONES, PRECIOUS STONES, DIAMONDS, CORAL JEWELRY, EMERALD, SAPPHIRE, RUBY, OPAL, TOPAZ, GEMSTONE IN THE NATURE OF AQUAMARINE; EARRINGS, RINGS, NECKLACES, BRACELETS, ORNAMENTAL PINS MADE OF PRECIOUS METAL, SHOE ORNAMENTS OF PRECIOUS METAL, PEARLS, DECORATIVE BOXES MADE OF PRECIOUS METAL, JEWELS CASES OF PRECIOUS METAL, BROOCHES, PINS BEING JEWELRY, TIE CLIPS, CUFF LINKS, LEATHER BRACELETS, IN CLASS 14 (U.S. CLS. 2, 27, 28 AND 50).

THE MARK CONSISTS OF THE LETTER "T". TO THE RIGHT OF THE "T" IS A PROFILE OF A LION'S HEAD.

PRIORITY DATE OF 8-9-2011 IS CLAIMED.

OWNER OF INTERNATIONAL REGISTRATION 1095022 DATED 8-10-2011, EXPIRES 8-10-2021.

SER. NO. 79-104,254, FILED 8-10-2011.

WENDY JUN, EXAMINING ATTORNEY



*David J. Kybas*

Director of the United States Patent and Trademark Office

# United States of America

United States Patent and Trademark Office

# A X W

**Reg. No. 4,196,477**

**Registered Aug. 28, 2012**

**Int. Cl.: 9**

**TRADEMARK**

**PRINCIPAL REGISTER**

YOKOGAWA ELECTRIC CORPORATION (JAPAN CORPORATION)  
9-32, NAKACHO 2-CHOME  
MUSASHINO-SHI  
TOKYO, JAPAN 1808750

FOR: FLOWMETERS; COMPUTER SOFTWARE FOR DATABASE MANAGEMENT FOR USE IN THE FIELD OF FLOW MEASUREMENT; DOWNLOADABLE COMPUTER SOFTWARE VIA COMPUTER NETWORKS FOR DATABASE MANAGEMENT; COMPUTER PROGRAMMES FOR DATABASE MANAGEMENT; COMPUTER SOFTWARE FOR DATABASE MANAGEMENT; COMPUTER HARDWARE; RESISTANCE WIRES; ELECTRODES; ELECTRIC WIRES AND CABLES, IN CLASS 9 (U.S. CLS. 21, 23, 26, 36 AND 38).

THE MARK CONSISTS OF STANDARD CHARACTERS WITHOUT CLAIM TO ANY PARTICULAR FONT, STYLE, SIZE, OR COLOR.

PRIORITY DATE OF 8-10-2011 IS CLAIMED.

OWNER OF INTERNATIONAL REGISTRATION 1095024 DATED 9-2-2011, EXPIRES 9-2-2021.

SER. NO. 79-104,255, FILED 9-2-2011.

MATTHEW EINSTEIN, EXAMINING ATTORNEY



*David J. Kyros*

Director of the United States Patent and Trademark Office

# United States of America

United States Patent and Trademark Office

# Combat Zone

**Reg. No. 4,196,478**

**Registered Aug. 28, 2012**

**Int. Cl.: 28**

**TRADEMARK**

**PRINCIPAL REGISTER**

JANE GOMES (AUSTRALIA INDIVIDUAL)  
248 RAMMUTT ROAD  
GYMPIE QLD 4570  
AUSTRALIA

FOR: EXERCISE EQUIPMENT AND APPARATUS, NAMELY, BODY BUILDING AND TRAINING APPARATUS; SKIPPING ROPES; EXERCISE EQUIPMENT FOR USE IN RELATION TO BOXING AND MARTIAL ARTS, NAMELY, PUNCHING BAGS, PUNCHING MITTS, PUNCHING BALLS, PUNCH PADS, BOXING GLOVES, TACKLING DUMMIES AND STRIKING SHIELDS, IN CLASS 28 (U.S. CLS. 22, 23, 38 AND 50).

THE MARK CONSISTS OF STANDARD CHARACTERS WITHOUT CLAIM TO ANY PARTICULAR FONT, STYLE, SIZE, OR COLOR.

PRIORITY DATE OF 11-30-2010 IS CLAIMED.

OWNER OF INTERNATIONAL REGISTRATION 1095811 DATED 5-27-2011, EXPIRES 5-27-2021.

SER. NO. 79-104,573, FILED 5-27-2011.

WILLIAM BRECKENFELD, EXAMINING ATTORNEY



*David J. Kyffers*

Director of the United States Patent and Trademark Office

# United States of America

United States Patent and Trademark Office



**Reg. No. 4,196,479**

**Registered Aug. 28, 2012**

**Int. Cl.: 37**

**SERVICE MARK**

**PRINCIPAL REGISTER**

OTKRYTOE AKTSIONERNOE OBSHCHESTVO; "STROITELNAYA KOMPANIA "MOST"  
(RUSSIAN FED. OTKRYTOE AKTSIONERNOE OBSHCHESTVO)  
KORP.4, D.9, MICHURINSKY PROSPECT  
RU-119192 MOSKVA, RUSSIAN FED.

FOR: RETREADING OF TIRES; INSTALLATION OF BUILDING INSULATIONS; PROVIDING INFORMATION ON REPAIR SERVICES IN THE FIELD OF INDUSTRIAL CONSTRUCTION; BUILDING CONSTRUCTION INFORMATION; SCAFFOLDING ERECTION; CAR WASHING; VEHICLE WASHING; CLEANING OF BUILDING EXTERIOR SURFACE; RENTAL OF BULLDOZERS, EXCAVATORS, CRANES AND CONSTRUCTION EQUIPMENT; CABINET REPAIR; VEHICLE SERVICE STATIONS; CONSTRUCTION OF ROADS, BRIDGES, ARTIFICIAL STRUCTURES IN THE NATURE OF BUILDINGS, TUNNELS, UNDERGROUND STRUCTURES, MASONRY WALLS AND STRUCTURES, AIRPORTS, HOUSING PADS, TELECOMMUNICATIONS TOWERS, PORTS, HYDRO-ELECTRIC POWER PLANTS, PIPELINES, EMBANKMENTS, NAMELY, WATERFRONT REINFORCEMENTS FOR RIVERS, LAKES, AND OTHER BODIES OF WATER, HOUSING AND COMMERCIAL BUILDINGS, STEEL STRUCTURES, HOTELS AND WAREHOUSES, STRUCTURES FOR THE PRODUCTION OF NATURAL GAS; INTERFERENCE SUPPRESSION SERVICES FOR ELECTRICAL APPARATUS; FLOOR, IN CLASS 37 (U.S. CLS. 100, 103 AND 106).

THE MARK CONSISTS OF A BLUE AND WHITE STYLIZED BRIDGE DESIGN COMPOSED OF VARIOUSLY POSITIONED TRIANGLES ABOVE THE STYLIZED WORDING "SKMOST" ALSO APPEARING IN THE COLOR BLUE WITH WHITE INTERSECTING LINES THROUGHOUT THE LETTERS.

OWNER OF INTERNATIONAL REGISTRATION 1095854 DATED 8-3-2011, EXPIRES 8-3-2021.

THE COLOR(S) WHITE AND BLUE IS/ARE CLAIMED AS A FEATURE OF THE MARK.

SER. NO. 79-104,589, FILED 8-3-2011.

GENE MACIOL, EXAMINING ATTORNEY



*David J. Kyffers*

Director of the United States Patent and Trademark Office

# United States of America

United States Patent and Trademark Office

ELENA IACHI

**Reg. No. 4,196,480**

**Registered Aug. 28, 2012**

**Int. Cl.: 25**

STRATEGIA; SOCIETA' A RESPONSABILITA' LIMITATA (ITALY LIMITED LIABILITY COMPANY)  
VIA ENZO FERRARI, 17  
I-62012 CIVITANOVA MARCHE (MC)  
ITALY

**TRADEMARK**

**PRINCIPAL REGISTER**

FOR: SHOES, BOOTS, HALF BOOTS, LEATHER SHOES, GALOSHES, RAIN BOOTS, SPORT FOOTWEAR, SANDALS, SLIPPERS, SHOE SOLES, SHOE HEELS, FOOTWEAR UPPERS; CLOTHING ITEMS, NAMELY, SWEATERS, CARDIGANS, WAISTCOATS, SUITS, TROUSERS, SHORTS, JUMPERS, RAINCOATS, CLOTHING MADE OF LEATHER IN THE NATURE OF COATS, JACKETS, VESTS, PANT SUITS, AND TROUSERS, STOCKINGS AND SOCKS, STOCKING SUSPENDERS, SOCK SUSPENDERS, WIND RESISTANT JACKETS, SKITROUSERS, FUR COATS, OVERCOATS, SKIRTS, DRESSES, JACKETS, UNDERSHIRTS, T-SHIRTS, SPORTS JERSEYS AND BREECHES FOR SPORTS, BLOUSES, SHIRT COLLARS, SHIRTS, FOULARDS, BEACHWEAR, SWIMSUITS, BIKINI, TRACKSUITS; WEDDING DRESSES, UNDERWEAR, BRAS, BRASSIERE, CORSETS, UNDERPANTS, BRIEFS, VESTS, NIGHTGOWNS, NEGLIGEES, PYJAMAS, GLOVES, SHAWLS, SCARVES, NECKTIES, BOW TIES, BELTS FOR CLOTHING, SUSPENDERS, HATS, CAPS, IN CLASS 25 (U.S. CLS. 22 AND 39).

THE NAME "ELENA IACHI" SHOWN IN THE MARK IDENTIFIES THE PSEUDONYM OF "ELENA IACHINI", WHOSE CONSENT(S) TO REGISTER IS MADE OF RECORD.

PRIORITY DATE OF 6-8-2011 IS CLAIMED.

OWNER OF INTERNATIONAL REGISTRATION 1096070 DATED 6-27-2011, EXPIRES 6-27-2021.

THE MARK CONSISTS OF THE WORDS "ELENA IACHI" WRITTEN IN CAPITAL LETTERS ON TWO LINES, WHERE THE LETTERS "A" ARE REPRESENTED BY A TRIANGLE AND PARTIALLY OVERLAP EACH OTHER.

SER. NO. 79-104,657, FILED 6-27-2011.

COURTNEY ALVAREZ, EXAMINING ATTORNEY



*David J. Kyros*

Director of the United States Patent and Trademark Office

# United States of America

United States Patent and Trademark Office

# ANKY

**Reg. No. 4,196,481**

**Registered Aug. 28, 2012**

**Int. Cls.: 18, 25 and 35**

ANKY VAN GRUNSVEN DRESSAGE; HORSES B.V. (NETHERLANDS LIMITED LIABILITY CORPORATION)

BOLST 13

NL-5469 SC ERP

NETHERLANDS

**TRADEMARK**

**SERVICE MARK**

**PRINCIPAL REGISTER**

FOR: ARTICLES FOR EQUESTRIAN SPORTS INCLUDED IN THIS CLASS, NAMELY, EQUINE LEG WRAPS, HORSE BRIDLES, PROTECTIVE PLASTIC HOOF PADS FOR HORSES FOR THE PROTECTION OF THE UNDERSIDE OF HORSES' HOOFS, HORSE TAIL WRAPS, TRAINING LEADS FOR HORSES, SPATS AND KNEE BANDAGES FOR HORSES, SADDLES, PADS FOR HORSE SADDLES, SNAFFLES, DOUBLE BRIDLES, HALTERS, BITS, HORSE BLANKETS, SADDLE CLOTHS, GAITERS AND KNEE-PADS FOR HORSES, FASTENERS FOR HORSE SADDLES, HORSESHOES, HORSE COLLARS, THONGS IN THE NATURE OF THIN LEATHER STRAPS FOR USE WITH HORSES, LEATHER LACES FOR USE WITH HORSES, LEATHER STRAPS FOR USE WITH HORSES, RIDING SADDLES, PADS FOR RIDING SADDLES, REINS AND TRACES, HORSESHOE OVER-REACH BOOTS, FETLOCK BOOTS; GEL CUSHIONS, INNER SOLES AND GEL PADS FOR THE PROTECTION OF HORSES' HOOVES; WHIPS; SADDLERY; SADDLES; HARNESSES AND BITS FOR ANIMALS; PROTECTIVE PADS AND COVERS FOR THE HOOVES, LEGS, BACK AND TAIL OF A HORSE FOR USE DURING TRANSPORTATION AND STABLING, IN CLASS 18 (U.S. CLS. 1, 2, 3, 22 AND 41).

FOR: CLOTHING, NAMELY, TROUSERS, PANTS, COATS, WIND RESISTANT JACKETS, JACKETS, JUMPERS, UNDERWEAR, SOCKS, STOCKINGS, SWEATERS, POLO SHIRTS, T-SHIRTS AND SKIRTS ALL FOR USE IN EQUESTRIAN SPORTS; HEADGEAR, NAMELY, COWBOY HATS, CAPS AND HATS FOR USE IN EQUESTRIAN SPORTS NOT INCLUDING HORSEBACK RIDING HELMETS; FOOTWEAR FOR USE IN EQUESTRIAN SPORTS, IN CLASS 25 (U.S. CLS. 22 AND 39).

FOR: ADVERTISING AND PROMOTIONAL SERVICES FOR OTHERS, IN CLASS 35 (U.S. CLS. 100, 101 AND 102).

THE MARK CONSISTS OF THE STYLIZED WORDING "ANKY".

OWNER OF INTERNATIONAL REGISTRATION 0694710 DATED 5-15-1998, EXPIRES 5-15-2018.



*David J. Kyjars*

Director of the United States Patent and Trademark Office



**Reg. No. 4,196,481** SER. NO. 79-104,707, FILED 12-29-2010.

MICHAEL TANNER, EXAMINING ATTORNEY

# United States of America

United States Patent and Trademark Office

## Digital Customer

**Reg. No. 4,196,482**

**Registered Aug. 28, 2012**

**Int. Cls.: 9, 35, 38 and 42**

**TRADEMARK**

**SERVICE MARK**

**PRINCIPAL REGISTER**

CEGEDIM (FRANCE SOCIÉTÉ ANONYME)  
127-137 RUE D'AGUESSEAU  
F-92100 BOULOGNE-BILLANCOURT  
FRANCE

FOR: COMPUTER SOFTWARE FOR THE MANAGEMENT OF SECURED DATABASES; COMPUTER SOFTWARE TO FACILITATE MANAGING THE DESIGN AND DISTRIBUTION OF QUESTIONNAIRES TO HEALTH-CARE PROFESSIONALS, IN CLASS 9 (U.S. CLS. 21, 23, 26, 36 AND 38).

FOR: CONDUCTING OF SURVEYS TO COLLECT STATISTICS FROM HEALTH-CARE PROFESSIONALS; COMPILATION AND SUPPLY OF INFORMATION RELATING TO THE HABITS, PREFERENCES AND EXPECTATIONS OF HEALTH-CARE PROFESSIONALS REGARDING THE USE OF THE MEDIA, NAMELY, COMPUTER SOFTWARE, THE INTERNET, TRADITIONAL MEDIA AND NEW MEDIA; COLLECTION AND SYSTEMIZATION IN A CENTRAL FILE OF DATA RELATING TO THE HABITS, PREFERENCES AND EXPECTATIONS OF HEALTH-CARE PROFESSIONALS REGARDING THE USE OF MEDIA; MANAGEMENT AND UPDATING OF COMPUTER FILES AND OF COMPUTER DATABASES RELATING TO THE HABITS, PREFERENCES AND EXPECTATIONS OF HEALTH-CARE PROFESSIONALS, PARTICULARLY REGARDING THE USE OF THE MEDIA; MARKET STUDIES, MARKETING STUDIES IN MEDICAL FIELDS, IN CLASS 35 (U.S. CLS. 100, 101 AND 102).

FOR: TRANSMISSION OF INFORMATION VIA COMMUNICATIONS NETWORKS, NAMELY, THE INTERNET OR VIA DATA COMMUNICATION MEANS, TO ALLOW IN PARTICULAR THE DISSEMINATION OF QUESTIONNAIRES ON COMPUTERS OF HEALTH-CARE PROFESSIONALS; RENTAL OF ACCESS TIME TO DATABASES, IN CLASS 38 (U.S. CLS. 100, 101 AND 104).

FOR: COMPUTER ENGINEERING, NAMELY, CREATION, RENTAL, INSTALLATION, MANAGEMENT, UPDATING AND DEVELOPMENT OF COMPUTER SOFTWARE FOR OTHERS; THE ABOVE SERVICES PROVIDED IN THE FIELD OF MEDICINE, PARTICULARLY IN CONNECTION WITH THE HABITS OF HEALTH-CARE PROFESSIONALS AS REGARDS THE USE OF THE MEDIA, IN CLASS 42 (U.S. CLS. 100 AND 101).

THE MARK CONSISTS OF STANDARD CHARACTERS WITHOUT CLAIM TO ANY PARTICULAR FONT, STYLE, SIZE, OR COLOR.



*David J. Kyjars*

Director of the United States Patent and Trademark Office

**Reg. No. 4,196,482** PRIORITY DATE OF 5-3-2011 IS CLAIMED.

OWNER OF INTERNATIONAL REGISTRATION 1096301 DATED 9-20-2011, EXPIRES 9-20-2021.

NO CLAIM IS MADE TO THE EXCLUSIVE RIGHT TO USE "DIGITAL", APART FROM THE MARK AS SHOWN.

SER. NO. 79-104,852, FILED 9-20-2011.

JOHN WILKE, EXAMINING ATTORNEY

# United States of America

United States Patent and Trademark Office

# XFLAM

**Reg. No. 4,196,483**

**Registered Aug. 28, 2012**

**Int. Cls.: 6, 17 and 19**

**TRADEMARK**

**PRINCIPAL REGISTER**

XFLAM PTY LIMITED  
270-280 HAMMOND ROAD  
DANDENONG SOUTH VIC 3175  
AUSTRALIA

FOR: METAL BUILDING MATERIALS, NAMELY, BUILDING WALL FRAMING, WALL PANELS, CEILING PANELS AND CEILING TILES, COMPOSITE PANELS, COMPOSITE PANELS COMPRISING AN INSULATION LAYER BONDED TO EXTERIOR METAL SKINS; COMPOSITE BUILDING PANELS PRIMARILY COMPRISED OF METAL LAMINATIONS AND ALSO CONTAINING INSULATION MATERIAL; COMPOSITE BUILDING PANELS PRIMARILY COMPRISED OF LAMINATIONS OF STEEL AND ALSO CONTAINING INSULATION MATERIAL; COMPOSITE BUILDING PANELS PRIMARILY COMPRISED OF METAL AND ALSO CONTAINING THERMAL INSULATION MATERIAL; COMPOSITE BUILDING PANELS PRIMARILY COMPRISED OF LAMINATIONS OF METAL AND ALSO CONTAINING FIRE-RESISTANT INSULATION MATERIAL; COMPOSITE BUILDING PANELS PRIMARILY COMPRISED OF LAMINATIONS OF METAL AND ALSO CONTAINING FIRE-RESISTANT THERMAL INSULATION MATERIAL; COMPOSITE BUILDING PANELS PRIMARILY COMPRISED OF LAMINATIONS OF METAL AND ALSO CONTAINING AN INSULATING MATERIAL BEING A SYNTACTIC PHENOLIC FOAM; COMPOSITE BUILDING PANELS PRIMARILY COMPRISED OF LAMINATIONS OF METAL AND ALSO CONTAINING INSULATION MATERIAL BEING A CASTABLE SYNTACTIC PHENOLIC FOAM OF MICROSPHERES IN A POLYSTYRENE MATRIX , IN CLASS 6 (U.S. CLS. 2, 12, 13, 14, 23, 25 AND 50).



*David J. Kypas*

Director of the United States Patent and Trademark Office

FOR: PACKAGING MATERIALS OF RUBBER OR PLASTICS, NAMELY, INDUSTRIAL PACKAGING CONTAINERS, EXPANDED PLASTIC PELLETS, PLASTIC FILMS USED AS PACKAGING FOR FOOD, RUBBER BAGS FOR MERCHANDISE PACKAGING, RUBBER LIDS AND CAPS FOR INDUSTRIAL PACKAGING CONTAINERS; INSULATION MATERIALS, NAMELY, BUILDING INSULATION, ELECTRICAL INSULATING TAPES; THERMAL INSULATION MATERIALS; FIRE RESISTANT PACKAGING MATERIALS IN THE NATURE OF INDUSTRIAL RUBBER PACKAGING CONTAINERS; FIRE RESISTANT INSULATION MATERIALS, NAMELY, FIRE-RESISTANT DOORS COMPRISED OF REINFORCED CEMENT AND STEEL, FIRE-RESISTANT COMPOSITE PANELS MADE OF ARAMID, GLASS, CARBON OR CERAMIC FIRES; FIRE RESISTANT THERMAL INSULATION MATERIALS; PACKAGING MATERIALS COMPRISING A SYNTACTIC PHENOLIC FOAM; INSULATION MATERIALS COMPRISING A SYNTACTIC PHENOLIC FOAM FOR USE IN BUILDING AND CONSTRUCTION; PACKAGING MATERIALS COMPRISING A CASTABLE SYNTACTIC

**Reg. No. 4,196,483** PHENOLIC FOAM OF MICROSPHERES IN A POLYSTYRENE MATRIX; INSULATION MATERIALS COMPRISING A CASTABLE SYNTACTIC PHENOLIC FOAM OF MICROSPHERES IN A POLYSTYRENE MATRIX FOR USE IN BUILDING AND CONSTRUCTION; CORES FOR LAMINATION INTO PANELS FOR INSULATION PURPOSES, INCLUDING THERMAL INSULATION PURPOSES IN THE NATURE OF COMPOSITE SHEETS AND PANELS COMPRISING A REINFORCED CEMENT CORE MECHANICALLY BONDED TO STEEL SHEETS ON BOTH OUTER SURFACES FOR USE IN BARRIERS, DOORS, DUCTS AND CEILINGS; PANELS INCLUDING CORES FOR INSULATION PURPOSES, INCLUDING THERMAL INSULATION PURPOSES, NAMELY, COMPOSITE SHEETS AND PANELS COMPRISING A REINFORCED CEMENT CORE MECHANICALLY BONDED TO STEEL SHEETS ON BOTH OUTER SURFACES FOR USE IN BARRIERS, DOORS, DUCTS AND CEILINGS, IN CLASS 17 (U.S. CLS. 1, 5, 12, 13, 35 AND 50).

FOR: NON-METALLIC BUILDING MATERIALS, NAMELY, FLASHING, FASCIA, SOFFITS, CLADDING, EXTERIOR BUILDING SHUTTERS, WALL BOARDS, CEILING PANELS AND CEILING TILES, COMPOSITE PANELS COMPOSED PRIMARILY OF NON-METAL MATERIALS, COMPOSITE PANELS COMPOSED OF AN INSULATING LAYER BONDED TO NON-METAL SKINS, IN CLASS 19 (U.S. CLS. 1, 12, 33 AND 50).

THE MARK CONSISTS OF STANDARD CHARACTERS WITHOUT CLAIM TO ANY PARTICULAR FONT, STYLE, SIZE, OR COLOR.

OWNER OF INTERNATIONAL REGISTRATION 1096319 DATED 9-9-2011, EXPIRES 9-9-2021.

SER. NO. 79-104,854, FILED 9-9-2011.

LAURIE MAYES, EXAMINING ATTORNEY

# United States of America

United States Patent and Trademark Office



**Reg. No. 4,196,484**

**Registered Aug. 28, 2012**

**Int. Cls.: 7 and 11**

**TRADEMARK**

**PRINCIPAL REGISTER**

KERAGLASS ENGINEERING S.R.L. (ITALY LIMITED LIABILITY COMPANY)  
VIA SASSOGATSTONE, 7/B  
I-42031 BAISO (REGGIO EMILIA)  
ITALY

FOR: CONVEYOR LINES FOR THE STORAGE AND PALLETISATION OF GOODS AND PRODUCTS, ENAMELING MACHINES AND SILKS SCREENING PRINTING MACHINES AND PARTS AND SPARE PARTS THEREFORE INCLUDED IN THIS CLASS, IN CLASS 7 (U.S. CLS. 13, 19, 21, 23, 31, 34 AND 35).

FOR: DRYING APPARATUS FOR CERAMIC TILES, NAMELY, INDUSTRIAL DRYERS FOR HEATING AND DEHUMIDIFYING, OVENS FOR CERAMICS IN THE NATURE OF KILNS, KILN OVENS FOR WORKING AND TEMPERING GLASS, AND PARTS AND SPARE PARTS THEREFORE INCLUDED IN THIS CLASS, IN CLASS 11 (U.S. CLS. 13, 21, 23, 31 AND 34).

NO CLAIM IS MADE TO THE EXCLUSIVE RIGHT TO USE "GLASS", APART FROM THE MARK AS SHOWN.

OWNER OF INTERNATIONAL REGISTRATION 1096450 DATED 7-15-2011, EXPIRES 7-15-2021.

THE MARK CONSISTS OF GRAPHIC DIAMOND DESIGN WITH A SHADOW AND CONTAINING THE LETTERS "KG" AND FOLLOWED BY THE WORDING "KERAGLASS". THE LETTERS AND THE WORDING ARE ARRANGED FLANKED AND ARE WRITTEN IN BORDERED FANTASY CHARACTERS, IN WHICH THE FIRST IS LOCATED SUPERPOSED ON A QUADRILATERAL/DIAMOND SHAPED FIGURE, AND THE SECOND IS COMPRISED BETWEEN TWO LINES.

SER. NO. 79-104,916, FILED 7-15-2011.

RENEE MCCRAY, EXAMINING ATTORNEY



*David J. Kypos*

Director of the United States Patent and Trademark Office

# United States of America

United States Patent and Trademark Office

## L'ART DE L'ESSENTIEL

**Reg. No. 4,196,485**

**Registered Aug. 28, 2012**

**Int. Cls.: 33 and 35**

**TRADEMARK**

**SERVICE MARK**

**PRINCIPAL REGISTER**

CHAMPAGNE JACQUART (FRANCE SOCIÉTÉ PAR ACTIONS SIMPLIFIÉE)  
34 BOULEVARD LUNDY  
F-51100 REIMS, FRANCE

FOR: ALCOHOLIC BEVERAGES EXCEPT BEER; HARD CIDER; LIQUEURS AND SPIRITS;  
WINE; DISTILLED SPIRITS; ALCOHOLIC EXTRACTS OR ESSENCES , IN CLASS 33 (U.S.  
CLS. 47 AND 49).

FOR: ADVERTISING; DIRECT MAIL ADVERTISING, ORGANIZATION OF EXHIBITIONS  
FOR COMMERCIAL OR ADVERTISING PURPOSES, ON-LINE ADVERTISING ON A  
COMPUTER NETWORK, RENTAL OF ADVERTISING TIME ON COMMUNICATION MEDIA;  
PUBLICATION OF PUBLICITY TEXTS; RENTAL OF ADVERTISING SPACE; DISSEMINA-  
TION OF ADVERTISING MATTER; PUBLIC RELATIONS, IN CLASS 35 (U.S. CLS. 100, 101  
AND 102).

THE MARK CONSISTS OF STANDARD CHARACTERS WITHOUT CLAIM TO ANY PAR-  
TICULAR FONT, STYLE, SIZE, OR COLOR.

PRIORITY DATE OF 3-21-2011 IS CLAIMED.

OWNER OF INTERNATIONAL REGISTRATION 1096717 DATED 9-9-2011, EXPIRES 9-9-  
2021.

THE ENGLISH TRANSLATION OF "L'ART DE L'ESSENTIEL" IN THE MARK IS "THE ART  
OF THE ESSENTIAL".

SER. NO. 79-105,009, FILED 9-9-2011.

JASON TURNER, EXAMINING ATTORNEY



*David J. Kyros*

Director of the United States Patent and Trademark Office

# United States of America

United States Patent and Trademark Office

## L'ESSENTIEL EST UN ART

**Reg. No. 4,196,486**

**Registered Aug. 28, 2012**

**Int. Cls.: 33 and 35**

**TRADEMARK**

**SERVICE MARK**

**PRINCIPAL REGISTER**

CHAMPAGNE JACQUART (FRANCE SOCIÉTÉ PAR ACTIONS SIMPLIFIÉE)  
34 BOULEVARD LUNDY  
F-51100 REIMS, FRANCE

FOR: ALCOHOLIC BEVERAGES EXCEPT BEER; HARD CIDER; LIQUEURS AND SPIRITS;  
WINE; DISTILLED SPIRITS; ALCOHOLIC EXTRACTS OR ESSENCES , IN CLASS 33 (U.S.  
CLS. 47 AND 49).

FOR: ADVERTISING; DIRECT MAIL ADVERTISING, ORGANIZATION OF EXHIBITIONS  
FOR COMMERCIAL OR ADVERTISING PURPOSES, ON-LINE ADVERTISING ON A  
COMPUTER NETWORK, RENTAL OF ADVERTISING TIME ON COMMUNICATION MEDIA;  
PUBLICATION OF PUBLICITY TEXTS; RENTAL OF ADVERTISING SPACE; DISSEMINA-  
TION OF ADVERTISING MATTER; PUBLIC RELATIONS, IN CLASS 35 (U.S. CLS. 100, 101  
AND 102).

THE MARK CONSISTS OF STANDARD CHARACTERS WITHOUT CLAIM TO ANY PAR-  
TICULAR FONT, STYLE, SIZE, OR COLOR.

PRIORITY DATE OF 3-11-2011 IS CLAIMED.

OWNER OF INTERNATIONAL REGISTRATION 1096718 DATED 9-9-2011, EXPIRES 9-9-  
2021.

THE ENGLISH TRANSLATION OF "L'ESSENTIEL EST UN ART" IN THE MARK IS "THE  
ESSENTIAL IS AN ART".

SER. NO. 79-105,010, FILED 9-9-2011.

JASON TURNER, EXAMINING ATTORNEY



*David J. Kybas*

Director of the United States Patent and Trademark Office



# United States of America

United States Patent and Trademark Office

# DFSK

**Reg. No. 4,196,487**

**Registered Aug. 28, 2012**

**Int. Cls.: 12 and 37**

**TRADEMARK**

**SERVICE MARK**

**PRINCIPAL REGISTER**

DFSK MOTOR CO., LTD (CHINA CORPORATION)  
EAST RING ROAD NO. 1  
SHIYAN, HUBEI  
CHINA

FOR: WAGONS; CYCLE CARS, NAMELY, SMALL MOTOR CARS FOR CARRYING LUGGAGE OR PEOPLE; AUTOMOBILES; MOTOR CARS FOR TRANSPORT ON LAND; VEHICLE BUMPERS; TIRES FOR VEHICLE WHEELS; MOTORS FOR LAND VEHICLES; SHOCK ABSORBERS FOR AUTOMOBILES; MOTORCYCLES; BICYCLES, IN CLASS 12 (U.S. CLS. 19, 21, 23, 31, 35 AND 44).

FOR: BUILDING CONSTRUCTION INFORMATION; FACTORY CONSTRUCTION; CONSTRUCTION OF BUILDINGS; MINING EXTRACTION; UPHOLSTERING; MOTOR VEHICLE MAINTENANCE AND REPAIR; VEHICLE WASH; VEHICLE SERVICE STATIONS; RETREADING OF TIRES; MACHINERY INSTALLATION, MAINTENANCE AND REPAIR, IN CLASS 37 (U.S. CLS. 100, 103 AND 106).

PRIORITY DATE OF 3-2-2011 IS CLAIMED.

OWNER OF INTERNATIONAL REGISTRATION 1096764 DATED 8-22-2011, EXPIRES 8-22-2021.

SER. NO. 79-105,028, FILED 8-22-2011.

AISHA CLARKE, EXAMINING ATTORNEY



*David J. Kyffers*

Director of the United States Patent and Trademark Office

# United States of America

United States Patent and Trademark Office

**LUXARDO**  
**LIMONCELLO**



**Reg. No. 4,196,488**

**Registered Aug. 28, 2012**

**Int. Cl.: 33**

**TRADEMARK**

**PRINCIPAL REGISTER**

GIROLAMO LUXARDO S.P.A.; PRIVILEGIATA FABBRICA MARASCHINO; "EXCELSIOR"  
(ITALY JOINT STOCK COMPANY)  
VIA ROMANA, 42  
I-35038 TORREGLIA (PADOVA)  
ITALY

FOR: LIQUEURS, IN CLASS 33 (U.S. CLS. 47 AND 49).

OWNER OF U.S. REG. NOS. 329,769 AND 636,931.

PRIORITY DATE OF 9-23-2011 IS CLAIMED.

OWNER OF INTERNATIONAL REGISTRATION 1096989 DATED 10-4-2011, EXPIRES 10-4-2021.

THE COLOR(S) RED, BLACK, WHITE, YELLOW, DARK GREEN, LIGHT GREEN AND BROWN IS/ARE CLAIMED AS A FEATURE OF THE MARK.

NO CLAIM IS MADE TO THE EXCLUSIVE RIGHT TO USE "LIMONCELLO" OR "LIQUEUR", APART FROM THE MARK AS SHOWN.

THE MARK CONSISTS OF THE WORDING "LUXARDO" IN A WHITE STYLIZED FONT OUTLINED IN BLACK, ON A RED RECTANGLE WITH CURVED SIDES, ALSO OUTLINED IN BLACK. BELOW THIS WORDING IS THE WORDING "LIMONCELLO" IN A BLACK FONT WITH WHITE AND BLACK EDGES. BELOW THIS WORDING IS A STYLIZED LEMON APPEARING WITH LIGHT GREEN, DARK GREEN AND BLACK LEAVES, WITH A BROWN AND BLACK STEM, AND WITH A YELLOW, WHITE AND BLACK FRUIT. BELOW THIS LEMON IS THE WORDING "LIQUER" IN A STYLIZED BLACK FONT, BE- NEATH WHICH ARE THREE SMALL RECTANGLES IN DARK GREEN, WHITE AND RED.

SER. NO. 79-105,139, FILED 10-4-2011.

JAMES MACFARLANE, EXAMINING ATTORNEY



*David J. Kyffers*

Director of the United States Patent and Trademark Office

United States of America  
United States Patent and Trademark Office

# Excelion

**Reg. No. 4,196,489**

**Registered Aug. 28, 2012**

**Int. Cl.: 1**

CHEMISCHE FABRIK BUDENHEIM KG (FED REP GERMANY  
KOMMANDITGESELLSCHAFT)  
RHEINSTRASSE 27  
55257 BUDENHEIM  
FED REP GERMANY

**TRADEMARK**

FOR: CHEMICALS FOR USE IN THE MANUFACTURE OF LITHIUM-ION BATTERIES, IN CLASS 1 (U.S. CLS. 1, 5, 6, 10, 26 AND 46).

**PRINCIPAL REGISTER**

THE MARK CONSISTS OF STANDARD CHARACTERS WITHOUT CLAIM TO ANY PARTICULAR FONT, STYLE, SIZE, OR COLOR.

OWNER OF INTERNATIONAL REGISTRATION 1097417 DATED 9-13-2011, EXPIRES 9-13-2021.

SER. NO. 79-105,299, FILED 9-13-2011.

LANA PHAM, EXAMINING ATTORNEY



*David J. Kyfos*

Director of the United States Patent and Trademark Office

United States of America  
United States Patent and Trademark Office

**PISANE**

**Reg. No. 4,196,490**

**Registered Aug. 28, 2012**

**Int. Cl.: 29**

**TRADEMARK**

**PRINCIPAL REGISTER**

COSUCRA GROUPE WARCOING S.A. (BELGIUM SOCIETE ANONYME)  
RUE DE LA SUCRERIE 1  
B-7740 WARCOING  
BELGIUM

FOR: PROTEINS BEING FOODSTUFFS FOR HUMAN CONSUMPTION; FIBERS OF PLANT ORIGIN, NAMELY, PROCESSED PEAS AS RAW MATERIALS FOR FOOD PURPOSES, IN CLASS 29 (U.S. CL. 46).

THE ENGLISH TRANSLATION OF THE WORD "PISANE" IN THE MARK IS "GIRL" OR "WOMAN FROM PISA".

OWNER OF INTERNATIONAL REGISTRATION 0569651 DATED 4-9-1991, EXPIRES 4-9-2021.

SER. NO. 79-105,353, FILED 9-19-2011.

MARY CRAWFORD, EXAMINING ATTORNEY



*David J. Kyffers*

Director of the United States Patent and Trademark Office

# United States of America

United States Patent and Trademark Office



**Reg. No. 4,196,491**

**Registered Aug. 28, 2012**

**Int. Cl.: 29**

**TRADEMARK**

**PRINCIPAL REGISTER**

KING S.P.A. (ITALY SOCIETÀ PER AZIONI (SPA))  
VIA CURIEL, 40  
I-51016 MONSUMMANO TERME (PT)  
ITALY

FOR: DEEP-FROZEN FISH; FROZEN FISH; PRESERVED FISH, IN CLASS 29 (U.S. CL. 46).

THE MARK CONSISTS OF THE WORDING "ARBI" AND A DESIGN OF A FISH SUPERIMPOSED ON AN OBLONG SHAPED CARRIER.

OWNER OF INTERNATIONAL REGISTRATION 0869748 DATED 10-5-2005, EXPIRES 10-5-2015.

SER. NO. 79-105,424, FILED 8-15-2011.

HAI-LY LAM, EXAMINING ATTORNEY



*David J. Kyros*

Director of the United States Patent and Trademark Office

# United States of America

United States Patent and Trademark Office



**Reg. No. 4,196,492**

**Registered Aug. 28, 2012**

**Int. Cl.: 36**

SYMTECO INTERNATIONAL LIMITED (CYPRUS PRIVATE COMPANY LIMITED BY SHARES)  
2, MICHAÏL KARAOLI STR.  
ENGOMI; CY-2404 NICOSIA  
CYPRUS

**SERVICE MARK**

**PRINCIPAL REGISTER**

FOR: PROVIDING SECURE FINANCIAL PAYMENT SYSTEMS SERVICES FOR THE PAYMENT OF BILLS RENDERED TO BANKS, NAMELY, PROVIDING BANKS WITH AN INTERNATIONAL COMPUTER-BASED SYSTEM FOR MOBILE AND ONLINE PAYMENTS SERVICES AND NOTIFYING ITS CUSTOMERS ON FINANCIAL EVENTS, PROVIDING FOR THIRD PARTY PAYMENT OF BILLS AND INDIVIDUALS TO SECURELY CONNECT TO BANK ACCOUNTS FOR CHARGES AND DEPOSITS; MONEY TRANSFERS, ELECTRONIC BANKING SERVICES, ELECTRONIC FUNDS TRANSFER, IN CLASS 36 (U.S. CLS. 100, 101 AND 102).

THE MARK CONSISTS OF A STYLIZED DESIGN OF A DAISY AND THE WORDING "DAISYPAY". THREE PETALS OF THE DAISY ARE SHOWN IN BLACK AND THREE ARE SHOWN IN RED. "DAISY" IS SHOWN IN BLACK AND "PAY" IS SHOWN IN RED.

PRIORITY DATE OF 8-26-2011 IS CLAIMED.

OWNER OF INTERNATIONAL REGISTRATION 1097671 DATED 9-21-2011, EXPIRES 9-21-2021.

THE COLOR(S) BLACK AND RED IS/ARE CLAIMED AS A FEATURE OF THE MARK.

SER. NO. 79-105,534, FILED 9-21-2011.

FRED CARL, EXAMINING ATTORNEY



*David J. Kyffers*

Director of the United States Patent and Trademark Office

# United States of America

United States Patent and Trademark Office

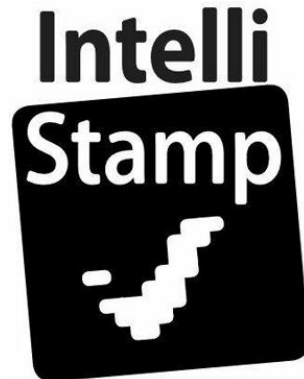

**Reg. No. 4,196,493**

**Registered Aug. 28, 2012**

**Int. Cls.: 9, 16, 41 and 42**

**TRADEMARK**

**SERVICE MARK**

**PRINCIPAL REGISTER**

INVENTIVE DESIGNERS NV (BELGIUM NV)  
SINT-BERNARDSESTEENWEG 552  
B-2660 HOBOKEN  
BELGIUM

FOR: COMPUTER HARDWARE AND COMPUTER PERIPHERAL DEVICES; BLANK MAGNETIC DATA CARRIERS; BLANK MAGNETIC DISCS; BLANK MAGNETIC COMPUTER TAPES; BLANK RECORDING DISCS; COMPUTER SOFTWARE, NAMELY, SOFTWARE FOR PRINTING STAMPS ON DIGITAL AND PAPER DOCUMENTS AND FOR CONTROLLING AND GUARANTEEING THE AUTHENTICITY OF DOCUMENTS; RECORDED COMPUTER PROGRAMS FOR PRINTING STAMPS ON DIGITAL AND PAPER DOCUMENTS, IN CLASS 9 (U.S. CLS. 21, 23, 26, 36 AND 38).

FOR: PAPER AND CARDBOARD AND GOODS MADE FROM THESE MATERIALS, NAMELY, POSTAGE STAMPS; PRINTED MATTER, NAMELY, BOOKS, MAGAZINES, BROCHURES AND NEWSLETTERS IN THE FIELD OF INFORMATION TECHNOLOGY AND COMPUTER SOFTWARE; STATIONERY; OFFICE REQUISITES, NAMELY, POSTAGE STAMPS; PRINTED INSTRUCTIONAL AND TEACHING MATERIAL, EXCEPT APPARATUS, IN THE FIELD OF INFORMATION TECHNOLOGY AND COMPUTER SOFTWARE, IN CLASS 16 (U.S. CLS. 2, 5, 22, 23, 29, 37, 38 AND 50).

FOR: TEACHING AND TRAINING AND COURSES IN THE FIELD OF INFORMATION TECHNOLOGY AND COMPUTER SOFTWARE, NAMELY, SOFTWARE FOR PRINTING STAMPS ON DIGITAL AND PAPER DOCUMENTS AND FOR CONTROLLING AND GUARANTEEING THE AUTHENTICITY OF DOCUMENTS; ARRANGING AND CONDUCTING OF SEMINARS, CONGRESSES, EDUCATIONAL CONFERENCES AND WORKSHOPS IN THE FIELD OF INFORMATION TECHNOLOGY AND COMPUTER SOFTWARE, NAMELY, SOFTWARE FOR PRINTING STAMPS ON DIGITAL AND PAPER DOCUMENTS AND FOR CONTROLLING AND GUARANTEEING THE AUTHENTICITY OF DOCUMENTS; PUBLICATION OF BOOKS, MAGAZINES, BROCHURES AND NEWSLETTERS IN THE FIELD OF INFORMATION TECHNOLOGY AND COMPUTER SOFTWARE, NAMELY SOFTWARE FOR PRINTING STAMPS ON DIGITAL AND PAPER DOCUMENTS AND FOR CONTROLLING AND GUARANTEEING THE AUTHENTICITY OF DOCUMENTS, IN CLASS 41 (U.S. CLS. 100, 101 AND 107).



*David J. Kybas*

Director of the United States Patent and Trademark Office

FOR: RESEARCH AND DEVELOPMENT OF TECHNOLOGY IN THE FIELD OF COMPUTER SOFTWARE; DESIGN, DEVELOPMENT, CREATION, UPDATING, IMPLEMENTATION,

**Reg. No. 4,196,493** INSTALLATION, MAINTENANCE AND UPGRADING OF COMPUTER SOFTWARE, NAMELY SOFTWARE FOR PRINTING STAMPS ON DIGITAL AND PAPER DOCUMENTS AND FOR CONTROLLING AND GUARANTEEING THE AUTHENTICITY OF DOCUMENTS; COMPUTER PROGRAMMING; TECHNICAL CONSULTANCY IN RELATION TO RESEARCH SERVICES RELATING TO COMPUTER HARDWARE AND COMPUTER SOFTWARE; RENTAL OF COMPUTER HARDWARE AND COMPUTER SOFTWARE; ADVISORY SERVICES RELATING TO THE USE AND APPLICATION OF COMPUTER HARDWARE AND COMPUTER SOFTWARE AND TECHNICAL SUPPORT SERVICES, NAMELY TROUBLESHOOTING IN THE NATURE OF DIAGNOSING COMPUTER HARDWARE AND SOFTWARE PROBLEMS, IN CLASS 42 (U.S. CLS. 100 AND 101).

OWNER OF U.S. REG. NO. 3,771,715.

PRIORITY DATE OF 3-1-2011 IS CLAIMED.

OWNER OF INTERNATIONAL REGISTRATION 1097795 DATED 8-23-2011, EXPIRES 8-23-2021.

NO CLAIM IS MADE TO THE EXCLUSIVE RIGHT TO USE "STAMP", APART FROM THE MARK AS SHOWN.

THE MARK CONSISTS OF THE STYLIZED WORDING "INTELLI" ABOVE A TILTED SQUARE FEATURING THE WORDING "STAMP" ABOVE A SEGMENTED CHECK MARK DESIGN ALL WITHIN A RECTANGULAR BACKGROUND.

SER. NO. 79-105,577, FILED 8-23-2011.

TASNEEM HUSSAIN, EXAMINING ATTORNEY



# United States of America

United States Patent and Trademark Office



**Reg. No. 4,196,494**

**Registered Aug. 28, 2012**

**Int. Cl.: 30**

INOSTRANNOE TCHASTNOE OUNITARNOE; PROIZVODSTVENNO-TORGOVOE  
PREDPRIATIE; "KARAVAN"; KORPORATSII "KAMBERLI MARKETING KORP."  
(BELARUS PRIVATE UNITARY ENTERPRISE)  
KOMM. 2, D. 1, OUL. ZAVODSKAIA  
ZASLAVL; 223034 MINSKAIA OBL.  
BELARUS

**TRADEMARK**

**PRINCIPAL REGISTER**

FOR: TEA, TEA-BASED BEVERAGES, FLAVORED TEA, TEA WITH ADDITIVES, NAMELY,  
TEA WITH FLAVORINGS, TEA WITH FRUITS, TEA WITH LEMON, ICE TEA; SPICES, IN  
CLASS 30 (U.S. CL. 46).

THE MARK CONSISTS OF A GREEN LEAF WITH GREEN WATER DROPLETS WITH WHITE HIGHLIGHTS BELOW A LANDSCAPE COMPRISING A GREEN FIELD AND GREEN FOREST WITH YELLOW RAYS OF SUN AND A RED AND ORANGE SKY; THESE DESIGN ELEMENTS ARE DIVIDED BY A RED BAND OUTLINED IN WHITE ON WHICH APPEARS A YELLOW CIRCLE WITH ORANGE ZIG-ZAG EDGES OUTLINED IN GREEN AND YELLOW CONCENTRIC CIRCLES. TWO GREEN AND YELLOW LEAFS APPEAR ON THE CIRCLE. A WHITE BAND APPEARS ON TOP OF THE CIRCLE AND A BROWN BAND WITH CURVED ENDS AND A YELLOW OUTLINE APPEARS NEAR THE BOTTOM OF THE MARK.

PRIORITY DATE OF 1-24-2011 IS CLAIMED.

OWNER OF INTERNATIONAL REGISTRATION 1097964 DATED 7-22-2011, EXPIRES 7-22-2021.

THE COLOR(S) WHITE, RED, ORANGE, GREEN, YELLOW AND BROWN IS/ARE CLAIMED AS A FEATURE OF THE MARK.

SER. NO. 79-105,620, FILED 7-22-2011.

APRIL HESIK, EXAMINING ATTORNEY



*David J. Kypos*

Director of the United States Patent and Trademark Office

United States of America  
United States Patent and Trademark Office

wibiya

**Reg. No. 4,196,495**

MODULAR PATTERNS LTD. (ISRAEL CORPORATION)

**Registered Aug. 28, 2012**

5 GOLDA MEIR ST.  
NESS ZIONA, ISRAEL 74140

**Int. Cls.: 9 and 42**

FOR: COMPUTER SOFTWARE PLATFORM THAT ENABLES WEB PUBLISHERS TO MAINTAIN AND PROMOTE THEIR WEB SITES, NAMELY, CREATE INTERNET APPLICATIONS FOR IMPROVING THE COMMUNICATION BETWEEN THE COMPUTER NETWORK USERS AND THE WEB PUBLISHERS; ALL INCLUDED IN THIS CLASS, IN CLASS 9 (U.S. CLS. 21, 23, 26, 36 AND 38).

**TRADEMARK**

**SERVICE MARK**

**PRINCIPAL REGISTER**

FOR: APPLICATION SERVICE PROVIDER (ASP) SERVICES, NAMELY, HOSTING COMPUTER OR MOBILE SOFTWARE APPLICATIONS, TOOLBAR SOFTWARE APPLICATIONS AND/OR OTHER INTERNET SOFTWARE APPLICATIONS THAT ENABLE WEB PUBLISHERS TO CREATE ADVERTISING MATERIAL TO PROMOTE THEIR WEB SITES, MAINTAIN THEIR WEBSITES AND IMPROVE THE ELECTRONIC COMMUNICATIONS BETWEEN THEM AND THE WEB COMMUNITY, IN CLASS 42 (U.S. CLS. 100 AND 101).

THE MARK CONSISTS OF STANDARD CHARACTERS WITHOUT CLAIM TO ANY PARTICULAR FONT, STYLE, SIZE, OR COLOR.

PRIORITY DATE OF 10-2-2011 IS CLAIMED.

OWNER OF INTERNATIONAL REGISTRATION 1098427 DATED 10-3-2011, EXPIRES 10-3-2021.

SER. NO. 79-105,770, FILED 10-3-2011.

GENE MACIOL, EXAMINING ATTORNEY



*David J. Kyros*

Director of the United States Patent and Trademark Office

United States of America  
United States Patent and Trademark Office

SHIME

**Reg. No. 4,196,496**

**Registered Aug. 28, 2012**

**Int. Cls.: 9, 42 and 44**

**TRADEMARK**

**SERVICE MARK**

**PRINCIPAL REGISTER**

PRODIGEST BVBA (BELGIUM PRIVATE LIMITED COMPANY)  
TECHNOLOGIEPARK 3  
B-9052 GENT  
BELGIUM AND

UNIVERSITEIT GENT.; PUBLIEK RECHTSPERSOON (BELGIUM PUBLIC UNIVERSITY)  
SINT-PIETERSNIEUWSTRAAT 25  
B-9000 GENT  
BELGIUM

FOR: LABORATORY APPARATUS, NAMELY, CENTRIFUGES, FURNACES FOR LABORATORY USE, HOMOGENIZERS, SPECTROSCOPES AND INCUBATORS; APPARATUS AND INSTRUMENTS FOR SCIENTIFIC RESEARCH AND FOOD ANALYSIS, NAMELY, BIOCHIPS FOR SCIENTIFIC RESEARCH PURPOSES, DIAGNOSTIC APPARATUS FOR TESTING OF FOOD, LASER SCANNERS FOR INDUSTRIAL INSPECTION, PLATES, GLASS SLIDES OR CHIPS HAVING MULTI-WELL ARRAYS THAT CAN BE USED IN CHEMICAL ANALYSIS, BIOLOGICAL ANALYSIS OR PATTERNING FOR SCIENTIFIC RESEARCH USE, IN CLASS 9 (U.S. CLS. 21, 23, 26, 36 AND 38).

FOR: SCIENTIFIC AND TECHNOLOGICAL SERVICES AND RESEARCH AND DESIGN RELATING THERETO, NAMELY, SCIENTIFIC RESEARCH, SCIENTIFIC CONSULTANCY REGARDING FOOD PRODUCTS, DESIGN AND TESTING OF NEW PRODUCTS FOR OTHERS; BIOLOGICAL, BACTERIOLOGICAL AND CHEMICAL RESEARCH, IN CLASS 42 (U.S. CLS. 100 AND 101).

FOR: CONSULTANCY IN THE FIELD OF HEALTHCARE AND MEDICAL CARE, IN CLASS 44 (U.S. CLS. 100 AND 101).

THE MARK CONSISTS OF STANDARD CHARACTERS WITHOUT CLAIM TO ANY PARTICULAR FONT, STYLE, SIZE, OR COLOR.

PRIORITY DATE OF 4-28-2011 IS CLAIMED.

OWNER OF INTERNATIONAL REGISTRATION 1098455 DATED 9-23-2011, EXPIRES 9-23-2021.

THE WORDING "SHIME" HAS NO MEANING IN A FOREIGN LANGUAGE.



*David J. Kyros*

Director of the United States Patent and Trademark Office

**Reg. No. 4,196,496** SER. NO. 79-105,780, FILED 9-23-2011.

TINA BROWN, EXAMINING ATTORNEY

# United States of America

United States Patent and Trademark Office

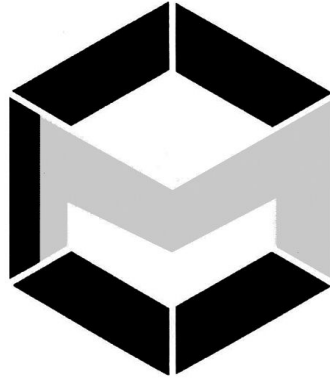

**Reg. No. 4,196,497**

**Registered Aug. 28, 2012**

**Int. Cl.: 1**

**TRADEMARK**

**PRINCIPAL REGISTER**

CHANGMAO BIOCHEMICAL; ENGINEERING CO., LTD. (CHINA CORPORATION)  
NO.1228, CHANGJIANG NORTH ROAD  
XINBEI DISTRICT.; CHANGZHOU CITY; JIANGSU PROVINCE  
CHINA

FOR: ACETIC ACID; TARTARIC ACID; SALTS FOR CHEMICAL PREPARATIONS; AMMONIUM SALTS; METHYL ESTER; ARTIFICIAL SWEETENERS FOR CHEMICAL PREPARATIONS; MALEIC ANHYDRIDE; SODIUM SALT FOR CHEMICAL PREPARATIONS; L-PHENYLALANINE; ASPARTAME, IN CLASS 1 (U.S. CLS. 1, 5, 6, 10, 26 AND 46).

THE MARK CONSISTS OF A HIGHLY STYLIZED CUBE SHAPE WITH THE TOP AND FRONT EDGES OF THE CUBE VISIBLE.

OWNER OF INTERNATIONAL REGISTRATION 1098475 DATED 10-31-2011, EXPIRES 10-31-2021.

SER. NO. 79-105,787, FILED 10-31-2011.

CURTIS FRENCH, EXAMINING ATTORNEY



*David J. Kypos*

Director of the United States Patent and Trademark Office

# United States of America

United States Patent and Trademark Office

# MKT STUDIO

**Reg. No. 4,196,498**

**Registered Aug. 28, 2012**

**Int. Cls.: 14, 18 and 25**

**TRADEMARK**

**PRINCIPAL REGISTER**

M-KIKES COMPAGNIE (FRANCE SOCIÉTÉ À RESPONSABILITÉ LIMITÉE)  
37 BIS RUE DU SENTIER  
F-75002 PARIS  
FRANCE

FOR: PRECIOUS METALS AND THEIR ALLOYS, OTHER THAN FOR DENTAL USE; JEWELRY, PRECIOUS STONES; HOROLOGICAL AND CHRONOMETRIC INSTRUMENTS; WATCHES; BRACELETS; RINGS; WATCH CASES AND CHAINS; ORNAMENTAL PINS; JEWELRY CASES OF PRECIOUS METAL; NECKLACES; EARRINGS; BUSTS, STATUETTES AND FIGURINES OF PRECIOUS METAL; BROOCHES; CHARMS; FANCY KEY RINGS OF PRECIOUS METAL; BOXES AND CASKETS OF PRECIOUS METAL FOR JEWELRY; MEDALS AND MEDALLIONS, IN CLASS 14 (U.S. CLS. 2, 27, 28 AND 50).

FOR: LEATHER AND IMITATIONS OF LEATHER; ANIMAL SKINS, HIDES; TRUNKS AND SUITCASES; PURSES; SCHOOL SATCHELS; BUSINESS, CREDIT, AND PAYMENT CARD CASES; UNFITTED VANITY CASES; BRIEFCASES; HAVERSACKS; TRAVELLING BAGS; HANDBAGS; GARMENT BAGS FOR TRAVEL; LEATHER AND IMITATION LEATHER ITEMS EXCLUDING CASES ADAPTED TO THE PRODUCTS THAT THEY ARE INTENDED TO CONTAIN, NAMELY, PURSES, WALLETS, HARNESSSES; SUITCASES AND LUGGAGE; POCKET CASES OF LEATHER OR IMITATION LEATHER, NAMELY, KEY CASES AND CREDIT CARD CASES; SHOULDER BELTS OF LEATHER; KEY CASES OF LEATHER; MONEY PURSES; SADDLERY; WALLETS; ATTACHÉ CASES; PARASOLS; UMBRELLAS; CANES, IN CLASS 18 (U.S. CLS. 1, 2, 3, 22 AND 41).

FOR: CLOTHING, NAMELY, SHORTS, SHIRTS, SKIRTS, PANTS, JACKETS, DRESSES, COATS, AND VESTS; GLOVES; BELTS; FOOTWEAR; HEADWEAR; SPORTSWEAR, NAMELY, JERSEYS, SPORTS BRAS, TRACK PANTS, SWEAT PANTS, SWEAT SHIRTS, SWEAT SHORTS, SWEAT JACKETS, AND SWEAT SUITS, IN CLASS 25 (U.S. CLS. 22 AND 39).

THE MARK CONSISTS OF STANDARD CHARACTERS WITHOUT CLAIM TO ANY PARTICULAR FONT, STYLE, SIZE, OR COLOR.

OWNER OF INTERNATIONAL REGISTRATION 1079224 DATED 2-15-2011, EXPIRES 2-15-2021.



*David J. Kyjars*

Director of the United States Patent and Trademark Office

**Reg. No. 4,196,498** NO CLAIM IS MADE TO THE EXCLUSIVE RIGHT TO USE "STUDIO", APART FROM THE MARK AS SHOWN.

SER. NO. 79-105,916, FILED 11-2-2011.

LEIGH LOWRY, EXAMINING ATTORNEY

# United States of America

United States Patent and Trademark Office

# iQCCert

**Reg. No. 4,196,499**

**Registered Aug. 28, 2012**

**Int. Cls.: 9 and 42**

SIEMENS HEALTHCARE DIAGNOSTICS; PRODUCTS GMBH (FED REP GERMANY  
LIMITED LIABILITY COMPANY)  
EMIL-VON-BEHRING-STRASSE 76  
35041 MARBURG  
FED REP GERMANY

**TRADEMARK**

FOR: DATA PROCESSING PROGRAMS FOR MEDICAL DIAGNOSTICS , IN CLASS 9 (U.S. CLS. 21, 23, 26, 36 AND 38).

**SERVICE MARK**

FOR: DEVELOPMENT, GENERATION AND LEASING OF DATA PROCESSING PROGRAMS; CHEMICAL LABORATORY SERVICES; SERVICES PROVIDED BY A TECHNICAL MEASUREMENT AND TEST LABORATORY IN THE MEDICAL FIELD; PERFORMANCE OF TECHNICAL TESTS IN THE MEDICAL FIELD; TECHNICAL CONSULTANCY AND RESEARCH IN THE FIELD OF MEDICINE, IN PARTICULAR RELATING TO MEDICAL DIAGNOSTICS; TECHNICAL PROJECT PLANNING; TECHNICAL TESTING SERVICES; ALL ABOVEMENTIONED SERVICES, PARTICULARLY IN THE FIELD OF MEDICAL DIAGNOSTICS, IN CLASS 42 (U.S. CLS. 100 AND 101).

**PRINCIPAL REGISTER**

THE MARK CONSISTS OF STANDARD CHARACTERS WITHOUT CLAIM TO ANY PARTICULAR FONT, STYLE, SIZE, OR COLOR.

OWNER OF INTERNATIONAL REGISTRATION 1098629 DATED 8-17-2011, EXPIRES 8-17-2021.

SER. NO. 79-105,967, FILED 8-17-2011.

ALAIN LAPTER, EXAMINING ATTORNEY



*David J. Kyros*

Director of the United States Patent and Trademark Office



# United States of America

United States Patent and Trademark Office



**Reg. No. 4,196,500**

**Registered Aug. 28, 2012**

**Int. Cls.: 9, 16 and 41**

**TRADEMARK**

**SERVICE MARK**

**PRINCIPAL REGISTER**

MONKUBE B.V.B.A. (BELGIUM BVBA)  
MADRIGALSTRAAT 55  
B-1080 SINT-JANS-MOLENBEEK  
BELGIUM

FOR: SOFTWARE FOR GAMES, NAMELY, VIDEO GAME SOFTWARE AND COMPUTER GAME SOFTWARE; PRERECORDED ANIMATED MOVIES ON DVD, IN CLASS 9 (U.S. CLS. 21, 23, 26, 36 AND 38).

FOR: PRINTED MATTER, NAMELY, COMIC BOOKS, IN CLASS 16 (U.S. CLS. 2, 5, 22, 23, 29, 37, 38 AND 50).

FOR: PRODUCTION OF ANIMATED MOVIES, IN CLASS 41 (U.S. CLS. 100, 101 AND 107).

THE MARK CONSISTS OF THE DESIGN OF A MONKEY'S FACE ON A CUBE OVER THE WORDING "MONKUBE".

PRIORITY DATE OF 12-9-2010 IS CLAIMED.

OWNER OF INTERNATIONAL REGISTRATION 1098747 DATED 6-9-2011, EXPIRES 6-9-2021.

SER. NO. 79-105,994, FILED 6-9-2011.

BARBARA BROWN, EXAMINING ATTORNEY



*David J. Kyffers*

Director of the United States Patent and Trademark Office

# United States of America

United States Patent and Trademark Office

SMOKE  
ON THE  
WATER

**Reg. No. 4,196,501**

**Registered Aug. 28, 2012**

**Int. Cls.: 34, 39 and 43**

**TRADEMARK**

**SERVICE MARK**

**PRINCIPAL REGISTER**

OETTINGER IMEX AG (SWITZERLAND AKTIENGESELLSCHAFT)  
NAUENSTRASSE 73  
BASEL, SWITZERLAND CH4002

FOR: TOBACCO PRODUCTS, NAMELY, CIGARS, CIGARILLOS, SMOKING TOBACCO; SMOKERS' ARTICLES, NAMELY, CIGAR CUTTERS, NON-ELECTRICAL CIGAR AND CIGARETTE LIGHTERS, CIGAR HUMIDIFIERS, CIGAR BOXES WITH HUMIDIFIERS; TOBACCO JARS, CIGAR CASES AND ASHTRAYS FOR SMOKERS, LIGHTERS FOR SMOKERS, MATCHES, IN CLASS 34 (U.S. CLS. 2, 8, 9 AND 17).

FOR: ARRANGING, ORGANIZING AND BOOKING TOURS AND EXCURSIONS AND EXCURSIONS BY MOTOR VEHICLE; BOAT TRANSPORT; FERRY TRANSPORT; GPS NAVIGATION SERVICES; TRANSPORT OF GOODS AND PASSENGERS; TRANSPORT OF TRAVELLERS; BOAT RENTAL, IN CLASS 39 (U.S. CLS. 100 AND 105).

FOR: RESTAURANT SERVICES; BAR SERVICES; RESTAURANT AND BAR SERVICES, IN CLASS 43 (U.S. CLS. 100 AND 101).

THE MARK CONSISTS OF THE WORDS "SMOKE ON THE WATER" WITH A STYLIZED SHIP'S STEERING WHEEL AS THE LETTER "O" IN THE WORD "SMOKE".

PRIORITY DATE OF 4-6-2011 IS CLAIMED.

OWNER OF INTERNATIONAL REGISTRATION 1098791 DATED 10-5-2011, EXPIRES 10-5-2021.

SER. NO. 79-106,011, FILED 10-5-2011.

COLLEEN DOMBROW, EXAMINING ATTORNEY



*David J. Kybas*

Director of the United States Patent and Trademark Office

# United States of America

United States Patent and Trademark Office

# window story

**Reg. No. 4,196,502**

**Registered Aug. 28, 2012**

**Int. Cls.: 20 and 24**

**TRADEMARK**

**PRINCIPAL REGISTER**

WINTEC KOREA INC. (REPUBLIC OF KOREA CORPORATION)  
366-71, CHUJA RI  
OPO EUP, GWANGJU SI  
GYEONGGI-DO 464-909, REPUBLIC OF KOREA

FOR: INDOOR BLINDS, IN CLASS 20 (U.S. CLS. 2, 13, 22, 25, 32 AND 50).

FOR: CURTAINS OF TEXTILE; FABRIC FOR THE MANUFACTURE OF WINDOW COVERINGS, IN CLASS 24 (U.S. CLS. 42 AND 50).

NO CLAIM IS MADE TO THE EXCLUSIVE RIGHT TO USE "WINDOW", APART FROM THE MARK AS SHOWN.

OWNER OF INTERNATIONAL REGISTRATION 1098910 DATED 11-4-2011, EXPIRES 11-4-2021.

THE MARK CONSISTS OF THE WORDING "WINDOW STORY" IN STYLIZED FONT.

SER. NO. 79-106,042, FILED 11-4-2011.

TINA BROWN, EXAMINING ATTORNEY



*David J. Kyros*

Director of the United States Patent and Trademark Office

# United States of America

United States Patent and Trademark Office

**B** **Bilture** FURNITURE

**Reg. No. 4,196,503**

**Registered Aug. 28, 2012**

**Int. Cl.: 20**

**TRADEMARK**

**PRINCIPAL REGISTER**

GUANGZHOU ZHENGHUI INDUSTRIAL CO., LTD. (CHINA COMPANY WITH LIMITED LIABILITY)  
MEISHAN INDUSTRIAL ZONE,  
NANCUN TOWN, PANYU DISTRICT,; GUANGZHOU CITY; GUANGDONG PROVINCE  
CHINA

FOR: SIDEBOARDS; FURNITURE; SEATS, NAMELY, CHAIRS; FURNITURE, NAMELY, SHOWCASES; ARMCHAIRS; TABLES; DIVANS; BEDS; FURNITURE OF METAL; SOFAS, IN CLASS 20 (U.S. CLS. 2, 13, 22, 25, 32 AND 50).

NO CLAIM IS MADE TO THE EXCLUSIVE RIGHT TO USE "FURNITURE", APART FROM THE MARK AS SHOWN.

OWNER OF INTERNATIONAL REGISTRATION 1098914 DATED 11-16-2011, EXPIRES 11-16-2021.

THE MARK CONSISTS OF THE WORDING "B BILTURE FURNITURE". THE LETTER "B" APPEARS IN A SQUARE TO THE LEFT OF THE WORD "BILTURE". THE WORD "FURNITURE" APPEARS ABOVE THE LETTERS "U", "R", "E" IN THE WORD "BILTURE".

THE WORDING "BILTURE" HAS NO MEANING IN A FOREIGN LANGUAGE.

SER. NO. 79-106,045, FILED 11-16-2011.

COLLEEN DOMBROW, EXAMINING ATTORNEY



*David J. Kyffers*

Director of the United States Patent and Trademark Office

# United States of America

United States Patent and Trademark Office

# iMAGI

**Reg. No. 4,196,504**

**Registered Aug. 28, 2012**

**Int. Cls.: 9, 37 and 38**

**TRADEMARK**

**SERVICE MARK**

**PRINCIPAL REGISTER**

ARBATAX (FRANCE SOCIÉTÉ PAR ACTIONS SIMPLIFIÉE)  
7 RUE DU GÉNÉRAL SARRAIL  
F-10000 TROYES, FRANCE

FOR: SCIENTIFIC APPARATUS AND INSTRUMENTS, NAMELY, ELECTRONIC ANALYZERS FOR MEASURING, TESTING AND DETECTING CONTAMINANTS AND ENVIRONMENTAL POLLUTANTS IN WATER; SURVEYING APPARATUS AND INSTRUMENTS, NAMELY, LEVEL MEASURING MACHINES, SURVEYING COMPASS NEEDLES, MAGNETIC COMPASSES; NAUTICAL, CINEMATOGRAPHIC AND PHOTOGRAPHIC APPARATUS AND INSTRUMENTS, NAMELY, UNDERWATER HOUSINGS FOR CAMERAS, UNDERWATER ENCLOSURES FOR CAMERAS AND UNDERWATER ENCLOSURES FOR PHOTOGRAPHIC LENSES; OPTICAL APPARATUS AND INSTRUMENTS, NAMELY, OPTICAL FILTERS, OPTICAL GLASSES, OPTICAL LANTERNS, OPTICAL SCANNERS, OPTICAL READERS, OPTICAL REFLECTORS; WEIGHING EQUIPMENT, NAMELY, SCALES AND BALANCES; MEASURING APPARATUS AND INSTRUMENTS, NAMELY, LIQUID LEVEL SENSORS; CHECKING APPARATUS AND INSTRUMENTS FOR MEASURING, TESTING AND CHECKING THE TEMPERATURE, PRESSURE, QUANTITY AND CONCENTRATION OF LIQUIDS; LIFE-SAVING APPARATUS AND INSTRUMENTS, NAMELY, LIFE JACKETS, LIFE BUOYS; TEACHING APPARATUS AND INSTRUMENTS, NAMELY, LIFE SAVING PRACTICE DUMMY; APPARATUS FOR RECORDING, TRANSMISSION OR REPRODUCTION OF SOUND OR IMAGES; BLANK MAGNETIC RECORDING MEDIA; BLANK RECORDABLE ACOUSTIC OR OPTICAL DISCS; BLANK FLOPPY DISCS; DATA PROCESSING EQUIPMENT AND COMPUTERS; COMPUTER SOFTWARE, RECORDED FOR PILOTING, CONTROLLING SWIMMING POOL EQUIPMENT; COMPUTER SOFTWARE RECORDED FOR REGULATING AND MONITORING WATER PRESSURE, COMPOSITION AND TEMPERATURE; COMPUTER PERIPHERAL DEVICES; DETECTORS, NAMELY, MOTION DETECTORS, FILLING LEVEL DETECTORS, TEMPERATURE DETECTORS; BATTERIES, ELECTRIC; WIRES, ELECTRIC; RELAYS, ELECTRIC; INTEGRATED CIRCUIT CARDS, IN CLASS 9 (U.S. CLS. 21, 23, 26, 36 AND 38).

FOR: CONSTRUCTION MANAGEMENT OF CIVIL ENGINEERING WORKS, PARTICULARLY SWIMMING POOLS; PROVIDING INFORMATION SERVICES ON CIVIL ENGINEERING CONSTRUCTION AND THE BUILDING OF SWIMMING POOLS; BUILDING, MAINTAINING AND REPAIRING OF SWIMMING POOLS AND RETENTION TANKS; MAINTENANCE AND REPAIR SERVICES FOR WATER FILTERING SYSTEMS AND PUMPS, IN CLASS 37 (U.S. CLS. 100, 103 AND 106).



*David J. Kypos*

Director of the United States Patent and Trademark Office

**Reg. No. 4,196,504** FOR: TELECOMMUNICATIONS ACCESS SERVICES; INFORMATION ABOUT TELECOMMUNICATION; COMMUNICATIONS VIA COMPUTER TERMINALS OR VIA FIBER-OPTIC NETWORKS; RADIO OR TELEPHONE COMMUNICATIONS; MOBILE RADIO TELEPHONE SERVICES; PROVIDING USER ACCESS TO A GLOBAL COMPUTER NETWORK; ELECTRONIC BULLETIN BOARD SERVICES; PROVIDING TELECOMMUNICATIONS CONNECTIONS TO A GLOBAL COMPUTER NETWORK; RENTAL OF TELECOMMUNICATION EQUIPMENT; RADIO OR TELEVISION BROADCASTING; ELECTRONIC MESSAGING; RENTAL OF ACCESS TIME TO GLOBAL COMPUTER NETWORKS, IN CLASS 38 (U.S. CLS. 100, 101 AND 104).

THE MARK CONSISTS OF STANDARD CHARACTERS WITHOUT CLAIM TO ANY PARTICULAR FONT, STYLE, SIZE, OR COLOR.

PRIORITY DATE OF 6-22-2011 IS CLAIMED.

OWNER OF INTERNATIONAL REGISTRATION 1099014 DATED 10-10-2011, EXPIRES 10-10-2021.

THE WORD(S) "IMAGI" HAS NO MEANING IN A FOREIGN LANGUAGE.

SER. NO. 79-106,076, FILED 10-10-2011.

RAUL CORDOVA, EXAMINING ATTORNEY

United States of America  
United States Patent and Trademark Office

# Windvent

**Reg. No. 4,196,505**

ABACUS BRAND AB (SWEDEN AKTIEBOLAG)  
BERAGÅRDEN, DALBYVÄGEN  
DALBY, SWEDEN SE247 94

**Registered Aug. 28, 2012**

**Int. Cl.: 25**

FOR: WOMEN'S AND MEN'S CLOTHING, NAMELY, TROUSERS, SHORTS, SKIRTS, SHIRTS, POLO SHIRTS, SWEATERS, PULLOVERS, VESTS, ANORAKS, RAIN AND WIND JACKETS, TRENCH COATS, SOCKS; FOOTWEAR; AND HEADWEAR, IN CLASS 25 (U.S. CLS. 22 AND 39).

**TRADEMARK**

**PRINCIPAL REGISTER**

THE MARK CONSISTS OF STANDARD CHARACTERS WITHOUT CLAIM TO ANY PARTICULAR FONT, STYLE, SIZE, OR COLOR.

PRIORITY DATE OF 5-20-2011 IS CLAIMED.

OWNER OF INTERNATIONAL REGISTRATION 1099079 DATED 11-18-2011, EXPIRES 11-18-2021.

SER. NO. 79-106,091, FILED 11-18-2011.

CHRISTOPHER BUONGIORNO, EXAMINING ATTORNEY



*David J. Kyros*

Director of the United States Patent and Trademark Office

United States of America  
United States Patent and Trademark Office

# StretchLite

**Reg. No. 4,196,506**

**Registered Aug. 28, 2012**

**Int. Cl.: 25**

**TRADEMARK**

**PRINCIPAL REGISTER**

ABACUS BRAND AB (SWEDEN AKTIEBOLAG)  
BERAGÅRDEN, DALBYVÄGEN  
SE-247 94 DALBY  
SWEDEN

FOR: WOMEN'S AND MEN'S CLOTHING, NAMELY, TROUSERS, SHORTS, SKIRTS, SHIRTS, POLO SHIRTS, SWEATERS, PULLOVERS, VESTS, ANORAKS, RAIN AND WIND JACKETS, TRENCH COATS, SOCKS; FOOTWEAR; AND HEADWEAR, IN CLASS 25 (U.S. CLS. 22 AND 39).

THE MARK CONSISTS OF STANDARD CHARACTERS WITHOUT CLAIM TO ANY PARTICULAR FONT, STYLE, SIZE, OR COLOR.

PRIORITY DATE OF 5-20-2011 IS CLAIMED.

OWNER OF INTERNATIONAL REGISTRATION 1099080 DATED 11-18-2011, EXPIRES 11-18-2021.

SER. NO. 79-106,092, FILED 11-18-2011.

CHRISTOPHER BUONGIORNO, EXAMINING ATTORNEY



*David J. Kyffers*

Director of the United States Patent and Trademark Office



# United States of America

United States Patent and Trademark Office

# MIO PICCOLO

ミオ ・ ピッコロ

**Reg. No. 4,196,507**

**Registered Aug. 28, 2012**

**Int. Cl.: 3**

**TRADEMARK**

**PRINCIPAL REGISTER**

DO-BEST, INC. (JAPAN CORPORATION)  
3-16, NISHIKATA 2-CHOME  
BUNKYO-KU; TOKYO 113-0024  
JAPAN

FOR: SOAPS AND DETERGENTS; DENTIFRICES; COSMETICS; NON-MEDICATED TOILETRIES; NATURAL PERFUMERY MADE FROM PLANTS; NATURAL PERFUMERY PREPARED FROM ANIMAL EXTRACTS; SYNTHETIC PERFUMERY; COMPOUND PERFUMERY; FOOD FLAVORINGS PREPARED FROM ESSENTIAL OILS; INCENSE AND FRAGRANCES, IN CLASS 3 (U.S. CLS. 1, 4, 6, 50, 51 AND 52).

THE MARK CONSISTS OF THE WORDING "MIO PICCOLO" AND NON-LATIN CHARACTERS THAT TRANSLITERATE TO "MIO PICCOLO" IN STYLIZED FORM.

OWNER OF INTERNATIONAL REGISTRATION 1099178 DATED 9-29-2011, EXPIRES 9-29-2021.

THE NON-LATIN CHARACTERS IN THE MARK TRANSLITERATE TO "MIO PICCOLO" AND THIS MEANS "MY LITTLE THINGS" IN ENGLISH.

THE ENGLISH TRANSLATION OF "MIO PICCOLO" IN THE MARK IS "MY LITTLE THINGS".

SER. NO. 79-106,126, FILED 9-29-2011.

ALLISON HOLTZ, EXAMINING ATTORNEY



*David J. Kyros*

Director of the United States Patent and Trademark Office

# United States of America

United States Patent and Trademark Office

# RAUCUT

**Reg. No. 4,196,508**

**Registered Aug. 28, 2012**

**Int. Cls.: 7 and 8**

**TRADEMARK**

**PRINCIPAL REGISTER**

REHAU AG + CO (FED REP GERMANY AG + CO)  
RHENIUMHAUS  
95111 REHAU  
FED REP GERMANY

FOR: HAND TOOLS OTHER THAN HAND-OPERATED, NAMELY, HAND-HELD DRILLS, HAND-HELD PNEUMATIC HAMMERS; BLADES BEING PARTS OF MACHINES; ELECTRIC KNIVES; BLADE HOLDERS BEING PARTS OF MACHINES IN THE NATURE OF MACHINE TOOL HOLDERS; SHEARS, ELECTRIC; CUTTERS AND CUTTING TOOLS OTHER THAN HAND-OPERATED, NAMELY, ELECTRIC PLASMA CUTTERS, MILLING CUTTERS; TOOLS BEING PARTS OF MACHINES, NAMELY, BRUSHES, BLADES, MANDRELS; TOOLS BEING HOLDING DEVICES FOR MACHINE, NAMELY, MACHINE TOOL HOLDERS, METAL CLAMPS USED FOR HOLDING PIECE PARTS ON MACHINE TOOL TABLES, IN CLASS 7 (U.S. CLS. 13, 19, 21, 23, 31, 34 AND 35).

FOR: HAND TOOLS AND IMPLEMENTS BEING HAND OPERATED FOR THE CONSTRUCTION OF MACHINES, APPARATUS AND VEHICLES, AND FOR STRUCTURAL ENGINEERING, NAMELY, SAWS, PLANES, PUNCHES; IRONS BEING NON-ELECTRIC HAND TOOLS, NAMELY, BRANDING IRONS, PRIMING IRONS; HAND TOOLS BEING HAND-OPERATED, NAMELY, ADZES, AUGERS, CLAMPS, FILES, HAMMERS, PICKS; KNIVES; BLADES FOR HANDSAWS, FOR SHEARS BEING HAND TOOLS; TUBE CUTTERS BEING HAND TOOLS; TUBE CUTTING INSTRUMENTS BEING HAND-OPERATED CUTTING TOOLS; SHEARERS BEING HAND INSTRUMENTS, NAMELY, SHEARS, ELECTRIC HAIR TRIMMERS; CUTTERS AND CUTTING TOOLS, NAMELY, BOLT CUTTERS, WIRE CUTTERS, BAR CUTTERS; EDGE TOOLS BEING HAND TOOLS, NAMELY, HAND-OPERATED LAWN EDGERS FOR GROUT, MORTAR OR CEMENT; DRAWING KNIVES, IN CLASS 8 (U.S. CLS. 23, 28 AND 44).

THE MARK CONSISTS OF STANDARD CHARACTERS WITHOUT CLAIM TO ANY PARTICULAR FONT, STYLE, SIZE, OR COLOR.

PRIORITY DATE OF 7-6-2011 IS CLAIMED.

OWNER OF INTERNATIONAL REGISTRATION 1099247 DATED 10-28-2011, EXPIRES 10-28-2021.

THE WORDING "RAUCUT" HAS NO MEANING IN A FOREIGN LANGUAGE.



*David J. Kypos*

Director of the United States Patent and Trademark Office

**Reg. No. 4,196,508** SER. NO. 79-106,157, FILED 10-28-2011.

MYRIAH HABEEB, EXAMINING ATTORNEY

# United States of America

United States Patent and Trademark Office

# NovaTherm

**Reg. No. 4,196,509**

**Registered Aug. 28, 2012**

**Int. Cl.: 10**

**TRADEMARK**

**PRINCIPAL REGISTER**

NOVALUNG GMBH (FED REP GERMANY PRIVATE LIMITED LIABILITY COMPANY)  
IM ZUKUNFTSPARK 1  
74076 HEILBRONN  
FED REP GERMANY

FOR: MEDICAL APPARATUS, NAMELY, HEAT EXCHANGING DEVICES FOR THE TEMPERATURE CONTROL OF BIOLOGICAL FLUIDS, PARTICULARLY OF BLOOD, IN CLASS 10 (U.S. CLS. 26, 39 AND 44).

THE MARK CONSISTS OF STANDARD CHARACTERS WITHOUT CLAIM TO ANY PARTICULAR FONT, STYLE, SIZE, OR COLOR.

PRIORITY DATE OF 3-2-2011 IS CLAIMED.

OWNER OF INTERNATIONAL REGISTRATION 1099394 DATED 8-24-2011, EXPIRES 8-24-2021.

SER. NO. 79-106,206, FILED 8-24-2011.

LINDSEY RUBIN, EXAMINING ATTORNEY



*David J. Kyjars*

Director of the United States Patent and Trademark Office

# United States of America

United States Patent and Trademark Office

# ARTOZ

**Reg. No. 4,196,510**

**Registered Aug. 28, 2012**

**Int. Cl.: 16**

**TRADEMARK**

**PRINCIPAL REGISTER**

ARTOZ CREA AG  
RINGSTRASSE WEST 23  
CH-5600 LENZBURG  
SWITZERLAND

FOR: PAPER, CARDBOARD AND GOODS MADE FROM THESE MATERIALS, NAMELY, PAPER BAGS, CARDBOARD BOXES; CARDS, NAMELY, CARDS STAMPED AND PRINTED IN THE NATURE OF STAMPED AND PRINTED GREETING CARDS, STAMPING AND PRINTED RECIPE CARDS; ANNOUNCEMENT AND INDICATION CARDS IN THE NATURE OF INVITATION CARDS; ORGANIZATION CARDS AND CHARTS, NAMELY, BUSINESS CARDS, FILING CARDS; PLACE CARDS, GREETING CARDS, VISITING OR BUSINESS CARDS, ADVERTISING CARDS, NAMELY, BUSINESS CARDS; POSTERS; PRINTED ADVERTISEMENT BOARDS OF PAPER OR CARDBOARD; PRINTED MATTER, NAMELY, NEWSPAPER, PHOTOGRAPHS, MAGAZINES, BOOKS, PRINTED PERIODICALS, NEWSLETTERS, AND BROCHURES ALL IN THE FIELD OF SECURITIES, OPTIONS AND OTHER FINANCIAL INSTRUMENTS, PAPER SIGNS, BOOKS, MANUALS, CURRICULUM, NEWSLETTERS, INFORMATIONAL CARDS AND BROCHURES IN THE FIELD OF ART; APPLIQUÉS IN THE FORM OF DECALS AND MATERIALS FOR DECORATIVE AND ADVERTISING PURPOSES OF PAPER AND CARDBOARD, NAMELY, DECORATIVE DECALS FOR VEHICLE WINDOWS, PAPER PARTY DECORATIONS; PRINTED INSTRUCTIONAL AND TEACHING MATERIAL EXCEPT APPARATUS IN THE FIELD OF MATHEMATICS, ENGINEERING, ART, MUSIC; ENGRAVING PLATES; WOOD-PULP PAPER, WOOD-PULP BOARD FOR PAPER AND STATIONERY; CALENDARS, ARTISTS' MATERIALS, NAMELY, INSTRUMENTS FOR MODELLING IN THE NATURE OF MODELLING CLAY, MODELLING PASTE, IN CLASS 16 (U.S. CLS. 2, 5, 22, 23, 29, 37, 38 AND 50).



OWNER OF U.S. REG. NOS. 3,423,059 AND 3,838,034.

OWNER OF INTERNATIONAL REGISTRATION 0659480 DATED 3-29-1996, EXPIRES 3-29-2016.

THE WORDING "ARTOZ" HAS NO MEANING IN A FOREIGN LANGUAGE.

SER. NO. 79-106,300, FILED 7-29-2011.

MYRIAH HABEEB, EXAMINING ATTORNEY

*David J. Kyffers*

Director of the United States Patent and Trademark Office

# United States of America

United States Patent and Trademark Office



**Reg. No. 4,196,511**

**Registered Aug. 28, 2012**

**Int. Cl.: 25**

**TRADEMARK**

**PRINCIPAL REGISTER**

JEMIE B.V. (NETHERLANDS LIMITED LIABILITY COMPANY)  
BENELUXWEG 37  
NL-4904 SJ OOSTERHOUT  
NETHERLANDS

FOR: CLOTHING, NAMELY, SOCKS, UNDERWEAR, VESTS, T-SHIRTS, TROUSERS, SHORTS, SWEATERS, JERSEYS, JUMPERS, WAISTCOATS, CARDIGANS, OVERCOATS AND TRACKSUITS; FOOTWEAR; HEADWEAR, INCLUDING HATS AND CAPS, IN CLASS 25 (U.S. CLS. 22 AND 39).

THE MARK CONSISTS OF A DESIGN OF A GORILLA PROFILE.

OWNER OF INTERNATIONAL REGISTRATION 0805288 DATED 6-4-2003, EXPIRES 6-4-2013.

SER. NO. 79-106,314, FILED 4-4-2011.

HAI-LY LAM, EXAMINING ATTORNEY



*David J. Kyffers*

Director of the United States Patent and Trademark Office

# United States of America

United States Patent and Trademark Office



# Robot Cook

**Reg. No. 4,196,512**

**Registered Aug. 28, 2012**

**Int. Cls.: 7 and 11**

**TRADEMARK**

**PRINCIPAL REGISTER**

ROBOT COUPE SNC (FRANCE SOCIÉTÉ EN NOM COLLECTIF)  
48 RUE DES VIGNERONS  
F-94300 VINCENNES  
FRANCE

FOR: ELECTRIC KITCHEN APPLIANCES AND MACHINES FOR CUTTING, MIXING, KNEADING, CHOPPING, PULVERIZING, MILLING, EMULSIFYING, MIXING, BEATING, SLICING, GRATING, FLAKING AND LIQUEFYING; ELECTRICAL DOMESTIC APPLIANCES FOR KITCHEN USE, NAMELY, MINCERS, BEATERS, MIXERS, PRESSES, CENTRIFUGAL JUICE EXTRACTORS, MILLS, SLICERS, CAN OPENERS, MACHINES FOR SHARPENING KNIVES, MACHINES AND APPARATUS FOR PREPARING BEVERAGES AND/OR FOODS IN THE NATURE OF FOOD PROCESSORS, IN CLASS 7 (U.S. CLS. 13, 19, 21, 23, 31, 34 AND 35).

FOR: APPARATUS FOR COOKING, DEFROSTING, REHEATING AND BROWNING FOODSTUFFS, NAMELY, ELECTRIC COOKING OVENS AND RANGES, MICROWAVE OVENS; MULTI-PURPOSE, ELECTRIC COUNTERTOP FOOD PREPARATION APPARATUS FOR COOKING, BAKING, BROILING, ROASTING, TOASTING, SEARING, BROWNING, BARBECUING AND GRILLING FOOD; ELECTRICAL PRESSURE COOKERS, ELECTRIC COOKING POTS FOR DOMESTIC USE, NAMELY, EARTHENWARE SAUCEPANS, STOCKPOTS, CASSEROLES, ELECTRIC SAUCE AND GRAVY BOATS; ELECTRIC OVENS AND MINI-OVENS, COOKING RINGS, HOT PLATES, ELECTRIC WATER KETTLES, HEATING PLATES, ELECTRIC EGG COOKERS, ELECTRIC YOGURT MAKERS, ELECTRIC GRILLS; PARTS AND CONSTITUENT ELEMENTS OF ALL THESE GOODS SOLD THEREWITH, IN CLASS 11 (U.S. CLS. 13, 21, 23, 31 AND 34).

NO CLAIM IS MADE TO THE EXCLUSIVE RIGHT TO USE "COOK", APART FROM THE MARK AS SHOWN.

PRIORITY DATE OF 4-29-2011 IS CLAIMED.

OWNER OF INTERNATIONAL REGISTRATION 1099737 DATED 10-3-2011, EXPIRES 10-3-2021.

THE COLOR(S) RED AND GRAY IS/ARE CLAIMED AS A FEATURE OF THE MARK.



*David J. Kappas*

Director of the United States Patent and Trademark Office

**Reg. No. 4,196,512** THE MARK CONSISTS OF A RED FLAME INSIDE A GRAY RING NEXT TO THE WORDING "ROBOT COOK" IN GRAY.

SER. NO. 79-106,419, FILED 10-3-2011.

REBECCA SMITH, EXAMINING ATTORNEY



# United States of America

United States Patent and Trademark Office



**Reg. No. 4,196,513**

**Registered Aug. 28, 2012**

**Int. Cl.: 5**

**TRADEMARK**

**PRINCIPAL REGISTER**

MEDICINSKI FAKULTET U RIJECI (CROATIA CORPORATION)  
BRACE BRANCHETTA 20  
HR-51000 RIJEKA  
CROATIA

FOR: DIAGNOSTIC PREPARATIONS FOR MEDICAL PURPOSES; ADHESIVE TAPE FOR MEDICAL PURPOSES; ADHESIVE STRIPS FOR DIAGNOSTIC PURPOSES FOR USE IN THE FIELD OF HISTOLOGY, PATHOLOGY, ENDOSCOPY AND ONCOLOGY, IN CLASS 5 (U.S. CLS. 6, 18, 44, 46, 51 AND 52).

THE MARK CONSISTS OF THE WORDING "ESOPATH" WITH THE LETTERING "ESO" IN BLUE AND "PATH" IN GREY. THE WORDING IS TO THE RIGHT AT A SQUARE DESIGN COMPRISED OF CURVED BLUE BAND ON THE TOP AND BOTTOM AND CURVED GREY BANDS ON THE RIGHT AND LEFT.

PRIORITY DATE OF 10-12-2011 IS CLAIMED.

OWNER OF INTERNATIONAL REGISTRATION 1099797 DATED 10-13-2011, EXPIRES 10-13-2021.

THE COLOR(S) BLUE AND GRAY IS/ARE CLAIMED AS A FEATURE OF THE MARK.

SER. NO. 79-106,438, FILED 10-13-2011.

DOMINIC FATHY, EXAMINING ATTORNEY



*David J. Kypos*

Director of the United States Patent and Trademark Office

# United States of America

United States Patent and Trademark Office

# AQUAVI

**Reg. No. 4,196,514**

**Registered Aug. 28, 2012**

**Int. Cls.: 1, 5 and 31**

**TRADEMARK**

**PRINCIPAL REGISTER**

EVONIK DEGUSSA GMBH (FED REP GERMANY LIMITED LIABILITY COMPANY)  
RELLINGHAUSER STRABE 1-11  
45128 ESSEN, FED REP GERMANY

FOR: CHEMICALS USED IN INDUSTRY AND SCIENCE, AS WELL AS IN AGRICULTURE, HORTICULTURE AND FORESTRY EXCEPT FUNGICIDES, HERBICIDES, INSECTICIDES AND PARASITICIDES; AMINO ACIDS, PEPTIDE SUBSTRATES AND PROTEINS IN RAW MATERIAL FORM FOR LABORATORY OR RESEARCH USE OR FOR INDUSTRIAL PURPOSES; UNPROCESSED ARTIFICIAL RESINS, UNPROCESSED PLASTICS; SEAWEEDS FERTILIZERS; CHEMICAL SUBSTANCES FOR PRESERVING FOODSTUFFS; AMINO ACIDS, PEPTIDE SUBSTRATES AND PROTEINS IN RAW MATERIAL FORM FOR THE MANUFACTURE OF ANIMAL FOOD AND FISH FODDER AS WELL AS FOR THE MANUFACTURE OF FOOD FOR AQUA CULTURES, IN CLASS 1 (U.S. CLS. 1, 5, 6, 10, 26 AND 46).

FOR: PHARMACEUTICAL PREPARATIONS, NAMELY, AMINO ACIDS FOR MEDICAL PURPOSES, AMINO ACIDS FOR NUTRITIONAL PURPOSES, SYNTHETIC PEPTIDES FOR THE TREATMENT OF NUTRITION CONDITIONS AND PROTEIN SUPPLEMENTS; VETERINARY PREPARATIONS NAMELY, AMINO ACIDS FOR VETERINARY PURPOSES, AMINO ACIDS FOR VETERINARY NUTRITIONAL PURPOSES, AND SYNTHETIC PEPTIDES FOR THE TREATMENT OF NUTRITION CONDITIONS IN ANIMALS; VETERINARY PREPARATIONS, NAMELY, PROTEIN SUPPLEMENTS; AMINO ACIDS AND PEPTIDES FOR THE TREATMENT OF NUTRITION CONDITIONS AND PROTEINS FOR MEDICAL AND VETERINARY PURPOSES; NUTRITIVE SUBSTANCES FOR MICROORGANISMS FOR MEDICAL PURPOSES; DIETETIC FOODS ADAPTED FOR MEDICAL USE, IN CLASS 5 (U.S. CLS. 6, 18, 44, 46, 51 AND 52).

FOR: AGRICULTURAL, AND HORTICULTURAL PRODUCTS, NAMELY, AGRICULTURAL GRAINS FOR PLANTING AND SEEDS FOR HORTICULTURAL PURPOSES; LIVE ANIMALS; FRESH FRUITS AND VEGETABLES; SEEDS FOR AGRICULTURAL PURPOSES, NATURAL PLANTS AND FLOWERS; FOODSTUFFS, ESPECIALLY FOR ANIMALS AND AQUA CULTURES; ADDITIVES TO FODDER, NOT FOR MEDICAL PURPOSES; AMINO ACIDS, PEPTIDES AND PROTEINS USED AS INTEGRAL COMPONENTS OF FODDER, ANIMAL FOOD AND FISH FODDER NOT FOR MEDICAL PURPOSES, IN CLASS 31 (U.S. CLS. 1 AND 46).

THE MARK CONSISTS OF STANDARD CHARACTERS WITHOUT CLAIM TO ANY PARTICULAR FONT, STYLE, SIZE, OR COLOR.



*David J. Kappas*

Director of the United States Patent and Trademark Office

**Reg. No. 4,196,514** PRIORITY DATE OF 3-21-2011 IS CLAIMED.

OWNER OF INTERNATIONAL REGISTRATION 1100018 DATED 7-13-2011, EXPIRES 7-13-2021.

THE WORDING "AQUAVI" HAS NO MEANING IN A FOREIGN LANGUAGE.

SER. NO. 79-106,503, FILED 7-13-2011.

BERNICE MIDDLETON, EXAMINING ATTORNEY

United States of America  
United States Patent and Trademark Office

# Chairmeng

**Reg. No. 4,196,515**

**Registered Aug. 28, 2012**

**Int. Cl.: 20**

**TRADEMARK**

**PRINCIPAL REGISTER**

ZHEJIANG CHAIRMAN FURNITURE CO., LTD. (CHINA CORPORATION)  
YANGGUANG INDUSTRIAL DEVELOPMENT ZONE  
DIPU TOWN; ANJI COUNTY; HUZHOU  
313300ZHEJIANG, CHINA

FOR: FURNITURE; SEATS; TABLES; FURNITURE OF METAL; OFFICE FURNITURE; EASY CHAIRS; SOFAS; DECK CHAIRS; MASSAGE TABLES; FURNITURE FITTINGS, NOT OF METAL, IN CLASS 20 (U.S. CLS. 2, 13, 22, 25, 32 AND 50).

THE ENGLISH TRANSLATION OF "MENG" IN THE MARK IS "DREAM".

OWNER OF INTERNATIONAL REGISTRATION 1100135 DATED 11-24-2011, EXPIRES 11-24-2021.

SER. NO. 79-106,548, FILED 11-24-2011.

LEIGH LOWRY, EXAMINING ATTORNEY



*David J. Kyffers*

Director of the United States Patent and Trademark Office

# United States of America

United States Patent and Trademark Office

## BOND MEISTER

**Reg. No. 4,196,516**

**Registered Aug. 28, 2012**

**Int. Cl.: 7**

**TRADEMARK**

**PRINCIPAL REGISTER**

MITSUBISHI HEAVY INDUSTRIES, LTD. (JAPAN CORPORATION)  
16-5 KONAN 2-CHOME,  
MINATO-KU; TOKYO 108-8215  
JAPAN

FOR: MACHINES FOR MANUFACTURING SEMICONDUCTORS; SEMICONDUCTOR  
WAFER PROCESSING MACHINES, IN CLASS 7 (U.S. CLS. 13, 19, 21, 23, 31, 34 AND 35).

THE ENGLISH TRANSLATION OF "MEISTER" IN THE MARK IS "MASTER".

PRIORITY DATE OF 6-16-2011 IS CLAIMED.

OWNER OF INTERNATIONAL REGISTRATION 1100186 DATED 11-16-2011, EXPIRES 11-  
16-2021.

SER. NO. 79-106,569, FILED 11-16-2011.

ALAIN LAPTER, EXAMINING ATTORNEY



*David J. Kybas*

Director of the United States Patent and Trademark Office

# United States of America

United States Patent and Trademark Office

# DULCISANA

**Reg. No. 4,196,517**

**Registered Aug. 28, 2012**

**Int. Cls.: 5 and 30**

**TRADEMARK**

**PRINCIPAL REGISTER**

CAVALIER, N.V. (BELGIUM JOINT STOCK COMPANY)  
BURGEMEESTER L. PUSSEMIERSTRAAT 46  
B-9900 EEKLO  
BELGIUM

FOR: DIETETIC SUBSTANCES, NAMELY, DIETARY SUPPLEMENTS FOR GENERAL HEALTH AND WELL-BEING AND FOR PROMOTING WEIGHT LOSS, SUGAR AND SUGAR SUBSTITUTES ADAPTED FOR MEDICAL USE, FOOD FOR BABIES, FOOD SUPPLEMENTS AND FOOD ADDITIVES, NAMELY, FOOD ADDITIVES FOR USE AS FOOD FLAVORING, NUTRITIONAL FOOD ADDITIVES FOR MEDICAL PURPOSES IN THE NATURE OF NATURAL FOOD EXTRACTS DERIVED FROM PLANTS, GLUCOSE FOR USE AS AN ADDITIVE TO FOODS FOR MEDICAL PURPOSES; SUGAR-FREE AND DIETETIC FOOD AND BEVERAGES, NAMELY, DIETETIC SUGAR SUBSTITUTES FOR MEDICAL USE AND DIETETIC BEVERAGES ADAPTED FOR MEDICAL PURPOSES, IN CLASS 5 (U.S. CLS. 6, 18, 44, 46, 51 AND 52).

FOR: COFFEE, TEA, COCOA, SUGAR, RICE, TAPIOCA, SAGO, ARTIFICIAL COFFEE; FLOUR AND PREPARATIONS MADE FROM CEREALS, NAMELY, BREADSTICKS, RUSKS, CRACKERS, BREAKFAST CEREALS, CEREAL-BASED SNACK FOODS AND CEREAL-BASED HIGH PROTEIN BARS; PASTRY AND CONFECTIONERY, NAMELY, FROZEN CONFECTIONERY, CHOCOLATE, CHOCOLATE MELTS, BISCUITS, COOKIES AND MARZIPAN; ICES; HONEY, TREACLE; YEAST, BAKING POWDER; SALT, MUSTARD; VINEGAR, SAUCES CONDIMENTS; SPICES; ICE, IN CLASS 30 (U.S. CL. 46).

THE MARK CONSISTS OF STANDARD CHARACTERS WITHOUT CLAIM TO ANY PARTICULAR FONT, STYLE, SIZE, OR COLOR.

PRIORITY DATE OF 4-4-2011 IS CLAIMED.

OWNER OF INTERNATIONAL REGISTRATION 1100263 DATED 7-26-2011, EXPIRES 7-26-2021.

THE WORDING "DULCISANA" HAS NO MEANING IN A FOREIGN LANGUAGE.

SER. NO. 79-106,595, FILED 7-26-2011.

RICHARD WHITE, EXAMINING ATTORNEY



*David J. Kyfos*

Director of the United States Patent and Trademark Office

# United States of America

United States Patent and Trademark Office

## SMOKE ON THE WATER

**Reg. No. 4,196,518**

**Registered Aug. 28, 2012**

**Int. Cls.: 34, 39 and 43**

**TRADEMARK**

**SERVICE MARK**

**PRINCIPAL REGISTER**

OETTINGER IMEX AG (SWITZERLAND AKTIENGESELLSCHAFT)  
NAUENSTRASSE 73  
CH-4002 BASEL  
SWITZERLAND

FOR: TOBACCO PRODUCTS, NAMELY, CIGARS, CIGARILLOS, SMOKING TOBACCO; SMOKERS' ARTICLES, NAMELY, CIGAR CUTTERS, NON-ELECTRICAL CIGAR AND CIGARETTE LIGHTERS, CIGAR HUMIDIFIERS, CIGAR BOXES WITH HUMIDIFIERS; TOBACCO JARS, CIGAR CASES AND ASHTRAYS FOR SMOKERS, LIGHTERS FOR SMOKERS, MATCHES, IN CLASS 34 (U.S. CLS. 2, 8, 9 AND 17).

FOR: ARRANGING, ORGANIZING AND BOOKING TOURS AND EXCURSIONS AND EXCURSIONS BY MOTOR VEHICLE; BOAT TRANSPORT; FERRY TRANSPORT; GPS NAVIGATION SERVICES; TRANSPORT OF GOODS AND PASSENGERS; TRANSPORT OF TRAVELLERS; BOAT RENTAL, IN CLASS 39 (U.S. CLS. 100 AND 105).

FOR: RESTAURANT SERVICES; BAR SERVICES; RESTAURANT AND BAR SERVICES, IN CLASS 43 (U.S. CLS. 100 AND 101).

THE MARK CONSISTS OF STANDARD CHARACTERS WITHOUT CLAIM TO ANY PARTICULAR FONT, STYLE, SIZE, OR COLOR.

PRIORITY DATE OF 4-6-2011 IS CLAIMED.

OWNER OF INTERNATIONAL REGISTRATION 1100278 DATED 10-5-2011, EXPIRES 10-5-2021.

SER. NO. 79-106,601, FILED 10-5-2011.

COLLEEN DOMBROW, EXAMINING ATTORNEY



*David J. Kybas*

Director of the United States Patent and Trademark Office

# United States of America

United States Patent and Trademark Office

# TiDiY

**Reg. No. 4,196,519**

**Registered Aug. 28, 2012**

**Int. Cls.: 19 and 21**

**TRADEMARK**

**PRINCIPAL REGISTER**

GUANGDONG TIDIY CERAMICS CO.,LTD. (CHINA CORPORATION)  
FANHU INDUSTRIAL ZONE  
LEPING TOWN,; SANSUI DISTRICT,; FOSHANCITY; 528138 GUANGDONG  
CHINA

FOR: BRICKS; NON-METAL TILES; CERAMIC TILES; NON-METAL FLOOR TILES; NON-METAL WALL TILES; NON-METAL PANTILES; NON-METAL FLOORS; GLASS MOSAICS FOR USE IN BUILDING CONSTRUCTION, IN CLASS 19 (U.S. CLS. 1, 12, 33 AND 50).

FOR: NON-ELECTRIC KITCHEN CONTAINERS NOT MADE OF PRECIOUS METAL; WORKS OF ART OF EARTHENWARE, GLASS OR PORCELAIN; CERAMIC SCULPTURES, VASES, VESSELS, BOWLS, PLATES, AND POTS; TEMPERED GLASS, NOT FOR BUILDING; NON-METAL PIGGY BANKS; TEA SERVICES NOT OF PRECIOUS METAL; EARTHENWARE BASINS, NAMELY, BOWLS, NOT PARTS OF SANITARY INSTALLATIONS; GLASS BEVERAGE WARE, IN CLASS 21 (U.S. CLS. 2, 13, 23, 29, 30, 33, 40 AND 50).

OWNER OF INTERNATIONAL REGISTRATION 1100598 DATED 11-24-2011, EXPIRES 11-24-2021.

SER. NO. 79-106,734, FILED 11-24-2011.

DAVID HOFFMAN, EXAMINING ATTORNEY



*David J. Kyfos*

Director of the United States Patent and Trademark Office



# United States of America

United States Patent and Trademark Office

# EVENSWISS

**Reg. No. 4,196,520**

**Registered Aug. 28, 2012**

**Int. Cl.: 3**

**TRADEMARK**

**PRINCIPAL REGISTER**

EVENSWISS GMBH (SWITZERLAND GESELLSCHAFT MIT BESCHRÄNKTER HAFTUNG)  
BÜRGLISTRASSE 8  
CH-8002 ZÜRICH  
SWITZERLAND

FOR: CLEANING, POLISHING, SCOURING AND ABRASIVE PREPARATIONS; SOAPS;  
PERFUMERY, ESSENTIAL OILS, COSMETICS, HAIR LOTIONS; DENTIFRICES; ALL THE  
AFORESAID PRODUCTS OF SWISS ORIGIN, IN CLASS 3 (U.S. CLS. 1, 4, 6, 50, 51 AND 52).

THE MARK CONSISTS OF STANDARD CHARACTERS WITHOUT CLAIM TO ANY PAR-  
TICULAR FONT, STYLE, SIZE, OR COLOR.

OWNER OF INTERNATIONAL REGISTRATION 1012075 DATED 6-9-2009, EXPIRES 6-9-  
2019.

SER. NO. 79-106,848, FILED 10-28-2011.

CHARISMA HAMPTON, EXAMINING ATTORNEY



*David J. Kyffers*

Director of the United States Patent and Trademark Office

# United States of America

United States Patent and Trademark Office

## MOMENTS OF TRUTH

**Reg. No. 4,196,521**

**Registered Aug. 28, 2012**

**Int. Cl.: 35**

**SERVICE MARK**

**PRINCIPAL REGISTER**

RAPIDE COMMUNICATION LIMITED (UNITED KINGDOM LIMITED COMPANY)  
HERON HOUSE  
MILLBURN HILL ROAD  
COVENTRY CV4 7HS, UNITED KINGDOM

FOR: DATA COLLECTION SERVICES, NAMELY, COLLECTION OF DATA ON INDIVIDUALS WHO USE THE SERVICES AND/OR PRODUCTS PROVIDED BY BUSINESSES; MARKET AND CONSUMER RESEARCH DATA COLLECTION IN RESPECT TO THE OPINIONS OF INDIVIDUALS IN RELATION TO THEIR INTERACTION WITH BUSINESSES; COLLECTION OF DATA RELATING TO CONSUMER FEEDBACK CONCERNING HOW THEIR EXPERIENCE MEETS THEIR EXPECTATIONS; BUSINESS DATA ANALYSIS SERVICES, IN CLASS 35 (U.S. CLS. 100, 101 AND 102).

THE MARK CONSISTS OF STANDARD CHARACTERS WITHOUT CLAIM TO ANY PARTICULAR FONT, STYLE, SIZE, OR COLOR.

PRIORITY DATE OF 7-11-2011 IS CLAIMED.

OWNER OF INTERNATIONAL REGISTRATION 1100836 DATED 11-12-2011, EXPIRES 11-12-2021.

SER. NO. 79-106,875, FILED 11-12-2011.

EDWARD NELSON, EXAMINING ATTORNEY



*David J. Kyffers*

Director of the United States Patent and Trademark Office

# United States of America

United States Patent and Trademark Office

# Swozh 速力

**Reg. No. 4,196,522**

**Registered Aug. 28, 2012**

**Int. Cl.: 3**

GUANGDONG PENGJIN INDUSTRY CO., LTD. (CHINA CORPORATION)  
WEST SIDE OF NATIONAL HIGHWAY 206  
(NEXT TO GUANGDA PIER), JIEDONG ECONOMIC DEVELOPMENT; EXPERIMENTAL  
ZONE, JIEYANG CITY; GUANGDONG  
CHINA

**TRADEMARK**

**PRINCIPAL REGISTER**

FOR: SOAP; SHAMPOOS; CLEANSING MILK FOR TOILET PURPOSES; LAUNDRY STARCH;  
LAUNDRY PREPARATIONS, NAMELY, SOAP, STARCH, DETERGENT; WASHING PRE-  
PARATIONS; FABRIC SOFTENERS FOR LAUNDRY USE; DRY-CLEANING PREPARATIONS,  
NAMELY, FLUIDS, STARCH, DETERGENT; STAIN REMOVERS; CLEANING PREPARA-  
TIONS; SHINING PREPARATIONS, NAMELY, POLISH; POLISH FOR FURNITURE AND  
FLOORING; ABRASIVES, NAMELY, PASTE, SHEETS, STRIPS; FURBISHING PREPARA-  
TIONS, NAMELY, SOAP, STARCH, DETERGENT; ESSENTIAL OILS; MAKE-UP; COSMETIC  
KITS IN THE NATURE OF MAKE UP KITS; DENTIFRICES; INCENSE; SHAMPOOS FOR  
PETS, IN CLASS 3 (U.S. CLS. 1, 4, 6, 50, 51 AND 52).

THE NON-LATIN CHARACTERS IN THE MARK ARE TRANSLATED INTO ENGLISH AS  
"SPEED" AND "POWER", WHICH HAVE NO MEANING AS A WHOLE.

PRIORITY DATE OF 8-3-2011 IS CLAIMED.

OWNER OF INTERNATIONAL REGISTRATION 1101018 DATED 11-16-2011, EXPIRES 11-  
16-2021.

THE NON-LATIN CHARACTERS IN THE MARK ARE TRANSLITERATED INTO "SU LI".

SER. NO. 79-106,947, FILED 11-16-2011.

ALAIN LAPTEY, EXAMINING ATTORNEY



*David J. Kyffers*

Director of the United States Patent and Trademark Office

# United States of America

United States Patent and Trademark Office

# ARISUN

**Reg. No. 4,196,523**

**Registered Aug. 28, 2012**

**Int. Cl.: 12**

**TRADEMARK**

**PRINCIPAL REGISTER**

HANGZHOU GENERAL RUBBER FACTORY (CHINA CORPORATION)  
HAICHAO ROAD  
WANGJIANGMENWAI, SHANGCHENG DISTRICT, HANGZHOU CITY, ZHEJIANG  
CHINA

FOR: WHEELS FOR AUTOMOBILES; TIRES FOR VEHICLES, IN CLASS 12 (U.S. CLS. 19, 21, 23, 31, 35 AND 44).

THE MARK CONSISTS OF THE WORDING "ARISUN" IN STYLIZED LETTERING FILLED WITH A DESIGN SUGGESTIVE OF A RISING SUN.

PRIORITY DATE OF 3-23-2011 IS CLAIMED.

OWNER OF INTERNATIONAL REGISTRATION 1101162 DATED 5-6-2011, EXPIRES 5-6-2021.

THE WORDING "ARISUN" HAS NO MEANING IN A FOREIGN LANGUAGE.

SER. NO. 79-106,992, FILED 5-6-2011.

KRISTIN DAHLING, EXAMINING ATTORNEY



*David J. Kyffers*

Director of the United States Patent and Trademark Office

# United States of America

United States Patent and Trademark Office

# DAE DO

**Reg. No. 4,196,524**

**Registered Aug. 28, 2012**

**Int. Cls.: 9, 25 and 28**

**TRADEMARK**

**PRINCIPAL REGISTER**

PARK - CHUEN WOOK (REPUBLIC OF KOREA INDIVIDUAL)  
BALMES, 55 - BAJOS  
E-08007 BARCELONA  
SPAIN

FOR: PROTECTIVE HELMETS FOR PRACTICING MARTIAL ARTS, BOXING AND GYMNASTICS, IN CLASS 9 (U.S. CLS. 21, 23, 26, 36 AND 38).

FOR: ATHLETIC UNIFORMS AND SUITS FOR PRACTICING MARTIAL ARTS AND GYMNASTICS, TRACKSUITS, TEE-SHIRTS, POLO SHIRTS, SPORTS TROUSERS AND JACKETS, SHOES FOR PRACTICING MARTIAL ARTS AND SHOULDER PADS INCORPORATED INTO CLOTHING, IN CLASS 25 (U.S. CLS. 22 AND 39).

FOR: SHIN GUARDS FOR ATHLETIC USE, ELBOW PADS FOR ATHLETIC USE, BOXING GLOVES AND GLOVES FOR PRACTICING MARTIAL ARTS; BOXING BAGS; PUNCHING-BALLS; SHOULDER PADS FOR ATHLETIC USE, IN CLASS 28 (U.S. CLS. 22, 23, 38 AND 50).

THE MARK CONSISTS OF STANDARD CHARACTERS WITHOUT CLAIM TO ANY PARTICULAR FONT, STYLE, SIZE, OR COLOR.

PRIORITY DATE OF 4-27-2011 IS CLAIMED.

OWNER OF INTERNATIONAL REGISTRATION 1101307 DATED 10-27-2011, EXPIRES 10-27-2021.

OWNER OF U.S. REG. NO. 2,874,315.

THE ENGLISH TRANSLATION OF "DAE DO" IN THE MARK IS "GREAT WAY" OR "GREAT PATH".

SER. NO. 79-107,037, FILED 10-27-2011.

KIMBERLY FRYE, EXAMINING ATTORNEY



*David J. Kyffers*

Director of the United States Patent and Trademark Office

# United States of America

United States Patent and Trademark Office

# XP Blade

**Reg. No. 4,196,525**

**Registered Aug. 28, 2012**

**Int. Cls.: 17, 23 and 27**

**TRADEMARK**

**PRINCIPAL REGISTER**

TEN CATE THIOLON B.V. (NETHERLANDS BESLOTEN VENNOOTSCHAP)  
G. VAN DER MUELENWEG 2  
NL-7443 RE NIJVERDAL, NETHERLANDS

FOR: SYNTHETIC FIBRES FOR MAKING ARTIFICIAL TURF, NOT FOR TEXTILE USE;  
SEMI-PROCESSED PLASTICS IN THE FORM OF GRANULES, NOT FOR TEXTILE USE;  
ARTIFICIAL GRASS YARNS, NOT FOR TEXTILE USE, IN CLASS 17 (U.S. CLS. 1, 5, 12, 13,  
35 AND 50).

FOR: YARNS; SPUN THREAD; PLASTIC OR RUBBER THREADS FOR TEXTILE USE, IN  
CLASS 23 (U.S. CL. 43).

FOR: ARTIFICIAL TURF; BACKING FOR ARTIFICIAL TURF MATS; ARTIFICIAL TURF  
MATS; UNDERLAY FOR ARTIFICIAL TURF FIELDS, IN CLASS 27 (U.S. CLS. 19, 20, 37,  
42 AND 50).

THE MARK CONSISTS OF STANDARD CHARACTERS WITHOUT CLAIM TO ANY PAR-  
TICULAR FONT, STYLE, SIZE, OR COLOR.

OWNER OF INTERNATIONAL REGISTRATION 1101633 DATED 9-30-2011, EXPIRES 9-30-  
2021.

OWNER OF U.S. REG. NO. 4,000,550.

NO CLAIM IS MADE TO THE EXCLUSIVE RIGHT TO USE "BLADE", APART FROM THE  
MARK AS SHOWN.

SER. NO. 79-107,153, FILED 9-30-2011.

TOBY BULLOFF, EXAMINING ATTORNEY



*David J. Kyffers*

Director of the United States Patent and Trademark Office

# United States of America

United States Patent and Trademark Office

# MOOVE

**Reg. No. 4,196,526**

**Registered Aug. 28, 2012**

**Int. Cl.: 44**

VITALIBERTY GMBH (FED REP GERMANY GESELLSCHAFT MIT BESCHRÄNKTER  
HAFTUNG (GMBH))  
MARKIRCHER STRASSE 22  
68229 MANNHEIM  
FED REP GERMANY

**SERVICE MARK**

**PRINCIPAL REGISTER**

FOR: MEDICAL SERVICES, HUMAN HEALTHCARE, CONDUCTING MEDICAL AND CLINICAL EXAMINATIONS, IN PARTICULAR ON COMPANY EMPLOYEES, INDIVIDUAL MEDICAL DIAGNOSIS OF COMPANY EMPLOYEES, TELEMEDICINE, CONSULTANCY RELATING TO COMPANY HEALTHCARE, DEVELOPMENT OF BUSINESS-SPECIFIC HEALTH PROGRAMMES, NAMELY, HEALTHCARE ADVICE, NUTRITION ADVICE, INFORMATION IN THE FIELD OF HEALTH CARE, NAMELY, MOTIVATION PROGRAMS FOR PROMOTING HEALTH, IN CLASS 44 (U.S. CLS. 100 AND 101).

THE MARK CONSISTS OF THE TERM "MOOVE" IN STYLIZED CHARACTERS.

PRIORITY DATE OF 9-1-2011 IS CLAIMED.

OWNER OF INTERNATIONAL REGISTRATION 1102032 DATED 11-22-2011, EXPIRES 11-22-2021.

SER. NO. 79-107,320, FILED 11-22-2011.

JESSICA A. POWERS, EXAMINING ATTORNEY



*David J. Kybas*

Director of the United States Patent and Trademark Office

# United States of America

United States Patent and Trademark Office



**Reg. No. 4,196,527**

**Registered Aug. 28, 2012**

**Int. Cls.: 18 and 25**

**TRADEMARK**

**PRINCIPAL REGISTER**

GI.MEL. S.R.L. (ITALY LIMITED LIABILITY COMPANY)  
S.S. 377 PER NOCI Z.I.  
I-70017 PUTIGNANO (BA)  
ITALY

FOR: LEATHER AND IMITATIONS OF LEATHER; LEATHER AND IMITATION LEATHER GOODS, NAMELY, BAGS, SUITCASES, TRAVELING BAGS, PURSES, KEY CASES , IN CLASS 18 (U.S. CLS. 1, 2, 3, 22 AND 41).

FOR: CLOTHING, NAMELY, T-SHIRTS, SHIRTS, JUMPERS, TROUSERS, SKIRTS, JEANS, JACKETS, UNDERCLOTHES, BATHING SUITS; HATS AND CAPS, FOOTWEAR, IN CLASS 25 (U.S. CLS. 22 AND 39).

THE TRADEMARK CONSISTS OF THE WORDING "ASAIS" WHOSE LETTERS DEVELOP ALONG THE WHOLE LENGTH OF A DARK SQUARE.

PRIORITY DATE OF 6-10-2011 IS CLAIMED.

OWNER OF INTERNATIONAL REGISTRATION 1102299 DATED 11-15-2011, EXPIRES 11-15-2021.

THE WORDING "ASAIS" HAS NO MEANING IN A FOREIGN LANGUAGE.

SER. NO. 79-107,414, FILED 11-15-2011.

MAYUR VAGHANI, EXAMINING ATTORNEY



*David J. Kybas*

Director of the United States Patent and Trademark Office



# United States of America

United States Patent and Trademark Office

# D-Vital ID

**Reg. No. 4,196,528**

**Registered Aug. 28, 2012**

**Int. Cls.: 5 and 42**

**TRADEMARK**

**SERVICE MARK**

**PRINCIPAL REGISTER**

IMMUNDIAGNOSTIK AG (FED REP GERMANY JOINT STOCK COMPANY)  
STUBENWALD-ALLEE 8A  
64625 BENSHEIM  
FED REP GERMANY

FOR: DIAGNOSTIC PREPARATIONS FOR MEDICAL PURPOSES, INCLUDING CHEMICAL PREPARATION FOR MEDICAL LABORATORY USE; CHEMICAL PREPARATIONS FOR USE IN DISEASE PREVENTION, NAMELY, DISEASES OF THE BONES AND SKELETAL SYSTEM AND DISEASES OF THE KIDNEYS IN THE FIELD OF NEPHROPATHY; CHEMICAL PREPARATIONS FOR MEDICAL PURPOSES FOR USE IN PHARMACEUTICAL AND DIAGNOSTIC DETECTION KITS FOR DETECTING DISEASES OF THE BONES AND SKELETAL SYSTEM AND DISEASES OF THE KIDNEYS IN THE FIELD OF NEPHROPATHY, IN CLASS 5 (U.S. CLS. 6, 18, 44, 46, 51 AND 52).

FOR: MEDICAL RESEARCH LABORATORY SERVICES; MEDICAL AND CHEMICAL RESEARCH, IN CLASS 42 (U.S. CLS. 100 AND 101).

THE MARK CONSISTS OF STANDARD CHARACTERS WITHOUT CLAIM TO ANY PARTICULAR FONT, STYLE, SIZE, OR COLOR.

OWNER OF INTERNATIONAL REGISTRATION 1102381 DATED 8-8-2011, EXPIRES 8-8-2021.

SER. NO. 79-107,472, FILED 8-8-2011.

WILLIAM BRECKENFELD, EXAMINING ATTORNEY



*David J. Kyros*

Director of the United States Patent and Trademark Office

# United States of America

United States Patent and Trademark Office

## dream for the world

**Reg. No. 4,196,529**

**Registered Aug. 28, 2012**

**Int. Cls.: 16 and 41**

**TRADEMARK**

**SERVICE MARK**

**PRINCIPAL REGISTER**

DREAM FOR THE WORLD (DFTW) SA (SWITZERLAND SOCIÉTÉ ANONYME (SA))  
18 PLACE DES PHILOSOPHES  
CH-1205 GENÈVE  
SWITZERLAND

FOR: BOOKMARKERS; LEDGERS BOOKS; BOOKS IN THE FIELD OF GRAPHIC ARTS; BOOKS IN THE FIELD OF BUSINESS, SCIENCE, PHILOSOPHY; PUBLICATIONS, NAMELY, BOOKS IN THE FIELD OF BUSINESS, SCIENCE, PHILOSOPHY; PRINTED PUBLICATIONS, NAMELY, BOOKS IN THE FIELD OF BUSINESS, SCIENCE, PHILOSOPHY; PRINTED INSTRUCTIONAL MATERIALS EXCEPT APPARATUS IN THE FIELD OF BUSINESS, SCIENCE, PHILOSOPHY; PRINTED TEACHING MATERIALS EXCEPT APPARATUS IN THE FIELD OF BUSINESS, SCIENCE, PHILOSOPHY, IN CLASS 16 (U.S. CLS. 2, 5, 22, 23, 29, 37, 38 AND 50).

FOR: TEACHING SERVICES, NAMELY, TEACHING IN THE FIELD OF BUSINESS, SCIENCE, PHILOSOPHY; PUBLICATION OF INTERACTIVE EDUCATIONAL AND ENTERTAINMENT PRODUCTS, NAMELY, COMPACT DISKS, DVDS, MINIDISKS, CD-ROMS; PUBLICATION OF TEXTS, OTHER THAN PUBLICITY TEXTS; EDITING, NAMELY, WRITTEN TEXT EDITING AND PUBLISHING SERVICES, NAMELY, PUBLISHING OF BOOKS; PUBLICATION AND RENTAL OF INTERACTIVE EDUCATIONAL AND ENTERTAINMENT PRODUCTS, NAMELY, FILMS AND BOOKS; EDUCATIONAL SERVICES, NAMELY, CONDUCTING CLASSES, SEMINARS, CONFERENCES, WORKSHOPS IN THE FIELD OF BUSINESS, SCIENCE, PHILOSOPHY, IN CLASS 41 (U.S. CLS. 100, 101 AND 107).

THE MARK CONSISTS OF STANDARD CHARACTERS WITHOUT CLAIM TO ANY PARTICULAR FONT, STYLE, SIZE, OR COLOR.

PRIORITY DATE OF 9-5-2011 IS CLAIMED.

OWNER OF INTERNATIONAL REGISTRATION 1102478 DATED 11-1-2011, EXPIRES 11-1-2021.

SER. NO. 79-107,513, FILED 11-1-2011.

HAI-LY LAM, EXAMINING ATTORNEY



*David J. Kyros*

Director of the United States Patent and Trademark Office

United States of America  
United States Patent and Trademark Office

HIP247

**Reg. No. 4,196,530**

**Registered Aug. 28, 2012**

**Int. Cl.: 9**

**TRADEMARK**

**PRINCIPAL REGISTER**

STMICROELECTRONICS NV (NETHERLANDS CORPORATION)  
WTC SCHIPHOL AIRPORT  
SCHIPHOL BOULEVARD 265., SCHIPHOL AIRPORT; NL-1118 BH AMSTERDAM  
NETHERLANDS

FOR: SEMICONDUCTORS; INTEGRATED CIRCUITS; INTEGRATED CIRCUIT CHIPS;  
MONITORING APPARATUS, DEVICES AND INSTRUMENTS FOR INTEGRATED CIRCUITS  
AND MICROPROCESSORS; PRINTED ELECTRONIC CIRCUITS FOR INTEGRATED CIRCUIT  
CARDS AND APPARATUS, IN CLASS 9 (U.S. CLS. 21, 23, 26, 36 AND 38).

THE MARK CONSISTS OF STANDARD CHARACTERS WITHOUT CLAIM TO ANY PAR-  
TICULAR FONT, STYLE, SIZE, OR COLOR.

PRIORITY DATE OF 5-23-2011 IS CLAIMED.

OWNER OF INTERNATIONAL REGISTRATION 1102574 DATED 11-18-2011, EXPIRES 11-  
18-2021.

SER. NO. 79-107,540, FILED 11-18-2011.

TOBY BULLOFF, EXAMINING ATTORNEY



*David J. Kyffers*

Director of the United States Patent and Trademark Office

# United States of America

United States Patent and Trademark Office



**Reg. No. 4,196,531**

**Registered Aug. 28, 2012**

**Int. Cls.: 2 and 3**

**TRADEMARK**

**PRINCIPAL REGISTER**

WOODCARE DENMARK A/S (DENMARK PRIVATE LIMITED LIABILITY COMPANY)  
TVÆRVEJ 6  
DK-6640 LUNDERSKOV  
DENMARK

FOR: PAINTS, VARNISHES, LACQUERS; PRESERVATIVES AGAINST RUST AND AGAINST DETERIORATION OF WOOD IN THE NATURE OF A COATING; COLORANTS; MORDANTS FOR USE IN THE STAINING OF WOOD SURFACES; RAW NATURAL RESINS; METALS IN FOIL AND POWDER FORM FOR PAINTERS, DECORATORS, PRINTERS AND ARTISTS, IN CLASS 2 (U.S. CLS. 6, 11 AND 16).

FOR: BLEACHING PREPARATIONS AND OTHER SUBSTANCES FOR LAUNDRY USE, NAMELY, LYE, SOFTWOOD LYE, HARD WOOD LYE; CLEANING, POLISHING, SCOURING AND ABRASIVE PREPARATIONS; SOAPS; PERFUMERY, ESSENTIAL OILS, COSMETICS, HAIR LOTIONS; DENTIFRICES, IN CLASS 3 (U.S. CLS. 1, 4, 6, 50, 51 AND 52).

NO CLAIM IS MADE TO THE EXCLUSIVE RIGHT TO USE "DENMARK", APART FROM THE MARK AS SHOWN.

OWNER OF INTERNATIONAL REGISTRATION 1103061 DATED 7-25-2011, EXPIRES 7-25-2021.

THE COLOR(S) BLACK, GREY, SILVER AND GOLD IS/ARE CLAIMED AS A FEATURE OF THE MARK.

THE MARK CONSISTS OF THE WORDING "WOCA DENMARK" IN DARK GOLD LETTERING WITH A BLACK OUTLINE AND SILVER SHADING ACCENTS. THE WORDS ARE ENGRAVED INTO A GOLD RECTANGULAR PLATE WITH LIGHT GOLD IN THE CENTER FADING TO A DARK GOLD ON THE ENDS. AT EITHER END OF THE RECTANGULAR PLATE THERE ARE TWO GOLD CIRCLES REPRESENTING NAILS. THE RECTANGULAR PLATE HAS A BLACK OUTLINE WITH GRAY SHADING ACCENTS LOCATED NEAR THE EDGE OF THE PLATING. TWO BLACK SWIRLS WITH GREY SHADING ACCENTS ARE ON EITHER SIDE OF THE WORD "DENMARK".



*David J. Kypas*

Director of the United States Patent and Trademark Office

SER. NO. 79-107,722, FILED 7-25-2011.

DAVID HOFFMAN, EXAMINING ATTORNEY

# United States of America

United States Patent and Trademark Office

# InnoLandscape

**Reg. No. 4,196,532**

**Registered Aug. 28, 2012**

**Int. Cls.: 16, 35, 41 and  
42**

**TRADEMARK**

**SERVICE MARK**

**PRINCIPAL REGISTER**

BODMER INNOCOACH AG (SWITZERLAND AKTIENGESELLSCHAFT (AG))  
BIRKENSTRASSE 49,  
POSTFACH 88; CH-6343 ROTKREUZ  
SWITZERLAND

FOR: BOOKS, PRINTED MATTER IN THE NATURE OF BROCHURES, NEWSLETTERS AND PAMPHLETS, PRINTED PUBLICATIONS IN THE NATURE OF BROCHURES, NEWSLETTERS AND PAMPHLETS, MAGAZINES, PERIODICALS, AND PRINTED INSTRUCTIONAL AND TEACHING MATERIALS ALL IN THE FIELDS OF TECHNOLOGY AND FINANCE, IN CLASS 16 (U.S. CLS. 2, 5, 22, 23, 29, 37, 38 AND 50).

FOR: BUSINESS CONSULTANCY; BUSINESS CONSULTANCY SERVICES RENDERED TO EMPLOYEES RELATING TO BUSINESS OPERATIONS; BUSINESS ORGANIZATION AND CORPORATE GOVERNANCE CONSULTANCY; BUSINESS MANAGEMENT CONSULTANCY; OPERATIONAL BUSINESS CONSULTANCY; ORGANIZATION CONSULTANCY IN BUSINESS MATTERS, IN CLASS 35 (U.S. CLS. 100, 101 AND 102).

FOR: EDUCATION AND TRAINING CONSULTANCY TO CONSUMERS IN THE FIELDS OF FINANCE AND TECHNOLOGY; COACHING IN THE FIELDS OF FINANCE AND TECHNOLOGY; ORGANIZATION AND CONDUCTING OF CONFERENCES, CONGRESSES, SYMPOSIUMS IN THE FIELDS OF FINANCE AND TECHNOLOGY; ARRANGING AND CONDUCTING OF SEMINARS AND WORKSHOPS IN THE FIELDS OF FINANCE AND TECHNOLOGY; ARRANGING AND CONDUCTING OF COLLOQUIUMS IN THE FIELDS OF FINANCE AND TECHNOLOGY; PUBLICATION OF BOOKS, IN CLASS 41 (U.S. CLS. 100, 101 AND 107).

FOR: INDUSTRIAL RESEARCH IN THE FIELD OF ENGINEERING; SCIENTIFIC RESEARCH; SERVICE OF AN ENGINEER; RESEARCH IN THE FIELD OF ENGINEERING, IN CLASS 42 (U.S. CLS. 100 AND 101).

THE MARK CONSISTS OF STANDARD CHARACTERS WITHOUT CLAIM TO ANY PARTICULAR FONT, STYLE, SIZE, OR COLOR.

OWNER OF INTERNATIONAL REGISTRATION 1103148 DATED 12-7-2011, EXPIRES 12-7-2021.

SER. NO. 79-107,756, FILED 12-7-2011.



*David J. Kyffers*

Director of the United States Patent and Trademark Office

**Reg. No. 4,196,532** MICHAEL KEATING, EXAMINING ATTORNEY

# United States of America

United States Patent and Trademark Office

# mobizcorp

**Reg. No. 4,196,533**

**Registered Aug. 28, 2012**

**Int. Cls.: 38 and 42**

**SERVICE MARK**

**PRINCIPAL REGISTER**

FRIEDHELM SCHARHAG (FED REP GERMANY INDIVIDUAL)  
GEORG-HERBERT-STRASSE 9  
68519 VIERNHEIM  
FED REP GERMANY

FOR: TELECOMMUNICATIONS SERVICES, NAMELY, PROVIDING ELECTRONIC MESSAGE ALERTS VIA THE INTERNET; TRANSFER OF DATA BY TELECOMMUNICATION, IN CLASS 38 (U.S. CLS. 100, 101 AND 104).

FOR: DESIGN OF COMPUTER PROGRAMS FOR E-COMMERCE PURPOSES; MAINTENANCE, INSTALLATION AND IMPLEMENTATION OF COMPUTER SOFTWARE, IN CLASS 42 (U.S. CLS. 100 AND 101).

THE MARK CONSISTS OF STANDARD CHARACTERS WITHOUT CLAIM TO ANY PARTICULAR FONT, STYLE, SIZE, OR COLOR.

OWNER OF INTERNATIONAL REGISTRATION 1103317 DATED 11-17-2011, EXPIRES 11-17-2021.

SER. NO. 79-107,805, FILED 11-17-2011.

MICHAEL WIENER, EXAMINING ATTORNEY



*David J. Kyffers*

Director of the United States Patent and Trademark Office

# United States of America

United States Patent and Trademark Office

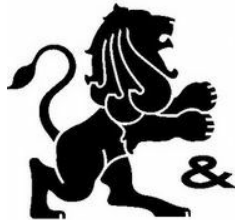

# MAXWELL & WILLIAMS

**Reg. No. 4,196,534**

**Registered Aug. 28, 2012**

**Int. Cls.: 8, 16, 21 and 24**

**TRADEMARK**

**PRINCIPAL REGISTER**

H.A.G. IMPORT CORPN.; (AUSTRALIA) PTY LTD (AUSTRALIA REGISTERED AUSTRALIAN COMPANY)  
11-27 MILLERS ROAD  
BROOKLYN VIC 3012, AUSTRALIA

FOR: CUTLERY; KNIVES; FORKS; SPOONS; HAND-OPERATED SPREADERS FOR FOOD; MORTAR AND PESTLE; HAND TOOLS AND HAND-OPERATED IMPLEMENTS, NAMELY, TONGS, NUTCRACKERS, NON-ELECTRIC CAN OPENERS, HAND-OPERATED FOOD DICERS, HAND OPERATED FOOD SLICERS, HAND-OPERATED FOOD PROCESSORS, HAND-OPERATED CUTTING TOOLS, HAND OPERATED TOOLS FOR MAKING SHAVED ICE, NON-ELECTRIC FRUIT AND VEGETABLE PEELERS, NON-ELECTRIC PIZZA CUTTERS AND SLICERS, KNIFE SHARPENERS, NON-ELECTRIC ICE CRUSHERS; HAND-OPERATED IMPLEMENTS FOR THE SERVING OF FOOD, NAMELY, SERVING KNIVES; SERVING UTENSILS, NAMELY, CARVING KNIVES, IN CLASS 8 (U.S. CLS. 23, 28 AND 44).

FOR: GOODS MADE FROM PAPER AND CARDBOARD, NAMELY, STORAGE CONTAINERS MADE OF PAPER, TABLE MATS AND PLACE MATS OF PAPER, PAPER TABLE CLOTHS, DECORATIVE PAPER CENTERPIECES, PAPER TOWELS, HANDKERCHIEFS OF PAPER, PAPER BABY BIBS, PAPER CAKE DECORATIONS, PAPER DOILIES, PAPER FLOOR MATS, PAPER TRAY COVERS, PAPER WASHCLOTHS, SCENTED PAPER DRAWER LINERS, SPECIALTY PAPERS, NAMELY, VEGETABLE PARCHMENT FOR USE IN FOOD WRAPPING, PREPARATION, PROCESSING AND PACKAGING APPLICATIONS; TABLE LINEN OF PAPER; NAPERY OF PAPER NAMELY, PAPER NAPKINS; PACKAGING CONTAINERS COMPRISED PREDOMINANTLY OF PAPER WITH OF PLASTIC-LINED PAPER BOARD FOR SOLIDS OR LIQUIDS; PACKAGING MATERIAL MADE OF STARCHES, IN CLASS 16 (U.S. CLS. 2, 5, 22, 23, 29, 37, 38 AND 50).

FOR: HOUSEHOLD OR KITCHEN UTENSILS AND CONTAINERS NOT OF PRECIOUS METAL OR COATED THEREWITH, NAMELY, CANISTER SETS, BREAD BINS, BREAD BOARDS, CONTAINERS FOR HOUSEHOLD OR KITCHEN USE, SPICE RACKS, CONTAINERS FOR FOODS, HOUSEHOLD STORAGE CONTAINERS FOR PET FOOD, INSULATED CONTAINERS FOR FOOD OR BEVERAGE FOR DOMESTIC USE, SOAP CONTAINERS, TRASH CONTAINERS FOR HOUSEHOLD USE, LUNCH BOXES, HAND OPERATED COFFEE GRINDERS, CHOPSTICKS, COOKERY MOULDS, COOKIE CUTTERS, COOKIE JARS, COOKING SKEWERS, CRUET STANDS FOR OIL AND VINEGAR, CRUETS, CUTTING BOARDS, NON-ELECTRIC FRUIT PRESSES FOR HOUSEHOLD USE, GLASS JARS, INSULATING JARS, FOOD PRESERVING JARS OF GLASS, NON-ELECTRIC KETTLES, TEA



*David J. Kyros*

Director of the United States Patent and Trademark Office



**Reg. No. 4,196,534** KETTLES, WHISKS, CORN COB HOLDERS, MIXING SPOONS, NON ELECTRIC KITCHEN MIXERS, JUGS, FLASKS, GRATERS, SPATULAS, SIEVES, STRAINERS, TURNERS, COOKING UTENSILS, NAMELY, GRILL COVERS, ROLLING PINS, POT AND PAN SCRAPERS, SPLATTER SCREENS, KITCHEN TONGS, FOOD SCOOPS, DOG FOOD SCOOPS, TEA INFUSERS, TEA STRAINERS, TEA POTS, TEA SERVICE, TEA SETS, TEA BALLS, NON ELECTRIC WAFFLE IRONS, PORTABLE COOLERS, COOLERS FOR WINE, VESSELS OF METAL FOR MAKING ICES AND ICED DRINKS IN THE NATURE OF COCKTAIL SHAKERS, ICE PAILS, CORKSCREWS, URNS, ICE CUBE MOULDS, ICE SCOOPS, ICE CREAM SCOOPS, CONTAINERS FOR ICE, BASINS, BUTTER DISHES AND COVERS, EGG CUPS, NON ELECTRIC EGG BEATERS, PITCHERS, DISH COVERS, COFFEE MEASURES, COFFEE POTS, COFFEE SERVERS, COFFEE SERVICE, COFFEE STIRRERS, NON ELECTRIC COFFEE MAKERS, COFFEE PLUNGERS IN THE NATURE OF NON-ELECTRIC COFFEE POTS, NON-ELECTRIC COFFEE PERCOLATORS, NON ELECTRIC COFFEE GRINDERS, VACUUM BOTTLE STOPPERS, BOTTLE OPENERS, BOTTLE STOPPERS SPECIALLY ADAPTED FOR USE WITH WINE BOTTLES, BOWLS, PLATES, LAZY SUSANS, DRINKING VESSELS, SUGAR BOWLS, MUGS, CUPS, DISHES, UTENSILS FOR BARBECUES, NAMELY, FORKS TONGS AND TURNERS; GLASSWARE, NAMELY, BEVERAGE GLASSWARE, DRINKING VESSELS, COFFEE PLUNGERS IN THE NATURE OF NON-ELECTRIC COFFEE POTS, TEA PLUNGERS IN THE NATURE OF NON-ELECTRIC TEA POTS, NON-ELECTRIC COFFEE PERCOLATORS, COFFEE SERVICE, COFFEE POTS, CANDLE RINGS, CANDLESTICKS, DECANTERS, SALT AND PEPPER SHAKERS, SALT CELLARS, GLASS STOPPERS, TOOTHPICK HOLDERS NOT OF PRECIOUS METAL, SALT AND PEPPER GRINDERS, SUGAR BOWLS, NAPKIN RINGS, GOBLETs, BEER MUGS, COCKTAIL SHAKERS, KNIFE RESTS, TEA POTS, TEA SERVICE, NAPKIN HOLDERS, PEPPER POTS, WINE TASTERS; DINNERWARE; COOKWARE, NAMELY, CASSEROLE DISHES, FRYING PANS, MUFFIN TINS, CAKE TINS, CUP CAKE MOULDS, PAPER BAKING CUPS, COOKING STEAMERS, SAUCEPANS, WAFFLE IRONS, GRILLS, PORTABLE COOKING KITS FOR OUTDOOR USE, RICE COOKING POTS, WIRE BASKETS, BAKING DISHES, BASTING SPOONS, COOKING FORKS, POTS, PANS; SERVING WARE, NAMELY, SERVINGWARE FOR SERVING FOOD AND DRINKS, SERVING TRAYS, PIE SERVERS; SERVING WARE FOR SERVING FOOD AND DRINKS; TABLEWARE, NAMELY, COASTERS AND PLACEMATS NOT OF PAPER AND NOT BEING TABLE LINEN, OVEN TO TABLE RACKS, TABLE PLACE CARD HOLDERS NOT OF PRECIOUS METAL, POTS, DISHES, PLATES, DRINKING CUPS AND SAUCERS, BOWLS, SERVING BOWLS AND TRAYS; CHINAWARE, PORCELAIN AND EARTHENWARE, NAMELY, NON-ELECTRIC KETTLES, TEA KETTLES, TEA INFUSERS, TEA STRAINERS, TEA POTS, TEA SERVICE, TEA SETS, TEA BALLS, COFFEE PLUNGERS IN THE NATURE OF NON-ELECTRIC COFFEE POTS, COFFEE PERCOLATORS, COFFEE SERVICE, COFFEE POTS, CANDLE RINGS, CANDLESTICKS, DECANTERS, SALT AND PEPPER SHAKERS, SALT CELLARS, TOOTHPICK HOLDERS, SALT AND PEPPER GRINDERS, SUGAR BOWLS, NAPKIN RINGS, OIL AND VINEGAR CRUETS, GOBLETs, BEER MUGS, COCKTAIL SHAKERS, KNIFE RESTS, TEA POTS, TEA SERVICE, NAPKIN HOLDERS, JARS FOR JAMS AND JELLIES; PEPPER POTS, WINE TASTERS, BOWLS, PLATES, MUGS, CUPS, DISHES, SOUP TUREENS, LAZY SUSANS; VASES; JARS, NAMELY, COTTON BALL JARS, COOKIE JARS, GLASS JARS, PET TREAT JARS, INSULATING JARS, FOOD PRESERVING JARS OF GLASS; CROCKERY, NAMELY, POTS, DISHES, PLATES, DRINKING CUPS AND SAUCERS, BOWLS, SERVING BOWLS AND TRAYS; HAND-OPERATED FOOD GRINDERS, IN CLASS 21 (U.S. CLS. 2, 13, 23, 29, 30, 33, 40 AND 50).

FOR: TEXTILES AND TEXTILE GOODS, NAMELY, BED LINEN, TOWELS OF TEXTILE, HANDKERCHIEFS OF TEXTILE; PLACE MATS OF TEXTILE, TEXTILE SERVIETTES, QUILTS OF TEXTILE, TEXTILE TABLECLOTHS, LAP RUGS, TRAVELLING RUGS, CLOTH COASTERS, OVEN MITTS; TABLE LINEN; NAPERY, NAMELY, LINEN TABLE CLOTHS, COASTERS, NAPKINS AND PLACE MATS, IN CLASS 24 (U.S. CLS. 42 AND 50).

OWNER OF U.S. REG. NOS. 3,402,125, 3,964,396 AND OTHERS.

PRIORITY DATE OF 4-20-2011 IS CLAIMED.

**Reg. No. 4,196,534** OWNER OF INTERNATIONAL REGISTRATION 1103658 DATED 10-4-2011, EXPIRES 10-4-2021.

THE MARK CONSISTS OF A LION DESIGN TO THE LEFT OF THE STACKED WORDING "MAXWELL & WILLIAMS".

SER. NO. 79-107,923, FILED 10-4-2011.

JENNIFER VASQUEZ, EXAMINING ATTORNEY

# United States of America

United States Patent and Trademark Office



# JACQUES LEMANS

**Reg. No. 4,196,535**

**Registered Aug. 28, 2012**

**Int. Cls.: 9 and 14**

**TRADEMARK**

**PRINCIPAL REGISTER**

JACQUES LEMANS GESMBH (AUSTRIA LIMITED LIABILITY COMPANY)  
JACQUES-LEMANS-STRASSE 1  
A-9300 ST. VEIT AN DER GLAN  
AUSTRIA

FOR: SUNGLASSES, SPECTACLE CASES, SPECTACLE FRAMES, IN CLASS 9 (U.S. CLS. 21, 23, 26, 36 AND 38).

FOR: JEWELLERY , IN CLASS 14 (U.S. CLS. 2, 27, 28 AND 50).

OWNER OF U.S. REG. NO. 3,761,458.

PRIORITY DATE OF 10-18-2011 IS CLAIMED.

OWNER OF INTERNATIONAL REGISTRATION 1103754 DATED 10-28-2011, EXPIRES 10-28-2021.

THE NAME "JACQUES LEMANS" DOES NOT IDENTIFY A LIVING INDIVIDUAL.

THE MARK CONSISTS OF THE STYLIZED LETTERS "JL" APPEARING ABOVE THE WORDING "JACQUES LEMANS".

SER. NO. 79-107,956, FILED 10-28-2011.

CHRISTINE MARTIN, EXAMINING ATTORNEY



*David J. Kybas*

Director of the United States Patent and Trademark Office

# United States of America

United States Patent and Trademark Office

# KUSTIE

# 寇斯汀

**Reg. No. 4,196,536**

**Registered Aug. 28, 2012**

**Int. Cl.: 3**

**TRADEMARK**

**PRINCIPAL REGISTER**

ZHONG ZHUYAN (CHINA INDIVIDUAL)  
NO.23, XINXUZHAINI AREA  
LIANGYING TOWN; CHAOYANG CITY  
GUANGDONG PROVINCE, CHINA

FOR: SOAP; FACIAL CLEANSING MILK; STAIN REMOVERS; SHOE CREAM; PERFUMERY;  
COSMETICS; PERFUMES; DENTIFRICES; SCENTED WOOD; COSMETICS FOR ANIMALS  
, IN CLASS 3 (U.S. CLS. 1, 4, 6, 50, 51 AND 52).

NO CLAIM IS MADE TO THE EXCLUSIVE RIGHT TO USE THE NON-LATIN CHARACTERS  
THAT TRANSLITERATE TO "CARDAMON", APART FROM THE MARK AS SHOWN.

OWNER OF INTERNATIONAL REGISTRATION 1103907 DATED 12-13-2011, EXPIRES 12-  
13-2021.

THE TRANSLITERATION OF THE NON-LATIN CHARACTERS IN THE MARK IS: THE  
NON-LATIN CHARACTERS IN THE MARK TRANSLITERATE INTO "KOU", "SI", "TING".

THE NON-LATIN CHARACTERS TRANSLATE INTO ENGLISH AS "CARDAMON", "SUCH",  
"SANDBANK", WHICH HAS NO MEANING AS A WHOLE.

SER. NO. 79-108,016, FILED 12-13-2011.

HEATHER THOMPSON, EXAMINING ATTORNEY



*David J. Kyros*

Director of the United States Patent and Trademark Office

# United States of America

United States Patent and Trademark Office

## TASTE SOLUTIONS

**Reg. No. 4,196,537**

**Registered Aug. 28, 2012**

**Int. Cl.: 35**

**SERVICE MARK**

**PRINCIPAL REGISTER**

GIVAUDAN SA (SWITZERLAND SOCIÉTÉ ANONYME)  
CHEMIN DE LA PARFUMERIE 5  
CH-1214 VERNIER  
SWITZERLAND

FOR: ADVERTISING, IN CLASS 35 (U.S. CLS. 100, 101 AND 102).

THE MARK CONSISTS OF STANDARD CHARACTERS WITHOUT CLAIM TO ANY PARTICULAR FONT, STYLE, SIZE, OR COLOR.

PRIORITY DATE OF 6-22-2011 IS CLAIMED.

OWNER OF INTERNATIONAL REGISTRATION 1103955 DATED 12-21-2011, EXPIRES 12-21-2021.

OWNER OF U.S. REG. NO. 3,335,349.

SER. NO. 79-108,047, FILED 12-21-2011.

MARK SHINER, EXAMINING ATTORNEY



*David J. Kyffers*

Director of the United States Patent and Trademark Office

# United States of America

United States Patent and Trademark Office

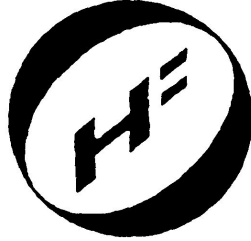

恒 丰

**Reg. No. 4,196,538**

**Registered Aug. 28, 2012**

**Int. Cl.: 29**

**TRADEMARK**

**PRINCIPAL REGISTER**

SHANXI HENGFENG SHIYE YOUXIANGONGSI (CHINA CORPORATION)  
SUITE 501, BLOCK A  
SHANGWU GUANGCHANG, 45 XINGHUA STREET  
TAIYUAN, 030000 SHANXI, CHINA

FOR: PRESERVED FRUIT; CRYSTALLIZED FRUITS; MARMALADE; DRIED PERSIMMON;  
PREPARED NUTS; BEAN CURD; DRIED DATE; DRY EDIBLE FUNGUS, IN CLASS 29 (U.S.  
CL. 46).

THE MARK CONSISTS OF THE LETTERS "HF" WITHIN A STYLIZED CIRCULAR DESIGN,  
APPEARING ABOVE TWO CHINESE CHARACTERS WHICH TRANSLATE TO "FOREVER  
FOISON".

OWNER OF INTERNATIONAL REGISTRATION 1104048 DATED 11-21-2011, EXPIRES 11-  
21-2021.

THE TRANSLITERATION OF THE NON-LATIN CHARACTERS IN THE MARK IS "HENG  
FENG".

THE ENGLISH TRANSLATION OF THE FOREIGN WORD(S) IN THE MARK IS: THE MARK  
CONSIST OF TWO CHINESE CHARACTERS, THE FIRST ONE MEANS "FOREVER", THE  
SECOND ONE MEANS "FOISON".

SER. NO. 79-108,080, FILED 11-21-2011.

MARC LEIPZIG, EXAMINING ATTORNEY



*David J. Kybas*

Director of the United States Patent and Trademark Office

# United States of America

United States Patent and Trademark Office

# vitaliberty

**Reg. No. 4,196,539**

**Registered Aug. 28, 2012**

**Int. Cls.: 35, 38, 41 and 44**

**SERVICE MARK**

**PRINCIPAL REGISTER**

VITALIBERTY GMBH (FED REP GERMANY GESELLSCHAFT MIT BESCHRÄNKTER HAFTUNG (GMBH))  
MARKIRCHER STRASSE 22  
68229 MANNHEIM  
FED REP GERMANY

FOR: COLLATING, UPDATING AND MAINTENANCE OF DATABASES, IN PARTICULAR ONLINE DATABASES, MAINLY FOR TELEMEDICAL PURPOSES, NAMELY, COLLECTION AND SYSTEMATISATION OF INFORMATION INTO COMPUTER DATABASES; HEALTH PROMOTION, NAMELY, ADVERTISING, MARKETING AND PROMOTION SERVICES, IN CLASS 35 (U.S. CLS. 100, 101 AND 102).

FOR: PROVIDING ACCESS TO DATABASES, IN PARTICULAR ONLINE DATABASES, WITH FIXED AND MOBILE ACCESSIBILITY, TELECOMMUNICATIONS ACCESS SERVICES BY MEANS OF PLATFORMS AND PORTALS ON THE INTERNET, IN PARTICULAR IN THE FIELD OF HEALTHCARE, IN CLASS 38 (U.S. CLS. 100, 101 AND 104).

FOR: ELECTRONIC GAME SERVICES PROVIDED ONLINE, IN PARTICULAR FOR CONDUCTING HEALTH COMPETITIONS, IN CLASS 41 (U.S. CLS. 100, 101 AND 107).

FOR: MEDICAL SERVICES, HUMAN HEALTHCARE, CONDUCTING MEDICAL AND CLINICAL EXAMINATIONS, IN PARTICULAR ON COMPANY EMPLOYEES, INDIVIDUAL MEDICAL DIAGNOSIS OF COMPANY EMPLOYEES, TELEMEDICINE, CONSULTANCY RELATING TO COMPANY HEALTHCARE, DEVELOPMENT OF BUSINESS-SPECIFIC HEALTH PROGRAMMES, NAMELY, HEALTHCARE ADVICE, NUTRITION ADVICE, INFORMATION IN THE FIELD OF HEALTH CARE, NAMELY, MOTIVATION PROGRAMS FOR PROMOTING HEALTH, ALL THE AFORESAID SERVICES OTHER THAN IN CONNECTION WITH DIALYSIS, IN CLASS 44 (U.S. CLS. 100 AND 101).

THE MARK CONSISTS OF THE WORDING "VITALIBERTY" IN STYLIZED CHARACTERS WITH TWO CURVED BANDS ABOVE THE LETTER "A".

PRIORITY DATE OF 10-26-2011 IS CLAIMED.

OWNER OF INTERNATIONAL REGISTRATION 1104299 DATED 11-22-2011, EXPIRES 11-22-2021.



*David J. Kyjars*

Director of the United States Patent and Trademark Office

**Reg. No. 4,196,539** SER. NO. 79-108,164, FILED 11-22-2011.

JESSICA A. POWERS, EXAMINING ATTORNEY



# United States of America

United States Patent and Trademark Office

# UC TRADER

**Reg. No. 4,196,540**

**Registered Aug. 28, 2012**

**Int. Cls.: 35, 36 and 38**

**SERVICE MARK**

**PRINCIPAL REGISTER**

UNICREDIT S.P.A. (ITALY JOINT STOCK COMPANY)  
VIA ALESSANDRO SPECCHI, 16  
I-00186 ROMA  
ITALY

FOR: ADVERTISING; NAMELY, COOPERATIVE ADVERTISING AND MARKETING; BUSINESS MANAGEMENT; BUSINESS ADMINISTRATION; PROVIDING STATISTICAL INFORMATION AND INDEXES OF MORTGAGES, INTERESTS, AND PRICES FOR OTHERS; COMPUTER FILE MANAGEMENT AND DATABASE MANAGEMENT; ORGANIZATION OF EXHIBITIONS FOR COMMERCIAL OR ADVERTISING PURPOSES, IN CLASS 35 (U.S. CLS. 100, 101 AND 102).

FOR: BANKING; FINANCIAL AFFAIRS AND MONETARY AFFAIRS, NAMELY, FINANCIAL INFORMATION, MANAGEMENT AND ANALYSIS SERVICES; INSURANCE INFORMATION AND CONSULTANCY; REAL ESTATE FINANCING SERVICES; FINANCIAL AND INVESTMENT CONSULTING; FINANCIAL INVESTMENT ANALYSIS AND STOCK RESEARCH; FINANCIAL PORTFOLIO MANAGEMENT, IN CLASS 36 (U.S. CLS. 100, 101 AND 102).

FOR: TELECOMMUNICATION SERVICES, NAMELY, PROVIDING ELECTRONIC TRANSMISSION OF INFORMATION STORED IN A DATABASE VIA INTERACTIVELY COMMUNICATING COMPUTER SYSTEMS, IN CLASS 38 (U.S. CLS. 100, 101 AND 104).

THE MARK CONSISTS OF STANDARD CHARACTERS WITHOUT CLAIM TO ANY PARTICULAR FONT, STYLE, SIZE, OR COLOR.

PRIORITY DATE OF 2-18-2011 IS CLAIMED.

OWNER OF INTERNATIONAL REGISTRATION 1104305 DATED 7-15-2011, EXPIRES 7-15-2021.

OWNER OF U.S. REG. NO. 3,864,535.

NO CLAIM IS MADE TO THE EXCLUSIVE RIGHT TO USE "TRADER", APART FROM THE MARK AS SHOWN.

SER. NO. 79-108,167, FILED 7-15-2011.



*David J. Kybas*

Director of the United States Patent and Trademark Office

**Reg. No. 4,196,540** KIMBERLY FRYE, EXAMINING ATTORNEY

**United States of America**  
United States Patent and Trademark Office

**MOJITO LAB**

**Reg. No. 4,196,541**

**Registered Aug. 28, 2012**

**Int. Cl.: 43**

**SERVICE MARK**

**PRINCIPAL REGISTER**

LAURENT GRECO (FRANCE INDIVIDUAL)  
28 RUE BREGUET  
F-75011 PARIS  
FRANCE

FOR: SERVICES FOR PROVIDING FOOD AND DRINK; BAR SERVICES; FOOD AND DRINK CATERING; RESTAURANT; BAR WITH MUSIC; RESTAURANT WITH MUSIC, IN CLASS 43 (U.S. CLS. 100 AND 101).

THE MARK CONSISTS OF STANDARD CHARACTERS WITHOUT CLAIM TO ANY PARTICULAR FONT, STYLE, SIZE, OR COLOR.

PRIORITY DATE OF 8-19-2011 IS CLAIMED.

OWNER OF INTERNATIONAL REGISTRATION 1104592 DATED 12-13-2011, EXPIRES 12-13-2021.

NO CLAIM IS MADE TO THE EXCLUSIVE RIGHT TO USE "MOJITO", APART FROM THE MARK AS SHOWN.

SER. NO. 79-108,299, FILED 12-13-2011.

MATTHEW EINSTEIN, EXAMINING ATTORNEY



*David J. Kyros*

Director of the United States Patent and Trademark Office

# United States of America

United States Patent and Trademark Office



**Reg. No. 4,196,542**

**Registered Aug. 28, 2012**

**Int. Cl.: 9**

**TRADEMARK**

**PRINCIPAL REGISTER**

MINELAB ELECTRONICS PTY LIMITED (AUSTRALIA COMPANY)  
118 HAYWARD AVENUE  
TORRENSVILLE SA 5031  
AUSTRALIA

FOR: METAL DETECTORS, IN CLASS 9 (U.S. CLS. 21, 23, 26, 36 AND 38).

THE MARK CONSISTS OF A DESIGN RESEMBLING A FAN WITH FOUR BLADES SUPER-IMPOSED OVER ANOTHER DESIGN COMPRISED OF LINES AND CURVES THAT ARE ORIENTED IN A COUNTER-CLOCKWISE MANNER.

PRIORITY DATE OF 9-6-2011 IS CLAIMED.

OWNER OF INTERNATIONAL REGISTRATION 1104641 DATED 12-5-2011, EXPIRES 12-5-2021.

SER. NO. 79-108,311, FILED 12-5-2011.

TASNEEM HUSSAIN, EXAMINING ATTORNEY



*David J. Kyffers*

Director of the United States Patent and Trademark Office

# United States of America

United States Patent and Trademark Office

# vitaliberty

**Reg. No. 4,196,543**

**Registered Aug. 28, 2012**

**Int. Cls.: 35, 38, 41 and 44**

**SERVICE MARK**

**PRINCIPAL REGISTER**

VITALIBERTY GMBH (FED REP GERMANY GESELLSCHAFT MIT BESCHRÄNKTER HAFTUNG (GMBH))  
MARKIRCHER STRASSE 22  
68229 MANNHEIM  
FED REP GERMANY

FOR: COLLATING, UPDATING AND MAINTENANCE OF DATABASES, IN PARTICULAR ONLINE DATABASES, MAINLY FOR TELEMEDICAL PURPOSES, NAMELY, COLLECTION AND SYSTEMATISATION OF INFORMATION INTO COMPUTER DATABASES; HEALTH PROMOTION, NAMELY, ADVERTISING, MARKETING AND PROMOTION SERVICES, IN CLASS 35 (U.S. CLS. 100, 101 AND 102).

FOR: PROVIDING ACCESS TO DATABASES, IN PARTICULAR ONLINE DATABASES, WITH FIXED AND MOBILE ACCESSIBILITY, TELECOMMUNICATIONS ACCESS SERVICES BY MEANS OF PLATFORMS AND PORTALS ON THE INTERNET, IN PARTICULAR IN THE FIELD OF HEALTHCARE, IN CLASS 38 (U.S. CLS. 100, 101 AND 104).

FOR: ELECTRONIC GAME SERVICES PROVIDED ONLINE, IN PARTICULAR FOR CONDUCTING HEALTH COMPETITIONS, IN CLASS 41 (U.S. CLS. 100, 101 AND 107).

FOR: MEDICAL SERVICES, HUMAN HEALTHCARE, CONDUCTING MEDICAL AND CLINICAL EXAMINATIONS, IN PARTICULAR ON COMPANY EMPLOYEES, INDIVIDUAL MEDICAL DIAGNOSIS OF COMPANY EMPLOYEES, TELEMEDICINE, CONSULTANCY RELATING TO COMPANY HEALTHCARE, DEVELOPMENT OF BUSINESS-SPECIFIC HEALTH PROGRAMMES, NAMELY, HEALTHCARE ADVICE, NUTRITION ADVICE, INFORMATION IN THE FIELD OF HEALTH CARE, NAMELY, MOTIVATION PROGRAMS FOR PROMOTING HEALTH, IN CLASS 44 (U.S. CLS. 100 AND 101).

THE MARK CONSISTS OF STANDARD CHARACTERS WITHOUT CLAIM TO ANY PARTICULAR FONT, STYLE, SIZE, OR COLOR.

PRIORITY DATE OF 10-26-2011 IS CLAIMED.

OWNER OF INTERNATIONAL REGISTRATION 1104817 DATED 11-22-2011, EXPIRES 11-22-2021.

SER. NO. 79-108,379, FILED 11-22-2011.



*David J. Kappas*

Director of the United States Patent and Trademark Office

**Reg. No. 4,196,543** JESSICA A. POWERS, EXAMINING ATTORNEY

# United States of America

United States Patent and Trademark Office



**Reg. No. 4,196,544**

**Registered Aug. 28, 2012**

**Int. Cl.: 39**

**SERVICE MARK**

**PRINCIPAL REGISTER**

DREAM YACHT MEDITERRANÉE (FRANCE SOCIÉTÉ À RESPONSABILITÉ LIMITÉE (SARL))  
ROUTE SAINT MANDRIER CD 18  
F-83430 ST MANDRIER SUR MER, FRANCE

FOR: TRANSPORT BY BOAT; TRANSPORT OF GOODS; TRANSPORTATION OF GOODS AND/OR PASSENGERS BY BOAT; TRANSPORTATION BROKERAGE BOAT RENTAL; RIVER TRANSPORT BY BOAT; MARINE TRANSPORT; REFLOATING OF SHIPS; MOTOR COACH RENTAL; STORAGE OF GOODS; ESCORTING AND TRANSPORTATION OF PASSENGERS, OF TRAVELERS; CONDUCTING SIGHTSEEING TOURS FOR OTHERS; FREIGHTING; BOAT TRANSPORT; ARRANGING OF TOURS; PLEASURE BOAT TRANSPORT; TRANSPORTATION BY AEROPLANE, BY RAIL, FERRY BOATS, BY WATER, BY SHIP; ARRANGEMENT OF CRUISES AND EXCURSIONS; BOOKING OF SEATS FOR TRAVEL, IN CLASS 39 (U.S. CLS. 100 AND 105).

NO CLAIM IS MADE TO THE EXCLUSIVE RIGHT TO USE "YACHT CHARTER", APART FROM THE MARK AS SHOWN.

PRIORITY DATE OF 7-12-2011 IS CLAIMED.

OWNER OF INTERNATIONAL REGISTRATION 1104991 DATED 12-2-2011, EXPIRES 12-2-2021.

THE COLOR(S) YELLOW AND KHAKI IS/ARE CLAIMED AS A FEATURE OF THE MARK.

THE MARK CONSISTS OF THE WORDING "DREAM YACHT CHARTER" BETWEEN A PAIR OF HORIZONTAL PARALLEL LINES, ALL IN YELLOW, WITH A DESIGN OF A SWIMMING TURTLE IN KHAKI.

SER. NO. 79-108,446, FILED 12-2-2011.

KATHERINE STOIDES, EXAMINING ATTORNEY



*David J. Kyros*

Director of the United States Patent and Trademark Office

# United States of America

United States Patent and Trademark Office



**Reg. No. 4,196,545**

**Registered Aug. 28, 2012**

**Int. Cls.: 35, 36, 39 and 43**

**SERVICE MARK**

**PRINCIPAL REGISTER**

BCD N.V. (NETHERLANDS NAAMLOZE VENNOOTSCHAP)  
UTRECHTSEWEG 67  
NL-3704 HB ZEIST  
NETHERLANDS

FOR: COMMERCIAL MANAGEMENT; BUSINESS MANAGEMENT; CONSULTANCY IN THE FIELD OF BUSINESS ORGANIZATION AND BUSINESS ECONOMICS FOR TRAVEL ORGANIZATIONS; OFFICE FUNCTIONS IN THE FIELD OF TRAVEL RESERVATIONS, EXCURSIONS, TOURS AND ACCOMMODATIONS; SYSTEMATIZATION OF INFORMATION INTO COMPUTER DATABASES; ADVERTISING, PUBLICITY AND SALES PROMOTION, AND COMMERCIAL INTERMEDIARY SERVICES, NAMELY, BUSINESS INTERMEDIARY AND ADVISORY SERVICES IN THE FIELD OF SELLING PRODUCTS AND RENDERING SERVICES; THE BRINGING TOGETHER, FOR THE BENEFIT OF OTHERS, OF A VARIETY OF TRAVEL PACKAGES OF OTHERS, ENABLING CUSTOMERS TO CONVENIENTLY VIEW AND PURCHASE THOSE TRIPS, IN CLASS 35 (U.S. CLS. 100, 101 AND 102).

FOR: FINANCIAL INTERMEDIARY SERVICES RELATED TO TRAVEL INSURANCE, NAMELY, DISBURSEMENT OF INSURANCE FUNDS; ISSUANCE OF TRAVELERS CHECKS, IN CLASS 36 (U.S. CLS. 100, 101 AND 102).

FOR: TRANSPORT OF GOODS AND PERSONS; TRAVEL AGENCY SERVICES, NAMELY, MAKING RESERVATIONS AND BOOKINGS FOR TRANSPORTATION; ESCORTING OF TRAVELERS; CAR RENTALS AND OTHER MEANS OF TRANSPORT, NAMELY, BOATS, AIRPLANES AND BUSES, AND INTERMEDIARY SERVICES RELATED THERETO, NAMELY, TRANSPORTATION RESERVATION SERVICES; TRANSPORTATION CONSULTANCY SERVICES; TRAVEL AGENCY SERVICES, NAMELY, ORGANIZATION AND RESERVATION OF TRIPS, EXCURSIONS AND TOURS, INCLUDING INTERMEDIARY SERVICES RELATED THERETO, NAMELY, PROVIDING TRAVEL INFORMATION TO TRAVELERS REGARDING FARES, TIMETABLES AND PUBLIC TRANSPORT, IN CLASS 39 (U.S. CLS. 100 AND 105).

FOR: PROVIDING FOOD AND BEVERAGE; PROVIDING TEMPORARY HOUSING ACCOMMODATION; RENTAL AND RESERVATION OF TEMPORARY HOUSING ACCOMMODATIONS COMPRISING APARTMENTS, HOLIDAY HOMES, HOTELS AND OTHER TEMPORARY HOUSING ACCOMMODATIONS; RESERVATION OF RESTAURANTS; PROVIDING INFORMATION AND ADVICE ON TEMPORARY HOUSING ACCOMMODATIONS AND RESTAURANTS TO TOURISTS AND BUSINESS TRAVELERS AND INTERMEDIARY



*David J. Kappas*

Director of the United States Patent and Trademark Office



**Reg. No. 4,196,545** SERVICES, NAMELY, PROVIDING A WEBSITE FOR MAKING RESERVATIONS AND BOOKING OF RESTAURANTS AND TEMPORARY HOUSING ACCOMMODATIONS, AND PROVIDING ORAL INFORMATION TO TOURISTS REGARDING TEMPORARY HOUSING ACCOMMODATIONS AND RESTAURANTS , IN CLASS 43 (U.S. CLS. 100 AND 101).

THE MARK CONSISTS OF A DARK BLUE RECTANGLE CONTAINING THREE YELLOW OUTLINED SQUARES AND THE WHITE STYLIZED WORDING "TRAVIX", WITH THE FIRST SQUARE CONTAINING A DESIGN OF A WHITE AIRPLANE, THE SECOND SQUARE CONTAINING A DESIGN OF A WHITE CAR AND THE THIRD SQUARE CONTAINING A DESIGN OF A WHITE BED. THE COLORS BLACK AND GRAY REPRESENT BACKGROUND, OUTLINING, SHADING AND/OR TRANSPARENT AREAS AND ARE NOT PART OF THE MARK.

PRIORITY DATE OF 5-5-2011 IS CLAIMED.

OWNER OF INTERNATIONAL REGISTRATION 1105108 DATED 11-3-2011, EXPIRES 11-3-2021.

THE COLOR(S) DARK BLUE, YELLOW, WHITE IS/ARE CLAIMED AS A FEATURE OF THE MARK.

SER. NO. 79-108,502, FILED 11-3-2011.

GENE MACIOL, EXAMINING ATTORNEY

# United States of America

United States Patent and Trademark Office



**Reg. No. 4,196,546**

**Registered Aug. 28, 2012**

**Int. Cl.: 29**

**TRADEMARK**

**PRINCIPAL REGISTER**

WENZHOU XIANGHAI FOOD CO., LTD (CHINA LIMITED COMPANY)  
NO.338, BINJIANG AVE.,  
RUIAN ECONOMIC DEVELOPMENT ZONE,; RUIAN,; WENZHOU; ZHEJIANG  
CHINA

FOR: FISH, NOT LIVE; PRESERVED FISH; PROCESSED SEAFOOD, NAMELY, FISH;  
FLAKES OF DRIED FISH MEAT (KEZURI-BUSHI); UNFLAVORED AND UNSWEETENED  
GELATINS; SHELLFISH, NOT LIVE; CAVIAR; SEA-CUCUMBERS, NOT LIVE; SHRIMPS,  
NOT LIVE; PRESERVED VEGETABLES, IN CLASS 29 (U.S. CL. 46).

THE MARK CONSISTS OF CHINESE CHARACTERS WITHIN A RECTANGLE SHAPED  
DESIGN IN THE NATURE OF A CHINESE LANTERN WITH A SERIES OF CONCENTRIC  
SEMI-CIRCLES ON EITHER SIDE MEANT TO REPRESENT A CHINESE KNOT.

OWNER OF INTERNATIONAL REGISTRATION 1105411 DATED 12-13-2011, EXPIRES 12-  
13-2021.

THE TRANSLITERATION OF THE NON-LATIN CHARACTERS IN THE MARK IS: XIANG  
HAI.

THE ENGLISH TRANSLATION OF THE FOREIGN WORD(S) IN THE MARK IS: SWEET-  
SMELLING SEA.

SER. NO. 79-108,640, FILED 12-13-2011.

SUE LAWRENCE, EXAMINING ATTORNEY



*David J. Kybas*

Director of the United States Patent and Trademark Office

# United States of America

United States Patent and Trademark Office



**Reg. No. 4,196,547**

**Registered Aug. 28, 2012**

**Int. Cl.: 35**

**SERVICE MARK**

**PRINCIPAL REGISTER**

PETROPLAN LIMITED (UNITED KINGDOM PRIVATE LIMITED COMPANY)  
99 WALNUT TREE CLOSE  
GUILDFORD GU1 4UQ  
UNITED KINGDOM

FOR: RECRUITMENT SERVICES FOR PLACEMENT OF SKILLED TECHNICAL PROFESSIONALS AND SUPPORT PERSONNEL IN THE OIL, GAS AND PETROCHEMICAL INDUSTRIES; SUPPORT SERVICES TO THE OIL, GAS AND PETROCHEMICAL INDUSTRIES, NAMELY, MARKETING, ADVERTISING AND PROJECT MANAGEMENT RELATED TO THE PROVISION OF RECRUITMENT SERVICES, IN CLASS 35 (U.S. CLS. 100, 101 AND 102).

THE MARK CONSISTS OF A BLUE SQUARE CONTAINING A WHITE WAVE THAT STRETCHES FROM THE TOP RIGHT CORNER TO THE BOTTOM OF THE LEFT CORNER AND THE WORDING "PETROPLAN" IN BLUE.

OWNER OF INTERNATIONAL REGISTRATION 1105443 DATED 10-28-2011, EXPIRES 10-28-2021.

THE COLOR(S) BLUE AND WHITE IS/ARE CLAIMED AS A FEATURE OF THE MARK.

SER. NO. 79-108,654, FILED 10-28-2011.

APRIL ROACH, EXAMINING ATTORNEY



*David J. Kyffers*

Director of the United States Patent and Trademark Office

United States of America  
United States Patent and Trademark Office

士甸玛

SDEARM

**Reg. No. 4,196,548**

**Registered Aug. 28, 2012**

**Int. Cl.: 25**

**TRADEMARK**

**PRINCIPAL REGISTER**

HUANG YIXIANG (CHINA INDIVIDUAL)  
ROOM 701, NO. 69, LANE 128  
FUQIAO STREET,; HAISHU DISTRICT,; NINGBO; ZHEJIANG  
CHINA

FOR: CLOTHING, NAMELY, SHIRTS, TOP COATS, PELISSES, JACKETS, T-SHIRTS;  
FOOTWEAR, NAMELY, SHOES, BATH SLIPPERS, BATH SANDALS, BOOTS, SANDALS,  
BOOTS FOR SPORT, GALOSHES, LACE BOOTS; HEADGEAR, NAMELY, CAPS, HATS,  
SHOWER CAPS, SKULL CAPS; NECKTIES; WATERPROOF CLOTHING, NAMELY, WA-  
TERPROOF JACKETS AND PANTS, IN CLASS 25 (U.S. CLS. 22 AND 39).

THE MARK CONSISTS OF THE WORDING "SDEARM" BELOW THREE NON-LATIN  
CHARACTERS IN STYLIZED FONT.

OWNER OF INTERNATIONAL REGISTRATION 1105568 DATED 12-20-2011, EXPIRES 12-  
20-2021.

THE TRANSLITERATION OF THE NON-LATIN CHARACTERS IN THE MARK IS: SHI,  
DIAN, MA.

THE ENGLISH TRANSLATION OF THE FOREIGN WORD(S) IN THE MARK IS: THE FIRST  
CHARACTER "SHI" HAS THE MEANING OF "A LEARNED PERSON OR A PETTY OFFICER";  
THE SECOND CHARACTER "DIAN" HAS THE MEANING OF "SUBURB"; THE THIRD  
CHARACTER "MA" HAS NO MEANING BY ITSELF, SOMETIMES USED IN TRANSLITER-  
ATION FROM OTHER LANGUAGE TO CHINESE; THE COMBINATION OF THE THREE  
CHARACTERS HAS NO SPECIFIC MEANING IN ANY TRADE IN CHINESE LANGUAGE,  
AND IS SIMPLY A SELECTION OF CHARACTERS TO RESEMBLE "SDEARM".

SER. NO. 79-108,707, FILED 12-20-2011.

WILLIAM ROSSMAN, EXAMINING ATTORNEY



*David J. Kyros*

Director of the United States Patent and Trademark Office

# United States of America

United States Patent and Trademark Office

# C 600 Sport

**Reg. No. 4,196,549**

**Registered Aug. 28, 2012**

**Int. Cl.: 12**

**TRADEMARK**

**PRINCIPAL REGISTER**

BAYERISCHE MOTOREN WERKE; AKTIENGESELLSCHAFT (FED REP GERMANY  
AKTIENGESELLSCHAFT (JOINT STOCK COMPANY))  
PETUELRING 130  
80809 MÜNCHEN  
FED REP GERMANY

FOR: MOTORCYCLES AND MOTOR SCOOTERS, IN CLASS 12 (U.S. CLS. 19, 21, 23, 31, 35  
AND 44).

THE MARK CONSISTS OF STANDARD CHARACTERS WITHOUT CLAIM TO ANY PAR-  
TICULAR FONT, STYLE, SIZE, OR COLOR.

PRIORITY DATE OF 9-8-2011 IS CLAIMED.

OWNER OF INTERNATIONAL REGISTRATION 1105785 DATED 12-13-2011, EXPIRES 12-  
13-2021.

NO CLAIM IS MADE TO THE EXCLUSIVE RIGHT TO USE "SPORT", APART FROM THE  
MARK AS SHOWN.

SER. NO. 79-108,796, FILED 12-13-2011.

SUSAN LESLIE DUBOIS, EXAMINING ATTORNEY



*David J. Kyffers*

Director of the United States Patent and Trademark Office

# United States of America

United States Patent and Trademark Office



**Reg. No. 4,196,550**

**Registered Aug. 28, 2012**

**Int. Cl.: 12**

**TRADEMARK**

**PRINCIPAL REGISTER**

DISC BRAKES AUSTRALIA PTY LIMITED (AUSTRALIA AUSTRALIAN PROPRIETARY COMPANY)  
UNIT 33 SLOUGH BUSINESS PARK  
HOLKER STREET  
SILVERWATER NSW 2128, AUSTRALIA

FOR: DISC BRAKES AND BRAKE PARTS FOR VEHICLES; DISC BRAKE ROTORS FOR VEHICLES; DISC BRAKE PADS FOR VEHICLES, IN CLASS 12 (U.S. CLS. 19, 21, 23, 31, 35 AND 44).

THE MARK CONSISTS OF "T2" WITH "T" IN WHITE AND "2" IN GRAY, "T2" BEING OUTLINED IN BLACK WITH A BLUE TRIANGULAR SHAPE BETWEEN THE "T" AND "2", AND A STYLIZED DESIGN OF A DISC BRAKE SLOT IN A T-SHAPE APPEARING IN BLUE.

PRIORITY DATE OF 4-1-2011 IS CLAIMED.

OWNER OF INTERNATIONAL REGISTRATION 1106483 DATED 9-30-2011, EXPIRES 9-30-2021.

THE COLOR(S) BLUE, GRAY, BLACK, AND WHITE IS/ARE CLAIMED AS A FEATURE OF THE MARK.

SER. NO. 79-109,024, FILED 9-30-2011.

APRIL HESIK, EXAMINING ATTORNEY



*David J. Kyffers*

Director of the United States Patent and Trademark Office

# United States of America

United States Patent and Trademark Office

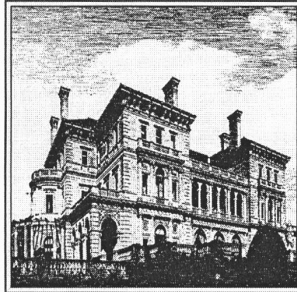

## DEWELLBON

**Reg. No. 4,196,551**

**Registered Aug. 28, 2012**

**Int. Cl.: 33**

**TRADEMARK**

**PRINCIPAL REGISTER**

GUANGZHOU LUSHIWEIFA COMPANY LIMITED (CHINA LIMITED COMPANY)  
GAODIKUANG, QIAZHONGTANWEI,  
ZHUJIANG BRIDGE., LIWAN DISTRICT., GUANGZHOU; GUANGDONG  
CHINA

FOR: ALCOHOLIC FRUIT EXTRACTS; DISTILLED SPIRITS; SPIRITS AND LIQUEURS;  
WINE; BRANDY; WHISKY; ALCOHOLIC ESSENCES; ALCOHOLIC BEVERAGES CON-  
TAINING FRUIT; ALCOHOLIC EXTRACTS; ALCOHOLIC FRUIT BEVERAGES, IN CLASS  
33 (U.S. CLS. 47 AND 49).

THE MARK CONSISTS OF A STYLIZED DEPICTION OF A LUXURIOUS VILLA APPEARING  
ABOVE THE STYLIZED WORDING "DEWELLBON".

OWNER OF INTERNATIONAL REGISTRATION 1107480 DATED 11-24-2011, EXPIRES 11-  
24-2021.

SER. NO. 79-109,418, FILED 11-24-2011.

ELI HELLMAN, EXAMINING ATTORNEY



*David J. Kyfos*

Director of the United States Patent and Trademark Office

# United States of America

United States Patent and Trademark Office

# Purchineering

**Reg. No. 4,196,552**

**Registered Aug. 28, 2012**

**Int. Cls.: 9, 16, 35, 38  
and 42**

**TRADEMARK**

**SERVICE MARK**

**PRINCIPAL REGISTER**

CADENAS KONSTRUKTIONS-; SOFTWAREENTWICKLUNGS- UND; VERTRIEBS GMBH  
(FED REP GERMANY LIMITED LIABILITY CORPORATION)  
BERLINER ALLEE 28 B+C  
86153 AUGSBURG  
FED REP GERMANY

FOR: COMPUTER SOFTWARE, NAMELY, COMPUTER SOFTWARE FOR CREATING SEARCHABLE DATABASES OF INFORMATION AND DATA; MACHINE-READABLE DATA CARRIERS CONTAINING COMPUTER PROGRAMS, DATABASES OR SOFTWARE TOOLS, NAMELY, COMPACT DISCS, DVDS, MAGNETIC DATA CARRIERS, FLOPPY DISCS, MAGNETIC CARDS, ALL CONTAINING COMPUTER PROGRAMS, DATABASES AND SOFTWARE TOOLS, IN CLASS 9 (U.S. CLS. 21, 23, 26, 36 AND 38).

FOR: GOODS MADE FROM PAPER AND CARD, NAMELY, BOXES OF PAPER OR CARDBOARD, PAPER, GREETING CARDS, POST CARDS, INDEX CARDS; CARDBOARD; PRINTED MATTER, NAMELY, BOOKS, MAGAZINES AND USER MANUALS FOR COMPUTER SOFTWARE; COMPUTER SOFTWARE DOCUMENTATION, NAMELY, COMPUTERS AND INSTRUCTIONAL MANUALS SOLD AS A UNIT; CATALOGUES IN THE FIELD OF COMPUTER SOFTWARE, IN CLASS 16 (U.S. CLS. 2, 5, 22, 23, 29, 37, 38 AND 50).

FOR: ONLINE COMPILING AND SYSTEMIZATION OF DATA, NAMELY, PRODUCT CATALOGUES AND STANDARDS, IN COMPUTER DATABASES; ELECTRONIC COMMERCE SERVICES, NAMELY, PROVIDING INFORMATION ABOUT PRODUCTS VIA TELECOMMUNICATION NETWORKS FOR ADVERTISING AND SALES PURPOSES; ADVERTISING, NAMELY, ADVERTISING AGENCIES AND ADVERTISING ON THE INTERNET FOR OTHERS, IN CLASS 35 (U.S. CLS. 100, 101 AND 102).

FOR: TRANSFER OF DATA, NAMELY, PRODUCT CATALOGUES AND STANDARDS, BY TELECOMMUNICATION ONTO ELECTRONIC MEDIA; PROVIDING ACCESS TO THE INTERNET WHICH ALLOWS ACCESS TO PRODUCT CATALOGUES AND STANDARDS; PROVIDING ACCESS TO THE INTERNET WHICH ALLOWS ACCESS TO B2B PLATFORMS, INTERNET PLATFORMS OR VIRTUAL INTERNET MARKETPLACES FOR ELECTRONIC COMMERCE SERVICES, IN CLASS 38 (U.S. CLS. 100, 101 AND 104).

FOR: DATABASE SERVICES, NAMELY, CREATING SOFTWARE FOR DATABASES, COMPUTER PROGRAMMING; CREATING AND MAINTENANCE OF COMPUTER PROGRAMS, SOFTWARE TOOLS AND SOFTWARE FOR DATABASES AND FOR DATA PRO-



*David J. Kappas*

Director of the United States Patent and Trademark Office



**Reg. No. 4,196,552** CESSING; DIGITAL DATA PROCESSING, NAMELY, DIGITAL FORMATTING OF PRODUCT DATA AND TECHNICAL DATA; ENGINEERING SERVICES, IN CLASS 42 (U.S. CLS. 100 AND 101).

THE MARK CONSISTS OF STANDARD CHARACTERS WITHOUT CLAIM TO ANY PARTICULAR FONT, STYLE, SIZE, OR COLOR.

OWNER OF INTERNATIONAL REGISTRATION 1107745 DATED 12-19-2011, EXPIRES 12-19-2021.

SER. NO. 79-109,523, FILED 12-19-2011.

JANICE KIM, EXAMINING ATTORNEY

# United States of America

United States Patent and Trademark Office

# F A M E

**Reg. No. 4,196,553**

**Registered Aug. 28, 2012**

**Int. Cl.: 9**

PHOENIX CONTACT GMBH & CO. KG (FED REP GERMANY LIMITED PARTNERSHIP  
WITH A LIMITED LIABILITY COMPANY AS GENERAL PARTNER)  
FLACHSMARKTSTRAÙE 8  
32825 BLOMBERG  
FED REP GERMANY

**TRADEMARK**

FOR: ELECTRIC PLUGS; ELECTRIC TERMINAL BLOCKS, IN CLASS 9 (U.S. CLS. 21, 23, 26, 36 AND 38).

**PRINCIPAL REGISTER**

THE MARK CONSISTS OF STANDARD CHARACTERS WITHOUT CLAIM TO ANY PARTICULAR FONT, STYLE, SIZE, OR COLOR.

PRIORITY DATE OF 7-22-2011 IS CLAIMED.

OWNER OF INTERNATIONAL REGISTRATION 1107859 DATED 1-20-2012, EXPIRES 1-20-2022.

SER. NO. 79-109,566, FILED 1-20-2012.

SCOTT BIBB, EXAMINING ATTORNEY



*David J. Kyffers*

Director of the United States Patent and Trademark Office

# United States of America

United States Patent and Trademark Office

## TESO LA MONJA

**Reg. No. 4,196,554**

**Registered Aug. 28, 2012**

**Int. Cl.: 33**

**TRADEMARK**

**PRINCIPAL REGISTER**

TESO LA MONJA, S.L. (SPAIN SOCIEDAD LIMITADA)  
CTRA. NAVARIDAS, S/N  
E-01307 PÁGANOS-LAGUARDIA (ALAVA)  
SPAIN

FOR: WINE, IN CLASS 33 (U.S. CLS. 47 AND 49).

THE MARK CONSISTS OF STANDARD CHARACTERS WITHOUT CLAIM TO ANY PARTICULAR FONT, STYLE, SIZE, OR COLOR.

OWNER OF INTERNATIONAL REGISTRATION 1107952 DATED 1-30-2012, EXPIRES 1-30-2022.

THE ENGLISH TRANSLATION OF THE FOREIGN WORD(S) IN THE MARK IS: "NUN'S CREST".

SER. NO. 79-109,607, FILED 1-30-2012.

MELISSA VALLILLO, EXAMINING ATTORNEY



*David J. Kybas*

Director of the United States Patent and Trademark Office

# United States of America

United States Patent and Trademark Office

# NEXSPEECH

**Reg. No. 4,196,555**

**Registered Aug. 28, 2012**

**Int. Cls.: 9, 10, 37, 41, 42  
and 44**

**TRADEMARK**

**SERVICE MARK**

**PRINCIPAL REGISTER**

NEXSTIM OY (FINLAND LIMITED COMPANY)  
ELIMÄENKATU 22 B  
FI-00150 HELSINKI  
FINLAND

FOR: SCIENTIFIC, PHOTOGRAPHIC, OPTICAL AND MEASURING APPARATUS AND INSTRUMENTS, NAMELY, FLUID AND SIGNAL SENSORS, ELECTRIC CURRENT SENSORS, 3D POSITION SENSORS AND INSTRUMENTS, MAGNETIC FIELD SENSORS, MAGNETIC FIELD DETECTORS, OPTICAL SENSORS, MAGNETIC AND ELECTROMAGNETIC SIGNAL RECEIVERS, MAGNETIC AND ELECTROMAGNETIC SIGNAL TRANSMITTERS, COMPUTERIZED AXIAL TOMOGRAPHY SCANNERS, SCANNERS, CAMERAS, VIDEO-CAMERAS, OVERHEAD PROJECTORS, TELEVISIONS, VIDEOTAPE RECORDS AND PLAYERS, COMPUTER STANDS, COMPUTER MONITORS, ELECTRONIC VISUAL DISPLAY UNITS FOR SCANNERS, FOR MAGNETIC RESONANCE IMAGING MACHINES, FOR COMPUTERIZED MACHINES TO MONITOR, MEASURE AND STIMULATE THE ELECTRICAL ACTIVITY AND NEURONAL FUNCTION OF THE BRAIN AND FOR ELECTROENCEPHALOGRAPHS, COMPUTERS FOR USE WITH MAGNETIC RESONANCE IMAGING MACHINES, WITH SCANNERS, WITH MAGNETO-ENCEPHALOGRAPHY MONITORS, WITH MACHINES TO MONITOR, MEASURE AND STIMULATE THE ELECTRICAL ACTIVITY AND NEURONAL FUNCTION OF THE BRAIN AND WITH ELECTROENCEPHALOGRAPHS, IMAGE PROCESSORS, SIGNAL PROCESSORS, VIDEO PROCESSORS, SIGNAL CONVERTERS, ELECTRODES, ELECTRODES FOR USE IN GENERATION AND MEASUREMENTS OF MAGNETIC FIELDS IN THE BRAIN, ELECTRIC AND MAGNETIC INDUCTION COILS, OPTICAL AND SIGNAL AMPLIFIERS, MICRO-DRIVES, ELECTRIC CURRENT DETECTORS, ELECTRIC CURRENT TRANSDUCERS, ELECTROPHORESIS APPARATUS NOT FOR MEDICAL PURPOSES, MAGNETIC FIELD GENERATORS AND MAGNETIC STIMULATORS FOR USE IN NEUROSCIENCE LABORATORY RESEARCH; COMPUTER AND DIGITAL STORAGE MEDIA, NAMELY, CD-ROMS AND DVDS CONTAINING BRAIN STIMULATION SOFTWARE, IMAGE PROCESSING SOFTWARE AND SOFTWARE FOR CONTROLLING AND OPERATING IMAGING MACHINES AND BRAIN STIMULATION APPARATUS, AND CD-ROMS AND DVDS CONTAINING INFORMATION RELATING TO THE SCIENCE AND TECHNOLOGY OF MONITORING, MEASURING AND STIMULATING THE ELECTRICAL ACTIVITY AND NEURONAL FUNCTION OF THE BRAIN, MAGNETO-OPTICAL DRIVES, HARD DISC DRIVES; DATA PROCESSING EQUIPMENT, NAMELY, DATA PROCESSORS, MEDICAL IMAGES ELECTRIC PROCESSORS AND MRI MACHINES AND COMPUTERIZED MACHINES FOR MEASURING ELECTROMAGNETIC FIELDS IN THE BRAIN; COMPUTERS; COMPUTER SOFTWARE FOR CONTROLLING AND OPERATING IMAGING MACHINES



*David J. Kyjars*

Director of the United States Patent and Trademark Office

**Reg. No. 4,196,555** AND BRAIN STIMULATION APPARATUS; COMPUTER SOFTWARE FOR MEDICAL IMAGING AND IMAGE PROCESSING; BRAIN STIMULATION SOFTWARE, IN CLASS 9 (U.S. CLS. 21, 23, 26, 36 AND 38).

FOR: SURGICAL, MEDICAL AND VETERINARY APPARATUS AND INSTRUMENTS, NAMELY, MEDICAL ELECTRODES, COILS FOR MAGNETIC BRAIN STIMULATION, OPTICAL AND SIGNAL AMPLIFIERS, CAPS WITH ELECTRODES FOR MEDICAL USE, RADIOLOGICAL APPARATUS FOR DIAGNOSTIC AND MEDICAL PURPOSES, NEUROLOGICAL APPARATUS FOR DIAGNOSTIC AND MEDICAL PURPOSES, ULTRASONIC MEDICAL DIAGNOSTIC APPARATUS, CEREBRAL BLOOD FLOW MONITORS, MAGNETO-ENCEPHALOGRAPHY MONITORS, NEUROCHEMICAL AND NEUROMAGNETIC MONITORS, X-RAY APPARATUS FOR MEDICAL USE, STEREOTACTIC FRAMES FOR USE IN LOCALIZATION OF THE POSITIONS OF ORGANS TO BE EXAMINED AND/OR TREATED, STEREOTACTIC POSITIONING HARDWARE FOR USE IN LOCALIZATION OF THE POSITION OF ANATOMICAL STRUCTURES TO BE EXAMINED AND/OR TREATED, ELECTROMYOGRAPHS, APPARATUS FOR ANALYZING BRAIN WAVES, BRAIN RESEARCH AND BRAIN STIMULATION APPARATUS AND INSTRUMENTS, NAMELY, NERVE/NEURONAL STIMULATION APPARATUS, TRANSCRANIAL MAGNETIC STIMULATORS FOR MAGNETICALLY STIMULATING THE BRAIN, NERVOUS SYSTEM, SKIN AND SCALP OF A PATIENT, ELECTROENCEPHALOGRAPHS, MEDICAL IMAGING APPARATUS AND INSTRUMENTS, APPARATUS AND INSTRUMENTS FOR USE IN THERAPEUTICAL TREATMENT AND THE DIAGNOSIS OF DISEASES AND TRAUMA OF THE CENTRAL NERVOUS SYSTEM, NAMELY, RADIATION THERAPY MACHINES, NERVE STIMULATION APPARATUS AND MAGNETIC FIELD PULSE GENERATORS, IN CLASS 10 (U.S. CLS. 26, 39 AND 44).

FOR: MAINTENANCE AND REPAIR OF MEDICAL EQUIPMENT, ELECTRIC AND ELECTRONIC APPARATUS AND INSTRUMENTS, AND COMPUTER SYSTEMS; INSTALLATION OF MEDICAL EQUIPMENT, ELECTRIC AND ELECTRONIC APPARATUS AND INSTRUMENTS, AND COMPUTER SYSTEMS, IN CLASS 37 (U.S. CLS. 100, 103 AND 106).

FOR: EDUCATION, NAMELY, CONDUCTING SEMINARS, CONFERENCES, WORKSHOPS, CLASSES, COURSES AND/OR OTHER PROGRAMS IN THE FIELDS OF MEDICAL ENGINEERING AND MEDICINE; PROVIDING OF TRAINING, NAMELY, CONDUCTING SEMINARS, CONFERENCES, WORKSHOPS, CLASSES, COURSES AND/OR OTHER PROGRAMS IN THE FIELDS OF MEDICAL ENGINEERING AND MEDICINE, IN CLASS 41 (U.S. CLS. 100, 101 AND 107).

FOR: SCIENTIFIC AND TECHNOLOGICAL SERVICES AND RESEARCH AND DESIGN RELATING THERETO IN THE FIELDS OF BIOLOGY, CHEMISTRY, MEDICINE AND MEDICAL ENGINEERING; MEDICAL AND SCIENTIFIC RESEARCH, NAMELY, CONDUCTING CLINICAL TRIALS, PROVIDING STATISTICS AND PREPARATION OF REPORTS RELATING TO SCIENTIFIC AND MEDICAL RESEARCH, TECHNICAL CONSULTATION AND RESEARCH IN THE FIELD OF MEDICAL ENGINEERING; INDUSTRIAL ANALYSIS AND RESEARCH SERVICES, NAMELY, CHEMICAL RESEARCH AND ANALYSIS; DESIGN AND DEVELOPMENT OF COMPUTER HARDWARE AND SOFTWARE; MAINTENANCE AND INSTALLATION OF COMPUTER SOFTWARE, IN CLASS 42 (U.S. CLS. 100 AND 101).

FOR: MEDICAL SERVICES, NAMELY, MEDICAL RESEARCH SERVICES, MEDICAL DIAGNOSTIC SERVICES, MEDICAL TESTING SERVICES, MEDICAL LABORATORY SERVICES, MEDICAL DIAGNOSTIC IMAGING SERVICES, MEDICAL DIAGNOSTIC RADIOLOGY SERVICES, PHYSICAL THERAPY SERVICES, RADIATION THERAPY SERVICES, MEDICAL CONSULTATIONS; VETERINARY SERVICES, IN CLASS 44 (U.S. CLS. 100 AND 101).

THE MARK CONSISTS OF STANDARD CHARACTERS WITHOUT CLAIM TO ANY PARTICULAR FONT, STYLE, SIZE, OR COLOR.

**Reg. No. 4,196,555** PRIORITY DATE OF 2-18-2011 IS CLAIMED.

OWNER OF INTERNATIONAL REGISTRATION 1108570 DATED 8-18-2011, EXPIRES 8-18-2021.

OWNER OF U.S. REG. NO. 3,034,118.

SER. NO. 79-109,840, FILED 8-18-2011.

ALEXANDER L. POWERS, EXAMINING ATTORNEY

United States of America  
United States Patent and Trademark Office

**SUISSEX**

**Reg. No. 4,196,556**

**Registered Aug. 28, 2012**

**Int. Cl.: 28**

**TRADEMARK**

**PRINCIPAL REGISTER**

AUTAIN PECHE (FRANCE SOCIÉTÉ PAR ACTIONS SIMPLIFIÉE)  
LONGÈVE  
F-86130 DISSAY  
FRANCE

FOR: FISHING TACKLE, WITH THE EXCEPTION OF FISHING NETS AND HARPOONS  
FOR FISHING, NAMELY FISHING SPINNERS, IN CLASS 28 (U.S. CLS. 22, 23, 38 AND 50).

THE MARK CONSISTS OF STANDARD CHARACTERS WITHOUT CLAIM TO ANY PAR-  
TICULAR FONT, STYLE, SIZE, OR COLOR.

OWNER OF INTERNATIONAL REGISTRATION 0750296 DATED 1-3-2001, EXPIRES 1-3-  
2021.

SER. NO. 79-109,923, FILED 1-24-2012.

JAMES MACFARLANE, EXAMINING ATTORNEY



*David J. Kybas*

Director of the United States Patent and Trademark Office

United States of America  
United States Patent and Trademark Office

**SOLANYL**

**Reg. No. 4,196,557**

**Registered Aug. 28, 2012**

**Int. Cls.: 1 and 17**

**TRADEMARK**

**PRINCIPAL REGISTER**

RODENBURG BIOPOLYMERS B.V. (NETHERLANDS BESLOTEN VENNOOTSCHAP)  
DENARIUSSTRAAT 19  
NL-4903 RC OOSTERHOUT  
NETHERLANDS

FOR: UNPROCESSED PLASTICS, IN CLASS 1 (U.S. CLS. 1, 5, 6, 10, 26 AND 46).

FOR: SEMI-PROCESSED PLASTICS, IN CLASS 17 (U.S. CLS. 1, 5, 12, 13, 35 AND 50).

OWNER OF INTERNATIONAL REGISTRATION 0756073 DATED 3-5-2001, EXPIRES 3-5-2021.

SER. NO. 79-110,828, FILED 1-27-2012.

SARA BENJAMIN, EXAMINING ATTORNEY



*David J. Kyjars*

Director of the United States Patent and Trademark Office



# United States of America

United States Patent and Trademark Office

## Salt and Pepper

**Reg. No. 4,196,558**

**Registered Aug. 28, 2012**

**Int. Cl.: 25**

**TRADEMARK**

**PRINCIPAL REGISTER**

RIGHT-ON CO., LTD. (JAPAN CORPORATION)  
11-1, AZUMA 1-CHOME  
TSUKUBA-SHI; IBARAKI-KEN 305-8503  
JAPAN

FOR: CLOTHING, NAMELY, JEANS, COATS, SHIRTS, T-SHIRTS, POLO SHIRTS, SWEAT SHIRTS, SWEATERS, SPORTS JERSEYS, NIGHTWEAR, UNDERWEAR, SWIMWEAR, SWIMMING CAPS, AND GLOVES; SOCKS AND STOCKINGS; APRONS; COLLAR PROTECTORS; FUR STOLEES; SHAWLS; SCARVES; NECKTIES; NECKERCHIEFS; BANDANAS; MUFFLERS; EAR MUFFS; GARTERS; SUSPENDERS; WAISTBANDS; BELTS FOR CLOTHING; FOOTWEAR, NAMELY, SHOES AND BOOTS, OTHER THAN: SHOE DOWELS, SHOE PEGS, TONGUES OR PULLSTRAPS FOR SHOES AND BOOTS, HOBNAILS AND PROTECTIVE METAL FITTINGS FOR SHOES, AND HORSE-RIDING BOOTS; HEADGEAR FOR WEAR, NAMELY, CAPS AND HATS, IN CLASS 25 (U.S. CLS. 22 AND 39).

THE MARK CONSISTS OF STANDARD CHARACTERS WITHOUT CLAIM TO ANY PARTICULAR FONT, STYLE, SIZE, OR COLOR.

OWNER OF INTERNATIONAL REGISTRATION 0950445 DATED 5-2-2007, EXPIRES 5-2-2017.

SER. NO. 79-110,852, FILED 1-31-2012.

ALLISON HOLTZ, EXAMINING ATTORNEY



*David J. Kyros*

Director of the United States Patent and Trademark Office

# United States of America

United States Patent and Trademark Office

# LAPITEC

**Reg. No. 4,196,559**

**Registered Aug. 28, 2012**

**Int. Cls.: 7 and 19**

**TRADEMARK**

**PRINCIPAL REGISTER**

BRETON S.P.A. (ITALY CORPORATION)  
VIA GARIBALDI, 27  
I-31030 CASTELLO DI GODEGO (TV)  
ITALY

FOR: PROCESSING MACHINES FOR FORMING, CUTTING, SIZING, CALIBRATING, POLISHING, CHAMFERING AND SHAPING OF NATURAL STONES, ARTIFICIAL STONES, AGGLOMERATED STONES, CERAMIC, METALLIC MATERIALS AND GLASS; NUMERICAL CONTROL MACHINES FOR PROCESSING OF NATURAL STONES, ARTIFICIAL STONES, AGGLOMERATED STONES, CERAMIC, METALLIC MATERIALS AND GLASS; MACHINES FOR MANUFACTURE OF ARTIFICIAL STONES, AGGLOMERATED STONES AND CERAMIC MATERIALS; TRANSPORT SYSTEMS COMPRISED OF CONVEYORS AND HANDLING MACHINES FOR MOVING AND CARRYING NATURAL STONES, ARTIFICIAL STONES, AGGLOMERATED STONES, CERAMIC, METALLIC MATERIALS AND GLASS; REPLACEMENT PARTS FOR THE AFORESAID GOODS, IN CLASS 7 (U.S. CLS. 13, 19, 21, 23, 31, 34 AND 35).

FOR: NATURAL AND ARTIFICIAL AGGLOMERATED STONES AND CERAMIC MATERIALS, NAMELY BLOCKS, SLABS, TILES AND OTHER SET MOULDED FORMS OF STONE AND CERAMIC FOR USE IN INDOOR AND OUTDOOR FLOORING, IN INDOOR AND OUTDOOR WALL CLADDING, FOR BUILDING CONSTRUCTION AND FURNITURE; NON-METALLIC COMPOSITE MATERIALS MADE OF NATURAL STONES, COMPOUND STONES AND CERAMIC MATERIALS, REINFORCED OR COATED WITH ELEMENTS COMPRISED OF FIBERS, MATS, WEB OR COMPOUNDED NATURAL LAYERS OF SAID MATERIALS FOR USE IN BUILDING, CONSTRUCTION AND FURNITURE, IN CLASS 19 (U.S. CLS. 1, 12, 33 AND 50).

THE MARK CONSISTS OF STANDARD CHARACTERS WITHOUT CLAIM TO ANY PARTICULAR FONT, STYLE, SIZE, OR COLOR.

PRIORITY DATE OF 11-11-2011 IS CLAIMED.

OWNER OF INTERNATIONAL REGISTRATION 1112234 DATED 1-20-2012, EXPIRES 1-20-2022.

SER. NO. 79-111,420, FILED 1-20-2012.



*David J. Kybas*

Director of the United States Patent and Trademark Office

**Reg. No. 4,196,559** JOHN DWYER, EXAMINING ATTORNEY

# United States of America

United States Patent and Trademark Office

# KETTLOTHERM

**Reg. No. 4,196,560**

**Registered Aug. 28, 2012**

**Int. Cl.: 20**

HEINZ KETTLER GMBH & CO. KG (FED REP GERMANY GMBH & CO. KG (LIMITED PARTNERSHIP))  
HAUPTSTRASSE 28  
59469 ENSE-PARSIT  
FED REP GERMANY

**TRADEMARK**

FOR: GARDEN FURNITURE; METAL CHAIRS; METAL STOOLS; METAL TABLES; METAL BENCHES; METAL ARMCHAIRS , IN CLASS 20 (U.S. CLS. 2, 13, 22, 25, 32 AND 50).

**PRINCIPAL REGISTER**

THE MARK CONSISTS OF STANDARD CHARACTERS WITHOUT CLAIM TO ANY PARTICULAR FONT, STYLE, SIZE, OR COLOR.

PRIORITY DATE OF 9-6-2011 IS CLAIMED.

OWNER OF INTERNATIONAL REGISTRATION 1112320 DATED 1-30-2012, EXPIRES 1-30-2022.

SER. NO. 79-111,435, FILED 1-30-2012.

MELISSA VALLILLO, EXAMINING ATTORNEY



*David J. Kyffers*

Director of the United States Patent and Trademark Office

United States of America  
United States Patent and Trademark Office

V<sup>o</sup> 73

**Reg. No. 4,196,561**

**Registered Aug. 28, 2012**

**Int. Cls.: 14, 18 and 25**

**TRADEMARK**

**PRINCIPAL REGISTER**

ELI BRAND'S SRL (ITALY LIMITED LIABILITY COMPANY)  
VIA ANNIBALE DA BASSANO, 9  
I-35100 PADOVA  
ITALY

FOR: JEWELRY AND IMITATION JEWELRY; KEY CHAINS AS JEWELLERY (TRINKETS OR FOBS); JEWELLERY CHAINS; CHARMS IN PRECIOUS METAL OR COATED THEREWITH; KEY RINGS OF PRECIOUS METALS, IN CLASS 14 (U.S. CLS. 2, 27, 28 AND 50).

FOR: HANDBAGS; SHOULDER BAGS; WRISTLET BAGS; BEACH BAGS; CLUTCH BAGS; WAIST BAGS; TRAVELLING BAGS; LEATHER SHOPPING BAGS; TEXTILE SHOPPING BAGS; SUITCASES; TRAVELLING TRUNKS; BRIEFCASES; ATTACHE CASES; RUCKSACKS; BACKPACKS; KNAPSACKS; HAVERSACKS; PURSES; POCKET WALLETS; CASES OF LEATHER OR LEATHERBOARD; VANITY CASES SOLD EMPTY; KEY CASES, OF LEATHER OR IMITATION LEATHER, IN CLASS 18 (U.S. CLS. 1, 2, 3, 22 AND 41).

FOR: FOOTWEAR; UNDERWEAR; NECKWEAR; NIGHTWEAR; TROUSERS; SHORTS; SINGLET; SUITS; JACKETS; GILETS; WINDCHEATERS; RAINCOATS; MANTLES; BANDANAS; SOCKS; GLOVES BEING CLOTHING; T-SHIRTS; SHIRTS; BLOUSES; SWEAT SHIRTS; SPORT SHIRTS; POLO SHIRTS; JERSEYS BEING CLOTHING; SKIRTS; PULLOVERS; SWEATERS; BATH ROBES; BELTS; MUFFS BEING CLOTHING; HEADWEAR, IN CLASS 25 (U.S. CLS. 22 AND 39).

THE MARK CONSISTS OF A SIGN DEPICTING THE WORDING "V 73" IN FANCY CHARACTERS, BEING PLACED A CIRCULAR FIGURE ON THE RIGHT SIDE OF THE LETTER "V".

PRIORITY DATE OF 9-5-2011 IS CLAIMED.

OWNER OF INTERNATIONAL REGISTRATION 1112432 DATED 10-14-2011, EXPIRES 10-14-2021.

SER. NO. 79-111,471, FILED 10-14-2011.

GINA FINK, EXAMINING ATTORNEY



*David J. Kypas*

Director of the United States Patent and Trademark Office

United States of America  
United States Patent and Trademark Office

Penguin

**Reg. No. 4,196,562**

**Registered Aug. 28, 2012**

**Int. Cl.: 9**

ALLIED VISION TECHNOLOGIES GMBH (FED REP GERMANY LIMITED LIABILITY COMPANY)  
TASCHENWEG 2A  
07646 STADTRODA  
FED REP GERMANY

**TRADEMARK**

**PRINCIPAL REGISTER**

FOR: CAMERAS AND COMPONENTS THEREOF FOR SCIENTIFIC AND INDUSTRIAL IMAGE CAPTURE AND IMAGE PROCESSING, CAMERA CABLES, LENSES, MONITORS, VIDEO PRINTERS, REMOTE CONTROLS, SOFTWARE FOR THE INTEGRATION OF CAMERAS FOR ELECTRONIC IMAGE CAPTURE AND IMAGE PROCESSING, CAMERA HOUSINGS, CAMERA FILTERS, LIGHTING DEVICES FOR CAMERAS, NAMELY ELECTRIC LAMPS, BULBS, FLASH UNITS, REFLECTORS AND CAMERA-ATTACHED LIGHTS, IN CLASS 9 (U.S. CLS. 21, 23, 26, 36 AND 38).

THE MARK CONSISTS OF STANDARD CHARACTERS WITHOUT CLAIM TO ANY PARTICULAR FONT, STYLE, SIZE, OR COLOR.

PRIORITY DATE OF 5-10-2011 IS CLAIMED.

OWNER OF INTERNATIONAL REGISTRATION 1112849 DATED 11-10-2011, EXPIRES 11-10-2021.

SER. NO. 79-111,663, FILED 11-10-2011.

ALLISON HOLTZ, EXAMINING ATTORNEY



*David J. Kyffers*

Director of the United States Patent and Trademark Office

# United States of America

United States Patent and Trademark Office

# PROCTAN

**Reg. No. 4,196,563**

**Registered Aug. 28, 2012**

**Int. Cls.: 5, 16, 35 and 44**

TOVARYSTVO Z OBMEZHENOIU; VIDPOVIDALNISTIU "KONTRAKTFARM" (UKRAINE LIMITED LIABILITY COMPANY)  
VUL. LODYHINA, BUD. 15, KV. 1  
PODILSKYI RAION; M. KYIV 04073  
UKRAINE

**TRADEMARK**

**SERVICE MARK**

**PRINCIPAL REGISTER**

FOR: CAMPHOR FOR MEDICAL PURPOSES; ANTI-INFLAMMATORY OINTMENTS; HEMORRHOIDAL OINTMENTS; HERBAL TOPICAL CREAMS, GELS, SALVES, SPRAYS, POWDER, BALMS, LINIMENT AND OINTMENTS FOR THE RELIEF OF ACHES AND PAIN; ANTISEPTICS; ANALGESIC PHARMACEUTICAL PREPARATIONS; ANTIMICROBIAL PREPARATIONS FOR INHIBITING MICROBIOLOGICAL DECOMPOSITION IN FOOD, BEVERAGES, ANIMAL FEED AND PHARMACEUTICALS; CHEMICAL PREPARATIONS FOR PHARMACEUTICAL OR MEDICAL PURPOSES, NAMELY, FOR HEMORRHOIDS, CHRONIC PROCTITIS, ANAL FISSURES, INFLAMMATION AND EROSIONS OF THE MUCOUS MEMBRANE OF THE RECTUM; PHARMACEUTICAL PREPARATIONS FOR THE TREATMENT OF HEMORRHOIDS, CHRONIC PROCTITIS, ANAL FISSURES, INFLAMMATION AND EROSIONS OF THE MUCOUS MEMBRANE OF THE RECTUM; PHARMACEUTICAL PREPARATIONS FOR THE TREATMENT OF INFECTIOUS DISEASES; PHARMACEUTICAL PREPARATIONS FOR THE PREVENTION OF HEMORRHOIDS, CHRONIC PROCTITIS, ANAL FISSURES, INFLAMMATION AND EROSIONS OF THE MUCOUS MEMBRANE OF THE RECTUM; PHARMACEUTICAL PREPARATIONS AND SUBSTANCES FOR THE TREATMENT OF GASTROINTESTINAL DISEASES AND DISORDERS; PHARMACEUTICAL PREPARATIONS FOR THE TREATMENT AND PREVENTION OF HEMORRHOIDS, CHRONIC PROCTITIS, ANAL FISSURES, INFLAMMATION AND EROSIONS OF THE MUCOUS MEMBRANE OF THE RECTUM; PHARMACEUTICAL PREPARATIONS USED AS A LOCAL ANESTHETIC, ANTI-INFLAMMATORY AND ANTIMICROBIAL AGENT FOR TREATMENT OF HEMORRHOIDS, CHRONIC PROCTITIS, ANAL FISSURES, INFLAMMATION AND EROSIONS OF THE MUCOUS MEMBRANE OF THE RECTUM; PHARMACEUTICAL PREPARATIONS FOR THE OINTMENT TREATMENT OF HEMORRHOIDS, CHRONIC PROCTITIS, ANAL FISSURES, INFLAMMATION AND EROSIONS OF THE MUCOUS MEMBRANES OF THE RECTUM; SULPHONAMIDES AS MEDICINES; GREASES FOR MEDICAL PURPOSES; MEDICAMENTS FOR TREATMENT OF HEMORRHOIDS, CHRONIC PROCTITIS, ANAL FISSURES, INFLAMMATION AND EROSIONS OF THE MUCOUS MEMBRANE OF THE RECTUM; MEDICINES FOR THE TREATMENT OF GASTROINTESTINAL DISEASES; PRESCRIPTION AND NON-PRESCRIPTION MEDICINES, NAMELY, PILLS, TABLETS, CAPSULES, CAPLETS, LIQUID DROPS, SACHETS AND



*David J. Kyjars*

Director of the United States Patent and Trademark Office

**Reg. No. 4,196,563** PHARMACEUTICAL PREPARATIONS FOR THE TREATMENT OF CARDIOVASCULAR DISORDERS, IN CLASS 5 (U.S. CLS. 6, 18, 44, 46, 51 AND 52).

FOR: BOOKLETS IN THE FIELD OF HEMORRHOIDAL OINTMENTS; PRINTED PAMPHLETS, BROCHURES, MANUALS, BOOKS, BOOKLETS, LEAFLETS, FLYERS, INFORMATIONAL SHEETS AND NEWSLETTERS, ADHESIVE BACKED STICKERS, AND KITS COMPRISING ONE OR MORE OF THE FOREGOING MATERIALS IN THE FIELD OF HEMORRHOIDAL OINTMENTS; PUBLICATIONS, NAMELY, BROCHURES, BOOKLETS, AND TEACHING MATERIALS IN THE FIELD OF HEMORRHOIDAL OINTMENTS, IN CLASS 16 (U.S. CLS. 2, 5, 22, 23, 29, 37, 38 AND 50).

FOR: DEMONSTRATION OF GOODS; DISTRIBUTION OF SAMPLES; PROVIDING INFORMATION PERTAINING TO PROCUREMENT, BUYING, SELLING AND TENDERING INFORMATION AND OPPORTUNITIES RELATING TO GOODS, SERVICES, AND CONSTRUCTION VIA COMPUTER, COMPUTER NETWORKS, TELEPHONE, THE INTERNET OR ELECTRONIC MAIL; PURCHASING AND PROCUREMENT SERVICES, NAMELY, PROCURING OF CONTRACTS FOR OTHERS FOR THE PURCHASE OF GOODS AND LABOR CONTRACTING SERVICES; PUBLICATION OF PUBLICITY TEXTS; SALES PROMOTION SERVICES, IN CLASS 35 (U.S. CLS. 100, 101 AND 102).

FOR: MEDICAL ASSISTANCE SERVICES; PHARMACEUTICAL ADVICE, IN CLASS 44 (U.S. CLS. 100 AND 101).

THE MARK CONSISTS OF STANDARD CHARACTERS WITHOUT CLAIM TO ANY PARTICULAR FONT, STYLE, SIZE, OR COLOR.

PRIORITY DATE OF 4-27-2011 IS CLAIMED.

OWNER OF INTERNATIONAL REGISTRATION 1112977 DATED 10-13-2011, EXPIRES 10-13-2021.

SER. NO. 79-111,728, FILED 10-13-2011.

SUSAN LESLIE DUBOIS, EXAMINING ATTORNEY



# United States of America

United States Patent and Trademark Office

# ENASOLAR

**Reg. No. 4,196,564**

**Registered Aug. 28, 2012**

**Int. Cl.: 9**

**TRADEMARK**

**PRINCIPAL REGISTER**

ENATEL LIMITED (NEW ZEALAND LIMITED LIABILITY COMPANY)  
321 TUAM STREET  
CHRISTCHURCH 8013  
NEW ZEALAND

FOR: RECTIFIERS; POWER SUPPLY DEVICES FOR BATTERY CHARGERS; DIRECT CURRENT CONVERTERS; ELECTRIC APPARATUS FOR CHARGING BATTERIES; ELECTRICITY INVERTERS; ALTERNATING CURRENT POWER SUPPLY APPARATUS; ELECTRIC SWITCH MODE POWER SUPPLY APPARATUS; ELECTRIC SWITCHED MODE POWER SUPPLY APPARATUS; ELECTRIC POWER CONTROLLERS; SOLAR ENERGY OPERATING APPARATUS, NAMELY PANELS, COLLECTORS AND CELLS FOR ELECTRICITY GENERATION AND BATTERIES, UNINTERRUPTABLE POWER SUPPLY APPARATUS; BATTERY CHARGE MONITORS; BATTERY CHARGERS; CURRENT RECTIFIERS; POWER SUPPLY DEVICES, NAMELY RECTIFIERS; ELECTRICAL APPARATUS FOR CONVERTING ALTERNATING CURRENT TO DIRECT CURRENT; ELECTRICAL INVERTERS; ELECTRIC POWER CONTROLLING APPARATUS, IN CLASS 9 (U.S. CLS. 21, 23, 26, 36 AND 38).

THE MARK CONSISTS OF STANDARD CHARACTERS WITHOUT CLAIM TO ANY PARTICULAR FONT, STYLE, SIZE, OR COLOR.

OWNER OF INTERNATIONAL REGISTRATION 1113268 DATED 11-29-2011, EXPIRES 11-29-2021.

SER. NO. 79-111,833, FILED 11-29-2011.

ERNEST SHOSHO, EXAMINING ATTORNEY



*David J. Kyros*

Director of the United States Patent and Trademark Office

# United States of America

United States Patent and Trademark Office

# SENSOPRENE

**Reg. No. 4,196,565**

**Registered Aug. 28, 2012**

**Int. Cls.: 9 and 10**

**TRADEMARK**

**PRINCIPAL REGISTER**

ANSELL HEALTHCARE EUROPE NV (BELGIUM CORPORATION)  
RIVERSIDE BUSINESS PARK, SPEY HOUSE  
BOULEVARD INTERNATIONAL, 55; B-1070 BRUXELLE  
BELGIUM

FOR: INDUSTRIAL PROTECTIVE WORK GLOVES, IN CLASS 9 (U.S. CLS. 21, 23, 26, 36 AND 38).

FOR: MEDICAL AND SURGICAL GLOVES, IN CLASS 10 (U.S. CLS. 26, 39 AND 44).

THE MARK CONSISTS OF STANDARD CHARACTERS WITHOUT CLAIM TO ANY PARTICULAR FONT, STYLE, SIZE, OR COLOR.

OWNER OF INTERNATIONAL REGISTRATION 1113272 DATED 1-26-2012, EXPIRES 1-26-2022.

SER. NO. 79-111,835, FILED 1-26-2012.

ALICIA COLLINS, EXAMINING ATTORNEY



*David J. Kybas*

Director of the United States Patent and Trademark Office

# United States of America

United States Patent and Trademark Office

# M o t o P l u s

**Reg. No. 4,196,566**

**Registered Aug. 28, 2012**

**Int. Cl.: 9**

**TRADEMARK**

**PRINCIPAL REGISTER**

KABUSHIKI KAISHA YASKAWA DENKI (JAPAN CORPORATION)  
2-1, KUROSAKI-SHIROISHI  
YAHATANISHI-KU.; KITAKYUSHU-SHI; FUKUOKA806-0004  
JAPAN

FOR: INVERTERS; ELECTRIC POWER CONVERTERS; PROGRAMMABLE LOGIC CONTROLLER (PLC); ELECTRONIC POWER SUPPLIES FOR DRIVING ELECTRIC MOTORS; ELECTRONIC NUMERICAL CONTROLLERS; ELECTRONIC CONTROLLERS FOR ROBOTS; ROTARY CONVERTERS; PHASE MODIFIERS; COMPUTER NETWORK ADAPTERS, SWITCHES, ROUTERS AND HUBS; COMPUTER HARDWARE AND PERIPHERAL DEVICES; ELECTRONIC CIRCUITS, NOT INCLUDING THOSE RECORDED WITH COMPUTER PROGRAMS; COMPUTER SOFTWARE DEVELOPMENT TOOLS; COMPUTER SOFTWARE DESIGNED FOR ENABLING THE USE AND CONTROL OF ROBOTS; COMPUTER SOFTWARE DEVELOPMENT TOOLS FOR PROGRAMMING ROBOT MOVEMENTS, IN CLASS 9 (U.S. CLS. 21, 23, 26, 36 AND 38).

THE MARK CONSISTS OF STANDARD CHARACTERS WITHOUT CLAIM TO ANY PARTICULAR FONT, STYLE, SIZE, OR COLOR.

PRIORITY DATE OF 9-28-2011 IS CLAIMED.

OWNER OF INTERNATIONAL REGISTRATION 1113346 DATED 12-27-2011, EXPIRES 12-27-2021.

SER. NO. 79-111,862, FILED 12-27-2011.

DAVID MURRAY, EXAMINING ATTORNEY



*David J. Kyros*

Director of the United States Patent and Trademark Office

# United States of America

United States Patent and Trademark Office

## SPRINGBOARDR

**Reg. No. 4,196,567**

**Registered Aug. 28, 2012**

**Int. Cl.: 45**

UNIVERSUM COMMUNICATIONS SWEDEN AB (SWEDEN LIMITED LIABILITY COMPANY)  
BOX 7053  
SE-103 86 STOCKHOLM  
SWEDEN

**SERVICE MARK**

**PRINCIPAL REGISTER**

FOR: ON-LINE SOCIAL NETWORKING SERVICES, IN CLASS 45 (U.S. CLS. 100 AND 101).

THE MARK CONSISTS OF STANDARD CHARACTERS WITHOUT CLAIM TO ANY PARTICULAR FONT, STYLE, SIZE, OR COLOR.

PRIORITY DATE OF 8-26-2010 IS CLAIMED.

OWNER OF INTERNATIONAL REGISTRATION 1083533 DATED 2-10-2011, EXPIRES 2-10-2021.

SER. NO. 79-975,226, FILED 2-10-2011.

HAI-LY LAM, EXAMINING ATTORNEY



*David J. Kyffers*

Director of the United States Patent and Trademark Office

# United States of America

United States Patent and Trademark Office

## COSMETIC WORLD

**Reg. No. 4,196,568**

THE LEDES GROUP INC. (DELAWARE CORPORATION)  
16 EAST 40TH STREET, SUITE 700  
NEW YORK, NY 10016

**Registered Aug. 28, 2012**

**Int. Cl.: 16**

FOR: NEWSLETTER ABOUT THE COSMETIC AND BEAUTY INDUSTRIES, AND DIRECTED SOLELY TO THOSE WHO WORK OR OPERATE IN THOSE INDUSTRIES, IN CLASS 16 (U.S. CLS. 2, 5, 22, 23, 29, 37, 38 AND 50).

**TRADEMARK**

FIRST USE 1-5-1966; IN COMMERCE 1-5-1966.

**PRINCIPAL REGISTER**

THE MARK CONSISTS OF STANDARD CHARACTERS WITHOUT CLAIM TO ANY PARTICULAR FONT, STYLE, SIZE, OR COLOR.

NO CLAIM IS MADE TO THE EXCLUSIVE RIGHT TO USE "COSMETIC", APART FROM THE MARK AS SHOWN.

SER. NO. 85-002,861, FILED 3-31-2010.

MYRIAH HABEEB, EXAMINING ATTORNEY



*David J. Kybas*

Director of the United States Patent and Trademark Office

# United States of America

United States Patent and Trademark Office

## Itty Bitty Sweets

**Reg. No. 4,196,569**

BOWMAN, REBEKAH PAGE (UNITED STATES INDIVIDUAL), DBA ITTY BITTY SWEETS  
127 SKLAR ST

**Registered Aug. 28, 2012**

LADERA RANCH, CA 92694

**Int. Cl.: 30**

FOR: BAKERY PRODUCTS, NAMELY, SWEET BAKERY GOODS; CAKES; CANDIES; CUP  
CAKES; EDIBLE CAKE DECORATIONS; EDIBLE DECORATIONS FOR CAKES; FRUIT  
PIES; MUFFINS; PIES, IN CLASS 30 (U.S. CL. 46).

**TRADEMARK**

FIRST USE 2-1-2010; IN COMMERCE 2-1-2010.

**PRINCIPAL REGISTER**

THE MARK CONSISTS OF STANDARD CHARACTERS WITHOUT CLAIM TO ANY PAR-  
TICULAR FONT, STYLE, SIZE, OR COLOR.

NO CLAIM IS MADE TO THE EXCLUSIVE RIGHT TO USE "SWEETS", APART FROM THE  
MARK AS SHOWN.

SER. NO. 85-008,828, FILED 4-7-2010.

LINDA E. BLOHM, EXAMINING ATTORNEY



*David J. Kyffers*

Director of the United States Patent and Trademark Office

# United States of America

United States Patent and Trademark Office



**Reg. No. 4,196,570**

MARIA SNYDER INC. (NEW YORK CORPORATION)  
800 FIFTH AVENUE 4A  
NEW YORK, NY 10065

**Registered Aug. 28, 2012**

**Int. Cls.: 25 and 41**

FOR: T-SHIRTS, IN CLASS 25 (U.S. CLS. 22 AND 39).

**TRADEMARK**

FIRST USE 12-17-2009; IN COMMERCE 4-24-2010.

**SERVICE MARK**

FOR: EDUCATIONAL SERVICES, NAMELY, PROVIDING EDUCATIONAL EXHIBITS, PROGRAMS AND PRESENTATIONS IN THE FIELD OF GLOBAL ECOLOGY AND SOCIAL ISSUES, IN CLASS 41 (U.S. CLS. 100, 101 AND 107).

**PRINCIPAL REGISTER**

FIRST USE 12-17-2009; IN COMMERCE 4-24-2010.

NO CLAIM IS MADE TO THE EXCLUSIVE RIGHT TO USE "ECO BOYS AND GIRLS", APART FROM THE MARK AS SHOWN.

THE MARK CONSISTS OF A GROUP OF CIRCULAR CHARACTERS, NAMELY, FROM LEFT TO RIGHT, A GLOBE WITH FACE, HANDS, AND FEET WITH THE CONTINENTS OF NORTH AMERICA, SOUTH AMERICA, AFRICA AND EUROPE VISIBLE, A HEART WITH FACE, HANDS, AND FEET, A PEACE SYMBOL WITH FACE, HANDS, AND FEET, A RECYCLE SYMBOL WITH FACE, HANDS, AND FEET, AND A SUN WEARING SUNGLASSES WITH FACE, HANDS, AND FEET, WITH THE WORDS "ECO BOYS AND GIRLS" BENEATH THE CHARACTERS.



SER. NO. 85-026,666, FILED 4-29-2010.

COLLEEN KEARNEY, EXAMINING ATTORNEY

*David J. Kyros*

Director of the United States Patent and Trademark Office

# United States of America

United States Patent and Trademark Office



**Reg. No. 4,196,571**

**Registered Aug. 28, 2012**

**Int. Cl.: 25**

**TRADEMARK**

**PRINCIPAL REGISTER**

POWER BALANCE, LLC (DELAWARE LIMITED LIABILITY COMPANY)  
30012 IVY GLENN SUITE 170  
LAGUNA NIGUEL, CA 92677

FOR: CLOTHING, NAMELY, SHIRTS, SHORTS, PANTS, JACKETS, DRESSES, JERSEYS;  
SWIMWEAR; FOOTWEAR; BELTS; SOCKS; HATS; GLOVES; UNDERGARMENTS; WET  
SUITS, IN CLASS 25 (U.S. CLS. 22 AND 39).

FIRST USE 1-25-2008; IN COMMERCE 1-25-2008.

OWNER OF U.S. REG. NOS. 3,524,766 AND 3,747,583.

NO CLAIM IS MADE TO THE EXCLUSIVE RIGHT TO USE "TECHNOLOGY", APART FROM  
THE MARK AS SHOWN.

THE MARK CONSISTS OF A STYLIZED LETTER "P" INTERTWINED WITH A STYLIZED  
LETTER "B", AND A DOT IN THE LOWER PORTION OF THE "B", ALL OVER THE STYL-  
IZED WORD "POWER" ABOVE THE STYLIZED WORD "BALANCE" ABOVE THE STYLIZED  
WORDS "PERFORMANCE TECHNOLOGY".

SER. NO. 85-026,919, FILED 4-30-2010.

BRENDAN REGAN, EXAMINING ATTORNEY



*David J. Kybas*

Director of the United States Patent and Trademark Office



# United States of America

United States Patent and Trademark Office



**Reg. No. 4,196,572**

POWER BALANCE, LLC (DELAWARE LIMITED LIABILITY COMPANY)  
30012 IVY GLENN SUITE 170  
LAGUNA NIGUEL, CA 92677

**Registered Aug. 28, 2012**

**Int. Cl.: 25**

FOR: CLOTHING, NAMELY, SHIRTS, SHORTS, PANTS, JACKETS, DRESSES, JERSEYS;  
SWIMWEAR; FOOTWEAR; BELTS; SOCKS; HATS; GLOVES; UNDERGARMENTS; WET  
SUITS, IN CLASS 25 (U.S. CLS. 22 AND 39).

**TRADEMARK**

FIRST USE 1-25-2008; IN COMMERCE 1-25-2008.

**PRINCIPAL REGISTER**

OWNER OF U.S. REG. NOS. 3,524,766 AND 3,747,583.

NO CLAIM IS MADE TO THE EXCLUSIVE RIGHT TO USE "TECHNOLOGY", APART FROM  
THE MARK AS SHOWN.

THE MARK CONSISTS OF A STYLIZED LETTER "P" INTERTWINED WITH A STYLIZED  
LETTER "B", AND A DOT IN THE LOWER PORTION OF THE "B", NEXT TO THE STYLIZED  
WORDING "POWER" AND "BALANCE" SEPARATED BY A DOT, ALL OVER THE STYLIZED  
WORDING "PERFORMANCE TECHNOLOGY".

SER. NO. 85-026,920, FILED 4-30-2010.

BRENDAN REGAN, EXAMINING ATTORNEY



*David J. Kyffers*

Director of the United States Patent and Trademark Office

# United States of America

United States Patent and Trademark Office

# STX

**Reg. No. 4,196,573**

**Registered Aug. 28, 2012**

**Int. Cls.: 7, 12, 37, 39  
and 40**

**TRADEMARK**

**SERVICE MARK**

**PRINCIPAL REGISTER**

STX CORPORATION (REPUBLIC OF KOREA CORPORATION)  
JINHAESI  
100, WONPO-DONG  
GYEONGSANGNAM-DO, REPUBLIC OF KOREA

FOR: ALTERNATORS FOR LAND VEHICLES; BOOKBINDING MACHINES; CYLINDER HEADS FOR ENGINES; CYLINDERS FOR MOTORS AND ENGINES; DC GENERATORS; DIESEL ENGINES FOR AIRCRAFTS; DIESEL ENGINES FOR SHIPS; DIESEL ENGINES NOT FOR LAND VEHICLES; DREDGING MACHINES; EXCAVATORS; GAS TURBINE ENGINES NOT FOR LAND VEHICLES; MOTORS AND ENGINES NOT FOR LAND VEHICLES; NET HAULING MACHINES; PACKING MACHINES; PAINTING MACHINES; PISTONS FOR ENGINES; WEAVING MACHINES; TURBOPROP ENGINES FOR AIRCRAFT; TURBOPROP ENGINES FOR SHIPS; BEARINGS FOR SHIPS OR AIRCRAFTS; BEARING BRACKETS FOR MACHINES; BEARINGS, OTHER THAN FOR LAND VEHICLES, NAMELY, AS PARTS OF MACHINES; CURRENT GENERATORS; DYNAMO BRUSHES; ELECTRIC POWER GENERATORS FOR SHIPS; ELECTROSTATIC GENERATORS; EMERGENCY POWER GENERATORS; GENERATORS FOR WIND TURBINES; IGNITING MAGNETOS FOR ENGINES; ROLLER BEARINGS FOR MACHINES; SUPERCHARGERS, NAMELY, AIR COMPRESSORS FOR MACHINES; TURBOCHARGERS FOR MACHINES; WIND MILLS; WIND TURBINES, IN CLASS 7 (U.S. CLS. 13, 19, 21, 23, 31, 34 AND 35).

FOR: CARGO SHIPS, NAMELY, CONTAINER SHIPS AND BULK CARGO CARRIER SHIPS; DIESEL ENGINES FOR LAND VEHICLES; COMMERCIAL FISHING BOATS; GAS TURBINES FOR LAND VEHICLES; OIL TANKERS, NAMELY, SHIPS DESIGNED TO TRANSPORT LIQUIDS; PASSENGER SHIPS, NAMELY, CRUISE SHIPS AND FERRIES; TURBOPROP ENGINES FOR LAND VEHICLES; NON-METAL MAST POLES FOR BOATS; WHEEL AND AXLE BEARINGS FOR LAND VEHICLES; RUDDERS FOR VESSELS; SCREW PROPELLERS FOR SHIPS, IN CLASS 12 (U.S. CLS. 19, 21, 23, 31, 35 AND 44).

FOR: ANTI-RUST TREATMENT FOR SHIPS; RESIDENTIAL AND COMMERCIAL BUILDING CONSTRUCTION; BUILDING OF CANAL LOCKS; CLEANING OF SHIPS; CLEANING OF STORAGE TANKS; PIPELINE CONSTRUCTION AND MAINTENANCE; WAREHOUSE CONSTRUCTION AND REPAIR; UNDERWATER CONSTRUCTION; PLANNING AND LAYING OUT OF FACTORY BUILDINGS; HARBOUR CONSTRUCTION; INSTALLATION OF COMPUTER NETWORKS; LAUNDERING FOR SHIPS; MAINTENANCE OF COMPUTER HARDWARES; NOISE PREVENTION WORKS, NAMELY, BUILDING CONSTRUCTION SERVICES; PIER CONSTRUCTION; PIPELINE MAINTENANCE; PLUMBING; REBUILDING



*David J. Kyffers*

Director of the United States Patent and Trademark Office

**Reg. No. 4,196,573** ENGINES THAT HAVE BEEN WORN OR PARTIALLY DESTROYED; REPAIR OF BUILDINGS; REPAIR OF INDUSTRIAL PACKING CONTAINERS; REPAIR OR MAINTENANCE OF DIVING MACHINES AND APPARATUS; REPAIR OF ELECTRIC MOTORS; MAINTENANCE AND REPAIR OF SHIPS; RUSTPROOFING; CLEANING AND POLISHING OF SHIPS; SHIPBUILDING; TUNNEL CONSTRUCTION; UNDERWATER CONSTRUCTION; UPHOLSTERING; WASHING OF SHIPS; WASHING OF BUILDINGS; REFUELING AND LUBRICATION SERVICES FOR SHIPS; TRASH COLLECTION, NAMELY, REFUSE CLEAN-UP; SHIP DISMANTLING, NAMELY, TAKING A SHIP APART TO PIECES AND PARTS; CONSTRUCTION OF COGENERATION POWER GENERATING PLANTS; CONSTRUCTION OF POWER PLANTS; HYDRO-ELECTRIC FACTORY CONSTRUCTION; INSTALLATION OF PHOTO-VOLTAIC POWER GENERATION INSTALLATIONS; INSTALLATION OF WIND POWER PLANTS; WASTE OIL COLLECTION FOR RECYCLING, IN CLASS 37 (U.S. CLS. 100, 103 AND 106).

FOR: COURIER SERVICES; WAREHOUSING SERVICES, NAMELY, STORAGE OF DANGEROUS GOODS; DISTRIBUTION OF ENERGY; UNDERWATER SALVAGE; ELECTRICITY DISTRIBUTION; FERRY-BOAT TRANSPORT; FREIGHT BROKERAGE; FREIGHT FORWARDING; STEVEDORING SERVICES; GENERAL WAREHOUSING SERVICES; HEAT SUPPLY DISTRIBUTION; WAREHOUSING SERVICES, NAMELY, STORAGE OF MARINE PRODUCTS; MARINE TRANSPORT; MARINE TRANSPORT BROKERAGE; TRANSPORT OF OIL BY PIPELINES, SHIPS OR VEHICLES; PARCEL DELIVERY; PETROLEUM RESERVE AGENCY SERVICES, NAMELY, STORAGE, DISTRIBUTION AND TRANSPORTATION OF PETROLEUM; PLEASURE BOAT CRUISES; REFLOATING OF SHIPS; WAREHOUSING SERVICES, NAMELY, STORAGE OF REFRIGERATED GOODS; RENTAL OF REFRIGERATOR-FREEZERS FOR HOUSEHOLD PURPOSES; RENTAL OF REFRIGERATOR FOR COMMERCIAL USE; RENTAL OF SHIPS; RENTAL OF STORAGE CONTAINERS; RENTAL OF WAREHOUSES; BOAT SALVAGE; AIRCRAFT SALVAGE; SHIP BROKERAGE; TRANSPORT BY SHIPS; SHIPPING OF GOODS; WAREHOUSING INFORMATION; STORAGE SERVICES, NAMELY, STORAGE OF BAGGAGE, GOODS, TRASH AND WASTE; TRANSPORT BROKERAGE; TRANSPORT BY PIPELINE; HAZARDOUS WASTE TRANSPORTATION SERVICES; TRANSPORTATION RESERVATION SERVICES; TRANSPORTATION INFORMATION; WATER DISTRIBUTION AND SUPPLY, IN CLASS 39 (U.S. CLS. 100 AND 105).

FOR: BURNISHING BY ABRASION; DESTRUCTION OF WASTE AND TRASH; INCINERATION OF WASTE AND TRASH; PATTERN PRINTING; PETROLEUM REFINING; RECYCLING OF WASTE AND TRASH; RENTAL OF GENERATORS; WASTE TREATMENT; ENVIRONMENTAL REMEDIATION SERVICES, NAMELY, SOIL, WASTE AND WATER TREATMENT SERVICES; TREATMENT OF WASTE MATERIAL RELATING TO ENVIRONMENTAL POLLUTION CONTROL; ELECTRICITY GENERATING; PRODUCTION OF ENERGY; WATER TREATING , IN CLASS 40 (U.S. CLS. 100, 103 AND 106).

THE MARK CONSISTS OF STANDARD CHARACTERS WITHOUT CLAIM TO ANY PARTICULAR FONT, STYLE, SIZE, OR COLOR.

PRIORITY CLAIMED UNDER SEC. 44(D) ON REPUBLIC OF KOREA APPLICATION NO. 2010-0000221, FILED 1-19-2010, REG. NO. 450038745, DATED 3-2-2012, EXPIRES 3-2-2022.

OWNER OF U.S. REG. NO. 3,741,561.

SER. NO. 85-028,636, FILED 5-3-2010.

JESSICA FATHY, EXAMINING ATTORNEY

# United States of America

United States Patent and Trademark Office

# TOOLGUARD

**Reg. No. 4,196,574**

**Registered Aug. 28, 2012**

**Int. Cl.: 9**

**TRADEMARK**

**PRINCIPAL REGISTER**

DYNAMCO PTY. LTD. (AUSTRALIA CORPORATION)  
10 BROWN STREET  
EAST PERTH, AUSTRALIA WESTERNAU

FOR: ELECTRONIC SECURITY SYSTEMS AND ALARM SYSTEMS COMPRISED OF ANTI-THEFT SIRENS, ELECTRIC WARNING LIGHTS, ELECTRIC SENSORS, ACCESS KEYPADS, ELECTRIC LOCATION SIGNAL TRACKING DEVICES FOR SIGNALING THE LOCATION OF OBJECTS SECURED BY THE ELECTRONIC SECURITY SYSTEMS AND CONTAINING AN ANTI-THEFT ALARM OR IMMOBILIZER, CONTROL CIRCUIT UNITS CONTAINED WITHIN HOUSINGS, AND REMOTE CONTROL UNITS FOR REGULATING USER ON/OFF CONTROL AND CONTROLLING SECURITY SYSTEM AND ALARM SYSTEM STATUS; VEHICLE SECURITY SYSTEMS AND ALARM SYSTEMS COMPRISED OF ELECTRIC RELAYS, IMMOBILIZATION DEVICES, ELECTRIC RELAYS CONTAINING ELECTRIC CONTROL CIRCUITS AND IMMOBILIZATION DEVICES, ANTI-THEFT SIRENS, ELECTRIC WARNING LIGHTS, ELECTRIC TAMPER WARNING SENSORS, ELECTRIC TILT WARNING SENSORS, IMMOBILIZERS, ACCESS KEYPADS, ELECTRIC REMOTE SIGNALING DEVICES FOR NOTIFYING THE STATUS OF SECURITY AND ANTI-THEFT ELECTRONIC ALARMS AND IMMOBILIZERS, ELECTRIC LOCATION TRACKING DEVICES FOR NOTIFYING THE LOCATION OF A VEHICLE, VEHICLE ANTI-THEFT SYSTEM CONTROL CIRCUIT UNITS CONTAINED WITHIN HOUSINGS, AND REMOTE CONTROL UNITS FOR REGULATING USER ON/OFF CONTROL, ANTI-THEFT SYSTEM STATUS, AND VEHICLE LOCATION, IN CLASS 9 (U.S. CLS. 21, 23, 26, 36 AND 38).



THE MARK CONSISTS OF STANDARD CHARACTERS WITHOUT CLAIM TO ANY PARTICULAR FONT, STYLE, SIZE, OR COLOR.

PRIORITY CLAIMED UNDER SEC. 44(D) ON AUSTRALIA APPLICATION NO. 1349653, FILED 3-9-2010, REG. NO. 1349653, DATED 11-28-2011, EXPIRES 3-9-2020.

SER. NO. 85-037,742, FILED 5-13-2010.

KATHERINE STOIDES, EXAMINING ATTORNEY

*David J. Kyros*

Director of the United States Patent and Trademark Office

# United States of America

United States Patent and Trademark Office

# TOOLGUARD

**Reg. No. 4,196,575**

DYNAMCO PTY. LTD. (AUSTRALIA CORPORATION)  
10 BROWN STREET

**Registered Aug. 28, 2012**

EAST PERTH, AUSTRALIA WESTERNAU

**Int. Cl.: 9**

FOR: VEHICLE PARTS, NAMELY, VEHICLE SECURITY AND ANTI-THEFT SYSTEMS COMPRISED OF AN ELECTRIC PLUG-IN RELAY CONTAINING A CONTROL CIRCUIT FOR CONTROLLING AND OVER-RIDING THE FUNCTIONING OF VEHICLE OPERATING SYSTEMS, INCLUDING VEHICLE POWER SYSTEMS, FUEL PUMPS, INJECTOR SYSTEMS, IGNITION SYSTEMS, AND STARTER MOTORS, IN CLASS 9 (U.S. CLS. 21, 23, 26, 36 AND 38).

**TRADEMARK**

**PRINCIPAL REGISTER**

THE MARK CONSISTS OF STANDARD CHARACTERS WITHOUT CLAIM TO ANY PARTICULAR FONT, STYLE, SIZE, OR COLOR.

PRIORITY CLAIMED UNDER SEC. 44(D) ON AUSTRALIA APPLICATION NO. 1349653, FILED 3-9-2010, REG. NO. 1349653, DATED 11-28-2011, EXPIRES 3-9-2020.

SER. NO. 85-037,779, FILED 5-13-2010.

KATHERINE STOIDES, EXAMINING ATTORNEY



*David J. Kyffers*

Director of the United States Patent and Trademark Office

# United States of America

United States Patent and Trademark Office



**Reg. No. 4,196,576**

DYNAMIC VIDEO, LLC (DELAWARE LIMITED LIABILITY COMPANY)  
71 WEST 23RD STREET, 17TH FLOOR  
NEW YORK, NY 10010

**Registered Aug. 28, 2012**

**Int. Cls.: 35 and 41**

FOR: PROVIDING ONLINE BASED SERVICES IN THE FIELD OF MARKETING AND ADVERTISING, IN CLASS 35 (U.S. CLS. 100, 101 AND 102).

**SERVICE MARK**

FIRST USE 2-11-2010; IN COMMERCE 2-11-2010.

**PRINCIPAL REGISTER**

FOR: ENTERTAINMENT SERVICES, NAMELY, PROVIDING A WEBSITE FEATURING PHOTOGRAPHIC, AUDIO, VIDEO AND PROSE PRESENTATIONS FEATURING ADVERTISING MULTIMEDIA; ENTERTAINMENT SERVICES, NAMELY, A CONTINUING PROGRAM ABOUT ADVERTISING ACCESSIBLE BY COMPUTER NETWORKS; ENTERTAINMENT SERVICES, NAMELY, PROVIDING A RADIO PROGRAM IN THE FIELD OF ADVERTISING MULTIMEDIA VIA A GLOBAL COMPUTER NETWORK; ENTERTAINMENT SERVICES, NAMELY, PROVIDING A WEB SITE FEATURING MUSICAL PERFORMANCES, MUSICAL VIDEOS, RELATED FILM CLIPS, PHOTOGRAPHS, AND OTHER MULTIMEDIA MATERIALS FEATURING ADVERTISING CONTENT; MULTIMEDIA ENTERTAINMENT SERVICES IN THE NATURE OF RECORDING, PRODUCTION AND POST-PRODUCTION SERVICES IN THE FIELDS OF MUSIC, VIDEO, AND FILMS; MULTIMEDIA ENTERTAINMENT SOFTWARE PRODUCTION SERVICES; PROVIDING A WEB SITE WHERE USERS CAN POST RATINGS, REVIEWS AND RECOMMENDATIONS ON EVENTS AND ACTIVITIES IN THE FIELD OF ENTERTAINMENT AND EDUCATION; PROVIDING INFORMATION IN THE FIELD OF ENTERTAINMENT, FEATURING ANIMATION RENDERED BY MEANS OF A GLOBAL COMPUTER NETWORK; PROVIDING INFORMATION, NEWS AND COMMENTARY IN THE FIELD OF ENTERTAINMENT; TRAINING COURSES IN STRATEGIC PLANNING RELATING TO ADVERTISING, PROMOTION, MARKETING AND BUSINESS; TRAINING IN THE FIELD OF DESIGN, ADVERTISING AND COMMUNICATION TECHNOLOGIES, IN CLASS 41 (U.S. CLS. 100, 101 AND 107).



FIRST USE 2-11-2010; IN COMMERCE 2-11-2010.

NO CLAIM IS MADE TO THE EXCLUSIVE RIGHT TO USE "DYNAMIC VIDEO" , APART FROM THE MARK AS SHOWN.

*David J. Kyjars*

THE MARK CONSISTS OF STYLISH WRITING OF THE WORDS "DYNAMIC VIDEO" WITH THREE TRIANGLES TO THE RIGHT OF THE WORD "VIDEO".

Director of the United States Patent and Trademark Office

**Reg. No. 4,196,576** SER. NO. 85-045,315, FILED S.R. 5-21-2010 AM. P.R. 5-21-2010.

ALEXANDER L. POWERS, EXAMINING ATTORNEY

# United States of America

United States Patent and Trademark Office

## MASS-TADON

**Reg. No. 4,196,577**

**Registered Aug. 28, 2012**

**Int. Cl.: 5**

**TRADEMARK**

**PRINCIPAL REGISTER**

NUTRIMIX LABORATORIES, INC. (CANADA CORPORATION)  
2487 KALADAR AVENUE  
UNIT 360E  
OTTAWA, ONTARIO, CANADA K1V8B9

FOR: NUTRITIONAL AND DIETARY SUPPLEMENTS, NAMELY, MEAL REPLACEMENT BARS AND NUTRITIONAL ENERGY AND ENERGY BOOSTING SNACK BARS FOR USE AS A MEAL SUBSTITUTE, ALL PROMOTING ENERGY, GOOD HEALTH AND WEIGHT LOSS; NUTRITIONAL AND DIETARY FOOD SUPPLEMENTS IN POWDER, TABLET AND CAPSULE FORM FOR PROMOTING ENERGY, GOOD HEALTH AND WEIGHT LOSS; NUTRITIONAL AND DIETARY FOOD SUPPLEMENTS IN LIQUID FORM FOR PROMOTING ENERGY, GOOD HEALTH AND WEIGHT LOSS, IN CLASS 5 (U.S. CLS. 6, 18, 44, 46, 51 AND 52).

THE MARK CONSISTS OF STANDARD CHARACTERS WITHOUT CLAIM TO ANY PARTICULAR FONT, STYLE, SIZE, OR COLOR.

PRIORITY CLAIMED UNDER SEC. 44(D) ON CANADA APPLICATION NO. 1481594, FILED 5-18-2010, REG. NO. TMA806,709, DATED 9-14-2011, EXPIRES 9-14-2026.

SER. NO. 85-050,514, FILED 5-28-2010.

ANDREW RHIM, EXAMINING ATTORNEY



*David J. Kypos*

Director of the United States Patent and Trademark Office



# United States of America

United States Patent and Trademark Office



**Reg. No. 4,196,578**

SEMICONDUCTOR ENERGY LABORATORY CO., LTD. (JAPAN CORPORATION)  
398 HASE, ATSUGI-SHI

**Registered Aug. 28, 2012**

KANAGAWA, JAPAN 243-0036

**Int. Cls.: 9, 42 and 45**

FOR: SEMICONDUCTOR DEVICES, IN CLASS 9 (U.S. CLS. 21, 23, 26, 36 AND 38).

**TRADEMARK**

FOR: TECHNICAL CONSULTING AND RESEARCH IN THE FIELD OF SEMICONDUCTOR DEVICES, IN CLASS 42 (U.S. CLS. 100 AND 101).

**SERVICE MARK**

FOR: LICENSING OF INTELLECTUAL PROPERTY IN THE FIELD OF SEMICONDUCTOR DEVICES, IN CLASS 45 (U.S. CLS. 100 AND 101).

**PRINCIPAL REGISTER**

OWNER OF JAPAN REG. NO. 3195383, DATED 9-30-1996, EXPIRES 9-30-2016.

THE COLOR(S) BLUE, RED, AND BLACK IS/ARE CLAIMED AS A FEATURE OF THE MARK.

OWNER OF JAPAN REG. NO. 2506566, DATED 2-26-1993, EXPIRES 2-26-2013.

NO CLAIM IS MADE TO THE EXCLUSIVE RIGHT TO USE "SEMICONDUCTOR ENERGY LABORATORY", APART FROM THE MARK AS SHOWN.

THE MARK CONSISTS OF THE LETTERS "SEL" IN BLUE FOLLOWED BY A RED DOT, ALL ABOVE THE WORDING "SEMICONDUCTOR ENERGY LABORATORY" IN BLACK.

SER. NO. 85-052,885, FILED 6-2-2010.

RUSS HERMAN, EXAMINING ATTORNEY



*David J. Kybas*

Director of the United States Patent and Trademark Office

# United States of America

United States Patent and Trademark Office

## PINNACLE ENTERTAINMENT

**Reg. No. 4,196,579**

PINNACLE ENTERTAINMENT, INC. (DELAWARE CORPORATION)  
8918 SPANISH RIDGE AVENUE

**Registered Aug. 28, 2012**

LAS VEGAS, NV 89148

**Int. Cl.: 41**

FOR: AMUSEMENT CENTERS; CASINOS; GOLF COURSES; NIGHT CLUBS, IN CLASS 41  
(U.S. CLS. 100, 101 AND 107).

**SERVICE MARK**

FIRST USE 10-27-2000; IN COMMERCE 10-27-2000.

**PRINCIPAL REGISTER**

THE MARK CONSISTS OF STANDARD CHARACTERS WITHOUT CLAIM TO ANY PARTICULAR FONT, STYLE, SIZE, OR COLOR.

NO CLAIM IS MADE TO THE EXCLUSIVE RIGHT TO USE "ENTERTAINMENT", APART FROM THE MARK AS SHOWN.

SER. NO. 85-058,777, FILED 6-9-2010.

AMY KELLY, EXAMINING ATTORNEY



*David J. Kyffers*

Director of the United States Patent and Trademark Office

# United States of America

United States Patent and Trademark Office

# HYBRIDCAST

**Reg. No. 4,196,580**

**Registered Aug. 28, 2012**

**Int. Cls.: 9 and 38**

**TRADEMARK**

**SERVICE MARK**

**PRINCIPAL REGISTER**

NHK ENGINEERING SERVICES, INC. (JAPAN CORPORATION)  
1-10-11, KINUTA  
SETAGAYA-KU, TOKYO, JAPAN 157-8504

FOR: PHOTOGRAPHIC MACHINES AND APPARATUS, NAMELY, CAMERAS; CINEMATOGRAPHIC MACHINES AND APPARATUS; OPTICAL APPARATUS AND INSTRUMENTS, NAMELY, TELESCOPES, PERISCOPES, BINOCULARS, MICROSCOPES, MAGNIFYING GLASSES; ELECTRIC WIRES AND CABLES; TELECOMMUNICATIONS DEVICES AND APPARATUS, NAMELY, TELEPHONE APPARATUS, MOBILE PHONES, FACSIMILE MACHINES, AUDIO FREQUENCY TRANSMITTERS, RELAYS FOR RADIO AND TV STATIONS; TELEVISION RECEIVERS, TV SETS, TELEVISION TRANSMITTERS, RADIO RECEIVERS, RADIO TRANSMITTERS, WIRELESS COMMUNICATION DEVICE FEATURING VOICE, DATA AND IMAGE TRANSMISSION, NAVIGATION APPARATUS FOR VEHICLES ON-BOARD COMPUTERS, PUBLIC-ADDRESS SYSTEMS AND INSTRUMENTS, COMPACT DISK PLAYERS, TAPE RECORDERS, ELECTRIC PHONOGRAPHS, RECORD PLAYERS, SOUND RECORDING MACHINES AND APPARATUS, DIGITAL CAMERAS, VIDEO CAMERAS, CAMCORDERS, VIDEO DISK PLAYERS, VIDEOTAPE RECORDERS, DVD PLAYERS, DVD RECORDERS; PARTS AND ACCESSORIES FOR TELECOMMUNICATION MACHINES AND APPARATUS, NAMELY, ANTENNAS, AERIALS, CABINETS FOR TELECOMMUNICATION APPARATUS, MAGNETIC TAPE ERASERS, MAGNETIC TAPE CLEANERS, MAGNETIC HEAD ERASERS, MAGNETIC HEAD CLEANERS APPARATUS, LOUDSPEAKERS, CONNECTORS FOR TELECOMMUNICATION APPARATUS, BLANK MAGNETIC TAPES FOR TAPE RECORDERS, BLANK VIDEO TAPES, HEADPHONES, MICROPHONES; ELECTRONIC MACHINES APPARATUS AND THEIR PARTS, NAMELY, COMPUTERS AND COMPUTER PERIPHERAL DEVICES, THERMISTORS, CENTRAL PROCESSING UNITS, DIODES, TRANSISTORS, DISK DRIVES FOR COMPUTERS, WORD PROCESSORS, SHIELD CASES FOR MAGNETIC DISKS, INTEGRATED CIRCUITS, LARGE SCALE INTEGRATED CIRCUITS, ELECTROSTATIC COPYING MACHINES, ELECTRON TUBES, COMPUTER PROGRAMS FOR EDITING IMAGES, SOUND AND VIDEO, COMPUTER PROGRAMS FOR DOCUMENT MANAGEMENT, COMPUTER PROGRAMS FOR USING THE INTERNET AND THE WORLD WIDE WEB, ELECTRONIC DESK CALCULATORS; PHONOGRAPH RECORDS FEATURING MUSIC; ELECTRONIC CIRCUITS; PRE-RECORDED CDS, VIDEO TAPES, LASER DISKS AND DVDS FEATURING MUSIC AND IMAGES; DOWNLOADABLE RING TONES VIA THE INTERNET AND WIRELESS DEVICES; DOWNLOADABLE MUSIC VIA THE INTERNET AND WIRELESS DEVICES; DOWNLOADABLE ELECTRONIC GAMES VIA THE INTERNET AND WIRELESS DEVICES; EXPOSED CINEMATOGRAPHIC FILMS; EXPOSED SLIDE FILMS; SLIDE FILM MOUNTS; DOWNLOADABLE IMAGE FILES CON-



*David J. Kybas*

Director of the United States Patent and Trademark Office

**Reg. No. 4,196,580** TAINING ARTWORK; TEXT, AUDIO, VIDEO, GAMES, AND INTERNET WEB LINKS RELATING TO SPORTING AND CULTURAL ACTIVITIES; DOWNLOADABLE ELECTRONIC PUBLICATIONS IN THE NATURE OF BOOKS, MAGAZINES, AND NEWSPAPERS FEATURING NEWS, SHEET MUSIC, CARTOON STRIPS, GAMES, AND IMAGES, IN CLASS 9 (U.S. CLS. 21, 23, 26, 36 AND 38).

FOR: TELECOMMUNICATION SERVICES, NAMELY, MOBILE TELEPHONE COMMUNICATION, ELECTRONIC BULLETIN BOARD SERVICES, ELECTRONIC MAIL, COMMUNICATIONS BY COMPUTER TERMINALS, COMMUNICATIONS BY FIBER OPTIC NETWORKS, FACSIMILE TRANSMISSION; BROADCAST COMMUNICATION SERVICES, NAMELY, TELEVISION BROADCASTING, CABLE TELEVISION BROADCASTING, RADIO BROADCASTING; WIRE SERVICES, NAMELY, THE TRANSMISSION OF NEWS ITEMS TO NEWS REPORTING ORGANIZATIONS, IN CLASS 38 (U.S. CLS. 100, 101 AND 104).

THE MARK CONSISTS OF STANDARD CHARACTERS WITHOUT CLAIM TO ANY PARTICULAR FONT, STYLE, SIZE, OR COLOR.

OWNER OF JAPAN REG. NO. 5364914, DATED 10-29-2010, EXPIRES 10-29-2020.

SER. NO. 85-061,809, FILED 6-14-2010.

JOHN DWYER, EXAMINING ATTORNEY

# United States of America

United States Patent and Trademark Office

## SYSTEM PLAST

**Reg. No. 4,196,581**

SYSTEM PLAST S.R.L. (ITALY LIMITED LIABILITY COMPANY)  
VIA SAN ROCCO, N 29/31, 24060 TELGATE  
BERGAMO, ITALY

**Registered Aug. 28, 2012**

**Int. Cls.: 37, 40 and 42**

FOR: TECHNICAL SUPPORT SERVICES, NAMELY, TECHNICAL ADVICE RELATED TO THE INSTALLATION AND REPAIR OF BEARINGS, CONVEYOR AND DRIVE SYSTEMS , IN CLASS 37 (U.S. CLS. 100, 103 AND 106).

**SERVICE MARK**

FIRST USE 12-31-2005; IN COMMERCE 12-31-2005.

**PRINCIPAL REGISTER**

FOR: TECHNICAL SUPPORT SERVICES, NAMELY, TECHNICAL ADVICE RELATED TO THE MANUFACTURE OF PLASTICS, IN CLASS 40 (U.S. CLS. 100, 103 AND 106).

FIRST USE 12-31-2005; IN COMMERCE 12-31-2005.

FOR: TECHNICAL SUPPORT SERVICES, NAMELY, TECHNICAL ADVICE RELATED TO THE DESIGN OF BEARINGS, CONVEYOR AND DRIVE SYSTEMS, IN CLASS 42 (U.S. CLS. 100 AND 101).

FIRST USE 12-31-2005; IN COMMERCE 12-31-2005.

THE MARK CONSISTS OF STANDARD CHARACTERS WITHOUT CLAIM TO ANY PARTICULAR FONT, STYLE, SIZE, OR COLOR.

OWNER OF U.S. REG. NOS. 2,551,895, 2,569,207, AND 2,611,490.

NO CLAIM IS MADE TO THE EXCLUSIVE RIGHT TO USE "SYSTEM", APART FROM THE MARK AS SHOWN.

SER. NO. 85-063,607, FILED 6-15-2010.

JOHN SCHUYLER YARD, EXAMINING ATTORNEY



*David J. Kyros*

Director of the United States Patent and Trademark Office

# United States of America

United States Patent and Trademark Office



**Reg. No. 4,196,582**

ABRAHAM, THOMAS G. (UNITED STATES INDIVIDUAL)  
6600 SW 57TH AVENUE, SUITE 300  
MIAMI, FL 33143

**Registered Aug. 28, 2012**

**Int. Cls.: 40, 41 and 42**

FOR: ELECTRONIC ALTERATION AND RETOUCHING FOR OTHERS OF PHOTOGRAPHIC IMAGES, ARTWORK AND PAINTINGS, IN CLASS 40 (U.S. CLS. 100, 103 AND 106).

**SERVICE MARK**

FIRST USE 1-0-2009; IN COMMERCE 1-0-2009.

**PRINCIPAL REGISTER**

FOR: PHOTOGRAPHIC COMPUTER IMAGING; PHOTOGRAPHY SERVICES FOR OTHERS; PORTRAIT PHOTOGRAPHY SERVICES; THREE-DIMENSIONAL DIGITAL PHOTOGRAPHY SERVICES FOR OTHERS, IN CLASS 41 (U.S. CLS. 100, 101 AND 107).

FIRST USE 1-0-2009; IN COMMERCE 1-0-2009.

FOR: COMPUTER SERVICES, NAMELY, ELECTRONIC THREE-DIMENSIONAL IMAGING, SCANNING AND BODY SCANNING SERVICES FOR OTHERS; ELECTRONIC IMAGING, SCANNING, DIGITIZING FOR OTHERS OF PHOTOGRAPHIC IMAGES, ARTWORK AND PAINTINGS; DIGITAL IMAGING SERVICES, NAMELY, THREE-DIMENSIONAL DIGITAL IMAGING OF THE HUMAN BODY FOR OTHERS, IN CLASS 42 (U.S. CLS. 100 AND 101).

FIRST USE 1-0-2009; IN COMMERCE 1-0-2009.

OWNER OF U.S. REG. NO. 3,715,638.

THE MARK CONSISTS OF THE FOLLOWING: THE LETTER "I" OVERLAPPING THE WORD "AM".

SER. NO. 85-077,140, FILED 7-2-2010.

MARK RADEMACHER, EXAMINING ATTORNEY



*David J. Kybas*

Director of the United States Patent and Trademark Office

# United States of America

United States Patent and Trademark Office



**Reg. No. 4,196,583**

**Registered Aug. 28, 2012**

**Int. Cls.: 9, 36, 38, 41  
and 42**

**TRADEMARK**

**SERVICE MARK**

**PRINCIPAL REGISTER**

MINDARK PE AB (SWEDEN LIMITED LIABILITY COMPANY)  
JÄRNTORGET 8  
GÖTEBORG, SWEDEN SE-41304

FOR: ENTERTAINMENT COMPUTER SOFTWARE, NAMELY, COMPUTER GAME SOFTWARE AND VIDEO GAME SOFTWARE FOR USE IN CREATING, EDITING AND SHARING VIRTUAL WORLD CONTENT, AND COMPUTER SOFTWARE FOR VISUALIZATION OF AND INTERACTION WITH AN ONLINE VIRTUAL WORLD FEATURING COMMUNICATIONS AMONG COMPUTER USERS, CHAT ROOMS, ELECTRONIC BULLETIN BOARDS, COMPUTER GAMES, ROLE PLAYING GAMES, VIRTUAL ENVIRONMENTS, EDUCATIONAL ACTIVITIES, A VIRTUAL ECONOMY AND A VIRTUAL CURRENCY FOR TRANSACTION OF VIRTUAL COMMERCE, ELECTRONIC COMMERCE, AND DELIVERY OF AUDIO, VIDEO AND MULTIMEDIA CONTENT; COMPUTER GAME PROGRAMS; INTERACTIVE COMPUTER SOFTWARE THAT PROVIDES MULTI-USER ACCESS TO AN ONLINE THREE DIMENSIONAL ENVIRONMENT; GAMES, NAMELY, COMPUTER GAME PROGRAMS AND VIDEO GAME SOFTWARE; SOFTWARE TO ENABLE UPLOADING, POSTING AND PROVIDING ACCESS TO ELECTRONICALLY TRANSMITTED CONTENT OVER COMPUTER NETWORKS; COMPUTER GAME SOFTWARE THAT MAY BE DOWNLOADED FROM A GLOBAL COMPUTER NETWORK; COMPUTER SOFTWARE TO ENABLE ELECTRONIC BUSINESS TRANSACTIONS VIA GLOBAL COMPUTER NETWORKS; COMPUTER SOFTWARE ENABLING USERS TO ELECTRONICALLY TRANSMIT AND RECEIVE CONTENT AND INFORMATION TO AND FROM COMPUTERS, AND MOBILE PHONES; COMPUTER COMMUNICATIONS SOFTWARE FOR CONNECTING USERS OF GLOBAL NETWORKS, IN CLASS 9 (U.S. CLS. 21, 23, 26, 36 AND 38).

FOR: COMPUTERIZED FINANCIAL SERVICES, NAMELY, PROVIDING A VIRTUAL CURRENCY FOR USE BY MEMBERS OF AN ON-LINE COMMUNITY VIA A GLOBAL COMPUTER NETWORK, IN CLASS 36 (U.S. CLS. 100, 101 AND 102).

FOR: PROVIDING INTERNET CHATROOMS; COMPUTER AIDED TRANSMISSION OF MESSAGES AND IMAGES; ELECTRONIC BULLETIN BOARD SERVICES; DATA COMMUNICATION SERVICES VIA THE INTERNET, NAMELY, ELECTRONIC TRANSMISSION OF DATA AMONG USERS OF COMPUTERS; ELECTRONIC TRANSMISSION AND STREAMING OF DIGITAL MEDIA CONTENT FOR OTHERS; WEBCASTING SERVICES; TRANSMISSION OF MESSAGES OVER ELECTRONIC MEDIA; PROVIDING AN INTERNET WEBSITE PORTAL FOR PURPOSES OF TELECOMMUNICATIONS, DATA COMMUNICATIONS, AND INFORMATION ACCESS, NAMELY, TELECOMMUNICATION SYSTEMS ACCESS SER-



*David J. Kyjars*

Director of the United States Patent and Trademark Office

**Reg. No. 4,196,583** VICES; DELIVERY OF DIGITAL MUSIC BY ELECTRONIC TRANSMISSION, IN CLASS 38 (U.S. CLS. 100, 101 AND 104).

FOR: ENTERTAINMENT SERVICES, NAMELY, AN ONLINE INTERACTIVE THREE DIMENSIONAL VIRTUAL ENVIRONMENT, NAMELY, ON-LINE COMPUTER GAMES FOR MULTI-USERS ACCESS VIA A GLOBAL COMPUTER NETWORK; MULTI-PLAYER GAME SERVICES, NAMELY, ENTERTAINMENT SERVICES, NAMELY, PROVIDING AN ON-LINE COMPUTER GAME ELECTRONICALLY VIA A GLOBAL COMPUTER NETWORK; ORGANIZATION OF COMPETITIONS AND ON-LINE EVENTS, NAMELY, ENTERTAINMENT AND EDUCATIONAL SERVICES IN THE NATURE OF ON-LINE COMPETITIONS IN THE FIELDS OF ENTERTAINMENT, EDUCATION, CULTURE, SPORTS, AND OTHER NON-BUSINESS AND NON-COMMERCIAL FIELDS; ENTERTAINMENT INFORMATION SERVICE, NAMELY, PROVIDING INFORMATION ON-LINE RELATING TO COMPUTER GAMES IN RELATIONS TO ADMINISTRATING, MANAGING, TRACKING AND RECORDING TRANSACTIONS WITH VIRTUAL CURRENCIES AND VIRTUAL OBJECTS FOR USE BY PARTICIPANTS OF AN ONLINE VIRTUAL ENVIRONMENT; PROVIDING ON-LINE INFORMATION IN THE FIELD OF COMPUTER GAMING ENTERTAINMENT AND THEIR ENHANCEMENT; ENTERTAINMENT SERVICES, NAMELY, ADMINISTRATING, TRACKING AND RECORDING ELECTRONIC TRANSACTIONS WITH VIRTUAL OBJECTS; CONSULTING AND PROVIDING INFORMATION REGARDING ALL AFORESAID SERVICES, IN CLASS 41 (U.S. CLS. 100, 101 AND 107).

FOR: SOFTWARE DESIGN, DEVELOPMENT AND MAINTENANCE AND THE UPDATING OF MULTIMEDIA AND 3D VIRTUAL ENVIRONMENT SOFTWARE IN THE FIELD OF MULTIMEDIA ENTERTAINMENT PRODUCTION; GRAPHIC ARTS DESIGN, MAINLY FOR COMPUTER GAMES AND VIRTUAL ENVIRONMENTS; HOSTING WEBSITES, MAINLY WEBSITE FEATURING A WIDE VARIETY OF END-USER SERVICES AVAILABLE VIA MULTI-USER ONLINE 3D VIRTUAL ENVIRONMENTS; APPLICATION SERVICE PROVIDER (ASP) FEATURING SOFTWARE TO ENABLE USER PARTICIPATION IN A MULTI-USER ONLINE 3D VIRTUAL ENVIRONMENT; APPLICATION SERVICE PROVIDER (ASP) FEATURING SOFTWARE TO ENABLE UPLOADING, POSTING, DISPLAYING AND PROVIDING ACCESS TO ELECTRONIC MULTIMEDIA CONTENT OVER GLOBAL COMMUNICATION NETWORKS; RENTAL OF COMPUTER SOFTWARE, MAINLY SOFTWARE WHICH PROVIDES ACCESS TO A MULTI-USER ONLINE 3D VIRTUAL ENVIRONMENT; CONSULTING, TECHNICAL ADVICE AND PROVIDING INFORMATION REGARDING ALL AFORESAID SERVICES, IN CLASS 42 (U.S. CLS. 100 AND 101).

PRIORITY CLAIMED UNDER SEC. 44(D) ON ERPN CMNTY TM OFC APPLICATION NO. 009218603, FILED 7-2-2010, REG. NO. 009218603, DATED 2-3-2011, EXPIRES 9-20-2020.

THE MARK CONSISTS OF A MONOGRAM CONSISTING OF THE LETTERS "M" AND "A" IN CAPITAL LETTERS APPEARING WITHIN A ROUNDED TRIANGLE, AND THE STYLIZED WORDING "MINDARK" TO THE RIGHT OF THE MONOGRAM.

SER. NO. 85-077,717, FILED 7-3-2010.

JESSICA A. POWERS, EXAMINING ATTORNEY



# United States of America

United States Patent and Trademark Office

**B A Y A**  
t e c h n o l o g i e s

**Reg. No. 4,196,584**

**Registered Aug. 28, 2012**

**Int. Cls.: 9 and 42**

**TRADEMARK**

**SERVICE MARK**

**PRINCIPAL REGISTER**

BAYA TECHNOLOGIES LTD. (ISRAEL LIMITED LIABILITY COMPANY)  
6 YAD HARUTZIM ST.  
KFAR SABA, ISRAEL 44641

FOR: CONNECTORS FOR ELECTRONIC CIRCUITS; ELECTRIC AND ELECTRONIC CIRCUITS; ELECTRICAL AND ELECTRONIC CONNECTORS; ELECTRONIC CHIPS FOR THE MANUFACTURER OF INTEGRATED CIRCUITS; ELECTRONIC CIRCUIT BOARD; ELECTRONIC CIRCUIT CARDS; ELECTRONIC CIRCUITS; ELECTRONIC INTEGRATED CIRCUITS, IN CLASS 9 (U.S. CLS. 21, 23, 26, 36 AND 38).

FOR: DEVELOPMENT AND IMPLEMENTATION OF SOFTWARE, HARDWARE AND TECHNOLOGY SOLUTIONS FOR THE PURPOSE OF PRODUCTIZATION OF ELECTRONIC COMPONENTS AND ELECTRONIC SYSTEMS, IN CLASS 42 (U.S. CLS. 100 AND 101).

PRIORITY CLAIMED UNDER SEC. 44(D) ON ISRAEL APPLICATION NO. 230896, FILED 6-20-2010, REG. NO. 230896, DATED 6-16-2011, EXPIRES 6-20-2020.

THE COLOR(S) BLACK AND LIGHT BLUE IS/ARE CLAIMED AS A FEATURE OF THE MARK.

NO CLAIM IS MADE TO THE EXCLUSIVE RIGHT TO USE "TECHNOLOGIES", APART FROM THE MARK AS SHOWN.

THE MARK CONSISTS OF THE NAME "BAYA" IN BLACK CAPITAL LETTERS, THE WORD "TECHNOLOGIES" IN BLACK SMALL LETTERS UNDER IT AND A LIGHT BLUE DECORATIVE ARC BETWEEN THEM.

SER. NO. 85-077,866, FILED 7-5-2010.

MICHELE SWAIN, EXAMINING ATTORNEY



*David J. Kyros*

Director of the United States Patent and Trademark Office

# United States of America

United States Patent and Trademark Office

## IMAGINE EDUCATION

**Reg. No. 4,196,585**

**Registered Aug. 28, 2012**

**Int. Cl.: 42**

**SERVICE MARK**

**PRINCIPAL REGISTER**

IMAGINE EDUCATION (UTAH LIMITED LIABILITY COMPANY)  
831 WESTMINSTER AVENUE  
SALT LAKE CITY, UT 84105

FOR: SOFTWARE AS A SERVICE (SAAS) SERVICES, NAMELY, HOSTING SOFTWARE FOR USE BY OTHERS FOR USE IN EDUCATIONAL PURPOSES, NAMELY, PROVIDING ACADEMIC MATH INSTRUCTION AND TRAINING, IN CLASS 42 (U.S. CLS. 100 AND 101).

FIRST USE 1-3-2002; IN COMMERCE 7-1-2009.

THE MARK CONSISTS OF STANDARD CHARACTERS WITHOUT CLAIM TO ANY PARTICULAR FONT, STYLE, SIZE, OR COLOR.

NO CLAIM IS MADE TO THE EXCLUSIVE RIGHT TO USE "EDUCATION", APART FROM THE MARK AS SHOWN.

SER. NO. 85-086,379, FILED 7-16-2010.

LOURDES AYALA, EXAMINING ATTORNEY



*David J. Kyffers*

Director of the United States Patent and Trademark Office

# United States of America

United States Patent and Trademark Office



## CORVAL GROUP

**Reg. No. 4,196,586**

**Registered Aug. 28, 2012**

**Int. Cl.: 37**

**SERVICE MARK**

**PRINCIPAL REGISTER**

CORVAL GROUP, INC. (MINNESOTA CORPORATION)  
1633 EUSTIS ST.  
ST. PAUL, MN 55108

FOR: BUILDING CONSTRUCTION; BUILDING CONSTRUCTION AND REPAIR; BUILDING CONSTRUCTION INFORMATION; BUILDING CONSTRUCTION SERVICES; BUILDING CONSTRUCTION SUPERVISION; BUILDING CONSTRUCTION, REMODELING AND REPAIR; BUILDING INSPECTION DURING THE COURSE OF BUILDING CONSTRUCTION; CONSTRUCTION AND INSTALLATION OF MASONRY WALLS AND STRUCTURES; CONSTRUCTION AND RENOVATION OF BUILDINGS; CONSTRUCTION AND REPAIR OF BUILDINGS; CONSTRUCTION CONSULTANCY; CONSTRUCTION CONSULTATION; CONSTRUCTION MANAGEMENT; CONSTRUCTION OF BUILDINGS; CONSTRUCTION OF MEDICAL ESTABLISHMENTS; CONSTRUCTION PLANNING; CONSTRUCTION PROJECT MANAGEMENT SERVICES; CONSTRUCTION PROJECT MANAGEMENT SERVICES IN THE FIELD OF CONSTRUCTION OF RENEWABLE ENERGY AND ENERGY GENERATION EQUIPMENT SUPPORT STRUCTURES AND ANCILLARY STRUCTURES FOR SUPPORTING METEOROLOGICAL DATA GATHERING EQUIPMENT; CONSTRUCTION SERVICES, NAMELY, INSTALLATION OF ENVIRONMENTAL CONTAINMENT SYSTEMS; CONSTRUCTION SERVICES, NAMELY, PLANNING, LAYING OUT AND CONSTRUCTION OF A PLANNED RESIDENTIAL COMMUNITY; CONSTRUCTION SERVICES, NAMELY, PLANNING, LAYING OUT AND CUSTOM CONSTRUCTION OF COMMERCIAL BUILDINGS; CONSTRUCTION SERVICES, NAMELY, PLANNING, LAYING OUT AND CUSTOM CONSTRUCTION OF RESIDENTIAL AND COMMERCIAL COMMUNITIES; CONSTRUCTION SUPERVISION; CONSULTATION IN BUILDING CONSTRUCTION SUPERVISION; CONSULTATION SERVICES IN THE FIELD OF CONSTRUCTION OF ENVIRONMENTALLY-CONSCIOUS BUILDINGS; CONSULTING IN THE FIELD OF BUILDING CONSTRUCTION; CONSULTING IN THE FIELD OF HOSPITAL CONSTRUCTION; CONSULTING SERVICES FOR THE CONSTRUCTION AND INSTALLATION OF MASONRY WALLS AND STRUCTURES; CONSULTING SERVICES FOR THE CONSTRUCTION OF WATER TREATMENT AND PURIFICATION PLANTS, SOLID WASTE TREATMENT PLANTS AND OTHER MUNICIPAL INFRASTRUCTURE FACILITIES; CONSULTING SERVICES IN THE FIELD OF CONSTRUCTION OF WIND ENERGY FACILITIES; GENERAL CONSTRUCTION CONTRACTING; HOUSING SERVICES, NAMELY, DEVELOPMENT OF REAL PROPERTY, NAMELY, REPAIR, IMPROVEMENT, AND NEW CONSTRUCTION; HOUSING SERVICES, NAMELY, REPAIR, IMPROVEMENT, AND CONSTRUCTION OF RESIDENTIAL REAL PROPERTY; HYDRO-ELECTRIC FACTORY CONSTRUCTION; PLANT CONSTRUCTION, MAINTENANCE AND CONSTRUCTION PROJECT MANAGEMENT SERVICES FOR BUSINESSES IN THE



*David J. Kyros*

Director of the United States Patent and Trademark Office

**Reg. No. 4,196,586** ENERGY PRODUCTION AND TRANSMISSION SECTOR; REAL ESTATE DEVELOPMENT AND CONSTRUCTION OF COMMERCIAL, RESIDENTIAL AND HOTEL PROPERTY; RESIDENTIAL AND BUILDING CONSTRUCTION CONSULTING; RESIDENTIAL AND COMMERCIAL BUILDING CONSTRUCTION; SCAFFOLDING, EARTHWORKS OR CONCRETE CONSTRUCTION; SELF-PERFORM CONSTRUCTION SKILLED TRADES, NAMELY, CONCRETE WORK, CARPENTRY AND SELECTIVE DEMOLITION SERVICES; STEEL STRUCTURE CONSTRUCTION WORKS; TECHNICAL CONSULTATION IN THE FIELD OF BUILDING CONSTRUCTION, IN CLASS 37 (U.S. CLS. 100, 103 AND 106).

FIRST USE 10-1-2009; IN COMMERCE 10-1-2009.

NO CLAIM IS MADE TO THE EXCLUSIVE RIGHT TO USE "GROUP", APART FROM THE MARK AS SHOWN.

THE COLOR(S) WHITE, NAVY, GREY, AND LIGHT BLUE IS/ARE CLAIMED AS A FEATURE OF THE MARK.

THE MARK CONSISTS OF NAVY, LIGHT BLUE, WHITE AND GREY BARS INTEGRATED IN THE SHAPE OF A CIRCLE, FOLLOWED BY THE WORD "CORVAL" IN ALL CAPS AND SLIGHTLY ITALICIZED IN NAVY, FOLLOWED BY THE WORD "GROUP" IN ALL CAPS AND SLIGHTLY ITALICIZED IN LIGHT BLUE.

SER. NO. 85-086,410, FILED 7-16-2010.

LAURIE MAYES, EXAMINING ATTORNEY

# United States of America

United States Patent and Trademark Office

## THE FUTURE OF SMOKING

**Reg. No. 4,196,587**

LJRD, LLC (CALIFORNIA LIMITED LIABILITY COMPANY)  
7270 FRANKLIN AVE #409  
LOS ANGELES, CA 90046

**Registered Aug. 28, 2012**

**Int. Cls.: 9 and 34**

FOR: BATTERIES FOR ELECTRONIC CIGARETTES AND CIGARS; BATTERY CHARGERS FOR ELECTRONIC CIGARETTES AND CIGARS, IN CLASS 9 (U.S. CLS. 21, 23, 26, 36 AND 38).

**TRADEMARK**

FIRST USE 4-27-2010; IN COMMERCE 4-27-2010.

**PRINCIPAL REGISTER**

FOR: ELECTRONIC CIGARETTES; ELECTRONIC CIGARS; BATTERIES FOR ELECTRONIC CIGARETTES AND CIGARS SOLD AS A UNIT WITH ELECTRONIC CIGARETTES AND CIGARS; REFILL CARTRIDGES FOR ELECTRONIC CIGARETTES AND CIGARS; PARTS FOR ELECTRONIC CIGARETTES AND CIGARS, NAMELY, VAPORIZERS; BATTERY CHARGERS FOR ELECTRONIC CIGARETTES AND CIGARS SOLD AS A UNIT WITH ELECTRONIC CIGARETTES AND CIGARS; CASES FOR ELECTRONIC CIGARETTES AND CIGARS, IN CLASS 34 (U.S. CLS. 2, 8, 9 AND 17).

FIRST USE 4-27-2010; IN COMMERCE 4-27-2010.

THE MARK CONSISTS OF STANDARD CHARACTERS WITHOUT CLAIM TO ANY PARTICULAR FONT, STYLE, SIZE, OR COLOR.

NO CLAIM IS MADE TO THE EXCLUSIVE RIGHT TO USE "SMOKING", APART FROM THE MARK AS SHOWN.

SER. NO. 85-093,462, FILED 7-27-2010.

KRISTINA MORRIS, EXAMINING ATTORNEY



*David J. Kyffers*

Director of the United States Patent and Trademark Office

# United States of America

United States Patent and Trademark Office

## GECKOS GONE WILD

**Reg. No. 4,196,588**

CADILLAC JACK, INC. (GEORGIA CORPORATION)  
2450 SATELLITE BOULEVARD  
DULUTH, GA 30096

**Registered Aug. 28, 2012**

**Int. Cl.: 9**

FOR: SLOT MACHINES, BINGO MACHINES, WITH OR WITHOUT VIDEO OUTPUT, IN CLASS 9 (U.S. CLS. 21, 23, 26, 36 AND 38).

**TRADEMARK**

FIRST USE 10-31-2008; IN COMMERCE 10-31-2008.

**PRINCIPAL REGISTER**

THE MARK CONSISTS OF STANDARD CHARACTERS WITHOUT CLAIM TO ANY PARTICULAR FONT, STYLE, SIZE, OR COLOR.

SER. NO. 85-095,337, FILED 7-28-2010.

MARK SPARACINO, EXAMINING ATTORNEY



*David J. Kybas*

Director of the United States Patent and Trademark Office

# United States of America

United States Patent and Trademark Office

# AVIPLUS

**Reg. No. 4,196,589**

VETAGRO S.P.A. (ITALY JOINT STOCK COMPANY)

**Registered Aug. 28, 2012**

VIA PORRO, 2  
42124 REGGIO EMILIA, ITALY

**Int. Cls.: 5 and 31**

FOR: NON-MEDICATED ADDITIVES FOR ANIMAL FEED FOR USE AS NUTRITIONAL SUPPLEMENTS, NAMELY, IRON, SODIUM, POTASSIUM, CALCIUM, MAGNESIUM AND SELENIUM WITH PROTEINS , IN CLASS 5 (U.S. CLS. 6, 18, 44, 46, 51 AND 52).

**TRADEMARK**

FOR: ANIMAL FOODSTUFFS AND ADDITIVES FOR FOODSTUFFS FOR ANIMALS, NOT FOR MEDICAL USE; SUPPLEMENTARY ANIMAL FEEDS; LIVESTOCK FEED; CATTLE FEED; SWINE FEED; POULTRY FEED; NON-MEDICATED ADDITIVES FOR ANIMAL FOODS; ANIMAL FOODSTUFFS AND FEED ADDITIVES, NOT FOR MEDICAL USE; ADDITIVES FOR ANIMAL FEEDS, NOT FOR MEDICAL USE; HAY; FODDER; MICROCAPSULED ANIMAL FOODSTUFFS AND MICROCAPSULED ADDITIVES FOR FOODSTUFFS FOR ANIMALS, NOT FOR MEDICAL USE , IN CLASS 31 (U.S. CLS. 1 AND 46).

**PRINCIPAL REGISTER**

THE MARK CONSISTS OF STANDARD CHARACTERS WITHOUT CLAIM TO ANY PARTICULAR FONT, STYLE, SIZE, OR COLOR.

OWNER OF ERPN CMNTY TM OFC REG. NO. 005829461, DATED 10-19-2009, EXPIRES 4-13-2017.

SER. NO. 85-102,016, FILED 8-6-2010.

MICHELE SWAIN, EXAMINING ATTORNEY



*David J. Kybas*

Director of the United States Patent and Trademark Office

# United States of America

United States Patent and Trademark Office

# PORTAL

**Reg. No. 4,196,590**

VALVE CORPORATION (WASHINGTON CORPORATION)  
10500 NE 8TH ST STE 1000  
BELLEVUE, WA 980044359

**Registered Aug. 28, 2012**

**Int. Cl.: 9**

FOR: COMPUTER GAME SOFTWARE; ELECTRONIC GAME SOFTWARE; VIDEO GAME SOFTWARE, IN CLASS 9 (U.S. CLS. 21, 23, 26, 36 AND 38).

**TRADEMARK**

FIRST USE 10-31-2007; IN COMMERCE 10-31-2007.

**PRINCIPAL REGISTER**

THE MARK CONSISTS OF STANDARD CHARACTERS WITHOUT CLAIM TO ANY PARTICULAR FONT, STYLE, SIZE, OR COLOR.

SER. NO. 85-102,271, FILED 8-6-2010.

MICHAEL SOUDERS, EXAMINING ATTORNEY



*David J. Kyffers*

Director of the United States Patent and Trademark Office



# United States of America

United States Patent and Trademark Office

## STAR IN THE HOOD

**Reg. No. 4,196,591**

**Registered Aug. 28, 2012**

**Int. Cls.: 9, 25, 35 and 41**

**TRADEMARK**

**SERVICE MARK**

**PRINCIPAL REGISTER**

UNIVERSAL INTERNATIONAL MUSIC B.V. (NETHERLANDS LIMITED LIABILITY COMPANY)  
GERRIT VAN DER VEENLAAN 4  
BAARN, NETHERLANDS 3743DN

FOR: APPARATUS FOR RECORDING, TRANSMISSION OR REPRODUCTION OF SOUND OR IMAGES; SOUND RECORDED MAGNETIC DATA CARRIERS FEATURING MUSIC AND ENTERTAINMENT; PRERECORDED DIGITAL DISCS FEATURING MUSIC AND ENTERTAINMENT; DOWNLOADABLE MP3 RECORDINGS FEATURING MUSIC; AUTOMATIC VENDING MACHINES AND MECHANISMS FOR COIN OPERATED APPARATUS; CASH REGISTERS; CALCULATING MACHINES, DATA PROCESSING EQUIPMENT AND COMPUTERS; PRE-RECORDED ELECTRONIC MEDIA FEATURING MUSIC AND MUSIC-RELATED ENTERTAINMENT; COMPUTER HARDWARE; COMPUTER SOFTWARE FOR PROCESSING DIGITAL MUSIC FILES AND CREATING AND EDITING MUSIC; SOFTWARE DOWNLOADABLE FROM THE INTERNET FOR PROCESSING DIGITAL MUSIC FILES AND CREATING AND EDITING MUSIC; DOWNLOADABLE ELECTRONIC PUBLICATIONS IN THE NATURE OF BOOKS MAGAZINES AND NEWSLETTERS FEATURING MUSIC AND MUSIC-RELATED ENTERTAINMENT; COMPACT DISCS FEATURING MUSIC; DIGITAL MUSIC DOWNLOADABLE FROM THE INTERNET; COMPUTER GAMES EQUIPMENT ADAPTED FOR USE WITH AN EXTERNAL DISPLAY SCREEN OR MONITOR; COMPUTER MOUSE MATS; MOBILE PHONE ACCESSORIES, NAMELY, CASES, HANDS-FREE DEVICES, HEADSETS, STRAPS AND SKINS; SPECTACLES AND SUNGLASSES; PRE-RECORDED AUDIO TAPES, DISCS AND CASSETTES, VIDEO TAPES, DISCS AND CASSETTES, DIGITAL AUDIO AND AUDIO VIDEO TAPES AND DISCS, CDS, DVDS, LASER DISCS, AND PHONOGRAPH RECORDS FEATURING MUSIC AND ENTERTAINMENT; THEATRICAL AND MUSICAL SOUND AND VIDEO RECORDINGS; VIRTUAL REALITY GAME SOFTWARE; DOWNLOADABLE RING TONES, MUSIC, MP3 FILES, GRAPHICS, GAMES, IMAGES AND VIDEOS FOR WIRELESS COMMUNICATION DEVICES; DOWNLOADABLE MUSIC, MP3 FILES, GRAPHICS, COMPUTER GAMES, IMAGES AND VIDEOS VIA THE INTERNET AND WIRELESS DEVICES; COMPUTER GAME SOFTWARE, TAPES, CARTRIDGES AND CASSETTES; VIDEO GAME SOFTWARE, TAPES, CARTRIDGES AND CASSETTES; CELL PHONES AND CELL PHONE ACCESSORIES, NAMELY, CASTS, HANDS-FREE DEVICES, HEADSETS, STRAPS AND SKINS; MOUSE PADS; VIDEO GAME CARTRIDGES, IN CLASS 9 (U.S. CLS. 21, 23, 26, 36 AND 38).



*David J. Kappas*

Director of the United States Patent and Trademark Office

FOR: HEADWEAR; BANDANAS; BATHING SUITS; BELTS; BLOUSES; BODY SUITS; FOOTWEAR; SHOES; UNDERWEAR; UNDERGARMENTS; TIES, BUSTIERS; COATS;

**Reg. No. 4,196,591** DRESSES; VESTS; GLOVES; GOWNS; HATS; CAPS; HOSIERY; JACKETS; LINGERIE; PAJAMAS; PANTS; ROBES; SCARVES; SHORTS; SHIRTS; VISORS; SKIRTS; HALLOWEEN COSTUMES; SUSPENDERS; EAR MUFFS; SWEAT SHIRTS; SWEAT PANTS; SWEAT JACKETS; SWEATERS; T-SHIRTS; TANK TOPS; SOCKS; TOPS; WRIST BANDS; AND CHILDRENS' CLOTHING, NAMELY, INFANTWEAR, HEADWEAR, FOOTWEAR, JACKETS, SWEATERS, COATS, SKIRTS, SHIRTS, T-SHIRTS, TANK TOPS, BLOUSES, DRESSES, SHORTS, PANTS, BATHROBES, CLOTH BIBS, BOOTIES, COVERALLS, CREEPERS, EAR MUFFS, HOSIERY, TIGHTS, JUMPERS, LEGGINGS, HATS, MITTENS, NIGHT GOWNS, OVERALLS, PAJAMAS, ROMPERS, SHAWLS, SHOES, SOCKS, SWIM WEAR, UNDERGARMENTS, SWEAT PANTS AND SWEAT SHIRTS, IN CLASS 25 (U.S. CLS. 22 AND 39).

FOR: PREPARING AUDIO-VISUAL DISPLAYS IN THE FIELD OF MUSIC; ADVERTISING AND PROMOTION SERVICES AND RELATED CONSULTING SERVICES; ADVERTISING AND PUBLICITY SERVICES; ASSOCIATION SERVICES, NAMELY, PROMOTING THE INTERESTS OF MUSICIANS, SINGERS, SONGWRITERS, MUSICAL PERFORMERS AND ARTISTS; COMPUTERIZED ON-LINE ORDERING FEATURING GENERAL MERCHANDISE AND GENERAL CONSUMER GOODS; COMPUTERIZED ON-LINE ORDERING SERVICES IN THE FIELD OF MUSIC; COMPUTERIZED ONLINE RETAIL STORE SERVICES FEATURING CD'S, CASSETTES, DVD'S, CLOTHING AND RELATED PROMOTIONAL MERCHANDISE; COMPUTERIZED ON-LINE GIFT ORDERING SERVICES WHICH MATCHES THE GIFT GIVER'S REQUIREMENTS WITH THE GIFT RECIPIENTS WANTS AND NEEDS; CONDUCTING AN ON-LINE TRADESHOW EXHIBITION, IN THE FIELD OF MUSIC, MUSICAL CONCERTS AND VIDEOS; MAIL ORDER CATALOG SERVICES FEATURING CD'S, CASSETTES, DVD'S, CLOTHING, AND RELATED PROMOTIONAL MERCHANDISE; ON-LINE RETAIL STORE SERVICES FEATURING DOWNLOADABLE PRE-RECORDED MUSIC AND AUDIO-VISUAL CONTENT, CLOTHING, AND RELATED PROMOTIONAL MERCHANDISE; ORGANIZATION OF PROMOTIONS USING AUDIO-VISUAL MEDIA; PREPARING AUDIO VISUAL PRESENTATIONS FOR USE IN ADVERTISING; ARRANGING AND CONDUCTING TRADE SHOW EXHIBITIONS IN THE FIELD OF MUSIC AND ENTERTAINMENT; ARRANGING AND CONDUCTING FAIRS AND EXHIBITIONS FOR BUSINESS AND ADVERTISING PURPOSES; PROMOTING AND CONDUCTING TRADE SHOWS IN THE FIELD OF MUSIC; PROMOTING THE CONCERTS OF OTHERS; PROMOTING THE GOODS AND SERVICES OF OTHERS BY ARRANGING FOR SPONSORS TO AFFILIATE THEIR GOODS AND SERVICES WITH CONCERTS AND MUSICAL EVENTS; PROMOTING THE GOODS OF OTHERS BY PREPARING AND PLACING ADVERTISEMENTS IN AN ELECTRONIC MAGAZINE ACCESSED THROUGH A GLOBAL COMPUTER NETWORK; PROVIDING BUSINESS INFORMATION ABOUT THE GOODS AND SERVICES OF OTHERS IN THE FIELDS OF MUSIC AND ENTERTAINMENT VIA A GLOBAL COMPUTER NETWORK; RETAIL STORE SERVICES AVAILABLE THROUGH COMPUTER COMMUNICATIONS AND INTERACTIVE TELEVISION FEATURING CD'S, CASSETTES, DVD'S, VIDEOCASSETTES AND RELATED PROMOTIONAL MERCHANDISE; AND SUBSCRIPTIONS TO BOOKS, REVIEWS, NEWSPAPERS OR COMIC BOOKS, IN CLASS 35 (U.S. CLS. 100, 101 AND 102).

FOR: PROVIDING OF TRAINING SERVICES IN THE FIELD OF MUSIC AND MUSIC-RELATED ENTERTAINMENT; ORGANIZING EXHIBITIONS FOR SPORTING AND CULTURAL PURPOSES; PRODUCTION OF TELEVISION AND RADIO PROGRAMS; DISTRIBUTION OF TELEVISION AND RADIO PROGRAMS FOR OTHERS; PRODUCTION AND PUBLISHING OF MUSIC; PROVIDING ONLINE ENTERTAINMENT, NAMELY, PROVIDING NON-DOWNLOADABLE SOUND AND VIDEO RECORDINGS IN THE FIELD OF MUSIC AND MUSIC BASED ENTERTAINMENT; ENTERTAINMENT SERVICES, NAMELY, PROVIDING ONLINE NON-DOWNLOADABLE PRERECORDED MUSICAL SOUND AND VIDEO RECORDINGS VIA A GLOBAL COMPUTER NETWORK; FAN CLUBS; DEVELOPMENT AND DISSEMINATION OF EDUCATIONAL MATERIALS OF OTHERS IN THE FIELD OF MUSIC AND MUSIC-RELATED ENTERTAINMENT; RADIO ENTERTAINMENT PRODUCTION AND DISTRIBUTION OF RADIO PROGRAMS; AUDIO AND SOUND RECORDING AND PRODUCTION; RECORD PRODUCTION; VIDEOTAPE PRODUCTION; PRODUCTION OF MOTION PICTURE FILMS; DISTRIBUTION OF MOTION PICTURE FILMS; TELEVISION PROGRAM SYNDICATION; ENTERTAINMENT IN THE NATURE OF ONGOING TELEVI-

**Reg. No. 4,196,591** SION PROGRAMS IN THE FIELD OF MUSIC AND MUSIC-RELATED ENTERTAINMENT; ENTERTAINMENT, NAMELY, A CONTINUING MUSIC AND ENTERTAINMENT SHOW DISTRIBUTED OVER TELEVISION, SATELLITE, AUDIO, AND VIDEO MEDIA; PUBLICATION OF BOOKS AND MAGAZINES; ENTERTAINMENT IN THE NATURE OF ONGOING RADIO PROGRAMS IN THE FIELD OF MUSIC AND MUSIC-RELATED ENTERTAINMENT; ENTERTAINMENT IN THE NATURE OF LIVE CONCERTS AND PERFORMANCES BY MUSICAL ARTISTS AND GROUPS; ENTERTAINMENT SERVICES, NAMELY, PERSONAL APPEARANCES BY MUSICAL GROUPS, MUSICAL ARTISTS AND CELEBRITIES; ENTERTAINMENT SERVICES IN THE NATURE OF LIVE PERFORMANCES RENDERED BY MUSICAL ARTISTS THROUGH THE MEDIUM OF TELEVISION, RADIO, AND AUDIO AND VIDEO RECORDINGS; ENTERTAINMENT SERVICES, NAMELY, RECORDED PERFORMANCES BY MUSICAL ARTISTS RENDERED LIVE AND RECORDED FOR FUTURE DISTRIBUTION; EDUCATIONAL AND ENTERTAINMENT SERVICES, NAMELY, PRODUCTION AND DISTRIBUTION OF TELEVISION SHOWS, SPORTS EVENTS, FASHION SHOWS, GAME SHOWS, MUSIC SHOWS, AWARD SHOWS AND COMEDY SHOWS BEFORE LIVE AUDIENCES WHICH ARE ALL BROADCAST LIVE OR TAPED FOR LATER BROADCAST; ENTERTAINMENT SERVICES, NAMELY, PROVIDING A WEB SITE FEATURING NON-DOWNLOADABLE MUSICAL PERFORMANCES, MUSICAL VIDEOS, RELATED FILM CLIPS, AND MULTIMEDIA MATERIALS FEATURING MUSIC AND MUSIC-RELATED ENTERTAINMENT AND PHOTOGRAPHS; ENTERTAINMENT SERVICES, NAMELY, PROVIDING ON-LINE REVIEWS OF MUSIC, MUSICAL ARTISTS AND MUSIC VIDEOS; ENTERTAINMENT SERVICES, NAMELY, PROVIDING NON-DOWNLOADABLE PRERECORDED MUSIC, INFORMATION IN THE FIELD OF MUSIC, AND COMMENTARY AND ARTICLES ABOUT MUSIC, ALL ON-LINE VIA A GLOBAL COMPUTER NETWORK; ENTERTAINMENT SERVICES, NAMELY, LIVE, TELEVISED AND MOVIE APPEARANCES BY A PROFESSIONAL ENTERTAINER; CONDUCTING ENTERTAINMENT EXHIBITIONS IN THE NATURE OF MUSIC FESTIVALS; ENTERTAINMENT SERVICES, NAMELY, CONDUCTING EXHIBITIONS IN THE FIELD OF MUSIC AND THE ARTS; ORGANIZING EXHIBITIONS FOR ENTERTAINMENT PURPOSES FEATURING MUSIC AND THE ARTS; AND PUBLISHING OF WEB MAGAZINES; DISTRIBUTION OF MUSIC RECORDINGS; DISTRIBUTION OF MUSICAL SOUND RECORDINGS AND VIDEO RECORDINGS, IN CLASS 41 (U.S. CLS. 100, 101 AND 107).

THE MARK CONSISTS OF STANDARD CHARACTERS WITHOUT CLAIM TO ANY PARTICULAR FONT, STYLE, SIZE, OR COLOR.

OWNER OF ERPN CMNTY TM OFC REG. NO. 008218935, DATED 6-28-2010, EXPIRES 4-15-2019.

SER. NO. 85-105,167, FILED 8-11-2010.

KATHLEEN LORENZO, EXAMINING ATTORNEY

# United States of America

United States Patent and Trademark Office



**Reg. No. 4,196,592**

**Registered Aug. 28, 2012**

**Int. Cl.: 24**

**TRADEMARK**

**PRINCIPAL REGISTER**

WIGLESWORTH, LEE S (SOUTH CAROLINA LIMITED LIABILITY COMPANY), DBA BEST WINDOW TREATMENTS  
266 CROOKED OAK DRIVE  
PAWLEYS ISLAND, SC 29585

FOR: DRAPERIES; DRAPERY; FABRIC WINDOW COVERINGS AND TREATMENTS, NAMELY, CURTAINS, DRAPERIES, SHEERS, SWAGS AND VALANCES, IN CLASS 24 (U.S. CLS. 42 AND 50).

FIRST USE 11-15-2006; IN COMMERCE 11-15-2006.

NO CLAIM IS MADE TO THE EXCLUSIVE RIGHT TO USE "BEST WINDOW TREATMENTS", APART FROM THE MARK AS SHOWN.

THE COLOR(S) BLUE AND GREEN IS/ARE CLAIMED AS A FEATURE OF THE MARK.

THE MARK CONSISTS OF THE LETTERS "BWT" IN THE COLOR BLUE ATOP A CURTAIN PANEL IN BLUE AND GREEN AND THE NAME "BEST WINDOW TREATMENTS" TO THE RIGHT OF THE CURTAIN PANEL WITH THE FIRST LETTER OF EACH WORD IN BLUE AND THE REMAINING LETTERS IN GREEN.

SER. NO. 85-116,468, FILED 8-26-2010.

MIDGE BUTLER, EXAMINING ATTORNEY



*David J. Kybas*

Director of the United States Patent and Trademark Office

# United States of America

United States Patent and Trademark Office

# GOOD WOOD NYC

**Reg. No. 4,196,593**

GOOD WOOD NYC LLC (NEW YORK LIMITED LIABILITY COMPANY)  
109 INGRAHAM STREET, SUITE 302  
BROOKLYN, NY 11237

**Registered Aug. 28, 2012**

**Int. Cl.: 14**

FOR: JEWELRY; WOODEN JEWELRY, NAMELY, PENDANTS, NECKLACES, RINGS, MULTI-FINGER RINGS, AND EARRINGS, IN CLASS 14 (U.S. CLS. 2, 27, 28 AND 50).

**TRADEMARK**

FIRST USE 6-1-2007; IN COMMERCE 1-0-2008.

**PRINCIPAL REGISTER**

THE MARK CONSISTS OF STANDARD CHARACTERS WITHOUT CLAIM TO ANY PARTICULAR FONT, STYLE, SIZE, OR COLOR.

NO CLAIM IS MADE TO THE EXCLUSIVE RIGHT TO USE "WOOD NYC", APART FROM THE MARK AS SHOWN.

SER. NO. 85-119,178, FILED 8-30-2010.

GRETCHEN ULRICH, EXAMINING ATTORNEY



*David J. Kyffers*

Director of the United States Patent and Trademark Office

# United States of America

United States Patent and Trademark Office



**Reg. No. 4,196,594**

**Registered Aug. 28, 2012**

**Int. Cls.: 1 and 9**

**TRADEMARK**

**PRINCIPAL REGISTER**

HANWHA CORPORATION (REPUBLIC OF KOREA CORPORATION)  
#1 JANGGYO-DONG, JUNG-GU  
SEOUL, REPUBLIC OF KOREA

FOR: POLYSILICONES; METALSILICONES; SILANES; POLYSILICONES AND SILANES USED IN MANUFACTURING SEMICONDUCTORS AND SOLAR CELLS; POLYCRYSTALLINE SILICON AND MONO-CRYSTALLINE SILICON FOR USE IN MANUFACTURING PHOTOVOLTAIC/SOLAR MODULES, PHOTOVOLTAIC/SOLAR WAFERS, AND PHOTOVOLTAIC/SOLAR CELLS; SILICON INGOTS USED IN MANUFACTURING SOLAR CELLS, IN CLASS 1 (U.S. CLS. 1, 5, 6, 10, 26 AND 46).

FOR: CRYSTALLINE SILICON SOLAR CELL MODULES FOR PRODUCTION OF ELECTRICITY; PHOTO VOLTAIC CELLS IN THE NATURE OF CRYSTALLINE CELLS; PHOTOVOLTAIC SOLAR MODULES; THIN-FILM SOLAR CELLS; THIN FILM TARGETS, NAMELY, SPUTTERING TARGETS USED TO MAKE CADMIUM TELLURIDE AND COPPER INDIUM GALLIUM SELENIUM THIN FILM SOLAR CELLS AND MODULES IN A TECHNIQUE KNOWN AS SPUTTERING DEPOSITIONS OR THIN FILM DEPOSITIONS, AND SOLD AS INTEGRAL COMPONENTS OF SOLAR CELLS AND SOLAR CELL MODULES FOR USE IN THE PRODUCTION OF ELECTRICITY; BATTERY SYSTEMS FOR USE IN CONNECTION WITH RENEWABLE ENERGY SYSTEMS, NAMELY, SOLAR PHOTOVOLTAIC MODULES; ELECTRICAL CONNECTORS FOR RENEWABLE ENERGY SYSTEMS; ANODES; CATHODES; ELECTRICAL CONNECTORS FOR SOLAR PHOTOVOLTAIC MODULES; SUNLIGHT STORAGE BATTERIES; SOLAR PANELS FOR THE PRODUCTION OF ELECTRICITY; CHARGING DEVICE FOR USE IN CONNECTION WITH SOLAR PHOTOVOLTAIC SYSTEMS; SOLAR PHOTOVOLTAIC INSTALLATION APPARATUS, NAMELY, SOLAR MODULES FOR PRODUCTION OF ELECTRICITY, SOLAR PHOTOVOLTAIC MODULES; SOLAR PHOTOVOLTAIC INVERTERS; SOLAR PHOTOVOLTAIC CONVERTERS; SOLAR PHOTOVOLTAIC ARRAYS; SOLAR PHOTOVOLTAIC WAFERS; SOLAR CELLS; SOLAR INVERTERS TO CONVERT SOLAR ENERGY TO ELECTRICITY; SOLAR CELL ARRAYS; CAPACITORS FOR SOLAR CELLS; SOLAR CELL MODULES FOR PRODUCTION OF ELECTRICITY; WAFERS FOR SOLAR CELLS, IN CLASS 9 (U.S. CLS. 21, 23, 26, 36 AND 38).



*David J. Kappas*

Director of the United States Patent and Trademark Office

OWNER OF REPUBLIC OF KOREA REG. NO. 0718510, DATED 6-28-2007, EXPIRES 6-28-2017.

THE COLOR(S) ORANGE AND BLACK IS/ARE CLAIMED AS A FEATURE OF THE MARK.

**Reg. No. 4,196,594** OWNER OF U.S. REG. NOS. 3,539,318, 3,684,396 AND OTHERS.

THE MARK CONSISTS OF THE STYLIZED WORD "HANWHA" IN BLACK, WITH THREE OVERLAPPING CIRCLES IN VARIOUS SHADES OF ORANGE.

THE WORD(S) "HANWHA" HAS NO MEANING IN A FOREIGN LANGUAGE.

SER. NO. 85-121,871, FILED 9-2-2010.

LINDA ESTRADA, EXAMINING ATTORNEY

# United States of America

United States Patent and Trademark Office

# inspower

**Reg. No. 4,196,595**

**Registered Aug. 28, 2012**

**Int. Cl.: 35**

**SERVICE MARK**

**PRINCIPAL REGISTER**

ADHIA, NIKHILKUMAR VIPIN (UNITED KINGDOM INDIVIDUAL)  
83 CLAYHALL AVENUE, CLAYHALL  
ILFORD, UNITED KINGDOM IG50PN

FOR: CHARITABLE SERVICES, NAMELY, PROVIDING ADMINISTRATION AND MANAGEMENT OF CARE FACILITIES, HOUSING FACILITIES, AND NURSING HOME FACILITIES FOR OTHERS, NAMELY, THE ELDERLY, CHILDREN IN NEED, AND ADULTS WITH DISABILITIES; CHARITABLE SERVICES, NAMELY, COORDINATION OF THE PROCUREMENT AND DISTRIBUTION OF FOOD DONATIONS FROM MANUFACTURERS, WHOLESALERS, RETAILERS, AND GOVERNMENT AGENCIES TO ORGANIZATIONS PROVIDING FREE FOOD TO NEEDY PEOPLE; CHARITABLE SERVICES, NAMELY, COORDINATION OF THE PROCUREMENT AND DISTRIBUTION OF GIFT-IN-KIND PRODUCT DONATIONS FROM MANUFACTURERS, WHOLESALERS, RETAILERS, AND GOVERNMENT AGENCIES TO ORGANIZATIONS PROVIDING FREE PRODUCTS TO NEEDY PEOPLE; CHARITABLE SERVICES, NAMELY, COORDINATION OF THE PROCUREMENT AND DISTRIBUTION OF HOLIDAY GIFT DONATIONS FROM THE GENERAL PUBLIC TO ORPHANED CHILDREN; CHARITABLE SERVICES, NAMELY, EMPLOYMENT COUNSELING SERVICES FOR THOSE LIVING IN POVERTY IN THE AREAS OF PREPARING FOR, OBTAINING, MAINTAINING AND ADVANCING IN EMPLOYMENT OPPORTUNITIES; CHARITABLE SERVICES, NAMELY, ORGANIZING AND CONDUCTING A VOLUNTEER OUTREACH PROGRAM PROVIDING FRESH FLOWERS TO PEOPLE LIVING WITH TERMINAL ILLNESSES, SENIOR IN ASSISTED LIVING FACILITIES AND THOSE IN NEED; CHARITABLE SERVICES, NAMELY, ORGANIZING AND CONDUCTING VOLUNTEER PROGRAMS AND COMMUNITY SERVICE PROJECTS; CHARITABLE SERVICES, NAMELY, ORGANIZING AND CONDUCTING VOLUNTEER PROGRAMS AND COMMUNITY SERVICE PROJECTS AIMED AT INCREASING SUPPORT AND MORALE OF FAMILIES OF DECEASED WAR VETERANS, WAR VETERANS, CURRENT MEMBERS AND FUTURE MEMBERS OF THE U.S. MILITARY; CHARITABLE SERVICES, NAMELY, ORGANIZING AND CONDUCTING VOLUNTEER PROGRAMS AND COMMUNITY SERVICE PROJECTS AIMED AT INCREASING SUPPORT AND MORALE OF MEMBERS OF THE U.S. MILITARY; CHARITABLE SERVICES, NAMELY, ORGANIZING AND DEVELOPING PROGRAMS THAT AIM TO IMPROVE THE LIVES OF FORMERLY INCARCERATED PERSONS, THEIR FAMILIES, AND THOSE AT RISK FOR INCARCERATION; CHARITABLE SERVICES, NAMELY, ORGANIZING AND DEVELOPING PROJECTS THAT AIM TO IMPROVE THE LIVES OF UNDERPRIVILEGED AND IMPOVERISHED PEOPLE; CHARITABLE SERVICES, NAMELY, ORGANIZING AND DEVELOPING PROJECTS THAT AIM TO PROMOTE GLOBAL AWARENESS ABOUT HUMAN TRAFFICKING AND COMMERCIAL SEX INDUSTRY; CHARITABLE SERVICES,



*David J. Kybas*

Director of the United States Patent and Trademark Office



**Reg. No. 4,196,595** NAMELY, ORGANIZING AND DEVELOPING PROJECTS TO PROMOTE AWARENESS OF TREE AND ENVIRONMENTAL CONSERVATION; CHARITABLE SERVICES, NAMELY, ORGANIZING WOMEN'S GROUPS TO UNDERTAKE PROJECTS WHICH BENEFIT THE HOMELESS, ABUSED, AT RISK WOMEN AND WOMEN IN TRANSITION AND IN PAIN, WHILE ENCOURAGING EMPOWERMENT AMONG WOMEN OF ALL AGES AND ETHNICITIES; CHARITABLE SERVICES, NAMELY, ORGANIZING YOUTH GROUPS TO UNDERTAKE CHARITABLE PROJECTS IN THE FIELD OF DISASTER RESPONSE; CHARITABLE SERVICES, NAMELY, ORGANIZING YOUTH GROUPS TO UNDERTAKE PROJECTS TO BENEFIT THE NEEDY AND THE COMMUNITY TO ENCOURAGE LEADERSHIP, CHARACTER, COMPASSION, AND GOOD CITIZENSHIP; CHARITABLE SERVICES, NAMELY, PROMOTING ENVIRONMENTAL AWARENESS TO CHILDREN; CHARITABLE SERVICES, NAMELY, PROMOTING PUBLIC AWARENESS ABOUT POVERTY IN THE UNITED STATES THROUGH A MEDIA FAST PROGRAM CONDUCTED BY YOUNG PEOPLE; CHARITABLE SERVICES, NAMELY, PROMOTING PUBLIC AWARENESS ABOUT THE DANGERS OF DRIVING WHILE DROWSY; CHARITABLE SERVICES, NAMELY, PROMOTING PUBLIC AWARENESS OF BLACK MUSIC; CHARITABLE SERVICES, NAMELY, PROVIDING A FREE ONLINE RESOURCE IN THE NATURE OF A WEBSITE FOR CONNECTING PEOPLE WHO HAVE SERVICE NEEDS WITH PEOPLE WHO ARE WILLING TO PROVIDE VOLUNTEER SERVICES; CHARITABLE SERVICES, NAMELY, PROVIDING OFFICE EQUIPMENT TO THOSE IN NEED; CHARITABLE SERVICES, NAMELY, PROVIDING OFFICE FACILITIES TO THOSE IN NEED; DEVELOPING AND COORDINATING VOLUNTEER PROJECTS FOR CHARITABLE ORGANIZATIONS; DEVELOPING AND MANAGING THE CHARITABLE GIVING PROGRAMS OF OTHERS; MARKETING SERVICES, NAMELY, PROMOTIONAL SERVICES IN THE FIELD OF PLANNED-GIVING FOR NON-PROFIT AND CHARITABLE ORGANIZATIONS; MATCHING INDIVIDUALS WITH LIKE-MINDED ORGANIZATIONS WHO PROVIDE CHARITABLE ACTIVITIES THROUGH AN ON-LINE PROFILING SURVEY AND ANALYSIS; ON-LINE AUCTION SERVICES IN WHICH BUYERS WHO DONATE TO CHARITY RECEIVE ADDITIONAL BIDDING RIGHTS; ORGANIZING AND CONDUCTING CHARITY AUCTIONS FOR CHARITABLE FUNDRAISING PURPOSES; ORGANIZING VOLUNTEER ACTIVITIES AND FIELD TRIPS TO ALLOW STUDENTS TO LEARN ABOUT STATE GOVERNMENT, THE LEGISLATIVE PROCESS AND INTERACTING WITH ADULTS; PROMOTING THE CHARITABLE GIVING OF OTHERS, NAMELY, TRACKING AND PUBLICIZING CHARITABLE DONATIONS AND RANDOM ACTS OF KINDNESS; PROMOTING THE CHARITABLE SERVICES OF OTHERS, NAMELY, PROVIDING INDIVIDUALS WITH INFORMATION FOR THE PURPOSE OF MAKING DONATIONS TO CHARITIES; PROMOTING THE DONATION OF BLOOD AND VOLUNTEER SERVICES AND FINANCIAL RESOURCES IN THE FIELD OF BLOOD DONATIONS BY MEANS OF ARRANGING AND CONDUCTING INCENTIVE REWARD PROGRAMS; PROMOTING THE INTERESTS OF WOUNDED UNITED STATES SERVICE PERSONS IN MILITARY HOSPITALS WORLDWIDE BY SOLICITING VOLUNTEERS TO CORRESPOND WITH AND SEND BACKPACKS WITH AMENITIES TO SAID SERVICEPERSONS; PROMOTIONAL SERVICES, NAMELY, PROMOTING THE CHARITIES OF OTHERS; PROVIDING A WEBSITE FEATURING CONTENT ON NEWS RELATING TO PHILANTHROPY MARKETING STRATEGIES, COVERING MONETARY GIVING TRENDS AND STATISTICS, VOLUNTEER/CAREER OPPORTUNITIES AND BEST PRACTICES FOR SUCCESSFUL DIGITAL PHILANTHROPY EFFORTS; PROVIDING A WEBSITE FOR MANAGING, CONDUCTING AND ORGANIZING ONLINE AUCTIONS THAT ARE DESIGNED TO RAISE MONEY FOR SELECTED CHARITIES, IN CLASS 35 (U.S. CLS. 100, 101 AND 102).

FIRST USE 9-4-2010; IN COMMERCE 9-4-2010.

THE MARK CONSISTS OF STANDARD CHARACTERS WITHOUT CLAIM TO ANY PARTICULAR FONT, STYLE, SIZE, OR COLOR.

SER. NO. 85-123,420, FILED 9-5-2010.

HOWARD B. LEVINE, EXAMINING ATTORNEY

# United States of America

United States Patent and Trademark Office

## GOINGLOBAL

**Reg. No. 4,196,596**

**Registered Aug. 28, 2012**

**Int. Cls.: 35 and 45**

**SERVICE MARK**

**PRINCIPAL REGISTER**

THOMPSON, MARY ANNE (UNITED STATES INDIVIDUAL)  
258 COLLEGE LANE  
MOBILE, AL 36608

FOR: PROVIDING INFORMATION IN THE FIELD OF WORKING IN INTERNATIONAL LOCATIONS VIA THE INTERNET, NAMELY, PROVIDING ON-LINE CAREER AND EMPLOYMENT INFORMATION, IN THE FIELD OF WORK CONDITIONS, CAREER AND EMPLOYMENT RESOURCES, RESUME AND CV GUIDELINES AND EXAMPLES, JOB OUTLOOK, INDUSTRY TRENDS, TRADE AND PROFESSIONAL ASSOCIATIONS, BUSINESS NETWORKING GROUPS, HOURS OF WORK, AND JOB INTERVIEWS; PROVIDING INFORMATION IN THE FIELD OF LIVING IN INTERNATIONAL LOCATIONS VIA THE INTERNET, NAMELY, PROVIDING ON-LINE INFORMATION REGARDING THE COST OF LIVING IN SPECIFIC COMMUNITIES, IN CLASS 35 (U.S. CLS. 100, 101 AND 102).

FIRST USE 1-31-2002; IN COMMERCE 1-31-2002.

FOR: PROVIDING INFORMATION IN THE FIELD OF WORKING IN INTERNATIONAL LOCATIONS VIA THE INTERNET, NAMELY, PROVIDING INFORMATION IN THE FIELD OF SOCIAL NETWORKING GROUPS, WORK PERMIT AND VISA REGULATIONS AND CULTURAL ADVICE, IN CLASS 45 (U.S. CLS. 100 AND 101).

FIRST USE 1-31-2002; IN COMMERCE 1-31-2002.

THE MARK CONSISTS OF STANDARD CHARACTERS WITHOUT CLAIM TO ANY PARTICULAR FONT, STYLE, SIZE, OR COLOR.

OWNER OF U.S. REG. NOS. 3,296,869 AND 3,394,146.

SER. NO. 85-125,735, FILED 9-9-2010.

EUGENIA MARTIN, EXAMINING ATTORNEY



*David J. Kyffers*

Director of the United States Patent and Trademark Office

# United States of America

United States Patent and Trademark Office

# 4DPLEX

**Reg. No. 4,196,597**

**Registered Aug. 28, 2012**

**Int. Cl.: 35**

**SERVICE MARK**

**PRINCIPAL REGISTER**

CJ 4DPLEX CO., LTD. (REPUBLIC OF KOREA CORPORATION)  
164-1 JEUNGSAN-DONG, EUNPYEONG-GU  
SEOUL, REPUBLIC OF KOREA

FOR: CINEMA ADVERTISING; ADVERTISING SERVICES, NAMELY, ADVERTISING THE PUBLISHED TEXTS OF OTHERS; ADVERTISING SERVICES, NAMELY, PROMOTING THE GOODS AND SERVICES OF OTHERS BY PROVIDING FILM ADVERTISING AND PROMOTING THE FILMS OF OTHERS BY PROVIDING FILM ADVERTISING; ON-LINE ADVERTISING ON COMPUTER COMMUNICATION NETWORKS; CONCESSION STANDS FEATURING FOOD, DRINKS, AND SOUVENIRS; MANAGEMENT OF PERFORMING ARTISTS; BUSINESS MANAGEMENT OF THEATERS AND MOVIE THEATERS FOR OTHERS, IN CLASS 35 (U.S. CLS. 100, 101 AND 102).

THE MARK CONSISTS OF STANDARD CHARACTERS WITHOUT CLAIM TO ANY PARTICULAR FONT, STYLE, SIZE, OR COLOR.

PRIORITY CLAIMED UNDER SEC. 44(D) ON REPUBLIC OF KOREA APPLICATION NO. 41-2010-2347, FILED 9-10-2010, REG. NO. 0227378, DATED 2-28-2012, EXPIRES 2-28-2022.

SER. NO. 85-128,153, FILED 9-13-2010.

RON FAIRBANKS, EXAMINING ATTORNEY



*David J. Kypos*

Director of the United States Patent and Trademark Office

# United States of America

United States Patent and Trademark Office

# nuk

**Reg. No. 4,196,598**

MAPA GMBH (FED REP GERMANY LIMITED LIABILITY COMPANY)  
INDUSTRIESTRASSE 21-25, D-27404  
ZEVEN, FED REP GERMANY

**Registered Aug. 28, 2012**

**Int. Cl.: 25**

FOR: CLOTHING, NAMELY, T SHIRTS, SHIRTS, POLO SHIRTS, IN CLASS 25 (U.S. CLS. 22 AND 39).

**TRADEMARK**

FIRST USE 12-4-1987; IN COMMERCE 12-4-1987.

**PRINCIPAL REGISTER**

THE MARK CONSISTS OF STANDARD CHARACTERS WITHOUT CLAIM TO ANY PARTICULAR FONT, STYLE, SIZE, OR COLOR.

SER. NO. 85-129,060, FILED 9-14-2010.

NAAKWAMA ANKRAH, EXAMINING ATTORNEY



*David J. Kyffers*

Director of the United States Patent and Trademark Office

# United States of America

United States Patent and Trademark Office

## BULLIONVAULT

**Reg. No. 4,196,599**

**Registered Aug. 28, 2012**

**Int. Cls.: 35, 36 and 42**

**SERVICE MARK**

**PRINCIPAL REGISTER**

GALMARLEY LIMITED (UNITED KINGDOM LIMITED COMPANY (LTD.))  
BROOK HOUSE, 229-243 SHEPHERD'S BUSH RD  
LONDON, UNITED KINGDOM W67AN

FOR: ADVERTISING; BUSINESS MANAGEMENT; BUSINESS ADMINISTRATION; OFFICE FUNCTIONS; COMPILATION, ANALYSIS, RETRIEVAL AND PROVISION OF INFORMATION RELATING TO THE TRADING OF GOLD AND PRECIOUS METALS; COMMERCIAL AND INDUSTRIAL MANAGEMENT ASSISTANCE, IN PARTICULAR BY MEANS OF MULTIMEDIA PLATFORMS FOR ONLINE TRADING; PROVIDING BUSINESS ADMINISTRATION FOR TRADING IN GOLD AND OTHER PRECIOUS METALS; DISSEMINATION OF BUSINESS AND COMMERCIAL INFORMATION FOR THE TRADING OF GOODS AND SERVICES VIA INTERNET AND ONLINE FORUM FACILITIES; PROVIDING AN ELECTRONIC MARKETPLACE FOR TRADING OF GOLD AND PRECIOUS METALS, IN CLASS 35 (U.S. CLS. 100, 101 AND 102).

FOR: INSURANCE ADMINISTRATION; FINANCIAL AFFAIRS AND MONETARY AFFAIRS, NAMELY, FINANCIAL INFORMATION, MANAGEMENT AND ANALYSIS SERVICES; FINANCIAL INFORMATION SERVICES PROVIDED ONLINE FROM A COMPUTER DATABASE OR A GLOBAL COMPUTER NETWORK, NAMELY, PROVIDING INFORMATION ON TRADING IN THE FIELD OF GOLD AND PRECIOUS METAL; PROVIDING FINANCIAL ADMINISTRATION FOR TRADING IN GOLD AND OTHER PRECIOUS METALS; COMMODITY TRADING; PROVIDING INFORMATION AND DATA FOR USE IN RELATION TO FINANCIAL RISK MANAGEMENT AND TRADING; TRADING IN GOLD AND PRECIOUS METALS; PROVIDING INFORMATION AND DATA FOR USE IN RELATION TO FINANCIAL RISK MANAGEMENT AND TRADING; PROVISION OF FINANCIAL INFORMATION AND GOLD TRADING PROVIDED VIA THE INTERNET, MP3 PLAYERS, MOBILE TELEPHONES, OR ANY OTHER COMMUNICATION APPARATUS OR NETWORKS; PROVIDING ONLINE ELECTRONIC COMPUTER DATABASES WHICH PROVIDE SUBSCRIBERS WITH TRADING INFORMATION CONCERNING GOLD AND PRECIOUS METALS WITH AN AUTOMATIC NETWORK FOR TRADING, IN CLASS 36 (U.S. CLS. 100, 101 AND 102).

FOR: INDUSTRIAL ANALYSIS AND RESEARCH SERVICES IN THE FINANCIAL INDUSTRIES FIELD; PROVIDING INFORMATION ABOUT COMPUTER SOFTWARE FOR USE IN THE FIELD OF GOLD AND PRECIOUS METALS EXCHANGE TRADING, IN CLASS 42 (U.S. CLS. 100 AND 101).



*David J. Kyjars*

Director of the United States Patent and Trademark Office

**Reg. No. 4,196,599** THE MARK CONSISTS OF STANDARD CHARACTERS WITHOUT CLAIM TO ANY PARTICULAR FONT, STYLE, SIZE, OR COLOR.

PRIORITY CLAIMED UNDER SEC. 44(D) ON ERPN CMNTY TM OFC APPLICATION NO. 009302852, FILED 8-9-2010, REG. NO. 9302852, DATED 3-8-2011, EXPIRES 3-8-2021.

SER. NO. 85-129,969, FILED 9-15-2010.

DOMINICK J. SALEMI, EXAMINING ATTORNEY

# United States of America

United States Patent and Trademark Office

## VERSA POWER

**Reg. No. 4,196,600**

**Registered Aug. 28, 2012**

**Int. Cl.: 7**

**TRADEMARK**

**PRINCIPAL REGISTER**

TECHTRONIC FLOOR CARE TECHNOLOGY LIMITED (BR. VIRGIN ISLANDS CORPORATION)  
P.O. BOX 957  
OFFSHORE INCORPORATIONS CENTRE  
ROAD TOWN, TORTOLA, BR. VIRGIN ISLANDS

FOR: VACUUM CLEANERS, IN CLASS 7 (U.S. CLS. 13, 19, 21, 23, 31, 34 AND 35).

FIRST USE 5-0-2007; IN COMMERCE 5-0-2007.

THE MARK CONSISTS OF STANDARD CHARACTERS WITHOUT CLAIM TO ANY PARTICULAR FONT, STYLE, SIZE, OR COLOR.

NO CLAIM IS MADE TO THE EXCLUSIVE RIGHT TO USE "POWER", APART FROM THE MARK AS SHOWN.

SER. NO. 85-130,211, FILED 9-15-2010.

PAUL E. FAHRENKOPF, EXAMINING ATTORNEY



*David J. Kyffers*

Director of the United States Patent and Trademark Office

# United States of America

United States Patent and Trademark Office

## APOSTHERAPY

**Reg. No. 4,196,601**

**Registered Aug. 28, 2012**

**Int. Cl.: 44**

**SERVICE MARK**

**PRINCIPAL REGISTER**

APOS - MEDICAL AND SPORTS TECHNOLOGIES LTD. (ISRAEL CORPORATION)  
BET MERKAZIM 2001, ABA EVEN 1  
HERZELIA PITUACH, ISRAEL

FOR: MEDICAL, ORTHOPEDIC MEDICAL, REHABILITATION PATIENT CARE AND HEALTH CARE SERVICES; CONDUCTING MEDICAL PHYSICAL EVALUATIONS AND PROVISION OF HEALTH CARE SERVICES IN THE FIELD OF ORTHOPEDICS, NEUROLOGY AND PEDIATRICS; NEUROMUSCULAR REHABILITATION PATIENT CARE SERVICES; FITTING OF ORTHOPEDIC DEVICES; FITTING OF ORTHOEPIC DEVICES; PROVISION OF ADVICE, CONSULTANCY AND INFORMATION IN THE FIELD OF THE AFOREMENTIONED SERVICES, IN CLASS 44 (U.S. CLS. 100 AND 101).

THE MARK CONSISTS OF STANDARD CHARACTERS WITHOUT CLAIM TO ANY PARTICULAR FONT, STYLE, SIZE, OR COLOR.

PRIORITY CLAIMED UNDER SEC. 44(D) ON ISRAEL APPLICATION NO. 228143, FILED 3-18-2010, REG. NO. 228143, DATED 7-11-2011, EXPIRES 3-18-2020.

OWNER OF U.S. REG. NOS. 3,343,813, 3,401,725 AND OTHERS.

SER. NO. 85-131,360, FILED 9-16-2010.

ALICE BENMAMAN, EXAMINING ATTORNEY



*David J. Kybas*

Director of the United States Patent and Trademark Office



# United States of America

United States Patent and Trademark Office

## DYNAMIC PULSE BURSTS

**Reg. No. 4,196,602**

**Registered Aug. 28, 2012**

**Int. Cl.: 9**

**TRADEMARK**

**PRINCIPAL REGISTER**

MULTIWAVE PHOTONICS SA (PORTUGAL CORPORATION)  
R ENG FREDENCO ULRICH 2650  
4470-605 MOREIRADA MAIA  
MOREIRADA MAIA, PORTUGAL

FOR: PULSED FIBER LASERS, VERSATILE NANOSECOND PULSED FIBER LASERS FOR NON-MEDICAL USE, THAT OFFER PULSES WITH BEAM QUALITY, STABILITY, ZERO LEAKAGE BETWEEN PULSES, OPERATION, FLEXIBILITY, EASE OF CONTROL, LOW COST PULSED FIBER LASERS WITH DIGITAL AND ANALOG CONTROLS, PROGRAMMED AND ON THE FLY CAN CHANGE CONTROL OF ALL KEY PULSE PARAMETERS; CONDUCTIVE FIBERS, NAMELY, HIGH POWER FIBERS FOR CONDUCTING LASER BEAMS IN VARIOUS WAVELENGTH RANGE, OPTICAL FIBER AMPLIFIERS FOR LASERS; LASERS AND COMPACT LASER DIODE DRIVERS FOR NON-MEDICAL LASER SYSTEMS; LASERS FOR MATERIAL PROCESSING, LASERS FOR DISTANCE RANGING AND SENSING; LASERS FOR DIAGNOSTIC SYSTEMS, IN CLASS 9 (U.S. CLS. 21, 23, 26, 36 AND 38).

FIRST USE 1-0-2008; IN COMMERCE 1-0-2008.

THE MARK CONSISTS OF STANDARD CHARACTERS WITHOUT CLAIM TO ANY PARTICULAR FONT, STYLE, SIZE, OR COLOR.

NO CLAIM IS MADE TO THE EXCLUSIVE RIGHT TO USE "PULSE BURSTS", APART FROM THE MARK AS SHOWN.

THE WORDING "DYNAMIC PULSE BURSTS" HAS NO MEANING IN A FOREIGN LANGUAGE.

SER. NO. 85-131,751, FILED 9-17-2010.

LINDA MICKLEBURGH, EXAMINING ATTORNEY



*David J. Kyffers*

Director of the United States Patent and Trademark Office

# United States of America

United States Patent and Trademark Office



**Reg. No. 4,196,603**

**Registered Aug. 28, 2012**

**Int. Cl.: 9**

**TRADEMARK**

**PRINCIPAL REGISTER**

MULTIWAVE PHOTONICS SA (PORTUGAL CORPORATION)  
R ENG FREDERICO ULRICH 2650  
4470 -605 MOREIRADA MAIA  
MOREIRADA MAIA, PORTUGAL

FOR: PULSED FIBER LASERS, VERSATILE NANOSECOND PULSED FIBER LASERS FOR NON-MEDICAL USE, THAT OFFER PULSES WITH BEAM QUALITY, STABILITY, ZERO LEAKAGE BETWEEN PULSES, OPERATION, FLEXIBILITY, EASE OF CONTROL, LOW COST PULSED FIBER LASERS WITH DIGITAL AND ANALOG CONTROLS, PROGRAMMED AND ON THE FLY CAN CHANGE CONTROL OF ALL KEY PULSE PARAMETERS; CONDUCTIVE FIBERS, NAMELY, HIGH POWER FIBERS FOR CONDUCTING LASER BEAMS IN VARIOUS WAVELENGTH RANGE, OPTICAL FIBER AMPLIFIERS FOR LASERS; LASERS AND COMPACT LASER DIODE DRIVERS FOR NON-MEDICAL LASER SYSTEMS; LASERS FOR MATERIAL PROCESSING, LASERS FOR DISTANCE RANGING AND SENSING; LASERS FOR DIAGNOSTIC SYSTEMS, IN CLASS 9 (U.S. CLS. 21, 23, 26, 36 AND 38).

FIRST USE 9-0-2003; IN COMMERCE 9-0-2003.

THE MARK CONSISTS OF THE LETTERS "MW" WITH THE "M" BEING MOSTLY DARK BLUE, BUT FADING AS IT REACHES THE "W" WHICH IS LIGHT BLUE; TO THE RIGHT IS THE WORDING "MULTIWAVE" IN DARK BLUE.

THE COLOR(S) LIGHT BLUE AND DARK BLUE IS/ARE CLAIMED AS A FEATURE OF THE MARK.

THE WORDING "MULTIWAVE" HAS NO MEANING IN A FOREIGN LANGUAGE.

SER. NO. 85-131,760, FILED 9-17-2010.

LINDA MICKLEBURGH, EXAMINING ATTORNEY



*David J. Kyros*

Director of the United States Patent and Trademark Office

# United States of America

United States Patent and Trademark Office

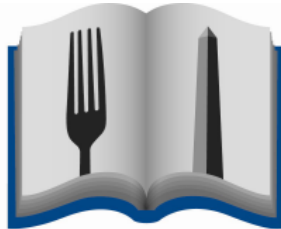

## EDUCATED EATS

*Creating the Next Generation of Culinary Professionals*

**Reg. No. 4,196,604**

THE RAMW EDUCATION FOUNDATION, INC. (D.C. CORPORATION)  
1200 17TH STREET, N.W.  
WASHINGTON, DC 20036

**Registered Aug. 28, 2012**

**Int. Cl.: 41**

FOR: CHARITABLE SERVICES, NAMELY, PROVIDING VOCATIONAL EDUCATION AND TRAINING IN THE FIELD OF CULINARY ARTS TO THOSE INTERESTED IN THE RESTAURANT AND FOODSERVICE INDUSTRY, IN CLASS 41 (U.S. CLS. 100, 101 AND 107).

**SERVICE MARK**

FIRST USE 10-0-2010; IN COMMERCE 10-0-2010.

**PRINCIPAL REGISTER**

THE MARK CONSISTS OF THE WORDING "EDUCATED EATS" IN BLUE ABOVE THE WORDING "CREATING THE NEXT GENERATION OF CULINARY PROFESSIONALS" IN GRAY, ALL UNDERNEATH A DESIGN OF A BLUE BOOK WITH GRAY PAGES SHOWING A FORK IN BLACK AND A MONOLITH IN GRAY AND BLACK.

THE COLOR(S) GRAY, BLUE AND BLACK IS/ARE CLAIMED AS A FEATURE OF THE MARK.

SER. NO. 85-133,797, FILED 9-20-2010.

JASON TURNER, EXAMINING ATTORNEY



*David J. Kyffers*

Director of the United States Patent and Trademark Office

# United States of America

United States Patent and Trademark Office

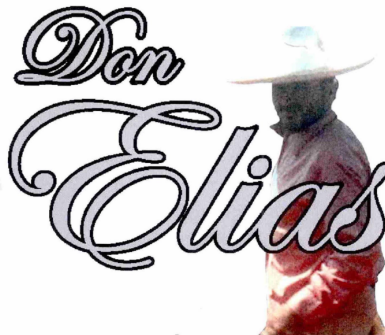

**Reg. No. 4,196,605**

HAPPY BOY DISTRIBUTOR, INC. (CALIFORNIA CORPORATION)  
2380 ALISAL RD  
SALINAS, CA 93908

**Registered Aug. 28, 2012**

**Int. Cl.: 33**

FOR: TEQUILA, IN CLASS 33 (U.S. CLS. 47 AND 49).

**TRADEMARK**

FIRST USE 6-19-2009; IN COMMERCE 6-19-2009.

**PRINCIPAL REGISTER**

THE NAME "DON ELIAS" AND THE PORTRAIT SHOWN IN THE MARK DO NOT IDENTIFY A PARTICULAR LIVING INDIVIDUAL.

THE COLOR(S) GRAY, BLACK, LIGHT BLUE, LIGHT BROWN AND ORANGE IS/ARE CLAIMED AS A FEATURE OF THE MARK.

THE MARK CONSISTS OF THE STYLIZED WORDS "DON ELIAS" AND DESIGN. THE WORDING "DON ELIAS" IS GRAY AND IS OUTLINED IN BLACK. THE TERM "DON" APPEARS ABOVE "ELIAS". THE TERM "ELIAS" IS SUPERIMPOSED ON THE DESIGN OF A MAN WEARING A HAT. THE MAN'S HAT IS LIGHT BROWN AND LIGHT BLUE, HIS SHIRT IS ORANGE AND HIS PANTS ARE LIGHT BROWN.

SER. NO. 85-134,092, FILED 9-20-2010.

MARLENE BELL, EXAMINING ATTORNEY



*David J. Kyffers*

Director of the United States Patent and Trademark Office

# United States of America

United States Patent and Trademark Office

# CUNNING

**Reg. No. 4,196,606**

**Registered Aug. 28, 2012**

**Int. Cls.: 35 and 42**

**SERVICE MARK**

**PRINCIPAL REGISTER**

CUNNING LIMITED (UNITED KINGDOM LIMITED LIABILITY COMPANY)  
12-18 HOXTON STREET  
LONDON, UNITED KINGDOM

FOR: (BASED ON USE IN COMMERCE AND 44E) ADVERTISEMENT AND PUBLICITY SERVICES VIA TRADITIONAL AND NON-TRADITIONAL MEDIA; ADVERTISING AGENCY SERVICES SPECIALIZING IN THE DESIGN AND EXECUTION OF WORD OF MOUTH, VIRAL, BUZZ AND EXPERIENTIAL MARKETING PROGRAMS, IN CLASS 35 (U.S. CLS. 100, 101 AND 102).

FIRST USE 2-0-2004; IN COMMERCE 2-0-2004.

FOR: (BASED ON 44E) DESIGN OF WEBSITES; GRAPHIC DRAWING SERVICES FOR OTHERS FOR USE ON WEBSITES; CREATING AND MAINTAINING WEBSITES, IN CLASS 42 (U.S. CLS. 100 AND 101).

THE MARK CONSISTS OF STANDARD CHARACTERS WITHOUT CLAIM TO ANY PARTICULAR FONT, STYLE, SIZE, OR COLOR.

OWNER OF GREAT BRITAIN REG. NO. 2548351, DATED 5-24-2010, EXPIRES 5-24-2020.

SER. NO. 85-135,759, FILED 9-22-2010.

MARGARET POWER, EXAMINING ATTORNEY



*David J. Kybas*

Director of the United States Patent and Trademark Office

# United States of America

United States Patent and Trademark Office

## WHAT'S YOUR SIGN?

**Reg. No. 4,196,607**

MATCHSIGN.COM, LLC (CONNECTICUT LIMITED LIABILITY COMPANY)

**Registered Aug. 28, 2012**

100 HOPE ST APT 34  
STAMFORD, CT 06906

**Int. Cl.: 45**

FOR: ASTROLOGICAL FORECASTING; ZODIAC CONSULTATION; DATING SERVICES, NAMELY, PROVIDING AN ON-LINE COMPUTER DATABASE FEATURING SINGLE PEOPLE INTERESTED IN MEETING OTHER SINGLE PEOPLE, IN CLASS 45 (U.S. CLS. 100 AND 101).

**SERVICE MARK**

**PRINCIPAL REGISTER**

FIRST USE 3-20-2010; IN COMMERCE 3-20-2010.

THE MARK CONSISTS OF STANDARD CHARACTERS WITHOUT CLAIM TO ANY PARTICULAR FONT, STYLE, SIZE, OR COLOR.

SER. NO. 85-137,170, FILED 9-24-2010.

DANIEL CAPSHAW, EXAMINING ATTORNEY



*David J. Kyffers*

Director of the United States Patent and Trademark Office

# United States of America

United States Patent and Trademark Office

# SeriousEnergy

**Reg. No. 4,196,608**

SERIOUS ENERGY, INC. (DELAWARE CORPORATION)  
1250 ELKO DR.  
SUNNYVALE, CA 94089

**Registered Aug. 28, 2012**

**Int. Cls.: 9, 35 and 42**

FOR: COMPUTER SOFTWARE FOR USE IN COLLECTING, TRACKING, ANALYZING, MONITORING AND CONTROLLING BUILDING ENERGY USE, IN CLASS 9 (U.S. CLS. 21, 23, 26, 36 AND 38).

**TRADEMARK**

FIRST USE 10-1-2010; IN COMMERCE 10-1-2010.

**SERVICE MARK**

FOR: CONSULTING SERVICES IN THE AREA OF SUSTAINABLE BUSINESS SOLUTIONS, IN CLASS 35 (U.S. CLS. 100, 101 AND 102).

**PRINCIPAL REGISTER**

FIRST USE 10-1-2010; IN COMMERCE 10-1-2010.

FOR: SOFTWARE AS A SERVICE (SAAS) SERVICES, NAMELY, HOSTING SOFTWARE FOR USE BY OTHERS FOR USE IN THE COLLECTING, TRACKING, ANALYZING, MONITORING AND CONTROLLING BUILDING ENERGY USE, CONSULTING SERVICES IN THE FIELD OF SOFTWARE AS A SERVICE (SAAS) , IN CLASS 42 (U.S. CLS. 100 AND 101).

FIRST USE 10-1-2010; IN COMMERCE 10-1-2010.

THE MARK CONSISTS OF STANDARD CHARACTERS WITHOUT CLAIM TO ANY PARTICULAR FONT, STYLE, SIZE, OR COLOR.

OWNER OF U.S. REG. NOS. 3,867,791 AND 3,883,574.

SER. NO. 85-137,821, FILED 9-24-2010.

LAURIE MAYES, EXAMINING ATTORNEY



*David J. Kypos*

Director of the United States Patent and Trademark Office

# United States of America

United States Patent and Trademark Office



**Reg. No. 4,196,609**

**Registered Aug. 28, 2012**

**Int. Cls.: 29 and 30**

**TRADEMARK**

**PRINCIPAL REGISTER**

MEDITERRANEAN GOURMET FOODS LTD. (CANADA CORPORATION)  
1465 KOOTENAY STREET  
VANCOUVER, BC, CANADA V5K4Y3

FOR: FOOD PRODUCTS, NAMELY, EDIBLE OIL, OLIVE OIL; VEGETABLE PROTEIN BITS HAVING A BACON FLAVOR FOOD PRODUCTS, NAMELY, BACON BITS, CONDIMENTS, NAMELY, VEGETABLE-BASED SPREADS AND FRUIT-BASED SPREADS, IN CLASS 29 (U.S. CL. 46).

FOR: SPICES AND HERBS, NAMELY, SPICE RUBS, DRIED SPICES, SPICE BLENDS AND SEASONING; FOOD PRODUCTS, NAMELY, VINEGAR AND OIL-BASED FOOD FLAVORINGS; BAKING PRODUCTS, NAMELY, VANILLA BEANS, FOOD FLAVORINGS, FLOUR AND YEAST, IN CLASS 30 (U.S. CL. 46).

PRIORITY CLAIMED UNDER SEC. 44(D) ON CANADA APPLICATION NO. 1474636, FILED 3-25-2010, REG. NO. TMA808081, DATED 10-12-2011, EXPIRES 10-12-2026.

NO CLAIM IS MADE TO THE EXCLUSIVE RIGHT TO USE "MERCHANTS SPICE", APART FROM THE MARK AS SHOWN.

THE MARK CONSISTS OF A CONCENTRIC CIRCLE WITH THE WORD "MERCHANT" IN A BANNER, A SHIP DESIGN ABOVE THE BANNER AND THE WORD "SPICE" BELOW THE BANNER.

SER. NO. 85-139,284, FILED 9-27-2010.

ESTHER A. BORSUK, EXAMINING ATTORNEY



*David J. Kyros*

Director of the United States Patent and Trademark Office



# United States of America

United States Patent and Trademark Office

## MIDWEST DAIRY COUNCIL

**Reg. No. 4,196,610**

**Registered Aug. 28, 2012**

**Int. Cls.: 41 and 44**

**SERVICE MARK**

**PRINCIPAL REGISTER**

MIDWEST DAIRY ASSOCIATION (MINNESOTA NON-PROFIT CORPORATION)  
2015 N. RICE STREET  
ST. PAUL, MN 55113

FOR: PROVIDING ONLINE INFORMATION AND NEWS IN THE NATURE OF A WEBSITE FEATURING NON-DOWNLOADABLE EDUCATIONAL VIDEOS, VIGNETTES, AND FARMER PROFILES ABOUT HOW DAIRY PRODUCTS ARE PRODUCED AND THE CARE OF FARM ANIMALS AND THE ENVIRONMENT; PROVIDING TRAINING AND EDUCATIONAL PRESENTATIONS IN THE FIELD OF DAIRY PRODUCTS AND NUTRITION EDUCATION, NAMELY, CONDUCTING CLASSES, SEMINARS, WORKSHOPS, AND EDUCATIONAL PRESENTATIONS IN THE FIELD OF DAIRY PRODUCTS AND NUTRITION AS IT RELATES TO DAIRY PRODUCTS; EDUCATIONAL SERVICES, NAMELY, DEVELOPING EDUCATIONAL PROGRAMS AND LESSON PLANS FOR OTHERS IN THE FIELD OF DAIRY PRODUCTS AND NUTRITION; ARRANGING AND CONDUCTING CONTESTS, SWEEPSTAKES, AND FAIRS FOR NON-COMMERCIAL PURPOSES IN THE FIELD OF DAIRY PRODUCTS AND NUTRITION; ORGANIZATION OF EXHIBITIONS FOR EDUCATIONAL PURPOSES IN THE FIELD OF DAIRY PRODUCTS AND NUTRITION, IN CLASS 41 (U.S. CLS. 100, 101 AND 107).

FIRST USE 1-1-2000; IN COMMERCE 1-1-2000.

FOR: PROVIDING ONLINE INFORMATION AND NEWS IN THE FIELD OF NUTRITION, IN CLASS 44 (U.S. CLS. 100 AND 101).

FIRST USE 1-1-2000; IN COMMERCE 1-1-2000.

THE MARK CONSISTS OF STANDARD CHARACTERS WITHOUT CLAIM TO ANY PARTICULAR FONT, STYLE, SIZE, OR COLOR.

NO CLAIM IS MADE TO THE EXCLUSIVE RIGHT TO USE "COUNCIL", APART FROM THE MARK AS SHOWN.

SEC. 2(F).

SER. NO. 85-140,833, FILED 9-29-2010.

MICHAEL TANNER, EXAMINING ATTORNEY



*David J. Kyros*

Director of the United States Patent and Trademark Office

# United States of America

United States Patent and Trademark Office

# ZEUS

**Reg. No. 4,196,611**

**Registered Aug. 28, 2012**

**Int. Cls.: 17 and 42**

**TRADEMARK**

**SERVICE MARK**

**PRINCIPAL REGISTER**

ZEUS INDUSTRIAL PRODUCTS, INC. (NEW JERSEY CORPORATION)  
3737 INDUSTRIAL BOULEVARD  
ORANGEBURG, SC 29118

FOR: POLYMERIC MATERIAL IN EXTRUDED FORM FOR USE IN MANUFACTURE;  
POLYMERIC MATERIAL COMPRISED OF ELECTROSPUN POLYMER STRANDS FOR USE  
IN MANUFACTURE, IN CLASS 17 (U.S. CLS. 1, 5, 12, 13, 35 AND 50).

FIRST USE 5-0-1966; IN COMMERCE 8-1-1966.

FOR: RESEARCH AND DEVELOPMENT IN THE FIELD OF POLYMERS FOR USE IN  
PRODUCTS; TESTING, ANALYSIS AND EVALUATION FOR OTHERS OF POLYMERS;  
PROCESS DEVELOPMENT IN THE FIELD OF POLYMERS FOR OTHERS, IN CLASS 42  
(U.S. CLS. 100 AND 101).

FIRST USE 0-0-1978; IN COMMERCE 0-0-1978.

THE MARK CONSISTS OF STANDARD CHARACTERS WITHOUT CLAIM TO ANY PAR-  
TICULAR FONT, STYLE, SIZE, OR COLOR.

OWNER OF U.S. REG. NO. 1,188,653.

SER. NO. 85-141,739, FILED 9-30-2010.

DAVID HOFFMAN, EXAMINING ATTORNEY



*David J. Kyros*

Director of the United States Patent and Trademark Office

# United States of America

United States Patent and Trademark Office



**Reg. No. 4,196,612**

PSORIA-SHIELD, INC. (FLORIDA CORPORATION)  
140 PUTNAM AVE.

**Registered Aug. 28, 2012**

ORMOND BEACH, FL 32174

**Int. Cl.: 5**

FOR: MEDICAL EQUIPMENT FOR USE IN THE TREATMENT OF SKIN DISEASE, NAMELY, PHOTOTHERAPEUTIC APPARATUS FOR MEDICAL PURPOSES IN THE NATURE OF AN ULTRAVIOLET (UV) LIGHT SOURCE FOR MEDICAL AND AESTHETIC SKIN TREATMENTS, IN CLASS 5 (U.S. CLS. 6, 18, 44, 46, 51 AND 52).

**TRADEMARK**

**PRINCIPAL REGISTER**

FIRST USE 1-15-2010; IN COMMERCE 1-15-2010.

THE MARK CONSISTS OF THE WORDING "PSORIA SHIELD" IN PURPLE. BETWEEN THE TWO WORDS IS A PURPLE OUTLINED SHIELD CONTAINING A YELLOW SUN WITH RAYS AGAINST AN ORANGE BACKGROUND. BELOW THE SUN ARE GREEN HILLS.

THE COLOR(S) PURPLE, YELLOW, ORANGE AND GREEN IS/ARE CLAIMED AS A FEATURE OF THE MARK.

SER. NO. 85-143,086, FILED 10-1-2010.

JESSICA FATHY, EXAMINING ATTORNEY



*David J. Kyros*

Director of the United States Patent and Trademark Office

# United States of America

United States Patent and Trademark Office

# VIRTTU

**Reg. No. 4,196,613**

**Registered Aug. 28, 2012**

**Int. Cls.: 5 and 42**

**TRADEMARK**

**SERVICE MARK**

**PRINCIPAL REGISTER**

VIRTTU BIOLOGICS LIMITED (UNITED KINGDOM PRIVATE LIMITED COMPANY)  
WINSFORD INDUSTRIAL ESTATE F1 HOUSE,  
ROAD, FOUR  
WINSFORD, CHESHIRE, UNITED KINGDOM CW73QN

FOR: PHARMACEUTICAL PREPARATIONS FOR USE IN ONCOLOGY OR GENE THERAPY; BIOLOGICAL AGENTS, NAMELY, VIRAL PREPARATIONS FOR THE TREATMENT OF CANCER; BIOLOGICAL AGENTS, NAMELY, VIRAL PREPARATIONS FOR USE IN GENE THERAPY; VIRAL VACCINES; VIRUSES FOR USE IN THE PREVENTION AND TREATMENT OF DISEASES; BIOLOGICAL DIAGNOSTIC AGENTS AND ASSAYS FOR DETECTION, MONITORING OR TREATMENT OF DISEASE, IN CLASS 5 (U.S. CLS. 6, 18, 44, 46, 51 AND 52).

FOR: DRUG DISCOVERY, MEDICAL AND BIOTECHNOLOGY RESEARCH, AND DRUG DEVELOPMENT SERVICES IN THE APPLICATION OF VIRUSES FOR THERAPEUTIC OR DIAGNOSTIC USE IN THE FIELD OF ONCOLOGY OR GENE THERAPY, IN CLASS 42 (U.S. CLS. 100 AND 101).

THE MARK CONSISTS OF STANDARD CHARACTERS WITHOUT CLAIM TO ANY PARTICULAR FONT, STYLE, SIZE, OR COLOR.

PRIORITY CLAIMED UNDER SEC. 44(D) ON ERPN CMNTY TM OFC APPLICATION NO. 009013021, FILED 4-8-2010, REG. NO. 009013021, DATED 9-27-2010, EXPIRES 4-8-2020.

SER. NO. 85-146,117, FILED 10-6-2010.

RAMONA ORTIGA, EXAMINING ATTORNEY



*David J. Kyjars*

Director of the United States Patent and Trademark Office

# United States of America

United States Patent and Trademark Office

tinyolive 

•a tiny green thing you can do•

**Reg. No. 4,196,614**

**Registered Aug. 28, 2012**

**Int. Cl.: 18**

**TRADEMARK**

**PRINCIPAL REGISTER**

TINY OLIVE LLC (MAINE LIMITED LIABILITY COMPANY)  
4 COLONY LANE  
SOUTH PORTLAND, ME 04106

FOR: BAGS, NAMELY, REUSABLE FABRIC SHOPPING BAGS AND TOTE BAGS, IN CLASS 18 (U.S. CLS. 1, 2, 3, 22 AND 41).

FIRST USE 5-1-2010; IN COMMERCE 5-1-2010.

NO CLAIM IS MADE TO THE EXCLUSIVE RIGHT TO USE "GREEN", APART FROM THE MARK AS SHOWN.

THE MARK CONSISTS OF AN OLIVE TILTED SLIGHTLY TO THE RIGHT WITH A PIMENTO, AND A "DOT" TO THE LEFT OF THE LETTER "A" AND TO THE RIGHT OF THE "O" IN THE WORD "DO" BELOW.

SER. NO. 85-148,330, FILED 10-8-2010.

BILL DAWE, EXAMINING ATTORNEY



*David J. Kybas*

Director of the United States Patent and Trademark Office

# United States of America

United States Patent and Trademark Office

# ELPAD

**Reg. No. 4,196,615**

**Registered Aug. 28, 2012**

**Int. Cl.: 9**

**TRADEMARK**

**PRINCIPAL REGISTER**

TEXMAG GMBH VERTRIEBSGESELLSCHAFT (FED REP GERMANY LIMITED LIABILITY COMPANY)  
ZEHNTENSTR. 17  
CH-8800 THALWIL, SWITZERLAND

FOR: CONTROL, MEASURING, SIGNALING, CHECKING BEING SUPERVISION, TESTING, SCANNING AND INSPECTION APPARATUS AND PARTS THEREFOR, IN PARTICULAR FOR TEXTILE, CARDBOARD AND PAPER MANUFACTURING AND PROCESSING, NAMELY MACHINES TESTING THE POSITION OF A RUNNING WEB OF MATERIAL, MACHINES TESTING THE TENSILE STRESS OF A RUNNING WEB OF MATERIAL, ELECTRONIC CONTROLLERS FOR CONTROLLING THE POSITION OF A RUNNING WEB OF MATERIAL, ELECTRONIC CONTROLLERS FOR CONTROLLING THE TENSILE STRESS OF A RUNNING WEB OF MATERIAL, DISPLAYS, NAMELY, LIQUID CRYSTAL DISPLAYS, LED DISPLAYS AND PLASMA DISPLAYS FOR DISPLAYING THE POSITION OF A RUNNING WEB OF MATERIAL, DISPLAYS, NAMELY, LIQUID CRYSTAL DISPLAYS, LED DISPLAYS AND PLASMA DISPLAYS FOR DISPLAYING THE TENSILE STRESS OF A RUNNING WEB OF MATERIAL AND TERMINALS FOR ENTERING DATA INTO MACHINES AS MENTIONED ABOVE; EDGE SENSORS FOR CAPTURING THE POSITION OF THE EDGE OF A CONTINUOUS WEB AND PARTS THEREFOR, NAMELY, OPTICAL SENSORS AND ACOUSTIC SENSORS; WEB TENSION SENSORS NAMELY FORCE SENSORS, IN CLASS 9 (U.S. CLS. 21, 23, 26, 36 AND 38).

THE MARK CONSISTS OF STANDARD CHARACTERS WITHOUT CLAIM TO ANY PARTICULAR FONT, STYLE, SIZE, OR COLOR.

PRIORITY CLAIMED UNDER SEC. 44(D) ON ERPN CMNTY TM OFC APPLICATION NO. 009349077, FILED 8-13-2010, REG. NO. 009349077, DATED 1-27-2011, EXPIRES 8-13-2020.

THE WORDING "ELPAD" HAS NO MEANING IN A FOREIGN LANGUAGE.

SER. NO. 85-152,506, FILED 10-14-2010.

MYRIAH HABEEB, EXAMINING ATTORNEY



*David J. Kyffers*

Director of the United States Patent and Trademark Office

# United States of America

United States Patent and Trademark Office

## ROCK RIVALS

**Reg. No. 4,196,616**

**Registered Aug. 28, 2012**

**Int. Cls.: 9, 41 and 42**

**TRADEMARK**

**SERVICE MARK**

**PRINCIPAL REGISTER**

STAGENAME, INC. (CANADA CORPORATION)  
ONE ATLANTIC AVENUE, SUITE 107  
TORONTO, ONTARIO, CANADA M6K3E7

FOR: COMPUTER SOFTWARE FOR CREATING, UPLOADING, POSTING, SHOWING, DISPLAYING, SHARING, AND DOWNLOADING ELECTRONIC DATA AND INFORMATION, NAMELY, MUSIC, SPOKEN WORD, IMAGES AND TEXT, VIA THE INTERNET, OR WIRELESS COMMUNICATIONS NETWORKS; AND DOWNLOADABLE MULTIMEDIA FILES FEATURING MUSIC AND MUSICAL ARTISTS, IN CLASS 9 (U.S. CLS. 21, 23, 26, 36 AND 38).

FOR: PROVIDING INFORMATION ABOUT MUSIC FOR ENTERTAINMENT PURPOSES VIA A WEBSITE WHERE USERS CAN VIEW, CREATE, POST AND RATE MUSIC, SPOKEN WORD, IMAGES AND TEXTS FEATURING MUSIC AND MUSICAL ARTISTS; ENTERTAINMENT SERVICES, NAMELY, PUBLISHING MUSIC AND ON-LINE TEXT PROMOTING MUSIC, A MUSIC SOFTWARE APPLICATION, AND MUSICAL ARTISTS; PROVIDING ENTERTAINMENT INFORMATION PROVIDED BY USERS IN THE FIELD OF MUSIC VIA A SOFTWARE APPLICATION THAT IS ACCESSIBLE ON THE INTERNET, MOBILE TELEPHONES, SMART PHONES, MOBILE AND HANDHELD COMPUTERS, AND OTHER MOBILE AND HANDHELD COMMUNICATIONS DEVICES, IN CLASS 41 (U.S. CLS. 100, 101 AND 107).

FOR: PROVIDING AN ON-LINE NON-DOWNLOADABLE SOFTWARE APPLICATION FOR ENTERTAINMENT PURPOSES IN WHICH USERS CAN VIEW, CREATE, POST AND RATE MUSIC, SPOKEN WORD, IMAGES AND TEXTS FEATURING MUSIC AND MUSICAL ARTISTS, IN CLASS 42 (U.S. CLS. 100 AND 101).

THE MARK CONSISTS OF STANDARD CHARACTERS WITHOUT CLAIM TO ANY PARTICULAR FONT, STYLE, SIZE, OR COLOR.

PRIORITY CLAIMED UNDER SEC. 44(D) ON CANADA APPLICATION NO. 1478206, FILED 4-23-2010, REG. NO. 1478206, DATED 3-8-2012, EXPIRES 3-8-2027.

NO CLAIM IS MADE TO THE EXCLUSIVE RIGHT TO USE "ROCK", APART FROM THE MARK AS SHOWN.

SER. NO. 85-156,041, FILED 10-19-2010.



*David J. Kyros*

Director of the United States Patent and Trademark Office

**Reg. No. 4,196,616** LEIGH CAROLINE CASE, EXAMINING ATTORNEY



# United States of America

United States Patent and Trademark Office

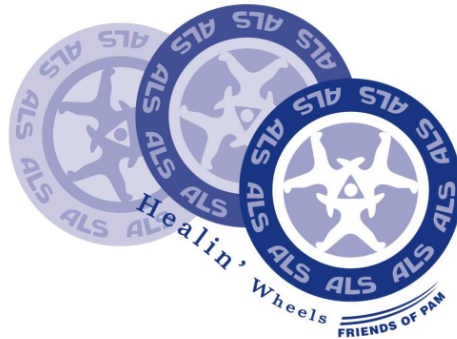

**Reg. No. 4,196,617**

HEALIN WHEELS, L.L.C. (NEW JERSEY LIMITED LIABILITY COMPANY)  
6 NAVESINK AVENUE  
RUMSON, NJ 07760

**Registered Aug. 28, 2012**

**Int. Cl.: 36**

FOR: CHARITABLE FUNDRAISING; CHARITABLE FUNDRAISING SERVICES, IN CLASS 36 (U.S. CLS. 100, 101 AND 102).

**SERVICE MARK**

FIRST USE 9-1-2009; IN COMMERCE 9-1-2009.

**PRINCIPAL REGISTER**

NO CLAIM IS MADE TO THE EXCLUSIVE RIGHT TO USE "ALS", APART FROM THE MARK AS SHOWN.

THE COLOR(S) BLUE, WHITE AND GRAY IS/ARE CLAIMED AS A FEATURE OF THE MARK.

THE MARK CONSISTS OF THREE CIRCLES ON TOP OF EACH OTHER EACH CONTAINING THE WORD "ALS" IN THE OUTER CIRCLE, THREE INDIVIDUALS WITH INTERLOCKING ARMS ON TOP OF EACH OTHER WITHIN THE INNER CIRCLE AND THE WORD "HEALIN' WHEELS" FRIENDS OF PAM" PROTRUDING FROM THE LEFT CIRCLE AND BELOW THE MIDDLE ON THE RIGHT CIRCLES, WRITTEN IN BLUE WITH TWO LINES IN BLUE OVER THE WORDS "FRIENDS OF PAM". THE BACKGROUND OF THE LEFT OUTER AND INNER CIRCLE IS GRAY WITH THE WORDS "ALS" IN BLUE-GRAY" AND THE INTERLOCKING PEOPLE AND THE CIRCLE AROUND THE INTERLOCKING PEOPLE IN BLUE-GRAY; THE MIDDLE CIRCLE THE WORDS "ALS" IN BLUE-GRAY, THE OUTER CIRCLE IN BLUE, THE INNER CIRCLE IN BLUE-GRAY, AND THE INTERLOCKING PEOPLE AND THE CIRCLE AROUND THE INTERLOCKING PEOPLE IN GRAY; THE RIGHT CIRCLE, THE WORDS "ALS" IN BLUE GRAY, THE OUTER CIRCLE IN BLUE, THE INNER CIRCLE IN BLUE GRAY, AND THE INTERLOCKING PEOPLE AND THE CIRCLE AROUND THE INTERLOCKING PEOPLE IN WHITE.



SER. NO. 85-158,473, FILED 10-21-2010.

DEZMONA MIZELLE, EXAMINING ATTORNEY

*David J. Kappas*

Director of the United States Patent and Trademark Office

# United States of America

United States Patent and Trademark Office

## TEACHER PROBLEM SOLVING SKILLS IN BEHAVIORAL DISORDERS

**Reg. No. 4,196,618**

**Registered Aug. 28, 2012**

**Int. Cl.: 9**

**TRADEMARK**

**PRINCIPAL REGISTER**

THE CURATORS OF THE UNIVERSITY OF MISSOURI (MISSOURI PUBLIC BENEFIT CORPORATION)  
227 UNIVERSITY HALL  
COLUMBIA, MO 65211

FOR: DIGITAL MEDIA, NAMELY, COMPACT DISCS FEATURING TRAINING AIDS FOR TEACHERS WORKING WITH CHILDREN WITH DISABILITIES, IN CLASS 9 (U.S. CLS. 21, 23, 26, 36 AND 38).

FIRST USE 7-15-1994; IN COMMERCE 7-15-1994.

THE MARK CONSISTS OF STANDARD CHARACTERS WITHOUT CLAIM TO ANY PARTICULAR FONT, STYLE, SIZE, OR COLOR.

SEC. 2(F).

SER. NO. 85-162,470, FILED 10-27-2010.

STEPHANIE ALI, EXAMINING ATTORNEY



*David J. Kyffers*

Director of the United States Patent and Trademark Office

# United States of America

United States Patent and Trademark Office

# Selam

**Reg. No. 4,196,619**

**Registered Aug. 28, 2012**

**Int. Cl.: 30**

**TRADEMARK**

**PRINCIPAL REGISTER**

SELAM FOODS, INC. (MINNESOTA CORPORATION)  
215 S 9TH ST APT 201  
MINNEAPOLIS, MN 55402

FOR: PROCESSED GRAINS, NAMELY, TEFF, IN CLASS 30 (U.S. CL. 46).

FIRST USE 7-1-2010; IN COMMERCE 8-1-2010.

THE MARK CONSISTS OF STANDARD CHARACTERS WITHOUT CLAIM TO ANY PARTICULAR FONT, STYLE, SIZE, OR COLOR.

THE ENGLISH TRANSLATION OF "SELAM" IN THE MARK IS "PEACE".

SER. NO. 85-163,425, FILED 10-28-2010.

KHANH LE, EXAMINING ATTORNEY



*David J. Kybas*

Director of the United States Patent and Trademark Office

# United States of America

United States Patent and Trademark Office

# TRUFORM

**Reg. No. 4,196,620**

NEWALTA CORPORATION (CANADA CORPORATION)

**Registered Aug. 28, 2012**

211 - 11 AVENUE S.W.

CALGARY, ALBERTA, CANADA T2R0C6

**Int. Cls.: 1 and 4**

FOR: ANTIFREEZE, GLYCOLS, TRANSMISSION FLUID, FUEL ADDITIVES, NAMELY, CHEMICAL ADDITIVES FOR FUEL TREATMENT, IN CLASS 1 (U.S. CLS. 1, 5, 6, 10, 26 AND 46).

**TRADEMARK**

FOR: INDUSTRIAL EXPLOSIVE CARRIER OIL, INDUSTRIAL DRILLING OIL AND FUEL, DE-ASHED FUEL OIL, LIGHT DISTILLATE FUEL OIL AND SEMI-PROCESSED FUEL OIL, MOULD RELEASING OILS, INDUSTRIAL BASE OILS, INDUSTRIAL LUBRICANTS, NAMELY, MOTOR OIL, TRACTOR LUBRICANTS, NAMELY, GRINDING FLUIDS, INDUSTRIAL CHAIN OIL, GENERAL PURPOSE GREASE, HYDRAULIC OIL, INDUSTRIAL GEAR LUBRICANT, PETROLEUM DISTILLATES, INDUSTRIAL FUEL OILS AND ASPHALT EMULSIONS, NAMELY, FLUXANT OIL FOR USE AS AN INGREDIENT IN ASPHALT, IN CLASS 4 (U.S. CLS. 1, 6 AND 15).

**PRINCIPAL REGISTER**

THE MARK CONSISTS OF STANDARD CHARACTERS WITHOUT CLAIM TO ANY PARTICULAR FONT, STYLE, SIZE, OR COLOR.

PRIORITY CLAIMED UNDER SEC. 44(D) ON CANADA APPLICATION NO. 1499750, FILED 10-14-2010, REG. NO. TMA818,100, DATED 2-22-2012, EXPIRES 2-22-2027.

SER. NO. 85-163,446, FILED 10-28-2010.

LESLIE RICHARDS, EXAMINING ATTORNEY



*David J. Kyros*

Director of the United States Patent and Trademark Office

# United States of America

United States Patent and Trademark Office



**Reg. No. 4,196,621**

**Registered Aug. 28, 2012**

**Int. Cls.: 35 and 36**

**SERVICE MARK**

**PRINCIPAL REGISTER**

PROLIFIC BUSINESS SOLUTIONS, LLC (DELAWARE LIMITED LIABILITY COMPANY),  
FORMERLY PROLIFIC PAYMENT SOLUTIONS, LLC  
14624 N. SCOTTSDALE ROAD, STE. 100  
SCOTTSDALE, AZ 85254

FOR: BUSINESS MARKETING SERVICES; BUSINESS PLANNING; BUSINESS SUPPORT SERVICES, NAMELY, BUSINESS CONSULTING TO FREELANCERS, START-UPS, EXISTING BUSINESSES AND NON-PROFIT ORGANIZATIONS; CONSULTING SERVICES IN BUSINESS ORGANIZATION AND MANAGEMENT; PAYROLL ADMINISTRATION AND MANAGEMENT SERVICES; PAYROLL PROCESSING SERVICES; PROFESSIONAL BUSINESS CONSULTATION; PROFESSIONAL BUSINESS CONSULTING, IN CLASS 35 (U.S. CLS. 100, 101 AND 102).

FIRST USE 10-1-2010; IN COMMERCE 10-1-2010.

FOR: CREDIT CARD AND DEBIT CARD SERVICES; CREDIT CARD AND PAYMENT CARD SERVICES; CREDIT CARD AUTHORIZATION SERVICES; CREDIT CARD PAYMENT PROCESSING SERVICES; CREDIT CARD SERVICES; CREDIT CARD TRANSACTION PROCESSING SERVICES; CREDIT CARD VERIFICATION; ELECTRONIC CREDIT CARD TRANSACTIONS; FINANCIAL SERVICES, NAMELY, FUNDING ONLINE CASH ACCOUNTS FROM PREPAID CASH CARDS, BANK ACCOUNTS AND CREDIT CARD ACCOUNTS; ISSUANCE OF CREDIT CARDS; ISSUING CREDIT CARDS; ISSUING OF CREDIT CARDS; PAYMENT PROCESSING SERVICES, NAMELY, CREDIT CARD AND DEBIT CARD TRANSACTION PROCESSING SERVICES; PROVIDING ELECTRONIC PROCESSING OF CREDIT CARD TRANSACTIONS AND ELECTRONIC PAYMENTS VIA A GLOBAL COMPUTER NETWORK, IN CLASS 36 (U.S. CLS. 100, 101 AND 102).

FIRST USE 10-1-2010; IN COMMERCE 10-1-2010.

OWNER OF U.S. REG. NOS. 3,448,316 AND 3,448,319.

NO CLAIM IS MADE TO THE EXCLUSIVE RIGHT TO USE "BUSINESS SOLUTIONS", APART FROM THE MARK AS SHOWN.

THE MARK CONSISTS OF THE LITERAL ELEMENT OF "PROLIFIC BUSINESS SOLUTIONS" ACCOMPANIED BY A STYLIZED CREDIT CARD WITHIN A SET OF LINES AND A SWIRL.



*David J. Kyjars*

Director of the United States Patent and Trademark Office

**Reg. No. 4,196,621** SER. NO. 85-164,159, FILED 10-28-2010.

MATTHEW KLINE, EXAMINING ATTORNEY

# United States of America

United States Patent and Trademark Office

## TEMASEK NOMINEES

**Reg. No. 4,196,622**

**Registered Aug. 28, 2012**

**Int. Cls.: 35, 36 and 41**

**SERVICE MARK**

**PRINCIPAL REGISTER**

TEMASEK HOLDINGS (PRIVATE) LIMITED (SINGAPORE CORPORATION)  
60B ORCHARD ROAD #06-18 TOWER 2  
THE ATRIUM@ORCHARD  
SINGAPORE, SINGAPORE 238891

FOR: BUSINESS MANAGEMENT; BUSINESS ADMINISTRATION; PROFESSIONAL BUSINESS CONSULTANCY; BUSINESS MANAGEMENT AND ORGANIZATION CONSULTANCY; BUSINESS MANAGEMENT CONSULTANCY; ADVISORY SERVICES FOR BUSINESS MANAGEMENT; RECORDING OF INTER PARTIES TRANSACTIONS IN RESPECT OF SHARES, NAMELY, RECORDING AND REGISTERING THE TRANSFER OF STOCKS, SHARES AND SECURITIES, IN CLASS 35 (U.S. CLS. 100, 101 AND 102).

FOR: FINANCIAL SERVICES, NAMELY, FINANCIAL PLANNING, FINANCIAL RESEARCH, FINANCIAL MANAGEMENT, FINANCIAL CONSULTATION; INVESTMENT SERVICES, NAMELY, MUTUAL FUND INVESTMENT; FINANCIAL CONSULTANCY SERVICES; FINANCIAL MANAGEMENT SERVICES; FUND INVESTMENTS; CAPITAL INVESTMENTS; MUTUAL FUNDS, NAMELY, MUTUAL FUND DISTRIBUTION AND ESTABLISHING MUTUAL FUNDS FOR OTHERS; FINANCIAL INFORMATION; STOCK EXCHANGE QUOTATIONS; INSURANCE INFORMATION; FINANCIAL EVALUATION FOR INSURANCE PURPOSES; CHARITABLE COLLECTIONS IN THE NATURE OF FUNDRAISING; PROVISION OF INFORMATION RELATING TO THE REAL ESTATE PROPERTY MARKET IN THE FIELD OF REAL ESTATE VALUES; PRICING INFORMATION SERVICES, NAMELY, QUOTATION OF STOCK MARKET PRICES; INVESTMENT INFORMATION SERVICES; INFORMATION ABOUT STOCK BROKING SERVICES; PROVISION OF INFORMATION RELATING TO SHARES PRICES, AND CORPORATE SAVINGS ACCOUNT SERVICES; PROVISION OF INFORMATION RELATING TO REAL ESTATE AND REAL PROPERTY IN THE FIELD OF EVALUATION OF REAL PROPERTY; COMPUTERIZED FINANCIAL INFORMATION RELATING TO COMMODITIES AND SECURITIES; COMPUTERIZED FINANCIAL SERVICES FOR RETAIL BUSINESSES; PROVISION OF FINANCIAL INFORMATION RELATING TO RATES OF EXCHANGE; REAL ESTATE PROPERTY APPRAISAL SERVICES; REAL ESTATE PROPERTY BROKERAGE SERVICES; REAL ESTATE PROPERTY CONSULTANCY SERVICES; REAL ESTATE PROPERTY EVALUATION SERVICES; REAL ESTATE PROPERTY FINANCING SERVICES; REAL ESTATE PROPERTY INVESTMENT SERVICES; REAL ESTATE RENTAL PROPERTY MANAGEMENT SERVICES; COMMERCIAL PROPERTY INVESTMENT SERVICES; ESTATE TRUST MANAGEMENT SERVICES RELATING TO REAL ESTATE AND PROPERTY; FINANCIAL SERVICES RELATING TO THE ACQUISITION AND SALE OF PROPERTY, NAMELY, REAL ESTATE MORTGAGE



*David J. Kybas*

Director of the United States Patent and Trademark Office

**Reg. No. 4,196,622** BROKERAGE; COLLECTION OF CREDIT SALES BEING CREDIT RECOVERY AND COLLECTION SERVICES; COLLECTION OF PAYMENT BEING RENT; FINANCIAL ADMINISTRATION OF STOCK EXCHANGE TRADING OF SHARES IN FINANCIAL MARKETS; BROKERAGE OF SHARES; COMPUTERIZED INFORMATION SERVICES RELATING TO SHARE PRICES; FINANCIAL MANAGEMENT OF SHARES; FINANCIAL INFORMATION RELATING TO SHARES; FINANCIAL SERVICES, NAMELY, THE TRADING OF SHARES; AUTOMATED BANKING SERVICES RELATING TO ELECTRONIC CHARGE CARD AND CREDIT CARD TRANSACTIONS; COMPUTERIZED INFORMATION SERVICES RELATING TO BANKING MATTERS; PROVIDING INFORMATION ABOUT BANKING SERVICES; PROVISION OF FINANCIAL NEWS, IN CLASS 36 (U.S. CLS. 100, 101 AND 102).

FOR: EDUCATIONAL SERVICES, NAMELY, CLASSES AND SEMINARS IN THE FIELD OF FINANCIAL AND BUSINESS MATTERS; TRAINING SERVICES IN THE FIELD OF FINANCIAL AND BUSINESS MATTERS; ARRANGING AND CONDUCTING OF EDUCATIONAL CONFERENCES, CONGRESSES, SEMINARS, SYMPOSIUMS AND TRAINING WORKSHOPS ALL IN THE FIELDS OF BUSINESS AND FINANCE, IN CLASS 41 (U.S. CLS. 100, 101 AND 107).

THE MARK CONSISTS OF STANDARD CHARACTERS WITHOUT CLAIM TO ANY PARTICULAR FONT, STYLE, SIZE, OR COLOR.

OWNER OF SINGAPORE REG. NO. T1013834D, DATED 10-22-2010, EXPIRES 10-22-2020.

OWNER OF U.S. REG. NO. 3,187,580.

THE ENGLISH TRANSLATION OF "TEMASEK" IN THE MARK IS "WATER TOWN".

SER. NO. 85-165,435, FILED 10-29-2010.

ANDREA HACK, EXAMINING ATTORNEY



# United States of America

United States Patent and Trademark Office

## TEMASEK OVERVIEW

**Reg. No. 4,196,623**

**Registered Aug. 28, 2012**

**Int. Cls.: 9, 16, 36, 38  
and 41**

**TRADEMARK**

**SERVICE MARK**

**PRINCIPAL REGISTER**

TEMASEK HOLDINGS (PRIVATE) LIMITED (SINGAPORE CORPORATION)  
60B ORCHARD ROAD #06-18 TOWER 2  
THE ATRIUM@ORCHARD  
SINGAPORE, SINGAPORE 238891

FOR: DOWNLOADABLE ELECTRONIC PUBLICATIONS, NAMELY, NEWSLETTERS, JOURNALS, BOOKS, IN THE FIELD OF BUSINESS AND FINANCIAL MATTERS; ELECTRONIC PUBLICATIONS IN COMPUTER READABLE FORM, NAMELY, NEWSLETTERS, JOURNALS, BOOKS IN THE FIELD OF BUSINESS AND FINANCIAL AFFAIRS RECORDED ON COMPUTER MEDIA; ELECTRONIC PUBLICATIONS IN MACHINE READABLE FORM, NAMELY, NEWSLETTERS, JOURNALS, BOOKS IN THE FIELD OF BUSINESS AND FINANCIAL MATTERS RECORDED ON COMPUTER MEDIA, IN CLASS 9 (U.S. CLS. 21, 23, 26, 36 AND 38).

FOR: PRINTED PUBLICATIONS, NAMELY, NEWSLETTERS, JOURNALS AND BOOKS IN THE FIELD OF BUSINESS AND FINANCIAL MATTERS; PERIODIC PUBLICATIONS, NAMELY, PERIODICALS IN THE FIELD OF BUSINESS AND FINANCIAL MATTERS; PRINTED REPORTS FEATURING BUSINESS AND FINANCIAL MATTERS, IN CLASS 16 (U.S. CLS. 2, 5, 22, 23, 29, 37, 38 AND 50).

FOR: FINANCIAL SERVICES, NAMELY, FINANCIAL PLANNING, FINANCIAL RESEARCH, FINANCIAL MANAGEMENT, FINANCIAL CONSULTATION; INVESTMENT SERVICES, NAMELY, MUTUAL FUND INVESTMENT; FINANCIAL CONSULTANCY SERVICES; FINANCIAL MANAGEMENT SERVICES; FUND INVESTMENTS; CAPITAL INVESTMENTS; MUTUAL FUNDS, NAMELY, MUTUAL FUND DISTRIBUTION AND ESTABLISHING MUTUAL FUNDS FOR OTHERS; FINANCIAL INFORMATION; STOCK EXCHANGE QUOTATIONS; INSURANCE INFORMATION; FINANCIAL EVALUATION FOR INSURANCE PURPOSES; CHARITABLE COLLECTIONS IN THE NATURE OF FUNDRAISING; PROVISION OF INFORMATION RELATING TO THE REAL ESTATE PROPERTY MARKET IN THE FIELD OF REAL ESTATE VALUES; PRICING INFORMATION SERVICES, NAMELY, QUOTATION OF STOCK MARKET PRICES; INVESTMENT INFORMATION SERVICES; INFORMATION ABOUT STOCK BROKING SERVICES; PROVISION OF INFORMATION RELATING TO SHARES PRICES, AND CORPORATE SAVINGS ACCOUNT SERVICES; PROVISION OF INFORMATION RELATING TO REAL ESTATE AND REAL PROPERTY IN THE FIELD OF EVALUATION OF REAL PROPERTY; COMPUTERIZED FINANCIAL INFORMATION RELATING TO COMMODITIES AND SECURITIES; COMPUTERIZED FINANCIAL SERVICES FOR RETAIL BUSINESSES; PROVISION OF FINANCIAL INFORMATION



*David J. Kypos*

Director of the United States Patent and Trademark Office

**Reg. No. 4,196,623** RELATING TO RATES OF EXCHANGE; REAL ESTATE PROPERTY APPRAISAL SERVICES; REAL ESTATE PROPERTY BROKERAGE SERVICES; REAL ESTATE PROPERTY CONSULTANCY SERVICES; REAL ESTATE PROPERTY EVALUATION SERVICES; REAL ESTATE PROPERTY FINANCING SERVICES; REAL ESTATE PROPERTY INVESTMENT SERVICES; REAL ESTATE RENTAL PROPERTY MANAGEMENT SERVICES; COMMERCIAL PROPERTY INVESTMENT SERVICES; ESTATE TRUST MANAGEMENT SERVICES RELATING TO REAL ESTATE AND PROPERTY; FINANCIAL SERVICES RELATING TO THE ACQUISITION AND SALE OF PROPERTY, NAMELY, REAL ESTATE MORTGAGE BROKERAGE; COLLECTION OF CREDIT SALES BEING CREDIT RECOVERY AND COLLECTION SERVICES; COLLECTION OF PAYMENT BEING RENT; FINANCIAL ADMINISTRATION OF STOCK EXCHANGE TRADING OF SHARES IN FINANCIAL MARKETS; BROKERAGE OF SHARES; COMPUTERIZED INFORMATION SERVICES RELATING TO SHARE PRICES; FINANCIAL MANAGEMENT OF SHARES; FINANCIAL INFORMATION RELATING TO SHARES; FINANCIAL SERVICES, NAMELY, THE TRADING OF SHARES; AUTOMATED BANKING SERVICES RELATING TO ELECTRONIC CHARGE CARD AND CREDIT CARD TRANSACTIONS; COMPUTERIZED INFORMATION SERVICES RELATING TO BANKING MATTERS; PROVIDING INFORMATION ABOUT BANKING SERVICES; PROVISION OF FINANCIAL NEWS, IN CLASS 36 (U.S. CLS. 100, 101 AND 102).

FOR: AUDIO AND VIDEO BROADCASTING SERVICES OVER THE INTERNET OR OTHER COMMUNICATIONS NETWORK, NAMELY, ELECTRONICALLY TRANSMITTING INFORMATION, AUDIO, AND VIDEO CLIPS; PROVIDING ACCESS TO DATABASES THAT CONTAIN INFORMATION, AUDIO, AND VIDEO MATERIAL FROM WEBSITES, ONLINE FORUMS, CHAT ROOMS, DISCUSSION GROUPS AND BLOGS OVER THE INTERNET; PROVIDING ON-LINE CHAT ROOMS AND ELECTRONIC BULLETIN BOARDS FOR TRANSMISSION OF MESSAGES AMONG USERS IN THE FIELD OF GENERAL INTEREST; PROVIDING DISCUSSION SERVICES IN THE NATURE OF ON-LINE FORUMS FOR TRANSMISSION OF MESSAGES AMONG COMPUTER USERS; PROVISION OF NEWS IN RELATION TO TELECOMMUNICATION SERVICES, IN CLASS 38 (U.S. CLS. 100, 101 AND 104).

FOR: ENTERTAINMENT IN THE NATURE OF ON-GOING VIDEO PROGRAMS IN THE FIELD OF NEWS; PROVISION OF NEWS IN RELATION TO EDUCATION, TRAINING, ENTERTAINMENT OR SPORTING AND CULTURAL ACTIVITIES; NEWS REPORTERS SERVICES; ON-LINE LIBRARY SERVICES, NAMELY, PROVIDING ELECTRONIC LIBRARY SERVICES BY MEANS OF A COMPUTERIZED DATABASE CONTAINING INFORMATION EXTRACTED FROM NEWSPAPERS VIA AN ON-LINE COMPUTER NETWORK; INFORMATION AND ADVISORY SERVICES RELATING TO CURRENT EVENTS IN THE NATURE OF PROVIDING NEWS REPORTER SERVICES ENTAILING NEWS ANALYSIS AND NEWS COMMENTARY ABOUT CURRENT EVENTS; PUBLICATION OF REVIEWS AND CRITIQUES; PUBLICATION OF ELECTRONIC BOOKS AND JOURNALS ON-LINE; PROVIDING NON-DOWNLOADABLE ON-LINE ELECTRONIC PUBLICATIONS IN THE NATURE OF JOURNALS AND BOOKS IN THE FIELD OF BUSINESS AND FINANCE; ELECTRONIC PUBLISHING SERVICES, NAMELY, PUBLICATION OF TEXT AND GRAPHIC WORKS OF OTHERS ON-LINE FEATURING BUSINESS AND FINANCIAL MATTERS; NON-DOWNLOADABLE WEB-BASED PUBLICATION IN THE NATURE OF JOURNALS CONSISTING PRIMARILY OF PERIODIC ARTICLES; PROVIDING NEWS FEEDS AS PART OF NEWS REPORTERS SERVICES; PUBLICATION OF TEXT, AUDIO, VIDEO AND GRAPHIC WORKS ONLINE FEATURING NEWS, DIARIES, COMMENTARY, PHOTOS, POETRY, MINI-ESSAYS, PROJECT UPDATES, NON-FICTION AND FICTION; PRODUCTION OF TELEVISION NEWS PROGRAMS FOR BROADCASTING; ON-LINE JOURNALS, NAMELY, WEBLOGS AND BLOGS FEATURING BUSINESS AND FINANCE; ADVISORY, INFORMATION AND CONSULTANCY SERVICES RELATING TO ALL THE AFORESAID, IN CLASS 41 (U.S. CLS. 100, 101 AND 107).

THE MARK CONSISTS OF STANDARD CHARACTERS WITHOUT CLAIM TO ANY PARTICULAR FONT, STYLE, SIZE, OR COLOR.

**Reg. No. 4,196,623** OWNER OF SINGAPORE REG. NO. T10138371, DATED 10-22-2010, EXPIRES 10-22-2020.

OWNER OF U.S. REG. NO. 3,187,580.

THE ENGLISH TRANSLATION OF "TEMASEK" IN THE MARK IS "WATER TOWN".

SER. NO. 85-165,493, FILED 10-30-2010.

ANDREA HACK, EXAMINING ATTORNEY

# United States of America

United States Patent and Trademark Office

## TEMASEK FINANCIALS

**Reg. No. 4,196,624**

**Registered Aug. 28, 2012**

**Int. Cls.: 9, 16, 36, 38  
and 41**

**TRADEMARK**

**SERVICE MARK**

**PRINCIPAL REGISTER**

TEMASEK HOLDINGS (PRIVATE) LIMITED (SINGAPORE CORPORATION)  
60B ORCHARD ROAD #06-18 TOWER 2  
THE ATRIUM@ORCHARD  
SINGAPORE, SINGAPORE 238891

FOR: DOWNLOADABLE ELECTRONIC PUBLICATIONS, NAMELY, NEWSLETTERS, JOURNALS, BOOKS, IN THE FIELD OF BUSINESS AND FINANCIAL MATTERS; ELECTRONIC PUBLICATIONS IN COMPUTER READABLE FORM, NAMELY, NEWSLETTERS, JOURNALS, BOOKS IN THE FIELD OF BUSINESS AND FINANCIAL AFFAIRS RECORDED ON COMPUTER MEDIA; ELECTRONIC PUBLICATIONS IN MACHINE READABLE FORM, NAMELY, NEWSLETTERS, JOURNALS, BOOKS IN THE FIELD OF BUSINESS AND FINANCIAL MATTERS RECORDED ON COMPUTER MEDIA, IN CLASS 9 (U.S. CLS. 21, 23, 26, 36 AND 38).

FOR: PRINTED PUBLICATIONS, NAMELY, NEWSLETTERS, JOURNALS AND BOOKS IN THE FIELD OF BUSINESS AND FINANCIAL MATTERS; PERIODIC PUBLICATIONS, NAMELY, PERIODICALS IN THE FIELD OF BUSINESS AND FINANCIAL MATTERS; PRINTED REPORTS FEATURING BUSINESS AND FINANCIAL MATTERS, IN CLASS 16 (U.S. CLS. 2, 5, 22, 23, 29, 37, 38 AND 50).

FOR: FINANCIAL SERVICES, NAMELY, FINANCIAL PLANNING, FINANCIAL RESEARCH, FINANCIAL MANAGEMENT, FINANCIAL CONSULTATION; INVESTMENT SERVICES, NAMELY, MUTUAL FUND INVESTMENT; FINANCIAL CONSULTANCY SERVICES; FINANCIAL MANAGEMENT SERVICES; FUND INVESTMENTS; CAPITAL INVESTMENTS; MUTUAL FUNDS, NAMELY, MUTUAL FUND DISTRIBUTION AND ESTABLISHING MUTUAL FUNDS FOR OTHERS; FINANCIAL INFORMATION; STOCK EXCHANGE QUOTATIONS; INSURANCE INFORMATION; FINANCIAL EVALUATION FOR INSURANCE PURPOSES; CHARITABLE COLLECTIONS IN THE NATURE OF FUNDRAISING; PROVISION OF INFORMATION RELATING TO THE REAL ESTATE PROPERTY MARKET IN THE FIELD OF REAL ESTATE VALUES; PRICING INFORMATION SERVICES, NAMELY, QUOTATION OF STOCK MARKET PRICES; INVESTMENT INFORMATION SERVICES; INFORMATION ABOUT STOCK BROKING SERVICES; PROVISION OF INFORMATION RELATING TO SHARES PRICES, AND CORPORATE SAVINGS ACCOUNT SERVICES; PROVISION OF INFORMATION RELATING TO REAL ESTATE AND REAL PROPERTY IN THE FIELD OF EVALUATION OF REAL PROPERTY; COMPUTERIZED FINANCIAL INFORMATION RELATING TO COMMODITIES AND SECURITIES; COMPUTERIZED FINANCIAL SERVICES FOR RETAIL BUSINESSES; PROVISION OF FINANCIAL INFORMATION



*David J. Kypas*

Director of the United States Patent and Trademark Office

**Reg. No. 4,196,624** RELATING TO RATES OF EXCHANGE; REAL ESTATE PROPERTY APPRAISAL SERVICES; REAL ESTATE PROPERTY BROKERAGE SERVICES; REAL ESTATE PROPERTY CONSULTANCY SERVICES; REAL ESTATE PROPERTY EVALUATION SERVICES; REAL ESTATE PROPERTY FINANCING SERVICES; REAL ESTATE PROPERTY INVESTMENT SERVICES; REAL ESTATE RENTAL PROPERTY MANAGEMENT SERVICES; COMMERCIAL PROPERTY INVESTMENT SERVICES; ESTATE TRUST MANAGEMENT SERVICES RELATING TO REAL ESTATE AND PROPERTY; FINANCIAL SERVICES RELATING TO THE ACQUISITION AND SALE OF PROPERTY, NAMELY, REAL ESTATE MORTGAGE BROKERAGE; COLLECTION OF CREDIT SALES BEING CREDIT RECOVERY AND COLLECTION SERVICES; COLLECTION OF PAYMENT BEING RENT; FINANCIAL ADMINISTRATION OF STOCK EXCHANGE TRADING OF SHARES IN FINANCIAL MARKETS; BROKERAGE OF SHARES; COMPUTERIZED INFORMATION SERVICES RELATING TO SHARE PRICES; FINANCIAL MANAGEMENT OF SHARES; FINANCIAL INFORMATION RELATING TO SHARES; FINANCIAL SERVICES, NAMELY, THE TRADING OF SHARES; AUTOMATED BANKING SERVICES RELATING TO ELECTRONIC CHARGE CARD AND CREDIT CARD TRANSACTIONS; COMPUTERIZED INFORMATION SERVICES RELATING TO BANKING MATTERS; PROVIDING INFORMATION ABOUT BANKING SERVICES; PROVISION OF FINANCIAL NEWS, IN CLASS 36 (U.S. CLS. 100, 101 AND 102).

FOR: AUDIO AND VIDEO BROADCASTING SERVICES OVER THE INTERNET OR OTHER COMMUNICATIONS NETWORK, NAMELY, ELECTRONICALLY TRANSMITTING INFORMATION, AUDIO, AND VIDEO CLIPS; PROVIDING ACCESS TO DATABASES THAT CONTAIN INFORMATION, AUDIO, AND VIDEO MATERIAL FROM WEBSITES, ONLINE FORUMS, CHAT ROOMS, DISCUSSION GROUPS AND BLOGS OVER THE INTERNET; PROVIDING ON-LINE CHAT ROOMS AND ELECTRONIC BULLETIN BOARDS FOR TRANSMISSION OF MESSAGES AMONG USERS IN THE FIELD OF GENERAL INTEREST; PROVIDING DISCUSSION SERVICES IN THE NATURE OF ON-LINE FORUMS FOR TRANSMISSION OF MESSAGES AMONG COMPUTER USERS; PROVISION OF NEWS IN RELATION TO TELECOMMUNICATION SERVICES, IN CLASS 38 (U.S. CLS. 100, 101 AND 104).

FOR: ENTERTAINMENT IN THE NATURE OF ON-GOING VIDEO PROGRAMS IN THE FIELD OF NEWS; PROVISION OF NEWS IN RELATION TO EDUCATION, TRAINING, ENTERTAINMENT OR SPORTING AND CULTURAL ACTIVITIES; NEWS REPORTERS SERVICES; ON-LINE LIBRARY SERVICES, NAMELY, PROVIDING ELECTRONIC LIBRARY SERVICES BY MEANS OF A COMPUTERIZED DATABASE CONTAINING INFORMATION EXTRACTED FROM NEWSPAPERS VIA AN ON-LINE COMPUTER NETWORK; INFORMATION AND ADVISORY SERVICES RELATING TO CURRENT EVENTS IN THE NATURE OF PROVIDING NEWS REPORTER SERVICES ENTAILING NEWS ANALYSIS AND NEWS COMMENTARY ABOUT CURRENT EVENTS; PUBLICATION OF REVIEWS AND CRITIQUES; PUBLICATION OF ELECTRONIC BOOKS AND JOURNALS ON-LINE; PROVIDING NON-DOWNLOADABLE ON-LINE ELECTRONIC PUBLICATIONS IN THE NATURE OF JOURNALS AND BOOKS IN THE FIELD OF BUSINESS AND FINANCE; ELECTRONIC PUBLISHING SERVICES, NAMELY, PUBLICATION OF TEXT AND GRAPHIC WORKS OF OTHERS ON-LINE FEATURING BUSINESS AND FINANCIAL MATTERS; NON-DOWNLOADABLE WEB-BASED PUBLICATION IN THE NATURE OF JOURNALS CONSISTING PRIMARILY OF PERIODIC ARTICLES; PROVIDING NEWS FEEDS AS PART OF NEWS REPORTERS SERVICES; PUBLICATION OF TEXT, AUDIO, VIDEO AND GRAPHIC WORKS ONLINE FEATURING NEWS, DIARIES, COMMENTARY, PHOTOS, POETRY, MINI-ESSAYS, PROJECT UPDATES, NON-FICTION AND FICTION; PRODUCTION OF TELEVISION NEWS PROGRAMS FOR BROADCASTING; ON-LINE JOURNALS, NAMELY, WEBLOGS AND BLOGS FEATURING BUSINESS AND FINANCE; ADVISORY, INFORMATION AND CONSULTANCY SERVICES RELATING TO ALL THE AFORESAID, IN CLASS 41 (U.S. CLS. 100, 101 AND 107).

THE MARK CONSISTS OF STANDARD CHARACTERS WITHOUT CLAIM TO ANY PARTICULAR FONT, STYLE, SIZE, OR COLOR.

**Reg. No. 4,196,624** OWNER OF SINGAPORE REG. NO. T1013838G, DATED 10-22-2010, EXPIRES 10-22-2020.

OWNER OF U.S. REG. NO. 3,187,580.

NO CLAIM IS MADE TO THE EXCLUSIVE RIGHT TO USE "FINANCIALS", APART FROM THE MARK AS SHOWN.

THE ENGLISH TRANSLATION OF "TEMASEK" IN THE MARK IS "WATER TOWN".

SER. NO. 85-165,495, FILED 10-30-2010.

ANDREA HACK, EXAMINING ATTORNEY

# United States of America

United States Patent and Trademark Office

## Belmont Apparel

**Reg. No. 4,196,625**

**Registered Aug. 28, 2012**

**Int. Cl.: 40**

**SERVICE MARK**

**PRINCIPAL REGISTER**

MIND CANDY INC. (CALIFORNIA CORPORATION)  
7162 BEVERLY BLVD  
#318  
LOS ANGELES, CA 90036

FOR: MANUFACTURING SERVICES FOR WHOLESALERS AND DESIGNERS IN THE FIELD OF CLOTHING, IN CLASS 40 (U.S. CLS. 100, 103 AND 106).

FIRST USE 1-0-2010; IN COMMERCE 6-0-2010.

THE MARK CONSISTS OF STANDARD CHARACTERS WITHOUT CLAIM TO ANY PARTICULAR FONT, STYLE, SIZE, OR COLOR.

NO CLAIM IS MADE TO THE EXCLUSIVE RIGHT TO USE "APPAREL", APART FROM THE MARK AS SHOWN.

SER. NO. 85-167,579, FILED 11-2-2010.

ALICIA COLLINS, EXAMINING ATTORNEY



*David J. Kyjars*

Director of the United States Patent and Trademark Office

# United States of America

United States Patent and Trademark Office

# DOSE STAR

**Reg. No. 4,196,626**

SANOFI (FRANCE SOCIETE ANONYME)  
54 RUE LA BOÉTIE  
PARIS, FRANCE 75008

**Registered Aug. 28, 2012**

**Int. Cls.: 5, 9 and 10**

FOR: BLOOD GLUCOSE MONITORING KITS COMPRISING STRIPS FOR MEASURING BLOOD GLUCOSE CONCENTRATIONS, LANCETS AND CONTROL SOLUTION, IN CLASS 5 (U.S. CLS. 6, 18, 44, 46, 51 AND 52).

**TRADEMARK**

FOR: SOFTWARE DOWNLOADABLE VIA THE INTERNET OR MOBILE PHONE APPLICATIONS FOR MONITORING AND TRACKING BLOOD GLUCOSE LEVELS, IN CLASS 9 (U.S. CLS. 21, 23, 26, 36 AND 38).

**PRINCIPAL REGISTER**

FOR: BLOOD GLUCOSE MONITORS, AND BLOOD GLUCOSE MONITORS SOLD AS A UNIT WITH BLOOD GLUCOSE MONITORING KITS COMPRISING STRIPS FOR MEASURING BLOOD GLUCOSE CONCENTRATIONS, LANCETS AND CONTROL SOLUTION, IN CLASS 10 (U.S. CLS. 26, 39 AND 44).

THE MARK CONSISTS OF STANDARD CHARACTERS WITHOUT CLAIM TO ANY PARTICULAR FONT, STYLE, SIZE, OR COLOR.

PRIORITY CLAIMED UNDER SEC. 44(D) ON FRANCE APPLICATION NO. 10/3764185, FILED 9-3-2010, REG. NO. 10/3764185, DATED 9-3-2010, EXPIRES 9-3-2020.



OWNER OF U.S. REG. NO. 3,806,246.

SER. NO. 85-168,383, FILED 11-3-2010.

JUDITH HELFMAN, EXAMINING ATTORNEY

*David J. Kyros*

Director of the United States Patent and Trademark Office



# United States of America

United States Patent and Trademark Office

## LOVE YOUR LIFE LINES

**Reg. No. 4,196,627**

**Registered Aug. 28, 2012**

**Int. Cl.: 3**

**TRADEMARK**

**PRINCIPAL REGISTER**

MAMA MIO LIMITED (UNITED KINGDOM LIMITED LIABILITY COMPANY)  
STUDIO G6, CLERKENWELL WORKSHOPS  
31 CLERKENWELL CLOSE  
LONDON, UNITED KINGDOM EC1R0AT

FOR: SKIN CARE AND BODY CARE PRODUCTS, NAMELY, MOISTURIZERS, BODY OILS AND MASSAGE OILS, NON-MEDICATED SKIN CARE AND BODY CARE PRODUCTS; PERFUMES, COSMETICS, EAU DE COLOGNES, SHOWER GEL, SOAP, NON-MEDICATED BODY CARE PREPARATIONS FOR COSMETIC USE, NON-MEDICATED SKIN CARE AND HAIR CARE PREPARATIONS, BATH PREPARATIONS, FRAGRANCES FOR PERSONAL USE AND ESSENTIAL OILS FOR PERSONAL USE, IN CLASS 3 (U.S. CLS. 1, 4, 6, 50, 51 AND 52).

THE MARK CONSISTS OF STANDARD CHARACTERS WITHOUT CLAIM TO ANY PARTICULAR FONT, STYLE, SIZE, OR COLOR.

PRIORITY CLAIMED UNDER SEC. 44(D) ON ERPN CMNTY TM OFC APPLICATION NO. 9323973, FILED 8-19-2010, REG. NO. 9323973, DATED 8-19-2010, EXPIRES 8-19-2020.

SER. NO. 85-171,190, FILED 11-8-2010.

MARK SHINER, EXAMINING ATTORNEY



*David J. Kyffers*

Director of the United States Patent and Trademark Office

# United States of America

United States Patent and Trademark Office

## TEMASEK ACADEMY

**Reg. No. 4,196,628**

**Registered Aug. 28, 2012**

**Int. Cls.: 9, 16, 35, 36  
and 41**

**TRADEMARK**

**SERVICE MARK**

**PRINCIPAL REGISTER**

TEMASEK HOLDINGS (PRIVATE) LIMITED (SINGAPORE CORPORATION)  
60B ORCHARD ROAD #06-18 TOWER 2  
THE ATRIUM@ORCHARD  
SINGAPORE, SINGAPORE 238891

FOR: DOWNLOADABLE ELECTRONIC PUBLICATIONS, NAMELY, NEWSLETTERS, JOURNALS, BOOKS, IN THE FIELD OF BUSINESS AND FINANCIAL MATTERS; ELECTRONIC PUBLICATIONS IN COMPUTER READABLE FORM, NAMELY, NEWSLETTERS, JOURNALS, BOOKS IN THE FIELD OF BUSINESS AND FINANCIAL AFFAIRS RECORDED ON COMPUTER MEDIA; ELECTRONIC PUBLICATIONS IN MACHINE READABLE FORM, NAMELY, NEWSLETTERS, JOURNALS, BOOKS IN THE FIELD OF BUSINESS AND FINANCIAL MATTERS RECORDED ON COMPUTER MEDIA, IN CLASS 9 (U.S. CLS. 21, 23, 26, 36 AND 38).

FOR: PRINTED PUBLICATIONS, NAMELY, NEWSLETTERS, JOURNALS AND BOOKS IN THE FIELD OF BUSINESS AND FINANCIAL MATTERS; PERIODIC PUBLICATIONS, NAMELY, PERIODICALS IN THE FIELD OF BUSINESS AND FINANCIAL MATTERS; PRINTED REPORTS FEATURING BUSINESS AND FINANCIAL MATTERS, IN CLASS 16 (U.S. CLS. 2, 5, 22, 23, 29, 37, 38 AND 50).

FOR: CHARITABLE SERVICES, NAMELY, PROVIDING BUSINESS MANAGEMENT AND ADMINISTRATION SERVICES, AND ORGANIZING AND CONDUCTING VOLUNTEER PROGRAMS AND COMMUNITY SERVICE PROJECTS, IN CLASS 35 (U.S. CLS. 100, 101 AND 102).

FOR: CHARITABLE FUNDRAISING; CHARITABLE SERVICES, NAMELY, PROVIDING FINANCIAL ADVICE TO FINANCIALLY DISTRESSED INDIVIDUALS; ORGANIZING OF CHARITABLE COLLECTIONS, NAMELY, ORGANIZING FUNDRAISING SERVICES AND EVENTS TO RAISE FUNDS IN THE FIELD OF COMMUNITY SERVICE PROJECTS, IN CLASS 36 (U.S. CLS. 100, 101 AND 102).

FOR: ENTERTAINMENT IN THE NATURE OF ON-GOING VIDEO PROGRAMS IN THE FIELD OF NEWS; PROVISION OF NEWS IN RELATION TO EDUCATION, TRAINING, ENTERTAINMENT OR SPORTING AND CULTURAL ACTIVITIES; NEWS REPORTERS SERVICES; ON-LINE LIBRARY SERVICES, NAMELY, PROVIDING ELECTRONIC LIBRARY SERVICES BY MEANS OF A COMPUTERIZED DATABASE CONTAINING INFORMATION EXTRACTED FROM NEWSPAPERS VIA AN ON-LINE COMPUTER NETWORK; INFORM-



*David J. Kyffers*

Director of the United States Patent and Trademark Office

**Reg. No. 4,196,628** ATION AND ADVISORY SERVICES RELATING TO CURRENT EVENTS IN THE NATURE OF PROVIDING NEWS REPORTER SERVICES ENTAILING NEWS ANALYSIS AND NEWS COMMENTARY ABOUT CURRENT EVENTS; PUBLICATION OF REVIEWS AND CRITIQUES; PUBLICATION OF ELECTRONIC BOOKS AND JOURNALS ON-LINE; PROVIDING NON-DOWNLOADABLE ON-LINE ELECTRONIC PUBLICATIONS IN THE NATURE OF JOURNALS AND BOOKS IN THE FIELD OF BUSINESS AND FINANCE; ELECTRONIC PUBLISHING SERVICES, NAMELY, PUBLICATION OF TEXT AND GRAPHIC WORKS OF OTHERS ON-LINE FEATURING BUSINESS AND FINANCIAL MATTERS; NON-DOWNLOADABLE WEB-BASED PUBLICATION IN THE NATURE OF JOURNALS CONSISTING PRIMARILY OF PERIODIC ARTICLES; PROVIDING NEWS FEEDS AS PART OF NEWS REPORTERS SERVICES; PUBLICATION OF TEXT, AUDIO, VIDEO AND GRAPHIC WORKS ONLINE FEATURING NEWS, DIARIES, COMMENTARY, PHOTOS, POETRY, MINI-ESSAYS, PROJECT UPDATES, NON-FICTION AND FICTION; PRODUCTION OF TELEVISION NEWS PROGRAMS FOR BROADCASTING; ON-LINE JOURNALS, NAMELY, WEBLOGS AND BLOGS FEATURING BUSINESS AND FINANCE; ADVISORY, INFORMATION AND CONSULTANCY SERVICES RELATING TO ALL THE AFORESAID; CHARITABLE SERVICE, NAMELY, ACADEMIC MENTORING OF SCHOOL AGE CHILDREN; CHARITABLE SERVICES, NAMELY, CONDUCTING CLASSES SEMINARS, AND TRAINING SESSIONS IN THE FIELD OF FINANCIAL ADVICE FOR FINANCIALLY DISTRESSED INDIVIDUALS; EDUCATIONAL SERVICES, NAMELY, CLASSES AND SEMINARS IN THE FIELD OF FINANCIAL AND BUSINESS MATTERS; EDUCATIONAL SERVICES, NAMELY, CLASSES AND SEMINARS IN THE FIELD OF FINANCIAL AND BUSINESS MATTERS; TRAINING SERVICES IN THE FIELD OF FINANCIAL AND BUSINESS MATTERS; ARRANGING AND CONDUCTING OF EDUCATIONAL CONFERENCES, CONGRESSES, SEMINARS, SYMPOSIUMS AND TRAINING WORKSHOPS ALL IN THE FIELDS OF BUSINESS AND FINANCE, IN CLASS 41 (U.S. CLS. 100, 101 AND 107).

THE MARK CONSISTS OF STANDARD CHARACTERS WITHOUT CLAIM TO ANY PARTICULAR FONT, STYLE, SIZE, OR COLOR.

OWNER OF SINGAPORE REG. NO. T1014685A, DATED 9-11-2010, EXPIRES 9-11-2020.

OWNER OF U.S. REG. NO. 3,187,580.

NO CLAIM IS MADE TO THE EXCLUSIVE RIGHT TO USE "ACADEMY", APART FROM THE MARK AS SHOWN.

THE ENGLISH TRANSLATION OF "TEMASEK" IN THE MARK IS "WATER TOWN".

SER. NO. 85-173,813, FILED 11-10-2010.

ANDREA HACK, EXAMINING ATTORNEY

# United States of America

United States Patent and Trademark Office

## TEMASEK LEARNING

**Reg. No. 4,196,629**

**Registered Aug. 28, 2012**

**Int. Cls.: 9, 16, 35, 36  
and 41**

**TRADEMARK**

**SERVICE MARK**

**PRINCIPAL REGISTER**

TEMASEK HOLDINGS (PRIVATE) LIMITED (SINGAPORE CORPORATION)  
60B ORCHARD ROAD #06-18 TOWER 2  
THE ATRIUM@ORCHARD  
SINGAPORE, SINGAPORE 238891

FOR: DOWNLOADABLE ELECTRONIC PUBLICATIONS, NAMELY, NEWSLETTERS, JOURNALS, BOOKS, IN THE FIELD OF BUSINESS AND FINANCIAL MATTERS; ELECTRONIC PUBLICATIONS IN COMPUTER READABLE FORM, NAMELY, NEWSLETTERS, JOURNALS, BOOKS IN THE FIELD OF BUSINESS AND FINANCIAL AFFAIRS RECORDED ON COMPUTER MEDIA; ELECTRONIC PUBLICATIONS IN MACHINE READABLE FORM, NAMELY, NEWSLETTERS, JOURNALS, BOOKS IN THE FIELD OF BUSINESS AND FINANCIAL MATTERS RECORDED ON COMPUTER MEDIA, IN CLASS 9 (U.S. CLS. 21, 23, 26, 36 AND 38).

FOR: PRINTED PUBLICATIONS, NAMELY, NEWSLETTERS, JOURNALS AND BOOKS IN THE FIELD OF BUSINESS AND FINANCIAL MATTERS; PERIODIC PUBLICATIONS, NAMELY, PERIODICALS IN THE FIELD OF BUSINESS AND FINANCIAL MATTERS; PRINTED REPORTS FEATURING BUSINESS AND FINANCIAL MATTERS, IN CLASS 16 (U.S. CLS. 2, 5, 22, 23, 29, 37, 38 AND 50).

FOR: CHARITABLE SERVICES, NAMELY, PROVIDING BUSINESS MANAGEMENT AND ADMINISTRATION SERVICES, AND ORGANIZING AND CONDUCTING VOLUNTEER PROGRAMS AND COMMUNITY SERVICE PROJECTS, IN CLASS 35 (U.S. CLS. 100, 101 AND 102).

FOR: CHARITABLE FUNDRAISING; CHARITABLE SERVICES, NAMELY, PROVIDING FINANCIAL ADVICE TO FINANCIALLY DISTRESSED INDIVIDUALS; ORGANIZING OF CHARITABLE COLLECTIONS, NAMELY, ORGANIZING FUNDRAISING SERVICES AND EVENTS TO RAISE FUNDS IN THE FIELD OF COMMUNITY SERVICE PROJECTS, IN CLASS 36 (U.S. CLS. 100, 101 AND 102).

FOR: ENTERTAINMENT IN THE NATURE OF ON-GOING VIDEO PROGRAMS IN THE FIELD OF NEWS; PROVISION OF NEWS IN RELATION TO EDUCATION, TRAINING, ENTERTAINMENT OR SPORTING AND CULTURAL ACTIVITIES; NEWS REPORTERS SERVICES; ON-LINE LIBRARY SERVICES, NAMELY, PROVIDING ELECTRONIC LIBRARY SERVICES BY MEANS OF A COMPUTERIZED DATABASE CONTAINING INFORMATION EXTRACTED FROM NEWSPAPERS VIA AN ON-LINE COMPUTER NETWORK; INFORM-



*David J. Kyffers*

Director of the United States Patent and Trademark Office

**Reg. No. 4,196,629** ATION AND ADVISORY SERVICES RELATING TO CURRENT EVENTS IN THE NATURE OF PROVIDING NEWS REPORTER SERVICES ENTAILING NEWS ANALYSIS AND NEWS COMMENTARY ABOUT CURRENT EVENTS; PUBLICATION OF REVIEWS AND CRITIQUES; PUBLICATION OF ELECTRONIC BOOKS AND JOURNALS ON-LINE; PROVIDING NON-DOWNLOADABLE ON-LINE ELECTRONIC PUBLICATIONS IN THE NATURE OF JOURNALS AND BOOKS IN THE FIELD OF BUSINESS AND FINANCE; ELECTRONIC PUBLISHING SERVICES, NAMELY, PUBLICATION OF TEXT AND GRAPHIC WORKS OF OTHERS ON-LINE FEATURING BUSINESS AND FINANCIAL MATTERS; NON-DOWNLOADABLE WEB-BASED PUBLICATION IN THE NATURE OF JOURNALS CONSISTING PRIMARILY OF PERIODIC ARTICLES; PROVIDING NEWS FEEDS AS PART OF NEWS REPORTERS SERVICES; PUBLICATION OF TEXT, AUDIO, VIDEO AND GRAPHIC WORKS ONLINE FEATURING NEWS, DIARIES, COMMENTARY, PHOTOS, POETRY, MINI-ESSAYS, PROJECT UPDATES, NON-FICTION AND FICTION; PRODUCTION OF TELEVISION NEWS PROGRAMS FOR BROADCASTING; ON-LINE JOURNALS, NAMELY, WEBLOGS AND BLOGS FEATURING BUSINESS AND FINANCE; ADVISORY, INFORMATION AND CONSULTANCY SERVICES RELATING TO ALL THE AFORESAID; CHARITABLE SERVICE, NAMELY, ACADEMIC MENTORING OF SCHOOL AGE CHILDREN; CHARITABLE SERVICES, NAMELY, CONDUCTING CLASSES SEMINARS, AND TRAINING SESSIONS IN THE FIELD OF FINANCIAL ADVICE FOR FINANCIALLY DISTRESSED INDIVIDUALS; EDUCATIONAL SERVICES, NAMELY, CLASSES AND SEMINARS IN THE FIELD OF FINANCIAL AND BUSINESS MATTERS; EDUCATIONAL SERVICES, NAMELY, CLASSES AND SEMINARS IN THE FIELD OF FINANCIAL AND BUSINESS MATTERS; TRAINING SERVICES IN THE FIELD OF FINANCIAL AND BUSINESS MATTERS; ARRANGING AND CONDUCTING OF EDUCATIONAL CONFERENCES, CONGRESSES, SEMINARS, SYMPOSIUMS AND TRAINING WORKSHOPS ALL IN THE FIELDS OF BUSINESS AND FINANCE, IN CLASS 41 (U.S. CLS. 100, 101 AND 107).

THE MARK CONSISTS OF STANDARD CHARACTERS WITHOUT CLAIM TO ANY PARTICULAR FONT, STYLE, SIZE, OR COLOR.

OWNER OF SINGAPORE REG. NO. T10147001, DATED 9-11-2010, EXPIRES 9-11-2020.

OWNER OF U.S. REG. NO. 3,187,580.

NO CLAIM IS MADE TO THE EXCLUSIVE RIGHT TO USE "LEARNING", APART FROM THE MARK AS SHOWN.

THE ENGLISH TRANSLATION OF "TEMASEK" IN THE MARK IS "WATER TOWN".

SER. NO. 85-173,959, FILED 11-10-2010.

ANDREA HACK, EXAMINING ATTORNEY

# United States of America

United States Patent and Trademark Office

## TEMASEK ANNUAL REPORT

**Reg. No. 4,196,630**

**Registered Aug. 28, 2012**

**Int. Cls.: 9, 16, 36, 38  
and 41**

**TRADEMARK**

**SERVICE MARK**

**PRINCIPAL REGISTER**

TEMASEK HOLDINGS (PRIVATE) LIMITED (SINGAPORE CORPORATION)  
60B ORCHARD ROAD #06-18 TOWER 2  
THE ATRIUM@ORCHARD  
SINGAPORE, SINGAPORE 238891

FOR: DOWNLOADABLE ELECTRONIC PUBLICATIONS, NAMELY, NEWSLETTERS, JOURNALS, BOOKS, IN THE FIELD OF BUSINESS AND FINANCIAL MATTERS; ELECTRONIC PUBLICATIONS IN COMPUTER READABLE FORM, NAMELY, NEWSLETTERS, JOURNALS, BOOKS IN THE FIELD OF BUSINESS AND FINANCIAL AFFAIRS RECORDED ON COMPUTER MEDIA; ELECTRONIC PUBLICATIONS IN MACHINE READABLE FORM, NAMELY, NEWSLETTERS, JOURNALS, BOOKS IN THE FIELD OF BUSINESS AND FINANCIAL MATTERS RECORDED ON COMPUTER MEDIA, IN CLASS 9 (U.S. CLS. 21, 23, 26, 36 AND 38).

FOR: PRINTED PUBLICATIONS, NAMELY, NEWSLETTERS, JOURNALS AND BOOKS IN THE FIELD OF BUSINESS AND FINANCIAL MATTERS; PERIODIC PUBLICATIONS, NAMELY, PERIODICALS IN THE FIELD OF BUSINESS AND FINANCIAL MATTERS; PRINTED REPORTS FEATURING BUSINESS AND FINANCIAL MATTERS, IN CLASS 16 (U.S. CLS. 2, 5, 22, 23, 29, 37, 38 AND 50).

FOR: FINANCIAL SERVICES, NAMELY, FINANCIAL PLANNING, FINANCIAL RESEARCH, FINANCIAL MANAGEMENT, FINANCIAL CONSULTATION; INVESTMENT SERVICES, NAMELY, MUTUAL FUND INVESTMENT; FINANCIAL CONSULTANCY SERVICES; FINANCIAL MANAGEMENT SERVICES; FUND INVESTMENTS; CAPITAL INVESTMENTS; MUTUAL FUNDS, NAMELY, MUTUAL FUND DISTRIBUTION AND ESTABLISHING MUTUAL FUNDS FOR OTHERS; FINANCIAL INFORMATION; STOCK EXCHANGE QUOTATIONS; INSURANCE INFORMATION; FINANCIAL EVALUATION FOR INSURANCE PURPOSES; CHARITABLE COLLECTIONS IN THE NATURE OF FUNDRAISING; PROVISION OF INFORMATION RELATING TO THE REAL ESTATE PROPERTY MARKET IN THE FIELD OF REAL ESTATE VALUES; PRICING INFORMATION SERVICES, NAMELY, QUOTATION OF STOCK MARKET PRICES; INVESTMENT INFORMATION SERVICES; INFORMATION ABOUT STOCK BROKING SERVICES; PROVISION OF INFORMATION RELATING TO SHARES PRICES, AND CORPORATE SAVINGS ACCOUNT SERVICES; PROVISION OF INFORMATION RELATING TO REAL ESTATE AND REAL PROPERTY IN THE FIELD OF EVALUATION OF REAL PROPERTY; COMPUTERIZED FINANCIAL INFORMATION RELATING TO COMMODITIES AND SECURITIES; COMPUTERIZED FINANCIAL SERVICES FOR RETAIL BUSINESSES; PROVISION OF FINANCIAL INFORMATION



*David J. Kyros*

Director of the United States Patent and Trademark Office

**Reg. No. 4,196,630** RELATING TO RATES OF EXCHANGE; REAL ESTATE PROPERTY APPRAISAL SERVICES; REAL ESTATE PROPERTY BROKERAGE SERVICES; REAL ESTATE PROPERTY CONSULTANCY SERVICES; REAL ESTATE PROPERTY EVALUATION SERVICES; REAL ESTATE PROPERTY FINANCING SERVICES; REAL ESTATE PROPERTY INVESTMENT SERVICES; REAL ESTATE RENTAL PROPERTY MANAGEMENT SERVICES; COMMERCIAL PROPERTY INVESTMENT SERVICES; ESTATE TRUST MANAGEMENT SERVICES RELATING TO REAL ESTATE AND PROPERTY; FINANCIAL SERVICES RELATING TO THE ACQUISITION AND SALE OF PROPERTY, NAMELY, REAL ESTATE MORTGAGE BROKERAGE; COLLECTION OF CREDIT SALES BEING CREDIT RECOVERY AND COLLECTION SERVICES; COLLECTION OF PAYMENT BEING RENT; FINANCIAL ADMINISTRATION OF STOCK EXCHANGE TRADING OF SHARES IN FINANCIAL MARKETS; BROKERAGE OF SHARES; COMPUTERIZED INFORMATION SERVICES RELATING TO SHARE PRICES; FINANCIAL MANAGEMENT OF SHARES; FINANCIAL INFORMATION RELATING TO SHARES; FINANCIAL SERVICES, NAMELY, THE TRADING OF SHARES; AUTOMATED BANKING SERVICES RELATING TO ELECTRONIC CHARGE CARD AND CREDIT CARD TRANSACTIONS; COMPUTERIZED INFORMATION SERVICES RELATING TO BANKING MATTERS; PROVIDING INFORMATION ABOUT BANKING SERVICES; PROVISION OF FINANCIAL NEWS, IN CLASS 36 (U.S. CLS. 100, 101 AND 102).

FOR: AUDIO AND VIDEO BROADCASTING SERVICES OVER THE INTERNET OR OTHER COMMUNICATIONS NETWORK, NAMELY, ELECTRONICALLY TRANSMITTING INFORMATION, AUDIO, AND VIDEO CLIPS; PROVIDING ACCESS TO DATABASES THAT CONTAIN INFORMATION, AUDIO, AND VIDEO MATERIAL FROM WEBSITES, ONLINE FORUMS, CHAT ROOMS, DISCUSSION GROUPS AND BLOGS OVER THE INTERNET; PROVIDING ON-LINE CHAT ROOMS AND ELECTRONIC BULLETIN BOARDS FOR TRANSMISSION OF MESSAGES AMONG USERS IN THE FIELD OF GENERAL INTEREST; PROVIDING DISCUSSION SERVICES IN THE NATURE OF ON-LINE FORUMS FOR TRANSMISSION OF MESSAGES AMONG COMPUTER USERS; PROVISION OF NEWS IN RELATION TO TELECOMMUNICATION SERVICES, IN CLASS 38 (U.S. CLS. 100, 101 AND 104).

FOR: ENTERTAINMENT IN THE NATURE OF ON-GOING VIDEO PROGRAMS IN THE FIELD OF NEWS; PROVISION OF NEWS IN RELATION TO EDUCATION, TRAINING, ENTERTAINMENT OR SPORTING AND CULTURAL ACTIVITIES; NEWS REPORTERS SERVICES; ON-LINE LIBRARY SERVICES, NAMELY, PROVIDING ELECTRONIC LIBRARY SERVICES BY MEANS OF A COMPUTERIZED DATABASE CONTAINING INFORMATION EXTRACTED FROM NEWSPAPERS VIA AN ON-LINE COMPUTER NETWORK; INFORMATION AND ADVISORY SERVICES RELATING TO CURRENT EVENTS IN THE NATURE OF PROVIDING NEWS REPORTER SERVICES ENTAILING NEWS ANALYSIS AND NEWS COMMENTARY ABOUT CURRENT EVENTS; PUBLICATION OF REVIEWS AND CRITIQUES; PUBLICATION OF ELECTRONIC BOOKS AND JOURNALS ON-LINE; PROVIDING NON-DOWNLOADABLE ON-LINE ELECTRONIC PUBLICATIONS IN THE NATURE OF JOURNALS AND BOOKS IN THE FIELD OF BUSINESS AND FINANCE; ELECTRONIC PUBLISHING SERVICES, NAMELY, PUBLICATION OF TEXT AND GRAPHIC WORKS OF OTHERS ON-LINE FEATURING BUSINESS AND FINANCIAL MATTERS; NON-DOWNLOADABLE WEB-BASED PUBLICATION IN THE NATURE OF JOURNALS CONSISTING PRIMARILY OF PERIODIC ARTICLES; PROVIDING NEWS FEEDS AS PART OF NEWS REPORTERS SERVICES; PUBLICATION OF TEXT, AUDIO, VIDEO AND GRAPHIC WORKS ONLINE FEATURING NEWS, DIARIES, COMMENTARY, PHOTOS, POETRY, MINI-ESSAYS, PROJECT UPDATES, NON-FICTION AND FICTION; PRODUCTION OF TELEVISION NEWS PROGRAMS FOR BROADCASTING; ON-LINE JOURNALS, NAMELY, WEBLOGS AND BLOGS FEATURING BUSINESS AND FINANCE; ADVISORY, INFORMATION AND CONSULTANCY SERVICES RELATING TO ALL THE AFORESAID, IN CLASS 41 (U.S. CLS. 100, 101 AND 107).

THE MARK CONSISTS OF STANDARD CHARACTERS WITHOUT CLAIM TO ANY PARTICULAR FONT, STYLE, SIZE, OR COLOR.

**Reg. No. 4,196,630** OWNER OF SINGAPORE REG. NO. T1014719Z, DATED 9-11-2010, EXPIRES 9-11-2020.

OWNER OF U.S. REG. NO. 3,187,580.

NO CLAIM IS MADE TO THE EXCLUSIVE RIGHT TO USE "ANNUAL REPORT", APART FROM THE MARK AS SHOWN.

THE ENGLISH TRANSLATION OF "TEMASEK" IN THE MARK IS "WATER TOWN".

SER. NO. 85-174,041, FILED 11-10-2010.

ANDREA HACK, EXAMINING ATTORNEY



# United States of America

United States Patent and Trademark Office



**Reg. No. 4,196,631**

**Registered Aug. 28, 2012**

**Int. Cls.: 30 and 43**

**TRADEMARK**

**SERVICE MARK**

**PRINCIPAL REGISTER**

BIG CITY BURGERS & GREENS, L.L.C. (IOWA LIMITED LIABILITY COMPANY)  
400 LOCUST STREET, SUITE 790  
DES MOINES, IA 50309

FOR: SANDWICHES, NAMELY, HAMBURGERS, TURKEY BURGERS AND VEGGIE BURGERS, IN CLASS 30 (U.S. CL. 46).

FIRST USE 11-29-2010; IN COMMERCE 11-29-2010.

FOR: CATERING SERVICES; RESTAURANT, IN CLASS 43 (U.S. CLS. 100 AND 101).

FIRST USE 11-29-2010; IN COMMERCE 11-29-2010.

NO CLAIM IS MADE TO THE EXCLUSIVE RIGHT TO USE "BURGERS AND GREENS", APART FROM THE MARK AS SHOWN.

THE COLOR(S) BLACK, WHITE, GRAY, BROWN, RED, ORANGE AND GREEN IS/ARE CLAIMED AS A FEATURE OF THE MARK.

THE MARK CONSISTS OF A STYLIZED DEPICTION OF A COW HEAD AND THE FRONT PORTION OF A COW BODY AND WORDING. THE COW HAS A BLACK, GRAY AND WHITE FACE, EYES AND MOUTH; BLACK EARS, AND BLACK, BROWN AND ORANGE BODY. SMALL AMOUNTS OF LIGHT GREEN APPEAR IN THE HAIR ON TOP OF THE COW'S HEAD. ORANGE APPEARS IN THE TOP LEFT PORTION OF THE COW'S BODY AND TOP LEFT CORNER OF THE MARK DRAWING. THE COW HOLDS GREEN GRASS, GREEN LEAVES AND A RED BEET IN ITS MOUTH. THE WORDING "BIG CITY" IS PRESENTED IN STYLIZED FONT WITH EACH LETTER BEING WHITE WITH RANDOM BLACK AND GRAY SPECKLING WITH EACH LETTER PRESENTED IN ITS OWN INDIVIDUAL BLACK RECTANGLE. THE WORDING "BURGERS AND GREENS" APPEARS IN STYLIZED WHITE FONT WITHIN A BLACK RECTANGLE DIRECTLY BELOW "CITY". THIS WORDING AND THE COW ARE PRESENTED ON A LIGHT GREEN RECTANGULAR BACKGROUND THAT IS ENCASED IN AN IRREGULAR BLACK OUTLINE. THE MARK IN ITS ENTIRETY IS PRESENTED ON A TRANSPARENT BACKGROUND



*David J. Kypas*

Director of the United States Patent and Trademark Office

SER. NO. 85-175,781, FILED 11-12-2010.

GRETCHEN ULRICH, EXAMINING ATTORNEY

# United States of America

United States Patent and Trademark Office



**Reg. No. 4,196,632**

**Registered Aug. 28, 2012**

**Int. Cl.: 1**

**TRADEMARK**

**PRINCIPAL REGISTER**

MORGAN COMPOSTING, INC. (MICHIGAN CORPORATION)  
4353 EAST U.S. HIGHWAY 10  
SEARS, MI 49679

FOR: COMPOST; COMPOST; POTTING COMPOST, IN CLASS 1 (U.S. CLS. 1, 5, 6, 10, 26 AND 46).

FIRST USE 4-1-2009; IN COMMERCE 4-1-2009.

OWNER OF U.S. REG. NO. 3,833,843.

THE MARK CONSISTS OF A COW HOLDING A SIGN THAT STATES "DAIRY DOO".

SER. NO. 85-176,351, FILED 11-14-2010.

CIMMERIAN COLEMAN, EXAMINING ATTORNEY



*David J. Kyffers*

Director of the United States Patent and Trademark Office

# United States of America

United States Patent and Trademark Office

# SAF'IR

**Reg. No. 4,196,633**

**Registered Aug. 28, 2012**

**Int. Cl.: 10**

**TRADEMARK**

**PRINCIPAL REGISTER**

ALCOHOL COUNTERMEASURE SYSTEMS (INTERNATIONAL) INC. (CANADA CORPORATION)  
60 INTERNATIONAL BOULEVARD  
TORONTO, ONTARIO, CANADA M9W6J2

FOR: BREATH ALCOHOL TESTING UNITS, IN CLASS 10 (U.S. CLS. 26, 39 AND 44).

THE MARK CONSISTS OF STANDARD CHARACTERS WITHOUT CLAIM TO ANY PARTICULAR FONT, STYLE, SIZE, OR COLOR.

OWNER OF CANADA REG. NO. TMA806,638, DATED 9-13-2011, EXPIRES 9-13-2026.

THE WORDING "SAF'IR" HAS NO MEANING IN A FOREIGN LANGUAGE.

SER. NO. 85-176,789, FILED 11-15-2010.

BARNEY CHARLON, EXAMINING ATTORNEY



*David J. Kybas*

Director of the United States Patent and Trademark Office

# United States of America

United States Patent and Trademark Office

## Prolific Business Solutions

**Reg. No. 4,196,634**

**Registered Aug. 28, 2012**

**Int. Cls.: 35 and 36**

**SERVICE MARK**

**PRINCIPAL REGISTER**

PROLIFIC BUSINESS SOLUTIONS, LLC (DELAWARE LIMITED LIABILITY COMPANY),  
FORMERLY PROLIFIC PAYMENT SOLUTIONS, LLC  
14624 N. SCOTTSDALE ROAD, STE. 100  
SCOTTSDALE, AZ 85254

FOR: BUSINESS CONSULTATION; BUSINESS MARKETING SERVICES; BUSINESS PLANNING; BUSINESS SUPPORT SERVICES, NAMELY, BUSINESS CONSULTING TO FREELANCERS, START-UPS, EXISTING BUSINESSES AND NON-PROFIT ORGANIZATIONS; CONSULTING SERVICES IN BUSINESS ORGANIZATION AND MANAGEMENT; PAYROLL ADMINISTRATION AND MANAGEMENT SERVICES; PAYROLL PREPARATION; PAYROLL PROCESSING SERVICES; PROFESSIONAL BUSINESS CONSULTATION; PROFESSIONAL BUSINESS CONSULTING, IN CLASS 35 (U.S. CLS. 100, 101 AND 102).

FIRST USE 10-1-2010; IN COMMERCE 10-1-2010.

FOR: CREDIT CARD AND DEBIT CARD SERVICES; CREDIT CARD AND PAYMENT CARD SERVICES; CREDIT CARD AUTHORIZATION SERVICES; CREDIT CARD PAYMENT PROCESSING SERVICES; CREDIT CARD SERVICES; CREDIT CARD TRANSACTION PROCESSING SERVICES; CREDIT CARD VERIFICATION; ELECTRONIC CREDIT CARD TRANSACTIONS; ELECTRONIC LOAN ORIGINATION SERVICES; ISSUANCE OF CREDIT CARDS; ISSUING CREDIT CARDS; ISSUING OF CREDIT CARDS; PAYMENT PROCESSING SERVICES, NAMELY, CREDIT CARD AND DEBIT CARD TRANSACTION PROCESSING SERVICES; PROVIDING ELECTRONIC PROCESSING OF ACH AND CREDIT CARD TRANSACTIONS AND ELECTRONIC PAYMENTS VIA A GLOBAL COMPUTER NETWORK; PROVIDING ELECTRONIC PROCESSING OF CREDIT CARD TRANSACTIONS AND ELECTRONIC PAYMENTS VIA A GLOBAL COMPUTER NETWORK; PROVIDING ELECTRONIC PROCESSING OF ELECTRONIC FUNDS TRANSFER, ACH, CREDIT CARD, DEBIT CARD, ELECTRONIC CHECK AND ELECTRONIC PAYMENTS, IN CLASS 36 (U.S. CLS. 100, 101 AND 102).

FIRST USE 10-1-2010; IN COMMERCE 10-1-2010.

THE MARK CONSISTS OF STANDARD CHARACTERS WITHOUT CLAIM TO ANY PARTICULAR FONT, STYLE, SIZE, OR COLOR.

OWNER OF U.S. REG. NOS. 3,448,316 AND 3,448,319.



*David J. Kyros*

Director of the United States Patent and Trademark Office

**Reg. No. 4,196,634** NO CLAIM IS MADE TO THE EXCLUSIVE RIGHT TO USE "BUSINESS SOLUTIONS",  
APART FROM THE MARK AS SHOWN.

SER. NO. 85-178,225, FILED 11-16-2010.

MATTHEW KLINE, EXAMINING ATTORNEY

# United States of America

United States Patent and Trademark Office

## KISS MY APP

**Reg. No. 4,196,635**

PATRICE, PAULA (UNITED STATES INDIVIDUAL)  
123 TOWN SQUARE PLACE #135  
JERSEY CITY, NJ 07310

**Registered Aug. 28, 2012**

**Int. Cl.: 25**

FOR: APPAREL FOR MEN, WOMEN, CHILDREN, NAMELY, T-SHIRTS, UNDERGARMENTS  
AND JACKETS, IN CLASS 25 (U.S. CLS. 22 AND 39).

**TRADEMARK**

FIRST USE 5-1-2010; IN COMMERCE 8-1-2010.

**PRINCIPAL REGISTER**

THE MARK CONSISTS OF STANDARD CHARACTERS WITHOUT CLAIM TO ANY PAR-  
TICULAR FONT, STYLE, SIZE, OR COLOR.

SER. NO. 85-179,565, FILED 11-18-2010.

AMY C. KEAN, EXAMINING ATTORNEY



*David J. Kappas*

Director of the United States Patent and Trademark Office

# United States of America

United States Patent and Trademark Office



**Reg. No. 4,196,636**

**Registered Aug. 28, 2012**

**Int. Cls.: 16 and 44**

**TRADEMARK**

**SERVICE MARK**

**PRINCIPAL REGISTER**

TA OPERATING LLC (DELAWARE LIMITED LIABILITY COMPANY)  
SUITE 200  
24601 CENTER RIDGE ROAD  
WESTLAKE, OH 441455639

FOR: MAGAZINES FEATURING TOPICS RELATING TO HEALTH, WELLNESS AND NUTRITION TO TRUCK DRIVERS AND OTHER DRIVERS; JOGGING AND WALKING TRAIL MAPS, IN CLASS 16 (U.S. CLS. 2, 5, 22, 23, 29, 37, 38 AND 50).

FIRST USE 1-1-2011; IN COMMERCE 1-1-2011.

FOR: PROVIDING A WEBSITE FEATURING INFORMATION ABOUT HEALTH, WELLNESS AND NUTRITION TO TRUCK DRIVERS AND OTHER DRIVERS, IN CLASS 44 (U.S. CLS. 100 AND 101).

FIRST USE 1-1-2011; IN COMMERCE 1-1-2011.

THE MARK CONSISTS OF THE WORDS "STAY FIT" IN WHITE CAPITAL LETTERS OUTLINED IN BLACK DEPICTED WITHIN A RED HEART WITH WHITE HIGHLIGHTS THAT IS POSITIONED OVER A BLACK AND WHITE CURVED ROAD LEADING FROM THE LOWER RIGHT SECTION TO THE MIDDLE OF THE HEART.

THE COLOR(S) RED, WHITE AND BLACK IS/ARE CLAIMED AS A FEATURE OF THE MARK.

SER. NO. 85-179,766, FILED 11-18-2010.

HOWARD SMIGA, EXAMINING ATTORNEY



*David J. Kybas*

Director of the United States Patent and Trademark Office

# United States of America

United States Patent and Trademark Office

The logo for CNPLUS features the word "CNPLUS" in a bold, dark blue, sans-serif font. A vertical line is positioned between the "N" and "P". The top portion of this line is orange, extending upwards from the top of the "N", and the bottom portion is dark blue, extending downwards from the bottom of the "P".

**Reg. No. 4,196,637**

**Registered Aug. 28, 2012**

**Int. Cl.: 9**

**TRADEMARK**

**PRINCIPAL REGISTER**

CNPLUS CO., LTD. (REPUBLIC OF KOREA LIMITED COMPANY (LTD.))  
151B-6L  
722, GOJAN-DONG, NAMDONG-GU  
INCHEON, REPUBLIC OF KOREA

FOR: ROUND PLUG CONNECTORS; ELECTRIC CONNECTORS; WIRE CONNECTORS FOR ELECTRICITY; CONNECTORS FOR ELECTRONIC CIRCUITS; TELEPHONE CONNECTORS; PLUG CONNECTORS; PLUG-IN CONNECTORS, IN CLASS 9 (U.S. CLS. 21, 23, 26, 36 AND 38).

PRIORITY CLAIMED UNDER SEC. 44(D) ON REPUBLIC OF KOREA APPLICATION NO. 2010-0056990, FILED 11-5-2010, REG. NO. 0900003, DATED 1-17-2012, EXPIRES 1-17-2022.

THE COLOR(S) DARK BLUE AND ORANGE IS/ARE CLAIMED AS A FEATURE OF THE MARK.

THE MARK CONSISTS OF THE LETTERS, "CNPLUS", IN ALL CAPITAL LETTERS, IN DARK BLUE COLOR. A DARK BLUE VERTICAL LINE IS POSITIONED SLIGHTLY BELOW AND BETWEEN THE "N" AND THE "P" AND EXTENDS DOWNWARD. AN ORANGE VERTICAL LINE EXTENDS UPWARD FROM SLIGHTLY ABOVE AND BETWEEN THE "N" AND THE "P".

SER. NO. 85-179,841, FILED 11-18-2010.

NAAKWAMA ANKRAH, EXAMINING ATTORNEY



*David J. Kyffers*

Director of the United States Patent and Trademark Office



# United States of America

United States Patent and Trademark Office

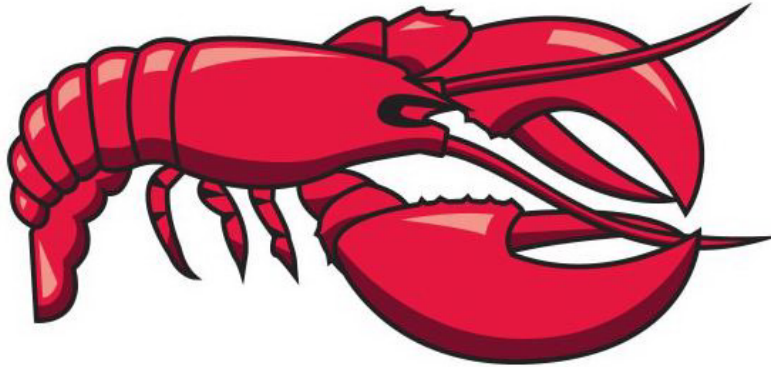

**Reg. No. 4,196,638**

**Registered Aug. 28, 2012**

**Int. Cl.: 43**

**SERVICE MARK**

**PRINCIPAL REGISTER**

DARDEN CONCEPTS, INC. (FLORIDA CORPORATION)  
INTELLECTUAL PROPERTY LAW  
1000 DARDEN CENTER DRIVE  
ORLANDO, FL 32837

FOR: RESTAURANT SERVICES AND RESTAURANT CARRY-OUT SERVICES, IN CLASS 43 (U.S. CLS. 100 AND 101).

FIRST USE 11-29-2004; IN COMMERCE 11-29-2004.

OWNER OF U.S. REG. NOS. 1,438,742, 1,502,609, AND 2,015,236.

THE COLOR(S) BLACK AND RED IS/ARE CLAIMED AS A FEATURE OF THE MARK.

THE MARK CONSISTS OF A DESIGN OF A STYLIZED LOBSTER IN RED WITH AREAS OF LIGHTER AND DARKER RED SHADING AND BLACK DETAILING.

SEC. 2(F).

SER. NO. 85-182,072, FILED 11-22-2010.

JOSETTE BEVERLY, EXAMINING ATTORNEY



*David J. Kybas*

Director of the United States Patent and Trademark Office

# United States of America

United States Patent and Trademark Office

## MERGENT BONDVIEWER

**Reg. No. 4,196,639**

MERGENT, INC. (DELAWARE CORPORATION)  
580 KINGSLEY PARK DRIVE  
FORT MILL, SC 29715

**Registered Aug. 28, 2012**

**Int. Cl.: 35**

FOR: PROVIDING FINANCIAL INDICES OF SELECT BONDS TO ENABLE CONSUMERS TO EVALUATE INVESTMENTS AND MARKET TRENDS IN THE BOND MARKET, IN CLASS 35 (U.S. CLS. 100, 101 AND 102).

**SERVICE MARK**

FIRST USE 4-30-2006; IN COMMERCE 4-30-2006.

**PRINCIPAL REGISTER**

THE MARK CONSISTS OF STANDARD CHARACTERS WITHOUT CLAIM TO ANY PARTICULAR FONT, STYLE, SIZE, OR COLOR.

OWNER OF U.S. REG. NOS. 2,514,127, 3,641,715 AND OTHERS.

SER. NO. 85-182,253, FILED 11-22-2010.

VIVIAN MICZNIK FIRST, EXAMINING ATTORNEY



*David J. Kyffers*

Director of the United States Patent and Trademark Office

# United States of America

United States Patent and Trademark Office

## MERGENT BONDVIEWER

**Reg. No. 4,196,640**

MERGENT, INC. (DELAWARE CORPORATION)  
580 KINGSLEY PARK DRIVE  
FORT MILL, SC 29715

**Registered Aug. 28, 2012**

**Int. Cl.: 36**

FOR: PROVIDING INVESTORS WITH FINANCIAL INFORMATION, DEBT RATINGS AND ANALYSIS TOOLS, FINANCIAL INVESTMENT ANALYSIS AND COMPANY RESEARCH AND TERMS AND CONDITIONS OF MUNICIPAL AND CORPORATE BONDS, IN CLASS 36 (U.S. CLS. 100, 101 AND 102).

**SERVICE MARK**

**PRINCIPAL REGISTER**

FIRST USE 4-30-2006; IN COMMERCE 4-30-2006.

THE MARK CONSISTS OF STANDARD CHARACTERS WITHOUT CLAIM TO ANY PARTICULAR FONT, STYLE, SIZE, OR COLOR.

OWNER OF U.S. REG. NOS. 2,514,127, 3,641,715 AND OTHERS.

SER. NO. 85-182,263, FILED 11-22-2010.

VIVIAN MICZNIK FIRST, EXAMINING ATTORNEY



*David J. Kybas*

Director of the United States Patent and Trademark Office

# United States of America

United States Patent and Trademark Office

## CHARLESTON COLLECTIONS

**Reg. No. 4,196,641**

CHARLESTON COLLECTIONS, LLC (SOUTH CAROLINA LIMITED LIABILITY COMPANY)  
625 SKYLARK DRIVE  
CHARLESTON, SC 29407

**Registered Aug. 28, 2012**

**Int. Cl.: 35**

FOR: ONLINE RETAIL GIFT SHOPS; RETAIL GIFT SHOPS, IN CLASS 35 (U.S. CLS. 100, 101 AND 102).

**SERVICE MARK**

FIRST USE 2-1-1982; IN COMMERCE 2-1-1982.

**PRINCIPAL REGISTER**

THE MARK CONSISTS OF STANDARD CHARACTERS WITHOUT CLAIM TO ANY PARTICULAR FONT, STYLE, SIZE, OR COLOR.

NO CLAIM IS MADE TO THE EXCLUSIVE RIGHT TO USE "COLLECTIONS", APART FROM THE MARK AS SHOWN.

SEC. 2(F).

SER. NO. 85-183,180, FILED 11-23-2010.

AMY ALFIERI, EXAMINING ATTORNEY



*David J. Kyffers*

Director of the United States Patent and Trademark Office

# United States of America

United States Patent and Trademark Office



**Reg. No. 4,196,642**

**Registered Aug. 28, 2012**

**Int. Cls.: 7 and 11**

**TRADEMARK**

**PRINCIPAL REGISTER**

BIOGAS & ELECTRIC LLC (CALIFORNIA LIMITED LIABILITY COMPANY)  
4186 SORRENTO VALLEY BLVD. SUITE M  
SAN DIEGO, CA 92121

FOR: ANTI-POLLUTION DEVICES FOR MOTORS AND ENGINES, IN CLASS 7 (U.S. CLS. 13, 19, 21, 23, 31, 34 AND 35).

FIRST USE 7-1-2010; IN COMMERCE 7-1-2010.

FOR: BIOGAS FERMENTATION REACTORS, NAMELY, PERCOLATING FERMENTERS AND DRY FERMENTERS, IN CLASS 11 (U.S. CLS. 13, 21, 23, 31 AND 34).

FIRST USE 7-1-2010; IN COMMERCE 7-1-2010.

NO CLAIM IS MADE TO THE EXCLUSIVE RIGHT TO USE "BIOGAS & ELECTRIC", APART FROM THE MARK AS SHOWN.

THE COLOR(S) DARK GREEN, LIME GREEN, WHITE, AND YELLOW IS/ARE CLAIMED AS A FEATURE OF THE MARK.

THE MARK CONSISTS OF A GRAPHIC OF A LIME GREEN, WHITE, AND YELLOW COMPACT FLUORESCENT LIGHT BULB MERGED WITH A LIME GREEN, WHITE AND YELLOW FLAME IN ADDITION TO THE WORDS "BIOGAS &" IN LIME GREEN, THE WORD "ELECTRIC" IN DARK GREEN.

SER. NO. 85-184,453, FILED 11-24-2010.

JULIE GUTTADAURO, EXAMINING ATTORNEY



*David J. Kybas*

Director of the United States Patent and Trademark Office

# United States of America

United States Patent and Trademark Office

# ECOPOLITAN

**Reg. No. 4,196,643**

MULTI-DISCIPLINARY CARE ASSOCIATION (MINNESOTA CORPORATION)  
2409 LYNDAL AVE S. #201  
MINNEAPOLIS, MN 55405

**Registered Aug. 28, 2012**

**Int. Cl.: 35**

FOR: RETAIL STORE SERVICES FEATURING THERAPEUTIC HEALTH AND WELLNESS PRODUCTS, EDUCATIONAL VIDEOS AND AUDIOS, ECOLOGICAL CLOTHING, BEDDING, WATER PURIFIERS, AIR PURIFIERS, PACKAGED FOOD PRODUCTS, IN CLASS 35 (U.S. CLS. 100, 101 AND 102).

**SERVICE MARK**

**PRINCIPAL REGISTER**

FIRST USE 12-31-2007; IN COMMERCE 12-31-2007.

THE MARK CONSISTS OF STANDARD CHARACTERS WITHOUT CLAIM TO ANY PARTICULAR FONT, STYLE, SIZE, OR COLOR.

SER. NO. 85-185,464, FILED 11-26-2010.

JAY BESCH, EXAMINING ATTORNEY



*David J. Kyffers*

Director of the United States Patent and Trademark Office

# United States of America

United States Patent and Trademark Office

# AMPS

**Reg. No. 4,196,644**

**Registered Aug. 28, 2012**

**Int. Cl.: 41**

**SERVICE MARK**

**PRINCIPAL REGISTER**

H2 KINETICS (VIRGINIA LIMITED LIABILITY COMPANY)  
6621 WAKEFIELD DRIVE  
ALEXANDRIA, VA 22307

FOR: CONSULTING SERVICES IN THE FIELDS OF FITNESS AND EXERCISE; COUNSELING SERVICES IN THE FIELD OF PHYSICAL FITNESS; EDUCATIONAL SERVICES, NAMELY, DEVELOPING AND CONDUCTING WORKOUTS, WORKSHOPS, PRESENTATIONS, RETREATS, AND PERSONAL TRAINING IN RIGHT-BRAIN FITNESS; EDUCATIONAL SERVICES, NAMELY, PROVIDING COGNITIVE FITNESS PROGRAMS FOR SENIORS; PERSONAL FITNESS TRAINING SERVICES AND CONSULTANCY; PERSONAL FITNESS TRAINING SERVICES FEATURING AEROBIC AND ANAEROBIC ACTIVITIES COMBINED WITH RESISTANCE AND FLEXIBILITY TRAINING; PERSONAL FITNESS TRAINING SERVICES, NAMELY, PROVIDING CROSS-TRAINING INSTRUCTION TO TENNIS PLAYERS, BASED ON PILATES METHODS AND TENNIS TECHNIQUES, IN A STUDIO OR ON A TENNIS COURT; PHYSICAL FITNESS CONDITIONING CLASSES; PHYSICAL FITNESS INSTRUCTION; PHYSICAL FITNESS STUDIO SERVICES, NAMELY, PROVIDING EXERCISE CLASSES, BODY SCULPTING CLASSES, AND GROUP FITNESS CLASSES; PHYSICAL FITNESS STUDIO SERVICES, NAMELY, PROVIDING GROUP EXERCISE INSTRUCTION, EQUIPMENT, AND FACILITIES; PHYSICAL FITNESS TRAINING OF INDIVIDUALS AND GROUPS; PHYSICAL FITNESS TRAINING SERVICES; PHYSICAL FITNESS TRAINING SERVICES USING PILATES APPARATUSES, PILATES TRAINING TECHNIQUES AND TENNIS TECHNIQUES TO IMPROVE CORE STRENGTH, ENDURANCE AND MATCH PLAY FOR TENNIS PLAYERS IN ORDER TO PREVENT TENNIS-RELATED INJURIES AND ASSIST IN THE REHABILITATION PROCESS OF INJURED TENNIS PLAYERS; PROVIDING A WEB SITE FEATURING INFORMATION ON EXERCISE AND FITNESS; PROVIDING A WEBSITE FEATURING INFORMATION ON EXERCISE AND FITNESS; PROVIDING AN INTERACTIVE WEBSITE FEATURING INFORMATION AND LINKS RELATING TO FITNESS; PROVIDING AN ON-LINE COMPUTER DATABASE FEATURING INFORMATION REGARDING EXERCISE AND FITNESS; PROVIDING AN ON-LINE COMPUTER DATABASE FEATURING INFORMATION REGARDING EXERCISE AND FITNESS BEFORE AND AFTER PREGNANCY; PROVIDING ASSISTANCE, PERSONAL TRAINING AND PHYSICAL FITNESS CONSULTATION TO CORPORATE CLIENTS TO HELP THEIR EMPLOYEES MAKE PHYSICAL FITNESS, STRENGTH, CONDITIONING, AND EXERCISE ALTERATIONS IN THEIR DAILY LIVING; PROVIDING ASSISTANCE, PERSONAL TRAINING AND PHYSICAL FITNESS CONSULTATION TO INDIVIDUALS TO HELP THEM MAKE PHYSICAL FITNESS, STRENGTH, CONDITIONING, AND EXERCISE IMPROVEMENT IN THEIR DAILY LIVING; PROVIDING CLASSES, WORKSHOPS, SEMINARS AND CAMPS IN THE FIELDS OF FIT-



*David J. Kybas*

Director of the United States Patent and Trademark Office

**Reg. No. 4,196,644** NESS, EXERCISE, BOXING, KICK BOXING AND MIXED MARTIAL ARTS; PROVIDING FITNESS AND EXERCISE FACILITIES; PROVIDING FITNESS AND EXERCISE STUDIO SERVICES, NAMELY, PILATES INSTRUCTION AND TRAINING; PROVIDING FITNESS AND EXERCISE STUDIO SERVICES, NAMELY, PROVIDING PILATES APPARATUSES AND TENNIS TRAINING EQUIPMENT; PROVIDING GENERAL FITNESS AND MIXED MARTIAL ARTS FACILITIES THAT REQUIRE MEMBERSHIPS AND ARE FOCUSED IN THE FIELDS OF GENERAL FITNESS, EXERCISE, AND MIXED MARTIAL ARTS, IN CLASS 41 (U.S. CLS. 100, 101 AND 107).

FIRST USE 7-7-2010; IN COMMERCE 7-7-2010.

THE MARK CONSISTS OF STANDARD CHARACTERS WITHOUT CLAIM TO ANY PARTICULAR FONT, STYLE, SIZE, OR COLOR.

SER. NO. 85-186,343, FILED 11-29-2010.

TAMARA FRAZIER, EXAMINING ATTORNEY



# United States of America

United States Patent and Trademark Office

## BLACK XANTUS

**Reg. No. 4,196,645**

FIRESTONE WALKER LLC (CALIFORNIA LIMITED LIABILITY COMPANY)  
620 MCMURRAY ROAD  
BUELLTON, CA 93427

**Registered Aug. 28, 2012**

**Int. Cl.: 32**

FOR: BEER, IN CLASS 32 (U.S. CLS. 45, 46 AND 48).

**TRADEMARK**

FIRST USE 9-30-2009; IN COMMERCE 9-30-2009.

**PRINCIPAL REGISTER**

THE MARK CONSISTS OF STANDARD CHARACTERS WITHOUT CLAIM TO ANY PARTICULAR FONT, STYLE, SIZE, OR COLOR.

NO CLAIM IS MADE TO THE EXCLUSIVE RIGHT TO USE "BLACK", APART FROM THE MARK AS SHOWN.

SER. NO. 85-186,561, FILED 11-29-2010.

SIMON TENG, EXAMINING ATTORNEY



*David J. Kyffers*

Director of the United States Patent and Trademark Office

# United States of America

United States Patent and Trademark Office



**Reg. No. 4,196,646**

**Registered Aug. 28, 2012**

**Int. Cl.: 41**

**SERVICE MARK**

**PRINCIPAL REGISTER**

SHAUNA HARRISON (UNITED STATES INDIVIDUAL)  
539 CASHMERE CT  
SUNNYVALE, CA 94087

FOR: PROVIDING CLASSES, WORKSHOPS, SEMINARS AND CAMPS IN THE FIELDS OF FITNESS, EXERCISE, BOXING, KICK BOXING AND MIXED MARTIAL ARTS, IN CLASS 41 (U.S. CLS. 100, 101 AND 107).

FIRST USE 1-0-2010; IN COMMERCE 2-0-2010.

NO CLAIM IS MADE TO THE EXCLUSIVE RIGHT TO USE "HIP HOP CYCLE" FOR THE SERVICES IN CLASS 41, APART FROM THE MARK AS SHOWN.

THE COLOR(S) BLACK, RED, WHITE, SILVERY GREY IS/ARE CLAIMED AS A FEATURE OF THE MARK.

THE MARK CONSISTS OF A BLACK AND RED BICYCLE WITH RED, BLACK, WHITE AND SILVERY GREY WHEELS. THE WHEELS ARE MADE TO LOOK LIKE RECORD PLAYER TURNTABLES. THE RED AND BLACK HANDLE BARS OF THE BICYCLE ARE ALSO THE TONE ARM OF THE RECORD PLAYER. THE SILVERY GREY AND WHITE SEAT OF THE BICYCLE IS A BASS CLEF AND THE SILVERY GREY AND WHITE BICYCLE PEDALS ARE MUSICAL NOTES. THE BICYCLE IS ROLLING OVER 5 WAVES, EACH DARKENING FROM RED TO BLACK, INTO THE WORDS HIP HOP CYCLE WHICH ARE WRITTEN IN BLACK ALSO IN A WAVE.

SER. NO. 85-187,574, FILED 11-30-2010.

KATINA MISTER, EXAMINING ATTORNEY



*David J. Kybas*

Director of the United States Patent and Trademark Office

# United States of America

United States Patent and Trademark Office

## ARAYA CLEAN

**Reg. No. 4,196,647**

TOURIAN, PETER (UNITED STATES INDIVIDUAL)  
1757 E. BASELINE ROAD, BLDG 6, SUITE 124  
GILBERT, AZ 85233

**Registered Aug. 28, 2012**

**Int. Cls.: 3, 5, 7, 35, 37  
and 41**

FOR: CLEANING AGENTS AND PREPARATIONS; CLEANING, SCOURING, WASHING AND POLISHING PREPARATIONS AND SUBSTANCES; GLASS CLEANERS; FLOOR CLEANER AND POLISHES; BRICK AND CONCRETE CLEANING PREPARATIONS; STAIN REMOVERS; DISINFECTANT SOAPS, CHEMICALS AND AGENTS; CLEANING PREPARATIONS FOR REMOVING GRAFFITI, IN CLASS 3 (U.S. CLS. 1, 4, 6, 50, 51 AND 52).

**TRADEMARK**

**SERVICE MARK**

FIRST USE 4-0-2011; IN COMMERCE 4-0-2011.

**PRINCIPAL REGISTER**

FOR: SANITIZING PREPARATIONS FOR HOUSEHOLD, HOSPITAL, INDUSTRIAL, RETAIL AND COMMERCIAL USE, IN CLASS 5 (U.S. CLS. 6, 18, 44, 46, 51 AND 52).

FIRST USE 4-0-2011; IN COMMERCE 4-0-2011.

FOR: MULTIPURPOSE HIGH, VARIABLE AND LOW PRESSURE WASHERS; PRESSURE WASHING MACHINES; MULTIPURPOSE POWER WASHERS AND POWER WASHING MACHINES; HIGH-PRESSURE PUMPS FOR WASHING APPLIANCES AND INSTALLATIONS; MACHINES FOR CLEANING SURFACES USING HIGH PRESSURE WATER; MACHINES FOR BLAST CLEANING A SURFACE; MULTI-PURPOSE HIGH PRESSURE WASHERS; CLEANING MACHINES FOR CLEANING MOLD, MILDEW, CALCIUM, OIL, GREASE AND STAINS FROM SURFACES; CLEANING MACHINES FOR EXTERIOR SURFACES, CONCRETE, WOOD, WINDOWS, BRICK AND STUCCO, SIDEWALKS, SIDES OF BUILDINGS, PARKING GARAGES, ROOFS, BUILDING FACADES; CLEANING MACHINES, NAMELY, ROTARY SURFACE CLEANERS; CLEANING MACHINES, NAMELY, WASTEWATER RECLAIM MACHINES AND MOBILE WASTEWATER RECLAIM MACHINES FOR FILTERING WASTE WATER FROM CLEANING FOR RE-USE; FLOOR POLISHING MACHINES, IN CLASS 7 (U.S. CLS. 13, 19, 21, 23, 31, 34 AND 35).

FIRST USE 4-0-2011; IN COMMERCE 4-0-2011.

FOR: FRANCHISE SERVICES, NAMELY, OFFERING BUSINESS MANAGEMENT ASSISTANCE IN THE ESTABLISHMENT, OPERATION AND PROMOTION OF CLEANING, PRESSURE WASHING AND SANITATION SERVICE BUSINESSES; FRANCHISE SERVICES IN THE AREA OF CLEANING SERVICES AND PRESSURE CLEANING SERVICES; ADVICE



*David J. Kyffers*

Director of the United States Patent and Trademark Office

**Reg. No. 4,196,647** IN THE RUNNING OF ESTABLISHMENTS AS FRANCHISES; ASSISTANCE IN BUSINESS MANAGEMENT AND PRODUCT COMMERCIALIZATION, WITHIN THE FRAMEWORK OF A FRANCHISE CONTRACT; CARRYING ON A BUSINESS OF ESTABLISHING FRANCHISE OPERATIONS, NAMELY, BUSINESSES PROVIDING CLEANING, PRESSURE WASHING, AND SANITATION SERVICES; FRANCHISE CONSULTING, NAMELY, PROVIDING ADVICE IN THE RUNNING OF ESTABLISHMENTS AS FRANCHISES AND GUIDANCE ON HOW TO OPERATE A PRESSURE WASHING BUSINESS; MAINTAINING AND SUPERVISING FRANCHISES IN THE FIELD OF CLEANING, PRESSURE WASHING AND SANITATION SERVICES, IN CLASS 35 (U.S. CLS. 100, 101 AND 102).

FIRST USE 5-0-2011; IN COMMERCE 5-0-2011.

FOR: PRESSURE WASHING SERVICES; CLEANING SERVICES, NAMELY, INTERIOR AND EXTERIOR CLEANING SERVICES FOR HOUSEHOLD, GOVERNMENT, COMMERCIAL AND RETAIL ESTABLISHMENTS; CLEANING SERVICES, NAMELY, DUMPSTER CLEANING, GUM, SIDEWALK SALT, BIRD DROPPING REMOVAL, WOOD FENCE CLEANING, SIDEWALK AND DRIVEWAY CLEANING; CLEANING OF BUILDINGS; CLEANING OF COMMERCIAL AND INDUSTRIAL PREMISES; CLEANING OF RESIDENTIAL HOMES; PARKING LOT CLEANING SERVICES; CLEANING OF BUILDING EXTERIOR SURFACES; COMMERCIAL AND RESIDENTIAL ROOF CLEANING; GREASE TRAP CLEANING; GRAFFITI REMOVAL SERVICES; MOLD AND ALGAE REMOVAL; FAT, OIL AND GREASE REMOVAL AND CLEANING; OIL STAIN AND SPILL CLEAN-UP; ENVIRONMENTAL SAFE CLEANUP; ALL NATURAL CLEANING SERVICES, NAMELY, INTERIOR AND EXTERIOR CLEANING SERVICES FOR HOUSEHOLD, GOVERNMENT, COMMERCIAL AND RETAIL ESTABLISHMENTS; PROVIDING TECHNICAL ADVICE AND ASSISTANCE IN THE FIELD OF FRANCHISED CLEANING AND SANITATION SERVICES, IN CLASS 37 (U.S. CLS. 100, 103 AND 106).

FIRST USE 5-0-2011; IN COMMERCE 5-0-2011.

FOR: TRAINING IN FRANCHISE OPERATIONS, IN CLASS 41 (U.S. CLS. 100, 101 AND 107).

FIRST USE 4-0-2011; IN COMMERCE 4-0-2011.

THE MARK CONSISTS OF STANDARD CHARACTERS WITHOUT CLAIM TO ANY PARTICULAR FONT, STYLE, SIZE, OR COLOR.

NO CLAIM IS MADE TO THE EXCLUSIVE RIGHT TO USE "CLEAN", APART FROM THE MARK AS SHOWN.

THE WORDING "ARAYA" HAS NO MEANING IN A FOREIGN LANGUAGE.

SER. NO. 85-187,623, FILED 11-30-2010.

JOHN WILKE, EXAMINING ATTORNEY

# United States of America

United States Patent and Trademark Office

## CHASE MARMALADE VODKA

**Reg. No. 4,196,648**

**Registered Aug. 28, 2012**

**Int. Cl.: 33**

**TRADEMARK**

**PRINCIPAL REGISTER**

CHASE DISTILLERY LIMITED (UNITED KINGDOM CORPORATION)  
ROSEMAUND COTTAGE, PRESTON WYNNE  
HEREFORD, UNITED KINGDOM HR1 3PF

FOR: ALCOHOLIC BEVERAGES (EXCEPT BEERS), IN CLASS 33 (U.S. CLS. 47 AND 49).

THE MARK CONSISTS OF STANDARD CHARACTERS WITHOUT CLAIM TO ANY PARTICULAR FONT, STYLE, SIZE, OR COLOR.

PRIORITY CLAIMED UNDER SEC. 44(D) ON ERPN CMNTY TM OFC APPLICATION NO. 009558065, FILED 11-29-2010, REG. NO. 009558065, DATED 4-12-2011, EXPIRES 11-29-2020.

NO CLAIM IS MADE TO THE EXCLUSIVE RIGHT TO USE "MARMALADE VODKA", APART FROM THE MARK AS SHOWN.

SER. NO. 85-188,517, FILED 12-1-2010.

CIMMERIAN COLEMAN, EXAMINING ATTORNEY



*David J. Kyffers*

Director of the United States Patent and Trademark Office

# United States of America

United States Patent and Trademark Office



**Reg. No. 4,196,649**

**Registered Aug. 28, 2012**

**Int. Cl.: 36**

**SERVICE MARK**

**PRINCIPAL REGISTER**

KIM SIMMONS (UNITED STATES INDIVIDUAL)  
307B RIDGEFIELD CIRCLE  
CLINTON, MA 01510

FOR: PROVIDE FUNDING FOR CHILDREN OF FINANCIALLY CHALLENGED FAMILIES TO PARTICIPATE IN SPORTS, NAMELY, CHARITABLE SERVICES IN THE NATURE OF PROVIDING FUNDRAISING ACTIVITIES, FUNDING, SCHOLARSHIPS AND/OR FINANCIAL ASSISTANCE, IN CLASS 36 (U.S. CLS. 100, 101 AND 102).

FIRST USE 9-17-2008; IN COMMERCE 9-17-2008.

NO CLAIM IS MADE TO THE EXCLUSIVE RIGHT TO USE "CHILDREN NEED SPORTS", APART FROM THE MARK AS SHOWN.

THE COLOR(S) GREEN, BLUE, AND WHITE IS/ARE CLAIMED AS A FEATURE OF THE MARK.

THE MARK CONSISTS OF THE STYLIZED WORDING "CNS CHILDREN NEED SPORTS WWW.CNSINTL.ORG" AND DESIGN. THE MARK CONSISTS OF SILHOUETTES IN BLUE OF: A CHILD PLAYING SOCCER KICKING A BLUE AND GREEN SOCCER BALL; A CHILD PLAYING FOOTBALL CARRYING A GREEN AND WHITE FOOTBALL; AND A CHILD PLAYING CRICKET, HOLDING A GREEN BAT HITTING A GREEN CRICKET BALL. ALL CHILDREN ON A BED OF GREEN GRASS. "CNS" IN BLUE CAPITAL LETTERS WITHIN A GREEN RECTANGLE ABOVE THE CHILDREN. THE WORDING "CHILDREN NEED SPORTS WWW.CNSINTL.ORG" IN BLUE BELOW THE GREEN GRASS.

SER. NO. 85-189,073, FILED 12-2-2010.

BRIAN PINO, EXAMINING ATTORNEY



*David J. Kybas*

Director of the United States Patent and Trademark Office

# United States of America

United States Patent and Trademark Office



**Reg. No. 4,196,650**

**Registered Aug. 28, 2012**

**Int. Cls.: 35 and 41**

**SERVICE MARK**

**PRINCIPAL REGISTER**

WILLIAMSON-DICKIE MANUFACTURING COMPANY (TEXAS CORPORATION)  
319 LIPSCOMB STREET  
FORT WORTH, TX 76104

FOR: PROMOTING PUBLIC AWARENESS OF THE CONTRIBUTIONS WORKERS HAVE MADE TO AMERICA BY RECOGNIZING UNITED STATES CITIZEN OR LEGAL RESIDENT WORKERS BY MEANS OF AN ESSAY CONTEST, IN CLASS 35 (U.S. CLS. 100, 101 AND 102).

FIRST USE 5-5-2009; IN COMMERCE 5-5-2009.

FOR: EDUCATIONAL SERVICES, NAMELY, PROVIDING INCENTIVES TO UNITED STATES CITIZEN OR LEGAL RESIDENT WORKERS TO DEMONSTRATE EXCELLENCE IN THEIR FIELD OF ENDEAVOR THROUGH THE ISSUANCE OF AWARDS; CONDUCTING AN ESSAY CONTEST TO RECOGNIZE THE CONTRIBUTIONS WORKERS HAVE MADE TO AMERICA BY RECOGNIZING UNITED STATES CITIZEN OR LEGAL RESIDENT WORKERS, IN CLASS 41 (U.S. CLS. 100, 101 AND 107).

FIRST USE 5-5-2009; IN COMMERCE 5-5-2009.

OWNER OF U.S. REG. NO. 2,552,686.

THE STIPPLING IS A FEATURE OF THE MARK AND DOES NOT INDICATE COLOR; THE STIPPLING IS FOR SHADING PURPOSES ONLY.



THE MARK CONSISTS OF AN ELONGATED CIRCLE CONTAINING THE DRAWING OF A HORSESHOE, AND A PARALLELOGRAM CENTERED ACROSS THE CIRCLE AND THE HORSESHOE, LEFT TO RIGHT. THE INITIAL CAPITAL, SENTENCE-CASED, ITALICIZED CLEAR LETTERING, "DICKIES", IS CENTERED INSIDE THE PARALLELOGRAM. THE CIRCLE AND PARALLELOGRAM ARE OUTLINED IN AN INNER, THICK, CLEAR LINE, AND THE ENTIRE DESIGN IS OUTLINED IN A THICK, DARKER LINE. THE WORDS, "AMERICAN WORKER OF THE YEAR", IN CLEAR, CAPITALIZED, STANDARD, STACKED LETTERING ARE PLACED AND CENTERED UNDER THE ELONGATED CIRCLE DESIGN, AND A FIVE-POINT STAR IS PLACED ON EITHER SIDE OF THE WORD, "AMERICAN". THE PHRASE, "AMERICAN WORKER OF THE YEAR", AND STARS ARE OUTLINED IN A THICK, CLEAR LINE, AND THAT DESIGN IS OUTLINED BY A THICK, DARK LINE.

*David J. Kybas*

Director of the United States Patent and Trademark Office

**Reg. No. 4,196,650** THE ELONGATED DESIGN SLIGHTLY OVERLAPS THE CENTER, TOP OF THE PHRASE DESIGN.

SEC. 2(F) AS TO "AMERICAN WORKER OF THE YEAR".

SER. NO. 85-190,440, FILED 12-3-2010.

TINA BROWN, EXAMINING ATTORNEY



# United States of America

United States Patent and Trademark Office

## CELEBRITIES STAFFING SERVICES

**Reg. No. 4,196,651**

CELEBRITIES GROUP, INC. (NEW YORK CORPORATION)  
20 VESEY ST., SUITE 510  
NEW YORK, NY 10007 AND

**Registered Aug. 28, 2012**

**Int. Cl.: 35**

CA & NY CELEBRITIES GROUP INC. (CALIFORNIA CORPORATION)  
9201 WILSHIRE BLVD., SUITE 205  
BEVERLY HILLS, CA 90210

**SERVICE MARK**

**PRINCIPAL REGISTER**

FOR: EMPLOYMENT HIRING, RECRUITING, PLACEMENT AND STAFFING SERVICES,  
IN CLASS 35 (U.S. CLS. 100, 101 AND 102).

FIRST USE 3-1-2003; IN COMMERCE 3-1-2003.

THE MARK CONSISTS OF STANDARD CHARACTERS WITHOUT CLAIM TO ANY PARTICULAR FONT, STYLE, SIZE, OR COLOR.

NO CLAIM IS MADE TO THE EXCLUSIVE RIGHT TO USE "STAFFING SERVICES", APART FROM THE MARK AS SHOWN.

SEC. 2(F).

SER. NO. 85-193,350, FILED 12-8-2010.

DARRYL SPRUILL, EXAMINING ATTORNEY



*David J. Kybas*

Director of the United States Patent and Trademark Office

# United States of America

United States Patent and Trademark Office

## Illuminate Opportunity

**Reg. No. 4,196,652**

DECIPHER, INC. (CALIFORNIA CORPORATION)  
7 RIVER PARK PLACE EAST, SUITE 110  
FRESNO, CA 93720

**Registered Aug. 28, 2012**

**Int. Cls.: 35 and 42**

FOR: MARKET RESEARCH SERVICES, NAMELY, SAMPLING OF SURVEY POPULATIONS FOR MARKET RESEARCH, DATA PROCESSING, ONLINE REPORTING OF CUSTOMER SURVEY RESULTS, AND CUSTOM COMMUNITY DEVELOPMENT FOR USE IN MARKET RESEARCH, IN CLASS 35 (U.S. CLS. 100, 101 AND 102).

**SERVICE MARK**

**PRINCIPAL REGISTER**

FIRST USE 12-1-2010; IN COMMERCE 12-1-2010.

FOR: PROVIDING ONLINE NON-DOWNLOADABLE SOFTWARE FOR USE IN DATA COLLECTION AND DATA MANAGEMENT IN THE FIELD OF MARKET RESEARCH; MARKET RESEARCH SERVICES, NAMELY, DEVELOPMENT OF ONLINE SURVEYS, IN CLASS 42 (U.S. CLS. 100 AND 101).

FIRST USE 12-1-2010; IN COMMERCE 12-1-2010.

THE MARK CONSISTS OF STANDARD CHARACTERS WITHOUT CLAIM TO ANY PARTICULAR FONT, STYLE, SIZE, OR COLOR.

SER. NO. 85-196,566, FILED 12-13-2010.

BRENDAN MCCAULEY, EXAMINING ATTORNEY



*David J. Kybas*

Director of the United States Patent and Trademark Office

# United States of America

United States Patent and Trademark Office

# TETESEPT

**Reg. No. 4,196,653**

**Registered Aug. 28, 2012**

**Int. Cls.: 3 and 5**

**TRADEMARK**

**PRINCIPAL REGISTER**

MERZ PHARMA GMBH & CO. KGAA (FED REP GERMANY KOMMANDITGESELLSCHAFT  
AUF AKTIEN (KGAA))  
ECKENHEIMER LANDSTRASSE 100  
FRANKFURT AM MAIN, FED REP GERMANY D-60318

FOR: PREPARATIONS FOR BODY AND BEAUTY CARE, NAMELY, ESSENTIAL OILS FOR  
PERSONAL USE, COSMETIC PREPARATIONS, SOAPS; PERFUMERY; CLEANING, POL-  
ISHING, SCOURING AND ABRASIVE PREPARATIONS, EXCEPT FOR POLISHING  
LEATHER, IN CLASS 3 (U.S. CLS. 1, 4, 6, 50, 51 AND 52).

FOR: PHARMACEUTICAL PREPARATIONS, NAMELY, PREPARATIONS FOR THE  
TREATMENT OF COLDS, DISEASES OF THE STOMACH, INTESTINE AND DIGESTIVE  
SYSTEM, RHEUMATISM, HEART AND CIRCULATION, BLADDER, KIDNEY, AND PRO-  
STATE; DIETARY SUPPLEMENTS; MEDICAL PLASTERS; WOUND, BURN AND SURGICAL  
DRESSINGS; HERBICIDES, IN CLASS 5 (U.S. CLS. 6, 18, 44, 46, 51 AND 52).

THE MARK CONSISTS OF STANDARD CHARACTERS WITHOUT CLAIM TO ANY PAR-  
TICULAR FONT, STYLE, SIZE, OR COLOR.

OWNER OF FED REP GERMANY REG. NO. 683557, DATED 10-31-1955, EXPIRES 5-31-  
2020.

THE WORDING "TETESEPT" HAS NO MEANING IN A FOREIGN LANGUAGE.

SER. NO. 85-196,706, FILED 12-13-2010.

MARLENE BELL, EXAMINING ATTORNEY



*David J. Kypos*

Director of the United States Patent and Trademark Office

# United States of America

United States Patent and Trademark Office

## TECHNOLOGY STARTS WITH "TECH"

**Reg. No. 4,196,654**

**Registered Aug. 28, 2012**

**Int. Cls.: 37 and 38**

**SERVICE MARK**

**PRINCIPAL REGISTER**

TECH ELECTRONICS, INC. (MISSOURI CORPORATION)  
6437 MANCHESTER  
ST. LOUIS, MO 63139

FOR: COMMUNICATIONS AND TELECOMMUNICATION SERVICES, NAMELY, CABLE INSTALLATION, INSTALLATION OF MASTER ANTENNA AND TELEPHONES; INSTALLATION OF COMPUTER HARDWARE AND TELECOMMUNICATION HARDWARE TO ENABLE VOICE MAIL, PAGING AND WIRELESS BROADBAND COMMUNICATION SERVICES, IN CLASS 37 (U.S. CLS. 100, 103 AND 106).

FIRST USE 1-0-1996; IN COMMERCE 1-0-1996.

FOR: PROVIDING VOICE MAIL, PAGING AND WIRELESS BROADBAND COMMUNICATION SERVICES, IN CLASS 38 (U.S. CLS. 100, 101 AND 104).

FIRST USE 1-0-1996; IN COMMERCE 1-0-1996.

THE MARK CONSISTS OF STANDARD CHARACTERS WITHOUT CLAIM TO ANY PARTICULAR FONT, STYLE, SIZE, OR COLOR.

OWNER OF U.S. REG. NO. 3,429,331.

SER. NO. 85-196,832, FILED 12-13-2010.

ELLEN PERKINS, EXAMINING ATTORNEY



*David J. Kybas*

Director of the United States Patent and Trademark Office

# United States of America

United States Patent and Trademark Office

## X20 FILTRATION

**Reg. No. 4,196,655**

X20 FILTRATION, LLC (NEW MEXICO LIMITED LIABILITY COMPANY)  
500 TENTH ST.

**Registered Aug. 28, 2012**

ALAMOGORDO, NM 88310

**Int. Cl.: 11**

FOR: WATER TREATMENT EQUIPMENT, NAMELY, A SELF-CONTAINED, TRANSPORTABLE WATER PURIFICATION, FILTRATION, REVERSE OSMOSIS APPARATUS THAT IS SOLAR-POWERED AND TURNS DIRTY WATER INTO POTABLE DRINKING WATER, IN CLASS 11 (U.S. CLS. 13, 21, 23, 31 AND 34).

**TRADEMARK**

**PRINCIPAL REGISTER**

FIRST USE 6-24-2010; IN COMMERCE 6-24-2010.

THE MARK CONSISTS OF STANDARD CHARACTERS WITHOUT CLAIM TO ANY PARTICULAR FONT, STYLE, SIZE, OR COLOR.

NO CLAIM IS MADE TO THE EXCLUSIVE RIGHT TO USE "FILTRATION", APART FROM THE MARK AS SHOWN.

SER. NO. 85-197,282, FILED 12-14-2010.

BARBARA BROWN, EXAMINING ATTORNEY



*David J. Kyjars*

Director of the United States Patent and Trademark Office

# United States of America

United States Patent and Trademark Office

# DESCENTE

**Reg. No. 4,196,656**

**Registered Aug. 28, 2012**

**Int. Cl.: 28**

**TRADEMARK**

**PRINCIPAL REGISTER**

DESCENTE, LTD. (JAPAN CORPORATION)  
11-3, DOGASHIBA 1-CHOME, TENNOJI-KU  
OSAKA, JAPAN

FOR: CARRIER BAGS FOR SKI GEAR, SKI CASES; DECORATIONS FOR CHRISTMAS TREES; GOLF EQUIPMENT, NAMELY, GOLF TEES, GOLF BALLS, GOLF BAGS WITH OR WITHOUT WHEELS, GOLF CLUBS, GOLF GLOVES; BASEBALL EQUIPMENT, NAMELY, BATTING GLOVES, BATS FOR GAMES, BASEBALL GLOVES, CASES FOR BATS, BASEBALL BALLS; SOCCER EQUIPMENT, NAMELY, SOCCER BALLS, GOALKEEPER GLOVES; TRACK AND FIELD EQUIPMENT, NAMELY, BARS, BATONS AND JAVELINS; TENNIS OR BADMINTON EQUIPMENT, NAMELY, BAG COVERS AND CASES FOR RACKETS, RACKETS, GUTS FOR RACKETS, TENNIS BALLS, SHUTTLECOCKS; RUGBY EQUIPMENT, NAMELY, RUGBY BALLS AND HEADGEARS; VOLLEYBALL EQUIPMENT, NAMELY, VOLLEYBALL BALLS; BASKETBALL EQUIPMENT, NAMELY, BASKETBALL BALLS; TABLE TENNIS EQUIPMENT, NAMELY, TABLES, NETS, TABLE TENNIS BALLS, RACKETS AND CASES FOR RACKETS; GYMNASTICS EQUIPMENT, NAMELY, BALLS, ROPES AND HOOPS; BALL GAME EQUIPMENT, NAMELY, BALLS FOR GAMES, BAGS FOR BALLS, SHIN GUARDS FOR ATHLETIC USE, ELBOW GUARDS FOR ATHLETIC USE, KNEE GUARDS FOR ATHLETIC USE, PROTECTIVE PADDING FOR PLAYING BASEBALL, SOCCER, FOOTBALL, LACROSSE, HOCKEY, FIELD HOCKEY; FLIPPERS FOR SWIMMING; GLOVES FOR USE IN SPORTS, NAMELY, LACROSSE, HOCKEY, GOLF; ICE SKATES; NETS FOR SPORTS; ROLLER SKATES; INLINE ROLLER SKATES; SAIL BOARDS; SCRAPERS FOR SKIS, COVERING FOR SKIS, NAMELY, SEAL SKINS; SKI BINDINGS, SKIS, SNOWBOARDS, WAX FOR SKIS; SKATEBOARDS; SKATING BOOTS WITH SKATES ATTACHED; SURF BOARDS, SURF SKIS; SWIMMING WEBS, NAMELY, FLIPPERS; WATER SKIS; HAND PADDLES FOR USE IN SWIMMING; WATER POLO BALLS, WATER POLO NETS, IN CLASS 28 (U.S. CLS. 22, 23, 38 AND 50).



THE MARK CONSISTS OF STANDARD CHARACTERS WITHOUT CLAIM TO ANY PARTICULAR FONT, STYLE, SIZE, OR COLOR.

OWNER OF JAPAN REG. NO. 1547349, DATED 10-27-1981, EXPIRES 10-27-2012.

OWNER OF U.S. REG. NOS. 1,121,455, 1,133,714, AND 1,435,428.

THE ENGLISH TRANSLATION OF "DESCENTE" IN THE MARK IS "DESCEND".

*David J. Kyros*

Director of the United States Patent and Trademark Office

**Reg. No. 4,196,656** SER. NO. 85-198,601, FILED 12-15-2010.

JULIE GUTTADAURO, EXAMINING ATTORNEY

# United States of America

United States Patent and Trademark Office

## MOVIES ON TRIAL

**Reg. No. 4,196,657**

**Registered Aug. 28, 2012**

**Int. Cl.: 41**

**SERVICE MARK**

**PRINCIPAL REGISTER**

SCHOPF & WEISS LLP (ILLINOIS LIMITED LIABILITY PARTNERSHIP)  
28TH FLOOR  
ONE SOUTH WACKER DRIVE  
CHICAGO, IL 60606

FOR: CONTINUING EDUCATION SERVICES, NAMELY, PROVIDING LIVE AND ON-LINE CONTINUING PROFESSIONAL EDUCATION SEMINARS IN THE LEGAL, MEDICAL, ACCOUNTING, AND REAL ESTATE FIELDS; PROVIDING CONTINUING LEGAL EDUCATION COURSES, IN CLASS 41 (U.S. CLS. 100, 101 AND 107).

FIRST USE 4-1-2009; IN COMMERCE 4-1-2009.

THE MARK CONSISTS OF STANDARD CHARACTERS WITHOUT CLAIM TO ANY PARTICULAR FONT, STYLE, SIZE, OR COLOR.

NO CLAIM IS MADE TO THE EXCLUSIVE RIGHT TO USE "MOVIES", APART FROM THE MARK AS SHOWN.

SER. NO. 85-199,588, FILED 12-16-2010.

PATRICIA EVANKO, EXAMINING ATTORNEY



*David J. Kyffers*

Director of the United States Patent and Trademark Office



# United States of America

United States Patent and Trademark Office

## PEOPLE. PARTNERSHIP. POTENTIAL.

**Reg. No. 4,196,658**

**Registered Aug. 28, 2012**

**Int. Cl.: 41**

**SERVICE MARK**

**PRINCIPAL REGISTER**

COOK INLET TRIBAL COUNCIL, INC. (ALASKA NON-PROFIT CORPORATION)  
3600 SAN JERONIMO DRIVE  
ANCHORAGE, AK 995082869

FOR: CHARITABLE SERVICES, NAMELY, PROVIDING CAREER ASSISTANCE IN THE NATURE OF VOCATIONAL GUIDANCE AND CAREER COUNSELING TO INDIGENT PERSONS SEEKING EMPLOYMENT; CHARITABLE SERVICES, NAMELY, PROVIDING PROGRAMS FOR THE TEMPORARY ASSISTANCE OF NEEDY FAMILIES AND FOR WOMEN, INFANTS AND CHILDREN, NAMELY, PROVIDING TOYS TO NEEDY PERSONS; CAREER COUNSELING; CONTINUING EDUCATION, NAMELY, CLASSES IN THE FIELD OF HIGH SCHOOL EQUIVALENCE EXAM PREPARATION, COMPUTER SKILLS, LIFE SKILLS AND CULTURAL ART INSTRUCTION; TUTORING IN THE FIELD OF HIGH SCHOOL EQUIVALENCE EXAM PREPARATION, MATH, LANGUAGE SKILLS, CORE CURRICULUM CLASSES FOR GRADES K-12, PROVIDING SEMINARS AND WORKSHOPS IN THE FIELD OF CAREER DEVELOPMENT, DRUG AND ALCOHOL EDUCATION AND YOUTH AND FAMILY ISSUES; VOCATIONAL EDUCATION IN THE FIELD OF HEALTH-CARE AND TRADES, NAMELY THE CONSTRUCTION TRADES, NURSING, AND MEDICAL BILLING PROFESSIONS; PARENTING INFORMATION, NAMELY, PROVIDING INFORMATION IN THE FIELD OF PARENTING SKILLS ABOUT EDUCATION; AND COMMUNITY OUTREACH SERVICES PROVIDED TO FAMILIES, SENIORS, MEN, WOMEN, YOUTH AND CHILDREN, NAMELY, PROVIDING INFORMATION, NEWS AND COMMENTARY IN THE FIELD OF CURRENT EVENTS RELATING TO IMPROVING LIFE FOR FAMILIES, SENIORS, MEN, WOMEN, YOUTH AND CHILDREN, IN CLASS 41 (U.S. CLS. 100, 101 AND 107).



FIRST USE 10-1-2009; IN COMMERCE 10-1-2009.

THE MARK CONSISTS OF STANDARD CHARACTERS WITHOUT CLAIM TO ANY PARTICULAR FONT, STYLE, SIZE, OR COLOR.

SER. NO. 85-199,820, FILED 12-16-2010.

CHARLOTTE CORWIN, EXAMINING ATTORNEY

*David J. Kyffers*

Director of the United States Patent and Trademark Office

# United States of America

United States Patent and Trademark Office

# LaurieAnna's

**Reg. No. 4,196,659**

**Registered Aug. 28, 2012**

**Int. Cl.: 35**

**SERVICE MARK**

**PRINCIPAL REGISTER**

LAURIEANNA'S VINTAGE HOME, LLC (TEXAS LIMITED LIABILITY COMPANY)  
1457 N. TRADE DAYS BLVD  
CANTON, TX 75103

FOR: RETAIL STORE AND ON-LINE RETAIL STORE SERVICES FEATURING HOME, GARDEN, AND OFFICE DECORATIONS, ACCESSORIES AND FURNISHINGS, NAMELY, CANDLES, SACHETS, SCENTED CANDLES, SACHETS FOR PERFUMING LINEN, FRAGRANCE SACHETS, PERFUMING SACHETS, TABLE LINEN, BATH LINEN, BED LINEN, HOUSEHOLD LINEN, DINING LINENS, KITCHEN LINENS, TOWELS, TOWEL SHEETS, TOWEL SETS, TEA TOWELS, TERRY TOWELS, TOWELS MADE OF TEXTILE MATERIALS, TURKISH TOWEL, CURTAINS, WINDOW CURTAINS, SHOWER CURTAINS, DRAPERIES, FABRIC WINDOW COVERINGS AND TREATMENTS, NAMELY, CURTAINS, DRAPERIES, SHEERS, SWAGS AND VALANCES, CANDLE HOLDERS, DISHES, FLATWARE, SERVING FORKS, SERVING KNIVES, SERVING SPOONS, SERVING LADLES, SERVING TONGS, PITCHERS, SERVING BOTTLES, SERVING PLATTERS, SERVING TRAYS, SOUP TUREENS, SERVING BOWLS, PLACE MATS, NOT OF PAPER, PAPER PLACE MATS, PLACE MATS OF TEXTILE MATERIAL, VINYL PLACE MATS, NAPKIN RINGS, BEVERAGE GLASSWARE, MEASURING GLASSWARE, FURNITURE, DINING CHAIRS, DINING TABLES, FURNITURE FOR HOUSE AND GARDEN, SCULPTURES AND WORKS OF ART, WALL ART, LIGHT FIXTURES, SOAPS, PILLOWS, ARTIFICIAL FLOWERS AND PLANTS, TABLES, SOFAS, CHAIRS, LAMPS, BEDS, BOOKSHELVES AND WARDROBES, STATIONERY, BLANK NOTE CARDS, NOTE PADS, WRITING JOURNALS, NOTE PAPER, DIARIES, BLANK WRITING JOURNALS, CHRISTMAS TREE ORNAMENTS AND DECORATIONS, CHRISTMAS DOLLS, CHRISTMAS TREE STANDS AND SKIRTS, CHRISTMAS WREATHS, STOCKINGS AND DOLLS, STUFFED TOY ANIMALS, DOLLS, DOLL ACCESSORIES; RETAIL AND ON-LINE RETAIL GIFT SHOPS, IN CLASS 35 (U.S. CLS. 100, 101 AND 102).



FIRST USE 3-27-2005; IN COMMERCE 5-1-2005.

THE MARK CONSISTS OF STANDARD CHARACTERS WITHOUT CLAIM TO ANY PARTICULAR FONT, STYLE, SIZE, OR COLOR.

SER. NO. 85-200,029, FILED 12-16-2010.

BARBARA A. GOLD, EXAMINING ATTORNEY

*David J. Kyros*

Director of the United States Patent and Trademark Office

# United States of America

United States Patent and Trademark Office

## FANCY NAIL'S BAR

**Reg. No. 4,196,660**

GUNLER, INC (FLORIDA CORPORATION)  
9595 SIX PINES DR.

**Registered Aug. 28, 2012**

THE WOODLANDS, TX 77382

**Int. Cl.: 44**

FOR: NAIL SALON SERVICES, IN CLASS 44 (U.S. CLS. 100 AND 101).

**SERVICE MARK**

FIRST USE 12-15-2010; IN COMMERCE 12-15-2010.

**PRINCIPAL REGISTER**

THE MARK CONSISTS OF STANDARD CHARACTERS WITHOUT CLAIM TO ANY PARTICULAR FONT, STYLE, SIZE, OR COLOR.

NO CLAIM IS MADE TO THE EXCLUSIVE RIGHT TO USE "NAILS BAR", APART FROM THE MARK AS SHOWN.

SER. NO. 85-200,190, FILED 12-17-2010.

KELLY TRUSILO, EXAMINING ATTORNEY



*David J. Kyffers*

Director of the United States Patent and Trademark Office

# United States of America

United States Patent and Trademark Office

# TRANSITION

**Reg. No. 4,196,661**

**Registered Aug. 28, 2012**

**Int. Cls.: 6 and 20**

**TRADEMARK**

**PRINCIPAL REGISTER**

MIDPOINT INTERNATIONAL, INC. (CANADA CORPORATION)  
189 EARL STEWART DRIVE, UNIT 1  
AURORA, CANADA L4G6V5

FOR: METAL SOURCE SEPARATION AND CUSTOMIZED CONTAINERS FOR SOLID WASTE AND RECYCLING COLLECTION/SORTATION; WASTE RECEPTACLES, RECYCLING RECEPTACLES AND STORAGE BOXES MADE OF METAL, ALUMINUM OR BRASS, IN CLASS 6 (U.S. CLS. 2, 12, 13, 14, 23, 25 AND 50).

FOR: SOURCE SEPARATION AND CUSTOMIZED CONTAINERS FOR SOLID WASTE AND RECYCLING COLLECTION/SORTATION MADE OF PLASTIC OR WOOD; WASTE RECEPTACLES, RECYCLING RECEPTACLES, STORAGE BOXES MADE FROM PLASTIC OR WOOD, IN CLASS 20 (U.S. CLS. 2, 13, 22, 25, 32 AND 50).

THE MARK CONSISTS OF STANDARD CHARACTERS WITHOUT CLAIM TO ANY PARTICULAR FONT, STYLE, SIZE, OR COLOR.

PRIORITY CLAIMED UNDER SEC. 44(D) ON CANADA APPLICATION NO. 1504294, FILED 11-18-2010, REG. NO. TMA822,835, DATED 4-24-2012, EXPIRES 4-24-2027.

SER. NO. 85-200,236, FILED 12-17-2010.

JOHN WILKE, EXAMINING ATTORNEY



*David J. Kybas*

Director of the United States Patent and Trademark Office

# United States of America

United States Patent and Trademark Office



**Reg. No. 4,196,662**

**Registered Aug. 28, 2012**

**Int. Cls.: 9, 10, 11, 40  
and 42**

**TRADEMARK**

**SERVICE MARK**

**PRINCIPAL REGISTER**

CAL-COMP ELECTRONICS & COMMUNICATIONS COMPANY LIMITED (TAIWAN CORPORATION)

3F., NO. 99, SEC. 5, NANJING E. ROAD  
SONGSHAN DISTRICT  
TAIPEI CITY, TAIWAN 10571

FOR: SATELLITE TELEVISION RECEIVERS; SATELLITE TELEVISION CONVERTER; TELEVISION SET-TOP BOXES AND ON-DEMAND VIDEO BOX; DVD PLAYERS AND PORTABLE VIDEO AND AUDIO PLAYERS; VIDEO RECORDERS; DIGITAL VIDEO AND AUDIO DISK PLAYERS; TELEPHONE APPARATUS, NAMELY, MOBILE PHONE CASINGS; TELEPHONE ANSWERING MACHINES; TWO-WAY RADIOS; WIRELESS TELEPHONES; CELLULAR TELEPHONES; VIDEO TELEPHONES; HAND-FREE SETS FOR CELLULAR TELEPHONES FOR USE IN VEHICLES; TELEPHONES NETWORK COMPRISING CELLULAR TELEPHONES, CAMERAS, MODEMS, PHONES, MICROPHONES; TELEPHONE HEADSETS; MOBILE TELEPHONES FOR VEHICLES; GLOBAL POSITIONING SYSTEM (GPS); LIQUID CRYSTAL DISPLAY COMPUTER MONITORS; LIQUID CRYSTAL DISPLAY TVS (LCD TVS); COMPUTER PRINTERS; COMPUTER DATA STORAGE APPARATUS, NAMELY, NETWORK CARDS; NOTEBOOKS COMPUTERS; PERSONAL DIGITAL ASSISTANTS (PDAS); MULTI-FUNCTION COMPUTER PERIPHERALS, NAMELY, COMPUTER PRINTERS, PHOTOCOPY MACHINES, FACSIMILE MACHINES, COMPUTER SCANNERS; BLANK COMPUTER DRIVES, NAMELY, FLOPPY DISC DRIVES; DISK STORAGE DRIVES, NAMELY, PORTABLE HARD DISC DRIVES, CD-ROM DRIVES, REMOVABLE HARD DISC DISKS, FLASH MEMORY CARDS; DIGITAL CAMERAS; USB CABLES; ELECTRONIC PUBLICATIONS, NAMELY, BOOKS, MAGAZINES AND MANUALS FEATURING LANGUAGE LEARNING, SHEET MUSIC, AND POP SONGS LYRICS RECORDED ON COMPUTER MEDIA; ELECTRONIC PUBLICATION, NAMELY, BOOKS FEATURING LITERATURE, STORIES, NEWS, TRAVEL INFORMATION, AND FOOD REVIEWS AND RECIPES RECORDED ON COMPUTER MEDIA; MULTIMEDIA PLAYERS; SOLAR POWER APPARATUS, NAMELY, PHOTOVOLTAIC SOLAR MODULES FOR CONVERTING ELECTRONIC RADIATION TO ELECTRICAL ENERGY AND PHOTOVOLTAIC SOLAR MODULES FOR PRODUCTION OF ELECTRICITY; PHOTOVOLTAIC CELLS ALSO INCLUDING A SOLAR THERMAL COLLECTOR SOLD AS A UNIT; SOLAR PANELS FOR PRODUCTION OF ELECTRICITY; POWER SUPPLIERS FOR SOLAR EQUIPMENT; SOLAR BATTERIES; SOLAR STORAGE BATTERIES; 3D EYEGLASSES; PRINTED CIRCUIT BOARDS; CALCULATORS; COMPUTERS; COMPUTER MICE; ELECTRONIC TRANSLATION MACHINES, NAMELY, COMPUTER HARDWARE AND SOFTWARE FOR TRANSLATING LANGUAGES, IN CLASS 9 (U.S. CLS. 21, 23, 26, 36 AND 38).



*David J. Kybas*

Director of the United States Patent and Trademark Office

**Reg. No. 4,196,662** FIRST USE 2-12-2007; IN COMMERCE 9-16-2010.

FOR: MEDICAL APPARATUS, NAMELY, LASERS FOR MEDICAL PURPOSES; ELECTRODES FOR MEDICAL USE; GALVANIC BELTS FOR MEDICAL PURPOSES; APPARATUS FOR ARTIFICIAL RESPIRATION; PATIENT BREATHING SYSTEM COMPRISING BREATHING CIRCUIT, CONNECTIONS TO PATIENT, VENTILATOR, SCAVENGER, FRESH GAS DELIVERY CIRCUIT AND CARBON DIOXIDE ABSORBER; MEDICAL APPARATUS FOR FACILITATING THE INHALATION OF PHARMACEUTICAL PREPARATIONS; MEDICAL GUIDE WIRES; COMPUTERIZED MEDICAL RECORDING AND ANALYSIS APPARATUS FOR THE DIAGNOSIS AND TREATMENT OF ARRHYTHMIAS; ORGANOLEPTIC DIAGNOSTIC TESTING APPARATUS FOR MEDICAL USE; BLOOD TESTING APPARATUS; EYE TESTING MACHINES AND APPARATUS; OPERATING TABLES; SURGICAL LAMPS; LAMPS FOR MEDICAL AND THERAPEUTIC PURPOSES, NAMELY, MEDICAL EXAMINATION LAMPS, QUARTZ LAMPS FOR MEDICAL PURPOSES, ULTRAVIOLET LAMPS FOR MEDICAL PURPOSES, AND CARBON ARC LAMP UNITS FOR THERAPEUTIC PURPOSES, IN CLASS 10 (U.S. CLS. 26, 39 AND 44).

FIRST USE 2-12-2007; IN COMMERCE 9-16-2010.

FOR: LED (LIGHT EMITTING DIODES) LIGHTING FIXTURES FOR USE IN DISPLAY, COMMERCIAL, INDUSTRIAL, RESIDENTIAL, AND ARCHITECTURAL ACCENT LIGHTING APPLICATIONS; LED (LIGHT EMITTING DIODE) LIGHTING FIXTURES; LED AND HID LIGHT FIXTURES; LED LIGHT ASSEMBLIES FOR STREET LIGHTS, SIGNS, COMMERCIAL LIGHTING, AUTOMOBILES, BUILDINGS, AND OTHER ARCHITECTURAL USES; LED LIGHT BULBS; LED LIGHTING FIXTURES FOR INDOOR AND OUTDOOR LIGHTING APPLICATIONS; LIGHT BARS FOR VEHICLES, NAMELY, AUTOMOBILES AND MOTORCYCLES; LIGHT BULBS; LIGHT DIFFUSERS; LIGHT PANELS FOR VEHICLES, NAMELY, AUTOMOBILES AND MOTORCYCLES; LIGHT REFLECTORS; LIGHTERS PRIMARILY FOR LIGHTING GRILLS, FIREPLACES AND CANDLES; LIGHTING APPARATUS FOR VEHICLES; LIGHTING DEVICES FOR SHOWCASES; LIGHTING FIXTURES; LIGHTING FIXTURES FOR USE IN PARKING DECKS AND GARAGES; LIGHTING FIXTURES FOR USE IN PARKING LOTS AND WALKWAYS; LIGHTING FIXTURES THAT INTEGRATE NATURAL DAYLIGHT AND FLUORESCENT LIGHTING INTO THE FIXTURE; LIGHTING TRACKS; LIGHTING TUBES; LIGHTS FOR ILLUMINATING STAIRS, DOORS AND OTHER PORTIONS OF BUILDINGS; LIGHTS FOR USE IN ILLUMINATING SIGNS AND DISPLAYS; LIGHTS FOR VEHICLES, IN CLASS 11 (U.S. CLS. 13, 21, 23, 31 AND 34).

FIRST USE 2-12-2007; IN COMMERCE 9-16-2010.

FOR: CUSTOM MANUFACTURING OF SATELLITE TELEVISION RECEIVERS, SATELLITE TELEVISION CONVERTERS, TELEVISION SET-TOP BOXES AND ON-DEMAND VIDEO BOX, DVD PLAYERS AND PORTABLE VIDEO AND AUDIO PLAYERS, VIDEO RECORDERS, DIGITAL VIDEO AND AUDIO DISK PLAYERS, TELEPHONE APPARATUS, NAMELY, MOBILE PHONE CASINGS, TELEPHONE ANSWERING MACHINES, TWO-WAY RADIOS, WIRELESS TELEPHONES, CELLULAR TELEPHONES, VIDEO TELEPHONES, HAND-FREE SETS FOR CELLULAR TELEPHONES FOR USE IN VEHICLES, TELEPHONES NETWORK SETS COMPRISED, TELEPHONE HEADSETS, MOBILE TELEPHONES FOR VEHICLES, GLOBAL POSITIONING SYSTEM (GPS), LIQUID CRYSTAL DISPLAY COMPUTER MONITORS, LIQUID CRYSTAL DISPLAY TVS (LCD TVS), COMPUTER PRINTERS, COMPUTER DATA STORAGE APPARATUS, NAMELY, NETWORK CARDS, NOTEBOOKS COMPUTERS, PERSONAL DIGITAL ASSISTANTS (PDAS), MULTI-FUNCTION PERIPHERALS, NAMELY, COMPUTER PRINTERS, PHOTOCOPY MACHINES, FACSIMILE MACHINES, COMPUTER SCANNERS, BLANK COMPUTER DRIVES, NAMELY, FLOPPY DISC DRIVES, DISK STORAGE DRIVES, NAMELY PORTABLE HARD DISC DRIVES, CD-ROM DRIVES, REMOVABLE HARD DISKS, FLASH MEMORY CARDS, ELECTRIC CHINESE LANTERNS, LIGHT BULBS, LIGHTING APPARATUS FOR VEHICLES, NAMELY, LAMPS FOR DIRECTIONAL SIGNAL OF AUTOMOBILES, VEHICLE HEADLIGHTS, TAIL LIGHTS FOR VEHICLES, LED LIGHT BULBS AND DIGITAL CAMERAS, USB CABLES, ELECTRONIC

**Reg. No. 4,196,662** PUBLICATIONS, ELECTRONIC BOOKS, MULTIMEDIA PLAYERS, SOLAR POWER APPARATUS INCLUDING SOLAR MODULES AND SOLAR ENERGY CONVERSION DEVICES, SOLAR RECEIVERS FOR POWER CONVERSION USE, SOLAR COLLECTING PANELS, SOLAR POWER CONCENTRATING PANELS FOR POWER CONVERSION USE, SOLAR MODULES, SOLAR POWER SUPPLIERS, SOLAR ENERGY CONVERTERS, SOLAR BATTERIES, SOLAR STORAGE BATTERIES, 3D EYEGLASSES, PCB (PRINTED CIRCUIT BOARD), CALCULATORS, COMPUTERS, COMPUTER MOUSE, ELECTRONIC TRANSLATION MACHINES, MEDICAL APPARATUS, MEDICAL INSTRUMENTS, OPERATING TABLES, SURGICAL LAMPS, LAMPS FOR MEDICAL AND THERAPEUTIC PURPOSES ALL TO THE SPECIFICATION OF THIRD PARTIES; INJECTION MOULD CREATING FOR RUBBER INJECTION MOLDING ACCORDING TO THE STANDARD FROM CLIENT'S INSTRUCTION; INJECTION MOULD CREATING FOR PLASTIC INJECTION MOLDING ACCORDING TO THE STANDARD FROM CLIENT'S INSTRUCTION; INJECTION MOULD CREATING FOR METAL INJECTION MOLDING ACCORDING TO THE STANDARD FROM CLIENT'S INSTRUCTION, IN CLASS 40 (U.S. CLS. 100, 103 AND 106).

FIRST USE 2-12-2007; IN COMMERCE 9-16-2010.

FOR: CONSULTING SERVICES FOR OTHERS, NAMELY COMPUTER CONSULTING; CONSULTING IN THE FIELD OF MULTI-FUNCTION COPY MACHINES, FACSIMILE MACHINES, AND CELLULAR TELEPHONE DESIGN; TECHNICAL SUPPORT SERVICES, NAMELY, TROUBLESHOOTING OF COMPUTER SOFTWARE PROBLEMS; DESIGNING AND MAINTAINING WEB SITES FOR OTHERS; PROVIDING SEARCH ENGINES FOR OBTAINING DATA ON A GLOBAL COMPUTER NETWORK; COMPUTER PROGRAMMING FOR OTHERS; DEVELOPMENT AND RENTING OF DATA PROCESSING PROGRAMS; RENTAL AND LEASING OF COMPUTERS AND COMPUTER PROGRAMS; PROVIDING NEWS AND INFORMATION VIA THE INTERNET IN THE FIELDS OF HIGH TECHNOLOGY AND INFORMATION TECHNOLOGY RELATED TO CLOUD STORAGE AND ACCESSING PRIVATE FILES FROM REMOTE COMPUTERS AND REMOTE LOCATIONS; INDUSTRIAL DESIGN; PACKAGING DESIGN, IN CLASS 42 (U.S. CLS. 100 AND 101).

FIRST USE 2-12-2007; IN COMMERCE 9-16-2010.

OWNER OF U.S. REG. NOS. 3,711,194 AND 3,785,642.

NO CLAIM IS MADE TO THE EXCLUSIVE RIGHT TO USE "SINCE 1973" AND "ODM & EMS", APART FROM THE MARK AS SHOWN.

THE MARK CONSISTS OF THE WORDING "NEW KINPO VALUE" ABOVE AN OVERLAPPING "CC" DESIGN AND THE WORDING "SINCE 1973" WITH THE WORDING "ODM & EMS PARTNER" BENEATH THAT.

SER. NO. 85-200,396, FILED 12-17-2010.

JOHN DWYER, EXAMINING ATTORNEY

# United States of America

United States Patent and Trademark Office

# EZ VALVE

**Reg. No. 4,196,663**

**Registered Aug. 28, 2012**

**Int. Cls.: 6 and 7**

**TRADEMARK**

**PRINCIPAL REGISTER**

ADVANCED VALVE TECHNOLOGIES, INC. (DELAWARE CORPORATION)  
800 BUSSE ROAD  
ELK GROVE VILLAGE, IL 60007

FOR: MANUALLY OPERATED METAL VALVES AND MANUALLY OPERATED METAL LINE-STOPPING VALVES NOT BEING PARTS OF MACHINES WHICH STOP THE FLOW OF WATER OR GAS IN WATER PIPES, GAS PIPES, AND PETRO-CHEMICAL PIPES USED FOR INDUSTRIAL PURPOSES; VALVE SYSTEMS COMPRISED OF MANUALLY OPERATED METAL VALVES FOR USE IN WATER PIPES, GAS PIPES, AND PETRO-CHEMICAL PIPES USED FOR INDUSTRIAL PURPOSES, IN CLASS 6 (U.S. CLS. 2, 12, 13, 14, 23, 25 AND 50).

FIRST USE 7-0-2005; IN COMMERCE 7-0-2005.

FOR: TAPPING MACHINES AND ELECTRIC DRILLS USED TO CUT AN ACCESS IN A PIPE; HYDRAULIC AND PNEUMATIC CUTTING AND DRILLING MACHINES TO CUT AN ACCESS IN A PIPE, IN CLASS 7 (U.S. CLS. 13, 19, 21, 23, 31, 34 AND 35).

FIRST USE 7-0-2005; IN COMMERCE 7-0-2005.

THE MARK CONSISTS OF STANDARD CHARACTERS WITHOUT CLAIM TO ANY PARTICULAR FONT, STYLE, SIZE, OR COLOR.

NO CLAIM IS MADE TO THE EXCLUSIVE RIGHT TO USE "VALVE", APART FROM THE MARK AS SHOWN.

SER. NO. 85-201,620, FILED 12-20-2010.

BARNEY CHARLON, EXAMINING ATTORNEY



*David J. Kyffers*

Director of the United States Patent and Trademark Office



# United States of America

United States Patent and Trademark Office

## MADemoiselle

**Reg. No. 4,196,664**

**Registered Aug. 28, 2012**

**Int. Cl.: 18**

**TRADEMARK**

**PRINCIPAL REGISTER**

CHANEL, INC. (NEW YORK CORPORATION)  
CHANEL LEGAL DEPARTMENT  
9 WEST 57TH STREET  
NEW YORK, NY 10019

FOR: HANDBAGS, PURSES AND WALLETS, IN CLASS 18 (U.S. CLS. 1, 2, 3, 22 AND 41).

FIRST USE 12-31-2004; IN COMMERCE 9-1-2008.

THE MARK CONSISTS OF STANDARD CHARACTERS WITHOUT CLAIM TO ANY PARTICULAR FONT, STYLE, SIZE, OR COLOR.

OWNER OF U.S. REG. NO. 2,557,185.

SER. NO. 85-204,225, FILED 12-22-2010.

SETH A. RAPPAPORT, EXAMINING ATTORNEY



*David J. Kyjars*

Director of the United States Patent and Trademark Office

# United States of America

United States Patent and Trademark Office

# PHASECORE

**Reg. No. 4,196,665**

FIRST LINE TECHNOLOGY, LLC (VIRGINIA LIMITED LIABILITY COMPANY)  
3656 CENTERVIEW DRIVE, SUITE 4  
CHANTILLY, VA 20151

**Registered Aug. 28, 2012**

**Int. Cls.: 1, 9, 10, 11, 17,  
18, 21 and 25**

FOR: CHEMICAL GEL FOR USE AS AN ICE SUBSTITUTE, IN CLASS 1 (U.S. CLS. 1, 5, 6, 10, 26 AND 46).

FIRST USE 6-1-2006; IN COMMERCE 6-1-2006.

**TRADEMARK**

**PRINCIPAL REGISTER**

FOR: PROTECTIVE CLOTHING, NAMELY, CLOTHING FOR PROTECTION AGAINST FIRE; CLOTHING FOR PROTECTION AGAINST HEAT, NAMELY, PROTECTIVE CLOTHING ESPECIALLY MADE FOR USE IN AREAS OF EXCESSIVE HEAT; INSULATING CLOTHING FOR PROTECTION AGAINST ACCIDENT OR INJURY; COMPUTER COOLING PADS FOR NOTEBOOKS OR COMPUTER PROCESSING UNITS, IN CLASS 9 (U.S. CLS. 21, 23, 26, 36 AND 38).

FIRST USE 6-1-2006; IN COMMERCE 6-1-2006.

FOR: MEDICAL COLD PACKS; MEDICAL STRETCHERS; MEDICAL STRETCHERS FOR PATIENT TRANSPORT; HOSPITAL BEDS FOR USE BY BURN PATIENTS; HOSPITAL GURNEYS; AIR PILLOWS FOR MEDICAL PURPOSES, IN CLASS 10 (U.S. CLS. 26, 39 AND 44).

FIRST USE 6-1-2006; IN COMMERCE 6-1-2006.

FOR: COLD PACKS FOR COOLING THE BODY AND NOT FOR MEDICAL PURPOSES; CHEMICALLY-ACTIVATED COLD PACKS FOR COOLING THE BODY AND NOT FOR MEDICAL PURPOSES; PERSONAL COOLING SYSTEM COMPRISING A COOLANT THAT MAY BE INCORPORATED INTO A GARMENT, IN CLASS 11 (U.S. CLS. 13, 21, 23, 31 AND 34).

FIRST USE 6-1-2006; IN COMMERCE 6-1-2006.

FOR: INSULATING POLYMERIC SHELLS, NAMELY, MACRO AND MICRO CAPSULES CONTAINING PHASE CHANGE MATERIAL USED FOR THERMAL REGULATION IN THE MANUFACTURE OF CLOTHING, FOOTWEAR AND HEADGEAR, IN CLASS 17 (U.S. CLS. 1, 5, 12, 13, 35 AND 50).



*David J. Kybas*

Director of the United States Patent and Trademark Office

**Reg. No. 4,196,665** FIRST USE 6-1-2006; IN COMMERCE 6-1-2006.

FOR: GENERAL USE MEDICAL BAGS; CLOTHING FOR ANIMALS AND DOMESTIC PETS; WRAPS FOR ANIMALS AND DOMESTIC PETS; EQUINE WRAPS; ALL-PURPOSE CARRYING BAGS, IN CLASS 18 (U.S. CLS. 1, 2, 3, 22 AND 41).

FIRST USE 6-1-2006; IN COMMERCE 6-1-2006.

FOR: PORTABLE THERMAL INSULATED BAGS FOR FOODS AND BEVERAGES; PORTABLE ICE CHESTS FOR FOOD AND BEVERAGES; THERMAL INSULATED CONTAINERS FOR FOOD OR BEVERAGES; REUSABLE PACKAGED REFRIGERANT GEL PACKS USED TO KEEP FOOD AND DRINKS COLD; PORTABLE THERMAL INSULATED BAGS, ICE CHESTS AND CONTAINERS FOR KEEPING FOOD AND BEVERAGES COLD WITH REFRIGERANT GEL PACKS, IN CLASS 21 (U.S. CLS. 2, 13, 23, 29, 30, 33, 40 AND 50).

FIRST USE 6-1-2006; IN COMMERCE 6-1-2006.

FOR: WEARABLE GARMENTS AND CLOTHING, NAMELY, VESTS, AND WRAPS; FOOTWEAR AND HEADGEAR, NAMELY, HATS AND CAPS; WRISTBANDS CONTAINING A COOLING SUBSTANCE TO COOL THE WEARER, IN CLASS 25 (U.S. CLS. 22 AND 39).

FIRST USE 6-1-2006; IN COMMERCE 6-1-2006.

THE MARK CONSISTS OF STANDARD CHARACTERS WITHOUT CLAIM TO ANY PARTICULAR FONT, STYLE, SIZE, OR COLOR.

OWNER OF U.S. REG. NO. 3,519,905.

SER. NO. 85-204,325, FILED 12-22-2010.

RENEE MCCRAY, EXAMINING ATTORNEY

# United States of America

United States Patent and Trademark Office



**Reg. No. 4,196,666**

GENKAST LLC (D.C. LIMITED LIABILITY COMPANY)  
1200 H. STREET, N.E.

**Registered Aug. 28, 2012**

WASHINGTON, DC 20002

**Int. Cl.: 45**

FOR: PROVIDING A WEBSITE FEATURING INFORMATION FOR AFRICAN AMERICAN MOTHERS IN THE FIELD OF PARENTING CONCERNING INTRAFAMILY RELATIONSHIPS, IN CLASS 45 (U.S. CLS. 100 AND 101).

**SERVICE MARK**

FIRST USE 11-5-2010; IN COMMERCE 11-5-2010.

**PRINCIPAL REGISTER**

THE MARK CONSISTS OF THE CHARACTERIZATION OF A WOMAN HOLDING A CHILD AND THE STYLIZED WORDS "BECCASTONE".

SER. NO. 85-204,546, FILED 12-22-2010.

KHANH LE, EXAMINING ATTORNEY



*David J. Kyffers*

Director of the United States Patent and Trademark Office

# United States of America

United States Patent and Trademark Office

# P2PMD

**Reg. No. 4,196,667**

**Registered Aug. 28, 2012**

**Int. Cl.: 42**

**SERVICE MARK**

**PRINCIPAL REGISTER**

HEALTHCARE INTERACTIVE, INC. (DELAWARE CORPORATION)  
3060 ROUTE 97, SUITE 290  
GLENWOOD, MD USA 21738

FOR: COMPUTER SERVICE, NAMELY, ACTING AS AN APPLICATION SERVICE PROVIDER IN THE FIELD OF HEALTHCARE PATIENT MANAGEMENT TO HOST NETWORK-ACCESSIBLE COMPUTER APPLICATION SOFTWARE FOR THE PURPOSE OF PATIENT MANAGEMENT VIA A HEALTHCARE SOCIAL NETWORK ENVIRONMENT, NAMELY, SOFTWARE FOR PATIENT DATABASE MANAGEMENT; HEALTHCARE PATIENT MANAGEMENT SERVICE, NAMELY, HOSTING AND MAINTAINING AN ON-LINE WEB SITE FOR CONNECTING PHYSICIANS, NURSES, CARE MANAGERS, MENTAL HEALTH PROFESSIONALS, CLINIC STAFF, PHARMACIES, PHARMACISTS, HOSPITALS, LABORATORIES, AND OTHER HEALTH CARE PROVIDERS AND PROFESSIONALS WITH ONE ANOTHER AND WITH PATIENTS TO PROMOTE SHARING OF HEALTHCARE INFORMATION; HEALTHCARE PATIENT MANAGEMENT SERVICE, NAMELY, HOSTING AND MAINTAINING AN ON LINE WEBSITE PROVIDING SECURE COMMUNICATION FOR EXCHANGE OF INFORMATION BETWEEN PROVIDERS AND PATIENTS, PROVIDERS AND OTHER PROVIDERS, ONLINE VIEWING OF PATIENTS' PRESCRIPTION MEDICATION, ONLINE VIEWING AND SORTING OF PATIENT INFORMATION, IN CLASS 42 (U.S. CLS. 100 AND 101).

FIRST USE 1-19-2010; IN COMMERCE 1-19-2010.

THE MARK CONSISTS OF STANDARD CHARACTERS WITHOUT CLAIM TO ANY PARTICULAR FONT, STYLE, SIZE, OR COLOR.

OWNER OF U.S. REG. NO. 3,911,910.

SER. NO. 85-205,588, FILED 12-24-2010.

JENNY PARK, EXAMINING ATTORNEY



*David J. Kyjars*

Director of the United States Patent and Trademark Office

# United States of America

United States Patent and Trademark Office

## DAILY DEALS MAKING A DIFFERENCE

**Reg. No. 4,196,668**

**Registered Aug. 28, 2012**

**Int. Cl.: 35**

**SERVICE MARK**

**PRINCIPAL REGISTER**

GROUPECOUPONS, LLC (TEXAS LIMITED LIABILITY COMPANY)  
1013 W UNIVERSITY STE 145  
GEORGETOWN, TX 78628

FOR: PROMOTING THE GOODS AND SERVICES OF OTHERS BY PROVIDING A WEB SITE FEATURING COUPONS, REBATES, PRICE-COMPARISON INFORMATION, PRODUCT REVIEWS, LINKS TO THE RETAIL WEB SITES OF OTHERS, AND DISCOUNT INFORMATION; PROMOTING THE GOODS OF OTHERS, NAMELY, PROVIDING COUPONS, REBATES AND VOUCHERS FOR THE GOODS OF OTHERS; PROMOTING THE GOODS OF OTHERS, NAMELY, PROVIDING INFORMATION REGARDING DISCOUNTS, COUPONS, REBATES, VOUCHERS AND SPECIAL OFFERS FOR THE GOODS OF OTHERS; PROMOTING THE SALE OF GOODS AND SERVICES OF OTHERS THROUGH ELECTRONIC COUPONING, PROMOTIONS AND DISCOUNTS; PROMOTIONAL SERVICES, NAMELY, PROMOTING THE GOODS OF OTHERS BY MEANS OF PROVIDING ONLINE COUPONS; ALL THE FOREGOING EXCLUDING ANY AUTOMOBILE PROMOTIONS, IN CLASS 35 (U.S. CLS. 100, 101 AND 102).

FIRST USE 12-1-2010; IN COMMERCE 12-1-2010.

THE MARK CONSISTS OF STANDARD CHARACTERS WITHOUT CLAIM TO ANY PARTICULAR FONT, STYLE, SIZE, OR COLOR.

NO CLAIM IS MADE TO THE EXCLUSIVE RIGHT TO USE "DAILY DEALS", APART FROM THE MARK AS SHOWN.

SER. NO. 85-206,143, FILED 12-27-2010.

CORY BOONE, EXAMINING ATTORNEY



*David J. Kybas*

Director of the United States Patent and Trademark Office

# United States of America

United States Patent and Trademark Office

# WebScore

**Reg. No. 4,196,669**

FRANKLIN SCOREKEEPER, LLC (DELAWARE LIMITED LIABILITY COMPANY)  
300 MAIN STREET  
LEWISTON, ME 04240

**Registered Aug. 28, 2012**

**Int. Cl.: 9**

FOR: INTERFACE SOFTWARE SOLD AS A COMPONENT OF COMPUTER HARDWARE AND SOFTWARE, FOR USE WITH MEDICAL PATIENT MONITORING EQUIPMENT, FOR RECEIVING, PROCESSING, TRANSMITTING AND DISPLAYING DATA IN THE FULLSCORE DATA COMPILATION PRODUCT, IN CLASS 9 (U.S. CLS. 21, 23, 26, 36 AND 38).

**TRADEMARK**

**PRINCIPAL REGISTER**

FIRST USE 6-1-2004; IN COMMERCE 7-1-2004.

THE MARK CONSISTS OF STANDARD CHARACTERS WITHOUT CLAIM TO ANY PARTICULAR FONT, STYLE, SIZE, OR COLOR.

SER. NO. 85-207,536, FILED 12-29-2010.

CHARLOTTE CORWIN, EXAMINING ATTORNEY



*David J. Kybas*

Director of the United States Patent and Trademark Office

# United States of America

United States Patent and Trademark Office

# FullScore

**Reg. No. 4,196,670**

FRANKLIN SCOREKEEPER, LLC (DELAWARE LIMITED LIABILITY COMPANY)  
300 MAIN STREET  
LEWISTON, ME 04240

**Registered Aug. 28, 2012**

**Int. Cl.: 9**

FOR: INTERFACE SOFTWARE SOLD ALONE AND WITH ADDITIONAL COMPONENTS OF COMPUTER HARDWARE AND SOFTWARE, FOR USE WITH MEDICAL PATIENT MONITORING EQUIPMENT, FOR RECEIVING, PROCESSING, TRANSMITTING AND DISPLAYING DATA, IN CLASS 9 (U.S. CLS. 21, 23, 26, 36 AND 38).

**TRADEMARK**

**PRINCIPAL REGISTER**

FIRST USE 6-1-2004; IN COMMERCE 7-1-2004.

THE MARK CONSISTS OF STANDARD CHARACTERS WITHOUT CLAIM TO ANY PARTICULAR FONT, STYLE, SIZE, OR COLOR.

SER. NO. 85-207,556, FILED 12-29-2010.

CHARLOTTE CORWIN, EXAMINING ATTORNEY



*David J. Kyffers*

Director of the United States Patent and Trademark Office



# United States of America

United States Patent and Trademark Office

## Back Office in a Box (BOB)

**Reg. No. 4,196,671**

**Registered Aug. 28, 2012**

**Int. Cl.: 35**

**SERVICE MARK**

**PRINCIPAL REGISTER**

CENTER FOR NONPROFIT ADVANCEMENT (D.C. CORPORATION)  
SUITE 440  
1666 K STREET, N.W.  
WASHINGTON, DC 20006

FOR: BUSINESS MANAGEMENT SERVICES, NAMELY, MANAGING OFFICE FUNCTIONS IN THE NATURE OF BOOKKEEPING, ACCOUNTING, TAX PREPARATION AND HUMAN RESOURCES FOR OTHERS, IN CLASS 35 (U.S. CLS. 100, 101 AND 102).

FIRST USE 4-22-2009; IN COMMERCE 4-22-2009.

THE MARK CONSISTS OF STANDARD CHARACTERS WITHOUT CLAIM TO ANY PARTICULAR FONT, STYLE, SIZE, OR COLOR.

SER. NO. 85-208,834, FILED 1-2-2011.

RAUL CORDOVA, EXAMINING ATTORNEY



*David J. Kyffers*

Director of the United States Patent and Trademark Office

# United States of America

United States Patent and Trademark Office

# Aztc

**Reg. No. 4,196,672**

**Registered Aug. 28, 2012**

**Int. Cl.: 9**

**TRADEMARK**

**PRINCIPAL REGISTER**

NHK SPRING CO., LTD (JAPAN CORPORATION)  
10, FUKUURA 3-CHOME, KANAZAWA-KU,  
YOKOHAMA-SHI, KANAGAWA, JAPAN 236-0004

FOR: ELECTRONIC TESTING APPARATUSES FOR SEMICONDUCTOR DEVICES, NAMELY, TEST PINS FOR TESTING PRINTED CIRCUIT BOARDS AND REPLACEMENT PARTS THEREOF; ELECTRONIC TESTING APPARATUSES FOR CIRCUIT BOARDS, NAMELY, TEST ADAPTERS FOR TESTING PRINTED CIRCUIT BOARDS AND REPLACEMENT PARTS THEREOF; ELECTRONIC TESTING APPARATUSES FOR SEMICONDUCTOR INTEGRATED CIRCUIT DEVICES, NAMELY, PROBES FOR TESTING INTEGRATED CIRCUITS; ELECTRONIC TESTING SOCKETS FOR SEMICONDUCTOR DEVICES, NAMELY, TEST ADAPTORS FOR TESTING PRINTED CIRCUIT BOARDS; ELECTRONIC TESTING PROBES FOR SEMICONDUCTOR INTEGRATED CIRCUIT CHIPS, ELECTRONIC TESTING PROBES FOR PRINTED CIRCUIT BOARDS; ELECTRONIC TESTING PROBES FOR TAB CHIPS, NAMELY, CHIPS MOUNTED ON FILM WIRED WITH COPPER FOIL, NAMELY, PROBES FOR TESTING INTEGRATED CIRCUITS; ELECTRONIC TESTING PROBES FOR COF CHIPS, NAMELY, CHIPS MOUNTED ON COPPER-PLATED FILM, NAMELY, PROBES FOR TESTING INTEGRATED CIRCUITS; ELECTRONIC TESTING PROBES FOR SEMICONDUCTOR DEVICES, NAMELY, TEST ADAPTORS FOR TESTING PRINTED CIRCUIT BOARDS, IN CLASS 9 (U.S. CLS. 21, 23, 26, 36 AND 38).

THE MARK CONSISTS OF STANDARD CHARACTERS WITHOUT CLAIM TO ANY PARTICULAR FONT, STYLE, SIZE, OR COLOR.

PRIORITY CLAIMED UNDER SEC. 44(D) ON JAPAN APPLICATION NO. 2010-052785, FILED 7-2-2010, REG. NO. 5409615, DATED 4-28-2011, EXPIRES 4-28-2021.

SER. NO. 85-209,176, FILED 1-3-2011.

CAROL SPILS, EXAMINING ATTORNEY



*David J. Kypos*

Director of the United States Patent and Trademark Office

# United States of America

United States Patent and Trademark Office

# ANA

**Reg. No. 4,196,673**

**Registered Aug. 28, 2012**

**Int. Cl.: 20**

**TRADEMARK**

**PRINCIPAL REGISTER**

WUXIANA INDUSTRIES CO.,LTD. (CHINA CORPORATION), DBA WUXIANA INDUSTRIES CO.,LTD.  
IND PARK B YANGJIAN TOWN XISHAN DISTRICT  
WUXI, JIANGSU PROVINCE, CHINA 214131

FOR: COFFINS; FUNERARY URNS; CASKETS, IN CLASS 20 (U.S. CLS. 2, 13, 22, 25, 32 AND 50).

FIRST USE 12-1-1984; IN COMMERCE 12-1-1985.

THE MARK CONSISTS OF STANDARD CHARACTERS WITHOUT CLAIM TO ANY PARTICULAR FONT, STYLE, SIZE, OR COLOR.

SER. NO. 85-209,815, FILED 1-4-2011.

AISHA SALEM, EXAMINING ATTORNEY



*David J. Kybas*

Director of the United States Patent and Trademark Office

# United States of America

United States Patent and Trademark Office



**Reg. No. 4,196,674**

**Registered Aug. 28, 2012**

**Int. Cl.: 30**

**TRADEMARK**

**PRINCIPAL REGISTER**

ALTO CAFEZAL COMÉRCIO IMPORTAÇÃO E EXPORTAÇÃO LTDA. (BRAZIL CORPORATION)  
RUA FIO GERMANO 264  
BAIRRO CONSTANTINO - P, BRAZIL 38.740-00 AND

JOSÉ CARLOS GROSSI (BRAZIL INDIVIDUAL)  
RUA FIO GERMANO 264  
BAIRRO CONSTANTINO - P, BRAZIL 38.740-00

FOR: COFFEE , IN CLASS 30 (U.S. CL. 46).

FIRST USE 0-0-1972; IN COMMERCE 2-27-2004.

NO CLAIM IS MADE TO THE EXCLUSIVE RIGHT TO USE REPRESENTATION OF THE COFFEE BEAN", "ALTO CAFEZAL", "CERRADO" AND "BRASIL", APART FROM THE MARK AS SHOWN.

THE NAME(S), PORTRAIT(S), AND/OR SIGNATURE(S) SHOWN IN THE MARK IDENTIFIES MR. "GROSSI", WHOSE CONSENT(S) TO REGISTER IS MADE OF RECORD.

THE MARK CONSISTS OF A STYLIZED DEPICTION OF COFFEE BEANS AND LEAVES SUPERIMPOSED OVER A STYLIZED DEPICTION OF ROWS OF COFFEE PLANTS, AND THE WORDS "ALTO CAFEZAL CERRADO BRAZIL GROSSI" ALL ENCLOSED IN A SQUARE SERVING AS A BORDER FOR THE MAALTO CAFEZ.

THE ENGLISH TRANSLATION OF "ALTO CAFEZAL" IN THE MARK IS "HIGH MOUNTAIN COFFEE PLANTATION". THE WORDING "GROSSI" HAS NO MEANING IN A FOREIGN LANGUAGE.

SER. NO. 85-210,007, FILED 1-4-2011.

DARRYL SPRUILL, EXAMINING ATTORNEY



*David J. Kybas*

Director of the United States Patent and Trademark Office

# United States of America

United States Patent and Trademark Office

## Brown Betties

**Reg. No. 4,196,675**

CHAMBERS, PEPPUR (UNITED STATES INDIVIDUAL)

**Registered Aug. 28, 2012**

5328 BEN AVENUE  
VALLEY VILLAGE, CA 91607

**Int. Cl.: 41**

**SERVICE MARK**

**PRINCIPAL REGISTER**

FOR: ENTERTAINMENT SERVICES, NAMELY, LIVE STAGE AND CABARET PERFORMANCES BY DANCING AND SINGING GROUPS OF PERFORMERS; ENTERTAINMENT SERVICES, NAMELY, PROVIDING WEBSITES FEATURING BIOGRAPHICAL INFORMATION, PHOTOGRAPHS, TOUR AND PERFORMANCE INFORMATION ON DANCING AND SINGING GROUPS OF PERFORMERS; ENTERTAINMENT SERVICES IN THE NATURE OF LIVE DANCE AND MUSICAL PERFORMANCES; EDUCATION SERVICES, NAMELY, PROVIDING A DANCE STUDIO AND DANCE INSTRUCTION WORKSHOPS AND SEMINARS ON CABARET DANCING; CONDUCTING ENTERTAINMENT EXHIBITIONS IN THE FIELD OF MUSIC AND THE ARTS; ORGANIZING EXHIBITIONS FOR ENTERTAINMENT PURPOSES FEATURING MUSIC AND THE ARTS; ENTERTAINMENT SERVICES, NAMELY, PERSONAL APPEARANCES BY MUSICAL GROUPS, MUSICAL ARTISTS, AND CELEBRITIES; ENTERTAINMENT SERVICES NAMELY, PRODUCTION OF WEBISODES AND TELEVISION AND RADIO PROGRAMS; TELEVISION PROGRAM SYNDICATION; ENTERTAINMENT SERVICES, NAMELY, PRODUCTION AND DISTRIBUTION OF MOTION PICTURE FILMS; ENTERTAINMENT SERVICES, NAMELY, ONLINE PUBLICATION OF MAGAZINES, IN CLASS 41 (U.S. CLS. 100, 101 AND 107).

FIRST USE 5-1-2005; IN COMMERCE 8-25-2005.

THE MARK CONSISTS OF STANDARD CHARACTERS WITHOUT CLAIM TO ANY PARTICULAR FONT, STYLE, SIZE, OR COLOR.

SER. NO. 85-210,454, FILED 1-4-2011.

DAVID ELTON, EXAMINING ATTORNEY



*David J. Kyros*

Director of the United States Patent and Trademark Office

# United States of America

United States Patent and Trademark Office



**Reg. No. 4,196,676**

JOHN GAFFNEY (UNITED STATES INDIVIDUAL), AKA BAD KITTY, LLC  
2918 W. VIRGINIA AVE  
PHOENIX, AZ 85009

**Registered Aug. 28, 2012**

**Int. Cl.: 25**

FOR: FITNESS APPAREL, NAMELY, SHIRTS, SHORTS, SKIRTS, LEGGINGS, CAMISOLES, HEADWEAR, TANK TOPS, UNDERGARMENTS, DRESSES, BIKINIS, IN CLASS 25 (U.S. CLS. 22 AND 39).

**TRADEMARK**

FIRST USE 8-1-2010; IN COMMERCE 8-1-2010.

**PRINCIPAL REGISTER**

THE MARK CONSISTS OF THE BLOCKED TERM "POLEFIT", THE TERM "POLE" DESIGNATED IN WHITE WITH VIOLET SURROUNDS AND THE TERM "FIT" IN VIOLET LETTERING WITH WHITE SURROUNDS, CENTERED ACROSS THE MARK ALL ON A RECTANGULAR BLACK BACKGROUND.

THE COLOR(S) BLACK, WHITE AND VIOLET IS/ARE CLAIMED AS A FEATURE OF THE MARK.

SER. NO. 85-210,508, FILED 1-4-2011.

JASON TURNER, EXAMINING ATTORNEY



*David J. Kyffers*

Director of the United States Patent and Trademark Office

# United States of America

United States Patent and Trademark Office



**Reg. No. 4,196,677**

NOACH, EYAL (UNITED STATES INDIVIDUAL)  
2445 EAST 65 ST  
BROOKLYN, NY 11234

**Registered Aug. 28, 2012**

**Int. Cl.: 30**

FOR: STAPLE FOOD PRODUCTS, NAMELY, COFFEE, TEA, COCOA, SUGAR, RICE, TAPIOCA, SAGO, ARTIFICIAL COFFEE, FLOUR MADE FROM CEREALS, BREAD, PASTRY, CONFECTIONERY MADE OF SUGAR, HONEY, TREACLE, YEAST, BAKING POWDER, SALT, MUSTARD, VINEGAR, SAUCES (CONDIMENTS) AND SPICES FOR CONSUMERS, ALL OF THE AFORESAID SOLD ONLY IN RETAIL GROCERY STORES, IN CLASS 30 (U.S. CL. 46).

**TRADEMARK**

**PRINCIPAL REGISTER**

FIRST USE 11-1-2003; IN COMMERCE 11-1-2003.

NO CLAIM IS MADE TO THE EXCLUSIVE RIGHT TO USE "FOODS", APART FROM THE MARK AS SHOWN.

THE COLOR(S) WHITE, BLACK, RED, YELLOW AND BLUE IS/ARE CLAIMED AS A FEATURE OF THE MARK.

THE MARK CONSISTS OF THE WORD "KING" IN WHITE WITH BLACK SHADOWING, THE WORDING "STAR FOODS" IN YELLOW COLOR WITH BLACK SHADOWING, A YELLOW STAR WITH BLACK SHADOWING, ALL WITHIN AN OVAL RED BACKGROUND, WITH A WHITE BORDER INTERIOR TO A BLUE BORDER.



SER. NO. 85-210,556, FILED 1-5-2011.

HANNO RITTNER, EXAMINING ATTORNEY

*David J. Kybas*

Director of the United States Patent and Trademark Office

# United States of America

United States Patent and Trademark Office

## THE ONE YOU RELY ON

**Reg. No. 4,196,678**

**Registered Aug. 28, 2012**

**Int. Cl.: 40**

**SERVICE MARK**

**PRINCIPAL REGISTER**

MARTIN SPROCKET & GEAR, INC. (TEXAS CORPORATION)  
P.O. BOX 91588  
ARLINGTON, TX 76015

FOR: CUSTOM MANUFACTURING OF MECHANICAL POWER TRANSMISSION MACHINES AND MACHINE PARTS, NAMELY, SPROCKETS, COUPLINGS, GEARS, SHEAVES, SYNCHRONOUS DRIVES AND BUSHINGS; CUSTOM MANUFACTURING OF BULK MATERIAL HANDLING PRODUCTS, NAMELY, SCREW CONVEYORS, SHAFTLESS CONVEYORS, DRAG CONVEYORS, CONVEYOR PULLEYS AND BUCKET ELEVATORS; CUSTOM MANUFACTURING OF INDUSTRIAL HAND TOOLS, NAMELY, WRENCHES, SCREWDRIVERS, PLIERS, HAMMERS, BODY AND FENDER TOOLS, IN CLASS 40 (U.S. CLS. 100, 103 AND 106).

FIRST USE 8-0-2010; IN COMMERCE 8-0-2010.

THE MARK CONSISTS OF STANDARD CHARACTERS WITHOUT CLAIM TO ANY PARTICULAR FONT, STYLE, SIZE, OR COLOR.

SER. NO. 85-211,612, FILED 1-6-2011.

MARY ROSSMAN, EXAMINING ATTORNEY



*David J. Kybas*

Director of the United States Patent and Trademark Office



# United States of America

United States Patent and Trademark Office

## RecruitingScience

**Reg. No. 4,196,679**

NYC RECRUITER, LLC (NEW YORK LIMITED LIABILITY COMPANY)  
550 CHURCH AVENUE  
WOODMERE, NY 11598

**Registered Aug. 28, 2012**

**Int. Cl.: 35**

FOR: PROFESSIONAL STAFFING AND RECRUITING SERVICES, IN CLASS 35 (U.S. CLS. 100, 101 AND 102).

**SERVICE MARK**

FIRST USE 10-4-2009; IN COMMERCE 9-1-2010.

**PRINCIPAL REGISTER**

THE MARK CONSISTS OF STANDARD CHARACTERS WITHOUT CLAIM TO ANY PARTICULAR FONT, STYLE, SIZE, OR COLOR.

SER. NO. 85-212,398, FILED 1-6-2011.

STEVEN R. FINE, EXAMINING ATTORNEY



*David J. Kybas*

Director of the United States Patent and Trademark Office

# United States of America

United States Patent and Trademark Office



**Reg. No. 4,196,680**

WASHINGTON SHOE COMPANY (WASHINGTON CORPORATION)  
21001 72ND AVE. SOUTH  
KENT, WA 98032

**Registered Aug. 28, 2012**

**Int. Cl.: 25**

FOR: BOOTS; FOOTWEAR; SHOES, IN CLASS 25 (U.S. CLS. 22 AND 39).

**TRADEMARK**

FIRST USE 8-31-2008; IN COMMERCE 8-31-2008.

**PRINCIPAL REGISTER**

THE NAME "EDDIE MORAN" AND/OR SIGNATURE SHOWN IN THE MARK DOES NOT IDENTIFY A PARTICULAR LIVING INDIVIDUAL.

THE MARK CONSISTS OF THE WORDS "EDDIE MORAN". AFTER THE WORD "EDDIE" AND BEFORE THE WORD "MORAN", THERE IS A PAIR OF DICE THAT ARE SURROUNDED BY FLAMES OF FIRE. THE WORDING AND DESIGN APPEAR INSIDE A SERIES OF THREE CONCENTRIC RECTANGLES.

SER. NO. 85-213,332, FILED 1-7-2011.

JAMES LOVELACE, EXAMINING ATTORNEY



*David J. Kyffers*

Director of the United States Patent and Trademark Office

# United States of America

United States Patent and Trademark Office

# Playrific

**Reg. No. 4,196,681**

**Registered Aug. 28, 2012**

**Int. Cls.: 9, 38, 41 and 42**

**TRADEMARK**

**SERVICE MARK**

**PRINCIPAL REGISTER**

PLAYRIFIC, INC. (DELAWARE CORPORATION), FORMERLY PLAYSMT, INC.  
7 ESQUIRE ROAD  
BILLERICA, MA 01862

FOR: COMPUTER SOFTWARE FOR MOBILE PHONES, PORTABLE MEDIA PLAYERS, HANDHELD COMPUTERS, DESKTOP COMPUTERS, AND SPECIAL-PURPOSE PORTABLE COMPUTING DEVICES, NAMELY, CHILDREN'S EDUCATIONAL SOFTWARE; DOWNLOADABLE COMPUTER SOFTWARE IN THE NATURE OF A MOBILE APPLICATION FOR PROVIDING EARLY CHILDHOOD INSTRUCTION; DIGITAL COMPUTER SOFTWARE, TO ORGANIZE AND ACCESS INTERNET WEB LINKS TO ELECTRONIC MEDIA, INCLUDING TEXT, ARTWORK, AUDIO, VIDEO AND INTERACTIVE APPLICATIONS RELATING TO EDUCATION AND ENTERTAINMENT FOR YOUNG CHILDREN; COMPUTER GAME APPLICATIONS DOWNLOADABLE FROM A GLOBAL COMPUTER NETWORK FOR YOUNG CHILDREN TOGETHER WHICH ALSO ORGANIZES INTERNET WEB LINKS TO THOSE GAMES, IN CLASS 9 (U.S. CLS. 21, 23, 26, 36 AND 38).

FIRST USE 11-1-2010; IN COMMERCE 12-14-2010.

FOR: STREAMING OF AUDIO, VIDEO, AUDIOVISUAL, MATERIAL ON THE INTERNET FOR YOUNG CHILDREN, IN CLASS 38 (U.S. CLS. 100, 101 AND 104).

FIRST USE 11-1-2010; IN COMMERCE 12-14-2010.

FOR: INTERACTIVE EDUCATIONAL AND ENTERTAINMENT SERVICES FOR YOUNG CHILDREN, NAMELY, PROVIDING A WEB-BASED VIRTUAL EDUCATIONAL PLAYGROUND FEATURING EARLY CHILDHOOD INSTRUCTION, AGE APPROPRIATE NON-DOWNLOADABLE FILMS AND MOVIES VIA A VIDEO-ON-DEMAND SERVICE, PROVIDING ON-LINE COMPUTER GAMES, PROVIDING ON-LINE INTERACTIVE CHILDREN'S STORIES, IN CLASS 41 (U.S. CLS. 100, 101 AND 107).

FIRST USE 11-1-2010; IN COMMERCE 12-14-2010.

FOR: PROVIDING TEMPORARY USE OF A WEB-BASED SOFTWARE APPLICATION FOR PROVIDING EARLY CHILDHOOD INSTRUCTION; PROVIDING A WEBSITE FEATURING ON-LINE NON-DOWNLOADABLE SOFTWARE THAT ENABLES USERS TO ORGANIZE AND ACCESS INTERNET WEB LINKS TO ELECTRONIC MEDIA, INCLUDING TEXT,



*David J. Kybas*

Director of the United States Patent and Trademark Office

**Reg. No. 4,196,681** ARTWORK, AUDIO, VIDEO AND INTERACTIVE APPLICATIONS FOR YOUNG CHILDREN,  
IN CLASS 42 (U.S. CLS. 100 AND 101).

FIRST USE 11-1-2010; IN COMMERCE 12-14-2010.

THE MARK CONSISTS OF STANDARD CHARACTERS WITHOUT CLAIM TO ANY PARTICULAR FONT, STYLE, SIZE, OR COLOR.

SER. NO. 85-213,727, FILED 1-10-2011.

BARBARA RUTLAND, EXAMINING ATTORNEY

# United States of America

United States Patent and Trademark Office

## fit food trainer

**Reg. No. 4,196,682**

ONE ON ONE PERSONAL TRAINING, LLC (WISCONSIN LIMITED LIABILITY COMPANY)  
19280 HAYDEN COURT  
BROOKFIELD, WI 53045

**Registered Aug. 28, 2012**

**Int. Cl.: 41**

FOR: PERSONAL FITNESS TRAINING SERVICES AND CONSULTANCY, IN CLASS 41  
(U.S. CLS. 100, 101 AND 107).

**SERVICE MARK**

FIRST USE 2-15-2010; IN COMMERCE 2-15-2010.

**PRINCIPAL REGISTER**

THE MARK CONSISTS OF STANDARD CHARACTERS WITHOUT CLAIM TO ANY PARTICULAR FONT, STYLE, SIZE, OR COLOR.

NO CLAIM IS MADE TO THE EXCLUSIVE RIGHT TO USE "FIT" AND "TRAINER" FOR CLASS 41, APART FROM THE MARK AS SHOWN.

SER. NO. 85-215,065, FILED 1-11-2011.

MARY ROSSMAN, EXAMINING ATTORNEY



*David J. Kyffers*

Director of the United States Patent and Trademark Office

# United States of America

United States Patent and Trademark Office

## ONE CALL SOLUTION

**Reg. No. 4,196,683**

PANTHER II TRANSPORTATION, INC. (OHIO CORPORATION)  
4940 PANTHER PARKWAY  
SEVILLE, OH 442738929

**Registered Aug. 28, 2012**

**Int. Cl.: 39**

FOR: PICK-UP, TRANSPORTATION, STORAGE AND DELIVERY OF DOCUMENTS, PACKAGES AND FREIGHT BY OCEAN AND AIR, IN CLASS 39 (U.S. CLS. 100 AND 105).

**SERVICE MARK**

FIRST USE 11-30-2007; IN COMMERCE 11-30-2007.

**PRINCIPAL REGISTER**

THE MARK CONSISTS OF STANDARD CHARACTERS WITHOUT CLAIM TO ANY PARTICULAR FONT, STYLE, SIZE, OR COLOR.

SER. NO. 85-217,782, FILED 1-14-2011.

MICHELLE DUBOIS, EXAMINING ATTORNEY



*David J. Kyffers*

Director of the United States Patent and Trademark Office

# United States of America

United States Patent and Trademark Office

## ONE CALL

**Reg. No. 4,196,684**

PANTHER II TRANSPORTATION, INC. (OHIO CORPORATION)  
4940 PANTHER PARKWAY  
SEVILLE, OH 442738929

**Registered Aug. 28, 2012**

**Int. Cl.: 39**

FOR: PICK-UP, TRANSPORTATION, STORAGE AND DELIVERY OF DOCUMENTS, PACKAGES AND FREIGHT BY OCEAN AND AIR, IN CLASS 39 (U.S. CLS. 100 AND 105).

**SERVICE MARK**

FIRST USE 11-30-2007; IN COMMERCE 11-30-2007.

**PRINCIPAL REGISTER**

THE MARK CONSISTS OF STANDARD CHARACTERS WITHOUT CLAIM TO ANY PARTICULAR FONT, STYLE, SIZE, OR COLOR.

SER. NO. 85-217,881, FILED 1-14-2011.

MICHELLE DUBOIS, EXAMINING ATTORNEY



*David J. Kyffers*

Director of the United States Patent and Trademark Office

# United States of America

United States Patent and Trademark Office

# ATR

**Reg. No. 4,196,685**

**Registered Aug. 28, 2012**

**Int. Cls.: 9, 10, 15, 28  
and 41**

**TRADEMARK**

**SERVICE MARK**

**PRINCIPAL REGISTER**

ADVANCED TELECOMMUNICATIONS RESEARCH INSTITUTE INTERNATIONAL (JAPAN CORPORATION)  
2-2-2, HIKARIDAI, SEIKA-CHO  
SORAKU-GUN, KYOTO, JAPAN 619-0288

FOR: AERIALS FOR RADIO COMMUNICATION APPARATUS; AERIALS FOR BROADCAST RECEIVING APPARATUS; AERIALS FOR TELEVISION APPARATUS; AERIALS FOR SPACE COMMUNICATION APPARATUS; AERIALS FOR SATELLITE COMMUNICATION APPARATUS; AERIALS FOR AMATEUR RADIO COMMUNICATION APPARATUS; AERIALS FOR PORTABLE COMMUNICATION APPARATUS; AERIALS FOR LAND VEHICLES; AERIALS FOR WATER VEHICLES; AERIALS FOR AIR VEHICLES; ANTENNAS FOR RADIO COMMUNICATION APPARATUS; ANTENNAS FOR BROADCAST RECEIVING APPARATUS; ANTENNAS FOR TELEVISION APPARATUS; ANTENNAS FOR SPACE COMMUNICATION APPARATUS; ANTENNAS FOR SATELLITE COMMUNICATION APPARATUS; ANTENNAS FOR AMATEUR RADIO COMMUNICATION APPARATUS; ANTENNAS FOR PORTABLE COMMUNICATION APPARATUS; ANTENNAS FOR LAND VEHICLES; ANTENNAS FOR WATER VEHICLES; ANTENNAS FOR AIR VEHICLES; ELECTRONIC POCKET TRANSLATORS FOR USE IN INFANT CHILD EDUCATION, STUDENT EDUCATION, LANGUAGE TEACHING AND TRAVELING; HIGH-FREQUENCY TRANSMITTERS FOR RADIO COMMUNICATION APPARATUS; HIGH-FREQUENCY TRANSMITTERS FOR BROADCAST RECEIVING APPARATUS; HIGH-FREQUENCY TRANSMITTERS FOR TELEVISION APPARATUS; HIGH-FREQUENCY TRANSMITTERS FOR SPACE COMMUNICATION APPARATUS; HIGH-FREQUENCY TRANSMITTERS FOR SATELLITE COMMUNICATION APPARATUS; HIGH-FREQUENCY TRANSMITTERS FOR AMATEUR RADIO COMMUNICATION APPARATUS; HIGH-FREQUENCY TRANSMITTERS FOR PORTABLE COMMUNICATION APPARATUS; HIGH-FREQUENCY TRANSMITTERS FOR LAND VEHICLES; HIGH-FREQUENCY TRANSMITTERS FOR WATER VEHICLES; HIGH-FREQUENCY TRANSMITTERS FOR AIR VEHICLES; HIGH-FREQUENCY RECEIVERS FOR RADIO COMMUNICATION APPARATUS; HIGH-FREQUENCY RECEIVERS FOR BROADCAST RECEIVING APPARATUS; HIGH-FREQUENCY RECEIVERS FOR TELEVISION APPARATUS; HIGH-FREQUENCY RECEIVERS FOR SPACE COMMUNICATION APPARATUS; HIGH-FREQUENCY RECEIVERS FOR SATELLITE COMMUNICATION APPARATUS; HIGH-FREQUENCY RECEIVERS FOR AMATEUR RADIO COMMUNICATION APPARATUS; HIGH-FREQUENCY RECEIVERS FOR PORTABLE COMMUNICATION APPARATUS; HIGH-FREQUENCY RECEIVERS FOR LAND VEHICLES; HIGH-FREQUENCY RECEIVERS FOR WATER VEHICLES; HIGH-FREQUENCY RECEIVERS FOR AIR VEHICLES; RADIO WAVE DIRECTION-OF-ARRIVAL



*David J. Kybas*

Director of the United States Patent and Trademark Office



**Reg. No. 4,196,685** FINDERS FOR RADAR MACHINES AND DIRECTION FINDING MACHINES, IN CLASS 9 (U.S. CLS. 21, 23, 26, 36 AND 38).

FOR: ROBOTS FOR NURSING, INCLUDING ROBOTS THAT ASSIST DISABLED AND INFIRM PERSONS WITH DAILY TASKS SUCH AS EATING, DRINKING, AND LIFTING, IN CLASS 10 (U.S. CLS. 26, 39 AND 44).

FOR: ELECTRONIC MUSICAL INSTRUMENTS, IN CLASS 15 (U.S. CLS. 2, 21 AND 36).

FOR: KALEIDOSCOPIES, IN CLASS 28 (U.S. CLS. 22, 23, 38 AND 50).

FOR: EDUCATIONAL SERVICES, NAMELY, PROVIDING INFORMATION RELATED TO PRESCHOOL EDUCATION AND LANGUAGE TEACHING EDUCATION, AND ARRANGING AND CONDUCTING WORKSHOPS FOR EDUCATORS IN THE FIELD OF PRESCHOOL EDUCATION AND LANGUAGE TEACHING EDUCATION; EDUCATIONAL EXAMINATION SERVICES; NURSERY SCHOOLS, IN CLASS 41 (U.S. CLS. 100, 101 AND 107).

OWNER OF JAPAN REG. NO. 5010884, DATED 12-15-2006, EXPIRES 12-15-2016.

THE MARK CONSISTS OF STYLIZED LETTERS "ATR".

SER. NO. 85-218,139, FILED 1-14-2011.

RAUL CORDOVA, EXAMINING ATTORNEY

# United States of America

United States Patent and Trademark Office

## GUTTERGLOVE

**Reg. No. 4,196,686**

GUTTERGLOVE, INC. (CALIFORNIA CORPORATION)  
4021 ALVIS COURT, SUITE 5  
ROCKLIN, CA 95677

**Registered Aug. 28, 2012**

**Int. Cl.: 6**

FOR: RAIN GUTTER DEBRIS SHIELDS MADE PRIMARILY OF ALUMINUM, IN CLASS 6  
(U.S. CLS. 2, 12, 13, 14, 23, 25 AND 50).

**TRADEMARK**

FIRST USE 3-1-2004; IN COMMERCE 3-1-2004.

**PRINCIPAL REGISTER**

THE MARK CONSISTS OF STANDARD CHARACTERS WITHOUT CLAIM TO ANY PARTICULAR FONT, STYLE, SIZE, OR COLOR.

OWNER OF U.S. REG. NO. 3,071,876.

SER. NO. 85-218,526, FILED 1-14-2011.

EDWARD NELSON, EXAMINING ATTORNEY



*David J. Kyffers*

Director of the United States Patent and Trademark Office

# United States of America

United States Patent and Trademark Office



**Reg. No. 4,196,687**

**Registered Aug. 28, 2012**

**Int. Cl.: 32**

**TRADEMARK**

**PRINCIPAL REGISTER**

JIMMY GREENS, LLC (ILLINOIS LIMITED LIABILITY COMPANY)  
SUITE G-02  
111 W. CHICAGO AVENUE  
HINSDALE, IL 60521

FOR: BEER, IN CLASS 32 (U.S. CLS. 45, 46 AND 48).

FIRST USE 11-0-2010; IN COMMERCE 11-0-2010.

OWNER OF U.S. REG. NO. 3,894,607.

NO CLAIM IS MADE TO THE EXCLUSIVE RIGHT TO USE "SOUTH LOOP LAGER", APART FROM THE MARK AS SHOWN.

THE NAME(S), PORTRAIT(S), AND/OR SIGNATURE(S) SHOWN IN THE MARK DOES NOT IDENTIFY A PARTICULAR LIVING INDIVIDUAL.

THE MARK CONSISTS OF A CIRCLE WITH A DRAWING OF A CITY SKYLINE WITH A BANNER SUPERIMPOSED OVER THE CIRCLE CONTAINING THE WORDS "SOUTH LOOP", WITH THE CIRCLE CONTAINING DOTTED LINES EXTENDING FROM THE CITY SKYLINE ON TOP AND WAVY LINES ON THE BOTTOM, WHILE THE WORDS "JIMMY GREEN'S" ARE ABOVE THE CIRCLE, AND THE WORD "LAGER" WITHIN AN OBLONG CARRIER IS BELOW THE CIRCLE.

SER. NO. 85-218,985, FILED 1-17-2011.

DOUGLAS LEE, EXAMINING ATTORNEY



*David J. Kybas*

Director of the United States Patent and Trademark Office

# United States of America

United States Patent and Trademark Office

## AUTOMOTIVE LIFT INSTITUTE

**Reg. No. 4,196,688**

AUTOMOTIVE LIFT INSTITUTE, INC. (NEW JERSEY CORPORATION)  
80 WHEELER AVENUE  
CORTLAND, NY 13045

**Registered Aug. 28, 2012**

**Int. Cl.: 35**

FOR: PROMOTING THE SAFE DESIGN, CONSTRUCTION, INSTALLATION, SERVICE,  
AND USE OF AUTOMOTIVE LIFTS, IN CLASS 35 (U.S. CLS. 100, 101 AND 102).

**SERVICE MARK**

FIRST USE 0-0-1945; IN COMMERCE 0-0-1945.

**PRINCIPAL REGISTER**

THE MARK CONSISTS OF STANDARD CHARACTERS WITHOUT CLAIM TO ANY PAR-  
TICULAR FONT, STYLE, SIZE, OR COLOR.

OWNER OF U.S. REG. NO. 1,543,101.

SEC. 2(F).

SER. NO. 85-219,115, FILED 1-17-2011.

SANI KHOURI, EXAMINING ATTORNEY



*David J. Kybas*

Director of the United States Patent and Trademark Office

# United States of America

United States Patent and Trademark Office

# WGSN

**Reg. No. 4,196,689**

**Registered Aug. 28, 2012**

**Int. Cls.: 16, 25, 35, 38,  
41, 42 and 45**

**TRADEMARK**

**SERVICE MARK**

**PRINCIPAL REGISTER**

WORTH GLOBAL STYLE NETWORK LIMITED (UNITED KINGDOM CORPORATION)  
GREATER LONDON HOUSE  
HAMPSTEAD ROAD  
LONDON, UNITED KINGDOM NW17EJ

FOR: PRINTED MATTER, NAMELY, POSTERS, PRINTED TICKETS, PRINTED ADVERTISING MATERIAL, NAMELY, HANDBILLS AND FLYERS FEATURING BUSINESS, FINANCE, ENTERTAINMENT, NEWS, STYLE AND FASHION, NAMELY, APPAREL; PUBLICATIONS, NAMELY, MAGAZINES, PERIODICAL PUBLICATIONS, NEWSPAPERS, BOOKS, NEWSLETTERS AND GUIDES, IN THE FIELD OF BUSINESS, FINANCE, ENTERTAINMENT, NEWS, STYLE AND FASHION, NAMELY, APPAREL; PRINTED PERIODICAL PUBLICATIONS, NAMELY, MAGAZINES, JOURNALS, BOOKS AND NEWSLETTERS IN THE FIELD OF BUSINESS, FINANCE, ENTERTAINMENT, NEWS, STYLE AND FASHION, NAMELY, APPAREL, PRINTED NEWSPAPERS FOR GENERAL CIRCULATION; PRINTED NEWSLETTERS IN THE FIELD OF BUSINESS, FINANCE, ENTERTAINMENT, NEWS, STYLE AND FASHION, NAMELY, APPAREL; BOOKS IN THE FIELD OF BUSINESS, FINANCE, ENTERTAINMENT, NEWS, STYLE AND FASHION, NAMELY, APPAREL; GUIDES IN THE FIELD OF BUSINESS, FINANCE, ENTERTAINMENT, NEWS, STYLE AND FASHION, NAMELY, APPAREL; STATIONERY, CALENDARS, DIARIES, PRINTED INSTRUCTIONAL AND TEACHING MATERIALS OTHER THAN APPARATUS IN THE FIELD OF BUSINESS, FINANCE, ENTERTAINMENT, NEWS, STYLE AND FASHION, NAMELY, APPAREL; LETTER-HEAD PAPER, PAPER COMPLIMENT SLIPS, NOTEPADS, PAMPHLETS, PRINTED CHARTS, WORKSHEETS, PRINTED DATA MATERIALS IN THE FIELD OF BUSINESS, FINANCE, ENTERTAINMENT, NEWS, STYLE AND FASHION, NAMELY, APPAREL; WRITING AND DRAWING INSTRUMENTS; WRAPPING AND PACKAGING PAPER, IN CLASS 16 (U.S. CLS. 2, 5, 22, 23, 29, 37, 38 AND 50).

FOR: ARTICLES OF OUTER CLOTHING, NAMELY, SWEATSHIRTS, JEANS, PRINTED T-SHIRTS, JACKETS, SHIRTS, SHORTS, TROUSERS, FLEECE PULLOVERS, SOCKS, SKIRTS, SCARVES, GLOVES, CARDIGANS, SWEATERS, DRESSES, SWIMWEAR, IN CLASS 25 (U.S. CLS. 22 AND 39).

FOR: PROMOTING THE GOODS AND SERVICES OF OTHERS BY PLACING ADVERTISEMENTS AND PROMOTIONAL DISPLAYS IN ELECTRONIC SITES ACCESSED THROUGH TELECOMMUNICATIONS OR COMPUTER NETWORKS; ON-LINE COMPUTER SERVICES, NAMELY, PROVIDING INFORMATION REGARDING GOODS AND SERVICES OF OTHERS IN THE NATURE OF AN INFORMATION AND BUYER'S GUIDE RELATING TO THE



*David J. Kybas*

Director of the United States Patent and Trademark Office

**Reg. No. 4,196,689** SUBJECT MATTER OF STYLE AND FASHION BY MEANS OF ELECTRONIC COMPUTER COMMUNICATIONS SYSTEMS; PROVIDING BUSINESS DATA ANALYSIS, BUSINESS FORECASTING ANALYSIS, BUSINESS ANALYSIS OF MARKETS, ASSISTANCE, ADVISORY SERVICES AND CONSULTANCY WITH REGARD TO BUSINESS ANALYSIS; ADVERTISING AND MARKETING SERVICES; ADMINISTRATION, PROCESSING AND ORGANIZING ELECTRONIC INFORMATION SERVICES, NAMELY, COMPILING AND MAINTAINING AN ON-LINE DATABASE OF INFORMATION AND DATA IN THE FIELD OF BUSINESS; ADMINISTRATION, PROCESSING AND ORGANIZING ELECTRONIC INFORMATION SERVICES IN THE FIELD OF BUSINESS, FOR RETRIEVAL AND ACCESS BY SUBSCRIBERS; COLLECTION AND COMPILATION OF INFORMATION INTO COMPUTER DATABASES IN THE FIELD OF STYLE AND FASHION, NAMELY, APPAREL; COMPILATION AND PROVISION OF TRADE AND BUSINESS PRICE AND STATISTICAL INFORMATION; COMPILATION AND SYSTEMIZATION OF INFORMATION IN DATA BANKS; COMPILATION AND SYSTEMIZATION OF INFORMATION INTO COMPUTER DATABASES; COMPILATION OF ADVERTISEMENTS FOR USE AS WEB PAGES ON THE INTERNET; COMPILATION OF BUSINESS DIRECTORIES; COMPILATION OF STATISTICS FOR BUSINESS OR COMMERCIAL PURPOSES; COMPILATION, PRODUCTION AND DISSEMINATION OF ADVERTISING MATTER; MANAGEMENT AND COMPILATION OF COMPUTERIZED DATABASES; SERVICES COMPRISING THE RECORDING, TRANSCRIPTION, COMPOSITION, COMPILATION AND SYSTEMIZATION OF WRITTEN COMMUNICATIONS AND RECORDINGS, AS WELL AS THE COMPILATION OF MATHEMATICAL OR STATISTICAL DATA; SERVICES CONSISTING OF THE REGISTRATION, COLLECTION, TRANSCRIPTION, COMPILATION AND SYSTEMIZATION OF WRITTEN COMMUNICATION AND DATA; COLLECTION AND SYSTEMIZATION OF INFORMATION INTO COMPUTER DATABASES; COMPILING OF INFORMATION INTO COMPUTER DATABASES; COMPUTERIZED DATABASE MANAGEMENT; DATABASE MANAGEMENT; AUCTIONEERING SERVICES; INTERACTIVE INFORMATION PROVIDED ON-LINE FROM COMPUTER DATABASES OR THE INTERNET IN THE FIELD OF BUSINESS; INFORMATION SERVICES FOR ACCESSING INFORMATION AND DATA VIA COMMUNICATION AND COMPUTER NETWORKS IN THE FIELD OF BUSINESS; PUBLICATION OF MAGAZINES, NEWSPAPERS, GUIDES AND BOOKS IN THE FIELD OF BUSINESS; EDUCATIONAL AND ENTERTAINMENT INFORMATION PROVIDED BY MEANS OF THE INTERNET AND ON-LINE COMPUTER DATABASES IN THE FIELD OF BUSINESS; ADMINISTRATION, PROCESSING AND ORGANIZING ELECTRONIC INFORMATION SERVICES, NAMELY, COMPILING OF INFORMATION INTO COMPUTER DATABASES IN THE FIELD OF ENTERTAINMENT, IN CLASS 35 (U.S. CLS. 100, 101 AND 102).

FOR: PROVIDING ON-LINE FACILITIES FOR REAL-TIME INTERACTION WITH OTHER COMPUTER USERS FOR THE DISSEMINATION OF INFORMATION VIA THE INTERNET IN THE FIELDS OF FASHION AND STYLE; AND PROVISION OF ACCESS TO ELECTRONIC ON-LINE NETWORKS FOR INFORMATION RETRIEVAL; PROVIDING MULTIPLE USER ACCESS TO GLOBAL COMPUTER NETWORKS FOR THE TRANSFER AND DISSEMINATION OF A WIDE RANGE OF INFORMATION, IN CLASS 38 (U.S. CLS. 100, 101 AND 104).

FOR: PROVIDING INTERACTIVE NEWS INFORMATION ON-LINE FROM COMPUTER DATABASES OR THE INTERNET IN THE FIELD OF ENTERTAINMENT; INFORMATION SERVICES FOR ACCESSING INFORMATION AND DATA VIA COMMUNICATION AND COMPUTER NETWORKS IN THE FIELD OF ENTERTAINMENT; PUBLICATION AND PUBLISHING OF MAGAZINES, NEWSPAPERS, GUIDES AND BOOKS IN THE FIELDS OF ENTERTAINMENT, NEWS, STYLE AND FASHION, NAMELY, APPAREL; CUSTOM WRITING SERVICES IN THE FIELDS OF FASHION AND STYLE; EDUCATIONAL INFORMATION PROVIDED BY MEANS OF THE INTERNET AND ON-LINE COMPUTER DATABASES IN THE FIELD OF ENTERTAINMENT; PROVIDING EDUCATION INFORMATION RELATING TO FASHION AND STYLE VIA COMPUTER NETWORKS; PROVIDING EDUCATION INFORMATION RELATING TO FASHION AND STYLE VIA COMPUTER NETWORKS TO SUBSCRIBERS, IN CLASS 41 (U.S. CLS. 100, 101 AND 107).

**Reg. No. 4,196,689** FOR: HOSTING OF WEBSITES FOR OTHERS; WEBSITE DESIGN FOR OTHERS; COMPUTER GRAPHIC DESIGN SERVICES; COMPUTER TIMESHARING; RENTAL AND LEASING OF COMPUTERS, IN CLASS 42 (U.S. CLS. 100 AND 101).

FOR: INFORMATION SERVICES RELATING TO FASHION AND FASHION STYLES; SECURITY AND FRAUD PREVENTION AND INFORMATION CONSULTATION RELATING THERETO IN THE FIELDS OF FASHION AND STYLE; ADMINISTRATION, PROCESSING AND ORGANIZING ELECTRONIC INFORMATION SERVICES, NAMELY, AN ON-LINE DATABASE OF INFORMATION AND DATA IN THE FIELDS OF STYLE AND FASHION, NAMELY, APPAREL; ADMINISTRATION, PROCESSING AND ORGANIZING ELECTRONIC INFORMATION SERVICES IN THE FIELDS OF STYLE AND FASHION, NAMELY, APPAREL, FOR RETRIEVAL AND ACCESS BY SUBSCRIBERS; INTERACTIVE INFORMATION PROVIDED ON-LINE FROM COMPUTER DATABASES OR THE INTERNET IN THE FIELDS OF STYLE AND FASHION, NAMELY, APPAREL; INFORMATION SERVICES FOR ACCESSING INFORMATION AND DATA VIA COMMUNICATION AND COMPUTER NETWORKS IN THE FIELDS OF STYLE AND FASHION, NAMELY, APPAREL; INFORMATION SERVICES PROVIDED ON-LINE FROM COMPUTER DATABASES OR THE INTERNET RELATING TO FASHION AND STYLE; INFORMATION RELATING TO FASHION AND STYLE, PROVIDED ON-LINE IN THE FORM OF A COMPUTER DATABASE VIA THE INTERNET; FASHION INDUSTRY INFORMATION PROVIDED BY MEANS OF THE INTERNET AND ON-LINE COMPUTER DATABASES IN THE FIELDS OF STYLE AND FASHION, NAMELY, APPAREL; PROVIDING AN ON-LINE COMPUTER DATABASE IN THE FIELD OF STYLE AND FASHION INFORMATION, NAMELY, APPAREL; PROVISION OF INFORMATION AND ADVICE RELATING TO THE SUPPLY OF AND PROMOTION OF COMMODITIES AND SELECTION AND DISPLAY OF GOODS IN THE FIELDS OF FASHION AND STYLE; PROVISION OF INFORMATION AND ADVICE TO PROSPECTIVE CUSTOMERS OF COMMODITIES AND GOODS IN THE FIELDS OF FASHION AND STYLE, IN CLASS 45 (U.S. CLS. 100 AND 101).

THE MARK CONSISTS OF STANDARD CHARACTERS WITHOUT CLAIM TO ANY PARTICULAR FONT, STYLE, SIZE, OR COLOR.

OWNER OF UNITED KINGDOM REG. NO. 2210490, DATED 3-17-2000, EXPIRES 10-5-2019.

OWNER OF U.S. REG. NO. 2,453,569.

SER. NO. 85-219,215, FILED 1-17-2011.

MARK T. MULLEN, EXAMINING ATTORNEY

# United States of America

United States Patent and Trademark Office



## Tech Electronics

**Reg. No. 4,196,690**

**Registered Aug. 28, 2012**

**Int. Cls.: 37 and 38**

**SERVICE MARK**

**PRINCIPAL REGISTER**

TECH ELECTRONICS, INC. (MISSOURI CORPORATION)  
6437 MANCHESTER  
ST. LOUIS, MO 63139

FOR: COMMUNICATIONS AND TELECOMMUNICATION SERVICES, NAMELY, CABLE INSTALLATION, INSTALLATION OF MASTER ANTENNA AND TELEPHONES; INSTALLATION OF COMPUTER HARDWARE AND TELECOMMUNICATION HARDWARE TO ENABLE VOICE MAIL, PAGING AND WIRELESS BROADBAND COMMUNICATION SERVICES, IN CLASS 37 (U.S. CLS. 100, 103 AND 106).

FIRST USE 1-0-1996; IN COMMERCE 1-0-1996.

FOR: PROVIDING VOICE MAIL, PAGING AND WIRELESS BROADBAND COMMUNICATION SERVICES, IN CLASS 38 (U.S. CLS. 100, 101 AND 104).

FIRST USE 1-0-1996; IN COMMERCE 1-0-1996.

OWNER OF U.S. REG. NO. 3,585,199.

NO CLAIM IS MADE TO THE EXCLUSIVE RIGHT TO USE "TECH ELECTRONICS", APART FROM THE MARK AS SHOWN.

THE MARK CONSISTS OF THE LETTERS "TE", WHICH ARE CAPITALIZED AND APPEAR IN ITALICS. THE LETTERS "TE" COMPRISE AN OUTER AND INNER BOUNDARY LINE WITH A SPACE IN THE MIDDLE OF EACH LETTER. THE UPPER PORTION OF THE LETTERS "TE" ARE JOINED AND INCLUDE A ZIG-ZAG LINE IN THE SPACE. THE WORDS "TECH ELECTRONICS" APPEAR DIRECTLY UNDERNEATH THE LETTERS "TE".

SER. NO. 85-219,548, FILED 1-18-2011.

ELLEN PERKINS, EXAMINING ATTORNEY



*David J. Kybas*

Director of the United States Patent and Trademark Office



# United States of America

United States Patent and Trademark Office

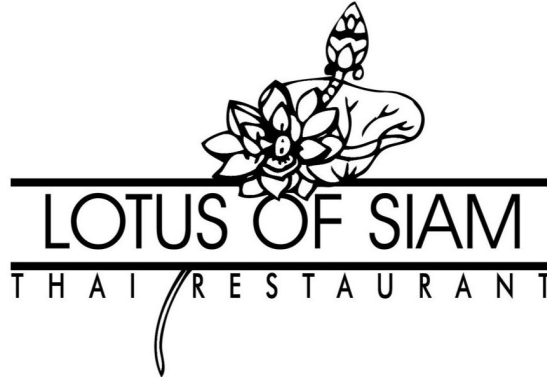

**Reg. No. 4,196,691**

**Registered Aug. 28, 2012**

**Int. Cl.: 43**

**SERVICE MARK**

**PRINCIPAL REGISTER**

TCHUTIMA, INC (NEVADA CORPORATION), DBA LOTUS OF SIAM  
953 E. SAHARA AVE., SUITE #A5  
LAS VEGAS, NV 89104

FOR: CARRY-OUT RESTAURANTS; DELICATESSENS; RESERVATION OF RESTAURANTS;  
RESTAURANT; RESTAURANT AND BAR SERVICES, INCLUDING RESTAURANT  
CARRYOUT SERVICES; RESTAURANT RESERVATION SERVICES; RESTAURANT SER-  
VICES; RESTAURANT SERVICES, INCLUDING SIT-DOWN SERVICE OF FOOD AND  
TAKE-OUT RESTAURANT SERVICES, IN CLASS 43 (U.S. CLS. 100 AND 101).

FIRST USE 12-25-2009; IN COMMERCE 12-25-2009.

NO CLAIM IS MADE TO THE EXCLUSIVE RIGHT TO USE "SIAM" AND "THAI RESTAUR-  
ANT", APART FROM THE MARK AS SHOWN.

THE MARK CONSISTS OF A LOTUS FLOWER LAYS ON THE VINE OF AN UN-BLOOMED  
LOTUS FLOWER WITH THE STEM (THE BUD) AND LOTUS PAD, PLACED ABOVE THE  
"LOTUS OF SIAM" TITLE, WITH THE "THAI RESTAURANT" UNDER THE REST OF THE  
IMAGE.

SER. NO. 85-225,323, FILED 1-25-2011.

BARNEY CHARLON, EXAMINING ATTORNEY



*David J. Kyffers*

Director of the United States Patent and Trademark Office

# United States of America

United States Patent and Trademark Office

# MESSAGE

**Reg. No. 4,196,692**

**Registered Aug. 28, 2012**

**Int. Cl.: 3**

**TRADEMARK**

**PRINCIPAL REGISTER**

PIERRE FABRE DERMO-COSMETIQUE (FRANCE SOCIÉTÉ PAR ACTIONS SIMPLIFIÉE (SAS))  
45, PLACE ABEL GANCE  
BOULOGNE, FRANCE 92100

FOR: COSMETICS, NAMELY, SKIN CREAMS AND SKIN GELS, IN CLASS 3 (U.S. CLS. 1, 4, 6, 50, 51 AND 52).

THE MARK CONSISTS OF STANDARD CHARACTERS WITHOUT CLAIM TO ANY PARTICULAR FONT, STYLE, SIZE, OR COLOR.

OWNER OF FRANCE REG. NO. 1,100,596, DATED 6-21-1979, EXPIRES 5-23-2019.

SER. NO. 85-227,611, FILED 1-27-2011.

LINDA ESTRADA, EXAMINING ATTORNEY



*David J. Kybas*

Director of the United States Patent and Trademark Office

# United States of America

United States Patent and Trademark Office



Change Leadership Network

**Reg. No. 4,196,693**

**Registered Aug. 28, 2012**

**Int. Cl.: 41**

**SERVICE MARK**

**PRINCIPAL REGISTER**

THE INSTITUTE OF CONTINUING LEGAL EDUCATION (MICHIGAN UNINCORPORATED ASSOCIATION)  
1020 GREENE STREET  
ANN ARBOR, MI 481091444

FOR: EDUCATIONAL SERVICES, NAMELY, PROVIDING ONLINE RESOURCE GUIDES AND A WEBSITE FEATURING NON-DOWNLOADABLE PUBLICATIONS IN THE NATURE OF BLOGS AND FORMS IN THE FIELD OF PROJECT MANAGEMENT AND STRATEGIC LEADERSHIP; PROVIDING PRACTICAL TRAINING INCLUDING INTERACTIVE EXERCISES AND BUSINESS TRAINING IN THE FIELD OF LEADERSHIP DEVELOPMENT IN THE FIELDS OF PROJECT MANAGEMENT AND STRATEGIC LEADERSHIP, PROVIDING INTERACTIVE ONLINE TRAINING SERVICES FEATURING EDUCATIONAL EXERCISES IN THE FIELDS OF STRATEGIC LEADERSHIP AND PROJECT MANAGEMENT, IN CLASS 41 (U.S. CLS. 100, 101 AND 107).

FIRST USE 1-20-2011; IN COMMERCE 1-20-2011.

NO CLAIM IS MADE TO THE EXCLUSIVE RIGHT TO USE "CHANGE LEADERSHIP NETWORK", APART FROM THE MARK AS SHOWN.

THE MARK CONSISTS OF A STYLIZED DESIGN OF THREE HUMAN FIGURES COMPRISED OF THREE OVERLAPPING ARROWS POINTING UPWARD, EACH TOPPED WITH A CIRCLE, AND THE WORDS "CHANGE LEADERSHIP NETWORK" APPEARING TO THE RIGHT OF THE DESIGN.

SER. NO. 85-227,963, FILED 1-27-2011.

SAIMA MAKHDOOM, EXAMINING ATTORNEY



*David J. Kyjars*

Director of the United States Patent and Trademark Office

# United States of America

United States Patent and Trademark Office



**Reg. No. 4,196,694**

**Registered Aug. 28, 2012**

**Int. Cl.: 41**

**SERVICE MARK**

**PRINCIPAL REGISTER**

THE INSTITUTE OF CONTINUING LEGAL EDUCATION (MICHIGAN UNINCORPORATED ASSOCIATION)  
1020 GREENE STREET  
ANN ARBOR, MI 481091444

FOR: EDUCATIONAL SERVICES, NAMELY, PROVIDING ONLINE RESOURCE GUIDES AND A WEBSITE FEATURING NON-DOWNLOADABLE PUBLICATIONS IN THE NATURE OF BLOGS AND FORMS IN THE FIELD OF PROJECT MANAGEMENT AND STRATEGIC LEADERSHIP; PROVIDING PRACTICAL TRAINING INCLUDING INTERACTIVE EXERCISES AND BUSINESS TRAINING IN THE FIELD OF LEADERSHIP DEVELOPMENT IN THE FIELDS OF PROJECT MANAGEMENT AND STRATEGIC LEADERSHIP, PROVIDING INTERACTIVE ONLINE TRAINING SERVICES FEATURING EDUCATIONAL EXERCISES IN THE FIELDS OF STRATEGIC LEADERSHIP AND PROJECT MANAGEMENT, IN CLASS 41 (U.S. CLS. 100, 101 AND 107).

FIRST USE 1-20-2011; IN COMMERCE 1-20-2011.

THE MARK CONSISTS OF A STYLIZED DESIGN OF THREE HUMAN FIGURES COMPRISED OF THREE OVERLAPPING ARROWS POINTING UPWARD, EACH TOPPED WITH A CIRCLE.

SER. NO. 85-228,002, FILED 1-27-2011.

SAIMA MAKHDOOM, EXAMINING ATTORNEY



*David J. Kybas*

Director of the United States Patent and Trademark Office

# United States of America

United States Patent and Trademark Office

# UNHAGGLE

**Reg. No. 4,196,695**

UNHAGGLE INC. (CANADA CORPORATION), AKA UNHAGGLE.COM  
3585 LAIRD ROAD, UNIT 3

**Registered Aug. 28, 2012**

MISSISSAUGA, ONTARIO, CANADA L5L5Z8

**Int. Cl.: 35**

FOR: (BASED ON USE IN COMMERCE) COMPARISON SHOPPING SERVICES; PRICE COMPARISON SERVICES; PROMOTING THE GOODS AND SERVICES OF OTHERS BY PROVIDING A WEB SITE FEATURING COUPONS, REBATES, PRICE-COMPARISON INFORMATION, PRODUCT REVIEWS, LINKS TO THE RETAIL WEB SITES OF OTHERS, AND DISCOUNT INFORMATION; SHOPPING FACILITATION SERVICES, NAMELY, PROVIDING AN ONLINE COMPARISON-SHOPPING SEARCH ENGINE FOR OBTAINING PURCHASING INFORMATION(BASED ON 44(E)) COMPARISON SHOPPING SERVICES; PRICE COMPARISON SERVICES; PROMOTING THE GOODS AND SERVICES OF OTHERS BY PROVIDING A WEB SITE FEATURING COUPONS, REBATES, PRICE-COMPARISON INFORMATION, PRODUCT REVIEWS, LINKS TO THE RETAIL WEB SITES OF OTHERS, AND DISCOUNT INFORMATION; SHOPPING FACILITATION SERVICES, NAMELY, PROVIDING AN ONLINE COMPARISON-SHOPPING SEARCH ENGINE FOR OBTAINING PURCHASING INFORMATION, IN CLASS 35 (U.S. CLS. 100, 101 AND 102).

**SERVICE MARK**

**PRINCIPAL REGISTER**

FIRST USE 6-27-2010; IN COMMERCE 6-27-2010.

THE MARK CONSISTS OF STANDARD CHARACTERS WITHOUT CLAIM TO ANY PARTICULAR FONT, STYLE, SIZE, OR COLOR.



PRIORITY CLAIMED UNDER SEC. 44(D) ON CANADA APPLICATION NO. 1512437, FILED 1-24-2011, REG. NO. 1512437, DATED 4-16-2012, EXPIRES 4-16-2027.

SER. NO. 85-228,338, FILED 1-27-2011.

FRANK LATTUCA, EXAMINING ATTORNEY

*David J. Kyjars*

Director of the United States Patent and Trademark Office

# United States of America

United States Patent and Trademark Office

## Goldilocks Approach

**Reg. No. 4,196,696**

**Registered Aug. 28, 2012**

**Int. Cl.: 35**

**SERVICE MARK**

**PRINCIPAL REGISTER**

MOXIE DESIGN & MARKETING LLC (PENNSYLVANIA LIMITED LIABILITY COMPANY)  
17 EAST PHILADELPHIA STREET  
YORK, PA 17401

FOR: ADVERTISEMENT AND PUBLICITY SERVICES BY TELEVISION, RADIO, MAIL; ADVERTISING AGENCIES; ADVERTISING AGENCIES, NAMELY, PROMOTING THE GOODS AND SERVICES OF OTHERS; ADVERTISING AGENCY SPECIALIZING IN THE DESIGN AND EXECUTION OF WORD OF MOUTH, VIRAL, BUZZ AND EXPERIENTIAL MARKETING PROGRAMS; ADVERTISING AND ADVERTISEMENT SERVICES; ADVERTISING AND MARKETING; ADVERTISING AND MARKETING CONSULTANCY; ADVERTISING AND MARKETING SERVICES PROVIDED BY MEANS OF INDIRECT METHODS OF MARKETING COMMUNICATIONS, NAMELY, SOCIAL MEDIA, SEARCH ENGINE MARKETING, INQUIRY MARKETING, INTERNET MARKETING, MOBILE MARKETING, BLOGGING AND OTHER FORMS OF PASSIVE, SHARABLE OR VIRAL COMMUNICATIONS CHANNELS; ADVERTISING AND MARKETING SERVICES, NAMELY, PROMOTING THE GOODS AND SERVICES OF OTHERS; ADVERTISING AND PROMOTIONAL SERVICES; ADVERTISING AND PUBLICITY SERVICES; ADVERTISING AND PUBLICITY SERVICES, NAMELY, PROMOTING THE GOODS, SERVICES, BRAND IDENTITY AND COMMERCIAL INFORMATION AND NEWS OF THIRD PARTIES THROUGH PRINT, AUDIO, VIDEO, DIGITAL AND ON-LINE MEDIUM; ADVERTISING CONSULTATION; ADVERTISING COPYWRITING; ADVERTISING SERVICES; ADVERTISING SERVICES, NAMELY, CREATING CORPORATE AND BRAND IDENTITY FOR OTHERS; ADVERTISING SERVICES, NAMELY, CREATING CORPORATE LOGOS FOR OTHERS; ADVERTISING SERVICES, NAMELY, PROMOTING AND MARKETING THE GOODS AND SERVICES OF OTHERS IN THE FIELD OF UPSCALE CHOICES SUCH AS CULTURAL EVENTS, RESTAURANTS, SHOPPING, AND TRAVEL VIA PRINT AND ELECTRONIC MEDIA; ADVERTISING SERVICES, NAMELY, PROMOTING AND MARKETING THE GOODS AND SERVICES OF OTHERS THROUGH ALL PUBLIC COMMUNICATION MEANS; ADVERTISING SERVICES, NAMELY, PROMOTING THE BRANDS, GOODS AND SERVICES OF OTHERS; ADVERTISING SERVICES, PUBLIC RELATIONS AND MARKETING SERVICES, NAMELY, PROMOTING AND MARKETING THE GOODS AND SERVICES OF OTHERS THROUGH ALL PUBLIC COMMUNICATION MEANS; ADVERTISING THROUGH ALL PUBLIC COMMUNICATION MEANS; ADVERTISING, MARKETING AND PROMOTION SERVICES; ADVERTISING, MARKETING AND PROMOTION SERVICES, NAMELY, PROMOTING THE GOODS AND SERVICES OF OTHERS BY PROVIDING CUSTOMIZED EXHIBITS; ADVERTISING, MARKETING AND PROMOTIONAL SERVICES RELATED TO ALL INDUSTRIES FOR THE PURPOSE OF FACILITATING NETWORKING AND SOCIALIZING OPPORTUNITIES FOR



*David J. Kyros*

Director of the United States Patent and Trademark Office

**Reg. No. 4,196,696** BUSINESS PURPOSES; ADVERTISING, PROMOTION AND MARKETING SERVICES IN THE NATURE OF E-MAIL BLAST CAMPAIGNS FOR OTHERS; ARRANGING AND CONDUCTING MARKETING PROMOTIONAL EVENTS FOR OTHERS; BRAND CONCEPT AND BRAND DEVELOPMENT SERVICES FOR CORPORATE AND INDIVIDUAL CLIENTS; BRAND CONCEPT AND BRAND DEVELOPMENT SERVICES FOR CORPORATE CLIENTS; BRAND EVALUATION SERVICES; BRANDING SERVICES, NAMELY, CONSULTING, DEVELOPMENT, MANAGEMENT AND MARKETING OF BRANDS FOR BUSINESSES; BUSINESS ADVICE AND ANALYSIS OF MARKETS; BUSINESS CONSULTATION AND MANAGEMENT REGARDING MARKETING ACTIVITIES AND LAUNCHING OF NEW PRODUCTS; BUSINESS MANAGEMENT CONSULTING WITH RELATION TO STRATEGY, MARKETING, SALES, OPERATION, PRODUCT DESIGN PARTICULARLY SPECIALIZING IN THE USE OF ANALYTIC AND STATISTIC MODELS FOR THE UNDERSTANDING AND PREDICTING OF CONSUMERS, BUSINESSES, AND MARKET TRENDS AND ACTIONS; BUSINESS MARKETING AND DIRECT MAIL CONSULTING SERVICES; BUSINESS MARKETING CONSULTING SERVICES; BUSINESS MARKETING SERVICES; BUSINESS MONITORING AND CONSULTING SERVICES, NAMELY, TRACKING WEB SITES AND APPLICATIONS OF OTHERS TO PROVIDE STRATEGY, INSIGHT, MARKETING, SALES, OPERATION, PRODUCT DESIGN, PARTICULARLY SPECIALIZING IN THE USE OF ANALYTIC AND STATISTIC MODELS FOR THE UNDERSTANDING AND PREDICTING OF CONSUMERS, BUSINESSES, AND MARKET TRENDS AND ACTIONS; CONCEPT AND BRAND DEVELOPMENT SERVICES FOR CORPORATE CLIENTS; CONDUCTING BUSINESS AND MARKET RESEARCH SURVEYS; CONDUCTING MARKET SURVEYS; CONDUCTING MARKETING STUDIES; CONSULTATION SERVICES, NAMELY, CREATIVE AND STRATEGIC CONSULTATION REGARDING DEVELOPMENT AND PRODUCTION OF MARKETING CAMPAIGNS FOR OTHERS; CONSULTING SERVICES IN THE FIELD OF INTERNET MARKETING; CONSUMER MARKETING RESEARCH AND CONSULTING RELATED THERETO; CREATING AND UPDATING ADVERTISING MATERIAL; CREATION OF MARKETING TOOLS DESIGNED TO INCREASE A CLIENT COMPANY'S KNOWLEDGE OF CUSTOMER NEEDS, AND ITS COMPETITORS' PRODUCTS AND SERVICES, PRICING, ADVERTISING STRATEGY AND SALES STRATEGY; CREATIVE MARKETING DESIGN SERVICES; DESIGN OF ADVERTISING BROCHURES FOR OTHERS; DESIGN OF ADVERTISING FLYERS FOR OTHERS; DESIGN OF ADVERTISING MATERIALS FOR OTHERS; DEVELOPMENT OF MARKETING STRATEGIES AND CONCEPTS; DEVELOPMENT OF MARKETING STRATEGIES, CONCEPTS AND TACTICS, NAMELY, AUDIENCE DEVELOPMENT, BRAND AWARENESS, CUSTOMER RELATIONS, ONLINE COMMUNITY BUILDING AND DIGITAL WORD OF MOUTH COMMUNICATIONS; DIRECT MARKETING; DIRECT MARKETING ADVERTISING FOR OTHERS; DIRECT MARKETING CONSULTING SERVICES; EVENT PLANNING AND MANAGEMENT FOR MARKETING, BRANDING, PROMOTING OR ADVERTISING THE GOODS AND SERVICES OF OTHERS; LAYOUT SERVICES FOR ADVERTISING PURPOSES; MARKETING ANALYSIS SERVICES; MARKETING AND BRANDING SERVICES, NAMELY, PERFORMING CONSUMER INSIGHT AND BRAND STRATEGY OF COMPANY LOGOS; MARKETING AND BRANDING SERVICES, NAMELY, PROVIDING CUSTOMIZED COMMUNICATION PROGRAMS TO OBTAIN CONSUMER INSIGHTS AND DEVELOP BRANDING STRATEGIES; MARKETING AND CONSULTING SERVICES IN THE FIELD OF PROMOTING AND TRACKING THE GOODS, SERVICES, AND BRANDS OF OTHERS THROUGH ALL PUBLIC COMMUNICATION MEANS, PARTICULARLY SPECIALIZING IN THE USE OF MOBILE, SOCIAL, AND PRINT MEDIA TO DRIVE CONSUMER INTEREST, ENGAGEMENT AND ACTION; MARKETING CONSULTING; MARKETING CONSULTING SERVICES RELATING TO LONG-TERM BUSINESS STRATEGY DEVELOPMENT FOR NON-PROFIT ORGANIZATIONS; MARKETING PLAN DEVELOPMENT; MEDIA BUYING ADVICE, NAMELY, ADVISING THE CLIENT HOW MUCH MEDIA TIME, AND AT WHAT TIMES THE CLIENT SHOULD BE PURCHASING ADVERTISING; MEDIA PLANNING, NAMELY, ADVISING THE CLIENT ON THE CORRECT TIMES AND STATIONS TO ADVERTISE BASED ON MEDIA ANALYSIS OF THE MARKET FOR THAT MEDIA; ON-LINE ADVERTISING AND MARKETING SERVICES; PLACING ADVERTISEMENTS FOR OTHERS; PLANNING, DESIGN, DEVELOPMENT, MAINTENANCE, TRACKING AND REPORTING OF ONLINE MARKETING ACTIVITIES FOR THIRD PARTIES; PREPARING ADVERTISEMENTS FOR OTHERS; PREPARING AND PLACING ADVERTISEMENTS

**Reg. No. 4,196,696** FOR OTHERS; PREPARING AND PLACING OF ADVERTISEMENTS; PRODUCTION OF ADVERTISING MATTER AND COMMERCIALS; PROMOTING THE GOODS AND SERVICES OF OTHERS BY DISTRIBUTING ADVERTISING MATERIALS THROUGH A VARIETY OF METHODS; PROMOTING THE GOODS AND SERVICES OF OTHERS BY MEANS OF WORD-OF-MOUTH AND NONTRADITIONAL MARKETING PROGRAMS; PROMOTING, ADVERTISING AND MARKETING OF THE BRANDS, PRODUCTS, SERVICES OR ONLINE WEBSITES OF INDIVIDUALS, BUSINESSES AND NONPROFIT ORGANIZATIONS; PROMOTION AND MARKETING SERVICES AND RELATED CONSULTING; PROVIDING ADVERTISING SERVICES; PROVIDING ADVERTISING, MARKETING AND PROMOTIONAL SERVICES, NAMELY, DEVELOPMENT OF ADVERTISING CAMPAIGNS PROVIDED THROUGH CABLE TELEVISION BROADCAST, WEB CASTS, RADIO BROADCASTS, NEWSPAPERS, MAGAZINES, ONLINE BANNERS, OUTDOOR BILLBOARDS, WILD POSTINGS, BUS AND SUBWAY ADS; PROVIDING BUSINESS MARKETING INFORMATION; PROVIDING MARKETING AND PROMOTION OF SPECIAL EVENTS; PUBLIC RELATIONS; SERVICES OF ADVERTISING AGENCIES; SERVICES RELATING TO THE ANALYSIS, EVALUATION, CREATION AND BRAND ESTABLISHMENT OF TRADEMARKS, TRADE NAMES AND DOMAIN NAMES; SOCIAL MEDIA STRATEGY AND MARKETING CONSULTANCY FOCUSING ON HELPING CLIENTS CREATE AND EXTEND THEIR PRODUCT AND BRAND STRATEGIES BY BUILDING VIRALLY ENGAGING MARKETING SOLUTIONS, IN CLASS 35 (U.S. CLS. 100, 101 AND 102).

FIRST USE 6-1-2008; IN COMMERCE 6-1-2008.

THE MARK CONSISTS OF STANDARD CHARACTERS WITHOUT CLAIM TO ANY PARTICULAR FONT, STYLE, SIZE, OR COLOR.

SER. NO. 85-228,522, FILED 1-28-2011.

JUDITH HELFMAN, EXAMINING ATTORNEY



# United States of America

United States Patent and Trademark Office

# Kichinto-San

**Reg. No. 4,196,697**

**Registered Aug. 28, 2012**

**Int. Cls.: 11, 16, 17, 20  
and 21**

KUREHA CORPORATION (JAPAN CORPORATION)  
3-3-2, NIHONBASHI-HAMACHO, CHUO-KU  
TOKYO, JAPAN 103-8552

FOR: FILTERS FOR REMOVING PARTICULATE IMPURITIES FOR USE WITH COOKING RANGE HOODS, NAMELY, FILTERS FOR AIR EXTRACTOR HOODS, IN CLASS 11 (U.S. CLS. 13, 21, 23, 31 AND 34).

**TRADEMARK**

**PRINCIPAL REGISTER**

FOR: PAPER SHEETS FOR COOKING; PAPERS FOR COOKING, NAMELY, WAX PAPER AND PARCHMENT PAPER; FOOD-WRAPPING PLASTIC FILM STORED INSIDE A DISPENSING CASE WITH A CUTTER; NON-INSULATED PLASTIC BAGS FOR FOOD PRESERVATION WITH ALUMINUM DEPOSITED ON THEM; PLASTIC FOOD-WRAPPING BAGS FOR HOUSEHOLD USE; PLASTIC FOOD BAGS FOR FREEZER PRESERVATION, NAMELY, PLASTIC FREEZER BAGS; PLASTIC BAGS FOR FOOD PRESERVATION FOR HOUSEHOLD USE; DRAINABLE GARBAGE BAGS, MADE OF PAPER OR PLASTIC, FOR USE IN SINK; DRAINABLE GARBAGE BAGS MADE OF NON-WOVEN FABRICS; FOOD-WRAPPING PLASTIC FILM FOR HOUSEHOLD USE; GARBAGE BAGS OF PAPERS FOR HOUSEHOLD USE; GARBAGE BAGS OF PLASTICS FOR HOUSEHOLD USE; INDUSTRIAL PACKAGING CONTAINERS OF PAPER; PAPER TOWELS; PAPERS FOR PAPER TOWELS; INSULATED PLASTIC BAGS FOR FOOD PRESERVATION WITH ALUMINUM DEPOSITED ON THEM; PLASTIC BAGS FOR FOOD WRAPPING, FOR INDUSTRIAL PURPOSES; CONTAINERS IN THE NATURE OF BAGS FOR COOKING IN MICROWAVE OVENS, IN CLASS 16 (U.S. CLS. 2, 5, 22, 23, 29, 37, 38 AND 50).

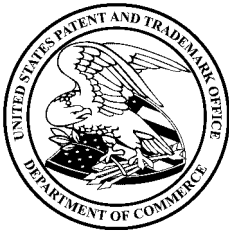

FOR: PLASTIC FILMS FOR FOOD WRAPPING, FOR INDUSTRIAL PURPOSES, IN CLASS 17 (U.S. CLS. 1, 5, 12, 13, 35 AND 50).

FOR: PLASTIC CONTAINERS AND COVERS FOR FOOD PRESERVATION FOR THE FOOD INDUSTRY USEABLE IN MICROWAVE OVENS; PLASTIC CLIPS FOR SEALING BAGS WHICH ARE USED FOR COOKING AND PRESERVING FOOD, IN CLASS 20 (U.S. CLS. 2, 13, 22, 25, 32 AND 50).

FOR: PLASTIC STORAGE CONTAINERS FOR FOOD PRESERVATION FOR HOUSEHOLD USE; CONTAINERS, NAMELY, COOKWARE FOR USE IN MICROWAVE OVENS; PLASTIC STORAGE CONTAINERS AND COVERS FOR FOOD PRESERVATION FOR HOUSEHOLD USE USABLE IN MICROWAVE OVENS; INSULATED CONTAINERS AND BAGS FOR

*David J. Kyjars*

Director of the United States Patent and Trademark Office

**Reg. No. 4,196,697** FOOD FOR DOMESTIC USE MADE OF ALUMINUM FOIL OR ALUMINUM, IN CLASS 21  
(U.S. CLS. 2, 13, 23, 29, 30, 33, 40 AND 50).

THE MARK CONSISTS OF STANDARD CHARACTERS WITHOUT CLAIM TO ANY PARTICULAR FONT, STYLE, SIZE, OR COLOR.

PRIORITY CLAIMED UNDER SEC. 44(D) ON JAPAN APPLICATION NO. 2011-005159, FILED 1-27-2011, REG. NO. 5421001, DATED 6-24-2011, EXPIRES 6-24-2021.

THE ENGLISH TRANSLATION OF "KICHINTO-SAN" IN THE MARK IS "MS. NEATLY".

SER. NO. 85-228,555, FILED 1-28-2011.

SEAN CROWLEY, EXAMINING ATTORNEY

# United States of America

United States Patent and Trademark Office

# MUX LAB

**Reg. No. 4,196,698**

**Registered Aug. 28, 2012**

**Int. Cl.: 9**

**TRADEMARK**

**PRINCIPAL REGISTER**

MUXLAB INC. (CANADA CORPORATION)  
8495 DALTON  
MONTRÉAL, QUÉBEC, CANADA

FOR: ELECTRONIC EQUIPMENT, NAMELY, TRANSFORMERS, BALUNS, COMMUNICATION HUBS, COMPUTER NETWORK HUBS AND DIGITAL MEDIA HUBS, ANALOG AND DIGITAL REPEATERS USED IN EXTENDED DISTANCE FOR AUDIO-VIDEO APPLICATIONS, CABLES USED IN CONNECTION WITH COMPUTERS, COMPUTERS PERIPHERAL DEVICES, TELEVISIONS, AUDIO-VIDEO EQUIPMENT, CLOSED-CIRCUIT TV EQUIPMENT AND TELECOMMUNICATION EQUIPMENT. MULTIPLEXERS AND COAXIAL CONVERTERS FOR COMMUNICATIONS BETWEEN COMPUTERS; COMPUTER PERIPHERALS FOR ENSURING PRIVACY OF COMMUNICATIONS VIA TELEPHONE LINES AND OTHER COMMUNICATION LINKS; COMPUTER MODEMS, TRANSCEIVERS FOR COMMUNICATIONS BETWEEN COMPUTERS AND FOR COMMUNICATION VIA TWISTED PAIR CABLE AND FIBER OPTICS, IN CLASS 9 (U.S. CLS. 21, 23, 26, 36 AND 38).

FIRST USE 9-0-1985; IN COMMERCE 2-0-1989.

THE MARK CONSISTS OF STANDARD CHARACTERS WITHOUT CLAIM TO ANY PARTICULAR FONT, STYLE, SIZE, OR COLOR.

OWNER OF CANADA REG. NO. TMA352,268, DATED 2-24-1989, EXPIRES 8-24-2018.

OWNER OF U.S. REG. NOS. 1,574,439 AND 2,437,253.

NO CLAIM IS MADE TO THE EXCLUSIVE RIGHT TO USE "LAB", APART FROM THE MARK AS SHOWN.

SEC. 2(F).

SER. NO. 85-228,896, FILED 1-28-2011.

ROBERT C. CLARK JR., EXAMINING ATTORNEY



*David J. Kyffers*

Director of the United States Patent and Trademark Office

# United States of America

United States Patent and Trademark Office

## The Yoga Collective

**Reg. No. 4,196,699**

GOTTFURCHT, GRANT E. (UNITED STATES INDIVIDUAL)  
1018 HARTZELL STREET  
PACIFIC PALISADES, CA 90272

**Registered Aug. 28, 2012**

**Int. Cl.: 41**

FOR: YOGA INSTRUCTION; YOGA STUDIO; EDUCATIONAL SERVICES, NAMELY, DEVELOPING AND CONDUCTING YOGA RETREATS AND WORKSHOPS; YOGA TEACHER TRAININGS; EDUCATIONAL SERVICES, NAMELY, CONDUCTING CLASSES IN THE FIELD OF YOGA AND MEDITATION, IN CLASS 41 (U.S. CLS. 100, 101 AND 107).

**SERVICE MARK**

**PRINCIPAL REGISTER**

FIRST USE 1-29-2011; IN COMMERCE 1-29-2011.

THE MARK CONSISTS OF STANDARD CHARACTERS WITHOUT CLAIM TO ANY PARTICULAR FONT, STYLE, SIZE, OR COLOR.

NO CLAIM IS MADE TO THE EXCLUSIVE RIGHT TO USE "YOGA", APART FROM THE MARK AS SHOWN.

SER. NO. 85-229,438, FILED 1-29-2011.

WENDY JUN, EXAMINING ATTORNEY



*David J. Kyffers*

Director of the United States Patent and Trademark Office

# United States of America

United States Patent and Trademark Office



**Reg. No. 4,196,700**

**Registered Aug. 28, 2012**

**Int. Cls.: 16, 35, 41 and 42**

**TRADEMARK**

**SERVICE MARK**

**PRINCIPAL REGISTER**

ANGELA WAN (NEW YORK SOLE PROPRIETORSHIP), AKA MINT PURPLE STUDIO  
6 BRIDLE PATH  
ROSLYN, NY 11576

FOR: ANNOUNCEMENT CARDS; BUSINESS CARDS; CARDS BEARING UNIVERSAL GREETINGS; GREETING CARDS; GREETINGS CARDS AND POSTCARDS; HOLIDAY CARDS; INVITATION CARDS; OCCASION CARDS; POSTCARDS AND GREETING CARDS; PRINTED MAIL RESPONSE CARDS RELATING TO INVITATIONS OR AN EVENT; WEDDING ALBUMS; WEDDING BOOKS, IN CLASS 16 (U.S. CLS. 2, 5, 22, 23, 29, 37, 38 AND 50).

FIRST USE 12-27-2009, THE MARK WAS FIRST USED ANYWHERE IN A DIFFERENT FORM OTHER THAN THAT SOUGHT TO BE REGISTERED AT LEAST AS EARLY AS 10/09/2009.; IN COMMERCE 5-10-2010, THE MARK WAS FIRST USED IN COMMERCE IN A DIFFERENT FORM OTHER THAN THAT SOUGHT TO BE REGISTERED AT LEAST AS EARLY AS 08/02/2010..

FOR: BRAND CONCEPT AND BRAND DEVELOPMENT SERVICES FOR CORPORATE AND INDIVIDUAL CLIENTS; BRAND CONCEPT AND BRAND DEVELOPMENT SERVICES FOR CORPORATE CLIENTS; CONCEPT AND BRAND DEVELOPMENT SERVICES FOR CORPORATE CLIENTS; CREATIVE MARKETING DESIGN SERVICES; DESIGN OF ADVERTISING FLYERS FOR OTHERS; DESIGN OF ADVERTISING MATERIALS FOR OTHERS; MARKETING AND BRANDING SERVICES, NAMELY, PERFORMING CONSUMER INSIGHT AND BRAND STRATEGY OF COMPANY LOGOS; PROMOTING, ADVERTISING AND MARKETING OF THE BRANDS, PRODUCTS, SERVICES OR ONLINE WEBSITES OF INDIVIDUALS, BUSINESSES AND NONPROFIT ORGANIZATIONS, IN CLASS 35 (U.S. CLS. 100, 101 AND 102).

FIRST USE 12-27-2009, THE MARK WAS FIRST USED ANYWHERE IN A DIFFERENT FORM OTHER THAN THAT SOUGHT TO BE REGISTERED AT LEAST AS EARLY AS 10/09/2009.; IN COMMERCE 2-1-2011, THE MARK WAS FIRST USED IN COMMERCE IN A DIFFERENT FORM OTHER THAN THAT SOUGHT TO BE REGISTERED AT LEAST AS EARLY AS 08/02/2010..

FOR: PARTY AND WEDDING PLANNING AND COORDINATION SERVICES; PARTY AND WEDDING PLANNING CONSULTATION SERVICES; PARTY AND WEDDING PLANNING, COORDINATION AND CONSULTATION SERVICES; PHOTOGRAPHY; PHOTOGRAPHY



*David J. Kyffers*

Director of the United States Patent and Trademark Office

**Reg. No. 4,196,700** SERVICES; PORTRAIT PHOTOGRAPHY; PROVIDING INFORMATION IN THE FIELD OF WEDDING PARTY PLANNING; PROVIDING INFORMATION REGARDING WEDDING PLANNING FOR WEDDING PARTIES; WEDDING PLANNING AND COORDINATION SERVICES, IN CLASS 41 (U.S. CLS. 100, 101 AND 107).

FIRST USE 12-27-2009, THE MARK WAS FIRST USED ANYWHERE IN A DIFFERENT FORM OTHER THAN THAT SOUGHT TO BE REGISTERED AT LEAST AS EARLY AS 10/09/2009.; IN COMMERCE 5-10-2010, THE MARK WAS FIRST USED IN COMMERCE IN A DIFFERENT FORM OTHER THAN THAT SOUGHT TO BE REGISTERED AT LEAST AS EARLY AS 08/02/2010..

FOR: CUSTOM DESIGN OF FAUX FOOD DECORATIVE ACCENTS FOR ATTACHMENT TO CELL PHONE CASES AND TOYS USING SILICONS AND CABOCHANS, CHARITABLE SERVICES, NAMELY, PROVIDING WEB SITE DESIGN FOR OTHERS; COMMERCIAL ART DESIGN; COMPUTER AIDED DESIGN FOR OTHERS; COMPUTER AIDED GRAPHIC DESIGN; COMPUTER GRAPHICS DESIGN SERVICES, NAMELY, CREATION OF CHARACTER DESIGNS; CREATING AND DESIGNING WEB PAGES FOR OTHERS; CREATING, DESIGNING AND MAINTAINING WEB SITES; CREATION, DESIGN, DEVELOPMENT AND MAINTENANCE OF WEB SITES FOR THIRD PARTIES; CUSTOM DESIGN OF CELLULAR TELEPHONE CASES BASED ON PERSONAL SELECTIONS MADE BY THE CUSTOMER; DESIGN AND CREATING WEB SITES FOR OTHERS; DESIGN AND MAINTENANCE OF WEB SITES FOR OTHERS; DESIGN OF HOME PAGES; DESIGN OF HOME PAGES AND WEB SITES; DESIGN OF HOMEPAGES AND WEBSITES; DESIGNING AND DEVELOPING WEBPAGES ON THE INTERNET; DESIGNING WEBSITES FOR ADVERTISING PURPOSES; DEVELOPMENT, DESIGN AND UPDATING OF HOME PAGES; GRAPHIC ART DESIGN; GRAPHIC ARTS DESIGNING; GRAPHIC DESIGN; GRAPHIC DESIGN SERVICES; HOMEPAGE AND WEBPAGE DESIGN; LETTERHEAD DESIGN SERVICES; MULTIDISCIPLINARY GRAPHIC DESIGN SERVICES; MULTIDISCIPLINARY VISUAL DESIGN SERVICES; PROVIDING GRAPHIC AND MULTIMEDIA DESIGN SERVICES FOR THE PURPOSE OF PROMOTING THE GOODS AND SERVICES OF OTHERS; WEB SITE DESIGN; WEBSITE DESIGN AND DEVELOPMENT FOR OTHERS, IN CLASS 42 (U.S. CLS. 100 AND 101).

FIRST USE 5-10-2010, THE MARK WAS FIRST USED ANYWHERE IN A DIFFERENT FORM OTHER THAN THAT SOUGHT TO BE REGISTERED AT LEAST AS EARLY AS 10/09/2009.; IN COMMERCE 9-17-2010, THE MARK WAS FIRST USED IN COMMERCE IN A DIFFERENT FORM OTHER THAN THAT SOUGHT TO BE REGISTERED AT LEAST AS EARLY AS 08/02/2010..

NO CLAIM IS MADE TO THE EXCLUSIVE RIGHT TO USE "STUDIO", APART FROM THE MARK AS SHOWN.

THE COLOR(S) LIGHT GREY, PURPLE, VIOLET, LAVENDER, GREEN AND WHITE IS/ARE CLAIMED AS A FEATURE OF THE MARK.

THE MARK CONSISTS OF THE STYLIZED WORDING "MINT PURPLE STUDIO" IN LIGHT GREY LETTERS AND A DESIGN COMPRISING OF TWO LEAVES IN SHADES OF PURPLE, VIOLET, LAVENDER AND GREEN WITH A WHITE STEM DOWN THE MIDDLE.

SER. NO. 85-231,452, FILED 2-1-2011.

PATRICIA EVANKO, EXAMINING ATTORNEY

# United States of America

United States Patent and Trademark Office

## MCARTHUR GLEN

**Reg. No. 4,196,701**

**Registered Aug. 28, 2012**

**Int. Cls.: 36 and 39**

MCARTHUR/GLEN EUROPE HOLDINGS LIMITED LLC (DELAWARE LIMITED LIABILITY COMPANY)  
CORPORATION TRUST CENTER  
1209 ORANGE STREET  
WILMINGTON, DE 19801

**SERVICE MARK**

**PRINCIPAL REGISTER**

FOR: FINANCIAL AFFAIRS, NAMELY, FINANCIAL MANAGEMENT AND ANALYSIS SERVICES; MONETARY AFFAIRS, NAMELY, MONETARY INFORMATION, MANAGEMENT AND ANALYSIS SERVICES; REAL ESTATE AFFAIRS, NAMELY, LEASING OF REAL ESTATE; PROPERTY MANAGEMENT SERVICES, NAMELY, RENTAL PROPERTY MANAGEMENT; FINANCIAL SERVICES, NAMELY, FINANCIAL CONSULTANCY; BANKING SERVICES; RENTAL PROPERTY PORTFOLIO MANAGEMENT; RENTAL OF REAL PROPERTY; ARRANGING LEASES FOR THE RENTAL OF REAL PROPERTY; INVESTING FOR OTHERS IN REAL PROPERTY; REAL ESTATE BROKERAGE, MANAGEMENT AND APPRAISAL SERVICES; RENT COLLECTION SERVICES; CREDIT CARD SERVICES; DEBIT CARD SERVICES; ISSUE OF TOKENS OF VALUE, NAMELY, STORED VALUE GIFT VOUCHERS; EXCHANGING MONEY; FINANCIAL VALUATIONS; ADVICE AND INFORMATION RELATING TO REAL PROPERTY; PROVISION, NAMELY, LEASING OF RETAIL SPACE AND SPACE FOR THE PROVISION OF SERVICES INCLUDING RESTAURANT, CAFE, CINEMA, CRECHE, NURSERY, HEALTH CLUB, BEAUTY SALON AND BANKING SERVICES; REAL ESTATE MANAGEMENT, INCLUDING IN THE FIELD OF SHOPPING CENTRES; FINANCIAL MANAGEMENT; DEBT COLLECTION; FINANCIAL SERVICES RELATING TO CREDIT CARDS, NAMELY, CREDIT CARD PAYMENT PROCESSING SERVICES; PROVISION, NAMELY, ISSUING, OF CREDIT CARDS; PROVISION OF CREDIT CARD SERVICES, IN CLASS 36 (U.S. CLS. 100, 101 AND 102).



*David J. Kyjars*

Director of the United States Patent and Trademark Office

FOR: TRANSPORT BY TRUCK, TRAIN AND AIR; PACKAGING GOODS FOR TRANSPORTATION AND STORAGE OF GOODS; TRANSPORT OF GOODS, PACKING ARTICLES FOR TRANSPORTATION AND STORAGE AND FREIGHT DEPOT SERVICES, NAMELY, FREIGHT WAREHOUSING, LOADING AND FORWARDING INCLUDING WITHIN COMMERCIAL CENTRES; CONSULTING SERVICES AND CO-ORDINATION AS REGARDS DISTRIBUTION IN A CONTROLLED AND EFFECTIVE MANNER OF SURPLUS STOCKS OF QUALITY AND DELUXE BRANDS, NAMELY, DELIVERY OF LUXURY GOODS AND RELATED CONSULTING SERVICES; PROVISION OF CAR PARKING FACILITIES, IN CLASS 39 (U.S. CLS. 100 AND 105).

**Reg. No. 4,196,701** THE MARK CONSISTS OF STANDARD CHARACTERS WITHOUT CLAIM TO ANY PARTICULAR FONT, STYLE, SIZE, OR COLOR.

OWNER OF ERPN CMNTY TM OFC REG. NO. 004685707, DATED 7-23-2009, EXPIRES 10-14-2015.

OWNER OF U.S. REG. NOS. 3,398,385, 3,934,008 AND OTHERS.

SER. NO. 85-233,599, FILED 2-3-2011.

KATHERINE CHANG, EXAMINING ATTORNEY



# United States of America

United States Patent and Trademark Office



**Reg. No. 4,196,702**

NATIONWIDE COURT SERVICES, INC. (NEW YORK CORPORATION)  
761 KOEHLER AVENUE, SUITE A  
RONKONKOMA, NY 11779

**Registered Aug. 28, 2012**

**Int. Cl.: 45**

FOR: LEGAL SERVICES, IN CLASS 45 (U.S. CLS. 100 AND 101).

**SERVICE MARK**

FIRST USE 12-19-1995; IN COMMERCE 12-19-1995.

**PRINCIPAL REGISTER**

NO CLAIM IS MADE TO THE EXCLUSIVE RIGHT TO USE "NATIONWIDE COURT SERVICES, INC.", APART FROM THE MARK AS SHOWN.

THE MARK CONSISTS OF THE WORD "NATIONWIDE" WITH A TRIANGLE 'ROOF' OVER THE "N" AND 3 PROGRESSIVELY LONGER LINES OR 'STEPS' UNDER THE "N" AND A BLOCK WITH THE WORDS "COURT SERVICES, INC." UNDER THE REST OF THE WORD.

SER. NO. 85-236,570, FILED 2-8-2011.

JULIE WATSON, EXAMINING ATTORNEY



*David J. Kybas*

Director of the United States Patent and Trademark Office

# United States of America

United States Patent and Trademark Office

# DRIFT

**Reg. No. 4,196,703**

**Registered Aug. 28, 2012**

**Int. Cl.: 9**

**TRADEMARK**

**PRINCIPAL REGISTER**

DRIFT INNOVATION LIMITED (UNITED KINGDOM CORPORATION), AKA DRIFT INNOVATION  
THE LIGHT BOX, PC126, 111 POWER ROAD  
LONDON, UNITED KINGDOM W45PY

FOR: SPECIALTY SPORTS VIDEO ACTION CAMERAS FOR USE DURING SPORTING ACTIVITIES WHILE MOUNTED UPON HELMETS, OTHER CLOTHING ITEMS, VEHICLES AND EQUIPMENT ASSOCIATED WITH SUCH SPORTING ACTIVITIES, EXCLUDING MOBILE HANDSETS IN THE NATURE OF A COMBINATION OF EITHER PERSONAL DIGITAL ASSISTANT, TELEPHONE, CAMERA, GLOBAL POSITION AND MAPPING DEVICE, TELEVISION, RADIO, OR VIDEO AND AUDIO PLAYER AND RECORDER, IN CLASS 9 (U.S. CLS. 21, 23, 26, 36 AND 38).

FIRST USE 5-20-2009; IN COMMERCE 9-20-2009.

THE MARK CONSISTS OF STANDARD CHARACTERS WITHOUT CLAIM TO ANY PARTICULAR FONT, STYLE, SIZE, OR COLOR.

SER. NO. 85-237,533, FILED 2-9-2011.

KATHERINE CHANG, EXAMINING ATTORNEY



*David J. Kyjars*

Director of the United States Patent and Trademark Office

# United States of America

United States Patent and Trademark Office

## DRIVERANYWHERE

**Reg. No. 4,196,704**

**Registered Aug. 28, 2012**

**Int. Cls.: 9, 38 and 39**

**TRADEMARK**

**SERVICE MARK**

**PRINCIPAL REGISTER**

LIMO ANYWHERE, INC. (TEXAS CORPORATION)  
17218 PRESTON ROAD, SUITE 4200  
DALLAS, TX 75252

FOR: COMPUTER SOFTWARE FOR COORDINATING TRANSPORTATION SERVICES, NAMELY, SOFTWARE FOR PROVIDING DIRECTIONS, PROVIDING TRANSPORTATION STATUS UPDATES, AND COORDINATING RESERVATIONS, SCHEDULING, AND DISPATCH, ALL RELATING TO MOTORIZED VEHICLES; DOWNLOADABLE SOFTWARE IN THE NATURE OF A MOBILE APPLICATION FOR COORDINATING TRANSPORTATION SERVICES, NAMELY, SOFTWARE FOR PROVIDING DIRECTIONS, PROVIDING TRANSPORTATION STATUS UPDATES, AND COORDINATING RESERVATIONS, SCHEDULING, AND DISPATCH, ALL RELATING TO MOTORIZED VEHICLES, IN CLASS 9 (U.S. CLS. 21, 23, 26, 36 AND 38).

FIRST USE 2-7-2011; IN COMMERCE 2-7-2011.

FOR: TELECOMMUNICATIONS SERVICES, NAMELY, ROUTING CALLS, SHORT MESSAGE SERVICE MESSAGES, TWO WAY MESSAGING MESSAGES, AND PUSH-NOTIFICATIONS TO LOCAL THIRD-PARTY MOTORIZED VEHICLE DISPATCHERS IN THE VICINITY OF CALLERS USING PORTABLE ELECTRONIC DEVICES, IN CLASS 38 (U.S. CLS. 100, 101 AND 104).

FIRST USE 2-7-2011; IN COMMERCE 2-7-2011.

FOR: PROVIDING ONLINE DRIVING DIRECTIONS, ONLINE TRANSPORTATION INFORMATION, AND ONLINE TRANSPORTATION RESERVATION SERVICES, ALL RELATING TO MOTORIZED VEHICLES, IN CLASS 39 (U.S. CLS. 100 AND 105).

FIRST USE 2-7-2011; IN COMMERCE 2-7-2011.

THE MARK CONSISTS OF STANDARD CHARACTERS WITHOUT CLAIM TO ANY PARTICULAR FONT, STYLE, SIZE, OR COLOR.

SER. NO. 85-240,708, FILED 2-11-2011.

JOHN GARTNER, EXAMINING ATTORNEY



*David J. Kyffers*

Director of the United States Patent and Trademark Office

# United States of America

United States Patent and Trademark Office



**Reg. No. 4,196,705**

**Registered Aug. 28, 2012**

**Int. Cl.: 41**

**SERVICE MARK**

**PRINCIPAL REGISTER**

WOOD, JAMES (UNITED STATES INDIVIDUAL), DBA PICULET PRESS  
20 WEST 64TH STREET  
NEW YORK, NY 10023

FOR: PUBLISHING SERVICES, NAMELY, PUBLISHING OF BOOKS, PERIODICALS, PLAYS, SHORT STORIES, SCRIPTS, PHOTOGRAPHS, IMAGES, DRAWINGS, ILLUSTRATIONS, BLOGS AND ELECTRONIC PUBLICATIONS, IN CLASS 41 (U.S. CLS. 100, 101 AND 107).

FIRST USE 4-16-2010; IN COMMERCE 4-16-2010.

THE MARK CONSISTS OF A BIRD DESIGN.

SER. NO. 85-241,558, FILED 2-14-2011.

LINDA M. KING, EXAMINING ATTORNEY



*David J. Kybas*

Director of the United States Patent and Trademark Office

# United States of America

United States Patent and Trademark Office

## PICULET PRESS

**Reg. No. 4,196,706**

**Registered Aug. 28, 2012**

**Int. Cl.: 41**

**SERVICE MARK**

**PRINCIPAL REGISTER**

WOOD, JAMES (UNITED STATES INDIVIDUAL), DBA PICULET PRESS  
20 WEST 64TH STREET  
NEW YORK, NY 10023

FOR: PUBLISHING SERVICES, NAMELY, PUBLISHING OF BOOKS, PERIODICALS, PLAYS, SHORT STORIES, SCRIPTS, PHOTOGRAPHS, IMAGES, DRAWINGS, ILLUSTRATIONS, BLOGS AND ELECTRONIC PUBLICATIONS, IN CLASS 41 (U.S. CLS. 100, 101 AND 107).

FIRST USE 4-16-2010; IN COMMERCE 4-16-2010.

THE MARK CONSISTS OF STANDARD CHARACTERS WITHOUT CLAIM TO ANY PARTICULAR FONT, STYLE, SIZE, OR COLOR.

NO CLAIM IS MADE TO THE EXCLUSIVE RIGHT TO USE "PRESS", APART FROM THE MARK AS SHOWN.

SER. NO. 85-241,567, FILED 2-14-2011.

LINDA M. KING, EXAMINING ATTORNEY



*David J. Kybas*

Director of the United States Patent and Trademark Office

# United States of America

United States Patent and Trademark Office

# AMBLE

**Reg. No. 4,196,707**

LOUIS VUITTON MALLETIER (FRANCE SOCIÉTÉ ANONYME (SA))  
2, RUE DU PONT-NEUF  
PARIS, FRANCE F-75001

**Registered Aug. 28, 2012**

**Int. Cls.: 9, 14 and 18**

FOR: EYEWEAR; EYEWEAR CASES, IN CLASS 9 (U.S. CLS. 21, 23, 26, 36 AND 38).

**TRADEMARK**

FOR: JEWELRY; FANCY JEWELRY; JEWELRY, NAMELY, RINGS, BUCKLES FOR WATCH STRAPS OF PRECIOUS METALS, THEIR ALLOYS, OR COATED THEREWITH, EARRINGS, CUFF LINKS, BRACELETS, CHARMS, BROOCHES, CHAINS, NECKLACES, PENDANTS, TIE PINS, ORNAMENTS, AND MEDALLIONS; FANCY KEY RINGS OF PRECIOUS METAL; TIMEPIECES AND CHRONOMETRIC INSTRUMENTS, NAMELY, WATCHES, WATCH STRAPS, WATCH CASES, WRISTWATCHES, IN CLASS 14 (U.S. CLS. 2, 27, 28 AND 50).

**PRINCIPAL REGISTER**

FOR: BOXES OF LEATHER OR IMITATION LEATHER; TRAVELING BAGS; LEATHER TRAVELING LUGGAGE SETS; TRUNKS; SUITCASES; GARMENT BAGS FOR TRAVEL; VANITY CASES SOLD EMPTY; BACKPACKS; HANDBAGS; BRIEFCASES; LEATHER DOCUMENT CASES; POCKET WALLETS; COIN PURSES; LEATHER KEY CASES, UMBRELLAS, IN CLASS 18 (U.S. CLS. 1, 2, 3, 22 AND 41).

THE MARK CONSISTS OF STANDARD CHARACTERS WITHOUT CLAIM TO ANY PARTICULAR FONT, STYLE, SIZE, OR COLOR.

PRIORITY CLAIMED UNDER SEC. 44(D) ON FRANCE APPLICATION NO. 10/3768980, FILED 9-24-2010, REG. NO. 10/3768980, DATED 9-24-2010, EXPIRES 9-24-2020.

SER. NO. 85-242,241, FILED 2-15-2011.

KHANH LE, EXAMINING ATTORNEY



*David J. Kyffers*

Director of the United States Patent and Trademark Office

# United States of America

United States Patent and Trademark Office

## Moon Technology

**Reg. No. 4,196,708**

**Registered Aug. 28, 2012**

**Int. Cl.: 9**

**TRADEMARK**

**PRINCIPAL REGISTER**

AURIA SOLAR CO., LTD. (TAIWAN CORPORATION)  
NO. 9, DAYE 1ST ROAD  
TAINAN SCIENCE PARK, SINSHIH TOWNSHIP  
TAINAN COUNTY 74146, TAIWAN

FOR: SOLAR CELLS; SOLAR ENERGY ABSORBER FOR ELECTRICITY CONVERSION;  
SOLAR ENERGY COLLECTOR FOR ELECTRICITY CONVERSION, IN CLASS 9 (U.S. CLS.  
21, 23, 26, 36 AND 38).

THE MARK CONSISTS OF STANDARD CHARACTERS WITHOUT CLAIM TO ANY PAR-  
TICULAR FONT, STYLE, SIZE, OR COLOR.

OWNER OF TAIWAN REG. NO. 01439248, DATED 9-16-2010, EXPIRES 9-15-2020.

NO CLAIM IS MADE TO THE EXCLUSIVE RIGHT TO USE "TECHNOLOGY", APART FROM  
THE MARK AS SHOWN.

SER. NO. 85-242,639, FILED 2-15-2011.

REBECCA EISINGER, EXAMINING ATTORNEY



*David J. Kybas*

Director of the United States Patent and Trademark Office

# United States of America

United States Patent and Trademark Office

# iMINING

**Reg. No. 4,196,709**

**Registered Aug. 28, 2012**

**Int. Cls.: 6, 14, 37 and 40**

EADIE, ROBERT (CANADA INDIVIDUAL)  
SUITE 750  
580 HORNBY STREET  
VANCOUVER, BC, CANADA V6C3B6

**TRADEMARK**

FOR: BASE METALS AND ALLOYS FOR USE FOR INDUSTRIAL PURPOSES IN MANUFACTURING, PRODUCTION AND ASSEMBLY , IN CLASS 6 (U.S. CLS. 2, 12, 13, 14, 23, 25 AND 50).

**SERVICE MARK**

FOR: GOLD; PRECIOUS METALS AND THEIR ALLOYS, IN CLASS 14 (U.S. CLS. 2, 27, 28 AND 50).

**PRINCIPAL REGISTER**

FOR: MINING EXTRACTION, NAMELY, MINING OF MINERALS; MINING EXTRACTION SERVICES; MINING EXTRACTION OF GOLD, IN CLASS 37 (U.S. CLS. 100, 103 AND 106).

FOR: DEVELOPMENT OF MINERAL PROPERTIES IN THE NATURE OF MATERIALS PROCESSING, NAMELY, OBTAINING METALS FROM NATIVE EARTH MATERIALS; PROCESSING AND REFINING OF MINERALS, NAMELY, OBTAINING METALS FROM NATIVE EARTH MATERIALS, IN CLASS 40 (U.S. CLS. 100, 103 AND 106).

THE MARK CONSISTS OF STANDARD CHARACTERS WITHOUT CLAIM TO ANY PARTICULAR FONT, STYLE, SIZE, OR COLOR.

PRIORITY CLAIMED UNDER SEC. 44(D) ON CANADA APPLICATION NO. 1516452, FILED 2-23-2011, REG. NO. TMA816922, DATED 2-3-2012, EXPIRES 2-3-2027.

SER. NO. 85-251,139, FILED 2-24-2011.

GRETCHEN ULRICH, EXAMINING ATTORNEY



*David J. Kybas*

Director of the United States Patent and Trademark Office



# United States of America

United States Patent and Trademark Office

## ROYALS INTERNATIONAL

**Reg. No. 4,196,710**

THOR TECH, INC. (NEVADA CORPORATION)  
419 WEST PIKE STREET

**Registered Aug. 28, 2012**

JACKSON CENTER, OH 45334

**Int. Cl.: 12**

FOR: TRAVEL TRAILERS, IN CLASS 12 (U.S. CLS. 19, 21, 23, 31, 35 AND 44).

**TRADEMARK**

FIRST USE 12-10-1975; IN COMMERCE 4-19-1976.

**PRINCIPAL REGISTER**

THE MARK CONSISTS OF STANDARD CHARACTERS WITHOUT CLAIM TO ANY PARTICULAR FONT, STYLE, SIZE, OR COLOR.

NO CLAIM IS MADE TO THE EXCLUSIVE RIGHT TO USE "INTERNATIONAL", APART FROM THE MARK AS SHOWN.

SER. NO. 85-254,507, FILED 3-1-2011.

SUNG IN, EXAMINING ATTORNEY



*David J. Kyffers*

Director of the United States Patent and Trademark Office

# United States of America

United States Patent and Trademark Office

## Pat-Chem Laboratories

**Reg. No. 4,196,711**

PAT CHEM LABORATORIES (CALIFORNIA CORPORATION)  
11990 DISCOVERY COURT  
MOORPARK, CA 93021

**Registered Aug. 28, 2012**

**Int. Cl.: 42**

FOR: CHEMICAL ANALYSIS, IN CLASS 42 (U.S. CLS. 100 AND 101).

**SERVICE MARK**

FIRST USE 1-8-1988; IN COMMERCE 1-8-1988.

**PRINCIPAL REGISTER**

THE MARK CONSISTS OF STANDARD CHARACTERS WITHOUT CLAIM TO ANY PARTICULAR FONT, STYLE, SIZE, OR COLOR.

NO CLAIM IS MADE TO THE EXCLUSIVE RIGHT TO USE "LABORATORIES", APART FROM THE MARK AS SHOWN.

SER. NO. 85-254,928, FILED 3-1-2011.

MICHELLE DUBOIS, EXAMINING ATTORNEY



*David J. Kyffers*

Director of the United States Patent and Trademark Office

# United States of America

United States Patent and Trademark Office



**Reg. No. 4,196,712**

**Registered Aug. 28, 2012**

**Int. Cl.: 33**

**TRADEMARK**

**PRINCIPAL REGISTER**

CHIVAS HOLDINGS (IP) LIMITED (UNITED KINGDOM COMPANY)  
111-113 RENFREW ROAD  
PAISLEY, RENFREWSHIRE, UNITED KINGDOM PA34DY

FOR: ALCOHOLIC BEVERAGES EXCLUDING BEERS; SPIRITS; WINES; LIQUEURS; DISTILLED SPIRITS; WHISKY; WHISKY LIQUEURS; ALCOHOLIC BEVERAGES FROM OR CONTAINING WHISKY; APERITIFS; AND PREPARED ALCOHOLIC COCKTAILS, IN CLASS 33 (U.S. CLS. 47 AND 49).

PRIORITY CLAIMED UNDER SEC. 44(D) ON ERPN CMNTY TM OFC APPLICATION NO. 9782161, FILED 3-3-2011, REG. NO. 009782161, DATED 8-22-2011, EXPIRES 3-3-2021.

THE COLOR(S) BLACK, WHITE, RED, GREEN, BLUE, YELLOW, TURQUOISE AND GOLD IS/ARE CLAIMED AS A FEATURE OF THE MARK.

OWNER OF U.S. REG. NO. 782,959.

NO CLAIM IS MADE TO THE EXCLUSIVE RIGHT TO USE "SCOTCH", APART FROM THE MARK AS SHOWN.

THE MARK CONSISTS OF A LABEL DESIGN COMPRISING OF THE WHITE WORDS "PASSPORT SCOTCH" WITHIN A BLACK RECTANGLE WITH GREEN AND YELLOW BORDERS, ABOVE A GREEN VERTICAL TAIL WITH FIVE CRESTS CONTAINING THE COLORS BLACK, WHITE, RED, GREEN, BLUE, YELLOW, TURQUOISE AND GOLD.

SER. NO. 85-257,180, FILED 3-3-2011.

PAUL MORENO, EXAMINING ATTORNEY



*David J. Kyros*

Director of the United States Patent and Trademark Office

# United States of America

United States Patent and Trademark Office



**Reg. No. 4,196,713**

SHIFRIN, SHARI (UNITED STATES INDIVIDUAL)  
9150 NALLE GRADE RD  
FT. MYERS, FL 33917

**Registered Aug. 28, 2012**

**Int. Cl.: 35**

FOR: PROMOTING THE GOODS AND SERVICES OF OTHERS BY DISTRIBUTING FLYERS, PROVIDING A COMMUNITY DRIVEN WEBSITE AND PROVIDING HYPERLINKS TO WEBSITES OF OTHERS IN THE FIELD OF EVENTS, MAGAZINES AND T-SHIRTS RELATING TO CARS AND MOTORCYCLES, IN CLASS 35 (U.S. CLS. 100, 101 AND 102).

**SERVICE MARK**

**PRINCIPAL REGISTER**

FIRST USE 6-1-2010; IN COMMERCE 6-1-2010.

NO CLAIM IS MADE TO THE EXCLUSIVE RIGHT TO USE "FLORIDA HOT RODS & HOGS", APART FROM THE MARK AS SHOWN.

THE COLOR(S) RED, BLACK, SILVER IS/ARE CLAIMED AS A FEATURE OF THE MARK.

THE MARK CONSISTS OF A RED OVAL OUTLINED IN SILVER, WITH THE WORD "FLORIDA" IN BLACK AND THE WORDS "HOT RODS & HOGS" IN SILVER OUTLINED IN BLACK.

SER. NO. 85-257,996, FILED 3-4-2011.

PAUL MORENO, EXAMINING ATTORNEY



*David J. Kyros*

Director of the United States Patent and Trademark Office

# United States of America

United States Patent and Trademark Office

## BROWNBOMBERMMA

**Reg. No. 4,196,714**

GOLDEN, JAMES (UNITED STATES INDIVIDUAL)  
10 INDUSTRIAL DRIVE  
WINDHAM, NH 03087

**Registered Aug. 28, 2012**

**Int. Cl.: 25**

FOR: MARKETING MATERIALS, NAMELY, T-SHIRTS, SPORT SHIRTS, DRESS SHIRTS, PULLOVERS, BOXER SHORTS, SWEATSHIRTS, JERSEYS, SHORTS, SWEAT PANTS, JACKETS, GLOVES, NECKTIES, PAJAMAS, ROBES, NIGHT SHIRTS UNDERWEAR, HEAD BANDS, WRIST BANDS, SWIMSUITS, SHIRTS, TANK TOPS, PANTS, COATS, SWEATERS, SOCKS, BELTS, RAIN WEAR, FOOTWEAR AND HEAD WEAR, IN CLASS 25 (U.S. CLS. 22 AND 39).

**TRADEMARK**

**PRINCIPAL REGISTER**

FIRST USE 1-28-2011; IN COMMERCE 1-28-2011.

THE MARK CONSISTS OF STANDARD CHARACTERS WITHOUT CLAIM TO ANY PARTICULAR FONT, STYLE, SIZE, OR COLOR.

SER. NO. 85-259,754, FILED 3-7-2011.

KEVIN CORWIN, EXAMINING ATTORNEY



*David J. Kyffers*

Director of the United States Patent and Trademark Office

# United States of America

United States Patent and Trademark Office

# LIGHTBOX

**Reg. No. 4,196,715**

**Registered Aug. 28, 2012**

**Int. Cl.: 9**

**TRADEMARK**

**PRINCIPAL REGISTER**

T2 LABS, INC. (DELAWARE CORPORATION)  
2711 CENTERVILLE ROAD, SUITE 400  
WILMINGTON, DE 19808

FOR: COMPUTER SOFTWARE APPLICATIONS FOR MOBILE PHONES, INCLUDING SMART PHONES, TELEVISIONS, TABLET DEVICES AND OTHER WIRELESS DEVICES FOR MANAGING AND SHARING PHOTOS; COMPUTER APPLICATIONS FOR ENABLING MOBILE CHATTING; COMPUTER APPLICATIONS FOR ACCESSING MOBILE NEWS; COMPUTER SOFTWARE FOR MANAGING AND SHARING PHOTOS; WEBSITES FEATURING DOWNLOADABLE SOFTWARE FOR MANAGING AND SHARING PHOTOS; ALL THE AFORESAID SOFTWARE ITEMS INCLUDING SOFTWARE WHICH IS DOWNLOADABLE, IN CLASS 9 (U.S. CLS. 21, 23, 26, 36 AND 38).

THE MARK CONSISTS OF STANDARD CHARACTERS WITHOUT CLAIM TO ANY PARTICULAR FONT, STYLE, SIZE, OR COLOR.

PRIORITY CLAIMED UNDER SEC. 44(D) ON ERPN CMNTY TM OFC APPLICATION NO. 009728536, FILED 2-10-2011, REG. NO. 009728536, DATED 9-29-2011, EXPIRES 2-10-2021.

OWNER OF U.S. REG. NO. 2,870,252.

SER. NO. 85-260,336, FILED 3-7-2011.

CAROLINE WOOD, EXAMINING ATTORNEY



*David J. Kyros*

Director of the United States Patent and Trademark Office

# United States of America

United States Patent and Trademark Office

# CITYSTREAM

**Reg. No. 4,196,716**

**Registered Aug. 28, 2012**

**Int. Cls.: 41 and 42**

**SERVICE MARK**

**PRINCIPAL REGISTER**

OPALMINE PUBLISHING (WASHINGTON CORPORATION)  
926 N ST NW RER, STE 3  
WASHINGTON, WA 20001

FOR: PROVIDING AN INTERNET WEBSITE PORTAL FEATURING LINKS TO ENTERTAINMENT EVENTS AROUND SPECIFIC GEOGRAPHIC AREAS, IN CLASS 41 (U.S. CLS. 100, 101 AND 107).

FIRST USE 4-30-2010; IN COMMERCE 7-30-2010.

FOR: CREATING AN ON-LINE COMMUNITY FOR REGISTERED USERS TO PARTICIPATE IN DISCUSSIONS, GET FEEDBACK FROM THEIR PEERS, FORM VIRTUAL COMMUNITIES, AND ENGAGE IN SOCIAL NETWORKING SERVICES IN THE FIELDS OF DINING, DATING AND DANCING, IN CLASS 42 (U.S. CLS. 100 AND 101).

FIRST USE 4-30-2010; IN COMMERCE 7-30-2010.

THE MARK CONSISTS OF STANDARD CHARACTERS WITHOUT CLAIM TO ANY PARTICULAR FONT, STYLE, SIZE, OR COLOR.

SER. NO. 85-263,411, FILED 3-10-2011.

FRED CARL, EXAMINING ATTORNEY



*David J. Kyros*

Director of the United States Patent and Trademark Office

# United States of America

United States Patent and Trademark Office

# KORK

**Reg. No. 4,196,717**

O2, LLC (MINNESOTA LIMITED LIABILITY COMPANY)  
18114 IRONSTONE WAY  
LAKEVILLE, MN 550445014

**Registered Aug. 28, 2012**

**Int. Cl.: 9**

FOR: GOGGLES FOR SPORTS; SKI GOGGLES; SNOW GOGGLES; SPORT GOGGLES FOR USE IN SNOWBOARDING, IN CLASS 9 (U.S. CLS. 21, 23, 26, 36 AND 38).

**TRADEMARK**

FIRST USE 2-4-2011; IN COMMERCE 2-4-2011.

**PRINCIPAL REGISTER**

THE MARK CONSISTS OF STANDARD CHARACTERS WITHOUT CLAIM TO ANY PARTICULAR FONT, STYLE, SIZE, OR COLOR.

SER. NO. 85-264,227, FILED 3-11-2011.

TINA BROWN, EXAMINING ATTORNEY



*David J. Kyffers*

Director of the United States Patent and Trademark Office



# United States of America

United States Patent and Trademark Office



**WALL STREET**  
**ALLIANCE GROUP**

**Reg. No. 4,196,718**

**Registered Aug. 28, 2012**

**Int. Cl.: 36**

**SERVICE MARK**

**PRINCIPAL REGISTER**

WALL STREET ALLIANCE GROUP (NEW YORK LIMITED LIABILITY COMPANY)  
WALL STREET ALLIANCE GROUP  
130 WILLIAM STREET 5TH FLOOR  
NEW YORK, NY 10038 AND

WALL STREET ALLIANCE GROUP (NEW YORK LIMITED LIABILITY COMPANY)  
WALL STREET ALLIANCE GROUP  
130 WILLIAM ST 5TH FLOOR  
NEW YORK, NY 10038

FOR: FINANCIAL INVESTMENT IN THE FIELD OF SECURITIES, LIFE INSURANCE; FINANCIAL PLANNING AND INVESTMENT ADVISORY SERVICES; FINANCIAL PLANNING CONSULTATION; FINANCIAL PLANNING FOR RETIREMENT; FINANCIAL PORTFOLIO ANALYSIS SERVICES; FINANCIAL PORTFOLIO MANAGEMENT, IN CLASS 36 (U.S. CLS. 100, 101 AND 102).

FIRST USE 3-11-2011; IN COMMERCE 3-11-2011.

NO CLAIM IS MADE TO THE EXCLUSIVE RIGHT TO USE "WALL STREET ALLIANCE GROUP", APART FROM THE MARK AS SHOWN.

THE COLOR(S) BLACK, WHITE, AND BLUE IS/ARE CLAIMED AS A FEATURE OF THE MARK.

THE MARK CONSISTS OF THE DESIGN OF TWO CLASPED SHAKING HANDS APPEARING OVER THE DESIGN OF A BORDER COMPRISED OF THREE CONCENTRIC CIRCLES WITH THE HANDS AND THE SECOND CIRCLE AND HANDS DESIGN IN WHITE OUTLINING AND THE INNER AND OUTER CIRCLES IN BLUE TO THE LEFT OF THE STYLIZED WORDING "WALL STREET" IN BLUE LETTERING OVER THE STYLIZED WORDING "ALLIANCE GROUP" IN BLACK LETTERING.

SER. NO. 85-265,315, FILED 3-12-2011.

AMY C. KEAN, EXAMINING ATTORNEY



*David J. Kappas*

Director of the United States Patent and Trademark Office

# United States of America

United States Patent and Trademark Office



**Reg. No. 4,196,719**

**Registered Aug. 28, 2012**

**Int. Cl.: 42**

**SERVICE MARK**

**PRINCIPAL REGISTER**

B&R BUSINESS SOLUTIONS, LLC (NEW JERSEY LIMITED LIABILITY COMPANY)  
SUITE 128  
315 ROUTE 34  
COLTS NECK, NJ 07722

FOR: INFORMATION TECHNOLOGY TECHNICAL CONSULTATION SERVICES IN THE FIELD OF BUSINESS APPLICATION SOFTWARE IMPLEMENTATION; INFORMATION TECHNOLOGY TECHNICAL CONSULTATION SERVICES IN THE FIELD OF WEB PUBLISHING, NAMELY, IN THE FIELD OF CREATING AND MAINTAINING A WEBSITE AND UPLOADING IT ONTO AN INTERNET SERVER, IN CLASS 42 (U.S. CLS. 100 AND 101).

FIRST USE 6-0-2002; IN COMMERCE 6-0-2002.

NO CLAIM IS MADE TO THE EXCLUSIVE RIGHT TO USE "BUSINESS SOLUTIONS", APART FROM THE MARK AS SHOWN.

THE MARK CONSISTS OF A DESIGN COMPRISING A "B" ON TOP OF AND INTERTWINED WITH AN "R" WITHIN A RECTANGLE. TO THE RIGHT OF THE DESIGN ARE THE BOLDED, UNDERLINED WORDS, "B&R BUSINESS," WHICH ARE STACKED ON TOP OF THE UNDERLINED WORD "SOLUTIONS".

SER. NO. 85-265,572, FILED 3-13-2011.

MEGHAN REINHART, EXAMINING ATTORNEY



*David J. Kybas*

Director of the United States Patent and Trademark Office

# United States of America

United States Patent and Trademark Office

## B&R BUSINESS SOLUTIONS

**Reg. No. 4,196,720**

**Registered Aug. 28, 2012**

**Int. Cl.: 42**

**SERVICE MARK**

**PRINCIPAL REGISTER**

B&R BUSINESS SOLUTIONS, LLC (NEW JERSEY LIMITED LIABILITY COMPANY)  
SUITE 128  
315 ROUTE 34  
COLTS NECK, NJ 07722

FOR: INFORMATION TECHNOLOGY TECHNICAL CONSULTATION SERVICES IN THE FIELD OF BUSINESS APPLICATION SOFTWARE IMPLEMENTATION; INFORMATION TECHNOLOGY TECHNICAL CONSULTATION SERVICES IN THE FIELD OF WEB PUBLISHING, NAMELY, IN THE FIELD OF CREATING AND MAINTAINING A WEBSITE AND UPLOADING IT ONTO AN INTERNET SERVER, IN CLASS 42 (U.S. CLS. 100 AND 101).

FIRST USE 6-0-2002; IN COMMERCE 6-0-2002.

THE MARK CONSISTS OF STANDARD CHARACTERS WITHOUT CLAIM TO ANY PARTICULAR FONT, STYLE, SIZE, OR COLOR.

NO CLAIM IS MADE TO THE EXCLUSIVE RIGHT TO USE "BUSINESS SOLUTIONS", APART FROM THE MARK AS SHOWN.

SER. NO. 85-265,576, FILED 3-13-2011.

MEGHAN REINHART, EXAMINING ATTORNEY



*David J. Kybas*

Director of the United States Patent and Trademark Office

# United States of America

United States Patent and Trademark Office

# ICON

**Reg. No. 4,196,721**

**Registered Aug. 28, 2012**

**Int. Cls.: 9 and 18**

**TRADEMARK**

**PRINCIPAL REGISTER**

MITZI INTERNATIONAL HANDBAGS & ACCESSORIES LTD. (NEW YORK CORPORATION)  
250 PASSAIC STREET  
NEWARK, NJ 07104

FOR: NOTEBOOK COMPUTER CARRYING CASES; NETBOOK COMPUTER CARRYING CASES; CAMERA CASES; PORTABLE DVD PLAYER CASES; AUDIO CD STORAGE WALLETS; DVD STORAGE WALLETS; GPS NAVIGATION DEVICE CASES; CASES FOR HANDHELD MOBILE DEVICES, NAMELY, CASES FOR CELL PHONES, SMART PHONES, COMPUTERS, TABLETS; CASES FOR WIRELESS DEVICES, NAMELY, CASES FOR CELL PHONES, SMART PHONES, COMPUTERS, TABLETS; CELL PHONE CASES; MP3 PLAYER CASES; TABLET COMPUTER CARRYING CASES; MEMORY CARD STORAGE WALLETS; WEBCAMS; USB, PRINTER, DIGITAL MEDIA AND SPEAKER HUBS; AUDIO HEADPHONES FOR COMPUTERS; CAMERA LENSES; LENS FILTERS; CHIP, ELECTRONIC, SD AND FLASH CARD READERS; CAMERA TRIPODS; DISPLAY PROTECTOR TO PROVIDE SHADE AND PRIVACY FOR ELECTRONIC DEVICES HAVING SCREENS; AUDIO HEADPHONES; EAR BUDS, IN CLASS 9 (U.S. CLS. 21, 23, 26, 36 AND 38).

FIRST USE 1-8-2002; IN COMMERCE 1-13-2002.

FOR: SHOULDER STRAPS, IN CLASS 18 (U.S. CLS. 1, 2, 3, 22 AND 41).

FIRST USE 1-21-2003; IN COMMERCE 1-21-2003.

THE MARK CONSISTS OF STANDARD CHARACTERS WITHOUT CLAIM TO ANY PARTICULAR FONT, STYLE, SIZE, OR COLOR.

OWNER OF U.S. REG. NO. 2,427,330.

SER. NO. 85-267,561, FILED 3-15-2011.

ANNE FARRELL, EXAMINING ATTORNEY



*David J. Kybas*

Director of the United States Patent and Trademark Office

# United States of America

United States Patent and Trademark Office

# INFOSCOPE

**Reg. No. 4,196,722**

**Registered Aug. 28, 2012**

**Int. Cls.: 9 and 42**

**TRADEMARK**

**SERVICE MARK**

**PRINCIPAL REGISTER**

INFOTEL S.A. (FRANCE SOCIÉTÉ ANONYME (SA))  
TOUR GALLIENI II  
36 AVENUE DU GENERAL DE GAULLE  
BAGNOLET, FRANCE 93175

FOR: COMPUTER SOFTWARE FOR AUTOMATICALLY MONITORING THE QUALITY AND PERFORMANCE OF SQL INQUIRIES AND FOR OPTIMIZING DATABASE OPERATION; COMPUTER SOFTWARE FOR SUPPLYING DETAILED ANALYSIS REPORTS AND RECOMMENDATIONS FOR OPTIMIZING SQL QUERIES AND DATABASE ACCESS POINTS AND FOR ANTICIPATING FUTURE DATA VOLUMES, IN CLASS 9 (U.S. CLS. 21, 23, 26, 36 AND 38).

FOR: DESIGN AND DEVELOPMENT FOR OTHERS OF COMPUTER SOFTWARE DESIGNED FOR ENSURING QUALITY AND CURRENT AND FUTURE PERFORMANCE; DESIGNING AND OPTIMIZING DATABASE OPERATIONS; CONVERSION OF DATA OR DOCUMENTS FROM A PHYSICAL STORAGE MEDIA TO AN ELECTRONIC MEDIA; SOFTWARE QUALITY CONTROL FOR OTHERS, IN CLASS 42 (U.S. CLS. 100 AND 101).

THE MARK CONSISTS OF STANDARD CHARACTERS WITHOUT CLAIM TO ANY PARTICULAR FONT, STYLE, SIZE, OR COLOR.

PRIORITY CLAIMED UNDER SEC. 44(D) ON ERPN CMNTY TM OFC APPLICATION NO. 009385147, FILED 9-20-2010, REG. NO. 009385147, DATED 4-1-2011, EXPIRES 4-1-2021.

SER. NO. 85-269,518, FILED 3-17-2011.

LOURDES AYALA, EXAMINING ATTORNEY



*David J. Kyros*

Director of the United States Patent and Trademark Office

# United States of America

United States Patent and Trademark Office

# Evangela

**Reg. No. 4,196,723**

**Registered Aug. 28, 2012**

**Int. Cl.: 42**

**SERVICE MARK**

**PRINCIPAL REGISTER**

BESHARPCREATIVE (GEORGIA LIMITED LIABILITY COMPANY), DBA  
CHURCHGRAPHICS.ORG  
6839 LOCKRIDGE DR.  
ATLANTA, GA 30360

FOR: COMPUTER AIDED GRAPHIC DESIGN, IN CLASS 42 (U.S. CLS. 100 AND 101).

FIRST USE 1-1-2011; IN COMMERCE 3-1-2011.

THE MARK CONSISTS OF STANDARD CHARACTERS WITHOUT CLAIM TO ANY PARTICULAR FONT, STYLE, SIZE, OR COLOR.

SER. NO. 85-269,873, FILED 3-17-2011.

GRETCHEN ULRICH, EXAMINING ATTORNEY



*David J. Kyffers*

Director of the United States Patent and Trademark Office

# United States of America

United States Patent and Trademark Office

# SOFIEZ

**Reg. No. 4,196,724**

**Registered Aug. 28, 2012**

**Int. Cl.: 24**

**TRADEMARK**

**PRINCIPAL REGISTER**

NISSAN JIDOSHA KABUSHIKI KAISHA (JAPAN CORPORATION), TA NISSAN MOTOR CO., LTD.  
NO. 2 TAKARACHO, KANAGAWA-KU  
YOKOHAMA-SHI, KANAGAWA, JAPAN 2208623

FOR: WOVEN FABRICS; OILCLOTHS; GUMMED WATERPROOF CLOTHS; VINYL COATED CLOTHS FOR USE IN THE MANUFACTURE OF APPAREL, FOOTWEAR, ACCESSORIES, LUGGAGE, AUTOMOTIVE PARTS, FURNITURE; RUBBERIZED CLOTHS; LEATHER CLOTHS; PERSONAL ARTICLES OF WOVEN TEXTILE, NAMELY, TOWELS AND HANDKERCHIEFS; MOSQUITO NETS; BED SHEETS; QUILTS FOR BEDS, QUILTS FOR SOFA; FUTON AND QUILT CASES, NAMELY, UNFITTED FUTON COVERS NOT OF PAPER; FUTON TICKS, NAMELY, UNSTUFFED FUTON COVERS NOT OF PAPER; PILLOWCASES; BLANKETS FOR BEDS, BLANKETS FOR SOFA, BLANKETS AS RUG, LAP BLANKETS AND OUTDOOR BLANKETS; TABLE NAPKINS OF TEXTILE; DISH CLOTHS; UNFITTED SEAT COVERS OF TEXTILE; WALL HANGINGS OF TEXTILE; CURTAINS; TABLE CLOTHS OF TEXTILES, NOT OF PAPER; DRAPERIES; LABELS OF CLOTH, IN CLASS 24 (U.S. CLS. 42 AND 50).

THE MARK CONSISTS OF STANDARD CHARACTERS WITHOUT CLAIM TO ANY PARTICULAR FONT, STYLE, SIZE, OR COLOR.

OWNER OF JAPAN REG. NO. 5432667, DATED 8-19-2011, EXPIRES 8-19-2021.

SER. NO. 85-269,903, FILED 3-17-2011.

BRIDGETT SMITH, EXAMINING ATTORNEY



*David J. Kyros*

Director of the United States Patent and Trademark Office

# United States of America

United States Patent and Trademark Office

**DEE**  
**Decor Experts Expo**

**Reg. No. 4,196,725**

**Registered Aug. 28, 2012**

**Int. Cls.: 19 and 35**

**TRADEMARK**

**SERVICE MARK**

**PRINCIPAL REGISTER**

3022528 CANADA INC. (CANADA CORPORATION)  
778 PLACE TRANS-CANADA  
LONGUEUIL, QUEBEC, CANADA J4G1P1

FOR: EXHIBITION STANDS AND BOOTHS FOR TRADE SHOWS AND EVENTS NOT MADE PRIMARILY OF METAL, NAMELY, PORTABLE TRADE SHOW DISPLAY BOOTH NOT MADE PRIMARILY OF METAL, NON-METAL WALL-MOUNTED PANEL UNITS FOR EXHIBITIONS, DISPLAYS AND PARTITIONING, NON-METAL VENDOR BOOTHS, IN CLASS 19 (U.S. CLS. 1, 12, 33 AND 50).

FOR: RENTAL OF EXHIBITION STANDS AND BOOTHS FOR TRADE SHOWS AND EVENTS, IN CLASS 35 (U.S. CLS. 100, 101 AND 102).

PRIORITY CLAIMED UNDER SEC. 44(D) ON CANADA APPLICATION NO. 85270563, FILED 3-2-2011, REG. NO. TMA819,527, DATED 3-8-2012, EXPIRES 3-8-2027.

NO CLAIM IS MADE TO THE EXCLUSIVE RIGHT TO USE "DECOR EXPERTS EXPO", APART FROM THE MARK AS SHOWN.

THE MARK CONSISTS OF THE STYLIZED LETTERS "DEE" APPEARING ABOVE THE STYLIZED WORDING "DECOR EXPERTS EXPO" WITH A LINE UNDER THE WORDING "DECOR EXPERTS EXPO".

SER. NO. 85-270,563, FILED 3-18-2011.

MICHAEL TANNER, EXAMINING ATTORNEY



*David J. Kybas*

Director of the United States Patent and Trademark Office



# United States of America

United States Patent and Trademark Office

# HOMIES

**Reg. No. 4,196,726**

HOMIESHOP, LLC (DELAWARE LIMITED LIABILITY COMPANY)  
1511 M SYCAMORE AVE #120  
HERCULES, CA 94547

**Registered Aug. 28, 2012**

**Int. Cl.: 16**

FOR: GREETING CARDS; HOLIDAY CARDS; PAPER FOLDERS; PAPER NOTEBOOKS; POSTERS; POSTERS MADE OF PAPER; PRE-PAID TELEPHONE CALLING CARDS, NOT MAGNETICALLY ENCODED; SPIRAL-BOUND NOTEBOOKS; STATIONERY FOLDERS; STICKERS, IN CLASS 16 (U.S. CLS. 2, 5, 22, 23, 29, 37, 38 AND 50).

**TRADEMARK**

**PRINCIPAL REGISTER**

FIRST USE 3-1-1996; IN COMMERCE 3-1-1996.

THE MARK CONSISTS OF STANDARD CHARACTERS WITHOUT CLAIM TO ANY PARTICULAR FONT, STYLE, SIZE, OR COLOR.

OWNER OF U.S. REG. NOS. 1,965,095, 3,698,956 AND OTHERS.

SER. NO. 85-271,440, FILED 3-19-2011.

ALAIN LAPTER, EXAMINING ATTORNEY



*David J. Kyffers*

Director of the United States Patent and Trademark Office

# United States of America

United States Patent and Trademark Office



**Reg. No. 4,196,727**

**Registered Aug. 28, 2012**

**Int. Cl.: 30**

**TRADEMARK**

**PRINCIPAL REGISTER**

CANDY'S SWEETS & TREATS, LLC (FLORIDA LIMITED LIABILITY COMPANY)  
129 NW 13TH STREET, SUITE D-19  
BOCA RATON, FL 33432

FOR: BAKERY DESSERTS, IN CLASS 30 (U.S. CL. 46).

FIRST USE 12-1-2010; IN COMMERCE 12-10-2010.

NO CLAIM IS MADE TO THE EXCLUSIVE RIGHT TO USE "CAKE POPS", APART FROM THE MARK AS SHOWN.

THE COLOR(S) PINK, GREEN AND BLACK IS/ARE CLAIMED AS A FEATURE OF THE MARK.

THE MARK CONSISTS OF A PINK AND GREEN POLKA DOT DESIGN ABOVE THE WORD "CANDY'S", APPEARING IN A STYLIZED BLACK SCRIPT ABOVE THE PHRASE "CAKE POPS", WHICH ALSO APPEARS IN PINK.

SER. NO. 85-272,000, FILED 3-21-2011.

WENDY JUN, EXAMINING ATTORNEY



*David J. Kyffers*

Director of the United States Patent and Trademark Office

# United States of America

United States Patent and Trademark Office



**Reg. No. 4,196,728**

**Registered Aug. 28, 2012**

**Int. Cl.: 41**

**SERVICE MARK**

**PRINCIPAL REGISTER**

JOSEPH A GIANNUNZIO JR (FLORIDA LIMITED LIABILITY COMPANY), DBA ELECTRIC BEACH PARTY, LLC  
345 OCEAN DRIVE APT. 816  
MIAMI BEACH, FL 33139

FOR: ORGANIZING COMMUNITY FESTIVALS FEATURING PRIMARILY PROVIDING LIVE ENTERTAINMENT AND ALSO PROVIDING PARTY PRODUCTIONS , IN CLASS 41 (U.S. CLS. 100, 101 AND 107).

FIRST USE 1-22-2011; IN COMMERCE 1-22-2011.

NO CLAIM IS MADE TO THE EXCLUSIVE RIGHT TO USE "BEACH PARTY", APART FROM THE MARK AS SHOWN.

THE COLOR(S) YELLOW, BLACK, AND LIGHT BLUE IS/ARE CLAIMED AS A FEATURE OF THE MARK.

THE MARK CONSISTS OF THE LITERAL ELEMENT OF THE MARK IS REPRESENTING AN ENTERTAINMENT EVENT/PARTY THAT HAS A PRIMARY LOCATION IN MIAMI BEACH AND WILL BE AN EVENT THAT ALSO TRAVELS THROUGH THE U.S. AND INTERNATIONALLY, THE LETTERS OF "ELECTRIC BEACH PARTY" ARE A YELLOW COLOR WITH A BLACK OUTLINE AND THE BACKGROUND IS A LIGHT BLUE SWIMMING POOL WATER COLOR/DESIGN.

SER. NO. 85-273,374, FILED S.R. 3-22-2011 AM. P.R. 11-12-2011.

C. DIONNE CLYBURN, EXAMINING ATTORNEY



*David J. Kybas*

Director of the United States Patent and Trademark Office

# United States of America

United States Patent and Trademark Office



CRUSADE AGAINST  
EQUINE COLIC

**Reg. No. 4,196,729**

FREEDOM HEALTH, LLC (DELAWARE LIMITED LIABILITY COMPANY)  
65 AURORA INDUSTRIAL PARKWAY  
AURORA, OH 44202

**Registered Aug. 28, 2012**

**Int. Cls.: 35 and 44**

FOR: PROMOTING PUBLIC AWARENESS OF THE ISSUE OF EQUINE COLIC THAT IS TARGETED TO HORSE OWNERS, RIDERS AND PROFESSIONALS, IN CLASS 35 (U.S. CLS. 100, 101 AND 102).

**SERVICE MARK**

FIRST USE 3-11-2011; IN COMMERCE 3-11-2011.

**PRINCIPAL REGISTER**

FOR: PROVIDING ONLINE INFORMATION FOR HORSE OWNERS, RIDERS AND PROFESSIONALS IN THE FIELD OF EQUINE HEALTH, NAMELY, EQUINE COLIC; PROVIDING A WEBSITE FEATURING EDUCATIONAL INFORMATION IN THE FIELD OF EQUINE COLIC TARGETED AT HORSE OWNERS, RIDERS AND PROFESSIONALS, IN CLASS 44 (U.S. CLS. 100 AND 101).

FIRST USE 3-11-2011; IN COMMERCE 3-11-2011.

NO CLAIM IS MADE TO THE EXCLUSIVE RIGHT TO USE "EQUINE COLIC" , APART FROM THE MARK AS SHOWN.

THE MARK CONSISTS OF THE CAPITAL LETTER WORDS "CRUSADE AGAINST" ON THE FIRST LINE; THE CAPITAL LETTER WORDS "EQUINE COLIC" ON THE SECOND LINE, WITH A HORSE AND HUMAN FORM DESIGN DIRECTLY TO THE LEFT FEATURING A HEART DESIGN IN BETWEEN THE TWO.

SER. NO. 85-274,900, FILED 3-23-2011.

ANTHONY RINKER, EXAMINING ATTORNEY



*David J. Kybas*

Director of the United States Patent and Trademark Office

# United States of America

United States Patent and Trademark Office

# ENDURO

**Reg. No. 4,196,730**

ENDURO COMPOSITES, INC. (DELAWARE CORPORATION)  
16602 CENTRAL GREEN BOULEVARD  
HOUSTON, TX 77032

**Registered Aug. 28, 2012**

**Int. Cls.: 6, 17, 19, 20, 37,  
40 and 42**

FOR: METAL BUILDING MATERIALS, NAMELY, STAINLESS STEEL SPLICE PLATES AND CONNECTOR PLATES; STAINLESS STEEL CABLE TRAY FASTENERS USED IN BUILDING CONSTRUCTION; METAL CLAMPS, IN CLASS 6 (U.S. CLS. 2, 12, 13, 14, 23, 25 AND 50).

**TRADEMARK**

FIRST USE 1-0-1996; IN COMMERCE 1-0-1996.

**SERVICE MARK**

FOR: FLEXIBLE PLASTIC AND REINFORCED FIBERGLASS PIPES, AND FITTINGS THEREFOR, NAMELY, LININGS AND DUCTS, ALL FOR HANDLING CORROSIVE LIQUIDS AND GASES, IN CLASS 17 (U.S. CLS. 1, 5, 12, 13, 35 AND 50).

**PRINCIPAL REGISTER**

FIRST USE 1-0-1996; IN COMMERCE 1-0-1996.

FOR: NON-METAL BUILDING CONSTRUCTION MATERIALS USED IN CONNECTION WITH CABLE TRAYS, NAMELY, NONMETAL CABLE TRAYS, ELECTRICAL INSTRUMENT TRAYS IN THE NATURE OF CABLE TRAYS, ELECTRICAL INSTRUMENT STANDS IN THE NATURE OF NON-METAL POSTS, WIREWAYS IN THE NATURE OF CABLE TRAYS, STRUT/CHANNEL FRAMES, SPLICE PLATES, CONNECTOR PLATES, WINDOW CLAMPS, SWIVEL CLAMPS, CLEVIS HANGERS, SUPPORT RACKS, POST BASES, THREADED RODS, CABLE TRAY SPLICE PLATES, COVERS, DIVIDER STRIPS, DROPOUTS, BLIND ENDS, ADAPTERS BEING CONNECTORS, HOLD-DOWN CLIPS, MARINE RUNGS, STRUT RUNGS, SWIVEL CLAMPS, AND CABLE TRAY FASTENERS, USED IN BUILDING CONSTRUCTION; NONMETAL THIRD RAIL COVER BOARDS; NON-METAL RIGID PIPES, PIPE FITTINGS, PIPE LININGS, AND PIPE DUCTING MADE OF PLASTICS, FIBERGLASS, AND LAMINATES; RIGID PLASTIC AND REINFORCED FIBERGLASS PIPES, AND PLASTIC AND REINFORCED FITTINGS THEREFOR, NAMELY, LININGS AND DUCTS, ALL FOR HANDLING CORROSIVE LIQUIDS AND GASES, IN CLASS 19 (U.S. CLS. 1, 12, 33 AND 50).



*David J. Kappas*

Director of the United States Patent and Trademark Office

FIRST USE 1-0-1996; IN COMMERCE 1-0-1996.

FOR: NON-METAL CLAMPS, NON-METAL PIPE CLAMPS; NON-METAL FLUID STORAGE TANKS; NON-METAL STORAGE TANK COVERS FOR COMMERCIAL, INDUSTRIAL,

**Reg. No. 4,196,730** WATER AND WASTEWATER APPLICATIONS, IN CLASS 20 (U.S. CLS. 2, 13, 22, 25, 32 AND 50).

FIRST USE 1-0-1996; IN COMMERCE 1-0-1996.

FOR: BUILDING CONSTRUCTION AND REPAIR; BUILDING, INSTALLATION, MAINTENANCE AND REPAIR SERVICES RELATED TO PLASTIC PRODUCTS, FIBERGLASS PRODUCTS, THERMOPLASTIC PRODUCTS, AND CONCRETE PRODUCTS AND DESIGNS IN THE FIELD OF BUILDING CONSTRUCTION; BUILDING INSPECTION; APPLICATION OF CONCRETE COATINGS FOR BEAUTIFICATION PURPOSES; CONCRETE COATING AND REPAIR SERVICES IN THE FIELD OF BUILDING CONSTRUCTION; CONCRETE POURING AND FORMING FOR BUILDINGS AND OTHER COMMERCIAL OR PUBLIC CONCRETE STRUCTURES; PLANT CONSTRUCTION, MAINTENANCE AND REPAIR SERVICES FOR THE CHEMICAL, OIL, GAS, FOOD PROCESSING, MINING, METAL PROCESSING, OFFSHORE EXPLORATION, PULP, PAPER, WATER, AND WASTEWATER INDUSTRIES, IN CLASS 37 (U.S. CLS. 100, 103 AND 106).

FIRST USE 1-0-1996; IN COMMERCE 1-0-1996.

FOR: CUSTOM FABRICATION AND CUSTOM MANUFACTURE OF NONMETAL BUILDING MATERIALS IN THE NATURE OF FIBERGLASS PRODUCTS AND MATERIALS AND FIBER REINFORCED PLASTIC PRODUCTS, IN CLASS 40 (U.S. CLS. 100, 103 AND 106).

FIRST USE 1-0-1996; IN COMMERCE 1-0-1996.

FOR: ENGINEERING, AND DESIGN SERVICES FOR COMMERCIAL AND INDUSTRIAL BUILDINGS, FIBERGLASS PRODUCTS AND MATERIALS, NONMETAL BUILDING MATERIALS, AND FIBER REINFORCED PLASTIC PRODUCTS, IN THE FIELD OF CONSTRUCTION MATERIALS, IN CLASS 42 (U.S. CLS. 100 AND 101).

FIRST USE 1-0-1996; IN COMMERCE 1-0-1996.

THE MARK CONSISTS OF STANDARD CHARACTERS WITHOUT CLAIM TO ANY PARTICULAR FONT, STYLE, SIZE, OR COLOR.

SER. NO. 85-275,111, FILED 3-23-2011.

APRIL HESIK, EXAMINING ATTORNEY

# United States of America

United States Patent and Trademark Office

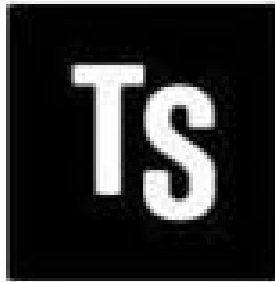

**Reg. No. 4,196,731**

THESTREET.COM, INC. (DELAWARE CORPORATION)  
14 WALL STREET, 14TH FLOOR  
NEW YORK, NY 10005

**Registered Aug. 28, 2012**

**Int. Cls.: 9, 35, 36, 41  
and 45**

FOR: DOWNLOADABLE VIDEOS AND PUBLICATIONS IN THE NATURE OF POLL REPORTS AND ARTICLES FROM WIKIS IN THE FIELD OF FINANCE; DOWNLOADABLE, ELECTRONIC SYNDICATED NEWSPAPER COLUMNS IN THE FIELDS OF FINANCIAL AND ECONOMIC NEWS; DOWNLOADABLE, ELECTRONIC SYNDICATED ARTICLES IN THE FIELD OF FINANCE; DOWNLOADABLE PUBLICATIONS IN THE NATURE OF FINANCIAL ARTICLES VIA A GLOBAL COMPUTER NETWORK, IN CLASS 9 (U.S. CLS. 21, 23, 26, 36 AND 38).

**TRADEMARK**

**SERVICE MARK**

**PRINCIPAL REGISTER**

FIRST USE 1-27-2011; IN COMMERCE 1-27-2011.

FOR: PROVIDING INFORMATION IN THE FIELDS OF ECONOMIC ANALYSIS AND ECONOMIC FORECASTING, IN CLASS 35 (U.S. CLS. 100, 101 AND 102).

FIRST USE 1-27-2011; IN COMMERCE 1-27-2011.

FOR: PROVIDING FINANCIAL INFORMATION, FINANCIAL NEWS, FINANCIAL COMMENTARY, FINANCIAL ANALYSIS, FINANCIAL ADVICE, AND INVESTMENT CLUB SERVICES VIA A GLOBAL COMPUTER NETWORK; PROVIDING A WEBSITE FEATURING NON-DOWNLOADABLE VIDEOS, POLLS, AND WIKIS IN THE FIELD OF FINANCE; PROVIDING INFORMATION IN THE FIELDS OF FINANCIAL MARKETS, AND FINANCIAL INVESTMENTS, IN CLASS 36 (U.S. CLS. 100, 101 AND 102).

FIRST USE 1-26-2011; IN COMMERCE 1-26-2011.

FOR: PROVIDING ONLINE, NON-DOWNLOADABLE, SYNDICATED ARTICLES IN THE FIELD OF FINANCE VIA A GLOBAL COMPUTER NETWORK; PROVIDING ONLINE, NON-DOWNLOADABLE PUBLICATIONS IN THE NATURE OF FINANCIAL ARTICLES VIA A GLOBAL COMPUTER NETWORK, IN CLASS 41 (U.S. CLS. 100, 101 AND 107).

FIRST USE 1-27-2011; IN COMMERCE 1-27-2011.

FOR: ONLINE SOCIAL NETWORKING SERVICES FOR SHARING FINANCIAL INFORMATION AND INVESTMENT STRATEGIES, IN CLASS 45 (U.S. CLS. 100 AND 101).



*David J. Kyjars*

Director of the United States Patent and Trademark Office

**Reg. No. 4,196,731** FIRST USE 1-26-2011; IN COMMERCE 1-26-2011.

THE MARK CONSISTS OF THE LETTERS "TS" INSIDE A SQUARE.

SER. NO. 85-277,557, FILED 3-25-2011.

KHANH LE, EXAMINING ATTORNEY



# United States of America

United States Patent and Trademark Office

## Buckle Your Belt

**Reg. No. 4,196,732**

**Registered Aug. 28, 2012**

**Int. Cl.: 26**

**TRADEMARK**

**PRINCIPAL REGISTER**

STACY LYNN DESIGNS LLC (FLORIDA LIMITED LIABILITY COMPANY), DBA BUCKLE  
YOUR BELT  
2736 NW 26TH STREET  
BOCA RATON, FL 33434

FOR: BELT BUCKLES; BELT BUCKLES NOT OF PRECIOUS METAL; BELT BUCKLES OF  
PRECIOUS METAL; BELT BUCKLES OF PRECIOUS METALS, IN CLASS 26 (U.S. CLS. 37,  
39, 40, 42 AND 50).

FIRST USE 11-15-2006; IN COMMERCE 11-15-2006.

THE MARK CONSISTS OF STANDARD CHARACTERS WITHOUT CLAIM TO ANY PAR-  
TICULAR FONT, STYLE, SIZE, OR COLOR.

SER. NO. 85-279,837, FILED 3-29-2011.

JOHN KELLY, EXAMINING ATTORNEY



*David J. Kyffers*

Director of the United States Patent and Trademark Office

# United States of America

United States Patent and Trademark Office

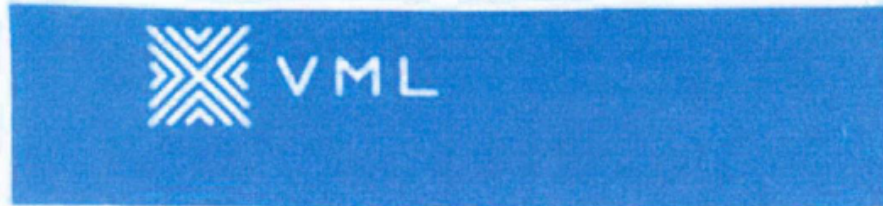

**Reg. No. 4,196,733**

VML, INC. (MISSOURI CORPORATION)  
250 RICHARDS ROAD  
KANSAS CITY, MO 64116

**Registered Aug. 28, 2012**

**Int. Cls.: 35 and 42**

FOR: DIGITAL ADVERTISING AND MARKETING SERVICES; ADVERTISING SERVICES, NAMELY, CREATING CORPORATE AND BRAND IDENTITY FOR OTHERS; CREATING CORPORATE LOGOS FOR OTHERS; CREATING TRADEMARKS FOR OTHERS; DEVELOPING PROMOTIONAL CAMPAIGNS FOR BUSINESS; MARKET ANALYSIS AND RESEARCH IN THE NATURE OF IDENTIFYING COMPETITORS AND CONSUMER PREFERENCES; PREPARATION OF CUSTOM ADVERTISEMENTS AND CUSTOM PROMOTIONAL PRODUCTS FOR OTHERS; PREPARING AUDIO-VISUAL PRESENTATIONS FOR USE IN ADVERTISING; PREPARING PROMOTION AND MERCHANDISING MATERIAL FOR OTHERS; PROVIDING BUSINESS MARKETING INFORMATION; PURCHASE AND PROCUREMENT OF MEDIA TIME FOR OTHERS; PLANNING, RESEARCH AND PLACEMENT OF PRINT, RADIO, TELEVISION, INTERNET AND WEBSITE ADVERTISING FOR OTHERS, IN CLASS 35 (U.S. CLS. 100, 101 AND 102).

**SERVICE MARK**

**PRINCIPAL REGISTER**

FIRST USE 10-6-2008; IN COMMERCE 10-6-2008.

FOR: COMMERCIAL ART DESIGN; COMPUTER WEBSITE DESIGN; GRAPHIC ART DESIGN; PACKAGING DESIGN FOR OTHERS; COMPUTER SERVICES, NAMELY, CREATING, DESIGNING, IMPLEMENTING AND MAINTAINING WEB SITES FOR OTHERS; COMPUTER SERVICES, NAMELY, MANAGING WEB SITES FOR OTHERS; PROVIDING CUSTOMIZED ON-LINE WEB PAGES FEATURING USER-DEFINED INFORMATION, WHICH INCLUDES SEARCH ENGINES AND ONLINE WEB LINKS TO OTHER WEB SITES; COMPUTER SOFTWARE DESIGN FOR OTHERS AND COMPUTER CONSULTATION SERVICES, IN CLASS 42 (U.S. CLS. 100 AND 101).

FIRST USE 10-6-2008; IN COMMERCE 10-6-2008.

OWNER OF U.S. REG. NOS. 3,029,081 AND 3,029,082.

THE COLOR(S) WHITE AND BLUE IS/ARE CLAIMED AS A FEATURE OF THE MARK.

THE MARK CONSISTS OF A WHITE SNOWFLAKE DESIGN TO THE LEFT OF THE WHITE TERM "VML", ON A BLUE BACKGROUND.



*David J. Kyffers*

Director of the United States Patent and Trademark Office

**Reg. No. 4,196,733** SER. NO. 85-282,563, FILED 3-31-2011.

MAUREEN DALL, EXAMINING ATTORNEY

# United States of America

United States Patent and Trademark Office

## NAUI GREEN DIVER INITIATIVE

**Reg. No. 4,196,734**

NAUI SERVICES GROUP, INC (FLORIDA CORPORATION)  
9030 CAMDEN FIELD PARKWAY  
RIVERVIEW, FL 33578

**Registered Aug. 28, 2012**

**Int. Cl.: 35**

FOR: PUBLIC ADVOCACY TO PROMOTE AWARENESS OF PRESERVATION AND CONSERVATION OF THE WORLDS AQUATIC ENVIRONMENT, IN CLASS 35 (U.S. CLS. 100, 101 AND 102).

**SERVICE MARK**

FIRST USE 11-11-2009; IN COMMERCE 11-11-2009.

**PRINCIPAL REGISTER**

THE MARK CONSISTS OF STANDARD CHARACTERS WITHOUT CLAIM TO ANY PARTICULAR FONT, STYLE, SIZE, OR COLOR.

NO CLAIM IS MADE TO THE EXCLUSIVE RIGHT TO USE "GREEN DIVER INITIATIVE", APART FROM THE MARK AS SHOWN.

SER. NO. 85-283,505, FILED 4-1-2011.

KIMBERLY FRYE, EXAMINING ATTORNEY



*David J. Kyffers*

Director of the United States Patent and Trademark Office

# United States of America

United States Patent and Trademark Office

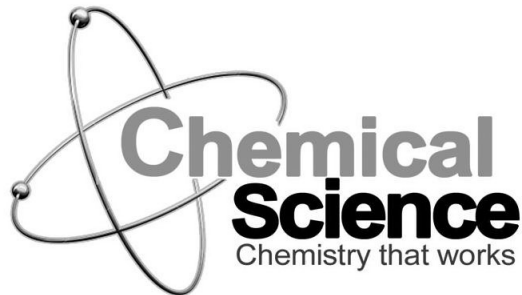

**Reg. No. 4,196,735**

**Registered Aug. 28, 2012**

**Int. Cls.: 3 and 17**

**TRADEMARK**

**PRINCIPAL REGISTER**

SWIFT MAINTENANCE PRODUCTS, INC. (FLORIDA CORPORATION)  
2690 WESTON ROAD  
SUITE 2000  
WESTON, FL 33331

FOR: ALUMINUM CLEANER; CARPET CLEANER; AUTO CLEANER, POLISH AND POLYMER SEALANT FOR CLEANING, SHINING AND PROTECTING AUTOMOBILE EXTERIOR SURFACES; AUTO PROTECTIVE WIPES IN THE NATURE OF DISPOSABLE WIPES IMPREGNATED WITH CLEANSING COMPOUNDS FOR USE IN CLEANING; BATTERY TERMINAL CLEANER; ALL-PURPOSE FOAM CLEANER; BRAKE PARTS CLEANER; BUFFING CLEANER, POLISH AND WAX FOR USE ON BOOTS AND SHOES; CARPET CLEANER WITH DEODORIZER; CARPET SPOT AND STAIN REMOVER; GLASS CLEANER; LEATHER CLEANER; PROTECTIVE SKIN CREAM; RUBBER AND TIRE DRESSING; RUST REMOVER; CLEANERS FOR USE ON TRUCKS AND AUTOMOBILES; VANDALISM MARK REMOVER IN THE NATURE OF PAINT REMOVER; GRAFFITI WIPES IN THE NATURE OF DISPOSABLE WIPES IMPREGNATED WITH CLEANSING COMPOUNDS FOR USE IN CLEANING GRAFFITI OFF OF CONCRETE, WOOD AND METAL; VINYL AND SYNTHETIC LEATHER CLEANER; ALUMINUM BRIGHTENER AND CLEANER; COBWEB REMOVER; ELECTRIC COIL CLEANER; CONTACT LENS CLEANING SPRAY; AIR DUSTERS IN THE NATURE OF COMPRESSED AIR IN CANS FOR CLEANING AND DUSTING; DEGREASING PREPARATIONS IN SPRAY, FOAM AND LIQUID FORM FOR USE ON OVENS AND COOKTOPS; LIQUID DRAIN CLEANER; GREASE TRAP AND DRAIN MAINTAINER IN THE NATURE OF DRAIN OPENERS AND CLEANING PREPARATIONS CONTAINING MICROBIAL ENZYMES, USED TO PRESERVE DRAIN SYSTEMS AND WATERWAYS; PAINT AND VARNISH REMOVER; RUST, IRON, SCALE AND CALCIUM STAIN REMOVER; LIME, RUST, SCALE AND HARD WATER STAIN CLEANER; MUD, SILT AND SAND REMOVER; BASEBOARD CLEANER AND WAX REMOVER; CARPET SHAMPOO; DUST MOP TREATMENT IN THE NATURE OF A TREATMENT THAT ATTRACTS DUST TO A MOP; FLOOR WAX STRIPPER; FLOOR SWEEPING COMPOUND IN THE NATURE OF A COMPOUND TO CONTROL DUST; FLOOR WAX; GUM REMOVING PREPARATIONS IN THE FORM OF A SPRAY; FLOOR AND COUNTER TOP SURFACE CLEANER; ALL-PURPOSE CLEANER; BATHROOM CLEANER; TOILET BOWL AND PORCELAIN CLEANER; CARPET CLEANER; COMPUTER SCREEN CLEANER; COMPUTER CABINET CLEANER; CHALKBOARD CLEANER; FURNITURE CLEANERS AND POLISH; GLASS CLEANER; DISPOSABLE WIPES IMPREGNATED WITH GLASS CLEANER; DISPOSABLE WIPES IMPREGNATED WITH HAND CLEANER; MARBLE AND GRANITE CLEANER; METAL CLEANER AND TARNISH REMOVER; OVEN AND GRILL CLEANER; SCANNER CLEANER; SHOWER



*David J. Kybas*

Director of the United States Patent and Trademark Office

**Reg. No. 4,196,735** CLEANER; METAL CLEANER; TILE AND GROUT CLEANER; OVEN CLEANER IN SPRAY FORM; WINTERIZING WAX FOR USE ON AUTOMOBILES; DRAIN CLEANER; DRAIN OPENER; DRAIN MAINTAINER, NAMELY, CLEANING PREPARATIONS FOR CLEANSING DRAINS; DEGREASING PREPARATIONS FOR USE ON GREASE TRAPS; CLEANERS FOR SEWER SYSTEMS; FREEZER AND MEAT LOCKER CLEANER; ICE MACHINE CLEANER; CONCRETE CLEANER; DISPOSABLE WIPES IMPREGNATED WITH SUNSCREEN AND INSECT REPELLENT; FOAMING HAND CLEANER; GRITTY HAND CLEANER; WATERLESS HAND CLEANER; HAND SOAP; BILGE AND BARGE CLEANER; BOAT CLEANER; ENGINE CLEANER AND DEGREASER; STEAM AND PRESSURE WASH CLEANER; TOOL CLEANER; WINDSHIELD WASHING FLUID; GLASS CLEANER; DEGREASERS FOR GREASE TRAPS, IN CLASS 3 (U.S. CLS. 1, 4, 6, 50, 51 AND 52).

FIRST USE 10-29-2009; IN COMMERCE 10-29-2009.

FOR: AEROSOL CAULK; GENERAL PURPOSE RUBBER-BASED SEALANT, IN CLASS 17 (U.S. CLS. 1, 5, 12, 13, 35 AND 50).

FIRST USE 10-28-2009; IN COMMERCE 10-28-2009.

NO CLAIM IS MADE TO THE EXCLUSIVE RIGHT TO USE "CHEMICAL", APART FROM THE MARK AS SHOWN.

THE MARK CONSISTS OF TWO INTERSECTING OVALS OR ORBITS, EACH HAVING A SINGLE SPHERE APPEARING ON THE OVAL OR ORBIT. THE WORDING "CHEMICAL SCIENCE" APPEARS STACKED TO THE RIGHT OF THE DESIGN AND THE TERM "CHEMICAL" INTERSECTS BOTH SPHERES. THE WORDING "CHEMISTRY THAT WORKS" APPEARS IN SMALLER FONT BENEATH THE TERM "SCIENCE".

SER. NO. 85-283,567, FILED 4-1-2011.

ELLEN PERKINS, EXAMINING ATTORNEY

# United States of America

United States Patent and Trademark Office

## RUSLYN PACK REEL

**Reg. No. 4,196,736**

**Registered Aug. 28, 2012**

**Int. Cl.: 9**

**TRADEMARK**

**PRINCIPAL REGISTER**

RUSLYN HOLDINGS PTY LTD (AUSTRALIA LIMITED LIABILITY COMPANY)  
PO BOX 3248  
KIRRAWEE DC  
SYDNEY, AUSTRALIA NSW 2232

FOR: REELS FOR ELECTRIC WIRE, IN CLASS 9 (U.S. CLS. 21, 23, 26, 36 AND 38).

THE MARK CONSISTS OF STANDARD CHARACTERS WITHOUT CLAIM TO ANY PARTICULAR FONT, STYLE, SIZE, OR COLOR.

OWNER OF AUSTRALIA REG. NO. 1365252, DATED 1-17-2011, EXPIRES 6-6-2020.

OWNER OF U.S. REG. NO. 3,296,252.

NO CLAIM IS MADE TO THE EXCLUSIVE RIGHT TO USE "PACK REEL", APART FROM THE MARK AS SHOWN.

SER. NO. 85-284,444, FILED 4-1-2011.

DAWN HAN, EXAMINING ATTORNEY



*David J. Kyfos*

Director of the United States Patent and Trademark Office

# United States of America

United States Patent and Trademark Office



**Reg. No. 4,196,737**

**Registered Aug. 28, 2012**

**Int. Cl.: 45**

**SERVICE MARK**

**PRINCIPAL REGISTER**

REACH FOR YOUTH, INC. (INDIANA NON-PROFIT CORPORATION)  
3505 NORTH WASHINGTON BOULEVARD  
INDIANAPOLIS, IN 46205

FOR: LEGAL SERVICES; LEGAL SERVICES, NAMELY, PROVIDING CUSTOMIZED LEGAL INFORMATION, COUNSELING, ADVICE, AND LITIGATION SERVICES IN ALL AREAS OF LAW TO PEOPLE AND FAMILIES OF MODEST INCOMES; PROVIDING EMOTIONAL COUNSELING AND EMOTIONAL SUPPORT SERVICES FOR TROUBLED AND AT-RISK YOUTH AND THEIR FAMILIES, IN CLASS 45 (U.S. CLS. 100 AND 101).

FIRST USE 1-1-2010; IN COMMERCE 1-1-2010.

NO CLAIM IS MADE TO THE EXCLUSIVE RIGHT TO USE "COURT", APART FROM THE MARK AS SHOWN.

THE MARK CONSISTS OF THE WORDS "TEEN COURT" UTILIZING THE SCALES OF JUSTICE AS THE "T" IN "TEEN".

SER. NO. 85-284,927, FILED 4-4-2011.

AISHA CLARKE, EXAMINING ATTORNEY



*David J. Kyjars*

Director of the United States Patent and Trademark Office



# United States of America

United States Patent and Trademark Office

## AFTER THE CATCH

**Reg. No. 4,196,738**

**Registered Aug. 28, 2012**

**Int. Cl.: 41**

**SERVICE MARK**

**PRINCIPAL REGISTER**

DISCOVERY COMMUNICATIONS, LLC (DELAWARE LIMITED LIABILITY COMPANY)  
ONE DISCOVERY PLACE  
SILVER SPRING, MD 20910

FOR: ENTERTAINMENT AND EDUCATIONAL SERVICES IN THE NATURE OF MULTIMEDIA PROGRAM SERIES FEATURING SUBJECTS OF GENERAL HUMAN INTEREST DISTRIBUTED VIA VARIOUS PLATFORMS ACROSS MULTIPLE FORMS OF TRANSMISSION MEDIA; PROVIDING ENTERTAINMENT INFORMATION TO OTHERS VIA A GLOBAL COMPUTER NETWORK, IN CLASS 41 (U.S. CLS. 100, 101 AND 107).

FIRST USE 5-29-2007; IN COMMERCE 5-29-2007.

THE MARK CONSISTS OF STANDARD CHARACTERS WITHOUT CLAIM TO ANY PARTICULAR FONT, STYLE, SIZE, OR COLOR.

SER. NO. 85-288,156, FILED 4-6-2011.

SHAUNIA CARLYLE, EXAMINING ATTORNEY



*David J. Kyffers*

Director of the United States Patent and Trademark Office

# United States of America

United States Patent and Trademark Office

# Cablebone.com

**Reg. No. 4,196,739**

**Registered Aug. 28, 2012**

**Int. Cl.: 9**

**TRADEMARK**

**PRINCIPAL REGISTER**

CABLE BONE INC (CALIFORNIA CORPORATION)  
105  
206 N. MADRONA AVE  
BREA, CA 92821

FOR: AUDIO CABLES; CONSUMER ELECTRONIC PRODUCTS, NAMELY, AUDIO AMPLIFIERS, AUDIO SPEAKERS, AUDIO RECEIVERS, ELECTRICAL AUDIO AND SPEAKER CABLES AND CONNECTORS; ELECTRONIC EQUIPMENT, NAMELY, TRANSFORMERS, BALUNS, CABLES USED IN CONNECTION WITH COMPUTERS, COMPUTER PERIPHERAL DEVICES, TELEVISIONS, AUDIO-VIDEO EQUIPMENT, CLOSED-CIRCUIT TV EQUIPMENT AND TELECOMMUNICATION EQUIPMENT; ETHERNET CABLES; COMPUTER CABLES; USB CABLES; TRADING CARD CDS; CABLES, ELECTRIC; ELECTRIC WIRES AND CABLES; ELECTRIC HAIR ROLLERS; ELECTRICAL AND OPTICAL CABLES; ELECTRICAL CABLES; ELECTRICAL CABLES AND CORDSETS; ELECTRICAL CABLES WITH INTEGRATED FITTINGS, NAMELY, CORDSETS; POWER CABLES; CABLE BROADCAST TRANSMISSION MACHINES AND APPARATUS; CABLE CONNECTORS; CONNECTING ELECTRICAL CABLES; CONNECTION CABLES; ELECTRICAL CABLES AND CORDSETS; ELECTRICAL INTERCONNECT CABLES; CABLES AND FIBRES FOR THE TRANSMISSION OF SOUNDS AND IMAGES; CALCULATING MACHINES, DATA-PROCESSING EQUIPMENT AND COMPUTERS; HIGH DEFINITION MULTIMEDIA INTERFACE CABLES; STEREO CABLES; VIDEO CABLES; COAXIAL CABLES; ELECTRIC CHARGING CABLES; ELECTRICAL CABLES FOR MUSICAL INSTRUMENTS; EXTENSION CABLES; MICROPHONE CABLES; PUBLIC ADDRESS (PA) AND SOUND SYSTEM ACCESSORIES, NAMELY, MICROPHONE STANDS, SPEAKER STANDS, MICROPHONE CABLES, SPEAKER CABLES, SPEAKER BOXES AND SOUND MIXERS, IN CLASS 9 (U.S. CLS. 21, 23, 26, 36 AND 38).



FIRST USE 1-14-2010; IN COMMERCE 1-14-2010.

THE MARK CONSISTS OF STANDARD CHARACTERS WITHOUT CLAIM TO ANY PARTICULAR FONT, STYLE, SIZE, OR COLOR.

SER. NO. 85-289,927, FILED 4-8-2011.

WARREN L. OLANDRIA, EXAMINING ATTORNEY

*David J. Kyffers*

Director of the United States Patent and Trademark Office

# United States of America

United States Patent and Trademark Office

# 1-800-IN-STOCK

**Reg. No. 4,196,740**

FERGUSON ENTERPRISES, INC. (VIRGINIA CORPORATION)  
12500 JEFFERSON AVE.

**Registered Aug. 28, 2012**

NEWPORT NEWS, VA 23602

**Int. Cl.: 35**

FOR: RETAIL PLUMBING SUPPLY STORES AND WHOLESALE PLUMBING SUPPLY DISTRIBUTORSHIPS, IN CLASS 35 (U.S. CLS. 100, 101 AND 102).

**SERVICE MARK**

FIRST USE 12-31-2000; IN COMMERCE 12-31-2000.

**PRINCIPAL REGISTER**

THE MARK CONSISTS OF STANDARD CHARACTERS WITHOUT CLAIM TO ANY PARTICULAR FONT, STYLE, SIZE, OR COLOR.

SEC. 2(F).

SER. NO. 85-290,236, FILED 4-8-2011.

CIMMERIAN COLEMAN, EXAMINING ATTORNEY



*David J. Kybas*

Director of the United States Patent and Trademark Office

# United States of America

United States Patent and Trademark Office



**Reg. No. 4,196,741**

**Registered Aug. 28, 2012**

**Int. Cl.: 12**

**TRADEMARK**

**PRINCIPAL REGISTER**

SANLUIS CORPORACIÓN, S.A.B DE C.V. (MEXICO CORPORATION)  
MONTE PELVOUX NO. 220  
8TH FLOOR LOMAS DE CHAPULTEPEC  
MEXICO, D.F., MEXICO 11000

FOR: VEHICLE AND AUTO-PARTS, NAMELY, AUTOMOBILES AND STRUCTURAL PARTS THEREFORE; APPARATUS FOR LOCOMOTION BY LAND, AIR OR WATER, NAMELY, ASSEMBLIES, HUBS, CASTINGS, CLUTCH HOUSINGS, FLY WHEELS, CLUTCH PRESSURE PLATES; BRAKES FOR LAND VEHICLES; BRAKE DRUMS; BRAKE ROTORS FOR LAND VEHICLES; CLUTCHES FOR LAND VEHICLES; AIRBAGS FOR VEHICLES; LAND VEHICLE SUSPENSION PARTS, NAMELY, SUSPENSION STRUTS, COIL SPRINGS AND PARABOLIC SPRINGS; LAND VEHICLE SUSPENSION PARTS, NAMELY, LEAF SPRINGS AND SUSPENSION SPRINGS FOR MOTOR CARS, IN CLASS 12 (U.S. CLS. 19, 21, 23, 31, 35 AND 44).

OWNER OF MEXICO REG. NO. 606807, DATED 4-26-1999, EXPIRES 3-5-2019.

OWNER OF U.S. REG. NO. 3,979,922.

NO CLAIM IS MADE TO THE EXCLUSIVE RIGHT TO USE "CORPORACION", APART FROM THE MARK AS SHOWN.

THE MARK CONSISTS OF A RECTANGLE WITH CURVED LINES NEXT TO THE WORDS "SANLUIS CORPORACION".

THE ENGLISH TRANSLATION OF "CORPORACION" IN THE MARK IS CORPORATION.

SER. NO. 85-290,509, FILED 4-8-2011.

PAM WILLIS, EXAMINING ATTORNEY



*David J. Kybas*

Director of the United States Patent and Trademark Office

# United States of America

United States Patent and Trademark Office

## FRAMING ON STONE

**Reg. No. 4,196,742**

KRAFFT, JACK S. (PENNSYLVANIA SOLE PROPRIETORSHIP), DBA FRAMING ON STONE  
1104 COSTELLO ROAD  
AUSTIN, PA 16720 AND

**Registered Aug. 28, 2012**

**Int. Cl.: 40**

KRAFFT, LINDA S. (PENNSYLVANIA SOLE PROPRIETORSHIP), DBA FRAMING ON  
STONE  
1104 COSTELLO ROAD  
AUSTIN, PA 16720

**SERVICE MARK**

**PRINCIPAL REGISTER**

FOR: FRAMING OF WORKS OF ART; MOUNTING OF WORKS OF ART AS PART OF THE  
FRAMING PROCESS, IN CLASS 40 (U.S. CLS. 100, 103 AND 106).

FIRST USE 10-1-1998; IN COMMERCE 5-6-2003.

THE MARK CONSISTS OF STANDARD CHARACTERS WITHOUT CLAIM TO ANY PAR-  
TICULAR FONT, STYLE, SIZE, OR COLOR.

OWNER OF U.S. REG. NO. 3,960,338.

SEC. 2(F).

SER. NO. 85-291,065, FILED 4-9-2011.

ANDREW RHIM, EXAMINING ATTORNEY



*David J. Kybas*

Director of the United States Patent and Trademark Office

# United States of America

United States Patent and Trademark Office

# YOUREKA

**Reg. No. 4,196,743**

**Registered Aug. 28, 2012**

**Int. Cls.: 28 and 41**

**TRADEMARK**

**SERVICE MARK**

**PRINCIPAL REGISTER**

INTERVISIO OY (FINLAND CORPORATION)  
RUNEBERGINKATU 29  
HELSINKI, FINLAND

FOR: APPARATUS FOR ELECTRONIC GAMES OTHER THAN THOSE ADAPTED FOR USE WITH AN EXTERNAL DISPLAY SCREEN OR MONITOR; ARCADE-TYPE ELECTRONIC VIDEO GAMES; BOARD GAMES; ELECTRONIC GAMES OTHER THAN THOSE ADAPTED FOR USE WITH TELEVISION RECEIVERS ONLY; MANIPULATIVE GAMES; MEMORY GAMES, IN CLASS 28 (U.S. CLS. 22, 23, 38 AND 50).

FOR: ENTERTAINMENT SERVICES, NAMELY, PROVIDING ONLINE ELECTRONIC GAMES; ENTERTAINMENT SERVICES, NAMELY, PROVIDING ONLINE VIDEO GAMES; ENTERTAINMENT SERVICES, NAMELY, PROVIDING TEMPORARY USE OF NON-DOWNLOADABLE COMPUTER GAMES; ENTERTAINMENT SERVICES, NAMELY, PROVIDING TEMPORARY USE OF NON-DOWNLOADABLE ELECTRONIC GAMES; ENTERTAINMENT SERVICES, NAMELY, PROVIDING TEMPORARY USE OF NON-DOWNLOADABLE INTERACTIVE GAMES; ENTERTAINMENT SERVICES, NAMELY, PROVIDING TEMPORARY USE OF NON-DOWNLOADABLE VIDEO GAMES, IN CLASS 41 (U.S. CLS. 100, 101 AND 107).

THE MARK CONSISTS OF STANDARD CHARACTERS WITHOUT CLAIM TO ANY PARTICULAR FONT, STYLE, SIZE, OR COLOR.

PRIORITY CLAIMED UNDER SEC. 44(D) ON ERPN CMNTY TM OFC APPLICATION NO. 009859802, FILED 4-1-2011, REG. NO. 00985802, DATED 8-23-2011, EXPIRES 4-1-2021.

SER. NO. 85-291,359, FILED 4-11-2011.

WON TEAK OH, EXAMINING ATTORNEY



*David J. Kyffers*

Director of the United States Patent and Trademark Office

# United States of America

United States Patent and Trademark Office

# Skin@LRG

**Reg. No. 4,196,744**

**Registered Aug. 28, 2012**

**Int. Cl.: 44**

**SERVICE MARK**

**PRINCIPAL REGISTER**

SKIN@LRG (MARYLAND LIMITED LIABILITY COMPANY)  
SUITE 400  
6900 WISCONSIN AVENUE  
CHEVY CHASE, MD 20815

FOR: DERMATOLOGY SERVICES; HEALTH SPA SERVICES, NAMELY, LASER TREATMENTS FOR ACNE, REJUVENATION, SCARS, TATTOO REMOVAL AND FOR FACIALS AND MASSAGE; LASER HAIR REMOVAL SERVICES; LASER TATTOO REMOVAL SERVICE; MEDICAL CLINIC PROVIDING WEIGHT LOSS SOLUTIONS, SERVICES AND PROGRAMS, NUTRITION COUNSELING, HORMONE THERAPY, INCLUDING, BIOIDENTICAL HORMONE REPLACEMENT, ANTI AGING THERAPY, AND NATURAL HORMONE THERAPY, MEDICAL AESTHETIC PROCEDURES, INCLUDING, LASER HAIR REMOVAL, LASER PEELS, BOTULINUM TOXIN TREATMENTS, MICRODERMABRASION, LIPOSUCTION, VEIN TREATMENTS, VEIN THERAPY, CELLULITE TREATMENTS, BODY CONTOURING TREATMENTS, INJECTABLE FILLER TREATMENTS, FACIALS, AND SKIN CARE; PROVIDING LASER THERAPY FOR TREATING MEDICAL CONDITIONS, IN CLASS 44 (U.S. CLS. 100 AND 101).

FIRST USE 8-31-2009; IN COMMERCE 8-31-2009.

THE MARK CONSISTS OF STANDARD CHARACTERS WITHOUT CLAIM TO ANY PARTICULAR FONT, STYLE, SIZE, OR COLOR.

SER. NO. 85-293,187, FILED 4-12-2011.

ANDREA K. NADELMAN, EXAMINING ATTORNEY



*David J. Kyros*

Director of the United States Patent and Trademark Office

# United States of America

United States Patent and Trademark Office

## SCHOOLBOOK

**Reg. No. 4,196,745**

THE NEW YORK TIMES COMPANY (NEW YORK CORPORATION)  
620 EIGHTH AVE.

**Registered Aug. 28, 2012**

NEW YORK, NY 10018

**Int. Cls.: 35 and 41**

FOR: PROVIDING CONSUMER INFORMATION AND RELATED NEWS IN THE FIELD OF EDUCATION, IN CLASS 35 (U.S. CLS. 100, 101 AND 102).

**SERVICE MARK**

FIRST USE 8-16-2011; IN COMMERCE 9-7-2011.

**PRINCIPAL REGISTER**

FOR: EDUCATIONAL SERVICES, NAMELY, PROVIDING ONLINE INSTRUCTION IN THE FIELD OF CHILDREN'S EDUCATION AND REPORTING CURRENT EVENTS VIA AN ONLINE WEBSITE; PROVIDING A WEBSITE FEATURING BLOGS AND NON-DOWNLOADABLE PUBLICATIONS IN THE NATURE OF ARTICLES, COLUMNS, NEWSPAPERS, MAGAZINES, GUIDES AND NEWSLETTERS IN THE FIELD OF EDUCATION; PROVIDING INFORMATION AND NEWS IN THE FIELD OF TEACHING METHODOLOGY AND EDUCATION; PROVIDING INFORMATION, NEWS AND COMMENTARY IN THE FIELD OF CURRENT EVENTS RELATING TO EDUCATION, IN CLASS 41 (U.S. CLS. 100, 101 AND 107).

FIRST USE 8-16-2011; IN COMMERCE 9-7-2011.

THE MARK CONSISTS OF STANDARD CHARACTERS WITHOUT CLAIM TO ANY PARTICULAR FONT, STYLE, SIZE, OR COLOR.

SER. NO. 85-294,188, FILED 4-13-2011.

CHARLES L. JENKINS, EXAMINING ATTORNEY



*David J. Kybas*

Director of the United States Patent and Trademark Office



# United States of America

United States Patent and Trademark Office



**Reg. No. 4,196,746**

RUBY MARTINEZ (UNITED STATES INDIVIDUAL)  
670 N CAROLINA # 30  
EL PASO, TX 79915

**Registered Aug. 28, 2012**

**Int. Cl.: 41**

FOR: ENTERTAINMENT SERVICES IN THE NATURE OF PRESENTING LIVE MUSICAL PERFORMANCES; ENTERTAINMENT, NAMELY, LIVE PERFORMANCES BY A MUSICAL BAND, IN CLASS 41 (U.S. CLS. 100, 101 AND 107).

**SERVICE MARK**

FIRST USE 3-30-2011; IN COMMERCE 3-30-2011.

**PRINCIPAL REGISTER**

NO CLAIM IS MADE TO THE EXCLUSIVE RIGHT TO USE "COLOMBIANO", APART FROM THE MARK AS SHOWN.

THE COLOR(S) WHITE GRAY, BLACK AND GOLD IS/ARE CLAIMED AS A FEATURE OF THE MARK.

THE MARK CONSISTS OF "MI BARRIO COLOMBIANO" IN BLACK WITH GRAY OUTLINING AND BANDS OF WHITE ACROSS THE LETTERS. TWO TRUMPETS IN GOLD APPEAR BELOW THE WORDING. IN THE BACKGROUND IS A BLACK SILHOUETTE OF A PACHUCO MAN WITH A WHITE BORDER OUTLINED IN GRAY.

THE ENGLISH TRANSLATION OF "MI BARRIO COLOMBIANO" IN THE MARK IS "MY COLOMBIAN NEIGHBORHOOD".

SER. NO. 85-295,855, FILED 4-15-2011.

MICHELLE DUBOIS, EXAMINING ATTORNEY



*David J. Kyros*

Director of the United States Patent and Trademark Office

# United States of America

United States Patent and Trademark Office



**Reg. No. 4,196,747**

**Registered Aug. 28, 2012**

**Int. Cl.: 30**

**TRADEMARK**

**PRINCIPAL REGISTER**

RIE RIE, INC. (TEXAS CORPORATION), DBA WHOLESOME FOODS BAKERY  
6506 VANDERBILT AVENUE  
DALLAS, TX 75214

FOR: BAKERY GOODS, NAMELY, GLUTEN-FREE BREADS, DINNER ROLLS, SANDWICH BREADS, MUFFINS, SWEET BREADS, BROWNIES, COOKIES, CAKES, PASTRIES; GLUTEN-FREE GRAIN-BASED FOOD BARS ALSO CONTAINING SEEDS, NUTS, DRIED FRUITS, HONEY AND/OR SYRUP; GLUTEN-FREE GRAIN-BASED SNACK MIX ALSO CONTAINING SEEDS, NUTS, HONEY, OIL AND SALT, IN CLASS 30 (U.S. CL. 46).

FIRST USE 4-1-2010; IN COMMERCE 4-1-2010.

THE MARK CONSISTS OF THE LETTERS "WFB" SURROUNDED BY A DASHED CIRCLE INSIDE A SOLID CIRCLE.

SER. NO. 85-296,414, FILED 4-15-2011.

AMY KERTGATE, EXAMINING ATTORNEY



*David J. Kyffers*

Director of the United States Patent and Trademark Office

# United States of America

United States Patent and Trademark Office

# Siam Legal

**Reg. No. 4,196,748**

RAMM, DENNIS (UNITED STATES INDIVIDUAL)  
250 N ROBERTSON BLVD., 104  
BEVERLY HILLS, CA 90211

**Registered Aug. 28, 2012**

**Int. Cl.: 45**

FOR: LEGAL SERVICES, IN CLASS 45 (U.S. CLS. 100 AND 101).

**SERVICE MARK**

FIRST USE 5-1-2007; IN COMMERCE 5-1-2007.

**PRINCIPAL REGISTER**

THE MARK CONSISTS OF STANDARD CHARACTERS WITHOUT CLAIM TO ANY PARTICULAR FONT, STYLE, SIZE, OR COLOR.

NO CLAIM IS MADE TO THE EXCLUSIVE RIGHT TO USE "LEGAL", APART FROM THE MARK AS SHOWN.

SER. NO. 85-297,509, FILED 4-18-2011.

MARGERIE A. TIERNEY, EXAMINING ATTORNEY



*David J. Kybas*

Director of the United States Patent and Trademark Office

# United States of America

United States Patent and Trademark Office



**Reg. No. 4,196,749**

**Registered Aug. 28, 2012**

**Int. Cl.: 37**

**SERVICE MARK**

**PRINCIPAL REGISTER**

BROWN, MELINDA (GEORGIA CORPORATION), DBA HUMMINGBIRD DREAM HOMES  
350  
ALPHARETTA, GA 30022

FOR: REMODELING OF HOMES, IN CLASS 37 (U.S. CLS. 100, 103 AND 106).

FIRST USE 2-1-2010; IN COMMERCE 2-1-2010.

NO CLAIM IS MADE TO THE EXCLUSIVE RIGHT TO USE "HOMES", APART FROM THE MARK AS SHOWN.

THE COLOR(S) GREEN / BLACK IS/ARE CLAIMED AS A FEATURE OF THE MARK.

THE MARK CONSISTS OF A BLACK BIRD WITH GREEN FEATHERS UNDER THE WINGS, TO THE LEFT OF THE WORD "HUMMINGBIRD" IN BLACK, WITH THE BIRD'S BEAK AS PART OF THE LETTER "H", AND THE WORDS "SERVING THE AMERICAN DREAM" IN GREEN ABOVE THE WORD "HUMMINGBIRD", AND THE GREEN WORDS "DREAM HOMES" BELOW THE WORD "HUMMINGBIRD". THE "H" IS CAPITALIZED IN "HUMMINGBIRD" AND "B" IN "HUMMINGBIRD" IS CAPITALIZED AS WELL.

SER. NO. 85-302,230, FILED 4-22-2011.

VIVIAN MICZNIK FIRST, EXAMINING ATTORNEY



*David J. Kybas*

Director of the United States Patent and Trademark Office

# United States of America

United States Patent and Trademark Office

# ShineTecs

**Reg. No. 4,196,750**

WASHTEC HOLDING GMBH (FED REP GERMANY LIMITED LIABILITY COMPANY)  
ARGONSTR. 7

**Registered Aug. 28, 2012**

AUGSBURG, FED REP GERMANY 86150

**Int. Cl.: 1**

FOR: CHEMICAL PREPARATIONS FOR USE IN INDUSTRY, NAMELY, CHEMICAL AGENTS FOR USE IN THE MANUFACTURING OF CLEANING AND POLISHING PREPARATIONS FOR AUTOMOBILES AND CHEMICAL AGENTS FOR USE IN THE MANUFACTURING OF PROTECTIVE AUTOMOBILE FINISHING PREPARATIONS APPLIED DURING THE CLEANING PROCESS, IN CLASS 1 (U.S. CLS. 1, 5, 6, 10, 26 AND 46).

**TRADEMARK**

**PRINCIPAL REGISTER**

THE MARK CONSISTS OF STANDARD CHARACTERS WITHOUT CLAIM TO ANY PARTICULAR FONT, STYLE, SIZE, OR COLOR.

OWNER OF ERPN CMNTY TM OFC REG. NO. 007547599, DATED 3-2-2011, EXPIRES 1-23-2019.

SER. NO. 85-302,594, FILED 4-22-2011.

COURTNEY ALVAREZ, EXAMINING ATTORNEY



*David J. Kyffers*

Director of the United States Patent and Trademark Office

# United States of America

United States Patent and Trademark Office

## SmartFuel Advantage

**Reg. No. 4,196,751**

SMARTFUEL INTERNATIONAL INC. (DELAWARE CORPORATION)  
650 CALIFORNIA STREET  
SAN FRANCISCO, CA 94108

**Registered Aug. 28, 2012**

**Int. Cl.: 1**

FOR: CHEMICAL ADDITIVES FOR USE WITH INTERNAL COMBUSTION ENGINE FUELS,  
IN CLASS 1 (U.S. CLS. 1, 5, 6, 10, 26 AND 46).

**TRADEMARK**

FIRST USE 4-25-2011; IN COMMERCE 4-25-2011.

**PRINCIPAL REGISTER**

THE MARK CONSISTS OF STANDARD CHARACTERS WITHOUT CLAIM TO ANY PAR-  
TICULAR FONT, STYLE, SIZE, OR COLOR.

SER. NO. 85-303,471, FILED 4-25-2011.

TINA L. SNAPP, EXAMINING ATTORNEY



*David J. Kyffers*

Director of the United States Patent and Trademark Office

# United States of America

United States Patent and Trademark Office



**Reg. No. 4,196,752**

**Registered Aug. 28, 2012**

**Int. Cl.: 12**

**TRADEMARK**

**PRINCIPAL REGISTER**

EARTHCRIUSER OVERLAND VEHICLES PTY LTD (AUSTRALIA PROPRIETARY LIMITED COMPANY)  
PO BOX 2602  
FORTITUDE VALLEY B.C., AUSTRALIA 4006

FOR: MOTOR HOMES; CAMPER VANS; CAMPING VEHICLES, IN CLASS 12 (U.S. CLS. 19, 21, 23, 31, 35 AND 44).

OWNER OF AUSTRALIA REG. NO. 1387210, DATED 10-6-2010, EXPIRES 10-6-2020.

THE COLOR(S) BLUE, LIGHT BLUE AND BLACK IS/ARE CLAIMED AS A FEATURE OF THE MARK.

OWNER OF U.S. REG. NO. 4,066,892.

THE MARK CONSISTS OF A DESIGN OF A GLOBE DEPICTING THE CONTENTS IN LIGHT BLUE AND WATER IN BLUE WITH BLACK DIRECTIONAL COMPASS POINTS ON THE CIRCUMFERENCE OF THE GLOBE AND A BLACK TIRE TRACKS APPEARING IN AN ARC ACROSS THE GLOBE, AND THE WORDING "EARTHCRIUSER" IN BLACK.

SER. NO. 85-306,628, FILED 4-27-2011.

SUSAN RICHARDS, EXAMINING ATTORNEY



*David J. Kyros*

Director of the United States Patent and Trademark Office

# United States of America

United States Patent and Trademark Office

## CATHOLIC FINANCIAL LIFE

**Reg. No. 4,196,753**

**Registered Aug. 28, 2012**

**Int. Cl.: 36**

**SERVICE MARK**

**PRINCIPAL REGISTER**

CATHOLIC FINANCIAL LIFE (WISCONSIN CHARITABLE, NON-PROFIT CORPORATION)  
1100 WEST WELLS STREET  
MILWAUKEE, WI 53233

FOR: FINANCIAL AND INSURANCE SERVICES, NAMELY, LIFE INSURANCE UNDERWRITING, FINANCIAL MANAGEMENT, INVESTMENT CONSULTATION, RETIREMENT PLANNING, MUTUAL FUND INVESTMENT, ANNUITY UNDERWRITING, FINANCIAL AND INSURANCE INFORMATION, ELECTRONIC PROCESSING OF INSURANCE CLAIMS AND PAYMENT DATA, INSURANCE ADMINISTRATION, FINANCIAL PORTFOLIO MANAGEMENT, INVESTMENT MANAGEMENT, INSURANCE, FINANCIAL AND INVESTMENT INFORMATION PROVIDED TO THE INSURANCE, FINANCIAL AND INVESTMENT INDUSTRIES, MORTGAGE LENDING; CHARITABLE OUTREACH PROGRAMS, NAMELY, PROVIDING FINANCIAL ANALYSIS AND CONSULTATION, AND LIFE INSURANCE UNDERWRITING SERVICES BY MEANS OF A NOT-FOR-PROFIT FRATERNAL BENEFIT SOCIETY COMMITTED TO CATHOLIC VALUES; CHARITABLE OUTREACH PROGRAMS, NAMELY, PROVIDING CHARITABLE FUNDRAISING SERVICES AND FINANCIAL SUPPORT TO CATHOLIC PARISHES, SCHOOLS, AND COMMUNITIES; LIFE INSURANCE BROKERAGE SERVICES, IN CLASS 36 (U.S. CLS. 100, 101 AND 102).

FIRST USE 8-1-2010; IN COMMERCE 8-1-2010.

THE MARK CONSISTS OF STANDARD CHARACTERS WITHOUT CLAIM TO ANY PARTICULAR FONT, STYLE, SIZE, OR COLOR.

OWNER OF U.S. REG. NOS. 2,799,551, 3,996,105, AND 4,010,625.

NO CLAIM IS MADE TO THE EXCLUSIVE RIGHT TO USE "CATHOLIC FINANCIAL", APART FROM THE MARK AS SHOWN.

SER. NO. 85-311,141, FILED 5-3-2011.

MARK RADEMACHER, EXAMINING ATTORNEY



*David J. Kybas*

Director of the United States Patent and Trademark Office



# United States of America

United States Patent and Trademark Office

## MY DADDY ROCKS

**Reg. No. 4,196,754**

**Registered Aug. 28, 2012**

**Int. Cl.: 41**

**SERVICE MARK**

**PRINCIPAL REGISTER**

UP PAST ELEVEN PRODUCTIONS, LLC (MINNESOTA LIMITED LIABILITY COMPANY),  
DBA ROCK CAMP FOR DADS  
2751 HENNEPIN AVENUE SO. #171  
MINNEAPOLIS, MN 55408

FOR: PROVIDING CLASSES, WORKSHOPS AND CAMPS IN THE FIELD OF MUSIC AND ENTERTAINMENT; AND ENTERTAINMENT SERVICES IN THE NATURE OF PRESENTING LIVE MUSICAL PERFORMANCES, IN CLASS 41 (U.S. CLS. 100, 101 AND 107).

FIRST USE 10-0-2010; IN COMMERCE 10-0-2010.

THE MARK CONSISTS OF STANDARD CHARACTERS WITHOUT CLAIM TO ANY PARTICULAR FONT, STYLE, SIZE, OR COLOR.

SER. NO. 85-311,367, FILED 5-3-2011.

RON FAIRBANKS, EXAMINING ATTORNEY



*David J. Kybas*

Director of the United States Patent and Trademark Office

# United States of America

United States Patent and Trademark Office

## GREAT REPEATABLE MODELS

**Reg. No. 4,196,755**

**Registered Aug. 28, 2012**

**Int. Cl.: 35**

**SERVICE MARK**

**PRINCIPAL REGISTER**

BAIN & COMPANY, INC. (MASSACHUSETTS CORPORATION)  
131 DARTMOUTH STREET  
BOSTON, MA 02116

FOR: BUSINESS MANAGEMENT CONSULTING SERVICES AND BUSINESS ORGANIZATION CONSULTING SERVICES; PROVISION OF BUSINESS INFORMATION IN THE FIELD OF GROWTH AND PROFITABILITY, IN CLASS 35 (U.S. CLS. 100, 101 AND 102).

FIRST USE 5-0-2011; IN COMMERCE 5-0-2011.

THE MARK CONSISTS OF STANDARD CHARACTERS WITHOUT CLAIM TO ANY PARTICULAR FONT, STYLE, SIZE, OR COLOR.

NO CLAIM IS MADE TO THE EXCLUSIVE RIGHT TO USE "GREAT", APART FROM THE MARK AS SHOWN.

SEC. 2(F) AS TO "REPEATABLE MODELS".

SER. NO. 85-311,918, FILED 5-4-2011.

AMY HELLA, EXAMINING ATTORNEY



*David J. Kyffers*

Director of the United States Patent and Trademark Office

# United States of America

United States Patent and Trademark Office

 **FUZION**

**Reg. No. 4,196,756**

TIMEPLUS SYSTEMS, LLC (INDIANA LIMITED LIABILITY COMPANY)  
25325 LEER DRIVE  
ELKHART, IN 46514

**Registered Aug. 28, 2012**

**Int. Cl.: 42**

FOR: COMPUTER SERVICES, NAMELY, ACTING AS AN APPLICATION SERVICE PROVIDER IN THE FIELD OF INFORMATION MANAGEMENT TO HOST COMPUTER APPLICATION SOFTWARE FOR THE MANAGEMENT AND FACILITATION OF PAYROLL PROCESSING, HUMAN RESOURCE INFORMATION TRACKING AND REPORTING, VIEWING OF PAY VOUCHERS AND SUBMISSION OF PERSONNEL DATA CHANGES, IN CLASS 42 (U.S. CLS. 100 AND 101).

**SERVICE MARK**

**PRINCIPAL REGISTER**

FIRST USE 3-1-2011; IN COMMERCE 3-1-2011.

THE MARK CONSISTS OF A PLUS SIGN SURROUNDED BY A PARTIAL CIRCLE ALL IN FRONT OF THE WORD "FUZION".

SER. NO. 85-312,102, FILED 5-4-2011.

GRETCHEN ULRICH, EXAMINING ATTORNEY



*David J. Kyros*

Director of the United States Patent and Trademark Office

# United States of America

United States Patent and Trademark Office

# Nginx

**Reg. No. 4,196,757**

**Registered Aug. 28, 2012**

**Int. Cl.: 9**

**TRADEMARK**

**PRINCIPAL REGISTER**

NGINX SOFTWARE INC. (DELAWARE CORPORATION)  
600 MONTGOMERY ST 43 FLOOR  
C/O BV CAP  
SAN FRANCISCO, CA 94111

FOR: COMPUTER SOFTWARE FOR HTTP AND REVERSE PROXY SERVERS AND MAIL PROXY SERVERS, NAMELY, FOR CONTROLLING AND MANAGING SERVER APPLICATIONS IN THE NATURE OF HTTP AND REVERSE PROXY SERVERS AND MAIL PROXY SERVERS, IN CLASS 9 (U.S. CLS. 21, 23, 26, 36 AND 38).

FIRST USE 5-1-2002; IN COMMERCE 5-1-2004.

THE MARK CONSISTS OF STANDARD CHARACTERS WITHOUT CLAIM TO ANY PARTICULAR FONT, STYLE, SIZE, OR COLOR.

SEC. 2(F).

SER. NO. 85-312,802, FILED 5-4-2011.

ERIN FALK, EXAMINING ATTORNEY



*David J. Kyffers*

Director of the United States Patent and Trademark Office

# United States of America

United States Patent and Trademark Office



**Reg. No. 4,196,758**

**Registered Aug. 28, 2012**

**Int. Cl.: 41**

**SERVICE MARK**

**PRINCIPAL REGISTER**

COUNTY OF ALAMEDA (CALIFORNIA POLITICAL SUBDIVISION OF THE STATE OF CALIFORNIA)  
1401 LAKESIDE DRIVE, 10TH FLOOR  
OAKLAND, CA 94612

FOR: EDUCATION SERVICES, NAMELY, PREPARING AT-RISK YOUTH FOR THE FUTURE THROUGH MENTORING AND ON-THE-JOB TRAINING, IN CLASS 41 (U.S. CLS. 100, 101 AND 107).

FIRST USE 9-14-2010; IN COMMERCE 9-14-2010.

OWNER OF U.S. REG. NO. 3,949,949.

NO CLAIM IS MADE TO THE EXCLUSIVE RIGHT TO USE "BENEFITING THE YOUTH OF ALAMEDA COUNTY", APART FROM THE MARK AS SHOWN.

THE MARK CONSISTS OF A SPIRAL DESIGN TO THE LEFT OF THE WORDS "NEW BEGINNINGS" AND THE WORDS "BENEFITING THE YOUTH OF ALAMEDA COUNTY" BELOW THE WORDS "NEW BEGINNINGS".

SER. NO. 85-313,674, FILED 5-5-2011.

MARK T. MULLEN, EXAMINING ATTORNEY



*David J. Kybas*

Director of the United States Patent and Trademark Office

# United States of America

United States Patent and Trademark Office



**Reg. No. 4,196,759**

**Registered Aug. 28, 2012**

**Int. Cl.: 45**

**SERVICE MARK**

**PRINCIPAL REGISTER**

GIANATASIO, PENNY (NEW YORK LIMITED LIABILITY COMPANY), DBA CERTIFIED SITE SAFETY  
2975 WESTCHESTER AVE, SUITE 114  
PURCHASE, NY 10577

FOR: ANALYSIS AND CONSULTATION PERTAINING TO JOB SITE SAFETY; CONSULTANCY ON REGULATIONS ON SAFETY AT WORK; CONSULTING IN THE FIELD OF WORKPLACE SAFETY; CONSULTING SERVICES IN THE FIELD OF PUBLIC SAFETY; CONSULTING SERVICES IN THE FIELD OF STATE AND FEDERAL REGULATORY COMPLIANCE REQUIREMENTS FOR PERSONNEL SAFETY, IN CLASS 45 (U.S. CLS. 100 AND 101).

FIRST USE 10-1-2006; IN COMMERCE 10-1-2006.

NO CLAIM IS MADE TO THE EXCLUSIVE RIGHT TO USE "CERTIFIED SITE SAFETY", APART FROM THE MARK AS SHOWN.

THE MARK CONSISTS OF THE STYLIZED WORDS "CERTIFIED SITE SAFETY WE'RE IN THE BUSINESS OF SAVING LIVES". AN IMAGE OF A CIRCLE AROUND THE WORDS "CERTIFIED SITE SAFETY". THE WORDS "WE'RE IN THE" IS THE HALF CIRCLE ABOVE. THE STYLIZED WORDS "BUSINESS OF SAVING LIVES" IS BELOW.

SER. NO. 85-313,679, FILED 5-5-2011.

ZACHARY BELLO, EXAMINING ATTORNEY



*David J. Kybas*

Director of the United States Patent and Trademark Office

# United States of America

United States Patent and Trademark Office

## ZI XIU TANG BEE POLLEN CAPSULES

**Reg. No. 4,196,760**

**Registered Aug. 28, 2012**

**Int. Cl.: 5**

**TRADEMARK**

**PRINCIPAL REGISTER**

ECHVERRIA, JULIA (UNITED STATES INDIVIDUAL)  
#632  
14001C SAINT GERMAIN DR.  
CENTREVILLE, VA 20121

FOR: PHARMACEUTICAL PREPARATIONS, NAMELY, CAPSULES FOR DIETING AND WEIGHT LOSS, ANTI-AGING, SKIN CARE, HEALTH FOOD SUPPLEMENTS, AND TREATMENT OF ENDOCRINE AND SMALL VESSEL RELATED DISEASES AND DISORDERS; ALL CONTAINING BEE POLLEN, IN CLASS 5 (U.S. CLS. 6, 18, 44, 46, 51 AND 52).

FIRST USE 1-1-2010; IN COMMERCE 1-1-2010.

THE MARK CONSISTS OF STANDARD CHARACTERS WITHOUT CLAIM TO ANY PARTICULAR FONT, STYLE, SIZE, OR COLOR.

NO CLAIM IS MADE TO THE EXCLUSIVE RIGHT TO USE "BEE POLLEN CAPSULES", APART FROM THE MARK AS SHOWN.

THE NAME(S), PORTRAIT(S), AND/OR SIGNATURE(S) SHOWN IN THE MARK DOES NOT IDENTIFY A PARTICULAR LIVING INDIVIDUAL.

THE ENGLISH TRANSLATION OF "ZI XIU TANG" IN THE MARK IS "ELEGANCE".

SER. NO. 85-313,940, FILED 5-6-2011.

NAKIA HENRY, EXAMINING ATTORNEY



*David J. Kyros*

Director of the United States Patent and Trademark Office

# United States of America

United States Patent and Trademark Office



**Reg. No. 4,196,761**

**Registered Aug. 28, 2012**

**Int. Cls.: 35 and 41**

**SERVICE MARK**

**PRINCIPAL REGISTER**

TECH COCKTAIL, LLC (ILLINOIS LIMITED LIABILITY COMPANY)  
#505  
1000 N. RANDOLPH STREET  
ARLINGTON, VA 22201

FOR: ORGANIZING EVENTS FOR PRODUCT DEMONSTRATIONS AND TO FACILITATE PROFESSIONAL BUSINESS NETWORKING AMONG TECHNOLOGY PROFESSIONALS AND ENTHUSIASTS, NAMELY, ORGANIZING EXHIBITIONS FOR COMMERCIAL OR ADVERTISING PURPOSES, IN CLASS 35 (U.S. CLS. 100, 101 AND 102).

FIRST USE 9-9-2010; IN COMMERCE 9-9-2010.

FOR: ONLINE JOURNALS, NAMELY, BLOGS IN THE FIELD OF TECHNOLOGY NEWS, UPDATES AND EVENT INFORMATION; ENTERTAINMENT SERVICES, NAMELY, PROVIDING WEBCASTS IN THE FIELD OF TECHNOLOGY NEWS, UPDATES AND EVENT INFORMATION, IN CLASS 41 (U.S. CLS. 100, 101 AND 107).

FIRST USE 9-9-2010, THE MARK WAS FIRST USED ANYWHERE IN A DIFFERENT FORM OTHER THAN THAT SOUGHT TO BE REGISTERED AT LEAST AS EARLY AS 07/06/2006; IN COMMERCE 9-9-2010, THE MARK WAS FIRST USED IN COMMERCE IN A DIFFERENT FORM OTHER THAN THAT SOUGHT TO BE REGISTERED AT LEAST AS EARLY AS 07/06/2006.

OWNER OF U.S. REG. NO. 3,637,453.

NO CLAIM IS MADE TO THE EXCLUSIVE RIGHT TO USE "TECH", APART FROM THE MARK AS SHOWN.

THE MARK CONSISTS OF AN OUTLINE OF A MARTINI GLASS WITH AN OLIVE COMPRISED OF TWO CONCENTRIC CIRCLES ON THE LEFT SIDE OF THE RIM. THE OUTLINED STEM OF THE GLASS OPENS SLIGHTLY AT THE BOTTOM, AND EACH SIDE ENDS WITH A CIRCLE. THE WORD "TECH" IS IN A STYLIZED FONT IN CAPITAL LETTERS TO THE RIGHT OF THE GLASS. IN SMALLER STYLIZED FONT AND CAPITAL LETTERS, THE WORD "COCKTAIL" IS TO THE RIGHT OF THE STEM DIRECTLY BELOW "TECH".

SER. NO. 85-315,082, FILED 5-7-2011.



*David J. Kappas*

Director of the United States Patent and Trademark Office



**Reg. No. 4,196,761** KATHRYN COWARD, EXAMINING ATTORNEY

# United States of America

United States Patent and Trademark Office



**Reg. No. 4,196,762**

**Registered Aug. 28, 2012**

**Int. Cls.: 16 and 41**

**TRADEMARK**

**SERVICE MARK**

**PRINCIPAL REGISTER**

I M M PUBLICATIONS INC. (OREGON CORPORATION), DBA THE SKANNER NEWS  
415 N KILLINGSWORTH STREET  
PORTLAND, OR 97217

FOR: NEWSPAPERS, IN CLASS 16 (U.S. CLS. 2, 5, 22, 23, 29, 37, 38 AND 50).

FIRST USE 4-20-1975; IN COMMERCE 4-20-1975.

FOR: NEWSPAPER PUBLICATION, IN CLASS 41 (U.S. CLS. 100, 101 AND 107).

FIRST USE 4-20-1985; IN COMMERCE 4-20-1985.

NO CLAIM IS MADE TO THE EXCLUSIVE RIGHT TO USE THE DESIGN OF A NEWSPAPER,  
APART FROM THE MARK AS SHOWN.

THE COLOR(S) BLUE, BLACK, GRAY, AND WHITE IS/ARE CLAIMED AS A FEATURE  
OF THE MARK.

THE MARK CONSISTS OF THE WORDS "THE SKANNER" IN BLUE FONT CENTERED  
OVER THE WORDS "CHALLENGING PEOPLE TO SHAPE A BETTER FUTURE NOW" IN  
BLACK FONT WITH THE PICTURE OF A FOLDED WHITE NEWSPAPER WITH GRAY  
AND BLACK PRINT ON THE RIGHT SIDE OF THE WORDS "THE SKANNER".

SER. NO. 85-316,952, FILED 5-10-2011.

JACQUELINE A. LAVINE, EXAMINING ATTORNEY



*David J. Kybas*

Director of the United States Patent and Trademark Office

# United States of America

United States Patent and Trademark Office

## Honeycomb Collector

**Reg. No. 4,196,763**

TIGI LTD (ISRAEL CORPORATION)  
30 HAPARDES STREET  
NEVE YARAK, ISRAEL 49945

**Registered Aug. 28, 2012**

**Int. Cl.: 11**

FOR: SOLAR COLLECTORS FOR HEATING, IN CLASS 11 (U.S. CLS. 13, 21, 23, 31 AND 34).

**TRADEMARK**

FIRST USE 6-1-2010; IN COMMERCE 2-2-2011.

**PRINCIPAL REGISTER**

THE MARK CONSISTS OF STANDARD CHARACTERS WITHOUT CLAIM TO ANY PARTICULAR FONT, STYLE, SIZE, OR COLOR.

NO CLAIM IS MADE TO THE EXCLUSIVE RIGHT TO USE "COLLECTOR", APART FROM THE MARK AS SHOWN.

SER. NO. 85-317,649, FILED 5-11-2011.

DAVID COLLIER, EXAMINING ATTORNEY



*David J. Kyffers*

Director of the United States Patent and Trademark Office

# United States of America

United States Patent and Trademark Office



# Leap

INTO LEADERSHIP

**Reg. No. 4,196,764**

**Registered Aug. 28, 2012**

**Int. Cl.: 35**

**SERVICE MARK**

**PRINCIPAL REGISTER**

LEAP INTO LEADERSHIP LLC (MISSOURI LIMITED LIABILITY COMPANY)  
4256 E LORI LEI CT.  
SPRINGFIELD, MO 65809

FOR: ACQUISITION AND MERGER CONSULTATION; ADVERTISING AGENCIES PROVIDING THE STRATEGY, DESIGN AND EXECUTION OF PROGRAMS TO PROMOTE BUSINESSES IN THE FOOD AND FOODSERVICE INDUSTRIES; ADVERTISING AND BUSINESS MANAGEMENT CONSULTANCY; ADVERTISING AND BUSINESS SERVICES, NAMELY, PROVIDING AN ONLINE WEBSITE WHERE ADVERTISERS, MARKETERS, AND CONTENT PROVIDERS CAN INTERACT WITH USERS FOR ADVERTISING, BRANDING, AND PROMOTING KNOWLEDGE, PRODUCTS, AND SERVICES, AND TRADESHOWS, ON BEHALF OF THEMSELVES AND OTHERS, AND FOR EVALUATING AND RATING THE SAME, ALL THE FOREGOING RELEVANT TO HUMAN ACTIVITIES AFFECTING CLIMATE CHANGE AND RELATED FIELDS; ADVERTISING AND BUSINESS SERVICES, NAMELY, SECURING AIRTIME ON ALL FORMS OF MEDIA COMMUNICATIONS STATIONS, SYSTEMS, NETWORKS, AND SERVICES FOR THE PURPOSE OF PROMOTING THE GOODS AND SERVICES OF OTHERS; ADVERTISING AND MARKETING CONSULTANCY; ADVERTISING AND PROMOTION SERVICES AND RELATED CONSULTING; ADVERTISING CONSULTATION; ADVERTISING, MARKETING AND PROMOTIONAL SERVICES RELATED TO ALL INDUSTRIES FOR THE PURPOSE OF FACILITATING NETWORKING AND SOCIALIZING OPPORTUNITIES FOR BUSINESS PURPOSES; ADVICE AND INFORMATION CONCERNING COMMERCIAL BUSINESS MANAGEMENT; ADVICE IN THE FIELD OF BUSINESS MANAGEMENT AND MARKETING; ADVICE RELATING TO THE ORGANIZATION AND MANAGEMENT OF BUSINESS; ADVISORY SERVICE FOR ORGANIZATIONAL ISSUES AND BUSINESS ADMINISTRATION, WITH AND WITHOUT THE HELP OF ELECTRONIC DATA BASES; ADVISORY SERVICES FOR OTHERS FOR BUSINESS PURPOSES IN THE FIELDS OF ARCHITECTURE, INTERIOR DESIGN AND URBAN PLANNING DESIGN; ADVISORY SERVICES RELATING TO BUSINESS MANAGEMENT AND BUSINESS OPERATIONS; ARRANGING AND CONDUCTING BUSINESS CONFERENCES; ARRANGING AND CONDUCTING OF FAIRS AND EXHIBITIONS FOR BUSINESS AND ADVERTISING PURPOSES; ARRANGING AND CONDUCTING SPECIAL EVENTS FOR BUSINESS PURPOSES; ASSISTANCE AND ADVICE REGARDING BUSINESS ORGANIZATION AND MANAGEMENT; ASSISTANCE AND CONSULTANCY SERVICES IN THE FIELD OF BUSINESS MANAGEMENT OF COMPANIES IN THE ENERGY SECTOR; ASSISTANCE IN BUSINESS MANAGEMENT AND PRODUCT COMMERCIALIZATION, WITHIN THE FRAMEWORK OF A FRANCHISE CONTRACT; ASSISTANCE IN FRANCHISED COMMERCIAL BUSINESS MANAGEMENT; ASSISTANCE IN MANAGEMENT OF BUSINESS



*David J. Kybas*

Director of the United States Patent and Trademark Office

**Reg. No. 4,196,764** ACTIVITIES; ASSISTANCE TO INDUSTRIAL OR COMMERCIAL ENTERPRISES IN THE RUNNING OF THEIR BUSINESS; ASSISTANCE WITH BUSINESS MANAGEMENT AND PLANNING; ASSISTANCE, ADVICE AND CONSULTANCY WITH REGARD TO BUSINESS PLANNING, BUSINESS ANALYSIS, BUSINESS MANAGEMENT AND BUSINESS ORGANIZATION RELATING TO PURCHASING FUNCTIONS; ASSISTANCE, ADVISORY SERVICES AND CONSULTANCY WITH REGARD TO BUSINESS PLANNING, BUSINESS ANALYSIS, BUSINESS MANAGEMENT, AND BUSINESS ORGANIZATION; ASSISTANCE, ADVISORY SERVICES AND CONSULTANCY WITH REGARD TO BUSINESS PLANNING, BUSINESS ANALYSIS, BUSINESS MANAGEMENT, AND BUSINESS ORGANIZATION RELATING TO MICRO CREDITS, MICRO FINANCE AND ENERGY PRODUCTS; ASSISTANCE, ADVISORY SERVICES AND CONSULTANCY WITH REGARD TO BUSINESS PLANNING, BUSINESS ANALYSIS, BUSINESS MANAGEMENT, BUSINESS ORGANIZATION, MARKETING AND CUSTOMER ANALYSIS; BRAND IMAGERY CONSULTING SERVICES; BRANDING SERVICES, NAMELY, CONSULTING, DEVELOPMENT, MANAGEMENT AND MARKETING OF BRANDS FOR BUSINESSES; BUSINESS ACQUISITION AND MERGER CONSULTATION; BUSINESS ACQUISITIONS CONSULTATION; BUSINESS ADMINISTRATION AND MANAGEMENT; BUSINESS ADMINISTRATION AND OFFICE WORK; BUSINESS ADMINISTRATION ASSISTANCE; BUSINESS ADMINISTRATION CONSULTANCY; BUSINESS ADMINISTRATION IN THE FIELD OF TRANSPORT AND DELIVERY; BUSINESS ADMINISTRATION SERVICES FOR PROCESSING SALES MADE ON THE INTERNET; BUSINESS ADMINISTRATION SERVICES, NAMELY, PERFORMING ADMINISTRATIVE REQUIREMENTS FOR ENTERING HORSES OF OTHERS IN HORSE RACES; BUSINESS ADVICE AND ANALYSIS OF MARKETS; BUSINESS ADVICE AND COMMERCIAL INFORMATION; BUSINESS ADVICE AND INFORMATION; BUSINESS ADVICE AND INFORMATION ABOUT A CORPORATE EXECUTIVE WHOSE WEALTH AMOUNTS TO AT LEAST A MILLION DOLLARS, POUNDS, OR THE EQUIVALENT IN OTHER CURRENCY; BUSINESS ADVICE AND INFORMATION RELATING TO LOANS, FINANCE AND CAPITAL; BUSINESS ADVICE, INQUIRIES OR INFORMATION; BUSINESS ADVISORY AND CONSULTANCY SERVICES RELATING TO EXPORT, EXPORT SERVICES, EXPORT PROMOTION INFORMATION AND SERVICES; BUSINESS ADVISORY SERVICES IN THE FIELDS OF ARCHITECTURE, INTERIOR DESIGN AND URBAN PLANNING DESIGN; BUSINESS ADVISORY SERVICES, CONSULTANCY AND INFORMATION; BUSINESS ADVISORY SERVICES, NAMELY, SEARCH FOR AND SELECTION OF THE BEST POTENTIAL SUPPLIERS FOR OTHERS; BUSINESS ANALYSIS AND BUSINESS STRATEGIC PLANNING SERVICES IN THE TECHNOLOGY INDUSTRY; BUSINESS AND MANAGEMENT CONSULTING FOR HEALTHCARE PROVIDERS AND RELATED BUSINESSES; BUSINESS APPRAISAL CONSULTATION; BUSINESS APPRAISALS; BUSINESS APPRAISALS AND EVALUATIONS IN BUSINESS MATTERS; BUSINESS ASSISTANCE SERVICES, NAMELY, ASSISTING HEALTH CARE FACILITIES AND OTHER COMPANIES WITH CUSTOMER FOLLOW-UP TO IMPROVE CUSTOMER OUTCOMES AND SATISFACTION THROUGH THE USE OF TELECOMMUNICATION DEVICES AND COMPUTER NETWORKS WITH AUTOMATED INTERACTION AND DATA FEEDBACK, MONITORING AND COMPILATION CAPACITY; BUSINESS ASSISTANCE, ADVISORY AND CONSULTING SERVICES IN THE FIELD OF HUMAN RESOURCES; BUSINESS ASSISTANCE, ADVISORY SERVICES AND CONSULTANCY IN THE FIELDS OF BUDGETING, BOOKKEEPING, PREPARATION AND FILING OF CLAIMS, PREPARATION AND FILING OF FORMS, BILL PAYING, ORGANIZING AND PROCESSING PAPERWORK, DEVELOPMENT OF PLAN TO ACHIEVE GOALS AND REFERRAL SERVICES TO BEREAVEMENT COUNSELORS; BUSINESS ASSISTANCE, MANAGEMENT AND INFORMATION SERVICES; BUSINESS AUDITING; BUSINESS COLLABORATION SERVICES, NAMELY, PROVIDING A NATIONAL COMPUTER-BASED NETWORKING WEB SITE FOR HEALTH CARE EDUCATORS AND MEDICAL EDUCATORS TO COLLABORATE ACROSS DISCIPLINES TO HELP IMPROVE HEALTH CARE EDUCATION AND MEDICAL EDUCATION; BUSINESS CONSULTATION; BUSINESS CONSULTATION AND MANAGEMENT REGARDING MARKETING ACTIVITIES AND LAUNCHING OF NEW PRODUCTS; BUSINESS CONSULTATION CONCERNING THE EFFECTS OF TERRESTRIAL WEATHER, SPACE WEATHER AND ATMOSPHERIC SCIENCE ON BUSINESS FUNCTIONS AND EFFICIENCIES; BUSINESS CONSULTATION IN THE FIELD OF BUSINESS LEADERSHIP DEVELOPMENT; BUSINESS CONSULTATION IN THE FIELD OF TELECOMMUNICATIONS

**Reg. No. 4,196,764** EXPENSE MANAGEMENT; BUSINESS CONSULTATION IN THE FIELD OF HUMAN RESOURCES; BUSINESS CONSULTATION SERVICES; BUSINESS CONSULTATION SERVICES IN THE FIELDS OF SUPPLY CHAIN ANALYSIS, REGULATION COMPLIANCE AND COUNTERFEIT DETECTION; BUSINESS CONSULTATION SERVICES TO ASSIST NON-PROFIT ORGANIZATIONS IN PLANNING, MANAGING, AND CONDUCTING FUNDRAISING ACTIVITIES VIA A GLOBAL COMPUTER NETWORK; BUSINESS CONSULTATION SERVICES, NAMELY, BUSINESS PROCESS IMPROVEMENT AND ENTERPRISE ARCHITECTURE DESIGN; BUSINESS CONSULTING AND ADVISORY SERVICES IN THE FIELD OF ENERGY EFFICIENCY; BUSINESS CONSULTING AND BUSINESS INFORMATION FOR ENTERPRISES; BUSINESS CONSULTING AND INFORMATION SERVICES; BUSINESS CONSULTING AND MANAGEMENT IN THE FIELD OF CLINICAL TRIALS, NAMELY, MANAGEMENT AND COMPILATION OF COMPUTERIZED DATABASES IN THE FIELD OF CLINICAL TRIALS FOR BUSINESS PURPOSES; BUSINESS CONSULTING AND MANAGEMENT IN THE FIELD OF CLINICAL TRIALS, NAMELY, PROVIDING INFORMATION MANAGEMENT SERVICES; BUSINESS CONSULTING IN THE CONSUMER PRODUCTS INDUSTRY; BUSINESS CONSULTING IN THE FIELD OF ENVIRONMENTAL MANAGEMENT, NAMELY, ADVISING BUSINESSES AND INDIVIDUALS ON ISSUES OF ENVIRONMENTAL IMPACT, CONSERVATION, PRESERVATION AND PROTECTION, AND ECONOMIC ANALYSIS FOR BUSINESS PURPOSES; BUSINESS CONSULTING SERVICE IN THE FIELD OF MEDICAL IMAGING CENTERS; BUSINESS CONSULTING SERVICE THAT PROVIDES TRANSFORMATIONAL STRATEGIES TO COMPANIES WISHING TO MOVE TOWARDS SUSTAINABILITY AND SOCIALLY RESPONSIBLE BUSINESS PRACTICES, PROVIDED MAINLY TO THE CONSUMER PRODUCTS INDUSTRY; BUSINESS CONSULTING SERVICES FOR THE CONCRETE INDUSTRY; BUSINESS CONSULTING SERVICES FOR THE ELECTRIC ENERGY INDUSTRY; BUSINESS CONSULTING SERVICES IN THE AGRICULTURAL FIELD; BUSINESS CONSULTING SERVICES IN THE FIELD OF BUSINESS KNOWLEDGE TRANSFER THROUGH AUDIO TOOLS, NAMELY, RECORDING INTERVIEWS WITH SUBJECT MATTER EXPERTS FOR AN ORGANIZATION'S CAPTURE AND FUTURE USE; BUSINESS CONSULTING SERVICES IN THE FIELD OF INFORMATION ASSURANCE; BUSINESS CONSULTING SERVICES IN THE FIELD OF ORGANIZATIONAL CHANGE MANAGEMENT; BUSINESS CONSULTING SERVICES IN THE FIELD OF HUMAN RESOURCES; BUSINESS CONSULTING SERVICES IN THE FIELDS OF ENERGY MEASUREMENT TO IMPROVE ENERGY EFFICIENCY WITHIN RESIDENTIAL, COMMERCIAL, INDUSTRIAL AND INSTITUTIONAL FACILITIES; BUSINESS CONSULTING SERVICES RELATED TO MONITORING, CONTROLLING, AND MANAGING TELEPRESENCE ENVIRONMENTS OF OTHERS; BUSINESS CONSULTING SERVICES RELATING TO PRODUCT DISTRIBUTION, OPERATIONS MANAGEMENT SERVICES, LOGISTICS, REVERSE LOGISTICS, SUPPLY CHAIN, AND PRODUCTION SYSTEMS AND DISTRIBUTION SOLUTIONS; BUSINESS CONSULTING SERVICES RELATING TO THE INTEGRATION OF THE AREAS OF BUSINESS PROCESS TECHNOLOGY, ORGANIZATIONAL LEARNING, CHANGE MANAGEMENT, AND OPERATIONAL SUSTAINABILITY; BUSINESS CONSULTING SERVICES, NAMELY, ASSISTING LEGAL PROFESSIONALS IN ORGANIZING AND SETTING UP THEIR PRACTICES FOR OFFERING DIVORCE PLANNING AND FACILITATION AND LEGAL DOCUMENT SERVICES TO THEIR CLIENTS; BUSINESS CONSULTING SERVICES, NAMELY, PROVIDING A TURNKEY BUSINESS SOLUTION FOR REVIEWING PRODUCTS AND SERVICES, PLANNING DOCUMENTATION AND WORKFLOW, HIRING TECHNICAL WRITERS, MANAGING PROJECTS FOR BUSINESS PURPOSES, TRACKING USER SATISFACTION, AND RUNNING USABILITY STUDIES FOR BUSINESS PURPOSES; BUSINESS CONSULTING SERVICES, NAMELY, PROVIDING A TURNKEY SOLUTION FOR REVIEWING PRODUCT AND SERVICE DOCUMENTATION AND WORKFLOW, MANAGING PROJECTS FOR BUSINESS PURPOSES, TRACKING USER SATISFACTION, AND RUNNING USABILITY STUDIES FOR BUSINESS PURPOSES; BUSINESS CONSULTING SERVICES, NAMELY, PROVIDING ASSISTANCE IN DEVELOPMENT OF BUSINESS STRATEGIES AND CREATIVE IDEATION; BUSINESS CONSULTING, BUSINESS MANAGEMENT AND PROVIDING INFORMATION IN THE MUSIC BUSINESS FIELD; BUSINESS CONSULTING, INQUIRIES OR INFORMATION; BUSINESS CONSULTING, MANAGEMENT, PLANNING AND SUPERVISION; BUSINESS DATA ANALYSIS; BUSINESS DEVELOPMENT CONSULTING SERVICES; BUSINESS DEVELOPMENT SERVICES; BUSINESS DEVELOP-

**Reg. No. 4,196,764** MENT SERVICES, NAMELY, PROVIDING START-UP SUPPORT FOR BUSINESSES OF OTHERS; BUSINESS EFFICIENCY ADVICE; BUSINESS EFFICIENCY EXPERT SERVICES; BUSINESS ENQUIRIES AND INVESTIGATIONS; BUSINESS EVALUATION OF HUMAN RESOURCES AND CAPITAL; BUSINESS FAILURE ANALYSIS SERVICES; BUSINESS FEASIBILITY STUDIES; BUSINESS INFORMATION AND ACCOUNTING ADVISORY SERVICES; BUSINESS INFORMATION AND INQUIRIES; BUSINESS INFORMATION IN THE FIELD OF HUMAN RESOURCES; BUSINESS INFORMATION MANAGEMENT; BUSINESS INFORMATION MANAGEMENT, NAMELY, ELECTRONIC REPORTING OF BUSINESS INFORMATION, BUSINESS ANALYTICS, NAMELY, BUSINESS INVESTIGATIONS, EVALUATIONS, EXPERT APPRAISALS, INFORMATION AND RESEARCH, TRADE SPEND BUSINESS MANAGEMENT; BUSINESS INFORMATION REPORTING SERVICES FOR HOSPITALS, NAMELY, PROVIDING HOSPITAL SPECIFIC REPORTS FOR THE PURPOSE OF ANALYZING GOVERNMENT REIMBURSEMENT DATA AND DRIVE BUSINESS DECISION MAKING; BUSINESS INFORMATION SERVICES AND APPRAISALS; BUSINESS INFORMATION SERVICES IN THE NATURE OF PROVIDING INFORMATION ON BUSINESS OPPORTUNITIES; BUSINESS INFORMATION SERVICES, NAMELY, GATHERING AND REPORTING INFORMATION REGARDING E-MAIL ADDRESSES OF OTHERS THAT ARE MADE AVAILABLE TO OTHER COMPANIES FOR COMMERCIAL PURPOSES; BUSINESS INFORMATION SERVICES, NAMELY, PROVIDING AN ONLINE COMPILATION OF ANNUAL EMPLOYMENT DATA AND STATISTICS FOR THE UNITED STATES' HIGH-TECH INDUSTRY; BUSINESS INTERMEDIARY AND ADVISORY SERVICES IN THE FIELD OF SELLING PRODUCTS AND RENDERING SERVICES; BUSINESS INVESTIGATIONS; BUSINESS INVESTIGATIONS, EVALUATIONS, EXPERT APPRAISALS, INFORMATION AND RESEARCH; BUSINESS KNOWLEDGE MANAGEMENT SERVICES; BUSINESS MANAGEMENT; BUSINESS MANAGEMENT ADVICE; BUSINESS MANAGEMENT ADVISORY SERVICES RELATING TO FRANCHISING; BUSINESS MANAGEMENT AND ADVICE; BUSINESS MANAGEMENT AND ADVISORY SERVICES TO COMPANIES IN FRAGMENTED INDUSTRIES DESIRING TO CONSOLIDATE/ROLL UP USING A PARTNERSHIP STRUCTURE; BUSINESS MANAGEMENT AND CONSULTATION; BUSINESS MANAGEMENT AND CONSULTATION IN THE FIELD OF CASE MANAGEMENT, INTEGRATED JUSTICE, DATA CONVERSIONS, AND BUSINESS INTELLIGENCE; BUSINESS MANAGEMENT AND CONSULTATION IN THE FIELD OF HUMAN RESOURCES; BUSINESS MANAGEMENT AND CONSULTATION REGARDING IN-HOUSE BUILDING CLEANING PROGRAMS; BUSINESS MANAGEMENT AND CONSULTING SERVICES FOR THE HEALTH CARE INDUSTRY, NAMELY, CUSTOMER SERVICE, ACCOUNTING SERVICES, AND MARKETING SERVICES; BUSINESS MANAGEMENT AND CONSULTING SERVICES FOR THE HEALTH CARE INDUSTRY, NAMELY, CUSTOMER SERVICE, ACCOUNTING SERVICES, AND WEB-BASED ADVERTISING AND MARKETING SERVICES; BUSINESS MANAGEMENT AND CONSULTING SERVICES FOR THE HEALTH CARE INDUSTRY, NAMELY, PROVIDING INDUSTRY EXPERTISE AND SUPPLIER PARTNERSHIPS; BUSINESS MANAGEMENT AND ENTERPRISE ORGANIZATION CONSULTANCY; BUSINESS MANAGEMENT AND OPERATION OF RETIREMENT COMMUNITIES FOR OTHERS; BUSINESS MANAGEMENT ASSISTANCE AND PARTICULARLY CARRYING OUT TASKS NECESSARY FOR THE SMOOTH CONDUCT OF SALES BY AUCTION; BUSINESS MANAGEMENT ASSISTANCE TO INDUSTRIAL OR COMMERCIAL COMPANIES; BUSINESS MANAGEMENT CONSULTANCY AND ADVISORY SERVICES; BUSINESS MANAGEMENT CONSULTANCY AS WELL AS DEVELOPMENT OF PROCESSES FOR THE ANALYSIS AND THE IMPLEMENTATION OF STRATEGY PLANS AND MANAGEMENT PROJECTS; BUSINESS MANAGEMENT CONSULTANCY IN THE FIELD OF INSOURCING, NAMELY, ASSISTING BUSINESSES IN THE DEVELOPMENT OF PROCESSES FOR THE ANALYSIS AND THE IMPLEMENTATION OF THE DELEGATION OF OPERATIONS OR JOBS FROM PRODUCTION WITHIN A BUSINESS TO AN INTERNAL ENTITY THAT SPECIALIZES IN THAT OPERATION; BUSINESS MANAGEMENT CONSULTANCY IN THE FIELD OF PURCHASES, NAMELY, ASSISTING BUSINESSES IN IMPROVEMENT OF PURCHASING FUNCTIONS; BUSINESS MANAGEMENT CONSULTANCY IN THE FIELD OF TRANSPORT AND DELIVERY; BUSINESS MANAGEMENT CONSULTANCY SERVICES; BUSINESS MANAGEMENT CONSULTANCY, ALSO VIA THE INTERNET; BUSINESS MANAGEMENT CONSULTATION; BUSINESS MANAGEMENT CONSULTATION AND SERVICES, NAMELY, MANAGING

**Reg. No. 4,196,764** AND ADMINISTERING NON-CORE FUNCTIONS, NAMELY, MAILING AND SHIPPING, RECORDS MANAGEMENT, INFORMATION SERVICES, ADMINISTRATION, PAYROLL AND ACCOUNTING, AND TELEMARKETING SERVICES; BUSINESS MANAGEMENT CONSULTATION IN THE FIELD OF EXECUTIVE AND LEADERSHIP DEVELOPMENT; BUSINESS MANAGEMENT CONSULTING; BUSINESS MANAGEMENT CONSULTING AND ADVISORY SERVICES; BUSINESS MANAGEMENT CONSULTING IN THE FIELD OF TEAM DEVELOPMENT; BUSINESS MANAGEMENT CONSULTING WITH RELATION TO STRATEGY, FINANCING, MARKETING, PRODUCTION, PERSONNEL AND SALE MATTERS FOR COMPANIES INVOLVED WITH THIN FILM AND NANO TECHNOLOGIES AND PLASMA PROCESSES; BUSINESS MANAGEMENT CONSULTING WITH RELATION TO STRATEGY, MARKETING, PRODUCTION, PERSONNEL AND RETAIL SALE MATTERS; BUSINESS MANAGEMENT CONSULTING WITH RELATION TO STRATEGY, MARKETING, SALES, OPERATION, PRODUCT DESIGN PARTICULARLY SPECIALIZING IN THE USE OF ANALYTIC AND STATISTIC MODELS FOR THE UNDERSTANDING AND PREDICTING OF CONSUMERS, BUSINESSES, AND MARKET TRENDS AND ACTIONS; BUSINESS MANAGEMENT CONSULTING, STRATEGIC PLANNING AND BUSINESS ADVISORY SERVICES PROVIDED TO THE VETERINARY MEDICAL PROFESSION; BUSINESS MANAGEMENT FOR A TRADE COMPANY AND FOR A SERVICE COMPANY; BUSINESS MANAGEMENT FOR SHOPS; BUSINESS MANAGEMENT FOR THE MOBILE VETERINARY PRACTICE OF OTHERS; BUSINESS MANAGEMENT IN THE FIELD OF TRANSPORT AND DELIVERY; BUSINESS MANAGEMENT INFORMATION ON A WIDE VARIETY OF TOPICS TO SERVICE PROVIDING PROFESSIONALS; BUSINESS MANAGEMENT OF THE NON-PROFIT CORPORATIONS AND TRADE ASSOCIATIONS OF OTHERS; BUSINESS MANAGEMENT PLANNING; BUSINESS MANAGEMENT SERVICES IN THE FIELD OF CONSERVING AND PRESERVING LAND FOR HUNTING AND FISHING; BUSINESS MANAGEMENT SERVICES, NAMELY, AIRCRAFT MANAGEMENT FOR OTHERS; BUSINESS MANAGEMENT SERVICES, NAMELY, MANAGING LOGISTICS, REVERSE LOGISTICS, SUPPLY CHAIN SERVICES, SUPPLY CHAIN VISIBILITY AND SYNCHRONIZATION, SUPPLY AND DEMAND FORECASTING AND PRODUCT DISTRIBUTION PROCESSES FOR OTHERS; BUSINESS MANAGEMENT SERVICES, NAMELY, PURCHASING OF AND SELLING OF COMPANIES FOR OTHERS; BUSINESS MANAGEMENT SERVICES, NAMELY, SUPPLY CHAIN LOGISTICS, REVERSE LOGISTICS AND LIQUIDATION OF GOODS OF OTHERS; BUSINESS MANAGEMENT SUPERVISION; BUSINESS MARKETING CONSULTING SERVICES; BUSINESS MARKETING SERVICES; BUSINESS MEETING PLANNING; BUSINESS MERGER CONSULTATION; BUSINESS MONITORING AND CONSULTING SERVICES, NAMELY, TRACKING WEB SITES AND APPLICATIONS OF OTHERS TO PROVIDE STRATEGY, INSIGHT, MARKETING, SALES, OPERATION, PRODUCT DESIGN, PARTICULARLY SPECIALIZING IN THE USE OF ANALYTIC AND STATISTIC MODELS FOR THE UNDERSTANDING AND PREDICTING OF CONSUMERS, BUSINESSES, AND MARKET TRENDS AND ACTIONS; BUSINESS MONITORING SERVICES, NAMELY, TRACKING WEB SITES OF OTHERS TO PROVIDE DETAILS ABOUT USER CLICK TRAFFIC OR VISITS TO THE WEB SITE; BUSINESS NETWORKING; BUSINESS NETWORKING OF PEER TO PEER LEARNING GROUPS OF HIGH NET WORTH INDIVIDUALS; BUSINESS OPERATION, BUSINESS ADMINISTRATION AND OFFICE FUNCTIONS; BUSINESS ORGANIZATION AND MANAGEMENT CONSULTING SERVICES; BUSINESS ORGANIZATION CONSULTING; BUSINESS ORGANIZATION ADVICE; BUSINESS ORGANIZATION AND MANAGEMENT CONSULTANCY INCLUDING PERSONNEL MANAGEMENT; BUSINESS ORGANIZATION AND MANAGEMENT CONSULTING; BUSINESS ORGANIZATION AND OPERATION CONSULTANCY; BUSINESS ORGANIZATION CONSULTING; BUSINESS ORGANIZATIONAL CONSULTATION; BUSINESS PLANNING; BUSINESS PROCESS OUTSOURCING SERVICES IN THE FIELD OF HUMAN RESOURCES; BUSINESS PROCESS RE-ENGINEERING SERVICES; BUSINESS RECORDS MANAGEMENT; BUSINESS RECORDS MANAGEMENT SERVICES RELATING TO BUSINESS ENTITY FORMATION AND ASSOCIATED STATE REPORTING REQUIREMENTS; BUSINESS RELOCATION CONSULTING; BUSINESS RELOCATION SERVICES; BUSINESS RESEARCH; BUSINESS RESEARCH AND SURVEYS; BUSINESS RESEARCH CONSULTATION; BUSINESS RESEARCH SERVICES IN THE FIELD OF HUMAN RESOURCES; BUSINESS RESEARCH SERVICES, NAMELY, PROVIDING ANALYSIS OF RETAIL DATA ON SPECIFIC BUSINESS LOCATIONS; BUSI-



**Reg. No. 4,196,764** NESS RESEARCH USING FOCUS GROUPS; BUSINESS RISK ASSESSMENT SERVICES; BUSINESS RISK MANAGEMENT; BUSINESS RISK MANAGEMENT CONSULTATION; BUSINESS SERVICES FOR FUNDRAISING PROGRAMS, NAMELY, DEVELOPING FUNDRAISING PROGRAM CATALOGS, BROCHURES, PRICE SHEETS, ORDER FORMS, AND OTHER DOCUMENTS FOR NOT-FOR-PROFIT ORGANIZATIONS; BUSINESS SERVICES, NAMELY, A NETWORK OF SOLAR CONTRACTORS RECEIVING LEADS AND BIDDING OPPORTUNITIES BY MEANS OF AN ONLINE MARKETPLACE FOR THE PURPOSE OF DEVELOPING INFORMATION TO EVALUATE THE INVESTMENT VALUE OF SOLAR ENERGY FOR A WEB-BASED CONSUMER; BUSINESS SERVICES, NAMELY, ADMINISTRATION OF A PROGRAM FOR ENABLING PARTICIPANTS TO RECEIVE EXPEDITED SERVICES IN THE FIELD OF HUMAN RESOURCES; BUSINESS SERVICES, NAMELY, ASSISTING OTHERS IN THE ESTABLISHMENT OF CHARITABLE ORGANIZATIONS; BUSINESS SERVICES, NAMELY, ASSISTING THE OWNERS OF INTELLECTUAL PROPERTY AND INTANGIBLE ASSETS IN FINDING INVESTORS; BUSINESS SERVICES, NAMELY, COMBINED STRATEGIC GOODS OR SERVICES SOURCING AND COOPERATIVE PURCHASING FOR OTHERS; BUSINESS SERVICES, NAMELY, CONSULTING IN THE FIELD OF SUPPLY CHAIN VERIFICATION FOR THE PRESENCE OF GENETICALLY MODIFIED ORGANISMS; BUSINESS SERVICES, NAMELY, CONSUMER RESEARCH AND CONSULTING RELATED THERETO; BUSINESS SERVICES, NAMELY, DESIGN, DEVELOPMENT AND ANALYSIS OF TESTS FOR TESTING PROFESSIONAL COMPETENCY; BUSINESS SERVICES, NAMELY, DEVELOPING FUNDRAISING CAMPAIGNS FOR OTHERS; BUSINESS SERVICES, NAMELY, FACILITIES MANAGEMENT OF TECHNICAL OPERATIONS; BUSINESS SERVICES, NAMELY, FORMULATION OF BEST PRACTICES FOR HUMAN RESOURCES; BUSINESS SERVICES, NAMELY, FREIGHT INFORMATION MANAGEMENT SERVICES, SHIPMENT PROCESSING, PREPARING SHIPPING DOCUMENTS AND INVOICES, TRACKING DOCUMENTS, PACKAGES AND FREIGHT OVER COMPUTER NETWORKS, INTRANETS AND INTERNETS; BUSINESS SERVICES, NAMELY, INDEPENDENT MEDICAL MANAGEMENT SERVICES FOR SELF-FUNDED MAJOR MEDICAL HEALTH PLANS; BUSINESS SERVICES, NAMELY, MANAGEMENT OF AIR AND WATER PROCESSING SYSTEMS AND FACILITIES FOR OTHERS; BUSINESS SERVICES, NAMELY, MATCHING POTENTIAL PRIVATE INVESTORS WITH ENTREPRENEURS NEEDING FUNDING; BUSINESS SERVICES, NAMELY, OPERATING TELEPRESENCE ENVIRONMENTS OF OTHERS; BUSINESS SERVICES, NAMELY, OPERATION OF POWER GENERATION EQUIPMENT AND FACILITIES FOR OTHERS; BUSINESS SERVICES, NAMELY, PROCURING QUALIFIED AND CREDENTIALLED THIRD-PARTY EXPERTS, PROFESSIONALS AND OTHER QUALIFIED PERSONNEL, AND DOCUMENTATION AND INFORMATION ALL ON BEHALF OF OTHERS; BUSINESS SERVICES, NAMELY, PROVIDING AN ONLINE NETWORK FOR CONTRACTORS TO RECEIVE BIDDING OPPORTUNITIES BY MEANS OF AN ONLINE MARKETPLACE FOR THE PURPOSE OF DEVELOPING BUSINESS FOR SUSTAINABLE RELATED BUILDING PRODUCTS AND SERVICES; BUSINESS SERVICES, NAMELY, PROVIDING AN ONLINE NETWORK FOR CONTRACTORS TO RECEIVE LEADS AND BIDDING OPPORTUNITIES BY MEANS OF AN ONLINE MARKETPLACE FOR THE PURPOSE OF DEVELOPING BUSINESS; BUSINESS SERVICES, NAMELY, PROVIDING AN ONLINE NETWORK FOR CONTRACTORS TO RECEIVE LEADS AND BIDDING OPPORTUNITIES BY MEANS OF AN ONLINE MARKETPLACE FOR THE PURPOSE OF DEVELOPING BUSINESS FOR ENERGY RELATED PRODUCTS AND SERVICES; BUSINESS SERVICES, NAMELY, PROVIDING COMPUTER DATABASES REGARDING THE PURCHASE AND SALE OF A WIDE VARIETY OF PRODUCTS AND SERVICES OF OTHERS; BUSINESS SERVICES, NAMELY, PROVIDING ONLINE INFORMATION IN RELATION TO RESOURCE PLANNING FOR THE MINING AND RESOURCE INDUSTRY, MINE PLANNING, EQUIPMENT SCHEDULING, MAINTENANCE SCHEDULING, FINANCE MODELING, PRODUCTION SCHEDULING, MATERIALS MANAGEMENT, QUALITY MANAGEMENT, HUMAN RESOURCES MANAGEMENT AND PROJECT MANAGEMENT; BUSINESS SERVICES, NAMELY, REGISTERING, SCREENING, CREDENTIALING, AND ORGANIZING THIRD-PARTY VENDORS, SUPPLIERS, AND CONTRACTORS, AND DOCUMENTATION AND INFORMATION ON BEHALF OF OTHERS; BUSINESS SERVICES, NAMELY, STRUCTURING, OPTIMIZING AND CHANGE MANAGEMENT CONSULTING RELATED TO CORPORATE IN-HOUSE INTELLECTUAL PROPERTY DEPARTMENTS AND

**Reg. No. 4,196,764** INTELLECTUAL PROPERTY ASSET MANAGEMENT PROGRAMS; BUSINESS SERVICES, NAMELY, TIMEKEEPING SERVICES FOR OTHERS; BUSINESS SERVICES, NAMELY, TRACKING AND MONITORING OF CALLS FOR OTHERS IN RESPONSE TO ADVERTISING ADS; BUSINESS SERVICES, NAMELY, TRACKING, COMPARING AND MONITORING EMPLOYEE COST ITEMS FOR OTHERS; BUSINESS STRATEGIC PLANNING SERVICES; BUSINESS STRATEGY DEVELOPMENT SERVICES; BUSINESS SUCCESSION PLANNING; BUSINESS SUPERVISION; BUSINESS SUPPORT SERVICES, NAMELY, BUSINESS CONSULTING TO FREELANCERS, START-UPS, EXISTING BUSINESSES AND NON-PROFIT ORGANIZATIONS; BUSINESS TO BUSINESS DIRECT MARKETING SERVICES; BUSINESS VENTURE DEVELOPMENT AND FORMATION CONSULTING SERVICES FOR THE RENEWABLE ENERGY INDUSTRY; COLLECTING AND ANALYZING CLAIMS DATA FROM HEALTHCARE ORGANIZATIONS FOR BUSINESS PURPOSES; COMMERCIAL ASSISTANCE IN BUSINESS MANAGEMENT; COMPANY MANAGEMENT, INCLUDING CONSULTANCY IN DEMOGRAPHIC MATTERS; COMPILATION OF STATISTICS; CONDUCTING BUSINESS AND MARKET RESEARCH SURVEYS; CONDUCTING BUSINESS RESEARCH AND SURVEYS; CONDUCTING FEASIBILITY STUDIES FOR BUSINESS PURPOSES; CONDUCTING ON-LINE BUSINESS MANAGEMENT RESEARCH SURVEYS; CONSULTANCY AND ADVISORY SERVICES IN THE FIELD OF BUSINESS STRATEGY; CONSULTANCY OF PERSONNEL RECRUITMENT; CONSULTANCY REGARDING THE ORGANIZATION OR MANAGING OF A TRADE COMPANY; CONSULTANCY SERVICES REGARDING BUSINESS STRATEGIES; CONSULTATION AND ADVICE FOR THE PURCHASE OF MUSICAL INSTRUMENTS AND SOUND RECORDING DEVICES; CONSULTATION IN THE FIELD OF BUSINESS ACQUISITIONS; CONSULTATION IN THE FIELD OF COMMERCIALS OR INFORMATION COMMERCIALS; CONSULTATION IN THE FIELD OF ENERGY EFFICIENCY; CONSULTATION RELATING TO TRADE FAIRS; CONSULTATION SERVICES IN THE FIELD OF BUSINESS MANAGEMENT AND OPERATION ASSISTANCE TO YACHT OWNERS AND OPERATORS; CONSULTATION SERVICES IN THE FIELD OF COMPANY, BUSINESS SECTOR AND INDUSTRY DATA AND RESEARCH; CONSULTATION SERVICES, NAMELY, CREATIVE AND STRATEGIC CONSULTATION REGARDING DEVELOPMENT AND PRODUCTION OF MARKETING CAMPAIGNS FOR OTHERS; CONSULTING AND INFORMATION CONCERNING ACCOUNTING; CONSULTING IN SALES TECHNIQUES AND SALES PROGRAMMES; CONSULTING IN THE FIELD OF PROCURING GOVERNMENT CONTRACTS FOR THE PURCHASE OF GOODS AND LABOR CONTRACTING SERVICES; CONSULTING IN THE FIELD OF SALES METHODS, SALES MANAGEMENT, AND SALES IMPROVEMENT; CONSULTING IN THE FIELDS OF HEALTHCARE OPERATIONS MANAGEMENT AND HOSPITAL OPERATIONS MANAGEMENT; CONSULTING REGARDING INTELLECTUAL PROPERTY BUSINESS RISK MITIGATION PROCESSES; CONSULTING SERVICES IN BUSINESS LEADERSHIP DEVELOPMENT AND BUSINESS MANAGEMENT; CONSULTING SERVICES IN BUSINESS ORGANIZATION AND MANAGEMENT; CONSULTING SERVICES IN THE AREA OF SUSTAINABLE BUSINESS SOLUTIONS; CONSULTING SERVICES IN THE COST AND PAYMENT MANAGEMENT OF HEALTH CARE; CONSULTING SERVICES IN THE FIELD OF DENTAL PRACTICE MANAGEMENT; CONSULTING SERVICES IN THE FIELD OF ENERGY EFFICIENCY FOR COMMERCIAL AND INSTITUTIONAL FACILITIES; CONSULTING SERVICES IN THE FIELD OF ENERGY USAGE MANAGEMENT AND ENERGY EFFICIENCY; CONSULTING SERVICES IN THE FIELD OF HIGHER EDUCATION ADMINISTRATION; CONSULTING SERVICES IN THE FIELD OF HUMAN RESOURCES DEVELOPMENT, NAMELY, FOR THE PROMOTION OF EMPLOYEE RETENTION, CAREER GROWTH, AND INCREASED PRODUCTIVITY FOR EMPLOYEES AND EMPLOYERS; CONSULTING SERVICES IN THE FIELD OF HUMAN RESOURCES DEVELOPMENT, NAMELY, UTILIZING TECHNOLOGY FOR THE PROMOTION OF EMPLOYEE RETENTION, CAREER GROWTH AND INCREASED PRODUCTIVITY FOR EMPLOYEES AND EMPLOYERS; CONSULTING SERVICES IN THE FIELD OF INTERNET MARKETING; CONSULTING SERVICES IN THE FIELD OF MANAGING INTELLECTUAL PROPERTIES; CONSULTING SERVICES IN THE FIELD OF MARKETING OF EDUCATIONAL TRAINING; CONSULTING SERVICES IN THE FIELD OF MEDICAL PRODUCT APPROVAL FOR COMMERCIAL PURPOSES; CONSULTING SERVICES IN THE FIELD OF PROVIDING BUSINESSES WITH CONSUMER INFORMATION ABOUT AND ADVICE ON SELECTION OF INDUSTRIAL RECYCLING PROCESSING AND HANDLING EQUIPMENT; CONSULTING

**Reg. No. 4,196,764** SERVICES IN THE FIELDS OF BUSINESS MANAGEMENT, HUMAN RESOURCES, AND BUSINESS ORGANIZATIONAL DESIGN; CONSULTING SERVICES IN THE FIELDS OF ENERGY CONSUMPTION AND USAGE CONSERVATION TO IMPROVE ENERGY EFFICIENCY; CONSULTING SERVICES RELATED TO THE ADMINISTRATION OF WATER PURIFICATION STRATEGIES; CONSULTING SERVICES RELATED TO THE ADMINISTRATIVE COORDINATION OF ORGANIZATIONS PROVIDING HUMANITARIAN ACTIVITIES; CONSULTING SERVICES RELATING TO PUBLICITY; CONSULTING SERVICES, NAMELY, TO EMPLOYERS, COMMUNITY ORGANIZATIONS, BROKERS AND BENEFICIARIES, RELATED TO CONSUMER INFORMATION REGARDING HEALTH CARE PLAN OPTIONS, PRODUCTS AND PROGRAMS IN THE FIELD OF MANAGED CARE AND STATE AND FEDERAL MEDICAL CARE PROGRAMS; CONSULTING SERVICES, NAMELY, EXPERT ANALYSIS AND MANAGEMENT CONSULTING IN ECONOMICS AND ACCOUNTING; CONSULTING SERVICES, NAMELY, PROVIDING EXPECTANT PARENTS WITH CONSUMER INFORMATION ON ALL TYPES OF BABY PRODUCTS AND SERVICES; CONSUMER MARKETING RESEARCH AND CONSULTING RELATED THERETO; CONSUMER STRATEGY BUSINESS CONSULTING IN THE FIELDS OF MARKETING, SALES, OPERATION, AND PRODUCT DESIGN PARTICULARLY SPECIALIZING IN THE USE OF ANALYTIC MODELS FOR THE UNDERSTANDING AND PREDICTING OF CONSUMER, BUSINESS, AND RETAIL MARKET TRENDS AND ACTIONS; DEMOGRAPHIC CONSULTATION; DEMOGRAPHIC CONSULTATION AND STUDIES; DEVELOPING PROMOTIONAL CAMPAIGNS FOR BUSINESS; DEVELOPMENT OF CONCEPTS FOR BUSINESS ECONOMY; DIRECT MARKETING CONSULTING SERVICES; DISASTER RECOVERY SERVICES, NAMELY, BUSINESS PLANNING AND BUSINESS CONTINUITY CONSULTING; ECONOMIC CONSULTING AND INFORMATION FOR THE INDUSTRIAL AND COMMERCIAL SECTORS FOR PLANNING, ORGANIZING, MONITORING AND CARRYING OUT UNIQUE AND COMPLEX PROJECTS IN DIFFERENT SECTORS OF ONE OR SEVERAL COMPANIES; ELECTRONIC DATA COLLECTION AND DATA SUBMISSION SERVICES FOR BUSINESS PURPOSES IN THE FIELDS OF MEDICINE AND HEALTHCARE; EMPLOYMENT AGENCY SERVICES, NAMELY, FILLING THE TEMPORARY AND PERMANENT STAFFING NEEDS OF BUSINESSES; EMPLOYMENT RECRUITING CONSULTATION; EMPLOYMENT STAFFING CONSULTATION SERVICES; EXPERT EVALUATIONS AND REPORTS RELATING TO BUSINESS MATTERS; FINANCIAL STATEMENT PREPARATION AND ANALYSIS FOR BUSINESSES; FOREIGN TRADE INFORMATION AND CONSULTATION; FOREST MANAGEMENT CONSULTATION; HUMAN RESOURCE ANALYSIS AND CONSULTING SERVICES; HUMAN RESOURCES CONSULTANCY; HUMAN RESOURCES CONSULTATION; INFORMATION AND DATA COMPILING AND ANALYZING RELATING TO BUSINESS MANAGEMENT; INFORMATION IN BUSINESS MATTERS; INFORMATION OR ENQUIRIES ON BUSINESS AND MARKETING; INFORMATION SERVICES RELATING TO BUSINESS MATTERS; INFORMATION, ADVISORY AND CONSULTANCY SERVICES RELATING TO BUSINESS AND MANAGEMENT OR BUSINESS ADMINISTRATION, INCLUDING SUCH SERVICES PROVIDED ON LINE OR VIA THE INTERNET; INFORMATION, ADVISORY, CONSULTING, BUSINESS RESEARCH AND PLANNING SERVICES RELATING TO PUBLICITY, MARKETING COMMUNICATIONS, REPUTATION MANAGEMENT OR BUSINESS ADMINISTRATION, INCLUDING SUCH SERVICES PROVIDED ONLINE OR VIA THE INTERNET; INTERNATIONAL BUSINESS CONSULTING SERVICES RELATING TO MERCHANDISE TRADING, HUMAN RESOURCE INTERCHANGE, MANAGEMENT SUPPORT, MARKETING, ADVERTISING, PROMOTION, AND DOMESTIC AND INTERNATIONAL MARKET RESEARCH AND DEVELOPMENT; MANAGEMENT AND BUSINESS CONSULTING SERVICES IN THE FIELD OF TRAINING AND RECRUITMENT; MANAGEMENT AND BUSINESS CONSULTING SERVICES IN THE FIELD OF HUMAN RESOURCES; MANAGEMENT AND OPERATION ASSISTANCE TO COMMERCIAL BUSINESSES; MANAGEMENT CONSULTING AND ADVISORY SERVICES IN THE AREAS OF CORPORATE GROWTH STRATEGY, INNOVATION AND GROWTH PROCESSES, ORGANIZATIONAL TRANSFORMATION, AND TALENT MANAGEMENT AND DEVELOPMENT STRATEGIES; MANAGEMENT SERVICES, NAMELY, ON-LINE BUSINESS DEVELOPMENT SERVICES, NAMELY, PROVIDING START-UP SUPPORT FOR BUSINESSES OF OTHERS; MANAGING AND OPERATING RESORT HOTELS AND BUSINESS CONFERENCE CENTERS OF OTHERS; MARKET RESEARCH AND BUSINESS ANALYSES; MARKET RESEARCH CONSULTATION;

**Reg. No. 4,196,764** MARKET SEGMENTATION CONSULTATION; MARKETING AND CONSULTING SERVICES IN THE FIELD OF PROMOTING AND TRACKING THE GOODS, SERVICES, AND BRANDS OF OTHERS THROUGH ALL PUBLIC COMMUNICATION MEANS, PARTICULARLY SPECIALIZING IN THE USE OF MOBILE, SOCIAL, AND PRINT MEDIA TO DRIVE CONSUMER INTEREST, ENGAGEMENT AND ACTION; MARKETING CONSULTATION IN THE FIELD OF HUMAN RESOURCES; MARKETING CONSULTING; MARKETING CONSULTING SERVICES RELATING TO LONG-TERM BUSINESS STRATEGY DEVELOPMENT FOR NON-PROFIT ORGANIZATIONS; MEDIA MONITORING SERVICES, NAMELY, MONITORING PRINT MEDIA, TELEVISION, RADIO, AND OTHER MEDIA FOR CUSTOMER-SPECIFIED TOPICS, GATHERING RELEVANT CONTENT ON THOSE TOPICS, AND PROVIDING DOCUMENTATION AND ANALYSIS OF THAT MEDIA CONTENT TO OTHERS FOR BUSINESS PURPOSES; MEDIATION OF TRADE BUSINESS FOR THIRD PARTIES; MEDICAL PERSONNEL RECRUITMENT SERVICES AND CONSULTATION RELATED THERETO; MEMBERSHIP CLUB SERVICES, NAMELY, PROVIDING ON-LINE INFORMATION TO MEMBERS IN THE FIELDS OF BRANDING, BUSINESS DEVELOPMENT, BUSINESS MARKETING, AND MARKETING; MONITORING SERVICES FOR BUSINESS PURPOSES TO ASCERTAIN THE GEOGRAPHIC LOCATIONS OF MOVABLE OBJECTS, NAMELY, MOTOR VEHICLES AND INDIVIDUALS; NEW BUSINESS VENTURE DEVELOPMENT AND FORMATION CONSULTING SERVICES; ON-LINE BUSINESS NETWORKING SERVICES; ON-LINE BUSINESS RESEARCH SERVICE THAT ALLOWS THE USER TO ANALYZE OPINION TRENDS CONTAINED IN DOCUMENTS ON THE INTERNET; ONLINE BUSINESS RESEARCH SERVICES THAT ALLOW USERS TO SHARE OPINIONS WITH A MARKETING RESEARCH COMPANY RELATED TO EVERYDAY CONSUMER PRODUCTS AND SERVICES; ONLINE MEDIA MONITORING SERVICES USING COMPUTER SOFTWARE TO AUTOMATICALLY MONITOR INTERNET WEBSITES AND ONLINE PUBLICATIONS FOR CUSTOMER-SPECIFIED TOPICS AND TO CAPTURE RELEVANT CONTENT ON THOSE TOPICS, AND PROVIDING DOCUMENTATION AND ANALYSIS OF THAT ONLINE CONTENT TO OTHERS FOR BUSINESS PURPOSES; OPERATIONAL BUSINESS ASSISTANCE TO ENTERPRISES; ORGANIZATION OF EXHIBITIONS AND TRADE FAIRS FOR BUSINESS AND PROMOTIONAL PURPOSES; ORGANIZATION OF BUSINESS CONVENTIONS; ORGANIZATIONAL SERVICES FOR BUSINESS PURPOSES; ORGANIZING OF BUSINESS COMPETITIONS; ORGANIZING, PROMOTING AND CONDUCTING EXHIBITIONS AND TRADESHOWS FOR BUSINESS PURPOSES FEATURING BOOTHS AND DISPLAYS RELATING TO ANTIQUES AND COLLECTIBLES; ORGANIZING, PROMOTING AND CONDUCTING EXHIBITIONS, TRADESHOWS AND EVENTS FOR BUSINESS PURPOSES; OUTSOURCING SERVICES; PERSONALITY TESTING FOR BUSINESS PURPOSES; PERSONNEL CONSULTANCY; PERSONNEL MANAGEMENT CONSULTATION; PERSONNEL MANAGEMENT CONSULTING; PLANNING CONCERNING BUSINESS MANAGEMENT, NAMELY, SEARCHING FOR PARTNERS FOR AMALGAMATIONS AND BUSINESS TAKE-OVERS AS WELL AS FOR BUSINESS ESTABLISHMENTS; POLITICAL CONSULTANCY; PREPARATION AND PRESENTATION OF BUSINESS PROSPECTUSES; PREPARATION OF BUSINESS REPORTS; PREPARATION OF CUSTOM OR NON-CUSTOM ADVERTISING FOR BUSINESSES FOR DISSEMINATION VIA THE WEB, CD OR DVD FOR OPTIONAL UPLOAD OR DOWNLOAD TO A COMPUTER; PREPARING BUSINESS REPORTS; PREPARING COMPUTER SLIDE TRANSPARENCIES FOR USE BY BUSINESS; PROCUREMENT CONSULTATION, NAMELY, ANALYSIS AND REDEFINITION OF PURCHASING PROCESSES WITHIN THE FRAMEWORK OF EXPENDITURE RATIONALIZATION PROJECTS; PROFESSIONAL BUSINESS CONSULTATION; PROFESSIONAL BUSINESS CONSULTING; PROJECT MANAGEMENT SERVICES FOR OTHERS FOR BUSINESS PURPOSES IN THE FIELDS OF ARCHITECTURE, INTERIOR DESIGN, URBAN PLANNING DESIGN; PROMOTING COMMERCIAL, TRADE, AND OTHER BUSINESS RELATIONSHIPS BETWEEN MEXICO AND THE UNITED STATES AND/OR CANADA AND THE UNITED STATES AND DISSEMINATING PROMOTIONAL INFORMATION CONCERNING COMMERCIAL, TRADE, AND OTHER BUSINESS RELATIONSHIPS BETWEEN SUCH COUNTRIES; PROMOTING THE GOODS AND SERVICES OF OTHERS BY ARRANGING FOR BUSINESSES TO AFFILIATE THEIR GOODS AND SERVICES WITH THE GOODS AND SERVICES OF THIRD PARTIES BY MEANS OF SPONSORSHIP RELATIONSHIPS; PROMOTING, ADVERTISING AND MARKETING OF THE BRANDS, PRODUCTS, SERVICES OR ONLINE WEBSITES OF

**Reg. No. 4,196,764** INDIVIDUALS, BUSINESSES AND NONPROFIT ORGANIZATIONS; PROMOTION OF BUSINESS OPPORTUNITIES; PROVIDING A WEB SITE FEATURING BUSINESS INFORMATION IN THE FORM OF AUDIO AND VIDEO INTERVIEWS, TRANSCRIPTS AND OTHER EDUCATIONAL MATERIALS; PROVIDING A WEB SITE THAT FEATURES AN ON-LINE MARKET FOR USERS TO LIST OFFERED OR WANTED PERSONAL AND BUSINESS ASSETS AND SKILLS FOR HIRE, RENT, SALE OR AUCTION TRANSACTED ON THE BASIS OF PREDEFINED PERFORMANCE AND CLOSING TERMS AND CONDITIONS; PROVIDING A WEB SITE WHERE USERS CAN POST RATINGS, REVIEWS AND RECOMMENDATIONS ON EMPLOYERS AND EMPLOYEES AND PLACES OF EMPLOYMENT FOR USE BY EMPLOYEES, EMPLOYERS, BUSINESS OWNERS, AND CONSUMERS; PROVIDING A WEB-BASED ON-LINE PORTAL THAT PROVIDES CUSTOMER ACCESS TO THEIR ELECTRIC BILL ACCOUNT INFORMATION, ENERGY USAGE PATTERN INFORMATION, AND ENERGY CONSUMPTION AND USAGE DATA, FOR PURPOSES OF UTILITY ACCOUNT BUSINESS MANAGEMENT AND ENERGY USAGE MANAGEMENT; PROVIDING A WEB-BASED SYSTEM AND ONLINE PORTALS IN THE FIELD OF CONSUMER-TO-BUSINESS COMMERCE FOR CONSUMERS TO ENTER, MANAGE AND MODIFY THEIR CONSUMER PREFERENCE INFORMATION FOR USE BY MERCHANTS TO CREATE AND MANAGE OFFERS FOR DELIVERY TO CONSUMERS; PROVIDING A WEBSITE FEATURING INFORMATION AND LINKS RELATING TO THE MUSIC INDUSTRY, NAMELY, PROMOTION, MARKETING AND BUSINESS ADVICE TO MUSICIANS; PROVIDING A WEBSITE FEATURING INFORMATION ON MULTI-LEVEL MARKETING BUSINESS SERVICES; PROVIDING ADVICE AND ASSISTANCE TO COMMERCIAL ENTITIES RELATING TO THE ESTABLISHMENT AND MAINTENANCE OF BUSINESS AND CONTRACTUAL RELATIONSHIPS WITH FEDERAL, STATE AND LOCAL GOVERNMENTS; PROVIDING AN ON-LINE COMPUTER DATABASE FOR THE REPORTING AND TRACKING OF VEHICLE AND BOAT MOVES AND LOCATION FOR BUSINESS PURPOSES; PROVIDING AN ON-LINE COMPUTER DATABASE IN THE FIELD OF BUSINESS INFORMATION AND BUSINESS CONTACTS; PROVIDING AN ON-LINE DATABASE PROVIDING BUSINESS INTELLIGENCE IN THE FIELDS OF MEDICAL DEVICES, PHARMACEUTICALS AND LIFE SCIENCES; PROVIDING AN ON-LINE SEARCHABLE DATABASE FEATURING BUSINESS INFORMATION AND BUSINESS CONTACTS; PROVIDING AN ONLINE COMPUTER DATABASE FOR COLLECTING AND REPORTING CONTROLLED SUBSTANCE PRESCRIPTION DRUG DISPENSING INFORMATION FOR BUSINESS PURPOSES; PROVIDING AN ONLINE VIDEO BUSINESS DIRECTORY; PROVIDING ASSISTANCE, FITNESS EVALUATION AND CONSULTATION TO CORPORATE CLIENTS TO HELP THEIR EMPLOYEES MAKE HEALTH, WELLNESS AND NUTRITIONAL CHANGES IN THEIR DAILY LIVING TO INCREASE PRODUCTIVITY AND LOWER HEALTH CARE COSTS; PROVIDING BUSINESS AND COMMERCIAL INFORMATION IN THE FIELD OF BUSINESS TRAVEL MANAGEMENT AND THE BUSINESS TRAVEL INDUSTRY; PROVIDING BUSINESS FEASIBILITY STUDIES FOR PROPERTY SELF-STORAGE BUSINESSES; PROVIDING BUSINESS INFORMATION, ALSO VIA INTERNET, THE CABLE NETWORK OR OTHER FORMS OF DATA TRANSFER; PROVIDING BUSINESS INFORMATION, NAMELY, COMMERCIAL CORPORATE AND STATISTICAL INFORMATION PROVIDED ON-LINE FROM A COMPUTER DATABASE OR THE INTERNET; PROVIDING BUSINESS INTELLIGENCE SERVICES; PROVIDING BUSINESS INTELLIGENCE SERVICES IN THE FIELDS OF MEDICAL DEVICES, PHARMACEUTICALS AND THE LIFE SCIENCES; PROVIDING BUSINESS MANAGEMENT INFORMATION IN CONNECTION WITH CONSULTING AND ADVISORY SERVICES IN THE FIELD OF STRATEGIC PLANNING; PROVIDING BUSINESS MARKETING INFORMATION; PROVIDING BUSINESS PLANNING AND MARKETING SOLUTIONS FOR REAL ESTATE PROFESSIONALS; PROVIDING BUSINESS RESEARCH SERVICES, NAMELY, RESEARCHING DENTAL PATIENT INSURANCE INFORMATION FOR DENTAL OFFICES; PROVIDING BUSINESS SUPPORT STAFF SERVICES; PROVIDING COMMERCIAL INFORMATION UPDATES ONLINE AND OVER A GLOBAL COMPUTER NETWORK IN THE FIELDS OF BUSINESS, COMMERCE, AND INDUSTRY; PROVIDING CONSULTING SERVICES IN THE FIELD OF FACILITATING THE PLANNING, BUYING, AND SELLING OF MEDIA; PROVIDING CONSULTING SERVICES IN THE FIELD OF REGULATORY SUBMISSION MANAGEMENT TO MEDICAL COMPANIES TO ASSIST THEM WITH APPLICATIONS FOR MEDICAL DEVICE APPROVAL; PROVIDING CONSUMER NEWS AND INFORMATION

**Reg. No. 4,196,764** IN THE FIELD OF EDUCATIONAL PRODUCTS AND SERVICES THAT HELP INDIVIDUALS AND BUSINESSES MAKE AND SAVE MONEY; PROVIDING FACILITIES FOR BUSINESS MEETINGS; PROVIDING INCENTIVE AWARD PROGRAMS FOR CUSTOMERS THROUGH THE ISSUANCE AND PROCESSING OF LOYALTY COUPONS FOR FREQUENT USE OF PARTICIPATING BUSINESSES; PROVIDING INDEPENDENT RATINGS AND REVIEWS OF OTHER BUSINESSES FOR COMMERCIAL PURPOSES; PROVIDING INDEPENDENT REVIEW OF CLINICAL TRIALS FOR BUSINESS PURPOSES; PROVIDING INFORMATION ABOUT COMMERCIAL BUSINESS AND COMMERCIAL INFORMATION VIA THE GLOBAL COMPUTER NETWORK; PROVIDING INFORMATION AND ANALYSIS IN THE FIELDS OF ECONOMICS AND BUSINESS; PROVIDING INFORMATION AND NEWS IN THE FIELD OF BUSINESS; PROVIDING INFORMATION AND NEWS ON CURRENT EVENTS AND ON ECONOMIC, LEGISLATIVE, AND REGULATORY DEVELOPMENTS AS IT RELATES TO AND CAN IMPACT BUSINESSES; PROVIDING INFORMATION IN THE FIELD OF TIME MANAGEMENT FOR BUSINESS PURPOSES; PROVIDING INFORMATION IN THE FIELDS OF BUSINESS INNOVATION PROCESS, BUSINESS MANAGEMENT AND BUSINESS OPPORTUNITIES; PROVIDING ONLINE BUSINESS MANAGEMENT SERVICES INCLUDING ACCOUNTING, MARKETING, BUSINESS PROJECT MANAGEMENT, AND BUSINESS DEVELOPMENT; PROVIDING ONLINE BUSINESS RISK MANAGEMENT SERVICE FOR USE IN PROJECT MANAGEMENT; PROVIDING ORGANIZATIONAL DEVELOPMENT CONSULTING SERVICES; PROVIDING PROMOTIONAL MARKETING SERVICES TO BUSINESSES IN THE BROADBAND AND MEDIA INDUSTRIES; PROVIDING PUBLIC SECTOR BUSINESS AND MARKET INTELLIGENCE; PROVIDING STATISTICAL INFORMATION; PROVIDING VIRTUAL ON-LINE OFFICE SUPPORT STAFF SERVICES FOR BUSINESSES; PROVISION OF BUSINESS INFORMATION VIA GLOBAL COMPUTER NETWORKS; PROVISION OF INFORMATION, ADVICE AND CONSULTANCY IN RELATION TO ENERGY EFFICIENCY; PUBLIC POLICY CONSULTANCY SERVICES; PUBLICITY CONSULTATION; RELOCATION SERVICES FOR BUSINESS; SOCIAL MEDIA STRATEGY AND MARKETING CONSULTANCY FOCUSING ON HELPING CLIENTS CREATE AND EXTEND THEIR PRODUCT AND BRAND STRATEGIES BY BUILDING VIRALLY ENGAGING MARKETING SOLUTIONS; SPECIAL EVENT PLANNING FOR BUSINESS PURPOSES; STATISTICAL ANALYSIS AND REPORTING SERVICES FOR BUSINESS PURPOSES; TALENT RECRUITING SERVICES IN THE FIELD OF HUMAN RESOURCES; TOTAL QUALITY MANAGEMENT SERVICES, NAMELY, BUSINESS MANAGEMENT SERVICES FOR ESTABLISHING BUSINESS QUALITY POLICY AND DETERMINING BUSINESS MEANS FOR IMPLEMENTING THOSE POLICIES TO IMPROVE CUSTOMER SATISFACTION, IN CLASS 35 (U.S. CLS. 100, 101 AND 102).

FIRST USE 4-28-2011; IN COMMERCE 4-28-2011.

THE MARK CONSISTS OF "LEAP INTO LEADERSHIP" WITH AN IMAGE OF A HUMAN JUMPING BETWEEN THE "L" AND THE "E" ABOVE THE WORD "LEAP".

SER. NO. 85-318,132, FILED 5-11-2011.

TAMARA FRAZIER, EXAMINING ATTORNEY

# United States of America

United States Patent and Trademark Office



**Reg. No. 4,196,765**

CINCINNATI FINANCIAL CORPORATION (OHIO CORPORATION)  
6200 S. GILMORE ROAD  
FAIRFIELD, OH 450145141

**Registered Aug. 28, 2012**

**Int. Cl.: 36**

FOR: INSURANCE SERVICES, NAMELY, UNDERWRITING EXCESS AND SURPLUS LINES OF PROPERTY AND CASUALTY INSURANCE, IN CLASS 36 (U.S. CLS. 100, 101 AND 102).

**SERVICE MARK**

FIRST USE 1-25-2011; IN COMMERCE 5-2-2011.

**PRINCIPAL REGISTER**

OWNER OF U.S. REG. NO. 2,186,224.

NO CLAIM IS MADE TO THE EXCLUSIVE RIGHT TO USE "SPECIALTY UNDERWRITERS INSURANCE COMPANY", APART FROM THE MARK AS SHOWN.

THE MARK CONSISTS OF THE IMAGE OF A BRIDGE ABOVE THE WORDS "THE CINCINNATI SPECIALTY UNDERWRITERS INSURANCE COMPANY".

SEC. 2(F) AS TO "CINCINNATI SPECIALTY UNDERWRITING INSURANCE COMPANY".

SER. NO. 85-319,345, FILED 5-12-2011.

LINDA M. KING, EXAMINING ATTORNEY



*David J. Kybas*

Director of the United States Patent and Trademark Office

# United States of America

United States Patent and Trademark Office

# Soundsnap

**Reg. No. 4,196,766**

OJOO LTD. (CYPRUS LIMITED COMPANY (LTD.))  
BOUBOULINAS 11, 1ST FLOOR  
NICOSIA, 1060, CYPRUS

**Registered Aug. 28, 2012**

**Int. Cls.: 35 and 41**

FOR: ENTERTAINMENT SERVICES, NAMELY, AN ONLINE SOUND LIBRARY FEATURING HIGH QUALITY SOUND EFFECTS AND MUSIC LOOPS, NAMELY, ON-LINE RETAIL STORE SERVICES FEATURING DOWNLOADABLE PRE-RECORDED MUSIC AND SOUND EFFECTS, IN CLASS 35 (U.S. CLS. 100, 101 AND 102).

**SERVICE MARK**

**PRINCIPAL REGISTER**

FIRST USE 7-2-2007; IN COMMERCE 7-2-2007.

FOR: ENTERTAINMENT SERVICES, NAMELY, AN ONLINE SOUND LIBRARY FEATURING HIGH QUALITY SOUND EFFECTS AND MUSIC LOOPS, NAMELY, PROVIDING NON-DOWNLOADABLE PLAYBACK OF MUSIC VIA GLOBAL COMMUNICATIONS NETWORKS, IN CLASS 41 (U.S. CLS. 100, 101 AND 107).

FIRST USE 7-2-2007; IN COMMERCE 7-2-2007.

THE MARK CONSISTS OF STANDARD CHARACTERS WITHOUT CLAIM TO ANY PARTICULAR FONT, STYLE, SIZE, OR COLOR.

SER. NO. 85-319,422, FILED 5-12-2011.

ROSELLE HERRERA, EXAMINING ATTORNEY



*David J. Kyros*

Director of the United States Patent and Trademark Office



# United States of America

United States Patent and Trademark Office



American Egg Board

**Reg. No. 4,196,767**

**Registered Aug. 28, 2012**

**Int. Cl.: 35**

**SERVICE MARK**

**PRINCIPAL REGISTER**

THE AMERICAN EGG BOARD (UNITED STATES AGENCY OF THE UNITED STATES GOVERNMENT)  
1460 RENAISSANCE DRIVE  
PARK RIDGE, IL 600681340

FOR: PROMOTION OF THE USE AND CONSUMPTION OF EGGS, IN CLASS 35 (U.S. CLS. 100, 101 AND 102).

FIRST USE 8-27-2010; IN COMMERCE 8-27-2010.

OWNER OF U.S. REG. NOS. 2,442,449, 3,871,156 AND OTHERS.

NO CLAIM IS MADE TO THE EXCLUSIVE RIGHT TO USE "BOARD" AND THE REPRESENTATION OF AN EGG, APART FROM THE MARK AS SHOWN.

THE MARK CONSISTS OF THE WORD "INCREDIBLE!" DISPLAYED HORIZONTALLY ACROSS A VERTICAL EGG ABOVE THE WORDS "AMERICAN EGG BOARD".

SEC. 2(F) AS TO "AMERICAN EGG BOARD".

SER. NO. 85-319,433, FILED 5-12-2011.

ESTHER BELENKER, EXAMINING ATTORNEY



*David J. Kyffers*

Director of the United States Patent and Trademark Office

# United States of America

United States Patent and Trademark Office



**Reg. No. 4,196,768**

**Registered Aug. 28, 2012**

**Int. Cls.: 2 and 30**

**TRADEMARK**

**PRINCIPAL REGISTER**

IMPORTACIONES GOICOCHEA E.I.R.L. (PERU CORPORATION)  
JR. JORGE CHÁVEZ 351 - BREÑA  
LIMA, PERU

FOR: COLORANTS FOR FOOD AND BEVERAGES; FOOD COLORS FOR DOMESTIC USE,  
IN CLASS 2 (U.S. CLS. 6, 11 AND 16).

FIRST USE 10-31-1987; IN COMMERCE 9-30-2009.

FOR: DOUGH; EXTRACTS USED AS FLAVORING IN DESSERTS AND CAKES; FLAVOR  
ENHANCERS USED IN FOOD PRODUCTS, NAMELY, IN DESSERTS AND CAKES; FLA-  
VORINGS FOR DESSERTS AND CAKES; GLUCOSE FOR FOOD; PIE CRUSTS, IN CLASS  
30 (U.S. CL. 46).

FIRST USE 10-31-1987; IN COMMERCE 9-30-2009.

NO CLAIM IS MADE TO THE EXCLUSIVE RIGHT TO USE "HIGH QUALITY INGREDIENTS",  
APART FROM THE MARK AS SHOWN.

THE COLOR(S) DARK GREEN, LIGHT GREEN, ORANGE AND WHITE IS/ARE CLAIMED  
AS A FEATURE OF THE MARK.



*David J. Kyffers*

Director of the United States Patent and Trademark Office

THE MARK CONSISTS OF A GREEN STRIP, A WHITE STRIP AND AN ORANGE STRIP.  
VARIOUS ABSTRACT DESIGNS FORMED BY TWO LEAF LIKE FIGURES APPEAR ABOVE  
THE GREEN AND ORANGE STRIPS. ABOVE A PORTION OF THE GREEN STRIP AND A  
PORTION OF THE WHITE STRIP APPEARS AN ORANGE RIBBON LIKE HORIZONTALLY  
POSITIONED FIGURE INSIDE OF WHICH APPEARS ONE LIGHT GREEN SQUARE COVER-  
ERING ALMOST THE TOTALITY OF A WHITE SQUARE OF THE SAME SIZE THAT IS  
BENEATH THE LIGHT GREEN SQUARE. OVER THE LIGHT GREEN SQUARE APPEARS  
A BIGGER VERSION OF THE ABSTRACT DESIGN FORMED BY THE TWO LEAF LIKE  
FIGURES IN A DARK GREEN COLOR. THIS IS FOLLOWED BY THE WORD "FRATELLO"  
IN STYLIZED DARK GREEN LETTERS THAT CONTAIN TWO OUTER BORDERS, FIRST  
A LIGHT GREEN BORDER AND THEN A WHITE BORDER. BELOW THE WORD "FRA-  
TELLO" APPEARS A WHITE HORIZONTAL LINE AND THE WORDING "HIGH QUALITY  
INGREDIENTS" IN WHITE STYLIZED LETTERS.

THE ENGLISH TRANSLATION OF "FRATELLO" IN THE MARK IS "BROTHER".

**Reg. No. 4,196,768** SER. NO. 85-319,667, FILED 5-12-2011.

MARC LEIPZIG, EXAMINING ATTORNEY

# United States of America

United States Patent and Trademark Office

# SIBARTH

**Reg. No. 4,196,769**

**Registered Aug. 28, 2012**

**Int. Cl.: 36**

**SERVICE MARK**

**PRINCIPAL REGISTER**

SOCIETE IMMOBILIERE DE SAINT-BARTHELEMY (FRANCE CORPORATION)  
RUE SAMUEL FAHLBERG GUSTAVIA  
SAINT-BARTHELEMY, FRANCE 97133

FOR: ASSESSMENT AND MANAGEMENT OF REAL ESTATE; REAL ESTATE AGENCIES,  
IN CLASS 36 (U.S. CLS. 100, 101 AND 102).

FIRST USE 0-0-1979; IN COMMERCE 0-0-1979.

THE MARK CONSISTS OF STANDARD CHARACTERS WITHOUT CLAIM TO ANY PAR-  
TICULAR FONT, STYLE, SIZE, OR COLOR.

OWNER OF FRANCE REG. NO. 063403481, DATED 1-16-2006, EXPIRES 1-16-2016.

THE WORDING "SIBARTH" HAS NO MEANING IN A FOREIGN LANGUAGE.

SER. NO. 85-319,678, FILED 5-12-2011.

TRICIA SONNEBORN, EXAMINING ATTORNEY



*David J. Kyfos*

Director of the United States Patent and Trademark Office

# United States of America

United States Patent and Trademark Office

## TRILLIUM VEIN

**Reg. No. 4,196,770**

ALABAMA PRODUCTIONS, INC. (PENNSYLVANIA CORPORATION)  
1120 OAKHURST LANE  
LOWER GWYNEDD, PA 19002

**Registered Aug. 28, 2012**

**Int. Cls.: 9 and 35**

FOR: COMPUTER APPLICATION SOFTWARE FOR MOBILE DEVICES AND TABLETS, NAMELY, SOFTWARE FOR THE DELIVERY OF MULTIMEDIA CONTENT; DIGITAL MUSIC DOWNLOADABLE FROM THE INTERNET; PRE-RECORDED CDS FEATURING MUSIC, IN CLASS 9 (U.S. CLS. 21, 23, 26, 36 AND 38).

**TRADEMARK**

**SERVICE MARK**

FIRST USE 11-27-2010; IN COMMERCE 11-27-2010.

**PRINCIPAL REGISTER**

FOR: ON-LINE RETAIL STORE SERVICES FEATURING PRE-RECORDED MUSIC, IN CLASS 35 (U.S. CLS. 100, 101 AND 102).

FIRST USE 11-27-2010; IN COMMERCE 11-27-2010.

THE MARK CONSISTS OF STANDARD CHARACTERS WITHOUT CLAIM TO ANY PARTICULAR FONT, STYLE, SIZE, OR COLOR.

SER. NO. 85-320,387, FILED S.R. 5-13-2011 AM. P.R. 9-19-2011.

JULIE WATSON, EXAMINING ATTORNEY



*David J. Kyfos*

Director of the United States Patent and Trademark Office

# United States of America

United States Patent and Trademark Office

# COGE

**Reg. No. 4,196,771**

**Registered Aug. 28, 2012**

**Int. Cl.: 14**

**TRADEMARK**

**PRINCIPAL REGISTER**

PLATZ, GERWIN R., JR. (FED REP GERMANY INDIVIDUAL), DBA COGE DESIGN GROUP  
17764 PRESTON ROAD, SUITE 250  
DALLAS, TX 75252

FOR: JEWELRY, IN CLASS 14 (U.S. CLS. 2, 27, 28 AND 50).

FIRST USE 7-11-1995; IN COMMERCE 7-11-1995.

THE MARK CONSISTS OF STANDARD CHARACTERS WITHOUT CLAIM TO ANY PARTICULAR FONT, STYLE, SIZE, OR COLOR.

SER. NO. 85-321,155, FILED 5-14-2011.

SUE LAWRENCE, EXAMINING ATTORNEY



*David J. Kybas*

Director of the United States Patent and Trademark Office

# United States of America

United States Patent and Trademark Office

# TrialCard

**Reg. No. 4,196,772**

**Registered Aug. 28, 2012**

**Int. Cl.: 35**

**SERVICE MARK**

**PRINCIPAL REGISTER**

TRIALCARD INCORPORATED (NORTH CAROLINA CORPORATION)  
SUITE 370  
6501 WESTON PARKWAY  
CARY, NC 27513

FOR: MANAGEMENT AND ADMINISTRATION OF A PHARMACY REIMBURSEMENT PROGRAM ON BEHALF OF PHARMACEUTICAL MANUFACTURERS; MANAGING AND ADMINISTERING THE DISTRIBUTION OF PRESCRIPTION PHARMACEUTICAL SAMPLES TO PHYSICIANS AND PATIENTS FOR PHARMACEUTICAL MANUFACTURERS; MANAGING PATIENT CO-PAY PROGRAMS ON BEHALF OF PHARMACEUTICAL MANUFACTURERS; TRACKING PHARMACEUTICAL PROMOTIONAL PROGRAMS FOR PHARMACEUTICAL MANUFACTURERS AND EVALUATING AND DETERMINING THEIR EFFECTIVENESS, IN CLASS 35 (U.S. CLS. 100, 101 AND 102).

FIRST USE 1-1-1998; IN COMMERCE 1-1-1998.

THE MARK CONSISTS OF STANDARD CHARACTERS WITHOUT CLAIM TO ANY PARTICULAR FONT, STYLE, SIZE, OR COLOR.

OWNER OF U.S. REG. NO. 2,948,216.

SER. NO. 85-322,830, FILED 5-17-2011.

CHRISTINE COOPER, EXAMINING ATTORNEY



*David J. Kybas*

Director of the United States Patent and Trademark Office

# United States of America

United States Patent and Trademark Office

## RACE Hawaii

**Reg. No. 4,196,773**

**Registered Aug. 28, 2012**

**Int. Cl.: 25**

**TRADEMARK**

**PRINCIPAL REGISTER**

BUCKNELL, LAWRENCE, SCOTT (HAWAII SOLE PROPRIETORSHIP), DBA 62-202 KAM HWY. HALEIWA HAWAII  
62-202 KAM HWY.  
HALEIWA, HI 96712

FOR: ATHLETIC APPAREL, NAMELY, SHIRTS, PANTS, JACKETS, FOOTWEAR, HATS AND CAPS, ATHLETIC UNIFORMS, IN CLASS 25 (U.S. CLS. 22 AND 39).

FIRST USE 10-1-1976; IN COMMERCE 10-1-1976.

THE MARK CONSISTS OF STANDARD CHARACTERS WITHOUT CLAIM TO ANY PARTICULAR FONT, STYLE, SIZE, OR COLOR.

NO CLAIM IS MADE TO THE EXCLUSIVE RIGHT TO USE "HAWAII", APART FROM THE MARK AS SHOWN.

SER. NO. 85-323,160, FILED 5-17-2011.

DORITT L. CARROLL, EXAMINING ATTORNEY



*David J. Kyffers*

Director of the United States Patent and Trademark Office



# United States of America

United States Patent and Trademark Office

# DYNE SIDE

**Reg. No. 4,196,774**

**Registered Aug. 28, 2012**

**Int. Cl.: 9**

**TRADEMARK**

**PRINCIPAL REGISTER**

SALCEDO, EDDIE (UNITED STATES INDIVIDUAL)  
2733 WEST 72 PLACE  
HIALEAH, FL 33016

FOR: MUSICAL SOUND AND VIDEO RECORDINGS, NAMELY, CD'S, DVD'S, AUDIO AND VIDEO TAPES AND CASSETTES, PHONOGRAPH AND DOWNLOADABLE DIGITAL FILES FEATURING MUSICAL AND DRAMATIC PERFORMANCES; SOUND AND AUDIO VISUAL RECORDINGS FEATURING MUSICAL PERFORMANCES, DRAMATIC WORKS AND DOCUMENTARIES, IN CLASS 9 (U.S. CLS. 21, 23, 26, 36 AND 38).

FIRST USE 3-17-2011; IN COMMERCE 3-25-2011.

THE MARK CONSISTS OF THE WORDS "DYNE SIDE" IN A STYLIZED FONT WITH BOTH LETTER "D"'S FILLED IN, AND SOME STREAK LINES ALONG THE TOP AND BOTTOM OF THE LETTERS.

SER. NO. 85-323,848, FILED 5-18-2011.

FRANK LATTUCA, EXAMINING ATTORNEY



*David J. Kyffers*

Director of the United States Patent and Trademark Office

# United States of America

United States Patent and Trademark Office

The logo for 'soundsnap' features the word 'soundsnap' in a lowercase, rounded, sans-serif font. The letters are white with a thick, light blue outline, and the entire word is set against a dark blue, bubbly background that resembles a sound wave or a cluster of bubbles.

**Reg. No. 4,196,775**

OJOO LTD. (CYPRUS LIMITED COMPANY (LTD.))  
BOUBOULINAS 11, 1ST FLOOR  
NICOSIA, 1060, CYPRUS

**Registered Aug. 28, 2012**

**Int. Cls.: 35 and 41**

FOR: ENTERTAINMENT SERVICES, NAMELY, AN ONLINE SOUND LIBRARY FEATURING HIGH QUALITY SOUND EFFECTS AND MUSIC LOOPS, NAMELY, ON-LINE RETAIL STORE SERVICES FEATURING DOWNLOADABLE PRE-RECORDED MUSIC AND SOUND EFFECTS, IN CLASS 35 (U.S. CLS. 100, 101 AND 102).

**SERVICE MARK**

**PRINCIPAL REGISTER**

FIRST USE 7-2-2007; IN COMMERCE 7-2-2007.

FOR: ENTERTAINMENT SERVICES, NAMELY, AN ONLINE SOUND LIBRARY FEATURING HIGH QUALITY SOUND EFFECTS AND MUSIC LOOPS, NAMELY, PROVIDING NON-DOWNLOADABLE PLAYBACK OF MUSIC VIA GLOBAL COMMUNICATIONS NETWORKS, IN CLASS 41 (U.S. CLS. 100, 101 AND 107).

FIRST USE 7-2-2007; IN COMMERCE 7-2-2007.

THE MARK CONSISTS OF THE WORD "SOUNDSNAP" IN LOWER CASE LETTERS WITH "SOUND" IN LIGHT BLUE AND "SNAP" IN WHITE ALL SURROUNDED BY A BUBBLE OUTLINE OF BLUE AND NAVY BLUE WITH A THIN SECOND LAYER BUBBLE OUTLINE IN LIGHT BLUE.

THE COLOR(S) WHITE, LIGHT BLUE, BLUE AND NAVY BLUE IS/ARE CLAIMED AS A FEATURE OF THE MARK.

SER. NO. 85-324,244, FILED 5-18-2011.

ROSELLE HERRERA, EXAMINING ATTORNEY



*David J. Kybas*

Director of the United States Patent and Trademark Office

# United States of America

United States Patent and Trademark Office



**Reg. No. 4,196,776**

TAPIZADOS FAMA, S.L. (SPAIN CORPORATION)

**Registered Aug. 28, 2012**

CTRA. DE VILLENA, KM. 2  
30510 YECLA (MURCIA), SPAIN

**Int. Cl.: 20**

FOR: SOFAS, EXTENDIBLE SOFAS, SLEEPER SOFAS, ARMCHAIRS, RECLINING ARMCHAIRS, RECLINING CHAIRS, DIVANS, BEDS, BED HEADBOARDS, CUSHIONS, FURNITURE, NAMELY, POUFS, CHAISE LONGUES, SEATS, IN CLASS 20 (U.S. CLS. 2, 13, 22, 25, 32 AND 50).

**TRADEMARK**

**PRINCIPAL REGISTER**

OWNER OF SPAIN REG. NO. 2897364, DATED 2-3-2010, EXPIRES 10-23-2019.

THE MARK CONSISTS OF THE WORD "FAMA." APPEARING TO NEXT TO A REPRESENTATION OF A PIECE OF FURNITURE.

THE ENGLISH TRANSLATION OF "FAMA" IN THE MARK IS "FAME".

SER. NO. 85-325,915, FILED 5-20-2011.

PAM WILLIS, EXAMINING ATTORNEY



*David J. Kybas*

Director of the United States Patent and Trademark Office

# United States of America

United States Patent and Trademark Office



**Reg. No. 4,196,777**

**Registered Aug. 28, 2012**

**Int. Cls.: 14 and 35**

**TRADEMARK**

**SERVICE MARK**

**PRINCIPAL REGISTER**

BRILLIANT GEMS LLC (CALIFORNIA LIMITED LIABILITY COMPANY)  
SUITE 408  
8335 SUNSET BLVD  
WEST HOLLYWOOD, CA 90069

FOR: BODY JEWELRY; BRACELETS; DIAMOND JEWELRY; GEMSTONE JEWELRY; PINS BEING JEWELRY; RINGS; WOMEN'S JEWELRY; ALL OF THE AFOREMENTIONED CONTAINING MOISSANITE, IN CLASS 14 (U.S. CLS. 2, 27, 28 AND 50).

FIRST USE 3-15-2011; IN COMMERCE 5-9-2011.

FOR: ON-LINE WHOLESALE AND RETAIL STORE SERVICES FEATURING MOISSANITE JEWELRY; RETAIL JEWELRY STORES FEATURING MOISSANITE JEWELRY; WHOLESALE AND RETAIL STORE SERVICES FEATURING MOISSANITE JEWELRY, IN CLASS 35 (U.S. CLS. 100, 101 AND 102).

FIRST USE 3-15-2011; IN COMMERCE 5-9-2011.

NO CLAIM IS MADE TO THE EXCLUSIVE RIGHT TO USE "MOISSANITE JEWELRY SHOP.COM MOISSANITE" AND THE PICTURE OF THE GEM. "BRILLIANT", APART FROM THE MARK AS SHOWN.

THE COLOR(S) WHITE, LIGHT BLUE, YELLOW, ORANGE, GREEN, BLUE AND SILVER IS/ARE CLAIMED AS A FEATURE OF THE MARK.

THE MARK CONSISTS OF THE STYLIZED WORDING "MOISSANITE JEWELRY SHOP.COM" IN THE COLOR WHITE, ABOVE THE STYLIZED WORDING "MOISSANITE", WHERE THE LETTERS "MO" AND "SSANITE" ARE IN THE COLOR WHITE, AND THE FIRST INSTANCE OF THE LETTER "I" IS IN THE COLOR LIGHT BLUE, AND THE WORDING "ETERNALLY BRILLIANT & BEAUTIFUL" IS BELOW THE OTHER WORDING IN THE MARK AND IS IN THE COLOR WHITE. THE DESIGN OF A SUN WITH A CORONA APPEARS ON THE UPPER LEFT SIDE OF THE MARK IN THE COLORS YELLOW, ORANGE, BLUE AND GREEN. THE DESIGN OF DIAGONAL BANDS APPEAR ON THE RIGHT SIDE OF THE MARK IN THE COLOR BLUE, ALONG WITH THE PICTURE OF A GEM IN THE COLORS SILVER, WHITE, BLUE, LIGHT BLUE AND YELLOW, AND THE REPRESENTATION OF THE ARMS OF A CLASPING DEVICE IN THE COLOR SILVER. THE COLOR BLACK REPRESENTS BACKGROUND AND IS NOT A PART OF THE MARK.



*David J. Kappas*

Director of the United States Patent and Trademark Office

**Reg. No. 4,196,777** SER. NO. 85-326,305, FILED 5-20-2011.

JAY BESCH, EXAMINING ATTORNEY

# United States of America

United States Patent and Trademark Office

## HYPERGENOMICS

**Reg. No. 4,196,778**

**Registered Aug. 28, 2012**

**Int. Cls.: 1, 5, 10 and 42**

**TRADEMARK**

**SERVICE MARK**

**PRINCIPAL REGISTER**

SINGAPORE VOLITION PTE. LIMITED (SINGAPORE LIMITED COMPANY (LTD.))  
UNIT 01-70  
165 GANGSA ROAD  
SINGAPORE, SINGAPORE 670165

FOR: CHEMICALS USED IN INDUSTRY AND SCIENCE; CHEMICAL REAGENTS FOR USE IN INDUSTRY AND SCIENCE; CHEMICAL, BIOLOGICAL AND DIAGNOSTIC REAGENTS, PREPARATIONS AND SUBSTANCES FOR SCIENTIFIC, MEDICAL, DIAGNOSTIC AND RESEARCH PURPOSES; CHEMICAL AND BIOLOGICAL PREPARATIONS AND REAGENTS FOR USE IN DIAGNOSTIC AND ANALYTICAL TESTS, NAMELY, IN VITRO DIAGNOSTIC LABORATORY TESTS, IN VITRO DIAGNOSTICS AND IN VITRO ANALYSIS OF CELLULAR EPIGENETIC STATUS; IN VITRO DIAGNOSTICS, DIAGNOSTIC REAGENTS FOR IN VITRO LABORATORY USE; PARTS AND FITTINGS FOR ALL THE AFORESAID, IN CLASS 1 (U.S. CLS. 1, 5, 6, 10, 26 AND 46).

FOR: PHARMACEUTICAL AND DIAGNOSTIC PRODUCTS AND PREPARATIONS FOR TREATING AND DETECTING CANCER AND TREATING AND DETECTING INFLAMMATION; LIFE SCIENCE REAGENTS; DIAGNOSTIC PREPARATIONS FOR CLINICAL OR MEDICAL LABORATORY PURPOSES; DIAGNOSTIC TESTING KITS CONSISTING PRIMARILY OF RESTRICTION ENZYMES, SEQUENCING ADAPTORS, PRIMERS, BUFFERS, REAGENTS AND CONSUMABLES FOR DNA PURIFICATION FOR USE IN DISEASE TESTING; DIAGNOSTIC REAGENTS FOR MEDICAL USE; DIAGNOSTIC REAGENTS INCLUDING CLINICAL DIAGNOSTIC REAGENTS FOR IN VITRO USE; ASSAYS FOR STEM CELL DIFFERENTIATION STATUS; PARTS AND FITTINGS FOR ALL THE AFORESAID, IN CLASS 5 (U.S. CLS. 6, 18, 44, 46, 51 AND 52).

FOR: SURGICAL, MEDICAL AND DIAGNOSTIC APPARATUS AND INSTRUMENTS FOR USE IN THE DETECTION AND DIAGNOSIS AND TREATMENT OF CANCER AND INFLAMMATION; DIAGNOSTIC MEASURING APPARATUS FOR DETECTING CELLULAR STATUS; IN VITRO DIAGNOSTIC TESTING APPARATUS FOR MEDICAL USE; DIAGNOSTIC APPARATUS FOR THE DETECTION OF CANCER; DIAGNOSTIC APPARATUS FOR THE DETECTION OF INFLAMMATION; PARTS AND FITTINGS FOR ALL THE AFORESAID, IN CLASS 10 (U.S. CLS. 26, 39 AND 44).

FOR: SCIENTIFIC AND TECHNOLOGICAL SERVICES AND RESEARCH AND DESIGN RELATING THERETO, NAMELY, BIOTECHNOLOGY, MEDICAL TECHNOLOGY, ASSAYS, MEDICAL DIAGNOSTICS, DIAGNOSTIC REAGENTS, SUBSTANCES, PREPARATIONS



*David J. Kybas*

Director of the United States Patent and Trademark Office

**Reg. No. 4,196,778** AND MATERIALS; INDUSTRIAL RESEARCH, NAMELY, BIOTECHNOLOGY, MEDICAL TECHNOLOGY, ASSAYS, MEDICAL DIAGNOSTICS, DIAGNOSTIC REAGENTS, SUBSTANCES, PREPARATIONS AND MATERIALS; RESEARCH AND DEVELOPMENT, CONSULTANCY AND ADVISORY SERVICES RELATING TO BIOTECHNOLOGY, MEDICAL TECHNOLOGY, ASSAYS, MEDICAL DIAGNOSTICS, DIAGNOSTIC REAGENTS, SUBSTANCES, PREPARATIONS AND MATERIALS; ANALYTICAL TESTING AND DIAGNOSTIC SERVICES IN THE FIELD OF MEDICAL DIAGNOSTICS, CANCER DIAGNOSTICS, INFLAMMATION DIAGNOSTICS AND DISEASE TESTING; DESIGN AND DEVELOPMENT OF MEDICAL DIAGNOSTIC TESTING APPARATUS AND REAGENTS; BLOOD TESTING SERVICES; INFORMATION, ADVISORY AND CONSULTANCY SERVICES RELATING TO ALL THE AFORESAID, IN CLASS 42 (U.S. CLS. 100 AND 101).

THE MARK CONSISTS OF STANDARD CHARACTERS WITHOUT CLAIM TO ANY PARTICULAR FONT, STYLE, SIZE, OR COLOR.

PRIORITY CLAIMED UNDER SEC. 44(D) ON ERPN CMNTY TM OFC APPLICATION NO. 009979626, FILED 5-19-2011, REG. NO. 009979626, DATED 11-28-2011, EXPIRES 5-19-2021.

SER. NO. 85-326,495, FILED 5-20-2011.

ANNE E. GUSTASON, EXAMINING ATTORNEY

# United States of America

United States Patent and Trademark Office

# corfire

**Reg. No. 4,196,779**

**Registered Aug. 28, 2012**

**Int. Cls.: 9, 38 and 42**

**TRADEMARK**

**SERVICE MARK**

**PRINCIPAL REGISTER**

SK C&C CO., LTD. (REPUBLIC OF KOREA CORPORATION)  
SK U-TOWER 25-1, JEONGJA-DONG,  
BUNDANG-GU  
SEONGNAM-SI, GYEONGGI-DO, REPUBLIC OF KOREA

FOR: SOFTWARE FOR USE WITH CELL PHONES, TABLET COMPUTERS, MOBILE DEVICES, AND HANDHELD DIGITAL ELECTRONIC DEVICES FOR PERFORMING ELECTRONIC PAYMENT, ELECTRONIC BANKING, STORAGE OF CREDIT, DEBIT AND GIFT CARD INFORMATION, ELECTRONIC TICKETING, ELECTRONIC COUPONING, ELECTRONIC PERSON-TO-PERSON (P2P) PAYMENTS, ONLINE STOCK TRADING, MOBILE VALUE ADDED SERVICES, AND LOYALTY CARD FUNCTIONS; SOFTWARE FOR OVER-THE-AIR AND OVER-THE-WIRE PROVISIONING OF APPLICATIONS TO MOBILE DEVICES AND HANDHELD DIGITAL ELECTRONIC DEVICES BY MEANS OF WIRELESS AND WIRED NETWORKS; SECURITY SOFTWARE FOR MOBILE DEVICE APPLICATIONS AND MOBILE DEVICES; SOFTWARE FOR TRANSMITTING DATA TO AND MANAGING MOBILE DEVICE SIM CARDS, SD CARDS, AND SECURE ELEMENTS IN THE NATURE OF SMARTCARD COMPUTER CHIPS, IN CLASS 9 (U.S. CLS. 21, 23, 26, 36 AND 38).

FIRST USE 5-26-2011; IN COMMERCE 5-26-2011.

FOR: ELECTRONIC TRANSMISSION OF DATA IN THE NATURE OF TRANSMITTING DATA TO MOBILE DEVICE SIM CARDS, SD CARDS, AND SECURE ELEMENTS IN THE NATURE OF SMARTCARD COMPUTER CHIPS, IN CLASS 38 (U.S. CLS. 100, 101 AND 104).

FIRST USE 5-26-2011; IN COMMERCE 5-26-2011.

FOR: IT CONSULTING SERVICES; COMPUTER SYSTEMS INTEGRATION SERVICES; DEVELOPMENT AND MAINTENANCE OF COMPUTER SOFTWARE FOR OTHERS; INSTALLATION OF COMPUTER SOFTWARE FOR OTHERS; TESTING OF MOBILE COMMERCE SERVICES OF OTHERS IN A DATA CENTER, NAMELY, TESTING OF COMPUTER SOFTWARE USED FOR MOBILE COMMERCE TRANSACTIONS; COMPUTER SOFTWARE TESTING SERVICES FOR OTHERS, IN CLASS 42 (U.S. CLS. 100 AND 101).

FIRST USE 5-26-2011; IN COMMERCE 5-26-2011.

THE MARK CONSISTS OF "CORFIRE" WITH A STYLIZED DESIGN REPRESENTING THE LETTERS "C" AND "F" TO THE UPPER RIGHT.



*David J. Kyjars*

Director of the United States Patent and Trademark Office



**Reg. No. 4,196,779** SER. NO. 85-327,786, FILED 5-23-2011.

ERIN FALK, EXAMINING ATTORNEY

# United States of America

United States Patent and Trademark Office

## Freez Entertainment

**Reg. No. 4,196,780**

**Registered Aug. 28, 2012**

**Int. Cl.: 41**

**SERVICE MARK**

**PRINCIPAL REGISTER**

RAYMOND C. ROWE (PENNSYLVANIA SOLE PROPRIETORSHIP), DBA FREEZ  
ENTERTAINMENT  
249 WHITTIER LANE  
LANCASTER, PA 17602

FOR: DISC JOCKEY SERVICES; DISC JOCKEYS FOR PARTIES AND SPECIAL EVENTS,  
IN CLASS 41 (U.S. CLS. 100, 101 AND 107).

FIRST USE 1-1-1997; IN COMMERCE 1-1-2011.

THE MARK CONSISTS OF STANDARD CHARACTERS WITHOUT CLAIM TO ANY PAR-  
TICULAR FONT, STYLE, SIZE, OR COLOR.

NO CLAIM IS MADE TO THE EXCLUSIVE RIGHT TO USE "ENTERTAINMENT", APART  
FROM THE MARK AS SHOWN.

THE NAME "FREEZE" IN THE MARK IDENTIFIES THE APPLICANT, A LIVING INDIVIDU-  
AL WHOSE CONSENT IS IMPLIED BY THE SIGNED VERIFICATION CURRENTLY OF  
RECORD.

SEC. 2(F).

SER. NO. 85-328,224, FILED 5-24-2011.

EDWARD FENNESSY, EXAMINING ATTORNEY



*David J. Kyros*

Director of the United States Patent and Trademark Office

# United States of America

United States Patent and Trademark Office

# 4DX

**Reg. No. 4,196,781**

**Registered Aug. 28, 2012**

**Int. Cl.: 42**

**SERVICE MARK**

**PRINCIPAL REGISTER**

CJ 4DPLEX CO., LTD. (REPUBLIC OF KOREA CORPORATION)  
164-1 JEUNGSAN-DONG, EUNPYEONG-GU  
SEOUL, REPUBLIC OF KOREA

FOR: DIGITAL SIGNAL PROCESSING FOR MOVIES AUDIENCE EFFECTS; DEVELOPMENT OF SOFTWARE FOR MOVIES AUDIENCE EFFECTS; DIGITAL SIGNAL PROCESSING FOR MOVIES AUDIENCE EFFECTS IN CINEMAS WITH SPECIAL EFFECTS SUCH AS WIND, SCENT, WATER SPRAY, MOTION, VIBRATION, SMOKE, BUBBLE, LASER OR FLASH; DEVELOPMENT OF SOFTWARE FOR MOVIES AUDIENCE EFFECTS IN CINEMAS WITH SPECIAL EFFECTS SUCH AS WIND, SCENT, WATER SPRAY, MOTION, VIBRATION, SMOKE, BUBBLE, LASER OR FLASH; COMPUTER PROGRAMMING; CONVERSION OF DATA OR DOCUMENTS FROM PHYSICAL TO ELECTRONIC MEDIA; RENTAL OF APPLICATION SOFTWARE, IN CLASS 42 (U.S. CLS. 100 AND 101).

THE MARK CONSISTS OF STANDARD CHARACTERS WITHOUT CLAIM TO ANY PARTICULAR FONT, STYLE, SIZE, OR COLOR.

PRIORITY CLAIMED UNDER SEC. 44(D) ON REPUBLIC OF KOREA APPLICATION NO. 41-2010-3068, FILED 11-30-2010, REG. NO. 0226358, DATED 2-13-2012, EXPIRES 2-13-2022.

SER. NO. 85-328,274, FILED 5-24-2011.

PATRICIA EVANKO, EXAMINING ATTORNEY



*David J. Kybas*

Director of the United States Patent and Trademark Office

# United States of America

United States Patent and Trademark Office

## GOOD CHEAP VIDEO

**Reg. No. 4,196,782**

**Registered Aug. 28, 2012**

**Int. Cl.: 35**

**SERVICE MARK**

**PRINCIPAL REGISTER**

CAPITALIST, INC. (ILLINOIS CORPORATION)  
STE 615  
600 W. CHICAGO AVE  
CHICAGO, IL 60654

FOR: ADVERTISING AGENCY SPECIALIZING IN THE PRODUCTION OF VIDEOS AIMED AT THE DESIGN AND EXECUTION OF WORD OF MOUTH, VIRAL, BUZZ AND EXPERIENTIAL MARKETING PROGRAMS; ADVERTISING AND MARKETING CONSULTANCY; ADVERTISING AND MARKETING SERVICES PROVIDED BY MEANS OF INDIRECT METHODS OF MARKETING COMMUNICATIONS, NAMELY, SOCIAL MEDIA, SEARCH ENGINE MARKETING, INQUIRY MARKETING, INTERNET MARKETING, MOBILE MARKETING, BLOGGING AND OTHER FORMS OF PASSIVE, SHARABLE OR VIRAL COMMUNICATIONS CHANNELS, IN CLASS 35 (U.S. CLS. 100, 101 AND 102).

FIRST USE 11-1-2010; IN COMMERCE 11-1-2010.

THE MARK CONSISTS OF STANDARD CHARACTERS WITHOUT CLAIM TO ANY PARTICULAR FONT, STYLE, SIZE, OR COLOR.

NO CLAIM IS MADE TO THE EXCLUSIVE RIGHT TO USE "VIDEO", APART FROM THE MARK AS SHOWN.

SER. NO. 85-328,509, FILED 5-24-2011.

CHERYL CLAYTON, EXAMINING ATTORNEY



*David J. Kyffers*

Director of the United States Patent and Trademark Office

# United States of America

United States Patent and Trademark Office

## Don't Sweat The Petty Things... Pet The Sweaty Things...

**Reg. No. 4,196,783**

**Registered Aug. 28, 2012**

**Int. Cl.: 25**

**TRADEMARK**

**PRINCIPAL REGISTER**

JACKIE O'NASTY INC. (NEVADA CORPORATION)  
247 INTEGRITY RIDGE DRIVE  
247 INTEGRITY RIDGE  
HENDERSON, NV 89052

FOR: LINGERIE, SWEAT SUITS, JEANS, CAPS, SHIRTS, IN CLASS 25 (U.S. CLS. 22 AND 39).

FIRST USE 1-1-1998; IN COMMERCE 5-11-2011.

THE MARK CONSISTS OF STANDARD CHARACTERS WITHOUT CLAIM TO ANY PARTICULAR FONT, STYLE, SIZE, OR COLOR.

SER. NO. 85-328,532, FILED 5-24-2011.

STEPHANIE ALI, EXAMINING ATTORNEY



*David J. Kyffers*

Director of the United States Patent and Trademark Office

# United States of America

United States Patent and Trademark Office

# RIEHLE

**Reg. No. 4,196,784**

**Registered Aug. 28, 2012**

**Int. Cl.: 7**

**TRADEMARK**

**PRINCIPAL REGISTER**

RIEHLE MASCHINENBAU GMBH & CO. KG (FED REP GERMANY CORPORATION)  
HEINRICH-RIEGER-STRASSE 5  
AALEN, FED REP GERMANY

FOR: BAKERY MACHINES, NAMELY, MACHINES FOR THE APPLICATION OF CAUSTIC SODA TO BAKERY GOODS, MACHINES FOR THE APPLICATION OF LYE TO BAKERY GOODS, LOADING AND UNLOADING MACHINES, MACHINES COMPRISED OF A CHAMBER TUNNEL FOR THE FERMENTATION AND COOLING OF BAKERY GOODS, DOUGH PROCESSING MACHINES FOR USE IN MAKING BAKERY GOODS, IN CLASS 7 (U.S. CLS. 13, 19, 21, 23, 31, 34 AND 35).

THE MARK CONSISTS OF STANDARD CHARACTERS WITHOUT CLAIM TO ANY PARTICULAR FONT, STYLE, SIZE, OR COLOR.

OWNER OF ERPN CMNTY TM OFC REG. NO. 008854465, DATED 7-27-2010, EXPIRES 2-3-2020.

SEC. 2(F).

SER. NO. 85-328,629, FILED 5-24-2011.

ANDREW RHIM, EXAMINING ATTORNEY



*David J. Kyffers*

Director of the United States Patent and Trademark Office

United States of America  
United States Patent and Trademark Office

XTREME

**Reg. No. 4,196,785**

LONZA WALKERSVILLE, INC. (DELAWARE CORPORATION)  
8830 BIGGS FORD ROAD  
WALKERSVILLE, MD 217930127

**Registered Aug. 28, 2012**

**Int. Cls.: 1 and 5**

FOR: CELL GROWTH MEDIA FOR GROWING CELLS FOR USE IN SCIENTIFIC RESEARCH, NAMELY, SERUM-FREE LIQUID FEED EXCLUDING TRANSFECTION AGENTS, IN CLASS 1 (U.S. CLS. 1, 5, 6, 10, 26 AND 46).

**TRADEMARK**

FIRST USE 3-0-2011; IN COMMERCE 3-0-2011.

**PRINCIPAL REGISTER**

FOR: CELL GROWTH MEDIA FOR GROWING CELLS FOR MEDICAL OR CLINICAL USE, NAMELY, SERUM-FREE LIQUID FEED EXCLUDING TRANSFECTION AGENTS, IN CLASS 5 (U.S. CLS. 6, 18, 44, 46, 51 AND 52).

FIRST USE 3-0-2011; IN COMMERCE 3-0-2011.

THE MARK CONSISTS OF STANDARD CHARACTERS WITHOUT CLAIM TO ANY PARTICULAR FONT, STYLE, SIZE, OR COLOR.

SER. NO. 85-328,865, FILED 5-24-2011.

MICHELLE DUBOIS, EXAMINING ATTORNEY



*David J. Kybas*

Director of the United States Patent and Trademark Office

# United States of America

United States Patent and Trademark Office

# SIEYUAN

**Reg. No. 4,196,786**

**Registered Aug. 28, 2012**

**Int. Cl.: 9**

**TRADEMARK**

**PRINCIPAL REGISTER**

SIEYUAN ELECTRIC CO., LTD. (CHINA CORPORATION)  
NO. 4399  
JINDU ROAD, MINHANG DISTRICT  
SHANGHAI, CHINA

FOR: DISTANCE MEASURING APPARATUS; GAS TESTING INSTRUMENTS; CAPACITORS; ELECTRIC RESISTANCES; ELECTRIC CONVERTERS; ELECTRIC SWITCHES; CIRCUIT BREAKERS; ELECTRIC DISTRIBUTION CONSOLES; INVERTERS; TRANSFORMERS; APPARATUS AND INSTRUMENTS FOR CONVEYING, DISTRIBUTING, TRANSFORMING, STORING, REGULATING OR CONTROLLING ELECTRIC CURRENT; ELECTRIC COILS; SWITCHGEARS, IN CLASS 9 (U.S. CLS. 21, 23, 26, 36 AND 38).

FIRST USE 3-5-2010; IN COMMERCE 3-5-2010.

THE MARK CONSISTS OF STANDARD CHARACTERS WITHOUT CLAIM TO ANY PARTICULAR FONT, STYLE, SIZE, OR COLOR.

THE WORDING "SIEYUAN" HAS NO MEANING IN A FOREIGN LANGUAGE.

SER. NO. 85-329,625, FILED 5-25-2011.

MARK SPARACINO, EXAMINING ATTORNEY



*David J. Kypos*

Director of the United States Patent and Trademark Office



# United States of America

United States Patent and Trademark Office



**Reg. No. 4,196,787**

**Registered Aug. 28, 2012**

**Int. Cl.: 12**

**TRADEMARK**

**PRINCIPAL REGISTER**

MEADOW STREAM DISTRIBUTING, L.L.C. (ILLINOIS LIMITED LIABILITY COMPANY)  
4969 BRITTANY COURT  
BETTENDORF, IA 52722

FOR: PARTS FOR COMMERCIAL TRUCKS AND TRAILERS, NAMELY, BRAKE SYSTEMS, WHEEL BEARINGS, HUBCAPS, REAR VIEW MIRRORS, LEAF SPRINGS BEING SUSPENSION PARTS, SPRING BRAKE CHAMBERS, BRAKE DRUMS, BRAKE ROTORS, TIRE REPAIR PATCHES, UNIVERSAL JOINTS, AND TRUCK AND TRAILER WHEEL HUBS, IN CLASS 12 (U.S. CLS. 19, 21, 23, 31, 35 AND 44).

FIRST USE 12-10-2010; IN COMMERCE 12-10-2010.

NO CLAIM IS MADE TO THE EXCLUSIVE RIGHT TO USE "PRO TRUCKING PRODUCTS", APART FROM THE MARK AS SHOWN.

THE COLOR(S) BLUE AND BLACK IS/ARE CLAIMED AS A FEATURE OF THE MARK.

THE MARK CONSISTS OF TWO BLOCK-LETTER CAPITAL "P"'S IN BLACK, WITH A LARGE BLOCK-LETTER BLUE "T" BETWEEN THE TWO "P"'S, THE CROSS OF THE "T" EXTENDING OVER THE TOP OF THE TWO "P"'S, WITH THE WORDS "PRO TRUCKING PRODUCTS" IN SMALLER BLUE LETTERING BELOW THE "PTP" LOGO.

SER. NO. 85-329,906, FILED 5-25-2011.

BRENDAN MCCAULEY, EXAMINING ATTORNEY



*David J. Kybas*

Director of the United States Patent and Trademark Office

# United States of America

United States Patent and Trademark Office

# TCAR

**Reg. No. 4,196,788**

**Registered Aug. 28, 2012**

**Int. Cls.: 16 and 41**

**TRADEMARK**

**SERVICE MARK**

**PRINCIPAL REGISTER**

THE LAURELWOOD GROUP, INC. (OREGON CORPORATION)  
31772 SW CALLAHAN RD.  
SCAPPOOSE, OR 97056

FOR: EDUCATIONAL PUBLICATIONS, NAMELY, TRAINING MANUALS IN THE FIELD OF HEALTHCARE AND NURSING PROFESSIONAL TRAINING , IN CLASS 16 (U.S. CLS. 2, 5, 22, 23, 29, 37, 38 AND 50).

FIRST USE 11-15-2009; IN COMMERCE 11-15-2009.

FOR: PROVIDING CONTINUING NURSING EDUCATION COURSES, IN CLASS 41 (U.S. CLS. 100, 101 AND 107).

FIRST USE 11-15-2009; IN COMMERCE 11-15-2009.

THE MARK CONSISTS OF THE LETTERS "TCAR" WITH A CONTINUOUS WHITE SUBSTANTIALLY HORIZONTAL CURVED BAND BISECTING EACH LETTER; THE TOP PORTION OF EACH LETTER IS LIGHT BLUE, WHILE THE BOTTOM PORTION OF EACH LETTER IS DARK BLUE; THE WHITE PORTION IS TRANSPARENT AND THE COLOR WHITE IS NOT CLAIMED AS A FEATURE OF THE MARK.

THE COLOR(S) LIGHT BLUE AND DARK BLUE IS/ARE CLAIMED AS A FEATURE OF THE MARK.

SER. NO. 85-330,420, FILED 5-25-2011.

HOWARD B. LEVINE, EXAMINING ATTORNEY



*David J. Kyjars*

Director of the United States Patent and Trademark Office

# United States of America

United States Patent and Trademark Office

## DATAVERSITY

**Reg. No. 4,196,789**

**Registered Aug. 28, 2012**

**Int. Cls.: 41 and 42**

**SERVICE MARK**

**PRINCIPAL REGISTER**

WILSHIRE CONFERENCES, INC. (UNITED STATES INDIVIDUAL)  
13020 DICKENS STREET  
STUDIO CITY, CA 91604

FOR: EDUCATIONAL SERVICES, NAMELY, PROVIDING EDUCATIONAL ONLINE MENTORING, WORKSHOPS, CLASSES AND SEMINARS IN THE FIELD OF DATA MANAGEMENT; PROVIDING EDUCATIONAL ONLINE SEMINARS TO BUSINESS LEADERS ABOUT DATA-DRIVEN TRENDS RELATING TO THEIR RESPECTIVE ORGANIZATIONS; PROVIDING EDUCATIONAL ONLINE MENTORING, WORKSHOPS, CLASSES, WEB-BASED SEMINARS, AND WEB-CASTS FOR ASSISTING PROFESSIONALS TO PREPARE FOR EXAMINATION CERTIFICATIONS IN THE FIELDS OF DATA MANAGEMENT; AND PROVIDING ONLINE RESOURCES FOR EDUCATING PERSONS IN THE FIELD OF DATA MANAGEMENT, SPECIFICALLY, PROVIDING ONLINE PUBLICATIONS BY PEERS AND EXPERTS IN THEIR RESPECTIVE FIELDS IN THE NATURE OF ARTICLES, CASE STUDIES, BEST PRACTICE REPORTS, SURVEYS, RESEARCH REPORTS, AND WHITE PAPERS; AND PROVIDING ONLINE JOURNALS IN THE NATURE OF BLOGS AND DISCUSSION BOARDS, IN CLASS 41 (U.S. CLS. 100, 101 AND 107).

FIRST USE 4-5-2009; IN COMMERCE 4-5-2009.

FOR: PROVIDING INFORMATION AND ADVICE ABOUT INFORMATION TECHNOLOGY DATA MANAGEMENT FOR EDUCATING THOSE IN THE TECHNICAL AND MANAGERIAL FIELDS WORKING WITH DATA MANAGEMENT; AND PROVIDING ONLINE RESOURCES IN THE FIELD OF DATA MANAGEMENT, NAMELY, HOSTING ONLINE WEB FACILITIES AND WEBINARS FOR OTHERS FOR CONDUCTING INTERACTIVE DISCUSSIONS, IN CLASS 42 (U.S. CLS. 100 AND 101).

FIRST USE 7-19-2011; IN COMMERCE 7-19-2011.

THE MARK CONSISTS OF STANDARD CHARACTERS WITHOUT CLAIM TO ANY PARTICULAR FONT, STYLE, SIZE, OR COLOR.

SER. NO. 85-330,521, FILED 5-25-2011.

REBECCA EISINGER, EXAMINING ATTORNEY



*David J. Kyros*

Director of the United States Patent and Trademark Office

# United States of America

United States Patent and Trademark Office

## YOUR HOME STORE

**Reg. No. 4,196,790**

THRIVE LLC (UTAH LIMITED LIABILITY COMPANY)  
810 N. 2800 W.  
LINDON, UT 84042

**Registered Aug. 28, 2012**

**Int. Cl.: 35**

FOR: RETAIL AND ON-LINE GROCERY STORE SERVICES FEATURING HOME DELIVERY SERVICE; RETAIL STORE SERVICES FEATURING FOOD, CANNED FOOD, DEHYDRATED AND FREEZE DRIED FOOD, IN CLASS 35 (U.S. CLS. 100, 101 AND 102).

**SERVICE MARK**

FIRST USE 11-26-2010; IN COMMERCE 11-26-2010.

**PRINCIPAL REGISTER**

THE MARK CONSISTS OF STANDARD CHARACTERS WITHOUT CLAIM TO ANY PARTICULAR FONT, STYLE, SIZE, OR COLOR.

NO CLAIM IS MADE TO THE EXCLUSIVE RIGHT TO USE "STORE", APART FROM THE MARK AS SHOWN.

SER. NO. 85-330,713, FILED 5-26-2011.

MATTHEW MCDOWELL, EXAMINING ATTORNEY



*David J. Kyffers*

Director of the United States Patent and Trademark Office

# United States of America

United States Patent and Trademark Office



**Reg. No. 4,196,791**

CERTIFIED GREEN PARTNERS (FLORIDA CORPORATION)  
1056 EAST 24 ST  
HIALEAH, FL 33013

**Registered Aug. 28, 2012**

**Int. Cl.: 35**

FOR: ASSOCIATION SERVICES, NAMELY, PROMOTING THE PUBLIC INTEREST AND AWARENESS IN PRESERVATION OF THE ENVIRONMENT AMONG ALL PROFESSIONALS WHO ARE SERVICED BY THE PRINTING AND OTHER INDUSTRIES, IN CLASS 35 (U.S. CLS. 100, 101 AND 102).

**SERVICE MARK**

**PRINCIPAL REGISTER**

FIRST USE 3-3-2006; IN COMMERCE 3-3-2006.

OWNER OF U.S. REG. NO. 3,823,326.

THE MARK CONSISTS OF THE WORDING "CERTIFIED GREEN PARTNERS" IN BLACK AND WHITE BACKGROUND INSIDE A CIRCULAR OUTLINE AND WITHIN THE OUTLINE IS A BLACK CENTERED CIRCLE WITH TWO WHITE HUMAN HANDS HOLDING/PROTECTING A WHITE TREE SYMBOLIZING THAT WE HUMANS MUST PROTECT OUR FORESTS.

SEC. 2(F).

SER. NO. 85-331,078, FILED S.R. 5-26-2011 AM. P.R. 5-1-2012.

STEVEN R. FINE, EXAMINING ATTORNEY



*David J. Kybas*

Director of the United States Patent and Trademark Office

# United States of America

United States Patent and Trademark Office

## ESTATEGUIDANCE

**Reg. No. 4,196,792**

**Registered Aug. 28, 2012**

**Int. Cl.: 42**

**SERVICE MARK**

**PRINCIPAL REGISTER**

COMPSYCH CORPORATION (ILLINOIS CORPORATION)  
NBC TOWER - 13TH FLOOR  
455 N. CITYFRONT PLAZA DRIVE  
CHICAGO, IL 60611

FOR: PROVIDING TEMPORARY USE OF ON-LINE, NON-DOWNLOADABLE SOFTWARE FOR USE IN CREATING AND PRINTING WILLS, LIVING WILLS, POWERS OF ATTORNEY AND LEGAL DOCUMENTS, IN CLASS 42 (U.S. CLS. 100 AND 101).

FIRST USE 9-26-2003; IN COMMERCE 9-26-2003.

THE MARK CONSISTS OF STANDARD CHARACTERS WITHOUT CLAIM TO ANY PARTICULAR FONT, STYLE, SIZE, OR COLOR.

OWNER OF U.S. REG. NO. 3,077,920.

SEC. 2(F).

SER. NO. 85-331,510, FILED 5-26-2011.

MICHAEL TANNER, EXAMINING ATTORNEY



*David J. Kybas*

Director of the United States Patent and Trademark Office

# United States of America

United States Patent and Trademark Office

## COURAGE, NEW HAMPSHIRE

**Reg. No. 4,196,793**

**Registered Aug. 28, 2012**

**Int. Cls.: 9 and 41**

**TRADEMARK**

**SERVICE MARK**

**PRINCIPAL REGISTER**

COLONY BAY PARTNERS (CALIFORNIA PARTNERSHIP)  
C/O KOENIG & ASSOCIATES  
920 GARDEN STREET, SUITE A  
SANTA BARBARA, CA 93101

FOR: DVDS FEATURING ENTERTAINMENT, EDUCATIONAL STORIES, HISTORY, DOCUMENTARIES, CHRISTIAN, AND HISTORICAL FICTION SUBJECT MATTER; PRE-RECORDED LASER DISKS AND DVD'S FEATURING DOCUMENTARIES WITH THE SUBJECT MATTER OF HISTORICAL, SOCIAL, CULTURAL, AND EDUCATIONAL ACTIVITIES; PRE-RECORDED VIDEOS, FILMS, GRAPHICS, AND MULTIMEDIA PRESENTATIONS IN THE FIELDS OF ENTERTAINMENT, ART, DRAMA, HISTORY, AND CURRENT EVENTS AND HISTORICAL DOCUMENTARIES, ALL IN DIGITAL FORM AND DISTRIBUTED ON COMPUTER DISCS, DVD DISCS, AND DOWNLOADABLE FROM COMPUTER NETWORKS AND GLOBAL COMMUNICATION NETWORKS, IN CLASS 9 (U.S. CLS. 21, 23, 26, 36 AND 38).

FIRST USE 6-26-2011; IN COMMERCE 6-26-2011.

FOR: EDUCATION SERVICES, NAMELY, PROVIDING ON-LINE CLASSES AND SEMINARS, IN THE FIELD OF HISTORY AND CULTURE; EDUCATION SERVICES, NAMELY, PROVIDING LIVE AND ON-LINE CLASSES AND SEMINARS IN THE FIELD OF HISTORY AND DOCUMENTARIES; PROVISION OF NON-DOWNLOADABLE FILMS VIA A VIDEO-ON-DEMAND SERVICE; PROVIDING A WEBSITE FEATURING BLOGS AND NON-DOWNLOADABLE PUBLICATIONS IN THE NATURE OF ARTICLES AND BACKSTAGE DOCUMENTARY SCENES IN THE FIELD OF FILM AND VIDEO PRODUCTION; INFORMATION RELATING TO ENTERTAINMENT AND EDUCATION, PROVIDED ON-LINE FROM THE INTERNET; ENTERTAINMENT SERVICES, NAMELY, PROVIDING ON-GOING WEBISODES FEATURING HISTORICAL DRAMA VIA A GLOBAL COMPUTER NETWORK; ENTERTAINMENT SERVICES, NAMELY, PROVIDING A WEB SITE FEATURING NON-DOWNLOADABLE MUSICAL PERFORMANCES, RELATED FILM CLIPS, PHOTOGRAPHS, AND OTHER MULTIMEDIA MATERIALS FEATURING HISTORICAL MULTIMEDIA MATERIALS; PROVIDING A WEBSITE FEATURING ENTERTAINMENT AND EDUCATIONAL INFORMATION IN THE FIELD OF HISTORY; ENTERTAINMENT SERVICES, NAMELY, A MULTIMEDIA PROGRAM SERIES FEATURING HISTORY AND HISTORICAL RE-CREATIONS; ENTERTAINMENT SERVICES, NAMELY, A WEBSITE FEATURING INFORMATION ON HISTORY; ENTERTAINMENT SERVICES, NAMELY, PRODUCTION AND DISTRIBUTION OF CINEMATOGRAPHIC FILMS AND MOTION-PICTURE FILMS FEATURING



*David J. Kappas*

Director of the United States Patent and Trademark Office

**Reg. No. 4,196,793** ACTION-ADVENTURE, DOCUMENTARY, HISTORICAL, AND CHILDREN'S ENTERTAINMENT; EDUCATIONAL SERVICES, NAMELY, PROVIDING INSTRUCTION, CLASSES, SCHOOL FIELD TRIPS, AGRITOURISM FIELD TRIPS, AND SEMINARS IN THE FIELD OF AGRICULTURE AND LIVING HISTORY INTERPRETATION OF THE AMERICAN REVOLUTION, CIVIL WAR, GOLD RUSH ERA, AND THE PIONEERING HISTORY OF CALIFORNIA; EDUCATIONAL SERVICES, NAMELY, PROVIDING ONLINE INSTRUCTION IN THE FIELD OF HISTORY, CULTURE, AND EDUCATION VIA AN ONLINE WEBSITE, IN CLASS 41 (U.S. CLS. 100, 101 AND 107).

FIRST USE 6-26-2011; IN COMMERCE 6-26-2011.

THE MARK CONSISTS OF STANDARD CHARACTERS WITHOUT CLAIM TO ANY PARTICULAR FONT, STYLE, SIZE, OR COLOR.

NO CLAIM IS MADE TO THE EXCLUSIVE RIGHT TO USE "NEW HAMPSHIRE", APART FROM THE MARK AS SHOWN.

SER. NO. 85-331,910, FILED 5-26-2011.

ASMAT KHAN, EXAMINING ATTORNEY



# United States of America

United States Patent and Trademark Office

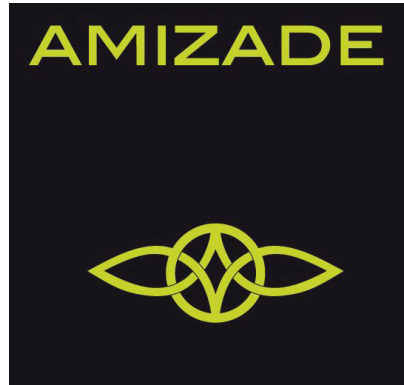

**Reg. No. 4,196,794**

**Registered Aug. 28, 2012**

**Int. Cls.: 33 and 35**

**TRADEMARK**

**SERVICE MARK**

**PRINCIPAL REGISTER**

BODEGAS GERARDO MÉNDEZ, S.L. (SPAIN LIMITED LIABILITY PARTNERSHIP)  
LG GALINANES 10, 36968 MEANO  
PONTEVEDRA, SPAIN

FOR: WINES, IN CLASS 33 (U.S. CLS. 47 AND 49).

FOR: ON LINE RETAIL AND WHOLESALE STORE SERVICES FEATURING WINE , IN CLASS 35 (U.S. CLS. 100, 101 AND 102).

PRIORITY CLAIMED UNDER SEC. 44(D) ON SPAIN APPLICATION NO. 2.964.898, FILED 1-20-2011, REG. NO. 2.964.898, DATED 5-20-2011, EXPIRES 1-20-2021.

THE COLOR(S) BLACK AND GREEN IS/ARE CLAIMED AS A FEATURE OF THE MARK.

THE MARK CONSISTS OF A BLACK RECTANGLE CONTAINING THE WORD "AMIZADE" IN GREEN ABOVE A GREEN CIRCLE CONTAINING A GREEN DIAMOND DESIGN WITH TWO HORIZONTALLY OPPOSING GREEN OVAL WING DESIGNS TOUCHING THE LEFT AND RIGHT ANGLES OF THE DIAMOND DESIGN AND EXTENDING BEYOND THE CIRCLE EDGE.

THE ENGLISH TRANSLATION OF "AMIZADE" IN THE MARK IS "FRIENDSHIP".

SER. NO. 85-332,285, FILED 5-27-2011.

JOHN DWYER, EXAMINING ATTORNEY



*David J. Kybas*

Director of the United States Patent and Trademark Office

# United States of America

United States Patent and Trademark Office

## Stan Winston

**Reg. No. 4,196,795**

STAN WINSTON ENTERPRISES LLC (CALIFORNIA LIMITED LIABILITY COMPANY)  
25440 PRADO DE AZUL  
CALABASAS, CA 91302

**Registered Aug. 28, 2012**

**Int. Cls.: 3, 9, 18, 25, 28  
and 40**

FOR: COSMETICS AND COSMETIC PREPARATIONS; COSMETICS AND MAKE-UP; FAKE BLOOD; MAKE-UP FOR THE FACE AND BODY; THEATRICAL MAKE-UP, IN CLASS 3 (U.S. CLS. 1, 4, 6, 50, 51 AND 52).

**TRADEMARK**

FIRST USE 4-7-1946; IN COMMERCE 1-15-2000.

**SERVICE MARK**

FOR: DIGITAL MEDIA, NAMELY, PRE-RECORDED VIDEO CASSETTES, DIGITAL VIDEO DISCS, DIGITAL VERSATILE DISCS, DOWNLOADABLE AUDIO AND VIDEO RECORDINGS, DVDS, AND HIGH DEFINITION DIGITAL DISCS FEATURING VISUAL EFFECTS; DOWNLOADABLE VIDEO RECORDINGS FEATURING VISUAL EFFECTS; DOWNLOADABLE WEBINARS IN THE FIELD OF VISUAL EFFECTS, IN CLASS 9 (U.S. CLS. 21, 23, 26, 36 AND 38).

**PRINCIPAL REGISTER**

FIRST USE 4-7-1946; IN COMMERCE 9-1-2007.

FOR: TOOL BAGS SOLD EMPTY; TOTE BAGS; TRAVEL CASES; WHEELED TOTE BAGS, IN CLASS 18 (U.S. CLS. 1, 2, 3, 22 AND 41).

FIRST USE 4-7-1946; IN COMMERCE 10-31-2004.

FOR: CAPS; JACKETS; SHIRTS; T-SHIRTS; TRACK JACKETS, IN CLASS 25 (U.S. CLS. 22 AND 39).

FIRST USE 4-7-1946; IN COMMERCE 10-31-2004.

FOR: ACTION FIGURE TOYS; BENDABLE TOYS; COLLECTABLE TOY FIGURES; POSITIONABLE TOY FIGURES; TOY ACTION FIGURES, IN CLASS 28 (U.S. CLS. 22, 23, 38 AND 50).

FIRST USE 4-7-1946; IN COMMERCE 11-30-1999.



*David J. Kyros*

Director of the United States Patent and Trademark Office

**Reg. No. 4,196,795** FOR: CUSTOM FABRICATION OF MODELS, SETS AND PROPS FOR MOTION PICTURES, VIDEOS, COMMERCIALS AND MOVIE TRAILERS, IN CLASS 40 (U.S. CLS. 100, 103 AND 106).

FIRST USE 4-7-1946; IN COMMERCE 2-15-1972.

THE MARK CONSISTS OF STANDARD CHARACTERS WITHOUT CLAIM TO ANY PARTICULAR FONT, STYLE, SIZE, OR COLOR.

THE NAME "STAN WINSTON" DOES NOT IDENTIFY A LIVING INDIVIDUAL.

SER. NO. 85-332,353, FILED 5-27-2011.

MARILYN IZZI, EXAMINING ATTORNEY

# United States of America

United States Patent and Trademark Office

## The Fantastic Flying Books of Mr. Morris Lessmore

**Reg. No. 4,196,796**

**Registered Aug. 28, 2012**

**Int. Cl.: 9**

**TRADEMARK**

**PRINCIPAL REGISTER**

MOONBOT STUDIOS LA, LLC (LOUISIANA LIMITED LIABILITY COMPANY)  
2031 KINGS HWY #102  
SHREVEPORT, LA 71104

FOR: CHILDREN'S EDUCATIONAL MUSIC CDS AND DVDS; CHILDREN'S EDUCATIONAL SOFTWARE; COMPUTER GAME PROGRAMMES DOWNLOADABLE VIA THE INTERNET; COMPUTER GAME PROGRAMS; COMPUTER GAME SOFTWARE; COMPUTER GAME SOFTWARE DOWNLOADABLE FROM A GLOBAL COMPUTER NETWORK; COMPUTER SOFTWARE FOR GAMES AND CHILDREN'S BOOKS FOR USE ON WIRELESS DEVICES, COMPUTERS AND PORTABLE AND HANDHELD DIGITAL ELECTRONIC DEVICES; COMPUTER SOFTWARE FOR GAMES AND CHILDREN'S BOOKS FOR USE ON WIRELESS DEVICES, COMPUTERS AND PORTABLE AND HANDHELD DIGITAL ELECTRONIC DEVICES THAT MAY BE DOWNLOADED FROM A GLOBAL COMPUTER NETWORK; DOWNLOADABLE COMPUTER GAME PROGRAMS; DOWNLOADABLE SOFTWARE FOR GAMES AND CHILDREN'S BOOKS FOR USE ON WIRELESS DEVICES, COMPUTERS AND PORTABLE AND HANDHELD DIGITAL ELECTRONIC DEVICES; DOWNLOADABLE SOFTWARE IN THE NATURE OF A MOBILE APPLICATION FOR GAMES AND CHILDREN'S BOOKS FOR USE ON WIRELESS DEVICES, COMPUTERS AND PORTABLE AND HANDHELD DIGITAL ELECTRONIC DEVICES; INTERACTIVE GAME SOFTWARE; INTERACTIVE MULTIMEDIA COMPUTER GAME PROGRAM; MOTION PICTURE FILMS AND FILMS FOR TELEVISION FEATURING CHILDREN'S ENTERTAINMENT; MOTION PICTURE FILMS FEATURING CHILDREN'S ENTERTAINMENT, IN CLASS 9 (U.S. CLS. 21, 23, 26, 36 AND 38).

FIRST USE 1-1-2009; IN COMMERCE 1-1-2009.

THE MARK CONSISTS OF STANDARD CHARACTERS WITHOUT CLAIM TO ANY PARTICULAR FONT, STYLE, SIZE, OR COLOR.

NO CLAIM IS MADE TO THE EXCLUSIVE RIGHT TO USE "BOOKS", APART FROM THE MARK AS SHOWN.

THE NAME(S), PORTRAIT(S), AND/OR SIGNATURE(S) SHOWN IN THE MARK DOES NOT IDENTIFY A PARTICULAR LIVING INDIVIDUAL.

SER. NO. 85-333,222, FILED 5-29-2011.



*David J. Kyffers*

Director of the United States Patent and Trademark Office

**Reg. No. 4,196,796** TIMOTHY FINNEGAN, EXAMINING ATTORNEY

# United States of America

United States Patent and Trademark Office

## Enclave - Shadow of Twilight

**Reg. No. 4,196,797**

**Registered Aug. 28, 2012**

**Int. Cl.: 9**

**TRADEMARK**

**PRINCIPAL REGISTER**

TOPWARE INTERACTIVE INC. (NEVADA CORPORATION)  
3960 HOWARD HUGHES PKWY 5TH FLOOR  
LAS VEGAS, NV 89109

FOR: APPARATUS FOR BROADCASTING, RECORDING AND TRANSMITTING SOUND AND IMAGES; APPARATUS, NAMELY, COMPUTER PROGRAMS FOR EDITING SOUND AND IMAGES; SCIENTIFIC, PHOTOGRAPHIC, CINEMATOGRAPHIC, OPTICAL, WEIGHING, MEASURING, SIGNALING, AND TEACHING APPARATUS AND INSTRUMENTS, NAMELY, CDS, DVDS, DIGITAL DISKS AND OPTICAL DISKS ALL FEATURING VIDEO GAME SOFTWARE; MAGNETIC, OPTICAL, NUMERICAL COMPUTER STORAGE MEDIA, NAMELY, CDS, DVDS, DIGITAL DISKS AND OPTICAL DISKS ALL FEATURING VIDEO GAME SOFTWARE ; COMPUTER PROGRAMS FOR USE AS VIDEO AND AUDIO GAMES, NAMELY, VIDEO GAME SOFTWARE; COMPUTER HARDWARE; AND COMPUTER SOFTWARE FOR USE AS VIDEO AND AUDIO GAMES, NAMELY, VIDEO GAME SOFTWARE; PERSONAL DIGITAL ASSISTANT (PDA); COMPUTER MEMORY; PRINTED CIRCUITS; DESKTOP AND LAPTOP COMPUTERS; COMPUTER PERIPHERALS, NAMELY, MONITORS, KEYBOARDS, MICE, INPUT DEVICES, CD-ROM DRIVES, CONTROL PANELS AND JOYSTICKS, DISK DRIVES FOR MAGNETIC, OPTICAL AND DIGITAL DISKS AND FLOPPY DISKS; STORED COMPUTER PROGRAMS FOR USE AS VIDEO AND AUDIO GAMES, NAMELY, VIDEO GAME SOFTWARE; COMPUTER GAME SOFTWARE; COMPUTER GAME SOFTWARE FOR USE AS VIDEO AND AUDIO GAMES, NAMELY, VIDEO GAME SOFTWARE; COMPUTER GAME AND VIDEO GAME SOFTWARE; COMPUTER GAME PROGRAMS; VIDEO AND AUDIO GAMES, NAMELY, VIDEO GAME SOFTWARE AND PROGRAMS; INTERACTIVE MULTIMEDIA COMPUTER GAME PROGRAMS; COMPUTER SCIENCE SOFTWARE ON MOBILE PHONES FOR USE AS VIDEO AND AUDIO GAMES, NAMELY, VIDEO GAME SOFTWARE; AUDIO-VISUAL GAMES IN THE NATURE OF COMPUTER GAME SOFTWARE FOR COMPUTER HARDWARE PLATFORMS; ELECTRONIC GAMING DEVICES, NAMELY, COMPUTER GAME CONSOLES FOR USE WITH AN EXTERNAL DISPLAY SCREEN OR MONITOR; MAGNETIC, OPTICAL AND DIGITAL MEDIA FOR COMPUTER PROGRAMS, NAMELY, BLANK DIGITAL STORAGE MEDIA, BLANK OPTICAL DISKS, BLANK MAGNETIC DISKS; GAME DEVICES AS ACCESSORIES FOR TVS, NAMELY, VIDEO GAME MACHINES FOR USE WITH TELEVISIONS; COMPUTER SOFTWARE CONTAINING INTEGRATED MUSIC AND INTEGRATED FILM RECORDINGS; CINEMATOGRAPHIC FILMS; VENDING MACHINES AND MECHANISMS FOR COIN OPERATED APPARATUS; DATA PROCESSING EQUIPMENT; ELECTRONIC PUBLICATIONS, NAMELY, OPERATING MANUALS AND USER MANUALS FOR COMPUTERS AND COMPUTER SOFTWARE STORED DIGITALLY, IN PARTICULAR ON FLOPPY DISKS, CD-



*David J. Kyros*

Director of the United States Patent and Trademark Office

**Reg. No. 4,196,797** ROM, DVD-ROM; SUNGLASSES AND GOGGLES; CONSUMER ELECTRONICS, NAMELY, AUDIO CASSETTE AND CD AND VIDEO CASSETTE PLAYERS AND RECORDERS, AUDIO MIXERS, ELECTRONIC CABLES, SATELLITE AND TERRESTRIAL DIGITAL SET-TOP BOXES, CALCULATORS, CAMCORDERS, CAMERAS, CD-ROM DRIVES, CD-ROM WRITERS, CELLULAR TELEPHONES, CELLULAR TELEPHONE ACCESSORIES, NAMELY, HEADPHONES, HEAD SETS, ADAPTERS AND BATTERIES FOR CELLULAR TELEPHONES; ELECTRONIC CHIPS CONTAINING MUSICAL RECORDINGS, CLOCK RADIOS, COMPACT DISC PLAYERS AND RECORDERS, COMPASSES, COMPUTER DISC DRIVES; COMPUTER GAME EQUIPMENT CONTAINING MEMORY DEVICES, NAMELY, VIDEO GAME CARTRIDGES AND DISCS; COMPUTER MODEMS, CORDLESS TELEPHONES, DICTATION MACHINES, DIGITAL CAMERAS, DIGITAL VIDEO RECORDERS AND PLAYERS, DVD PLAYERS AND RECORDERS, ELECTRONIC PERSONAL ORGANIZERS, HANDHELD COMPUTERS, HEADPHONES, INTERACTIVE VIDEO GAMES OF VIRTUAL REALITY COMPRISED OF COMPUTER HARDWARE AND SOFTWARE, KARAOKE MACHINES, LASER DISC RECORDERS AND PLAYERS, MICROPHONES, MICROSCOPES, MOBILE TELEPHONES, MP3 PLAYERS AND RECORDERS, MULTI MEDIA PLAYERS, MULTI MEDIA RECORDERS, PAGERS, PERSONAL VIDEO PLAYERS, PHOTOGRAPHIC PROJECTORS, PRINTERS, RADAR DETECTORS, RADIO PAGERS, RADIOS, RADON DETECTORS, ROBOTS, SCALES, SPEAKERS, STEREO AMPLIFIERS, STEREO RECEIVERS, STEREO TUNERS, STEREOS, TELEPHONE ANSWERING MACHINES, TELEPHONES, TELESCOPES, TELEVISION SET-TOP BOXES, TELEVISIONS, VIDEO CAMERAS, VIDEO CASSETTE RECORDERS AND PLAYERS, VIDEO GAME MACHINES FOR USE WITH TELEVISIONS, VIDEO GAME PLAYERS, NAMELY, GAME CONSOLES FOR USE WITH TELEVISION VIDEO MONITORS, VIDEOPHONES, VIDEO TAPE PLAYERS AND RECORDERS, VOICE MESSAGING SYSTEMS COMPRISING COMPUTER HARDWARE AND SOFTWARE FOR USE IN OPERATING VOICE MAIL AND VOICE MESSAGING, WALKIE-TALKIES, WEB TELEPHONES; HAND-HELD UNITS FOR PLAYING ELECTRONIC GAMES FOR USE WITH AN EXTERNAL DISPLAY SCREEN OR MONITOR; DECORATIVE REFRIGERATOR MAGNETS; SPECTACLE CASES; MOUSE PADS; WRIST AND ARM RESTS FOR USE WITH COMPUTERS; ELECTRONICALLY DOWNLOADABLE SOFTWARE, NAMELY, COMPUTER AND VIDEO GAME SOFTWARE; DVDS CONTAINING VIDEO GAME RELATED TELEVISION AND RADIO PROGRAMS; DVDS AND CDS CONTAINING AUDIO AND VIDEO RECORDINGS IN THE NATURE OF MUSIC AND ARTISTIC PERFORMANCES, IN CLASS 9 (U.S. CLS. 21, 23, 26, 36 AND 38).

FIRST USE 1-1-2010; IN COMMERCE 1-1-2010.

THE MARK CONSISTS OF STANDARD CHARACTERS WITHOUT CLAIM TO ANY PARTICULAR FONT, STYLE, SIZE, OR COLOR.

SER. NO. 85-333,422, FILED 5-30-2011.

ERNEST SHOSHO, EXAMINING ATTORNEY

# United States of America

United States Patent and Trademark Office

# LOVE

**Reg. No. 4,196,798**

**Registered Aug. 28, 2012**

**Int. Cl.: 30**

**TRADEMARK**

**PRINCIPAL REGISTER**

PUKKA HERBS LIMITED (UNITED KINGDOM CORPORATION)  
8 HAWKFIELD BUSINESS PARK  
BRISTOL BS14 0BY, UNITED KINGDOM

FOR: NON-MEDICINAL HERBAL TEAS FOR FOOD PURPOSES; DRIED AND PROCESSED  
HERBS; TEAS, IN CLASS 30 (U.S. CL. 46).

THE MARK CONSISTS OF STANDARD CHARACTERS WITHOUT CLAIM TO ANY PAR-  
TICULAR FONT, STYLE, SIZE, OR COLOR.

OWNER OF UNITED KINGDOM REG. NO. 2505509, DATED 12-24-2008, EXPIRES 12-24-  
2018.

SER. NO. 85-333,641, FILED 5-31-2011.

MARY CRAWFORD, EXAMINING ATTORNEY



*David J. Kyffers*

Director of the United States Patent and Trademark Office



# United States of America

United States Patent and Trademark Office



**Reg. No. 4,196,799**

**Registered Aug. 28, 2012**

**Int. Cls.: 9, 40 and 42**

**TRADEMARK**

**SERVICE MARK**

**PRINCIPAL REGISTER**

TRIPP ENTERPRISES, INC. (NEVADA CORPORATION)  
250 GREG STREET  
SPARKS, NV 89431

FOR: ELECTRICAL DISPLAYS, NAMELY, ELECTRONIC LED SIGNS, IN CLASS 9 (U.S. CLS. 21, 23, 26, 36 AND 38).

FIRST USE 3-1-2010; IN COMMERCE 9-10-2010.

FOR: CUSTOM MANUFACTURE OF PLASTIC SIGN BOARDS AND PLASTIC DISPLAYS, IN CLASS 40 (U.S. CLS. 100, 103 AND 106).

FIRST USE 3-1-2010; IN COMMERCE 9-1-2010.

FOR: DESIGN OF PLASTIC SIGN BOARDS AND PLASTIC DISPLAYS, IN CLASS 42 (U.S. CLS. 100 AND 101).

FIRST USE 3-1-2010; IN COMMERCE 9-1-2010.

NO CLAIM IS MADE TO THE EXCLUSIVE RIGHT TO USE "ENTERPRISES", APART FROM THE MARK AS SHOWN.

THE COLOR(S) BLUE AND WHITE IS/ARE CLAIMED AS A FEATURE OF THE MARK.

THE MARK CONSISTS OF THE WHITE STYLIZED LETTERS "TE" ON A BLUE RECTANGLE, APPEARING TO THE LEFT OF THE STYLIZED WORDING "TRIPP" IN BLUE ABOVE THE STYLIZED WORDING "ENTERPRISES" IN BLUE, WITH A SINGLE HORIZONTAL BLUE LINE UNDER THE WORD "TRIPP".

SER. NO. 85-333,806, FILED 5-31-2011.

JAMES MACFARLANE, EXAMINING ATTORNEY



*David J. Kypos*

Director of the United States Patent and Trademark Office

# United States of America

United States Patent and Trademark Office

# BLIS

**Reg. No. 4,196,800**

**Registered Aug. 28, 2012**

**Int. Cls.: 40 and 41**

**SERVICE MARK**

**PRINCIPAL REGISTER**

BELL LITHO, INC. (ILLINOIS CORPORATION)  
370 CROSSEN AVENUE  
ELK GROVE, IL 60007

FOR: PRINTING SERVICES, NAMELY, SMALL SIZE PRINTING, LARGE FORMAT PRINTING, LABEL PRINTING, CUSTOM DIE CUTTING, BINDERY SERVICES FOR OTHERS, NAMELY, COLLATING, FOLDING, STAPLING, PERFORATING, CUTTING AND BINDING OF PRINTED, PHOTOCOPIES AND TYPEWRITTEN MATERIALS, CD DUPLICATION AND CD IMPRINTING WITH DECORATIVE DESIGNS, IN CLASS 40 (U.S. CLS. 100, 103 AND 106).

FIRST USE 8-1-2006; IN COMMERCE 8-1-2006.

FOR: ONLINE ELECTRONIC PUBLISHING OF TEXT AND GRAPHIC WORKS OF OTHERS UTILIZING A WEBSITE, IN CLASS 41 (U.S. CLS. 100, 101 AND 107).

FIRST USE 8-1-2006; IN COMMERCE 8-1-2006.

THE MARK CONSISTS OF STANDARD CHARACTERS WITHOUT CLAIM TO ANY PARTICULAR FONT, STYLE, SIZE, OR COLOR.

SER. NO. 85-334,003, FILED 5-31-2011.

TRACY WHITTAKER-BROWN, EXAMINING ATTORNEY



*David J. Kyffers*

Director of the United States Patent and Trademark Office

# United States of America

United States Patent and Trademark Office

# EatMe

**Reg. No. 4,196,801**

**Registered Aug. 28, 2012**

**Int. Cl.: 30**

**TRADEMARK**

**PRINCIPAL REGISTER**

EATME LLC (CALIFORNIA LIMITED LIABILITY COMPANY)  
#10  
1515 N FAIRFAX AVE.  
LOS ANGELES, CA 90046

FOR: BAKERY GOODS, IN CLASS 30 (U.S. CL. 46).

FIRST USE 9-1-2010; IN COMMERCE 12-3-2010.

THE MARK CONSISTS OF STANDARD CHARACTERS WITHOUT CLAIM TO ANY PARTICULAR FONT, STYLE, SIZE, OR COLOR.

SER. NO. 85-334,122, FILED 5-31-2011.

STEVEN PEREZ, EXAMINING ATTORNEY



*David J. Kybas*

Director of the United States Patent and Trademark Office

# United States of America

United States Patent and Trademark Office



**OCEANMIND**  
THERAPY

**Reg. No. 4,196,802**

**Registered Aug. 28, 2012**

**Int. Cl.: 44**

**SERVICE MARK**

**PRINCIPAL REGISTER**

WALKER, ERIC BEN (UNITED STATES INDIVIDUAL)  
PO BOX 1133  
21229 PACIFIC COAST HIGHWAY  
MALIBU, CA 90265

FOR: CLINICAL MENTAL HEALTH COUNSELING SERVICES; COUNSELING SERVICES IN THE FIELDS OF HEALTH, HERBALISM, AND LIFESTYLE WELLNESS; COUNSELING SERVICES IN THE FIELDS OF HEALTH, NUTRITION AND LIFESTYLE WELLNESS; ENERGY HEALING SERVICES, NAMELY, STRESS MANAGEMENT AND STRESS REDUCTION COUNSELING FOR INDIVIDUALS TO ENHANCE THEIR LIVES; GENETIC COUNSELING; MEDICAL CLINIC PROVIDING WEIGHT LOSS SOLUTIONS, SERVICES AND PROGRAMS, NUTRITION COUNSELING, HORMONE THERAPY, INCLUDING, BIOIDENTICAL HORMONE REPLACEMENT, ANTI AGING THERAPY, AND NATURAL HORMONE THERAPY, MEDICAL AESTHETIC PROCEDURES, INCLUDING, LASER HAIR REMOVAL, LASER PEELS, BOTULINUM TOXIN TREATMENTS, MICRODERMABRASION, LIPOSUCTION, VEIN TREATMENTS, VEIN THERAPY, CELLULITE TREATMENTS, BODY CONTOURING TREATMENTS, INJECTABLE FILLER TREATMENTS, FACIALS, AND SKIN CARE; MEDICAL COUNSELING; MENTAL HEALTH COUNSELING AND PSYCHOTHERAPY AS IT RELATES TO RELATIONSHIPS; NUTRITION COUNSELING; PROVIDING HEALTHY LIFESTYLE AND NUTRITION SERVICES, NAMELY, PERSONAL ASSESSMENTS, PERSONALIZED ROUTINES, MAINTENANCE SCHEDULES, AND COUNSELING; PROVIDING WELLNESS SERVICES, NAMELY, PERSONAL ASSESSMENTS, PERSONALIZED ROUTINES, MAINTENANCE SCHEDULES, AND COUNSELING; PSYCHOLOGICAL COUNSELING; PSYCHOLOGICAL COUNSELING SERVICES IN THE FIELD OF SPORTS; PSYCHOTHERAPY AND PSYCHOTHERAPY COUNSELING FOR CHILDREN AND ADULTS IN INDIVIDUAL AND FAMILY SESSIONS; PSYCHOTHERAPY COMPLEMENTED BY BODY WORK, NAMELY, MYOFASCIAL PHYSICAL THERAPY TECHNIQUES; PSYCHOTHERAPY SERVICES, IN CLASS 44 (U.S. CLS. 100 AND 101).



FIRST USE 3-1-2010; IN COMMERCE 3-1-2010.

NO CLAIM IS MADE TO THE EXCLUSIVE RIGHT TO USE "OCEANMIND THERAPY" , APART FROM THE MARK AS SHOWN.

*David J. Kyros*

Director of the United States Patent and Trademark Office

THE MARK CONSISTS OF A SILHOUETTE OF A FULL PROFILE OF A HUMAN HEAD WITH TWO ADDITIONAL PROFILES EMANATING THEREFROM. THE HEAD ALSO FEATURES A CIRCULAR FIGURATIVE WINDOW REVEALING AN ENCAPSULATED

**Reg. No. 4,196,802** SINGLE WAVE INSIDE THE BRAIN. THE WORDING "OCEANMIND THERAPY" APPEARS BELOW THE HEAD.

SER. NO. 85-334,659, FILED 6-1-2011.

ZHALEH DELANEY, EXAMINING ATTORNEY

# United States of America

United States Patent and Trademark Office

## AUSTIN'S CREATIVE HOME

**Reg. No. 4,196,803**

**Registered Aug. 28, 2012**

**Int. Cl.: 41**

**SERVICE MARK**

**PRINCIPAL REGISTER**

GREATER AUSTIN PERFORMING ARTS CENTER, INC. (TEXAS NON-PROFIT CORPORATION)  
701 W. RIVERSIDE DRIVE  
AUSTIN, TX 78704

FOR: ENTERTAINMENT IN THE NATURE OF THEATER PRODUCTIONS AND THE PRESENTATION OF LIVE MUSIC, DANCE, AND ARTISTIC PERFORMANCES; EDUCATIONAL SERVICES, NAMELY, CLASSES, CONFERENCES, AND WORKSHOPS IN THE FIELD OF MUSIC, DANCE, THEATER, AND THE ARTS, IN CLASS 41 (U.S. CLS. 100, 101 AND 107).

FIRST USE 5-13-2011; IN COMMERCE 5-13-2011.

THE MARK CONSISTS OF STANDARD CHARACTERS WITHOUT CLAIM TO ANY PARTICULAR FONT, STYLE, SIZE, OR COLOR.

NO CLAIM IS MADE TO THE EXCLUSIVE RIGHT TO USE "AUSTIN'S", APART FROM THE MARK AS SHOWN.

SER. NO. 85-334,971, FILED 6-1-2011.

TRICIA SONNEBORN, EXAMINING ATTORNEY



*David J. Kyffers*

Director of the United States Patent and Trademark Office

United States of America  
United States Patent and Trademark Office

# LabVIEW

**Reg. No. 4,196,804**

**Registered Aug. 28, 2012**

**Int. Cl.: 9**

**TRADEMARK**

**PRINCIPAL REGISTER**

NATIONAL INSTRUMENTS CORPORATION (DELAWARE CORPORATION)  
BUILDING "B"  
11500 NORTH MOPAC  
AUSTIN, TX 78759

FOR: COMPUTER SOFTWARE FOR INDUSTRIAL AUTOMATION AND SCIENTIFIC AND  
ENGINEERING DATA ACQUISITION, CONTROL AND ANALYSIS, IN CLASS 9 (U.S. CLS.  
21, 23, 26, 36 AND 38).

FIRST USE 10-24-1981; IN COMMERCE 10-24-1986.

OWNER OF U.S. REG. NO. 1,462,634.

THE MARK CONSISTS OF THE WORDING "LABVIEW" IN STYLIZED FONT, WITH THE  
FIRST LETTER "L" CAPITALIZED, THE "AB" IN LOWER CASE AND "VIEW" CAPITALIZED.

SER. NO. 85-335,202, FILED 6-1-2011.

SUZANNE BLANE, EXAMINING ATTORNEY



*David J. Kyffers*

Director of the United States Patent and Trademark Office

# United States of America

United States Patent and Trademark Office

## CERTIFIED PROTECTION PROFESSIONAL

**Reg. No. 4,196,805**

ASIS INTERNATIONAL, INC. (DELAWARE CORPORATION)  
1625 PRINCE STREET  
ALEXANDRIA, VA 22314

**Registered Aug. 28, 2012**

**Int. Cls.: 41 and 42**

FOR: PREPARING, ADMINISTERING AND SCORING OF STANDARDIZED TESTS IN THE FIELD OF INDUSTRIAL SECURITY MANAGEMENT AND PROTECTION AND CONDUCTING EDUCATIONAL COURSES IN INDUSTRIAL SECURITY MANAGEMENT AND PROTECTION, IN CLASS 41 (U.S. CLS. 100, 101 AND 107).

**SERVICE MARK**

**PRINCIPAL REGISTER**

FIRST USE 0-0-1978; IN COMMERCE 0-0-1978.

FOR: TESTING, ANALYSIS AND EVALUATION OF THE KNOWLEDGE, SKILLS AND ABILITIES OF OTHERS FOR THE PURPOSE OF CERTIFICATION AND RE-CERTIFICATION IN THE FIELD OF INDUSTRIAL SECURITY MANAGEMENT AND PROTECTION, IN CLASS 42 (U.S. CLS. 100 AND 101).

FIRST USE 0-0-1978; IN COMMERCE 0-0-1978.

THE MARK CONSISTS OF STANDARD CHARACTERS WITHOUT CLAIM TO ANY PARTICULAR FONT, STYLE, SIZE, OR COLOR.

SEC. 2(F).

SER. NO. 85-335,946, FILED 6-2-2011.

HENRY S. ZAK, EXAMINING ATTORNEY



*David J. Kyffers*

Director of the United States Patent and Trademark Office



# United States of America

United States Patent and Trademark Office



**Reg. No. 4,196,806**

**Registered Aug. 28, 2012**

**Int. Cl.: 44**

**SERVICE MARK**

**PRINCIPAL REGISTER**

BOWERS, RACHEL B. (NEW YORK SOLE PROPRIETORSHIP), DBA BROOKLYN BARK  
171 CLERMONT AVE.  
BROOKLYN, NY 11205

FOR: PET CARE SERVICES, NAMELY, DOG WALKING, DOG BATHING, NON-MEDICATED  
PET GROOMING AND IN-HOME MEDICAL CARE, IN CLASS 44 (U.S. CLS. 100 AND 101).

FIRST USE 2-16-2010; IN COMMERCE 2-16-2010.

THE MARK CONSISTS OF A SQUARE BOX WITH A STYLIZED PAW PRINT INSIDE THE  
BOX, THE WORDS/LETTERS "BKLYN BARK" SURROUND THE TOP AND LEFT SIDE OF  
THE BOX.

SER. NO. 85-336,035, FILED 6-2-2011.

JAY FLOWERS, EXAMINING ATTORNEY



*David J. Kyffers*

Director of the United States Patent and Trademark Office

# United States of America

United States Patent and Trademark Office

## ARTY BRUSH

**Reg. No. 4,196,807**

**Registered Aug. 28, 2012**

**Int. Cl.: 3**

**TRADEMARK**

**PRINCIPAL REGISTER**

SILLY FARM SUPPLIES (FLORIDA CORPORATION)  
SUITE B1  
11860 WEST STATE RD 84  
DAVIE, FL 33325

FOR: FACE PAINT, IN CLASS 3 (U.S. CLS. 1, 4, 6, 50, 51 AND 52).

FIRST USE 2-1-2008; IN COMMERCE 4-1-2008.

THE MARK CONSISTS OF STANDARD CHARACTERS WITHOUT CLAIM TO ANY PARTICULAR FONT, STYLE, SIZE, OR COLOR.

NO CLAIM IS MADE TO THE EXCLUSIVE RIGHT TO USE "BRUSH", APART FROM THE MARK AS SHOWN.

SER. NO. 85-337,015, FILED 6-3-2011.

CHARLOTTE CORWIN, EXAMINING ATTORNEY



*David J. Kyffers*

Director of the United States Patent and Trademark Office

# United States of America

United States Patent and Trademark Office

## WeCounsel Solutions

**Reg. No. 4,196,808**

**Registered Aug. 28, 2012**

**Int. Cl.: 44**

**SERVICE MARK**

**PRINCIPAL REGISTER**

WECOUNSEL SOLUTIONS, LLC (DELAWARE LIMITED LIABILITY COMPANY)  
1333 BROW ESTATES DRIVE  
SIGNAL MOUNTAIN, TN 37377

FOR: PSYCHOLOGICAL COUNSELING, IN CLASS 44 (U.S. CLS. 100 AND 101).

FIRST USE 6-1-2011; IN COMMERCE 6-1-2011.

THE MARK CONSISTS OF STANDARD CHARACTERS WITHOUT CLAIM TO ANY PARTICULAR FONT, STYLE, SIZE, OR COLOR.

NO CLAIM IS MADE TO THE EXCLUSIVE RIGHT TO USE "SOLUTIONS", APART FROM THE MARK AS SHOWN.

SER. NO. 85-338,455, FILED 6-6-2011.

JOHN KELLY, EXAMINING ATTORNEY



*David J. Kyffers*

Director of the United States Patent and Trademark Office

# United States of America

United States Patent and Trademark Office



**Reg. No. 4,196,809**

**Registered Aug. 28, 2012**

**Int. Cls.: 9, 41 and 42**

**TRADEMARK**

**SERVICE MARK**

**PRINCIPAL REGISTER**

NODEJITSU INC. (DELAWARE CORPORATION)  
135 E 27TH STREET  
NEW YORK, NY 10016

FOR: COMPUTER SOFTWARE DEVELOPMENT TOOLS; DOWNLOADABLE COMPUTER SOFTWARE FOR USE IN CLOUD COMPUTING, IN CLASS 9 (U.S. CLS. 21, 23, 26, 36 AND 38).

FIRST USE 1-5-2011; IN COMMERCE 1-5-2011.

FOR: TRAINING SERVICES IN THE FIELDS OF COMPUTER SOFTWARE, COMPUTER HARDWARE, SOFTWARE DEVELOPMENT, WEB SITES, VIRTUALIZATION TECHNOLOGIES, CLOUD COMPUTING, INFORMATION SYSTEMS AND COMPUTER SERVICES, IN CLASS 41 (U.S. CLS. 100, 101 AND 107).

FIRST USE 1-5-2011; IN COMMERCE 1-5-2011.

FOR: COMPUTER SOFTWARE DEVELOPMENT; COMPUTER SERVICES, NAMELY, HOSTING COMPUTER SOFTWARE APPLICATIONS OF OTHERS; CLOUD COMPUTING FEATURING SOFTWARE FOR USE IN VIRTUALIZED ENVIRONMENT FOR HOSTING OPERATING SYSTEMS, APPLICATIONS, WEB SITES AND SERVICES; PROVIDING TEMPORARY USE OF ONLINE NON-DOWNLOADABLE SOFTWARE FOR USE IN CLOUD COMPUTING, IN CLASS 42 (U.S. CLS. 100 AND 101).

FIRST USE 1-5-2011; IN COMMERCE 1-5-2011.

THE MARK CONSISTS OF IMAGE OF A BONSAI TREE.

SER. NO. 85-338,661, FILED 6-6-2011.

WILLIAM BRECKENFELD, EXAMINING ATTORNEY



*David J. Kybas*

Director of the United States Patent and Trademark Office

# United States of America

United States Patent and Trademark Office



**Reg. No. 4,196,810**

**Registered Aug. 28, 2012**

**Int. Cl.: 36**

**SERVICE MARK**

**PRINCIPAL REGISTER**

RUSSIAN CHILDREN'S WELFARE SOCIETY, INC. (NEW YORK NON-PROFIT CORPORATION)  
200 PARK AVENUE SOUTH, SUITE 1617  
NEW YORK, NY 10003

FOR: CHARITABLE FUNDRAISING SERVICES, IN CLASS 36 (U.S. CLS. 100, 101 AND 102).

FIRST USE 10-0-1998; IN COMMERCE 10-0-1998.

THE MARK CONSISTS OF AN ADULT FACING A CHILD WITH OUTSTRETCHED ARMS. THERE IS AN IMAGE OF A SUN WITH RAYS IN THE RIGHT HAND CORNER AND ALL ARE WITHIN AN OVAL. THE WORDING "RUSSIAN CHILDREN'S WELFARE SOCIETY, INC" BORDERS THE OVAL.

SEC. 2(F) AS TO "RUSSIAN CHILDREN'S WELFARE SOCIETY, INC".

SER. NO. 85-338,903, FILED 6-6-2011.

JESSICA FATHY, EXAMINING ATTORNEY



*David J. Kybas*

Director of the United States Patent and Trademark Office

# United States of America

United States Patent and Trademark Office

# XLOCK

**Reg. No. 4,196,811**

EXTREMITY MEDICAL, LLC (NEW JERSEY LIMITED LIABILITY COMPANY)  
300 INTERPACE PARKWAY  
PARSIPPANY, NJ 07054

**Registered Aug. 28, 2012**

**Int. Cl.: 10**

FOR: MEDICAL DEVICE, NAMELY, A LOCKING MECHANISM FOR INTRAOSSEOUS AND INTRAMEDULLARY FUSION DEVICES, IN CLASS 10 (U.S. CLS. 26, 39 AND 44).

**TRADEMARK**

FIRST USE 6-0-2011; IN COMMERCE 6-0-2011.

**PRINCIPAL REGISTER**

THE MARK CONSISTS OF STANDARD CHARACTERS WITHOUT CLAIM TO ANY PARTICULAR FONT, STYLE, SIZE, OR COLOR.

OWNER OF U.S. REG. NOS. 3,645,143, 3,797,824 AND OTHERS.

SER. NO. 85-339,095, FILED 6-6-2011.

MICHELE SWAIN, EXAMINING ATTORNEY



*David J. Kybas*

Director of the United States Patent and Trademark Office

# United States of America

United States Patent and Trademark Office

# SOLAIR

**Reg. No. 4,196,812**

GLEN RAVEN, INC. (NORTH CAROLINA CORPORATION)  
1831 NORTH PARK AVENUE  
GLEN RAVEN, NC 27217

**Registered Aug. 28, 2012**

**Int. Cls.: 6, 19 and 22**

FOR: AWNING HARDWARE, IN CLASS 6 (U.S. CLS. 2, 12, 13, 14, 23, 25 AND 50).

FIRST USE 0-0-1980; IN COMMERCE 0-0-1980.

**TRADEMARK**

FOR: SCREENS, IN CLASS 19 (U.S. CLS. 1, 12, 33 AND 50).

**PRINCIPAL REGISTER**

FIRST USE 2-0-2009; IN COMMERCE 2-0-2009.

FOR: AWNINGS; RETRACTABLE AWNINGS; WINDOW AWNINGS, IN CLASS 22 (U.S. CLS. 1, 2, 7, 19, 22, 42 AND 50).

FIRST USE 0-0-1979; IN COMMERCE 0-0-1979.

THE MARK CONSISTS OF STANDARD CHARACTERS WITHOUT CLAIM TO ANY PARTICULAR FONT, STYLE, SIZE, OR COLOR.

OWNER OF U.S. REG. NOS. 1,181,824 AND 3,660,882.

SER. NO. 85-339,117, FILED 6-6-2011.

ROSELLE HERRERA, EXAMINING ATTORNEY



*David J. Kybas*

Director of the United States Patent and Trademark Office

# United States of America

United States Patent and Trademark Office

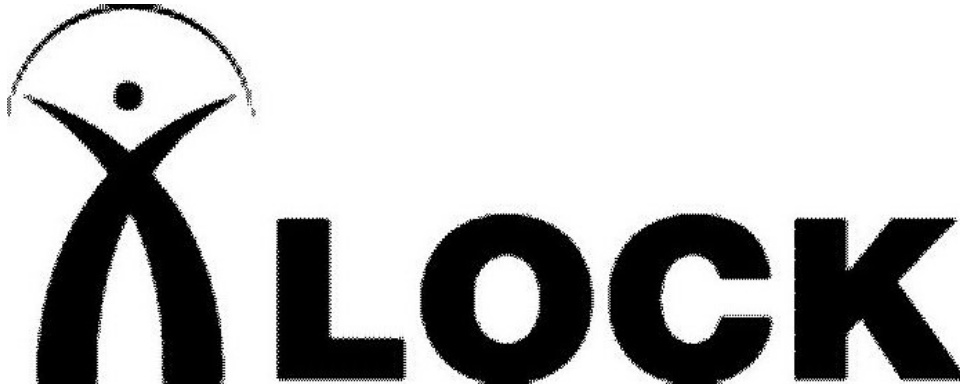

**Reg. No. 4,196,813**

EXTREMITY MEDICAL, LLC (NEW JERSEY LIMITED LIABILITY COMPANY)  
300 INTERPACE PARKWAY  
PARSIPPANY, NJ 07054

**Registered Aug. 28, 2012**

**Int. Cl.: 10**

FOR: MEDICAL DEVICE, NAMELY, A LOCKING MECHANISM FOR INTRAOSSEOUS AND INTRAMEDULLARY FUSION DEVICES, IN CLASS 10 (U.S. CLS. 26, 39 AND 44).

**TRADEMARK**

FIRST USE 6-0-2011; IN COMMERCE 6-0-2011.

**PRINCIPAL REGISTER**

OWNER OF U.S. REG. NOS. 3,652,074, 3,865,626 AND OTHERS.

THE MARK CONSISTS OF LETTERS, "XLOCK", WITH THE "X" REPRESENTED BY THE DESIGN OF A PERSON WITH A SOLID CIRCLE FOR A HEAD AND A THIN LINE CURVED DOWNWARD AND RUNNING FROM THE LEFT HAND TO THE RIGHT HAND OF THE PERSON.

SER. NO. 85-339,162, FILED 6-6-2011.

MICHELE SWAIN, EXAMINING ATTORNEY



*David J. Kybas*

Director of the United States Patent and Trademark Office



# United States of America

United States Patent and Trademark Office

# #GBNB

**Reg. No. 4,196,814**

TYLER J. SASH (UNITED STATES INDIVIDUAL)  
1315 BARCLAY STREET  
OSKALOOSA, IA 525771716

**Registered Aug. 28, 2012**

**Int. Cl.: 25**

FOR: CLOTHING, NAMELY, T-SHIRTS, SWEATSHIRTS, HOODED SWEATSHIRTS, SWEAT PANTS, ATHLETIC SHORTS, BEANIES, HEAD BAND EAR WARMERS, CAPS, INFANT BODYSUITS, WRISTBANDS, IN CLASS 25 (U.S. CLS. 22 AND 39).

**TRADEMARK**

FIRST USE 6-21-2011; IN COMMERCE 6-21-2011.

**PRINCIPAL REGISTER**

THE MARK CONSISTS OF STANDARD CHARACTERS WITHOUT CLAIM TO ANY PARTICULAR FONT, STYLE, SIZE, OR COLOR.

SER. NO. 85-339,629, FILED 6-7-2011.

CHRISTINE COOPER, EXAMINING ATTORNEY



*David J. Kyffers*

Director of the United States Patent and Trademark Office

# United States of America

United States Patent and Trademark Office



**Reg. No. 4,196,815**

**Registered Aug. 28, 2012**

**Int. Cl.: 16**

**TRADEMARK**

**PRINCIPAL REGISTER**

SHEBOYGAN PAPER BOX CO. (WISCONSIN CORPORATION)  
716 CLARA AVENUE  
SHEBOYGAN, WI 53081

FOR: PAPER GOODS, NAMELY, PAPER BOXES, CORRUGATED PAPER AND PAPER BOARD CONTAINERS, AND PAPER CONTAINERS AND WRAPS, IN CLASS 16 (U.S. CLS. 2, 5, 22, 23, 29, 37, 38 AND 50).

FIRST USE 10-0-1997; IN COMMERCE 10-0-1997.

NO CLAIM IS MADE TO THE EXCLUSIVE RIGHT TO USE "PAPER BOX COMPANY", APART FROM THE MARK AS SHOWN.

THE MARK CONSISTS OF THE WORDS "SHEBOYGAN PAPER BOX COMPANY" WITH THE LETTER "O" IN "BOX" APPEARING AS A STYLIZED SQUARE CONTAINING A THREE DIMENSIONAL BOX IN THE UPPER LEFT CORNER.

SEC. 2(F).

SER. NO. 85-339,632, FILED 6-7-2011.

CHRISTINE COOPER, EXAMINING ATTORNEY



*David J. Kybas*

Director of the United States Patent and Trademark Office

# United States of America

United States Patent and Trademark Office

# SALTEX

**Reg. No. 4,196,816**

**Registered Aug. 28, 2012**

**Int. Cl.: 1**

**TRADEMARK**

**PRINCIPAL REGISTER**

SALTEX, LLC (DELAWARE LIMITED LIABILITY COMPANY)  
2407 EAST SKELLY DRIVE  
TULSA, OK 741056006

FOR: SODIUM SULFATE, IN CLASS 1 (U.S. CLS. 1, 5, 6, 10, 26 AND 46).

FIRST USE 1-15-2005; IN COMMERCE 1-15-2005.

THE MARK CONSISTS OF STANDARD CHARACTERS WITHOUT CLAIM TO ANY PARTICULAR FONT, STYLE, SIZE, OR COLOR.

SER. NO. 85-339,937, FILED 6-7-2011.

KAREN K. BUSH, EXAMINING ATTORNEY



*David J. Kyffers*

Director of the United States Patent and Trademark Office

# United States of America

United States Patent and Trademark Office



**Reg. No. 4,196,817**

**Registered Aug. 28, 2012**

**Int. Cls.: 4, 11 and 30**

**TRADEMARK**

**PRINCIPAL REGISTER**

BRADLEY TECHNOLOGIES (CANADA) INC. (CANADA CORPORATION)  
8380 RIVER ROAD  
DELTA, B.C., CANADA V4G1B5

FOR: WOOD CHIPS FOR SMOKING AND GRILLING FOODS; WOOD CHIPS FOR USE AS FUEL, IN CLASS 4 (U.S. CLS. 1, 6 AND 15).

FIRST USE 12-31-1999; IN COMMERCE 12-31-1999.

FOR: MEAT AND FOOD SMOKERS, NAMELY, GRILLS USED FOR SMOKING FOOD, AND REPLACEMENT PARTS AND FITTINGS FOR THE AFOREMENTIONED GOODS; ACCESSORIES FOR MEAT AND FOOD SMOKERS, NAMELY, SMOKE GENERATORS, FUEL STARTERS, COLD SMOKE ADAPTER BOXES, CARRYING BAGS FOR GRILLS AND WEATHER GUARDS FOR GRILLS, IN CLASS 11 (U.S. CLS. 13, 21, 23, 31 AND 34).

FIRST USE 12-31-1999; IN COMMERCE 12-31-1999.

FOR: MEAT CURES, IN CLASS 30 (U.S. CL. 46).

FIRST USE 12-31-2007; IN COMMERCE 12-31-2007.

OWNER OF U.S. REG. NO. 2,366,059.

NO CLAIM IS MADE TO THE EXCLUSIVE RIGHT TO USE "SMOKER", APART FROM THE MARK AS SHOWN.

THE MARK CONSISTS OF AN OVAL WITH A RIBBON WRAPPED AROUND THE BOTTOM, WITH THE WORD "SMOKER" INSIDE OF THE RIBBON, EACH LETTER SEPARATED BY A BLACK DOT, AND THE WORD "BRADLEY" WRITTEN IN CURSIVE LETTERS IN THE OVAL ABOVE THE RIBBON.

SER. NO. 85-340,500, FILED 6-7-2011.

SHARON MEIER, EXAMINING ATTORNEY



*David J. Kyffers*

Director of the United States Patent and Trademark Office

# United States of America

United States Patent and Trademark Office



# CHICHITEC

**Reg. No. 4,196,818**

**Registered Aug. 28, 2012**

**Int. Cl.: 9**

**TRADEMARK**

**PRINCIPAL REGISTER**

CHICHITEC CO. (UNITED STATES INDIVIDUAL)  
#398  
1618 SULLIVAN AVE  
DALY CITY, CA 94015

FOR: BATTERIES AND BATTERY CHARGERS; BATTERY PACKS FOR CELLPHONE, PDA, XDA; CARRYING CASES FOR ELECTRONIC EQUIPMENT, NAMELY, PERSONAL TABLET COMPUTER, CELLPHONE, TABLET COMPUTER; CARRYING CASES SPECIALLY ADAPTED FOR POCKET CALCULATORS AND CELLPHONES; CARRYING CASES, HOLDERS, PROTECTIVE CASES AND STANDS FEATURING POWER SUPPLY CONNECTORS, ADAPTORS, SPEAKERS AND BATTERY CHARGING DEVICES, SPECIALLY ADAPTED FOR USE WITH HANDHELD DIGITAL ELECTRONIC DEVICES; CASES FOR MUSIC, AUDIO AND RELATED ELECTRONIC EQUIPMENT, NAMELY, CASES FOR AUDIO TUNERS, AUDIO RECEIVERS, AMPLIFIERS, TAPE PLAYERS, COMPACT DISC PLAYERS, MP3 CONTROLLERS/PLAYERS, AUDIO MIXERS, AUDIO SPEAKERS IN THE NATURE OF MUSIC STUDIO MONITORS, MICROPHONES, AUDIO SPEAKERS, COMPACT DISCS, AUDIO TAPES, PORTABLE COMPUTERS, ANTENNAS, PHONOGRAPHIC RECORD PLAYERS, AUDIO RECORDING EQUIPMENT, AND THE CABLES ASSOCIATED WITH ALL OF THE FOREGOING EQUIPMENT; CELL PHONE BATTERY CHARGERS; CELL PHONE BATTERY CHARGERS FOR USE IN VEHICLES; CHARGERS FOR BATTERIES; CHARGERS FOR ELECTRIC BATTERIES; COMPUTER STORAGE DEVICES, NAMELY, HIGH-SPEED STORAGE SUBSYSTEMS FOR STORAGE AND BACKUP OF ELECTRONIC DATA EITHER LOCALLY OR VIA A TELECOMMUNICATIONS NETWORK; CONNECTORS FOR ELECTRONIC CIRCUITS; CONSUMER ELECTRONIC PRODUCTS, NAMELY, AUDIO AMPLIFIERS, AUDIO SPEAKERS, AUDIO RECEIVERS, ELECTRICAL AUDIO AND SPEAKER CABLES AND CONNECTORS, AUDIO DECODERS, VIDEO DECODERS, SPEAKERS, POWER CONVERSION DEVICES, POWER CONVERTERS, AND POWER INVERTERS; DOWNLOADABLE ELECTRONIC DATA FILES AND DATABASES, NAMELY, BUSINESS AND TAX FORMS, FOR USE WITH COMPUTER SOFTWARE; DOWNLOADABLE ELECTRONIC GAME PROGRAMS, IN CLASS 9 (U.S. CLS. 21, 23, 26, 36 AND 38).



FIRST USE 6-8-2011; IN COMMERCE 6-8-2011.

*David J. Kyros*

THE MARK CONSISTS OF TWO HIGHLY STYLIZED, CONSTRUCTED LETTER "CS" NESTED ONE INSIDE THE OTHER FACING UPWARD AND RIGHT WITH THE OUTER "C" IN ORANGE AND THE INNER "C" IN RED AND BOTH OF THEM WHITE ON THE TOP.

**Reg. No. 4,196,818** BELOW THE DOUBLE "C" DESIGN IS THE WORD "CHICHITEC" IN STYLIZED CAPITAL LETTERS, IN BLACK FOR THE "CHICHI" PORTION, AND IN RED FOR THE "TEC".

THE COLOR(S) BLACK, WHITE, RED AND ORANGE IS/ARE CLAIMED AS A FEATURE OF THE MARK.

SER. NO. 85-341,127, FILED 6-8-2011.

RAUL CORDOVA, EXAMINING ATTORNEY

# United States of America

United States Patent and Trademark Office

# Sing To Learn

**Reg. No. 4,196,819**

OBIE LEFF (UNITED STATES INDIVIDUAL)  
2515 MAPLE STREET  
SUTTER, CA 95982

**Registered Aug. 28, 2012**

**Int. Cl.: 9**

FOR: CHILDREN'S EDUCATIONAL MUSIC CDS AND DVDS; CHILDREN'S EDUCATIONAL SOFTWARE, IN CLASS 9 (U.S. CLS. 21, 23, 26, 36 AND 38).

**TRADEMARK**

FIRST USE 7-1-2001; IN COMMERCE 7-27-2002.

**PRINCIPAL REGISTER**

THE MARK CONSISTS OF STANDARD CHARACTERS WITHOUT CLAIM TO ANY PARTICULAR FONT, STYLE, SIZE, OR COLOR.

SER. NO. 85-341,367, FILED 6-8-2011.

CHARLES L. JENKINS, EXAMINING ATTORNEY



*David J. Kybas*

Director of the United States Patent and Trademark Office

# United States of America

United States Patent and Trademark Office



**Reg. No. 4,196,820**

**Registered Aug. 28, 2012**

**Int. Cl.: 16**

**TRADEMARK**

**PRINCIPAL REGISTER**

TRUONG, HANG KIM (UNITED STATES INDIVIDUAL)  
9811 CASTLE CREST DR.  
HOUSTON, TX 77083 AND

NGUYEN, CHAU HUU-QUYNH (VIETNAM INDIVIDUAL)  
9811 CASTLE CREST DR.  
HOUSTON, TX 77083

FOR: PRINTED PUBLICATIONS, NAMELY, COMMERCIAL INFORMATION DIRECTORIES RELATING TO VIETNAMESE BUSINESSES INVOLVED IN THE INTERNATIONAL IMPORT AND EXPORT OF GOODS AND SERVICES, IN CLASS 16 (U.S. CLS. 2, 5, 22, 23, 29, 37, 38 AND 50).

FIRST USE 6-6-2011; IN COMMERCE 6-6-2011.

NO CLAIM IS MADE TO THE EXCLUSIVE RIGHT TO USE "VIETNAM BUSINESS DIRECTORY SINCE JOINING THE WTO", APART FROM THE MARK AS SHOWN.

THE COLOR(S) BLUE IS/ARE CLAIMED AS A FEATURE OF THE MARK.

THE MARK CONSISTS OF THE PHRASE "VIETNAM BUSINESS DIRECTORY SINCE JOINING THE WTO" IN BLUE, STYLIZED LETTERING. A BLUE RECTANGLE BORDERS THE WORDING IN THE MARK.

SER. NO. 85-341,531, FILED 6-8-2011.

INGA ERVIN, EXAMINING ATTORNEY



*David J. Kybas*

Director of the United States Patent and Trademark Office



# United States of America

United States Patent and Trademark Office

悠易互通

**Reg. No. 4,196,821**

**Registered Aug. 28, 2012**

**Int. Cls.: 35 and 42**

**SERVICE MARK**

**PRINCIPAL REGISTER**

YOYI INTERACTIVE (BEIJING) ADVERTISING CO., LTD. (CHINA LIMITED LIABILITY COMPANY)

2201 UNIT NO.3 BLDG., ORIENTAL MEDIA CTR.  
NO.4 GUANGHUA ROAD, CHAOYANG DISTRICT  
BEIJING, CHINA

FOR: ADVERTISING AGENCIES; ADVERTISING SERVICES; BUSINESS INVESTIGATIONS; DESIGN OF ADVERTISING MATERIALS FOR OTHERS; DESIGN OF INTERNET ADVERTISING; ON-LINE ADVERTISING ON COMPUTER COMMUNICATION NETWORKS; PREPARING AND PLACING OF ADVERTISEMENTS; PUBLIC RELATIONS; PUBLICITY AGENTS; TELEVISION ADVERTISING AGENCIES, IN CLASS 35 (U.S. CLS. 100, 101 AND 102).

FIRST USE 3-12-2009; IN COMMERCE 3-12-2009.

FOR: COMPUTER PROGRAMMING AND COMPUTER SYSTEM ANALYSIS; COMPUTER SOFTWARE DESIGN AND UPDATING; COMPUTER SYSTEM DESIGN SERVICES; DUPLICATION OF COMPUTER PROGRAMS; MAINTENANCE OF COMPUTER SOFTWARE; PROGRAMMING OF COMPUTER SOFTWARE FOR OTHERS; SCIENTIFIC RESEARCH; SCIENTIFIC RESEARCH AND DEVELOPMENT; SOFTWARE DESIGN AND DEVELOPMENT; SURVEY DESIGN AND RESEARCH, IN CLASS 42 (U.S. CLS. 100 AND 101).

FIRST USE 3-20-2009; IN COMMERCE 3-20-2009.

NO CLAIM IS MADE TO THE EXCLUSIVE RIGHT TO USE THE NON-LATIN CHARACTERS THAT TRANSLITERATE TO HU TONG, APART FROM THE MARK AS SHOWN.

THE NON-LATIN CHARACTERS IN THE MARK TRANSLITERATE TO YOU YI HU TONG; YOU YI HAS NO MEANING IN A FOREIGN LANGUAGE AND HU TONG MEANS INTERACTIVE IN ENGLISH.

THE MARK CONSISTS OF STYLIZED CHINESE CHARACTERS.

SER. NO. 85-341,815, FILED 6-9-2011.

KRISTIN CARLSON, EXAMINING ATTORNEY



*David J. Kyros*

Director of the United States Patent and Trademark Office

# United States of America

United States Patent and Trademark Office

GRAND  MEADOWS

**Reg. No. 4,196,822**

HARTOG, NICHOLAS C. (UNITED STATES INDIVIDUAL)  
685 VISTA BONITA

**Registered Aug. 28, 2012**

NEWPORT BEACH, CA 92660

**Int. Cl.: 5**

FOR: ANIMAL FEED ADDITIVE FOR USE AS A NUTRITIONAL SUPPLEMENT FOR MEDICAL PURPOSES; ANIMAL FEED SUPPLEMENTS; DIETARY AND NUTRITIONAL SUPPLEMENTS; DIETARY AND NUTRITIONAL SUPPLEMENTS FOR ENDURANCE SPORTS; DIETARY SUPPLEMENTS FOR ANIMALS; DIETARY SUPPLEMENTS FOR PETS; FEED SUPPLEMENTS FOR DOGS, CATS, HORSES; MEDICATED SUPPLEMENTS FOR FOODSTUFFS FOR ANIMALS; MINERAL SUPPLEMENTS; NON-MEDICATED ADDITIVES FOR ANIMAL FEED FOR USE AS NUTRITIONAL SUPPLEMENTS; NUTRACEUTICALS FOR USE AS A DIETARY SUPPLEMENT; NUTRITIONAL SUPPLEMENTS; NUTRITIONAL SUPPLEMENTS IN CAPSULE FORM FOR DOGS; VITAMIN AND MINERAL SUPPLEMENTS; VITAMIN SUPPLEMENTS; VITAMINS AND DIETARY FOOD SUPPLEMENTS FOR ANIMALS, IN CLASS 5 (U.S. CLS. 6, 18, 44, 46, 51 AND 52).

**TRADEMARK**

**PRINCIPAL REGISTER**

FIRST USE 5-18-2005; IN COMMERCE 5-18-2005.

OWNER OF U.S. REG. NOS. 3,144,091 AND 3,144,092.

THE MARK CONSISTS OF THE WORDS "GRAND MEADOWS". BETWEEN THE WORDS, THE DESIGN OF A HORSE APPEARS IN SILHOUETTE GALLOPING FROM LEFT TO RIGHT. THE FORELEGS AND ONE HIND LEG ARE RAISED ABOVE THE GROUND. THE HORSE IS SURROUNDED BY TWO CURVED LAUREL BRANCHES. THE HORSE STANDS ON A GENTLY CURVING SLIM LINE.

SER. NO. 85-342,130, FILED 6-9-2011.

LEIGH CAROLINE CASE, EXAMINING ATTORNEY



*David J. Kypos*

Director of the United States Patent and Trademark Office

# United States of America

United States Patent and Trademark Office

# petslovedeals.com

**Reg. No. 4,196,823**

**Registered Aug. 28, 2012**

**Int. Cl.: 35**

**SERVICE MARK**

**PRINCIPAL REGISTER**

PETSLOVEDEALS, INC. (DELAWARE CORPORATION)  
54 LA CAMPANA RD  
ORINDA, CA 94563

FOR: PET-RELATED ADVERTISING AND MARKETING SERVICES PROVIDED BY MEANS OF INDIRECT METHODS OF MARKETING COMMUNICATIONS, NAMELY, SOCIAL MEDIA, SEARCH ENGINE MARKETING, INQUIRY MARKETING, INTERNET MARKETING, MOBILE MARKETING, BLOGGING AND OTHER FORMS OF PASSIVE, SHARABLE OR VIRAL COMMUNICATIONS CHANNELS; PET-RELATED CONSULTING SERVICES IN THE FIELD OF INTERNET MARKETING; THE BRINGING TOGETHER, FOR THE BENEFIT OF OTHERS, OF A VARIETY OF PET-RELATED GOODS AND SERVICES, ENABLING CUSTOMERS TO CONVENIENTLY VIEW AND PURCHASE THOSE GOODS AND SERVICES FROM AN INTERNET WEB SITE PARTICULARLY SPECIALIZING IN THE MARKETING OF THE SALE OF PET GOODS AND PET SERVICES, IN CLASS 35 (U.S. CLS. 100, 101 AND 102).

FIRST USE 5-28-2011; IN COMMERCE 7-5-2011.

THE MARK CONSISTS OF STANDARD CHARACTERS WITHOUT CLAIM TO ANY PARTICULAR FONT, STYLE, SIZE, OR COLOR.

SER. NO. 85-342,609, FILED 6-9-2011.

CHERYL CLAYTON, EXAMINING ATTORNEY



*David J. Kybas*

Director of the United States Patent and Trademark Office

# United States of America

United States Patent and Trademark Office

# Viviona

**Reg. No. 4,196,824**

**Registered Aug. 28, 2012**

**Int. Cl.: 25**

**TRADEMARK**

**PRINCIPAL REGISTER**

VERA ORGANICS, LLC (TEXAS LIMITED LIABILITY COMPANY), DBA VIVIONA  
VIVIONA  
2908 WEST ROYAL LANE #1040  
IRVING, TX 75063

FOR: ADULT NOVELTY GAG CLOTHING ITEM, NAMELY, SOCKS; BABY LAYETTES FOR CLOTHING; BELTS; BELTS FOR CLOTHING; BELTS MADE OUT OF CLOTH; BIBS NOT OF CLOTH OR PAPER; BOTTOMS; CHILDREN'S AND INFANTS' CLOTH BIBS; CHILDREN'S CLOTH EATING BIBS; CLOTH BIBS; CLOTH BIBS FOR ADULT DINERS; CLOTH BIBS FOR USE BY SENIOR CITIZENS OR PHYSICALLY- OR MENTALLY-CHALLENGED PERSONS; CLOTH DIAPERS; CLOTHING EXTENSION USED TO EXTEND THE NORMAL SIZE RANGE OF CLOTHING ITEMS TO ACCOMMODATE PREGNANCY SIZE CHANGES; CLOTHING FOR ATHLETIC USE, NAMELY, PADDED ELBOW COMPRESSION SLEEVES BEING PART OF AN ATHLETIC GARMENT; CLOTHING FOR ATHLETIC USE, NAMELY, PADDED PANTS; CLOTHING FOR ATHLETIC USE, NAMELY, PADDED SHIRTS; CLOTHING FOR ATHLETIC USE, NAMELY, PADDED SHORTS; CLOTHING FOR BABIES, TODDLERS AND CHILDREN, TREATED WITH FIRE AND HEAT RETARDANTS, NAMELY, PAJAMAS, JACKETS, SHIRTS, PANTS, JUMPERS; CLOTHING FOR WEAR IN JUDO PRACTICES; CLOTHING FOR WEAR IN WRESTLING GAMES; CLOTHING ITEMS, NAMELY, ADHESIVE POCKETS THAT MAY BE AFFIXED DIRECTLY TO THE BODY AS A DECORATIVE PIECE OF CLOTHING WITH UTILITY; CLOTHING ITEMS, NAMELY, ADHESIVE POCKETS THAT MAY BE AFFIXED DIRECTLY TO THE INSIDE OF CLOTHING FOR STORAGE AND SAFEKEEPING OF PERSONAL ITEMS; CLOTHING ITEMS, NAMELY, BLINDFOLDS WORN OVER THE EYES; CLOTHING ITEMS, NAMELY, GAGS WORN OVER THE MOUTH; CLOTHING SHIELDS, NAMELY, PADS APPLIED TO THE UNDERARMS OF SHIRTS, BLOUSES AND SWEATERS; CLOTHING, NAMELY, ARM WARMERS; CLOTHING, NAMELY, ATHLETIC SLEEVES; CLOTHING, NAMELY, BASE LAYERS; CLOTHING, NAMELY, COWLS AND SMOKE RING SCARVES; CLOTHING, NAMELY, CROPS; CLOTHING, NAMELY, FOLK COSTUMES; CLOTHING, NAMELY, HAND-WARMERS; CLOTHING, NAMELY, KHAKIS; CLOTHING, NAMELY, KNEE WARMERS; CLOTHING, NAMELY, MATERNITY BANDS; CLOTHING, NAMELY, NECK TUBES; CLOTHING, NAMELY, THOBES; CLOTHING, NAMELY, WRAP-AROUNDS; CORSETS; DUSTERS; EYESHADES; FABRIC SOLD AS AN INTEGRAL COMPONENT OF FINISHED CLOTHING ITEMS, NAMELY, FABRIC ACCESSORIES, SOLD AS A COMPONENT OF FINISHED DRESS, TOPS, JEANS, PANTS, SUITS, SWEATERS, SWIMWEAR, TSHIRTS, SWEATSHIRT AND JACKETS; FIGURE SKATING CLOTHING, NAMELY, FIGURE SKATING UNIFORMS; FOULARDS; GLOVES AS CLOTHING; HEADBANDS FOR CLOTHING; HOODS; INFANT



*David J. Kybas*

Director of the United States Patent and Trademark Office

**Reg. No. 4,196,824** AND TODDLER ONE PIECE CLOTHING; INFANT CLOTH DIAPERS; INSERTS SPECIALLY ADAPTED FOR CLOTH DIAPERS MADE OF BAMBOO; INSERTS SPECIALLY ADAPTED FOR CLOTH DIAPERS MADE OF HEMP; INSERTS SPECIALLY ADAPTED FOR CLOTH DIAPERS MADE OF MICROFIBER; JACKETS; JERSEYS; LEATHER BELTS; MANTLES; MATERNITY CLOTHING, NAMELY, MATERNITY APPAREL IN THE NATURE OF SHIRTS, PANTS, SHORTS, SWEATERS, JACKETS; MUFFLERS; NON-DISPOSABLE CLOTH TRAINING PANTS; PAPER HATS FOR USE AS CLOTHING ITEMS; PARTS OF CLOTHING, NAMELY, GUSSETS FOR TIGHTS, GUSSETS FOR STOCKINGS, GUSSETS FOR BATHING SUITS, GUSSETS FOR UNDERWEAR, GUSSETS FOR LEOTARDS AND GUSSETS FOR FOOTLETS; PARTS OF CLOTHING, NAMELY, UNDERARM GUSSETS; PARTY HATS; PERSPIRATION ABSORBENT UNDERWEAR CLOTHING; POCKET SQUARES; SHIRTS; SHORT SETS; SHOULDER WRAPS; SHOULDER WRAPS FOR CLOTHING; SUN PROTECTIVE CLOTHING, NAMELY, UV PROTECTION CLOTHES IN THE NATURE OF SWIMMING SUITS, SHIRTS, COVERUPS; SWADDLING CLOTHES; SWIMWEAR; TIES; TOPS; TRAVEL CLOTHING CONTAINED IN A PACKAGE COMPRISING REVERSIBLE JACKETS, PANTS, SKIRTS, TOPS AND A BELT OR SCARF; TRIATHLON CLOTHING, NAMELY, TRIATHLON TIGHTS, TRIATHLON SHORTS, TRIATHLON SINGLET, TRIATHLON SHIRTS, TRIATHLON SUITS; UNDERARM CLOTHING SHIELDS; WEARABLE GARMENTS AND CLOTHING, NAMELY, SHIRTS; WOMEN'S CLOTHING, NAMELY, SHIRTS, DRESSES, SKIRTS, BLOUSES; WRAPS, IN CLASS 25 (U.S. CLS. 22 AND 39).

FIRST USE 7-17-2009; IN COMMERCE 7-17-2009.

THE MARK CONSISTS OF STANDARD CHARACTERS WITHOUT CLAIM TO ANY PARTICULAR FONT, STYLE, SIZE, OR COLOR.

THE WORDING "VIVIONA" HAS NO MEANING IN A FOREIGN LANGUAGE.

SER. NO. 85-342,617, FILED 6-9-2011.

ROBIN MITTLER, EXAMINING ATTORNEY

# United States of America

United States Patent and Trademark Office

# GAS DOC

**Reg. No. 4,196,825**

WARFIELD MD, BRETT H. (UNITED STATES INDIVIDUAL)  
6340 ELDRIDGE PKWY #317  
HOUSTON, TX 77041

**Registered Aug. 28, 2012**

**Int. Cl.: 44**

FOR: MEDICAL SERVICES, NAMELY, PROVIDING ANESTHESIA IN A MOBILE ENVIRONMENT, IN CLASS 44 (U.S. CLS. 100 AND 101).

**SERVICE MARK**

FIRST USE 10-18-2010; IN COMMERCE 10-18-2010.

**PRINCIPAL REGISTER**

THE MARK CONSISTS OF STANDARD CHARACTERS WITHOUT CLAIM TO ANY PARTICULAR FONT, STYLE, SIZE, OR COLOR.

NO CLAIM IS MADE TO THE EXCLUSIVE RIGHT TO USE "DOC", APART FROM THE MARK AS SHOWN.

SER. NO. 85-342,766, FILED 6-9-2011.

RON FAIRBANKS, EXAMINING ATTORNEY



*David J. Kybas*

Director of the United States Patent and Trademark Office

# United States of America

United States Patent and Trademark Office

# OdorSorb

**Reg. No. 4,196,826**

ENDURO COMPOSITES, INC. (DELAWARE CORPORATION)  
16602 CENTRAL GREEN BLVD.  
HOUSTON, TX 77032

**Registered Aug. 28, 2012**

**Int. Cl.: 1**

FOR: TYPE OF MEDIA, NAMELY, ACTIVATED CARBON AND ADSORBING CARBON,  
USED FOR AIR REMEDIATION, IN CLASS 1 (U.S. CLS. 1, 5, 6, 10, 26 AND 46).

**TRADEMARK**

FIRST USE 2-1-2003; IN COMMERCE 2-1-2003.

**PRINCIPAL REGISTER**

THE MARK CONSISTS OF STANDARD CHARACTERS WITHOUT CLAIM TO ANY PAR-  
TICULAR FONT, STYLE, SIZE, OR COLOR.

SER. NO. 85-342,785, FILED 6-10-2011.

CHRISTINA SOBRAL, EXAMINING ATTORNEY



*David J. Kyffers*

Director of the United States Patent and Trademark Office

# United States of America

United States Patent and Trademark Office

## 悠易互通中国受众网络

**Reg. No. 4,196,827**

**Registered Aug. 28, 2012**

**Int. Cls.: 35 and 42**

**SERVICE MARK**

**PRINCIPAL REGISTER**

YOYI INTERACTIVE (BEIJING) ADVERTISING CO., LTD. (CHINA LIMITED LIABILITY COMPANY)

2201 UNIT NO.3 BLDG., ORIENTAL MEDIA CTR.  
NO.4 GUANGHUA ROAD, CHAOYANG DISTRICT  
BEIJING, CHINA

FOR: ADVERTISING AGENCIES; ADVERTISING SERVICES; BUSINESS INVESTIGATIONS; DESIGN OF ADVERTISING MATERIALS FOR OTHERS; DESIGN OF INTERNET ADVERTISING; ON-LINE ADVERTISING ON COMPUTER COMMUNICATION NETWORKS; PREPARING AND PLACING OF ADVERTISEMENTS; PUBLIC RELATIONS; PUBLICITY AGENTS; TELEVISION ADVERTISING AGENCIES, IN CLASS 35 (U.S. CLS. 100, 101 AND 102).

FIRST USE 3-12-2009; IN COMMERCE 3-12-2009.

FOR: COMPUTER PROGRAMMING AND COMPUTER SYSTEM ANALYSIS; COMPUTER SOFTWARE DESIGN AND UPDATING; COMPUTER SYSTEM DESIGN SERVICES; DUPLICATION OF COMPUTER PROGRAMS; MAINTENANCE OF COMPUTER SOFTWARE; PROGRAMMING OF COMPUTER SOFTWARE FOR OTHERS; SCIENTIFIC RESEARCH; SCIENTIFIC RESEARCH AND DEVELOPMENT; SOFTWARE DESIGN AND DEVELOPMENT; SURVEY DESIGN AND RESEARCH, IN CLASS 42 (U.S. CLS. 100 AND 101).

FIRST USE 3-20-2009; IN COMMERCE 3-20-2009.

NO CLAIM IS MADE TO THE EXCLUSIVE RIGHT TO USE THE NON-LATIN CHARACTERS THAT TRANSLITERATE TO HU TONG ZHONG GUO SHOU ZHONG WANG LUO, APART FROM THE MARK AS SHOWN.

THE NON-LATIN CHARACTERS IN THE MARK TRANSLITERATE TO YOU YI HU TONG ZHONG GUO SHOU ZHONG WANG LUO; YOU YI" HAS NO MEANING IN A FOREIGN LANGUAGE AND HU TONG ZHONG GUO SHOU ZHONG WANG LUO MEANS INTERACTIVE CHINA AUDIENCE NETWORK IN ENGLISH.

THE MARK CONSISTS OF STYLIZED CHINESE CHARACTERS.

SER. NO. 85-343,838, FILED 6-10-2011.



*David J. Kyffers*

Director of the United States Patent and Trademark Office



**Reg. No. 4,196,827** KRISTIN CARLSON, EXAMINING ATTORNEY

# United States of America

United States Patent and Trademark Office

# Bacone

**Reg. No. 4,196,828**

**Registered Aug. 28, 2012**

**Int. Cl.: 21**

**TRADEMARK**

**PRINCIPAL REGISTER**

GENUINE ENTERTAINMENT, INC. (CALIFORNIA CORPORATION), AKA THE IDEA  
FACTORY  
7453 WOODLEY AVENUE  
VAN NUYS, CA 91406

FOR: BAKING DISHES; COOKWARE FOR USE IN MICROWAVE OVENS, IN CLASS 21  
(U.S. CLS. 2, 13, 23, 29, 30, 33, 40 AND 50).

FIRST USE 11-17-2011; IN COMMERCE 11-17-2011.

THE MARK CONSISTS OF STANDARD CHARACTERS WITHOUT CLAIM TO ANY PAR-  
TICULAR FONT, STYLE, SIZE, OR COLOR.

THE WORDING "BACONE" HAS NO MEANING IN A FOREIGN LANGUAGE.

SER. NO. 85-343,887, FILED S.R. 6-11-2011 AM. P.R. 4-17-2012.

STEVEN PEREZ, EXAMINING ATTORNEY



*David J. Kybas*

Director of the United States Patent and Trademark Office

# United States of America

United States Patent and Trademark Office

EARTH YOGA  
sustainable organic clothing



**Reg. No. 4,196,829**

**Registered Aug. 28, 2012**

**Int. Cl.: 25**

**TRADEMARK**

**PRINCIPAL REGISTER**

ECO MALIBU DESIGNS, INC (CALIFORNIA CORPORATION)  
22337 PACIFIC COAST HWY  
SUITE 326  
MALIBU, CA 90265

FOR: APPAREL FOR DANCERS, NAMELY, TEE SHIRTS, SWEATSHIRTS, PANTS, LEGGINGS, SHORTS AND JACKETS; ATHLETIC APPAREL, NAMELY, SHIRTS, PANTS, JACKETS, HATS AND CAPS, ATHLETIC UNIFORMS, IN CLASS 25 (U.S. CLS. 22 AND 39).

FIRST USE 8-1-2009; IN COMMERCE 12-15-2009.

NO CLAIM IS MADE TO THE EXCLUSIVE RIGHT TO USE "YOGA" AND "SUSTAINABLE ORGANIC CLOTHING", APART FROM THE MARK AS SHOWN.

THE COLOR(S) GREEN, BROWN AND WHITE IS/ARE CLAIMED AS A FEATURE OF THE MARK.

THE MARK CONSISTS OF THE WORDING "EARTH YOGA" IN GREEN, ABOVE THE WORDING "SUSTAINABLE ORGANIC CLOTHING" IN BROWN, ABOVE A GREEN AND WHITE STYLIZED DESIGN OF THE UPPER QUARTER OF THE PLANET EARTH.

SER. NO. 85-343,998, FILED 6-12-2011.

JOHN DWYER, EXAMINING ATTORNEY



*David J. Kybas*

Director of the United States Patent and Trademark Office

# United States of America

United States Patent and Trademark Office

## CURRITO BURRITOS WITHOUT BORDERS

**Reg. No. 4,196,830**

**Registered Aug. 28, 2012**

**Int. Cl.: 43**

**SERVICE MARK**

**PRINCIPAL REGISTER**

NICAR ENTERPRISES LLC (OHIO LIMITED LIABILITY COMPANY)  
188 N. BROOKWOOD AVE., STE. 100  
HAMILTON, OH 45013

FOR: RESTAURANT SERVICES, IN CLASS 43 (U.S. CLS. 100 AND 101).

FIRST USE 3-0-2007; IN COMMERCE 3-0-2007.

THE MARK CONSISTS OF STANDARD CHARACTERS WITHOUT CLAIM TO ANY PARTICULAR FONT, STYLE, SIZE, OR COLOR.

OWNER OF U.S. REG. NOS. 3,415,258 AND 4,012,250.

THE ENGLISH TRANSLATION OF "CURRITO" IN THE MARK IS "WORKING MAN, BLOKE".

SER. NO. 85-344,102, FILED 6-12-2011.

MICHELLE DUBOIS, EXAMINING ATTORNEY



*David J. Kyffers*

Director of the United States Patent and Trademark Office

# United States of America

United States Patent and Trademark Office

## BURRITOS WITHOUT BORDERS

**Reg. No. 4,196,831**

NICAR ENTERPRISES LLC (OHIO LIMITED LIABILITY COMPANY)  
188 N. BROOKWOOD AVE., STE. 100  
HAMILTON, OH 45013

**Registered Aug. 28, 2012**

**Int. Cl.: 43**

FOR: RESTAURANT SERVICES, IN CLASS 43 (U.S. CLS. 100 AND 101).

**SERVICE MARK**

FIRST USE 3-0-2007; IN COMMERCE 3-0-2007.

**PRINCIPAL REGISTER**

THE MARK CONSISTS OF STANDARD CHARACTERS WITHOUT CLAIM TO ANY PARTICULAR FONT, STYLE, SIZE, OR COLOR.

SER. NO. 85-344,106, FILED 6-12-2011.

MICHELLE DUBOIS, EXAMINING ATTORNEY



*David J. Kyffers*

Director of the United States Patent and Trademark Office

# United States of America

United States Patent and Trademark Office



**Reg. No. 4,196,832**

**Registered Aug. 28, 2012**

**Int. Cl.: 25**

**TRADEMARK**

**PRINCIPAL REGISTER**

SHOE COVER, INC. (GEORGIA CORPORATION), DBA SHUBEE INC.  
110 COLUMBUS WEST DRIVE  
MACON, GA 31206

FOR: COVERALLS; UNIFORMS, IN CLASS 25 (U.S. CLS. 22 AND 39).

FIRST USE 9-1-2000; IN COMMERCE 9-1-2000.

OWNER OF U.S. REG. NO. 3,621,379.

THE COLOR(S) WHITE, YELLOW, BLACK AND BLUE IS/ARE CLAIMED AS A FEATURE OF THE MARK.

THE MARK CONSISTS OF THE TERMS "SHU" AND "BEE" WRITTEN IN BLACK LETTERS WITH A WHITE OUTLINE AND IN BETWEEN THE DESIGN OF A BEE WITH A BLACK FACE AND BLACK ANTENNAE, BLACK WINGS WITH LIGHT YELLOW LINES, BLACK ARMS AND BLACK LEGS, A YELLOW AND BLACK STRIPED BODY WITH BLUE SHOE COVERS OUTLINED IN BLACK, AND A YELLOW NOSE AND YELLOW CIRCLES AROUND THE EYES.

SER. NO. 85-344,111, FILED 6-12-2011.

NORA BUCHANAN WILL, EXAMINING ATTORNEY



*David J. Kyffers*

Director of the United States Patent and Trademark Office

# United States of America

United States Patent and Trademark Office

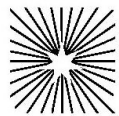

**DAYSTAR**  
FOUNDATION & LIBRARY

**Reg. No. 4,196,833**

**Registered Aug. 28, 2012**

**Int. Cl.: 41**

**SERVICE MARK**

**PRINCIPAL REGISTER**

DAYSTAR FOUNDATION AND LIBRARY, INC. (OKLAHOMA CHARITABLE, NON-PROFIT CORPORATION)  
3015 UNITED FOUNDERS BOULEVARD  
OKLAHOMA CITY, OK 73112

FOR: EDUCATIONAL SERVICES, NAMELY, LENDING LIBRARIES; LIBRARIES; REFERENCE LIBRARIES OF LITERATURE, HISTORICAL, AND DOCUMENTARY RECORDS; ON-LINE LIBRARY SERVICES, NAMELY, PROVIDING ELECTRONIC LIBRARY SERVICES WHICH FEATURE NEWSPAPERS, MAGAZINES, PHOTOGRAPHS AND PICTURES VIA AN ON-LINE COMPUTER NETWORK; DEVELOPMENT AND DISSEMINATION OF EDUCATIONAL MATERIALS OF OTHERS IN THE FIELD OF RELIGION, IN CLASS 41 (U.S. CLS. 100, 101 AND 107).

FIRST USE 8-0-2010; IN COMMERCE 8-0-2010.

NO CLAIM IS MADE TO THE EXCLUSIVE RIGHT TO USE "FOUNDATION & LIBRARY", APART FROM THE MARK AS SHOWN.

THE MARK CONSISTS OF A SEVEN-PRONG STAR SURROUNDED BY LIGHT RAYS, THE LIGHT RAYS BEING CONFINED TO AN OVERALL SQUARE SHAPE WITH THE WORDS "DAYSTAR FOUNDATION & LIBRARY" APPEARING BESIDE THE STAR AND LIGHT RAYS.

SER. NO. 85-344,205, FILED 6-13-2011.

H. M. FISHER, EXAMINING ATTORNEY



*David J. Kyffers*

Director of the United States Patent and Trademark Office

# United States of America

United States Patent and Trademark Office

# BOOMERANG

**Reg. No. 4,196,834**

**Registered Aug. 28, 2012**

**Int. Cl.: 28**

**TRADEMARK**

**PRINCIPAL REGISTER**

MOORE, ALEXANDER (UNITED KINGDOM INDIVIDUAL)  
LES SABLONS, GOLF LANE  
GROUVILLE, JERSEY, UNITED KINGDOM JE39ED

FOR: SPORTS APPARATUS NOT INCLUDING BOOMERANGS, NAMELY, PUTTING AIDS, GOLF PRACTICE AIDS; GOLFING EQUIPMENT, NAMELY, GOLF CLUBS, GOLF CLUB SHAFTS, GOLF CLUB HEADS, GOLF BAGS, GOLF BAG TRAVEL COVERS, STIMP METERS, GOLF BALLS, GOLF TEES, IN CLASS 28 (U.S. CLS. 22, 23, 38 AND 50).

FIRST USE 1-0-2001; IN COMMERCE 1-0-2001.

THE MARK CONSISTS OF STANDARD CHARACTERS WITHOUT CLAIM TO ANY PARTICULAR FONT, STYLE, SIZE, OR COLOR.

SER. NO. 85-344,754, FILED 6-13-2011.

FLORENTINA BLANDU, EXAMINING ATTORNEY



*David J. Kyjars*

Director of the United States Patent and Trademark Office



# United States of America

United States Patent and Trademark Office

## SENTRY CENTERS

**Reg. No. 4,196,835**

SENTRY CENTER MID-TOWN EAST LLC (DELAWARE LIMITED LIABILITY COMPANY)  
730 THIRD AVENUE  
NEW YORK, NY 10017

**Registered Aug. 28, 2012**

**Int. Cls.: 35 and 43**

FOR: ARRANGING AND CONDUCTING BUSINESS CONFERENCES AND SPECIAL EVENTS FOR BUSINESS PURPOSES, IN CLASS 35 (U.S. CLS. 100, 101 AND 102).

**SERVICE MARK**

FIRST USE 8-1-2009; IN COMMERCE 8-1-2009.

**PRINCIPAL REGISTER**

FOR: PROVISION OF CONFERENCE, EXHIBITION AND MEETING FACILITIES; CATERING SERVICES, IN CLASS 43 (U.S. CLS. 100 AND 101).

FIRST USE 8-1-2009; IN COMMERCE 8-1-2009.

THE MARK CONSISTS OF STANDARD CHARACTERS WITHOUT CLAIM TO ANY PARTICULAR FONT, STYLE, SIZE, OR COLOR.

NO CLAIM IS MADE TO THE EXCLUSIVE RIGHT TO USE "CENTERS", APART FROM THE MARK AS SHOWN.

SER. NO. 85-344,910, FILED 6-13-2011.

JOHN E. MICHOS, EXAMINING ATTORNEY



*David J. Kyros*

Director of the United States Patent and Trademark Office

# United States of America

United States Patent and Trademark Office

## CRAFT SUPPLIES USA

**Reg. No. 4,196,836**

CRAFT SUPPLIES USA (UTAH CORPORATION)  
1287 E 1120 S  
PROVO, UT 84606

**Registered Aug. 28, 2012**

**Int. Cl.: 16**

FOR: WRITING PEN KITS COMPRISING PARTS FOR MAKING WRITING PENS, IN CLASS 16 (U.S. CLS. 2, 5, 22, 23, 29, 37, 38 AND 50).

**TRADEMARK**

FIRST USE 9-1-1994; IN COMMERCE 9-1-1994.

**PRINCIPAL REGISTER**

THE MARK CONSISTS OF STANDARD CHARACTERS WITHOUT CLAIM TO ANY PARTICULAR FONT, STYLE, SIZE, OR COLOR.

NO CLAIM IS MADE TO THE EXCLUSIVE RIGHT TO USE "CRAFT SUPPLIES", APART FROM THE MARK AS SHOWN.

SEC. 2(F).

SER. NO. 85-345,035, FILED 6-13-2011.

PRISCILLA MILTON, EXAMINING ATTORNEY



*David J. Kybas*

Director of the United States Patent and Trademark Office

# United States of America

United States Patent and Trademark Office



**Reg. No. 4,196,837**

MERRICK, MK, CORP. (TEXAS CORPORATION)  
515 W. 15TH ST  
AUSTIN, TX 78701

**Registered Aug. 28, 2012**

**Int. Cl.: 44**

FOR: ARTIFICIAL SUNTANNING SERVICES INCLUDING ORGANIC ARTIFICIAL SUN-TANNING SERVICES; SKIN TANNING SERVICE INCLUDING ORGANIC SKIN TANNING SERVICE, ALL FOR HUMANS FOR COSMETIC PURPOSES , IN CLASS 44 (U.S. CLS. 100 AND 101).

**SERVICE MARK**

**PRINCIPAL REGISTER**

FIRST USE 9-24-2008; IN COMMERCE 1-1-2009.

NO CLAIM IS MADE TO THE EXCLUSIVE RIGHT TO USE "ORGANIC" AND "SUNLESS TAN", APART FROM THE MARK AS SHOWN.

THE MARK CONSISTS OF THE LETTERS "O" AND "G" IN A CIRCLE WITH LINES RADIATING OUTWARD FROM THE CIRCLE, ON TOP OF THE WORDS "ORGANIC GLOW" IN LARGE LOWERCASE LETTERS, WITH THE WORDS "NATURE'S SUNLESS TAN" IN SMALL UPPERCASE LETTERS LOCATED IN BETWEEN THE WORDS "ORGANIC" AND "GLOW".

SER. NO. 85-345,082, FILED 6-13-2011.

ERNEST SHOSHO, EXAMINING ATTORNEY



*David J. Kyffers*

Director of the United States Patent and Trademark Office

# United States of America

United States Patent and Trademark Office

## OSMOCOTE PRO WITH FUSION TECHNOLOGY

**Reg. No. 4,196,838**

EVERRIS INTERNATIONAL B.V. (NETHERLANDS COMPANY)  
NIJVERHEIDSWEG 1-5  
HEERLEN, NETHERLANDS 6422PD

**Registered Aug. 28, 2012**

**Int. Cl.: 1**

FOR: FERTILIZERS, IN CLASS 1 (U.S. CLS. 1, 5, 6, 10, 26 AND 46).

**TRADEMARK**

FIRST USE 1-31-2010; IN COMMERCE 1-31-2010.

**PRINCIPAL REGISTER**

THE MARK CONSISTS OF STANDARD CHARACTERS WITHOUT CLAIM TO ANY PARTICULAR FONT, STYLE, SIZE, OR COLOR.

OWNER OF U.S. REG. NOS. 781,205, 2,760,825, AND 3,748,581.

NO CLAIM IS MADE TO THE EXCLUSIVE RIGHT TO USE "PRO WITH" AND "TECHNOLOGY", APART FROM THE MARK AS SHOWN.

SER. NO. 85-345,359, FILED 6-14-2011.

SHAILA SETTLES, EXAMINING ATTORNEY



*David J. Kyffers*

Director of the United States Patent and Trademark Office

# United States of America

United States Patent and Trademark Office

# TileFlow

**Reg. No. 4,196,839**

**Registered Aug. 28, 2012**

**Int. Cl.: 9**

**TRADEMARK**

**PRINCIPAL REGISTER**

INNOVATIVE RESEARCH, INC. (MINNESOTA CORPORATION)  
SUITE 300  
3025 HARBOR LANE NORTH  
PLYMOUTH, MN 55447

FOR: PROPRIETARY THREE-DIMENSIONAL COMPUTER SOFTWARE FOR SIMULATING THE COOLING PERFORMANCE OF DATA CENTERS, IN CLASS 9 (U.S. CLS. 21, 23, 26, 36 AND 38).

FIRST USE 12-18-2001; IN COMMERCE 12-18-2001.

THE MARK CONSISTS OF STANDARD CHARACTERS WITHOUT CLAIM TO ANY PARTICULAR FONT, STYLE, SIZE, OR COLOR.

SER. NO. 85-345,457, FILED 6-14-2011.

CHARLES L. JENKINS, EXAMINING ATTORNEY



*David J. Kybas*

Director of the United States Patent and Trademark Office

# United States of America

United States Patent and Trademark Office

## THE TRUSTED RESOURCE

**Reg. No. 4,196,840**

**Registered Aug. 28, 2012**

**Int. Cl.: 9**

**TRADEMARK**

**PRINCIPAL REGISTER**

KELLEY BLUE BOOK CO., INC. (CALIFORNIA CORPORATION)  
195 TECHNOLOGY DRIVE  
IRVINE, CA 92618

FOR: COMPUTER APPLICATION SOFTWARE FOR MOBILE PHONES, PORTABLE MEDIA PLAYERS, HANDHELD COMPUTERS, NAMELY, SOFTWARE FEATURING INFORMATION IN THE FIELDS OF VEHICLE PRICING AND VEHICULAR INVENTORY MANAGEMENT, INFORMATION ON VEHICLES TO HELP GUIDE CONSUMERS IN THEIR PURCHASE OF A NEW OR USED VEHICLE, INFORMATION ABOUT VEHICLES FOR SALE, RANKINGS, RATINGS, AND REVIEWS IN THE FIELD OF VEHICLES; COMPUTER APPLICATION SOFTWARE FOR MOBILE PHONES, PORTABLE MEDIA PLAYERS, HANDHELD COMPUTERS, NAMELY, SOFTWARE TO ASSIST CUSTOMERS IN LOCATING AUTOMOTIVE DEALERS AND TO MATCH CONSUMER REQUESTS FOR VEHICLE PRICING AND INFORMATION TO AUTOMOTIVE DEALERS, IN CLASS 9 (U.S. CLS. 21, 23, 26, 36 AND 38).

FIRST USE 8-22-2008; IN COMMERCE 8-22-2008.

THE MARK CONSISTS OF STANDARD CHARACTERS WITHOUT CLAIM TO ANY PARTICULAR FONT, STYLE, SIZE, OR COLOR.

OWNER OF U.S. REG. NO. 3,067,803.

SER. NO. 85-345,474, FILED 6-14-2011.

SARA BENJAMIN, EXAMINING ATTORNEY



*David J. Kyros*

Director of the United States Patent and Trademark Office

# United States of America

United States Patent and Trademark Office

## CATALOG SPREE

**Reg. No. 4,196,841**

**Registered Aug. 28, 2012**

**Int. Cls.: 35 and 42**

**SERVICE MARK**

**PRINCIPAL REGISTER**

PADOPOLIS, INC. (DELAWARE CORPORATION)  
1641 JAMESTOWN DRIVE  
CUPERTINO, CA 94014

FOR: ADVERTISEMENT VIA MOBILE PHONE NETWORKS; ADVERTISING, PROMOTION AND MARKETING SERVICES IN THE NATURE OF E-MAIL BLAST CAMPAIGNS FOR OTHERS; ADVERTISING, PROMOTION, AND MARKETING SERVICES IN THE NATURE OF A WEBSITE, EMAIL SERVICE AND MOBILE APPLICATION FOR PROVIDING INFORMATION ABOUT RETAIL SHOPPING; COMPUTERIZED ON-LINE RETAIL STORE SERVICES IN THE FIELD OF A WIDE VARIETY OF CONSUMER GOODS AND SERVICES; DISSEMINATION OF ADVERTISING FOR OTHERS VIA PUBLIC AND PRIVATE WIRELESS NETWORKS FOR DISPLAY ON MOBILE DEVICES; ELECTRONIC CATALOG SERVICES FEATURING A WIDE VARIETY OF CONSUMER GOODS AND SERVICES OF OTHERS; MARKETING, ADVERTISING, AND PROMOTING THE RETAIL GOODS AND SERVICES OF OTHERS TO WIRELESS ELECTRONIC DEVICES; MOBILE RETAIL STORE SERVICES FEATURING A WIDE VARIETY OF CONSUMER GOODS AND SERVICES OF OTHERS; ON-LINE RETAIL STORE SERVICES FEATURING A WIDE VARIETY OF CONSUMER GOODS OF OTHERS; ONLINE SERVICE FOR CONNECTING SOCIAL NETWORK USERS WITH RETAILERS FOR THE PURPOSE OF FACILITATING DISCOUNTED PURCHASES; PRESENTATION OF GOODS ON COMMUNICATION MEDIA FOR RETAIL PURPOSES; PROMOTING THE GOODS AND SERVICES OF OTHERS BY MEANS OF OPERATING AN ON-LINE SHOPPING MALL WITH LINKS TO THE RETAIL WEB SITES OF OTHERS; PROMOTING THE GOODS AND SERVICES OF OTHERS THROUGH ON-LINE ORDERING AND CATALOGING OF THOSE GOODS AND SERVICES; PROMOTIONAL SERVICES, NAMELY, DISTRIBUTION OF ADVERTISING FLYERS, COUPONS, CATALOGS AND PROMOTIONAL ITEMS OF OTHERS; WEB-BASED CATALOG SERVICES FEATURING A WIDE VARIETY OF CONSUMER GOODS AND SERVICES OF OTHERS, IN CLASS 35 (U.S. CLS. 100, 101 AND 102).

FIRST USE 4-20-2011; IN COMMERCE 4-20-2011.

FOR: APPLICATION SERVICE PROVIDER (ASP) FEATURING SOFTWARE FOR USE IN PROMOTING, SEARCHING AND SHOPPING FOR THE GOODS AND SERVICES OF OTHERS; DESIGN, DEVELOPMENT AND IMPLEMENTATION OF SOFTWARE; DEVELOPING AND UPDATING COMPUTER SOFTWARE; PROVIDING A WEBSITE FEATURING TECHNOLOGY THAT ENABLES USERS TO PROMOTE, SEARCH AND SHOP FOR GOODS AND SERVICES OF OTHERS; PROVIDING AN ONLINE NON-DOWNLOADABLE INTERNET-BASED SYS-



*David J. Kyros*

Director of the United States Patent and Trademark Office

**Reg. No. 4,196,841** TEM APPLICATION FEATURING TECHNOLOGY ENABLING USERS TO SHOP FOR GOODS AND SERVICES OF OTHERS; PROVIDING CUSTOMER-DEFINED GENERATED CONTENT AND CONTENT OF OTHERS AUTOMATICALLY SELECTED AND CUSTOMIZED BASED ON THE KNOWN OR ESTIMATED GEOGRAPHICAL LOCATION OF AN INTERNET, MOBILE TELEPHONE OR OTHER WIRED OR WIRELESS DIGITAL NETWORK BASED CUSTOMER; PROVIDING TEMPORARY USE OF A WEB-BASED SOFTWARE APPLICATION FOR SEARCHING AND SHOPPING FOR THE GOODS AND SERVICES OF OTHERS; PROVIDING TEMPORARY USE OF ON-LINE NONDOWNLOADABLE SOFTWARE AND APPLICATIONS FOR ONLINE RETAIL SHOPPING, IN CLASS 42 (U.S. CLS. 100 AND 101).

FIRST USE 4-20-2011; IN COMMERCE 4-20-2011.

THE MARK CONSISTS OF STANDARD CHARACTERS WITHOUT CLAIM TO ANY PARTICULAR FONT, STYLE, SIZE, OR COLOR.

NO CLAIM IS MADE TO THE EXCLUSIVE RIGHT TO USE "CATALOG", APART FROM THE MARK AS SHOWN.

SER. NO. 85-345,607, FILED 6-14-2011.

JEFFREY LOOK, EXAMINING ATTORNEY



# United States of America

United States Patent and Trademark Office

# CORWAVE

**Reg. No. 4,196,842**

**Registered Aug. 28, 2012**

**Int. Cl.: 9**

**TRADEMARK**

**PRINCIPAL REGISTER**

ARRIS GROUP, INC. (DELAWARE CORPORATION)  
3871 LAKEFIELD DRIVE  
SUWANEE, GA 30024

FOR: MULTI WAVELENGTH OPTICAL AND RADIO FREQUENCY TRANSMITTERS AND RECEIVERS USED IN A NETWORK INFRASTRUCTURE TO TRANSMIT OR RECEIVE VOICE, VIDEO AND DATA SIGNALS CONTAINING EMBEDDED SOFTWARE FOR OPERATING, CONTROLLING, MANAGING AND USING THE AFOREMENTIONED WIRED TELECOMMUNICATIONS TRANSMISSION EQUIPMENT; ELECTRICAL AND OPTICAL TRANSMITTERS/RECEIVERS USED IN A NETWORK INFRASTRUCTURE TO PROVIDE VOICE, VIDEO AND DATA, AND SOFTWARE TO MANAGE OPERATION OF SAME, NAMELY, ELECTRICAL AND OPTICAL TRANSMITTERS/RECEIVERS CONTAINING EMBEDDED SOFTWARE FOR OPERATING, CONTROLLING, MANAGING AND USING THE AFOREMENTIONED WIRED TRANSMISSION EQUIPMENT, IN CLASS 9 (U.S. CLS. 21, 23, 26, 36 AND 38).

FIRST USE 5-1-2005; IN COMMERCE 5-1-2005.

THE MARK CONSISTS OF STANDARD CHARACTERS WITHOUT CLAIM TO ANY PARTICULAR FONT, STYLE, SIZE, OR COLOR.

SER. NO. 85-345,882, FILED 6-14-2011.

MICHAEL TANNER, EXAMINING ATTORNEY



*David J. Kybas*

Director of the United States Patent and Trademark Office

# United States of America

United States Patent and Trademark Office

# LA VERITE

**Reg. No. 4,196,843**

TATUAJE CIGARS, INC. (CALIFORNIA CORPORATION)  
7518 W. SUNSET BLVD.  
LOS ANGELES, CA 90046

**Registered Aug. 28, 2012**

**Int. Cl.: 34**

FOR: CIGARS, IN CLASS 34 (U.S. CLS. 2, 8, 9 AND 17).

**TRADEMARK**

FIRST USE 7-16-2010; IN COMMERCE 7-16-2010.

**PRINCIPAL REGISTER**

THE MARK CONSISTS OF STANDARD CHARACTERS WITHOUT CLAIM TO ANY PARTICULAR FONT, STYLE, SIZE, OR COLOR.

THE ENGLISH TRANSLATION OF "LA VERITE" IN THE MARK IS "THE TRUTH".

SER. NO. 85-346,271, FILED 6-14-2011.

JAMES MACFARLANE, EXAMINING ATTORNEY



*David J. Kyffers*

Director of the United States Patent and Trademark Office

# United States of America

United States Patent and Trademark Office

# HDFEST

**Reg. No. 4,196,844**

**Registered Aug. 28, 2012**

**Int. Cl.: 41**

**SERVICE MARK**

**PRINCIPAL REGISTER**

DIGITAL DEFINITION CORPORATION (FLORIDA CORPORATION)  
3439 NE SANDY BLVD., #217  
PORTLAND, OR 97232

FOR: EDUCATIONAL SERVICES, NAMELY, CONDUCTING PROGRAMS, CLASSES, SEMINARS, CONFERENCES, WORKSHOPS IN THE FIELD OF MUSIC, VIDEO, AND FILM; EDUCATIONAL SERVICES, NAMELY, PROVIDING PROGRAMS, CLASSES, SEMINARS, CONFERENCES, WORKSHOPS IN THE FIELDS OF MUSIC, VIDEO, AND FILM; ENTERTAINMENT AND EDUCATIONAL SERVICES, NAMELY, PROVIDING ADVICE AND INFORMATION FOR MUSIC, VIDEO AND FILM CONCEPT AND SCRIPT DEVELOPMENT; ENTERTAINMENT IN THE NATURE OF ORGANIZING AND CONDUCTING FILM FESTIVALS, MUSIC FESTIVALS, CULTURAL AND ARTS EVENTS; PROVIDING EDUCATIONAL DEMONSTRATIONS IN THE FIELD OF FILM PRODUCTION TECHNIQUES; ENTERTAINMENT MEDIA PRODUCTION SERVICES FOR MOTION PICTURES, TELEVISION AND INTERNET; ENTERTAINMENT SERVICES IN THE NATURE OF DEVELOPMENT, CREATION, PRODUCTION AND POST-PRODUCTION SERVICES OF MULTIMEDIA ENTERTAINMENT CONTENT; ENTERTAINMENT SERVICES, NAMELY, PLANNING AND CONDUCTING A SERIES OF FILM FESTIVALS; ENTERTAINMENT SERVICES, NAMELY, PROVIDING A WEB SITE FEATURING NON-DOWNLOADABLE MUSICAL PERFORMANCES, MUSICAL VIDEOS, RELATED FILM CLIPS, PHOTOGRAPHS, AND OTHER MULTIMEDIA MATERIALS FEATURING MUSIC, MOVIES, AND FILMS; FILM AND VIDEO FILM PRODUCTION; FILM AND VIDEO PRODUCTION; FILM AND VIDEO PRODUCTION CONSULTING SERVICES; FILM AND VIDEO TAPE FILM PRODUCTION; MEDIA PRODUCTION SERVICES, NAMELY, VIDEO AND FILM PRODUCTION; MOTION PICTURE FILM PRODUCTION; MULTIMEDIA ENTERTAINMENT SERVICES IN THE NATURE OF DEVELOPMENT, PRODUCTION AND POST-PRODUCTION SERVICES IN THE FIELDS OF VIDEO AND FILMS; MULTIMEDIA ENTERTAINMENT SERVICES IN THE NATURE OF RECORDING, PRODUCTION AND POST-PRODUCTION SERVICES IN THE FIELDS OF MUSIC, VIDEO, AND FILMS; ON-LINE JOURNALS, NAMELY, BLOGS FEATURING MUSIC, VIDEO, AND FILM; OPERATING OF FILM STUDIOS; POST-PRODUCTION EDITING SERVICES IN THE FIELD OF MUSIC, VIDEOS AND FILM; PRODUCTION AND DISTRIBUTION OF MONOSCOPIC AND STEREOSCOPIC, ELECTRONIC, DIGITAL VIDEO AND FILM; PRODUCTION OF FILMS; PROVIDING A WEBSITE FEATURING BLOGS AND NON-DOWNLOADABLE PUBLICATIONS IN THE NATURE OF BOOKS, MAGAZINES, NEWSLETTERS, BROCHURES, BOOKLETS, PAMPHLETS, MANUALS, JOURNALS, CATALOGS AND LEAFLETS IN THE FIELD(S) OF MUSIC, VIDEOS, TELEVISION PROGRAMS, MOTION PICTURES, CURRENT EVENT AND ENTERTAINMENT NEWS, GAMES, CULTURAL



*David J. Kyros*

Director of the United States Patent and Trademark Office

**Reg. No. 4,196,844** EVENTS, COMPUTERS, COMPUTER SOFTWARE, COMPUTER HARDWARE, CONSUMER ELECTRONICS, MULTIMEDIA PRODUCTS, INTERACTIVE PRODUCTS AND ONLINE SERVICES, TECHNOLOGY, DIGITAL TECHNOLOGY, GADGETS, ON-LINE RETAILING, MULTIMEDIA APPARATUS AND INSTRUMENTS, TELECOMMUNICATIONS, MOBILE PHONES, HANDHELD AND MOBILE DIGITAL ELECTRONIC DEVICES; VIDEO TAPE FILM PRODUCTION, IN CLASS 41 (U.S. CLS. 100, 101 AND 107).

FIRST USE 11-13-2000; IN COMMERCE 11-13-2000.

THE MARK CONSISTS OF STANDARD CHARACTERS WITHOUT CLAIM TO ANY PARTICULAR FONT, STYLE, SIZE, OR COLOR.

SEC. 2(F).

SER. NO. 85-346,310, FILED 6-14-2011.

CYNTHIA TRIPI, EXAMINING ATTORNEY

# United States of America

United States Patent and Trademark Office



**Reg. No. 4,196,845**

**Registered Aug. 28, 2012**

**Int. Cl.: 43**

**SERVICE MARK**

**PRINCIPAL REGISTER**

NORDIC LODGE, INC. (RHODE ISLAND CORPORATION)  
178 EAST PASQUISET TRAIL  
CHARLESTOWN, RI 02813

FOR: RESTAURANT, IN CLASS 43 (U.S. CLS. 100 AND 101).

FIRST USE 1-1-1963; IN COMMERCE 1-1-1963.

NO CLAIM IS MADE TO THE EXCLUSIVE RIGHT TO USE "NORDIC", APART FROM THE MARK AS SHOWN.

THE MARK CONSISTS OF AN OVAL CONTAINING A VIKING SHIP WITH A BANNER ABOVE CONTAINING THE WORDING "NORDIC LODGE".

SER. NO. 85-346,655, FILED 6-15-2011.

KHANH LE, EXAMINING ATTORNEY



*David J. Kyffers*

Director of the United States Patent and Trademark Office

United States of America  
United States Patent and Trademark Office

SANDOW

**Reg. No. 4,196,846**

SANDOW MEDIA, LLC (DELAWARE LIMITED LIABILITY COMPANY)  
3731 NW 8TH AVENUE  
BOCA RATON, FL 33431

**Registered Aug. 28, 2012**

**Int. Cl.: 41**

FOR: PUBLISHING OF MAGAZINES AND ELECTRONIC PUBLICATIONS, IN CLASS 41  
(U.S. CLS. 100, 101 AND 107).

**SERVICE MARK**

FIRST USE 9-21-2005; IN COMMERCE 9-21-2005.

**PRINCIPAL REGISTER**

THE MARK CONSISTS OF STANDARD CHARACTERS WITHOUT CLAIM TO ANY PARTICULAR FONT, STYLE, SIZE, OR COLOR.

SEC. 2(F) AS TO " SANDOW".

SER. NO. 85-347,257, FILED 6-15-2011.

JOHN DWYER, EXAMINING ATTORNEY



*David J. Kyffers*

Director of the United States Patent and Trademark Office

# United States of America

United States Patent and Trademark Office

# MOSS

**Reg. No. 4,196,847**

COMMERCIAL FURNITURE GROUP, INC. (DELAWARE CORPORATION)  
810 W. HWY. 25/70  
NEWPORT, TN 378218044

**Registered Aug. 28, 2012**

**Int. Cl.: 20**

FOR: COMMERCIAL FURNITURE FOR WHOLESALE DISTRIBUTION, IN CLASS 20 (U.S. CLS. 2, 13, 22, 25, 32 AND 50).

**TRADEMARK**

FIRST USE 7-0-2009; IN COMMERCE 7-0-2009.

**PRINCIPAL REGISTER**

THE MARK CONSISTS OF STANDARD CHARACTERS WITHOUT CLAIM TO ANY PARTICULAR FONT, STYLE, SIZE, OR COLOR.

SER. NO. 85-347,307, FILED 6-15-2011.

SUNG IN, EXAMINING ATTORNEY



*David J. Kyffers*

Director of the United States Patent and Trademark Office

United States of America  
United States Patent and Trademark Office

LILLIE'S Q

**Reg. No. 4,196,848**

LILLIE'S Q LLC (ILLINOIS CORPORATION)  
1856 W. NORTH AVE.  
CHICAGO, IL 60622

**Registered Aug. 28, 2012**

**Int. Cls.: 30 and 43**

FOR: BARBECUE DRY RUB; BARBECUE SAUCE; DRY SPICE RUB FOR MEATS AND FISH; READY-MADE SAUCES; SAUCES; SAUCES FOR BARBECUED MEAT; SPICE RUBS, IN CLASS 30 (U.S. CL. 46).

**TRADEMARK**

FIRST USE 5-18-2010; IN COMMERCE 5-18-2010.

**SERVICE MARK**

FOR: RESTAURANT AND BAR SERVICES, INCLUDING RESTAURANT CARRYOUT SERVICES; RESTAURANT SERVICES FEATURING BARBECUE; RESTAURANT SERVICES, INCLUDING SIT-DOWN SERVICE OF FOOD AND TAKE-OUT RESTAURANT SERVICES, IN CLASS 43 (U.S. CLS. 100 AND 101).

**PRINCIPAL REGISTER**

FIRST USE 7-29-2010; IN COMMERCE 7-29-2010.

THE MARK CONSISTS OF STANDARD CHARACTERS WITHOUT CLAIM TO ANY PARTICULAR FONT, STYLE, SIZE, OR COLOR.

NO CLAIM IS MADE TO THE EXCLUSIVE RIGHT TO USE "Q", APART FROM THE MARK AS SHOWN.

SER. NO. 85-347,318, FILED 6-15-2011.

ELI HELLMAN, EXAMINING ATTORNEY



*David J. Kyros*

Director of the United States Patent and Trademark Office



# United States of America

United States Patent and Trademark Office

## ALEX RODRIGUEZ

**Reg. No. 4,196,849**

**Registered Aug. 28, 2012**

**Int. Cl.: 41**

**SERVICE MARK**

**PRINCIPAL REGISTER**

AROD CORPORATION (FLORIDA CORPORATION)  
C/O BOULEVARD MANAGEMENT, INC.  
21731 VENTURA BLVD., SUITE 300  
WOODLAND HILLS, CA 91364

FOR: ENTERTAINMENT IN THE NATURE OF PROVIDING INFORMATION BY MEANS OF A GLOBAL COMPUTER NETWORK IN THE FIELDS OF SPORTS, ENTERTAINMENT AND POP CULTURE; ENTERTAINMENT SERVICES, NAMELY, PERSONAL APPEARANCES BY A CELEBRITY AND ATHLETE, IN CLASS 41 (U.S. CLS. 100, 101 AND 107).

FIRST USE 4-30-1996; IN COMMERCE 4-30-1996.

THE MARK CONSISTS OF STANDARD CHARACTERS WITHOUT CLAIM TO ANY PARTICULAR FONT, STYLE, SIZE, OR COLOR.

THE NAME(S), PORTRAIT(S), AND/OR SIGNATURE(S) SHOWN IN THE MARK IDENTIFIES "ALEX RODRIGUEZ", WHOSE CONSENT(S) TO REGISTER IS MADE OF RECORD.

SER. NO. 85-347,464, FILED 6-15-2011.

ZHALEH DELANEY, EXAMINING ATTORNEY



*David J. Kyffers*

Director of the United States Patent and Trademark Office

# United States of America

United States Patent and Trademark Office

## AUTOGRAPH II OFFICE

**Reg. No. 4,196,850**

SHAMIR INSIGHT, INC. (CALIFORNIA CORPORATION)  
9938 VIA PASAR

**Registered Aug. 28, 2012**

SAN DIEGO, CA 92126

**Int. Cl.: 9**

FOR: OPTICAL LENSES FOR SPECTACLES AND OPTICAL INSTRUMENTS; SPECTACLES; CONTACT LENSES; CONTAINERS FOR OPTICAL LENSES, SPECTACLES AND CONTACT LENSES; CASES, HOLDERS, PARTS AND FITTINGS FOR OPTICAL LENSES, SPECTACLES AND CONTACT LENSES; COMPUTER SOFTWARE FOR PRODUCTION OF OPTICAL LENSE, IN CLASS 9 (U.S. CLS. 21, 23, 26, 36 AND 38).

**TRADEMARK**

**PRINCIPAL REGISTER**

FIRST USE 1-1-2009; IN COMMERCE 1-1-2009.

THE MARK CONSISTS OF STANDARD CHARACTERS WITHOUT CLAIM TO ANY PARTICULAR FONT, STYLE, SIZE, OR COLOR.

OWNER OF U.S. REG. NO. 3,668,986.

NO CLAIM IS MADE TO THE EXCLUSIVE RIGHT TO USE "OFFICE", APART FROM THE MARK AS SHOWN.

SER. NO. 85-347,527, FILED 6-16-2011.

NICHOLAS ALTREE, EXAMINING ATTORNEY



*David J. Kyros*

Director of the United States Patent and Trademark Office

# United States of America

United States Patent and Trademark Office

## CHANGE IS CENTRAL

**Reg. No. 4,196,851**

**Registered Aug. 28, 2012**

**Int. Cl.: 41**

**SERVICE MARK**

**PRINCIPAL REGISTER**

CENTRAL STATE UNIVERSITY (OHIO STATE UNIVERSITY)  
OFFICE OF GENERAL COUNSEL  
1400 BRUSH ROW ROAD; P.O. BOX 1004  
WILBERFORCE, OH 45384

FOR: EDUCATIONAL SERVICES, NAMELY, ARRANGING AND CONDUCTING COLLEGE AND GRADUATE LEVEL COURSES OF INSTRUCTION; ENTERTAINMENT SERVICES, NAMELY, ORGANIZING AND CONDUCTING COLLEGIATE ATHLETIC COMPETITIONS, LIVE MUSICAL PERFORMANCES AND PERFORMANCES OF DRAMATIC WORKS; AND EDUCATIONAL SERVICES, NAMELY, CONDUCTING LECTURES AND SYMPOSIA IN THE FIELD OF HUMANITIES, ARTS, SOCIAL SCIENCES, BUSINESS, SCIENCE, ENGINEERING, AND EDUCATION, IN CLASS 41 (U.S. CLS. 100, 101 AND 107).

FIRST USE 10-1-2009; IN COMMERCE 10-1-2009.

THE MARK CONSISTS OF STANDARD CHARACTERS WITHOUT CLAIM TO ANY PARTICULAR FONT, STYLE, SIZE, OR COLOR.

SER. NO. 85-347,572, FILED 6-16-2011.

NELSON SNYDER, EXAMINING ATTORNEY



*David J. Kypos*

Director of the United States Patent and Trademark Office

# United States of America

United States Patent and Trademark Office

# casa blu

**Reg. No. 4,196,852**

**Registered Aug. 28, 2012**

**Int. Cl.: 24**

**TRADEMARK**

**PRINCIPAL REGISTER**

MICHAEL WINTER (UNITED STATES INDIVIDUAL)  
16 SUNNYRIDGE RD.  
KATONAH, NY 10536 AND

ROBIN KRAMER (UNITED STATES INDIVIDUAL)  
16 SUNNYRIDGE RD.  
KATONAH, NY 10536

FOR: HOME FURNISHINGS, NAMELY, LINENS, NAMELY, BED BLANKETS, BED LINENS, BED SHEETS, BED SPREADS, BLANKET THROWS, COVERLETS AND TABLE LINENS; HOUSEWARES, NAMELY, OVEN MITTS, KITCHEN TOWELS, DISH CLOTHS, POT HOLDERS, TEXTILE NAPKINS, CLOTH AND TEXTILE PLACEMATS; TABLECLOTHS OF TEXTILE; BATHWARE, NAMELY, SHOWER CURTAINS; FABRIC WINDOW TREATMENTS, NAMELY, WINDOW CURTAINS, SWAGS, SHEERS; BED SPREADS; BED SHEETS; FITTED BED SHEETS; FLAT BED SHEETS; POPLIN AND T-SHIRT BED SHEETS; BED BLANKETS; RECEIVING BLANKETS; BED CANOPIES; DUVETS; DUVET COVERS; BED PADS; BEDDING LINEN; DUST RUFFLES; PILLOW CASES; PILLOW SHAMS; FABRIC FOR DECORATIVE, ORNATE, AND SLEEPING PILLOWS; RUFFLED BEDSKIRTS; BEDSKIRTS; COMFORTERS; TOWELS; BATH TOWELS; HOODED TOWELS; BATH LINENS; WASHCLOTHS, IN CLASS 24 (U.S. CLS. 42 AND 50).

FIRST USE 11-29-2010; IN COMMERCE 11-29-2010.

THE MARK CONSISTS OF STANDARD CHARACTERS WITHOUT CLAIM TO ANY PARTICULAR FONT, STYLE, SIZE, OR COLOR.

NO CLAIM IS MADE TO THE EXCLUSIVE RIGHT TO USE "BLU", APART FROM THE MARK AS SHOWN.

THE ENGLISH TRANSLATION OF "CASA" IN THE MARK IS "HOUSE".

SER. NO. 85-347,805, FILED 6-16-2011.

HELENE LIWINSKI, EXAMINING ATTORNEY



*David J. Kyros*

Director of the United States Patent and Trademark Office

# United States of America

United States Patent and Trademark Office

## PLAID TO THE BONE

**Reg. No. 4,196,853**

CARNEGIE MELLON UNIVERSITY (PENNSYLVANIA NON-PROFIT CORPORATION)  
5000 FORBES AVENUE  
PITTSBURGH, PA 15213

**Registered Aug. 28, 2012**

**Int. Cls.: 35 and 36**

FOR: ADVERTISING AND PUBLICITY SERVICES, IN CLASS 35 (U.S. CLS. 100, 101 AND 102).

**SERVICE MARK**

FIRST USE 5-1-2010; IN COMMERCE 5-1-2010.

**PRINCIPAL REGISTER**

FOR: CHARITABLE FUNDRAISING SERVICES TO SUPPORT THE INTERESTS OF THE UNIVERSITY, ITS STUDENTS, AND ITS ALUMNI, IN CLASS 36 (U.S. CLS. 100, 101 AND 102).

FIRST USE 5-1-2010; IN COMMERCE 5-1-2010.

THE MARK CONSISTS OF STANDARD CHARACTERS WITHOUT CLAIM TO ANY PARTICULAR FONT, STYLE, SIZE, OR COLOR.

SER. NO. 85-347,882, FILED 6-16-2011.

JOHN DWYER, EXAMINING ATTORNEY



*David J. Kybas*

Director of the United States Patent and Trademark Office

# United States of America

United States Patent and Trademark Office

## PRIME CONTENT

**Reg. No. 4,196,854**

**Registered Aug. 28, 2012**

**Int. Cls.: 41 and 42**

**SERVICE MARK**

**PRINCIPAL REGISTER**

PRIME CONTENT, INC. (NEW YORK CORPORATION)  
6TH FLOOR  
45 WEST 18TH STREET  
NEW YORK, NY 10011

FOR: MEDIA PRODUCTION SERVICES, NAMELY, VIDEO AND FILM PRODUCTION, IN CLASS 41 (U.S. CLS. 100, 101 AND 107).

FIRST USE 10-1-2011; IN COMMERCE 10-1-2011.

FOR: PLANNING, DESIGN, DEVELOPMENT, MAINTENANCE AND OPTIMIZATION OF ONLINE WEBSITES FOR THIRD PARTIES, IN CLASS 42 (U.S. CLS. 100 AND 101).

FIRST USE 10-1-2011; IN COMMERCE 10-1-2011.

THE MARK CONSISTS OF STANDARD CHARACTERS WITHOUT CLAIM TO ANY PARTICULAR FONT, STYLE, SIZE, OR COLOR.

NO CLAIM IS MADE TO THE EXCLUSIVE RIGHT TO USE "CONTENT", APART FROM THE MARK AS SHOWN.

SER. NO. 85-348,163, FILED 6-16-2011.

MAYUR VAGHANI, EXAMINING ATTORNEY



*David J. Kyjars*

Director of the United States Patent and Trademark Office

# United States of America

United States Patent and Trademark Office

## KILLER INTERACTIVE

**Reg. No. 4,196,855**

HAND, KEVIN (UNITED STATES INDIVIDUAL)  
176 SHERMAN AVE. PH#1  
JERSEY CITY, NJ 07307

**Registered Aug. 28, 2012**

**Int. Cl.: 42**

FOR: DESIGN FOR OTHERS IN THE FIELD OF TOYS; DESIGN AND DEVELOPMENT OF COMPUTER GAME SOFTWARE FOR PLAY; GRAPHIC DESIGN SERVICES; WEB SITE DESIGN SERVICES, IN CLASS 42 (U.S. CLS. 100 AND 101).

**SERVICE MARK**

FIRST USE 1-1-2007; IN COMMERCE 1-1-2007.

**PRINCIPAL REGISTER**

THE MARK CONSISTS OF STANDARD CHARACTERS WITHOUT CLAIM TO ANY PARTICULAR FONT, STYLE, SIZE, OR COLOR.

NO CLAIM IS MADE TO THE EXCLUSIVE RIGHT TO USE "INTERACTIVE", APART FROM THE MARK AS SHOWN.

SER. NO. 85-348,400, FILED 6-16-2011.

BERYL GARDNER, EXAMINING ATTORNEY



*David J. Kyros*

Director of the United States Patent and Trademark Office

# United States of America

United States Patent and Trademark Office

## Jolly Reindeer

**Reg. No. 4,196,856**

**Registered Aug. 28, 2012**

**Int. Cls.: 35 and 41**

**SERVICE MARK**

**PRINCIPAL REGISTER**

SANDQUIST, REBECCA (UNITED STATES INDIVIDUAL)  
16970 SAN CARLOS BLVD.  
SUITE 160-224  
FORT MYERS, FL 33908

FOR: PROVIDING ONLINE WHOLESALE AND RETAIL STORE SERVICES FEATURING CHRISTMAS HOLIDAY SEASON DECORATIONS, ENTERTAINMENT PRODUCTS AND GIFTS , IN CLASS 35 (U.S. CLS. 100, 101 AND 102).

FIRST USE 2-1-2011; IN COMMERCE 9-19-2011.

FOR: PROVIDING A WEBSITE FEATURING ENTERTAINMENT INFORMATION, NEWS AND COMMENTARY IN THE FIELD OF THE CHRISTMAS HOLIDAY SEASON, AND REVIEWS OF MOVIES, BOOKS, TOYS, GAMES, TELEVISION SHOWS, COMPUTER APPS, GIFTS AND MUSIC; AND PROVIDING ON-LINE INTERVIEWS FEATURING CELEBRITIES, AUTHORS, MUSICIANS, ATHLETES IN THE FIELDS OF MOVIES, PUBLISHING, TELEVISION, MUSIC AND SPORTS FOR ENTERTAINMENT PURPOSES; ON-LINE JOURNALS, NAMELY, BLOGS FEATURING DECORATING AND CELEBRATION IDEAS, RECIPES, ARTS AND CRAFTS RESOURCES AND PROJECTS, ALL REGARDING THE CHRISTMAS HOLIDAY SEASON, IN CLASS 41 (U.S. CLS. 100, 101 AND 107).

FIRST USE 2-1-2011; IN COMMERCE 9-19-2011.

THE MARK CONSISTS OF STANDARD CHARACTERS WITHOUT CLAIM TO ANY PARTICULAR FONT, STYLE, SIZE, OR COLOR.

SER. NO. 85-348,537, FILED 6-16-2011.

ANDREA K. NADELMAN, EXAMINING ATTORNEY



*David J. Kybas*

Director of the United States Patent and Trademark Office



# United States of America

United States Patent and Trademark Office

## DATEVITATION

**Reg. No. 4,196,857**

DATEVITATION, INC. (DELAWARE CORPORATION)

**Registered Aug. 28, 2012**

7119 W SUNSET BLVD #525  
LOS ANGELES, CA 90046

**Int. Cls.: 16 and 45**

FOR: PERSONALIZED GIFT BOOKS FEATURING ACTIVITIES TO EXPERIENCE WITH FRIENDS, FAMILY, OR SIGNIFICANT OTHERS, INCLUDING, BUT NOT LIMITED TO, DINING, TRAVELING, PAMPERING AND EXERCISING, IN CLASS 16 (U.S. CLS. 2, 5, 22, 23, 29, 37, 38 AND 50).

**TRADEMARK**

**SERVICE MARK**

FIRST USE 6-2-2011; IN COMMERCE 6-7-2011.

**PRINCIPAL REGISTER**

FOR: PROVIDING A SELECTION OF ONLINE ELECTRONIC GREETING CARDS, IN CLASS 45 (U.S. CLS. 100 AND 101).

FIRST USE 6-2-2011; IN COMMERCE 6-7-2011.

THE MARK CONSISTS OF STANDARD CHARACTERS WITHOUT CLAIM TO ANY PARTICULAR FONT, STYLE, SIZE, OR COLOR.

SER. NO. 85-348,631, FILED 6-16-2011.

DAVID TAYLOR, EXAMINING ATTORNEY



*David J. Kyfos*

Director of the United States Patent and Trademark Office

# United States of America

United States Patent and Trademark Office

# SAQ

**Reg. No. 4,196,858**

**Registered Aug. 28, 2012**

**Int. Cl.: 9**

**TRADEMARK**

**PRINCIPAL REGISTER**

SPEED AGILITY & QUICKNESS INTERNATIONAL LIMITED (UNITED KINGDOM LIMITED COMPANY (LTD.))  
UNIT 12, ASFORDBY BUSINESS PARK WELBY  
MELTON MOWBRAY, UNITED KINGDOM LE143JL

FOR: ELECTRONIC EQUIPMENT FOR MEASURING FITNESS PERFORMANCE; AUDIO AND VIDEO RECORDINGS FEATURING INSTRUCTION IN HEALTH AND FITNESS, IN CLASS 9 (U.S. CLS. 21, 23, 26, 36 AND 38).

FIRST USE 10-1-2006; IN COMMERCE 10-1-2006.

THE MARK CONSISTS OF STANDARD CHARACTERS WITHOUT CLAIM TO ANY PARTICULAR FONT, STYLE, SIZE, OR COLOR.

OWNER OF U.S. REG. NO. 3,057,958.

SEC. 2(F).

SER. NO. 85-348,643, FILED 6-17-2011.

ALAIN LAPTEY, EXAMINING ATTORNEY



*David J. Kyffers*

Director of the United States Patent and Trademark Office

# United States of America

United States Patent and Trademark Office



**Reg. No. 4,196,859**

**Registered Aug. 28, 2012**

**Int. Cls.: 35 and 41**

**SERVICE MARK**

**PRINCIPAL REGISTER**

REED ELSEVIER INC. (MASSACHUSETTS CORPORATION)  
SUITE 350  
2 NEWTON PLACE  
NEWTON, MA 02458

FOR: ENTERTAINMENT BUSINESS RESEARCH AND BUSINESS DATA ANALYSIS SERVICES IN THE ENTERTAINMENT AND MEDIA BUSINESS INCLUDING TELEVISION, FEATURE FILM AND DIGITAL ENTERTAINMENT; PROVIDING ON LINE NEWS AND INFORMATION ABOUT THE BUSINESS OF THE ENTERTAINMENT INDUSTRY, IN CLASS 35 (U.S. CLS. 100, 101 AND 102).

FIRST USE 10-4-1999; IN COMMERCE 10-4-1999.

FOR: PROVIDING ON LINE NEWS AND INFORMATION IN THE FIELD OF ENTERTAINMENT; NON-DOWNLOADABLE ELECTRONIC PUBLICATIONS IN THE NATURE OF NEWSLETTERS RELATING TO THE ENTERTAINMENT INDUSTRY; ON-LINE ELECTRONIC NEWSLETTER DELIVERED BY EMAIL RELATING TO THE ENTERTAINMENT INDUSTRY, IN CLASS 41 (U.S. CLS. 100, 101 AND 107).

FIRST USE 10-4-1999; IN COMMERCE 10-4-1999.

THE MARK CONSISTS OF THE LETTERS "TV" IN LOWER CASE FOLLOWED BY "TRACKER" WITH ".COM" UNDER "TRACKER", AND THE LETTERS "TV" ARE BORDERED BY A CURVED LINE ABOVE AND BELOW TO REPRESENT A STYLIZED TELEVISION WITH ANTENNA. ALL OF THE WORDING AND THE TELEVISION WITH ANTENNA DESIGN ARE CONTAINED IN AN OVAL.

SEC. 2(F) AS TO "TVTRACKER.COM".

SER. NO. 85-348,976, FILED 6-17-2011.

NELSON SNYDER, EXAMINING ATTORNEY



*David J. Kybas*

Director of the United States Patent and Trademark Office

# United States of America

United States Patent and Trademark Office

## THE HEATER

**Reg. No. 4,196,860**

**Registered Aug. 28, 2012**

**Int. Cls.: 6 and 11**

**TRADEMARK**

**PRINCIPAL REGISTER**

CANDLE LAMP COMPANY, LLC (DELAWARE LIMITED LIABILITY COMPANY)  
1799 RUSTIN AVENUE  
RIVERSIDE, CA 92507

FOR: METAL CHAFING DISH FRAMES, IN CLASS 6 (U.S. CLS. 2, 12, 13, 14, 23, 25 AND 50).

FIRST USE 6-0-1996; IN COMMERCE 6-0-1996.

FOR: BUFFET EQUIPMENT, NAMELY, WARMING TRAYS, CHAFING DISHES, IN CLASS 11 (U.S. CLS. 13, 21, 23, 31 AND 34).

FIRST USE 6-0-1996; IN COMMERCE 6-0-1996.

THE MARK CONSISTS OF STANDARD CHARACTERS WITHOUT CLAIM TO ANY PARTICULAR FONT, STYLE, SIZE, OR COLOR.

SEC. 2(F).

SER. NO. 85-348,985, FILED 6-17-2011.

BARBARA GAYNOR, EXAMINING ATTORNEY



*David J. Kyros*

Director of the United States Patent and Trademark Office

# United States of America

United States Patent and Trademark Office

## TVTRACKER.COM

**Reg. No. 4,196,861**

**Registered Aug. 28, 2012**

**Int. Cls.: 35 and 41**

**SERVICE MARK**

**PRINCIPAL REGISTER**

REED ELSEVIER INC. (MASSACHUSETTS CORPORATION)  
SUITE 350  
2 NEWTON PLACE  
NEWTON, MA 02458

FOR: ENTERTAINMENT BUSINESS RESEARCH AND BUSINESS DATA ANALYSIS SERVICES IN THE ENTERTAINMENT AND MEDIA BUSINESS INCLUDING TELEVISION, FEATURE FILM AND DIGITAL ENTERTAINMENT; PROVIDING ON LINE NEWS AND INFORMATION ABOUT THE BUSINESS OF THE ENTERTAINMENT INDUSTRY, IN CLASS 35 (U.S. CLS. 100, 101 AND 102).

FIRST USE 10-4-1999; IN COMMERCE 10-4-1999.

FOR: PROVIDING ON LINE NEWS AND INFORMATION IN THE FIELD OF ENTERTAINMENT; NON-DOWNLOADABLE ELECTRONIC PUBLICATIONS IN THE NATURE OF NEWSLETTERS RELATING TO THE ENTERTAINMENT INDUSTRY; ON-LINE ELECTRONIC NEWSLETTER DELIVERED BY E-MAIL RELATING TO THE ENTERTAINMENT INDUSTRY, IN CLASS 41 (U.S. CLS. 100, 101 AND 107).

FIRST USE 10-4-1999; IN COMMERCE 10-4-1999.

THE MARK CONSISTS OF STANDARD CHARACTERS WITHOUT CLAIM TO ANY PARTICULAR FONT, STYLE, SIZE, OR COLOR.

SEC. 2(F).

SER. NO. 85-349,116, FILED 6-17-2011.

NELSON SNYDER, EXAMINING ATTORNEY



*David J. Kyros*

Director of the United States Patent and Trademark Office

# United States of America

United States Patent and Trademark Office

## Algae Bone Factor

**Reg. No. 4,196,862**

**Registered Aug. 28, 2012**

**Int. Cl.: 5**

**TRADEMARK**

**PRINCIPAL REGISTER**

ARMANDO VILLANUEVA (UNITED STATES INDIVIDUAL), DBA BALANCE FACTOR  
#1  
1416 N. VISTA  
LOS ANGELES, CA 90046

FOR: VITAMIN SUPPLEMENTS CONTAINING ALGAE, IN CLASS 5 (U.S. CLS. 6, 18, 44,  
46, 51 AND 52).

FIRST USE 6-14-2011; IN COMMERCE 6-14-2011.

THE MARK CONSISTS OF STANDARD CHARACTERS WITHOUT CLAIM TO ANY PAR-  
TICULAR FONT, STYLE, SIZE, OR COLOR.

NO CLAIM IS MADE TO THE EXCLUSIVE RIGHT TO USE "ALGAE BONE", APART FROM  
THE MARK AS SHOWN.

SER. NO. 85-349,203, FILED 6-17-2011.

TINA L. SNAPP, EXAMINING ATTORNEY



*David J. Kybas*

Director of the United States Patent and Trademark Office

# United States of America

United States Patent and Trademark Office



**Reg. No. 4,196,863**

**Registered Aug. 28, 2012**

**Int. Cl.: 7**

**TRADEMARK**

**PRINCIPAL REGISTER**

CHIORINO S.P.A. (ITALY JOINT STOCK COMPANY)  
VIA S. AGATA 9  
BIELLA, ITALY 13900

FOR: TRANSMISSION BELTS FOR MACHINES; CONVEYOR AND PROCESS BELTS, IN CLASS 7 (U.S. CLS. 13, 19, 21, 23, 31, 34 AND 35).

PRIORITY CLAIMED UNDER SEC. 44(D) ON ERPN CMNTY TM OFC APPLICATION NO. 010052207, FILED 6-16-2011, REG. NO. 10052207, DATED 11-17-2011, EXPIRES 6-16-2021.

THE COLOR(S) LIGHT GRAY, DARK GRAY, AND GREEN IS/ARE CLAIMED AS A FEATURE OF THE MARK.

OWNER OF U.S. REG. NO. 3,958,511.

THE MARK CONSISTS OF STYLIZED "H" IN LIGHT GRAY, DARK GRAY, AND GREEN, AND STYLIZED "S" IN GREEN.

SER. NO. 85-349,413, FILED 6-17-2011.

LINDA ORNDORFF, EXAMINING ATTORNEY



*David J. Kybas*

Director of the United States Patent and Trademark Office

# United States of America

United States Patent and Trademark Office

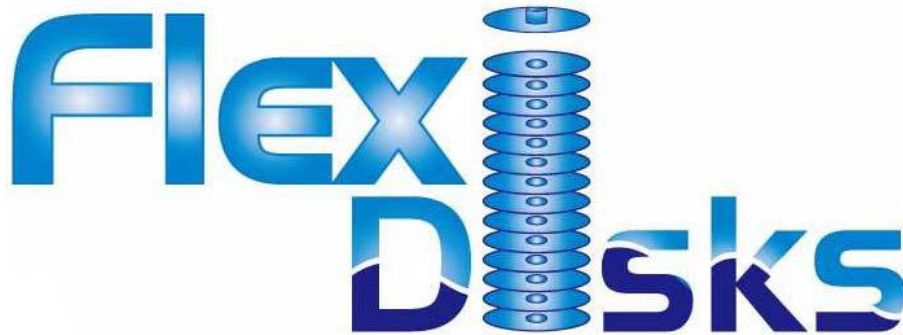

**Reg. No. 4,196,864**

**Registered Aug. 28, 2012**

**Int. Cl.: 11**

**TRADEMARK**

**PRINCIPAL REGISTER**

NEW CENTURY MEMBRANE TECHNOLOGY CO., LTD. (TAIWAN CORPORATION)  
1, 2F., NO. 110, SEC. 2, GANSU RD.  
SITUN DISTRICT  
TAICHUNG CITY 407, TAIWAN

FOR: WATER PURIFICATION AND FILTRATION APPARATUS, WATER STERILIZERS, WATER SOFTENING APPARATUS AND INSTALLATIONS, WATER DESALINATION PLANTS, WATER DISTILLATION UNITS, FILTERS FOR DRINKING WATER, WATER TREATMENT EQUIPMENT, NAMELY, REVERSE OSMOSIS FILTRATION UNITS, PURIFICATION INSTALLATIONS FOR SEWAGE, IN CLASS 11 (U.S. CLS. 13, 21, 23, 31 AND 34).

FIRST USE 5-23-2010; IN COMMERCE 5-23-2010.

NO CLAIM IS MADE TO THE EXCLUSIVE RIGHT TO USE "FLEXI" OR "DISKS", APART FROM THE MARK AS SHOWN.

THE COLOR(S) LIGHT BLUE, DARK BLUE AND WHITE IS/ARE CLAIMED AS A FEATURE OF THE MARK.

THE MARK CONSISTS OF THE WORDS "FLEXI" AND "DISKS" AND A DESIGN ELEMENT. "FLEXI" IS STACKED ABOVE "DISKS" SO THAT THAT "I" IN THE WORDS ARE ALIGNED AND SHARED. THE "I" IS COMPRISED OF A STACK OF LIGHT BLUE AND WHITE STYLIZED DEPICTIONS OF CIRCULAR DISKS WITH ONE ADDITIONAL BLUE AND WHITE DISK FLOATING ABOVE THE STACK. "FLEXI" IS PRESENTED IN STYLIZED FONT THAT IS OUTLINED IN BLUE AND FADES FROM BLUE IN ITS PERIPHERY TO WHITE IN THE CENTER. THE "D", "S", "K" AND "S" IN "DISKS" ARE PRESENTED IN LIGHT BLUE, WHITE AND DARK BLUE STYLIZED FONT. THE MARK IN ITS ENTIRETY IS PRESENTED ON A TRANSPARENT BACKGROUND.

SER. NO. 85-349,437, FILED 6-17-2011.

GRETCHEN ULRICH, EXAMINING ATTORNEY



*David J. Kyros*

Director of the United States Patent and Trademark Office



# United States of America

United States Patent and Trademark Office

# STUDIO S

**Reg. No. 4,196,865**

**Registered Aug. 28, 2012**

**Int. Cls.: 9 and 25**

**TRADEMARK**

**PRINCIPAL REGISTER**

SEARS BRANDS, LLC (ILLINOIS LIMITED LIABILITY COMPANY)  
3333 BEVERLY DRIVE  
HOFFMAN ESTATES, IL 60179

FOR: SUNGLASSES, IN CLASS 9 (U.S. CLS. 21, 23, 26, 36 AND 38).

FIRST USE 2-0-2011; IN COMMERCE 2-0-2011.

FOR: FOOTWEAR AND SLIPPER SOCKS , IN CLASS 25 (U.S. CLS. 22 AND 39).

FIRST USE 2-0-2012; IN COMMERCE 2-0-2012.

THE MARK CONSISTS OF STANDARD CHARACTERS WITHOUT CLAIM TO ANY PARTICULAR FONT, STYLE, SIZE, OR COLOR.

SER. NO. 85-349,464, FILED 6-17-2011.

KHANH LE, EXAMINING ATTORNEY



*David J. Kybas*

Director of the United States Patent and Trademark Office

# United States of America

United States Patent and Trademark Office

# STUDIO S

**Reg. No. 4,196,866**

SEARS BRANDS, LLC (ILLINOIS LIMITED LIABILITY COMPANY)  
3333 BEVERLY DRIVE  
HOFFMAN ESTATES, IL 60179

**Registered Aug. 28, 2012**

**Int. Cl.: 14**

FOR: JEWELRY, IN CLASS 14 (U.S. CLS. 2, 27, 28 AND 50).

**TRADEMARK**

FIRST USE 2-0-2011; IN COMMERCE 2-0-2011.

**PRINCIPAL REGISTER**

THE MARK CONSISTS OF STANDARD CHARACTERS WITHOUT CLAIM TO ANY PARTICULAR FONT, STYLE, SIZE, OR COLOR.

SER. NO. 85-349,475, FILED 6-17-2011.

KHANH LE, EXAMINING ATTORNEY



*David J. Kybas*

Director of the United States Patent and Trademark Office

# United States of America

United States Patent and Trademark Office

# NADCP

**Reg. No. 4,196,867**

**Registered Aug. 28, 2012**

**Int. Cls.: 35 and 41**

NATIONAL ASSOCIATION OF DRUG COURT PROFESSIONALS (VIRGINIA CORPORATION)  
SUITE 201  
1029 N. ROYAL STREET  
ALEXANDRIA, VA 22314

**SERVICE MARK**

**PRINCIPAL REGISTER**

FOR: ASSOCIATION SERVICES, NAMELY, PROMOTING THE INTERESTS OF LEGAL PROFESSIONALS, CLINICAL PROFESSIONALS, AND OTHER DRUG COURT, DWI COURT AND MENTAL HEALTH COURT PROFESSIONALS AND THE DRUG COURT FIELD IN GENERAL; PROMOTING PUBLIC AWARENESS OF DRUG COURTS AND IMPROVING THE JUSTICE SYSTEM THROUGH A COMBINATION OF JUDICIAL MONITORING AND EFFECTIVE TREATMENT TO COMPEL DRUG-USING OFFENDERS TO CHANGE THEIR LIVES, IN CLASS 35 (U.S. CLS. 100, 101 AND 102).

FIRST USE 0-0-1994; IN COMMERCE 0-0-1994.

FOR: EDUCATIONAL SERVICES, NAMELY, ARRANGING AND CONDUCTING EDUCATIONAL CONFERENCES, SEMINARS, WEBINARS, CLASSES, WORKSHOPS AND SYMPO-SIA IN THE FIELDS OF DRUG COURTS, COURT-BASED TREATMENT PROGRAMS, SUBSTANCE ABUSE AND CRIME, IN CLASS 41 (U.S. CLS. 100, 101 AND 107).

FIRST USE 0-0-1994; IN COMMERCE 0-0-1994.

THE MARK CONSISTS OF STANDARD CHARACTERS WITHOUT CLAIM TO ANY PARTICULAR FONT, STYLE, SIZE, OR COLOR.

SER. NO. 85-349,597, FILED 6-17-2011.

FLORENTINA BLANDU, EXAMINING ATTORNEY



*David J. Kybas*

Director of the United States Patent and Trademark Office

# United States of America

United States Patent and Trademark Office

## PEACE.LOVE.FEATHERS.

**Reg. No. 4,196,868**

FEATHERSTON, ASHLEY A. (UNITED STATES INDIVIDUAL)  
1401 HIGHWAY 360, APT. 435  
EULESS, TX 76039

**Registered Aug. 28, 2012**

**Int. Cl.: 14**

FOR: FEATHER EARRINGS, IN CLASS 14 (U.S. CLS. 2, 27, 28 AND 50).

**TRADEMARK**

FIRST USE 6-17-2011; IN COMMERCE 6-17-2011.

**PRINCIPAL REGISTER**

THE MARK CONSISTS OF STANDARD CHARACTERS WITHOUT CLAIM TO ANY PARTICULAR FONT, STYLE, SIZE, OR COLOR.

NO CLAIM IS MADE TO THE EXCLUSIVE RIGHT TO USE "FEATHERS", APART FROM THE MARK AS SHOWN.

SER. NO. 85-349,790, FILED 6-17-2011.

MARLENE BELL, EXAMINING ATTORNEY



*David J. Kyffers*

Director of the United States Patent and Trademark Office

# United States of America

United States Patent and Trademark Office

## ABENITY, INC.

**Reg. No. 4,196,869**

**Registered Aug. 28, 2012**

**Int. Cl.: 35**

**SERVICE MARK**

**PRINCIPAL REGISTER**

ABENITY, INC. (TENNESSEE CORPORATION)  
SUITE 600  
725 COOL SPRINGS BOULEVARD  
FRANKLIN, TN 37067

FOR: DEVELOPING, IMPLEMENTING AND SUPERVISING PRIVATE WEB-BASED DISCOUNT PROGRAMS FOR EMPLOYERS, MEMBERSHIP GROUPS, AFFINITY PROGRAMS AND ALUMNI ASSOCIATIONS TO OBTAIN DISCOUNTS ON PRODUCTS AND SERVICES, IN CLASS 35 (U.S. CLS. 100, 101 AND 102).

FIRST USE 7-29-2009; IN COMMERCE 11-24-2009.

THE MARK CONSISTS OF STANDARD CHARACTERS WITHOUT CLAIM TO ANY PARTICULAR FONT, STYLE, SIZE, OR COLOR.

NO CLAIM IS MADE TO THE EXCLUSIVE RIGHT TO USE "INC.", APART FROM THE MARK AS SHOWN.

SEC. 2(F).

SER. NO. 85-349,880, FILED 6-18-2011.

DEZMONA MIZELLE, EXAMINING ATTORNEY



*David J. Kyffers*

Director of the United States Patent and Trademark Office

# United States of America

United States Patent and Trademark Office

## KVZ Music Ltd.

**Reg. No. 4,196,870**

**Registered Aug. 28, 2012**

**Int. Cl.: 9**

**TRADEMARK**

**PRINCIPAL REGISTER**

ZDRAVKOV KIRIL VALERI (AUSTRIA LIMITED LIABILITY COMPANY), TA KVZ MUSIC LTD.  
GRUENGASSE 15/10  
VIENNA, AUSTRIA 1050

FOR: DIGITAL MUSIC DOWNLOADABLE FROM THE INTERNET, IN CLASS 9 (U.S. CLS. 21, 23, 26, 36 AND 38).

FIRST USE 0-0-2007; IN COMMERCE 0-0-2007.

THE MARK CONSISTS OF STANDARD CHARACTERS WITHOUT CLAIM TO ANY PARTICULAR FONT, STYLE, SIZE, OR COLOR.

NO CLAIM IS MADE TO THE EXCLUSIVE RIGHT TO USE "MUSIC LTD.", APART FROM THE MARK AS SHOWN.

SER. NO. 85-349,936, FILED 6-19-2011.

MATTHEW EINSTEIN, EXAMINING ATTORNEY



*David J. Kyffers*

Director of the United States Patent and Trademark Office

# United States of America

United States Patent and Trademark Office

# KVZ Digital

**Reg. No. 4,196,871**

ZDRAVKOV KIRIL VALERI (AUSTRIA INDIVIDUAL), DBA KVZ DIGITAL  
GRUENGASSE 15/10  
VIENNA, AUSTRIA 1050 AND

**Registered Aug. 28, 2012**

**Int. Cl.: 9**

ZDRAVKOV KIRIL VALERI (AUSTRIA LIMITED LIABILITY COMPANY), DBA KVZ MUSIC  
LTD.

**TRADEMARK**

GRUENGASSE 15/10  
VIENNA, AUSTRIA 1050

**PRINCIPAL REGISTER**

FOR: DOWNLOADABLE MUSICAL SOUND RECORDINGS, IN CLASS 9 (U.S. CLS. 21, 23,  
26, 36 AND 38).

FIRST USE 0-0-2010; IN COMMERCE 0-0-2010.

THE MARK CONSISTS OF STANDARD CHARACTERS WITHOUT CLAIM TO ANY PAR-  
TICULAR FONT, STYLE, SIZE, OR COLOR.

NO CLAIM IS MADE TO THE EXCLUSIVE RIGHT TO USE "DIGITAL", APART FROM THE  
MARK AS SHOWN.

SER. NO. 85-349,940, FILED 6-19-2011.

MATTHEW EINSTEIN, EXAMINING ATTORNEY



*David J. Kybas*

Director of the United States Patent and Trademark Office

# United States of America

United States Patent and Trademark Office

## Livin' Country

**Reg. No. 4,196,872**

HOCHMUTH, STEVEN M. (UNITED STATES INDIVIDUAL)  
345 MAIN ST. SOUTH  
WOODBURY, CT 06798

**Registered Aug. 28, 2012**

**Int. Cl.: 25**

FOR: HOODED SWEATSHIRTS; SHORT-SLEEVED OR LONG SLEEVED T-SHIRTS; TANK TOPS; SPORT CAPS AND HATS; SWEATSHIRTS; SHORTS; SOCKS; JACKETS, IN CLASS 25 (U.S. CLS. 22 AND 39).

**TRADEMARK**

FIRST USE 5-7-2011; IN COMMERCE 6-15-2011.

**PRINCIPAL REGISTER**

THE MARK CONSISTS OF STANDARD CHARACTERS WITHOUT CLAIM TO ANY PARTICULAR FONT, STYLE, SIZE, OR COLOR.

SER. NO. 85-349,964, FILED 6-19-2011.

TINA BROWN, EXAMINING ATTORNEY



*David J. Kyffers*

Director of the United States Patent and Trademark Office



# United States of America

United States Patent and Trademark Office

## MINNESOTA POLL

**Reg. No. 4,196,873**

STAR TRIBUNE MEDIA COMPANY LLC (DELAWARE LIMITED LIABILITY COMPANY)  
425 PORTLAND AVE. S.  
MINNEAPOLIS, MN 55488

**Registered Aug. 28, 2012**

**Int. Cls.: 16 and 41**

FOR: COLUMNS FEATURING THE RESULTS OF PUBLIC OPINION SURVEYS, IN CLASS 16 (U.S. CLS. 2, 5, 22, 23, 29, 37, 38 AND 50).

**TRADEMARK**

FIRST USE 3-19-1944; IN COMMERCE 3-19-1944.

**SERVICE MARK**

FOR: PROVIDING ON-LINE CURRENT EVENT NEWS FEATURING THE RESULTS OF PUBLIC OPINION SURVEYS, IN CLASS 41 (U.S. CLS. 100, 101 AND 107).

**PRINCIPAL REGISTER**

FIRST USE 0-0-1996; IN COMMERCE 0-0-1996.

THE MARK CONSISTS OF STANDARD CHARACTERS WITHOUT CLAIM TO ANY PARTICULAR FONT, STYLE, SIZE, OR COLOR.

OWNER OF U.S. REG. NO. 3,152,719.

NO CLAIM IS MADE TO THE EXCLUSIVE RIGHT TO USE "POLL", APART FROM THE MARK AS SHOWN.

SEC. 2(F).

SER. NO. 85-350,151, FILED 6-20-2011.

SIMON TENG, EXAMINING ATTORNEY

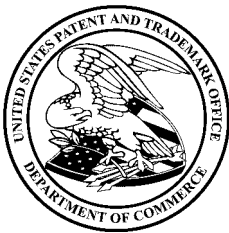

*David J. Kybas*

Director of the United States Patent and Trademark Office

# United States of America

United States Patent and Trademark Office

Little Flower Yoga 

**Reg. No. 4,196,874**

**Registered Aug. 28, 2012**

**Int. Cl.: 41**

**SERVICE MARK**

**PRINCIPAL REGISTER**

LITTLE FLOWER YOGA STUDIO, LLC (NEW YORK LIMITED LIABILITY COMPANY)  
212 COLABAUGH POND ROAD  
CROTON ON HUDSON, NY 10520

FOR: YOGA INSTRUCTION, IN CLASS 41 (U.S. CLS. 100, 101 AND 107).

FIRST USE 10-0-2006; IN COMMERCE 10-0-2006.

NO CLAIM IS MADE TO THE EXCLUSIVE RIGHT TO USE "YOGA", APART FROM THE MARK AS SHOWN.

THE MARK CONSISTS OF THE WORDING "LITTLE FLOWER YOGA" IN INITIAL CAPS AND A PETALED FLOWER DESIGN OVER THE LETTERS "O", "G", AND "A" AND THE STEM OF THE FLOWER WINDING AROUND THE LETTER "A", WRAPPING THE BOTTOM OF THE LETTER "G" AND STOPPING UNDER THE LETTER "Y".

SER. NO. 85-350,234, FILED 6-20-2011.

SCOTT BIBB, EXAMINING ATTORNEY



*David J. Kybas*

Director of the United States Patent and Trademark Office

# United States of America

United States Patent and Trademark Office



SHRENUJ  
HERITAGE • INNOVATION • PASSION

**Reg. No. 4,196,875**

**Registered Aug. 28, 2012**

**Int. Cl.: 14**

**TRADEMARK**

**PRINCIPAL REGISTER**

SHRENUJ & COMPANY LIMITED (INDIA CORPORATION)  
405, DHARAM PALACE  
100-103, N.S. PATKAR MARG  
MUMBAI - 400 007, INDIA

FOR: PRECIOUS JEWELLERY IN THE FORM OF DIAMONDS STUDDED ON GOLD AND PLATINUM, DIAMONDS USED TO ACCESSORIZE OTHER GOODS, DIAMOND STUDDED WATCHES, PRECIOUS AND SEMI-PRECIOUS STONES, JEWELLERY STUDDED ON HOLOGICAL INSTRUMENTS, JEWELLERY CONTAINING DIAMONDS AND PRECIOUS STONES, IN CLASS 14 (U.S. CLS. 2, 27, 28 AND 50).

FIRST USE 0-0-2008; IN COMMERCE 0-0-2008.

THE MARK CONSISTS OF AN OCTAGON FIGURE WITH TWO FLIPPED SQUARES INSIDE AND A WHITE LETTER S IN THE MIDDLE DIVIDING THE OCTAGON. THE LEFT SIDE OF THE OCTAGON APPEARS IN COLOR BLUE AND THE RIGHT SIDE OF THE OCTAGON APPEARS IN COLOR GRAY. UNDERNEATH THE OCTAGON IS FOUND THE WORD "SHRENUJ" WRITTEN IN UPPERCASE GRAY LETTERS. IMMEDIATELY BELOW THE WORD "SHRENUJ" ARE FOUND THE WORDS "HERITAGE", "INNOVATION" AND "PASSION" WRITTEN IN UPPERCASE GRAY LETTERS POSITIONED NEXT TO EACH OTHER WITH ONE GRAY DOT BEFORE AND AFTER THE WORD "INNOVATION". THE WORDS AND DESIGN ARE DISPLAYED AGAINST A WHITE RECTANGULAR BACKGROUND.

THE COLOR(S) BLUE, GRAY AND WHITE IS/ARE CLAIMED AS A FEATURE OF THE MARK.

SER. NO. 85-350,336, FILED 6-20-2011.

PAM WILLIS, EXAMINING ATTORNEY



*David J. Kybas*

Director of the United States Patent and Trademark Office

# United States of America

United States Patent and Trademark Office

## The Legal Arena

**Reg. No. 4,196,876**

**Registered Aug. 28, 2012**

**Int. Cl.: 42**

**SERVICE MARK**

**PRINCIPAL REGISTER**

THE LEGAL ARENA, LLC (FLORIDA LIMITED LIABILITY COMPANY)  
273 KENSINGTON WAY  
WEST PALM BEACH, FL 33414

FOR: PROVIDING A WEBSITE FEATURING ON-LINE NON-DOWNLOADABLE SOFTWARE THAT ENABLES USERS TO REVIEW THE SERVICES PROVIDED BY A PROFESSIONAL IN THE LEGAL SERVICES INDUSTRY AND OBTAIN SUCH SERVICES THEREOF; PROVIDING A WEBSITE THAT FEATURES TECHNOLOGY THAT ENABLES USERS TO GEOGRAPHICALLY LOCATE LEGAL PROFESSIONALS AND POST QUESTIONS AND CONFLICTS FOR THE PURPOSE OF OBTAINING THE LEGAL SERVICES PROVIDED BY THE LEGAL PROFESSIONAL VIA A GLOBAL COMPUTER NETWORK, IN CLASS 42 (U.S. CLS. 100 AND 101).

FIRST USE 6-1-2011; IN COMMERCE 6-1-2011.

THE MARK CONSISTS OF STANDARD CHARACTERS WITHOUT CLAIM TO ANY PARTICULAR FONT, STYLE, SIZE, OR COLOR.

NO CLAIM IS MADE TO THE EXCLUSIVE RIGHT TO USE "LEGAL", APART FROM THE MARK AS SHOWN.

SER. NO. 85-350,450, FILED 6-20-2011.

SARA BENJAMIN, EXAMINING ATTORNEY



*David J. Kybas*

Director of the United States Patent and Trademark Office

# United States of America

United States Patent and Trademark Office



**Reg. No. 4,196,877**

PEORIA CHARTER SCHOOL INITIATIVE CO., NFP (ILLINOIS CORPORATION)  
100 SW WATER STREET  
PEORIA, IL 61602

**Registered Aug. 28, 2012**

**Int. Cl.: 41**

FOR: EDUCATIONAL SERVICES, NAMELY, CHARTER SCHOOLS PROVIDING A COLLEGE PREPARATORY CURRICULUM WITH AN EMPHASIS IN MATH, SCIENCE, TECHNOLOGY, AND COMMUNITY INVOLVEMENT, IN CLASS 41 (U.S. CLS. 100, 101 AND 107).

**SERVICE MARK**

FIRST USE 4-22-2010; IN COMMERCE 4-22-2010.

**PRINCIPAL REGISTER**

NO CLAIM IS MADE TO THE EXCLUSIVE RIGHT TO USE "CHARTER ACADEMY", APART FROM THE MARK AS SHOWN.

THE MARK CONSISTS OF THE WORD "QUEST" WITH RAYS FROM THE SUN RADIATING FROM THE UPPER THIRD OF "Q" AND THE WORDS CHARTER ACADEMY NEXT TO IT.

SER. NO. 85-350,584, FILED 6-20-2011.

JEAN IM, EXAMINING ATTORNEY



*David J. Kybas*

Director of the United States Patent and Trademark Office

# United States of America

United States Patent and Trademark Office

## PURE WINE CAFE

**Reg. No. 4,196,878**

**Registered Aug. 28, 2012**

**Int. Cl.: 43**

**SERVICE MARK**

**PRINCIPAL REGISTER**

VIN REGIUM LLC (MARYLAND LIMITED LIABILITY COMPANY)  
6680 GUILFORD ROAD  
CLARKSVILLE, MD 21029

FOR: RESTAURANT AND BAR SERVICES, IN CLASS 43 (U.S. CLS. 100 AND 101).

FIRST USE 5-25-2009; IN COMMERCE 5-25-2009.

THE MARK CONSISTS OF STANDARD CHARACTERS WITHOUT CLAIM TO ANY PARTICULAR FONT, STYLE, SIZE, OR COLOR.

NO CLAIM IS MADE TO THE EXCLUSIVE RIGHT TO USE "WINE CAFE", APART FROM THE MARK AS SHOWN.

SER. NO. 85-350,685, FILED 6-20-2011.

NELSON SNYDER, EXAMINING ATTORNEY



*David J. Kyffers*

Director of the United States Patent and Trademark Office

# United States of America

United States Patent and Trademark Office

## ADVANTA-STAR AUTOMOTIVE RESEARCH

**Reg. No. 4,196,879**

**Registered Aug. 28, 2012**

**Int. Cls.: 9, 16 and 35**

**TRADEMARK**

**SERVICE MARK**

**PRINCIPAL REGISTER**

ADVANTA-STAR AUTOMOTIVE RESEARCH CORPORATION OF AMERICA (LOUISIANA CORPORATION)  
83337 SHEPHERD LANE  
FOLSOM, LA 70437

FOR: SOFTWARE USED TO PROVIDE INFORMATION ABOUT NEW CARS AND TRUCKS AND THE BENEFITS OF A PARTICULAR AUTOMOBILE, IN CLASS 9 (U.S. CLS. 21, 23, 26, 36 AND 38).

FIRST USE 11-16-1999; IN COMMERCE 11-16-1999.

FOR: BOOKS IN THE FIELD OF NEW CAR AND TRUCK COMPARISON TO SHOW BENEFITS OF A PARTICULAR LINE OF AUTOMOBILE, IN CLASS 16 (U.S. CLS. 2, 5, 22, 23, 29, 37, 38 AND 50).

FIRST USE 11-11-1991; IN COMMERCE 11-11-1991.

FOR: PROVIDING PURCHASING INFORMATION IN THE FIELD OF NEW CARS AND TRUCKS TO SHOW THE BENEFITS OF A PARTICULAR LINE OF AUTOMOBILE VIA WEB-SITES ON THE INTERNET, IN CLASS 35 (U.S. CLS. 100, 101 AND 102).

FIRST USE 1-1-1999; IN COMMERCE 1-1-1999.

THE MARK CONSISTS OF STANDARD CHARACTERS WITHOUT CLAIM TO ANY PARTICULAR FONT, STYLE, SIZE, OR COLOR.

NO CLAIM IS MADE TO THE EXCLUSIVE RIGHT TO USE "AUTOMOTIVE RESEARCH", APART FROM THE MARK AS SHOWN.

SER. NO. 85-350,795, FILED 6-20-2011.

SHANNON TWOHIG, EXAMINING ATTORNEY



*David J. Kyffers*

Director of the United States Patent and Trademark Office

# United States of America

United States Patent and Trademark Office

A V M A



P L I T

**Reg. No. 4,196,880**

**Registered Aug. 28, 2012**

**Int. Cl.: 36**

**SERVICE MARK**

**PRINCIPAL REGISTER**

AMERICAN VETERINARY MEDICAL ASSOCIATION (ILLINOIS NOT-FOR-PROFIT CORPORATION)  
1931 NORTH MEACHAM ROAD, SUITE 100  
SCHAMBURG, IL 60173

FOR: ADMINISTRATION OF A MEMBER TRUST TO PROVIDE INSURANCE FOR VETERINARY PROFESSIONAL LIABILITY, DIRECTORS AND OFFICERS LIABILITY, EMPLOYMENT PRACTICES LIABILITY, BUSINESS PROPERTY AND GENERAL LIABILITY, STUDENT LIABILITY, WORKERS' COMPENSATION, AND FLOOD COVERAGE, IN CLASS 36 (U.S. CLS. 100, 101 AND 102).

FIRST USE 0-0-1962; IN COMMERCE 0-0-1962.

OWNER OF U.S. REG. NOS. 1,708,125, 1,820,664 AND OTHERS.

THE MARK CONSISTS OF "AVMA" ON TOP OF THE IMAGE WITH "PLIT" ON THE BOTTOM OF THE IMAGE. IN THE MIDDLE OF THE IMAGE IS A SERPENT WRAPPED AROUND A STAFF AND THE LETTER "V" ENCASED INSIDE OF A CIRCLE WHICH IS INSIDE A SHADED SQUARE. THERE ARE STRAIGHT HORIZONTAL LINES ABOVE AND BELOW THE DESIGN ELEMENT.

SER. NO. 85-350,828, FILED 6-20-2011.

AMY HELLA, EXAMINING ATTORNEY



*David J. Kyjars*

Director of the United States Patent and Trademark Office



# United States of America

United States Patent and Trademark Office



**Reg. No. 4,196,881**

**Registered Aug. 28, 2012**

**Int. Cl.: 29**

**TRADEMARK**

**PRINCIPAL REGISTER**

SOY INVESTORS II, L.L.C. (IOWA LIMITED LIABILITY COMPANY)  
1210 NORTH 14TH STREET  
INDIANOLA, IA 50125

FOR: SOY PROTEIN FOR USE AS A FOOD ADDITIVE, IN CLASS 29 (U.S. CL. 46).

FIRST USE 5-16-2011; IN COMMERCE 5-16-2011.

OWNER OF U.S. REG. NOS. 3,840,925, 3,849,806, AND 3,999,721.

THE MARK CONSISTS OF THE FOLLOWING: THE WORD 'HI' SURROUNDED DIAGONALLY BY AN OVAL WITH A LEAF AT THE TOP RIGHT PORTION OF THE OVAL, FOLLOWED BY THE TERM EGGOUT, THE "O" OF WHICH IS REPLACED BY A "NO" SYMBOL CONSISTING OF A CIRCLE AND AN INTERIOR DIAGONAL LINE RUNNING FROM THE INTERIOR TOP LEFT OF THE "O" TO THE INTERIOR BOTTOM RIGHT OF THE "O", AND WITH AN EGG IN THE CENTER OF THE "O", OF WHICH THE INTERIOR DIAGONAL LINE CROSSES.

SER. NO. 85-350,912, FILED 6-20-2011.

MAYUR VAGHANI, EXAMINING ATTORNEY



*David J. Kybas*

Director of the United States Patent and Trademark Office

# United States of America

United States Patent and Trademark Office



**TRUTH**CENTER

**Reg. No. 4,196,882**

**Registered Aug. 28, 2012**

**Int. Cls.: 16, 41 and 45**

**TRADEMARK**

**SERVICE MARK**

**PRINCIPAL REGISTER**

TRUTH CENTER (NEW YORK CORPORATION)  
P.O. BOX 477  
ROSLYN HEIGHTS, NY 11577

FOR: EDUCATIONAL PUBLICATIONS, NAMELY, PRINTED PAMPHLETS, EVENT PROGRAMS, STUDY GUIDES, BOOKS AND HANDBOOKS IN THE FIELD OF CHRISTIANITY AND BIBLE STUDY, IN CLASS 16 (U.S. CLS. 2, 5, 22, 23, 29, 37, 38 AND 50).

FIRST USE 6-13-2011; IN COMMERCE 6-13-2011.

FOR: EDUCATIONAL SERVICES, NAMELY, SEMINARS, WORKSHOPS, LECTURES AND RELIGIOUS INSTRUCTION SERVICES IN THE FIELD OF CHRISTIANITY AND BIBLE STUDY; PROVIDING AN INTERACTIVE WEBSITE FEATURING INFORMATION AND LINKS RELATING TO RELIGIOUS EDUCATION, NAMELY, BIBLE STUDY, IN CLASS 41 (U.S. CLS. 100, 101 AND 107).

FIRST USE 6-13-2011; IN COMMERCE 6-13-2011.

FOR: CHRISTIAN MINISTRY SERVICES, NAMELY, PREACHING, PROVIDING BIBLE BASED SERMONS, CONDUCTING REVIVAL MEETINGS AND CONDUCTING CHURCH SERVICES; PROVIDING AN INTERACTIVE WEBSITE FEATURING INFORMATION AND LINKS RELATING TO RELIGION, NAMELY, CHRISTIANITY AND THE BIBLE, IN CLASS 45 (U.S. CLS. 100 AND 101).

FIRST USE 6-13-2011; IN COMMERCE 6-13-2011.

NO CLAIM IS MADE TO THE EXCLUSIVE RIGHT TO USE "CENTER", APART FROM THE MARK AS SHOWN.

THE MARK CONSISTS OF THE WORDS "TRUTH CENTER" IN SPECIAL FORM WITH A GLOBE WITH A SUPERIMPOSED CROSS AND HORIZONTAL AND VERTICAL BANDS.

SER. NO. 85-351,072, FILED 6-20-2011.

STEVEN PEREZ, EXAMINING ATTORNEY

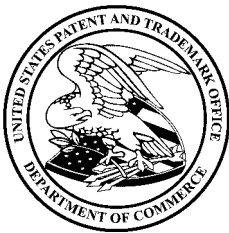

*David J. Kybas*

Director of the United States Patent and Trademark Office

# United States of America

United States Patent and Trademark Office

## FLEETHANDLER

**Reg. No. 4,196,883**

**Registered Aug. 28, 2012**

**Int. Cls.: 35 and 36**

**SERVICE MARK**

**PRINCIPAL REGISTER**

SEARS BRANDS, LLC (ILLINOIS LIMITED LIABILITY COMPANY)  
3333 BEVERLY DRIVE  
HOFFMAN ESTATES, IL 60179

FOR: FLEET MANAGEMENT SERVICES, NAMELY, MANAGING, TRACKING, ANALYZING, CONTROLLING AND REPORTING FLEET FUEL AND MAINTENANCE COSTS FOR OTHERS , IN CLASS 35 (U.S. CLS. 100, 101 AND 102).

FIRST USE 6-0-2009; IN COMMERCE 6-0-2009.

FOR: CREDIT CARD SERVICES, IN CLASS 36 (U.S. CLS. 100, 101 AND 102).

FIRST USE 6-0-2009; IN COMMERCE 6-0-2009.

THE MARK CONSISTS OF STANDARD CHARACTERS WITHOUT CLAIM TO ANY PARTICULAR FONT, STYLE, SIZE, OR COLOR.

OWNER OF U.S. REG. NO. 3,998,531.

SER. NO. 85-351,301, FILED 6-21-2011.

KHANH LE, EXAMINING ATTORNEY



*David J. Kyffers*

Director of the United States Patent and Trademark Office

# United States of America

United States Patent and Trademark Office

# PUREfrex

**Reg. No. 4,196,884**

**Registered Aug. 28, 2012**

**Int. Cls.: 1 and 42**

**TRADEMARK**

**SERVICE MARK**

**PRINCIPAL REGISTER**

GENEFONTIER CORPORATION (JAPAN CORPORATION)  
RM#308, 5-4-19, KASHIWA-NO-HA  
TODAI-KASHIWA VENTURE PLAZA  
KASHIWA-SHI, CHIBA, JAPAN 277-0882

FOR: PROTEINS FOR SCIENTIFIC OR MEDICAL RESEARCH; REAGENTS FOR USE IN MANUFACTURE, SEPARATION, DETECTION, MEASUREMENT, IDENTIFICATION OR ANALYSIS OF PROTEINS FOR SCIENTIFIC OR MEDICAL RESEARCH; CHEMICALS FOR SCIENTIFIC OR MEDICAL RESEARCH, IN CLASS 1 (U.S. CLS. 1, 5, 6, 10, 26 AND 46).

FOR: TESTING OR RESEARCH IN THE FIELD OF GENETIC OR PROTEIN ENGINEERING; TESTING OR RESEARCH ON BIOTECHNOLOGY AND ADVICE RELATING THERETO; TESTING, INSPECTION OR RESEARCH OF PHARMACEUTICALS, COSMETICS OR FOODSTUFF, IN CLASS 42 (U.S. CLS. 100 AND 101).

THE MARK CONSISTS OF STANDARD CHARACTERS WITHOUT CLAIM TO ANY PARTICULAR FONT, STYLE, SIZE, OR COLOR.

PRIORITY CLAIMED UNDER SEC. 44(D) ON JAPAN APPLICATION NO. 2011-028501, FILED 4-22-2011, REG. NO. 5443077, DATED 11-7-2011, EXPIRES 11-7-2021.

SER. NO. 85-351,327, FILED 6-21-2011.

SUNG IN, EXAMINING ATTORNEY



*David J. Kypos*

Director of the United States Patent and Trademark Office

# United States of America

United States Patent and Trademark Office

# ELUSIV

**Reg. No. 4,196,885**

**Registered Aug. 28, 2012**

**Int. Cl.: 9**

**TRADEMARK**

**PRINCIPAL REGISTER**

NTREPID CORPORATION (FLORIDA CORPORATION)  
SUITE 800  
12801 WORLDGATE DRIVE  
HERNDON, VA 20170

FOR: MODULAR ELECTRONIC SENSING AND SECURITY DEVICES, NAMELY, COMPUTER HARDWARE AND SOFTWARE FOR USE TO CONTROL AND ENABLE SENSING, COLLECTION OF INFORMATION AND COMMUNICATION OF THE DEVICE'S LOCATION, MOTION, EXPOSURE TO LIGHT AND OTHER ENVIRONMENTAL CONDITION CHANGES; COMPUTER HARDWARE FOR WIRELESS TRACKING AND GEOGRAPHIC LOCATING, NAMELY, MICROPROCESSORS, POWER CONDITIONING MODULES RADIO FREQUENCY TRANSCEIVERS, LIGHT SENSORS, MOTION SENSORS AND ADDITIONAL ELECTROMECHANICAL ENVIRONMENTAL SENSORS AND ELECTRONIC SWITCHING COMPONENTS, IN CLASS 9 (U.S. CLS. 21, 23, 26, 36 AND 38).

FIRST USE 12-0-2009; IN COMMERCE 12-0-2009.

THE MARK CONSISTS OF STANDARD CHARACTERS WITHOUT CLAIM TO ANY PARTICULAR FONT, STYLE, SIZE, OR COLOR.

SER. NO. 85-351,419, FILED 6-21-2011.

RUDY R. SINGLETON, EXAMINING ATTORNEY



*David J. Kyros*

Director of the United States Patent and Trademark Office

# United States of America

United States Patent and Trademark Office

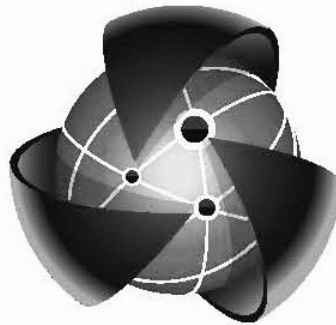

**Reg. No. 4,196,886**

**Registered Aug. 28, 2012**

**Int. Cl.: 9**

**TRADEMARK**

**PRINCIPAL REGISTER**

NTREPID CORPORATION (FLORIDA CORPORATION)  
SUITE 800  
12801 WORLDGATE DRIVE  
HERNDON, VA 20170

FOR: MODULAR ELECTRONIC SENSING AND SECURITY DEVICES, NAMELY, COMPUTER HARDWARE AND SOFTWARE FOR USE TO CONTROL AND ENABLE SENSING, COLLECTION OF INFORMATION AND COMMUNICATION OF THE DEVICE'S LOCATION, MOTION, EXPOSURE TO LIGHT AND OTHER ENVIRONMENTAL CONDITION CHANGES; COMPUTER HARDWARE FOR WIRELESS TRACKING AND GEOGRAPHIC LOCATING, NAMELY, MICROPROCESSORS, POWER CONDITIONING MODULES RADIO FREQUENCY TRANSCEIVERS, LIGHT SENSORS, MOTION SENSORS AND ADDITIONAL ELECTROMECHANICAL ENVIRONMENTAL SENSORS AND ELECTRONIC SWITCHING COMPONENTS, IN CLASS 9 (U.S. CLS. 21, 23, 26, 36 AND 38).

FIRST USE 12-0-2009; IN COMMERCE 12-0-2009.

THE MARK CONSISTS OF A SPHERE DISPOSED WITHIN A 3-SEGMENT PARTIAL COVER. ON THE SURFACE OF THE SPHERE ARE MERIDIANS AND PARALLELS, WITH THREE CIRCLES AT THREE INTERSECTS OF THE MERIDIANS AND PARALLELS.

SER. NO. 85-351,425, FILED 6-21-2011.

RUDY R. SINGLETON, EXAMINING ATTORNEY



*David J. Kybas*

Director of the United States Patent and Trademark Office

# United States of America

United States Patent and Trademark Office

## LOYAL SCOT

**Reg. No. 4,196,887**

CARNEGIE MELLON UNIVERSITY (PENNSYLVANIA NON-PROFIT CORPORATION)  
5000 FORBES AVENUE  
PITTSBURGH, PA 15213

**Registered Aug. 28, 2012**

**Int. Cls.: 35 and 36**

FOR: ADVERTISING AND PUBLICITY SERVICES, IN CLASS 35 (U.S. CLS. 100, 101 AND 102).

**SERVICE MARK**

FIRST USE 5-1-2010; IN COMMERCE 5-1-2010.

**PRINCIPAL REGISTER**

FOR: CHARITABLE FUNDRAISING SERVICES TO SUPPORT THE INTERESTS OF THE UNIVERSITY, ITS STUDENTS, AND ITS ALUMNI, IN CLASS 36 (U.S. CLS. 100, 101 AND 102).

FIRST USE 5-1-2010; IN COMMERCE 5-1-2010.

THE MARK CONSISTS OF STANDARD CHARACTERS WITHOUT CLAIM TO ANY PARTICULAR FONT, STYLE, SIZE, OR COLOR.

SER. NO. 85-351,568, FILED 6-21-2011.

JOHN DWYER, EXAMINING ATTORNEY



*David J. Kybas*

Director of the United States Patent and Trademark Office

# United States of America

United States Patent and Trademark Office

## SENSE OF SECURITY

**Reg. No. 4,196,888**

SENSE OF SECURITY, INC. (COLORADO CORPORATION)  
3450 WEST 32ND AVENUE  
DENVER, CO 80211

**Registered Aug. 28, 2012**

**Int. Cl.: 36**

FOR: CHARITABLE SERVICES, NAMELY, SOLICITING, PROCURING, ACCEPTING, MANAGING, COORDINATING, ADMINISTERING AND DISTRIBUTING CHARITABLE FINANCIAL DONATIONS TO ASSIST CANCER PATIENTS WITH EXPENSES, IN CLASS 36 (U.S. CLS. 100, 101 AND 102).

**SERVICE MARK**

**PRINCIPAL REGISTER**

FIRST USE 3-15-2000; IN COMMERCE 3-15-2000.

THE MARK CONSISTS OF STANDARD CHARACTERS WITHOUT CLAIM TO ANY PARTICULAR FONT, STYLE, SIZE, OR COLOR.

SER. NO. 85-351,666, FILED 6-21-2011.

ANGELA DUONG, EXAMINING ATTORNEY



*David J. Kyjars*

Director of the United States Patent and Trademark Office



# United States of America

United States Patent and Trademark Office

## GREENGUARD

**Reg. No. 4,196,889**

KASON INDUSTRIES, INC. (NEW YORK CORPORATION)  
57 AMLAJACK BOULEVARD  
SHENANDOAH, GA 30265

**Registered Aug. 28, 2012**

**Int. Cls.: 6, 7, 9, 11 and 19**

FOR: METAL WALL VENTS FOR PRESSURE RELIEF OF REFRIGERATED COLD ROOMS; METAL HINGES; METAL DOOR HARDWARE, NAMELY, NON-POWERED METAL DOOR CLOSERS, IN CLASS 6 (U.S. CLS. 2, 12, 13, 14, 23, 25 AND 50).

**TRADEMARK**

FIRST USE 5-24-2011; IN COMMERCE 5-24-2011.

**PRINCIPAL REGISTER**

FOR: HYDRAULIC DOOR CLOSERS OF METAL, IN CLASS 7 (U.S. CLS. 13, 19, 21, 23, 31, 34 AND 35).

FIRST USE 5-24-2011; IN COMMERCE 5-24-2011.

FOR: ENVIRONMENTALLY FRIENDLY CLIMATE CONTROL SYSTEMS CONSISTING OF THERMOSTATS, AIR CONDITIONING AND VENTILATION CONTROLS; AN ELECTRONIC APPARATUS, NAMELY, MOTION DETECTORS, IN CLASS 9 (U.S. CLS. 21, 23, 26, 36 AND 38).

FIRST USE 5-24-2011; IN COMMERCE 5-24-2011.

FOR: ENVIRONMENTALLY FRIENDLY ELECTRIC LIGHTING FIXTURES, IN CLASS 11 (U.S. CLS. 13, 21, 23, 31 AND 34).

FIRST USE 5-0-2007; IN COMMERCE 5-0-2007.

FOR: NON-METAL CURTAIN WALLS, NAMELY, FLEXIBLE PLASTIC CURTAIN WALLS TO DIVIDE, ENCLOSE AND CONTAIN ROOMS, IN CLASS 19 (U.S. CLS. 1, 12, 33 AND 50).

FIRST USE 5-24-2011; IN COMMERCE 5-24-2011.

THE MARK CONSISTS OF STANDARD CHARACTERS WITHOUT CLAIM TO ANY PARTICULAR FONT, STYLE, SIZE, OR COLOR.

SER. NO. 85-351,935, FILED 6-21-2011.



*David J. Kyros*

Director of the United States Patent and Trademark Office

**Reg. No. 4,196,889** CYNTHIA TRIPI, EXAMINING ATTORNEY

# United States of America

United States Patent and Trademark Office

ALLPACKFULFILLMENT.COM

**Reg. No. 4,196,890**

**Registered Aug. 28, 2012**

**Int. Cl.: 35**

**SERVICE MARK**

**PRINCIPAL REGISTER**

ALLPACK ASSEMBLY, INC. (NORTH CAROLINA CORPORATION), DBA  
ALLPACKFULLFILMENT.COM  
1604 EAST LAWSON STREET  
DURHAM, NC 27703

FOR: PROVIDING ORDER FULFILLMENT; PROVIDING ORDER MANAGEMENT, NAMELY,  
ELECTRONIC PROCESSING OF ORDERS FOR OTHERS; INVENTORY MANAGEMENT ,  
IN CLASS 35 (U.S. CLS. 100, 101 AND 102).

FIRST USE 9-15-2008; IN COMMERCE 9-15-2008.

THE MARK CONSISTS OF STANDARD CHARACTERS WITHOUT CLAIM TO ANY PAR-  
TICULAR FONT, STYLE, SIZE, OR COLOR.

SER. NO. 85-352,056, FILED 6-21-2011.

JENNIFER WILLISTON, EXAMINING ATTORNEY



*David J. Kybas*

Director of the United States Patent and Trademark Office

# United States of America

United States Patent and Trademark Office

# Maca Extreme

**Reg. No. 4,196,891**

SUNFOOD, LLC (DELAWARE LIMITED LIABILITY COMPANY)  
16192 COASTAL HIGHWAY  
LEWES, DE 19958

**Registered Aug. 28, 2012**

**Int. Cl.: 5**

FOR: DIETARY SUPPLEMENTS CONTAINING MACA, IN CLASS 5 (U.S. CLS. 6, 18, 44, 46, 51 AND 52).

**TRADEMARK**

FIRST USE 12-28-2004; IN COMMERCE 12-28-2004.

**PRINCIPAL REGISTER**

THE MARK CONSISTS OF STANDARD CHARACTERS WITHOUT CLAIM TO ANY PARTICULAR FONT, STYLE, SIZE, OR COLOR.

NO CLAIM IS MADE TO THE EXCLUSIVE RIGHT TO USE "MACA", APART FROM THE MARK AS SHOWN.

SER. NO. 85-352,228, FILED 6-21-2011.

JOSETTE BEVERLY, EXAMINING ATTORNEY



*David J. Kybas*

Director of the United States Patent and Trademark Office

# United States of America

United States Patent and Trademark Office

# D.Rec.or.d

**Reg. No. 4,196,892**

RECORD, DERRELL W (UNITED STATES INDIVIDUAL)  
PO BOX 93142  
LOS ANGELES, CA 90093

**Registered Aug. 28, 2012**

**Int. Cl.: 9**

FOR: DOWNLOADABLE MUSICAL SOUND RECORDINGS; MUSICAL RECORDINGS;  
MUSICAL SOUND RECORDINGS; SERIES OF MUSICAL SOUND RECORDINGS, IN CLASS  
9 (U.S. CLS. 21, 23, 26, 36 AND 38).

**TRADEMARK**

FIRST USE 0-0-2009; IN COMMERCE 0-0-2009.

**PRINCIPAL REGISTER**

THE MARK CONSISTS OF STANDARD CHARACTERS WITHOUT CLAIM TO ANY PAR-  
TICULAR FONT, STYLE, SIZE, OR COLOR.

THE NAME(S), PORTRAIT(S), AND/OR SIGNATURE(S) SHOWN IN THE MARK IDENTIFIES  
THE STAGE NAME OF DERRELL W RECORD, WHOSE CONSENT(S) TO REGISTER IS  
MADE OF RECORD.

SER. NO. 85-352,383, FILED 6-22-2011.

ROSELLE HERRERA, EXAMINING ATTORNEY



*David J. Kyffers*

Director of the United States Patent and Trademark Office

# United States of America

United States Patent and Trademark Office

# STEILMANN

**Reg. No. 4,196,893**

**Registered Aug. 28, 2012**

**Int. Cl.: 25**

**TRADEMARK**

**PRINCIPAL REGISTER**

KLAUS STEILMANN GMBH & CO. KG (FED REP GERMANY LIMITED PARTNERSHIP)  
INDUSTRIESTRASSE 42  
BERGKAMEN, FED REP GERMANY 59192

FOR: CLOTHING, NAMELY, COATS, SUITS, JACKETS, SKIRTS, PANTS, BLOUSES, SHIRTS, SWEATERS AND UNDERWEAR FOR MEN, WOMEN AND CHILDREN FOR ORDINARY AND SPORTS-RELATED ACTIVITIES; FOOTWEAR; BOOTS, SNEAKERS, LOAFERS, SHOES, SPECIAL SPORTS-SHOES, SANDALS AND SLIPPERS, IN CLASS 25 (U.S. CLS. 22 AND 39).

FIRST USE 8-0-1984; IN COMMERCE 8-0-1984.

THE MARK CONSISTS OF STANDARD CHARACTERS WITHOUT CLAIM TO ANY PARTICULAR FONT, STYLE, SIZE, OR COLOR.

SEC. 2(F).

SER. NO. 85-352,545, FILED 6-22-2011.

KRISTIN DAHLING, EXAMINING ATTORNEY



*David J. Kyffers*

Director of the United States Patent and Trademark Office

# United States of America

United States Patent and Trademark Office

# RESAGEN

**Reg. No. 4,196,894**

**Registered Aug. 28, 2012**

**Int. Cl.: 5**

**TRADEMARK**

**PRINCIPAL REGISTER**

UNIVERSITY OF SHEFFIELD (UNITED KINGDOM CORPORATION)  
FIRTH COURT, WESTERN BANK  
SHEFFIELD, UNITED KINGDOM S102TN

FOR: PHARMACEUTICAL PREPARATIONS FOR THE TREATMENT OF TYPE I, TYPE II, AND TYPE III SPINAL MUSCULAR ATROPHY; SANITARY PREPARATIONS FOR MEDICAL PURPOSES; DIETETIC FOODS ADAPTED FOR MEDICAL USE, FOOD FOR BABIES; MEDICAL PLASTERS, GAUZE FOR DRESSINGS; MATERIAL FOR STOPPING TEETH, DENTAL WAX; ALL PURPOSE DISINFECTANTS; PREPARATIONS FOR DESTROYING VERMIN; FUNGICIDES, HERBICIDES, IN CLASS 5 (U.S. CLS. 6, 18, 44, 46, 51 AND 52).

THE MARK CONSISTS OF STANDARD CHARACTERS WITHOUT CLAIM TO ANY PARTICULAR FONT, STYLE, SIZE, OR COLOR.

PRIORITY CLAIMED UNDER SEC. 44(D) ON UNITED KINGDOM APPLICATION NO. 009695271, FILED 1-28-2011, REG. NO. 009695271, DATED 6-9-2011, EXPIRES 1-28-2021.

SER. NO. 85-352,697, FILED 6-22-2011.

TEJBIR SINGH, EXAMINING ATTORNEY



*David J. Kyffers*

Director of the United States Patent and Trademark Office

# United States of America

United States Patent and Trademark Office



Children's  
of Alabama

**Reg. No. 4,196,895**

**Registered Aug. 28, 2012**

**Int. Cls.: 36, 41 and 44**

**SERVICE MARK**

**PRINCIPAL REGISTER**

THE CHILDREN'S HOSPITAL OF ALABAMA (ALABAMA CORPORATION)  
1600 - 7TH AVENUE SOUTH  
BIRMINGHAM, AL 35233

FOR: CHARITABLE FUNDRAISING SERVICES FOR THE MEDICAL CARE AND HOSPITAL CARE OF CHILDREN, IN CLASS 36 (U.S. CLS. 100, 101 AND 102).

FIRST USE 6-20-2011; IN COMMERCE 6-20-2011.

FOR: EDUCATIONAL SERVICES, NAMELY, CONDUCTING PEDIATRIC SURGICAL SEMINARS AND CLASSES INTO MEDICAL RESIDENCY PROGRAMS IN THE FIELD OF PEDIATRIC HEALTHCARE, IN CLASS 41 (U.S. CLS. 100, 101 AND 107).

FIRST USE 6-20-2011; IN COMMERCE 6-20-2011.

FOR: HEALTH CARE SERVICES AND HOSPITAL SERVICES, IN CLASS 44 (U.S. CLS. 100 AND 101).

FIRST USE 6-20-2011; IN COMMERCE 6-20-2011.

OWNER OF U.S. REG. NOS. 2,177,980 AND 2,181,916.

NO CLAIM IS MADE TO THE EXCLUSIVE RIGHT TO USE "CHILDREN'S OF ALABAMA", APART FROM THE MARK AS SHOWN.

THE MARK CONSISTS OF THE WORDING "CHILDREN'S OF ALABAMA" BELOW A CIRCLE DEVICE CONTAINING A SILHOUETTE IMAGE OF TWO CHILDREN.

SER. NO. 85-352,765, FILED 6-22-2011.

MICHELLE DUBOIS, EXAMINING ATTORNEY



*David J. Kyjars*

Director of the United States Patent and Trademark Office



United States of America  
United States Patent and Trademark Office

RYQUIN

**Reg. No. 4,196,896**

MCLAUGHLIN, TASHA E. (CALIFORNIA SOLE PROPRIETORSHIP), DBA RYQUIN  
26 PADDLE COURT  
SACRAMENTO, CA 95833

**Registered Aug. 28, 2012**

**Int. Cl.: 41**

FOR: ENCOURAGING AMATEUR SPORTS AND PHYSICAL EDUCATION BY ORGANIZING, SANCTIONING, CONDUCTING, REGULATING AND GOVERNING AMATEUR ATHLETIC PROGRAMS AND ACTIVITIES WITH THE FOCUS IN LACROSSE, IN CLASS 41 (U.S. CLS. 100, 101 AND 107).

**SERVICE MARK**

**PRINCIPAL REGISTER**

FIRST USE 7-18-2009; IN COMMERCE 9-11-2009.

THE MARK CONSISTS OF STANDARD CHARACTERS WITHOUT CLAIM TO ANY PARTICULAR FONT, STYLE, SIZE, OR COLOR.

SER. NO. 85-352,864, FILED 6-22-2011.

KAREN BRACEY, EXAMINING ATTORNEY



*David J. Kyffers*

Director of the United States Patent and Trademark Office

# United States of America

United States Patent and Trademark Office

## The Urban Alternative

**Reg. No. 4,196,897**

**Registered Aug. 28, 2012**

**Int. Cls.: 9, 16, 35, 41  
and 45**

**TRADEMARK**

**SERVICE MARK**

**PRINCIPAL REGISTER**

THE URBAN ALTERNATIVE (TEXAS CORPORATION)  
C/O JOY GLOVER  
P.O. BOX 4000  
DALLAS, TX 75208

FOR: COMPUTER APPLICATION SOFTWARE FOR MOBILE PHONES, PORTABLE MEDIA PLAYERS, HANDHELD COMPUTERS, COMPUTER TABLETS, NAMELY, SOFTWARE FOR USE IN THE TRANSMISSION AND SHARING OF DATA, CONTENT AND INFORMATION IN THE FIELDS OF RELIGION, CHRISTIAN LIFESTYLE MESSAGES, CHRISTIAN FAMILY VALUES, LEADERSHIP TRAINING, SPIRITUAL GROWTH, YOUTH DEVELOPMENT, ACADEMIC MENTORING, COMMUNITY OUTREACH AND MINISTRY DEVELOPMENT; DIGITAL MEDIA, NAMELY, PRE-RECORDED AUDIO CASSETTES AND VIDEO TAPES, CDS, DVDS, AND DOWNLOADABLE AUDIO AND VIDEO RECORDINGS FEATURING RELIGION, CHRISTIAN LIFESTYLE MESSAGES, CHRISTIAN FAMILY VALUES, LEADERSHIP TRAINING, SPIRITUAL GROWTH, YOUTH DEVELOPMENT, ACADEMIC MENTORING, COMMUNITY OUTREACH AND MINISTRY DEVELOPMENT, IN CLASS 9 (U.S. CLS. 21, 23, 26, 36 AND 38).

FIRST USE 12-31-1981; IN COMMERCE 12-31-1981.

FOR: PRINTED INSTRUCTIONAL, EDUCATIONAL, AND TEACHING MATERIALS IN THE FIELD OF RELIGION, CHRISTIAN LIFESTYLES, CHRISTIAN FAMILY VALUES, LEADERSHIP TRAINING, SPIRITUAL GROWTH, YOUTH DEVELOPMENT, ACADEMIC MENTORING, COMMUNITY OUTREACH AND MINISTRY DEVELOPMENT; PRINTED PAMPHLETS, BROCHURES, MANUALS, BOOKS, BOOKLETS, LEAFLETS, FLYERS, INFORMATIONAL SHEETS AND NEWSLETTERS, ADHESIVE BACKED STICKERS, AND KITS COMPRISING ONE OR MORE OF THE FOREGOING MATERIALS IN THE FIELD OF RELIGION, CHRISTIAN LIFESTYLES, CHRISTIAN FAMILY VALUES, LEADERSHIP TRAINING, SPIRITUAL GROWTH, YOUTH DEVELOPMENT, ACADEMIC MENTORING, COMMUNITY OUTREACH AND MINISTRY DEVELOPMENT, IN CLASS 16 (U.S. CLS. 2, 5, 22, 23, 29, 37, 38 AND 50).

FIRST USE 12-31-1981; IN COMMERCE 12-31-1981.

FOR: CHARITABLE SERVICES, NAMELY, ORGANIZING AND CONDUCTING VOLUNTEER PROGRAMS AND COMMUNITY SERVICE PROJECTS, IN CLASS 35 (U.S. CLS. 100, 101 AND 102).



*David J. Kyjars*

Director of the United States Patent and Trademark Office

**Reg. No. 4,196,897** FIRST USE 12-31-1981; IN COMMERCE 12-31-1981.

FOR: CHARITABLE SERVICES, NAMELY, ACADEMIC MENTORING OF SCHOOL AGE CHILDREN; EDUCATION SERVICES, NAMELY, PROVIDING MENTORING, TUTORING, CLASSES, SEMINARS AND WORKSHOPS IN THE FIELD OF RELIGION, CHRISTIAN LIFESTYLES, CHRISTIAN FAMILY VALUES, LEADERSHIP TRAINING, SPIRITUAL GROWTH, YOUTH DEVELOPMENT, ACADEMIC MENTORING, COMMUNITY OUTREACH AND MINISTRY DEVELOPMENT; EDUCATIONAL AND ENTERTAINMENT SERVICES, NAMELY, A CONTINUING PROGRAM ABOUT RELIGION, CHRISTIAN LIFESTYLES, CHRISTIAN FAMILY VALUES, LEADERSHIP TRAINING, SPIRITUAL GROWTH, YOUTH DEVELOPMENT, ACADEMIC MENTORING, COMMUNITY OUTREACH AND MINISTRY DEVELOPMENT ACCESSIBLE BY RADIO, TELEVISION, SATELLITE, AUDIO, VIDEO AND COMPUTER NETWORKS; EDUCATIONAL SERVICES, NAMELY, CONDUCTING CLASSES, SEMINARS, CONFERENCES AND WORKSHOPS IN THE FIELD OF RELIGION, CHRISTIAN LIFESTYLES, CHRISTIAN FAMILY VALUES, LEADERSHIP TRAINING, SPIRITUAL GROWTH, YOUTH DEVELOPMENT, ACADEMIC MENTORING, COMMUNITY OUTREACH AND MINISTRY DEVELOPMENT AND DISTRIBUTION OF PRINTED MATERIALS IN CONNECTION THEREWITH IN HARD COPY OR ELECTRONIC FORMAT ON THE SAME TOPICS; PROVIDING ON-LINE RELIGIOUS INSTRUCTION PROMOTING CHRISTIAN AND FAMILY VALUES, IN CLASS 41 (U.S. CLS. 100, 101 AND 107).

FIRST USE 12-31-1981; IN COMMERCE 12-31-1981.

FOR: EVANGELISTIC AND MINISTERIAL SERVICES; PROVIDING A WEBSITE FEATURING INFORMATION FOR LOCAL CHURCH LEADERS IN THE FIELD OF CHRISTIAN GROWTH, IN CLASS 45 (U.S. CLS. 100 AND 101).

FIRST USE 12-31-1981; IN COMMERCE 12-31-1981.

THE MARK CONSISTS OF STANDARD CHARACTERS WITHOUT CLAIM TO ANY PARTICULAR FONT, STYLE, SIZE, OR COLOR.

SER. NO. 85-353,521, FILED 6-22-2011.

BRENDAN REGAN, EXAMINING ATTORNEY

# United States of America

United States Patent and Trademark Office

## Waves Plugins

**Reg. No. 4,196,898**

**Registered Aug. 28, 2012**

**Int. Cl.: 9**

**TRADEMARK**

**PRINCIPAL REGISTER**

WAVES AUDIO LTD. (ISRAEL CORPORATION)  
THE TRIANGLE TOWER  
AZRIELI CENTER 3  
TEL AVIV, ISRAEL 67023

FOR: COMPUTER SOFTWARE FOR PROCESSING DIGITAL MUSIC FILES; COMPUTER SOFTWARE FEATURING MUSICAL SOUND RECORDINGS AND MUSICAL VIDEO RECORDINGS; COMPUTER SOFTWARE FOR MANIPULATING DIGITAL AUDIO INFORMATION FOR USE IN AUDIO MEDIA APPLICATIONS; COMPUTER SOFTWARE TO ENHANCE THE AUDIO-VISUAL CAPABILITIES OF MULTIMEDIA APPLICATIONS, NAMELY, FOR THE INTEGRATION OF TEXT, AUDIO, GRAPHICS, STILL IMAGES AND MOVING PICTURES, IN CLASS 9 (U.S. CLS. 21, 23, 26, 36 AND 38).

THE MARK CONSISTS OF STANDARD CHARACTERS WITHOUT CLAIM TO ANY PARTICULAR FONT, STYLE, SIZE, OR COLOR.

PRIORITY CLAIMED UNDER SEC. 44(D) ON ISRAEL APPLICATION NO. 238538, FILED 6-22-2011, REG. NO. 238538, DATED 3-5-2012, EXPIRES 6-22-2021.

OWNER OF U.S. REG. NO. 4,020,114.

NO CLAIM IS MADE TO THE EXCLUSIVE RIGHT TO USE "PLUGINS", APART FROM THE MARK AS SHOWN.

SER. NO. 85-353,689, FILED 6-23-2011.

WARREN L. OLANDRIA, EXAMINING ATTORNEY



*David J. Kyffers*

Director of the United States Patent and Trademark Office

# United States of America

United States Patent and Trademark Office

## TOLL GREEN

**Reg. No. 4,196,899**

**Registered Aug. 28, 2012**

**Int. Cls.: 35 and 37**

**SERVICE MARK**

**PRINCIPAL REGISTER**

TB PROPRIETARY CORPORATION (DELAWARE CORPORATION)  
SUITE 1414  
1105 NORTH MARKET STREET  
WILMINGTON, DE 19801

FOR: REAL ESTATE SALES MANAGEMENT, IN CLASS 35 (U.S. CLS. 100, 101 AND 102).

FIRST USE 10-27-2010; IN COMMERCE 10-27-2010.

FOR: LAND DEVELOPMENT AND CONSTRUCTION SERVICES, NAMELY, PLANNING, LAYING OUT AND CUSTOM CONSTRUCTION OF RESIDENTIAL COMMUNITIES; CONSTRUCTION OF ENVIRONMENTALLY FRIENDLY RESIDENTIAL COMMUNITIES, IN CLASS 37 (U.S. CLS. 100, 103 AND 106).

FIRST USE 10-27-2010; IN COMMERCE 10-27-2010.

THE MARK CONSISTS OF STANDARD CHARACTERS WITHOUT CLAIM TO ANY PARTICULAR FONT, STYLE, SIZE, OR COLOR.

OWNER OF U.S. REG. NOS. 1,453,539, 3,111,105, AND 3,290,169.

NO CLAIM IS MADE TO THE EXCLUSIVE RIGHT TO USE "GREEN", APART FROM THE MARK AS SHOWN.

SER. NO. 85-353,758, FILED 6-23-2011.

CARYN GLASSER, EXAMINING ATTORNEY



*David J. Kybas*

Director of the United States Patent and Trademark Office

# United States of America

United States Patent and Trademark Office

# Toll Green

**Reg. No. 4,196,900**

**Registered Aug. 28, 2012**

**Int. Cls.: 35 and 37**

**SERVICE MARK**

**PRINCIPAL REGISTER**

TB PROPRIETARY CORPORATION (DELAWARE CORPORATION)  
SUITE 1414  
1105 NORTH MARKET STREET  
WILMINGTON, DE 19801

FOR: REAL ESTATE SALES MANAGEMENT, IN CLASS 35 (U.S. CLS. 100, 101 AND 102).

FIRST USE 10-27-2010; IN COMMERCE 10-27-2010.

FOR: LAND DEVELOPMENT AND CONSTRUCTION SERVICES, NAMELY, PLANNING, LAYING OUT AND CUSTOM CONSTRUCTION OF RESIDENTIAL COMMUNITIES; CONSTRUCTION OF ENVIRONMENTALLY FRIENDLY RESIDENTIAL COMMUNITIES, IN CLASS 37 (U.S. CLS. 100, 103 AND 106).

FIRST USE 10-27-2010; IN COMMERCE 10-27-2010.

OWNER OF U.S. REG. NOS. 1,453,539, 3,111,105, AND 3,290,169.

NO CLAIM IS MADE TO THE EXCLUSIVE RIGHT TO USE "GREEN", APART FROM THE MARK AS SHOWN.

THE MARK CONSISTS OF A LEAF DESIGN BETWEEN THE TERMS "TOLL" AND "GREEN".

SER. NO. 85-353,782, FILED 6-23-2011.

CARYN GLASSER, EXAMINING ATTORNEY



*David J. Kybas*

Director of the United States Patent and Trademark Office

# United States of America

United States Patent and Trademark Office

## A BETTER WAY TO LIVE TODAY

**Reg. No. 4,196,901**

**Registered Aug. 28, 2012**

**Int. Cls.: 35 and 37**

**SERVICE MARK**

**PRINCIPAL REGISTER**

TB PROPRIETARY CORPORATION (DELAWARE CORPORATION)  
SUITE 1414  
1105 NORTH MARKET STREET  
WILMINGTON, DE 19801

FOR: REAL ESTATE SALES MANAGEMENT, IN CLASS 35 (U.S. CLS. 100, 101 AND 102).

FIRST USE 10-27-2010; IN COMMERCE 10-27-2010.

FOR: LAND DEVELOPMENT AND CONSTRUCTION SERVICES, NAMELY, PLANNING, LAYING OUT AND CUSTOM CONSTRUCTION OF RESIDENTIAL COMMUNITIES; CONSTRUCTION OF ENVIRONMENTALLY FRIENDLY RESIDENTIAL COMMUNITIES, IN CLASS 37 (U.S. CLS. 100, 103 AND 106).

FIRST USE 10-27-2010; IN COMMERCE 10-27-2010.

THE MARK CONSISTS OF STANDARD CHARACTERS WITHOUT CLAIM TO ANY PARTICULAR FONT, STYLE, SIZE, OR COLOR.

SER. NO. 85-353,800, FILED 6-23-2011.

CARYN GLASSER, EXAMINING ATTORNEY



*David J. Kyfos*

Director of the United States Patent and Trademark Office

# United States of America

United States Patent and Trademark Office



**Reg. No. 4,196,902**

**Registered Aug. 28, 2012**

**Int. Cl.: 36**

**SERVICE MARK**

**PRINCIPAL REGISTER**

UMG, LLC (OKLAHOMA LIMITED LIABILITY COMPANY)  
P.O. BOX 603  
JENKS, OK 74037

FOR: REAL ESTATE SERVICES, NAMELY, RENTAL, BROKERAGE, LEASING AND MANAGEMENT OF RESIDENTIAL PROPERTY, COMMERCIAL PROPERTY, OFFICES AND OFFICE SPACE, IN CLASS 36 (U.S. CLS. 100, 101 AND 102).

FIRST USE 6-1-2008; IN COMMERCE 6-1-2008.

NO CLAIM IS MADE TO THE EXCLUSIVE RIGHT TO USE "GROUP", APART FROM THE MARK AS SHOWN.

THE MARK CONSISTS OF THE LETTERS "U M G" BENEATH A HOUSE SHAPED DESIGN WITH THE STYLIZED TEXT "UPPER MANAGEMENT GROUP" CENTERED BENEATH THE LETTERS "U M G".

SER. NO. 85-353,954, FILED 6-23-2011.

CHARLOTTE CORWIN, EXAMINING ATTORNEY



*David J. Kyffers*

Director of the United States Patent and Trademark Office



# United States of America

United States Patent and Trademark Office

# SPLICE

**Reg. No. 4,196,903**

**Registered Aug. 28, 2012**

**Int. Cl.: 41**

**SERVICE MARK**

**PRINCIPAL REGISTER**

SPLICE HERE, INC. (MINNESOTA CORPORATION)  
7339 ONTARIO BLVD  
EDEN PRAIRIE, MN 55346

FOR: PRODUCTION OF MOVIES, MOTION PICTURE FILMS; FILM AND VIDEO PRODUCTION; VIDEO PRODUCTION, NAMELY, PRODUCING DIGITAL SIGNAGE FOR TELEVISION SHOWS, IN CLASS 41 (U.S. CLS. 100, 101 AND 107).

FIRST USE 0-0-2002; IN COMMERCE 0-0-2002.

THE MARK CONSISTS OF STANDARD CHARACTERS WITHOUT CLAIM TO ANY PARTICULAR FONT, STYLE, SIZE, OR COLOR.

SER. NO. 85-354,390, FILED 6-23-2011.

MARK SPARACINO, EXAMINING ATTORNEY



*David J. Kyffers*

Director of the United States Patent and Trademark Office

# United States of America

United States Patent and Trademark Office

b a b e t t e

**Reg. No. 4,196,904**

**Registered Aug. 28, 2012**

**Int. Cls.: 25 and 35**

**TRADEMARK**

**SERVICE MARK**

**PRINCIPAL REGISTER**

BABETTE, INC. (CALIFORNIA CORPORATION)  
867 ISABELLA STREET  
OAKLAND, CA 94607

FOR: WOMEN'S CLOTHING, NAMELY, BLOUSES, SHIRTS, TANK-TOPS, SWEATERS, TROUSERS, JEANS, PANTS, SKIRTS, DRESSES, SUITS, SCARVES, COATS, JACKETS, RAINCOATS, TEE SHIRTS, SOCKS; SHOES, IN CLASS 25 (U.S. CLS. 22 AND 39).

FIRST USE 12-31-1997; IN COMMERCE 12-31-1997.

FOR: RETAIL STORE AND DISTRIBUTORSHIP SERVICES FOR WOMEN'S CLOTHING AND ACCESSORIES, IN CLASS 35 (U.S. CLS. 100, 101 AND 102).

FIRST USE 12-31-1997; IN COMMERCE 12-31-1997.

OWNER OF U.S. REG. NOS. 2,740,006 AND 3,728,287.

THE MARK CONSISTS OF THE LITERAL ELEMENT "BABETTE" IN A STYLIZED FONT.

SER. NO. 85-354,457, FILED 6-23-2011.

TRACY CROSS, EXAMINING ATTORNEY



*David J. Kypos*

Director of the United States Patent and Trademark Office

# United States of America

United States Patent and Trademark Office



**Reg. No. 4,196,905**

**Registered Aug. 28, 2012**

**Int. Cl.: 41**

**SERVICE MARK**

**PRINCIPAL REGISTER**

ZOOLOGICAL SOCIETY OF PHILADELPHIA (PENNSYLVANIA NON-PROFIT CORPORATION)  
3400 WEST GIRARD AVENUE  
PHILADELPHIA, PA 19104

FOR: EDUCATIONAL AND ENTERTAINMENT SERVICES IN THE NATURE OF LIVE, MULTIMEDIA PERFORMANCES AND PRESENTATIONS FEATURING PUPPETS IN THE FORM OF EXTINCT AND ENDANGERED ANIMALS TELLING STORIES AND PROVIDING SUGGESTIONS ABOUT PROTECTING, PRESERVING, AND SUSTAINING ANIMAL HABITATS, IN CLASS 41 (U.S. CLS. 100, 101 AND 107).

FIRST USE 4-8-2011; IN COMMERCE 4-8-2011.

NO CLAIM IS MADE TO THE EXCLUSIVE RIGHT TO USE "EXTINCTION", APART FROM THE MARK AS SHOWN.

THE MARK CONSISTS OF THE TERM "X TINK SHUN", WITH THE "X" FORMING THE SHAPE OF AN ANIMAL'S OPEN MOUTH WITH TEETH ABOVE AND BELOW AND A NOSE AND WHISKERS ON THE UPPER PART OF THE "X". THERE IS A PAW PRINT AFTER THE "X" AND A PAW PRINT AFTER "TINK" AND THE WORDS "A WILD PUPPET XPERIENCE" WITH A CENTERED DOT BETWEEN THE "X" AND "PERIENCE".

SER. NO. 85-354,472, FILED 6-23-2011.

JOHN WILKE, EXAMINING ATTORNEY



*David J. Kyros*

Director of the United States Patent and Trademark Office

# United States of America

United States Patent and Trademark Office

## Truth from chatter

**Reg. No. 4,196,906**

RATE THE TRUTH, INC. (GEORGIA CORPORATION), DBA MOTIVIST.COM  
206 11TH STREET  
ATLANTA, GA 30309

**Registered Aug. 28, 2012**

**Int. Cl.: 35**

FOR: NEWS CLIPPING SERVICES, IN CLASS 35 (U.S. CLS. 100, 101 AND 102).

**SERVICE MARK**

FIRST USE 4-1-2009; IN COMMERCE 6-1-2009.

**PRINCIPAL REGISTER**

THE MARK CONSISTS OF STANDARD CHARACTERS WITHOUT CLAIM TO ANY PARTICULAR FONT, STYLE, SIZE, OR COLOR.

SER. NO. 85-354,496, FILED 6-23-2011.

JAMES MACFARLANE, EXAMINING ATTORNEY



*David J. Kyffers*

Director of the United States Patent and Trademark Office

United States of America  
United States Patent and Trademark Office

# AEROBOT

**Reg. No. 4,196,907**

INTELLIBOT ROBOTICS LLC (OREGON LIMITED LIABILITY COMPANY)  
1331 NORTHWEST 17TH AVENUE  
PORTLAND, OR 97209

**Registered Aug. 28, 2012**

**Int. Cl.: 7**

FOR: FLOOR MAINTENANCE MACHINES, NAMELY, VACUUM CLEANERS AND POWER-OPERATED FLOOR CLEANERS, IN CLASS 7 (U.S. CLS. 13, 19, 21, 23, 31, 34 AND 35).

**TRADEMARK**

FIRST USE 5-26-2011; IN COMMERCE 5-26-2011.

**PRINCIPAL REGISTER**

THE MARK CONSISTS OF STANDARD CHARACTERS WITHOUT CLAIM TO ANY PARTICULAR FONT, STYLE, SIZE, OR COLOR.

OWNER OF U.S. REG. NO. 3,057,794.

SER. NO. 85-354,523, FILED 6-23-2011.

SHANNON TWOHIG, EXAMINING ATTORNEY



*David J. Kybas*

Director of the United States Patent and Trademark Office

**United States of America**  
United States Patent and Trademark Office

# DUOBOT

**Reg. No. 4,196,908**

INTELLIBOT ROBOTICS LLC (OREGON LIMITED LIABILITY COMPANY)  
1331 NORTHWEST 17TH AVENUE  
PORTLAND, OR 97209

**Registered Aug. 28, 2012**

**Int. Cl.: 7**

FOR: FLOOR MAINTENANCE MACHINES, NAMELY, VACUUM CLEANERS AND POWER-OPERATED FLOOR SCRUBBERS, IN CLASS 7 (U.S. CLS. 13, 19, 21, 23, 31, 34 AND 35).

**TRADEMARK**

FIRST USE 5-26-2011; IN COMMERCE 5-26-2011.

**PRINCIPAL REGISTER**

THE MARK CONSISTS OF STANDARD CHARACTERS WITHOUT CLAIM TO ANY PARTICULAR FONT, STYLE, SIZE, OR COLOR.

OWNER OF U.S. REG. NO. 3,057,794.

SER. NO. 85-354,537, FILED 6-23-2011.

SHANNON TWOHIG, EXAMINING ATTORNEY



*David J. Kyffers*

Director of the United States Patent and Trademark Office

# United States of America

United States Patent and Trademark Office

# ServMax

**Reg. No. 4,196,909**

**Registered Aug. 28, 2012**

**Int. Cl.: 9**

**TRADEMARK**

**PRINCIPAL REGISTER**

AMAX ENGINEERING CORPORATION (CALIFORNIA CORPORATION)  
1565 RELIANCE WAY  
FREMONT, CA 94539

FOR: COMPUTER SERVERS; STORAGE COMPUTER SERVERS; COMPUTER NETWORK SERVERS; INTRANET SERVERS; NETWORK SERVERS; COMPUTER CLUSTERS COMPRISED OF COMPUTERS, LAN (LOCAL AREA NETWORK) OPERATING SOFTWARE AND LAN (LOCAL AREA NETWORK) HARDWARE; SERVER APPLIANCES, NAMELY, COMPUTER SERVERS AND COMPUTER NETWORK SERVERS; COMPUTER STORAGE APPLIANCES, NAMELY, STORAGE COMPUTER SERVERS WITH INTEGRATED STORAGE SOFTWARE AND BLANK FLASH DRIVES; COMPUTER NETWORK APPLIANCES, NAMELY, COMPUTER NETWORK SERVERS WITH INTEGRATED NETWORKING SOFTWARE, NETWORK ADAPTERS AND SWITCHES, IN CLASS 9 (U.S. CLS. 21, 23, 26, 36 AND 38).

FIRST USE 1-1-2008; IN COMMERCE 1-1-2008.

THE MARK CONSISTS OF STANDARD CHARACTERS WITHOUT CLAIM TO ANY PARTICULAR FONT, STYLE, SIZE, OR COLOR.

SER. NO. 85-354,584, FILED 6-23-2011.

NATALIE POLZER, EXAMINING ATTORNEY



*David J. Kyros*

Director of the United States Patent and Trademark Office

# United States of America

United States Patent and Trademark Office

# D.Rec.or.d

**Reg. No. 4,196,910**

RECORD, DERRELL W (UNITED STATES INDIVIDUAL)  
PO BOX 93142

**Registered Aug. 28, 2012**

LOS ANGELES, CA 90093

**Int. Cl.: 41**

FOR: ENTERTAINMENT SERVICES IN THE NATURE OF LIVE MUSICAL PERFORMANCES; ENTERTAINMENT SERVICES IN THE NATURE OF RECORDING, PRODUCTION AND POST-PRODUCTION SERVICES IN THE FIELD OF MUSIC; ENTERTAINMENT SERVICES, NAMELY, PROVIDING A WEB SITE FEATURING NON-DOWNLOADABLE MUSICAL PERFORMANCES, MUSICAL VIDEOS, RELATED FILM CLIPS, PHOTOGRAPHS, AND OTHER MULTIMEDIA MATERIALS FEATURING A MUSICAL ARTIST; MUSIC PRODUCTION SERVICES, IN CLASS 41 (U.S. CLS. 100, 101 AND 107).

**SERVICE MARK**

**PRINCIPAL REGISTER**

FIRST USE 0-0-2009; IN COMMERCE 0-0-2009.

THE MARK CONSISTS OF STANDARD CHARACTERS WITHOUT CLAIM TO ANY PARTICULAR FONT, STYLE, SIZE, OR COLOR.

THE NAME(S), PORTRAIT(S), AND/OR SIGNATURE(S) SHOWN IN THE MARK IDENTIFIES THE STAGE NAME OF DERRELL W RECORD, WHOSE CONSENT(S) TO REGISTER IS MADE OF RECORD.

SER. NO. 85-354,843, FILED 6-23-2011.

ROSELLE HERRERA, EXAMINING ATTORNEY



*David J. Kybas*

Director of the United States Patent and Trademark Office



# United States of America

United States Patent and Trademark Office

## ANCIENT TITLE STAKES

**Reg. No. 4,196,911**

OAK TREE RACING ASSOCIATION (CALIFORNIA NON-PROFIT CORPORATION)  
285 W. HUNTINGTON DRIVE  
ARCADIA, CA 91007

**Registered Aug. 28, 2012**

**Int. Cl.: 41**

FOR: ENTERTAINMENT, NAMELY, CONDUCTING HORSE RACES AND PROVIDING HORSE RACING ENTERTAINMENT INFORMATION THROUGH VARIOUS FORMS OF MEDIA, IN CLASS 41 (U.S. CLS. 100, 101 AND 107).

**SERVICE MARK**

FIRST USE 0-0-1985; IN COMMERCE 0-0-1985.

**PRINCIPAL REGISTER**

THE MARK CONSISTS OF STANDARD CHARACTERS WITHOUT CLAIM TO ANY PARTICULAR FONT, STYLE, SIZE, OR COLOR.

NO CLAIM IS MADE TO THE EXCLUSIVE RIGHT TO USE "STAKES", APART FROM THE MARK AS SHOWN.

SER. NO. 85-354,910, FILED 6-23-2011.

LOURDES AYALA, EXAMINING ATTORNEY



*David J. Kybas*

Director of the United States Patent and Trademark Office

# United States of America

United States Patent and Trademark Office



**Reg. No. 4,196,912**

HLAVAC, LAURA (UNITED STATES INDIVIDUAL)  
1190 JAMES AVE  
ST. PAUL, MN 55105

**Registered Aug. 28, 2012**

**Int. Cl.: 25**

FOR: CLOTHING, NAMELY, DRAWERS, HEADWEAR, FOOTWEAR, LAYETTES, IN CLASS 25 (U.S. CLS. 22 AND 39).

**TRADEMARK**

FIRST USE 2-20-2003; IN COMMERCE 5-20-2003.

**PRINCIPAL REGISTER**

THE MARK CONSISTS OF AN IMAGE OF BABY IN BROWN OUTLINED IN BLACK SITTING IN THE CLOUDS, WHICH ARE OUTLINED IN BLUE AND BLACK, AND ABOVE THIS DESIGN APPEARS THE STYLIZED WORDING "LULLABY DREAM" IN BLACK, WITH SEVEN FIVE-POINT STARS OUTLINED IN BLACK APPEARING AROUND THE FOREGOING, AND AT THE BOTTOM OF THE MARK IS THE STYLIZED WORDING "WWW.LULLABYDREAM.COM" IN BLACK. THE COLOR WHITE APPEARING IN THE MARK REPRESENTS BACKGROUND AND/OR TRANSPARENT AREAS AND IS NOT CLAIMED AS A FEATURE OF THE MARK.

THE COLOR(S) BLACK, BLUE, BROWN IS/ARE CLAIMED AS A FEATURE OF THE MARK.

SER. NO. 85-354,954, FILED 6-24-2011.

ANDREW LEASER, EXAMINING ATTORNEY



*David J. Kyros*

Director of the United States Patent and Trademark Office

# United States of America

United States Patent and Trademark Office

## TOPS PROFESSIONAL

**Reg. No. 4,196,913**

**Registered Aug. 28, 2012**

**Int. Cl.: 9**

**TRADEMARK**

**PRINCIPAL REGISTER**

TOPS SOFTWARE, LLC (MARYLAND LIMITED LIABILITY COMPANY)  
364-C CHRISTOPHER AVE.  
GAITHERSBURG, MD 20879

FOR: COMPUTER SOFTWARE APPLICATIONS FOR PROPERTY MANAGEMENT OPERATIONS, NAMELY, CONDOMINIUM AND HOMEOWNER ASSOCIATION ACCOUNTING AND DATA ADMINISTRATION SOFTWARE FOR USE IN MANAGING CONDOMINIUM ASSOCIATIONS AND HOMEOWNER ASSOCIATIONS, IN CLASS 9 (U.S. CLS. 21, 23, 26, 36 AND 38).

FIRST USE 4-0-2010; IN COMMERCE 4-0-2010.

THE MARK CONSISTS OF STANDARD CHARACTERS WITHOUT CLAIM TO ANY PARTICULAR FONT, STYLE, SIZE, OR COLOR.

NO CLAIM IS MADE TO THE EXCLUSIVE RIGHT TO USE "PROFESSIONAL", APART FROM THE MARK AS SHOWN.

SER. NO. 85-355,033, FILED 6-24-2011.

LINDA M. KING, EXAMINING ATTORNEY



*David J. Kybas*

Director of the United States Patent and Trademark Office

# United States of America

United States Patent and Trademark Office

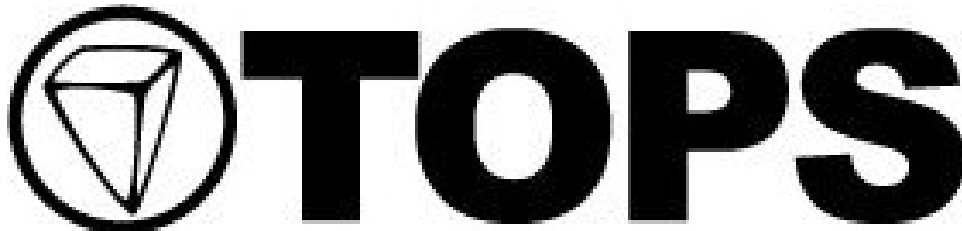

**Reg. No. 4,196,914**

**Registered Aug. 28, 2012**

**Int. Cls.: 9 and 41**

**TRADEMARK**

**SERVICE MARK**

**PRINCIPAL REGISTER**

TOPS SOFTWARE, LLC (MARYLAND LIMITED LIABILITY COMPANY)  
364-C CHRISTOPHER AVENUE  
GAITHERSBURG, MD 20879

FOR: COMPUTER SOFTWARE APPLICATIONS, NAMELY, APPLICATIONS FOR USE IN DATABASE MANAGEMENT AND ELECTRONIC STORAGE AND RETRIEVAL OF DATA FOR USE BY CONDOMINIUM ASSOCIATIONS AND HOMEOWNER ASSOCIATIONS IN THE FIELDS OF PROPERTY MANAGEMENT, COMMUNITY MANAGEMENT AND MEMBERSHIP MANAGEMENT; COMPUTER SOFTWARE APPLICATIONS, NAMELY, APPLICATIONS FOR USE IN DATABASE MANAGEMENT AND ELECTRONIC STORAGE AND RETRIEVAL OF DATA FOR USE BY BUSINESS ORGANIZATIONS IN THE FIELDS OF PROPERTY MANAGEMENT AND MEMBERSHIP MANAGEMENT, IN CLASS 9 (U.S. CLS. 21, 23, 26, 36 AND 38).

FIRST USE 10-0-1988; IN COMMERCE 12-29-1988.

FOR: EDUCATIONAL SERVICES, NAMELY, CONDUCTING SEMINARS, WEBINARS, AND TECHNICAL TRAINING IN THE USE OF COMMUNITY MANAGEMENT, PROPERTY MANAGEMENT AND MEMBERSHIP MANAGEMENT SOFTWARE APPLICATIONS, IN CLASS 41 (U.S. CLS. 100, 101 AND 107).

FIRST USE 10-0-1988; IN COMMERCE 12-29-1988.

THE MARK CONSISTS OF THE WORD "TOPS" AND A TOP INSIDE A CIRCLE.

SER. NO. 85-355,035, FILED 6-24-2011.

LINDA M. KING, EXAMINING ATTORNEY



*David J. Kypos*

Director of the United States Patent and Trademark Office

# United States of America

United States Patent and Trademark Office

## TOPS ONPOINT

**Reg. No. 4,196,915**

**Registered Aug. 28, 2012**

**Int. Cl.: 42**

**SERVICE MARK**

**PRINCIPAL REGISTER**

TOPS SOFTWARE, LLC (MARYLAND LIMITED LIABILITY COMPANY)  
364-C CHRISOPHER AVE.  
GAITHERSBURG, MD 20879

FOR: PROVIDING TEMPORARY USE OF WEB-BASED SOFTWARE APPLICATIONS FOR USE IN DATABASE MANAGEMENT AND ELECTRONIC STORAGE AND RETRIEVAL OF DATA FOR USE BY CONDOMINIUM ASSOCIATIONS AND HOMEOWNER ASSOCIATIONS IN THE FIELDS OF PROPERTY MANAGEMENT AND MEMBERSHIP MANAGEMENT; PROVIDING TEMPORARY USE OF WEB-BASED SOFTWARE APPLICATIONS FOR USE IN DATABASE MANAGEMENT AND ELECTRONIC STORAGE AND RETRIEVAL OF DATA FOR USE BY BUSINESS ORGANIZATIONS IN THE FIELDS OF PROPERTY MANAGEMENT AND MEMBERSHIP MANAGEMENT, IN CLASS 42 (U.S. CLS. 100 AND 101).

FIRST USE 6-0-2010; IN COMMERCE 2-0-2011.

THE MARK CONSISTS OF STANDARD CHARACTERS WITHOUT CLAIM TO ANY PARTICULAR FONT, STYLE, SIZE, OR COLOR.

SER. NO. 85-355,039, FILED 6-24-2011.

LINDA M. KING, EXAMINING ATTORNEY



*David J. Kyffers*

Director of the United States Patent and Trademark Office

# United States of America

United States Patent and Trademark Office

# TOPS IMAIL

**Reg. No. 4,196,916**

TOPS SOFTWARE, LLC (MARYLAND LIMITED LIABILITY COMPANY)  
364-C CHRISTOPHER AVE.  
GAITHERSBURG, MD 20879

**Registered Aug. 28, 2012**

**Int. Cl.: 42**

FOR: PROVIDING TEMPORARY USE OF ONLINE NON-DOWNLOADABLE SOFTWARE FOR ENABLING USERS TO ORGANIZE AND MANAGE E-MAILS HOSTED ON A WEB SERVER FOR PROPERTY MANAGEMENT COMMUNICATIONS, IN CLASS 42 (U.S. CLS. 100 AND 101).

**SERVICE MARK**

**PRINCIPAL REGISTER**

FIRST USE 4-0-2010; IN COMMERCE 9-0-2010.

THE MARK CONSISTS OF STANDARD CHARACTERS WITHOUT CLAIM TO ANY PARTICULAR FONT, STYLE, SIZE, OR COLOR.

NO CLAIM IS MADE TO THE EXCLUSIVE RIGHT TO USE "IMAIL", APART FROM THE MARK AS SHOWN.

SER. NO. 85-355,040, FILED 6-24-2011.

LINDA M. KING, EXAMINING ATTORNEY



*David J. Kyffers*

Director of the United States Patent and Trademark Office

# United States of America

United States Patent and Trademark Office



**Reg. No. 4,196,917**

**Registered Aug. 28, 2012**

**Int. Cl.: 16**

**TRADEMARK**

**PRINCIPAL REGISTER**

DEWINE SEEDS-SILVER DOLLAR BASEBALL, LLC (NORTH CAROLINA LIMITED LIABILITY COMPANY)  
30 BUCHANAN PLACE  
ASHEVILLE, NC 28001

FOR: PAPER GOODS AND PRINTED MATTER, NAMELY AUTOGRAPH BOOKS, BINDERS, BOOKMARKS, BUMPER STICKERS, CALENDARS, CATALOGS IN THE FIELD OF BASEBALL, DECALS, MERCHANDISE BAGS, NEWSLETTERS IN THE FIELD OF BASEBALL, NOTE PADS, PAPER CONTAINERS, PAPER PENNANTS, PRINTED GAME SCHEDULES FOR SPORTING EVENTS, PENS, PENCILS, POSTCARDS, POSTERS, PRINTED AWARDS, PRINTED TICKETS FOR SPORTING EVENTS, PRINTED GUIDES IN THE FIELD OF BASEBALL, REFERENCE BOOKS IN THE FIELD OF BASEBALL, SCORE BOOKS, SCORE CARDS, SCORE SHEETS, STATIONERY, STICKERS, STICKER ALBUMS AND TRADING CARDS, IN CLASS 16 (U.S. CLS. 2, 5, 22, 23, 29, 37, 38 AND 50).

FIRST USE 11-9-2010; IN COMMERCE 11-9-2010.

OWNER OF U.S. REG. NOS. 2,029,636 AND 2,881,428.

NO CLAIM IS MADE TO THE EXCLUSIVE RIGHT TO USE "ASHEVILLE", APART FROM THE MARK AS SHOWN.

THE MARK CONSISTS OF THE WORDING "ASHEVILLE" IN STYLIZED FONT WHICH APPEARS ABOVE A CIRCULAR DESIGN DEPICTING A BASEBALL FLYING OVER A MOON AND STARS WITH THE WORDING "TOURISTS" FEATURING A STAR DOTTING THE LETTER "I," PARTIALLY SUPERIMPOSED OVER A MOUNTAIN RANGE, BATTER'S BOX AND HOME PLATE DESIGN.

SER. NO. 85-355,198, FILED 6-24-2011.

AMY KELLY, EXAMINING ATTORNEY



*David J. Kybas*

Director of the United States Patent and Trademark Office

# United States of America

United States Patent and Trademark Office

# LISVY

**Reg. No. 4,196,918**

**Registered Aug. 28, 2012**

**Int. Cl.: 5**

**TRADEMARK**

**PRINCIPAL REGISTER**

BAYER AKTIENGESELLSCHAFT (FED REP GERMANY AKTIENGESELLSCHAFT)  
KAISER-WILHELM-ALLEE  
LEVERKUSEN, FED REP GERMANY 51373

FOR: PHARMACEUTICAL PREPARATIONS, NAMELY, HORMONAL PREPARATIONS, IN CLASS 5 (U.S. CLS. 6, 18, 44, 46, 51 AND 52).

THE MARK CONSISTS OF STANDARD CHARACTERS WITHOUT CLAIM TO ANY PARTICULAR FONT, STYLE, SIZE, OR COLOR.

OWNER OF FED REP GERMANY REG. NO. 302011029781, DATED 6-28-2011, EXPIRES 5-31-2021.

SER. NO. 85-355,255, FILED 6-24-2011.

JULIE VEPPUMTHARA, EXAMINING ATTORNEY



*David J. Kyros*

Director of the United States Patent and Trademark Office



# United States of America

United States Patent and Trademark Office

# POWERBILT

**Reg. No. 4,196,919**

PREMIER SHEEP SUPPLIES, LTD. (IOWA CORPORATION)  
2031 300TH STREET  
WASHINGTON, IA 52353

**Registered Aug. 28, 2012**

**Int. Cl.: 6**

FOR: METAL FENCE PANELS FOR FENCING IN LIVESTOCK, IN CLASS 6 (U.S. CLS. 2, 12, 13, 14, 23, 25 AND 50).

**TRADEMARK**

FIRST USE 11-8-2006; IN COMMERCE 11-8-2006.

**PRINCIPAL REGISTER**

THE MARK CONSISTS OF STANDARD CHARACTERS WITHOUT CLAIM TO ANY PARTICULAR FONT, STYLE, SIZE, OR COLOR.

SER. NO. 85-355,266, FILED 6-24-2011.

YAT SYE, LEE, EXAMINING ATTORNEY



*David J. Kybas*

Director of the United States Patent and Trademark Office

# United States of America

United States Patent and Trademark Office

## KETTLE KORNER

**Reg. No. 4,196,920**

FESTFARE, INC (NEVADA CORPORATION)

**Registered Aug. 28, 2012**

5348 VEGAS DRIVE  
LAS VEGAS, NV 89108

**Int. Cl.: 30**

FOR: CANDY FOR FOOD; CHEESE FLAVORED PUFFED CORN SNACKS; CHEESE-FLAVORED CORN SNACKS; CHOCOLATES AND CHOCOLATE BASED READY TO EAT CANDIES AND SNACKS; CORN-BASED SNACK FOODS; PUFFED CORN SNACKS; SNACK CAKES; SNACK FOODS, NAMELY, CHOCOLATE-BASED SNACK FOODS; SNACK MIX CONSISTING PRIMARILY OF CRACKERS, PRETZELS AND/OR POPPED POPCORN, IN CLASS 30 (U.S. CL. 46).

**TRADEMARK**

**PRINCIPAL REGISTER**

FIRST USE 6-23-2011; IN COMMERCE 6-23-2011.

THE MARK CONSISTS OF STANDARD CHARACTERS WITHOUT CLAIM TO ANY PARTICULAR FONT, STYLE, SIZE, OR COLOR.

SER. NO. 85-355,532, FILED 6-24-2011.

SUNG IN, EXAMINING ATTORNEY



*David J. Kyfos*

Director of the United States Patent and Trademark Office

# United States of America

United States Patent and Trademark Office

## SENATOR KEN MADDY HANDICAP

**Reg. No. 4,196,921**

OAK TREE RACING ASSOCIATION (CALIFORNIA NON-PROFIT CORPORATION)  
285 W. HUNTINGTON DRIVE  
ARCADIA, CA 91007

**Registered Aug. 28, 2012**

**Int. Cl.: 41**

FOR: ENTERTAINMENT, NAMELY, CONDUCTING HORSE RACES AND PROVIDING HORSE RACING ENTERTAINMENT INFORMATION THROUGH VARIOUS FORMS OF MEDIA, IN CLASS 41 (U.S. CLS. 100, 101 AND 107).

**SERVICE MARK**

FIRST USE 0-0-1969; IN COMMERCE 0-0-1969.

**PRINCIPAL REGISTER**

THE MARK CONSISTS OF STANDARD CHARACTERS WITHOUT CLAIM TO ANY PARTICULAR FONT, STYLE, SIZE, OR COLOR.

NO CLAIM IS MADE TO THE EXCLUSIVE RIGHT TO USE "SENATOR OR HANDICAP", APART FROM THE MARK AS SHOWN.

THE NAME(S), PORTRAIT(S), AND/OR SIGNATURE(S) SHOWN IN THE MARK DOES NOT IDENTIFY A PARTICULAR LIVING INDIVIDUAL.

SER. NO. 85-355,600, FILED 6-24-2011.

LOURDES AYALA, EXAMINING ATTORNEY



*David J. Kyffers*

Director of the United States Patent and Trademark Office

# United States of America

United States Patent and Trademark Office

## DR. RONALD E. MCNAIR

**Reg. No. 4,196,922**

CHERYL MCNAIR (UNITED STATES INDIVIDUAL)

**Registered Aug. 28, 2012**

1623 WEST CHELSEA PLACE  
SEABROOK, TX 77586

**Int. Cl.: 41**

FOR: CHARITABLE SERVICES, NAMELY, PROVIDING TRAINING IN THE FIELD OF MENTORSHIP OF CHILDREN; CONDUCTING EDUCATIONAL EXHIBITIONS IN THE NATURE OF CAMPS, WORKSHOPS, SEMINARS, AND PROGRAMS IN THE FIELDS OF SCIENCE, TECHNOLOGY, ENGINEERING AND MATH; EDUCATION SERVICES, NAMELY, PROVIDING EDUCATIONAL CONFERENCES, SEMINARS, WORKSHOPS AND PROGRAMS FOR TEACHERS IN THE FIELD OF SCIENCE, TECHNOLOGY, ENGINEERING AND MATH; EDUCATIONAL SERVICES, NAMELY, DEVELOPING, ARRANGING, AND CONDUCTING EDUCATIONAL CONFERENCES AND PROGRAMS AND PROVIDING COURSES OF INSTRUCTION IN THE FIELD OF SCIENCE, TECHNOLOGY, ENGINEERING AND MATH; PROVIDING SCIENCE EDUCATIONAL MENTORING SERVICES AND PROGRAMS; SUMMER CAMPS, IN CLASS 41 (U.S. CLS. 100, 101 AND 107).

**SERVICE MARK**

**PRINCIPAL REGISTER**

FIRST USE 11-15-2001; IN COMMERCE 11-15-2001.

THE MARK CONSISTS OF STANDARD CHARACTERS WITHOUT CLAIM TO ANY PARTICULAR FONT, STYLE, SIZE, OR COLOR.

THE NAME(S), PORTRAIT(S), AND/OR SIGNATURE(S) SHOWN IN THE MARK DOES NOT IDENTIFY A PARTICULAR LIVING INDIVIDUAL.

SER. NO. 85-355,620, FILED 6-24-2011.

DAVID MURRAY, EXAMINING ATTORNEY



*David J. Kyffers*

Director of the United States Patent and Trademark Office

# United States of America

United States Patent and Trademark Office

## NATIONAL DRUG COURT MONTH

**Reg. No. 4,196,923**

**Registered Aug. 28, 2012**

**Int. Cl.: 35**

NATIONAL ASSOCIATION OF DRUG COURT PROFESSIONALS (VIRGINIA CORPORATION)  
SUITE 201  
1029 N. ROYAL STREET  
ALEXANDRIA, VA 22314

**SERVICE MARK**

**PRINCIPAL REGISTER**

FOR: PROMOTING PUBLIC AWARENESS OF DRUG COURTS; PROMOTING PUBLIC AWARENESS OF IMPROVING THE JUSTICE SYSTEM THROUGH A COMBINATION OF JUDICIAL MONITORING AND EFFECTIVE TREATMENT TO COMPEL DRUG-USING OFFENDERS TO CHANGE THEIR LIVES; PROMOTING PUBLIC AWARENESS OF THE SUCCESS OF DRUG COURTS AND THE EXPANSION OF DRUG COURTS NATIONWIDE, IN CLASS 35 (U.S. CLS. 100, 101 AND 102).

FIRST USE 5-0-2000; IN COMMERCE 5-0-2000.

THE MARK CONSISTS OF STANDARD CHARACTERS WITHOUT CLAIM TO ANY PARTICULAR FONT, STYLE, SIZE, OR COLOR.

OWNER OF U.S. REG. NO. 2,593,467.

SEC. 2(F).

SER. NO. 85-355,649, FILED 6-24-2011.

FLORENTINA BLANDU, EXAMINING ATTORNEY



*David J. Kyffers*

Director of the United States Patent and Trademark Office

# United States of America

United States Patent and Trademark Office

## SIGNATURE COLORS

**Reg. No. 4,196,924**

LF, LLC (DELAWARE LIMITED LIABILITY COMPANY)

**Registered Aug. 28, 2012**

P.O. BOX 39  
MOUNT MOURNE, NC 28123

**Int. Cls.: 8 and 16**

FOR: HAND TOOLS, NAMELY, TROWELS, SMOOTHERS FOR USE IN APPLYING FAUX FINISHES AND STEEL SPATULAS, IN CLASS 8 (U.S. CLS. 23, 28 AND 44).

**TRADEMARK**

FIRST USE 1-0-2008; IN COMMERCE 1-0-2008.

**PRINCIPAL REGISTER**

FOR: PAINT ROLLERS; PAINT APPLICATORS, IN CLASS 16 (U.S. CLS. 2, 5, 22, 23, 29, 37, 38 AND 50).

FIRST USE 1-0-2008; IN COMMERCE 1-0-2008.

THE MARK CONSISTS OF STANDARD CHARACTERS WITHOUT CLAIM TO ANY PARTICULAR FONT, STYLE, SIZE, OR COLOR.

OWNER OF U.S. REG. NOS. 3,162,985, 3,873,867 AND OTHERS.

SER. NO. 85-355,916, FILED 6-24-2011.

LOURDES AYALA, EXAMINING ATTORNEY



*David J. Kyffers*

Director of the United States Patent and Trademark Office

# United States of America

United States Patent and Trademark Office

# PRINTELLECT

**Reg. No. 4,196,925**

PRINTELLECT, LLC (PENNSYLVANIA LIMITED LIABILITY COMPANY)  
40 24TH STREET  
PITTSBURGH, PA 15222

**Registered Aug. 28, 2012**

**Int. Cl.: 42**

FOR: SOFTWARE SERVICES, NAMELY, DEVELOPING AND SUPPORTING INTERNET-BASED PRINT MANAGEMENT SOLUTIONS FEATURING DESIGN, DEVELOPMENT, AND IMPLEMENTATION OF SOFTWARE FOR PRINT MANAGEMENT APPLICATIONS, IN CLASS 42 (U.S. CLS. 100 AND 101).

**SERVICE MARK**

**PRINCIPAL REGISTER**

FIRST USE 6-19-2002; IN COMMERCE 6-19-2002.

THE MARK CONSISTS OF STANDARD CHARACTERS WITHOUT CLAIM TO ANY PARTICULAR FONT, STYLE, SIZE, OR COLOR.

SER. NO. 85-356,054, FILED 6-24-2011.

EMILY CHUO, EXAMINING ATTORNEY



*David J. Kybas*

Director of the United States Patent and Trademark Office

# United States of America

United States Patent and Trademark Office

# BELLA EVER

**Reg. No. 4,196,926**

**Registered Aug. 28, 2012**

**Int. Cl.: 25**

**TRADEMARK**

**PRINCIPAL REGISTER**

BELLA EVER LLC (CALIFORNIA LIMITED LIABILITY COMPANY)  
10036 E. RUSH ST.  
S. EL MONTE, CA 91733

FOR: FOOTWEAR FOR MEN AND WOMEN, IN CLASS 25 (U.S. CLS. 22 AND 39).

FIRST USE 11-10-2010; IN COMMERCE 4-15-2011.

THE MARK CONSISTS OF STANDARD CHARACTERS WITHOUT CLAIM TO ANY PARTICULAR FONT, STYLE, SIZE, OR COLOR.

THE ENGLISH TRANSLATION OF "BELLA" IN THE MARK IS "BEAUTY".

SER. NO. 85-356,079, FILED 6-24-2011.

KRISTINA MORRIS, EXAMINING ATTORNEY



*David J. Kyffers*

Director of the United States Patent and Trademark Office



# United States of America

United States Patent and Trademark Office



**Kids 'n' Cancer**  
**CAMP AGAPE**

**Reg. No. 4,196,927**

**Registered Aug. 28, 2012**

**Int. Cl.: 41**

THE GREEK ORTHODOX METROPOLIS OF SAN FRANCISCO (CALIFORNIA CORPORATION), AKA METROPOLIS OF SAN FRANCISCO LADIES PHILOPTOCHOS SOCIETY  
245 VALENCIA STREET  
SAN FRANCISCO, CA 94103

**SERVICE MARK**

**PRINCIPAL REGISTER**

FOR: CHARITABLE SERVICES, NAMELY, PROVIDING CAMPS FOR CHILDREN AFFECTED BY CANCER; DAY CAMP SERVICES; PROVIDING A WEBSITE FEATURING INFORMATION IN THE FIELDS OF EDUCATION AND ENTERTAINMENT FOR CHILDREN; PROVIDING FACILITIES FOR RECREATION ACTIVITIES; PROVISION OF PLAY FACILITIES FOR CHILDREN; RECREATIONAL CAMPS; SPORT CAMPS; SPORTS CAMP SERVICES; SUMMER CAMPS, IN CLASS 41 (U.S. CLS. 100, 101 AND 107).

FIRST USE 6-20-2006; IN COMMERCE 6-20-2006.

NO CLAIM IS MADE TO THE EXCLUSIVE RIGHT TO USE "KIDS 'N' CANCER CAMP", APART FROM THE MARK AS SHOWN.

THE NAME(S), PORTRAIT(S), AND/OR SIGNATURE(S) SHOWN IN THE MARK IDENTIFIES "BRYNA NATHAN", WHOSE CONSENT(S) TO REGISTER IS MADE OF RECORD.

THE MARK CONSISTS OF A PORTRAIT OF A GIRL HOLDING A STUFFED ANIMAL BEAR AGAINST A BACKGROUND SHAPED LIKE A HEART WITH THE WORDS "KIDS 'N' CANCER CAMP AGAPE" NEXT TO HER.

THE ENGLISH TRANSLATION OF THE GREEK WORD "AGAPE" IN THE MARK IS "LOVE".

SER. NO. 85-356,136, FILED 6-24-2011.

STEPHANIE ALI, EXAMINING ATTORNEY



*David J. Kyros*

Director of the United States Patent and Trademark Office

# United States of America

United States Patent and Trademark Office

# SteriSpine

**Reg. No. 4,196,928**

**Registered Aug. 28, 2012**

**Int. Cl.: 10**

**TRADEMARK**

**PRINCIPAL REGISTER**

SAFE ORTHOPAEDICS (FRANCE SOCIETE PAR ACTIONS SIMPLIFIEE)  
PARC DES BELLEVUES - B??TIMENT LE  
CALIFORNIEALL??E ROSE DE LUXEMBOURG  
ERAGNY SUR OISE, FRANCE 95610

FOR: SURGICAL APPARATUS AND INSTRUMENTS MADE TO INSERT SPINALS IMPLANTS COMPOSED OF ARTIFICIAL MATERIAL; DRILL BITS FOR MEDICAL USE, DRILLS FOR MEDICAL USE, SPANNERS AND SCREWDRIVERS FOR MEDICAL USE, SCISSORS FOR MEDICAL USE; ORTHOPAEDIC IMPLANTS MADE OF ARTIFICIAL MATERIAL, NAMELY, SPINAL IMPLANTS; SURGICAL IMPLANTS MADE OF ARTIFICIAL MATERIALS; ARTIFICIAL LIGAMENTS AND TISSUES FOR MEDICAL OR SURGICAL USE, IN CLASS 10 (U.S. CLS. 26, 39 AND 44).

THE MARK CONSISTS OF STANDARD CHARACTERS WITHOUT CLAIM TO ANY PARTICULAR FONT, STYLE, SIZE, OR COLOR.

PRIORITY CLAIMED UNDER SEC. 44(D) ON ERPN CMNTY TM OFC APPLICATION NO. 009700378, FILED 2-1-2011, REG. NO. 009700378, DATED 7-5-2011, EXPIRES 2-1-2021.

SER. NO. 85-356,563, FILED 6-27-2011.

TINA BROWN, EXAMINING ATTORNEY



*David J. Kybas*

Director of the United States Patent and Trademark Office

# United States of America

United States Patent and Trademark Office

## Guns International

**Reg. No. 4,196,929**

GUNSINTERNATIONAL.COM, LLC (FLORIDA LIMITED LIABILITY COMPANY)  
36181 EAST LAKE ROAD, #308  
PALM HARBOR, FL 34685

**Registered Aug. 28, 2012**

**Int. Cl.: 35**

FOR: PROVIDING A WEB SITE WHERE USERS CAN POST ITEMS FOR SALE THROUGH ON-LINE CLASSIFIED ADVERTISEMENTS, IN CLASS 35 (U.S. CLS. 100, 101 AND 102).

**SERVICE MARK**

FIRST USE 3-0-2007; IN COMMERCE 3-0-2007.

**PRINCIPAL REGISTER**

THE MARK CONSISTS OF STANDARD CHARACTERS WITHOUT CLAIM TO ANY PARTICULAR FONT, STYLE, SIZE, OR COLOR.

SEC. 2(F).

SER. NO. 85-356,572, FILED 6-27-2011.

TARAH HARDY, EXAMINING ATTORNEY



*David J. Kyros*

Director of the United States Patent and Trademark Office

# United States of America

United States Patent and Trademark Office

# Veri

**Reg. No. 4,196,930**

**Registered Aug. 28, 2012**

**Int. Cls.: 41 and 42**

**SERVICE MARK**

**PRINCIPAL REGISTER**

VERI, INC. (DELAWARE CORPORATION), DBA VERI  
APT 10F  
10 HANOVER SQUARE  
NEW YORK, NY 10005

FOR: EDUCATIONAL SERVICES, NAMELY, PROVIDING ON-LINE COURSES IN THE FIELD OF BUSINESS, SCIENCE, TECHNOLOGY, HUMANITIES, ENTERTAINMENT, AND SUBJECTS OF GENERAL INTEREST; ENTERTAINMENT SERVICES, NAMELY, PROVIDING ON-LINE COMPUTER GAMES, IN CLASS 41 (U.S. CLS. 100, 101 AND 107).

FIRST USE 2-28-2011; IN COMMERCE 2-28-2011.

FOR: COMPUTER SERVICES, NAMELY, CREATING AN ON-LINE COMMUNITY FOR REGISTERED USERS TO PARTICIPATE IN DISCUSSIONS, GET FEEDBACK FROM THEIR PEERS, FORM VIRTUAL COMMUNITIES, AND ENGAGE IN SOCIAL NETWORKING SERVICES; COMPUTER SERVICES, NAMELY, PROVIDING CUSTOMIZED WEB PAGES FEATURING USER-DEFINED INFORMATION, IN CLASS 42 (U.S. CLS. 100 AND 101).

FIRST USE 2-28-2011; IN COMMERCE 2-28-2011.

THE MARK CONSISTS OF STANDARD CHARACTERS WITHOUT CLAIM TO ANY PARTICULAR FONT, STYLE, SIZE, OR COLOR.

SER. NO. 85-356,649, FILED 6-27-2011.

ELIZABETH KAJUBI, EXAMINING ATTORNEY



*David J. Kyjars*

Director of the United States Patent and Trademark Office

# United States of America

United States Patent and Trademark Office

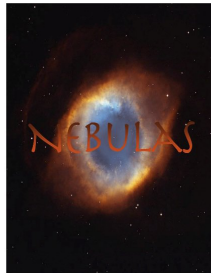

**Reg. No. 4,196,931**

FILOSA, MATTHEW (UNITED STATES INDIVIDUAL)  
159 IVERNIA LOOP  
TALLAHASSEE, FL 32312

**Registered Aug. 28, 2012**

**Int. Cl.: 41**

FOR: ENTERTAINMENT SERVICES IN THE NATURE OF A VEGAS-STYLE SHOW COMBINING LIVE MUSICIANS, LIGHTING, ACTING, AND PERCUSSION; PRESENTATION OF LIVE SHOW PERFORMANCES, IN CLASS 41 (U.S. CLS. 100, 101 AND 107).

**SERVICE MARK**

FIRST USE 5-31-2011; IN COMMERCE 5-31-2011.

**PRINCIPAL REGISTER**

THE MARK CONSISTS OF THE LITERAL ELEMENT "NEBULAS" IN ORANGE COLOR SUPERIMPOSED ON AN IMAGE OF A SPACE AND AN ASTRONOMICAL OBJECT COMPRISING OF ORANGE, BLACK, WHITE, YELLOW AND BLUE COLOR WITH STARS AROUND AS SHOWN IN THE MARK.

THE COLOR(S) ORANGE, BLACK, WHITE, YELLOW AND BLUE COLOR IS/ARE CLAIMED AS A FEATURE OF THE MARK.

SER. NO. 85-356,869, FILED 6-27-2011.

ZACHARY BELLO, EXAMINING ATTORNEY



*David J. Kypos*

Director of the United States Patent and Trademark Office

# United States of America

United States Patent and Trademark Office

# 360VERSE

**Reg. No. 4,196,932**

**Registered Aug. 28, 2012**

**Int. Cl.: 42**

**SERVICE MARK**

**PRINCIPAL REGISTER**

OCCIPITAL, LLC (DELAWARE LIMITED LIABILITY COMPANY)  
SUITE 202  
1801 13TH STREET  
BOULDER, CO 80302

FOR: SOFTWARE AS A SERVICE (SAAS) SERVICES FEATURING WEBSITE-BASED SOFTWARE IN THE NATURE OF AN APPLICATION FOR IMAGE SHARING, IMAGE SEARCH AND IMAGE COLLABORATION, IN CLASS 42 (U.S. CLS. 100 AND 101).

FIRST USE 5-17-2011; IN COMMERCE 5-17-2011.

THE MARK CONSISTS OF STANDARD CHARACTERS WITHOUT CLAIM TO ANY PARTICULAR FONT, STYLE, SIZE, OR COLOR.

SER. NO. 85-356,969, FILED 6-27-2011.

TOBY BULLOFF, EXAMINING ATTORNEY



*David J. Kyffers*

Director of the United States Patent and Trademark Office

# United States of America

United States Patent and Trademark Office



**Reg. No. 4,196,933**

**Registered Aug. 28, 2012**

**Int. Cl.: 9**

**TRADEMARK**

**PRINCIPAL REGISTER**

DR.'S OWN, INC. (CALIFORNIA CORPORATION)  
2270 COSMOS COURT, SUITE 100  
CARLSBAD, CA 92011

FOR: FOOT SCANNING DEVICE, NAMELY, ELECTRONIC SENSOR UNITS WITH COMPUTER HARDWARE AND SOFTWARE FOR USE IN MEASURING AND DETECTING FOOT PRESSURE OF INDIVIDUALS AND IMAGING THE FOOT AND ARCH LENGTH FOR THE PROVISION OF ORTHOTIC INSERTS FOR FEET AND FOOTWEAR, IN CLASS 9 (U.S. CLS. 21, 23, 26, 36 AND 38).

FIRST USE 7-25-2011; IN COMMERCE 7-25-2011.

OWNER OF U.S. REG. NOS. 2,852,408, 3,183,328 AND OTHERS.

NO CLAIM IS MADE TO THE EXCLUSIVE RIGHT TO USE "TOPO SCAN", APART FROM THE MARK AS SHOWN.

THE MARK CONSISTS OF THE WORD "TOPO" ON THE TOP LINE, WITH AN OUTLINE OF A FOOT AND TOES ON THE NEXT LINE CENTERED UNDER THE "T" AND "O" WITH THE WORD "SCAN" TO THE RIGHT OF THE FOOT; THE WORDS "BY GOOD FEET" ARE CENTERED ON THE NEXT LINE BELOW UNDER THE WORD "SCAN".

SER. NO. 85-357,042, FILED 6-27-2011.

KAREN K. BUSH, EXAMINING ATTORNEY



*David J. Kyjars*

Director of the United States Patent and Trademark Office

# United States of America

United States Patent and Trademark Office

## WHERE CURIOSITY COMES TO PLAY

**Reg. No. 4,196,934**

**Registered Aug. 28, 2012**

**Int. Cl.: 41**

**SERVICE MARK**

**PRINCIPAL REGISTER**

HENDRICKS INVESTMENT HOLDINGS, LLC (DELAWARE LIMITED LIABILITY COMPANY)  
8484 GEORGIA AVENUE  
SILVER SPRING, MD 20910

FOR: ACADEMIC ENRICHMENT PROGRAMS IN THE FIELDS OF SCIENCE, HISTORY, HUMANITIES, THE ARTS, AND FINE ART; EDUCATIONAL SERVICES, NAMELY, DEVELOPING AND CONDUCTING WORKSHOPS, PRESENTATIONS, AND RETREATS IN SCIENCE, HISTORY, HUMANITIES, THE ARTS, AND FINE ART; PROVIDING A WEBSITE FEATURING INFORMATION AND EDUCATIONAL MATERIALS, NAMELY, ONLINE PUBLICATIONS IN THE NATURE OF NEWSLETTERS, WEBLOGS, EDUCATIONAL TEXTS, COURSE MATERIALS AND INFORMATION IN THE FIELDS OF SCIENCE, HISTORY, HUMANITIES, THE ARTS AND FINE ART, IN CLASS 41 (U.S. CLS. 100, 101 AND 107).

FIRST USE 1-0-2011; IN COMMERCE 1-0-2011.

THE MARK CONSISTS OF STANDARD CHARACTERS WITHOUT CLAIM TO ANY PARTICULAR FONT, STYLE, SIZE, OR COLOR.

SER. NO. 85-357,409, FILED 6-27-2011.

ALEX KEAM, EXAMINING ATTORNEY



*David J. Kybas*

Director of the United States Patent and Trademark Office



**United States of America**  
United States Patent and Trademark Office

# Mauicello

**Reg. No. 4,196,935**

HAIKU LEMON SCENTS, LLC (HAWAII LIMITED LIABILITY COMPANY)

**Registered Aug. 28, 2012**

P.O. BOX 999  
HAIKU, HI 96708

**Int. Cl.: 33**

FOR: LIQUOR AND LIQUEUR, NAMELY, SPRITS DISTILLED USING LEMONS, IN CLASS 33 (U.S. CLS. 47 AND 49).

**TRADEMARK**

FIRST USE 1-13-2009; IN COMMERCE 9-30-2010.

**PRINCIPAL REGISTER**

THE MARK CONSISTS OF STANDARD CHARACTERS WITHOUT CLAIM TO ANY PARTICULAR FONT, STYLE, SIZE, OR COLOR.

SER. NO. 85-357,546, FILED 6-27-2011.

STEVEN JACKSON, EXAMINING ATTORNEY



*David J. Kyffers*

Director of the United States Patent and Trademark Office

# United States of America

United States Patent and Trademark Office

## SIMPLICITY HR

**Reg. No. 4,196,936**

**Registered Aug. 28, 2012**

**Int. Cl.: 35**

**SERVICE MARK**

**PRINCIPAL REGISTER**

ALTRES, INC. (HAWAII CORPORATION)  
967 KAPIOLANI BOULEVARD  
HONOLULU, HI 968142101

FOR: BUSINESS ADMINISTRATION AND MANAGEMENT, NAMELY HUMAN RESOURCES ADMINISTRATION, PAYROLL ADMINISTRATION, EMPLOYEE BENEFITS ADMINISTRATION, AND HUMAN RESOURCES CONSULTATION SERVICES FOR OTHERS; PROVIDING BUSINESS RISK MANAGEMENT AND BUSINESS SUPPORT SERVICES FOR OTHERS, IN CLASS 35 (U.S. CLS. 100, 101 AND 102).

FIRST USE 2-28-2009; IN COMMERCE 2-28-2009.

THE MARK CONSISTS OF STANDARD CHARACTERS WITHOUT CLAIM TO ANY PARTICULAR FONT, STYLE, SIZE, OR COLOR.

NO CLAIM IS MADE TO THE EXCLUSIVE RIGHT TO USE "HR", APART FROM THE MARK AS SHOWN.

SER. NO. 85-357,571, FILED 6-27-2011.

GIANCARLO CASTRO, EXAMINING ATTORNEY



*David J. Kyffers*

Director of the United States Patent and Trademark Office

# United States of America

United States Patent and Trademark Office



**Reg. No. 4,196,937**

**Registered Aug. 28, 2012**

**Int. Cl.: 39**

**SERVICE MARK**

**PRINCIPAL REGISTER**

PHILADELPHIA SIGHTSEEING TOURS INC. (DELAWARE CORPORATION)  
SUITE 5  
111 SOUTH INDEPENDENCE MALL EAST  
PHILADELPHIA, PA 19106

FOR: CONDUCTING AND ORGANIZING SIGHTSEEING TOURS FOR OTHERS, IN CLASS  
39 (U.S. CLS. 100 AND 105).

FIRST USE 8-27-2010; IN COMMERCE 8-27-2010.

NO CLAIM IS MADE TO THE EXCLUSIVE RIGHT TO USE "PHILADELPHIA SIGHTSEEING  
TOURS", APART FROM THE MARK AS SHOWN.

THE COLOR(S) RED, BLACK, WHITE, GRAY AND BLUE IS/ARE CLAIMED AS A FEATURE  
OF THE MARK.

THE MARK CONSISTS OF THE LITERAL ELEMENTS "PHILADELPHIA SIGHTSEEING  
TOURS" WRITTEN IN RED COLOR WHEREIN THE LETTER "A" OF THE WORD "PHIL-  
ADELPHIA" IS DEPICTING A BELL PLACED ABOVE THE WORD "SIGHTSEEING" AND  
THE WORD "TOURS" IS PLACED BENEATH THE WORD "SIGHTSEEING" ON LEFT  
CORNER. PLACED ON THE LEFT HAND SIDE OF ALL LITERAL ELEMENTS IS AN IMAGE  
OF A CAMERA, IN GRAY COLOR HAVING TWO EYES, A BLUE LENS DEPICTING A  
NOSE, BLACK HANDS WITH WHITE GLOVES AND TWO BLACK LEGS WEARING RED  
PANTS, SHOES AND CAP IN RED AND WHITE COLORS AS SHOWN IN THE MARK.

SER. NO. 85-357,662, FILED 6-28-2011.

PAM WILLIS, EXAMINING ATTORNEY



*David J. Kybas*

Director of the United States Patent and Trademark Office

# United States of America

United States Patent and Trademark Office

## CAMP REVEILLE

**Reg. No. 4,196,938**

**Registered Aug. 28, 2012**

**Int. Cl.: 41**

**SERVICE MARK**

**PRINCIPAL REGISTER**

REVEILLE, LLC (MAINE LIMITED LIABILITY COMPANY)  
60 TAKAJO ROAD  
NAPLES, ME 04055

FOR: RECREATIONAL CAMPS, IN CLASS 41 (U.S. CLS. 100, 101 AND 107).

FIRST USE 9-0-2006; IN COMMERCE 8-16-2007.

THE MARK CONSISTS OF STANDARD CHARACTERS WITHOUT CLAIM TO ANY PARTICULAR FONT, STYLE, SIZE, OR COLOR.

NO CLAIM IS MADE TO THE EXCLUSIVE RIGHT TO USE "CAMP", APART FROM THE MARK AS SHOWN.

SER. NO. 85-357,979, FILED 6-28-2011.

SUSAN STIGLITZ, EXAMINING ATTORNEY



*David J. Kyffers*

Director of the United States Patent and Trademark Office

# United States of America

United States Patent and Trademark Office



**Reg. No. 4,196,939**

**Registered Aug. 28, 2012**

**Int. Cl.: 42**

**SERVICE MARK**

**PRINCIPAL REGISTER**

GNAX HOLDINGS, LLC (DELAWARE LIMITED LIABILITY COMPANY)  
1100 WHITE STREET, SW  
ATLANTA, GA 30310

FOR: COMPUTER SERVICES, NAMELY, CLOUD HOSTING PROVIDER SERVICES, DATA RECOVERY SERVICES, REMOTE ON-LINE BACKUP OF COMPUTER DATA, AND PROVIDING VIRTUAL AND NON VIRTUAL APPLICATION SERVERS, WEB SERVERS, FILE SERVERS, CO-LOCATION SERVERS, LOAD BALANCING SERVERS, REDUNDANCY SERVERS, AND DATABASE SERVERS OF VARIABLE CAPACITY FOR USE BY OTHERS; DATA WAREHOUSING; DESIGN AND DEVELOPMENT OF ELECTRONIC DATA SECURITY SYSTEMS; CONSULTING SERVICES RELATED TO THE DESIGN, IMPLEMENTATION, AND MANAGEMENT OF VIRTUAL AND NON-VIRTUAL NETWORK SOLUTIONS, DATA RECOVERY SYSTEMS, AND VIRTUAL AND NON-VIRTUAL APPLICATION SERVERS, WEB SERVERS, FILE SERVERS, CO-LOCATION SERVERS, LOAD BALANCING SERVERS, REDUNDANCY SERVERS, AND DATABASE SERVERS OF VARIABLE CAPACITY FOR USE BY OTHERS; COMPUTER SERVICES, NAMELY REMOTE MANAGEMENT OF THE INFORMATION TECHNOLOGY SYSTEMS OF OTHERS, IN CLASS 42 (U.S. CLS. 100 AND 101).

FIRST USE 3-1-2003; IN COMMERCE 3-1-2003.

THE MARK CONSISTS OF A GLOBE DESIGN ENCIRCLED BY A RING OF VARYING WIDTH.

SER. NO. 85-358,013, FILED 6-28-2011.

JAY FLOWERS, EXAMINING ATTORNEY



*David J. Kyros*

Director of the United States Patent and Trademark Office

# United States of America

United States Patent and Trademark Office

# GNAX

**Reg. No. 4,196,940**

**Registered Aug. 28, 2012**

**Int. Cl.: 42**

**SERVICE MARK**

**PRINCIPAL REGISTER**

GLOBAL NET ACCESS HOLDINGS, LLC (GEORGIA LIMITED LIABILITY COMPANY)  
1100 WHITE STREET SW  
ATLANTA, GA 30310

FOR: COMPUTER SERVICES, NAMELY, CLOUD HOSTING PROVIDER SERVICES, DATA RECOVERY SERVICES, REMOTE ON-LINE BACKUP OF COMPUTER DATA, AND PROVIDING VIRTUAL AND NON VIRTUAL APPLICATION SERVERS, WEB SERVERS, FILE SERVERS, CO-LOCATION SERVERS, LOAD BALANCING SERVERS, REDUNDANCY SERVERS, AND DATABASE SERVERS OF VARIABLE CAPACITY FOR USE BY OTHERS; DATA WAREHOUSING; DESIGN AND DEVELOPMENT OF ELECTRONIC DATA SECURITY SYSTEMS; CONSULTING SERVICES RELATED TO THE DESIGN, IMPLEMENTATION, AND MANAGEMENT OF VIRTUAL AND NON-VIRTUAL NETWORK SOLUTIONS, DATA RECOVERY SYSTEMS, AND VIRTUAL AND NON-VIRTUAL APPLICATION SERVERS, WEB SERVERS, FILE SERVERS, CO-LOCATION SERVERS, LOAD BALANCING SERVERS, REDUNDANCY SERVERS, AND DATABASE SERVERS OF VARIABLE CAPACITY FOR USE BY OTHERS; COMPUTER SERVICES, NAMELY, REMOTE MANAGEMENT OF THE INFORMATION TECHNOLOGY SYSTEMS OF OTHERS, IN CLASS 42 (U.S. CLS. 100 AND 101).

FIRST USE 3-1-2003; IN COMMERCE 3-1-2003.

THE MARK CONSISTS OF STANDARD CHARACTERS WITHOUT CLAIM TO ANY PARTICULAR FONT, STYLE, SIZE, OR COLOR.

SER. NO. 85-358,019, FILED 6-28-2011.

JAY FLOWERS, EXAMINING ATTORNEY



*David J. Kyffers*

Director of the United States Patent and Trademark Office

# United States of America

United States Patent and Trademark Office

## LOVE ME GREEN

**Reg. No. 4,196,941**

**Registered Aug. 28, 2012**

**Int. Cls.: 3, 5 and 44**

**TRADEMARK**

**SERVICE MARK**

**PRINCIPAL REGISTER**

LERCH, KATARZYNA (POLAND INDIVIDUAL)  
FLORCZAKI SA  
LUKTOA, POLAND 14-105 AND

LERCH, DIETMAR (POLAND INDIVIDUAL)  
FLORCZAKI SA  
LUKTOA, POLAND 14-105

FOR: SOAPS, PERFUMERY, ESSENTIAL OILS, COSMETICS, COSMETIC CREAMS, BODY SCRUBS, BODY EMULSIONS, MAKE-UP, HAIR CARE PREPARATIONS AND HAIR RINSES; MAKE-UP POWDER, TALCUM POWDER FOR COSMETIC USE, OILS FOR COSMETIC PURPOSES, COSMETIC PREPARATIONS FOR BATHS, BATH SALT, IN CLASS 3 (U.S. CLS. 1, 4, 6, 50, 51 AND 52).

FOR: MINERAL FOOD SUPPLEMENTS, FOOD SUPPLEMENTS FOR MEDICAL PURPOSES AND VITAMIN PREPARATIONS, IN CLASS 5 (U.S. CLS. 6, 18, 44, 46, 51 AND 52).

FOR: HYGIENIC AND BEAUTY CARE FOR HUMAN BEINGS; COSMETOLOGY ADVICE; COSMETIC TREATMENT, NAMELY, COSMETIC FACIAL TREATMENT SERVICES, COSMETIC BODY CARE SERVICES, IN CLASS 44 (U.S. CLS. 100 AND 101).

THE MARK CONSISTS OF STANDARD CHARACTERS WITHOUT CLAIM TO ANY PARTICULAR FONT, STYLE, SIZE, OR COLOR.

OWNER OF ERPN CMNTY TM OFC REG. NO. 009274911, DATED 12-24-2010, EXPIRES 7-12-2020.

SER. NO. 85-358,362, FILED 6-28-2011.

CURTIS FRENCH, EXAMINING ATTORNEY



*David J. Kypos*

Director of the United States Patent and Trademark Office

# United States of America

United States Patent and Trademark Office



**Reg. No. 4,196,942**

**Registered Aug. 28, 2012**

**Int. Cl.: 29**

**TRADEMARK**

**PRINCIPAL REGISTER**

MSN CORPORATION DBA BUDD FOODS, INC. (MASSACHUSETTS CORPORATION)  
431 SOMERVILLE STREET  
MANCHESTER, NH 03103

FOR: PREPARED AND PACKAGED ENTREES CONSISTING PRIMARILY OF MEAT, POULTRY OR VEGETABLES; CHICKEN PIE; SHEPHERD'S PIE; FROZEN ENTREES CONSISTING PRIMARILY OF MEAT, POULTRY OR VEGETABLES, IN CLASS 29 (U.S. CL. 46).

FIRST USE 1-2-2002; IN COMMERCE 1-2-2002.

OWNER OF U.S. REG. NO. 1,665,991.

THE NAME(S), PORTRAIT(S), AND/OR SIGNATURE(S) SHOWN IN THE MARK DOES NOT IDENTIFY A PARTICULAR LIVING INDIVIDUAL.

THE MARK CONSISTS OF THE PICTURE OF A WOMAN INSIDE AN OVAL WITH A DECORATIVE BORDER ABOVE THE WORDS "MRS. BUDD'S" IN STYLIZED FONT.

SER. NO. 85-358,522, FILED 6-28-2011.

ALICIA COLLINS, EXAMINING ATTORNEY



*David J. Kyjars*

Director of the United States Patent and Trademark Office



# United States of America

United States Patent and Trademark Office



**Reg. No. 4,196,943**

**Registered Aug. 28, 2012**

**Int. Cl.: 9**

**TRADEMARK**

**PRINCIPAL REGISTER**

PATROL INCIDENT GEAR, LLC. (WYOMING LIMITED LIABILITY COMPANY)  
P.O. BOX 245  
HIGHLAND FALLS, NY 10928

FOR: TACTICAL EQUIPMENT FOR MILITARY AND LAW ENFORCEMENT, NAMELY,  
SPECIALIZED CARRIERS FOR BODY ARMOR AND BALLISTIC RESISTANT BODY ARMOR  
PLATES, IN CLASS 9 (U.S. CLS. 21, 23, 26, 36 AND 38).

FIRST USE 1-15-2010; IN COMMERCE 1-15-2010.

THE MARK CONSISTS OF A TIGER STRIPED PIG.

SER. NO. 85-358,683, FILED 6-28-2011.

KEVIN DINALLO, EXAMINING ATTORNEY



*David J. Kybas*

Director of the United States Patent and Trademark Office

# United States of America

United States Patent and Trademark Office

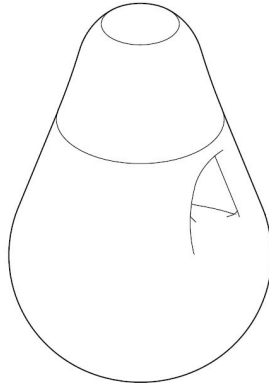

**Reg. No. 4,196,944**

**Registered Aug. 28, 2012**

**Int. Cl.: 1**

**TRADEMARK**

**PRINCIPAL REGISTER**

SILK WATER SOLUTIONS INC. (CANADA CORPORATION)  
101-12080 NORDEL WAY  
SURREY, BC, CANADA V3W6Y7

FOR: WATER TREATMENT CHEMICALS FOR USE IN SWIMMING POOLS AND SPAS, IN CLASS 1 (U.S. CLS. 1, 5, 6, 10, 26 AND 46).

FIRST USE 12-0-2007; IN COMMERCE 12-0-2007.

THE MARK CONSISTS OF A CONTOURED BULB-SHAPED THREE-DIMENSIONAL BOTTLE TAPERED TOWARDS THE CAP AND CURVED HANDLE PROTRUDING FROM THE BOTTLE.

SEC. 2(F).

SER. NO. 85-358,742, FILED 6-28-2011.

LINDA E. BLOHM, EXAMINING ATTORNEY



*David J. Kybas*

Director of the United States Patent and Trademark Office

# United States of America

United States Patent and Trademark Office

# PIG

**Reg. No. 4,196,945**

PATROL INCIDENT GEAR, LLC. (WYOMING LIMITED LIABILITY COMPANY)  
P.O. BOX 245

**Registered Aug. 28, 2012**

HIGHLAND FALLS, NY 10928

**Int. Cl.: 9**

FOR: TACTICAL EQUIPMENT FOR MILITARY AND LAW ENFORCEMENT, NAMELY, SPECIALIZED CARRIERS FOR BODY ARMOR AND BALLISTIC RESISTANT BODY ARMOR PLATES, IN CLASS 9 (U.S. CLS. 21, 23, 26, 36 AND 38).

**TRADEMARK**

FIRST USE 1-15-2010; IN COMMERCE 1-15-2010.

**PRINCIPAL REGISTER**

THE MARK CONSISTS OF STANDARD CHARACTERS WITHOUT CLAIM TO ANY PARTICULAR FONT, STYLE, SIZE, OR COLOR.

SER. NO. 85-358,787, FILED 6-28-2011.

KEVIN DINALLO, EXAMINING ATTORNEY



*David J. Kybas*

Director of the United States Patent and Trademark Office

# United States of America

United States Patent and Trademark Office

国瓷永丰源

**Reg. No. 4,196,946**

**Registered Aug. 28, 2012**

**Int. Cl.: 21**

SHENZHEN YONG FENG YUAN INDUSTRY CO., LTD. (CHINA LIMITED LIABILITY COMPANY)

BLOCK 2, YONGFENGYUAN INDUSTRIAL DISTRICT  
HUANGUAN SOUTH RD., GUANLAN TOWN, BAOAN  
SHENZHEN, GUANGDONG, CHINA

**TRADEMARK**

**PRINCIPAL REGISTER**

FOR: BEVERAGE GLASSWARE; CERAMIC SCULPTURES, VASES, VESSELS, BOWLS, PLATES AND POTS; COFFEE SERVICES NOT OF PRECIOUS METAL; DRINKING VESSELS; JARS FOR JAMS AND JELLIES OF PORCELAIN; TEA SERVICES NOT OF PRECIOUS METAL; WORKS OF ART OF GLASS, PORCELAIN, TERRA COTTA, IN CLASS 21 (U.S. CLS. 2, 13, 23, 29, 30, 33, 40 AND 50).

FIRST USE 4-15-2008; IN COMMERCE 4-15-2008.

OWNER OF U.S. REG. NO. 3,817,851.

THE NON-LATIN CHARACTERS IN THE MARK TRANSLITERATE TO "GUO CI YONG FENG YUAN" AND THIS MEANS "NATIONAL PORCELAIN FOREVER ABUNDANT FOUNTAIN" IN ENGLISH.

NO CLAIM IS MADE TO THE EXCLUSIVE RIGHT TO USE THE NON-LATIN CHARACTERS THAT TRANSLATE TO "NATIONAL PORCELAIN", APART FROM THE MARK AS SHOWN.

THE MARK CONSISTS OF STYLIZED CHINESE CHARACTERS.

SER. NO. 85-358,964, FILED 6-29-2011.

JOHN GARTNER, EXAMINING ATTORNEY



*David J. Kyros*

Director of the United States Patent and Trademark Office

# United States of America

United States Patent and Trademark Office



**Reg. No. 4,196,947**

**Registered Aug. 28, 2012**

**Int. Cl.: 28**

**TRADEMARK**

**PRINCIPAL REGISTER**

ALEX GOLDBERG (AUSTRALIA INDIVIDUAL)  
6/99 CURLEWIS ST, BONDI BEACH  
SYDNEY, AUSTRALIA 2026

FOR: ACCESSORY FOR MANUALLY-OPERATED EXERCISE EQUIPMENT, NAMELY, ACCESSORY ATTACHMENT TO INCREASE MUSCLE RESISTANCE; ANKLE AND WRIST WEIGHTS FOR EXERCISE; BODY-TRAINING APPARATUS AND DEVICES FOR PHYSICAL EXERCISES, NAMELY, BASEBALL BATS AND BASEBALL SWING TRAINING DEVICES; EXERCISE EQUIPMENT, NAMELY, STRAPS THAT ARE AFFIXED TO DOORS FOR PERFORMANCE OF VARIOUS EXERCISES USING BODY WEIGHT RESISTANCE, IN CLASS 28 (U.S. CLS. 22, 23, 38 AND 50).

OWNER OF AUSTRALIA REG. NO. 1346712, DATED 3-3-2010, EXPIRES 3-3-2020.

THE COLOR(S) RED, BLACK, GREY IS/ARE CLAIMED AS A FEATURE OF THE MARK.

THE MARK CONSISTS OF "POWERTUBE PRO TP" WITH "POWERTUBE" AND "P" BEING BLACK, "PRO" BEING GREY, AND "T" BEING RED.

SER. NO. 85-359,007, FILED 6-29-2011.

JOHN DWYER, EXAMINING ATTORNEY



*David J. Kybas*

Director of the United States Patent and Trademark Office

# United States of America

United States Patent and Trademark Office

## 2/90 SIGN SYSTEMS

**Reg. No. 4,196,948**

SYSTEM 2/90, INC. (MICHIGAN CORPORATION), AKA 2/90 SIGN SYSTEMS  
5350 CORPORATE GROVE BLVD SE  
GRAND RAPIDS, MI 49512

**Registered Aug. 28, 2012**

**Int. Cl.: 37**

FOR: INSTALLATION AND MAINTENANCE OF SIGNAGE, IN CLASS 37 (U.S. CLS. 100, 103 AND 106).

**SERVICE MARK**

FIRST USE 10-1-1979; IN COMMERCE 10-1-1979.

**PRINCIPAL REGISTER**

THE MARK CONSISTS OF STANDARD CHARACTERS WITHOUT CLAIM TO ANY PARTICULAR FONT, STYLE, SIZE, OR COLOR.

NO CLAIM IS MADE TO THE EXCLUSIVE RIGHT TO USE "SIGN SYSTEMS", APART FROM THE MARK AS SHOWN.

SER. NO. 85-359,068, FILED 6-29-2011.

PRISCILLA MILTON, EXAMINING ATTORNEY



*David J. Kybas*

Director of the United States Patent and Trademark Office

# United States of America

United States Patent and Trademark Office

LECO

**Reg. No. 4,196,949**

**Registered Aug. 28, 2012**

**Int. Cl.: 9**

**TRADEMARK**

**PRINCIPAL REGISTER**

LECO CORPORATION (MICHIGAN CORPORATION)  
3000 LAKEVIEW AVENUE  
ST. JOSEPH, MI 490852396

FOR: ANALYTICAL INSTRUMENTS, NAMELY, ANALYZERS FOR THE DETERMINATION OF CHEMICAL ELEMENTS, NAMELY, CARBON, SULFUR, OXYGEN, NITROGEN, HYDROGEN, OR MERCURY, AND MOLECULAR CHEMICALS, NAMELY, PROTEINS, PEPTIDES, METABOLITES, LIPIDS, AND COMPLEX MOLECULES; LABORATORY FURNACES USED FOR HEATING, COMBUSTING, OR REDUCING SAMPLES FOR ANALYTICAL DETERMINATION; SEPARATION DEVICES, NAMELY, MASS SPECTROMETERS, OPTICAL EMISSION SPECTROMETERS, CHROMATOGRAPHS AND OTHER FLUIDIC, LIQUID OR GAS, SEPARATION DEVICES FOR THE PURPOSE OF SEPARATING MIXTURES; IONIZATION DEVICES, NAMELY, IONIZATION SOURCE FOR THE PURPOSE OF IONIZING ELEMENTS OR MOLECULES SO THEY MAY BE MEASURED BY MASS, CHARGE, MASS/CHARGE, OR SHAPE; INSTRUMENTS FOR THE DETERMINATION OF PHYSICAL PROPERTIES OF SAMPLES; COMPUTERS FOR SIGNAL ACQUISITION FROM SAID INSTRUMENTS AND SUBSEQUENT PROCESSING; INSTRUMENTS, NAMELY, TESTERS FOR MATERIAL CHARACTERIZATION ANALYSIS, NAMELY, IMAGE ANALYSIS, HARDNESS, INCLUSIONS AND SURFACE FINISH; MACHINERY AND PARTS FOR MATERIAL CHARACTERIZATION PREPARATION, NAMELY, GRINDERS, POLISHERS, MOLD PRESSES, AND CUT-OFF SAWS; REFERENCE MATERIALS, NAMELY, SPECIMEN STANDARDS TO FACILITATE CALIBRATION AND QUALITY CONTROL OF INSTRUMENTS; LABORATORY EQUIPMENT, NAMELY, COMBUSTION BOATS, COMBUSTION TUBES, CRUCIBLES, AND AUTO LOADERS FOR USE WITH COMBUSTION BOATS AND CRUCIBLES, SHIELDS, SHROUDS, TUNDISH NOZZLES, CORES, CERAMIC LABORATORY VESSELS AND LABORATORY GLASSWARE; COMPUTER SOFTWARE FOR IMAGE ANALYSIS, HARDNESS TESTING, INCLUSIONS ANALYSIS, COMPUTATIONAL ANALYSIS, DATA PROCESSING, AND DATA REPORTING, IN CLASS 9 (U.S. CLS. 21, 23, 26, 36 AND 38).



FIRST USE 3-7-2011; IN COMMERCE 3-7-2011.

OWNER OF U.S. REG. NOS. 394,757 AND 1,599,260.

THE MARK CONSISTS OF "LECO" IN A STYLIZED FORMAT.

SER. NO. 85-359,283, FILED 6-29-2011.

*David J. Kyros*

Director of the United States Patent and Trademark Office

**Reg. No. 4,196,949** MATTHEW KLINE, EXAMINING ATTORNEY



# United States of America

United States Patent and Trademark Office

## CITY BUILDER

**Reg. No. 4,196,950**

**Registered Aug. 28, 2012**

**Int. Cl.: 9**

**TRADEMARK**

**PRINCIPAL REGISTER**

COLLISION STUDIOS INC. (CALIFORNIA CORPORATION)  
2919 ½ MAIN STREET  
SANTA MONICA, CA 90405

FOR: AMUSEMENT APPARATUS AND GAMES ADAPTED FOR USE WITH TELEVISION RECEIVERS OR WITH VIDEO OR COMPUTER MONITORS; COMPUTER GAME DISCS; COMPUTER GAME PROGRAMS; COMPUTER GAME SOFTWARE, IN CLASS 9 (U.S. CLS. 21, 23, 26, 36 AND 38).

FIRST USE 10-20-2009; IN COMMERCE 10-20-2009.

THE MARK CONSISTS OF STANDARD CHARACTERS WITHOUT CLAIM TO ANY PARTICULAR FONT, STYLE, SIZE, OR COLOR.

SER. NO. 85-359,367, FILED 6-29-2011.

KELLY BOULTON, EXAMINING ATTORNEY



*David J. Kybas*

Director of the United States Patent and Trademark Office

# United States of America

United States Patent and Trademark Office



**Reg. No. 4,196,951**

**Registered Aug. 28, 2012**

**Int. Cl.: 21**

**TRADEMARK**

**PRINCIPAL REGISTER**

RAKUPURI, INC. (JAPAN CORPORATION)  
10-1, HIGASHINAKA-CHO  
URAWA-KU, SAITAMA-SHI  
SAITAMA, JAPAN 330-0056

FOR: CLEANING CLOTHS NOT IMPREGNATED WITH A DETERGENT FOR CLEANING CELLULAR TELEPHONE DISPLAY SCREENS, TELEVISION SCREENS, DIGITAL CAMERA SCREENS, PORTABLE DIGITAL MUSIC PLAYER SCREENS, PERSONAL COMPUTER SCREENS, MIRRORS, AND HANDHELD GAME MACHINE SCREENS, IN CLASS 21 (U.S. CLS. 2, 13, 23, 29, 30, 33, 40 AND 50).

PRIORITY CLAIMED UNDER SEC. 44(D) ON JAPAN APPLICATION NO. 2011-043825, FILED 6-23-2011, REG. NO. 5461261, DATED 1-6-2012, EXPIRES 1-6-2022.

THE MARK CONSISTS OF A STYLIZED LETTER "D" INSIDE A RECTANGLE.

SER. NO. 85-359,576, FILED 6-29-2011.

JIM RINGLE, EXAMINING ATTORNEY



*David J. Kybas*

Director of the United States Patent and Trademark Office

# United States of America

United States Patent and Trademark Office

## LEBANESE BOMBSHELL

**Reg. No. 4,196,952**

STARBUZZ TOBACCO, INC. (CALIFORNIA CORPORATION)  
2116 W. LINCOLN AVE.  
ANAHEIM, CA 92801

**Registered Aug. 28, 2012**

**Int. Cl.: 34**

FOR: PIPE TOBACCO; MOLASSES TOBACCO; TOBACCO; SMOKING TOBACCO;  
FLAVORED TOBACCO, IN CLASS 34 (U.S. CLS. 2, 8, 9 AND 17).

**TRADEMARK**

FIRST USE 3-5-2011; IN COMMERCE 3-5-2011.

**PRINCIPAL REGISTER**

THE MARK CONSISTS OF STANDARD CHARACTERS WITHOUT CLAIM TO ANY PARTICULAR FONT, STYLE, SIZE, OR COLOR.

NO CLAIM IS MADE TO THE EXCLUSIVE RIGHT TO USE "LEBANESE", APART FROM THE MARK AS SHOWN.

SER. NO. 85-359,842, FILED 6-29-2011.

RONALD MCMORROW, EXAMINING ATTORNEY



*David J. Kyfos*

Director of the United States Patent and Trademark Office

# United States of America

United States Patent and Trademark Office

## HAWAIIAN MIST

**Reg. No. 4,196,953**

STARBUZZ TOBACCO, INC. (CALIFORNIA CORPORATION)  
2116 W. LINCOLN AVE.  
ANAHEIM, CA 92801

**Registered Aug. 28, 2012**

**Int. Cl.: 34**

FOR: PIPE TOBACCO; MOLASSES TOBACCO; TOBACCO; SMOKING TOBACCO;  
FLAVORED TOBACCO, IN CLASS 34 (U.S. CLS. 2, 8, 9 AND 17).

**TRADEMARK**

FIRST USE 6-22-2011; IN COMMERCE 6-22-2011.

**PRINCIPAL REGISTER**

THE MARK CONSISTS OF STANDARD CHARACTERS WITHOUT CLAIM TO ANY PARTICULAR FONT, STYLE, SIZE, OR COLOR.

NO CLAIM IS MADE TO THE EXCLUSIVE RIGHT TO USE "HAWAIIAN", APART FROM THE MARK AS SHOWN.

SER. NO. 85-359,875, FILED 6-29-2011.

RONALD MCMORROW, EXAMINING ATTORNEY



*David J. Kyffers*

Director of the United States Patent and Trademark Office

# United States of America

United States Patent and Trademark Office

# UINTA

**Reg. No. 4,196,954**

**Registered Aug. 28, 2012**

**Int. Cls.: 32 and 43**

**TRADEMARK**

**SERVICE MARK**

**PRINCIPAL REGISTER**

UINTA BREWING COMPANY (UTAH CORPORATION)  
1722 S. FREMONT DR.  
SALT LAKE CITY, UT 84104

FOR: BEER, IN CLASS 32 (U.S. CLS. 45, 46 AND 48).

FIRST USE 6-0-1993; IN COMMERCE 6-0-1993.

FOR: RESTAURANT AND BAR SERVICES, IN CLASS 43 (U.S. CLS. 100 AND 101).

FIRST USE 2-24-1994; IN COMMERCE 2-24-1994.

THE MARK CONSISTS OF STANDARD CHARACTERS WITHOUT CLAIM TO ANY PARTICULAR FONT, STYLE, SIZE, OR COLOR.

SEC. 2(F).

SER. NO. 85-359,949, FILED 6-29-2011.

GRETCHEN ULRICH, EXAMINING ATTORNEY



*David J. Kyffers*

Director of the United States Patent and Trademark Office

# United States of America

United States Patent and Trademark Office

## OVER THE WALL

**Reg. No. 4,196,955**

**Registered Aug. 28, 2012**

**Int. Cls.: 9 and 41**

**TRADEMARK**

**SERVICE MARK**

**PRINCIPAL REGISTER**

OVER THE WALL, LLC (CALIFORNIA LIMITED LIABILITY COMPANY)  
73-850 DINAH SHORE DRIVE, SUITE 115  
PALM DESERT, CA 92211

FOR: MUSICAL SOUND RECORDINGS; VIDEO AND AUDIO RECORDINGS FEATURING MUSIC AND ARTISTIC PERFORMANCES; COMPACT DISCS FEATURING MUSIC; DOWNLOADABLE MUSIC VIA THE INTERNET AND WIRELESS DEVICES, IN CLASS 9 (U.S. CLS. 21, 23, 26, 36 AND 38).

FIRST USE 4-1-2009; IN COMMERCE 3-30-2010.

FOR: ENTERTAINMENT SERVICES, NAMELY, LIVE MUSICAL ENTERTAINMENT PERFORMANCES RENDERED BY A VOCAL AND INSTRUMENTAL GROUP; PROVIDING A WEB SITE FEATURING INFORMATION RELATING TO LIVE MUSICAL PERFORMANCES; PROVIDING A WEB SITE FEATURING NON-DOWNLOADABLE MUSICAL RECORDINGS AND VIDEO RECORDINGS FEATURING MUSICAL PERFORMANCES AND ENTERTAINMENT CONTENT OF THE MUSIC PERFORMERS, IN CLASS 41 (U.S. CLS. 100, 101 AND 107).

FIRST USE 4-1-2009; IN COMMERCE 3-30-2010.

THE MARK CONSISTS OF STANDARD CHARACTERS WITHOUT CLAIM TO ANY PARTICULAR FONT, STYLE, SIZE, OR COLOR.

SER. NO. 85-360,008, FILED 6-29-2011.

BRENDAN REGAN, EXAMINING ATTORNEY



*David J. Kypos*

Director of the United States Patent and Trademark Office

# United States of America

United States Patent and Trademark Office

# OTW

**Reg. No. 4,196,956**

**Registered Aug. 28, 2012**

**Int. Cls.: 9 and 41**

**TRADEMARK**

**SERVICE MARK**

**PRINCIPAL REGISTER**

OVER THE WALL, LLC (CALIFORNIA LIMITED LIABILITY COMPANY)  
73-850 DINAH SHORE DRIVE, SUITE 115  
PALM DESERT, CA 92211

FOR: MUSICAL SOUND RECORDINGS; VIDEO AND AUDIO RECORDINGS FEATURING MUSIC AND ARTISTIC PERFORMANCES; COMPACT DISCS FEATURING MUSIC; DOWNLOADABLE MUSIC VIA THE INTERNET AND WIRELESS DEVICES, IN CLASS 9 (U.S. CLS. 21, 23, 26, 36 AND 38).

FIRST USE 4-1-2009; IN COMMERCE 3-30-2010.

FOR: ENTERTAINMENT SERVICES, NAMELY, LIVE MUSICAL ENTERTAINMENT PERFORMANCES RENDERED BY A VOCAL AND INSTRUMENTAL GROUP; PROVIDING A WEB SITE FEATURING INFORMATION RELATING TO LIVE MUSICAL PERFORMANCES; PROVIDING A WEB SITE FEATURING NON-DOWNLOADABLE MUSICAL RECORDINGS AND VIDEO RECORDINGS FEATURING MUSICAL PERFORMANCES AND ENTERTAINMENT CONTENT OF THE MUSIC PERFORMERS, IN CLASS 41 (U.S. CLS. 100, 101 AND 107).

FIRST USE 4-1-2009; IN COMMERCE 3-30-2010.

THE MARK CONSISTS OF STANDARD CHARACTERS WITHOUT CLAIM TO ANY PARTICULAR FONT, STYLE, SIZE, OR COLOR.

SER. NO. 85-360,020, FILED 6-29-2011.

BRENDAN REGAN, EXAMINING ATTORNEY



*David J. Kyffers*

Director of the United States Patent and Trademark Office

# United States of America

United States Patent and Trademark Office

## TROPICAL MIST

**Reg. No. 4,196,957**

STARBUZZ TOBACCO, INC. (CALIFORNIA CORPORATION)  
2116 W. LINCOLN AVE.  
ANAHEIM, CA 92801

**Registered Aug. 28, 2012**

**Int. Cl.: 34**

FOR: PIPE TOBACCO; MOLASSES TOBACCO; TOBACCO; SMOKING TOBACCO;  
FLAVORED TOBACCO, IN CLASS 34 (U.S. CLS. 2, 8, 9 AND 17).

**TRADEMARK**

FIRST USE 6-22-2011; IN COMMERCE 6-22-2011.

**PRINCIPAL REGISTER**

THE MARK CONSISTS OF STANDARD CHARACTERS WITHOUT CLAIM TO ANY PARTICULAR FONT, STYLE, SIZE, OR COLOR.

SER. NO. 85-360,053, FILED 6-29-2011.

RONALD MCMORROW, EXAMINING ATTORNEY



*David J. Kyffers*

Director of the United States Patent and Trademark Office



# United States of America

United States Patent and Trademark Office

## Erin Rose Design

**Reg. No. 4,196,958**

**Registered Aug. 28, 2012**

**Int. Cls.: 18 and 25**

**TRADEMARK**

**PRINCIPAL REGISTER**

ERIN GALLAGHER (UNITED STATES INDIVIDUAL)  
SUITE 1N  
6517 N. HOYNE AVENUE  
CHICAGO, IL 60645

FOR: HANDBAGS; PURSES; WALLETS, IN CLASS 18 (U.S. CLS. 1, 2, 3, 22 AND 41).

FIRST USE 12-10-2010; IN COMMERCE 12-10-2010.

FOR: HATS; UNDERGARMENTS , IN CLASS 25 (U.S. CLS. 22 AND 39).

FIRST USE 12-10-2010; IN COMMERCE 12-10-2010.

THE MARK CONSISTS OF STANDARD CHARACTERS WITHOUT CLAIM TO ANY PARTICULAR FONT, STYLE, SIZE, OR COLOR.

NO CLAIM IS MADE TO THE EXCLUSIVE RIGHT TO USE "DESIGN", APART FROM THE MARK AS SHOWN.

THE NAME(S), PORTRAIT(S), AND/OR SIGNATURE(S) SHOWN IN THE MARK IDENTIFIES ERIN GALLAGHER, WHOSE CONSENT(S) TO REGISTER IS MADE OF RECORD.

SER. NO. 85-360,073, FILED 6-29-2011.

BENJAMIN OKEKE, EXAMINING ATTORNEY



*David J. Kyffers*

Director of the United States Patent and Trademark Office

# United States of America

United States Patent and Trademark Office

## ERIN ROSE DESIGN

**Reg. No. 4,196,959**

**Registered Aug. 28, 2012**

**Int. Cls.: 42 and 44**

**SERVICE MARK**

**PRINCIPAL REGISTER**

ERIN GALLAGHER (UNITED STATES INDIVIDUAL)  
SUITE 1N  
6517 N. HOYNE AVENUE  
CHICAGO, IL 60645

FOR: DESIGN SERVICES, NAMELY, THE DESIGN OF CLOTHING, COSTUME CLOTHING, COSTUME ITEMS, JEWELRY, EVENING CLOTHING, BRIDAL CLOTHING, THEATRICAL CLOTHING, MILLINERY, IN CLASS 42 (U.S. CLS. 100 AND 101).

FIRST USE 1-20-2011; IN COMMERCE 1-20-2011.

FOR: HAIR STYLIST SERVICES, NAMELY, HAIR DESIGNS; AND SERVICES OF A MAKE-UP ARTIST, NAMELY, MAKE-UP DESIGNS, IN CLASS 44 (U.S. CLS. 100 AND 101).

FIRST USE 1-20-2011; IN COMMERCE 1-20-2011.

THE MARK CONSISTS OF STANDARD CHARACTERS WITHOUT CLAIM TO ANY PARTICULAR FONT, STYLE, SIZE, OR COLOR.

NO CLAIM IS MADE TO THE EXCLUSIVE RIGHT TO USE "DESIGN", APART FROM THE MARK AS SHOWN.

THE NAME(S), PORTRAIT(S), AND/OR SIGNATURE(S) SHOWN IN THE MARK IDENTIFIES ERIN GALLAGHER, WHOSE CONSENT(S) TO REGISTER IS MADE OF RECORD.

SER. NO. 85-360,096, FILED 6-29-2011.

BENJAMIN OKEKE, EXAMINING ATTORNEY



*David J. Kybas*

Director of the United States Patent and Trademark Office

# United States of America

United States Patent and Trademark Office

# GOOF PROOF

**Reg. No. 4,196,960**

**Registered Aug. 28, 2012**

**Int. Cl.: 8**

**TRADEMARK**

**PRINCIPAL REGISTER**

MARK E. INDUSTRIES, INC. (FLORIDA CORPORATION)  
28921 U.S. 19 NORTH  
CLEARWATER, FL 33761

FOR: HAND OPERATED TOOLS USED TO INSTALL SHOWER LINERS, NAMELY, ELONGATED PLASTIC FORMS USED WHEN POURING CONCRETE THAT PROVIDE A PREDETERMINED DRAINAGE SLOPE TO A SHOWER FLOOR WHEN THE UNDERLYING FLOOR IS LEVEL OR NOT LEVEL, IN CLASS 8 (U.S. CLS. 23, 28 AND 44).

FIRST USE 11-0-2010; IN COMMERCE 11-0-2010.

THE MARK CONSISTS OF STANDARD CHARACTERS WITHOUT CLAIM TO ANY PARTICULAR FONT, STYLE, SIZE, OR COLOR.

SER. NO. 85-360,190, FILED 6-30-2011.

SEAN CROWLEY, EXAMINING ATTORNEY



*David J. Kyffers*

Director of the United States Patent and Trademark Office

# United States of America

United States Patent and Trademark Office

# INTESA

**Reg. No. 4,196,961**

**Registered Aug. 28, 2012**

**Int. Cl.: 36**

**SERVICE MARK**

**PRINCIPAL REGISTER**

INTESA SANPAOLO S.P.A. (ITALY JOINT STOCK COMPANY)  
PIAZZA SAN CARLO 156  
TORINO, ITALY

FOR: BANKING SERVICES; INVESTMENT BANKING SERVICES; FINANCIAL SERVICES IN THE NATURE OF UNDERWRITING, DISTRIBUTION, AND TRADING OF SECURITIES; FINANCIAL SERVICES IN THE NATURE OF MERGER, ACQUISITION AND RESTRUCTURING OF CORPORATE DEBT AND ASSETS; SECURITIES BROKERAGE SERVICES, INVESTMENT RESEARCH SERVICES; INVESTMENT MANAGEMENT AND ADVICE; FINANCIAL SERVICES IN THE NATURE OF TRADING FUTURES, CURRENCIES, OPTIONS, FOREIGN EXCHANGE, AND COMMODITIES; MONETARY CLEARANCE SERVICES, NAMELY, FINANCIAL CLEARING HOUSES; SECURITIES AND MUTUAL FUND CUSTODY SERVICES, NAMELY, SECURITIES AND MUTUAL FUND BROKERAGE; ESTATE PLANNING SERVICES; REAL ESTATE TRUSTEE SERVICES; PENSION ADMINISTRATION SERVICES; MUTUAL FUND BROKERAGE, INVESTMENT, DISTRIBUTION OR ESTABLISHING MUTUAL FUNDS FOR OTHERS; DERIVATIVE INVESTMENT SECURITIES; FINANCIAL RISK MANAGEMENT SERVICES; INSURANCE INVESTMENT SECURITIES; INSURANCE BROKERAGE, INSURANCE ADMINISTRATION IN THE FIELDS OF HOME, VEHICLE, LIFE, ACCIDENT, AND PERSONAL LIABILITY INSURANCE; FINANCIAL PLANNING SERVICES; CREDIT CARD SERVICES AND CREDIT CARD BENEFIT SERVICES, NAMELY, CREDIT CARD INSURANCE; DEBIT CARD SERVICES AND DEBIT CARD BENEFIT SERVICES, NAMELY, TRAVEL ACCIDENT INSURANCE SERVICES; CHECK CARD SERVICES AND CHECK CARD BENEFIT SERVICES, NAMELY, TRAVEL ACCIDENT INSURANCE SERVICES; REAL ESTATE AGENCY, VALUATION, NAMELY, FINANCIAL VALUATION OF PERSONAL PROPERTY AND REAL ESTATE, AND REAL ESTATE MANAGEMENT AND BROKERAGE, IN CLASS 36 (U.S. CLS. 100, 101 AND 102).



THE MARK CONSISTS OF STANDARD CHARACTERS WITHOUT CLAIM TO ANY PARTICULAR FONT, STYLE, SIZE, OR COLOR.

OWNER OF ERPN CMNTY TM OFC REG. NO. 003105277, DATED 2-13-2009, EXPIRES 3-21-2013.

OWNER OF U.S. REG. NOS. 3,109,432, 3,204,146 AND OTHERS.

THE ENGLISH TRANSLATION OF "INTESA" IN THE MARK IS "AGREEMENT".

*David J. Kybas*

Director of the United States Patent and Trademark Office

**Reg. No. 4,196,961** SER. NO. 85-360,193, FILED 6-30-2011.

SEAN CROWLEY, EXAMINING ATTORNEY

# United States of America

United States Patent and Trademark Office



**Reg. No. 4,196,962**

GALLS, LLC (DELAWARE LIMITED LIABILITY COMPANY)  
1340 RUSSELL CAVE ROAD  
LEXINGTON, KY 40505

**Registered Aug. 28, 2012**

**Int. Cls.: 25 and 35**

FOR: CLOTHING, NAMELY, SHIRTS, PANTS, JACKETS, FOOTWEAR, SOCKS, TIES, BELTS FOR CLOTHING, IN CLASS 25 (U.S. CLS. 22 AND 39).

**TRADEMARK**

FIRST USE 1-0-2000; IN COMMERCE 1-0-2000.

**SERVICE MARK**

FOR: MAIL ORDER AND CATALOG SERVICES FOR EQUIPMENT AND SUPPLIES IN THE FIELDS OF LAW ENFORCEMENT, FIRE AND RESCUE, TRAFFIC AND MUNICIPAL SAFETY AND EMERGENCY MEDICAL RESPONSE; ONLINE RETAIL STORE SERVICES FEATURING EQUIPMENT AND SUPPLIES IN THE FIELDS OF LAW ENFORCEMENT, FIRE AND RESCUE, TRAFFIC AND MUNICIPAL SAFETY AND EMERGENCY MEDICAL RESPONSE; RETAIL STORE SERVICES FEATURING EQUIPMENT AND SUPPLIES IN THE FIELDS OF LAW ENFORCEMENT, FIRE AND RESCUE, TRAFFIC AND MUNICIPAL SAFETY AND EMERGENCY MEDICAL RESPONSE, IN CLASS 35 (U.S. CLS. 100, 101 AND 102).

**PRINCIPAL REGISTER**

FIRST USE 1-3-2000; IN COMMERCE 1-3-2000.

THE MARK CONSISTS OF THE LETTER "G" IN A SHIELD DESIGN.

SER. NO. 85-360,351, FILED 6-30-2011.

COLLEEN DOMBROW, EXAMINING ATTORNEY



*David J. Kybas*

Director of the United States Patent and Trademark Office

# United States of America

United States Patent and Trademark Office

# DYMOTEK

**Reg. No. 4,196,963**

**Registered Aug. 28, 2012**

**Int. Cls.: 40 and 42**

**SERVICE MARK**

**PRINCIPAL REGISTER**

DYMOTEK, INC. (CONNECTICUT CORPORATION)  
SEVEN MAIN STREET  
ELLINGTON, CT 06029

FOR: CUSTOM MANUFACTURE, PROCESSING AND ASSEMBLY OF INJECTION MOLDED PLASTIC PRODUCTS INCLUDING ROBOTIC-ASSISTED MOLDING AND ASSEMBLY; INJECTION MOLDING OF PLASTIC FOR OTHERS, IN CLASS 40 (U.S. CLS. 100, 103 AND 106).

FIRST USE 4-30-2005; IN COMMERCE 4-30-2005.

FOR: COMPUTER AIDED DESIGN FOR OTHERS IN THE FIELD OF INJECTION MOLDED PLASTIC PRODUCTS, IN CLASS 42 (U.S. CLS. 100 AND 101).

FIRST USE 4-30-2005; IN COMMERCE 4-30-2005.

THE MARK CONSISTS OF STANDARD CHARACTERS WITHOUT CLAIM TO ANY PARTICULAR FONT, STYLE, SIZE, OR COLOR.

SER. NO. 85-360,403, FILED 6-30-2011.

CHRIS WELLS, EXAMINING ATTORNEY



*David J. Kypos*

Director of the United States Patent and Trademark Office

# United States of America

United States Patent and Trademark Office

# Dymotek

**Reg. No. 4,196,964**

**Registered Aug. 28, 2012**

**Int. Cls.: 40 and 42**

**SERVICE MARK**

**PRINCIPAL REGISTER**

DYMOTEK, INC. (CONNECTICUT CORPORATION)  
SEVEN MAIN STREET  
ELLINGTON, CT 06029

FOR: CUSTOM MANUFACTURE, PROCESSING AND ASSEMBLY OF INJECTION MOLDED PLASTIC PRODUCTS INCLUDING ROBOTIC-ASSISTED MOLDING AND ASSEMBLY; INJECTION MOLDING OF PLASTIC FOR OTHERS, IN CLASS 40 (U.S. CLS. 100, 103 AND 106).

FIRST USE 4-30-2005; IN COMMERCE 4-30-2005.

FOR: COMPUTER AIDED DESIGN FOR OTHERS IN THE FIELD OF INJECTION MOLDED PLASTIC PRODUCTS, IN CLASS 42 (U.S. CLS. 100 AND 101).

FIRST USE 4-30-2005; IN COMMERCE 4-30-2005.

THE MARK CONSISTS OF THE WORD "DYMOTEK" AND A SET OF CIRCULAR DOTS IN AN INVERTED TRIANGLE PATTERN OVER THE LETTER "Y" OF THE WORD "DYMOTEK".

SER. NO. 85-360,408, FILED 6-30-2011.

CHRIS WELLS, EXAMINING ATTORNEY



*David J. Kyros*

Director of the United States Patent and Trademark Office



# United States of America

United States Patent and Trademark Office



**Reg. No. 4,196,965**

MYUNG SIK CHO (UNITED STATES INDIVIDUAL)  
1513 U STREET N.W.  
WASHINGTON, DC 20009

**Registered Aug. 28, 2012**

**Int. Cls.: 37 and 39**

FOR: DRY CLEANING; LAUNDRY SERVICES; LEATHER CLEANING AND REPAIR, IN CLASS 37 (U.S. CLS. 100, 103 AND 106).

**SERVICE MARK**

FIRST USE 1-0-2005; IN COMMERCE 1-0-2005.

**PRINCIPAL REGISTER**

FOR: LAUNDRY PICK-UP AND DELIVERY; FUR STORAGE, IN CLASS 39 (U.S. CLS. 100 AND 105).

FIRST USE 1-0-2005; IN COMMERCE 1-0-2005.

NO CLAIM IS MADE TO THE EXCLUSIVE RIGHT TO USE "U STREET", "CLEANERS" AND "ORGANIC", APART FROM THE MARK AS SHOWN.

THE MARK CONSISTS OF THE TERMS "U STREET CLEANERS" WITHIN A DOUBLE CIRCLE DESIGN, A DEPICTION OF A GLOBE INSIDE THE CIRCLE AND THE TERM "ORGANIC" SUPERIMPOSED ON THE DESIGN.

SER. NO. 85-360,477, FILED 6-30-2011.

ROBERT C. CLARK JR., EXAMINING ATTORNEY



*David J. Kybas*

Director of the United States Patent and Trademark Office

# United States of America

United States Patent and Trademark Office



**Reg. No. 4,196,966**

BEVERLY CROCKER (UNITED STATES INDIVIDUAL)  
561 10TH AVENUE 8F  
NEW YORK, NY 10036

**Registered Aug. 28, 2012**

**Int. Cl.: 35**

FOR: CHARITABLE SERVICES PROVIDED TO RESIDENTS OF WOMEN'S SHELTERS, NAMELY, CAREER PLACEMENT SERVICES, IN CLASS 35 (U.S. CLS. 100, 101 AND 102).

**SERVICE MARK**

FIRST USE 1-1-2009; IN COMMERCE 1-1-2009.

**PRINCIPAL REGISTER**

THE MARK CONSISTS OF HOT PINK LIPS AND THE BLACK WORDING "PROJECT LIPSTICK". THE COLOR WHITE IN THE DRAWING REPRESENTS TRANSPARENT AREAS AND A TRANSPARENT BACKGROUND THAT ARE NOT PART OF THE MARK.

THE COLOR(S) HOT PINK AND BLACK IS/ARE CLAIMED AS A FEATURE OF THE MARK.

SER. NO. 85-360,539, FILED 6-30-2011.

KIM MONINGHOFF, EXAMINING ATTORNEY



*David J. Kybas*

Director of the United States Patent and Trademark Office

# United States of America

United States Patent and Trademark Office

# UFO

**Reg. No. 4,196,967**

STARBUZZ TOBACCO, INC. (CALIFORNIA CORPORATION)  
2116 W. LINCOLN AVE.  
ANAHEIM, CA 92801

**Registered Aug. 28, 2012**

**Int. Cl.: 34**

FOR: PIPE TOBACCO; MOLASSES TOBACCO; TOBACCO; SMOKING TOBACCO;  
FLAVORED TOBACCO, IN CLASS 34 (U.S. CLS. 2, 8, 9 AND 17).

**TRADEMARK**

FIRST USE 6-22-2011; IN COMMERCE 6-22-2011.

**PRINCIPAL REGISTER**

THE MARK CONSISTS OF STANDARD CHARACTERS WITHOUT CLAIM TO ANY PARTICULAR FONT, STYLE, SIZE, OR COLOR.

SER. NO. 85-360,763, FILED 6-30-2011.

RONALD MCMORROW, EXAMINING ATTORNEY



*David J. Kyffers*

Director of the United States Patent and Trademark Office

# United States of America

United States Patent and Trademark Office

# SNACHE

**Reg. No. 4,196,968**

SAMPLES, RANDOLPH S. (UNITED STATES INDIVIDUAL)  
133 TIBURON COURT  
LITHONIA, GA 30038

**Registered Aug. 28, 2012**

**Int. Cl.: 28**

FOR: TRAINING APPARATUS FOR BOXING, MARTIAL ARTS, AND SIMILAR SPORTS,  
IN CLASS 28 (U.S. CLS. 22, 23, 38 AND 50).

**TRADEMARK**

FIRST USE 1-1-1992; IN COMMERCE 1-1-1992.

**PRINCIPAL REGISTER**

THE MARK CONSISTS OF STANDARD CHARACTERS WITHOUT CLAIM TO ANY PAR-  
TICULAR FONT, STYLE, SIZE, OR COLOR.

SER. NO. 85-360,840, FILED 6-30-2011.

CHRISTOPHER BUONGIORNO, EXAMINING ATTORNEY



*David J. Kybas*

Director of the United States Patent and Trademark Office

# United States of America

United States Patent and Trademark Office

# EQUIPRENT

**Reg. No. 4,196,969**

**Registered Aug. 28, 2012**

**Int. Cls.: 35 and 42**

**SERVICE MARK**

**PRINCIPAL REGISTER**

EQUIPCO, LLC (ARIZONA LIMITED LIABILITY COMPANY), DBA EQUIPRENT  
#360  
7114 E. STETSON DRIVE  
SCOTTSDALE, AZ 85251

FOR: PROVIDING AN ONLINE COMPUTER DATABASE FOR CUSTOMERS TO LOCATE VARIOUS PROVIDERS OF GOODS AND SERVICES BY MEANS OF AN ONLINE MARKETPLACE; BUSINESS SERVICES, NAMELY, PROVIDING AN ONLINE NETWORK FOR VENDORS TO RECEIVE CUSTOMER BIDDING OPPORTUNITIES BY MEANS OF AN ONLINE MARKETPLACE, IN CLASS 35 (U.S. CLS. 100, 101 AND 102).

FIRST USE 5-31-2011, THE MARK WAS FIRST USED ANYWHERE IN A DIFFERENT FORM OTHER THAN THAT SOUGHT TO BE REGISTERED AT LEAST AS EARLY AS 01/01/2011.; IN COMMERCE 5-31-2011, THE MARK WAS FIRST USED IN COMMERCE IN A DIFFERENT FORM OTHER THAN THAT SOUGHT TO BE REGISTERED AT LEAST AS EARLY AS 01/01/2011..

FOR: PROVIDING TEMPORARY USE OF ONLINE NON-DOWNLOADABLE SOFTWARE AND APPLICATIONS FOR MATCHING VENDORS OF GOODS AND SERVICES AND CUSTOMERS SEEKING SUCH GOODS AND SERVICES VIA GLOBAL COMPUTER NETWORK, IN CLASS 42 (U.S. CLS. 100 AND 101).

FIRST USE 5-31-2011, THE MARK WAS FIRST USED ANYWHERE IN A DIFFERENT FORM OTHER THAN THAT SOUGHT TO BE REGISTERED AT LEAST AS EARLY AS 01/01/2011.; IN COMMERCE 5-31-2011, THE MARK WAS FIRST USED IN COMMERCE IN A DIFFERENT FORM OTHER THAN THAT SOUGHT TO BE REGISTERED AT LEAST AS EARLY AS 01/01/2011..

THE MARK CONSISTS OF STANDARD CHARACTERS WITHOUT CLAIM TO ANY PARTICULAR FONT, STYLE, SIZE, OR COLOR.

SER. NO. 85-360,848, FILED 6-30-2011.

MICHAEL KEATING, EXAMINING ATTORNEY



*David J. Kyffers*

Director of the United States Patent and Trademark Office

# United States of America

United States Patent and Trademark Office

## H.I.P. CONCEPT

**Reg. No. 4,196,970**

**Registered Aug. 28, 2012**

**Int. Cl.: 10**

**TRADEMARK**

**PRINCIPAL REGISTER**

HYPREVENTION (FRANCE COMPANY)  
HÔPITAL XAVIER ARNOZAN  
AVENUE DU HAUT LEVÊQUE  
PESSAC, FRANCE F-33600

FOR: BONE IMPLANTS COMPOSED OF ARTIFICIAL MATERIALS; BONE PROSTHESES; BONE REPAIR COMPOUND FOR USE IN ORTHOPEDIC SURGERY; BONE SETTING MACHINES AND INSTRUMENTS; BONE VOID FILLER CONSISTING OF SYNTHETIC MATERIALS; BONE PROSTHESES; MEDICAL APPARATUS AND INSTRUMENTS FOR USE IN BONE SURGERY; REINFORCEMENT PROSTHESES FOR BONE IN PREVENTION OF BREAKING; ANCILLARY MEDICAL APPARATUS FOR PLACING BONE PROSTHESES, IN CLASS 10 (U.S. CLS. 26, 39 AND 44).

THE MARK CONSISTS OF STANDARD CHARACTERS WITHOUT CLAIM TO ANY PARTICULAR FONT, STYLE, SIZE, OR COLOR.

OWNER OF FRANCE REG. NO. 113796810, DATED 1-11-2011, EXPIRES 1-11-2021.

NO CLAIM IS MADE TO THE EXCLUSIVE RIGHT TO USE "HIP", APART FROM THE MARK AS SHOWN.

SER. NO. 85-360,896, FILED 6-30-2011.

SEAN CROWLEY, EXAMINING ATTORNEY



*David J. Kybas*

Director of the United States Patent and Trademark Office

# United States of America

United States Patent and Trademark Office

# D.U.I.

**Reg. No. 4,196,971**

STARBUZZ TOBACCO, INC. (CALIFORNIA CORPORATION)  
2116 W. LINCOLN AVE.  
ANAHEIM, CA 92801

**Registered Aug. 28, 2012**

**Int. Cl.: 34**

FOR: PIPE TOBACCO; MOLASSES TOBACCO; TOBACCO; SMOKING TOBACCO;  
FLAVORED TOBACCO, IN CLASS 34 (U.S. CLS. 2, 8, 9 AND 17).

**TRADEMARK**

FIRST USE 6-22-2011; IN COMMERCE 6-22-2011.

**PRINCIPAL REGISTER**

THE MARK CONSISTS OF STANDARD CHARACTERS WITHOUT CLAIM TO ANY PARTICULAR FONT, STYLE, SIZE, OR COLOR.

SER. NO. 85-360,926, FILED 6-30-2011.

RONALD MCMORROW, EXAMINING ATTORNEY



*David J. Kybas*

Director of the United States Patent and Trademark Office

# United States of America

United States Patent and Trademark Office

## ISTOCKPHOTO

**Reg. No. 4,196,972**

**Registered Aug. 28, 2012**

**Int. Cl.: 45**

**SERVICE MARK**

**PRINCIPAL REGISTER**

ISTOCKPHOTO LP (CANADA LIMITED PARTNERSHIP)  
200, 1240-20TH AVENUE S.E.  
CALGARY, ALBERTA, CANADA T2G1M8

FOR: LICENSING OF INTELLECTUAL PROPERTY; LICENSING OF INTELLECTUAL PROPERTY OF OTHERS; LICENSING OF INTELLECTUAL PROPERTY VIA COMPUTER NETWORKS AND GLOBAL COMMUNICATIONS NETWORKS; LICENSING OF INTELLECTUAL PROPERTY, NAMELY, IMAGES, PICTURES, PHOTOGRAPHS, STOCK PHOTOGRAPHS, STOCK PHOTOGRAPHY PICTORIAL IMAGES, STILL IMAGES, MOVING IMAGES, FILM, VIDEO, GRAPHIC DESIGNS, CLIP ART, NEWS IMAGES, AUDIO DATA, MUSICAL SOUND RECORDINGS, MULTIMEDIA RECORDINGS, ANIMATIONS, ILLUSTRATIONS, COMPUTER SOURCE CODE SNIPPETS, WEBSITE TEMPLATES, ELECTRONIC MAIL TEMPLATES, ELECTRONIC TEMPLATES FOR BROCHURES, ELECTRONIC TEMPLATES FOR CARDS, AND ELECTRONIC TEMPLATES FOR AUDIO, VIDEO, MULTIMEDIA, AND PHOTOGRAPHIC PRESENTATIONS IN DOWNLOADABLE AND NON-DOWNLOADABLE FORM; STOCK PHOTOGRAPHY SERVICES, NAMELY, LEASING REPRODUCTION RIGHTS OF PHOTOGRAPHS, TRANSPARENCIES AND DIGITAL CONTENT TO OTHERS, IN CLASS 45 (U.S. CLS. 100 AND 101).

FIRST USE 6-30-2011; IN COMMERCE 6-30-2011.

THE MARK CONSISTS OF STANDARD CHARACTERS WITHOUT CLAIM TO ANY PARTICULAR FONT, STYLE, SIZE, OR COLOR.

OWNER OF U.S. REG. NOS. 3,440,599 AND 3,865,979.

SEC. 2(F).

SER. NO. 85-361,086, FILED 6-30-2011.

JIM RINGLE, EXAMINING ATTORNEY



*David J. Kyffers*

Director of the United States Patent and Trademark Office



# United States of America

United States Patent and Trademark Office



**Reg. No. 4,196,973**

**Registered Aug. 28, 2012**

**Int. Cl.: 35**

**SERVICE MARK**

**PRINCIPAL REGISTER**

BAPTIST GLOBAL RESPONSE, INC. (VIRGINIA CORPORATION)  
SUITE 411  
402 BNA DRIVE  
NASHVILLE, TN 37217

FOR: PROMOTION AND COORDINATION OF ASSISTANCE IN THE FIELD OF INTERNATIONAL DEVELOPMENT AND RELIEF, NAMELY, DEVELOPING AND COORDINATING VOLUNTEER PROJECTS FOR CHARITABLE ORGANIZATIONS, IN CLASS 35 (U.S. CLS. 100, 101 AND 102).

FIRST USE 10-5-2010; IN COMMERCE 10-5-2010.

OWNER OF U.S. REG. NO. 3,503,999.

NO CLAIM IS MADE TO THE EXCLUSIVE RIGHT TO USE "BAPTIST GLOBAL RESPONSE", APART FROM THE MARK AS SHOWN.

THE MARK CONSISTS OF THE LARGE LETTERS "BGR" IN A STYLIZED "WORN" FORMAT ABOVE THE SMALLER WORDS "BAPTIST GLOBAL RESPONSE", SURROUNDED BY A CIRCULAR ARROW WITH ITS BEGINNING TO THE RIGHT OF THE LETTERS AND WORDS AND ENDING IMMEDIATELY ABOVE THEM

SER. NO. 85-361,141, FILED 6-30-2011.

PATRICIA EVANKO, EXAMINING ATTORNEY



*David J. Kyjars*

Director of the United States Patent and Trademark Office

# United States of America

United States Patent and Trademark Office



**Reg. No. 4,196,974**

**Registered Aug. 28, 2012**

**Int. Cl.: 36**

**SERVICE MARK**

**PRINCIPAL REGISTER**

BAPTIST GLOBAL RESPONSE, INC. (VIRGINIA CORPORATION)  
SUITE 411  
402 BNA DRIVE  
NASHVILLE, TN 37217

FOR: CHARITABLE FUNDRAISING SERVICES, IN CLASS 36 (U.S. CLS. 100, 101 AND 102).

FIRST USE 10-5-2010; IN COMMERCE 10-5-2010.

OWNER OF U.S. REG. NO. 3,503,999.

NO CLAIM IS MADE TO THE EXCLUSIVE RIGHT TO USE "BAPTIST GLOBAL RESPONSE",  
APART FROM THE MARK AS SHOWN.

THE MARK CONSISTS OF THE LARGE LETTERS "BGR" IN A STYLIZED "WORN" FORMAT  
ABOVE THE SMALLER WORDS "BAPTIST GLOBAL RESPONSE", SURROUNDED BY A  
CIRCULAR ARROW WITH ITS BEGINNING TO THE RIGHT OF THE LETTERS AND WORDS  
AND ENDING IMMEDIATELY ABOVE THEM

SER. NO. 85-361,146, FILED 6-30-2011.

PATRICIA EVANKO, EXAMINING ATTORNEY



*David J. Kyffers*

Director of the United States Patent and Trademark Office

# United States of America

United States Patent and Trademark Office

# TimeKeeper

**Reg. No. 4,196,975**

**Registered Aug. 28, 2012**

**Int. Cl.: 9**

**TRADEMARK**

**PRINCIPAL REGISTER**

FINITE STATE MACHINE LABS INC. (DELAWARE CORPORATION)  
UNIT 82  
1600 BARTON SPRINGS ROAD  
AUSTIN, TX 78704

FOR: COMPUTER SOFTWARE FOR SYNCHRONIZING THE CLOCKS ON DATA-CENTER, SERVER, DESKTOP, EMBEDDED OR MOBILE COMPUTERS CONNECTED ON A NETWORK TO EACH OTHER, OR TO ONE OR MORE REFERENCE CLOCKS SUCH AS A GLOBAL POSITIONING SYSTEM CLOCK, IN CLASS 9 (U.S. CLS. 21, 23, 26, 36 AND 38).

FIRST USE 2-0-2010; IN COMMERCE 2-0-2010.

THE MARK CONSISTS OF STANDARD CHARACTERS WITHOUT CLAIM TO ANY PARTICULAR FONT, STYLE, SIZE, OR COLOR.

SER. NO. 85-361,304, FILED 6-30-2011.

JAY FLOWERS, EXAMINING ATTORNEY



*David J. Kybas*

Director of the United States Patent and Trademark Office

# United States of America

United States Patent and Trademark Office

## MADAM GENEVA

**Reg. No. 4,196,976**

AVROKO HOSPITALITY GROUP, INC. (DELAWARE CORPORATION)  
210 ELIZABETH STREET  
NEW YORK, NY 10012

**Registered Aug. 28, 2012**

**Int. Cls.: 41 and 43**

FOR: NIGHTCLUB SERVICES, IN CLASS 41 (U.S. CLS. 100, 101 AND 107).

**SERVICE MARK**

FIRST USE 9-0-2008; IN COMMERCE 9-0-2008.

**PRINCIPAL REGISTER**

FOR: RESTAURANT, CATERING, AND BAR SERVICES, IN CLASS 43 (U.S. CLS. 100 AND 101).

FIRST USE 9-0-2008; IN COMMERCE 9-0-2008.

THE MARK CONSISTS OF STANDARD CHARACTERS WITHOUT CLAIM TO ANY PARTICULAR FONT, STYLE, SIZE, OR COLOR.

THE NAME(S), PORTRAIT(S), AND/OR SIGNATURE(S) SHOWN IN THE MARK DOES NOT IDENTIFY A PARTICULAR LIVING INDIVIDUAL.

SER. NO. 85-361,457, FILED 7-1-2011.

FRANK LATTUCA, EXAMINING ATTORNEY



*David J. Kyffers*

Director of the United States Patent and Trademark Office

# United States of America

United States Patent and Trademark Office

# PRODJIN

**Reg. No. 4,196,977**

BRELIAN, INC. (TEXAS CORPORATION), DBA SHIVA LABORATORIES  
7830 WESTPARK DRIVE  
HOUSTON, TX 77063

**Registered Aug. 28, 2012**

**Int. Cl.: 3**

FOR: HAIR CARE PRODUCTS, NAMELY, SHAMPOOS, CONDITIONERS AND NON-MEDICATED SERUMS, IN CLASS 3 (U.S. CLS. 1, 4, 6, 50, 51 AND 52).

**TRADEMARK**

FIRST USE 7-31-2010; IN COMMERCE 7-31-2010.

**PRINCIPAL REGISTER**

THE MARK CONSISTS OF STANDARD CHARACTERS WITHOUT CLAIM TO ANY PARTICULAR FONT, STYLE, SIZE, OR COLOR.

SER. NO. 85-361,750, FILED 7-1-2011.

MARC LEIPZIG, EXAMINING ATTORNEY



*David J. Kyros*

Director of the United States Patent and Trademark Office

# United States of America

United States Patent and Trademark Office

# SureRetainer

**Reg. No. 4,196,978**

SUREVOID PRODUCTS, INC. (COLORADO CORPORATION)  
1895 W. DARTMOUTH AVE.  
ENGLEWOOD, CO 80110

**Registered Aug. 28, 2012**

**Int. Cl.: 19**

FOR: BUILDING MATERIALS, NAMELY, PLASTIC BLOCKS THAT PREVENT BACKFILL SOIL FROM DISPLACING CAVITIES FORMED UNDER GRADE BEAMS AND SLAB EDGES, IN CLASS 19 (U.S. CLS. 1, 12, 33 AND 50).

**TRADEMARK**

FIRST USE 1-16-1998; IN COMMERCE 1-16-1998.

**PRINCIPAL REGISTER**

THE MARK CONSISTS OF STANDARD CHARACTERS WITHOUT CLAIM TO ANY PARTICULAR FONT, STYLE, SIZE, OR COLOR.

SER. NO. 85-361,814, FILED 7-1-2011.

MARGARET POWER, EXAMINING ATTORNEY



*David J. Kyffers*

Director of the United States Patent and Trademark Office

# United States of America

United States Patent and Trademark Office

# Trap Void

**Reg. No. 4,196,979**

SUREVOID PRODUCTS, INC. (COLORADO CORPORATION)  
1895 W. DARTMOUTH AVE.  
ENGLEWOOD, CO 80110

**Registered Aug. 28, 2012**

**Int. Cl.: 19**

FOR: BUILDING MATERIALS, NAMELY, CORRUGATED PAPER FORMS USED IN CONSTRUCTION THAT CREATE A SPACE BETWEEN CONCRETE GRADE BEAMS AND UNDERLYING EXPANSIVE SOILS, WHILE CREATING A CONCRETE BARRIER TO BACKFILL SOILS, IN CLASS 19 (U.S. CLS. 1, 12, 33 AND 50).

**TRADEMARK**

**PRINCIPAL REGISTER**

FIRST USE 12-6-1995; IN COMMERCE 12-6-1995.

THE MARK CONSISTS OF STANDARD CHARACTERS WITHOUT CLAIM TO ANY PARTICULAR FONT, STYLE, SIZE, OR COLOR.

SER. NO. 85-362,002, FILED 7-1-2011.

MARGARET POWER, EXAMINING ATTORNEY



*David J. Kybas*

Director of the United States Patent and Trademark Office

# United States of America

United States Patent and Trademark Office

# Become

**Reg. No. 4,196,980**

ONE HEART BEAT, INC. (GEORGIA CORPORATION)

**Registered Aug. 28, 2012**

P.O. BOX 1577  
THOMASVILLE, GA 31799

**Int. Cl.: 45**

FOR: CHRISTIAN MINISTRY AND RELIGIOUS SERVICES, NAMELY, ORGANIZING AND CONDUCTING RELIGIOUS WORSHIP FEATURING PRAYERS, TEACHINGS, AND MUSIC ROOTED IN CHRISTIANITY, IN CLASS 45 (U.S. CLS. 100 AND 101).

**SERVICE MARK**

FIRST USE 11-0-2010; IN COMMERCE 11-0-2010.

**PRINCIPAL REGISTER**

THE MARK CONSISTS OF THE WORD "BECOME"; THE LETTERS "BEC" CONSIST OF AN OUTLINE; THE LETTERS "O" AND "E" ARE SOLID; THE FIRST CURVE OF THE LOWERCASE "M" IS SOLID SUCH THAT IT APPEARS AS THE "N" IN THE WORD "ONE"; HOWEVER THE SECOND CURVE OF THE "M" IS OUTLINED SUCH THAT IT OPERATES AS THE "M" IN "BECOME".

SER. NO. 85-362,037, FILED 7-1-2011.

BARBARA GAYNOR, EXAMINING ATTORNEY



*David J. Kybas*

Director of the United States Patent and Trademark Office



# United States of America

United States Patent and Trademark Office

**INSIDE  OUT**

**Reg. No. 4,196,981**

ONE HEART BEAT, INC. (GEORGIA CORPORATION)

**Registered Aug. 28, 2012**

P.O. BOX 1577  
THOMASVILLE, GA 31799

**Int. Cl.: 41**

FOR: ENTERTAINMENT SERVICES, NAMELY, LIVE SHOWS FEATURING MUSIC, WORSHIP, PRAYERS AND TEACHINGS ROOTED IN CHRISTIANITY, IN CLASS 41 (U.S. CLS. 100, 101 AND 107).

**SERVICE MARK**

FIRST USE 3-0-2010; IN COMMERCE 3-0-2010.

**PRINCIPAL REGISTER**

OWNER OF U.S. REG. NO. 3,981,933.

THE MARK CONSISTS OF THE WORDS "INSIDE OUT"; THE "S" IS BACKWARDS WITH AN ARROW AT THE BOTTOM END OF THE "S"; THE "O" CONTAINS A HEART WITH A CROSS AT ITS CENTER AND SMALLER VINES EXTENDING OUTWARD FROM THE HEART CONTAINING SMALLER CROSSES IN SEVERAL OF THE LEAVES.

SER. NO. 85-362,180, FILED 7-1-2011.

BARBARA GAYNOR, EXAMINING ATTORNEY



*David J. Kyffers*

Director of the United States Patent and Trademark Office

# United States of America

United States Patent and Trademark Office

## INSIDE OUT NATION

**Reg. No. 4,196,982**

ONE HEART BEAT, INC. (GEORGIA CORPORATION)

**Registered Aug. 28, 2012**

P.O. BOX 1577  
THOMASVILLE, GA 31799

**Int. Cl.: 41**

FOR: ENTERTAINMENT SERVICES, NAMELY, LIVE PRESENTATIONS FEATURING MUSIC, WORSHIP, PRAYERS AND TEACHINGS ROOTED IN CHRISTIANITY, IN CLASS 41 (U.S. CLS. 100, 101 AND 107).

**SERVICE MARK**

FIRST USE 3-0-2010; IN COMMERCE 3-0-2010.

**PRINCIPAL REGISTER**

THE MARK CONSISTS OF STANDARD CHARACTERS WITHOUT CLAIM TO ANY PARTICULAR FONT, STYLE, SIZE, OR COLOR.

OWNER OF U.S. REG. NO. 3,981,933.

SER. NO. 85-362,210, FILED 7-1-2011.

BARBARA GAYNOR, EXAMINING ATTORNEY



*David J. Kyffers*

Director of the United States Patent and Trademark Office

# United States of America

United States Patent and Trademark Office

## CHAMPIONS BY DESIGN

**Reg. No. 4,196,983**

ASSOCIATED ELECTRICS, INC (CALIFORNIA CORPORATION)  
26021 COMMERCENTRE DR.

**Registered Aug. 28, 2012**

LAKE FOREST, CA 92630

**Int. Cl.: 28**

FOR: REMOTE CONTROLLED SCALE MODEL VEHICLES, IN CLASS 28 (U.S. CLS. 22, 23, 38 AND 50).

**TRADEMARK**

FIRST USE 11-1-2003; IN COMMERCE 11-1-2003.

**PRINCIPAL REGISTER**

THE MARK CONSISTS OF STANDARD CHARACTERS WITHOUT CLAIM TO ANY PARTICULAR FONT, STYLE, SIZE, OR COLOR.

SER. NO. 85-362,224, FILED 7-1-2011.

CAROLINE WOOD, EXAMINING ATTORNEY



*David J. Kyffers*

Director of the United States Patent and Trademark Office

# United States of America

United States Patent and Trademark Office

## ELEVATE YOUR WORK

**Reg. No. 4,196,984**

**Registered Aug. 28, 2012**

**Int. Cl.: 20**

**TRADEMARK**

**PRINCIPAL REGISTER**

CLARITY CONSULTING GROUP, LLC (CALIFORNIA LIMITED LIABILITY COMPANY)  
415 W. NOBLE AVE., NO. 319  
VISALIA, CA 93277

FOR: ADJUSTABLE DESKS, IN CLASS 20 (U.S. CLS. 2, 13, 22, 25, 32 AND 50).

FIRST USE 4-18-2011; IN COMMERCE 5-31-2011.

THE MARK CONSISTS OF STANDARD CHARACTERS WITHOUT CLAIM TO ANY PARTICULAR FONT, STYLE, SIZE, OR COLOR.

SER. NO. 85-362,309, FILED 7-1-2011.

ANDREW LEASER, EXAMINING ATTORNEY



*David J. Kyffers*

Director of the United States Patent and Trademark Office

# United States of America

United States Patent and Trademark Office

## HAMMERSMITH

**Reg. No. 4,196,985**

**Registered Aug. 28, 2012**

**Int. Cl.: 9**

**TRADEMARK**

**PRINCIPAL REGISTER**

SORKIN TYPE CO. (MASSACHUSETTS CORPORATION)  
143 MASS AVE, SUITE 5  
BOSTON, MA 02115

FOR: PRINTING FONTS THAT CAN BE DOWNLOADED PROVIDED BY MEANS OF ELECTRONIC TRANSMISSION; TYPEFACE FONTS RECORDED ON MAGNETIC MEDIA, IN CLASS 9 (U.S. CLS. 21, 23, 26, 36 AND 38).

FIRST USE 6-28-2011; IN COMMERCE 6-28-2011.

THE MARK CONSISTS OF STANDARD CHARACTERS WITHOUT CLAIM TO ANY PARTICULAR FONT, STYLE, SIZE, OR COLOR.

SER. NO. 85-362,523, FILED 7-3-2011.

KEVIN DINALLO, EXAMINING ATTORNEY



*David J. Kybas*

Director of the United States Patent and Trademark Office

# United States of America

United States Patent and Trademark Office

# PETRO-PLUG

**Reg. No. 4,196,986**

**Registered Aug. 28, 2012**

**Int. Cl.: 1**

**TRADEMARK**

**PRINCIPAL REGISTER**

SPI BRANDS LLC (CONNECTICUT LIMITED LIABILITY COMPANY)  
215 VILLAGE STREET  
NORTHFORD, CT 06472

FOR: CHEMICAL COMPOSITIONS FOR FILTERING CONTAMINATED WATER AND FOR SEPARATING HYDROCARBONS FROM WATER; CHEMICALS FOR ABSORBING LIQUID HYDROCARBONS; CHEMICALS FOR THE TREATMENT OF WATER AND WASTEWATER; CHEMICALS FOR TREATING HAZARDOUS WASTE; CHEMICALS FOR USE IN DECONTAMINATION OF POLLUTED SITES; CHEMICALS FOR USE IN PURIFICATION OF WATER; CHEMICALS IN THE NATURE OF SORBENTS, IN CLASS 1 (U.S. CLS. 1, 5, 6, 10, 26 AND 46).

FIRST USE 3-25-1999; IN COMMERCE 3-25-1999.

THE MARK CONSISTS OF STANDARD CHARACTERS WITHOUT CLAIM TO ANY PARTICULAR FONT, STYLE, SIZE, OR COLOR.

SER. NO. 85-362,716, FILED 7-4-2011.

DORITT L. CARROLL, EXAMINING ATTORNEY



*David J. Kyffers*

Director of the United States Patent and Trademark Office

# United States of America

United States Patent and Trademark Office



**Reg. No. 4,196,987**

**Registered Aug. 28, 2012**

**Int. Cl.: 41**

**SERVICE MARK**

**PRINCIPAL REGISTER**

MICHAEL D. ADELMAN (UNITED STATES INDIVIDUAL)  
103 COUNTRY CLUB LANE  
LEWISBURG, WV 24901

FOR: ENTERTAINMENT IN THE NATURE OF MAGIC SHOWS FOR CHILDREN, IN CLASS 41 (U.S. CLS. 100, 101 AND 107).

FIRST USE 12-31-1997, THE MARK WAS FIRST USED ANYWHERE IN A DIFFERENT FORM OTHER THAN THAT SOUGHT TO BE REGISTERED AT LEAST AS EARLY AS 09/00/1989; IN COMMERCE 12-31-1997, THE MARK WAS FIRST USED IN COMMERCE IN A DIFFERENT FORM OTHER THAN THAT SOUGHT TO BE REGISTERED AT LEAST AS EARLY AS 09/00/1989.

NO CLAIM IS MADE TO THE EXCLUSIVE RIGHT TO USE "PRODUCTIONS", APART FROM THE MARK AS SHOWN.

THE MARK CONSISTS OF A MAGICIAN HOLDING A MAGIC WAND, EMERGING FROM A TOP HAT, INCLUDING THE WORDING MIKE & JOEY PRODUCTIONS.

SER. NO. 85-363,111, FILED 7-5-2011.

BARBARA RUTLAND, EXAMINING ATTORNEY



*David J. Kybas*

Director of the United States Patent and Trademark Office

# United States of America

United States Patent and Trademark Office

# LookToRent

**Reg. No. 4,196,988**

**Registered Aug. 28, 2012**

**Int. Cls.: 35 and 36**

**SERVICE MARK**

**PRINCIPAL REGISTER**

LOOKTORENT, LLC (VIRGINIA LIMITED LIABILITY COMPANY)  
2317 WESTWOOD AVE., SUITE 112  
RICHMOND, VA 23230

FOR: PROVIDING AN INTERACTIVE REAL ESTATE WEBSITE WHICH PROMOTES RENTAL PROPERTIES BY CONNECTING LANDLORDS WITH TENANTS BY ALLOWING LANDLORDS TO PROMOTE THEIR RESIDENTIAL REAL PROPERTY BASED ON DESCRIPTION, PRICE, AVAILABILITY, LOCATION, MAPS, AND OTHER IDENTIFYING INFORMATION TO ASSIST PROSPECTIVE TENANTS WITH LOCATING PROPERTIES AND ALLOWING LANDLORDS TO EVALUATE APPLICATIONS SUBMITTED BY PROSPECTIVE TENANTS, IN CLASS 35 (U.S. CLS. 100, 101 AND 102).

FIRST USE 8-1-2009; IN COMMERCE 2-2-2011.

FOR: PROVIDING AN INTERACTIVE REAL ESTATE WEB SITE WHICH CONNECTS LANDLORDS WITH TENANTS ALLOWING LANDLORDS TO ACCEPT AND PROCESS RENTAL APPLICATIONS FROM TENANTS WITH OPTIONS TO PURCHASE THE REAL ESTATE BASED ON DESCRIPTION, PRICE, AVAILABILITY, LOCATION, MAPS, AND OTHER IDENTIFYING INFORMATION, IN CLASS 36 (U.S. CLS. 100, 101 AND 102).

FIRST USE 8-1-2009; IN COMMERCE 2-2-2011.

THE MARK CONSISTS OF STANDARD CHARACTERS WITHOUT CLAIM TO ANY PARTICULAR FONT, STYLE, SIZE, OR COLOR.

SER. NO. 85-363,340, FILED 7-5-2011.

DANNEAN HETZEL, EXAMINING ATTORNEY



*David J. Kyros*

Director of the United States Patent and Trademark Office



# United States of America

United States Patent and Trademark Office

## Big Oven Bakeshop

**Reg. No. 4,196,989**

**Registered Aug. 28, 2012**

**Int. Cl.: 30**

**TRADEMARK**

**PRINCIPAL REGISTER**

BIG OVEN BAKESHOP LLC (IOWA LIMITED LIABILITY COMPANY)  
111 MAIN STREET  
AMES, IA 50010

FOR: COOKIES, IN CLASS 30 (U.S. CL. 46).

FIRST USE 6-30-2011; IN COMMERCE 6-30-2011.

THE MARK CONSISTS OF STANDARD CHARACTERS WITHOUT CLAIM TO ANY PARTICULAR FONT, STYLE, SIZE, OR COLOR.

NO CLAIM IS MADE TO THE EXCLUSIVE RIGHT TO USE "BAKESHOP", APART FROM THE MARK AS SHOWN.

SER. NO. 85-363,341, FILED 7-5-2011.

JIM RINGLE, EXAMINING ATTORNEY



*David J. Kyffers*

Director of the United States Patent and Trademark Office

# United States of America

United States Patent and Trademark Office



**Reg. No. 4,196,990**

**Registered Aug. 28, 2012**

**Int. Cls.: 8 and 25**

**TRADEMARK**

**PRINCIPAL REGISTER**

ROBERT YOUNG PELTON (UNITED STATES INDIVIDUAL)  
1119 S. MISSION RD. #332  
FALLBROOK, CA 92028

FOR: FIXED BLADE KNIVES; FOLDING KNIVES; KNIVES; MULTI-FUNCTION HAND TOOLS COMPRISED OF BOTTLE OPENER, POT HOLDER, HEX BIT HOLDER, WIRE STRIPPER, GLASS BREAKER, IN CLASS 8 (U.S. CLS. 23, 28 AND 44).

FIRST USE 0-0-2001; IN COMMERCE 0-0-2003.

FOR: T-SHIRTS, IN CLASS 25 (U.S. CLS. 22 AND 39).

FIRST USE 0-0-2001; IN COMMERCE 0-0-2003.

THE MARK CONSISTS OF A SKULL WITH OPEN MOUTH. SKULL IS WEARING SUNGLASSES AND CAP WITH THE LETTERS "D", "P" INSCRIBED ON THE INSIDE OF BILL.

SER. NO. 85-363,433, FILED 7-5-2011.

AMY ALFIERI, EXAMINING ATTORNEY



*David J. Kybas*

Director of the United States Patent and Trademark Office

# United States of America

United States Patent and Trademark Office

# LEGENDS

**Reg. No. 4,196,991**

**Registered Aug. 28, 2012**

**Int. Cl.: 41**

**SERVICE MARK**

**PRINCIPAL REGISTER**

MURTAUGH ENTERPRISES INC. (NEBRASKA CORPORATION)  
3920 N. 157TH ST.  
OMAHA, NE 68116

FOR: ENTERTAINMENT SERVICES, NAMELY, THE PROVISION OF CONTINUING SHOWS FEATURING SPORTS COMMENTARY DELIVERED BY RADIO AND INTERNET IN THE FIELDS OF COLLEGE SPORTS AND PROFESSIONAL FOOTBALL, BASEBALL, BASKETBALL, GOLF, HOCKEY AND SOCCER; ENTERTAINMENT, NAMELY, A CONTINUING SPORTS COMMENTARY SHOW BROADCAST OVER RADIO AND INTERNET IN THE FIELDS OF COLLEGE SPORTS AND PROFESSIONAL FOOTBALL, BASEBALL, BASKETBALL, GOLF, HOCKEY AND SOCCER, IN CLASS 41 (U.S. CLS. 100, 101 AND 107).

FIRST USE 7-1-2008; IN COMMERCE 7-1-2008.

THE MARK CONSISTS OF STANDARD CHARACTERS WITHOUT CLAIM TO ANY PARTICULAR FONT, STYLE, SIZE, OR COLOR.

SER. NO. 85-363,961, FILED 7-6-2011.

JAMES GRIFFIN, EXAMINING ATTORNEY



*David J. Kyffers*

Director of the United States Patent and Trademark Office

# United States of America

United States Patent and Trademark Office

## cosmic cajun universal seasoning

**Reg. No. 4,196,992**

ISLANDER JEWELL ENTERPRISES INC (FLORIDA CORPORATION)  
6624 GREEN ACRES BLVD  
NEW PORT RICHEY, FL 34655

**Registered Aug. 28, 2012**

**Int. Cl.: 30**

FOR: SEASONINGS; SPICES, IN CLASS 30 (U.S. CL. 46).

**TRADEMARK**

FIRST USE 9-12-2009; IN COMMERCE 12-25-2009.

**PRINCIPAL REGISTER**

THE MARK CONSISTS OF STANDARD CHARACTERS WITHOUT CLAIM TO ANY PARTICULAR FONT, STYLE, SIZE, OR COLOR.

NO CLAIM IS MADE TO THE EXCLUSIVE RIGHT TO USE "CAJUN UNIVERSAL SEASONING", APART FROM THE MARK AS SHOWN.

SER. NO. 85-363,982, FILED 7-6-2011.

LINDA ORNDORFF, EXAMINING ATTORNEY



*David J. Kyffers*

Director of the United States Patent and Trademark Office

# United States of America

United States Patent and Trademark Office

# 2CHK

**Reg. No. 4,196,993**

**Registered Aug. 28, 2012**

**Int. Cl.: 36**

**SERVICE MARK**

**PRINCIPAL REGISTER**

AUTHENTIFY, INC. (DELAWARE CORPORATION)  
8745 W. HIGGINS ROAD, SUITE 240  
CHICAGO, IL 60631

FOR: COMPUTER SERVICES, NAMELY, PROVIDING ONLINE PAYMENT TRANSACTION AUTHENTICATION AND VERIFICATION SERVICES VIA MOBILE DEVICES AND/OR DESKTOP COMPUTERS, IN CLASS 36 (U.S. CLS. 100, 101 AND 102).

FIRST USE 6-28-2011; IN COMMERCE 6-28-2011.

THE MARK CONSISTS OF STANDARD CHARACTERS WITHOUT CLAIM TO ANY PARTICULAR FONT, STYLE, SIZE, OR COLOR.

SER. NO. 85-364,033, FILED 7-6-2011.

HENRY S. ZAK, EXAMINING ATTORNEY



*David J. Kyjars*

Director of the United States Patent and Trademark Office

**United States of America**  
United States Patent and Trademark Office

# ResponseTek

**Reg. No. 4,196,994**

RESPONSETEK NETWORKS CORP. (CANADA CORPORATION)

**Registered Aug. 28, 2012**

#863 - 409 GRANVILLE STREET  
VANCOUVER, BC, CANADA V6Y1X9

**Int. Cl.: 9**

FOR: COMPUTER SOFTWARE FOR USE IN CUSTOMER RELATIONSHIP MANAGEMENT (CRM), IN CLASS 9 (U.S. CLS. 21, 23, 26, 36 AND 38).

**TRADEMARK**

FIRST USE 1-1-2000; IN COMMERCE 1-1-2001.

**PRINCIPAL REGISTER**

THE MARK CONSISTS OF STANDARD CHARACTERS WITHOUT CLAIM TO ANY PARTICULAR FONT, STYLE, SIZE, OR COLOR.

SER. NO. 85-364,715, FILED 7-6-2011.

MICHAEL KEATING, EXAMINING ATTORNEY



*David J. Kyffers*

Director of the United States Patent and Trademark Office

# United States of America

United States Patent and Trademark Office

# COVER-UP

**Reg. No. 4,196,995**

**Registered Aug. 28, 2012**

**Int. Cls.: 9, 18 and 35**

**TRADEMARK**

**SERVICE MARK**

**PRINCIPAL REGISTER**

EBOOK ACCESSORIES LIMITED (UNITED KINGDOM LIMITED COMPANY (LTD.))  
WOODSTOCK HOUSE  
4 STONEY LANE, CORNTOWN, BRIDGEND  
VALE OF GLAMORGAN, UNITED KINGDOM CF355AL

FOR: PORTABLE ELECTRONIC DEVICES IN THE NATURE OF ELECTRONIC BOOK READERS FOR THE DISPLAY OF ELECTRICALLY PUBLISHED MATERIALS, INCLUDING BOOKS, JOURNALS, NEWSPAPERS, MAGAZINES AND MULTIMEDIA PRESENTATIONS AND STRUCTURAL PARTS AND FITTINGS FOR USE THEREWITH; CASES, CARRYING CASES, BAGS AND PROTECTIVE SLEEVES FOR PROTECTING AND COVERING, ALL BEING SPECIFICALLY FITTED, ADAPTED OR SHAPED FOR COMPUTER EQUIPMENT, ELECTRONIC BOOK READERS, MOBILE PHONES, HANDHELD COMPUTERS AND PERSONAL DIGITAL ASSISTANTS; SCREEN SAVERS AND SCREEN PROTECTORS, NAMELY, DISPLAY PROTECTOR TO PROVIDE SHADE AND PRIVACY FOR ELECTRONIC DEVICES HAVING SCREENS; COMPUTER HARDWARE AND SOFTWARE TRANSMITTING TEXT, IMAGE AND SOUND; PORTABLE ELECTRONIC DEVICES, NAMELY, MOBILE PHONES, LAP TOPS, HANDHELD COMPUTERS AND PERSONAL DIGITAL ASSISTANTS FOR RECEIVING AND READING TEXT, IMAGES AND SOUND THROUGH WIRELESS INTERNET ACCESS; ELECTRONIC DOCKING STATIONS; ELECTRONIC MEMORY CARD READERS; BATTERY CHARGERS; BATTERY PACKS; ELECTRICAL CONNECTORS, POWER CABLES, ELECTRICAL WIRES, ELECTRICAL CABLES, AND POWER SUPPLY ADAPTORS FOR USE WITH PORTABLE ELECTRONIC DEVICES; ELECTRONIC STYLUS PENS, AUDIO EQUIPMENT, NAMELY, AUDIO SPEAKERS, HEADPHONES AND EARPHONES; CLEANING DISCS FOR CLEANING THE LENS OF OPTICAL DISC DRIVES USED IN COMPUTERS AND DIGITAL VIDEO RECORDERS; TELECOMMUNICATIONS APPARATUS, NAMELY, AUDIO SPEAKERS, MICROPHONES, AND HEADSETS FOR USE WITH COMPUTER EQUIPMENT, ELECTRONIC BOOK READERS, MOBILE PHONES, HANDHELD COMPUTERS, PERSONAL DIGITAL ASSISTANTS; REMOTE CONTROLS, STANDS AND VIDEO MONITORS SPECIALLY ADAPTED FOR USE WITH COMPUTER EQUIPMENT, ELECTRONIC BOOK READERS, MOBILE PHONES, HANDHELD COMPUTERS, PERSONAL DIGITAL ASSISTANTS; AUDIO, VIDEO, AND RADIO RECEIVERS AND TRANSMITTERS; STRUCTURAL PARTS AND FITTINGS FOR ALL THE AFORESAID GOODS, IN CLASS 9 (U.S. CLS. 21, 23, 26, 36 AND 38).



*David J. Kyros*

Director of the United States Patent and Trademark Office

FOR: CASES OF LEATHER OR IMITATION LEATHER, CARRYING CASES, BAGS OF LEATHER OR IMITATION LEATHER AND TEXTILE BAGS, NAMELY, SATCHELS, MESSENGER BAGS, SHOULDER BAGS AND TOTE BAGS, NOT SHAPED OR FITTED, ALL

**Reg. No. 4,196,995** FOR COMPUTER EQUIPMENT, ELECTRONIC BOOK READERS, MOBILE PHONES, PERSONAL DIGITAL ASSISTANTS AND OTHER PORTABLE ELECTRONIC DEVICES; STRUCTURAL PARTS AND FITTINGS FOR ALL THE AFORESAID GOODS, IN CLASS 18 (U.S. CLS. 1, 2, 3, 22 AND 41).

FOR: RETAIL SERVICES, NAMELY, MAIL ORDER, HOME SHOPPING SERVICES BY MEANS OF TELEVISION AND THE INTERNET AND ON-LINE RETAIL STORE SERVICES FEATURING ELECTRONIC BOOK READERS, MOBILE PHONES, HANDHELD COMPUTERS, PERSONAL DIGITAL ASSISTANTS AND OTHER PORTABLE AND HANDHELD DIGITAL ELECTRONIC DEVICES, AND PARTS, FITTINGS AND ACCESSORIES THEREFOR; RETAIL ADVERTISING SERVICES, NAMELY, THE DISSEMINATION OF ADVERTISING MATERIAL FOR OTHERS FEATURING GOODS SOLD THROUGH AN ONLINE RETAIL STORE; PRESENTATION OF GOODS ON COMMUNICATION MEDIA, FOR RETAIL PURPOSES, NAMELY, ADVERTISING AND PROMOTION OF GOODS OF OTHERS VIA AN INTERNET WEB-SITE; PROVIDING A SEARCHABLE WEBSITE FEATURING THE GOODS AND SERVICES OF OTHER VENDORS; COMPUTERIZED ONLINE ORDERING SERVICES IN THE FIELD OF ELECTRONIC BOOK READERS, MOBILE PHONES, HANDHELD COMPUTERS, PERSONAL DIGITAL ASSISTANTS AND OTHER PORTABLE AND HANDHELD ELECTRONIC DEVICES, AND PARTS, FITTINGS AND ACCESSORIES THEREFORE; ADMINISTRATIVE PROCESSING OF PURCHASE ORDERS; DEMONSTRATION OF GOODS AND DISTRIBUTION OF SAMPLES FOR ADVERTISING AND PROMOTIONAL PURPOSES; PROVIDING CONSUMER INFORMATION AND ADVICE IN RELATION TO ALL OF THE AFORESAID SERVICES, IN CLASS 35 (U.S. CLS. 100, 101 AND 102).

THE MARK CONSISTS OF STANDARD CHARACTERS WITHOUT CLAIM TO ANY PARTICULAR FONT, STYLE, SIZE, OR COLOR.

OWNER OF ERPN CMNTY TM OFC REG. NO. 9644865, DATED 6-15-2011, EXPIRES 1-7-2021.

SER. NO. 85-364,723, FILED 7-6-2011.

JAMES LOVELACE, EXAMINING ATTORNEY



# United States of America

United States Patent and Trademark Office

## Listening Platform

**Reg. No. 4,196,996**

RESPONSETEK NETWORKS CORP. (CANADA CORPORATION)

**Registered Aug. 28, 2012**

#863 - 409 GRANVILLE STREET  
VANCOUVER, BC, CANADA V6C1T2

**Int. Cl.: 9**

FOR: COMPUTER SOFTWARE FOR USE IN CUSTOMER RELATIONSHIP MANAGEMENT (CRM), IN CLASS 9 (U.S. CLS. 21, 23, 26, 36 AND 38).

**TRADEMARK**

FIRST USE 1-1-2011; IN COMMERCE 1-1-2011.

**PRINCIPAL REGISTER**

THE MARK CONSISTS OF STANDARD CHARACTERS WITHOUT CLAIM TO ANY PARTICULAR FONT, STYLE, SIZE, OR COLOR.

NO CLAIM IS MADE TO THE EXCLUSIVE RIGHT TO USE "PLATFORM", APART FROM THE MARK AS SHOWN.

SER. NO. 85-364,728, FILED 7-6-2011.

MICHAEL KEATING, EXAMINING ATTORNEY



*David J. Kybas*

Director of the United States Patent and Trademark Office

# United States of America

United States Patent and Trademark Office

## GOLF MOOLAH

**Reg. No. 4,196,997**

**Registered Aug. 28, 2012**

**Int. Cl.: 9**

**TRADEMARK**

**PRINCIPAL REGISTER**

GOLFMOLAH, LLC (CONNECTICUT LIMITED LIABILITY COMPANY)  
76 PURITAN ROAD  
FAIRFIELD, CT 06824

FOR: MOBILE COMPUTER APPLICATION SOFTWARE WHICH PERMITS USERS TO KEEP TRACK OF THEIR WAGERS ON THE GOLF COURSE, AND MOBILE COMPUTER SOFTWARE FOR ACCESSING A DATABASE CONTAINING ALL GOLF COURSES WORLDWIDE AND A LIST OF GAMES FOR THE GOLF-USER TO PLAY, IN CLASS 9 (U.S. CLS. 21, 23, 26, 36 AND 38).

FIRST USE 3-10-2009; IN COMMERCE 6-15-2010.

THE MARK CONSISTS OF STANDARD CHARACTERS WITHOUT CLAIM TO ANY PARTICULAR FONT, STYLE, SIZE, OR COLOR.

NO CLAIM IS MADE TO THE EXCLUSIVE RIGHT TO USE "GOLF", APART FROM THE MARK AS SHOWN.

SER. NO. 85-364,860, FILED 7-7-2011.

LINDA E. BLOHM, EXAMINING ATTORNEY



*David J. Kyros*

Director of the United States Patent and Trademark Office

# United States of America

United States Patent and Trademark Office



**LPGA**  
GOLF'S GLOBAL TOUR

**Reg. No. 4,196,998**

**Registered Aug. 28, 2012**

**Int. Cl.: 41**

**SERVICE MARK**

**PRINCIPAL REGISTER**

LADIES PROFESSIONAL GOLF ASSOCIATION (OHIO NON-PROFIT CORPORATION)  
100 INTERNATIONAL GOLF DRIVE  
DAYTONA BEACH, FL 32124

FOR: ORGANIZING AND CONDUCTING ENTERTAINMENT IN THE NATURE OF GOLF TOURNAMENTS; EDUCATIONAL GOLF-RELATED EVENTS, NAMELY, WORKSHOPS, CLINICS, SEMINARS AND TEACHING ACADEMIES ALL FEATURING INFORMATION IN THE FIELD OF GOLF AND GOLF INSTRUCTION; GOLF-RELATED ENTERTAINMENT EVENTS, NAMELY, PROVIDING RECOGNITION AND INCENTIVES BY WAY OF AWARDS TO DEMONSTRATE EXCELLENCE IN THE FIELD OF GOLF, IN CLASS 41 (U.S. CLS. 100, 101 AND 107).

FIRST USE 9-15-2010; IN COMMERCE 9-15-2010.

OWNER OF U.S. REG. NOS. 3,600,065, 3,719,126 AND OTHERS.

NO CLAIM IS MADE TO THE EXCLUSIVE RIGHT TO USE "GOLF'S GLOBAL TOUR", APART FROM THE MARK AS SHOWN.

THE MARK CONSISTS OF THE DEPICTION OF A WOMAN GOLFER SWINGING A GOLF CLUB APPEARING ABOVE THE STYLIZED WORDING "LPGA" WHICH APPEARS ABOVE THE STYLIZED WORDING "GOLF'S GLOBAL TOUR".

SER. NO. 85-364,920, FILED 7-7-2011.

MICHAEL TANNER, EXAMINING ATTORNEY



*David J. Kyjars*

Director of the United States Patent and Trademark Office

# United States of America

United States Patent and Trademark Office

## PYRAMID APPROACH TO EDUCATION

**Reg. No. 4,196,999**

**Registered Aug. 28, 2012**

**Int. Cls.: 16 and 41**

**TRADEMARK**

**SERVICE MARK**

**PRINCIPAL REGISTER**

PYRAMID EDUCATIONAL CONSULTANTS, INC. (NEW JERSEY CORPORATION)  
13 GARFIELD WAY  
NEWARK, DE 19713

FOR: PRINTED TEACHING AND INSTRUCTION MANUALS IN THE FIELDS OF COMMUNICATION, CHILDHOOD EDUCATION, AND SPECIAL EDUCATION; BOOKS IN THE FIELD OF EDUCATION AND TRAINING, IN CLASS 16 (U.S. CLS. 2, 5, 22, 23, 29, 37, 38 AND 50).

FIRST USE 0-0-1992; IN COMMERCE 0-0-1992.

FOR: EDUCATIONAL SERVICES, NAMELY, WORKSHOPS AND TRAINING IN THE FIELD OF COMMUNICATION, CHILDHOOD EDUCATION, AND SPECIAL EDUCATION; CONSULTING IN THE FIELD OF COMMUNICATION, CHILDHOOD EDUCATION, AND SPECIAL EDUCATION, IN CLASS 41 (U.S. CLS. 100, 101 AND 107).

FIRST USE 0-0-1992; IN COMMERCE 0-0-1992.

THE MARK CONSISTS OF STANDARD CHARACTERS WITHOUT CLAIM TO ANY PARTICULAR FONT, STYLE, SIZE, OR COLOR.

SER. NO. 85-364,931, FILED 7-7-2011.

JORDAN BAKER, EXAMINING ATTORNEY



*David J. Kyros*

Director of the United States Patent and Trademark Office

# United States of America

## United States Patent and Trademark Office

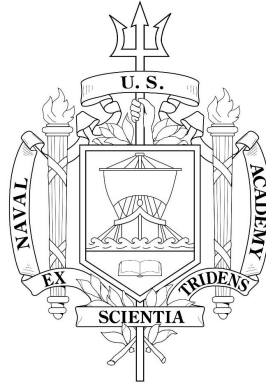

**Reg. No. 4,197,000**

**Registered Aug. 28, 2012**

**Int. Cl.: 41**

UNITED STATES NAVAL ACADEMY, DEPARTMENT OF THE NAVY (UNITED STATES AGENCY OF THE UNITED STATES GOVERNMENT)  
875 NORTH RANDOLPH STREET  
CODE 00CC  
ARLINGTON, VA 222031995

**SERVICE MARK**

**PRINCIPAL REGISTER**

FOR: EDUCATIONAL SERVICES, NAMELY, PROVIDING UNIVERSITY LEVEL COURSES IN ENGINEERING, WEAPONS TECHNOLOGY, MATHEMATICS, SCIENCE, HUMANITIES, AND SOCIAL SCIENCES; PROVIDING MILITARY TACTIC TRAINING AND MILITARY TRAINING DEGREES AT THE UNIVERSITY LEVEL; PHYSICAL EDUCATION SERVICES; AND ENTERTAINMENT SERVICES, NAMELY, CONDUCTING LIVE FOOTBALL, BASKETBALL, AND BASEBALL GAMES AT THE UNIVERSITY LEVEL FOR BROADCAST OVER THE MEDIA OF RADIO AND TELEVISION, IN CLASS 41 (U.S. CLS. 100, 101 AND 107).

FIRST USE 12-31-1902; IN COMMERCE 12-31-1902.

NO CLAIM IS MADE TO THE EXCLUSIVE RIGHT TO USE "NAVAL ACADEMY", APART FROM THE MARK AS SHOWN.

THE MARK CONSISTS OF AN OUTLINED SHIELD BEARING A FRONTAL VIEW IMAGE OF AN ANCIENT WAR SHIP WITH SAILS AND OARS RIDING ON WAVES, A LINE BELOW THE IMAGE SEPARATES AN OPEN BOOK, CENTERED ABOVE THE SHIELD A HAND APPEARS GRASPING A LONG TRIDENT THAT EXTENDS ABOVE AND BELOW BEHIND THE SHIELD, AN ORATE SCROLLING BANNER SURROUNDS THE FOUR SIDES OF THE SHIELD, THE TERM "U.S." APPEARS ON THE TOP OF THE BANNER, "NAVAL" ON THE LEFT SIDE OF THE BANNER, "ACADEMY" ON THE RIGHT SIDE OF THE BANNER, AND "EX SCIENTIA TRIDENS" APPEARS SEPARATED IN THREE SECTIONS OF THE BANNER BENEATH THE SHIELD, A LARGE TORCH APPEARS ON THE LEFT AND ON THE RIGHT SIDE OF THE SHIELD AND IS INTERTWINED IN THE BANNER, LEAVES APPEAR ON EACH SIDE OF THE GRASPING HAND AND TWO BRANCHES WITH LEAVES APPEAR CROSSED BEHIND THE BOTTOM OF THE TRIDENT.



SER. NO. 85-364,948, FILED 7-7-2011.

*David J. Kyffers*

ANTHONY RINKER, EXAMINING ATTORNEY

# United States of America

United States Patent and Trademark Office

# FREEANCE

**Reg. No. 4,197,001**

TDC GROUP, INC. (OHIO CORPORATION)  
3055 KETTERING BLVD.  
DAYTON, OH 45439

**Registered Aug. 28, 2012**

**Int. Cls.: 9 and 41**

FOR: COMPUTER APPLICATION SOFTWARE FOR MOBILE DEVICES, NAMELY, SOFTWARE FOR USE IN STORING, ACCESSING, EDITING, DISPLAYING, CREATING AND PROVIDING USER ACCESS TO GEOGRAPHIC INFORMATION DATA AND SYSTEMS AND OTHER DATA AND SYSTEMS, IN CLASS 9 (U.S. CLS. 21, 23, 26, 36 AND 38).

**TRADEMARK**

**SERVICE MARK**

FIRST USE 4-3-2001; IN COMMERCE 4-3-2001.

**PRINCIPAL REGISTER**

FOR: PROVIDING A WEBSITE FEATURING NON-DOWNLOADABLE SOFTWARE FOR USE IN STORING, ACCESSING, EDITING, DISPLAYING, CREATING AND PROVIDING USER ACCESS TO GEOGRAPHIC INFORMATION DATA AND SYSTEMS AND OTHER DATA AND SYSTEMS, IN CLASS 41 (U.S. CLS. 100, 101 AND 107).

FIRST USE 4-3-2001; IN COMMERCE 4-3-2001.

THE MARK CONSISTS OF STANDARD CHARACTERS WITHOUT CLAIM TO ANY PARTICULAR FONT, STYLE, SIZE, OR COLOR.

SER. NO. 85-365,452, FILED 7-7-2011.

THEODORE MCBRIDE, EXAMINING ATTORNEY



*David J. Kybas*

Director of the United States Patent and Trademark Office

# United States of America

United States Patent and Trademark Office



**Reg. No. 4,197,002**

**Registered Aug. 28, 2012**

**Int. Cls.: 9 and 42**

**TRADEMARK**

**SERVICE MARK**

**PRINCIPAL REGISTER**

TDC GROUP, INC. (OHIO CORPORATION)  
3055 KETTERING BLVD.  
DAYTON, OH 45439

FOR: COMPUTER APPLICATION SOFTWARE FOR MOBILE DEVICES, NAMELY, SOFTWARE FOR USE IN STORING, ACCESSING, EDITING, DISPLAYING, CREATING AND PROVIDING USER ACCESS TO GEOGRAPHIC INFORMATION DATA AND SYSTEMS AND OTHER DATA AND SYSTEMS, IN CLASS 9 (U.S. CLS. 21, 23, 26, 36 AND 38).

FIRST USE 5-31-2005; IN COMMERCE 5-31-2005.

FOR: PROVIDING A WEBSITE FEATURING NON-DOWNLOADABLE SOFTWARE FOR USE IN STORING, ACCESSING, EDITING, DISPLAYING, CREATING AND PROVIDING USER ACCESS TO GEOGRAPHIC INFORMATION DATA AND SYSTEMS AND OTHER DATA AND SYSTEMS, IN CLASS 42 (U.S. CLS. 100 AND 101).

FIRST USE 5-31-2005; IN COMMERCE 5-31-2005.

THE MARK CONSISTS OF TWO OVALS CONNECTED BY A ZIG ZAG LINE.

SER. NO. 85-365,455, FILED 7-7-2011.

THEODORE MCBRIDE, EXAMINING ATTORNEY



*David J. Kybas*

Director of the United States Patent and Trademark Office

# United States of America

United States Patent and Trademark Office



**Reg. No. 4,197,003**

**Registered Aug. 28, 2012**

**Int. Cl.: 35**

**SERVICE MARK**

**PRINCIPAL REGISTER**

FLAMENGO APPAREL LLC (FLORIDA LIMITED LIABILITY COMPANY)  
3700 DURANGO STREET  
CORAL GABLES, FL 33134

FOR: RETAIL STORE SERVICES FEATURING CLOTHING AND ACCESSORIES FEATURING MERCHANDISE ALL MADE FROM UV PROTECTIVE FABRICS AND MATERIALS , IN CLASS 35 (U.S. CLS. 100, 101 AND 102).

FIRST USE 6-29-2011; IN COMMERCE 6-29-2011.

NO CLAIM IS MADE TO THE EXCLUSIVE RIGHT TO USE "UV WEAR" AND "SUN PROTECTION", APART FROM THE MARK AS SHOWN.

THE MARK CONSISTS OF THE STYLIZED TEXT "UV WEAR SUN PROTECTION" WITH A PARTIAL SUN ON THE TOP.

SER. NO. 85-365,701, FILED 7-7-2011.

ELI HELLMAN, EXAMINING ATTORNEY



*David J. Kyffers*

Director of the United States Patent and Trademark Office



# United States of America

United States Patent and Trademark Office

## GALAVANTIER

**Reg. No. 4,197,004**

**Registered Aug. 28, 2012**

**Int. Cls.: 35 and 42**

**SERVICE MARK**

**PRINCIPAL REGISTER**

GALAVANTIER, INC. (DELAWARE CORPORATION)  
SUITE 110-380  
10620 SOUTHERN HIGHLANDS PKWY  
LAS VEGAS, NV 89141

FOR: PROMOTING THE GOODS AND SERVICES OF OTHERS BY PROVIDING A WEBSITE FOR AGGREGATING AND DISPLAYING DEALS AND DISCOUNTS ON HOTEL ROOMS, AIRPLANE TICKETS, CAR RENTALS, CRUISE SHIPS, AND OTHER TRAVEL RELATED RESERVATIONS, IN CLASS 35 (U.S. CLS. 100, 101 AND 102).

FIRST USE 9-23-2010; IN COMMERCE 9-23-2010.

FOR: PROVIDING A WEBSITE FEATURING TECHNOLOGY THAT ENABLES INTERNET USERS TO BOOK TRAVEL RESERVATIONS AND ARRANGEMENTS; PROVIDING A WEBSITE THAT ENABLES USERS TO SUBSCRIBE TO NEWSLETTERS AND UPDATES REGARDING TRAVEL; PROVIDING A WEBSITE THAT GIVES USERS THE ABILITY TO POST BLOGS, VIDEOS, MOVIES, COMMENTS, REVIEWS, PHOTOGRAPHS AND PICTURES, IN CLASS 42 (U.S. CLS. 100 AND 101).

FIRST USE 9-23-2010; IN COMMERCE 9-23-2010.

THE MARK CONSISTS OF STANDARD CHARACTERS WITHOUT CLAIM TO ANY PARTICULAR FONT, STYLE, SIZE, OR COLOR.

SER. NO. 85-365,843, FILED 7-7-2011.

KATINA MISTER, EXAMINING ATTORNEY



*David J. Kybas*

Director of the United States Patent and Trademark Office

# United States of America

United States Patent and Trademark Office

# REALGOLDX

**Reg. No. 4,197,005**

SOUND MONEY MANAGEMENT (HONG KONG UNINCORPORATED ASSOCIATION)  
18TH FLOOR, 2 CHINACHEM PLAZA, 68 CONNAUG  
CENTRAL HONG KONG, HONG KONG

**Registered Aug. 28, 2012**

**Int. Cl.: 9**

FOR: COMPUTER SOFTWARE FOR USE IN GOLD TRADING, IN CLASS 9 (U.S. CLS. 21, 23, 26, 36 AND 38).

**TRADEMARK**

FIRST USE 8-6-2010; IN COMMERCE 8-6-2010.

**PRINCIPAL REGISTER**

THE MARK CONSISTS OF STANDARD CHARACTERS WITHOUT CLAIM TO ANY PARTICULAR FONT, STYLE, SIZE, OR COLOR.

SER. NO. 85-365,922, FILED 7-7-2011.

NAKIA HENRY, EXAMINING ATTORNEY



*David J. Kyffers*

Director of the United States Patent and Trademark Office

# United States of America

United States Patent and Trademark Office



**Reg. No. 4,197,006**

BODY BEAUTIFUL CAR WASH, INC. (CALIFORNIA CORPORATION)  
4282 CAMINO DEL RIO NORTH  
SAN DIEGO, CA 92108

**Registered Aug. 28, 2012**

**Int. Cl.: 37**

FOR: AUTOMOBILE CLEANING AND DETAILING SERVICES AND VEHICLE SERVICE STATION SERVICES, IN CLASS 37 (U.S. CLS. 100, 103 AND 106).

**SERVICE MARK**

FIRST USE 1-0-1974; IN COMMERCE 1-0-1974.

**PRINCIPAL REGISTER**

OWNER OF U.S. REG. NO. 1,626,296.

NO CLAIM IS MADE TO THE EXCLUSIVE RIGHT TO USE "CAR WASH", APART FROM THE MARK AS SHOWN.

THE MARK CONSISTS OF LOGO COMPRISING A VINTAGE CAR IN FRONT OF PALM TREES WITH SUN AND MOUNTAINS IN THE BACKGROUND AND THE WORDS "BODY BEAUTIFUL CAR WASH" IN CURVED WORDING PARTIALLY ON AND PARTIALLY BELOW THE CAR WITH "CAR WASH" IN A CURVED BANNER.

SER. NO. 85-366,011, FILED 7-7-2011.

MEGHAN REINHART, EXAMINING ATTORNEY



*David J. Kyffers*

Director of the United States Patent and Trademark Office

# United States of America

United States Patent and Trademark Office

## CONTINUING LEADERSHIP IN PROFESSIONAL EDUCATION

**Reg. No. 4,197,007**

**Registered Aug. 28, 2012**

**Int. Cls.: 16 and 41**

**TRADEMARK**

**SERVICE MARK**

**PRINCIPAL REGISTER**

AMERICAN LAW INSTITUTE (D.C. CORPORATION)  
4025 CHESTNUT STREET  
PHILADELPHIA, PA 19104

FOR: PUBLICATIONS, NAMELY, BOOKS ON LEGAL TOPICS; SERIES OF BOOKS CONCERNING LEGAL TOPICS AND SUPPLEMENTS THEREOF; MAGAZINES AND ANNUAL REPORTS IN THE LEGAL FIELD, IN CLASS 16 (U.S. CLS. 2, 5, 22, 23, 29, 37, 38 AND 50).

FIRST USE 4-0-2006; IN COMMERCE 4-0-2006.

FOR: EDUCATIONAL SERVICES, NAMELY, CONDUCTING COURSES OF STUDY, WORKSHOPS, PROGRAMS, SEMINARS, CONTINUING LEGAL EDUCATION CLASSES AND CONFERENCES ON VARIOUS LEGAL SUBJECTS, IN CLASS 41 (U.S. CLS. 100, 101 AND 107).

FIRST USE 4-0-2006; IN COMMERCE 4-0-2006.

THE MARK CONSISTS OF STANDARD CHARACTERS WITHOUT CLAIM TO ANY PARTICULAR FONT, STYLE, SIZE, OR COLOR.

SER. NO. 85-366,430, FILED 7-8-2011.

MATTHEW PAPPAS, EXAMINING ATTORNEY



*David J. Kyppas*

Director of the United States Patent and Trademark Office

# United States of America

United States Patent and Trademark Office

# ISACADE

**Reg. No. 4,197,008**

**Registered Aug. 28, 2012**

**Int. Cl.: 5**

**TRADEMARK**

**PRINCIPAL REGISTER**

ASTELLAS PHARMA INC. (JAPAN CORPORATION)  
3-11, NIHONBASHI-HONCHO 2-CHOME, CHUO-KU  
TOKYO, JAPAN 103-8411

FOR: PHARMACEUTICAL PREPARATIONS AND SUBSTANCES, NAMELY, ANTIFUNGALS,  
IN CLASS 5 (U.S. CLS. 6, 18, 44, 46, 51 AND 52).

THE MARK CONSISTS OF STANDARD CHARACTERS WITHOUT CLAIM TO ANY PAR-  
TICULAR FONT, STYLE, SIZE, OR COLOR.

PRIORITY CLAIMED UNDER SEC. 44(D) ON UNITED KINGDOM APPLICATION NO.  
2570085, FILED 1-25-2011.

OWNER OF JAPAN REG. NO. 5464795, DATED 1-20-2012, EXPIRES 1-20-2022.

SER. NO. 85-366,597, FILED 7-8-2011.

APRIL HESIK, EXAMINING ATTORNEY



*David J. Kyros*

Director of the United States Patent and Trademark Office

# United States of America

United States Patent and Trademark Office



**GRYPHEX**

**Reg. No. 4,197,009**

**Registered Aug. 28, 2012**

**Int. Cls.: 9, 35, 37, 38  
and 45**

**TRADEMARK**

**SERVICE MARK**

**PRINCIPAL REGISTER**

ASCEND SYSTEMS, LLC (DELAWARE LIMITED LIABILITY COMPANY)  
1035 WINDWARD RIDGE PARKWAY, STE 575  
ALPHARETTA, GA 30005

FOR: ELECTRONIC UNITS IN THE NATURE OF A GPS TRACKING DEVICE AND COMPUTER HARDWARE AND SOFTWARE SYSTEM FOR TRACKING PEOPLE THAT PROVIDES ELECTRONIC TRANSMISSION OF DATA AND INFORMATION UTILIZING GLOBAL POSITIONING SATELLITE AND TERRESTRIAL LOCATION SYSTEMS TO LOCATE, MONITOR AND MANAGE PRE-TRIAL PERSONS AND CRIMINAL/CIVIL OFFENDERS WHO WEAR THE UNITS, TRACK MOVEMENT OF THESE PEOPLE, AND PROVIDE ALARMS BASED ON LOCATION OF THE PEOPLE WHICH CAN BE TRACKED AT A CENTRAL LOCATION SUCH AS A CENTRAL COMPUTER SERVER RUNNING THE RELATED SOFTWARE, IN CLASS 9 (U.S. CLS. 21, 23, 26, 36 AND 38).

FIRST USE 9-7-2011; IN COMMERCE 9-7-2011.

FOR: RETAIL STORE SERVICES, FEATURING, ELECTRONIC UNITS IN THE NATURE OF GPS TRACKING DEVICES AND RELATED COMPUTER HARDWARE AND SOFTWARE, IN CLASS 35 (U.S. CLS. 100, 101 AND 102).

FIRST USE 9-7-2011; IN COMMERCE 9-7-2011.

FOR: REPAIR AND MAINTENANCE OF ELECTRONIC UNITS IN THE NATURE OF GPS TRACKING DEVICES AND COMPUTER HARDWARE, IN CLASS 37 (U.S. CLS. 100, 103 AND 106).

FIRST USE 9-7-2011; IN COMMERCE 9-7-2011.

FOR: PROVIDING ELECTRONIC TRANSMISSION OF DATA UTILIZING GLOBAL POSITIONING SATELLITE AND TERRESTRIAL LOCATION SYSTEMS TO LOCATE, MONITOR AND MANAGE PRE-TRIAL PERSONS AND CRIMINAL/CIVIL OFFENDERS WHO WEAR TRACKING DEVICES, IN CLASS 38 (U.S. CLS. 100, 101 AND 104).

FIRST USE 9-7-2011; IN COMMERCE 9-7-2011.

FOR: COMPUTERIZED SECURITY SERVICES, NAMELY, MONITORING AND TRACKING PRE-TRIAL CRIMINAL/CIVIL OFFENDERS AND REMOTE DEVICE ACTIVATION AND



*David J. Kybas*

Director of the United States Patent and Trademark Office

**Reg. No. 4,197,009** DEACTIVATION OF PERSONAL MONITORING UNITS , IN CLASS 45 (U.S. CLS. 100 AND 101).

FIRST USE 9-7-2011; IN COMMERCE 9-7-2011.

THE MARK CONSISTS OF A GRIFFIN POSITIONED WITHIN A SHIELD, THE GRIFFIN INCLUDES THE TORSO OF A LION AND THE HEAD OF AN EAGLE, THE TORSO HAS A SINGLE WING OF AN EAGLE, THE HEAD OF THE EAGLE HAS A LONG SNAKE-LIKE TONGUE THAT EXTENDS BEYOND THE BEAK OF THE EAGLE HEAD, THE FEET INCLUDE TALONS OF AN EAGLE, THE GRIFFIN IS STANDING ON ITS HIND LEGS WITH ITS FRONT TWO LEGS RAISED, THE FRONT TWO RAISED LEGS FACE THE LEFT SECTION OF THE SHIELD WHILE THE TAIL OF THE BODY FACES THE RIGHT SECTION OF THE SHIELD, THE TAIL HAS A LETTER S SHAPE, THE SHIELD IS POSITIONED IN PROXIMITY TO THE WORD "GRYPHEX", THE BOTTOM SHIELD SHAPE CONVERGES TO A POINT, THE TOP SECTION OF THE SHIELD HAS A CONCAVE SHAPED LINE.

SER. NO. 85-366,935, FILED 7-8-2011.

TARAH HARDY, EXAMINING ATTORNEY

# United States of America

United States Patent and Trademark Office

## OLD RITUAL BREWERY

**Reg. No. 4,197,010**

ZAWAYDEH, DERAR (UNITED STATES INDIVIDUAL)  
330 3RD STREET  
DAVIS, CA 95616

**Registered Aug. 28, 2012**

**Int. Cl.: 40**

FOR: BREWERY SERVICES, IN CLASS 40 (U.S. CLS. 100, 103 AND 106).

**SERVICE MARK**

FIRST USE 6-25-2011; IN COMMERCE 6-25-2011.

**PRINCIPAL REGISTER**

THE MARK CONSISTS OF STANDARD CHARACTERS WITHOUT CLAIM TO ANY PARTICULAR FONT, STYLE, SIZE, OR COLOR.

NO CLAIM IS MADE TO THE EXCLUSIVE RIGHT TO USE "BREWERY", APART FROM THE MARK AS SHOWN.

SER. NO. 85-367,065, FILED 7-8-2011.

ROBIN MITTLER, EXAMINING ATTORNEY



*David J. Kybas*

Director of the United States Patent and Trademark Office



# United States of America

United States Patent and Trademark Office

## CONCRETE CANVAS

**Reg. No. 4,197,011**

**Registered Aug. 28, 2012**

**Int. Cl.: 19**

**TRADEMARK**

**PRINCIPAL REGISTER**

CONCRETE CANVAS TECHNOLOGY LTD. (UNITED KINGDOM LIMITED LIABILITY COMPANY)  
TREForest IND EST  
PONTYPRIDD, UNITED KINGDOM CF375SP

FOR: NON-METALLIC CONSTRUCTION MATERIALS, NAMELY, COMPOSITES FOR USE IN CIVIL ENGINEERING, ARCHITECTURE, SCULPTURE, FURNITURE DESIGN, MILITARY ENGINEERING, FILM SET CONSTRUCTION AND BUILDING STRUCTURES, IN CLASS 19 (U.S. CLS. 1, 12, 33 AND 50).

FIRST USE 11-1-2004; IN COMMERCE 8-16-2005.

THE MARK CONSISTS OF STANDARD CHARACTERS WITHOUT CLAIM TO ANY PARTICULAR FONT, STYLE, SIZE, OR COLOR.

SEC. 2(F).

SER. NO. 85-367,620, FILED 7-11-2011.

JOHN WILKE, EXAMINING ATTORNEY



*David J. Kyffers*

Director of the United States Patent and Trademark Office

# United States of America

United States Patent and Trademark Office

## C.A.R.E. Collaboration Access Review Education

**Reg. No. 4,197,012**

CONWAY & PANNELL, PC (VIRGINIA CORPORATION)  
6718 WHITTIER AVENUE  
MCLEAN, VA 22101

**Registered Aug. 28, 2012**

**Int. Cl.: 45**

FOR: LEGAL SERVICES, IN CLASS 45 (U.S. CLS. 100 AND 101).

**SERVICE MARK**

FIRST USE 3-15-2011; IN COMMERCE 3-15-2011.

**PRINCIPAL REGISTER**

THE MARK CONSISTS OF STANDARD CHARACTERS WITHOUT CLAIM TO ANY PARTICULAR FONT, STYLE, SIZE, OR COLOR.

NO CLAIM IS MADE TO THE EXCLUSIVE RIGHT TO USE "COLLABORATION ACCESS REVIEW EDUCATION", APART FROM THE MARK AS SHOWN.

SER. NO. 85-367,707, FILED 7-11-2011.

KAREN K. BUSH, EXAMINING ATTORNEY



*David J. Kyffers*

Director of the United States Patent and Trademark Office

# United States of America

United States Patent and Trademark Office

# CROWDCEPT

**Reg. No. 4,197,013**

INCLUD LIMITED (HONG KONG LIMITED LIABILITY COMPANY)  
2512, LANGHAM PLACE TOWER, 8 ARGYLE ST.  
HONG KONG, HONG KONG

**Registered Aug. 28, 2012**

**Int. Cl.: 42**

FOR: COMPUTER SERVICES, NAMELY, PROVIDING SEARCH ENGINES FOR OBTAINING AND ANALYZING DATA ON A GLOBAL COMPUTER NETWORK, IN CLASS 42 (U.S. CLS. 100 AND 101).

**SERVICE MARK**

FIRST USE 7-10-2011; IN COMMERCE 7-10-2011.

**PRINCIPAL REGISTER**

THE MARK CONSISTS OF STANDARD CHARACTERS WITHOUT CLAIM TO ANY PARTICULAR FONT, STYLE, SIZE, OR COLOR.

SER. NO. 85-367,722, FILED 7-11-2011.

SHANNON TWOHIG, EXAMINING ATTORNEY



*David J. Kybas*

Director of the United States Patent and Trademark Office

# United States of America

United States Patent and Trademark Office



**Reg. No. 4,197,014**

**Registered Aug. 28, 2012**

**Int. Cl.: 36**

**SERVICE MARK**

**PRINCIPAL REGISTER**

CFS MORTGAGE CORPORATION (ARIZONA CORPORATION)  
SUITE 325  
7720 N 16TH STREET  
PHOENIX, AZ 85020

FOR: FINANCIAL LOAN CONSULTATION; MORTGAGE BANKING, IN CLASS 36 (U.S. CLS. 100, 101 AND 102).

FIRST USE 4-1-2011; IN COMMERCE 4-1-2011.

NO CLAIM IS MADE TO THE EXCLUSIVE RIGHT TO USE "MORTGAGE CORPORATION", APART FROM THE MARK AS SHOWN.

THE MARK CONSISTS OF A ROOFTOP WITH WINDOWS AND THE LETTER "CFS" INSIDE. TO THE RIGHT THERE IS THE STYLIZED TEXT "MORTGAGE CORPORATION".

SER. NO. 85-367,851, FILED 7-11-2011.

DAWN FELDMAN, EXAMINING ATTORNEY



*David J. Kyffers*

Director of the United States Patent and Trademark Office

# United States of America

United States Patent and Trademark Office



**Reg. No. 4,197,015**

**Registered Aug. 28, 2012**

**Int. Cl.: 35**

**SERVICE MARK**

**PRINCIPAL REGISTER**

PROSPECT MORTGAGE, LLC (DELAWARE LIMITED LIABILITY COMPANY)  
15301 VENTURA BLVD.  
SHERMAN OAKS, CA 91403

FOR: MARKETING AND ADVERTISING SERVICES PROVIDED FOR REAL ESTATE AND MORTGAGE LOAN PROFESSIONALS, AND NOT OFFERED TO PROSPECTIVE BUYERS OR LEASERS, IN CLASS 35 (U.S. CLS. 100, 101 AND 102).

FIRST USE 12-31-2010; IN COMMERCE 12-31-2010.

OWNER OF U.S. REG. NOS. 3,744,672 AND 3,744,674.

NO CLAIM IS MADE TO THE EXCLUSIVE RIGHT TO USE "MORTGAGE" AND "BEST OPEN HOUSE SALES SYSTEM", APART FROM THE MARK AS SHOWN.

THE MARK CONSISTS OF A BOX WITH THE WORDS "PROSPECT MORTGAGE" ALONG THE TOP AND "BEST OPEN HOUSE SALES SYSTEM" ALONG THE BOTTOM. THERE IS AN INTERNAL BOX THAT CONTAINS THE LETTERS "BOSS".

SER. NO. 85-367,980, FILED 7-11-2011.

LYDIA BELZER, EXAMINING ATTORNEY



*David J. Kyros*

Director of the United States Patent and Trademark Office

# United States of America

United States Patent and Trademark Office



**Reg. No. 4,197,016**

**Registered Aug. 28, 2012**

**Int. Cl.: 9**

**TRADEMARK**

**PRINCIPAL REGISTER**

NOHMI BOSAI LTD. (JAPAN CORPORATION)  
7-3, KUDAN-MINAMI 4-CHOME  
CHIYODA-KU, TOKYO, JAPAN AND

KOATSU CO., LTD. (JAPAN CORPORATION)  
1-310, KITAHONMACHI, ITAMI  
HYOGO PREF., JAPAN

FOR: FIRE-EXTINGUISHING SYSTEMS; GAS FIRE SUPPRESSION SYSTEMS AND COMPONENT PARTS THEREOF, FOR USE IN BUILDINGS, HOMES, MUSEUMS, COMPUTER ROOMS, OCCUPIED SIGNAL TRANSITION MACHINE ROOMS, FIRE PROTECTION CENTERS, CONTROL ROOMS OR OTHER ROOMS CONTAINING ELECTRONICS, MACHINERY OR OTHER SENSITIVE ITEMS, MATERIALS OR EQUIPMENT, RACING VEHICLES, ARMORED VEHICLES, MILITARY VEHICLES, COMMERCIAL VEHICLES, MARINE VEHICLES, AND AVIATION VEHICLES, COMPRISED OF CHARGED BOTTLES, CHARGE GAGES, MOUNTING BASES AND STRAPS, PULL CABLES, NOZZLES, FITTINGS, TUBING, LOCK-OUT VALVES AND SWITCHES, MANUAL CONTROL PANELS, RELEASE VALVES AND SWITCHES, AND STICKERS; FIRE EXTINGUISHERS; FIRE HYDRANTS; FIRE HOSE NOZZLES; SPRINKLER SYSTEMS FOR FIRE PROTECTION; FIRE ALARMS; GAS ALARMS; AUTOMATIC ELECTRIC CONTROL PANELS AND MANUAL CONTROL PANELS FOR USE IN WATER, BUBBLE, POWDER, GAS, CARBON DIOXIDE, NITROGEN GAS, ARGON GAS AND FLUORINE GAS FIRE EXTINGUISHING AND SUPPRESSION SYSTEMS, IN CLASS 9 (U.S. CLS. 21, 23, 26, 36 AND 38).

FIRST USE 12-27-2001; IN COMMERCE 5-1-2010.

THE MARK CONSISTS OF A FLAME DESIGN TO THE LEFT OF THE STYLIZED LETTERING/NUMBERING "NN100".

SER. NO. 85-368,059, FILED 7-11-2011.

TARAH HARDY, EXAMINING ATTORNEY



*David J. Kyros*

Director of the United States Patent and Trademark Office

# United States of America

United States Patent and Trademark Office

## BRAIN TWIST

**Reg. No. 4,197,017**

**Registered Aug. 28, 2012**

**Int. Cl.: 28**

**TRADEMARK**

**PRINCIPAL REGISTER**

HOBERMAN, CHARLES (UNITED STATES INDIVIDUAL)  
C/O HOBERMAN DESIGNS, INC.  
472 GREENWICH STREET, NO. 7  
NEW YORK, NY 10013

FOR: TOYS, NAMELY, THREE DIMENSIONAL PUZZLES, IN CLASS 28 (U.S. CLS. 22, 23, 38 AND 50).

FIRST USE 12-31-2004; IN COMMERCE 12-31-2004.

THE MARK CONSISTS OF STANDARD CHARACTERS WITHOUT CLAIM TO ANY PARTICULAR FONT, STYLE, SIZE, OR COLOR.

SER. NO. 85-368,165, FILED 7-11-2011.

ZACHARY BELLO, EXAMINING ATTORNEY



*David J. Kybas*

Director of the United States Patent and Trademark Office

# United States of America

United States Patent and Trademark Office

# GOLDSILVER

**Reg. No. 4,197,018**

**Registered Aug. 28, 2012**

**Int. Cl.: 36**

**SERVICE MARK**

**PRINCIPAL REGISTER**

SILVER & GOLD, INC. (CALIFORNIA CORPORATION), DBA GOLDSILVER.COM  
SUITE 620  
429 SANTA MONICA BOULEVARD  
SANTA MONICA, CA 90401

FOR: COMMODITY BROKERAGE, IN CLASS 36 (U.S. CLS. 100, 101 AND 102).

FIRST USE 4-13-2006; IN COMMERCE 4-13-2006.

THE MARK CONSISTS OF STANDARD CHARACTERS WITHOUT CLAIM TO ANY PARTICULAR FONT, STYLE, SIZE, OR COLOR.

SEC. 2(F).

SER. NO. 85-368,546, FILED 7-11-2011.

ANDREW LEASER, EXAMINING ATTORNEY



*David J. Kyffers*

Director of the United States Patent and Trademark Office



# United States of America

United States Patent and Trademark Office

## DINGOLAY ENTERTAINMENT

**Reg. No. 4,197,019**

WILSON, SUZETTE (UNITED STATES INDIVIDUAL), DBA DINGOLAY ENTERTAINMENT  
63 PARKVIEW DRIVE  
UNION, NJ 07083 AND

**Registered Aug. 28, 2012**

**Int. Cl.: 41**

SAMUELS, GLADSTONE (UNITED STATES INDIVIDUAL), DBA DINGOLAY  
ENTERTAINMENT

**SERVICE MARK**

63 PARKVIEW DR  
UNION, NJ 07083 AND

**PRINCIPAL REGISTER**

ROBERTS, COLIN (UNITED STATES INDIVIDUAL), DBA DINGOLAY ENTERTAINMENT  
63 PARKVIEW DR  
UNION, NJ 07083

FOR: CONSULTATION IN THE FIELD OF SPECIAL EVENT PLANNING FOR SOCIAL ENTERTAINMENT PURPOSES, SPECIAL EVENT PLANNING FOR SOCIAL ENTERTAINMENT PURPOSES, ENTERTAINMENT SERVICES, NAMELY, CONDUCTING GLOBAL CARNIVALS AND STREET PARADES, ENTERTAINMENT SERVICES, NAMELY, CONDUCTING PARTIES, PARTY PLANNING, PARTY PLANNING CONSULTATION, SOCIAL CLUB SERVICES, NAMELY, ARRANGING, ORGANIZING, AND HOSTING SOCIAL EVENTS, GET-TOGETHERS, AND PARTIES FOR CARNIVAL AND STREET PARADE CLUB MEMBERS, IN CLASS 41 (U.S. CLS. 100, 101 AND 107).

FIRST USE 10-19-2010; IN COMMERCE 12-15-2010.

THE MARK CONSISTS OF STANDARD CHARACTERS WITHOUT CLAIM TO ANY PARTICULAR FONT, STYLE, SIZE, OR COLOR.

NO CLAIM IS MADE TO THE EXCLUSIVE RIGHT TO USE "ENTERTAINMENT", APART FROM THE MARK AS SHOWN.

THE WORDING "DINGOLAY" HAS NO MEANING IN A FOREIGN LANGUAGE.

SER. NO. 85-368,886, FILED 7-12-2011.

BILL DAWE, EXAMINING ATTORNEY



*David J. Kypos*

Director of the United States Patent and Trademark Office

# United States of America

United States Patent and Trademark Office



**Reg. No. 4,197,020**

**Registered Aug. 28, 2012**

**Int. Cls.: 14 and 35**

**TRADEMARK**

**SERVICE MARK**

**PRINCIPAL REGISTER**

CARTIER INTERNATIONAL A.G. (SWITZERLAND CORPORATION)  
HINTERBERGSTRASSE 22, POSTFACH 61  
6312 STEINHAUSEN, SWITZERLAND

FOR: JEWELRY AND WATCHES, IN CLASS 14 (U.S. CLS. 2, 27, 28 AND 50).

FIRST USE 2-0-1977; IN COMMERCE 2-0-1977.

FOR: RETAIL STORE SERVICES FEATURING JEWELRY AND WATCHES; ONLINE RETAIL STORE SERVICES FEATURING JEWELRY AND WATCHES, IN CLASS 35 (U.S. CLS. 100, 101 AND 102).

FIRST USE 2-0-1977; IN COMMERCE 2-0-1977.

THE MARK CONSISTS OF THREE-DIMENSIONAL PRODUCT PACKAGING COMPOSED OF AN 8-SIDED BOX AND LID IN THE COLOR RED WITH GOLD MARKINGS. THE FOUR CORNERS OF THE BOX ARE CHAMFERED. THE TOP HORIZONTAL SIDE OF THE LID IS IMPRINTED WITH A SERIES OF EQUALLY-SPACED GARLANDS IN THE COLOR GOLD, ABUTTING A GOLD LINE AROUND THE PERIMETER OF THE LID. THE VERTICAL SIDES OF THE PACKAGING FEATURE A GOLD HORIZONTAL CHAIN-LIKE PATTERN, POSITIONED ON THE UPPER SIDES OF THE LID AND THE LOWER SIDES OF THE BOX. THE VERTICAL SIDES OF THE PACKAGING ALSO FEATURE A LINE OF GOLD DOTS ON THE LOWER SIDES OF THE LID AND THE UPPER SIDES OF THE BOX. THE COLORS RED AND GOLD ARE CLAIMED AS FEATURES OF THE MARK. THE PROPORTIONAL RELATIONSHIP BETWEEN THE WIDTH, HEIGHT, AND DEPTH IS NOT A FEATURE OF THE MARK, AND THE PROPORTIONAL RELATIONSHIP BETWEEN THE HEIGHT OF THE LID AND HEIGHT OF THE BOX IS NOT A FEATURE OF THE MARK. THE PROPORTIONAL RELATIONSHIPS ARE SHOWN IN BROKEN OR DOTTED LINES, WHICH INDICATE THAT THEY ARE NOT A PART OF THE MARK.

THE COLOR(S) RED AND GOLD IS/ARE CLAIMED AS A FEATURE OF THE MARK.

SEC. 2(F).

SER. NO. 85-369,086, FILED 7-12-2011.

SEAN CROWLEY, EXAMINING ATTORNEY



*David J. Kyros*

Director of the United States Patent and Trademark Office

# United States of America

United States Patent and Trademark Office

## LARAMIE RIVER RANCH

**Reg. No. 4,197,021**

**Registered Aug. 28, 2012**

**Int. Cl.: 43**

**SERVICE MARK**

**PRINCIPAL REGISTER**

LARAMIE RIVER GUEST RANCH, LLC (COLORADO CORPORATION), DBA LARAMIE RIVER RANCH  
25777 N. COUNTY ROAD 103  
JELM, WY 82063

FOR: DUDE RANCH SERVICES; GUEST RANCH SERVICES, IN CLASS 43 (U.S. CLS. 100 AND 101).

FIRST USE 7-13-1997; IN COMMERCE 7-13-1997.

THE MARK CONSISTS OF STANDARD CHARACTERS WITHOUT CLAIM TO ANY PARTICULAR FONT, STYLE, SIZE, OR COLOR.

NO CLAIM IS MADE TO THE EXCLUSIVE RIGHT TO USE "RANCH", APART FROM THE MARK AS SHOWN.

SEC. 2(F).

SER. NO. 85-369,091, FILED 7-12-2011.

WARREN L. OLANDRIA, EXAMINING ATTORNEY



*David J. Kyffers*

Director of the United States Patent and Trademark Office

# United States of America

United States Patent and Trademark Office



**SNOWLION**  
CENTER SCHOOL



**Training and Transformation in the Heart of Healing**

**Reg. No. 4,197,022**

BLUE, JOEY (UNITED STATES INDIVIDUAL)  
P.O. BOX 1840

**Registered Aug. 28, 2012**

RANCHOS DE TAOS, NM 87557 AND

**Int. Cl.: 41**

DEMERS, KARLA JOY (UNITED STATES INDIVIDUAL)  
P.O. BOX 1840  
RANCHOS DE TAOS, NM 87557

**SERVICE MARK**

**PRINCIPAL REGISTER**

FOR: EDUCATIONAL SERVICES, NAMELY, ARRANGING AND CONDUCTING CLASSES, SEMINARS, CONFERENCES, WORKSHOPS, IN THE FIELD OF HOLISTIC HEALTH, IN CLASS 41 (U.S. CLS. 100, 101 AND 107).

FIRST USE 11-11-2004; IN COMMERCE 11-11-2004.

NO CLAIM IS MADE TO THE EXCLUSIVE RIGHT TO USE "CENTER SCHOOL", APART FROM THE MARK AS SHOWN.

THE MARK CONSISTS OF THE TEXT "SNOWLION" AT THE TOP, "CENTER SCHOOL" BELOW "SNOWLION", AN IMAGE OF A LION'S HEAD ON EACH SIDE, AND "TRAINING AND TRANSFORMATION IN THE HEART OF HEALING" CENTERED BELOW.

SER. NO. 85-369,329, FILED 7-12-2011.

WILLIAM ROSSMAN, EXAMINING ATTORNEY



*David J. Kyros*

Director of the United States Patent and Trademark Office

# United States of America

United States Patent and Trademark Office

## POLAR IGLOO

**Reg. No. 4,197,023**

7 A.M. ENFANT INC. (NEW YORK CORPORATION)  
150 BEEKMAN STREET #2  
NEW YORK, NY 10038

**Registered Aug. 28, 2012**

**Int. Cl.: 12**

FOR: INFANT AND CHILD BUNTING SPECIALLY ADAPTED FOR USE WITH CHILDREN'S CAR SEATS AND STROLLERS, WHICH MAY ALSO BE USED AS A BLANKET, IN CLASS 12 (U.S. CLS. 19, 21, 23, 31, 35 AND 44).

**TRADEMARK**

FIRST USE 3-1-2011; IN COMMERCE 3-1-2011.

**PRINCIPAL REGISTER**

THE MARK CONSISTS OF STANDARD CHARACTERS WITHOUT CLAIM TO ANY PARTICULAR FONT, STYLE, SIZE, OR COLOR.

OWNER OF U.S. REG. NO. 3,271,950.

SER. NO. 85-369,632, FILED 7-12-2011.

KIMBERLY FRYE, EXAMINING ATTORNEY



*David J. Kyffers*

Director of the United States Patent and Trademark Office

# United States of America

United States Patent and Trademark Office

## ALGUIEN TE MIRA

**Reg. No. 4,197,024**

TELEVISIÓN NACIONAL DE CHILE (CHILE CHILEAN STATE AGENCY)  
BELLAVISTA NO. 0990; PROVIDENCIA  
SANTIAGO, CHILE

**Registered Aug. 28, 2012**

**Int. Cl.: 38**

FOR: CABLE TELEVISION BROADCASTING SERVICES; SATELLITE TELEVISION BROADCASTING SERVICES; INTERNET BROADCASTING SERVICES, NAMELY, STREAMING OF AUDIO, VIDEO AND AUDIO/VIDEO MATERIALS OVER THE INTERNET, IN CLASS 38 (U.S. CLS. 100, 101 AND 104).

**SERVICE MARK**

**PRINCIPAL REGISTER**

THE MARK CONSISTS OF STANDARD CHARACTERS WITHOUT CLAIM TO ANY PARTICULAR FONT, STYLE, SIZE, OR COLOR.

OWNER OF CHILE REG. NO. 862.177, DATED 10-2-2009, EXPIRES 10-2-2019.

THE ENGLISH TRANSLATION OF "ALGUIEN TE MIRA" IN THE MARK IS "SOMEONE'S WATCHING YOU".

SER. NO. 85-369,874, FILED 7-13-2011.

DAVID MURRAY, EXAMINING ATTORNEY



*David J. Kyfos*

Director of the United States Patent and Trademark Office

# United States of America

United States Patent and Trademark Office

## DONDE ESTA ELISA?

**Reg. No. 4,197,025**

TELEVISIÓN NACIONAL DE CHILE (CHILE CHILEAN STATE AGENCY)  
BELLAVISTA NO. 0990; PROVIDENCIA  
SANTIAGO, CHILE

**Registered Aug. 28, 2012**

**Int. Cl.: 38**

FOR: CABLE TELEVISION BROADCASTING SERVICES; SATELLITE TELEVISION BROADCASTING SERVICES; INTERNET BROADCASTING SERVICES, NAMELY, STREAMING OF AUDIO, VIDEO AND AUDIO/VIDEO MATERIALS OVER THE INTERNET, IN CLASS 38 (U.S. CLS. 100, 101 AND 104).

**SERVICE MARK**

**PRINCIPAL REGISTER**

THE MARK CONSISTS OF STANDARD CHARACTERS WITHOUT CLAIM TO ANY PARTICULAR FONT, STYLE, SIZE, OR COLOR.

OWNER OF CHILE REG. NO. 834.993, DATED 11-27-2008, EXPIRES 11-27-2018.

THE ENGLISH TRANSLATION OF "DONDE ESTA ELISA?" IN THE MARK IS "WHERE IS ELISA?".

SER. NO. 85-369,877, FILED 7-13-2011.

DAVID MURRAY, EXAMINING ATTORNEY



*David J. Kyffers*

Director of the United States Patent and Trademark Office

# United States of America

United States Patent and Trademark Office

## LA FAMILIA DE AL LADO

**Reg. No. 4,197,026**

TELEVISIÓN NACIONAL DE CHILE (CHILE CHILEAN STATE AGENCY)  
BELLAVISTA NO. 0990; PROVIDENCIA  
SANTIAGO, CHILE

**Registered Aug. 28, 2012**

**Int. Cl.: 38**

FOR: CABLE TELEVISION BROADCASTING SERVICES; SATELLITE TELEVISION BROADCASTING SERVICES; INTERNET BROADCASTING SERVICES, NAMELY, STREAMING OF AUDIO, VIDEO AND AUDIO/VIDEO MATERIALS OVER THE INTERNET, IN CLASS 38 (U.S. CLS. 100, 101 AND 104).

**SERVICE MARK**

**PRINCIPAL REGISTER**

THE MARK CONSISTS OF STANDARD CHARACTERS WITHOUT CLAIM TO ANY PARTICULAR FONT, STYLE, SIZE, OR COLOR.

OWNER OF CHILE REG. NO. 905.964, DATED 12-23-2010, EXPIRES 12-23-2020.

THE ENGLISH TRANSLATION OF "LA FAMILIA DE AL LADO" IN THE MARK IS "THE FAMILY NEXT DOOR".

SER. NO. 85-369,909, FILED 7-13-2011.

DAVID MURRAY, EXAMINING ATTORNEY



*David J. Kyffers*

Director of the United States Patent and Trademark Office



# United States of America

United States Patent and Trademark Office

# PAPOOSE

**Reg. No. 4,197,027**

7 A.M. ENFANT INC. (NEW YORK CORPORATION)  
150 BEEKMAN STREET #2  
NEW YORK, NY 10038

**Registered Aug. 28, 2012**

**Int. Cl.: 20**

FOR: INFANT AND CHILD BUNTING IN THE NATURE OF A SLEEPING BAG FOR USE WITH CAR SEATS AND STROLLERS, IN CLASS 20 (U.S. CLS. 2, 13, 22, 25, 32 AND 50).

**TRADEMARK**

FIRST USE 3-1-2011; IN COMMERCE 3-1-2011.

**PRINCIPAL REGISTER**

THE MARK CONSISTS OF STANDARD CHARACTERS WITHOUT CLAIM TO ANY PARTICULAR FONT, STYLE, SIZE, OR COLOR.

SER. NO. 85-369,928, FILED 7-13-2011.

KIMBERLY FRYE, EXAMINING ATTORNEY



*David J. Kyffers*

Director of the United States Patent and Trademark Office

**United States of America**  
United States Patent and Trademark Office

# BAGOCOAT

**Reg. No. 4,197,028**

7 A.M. ENFANT INC. (NEW YORK CORPORATION)  
150 BEEKMAN STREET #2  
NEW YORK, NY 10038

**Registered Aug. 28, 2012**

**Int. Cl.: 25**

FOR: INFANT BUNTING CONVERTIBLE TO AN INFANT COAT, IN CLASS 25 (U.S. CLS. 22 AND 39).

**TRADEMARK**

FIRST USE 3-1-2011; IN COMMERCE 3-1-2011.

**PRINCIPAL REGISTER**

THE MARK CONSISTS OF STANDARD CHARACTERS WITHOUT CLAIM TO ANY PARTICULAR FONT, STYLE, SIZE, OR COLOR.

SER. NO. 85-369,973, FILED 7-13-2011.

KIMBERLY FRYE, EXAMINING ATTORNEY



*David J. Kyffers*

Director of the United States Patent and Trademark Office

# United States of America

United States Patent and Trademark Office

# SLIMLINE

**Reg. No. 4,197,029**

AIRWAVE TECHNOLOGIES INC. (FLORIDA CORPORATION)

**Registered Aug. 28, 2012**

1925 NE 148 ST  
NORTH MIAMI, FL 33181

**Int. Cl.: 9**

FOR: HEADPHONES, HEARING PROTECTION HEADSETS, MICROPHONES FOR COMMUNICATION DEVICES, MICROPHONE CABLES, MICROPHONE MODULES, SPEAKER MICROPHONES, AMPLIFIER FOR WIRELESS COMMUNICATION, APPARATUS FOR WIRELESS TRANSMISSION OF ACOUSTIC INFORMATION, WIRELESS BROADBAND RADIOS, WIRELESS TRANSCEIVER RADIO, WIRELESS TRANSMITTERS AND RECEIVERS, IN CLASS 9 (U.S. CLS. 21, 23, 26, 36 AND 38).

**TRADEMARK**

**PRINCIPAL REGISTER**

FIRST USE 11-8-2005; IN COMMERCE 11-8-2005.

THE MARK CONSISTS OF STANDARD CHARACTERS WITHOUT CLAIM TO ANY PARTICULAR FONT, STYLE, SIZE, OR COLOR.

SER. NO. 85-370,512, FILED 7-13-2011.

KIMBERLY PERRY, EXAMINING ATTORNEY



*David J. Kypos*

Director of the United States Patent and Trademark Office

# United States of America

United States Patent and Trademark Office



**Reg. No. 4,197,030**

**Registered Aug. 28, 2012**

**Int. Cls.: 9 and 41**

**TRADEMARK**

**SERVICE MARK**

**PRINCIPAL REGISTER**

MASTIFF LLC (CALIFORNIA LIMITED LIABILITY COMPANY)  
268 BUSH STREET #4207  
SAN FRANCISCO, CA 941043503

FOR: VIDEO GAME PROGRAMS, VIDEO GAME SOFTWARE, VIDEO GAME PROGRAMS PRODUCED ON PRE-RECORDED OPTICAL MEDIA, DOWNLOADABLE VIDEO GAME SOFTWARE FOR USE ON WIRELESS DEVICES AND ON A GLOBAL COMPUTER NETWORK, IN CLASS 9 (U.S. CLS. 21, 23, 26, 36 AND 38).

FIRST USE 6-16-2009; IN COMMERCE 6-16-2009.

FOR: ENTERTAINMENT SERVICES, NAMELY, PRODUCTION OF VIDEO GAME SOFTWARE AND MULTIMEDIA PUBLISHING OF VIDEO GAME SOFTWARE, IN CLASS 41 (U.S. CLS. 100, 101 AND 107).

FIRST USE 6-16-2009; IN COMMERCE 6-16-2009.

THE MARK CONSISTS OF THE HEAD OF A DOG WHICH APPEARS IN THE COLORS RED, DARK RED, AND BLACK, BELOW WHICH IS WRITTEN THE WORD "MASTIFF" IN YELLOW, ALL OF WHICH IS AGAINST A RED BACKGROUND.

THE COLOR(S) RED, BLACK AND YELLOW IS/ARE CLAIMED AS A FEATURE OF THE MARK.

SER. NO. 85-370,705, FILED 7-13-2011.

JAY FLOWERS, EXAMINING ATTORNEY



*David J. Kyros*

Director of the United States Patent and Trademark Office

# United States of America

United States Patent and Trademark Office

## REID & TAYLOR

**Reg. No. 4,197,031**

**Registered Aug. 28, 2012**

**Int. Cls.: 3, 16, 18, 24  
and 25**

**TRADEMARK**

**PRINCIPAL REGISTER**

REID & TAYLOR (INTERNATIONAL) LIMITED (BAHAMAS LIMITED CORPORATION)  
KINGS COURT BAY STREET  
NASSAU, BAHAMAS

FOR: CLEANING, POLISHING, SCOURING AND ABRASIVE PREPARATIONS; SOAPS;  
PERFUMERY, ESSENTIAL OILS, COSMETICS, HAIR LOTIONS; DENTIFRICES, IN CLASS  
3 (U.S. CLS. 1, 4, 6, 50, 51 AND 52).

FOR: DOCUMENT HOLDERS; PERSONAL ORGANISERS, IN CLASS 16 (U.S. CLS. 2, 5, 22,  
23, 29, 37, 38 AND 50).

FOR: ARTICLES MADE OF LEATHER AND IMITATIONS OF LEATHER, NAMELY,  
HANDBAGS AND SUITCASES; BAGS, NAMELY, SPORTS BAGS, HANDBAGS; LUGGAGE;  
HANDBAGS; SHOULDER BAGS; WALLETS; BRIEFCASE; DOCUMENT CASES; CARRYING  
CASES FOR DOCUMENTS; SUIT CARRIERS; SUITCASES; UMBRELLAS; ATTACHÉ CASE;  
HOLDALLS; RUCKSACKS; BELTS, NAMELY, SADDLE BELTS, LEATHER SHOULDER  
BELTS, BELT BAGS AND HIP BAGS; SACHELS; CREDIT CARD HOLDERS; CHEQUE  
BOOK HOLDERS, IN CLASS 18 (U.S. CLS. 1, 2, 3, 22 AND 41).

FOR: TEXTILES, NAMELY, FABRICS FOR TEXTILE USE; TEXTILE FABRICS FOR USE  
IN THE MANUFACTURE OF CLOTHING, GARMENTS, BAGS, JACKETS, UPHOLSTERY,  
GLOVES AND APPAREL; TEXTILE FABRICS FOR THE MANUFACTURE OF CLOTHING;  
TEXTILE PIECE GOODS, NAMELY, FABRICS FOR TEXTILE USE; TEXTILE PIECE GOODS  
FOR MAKING CLOTHING, INCLUDING SUITS, COATS, SKIRTS AND DRESSES, IN CLASS  
24 (U.S. CLS. 42 AND 50).

FOR: CLOTHING, NAMELY, SUITS, SHIRTS, T-SHIRTS, LONG SLEEVE SHIRTS, SHORTS,  
JERSEYS, SWEATSHIRTS, SWEATPANTS, PANTS, JACKETS, TIES, SCARVES, COATS,  
DRESSES, SKIRTS; FOOTWEAR; HEADGEAR, NAMELY, HATS AND CAPS, IN CLASS 25  
(U.S. CLS. 22 AND 39).

THE MARK CONSISTS OF STANDARD CHARACTERS WITHOUT CLAIM TO ANY PAR-  
TICULAR FONT, STYLE, SIZE, OR COLOR.

OWNER OF ERPN CMNTY TM OFC REG. NO. 2502961, DATED 10-13-2005, RENEWED AS  
REG. NO. 002502961, DATED 1-1-2012, EXPIRES 12-14-2021.



*David J. Kyffers*

Director of the United States Patent and Trademark Office

**Reg. No. 4,197,031** OWNER OF ERPN CMNTY TM OFC REG. NO. 009888769, DATED 8-23-2011, EXPIRES 4-12-2021.

OWNER OF U.S. REG. NO. 2,737,232.

SER. NO. 85-370,718, FILED 7-13-2011.

LAURIE KAUFMAN, EXAMINING ATTORNEY

# United States of America

## United States Patent and Trademark Office



**Reg. No. 4,197,032**

**Registered Aug. 28, 2012**

**Int. Cls.: 3, 16, 18, 24  
and 25**

**TRADEMARK**

**PRINCIPAL REGISTER**

REID & TAYLOR (INTERNATIONAL) LIMITED (BAHAMAS LIMITED CORPORATION)  
KINGS COURT BAY STREET  
NASSAU, BAHAMAS

FOR: CLEANING, POLISHING, SCOURING AND ABRASIVE PREPARATIONS; SOAPS; PERFUMERY, ESSENTIAL OILS, COSMETICS, HAIR LOTIONS; DENTIFRICES, IN CLASS 3 (U.S. CLS. 1, 4, 6, 50, 51 AND 52).

FOR: DOCUMENT HOLDERS; PERSONAL ORGANISERS, IN CLASS 16 (U.S. CLS. 2, 5, 22, 23, 29, 37, 38 AND 50).

FOR: ARTICLES MADE OF LEATHER AND IMITATIONS OF LEATHER, NAMELY, HANDBAGS AND SUITCASES; BAGS, NAMELY, SPORTS BAGS, HANDBAGS; LUGGAGE; HANDBAGS; SHOULDER BAGS; WALLETS; BRIEFCASE; DOCUMENT CASES; CARRYING CASES FOR DOCUMENTS; SUIT CARRIERS; SUITCASES; UMBRELLAS; ATTACHÉ CASE; HOLDALLS; RUCKSACKS; BELTS, NAMELY, SADDLE BELTS, LEATHER SHOULDER BELTS, BELT BAGS AND HIP BAGS; SACHELS; CREDIT CARD HOLDERS; CHEQUE BOOK HOLDERS, IN CLASS 18 (U.S. CLS. 1, 2, 3, 22 AND 41).

FOR: TEXTILES, NAMELY, FABRICS FOR TEXTILE USE; TEXTILE FABRICS FOR USE IN THE MANUFACTURE OF CLOTHING, GARMENTS, BAGS, JACKETS, UPHOLSTERY, GLOVES AND APPAREL; TEXTILE FABRICS FOR THE MANUFACTURE OF CLOTHING; TEXTILE PIECE GOODS, NAMELY, FABRICS FOR TEXTILE USE; TEXTILE PIECE GOODS FOR MAKING CLOTHING, INCLUDING SUITS, COATS, SKIRTS AND DRESSES, IN CLASS 24 (U.S. CLS. 42 AND 50).

FOR: CLOTHING, NAMELY, SUITS, SHIRTS, T-SHIRTS, LONG SLEEVE SHIRTS, SHORTS, JERSEYS, SWEATSHIRTS, SWEATPANTS, PANTS, JACKETS, TIES, SCARVES, COATS, DRESSES, SKIRTS; FOOTWEAR; HEADGEAR, NAMELY, HATS AND CAPS, IN CLASS 25 (U.S. CLS. 22 AND 39).

PRIORITY CLAIMED UNDER SEC. 44(D) ON ERPN CMNTY TM OFC APPLICATION NO. 9888678, FILED 4-12-2011, REG. NO. 009888678, DATED 8-23-2011, EXPIRES 4-12-2021.

OWNER OF ERPN CMNTY TM OFC REG. NO. 2502961, DATED 10-13-2005, RENEWED AS REG. NO. 002502961, DATED 1-1-2012, EXPIRES 12-14-2021.



*David J. Kybas*

Director of the United States Patent and Trademark Office

**Reg. No. 4,197,032** OWNER OF ERPN CMNTY TM OFC REG. NO. 2502243, DATED 6-17-2003, RENEWED AS REG. NO. 002502243, DATED 1-1-2012, EXPIRES 12-14-2021.

OWNER OF U.S. REG. NO. 2,737,232.

THE MARK CONSISTS OF A STYLIZED REPRESENTATION OF A RAM WEARING A TOP HAT AND COAT WITH A MONOCLE IN ITS RIGHT EYE.

SER. NO. 85-370,746, FILED 7-13-2011.

LAURIE KAUFMAN, EXAMINING ATTORNEY



# United States of America

United States Patent and Trademark Office

## PLANTED THOUGHTS

**Reg. No. 4,197,033**

**Registered Aug. 28, 2012**

**Int. Cl.: 16**

**TRADEMARK**

**PRINCIPAL REGISTER**

VIRTUAL AGENCY NETWORK, LLC (CALIFORNIA LIMITED LIABILITY COMPANY)  
300 CARLSBAD VILLAGE DRIVE  
SUITE # 108A-386  
CARLSBAD, CA 92008

FOR: PAPER AND CARDBOARD GREETING CARDS, IN CLASS 16 (U.S. CLS. 2, 5, 22, 23, 29, 37, 38 AND 50).

FIRST USE 5-20-2011; IN COMMERCE 5-20-2011.

THE MARK CONSISTS OF STANDARD CHARACTERS WITHOUT CLAIM TO ANY PARTICULAR FONT, STYLE, SIZE, OR COLOR.

SER. NO. 85-370,776, FILED 7-13-2011.

KIM MONINGHOFF, EXAMINING ATTORNEY



*David J. Kybas*

Director of the United States Patent and Trademark Office

# United States of America

United States Patent and Trademark Office



**Reg. No. 4,197,034**

**Registered Aug. 28, 2012**

**Int. Cl.: 41**

**SERVICE MARK**

**PRINCIPAL REGISTER**

GOOD BETTER BEST LLC (WASHINGTON LIMITED LIABILITY COMPANY)  
2910 E 57TH SUITE 5-222  
SPOKANE, WA 99223

FOR: ARRANGING AND HOSTING MOTIVATIONAL EVENTS FOR NON-COMMERCIAL PURPOSES, NAMELY, PROVIDING MOTIVATIONAL SPEAKERS IN THE FIELD OF GRIEF RECOVERY, GRIEF PREPARATION, GRIEF COACHING; PROVIDING MOTIVATIONAL SPEAKING ENGAGEMENTS, NAMELY, PROVIDING MOTIVATIONAL SPEAKERS IN THE FIELD OF GRIEF RECOVERY, GRIEF PREPARATION, GRIEF COACHING; PROVIDING ONE-ON-ONE AND GROUP COACHING IN THE FIELD OF ATHLETICS, MOTIVATION AFTER A GRIEVOUS LIFE EVENT, GRIEF RECOVERY, GRIEF PREPARATION, GRIEF COACHING AND THE DISTRIBUTION OF EDUCATIONAL TRAINING MATERIAL IN CONNECTION THEREWITH; PROVIDING A WEBSITE WHERE USERS CAN POST RATINGS ON EVENTS AND ACTIVITIES IN THE FIELD OF ENTERTAINMENT AND EDUCATION, NAMELY, EDUCATIONAL INSTITUTIONS AND THE PERFORMANCES OF ATHLETES, IN CLASS 41 (U.S. CLS. 100, 101 AND 107).

FIRST USE 6-10-2011; IN COMMERCE 6-12-2011.

THE STIPLING IS FOR SHADING PURPOSES ONLY.

THE MARK CONSISTS OF THE LETTERS "GBB". ON THE BACKGROUND THERE IS A BIRD, WHICH IS A PEACOCK. THE PEACOCK HAS FEATHERS WITH 18 PEACOCK OCELLUS EYES AT THE TIPS OF THE FEATHERS.

SER. NO. 85-370,823, FILED 7-13-2011.

ANGELA DUONG, EXAMINING ATTORNEY



*David J. Kyjars*

Director of the United States Patent and Trademark Office

# United States of America

United States Patent and Trademark Office

## TOPGOLF BURGERS & BOTTLES

**Reg. No. 4,197,035**

TOPGOLF SYSTEMS LIMITED (UNITED KINGDOM COMPANY)  
1 PARK ROW

**Registered Aug. 28, 2012**

LEEDS, UNITED KINGDOM LS1 5AB

**Int. Cl.: 43**

FOR: BAR AND RESTAURANT SERVICES, IN CLASS 43 (U.S. CLS. 100 AND 101).

**SERVICE MARK**

FIRST USE 6-30-2011; IN COMMERCE 6-30-2011.

**PRINCIPAL REGISTER**

THE MARK CONSISTS OF STANDARD CHARACTERS WITHOUT CLAIM TO ANY PARTICULAR FONT, STYLE, SIZE, OR COLOR.

NO CLAIM IS MADE TO THE EXCLUSIVE RIGHT TO USE "BURGERS & BOTTLES", APART FROM THE MARK AS SHOWN.

SER. NO. 85-371,102, FILED 7-14-2011.

FRANK LATTUCA, EXAMINING ATTORNEY



*David J. Kyros*

Director of the United States Patent and Trademark Office

# United States of America

United States Patent and Trademark Office



**Reg. No. 4,197,036**

**Registered Aug. 28, 2012**

**Int. Cl.: 43**

**SERVICE MARK**

**PRINCIPAL REGISTER**

TOPGOLF SYSTEMS LIMITED (UNITED KINGDOM COMPANY)  
1 PARK ROW  
LEEDS, UNITED KINGDOM LS1 5AB

FOR: BAR AND RESTAURANT SERVICES, IN CLASS 43 (U.S. CLS. 100 AND 101).

FIRST USE 5-1-2011; IN COMMERCE 5-1-2011.

OWNER OF U.S. REG. NO. 3,496,840.

NO CLAIM IS MADE TO THE EXCLUSIVE RIGHT TO USE "BURGERS & BOTTLES",  
APART FROM THE MARK AS SHOWN.

THE MARK CONSISTS OF A BOTTLE CAP DESIGN ON WHICH IS A TRIANGLE WITH A  
CIRCULAR GOLFING GREEN AND FLAG DESIGN OVER WHICH ARE THE WORDS  
"BURGERS & BOTTLES".

SER. NO. 85-371,106, FILED 7-14-2011.

FRANK LATTUCA, EXAMINING ATTORNEY



*David J. Kyffers*

Director of the United States Patent and Trademark Office

# United States of America

United States Patent and Trademark Office

# HamiltonSFA

**Reg. No. 4,197,037**

**Registered Aug. 28, 2012**

**Int. Cls.: 9 and 42**

**TRADEMARK**

**SERVICE MARK**

**PRINCIPAL REGISTER**

VISICOM A.S. (SLOVAKIA CORPORATION)  
RONTGENOVA 26  
BRATISLAVA, SLOVAKIA

FOR: COMPUTER SOFTWARE FOR CUSTOMER RELATIONSHIP MANAGEMENT, SALES-FORCE AUTOMATION, AND FIELD SERVICE MANAGEMENT, IN CLASS 9 (U.S. CLS. 21, 23, 26, 36 AND 38).

FIRST USE 1-10-2006; IN COMMERCE 1-10-2006.

FOR: SOFTWARE AS A SERVICE (SAAS) SERVICES, NAMELY, HOSTING SOFTWARE FOR USE BY OTHERS FOR USE IN CUSTOMER RELATIONSHIP MANAGEMENT, SALES-FORCE AUTOMATION, AND FIELD SERVICE MANAGEMENT, IN CLASS 42 (U.S. CLS. 100 AND 101).

FIRST USE 1-10-2006; IN COMMERCE 1-10-2006.

THE MARK CONSISTS OF STANDARD CHARACTERS WITHOUT CLAIM TO ANY PARTICULAR FONT, STYLE, SIZE, OR COLOR.

OWNER OF ERPN CMNTY TM OFC REG. NO. 005383724, DATED 10-4-2007, EXPIRES 2-10-2016.

SER. NO. 85-371,252, FILED 7-14-2011.

MIDGE BUTLER, EXAMINING ATTORNEY



*David J. Kyros*

Director of the United States Patent and Trademark Office

# United States of America

## United States Patent and Trademark Office



VICTORY OUTREACH INTERNATIONAL  
SINCE 1967

**Reg. No. 4,197,038**

**Registered Aug. 28, 2012**

**Int. Cls.: 41 and 45**

**SERVICE MARK**

**PRINCIPAL REGISTER**

VICTORY OUTREACH INTERNATIONAL (CALIFORNIA CORPORATION)  
250 WEST ARROW HIGHWAY  
SAN DIMAS, CA 91773

FOR: EDUCATIONAL SERVICES, NAMELY PROVIDING WORKSHOPS AND SEMINARS  
IN THE FIELD OF RELIGION, IN CLASS 41 (U.S. CLS. 100, 101 AND 107).

FIRST USE 3-1-2000; IN COMMERCE 3-1-2000.

FOR: CHRISTIAN MINISTERIAL SERVICES, IN CLASS 45 (U.S. CLS. 100 AND 101).

FIRST USE 3-1-2000; IN COMMERCE 3-1-2000.

OWNER OF U.S. REG. NOS. 1,210,107, 3,384,310 AND OTHERS.

NO CLAIM IS MADE TO THE EXCLUSIVE RIGHT TO USE "OUTREACH INTERNATIONAL  
SINCE 1967", APART FROM THE MARK AS SHOWN.

THE MARK CONSISTS OF THE OUTLINE OF A WINDOW AND INSIDE THE WINDOW A  
STYLIZED "V" AND "O" AND INSIDE THE "O" THE IMAGE OF A GLOBE. UNDERNEATH  
THE DESIGN ARE THE WORDS "VICTORY OUTREACH INTERNATIONAL SINCE 1967".

SER. NO. 85-371,352, FILED 7-14-2011.

BARBARA A. GOLD, EXAMINING ATTORNEY



*David J. Kybas*

Director of the United States Patent and Trademark Office

# United States of America

United States Patent and Trademark Office

## Good Riddance

**Reg. No. 4,197,039**

**Registered Aug. 28, 2012**

**Int. Cl.: 32**

**TRADEMARK**

**PRINCIPAL REGISTER**

GOOD RIDDANCE BEVERAGE COMPANY, LLC (NORTH CAROLINA LIMITED LIABILITY COMPANY)  
110 RAPHAEL DRIVE  
CARY, NC 27511

FOR: NON-ALCOHOLIC BEVERAGES, NAMELY, CARBONATED BEVERAGES, IN CLASS 32 (U.S. CLS. 45, 46 AND 48).

FIRST USE 3-1-2011; IN COMMERCE 3-1-2011.

THE MARK CONSISTS OF STANDARD CHARACTERS WITHOUT CLAIM TO ANY PARTICULAR FONT, STYLE, SIZE, OR COLOR.

OWNER OF U.S. REG. NO. 3,838,403.

SER. NO. 85-371,436, FILED 7-14-2011.

COURTNEY ALVAREZ, EXAMINING ATTORNEY



*David J. Kyffers*

Director of the United States Patent and Trademark Office

# United States of America

United States Patent and Trademark Office

## LEWIS & CLARK OUTFITTERS

**Reg. No. 4,197,040**

**Registered Aug. 28, 2012**

**Int. Cls.: 12 and 25**

**TRADEMARK**

**PRINCIPAL REGISTER**

LEWIS & CLARK OUTDOORS, INC. (ARKANSAS CORPORATION), DBA LEWIS & CLARK  
OUTFITTERS  
SUITE 100  
2530 PINNACLE HILLS PARKWAY  
ROGERS, AR 72758

FOR: KAYAK PADDLES, IN CLASS 12 (U.S. CLS. 19, 21, 23, 31, 35 AND 44).

FIRST USE 8-1-2000; IN COMMERCE 7-14-2010.

FOR: CYCLISTS' JERSEYS, IN CLASS 25 (U.S. CLS. 22 AND 39).

FIRST USE 8-1-2000; IN COMMERCE 5-1-2002.

THE MARK CONSISTS OF STANDARD CHARACTERS WITHOUT CLAIM TO ANY PARTICULAR FONT, STYLE, SIZE, OR COLOR.

OWNER OF U.S. REG. NO. 3,892,568.

NO CLAIM IS MADE TO THE EXCLUSIVE RIGHT TO USE "OUTFITTERS", APART FROM THE MARK AS SHOWN.

SER. NO. 85-371,462, FILED 7-14-2011.

KATHERINE E. HALMEN, EXAMINING ATTORNEY



*David J. Kybas*

Director of the United States Patent and Trademark Office



# United States of America

United States Patent and Trademark Office



**Reg. No. 4,197,041**

**Registered Aug. 28, 2012**

**Int. Cl.: 41**

**SERVICE MARK**

**PRINCIPAL REGISTER**

BOKWA, LTD. (HONG KONG CORPORATION)  
136-138, AUSTIN ROAD  
502-3 GOLDEN GATE COMMERCIAL BUILDING  
KOWLOON, HONG KONG 99999

FOR: ARRANGING PROFESSIONAL WORKSHOP AND TRAINING COURSES; EDUCATIONAL SERVICES, NAMELY, CONDUCTING CLASSES, SEMINARS, WORKOUTS, WORKSHOPS, PRESENTATIONS, PROGRAMS AND GROUP AND PERSONAL TRAINING IN THE FIELDS OF PHYSICAL FITNESS, EXERCISE, DANCE, KICK BOXING, INDOOR CYCLING, MOVEMENT, SPORTS PERFORMANCE AND KINESIOLOGY AND DISTRIBUTION OF TRAINING MATERIALS IN CONNECTION THEREWITH; EDUCATIONAL SERVICES, NAMELY, TEACHER TRAINING IN THE FIELD OF PHYSICAL FITNESS, EXERCISE, DANCE AND SPORTS PERFORMANCE PROVIDED ON A REAL-TIME BASIS DURING CLASSROOM INSTRUCTION; PERSONAL FITNESS TRAINING SERVICES AND CONSULTANCY; PHYSICAL FITNESS TRAINING OF INDIVIDUALS AND GROUPS; PHYSICAL FITNESS TRAINING SERVICES; TRAINING OF DANCE INSTRUCTORS; TRAINING SERVICES IN THE FIELD OF HEALTH AND FITNESS, PERSONAL TRAINING AND GROUP TRAINING OFFERED IN SUPPORT OF CERTIFICATION AND CONTINUING EDUCATION FOR PHYSICAL EDUCATION TEACHERS AND DANCE INSTRUCTORS, IN CLASS 41 (U.S. CLS. 100, 101 AND 107).

FIRST USE 8-10-2008; IN COMMERCE 8-10-2008.

OWNER OF U.S. REG. NO. 4,017,117.

THE COLOR(S) BLACK, GREEN AND YELLOW IS/ARE CLAIMED AS A FEATURE OF THE MARK.

NO CLAIM IS MADE TO THE EXCLUSIVE RIGHT TO USE "FITNESS", APART FROM THE MARK AS SHOWN.

THE MARK CONSISTS OF THE WORD: "BOKWA", IN STYLIZED SCRIPT, IN BLACK, ABOVE THE WORD: "FITNESS", IN GREEN, BESIDE A FLAME DESIGN, IN YELLOW, ACCENTED BY GREEN.

THE WORDING "BOKWA" HAS NO MEANING IN A FOREIGN LANGUAGE.



*David J. Kybas*

Director of the United States Patent and Trademark Office

**Reg. No. 4,197,041** SER. NO. 85-371,983, FILED 7-14-2011.

CYNTHIA TRIPI, EXAMINING ATTORNEY

# United States of America

United States Patent and Trademark Office

## The power to change what's in-store

**Reg. No. 4,197,042**

**Registered Aug. 28, 2012**

**Int. Cls.: 2 and 16**

**TRADEMARK**

**PRINCIPAL REGISTER**

DEETZ, DAYTON J. (UNITED STATES INDIVIDUAL)  
73 WASHINGTON STREET  
MENDON, MA 01756

FOR: COATINGS IN THE NATURE OF PAINTS FOR INTERIOR USE ON A VARIETY OF SUBSTRATES; INTERIOR PAINT; PAINT FOR USE IN THE MANUFACTURE OF WALLCOVERINGS; PAINT PRIMERS; PAINTS; PAINTS FOR THE USE OF CREATING MAGNETIC-RECEPTIVE SURFACES; PRIMER; PRIMERS FOR PREPARING SURFACES TO BE PAINTED, IN CLASS 2 (U.S. CLS. 6, 11 AND 16).

FIRST USE 3-1-2011; IN COMMERCE 3-1-2011.

FOR: ART PRINTS; ART PRINTS ON CANVAS; CHALK BOARDS FOR SCHOOL AND HOME USE; CHALKBOARDS; CHILDREN'S WALL STICKERS AND MURALS; DRAWING BOARDS; DRAWING PAPER; DRY ERASE WRITING BOARDS AND WRITING SURFACES; GRAPHIC PRINTS AND REPRESENTATIONS; LASER PRINTING PAPER; MAGNETIC BOARDS; MAGNETIC BOARDS FOR SCHEDULING ACTIVITIES AND APPOINTMENTS; PAPER; PAPER FOR USE IN MAKING SIGNS; PAPER FOR USE IN THE GRAPHIC ARTS INDUSTRY; PAPER FOR USE IN THE MANUFACTURE OF WALLPAPER; PHOTOGRAPHIC PRINTS; PICTORIAL PRINTS; PLASTIC SHEETS FOR WRITING, PRINTING, AND MARKING; POLYESTER FILM FOR USE AS A PAPER SUBSTITUTE FOR DRY TONER XEROGRAPHIC IMAGING, NAMELY, LASER PRINTING, COLOR COPIER PRINTING, DRY TONER PRINTING, SCREEN PRINTING, AND OFFSET PRINTING; PRINT SUBSTRATE, NAMELY, TRANSPARENT, OPAQUE, AND TRANSLUCENT FILMS FOR USE WITH INK JET COPIERS AND LASER PRINTERS; PRINTED ADVERTISING BOARDS OF PAPER OR CARDBOARD; PRINTED CHARTS; PRINTED GRAPHS; PRINTED PAPER SIGNS; PRINTED PRODUCTS, NAMELY, MENU BOARDS; PRINTED VISUALS IN THE NATURE OF MARKETING AND PROMOTIONAL MATERIALS, IN CLASS 16 (U.S. CLS. 2, 5, 22, 23, 29, 37, 38 AND 50).

FIRST USE 3-1-2011; IN COMMERCE 3-1-2011.

THE MARK CONSISTS OF STANDARD CHARACTERS WITHOUT CLAIM TO ANY PARTICULAR FONT, STYLE, SIZE, OR COLOR.

SER. NO. 85-372,691, FILED 7-15-2011.



*David J. Kyros*

Director of the United States Patent and Trademark Office

**Reg. No. 4,197,042** ANDREA HACK, EXAMINING ATTORNEY

# United States of America

United States Patent and Trademark Office

# EZCAL

**Reg. No. 4,197,043**

ZHANG, MENG (UNITED STATES INDIVIDUAL)  
1705 COLINA TERRESTRE  
SAN CLEMENTE, CA 92673

**Registered Aug. 28, 2012**

**Int. Cl.: 9**

FOR: INSTRUMENTS FOR MEASURING LENGTH, IN CLASS 9 (U.S. CLS. 21, 23, 26, 36 AND 38).

**TRADEMARK**

FIRST USE 11-1-2010; IN COMMERCE 11-1-2010.

**PRINCIPAL REGISTER**

THE MARK CONSISTS OF STANDARD CHARACTERS WITHOUT CLAIM TO ANY PARTICULAR FONT, STYLE, SIZE, OR COLOR.

SER. NO. 85-373,151, FILED 7-16-2011.

BARBARA A. GOLD, EXAMINING ATTORNEY



*David J. Kybas*

Director of the United States Patent and Trademark Office

United States of America  
United States Patent and Trademark Office

replenish

**Reg. No. 4,197,044**

REPLENISH MINISTRIES (CALIFORNIA CORPORATION)  
2557 DUBLIN DRIVE  
CASTLE ROCK, CO 80104

**Registered Aug. 28, 2012**

**Int. Cl.: 41**

FOR: EDUCATIONAL SERVICES, NAMELY, MINISTERIAL COACHING AND PROVIDING SEMINARS RELATING TO THE MINISTRY, IN CLASS 41 (U.S. CLS. 100, 101 AND 107).

**SERVICE MARK**

FIRST USE 4-30-1996; IN COMMERCE 4-30-1996.

**PRINCIPAL REGISTER**

THE MARK CONSISTS OF THE STYLIZED WORD MARK "REPLENISH" WITH A WATER DROP DESIGN INCORPORATING THE LETTER "R" IN PLACE OF THE DOT OVER THE "I" OF THE WORD REPLENISH.

SER. NO. 85-373,184, FILED 7-16-2011.

ALICIA COLLINS, EXAMINING ATTORNEY



*David J. Kyffers*

Director of the United States Patent and Trademark Office

# United States of America

United States Patent and Trademark Office

## BARDSLEY YOU CLEVER FOX!

**Reg. No. 4,197,045**

BARDSLEY PRODUCTS, INC. (CALIFORNIA CORPORATION)

**Registered Aug. 28, 2012**

PO BOX 61514  
SANTA BARBARA, CA 93160

**Int. Cl.: 3**

FOR: NON-MEDICATED GROOMING PREPARATIONS FOR HORSES AND PONIES, NAMELY, SHAMPOOS, CONDITIONERS AND DETANGLERS, IN CLASS 3 (U.S. CLS. 1, 4, 6, 50, 51 AND 52).

**TRADEMARK**

FIRST USE 3-1-2002; IN COMMERCE 3-1-2002.

**PRINCIPAL REGISTER**

THE MARK CONSISTS OF STANDARD CHARACTERS WITHOUT CLAIM TO ANY PARTICULAR FONT, STYLE, SIZE, OR COLOR.

SER. NO. 85-373,188, FILED 7-16-2011.

ALICIA COLLINS, EXAMINING ATTORNEY



*David J. Kyffers*

Director of the United States Patent and Trademark Office

# United States of America

United States Patent and Trademark Office

# Torix

**Reg. No. 4,197,046**

**Registered Aug. 28, 2012**

**Int. Cl.: 41**

**SERVICE MARK**

**PRINCIPAL REGISTER**

CHRIO MEDIA, LLC (ILLINOIS LIMITED LIABILITY COMPANY)  
8770 W. BRYN MAWR AVE., SUITE 1300  
CHICAGO, IL 60631

FOR: ENTERTAINMENT SERVICES, NAMELY, PROVIDING A WEB SITE FEATURING NON-DOWNLOADABLE MUSICAL PERFORMANCES, MUSICAL VIDEOS, RELATED FILM CLIPS, PHOTOGRAPHS, AND OTHER MULTIMEDIA MATERIALS FEATURING MUSIC; PROVIDING AN INTERNET WEBSITE PORTAL IN THE FIELD OF MUSIC, IN CLASS 41 (U.S. CLS. 100, 101 AND 107).

FIRST USE 4-15-2011; IN COMMERCE 4-15-2011.

THE MARK CONSISTS OF STANDARD CHARACTERS WITHOUT CLAIM TO ANY PARTICULAR FONT, STYLE, SIZE, OR COLOR.

SER. NO. 85-373,198, FILED 7-16-2011.

EDWARD FENNESSY, EXAMINING ATTORNEY



*David J. Kyffers*

Director of the United States Patent and Trademark Office



# United States of America

United States Patent and Trademark Office

## Cheese Force One

**Reg. No. 4,197,047**

BCDC PARTNERS INC (ILLINOIS CORPORATION)  
259 SPRING VALLEY WAY  
ROUND LAKE, IL 60073

**Registered Aug. 28, 2012**

**Int. Cl.: 35**

FOR: MOBILE STREET VENDOR SERVICES FEATURING FOOD AND DRINK, IN CLASS 35 (U.S. CLS. 100, 101 AND 102).

**SERVICE MARK**

FIRST USE 1-17-2011; IN COMMERCE 4-1-2011.

**PRINCIPAL REGISTER**

THE MARK CONSISTS OF STANDARD CHARACTERS WITHOUT CLAIM TO ANY PARTICULAR FONT, STYLE, SIZE, OR COLOR.

NO CLAIM IS MADE TO THE EXCLUSIVE RIGHT TO USE "CHEESE", APART FROM THE MARK AS SHOWN.

SER. NO. 85-373,324, FILED 7-17-2011.

NAAKWAMA ANKRAH, EXAMINING ATTORNEY



*David J. Kyffers*

Director of the United States Patent and Trademark Office

# United States of America

United States Patent and Trademark Office

## SIN Eyewear

**Reg. No. 4,197,048**

**Registered Aug. 28, 2012**

**Int. Cl.: 9**

**TRADEMARK**

**PRINCIPAL REGISTER**

PACIFIC OPTICS PTY LTD (AUSTRALIA LIMITED LIABILITY COMPANY)  
18 TAREE STREET BURLEIGH HEADS  
GOLD COAST, AUSTRALIA 4221

FOR: EYEWEAR, NAMELY, SUNGLASSES, EYEGLASSES AND OPHTHALMIC FRAMES AND CASES THEREFOR; LENSES FOR SUNGLASSES; SUNGLASSES, IN CLASS 9 (U.S. CLS. 21, 23, 26, 36 AND 38).

THE MARK CONSISTS OF STANDARD CHARACTERS WITHOUT CLAIM TO ANY PARTICULAR FONT, STYLE, SIZE, OR COLOR.

PRIORITY CLAIMED UNDER SEC. 44(D) ON AUSTRALIA APPLICATION NO. 1427725, FILED 5-30-2011, REG. NO. 1427725, DATED 1-11-2012, EXPIRES 5-30-2021.

NO CLAIM IS MADE TO THE EXCLUSIVE RIGHT TO USE "EYEWEAR", APART FROM THE MARK AS SHOWN.

SER. NO. 85-373,390, FILED 7-18-2011.

JANICE L. MCMORROW, EXAMINING ATTORNEY



*David J. Kyffers*

Director of the United States Patent and Trademark Office

# United States of America

United States Patent and Trademark Office

THE  AEGIS

**Reg. No. 4,197,049**

HOMESTEAD PUBLISHING COMPANY (MARYLAND CORPORATION)  
501 NORTH CALVERT STREET  
BALTIMORE, MD 21278

**Registered Aug. 28, 2012**

**Int. Cl.: 16**

FOR: NEWSPAPERS FOR GENERAL CIRCULATION, IN CLASS 16 (U.S. CLS. 2, 5, 22, 23, 29, 37, 38 AND 50).

**TRADEMARK**

FIRST USE 5-25-2011; IN COMMERCE 5-25-2011.

**PRINCIPAL REGISTER**

OWNER OF U.S. REG. NOS. 2,234,065 AND 2,268,522.

THE MARK CONSISTS OF THE STYLIZED WORDS "THE AEGIS" WITH STYLIZED DEPICTION OF A COAT OF ARMS FEATURING A CREST IN A CIRCLE OVER A NAUTICAL SCENERY FEATURING AN OCEAN, SHIPS, BALES OF HAY, PLANTS, PLOW, MAN AND A HORSE, SEPARATING THE TWO WORDS.

SER. NO. 85-373,738, FILED 7-18-2011.

ANN E. SAPPENFIELD, EXAMINING ATTORNEY



*David J. Kybas*

Director of the United States Patent and Trademark Office

# United States of America

United States Patent and Trademark Office

# Shredz

**Reg. No. 4,197,050**

**Registered Aug. 28, 2012**

**Int. Cl.: 5**

**TRADEMARK**

**PRINCIPAL REGISTER**

LAL, ARVIN (UNITED STATES INDIVIDUAL)  
955 MAIN STREET APT. 312  
BRIDGEPORT, CT 06604

FOR: DIETARY SUPPLEMENT FOR WEIGHT LOSS; SUPPLEMENTS FOR BODY BUILDING;  
FOOD AND SPORT NUTRITIONAL SUPPLEMENTS FOR WEIGHT LOSS, STRENGTH AND  
PERFORMANCE ENHANCEMENT; NUTRITIONAL SUPPLEMENTS, IN CLASS 5 (U.S. CLS.  
6, 18, 44, 46, 51 AND 52).

FIRST USE 4-1-2011; IN COMMERCE 4-1-2011.

THE MARK CONSISTS OF STANDARD CHARACTERS WITHOUT CLAIM TO ANY PAR-  
TICULAR FONT, STYLE, SIZE, OR COLOR.

SER. NO. 85-374,070, FILED 7-18-2011.

HENRY S. ZAK, EXAMINING ATTORNEY



*David J. Kyffers*

Director of the United States Patent and Trademark Office

# United States of America

United States Patent and Trademark Office

## Cyberhero League

**Reg. No. 4,197,051**

DANA KLISANIN (UNITED STATES INDIVIDUAL)  
88 WHITE STREET, 4TH FLOOR  
NEW YORK, NY 10013

**Registered Aug. 28, 2012**

**Int. Cls.: 41 and 45**

FOR: INTERACTIVE EDUCATIONAL AND ENTERTAINMENT SERVICES, NAMELY, PROVIDING A WEB-BASED VIRTUAL EDUCATIONAL THEME-PARK FEATURING INDIVIDUALS, COMPANIES, AND ORGANIZATIONS ENGAGED IN CHARITABLE ACTIVITIES, WHICH ACTIVELY USE THE INTERNET TO HELP OTHER PEOPLE, ANIMALS, OR THE ENVIRONMENT, IN CLASS 41 (U.S. CLS. 100, 101 AND 107).

**SERVICE MARK**

**PRINCIPAL REGISTER**

FIRST USE 8-1-2010; IN COMMERCE 2-1-2011.

FOR: PROVIDING A SOCIAL NETWORKING WEBSITE AT WHICH A USER CAN GIVE CHARITABLE GIFTS TO OTHERS; PROVIDING A SOCIAL NETWORKING WEBSITE FOR ENTERTAINMENT PURPOSES, FEATURING INDIVIDUALS, COMPANIES, AND ORGANIZATIONS ENGAGED IN CHARITABLE ACTIVITIES, WHICH ACTIVELY USE THE INTERNET TO HELP OTHER PEOPLE, ANIMALS, OR THE ENVIRONMENT, IN CLASS 45 (U.S. CLS. 100 AND 101).

FIRST USE 8-1-2010; IN COMMERCE 2-1-2011.

THE MARK CONSISTS OF STANDARD CHARACTERS WITHOUT CLAIM TO ANY PARTICULAR FONT, STYLE, SIZE, OR COLOR.

SER. NO. 85-374,322, FILED 7-18-2011.

JORDAN BAKER, EXAMINING ATTORNEY



*David J. Kyros*

Director of the United States Patent and Trademark Office

# United States of America

United States Patent and Trademark Office

# WALSLIDE

**Reg. No. 4,197,052**

GOLDBERG, ELLIOTT (UNITED STATES INDIVIDUAL)  
45 FRANKLIN ROAD  
SCARSDALE, NY 10583

**Registered Aug. 28, 2012**

**Int. Cl.: 10**

FOR: MANUALLY-OPERATED, ADJUSTABLE HEIGHT EXERCISE EQUIPMENT FOR PHYSICAL THERAPY PURPOSES IN THE NATURE OF A WALL RAIL FOR ATTACHING BANDS AND TUBING, IN CLASS 10 (U.S. CLS. 26, 39 AND 44).

**TRADEMARK**

FIRST USE 1-1-2005; IN COMMERCE 1-1-2005.

**PRINCIPAL REGISTER**

THE MARK CONSISTS OF STANDARD CHARACTERS WITHOUT CLAIM TO ANY PARTICULAR FONT, STYLE, SIZE, OR COLOR.

SEC. 2(F).

SER. NO. 85-374,447, FILED 7-18-2011.

TRICIA SONNEBORN, EXAMINING ATTORNEY



*David J. Kyffers*

Director of the United States Patent and Trademark Office

# United States of America

United States Patent and Trademark Office



**Reg. No. 4,197,053**

**Registered Aug. 28, 2012**

**Int. Cl.: 31**

**TRADEMARK**

**PRINCIPAL REGISTER**

BOUNTY FRESH LLC (FLORIDA LIMITED LIABILITY COMPANY), DBA CHESTNUT HILL FARMS  
SUITE 580  
806 SOUTH DOUGLAS ROAD  
CORAL GABLES, FL 33134

FOR: FRESH FRUIT, NAMELY, PINEAPPLES, IN CLASS 31 (U.S. CLS. 1 AND 46).

FIRST USE 9-0-2000; IN COMMERCE 9-0-2000.

OWNER OF U.S. REG. NO. 1,702,014.

NO CLAIM IS MADE TO THE EXCLUSIVE RIGHT TO USE "FARMS", APART FROM THE MARK AS SHOWN.

THE MARK CONSISTS OF THE FIGURES OF TWO TREES WITH THE WORDS "CHESTNUT HILL FARMS" ALL INSIDE AN OVAL SHAPE.

SER. NO. 85-374,596, FILED 7-19-2011.

VERNA BETH RIRIE, EXAMINING ATTORNEY



*David J. Kyffers*

Director of the United States Patent and Trademark Office

# United States of America

United States Patent and Trademark Office

## BLANC MORPHOSE

**Reg. No. 4,197,054**

L'OREAL (FRANCE SOCIÉTÉ ANONYME (SA))

**Registered Aug. 28, 2012**

14 RUE ROYALE  
PARIS, FRANCE 75008

**Int. Cl.: 3**

FOR: BATH AND SHOWER GELS AND SALTS NOT FOR MEDICAL PURPOSE; TOILET SOAPS; COSMETICS, NAMELY, CREAMS, MILKS, LOTIONS, GELS AND POWDERS FOR THE FACE, THE BODY AND THE HANDS; NON-MEDICATED SUN CARE PREPARATIONS; MAKEUP PREPARATIONS; SHAMPOOS; PRODUCTS FOR HAIR STYLING AND HAIR CARE, NAMELY, GELS, SPRAYS, MOUSSES, BALMS, CREAM, SERUMS, WAX AND LOTIONS; HAIR LACQUERS; HAIR COLOURING AND HAIR DECOLORANT PREPARATIONS; PROTECTIVE COLORING PREPARATIONS FOR TREATED HAIR; PERMANENT WAVING AND CURLING PREPARATIONS; ESSENTIAL OILS FOR PERSONAL USE, IN CLASS 3 (U.S. CLS. 1, 4, 6, 50, 51 AND 52).

**TRADEMARK**

**PRINCIPAL REGISTER**

THE MARK CONSISTS OF STANDARD CHARACTERS WITHOUT CLAIM TO ANY PARTICULAR FONT, STYLE, SIZE, OR COLOR.

PRIORITY CLAIMED UNDER SEC. 44(D) ON FRANCE APPLICATION NO. 11/3805580, FILED 2-11-2011, REG. NO. 11/3805580, DATED 2-11-2011, EXPIRES 2-11-2021.

THE ENGLISH TRANSLATION OF "BLANC" IN THE MARK IS "WHITE".

SER. NO. 85-374,619, FILED 7-19-2011.

RENEE MCCRAY, EXAMINING ATTORNEY



*David J. Kyros*

Director of the United States Patent and Trademark Office



# United States of America

United States Patent and Trademark Office

## TOTAL INSTRUCTIONAL ALIGNMENT

**Reg. No. 4,197,055**

WARING, LISA CARTER (UNITED STATES INDIVIDUAL)  
3628 LAKESHORE DRIVE  
HOPE MILLS, NC 28348

**Registered Aug. 28, 2012**

**Int. Cl.: 41**

FOR: PROVIDING EDUCATIONAL INSTRUCTION AND PRESENTATIONS IN THE FIELD OF EDUCATOR TRAINING, EDUCATIONAL STANDARDS AND EDUCATIONAL CURRICULUM DEVELOPMENT; CONSULTING SERVICES IN THE FIELD OF EDUCATION AND EDUCATIONAL CURRICULUM DEVELOPMENT, IN CLASS 41 (U.S. CLS. 100, 101 AND 107).

**SERVICE MARK**

**PRINCIPAL REGISTER**

FIRST USE 6-30-2006; IN COMMERCE 6-30-2006.

THE MARK CONSISTS OF STANDARD CHARACTERS WITHOUT CLAIM TO ANY PARTICULAR FONT, STYLE, SIZE, OR COLOR.

SEC. 2(F).

SER. NO. 85-375,195, FILED 7-19-2011.

KATHLEEN M. VANSTON, EXAMINING ATTORNEY



*David J. Kybas*

Director of the United States Patent and Trademark Office

# United States of America

United States Patent and Trademark Office

## 1-800-CHEAPCLUB

**Reg. No. 4,197,056**

**Registered Aug. 28, 2012**

**Int. Cl.: 35**

**SERVICE MARK**

**PRINCIPAL REGISTER**

FESTFARE, INC (NEVADA CORPORATION)  
5438 VEGAS BLVD  
5348 VEGAS DRIVE  
LAS VEGAS, CA 89108

FOR: ON-LINE RETAIL STORE SERVICES FEATURING A WIDE VARIETY OF CONSUMER GOODS OF OTHERS; ON-LINE RETAIL STORE SERVICES FEATURING VARIETY OR DEPARTMENT STORE ITEMS, IN CLASS 35 (U.S. CLS. 100, 101 AND 102).

FIRST USE 2-4-1994; IN COMMERCE 0-0-1996.

THE MARK CONSISTS OF STANDARD CHARACTERS WITHOUT CLAIM TO ANY PARTICULAR FONT, STYLE, SIZE, OR COLOR.

SER. NO. 85-375,650, FILED 7-19-2011.

SUNG IN, EXAMINING ATTORNEY



*David J. Kyfos*

Director of the United States Patent and Trademark Office

# United States of America

United States Patent and Trademark Office

# SofCare

**Reg. No. 4,197,057**

SYNGETICS INC. (PENNSYLVANIA CORPORATION)

**Registered Aug. 28, 2012**

4130 RIDGE AVE, #43424  
PHILADELPHIA, PA 19129

**Int. Cl.: 9**

FOR: COMPUTER SOFTWARE FOR USE IN THE MANAGEMENT OF CHILDCARE RELATED BUSINESSES, INCLUDING ACCOUNTING, MEALS REPORTING, HEALTH RECORD KEEPING, ATTENDANCE TRACKING AND SCHEDULING, IN CLASS 9 (U.S. CLS. 21, 23, 26, 36 AND 38).

**TRADEMARK**

**PRINCIPAL REGISTER**

FIRST USE 7-1-1993; IN COMMERCE 7-1-1993.

THE MARK CONSISTS OF STANDARD CHARACTERS WITHOUT CLAIM TO ANY PARTICULAR FONT, STYLE, SIZE, OR COLOR.

SER. NO. 85-375,869, FILED 7-20-2011.

ANDREA HACK, EXAMINING ATTORNEY



*David J. Kyffers*

Director of the United States Patent and Trademark Office

# United States of America

United States Patent and Trademark Office



**Reg. No. 4,197,058**

**Registered Aug. 28, 2012**

**Int. Cl.: 4**

**TRADEMARK**

**PRINCIPAL REGISTER**

ASTONFIELD MANAGEMENT LIMITED (BR. VIRGIN ISLANDS CORPORATION)  
C/O GESTRUST SA  
2 RUE THALBERG  
1211 GENEVA 1, SWITZERLAND

FOR: RENEWABLE ENERGY, NAMELY, SOLAR ENERGY, WASTE ENERGY AND BIOMASS ENERGY, IN CLASS 4 (U.S. CLS. 1, 6 AND 15).

FIRST USE 4-1-2010; IN COMMERCE 4-1-2010.

THE MARK CONSISTS OF A CIRCULAR DESIGN RESEMBLING INTERLOCKING RINGS TO THE LEFT OF THE WORD "ASTONFIELD." THE LETTER "F" IN "ASTONFIELD" IS ENLARGED AND STYLIZED.

SER. NO. 85-375,899, FILED 7-20-2011.

JORDAN BAKER, EXAMINING ATTORNEY



*David J. Kyros*

Director of the United States Patent and Trademark Office

# United States of America

United States Patent and Trademark Office

## Naturally the Best

**Reg. No. 4,197,059**

EVANGER'S DOG & CAT FOOD CO., INC. (ILLINOIS CORPORATION)  
221 S. WHEELING RD.  
WHEELING, IL 60090

**Registered Aug. 28, 2012**

**Int. Cl.: 31**

FOR: DOG AND CAT FOODS, IN CLASS 31 (U.S. CLS. 1 AND 46).

**TRADEMARK**

FIRST USE 2-15-2005; IN COMMERCE 2-15-2005.

**PRINCIPAL REGISTER**

THE MARK CONSISTS OF STANDARD CHARACTERS WITHOUT CLAIM TO ANY PARTICULAR FONT, STYLE, SIZE, OR COLOR.

SER. NO. 85-376,031, FILED 7-20-2011.

TRACY CROSS, EXAMINING ATTORNEY



*David J. Kyffers*

Director of the United States Patent and Trademark Office

# United States of America

United States Patent and Trademark Office

TOTM!

**Reg. No. 4,197,060**

**Registered Aug. 28, 2012**

**Int. Cl.: 21**

**TRADEMARK**

**PRINCIPAL REGISTER**

VALARIE CAREY (UNITED STATES INDIVIDUAL)  
SUITE 526  
315 FLATBUSH AVENUE  
BROOKLYN, NY 11217

FOR: COFFEE CUPS, TEA CUPS AND MUGS, IN CLASS 21 (U.S. CLS. 2, 13, 23, 29, 30, 33, 40 AND 50).

FIRST USE 6-1-2010; IN COMMERCE 9-9-2010.

OWNER OF U.S. REG. NO. 3,956,965.

THE COLOR(S) RED ON THE DOT OF THE EXCLAMATION POINT IS/ARE CLAIMED AS A FEATURE OF THE MARK.

THE MARK CONSISTS OF THE TERM "TOTM!" IN DRAGLINE FONT WITH A RED DOT ON THE EXCLAMATION POINT.

SER. NO. 85-376,347, FILED 7-20-2011.

RAUL CORDOVA, EXAMINING ATTORNEY



*David J. Kyffers*

Director of the United States Patent and Trademark Office

# United States of America

United States Patent and Trademark Office

## GOLDEN SPIKE

**Reg. No. 4,197,061**

UINTA BREWING COMPANY (UTAH CORPORATION)  
1722 S. FREMONT DR.

**Registered Aug. 28, 2012**

SALT LAKE CITY, UT 84104

**Int. Cl.: 32**

FOR: BEER, IN CLASS 32 (U.S. CLS. 45, 46 AND 48).

**TRADEMARK**

FIRST USE 6-0-1997; IN COMMERCE 6-0-1997.

**PRINCIPAL REGISTER**

THE MARK CONSISTS OF STANDARD CHARACTERS WITHOUT CLAIM TO ANY PARTICULAR FONT, STYLE, SIZE, OR COLOR.

SER. NO. 85-376,559, FILED 7-20-2011.

GRETCHEN ULRICH, EXAMINING ATTORNEY



*David J. Kybas*

Director of the United States Patent and Trademark Office

# United States of America

United States Patent and Trademark Office

## SALON DENZO

**Reg. No. 4,197,062**

DANIELLE M. BUCCI (UNITED STATES INDIVIDUAL)  
271 MAMARONECK AVENUE  
WHITE PLAINS, NY 10605

**Registered Aug. 28, 2012**

**Int. Cl.: 44**

FOR: BEAUTY SALONS, IN CLASS 44 (U.S. CLS. 100 AND 101).

**SERVICE MARK**

FIRST USE 9-1-2010; IN COMMERCE 9-1-2010.

**PRINCIPAL REGISTER**

THE MARK CONSISTS OF STANDARD CHARACTERS WITHOUT CLAIM TO ANY PARTICULAR FONT, STYLE, SIZE, OR COLOR.

NO CLAIM IS MADE TO THE EXCLUSIVE RIGHT TO USE "SALON", APART FROM THE MARK AS SHOWN.

THE WORDING "DENZO" HAS NO MEANING IN A FOREIGN LANGUAGE.

SER. NO. 85-376,622, FILED 7-20-2011.

MYRIAH HABEEB, EXAMINING ATTORNEY



*David J. Kyffers*

Director of the United States Patent and Trademark Office



# United States of America

United States Patent and Trademark Office

## Boston Appliance

**Reg. No. 4,197,063**

**Registered Aug. 28, 2012**

**Int. Cl.: 35**

**SERVICE MARK**

**PRINCIPAL REGISTER**

BOSTON APPLIANCE COMPANY (MASSACHUSETTS CORPORATION)  
840 SUMMER STREET  
BOSTON, MA 02127

FOR: RETAIL STORE AND ON-LINE RETAIL STORE SERVICES FEATURING KITCHEN APPLIANCES; RETAIL STORE SERVICES FEATURING KITCHEN RELATED PRODUCTS, IN CLASS 35 (U.S. CLS. 100, 101 AND 102).

FIRST USE 2-15-2006; IN COMMERCE 2-15-2006.

THE MARK CONSISTS OF STANDARD CHARACTERS WITHOUT CLAIM TO ANY PARTICULAR FONT, STYLE, SIZE, OR COLOR.

NO CLAIM IS MADE TO THE EXCLUSIVE RIGHT TO USE "APPLIANCE", APART FROM THE MARK AS SHOWN.

SEC. 2(F).

SER. NO. 85-376,911, FILED 7-21-2011.

ZACHARY BELLO, EXAMINING ATTORNEY



*David J. Kyffers*

Director of the United States Patent and Trademark Office

# United States of America

United States Patent and Trademark Office



**Reg. No. 4,197,064**

JONES, FLOYD B. (UNITED STATES INDIVIDUAL), DBA U.S.A. GOLFMASTERS  
1262 BROADWAY  
EL CAJON, CA 92021

**Registered Aug. 28, 2012**

**Int. Cl.: 28**

**TRADEMARK**

**PRINCIPAL REGISTER**

FOR: COVERS FOR GOLF CLUBS; DIVOT REPAIR TOOLS; DRIVING PRACTICE MATS; FITTED COVERS FOR NON-MOTORIZED GOLF CARTS; FITTED HEAD COVERS FOR GOLF CLUBS; GLOVES FOR GOLF; GOLF ACCESSORIES, NAMELY, CARRIERS AND DISPENSERS FOR GOLF BALLS; GOLF ACCESSORIES, NAMELY, HOLDERS SPECIALLY ADAPTED FOR HOLDING GOLF BALL MARKERS; GOLF ACCESSORY POUCHES; GOLF ACCESSORY, NAMELY, SUPPORT FOR HOLDING A GOLF CLUB; GOLF BAG COVERS; GOLF BAG PEGS; GOLF BAG TAGS; GOLF BAGS; GOLF BAGS WITH OR WITHOUT WHEELS; GOLF BALL MARKERS; GOLF BALL RETRIEVERS; GOLF BALL SLEEVES; GOLF BALLS; GOLF CLUB BAGS; GOLF CLUB COVERS; GOLF CLUB GRIPS; GOLF CLUB HEADS; GOLF CLUB HOLDERS FOR USE ON A DRIVING RANGE OR GOLF COURSE; GOLF CLUB INSERTS; GOLF CLUB SHAFTS; GOLF CLUBS; GOLF FLAGS; GOLF GLOVES; GOLF IRONS; GOLF PRACTICE NETS; GOLF PUTTER COVERS; GOLF PUTTERS; GOLF TEE MARKERS; GOLF TEES; GOLF TOWEL CLIPS FOR ATTACHMENT TO GOLF BAGS; GOLF TRAINING APPARATUS, NAMELY, DEVICES USED TO HELP GROOVE A REPETITIVE PUTTING STROKE; GOLF TRAINING APPARATUS, NAMELY, GOLF PRACTICE PLATFORMS; GRIP TAPES FOR GOLF CLUBS; HAND GRIPS FOR GOLF CLUBS; HEAD COVERS FOR GOLF CLUBS; IMPACT MARKERS IN THE NATURE OF PRESSURE SENSITIVE REUSABLE IMPACT LABELS FOR ATTACHMENT TO THE HEAD OF A GOLF CLUB TO INDICATE WHERE THE CLUB HITS THE BALL; PUTTING PRACTICE MATS; STANDS SPECIALLY ADAPTED FOR HOLDING GOLF CLUBS, IN CLASS 28 (U.S. CLS. 22, 23, 38 AND 50).



FIRST USE 7-18-2011; IN COMMERCE 7-18-2011.

NO CLAIM IS MADE TO THE EXCLUSIVE RIGHT TO USE "U.S.A.", APART FROM THE MARK AS SHOWN.

THE COLOR(S) RED, WHITE AND BLUE IS/ARE CLAIMED AS A FEATURE OF THE MARK.

*David J. Kybas*

THE MARK CONSISTS OF THE WORDS "GOLFMASTERS" IN BLUE TYPE ALL CAPS WITH THE "G" AND THE "M" IN LARGE CAPS AND THE OTHER LETTERS IN SMALLER CAPS, AND THE WORD "U.S.A." IN RED OVER THE "G" WITH THE "O" HAVING A RED, WHITE, AND BLUE TAPERING TRAIL GOING UP THEN DOWN TO THE "M".

Director of the United States Patent and Trademark Office

**Reg. No. 4,197,064** SER. NO. 85-377,261, FILED 7-21-2011.

Laurie Kaufman, Examining Attorney

# United States of America

United States Patent and Trademark Office

# R-Works

**Reg. No. 4,197,065**

**Registered Aug. 28, 2012**

**Int. Cls.: 7 and 9**

**TRADEMARK**

**PRINCIPAL REGISTER**

ROLAND DG CORPORATION (JAPAN CORPORATION)  
1-6-4 SHIN MIYAKODA, KITA-KU  
HAMAMATSU-SHI  
SHIZUOKA-KEN, JAPAN 431-2103

FOR: (BASED ON SECTION 44(E)) CUTTING, DRILLING, GRINDING AND ENGRAVING MACHINES FOR HOME AND BUSINESS USE AND UNIVERSAL COMPUTERIZED NUMERICAL CONTROLLERS SOLD AS AN INTEGRAL PART THEREOF; POWER OPERATED COMPUTERIZED MACHINE CUTTERS, DRILLERS, AND GRINDERS; ENGRAVING MACHINES; LASER ENGRAVING MACHINES; THREE DIMENSIONAL MODELING MACHINES; REPLACEMENT PARTS FOR THE ABOVE-MENTIONED GOODS; ALL THE AFORESAID GOODS FOR USE WITH METAL, GLASS, WOOD OR PLASTICS PROCESSING, IN CLASS 7 (U.S. CLS. 13, 19, 21, 23, 31, 34 AND 35).

FOR: (BASED ON USE IN COMMERCE AND SECTION 44(E)) COMPUTER PROGRAMS FOR CONTROLLING PLOTTER PRINTERS, CUTTING PLOTTERS FOR USE AS SIGN MAKERS, PRINTING AND CUTTING MACHINES AND COMPUTER PRINTERS; (BASED ON SECTION 44(E) ONLY) APPARATUS CONTROLLED BY COMPUTERS, NAMELY, COMPUTER MONITOR DISPLAYS, PRINTERS AND X-Y PLOTTERS; PLOTTER PRINTERS; CUTTING PLOTTERS FOR USE AS SIGN MAKERS; COMBINATION INK JET PRINTER AND CUTTER; COMBINATION THERMAL PRINTER AND CUTTER; COMPUTER PRINTERS; X-Y PLOTTERS; THREE DIMENSIONAL SCANNERS; COMPUTER PROGRAMS FOR CONTROLLING CUTTING, DRILLING, GRINDING, AND ENGRAVING MACHINES, POWER OPERATED COMPUTERIZED MACHINE CUTTERS, DRILLERS, AND GRINDERS, ENGRAVING MACHINES, LASER ENGRAVING MACHINES, THREE DIMENSIONAL MODELING MACHINES, X-Y PLOTTERS AND THREE DIMENSION SCANNERS, IN CLASS 9 (U.S. CLS. 21, 23, 26, 36 AND 38).

FIRST USE 5-24-2011; IN COMMERCE 5-24-2011.

OWNER OF JAPAN REG. NO. 5456811, DATED 12-9-2011, EXPIRES 12-9-2021.

THE MARK CONSISTS OF THE TERM "R-WORKS" IN STYLIZED LETTERS.

SER. NO. 85-377,334, FILED 7-21-2011.

MEGHAN REINHART, EXAMINING ATTORNEY



*David J. Kyfos*

Director of the United States Patent and Trademark Office

# United States of America

United States Patent and Trademark Office



**Reg. No. 4,197,066**

**Registered Aug. 28, 2012**

**Int. Cls.: 5, 35 and 42**

**TRADEMARK**

**SERVICE MARK**

**PRINCIPAL REGISTER**

AMNEAL PHARMACEUTICALS, LLC (DELAWARE LIMITED LIABILITY COMPANY)  
1 NEW ENGLAND AVENUE  
PISCATAWAY, NJ 08854

FOR: FULL LINE OF PRESCRIPTION AND OVER-THE-COUNTER PHARMACEUTICAL PREPARATIONS FOR HUMANS , IN CLASS 5 (U.S. CLS. 6, 18, 44, 46, 51 AND 52).

FIRST USE 1-0-2008; IN COMMERCE 1-0-2008.

FOR: PHARMACEUTICAL SERVICES, NAMELY, PROCESSING ORDERS FOR PHARMACIES AND HEALTH CARE FACILITIES AND ORGANIZATIONS, DISTRIBUTORSHIP SERVICES AND BUSINESS DEVELOPMENT IN THE FIELD OF PRESCRIPTION AND OVER-THE-COUNTER PHARMACEUTICAL PREPARATIONS FOR HUMANS, IN CLASS 35 (U.S. CLS. 100, 101 AND 102).

FIRST USE 9-0-2007; IN COMMERCE 9-0-2007.

FOR: RESEARCH AND PRODUCT DEVELOPMENT FOR OTHERS IN THE FIELD OF PRESCRIPTION AND OVER-THE-COUNTER PHARMACEUTICAL PREPARATIONS FOR HUMANS; PRODUCT DEVELOPMENT FOR OTHERS OF A WIDE VARIETY OF PRESCRIPTION AND OVER-THE-COUNTER PHARMACEUTICAL PREPARATIONS FOR HUMANS, IN CLASS 42 (U.S. CLS. 100 AND 101).

FIRST USE 9-0-2007; IN COMMERCE 9-0-2007.

OWNER OF U.S. REG. NO. 3,256,227.

NO CLAIM IS MADE TO THE EXCLUSIVE RIGHT TO USE "PHARMACEUTICALS", APART FROM THE MARK AS SHOWN.

THE MARK CONSISTS OF A LEAPING FIGURE SHAPE OVER THE TOP LEFT OF THE WORDING "AMNEAL PHARMACUETICALS".

THE WORDING "AMNEAL" HAS NO MEANING IN A FOREIGN LANGUAGE.

SER. NO. 85-377,805, FILED 7-21-2011.



*David J. Kyjars*

Director of the United States Patent and Trademark Office

**Reg. No. 4,197,066** ELISSA GARBER KON, EXAMINING ATTORNEY

# United States of America

United States Patent and Trademark Office

## DISTRICT 13

**Reg. No. 4,197,067**

SADDLEBACK EDUCATIONAL, INC. (CALIFORNIA CORPORATION)  
3120-A PULLMAN STREET  
COSTA MESA, CA 926264564

**Registered Aug. 28, 2012**

**Int. Cl.: 16**

FOR: SERIES OF FICTION BOOKS IN THE FIELD OF REMEDIAL EDUCATION FOR SECONDARY AND ADULT EDUCATION; PRINTED MATTER, NAMELY, BOOKS IN THE FIELD OF REMEDIAL EDUCATION FOR SECONDARY AND ADULT EDUCATION, IN CLASS 16 (U.S. CLS. 2, 5, 22, 23, 29, 37, 38 AND 50).

**TRADEMARK**

**PRINCIPAL REGISTER**

FIRST USE 0-0-2010; IN COMMERCE 0-0-2010.

THE MARK CONSISTS OF STANDARD CHARACTERS WITHOUT CLAIM TO ANY PARTICULAR FONT, STYLE, SIZE, OR COLOR.

SER. NO. 85-377,931, FILED 7-21-2011.

JULIE GUTTADAURO, EXAMINING ATTORNEY



*David J. Kyffers*

Director of the United States Patent and Trademark Office

**United States of America**  
United States Patent and Trademark Office

# POMPIERE

**Reg. No. 4,197,068**

**Registered Aug. 28, 2012**

**Int. Cl.: 9**

**TRADEMARK**

**PRINCIPAL REGISTER**

SORKIN TYPE CO. (MASSACHUSETTS CORPORATION)  
143 MASS AVE., SUITE 5  
BOSTON, MA 02115

FOR: PRINTING FONTS THAT CAN BE DOWNLOADED PROVIDED BY MEANS OF ELECTRONIC TRANSMISSION; TYPEFACE FONTS RECORDED ON MAGNETIC MEDIA, IN CLASS 9 (U.S. CLS. 21, 23, 26, 36 AND 38).

FIRST USE 7-21-2011; IN COMMERCE 7-21-2011.

THE MARK CONSISTS OF STANDARD CHARACTERS WITHOUT CLAIM TO ANY PARTICULAR FONT, STYLE, SIZE, OR COLOR.

THE ENGLISH TRANSLATION OF "POMPIERE" IN THE MARK IS "FIREFIGHTER".

SER. NO. 85-378,170, FILED 7-22-2011.

KEVIN DINALLO, EXAMINING ATTORNEY



*David J. Kybas*

Director of the United States Patent and Trademark Office



# United States of America

United States Patent and Trademark Office



**Reg. No. 4,197,069**

**Registered Aug. 28, 2012**

**COLLECTIVE  
MEMBERSHIP**

**PRINCIPAL REGISTER**

SAGINAW CHIPPEWA INDIAN TRIBE OF MICHIGAN (UNITED STATES  
FEDERALLY-RECOGNIZED INDIAN TRIBE)

ATTN: LEGAL DEPARTMENT  
7070 E. BROADWAY  
MT. PLEASANT, MI 48858

FOR: INDICATING MEMBERSHIP IN THE SAGINAW CHIPPEWA INDIAN TRIBE OF MICHIGAN, A FEDERALLY RECOGNIZED SOVEREIGN TRIBE, IN CLASS 200 (U.S. CL. 200).

FIRST USE 4-5-1982; IN COMMERCE 4-5-1982.

NO CLAIM IS MADE TO THE EXCLUSIVE RIGHT TO USE "INDIAN TRIBE OF MICHIGAN", APART FROM THE MARK AS SHOWN.

THE COLOR(S) BLACK, WHITE, RED, LIGHT BLUE, GREEN, YELLOW, ORANGE, BROWN (CAMEL), AND BEIGE IS/ARE CLAIMED AS A FEATURE OF THE MARK.

THE MARK CONSISTS OF A BLACK CIRCLE WHICH IS ENCASED BY THE WORDS "SAGINAW CHIPPEWA INDIAN" IN BLACK ACROSS THE TOP PORTION OF THE CIRCLE AND "TRIBE OF MICHIGAN" IN BLACK ACROSS THE BOTTOM PORTION OF THE CIRCLE (HUGGING THE OUTSIDES). INSIDE THE CIRCLE IS THE TRIBAL DECORATION WHICH CONSISTS OF AN ARTIST'S RENDERING OF AN OJIBWAAY HEADDRESS WITH EAGLE FEATHERS IN BLACK, WHITE, CAMEL BROWN AND BEIGE AND OJIBWAAY FLORAL PATTERNS IN RED, LIGHT BLUE, GREEN, YELLOW, ORANGE, CAMEL BROWN AND BEIGE. THE WHITE BACKGROUND IS TRANSPARENT AREA AND IS NOT PART OF THE MARK.

SER. NO. 85-378,580, FILED 7-22-2011.

KATHLEEN M. VANSTON, EXAMINING ATTORNEY



*David J. Kybas*

Director of the United States Patent and Trademark Office

# United States of America

United States Patent and Trademark Office

# QARMA

**Reg. No. 4,197,070**

**Registered Aug. 28, 2012**

**Int. Cls.: 9, 36 and 42**

**TRADEMARK**

**SERVICE MARK**

**PRINCIPAL REGISTER**

QARMA TECHNOLOGY LIMITED (JERSEY COMPANY)  
WALKER HOUSE, 28-34 HILL STREET  
ST HELIER, JERSEY JE45TF

FOR: COMPUTER SOFTWARE FOR USE IN ASSET MANAGEMENT, FUND MANAGEMENT AND FINANCIAL BROKERAGE, IN CLASS 9 (U.S. CLS. 21, 23, 26, 36 AND 38).

FOR: ASSET MANAGEMENT SERVICES, FUND MANAGEMENT SERVICES, FINANCIAL BROKERAGE SERVICES, IN CLASS 36 (U.S. CLS. 100, 101 AND 102).

FOR: RENTAL, LEASING, INSTALLATION, DESIGN, DEVELOPMENT, MAINTENANCE AND UPDATING OF COMPUTER SOFTWARE FOR ASSET MANAGEMENT, FUND MANAGEMENT AND FINANCIAL BROKERAGE, IN CLASS 42 (U.S. CLS. 100 AND 101).

THE MARK CONSISTS OF STANDARD CHARACTERS WITHOUT CLAIM TO ANY PARTICULAR FONT, STYLE, SIZE, OR COLOR.

PRIORITY CLAIMED UNDER SEC. 44(D) ON ERPN CMNTY TM OFC APPLICATION NO. 010136828, FILED 7-20-2011, REG. NO. 010136828, DATED 1-25-2012, EXPIRES 7-20-2021.

SER. NO. 85-378,784, FILED 7-22-2011.

EMILY CHUO, EXAMINING ATTORNEY



*David J. Kyros*

Director of the United States Patent and Trademark Office

# United States of America

United States Patent and Trademark Office



**Reg. No. 4,197,071**

**Registered Aug. 28, 2012**

**Int. Cl.: 25**

**TRADEMARK**

**PRINCIPAL REGISTER**

FOREVER FAITH LLC (OKLAHOMA LIMITED LIABILITY COMPANY)  
P. O. BOX 700094  
TULSA, OK 741407094

FOR: MEN'S AND WOMEN'S CLOTHING, NAMELY, TEE SHIRTS, POLO SHIRTS, SWEAT SHIRTS, CUTOFFS SHIRTS, TANK TOPS, HOODED SWEATSHIRTS, SWEATER-SHIRTS, JEANS, JEAN SHORTS, JEAN SKIRTS, SPORT COATS, SLACKS, SKIRTS, TIES, SCARVES, BELTS, SOCKS, ATHLETIC SOCKS AND DRESS SOCKS, UNDERWEAR, UNDERGARMENTS, POCKET SQUARES, TUXEDOS, TUXEDO SHIRTS, VESTS, CUMMERBUNDS, COATS, AND WIND RESISTANT JACKETS; ATHLETIC WEAR, NAMELY, WORKOUT TEE SHIRTS, TANK TOPS, COMPRESSION SHIRTS, COMPRESSION SLEEVELESS TEE SHIRTS, COMPRESSION SHORTS, WORKOUT PANTS AND SHORTS, LONG SLEEVE HOODED THIN FABRIC SHIRTS, WORKOUT / WARM-UP SUITS INCLUDING LONG OR SHORT SLEEVE TOPS AND PANTS; YOGA WEAR TYPE WORKOUT CLOTHES, NAMELY, SHORT AND LONG SLEEVE TOPS, WOMEN'S SPORTS BRAS AND SLEEVELESS BRA TOPS, SHORTS, AND PANTS; GLOVES, SCARVES, WALKING SHORTS, CARGO SHORTS, SPANDEX SHORTS, SPANDEX PANTS, KHAKIS, PANTS, DRESS SLACKS, BASEBALL CAPS, BEANIES, DRESS HATS, DECORATED HATS; SPORTS UNIFORMS, NAMELY, SHIRTS, JERSEYS, PANTS, SHORTS, UNDERGARMENTS AND, SOCKS, CLEATS OR SHOES, BELTS, HATS; SHOES NAMELY, ATHLETIC SHOES, CASUAL SHOES, DRESS SHOES; MEN'S DRESS SUITS; WOMEN'S DRESS SUITS, IN CLASS 25 (U.S. CLS. 22 AND 39).

FIRST USE 3-0-2010; IN COMMERCE 3-0-2010.

THE MARK CONSISTS OF THE STYLIZED LETTERS "FF" WITH ONE "F" REVERSED SO THE TWO LETTERS ARE BACK TO BACK AND CONNECTED BY A BAR BETWEEN THEM.

SER. NO. 85-379,056, FILED 7-22-2011.

JULIE WATSON, EXAMINING ATTORNEY



*David J. Kybas*

Director of the United States Patent and Trademark Office

# United States of America

United States Patent and Trademark Office

# MIISTA

**Reg. No. 4,197,072**

**Registered Aug. 28, 2012**

**Int. Cl.: 25**

**TRADEMARK**

**PRINCIPAL REGISTER**

MIISTA LIMITED (UNITED KINGDOM LIMITED LIABILITY COMPANY)  
39 ETCHINGHAM PARK ROAD, FINCHLEY  
LONDON, UNITED KINGDOM N32DU

FOR: CLOTHING, NAMELY, JACKETS, JERSEYS, MUFFLERS, TIES, TOPS, SHIRTS, PANTS, SKIRTS, SOCKS, STOCKINGS, TIGHTS, LEOTARDS, DRESSES, BLOUSES, LADIES UNDERWEAR, LONG UNDERWEAR, THERMAL UNDERWEAR, THONGS, BOY SHORTS, CORSETS, BATHING SUITS, GLOVES AS CLOTHING, KNEE WARMERS, HAND-WARMERS, ARM WARMERS, NECK TUBES, HOODS FOR CLOTHING; CLOTHING FOR ATHLETIC USE, NAMELY, PADDED SHORTS, PADDED PANTS, PADDED SHIRTS, PADDED ELBOW COMPRESSION SLEEVES BEING PART OF AN ATHLETIC GARMENT; CLOTHING FOR WEAR IN WRESTLING GAMES; BELTS FOR CLOTHING; MATERNITY CLOTHING, NAMELY, SHIRTS, PANTS, SHORTS, SKIRTS, DRESSES, BLOUSES; MOISTURE-WICKING SPORTS SHIRTS, MOISTURE-WICKING SPORTS PANTS, MOISTURE-WICKING SPORTS BRAS, COMBATIVE SPORTS UNIFORMS, SPORT COATS, SPORT STOCKINGS, ATHLETIC APPAREL, NAMELY, SHIRTS, PANTS, JACKETS, FOOTWEAR, HATS AND CAPS, ATHLETIC UNIFORMS; ARTICLES OF WEATHERPROOF, WINDPROOF AND WATERPROOF CLOTHING, NAMELY, WATER SOCKS, WET SUITS FOR WATER-SKIING AND SUB-AQUA, FOUL WEATHER GEAR, WIND COATS, WIND PANTS, WIND RESISTANT JACKETS, WIND SHIRTS AND WIND VESTS; FOOTWEAR, NAMELY, ATHLETIC FOOTWEAR, BEACH FOOTWEAR, CLIMBING FOOTWEAR, FLIP FLOPS, WATER REPELLING FOOTWEAR, WATERPROOF FOOTWEAR, WORK BOOTS, FOOTWEAR FOR MEN, FOOTWEAR FOR WOMEN; BOOTS FOR SPORT, FOOTWEAR FOR TRACK AND FIELD ATHLETICS; TRAINERS, NAMELY, RUNNING SHOES; PLIMSOLLS, NAMELY, CANVAS SHOES, SNEAKERS; HEADGEAR, NAMELY, HEADBANDS FOR CLOTHING, HATS, CAPS; HEADGEAR FOR SPORTS, GYMNASTICS, ATHLETICS, EXERCISE AND FITNESS TRAINING, NAMELY, SPORTS CAPS AND HATS; PARTS OF CLOTHING, NAMELY, UNDERARM GUSSETS, GUSSETS FOR TIGHTS, GUSSETS FOR STOCKINGS, GUSSETS FOR BATHING SUITS, GUSSETS FOR UNDERWEAR, GUSSETS FOR LEOTARDS; PARTS AND FITTING FOR FOOTWEAR, NAMELY, INSOLES FOR FOOTWEAR, NON-SLIP SOLES FOR FOOTWEAR, NAMELY, FOR SLIPPERS, MOCCASINS, SOLES FOR FOOTWEAR, THONGS FOR FOOTWEAR, TIPS FOR FOOTWEAR, IN CLASS 25 (U.S. CLS. 22 AND 39).



*David J. Kyros*

THE MARK CONSISTS OF STANDARD CHARACTERS WITHOUT CLAIM TO ANY PARTICULAR FONT, STYLE, SIZE, OR COLOR.

**Reg. No. 4,197,072** PRIORITY CLAIMED UNDER SEC. 44(D) ON UNITED KINGDOM APPLICATION NO. 2587514, FILED 7-12-2011, REG. NO. 2587514, DATED 7-12-2011, EXPIRES 7-12-2021.

SER. NO. 85-379,764, FILED 7-25-2011.

KATINA MISTER, EXAMINING ATTORNEY

# United States of America

United States Patent and Trademark Office

## INIGO ELIZALDE RUGS

**Reg. No. 4,197,073**

**Registered Aug. 28, 2012**

**Int. Cl.: 27**

**TRADEMARK**

**PRINCIPAL REGISTER**

PLS-USE, LLC. (NEW YORK LIMITED LIABILITY COMPANY), DBA INIGO ELIZALDE  
RUGS  
SUITE 310  
551 W 21ST STREET  
NEW YORK, NY 10011

FOR: AREA RUGS; CARPETS AND RUGS; RUGS, IN CLASS 27 (U.S. CLS. 19, 20, 37, 42  
AND 50).

FIRST USE 1-1-2009; IN COMMERCE 1-1-2009.

THE MARK CONSISTS OF STANDARD CHARACTERS WITHOUT CLAIM TO ANY PAR-  
TICULAR FONT, STYLE, SIZE, OR COLOR.

NO CLAIM IS MADE TO THE EXCLUSIVE RIGHT TO USE "RUGS", APART FROM THE  
MARK AS SHOWN.

THE NAME INIGO ELIZALDE IDENTIFIES A LIVING INDIVIDUAL WHOSE CONSENT IS  
OF RECORD.

SER. NO. 85-379,878, FILED 7-25-2011.

FRANK LATTUCA, EXAMINING ATTORNEY



*David J. Kyffers*

Director of the United States Patent and Trademark Office

# United States of America

United States Patent and Trademark Office



**Reg. No. 4,197,074**

**Registered Aug. 28, 2012**

**Int. Cl.: 30**

**TRADEMARK**

**PRINCIPAL REGISTER**

THE PILLSBURY COMPANY, LLC (DELAWARE LIMITED LIABILITY COMPANY)  
NUMBER ONE GENERAL MILLS BOULEVARD  
MINNEAPOLIS, MN 55426

FOR: FROZEN BAKED GOODS; PRE-MIXED BATTER FOR MAKING MUFFINS, IN CLASS  
30 (U.S. CL. 46).

FIRST USE 3-10-2011; IN COMMERCE 3-10-2011.

NO CLAIM IS MADE TO THE EXCLUSIVE RIGHT TO USE "MUFFINS", APART FROM  
THE MARK AS SHOWN.

THE MARK CONSISTS OF A DOUGHBOY CHARACTER HOLDING A CIRCLE WITH THE  
WORD "PILLSBURY" INSIDE, ABOVE A CURVED RIBBON WITH THE WORD "MUFFINS"  
INSIDE. THE CHARACTER WEARS A SCARF AND CHEF'S HAT, WHICH ALSO FEATURES  
A CIRCLE WITH THE WORD "PILLSBURY" INSIDE.

SER. NO. 85-381,164, FILED 7-26-2011.

STEVEN R. FINE, EXAMINING ATTORNEY



*David J. Kybas*

Director of the United States Patent and Trademark Office

# United States of America

United States Patent and Trademark Office

## NEW CHALLENGES NEW SOLUTIONS NEW TRIZETTO

**Reg. No. 4,197,075**

THE TRIZETTO GROUP, INC. (DELAWARE CORPORATION)  
6061 S. WILLOW DRIVE  
GREENWOOD VILLAGE, CO 80111

**Registered Aug. 28, 2012**

**Int. Cls.: 35 and 36**

FOR: BUSINESS CONSULTATION SERVICES, NAMELY, TRACKING AND MONITORING INSURANCE COMPLIANCE, IN CLASS 35 (U.S. CLS. 100, 101 AND 102).

**SERVICE MARK**

FIRST USE 3-23-2011; IN COMMERCE 3-23-2011.

**PRINCIPAL REGISTER**

FOR: FINANCIAL CONSULTANCY SERVICES IN THE AREA OF HEALTHCARE, IN CLASS 36 (U.S. CLS. 100, 101 AND 102).

FIRST USE 3-23-2011; IN COMMERCE 3-23-2011.

THE MARK CONSISTS OF THE WORDS "NEW CHALLENGES" WHICH APPEAR IN BLACK ABOVE THE WORDS "NEW SOLUTIONS" WHICH APPEAR IN BLACK AND ABOVE THE WORDS "NEW TRIZETTO" IN BLUE.

THE COLOR(S) BLACK AND BLUE IS/ARE CLAIMED AS A FEATURE OF THE MARK.

SER. NO. 85-381,279, FILED 7-26-2011.

ROBERT C. CLARK JR., EXAMINING ATTORNEY



*David J. Kyros*

Director of the United States Patent and Trademark Office



# United States of America

United States Patent and Trademark Office

# FIRE STRIKE

**Reg. No. 4,197,076**

**Registered Aug. 28, 2012**

**Int. Cl.: 9**

**TRADEMARK**

**PRINCIPAL REGISTER**

ADVANCED BIONOMICS, INCORPORATED (WISCONSIN CORPORATION), DBA  
ADVANCED BIONOMICS, INC.  
610 W. RAWSON AVENUE  
OAK CREEK, WI 53154

FOR: FIRE EXTINGUISHERS; FIRE EXTINGUISHING APPARATUS; FIRE-EXTINGUISHERS,  
IN CLASS 9 (U.S. CLS. 21, 23, 26, 36 AND 38).

FIRST USE 3-30-1995; IN COMMERCE 3-30-1995.

THE MARK CONSISTS OF STANDARD CHARACTERS WITHOUT CLAIM TO ANY PAR-  
TICULAR FONT, STYLE, SIZE, OR COLOR.

NO CLAIM IS MADE TO THE EXCLUSIVE RIGHT TO USE "FIRE", APART FROM THE  
MARK AS SHOWN.

SER. NO. 85-382,668, FILED 7-27-2011.

JENNIFER DIXON, EXAMINING ATTORNEY



*David J. Kyffers*

Director of the United States Patent and Trademark Office

# United States of America

United States Patent and Trademark Office



Grantuoso.org

**Reg. No. 4,197,077**

HAKIM, TOUFIC M. (UNITED STATES INDIVIDUAL)  
1219 FRANCYNE WAY  
UNION, NJ 07083

**Registered Aug. 28, 2012**

**Int. Cl.: 35**

FOR: WRITING OF GRANT PROPOSALS FOR NON-PROFIT ORGANIZATIONS, EDUCATIONAL INSTITUTIONS AND OTHER COMMUNITY ORGANIZATIONS, IN CLASS 35 (U.S. CLS. 100, 101 AND 102).

**SERVICE MARK**

FIRST USE 3-30-2011; IN COMMERCE 3-30-2011.

**PRINCIPAL REGISTER**

THE MARK CONSISTS OF UPPER CASE "G" WITH THE NAME "GRANTUOSO.ORG" APPEARING BELOW.

SER. NO. 85-383,171, FILED 7-28-2011.

BRENDAN MCCAULEY, EXAMINING ATTORNEY



*David J. Kybas*

Director of the United States Patent and Trademark Office

# United States of America

United States Patent and Trademark Office

## PARADE PLASTICS

**Reg. No. 4,197,078**

**Registered Aug. 28, 2012**

**Int. Cls.: 20 and 21**

**TRADEMARK**

**PRINCIPAL REGISTER**

MD HOLDINGS, LLC (INDIANA LIMITED LIABILITY COMPANY)  
451 EAST COUNTY LINE ROAD  
MOORESVILLE, IN 46158

FOR: DECORATIONS OF PLASTIC FOR FOODSTUFFS; PLASTIC BINS; PLASTIC BOXES; PLASTIC CONTAINERS AND COVERS FOR THE FOOD INDUSTRY; PLASTIC CONTAINERS FOR COMMERCIAL USE, NAMELY, FOR STORING AND DISPENSING BULK FOODS; PLASTIC STORAGE CONTAINERS FOR COMMERCIAL OR INDUSTRIAL USE; PLASTIC TUBS, IN CLASS 20 (U.S. CLS. 2, 13, 22, 25, 32 AND 50).

FIRST USE 5-16-2008; IN COMMERCE 5-16-2008.

FOR: BOWLS; COLANDERS; CROCKERY, NAMELY, POTS, DISHES, DRINKING CUPS AND SAUCERS, BOWLS, SERVING BOWLS AND TRAYS; DISHES AND PLATES; DRINKING GLASSES, NAMELY, TUMBLERS; LADLES, FOR KITCHEN USE; MUGS; PAILS; PITCHERS; PLASTIC BUCKETS; SCOOPS; SERVING DISHES; SERVING LADLES; SERVING TONGS; SERVING TRAYS; TRASH CANS, IN CLASS 21 (U.S. CLS. 2, 13, 23, 29, 30, 33, 40 AND 50).

FIRST USE 5-16-2008; IN COMMERCE 5-16-2008.

THE MARK CONSISTS OF STANDARD CHARACTERS WITHOUT CLAIM TO ANY PARTICULAR FONT, STYLE, SIZE, OR COLOR.

NO CLAIM IS MADE TO THE EXCLUSIVE RIGHT TO USE "PLASTICS", APART FROM THE MARK AS SHOWN.

SER. NO. 85-383,377, FILED 7-28-2011.

JAY FLOWERS, EXAMINING ATTORNEY



*David J. Kyffers*

Director of the United States Patent and Trademark Office

# United States of America

United States Patent and Trademark Office

# laudeo

**Reg. No. 4,197,079**

**Registered Aug. 28, 2012**

**Int. Cl.: 42**

**SERVICE MARK**

**PRINCIPAL REGISTER**

LAUDEO MEDIA LLC (MARYLAND LIMITED LIABILITY COMPANY)  
PO BOX 6423  
COLUMBIA, MD 21045

FOR: PROVIDING ONLINE NON-DOWNLOADABLE COMPUTER SOFTWARE APPLICATIONS FOR THE INTEGRATION OF TEXT, AUDIO, GRAPHICS, STILL IMAGES AND MOVING PICTURES INTO AN INTERACTIVE DELIVERY FOR MULTIMEDIA APPLICATIONS, IN CLASS 42 (U.S. CLS. 100 AND 101).

FIRST USE 7-2-2011; IN COMMERCE 1-19-2012.

THE MARK CONSISTS OF STANDARD CHARACTERS WITHOUT CLAIM TO ANY PARTICULAR FONT, STYLE, SIZE, OR COLOR.

THE WORDING "LAUDEO" HAS NO MEANING IN A FOREIGN LANGUAGE.

SER. NO. 85-383,695, FILED 7-28-2011.

MARILYN IZZI, EXAMINING ATTORNEY



*David J. Kybas*

Director of the United States Patent and Trademark Office

# United States of America

United States Patent and Trademark Office

## Boston Appliance Showroom

**Reg. No. 4,197,080**

BOSTON APPLIANCE COMPANY (MASSACHUSETTS CORPORATION)  
840 SUMMER STREET  
BOSTON, MA 02127

**Registered Aug. 28, 2012**

**Int. Cl.: 35**

FOR: RETAIL STORE AND ON-LINE RETAIL STORE SERVICES FEATURING KITCHEN APPLIANCES; RETAIL STORE SERVICES FEATURING KITCHEN RELATED PRODUCTS, IN CLASS 35 (U.S. CLS. 100, 101 AND 102).

**SERVICE MARK**

FIRST USE 2-15-2006; IN COMMERCE 2-15-2006.

**PRINCIPAL REGISTER**

THE MARK CONSISTS OF STANDARD CHARACTERS WITHOUT CLAIM TO ANY PARTICULAR FONT, STYLE, SIZE, OR COLOR.

NO CLAIM IS MADE TO THE EXCLUSIVE RIGHT TO USE "APPLIANCE SHOWROOM", APART FROM THE MARK AS SHOWN.

SEC. 2(F).

SER. NO. 85-383,819, FILED 7-28-2011.

ZACHARY BELLO, EXAMINING ATTORNEY



*David J. Kyffers*

Director of the United States Patent and Trademark Office

# United States of America

United States Patent and Trademark Office

# PrimoCocktail

**Reg. No. 4,197,081**

PRIMO ANALYTICS, INC. (TEXAS CORPORATION)  
10709 BERTHOUND DRIVE  
AUSTIN, TX 78758

**Registered Aug. 28, 2012**

**Int. Cl.: 35**

FOR: PROVIDING A WEBSITE WHERE USERS CAN POST RATINGS, REVIEWS AND RECOMMENDATIONS ON RESTAURANTS, FOOD AND WINE FOR COMMERCIAL PURPOSES, IN CLASS 35 (U.S. CLS. 100, 101 AND 102).

**SERVICE MARK**

FIRST USE 7-28-2011; IN COMMERCE 4-14-2012.

**PRINCIPAL REGISTER**

THE MARK CONSISTS OF STANDARD CHARACTERS WITHOUT CLAIM TO ANY PARTICULAR FONT, STYLE, SIZE, OR COLOR.

SER. NO. 85-383,982, FILED 7-28-2011.

GIANCARLO CASTRO, EXAMINING ATTORNEY



*David J. Kybas*

Director of the United States Patent and Trademark Office

# United States of America

United States Patent and Trademark Office

## Download N Go

**Reg. No. 4,197,082**

**Registered Aug. 28, 2012**

**Int. Cl.: 9**

**TRADEMARK**

**PRINCIPAL REGISTER**

UNIT STUDIES BY AMANDA BENNETT, LLC (TEXAS LIMITED LIABILITY COMPANY)  
P.O. BOX 637  
HONDO, TX 78861

FOR: CHILDREN'S EDUCATIONAL SOFTWARE; DIGITAL MATERIALS, NAMELY, EDUCATIONAL CD-ROMS, DVDS AND DOWNLOADABLE EDUCATIONAL BOOKS, VIDEOS AND WORKSHEETS FEATURING K-4 INSTRUCTIONAL MATERIALS, ACTIVITIES, WORKSHEETS, READINGS, VIDEO LINKS, TEACHER AND USER GUIDES IN THE AREAS OF HISTORY, LANGUAGE, ART, SCIENCE, CULTURE, RELIGION, INTEGRATED LEARNING, READING, MATHEMATICS, MUSIC, HOLIDAYS AND OBSERVANCES, ENGINEERING, ARCHITECTURE, SPORTING AND CULTURAL ACTIVITIES, AND SOCIAL STUDIES; DIGITAL MEDIA, NAMELY, PRE-RECORDED DVDS, DOWNLOADABLE AUDIO AND VIDEO RECORDINGS, AND CDS FEATURING AND PROMOTING K-4 INSTRUCTIONAL MATERIALS, ACTIVITIES, WORKSHEETS, READINGS, VIDEO LINKS, TEACHER AND USER GUIDES IN THE AREAS OF HISTORY, LANGUAGE, ART, SCIENCE, CULTURE, RELIGION, INTEGRATED LEARNING, READING, MATHEMATICS, MUSIC, HOLIDAYS AND OBSERVANCES, ENGINEERING, ARCHITECTURE, SPORTING AND CULTURAL ACTIVITIES, AND SOCIAL STUDIES; DIGITAL MEDIA, NAMELY, EDUCATIONAL CD-ROMS, DVDS AND DOWNLOADABLE EDUCATIONAL AUDIO FILES, VIDEO FILES, TEXT-BASED LESSONS AND WORKSHEETS FEATURING K-4 INSTRUCTIONAL MATERIALS, ACTIVITIES, WORKSHEETS, READINGS, VIDEO LINKS, TEACHER AND USER GUIDES IN THE AREAS OF HISTORY, LANGUAGE, ART, SCIENCE, CULTURE, RELIGION, INTEGRATED LEARNING, READING, MATHEMATICS, MUSIC, HOLIDAYS AND OBSERVANCES, ENGINEERING, ARCHITECTURE, SPORTING AND CULTURAL ACTIVITIES, AND SOCIAL STUDIES; DOWNLOADABLE ELECTRONIC PUBLICATIONS IN THE NATURE OF EDUCATIONAL LESSON PLANS, WORKSHEETS, TEXT-BASED LESSONS, READINGS, VIDEOS AND VIDEO CLIPS, AUDIO FILES AND AUDIO CLIPS, TEACHER AND USER GUIDES IN THE FIELD OF K-4 INSTRUCTIONAL MATERIALS AND IN THE AREAS OF HISTORY, LANGUAGE, ART, SCIENCE, CULTURE, RELIGION, INTEGRATED LEARNING, READING, MATHEMATICS, MUSIC, HOLIDAYS AND OBSERVANCES, ENGINEERING, ARCHITECTURE, SPORTING AND CULTURAL ACTIVITIES, AND SOCIAL STUDIES; EDUCATIONAL SOFTWARE FEATURING INSTRUCTION AND INSTRUCTIONAL MATERIALS IN THE AREAS OF HISTORY, LANGUAGE, ART, SCIENCE, CULTURE, RELIGION, INTEGRATED LEARNING, READING, MATHEMATICS, MUSIC, HOLIDAYS AND OBSERVANCES, ENGINEERING, ARCHITECTURE, SPORTING AND CULTURAL ACTIVITIES, AND SOCIAL STUDIES; MULTIMEDIA SOFTWARE RECORDED ON CD-ROM FEATURING INSTRUCTION AND INSTRUCTIONAL MATERIALS IN THE AREAS OF HISTORY, LAN-



*David J. Kyros*

Director of the United States Patent and Trademark Office

**Reg. No. 4,197,082** GUAGE, ART, SCIENCE, CULTURE, RELIGION, INTEGRATED LEARNING, READING, MATHEMATICS, MUSIC, HOLIDAYS AND OBSERVANCES, ENGINEERING, ARCHITECTURE, SPORTING AND CULTURAL ACTIVITIES, AND SOCIAL STUDIES, IN CLASS 9 (U.S. CLS. 21, 23, 26, 36 AND 38).

FIRST USE 10-1-2009; IN COMMERCE 10-1-2009.

THE MARK CONSISTS OF STANDARD CHARACTERS WITHOUT CLAIM TO ANY PARTICULAR FONT, STYLE, SIZE, OR COLOR.

NO CLAIM IS MADE TO THE EXCLUSIVE RIGHT TO USE "DOWNLOAD", APART FROM THE MARK AS SHOWN.

SER. NO. 85-384,019, FILED 7-28-2011.

DAVID I, EXAMINING ATTORNEY



# United States of America

United States Patent and Trademark Office

# NWC

**Reg. No. 4,197,083**

LARRIVEE, NICOLAS (UNITED STATES INDIVIDUAL)  
12132 SE 10TH ST  
BELLEVUE, WA 98005

**Registered Aug. 28, 2012**

**Int. Cl.: 25**

FOR: CLOTHING, NAMELY, TOPS, BOTTOMS, T-SHIRTS, SHORTS, SWEAT PANTS, SWEAT SHIRTS, SWIM WEAR, JACKETS, WET SUITS, BELTS, JEANS, SLACKS, WOVEN SHIRTS, KNIT SHIRTS, TANK TOPS, SOCKS, SWEATERS, HATS, BEANIES, CAPS, FOOTWEAR, IN CLASS 25 (U.S. CLS. 22 AND 39).

**TRADEMARK**

**PRINCIPAL REGISTER**

FIRST USE 6-18-2008; IN COMMERCE 6-18-2008.

THE MARK CONSISTS OF STANDARD CHARACTERS WITHOUT CLAIM TO ANY PARTICULAR FONT, STYLE, SIZE, OR COLOR.

SER. NO. 85-384,185, FILED 7-29-2011.

ALICIA COLLINS, EXAMINING ATTORNEY



*David J. Kyffers*

Director of the United States Patent and Trademark Office

# United States of America

United States Patent and Trademark Office

# CALIBER

**Reg. No. 4,197,084**

POISE, LLC (CALIFORNIA LIMITED LIABILITY COMPANY)  
4377 N. BALDWIN AVE.,  
EL MONTE, CA 91731

**Registered Aug. 28, 2012**

**Int. Cl.: 19**

FOR: HARDWOOD FLOORING; LAMINATE FLOORING, IN CLASS 19 (U.S. CLS. 1, 12, 33 AND 50).

**TRADEMARK**

FIRST USE 0-0-2006; IN COMMERCE 0-0-2006.

**PRINCIPAL REGISTER**

THE MARK CONSISTS OF STANDARD CHARACTERS WITHOUT CLAIM TO ANY PARTICULAR FONT, STYLE, SIZE, OR COLOR.

SER. NO. 85-384,188, FILED 7-29-2011.

KATINA MISTER, EXAMINING ATTORNEY



*David J. Kybas*

Director of the United States Patent and Trademark Office

# United States of America

United States Patent and Trademark Office

# SalsaScript

**Reg. No. 4,197,085**

**Registered Aug. 28, 2012**

**Int. Cl.: 9**

SALSA LABS, INC. (ARKANSAS CORPORATION), FORMERLY WIRED FOR CHANGE, INC.  
1700 CONNECTICUT AVENUE NW  
SUITE 403  
WASHINGTON, DC 20009

**TRADEMARK**

**PRINCIPAL REGISTER**

FOR: DOWNLOADABLE COMPUTER SOFTWARE COMPONENTS FOR USE WITH A SOFTWARE AS A SERVICE (SAAS) PLATFORM WHICH ALLOW THE USER TO BUILD CUSTOMIZATIONS TO THE SOFTWARE PLATFORM FOR USE IN ONLINE ORGANIZING OF POLITICAL CAMPAIGNS, COMMUNITY, BUSINESS, GROUP AND CONSTITUENT CAMPAIGNS AND ENGAGEMENTS, ISSUE ADVOCACY, VOTERS AND PETITION CAMPAIGNS, FUNDRAISING AND DONATION CAMPAIGNS, AND EVENT PLANNING, AND FOR USE AS APPLICATION PROGRAM INTERFACES TO INTEGRATE APPLICANT'S SOFTWARE AND THIRD-PARTY SOFTWARE, IN CLASS 9 (U.S. CLS. 21, 23, 26, 36 AND 38).

FIRST USE 3-31-2008; IN COMMERCE 3-31-2008.

THE MARK CONSISTS OF STANDARD CHARACTERS WITHOUT CLAIM TO ANY PARTICULAR FONT, STYLE, SIZE, OR COLOR.

SER. NO. 85-384,228, FILED 7-29-2011.

MARY CRAWFORD, EXAMINING ATTORNEY



*David J. Kyffers*

Director of the United States Patent and Trademark Office

# United States of America

United States Patent and Trademark Office

## Sanctuary Pilates

**Reg. No. 4,197,086**

**Registered Aug. 28, 2012**

**Int. Cl.: 41**

**SERVICE MARK**

**PRINCIPAL REGISTER**

ARTIBEE, KATHERINE (UNITED STATES INDIVIDUAL)  
APT. 5D  
531 E 87TH ST.  
NEW YORK, NY 10128

FOR: PROVIDING FITNESS AND EXERCISE STUDIO SERVICES, NAMELY, PILATES INSTRUCTION AND TRAINING, IN CLASS 41 (U.S. CLS. 100, 101 AND 107).

FIRST USE 4-0-2006; IN COMMERCE 4-0-2006.

THE MARK CONSISTS OF STANDARD CHARACTERS WITHOUT CLAIM TO ANY PARTICULAR FONT, STYLE, SIZE, OR COLOR.

NO CLAIM IS MADE TO THE EXCLUSIVE RIGHT TO USE "PILATES", APART FROM THE MARK AS SHOWN.

SER. NO. 85-384,810, FILED 7-29-2011.

ESTHER BELENKER, EXAMINING ATTORNEY



*David J. Kybas*

Director of the United States Patent and Trademark Office

# United States of America

United States Patent and Trademark Office



**Reg. No. 4,197,087**

ABIGAIL C SPARKS, LLC (COLORADO LIMITED LIABILITY COMPANY)  
460 S MARION PKWY #556B  
DENVER, CO 74114

**Registered Aug. 28, 2012**

**Int. Cl.: 14**

FOR: PRECIOUS METALS, THEIR ALLOYS AND GOODS IN PRECIOUS METALS OR COATED THEREWITH, NAMELY, GEMS, PRECIOUS AND SEMI-PRECIOUS GEMS AND MINERALS, JEWELRY, IN CLASS 14 (U.S. CLS. 2, 27, 28 AND 50).

**TRADEMARK**

FIRST USE 4-8-2011; IN COMMERCE 5-20-2011.

**PRINCIPAL REGISTER**

THE MARK CONSISTS OF THE LETTER "S" OVER THE LETTER "A" WHERE THE TAIL END OF LETTER "S" AND LEFT STROKE OF THE LETTER "A" ARE CONNECTED AND A DIAMOND CONNECTING THE LETTERS "S" AND "A" WHERE THE HORIZONTAL STROKE OF THE LETTER "A" APPEARS.

SER. NO. 85-384,873, FILED 7-29-2011.

SALLY SHIH, EXAMINING ATTORNEY



*David J. Kybas*

Director of the United States Patent and Trademark Office

# United States of America

United States Patent and Trademark Office

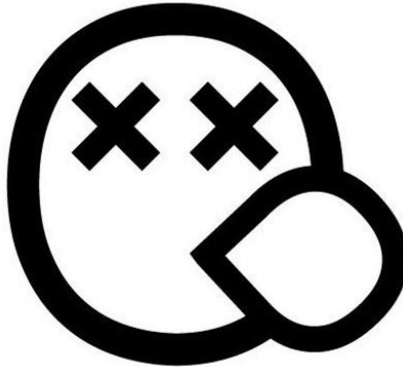

**Reg. No. 4,197,088**

**Registered Aug. 28, 2012**

**Int. Cls.: 3 and 25**

**TRADEMARK**

**PRINCIPAL REGISTER**

HILLYARD, BRETT S. (UNITED STATES INDIVIDUAL)  
1419 EMERALD BAY  
LAGUNA BEACH, CA 92672 AND

MORAN, JEFFERY R. (UNITED STATES INDIVIDUAL)  
29 DAUPHINE  
NEWPORT COAST, CA 92657

FOR: BREATH FRESHENING CONFECTIONARY, NAMELY, DISSOLVABLE BREATH STRIPS, BREATH MINTS, CANDY AND GUM, IN CLASS 3 (U.S. CLS. 1, 4, 6, 50, 51 AND 52).

FIRST USE 7-26-2011; IN COMMERCE 7-26-2011.

FOR: CASUAL APPAREL, NAMELY, SHIRTS, PANTS, JACKETS, SWEATSHIRTS, FOOTWEAR, HATS AND CAPS, IN CLASS 25 (U.S. CLS. 22 AND 39).

FIRST USE 7-13-2011; IN COMMERCE 7-13-2011.

THE MARK CONSISTS OF A STICK FIGURE FACE WITH "X"'S FOR EYES, NO NOSE, NO EARS AND NO HAIR, AND INSTEAD OF A MOUTH, A CHEWING GUM BUBBLE EXTENDING BEYOND THE RIGHT SIDE OF THE FACE.

SER. NO. 85-386,330, FILED 8-1-2011.

KATHERINE CONNOLLY, EXAMINING ATTORNEY



*David J. Kybas*

Director of the United States Patent and Trademark Office

# United States of America

United States Patent and Trademark Office

# PREP

**Reg. No. 4,197,089**

OMID USA, INC. (OHIO CORPORATION)

**Registered Aug. 28, 2012**

P.O. BOX 2  
TERRACE PARK, OH 45174

**Int. Cl.: 7**

FOR: SOLAR-POWERED ELECTRICITY GENERATORS, IN CLASS 7 (U.S. CLS. 13, 19, 21, 23, 31, 34 AND 35).

**TRADEMARK**

FIRST USE 2-1-2010; IN COMMERCE 4-1-2012.

**PRINCIPAL REGISTER**

THE MARK CONSISTS OF STANDARD CHARACTERS WITHOUT CLAIM TO ANY PARTICULAR FONT, STYLE, SIZE, OR COLOR.

SER. NO. 85-386,596, FILED 8-2-2011.

RUSS HERMAN, EXAMINING ATTORNEY



*David J. Kyffers*

Director of the United States Patent and Trademark Office

# United States of America

United States Patent and Trademark Office

## APPRAISAL MANAGEMENT SYSTEMS

**Reg. No. 4,197,090**

**Registered Aug. 28, 2012**

**Int. Cl.: 36**

**SERVICE MARK**

**PRINCIPAL REGISTER**

SIEGLER, STEVEN N (UNITED STATES INDIVIDUAL)  
5113 BOTTLEBRUSH STREET, SUITE 1  
DELRAY BEACH, FL 33484

FOR: ANTIQUE APPRAISAL; APPRAISAL AND EVALUATION OF REAL ESTATE; APPRAISAL OF PERSONAL PROPERTY FOR OTHERS; APPRAISAL OF REAL ESTATE; APPRAISAL SERVICES, NAMELY, PROVIDING A COMPUTER DATABASE FOR THE PURPOSE OF APPRAISING REPAIRS TO DAMAGED AUTOMOBILES; APPRAISALS FOR INSURANCE CLAIMS OF PERSONAL PROPERTY; APPRAISALS FOR INSURANCE CLAIMS OF REAL ESTATE; ART APPRAISAL; AUTOMOBILE APPRAISAL; COIN APPRAISAL; CONSULTATION RELATING TO THE APPRAISAL OF GOODS; EQUINE APPRAISALS; HOME APPRAISAL SERVICES; HORSE APPRAISALS; JEWELRY APPRAISAL; NUMISMATIC APPRAISAL; PRECIOUS STONE APPRAISAL; REAL ESTATE APPRAISAL; REAL ESTATE APPRAISAL AND VALUATION; REAL ESTATE SERVICES, NAMELY, AD VALOREM APPRAISALS; REAL ESTATE SERVICES, NAMELY, MASS APPRAISALS; REAL ESTATE SERVICES, NAMELY, TAX APPRAISALS; REPAIR COST EVALUATION; STAMP APPRAISAL, IN CLASS 36 (U.S. CLS. 100, 101 AND 102).

FIRST USE 6-1-1986; IN COMMERCE 6-1-1986.

THE MARK CONSISTS OF STANDARD CHARACTERS WITHOUT CLAIM TO ANY PARTICULAR FONT, STYLE, SIZE, OR COLOR.

NO CLAIM IS MADE TO THE EXCLUSIVE RIGHT TO USE "APPRAISAL MANAGEMENT", APART FROM THE MARK AS SHOWN.

SEC. 2(F).

SER. NO. 85-386,599, FILED 8-2-2011.

HENRY S. ZAK, EXAMINING ATTORNEY



*David J. Kybas*

Director of the United States Patent and Trademark Office



# United States of America

United States Patent and Trademark Office



**Reg. No. 4,197,091**

**Registered Aug. 28, 2012**

**Int. Cl.: 41**

**SERVICE MARK**

**PRINCIPAL REGISTER**

INTERNATIONAL ASSOCIATION OF MARINE INVESTIGATORS, INC. (OREGON CORPORATION)  
2053 MANCHESTER DRIVE  
MEDFORD, OR 97501

FOR: DEVELOPMENT OF AND PROVISION OF INVESTIGATIVE TRAINING TO MARINE PROFESSIONALS, LAW ENFORCEMENT PROFESSIONALS, AND INSURANCE INVESTIGATORS ON THE TOPICS OF THE CRIMES OF THEFT, ARSON AND FRAUD IN THE MARINE ENVIRONMENT, IN CLASS 41 (U.S. CLS. 100, 101 AND 107).

FIRST USE 0-0-1996; IN COMMERCE 0-0-1996.

THE MARK CONSISTS OF THE ACRONYM "IAMI" APPEARING ON A MAP OF THE WORLD SURROUNDED BY THE WORDS "INTERNATIONAL ASSOCIATION OF MARINE INVESTIGATORS, INC.".

SEC. 2(F) AS TO "INTERNATIONAL ASSOCIATION OF MARINE INVESTIGATORS, INC."..

SER. NO. 85-386,606, FILED 8-2-2011.

DAVID MURRAY, EXAMINING ATTORNEY



*David J. Kypos*

Director of the United States Patent and Trademark Office

# United States of America

United States Patent and Trademark Office

## Healthcare Comes Home

**Reg. No. 4,197,092**

ROBIN PATRICE LOWMAN (UNITED STATES INDIVIDUAL)  
1950 SAXON VALLEY CIRCLE NE  
ATLANTA, GA 30319 AND

**Registered Aug. 28, 2012**

**Int. Cl.: 44**

MBOH ELANGO (CAMEROON INDIVIDUAL)  
1950 SAXON VALLEY CIRCLE NE  
ATLANTA, GA 30319

**SERVICE MARK**

FOR: CONCIERGE HEALTHCARE SERVICES, IN CLASS 44 (U.S. CLS. 100 AND 101).

**PRINCIPAL REGISTER**

FIRST USE 7-1-2009; IN COMMERCE 7-1-2009.

THE MARK CONSISTS OF STANDARD CHARACTERS WITHOUT CLAIM TO ANY PARTICULAR FONT, STYLE, SIZE, OR COLOR.

NO CLAIM IS MADE TO THE EXCLUSIVE RIGHT TO USE "HEALTHCARE", APART FROM THE MARK AS SHOWN.

SER. NO. 85-386,725, FILED 8-2-2011.

MATTHEW KLINE, EXAMINING ATTORNEY



*David J. Kyffers*

Director of the United States Patent and Trademark Office

# United States of America

United States Patent and Trademark Office

# FWi

**Reg. No. 4,197,093**

FOUR WINDS INTERACTIVE, LLC (COLORADO LIMITED LIABILITY COMPANY)  
1859 YORK STREET  
DENVER, CO 80206

**Registered Aug. 28, 2012**

**Int. Cls.: 9, 35 and 37**

FOR: COMPUTER SOFTWARE, NAMELY, CONTENT MANAGER AND CONTENT PLAYER SOFTWARE FOR DIGITAL SIGNAGE, IN CLASS 9 (U.S. CLS. 21, 23, 26, 36 AND 38).

**TRADEMARK**

FIRST USE 0-0-2009; IN COMMERCE 0-0-2009.

**SERVICE MARK**

FOR: BUSINESS CONSULTING IN THE FIELD OF DIGITAL SIGNAGE; DESIGN OF ADVERTISING DIGITAL SIGNAGE CONTENT FOR OTHERS, IN CLASS 35 (U.S. CLS. 100, 101 AND 102).

**PRINCIPAL REGISTER**

FIRST USE 0-0-2009; IN COMMERCE 0-0-2009.

FOR: INSTALLATION OF DIGITAL SIGNAGE; TECHNICAL SUPPORT SERVICES, NAMELY, TROUBLE SHOOTING IN THE NATURE OF COMPUTER HARDWARE REPAIR OF DIGITAL SIGNAGE, IN CLASS 37 (U.S. CLS. 100, 103 AND 106).

FIRST USE 0-0-2009; IN COMMERCE 0-0-2009.

THE MARK CONSISTS OF THE STYLIZED LETTERS OF "FWI".

SER. NO. 85-387,137, FILED 8-2-2011.

TAMARA FRAZIER, EXAMINING ATTORNEY



*David J. Kybas*

Director of the United States Patent and Trademark Office

# United States of America

United States Patent and Trademark Office

## THE PARKING LOT HEART

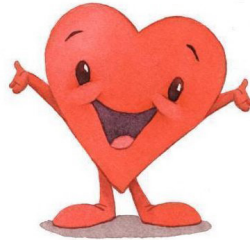

**Reg. No. 4,197,094**

**Registered Aug. 28, 2012**

**Int. Cls.: 16, 21, 25 and  
28**

**TRADEMARK**

**PRINCIPAL REGISTER**

ILLUSIVE DREAMS INC. (CALIFORNIA CORPORATION)  
2825 N. KEYSTONE STREET  
BURBANK, CA 91504

FOR: PRINTED MATTER AND PAPER GOODS, NAMELY, BOOKS FEATURING CHARACTERS FROM ANIMATED, ACTION ADVENTURE, COMEDY AND/OR DRAMA FEATURES, CHILDREN'S BOOKS, COLORING BOOKS, CHILDREN'S ACTIVITY BOOKS; STATIONERY, WRITING PAPER, ENVELOPES, NOTEBOOKS, DIARIES, NOTE CARDS, GREETING CARDS, DECALS, POSTERS; BOOK COVERS, BOOK MARKS, CALENDARS, GIFT WRAPPING PAPER; PRINTED TRANSFERS FOR EMBROIDERY OR FABRIC APPLIQUÉS, NAMELY, IRON-ON TRANSFERS; PRINTED PATTERNS FOR COSTUMES, PAJAMAS, SWEATSHIRTS AND T-SHIRTS, IN CLASS 16 (U.S. CLS. 2, 5, 22, 23, 29, 37, 38 AND 50).

FIRST USE 5-9-2008; IN COMMERCE 5-9-2008.

FOR: GLASS, CERAMIC AND EARTHENWARE GOODS, NAMELY, COFFEE MUGS, MUGS, JUGS, BOWLS, PLATES, COFFEE CUPS, AND CUPS; BEVERAGE GLASSWARE, NAMELY, JUGS, MUGS AND DRINKING GLASSES; INFANT CUPS; COOKIE JARS; CERAMIC, GLASS AND CHINA FIGURINES; PLASTIC BUCKETS; CAKE MOLDS; SERVING UTENSILS, NAMELY, SERVING SPOONS, SERVING FORKS, SERVING TONGS; CANTEENS; PLASTIC COASTERS; THERMAL INSULATED CONTAINERS FOR FOOD OR BEVERAGES; AND WATER BOTTLES, NAMELY, PLASTIC WATER BOTTLES SOLD EMPTY, IN CLASS 21 (U.S. CLS. 2, 13, 23, 29, 30, 33, 40 AND 50).

FIRST USE 5-9-2008; IN COMMERCE 5-9-2008.

FOR: CLOTHING FOR MEN, WOMEN AND CHILDREN, NAMELY, SHIRTS, T-SHIRTS, SWEATSHIRTS, JOGGING SUITS, TROUSERS, PANTS, SHORTS, TANK TOPS, RAINWEAR, CLOTH BIBS, SKIRTS, BLOUSES, DRESSES, SUSPENDERS, SWEATERS, JACKETS, COATS, RAINCOATS, TIES, ROBES, HATS, CAPS, SUN-VISORS, BELTS, SCARVES, SLEEPWEAR, PAJAMAS, LINGERIE, UNDERWEAR, BOOTS, SHOES, SNEAKERS, SANDALS, BOOTIES, SLIPPER SOCKS, SWIMWEAR AND MASQUERADE AND HALLOWEEN COSTUMES AND MASKS SOLD IN CONNECTION THEREWITH, IN CLASS 25 (U.S. CLS. 22 AND 39).

FIRST USE 5-9-2008; IN COMMERCE 5-9-2008.



*David J. Kyffers*

Director of the United States Patent and Trademark Office

**Reg. No. 4,197,094** FOR: TOYS AND SPORTING GOODS INCLUDING GAMES AND PLAYTHINGS, NAMELY, ACTION FIGURES AND ACCESSORIES THEREFORE, PLUSH TOYS, BALLOONS, BATHTUB TOYS, RIDE-ON TOYS, EQUIPMENT SOLD AS A UNIT FOR PLAYING CARD GAMES, DOLLS, GAME EQUIPMENT SOLD AS A UNIT FOR PLAYING A BOARD GAME, A CARD GAME, A MANIPULATIVE GAME, A PARLOR GAME, AND AN ACTION TYPE TARGET GAME, JIGSAW AND MANIPULATIVE PUZZLES, PAPER FACE MASKS, AND CHRISTMAS TREE ORNAMENTS, IN CLASS 28 (U.S. CLS. 22, 23, 38 AND 50).

FIRST USE 5-9-2008; IN COMMERCE 5-9-2008.

OWNER OF U.S. REG. NO. 3,983,178.

THE COLOR(S) RED, BLACK AND GRAY IS/ARE CLAIMED AS A FEATURE OF THE MARK.

THE MARK CONSISTS OF A RED HEART WITH ARMS AND HANDS AND FEET WITH THE COLOR BLACK APPEARING IN THE TWO EYES, EYEBROWS AND MOUTH. RIGHT ABOVE THE HEART CHARACTER APPEAR THE WORDS "THE PARKING LOT HEART" IN THE COLOR BLACK. THERE IS A GRAY SHADOW BENEATH THE HEART CHARACTER.

SER. NO. 85-387,432, FILED 8-2-2011.

LINDSEY RUBIN, EXAMINING ATTORNEY

# United States of America

United States Patent and Trademark Office



**Reg. No. 4,197,095**

**Registered Aug. 28, 2012**

**Int. Cl.: 9**

**TRADEMARK**

**PRINCIPAL REGISTER**

LIU, CHIA-JU (TAIWAN INDIVIDUAL)  
2071 WINTERWOOD DR.  
FULLERTON, CA 92833

FOR: CARRYING CASES FOR ELECTRONIC EQUIPMENT, NAMELY, TABLETS, CELL PHONES, MP3 PLAYERS AND MEDIA PLAYERS; CARRYING CASES, HOLDERS, PROTECTIVE CASES AND STANDS FEATURING POWER SUPPLY CONNECTORS, ADAPTORS, SPEAKERS AND BATTERY CHARGING DEVICES, SPECIALLY ADAPTED FOR USE WITH HANDHELD DIGITAL ELECTRONIC DEVICES; PROTECTIVE CARRYING CASES FOR PORTABLE MUSIC PLAYERS, NAMELY, MP3 PLAYERS; PROTECTIVE COVERS AND CASES FOR CELL PHONES, LAPTOPS AND PORTABLE MEDIA PLAYERS, IN CLASS 9 (U.S. CLS. 21, 23, 26, 36 AND 38).

FIRST USE 0-0-2011; IN COMMERCE 7-0-2011.

THE MARK CONSISTS OF A STYLIZED DRAWING OF THE LETTER "W" FOLLOWED BY A PERIOD IN THE FORM OF A SMALL CIRCLE.

SER. NO. 85-387,566, FILED 8-2-2011.

JOHN WILKE, EXAMINING ATTORNEY



*David J. Kybas*

Director of the United States Patent and Trademark Office

# United States of America

United States Patent and Trademark Office

## JESSICA LONDON

**Reg. No. 4,197,096**

**Registered Aug. 28, 2012**

**Int. Cls.: 35 and 36**

**SERVICE MARK**

**PRINCIPAL REGISTER**

JESSICA LONDON, INC. (DELAWARE CORPORATION)  
2300 SOUTHEASTERN AVENUE  
INDIANAPOLIS, IN 46201

FOR: RETAIL STORE SERVICES IN THE FIELD OF WOMEN'S CLOTHING, SHOES, AND CLOTHING ACCESSORIES FEATURING A BONUS INCENTIVE PROGRAM FOR CUSTOMERS, IN CLASS 35 (U.S. CLS. 100, 101 AND 102).

FIRST USE 7-25-2011; IN COMMERCE 7-25-2011.

FOR: CREDIT CARD SERVICES, IN CLASS 36 (U.S. CLS. 100, 101 AND 102).

FIRST USE 7-25-2011; IN COMMERCE 7-25-2011.

THE MARK CONSISTS OF STANDARD CHARACTERS WITHOUT CLAIM TO ANY PARTICULAR FONT, STYLE, SIZE, OR COLOR.

OWNER OF U.S. REG. NOS. 2,210,503, 2,645,682, AND 2,799,241.

THE NAME(S), PORTRAIT(S), AND/OR SIGNATURE(S) SHOWN IN THE MARK DOES NOT IDENTIFY A PARTICULAR LIVING INDIVIDUAL.

SER. NO. 85-388,311, FILED 8-3-2011.

LOURDES AYALA, EXAMINING ATTORNEY



*David J. Kybas*

Director of the United States Patent and Trademark Office

# United States of America

United States Patent and Trademark Office

## Universal Quality Audit

**Reg. No. 4,197,097**

**Registered Aug. 28, 2012**

**Int. Cl.: 35**

**SERVICE MARK**

**PRINCIPAL REGISTER**

QUALITY ENGINEERING CONSULTANTS LLC (MINNESOTA LIMITED LIABILITY COMPANY), DBA QUALITY AUDITING  
100 S. FIFTH STREET, SUITE 1900  
MINNEAPOLIS, MN 55402

FOR: BUSINESS AUDITING, IN CLASS 35 (U.S. CLS. 100, 101 AND 102).

FIRST USE 1-25-2011; IN COMMERCE 3-6-2011.

THE MARK CONSISTS OF STANDARD CHARACTERS WITHOUT CLAIM TO ANY PARTICULAR FONT, STYLE, SIZE, OR COLOR.

NO CLAIM IS MADE TO THE EXCLUSIVE RIGHT TO USE "QUALITY AUDIT", APART FROM THE MARK AS SHOWN.

SER. NO. 85-389,027, FILED 8-3-2011.

SALLY SHIH, EXAMINING ATTORNEY



*David J. Kyffers*

Director of the United States Patent and Trademark Office



# United States of America

United States Patent and Trademark Office



**Reg. No. 4,197,098**

**Registered Aug. 28, 2012**

**Int. Cl.: 42**

**SERVICE MARK**

**PRINCIPAL REGISTER**

WASHINGTON SOFTWARE, INC. (MARYLAND CORPORATION)  
20410 CENTURY BLVD, SUITE 220  
GERMANTOWN, MD 20874

FOR: APPLICATION SERVICE PROVIDER (ASP), NAMELY, HOSTING COMPUTER SOFTWARE APPLICATIONS OF OTHERS; APPLICATION SERVICE PROVIDER, NAMELY, HOSTING, MANAGING, DEVELOPING, ANALYZING, AND MAINTAINING APPLICATIONS, SOFTWARE, AND WEB SITES, OF OTHERS IN THE FIELDS OF ADVERTISING AND MARKETING; APPLICATION SERVICE PROVIDER, NAMELY, HOSTING, MANAGING, DEVELOPING, ANALYZING, AND MAINTAINING APPLICATIONS, SOFTWARE, AND WEB SITES, OF OTHERS IN THE FIELDS OF HEALTHCARE, BENEFITS PROGRAMS, EMPLOYEE PRODUCTIVITY, RISK MANAGEMENT; BUSINESS TECHNOLOGY SOFTWARE CONSULTATION SERVICES; COMPUTER AIDED GRAPHIC DESIGN; COMPUTER CONSULTATION; COMPUTER CONSULTATION IN THE FIELD OF COMPUTER SECURITY; COMPUTER GRAPHICS DESIGN SERVICES; COMPUTER HARDWARE AND SOFTWARE CONSULTING SERVICES; COMPUTER HARDWARE AND SOFTWARE DESIGN; COMPUTER HARDWARE DEVELOPMENT; COMPUTER MONITORING SERVICE WHICH TRACKS APPLICATION SOFTWARE PERFORMANCE, PERFORMS PERIODIC MAINTENANCE AND PROVIDES REPORTS AND ALERTS CONCERNING SUCH PERFORMANCE; COMPUTER MONITORING SERVICE WHICH TRACKS HARDWARE PERFORMANCE AND PROCESSES AND SENDS OUT HISTORICAL REPORTS AND ALERTS; COMPUTER NETWORK CONFIGURATION SERVICES; COMPUTER PROGRAMMING AND COMPUTER SYSTEM ANALYSIS; COMPUTER PROGRAMMING AND MAINTENANCE OF COMPUTER PROGRAMS; COMPUTER PROGRAMMING AND SOFTWARE DESIGN; COMPUTER PROGRAMMING CONSULTANCY; COMPUTER PROGRAMMING SERVICES, NAMELY, CONTENT CREATION FOR VIRTUAL WORLDS AND THREE DIMENSIONAL PLATFORMS; COMPUTER SECURITY CONSULTANCY; COMPUTER SECURITY CONSULTANCY IN THE FIELD OF SCANNING AND PENETRATION TESTING OF COMPUTERS AND NETWORKS TO ASSESS INFORMATION SECURITY VULNERABILITY; COMPUTER SECURITY SERVICE, NAMELY, RESTRICTING ACCESS TO AND BY COMPUTER NETWORKS TO AND OF UNDESIRE WEB SITES, MEDIA AND INDIVIDUALS AND FACILITIES; COMPUTER SERVICES, NAMELY, COMPUTER SYSTEM ADMINISTRATION FOR OTHERS; COMPUTER SERVICES, NAMELY, CREATING COMPUTER NETWORK-BASED INDEXES OF INFORMATION, WEBSITES AND RESOURCES; COMPUTER SERVICES, NAMELY, CREATING, MAINTAINING, DESIGNING AND IMPLEMENTING WEB SITES FOR OTHERS; COMPUTER SERVICES, NAMELY, DESIGNING AND IMPLEMENTING WEB PAGES FOR OTHERS; COMPUTER SERVICES, NAMELY, DESIGNING AND IMPLEMENTING WEB



*David J. Kybas*

Director of the United States Patent and Trademark Office

**Reg. No. 4,197,098** SITES FOR OTHERS; COMPUTER SERVICES, NAMELY, INTEGRATION OF COMPUTER SOFTWARE INTO MULTIPLE SYSTEMS AND NETWORKS; COMPUTER SERVICES, NAMELY, MANAGING WEB SITES FOR OTHERS; COMPUTER SERVICES, NAMELY, MONITORING AND REPORTING ON THE PERFORMANCE, AVAILABILITY, AND ERRORS OF WEB SITES OF OTHERS; COMPUTER SERVICES, NAMELY, MONITORING THE WEB SITES OF OTHERS TO IMPROVE THEIR SCALABILITY AND PERFORMANCE; COMPUTER SERVICES, NAMELY, MONITORING, TESTING, ANALYZING, AND REPORTING ON THE INTERNET TRAFFIC CONTROL AND CONTENT CONTROL OF THE WEB SITES OF OTHERS; COMPUTER SERVICES, NAMELY, ON-SITE MANAGEMENT OF INFORMATION TECHNOLOGY (IT) SYSTEMS; COMPUTER SERVICES, NAMELY, PROVIDING VIRTUAL AND NON VIRTUAL APPLICATION SERVERS, WEB SERVERS, FILE SERVERS, CO-LOCATION SERVERS, LOAD BALANCING SERVERS, REDUNDANCY SERVERS, MEDIA SERVERS AND DATABASE SERVERS OF VARIABLE CAPACITY TO THIRD PARTY COMPUTING AND DATA STORAGE FACILITIES; COMPUTER SERVICES, NAMELY, REMOTE AND ON-SITE MANAGEMENT OF IT OF OTHERS; COMPUTER SERVICES, NAMELY, REMOTE MANAGEMENT OF THE INFORMATION TECHNOLOGY (IT) SYSTEMS OF OTHERS; COMPUTER SERVICES, NAMELY, REMOTE MANAGEMENT OF IT FOR OTHERS; COMPUTER SOFTWARE CONSULTANCY; COMPUTER SOFTWARE CONSULTING; COMPUTER SOFTWARE DESIGN; COMPUTER SOFTWARE DESIGN AND UPDATING; COMPUTER SOFTWARE DESIGN FOR OTHERS; COMPUTER SOFTWARE DESIGN, COMPUTER PROGRAMMING, OR MAINTENANCE OF COMPUTER SOFTWARE; COMPUTER SOFTWARE DEVELOPMENT; COMPUTER SOFTWARE DEVELOPMENT AND COMPUTER PROGRAMMING DEVELOPMENT FOR OTHERS; COMPUTER SOFTWARE INSTALLATION AND MAINTENANCE; COMPUTER SYSTEM DESIGN SERVICES; COMPUTER SYSTEMS ANALYSIS; COMPUTER SYSTEMS INTEGRATION SERVICES; COMPUTER TECHNICAL SUPPORT SERVICES, NAMELY, 24/7 SERVICE DESK/HELP DESK SERVICES FOR IT INFRASTRUCTURE, OPERATING SYSTEMS, DATABASE SYSTEMS, AND WEB APPLICATIONS.; COMPUTER TECHNOLOGY SUPPORT SERVICES, NAMELY, HELP DESK SERVICES; CONSULTANCY IN THE FIELD OF SOFTWARE DESIGN; CONSULTANCY WITH REGARD TO WEBPAGE DESIGN; CONSULTING IN THE FIELD OF CONFIGURATION MANAGEMENT FOR COMPUTER HARDWARE AND SOFTWARE; CONSULTING IN THE FIELD OF DESIGNING GRAPHIC ARTS; CONSULTING IN THE FIELD OF INFORMATION TECHNOLOGY; CONSULTING IN THE FIELD OF IT PROJECT MANAGEMENT; CONSULTING IN THE FIELD OF VIRTUALIZATION TECHNOLOGIES FOR ENTERPRISES AND BUSINESSES; CONSULTING IN THE FIELD OF GRAPHIC DESIGN; CONSULTING SERVICES IN THE DESIGN AND IMPLEMENTATION OF COMPUTER-BASED INFORMATION SYSTEMS FOR BUSINESSES; CONSULTING SERVICES IN THE FIELD OF COMPUTER-BASED INFORMATION SYSTEMS FOR BUSINESSES; CONSULTING SERVICES IN THE FIELD OF DESIGN, SELECTION, IMPLEMENTATION AND USE OF COMPUTER HARDWARE AND SOFTWARE SYSTEMS FOR OTHERS; CONSULTING SERVICES IN THE FIELD OF HOSTING COMPUTER SOFTWARE APPLICATIONS; CONSULTING SERVICES IN THE FIELD OF SEARCH ENGINE OPTIMIZATION; CONSULTING SERVICES IN THE FIELDS OF SELECTION, IMPLEMENTATION AND USE OF COMPUTER HARDWARE AND SOFTWARE SYSTEMS FOR OTHERS; CREATING AND DESIGNING WEB PAGES FOR OTHERS; CREATING AND MAINTAINING INTERNET SITES FOR OTHERS; CREATING AND MAINTAINING WEB SITES FOR OTHERS; CREATING WEB PAGES FOR OTHERS; CREATING, DESIGNING AND MAINTAINING WEB SITES; CREATING, MAINTAINING, AND MODERNIZING COMPUTER SOFTWARE; CREATION AND MAINTENANCE OF WEB SITES FOR OTHERS; CREATION, DESIGN, DEVELOPMENT AND MAINTENANCE OF WEB SITES FOR THIRD PARTIES; CUSTOMIZATION OF COMPUTER HARDWARE AND SOFTWARE; CUSTOMIZED SOFTWARE DEVELOPMENT SERVICES; DATA AUTOMATION AND COLLECTION SERVICE USING PROPRIETARY SOFTWARE TO EVALUATE, ANALYZE AND COLLECT SERVICE DATA; DATA ENCRYPTION AND DECODING SERVICES; DATABASE DEVELOPMENT SERVICES; DESIGN AND CREATING WEB SITES FOR OTHERS; DESIGN AND DEVELOPMENT OF COMPUTER HARDWARE; DESIGN AND DEVELOPMENT OF COMPUTER HARDWARE AND SOFTWARE; DESIGN AND DEVELOPMENT OF COMPUTER SOFTWARE; DESIGN AND DEVELOPMENT OF COMPUTERS AND PROGRAMS FOR COMPUTERS; DESIGN AND DEVELOP-

**Reg. No. 4,197,098** MENT OF ON-LINE COMPUTER SOFTWARE SYSTEMS; DESIGN AND DEVELOPMENT OF WIRELESS COMPUTER NETWORKS; DESIGN AND MAINTENANCE OF COMPUTER SITES FOR THIRD PARTIES; DESIGN AND MAINTENANCE OF WEB SITES FOR OTHERS; DESIGN AND WRITING OF COMPUTER SOFTWARE; DESIGN OF HOME PAGES AND WEB SITES; DESIGN OF HOME PAGES, COMPUTER SOFTWARE AND WEB SITES; DESIGN OF HOMEPAGES AND WEBSITES; DESIGN, CREATION, HOSTING, MAINTENANCE OF WEBSITES FOR OTHERS; DESIGN, DEPLOYMENT AND MANAGEMENT OF WIRELESS NETWORKS FOR OTHERS; DESIGN, DEVELOPMENT AND IMPLEMENTATION OF SOFTWARE; DESIGN, DEVELOPMENT, AND CONSULTING SERVICES RELATED THERETO IN THE FIELD OF GRAPHIC DESIGN; DESIGN, DEVELOPMENT, INSTALLATION AND MAINTENANCE OF COMPUTER SOFTWARE; DESIGN, INSTALLATION, UPDATING AND MAINTENANCE OF COMPUTER SOFTWARE; DESIGN, MAINTENANCE, DEVELOPMENT AND UPDATING OF COMPUTER SOFTWARE; DESIGNING AND DEVELOPING WEBPAGES ON THE INTERNET; DESIGNING WEB PAGES FOR OTHERS; DESIGNING WEBSITES FOR ADVERTISING PURPOSES; DESIGNING WEBSITES FOR OTHERS; DESIGNING, CREATING, MAINTAINING, AND HOSTING ECOMMERCE WEBSITES FOR OTHERS; DEVELOPING AND UPDATING COMPUTER SOFTWARE; DEVELOPING COMPUTER SOFTWARE; DEVELOPMENT AND CREATION OF COMPUTER PROGRAMMES FOR DATA PROCESSING; DEVELOPMENT OF CUSTOMIZED SOFTWARE FOR OTHERS FOR USE IN RISK ASSESSMENT, INFORMATION SECURITY, BUSINESS ANALYSIS, AUDIT AND AUDIT PLANNING, AND SALES MANAGEMENT; DEVELOPMENT OF DATA PROCESSING PROGRAMS BY ORDER OF THIRD PARTIES; DEVELOPMENT OF SECURITY SYSTEMS AND CONTINGENCY PLANNING FOR INFORMATION SYSTEMS; DEVELOPMENT OF SOFTWARE FOR SECURE NETWORK OPERATIONS; DEVELOPMENT, DESIGN AND UPDATING OF HOME PAGES; DEVELOPMENT, UPDATING AND MAINTENANCE OF SOFTWARE AND DATA BASES; ELABORATION AND MAINTENANCE OF WEB SITES FOR THIRD PARTIES; GRAPHIC ART DESIGN; GRAPHIC ARTS DESIGNING; GRAPHIC DESIGN; GRAPHIC DESIGN SERVICES; GRAPHIC DESIGN SERVICES FOR CREATING GRAPHIC ELEMENTS OF CORPORATE LOGOS, MARKETING MATERIALS, ETC; HOMEPAGE AND WEBPAGE DESIGN; HOSTING THE SOFTWARE, WEBSITES AND OTHER COMPUTER APPLICATIONS OF OTHERS ON A VIRTUAL PRIVATE SERVER; INDUSTRIAL AND GRAPHIC ART DESIGN; INFORMATION TECHNOLOGY CONSULTATION; INSTALLATION AND MAINTENANCE OF COMPUTER SOFTWARE; INSTALLATION, MAINTENANCE AND REPAIR OF COMPUTER SOFTWARE; INSTALLATION, MAINTENANCE AND REPAIR OF SOFTWARE FOR COMPUTER SYSTEMS; INSTALLATION, REPAIR AND MAINTENANCE OF COMPUTER SOFTWARE; INTEGRATION OF COMPUTER SYSTEMS AND NETWORKS; IT CONSULTING SERVICES; IT INTEGRATION SERVICES; MAINTENANCE AND UPDATING OF COMPUTER SOFTWARE; MAINTENANCE AND UPGRADING OF COMPUTER SOFTWARE; MAINTENANCE OF COMPUTER SOFTWARE RELATING TO COMPUTER SECURITY AND PREVENTION OF COMPUTER RISKS; MAINTENANCE OF WEBSITES AND HOSTING ON-LINE WEB FACILITIES FOR OTHERS; MONITORING THE COMPUTER SYSTEMS OF OTHERS FOR TECHNICAL PURPOSES AND PROVIDING BACK-UP COMPUTER PROGRAMS AND FACILITIES; PLANNING, DESIGN AND IMPLEMENTATION OF COMPUTER TECHNOLOGIES FOR OTHERS; PLANNING, DESIGN AND MANAGEMENT OF INFORMATION TECHNOLOGY SYSTEMS; PLANNING, DESIGN, DEVELOPMENT, MAINTENANCE AND OPTIMIZATION OF ONLINE WEBSITES FOR THIRD PARTIES; PREPARATION, UPDATE, INSTALLATION AND MAINTENANCE OF COMPUTER SOFTWARE; PROCESSING OF VIDEO DATA, NAMELY, INTERPRETING VIDEO CONTENT AND IDENTIFYING SEGMENTS THAT CONTAIN PREDEFINED KEY EVENTS; PROFESSIONAL COMPUTER SERVICES, NAMELY, NETWORK ANALYSIS, LAN/WAN DESIGN, WIRELESS ENGINEERING, VIRTUALIZATION AND COMPUTER PROJECT MANAGEMENT; PROVIDING A WEB SITE THAT FEATURES INFORMATION ON COMPUTER TECHNOLOGY AND PROGRAMMING; REMOTE COMPUTER NETWORK TECHNICAL MONITORING AND SOFTWARE MAINTENANCE SERVICES; RESEARCH AND DEVELOPMENT OF COMPUTER SOFTWARE; RESEARCH IN THE FIELD OF INTELLIGENCE AND SECURITY TECHNOLOGY; RESEARCH, DEVELOPMENT, DESIGN AND UPGRADING OF COMPUTER SOFTWARE; SEARCHING AND RETRIEVING INFORMATION, SITES, AND OTHER RESOURCES AVAILABLE ON COMPUTER

**Reg. No. 4,197,098** NETWORKS FOR OTHERS; SOFTWARE DESIGN AND DEVELOPMENT; SOFTWARE DEVELOPMENT CONSULTING IN THE FIELD OF IT; SOFTWARE DEVELOPMENT FOR OTHERS IN THE FIELD OF SOFTWARE CONFIGURATION MANAGEMENT; TECHNICAL ADVICE RELATING TO OPERATION OF COMPUTERS; TECHNICAL SUPPORT SERVICES, NAMELY, 24X7 MONITORING OF NETWORK SYSTEMS, SERVERS AND WEB AND DATABASE APPLICATIONS AND NOTIFICATION OF RELATED EVENTS AND ALERTS; TECHNICAL SUPPORT SERVICES, NAMELY, INSTALLATION, ADMINISTRATION, AND TROUBLESHOOTING OF WEB AND DATABASE APPLICATIONS; TECHNICAL SUPPORT SERVICES, NAMELY, MIGRATION OF DATACENTER, SERVER AND DATABASE APPLICATIONS; TECHNICAL SUPPORT SERVICES, NAMELY, REMOTE ADMINISTRATION AND MANAGEMENT OF IN-HOUSE AND HOSTED DATACENTER DEVICES, DATABASES AND SOFTWARE APPLICATIONS; TECHNICAL SUPPORT SERVICES, NAMELY, REMOTE AND ON-SITE INFRASTRUCTURE MANAGEMENT SERVICES FOR MONITORING, ADMINISTRATION AND MANAGEMENT OF PUBLIC AND PRIVATE CLOUD COMPUTING IT AND APPLICATION SYSTEMS; TECHNICAL SUPPORT SERVICES, NAMELY, TECHNICAL ADMINISTRATION OF SERVERS FOR OTHERS AND TROUBLESHOOTING IN THE NATURE OF DIAGNOSING SERVER PROBLEMS; TECHNICAL SUPPORT SERVICES, NAMELY, TROUBLESHOOTING IN THE NATURE OF DIAGNOSING COMPUTER HARDWARE AND SOFTWARE PROBLEMS; TECHNICAL SUPPORT SERVICES, NAMELY, TROUBLESHOOTING OF COMPUTER SOFTWARE PROBLEMS; TECHNICAL SUPPORT, NAMELY, MONITORING OF NETWORK SYSTEMS; TESTING OF SECURITY SYSTEMS; TRACKING AND REPORTING OF ONLINE WEBSITE PERFORMANCE TO DETERMINE THE TECHNOLOGICAL EFFECTIVENESS OF THE WEBSITES FOR NON-BUSINESS PURPOSES; UPDATING AND DESIGN OF COMPUTER SOFTWARE; UPDATING AND MAINTENANCE OF COMPUTER SOFTWARE; UPDATING OF COMPUTER SOFTWARE RELATING TO COMPUTER SECURITY AND PREVENTION OF COMPUTER RISKS; WEB PUBLISHING, NAMELY, CREATING A WEBSITE AND UPLOADING IT ONTO AN INTERNET SERVER; WEB SITE DESIGN; WEB SITE DEVELOPMENT FOR OTHERS; WEBSITE DESIGN AND DEVELOPMENT FOR OTHERS; WEBSITE DEVELOPMENT FOR OTHERS; WEBSITE USABILITY TESTING SERVICES, IN CLASS 42 (U.S. CLS. 100 AND 101).

FIRST USE 8-15-1998; IN COMMERCE 9-1-1998.

THE MARK CONSISTS OF A STYLIZED LETTER "W" IN BLUE TO THE LEFT OF AN ORANGE SPHERE WITH WHITE HIGHLIGHTING. THE BACKGROUND OF THE ENTIRE MARK IS TRANSLUCENT.

THE COLOR(S) BLUE, WHITE, AND ORANGE IS/ARE CLAIMED AS A FEATURE OF THE MARK.

SER. NO. 85-390,473, FILED 8-5-2011.

JIM RINGLE, EXAMINING ATTORNEY

# United States of America

United States Patent and Trademark Office



**We Offer More Than You Think!!**

**Reg. No. 4,197,099**

PREMIER OFFICE & MEDICAL SUPPLIERS (D.C. LIMITED LIABILITY COMPANY)  
1020 49TH ST. NE  
WASHINGTON, DC 20019

**Registered Aug. 28, 2012**

**Int. Cl.: 35**

FOR: ON-LINE RETAIL STORE SERVICES FEATURING A WIDE VARIETY OF CONSUMER GOODS OF OTHERS, IN CLASS 35 (U.S. CLS. 100, 101 AND 102).

**SERVICE MARK**

FIRST USE 2-0-2007; IN COMMERCE 2-0-2007.

**PRINCIPAL REGISTER**

NO CLAIM IS MADE TO THE EXCLUSIVE RIGHT TO USE "PREMIER SUPPLIERS", APART FROM THE MARK AS SHOWN.

THE STIPPLING IS FOR SHADING PURPOSES ONLY.

THE MARK CONSISTS OF A DIAMOND PLATE IN THE BACKGROUND, THE OUTLINED WORD "PREMIER" SETTING OFF TO THE RIGHT, THE OUTLINED WORD "SUPPLIERS" IN THE DIAMOND PLATE UNDERNEATH THE "PREMIER", A CHECK MARK WITH ITS TAIL HOVERING OVER THE WORD "PREMIER", BEHIND THE HEAD (V) OF THE CHECK MARK IS A SLANTED SQUARE AND FILLED IN WITH A DIAMOND PLATE DESIGN, "PREMIER SUPPLIERS" ARE IN ALL CAPS, AND BELOW THE IMAGE IS "WE OFFER MORE THAN YOU THINK!!".

SER. NO. 85-390,503, FILED 8-5-2011.

STEPHANIE ALI, EXAMINING ATTORNEY



*David J. Kybas*

Director of the United States Patent and Trademark Office

# United States of America

United States Patent and Trademark Office

## Ride Your Own

**Reg. No. 4,197,100**

**Registered Aug. 28, 2012**

**Int. Cl.: 25**

**TRADEMARK**

**PRINCIPAL REGISTER**

VOJOA CLOTHING COMPANY, LLC (NEW JERSEY LIMITED LIABILITY COMPANY),  
DBA RYO (RIDEYOUROWN) CLOTHING COMPANY  
P O BOX 486  
KEARNY, NJ 07032

FOR: CLOTHING, NAMELY, SUITS, BELTS, GLOVES, SCARVES, TIES, JACKETS, WOVEN SHIRTS, TOPS, CARGO SHORTS, LEATHER BIKE JACKETS, COATS, DOWN JACKETS, POLO SHIRTS, BLAZERS, LONG SLEEVE SHIRTS, PULLOVERS, PANTS, TROUSERS, T-SHIRTS, SWEATERS, SWEAT-SHIRTS, RAIN JACKETS, RAIN PANTS, WIND PANTS, WIND SHIRTS, WIND SWEATERS, SOCKS, CAPS, HATS, GOLF BUCKET HATS, GOLF CAPS, GOLF SWEATERS, GOLF RAIN JACKETS, GOLF RAIN PANTS, GOLF WIND SWEATERS, RUNNING TIGHTS, TRAINING SHORTS, TENNIS PANTS, LAYETTES, BATHING SUITS, BATHING TRUNKS, BATH ROBES, BATHING CAPS, BANDANAS, MOTORISTS' CLOTHING, NAMELY, JACKETS, PANTS, GLOVES; STUFF JACKETS, SKULLCAPS, HOODS, NECKTIES, ASCOTS, CLOTH BIBS; CLOTHING OF LEATHER, NAMELY, JACKETS, PANTS, COATS, GLOVES; CLOTHING OF IMITATIONS OF LEATHER, NAMELY, JACKETS, PANTS, COATS, GLOVES; UNDERWEAR, SWEAT-ABSORBENT UNDERCLOTHES, CUFFS, PELISSES, DRESSING GOWNS, MUFFS; OUTER CLOTHING, NAMELY, JACKETS, COATS, CAPES; EAR MUFFS, JUMP SUITS; FURS, NAMELY, FUR COATS, FUR MUFFS; PETTICOATS, PARKAS, PAJAMAS; CYCLISTS' CLOTHING, NAMELY, SHORTS, WIND-RESISTANT JACKETS, TIGHTS, JERSEYS; WATERPROOF CLOTHING, NAMELY, JACKETS, RAIN BOOTS; SKIRTS, SARIS, COLLAR PROTECTORS, SASHES FOR WEAR, BREECHES FOR WEAR, HEADBANDS, SHAWLS; BEACH CLOTHES, NAMELY, BATHING SUITS, SANDALS, BIKINIS; GARTERS, STOCKINGS, SWEAT-ABSORBENT STOCKINGS, STOCKING SUSPENDERS, TIGHTS; KNITWEAR, NAMELY, SWEATERS, SCARVES; SINGLET, UNIFORMS, WET SUITS, WAISTCOATS; HATS, CAPS AND VISORS; BOOTS; SHOES; SLIPPERS ALL THE FOREGOING EXCLUDING CLOTHING AND FOOTWEAR DESIGNED OR PROMOTED SPECIFICALLY FOR WINTER SPORTS SUCH AS SKIING OR SNOWBOARDING, IN CLASS 25 (U.S. CLS. 22 AND 39).



FIRST USE 1-10-2009; IN COMMERCE 3-15-2010.

THE MARK CONSISTS OF STANDARD CHARACTERS WITHOUT CLAIM TO ANY PARTICULAR FONT, STYLE, SIZE, OR COLOR.

SER. NO. 85-391,060, FILED 8-5-2011.

*David J. Kappas*

Director of the United States Patent and Trademark Office

**Reg. No. 4,197,100** JACQUELINE A. LAVINE, EXAMINING ATTORNEY

# United States of America

United States Patent and Trademark Office

# M2Execution

**Reg. No. 4,197,101**

M2EXECUTION, INC. (ILLINOIS CORPORATION)

**Registered Aug. 28, 2012**

3644 ELIOT LN.  
NAPERVILLE, IL 60564

**Int. Cl.: 42**

FOR: PROVIDING TEMPORARY USE OF ON-LINE NON-DOWNLOADABLE SOFTWARE THAT ENABLES ON-DEMAND COACHING RELATED TO NEW BUSINESS DEVELOPMENT, SALES EXECUTION, SALES PERFORMANCE DEVELOPMENT, SALES LEADERSHIP DEVELOPMENT AND CHANGE MANAGEMENT, AND CONSULTING SERVICES RELATED THERETO, IN CLASS 42 (U.S. CLS. 100 AND 101).

**SERVICE MARK**

**PRINCIPAL REGISTER**

FIRST USE 3-31-2009; IN COMMERCE 6-30-2009.

THE MARK CONSISTS OF STANDARD CHARACTERS WITHOUT CLAIM TO ANY PARTICULAR FONT, STYLE, SIZE, OR COLOR.

SER. NO. 85-391,117, FILED 8-5-2011.

CURTIS FRENCH, EXAMINING ATTORNEY



*David J. Kyros*

Director of the United States Patent and Trademark Office



United States of America  
United States Patent and Trademark Office

M<sup>2</sup>eX

**Reg. No. 4,197,102**

M2EXECUTION, INC. (ILLINOIS CORPORATION)  
3644 ELIOT LN.  
NAPERVILLE, IL 60564

**Registered Aug. 28, 2012**

**Int. Cl.: 42**

FOR: PROVIDING TEMPORARY USE OF ON-LINE NON-DOWNLOADABLE SOFTWARE THAT ENABLES ON-DEMAND COACHING RELATED TO NEW BUSINESS DEVELOPMENT, SALES EXECUTION, SALES PERFORMANCE DEVELOPMENT, SALES LEADERSHIP DEVELOPMENT AND CHANGE MANAGEMENT, AND CONSULTING SERVICES RELATED THERETO, IN CLASS 42 (U.S. CLS. 100 AND 101).

**SERVICE MARK**

**PRINCIPAL REGISTER**

FIRST USE 6-30-2009; IN COMMERCE 7-31-2009.

THE MARK CONSISTS OF THE CHARACTERS "M" IN UPPERCASE AND IN BLACK, A SUPERSCRIPED "2" IN GOLD, WHICH CONNECTS TO A NON-SUPERSCRIPED LOWER CASE "E" IN GOLD, WHERE BOTH THE "2" AND THE "E" ARE SMALLER IN SIZE THAN THE "M", AND AN "X" IN UPPERCASE AND IN BLACK, WHERE THE "X" IS THE LARGEST CHARACTER OF THE FOUR.

THE COLOR(S) BLACK AND GOLD IS/ARE CLAIMED AS A FEATURE OF THE MARK.

SER. NO. 85-391,137, FILED 8-5-2011.

CURTIS FRENCH, EXAMINING ATTORNEY



*David J. Kyros*

Director of the United States Patent and Trademark Office

# United States of America

United States Patent and Trademark Office

## My Mobile Coach

**Reg. No. 4,197,103**

**Registered Aug. 28, 2012**

**Int. Cl.: 42**

**SERVICE MARK**

**PRINCIPAL REGISTER**

M2EXECUTION, INC. (ILLINOIS CORPORATION)  
3644 ELIOT LN.  
NAPERVILLE, IL 60564

FOR: PROVIDING TEMPORARY USE OF ON-LINE NON-DOWNLOADABLE SOFTWARE THAT ENABLES, THROUGH ACCESS BY MOBILE DEVICE, ON-DEMAND COACHING RELATED TO NEW BUSINESS DEVELOPMENT, SALES EXECUTION, SALES PERFORMANCE DEVELOPMENT, SALES LEADERSHIP DEVELOPMENT AND CHANGE MANAGEMENT, AND CONSULTING SERVICES RELATED THERETO, IN CLASS 42 (U.S. CLS. 100 AND 101).

FIRST USE 4-30-2009; IN COMMERCE 7-31-2009.

THE MARK CONSISTS OF STANDARD CHARACTERS WITHOUT CLAIM TO ANY PARTICULAR FONT, STYLE, SIZE, OR COLOR.

NO CLAIM IS MADE TO THE EXCLUSIVE RIGHT TO USE "MOBILE COACH", APART FROM THE MARK AS SHOWN.

SER. NO. 85-391,150, FILED 8-5-2011.

CURTIS FRENCH, EXAMINING ATTORNEY



*David J. Kypos*

Director of the United States Patent and Trademark Office

United States of America  
United States Patent and Trademark Office

M<sup>2</sup>Coach  
My Mobile Coach

**Reg. No. 4,197,104**

M2EXECUTION, INC. (ILLINOIS CORPORATION)

**Registered Aug. 28, 2012**

3644 ELIOT LN.  
NAPERVILLE, IL 60564

**Int. Cl.: 42**

FOR: PROVIDING TEMPORARY USE OF ON-LINE NON-DOWNLOADABLE SOFTWARE THAT ENABLES, THROUGH ACCESS BY MOBILE DEVICE, ON-DEMAND COACHING RELATED TO NEW BUSINESS DEVELOPMENT, SALES EXECUTION, SALES PERFORMANCE DEVELOPMENT, SALES LEADERSHIP DEVELOPMENT AND CHANGE MANAGEMENT, AND CONSULTING SERVICES RELATED THERETO, IN CLASS 42 (U.S. CLS. 100 AND 101).

**SERVICE MARK**

**PRINCIPAL REGISTER**

FIRST USE 10-31-2010; IN COMMERCE 11-30-2010.

NO CLAIM IS MADE TO THE EXCLUSIVE RIGHT TO USE "MOBILE COACH", APART FROM THE MARK AS SHOWN.

THE COLOR(S) BLACK AND GOLD IS/ARE CLAIMED AS A FEATURE OF THE MARK.

THE MARK CONSISTS OF TWO GENERAL HORIZONTAL TEXT LINES, ONE CONTAINING A BLACK UPPERCASE "M", A GOLD SUPERSCRIPED "2", A SUBSCRIPED BLACK UPPERCASE "C" AND THEN "OACH" IN BLACK, THE SECOND LINE CONTAINING ALL IN BLACK, UNDER THE FIRST LINE AND TO THE RIGHT OF THE "C" OF THE FIRST LINE THE PHRASE "MY MOBILE COACH", EACH WORD WITH AN INITIAL UPPERCASE. ABOVE THE FIRST LINE "C" ARE THREE HORIZONTAL BLACK DASHES.

SER. NO. 85-391,172, FILED 8-5-2011.

CURTIS FRENCH, EXAMINING ATTORNEY



David J. Kyjars

Director of the United States Patent and Trademark Office

United States of America  
United States Patent and Trademark Office

**CNT**  
**RACING**

**Reg. No. 4,197,105**

**Registered Aug. 28, 2012**

**Int. Cl.: 7**

**TRADEMARK**

**PRINCIPAL REGISTER**

ERZ INDUSTRIES LLC (CALIFORNIA LIMITED LIABILITY COMPANY)  
SUITE 3  
1680 WEST WINTON AVE  
HAYWARD, CA 94545

FOR: EXHAUST PIPES FOR LAND VEHICLES; HEADERS AS PART OF VEHICLE EXHAUST SYSTEM, IN CLASS 7 (U.S. CLS. 13, 19, 21, 23, 31, 34 AND 35).

FIRST USE 6-10-2010; IN COMMERCE 6-10-2010.

NO CLAIM IS MADE TO THE EXCLUSIVE RIGHT TO USE "RACING", APART FROM THE MARK AS SHOWN.

THE MARK CONSISTS OF THE STYLIZED TEXT "CNT" WITH A RECTANGLE AT THE BOTTOM AND THE STYLIZED TEXT "RACING".

SER. NO. 85-391,187, FILED 8-5-2011.

WILLIAM BRECKENFELD, EXAMINING ATTORNEY



*David J. Kybas*

Director of the United States Patent and Trademark Office

# United States of America

United States Patent and Trademark Office

## Lee Calhoun's 1/2 now 1/2 later bail bonds

**Reg. No. 4,197,106**

CALHOUN CASH ADVANCE (FLORIDA CORPORATION)  
1517 NW 23RD AVE.  
GAINESVILLE, FL 32605

**Registered Aug. 28, 2012**

**Int. Cl.: 36**

FOR: BAIL BONDING, IN CLASS 36 (U.S. CLS. 100, 101 AND 102).

**SERVICE MARK**

FIRST USE 1-1-2009; IN COMMERCE 1-1-2009.

**PRINCIPAL REGISTER**

THE MARK CONSISTS OF STANDARD CHARACTERS WITHOUT CLAIM TO ANY PARTICULAR FONT, STYLE, SIZE, OR COLOR.

NO CLAIM IS MADE TO THE EXCLUSIVE RIGHT TO USE "1/2 NOW 1/2 LATER BAIL BONDS", APART FROM THE MARK AS SHOWN.

THE NAME(S), PORTRAIT(S), AND/OR SIGNATURE(S) SHOWN IN THE MARK IDENTIFIES "LEE CALHOUN", WHOSE CONSENT(S) TO REGISTER IS MADE OF RECORD.

SER. NO. 85-391,403, FILED 8-6-2011.

LAKEISHA LEWIS, EXAMINING ATTORNEY



*David J. Kyffers*

Director of the United States Patent and Trademark Office

# United States of America

United States Patent and Trademark Office



**LAS PALOMAS**  
RESTAURANT-BAR

**Reg. No. 4,197,107**

**Registered Aug. 28, 2012**

**Int. Cl.: 43**

**SERVICE MARK**

**PRINCIPAL REGISTER**

LAS PALOMAS RESTAURANT & BAR, INC. (TEXAS CORPORATION)  
SUITE 122  
3201 BEE CAVES ROAD  
AUSTIN, TX 78746

FOR: RESTAURANT SERVICES, IN CLASS 43 (U.S. CLS. 100 AND 101).

FIRST USE 1-14-1982; IN COMMERCE 2-14-1983.

NO CLAIM IS MADE TO THE EXCLUSIVE RIGHT TO USE "RESTAURANT-BAR", APART FROM THE MARK AS SHOWN.

THE MARK CONSISTS OF A CIRCULAR DESIGN ELEMENT WITH FOUR CREASED CORNER ELEMENTS. WITHIN THE CIRCLE TWO DOVES NEST ON A BRANCH. THE WORDS "LAS PALOMAS RESTAURANT-BAR" APPEAR BELOW THE DOVES AS SHOWN.

THE ENGLISH TRANSLATION OF "PALOMAS" IN THE MARK IS "DOVES".

SER. NO. 85-391,944, FILED 8-8-2011.

BRIDGETT SMITH, EXAMINING ATTORNEY



*David J. Kybas*

Director of the United States Patent and Trademark Office

# United States of America

United States Patent and Trademark Office

## SAN DIEGO UNION-TRIBUNE

**Reg. No. 4,197,108**

**Registered Aug. 28, 2012**

**Int. Cl.: 16**

**TRADEMARK**

**PRINCIPAL REGISTER**

THE SAN DIEGO UNION-TRIBUNE, LLC (DELAWARE LIMITED LIABILITY COMPANY)  
350 CAMINO DE LA REINA  
SAN DIEGO, CA 921083090

FOR: NEWSPAPERS, IN CLASS 16 (U.S. CLS. 2, 5, 22, 23, 29, 37, 38 AND 50).

FIRST USE 2-2-1992; IN COMMERCE 2-2-1992.

THE MARK CONSISTS OF STANDARD CHARACTERS WITHOUT CLAIM TO ANY PARTICULAR FONT, STYLE, SIZE, OR COLOR.

SEC. 2(F) AS TO "SAN DIEGO".

SER. NO. 85-392,066, FILED 8-8-2011.

JAY BESCH, EXAMINING ATTORNEY



*David J. Kyffers*

Director of the United States Patent and Trademark Office

# United States of America

United States Patent and Trademark Office

# MINI-CAT

**Reg. No. 4,197,109**

**Registered Aug. 28, 2012**

**Int. Cl.: 9**

**TRADEMARK**

**PRINCIPAL REGISTER**

HALL RESEARCH TECHNOLOGIES, INC. (CALIFORNIA CORPORATION), DBA HALL  
RESEARCH  
1163 WARNER AVENUE  
TUSTIN, CA 92780

FOR: TRANSMITTERS AND RECEIVERS FOR AUDIO AND VIDEO SIGNALS FOR  
TRANSMISSION OVER TWISTED PAIR CABLES, IN CLASS 9 (U.S. CLS. 21, 23, 26, 36 AND  
38).

FIRST USE 9-4-2002; IN COMMERCE 1-22-2003.

THE MARK CONSISTS OF STANDARD CHARACTERS WITHOUT CLAIM TO ANY PAR-  
TICULAR FONT, STYLE, SIZE, OR COLOR.

SER. NO. 85-392,316, FILED 8-8-2011.

ANTHONY RINKER, EXAMINING ATTORNEY



*David J. Kybas*

Director of the United States Patent and Trademark Office



# United States of America

United States Patent and Trademark Office



**Reg. No. 4,197,110**

**Registered Aug. 28, 2012**

**Int. Cl.: 35**

**SERVICE MARK**

**PRINCIPAL REGISTER**

SALEM OFFICE OF TOURISM AND CULTURAL AFFAIRS, INC. (MASSACHUSETTS CORPORATION), DBA DESTINATION SALEM  
SALEM CITY HALL  
SALEM, MA 01970

FOR: PROMOTING RECREATION, TOURISM AND ECONOMIC DEVELOPMENT IN THE CITY OF SALEM, MASSACHUSETTS, IN CLASS 35 (U.S. CLS. 100, 101 AND 102).

FIRST USE 3-1-2011; IN COMMERCE 3-1-2011.

NO CLAIM IS MADE TO THE EXCLUSIVE RIGHT TO USE "SALEM", APART FROM THE MARK AS SHOWN.

THE MARK CONSISTS OF THE STYLIZED WORD SALEM, ABOVE WHICH APPEARS A STYLIZED SAILBOAT/WITCHES HAT, AND BELOW WHICH APPEARS THE WORDS STILL MAKING HISTORY.

SER. NO. 85-393,340, FILED 8-9-2011.

JASON TURNER, EXAMINING ATTORNEY



*David J. Kyffers*

Director of the United States Patent and Trademark Office

**United States of America**  
United States Patent and Trademark Office

# AfterShock

**Reg. No. 4,197,111**

RADIANS, INC. (TENNESSEE CORPORATION)  
5305 DISTRIplex FARMS DRIVE  
MEMPHIS, TN 381418231

**Registered Aug. 28, 2012**

**Int. Cl.: 9**

FOR: PROTECTIVE EYEWEAR FOR WORKPLACE SAFETY AND NOT FOR USE OR SALE IN FASHION OUTLETS; SAFETY EYEWEAR FOR WORKPLACE SAFETY AND NOT FOR USE OR SALE IN FASHION OUTLETS, IN CLASS 9 (U.S. CLS. 21, 23, 26, 36 AND 38).

**TRADEMARK**

FIRST USE 8-5-2011; IN COMMERCE 8-5-2011.

**PRINCIPAL REGISTER**

THE MARK CONSISTS OF STANDARD CHARACTERS WITHOUT CLAIM TO ANY PARTICULAR FONT, STYLE, SIZE, OR COLOR.

SER. NO. 85-393,554, FILED 8-9-2011.

WILLIAM JACKSON, EXAMINING ATTORNEY



*David J. Kyffers*

Director of the United States Patent and Trademark Office

# United States of America

United States Patent and Trademark Office



**Reg. No. 4,197,112**

**Registered Aug. 28, 2012**

**Int. Cl.: 25**

**TRADEMARK**

**PRINCIPAL REGISTER**

WOUNDED WARRIOR OUTDOORS, INC. (FLORIDA CORPORATION)  
1041 CROWN PARK CIRCLE  
WINTER GARDEN, FL 34787

FOR: CAPS; SWEATSHIRTS; T-SHIRTS, IN CLASS 25 (U.S. CLS. 22 AND 39).

FIRST USE 2-12-2010; IN COMMERCE 2-12-2010.

NO CLAIM IS MADE TO THE EXCLUSIVE RIGHT TO USE "OUTDOORS", APART FROM THE MARK AS SHOWN.

THE MARK CONSISTS OF THE STYLIZED TEXT "WOUNDED WARRIOR OUTDOORS" WITH A BEAR PAW AND A SILHOUETTE OF SALUTING SOLDIER IN THE CENTER.

SER. NO. 85-393,798, FILED 8-9-2011.

IRA J. GOODSaid, EXAMINING ATTORNEY



*David J. Kybas*

Director of the United States Patent and Trademark Office

# United States of America

United States Patent and Trademark Office

## MONTAUK ENERGY

**Reg. No. 4,197,113**

**Registered Aug. 28, 2012**

**Int. Cls.: 35, 37 and 40**

**SERVICE MARK**

**PRINCIPAL REGISTER**

MONTAUK ENERGY CAPITAL, LLC (DELAWARE LIMITED LIABILITY COMPANY)  
FOSTER PLAZA 10, 5TH FLOOR  
680 ANDERSEN DRIVE  
PITTSBURGH, PA 15220

FOR: OPERATION OF LANDFILL GAS RECOVERY SYSTEMS, COLLECTION SYSTEMS, FLARING FACILITIES, GAS PROCESSING FACILITIES, ELECTRIC GENERATION FACILITIES AND RENEWABLE FUEL FACILITIES FOR OTHERS; LANDFILL GAS WELL DRILLING FOR OTHERS; OPERATION OF RENEWABLE ENERGY GAS PROCESSING AND ELECTRIC GENERATION FACILITIES FOR OTHERS; AND OPERATION OF GAS WELL RECOVERY MACHINERY FOR OTHERS, IN CLASS 35 (U.S. CLS. 100, 101 AND 102).

FIRST USE 3-31-2000; IN COMMERCE 3-31-2000.

FOR: CONSTRUCTION OF LANDFILL GAS RECOVERY SYSTEMS, COLLECTION SYSTEMS, FLARING FACILITIES, GAS PROCESSING FACILITIES, ELECTRIC GENERATION FACILITIES AND RENEWABLE FUEL FACILITIES; LANDFILL GAS WELL DRILLING; MAINTENANCE OF RENEWABLE ENERGY GAS PROCESSING AND ELECTRIC GENERATION FACILITIES; AND MAINTENANCE OF GAS WELL RECOVERY MACHINERY, IN CLASS 37 (U.S. CLS. 100, 103 AND 106).

FIRST USE 3-31-2000; IN COMMERCE 3-31-2000.

FOR: LANDFILL GAS AND RENEWABLE BIOGAS REFINING, ENERGY PROCESSING AND TREATMENT SERVICES, IN CLASS 40 (U.S. CLS. 100, 103 AND 106).

FIRST USE 3-31-2000; IN COMMERCE 3-31-2000.

THE MARK CONSISTS OF STANDARD CHARACTERS WITHOUT CLAIM TO ANY PARTICULAR FONT, STYLE, SIZE, OR COLOR.

NO CLAIM IS MADE TO THE EXCLUSIVE RIGHT TO USE "ENERGY", APART FROM THE MARK AS SHOWN.

SER. NO. 85-394,202, FILED 8-10-2011.



*David J. Kypos*

Director of the United States Patent and Trademark Office

**Reg. No. 4,197,113** HENRY S. ZAK, EXAMINING ATTORNEY

# United States of America

United States Patent and Trademark Office



## World's Children

**Reg. No. 4,197,114**

**Registered Aug. 28, 2012**

**Int. Cl.: 36**

**SERVICE MARK**

**PRINCIPAL REGISTER**

WORLD'S CHILDREN (OREGON CHARITABLE, NON-PROFIT CORPORATION)  
P.O. BOX 2708  
CORVALLIS, OR 97339

FOR: ACCEPTING AND ADMINISTERING MONETARY CHARITABLE CONTRIBUTIONS; CHARITABLE FUNDRAISING; CHARITABLE SERVICES, NAMELY, PROVIDING FINANCIAL SUPPORT TO CHILDREN AND OTHER PEOPLE AROUND THE WORLD FOR THE PURPOSE OF FACILITATING EDUCATIONAL OPPORTUNITIES; CHARITABLE SERVICES, NAMELY, PROVIDING FINANCIAL SUPPORT TO DISADVANTAGED CHILDREN AND OTHER INDIVIDUALS AROUND THE WORLD FOR THE PURPOSE OF FACILITATING HEALTH, WELLNESS AND ECONOMIC DEVELOPMENT; SPONSORING ORPHANS IN THE NATURE OF CHARITABLE FUNDRAISING, IN CLASS 36 (U.S. CLS. 100, 101 AND 102).

FIRST USE 3-28-2009; IN COMMERCE 3-28-2009.

NO CLAIM IS MADE TO THE EXCLUSIVE RIGHT TO USE "WORLD'S CHILDREN", APART FROM THE MARK AS SHOWN.

THE MARK CONSISTS OF A STICK FIGURE IMAGE OF AN ADULT WITH ARMS OUTSTRETCHED OVER TWO CHILDREN WHO ARE REACHING TOWARDS A CENTRAL FIGURE. THE WORDS "WORLD'S CHILDREN" APPEAR ADJACENT TO THE IMAGE.

SER. NO. 85-394,356, FILED 8-10-2011.

SHAUNIA CARLYLE, EXAMINING ATTORNEY



*David J. Kyjars*

Director of the United States Patent and Trademark Office

# United States of America

United States Patent and Trademark Office

ROSSETTI Italy

**Reg. No. 4,197,115**

CONTRERAS, ANDRES (UNITED STATES INDIVIDUAL)  
PO BOX 431906  
MIAMI, FL 33243

**Registered Aug. 28, 2012**

**Int. Cl.: 12**

FOR: BICYCLE FRAMES; BICYCLE PARTS, NAMELY, HANDLE BAR STEMS; BICYCLE SADDLES; BICYCLE SEATS; BICYCLE WATER BOTTLE CAGES; BICYCLE WHEELS; BICYCLE WHEELS, RIMS AND STRUCTURAL PARTS THEREFOR; BICYCLES; FRAMES FOR BICYCLES; WATER BOTTLE CAGES FOR BICYCLES; WHEELS FOR BICYCLES AND CYCLES; ALL OF THE FOREGOING DESIGNED ENTIRELY IN ITALY, IN CLASS 12 (U.S. CLS. 19, 21, 23, 31, 35 AND 44).

**TRADEMARK**

**PRINCIPAL REGISTER**

FIRST USE 1-1-2011; IN COMMERCE 1-1-2011.

NO CLAIM IS MADE TO THE EXCLUSIVE RIGHT TO USE "ITALY", APART FROM THE MARK AS SHOWN.

SER. NO. 85-394,530, FILED S.R. 8-10-2011 AM. P.R. 4-13-2012.

JOHN WILKE, EXAMINING ATTORNEY



*David J. Kybas*

Director of the United States Patent and Trademark Office

# United States of America

United States Patent and Trademark Office

# MYECHAIN

**Reg. No. 4,197,116**

KRAUSE, MITCHEL (UNITED STATES INDIVIDUAL)  
86 ELKWOOD AVE

**Registered Aug. 28, 2012**

NEW PROVIDENCE, NJ 07974

**Int. Cls.: 9, 35 and 42**

FOR: SOFTWARE FOR PROCESSING ELECTRONIC PAYMENTS TO AND FROM OTHERS AND INSTRUCTIONS PROVIDED THEREWITH; SOFTWARE FOR PROVIDING SECURE COMMERCIAL TRANSACTIONS AND PAYMENT OPTIONS USING HANDHELD COMPUTERS OR MOBILE ELECTRONIC DEVICES AT A POINT OF SALE; USER AUTHENTICATION SOFTWARE; AUTHENTICATION SOFTWARE, NAMELY, SOFTWARE FOR USE IN AUTHENTICATING USER ACCOUNTS; SOFTWARE FOR PROVIDING ACCESS TO APPLICATIONS AND SERVICES THROUGH HANDHELD COMPUTERS AND MOBILE ELECTRONIC DEVICES FOR USE IN RETAIL SALES; COMPUTER SOFTWARE PLATFORMS FOR MOBILE ELECTRONIC DEVICES, NAMELY, SOFTWARE FOR UPLOADING, STORING, ORGANIZING AND MANAGING PERSONAL RETAIL CARD, MEMBERSHIP CARD, GIFT CARD, REWARD CARD AND CREDIT/DEBIT CARD INFORMATION; SOFTWARE FOR MANAGING PERSONAL RETAIL CARD, MEMBERSHIP CARDS, GIFT CARD, REWARD CARD AND CREDIT/DEBIT CARD INFORMATION THROUGH COMPUTER, MOBILE AND DATA NETWORKS, AND INSTRUCTIONS THEREFOR; SOFTWARE FOR ENABLING CONSUMERS TO MAKE PURCHASES WITH PERSONAL RETAIL CARDS, MEMBERSHIP CARDS, GIFT CARDS, REWARD CARDS AND CREDIT/DEBIT CARDS VIA HANDHELD COMPUTERS AND MOBILE ELECTRONIC DEVICES; SOFTWARE FOR READING BAR CODES AND QR CODES, IN CLASS 9 (U.S. CLS. 21, 23, 26, 36 AND 38).

**TRADEMARK**

**SERVICE MARK**

**PRINCIPAL REGISTER**



FIRST USE 5-21-2011; IN COMMERCE 5-21-2011.

FOR: PROMOTING THE SALE OF GOODS AND SERVICES OF OTHERS BY PROVIDING HYPERTEXT LINKS TO THE WEB SITES AND MOBILE APPLICATIONS OF OTHERS; PROVIDING SPECIAL OFFERS, PRICE COMPARISON INFORMATION, DISCOUNT INFORMATION AND COUPONS FOR PRODUCTS AND SERVICES FOR USE BY CONSUMERS; CONSUMER COMPARISON SHOPPING SERVICES THROUGH GLOBAL COMPUTER, MOBILE AND DATA NETWORKS; PROVIDING DATABASES CONTAINING CONSUMER INFORMATION RELATING TO PRODUCTS, SERVICES AND MERCHANTS; RATING SERVICES, NAMELY, REAL TIME ON-LINE CUSTOMIZED RATING OF BUSINESSES WHO OFFER GOODS AND SERVICES ON A GLOBAL COMPUTER NETWORK; CONDUCTING SURVEYS TO COMPILE DATA ABOUT BUSINESSES AND CONSUMERS; PROVIDING BUSINESS AND MARKET RESEARCH INFORMATION, NAMELY, BUSINESS AND MARKET RESEARCH REPORTS, IN CLASS 35 (U.S. CLS. 100, 101 AND 102).

*David J. Kyffers*

Director of the United States Patent and Trademark Office



**Reg. No. 4,197,116** FIRST USE 5-21-2011; IN COMMERCE 5-21-2011.

FOR: COMPUTER SOFTWARE DEVELOPMENT IN THE FIELD OF APPLICATIONS FOR COMPUTERS, MOBILE PHONES, SMART PHONES AND PORTABLE ELECTRONIC DEVICES; APPLICATION SERVICE PROVIDER, NAMELY, HOSTING, MANAGING, DEVELOPING, AND MAINTAINING APPLICATIONS, SOFTWARE, AND WEB SITES, IN THE FIELDS OF PERSONAL PRODUCTIVITY, WIRELESS COMMUNICATION, MOBILE INFORMATION ACCESS, MOBILE PAYMENTS AND REMOTE DATA MANAGEMENT FOR THE DELIVERY OF INFORMATION TO AND FROM COMPUTERS, MOBILE PHONES, SMART PHONES AND PORTABLE ELECTRONIC DEVICES; PROVIDING PRICE COMPARISONS CUSTOMIZED BASED ON THE KNOWN OR ESTIMATED GEOGRAPHICAL LOCATION OF INTERNET, MOBILE TELEPHONE OR OTHER WIRED OR WIRELESS DIGITAL NETWORK BASED CUSTOMER USERS; PROVIDING NON-DOWNLOADABLE COMPUTER SOFTWARE APPLICATIONS FOR MANAGING PERSONAL RETAIL CARD, MEMBERSHIP CARDS, GIFT CARD, REWARD CARD AND CREDIT/DEBIT CARD INFORMATION, VIA COMPUTER, MOBILE AND DATA NETWORKS; PLATFORM AS A SERVICE (PAAS) FEATURING COMPUTER SOFTWARE WEB-BASED PLATFORMS FOR UPLOADING, STORING, ORGANIZING AND MANAGING PERSONAL RETAIL CARD, MEMBERSHIP CARD, GIFT CARD, REWARD CARD AND CREDIT/DEBIT CARD INFORMATION, IN CLASS 42 (U.S. CLS. 100 AND 101).

FIRST USE 5-21-2011; IN COMMERCE 5-21-2011.

THE MARK CONSISTS OF STANDARD CHARACTERS WITHOUT CLAIM TO ANY PARTICULAR FONT, STYLE, SIZE, OR COLOR.

SER. NO. 85-394,776, FILED 8-10-2011.

KIM MONINGHOFF, EXAMINING ATTORNEY

# United States of America

United States Patent and Trademark Office

## WHITNEY STERN

**Reg. No. 4,197,117**

**Registered Aug. 28, 2012**

**Int. Cls.: 14 and 42**

**TRADEMARK**

**SERVICE MARK**

**PRINCIPAL REGISTER**

WHITNEY STERN JEWELRY DESIGN LLC (WASHINGTON LIMITED LIABILITY COMPANY)  
530 BROADWAY EAST, #129  
SEATTLE, WA 98154

FOR: JEWELRY, IN CLASS 14 (U.S. CLS. 2, 27, 28 AND 50).

FIRST USE 9-30-2010; IN COMMERCE 9-30-2010.

FOR: DESIGN FOR OTHERS IN THE FIELD OF CUSTOM JEWELRY, IN CLASS 42 (U.S. CLS. 100 AND 101).

FIRST USE 3-31-2011; IN COMMERCE 3-31-2011.

THE MARK CONSISTS OF STANDARD CHARACTERS WITHOUT CLAIM TO ANY PARTICULAR FONT, STYLE, SIZE, OR COLOR.

THE NAME "WHITNEY STERN" IDENTIFIES A LIVING INDIVIDUAL WHOSE CONSENT IS OF RECORD.

SER. NO. 85-394,981, FILED 8-10-2011.

EMILY CARLSEN, EXAMINING ATTORNEY



*David J. Kybas*

Director of the United States Patent and Trademark Office

# United States of America

United States Patent and Trademark Office

## Terrapin Crossroads

**Reg. No. 4,197,118**

**Registered Aug. 28, 2012**

**Int. Cl.: 41**

**SERVICE MARK**

**PRINCIPAL REGISTER**

LESH, PHILIP AND JILL (CALIFORNIA LIMITED LIABILITY COMPANY), DBA TERRAPIN  
CROSSROADS COMPANY  
862 SIR FRANCIS DRAKE BL. #236  
SAN ANSELMO, CA 94960

FOR: LIVE AND TELEVISED MUSIC PERFORMANCES AND ORGANIZATION AND  
PRODUCTION OF CULTURAL EVENTS , IN CLASS 41 (U.S. CLS. 100, 101 AND 107).

FIRST USE 7-15-2011; IN COMMERCE 7-15-2011.

THE MARK CONSISTS OF STANDARD CHARACTERS WITHOUT CLAIM TO ANY PAR-  
TICULAR FONT, STYLE, SIZE, OR COLOR.

SER. NO. 85-395,494, FILED 8-11-2011.

JASON TURNER, EXAMINING ATTORNEY



*David J. Kyffers*

Director of the United States Patent and Trademark Office

# United States of America

United States Patent and Trademark Office



**Reg. No. 4,197,119**

**Registered Aug. 28, 2012**

**Int. Cl.: 28**

**TRADEMARK**

**PRINCIPAL REGISTER**

ACEBUILDER, LLC (NEVADA LIMITED LIABILITY COMPANY)  
10001 PARK RUN DRIVE  
LAS VEGAS, NV 89145

FOR: SPORTS EQUIPMENT, NAMELY, A TENNIS TRAINING DEVICE, SPECIFICALLY, A TARGET FOR USE IN IMPROVING THE ACCURACY OF TENNIS SERVES, IN CLASS 28 (U.S. CLS. 22, 23, 38 AND 50).

FIRST USE 12-6-2010; IN COMMERCE 3-15-2011.

THE MARK CONSISTS OF THE FOLLOWING: THE WORD "ACEBUILDER" WITH THE LETTERS "ACE" BEING IN BLACK AND THE LETTERS "BUILDER" BEING IN GREEN; DEPICTED ABOVE THE WORD IS A SERIES OF BLACK DOTS GRADUATING IN SIZE WITH ONE GREEN AND WHITE TENNIS BALL DIRECTLY ABOVE THE LETTER "U".

THE COLOR(S) BLACK, GREEN AND WHITE IS/ARE CLAIMED AS A FEATURE OF THE MARK.

SER. NO. 85-396,053, FILED 8-11-2011.

TINA L. SNAPP, EXAMINING ATTORNEY



*David J. Kyffers*

Director of the United States Patent and Trademark Office

# United States of America

United States Patent and Trademark Office



**Reg. No. 4,197,120**

**Registered Aug. 28, 2012**

**Int. Cl.: 11**

**TRADEMARK**

**PRINCIPAL REGISTER**

RHYTHM CHINA LIMITED (HONG KONG LIMITED LIABILITY COMPANY)  
RM 745, 7/F  
NO. 1 TRADEMART DRIVE, KLN BAY, KL  
HONG KONG, HONG KONG

FOR: COLD CATHODE FLUORESCENT LAMP, IN CLASS 11 (U.S. CLS. 13, 21, 23, 31 AND 34).

PRIORITY CLAIMED UNDER SEC. 44(D) ON HONG KONG APPLICATION NO. 302000447, FILED 8-10-2011, REG. NO. 302000447, DATED 8-10-2011, EXPIRES 8-10-2021.

THE MARK CONSISTS OF A DRAWING OF A LIGHT BULB.

SER. NO. 85-396,114, FILED 8-12-2011.

ROSELLE HERRERA, EXAMINING ATTORNEY



*David J. Kybas*

Director of the United States Patent and Trademark Office

# United States of America

United States Patent and Trademark Office

# OSTEOMOLL

**Reg. No. 4,197,121**

MERCK KGAA (FED REP GERMANY KOMMANDITGESELLSCHAFT AUF AKTIEN (KGAA))  
FRANKFURTER STR. 250

**Registered Aug. 28, 2012**

64293 DARMSTADT, FED REP GERMANY

**Int. Cls.: 1 and 5**

FOR: CHEMICALS USED IN INDUSTRY AND SCIENCE FOR DECALCIFICATION OF HARD TISSUE, IN CLASS 1 (U.S. CLS. 1, 5, 6, 10, 26 AND 46).

**TRADEMARK**

FOR: CHEMICAL REAGENT MIXTURES CONSTITUTING PATHOLOGY TISSUE DECALCIFYING AGENTS FOR IN VITRO ANALYSIS FOR MEDICAL USE, IN CLASS 5 (U.S. CLS. 6, 18, 44, 46, 51 AND 52).

**PRINCIPAL REGISTER**

THE MARK CONSISTS OF STANDARD CHARACTERS WITHOUT CLAIM TO ANY PARTICULAR FONT, STYLE, SIZE, OR COLOR.

OWNER OF FED REP GERMANY REG. NO. 30224612, DATED 6-19-2002, RENEWED AS REG. NO. 30224612, EXPIRES 5-31-2022.

SER. NO. 85-396,285, FILED 8-12-2011.

JULIE GUTTADAURO, EXAMINING ATTORNEY



*David J. Kybas*

Director of the United States Patent and Trademark Office

# United States of America

United States Patent and Trademark Office

# OSTEOSOFT

**Reg. No. 4,197,122**

MERCK KGAA (FED REP GERMANY KOMMANDITGESELLSCHAFT AUF AKTIEN (KGAA))  
FRANKFURTER STR. 250

**Registered Aug. 28, 2012**

64293 DARMSTADT, FED REP GERMANY

**Int. Cls.: 1 and 5**

FOR: CHEMICALS USED IN INDUSTRY AND SCIENCE FOR DECALCIFICATION OF HARD TISSUE, IN CLASS 1 (U.S. CLS. 1, 5, 6, 10, 26 AND 46).

**TRADEMARK**

FOR: CHEMICAL REAGENT MIXTURES CONSTITUTING PATHOLOGY TISSUE DECALCIFYING AGENTS FOR IN VITRO ANALYSIS FOR MEDICAL USE, IN CLASS 5 (U.S. CLS. 6, 18, 44, 46, 51 AND 52).

**PRINCIPAL REGISTER**

THE MARK CONSISTS OF STANDARD CHARACTERS WITHOUT CLAIM TO ANY PARTICULAR FONT, STYLE, SIZE, OR COLOR.

OWNER OF FED REP GERMANY REG. NO. 30224613, DATED 6-19-2002, RENEWED AS REG. NO. 30224613, EXPIRES 5-31-2022.

SER. NO. 85-396,296, FILED 8-12-2011.

JULIE GUTTADAURO, EXAMINING ATTORNEY



*David J. Kybas*

Director of the United States Patent and Trademark Office

# United States of America

United States Patent and Trademark Office

# ORICO

**Reg. No. 4,197,123**

**Registered Aug. 28, 2012**

**Int. Cls.: 3, 4, 5 and 35**

**TRADEMARK**

**SERVICE MARK**

**PRINCIPAL REGISTER**

TRUE ORGANIC BRANDS LIMITED (ENGLAND COMPANY)  
3 LOCKS YARD HIGH STREET  
SEVENOAKS, KENT, UNITED KINGDOM TN131LT

FOR: NON-MEDICATED TOILETRIES, FOUNDATIONS, CONCEALERS, FACE POWDERS, BLUSHERS, LIP LINERS, LIP GLOSS, MASCARA, EYE SHADOW, EYE LINER, NAIL POLISH REMOVER, EYE CLEANSERS, FACE CLEANSERS, SKIN TONERS, SKIN EXFOLIATING SCRUBS, GEL EYE MASKS, FACIAL MASKS, MOISTURIZERS, EYE MAKE UP REMOVER, EYE CREAM, EYE GEL, LIP MOISTURIZERS, HAND CREAM, BODY LOTIONS, BODY WASHES, SHOWER GELS, NON-MEDICATED FOOT BALMS, BODY SCRUBS, DEODORANTS, MASSAGE OILS, ESSENTIAL OILS, FRAGRANCES, TALCUM POWDER, SOAP, BATH ESSENCES, SHAMPOO, CONDITIONER, HAIR STYLING PREPARATIONS, HAIR DYES, SUN TANNING PREPARATIONS, SHAVING PREPARATIONS, DENTIFRICES, FACIAL PACKS FOR COSMETIC PURPOSES, NAIL CARE PREPARATIONS, EMERY BOARDS, PUMICE STONES, COTTON STICKS AND WOOL FOR NON-MEDICAL PURPOSES, ALL FOR USE ON THE BODY; AROMATHERAPY PREPARATIONS, NAMELY, ESSENTIAL OILS FOR AROMATHERAPY USE; NON-MEDICATED BABY BATH CARE PREPARATIONS AND NON-MEDICATED BABY CARE PRODUCTS, NAMELY, BABY LOTIONS, BABY BUBBLE BATH, BABY SHAMPOO AND BABY HAIR CONDITIONER; ESSENTIAL OILS FOR USE IN AIR FRESHENERS; ROOM PERFUME SPRAYS; ANTI-PERSPIRANTS, IN CLASS 3 (U.S. CLS. 1, 4, 6, 50, 51 AND 52).

FOR: CANDLES AND WICKS FOR LIGHTING; SCENTED CANDLES, IN CLASS 4 (U.S. CLS. 1, 6 AND 15).

FOR: VITAMINS, VITAMIN PREPARATIONS, MINERAL SUPPLEMENTS; MINERAL PREPARATIONS, NAMELY, MINERAL NUTRITIONAL SUPPLEMENTS; FRAGRANT PREPARATIONS CONTAINED IN CERAMIC DIFFUSERS FOR DEODORISING THE AIR; ROOM AIR FRESHENERS, IN CLASS 5 (U.S. CLS. 6, 18, 44, 46, 51 AND 52).

FOR: MAIL ORDER, MAIL ORDER CATALOGUE, RETAIL STORE SERVICES, ONLINE RETAIL STORE SERVICES, AND SHOP-AT-HOME PARTIES FEATURING TOILETRIES, FOUNDATIONS, CONCEALERS, FACE POWDERS, BLUSHERS, LIP LINERS, LIP GLOSS, MASCARA, EYE SHADOW, EYE LINER, NAIL POLISH REMOVER, EYE CLEANSERS, FACE CLEANSERS, SKIN TONERS, EXFOLIATORS, EYE MASKS, FACE MASKS, MOISTURISERS, EYE MAKE UP REMOVER, EYE CREAM, EYE GEL, LIP MOISTURISERS, HAND CREAM, BODY LOTIONS, BODY WASHES, SHOWER GELS, FOOT BALMS, BODY



*David J. Kyros*

Director of the United States Patent and Trademark Office



**Reg. No. 4,197,123** SCRUBS, DEODORANTS, MASSAGE OILS, ESSENTIAL OILS, FRAGRANCES, TALCUM POWDER, SOAP, BATH ESSENCES, SHAMPOO, CONDITIONER, HAIR STYLING PREPARATIONS, HAIR DYES, SUN TANNING PREPARATIONS, SHAVING PREPARATIONS, DENTIFRICES, FACIAL PACKS, NAIL CARE PREPARATIONS, EMERY BOARDS, PUMICE STONES, COTTON STICKS AND WOOL FOR NON-MEDICAL PURPOSES, AROMATHERAPY PREPARATIONS, NON-MEDICATED BABY BATH PREPARATIONS, NON-MEDICATED BABY CARE PRODUCTS, BABY LOTIONS, ESSENTIAL OILS FOR USE IN AIR FRESHENERS, ROOM PERFUME SPRAYS, CANDLES AND WICKS FOR LIGHTING, SCENTED CANDLES, VITAMINS, VITAMIN PREPARATIONS, MINERALS, MINERAL PREPARATIONS, ANTI PERSPIRANTS, FRAGRANT PREPARATIONS CONTAINED IN CERAMIC DIFFUSERS FOR DEODORISING THE AIR, AND ROOM AIR FRESHENERS; PROVIDING BUSINESS ADVICE REGARDING MARKETING, PROMOTION, BUSINESS MANAGEMENT AND SALE OF PRODUCTS BY RETAIL, ONLINE RETAIL, MAIL ORDER, MAIL ORDER CATALOGUE, AND SHOP-AT-HOME PARTIES IN THE FIELD OF BEAUTY CARE, HEALTH AND FITNESS, IN CLASS 35 (U.S. CLS. 100, 101 AND 102).

THE MARK CONSISTS OF STANDARD CHARACTERS WITHOUT CLAIM TO ANY PARTICULAR FONT, STYLE, SIZE, OR COLOR.

PRIORITY CLAIMED UNDER SEC. 44(D) ON ERPN CMNTY TM OFC APPLICATION NO. 010145531, FILED 7-22-2011, REG. NO. 010145531, DATED 1-3-2012, EXPIRES 7-22-2021.

SER. NO. 85-396,494, FILED 8-12-2011.

ALEX KEAM, EXAMINING ATTORNEY

# United States of America

United States Patent and Trademark Office

# ZONDERVAN

**Reg. No. 4,197,124**

**Registered Aug. 28, 2012**

**Int. Cl.: 41**

**SERVICE MARK**

**PRINCIPAL REGISTER**

THE ZONDERVAN CORPORATION L.L.C. (DELAWARE LIMITED LIABILITY COMPANY)  
5300 PATTERSON AVENUE SE  
GRAND RAPIDS, MI 49530

FOR: BOOK PUBLISHING SERVICES, IN CLASS 41 (U.S. CLS. 100, 101 AND 107).

FIRST USE 0-0-1933; IN COMMERCE 0-0-1933.

THE MARK CONSISTS OF STANDARD CHARACTERS WITHOUT CLAIM TO ANY PARTICULAR FONT, STYLE, SIZE, OR COLOR.

OWNER OF U.S. REG. NO. 1,369,913.

SEC. 2(F).

SER. NO. 85-396,868, FILED 8-12-2011.

ANTHONY RINKER, EXAMINING ATTORNEY



*David J. Kyffers*

Director of the United States Patent and Trademark Office

# United States of America

United States Patent and Trademark Office

T L T

**Reg. No. 4,197,125**

TORAY KABUSHIKI KAISHA (TORAY INDUSTRIES, INC.) (JAPAN CORPORATION)  
1-1 NIHONBASHI-MUROMACHI 2-CHOME CHUO-KU  
TOKYO, JAPAN

**Registered Aug. 28, 2012**

**Int. Cl.: 17**

FOR: PLASTIC FILMS OTHER THAN FOR WRAPPING, IN CLASS 17 (U.S. CLS. 1, 5, 12, 13, 35 AND 50).

**TRADEMARK**

OWNER OF JAPAN REG. NO. 5461560, DATED 1-6-2012, EXPIRES 1-6-2022.

**PRINCIPAL REGISTER**

THE MARK CONSISTS OF THE LETTERS "T" AND "L" AND "T" WITH SPACE BETWEEN THE LETTERS IN A STYLIZED FORMAT.

SER. NO. 85-396,991, FILED 8-12-2011.

SHAILA SETTLES, EXAMINING ATTORNEY



*David J. Kyffers*

Director of the United States Patent and Trademark Office

# United States of America

United States Patent and Trademark Office



**Reg. No. 4,197,126**

**Registered Aug. 28, 2012**

**Int. Cl.: 17**

**TRADEMARK**

**PRINCIPAL REGISTER**

PARRISH ENTERPRISES, LTD. (OKLAHOMA CORPORATION)  
1414 E. WILLOW  
ENID, OK 73701

FOR: NON-METAL CAPS FOR PROTECTING END FITTINGS OF TANKER TRUCK HOSES,  
IN CLASS 17 (U.S. CLS. 1, 5, 12, 13, 35 AND 50).

FIRST USE 9-17-2007; IN COMMERCE 9-17-2007.

THE MARK CONSISTS OF AN IMAGE OF A TANKER TRUCK HOSE ARRANGED IN THE  
SHAPE OF THE LETTERS "S" AND "B" AND THE WORDS "SAFETY BUMP" BELOW THE  
IMAGE.

SER. NO. 85-397,031, FILED 8-12-2011.

DAVID ELTON, EXAMINING ATTORNEY



*David J. Kybas*

Director of the United States Patent and Trademark Office

# United States of America

United States Patent and Trademark Office

## GOLDEN GRAPE

**Reg. No. 4,197,127**

STARBUZZ TOBACCO, INC. (CALIFORNIA CORPORATION)  
2116 W. LINCOLN AVENUE  
ANAHEIM, CA 92801

**Registered Aug. 28, 2012**

**Int. Cl.: 34**

FOR: PIPE TOBACCO; MOLASSES TOBACCO; TOBACCO; SMOKING TOBACCO;  
FLAVORED TOBACCO, IN CLASS 34 (U.S. CLS. 2, 8, 9 AND 17).

**TRADEMARK**

FIRST USE 1-21-2009; IN COMMERCE 1-21-2009.

**PRINCIPAL REGISTER**

THE MARK CONSISTS OF STANDARD CHARACTERS WITHOUT CLAIM TO ANY PARTICULAR FONT, STYLE, SIZE, OR COLOR.

NO CLAIM IS MADE TO THE EXCLUSIVE RIGHT TO USE "GRAPE", APART FROM THE MARK AS SHOWN.

SER. NO. 85-397,170, FILED 8-12-2011.

RONALD MCMORROW, EXAMINING ATTORNEY



*David J. Kyffers*

Director of the United States Patent and Trademark Office

# United States of America

United States Patent and Trademark Office

## BOW WOW BUCKS

**Reg. No. 4,197,128**

**Registered Aug. 28, 2012**

**Int. Cls.: 28 and 35**

**TRADEMARK**

**SERVICE MARK**

**PRINCIPAL REGISTER**

CAMP BOW WOW DISTRIBUTION LLC (COLORADO LIMITED LIABILITY COMPANY)  
8820 W. 116TH CIRCLE, UNIT D  
BROOMFIELD, CO 80021

FOR: PLAY MONEY FOR USE IN CONNECTION WITH PET CARE FACILITIES, IN CLASS 28 (U.S. CLS. 22, 23, 38 AND 50).

FIRST USE 12-1-2010; IN COMMERCE 12-1-2010.

FOR: ISSUING GIFT CERTIFICATES WHICH MAY THEN BE REDEEMED FOR GOODS OR SERVICES; PROVIDING INCENTIVE AWARD PROGRAMS FOR CUSTOMERS AND EMPLOYEES THROUGH THE DISTRIBUTION OF PREPAID STORED VALUE CARDS FOR THE PURPOSE OF PROMOTING AND REWARDING LOYALTY, IN CLASS 35 (U.S. CLS. 100, 101 AND 102).

FIRST USE 10-1-2009; IN COMMERCE 10-1-2009.

THE MARK CONSISTS OF STANDARD CHARACTERS WITHOUT CLAIM TO ANY PARTICULAR FONT, STYLE, SIZE, OR COLOR.

NO CLAIM IS MADE TO THE EXCLUSIVE RIGHT TO USE "BUCKS", APART FROM THE MARK AS SHOWN.

SER. NO. 85-397,489, FILED 8-14-2011.

COURTNEY ALVAREZ, EXAMINING ATTORNEY



*David J. Kybas*

Director of the United States Patent and Trademark Office

# United States of America

United States Patent and Trademark Office

## EMATIC ESPORT CLIP

**Reg. No. 4,197,129**

SHAGAL, LTD. (CALIFORNIA CORPORATION)  
2231 COLBY AVENUE  
LOS ANGELES, CA 90064

**Registered Aug. 28, 2012**

**Int. Cl.: 9**

FOR: MP3 PLAYERS, TABLET PERSONAL COMPUTERS, COMPUTERS, HEADPHONES, HIGH DEFINITION MULTIMEDIA INTERFACE CABLES, EBOOK READERS, AUDIO ACCESSORIES, NAMELY, USB CABLES, AUX CABLES, MP3 MOUNTS, MP3 PLAYER CASES, MOBILE PHONE CASES; GAMING ACCESSORIES, NAMELY, ELECTRONIC CONTROLLERS, ELECTRIC CABLES, STANDS, AUDIO SPEAKERS, AND MOBILE PHONE HANDS FREE HEADSETS, IN CLASS 9 (U.S. CLS. 21, 23, 26, 36 AND 38).

**TRADEMARK**

**PRINCIPAL REGISTER**

FIRST USE 3-8-2011; IN COMMERCE 3-8-2011.

THE MARK CONSISTS OF STANDARD CHARACTERS WITHOUT CLAIM TO ANY PARTICULAR FONT, STYLE, SIZE, OR COLOR.

OWNER OF U.S. REG. NO. 3,810,020.

NO CLAIM IS MADE TO THE EXCLUSIVE RIGHT TO USE "CLIP" , APART FROM THE MARK AS SHOWN.

SER. NO. 85-398,128, FILED 8-15-2011.

PRISCILLA MILTON, EXAMINING ATTORNEY



*David J. Kyffers*

Director of the United States Patent and Trademark Office

# United States of America

United States Patent and Trademark Office

## URBAN SKINTRITION

**Reg. No. 4,197,130**

**Registered Aug. 28, 2012**

**Int. Cls.: 3 and 35**

**TRADEMARK**

**SERVICE MARK**

**PRINCIPAL REGISTER**

URBAN SKINTRITION LLC (CALIFORNIA LIMITED LIABILITY COMPANY)  
2351 SUNSET BOULEVARD, SUITE 170-650  
ROCKLIN, CA 95765

FOR: NON-MEDICATED SKIN CARE PREPARATIONS FOR STRETCH MARKS, IN CLASS 3 (U.S. CLS. 1, 4, 6, 50, 51 AND 52).

FIRST USE 7-26-2009; IN COMMERCE 7-26-2009.

FOR: ONLINE RETAIL STORE SERVICES FEATURING NON-MEDICATED SKIN CARE PREPARATIONS FOR STRETCH MARKS, IN CLASS 35 (U.S. CLS. 100, 101 AND 102).

FIRST USE 7-26-2009; IN COMMERCE 7-26-2009.

THE MARK CONSISTS OF STANDARD CHARACTERS WITHOUT CLAIM TO ANY PARTICULAR FONT, STYLE, SIZE, OR COLOR.

SER. NO. 85-398,868, FILED 8-16-2011.

JAY FLOWERS, EXAMINING ATTORNEY



*David J. Kyros*

Director of the United States Patent and Trademark Office



# United States of America

United States Patent and Trademark Office

## MAJESTIC CINEMA PRODUCTIONS

**Reg. No. 4,197,131**

**Registered Aug. 28, 2012**

**Int. Cls.: 40 and 41**

**SERVICE MARK**

**PRINCIPAL REGISTER**

DELLA RATTA, ANTHONY (UNITED STATES INDIVIDUAL)  
293 GANSEVOORT BOULEVARD  
STATEN ISLAND, NY 10314

FOR: ALTERATION AND RETOUCHING OF PHOTOGRAPHS; CUSTOM FABRICATION OF CONFECTION DISPLAYS FOR WEDDINGS, CELEBRATIONS, AND SPECIAL EVENTS; DEVELOPMENT OF PHOTOGRAPHIC FILMS; DIGITAL PHOTO PRINTING SERVICES; DIGITAL PRINTING; EMBOSSING SERVICES, NAMELY, EMBOSSING WORDS, DESIGNS OR IMAGES ON PHOTOGRAPHS; ENHANCEMENT OF PHOTOGRAPHS; FILM DEVELOPMENT AND REPRODUCTION OF PHOTOGRAPHS; FILM PROCESSING AND PHOTOFINISHING; PHOTO RESTORATION SERVICES; PHOTOFINISHING; PHOTOGRAPH DEVELOPING; PHOTOGRAPHIC ENLARGING; PHOTOGRAPHIC FILM DEVELOPING; PHOTOGRAPHIC FILM DEVELOPMENT; PHOTOGRAPHIC PRESERVATION; PHOTOGRAPHIC PRESERVATION AND CONSERVATION; PHOTOGRAPHIC PRINTING; PHOTOGRAPHIC PROCESSING; PHOTOGRAPHIC REPRODUCTION; PHOTOGRAPHIC RESTORATION; PHOTOGRAPHIC RETOUCHING; PHOTOGRAPHIC SLIDE AND/OR PRINT PROCESSING; PRINTING OF PHOTOGRAPHIC IMAGES FROM DIGITAL MEDIA; RENTAL OF MACHINES AND APPARATUS FOR FILM DEVELOPMENT, PHOTOGRAPH PRINTING, PHOTOGRAPH ENLARGEMENT OR PHOTOGRAPH FINISHING; RESTORATION AND/OR ENHANCEMENT OF PHOTOGRAPHS; RESTORATION OF PHOTOGRAPHS, IN CLASS 40 (U.S. CLS. 100, 103 AND 106).

FIRST USE 4-26-2010; IN COMMERCE 4-26-2010.



*David J. Kyffers*

Director of the United States Patent and Trademark Office

FOR: ARRANGING AND CONDUCTING NIGHTCLUB PARTIES; ARRANGING AND CONDUCTING SPECIAL EVENTS FOR SOCIAL ENTERTAINMENT PURPOSES; ARRANGING, ORGANIZING, CONDUCTING AND HOSTING BIRTHDAY PARTIES; AUDIO RECORDING AND PRODUCTION; CONSULTATION AND ADVICE REGARDING MUSICAL SELECTIONS AND ARRANGEMENTS FOR SOUND RECORDINGS AND LIVE PERFORMANCES; CONSULTATION IN THE FIELD OF SPECIAL EVENT PLANNING FOR SOCIAL ENTERTAINMENT PURPOSES; DIGITAL IMAGING SERVICES; DIGITAL VIDEO, AUDIO, AND MULTIMEDIA PUBLISHING SERVICES; DISC JOCKEYS FOR PARTIES AND SPECIAL EVENTS; EDITING OR RECORDING OF SOUNDS AND IMAGES; ENTERTAINMENT AND EDUCATION SERVICES IN THE NATURE OF LIVE DANCE AND MUSICAL PERFORMANCES; ENTERTAINMENT IN THE NATURE OF DANCE PERFORMANCES; ENTERTAINMENT IN THE NATURE OF THEATER PRODUCTIONS; ENTERTAINMENT MEDIA PRODUCTION SERVICES FOR MOTION PICTURES, TELEVISION AND INTERNET; ENTER-

**Reg. No. 4,197,131** TAINMENT SERVICES IN THE NATURE OF DEVELOPMENT, CREATION, PRODUCTION AND POST-PRODUCTION SERVICES OF MULTIMEDIA ENTERTAINMENT CONTENT; ENTERTAINMENT SERVICES IN THE NATURE OF LIVE MUSICAL PERFORMANCES; ENTERTAINMENT SERVICES IN THE NATURE OF PRESENTING LIVE MUSICAL PERFORMANCES; ENTERTAINMENT SERVICES IN THE NATURE OF RECORDING, PRODUCTION AND POST-PRODUCTION SERVICES IN THE FIELD OF MUSIC; ENTERTAINMENT SERVICES, NAMELY, CONDUCTING PARTIES; ENTERTAINMENT SERVICES, NAMELY, CONDUCTING PARTIES FOR THE PURPOSE OF DATING AND SOCIAL INTRODUCTION FOR ADULTS; ENTERTAINMENT SERVICES, NAMELY, MULTIMEDIA PRODUCTION SERVICES; ENTERTAINMENT SERVICES, NAMELY, PRODUCTION OF COMPUTER-GENERATED IMAGERY FOR USE IN MOTION PICTURES; ENTERTAINMENT SERVICES, NAMELY, PRODUCTION OF SPECIAL EFFECTS INCLUDING MODEL-MAKING SERVICES AND RELATED PHYSICAL PRODUCTION ELEMENTS FOR USE IN MOTION PICTURES; ENTERTAINMENT SERVICES, NAMELY, PROVIDING A WEB SITE FEATURING NON-DOWNLOADABLE MUSICAL PERFORMANCES, MUSICAL VIDEOS, RELATED FILM CLIPS, PHOTOGRAPHS, AND OTHER MULTIMEDIA MATERIALS FEATURING SPECIAL EVENTS AND WEDDINGS; ENTERTAINMENT SERVICES, NAMELY, PROVIDING A WEB SITE FEATURING PHOTOGRAPHIC AND PROSE PRESENTATIONS FEATURING SPECIAL EVENTS AND WEDDINGS; ENTERTAINMENT SERVICES, NAMELY, PROVIDING A WEB SITE FEATURING PHOTOGRAPHIC, AUDIO, VIDEO AND PROSE PRESENTATIONS FEATURING SPECIAL EVENTS AND WEDDINGS; ENTERTAINMENT SERVICES, NAMELY, PROVIDING A WEB SITE FEATURING PHOTOGRAPHIC, VIDEO AND PROSE PRESENTATIONS FEATURING SPECIAL EVENTS AND WEDDINGS; ENTERTAINMENT, NAMELY, LIVE PERFORMANCES BY A MUSICAL BAND; ENTERTAINMENT, NAMELY, PREPARATION OF SPECIAL EFFECTS; FILM AND VIDEO FILM PRODUCTION; FILM AND VIDEO PRODUCTION; FILM AND VIDEO PRODUCTION CONSULTING SERVICES; FILM AND VIDEO TAPE FILM PRODUCTION; FILM EDITING; FILM PRODUCTION; MASTER OF CEREMONY SERVICES FOR PARTIES AND SPECIAL EVENTS; MEDIA PRODUCTION LOCATION SCOUTING SERVICES FOR ENTERTAINMENT PURPOSES; MEDIA PRODUCTION SERVICES, NAMELY, VIDEO AND FILM PRODUCTION; MOTION PICTURE AND VIDEO RENTAL SERVICES; MOTION PICTURE FILM PRODUCTION; MOTION PICTURE SONG PRODUCTION; PARTY AND WEDDING PLANNING AND COORDINATION SERVICES; PARTY AND WEDDING PLANNING CONSULTATION SERVICES; PARTY AND WEDDING PLANNING, COORDINATION AND CONSULTATION SERVICES; PARTY PLANNING; PARTY PLANNING CONSULTATION; PERFORMANCE HALL RENTAL SERVICES; PHOTO EDITING; PHOTOGRAPHIC AND VIDEO SERVICES, NAMELY, PHOTOGRAPHIC AND VIDEO CAPTURE; PHOTOGRAPHIC COMPOSITION FOR OTHERS; PHOTOGRAPHIC COMPUTER IMAGING; PHOTOGRAPHIC REPORTING; PLANNING ARRANGEMENT OF SHOWING MOVIES, SHOWS, PLAYS OR MUSICAL PERFORMANCES; POST-PRODUCTION EDITING SERVICES IN THE FIELD OF MUSIC, VIDEOS AND FILM; PRESENTATION OF LIVE SHOW PERFORMANCES; PRESENTATION OF MUSICAL PERFORMANCE; PRODUCTION AND DISTRIBUTION OF MONOSCOPIC AND STEREOSCOPIC, ELECTRONIC, DIGITAL VIDEO AND FILM; PRODUCTION AND DISTRIBUTION OF MOTION PICTURES; PRODUCTION OF AUDIO RECORDING; PRODUCTION OF DVDS FEATURING SPECIAL EVENTS AND WEDDINGS; PRODUCTION OF DVDS, VIDEOTAPES AND TELEVISION PROGRAMS FEATURING SPECIAL EVENTS AND WEDDINGS; PRODUCTION OF FILMS; PRODUCTION OF MUSICAL SOUND RECORDING; PRODUCTION OF MUSICAL VIDEOS; PRODUCTION OF SOUND AND IMAGE RECORDINGS ON SOUND AND IMAGE CARRIERS; PRODUCTION OF SOUND RECORDINGS; PRODUCTION OF VISUAL EFFECTS FOR VIDEOS, DVDS, TELEVISION AND FOR INTERNET WEB SITES; PROVIDING A WEBSITE FOR ENTERTAINMENT PURPOSES WHERE USERS CAN VIEW AND POST VIDEOS AND PHOTOGRAPHS FEATURING SPECIAL EVENTS AND WEDDINGS; PROVIDING INFORMATION IN THE FIELD OF WEDDING PARTY PLANNING; PROVIDING INFORMATION REGARDING WEDDING PLANNING FOR WEDDING PARTIES; RENTAL AND COMPUTERIZED ON-LINE RENTAL SERVICES FEATURING INTERACTIVE SOFTWARE AND HARDWARE HOME ENTERTAINMENT AND CONSUMER ELECTRONICS IN THE NATURE OF MOTION PICTURES, FILMS, MOVIES, PRERECORDED DIGITAL VERSATILE DISCS (OR DVDS), PRERECORDED VIDEOTAPE CASSETTES, AUDIO, AUDIO

**Reg. No. 4,197,131** RECORDINGS IN A VARIETY OF GENRES; RENTAL OF MOTION PICTURE FILMS; RENTAL OF MOTION PICTURES AND OF SOUND RECORDINGS; RENTAL OF PHOTOGRAPHIC EQUIPMENT; SOCIAL CLUB SERVICES, NAMELY, ARRANGING, ORGANIZING, AND HOSTING SOCIAL EVENTS, GET-TOGETHERS, AND PARTIES FOR CLUB MEMBERS; SPECIAL EFFECTS ANIMATION SERVICES FOR FILM AND VIDEO; SPECIAL EVENT PLANNING FOR SOCIAL ENTERTAINMENT PURPOSES; VIDEO EDITING; VIDEO TAPE EDITING, IN CLASS 41 (U.S. CLS. 100, 101 AND 107).

FIRST USE 4-26-2010; IN COMMERCE 4-26-2010.

THE MARK CONSISTS OF STANDARD CHARACTERS WITHOUT CLAIM TO ANY PARTICULAR FONT, STYLE, SIZE, OR COLOR.

NO CLAIM IS MADE TO THE EXCLUSIVE RIGHT TO USE "CINEMA PRODUCTIONS", APART FROM THE MARK AS SHOWN.

SER. NO. 85-400,433, FILED 8-17-2011.

JACLYN KIDWELL WALKER, EXAMINING ATTORNEY

# United States of America

United States Patent and Trademark Office



**Reg. No. 4,197,132**

**Registered Aug. 28, 2012**

**Int. Cls.: 9, 15 and 20**

**TRADEMARK**

**PRINCIPAL REGISTER**

BRUNT, ANDREW (UNITED KINGDOM INDIVIDUAL)  
TOCH UNIT, MANOR COURT FARM, ASHURST RD.  
ASHURST, KENT, UNITED KINGDOM TN39TB

FOR: APPARATUS AND INSTRUMENTS FOR CONDUCTING, SWITCHING, TRANSFORMING, ACCUMULATING, REGULATING OR CONTROLLING ELECTRICITY; APPARATUS FOR RECORDING, TRANSMISSION OR REPRODUCTION OF SOUND OR IMAGES; MAGNETIC DATA CARRIERS; BLANK RECORDING DISCS; COMPUTER SOFTWARE FOR TESTING AND CALIBRATING AUDIO VISUAL EQUIPMENT; ELECTRIC CABLES; ELECTRICAL SWITCHES; ELECTRICAL PLUGS; ELECTRICAL SOCKETS; ELECTRICAL CONNECTIONS; ELECTRICAL TERMINALS; ELECTRICAL COMPONENTS, NAMELY, AC AND DC POWER PLUGS AND RECEPTACLES; ELECTRONIC COMPONENTS, NAMELY, AUDIO CONNECTORS; ELECTRICAL JACK SOCKETS; AUDIO AND ELECTRICAL WIRE BINDING POSTS; PUSH-BUTTON AND TOGGLE SWITCHES FOR SWITCHING AUDIO EQUIPMENT; DIECAST ZINC AND ALUMINUM ENCLOSURES FOR HOUSING AUDIO AND ELECTRONIC EQUIPMENT; AUDIO VISUAL APPARATUS AND INSTRUMENTS, NAMELY, AUDIO TEST AND DEMONSTRATION CDS AND ANALYZERS; PARTS AND FITTINGS FOR THE AFOREMENTIONED GOODS, IN CLASS 9 (U.S. CLS. 21, 23, 26, 36 AND 38).

FOR: STANDS AND CASES ADAPTED FOR MUSICAL INSTRUMENTS; PARTS AND FITTINGS FOR ELECTRIC MUSICAL INSTRUMENTS; PARTS AND FITTINGS FOR ELECTRONIC MUSICAL INSTRUMENTS, IN CLASS 15 (U.S. CLS. 2, 21 AND 36).

FOR: PARTS AND FITTINGS FOR CABINETS, NAMELY, PLASTIC STRAP HANDLES, LEATHER STRAP HANDLES, RECESSED METAL SPRING HANDLES, PLASTIC FEET, RUBBER FEET, PLASTIC POCKET HANDLES, METAL PROTECTIVE CORNERS, PLASTIC PROTECTIVE CORNERS, RECESSED PLATES, RECESSED METAL LATCHES, CASTERS, CASTER CUPS AND WHEELS, IN CLASS 20 (U.S. CLS. 2, 13, 22, 25, 32 AND 50).

OWNER OF ERPN CMNTY TM OFC REG. NO. 009232588, DATED 1-27-2011, EXPIRES 7-8-2020.

THE MARK CONSISTS OF A CIRCLE THAT DARKENS FROM TOP LEFT TO BOTTOM RIGHT. WITHIN THAT CIRCLE IS A SLIGHTLY SMALLER CIRCLE AND THE LETTERS "CHK" DESCENDING FROM TOP LEFT TO BOTTOM RIGHT.



*David J. Kybas*

Director of the United States Patent and Trademark Office

**Reg. No. 4,197,132** SER. NO. 85-401,178, FILED 8-18-2011.

THOMAS MANOR, EXAMINING ATTORNEY

# United States of America

United States Patent and Trademark Office



**Reg. No. 4,197,133**

**Registered Aug. 28, 2012**

**Int. Cls.: 12, 37 and 39**

**TRADEMARK**

**SERVICE MARK**

**PRINCIPAL REGISTER**

DAIMLER AG (FED REP GERMANY CORPORATION)  
MERCEDSSTRASSE 137  
STUTTGART, FED REP GERMANY 70327

FOR: AUTOMOBILES AND THEIR STRUCTURAL PARTS, IN CLASS 12 (U.S. CLS. 19, 21, 23, 31, 35 AND 44).

FOR: REPAIR, MAINTENANCE AND SERVICING OF VEHICLES, IN CLASS 37 (U.S. CLS. 100, 103 AND 106).

FOR: LEASING AND RENTING OF VEHICLES AND THEIR STRUCTURAL PARTS, IN CLASS 39 (U.S. CLS. 100 AND 105).

PRIORITY CLAIMED UNDER SEC. 44(D) ON FED REP GERMANY APPLICATION NO. 302011015132, FILED 3-14-2011, REG. NO. 302011015132, DATED 5-24-2011, EXPIRES 3-31-2021.

THE MARK CONSISTS OF A STYLIZED DEPICTION OF AN EXTERIOR SILHOUETTE OF A HOUSE WITHIN A SQUARE WITH CURVED CORNERS. TWO ARROWS POINTING IN OPPOSITE DIRECTIONS ARE SITUATED TO THE LEFT OF THE HOUSE. THE LOWER PORTION OF A TRANSLUCENT SEMICIRCLE APPEARS IN THE MIDDLE OF THE SQUARE IN THE BACKGROUND BEHIND THE HOUSE AND ARROWS. THE LOWER HALF OF THE SQUARE CONTAINS AN OUTLINE WHICH FADES AWAY AS IT APPROACHES THE TOP HALF OF THE SQUARE.

SER. NO. 85-401,250, FILED 8-18-2011.

GRETCHEN ULRICH, EXAMINING ATTORNEY



*David J. Kybas*

Director of the United States Patent and Trademark Office

# United States of America

United States Patent and Trademark Office



**Reg. No. 4,197,134**

**Registered Aug. 28, 2012**

**Int. Cl.: 37**

**SERVICE MARK**

**PRINCIPAL REGISTER**

CATCON GROUP, LLC (SOUTH CAROLINA LIMITED LIABILITY COMPANY)  
#165  
334 EAST BAY STREET  
CHARLESTON, SC 29401

FOR: CONTRACTING AND DISASTER RESTORATION SERVICES, NAMELY, WATER REMOVAL, DEHUMIDIFICATION, HOUSE AND BUILDING DEMOLITION AND REBUILDING SERVICES, IN CLASS 37 (U.S. CLS. 100, 103 AND 106).

FIRST USE 1-31-2007; IN COMMERCE 1-31-2007.

NO CLAIM IS MADE TO THE EXCLUSIVE RIGHT TO USE "CATASTROPHE CONTRACTING GROUP", APART FROM THE MARK AS SHOWN.

THE MARK CONSISTS OF A STYLIZED IMAGE OF A CONSTRUCTION WORKER WITH ARMS RAISED, WEARING A HARD HAT, APPEARING TO STAND ON TOP OF THE WORD "CATCON" IN WHITE, STYLIZED UPPERCASE LETTERS, WITH THE WORDS "CATASTROPHE CONTRACTING GROUP" IN SMALLER, BLACK, STYLIZED UPPERCASE LETTERS ACROSS THE BOTTOM.

SER. NO. 85-401,499, FILED 8-18-2011.

KATINA MISTER, EXAMINING ATTORNEY



*David J. Kyffers*

Director of the United States Patent and Trademark Office

# United States of America

United States Patent and Trademark Office

## Stitcher SmartRadio

**Reg. No. 4,197,135**

**Registered Aug. 28, 2012**

**Int. Cl.: 9**

**TRADEMARK**

**PRINCIPAL REGISTER**

STITCHER, INC. (CALIFORNIA CORPORATION)  
6TH FLOOR  
121 2ND STREET  
SAN FRANCISCO, CA 94105

FOR: COMPUTER SOFTWARE FOR USE IN LISTENING TO PODCASTS AND INTERNET RADIO, IN CLASS 9 (U.S. CLS. 21, 23, 26, 36 AND 38).

FIRST USE 4-30-2008; IN COMMERCE 4-30-2008.

THE MARK CONSISTS OF STANDARD CHARACTERS WITHOUT CLAIM TO ANY PARTICULAR FONT, STYLE, SIZE, OR COLOR.

OWNER OF U.S. REG. NO. 3,488,131.

SER. NO. 85-401,725, FILED 8-18-2011.

NANCY CLARKE, EXAMINING ATTORNEY



*David J. Kybas*

Director of the United States Patent and Trademark Office



# United States of America

United States Patent and Trademark Office

# NW Elixirs

**Reg. No. 4,197,136**

**Registered Aug. 28, 2012**

**Int. Cl.: 30**

**TRADEMARK**

**PRINCIPAL REGISTER**

NW ELIXIRS LLC (OREGON LIMITED LIABILITY COMPANY)  
#319  
814 NW 22ND AVENUE  
PORTLAND, OR 97210

FOR: BARBECUE SAUCE; BARBEQUE SAUCE; CHICKEN WING SAUCE; CHILI SAUCE; CONDIMENT, NAMELY, PEPPER SAUCE; COOKING SAUCES; DIPPING SAUCES; HOT CHILI PEPPER SAUCE; HOT SAUCE; MARINADE MIXES; MARINADES; PICANTE SAUCE; READY-MADE SAUCES; SAUCES; SAUCES FOR BARBECUED MEAT, IN CLASS 30 (U.S. CL. 46).

FIRST USE 6-1-2011; IN COMMERCE 6-24-2011.

THE MARK CONSISTS OF STANDARD CHARACTERS WITHOUT CLAIM TO ANY PARTICULAR FONT, STYLE, SIZE, OR COLOR.

SER. NO. 85-403,030, FILED 8-20-2011.

ANGELA DUONG, EXAMINING ATTORNEY



*David J. Kyffers*

Director of the United States Patent and Trademark Office

# United States of America

United States Patent and Trademark Office

## SCENE SETTERS

**Reg. No. 4,197,137**

**Registered Aug. 28, 2012**

**Int. Cl.: 16**

**TRADEMARK**

**PRINCIPAL REGISTER**

AMSCAN HOLDINGS, INC. (DELAWARE CORPORATION)  
80 GRASSLANDS ROAD  
ELMSFORD, NY 10523

FOR: POSTERS, IN CLASS 16 (U.S. CLS. 2, 5, 22, 23, 29, 37, 38 AND 50).

FIRST USE 3-0-2002; IN COMMERCE 3-0-2002.

THE MARK CONSISTS OF STANDARD CHARACTERS WITHOUT CLAIM TO ANY PARTICULAR FONT, STYLE, SIZE, OR COLOR.

SER. NO. 85-403,735, FILED 8-22-2011.

KELLY BOULTON, EXAMINING ATTORNEY



*David J. Kyffers*

Director of the United States Patent and Trademark Office

# United States of America

United States Patent and Trademark Office

# Peter Storm

**Reg. No. 4,197,138**

PETER STORM, INC (CALIFORNIA CORPORATION)  
411 BOREL AVE, SUITE 504  
SAN MATEO, CA 94402

**Registered Aug. 28, 2012**

**Int. Cl.: 14**

FOR: DIAMOND JEWELRY; GEMSTONE JEWELRY; JEWELRY, IN CLASS 14 (U.S. CLS. 2, 27, 28 AND 50).

**TRADEMARK**

FIRST USE 4-30-2010; IN COMMERCE 5-30-2010.

**PRINCIPAL REGISTER**

THE MARK CONSISTS OF STANDARD CHARACTERS WITHOUT CLAIM TO ANY PARTICULAR FONT, STYLE, SIZE, OR COLOR.

THE NAME "PETER STORM" IDENTIFIES A LIVING INDIVIDUAL WHOSE CONSENT IS OF RECORD.

SER. NO. 85-404,087, FILED 8-22-2011.

DOMINICK J. SALEMI, EXAMINING ATTORNEY



*David J. Kybas*

Director of the United States Patent and Trademark Office

# United States of America

United States Patent and Trademark Office

# ARIAN SIMONE

**Reg. No. 4,197,139**

REED, ARIAN SIMONE (UNITED STATES INDIVIDUAL)  
19521 RENFREW ST.  
DETROIT, MI 48221

**Registered Aug. 28, 2012**

**Int. Cl.: 3**

FOR: AROMATIC BODY CARE PRODUCTS, NAMELY, BODY LOTION, SHOWER GEL, CUTICLE CREAM, SHAMPOO, CONDITIONER, NON-MEDICATED LIP BALM, SOAP, BODY POLISH, BODY AND FOOT SCRUB AND NON-MEDICATED FOOT CREAM; BODY AND BEAUTY CARE COSMETICS; BODY BUTTER; BODY CREAM; BODY LOTION; BODY OILS; BODY SCRUB; COLOGNES, PERFUMES AND COSMETICS; COSMETICS AND MAKE-UP; COSMETICS IN GENERAL, INCLUDING PERFUMES; FRAGRANCED BODY CARE PREPARATIONS, NAMELY, BODY SCRUBS, BODY BUTTERS, BODY LOTIONS; MAKE-UP FOR THE FACE AND BODY; PERFUME OILS; PERFUMED CREAMS; PERFUMED SOAPS; SCENTED BODY LOTIONS AND CREAMS; SKIN AND BODY TOPICAL LOTIONS, CREAMS AND OILS FOR COSMETIC USE; SOAPS FOR BODY CARE , IN CLASS 3 (U.S. CLS. 1, 4, 6, 50, 51 AND 52).

**TRADEMARK**

**PRINCIPAL REGISTER**

FIRST USE 8-1-2011; IN COMMERCE 8-1-2011.

THE NAME(S), PORTRAIT(S), AND/OR SIGNATURE(S) SHOWN IN THE MARK IDENTIFIES "ARIAN SIMONE", WHOSE CONSENT(S) TO REGISTER IS MADE OF RECORD.

THE MARK CONSISTS OF THE WORDS "ARIAN SIMONE" OVER THE INITIALS "AS".

SER. NO. 85-404,121, FILED 8-22-2011.

FLORENTINA BLANDU, EXAMINING ATTORNEY



*David J. Kyffers*

Director of the United States Patent and Trademark Office

# United States of America

United States Patent and Trademark Office



**Reg. No. 4,197,140**

**Registered Aug. 28, 2012**

**Int. Cls.: 8 and 26**

**TRADEMARK**

**PRINCIPAL REGISTER**

WILLIAM PRYM GMBH & CO. KG (FED REP GERMANY LIMITED PARTNERSHIP)  
POSTFACH 1948  
STOLBERG, FED REP GERMANY D-52206

FOR: NEEDLE THREADERS, AFFIXING TOOLS IN THE NATURE OF HAND-HELD PUNCHES WHICH ADHERE BUTTONS TO MATERIAL WITHOUT SEWING, PLIERS FOR AFFIXING BUTTONS AND SCISSORS, IN CLASS 8 (U.S. CLS. 23, 28 AND 44).

FIRST USE 12-31-1963; IN COMMERCE 12-31-1975.

FOR: CHAIN LOOPS FOR COATS, DRESS FASTENINGS, NAMELY, DRESS HOOKS, SNAP FASTENERS AND ZIPPER FASTENERS OF METAL AND PLASTICS; CLOTHES CLASPS, BELT CLASPS, COAT FASTENERS, NAMELY, COAT SNAP HOOKS, STUD BUTTONS, ZIPPER FASTENERS, TOGGLE SLIDE FASTENERS AND SNAP BUTTONS; KNITTING NEEDLES, CROCHET HOOKS, NEEDLE CUSHIONS, NEEDLE CASES NOT OF PRECIOUS METAL, NEEDLES, SEWING NEEDLES, SEWING MACHINE NEEDLES, STRAIGHT PINS FOR SEWING, SAFETY PINS, CURLING PINS, SEWING NEEDLES FOR THE BLIND, BODKINS, NEEDLES FOR SEWING WITH THREAD, WAVING PINS FOR THE HAIR, HAIR PINS, SEWING NEEDLES WITH EYES OF ALL KIND, PACKING NEEDLES IN THE NATURE OF LARGE, SHARP-POINTED NEEDLES USED FOR SEWING UP CANVAS PACKAGES, SADDLERS' NEEDLES, SHOEMAKERS' NEEDLES, SAIL NEEDLES IN THE NATURE OF SEWING NEEDLES FOR MAKING SAILS, EMBROIDERING NEEDLES, DARNING NEEDLES, ZIP FASTENERS, CLOTHING BUTTONS, SNAP FASTENERS, FOUR-PIECE-SNAP-FASTENERS, THIMBLES, GARTER SNAP FASTENERS, BUCKLES FOR CLOTHES, HOOKS AND EYES, RIVET BUTTONS, UNDERWEAR BUTTONS, CLIPS FOR SUSPENDERS, IN CLASS 26 (U.S. CLS. 37, 39, 40, 42 AND 50).

FIRST USE 12-31-1963; IN COMMERCE 12-31-1975.

OWNER OF U.S. REG. NO. 1,654,725.

THE MARK CONSISTS OF THE TERM "PRYM" IN STYLIZED LETTERING INSIDE A RECTANGLE.

SER. NO. 85-404,708, FILED 8-23-2011.

ANDREA K. NADELMAN, EXAMINING ATTORNEY



*David J. Kyffers*

Director of the United States Patent and Trademark Office

# United States of America

United States Patent and Trademark Office



**Reg. No. 4,197,141**

**Registered Aug. 28, 2012**

**Int. Cl.: 30**

**TRADEMARK**

**PRINCIPAL REGISTER**

NW ELIXIRS LLC (OREGON LIMITED LIABILITY COMPANY)  
#319  
814 NW 22ND AVE  
PORTLAND, OR 97210

FOR: BARBECUE SAUCE; BARBEQUE SAUCE; CHICKEN WING SAUCE; CHILI SAUCE; CONDIMENT, NAMELY, PEPPER SAUCE; COOKING SAUCES; DIPPING SAUCES; HOT CHILI PEPPER SAUCE; HOT SAUCE; MARINADE MIXES; MARINADES; PICANTE SAUCE; READY-MADE SAUCES; SAUCES; SAUCES FOR BARBECUED MEAT, IN CLASS 30 (U.S. CL. 46).

FIRST USE 6-1-2011; IN COMMERCE 6-24-2011.

NO CLAIM IS MADE TO THE EXCLUSIVE RIGHT TO USE "1 HOT SAUCE 8 OZ", APART FROM THE MARK AS SHOWN.

SER. NO. 85-405,319, FILED 8-23-2011.

ANGELA DUONG, EXAMINING ATTORNEY



*David J. Kyffers*

Director of the United States Patent and Trademark Office

# United States of America

United States Patent and Trademark Office



**Reg. No. 4,197,142**

**Registered Aug. 28, 2012**

**Int. Cl.: 25**

**TRADEMARK**

**PRINCIPAL REGISTER**

CALIFORNIA MILK PROCESSOR BOARD (CALIFORNIA STATE INSTRUMENTALITY)  
SUITE 202  
101 SOUTH EL CAMINO REAL  
SAN CLEMENTE, CA 92672

FOR: T-SHIRTS, IN CLASS 25 (U.S. CLS. 22 AND 39).

FIRST USE 1-31-2000; IN COMMERCE 1-31-2000.

OWNER OF U.S. REG. NOS. 1,903,870, 3,902,992, AND 3,965,245.

THE COLOR(S) BLACK AND BROWN IS/ARE CLAIMED AS A FEATURE OF THE MARK.

THE MARK CONSISTS OF THE WORDING "GOT MILK?" IN BLACK LOWER CASE LETTERS IN A STYLIZED FONT WITH THE WORD "CHOCOLATE" IN BROWN CAPITAL LETTERS INSERTED WITH A CARET BETWEEN THE WORDS "GOT" AND "MILK".

SER. NO. 85-406,436, FILED 8-24-2011.

LINDA M. KING, EXAMINING ATTORNEY



*David J. Kyffers*

Director of the United States Patent and Trademark Office

# United States of America

United States Patent and Trademark Office

## Amped Apparel

**Reg. No. 4,197,143**

SINZ, ADAM (UNITED STATES INDIVIDUAL)  
301 GOODS ROAD  
CONESTOGA, PA 17516

**Registered Aug. 28, 2012**

**Int. Cl.: 25**

FOR: CLOTHING, NAMELY, T-SHIRTS, SWEATSHIRTS, HATS, AND TANK-TOPS, IN CLASS 25 (U.S. CLS. 22 AND 39).

**TRADEMARK**

FIRST USE 12-31-2008; IN COMMERCE 3-31-2009.

**PRINCIPAL REGISTER**

THE MARK CONSISTS OF STANDARD CHARACTERS WITHOUT CLAIM TO ANY PARTICULAR FONT, STYLE, SIZE, OR COLOR.

NO CLAIM IS MADE TO THE EXCLUSIVE RIGHT TO USE "APPAREL", APART FROM THE MARK AS SHOWN.

SER. NO. 85-406,915, FILED 8-25-2011.

NICHOLAS COLEMAN, EXAMINING ATTORNEY



*David J. Kybas*

Director of the United States Patent and Trademark Office



# United States of America

United States Patent and Trademark Office

## PULASKI MEAT

**Reg. No. 4,197,144**

**Registered Aug. 28, 2012**

**Int. Cls.: 29, 30 and 40**

**TRADEMARK**

**SERVICE MARK**

**PRINCIPAL REGISTER**

PULASKI MEAT PRODUCTS COMPNAY, INCORPORATED (NEW JERSEY CORPORATION)  
123 NORTH WOOD AVENUE  
LINDEN, NJ 07036

FOR: BACON; BEEF; BEEF JERKY; BEEF PATTIES; BLOOD SAUSAGE; BOLOGNA; EDIBLE FATS; FRANKFURTERS; HAM; HEAD CHEESE; HOT DOGS; KNOCKWURST; LIVER; LIVER PATE; LUNCHEON MEATS; MEAT; MEAT, FISH, POULTRY AND GAME; MEAT, FROZEN; PACKAGED MEATS; PORK; PORK CUTLETS; PORK RINDS; PREPARED BEEF; PREPARED MEAT; PRESERVED MEATS AND SAUSAGES; PROCESSED MEAT; PROCESSED MEAT, NAMELY, HAM, SMOKED SAUSAGES, PORK, BEEF, LIVER; ROAST BEEF; SALTED MEAT; SAUSAGES; SEASONED MEAT; SLICED MEAT; UNCOOKED SAUSAGES, IN CLASS 29 (U.S. CL. 46).

FIRST USE 0-0-1964; IN COMMERCE 0-0-1964.

FOR: HAM GLAZE, IN CLASS 30 (U.S. CL. 46).

FIRST USE 0-0-1964; IN COMMERCE 0-0-1964.

FOR: FOOD SMOKING, IN CLASS 40 (U.S. CLS. 100, 103 AND 106).

FIRST USE 0-0-1964; IN COMMERCE 0-0-1964.

THE MARK CONSISTS OF STANDARD CHARACTERS WITHOUT CLAIM TO ANY PARTICULAR FONT, STYLE, SIZE, OR COLOR.

NO CLAIM IS MADE TO THE EXCLUSIVE RIGHT TO USE "MEAT", APART FROM THE MARK AS SHOWN.

SEC. 2(F).

SER. NO. 85-407,014, FILED 8-25-2011.

NAKIA HENRY, EXAMINING ATTORNEY



*David J. Kyffers*

Director of the United States Patent and Trademark Office

# United States of America

United States Patent and Trademark Office



*your partner in food safety*

**Reg. No. 4,197,145**

**Registered Aug. 28, 2012**

**Int. Cl.: 3**

**TRADEMARK**

**PRINCIPAL REGISTER**

BIRKO CORPORATION (COLORADO CORPORATION)  
9152 YOSEMITE STREET  
HENDERSON, CO 80640

FOR: CLEANERS AND FOAM CLEANERS FOR USE IN MEAT-PACKING AND FOOD PROCESSING PLANTS; LAUNDRY PRODUCTS, NAMELY, BLEACHES AND DETERGENTS, IN CLASS 3 (U.S. CLS. 1, 4, 6, 50, 51 AND 52).

FIRST USE 4-15-2011; IN COMMERCE 4-15-2011.

THE MARK CONSISTS OF THE WORD "BIRKO" CENTERED INSIDE A SPHERE WHICH IS ENCOMPASSED BY THREE ARROWS AND CONTAINS THE WORDS "YOUR PARTNER IN FOOD SAFETY" DIRECTLY BELOW THE SPHERE.

SER. NO. 85-407,068, FILED 8-25-2011.

MIDGE BUTLER, EXAMINING ATTORNEY



*David J. Kybas*

Director of the United States Patent and Trademark Office

# United States of America

United States Patent and Trademark Office

## TECH BRIEFCASE

**Reg. No. 4,197,146**

**Registered Aug. 28, 2012**

**Int. Cl.: 9**

**TRADEMARK**

**PRINCIPAL REGISTER**

INTERNATIONAL DATA GROUP, INC. (MASSACHUSETTS CORPORATION)  
2ND FL. LEGAL DEPT  
5 SPEEN ST.  
FRAMINGHAM, MA 01701

FOR: DOWNLOADABLE COMPUTER SOFTWARE APPLICATION FOR DOWNLOADING WHITE PAPERS AND DIGITAL CONTENT IN THE FIELDS OF COMPUTERS, COMPUTER SOFTWARE, HIGH TECHNOLOGY, INFORMATION TECHNOLOGY, ONLINE IT SERVICES OF OTHERS, COMPUTER SECURITY, TELECOMMUNICATIONS, COMMUNICATIONS, AND INFORMATION SERVICES OF OTHERS WHICH ALLOWS USERS TO ACCESS DOWNLOADED CONTENT VIA A MOBILE DEVICE, PORTABLE DIGITAL DEVICE OR VIA A WEBSITE, IN CLASS 9 (U.S. CLS. 21, 23, 26, 36 AND 38).

FIRST USE 3-31-2011; IN COMMERCE 3-31-2011.

THE MARK CONSISTS OF STANDARD CHARACTERS WITHOUT CLAIM TO ANY PARTICULAR FONT, STYLE, SIZE, OR COLOR.

NO CLAIM IS MADE TO THE EXCLUSIVE RIGHT TO USE "TECH", APART FROM THE MARK AS SHOWN.

SER. NO. 85-407,070, FILED 8-25-2011.

MYRIAH HABEEB, EXAMINING ATTORNEY



*David J. Kyffers*

Director of the United States Patent and Trademark Office

# United States of America

United States Patent and Trademark Office

## REVERSE TRANSFERENCE PAINTING Painting beyond the brush

**Reg. No. 4,197,147**

**Registered Aug. 28, 2012**

**Int. Cl.: 41**

**SERVICE MARK**

**PRINCIPAL REGISTER**

DOLBERG SONIA (UNITED STATES INDIVIDUAL), AKA DOLBERG SUNNY  
945 SHEPARD CREST DR  
CORONA, CA 92882

FOR: CONDUCTING WORKSHOPS AND SEMINARS IN MUSEUMS AND PRIVATE ART SCHOOLS; CONDUCTING EDUCATIONAL EXHIBITIONS IN THE FIELD OF ART , IN CLASS 41 (U.S. CLS. 100, 101 AND 107).

FIRST USE 7-1-2011; IN COMMERCE 7-1-2011.

THE MARK CONSISTS OF STANDARD CHARACTERS WITHOUT CLAIM TO ANY PARTICULAR FONT, STYLE, SIZE, OR COLOR.

NO CLAIM IS MADE TO THE EXCLUSIVE RIGHT TO USE "REVERSE TRANSFERENCE PAINTING", APART FROM THE MARK AS SHOWN.

SER. NO. 85-407,203, FILED 8-25-2011.

INGA ERVIN, EXAMINING ATTORNEY



*David J. Kyfos*

Director of the United States Patent and Trademark Office

# United States of America

United States Patent and Trademark Office

# SunSense

**Reg. No. 4,197,148**

**Registered Aug. 28, 2012**

**Int. Cl.: 3**

**TRADEMARK**

**PRINCIPAL REGISTER**

NORTH AMERICAN MEDICAL SERVICES INC. (CANADA CORPORATION)  
P.O. BOX 48228  
BENTALL CENTRE  
VANCOUVER, B.C., CANADA V7X1N8

FOR: SUN SCREEN PREPARATIONS, IN CLASS 3 (U.S. CLS. 1, 4, 6, 50, 51 AND 52).

FIRST USE 0-0-2001; IN COMMERCE 0-0-2001.

THE MARK CONSISTS OF STANDARD CHARACTERS WITHOUT CLAIM TO ANY PARTICULAR FONT, STYLE, SIZE, OR COLOR.

SER. NO. 85-407,720, FILED 8-25-2011.

WON TEAK OH, EXAMINING ATTORNEY



*David J. Kyffers*

Director of the United States Patent and Trademark Office

# United States of America

United States Patent and Trademark Office

# ENDAVO

**Reg. No. 4,197,149**

**Registered Aug. 28, 2012**

**Int. Cl.: 42**

**SERVICE MARK**

**PRINCIPAL REGISTER**

ENDAVO MEDIA AND COMMUNICATIONS, INC. (DELAWARE CORPORATION)  
555 NORTH POINT CENTER EAST, 4TH FLOOR  
ALPHARETTA, GA 30022

FOR: PLATFORM AS A SERVICE (PAAS) FEATURING COMPUTER SOFTWARE PLATFORMS FOR HOSTING AND DELIVERING DIGITAL MEDIA CONTENT ON THE INTERNET, IN CLASS 42 (U.S. CLS. 100 AND 101).

FIRST USE 0-0-2004; IN COMMERCE 0-0-2004.

THE MARK CONSISTS OF STANDARD CHARACTERS WITHOUT CLAIM TO ANY PARTICULAR FONT, STYLE, SIZE, OR COLOR.

THE WORD(S) "ENDAVO" HAS NO MEANING IN A FOREIGN LANGUAGE.

SER. NO. 85-408,234, FILED 8-26-2011.

WILLIAM ROSSMAN, EXAMINING ATTORNEY



*David J. Kyffers*

Director of the United States Patent and Trademark Office

# United States of America

United States Patent and Trademark Office

# TZ MEDICAL

**Reg. No. 4,197,150**

**Registered Aug. 28, 2012**

**Int. Cls.: 5 and 10**

**TRADEMARK**

**PRINCIPAL REGISTER**

TZ MEDICAL, INC. (OREGON CORPORATION)  
7272 S.W. DURHAM RD., STE. 800  
PORTLAND, OR 97224

FOR: MEDICAL DRESSINGS; WOUND DRESSINGS, IN CLASS 5 (U.S. CLS. 6, 18, 44, 46, 51 AND 52).

FIRST USE 6-13-2003; IN COMMERCE 6-13-2003.

FOR: MEDICAL EQUIPMENT, CONSISTING OF MEDICAL DEVICES THAT PROVIDE DETECTION, RECORDING AND TRANSMISSION OF INFORMATION RELATING TO CARDIAC ARRHYTHMIA; CARDIAC RADIOTRANSSPARENT DEFIBRILLATION PADS; CARDIAC RADIOTRANSLUCENT DEFIBRILLATION PADS; ELECTRODES; CARDIAC ELECTRODES; ELECTRODES FOR MEDICAL USE; MEDICAL ELECTRODES; CARDIAC DEFIBRILLATION PADS; MEDICAL EQUIPMENT ACCESSORIES, NAMELY, ELECTRO-DIAGNOSTIC AUTOMATED CONSTANT CURRENT SINUSOID WAVEFORM NEUROSELECTIVE SENSORY NERVE TESTING DEVICES, NAMELY, DISPOSABLE ELECTRODES; CATHETERS; CATHETERS AND PARTS AND FITTINGS THEREFOR; INTRACARDIAC CATHETER; MEDICAL AND SURGICAL CATHETERS; TRANSSEPTAL NEEDLES; ARM BOARDS; AND DISTRACTION PINS, IN CLASS 10 (U.S. CLS. 26, 39 AND 44).

FIRST USE 3-26-1992; IN COMMERCE 3-26-1992.

THE MARK CONSISTS OF STANDARD CHARACTERS WITHOUT CLAIM TO ANY PARTICULAR FONT, STYLE, SIZE, OR COLOR.

NO CLAIM IS MADE TO THE EXCLUSIVE RIGHT TO USE "MEDICAL", APART FROM THE MARK AS SHOWN.

SER. NO. 85-408,342, FILED 8-26-2011.

KEVON CHISOLM, EXAMINING ATTORNEY



*David J. Kypos*

Director of the United States Patent and Trademark Office

# United States of America

United States Patent and Trademark Office

## ROSEANNE'S NUTS

**Reg. No. 4,197,151**

**Registered Aug. 28, 2012**

**Int. Cl.: 41**

**SERVICE MARK**

**PRINCIPAL REGISTER**

THE TRUSTEES OF THE ROSEANNE LIVING TRUST (CALIFORNIA TRUST)  
C/O FOX LAW GROUP  
14724 VENTURA BLVD., PENTHOUSE  
SHERMAN OAKS, CA 914033513

FOR: ENTERTAINMENT IN THE NATURE OF A REALITY BASED TELEVISION SERIES,  
IN CLASS 41 (U.S. CLS. 100, 101 AND 107).

FIRST USE 7-13-2011; IN COMMERCE 7-13-2011.

THE MARK CONSISTS OF STANDARD CHARACTERS WITHOUT CLAIM TO ANY PAR-  
TICULAR FONT, STYLE, SIZE, OR COLOR.

THE NAME(S), PORTRAIT(S), AND/OR SIGNATURE(S) SHOWN IN THE MARK IDENTIFIES  
"ROSEANNE BARR", WHOSE CONSENT(S) TO REGISTER IS MADE OF RECORD.

SER. NO. 85-408,406, FILED 8-26-2011.

BARBARA GAYNOR, EXAMINING ATTORNEY



*David J. Kybas*

Director of the United States Patent and Trademark Office



# United States of America

United States Patent and Trademark Office

## The Fertility Center of Las Vegas

**Reg. No. 4,197,152**

**Registered Aug. 28, 2012**

**Int. Cl.: 44**

**SERVICE MARK**

**PRINCIPAL REGISTER**

FERTILITY CENTER OF LAS VEGAS, LLP (NEVADA LIMITED PARTNERSHIP)  
100  
8851 W. SAHARA AVE.  
LAS VEGAS, NV 89117

FOR: HUMAN FERTILITY TREATMENT SERVICES; MEDICAL SERVICES, NAMELY, IN VITRO FERTILIZATION, IN CLASS 44 (U.S. CLS. 100 AND 101).

FIRST USE 12-29-2005; IN COMMERCE 12-29-2005.

THE MARK CONSISTS OF STANDARD CHARACTERS WITHOUT CLAIM TO ANY PARTICULAR FONT, STYLE, SIZE, OR COLOR.

NO CLAIM IS MADE TO THE EXCLUSIVE RIGHT TO USE "FERTILITY CENTER", APART FROM THE MARK AS SHOWN.

SEC. 2(F).

SER. NO. 85-408,416, FILED 8-26-2011.

JAY BESCH, EXAMINING ATTORNEY



*David J. Kyffers*

Director of the United States Patent and Trademark Office

# United States of America

United States Patent and Trademark Office

# DateRoulette

**Reg. No. 4,197,153**

**Registered Aug. 28, 2012**

**Int. Cl.: 45**

**SERVICE MARK**

**PRINCIPAL REGISTER**

KUPELIAN ALEXANDER H. (UNITED STATES INDIVIDUAL), DBA DATEROULETTE.COM  
27 BENNETT ROAD  
WATERTOWN, MA 02472

FOR: BACKGROUND INVESTIGATION AND RESEARCH SERVICES; BACKGROUND INVESTIGATION SERVICES; COMPUTER DATING SERVICES; DATING SERVICES; DATING SERVICES, NAMELY, PROVIDING AN ON-LINE COMPUTER DATABASE FEATURING SINGLE PEOPLE INTERESTED IN MEETING OTHER SINGLE PEOPLE; ESCORT SERVICES; INTERMENT SERVICES; INTERNET BASED SOCIAL NETWORKING, INTRODUCTION, AND DATING SERVICES; INTERNET-BASED DATING, SOCIAL INTRODUCTION AND SOCIAL NETWORKING SERVICES; INTERNET-BASED SOCIAL NETWORKING SERVICES; MARRIAGE PARTNER INTRODUCTION OR DATING SERVICES; MATCHMAKING SERVICES; ON-LINE GAY, LESBIAN AND BISEXUAL SOCIAL NETWORKING SERVICES; ON-LINE IDENTITY RELIABILITY INVESTIGATION IN THE FIELD OF ON-LINE DATING AND CLAIMS MADE ABOUT AGE, GENDER; ON-LINE SOCIAL NETWORKING SERVICES; PROVIDING A WEB SITE FEATURING INFORMATION AND CONTENT IN THE FIELDS OF PERSONAL RELATIONSHIPS, DATING AND FASHION; SOCIAL INTRODUCTION AGENCIES; VIDEO DATING SERVICES; WEB SITE SERVICES FEATURING ON-LINE DATING CLUB, IN CLASS 45 (U.S. CLS. 100 AND 101).

FIRST USE 11-19-2009; IN COMMERCE 2-22-2010.

THE MARK CONSISTS OF STANDARD CHARACTERS WITHOUT CLAIM TO ANY PARTICULAR FONT, STYLE, SIZE, OR COLOR.

SER. NO. 85-408,791, FILED 8-26-2011.

GEORGE LORENZO, EXAMINING ATTORNEY



*David J. Kyros*

Director of the United States Patent and Trademark Office

# United States of America

United States Patent and Trademark Office

## SHOP FAST & SAVE MONEY

**Reg. No. 4,197,154**

WEBER ADVERTISING AND MARKETING (PENNSYLVANIA CORPORATION)  
533 JANET AVENUE  
LANCASTER, PA 17601

**Registered Aug. 28, 2012**

**Int. Cl.: 35**

FOR: RETAIL GROCERY STORES, IN CLASS 35 (U.S. CLS. 100, 101 AND 102).

**SERVICE MARK**

FIRST USE 2-1-2010; IN COMMERCE 2-1-2010.

**PRINCIPAL REGISTER**

THE MARK CONSISTS OF STANDARD CHARACTERS WITHOUT CLAIM TO ANY PARTICULAR FONT, STYLE, SIZE, OR COLOR.

SER. NO. 85-410,521, FILED 8-30-2011.

KATHERINE E. HALMEN, EXAMINING ATTORNEY



*David J. Kybas*

Director of the United States Patent and Trademark Office

# United States of America

United States Patent and Trademark Office

## HYDRA-STYLE

**Reg. No. 4,197,155**

PIERRE FABRE S.A. (FRANCE SOCIÉTÉ ANONYME (SA))  
12, AVENUE HOCHÉ  
PARIS, FRANCE F-75008

**Registered Aug. 28, 2012**

**Int. Cls.: 3 and 5**

FOR: TOILET SOAPS; PERFUMES; NON-MEDICATED SKIN CARE PREPARATIONS IN THE NATURE OF CREAMS, GELS, MILKS AND LOTIONS; MAKE-UP, IN CLASS 3 (U.S. CLS. 1, 4, 6, 50, 51 AND 52).

**TRADEMARK**

FOR: MEDICATED SKIN CARE PREPARATIONS FOR THE HYGIENE AND CARE OF THE SKIN, IN CLASS 5 (U.S. CLS. 6, 18, 44, 46, 51 AND 52).

**PRINCIPAL REGISTER**

THE MARK CONSISTS OF STANDARD CHARACTERS WITHOUT CLAIM TO ANY PARTICULAR FONT, STYLE, SIZE, OR COLOR.

OWNER OF FRANCE REG. NO. 96607818, DATED 1-24-1996, EXPIRES 1-24-2016.

SER. NO. 85-410,719, FILED 8-30-2011.

ELI HELLMAN, EXAMINING ATTORNEY



*David J. Kypos*

Director of the United States Patent and Trademark Office

# United States of America

United States Patent and Trademark Office

## MAGE SOLAR ACADEMY

**Reg. No. 4,197,156**

MAGE SOLAR AG (FED REP GERMANY CORPORATION)  
AN DER BLEICHEREI 15

**Registered Aug. 28, 2012**

RAVENSBURG, FED REP GERMANY 88214

**Int. Cl.: 41**

FOR: EDUCATIONAL SERVICES, NAMELY, PROVIDING TRAINING FOR THE INSTALLATION AND OPERATION OF SOLAR POWER GENERATION EQUIPMENT, IN CLASS 41 (U.S. CLS. 100, 101 AND 107).

**SERVICE MARK**

FIRST USE 1-1-2011; IN COMMERCE 1-1-2011.

**PRINCIPAL REGISTER**

THE MARK CONSISTS OF STANDARD CHARACTERS WITHOUT CLAIM TO ANY PARTICULAR FONT, STYLE, SIZE, OR COLOR.

NO CLAIM IS MADE TO THE EXCLUSIVE RIGHT TO USE "SOLAR ACADEMY", APART FROM THE MARK AS SHOWN.

SER. NO. 85-411,021, FILED 8-30-2011.

SUNG IN, EXAMINING ATTORNEY



*David J. Kyffers*

Director of the United States Patent and Trademark Office

# United States of America

United States Patent and Trademark Office

# LA BANDITA

**Reg. No. 4,197,157**

DRHIP INTELLECTUAL PROPERTIES, INC. (DELAWARE CORPORATION)  
9321 FERMI AVENUE  
SAN DIEGO, CA 92123

**Registered Aug. 28, 2012**

**Int. Cls.: 5 and 32**

FOR: VITAMIN FORTIFIED BEVERAGES; DIETARY SUPPLEMENTAL DRINKS IN THE NATURE OF VITAMIN AND MINERAL BEVERAGES; WEIGHT LOSS DRINKS, NAMELY, MEAL REPLACEMENT DRINKS; NUTRITIONAL DRINKS USED FOR MEAL REPLACEMENT, IN CLASS 5 (U.S. CLS. 6, 18, 44, 46, 51 AND 52).

**TRADEMARK**

**PRINCIPAL REGISTER**

FIRST USE 5-12-2009; IN COMMERCE 5-12-2009.

FOR: BEVERAGES, NAMELY, ENERGY DRINKS; SPORTS DRINKS; SPORTS DRINKS ENHANCED WITH VITAMINS, MINERALS, NUTRIENTS, AMINO ACIDS AND/OR HERBS; CARBONATED SOFT DRINKS; CARBONATED SPORTS DRINKS ENHANCED WITH VITAMINS, MINERALS, NUTRIENTS, AMINO ACIDS AND/OR HERBS; NUTRITIONAL DRINKS IN THE NATURE OF BEAUTY BEVERAGES, NAMELY, FRUIT JUICES AND ENERGY DRINKS CONTAINING NUTRITIONAL SUPPLEMENTS; NON-ALCOHOLIC DRINKS, NAMELY, ENERGY SHOTS, IN CLASS 32 (U.S. CLS. 45, 46 AND 48).

FIRST USE 3-2-2009; IN COMMERCE 3-2-2009.

THE MARK CONSISTS OF STANDARD CHARACTERS WITHOUT CLAIM TO ANY PARTICULAR FONT, STYLE, SIZE, OR COLOR.

THE ENGLISH TRANSLATION OF "LA BANDITA" IN THE MARK IS "LITTLE BAND".

SER. NO. 85-411,658, FILED 8-31-2011.

ROBERT STRUCK, EXAMINING ATTORNEY



*David J. Kypos*

Director of the United States Patent and Trademark Office

# United States of America

United States Patent and Trademark Office



**Reg. No. 4,197,158**

**Registered Aug. 28, 2012**

**Int. Cls.: 5 and 10**

**TRADEMARK**

**PRINCIPAL REGISTER**

TZ MEDICAL, INC. (OREGON CORPORATION)  
7272 S.W. DURHAM RD., STE. 800  
PORTLAND, OR 97224

FOR: MEDICAL DRESSINGS; WOUND DRESSINGS, IN CLASS 5 (U.S. CLS. 6, 18, 44, 46, 51 AND 52).

FIRST USE 1-18-2011; IN COMMERCE 1-18-2011.

FOR: MEDICAL EQUIPMENT, CONSISTING OF MEDICAL DEVICES THAT PROVIDE DETECTION, RECORDING AND TRANSMISSION OF INFORMATION RELATING TO CARDIAC ARRHYTHMIA; CARDIAC RADIOTRANSSPARENT DEFIBRILLATION PADS; CARDIAC RADIOTRANSLUCENT DEFIBRILLATION PADS; ELECTRODES; CARDIAC ELECTRODES; ELECTRODES FOR MEDICAL USE; MEDICAL ELECTRODES; CARDIAC DEFIBRILLATION PADS; MEDICAL EQUIPMENT ACCESSORIES, NAMELY, ELECTRO-DIAGNOSTIC AUTOMATED CONSTANT CURRENT SINUSOID WAVEFORM NEUROSELECTIVE SENSORY NERVE TESTING DEVICES, NAMELY, DISPOSABLE ELECTRODES; CATHETERS; CATHETERS AND PARTS AND FITTINGS THEREFOR; INTRACARDIAC CATHETER; MEDICAL AND SURGICAL CATHETERS; TRANNSEPTAL NEEDLES; ARM BOARDS; AND DISTRACTION PINS, IN CLASS 10 (U.S. CLS. 26, 39 AND 44).

FIRST USE 1-18-2011; IN COMMERCE 1-18-2011.

THE MARK CONSISTS OF THE LETTERS "TZ" WITHIN A SINGLE BLACK CIRCLE WITH WHITE BACKGROUND, THE LETTER "T" IN BLACK AND THE LETTER "Z" IN RED.

THE COLOR(S) RED, BLACK AND WHITE IS/ARE CLAIMED AS A FEATURE OF THE MARK.

SER. NO. 85-411,677, FILED 8-31-2011.

KEVON CHISOLM, EXAMINING ATTORNEY



*David J. Kypos*

Director of the United States Patent and Trademark Office

# United States of America

United States Patent and Trademark Office

## PROVIDERLINK

**Reg. No. 4,197,159**

**Registered Aug. 28, 2012**

**Int. Cl.: 38**

**SERVICE MARK**

**PRINCIPAL REGISTER**

COMPUWARE CORPORATION (MICHIGAN CORPORATION)  
ONE CAMPUS MARTIUS  
DETROIT, MI 48226

FOR: PROVIDING SECURE ELECTRONIC TRANSMISSION OF DATA AND DOCUMENTS TO ALLOW HOSPITALS, DOCTORS AND OTHER HEALTH CARE PROFESSIONALS TO ACCESS AND TRANSMIT MEDICAL INFORMATION AND PATIENT RECORDS, IN CLASS 38 (U.S. CLS. 100, 101 AND 104).

FIRST USE 2-7-2002; IN COMMERCE 7-1-2002.

THE MARK CONSISTS OF STANDARD CHARACTERS WITHOUT CLAIM TO ANY PARTICULAR FONT, STYLE, SIZE, OR COLOR.

SER. NO. 85-411,824, FILED 8-31-2011.

JASON TURNER, EXAMINING ATTORNEY



*David J. Kyffers*

Director of the United States Patent and Trademark Office



# United States of America

United States Patent and Trademark Office

# ZEIGLERS

**Reg. No. 4,197,160**

**Registered Aug. 28, 2012**

**Int. Cls.: 30 and 32**

**TRADEMARK**

**PRINCIPAL REGISTER**

ZEIGLER'S BEVERAGES, LLC (DELAWARE LIMITED LIABILITY COMPANY)  
1513 NORTH BROAD ST.  
LANDSDALE, PA 19446

FOR: GREEN TEA; TEA; TEA-BASED BEVERAGES; HERBS AND SPICES; MULLING SPICES; HERB AND SPICE BLENDS, IN CLASS 30 (U.S. CL. 46).

FIRST USE 1-11-2006; IN COMMERCE 1-11-2006.

FOR: APPLE JUICE BEVERAGES; FRUIT DRINKS AND FRUIT JUICES; GRAPE JUICE; LEMONADE; FRUIT BEVERAGES MADE FROM APPLES; APPLE CIDER; SPARKLING NON-ALCOHOLIC APPLE CIDER, IN CLASS 32 (U.S. CLS. 45, 46 AND 48).

FIRST USE 1-11-2006; IN COMMERCE 1-11-2006.

OWNER OF U.S. REG. NOS. 1,331,172, 1,775,411 AND OTHERS.

THE MARK CONSISTS OF THE WORD "ZEIGLER'S" DEPICTED IN A STYLIZED FONT, WITH A LEAF DEPICTED IN PLACE OF THE APOSTROPHE IN FRONT OF THE LETTER "S".

SEC. 2(F).

SER. NO. 85-412,663, FILED 9-1-2011.

MICHAEL ENGEL, EXAMINING ATTORNEY



*David J. Kybas*

Director of the United States Patent and Trademark Office

# United States of America

United States Patent and Trademark Office

## LET'S GET ROLLING

**Reg. No. 4,197,161**

**Registered Aug. 28, 2012**

**Int. Cl.: 36**

**SERVICE MARK**

**PRINCIPAL REGISTER**

BLUE HILLS BANK (MASSACHUSETTS CHARTERED BANK)  
1196 RIVER STREET  
HYDE PARK, MA 02136

FOR: BANKING AND FINANCIAL SERVICES, NAMELY, PROVIDING DIRECT AND INDIRECT RESIDENTIAL MORTGAGE LENDING, PROVIDING CONSUMER, COMMERCIAL AND SMALL BUSINESS LOANS; CONSUMER AND COMMERCIAL DEPOSIT ACCOUNTS, NAMELY, PROVISION OF CONSUMER AND CORPORATE CHECKING ACCOUNT SERVICES AND SAVINGS ACCOUNT SERVICES AND PROVISION OF CERTIFICATES OF DEPOSIT; COMMERCIAL CASH MANAGEMENT SERVICES, AND ECOMMERCE BANKING SERVICES, NAMELY, RETAIL AND BUSINESS ONLINE BANKING SERVICES AND BILL PAYMENT SERVICES, IN CLASS 36 (U.S. CLS. 100, 101 AND 102).

FIRST USE 11-1-2011; IN COMMERCE 11-1-2011.

THE MARK CONSISTS OF STANDARD CHARACTERS WITHOUT CLAIM TO ANY PARTICULAR FONT, STYLE, SIZE, OR COLOR.

SER. NO. 85-413,140, FILED 9-1-2011.

JANICE KIM, EXAMINING ATTORNEY



*David J. Kyffers*

Director of the United States Patent and Trademark Office

# United States of America

United States Patent and Trademark Office

## LEARNING READINESS PE

**Reg. No. 4,197,162**

**Registered Aug. 28, 2012**

**Int. Cl.: 41**

**SERVICE MARK**

**PRINCIPAL REGISTER**

NAPERVILLE COMMUNITY UNIT SCHOOL DISTRICT 203 (ILLINOIS PUBLIC BENEFIT CORPORATION)  
203 WEST HILLSIDE ROAD  
NAPERVILLE, IL 605406589

FOR: EDUCATIONAL SERVICES, NAMELY, CONDUCTING CLASSES FEATURING A MULTIDISCIPLINARY METHOD OF INSTRUCTION FOR CHILDREN THAT COMBINES CARDIOVASCULAR EXERCISE, CORE STRENGTH TRAINING, CROSS LATERAL MOVEMENTS AND LITERACY AND MATH STRATEGIES WITH LITERACY, MATH AND SCIENCE CLASSES TO ENHANCE LEARNING AND IMPROVE ACHIEVEMENT, IN CLASS 41 (U.S. CLS. 100, 101 AND 107).

FIRST USE 11-0-2005; IN COMMERCE 11-0-2005.

THE MARK CONSISTS OF STANDARD CHARACTERS WITHOUT CLAIM TO ANY PARTICULAR FONT, STYLE, SIZE, OR COLOR.

SEC. 2(F).

SER. NO. 85-414,151, FILED 9-2-2011.

SHANNON TWOHIG, EXAMINING ATTORNEY



*David J. Kyfos*

Director of the United States Patent and Trademark Office

# United States of America

United States Patent and Trademark Office

## Found In Town

**Reg. No. 4,197,163**

HALLER, ZACH (UNITED STATES INDIVIDUAL)  
2949 NORTH HALSTED ST.  
CHICAGO, IL 60657

**Registered Aug. 28, 2012**

**Int. Cl.: 45**

FOR: LOST PROPERTY RETURN SERVICES, NAMELY, PROVIDING A WEBSITE WHICH ASSISTS USERS IN THE RETURN OF LOST OR MISPLACED ITEMS TO THEIR OWNERS, IN CLASS 45 (U.S. CLS. 100 AND 101).

**SERVICE MARK**

FIRST USE 9-3-2011; IN COMMERCE 9-3-2011.

**PRINCIPAL REGISTER**

THE MARK CONSISTS OF STANDARD CHARACTERS WITHOUT CLAIM TO ANY PARTICULAR FONT, STYLE, SIZE, OR COLOR.

SER. NO. 85-415,118, FILED 9-5-2011.

MARK SPARACINO, EXAMINING ATTORNEY



*David J. Kyffers*

Director of the United States Patent and Trademark Office

# United States of America

United States Patent and Trademark Office

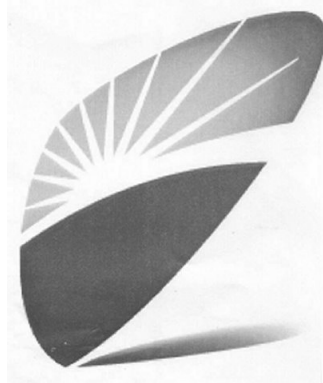

**Reg. No. 4,197,164**

**Registered Aug. 28, 2012**

**Int. Cls.: 1, 9, 37 and 42**

**TRADEMARK**

**SERVICE MARK**

**PRINCIPAL REGISTER**

UTC FIRE & SECURITY CORPORATION (DELAWARE CORPORATION)  
NINE FARM SPRINGS ROAD  
FARMINGTON, CT 06032

FOR: FIRE EXTINGUISHING AND EXPLOSION PROTECTION CHEMICALS AND COMPOUNDS, NAMELY, FIRE PROTECTION PREPARATIONS IN THE NATURE OF FIRE FIGHTING POWDERS, WATER CONTAINING CHEMICAL ADDITIVES, NAMELY, FOAMING ADDITIVES AS CHEMICAL ADDITIVES FOR USE IN FIRE FIGHTING, FIRE FIGHTING FOAM, NAMELY, FIRE RETARDANT CHEMICALS, FIRE FIGHTING CHEMICALS, NAMELY, VAPORIZING LIQUIDS AND FIREFIGHTING CHEMICALS IN LIQUID FORM; CHEMICAL ADDITIVES FOR USE IN FIRE EXTINGUISHING AND EXPLOSION PROTECTION COMPOSITIONS, IN CLASS 1 (U.S. CLS. 1, 5, 6, 10, 26 AND 46).

FIRST USE 1-18-2001; IN COMMERCE 1-18-2001.

FOR: ELECTROMECHANICAL SENSORS, ELECTRICAL, ELECTRONIC, OPTICAL AND THERMAL SENSORS AND ELECTRONIC REMOTE CONTROLS FOR USE IN MEASURING, DETECTING AND INDICATING TEMPERATURE OR OVERHEAT; OPTICAL SCANNERS AND SENSORS FOR DETECTING LIGHT-OBSCURING SUBSTANCES; GAS DETECTORS FOR DETECTING THE PRESENCE OF GAS, FLAME DETECTORS AND SMOKE DETECTORS; FIRE EXTINGUISHERS; PRESSURE GAUGES, AUTOMATIC VALVES AND GAS METERS FOR USE IN RELATION TO THE MONITORING, MEASURING, CHARGING AND REFILLING OF CONTAINERS AND CYLINDERS WITH GAS, INCLUDING COMPRESSED GAS; FIRE ALARMS; FIRE BLANKETS; SAFETY EQUIPMENT, NAMELY, FIRE ESCAPE LADDERS; FIRE HOSE NOZZLES; FIRE SPRINKLERS; FIRE TRUCKS; OXYGEN MASKS NOT FOR MEDICAL USE; LIFE BELTS; LIFE JACKETS; LIFE NETS; LIFE PRESERVERS; LIFE BUOYS; LIFE-SAVING RAFTS; FIRE-FIGHTING EQUIPMENT, NAMELY, WATER PUMPING SYSTEMS FOR EXTINGUISHING FIRES INCORPORATING ENGINES AND MACHINES FOR WATER PUMPING IN CONNECTION WITH WATER CANNONS, IN CLASS 9 (U.S. CLS. 21, 23, 26, 36 AND 38).

FIRST USE 1-18-2001; IN COMMERCE 1-18-2001.

FOR: FIRE PROTECTION SERVICES, NAMELY, INSTALLATION AND MAINTENANCE OF EQUIPMENT AND INSTALLATIONS FOR PROTECTION AGAINST FIRE, IN CLASS 37 (U.S. CLS. 100, 103 AND 106).



*David J. Kybas*

Director of the United States Patent and Trademark Office

**Reg. No. 4,197,164** FIRST USE 1-18-2001; IN COMMERCE 1-18-2001.

FOR: FIRE PROTECTION SERVICES, NAMELY, INSPECTION AND ENGINEERING OF EQUIPMENT AND INSTALLATIONS FOR PROTECTION AGAINST FIRE, IN CLASS 42 (U.S. CLS. 100 AND 101).

FIRST USE 1-18-2001; IN COMMERCE 1-18-2001.

THE MARK CONSISTS OF A SHIELD DESIGN WITH A NINE POINT STAR AT THE TOP OF THE SHIELD AND A SHADOW OF THE SHIELD AT THE BOTTOM OF THE MARK.

SER. NO. 85-415,458, FILED 9-6-2011.

WILLIAM ROSSMAN, EXAMINING ATTORNEY

# United States of America

United States Patent and Trademark Office

## Visual Magnetics Graphic System

**Reg. No. 4,197,165**

**Registered Aug. 28, 2012**

**Int. Cls.: 2 and 16**

**TRADEMARK**

**PRINCIPAL REGISTER**

DEETZ, DAYTON J. (UNITED STATES INDIVIDUAL)  
1 EMERSON STREET  
MENDON, MA 01756

FOR: INTERIOR PAINT; PAINT FOR USE IN THE MANUFACTURE OF WALLCOVERINGS; PAINT PRIMERS; PAINTS; PAINTS FOR CREATING MAGNETIC-RECEPTIVE SURFACES TO ADHERE MAGNET TO; PRIMER, IN CLASS 2 (U.S. CLS. 6, 11 AND 16).

FIRST USE 3-1-2007; IN COMMERCE 3-1-2007.

FOR: ART PRINTS; ART PRINTS ON CANVAS; CANVAS FOR PRINTING; CHALK BOARDS FOR SCHOOL AND HOME USE; CHILDREN'S WALL STICKERS AND MURALS; DIGITAL PRINTING PAPER; DRAWING BOARDS; DRY ERASE WRITING BOARDS AND WRITING SURFACES; DYE-SUBLIMATION PRINT PAPER; GRAPHIC PRINTS AND REPRESENTATIONS; LASER PRINT PAPER; PAPER; PAPER FOR USE IN THE GRAPHIC ARTS INDUSTRY; PAPER FOR USE IN THE MANUFACTURE OF WALLPAPER; PAPER FOR USE IN THE MANUFACTURE OF VISUAL GRAPHIC DISPLAYS; PAPER SUBSTRATES ONTO WHICH DIGITAL IMAGES ARE PRINTED; PAPERS FOR USE IN THE GRAPHIC ARTS INDUSTRY; PHOTOGRAPHIC PRINTS; PLASTIC SHEETS FOR WRITING, PRINTING, AND MARKING; POLYESTER FILM FOR USE AS A PAPER SUBSTITUTE FOR DRY TONER XEROGRAPHIC IMAGING, NAMELY, LASER PRINTING, COLOR COPIER PRINTING, DRY TONER PRINTING, SCREEN PRINTING, AND OFFSET PRINTING; PRINT SUBSTRATE, NAMELY, TRANSPARENT, OPAQUE, AND TRANSLUCENT FILMS FOR USE WITH INK JET COPIERS AND LASER PRINTERS; PRINTED GRAPHS; PRINTED MENUS; PRINTED PAPER SIGNS; PRINTED PRODUCTS, NAMELY, MENU BOARDS; PRINTED VISUALS IN THE NATURE OF MARKETING/PROMOTIONAL MATERIAL; STICK-ON WHITEBOARDS AND DRY-ERASE BOARDS; SYNTHETIC PAPER, IN CLASS 16 (U.S. CLS. 2, 5, 22, 23, 29, 37, 38 AND 50).

FIRST USE 3-1-2007; IN COMMERCE 3-1-2007.

THE MARK CONSISTS OF STANDARD CHARACTERS WITHOUT CLAIM TO ANY PARTICULAR FONT, STYLE, SIZE, OR COLOR.

OWNER OF U.S. REG. NO. 3,593,945.



*David J. Kyffers*

Director of the United States Patent and Trademark Office

**Reg. No. 4,197,165** NO CLAIM IS MADE TO THE EXCLUSIVE RIGHT TO USE "MAGNETICS GRAPHIC SYSTEM", APART FROM THE MARK AS SHOWN.

SER. NO. 85-415,538, FILED 9-6-2011.

ANDREA HACK, EXAMINING ATTORNEY



# United States of America

United States Patent and Trademark Office



**Reg. No. 4,197,166**

**Registered Aug. 28, 2012**

**Int. Cl.: 16**

**TRADEMARK**

**PRINCIPAL REGISTER**

DEWINE SEEDS-SILVER DOLLAR BASEBALL, LLC (NORTH CAROLINA LIMITED LIABILITY COMPANY)  
30 BUCHANAN PLACE  
ASHEVILLE, NC 28001

FOR: PAPER GOODS AND PRINTED MATTER, NAMELY, AUTOGRAPH BOOKS, BINDERS, BOOKMARKS, BUMPER STICKERS, CALENDARS, CATALOGS IN THE FIELD OF BASEBALL, DECALS, MERCHANDISE BAGS, NEWSLETTERS IN THE FIELD OF BASEBALL, NOTE PADS, PAPER CONTAINERS, PAPER PENNANTS, PRINTED GAME SCHEDULES FOR SPORTING EVENTS, PENS, PENCILS, POSTCARDS, POSTERS, PRINTED AWARDS, PRINTED TICKETS FOR SPORTING EVENTS, PRINTED GUIDES IN THE FIELD OF BASEBALL, REFERENCE BOOKS IN THE FIELD OF BASEBALL, SCORE BOOKS, SCORE CARDS, SCORE SHEETS, STATIONERY, STICKERS, STICKER ALBUMS AND TRADING CARDS, IN CLASS 16 (U.S. CLS. 2, 5, 22, 23, 29, 37, 38 AND 50).

FIRST USE 11-9-2010; IN COMMERCE 11-9-2010.

THE MARK CONSISTS OF AN ANIMATED MOON MAN CHARACTER WEARING A BASEBALL UNIFORM AND SUNGLASSES POSING IN A BATTING STANCE WITH A HANDKERCHIEF BEARING STARS TIED AROUND THE BAT.

SER. NO. 85-415,618, FILED 9-6-2011.

AMY KELLY, EXAMINING ATTORNEY



*David J. Kyfos*

Director of the United States Patent and Trademark Office

# United States of America

United States Patent and Trademark Office

## MAGIC MITTEN

**Reg. No. 4,197,167**

**Registered Aug. 28, 2012**

**Int. Cl.: 9**

**TRADEMARK**

**PRINCIPAL REGISTER**

MAGIC MITTEN LIMITED (NEW ZEALAND LIMITED LIABILITY COMPANY)  
LEVEL 9, JAMES & WELLS TOWER  
56 CAWLEY STREET, ELLERSLIE  
AUCKLAND, NEW ZEALAND

FOR: APPARATUS FOR TRANSMISSION OR REPRODUCTION OF SOUND; SOUND EMITTING DEVICES FOR NON-MEDICAL USE, IN THE NATURE OF AN ELECTRONIC SOUND GENERATOR, USED TO PACIFY INFANTS; BABY MONITORS, IN CLASS 9 (U.S. CLS. 21, 23, 26, 36 AND 38).

THE MARK CONSISTS OF STANDARD CHARACTERS WITHOUT CLAIM TO ANY PARTICULAR FONT, STYLE, SIZE, OR COLOR.

OWNER OF NEW ZEALAND REG. NO. 839045, DATED 3-23-2011, EXPIRES 3-23-2022.

NO CLAIM IS MADE TO THE EXCLUSIVE RIGHT TO USE "MITTEN", APART FROM THE MARK AS SHOWN.

SER. NO. 85-416,155, FILED 9-6-2011.

INGA ERVIN, EXAMINING ATTORNEY



*David J. Kyffers*

Director of the United States Patent and Trademark Office

# United States of America

United States Patent and Trademark Office

## UNIQUELY MINNESOTA

**Reg. No. 4,197,168**

**Registered Aug. 28, 2012**

**Int. Cls.: 39 and 41**

**SERVICE MARK**

**PRINCIPAL REGISTER**

COVALENT GROUP, LLC (MINNESOTA LIMITED LIABILITY COMPANY), DBA UNIQUELY MINNESOTA  
825 BERRY STREET SUITE #309  
ST. PAUL, MN 55114

FOR: PROVIDING A WEBSITE THAT FEATURES INFORMATION, NEWS AND COMMENTARY ABOUT TRAVEL IN MINNESOTA, IN CLASS 39 (U.S. CLS. 100 AND 105).

FIRST USE 4-19-2010; IN COMMERCE 5-13-2010.

FOR: PROVIDING A WEBSITE FOR ENTERTAINMENT PURPOSES WHERE USERS CAN VIEW PHOTOS ABOUT MINNESOTA CENTRIC AND SOCIAL AND CULTURAL EVENTS HAPPENING IN MINNESOTA, IN CLASS 41 (U.S. CLS. 100, 101 AND 107).

FIRST USE 4-19-2010; IN COMMERCE 5-13-2010.

THE MARK CONSISTS OF STANDARD CHARACTERS WITHOUT CLAIM TO ANY PARTICULAR FONT, STYLE, SIZE, OR COLOR.

NO CLAIM IS MADE TO THE EXCLUSIVE RIGHT TO USE "MINNESOTA", APART FROM THE MARK AS SHOWN.

SER. NO. 85-418,297, FILED 9-8-2011.

ARETHA SOMERVILLE, EXAMINING ATTORNEY



*David J. Kyros*

Director of the United States Patent and Trademark Office

# United States of America

United States Patent and Trademark Office



**Reg. No. 4,197,169**

**Registered Aug. 28, 2012**

**COLLECTIVE  
MEMBERSHIP**

**PRINCIPAL REGISTER**

THE FASHION GROUP INTERNATIONAL, INC. (NEW YORK CORPORATION)  
8 WEST 40TH STREET, 7TH FLOOR  
NEW YORK, NY 10018

FOR: INDICATING MEMBERSHIP IN A NON-COMMERCIAL ASSOCIATION OF WOMEN ENGAGED IN FASHION WORK, FORMED TO ADVANCE THE PRINCIPLES OF APPLIED ART IN INDUSTRY AND TO FOSTER GOOD TASTE IN FASHION, IN CLASS 200 (U.S. CL. 200).

FIRST USE 0-0-2006; IN COMMERCE 0-0-2006.

OWNER OF U.S. REG. NO. 1,684,098.

THE COLOR(S) RED AND GREY IS/ARE CLAIMED AS A FEATURE OF THE MARK.

THE MARK CONSISTS OF THE STYLIZED LETTERING "FGI" IN RED AND BELOW APPEARS THE WORDING "THE FASHION GROUP INTERNATIONAL" IN GREY EXCEPT FOR THE WORD "FASHION" WHICH APPEARS IN RED; THE COLOR WHITE IS NOT A FEATURE OF THE MARK AND REPRESENTS TRANSPARENT BACKGROUND.

SEC. 2(F) AS TO "FASHION GROUP INTERNATIONAL".

SER. NO. 85-418,450, FILED 9-9-2011.

AMY KELLY, EXAMINING ATTORNEY



*David J. Kyjars*

Director of the United States Patent and Trademark Office

# United States of America

United States Patent and Trademark Office

# HERMANAKI

**Reg. No. 4,197,170**

HERMAN PERRYMAN (UNITED STATES INDIVIDUAL)  
1139 CANTERBURY COURT APT. D  
INDIANAPOLIS, IN 46260

**Registered Aug. 28, 2012**

**Int. Cl.: 30**

FOR: SAUCES, IN CLASS 30 (U.S. CL. 46).

**TRADEMARK**

FIRST USE 8-15-2004; IN COMMERCE 8-15-2004.

**PRINCIPAL REGISTER**

THE MARK CONSISTS OF STANDARD CHARACTERS WITHOUT CLAIM TO ANY PARTICULAR FONT, STYLE, SIZE, OR COLOR.

SER. NO. 85-419,172, FILED 9-9-2011.

DOMINICK J. SALEMI, EXAMINING ATTORNEY



*David J. Kyffers*

Director of the United States Patent and Trademark Office

# United States of America

United States Patent and Trademark Office



**Reg. No. 4,197,171**

**Registered Aug. 28, 2012**

**Int. Cl.: 25**

**TRADEMARK**

**PRINCIPAL REGISTER**

HILLSON LIMITED (HONG KONG CORPORATION)  
77-79 GLOUCESTER ROAD  
8/F FORTIS TOWER  
WANCHAI, HONG KONG AND

RITTER, ALICE (UNITED STATES INDIVIDUAL)  
209 W. 38TH STREET, #305  
NEW YORK, NY 10018

FOR: DRESSES, SKIRTS, PANTS, BLOUSES, JACKETS, SHORTS, SWEATERS, COATS, BLAZERS AND CAPES, IN CLASS 25 (U.S. CLS. 22 AND 39).

FIRST USE 3-23-2011; IN COMMERCE 6-28-2011.

OWNER OF U.S. REG. NO. 3,440,730.

THE NAME "ALICE RITTER" IDENTIFIES A LIVING INDIVIDUAL WHOSE CONSENT IS OF RECORD.

THE MARK CONSISTS OF THE WORDS "PIPETTE BY ALICE RITTER" IN STYLIZED LETTERS WITH A FLYING BIRD HOLDING A BRANCH WITH LEAVES IN ITS BEAK ALL WITHIN A RECTANGLE.

THE ENGLISH TRANSLATION OF "PIPETTE" IN THE MARK IS "TALKATIVE".

SER. NO. 85-419,197, FILED 9-9-2011.

MICHELLE DUBOIS, EXAMINING ATTORNEY



*David J. Kybas*

Director of the United States Patent and Trademark Office

# United States of America

United States Patent and Trademark Office

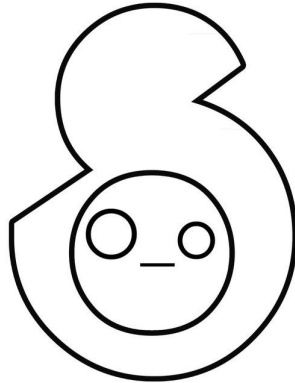

**Reg. No. 4,197,172**

**Registered Aug. 28, 2012**

**Int. Cl.: 25**

THE HENRY LEWISTON COMPANY LLC (MICHIGAN LIMITED LIABILITY COMPANY),  
DBA SPLATT CLOTHING  
APARTMENT 202  
4055 CAMBRIDGE  
CANTON, MI 48187

**TRADEMARK**

**PRINCIPAL REGISTER**

FOR: ATHLETIC APPAREL, NAMELY, SHIRTS, PANTS, JACKETS, FOOTWEAR, HATS AND CAPS, ATHLETIC UNIFORMS; GOLF SHIRTS; GYM PANTS; HOODED SWEAT SHIRTS; HOODED SWEATSHIRTS; JACKETS; PANTS; SHIRTS; SNOWBOARD JACKETS; SNOWBOARD PANTS; SWEATSHIRTS; T-SHIRTS, IN CLASS 25 (U.S. CLS. 22 AND 39).

FIRST USE 3-28-2011; IN COMMERCE 5-2-2011.

THE MARK CONSISTS OF A STYLIZED "S" WITH A FACE IN THE BOTTOM CURVE OF THE "S".

SER. NO. 85-419,676, FILED 9-10-2011.

HOWARD B. LEVINE, EXAMINING ATTORNEY



*David J. Kyffers*

Director of the United States Patent and Trademark Office

# United States of America

United States Patent and Trademark Office

# calcas.com

**Reg. No. 4,197,173**

CALIFORNIA CASUALTY MANAGEMENT COMPANY (CALIFORNIA CORPORATION)  
1900 ALAMEDA DE LAS PULGAS  
SAN MATEO, CA 94403

**Registered Aug. 28, 2012**

**Int. Cls.: 35 and 36**

FOR: INSURANCE BUSINESS SERVICES, NAMELY, SALES PROMOTION AND MARKETING FOR OTHERS IN THE FIELDS OF PRIVATE PASSENGER AUTOMOBILE INSURANCE AND HOMEOWNERS INSURANCE THAT IS MADE AVAILABLE TO MEMBERS OF SPECIFIC GROUPS, IN CLASS 35 (U.S. CLS. 100, 101 AND 102).

**SERVICE MARK**

**PRINCIPAL REGISTER**

FIRST USE 4-20-2012; IN COMMERCE 4-20-2012.

FOR: INSURANCE SERVICES, NAMELY, ADMINISTRATION, ACTUARIAL, AGENCY, CLAIMS ADMINISTRATION AND UNDERWRITING IN THE FIELDS OF PRIVATE PASSENGER AUTOMOBILE INSURANCE AND HOMEOWNERS INSURANCE THAT IS MADE AVAILABLE TO MEMBERS OF SPECIFIC GROUPS, IN CLASS 36 (U.S. CLS. 100, 101 AND 102).

FIRST USE 4-20-2012; IN COMMERCE 4-20-2012.

THE MARK CONSISTS OF STANDARD CHARACTERS WITHOUT CLAIM TO ANY PARTICULAR FONT, STYLE, SIZE, OR COLOR.

SER. NO. 85-420,106, FILED 9-12-2011.

TINA MAI, EXAMINING ATTORNEY



*David J. Kybas*

Director of the United States Patent and Trademark Office



# United States of America

United States Patent and Trademark Office

# BARENIA

**Reg. No. 4,197,174**

**Registered Aug. 28, 2012**

**Int. Cl.: 14**

**TRADEMARK**

**PRINCIPAL REGISTER**

LA MONTRE HERMES S.A. (SWITZERLAND SOCIÉTÉ ANONYME (SA))  
ERLENSTRASSE 31A  
2555 BRUGG, SWITZERLAND

FOR: HOROLOGICAL AND CHRONOMETRIC INSTRUMENTS, NAMELY, WATCHES AND THEIR COMPONENT PARTS, WATCH BANDS, WATCH CLASPS, IN CLASS 14 (U.S. CLS. 2, 27, 28 AND 50).

THE MARK CONSISTS OF STANDARD CHARACTERS WITHOUT CLAIM TO ANY PARTICULAR FONT, STYLE, SIZE, OR COLOR.

OWNER OF SWITZERLAND REG. NO. 513932, DATED 9-2-2003, EXPIRES 6-26-2013.

SER. NO. 85-420,435, FILED 9-12-2011.

MATTHEW PAPPAS, EXAMINING ATTORNEY



*David J. Kyffers*

Director of the United States Patent and Trademark Office

# United States of America

United States Patent and Trademark Office

# Salmonstock

**Reg. No. 4,197,175**

**Registered Aug. 28, 2012**

**Int. Cls.: 36 and 41**

**SERVICE MARK**

**PRINCIPAL REGISTER**

RENEWABLE RESOURCES FOUNDATION, INCORPORATED (ALASKA CORPORATION)  
605 WEST 2ND AVENUE  
ANCHORAGE, AK 99501

FOR: CHARITABLE FUNDRAISING SERVICES, NAMELY, ORGANIZING AND CONDUCTING FUNDRAISING FOOD TASTING EVENTS; CHARITABLE FUNDRAISING SERVICES BY MEANS OF A FESTIVAL CELEBRATING FISH, FUN AND MUSIC TO RAISE FUNDS, IN CLASS 36 (U.S. CLS. 100, 101 AND 102).

FIRST USE 3-3-2011; IN COMMERCE 3-3-2011.

FOR: CHARITABLE OUTREACH SERVICES, NAMELY, PROVIDING ENTERTAINMENT IN THE FIELD OF MUSIC, FISH AND FUN; CONDUCTING EDUCATIONAL EXHIBITIONS CELEBRATING FISH, FUN AND MUSIC, IN CLASS 41 (U.S. CLS. 100, 101 AND 107).

FIRST USE 12-9-2011; IN COMMERCE 12-9-2011.

THE MARK CONSISTS OF STANDARD CHARACTERS WITHOUT CLAIM TO ANY PARTICULAR FONT, STYLE, SIZE, OR COLOR.

SER. NO. 85-420,765, FILED 9-12-2011.

INGA ERVIN, EXAMINING ATTORNEY



*David J. Kybas*

Director of the United States Patent and Trademark Office

# United States of America

United States Patent and Trademark Office

## FORSTA FILTERS

**Reg. No. 4,197,176**

FORSTA FILTERS INC. (CALIFORNIA CORPORATION)

**Registered Aug. 28, 2012**

3716 W. 102ND STREET, UNIT J  
INGLEWOOD, CA 90303

**Int. Cls.: 9 and 11**

FOR: ELECTRONIC CONTROLLERS FOR WATER FILTRATION SYSTEMS; FLUID PRESSURE GAUGES, IN CLASS 9 (U.S. CLS. 21, 23, 26, 36 AND 38).

**TRADEMARK**

FIRST USE 3-31-2010; IN COMMERCE 3-31-2010.

**PRINCIPAL REGISTER**

FOR: WATER FILTERS, IN CLASS 11 (U.S. CLS. 13, 21, 23, 31 AND 34).

FIRST USE 3-31-2010; IN COMMERCE 3-31-2010.

THE MARK CONSISTS OF STANDARD CHARACTERS WITHOUT CLAIM TO ANY PARTICULAR FONT, STYLE, SIZE, OR COLOR.

OWNER OF U.S. REG. NO. 4,017,061.

NO CLAIM IS MADE TO THE EXCLUSIVE RIGHT TO USE "FILTERS", APART FROM THE MARK AS SHOWN.

THE WORDING "FORSTA" HAS NO MEANING IN A FOREIGN LANGUAGE.

SER. NO. 85-421,520, FILED 9-13-2011.

ROBIN CHOSID, EXAMINING ATTORNEY



*David J. Kyffers*

Director of the United States Patent and Trademark Office

# United States of America

United States Patent and Trademark Office

## RESTORING THE BALANCE

**Reg. No. 4,197,177**

HGI INDUSTRIES, INC. (NEVADA CORPORATION)  
2055 HIGH RIDGE ROAD  
BOYNTON BEACH, FL 33426

**Registered Aug. 28, 2012**

**Int. Cl.: 40**

FOR: ODOR NEUTRALIZATION SERVICES, NAMELY, NEUTRALIZATION OF AIRBORNE GASSES, MICRO-ORGANISMS, VIRUSES AND MOLD SPECIES, IN CLASS 40 (U.S. CLS. 100, 103 AND 106).

**SERVICE MARK**

FIRST USE 4-30-2011; IN COMMERCE 5-2-2011.

**PRINCIPAL REGISTER**

THE MARK CONSISTS OF STANDARD CHARACTERS WITHOUT CLAIM TO ANY PARTICULAR FONT, STYLE, SIZE, OR COLOR.

SER. NO. 85-421,695, FILED 9-13-2011.

EMILY CARLSEN, EXAMINING ATTORNEY



*David J. Kyffers*

Director of the United States Patent and Trademark Office

# United States of America

United States Patent and Trademark Office



**Reg. No. 4,197,178**

**Registered Aug. 28, 2012**

**Int. Cls.: 37 and 45**

**SERVICE MARK**

**PRINCIPAL REGISTER**

SECURITY NETWORKS LLC (FLORIDA LIMITED LIABILITY COMPANY)  
3223 COMMERCE PL., SUITE 101  
WEST PALM BEACH, FL 33407

FOR: INSTALLATION AND MAINTENANCE OF INTRUDER AND BURGLAR ALARMS, FIRE ALARMS, MEDICAL ALERTS AND ACCESS CONTROL ALARMS, IN CLASS 37 (U.S. CLS. 100, 103 AND 106).

FIRST USE 4-0-2000; IN COMMERCE 4-0-2000.

FOR: ALARM MONITORING SERVICES, NAMELY, MONITORING OF INTRUDER AND BURGLAR ALARMS, FIRE ALARMS, MEDICAL ALERTS AND ACCESS CONTROL ALARMS, IN CLASS 45 (U.S. CLS. 100 AND 101).

FIRST USE 4-0-2000; IN COMMERCE 4-0-2000.

NO CLAIM IS MADE TO THE EXCLUSIVE RIGHT TO USE "SECURITY NETWORKS", APART FROM THE MARK AS SHOWN.

THE MARK CONSISTS OF A SHADED CIRCULAR DESIGN WITH INTERCONNECTED CURVED BANDS RESEMBLING AN "S" ABOVE THE "I" IN THE TERM "SECURITY". THE WORD "SECURITY" IS IN ALL CAPITAL FONT ABOVE "NETWORKS" IN LOWER CASE FONT.

SER. NO. 85-421,836, FILED 9-13-2011.

JEFFREY LOOK, EXAMINING ATTORNEY



*David J. Kybas*

Director of the United States Patent and Trademark Office

# United States of America

United States Patent and Trademark Office

## NADA SCIENTIFIC

**Reg. No. 4,197,179**

**Registered Aug. 28, 2012**

**Int. Cl.: 9**

**TRADEMARK**

**PRINCIPAL REGISTER**

NADA SCIENTIFIC LTD. (NEW YORK CORPORATION), DBA NADASCIENTIFIC.COM  
39 BUTTERNUT ST, P.O. BOX 1336  
CHAMPLAIN, NY 12919

FOR: ACCELERATION SENSORS; ANALOG MULTIMETERS; APPARATUS FOR TESTING GAS, LIQUIDS AND SOLIDS; LABORATORY EQUIPMENT AND SUPPLIES, NAMELY, THERMOMETERS; LABORATORY GLASSWARE; MAGNETIC COMPASSES; MAGNETS; MAGNIFYING GLASSES; MEASURING APPARATUS FOR TEMPERATURE AND HUMIDITY LEVELS IN GASES AND SOLID SUBSTANCES; MEASURING APPARATUS, NAMELY, CLAMP METERS FOR MEASURING ELECTRICITY; MEASURING GLASSWARE; MECHANICAL TIMERS; MICROMETERS; MICROSCOPES; MICROSENSORS FOR MEASUREMENT OF PRESSURE, ACCELERATION, FORCE AND FLOW, NAMELY, SILICON PIEZORESISTIVE PRESSURE SENSORS; OPTICAL LENSES; PETRI DISHES USED IN LABORATORY RESEARCH; PHOTOVOLTAIC SOLAR MODULES FOR PRODUCTION OF ELECTRICITY; PRESSURE SENSORS; PRISMS FOR OPTICS PURPOSES; PRISMS FOR SCIENTIFIC PURPOSES; RESISTANCE MEASURING INSTRUMENTS; SCIENTIFIC AND TECHNICAL APPARATUS, NAMELY, OPTICAL MIRRORS; SCIENTIFIC APPARATUS, NAMELY, SPECTROMETERS AND PARTS AND FITTINGS THEREFOR; SENSORS FOR DETERMINING POSITION, VELOCITY, ACCELERATION AND TEMPERATURE; SENSORS FOR THE DETERMINATION OF TEMPERATURES, POSITIONS AND DISTANCES, IN CLASS 9 (U.S. CLS. 21, 23, 26, 36 AND 38).

FIRST USE 5-27-1986; IN COMMERCE 5-27-1986.

THE MARK CONSISTS OF STANDARD CHARACTERS WITHOUT CLAIM TO ANY PARTICULAR FONT, STYLE, SIZE, OR COLOR.

NO CLAIM IS MADE TO THE EXCLUSIVE RIGHT TO USE "SCIENTIFIC", APART FROM THE MARK AS SHOWN.

THE ENGLISH TRANSLATION OF THE SPANISH LANGUAGE WORD "NADA" IN THE MARK IS "NOTHING" OR "ANYTHING."

SER. NO. 85-422,033, FILED 9-14-2011.

AMY C. KEAN, EXAMINING ATTORNEY



*David J. Kappas*

Director of the United States Patent and Trademark Office

# United States of America

United States Patent and Trademark Office

# ARTOGRAPH

**Reg. No. 4,197,180**

**Registered Aug. 28, 2012**

**Int. Cls.: 6, 9 and 20**

**TRADEMARK**

**PRINCIPAL REGISTER**

ARTOGRAPH, INC. (MINNESOTA CORPORATION)  
525 9TH STREET SOUTH  
DELANO, MN 553288624

FOR: PAINT SPRAY BOOTHS OF METAL, IN CLASS 6 (U.S. CLS. 2, 12, 13, 14, 23, 25 AND 50).

FIRST USE 9-0-1989; IN COMMERCE 9-0-1989.

FOR: ELECTRIC LIGHT BOXES AND LIGHT BOARDS, NAMELY, ELECTRONIC DEVICES FOR TRACING DESIGNS AND PATTERNS AND FOR BACKLIGHTING AND ILLUMINATING BEADS AND BEADING TRAYS; PHOTOGRAPHIC AND PICTURE LED PROJECTORS, IN CLASS 9 (U.S. CLS. 21, 23, 26, 36 AND 38).

FIRST USE 5-10-1997; IN COMMERCE 5-10-1997.

FOR: FURNITURE, IN CLASS 20 (U.S. CLS. 2, 13, 22, 25, 32 AND 50).

FIRST USE 1-0-2007; IN COMMERCE 1-0-2007.

THE MARK CONSISTS OF STANDARD CHARACTERS WITHOUT CLAIM TO ANY PARTICULAR FONT, STYLE, SIZE, OR COLOR.

OWNER OF U.S. REG. NO. 1,446,075.

SER. NO. 85-422,289, FILED 9-14-2011.

JEAN IM, EXAMINING ATTORNEY



*David J. Kybas*

Director of the United States Patent and Trademark Office

**United States of America**  
United States Patent and Trademark Office

**JON JOSEF**

**Reg. No. 4,197,181**

EGIDO, JUAN JOSE (UNITED STATES INDIVIDUAL)  
1245 CEDAR DRIVE  
BIRMINGHAM, MI 48009

**Registered Aug. 28, 2012**

**Int. Cl.: 25**

FOR: FOOTWEAR; SHOES, IN CLASS 25 (U.S. CLS. 22 AND 39).

**TRADEMARK**

FIRST USE 11-8-2006; IN COMMERCE 11-8-2006.

**PRINCIPAL REGISTER**

THE MARK CONSISTS OF STANDARD CHARACTERS WITHOUT CLAIM TO ANY PARTICULAR FONT, STYLE, SIZE, OR COLOR.

"JON JOSEF" IDENTIFIES THE NICKNAME OF JUAN JOSE EGIDO, A LIVING INDIVIDUAL WHOSE CONSENT IS OF RECORD.

SER. NO. 85-422,700, FILED 9-14-2011.

ANNE FARRELL, EXAMINING ATTORNEY



*David J. Kybas*

Director of the United States Patent and Trademark Office



# United States of America

United States Patent and Trademark Office

# Lathergy

**Reg. No. 4,197,182**

**Registered Aug. 28, 2012**

**Int. Cl.: 3**

**TRADEMARK**

**PRINCIPAL REGISTER**

SAMUEL LOPEZ (SPAIN INDIVIDUAL), DBA LATHERGY  
38 HARLOW ST.  
WORCESTER, MA 01605

FOR: BAR SOAP; BATH SOAPS; HAND SOAPS; HANDMADE SOAP BARS; LOOFAH SOAPS; NATURAL COCOA BUTTER BASED PERSONAL CARE PRODUCTS, NAMELY, BODY LOTION, SHOWER GEL, SOAP, BODY POLISH, BODY AND FOOT SCRUB AND NON-MEDICATED SKIN CREAMS; NATURAL SOAP BARS; NATURALLY HANDMADE SOAP BARS; SHAVING SOAP; SOAPS FOR BODY CARE, IN CLASS 3 (U.S. CLS. 1, 4, 6, 50, 51 AND 52).

FIRST USE 4-1-2011; IN COMMERCE 4-1-2011.

THE MARK CONSISTS OF STANDARD CHARACTERS WITHOUT CLAIM TO ANY PARTICULAR FONT, STYLE, SIZE, OR COLOR.

SER. NO. 85-423,194, FILED 9-15-2011.

DOMINIC FATHY, EXAMINING ATTORNEY



*David J. Kyffers*

Director of the United States Patent and Trademark Office

# United States of America

United States Patent and Trademark Office

## ADVANCING SYNERGY

**Reg. No. 4,197,183**

**Registered Aug. 28, 2012**

**Int. Cl.: 42**

**SERVICE MARK**

**PRINCIPAL REGISTER**

ARTI PATEL VARANASI (UNITED STATES INDIVIDUAL)  
12155 POND PINE DRIVE  
CLARKSBURG, MD 20871

FOR: PROVIDING TEMPORARY USE OF ONLINE NON-DOWNLOADABLE SOFTWARE FOR TELE HEALTH APPLICATIONS, NAMELY, PATIENT ENGAGEMENT, VIRTUAL OUTREACH, NAVIGATION SUPPORT, AND HEALTH AND DISEASE MANAGEMENT AND PROJECTIONS, FOR IMPROVING PUBLIC HEALTH, HEALTH CARE AND RESEARCH THROUGH SCREENING, DIAGNOSIS, TREATMENT AND CARE; COMPUTER SOFTWARE DEVELOPMENT IN THE FIELD OF TELE HEALTH APPLICATIONS FOR IMPROVING PUBLIC HEALTH, HEALTH CARE AND RESEARCH THROUGH SCREENING, DIAGNOSIS, TREATMENT AND CARE, IN CLASS 42 (U.S. CLS. 100 AND 101).

FIRST USE 11-1-2009; IN COMMERCE 11-1-2009.

THE MARK CONSISTS OF STANDARD CHARACTERS WITHOUT CLAIM TO ANY PARTICULAR FONT, STYLE, SIZE, OR COLOR.

SER. NO. 85-423,451, FILED 9-15-2011.

MARK SPARACINO, EXAMINING ATTORNEY



*David J. Kyffers*

Director of the United States Patent and Trademark Office

# United States of America

United States Patent and Trademark Office

innovate.empower.impact

**Reg. No. 4,197,184**

**Registered Aug. 28, 2012**

**Int. Cl.: 42**

**SERVICE MARK**

**PRINCIPAL REGISTER**

ARTI PATEL VARANASI (UNITED STATES INDIVIDUAL)  
12155 POND PINE DRIVE  
CLARKSBURG, MD 20871

FOR: PROVIDING TEMPORARY USE OF ONLINE NON-DOWNLOADABLE SOFTWARE FOR TELE HEALTH APPLICATIONS, NAMELY, PATIENT ENGAGEMENT, VIRTUAL OUTREACH, NAVIGATION SUPPORT, AND HEALTH AND DISEASE MANAGEMENT AND PROJECTIONS, FOR IMPROVING PUBLIC HEALTH, HEALTH CARE AND RESEARCH THROUGH SCREENING, DIAGNOSIS, TREATMENT AND CARE; COMPUTER SOFTWARE DEVELOPMENT IN THE FIELD OF TELE HEALTH APPLICATIONS FOR IMPROVING PUBLIC HEALTH, HEALTH CARE AND RESEARCH THROUGH SCREENING, DIAGNOSIS, TREATMENT AND CARE, IN CLASS 42 (U.S. CLS. 100 AND 101).

FIRST USE 1-1-2011; IN COMMERCE 1-1-2011.

THE MARK CONSISTS OF STANDARD CHARACTERS WITHOUT CLAIM TO ANY PARTICULAR FONT, STYLE, SIZE, OR COLOR.

SER. NO. 85-423,462, FILED 9-15-2011.

MARK SPARACINO, EXAMINING ATTORNEY



*David J. Kyros*

Director of the United States Patent and Trademark Office

# United States of America

United States Patent and Trademark Office



**Reg. No. 4,197,185**

ELEGANT FOOTWEAR, INC. (CALIFORNIA CORPORATION)  
18130 ROWLAND STREET  
CITY OF INDUSTRY, CA 91748

**Registered Aug. 28, 2012**

**Int. Cl.: 35**

FOR: WHOLESALE AND RETAIL STORE SERVICES FEATURING SHOES, IN CLASS 35 (U.S. CLS. 100, 101 AND 102).

**SERVICE MARK**

FIRST USE 1-9-2011; IN COMMERCE 1-9-2011.

**PRINCIPAL REGISTER**

OWNER OF U.S. REG. NOS. 2,956,141 AND 3,426,657.

THE COLOR(S) RED, BLUE, GREEN, PINK, YELLOW AND PURPLE IS/ARE CLAIMED AS A FEATURE OF THE MARK.

NO CLAIM IS MADE TO THE EXCLUSIVE RIGHT TO USE "FOOTWEAR INC.", APART FROM THE MARK AS SHOWN.

THE MARK CONSISTS OF STYLIZED "ELEGANT FOOTWEAR INC." WORDINGS ON THE RIGHT SIDE, WHERE "ELEGANT" IS IN PINK AND "FOOTWEAR INC." ARE IN BLUE. LEFT SIDE SHOWS A BUTTERFLY IN PINK, YELLOW AND PURPLE, A YELLOW SHOE AND A FLOWER IN PINK AND PURPLE, ALONG WITH SOME ARTISTIC DESIGNS IN BLUE, GREEN, RED, PINK, YELLOW, AND PURPLE.

SER. NO. 85-423,520, FILED 9-15-2011.

KATHY DE JONGE, EXAMINING ATTORNEY



*David J. Kybas*

Director of the United States Patent and Trademark Office

# United States of America

United States Patent and Trademark Office

*Kayleen*



*By* Los Angeles

**Reg. No. 4,197,186**

**Registered Aug. 28, 2012**

**Int. Cl.: 25**

**TRADEMARK**

**PRINCIPAL REGISTER**

ELEGANT FOOTWEAR, INC. (CALIFORNIA CORPORATION)  
18130 ROWLAND STREET  
CITY OF INDUSTRY, CA 91748

FOR: SHOES, IN CLASS 25 (U.S. CLS. 22 AND 39).

FIRST USE 8-1-2011; IN COMMERCE 8-1-2011.

NO CLAIM IS MADE TO THE EXCLUSIVE RIGHT TO USE "LOS ANGELES" , APART FROM THE MARK AS SHOWN.

THE COLOR(S) RED AND BLACK IS/ARE CLAIMED AS A FEATURE OF THE MARK.

THE MARK CONSISTS OF STYLIZED "KAYLEEN" IN BLACK ON THE TOP. A BLACK LETTER "K" OVERLAPS A RED SHOE IS SHOWN IN THE MIDDLE OF THE DESIGN. "BY LOS ANGELES" WORDINGS IN BLACK ARE ON THE BOTTOM.

SER. NO. 85-423,553, FILED 9-15-2011.

KATHY DE JONGE, EXAMINING ATTORNEY



*David J. Kyffers*

Director of the United States Patent and Trademark Office

# United States of America

United States Patent and Trademark Office

## Real Guys. Real Stories. Real Opinions.

**Reg. No. 4,197,187**

SIX OMEGA LLC (ILLINOIS LIMITED LIABILITY COMPANY)  
501 N. WELLS SUITE 3W  
CHICAGO, IL 60654

**Registered Aug. 28, 2012**

**Int. Cl.: 41**

FOR: ENTERTAINMENT SERVICES, NAMELY, AN ON-GOING SERIES FEATURING FUNNY, THOUGHT-PROVOKING, ENTERTAINING COMMENTARY FOR MEN AND THE WOMEN WHO LOVE THEM PROVIDED THROUGH THE INTERNET, WEBCASTS, AND CABLE AND NETWORK TELEVISION, IN CLASS 41 (U.S. CLS. 100, 101 AND 107).

**SERVICE MARK**

**PRINCIPAL REGISTER**

FIRST USE 4-20-2007; IN COMMERCE 1-15-2011.

THE MARK CONSISTS OF STANDARD CHARACTERS WITHOUT CLAIM TO ANY PARTICULAR FONT, STYLE, SIZE, OR COLOR.

SER. NO. 85-425,035, FILED 9-16-2011.

ANDREW RHIM, EXAMINING ATTORNEY



*David J. Kybas*

Director of the United States Patent and Trademark Office

# United States of America

United States Patent and Trademark Office

## Engaging Talent

**Reg. No. 4,197,188**

ENGAGING TALENT LLC (NEW YORK LIMITED LIABILITY COMPANY)  
22-69 19TH STREET  
ASTORIA, NY 11105

**Registered Aug. 28, 2012**

**Int. Cl.: 35**

FOR: HUMAN RESOURCES CONSULTATION; PERSONNEL RECRUITMENT SERVICES AND EMPLOYMENT AGENCIES, IN CLASS 35 (U.S. CLS. 100, 101 AND 102).

**SERVICE MARK**

FIRST USE 1-5-2011; IN COMMERCE 1-11-2011.

**PRINCIPAL REGISTER**

THE MARK CONSISTS OF STANDARD CHARACTERS WITHOUT CLAIM TO ANY PARTICULAR FONT, STYLE, SIZE, OR COLOR.

NO CLAIM IS MADE TO THE EXCLUSIVE RIGHT TO USE "TALENT", APART FROM THE MARK AS SHOWN.

SER. NO. 85-425,742, FILED 9-19-2011.

JANICE KIM, EXAMINING ATTORNEY



*David J. Kybas*

Director of the United States Patent and Trademark Office

# United States of America

United States Patent and Trademark Office



**Reg. No. 4,197,189**

**Registered Aug. 28, 2012**

**Int. Cl.: 3**

**TRADEMARK**

**PRINCIPAL REGISTER**

BIRKO CORPORATION (COLORADO CORPORATION)  
9152 YOSEMITE STREET  
HENDERSON, CO 80640

FOR: CLEANERS AND FOAM CLEANERS FOR USE IN MEAT-PACKING AND FOOD PROCESSING PLANTS; LAUNDRY PRODUCTS, NAMELY, BLEACHES AND DETERGENTS, IN CLASS 3 (U.S. CLS. 1, 4, 6, 50, 51 AND 52).

FIRST USE 4-15-2011; IN COMMERCE 4-15-2011.

THE MARK CONSISTS OF THE WORD "BIRKO" CENTERED INSIDE A SPHERE WHICH IS ENCOMPASSED BY THREE ARROWS.

SER. NO. 85-425,872, FILED 9-19-2011.

MIDGE BUTLER, EXAMINING ATTORNEY



*David J. Kyffers*

Director of the United States Patent and Trademark Office



# United States of America

United States Patent and Trademark Office

## PROSTAGRAPH

**Reg. No. 4,197,190**

ENDOCARE, INC. (DELAWARE CORPORATION)  
100 ENDO BOULEVARD  
CHADDS FORD, PA 19317

**Registered Aug. 28, 2012**

**Int. Cl.: 10**

FOR: MEDICAL AND SURGICAL APPARATUS AND INSTRUMENTS, NAMELY, COMPUTER SOFTWARE CONTROLS USED TO GUIDE CRYOPROBE PLACEMENT AS A COMPONENT OF PROSTATE CRYOTHERAPY MACHINES, IN CLASS 10 (U.S. CLS. 26, 39 AND 44).

**TRADEMARK**

FIRST USE 4-0-2007; IN COMMERCE 4-0-2007.

**PRINCIPAL REGISTER**

THE MARK CONSISTS OF STANDARD CHARACTERS WITHOUT CLAIM TO ANY PARTICULAR FONT, STYLE, SIZE, OR COLOR.

THE WORDING "PROSTAGRAPH" HAS NO MEANING IN A FOREIGN LANGUAGE.

SER. NO. 85-426,757, FILED 9-20-2011.

NAKIA HENRY, EXAMINING ATTORNEY



*David J. Kyffers*

Director of the United States Patent and Trademark Office

# United States of America

United States Patent and Trademark Office



**Reg. No. 4,197,191**

**Registered Aug. 28, 2012**

**Int. Cls.: 35 and 38**

**SERVICE MARK**

**PRINCIPAL REGISTER**

STRIDER INC (CANADA CORPORATION)  
250 THE EAST MALL SUITE 1264  
TORONTO, ON, CANADA M9B6L3

FOR: ONLINE BUSINESS NETWORKING SERVICES FOR FLORISTS; PROVIDING ONLINE NEWS DEALING WITH BUSINESS DEVELOPMENTS AND CURRENT BUSINESS EVENTS IN THE FLORAL INDUSTRY; ORGANIZATION OF FLORAL INDUSTRY EVENTS FOR ADVERTISING PURPOSES; ONLINE AND OFFLINE BUSINESS MARKETING SERVICES; PROVIDING A WEBSITE FEATURING BUSINESS INFORMATION IN THE FORM OF EDUCATIONAL ARTICLES AND ADVICE COLUMNS, IN CLASS 35 (U.S. CLS. 100, 101 AND 102).

FIRST USE 10-31-2002; IN COMMERCE 10-31-2002.

FOR: PROVIDING ONLINE CHAT ROOMS AND ONLINE FORUMS FOR TRANSMISSION OF MESSAGES AMONG FLORISTS WORKING IN THE FLORAL INDUSTRY, IN CLASS 38 (U.S. CLS. 100, 101 AND 104).

FIRST USE 10-31-2002; IN COMMERCE 10-31-2002.

THE MARK CONSISTS OF THE STYLIZED WORD "FLOWERCHAT" IN DARK GREEN WITH A LIGHT GREEN BORDER. GROWING OUT OF THE WORD ARE LIGHT GREEN FLOWERS, LIGHT GREEN STEMS AND LIGHT GREEN DECORATIVE SWIRLS.

THE COLOR(S) LIGHT GREEN AND DARK GREEN IS/ARE CLAIMED AS A FEATURE OF THE MARK.

SER. NO. 85-426,784, FILED 9-20-2011.

RUSS HERMAN, EXAMINING ATTORNEY



*David J. Kybas*

Director of the United States Patent and Trademark Office

# United States of America

United States Patent and Trademark Office

# TEMPGRAPH

**Reg. No. 4,197,192**

**Registered Aug. 28, 2012**

**Int. Cl.: 10**

**TRADEMARK**

**PRINCIPAL REGISTER**

ENDOCARE, INC. (DELAWARE CORPORATION)  
100 ENDO BOULEVARD  
CHADDS FORD, PA 19137

FOR: MEDICAL AND SURGICAL APPARATUS AND INSTRUMENTS, NAMELY, COMPUTER SOFTWARE CONTROLS USED TO GUIDE CRYOPROBE PLACEMENT AS A COMPONENT OF PROSTATE CRYOTHERAPY MACHINES, IN CLASS 10 (U.S. CLS. 26, 39 AND 44).

FIRST USE 2-0-2009; IN COMMERCE 2-0-2009.

THE MARK CONSISTS OF STANDARD CHARACTERS WITHOUT CLAIM TO ANY PARTICULAR FONT, STYLE, SIZE, OR COLOR.

THE WORDING "TEMPGRAPH" HAS NO MEANING IN A FOREIGN LANGUAGE.

SER. NO. 85-426,787, FILED 9-20-2011.

NAKIA HENRY, EXAMINING ATTORNEY



*David J. Kyffers*

Director of the United States Patent and Trademark Office

# United States of America

United States Patent and Trademark Office

STILLHEART  
INSTITUTE



*Transforming Humanity*

**Reg. No. 4,197,193**

**Registered Aug. 28, 2012**

**Int. Cls.: 41 and 43**

**SERVICE MARK**

**PRINCIPAL REGISTER**

STILLHEART INSTITUTE (CALIFORNIA NON-PROFIT CORPORATION)  
16350 SKYLINE BLVD.  
WOODSIDE, DC 94062

FOR: EDUCATIONAL SERVICES, NAMELY, DEVELOPING, ARRANGING, AND CONDUCTING EDUCATIONAL CONFERENCES AND PROGRAMS AND PROVIDING COURSES OF INSTRUCTION IN THE FIELD OF PERSONAL, PROFESSIONAL, OR SPIRITUAL GROWTH AND DEVELOPMENT, IN CLASS 41 (U.S. CLS. 100, 101 AND 107).

FIRST USE 11-1-2009; IN COMMERCE 11-1-2009.

FOR: HEALTH RESORT SERVICES, NAMELY, PROVIDING FOOD AND LODGING THAT SPECIALIZE IN PROMOTING PATRONS' GENERAL HEALTH AND WELL-BEING, IN CLASS 43 (U.S. CLS. 100 AND 101).

FIRST USE 11-1-2009; IN COMMERCE 11-1-2009.

NO CLAIM IS MADE TO THE EXCLUSIVE RIGHT TO USE "INSTITUTE", APART FROM THE MARK AS SHOWN.

THE MARK CONSISTS OF THE TEXT "STILLHEART" AT THE TOP, THE TEXT "INSTITUTE" CENTERED BELOW "STILLHEART", A CIRCULAR IMAGE CENTERED BELOW "INSTITUTE" WHICH CONTAINS A HEART ABOVE AN ABSTRACT DESIGN, AND THE TEXT "TRANSFORMING HUMANITY" CENTERED BELOW THE IMAGE.

SER. NO. 85-426,794, FILED 9-20-2011.

DORITT L. CARROLL, EXAMINING ATTORNEY



*David J. Kyros*

Director of the United States Patent and Trademark Office

# United States of America

United States Patent and Trademark Office

## Brian Bemis

**Reg. No. 4,197,194**

BRIAN BEMIS AUTOMOTIVE GROUP (ILLINOIS CORPORATION)  
1875 DEKALB AVE.  
SYCAMORE, IL 60178

**Registered Aug. 28, 2012**

**Int. Cl.: 35**

FOR: AUTOMOBILE DEALERSHIPS, IN CLASS 35 (U.S. CLS. 100, 101 AND 102).

**SERVICE MARK**

FIRST USE 8-1-1984; IN COMMERCE 8-1-1984.

**PRINCIPAL REGISTER**

THE MARK CONSISTS OF STANDARD CHARACTERS WITHOUT CLAIM TO ANY PARTICULAR FONT, STYLE, SIZE, OR COLOR.

THE NAME(S), PORTRAIT(S), AND/OR SIGNATURE(S) SHOWN IN THE MARK IDENTIFIES "BRIAN BEMIS", WHOSE CONSENT(S) TO REGISTER IS MADE OF RECORD.

SER. NO. 85-426,811, FILED 9-20-2011.

ALEXANDER L. POWERS, EXAMINING ATTORNEY



*David J. Kyffers*

Director of the United States Patent and Trademark Office

# United States of America

United States Patent and Trademark Office

## Leadership Journal

**Reg. No. 4,197,195**

**Registered Aug. 28, 2012**

**Int. Cl.: 16**

**TRADEMARK**

**PRINCIPAL REGISTER**

CHRISTIANITY TODAY INTERNATIONAL (ILLINOIS NON-PROFIT CORPORATION)  
465 GUNDERSEN DRIVE  
CAROL STREAM, IL 60188

FOR: PRINTED PERIODICALS IN THE FIELD OF CHURCH LEADERSHIP, IN CLASS 16  
(U.S. CLS. 2, 5, 22, 23, 29, 37, 38 AND 50).

FIRST USE 1-0-2007; IN COMMERCE 1-0-2007.

THE MARK CONSISTS OF STANDARD CHARACTERS WITHOUT CLAIM TO ANY PARTICULAR FONT, STYLE, SIZE, OR COLOR.

OWNER OF U.S. REG. NO. 1,197,840.

NO CLAIM IS MADE TO THE EXCLUSIVE RIGHT TO USE "JOURNAL", APART FROM THE MARK AS SHOWN.

SEC. 2(F).

SER. NO. 85-427,439, FILED 9-20-2011.

GENE MACIOL, EXAMINING ATTORNEY



*David J. Kyjars*

Director of the United States Patent and Trademark Office

# United States of America

United States Patent and Trademark Office

# LederMeister

**Reg. No. 4,197,196**

WINTER HEAVY INDUSTRIES (WASHINGTON LIMITED LIABILITY COMPANY)  
1122 EAST PIKE STREET #549  
SEATTLE, WA 98122

**Registered Aug. 28, 2012**

**Int. Cl.: 18**

FOR: ADULT SEXUAL STIMULATION AIDS, NAMELY, LEATHER RESTRAINTS, IN CLASS 18 (U.S. CLS. 1, 2, 3, 22 AND 41).

**TRADEMARK**

FIRST USE 3-7-2001; IN COMMERCE 5-10-2005.

**PRINCIPAL REGISTER**

THE MARK CONSISTS OF STANDARD CHARACTERS WITHOUT CLAIM TO ANY PARTICULAR FONT, STYLE, SIZE, OR COLOR.

THE ENGLISH TRANSLATION OF "LEDERMEISTER" IN THE MARK IS "LEATHER MASTER".

SER. NO. 85-427,523, FILED 9-20-2011.

ALEX KEAM, EXAMINING ATTORNEY



*David J. Kybas*

Director of the United States Patent and Trademark Office

# United States of America

United States Patent and Trademark Office

# KEG

**Reg. No. 4,197,197**

**Registered Aug. 28, 2012**

**Int. Cl.: 16**

**TRADEMARK**

**PRINCIPAL REGISTER**

ELEANOR AVINOR (ISRAEL INDIVIDUAL)  
P.O. BOX 56008  
24 SHLONSKY ST.  
HAIFA, ISRAEL 34987

FOR: PRINTED MATERIALS, NAMELY, BOOKS, PAMPHLETS AND NEWSLETTERS IN THE FIELD OF THERAPY; THERAPY CARDS WITH PICTURES AND GUIDING QUESTIONS TO PROMOTE AND STIMULATE DISCUSSION AND DECISIONS; THERAPY BOOKS, IN CLASS 16 (U.S. CLS. 2, 5, 22, 23, 29, 37, 38 AND 50).

FIRST USE 10-1-2009; IN COMMERCE 6-1-2010.

THE MARK CONSISTS OF STANDARD CHARACTERS WITHOUT CLAIM TO ANY PARTICULAR FONT, STYLE, SIZE, OR COLOR.

OWNER OF U.S. REG. NO. 4,067,824.

SER. NO. 85-427,824, FILED 9-21-2011.

TRICIA SONNEBORN, EXAMINING ATTORNEY



*David J. Kyffers*

Director of the United States Patent and Trademark Office



# United States of America

United States Patent and Trademark Office

## LEMON WATER SALON

**Reg. No. 4,197,198**

LEMON WATER HOLDINGS, LLC (MINNESOTA LIMITED LIABILITY COMPANY)  
1571 STONEYBROOK DRIVE  
HUGO, MN 55038

**Registered Aug. 28, 2012**

**Int. Cls.: 35 and 44**

FOR: RETAIL STORE SERVICES AND ONLINE RETAIL STORE SERVICES FEATURING HAIR AND SPA PRODUCTS, IN CLASS 35 (U.S. CLS. 100, 101 AND 102).

**SERVICE MARK**

FIRST USE 1-1-2005; IN COMMERCE 1-1-2005.

**PRINCIPAL REGISTER**

FOR: SALON AND SPA SERVICES, NAMELY, NAIL CARE SALON SERVICES, SKIN CARE SALON SERVICES; BEAUTY SPA SERVICES, NAMELY, COSMETIC BODY CARE, IN CLASS 44 (U.S. CLS. 100 AND 101).

FIRST USE 1-1-2005; IN COMMERCE 1-1-2005.

THE MARK CONSISTS OF STANDARD CHARACTERS WITHOUT CLAIM TO ANY PARTICULAR FONT, STYLE, SIZE, OR COLOR.

NO CLAIM IS MADE TO THE EXCLUSIVE RIGHT TO USE "SALON", APART FROM THE MARK AS SHOWN.

SER. NO. 85-428,008, FILED 9-21-2011.

TARAH HARDY, EXAMINING ATTORNEY



*David J. Kybas*

Director of the United States Patent and Trademark Office

# United States of America

United States Patent and Trademark Office

# IART

**Reg. No. 4,197,199**

**Registered Aug. 28, 2012**

**Int. Cls.: 1 and 44**

**TRADEMARK**

**SERVICE MARK**

**PRINCIPAL REGISTER**

SIGMA-TAU INDUSTRIE FARMACEUTICHE RIUNITE S.P.A. (ITALY CORPORATION)  
VIALE SHAKESPEARE, 47  
ROMA, ITALY 00144

FOR: RADIOIMMUNOTHERAPY PREPARATIONS FOR SCIENTIFIC OR RESEARCH USE,  
IN CLASS 1 (U.S. CLS. 1, 5, 6, 10, 26 AND 46).

FOR: NEOPLASTIC PATIENTS TREATMENT REGIMES FOR THE THERAPY OR DIAGNOSIS  
OF TUMOROUS DISEASES, IN CLASS 44 (U.S. CLS. 100 AND 101).

THE MARK CONSISTS OF STANDARD CHARACTERS WITHOUT CLAIM TO ANY PAR-  
TICULAR FONT, STYLE, SIZE, OR COLOR.

OWNER OF ERPN CMNTY TM OFC REG. NO. 008846991, DATED 7-27-2010, EXPIRES 1-  
29-2020.

OWNER OF U.S. REG. NO. 2,995,411.

SER. NO. 85-429,653, FILED 9-22-2011.

DANNEAN HETZEL, EXAMINING ATTORNEY



*David J. Kyffers*

Director of the United States Patent and Trademark Office

# United States of America

United States Patent and Trademark Office



**PrimeState**  
Public Adjusters, Inc.  
Public Insurance Adjusters

**Reg. No. 4,197,200**

PRIMESTATE PUBLIC ADJUSTERS, INC. (FLORIDA CORPORATION)  
127 GRAND AVENUE  
CORAL GABLES, FL 33133

**Registered Aug. 28, 2012**

**Int. Cl.: 36**

FOR: CLAIMS ADJUSTMENT IN THE FIELD OF INSURANCE, IN CLASS 36 (U.S. CLS. 100, 101 AND 102).

**SERVICE MARK**

FIRST USE 1-26-1998; IN COMMERCE 1-26-1998.

**PRINCIPAL REGISTER**

NO CLAIM IS MADE TO THE EXCLUSIVE RIGHT TO USE "INTEGRITY SERVICE QUALITY", "PUBLIC ADJUSTERS, INC." AND "PUBLIC INSURANCE ADJUSTERS", APART FROM THE MARK AS SHOWN.

THE MARK CONSISTS OF THE WORDS "INTEGRITY SERVICE QUALITY" INSIDE A CIRCLE IN A STYLIZED FONT. AN IMAGE OF A BADGE IN THE CIRCLE WITH AN IMAGE OF THE STATE OF FLORIDA AND A KEY INSIDE THE BADGE. THE WORDS "PRIMESTATE" TO THE LEFT OF THE CIRCLE, THE WORDS "PUBLIC ADJUSTERS, INC." BELOW "PRIMESTATE" AND THE WORDS "PUBLIC INSURANCE ADJUSTERS" BELOW "PUBLIC ADJUSTERS, INC." IN A STYLIZED FONT.

SER. NO. 85-429,695, FILED 9-22-2011.

ROBERT C. CLARK JR., EXAMINING ATTORNEY



*David J. Kyros*

Director of the United States Patent and Trademark Office

# United States of America

United States Patent and Trademark Office

# HTT

**Reg. No. 4,197,201**

**Registered Aug. 28, 2012**

**Int. Cl.: 6**

WOLVERINE / WIELAND HEAT TRANSFER TECHNOLOGIES LLC (FED REP GERMANY  
LIMITED LIABILITY COMPANY)  
ZWEIGNIEDERLASSUNG DEUTSCHLAND  
GRAF-ARCO STRASSE 36  
ULM, FED REP GERMANY 89079

**TRADEMARK**

FOR: METAL TUBES; METAL FINNED TUBES; METAL HEAT EXCHANGER TUBES , IN  
CLASS 6 (U.S. CLS. 2, 12, 13, 14, 23, 25 AND 50).

**PRINCIPAL REGISTER**

THE MARK CONSISTS OF STANDARD CHARACTERS WITHOUT CLAIM TO ANY PAR-  
TICULAR FONT, STYLE, SIZE, OR COLOR.

PRIORITY CLAIMED UNDER SEC. 44(D) ON FED REP GERMANY APPLICATION NO.  
302011026137, FILED 5-10-2011, REG. NO. 302011026137, DATED 10-19-2011, EXPIRES 5-  
31-2021.

SER. NO. 85-429,794, FILED 9-22-2011.

FRANK LATTUCA, EXAMINING ATTORNEY



*David J. Kyffers*

Director of the United States Patent and Trademark Office

# United States of America

United States Patent and Trademark Office

# AICO

**Reg. No. 4,197,202**

**Registered Aug. 28, 2012**

**Int. Cls.: 20 and 24**

**TRADEMARK**

**PRINCIPAL REGISTER**

AMINI INNOVATION CORP. (CALIFORNIA CORPORATION)  
8725 REX ROAD  
PICO RIVERA, CA 90660

FOR: ACCENT PILLOWS, IN CLASS 20 (U.S. CLS. 2, 13, 22, 25, 32 AND 50).

FIRST USE 7-30-2007; IN COMMERCE 7-30-2007.

FOR: BEDDING, NAMELY, COMFORTERS, BED SKIRTS, BED SHAMS, IN CLASS 24 (U.S. CLS. 42 AND 50).

FIRST USE 7-30-2007; IN COMMERCE 7-30-2007.

THE MARK CONSISTS OF STANDARD CHARACTERS WITHOUT CLAIM TO ANY PARTICULAR FONT, STYLE, SIZE, OR COLOR.

OWNER OF U.S. REG. NOS. 2,853,087, 3,089,302, AND 3,267,076.

SER. NO. 85-429,823, FILED 9-22-2011.

MICHAEL SOUDERS, EXAMINING ATTORNEY



*David J. Kyffers*

Director of the United States Patent and Trademark Office

# United States of America

United States Patent and Trademark Office

## VERY MERRY FESTIVAL

**Reg. No. 4,197,203**

**Registered Aug. 28, 2012**

**Int. Cls.: 29 and 30**

**TRADEMARK**

**PRINCIPAL REGISTER**

EDIBLE ARRANGEMENTS, LLC (CONNECTICUT LIMITED LIABILITY COMPANY)  
95 BARNES ROAD  
WALLINGFORD, CT 06492

FOR: FRUIT CUT INTO SHAPES AND ARRANGED IN CONTAINERS AS FLORAL DESIGNS; PROCESSED FRUITS; ARRANGEMENTS MADE OF FRESH PROCESSED FRUIT; FRUIT CUT INTO SHAPES AND AT LEAST PARTIALLY COATED WITH AN EDIBLE TOPPING, NAMELY, COCONUT, PROCESSED NUTS AND COMBINATIONS THEREOF; FRUIT CUT INTO SHAPES AND AT LEAST PARTIALLY COATED WITH AN EDIBLE TOPPING, NAMELY, COCONUT, PROCESSED NUTS AND COMBINATIONS THEREOF AND ARRANGED IN CONTAINERS AS FLORAL DESIGNS, IN CLASS 29 (U.S. CL. 46).

FIRST USE 9-20-2010; IN COMMERCE 9-20-2010.

FOR: FRUIT CUT INTO SHAPES AND AT LEAST PARTIALLY COATED WITH AN EDIBLE TOPPING, NAMELY, CHOCOLATE, CINNAMON AND COMBINATIONS THEREOF; FRUIT CUT INTO SHAPES AND AT LEAST PARTIALLY COATED WITH AN EDIBLE TOPPING, NAMELY, CHOCOLATE, CINNAMON AND COMBINATIONS THEREOF AND ARRANGED IN CONTAINERS AS FLORAL DESIGNS; FRUIT CUT INTO SHAPES, SKEWERED, AND AT LEAST PARTIALLY COATED WITH AN EDIBLE TOPPING, NAMELY, CHOCOLATE; ARRANGEMENTS MADE OF PROCESSED FRUIT AT LEAST PARTIALLY COATED WITH AN EDIBLE TOPPING, NAMELY, CHOCOLATE, CINNAMON AND COMBINATIONS THEREOF, IN CLASS 30 (U.S. CL. 46).

FIRST USE 9-20-2010; IN COMMERCE 9-20-2010.

THE MARK CONSISTS OF STANDARD CHARACTERS WITHOUT CLAIM TO ANY PARTICULAR FONT, STYLE, SIZE, OR COLOR.

OWNER OF U.S. REG. NOS. 3,434,395, 3,527,134, AND 3,714,560.

SER. NO. 85-430,179, FILED 9-23-2011.

JEFF DEFORD, EXAMINING ATTORNEY



*David J. Kyffers*

Director of the United States Patent and Trademark Office

# United States of America

United States Patent and Trademark Office

## VERY MERRY DAISY

**Reg. No. 4,197,204**

**Registered Aug. 28, 2012**

**Int. Cls.: 29 and 30**

**TRADEMARK**

**PRINCIPAL REGISTER**

EDIBLE ARRANGEMENTS, LLC (CONNECTICUT LIMITED LIABILITY COMPANY)  
95 BARNES ROAD  
WALLINGFORD, CT 06492

FOR: FRUIT CUT INTO SHAPES AND ARRANGED IN CONTAINERS AS FLORAL DESIGNS; PROCESSED FRUITS; ARRANGEMENTS MADE OF FRESH PROCESSED FRUIT; FRUIT CUT INTO SHAPES AND AT LEAST PARTIALLY COATED WITH AN EDIBLE TOPPING, NAMELY, COCONUT, PROCESSED NUTS AND COMBINATIONS THEREOF; FRUIT CUT INTO SHAPES AND AT LEAST PARTIALLY COATED WITH AN EDIBLE TOPPING, NAMELY, COCONUT, PROCESSED NUTS AND COMBINATIONS THEREOF AND ARRANGED IN CONTAINERS AS FLORAL DESIGNS, IN CLASS 29 (U.S. CL. 46).

FIRST USE 9-20-2010; IN COMMERCE 9-20-2010.

FOR: FRUIT CUT INTO SHAPES AND AT LEAST PARTIALLY COATED WITH AN EDIBLE TOPPING, NAMELY, CHOCOLATE, CINNAMON AND COMBINATIONS THEREOF; FRUIT CUT INTO SHAPES AND AT LEAST PARTIALLY COATED WITH AN EDIBLE TOPPING, NAMELY, CHOCOLATE, CINNAMON AND COMBINATIONS THEREOF AND ARRANGED IN CONTAINERS AS FLORAL DESIGNS; FRUIT CUT INTO SHAPES, SKEWERED, AND AT LEAST PARTIALLY COATED WITH AN EDIBLE TOPPING, NAMELY, CHOCOLATE; ARRANGEMENTS MADE OF PROCESSED FRUIT AT LEAST PARTIALLY COATED WITH AN EDIBLE TOPPING, NAMELY, CHOCOLATE, CINNAMON AND COMBINATIONS THEREOF, IN CLASS 30 (U.S. CL. 46).

FIRST USE 9-20-2010; IN COMMERCE 9-20-2010.

THE MARK CONSISTS OF STANDARD CHARACTERS WITHOUT CLAIM TO ANY PARTICULAR FONT, STYLE, SIZE, OR COLOR.

OWNER OF U.S. REG. NOS. 3,387,966, 3,414,147, AND 3,429,716.

SER. NO. 85-430,202, FILED 9-23-2011.

JEFF DEFORD, EXAMINING ATTORNEY



*David J. Kyffers*

Director of the United States Patent and Trademark Office

# United States of America

United States Patent and Trademark Office



**Reg. No. 4,197,205**

SILVIES VALLEY RANCH, LLC (OREGON LIMITED LIABILITY COMPANY)  
7610 SE 162ND AVENUE  
PORTLAND, OR 97236

**Registered Aug. 28, 2012**

**Int. Cl.: 31**

FOR: HAY, IN CLASS 31 (U.S. CLS. 1 AND 46).

**TRADEMARK**

FIRST USE 7-1-2010; IN COMMERCE 7-1-2010.

**PRINCIPAL REGISTER**

THE MARK CONSISTS OF THE LETTER "S" WITH AN ARCHED LINE ON TOP AND A SLANTED LINE ON THE RIGHT AND LEFT OF THE LETTER.

SER. NO. 85-430,464, FILED 9-23-2011.

MARC LEIPZIG, EXAMINING ATTORNEY



*David J. Kyffers*

Director of the United States Patent and Trademark Office



# United States of America

United States Patent and Trademark Office

# CDAMS

**Reg. No. 4,197,206**

**Registered Aug. 28, 2012**

**Int. Cls.: 35, 37 and 42**

**SERVICE MARK**

**PRINCIPAL REGISTER**

ITECHNOLOGY GROUP LLC (DELAWARE LIMITED LIABILITY COMPANY), DBA  
ITGROUP  
10 NED ROAD  
WAYNE, NJ 07470

FOR: PROJECT MANAGEMENT SERVICES FOR BUSINESS PURPOSES IN THE FIELD OF DATA MIGRATION; BUSINESS ANALYSIS SERVICES, NAMELY, INTERPRETING REPORTS AND RECOMMENDING WAYS TO OPTIMIZE DATA MIGRATION AND TARGET STORAGE, IN CLASS 35 (U.S. CLS. 100, 101 AND 102).

FIRST USE 8-2-2011; IN COMMERCE 8-2-2011.

FOR: INSTALLATION, MAINTENANCE, REPAIR AND DEINSTALLATION OF COMPUTER HARDWARE FOR PURPOSES OF DATA MIGRATION, IN CLASS 37 (U.S. CLS. 100, 103 AND 106).

FIRST USE 8-2-2011; IN COMMERCE 8-2-2011.

FOR: DATA MIGRATION SERVICES; ENGINEERING SERVICES IN THE FIELD OF COMPUTER HARDWARE; COMPUTER HARDWARE AND SOFTWARE MONITORING SERVICES, NAMELY, MONITORING THE PERFORMANCE OF DATA MIGRATION HARDWARE AND SOFTWARE, IN CLASS 42 (U.S. CLS. 100 AND 101).

FIRST USE 8-2-2011; IN COMMERCE 8-2-2011.

THE MARK CONSISTS OF STANDARD CHARACTERS WITHOUT CLAIM TO ANY PARTICULAR FONT, STYLE, SIZE, OR COLOR.

SER. NO. 85-430,729, FILED 9-23-2011.

DAVID ELTON, EXAMINING ATTORNEY



*David J. Kyffers*

Director of the United States Patent and Trademark Office

# United States of America

United States Patent and Trademark Office

# MSEP

**Reg. No. 4,197,207**

**Registered Aug. 28, 2012**

**Int. Cl.: 9**

**TRADEMARK**

**PRINCIPAL REGISTER**

EMCEE ELECTRONICS, INC. (DELAWARE CORPORATION)  
520 CYPRESS AVENUE  
VENICE, FL 34285

FOR: EQUIPMENT, NAMELY, FUEL TESTING INSTRUMENTATION FOR MEASURING MATERIALS IN FUEL THAT AFFECT THE ABILITY OF FILTER SEPARATORS TO SEPARATE WATER FROM FUEL, IN CLASS 9 (U.S. CLS. 21, 23, 26, 36 AND 38).

FIRST USE 0-0-1980; IN COMMERCE 0-0-1980.

THE MARK CONSISTS OF STANDARD CHARACTERS WITHOUT CLAIM TO ANY PARTICULAR FONT, STYLE, SIZE, OR COLOR.

SER. NO. 85-430,749, FILED 9-23-2011.

CHRISTOPHER LAW, EXAMINING ATTORNEY



*David J. Kybas*

Director of the United States Patent and Trademark Office

# United States of America

United States Patent and Trademark Office

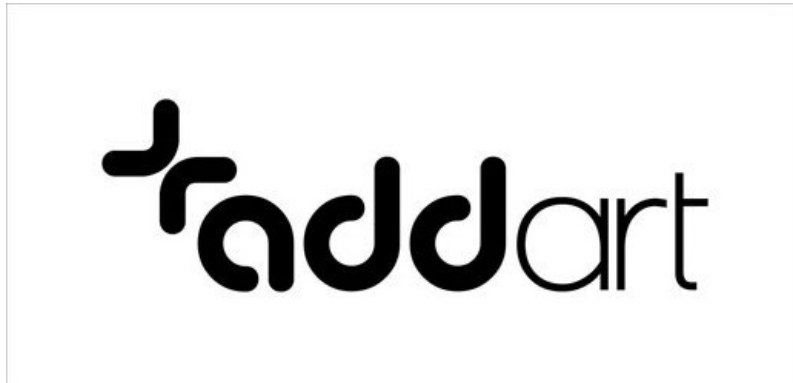

**Reg. No. 4,197,208**

**Registered Aug. 28, 2012**

**Int. Cl.: 42**

**SERVICE MARK**

**PRINCIPAL REGISTER**

HEARN, CHRISTOPHER JEREMY (ARIZONA SOLE PROPRIETORSHIP), DBA ADDART  
12000 WEST NADINE WAY  
12000 WEST NADINE WAY  
PEORIA, AZ 85383

FOR: COMMERCIAL ART DESIGN; COMPUTER AIDED GRAPHIC DESIGN; CONSULTING SERVICES IN THE FIELD OF THE DESIGN OF ART; GRAPHIC ART DESIGN; GRAPHIC ARTS DESIGNING; GRAPHIC DESIGN; GRAPHIC DESIGN SERVICES, IN CLASS 42 (U.S. CLS. 100 AND 101).

FIRST USE 10-9-2007; IN COMMERCE 10-9-2007.

THE MARK CONSISTS OF LOGO LEFT IS (2) TWO IDENTICAL L SHAPED OBJECTS WITH CURVED EDGES (1) ONE IS FLIPPED OPPOSITELY THE OTHER. AS PLACED LOGO IS REPRESENTATION OF A ADDITION SYMBOL (+). SIZE IS PROPORTIONAL. RIGHT OF LOGO BUSINESS NAME, "ADDART". FONT NAMED ALBA SPELLING "A D D" AND FONT NAMED ASENINE SPELLING "A R T".

SER. NO. 85-431,438, FILED 9-25-2011.

DAVID I, EXAMINING ATTORNEY



*David J. Kyros*

Director of the United States Patent and Trademark Office

# United States of America

United States Patent and Trademark Office

# TEFRA

**Reg. No. 4,197,209**

**Registered Aug. 28, 2012**

**Int. Cl.: 7**

**TRADEMARK**

**PRINCIPAL REGISTER**

HILL ENGINEERING LIMITED (IRELAND COMPANY)  
UNIT 6, CARNBANE BUSINESS PARK  
NEWRY, COUNTY DOWN, UNITED KINGDOM BT356QH

FOR: MACHINE PARTS, NAMELY, NON-ELECTRIC COUPLERS; NON-ELECTRIC COUPLERS FOR EXCAVATING MACHINES AND BACKHOES; BUCKETS FOR EXCAVATING MACHINES AND BACKHOES; ATTACHMENTS FOR EXCAVATORS, NAMELY, NON-ELECTRIC COUPLERS AND BUCKETS; REPLACEMENT PARTS AND FITTINGS FOR EXCAVATORS, NAMELY, NON-ELECTRIC COUPLERS, HYDRAULIC AND PNEUMATIC PARTS; REPLACEMENT AND STRUCTURAL PARTS AND FITTINGS FOR NON-ELECTRIC COUPLERS FOR EXCAVATING MACHINES AND BACKHOES, IN CLASS 7 (U.S. CLS. 13, 19, 21, 23, 31, 34 AND 35).

THE MARK CONSISTS OF STANDARD CHARACTERS WITHOUT CLAIM TO ANY PARTICULAR FONT, STYLE, SIZE, OR COLOR.

PRIORITY CLAIMED UNDER SEC. 44(D) ON ERPN CMNTY TM OFC APPLICATION NO. 9861816, FILED 4-1-2011, REG. NO. 9861816, DATED 9-5-2011, EXPIRES 4-1-2021.

SER. NO. 85-431,632, FILED 9-26-2011.

MICHELLE DUBOIS, EXAMINING ATTORNEY



*David J. Kyros*

Director of the United States Patent and Trademark Office

# United States of America

United States Patent and Trademark Office



**Reg. No. 4,197,210**

**Registered Aug. 28, 2012**

**Int. Cls.: 37 and 39**

**SERVICE MARK**

**PRINCIPAL REGISTER**

DRYCLEAN TO GO, LLC (FLORIDA LIMITED LIABILITY COMPANY)  
103 NW 43RD STREET, SUITE C  
BOCA RATON, FL 33431

FOR: DRY CLEANING AND STAIN REMOVAL SERVICES FOR CLOTHING AND OTHER FABRICS; LAUNDRY SERVICE FOR CLOTHING, IN CLASS 37 (U.S. CLS. 100, 103 AND 106).

FIRST USE 4-1-2011; IN COMMERCE 4-1-2011.

FOR: TRANSPORTATION AND DELIVERY SERVICES OF DRY CLEANING AND LAUNDRY BY ROAD, IN CLASS 39 (U.S. CLS. 100 AND 105).

FIRST USE 4-1-2011; IN COMMERCE 4-1-2011.

NO CLAIM IS MADE TO THE EXCLUSIVE RIGHT TO USE "DRYCLEAN TO GO", APART FROM THE MARK AS SHOWN.

THE COLOR(S) LIGHT BLUE, DARK BLUE, WHITE AND GREEN IS/ARE CLAIMED AS A FEATURE OF THE MARK.

THE MARK CONSISTS OF THE FOLLOWING: THE WORDING "DRYCLEAN" HAS A WHITE BORDER, WITH EACH LETTER STARTING AT THE TOP IN LIGHT BLUE TURNING TO DARK BLUE AT THE BOTTOM OF EACH LETTER. THE WORDS "TO" AND "GO" ARE IN LIGHT GREEN COLOR. THE DESIGN ELEMENT ABOVE THE LETTERS "A" AND "N" OF THE WORDS "DRYCLEAN" CONSIST OF TWO LIGHT AND DARK BLUE APOSTROPHES AND TWO GREEN APOSTROPHES.

SER. NO. 85-431,892, FILED 9-26-2011.

ANNE E. GUSTASON, EXAMINING ATTORNEY



*David J. Kypos*

Director of the United States Patent and Trademark Office

# United States of America

United States Patent and Trademark Office

**Levin Group** Inc.  
● ● ● ● ● ● ● ● ● ●

**Reg. No. 4,197,211**

**Registered Aug. 28, 2012**

**Int. Cls.: 35 and 41**

**SERVICE MARK**

**PRINCIPAL REGISTER**

LEVIN GROUP INC. (MARYLAND CORPORATION)  
10 NEW PLANT CT.  
OWINGS MILLS, MD 21117

FOR: BUSINESS ADVISORY SERVICES IN THE FIELD OF TECHNIQUES TO IMPROVE PROFITABILITY OF DENTAL AND DENTAL SPECIALTY PRACTICES, NAMELY, DENTISTS, ORTHODONTISTS, PERIODONTISTS, PEDIATRIC DENTISTS, ENDODONTISTS, ORAL SURGEONS; BUSINESS MANAGEMENT AND CONSULTATION IN THE FIELD OF MARKETING OF DENTAL AND DENTAL SPECIALTY PRACTICES; BUSINESS MANAGEMENT CONSULTATION IN THE FIELD OF DENTAL AND DENTAL SPECIALTY PRACTICE; DENTAL PRACTICE MANAGEMENT FOR OTHERS, IN CLASS 35 (U.S. CLS. 100, 101 AND 102).

FIRST USE 3-1-2009; IN COMMERCE 1-1-2011.

FOR: EDUCATION SERVICES, NAMELY, PROVIDING COURSES FOR DENTISTS, DENTAL SPECIALISTS, LAB TECHNICIANS, DENTAL HYGIENISTS, DENTAL TREATMENT COORDINATORS, AND OTHER DENTAL PROFESSIONALS AND ASSOCIATES IN THE FIELD OF OFFICE MANAGEMENT, SKILLS, AND WORK PROCEDURES, FEATURING TECHNIQUES TO IMPROVE PROFITABILITY OF A DENTAL OR DENTAL SPECIALTY PRACTICE, IN CLASS 41 (U.S. CLS. 100, 101 AND 107).

FIRST USE 3-1-2009; IN COMMERCE 1-1-2011.

OWNER OF U.S. REG. NO. 3,033,760.

NO CLAIM IS MADE TO THE EXCLUSIVE RIGHT TO USE "GROUP INC.", APART FROM THE MARK AS SHOWN.

THE MARK CONSISTS OF THE TERMS "LEVIN GROUP INC.", UNDERLINED, WITH 9 SMALL BALLS IN A HORIZONTAL ROW IMMEDIATELY BENEATH.

SER. NO. 85-431,942, FILED 9-26-2011.

ASMAT KHAN, EXAMINING ATTORNEY



*David J. Kyffers*

Director of the United States Patent and Trademark Office

# United States of America

United States Patent and Trademark Office



**Reg. No. 4,197,212**

**Registered Aug. 28, 2012**

**Int. Cl.: 30**

**TRADEMARK**

**PRINCIPAL REGISTER**

PRICE, DAN (UNITED STATES INDIVIDUAL)  
P.O. BOX 3791  
PASO ROBLES, CA 93447 AND

PRICE, CARA (UNITED STATES INDIVIDUAL)  
P.O. BOX 3791  
PASO ROBLES, CA 93447

FOR: FLAVORINGS; SAUCES; SEASONINGS; SPICES, IN CLASS 30 (U.S. CL. 46).

FIRST USE 2-1-2010; IN COMMERCE 12-1-2010.

NO CLAIM IS MADE TO THE EXCLUSIVE RIGHT TO USE "SPICE TRADING COMPANY",  
APART FROM THE MARK AS SHOWN.

THE MARK CONSISTS OF THE STYLIZED TEXT "OHANA" WITH AN IMAGE OF A  
BANYON/MONKEY POD TREE ABOVE THE TEXT, AND THE STYLIZED TEXT "SPICE  
TRADING COMPANY" BELOW AND TO THE RIGHT.

THE ENGLISH TRANSLATION OF THE WORD "OHANA" IN THE MARK IS "FAMILY".

SER. NO. 85-432,064, FILED 9-26-2011.

AMY KELLY, EXAMINING ATTORNEY



*David J. Kybas*

Director of the United States Patent and Trademark Office

# United States of America

United States Patent and Trademark Office

## I AM VERMONT STRONG

**Reg. No. 4,197,213**

I AM VERMONT STRONG, INC. (VERMONT CORPORATION)  
52 CHURCH ST.  
RUTLAND, VT 05701

**Registered Aug. 28, 2012**

**Int. Cl.: 36**

FOR: CHARITABLE FUNDRAISING TO SUPPORT DISASTER RELIEF ORGANIZATIONS,  
IN CLASS 36 (U.S. CLS. 100, 101 AND 102).

**SERVICE MARK**

FIRST USE 8-28-2011; IN COMMERCE 8-28-2011.

**PRINCIPAL REGISTER**

THE MARK CONSISTS OF STANDARD CHARACTERS WITHOUT CLAIM TO ANY PARTICULAR FONT, STYLE, SIZE, OR COLOR.

NO CLAIM IS MADE TO THE EXCLUSIVE RIGHT TO USE "VERMONT", APART FROM THE MARK AS SHOWN.

SER. NO. 85-432,192, FILED 9-26-2011.

DORITT L. CARROLL, EXAMINING ATTORNEY



*David J. Kybas*

Director of the United States Patent and Trademark Office



# United States of America

United States Patent and Trademark Office



**Reg. No. 4,197,214**

**Registered Aug. 28, 2012**

**Int. Cl.: 12**

**TRADEMARK**

**PRINCIPAL REGISTER**

BROOKLYN CRUISER LLC (NEW YORK LIMITED LIABILITY COMPANY)  
#1B  
450 MANHATTAN AVENUE  
BROOKLYN, NY 11222

FOR: BASKETS ADAPTED FOR BICYCLES; BICYCLES, IN CLASS 12 (U.S. CLS. 19, 21, 23, 31, 35 AND 44).

FIRST USE 7-1-2011; IN COMMERCE 7-1-2011.

NO CLAIM IS MADE TO THE EXCLUSIVE RIGHT TO USE "BROOKLYN CRUISER", APART FROM THE MARK AS SHOWN.

THE MARK CONSISTS OF THE TEXT "BROOKLYN CRUISER" CENTERED OVER A PROFILE OF A BICYCLE WITH A DOUBLE TOP TUBE FRAME ALL WITHIN A BORDERED SQUARE.

SER. NO. 85-432,782, FILED 9-27-2011.

TEJBIR SINGH, EXAMINING ATTORNEY



*David J. Kyffers*

Director of the United States Patent and Trademark Office

# United States of America

United States Patent and Trademark Office

# CRIBBLOCK

**Reg. No. 4,197,215**

**Registered Aug. 28, 2012**

**Int. Cl.: 19**

**TRADEMARK**

**PRINCIPAL REGISTER**

DAVIS, VAN L (UNITED STATES INDIVIDUAL)  
1342 BARHAM DRIVE  
SAN MARCOS, CA 92078

FOR: INTERLOCKING REINFORCED CONCRETE COMPONENTS, NAMELY, REINFORCED, ENGINEERED, AND DRY MIXED CONCRETE BLOCKS FORMED AS EITHER A HEADER PIECE 5' X 8" X 4" WEIGHING 135 LBS, A FRONT STRETCHER 5' BY 6" BY 4" WEIGHING 125 POUNDS, A BACK STRETCHER 3' 9" BY 6" BY 4" WEIGHING 95 POUNDS, OR A FALSE HEADER 9.5" BY 8" BY 4" WEIGHING 30 POUNDS FOR BUILDING BULK GRAVITY CRIB RETAINING WALLS IN THE NATURE OF AN OPEN FACED CONCRETE BULK GRAVITY RETAINING WALL IN AN OPEN GRID PATTERN THAT PERMITS PLANTING IN THE EXPOSED EARTH FACE BETWEEN THE CONCRETE SIDES, IN CLASS 19 (U.S. CLS. 1, 12, 33 AND 50).

FIRST USE 6-11-1980; IN COMMERCE 6-11-1980.

THE MARK CONSISTS OF STANDARD CHARACTERS WITHOUT CLAIM TO ANY PARTICULAR FONT, STYLE, SIZE, OR COLOR.

SER. NO. 85-432,907, FILED 9-27-2011.

JAMES STEIN, EXAMINING ATTORNEY



*David J. Kypos*

Director of the United States Patent and Trademark Office

# United States of America

United States Patent and Trademark Office

## DIXIE CLASSICS

**Reg. No. 4,197,216**

DOWLING GRAPHICS, INC. (FLORIDA CORPORATION)  
12920 AUTOMOBILE BLVD.  
CLEARWATER, FL 33762

**Registered Aug. 28, 2012**

**Int. Cls.: 16 and 25**

FOR: IRON-ON AND HEAT TRANSFERS, IN CLASS 16 (U.S. CLS. 2, 5, 22, 23, 29, 37, 38 AND 50).

**TRADEMARK**

FIRST USE 8-25-2003; IN COMMERCE 8-25-2003.

**PRINCIPAL REGISTER**

FOR: HATS; SHIRTS; T-SHIRTS, IN CLASS 25 (U.S. CLS. 22 AND 39).

FIRST USE 8-25-2003; IN COMMERCE 8-25-2003.

THE MARK CONSISTS OF STANDARD CHARACTERS WITHOUT CLAIM TO ANY PARTICULAR FONT, STYLE, SIZE, OR COLOR.

SER. NO. 85-432,945, FILED 9-27-2011.

CURTIS FRENCH, EXAMINING ATTORNEY



*David J. Kybas*

Director of the United States Patent and Trademark Office

# United States of America

United States Patent and Trademark Office

## CHOSEN IMAGES

**Reg. No. 4,197,217**

**Registered Aug. 28, 2012**

**Int. Cl.: 41**

**SERVICE MARK**

**PRINCIPAL REGISTER**

FORWARD ASSOCIATION, INC. (NEW YORK NON-PROFIT CORPORATION)  
8TH FLOOR  
125 MAIDEN LANE  
NEW YORK, NY 100385015

FOR: PROVIDING AN ONLINE DAILY COLUMN IN THE FIELDS OF CELEBRITIES, CELEBRITY NEWS, CELEBRITIES PHOTOGRAPHS, POPULAR CULTURE, IN CLASS 41 (U.S. CLS. 100, 101 AND 107).

FIRST USE 9-20-2011; IN COMMERCE 9-20-2011.

THE MARK CONSISTS OF STANDARD CHARACTERS WITHOUT CLAIM TO ANY PARTICULAR FONT, STYLE, SIZE, OR COLOR.

NO CLAIM IS MADE TO THE EXCLUSIVE RIGHT TO USE "IMAGES", APART FROM THE MARK AS SHOWN.

SER. NO. 85-433,241, FILED 9-27-2011.

WON TEAK OH, EXAMINING ATTORNEY



*David J. Kyffers*

Director of the United States Patent and Trademark Office

# United States of America

United States Patent and Trademark Office

# CHADILLAC

**Reg. No. 4,197,218**

RIBERA, CHAD (UNITED STATES INDIVIDUAL), DBA CHADILLAC  
14288 DANIELSON STREET #101  
POWAY, CA 92064

**Registered Aug. 28, 2012**

**Int. Cl.: 42**

FOR: GRAPHIC ILLUSTRATION AND DRAWING SERVICES, NAMELY, CUSTOM DESIGN OF GRAPHICS FOR USE IN TATTOOS, PROMOTION OF GOODS AND SERVICES OF OTHERS, CORPORATE LOGOS, CLOTHING, AND ACCESSORIES, IN CLASS 42 (U.S. CLS. 100 AND 101).

**SERVICE MARK**

**PRINCIPAL REGISTER**

FIRST USE 1-15-2011; IN COMMERCE 1-15-2011.

THE MARK CONSISTS OF STANDARD CHARACTERS WITHOUT CLAIM TO ANY PARTICULAR FONT, STYLE, SIZE, OR COLOR.

SER. NO. 85-433,479, FILED 9-27-2011.

DEZMONA MIZELLE, EXAMINING ATTORNEY



*David J. Kyros*

Director of the United States Patent and Trademark Office

# United States of America

United States Patent and Trademark Office

## LEAN MUSCLE X

**Reg. No. 4,197,219**

**Registered Aug. 28, 2012**

**Int. Cl.: 5**

**TRADEMARK**

**PRINCIPAL REGISTER**

ACTIVE CREST LIMITED (UNITED KINGDOM PRIVATE LIMITED COMPANY)  
UNIT 1  
27 ACKMAR ROAD  
LONDON, UNITED KINGDOM SW64UR

FOR: DIETARY AND NUTRITIONAL SUPPLEMENT, IN CLASS 5 (U.S. CLS. 6, 18, 44, 46, 51 AND 52).

FIRST USE 1-1-2010; IN COMMERCE 1-1-2010.

THE MARK CONSISTS OF STANDARD CHARACTERS WITHOUT CLAIM TO ANY PARTICULAR FONT, STYLE, SIZE, OR COLOR.

NO CLAIM IS MADE TO THE EXCLUSIVE RIGHT TO USE "LEAN MUSCLE", APART FROM THE MARK AS SHOWN.

SER. NO. 85-433,691, FILED 9-28-2011.

AMY HELLA, EXAMINING ATTORNEY



*David J. Kyffers*

Director of the United States Patent and Trademark Office

# United States of America

United States Patent and Trademark Office

## LA PREDILECTA

**Reg. No. 4,197,220**

**Registered Aug. 28, 2012**

**Int. Cl.: 30**

**TRADEMARK**

**PRINCIPAL REGISTER**

GRUMA CORPORATION (NEVADA CORPORATION)  
SUITE 200  
1159 COTTONWOOD LANE  
IRVING, TX 75038

FOR: TOSTADAS, IN CLASS 30 (U.S. CL. 46).

FIRST USE 4-0-2008; IN COMMERCE 4-0-2008.

THE MARK CONSISTS OF STANDARD CHARACTERS WITHOUT CLAIM TO ANY PARTICULAR FONT, STYLE, SIZE, OR COLOR.

OWNER OF U.S. REG. NOS. 2,575,993 AND 3,530,343.

THE ENGLISH TRANSLATION OF "LA PREDILECTA" IN THE MARK IS "THE PREFERENCE".

SER. NO. 85-433,780, FILED 9-28-2011.

JANICE L. MCMORROW, EXAMINING ATTORNEY



*David J. Kybas*

Director of the United States Patent and Trademark Office

# United States of America

United States Patent and Trademark Office

## CLIPHANG STAND

**Reg. No. 4,197,221**

LAM HO, AMY L. Y. (UNITED STATES INDIVIDUAL)  
P.O. BOX 8811

**Registered Aug. 28, 2012**

ROWLAND HEIGHTS, CA 91748

**Int. Cl.: 16**

FOR: PAPER AND CARDBOARD CONVERTIBLE JEWELRY DISPLAY SUPPORT STANDS,  
IN CLASS 16 (U.S. CLS. 2, 5, 22, 23, 29, 37, 38 AND 50).

**TRADEMARK**

FIRST USE 9-8-2002; IN COMMERCE 9-8-2002.

**PRINCIPAL REGISTER**

THE MARK CONSISTS OF STANDARD CHARACTERS WITHOUT CLAIM TO ANY PAR-  
TICULAR FONT, STYLE, SIZE, OR COLOR.

NO CLAIM IS MADE TO THE EXCLUSIVE RIGHT TO USE "STAND", APART FROM THE  
MARK AS SHOWN.

SER. NO. 85-434,813, FILED 9-28-2011.

TASNEEM HUSSAIN, EXAMINING ATTORNEY



*David J. Kybas*

Director of the United States Patent and Trademark Office



# United States of America

United States Patent and Trademark Office

## BURSTING WITH FLAVOR

**Reg. No. 4,197,222**

**Registered Aug. 28, 2012**

**Int. Cl.: 30**

**TRADEMARK**

**PRINCIPAL REGISTER**

ACH FOOD COMPANIES, INC. (DELAWARE CORPORATION)  
7171 GOODLETT FARMS PARKWAY  
CORDOVA, TN 38016

FOR: PROCESSED HERBS, SPICES, SPICE BLENDS, SEASONINGS, SEASONING BLENDS, SEASONING MIXES; SEASONING MIXES; EXTRACTS, NOT ESSENTIAL OILS, USED AS FOOD FLAVORINGS; FOOD FLAVORING MIXES; GRAVY MIXES; PEPPER, MUSTARD; SALT, SEASONED SALT, SAUCES, SAUCE AND GRAVY MIXES; SPAGHETTI AND CHILI SAUCE MIXES, IN CLASS 30 (U.S. CL. 46).

FIRST USE 11-1-2010; IN COMMERCE 1-1-2011.

THE MARK CONSISTS OF STANDARD CHARACTERS WITHOUT CLAIM TO ANY PARTICULAR FONT, STYLE, SIZE, OR COLOR.

SER. NO. 85-434,911, FILED 9-29-2011.

EMILY CHUO, EXAMINING ATTORNEY



*David J. Kybas*

Director of the United States Patent and Trademark Office

# United States of America

United States Patent and Trademark Office

# KERR:HEALTH

**Reg. No. 4,197,223**

**Registered Aug. 28, 2012**

**Int. Cls.: 35, 41 and 44**

**SERVICE MARK**

**PRINCIPAL REGISTER**

KERR HEALTH, LLC (NORTH CAROLINA LIMITED LIABILITY COMPANY)  
3220 SPRING FOREST ROAD  
RALEIGH, NC 27616

FOR: PHARMACY SERVICES, NAMELY, PROVIDING PRESCRIPTION DRUG FULFILLMENT SERVICES FOR OTHERS; PROVIDING PRESCRIPTION DRUG FULFILLMENT SERVICES AND INFORMATION MANAGEMENT SERVICES FOR SPECIALIZED DISEASE MANAGEMENT; PROVIDING PRESCRIPTION DRUG FULFILLMENT SERVICES FOR RESIDENTS OF LONG-TERM CARE FACILITIES AND GROUP HOMES, IN CLASS 35 (U.S. CLS. 100, 101 AND 102).

FIRST USE 12-11-2009; IN COMMERCE 12-11-2009.

FOR: EDUCATION SERVICES, NAMELY, PROVIDING COURSES IN THE FIELDS OF HEALTH AND WELLNESS; PROVIDING MEDICATION ADMINISTRATION AND HEALTH AND WELLNESS EDUCATION SERVICES THROUGH LIVE, PRINTED, TELEPHONIC, AND ONLINE CLASSES AND INSTRUCTION, IN CLASS 41 (U.S. CLS. 100, 101 AND 107).

FIRST USE 12-11-2009; IN COMMERCE 12-11-2009.

FOR: HEALTHCARE SERVICES, NAMELY, PROVIDING MEDICATION THERAPY MANAGEMENT SERVICES; ADMINISTERING INFLUENZA, PNEUMONIA, SHINGLES, AND OTHER VACCINATIONS TO HUMANS; PROVIDING SCREENING SERVICES AND PREVENTATIVE CARE FOR DIABETES, HIGH CHOLESTEROL, AND HIGH BLOOD PRESSURE; PROVIDING MONITORING AND REMINDER SERVICES FOR ADHERENCE TO PRESCRIBED DRUG THERAPY; CUSTOM COMPOUNDING OF PRESCRIPTION DRUGS FOR OTHERS, IN CLASS 44 (U.S. CLS. 100 AND 101).

FIRST USE 12-11-2009; IN COMMERCE 12-11-2009.

THE MARK CONSISTS OF THE WORD "KERR" IN RED TO THE LEFT OF A CIRCLE COMPRISED OF FOUR GREEN DOTS, ONE RED DOT, TWO MORE GREEN DOTS, AND A LEAF-LIKE SHAPE GENERALLY OPPOSITE THE RED DOT AND TO THE RIGHT OF THE DESIGN THE WORD "HEALTH" IN GREEN.

THE COLOR(S) RED AND GREEN IS/ARE CLAIMED AS A FEATURE OF THE MARK.



*David J. Kyros*

Director of the United States Patent and Trademark Office

**Reg. No. 4,197,223** SER. NO. 85-434,995, FILED 9-29-2011.

KAREN K. BUSH, EXAMINING ATTORNEY

# United States of America

United States Patent and Trademark Office

## GRAF'S RELOADING SUPERCENTER

**Reg. No. 4,197,224**

GRAF'S RELOADING SUPERCENTER, L.L.C. (MISSOURI LIMITED LIABILITY COMPANY)  
4050 S. CLARK ST.  
MEXICO, MO 65265

**Registered Aug. 28, 2012**

**Int. Cl.: 35**

FOR: RETAIL STORE SERVICES, ON-LINE RETAIL STORE SERVICES, AND MAIL-ORDER CATALOG SERVICES IN THE FIELDS OF FIREARMS, GUNSMITHING, AMMUNITION, RELOADING EQUIPMENT, AND ACCESSORIES FOR FIREARMS, GUNSMITHING, AMMUNITION, AND RELOADING EQUIPMENT, IN CLASS 35 (U.S. CLS. 100, 101 AND 102).

**SERVICE MARK**

**PRINCIPAL REGISTER**

FIRST USE 12-31-2002; IN COMMERCE 12-31-2002.

THE MARK CONSISTS OF STANDARD CHARACTERS WITHOUT CLAIM TO ANY PARTICULAR FONT, STYLE, SIZE, OR COLOR.

NO CLAIM IS MADE TO THE EXCLUSIVE RIGHT TO USE "RELOADING SUPERCENTER", APART FROM THE MARK AS SHOWN.

SER. NO. 85-435,462, FILED 9-29-2011.

MICHAEL LITZAU, EXAMINING ATTORNEY



*David J. Kyffers*

Director of the United States Patent and Trademark Office

# United States of America

United States Patent and Trademark Office

## TRAINING LEADERS TO TRANSFORM LIVES

**Reg. No. 4,197,225**

CITY SCHOLARS FOUNDATION (CALIFORNIA NON-PROFIT CORPORATION)  
900 WILSHIRE BOULEVARD, SUITE 1518  
LOS ANGELES, CA 90017

**Registered Aug. 28, 2012**

**Int. Cl.: 41**

FOR: EDUCATIONAL SERVICES, NAMELY, PROVIDING TRAINING AND PROFESSIONAL DEVELOPMENT COURSES, SEMINARS AND WORKSHOPS FOR LEADERS OF NEIGHBORHOOD AFTER-SCHOOL PROGRAMS SERVING LOW INCOME AND AT RISK YOUTH, IN CLASS 41 (U.S. CLS. 100, 101 AND 107).

**SERVICE MARK**

**PRINCIPAL REGISTER**

FIRST USE 9-1-2010; IN COMMERCE 9-1-2010.

THE MARK CONSISTS OF STANDARD CHARACTERS WITHOUT CLAIM TO ANY PARTICULAR FONT, STYLE, SIZE, OR COLOR.

SER. NO. 85-435,481, FILED 9-29-2011.

BRIAN CALLAGHAN, EXAMINING ATTORNEY



*David J. Kybas*

Director of the United States Patent and Trademark Office

# United States of America

United States Patent and Trademark Office

# Epic History

**Reg. No. 4,197,226**

**Registered Aug. 28, 2012**

**Int. Cl.: 42**

**SERVICE MARK**

**PRINCIPAL REGISTER**

GUTEKUNST, BRENT L (UNITED STATES INDIVIDUAL)  
EPIC HISTORY  
407 W. SPRUCE ST  
SAN DIEGO, CA 92103

FOR: PROVIDING A WEBSITE FEATURING NON-DOWNLOADABLE SOFTWARE FOR VISUALIZATION AND NAVIGATION OF INFORMATION AND DATA IN THE FIELD OF HISTORY, IN CLASS 42 (U.S. CLS. 100 AND 101).

FIRST USE 2-1-2009; IN COMMERCE 4-2-2011.

THE MARK CONSISTS OF STANDARD CHARACTERS WITHOUT CLAIM TO ANY PARTICULAR FONT, STYLE, SIZE, OR COLOR.

NO CLAIM IS MADE TO THE EXCLUSIVE RIGHT TO USE "HISTORY", APART FROM THE MARK AS SHOWN.

SER. NO. 85-436,392, FILED 9-30-2011.

BRIDGETT SMITH, EXAMINING ATTORNEY



*David J. Kyffers*

Director of the United States Patent and Trademark Office

# United States of America

United States Patent and Trademark Office

## Choice Infinite Messaging

**Reg. No. 4,197,227**

**Registered Aug. 28, 2012**

**Int. Cl.: 38**

**SERVICE MARK**

**PRINCIPAL REGISTER**

CELLULAR SOUTH, INC. (MISSISSIPPI CORPORATION)  
1018 HIGHLAND COLONY PARKWAY  
RIDGELAND, MS 39157

FOR: CELLULAR TELEPHONE COMMUNICATION; COMMUNICATION BY MOBILE TELEPHONE; COMMUNICATION SERVICES, NAMELY, TRANSMISSION OF VOICE, AUDIO, VISUAL IMAGES AND DATA BY TELECOMMUNICATIONS NETWORKS, WIRELESS COMMUNICATION NETWORKS, THE INTERNET, INFORMATION SERVICES NETWORKS AND DATA NETWORKS; INSTANT MESSAGING SERVICES; PROVIDING E-MAIL AND INSTANT MESSAGING SERVICES; PROVIDING TELECOMMUNICATION CONNECTIONS TO THE INTERNET OR DATABASES; PROVIDING TELECOMMUNICATION CONNECTIVITY SERVICES FOR TRANSFER OF IMAGES, MESSAGES, AUDIO, VISUAL, AUDIOVISUAL AND MULTIMEDIA WORKS; PROVIDING TELECOMMUNICATIONS CONNECTIONS TO A GLOBAL COMPUTER NETWORK; TELECOMMUNICATION SERVICES, NAMELY, LOCAL AND LONG DISTANCE TRANSMISSION OF VOICE, DATA, GRAPHICS AND VIDEO BY MEANS OF BROADBAND, COPPER AND OPTICAL OR WIRELESS NETWORKS; TELECOMMUNICATION SERVICES, NAMELY, PROVIDING ADVANCED CALLING FEATURES; TELECOMMUNICATION SERVICES, NAMELY, PROVIDING ADVANCED CALLING FEATURES, NAMELY, PROVIDING AN INTERNATIONAL CALLING FUNCTION TO EASILY PLACE INTERNATIONAL CALLS; TELECOMMUNICATION SERVICES, NAMELY, PROVIDING INTERNET ACCESS VIA BROADBAND OPTICAL OR WIRELESS NETWORKS; TELECOMMUNICATION SERVICES, NAMELY, TRANSMISSION OF VOICE, DATA, GRAPHICS, IMAGES, AUDIO AND VIDEO BY MEANS OF TELECOMMUNICATIONS NETWORKS, WIRELESS COMMUNICATION NETWORKS, AND THE INTERNET; TELECOMMUNICATIONS BY E-MAIL; TELECOMMUNICATIONS SERVICES, NAMELY, PERSONAL COMMUNICATION SERVICES; TELEPHONE VOICE MESSAGING SERVICES; WIRELESS TELEPHONE TELECOMMUNICATIONS SERVICES, NAMELY, WIRELESS MOBILE TELEPHONE CALLING PLANS, IN CLASS 38 (U.S. CLS. 100, 101 AND 104).



FIRST USE 9-26-2011; IN COMMERCE 9-26-2011.

THE MARK CONSISTS OF STANDARD CHARACTERS WITHOUT CLAIM TO ANY PARTICULAR FONT, STYLE, SIZE, OR COLOR.

NO CLAIM IS MADE TO THE EXCLUSIVE RIGHT TO USE "INFINITE MESSAGING", APART FROM THE MARK AS SHOWN.

*David J. Kappas*

Director of the United States Patent and Trademark Office

**Reg. No. 4,197,227** SER. NO. 85-436,724, FILED 9-30-2011.

LIEF MARTIN, EXAMINING ATTORNEY



# United States of America

United States Patent and Trademark Office

## ChoiceD Infinite Data and Messaging

**Reg. No. 4,197,228**

**Registered Aug. 28, 2012**

**Int. Cl.: 38**

**SERVICE MARK**

**PRINCIPAL REGISTER**

CELLULAR SOUTH, INC. (MISSISSIPPI CORPORATION)  
1018 HIGHLAND COLONY PARKWAY  
RIDGELAND, MS 39157

FOR: CELLULAR TELEPHONE COMMUNICATION; COMMUNICATION BY MOBILE TELEPHONE; COMMUNICATION SERVICES, NAMELY, TRANSMISSION OF VOICE, AUDIO, VISUAL IMAGES AND DATA BY TELECOMMUNICATIONS NETWORKS, WIRELESS COMMUNICATION NETWORKS, THE INTERNET, INFORMATION SERVICES NETWORKS AND DATA NETWORKS; INSTANT MESSAGING SERVICES; PROVIDING E-MAIL AND INSTANT MESSAGING SERVICES; PROVIDING TELECOMMUNICATION CONNECTIONS TO THE INTERNET OR DATABASES; PROVIDING TELECOMMUNICATION CONNECTIVITY SERVICES FOR TRANSFER OF IMAGES, MESSAGES, AUDIO, VISUAL, AUDIOVISUAL AND MULTIMEDIA WORKS; PROVIDING TELECOMMUNICATIONS CONNECTIONS TO A GLOBAL COMPUTER NETWORK; TELECOMMUNICATION SERVICES, NAMELY, LOCAL AND LONG DISTANCE TRANSMISSION OF VOICE, DATA, GRAPHICS AND VIDEO BY MEANS OF BROADBAND, COPPER AND OPTICAL OR WIRELESS NETWORKS; TELECOMMUNICATION SERVICES, NAMELY, LOCAL AND LONG DISTANCE TRANSMISSION OF VOICE, DATA, GRAPHICS BY MEANS OF TELEPHONE, TELEGRAPHIC, CABLE, AND SATELLITE TRANSMISSIONS; TELECOMMUNICATION SERVICES, NAMELY, PROVIDING ADVANCED CALLING FEATURES; TELECOMMUNICATION SERVICES, NAMELY, PROVIDING ADVANCED CALLING FEATURES, NAMELY, PROVIDING AN INTERNATIONAL CALLING FUNCTION TO EASILY PLACE INTERNATIONAL CALLS; TELECOMMUNICATION SERVICES, NAMELY, PROVIDING INTERNET ACCESS VIA BROADBAND OPTICAL OR WIRELESS NETWORKS; TELECOMMUNICATION SERVICES, NAMELY, TRANSMISSION OF VOICE, DATA, GRAPHICS, IMAGES, AUDIO AND VIDEO BY MEANS OF TELECOMMUNICATIONS NETWORKS, WIRELESS COMMUNICATION NETWORKS, AND THE INTERNET; TELECOMMUNICATIONS BY E-MAIL; TELECOMMUNICATIONS SERVICES, NAMELY, PERSONAL COMMUNICATION SERVICES; TELEPHONE VOICE MESSAGING SERVICES; WIRELESS TELEPHONE TELECOMMUNICATIONS SERVICES, NAMELY, WIRELESS MOBILE TELEPHONE CALLING PLANS, IN CLASS 38 (U.S. CLS. 100, 101 AND 104).

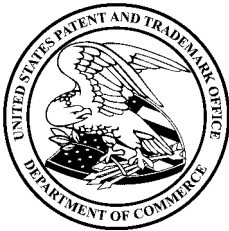

*David J. Kyros*

Director of the United States Patent and Trademark Office

FIRST USE 9-26-2011; IN COMMERCE 9-26-2011.

THE MARK CONSISTS OF STANDARD CHARACTERS WITHOUT CLAIM TO ANY PARTICULAR FONT, STYLE, SIZE, OR COLOR.

**Reg. No. 4,197,228** NO CLAIM IS MADE TO THE EXCLUSIVE RIGHT TO USE "INFINITE DATA AND MESSAGING", APART FROM THE MARK AS SHOWN.

SER. NO. 85-436,759, FILED 9-30-2011.

LIEF MARTIN, EXAMINING ATTORNEY

# United States of America

United States Patent and Trademark Office

# Iconik

**Reg. No. 4,197,229**

**Registered Aug. 28, 2012**

**Int. Cl.: 36**

**SERVICE MARK**

**PRINCIPAL REGISTER**

CEBEL, DAVID (UNITED STATES INDIVIDUAL)  
6 BARNES RD.  
OSSINING, NY 10562

FOR: COMMERCIAL AND RESIDENTIAL REAL ESTATE AGENCY SERVICES; REAL ESTATE AGENCIES; REAL ESTATE CONSULTATION; REAL ESTATE LISTING, IN CLASS 36 (U.S. CLS. 100, 101 AND 102).

FIRST USE 3-20-2011; IN COMMERCE 3-20-2011.

THE MARK CONSISTS OF STANDARD CHARACTERS WITHOUT CLAIM TO ANY PARTICULAR FONT, STYLE, SIZE, OR COLOR.

SER. NO. 85-436,793, FILED 9-30-2011.

CURTIS FRENCH, EXAMINING ATTORNEY



*David J. Kyffers*

Director of the United States Patent and Trademark Office

# United States of America

United States Patent and Trademark Office

# CRAFT CFD

**Reg. No. 4,197,230**

**Registered Aug. 28, 2012**

**Int. Cl.: 9**

**TRADEMARK**

**PRINCIPAL REGISTER**

COMBUSTION RESEARCH AND FLOW TECHNOLOGY, INC (PENNSYLVANIA CORPORATION)  
174 NORTH MAIN STREET, BUILDING 3  
DUBLIN, PA 18917

FOR: COMPUTER SOFTWARE FOR SIMULATING AND TESTING AERODYNAMIC AND FLUID DYNAMIC PRINCIPLES, IN CLASS 9 (U.S. CLS. 21, 23, 26, 36 AND 38).

FIRST USE 8-16-2001; IN COMMERCE 8-16-2001.

THE MARK CONSISTS OF STANDARD CHARACTERS WITHOUT CLAIM TO ANY PARTICULAR FONT, STYLE, SIZE, OR COLOR.

OWNER OF U.S. REG. NO. 2,621,075.

NO CLAIM IS MADE TO THE EXCLUSIVE RIGHT TO USE "CFD", APART FROM THE MARK AS SHOWN.

SER. NO. 85-436,800, FILED 9-30-2011.

FRED CARL, EXAMINING ATTORNEY



*David J. Kyffers*

Director of the United States Patent and Trademark Office

# United States of America

United States Patent and Trademark Office

The logo for 'econokit' features the word in a lowercase, sans-serif font. The 'e' is black with two horizontal lines crossing it. The two 'o's are green circles with a light-to-dark gradient. The 'n' and 'kit' are black. Above the 'n' and 'kit' are two stylized green leaf shapes pointing upwards and to the right.

**Reg. No. 4,197,231**

UBIQUITY (FRANCE SOCIÉTÉ À RESPONSABILITÉ LIMITÉE (SARL))

**Registered Aug. 28, 2012**

361 AVENUE DES ROMARINS  
SAINT AUNES, FRANCE 34130

**Int. Cl.: 7**

FOR: FUEL ECONOMIZERS FOR MOTORS AND ENGINES; APPARATUS FOR INTERNAL COMBUSTION ENGINES TO SAVE FUEL AND REDUCE POLLUTION, NAMELY, FUEL ECONOMIZERS FOR ENGINES, IN CLASS 7 (U.S. CLS. 13, 19, 21, 23, 31, 34 AND 35).

**TRADEMARK**

**PRINCIPAL REGISTER**

OWNER OF ERPN CMNTY TM OFC REG. NO. 009888199, DATED 8-31-2011, EXPIRES 8-31-2021.

THE COLOR(S) BLACK, DARK GREEN, MEDIUM GREEN AND LIGHT GREEN IS/ARE CLAIMED AS A FEATURE OF THE MARK.

THE MARK CONSISTS OF THE TERM "ECONOKIT," WITH "EC," "N," AND "KIT" IN BLACK STYLIZED FONT, THE LETTER "C" HAVING TWO EQUAL HORIZONTAL LINES CROSSED THROUGH THE MIDDLE LEFT SIDE CREATING A STYLIZED EURO SYMBOL, THE TWO LETTER "O'S BEING REPRESENTED BY CIRCLES THAT HAVE THE UPPER PORTION SHADED LIGHT GREEN AND THE LOWER PORTION SHADED MEDIUM GREEN WITH DARK GREEN OUTLINING, AND WITH TWO LIGHT GREEN STYLIZED LEAF SHAPES EXTENDING UPWARD LOCATED ABOVE AND TO THE RIGHT OF THE TERM.

SER. NO. 85-436,875, FILED 9-30-2011.

WILLIAM JACKSON, EXAMINING ATTORNEY



*David J. Kybas*

Director of the United States Patent and Trademark Office

# United States of America

United States Patent and Trademark Office

## A-1 BEST FOOD, INC.

**Reg. No. 4,197,232**

THE NGU CORPORATION (CALIFORNIA CORPORATION)  
4152 WEST WASHINGTON BLVD  
LOS ANGELES, CA 90018

**Registered Aug. 28, 2012**

**Int. Cl.: 40**

FOR: BAKERY SERVICES, NAMELY, THE MANUFACTURE OF BAKERY PRODUCTS TO ORDER AND/OR SPECIFICATION OF OTHERS, IN CLASS 40 (U.S. CLS. 100, 103 AND 106).

**SERVICE MARK**

FIRST USE 5-28-2011; IN COMMERCE 5-28-2011.

**PRINCIPAL REGISTER**

THE MARK CONSISTS OF STANDARD CHARACTERS WITHOUT CLAIM TO ANY PARTICULAR FONT, STYLE, SIZE, OR COLOR.

NO CLAIM IS MADE TO THE EXCLUSIVE RIGHT TO USE "BEST FOOD, INC.", APART FROM THE MARK AS SHOWN.

SER. NO. 85-437,055, FILED 9-30-2011.

LINDA M. KING, EXAMINING ATTORNEY



*David J. Kyros*

Director of the United States Patent and Trademark Office

# United States of America

United States Patent and Trademark Office



**Reg. No. 4,197,233**

**Registered Aug. 28, 2012**

**Int. Cl.: 9**

**TRADEMARK**

**PRINCIPAL REGISTER**

TIME PLAZA (CALIFORNIA CORPORATION)  
350 S LOS ANGELES STREET  
LOS ANGELES, CA 90013

FOR: CASES FOR EYEGLASSES AND SUNGLASSES; CASES FOR SPECTACLES AND SUNGLASSES; CHAINS FOR SPECTACLES AND FOR SUNGLASSES; EYEWEAR, NAMELY, SUNGLASSES, EYEGLASSES AND OPHTHALMIC FRAMES AND CASES THEREFOR; EYEWEAR, NAMELY, SUNGLASSES; FRAMES FOR SPECTACLES AND SUNGLASSES; LENSES FOR SUNGLASSES; NOSE GUARDS WHICH CAN BE WORN BY ATTACHMENT TO EYEWEAR SUCH AS SUNGLASSES AND SKI GOGGLES; SPECTACLES AND SUNGLASSES; SUNGLASS CHAINS AND CORDS; SUNGLASS LENSES; SUNGLASSES; SUNGLASSES AND SPECTACLES, IN CLASS 9 (U.S. CLS. 21, 23, 26, 36 AND 38).

FIRST USE 5-10-2010; IN COMMERCE 3-10-2011.

THE MARK CONSISTS OF THE LETTER "V" INSIDE A CIRCLE WITH THE BORDER OF THE CIRCLE COMPRISED OF A REPEATING PATTERN OF STYLIZED LETTER "T'S AND INVERTED LETTER "T'S.

SER. NO. 85-437,227, FILED 10-1-2011.

JAMES LOVELACE, EXAMINING ATTORNEY



*David J. Kyffers*

Director of the United States Patent and Trademark Office

# United States of America

United States Patent and Trademark Office

## THE HEAD CHEESE

**Reg. No. 4,197,234**

SINYKIN, DAVID (UNITED STATES INDIVIDUAL), DBA THE HEAD CHEESE  
13002 INVERNESS ROAD  
HOPKINS, MN 55305

**Registered Aug. 28, 2012**

**Int. Cls.: 25, 35 and 41**

FOR: BABY TOPS; BIBS NOT OF CLOTH OR PAPER; BUTTON DOWN SHIRTS; FLEECE PULLOVERS; FLEECE VESTS; GOLF SHIRTS; HATS; JACKETS; LONG-SLEEVED SHIRTS; PANTS; POLO SHIRTS; SHORT TROUSERS; SHORTS; SWEATSHIRTS; T-SHIRTS, IN CLASS 25 (U.S. CLS. 22 AND 39).

**TRADEMARK**

**SERVICE MARK**

FIRST USE 1-1-2010; IN COMMERCE 1-1-2010.

**PRINCIPAL REGISTER**

FOR: COMPUTERIZED ON-LINE RETAIL STORE SERVICES IN THE FIELD OF GIFTWARE AND CLOTHING; ON-LINE RETAIL GIFT SHOPS; ON-LINE RETAIL STORE SERVICES FEATURING GIFTWARE AND CLOTHING; ONLINE ADVERTISEMENTS, IN CLASS 35 (U.S. CLS. 100, 101 AND 102).

FIRST USE 1-1-2010; IN COMMERCE 1-1-2010.

FOR: ON-LINE JOURNALS, NAMELY, BLOGS FEATURING INFORMATION AND TOPICS OF GENERAL INTEREST TO FANS OF PROFESSIONAL FOOTBALL TEAMS IN WISCONSIN, IN CLASS 41 (U.S. CLS. 100, 101 AND 107).

FIRST USE 1-1-2010; IN COMMERCE 1-1-2010.

THE MARK CONSISTS OF STANDARD CHARACTERS WITHOUT CLAIM TO ANY PARTICULAR FONT, STYLE, SIZE, OR COLOR.

OWNER OF U.S. REG. NO. 4,030,987.

SER. NO. 85-438,428, FILED 10-4-2011.

MATTHEW PAPPAS, EXAMINING ATTORNEY



*David J. Kyppas*

Director of the United States Patent and Trademark Office



# United States of America

United States Patent and Trademark Office

## REBIRTHday GIFT

**Reg. No. 4,197,235**

CHRIST CENTERED HOMES, INC. (TEXAS CORPORATION)

**Registered Aug. 28, 2012**

P.O. BOX 777  
ATLANTA, TX 75551

**Int. Cl.: 36**

FOR: CHARITABLE FUNDRAISING SERVICES, IN CLASS 36 (U.S. CLS. 100, 101 AND 102).

**SERVICE MARK**

FIRST USE 6-0-2011; IN COMMERCE 6-0-2011.

**PRINCIPAL REGISTER**

THE MARK CONSISTS OF STANDARD CHARACTERS WITHOUT CLAIM TO ANY PARTICULAR FONT, STYLE, SIZE, OR COLOR.

SER. NO. 85-438,892, FILED 10-4-2011.

KATHERINE CHANG, EXAMINING ATTORNEY



*David J. Kyffers*

Director of the United States Patent and Trademark Office

# United States of America

United States Patent and Trademark Office



**Reg. No. 4,197,236**

**Registered Aug. 28, 2012**

**Int. Cl.: 32**

**TRADEMARK**

**PRINCIPAL REGISTER**

SPANISH MONK, S.L. (SPAIN SOCIEDAD DE RESPONSABILIDAD LIMITADA)  
C/JUAN II DE CASTILLA 2 - 1C  
VALLADOLID, SPAIN 47009

FOR: NON-ALCOHOLIC SANGRIA IN BOTH SPARKLING AND NON-SPARKLING VARIETIES, IN CLASS 32 (U.S. CLS. 45, 46 AND 48).

FIRST USE 7-14-1999; IN COMMERCE 7-14-1999.

NO CLAIM IS MADE TO THE EXCLUSIVE RIGHT TO USE "SANGRIA", APART FROM THE MARK AS SHOWN.

THE COLOR(S) BLACK, RED, YELLOW AND GREY IS/ARE CLAIMED AS A FEATURE OF THE MARK.

THE MARK CONSISTS OF THE LETTERS "SPASSION" IN STYLIZED PRINTING IN BLACK, WITH THE LETTER "O" OVERLAYED IN LARGER SIZE BOTH IN RED AND GREY, WITH AN ELEMENT CONSISTING OF THREE HORIZONTAL LINES OF COLOR IN RED, YELLOW AND RED (IN DESCENDING ORDER) ON THE TOP LEFT AND THE LAST HORIZONTAL LINE OF RED OVERLAYING THE STYLIZED LETTER "S" IN "SPASSION," AND THE LETTERS "SANGRIA" IN STYLIZED CAPITAL LETTERS IN BLACK.

SER. NO. 85-439,168, FILED S.R. 10-4-2011 AM. P.R. 3-30-2012.

SANI KHOURI, EXAMINING ATTORNEY



*David J. Kybas*

Director of the United States Patent and Trademark Office

# United States of America

United States Patent and Trademark Office

# Dot Calm

**Reg. No. 4,197,237**

CRAIG, WILLIAM, ROBERT (UNITED STATES INDIVIDUAL)  
P.O. BOX 1478

**Registered Aug. 28, 2012**

SANTA YNEZ, CA 93460

**Int. Cl.: 5**

FOR: DIETARY SUPPLEMENT BEVERAGE FOR RELAXATION, CALMING, IN CLASS 5  
(U.S. CLS. 6, 18, 44, 46, 51 AND 52).

**TRADEMARK**

FIRST USE 11-1-2011; IN COMMERCE 11-1-2011.

**PRINCIPAL REGISTER**

THE MARK CONSISTS OF STANDARD CHARACTERS WITHOUT CLAIM TO ANY PARTICULAR FONT, STYLE, SIZE, OR COLOR.

SER. NO. 85-439,200, FILED 10-4-2011.

CAROLINE WOOD, EXAMINING ATTORNEY



*David J. Kyffers*

Director of the United States Patent and Trademark Office

# United States of America

United States Patent and Trademark Office

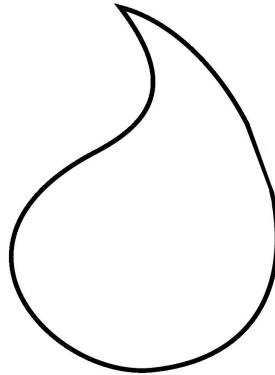

**Reg. No. 4,197,238**

**Registered Aug. 28, 2012**

**Int. Cls.: 3, 4 and 9**

**TRADEMARK**

**PRINCIPAL REGISTER**

A.B.C. COMPOUNDING COMPANY, INC. (GEORGIA CORPORATION)  
6970 JONESBORO ROAD  
MORROW, GA 30260

FOR: CLEANING PREPARATIONS, NAMELY, DEGREASING PREPARATIONS AND CLEANING WASHES FOR AUTOMOTIVE, MOTORCYCLE, AND BICYCLE USE, IN CLASS 3 (U.S. CLS. 1, 4, 6, 50, 51 AND 52).

FIRST USE 0-0-1993; IN COMMERCE 0-0-1994.

FOR: NON-CHEMICAL ADDITIVES AND TREATMENTS FOR ENGINE OILS; LUBRICANT DISPENSED BY A PEN FOR PINPOINT APPLICATION OF LUBRICANT TO POWER TOOLS AND CONVEYANCE SYSTEMS, AND PINPOINT APPLICATION OF LUBRICANT FOR AUTOMOTIVE, MOTORCYCLE, AND BICYCLE USE; AND INDUSTRIAL, AUTOMOTIVE, MOTORCYCLE, AND BICYCLE LUBRICANTS AND GREASE; AND, IN CLASS 4 (U.S. CLS. 1, 6 AND 15).

FIRST USE 0-0-1993; IN COMMERCE 0-0-1994.

FOR: CHAIN GAUGE USED TO MEASURE BICYCLE AND MOTORCYCLE CHAIN WEAR, IN CLASS 9 (U.S. CLS. 21, 23, 26, 36 AND 38).

FIRST USE 0-0-1993; IN COMMERCE 0-0-1994.

THE MARK CONSISTS OF A DROP.

SER. NO. 85-439,789, FILED 10-5-2011.

SUSAN LESLIE DUBOIS, EXAMINING ATTORNEY



*David J. Kybas*

Director of the United States Patent and Trademark Office

# United States of America

United States Patent and Trademark Office

## Khrome Studios

**Reg. No. 4,197,239**

**Registered Aug. 28, 2012**

**Int. Cl.: 35**

**SERVICE MARK**

**PRINCIPAL REGISTER**

LIAMIA, INC. (CALIFORNIA CORPORATION), DBA KHROME STUDIOS  
2105 MAR EAST  
PO 1045  
TIBURON, CA 95920

FOR: WHOLESALE AND RETAIL STORE SERVICES AND ON-LINE RETAIL AND WHOLESALE STORE SERVICES FEATURING HOME FURNISHINGS, IN CLASS 35 (U.S. CLS. 100, 101 AND 102).

FIRST USE 1-1-2009; IN COMMERCE 1-1-2009.

THE MARK CONSISTS OF STANDARD CHARACTERS WITHOUT CLAIM TO ANY PARTICULAR FONT, STYLE, SIZE, OR COLOR.

NO CLAIM IS MADE TO THE EXCLUSIVE RIGHT TO USE "STUDIOS", APART FROM THE MARK AS SHOWN.

SER. NO. 85-440,076, FILED 10-5-2011.

ROBERT C. CLARK JR., EXAMINING ATTORNEY



*David J. Kyffers*

Director of the United States Patent and Trademark Office

# United States of America

United States Patent and Trademark Office



**Reg. No. 4,197,240**

SINCERELY FEARLESS LLC (FLORIDA LIMITED LIABILITY COMPANY)

**Registered Aug. 28, 2012**

3655 BARKIS AVENUE  
BOYNTON BEACH, FL 33436

**Int. Cl.: 35**

FOR: COMPUTERIZED ON-LINE RETAIL STORE SERVICES IN THE FIELD OF WOMEN'S FASHION ACCESSORIES AND SHOES, IN CLASS 35 (U.S. CLS. 100, 101 AND 102).

**SERVICE MARK**

FIRST USE 8-9-2011; IN COMMERCE 9-25-2011.

**PRINCIPAL REGISTER**

THE MARK CONSISTS OF THE WORDING "SINCERELY, FEARLESS . . . P.S. ACCESSORIES A MUST, CLOTHING OPTIONAL." WRITTEN IN BLACK WITH THE EXCEPTION OF "FEARLESS" WHICH APPEARS IN PINK. TO THE LEFT OF THE WORDING IS A CIRCLE OUTLINED IN GREY AND BLACK, WITH A BLACK CURVED LINE CUTTING ACROSS THE BOTTOM OF IT. INSIDE THE CIRCLE IS THE SILHOUETTE OF A WOMAN DEPICTED IN BLACK WEARING WHITE EARRINGS AND A WHITE BRACELET. BEHIND AND SURROUNDING THE SILHOUETTE ARE SEVERAL BLACK, GREY, AND PURPLE CIRCLES AND INCOMPLETE PINK AND WHITE CIRCLES.

THE COLOR(S) BLACK, WHITE, PINK, PURPLE, AND GREY IS/ARE CLAIMED AS A FEATURE OF THE MARK.

SER. NO. 85-440,415, FILED 10-6-2011.

EMILY CARLSEN, EXAMINING ATTORNEY



*David J. Kyros*

Director of the United States Patent and Trademark Office

# United States of America

United States Patent and Trademark Office



**Reg. No. 4,197,241**

LAUERMAN, SARA R (UNITED STATES INDIVIDUAL), DBA BELOVED BOUTIQUE  
1619 EAST MONTOYA LANE  
PHOENIX, AZ 85024

**Registered Aug. 28, 2012**

**Int. Cl.: 42**

FOR: CUSTOM DESIGN OF CLOTHING BASED ON PERSONAL SELECTIONS MADE BY  
THE CUSTOMER, IN CLASS 42 (U.S. CLS. 100 AND 101).

**SERVICE MARK**

FIRST USE 5-20-2009; IN COMMERCE 5-20-2009.

**PRINCIPAL REGISTER**

THE MARK CONSISTS OF A STYLIZED SIDEWAYS HEART IN THE SHAPE OF A "B".

SER. NO. 85-440,426, FILED 10-6-2011.

ELIZABETH HUGHITT, EXAMINING ATTORNEY



*David J. Kyffers*

Director of the United States Patent and Trademark Office

# United States of America

United States Patent and Trademark Office

# HEUER M.D. RESEARCH

**Reg. No. 4,197,242**

HCG INTERNATIONAL, INC. (FLORIDA CORPORATION)  
4630 S KIRKMAN RD UNIT 368  
ORLANDO, FL 32811

**Registered Aug. 28, 2012**

**Int. Cl.: 5**

**TRADEMARK**

**PRINCIPAL REGISTER**

FOR: ANIMAL FEED SUPPLEMENTS; DIETARY AND NUTRITIONAL SUPPLEMENTS; DIETARY AND NUTRITIONAL SUPPLEMENTS FOR ENDURANCE SPORTS; DIETARY AND NUTRITIONAL SUPPLEMENTS USED FOR WEIGHT LOSS; DIETARY BEVERAGE SUPPLEMENTS FOR HUMAN CONSUMPTION IN LIQUID AND DRY MIX FORM FOR THERAPEUTIC PURPOSES; DIETARY FOOD SUPPLEMENTS; DIETARY PET SUPPLEMENTS IN THE FORM OF PET TREATS; DIETARY SUPPLEMENTAL DRINKS; DIETARY SUPPLEMENTAL DRINKS IN THE NATURE OF VITAMIN AND MINERAL BEVERAGES; DIETARY SUPPLEMENTS; DIETARY SUPPLEMENTS FOR ANIMALS; DIETARY SUPPLEMENTS FOR CONTROLLING CHOLESTEROL; DIETARY SUPPLEMENTS FOR HUMAN CONSUMPTION; DIETARY SUPPLEMENTS FOR PETS; DIETARY SUPPLEMENTS FOR PETS IN THE NATURE OF A POWDERED DRINK MIX; DIETARY SUPPLEMENTS IN THE NATURE OF WEIGHT LOSS POWDERS; FOOD SUPPLEMENTS; FOOD SUPPLEMENTS, NAMELY, ANTI-OXIDANTS; HERBAL SUPPLEMENTS; HERBAL SUPPLEMENTS FOR SLEEPING PROBLEMS; HOMEOPATHIC SUPPLEMENTS; LIQUID NUTRITIONAL SUPPLEMENT; LIQUID PROTEIN SUPPLEMENTS; LIQUID VITAMIN SUPPLEMENTS; MEAL REPLACEMENT AND DIETARY SUPPLEMENT DRINK MIXES; MINERAL NUTRITIONAL SUPPLEMENTS; MINERAL SUPPLEMENTS; NATURAL HERBAL SUPPLEMENTS; NATURAL SUPPLEMENTS FOR TREATING ERECTILE DYSFUNCTION; NON-MEDICATED ADDITIVES FOR ANIMAL FEED FOR USE AS NUTRITIONAL SUPPLEMENTS; NUTRACEUTICALS FOR USE AS A DIETARY SUPPLEMENT; NUTRITIONAL AND DIETARY SUPPLEMENTS FORMED AND PACKAGED AS BARS; NUTRITIONAL SUPPLEMENT FOR ELIMINATING TOXINS FROM THE BODY; NUTRITIONAL SUPPLEMENT IN THE NATURE OF A NUTRIENT-DENSE, PROTEIN-BASED DRINK MIX; NUTRITIONAL SUPPLEMENTS; NUTRITIONAL SUPPLEMENTS IN CAPSULE FORM FOR DOGS; NUTRITIONAL SUPPLEMENTS IN LOTION FORM SOLD AS A COMPONENT OF NUTRITIONAL SKIN CARE PRODUCTS; NUTRITIONAL SUPPLEMENTS IN THE NATURE OF NUTRITIONALLY FORTIFIED SOFT CHEWS; NUTRITIONAL SUPPLEMENTS, NAMELY, CARBOHYDRATES IN POWDERED FORM; NUTRITIONAL SUPPLEMENTS, NAMELY, PROBIOTIC COMPOSITIONS; POWDERED FRUIT-FLAVORED DIETARY SUPPLEMENT DRINK MIX; POWDERED NUTRITIONAL SUPPLEMENT CONCENTRATE; POWDERED NUTRITIONAL SUPPLEMENT DRINK MIX; POWDERED NUTRITIONAL SUPPLEMENT DRINK MIX AND CONCENTRATE; PROTEIN SUPPLEMENTS; VITAMIN AND MINERAL SUPPLEMENTS; VITAMIN SUPPLEMENT IN TABLET FORM FOR USE IN MAKING AN EFFERVESCENT BEVERAGE WHEN



*David J. Kyros*

Director of the United States Patent and Trademark Office



**Reg. No. 4,197,242** ADDED TO WATER; VITAMIN SUPPLEMENTS; VITAMINS AND DIETARY FOOD SUPPLEMENTS FOR ANIMALS; WEIGHT MANAGEMENT SUPPLEMENTS; WHEY PROTEIN SUPPLEMENTS, IN CLASS 5 (U.S. CLS. 6, 18, 44, 46, 51 AND 52).

FIRST USE 10-31-2009; IN COMMERCE 1-15-2010.

OWNER OF U.S. REG. NO. 4,022,065.

NO CLAIM IS MADE TO THE EXCLUSIVE RIGHT TO USE "M.D." & "RESEARCH", APART FROM THE MARK AS SHOWN.

THE NAME MARVIN HEUER IDENTIFIES A LIVING INDIVIDUAL WHOSE CONSENT IS OF RECORD.

THE MARK CONSISTS OF STYLIZED LETTERS/WORDS "HEUER M.D. RESEARCH" WITH TWO DOTS ABOVE THE "U" TO THE RIGHT OF CURVED AND HORIZONTAL LINES DEPICTING A DNA STRAND, DOUBLE HELIX.

SER. NO. 85-440,428, FILED 10-6-2011.

ELIZABETH HUGHITT, EXAMINING ATTORNEY

# United States of America

United States Patent and Trademark Office

# PRI

**Reg. No. 4,197,243**

**Registered Aug. 28, 2012**

**Int. Cl.: 1**

**TRADEMARK**

**PRINCIPAL REGISTER**

PIPE RECONSTRUCTION, INC. (ARIZONA CORPORATION)  
9308 RAINTREE DRIVE  
SCOTTSDALE, AZ 85260

FOR: COMPOSITE INDUSTRIAL FIBER REINFORCED POLYMER (FRP) AND CARBON EPOXY RESIN PRODUCTS, NAMELY, INDUSTRIAL SEALANTS AND ADHESIVES, IN PARTICULAR, CARBON COMPOSITE MATERIALS CONSISTING OF FIBROUS CARBON FIBERS, EPOXY RESINS, EPOXY HARDENING COMPOUNDS IN THE NATURE OF COMPOSITE CARBON EPOXY RESINS, INJECTABLE EPOXY RESIN AND HARDENER ADHESIVE, AND FIRE-RETARDANT RESINS AND HARDENERS, ALL USED TO REPAIR, REINFORCE, RESTORE, SEAL, COAT, RESURFACE AND PROTECT CORROSIVE OR LEAKING PIPES AND CONDUITS, STORAGE VESSELS, STRUCTURAL ELEMENTS OF BUILDINGS, HIGHWAYS, BRIDGES, AND OTHER INFRASTRUCTURE COMPONENTS, SPECIFICALLY, IN THE CONSTRUCTION, AEROSPACE, NUCLEAR, AND MECHANICAL ENGINEERING INDUSTRIES, IN CLASS 1 (U.S. CLS. 1, 5, 6, 10, 26 AND 46).

FIRST USE 9-1-1998; IN COMMERCE 1-15-1999.

THE MARK CONSISTS OF STANDARD CHARACTERS WITHOUT CLAIM TO ANY PARTICULAR FONT, STYLE, SIZE, OR COLOR.

SER. NO. 85-440,634, FILED 10-6-2011.

JESSICA A. POWERS, EXAMINING ATTORNEY



*David J. Kyjars*

Director of the United States Patent and Trademark Office

# United States of America

United States Patent and Trademark Office



**Reg. No. 4,197,244**

**Registered Aug. 28, 2012**

**Int. Cl.: 1**

**TRADEMARK**

**PRINCIPAL REGISTER**

PIPE RECONSTRUCTION, INC. (ARIZONA CORPORATION)  
9308 RAIN TREE DRIVE  
SCOTTSDALE, AZ 85260

FOR: COMPOSITE INDUSTRIAL FIBER REINFORCED POLYMER (FRP) AND CARBON EPOXY RESIN PRODUCTS, NAMELY, INDUSTRIAL SEALANTS AND ADHESIVES, IN PARTICULAR, CARBON COMPOSITE MATERIALS CONSISTING OF FIBROUS CARBON FIBERS, EPOXY RESINS, EPOXY HARDENING COMPOUNDS IN THE NATURE OF COMPOSITE CARBON EPOXY RESINS, INJECTABLE EPOXY RESIN AND HARDENER ADHESIVE, AND FIRE-RETARDANT RESINS AND HARDENERS, ALL USED TO REPAIR, REINFORCE, RESTORE, SEAL, COAT, RESURFACE AND PROTECT CORROSIVE OR LEAKING PIPES AND CONDUITS, STORAGE VESSELS, STRUCTURAL ELEMENTS OF BUILDINGS, HIGHWAYS, BRIDGES, AND OTHER INFRASTRUCTURE COMPONENTS, SPECIFICALLY, IN THE CONSTRUCTION, AEROSPACE, NUCLEAR, AND MECHANICAL ENGINEERING INDUSTRIES, IN CLASS 1 (U.S. CLS. 1, 5, 6, 10, 26 AND 46).

FIRST USE 9-1-1998; IN COMMERCE 1-15-1999.

NO CLAIM IS MADE TO THE EXCLUSIVE RIGHT TO USE "PIPE RECONSTRUCTION INC.", APART FROM THE MARK AS SHOWN.

THE COLOR(S) BLACK, BLUE AND GRAY IS/ARE CLAIMED AS A FEATURE OF THE MARK.

THE MARK CONSISTS OF THE WORDING "PIPE RECONSTRUCTION INC." WITH "PIPE" IN BLACK, "RECONSTRUCTION" IN BLUE AND "INC." IN BLACK. TO THE LEFT IS A CRESCENT MOON IN BLUE AND ON TOP OF THAT ARE HORIZONTAL AND VERTICAL INTERSECTING LINES IN GRAY. THE COLOR WHITE MERELY APPEARS AS BACKGROUND.

SER. NO. 85-440,719, FILED 10-6-2011.

JESSICA A. POWERS, EXAMINING ATTORNEY



*David J. Kyffers*

Director of the United States Patent and Trademark Office

# United States of America

United States Patent and Trademark Office

## TRUE THE MAGAZINE

**Reg. No. 4,197,245**

GRAY, GEOFFREY (UNITED STATES INDIVIDUAL)  
504 GRAND STREET, APT. E62  
NEW YORK, NY 10002

**Registered Aug. 28, 2012**

**Int. Cls.: 9 and 41**

FOR: DOWNLOADABLE ELECTRONIC PUBLICATIONS, NAMELY, GENERAL INTEREST MAGAZINES, IN CLASS 9 (U.S. CLS. 21, 23, 26, 36 AND 38).

**TRADEMARK**

FIRST USE 9-1-2011; IN COMMERCE 9-1-2011.

**SERVICE MARK**

FOR: NON-DOWNLOADABLE ELECTRONIC PUBLICATIONS, NAMELY, GENERAL INTEREST MAGAZINES, IN CLASS 41 (U.S. CLS. 100, 101 AND 107).

**PRINCIPAL REGISTER**

FIRST USE 9-1-2011; IN COMMERCE 9-1-2011.

THE MARK CONSISTS OF STANDARD CHARACTERS WITHOUT CLAIM TO ANY PARTICULAR FONT, STYLE, SIZE, OR COLOR.

OWNER OF U.S. REG. NO. 3,924,617.

NO CLAIM IS MADE TO THE EXCLUSIVE RIGHT TO USE "MAGAZINE", APART FROM THE MARK AS SHOWN.

SER. NO. 85-440,867, FILED 10-6-2011.

ELISSA GARBER KON, EXAMINING ATTORNEY



*David J. Kybas*

Director of the United States Patent and Trademark Office

# United States of America

United States Patent and Trademark Office



**Reg. No. 4,197,246**

**Registered Aug. 28, 2012**

**Int. Cl.: 9**

**TRADEMARK**

**PRINCIPAL REGISTER**

BLUE WOLF ENTERPRISES, INC. (IDAHO CORPORATION), DBA BLUE WOLF ROBOTICS  
9179 W. STATE ST.  
GARDEN CITY, ID 83714

FOR: ROBOTS FOR PERSONAL OR HOBBY USE; ROBOTS FOR PERSONAL, EDUCATION-  
AL AND HOBBY USE AND STRUCTURAL PARTS THEREFORE, IN CLASS 9 (U.S. CLS.  
21, 23, 26, 36 AND 38).

FIRST USE 2-1-2011; IN COMMERCE 2-1-2011.

NO CLAIM IS MADE TO THE EXCLUSIVE RIGHT TO USE "ROBOTICS", APART FROM  
THE MARK AS SHOWN.

THE COLOR(S) MIDNIGHT BLUE, MOON YELLOW, AND BLACK IS/ARE CLAIMED AS  
A FEATURE OF THE MARK.

THE MARK CONSISTS OF THE STYLIZED WORDING "BLUEWOLF ROBOTICS  
"WWW.BLUEWOLFINC.COM" TO THE RIGHT OF A WOLF DESIGN. THE WORDING  
"BLUEWOLF" AND "WWW.BLUEWOLFINC.COM" IS MIDNIGHT BLUE AND THE  
WORDING "ROBOTICS" IS BLACK. THE WOLF DESIGN IS COMPRISED OF A MIDNIGHT  
BLUE WOLF IN A MIDNIGHT BLUE CIRCLE WITH JAGGED LINES ON THE LEFT SIDE.  
THE WOLF IS IN A HOWLING POSTURE WITH HIS HEAD AND MOUTH FACING TO THE  
UPPER RIGHT OF THE CIRCLE. ON THE RIGHT SIDE OF THE CIRCLE IS A HALF CIRCLE  
IN MOON YELLOW. THE WHITE IN THE MARK REPRESENTS BACKGROUND OR  
TRANSPARENCY AND IS NOT CLAIMED AS A FEATURE OF THE MARK.

SER. NO. 85-441,231, FILED 10-6-2011.

KIMBERLY FRYE, EXAMINING ATTORNEY



*David J. Kyros*

Director of the United States Patent and Trademark Office

# United States of America

United States Patent and Trademark Office



**Reg. No. 4,197,247**

OBJECTFABRIC INC. (DELAWARE CORPORATION)  
1717A MARSHALL CT.

**Registered Aug. 28, 2012**

LOS ALTOS, CA 940247220

**Int. Cl.: 9**

FOR: DOWNLOADABLE COMPUTER SOFTWARE DEVELOPMENT TOOLS, IN CLASS 9  
(U.S. CLS. 21, 23, 26, 36 AND 38).

**TRADEMARK**

FIRST USE 1-15-2011; IN COMMERCE 1-15-2011.

**PRINCIPAL REGISTER**

NO CLAIM IS MADE TO THE EXCLUSIVE RIGHT TO USE "OBJECT FABRIC", APART  
FROM THE MARK AS SHOWN.

THE COLOR(S) RED, BLACK AND GREY IS/ARE CLAIMED AS A FEATURE OF THE  
MARK.

THE MARK CONSISTS OF A WAVE OF DOTS WITH A LEFT TO RIGHT GRADIENT FROM  
DARK RED TO LIGHT RED, NEXT TO THE WORD "OBJECTFABRIC". THIS WORD IS  
PAINTED WITH TWO COLORS, "OBJECT" HAS A TOP TO DOWN GRADIENT FROM  
LIGHT RED TO DARK RED, AND "FABRIC" HAS A TOP TO DOWN GRADIENT FROM  
DARK GREY TO BLACK.

SER. NO. 85-441,244, FILED 10-6-2011.

DEIRDRE ROBERTSON, EXAMINING ATTORNEY



*David J. Kyjars*

Director of the United States Patent and Trademark Office

# United States of America

United States Patent and Trademark Office

## SENECA ALLEGANY CASINO & HOTEL

**Reg. No. 4,197,248**

**Registered Aug. 28, 2012**

**Int. Cls.: 41 and 44**

**SERVICE MARK**

**PRINCIPAL REGISTER**

SENECA GAMING CORPORATION (UNITED STATES A TRIBALLY-CHARTERED CORPORATION OF THE SENECA NATION OF INDIANS, A FEDERALLY-RECOGNIZED INDIAN TRIBE, ORGANIZED UNDER THE LAWS OF THE UNITED STATES)  
310 FOURTH STREET  
NIAGARA FALLS, NY 14303

FOR: ENTERTAINMENT, NAMELY, LIVE MUSIC CONCERTS, IN CLASS 41 (U.S. CLS. 100, 101 AND 107).

FIRST USE 7-31-2004; IN COMMERCE 7-31-2004.

FOR: HEALTH SPA SERVICES, NAMELY, COSMETIC BODY CARE SERVICES AND MASSAGES; HEALTH SPA SERVICES FOR HEALTH AND WELLNESS OF THE BODY AND SPIRIT OFFERED AT A GAMING RESORT; BEAUTY SALON SERVICES, IN CLASS 44 (U.S. CLS. 100 AND 101).

FIRST USE 3-31-2007; IN COMMERCE 3-31-2007.

THE MARK CONSISTS OF STANDARD CHARACTERS WITHOUT CLAIM TO ANY PARTICULAR FONT, STYLE, SIZE, OR COLOR.

OWNER OF U.S. REG. NOS. 3,296,030, 3,457,952 AND OTHERS.

NO CLAIM IS MADE TO THE EXCLUSIVE RIGHT TO USE "ALLEGANY CASINO & HOTEL", APART FROM THE MARK AS SHOWN.

SER. NO. 85-441,601, FILED 10-7-2011.

KATHY DE JONGE, EXAMINING ATTORNEY



*David J. Kypos*

Director of the United States Patent and Trademark Office

# United States of America

## United States Patent and Trademark Office



**Reg. No. 4,197,249**

**Registered Aug. 28, 2012**

**Int. Cls.: 35, 38 and 39**

**SERVICE MARK**

**PRINCIPAL REGISTER**

QOQA SERVICES SÀRL (SWITZERLAND LIMITED LIABILITY COMPANY)  
RUE DE L'ARC-EN-CIEL 14  
1030 BUSSIGNY-LAUSANNE, SWITZERLAND

FOR: ADVERTISING SERVICES; BUSINESS MANAGEMENT; BUSINESS ADMINISTRATION AND MANAGEMENT; PROVIDING OFFICE FUNCTIONS; ON-LINE RETAIL STORE SERVICES VIA A GLOBAL COMPUTER NETWORK FEATURING CONSUMER ELECTRONIC PRODUCTS, COMPUTERS AND COMPUTER ACCESSORIES, KITCHEN AND HOUSEHOLD APPARATUS AND UTENSILS, AUTOMOBILES AND AUTOMOBILE ACCESSORIES, JEWELLERY AND WATCHES, HEALTHCARE AND COSMETIC PRODUCTS, WINES, FURNITURE; ELECTRONIC BUSINESS SERVICES, NAMELY, PROVIDING INFORMATION ON PRODUCTS VIA TELECOMMUNICATION NETWORKS FOR PUBLICITY AND SALES PROMOTION PURPOSES; PROMOTING THE GOODS OF OTHERS, NAMELY, PROVIDING ON-LINE INFORMATION REGARDING DAILY OFFER ON THE INTERNET FOR A NEW PRODUCT IN LIMITED QUANTITIES; ELECTRONIC BUSINESS SERVICES, NAMELY, ADVERTISING IN THE FORM OF DATA, TEXTS, IMAGES, SOUNDS, ALONE OR COMBINED, VIA COMPUTER NETWORKS, FOR THE SALES OF GOODS AND SERVICES OF ALL KINDS; ADVERTISING FOR A NEW PRODUCT OFFERED DAILY ON THE INTERNET IN LIMITED QUANTITIES; COMPUTER DATA PROCESSING SERVICES; ELECTRONIC PROCESSING ORDERS AND VOUCHERS FOR OTHERS, AND SUBSEQUENT INVOICING THEREOF; ADMINISTRATIVE PROCESSING OF SALES ORDERS FOR OTHERS; ELECTRONIC DATA COLLECTION, COMPILING DATABANKS AND ANALYSIS OF DATA; PROVIDING BUSINESS INFORMATION AND BUSINESS ADVICE TO THE CONSUMERS; PROVIDING AND PRESENTING CONSUMERS INFORMATION ON GOODS OF ALL KINDS AVAILABLE ON-LINE; PROMOTING SALES FOR OTHERS, IN CLASS 35 (U.S. CLS. 100, 101 AND 102).

FOR: PROVIDING ACCESS TO INTERNET PLATFORMS OFFERING GOODS AND SERVICES IN ELECTRONICALLY ACCESSIBLE DATABANKS, WITH INTERACTIVE ACCESS AND WITH THE POSSIBILITY OF PASSING A DIRECT ORDER; ELECTRONIC TRANSMISSION OF DATA IN THE FIELD OF RETAIL SALES; ELECTRONIC DIGITAL MESSAGING, IN CLASS 38 (U.S. CLS. 100, 101 AND 104).

FOR: DELIVERY OF GOODS ORDERED VIA MAIL ORDER, EITHER ON-LINE OR NOT; PHYSICAL STORAGE OF ELECTRONICALLY-STORED DATA OR DOCUMENTS, IN CLASS 39 (U.S. CLS. 100 AND 105).



*David J. Kybas*

Director of the United States Patent and Trademark Office



**Reg. No. 4,197,249** PRIORITY CLAIMED UNDER SEC. 44(D) ON SWITZERLAND APPLICATION NO. 54632/2011, FILED 4-13-2011, REG. NO. 619206, DATED 8-29-2011, EXPIRES 4-13-2021.

THE COLOR(S) LIGHT PINK AND DARK PINK IS/ARE CLAIMED AS A FEATURE OF THE MARK.

THE MARK CONSISTS OF THE LETTERS "QOQA" IN JUXTAPOSITION WITH A SIMULATED WAVE LINE RUNNING THROUGH THEM WITH THE LETTERS APPEARING IN DARK PINK BELOW THE WAVE LINE AND APPEARING IN LIGHT PINK ABOVE THE WAVE LINE.

SER. NO. 85-441,642, FILED 10-7-2011.

VIVIAN MICZNIK FIRST, EXAMINING ATTORNEY

# United States of America

United States Patent and Trademark Office

# IRON DISC

**Reg. No. 4,197,250**

**Registered Aug. 28, 2012**

**Int. Cl.: 9**

**TRADEMARK**

**PRINCIPAL REGISTER**

EZ MEDIA LLC. (MICHIGAN LIMITED LIABILITY COMPANY), DBA EZ MEDIA LLC.  
SUITE F.  
3380 TRAVIS POINTE DR.  
ANN ARBOR, MI 48108

FOR: BLANK RECORDABLE CD-RS AND DVD-RS, IN CLASS 9 (U.S. CLS. 21, 23, 26, 36 AND 38).

FIRST USE 10-28-2011; IN COMMERCE 10-28-2011.

THE MARK CONSISTS OF STANDARD CHARACTERS WITHOUT CLAIM TO ANY PARTICULAR FONT, STYLE, SIZE, OR COLOR.

NO CLAIM IS MADE TO THE EXCLUSIVE RIGHT TO USE "DISC", APART FROM THE MARK AS SHOWN.

SER. NO. 85-441,906, FILED 10-7-2011.

HANNO RITTNER, EXAMINING ATTORNEY



*David J. Kyffers*

Director of the United States Patent and Trademark Office

# United States of America

United States Patent and Trademark Office



**Reg. No. 4,197,251**

SPORT-ON AB (SWEDEN CORPORATION)  
BOX 3029

**Registered Aug. 28, 2012**

UPPSALA, SWEDEN SE-75003

**Int. Cl.: 9**

FOR: DOWNLOADABLE VIDEO RECORDINGS FEATURING CINEMA FILMS, CARTOONS, ANIMATED FILMS, MANGA FILMS, MUSIC, THEATRE PLAYS, OPERAS, CONCERTS, TV-ENTERTAINMENT PROGRAMS, DOCUMENTARY FILMS, CLIPS FROM PRESS CONFERENCES, STILL PICTURES, PRIVATE PERSONS' VIDEO CLIPS IN THE FIELD OF NEWS AND CURRENT EVENTS, EXTREME SPORTSMEN'S PRIVATE VIDEO CLIPS IN THE FIELD OF EXTREME SPORTS, QUOTATIONS ON VIDEO AND FILM, FILM SEQUENCES AND DOCUMENTARY FILMS BY AND ABOUT CELEBRITIES, SPORTS EVENTS, INTERVIEWS AND DOCUMENTARY FILMS OF AND ABOUT ATHLETES ALL FOR MOBILE PHONES, IN CLASS 9 (U.S. CLS. 21, 23, 26, 36 AND 38).

**TRADEMARK**

**PRINCIPAL REGISTER**

FIRST USE 9-14-2011; IN COMMERCE 9-14-2011.

NO CLAIM IS MADE TO THE EXCLUSIVE RIGHT TO USE "SPORT ON", APART FROM THE MARK AS SHOWN.

THE MARK CONSISTS OF A SQUARE CONTAINING THE WORD "SPORT" ABOVE THE LETTER "O" OF THE WORD "ON".

SER. NO. 85-442,180, FILED 10-7-2011.

SALLY SHIH, EXAMINING ATTORNEY



*David J. Kybas*

Director of the United States Patent and Trademark Office

# United States of America

United States Patent and Trademark Office

## Sea to Tee Sports

**Reg. No. 4,197,252**

**Registered Aug. 28, 2012**

**Int. Cl.: 41**

**SERVICE MARK**

**PRINCIPAL REGISTER**

JANIKOWSKI, DAVID (UNITED STATES INDIVIDUAL)  
#1125  
1088 BISHOP ST.  
HONOLULU, HI 96813

FOR: ENTERTAINMENT SERVICES, NAMELY, PROVIDING A WEBSITE FEATURING INFORMATION AND PHOTOGRAPHS IN THE FIELD OF SPORTS, IN CLASS 41 (U.S. CLS. 100, 101 AND 107).

FIRST USE 6-1-2008; IN COMMERCE 6-1-2008.

THE MARK CONSISTS OF STANDARD CHARACTERS WITHOUT CLAIM TO ANY PARTICULAR FONT, STYLE, SIZE, OR COLOR.

NO CLAIM IS MADE TO THE EXCLUSIVE RIGHT TO USE "SPORTS", APART FROM THE MARK AS SHOWN.

SER. NO. 85-443,649, FILED 10-10-2011.

MICHAEL WIENER, EXAMINING ATTORNEY



*David J. Kyros*

Director of the United States Patent and Trademark Office

# United States of America

United States Patent and Trademark Office

## Forward Thinking Energy



**Reg. No. 4,197,253**

**Registered Aug. 28, 2012**

**Int. Cl.: 35**

**SERVICE MARK**

**PRINCIPAL REGISTER**

HESS CORPORATION (DELAWARE CORPORATION)  
1185 AVENUE OF THE AMERICAS  
NEW YORK, NY 10036

FOR: MARKETING CONSULTING AS TO NATURAL GAS, ELECTRICITY, MOTOR OIL AND FUEL; BUSINESS CONSULTING IN THE FIELD OF ENVIRONMENTAL MANAGEMENT, NAMELY, ADVISING BUSINESSES ON ISSUES OF ENVIRONMENTAL IMPACT, CONSERVATION AND PRESERVATION; BUSINESS MANAGEMENT AND ADVISORY SERVICES; BUSINESS CONSULTING SERVICES REGARDING THE MANAGING, THE TIMING AND THE QUANTITIES OF ENERGY PURCHASES; PROVIDING BUSINESS AND CONSUMER INFORMATION ON ENERGY MARKETS AS WELL AS NATURAL GAS, ELECTRICITY, MOTOR OIL AND FUEL; RETAIL ELECTRICITY PROVIDER SERVICES, NAMELY, PROVIDING A SERVICE THAT ALLOWS CUSTOMERS TO PURCHASE ENERGY, NAMELY, NATURAL GAS, ELECTRICITY AND FUEL; ENERGY MANAGEMENT SERVICES, NAMELY, PROVIDING A SERVICE THAT ALLOWS CUSTOMERS TO PURCHASE ENERGY, NAMELY, ELECTRICITY, NATURAL GAS AND FUEL OIL AT A FIXED PRICE; ENERGY MANAGEMENT SERVICES, NAMELY, PROVIDING A SERVICE THAT ALLOWS CUSTOMERS TO PURCHASE ENERGY, NAMELY, ELECTRICITY AND FUEL OIL AT MARKET RATES; ENERGY ASSESSMENT SERVICES FOR THE PURPOSE OF DETERMINING ENERGY EFFICIENCY OR USAGE MANAGEMENT; ENERGY USAGE MANAGEMENT; ENERGY USAGE MANAGEMENT INFORMATION SERVICES; ENERGY MANAGEMENT SERVICES, NAMELY, PROVIDING A SERVICE THAT ALLOWS CUSTOMERS TO SWITCH BETWEEN NATURAL GAS AND FUEL OIL, IN CLASS 35 (U.S. CLS. 100, 101 AND 102).

FIRST USE 12-1-2009; IN COMMERCE 12-1-2009.

NO CLAIM IS MADE TO THE EXCLUSIVE RIGHT TO USE "ENERGY", APART FROM THE MARK AS SHOWN.

THE MARK CONSISTS OF AN IMAGE OF A LIGHT BULB ENCLOSED IN A RECTANGLE WITH ROUNDED CORNERS, AN IMAGE OF A FLAME ENCLOSED IN A RECTANGLE WITH ROUNDED CORNERS, AN IMAGE OF A RAINDROP ENCLOSED IN A RECTANGLE WITH ROUNDED CORNERS, AND AN IMAGE OF A LEAF ENCLOSED IN A RECTANGLE WITH ROUNDED CORNERS BELOW THE WORDS "FORWARD THINKING ENERGY".

SER. NO. 85-444,109, FILED 10-11-2011.



*David J. Kappas*

Director of the United States Patent and Trademark Office

**Reg. No. 4,197,253** BRIAN PINO, EXAMINING ATTORNEY

# United States of America

United States Patent and Trademark Office

## Bunny Yeager

**Reg. No. 4,197,254**

BRUNO BANANI UNDERWEAR GMBH (FED REP GERMANY CORPORATION)  
MAUERSBERGER STRAÙE 5

**Registered Aug. 28, 2012**

CHEMNITZ, FED REP GERMANY D-09117

**Int. Cls.: 3, 9, 14, 16, 18,  
24, 25, 28, 29, 32, 33 and  
35**

FOR: PERFUMERY, ESSENTIAL OILS FOR PERSONAL USE; ESSENTIAL OILS FOR USE  
IN THE MANUFACTURE OF SCENTED PRODUCTS, COSMETICS, HAIR LOTIONS, IN  
CLASS 3 (U.S. CLS. 1, 4, 6, 50, 51 AND 52).

**TRADEMARK**

FOR: SPECTACLES, INCLUDING SUNGLASSES; APPARATUS FOR TRANSMISSION OF  
COMMUNICATION, NAMELY, TELEPHONE APPARATUS, MOBILE TELEPHONES, CEL-  
LULAR TELEPHONES, CORDLESS TELEPHONES, FACSIMILE MACHINES AND SCAN-  
NERS; MAGNETIC IDENTIFYING CARDS, MAGNETIC CODED GIFT CARDS, ELECTRONIC  
AND MAGNETIC ID CARDS FOR USE IN CONNECTION WITH PAYMENT FOR SERVICES;  
TRANSMITTING AND RECEIVING APPARATUS FOR RADIO AND TELEVISION  
BROADCASTING AND FOR LONG-DISTANCE TRANSMISSION; APPARATUS FOR RE-  
CORDING, TRANSMISSION OR REPRODUCTION OF SOUND OR IMAGES; BLANK  
MAGNETIC DATA CARRIERS, BLANK RECORD DISCS; EXPOSED CAMERA AND X-RAY  
FILMS; BLANK CD-ROMS FOR SOUND OR VIDEO RECORDING; BLANK MAGNETIC  
TAPES FOR TAPE RECORDERS; CASH REGISTERS, CALCULATING MACHINES, IN  
CLASS 9 (U.S. CLS. 21, 23, 26, 36 AND 38).

**SERVICE MARK**

**PRINCIPAL REGISTER**

FOR: JEWELRY, PRECIOUS STONES; COSTUME JEWELRY; HOROLOGICAL AND  
CHRONOMETRIC INSTRUMENTS, IN CLASS 14 (U.S. CLS. 2, 27, 28 AND 50).



FOR: PAPER, CARDBOARD; GOODS OF PAPER AND CARDBOARD, NAMELY, HAND  
TOWELS OF PAPER, WEDDING ALBUMS, PHOTOGRAPH ALBUMS, SCRAPBOOKS, EN-  
VELOPES, WRITING AND LETTER PAPER, NOTEPAPER, CALENDARS AND AGENDAS;  
STATIONERY; ADHESIVES FOR STATIONERY OR HOUSEHOLD PURPOSES; ARTISTS'  
MATERIALS, NAMELY, ARTISTS' BRUSHES, ARTISTS' PENCILS, ARTISTS' PASTELS;  
DRAWING-MATERIALS, NAMELY, DRAWING PADS, DRAWING PENCILS, DRAWING  
BRUSHES, DRAWING RULERS, DRAWING TEMPLATES; PAINTING MATERIALS,  
NAMELY, CANVAS FOR PAINTING, PAINTING PALETTES; MODELING MATERIALS,  
NAMELY, MODELING CLAY; PAINT BRUSHES; ELECTRIC TYPEWRITERS AND OFFICE  
REQUISITES, NAMELY, ENVELOPE SEALING MACHINES, OFFICE LETTERING MA-  
CHINES, IN CLASS 16 (U.S. CLS. 2, 5, 22, 23, 29, 37, 38 AND 50).

*David J. Kappas*

Director of the United States Patent and Trademark Office

**Reg. No. 4,197,254** FOR: LEATHER AND IMITATION LEATHER; LEATHER AND IMITATION LEATHER BAGS, LEATHER BAGS FOR MERCHANDISE PACKAGING, BANDS OF LEATHER, LEATHER STRAPS, LEATHER BOXES FOR STORING GREETING CARDS; LEATHER BAGS AND CASES, NAMELY, PURSES, POCKET WALLETS, KEY WALLETS, TRUNKS AND TRAVELING BAGS; UMBRELLAS, PARASOLS AND WALKING STICKS, IN CLASS 18 (U.S. CLS. 1, 2, 3, 22 AND 41).

FOR: TEXTILES AND TEXTILE GOODS, NAMELY, FABRIC FOR TEXTILE USE AND FOR THE MANUFACTURE OF CLOTHING, FOOTWEAR AND HEADGEAR; CURTAINS, HOUSEHOLD LINEN, TABLE AND BED LINEN, PAPER BED COVERS; TABLE COVERS, NAMELY, TABLE CLOTHS NOT OF PAPER; HANDKERCHIEFS OF TEXTILE; IMITATION LEATHER FABRIC, NAMELY, COTTON FABRIC MADE TO LOOK LIKE IMITATION LEATHER, AND FABRIC FOR TEXTILE USE MADE TO LOOK LIKE IMITATION LEATHER; NON-WOVEN TEXTILE FABRICS, IN CLASS 24 (U.S. CLS. 42 AND 50).

FOR: CLOTHING, NAMELY, LADIES' UNDERWEAR, MEN'S UNDERWEAR, SWIM WEAR, PANTS, SHIRTS, SHORTS, WOMEN'S TOPS, NAMELY, CAMIS, SKIRTS AND DRESSES, SUITS, LEISURE SUITS, SHORT-SLEEVED OR LONG-SLEEVED T-SHIRTS, SWEATERS, BELTS FOR CLOTHING, NECKTIES, FOULARDS, JACKETS, COATS, SOCKS, HAND-WARMERS, KNEE WARMERS, WRAP-AROUNDS, TIES, GLOVES, CLOTHING FOR ATHLETIC USE, NAMELY, PADDED SHORTS, PADDED PANTS, PADDED SHIRTS; FOOTWEAR; HEADGEAR, NAMELY, HATS, CAPS, HEAD SCARVES, SWEATBANDS, IN CLASS 25 (U.S. CLS. 22 AND 39).

FOR: GAMES, NAMELY, DARTBOARD GAMES, DICE GAMES, BOARD GAMES, ADULT AND CHILDREN'S PARTY GAMES, CARD GAMES, ARCADE GAMES, BINGO GAME PLAYING EQUIPMENT, BILLIARD GAME PLAYING EQUIPMENT; GYMNASTIC AND SPORTING APPARATUS, NAMELY, STATIONARY EXERCISE BICYCLES, BODY-TRAINING APPARATUS, VIBRATING APPARATUS USED IN FITNESS AND EXERCISE PROGRAMS TO STIMULATE MUSCLES AND INCREASE STRENGTH AND PHYSICAL PERFORMANCE; SKIING EQUIPMENT, NAMELY, SKIS, SKI POLES, COVERS FOR SKIS AND SKI BINDINGS, HARNESES SPECIALLY ADAPTED FOR CARRYING SKIS; TENNIS EQUIPMENT, NAMELY, TENNIS BALLS, TENNIS BALL CASES, TENNIS RACKETS AND TENNIS RACKET CASES, TENNIS NETS; PLAYING CARDS, IN CLASS 28 (U.S. CLS. 22, 23, 38 AND 50).

FOR: MEAT, FISH, POULTRY AND GAME; MEAT EXTRACTS; EDIBLE OILS AND FATS, FISH AND MEAT PRESERVES, CANNED FISH; CAVIAR; FROZEN, PREPARED OR PACKAGED MEALS CONSISTING PRIMARILY OF MEAT, FISH, POULTRY OR VEGETABLES; PRESERVED, DRIED AND COOKED FRUITS AND VEGETABLES; JELLIES, JAMS, COMPOTES; EGGS, MILK AND MILK PRODUCTS EXCLUDING ICE CREAM, ICE MILK AND FROZEN YOGURT, IN CLASS 29 (U.S. CL. 46).

FOR: BEER, ALE, LAGER, STOUT, PORTER, SHANDY; MINERAL AND AERATED WATERS; NON-ALCOHOLIC BEVERAGES, NAMELY, BEER, CIDER, COCKTAIL MIXES, ENERGY SHOTS, HONEY-BASED BEVERAGES, RICE-BASED BEVERAGES NOT BEING MILK SUBSTITUTES, MALT BASED BEVERAGES, PUNCH; NON-ALCOHOLIC FRUIT EXTRACTS USED IN THE PREPARATION OF BEVERAGES; NON-ALCOHOLIC FRUIT JUICE BEVERAGES; SYRUPS FOR MAKING NON-ALCOHOLIC BEVERAGES, IN CLASS 32 (U.S. CLS. 45, 46 AND 48).

FOR: ALCOHOLIC BEVERAGES, NAMELY, WINES, LIQUEURS AND SPARKLING WINES, STILL WINES, PORT WINES, PREPARED WINE COCKTAILS, WINE COOLERS, WINE PUNCHES, AND WINE BASED DRINKS, IN CLASS 33 (U.S. CLS. 47 AND 49).

FOR: ORGANIZATION AND CONDUCTING OF PRODUCT PRESENTATIONS FOR ADVERTISING PURPOSES; ADVERTISING AND PROMOTIONAL SERVICES, NAMELY, ADVERTISING MAIL; RETAIL AND WHOLESALE STORE SERVICES, INCLUDING COMPUTERIZED



**Reg. No. 4,197,254** ONLINE RETAIL AND WHOLESALE STORE SERVICES, AND BRINGING TOGETHER, FOR OTHERS, OF A VARIETY OF GOODS FOR PRODUCT PRESENTATION AND SALES PURPOSES TO ALLOW CUSTOMERS TO VIEW AND PURCHASE GOODS, ALL IN THE FIELD OF CLOTHING, FOOTWEAR, HEADGEAR, ACCESSORIES FOR CLOTHING, TEXTILE GOODS, HABERDASHERY, BED AND TABLE LINEN AND BEDDING, SPORTING ARTICLES AND SPORTS EQUIPMENT, BAGS, SPORTS BAGS, BAGS FOR SPORTS EQUIPMENT, CASES, LEATHER GOODS, COSMETICS, PHARMACY ARTICLES AND PERFUMERY, GOODS FOR THE HEALTH SECTOR, JEWELRY, CLOCKS AND WATCHES, STATIONERY, ARTISTS' MATERIALS, PAPER GOODS, OFFICE REQUISITES, HOBBY REQUISITES AND CRAFT SUPPLIES, SPECTACLES AND SUNGLASSES, AND ACCESSORIES THEREFOR, TOYS, GAMES, FURNISHINGS, DECORATIVE ARTICLES, NAMELY, MIRRORS, PICTURE FRAMES, SILVERWARE, GOODS OF PRECIOUS METAL, STAINLESS STEEL, GOODS OF WOOD, CORK, REED, CANE, WICKER, HORN, BONE, IVORY, WHALEBONE, SHELL, AMBER, MOTHER-OF-PEARL, MEERSCHAUM AND SUBSTITUTES FOR ALL THESE MATERIALS, OR OF PLASTICS; MAIL ORDER SERVICES AND ONLINE ORDERING SERVICES, NAMELY, ELECTRONIC PROCESSING OF ORDERS FOR OTHERS, ONLINE OR CATALOGUE MAIL ORDER SERVICES IN THE FIELD OF CLOTHING, FOOTWEAR, HEADGEAR, ACCESSORIES FOR CLOTHING, TEXTILE GOODS, HABERDASHERY, BED AND TABLE LINEN AND BEDDING, SPORTING ARTICLES AND SPORTS EQUIPMENT, BAGS, SPORTS BAGS, BAGS FOR SPORTS EQUIPMENT, CASES, LEATHER GOODS, COSMETICS, PHARMACY ARTICLES AND PERFUMERY, GOODS FOR THE HEALTH SECTOR, JEWELRY, CLOCKS AND WATCHES, STATIONERY, ARTISTS' MATERIALS, PAPER GOODS, OFFICE REQUISITES, HOBBY REQUISITES AND CRAFT SUPPLIES, SPECTACLES AND SUNGLASSES, AND ACCESSORIES THEREFOR, TOYS, GAMES, FURNISHINGS, DECORATIVE ARTICLES, NAMELY, MIRRORS, PICTURE FRAMES, SILVERWARE, GOODS OF PRECIOUS METAL, STAINLESS STEEL, GOODS OF WOOD, CORK, REED, CANE, WICKER, HORN, BONE, IVORY, WHALEBONE, SHELL, AMBER, MOTHER-OF-PEARL, MEERSCHAUM AND SUBSTITUTES FOR ALL THESE MATERIALS, OR OF PLASTICS; ORDER FULFILLMENT SERVICES WITHIN THE FRAMEWORK OF E-COMMERCE AND TRADITIONAL COMMERCE; COMMERCIAL CONSULTANCY REGARDING THE ARRANGING AND CONCLUDING OF COMMERCIAL TRANSACTIONS, FOR OTHERS, INCLUDING WITHIN THE FRAMEWORK OF E-COMMERCE; ARRANGING AND CONCLUDING OF CONTRACTS, FOR OTHERS, FOR THE BUYING AND SELLING OF GOODS AND THE PROVIDING OF SERVICES, IN PARTICULAR MEDIATION BETWEEN CUSTOMERS AND MANUFACTURERS WITH REGARD TO THE PROVIDING OF SERVICING AND REPAIR SERVICES; PLANNING AND CONDUCTING EVENTS, NAMELY, ADVERTISING EVENTS AND FASHION SHOWS FOR ADVERTISING AND PROMOTIONAL PURPOSES, IN CLASS 35 (U.S. CLS. 100, 101 AND 102).

THE MARK CONSISTS OF STANDARD CHARACTERS WITHOUT CLAIM TO ANY PARTICULAR FONT, STYLE, SIZE, OR COLOR.

PRIORITY CLAIMED UNDER SEC. 44(D) ON ERPN CMNTY TM OFC APPLICATION NO. 010149805, FILED 7-26-2011, REG. NO. 010149805, DATED 12-28-2011, EXPIRES 7-26-2021.

THE NAME(S), PORTRAIT(S), AND/OR SIGNATURE(S) SHOWN IN THE MARK IDENTIFIES A LIVING INDIVIDUAL, WHOSE CONSENT(S) TO REGISTER IS MADE OF RECORD.

SER. NO. 85-444,392, FILED 10-11-2011.

JOHN E. MICHOS, EXAMINING ATTORNEY

# United States of America

United States Patent and Trademark Office

## HEDGE FUND IN A BOX

**Reg. No. 4,197,255**

**Registered Aug. 28, 2012**

**Int. Cl.: 36**

**SERVICE MARK**

**PRINCIPAL REGISTER**

STONEGATE CAPITAL PARTNERS, LLC (GEORGIA LIMITED LIABILITY COMPANY)  
SIX CONCOURSE PARKWAY, SUITE 600  
ATLANTA, GA 30328

FOR: BANKING AND FINANCING SERVICES; BROKERAGE SERVICES FOR CAPITAL INVESTMENTS; INVESTMENT BANKING SERVICES, IN CLASS 36 (U.S. CLS. 100, 101 AND 102).

FIRST USE 5-1-2011; IN COMMERCE 10-11-2011.

THE MARK CONSISTS OF STANDARD CHARACTERS WITHOUT CLAIM TO ANY PARTICULAR FONT, STYLE, SIZE, OR COLOR.

NO CLAIM IS MADE TO THE EXCLUSIVE RIGHT TO USE "HEDGE FUND", APART FROM THE MARK AS SHOWN.

SER. NO. 85-444,686, FILED 10-11-2011.

ALYSSA STEEL, EXAMINING ATTORNEY



*David J. Kyffers*

Director of the United States Patent and Trademark Office

# United States of America

United States Patent and Trademark Office



**Reg. No. 4,197,256**

ISLETON CHAMBER OF COMMERCE (CALIFORNIA CORPORATION)  
P.O. BOX 758  
ISLETON, CA 95641

**Registered Aug. 28, 2012**

**Int. Cl.: 41**

FOR: ENTERTAINMENT IN THE NATURE OF LIVE MUSICAL PERFORMANCES OF CAJUN AND ZYDECO MUSIC, IN CLASS 41 (U.S. CLS. 100, 101 AND 107).

**SERVICE MARK**

FIRST USE 3-0-2010; IN COMMERCE 3-0-2010.

**PRINCIPAL REGISTER**

NO CLAIM IS MADE TO THE EXCLUSIVE RIGHT TO USE "ISLETON CAJUN FESTIVAL", APART FROM THE MARK AS SHOWN.

THE STIPPLING IS FOR SHADING PURPOSES ONLY.

THE MARK CONSISTS OF A STYLIZED ALLIGATOR TORSO AND HEAD PLAYING A MUSICAL INSTRUMENT ON AN OVAL BACKGROUND, WITH THE TEXT "ISLETON CAJUN FESTIVAL" CURVED ABOVE THE TOP OF THE OVAL.

SER. NO. 85-444,852, FILED 10-11-2011.

ERNEST SHOSHO, EXAMINING ATTORNEY



*David J. Kyfos*

Director of the United States Patent and Trademark Office

# United States of America

United States Patent and Trademark Office

**TEAM  DAWG**

**Reg. No. 4,197,257**

FORTIER, ROBERT E. (UNITED STATES INDIVIDUAL)

**Registered Aug. 28, 2012**

P.O. BOX 105  
NESCONSET, NY 11767

**Int. Cl.: 16**

FOR: SERIES OF FICTIONAL CHILDREN'S BOOKS; CHILDREN'S ACTIVITY BOOKS; CHILDREN'S COLORING BOOKS; EDUCATIONAL BOOKS FEATURING ELEMENTARY LEVEL CHARACTER EDUCATION; EDUCATIONAL KITS SOLD AS A UNIT IN THE FIELD OF CHARACTER EDUCATION CONSISTING PRIMARILY OF EDUCATIONAL BOOKS AND ALSO T-SHIRTS; EDUCATIONAL PUBLICATIONS, NAMELY, EDUCATIONAL LEARNING CARDS, FLASH CARDS, ACTIVITY CARDS, WORKBOOKS, TEXTBOOKS, ACTIVITY BOOKS, STORY BOOKS, PUZZLE BOOKS, PRINTED PUZZLES, TEACHER GUIDES, MANUALS, POSTERS AND EDUCATIONAL BOOKLETS IN THE FIELD OF CHARACTER EDUCATION; LETTERHEAD PAPER; STICKERS; DECALS; TRADING CARDS; PRINTED EDUCATIONAL MATERIALS IN THE FIELD OF CHARACTER EDUCATION; CARTOON PRINTS, IN CLASS 16 (U.S. CLS. 2, 5, 22, 23, 29, 37, 38 AND 50).

**TRADEMARK**

**PRINCIPAL REGISTER**

FIRST USE 1-1-2008; IN COMMERCE 1-1-2008.

THE MARK CONSISTS OF THE WORDING "TEAM DAWG" IN RED AND OUTLINED IN BLACK WITH A RED PAW DESIGN BETWEEN THE WORDS "TEAM" AND "DAWG" ALSO OUTLINED IN BLACK AND THE LETTERS "TD" ARE WHITE AND INSIDE THE PAW DESIGN.

THE COLOR(S) RED, BLACK AND WHITE IS/ARE CLAIMED AS A FEATURE OF THE MARK.

SER. NO. 85-444,932, FILED 10-11-2011.

DARRYL SPRUILL, EXAMINING ATTORNEY



*David J. Kybas*

Director of the United States Patent and Trademark Office

# United States of America

United States Patent and Trademark Office



**Reg. No. 4,197,258**

**Registered Aug. 28, 2012**

**Int. Cls.: 29 and 30**

**TRADEMARK**

**PRINCIPAL REGISTER**

DOMINGUEZ FAMILY ENTERPRISES (OREGON CORPORATION)  
2885 VAN HORN DR.  
HOOD RIVER, OR 97031

FOR: FRIED PORK RINDS; VEGETABLE-BASED SNACK FOODS, IN CLASS 29 (U.S. CL. 46).

FIRST USE 9-10-1977; IN COMMERCE 9-10-1977.

FOR: TORTILLA SHELLS; TORTILLA CHIPS; TACO SHELLS; TORTILLAS; MASA, NAMELY, FLOUR FOR MAKING TAMALES AND CORN FLOUR; MEXICAN PASTRIES; MEXICAN CANDY; SPICES, IN CLASS 30 (U.S. CL. 46).

FIRST USE 9-10-1977; IN COMMERCE 9-10-1977.

THE MARK CONSISTS OF THE DESIGN OF A SPANISH FEMALE WEARING A SOMBRERO RIDING A DONKEY PAUSED ALONGSIDE A CACTUS.

SER. NO. 85-445,541, FILED 10-12-2011.

KATHERINE CHANG, EXAMINING ATTORNEY



*David J. Kybas*

Director of the United States Patent and Trademark Office

# United States of America

United States Patent and Trademark Office



**RIVIERA**

**Reg. No. 4,197,259**

**Registered Aug. 28, 2012**

**Int. Cl.: 28**

**TRADEMARK**

**PRINCIPAL REGISTER**

RAMBO, BRAD (UNITED STATES INDIVIDUAL)  
1341 CALLE AVANZADO  
SAN CLEMENTE, CA 92673 AND

RAMBO, WENDY (UNITED STATES INDIVIDUAL)  
1341 CALLE AVANZADO  
SAN CLEMENTE, CA 92673

FOR: PADDLE SURF BOARDS, STAND UP PADDLE BOARDS, STAND-UP PADDLE BOARD PADDLES, PADDLE BOARD STRAPS, FINS OR SKAGS, PADDLE BOARD STRAPS AND PADDLE BOARD BAGS, IN CLASS 28 (U.S. CLS. 22, 23, 38 AND 50).

FIRST USE 7-30-2009; IN COMMERCE 7-30-2009.

THE MARK CONSISTS OF A STYLIZED CHARACTER "R" IN UPPER CASE INSIDE A SHIELD INTERNALLY VERTICALLY DIVIDED WITH LIGHT AND DARK BACKGROUND WITH THE SHIELD OVER STYLIZED WORD "RIVIERA".

SER. NO. 85-445,941, FILED 10-12-2011.

DAWN FELDMAN, EXAMINING ATTORNEY



*David J. Kypos*

Director of the United States Patent and Trademark Office

# United States of America

United States Patent and Trademark Office

## I PARTY IN

**Reg. No. 4,197,260**

**Registered Aug. 28, 2012**

**Int. Cl.: 35**

**SERVICE MARK**

**PRINCIPAL REGISTER**

RAMADAN, WAAIL (UNITED STATES INDIVIDUAL)  
UNIT 3007C  
4200 SOUTH VALLEY VIEW  
LAS VEGAS, NV 89103

FOR: PROVIDING CONSUMER REFERRAL INFORMATION AND MAKING REFERRALS IN THE FIELD OF CONSUMER SERVICES FOR NIGHT CLUBS, BARS, LOUNGES, HOTEL, CULTURAL EVENTS, AND RESTAURANTS, CONCERNING PRODUCTS, SERVICES, EVENTS, ACTIVITIES, ATTRACTIONS AND FACILITIES IN PARTICULAR GEOGRAPHIC LOCATIONS; ADVERTISING SERVICES, NAMELY, PROMOTING AND MARKETING THE GOODS AND SERVICES OF OTHERS IN THE FIELD OF UPSCALE CHOICES SUCH AS NIGHT CLUBS, BARS, LOUNGES, HOTELS, CULTURAL EVENTS, AND RESTAURANTS VIA PRINT AND ELECTRONIC MEDIA; ARRANGING AND CONDUCTING MARKETING PROMOTIONAL EVENTS FOR OTHERS; CORPORATE EVENT MANAGEMENT SERVICES; PROMOTING THE PARTIES AND SPECIAL EVENTS OF OTHERS; PROVIDING CONSUMER INFORMATION SERVICES AND MAKING REFERRALS IN THE FIELD OF ENTERTAINMENT SERVICES FOR PRODUCTS, SERVICES, EVENTS, ACTIVITIES, FACILITIES AND LOCATIONS AND PROMOTING THE GOODS AND SERVICES OF OTHERS BY PROVIDING LINKS TO THE RETAIL WEB SITES OF OTHERS, IN CLASS 35 (U.S. CLS. 100, 101 AND 102).

FIRST USE 3-8-2010; IN COMMERCE 3-8-2010.

THE MARK CONSISTS OF STANDARD CHARACTERS WITHOUT CLAIM TO ANY PARTICULAR FONT, STYLE, SIZE, OR COLOR.

SER. NO. 85-446,125, FILED 10-12-2011.

JENNIFER WILLISTON, EXAMINING ATTORNEY



*David J. Kypos*

Director of the United States Patent and Trademark Office

# United States of America

United States Patent and Trademark Office

## SHAKE, SHARE & CARE

**Reg. No. 4,197,261**

FERRERO U.S.A., INC. (DELAWARE CORPORATION)  
600 COTTONTAIL LANE  
SOMERSET, NJ 08873

**Registered Aug. 28, 2012**

**Int. Cls.: 30, 35 and 36**

FOR: CANDY MINTS, IN CLASS 30 (U.S. CL. 46).

**TRADEMARK**

FIRST USE 8-1-2009; IN COMMERCE 8-1-2009.

**SERVICE MARK**

FOR: CHARITABLE SERVICES, NAMELY, PROMOTING PUBLIC AWARENESS, RESEARCH, EDUCATION AND OTHER ACTIVITIES RELATING TO CANCER, IN CLASS 35 (U.S. CLS. 100, 101 AND 102).

**PRINCIPAL REGISTER**

FIRST USE 8-1-2009; IN COMMERCE 8-1-2009.

FOR: CHARITABLE FUNDRAISING FOR PROMOTING PUBLIC AWARENESS, RESEARCH, EDUCATION AND OTHER ACTIVITIES RELATING TO CANCER, IN CLASS 36 (U.S. CLS. 100, 101 AND 102).

FIRST USE 8-1-2009; IN COMMERCE 8-1-2009.

THE MARK CONSISTS OF STANDARD CHARACTERS WITHOUT CLAIM TO ANY PARTICULAR FONT, STYLE, SIZE, OR COLOR.

SER. NO. 85-446,372, FILED 10-13-2011.

DOMINIC FATHY, EXAMINING ATTORNEY



*David J. Kybas*

Director of the United States Patent and Trademark Office



# United States of America

United States Patent and Trademark Office



**Reg. No. 4,197,262**

ALASO U.S.A., CORP. (FLORIDA CORPORATION)  
2725 MINE MILL ROAD  
LAKELAND, FL 33801

**Registered Aug. 28, 2012**

**Int. Cls.: 6 and 7**

FOR: POULTRY CAGES OF METAL, METAL POULTRY LAYING CAGES AND METAL PULLET CAGES, IN CLASS 6 (U.S. CLS. 2, 12, 13, 14, 23, 25 AND 50).

**TRADEMARK**

FIRST USE 6-15-1986; IN COMMERCE 6-15-1986.

**PRINCIPAL REGISTER**

FOR: MECHANIZED FEEDERS AND WATERERS FOR POULTRY, MECHANIZED POULTRY MANURE REMOVERS AND MECHANIZED EGG COLLECTORS FOR COLLECTING AND CONVEYING EGGS, IN CLASS 7 (U.S. CLS. 13, 19, 21, 23, 31, 34 AND 35).

FIRST USE 6-15-1986; IN COMMERCE 6-15-1986.

THE MARK CONSISTS OF THE WORD "ALASO" IN STYLIZED LETTERS TO THE LEFT OF WHICH IS A DESIGN DEPICTING WELDED CAGE WIRES.

SER. NO. 85-447,671, FILED 10-14-2011.

KRISTIN DAHLING, EXAMINING ATTORNEY



*David J. Kyjars*

Director of the United States Patent and Trademark Office

# United States of America

United States Patent and Trademark Office

## DAVES HIGHWAY

**Reg. No. 4,197,263**

DAVES, DARRYL (UNITED STATES INDIVIDUAL)  
207 LEGACY DR.

**Registered Aug. 28, 2012**

BRANDON, MS 39042

**Int. Cl.: 41**

FOR: ENTERTAINMENT SERVICES IN THE NATURE OF LIVE MUSICAL PERFORMANCES; ENTERTAINMENT, NAMELY, LIVE PERFORMANCES BY A MUSICAL BAND; ENTERTAINMENT, NAMELY, LIVE PERFORMANCES BY ROCK GROUPS; PRODUCTION OF SOUND AND MUSIC VIDEO RECORDINGS, IN CLASS 41 (U.S. CLS. 100, 101 AND 107).

**SERVICE MARK**

**PRINCIPAL REGISTER**

FIRST USE 1-1-2009; IN COMMERCE 1-1-2009.

THE MARK CONSISTS OF STANDARD CHARACTERS WITHOUT CLAIM TO ANY PARTICULAR FONT, STYLE, SIZE, OR COLOR.

SER. NO. 85-448,005, FILED 10-14-2011.

GIANCARLO CASTRO, EXAMINING ATTORNEY



*David J. Kyffers*

Director of the United States Patent and Trademark Office

# United States of America

United States Patent and Trademark Office

## The Youngest Loser

**Reg. No. 4,197,264**

JUDY LINDSAY AND BETH WOODCOCK (UNITED STATES JOINT APPLICANTS)  
P.O. BOX 13861

**Registered Aug. 28, 2012**

JACKSON, MS 39236

**Int. Cl.: 44**

FOR: CONSULTING TO INDIVIDUALS AND COMMUNITIES ENGAGED IN GROUP WEIGHT LOSS PROGRAMS; HEALTH CARE SERVICES, NAMELY, HEALTH AND WELLNESS PROGRAMS IN FIELD OF CHILDHOOD OBESITY; HEALTH CARE SERVICES, NAMELY, WELLNESS PROGRAMS; PROVIDING INFORMATION ON MAINTAINING A HEALTHY LIFESTYLE AND LOSING WEIGHT; PROVIDING WEIGHT LOSS PROGRAM SERVICES; PROVIDING WEIGHT LOSS PROGRAMS AND COSMETIC BODY CARE SERVICES IN THE NATURE OF NON-SURGICAL BODY CONTOURING; PROVIDING WELLNESS SERVICES, NAMELY, WEIGHT LOSS PROGRAMS OFFERED AT A WELLNESS CENTER; WEIGHT MANAGEMENT SERVICES, NAMELY, PROVIDING WEIGHT LOSS AND/OR WEIGHT MAINTENANCE PROGRAMS; WEIGHT REDUCTION DIET PLANNING AND SUPERVISION, IN CLASS 44 (U.S. CLS. 100 AND 101).

**SERVICE MARK**

**PRINCIPAL REGISTER**

FIRST USE 4-1-2011; IN COMMERCE 4-1-2011.

THE MARK CONSISTS OF STANDARD CHARACTERS WITHOUT CLAIM TO ANY PARTICULAR FONT, STYLE, SIZE, OR COLOR.

SER. NO. 85-448,089, FILED 10-14-2011.

STEVEN R. FINE, EXAMINING ATTORNEY



*David J. Kyffers*

Director of the United States Patent and Trademark Office

# United States of America

United States Patent and Trademark Office



**DOWNTOWN FORT MYERS**

**Reg. No. 4,197,265**

**Registered Aug. 28, 2012**

**Int. Cl.: 41**

**SERVICE MARK**

**PRINCIPAL REGISTER**

RIVER DISTRICT ALLIANCE (FLORIDA CORPORATION)  
#101  
1514 BROADWAY  
FORT MYERS, FL 33901

FOR: ORGANIZING COMMUNITY FESTIVALS FEATURING PRIMARILY LIVE MUSIC,  
IN CLASS 41 (U.S. CLS. 100, 101 AND 107).

FIRST USE 8-1-2010; IN COMMERCE 8-1-2010.

NO CLAIM IS MADE TO THE EXCLUSIVE RIGHT TO USE "MUSIC WALK DOWNTOWN  
FORT MYERS", APART FROM THE MARK AS SHOWN.

THE MARK CONSISTS OF STYLIZED IMAGES OF A GUITAR AND A PIANO WHERE THE  
GUITAR HAS TWO LEGS AND THE PIANO HAS THREE. THE STYLIZED TEXT "MUSIC"  
IS INSIDE THE GUITAR ICON AND THE STYLIZED TEXT "WALK" IS INSIDE THE PIANO  
ICON. BELOW THESE IMAGES IS THE STYLIZED TEXT "DOWNTOWN FORT MYERS".

SER. NO. 85-448,102, FILED 10-14-2011.

CURTIS FRENCH, EXAMINING ATTORNEY



*David J. Kyffers*

Director of the United States Patent and Trademark Office

# United States of America

United States Patent and Trademark Office

# CREATE.org

Center for Responsible Enterprise And Trade

**Reg. No. 4,197,266**

**Registered Aug. 28, 2012**

**Int. Cl.: 35**

**SERVICE MARK**

**PRINCIPAL REGISTER**

THE CENTER FOR RESPONSIBLE ENTERPRISE AND TRADE (D.C. CORPORATION)  
SUITE 500  
1401 EYE STREET, NORTHWEST  
WASHINGTON, DC 20005

FOR: ASSOCIATION SERVICES, NAMELY, PROMOTING RESPONSIBLE BUSINESS PRACTICES INCLUDING RESPECT FOR INTELLECTUAL PROPERTY AND THE LEGAL USE OF SOFTWARE, IN CLASS 35 (U.S. CLS. 100, 101 AND 102).

FIRST USE 10-14-2011; IN COMMERCE 10-14-2011.

NO CLAIM IS MADE TO THE EXCLUSIVE RIGHT TO USE "CENTER FOR RESPONSIBLE ENTERPRISE AND TRADE", APART FROM THE MARK AS SHOWN.

THE MARK CONSISTS OF A STYLIZED VERSION "CREATE.ORG" ABOVE THE PHRASE "CENTER FOR RESPONSIBLE ENTERPRISE AND TRADE".

SER. NO. 85-448,199, FILED 10-14-2011.

ELIZABETH HUGHITT, EXAMINING ATTORNEY



*David J. Kyjars*

Director of the United States Patent and Trademark Office

# United States of America

United States Patent and Trademark Office

# 1014

**Reg. No. 4,197,267**

**Registered Aug. 28, 2012**

**Int. Cl.: 14**

**TRADEMARK**

**PRINCIPAL REGISTER**

GNS TRADING CORP. (NEW JERSEY CORPORATION)  
223 W. BERGEN TURNPIKE #1  
RIDGEFIELD PARK, NJ 07660

FOR: JEWELRY; JEWELRY ARMOIRES, IN CLASS 14 (U.S. CLS. 2, 27, 28 AND 50).

FIRST USE 1-1-2004; IN COMMERCE 1-1-2004.

THE MARK CONSISTS OF STANDARD CHARACTERS WITHOUT CLAIM TO ANY PARTICULAR FONT, STYLE, SIZE, OR COLOR.

SER. NO. 85-448,338, FILED 10-15-2011.

ZACHARY BELLO, EXAMINING ATTORNEY



*David J. Kyffers*

Director of the United States Patent and Trademark Office

# United States of America

United States Patent and Trademark Office

## VIXEN BODY ART

**Reg. No. 4,197,268**

**Registered Aug. 28, 2012**

**Int. Cl.: 16**

**TRADEMARK**

**PRINCIPAL REGISTER**

CHEMCORP PTY LTD (AUSTRALIA CORPORATION)  
7 BOX ROAD  
TAREN POINT, AUSTRALIA NSW2229

FOR: TEMPORARY TATTOOS, IN CLASS 16 (U.S. CLS. 2, 5, 22, 23, 29, 37, 38 AND 50).

FIRST USE 10-1-2011; IN COMMERCE 10-1-2011.

THE MARK CONSISTS OF STANDARD CHARACTERS WITHOUT CLAIM TO ANY PARTICULAR FONT, STYLE, SIZE, OR COLOR.

NO CLAIM IS MADE TO THE EXCLUSIVE RIGHT TO USE "BODY ART", APART FROM THE MARK AS SHOWN.

SER. NO. 85-448,445, FILED 10-16-2011.

MEGHAN REINHART, EXAMINING ATTORNEY



*David J. Kyffers*

Director of the United States Patent and Trademark Office

# United States of America

United States Patent and Trademark Office

# YUTA

**Reg. No. 4,197,269**

**Registered Aug. 28, 2012**

**Int. Cl.: 7**

**TRADEMARK**

**PRINCIPAL REGISTER**

YU-TAI PATTERN CO., LTD. (TAIWAN CORPORATION)  
NO. 38, LANE 37  
KEJI 2ND RD., GUEISHAN TOWNSHIP  
TAOYUAN COUNTY, TAIWAN 333

FOR: PUNCHING PRESSES FOR METALWORKING, NAMELY, SCREWS; TRIMMING DIES FOR USE WITH MACHINE TOOLS; POWERED MACHINES FOR CUTTING, SHAPING OR FINISHING METALS, NAMELY, SCREWS AND NUTS; POWER TOOLS, NAMELY, THREAD MILLS AND THREAD MILLING CUTTERS; TOOLING FOR USE IN MACHINES FOR PUNCHING AND STAMPING SCREWS, NAMELY, PUNCHES, IN CLASS 7 (U.S. CLS. 13, 19, 21, 23, 31, 34 AND 35).

FIRST USE 8-1-2005; IN COMMERCE 6-22-2007.

THE MARK CONSISTS OF STANDARD CHARACTERS WITHOUT CLAIM TO ANY PARTICULAR FONT, STYLE, SIZE, OR COLOR.

THE WORDING "YUTA" OR "YU TA" HAS NO MEANING IN A FOREIGN LANGUAGE.

SER. NO. 85-448,495, FILED 10-17-2011.

AMY KELLY, EXAMINING ATTORNEY



*David J. Kyfos*

Director of the United States Patent and Trademark Office



# United States of America

United States Patent and Trademark Office

*RumbleRide*

**Reg. No. 4,197,270**

**Registered Aug. 28, 2012**

**Int. Cl.: 9**

**TRADEMARK**

**PRINCIPAL REGISTER**

RUMBLERIDE, LLC (DELAWARE LIMITED LIABILITY COMPANY)  
615 GLENNEYRE ST.  
LAGUNA BEACH, CA 92651

FOR: DIGITAL MEDIA, NAMELY, PRE-RECORDED DVDS AND DOWNLOADABLE VIDEO RECORDINGS FEATURING MOTORSPORTS, EXHIBITIONS FEATURING MOTOR VEHICLES, AND INSTRUCTIONAL VIDEOS FEATURING FABRICATION OF MOTOR VEHICLES; DOWNLOADABLE VIDEO RECORDINGS FEATURING MOTORSPORTS, EXHIBITIONS FEATURING MOTOR VEHICLES, AND INSTRUCTIONAL VIDEOS FEATURING FABRICATION OF MOTOR VEHICLES PROVIDED BY VIDEO ON DEMAND SERVICE, DIGITAL MEDIA STREAMING, PAY PER VIEW SERVICE AND MOBILE APPLICATIONS, IN CLASS 9 (U.S. CLS. 21, 23, 26, 36 AND 38).

FIRST USE 10-13-2011; IN COMMERCE 10-13-2011.

THE MARK CONSISTS OF THE DESIGN OF SCATTERED LEAVES THROUGHOUT THE TERM "RUMBLERIDE".

SER. NO. 85-448,655, FILED 10-17-2011.

SALLY SHIH, EXAMINING ATTORNEY



*David J. Kyfos*

Director of the United States Patent and Trademark Office

# United States of America

United States Patent and Trademark Office

# AR. RESCUE

**Reg. No. 4,197,271**

**Registered Aug. 28, 2012**

**Int. Cls.: 9 and 28**

**TRADEMARK**

**PRINCIPAL REGISTER**

PARROT (FRANCE SOCIÉTÉ ANONYME (SA))  
174 QUAI DE JEMMAPES  
PARIS, FRANCE 75010

FOR: ELECTRONIC GAME SOFTWARE FOR CELLULAR TELEPHONES; ELECTRONIC GAME SOFTWARE FOR WIRELESS DEVICES; VIDEO AND COMPUTER GAME PROGRAMS; VIDEO GAME MACHINES FOR USE WITH EXTERNAL DISPLAY SCREEN OR MONITOR; HAND-HELD UNITS FOR PLAYING ELECTRONIC GAMES FOR USE WITH EXTERNAL DISPLAY SCREEN OR MONITOR; COMPUTER GAME SOFTWARE AND DOWNLOADABLE ELECTRONIC GAMES VIA THE INTERNET AND WIRELESS DEVICES; VIDEO GAME MACHINES FOR USE WITH TELEPHONES, IN CLASS 9 (U.S. CLS. 21, 23, 26, 36 AND 38).

FOR: REMOTE CONTROL TOYS, NAMELY, VEHICLES AND FLYING OBJECTS; HAND HELD UNITS FOR PLAYING VIDEO GAMES OTHER THAN THOSE ADAPTED FOR USE WITH AN EXTERNAL DISPLAY SCREEN OR MONITOR; TRANSFORMING ROBOTIC TOYS; TOY ROBOTS; STAND ALONE VIDEO GAME MACHINES; ELECTRONIC ACTION TOYS; INTERACTIVE ELECTRONIC TOY ROBOT AND REMOTE CONTROL TOY ROBOT, SOLD AS A UNIT; HAND HELD UNIT FOR PLAYING ELECTRONIC GAMES OTHER THAN THOSE ADAPTED FOR USE WITH AN EXTERNAL DISPLAY SCREEN OR MONITOR; VIDEO GAME APPARATUS AND INSTRUMENTS, NAMELY, STAND ALONE VIDEO GAME MACHINES, STAND ALONE VIDEO OUTPUT GAME MACHINES AND HAND HELD UNIT FOR PLAYING VIDEO GAMES OTHER THAN THOSE ADAPTED FOR USE WITH AN EXTERNAL DISPLAY SCREEN OR MONITOR, IN CLASS 28 (U.S. CLS. 22, 23, 38 AND 50).



PRIORITY CLAIMED UNDER SEC. 44(D) ON ERPN CMNTY TM OFC APPLICATION NO. 010333003, FILED 10-12-2011, REG. NO. 010333003, DATED 3-30-2012, EXPIRES 10-21-2021.

THE COLOR(S) WHITE, YELLOW, RED AND BLUE IS/ARE CLAIMED AS A FEATURE OF THE MARK.

THE MARK CONSISTS OF THE STYLIZED LETTERS "AR". RESCUE, WITH "AR". IN BLUE AND THE LOWER TO MID PORTION OF THE WORD "RESCUE" BEING IN YELLOW, THE UPPER PORTION IN WHITE, AND THE ENTIRE WORD OUTLINED IN A SHADED RED.

*David J. Kypos*

Director of the United States Patent and Trademark Office

SER. NO. 85-448,863, FILED 10-17-2011.

**Reg. No. 4,197,271** DEIRDRE ROBERTSON, EXAMINING ATTORNEY

# United States of America

United States Patent and Trademark Office



**Reg. No. 4,197,272**

**Registered Aug. 28, 2012**

**Int. Cl.: 36**

**SERVICE MARK**

**PRINCIPAL REGISTER**

LONGLEAF PARTNERS FUNDS TRUST (MASSACHUSETTS BUSINESS TRUST)  
6410 POPLAR AVENUE, SUITE 900  
MEMPHIS, TN 38119

FOR: MUTUAL FUND INVESTMENT AND DISTRIBUTION SERVICES, IN CLASS 36 (U.S. CLS. 100, 101 AND 102).

FIRST USE 4-0-2011; IN COMMERCE 4-0-2011.

OWNER OF U.S. REG. NO. 1,985,116.

THE COLOR(S) BROWN IS/ARE CLAIMED AS A FEATURE OF THE MARK.

THE MARK CONSISTS OF THE TOP PORTION OF A PINE CONE, DISPLAYED IN THE COLOR BROWN.

SER. NO. 85-448,876, FILED 10-17-2011.

WENDY JUN, EXAMINING ATTORNEY



*David J. Kyros*

Director of the United States Patent and Trademark Office

# United States of America

United States Patent and Trademark Office

## NOPAL BROS.

**Reg. No. 4,197,273**

**Registered Aug. 28, 2012**

**Int. Cl.: 29**

**TRADEMARK**

**PRINCIPAL REGISTER**

OSCAR TORRES HERNANDEZ (MEXICO INDIVIDUAL)  
LADERA 227, COLONIA VEREDALTA  
SAN PEDRO GARZA GARCÍA  
NUEVO LEÓN, MEXICO 66270

FOR: SPICY, SWEET AND DRIED CACTUS FOR FOOD PURPOSES, IN CLASS 29 (U.S. CL. 46).

FIRST USE 9-1-2011; IN COMMERCE 9-1-2011.

THE MARK CONSISTS OF STANDARD CHARACTERS WITHOUT CLAIM TO ANY PARTICULAR FONT, STYLE, SIZE, OR COLOR.

NO CLAIM IS MADE TO THE EXCLUSIVE RIGHT TO USE "NOPAL", APART FROM THE MARK AS SHOWN.

THE ENGLISH TRANSLATION OF "NOPAL" IN THE MARK IS "PRICKLY PEAR CACTUS".

SER. NO. 85-449,671, FILED 10-18-2011.

INGA ERVIN, EXAMINING ATTORNEY



*David J. Kyffers*

Director of the United States Patent and Trademark Office

# United States of America

United States Patent and Trademark Office

## the Abbey Cap

**Reg. No. 4,197,274**

TURBAN PLUS (CALIFORNIA SOLE PROPRIETORSHIP)  
13692 NEWHOPE ST.  
GARDEN GROVE, CA 92843

**Registered Aug. 28, 2012**

**Int. Cl.: 25**

FOR: CAPS, IN CLASS 25 (U.S. CLS. 22 AND 39).

**TRADEMARK**

FIRST USE 10-1-2010; IN COMMERCE 10-1-2010.

**PRINCIPAL REGISTER**

THE MARK CONSISTS OF STANDARD CHARACTERS WITHOUT CLAIM TO ANY PARTICULAR FONT, STYLE, SIZE, OR COLOR.

NO CLAIM IS MADE TO THE EXCLUSIVE RIGHT TO USE "CAP", APART FROM THE MARK AS SHOWN.

SER. NO. 85-451,581, FILED 10-19-2011.

ALYSSA STEEL, EXAMINING ATTORNEY



*David J. Kyffers*

Director of the United States Patent and Trademark Office

# United States of America

United States Patent and Trademark Office

## UGLY BETTY

**Reg. No. 4,197,275**

RCN TELEVISION S.A. (COLOMBIA CORPORATION)  
AVENIDA DE LAS AMERICAS NO. 65-82  
BOGOTA, COLOMBIA

**Registered Aug. 28, 2012**

**Int. Cls.: 9 and 41**

FOR: PRE-RECORDED DVDS AND LASER DISCS FEATURING ENTERTAINMENT IN THE NATURE OF AN ON-GOING COMEDY SERIES, IN CLASS 9 (U.S. CLS. 21, 23, 26, 36 AND 38).

**TRADEMARK**

FIRST USE 8-21-2007; IN COMMERCE 8-21-2007.

**SERVICE MARK**

FOR: ENTERTAINMENT SERVICES, NAMELY, AN ON-GOING TELEVISION COMEDY SERIES, IN CLASS 41 (U.S. CLS. 100, 101 AND 107).

**PRINCIPAL REGISTER**

FIRST USE 9-28-2006; IN COMMERCE 9-28-2006.

THE MARK CONSISTS OF STANDARD CHARACTERS WITHOUT CLAIM TO ANY PARTICULAR FONT, STYLE, SIZE, OR COLOR.

SER. NO. 85-451,778, FILED 10-20-2011.

FLORENTINA BLANDU, EXAMINING ATTORNEY



*David J. Kyffers*

Director of the United States Patent and Trademark Office

# United States of America

United States Patent and Trademark Office

## TASTE WASHINGTON

**Reg. No. 4,197,276**

WASHINGTON WINE COMMISSION (WASHINGTON TRADE ASSOCIATION)  
1201 WESTERN AVENUE, SUITE 450  
SEATTLE, WA 98101

**Registered Aug. 28, 2012**

**Int. Cls.: 35 and 41**

FOR: PROVIDING CONSUMER INFORMATION IN THE FIELD OF WINES; PROVIDING TRADE INFORMATION IN THE FIELD OF WINES; AND ASSOCIATION SERVICES, NAMELY, PROMOTING THE INTERESTS OF WINEMAKERS AND WINERIES, IN CLASS 35 (U.S. CLS. 100, 101 AND 102).

**SERVICE MARK**

**PRINCIPAL REGISTER**

FIRST USE 3-0-1998; IN COMMERCE 3-0-1998.

FOR: CONDUCTING ENTERTAINMENT EXHIBITIONS IN THE NATURE OF WINE TASTINGS AND WINE FESTIVALS; CONDUCTING WORKSHOPS AND SEMINARS IN THE FIELD OF WINE APPRECIATION; AND EDUCATIONAL SERVICES, NAMELY, CONDUCTING WORKSHOPS AND SEMINARS IN THE FIELD OF WINE APPRECIATION, IN CLASS 41 (U.S. CLS. 100, 101 AND 107).

FIRST USE 3-0-1998; IN COMMERCE 3-0-1998.

THE MARK CONSISTS OF STANDARD CHARACTERS WITHOUT CLAIM TO ANY PARTICULAR FONT, STYLE, SIZE, OR COLOR.

NO CLAIM IS MADE TO THE EXCLUSIVE RIGHT TO USE "WASHINGTON", APART FROM THE MARK AS SHOWN.

SER. NO. 85-451,942, FILED 10-20-2011.

TINA L. SNAPP, EXAMINING ATTORNEY



*David J. Kyffers*

Director of the United States Patent and Trademark Office



# United States of America

United States Patent and Trademark Office

# SQS

**Reg. No. 4,197,277**

BREMEN CASTINGS, INC. (INDIANA CORPORATION)  
500 N. BALTIMORE STREET  
BREMEN, IN 46506

**Registered Aug. 28, 2012**

**Int. Cl.: 25**

FOR: CLOTHING, NAMELY, HATS, T-SHIRTS, GOLF SHIRTS, POLO SHIRTS, LONG SLEEVE BUTTON DOWN SHIRTS, SHORT SLEEVE BUTTON DOWN SHIRTS, WIND SHIRTS, TANK TOPS, SWEAT SHIRTS, VESTS, JACKETS, COATS AND BANDANAS, IN CLASS 25 (U.S. CLS. 22 AND 39).

**TRADEMARK**

**PRINCIPAL REGISTER**

FIRST USE 9-30-2008; IN COMMERCE 9-30-2008.

THE MARK CONSISTS OF STANDARD CHARACTERS WITHOUT CLAIM TO ANY PARTICULAR FONT, STYLE, SIZE, OR COLOR.

SER. NO. 85-452,031, FILED 10-20-2011.

ASMAT KHAN, EXAMINING ATTORNEY



*David J. Kybas*

Director of the United States Patent and Trademark Office

# United States of America

United States Patent and Trademark Office

## FORTITUDE SYSTEMS

**Reg. No. 4,197,278**

**Registered Aug. 28, 2012**

**Int. Cl.: 35**

**SERVICE MARK**

**PRINCIPAL REGISTER**

FORTITUDE INTERNATIONAL LLC (TEXAS LIMITED LIABILITY COMPANY)  
SUITE 140  
1420 BEVERLY ROAD  
MCLEAN, VA 22101

FOR: EMPLOYEE RECRUITING, SEARCH, AND SELECTION SERVICES FOR OTHERS;  
EMPLOYMENT AGENCY SERVICES; STAFFING SERVICES; AND HUMAN RESOURCES  
MANAGEMENT SERVICES, IN CLASS 35 (U.S. CLS. 100, 101 AND 102).

FIRST USE 6-9-2008; IN COMMERCE 6-9-2008.

THE MARK CONSISTS OF STANDARD CHARACTERS WITHOUT CLAIM TO ANY PAR-  
TICULAR FONT, STYLE, SIZE, OR COLOR.

NO CLAIM IS MADE TO THE EXCLUSIVE RIGHT TO USE "SYSTEMS", APART FROM  
THE MARK AS SHOWN.

SER. NO. 85-452,051, FILED 10-20-2011.

ALLISON SCHRODY, EXAMINING ATTORNEY



*David J. Kybas*

Director of the United States Patent and Trademark Office

# United States of America

United States Patent and Trademark Office

# HUNTER

**Reg. No. 4,197,279**

HUNTER INDUSTRIES, INC. (DELAWARE CORPORATION)  
1940 DIAMOND STREET  
SAN MARCOS, CA 92069

**Registered Aug. 28, 2012**

**Int. Cl.: 21**

FOR: LAWN SPRINKLERS; SHUT-OFF VALVES FOR WATER SPRINKLER NOZZLES; SPRINKLER HEADS FOR LAWN SPRINKLERS; SPRINKLERS FOR WATERING FLOWERS AND PLANTS; PLASTIC SPRAY NOZZLES; NOZZLES FOR SPRINKLER HOSE, IN CLASS 21 (U.S. CLS. 2, 13, 23, 29, 30, 33, 40 AND 50).

**TRADEMARK**

**PRINCIPAL REGISTER**

FIRST USE 0-0-1983; IN COMMERCE 0-0-1983.

THE MARK CONSISTS OF STANDARD CHARACTERS WITHOUT CLAIM TO ANY PARTICULAR FONT, STYLE, SIZE, OR COLOR.

OWNER OF U.S. REG. NOS. 1,373,643, 2,826,811 AND OTHERS.

SER. NO. 85-452,283, FILED 10-20-2011.

MICHAEL LITZAU, EXAMINING ATTORNEY



*David J. Kyffers*

Director of the United States Patent and Trademark Office

# United States of America

United States Patent and Trademark Office

## The Play Ball

**Reg. No. 4,197,280**

**Registered Aug. 28, 2012**

**Int. Cl.: 41**

**SERVICE MARK**

**PRINCIPAL REGISTER**

MARGARET WOODBURY STRONG MUSEUM (NEW YORK CORPORATION), DBA THE STRONG  
ONE MANHATTAN SQUARE  
ROCHESTER, NY 14604

FOR: ENTERTAINMENT IN THE NATURE OF CONDUCTING PARTIES, NAMELY, MUSEUM THEMED GALAS INCLUDING LIVE ENTERTAINMENT, DANCING, FOOD, AND SILENT AUCTIONS, IN CLASS 41 (U.S. CLS. 100, 101 AND 107).

FIRST USE 9-2-2011; IN COMMERCE 9-2-2011.

THE MARK CONSISTS OF STANDARD CHARACTERS WITHOUT CLAIM TO ANY PARTICULAR FONT, STYLE, SIZE, OR COLOR.

NO CLAIM IS MADE TO THE EXCLUSIVE RIGHT TO USE "BALL", APART FROM THE MARK AS SHOWN.

SER. NO. 85-452,613, FILED 10-20-2011.

CHRISTOPHER LAW, EXAMINING ATTORNEY



*David J. Kyfos*

Director of the United States Patent and Trademark Office

# United States of America

United States Patent and Trademark Office

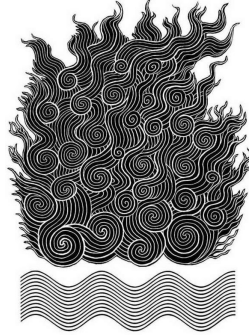

WATERFIRE

**Reg. No. 4,197,281**

**Registered Aug. 28, 2012**

**Int. Cl.: 41**

**SERVICE MARK**

**PRINCIPAL REGISTER**

EVANS, BARNABY M. (UNITED STATES INDIVIDUAL)  
101 REGENT AVENUE  
PROVIDENCE, RI 02908

FOR: ARRANGING AND CONDUCTING SPECIAL EVENTS FOR SOCIAL ENTERTAINMENT PURPOSES; ART EXHIBITION SERVICES; ART EXHIBITIONS; CONSULTATION IN THE FIELD OF SPECIAL EVENT PLANNING FOR SOCIAL ENTERTAINMENT PURPOSES; ENTERTAINMENT IN THE NATURE OF LIGHT SHOWS; ENTERTAINMENT IN THE NATURE OF LIVE PERFORMANCES BY MUSICIANS, MUSIC GROUPS, AND ORCHESTRAS; ENTERTAINMENT IN THE NATURE OF VISUAL AND AUDIO PERFORMANCES, NAMELY, MUSICAL BAND, ROCK GROUP, GYMNASTIC, DANCE, AND BALLET PERFORMANCES; ENTERTAINMENT SERVICES IN THE NATURE OF PRESENTING LIVE MUSICAL PERFORMANCES; ENTERTAINMENT, NAMELY, PREPARATION OF SPECIAL EFFECTS; ORGANIZING AND ARRANGING EXHIBITIONS FOR ENTERTAINMENT PURPOSES; ORGANIZING COMMUNITY FESTIVALS FEATURING A VARIETY OF ACTIVITIES, NAMELY, ART EXHIBITIONS, HERITAGE MARKETS, ETHNIC DANCES, AND THE LIKE; ORGANIZING COMMUNITY FESTIVALS FEATURING A VARIETY OF ACTIVITIES, NAMELY, SPORTING EVENTS, ART EXHIBITIONS, FLEA MARKETS, ETHNIC DANCES AND THE LIKE; ORGANIZING CULTURAL AND ARTS EVENTS, IN CLASS 41 (U.S. CLS. 100, 101 AND 107).

FIRST USE 9-1-1996; IN COMMERCE 6-1-1997.

THE STIPPLING IS A FEATURE OF THE MARK AND DOES NOT INDICATE COLOR.

THE MARK CONSISTS OF AN ABSTRACT PORTRAYAL OF WATER UNDER FIRE, WITH THE LITERAL ELEMENT "WATERFIRE" WRITTEN IN UPPER-CASE LETTERS UNDER THE WATER.

SER. NO. 85-452,966, FILED 10-21-2011.

JULIE VEPPUMTHARA, EXAMINING ATTORNEY



*David J. Kypos*

Director of the United States Patent and Trademark Office

# United States of America

United States Patent and Trademark Office

## The Liberal News

**Reg. No. 4,197,282**

JAMES WARNER, STEPHEN (UNITED STATES INDIVIDUAL)  
721 MILES AVENUE  
DICKSON CITY, PA 184471319

**Registered Aug. 28, 2012**

**Int. Cl.: 35**

FOR: PROMOTING CHARITABLE SERVICES OF OTHERS, NAMELY, PROVIDING INDIVIDUALS WITH INFORMATION ABOUT VARIOUS CHARITIES FOR THE PURPOSE OF MAKING CHARITABLE DONATIONS TO BENEFIT SINGLE MOTHERS, IN CLASS 35 (U.S. CLS. 100, 101 AND 102).

**SERVICE MARK**

**PRINCIPAL REGISTER**

FIRST USE 8-21-2000; IN COMMERCE 8-21-2000.

THE MARK CONSISTS OF STANDARD CHARACTERS WITHOUT CLAIM TO ANY PARTICULAR FONT, STYLE, SIZE, OR COLOR.

SEC. 2(F).

SER. NO. 85-453,521, FILED 10-21-2011.

H. M. FISHER, EXAMINING ATTORNEY



*David J. Kybas*

Director of the United States Patent and Trademark Office

United States of America  
United States Patent and Trademark Office

# BLADE-TECH

**Reg. No. 4,197,283**

**Registered Aug. 28, 2012**

**Int. Cls.: 8, 13 and 25**

BLADE-TECH INDUSTRIES, INC. (WASHINGTON CORPORATION), DBA BLADE-TECH INDUSTRIES, INC.  
SUITE A  
5530 184TH ST. E.  
PUYALLUP, WA 98375

**TRADEMARK**

FOR: KNIVES; HUNTING, FOLDING, AND SPORT KNIVES; POLICE BATONS AND POUCHES ADAPTED FOR USE THEREWITH, IN CLASS 8 (U.S. CLS. 23, 28 AND 44).

**PRINCIPAL REGISTER**

FIRST USE 1-1-1995; IN COMMERCE 1-1-1995.

FOR: HOLSTERS; CARTRIDGE CASES; FIREARM TRAINING DEVICES, NAMELY, NON-FIRING TRAINING BOLTS AND TRAINING BARRELS FOR TEMPORARY REPLACEMENT OF FIREARM BOLTS AND BARRELS DURING WEAPON HANDLING PRACTICE AND TRAINING, AND POUCHES ADAPTED FOR USE THEREWITH; POUCHES FOR AMMUNITION MAGAZINES; POUCHES SPECIALLY ADAPTED FOR PEPPER SPRAY CONTAINERS; LOADING TOOLS FOR WEAPONS, NAMELY, REVOLVER SPEED LOADERS; STUN GUNS THAT LAUNCH PROJECTILES TO DELIVER AN INCAPACITATING ELECTRICAL CURRENT TO THE PERSON BEING TARGETED, AND POUCHES ADAPTED FOR USE THEREWITH; AND WEARABLE MODULAR MOUNTING SYSTEMS FOR FIREARMS CONSISTING OF HAND GUN ACCESSORIES, NAMELY, BELT CLIPS FOR SECURING A GUN WITHOUT THE USE OF A HOLSTER, IN CLASS 13 (U.S. CLS. 2 AND 9).

FIRST USE 1-1-1995; IN COMMERCE 1-1-1995.

FOR: BELTS, SHIRTS, VESTS, AND HATS, IN CLASS 25 (U.S. CLS. 22 AND 39).

FIRST USE 1-1-1995; IN COMMERCE 1-1-1995.

OWNER OF U.S. REG. NO. 4,094,486.

THE 2(F) CLAIM IS RESTRICTED TO CLASS(ES) 008

THE MARK CONSISTS OF THE STYLIZED WORDING "BLADE-TECH".

SEC. 2(F).



*David J. Kyjars*

Director of the United States Patent and Trademark Office

**Reg. No. 4,197,283** SER. NO. 85-453,532, FILED S.R. 10-21-2011 AM. P.R. 4-20-2012.

NELSON SNYDER, EXAMINING ATTORNEY



# United States of America

United States Patent and Trademark Office

# JUBILEE

**Reg. No. 4,197,284**

HART SPECIALTIES, INC. (NEW YORK CORPORATION)  
5000 NEW HORIZONS BLVD  
AMITYVILLE, NY 11701

**Registered Aug. 28, 2012**

**Int. Cl.: 9**

FOR: EYEGLASSES, SUNGLASSES, EYEGLASS ACCESSORIES, NAMELY, CASES FOR EYEGLASSES AND SUNGLASSES, IN CLASS 9 (U.S. CLS. 21, 23, 26, 36 AND 38).

**TRADEMARK**

FIRST USE 8-1-2000; IN COMMERCE 10-6-2000.

**PRINCIPAL REGISTER**

THE MARK CONSISTS OF STANDARD CHARACTERS WITHOUT CLAIM TO ANY PARTICULAR FONT, STYLE, SIZE, OR COLOR.

SER. NO. 85-453,801, FILED 10-22-2011.

TARAH HARDY, EXAMINING ATTORNEY



*David J. Kybas*

Director of the United States Patent and Trademark Office

# United States of America

United States Patent and Trademark Office

# DIVAR

**Reg. No. 4,197,285**

**Registered Aug. 28, 2012**

**Int. Cl.: 7**

**TRADEMARK**

**PRINCIPAL REGISTER**

ERNST PFAFF (FED REP GERMANY INDIVIDUAL)  
ZWERCHGASSE 9  
86150 AUGSBURG, FED REP GERMANY

FOR: MACHINES, MECHANICAL APPARATUS AND APPARATUS FOR WOODWORKING, METALWORKING, PLASTIC PROCESSING, SOIL CULTIVATION, AGRICULTURAL AND FORESTRY SERVICES, CONSTRUCTION WORK, NAMELY, TRUEING MACHINES, PLANING MACHINES, CIRCULAR SAWS, MITRE-BOX SAWS, CHOP SAWS, BAND SAWS, SCROLL SAWS, MILLING MACHINES, WOOD TURNING LATHES, DRILLING MACHINES, GRINDERS, POLISHING MACHINES FOR USE IN GRINDING AND POLISHING WOOD, DUST AND CHIP SUCKERS FOR USE WITH WOODWORKING MACHINES, METALWORKING MACHINES, AND PLASTIC PROCESSING MACHINES; DUST REMOVING APPARATUS, NAMELY, AIR BLOWERS FOR USE WITH WOODWORKING MACHINES, METALWORKING MACHINES, AND PLASTIC PROCESSING MACHINES; SHARPENING MACHINES FOR SHARPENING TOOLS AND TOOL BLADES, PNEUMATIC AIR COMPRESSORS; POWER-OPERATED FIREWOOD SAWS, CHAINSAWS, WOOD SPLITTER FOR SPLITTING WOOD LOGS, WOOD PEELING MACHINES; HAND-HELD ELECTRIC DRILLS, HAND-HELD ELECTRIC JIG SAWS, HAND-HELD ELECTRIC CIRCULAR SAWS, HAND-HELD ELECTRIC VIBRATING CHISELS, HAND-HELD ELECTRIC SCREW DRIVERS, VACUUM CLEANERS; COMPRESSED AIR PUMPS; ELECTRIC PUMPS; AIR COMPRESSORS; COMPRESSORS FOR MACHINES; AND PARTS FOR THE AFORESAID GOODS, IN CLASS 7 (U.S. CLS. 13, 19, 21, 23, 31, 34 AND 35).



THE MARK CONSISTS OF STANDARD CHARACTERS WITHOUT CLAIM TO ANY PARTICULAR FONT, STYLE, SIZE, OR COLOR.

PRIORITY CLAIMED UNDER SEC. 44(D) ON ERPN CMNTY TM OFC APPLICATION NO. 010036283, FILED 6-10-2011, REG. NO. 010036283, DATED 11-10-2011, EXPIRES 6-10-2021.

THE WORDING "DIVAR" HAS NO MEANING IN A FOREIGN LANGUAGE.

SER. NO. 85-454,125, FILED 10-24-2011.

JERI J. FICKES, EXAMINING ATTORNEY

*David J. Kyffers*

Director of the United States Patent and Trademark Office

# United States of America

United States Patent and Trademark Office

## Quality Secure

**Reg. No. 4,197,286**

**Registered Aug. 28, 2012**

**Int. Cls.: 7, 9 and 11**

**TRADEMARK**

**PRINCIPAL REGISTER**

BSH BOSCH UND SIEMENS HAUSGERATE GMBH (FED REP GERMANY CORPORATION)  
CARL-WERY-STRASSE 34  
MUNICH, FED REP GERMANY 81739

FOR: HOUSEHOLD AND KITCHEN MACHINES AND EQUIPMENT, NAMELY, ELECTRIC KITCHEN MACHINES AND EQUIPMENT, NAMELY, MINCING MACHINES, MIXING AND KNEADING MACHINES, ELECTRIC FOOD-PRESSING MACHINES, JUICE EXTRACTORS, JUICE CENTRIFUGES, ELECTRIC FOOD GRINDERS, SLICING MACHINES; ELECTRIC MOTOR-DRIVEN TOOLS, NAMELY, ELECTRIC CAN OPENERS, ELECTRIC KNIFE SHARPENERS; FOOD MACHINES AND DEVICES FOR THE PREPARATION OF BEVERAGES AND/OR FOODS, NAMELY, ELECTRIC FOOD PROCESSORS, ELECTRIC BLENDERS; ELECTRIC WASTE DISPOSAL UNITS, NAMELY, WASTE MASTICATORS AND COMPRESSORS; DISHWASHERS; ELECTRIC MACHINES AND APPLIANCES FOR TREATING LAUNDRY AND CLOTHING, NAMELY, WASHING MACHINES, MANGLES; ELECTRIC CLEANING EQUIPMENT FOR HOUSEHOLD USE, NAMELY, VACUUM CLEANERS; AND STRUCTURAL PARTS OF ALL AFOREMENTIONED GOODS SOLD AS A UNIT, IN CLASS 7 (U.S. CLS. 13, 19, 21, 23, 31, 34 AND 35).

FOR: HOUSEHOLD AND KITCHEN MACHINES AND EQUIPMENT, NAMELY, ELECTRIC APPARATUS AND INSTRUMENTS, NAMELY, ELECTRIC IRONS; ELECTRIC HAIR STRAIGHTENERS, ELECTRIC ROTARY HAIR BRUSHES, KITCHEN SCALES, PERSONAL SCALES; ELECTRIC FILM WRAP WELDERS, REMOTE CONTROLS, SIGNALING CONTROLLERS, AND MONITORS OF HOUSEHOLD AND KITCHEN MACHINES AND EQUIPMENT; RECORDED AND NOT RECORDED MACHINE READABLE DATA CARRIERS, NAMELY, MAGNETIC DATA CARRIERS FOR HOUSEHOLD APPLIANCES; ELECTRIC APPARATUS FOR DISPENSING BEVERAGE OR FOODS, NAMELY, VENDING MACHINES; DATA PROCESSING DEVICES AND DATA PROCESSING PROGRAMMES FOR CONTROLLING AND OPERATING HOUSEHOLD APPLIANCES; AND STRUCTURAL PARTS OF ALL AFOREMENTIONED GOODS SOLD AS A UNIT, IN CLASS 9 (U.S. CLS. 21, 23, 26, 36 AND 38).

FOR: HOUSEHOLD AND KITCHEN MACHINES AND EQUIPMENT, NAMELY, HEATING, STEAM PRODUCING, AND COOKING DEVICES, NAMELY, COOKING, BAKING, FRYING, GRILLING, TOASTING, THAWING, AND HOT-KEEPING APPARATUS, NAMELY, DOMESTIC COOKING OVENS, ELECTRIC AND GAS RANGES, COOKTOPS, WARMING DRAWERS SOLD AS PARTS OF OVENS, RANGES AND COOKTOPS, MICROWAVE APPLIANCES, NAMELY, MICROWAVE OVENS, ELECTRIC FOOD IMMERSION HEATERS, COOKING



*David J. Kyffers*

Director of the United States Patent and Trademark Office

**Reg. No. 4,197,286** POTS WITH INTEGRATED HEATING, NAMELY, ELECTRIC COOKING POTS, ELECTRIC TOASTERS, ELECTRIC EGG BOILERS, BEVERAGE MAKING APPARATUS, NAMELY, ELECTRIC BEVERAGE MACHINES, ESPRESSO MAKING MACHINES, ELECTRIC BEVERAGE DISPENSERS, ELECTRIC HOT WATER KETTLES, AND ELECTRIC TEA POTS; COOLING DEVICES, NAMELY, REFRIGERATORS, FREEZERS, COMBINATION REFRIGERATOR-FREEZERS, DEEP FREEZERS, ICE MAKING MACHINES, ICE-CREAM MACHINES; DRYERS, NAMELY, SPIN CLOTHES DRYERS, TUMBLE LAUNDRY DRYERS, HAND DRYERS, HAIR DRYERS; VENTILATION DEVICES, NAMELY, VENTILATORS SOLD AS PARTS OF HOODS FOR RANGES, OVENS AND COOKTOPS, GREASE FILTER DEVICES SOLD AS PARTS OF HOODS FOR RANGES, OVENS AND COOKTOPS; EXTRACTOR DEVICES, NAMELY, EXTRACTOR HOODS; AIR CONDITIONING DEVICES AND DEVICES TO IMPROVE AIR QUALITY, NAMELY, AIR HUMIDIFIERS, PIPES BEING PARTS OF SANITARY FACILITIES; WARM WATER DEVICES, NAMELY, STORAGE WATER HEATERS AND CONTINUOUS FLOW WATER HEATERS; KITCHEN SINKS; HEAT PUMPS; AND STRUCTURAL PARTS OF ALL AFOREMENTIONED GOODS SOLD AS A UNIT, IN CLASS 11 (U.S. CLS. 13, 21, 23, 31 AND 34).

PRIORITY CLAIMED UNDER SEC. 44(D) ON FED REP GERMANY APPLICATION NO. 302011024753, FILED 5-3-2011, REG. NO. 302011024753, DATED 7-11-2011, EXPIRES 5-31-2021.

THE MARK CONSISTS OF THE WORDS "QUALITY" AND "SECURE" CONTAINING AN IMAGE IN BETWEEN. THE IMAGE CONTAINS A CIRCLE, WITHIN A CIRCLE, WITHIN A CIRCLE. THE CIRCLES ARE BISECTED FROM TOP LEFT TO BOTTOM RIGHT BY A BAND OF WHITE WHICH CONTAINS A BLACK DOT IN THE MIDDLE.

SER. NO. 85-454,238, FILED 10-24-2011.

STEPHANIE ALI, EXAMINING ATTORNEY

# United States of America

United States Patent and Trademark Office

# PELLA

**Reg. No. 4,197,287**

**Registered Aug. 28, 2012**

**Int. Cl.: 24**

**TRADEMARK**

**PRINCIPAL REGISTER**

PELLA CORPORATION (IOWA CORPORATION)  
102 MAIN STREET  
PELLA, IA 50219

FOR: FABRIC WINDOW COVERINGS AND TREATMENTS, NAMELY, CURTAINS, DRAPERIES, SHEERS, SWAGS AND VALANCES, IN CLASS 24 (U.S. CLS. 42 AND 50).

FIRST USE 7-25-2011; IN COMMERCE 7-25-2011.

THE MARK CONSISTS OF STANDARD CHARACTERS WITHOUT CLAIM TO ANY PARTICULAR FONT, STYLE, SIZE, OR COLOR.

OWNER OF U.S. REG. NOS. 811,964, 1,184,785 AND OTHERS.

SEC. 2(F).

SER. NO. 85-454,263, FILED 10-24-2011.

DOUGLAS LEE, EXAMINING ATTORNEY



*David J. Kybas*

Director of the United States Patent and Trademark Office

# United States of America

United States Patent and Trademark Office

## I am S.H.A.N.T.E.

**Reg. No. 4,197,288**

**Registered Aug. 28, 2012**

**Int. Cls.: 35 and 36**

**SERVICE MARK**

**PRINCIPAL REGISTER**

I AM S.H.A.N.T.E. (CALIFORNIA CHARITABLE, NON-PROFIT CORPORATION)  
1249 S. DIAMOND BAR BLVD #333  
DIAMOND BAR, CA 91765

FOR: BUSINESS SERVICES, NAMELY, ASSISTING OTHERS IN THE ESTABLISHMENT OF CHARITABLE ORGANIZATIONS; CHARITABLE SERVICES, NAMELY, COORDINATION OF NON-MONETARY CONTRIBUTIONS TO CHARITIES AND NON-PROFITS; CHARITABLE SERVICES, NAMELY, COORDINATION OF THE PROCUREMENT AND DISTRIBUTION OF FOOD DONATIONS FROM MANUFACTURERS, WHOLESALERS, RETAILERS, AND GOVERNMENT AGENCIES TO ORGANIZATIONS PROVIDING FREE FOOD TO NEEDY PEOPLE; CHARITABLE SERVICES, NAMELY, COORDINATION OF THE PROCUREMENT AND DISTRIBUTION OF GIFT-IN-KIND PRODUCT DONATIONS FROM MANUFACTURERS, WHOLESALERS, RETAILERS, AND GOVERNMENT AGENCIES TO ORGANIZATIONS PROVIDING FREE PRODUCTS TO NEEDY PEOPLE; CHARITABLE SERVICES, NAMELY, COORDINATION OF THE PROCUREMENT AND DISTRIBUTION OF HOLIDAY GIFT DONATIONS FROM THE GENERAL PUBLIC TO ORPHANED CHILDREN; CHARITABLE SERVICES, NAMELY, EMPLOYMENT COUNSELING SERVICES FOR THOSE LIVING IN POVERTY IN THE AREAS OF PREPARING FOR, OBTAINING, MAINTAINING AND ADVANCING IN EMPLOYMENT OPPORTUNITIES; CHARITABLE SERVICES, NAMELY, ORGANIZING AND CONDUCTING VOLUNTEER PROGRAMS AND COMMUNITY SERVICE PROJECTS; CHARITABLE SERVICES, NAMELY, ORGANIZING AND DEVELOPING PROGRAMS THAT AIM TO IMPROVE THE LIVES OF FORMERLY INCARCERATED PERSONS, THEIR FAMILIES, AND THOSE AT RISK FOR INCARCERATION; CHARITABLE SERVICES, NAMELY, ORGANIZING AND DEVELOPING PROJECTS THAT AIM TO IMPROVE THE LIVES OF UNDERPRIVILEGED AND IMPOVERISHED PEOPLE; CHARITABLE SERVICES, NAMELY, ORGANIZING AND DEVELOPING PROJECTS TO PROMOTE AWARENESS OF TREE AND ENVIRONMENTAL CONSERVATION; CHARITABLE SERVICES, NAMELY, ORGANIZING AND DEVELOPING WOMEN'S ECONOMIC DEVELOPMENT AND HEALTH PROJECTS IN SUPPORT OF NGO (NON-GOVERNMENTAL ORGANIZATION) PROGRAMS; CHARITABLE SERVICES, NAMELY, ORGANIZING WOMEN'S GROUPS TO UNDERTAKE PROJECTS WHICH BENEFIT THE HOMELESS, ABUSED, AT RISK WOMEN AND WOMEN IN TRANSITION AND IN PAIN, WHILE ENCOURAGING EMPOWERMENT AMONG WOMEN OF ALL AGES AND ETHNICITIES; CHARITABLE SERVICES, NAMELY, ORGANIZING YOUTH GROUPS TO UNDERTAKE CHARITABLE PROJECTS IN THE FIELD OF DISASTER RESPONSE; CHARITABLE SERVICES, NAMELY, ORGANIZING YOUTH GROUPS TO UNDERTAKE PROJECTS TO BENEFIT THE NEEDY AND THE COMMUNITY TO ENCOURAGE LEADERSHIP, CHARACTER, COMPASSION,



*David J. Kyffers*

Director of the United States Patent and Trademark Office

**Reg. No. 4,197,288** AND GOOD CITIZENSHIP; CHARITABLE SERVICES, NAMELY, PROMOTING ENVIRONMENTAL AWARENESS TO CHILDREN; CHARITABLE SERVICES, NAMELY, PROMOTING PUBLIC AWARENESS ABOUT POVERTY IN THE UNITED STATES THROUGH A MEDIA FAST PROGRAM CONDUCTED BY YOUNG PEOPLE; CHARITABLE SERVICES, NAMELY, PROMOTING PUBLIC AWARENESS OF ENVIRONMENTAL ISSUES RELATED TO MARINE ECO-SYSTEMS TO YOUNG PEOPLE; CHARITABLE SERVICES, NAMELY, PROVIDING A FREE ONLINE RESOURCE IN THE NATURE OF A WEBSITE FOR CONNECTING PEOPLE WHO HAVE SERVICE NEEDS WITH PEOPLE WHO ARE WILLING TO PROVIDE VOLUNTEER SERVICES; DEVELOPING AND COORDINATING VOLUNTEER PROJECTS FOR CHARITABLE ORGANIZATIONS; DEVELOPING AND MANAGING THE CHARITABLE GIVING PROGRAMS OF OTHERS; MATCHING INDIVIDUALS WITH LIKE-MINDED ORGANIZATIONS WHO PROVIDE CHARITABLE ACTIVITIES THROUGH AN ON-LINE PROFILING SURVEY AND ANALYSIS; ORGANIZING AND CONDUCTING CHARITY AUCTIONS FOR CHARITABLE FUNDRAISING PURPOSES; PROMOTING THE CHARITABLE GIVING OF OTHERS, NAMELY, TRACKING AND PUBLICIZING CHARITABLE DONATIONS AND RANDOM ACTS OF KINDNESS, IN CLASS 35 (U.S. CLS. 100, 101 AND 102).

FIRST USE 1-7-2010; IN COMMERCE 1-7-2010.

FOR: ACCEPTING AND ADMINISTERING MONETARY CHARITABLE CONTRIBUTIONS; CHARITABLE FOUNDATION SERVICES, NAMELY, PROVIDING FINANCIAL ASSISTANCE FOR PROGRAMS AND SERVICES OF OTHERS; CHARITABLE FOUNDATION SERVICES, NAMELY, PROVIDING FINANCIAL SUPPORT TO INDIVIDUALS WHO ARE SEEKING TO BE WITH FAMILY DURING THE HOLIDAYS BUT ARE UNABLE DUE TO FINANCIAL CONSTRAINTS; CHARITABLE FOUNDATION SERVICES, NAMELY, PROVIDING FUNDRAISING ACTIVITIES AND INVESTMENT MANAGEMENT SERVICES TO SUPPORT MEDICAL EDUCATION AND RESEARCH AND PROCEDURES FOR THOSE IN NEED; CHARITABLE FOUNDATION SERVICES, NAMELY, PROVIDING FUNDRAISING ACTIVITIES, FUNDING, SCHOLARSHIPS AND/OR FINANCIAL ASSISTANCE FOR UNDERPRIVILEGED YOUTH IN THE LONG BEACH, CALIFORNIA AREA; CHARITABLE FOUNDATION SERVICES, NAMELY, PROVIDING FUNDRAISING ACTIVITIES, SUPPLEMENTAL FUNDING, CAPITAL IMPROVEMENT FUNDING, SCHOLARSHIPS AND FINANCIAL ASSISTANCE FOR PROGRAMS AND SERVICES OF OTHERS; CHARITABLE FUNDRAISING; CHARITABLE FUNDRAISING SERVICES; CHARITABLE FUNDRAISING SERVICES BY MEANS OF AN ENTERTAINMENT EVENT; CHARITABLE FUNDRAISING SERVICES BY MEANS OF COLLECTING AND REDEEMING RECYCLABLES FOR DONATION OF REDEMPTION PROCEEDS TO CHARITABLE ORGANIZATIONS; CHARITABLE FUNDRAISING SERVICES BY MEANS OF MUSICAL CONCERTS; CHARITABLE FUNDRAISING SERVICES BY MEANS OF ORGANIZING AND CONDUCTING SPECIAL EVENTS; CHARITABLE FUNDRAISING SERVICES BY MEANS OF RUNNING AND WALKING EVENTS; CHARITABLE FUNDRAISING SERVICES BY MEANS OF SELLING GOODS TO RAISE FUNDS; CHARITABLE FUNDRAISING SERVICES BY MEANS OF SELLING T-SHIRTS TO RAISE FUNDS FOR YOUTH SUMMER PROGRAMS; CHARITABLE FUNDRAISING SERVICES FOR PROMOTING RESEARCH, EDUCATION AND OTHER ACTIVITIES RELATING TO THE PROVISION OF SOCIAL SERVICES; CHARITABLE FUNDRAISING SERVICES FOR SENDING UNDERPRIVILEGED CHILDREN TO ONE OF SEVERAL CAMPS AROUND THE UNITED STATES WHICH ACCEPT THESE CHILDREN AT DISCOUNTED RATES FOR ONE OR MORE WEEKS; CHARITABLE FUNDRAISING SERVICES, NAMELY, RAISING FUNDS FOR COLLEGE EDUCATION COSTS; CHARITABLE SERVICES, NAMELY, PROVIDING FINANCIAL ASSISTANCE TO MEET THE PHYSICAL, PSYCHOLOGICAL, SOCIAL AND OTHER SPECIAL NEEDS OF CHILDREN; CHARITABLE SERVICES, NAMELY, PROVIDING FINANCIAL SUPPORT TO PEOPLE FROM DISADVANTAGED COUNTRIES FOR THE PURPOSE OF FACILITATING EDUCATIONAL OPPORTUNITIES; CHARITABLE SERVICES, NAMELY, RAISING MONEY FOR ANIMAL WELFARE ORGANIZATIONS THROUGH PROMOTIONS AND/OR INCENTIVES; FINANCIAL CONSULTING SERVICES IN THE FIELD OF PLANNED GIVING FOR NON-PROFIT AND CHARITABLE ORGANIZATIONS; FINANCIAL PLANNING SERVICES, NAMELY, DEVELOPING AND MANAGING CHARIT-

**Reg. No. 4,197,288** ABLE GIVING PROGRAMS ON BEHALF OF WEALTHY INDIVIDUALS OR FAMILIES, IN CLASS 36 (U.S. CLS. 100, 101 AND 102).

FIRST USE 1-7-2010; IN COMMERCE 1-7-2010.

THE MARK CONSISTS OF STANDARD CHARACTERS WITHOUT CLAIM TO ANY PARTICULAR FONT, STYLE, SIZE, OR COLOR.

THE NAME "SHANTE" IDENTIFIES A LIVING INDIVIDUAL WHOSE CONSENT IS OF RECORD.

SER. NO. 85-454,891, FILED 10-24-2011.

MYRIAH HABEEB, EXAMINING ATTORNEY



# United States of America

United States Patent and Trademark Office

## COPPER PENNY FILMS

**Reg. No. 4,197,289**

**Registered Aug. 28, 2012**

**Int. Cl.: 41**

**SERVICE MARK**

**PRINCIPAL REGISTER**

JUSTICE VIDEO PRODUCTIONS (TEXAS LIMITED LIABILITY COMPANY)  
1500 CHANCELLOR LANE  
MCKINNEY, TX 75070

FOR: PRODUCTION OF VIDEO DISCS FOR OTHERS; VIDEO EDITING; VIDEO PRODUCTION SERVICES; VIDEO RECORDING SERVICES, IN CLASS 41 (U.S. CLS. 100, 101 AND 107).

FIRST USE 7-31-2011; IN COMMERCE 7-31-2011.

THE MARK CONSISTS OF STANDARD CHARACTERS WITHOUT CLAIM TO ANY PARTICULAR FONT, STYLE, SIZE, OR COLOR.

NO CLAIM IS MADE TO THE EXCLUSIVE RIGHT TO USE "FILMS", APART FROM THE MARK AS SHOWN.

SER. NO. 85-455,380, FILED 10-25-2011.

NORA BUCHANAN WILL, EXAMINING ATTORNEY



*David J. Kyffers*

Director of the United States Patent and Trademark Office

# United States of America

United States Patent and Trademark Office

# Color Splash

**Reg. No. 4,197,290**

**Registered Aug. 28, 2012**

**Int. Cl.: 9**

**TRADEMARK**

**PRINCIPAL REGISTER**

POCKET PIXELS INC. (CANADA CORPORATION)  
1802-1188 HOWE ST  
VANCOUVER, BC, CANADA V6Z2S8

FOR: DOWNLOADABLE SOFTWARE IN THE NATURE OF A MOBILE APPLICATION FOR PHOTOGRAPHY PERMITTING MANIPULATION OF IMAGE COLOURS VIA TOUCHSCREEN INTERFACE, IN CLASS 9 (U.S. CLS. 21, 23, 26, 36 AND 38).

FIRST USE 2-15-2009; IN COMMERCE 2-15-2009.

THE MARK CONSISTS OF STANDARD CHARACTERS WITHOUT CLAIM TO ANY PARTICULAR FONT, STYLE, SIZE, OR COLOR.

NO CLAIM IS MADE TO THE EXCLUSIVE RIGHT TO USE "COLOR", APART FROM THE MARK AS SHOWN.

SER. NO. 85-456,024, FILED 10-25-2011.

ARETHA SOMERVILLE, EXAMINING ATTORNEY



*David J. Kyros*

Director of the United States Patent and Trademark Office

# United States of America

United States Patent and Trademark Office

# Sandboss

**Reg. No. 4,197,291**

H.T. MOULD INC. (CANADA CORPORATION)  
5652 THIMENS

**Registered Aug. 28, 2012**

ST. LAURENT, QUEBEC, CANADA H4R2K9

**Int. Cl.: 7**

FOR: PNEUMATIC DRUM SANDERS FOR USE WITH POWER OPERATED DRILLS, IN CLASS 7 (U.S. CLS. 13, 19, 21, 23, 31, 34 AND 35).

**TRADEMARK**

FIRST USE 5-1-1990; IN COMMERCE 9-1-1990.

**PRINCIPAL REGISTER**

THE MARK CONSISTS OF STANDARD CHARACTERS WITHOUT CLAIM TO ANY PARTICULAR FONT, STYLE, SIZE, OR COLOR.

OWNER OF CANADA REG. NO. TMA360508, DATED 9-15-1989, RENEWED AS REG. NO. TMA360508, DATED 9-15-2004, EXPIRES 9-15-2019.

SER. NO. 85-456,533, FILED 10-26-2011.

GEORGE LORENZO, EXAMINING ATTORNEY



*David J. Kybas*

Director of the United States Patent and Trademark Office

# United States of America

United States Patent and Trademark Office

## COMPUTER GENERATED SOLUTIONS

**Reg. No. 4,197,292**

COMPUTER GENERATED SOLUTIONS, INC. (DELAWARE CORPORATION)  
3 WORLD FINANCIAL CENTER, 200 VESEY ST.  
NEW YORK, NY 10281

**Registered Aug. 28, 2012**

**Int. Cls.: 9, 35, 37, 38, 39,  
41 and 42**

FOR: COMPUTER SOFTWARE FOR TRACKING THE FOLLOWING ORDER MANAGEMENT, DISTRIBUTION, ACCOUNTS PAYABLE, PRODUCTION AND IMPORT MANAGEMENT, GENERAL LEDGER, MATERIALS MANAGEMENT, SHOP FLOOR CONTROL, ORDER ENTRY AND CUSTOMER SALES AUTOMATION IN THE CLOTHING INDUSTRY; COMPUTER SOFTWARE FOR ENTERPRISE RESOURCE PLANNING, SUPPLY CHAIN MANAGEMENT, SALES FORCE AUTOMATION AND CUSTOMER RELATIONSHIP MANAGEMENT; SOFTWARE FOR EMAIL STORAGE AND ARCHIVING; A REAL-TIME SHOP FLOOR CONTROL SYSTEM COMPRISED OF COMPUTER HARDWARE AND COMPUTER PERIPHERALS AND COMPUTER SOFTWARE FOR USE IN MONITORING AND PROVIDING INFORMATION RELATING TO FACTORY OPERATIONS, PRODUCTIVITY, AND OUTPUT IN APPAREL, SOFT GOODS AND SEWN PRODUCTS MANUFACTURING, IN CLASS 9 (U.S. CLS. 21, 23, 26, 36 AND 38).

**TRADEMARK**

**SERVICE MARK**

**PRINCIPAL REGISTER**

FIRST USE 0-0-1994; IN COMMERCE 0-0-1994.

FOR: CALL MANAGEMENT SERVICES, NAMELY, HELP DESK SERVICES IN THE NATURE OF RESPONDING TO CUSTOMER INQUIRIES FOR OTHERS IN THE APPAREL, SOFT GOODS, AND SEWN PRODUCTS MANUFACTURING INDUSTRIES VIA TELEPHONE; CALL MANAGEMENT SERVICES, NAMELY, CUSTOMER SERVICE MANAGEMENT FOR OTHERS; CALL MANAGEMENT SERVICES, NAMELY, ELECTRONIC PROCESSING OF ORDERS FOR OTHERS; COMPUTER SERVICES, NAMELY, RESPONDING TO CUSTOMER INQUIRIES FOR OTHERS IN THE FIELD OF MANAGING COMPUTER NETWORKS, IN CLASS 35 (U.S. CLS. 100, 101 AND 102).

FIRST USE 0-0-1984; IN COMMERCE 0-0-1984.

FOR: INSTALLATION OF COMPUTER NETWORKS, NAMELY, INSTALLATION OF COMPUTER NETWORKING HARDWARE; INSTALLATION OF COMPUTER NETWORKS, NAMELY, INSTALLATION OF COMPUTER SYSTEMS, IN CLASS 37 (U.S. CLS. 100, 103 AND 106).

FIRST USE 0-0-1984; IN COMMERCE 0-0-1984.



*David J. Kyjars*

Director of the United States Patent and Trademark Office

**Reg. No. 4,197,292** FOR: CALL MANAGEMENT SERVICES, NAMELY, CALL SCREENING, MULTIPLE LOCATION SEARCH CAPABILITIES IN THE NATURE OF CALL HUNTING AND CALL-ROUTING IN THE NATURE OF CALL FORWARDING IN RESPONSE TO CUSTOMER INQUIRIES AND PROPER ROUTING OF SUCH CALLS, UNIFIED TELEPHONE VOICE MESSAGING AND MANAGED FAX TRANSMISSIONS; TELECOMMUNICATIONS SERVICES, NAMELY, PROVIDING ON-LINE VIRTUAL ACCESS FOR OTHERS TO PRESENT LIVE AND RECORDED KEYNOTE SPEAKERS, PRESENTATIONS, VIRTUAL JOB FAIRS, PANEL DISCUSSIONS, TRAINING, LECTURES, PRODUCT DEMONSTRATIONS AND SPONSOR EXHIBITS; PROVIDING VIRTUAL CHATROOMS ESTABLISHED VIA TEXT MESSAGING; VIDEOCONFERENCING SERVICES, IN CLASS 38 (U.S. CLS. 100, 101 AND 104).

FIRST USE 0-0-1984; IN COMMERCE 0-0-1984.

FOR: DOCUMENT MANAGEMENT SERVICES, NAMELY, ELECTRONIC STORAGE FOR OTHERS OF CORPORATE RECORDS, INVOICES, CONTRACTS, IN CLASS 39 (U.S. CLS. 100 AND 105).

FIRST USE 0-0-1984; IN COMMERCE 0-0-1984.

FOR: TECHNICAL AND END USER COMPUTER EDUCATION TRAINING SERVICES, IN CLASS 41 (U.S. CLS. 100, 101 AND 107).

FIRST USE 0-0-1984; IN COMMERCE 0-0-1984.

FOR: COMPUTER CONSULTATION IN THE NATURE OF HELP DESK SUPPORT SERVICES IN THE FIELD OF COMPUTER HARDWARE AND SOFTWARE; COMPUTER SERVICES, NAMELY, PROVIDING INFORMATION IN THE FIELD OF COMPUTER NETWORKING MANAGEMENT; COMPUTER SERVICES, NAMELY, COMPUTER SOFTWARE APPLICATIONS DEVELOPMENT FOR OTHERS, INTEGRATION OF COMPUTER SYSTEMS AND NETWORKS, AND CALL MANAGEMENT SOFTWARE DESIGN AND DEVELOPMENT FOR OTHERS; COMPUTER SERVICES, NAMELY, ENTERPRISE SOFTWARE DESIGN AND DEVELOPMENT FOR OTHERS; PROVIDING TEMPORARY USE OF ON-LINE NON-DOWNLOADABLE SOFTWARE FOR USE IN DATABASE MANAGEMENT AND HELP DESK SERVICES IN THE FIELD OF PROFESSIONAL STAFFING; OUTSOURCING IN THE FIELD OF HELP DESK SERVICES FOR COMPUTER SOFTWARE LEGACY SYSTEMS AND IN THE FIELD OF PROFESSIONAL STAFFING; SOFTWARE AS A SERVICE (SAAS), NAMELY, SOFTWARE FOR MANAGING AND OPERATING ON-LINE VIRTUAL WEB FACILITIES OF OTHERS TO PRESENT LIVE BUSINESS MEETINGS AND CONFERENCES, VIRTUAL JOB FAIRS, TRADE SHOWS, PRODUCT DEMONSTRATIONS AND EXHIBITS, ALL FOR AN ORGANIZATION'S CUSTOMERS, PROSPECTS, BUSINESS PARTNERS AND EMPLOYEES; COMPUTER SERVICES, NAMELY, MAINTENANCE OF WEB SITES AND HOSTING ON-LINE WEB FACILITIES FOR OTHERS, DEVELOPING SOFTWARE FOR OTHERS FOR ORGANIZING AND CONDUCTING ONLINE MEETINGS, VIRTUAL JOB FAIRS, GATHERINGS, AND INTERACTIVE DISCUSSIONS; SOFTWARE AS A SERVICE (SAAS) SERVICES FEATURING SOFTWARE FOR ENTERPRISE RESOURCE PLANNING, SUPPLY CHAIN MANAGEMENT, SALES FORCE AUTOMATION AND CUSTOMER RELATIONSHIP MANAGEMENT; CALL MANAGEMENT SERVICES, NAMELY, COMPUTER TECHNOLOGY SUPPORT SERVICES IN THE NATURE OF HELP DESK SERVICES; INSTALLATION OF COMPUTER NETWORKS, NAMELY, INSTALLATION OF COMPUTER NETWORKING SOFTWARE, IN CLASS 42 (U.S. CLS. 100 AND 101).

FIRST USE 0-0-1984; IN COMMERCE 0-0-1984.

THE MARK CONSISTS OF STANDARD CHARACTERS WITHOUT CLAIM TO ANY PARTICULAR FONT, STYLE, SIZE, OR COLOR.

OWNER OF U.S. REG. NO. 2,489,516.

**Reg. No. 4,197,292** SEC. 2(F).

SER. NO. 85-456,708, FILED 10-26-2011.

MARY CRAWFORD, EXAMINING ATTORNEY

# United States of America

United States Patent and Trademark Office

# NEXIRA

**Reg. No. 4,197,293**

**Registered Aug. 28, 2012**

**Int. Cls.: 1, 29 and 30**

**TRADEMARK**

**PRINCIPAL REGISTER**

IRANEX INTERNATIONAL (FRANCE SOCIÉTÉ PAR ACTIONS SIMPLIFIÉE (SAS))  
129 CHEMIN DE CROISSET  
ROUEN, FRANCE 76000

FOR: CHEMICAL PREPARATIONS FOR USE IN THE FOOD, PHARMACEUTICAL AND COSMETICS INDUSTRIES; CHEMICAL PREPARATIONS FOR PRESERVING FOODSTUFFS; CHEMICALS FOR USE IN AGRICULTURE EXCEPT FUNGICIDES, HERBICIDES, INSECTICIDES AND PARASITICIDES; ACACIA GUM FOR USE AS A CHEMICAL COATING AGENT IN THE PRODUCTION OF SUGAR-COATED CONFECTIONERY; CHEMICAL REAGENTS OTHER THAN FOR MEDICAL OR VETERINARY USE; GUM ARABIC GLUE; CHEMICAL ADDITIVES FOR USE IN THE MANUFACTURE OF GUM ACACIA FOR FOOD, IN CLASS 1 (U.S. CLS. 1, 5, 6, 10, 26 AND 46).

FOR: SEAWEED EXTRACTS FOR FOOD; ALGINATES FOR CULINARY PURPOSES; UN-FLAVORED GELATIN FOR FOODSTUFFS; DRIED AND COOKED FRUITS AND VEGETABLES; FRUIT AND VEGETABLE EXTRACTS FOR FOOD; VEGETABLE JUICES FOR COOKING; EDIBLE OILS AND FATS; EDIBLE FATS, IN CLASS 29 (U.S. CL. 46).

FOR: STARCH FOR USE IN MANUFACTURING FOOD; FOOD STARCH; THICKENING AGENTS FOR COOKING FOODSTUFFS; GUM SWEETS; CHEWING GUM; SPICES; COFFEE, TEA, COCOA, SUGAR, RICE, TAPIOCA, SAGO, ARTIFICIAL COFFEE; FLOUR AND PREPARATIONS MADE FROM CEREALS, NAMELY, FLOUR, BREAKFAST CEREALS, PROCESSED CEREALS, READY TO EAT CEREAL DERIVED FOOD BARS AND CEREAL BASED SNACK FOODS; SALTS; HONEY, TREACLE; YEAST, BAKING-POWDER, IN CLASS 30 (U.S. CL. 46).

THE MARK CONSISTS OF STANDARD CHARACTERS WITHOUT CLAIM TO ANY PARTICULAR FONT, STYLE, SIZE, OR COLOR.

OWNER OF FRANCE REG. NO. 113838180, DATED 6-10-2011, EXPIRES 6-9-2021.

SER. NO. 85-456,732, FILED 10-26-2011.

CHARLES L. JENKINS, EXAMINING ATTORNEY



*David J. Kyros*

Director of the United States Patent and Trademark Office

# United States of America

United States Patent and Trademark Office

## ANNIE SELKE

**Reg. No. 4,197,294**

**Registered Aug. 28, 2012**

**Int. Cl.: 27**

**TRADEMARK**

**PRINCIPAL REGISTER**

SELKE, CHRISTIAN L. (UNITED STATES INDIVIDUAL)  
301 OLD STOCKBRIDGE ROAD  
LENOX, MA 01240

FOR: RUGS, IN CLASS 27 (U.S. CLS. 19, 20, 37, 42 AND 50).

FIRST USE 7-1-2006; IN COMMERCE 7-1-2006.

THE MARK CONSISTS OF STANDARD CHARACTERS WITHOUT CLAIM TO ANY PARTICULAR FONT, STYLE, SIZE, OR COLOR.

THE NAME(S), PORTRAIT(S), AND/OR SIGNATURE(S) SHOWN IN THE MARK IDENTIFIES THE NICKNAME OF THE APPLICANT CHRISTIAN L. SELKE, WHOSE CONSENT TO REGISTER IS MADE OF RECORD.

SER. NO. 85-456,837, FILED 10-26-2011.

LESLEY LAMOTHE, EXAMINING ATTORNEY



*David J. Kyffers*

Director of the United States Patent and Trademark Office



# United States of America

United States Patent and Trademark Office



**Reg. No. 4,197,295**

**Registered Aug. 28, 2012**

**Int. Cl.: 9**

**TRADEMARK**

**PRINCIPAL REGISTER**

COMPASSION CONSULTING AND DISTRIBUTION (TEXAS LIMITED PARTNERSHIP),  
DBA TOP DAWG ELECTRONICS  
13630 IMMANUEL RD STE E  
PFLUGERVILLE, TX 78660

FOR: AUDIO AND VISUAL HEADSETS FOR USE IN PLAYING VIDEO GAMES; GAMING HEADSETS FOR USE IN PLAYING VIDEO GAMES; HEADSETS FOR CELLULAR OR MOBILE PHONES; HEADSETS FOR MOBILE TELEPHONES; HEADSETS FOR TELEPHONES; HEADSETS FOR USE WITH COMPUTERS; TELEPHONE HEADSETS; VIRTUAL REALITY HEADSETS AND HELMETS FOR USE IN PLAYING VIDEO GAMES; WIRELESS CELLULAR PHONE HEADSETS, IN CLASS 9 (U.S. CLS. 21, 23, 26, 36 AND 38).

FIRST USE 3-22-2009; IN COMMERCE 3-22-2009.

THE MARK CONSISTS OF A BROWN BANNER WITH A CIRCLE IN THE MIDDLE AND BLACK BORDER. THE CIRCLE HAS A PICTURE OF A DOG IN BLUE WITH BLACK SHADES. TO THE LEFT OF THE CIRCLE APPEARS THE WORDING "TOP" IN BLACK AND TO THE RIGHT OF THE CIRCLE APPEARS THE WORDING "DAWG" IN BLACK

THE COLOR(S) BROWN, BLUE AND BLACK IS/ARE CLAIMED AS A FEATURE OF THE MARK.

SER. NO. 85-456,987, FILED 10-26-2011.

ALICE BENMAMAN, EXAMINING ATTORNEY



*David J. Kyffers*

Director of the United States Patent and Trademark Office

# United States of America

United States Patent and Trademark Office

## HEALTHSTAR MY VIRTUAL RESOURCE

**Reg. No. 4,197,296**

HEALTHSTAR COMMUNICATIONS (DELAWARE CORPORATION)

**Registered Aug. 28, 2012**

1000 WYCKOFF AVE.  
MAHWAH, NJ 07430

**Int. Cl.: 42**

FOR: PLATFORM AS A SERVICE (PAAS) FEATURING COMPUTER SOFTWARE PLATFORMS FOR SHARING CONTENT IN THE MEDICAL FIELD, IN CLASS 42 (U.S. CLS. 100 AND 101).

**SERVICE MARK**

FIRST USE 10-20-2011; IN COMMERCE 10-20-2011.

**PRINCIPAL REGISTER**

THE MARK CONSISTS OF STANDARD CHARACTERS WITHOUT CLAIM TO ANY PARTICULAR FONT, STYLE, SIZE, OR COLOR.

SER. NO. 85-457,070, FILED 10-26-2011.

HOWARD B. LEVINE, EXAMINING ATTORNEY



*David J. Kyffers*

Director of the United States Patent and Trademark Office

# United States of America

United States Patent and Trademark Office



**Reg. No. 4,197,297**

HARDISON, STEWART (UNITED STATES INDIVIDUAL)  
14 HAZEL STREET  
ONEONTA, NY 13820

**Registered Aug. 28, 2012**

**Int. Cl.: 6**

FOR: NON-METAL OR CONCRETE ANCHORS FOR THE MOORING OF VESSELS, RAFTS, FLOATING WIND TURBINES AND POWER GENERATORS, AND OTHER FLOATING OR SEMI-FLOATING STRUCTURES, IN CLASS 6 (U.S. CLS. 2, 12, 13, 14, 23, 25 AND 50).

**TRADEMARK**

FIRST USE 10-22-2010; IN COMMERCE 10-22-2010.

**PRINCIPAL REGISTER**

OWNER OF U.S. REG. NO. 4,082,515.

NO CLAIM IS MADE TO THE EXCLUSIVE RIGHT TO USE MOORING SYSTEMS, APART FROM THE MARK AS SHOWN.

THE MARK CONSISTS OF A MOORING BLOCK NEXT TO "HABITAT" WITH THE WORDS "MOORING SYSTEMS" UNDERNEATH THE WORD "HABITAT".

SER. NO. 85-457,428, FILED 10-27-2011.

RUSS HERMAN, EXAMINING ATTORNEY



*David J. Kyffers*

Director of the United States Patent and Trademark Office

# United States of America

United States Patent and Trademark Office



**Reg. No. 4,197,298**

**Registered Aug. 28, 2012**

**Int. Cl.: 41**

**SERVICE MARK**

**PRINCIPAL REGISTER**

KATHERINE KING SIEGEL (UNITED STATES INDIVIDUAL), AKA KATHRIN KING SEGAL  
22350 GERMAIN ST. #3  
CHATSWORTH, CA 91311

FOR: PUBLISHING OF BOOKS, E-BOOKS, AUDIO BOOKS, MUSIC AND ILLUSTRATIONS,  
IN CLASS 41 (U.S. CLS. 100, 101 AND 107).

FIRST USE 6-1-2011; IN COMMERCE 6-1-2011.

NO CLAIM IS MADE TO THE EXCLUSIVE RIGHT TO USE "BOOKS", APART FROM THE  
MARK AS SHOWN.

THE COLOR(S) LIGHT BLUE, DARK BLUE, DARK GREY AND WHITE IS/ARE CLAIMED  
AS A FEATURE OF THE MARK.

THE MARK CONSISTS OF "BUCKET LIST BOOKS", DARK GREY DOLPHIN LEAPING  
OUT OF BLUE OCEAN WITH LIGHT BLUE SKY. "BUCKET" IS PRINTED IN DARK BLUE.  
"LIST" AND "BOOKS" ARE LIGHT BLUE. THERE IS A SPLASH OF WHITE WATER BE-  
NEATH DOLPHIN AND THERE ARE SURROUNDING WAVES. THERE ARE FAINT CLOUDS  
IN THE SKY OF A LIGHTER BLUE AND WHITE.

SER. NO. 85-457,769, FILED 10-27-2011.

JACQUELINE A. LAVINE, EXAMINING ATTORNEY



*David J. Kyffers*

Director of the United States Patent and Trademark Office

# United States of America

United States Patent and Trademark Office



**Reg. No. 4,197,299**

HASHEM, THOMAS (UNITED STATES INDIVIDUAL)  
348 REBECCA AVE  
SCRANTON, PA 18504

**Registered Aug. 28, 2012**

**Int. Cl.: 43**

FOR: RESTAURANT SERVICES, INCLUDING SIT-DOWN SERVICE OF FOOD AND TAKE-OUT RESTAURANT SERVICES; RESTAURANT SERVICES, NAMELY, PROVIDING OF FOOD AND BEVERAGES FOR CONSUMPTION ON AND OFF THE PREMISES, IN CLASS 43 (U.S. CLS. 100 AND 101).

**SERVICE MARK**

**PRINCIPAL REGISTER**

FIRST USE 1-2-2002; IN COMMERCE 1-2-2002.

NO CLAIM IS MADE TO THE EXCLUSIVE RIGHT TO USE "PIZZA", APART FROM THE MARK AS SHOWN.

THE MARK CONSISTS OF A CIRCLE WITH THREE HORIZONTAL SECTIONS; THE UPPER SECTION INCLUDES "AMERICA'S" WITH A STAR OVER THE I, THE MIDDLE SECTION INCLUDES "MOST WANTED", THE BOTTOM SECTION INCLUDES "PIZZA".

SEC. 2(F).

SER. NO. 85-458,079, FILED 10-27-2011.

JACQUELINE A. LAVINE, EXAMINING ATTORNEY



*David J. Kybas*

Director of the United States Patent and Trademark Office

# United States of America

United States Patent and Trademark Office

## I FEEL, THEREFORE I AM

**Reg. No. 4,197,300**

PROJECT THEOHUMANITY (ARIZONA CORPORATION)

**Registered Aug. 28, 2012**

PO BOX 482  
ASHLAND, OR 97520

**Int. Cl.: 41**

FOR: EDUCATION SERVICES, NAMELY, CONDUCTING CLASSES, SEMINARS, AND INFORMATIONAL WORKSHOPS IN THE FIELD OF ENLIGHTENMENT OF THE HUMAN EMOTIONAL BODY AND THE BELIEF THAT THE INDIVIDUAL IS A SPIRITUAL BEING FOR PSYCHOLOGISTS, PHILOSOPHERS, RELIGIOUS AND SPIRITUAL LEADERS AND COUNSELORS, AND ALL THOSE SERVED BY THEM, AND DISTRIBUTION OF COURSE MATERIALS IN CONNECTION THEREWITH, IN CLASS 41 (U.S. CLS. 100, 101 AND 107).

**SERVICE MARK**

**PRINCIPAL REGISTER**

FIRST USE 6-1-2008; IN COMMERCE 6-1-2008.

THE MARK CONSISTS OF STANDARD CHARACTERS WITHOUT CLAIM TO ANY PARTICULAR FONT, STYLE, SIZE, OR COLOR.

SER. NO. 85-458,565, FILED 10-28-2011.

TEJBIR SINGH, EXAMINING ATTORNEY



*David J. Kyffers*

Director of the United States Patent and Trademark Office

# United States of America

United States Patent and Trademark Office

# TARKOV

**Reg. No. 4,197,301**

ABC LIQUORS, INC. (FLORIDA CORPORATION)  
P.O. BOX 593688  
ORLANDO, FL 32859

**Registered Aug. 28, 2012**

**Int. Cl.: 33**

FOR: LIQUOR, NAMELY, VODKA, IN CLASS 33 (U.S. CLS. 47 AND 49).

**TRADEMARK**

FIRST USE 6-18-1980; IN COMMERCE 6-18-1980.

**PRINCIPAL REGISTER**

THE MARK CONSISTS OF STANDARD CHARACTERS WITHOUT CLAIM TO ANY PARTICULAR FONT, STYLE, SIZE, OR COLOR.

SEC. 2(F).

SER. NO. 85-458,605, FILED 10-28-2011.

YAT SYE, LEE, EXAMINING ATTORNEY



*David J. Kyffers*

Director of the United States Patent and Trademark Office

**United States of America**  
United States Patent and Trademark Office

# ESERIES

**Reg. No. 4,197,302**

VICAR OPERATING, INC. (DELAWARE CORPORATION)  
12401 WEST OLYMPIC BOULEVARD  
LOS ANGELES, CA 900641022

**Registered Aug. 28, 2012**

**Int. Cl.: 9**

FOR: COMPUTER SOFTWARE FOR USE IN DIGITAL RADIOGRAPHY APPLICATIONS FOR VETERINARY USE, IN CLASS 9 (U.S. CLS. 21, 23, 26, 36 AND 38).

**TRADEMARK**

FIRST USE 9-0-2010; IN COMMERCE 9-0-2010.

**PRINCIPAL REGISTER**

THE MARK CONSISTS OF STANDARD CHARACTERS WITHOUT CLAIM TO ANY PARTICULAR FONT, STYLE, SIZE, OR COLOR.

SER. NO. 85-458,755, FILED 10-28-2011.

RUSS HERMAN, EXAMINING ATTORNEY



*David J. Kybas*

Director of the United States Patent and Trademark Office



# United States of America

United States Patent and Trademark Office

## SOUND ASSURANCE

**Reg. No. 4,197,303**

VICAR OPERATING, INC. (DELAWARE CORPORATION)  
12401 WEST OLYMPIC BOULEVARD  
LOS ANGELES, CA 900641022

**Registered Aug. 28, 2012**

**Int. Cls.: 39, 41 and 42**

FOR: STORAGE OF DIGITAL RADIOGRAPHIC IMAGES AND RELATED TEXTUAL DATA IN THE VETERINARY FIELD; STORAGE SERVICES FOR ARCHIVING RADIOGRAPHIC IMAGES AND OTHER ELECTRONIC DATA IN THE NATURE OF PATIENT AND OWNER INFORMATION IN THE VETERINARY FIELD, IN CLASS 39 (U.S. CLS. 100 AND 105).

**SERVICE MARK**

**PRINCIPAL REGISTER**

FIRST USE 0-0-2006; IN COMMERCE 0-0-2006.

FOR: TRAINING AND EDUCATIONAL SERVICES, NAMELY, PROVIDING ONLINE TUTORING AND COURSES OF INSTRUCTION IN THE USE OF DIGITAL RADIOGRAPHY AND IMAGE ARCHIVING EQUIPMENT FOR USE IN THE VETERINARY FIELD, IN CLASS 41 (U.S. CLS. 100, 101 AND 107).

FIRST USE 0-0-2006; IN COMMERCE 0-0-2006.

FOR: TECHNICAL SUPPORT SERVICES, NAMELY, TROUBLESHOOTING IN THE NATURE OF PROVIDING TECHNICAL ADVICE CONCERNING THE DIAGNOSIS OF PROBLEMS DEALING WITH EQUIPMENT DESIGNED FOR PROVIDING DIGITAL RADIOGRAPHY AND RADIOGRAPHIC IMAGE ARCHIVING IN THE VETERINARY FIELD, IN CLASS 42 (U.S. CLS. 100 AND 101).

FIRST USE 0-0-2006; IN COMMERCE 0-0-2006.

THE MARK CONSISTS OF STANDARD CHARACTERS WITHOUT CLAIM TO ANY PARTICULAR FONT, STYLE, SIZE, OR COLOR.

SER. NO. 85-458,821, FILED 10-28-2011.

RUSS HERMAN, EXAMINING ATTORNEY



*David J. Kyffers*

Director of the United States Patent and Trademark Office

# United States of America

United States Patent and Trademark Office

## Genuine African Formula

**Reg. No. 4,197,304**

SMITH, ADEYEMIR (UNITED STATES INDIVIDUAL), DBA GENUINE AFRICAN FORMULA  
P.O. BOX 935

**Registered Aug. 28, 2012**

ARCHER, FL 32618

**Int. Cl.: 3**

FOR: AFTER-SUN GELS; AFTER-SUN OILS; ALOE VERA GEL FOR COSMETIC PURPOSES; BATH OILS FOR COSMETIC PURPOSES; BLEACHING PREPARATIONS FOR COSMETIC PURPOSES; BODY AND BEAUTY CARE COSMETICS; CLEANSING CREAMS; COCOA BUTTER FOR COSMETIC PURPOSES; COLOGNES, PERFUMES AND COSMETICS; COSMETIC CREAMS; COSMETIC CREAMS FOR SKIN CARE; COSMETIC HAIR DRESSING PREPARATIONS; COSMETIC HAND CREAMS; COSMETIC MASSAGE CREAMS; COSMETIC NOURISHING CREAMS; COSMETIC OILS; COSMETIC OILS FOR THE EPIDERMIS; COSMETIC OLIVE OIL FOR THE FACE AND BODY; COSMETIC PREPARATIONS; COSMETIC PREPARATIONS AGAINST SUNBURN; COSMETIC PREPARATIONS FOR BATH AND SHOWER; COSMETIC PREPARATIONS FOR BODY CARE; COSMETIC PREPARATIONS FOR EYE LASHES; COSMETIC PREPARATIONS FOR PROTECTING THE SKIN FROM THE SUN'S RAYS; COSMETIC PREPARATIONS FOR SKIN CARE; COSMETIC PREPARATIONS FOR SKIN RENEWAL; COSMETIC PREPARATIONS FOR SLIMMING PURPOSES; COSMETIC PREPARATIONS FOR THE HAIR AND SCALP; COSMETIC PREPARATIONS, NAMELY, FIRMING LOTIONS; COSMETIC PREPARATIONS, NAMELY, SKIN BALSAMS; COSMETIC SKIN FRESHENERS; COSMETIC SOAPS; COSMETIC SUN-PROTECTING PREPARATIONS; COSMETIC SUNSCREEN PREPARATIONS; COSMETICS AND COSMETIC PREPARATIONS, IN CLASS 3 (U.S. CLS. 1, 4, 6, 50, 51 AND 52).

**TRADEMARK**

**PRINCIPAL REGISTER**



FIRST USE 7-1-1983; IN COMMERCE 7-1-1983.

THE MARK CONSISTS OF STANDARD CHARACTERS WITHOUT CLAIM TO ANY PARTICULAR FONT, STYLE, SIZE, OR COLOR.

NO CLAIM IS MADE TO THE EXCLUSIVE RIGHT TO USE "GENUINE" AND "FORMULA", APART FROM THE MARK AS SHOWN.

SEC. 2(F).

SER. NO. 85-458,848, FILED 10-28-2011.

LINDA ESTRADA, EXAMINING ATTORNEY

*David J. Kyros*

Director of the United States Patent and Trademark Office

# United States of America

United States Patent and Trademark Office

## International Ivy

**Reg. No. 4,197,305**

**Registered Aug. 28, 2012**

**Int. Cl.: 41**

**SERVICE MARK**

**PRINCIPAL REGISTER**

INTERNATIONAL IVY L.L.C. (NEW JERSEY LIMITED LIABILITY COMPANY)  
232 SPRINGFIELD AVENUE  
SUMMIT, NJ 07901 AND

WONG, PUI WAN LILY (UNITED STATES INDIVIDUAL)  
232 SPRINGFIELD AVENUE  
SUMMIT, NJ 07901

FOR: EDUCATION SERVICES, NAMELY, PROVIDING KINDERGARTEN THROUGH 12TH GRADE (K-12) CLASSROOM INSTRUCTION; EDUCATION SERVICES, NAMELY, PROVIDING LIVE AND ON-LINE INSTRUCTION, TUTORING, MENTORING, CLASSES, SEMINARS, WORKSHOPS AND ADVICE IN THE FIELD OF ENGLISH AS A SECOND OR FOREIGN LANGUAGE, TECHNOLOGY, SCIENCE, ARTS, SPORT, CREATIVITY, INNOVATION, BUSINESS, COLLEGE PREPARATION AND COGNITIVE TRAINING, IN CLASS 41 (U.S. CLS. 100, 101 AND 107).

FIRST USE 7-28-2011; IN COMMERCE 7-28-2011.

THE MARK CONSISTS OF STANDARD CHARACTERS WITHOUT CLAIM TO ANY PARTICULAR FONT, STYLE, SIZE, OR COLOR.

NO CLAIM IS MADE TO THE EXCLUSIVE RIGHT TO USE "INTERNATIONAL", APART FROM THE MARK AS SHOWN.

SER. NO. 85-459,323, FILED 10-28-2011.

ERIN FALK, EXAMINING ATTORNEY



*David J. Kybas*

Director of the United States Patent and Trademark Office

# United States of America

United States Patent and Trademark Office

# HOPSCOTCH

**Reg. No. 4,197,306**

GILGAMESH BREWING, L.L.C. (OREGON LIMITED LIABILITY COMPANY)  
2953 RIDGEWAY DR SE  
TURNER, OR 97392

**Registered Aug. 28, 2012**

**Int. Cl.: 32**

FOR: BEER, IN CLASS 32 (U.S. CLS. 45, 46 AND 48).

**TRADEMARK**

FIRST USE 2-1-2010; IN COMMERCE 2-1-2010.

**PRINCIPAL REGISTER**

THE MARK CONSISTS OF STANDARD CHARACTERS WITHOUT CLAIM TO ANY PARTICULAR FONT, STYLE, SIZE, OR COLOR.

SER. NO. 85-459,359, FILED 10-28-2011.

SIMON TENG, EXAMINING ATTORNEY



*David J. Kybas*

Director of the United States Patent and Trademark Office

# United States of America

United States Patent and Trademark Office

# PUMPHOUSE

**Reg. No. 4,197,307**

GILGAMESH BREWING, L.L.C. (OREGON LIMITED LIABILITY COMPANY)  
2953 RIDGEWAY DR SE  
TURNER, OR 97392

**Registered Aug. 28, 2012**

**Int. Cl.: 32**

FOR: BEER, IN CLASS 32 (U.S. CLS. 45, 46 AND 48).

**TRADEMARK**

FIRST USE 2-1-2010; IN COMMERCE 2-1-2010.

**PRINCIPAL REGISTER**

THE MARK CONSISTS OF STANDARD CHARACTERS WITHOUT CLAIM TO ANY PARTICULAR FONT, STYLE, SIZE, OR COLOR.

SER. NO. 85-459,363, FILED 10-28-2011.

SIMON TENG, EXAMINING ATTORNEY



*David J. Kybas*

Director of the United States Patent and Trademark Office

# United States of America

United States Patent and Trademark Office

## PLATE FOR A PLATE

**Reg. No. 4,197,308**

MECHTENBERG, SUNSHINE (UNITED STATES INDIVIDUAL), DBA PLATE FOR A PLATE  
64 MIDDLE BAY ROAD  
BRUNSWICK, ME 04011

**Registered Aug. 28, 2012**

**Int. Cl.: 21**

FOR: DINNERWARE; DINNERWARE, NAMELY, PLATES, BOWLS, MUGS, CUPS, PLAT-  
TERS, VASE, CROCKS, BAKERS, CREAMERS, PITCHERS, TRIVETS, GLASSES, IN CLASS  
21 (U.S. CLS. 2, 13, 23, 29, 30, 33, 40 AND 50).

**TRADEMARK**

FIRST USE 10-1-2011; IN COMMERCE 10-15-2011.

**PRINCIPAL REGISTER**

THE MARK CONSISTS OF STANDARD CHARACTERS WITHOUT CLAIM TO ANY PAR-  
TICULAR FONT, STYLE, SIZE, OR COLOR.

SER. NO. 85-459,678, FILED S.R. 10-29-2011 AM. P.R. 4-24-2012.

JORDAN BAKER, EXAMINING ATTORNEY



*David J. Kyffers*

Director of the United States Patent and Trademark Office

# United States of America

United States Patent and Trademark Office

# TOWNSPREE

**Reg. No. 4,197,309**

XL411 INC. (FLORIDA CORPORATION)  
8586 POTTER PARK DRIVE  
SARASOTA, FL 34238

**Registered Aug. 28, 2012**

**Int. Cl.: 35**

FOR: PROMOTIONAL SERVICES, NAMELY, PROMOTING THE GOODS OF OTHERS BY MEANS OF PROVIDING ONLINE COUPONS AND DEALS; PROVIDING A SEARCHABLE ON-LINE ADVERTISING WEBSITE AND GUIDE FEATURING THE GOODS AND SERVICES OF OTHER VENDORS VIA THE INTERNET, IN CLASS 35 (U.S. CLS. 100, 101 AND 102).

**SERVICE MARK**

**PRINCIPAL REGISTER**

FIRST USE 8-2-2011; IN COMMERCE 9-1-2011.

THE MARK CONSISTS OF STANDARD CHARACTERS WITHOUT CLAIM TO ANY PARTICULAR FONT, STYLE, SIZE, OR COLOR.

SER. NO. 85-459,938, FILED 10-31-2011.

EMILY CARLSEN, EXAMINING ATTORNEY



*David J. Kyffers*

Director of the United States Patent and Trademark Office

# United States of America

United States Patent and Trademark Office

# MAMA LIL'S

**Reg. No. 4,197,310**

PACIFIC SPECIALITY FOODS LLC (OREGON CORPORATION)  
0341 SW FLORIDA STREET  
PORTLAND, OR 97219

**Registered Aug. 28, 2012**

**Int. Cls.: 29 and 30**

FOR: PRESERVED VEGETABLES, NAMELY, PEPPERS, PICKLES, MUSTARD PICKLES AND ASPARAGUS, IN CLASS 29 (U.S. CL. 46).

**TRADEMARK**

FIRST USE 2-28-1996; IN COMMERCE 2-28-1996.

**PRINCIPAL REGISTER**

FOR: RELISH AND CHOW CHOW, IN CLASS 30 (U.S. CL. 46).

FIRST USE 8-31-1999; IN COMMERCE 8-31-1999.

THE MARK CONSISTS OF STANDARD CHARACTERS WITHOUT CLAIM TO ANY PARTICULAR FONT, STYLE, SIZE, OR COLOR.

THE NAME(S), PORTRAIT(S), AND/OR SIGNATURE(S) SHOWN IN THE MARK DOES NOT IDENTIFY A PARTICULAR LIVING INDIVIDUAL.

SER. NO. 85-460,301, FILED 10-31-2011.

KRISTINA MORRIS, EXAMINING ATTORNEY



*David J. Kyjars*

Director of the United States Patent and Trademark Office



# United States of America

United States Patent and Trademark Office

## NOW YOU'RE TALKIN

**Reg. No. 4,197,311**

KLEIN ELECTRONICS, INC. (CALIFORNIA CORPORATION)  
349 N. VINEWOOD STREET  
ESCONDIDO, CA 92029

**Registered Aug. 28, 2012**

**Int. Cl.: 35**

FOR: ONLINE RETAIL STORE SERVICES AND MAIL ORDER SERVICES IN THE FIELD OF ELECTRONIC PRODUCTS, IN CLASS 35 (U.S. CLS. 100, 101 AND 102).

**SERVICE MARK**

FIRST USE 7-14-2011; IN COMMERCE 7-14-2011.

**PRINCIPAL REGISTER**

THE MARK CONSISTS OF STANDARD CHARACTERS WITHOUT CLAIM TO ANY PARTICULAR FONT, STYLE, SIZE, OR COLOR.

SER. NO. 85-460,356, FILED 10-31-2011.

JEFF DEFORD, EXAMINING ATTORNEY



*David J. Kyffers*

Director of the United States Patent and Trademark Office

# United States of America

United States Patent and Trademark Office

## Tree Messenger

**Reg. No. 4,197,312**

OBLEDO, JR., MARIO (UNITED STATES INDIVIDUAL), DBA TREE MESSENGER  
24411 CAMPING TRAIL  
SAN ANTONIO, TX 78255

**Registered Aug. 28, 2012**

**Int. Cl.: 38**

FOR: ELECTRONIC MAIL AND MESSAGING SERVICES, IN CLASS 38 (U.S. CLS. 100, 101 AND 104).

**SERVICE MARK**

FIRST USE 4-1-2009; IN COMMERCE 4-1-2009.

**PRINCIPAL REGISTER**

THE MARK CONSISTS OF STANDARD CHARACTERS WITHOUT CLAIM TO ANY PARTICULAR FONT, STYLE, SIZE, OR COLOR.

NO CLAIM IS MADE TO THE EXCLUSIVE RIGHT TO USE "MESSENGER", APART FROM THE MARK AS SHOWN.

SER. NO. 85-460,706, FILED 10-31-2011.

RAUL CORDOVA, EXAMINING ATTORNEY



*David J. Kybas*

Director of the United States Patent and Trademark Office

# United States of America

United States Patent and Trademark Office



**Reg. No. 4,197,313**

**Registered Aug. 28, 2012**

**Int. Cls.: 41 and 42**

**SERVICE MARK**

**PRINCIPAL REGISTER**

TOTAL EQUIPMENT TRAINING (PENNSYLVANIA CORPORATION)  
1846 EAGLE FARMS ROAD  
CHESTER SPRINGS, PA 19425

FOR: TRAINING SERVICES IN THE FIELD OF SAFELY OPERATING HEAVY MACHINERY AND EQUIPMENT, IN CLASS 41 (U.S. CLS. 100, 101 AND 107).

FIRST USE 4-0-2003; IN COMMERCE 4-0-2003.

FOR: TESTING, ANALYSIS AND EVALUATION OF THE SERVICES OF OTHERS FOR THE PURPOSE OF CERTIFICATION, IN CLASS 42 (U.S. CLS. 100 AND 101).

FIRST USE 4-0-2003; IN COMMERCE 4-0-2003.

NO CLAIM IS MADE TO THE EXCLUSIVE RIGHT TO USE "TOTAL EQUIPMENT TRAINING", APART FROM THE MARK AS SHOWN.

THE MARK CONSISTS OF A CIRCLE WITH A LETTER "T" IN THE CENTER, AND LETTERING SAYING "TOTAL EQUIPMENT TRAINING" AROUND THE CIRCLE.

SER. NO. 85-461,285, FILED 11-1-2011.

CAROLINE WOOD, EXAMINING ATTORNEY



*David J. Kybas*

Director of the United States Patent and Trademark Office

# United States of America

United States Patent and Trademark Office



**NEW WORLD AVIATION**  
A World Of Difference

**Reg. No. 4,197,314**

**Registered Aug. 28, 2012**

**Int. Cls.: 35, 37, 39 and 42**

NEW WORLD AVIATION, INC. (NEW JERSEY CORPORATION)  
3405 AIRPORT ROAD  
ALLENTOWN, PA 18109

FOR: BUSINESS MANAGEMENT SERVICES, NAMELY, AIRCRAFT MANAGEMENT FOR OTHERS, IN CLASS 35 (U.S. CLS. 100, 101 AND 102).

FIRST USE 1-2-2007; IN COMMERCE 1-2-2007.

**SERVICE MARK**

**PRINCIPAL REGISTER**

FOR: AIRCRAFT MAINTENANCE AND INSTALLATION AND MAINTENANCE OF AVIONICS IN THE FORM OF AIRCRAFT INSTRUMENTATION, FLIGHT MANAGEMENT SYSTEMS, TRAFFIC COLLISION AVOIDANCE SYSTEMS, GROUND PROXIMITY WARNING SYSTEMS, AIRBORNE DIGITAL AND SATELLITE TELEPHONE SYSTEMS AND CABIN ENTERTAINMENT SYSTEMS, IN CLASS 37 (U.S. CLS. 100, 103 AND 106).

FIRST USE 1-2-2007; IN COMMERCE 1-2-2007.

FOR: AIRPLANE CHARTERING AND HELICOPTER CHARTERING, IN CLASS 39 (U.S. CLS. 100 AND 105).

FIRST USE 1-2-2007; IN COMMERCE 1-2-2007.

FOR: CONSULTING FOR AIRCRAFT OWNERS FOR COMPLIANCE WITH REGULATORY REQUIREMENTS IN THE NATURE OF PROVIDING TECHNICAL CONSULTATION RELATING TO AIRCRAFT MAINTENANCE AND THE EVALUATION OF AN AIRCRAFT'S SAFETY AND REPAIR IN ACCORDANCE WITH FEDERAL SAFETY STANDARDS, IN CLASS 42 (U.S. CLS. 100 AND 101).

FIRST USE 1-2-2007; IN COMMERCE 1-2-2007.

OWNER OF U.S. REG. NO. 2,495,581.

NO CLAIM IS MADE TO THE EXCLUSIVE RIGHT TO USE "AVIATION" , APART FROM THE MARK AS SHOWN.

THE MARK CONSISTS OF AN OUTLINE OF A JET AIRPLANE TO THE LEFT OF THE WORDS "NEW WORLD AVIATION". THE WORDS "NEW WORLD AVIATION" START



*David J. Kyros*

Director of the United States Patent and Trademark Office

**Reg. No. 4,197,314** JUST TO THE RIGHT OF THE BOTTOM WING OF THE AIRPLANE. CENTERED BELOW THE WORDS "NEW WORLD AVIATION" ARE THE WORDS "A WORLD OF DIFFERENCE".

SER. NO. 85-461,299, FILED 11-1-2011.

DOMINICK J. SALEMI, EXAMINING ATTORNEY

# United States of America

United States Patent and Trademark Office

## A World of Difference

**Reg. No. 4,197,315**

NEW WORLD AVIATION, INC. (PENNSYLVANIA CORPORATION)  
3405 AIRPORT ROAD  
ALLENTOWN, PA 18109

**Registered Aug. 28, 2012**

**Int. Cls.: 35, 37, 39 and 42**

FOR: BUSINESS MANAGEMENT SERVICES, NAMELY, AIRCRAFT MANAGEMENT FOR OTHERS; ARRANGING FOR THE STAFFING OF AIRCRAFT FOR AIRCRAFT OWNERS; AND CONSULTING WITH AIRCRAFT OWNERS IN THE SELECTION OF AIRCRAFT AND SELECTION OF AVIONICS SYSTEMS FOR USE IN THEIR BUSINESS, IN CLASS 35 (U.S. CLS. 100, 101 AND 102).

**SERVICE MARK**

**PRINCIPAL REGISTER**

FIRST USE 1-2-2007; IN COMMERCE 1-2-2007.

FOR: ARRANGING FOR THE MAINTENANCE AND FUELING OF AIRCRAFT FOR AIRCRAFT OWNERS, IN CLASS 37 (U.S. CLS. 100, 103 AND 106).

FIRST USE 1-2-2007; IN COMMERCE 1-2-2007.

FOR: AIRPLANE CHARTERING AND HELICOPTER CHARTERING, IN CLASS 39 (U.S. CLS. 100 AND 105).

FIRST USE 1-2-2007; IN COMMERCE 1-2-2007.

FOR: CONSULTING FOR AIRCRAFT OWNERS FOR COMPLIANCE WITH REGULATORY REQUIREMENTS IN THE NATURE OF PROVIDING TECHNICAL CONSULTATION RELATING TO AIRCRAFT MAINTENANCE AND THE EVALUATION OF THE AIRCRAFT'S SAFETY AND REPAIR IN ACCORDANCE WITH FEDERAL SAFETY STANDARDS; AND CONSULTING SERVICES IN THE FIELD OF SELECTION OF AIRCRAFT FURNISHINGS, IN CLASS 42 (U.S. CLS. 100 AND 101).

FIRST USE 1-2-2007; IN COMMERCE 1-2-2007.

THE MARK CONSISTS OF STANDARD CHARACTERS WITHOUT CLAIM TO ANY PARTICULAR FONT, STYLE, SIZE, OR COLOR.

SER. NO. 85-461,321, FILED 11-1-2011.

DOMINICK J. SALEMI, EXAMINING ATTORNEY



*David J. Kyffers*

Director of the United States Patent and Trademark Office

**United States of America**  
United States Patent and Trademark Office

# GABA-VAL

**Reg. No. 4,197,316**

PROGRESSIVE LABORATORIES, INC. (TEXAS CORPORATION)  
1701 W. WALNUT HILL LANE  
IRVING, TX 75038

**Registered Aug. 28, 2012**

**Int. Cl.: 5**

FOR: DIETARY NUTRITIONAL SUPPLEMENT CONTAINING GABA USED FOR CENTRAL NERVOUS SYSTEM SUPPORT, IN CLASS 5 (U.S. CLS. 6, 18, 44, 46, 51 AND 52).

**TRADEMARK**

FIRST USE 11-13-1989; IN COMMERCE 12-13-1989.

**PRINCIPAL REGISTER**

THE MARK CONSISTS OF STANDARD CHARACTERS WITHOUT CLAIM TO ANY PARTICULAR FONT, STYLE, SIZE, OR COLOR.

OWNER OF U.S. REG. NO. 2,694,683.

SER. NO. 85-461,366, FILED 11-1-2011.

WILLIAM P. SHANAHAN, EXAMINING ATTORNEY



*David J. Kybas*

Director of the United States Patent and Trademark Office

# United States of America

United States Patent and Trademark Office



**Reg. No. 4,197,317**

**Registered Aug. 28, 2012**

**Int. Cl.: 35**

GLADIATOR CAPITAL FUNDS, LLC (CALIFORNIA LIMITED LIABILITY COMPANY),  
DBA 180SPIN  
2455 BENNETT VALLEY RD. SUITE C 116  
2455 BENNETT VALLEY RD. SUITE C 116  
SANTA ROSA, CA 95404

**SERVICE MARK**

**PRINCIPAL REGISTER**

FOR: ADVERTISING AND DIRECTORY SERVICES, NAMELY, PROMOTING THE SERVICES OF OTHERS BY PROVIDING A WEB PAGE FEATURING LINKS TO THE WEBSITES OF OTHERS; PROMOTING THE GOODS AND SERVICES OF OTHERS BY PROVIDING A WEBSITE FEATURING COUPONS, REBATES, PRICE-COMPARISON INFORMATION, PRODUCT REVIEWS, LINKS TO THE RETAIL WEBSITES OF OTHERS, AND DISCOUNT INFORMATION; PROMOTING THE GOODS AND SERVICES OF OTHERS BY PROVIDING A WEBSITE FEATURING DISCOUNT VOUCHERS, REBATES, DISCOUNT INFORMATION, PROMOTIONAL GAMES AND CONTESTS; PROMOTING, ADVERTISING AND MARKETING OF THE BRANDS, PRODUCTS, SERVICES AND ONLINE WEBSITES OF INDIVIDUALS, BUSINESSES AND NONPROFIT ORGANIZATIONS; PROVIDING A SEARCHABLE ON-LINE ADVERTISING WEBSITE AND GUIDE FEATURING THE GOODS AND SERVICES OF OTHER VENDORS VIA THE INTERNET, IN CLASS 35 (U.S. CLS. 100, 101 AND 102).

FIRST USE 9-30-2011; IN COMMERCE 9-30-2011.

THE MARK CONSISTS OF A STYLIZED LETTER "S" MADE UP OF PURPLE, ORANGE, DARK BLUE, LIGHT GREEN, RED, BLUE, YELLOW AND GREEN POLKA DOTS.

THE COLOR(S) PURPLE, ORANGE, DARK BLUE, LIGHT GREEN, RED, BLUE, YELLOW, AND GREEN IS/ARE CLAIMED AS A FEATURE OF THE MARK.

SER. NO. 85-461,404, FILED S.R. 11-1-2011 AM. P.R. 4-30-2012.

ERIN FALK, EXAMINING ATTORNEY



*David J. Kyjars*

Director of the United States Patent and Trademark Office



# United States of America

United States Patent and Trademark Office

## WORLDWIDE

**Reg. No. 4,197,318**

HART SPECIALTIES, INC. (NEW YORK CORPORATION)  
5000 NEW HORIZONS BLVD  
AMITYVILLE, NY 11701

**Registered Aug. 28, 2012**

**Int. Cl.: 9**

FOR: EYEGLOSS FRAMES, EYEGLOSSES AND RELATED EYE GLASS ACCESSORIES, NAMELY, EYEGLOSS CHAINS, STRAPS, CORDS, AND EYEGLOSS FLOATS IN THE NATURE OF DEVICES ATTACHED TO THE SIDE OF THE FRAME TO AID IN FLOATATION; EYEGLOSS CASES, IN CLASS 9 (U.S. CLS. 21, 23, 26, 36 AND 38).

**TRADEMARK**

**PRINCIPAL REGISTER**

FIRST USE 1-1-2002; IN COMMERCE 1-1-2002.

THE MARK CONSISTS OF STANDARD CHARACTERS WITHOUT CLAIM TO ANY PARTICULAR FONT, STYLE, SIZE, OR COLOR.

SER. NO. 85-461,576, FILED 11-1-2011.

TARAH HARDY, EXAMINING ATTORNEY



*David J. Kyffers*

Director of the United States Patent and Trademark Office

# United States of America

United States Patent and Trademark Office



**Reg. No. 4,197,319**

JEAN C. ANDERSEN (UNITED STATES INDIVIDUAL)  
5121 LAIRD LANE  
JUPITER, FL 33458

**Registered Aug. 28, 2012**

**Int. Cl.: 25**

FOR: SWIM SUITS, IN CLASS 25 (U.S. CLS. 22 AND 39).

**TRADEMARK**

FIRST USE 7-12-2010; IN COMMERCE 7-12-2010.

**PRINCIPAL REGISTER**

NO CLAIM IS MADE TO THE EXCLUSIVE RIGHT TO USE "SWIMWEAR", APART FROM THE MARK AS SHOWN.

THE MARK CONSISTS OF STYLIZED MONKEY IN A CONCENTRIC CIRCLE COMPRISING HIS TAIL WITH HAND ON CHIN IN PONDERING POSE.

SER. NO. 85-461,730, FILED 11-1-2011.

LINDA POWELL, EXAMINING ATTORNEY



*David J. Kybas*

Director of the United States Patent and Trademark Office

# United States of America

United States Patent and Trademark Office

# VIA ROMA

**Reg. No. 4,197,320**

HART SPECIALTIES, INC. (NEW YORK CORPORATION)  
5000 NEW HORIZONS BLVD  
AMITYVILLE, NY 11701

**Registered Aug. 28, 2012**

**Int. Cl.: 9**

FOR: EYEGLASS FRAMES, SUNGLASSES, EYEGLASSES AND RELATED EYE GLASS ACCESSORIES, NAMELY, EYEGLASS CHAINS, STRAPS, CORDS, AND EYEGLASS FLOATS IN THE NATURE OF DEVICES ATTACHED TO THE SIDE OF THE FRAME TO AID IN FLOATATION; EYEGLASS CASES, IN CLASS 9 (U.S. CLS. 21, 23, 26, 36 AND 38).

**TRADEMARK**

**PRINCIPAL REGISTER**

FIRST USE 5-27-1997; IN COMMERCE 5-27-1997.

THE MARK CONSISTS OF STANDARD CHARACTERS WITHOUT CLAIM TO ANY PARTICULAR FONT, STYLE, SIZE, OR COLOR.

THE ENGLISH TRANSLATION OF "VIA ROMA" IN THE MARK IS "VIA ROME".

SER. NO. 85-462,059, FILED 11-2-2011.

TARAH HARDY, EXAMINING ATTORNEY



*David J. Kyffers*

Director of the United States Patent and Trademark Office

# United States of America

United States Patent and Trademark Office

## Water's Worth It

**Reg. No. 4,197,321**

WATER ENVIRONMENT FEDERATION (ILLINOIS CORPORATION)  
601 WYTHE STREET  
ALEXANDRIA, VA 22314

**Registered Aug. 28, 2012**

**Int. Cl.: 35**

FOR: PROMOTING PUBLIC AWARENESS OF THE VALUE AND IMPORTANCE OF WATER, WATER RELATED ISSUES AND THE WATER PROFESSION AND WATER PROFESSIONALS, IN CLASS 35 (U.S. CLS. 100, 101 AND 102).

**SERVICE MARK**

FIRST USE 10-15-2011; IN COMMERCE 10-15-2011.

**PRINCIPAL REGISTER**

THE MARK CONSISTS OF STANDARD CHARACTERS WITHOUT CLAIM TO ANY PARTICULAR FONT, STYLE, SIZE, OR COLOR.

SER. NO. 85-462,165, FILED 11-2-2011.

FRANK LATTUCA, EXAMINING ATTORNEY



*David J. Kybas*

Director of the United States Patent and Trademark Office

# United States of America

United States Patent and Trademark Office

## CUPIDCLASSIFIEDS.COM

**Reg. No. 4,197,322**

**Registered Aug. 28, 2012**

**Int. Cl.: 45**

**SERVICE MARK**

**PRINCIPAL REGISTER**

FIESTA CATERING INTERNATIONAL, INC. (ANGUILLA CORPORATION)  
P.O. BOX 371  
BABROW BUILDING  
THE VALLEY, ANGUILLA

FOR: DATING SERVICES; AND INTERNET BASED SOCIAL NETWORKING AND INTRODUCTION SERVICES, IN CLASS 45 (U.S. CLS. 100 AND 101).

FIRST USE 5-18-2011; IN COMMERCE 5-18-2011.

THE MARK CONSISTS OF STANDARD CHARACTERS WITHOUT CLAIM TO ANY PARTICULAR FONT, STYLE, SIZE, OR COLOR.

SER. NO. 85-462,394, FILED 11-2-2011.

SARA BENJAMIN, EXAMINING ATTORNEY



*David J. Kybas*

Director of the United States Patent and Trademark Office

# United States of America

United States Patent and Trademark Office

# 403

**Reg. No. 4,197,323**

403 LABS, LLC (DELAWARE LIMITED LIABILITY COMPANY)  
27 NORTH WACKER DRIVE, SUITE 204  
CHICAGO, IL 60606

**Registered Aug. 28, 2012**

**Int. Cls.: 35, 42 and 45**

FOR: BUSINESS DEVELOPMENT SERVICES OF POLICIES FOR COMPUTER SECURITY SYSTEMS, IN CLASS 35 (U.S. CLS. 100, 101 AND 102).

**SERVICE MARK**

FIRST USE 9-12-2005; IN COMMERCE 9-23-2005.

**PRINCIPAL REGISTER**

FOR: IT CONSULTING SERVICES; COMPUTER CONSULTATION IN THE FIELD OF COMPUTER SECURITY; DEVELOPMENT AND MAINTENANCE OF SOFTWARE FOR COMPUTER SECURITY PURPOSES; DEVELOPMENT AND CONFIGURATION OF COMPUTER SECURITY SYSTEMS; TESTING OF COMPUTER SECURITY SYSTEMS; COMPUTER FORENSIC SERVICES; PROVIDING A WEBSITE FEATURING TECHNOLOGY INFORMATION IN THE FIELD OF COMPUTER SECURITY; RESEARCH IN THE FIELD OF INTELLIGENCE AND SECURITY TECHNOLOGY, IN CLASS 42 (U.S. CLS. 100 AND 101).

FIRST USE 9-12-2005; IN COMMERCE 9-23-2005.

FOR: CONSULTING SERVICES IN THE FIELD OF PRIVACY AND SECURITY LAWS, REGULATIONS, AND REQUIREMENTS, NAMELY, COMPLIANCE ASSESSMENTS; MONITORING OF COMPUTER SYSTEMS FOR SECURITY PURPOSES, IN CLASS 45 (U.S. CLS. 100 AND 101).

FIRST USE 9-12-2005; IN COMMERCE 9-23-2005.

THE MARK CONSISTS OF STANDARD CHARACTERS WITHOUT CLAIM TO ANY PARTICULAR FONT, STYLE, SIZE, OR COLOR.

OWNER OF U.S. REG. NOS. 3,456,261, 3,456,262, AND 3,465,173.

SER. NO. 85-462,752, FILED 11-2-2011.

STEVEN JACKSON, EXAMINING ATTORNEY



*David J. Kyffers*

Director of the United States Patent and Trademark Office

# United States of America

United States Patent and Trademark Office



**Reg. No. 4,197,324**

**Registered Aug. 28, 2012**

**Int. Cl.: 9**

**TRADEMARK**

**PRINCIPAL REGISTER**

APPLE INC. (CALIFORNIA CORPORATION)  
1 INFINITE LOOP  
CUPERTINO, CA 95014

FOR: COMPUTER SOFTWARE FOR USE IN GEOGRAPHICALLY LOCATING AND TRACKING PEOPLE VIA GLOBAL POSITIONING SYSTEMS OR OTHER LOCATION TECHNOLOGY AND SHARING A USER'S GEOGRAPHIC LOCATION; COMPUTER SOFTWARE FOR USE IN SOCIAL NETWORKING, NAMELY, SOFTWARE FOR DISPLAYING AND SHARING A USER'S LOCATION AND FINDING, LOCATING, AND INTERACTING WITH OTHER USERS, IN CLASS 9 (U.S. CLS. 21, 23, 26, 36 AND 38).

FIRST USE 10-4-2011; IN COMMERCE 10-13-2011.

PRIORITY CLAIMED UNDER SEC. 44(D) ON JAMAICA APPLICATION NO. 58064, FILED 5-3-2011.

THE COLOR(S) DARK BROWN, LIGHT BROWN, AND WHITE IS/ARE CLAIMED AS A FEATURE OF THE MARK.

THE MARK CONSISTS OF A LIGHT BROWN RECTANGLE WITH ROUNDED CORNERS OUTLINED WITH WHITE STITCHING AND FEATURING A STYLIZED IMAGE OF TWO PEOPLE IN DARK BROWN.

SER. NO. 85-462,987, FILED 11-2-2011.

KEVIN CORWIN, EXAMINING ATTORNEY



*David J. Kybas*

Director of the United States Patent and Trademark Office

# United States of America

United States Patent and Trademark Office

## Sound Investors

**Reg. No. 4,197,325**

**Registered Aug. 28, 2012**

**Int. Cl.: 41**

**SERVICE MARK**

**PRINCIPAL REGISTER**

SOUND INVESTORS, LLC (DELAWARE LIMITED LIABILITY COMPANY)  
2858 LADBROOK WAY  
THOUSAND OAKS, CA 91361

FOR: MUSIC PUBLISHING SERVICES, IN CLASS 41 (U.S. CLS. 100, 101 AND 107).

FIRST USE 5-25-2005; IN COMMERCE 5-25-2005.

THE MARK CONSISTS OF STANDARD CHARACTERS WITHOUT CLAIM TO ANY PARTICULAR FONT, STYLE, SIZE, OR COLOR.

SER. NO. 85-463,083, FILED 11-2-2011.

PRISCILLA MILTON, EXAMINING ATTORNEY



*David J. Kyffers*

Director of the United States Patent and Trademark Office



# United States of America

United States Patent and Trademark Office

## SMARTSTREET

**Reg. No. 4,197,326**

HART SPECIALTIES, INC. (NEW YORK CORPORATION)  
5000 NEW HORIZONS BLVD  
AMITYVILLE, NY 11701

**Registered Aug. 28, 2012**

**Int. Cl.: 9**

FOR: EYEGLASS FRAMES, SUNGLASSES, EYEGLASSES AND RELATED EYE GLASS ACCESSORIES, NAMELY, EYEGLASS CHAINS, STRAPS, CORDS, AND EYEGLASS FLOATS IN THE NATURE OF DEVICES ATTACHED TO THE SIDE OF THE FRAME TO AID IN FLOATATION; EYEGLASS CASES, IN CLASS 9 (U.S. CLS. 21, 23, 26, 36 AND 38).

**TRADEMARK**

**PRINCIPAL REGISTER**

FIRST USE 4-30-1999; IN COMMERCE 4-30-1999.

THE MARK CONSISTS OF STANDARD CHARACTERS WITHOUT CLAIM TO ANY PARTICULAR FONT, STYLE, SIZE, OR COLOR.

SER. NO. 85-463,124, FILED 11-3-2011.

TARAH HARDY, EXAMINING ATTORNEY



*David J. Kyffers*

Director of the United States Patent and Trademark Office

# United States of America

United States Patent and Trademark Office

# SMARTIES

**Reg. No. 4,197,327**

HART SPECIALTIES, INC. (NEW YORK CORPORATION)  
5000 NEW HORIZONS BLVD  
AMITYVILLE, NY 11701

**Registered Aug. 28, 2012**

**Int. Cl.: 9**

FOR: EYEGLASS FRAMES, SUNGLASSES, EYEGLASSES AND RELATED EYE GLASS ACCESSORIES, NAMELY, EYEGLASS CHAINS, STRAPS, CORDS, AND EYEGLASS FLOATS IN THE NATURE OF DEVICES ATTACHED TO THE SIDE OF THE FRAME TO AID IN FLOATATION; EYEGLASS CASES, IN CLASS 9 (U.S. CLS. 21, 23, 26, 36 AND 38).

**TRADEMARK**

**PRINCIPAL REGISTER**

FIRST USE 2-24-1999; IN COMMERCE 2-24-1999.

THE MARK CONSISTS OF STANDARD CHARACTERS WITHOUT CLAIM TO ANY PARTICULAR FONT, STYLE, SIZE, OR COLOR.

SER. NO. 85-463,130, FILED 11-3-2011.

TARAH HARDY, EXAMINING ATTORNEY



*David J. Kyffers*

Director of the United States Patent and Trademark Office

# United States of America

United States Patent and Trademark Office

## EASY STREET

**Reg. No. 4,197,328**

HART SPECIALTIES, INC. (NEW YORK CORPORATION)  
5000 NEW HORIZONS BLVD  
AMITYVILLE, NY 11701

**Registered Aug. 28, 2012**

**Int. Cl.: 9**

FOR: EYEGLOSS FRAMES, SUNGLASSES, EYEGASSES AND RELATED EYE GLASS ACCESSORIES, NAMELY, EYEGLOSS CHAINS, STRAPS, CORDS, AND EYEGLOSS FLOATS IN THE NATURE OF DEVICES ATTACHED TO THE SIDE OF THE FRAME TO AID IN FLOATATION; EYEGLOSS CASES, IN CLASS 9 (U.S. CLS. 21, 23, 26, 36 AND 38).

**TRADEMARK**

**PRINCIPAL REGISTER**

FIRST USE 8-11-1997; IN COMMERCE 8-11-1997.

THE MARK CONSISTS OF STANDARD CHARACTERS WITHOUT CLAIM TO ANY PARTICULAR FONT, STYLE, SIZE, OR COLOR.

SER. NO. 85-463,132, FILED 11-3-2011.

TARAH HARDY, EXAMINING ATTORNEY



*David J. Kyffers*

Director of the United States Patent and Trademark Office

# United States of America

United States Patent and Trademark Office

## ARMUNE BIOSCIENCE

**Reg. No. 4,197,329**

ARMUNE BIOSCIENCE, INC. (DELAWARE CORPORATION)  
350 E. MICHIGAN AVENUE, SUITE 500  
KALAMAZOO, MI 49007

**Registered Aug. 28, 2012**

**Int. Cl.: 42**

FOR: DESIGN, RESEARCH AND DEVELOPMENT OF MEDICAL DIAGNOSTIC TESTS, IN CLASS 42 (U.S. CLS. 100 AND 101).

**SERVICE MARK**

FIRST USE 10-0-2007; IN COMMERCE 9-0-2008.

**PRINCIPAL REGISTER**

THE MARK CONSISTS OF STANDARD CHARACTERS WITHOUT CLAIM TO ANY PARTICULAR FONT, STYLE, SIZE, OR COLOR.

NO CLAIM IS MADE TO THE EXCLUSIVE RIGHT TO USE "BIOSCIENCE", APART FROM THE MARK AS SHOWN.

SER. NO. 85-463,144, FILED 11-3-2011.

WILLIAM BRECKENFELD, EXAMINING ATTORNEY



*David J. Kyffers*

Director of the United States Patent and Trademark Office

# United States of America

United States Patent and Trademark Office



**Reg. No. 4,197,330**

**Registered Aug. 28, 2012**

**Int. Cl.: 43**

**SERVICE MARK**

**PRINCIPAL REGISTER**

HOANG HUONG INC. (TEXAS CORPORATION)  
SUITE 200  
2150 EAST ARAPAHO ROAD  
RICHARDSAON, TX 75081

FOR: RESTAURANT, IN CLASS 43 (U.S. CLS. 100 AND 101).

FIRST USE 4-10-2008; IN COMMERCE 4-10-2008.

THE MARK CONSISTS OF A STYLIZED LETTER "S" WITH A RECTANGLE BLOCK OF SOLID COLOR, ENCLOSED IN THE LOWER CURVE OF THE "S". ON THE RIGHT OF THIS STYLIZED LETTER "S" IS THE WORDING "SAIGON BLOCK" WITH THE WORD "SAIGON" IN CASMIRA FONT AND THE WORD "BLOCK" IN AZRAEL FONT.

SER. NO. 85-463,226, FILED 11-3-2011.

WILLIAM BRECKENFELD, EXAMINING ATTORNEY



*David J. Kyffers*

Director of the United States Patent and Trademark Office

# United States of America

United States Patent and Trademark Office

## SCRAPPY AMERICA CENTRAL

**Reg. No. 4,197,331**

IDT TELECOM, INC. (DELAWARE CORPORATION)  
550 BROAD STREET  
NEWARK, NJ 07102

**Registered Aug. 28, 2012**

**Int. Cls.: 16, 36 and 38**

FOR: PREPAID TELEPHONE CALLING CARDS, NOT MAGNETICALLY ENCODED, IN CLASS 16 (U.S. CLS. 2, 5, 22, 23, 29, 37, 38 AND 50).

**TRADEMARK**

FIRST USE 10-14-2011; IN COMMERCE 10-14-2011.

**SERVICE MARK**

FOR: PREPAID TELEPHONE CALLING CARD AND TELEPHONE DEBIT CARD SERVICES, IN CLASS 36 (U.S. CLS. 100, 101 AND 102).

**PRINCIPAL REGISTER**

FIRST USE 10-14-2011; IN COMMERCE 10-14-2011.

FOR: TELEPHONE TELECOMMUNICATIONS SERVICES PROVIDED VIA PREPAID TELEPHONE CALLING CARDS, IN CLASS 38 (U.S. CLS. 100, 101 AND 104).

FIRST USE 10-14-2011; IN COMMERCE 10-14-2011.

THE MARK CONSISTS OF STANDARD CHARACTERS WITHOUT CLAIM TO ANY PARTICULAR FONT, STYLE, SIZE, OR COLOR.

NO CLAIM IS MADE TO THE EXCLUSIVE RIGHT TO USE "AMERICA CENTRAL", APART FROM THE MARK AS SHOWN.

SER. NO. 85-463,395, FILED 11-3-2011.

LEIGH CAROLINE CASE, EXAMINING ATTORNEY



*David J. Kyffers*

Director of the United States Patent and Trademark Office

# United States of America

United States Patent and Trademark Office

## LAUNDRODESIGN

**Reg. No. 4,197,332**

**Registered Aug. 28, 2012**

**Int. Cl.: 42**

**SERVICE MARK**

**PRINCIPAL REGISTER**

COIN AUTOMATIC LAUNDRY EQUIPMENT COMPANY (PENNSYLVANIA CORPORATION)  
P.O. BOX 1239  
AIRPORT ROAD AND WILSON DRIVE  
WEST CHESTER, PA 19380

FOR: DESIGN OF COMMERCIAL LAUNDRY CENTERS, WHICH INCLUDES HARDWARE,  
SOFTWARE AND COLLECTION FUNCTIONS, IN CLASS 42 (U.S. CLS. 100 AND 101).

FIRST USE 12-0-2006; IN COMMERCE 12-0-2006.

THE MARK CONSISTS OF STANDARD CHARACTERS WITHOUT CLAIM TO ANY PAR-  
TICULAR FONT, STYLE, SIZE, OR COLOR.

SER. NO. 85-463,542, FILED 11-3-2011.

LINDA MICKLEBURGH, EXAMINING ATTORNEY



*David J. Kyffers*

Director of the United States Patent and Trademark Office

# United States of America

United States Patent and Trademark Office

## Where the smart money goes prospecting

**Reg. No. 4,197,333**

**Registered Aug. 28, 2012**

**Int. Cls.: 35 and 41**

**SERVICE MARK**

**PRINCIPAL REGISTER**

PRECIOUS METALS SUMMIT CONFERENCES, LLC (DELAWARE LIMITED LIABILITY COMPANY)  
727 E. 16TH AVENUE  
DENVER, CO 80203

FOR: ARRANGING AND CONDUCTING BUSINESS CONFERENCES IN THE FIELD OF FINANCIAL INVESTMENTS, IN CLASS 35 (U.S. CLS. 100, 101 AND 102).

FIRST USE 5-6-2011; IN COMMERCE 5-26-2011.

FOR: ARRANGING AND CONDUCTING BUSINESS SEMINARS IN THE FIELD OF FINANCIAL INVESTMENTS, IN CLASS 41 (U.S. CLS. 100, 101 AND 107).

FIRST USE 5-6-2011; IN COMMERCE 5-26-2011.

THE MARK CONSISTS OF STANDARD CHARACTERS WITHOUT CLAIM TO ANY PARTICULAR FONT, STYLE, SIZE, OR COLOR.

SER. NO. 85-464,083, FILED 11-3-2011.

BARNEY CHARLON, EXAMINING ATTORNEY



*David J. Kyffers*

Director of the United States Patent and Trademark Office



# United States of America

United States Patent and Trademark Office

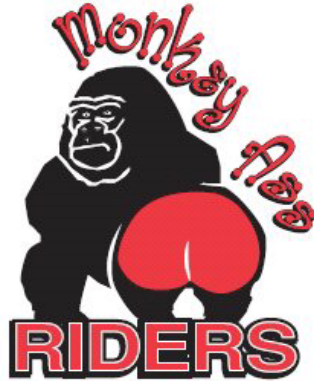

**Reg. No. 4,197,334**

**Registered Aug. 28, 2012**

**Int. Cls.: 25 and 41**

**TRADEMARK**

**SERVICE MARK**

**PRINCIPAL REGISTER**

WORTHY, DENNIS (UNITED STATES INDIVIDUAL)  
7058 LINDER DRIVE  
FRANKLIN, WI 53132

FOR: GLOVES; HATS; JACKETS; SHIRTS, IN CLASS 25 (U.S. CLS. 22 AND 39).

FIRST USE 0-0-1999; IN COMMERCE 0-0-1999.

FOR: ENTERTAINMENT SERVICES IN THE NATURE OF ORGANIZING, ARRANGING AND CONDUCTING MOTORCYCLE RIDING EXCURSIONS, IN CLASS 41 (U.S. CLS. 100, 101 AND 107).

FIRST USE 0-0-1999; IN COMMERCE 0-0-1999.

THE MARK CONSISTS OF THE DESIGN OF A BLACK MONKEY WITH A FACE DETAILED IN WHITE AND WITH A RED BEHIND DETAILED IN WHITE. THE WORDS "MONKEY ASS RIDERS" ARE IN RED AND OUTLINED IN BLACK.

THE COLOR(S) BLACK, RED AND WHITE IS/ARE CLAIMED AS A FEATURE OF THE MARK.

SER. NO. 85-464,325, FILED 11-4-2011.

SHANNON TWOHIG, EXAMINING ATTORNEY



*David J. Kybas*

Director of the United States Patent and Trademark Office

# United States of America

United States Patent and Trademark Office

# TimeLight

**Reg. No. 4,197,335**

BSH BOSCH UND SIEMENS HAUSGERATE GMBH (FED REP GERMANY CORPORATION)  
CARL-WERY-STRASSE 34

**Registered Aug. 28, 2012**

MUNICH, FED REP GERMANY 81739

**Int. Cl.: 7**

FOR: HOUSEHOLD AND KITCHEN MACHINES AND EQUIPMENT, NAMELY, DISHWASHERS; AND STRUCTURAL PARTS OF AFOREMENTIONED GOODS, IN CLASS 7 (U.S. CLS. 13, 19, 21, 23, 31, 34 AND 35).

**TRADEMARK**

THE MARK CONSISTS OF STANDARD CHARACTERS WITHOUT CLAIM TO ANY PARTICULAR FONT, STYLE, SIZE, OR COLOR.

**PRINCIPAL REGISTER**

PRIORITY CLAIMED UNDER SEC. 44(D) ON FED REP GERMANY APPLICATION NO. 302011027381, FILED 5-17-2011, REG. NO. 302011027381, DATED 6-8-2011, EXPIRES 5-31-2021.

SER. NO. 85-464,401, FILED 11-4-2011.

STEPHANIE ALI, EXAMINING ATTORNEY



*David J. Kyffers*

Director of the United States Patent and Trademark Office

# United States of America

United States Patent and Trademark Office

## NST IS THE WAY TO GO...

**Reg. No. 4,197,336**

**Registered Aug. 28, 2012**

**Int. Cl.: 45**

**SERVICE MARK**

**PRINCIPAL REGISTER**

NAHON, SAHAROVICH & TROTZ, PLC (TENNESSEE LIMITED LIABILITY COMPANY)  
488 SOUTH MENDENHALL  
MEMPHIS, TN 38117

FOR: LEGAL SERVICES, IN CLASS 45 (U.S. CLS. 100 AND 101).

FIRST USE 11-25-2008; IN COMMERCE 11-25-2008.

THE MARK CONSISTS OF STANDARD CHARACTERS WITHOUT CLAIM TO ANY PARTICULAR FONT, STYLE, SIZE, OR COLOR.

SER. NO. 85-464,412, FILED 11-4-2011.

VIVIAN MICZNIK FIRST, EXAMINING ATTORNEY



*David J. Kybas*

Director of the United States Patent and Trademark Office

# United States of America

United States Patent and Trademark Office

NST ARE THE ONES FOR YOU...

**Reg. No. 4,197,337**

NAHON, SAHAROVICH & TROTZ, PLLC (TENNESSEE LIMITED LIABILITY COMPANY)  
488 SOUTH MENDENHALL ROAD  
MEMPHIS, TN 38117

**Registered Aug. 28, 2012**

**Int. Cl.: 45**

FOR: LEGAL SERVICES, IN CLASS 45 (U.S. CLS. 100 AND 101).

**SERVICE MARK**

FIRST USE 1-25-2008; IN COMMERCE 1-25-2008.

**PRINCIPAL REGISTER**

THE MARK CONSISTS OF STANDARD CHARACTERS WITHOUT CLAIM TO ANY PARTICULAR FONT, STYLE, SIZE, OR COLOR.

SER. NO. 85-464,465, FILED 11-4-2011.

VIVIAN MICZNIK FIRST, EXAMINING ATTORNEY



*David J. Kybas*

Director of the United States Patent and Trademark Office

# United States of America

## United States Patent and Trademark Office

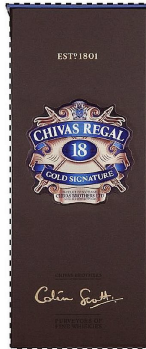

**Reg. No. 4,197,338**

**Registered Aug. 28, 2012**

**Int. Cl.: 33**

**TRADEMARK**

**PRINCIPAL REGISTER**

CHIVAS HOLDINGS (IP) LIMITED (UNITED KINGDOM LIMITED COMPANY (LTD.))  
111-113 RENFREW ROAD  
PAISLEY, RENFREWSHIRE, UNITED KINGDOM PA34DY

FOR: ALCOHOLIC BEVERAGES EXCEPT BEERS, IN CLASS 33 (U.S. CLS. 47 AND 49).

FIRST USE 9-0-2011; IN COMMERCE 9-0-2011.

PRIORITY CLAIMED UNDER SEC. 44(D) ON ERPN CMNTY TM OFC APPLICATION NO.  
010271741, FILED 9-16-2011, REG. NO. 010271741, DATED 2-17-2012, EXPIRES 9-16-2021.

THE COLOR(S) BEIGE, BLACK, GOLD, BLUE, BROWN, GREY, AND WHITE IS/ARE  
CLAIMED AS A FEATURE OF THE MARK.

OWNER OF U.S. REG. NOS. 3,215,927, 4,085,826 AND OTHERS.

NO CLAIM IS MADE TO THE EXCLUSIVE RIGHT TO USE "ESTD 1801" AND "AGED 18  
YEARS" AND "PRODUCE OF SCOTLAND" AND "BROTHERS LTD. DISTILLERS KEITH  
SCOTLAND", APART FROM THE MARK AS SHOWN.

THE NAME "COLIN SCOTT" IDENTIFIES A LIVING INDIVIDUAL WHOSE CONSENT IS  
OF RECORD.



*David J. Kybas*

Director of the United States Patent and Trademark Office

THE MARK CONSISTS OF A THREE-DIMENSIONAL CONFIGURATION OF PRODUCT  
PACKAGING FOR THE GOODS COMPRISING A BROWN BOX WITH A BLUE TOP. AT  
THE TOP OF THE BOX IS THE GOLD WORDING "ESTD 1801". A LABEL APPEARS IN  
THE CENTER OF THE BOX FRONT AND CONSISTS OF A BEIGE AND BROWN SHIELD  
WITH A LARGE BROWN OUTLINE WITH SCALLOPED EDGES AND A THIN, SINGLE-  
LINE BLUE OUTLINE JUST INSIDE THE EDGE OF THE SHIELD. THERE IS A BEIGE,  
GOLD, BLUE AND BROWN BACKGROUND SHIELD-TYPE DESIGN WITHIN THE LARGER  
SHIELD. ACROSS THE FRONT OF THE SHIELD ARE TWO CROSSED BROWN SPEARS  
THAT ARE OUTLINED IN BEIGE. AT THE TOP OF THE SHIELD AND CENTERED  
BETWEEN THE SPEARS APPEARS A COAT OF ARMS IN BLUE, BLACK AND GRAY WITH  
WHITE AND BLACK LEAVES SURROUNDING IT AND WITH THE WORDING "TREIB-  
HIREAS BUNAITEACHD" IN BLACK ON A WHITE SCROLL ABOVE THE COAT OF ARMS  
AND THE WORDING "FOUNDED 1801" IN BLACK ON A WHITE SCROLL BELOW THE  
COAT OF ARMS. BELOW THE COAT OF ARMS APPEARS A BLUE BANNER OUTLINED

**Reg. No. 4,197,338** IN GOLD AND BLUE, WITH THE WORDING "CHIVAS REGAL" IN THE COLOR WHITE ACROSS THE BANNER. BELOW THAT BANNER IS THE WORDING "AGED 18 YEARS" IN WHICH THE WORDS "AGED" AND "YEARS" ARE GOLD AND THE NUMBER "18" IS IN WHITE, ALL CENTERED IN A BLUE OVAL THAT IS OUTLINED IN GOLD WITH BEIGE DOTS. BELOW THE OVAL IS A BLUE BANNER OUTLINED IN THE COLOR GOLD, WITH THE WORDING "GOLD SIGNATURE" IN THE COLOR WHITE ACROSS THE BANNER. A SMALLER BEIGE BANNER OUTLINED IN GOLD APPEARS AT THE BOTTOM OF THE SHIELD AND CONTAINS THE WORDING "PRODUCE OF SCOTLAND CHIVAS BROTHERS LTD DISTILLERS KEITH SCOTLAND" IN THE COLOR BLUE. THE LOWER PORTION OF THE BOX FEATURES THE DARK BROWN WORDING "CHIVAS BROTHERS" UNDERLINED IN DARK BROWN, THE GOLD SCRIPT WORDING "COLIN SCOTT", AND THE BROWN WORDING "PURVEYORS OF FINE WHISKIES" WITH A DARK BROWN OVERLINE. THE MATTER SHOWN IN DOTTED LINES IS NOT A PART OF THE MARK AND SERVES ONLY TO SHOW PLACEMENT OF THE MARK.

THE ENGLISH TRANSLATION OF "TREIBHIREAS BUNAITEACHD" IN THE MARK IS FIDELITY, STABILITY.

SER. NO. 85-464,512, FILED 11-4-2011.

ELLEN BURNS, EXAMINING ATTORNEY

# United States of America

United States Patent and Trademark Office



**Reg. No. 4,197,339**

**Registered Aug. 28, 2012**

**Int. Cl.: 41**

**SERVICE MARK**

**PRINCIPAL REGISTER**

BERGIN UNIVERSITY OF CANINE STUDIES (CALIFORNIA CORPORATION)  
1215 SEBASTOPOL ROAD  
SANTA ROSA, CA 95407

FOR: TRAINING ANIMALS FOR OTHERS, IN CLASS 41 (U.S. CLS. 100, 101 AND 107).

FIRST USE 6-1-2011; IN COMMERCE 6-1-2011.

THE MARK CONSISTS OF A PURPLE RIBBON WITH KHAKI OUTER STRIPS CONNECTED BY A KHAKI CIRCLE TO A PURPLE HEART WITH A KHAKI PAW PRINT ON THE INSIDE OF THE PURPLE HEART.

THE COLOR(S) PURPLE AND KHAKI IS/ARE CLAIMED AS A FEATURE OF THE MARK.

SER. NO. 85-465,128, FILED 11-4-2011.

JANICE KIM, EXAMINING ATTORNEY



*David J. Kybas*

Director of the United States Patent and Trademark Office

# United States of America

United States Patent and Trademark Office

## Vostice

**Reg. No. 4,197,340**

**Registered Aug. 28, 2012**

**Int. Cl.: 42**

**SERVICE MARK**

**PRINCIPAL REGISTER**

BOLDER IT SOLUTIONS (COLORADO CORPORATION)  
JASON JARVIS  
P.O. BOX 4067  
BOULDER, CO 80306

FOR: APPLICATION SERVICE PROVIDER (ASP), NAMELY, HOSTING COMPUTER SOFTWARE APPLICATIONS OF OTHERS; APPLICATION SERVICE PROVIDER, NAMELY, HOSTING, MANAGING, DEVELOPING, ANALYZING, AND MAINTAINING APPLICATIONS, SOFTWARE, AND WEB SITES, OF OTHERS IN THE FIELDS OF ADVERTISING AND MARKETING; APPLICATION SERVICE PROVIDER, NAMELY, HOSTING, MANAGING, DEVELOPING, ANALYZING, AND MAINTAINING APPLICATIONS, SOFTWARE, AND WEB SITES, OF OTHERS IN THE FIELDS OF HEALTHCARE, BENEFITS PROGRAMS, EMPLOYEE PRODUCTIVITY, RISK MANAGEMENT; APPLICATION SERVICE PROVIDER, NAMELY, HOSTING, MANAGING, DEVELOPING, AND MAINTAINING APPLICATIONS, SOFTWARE, AND WEB SITES, IN THE FIELDS OF PERSONAL PRODUCTIVITY, WIRELESS COMMUNICATION, MOBILE INFORMATION ACCESS, AND REMOTE DATA MANAGEMENT FOR WIRELESS DELIVERY OF CONTENT TO HANDHELD COMPUTERS, LAPTOPS AND MOBILE ELECTRONIC DEVICES; COMPUTER SERVICES, NAMELY, ACTING AS AN APPLICATION SERVICE PROVIDER IN THE FIELD OF INFORMATION MANAGEMENT TO HOST COMPUTER APPLICATION SOFTWARE FOR THE PURPOSE OF EMAIL; COMPUTER SERVICES, NAMELY, CLOUD HOSTING PROVIDER SERVICES; COMPUTER SERVICES, NAMELY, CREATING AN ON-LINE VIRTUAL ENVIRONMENT FOR PROVIDING VIRTUAL COMPUTER SYSTEMS AND VIRTUAL COMPUTER ENVIRONMENTS THROUGH CLOUD COMPUTING FOR USE BY BUSINESS OFFICES; COMPUTER SERVICES, NAMELY, PROVIDING VIRTUAL AND NON VIRTUAL APPLICATION SERVERS, WEB SERVERS, FILE SERVERS, CO-LOCATION SERVERS, LOAD BALANCING SERVERS, REDUNDANCY SERVERS, MEDIA SERVERS AND DATABASE SERVERS OF VARIABLE CAPACITY TO THIRD PARTY COMPUTING AND DATA STORAGE FACILITIES; CONSULTING IN THE FIELD OF VIRTUALIZATION TECHNOLOGIES FOR ENTERPRISES AND BUSINESSES; CONSULTING SERVICES IN THE FIELD OF HOSTING COMPUTER SOFTWARE APPLICATIONS; CONSULTING SERVICES IN THE FIELD OF OFFICE AND WORKPLACE AUTOMATION; DESIGN, CREATION, HOSTING AND MAINTENANCE OF INTERNET SITES FOR THIRD PARTIES; DESIGN, CREATION, HOSTING, MAINTENANCE OF WEBSITES FOR OTHERS; DEVELOPING AND HOSTING A SERVER ON A GLOBAL COMPUTER NETWORK FOR THE PURPOSE OF FACILITATING E-COMMERCE VIA SUCH A SERVER; HOSTING THE SOFTWARE, WEBSITES AND OTHER COMPUTER APPLICATIONS OF OTHERS ON A VIRTUAL PRIVATE SERVER; MAINTENANCE OF WEBSITES



*David J. Kybas*

Director of the United States Patent and Trademark Office



**Reg. No. 4,197,340** AND HOSTING ON-LINE WEB FACILITIES FOR OTHERS, IN CLASS 42 (U.S. CLS. 100 AND 101).

FIRST USE 1-1-2009; IN COMMERCE 1-1-2009.

THE MARK CONSISTS OF STANDARD CHARACTERS WITHOUT CLAIM TO ANY PARTICULAR FONT, STYLE, SIZE, OR COLOR.

SER. NO. 85-465,306, FILED 11-4-2011.

MARY CRAWFORD, EXAMINING ATTORNEY

# United States of America

United States Patent and Trademark Office

## UnHerd of Marketing

**Reg. No. 4,197,341**

JONES, CHRISTOPHER, W. (UNITED STATES INDIVIDUAL)  
1903 HIGHPOINT DRIVE  
OPELIKA, AL 36801

**Registered Aug. 28, 2012**

**Int. Cl.: 35**

FOR: ADVERTISING AND MARKETING CONSULTANCY, IN CLASS 35 (U.S. CLS. 100, 101 AND 102).

**SERVICE MARK**

FIRST USE 10-17-2011; IN COMMERCE 10-17-2011.

**PRINCIPAL REGISTER**

THE MARK CONSISTS OF STANDARD CHARACTERS WITHOUT CLAIM TO ANY PARTICULAR FONT, STYLE, SIZE, OR COLOR.

NO CLAIM IS MADE TO THE EXCLUSIVE RIGHT TO USE "MARKETING", APART FROM THE MARK AS SHOWN.

SER. NO. 85-465,363, FILED 11-5-2011.

NELSON SNYDER, EXAMINING ATTORNEY



*David J. Kyffers*

Director of the United States Patent and Trademark Office

# United States of America

United States Patent and Trademark Office

## DISCOVERING NEW MYSTERIES INTERNATIONAL MYSTERY WRITERS' FESTIVAL

**Reg. No. 4,197,342**

RIVERPARK CENTER, INC. (KENTUCKY CORPORATION)  
101 DAVIESS STREET  
OWENSBORO, KY 42303

**Registered Aug. 28, 2012**

**Int. Cl.: 41**

FOR: ENTERTAINMENT SERVICES, NAMELY, PLANNING AND CONDUCTING A WRITERS' COMPETITION AND FESTIVAL, INCLUDING LIVE THEATRICAL PERFORMANCES, IN CLASS 41 (U.S. CLS. 100, 101 AND 107).

**SERVICE MARK**

FIRST USE 6-17-2007; IN COMMERCE 6-17-2007.

**PRINCIPAL REGISTER**

THE MARK CONSISTS OF STANDARD CHARACTERS WITHOUT CLAIM TO ANY PARTICULAR FONT, STYLE, SIZE, OR COLOR.

NO CLAIM IS MADE TO THE EXCLUSIVE RIGHT TO USE "NEW MYSTERIES INTERNATIONAL MYSTERY WRITERS' FESTIVAL", APART FROM THE MARK AS SHOWN.

SER. NO. 85-465,891, FILED 11-7-2011.

NAAKWAMA ANKRAH, EXAMINING ATTORNEY



*David J. Kyros*

Director of the United States Patent and Trademark Office

# United States of America

United States Patent and Trademark Office

# VIDANT

**Reg. No. 4,197,343**

**Registered Aug. 28, 2012**

**Int. Cl.: 44**

**SERVICE MARK**

**PRINCIPAL REGISTER**

UNIVERSITY HEALTH SYSTEMS OF EASTERN CAROLINA, INC. (NORTH CAROLINA  
NON-PROFIT CORPORATION)  
P.O. BOX 6028  
2100 STANTONSBURG ROAD  
GREENVILLE, NC 27835

FOR: HOSPITALS; BEHAVIORAL HEALTH SERVICES; EMERGENCY MEDICAL ASSIST-  
ANCE; HEALTHCARE SERVICES; MEDICAL SERVICES; MEDICAL IMAGING SERVICES;  
MEDICAL CLINICS; PHYSICIAN SERVICES; PROVIDING A WEBSITE FEATURING  
MEDICAL INFORMATION; REHABILITATION PATIENT CARE SERVICES; SURGERY, IN  
CLASS 44 (U.S. CLS. 100 AND 101).

FIRST USE 1-25-2012; IN COMMERCE 1-25-2012.

THE MARK CONSISTS OF STANDARD CHARACTERS WITHOUT CLAIM TO ANY PAR-  
TICULAR FONT, STYLE, SIZE, OR COLOR.

THE WORDING "VIDANT" HAS NO MEANING IN A FOREIGN LANGUAGE.

SER. NO. 85-466,040, FILED 11-7-2011.

MYRIAH HABEEB, EXAMINING ATTORNEY



*David J. Kyros*

Director of the United States Patent and Trademark Office

# United States of America

United States Patent and Trademark Office

## Harvest Thy Me

**Reg. No. 4,197,344**

HARVEST THYME LLC (NEW YORK LIMITED LIABILITY COMPANY)  
133 S. WARSAW ST.  
DUNKIRK, NY 14048

**Registered Aug. 28, 2012**

**Int. Cl.: 16**

**TRADEMARK**

**PRINCIPAL REGISTER**

FOR: 3D DECALS FOR USE ON ANY SURFACE; A CREATIVE TOOL CONSISTING OF PHOTOGRAPHS AND WRITTEN WORK THAT ALLOWS STUDENTS TO ENCAPSULATE WILDERNESS EXPERIENCES THEY HAVE ENCOUNTERED IN A SPECIALIZED TREATMENT PROGRAM AND PROVIDE A BASIS FOR COMMUNICATION WITH OTHERS; A SERIES OF BOOKS AND WRITTEN ARTICLES IN THE FIELD OF SELF-DEVELOPMENT; A SERIES OF BOOKS, WRITTEN ARTICLES, HANDOUTS AND WORKSHEETS IN THE FIELD OF SELF-DEVELOPMENT; ART ETCHINGS; ART MOUNTS; ART PADS; ART PAPER; ART PICTURES; ART PRINTS; BLACKBOARDS, DRAWING BOARDS AND EASELS; BLANK CARDS; BLANK FORMS; BLANK JOURNAL BOOKS; BLANK JOURNALS; BLANK NOTE CARDS; BLANK OR PARTIALLY PRINTED PAPER LABELS; BLANK OR PARTIALLY PRINTED POSTCARDS; BLANK PAPER COMPUTER TAPES; BLANK PAPER COMPUTER TAPES FOR RECORDING PROGRAMS; BLANK PAPER NOTEBOOKS; BOND PAPER; BOOK BINDING MATERIALS; BOOK BINDINGS; BOOK COVERS; BOOK ENDS; BOOK HOLDERS; BOOK MARKERS; BOOK MARKERS OF PRECIOUS METAL; BOOK MARKS; BOOK PLATES; BOOK-COVER PAPER; BOOKBINDING CLOTH; BOOKBINDING CORDS; BOOKBINDING MATERIALS; BOOKBINDING MATERIALS FOR CREATING HARDCOVER BOOKS, NAMELY, BOOK COVERS, CRACK-AND-PEEL BINDING PAPER, REINFORCEMENT STRIPS, PEEL-AND-STICK LABELS, STAPLER AND STAPLES; BOOKBINDING TAPE; BOOKBINDING WIRE; BOOKBINDINGS; BOOKENDS; BOOKKEEPING FORMS; BOOKLETS IN THE FIELD OF SELF-DEVELOPMENT; BOOKMARKERS; BOOKMARKS; BOOKS AND PAMPHLETS IN THE FIELD OF FINANCIAL CLASSIFICATION OF COMPANIES AND SECURITIES; BOOKS IN THE FIELD OF MEMORY TRAINING ACTIVITIES SOLD AS A UNIT WITH TWO AND THREE DIMENSIONAL POSITIONABLE FIGURES; BOOKS IN THE FIELD OF SELF-DEVELOPMENT; BOXES OF CARDBOARD OR PAPER; BOXES OF PAPER; BOXES OF PAPER OR CARDBOARD. BOXES, CARTONS, STORAGE CONTAINERS, AND PACKAGING CONTAINERS MADE OF PAPER OR CARDBOARD; BOXES, CONTAINERS, AND CARTONS OF PAPERBOARD OR CARDBOARD FOR COMMERCIAL OR INDUSTRIAL PACKAGING; BRAG BOOKS; BROCHURES ABOUT SELF-DEVELOPMENT; BUMPER STICKERS; BUSINESS CARD PAPER; BUSINESS CARDS; BUSINESS FORMS; BUSINESS RECORD BOOKS; CALENDAR DESK PADS; CALENDAR DESK STANDS; CALENDAR REFILLS; CALENDAR STANDS; CALENDAR-FINISHED PAPER; CALENDARS; CALENDARS AND DIARIES; CANVAS FOR PRINTING; CANVAS PANELS FOR ARTISTS; CARD FILES; CARDBOARD; CARDBOARD CAKE BOXES; CARDBOARD



*David J. Kappas*

Director of the United States Patent and Trademark Office

**Reg. No. 4,197,344** CARRIERS FOR FOOD AND BEVERAGES; CARDBOARD CARTONS; CARDBOARD CONTAINERS; CARDBOARD HANG TAGS; CARDBOARD MADE FROM PAPER MULBERRY (SENKASI); CARDBOARD MAILING TUBES; CARDBOARD PACKAGING; CARDBOARD PACKAGING BOXES IN COLLAPSIBLE FORM; CARDBOARD PACKAGING BOXES IN MADE-UP FORM; CARDBOARD SIGNBOARDS; CARDBOARD TUBES; CARDS BEARING UNIVERSAL GREETINGS; CARDS NOT MAGNETICALLY CODED FOR USE IN BUSINESS TRANSACTIONS; CARDS, NAMELY, NOTE CARDS FEATURING SELF-DEVELOPMENT INFORMATION; CHECK MARKING MACHINES FOR PREVENTING FRAUD; CHECKBOOK AND PASSBOOK WALLETS; CHECKBOOK COVERS; CHECKBOOK HOLDERS; CHEQUE BOOKS; CHILDREN'S ACTIVITY BOOKS; CHILDREN'S BOOKS; CHILDREN'S INTERACTIVE EDUCATIONAL BOOKS; CHILDREN'S STORYBOOKS; CHILDREN'S WALL STICKERS AND MURALS; CHILDREN'S ARTS AND CRAFTS PAPER KITS; CHRISTMAS CARDS; COASTERS MADE OF CARDBOARD; COASTERS MADE OF PAPER; COASTERS OF PAPER; COFFEE TABLE BOOKS FEATURING SELF-DEVELOPMENT; COIN ALBUMS; COIN HOLDERS; COIN MATS; COIN WRAPPERS; COLLAGES; COLLAPSIBLE BOXES OF PAPER; COLLAPSIBLE CARDBOARD BOXES; COLLATORS FOR OFFICE USE; COLLECTIBLE PAPER MONEY; COLLECTOR'S PHOTOGRAPHS OF PLAYERS; COLOR PENCILS; COLOR PRINTS; COLORBOARD; COLORED CRAFT AND ART SAND; COLORING BOOKS; COLOUR PENCILS; COLUMNS ON THE SUBJECT OF SELF-DEVELOPMENT; COMIC BOOKS; COMIC MAGAZINES; COMIC STRIPS; COMICS; COMMEMORATIVE BOOKS FEATURING SELF-DEVELOPMENT; CONTAINERS FOR ICE MADE OF PAPER OR CARDBOARD. CONTAINERS FOR STORAGE OR TRANSPORT MADE OF PAPER OR CARDBOARD; COOK BOOKS; COOKBOOK HOLDERS; COPY PAPER; COPYBOOKS; CRAYONS; CREPED WOOD PULP PAPER FILTER THAT IS ACID AND ALKALI RESISTANT FOR LABORATORY AND INDUSTRIAL PURPOSES; CROSSWORD PUZZLES; CUSTOM PAINTINGS; CUSTOMIZABLE JOURNAL BOOKS; DAILY PLANNERS; DATA BOOKS; DATE INDICATORS; DATE STAMPS; DAY PLANNERS; DECORATIVE DECALS FOR VEHICLE WINDOWS; DECORATIVE PAPER CENTERPIECES; DECORATIVE PENCIL-TOP ORNAMENTS; DECORATIVE STICKERS FOR HELMETS; DECORATORS' PAINTBRUSHES; DESK BASKETS FOR DESK ACCESSORIES; DESK BLOTTERS; DESK CALENDARS; DESK FILE TRAYS; DESK MOUNT BOARDS FOR READING AND WRITING; DESK MOUNTED STATIONERY CABINETS; DESK PADS; DESK SETS; DESK STANDS AND HOLDERS FOR PENS, PENCILS, AND INK; DESKTOP BUSINESS CARD HOLDERS; DESKTOP DOCUMENT FILE STANDS; DESKTOP DOCUMENT RACKS; DESKTOP DOCUMENT STANDS; DESKTOP ORGANIZERS; DESKTOP PLANNERS; DESKTOP REVOLVING ROTARY CARD FILES; DESKTOP STATIONERY CABINETS; DIAGRAMS FOR SELF-DEVELOPMENT; DIARIES; DICTATION BOOKS; DICTIONARIES; DIRECTORIES OF SELF-DEVELOPMENT; DOCUMENT COVERS; DOCUMENT FILE RACKS; DOCUMENT FILE TRAYS; DOCUMENT FOLDERS IN THE FORM OF WALLETS; DOCUMENT MARKERS; DOCUMENT PORTFOLIOS; DRAFTING RULERS; DRAFTING SQUARES; DRAFTING TEMPLATES; DRAFTING TRAYS; DRAFTING TRIANGLES; DRAWER LINERS; DRAWING BOARDS; DRAWING BRUSHES; DRAWING COMPASSES; DRAWING CURVES; DRAWING IMPLEMENTS, NAMELY, SQUARE RULERS; DRAWING INSTRUMENTS; DRAWING MATERIALS FOR BLACKBOARDS; DRAWING PADS; DRAWING PAPER; DRAWING PENCILS; DRAWING RULERS; DRAWING SHIELDS; DRAWING TABLETS; DRAWING TEMPLATES; DRAWING TRAYS; DRAWING TRIANGLES; DRAWINGS; DRY TRANSFER CHARACTERS; DUPLICATING INK; DUPLICATING MACHINES; DUPLICATING PAPER; DYE-SUBLIMATION PRINT PAPER; EASEL PADS; EASELS; EDUCATIONAL PUBLICATIONS, NAMELY, TRAINING MANUALS IN THE FIELD OF SELF-DEVELOPMENT; ENTRY TICKETS; ENVELOPE PAPER; ENVELOPE PAPERS; ENVELOPE SEALING MACHINES FOR OFFICES; ENVELOPES; ENVELOPES FOR STATIONERY USE; EPHEMERA, NAMELY, AUTOGRAPHS OF FAMOUS INDIVIDUALS; ERASABLE MARKERS FOR MARKING THE SURFACE OF A DRINKING GLASS FOR PURPOSES OF DECORATION AND/OR IDENTIFICATION; EVENT ALBUMS; EVENT PROGRAMS; EVENTS ALBUMS; EVENTS PROGRAMMES; EXPENSE BOOKS; FABRIC GIFT BAGS; FABRICS FOR BOOKBINDING; FACE TOWELS OF PAPER; FACSIMILE TRANSMISSION PAPER; FELT MARKING PENS; FELT PENS; FELT TIP MARKERS; FILING FOLDERS, PAPER LABELS AND PRINTED INSTRUCTIONAL MATERIALS FOR ORGANIZING PERSONAL FILES; FINGERPRINT KITS; FLAGS

**Reg. No. 4,197,344** OF PAPER; FLASH CARDS; FLIP BOOKS; FLIP CHART CARRYING CASES; FOLDERS; FOLDERS FOR LETTERS; FOLDING BOXBOARD MADE OF CHEMICAL AND MECHANICAL PULP; FOOD BAG TAPE FOR FREEZER USE; FOOD CONTAINER BAGS FOR USE IN TOASTERS; FOOD WRAPPERS; FOOD WRAPPING PLASTIC FILM FOR HOUSEHOLD USE; FOUNTAIN PENS; GEL ROLLER PENS; GENERAL FEATURE MAGAZINE IN THE FIELD OF SELF-DEVELOPMENT; GENERAL PURPOSE PLASTIC BAGS; GIFT BOOKS FEATURING SELF-DEVELOPMENT; GIFT BOXES; GIFT BOXES CONTAINING NOTE CARDS; GIFT BOXES MADE OF CARDBOARD; GIFT SETS CONSISTING OF A BOOK IN THE FIELD OF SELF-DEVELOPMENT AND ALSO INCLUDING A BLANKET; GIFT SETS CONSISTING PRIMARILY OF PRINTED MESSAGES CONTAINED IN A BOTTLE, GIFT CARDS AND ALSO INCLUDING STONES AND CHOCOLATES; GIFT WRAP PAPER; GIFT WRAP PAPER EMBEDDED WITH WILDFLOWER SEEDS; GIFT WRAPPING PAPER; GIFT-WRAPPING PAPER; GLASSINE PAPER; GLITTER GLUE FOR STATIONERY PURPOSES; GLUE FOR STATIONERY OR HOUSEHOLD PURPOSES; GRAPHIC ART PRINTS; GRAPHIC ART REPRODUCTIONS; GRAPHIC FINE ART PRINTS; GRAPHIC NOVELS; GRAPHIC PRINTS AND REPRESENTATIONS; GREETING CARDS; GREETING CARDS HAVING A CHRISTIAN MESSAGE. GREETINGS CARDS AND POSTCARDS; GUIDE BOOKS FEATURING SELF-DEVELOPMENT; HANGING FOLDERS; HAT BOXES OF CARDBOARD; HAT BOXES OF PAPER; INFORMATIONAL FLYERS FEATURING SELF-DEVELOPMENT; INFORMATIONAL LETTERS CONCERNING SELF-DEVELOPMENT; INFORMATIONAL SHEETS ABOUT SELF-DEVELOPMENT; INSTRUCTION SHEETS IN THE FIELD OF SELF-DEVELOPMENT; INVITATION CARDS; JOURNALS CONCERNING SELF-DEVELOPMENT; LAP BOARDS FOR READING AND WRITING; LAP DESKS; LEAFLETS ABOUT SELF-DEVELOPMENT; LEATHER APPOINTMENT BOOK COVERS; LEDGER BOOKS; LETTER RACKS; LETTER TRAYS; LETTERHEAD PAPER; LOG BOOKS; LOOSE LEAF BINDERS; LOOSE LEAF PAPER; LOOSE-LEAF PADS; MAGNETIC BUMPER STICKERS; MAGNETIC PAPER; MAILING LABELS; MARKING TEMPLATES; MEMO BLOCKS; MEMO PADS; MEMO SORTERS; MEMORANDUM BOARDS; MEMORANDUM BOOKS; MEMORY BOOKS; MEMORY BOXES, NAMELY, CARDBOARD BOXES CONTAINING CARDBOARD CARDS FOR DISPLAYING AND STORING SELF-DEVELOPMENT KEEPSAKES AND MEMENTOS; PEN AND PENCIL CASES; PEN AND PENCIL CASES AND BOXES; PEN AND PENCIL HOLDERS; PEN AND PENCIL TRAYS; PEN CASES; PEN TRAYS; PENCIL BOXES; PENCIL OR PEN BOXES; PENCIL ORNAMENTS; PENCIL SHARPENERS; PENCILS; PENCILS FOR PAINTING AND DRAWING; PENHOLDERS; PENS; PERSONALIZED WRITING JOURNALS; PERSONALIZED WRITTEN OR PRINTED MESSAGES IN DECORATIVE MINIATURE ENVELOPES CONTAINED IN A JAR; PICTURE POSTCARDS; PICTURES; POCKET MEMORANDUM BOOKS; PORTRAITS; POST CARDS; POSTCARD PAPER; POSTCARDS; POSTCARDS AND GREETING CARDS; POSTCARDS AND PICTURE POSTCARDS; POSTER BOARD; POSTERS; POSTERS MADE OF PAPER; PRINTED CALENDARS; PRINTED CHILDREN'S COLORING PAGES; PRINTED CORRESPONDENCE COURSE MATERIALS IN THE FIELD OF SELF-DEVELOPMENT; PRINTED EDUCATIONAL MATERIAL, NAMELY, TEACHING TILES; PRINTED EDUCATIONAL MATERIALS IN THE FIELD OF SELF-DEVELOPMENT; PRINTED FORMS; PRINTED GUIDES FOR SELF-DEVELOPMENT; PRINTED HOLOGRAMS; PRINTED INFORMATIONAL CARDS IN THE FIELD OF SELF-DEVELOPMENT; PRINTED INFORMATIONAL FOLDERS IN THE FIELD OF SELF-DEVELOPMENT; PRINTED INSTRUCTIONAL, EDUCATIONAL, AND TEACHING MATERIALS IN THE FIELD OF SELF-DEVELOPMENT; PRINTED INVITATIONS; PRINTED LECTURES; PRINTED LESSONS ON SELF-DEVELOPMENT; PRINTED MAIL RESPONSE CARDS RELATING TO SELF-DEVELOPMENT; PRINTED MATERIALS, NAMELY, CURRICULA IN THE FIELD OF SELF-DEVELOPMENT; PRINTED MATERIALS, NAMELY, JOURNALS FEATURING SELF-DEVELOPMENT; PRINTED MATERIALS, NAMELY, WRITTEN ARTICLES IN THE FIELD OF SELF-DEVELOPMENT; PRINTED MATTER, NAMELY, NEWSPAPERS, PHOTOGRAPHS, MAGAZINES, BOOKS, PRINTED PERIODICALS, NEWSLETTERS, AND BROCHURES ALL IN THE FIELDS OF SECURITIES, OPTIONS AND OTHER FINANCIAL INSTRUMENTS; PRINTED MATTER, NAMELY, PAPER SIGNS, BOOKS, MANUALS, CURRICULUM, NEWSLETTERS, INFORMATIONAL CARDS AND BROCHURES IN THE FIELD OF SELF-DEVELOPMENT; PRINTED PAMPHLETS, BROCHURES, MANUALS, BOOKS, BOOKLETS, LEAFLETS, FLYERS, INFORMATIONAL SHEETS AND NEWSLETTERS,

**Reg. No. 4,197,344** ADHESIVE BACKED STICKERS, AND KITS COMPRISING ONE OR MORE OF THE FOREGOING MATERIALS IN THE FIELD OF SELF-DEVELOPMENT; PRINTED PAPER SIGNS, NAMELY, TABLE TENTS; PRINTED PATTERNS; PRINTED ROTARY WHEELS FOR SELF-DEVELOPMENT; PRINTED SEMINAR NOTES; PRINTED SPEECH AND LANGUAGE THERAPY CARDS TO ENHANCE SPEECH AND LANGUAGE SKILLS; PRINTED TEACHING ACTIVITY GUIDES IN THE FIELD OF SELF-DEVELOPMENT; PRINTED TEACHING MATERIALS IN THE FIELD OF SELF-DEVELOPMENT; PRINTED TRAINING MATERIALS IN THE FIELD OF SELF-DEVELOPMENT; PUBLICATIONS, NAMELY, BROCHURES, BOOKLETS, AND TEACHING MATERIALS IN THE FIELD OF SELF-DEVELOPMENT; RELIGIOUS BOOKS; RELIGIOUS CIRCULAR LETTERS; REPRODUCTION PAPER; ROLLER BALL PENS; SCENTED DRAWER LINERS; SCENTED PAPER DRAWER LINERS; SCRAP BOOKS; SCRAPBOOK ALBUMS; SCRAPBOOK PAGES; SCRAPBOOKS. SCRATCH CARDS; SCRATCH PADS; SCRIBBLE PADS; SEAL INK PADS; SEALING STAMPS; SEALING WAX; SEALS; SEALS FOR OFFICES; SEMI-PROCESSED PAPER; SKETCH BOOKS; SKETCH PADS; SKETCHBOOKS; SKETCHES; SMALL BLACKBOARDS; SOCIAL NOTE CARDS; SONG BOOKS; SPIRAL BINDING MACHINES FOR OFFICE USE; SPIRAL-BOUND NOTEBOOKS; STAMP ALBUMS; STAMP CASES; STAMP INKS; STAMP PAD INKS; STAMP PADS; STAMP STANDS; STAMPING INKS; STAPLING PRESSES; STATIONERY; STATIONERY CASES; STATIONERY FOLDERS; STATIONERY WRITING PAPER AND ENVELOPES; STATIONERY-TYPE PORTFOLIOS; STEEL PENS; STENCIL CASES; STENCIL PAPER; STENCIL PLATES; STENCILING MACHINES; STENCILS; STENCILS USED IN THE PRODUCTION OF ELECTRONIC CIRCUIT BOARDS AND OTHER ELECTRONIC COMPONENTS; STENCILS USED TO APPLY DESIGNS ONTO TENNIS RACKETS; STICKER ALBUMS; STICKERS; STICKERS AND DECALCOMANIAS; STICKERS AND STICKER ALBUMS; STORAGE ALBUMS FOR TYPEWRITER PRINTWHEELS AND TYPEBALLS; STORAGE CONTAINERS MADE OF PAPER; STORY BOOKS; TABLE MATS MADE OF CARDBOARD; TABLE MATS OF PAPER; TAGS FOR INDEX CARDS; TALKING CHILDREN'S BOOKS; TAROT CARDS; TEAR-OFF CALENDARS; TRAVEL BOOKS; TREATED PAPER FOR WRAPPING FLOWERS AND FLORAL DISPLAYS; TRIVIA CARDS; UNMOUNTED POSTERS; UNPRINTED PAPER; VISITING CARDS; WALL CALENDARS; WALL COVERING SAMPLE BOOKS; WALLPAPER SAMPLE BOOK; WALLPAPER STENCILS; WEDDING ALBUMS; WEDDING BOOKS; WIRE-BOUND NOTEBOOKS; WIREBOUND BOOKS; WOOD PULP PAPER; WORKBOOKS DIRECTED TO SELF-DEVELOPMENT; WORKS OF ART MADE FROM CUSTOM MANUFACTURED PAPER; WRAPPING PAPER; WRISTBANDS FOR THE RETENTION OF WRITING INSTRUMENTS; WRITING BRUSHES; WRITING GRIPS; WRITING IMPLEMENTS; WRITING INK; WRITING INSTRUMENTS; WRITING JOURNAL SHEETS; WRITING PADS; WRITING PAPER; WRITING PAPER HOLDERS; WRITING PAPER PADS; WRITING PEN KITS COMPRISING PARTS FOR MAKING WRITING PENS. WRITING PENS THAT MAY ALSO BE USED TO PERFORM PEN SPINNING TRICKS; WRITING SLATES; WRITING TABLETS; WRITING UTENSILS; WRITING UTENSILS MADE OF FIBRES, IN CLASS 16 (U.S. CLS. 2, 5, 22, 23, 29, 37, 38 AND 50).

FIRST USE 0-0-2011; IN COMMERCE 0-0-2011.

THE MARK CONSISTS OF STANDARD CHARACTERS WITHOUT CLAIM TO ANY PARTICULAR FONT, STYLE, SIZE, OR COLOR.

SER. NO. 85-466,275, FILED S.R. 11-7-2011 AM. P.R. 3-19-2012.

JASON TURNER, EXAMINING ATTORNEY



# United States of America

United States Patent and Trademark Office



**Reg. No. 4,197,345**

**Registered Aug. 28, 2012**

**Int. Cl.: 44**

**SERVICE MARK**

**PRINCIPAL REGISTER**

MIDWEST ENDOSCOPY CENTER, LLC (ILLINOIS LIMITED LIABILITY COMPANY)  
1243 RICKERT DRIVE  
NAPERVILLE, IL 60540

FOR: MEDICAL CLINICS; MEDICAL SCREENING SERVICES IN THE FIELD OF GASTROINTESTINAL DISEASE AND DISTRESS; MEDICAL SERVICES; MEDICAL SERVICES, NAMELY, ENDOSCOPY AND GASTROENTEROLOGY; MEDICAL TESTING FOR DIAGNOSTIC OR TREATMENT PURPOSES IN THE FIELD OF ENDOSCOPY AND GASTROENTEROLOGY, IN CLASS 44 (U.S. CLS. 100 AND 101).

FIRST USE 8-1-2010; IN COMMERCE 8-1-2010.

THE MARK CONSISTS OF A BLUE RECTANGLE WITH THE LETTERS "E" AND "C" APPEARING IN THE CENTER; THE LETTERS "E" AND "C" ARE IN THE COLOR WHITE AND PARTIALLY OVERLAP.

THE COLOR(S) BLUE AND WHITE IS/ARE CLAIMED AS A FEATURE OF THE MARK.

SER. NO. 85-466,364, FILED 11-7-2011.

DAVID TAYLOR, EXAMINING ATTORNEY



*David J. Kypos*

Director of the United States Patent and Trademark Office

# United States of America

United States Patent and Trademark Office

# CriticalPast

**Reg. No. 4,197,346**

CRITICAL PAST LLC (DELAWARE LIMITED LIABILITY COMPANY)  
12100 SUNRISE VALLEY DRIVE SUITE 230-36  
RESTON, VA 20191

**Registered Aug. 28, 2012**

**Int. Cl.: 9**

FOR: DOWNLOADABLE IMAGE FILES CONTAINING ARTWORK, TEXT, AUDIO AND VIDEO, NAMELY, DOWNLOADABLE PHOTOGRAPHS, STOCK FOOTAGE, NEWSREEL FILMS, FILMS, VIDEO RECORDINGS, AUDIO RECORDINGS, STILL IMAGES, MOVING IMAGES, PICTURES AND DIGITAL CONTENT IN THE FIELD OF SOCIETAL HISTORY VIA THE INTERNET AND WIRELESS DEVICES; EXPOSED PHOTOGRAPHIC FILM; EXPOSED CINEMATOGRAPHIC FILM; AUDIO AND VIDEO RECORDINGS FEATURING TOPICS OF HISTORICAL INTEREST, IN CLASS 9 (U.S. CLS. 21, 23, 26, 36 AND 38).

**TRADEMARK**

**PRINCIPAL REGISTER**

FIRST USE 4-0-2010; IN COMMERCE 4-0-2010.

THE MARK CONSISTS OF STANDARD CHARACTERS WITHOUT CLAIM TO ANY PARTICULAR FONT, STYLE, SIZE, OR COLOR.

SER. NO. 85-466,838, FILED 11-8-2011.

BENJAMIN OKEKE, EXAMINING ATTORNEY



*David J. Kyffers*

Director of the United States Patent and Trademark Office

# United States of America

United States Patent and Trademark Office

# RETROSHEAR

**Reg. No. 4,197,347**

ADVANCED RESEARCH, LTD (OREGON CORPORATION)  
PO BOX 1705  
OREGON CITY, OR 97045

**Registered Aug. 28, 2012**

**Int. Cl.: 19**

FOR: BUILDING MATERIALS, NAMELY, SEMI-WORKED WOODS, IN CLASS 19 (U.S. CLS. 1, 12, 33 AND 50).

**TRADEMARK**

FIRST USE 12-9-2010; IN COMMERCE 1-28-2011.

**PRINCIPAL REGISTER**

THE MARK CONSISTS OF STANDARD CHARACTERS WITHOUT CLAIM TO ANY PARTICULAR FONT, STYLE, SIZE, OR COLOR.

SER. NO. 85-467,041, FILED 11-8-2011.

WILLIAM BRECKENFELD, EXAMINING ATTORNEY



*David J. Kybas*

Director of the United States Patent and Trademark Office

# United States of America

United States Patent and Trademark Office

# DECAYSTOP

**Reg. No. 4,197,348**

ADVANCED RESEARCH LTD (OREGON CORPORATION)  
PO BOX 1705  
OREGON CITY, OR 97045

**Registered Aug. 28, 2012**

**Int. Cl.: 2**

FOR: WOOD PRESERVATIVES, IN CLASS 2 (U.S. CLS. 6, 11 AND 16).

**TRADEMARK**

FIRST USE 12-9-2010; IN COMMERCE 1-28-2011.

**PRINCIPAL REGISTER**

THE MARK CONSISTS OF STANDARD CHARACTERS WITHOUT CLAIM TO ANY PARTICULAR FONT, STYLE, SIZE, OR COLOR.

SER. NO. 85-467,156, FILED 11-8-2011.

HOWARD B. LEVINE, EXAMINING ATTORNEY



*David J. Kyros*

Director of the United States Patent and Trademark Office

# United States of America

United States Patent and Trademark Office

## WAIST AWAY

**Reg. No. 4,197,349**

**Registered Aug. 28, 2012**

**Int. Cl.: 5**

**TRADEMARK**

**PRINCIPAL REGISTER**

EMPIRE BOTANICAL LABS, LLC (NEW YORK LIMITED LIABILITY COMPANY)  
70 CAROLYN BOULEVARD  
FARMINGDALE, NY 11734

FOR: NUTRITIONAL SUPPLEMENTS, IN CLASS 5 (U.S. CLS. 6, 18, 44, 46, 51 AND 52).

FIRST USE 2-20-2012; IN COMMERCE 2-20-2012.

THE MARK CONSISTS OF STANDARD CHARACTERS WITHOUT CLAIM TO ANY PARTICULAR FONT, STYLE, SIZE, OR COLOR.

SER. NO. 85-467,224, FILED 11-8-2011.

ROBIN CHOSID, EXAMINING ATTORNEY



*David J. Kyffers*

Director of the United States Patent and Trademark Office

# United States of America

United States Patent and Trademark Office



**Reg. No. 4,197,350**

JOONG ANG MEDIA NETWORK U.S.A., INC. (CALIFORNIA CORPORATION)  
690 WILSHIRE PLACE  
LOS ANGELES, CA 90005

**Registered Aug. 28, 2012**

**Int. Cl.: 35**

FOR: TELEPHONE DIRECTORY ASSISTANCE SERVICES, IN CLASS 35 (U.S. CLS. 100, 101 AND 102).

**SERVICE MARK**

FIRST USE 4-7-2003; IN COMMERCE 4-7-2003.

**PRINCIPAL REGISTER**

THE MARK CONSISTS OF THE STYLIZED WORDING "HANANET" WITH "HANA" IN BLUE AND "NET" IN LIME GREEN, TO THE LEFT OF A SUPERSCRIPT LETTER "J" IN A SMALL CIRCLE, BOTH IN BLACK, AND ABOVE KOREAN CHARACTERS IN BLACK, BLUE AND LIME GREEN, WHICH TRANSLITERATE TO "HANANET". ABOVE THE WORDING IN THE MARK APPEARS THE NUMBER "1" IN WHITE WITHIN A BLUE CIRCLE.

THE COLOR(S) BLUE, LIME GREEN, BLACK AND WHITE IS/ARE CLAIMED AS A FEATURE OF THE MARK.

THE NON-LATIN CHARACTERS IN THE MARK TRANSLITERATE TO "HANANET" AND THIS MEANS "ONE NET" OR "FOUR ONES" IN ENGLISH.

SER. NO. 85-467,672, FILED 11-8-2011.

NICHOLAS ALTREE, EXAMINING ATTORNEY



*David J. Kybas*

Director of the United States Patent and Trademark Office

# United States of America

United States Patent and Trademark Office



**LIVE-WALK-AROUND**

**Reg. No. 4,197,351**

**Registered Aug. 28, 2012**

**Int. Cl.: 38**

**SERVICE MARK**

**PRINCIPAL REGISTER**

I DO STREAM LLC (CONNECTICUT LIMITED LIABILITY COMPANY)  
132 WILDWOOD RD.  
TOLLAND, CT 06084

FOR: ELECTRONIC TRANSMISSION AND STREAMING OF DIGITAL MEDIA CONTENT FOR OTHERS VIA GLOBAL AND LOCAL COMPUTER NETWORKS; STREAMING OF VIDEO MATERIAL ON THE INTERNET; STREAMING OF LIVE VIDEO MATERIAL ON THE INTERNET; TELECOMMUNICATION SERVICES, NAMELY, TRANSMISSION OF WEBCASTS, IN CLASS 38 (U.S. CLS. 100, 101 AND 104).

FIRST USE 12-0-2010; IN COMMERCE 12-0-2010.

THE MARK CONSISTS OF "LIVE-WALK-AROUND" BELOW A STYLIZED CAR AND PERSON HOLDING A CAMERA DESIGN WITHIN A RECTANGLE. THE WORDS "LIVE-WALK-AROUND" APPEAR IN THE COLOR BLACK. THE RECTANGLE APPEARS IN THE COLOR GREEN AND IS OUTLINED IN BLACK. THE CAR APPEARS IN THE COLORS BLACK AND WHITE AND THE PERSON AND CAMERA APPEAR IN THE COLOR BLACK.

THE COLOR(S) GREEN, BLACK AND WHITE IS/ARE CLAIMED AS A FEATURE OF THE MARK.

SER. NO. 85-467,918, FILED 11-9-2011.

PAUL MORENO, EXAMINING ATTORNEY



*David J. Kyffers*

Director of the United States Patent and Trademark Office

# United States of America

United States Patent and Trademark Office

## IPM PREMIUM FOOD SOURCE

**Reg. No. 4,197,352**

LIMSON TRADING, INC. (DELAWARE CORPORATION)  
1045 GEZON PARKWAY  
GRAND RAPIDS, MI 49509

**Registered Aug. 28, 2012**

**Int. Cl.: 29**

FOR: FRUITS, NAMELY, CANNED GRAPEFRUIT SECTIONS; SEAFOOD, NAMELY, YELLOWFIN TUNA, SHRIMP, POLLOCK, SQUID RINGS, AND CAPE WHITING FILLETS; VEGETABLES, NAMELY, CANNED WATER CHESTNUTS, BAMBOO SHOOTS, CARROTS, AND ROASTED PEPPERS, IN CLASS 29 (U.S. CL. 46).

**TRADEMARK**

**PRINCIPAL REGISTER**

FIRST USE 6-15-1997; IN COMMERCE 6-15-1997.

THE MARK CONSISTS OF STANDARD CHARACTERS WITHOUT CLAIM TO ANY PARTICULAR FONT, STYLE, SIZE, OR COLOR.

OWNER OF U.S. REG. NO. 2,642,628.

NO CLAIM IS MADE TO THE EXCLUSIVE RIGHT TO USE "PREMIUM FOOD SOURCE", APART FROM THE MARK AS SHOWN.

SER. NO. 85-468,433, FILED 11-9-2011.

ALICE BENMAMAN, EXAMINING ATTORNEY



*David J. Kybas*

Director of the United States Patent and Trademark Office



# United States of America

United States Patent and Trademark Office

## THESPOTCLUB

**Reg. No. 4,197,353**

**Registered Aug. 28, 2012**

**Int. Cl.: 35**

**SERVICE MARK**

**PRINCIPAL REGISTER**

TPS PARKING MANAGEMENT, LLC (DELAWARE LIMITED LIABILITY COMPANY)  
200 W. MONROE  
37TH FLOOR  
CHICAGO, IL 60606

FOR: OFFERING, ARRANGING, AND CONDUCTING A CUSTOMER LOYALTY AND INCENTIVE REWARD PROGRAM WHICH OFFERS LOYALTY POINTS TO CUSTOMERS WHO PURCHASE VEHICLE PARKING LOT AND SHUTTLE SERVICES FROM THE APPLICANT TO PROMOTE VEHICLE PARKING LOT AND SHUTTLE SERVICES, IN CLASS 35 (U.S. CLS. 100, 101 AND 102).

FIRST USE 8-12-2002; IN COMMERCE 8-12-2002.

THE MARK CONSISTS OF STANDARD CHARACTERS WITHOUT CLAIM TO ANY PARTICULAR FONT, STYLE, SIZE, OR COLOR.

SER. NO. 85-468,560, FILED 11-9-2011.

YAT SYE, LEE, EXAMINING ATTORNEY



*David J. Kybas*

Director of the United States Patent and Trademark Office

# United States of America

United States Patent and Trademark Office

# YOCHI

**Reg. No. 4,197,354**

**Registered Aug. 28, 2012**

**Int. Cl.: 43**

**SERVICE MARK**

**PRINCIPAL REGISTER**

YOCHI YOGURT, INC. (NEW YORK CORPORATION)  
83 SOUTH OCEAN AVENUE  
PATCHOGUE, NY 11772

FOR: RESTAURANT SERVICES FEATURING FROZEN YOGURT, IN CLASS 43 (U.S. CLS. 100 AND 101).

FIRST USE 8-19-2010; IN COMMERCE 8-19-2010.

THE MARK CONSISTS OF STANDARD CHARACTERS WITHOUT CLAIM TO ANY PARTICULAR FONT, STYLE, SIZE, OR COLOR.

THE ENGLISH TRANSLATION OF THE JAPANESE TERM "YOCHI" IS "EARTH".

SER. NO. 85-468,777, FILED 11-9-2011.

PRISCILLA MILTON, EXAMINING ATTORNEY



*David J. Kybas*

Director of the United States Patent and Trademark Office

# United States of America

United States Patent and Trademark Office

## SILVER ANGELS

**Reg. No. 4,197,355**

**Registered Aug. 28, 2012**

**Int. Cls.: 37 and 45**

**SERVICE MARK**

**PRINCIPAL REGISTER**

SIGNATURE HEALTHCARE, LLC (DELAWARE LIMITED LIABILITY COMPANY)  
12201 BLUEGRASS PARKWAY  
LOUISVILLE, KY 40299

FOR: HOME REPAIR, HOME MODIFICATION AND GENERAL HOME MAINTENANCE SERVICES; ELDER CARE, NON-MEDICAL IN-HOME CARE, AND ASSISTED LIVING SERVICES TO THE ELDERLY AND OTHER PEOPLE NEEDING ASSISTANCE, NAMELY, MAKING AND CHANGING BEDS, IN CLASS 37 (U.S. CLS. 100, 103 AND 106).

FIRST USE 11-1-2011; IN COMMERCE 11-1-2011.

FOR: ELDER CARE, NON-MEDICAL IN-HOME CARE, AND ASSISTED LIVING SERVICES TO THE ELDERLY AND OTHER PEOPLE NEEDING PERSONAL ASSISTANCE, NAMELY, PERSONALLY PROVIDING COMPANIONSHIP AND CONVERSATION, PERSONAL REMINDER SERVICES IN THE AREA OF UPCOMING APPOINTMENTS AND EVENTS, PERSONALLY ASSISTING WITH CLOTHING SELECTION, DRESSING, BASIC GROOMING, PERSONAL HYGIENE IN THE FORM OF BATHING OR SHOWERING, AMBULATING, FEEDING, AND RUNNING OF ERRANDS; INVESTIGATION AND SURVEILLANCE SERVICES RELATING TO THE SAFETY OF SENIOR CITIZENS, IN CLASS 45 (U.S. CLS. 100 AND 101).

FIRST USE 11-1-2011; IN COMMERCE 11-1-2011.

THE MARK CONSISTS OF STANDARD CHARACTERS WITHOUT CLAIM TO ANY PARTICULAR FONT, STYLE, SIZE, OR COLOR.

SER. NO. 85-469,050, FILED 11-10-2011.

SANDRA BUJA, EXAMINING ATTORNEY



*David J. Kyjars*

Director of the United States Patent and Trademark Office

# United States of America

United States Patent and Trademark Office

# Brother Grey

**Reg. No. 4,197,356**

**Registered Aug. 28, 2012**

**Int. Cl.: 41**

**SERVICE MARK**

**PRINCIPAL REGISTER**

BROTHER GREY ENTERTAINMENT GROUP, LLC (GEORGIA LIMITED LIABILITY COMPANY)  
3776 CLAIRMONT RD.  
ATLANTA, GA 30341

FOR: ENTERTAINMENT, NAMELY, LIVE PERFORMANCES BY ROCK GROUPS, IN CLASS 41 (U.S. CLS. 100, 101 AND 107).

FIRST USE 1-1-2008; IN COMMERCE 1-1-2008.

THE MARK CONSISTS OF STANDARD CHARACTERS WITHOUT CLAIM TO ANY PARTICULAR FONT, STYLE, SIZE, OR COLOR.

SER. NO. 85-469,337, FILED 11-10-2011.

KAREN K. BUSH, EXAMINING ATTORNEY



*David J. Kyffers*

Director of the United States Patent and Trademark Office

# United States of America

United States Patent and Trademark Office

## Herbal Cup

Enjoy healing herbs in a  
cup!

**Reg. No. 4,197,357**

SINGH, GURCHARAN (UNITED STATES INDIVIDUAL)  
P.O. BOX 352132

**Registered Aug. 28, 2012**

LOS ANGELES, CA 900352132

**Int. Cl.: 30**

FOR: HERBAL TEA, IN CLASS 30 (U.S. CL. 46).

**TRADEMARK**

FIRST USE 10-27-2011; IN COMMERCE 10-27-2011.

**PRINCIPAL REGISTER**

THE MARK CONSISTS OF STANDARD CHARACTERS WITHOUT CLAIM TO ANY PARTICULAR FONT, STYLE, SIZE, OR COLOR.

NO CLAIM IS MADE TO THE EXCLUSIVE RIGHT TO USE "HERBAL", APART FROM THE MARK AS SHOWN.

SER. NO. 85-469,566, FILED 11-10-2011.

KATHERINE CONNOLLY, EXAMINING ATTORNEY



*David J. Kybas*

Director of the United States Patent and Trademark Office

# United States of America

United States Patent and Trademark Office

# SMART APA

**Reg. No. 4,197,358**

IBEZA LLC (FLORIDA LIMITED LIABILITY COMPANY)  
2550 DOUGLAS ROAD  
CORAL GABLES, FL 33133

**Registered Aug. 28, 2012**

**Int. Cl.: 9**

FOR: MEDICAL SOFTWARE FOR PROVIDING MEDICAL PROFESSIONALS WITH INFORMATION NEEDED TO MAKE MEDICAL RELATED DECISIONS AND FOR AUTOMATING PRIOR AUTHORIZATION PROCESSES, IN CLASS 9 (U.S. CLS. 21, 23, 26, 36 AND 38).

**TRADEMARK**

FIRST USE 11-7-2011; IN COMMERCE 11-7-2011.

**PRINCIPAL REGISTER**

THE MARK CONSISTS OF STANDARD CHARACTERS WITHOUT CLAIM TO ANY PARTICULAR FONT, STYLE, SIZE, OR COLOR.

NO CLAIM IS MADE TO THE EXCLUSIVE RIGHT TO USE "SMART", APART FROM THE MARK AS SHOWN.

SER. NO. 85-469,569, FILED 11-10-2011.

PRISCILLA MILTON, EXAMINING ATTORNEY



*David J. Kyjars*

Director of the United States Patent and Trademark Office

# United States of America

United States Patent and Trademark Office

## Archer Healthcare

**Reg. No. 4,197,359**

**Registered Aug. 28, 2012**

**Int. Cl.: 35**

**SERVICE MARK**

**PRINCIPAL REGISTER**

AOS RESEARCH INC. (NORTH CAROLINA CORPORATION), DBA ARCHER HEALTHCARE  
361 N FRONT ST  
WILMINGTON, NC 28401

FOR: OPERATION OF TELEPHONE CALL CENTERS FOR OTHERS; PROVIDING ADVERTISING, MARKETING AND PROMOTIONAL SERVICES FOR THE PHARMACEUTICAL AND MEDICAL PRODUCTS OF OTHERS; TELEMARKETING, IN CLASS 35 (U.S. CLS. 100, 101 AND 102).

FIRST USE 11-10-2011; IN COMMERCE 11-10-2011.

THE MARK CONSISTS OF STANDARD CHARACTERS WITHOUT CLAIM TO ANY PARTICULAR FONT, STYLE, SIZE, OR COLOR.

NO CLAIM IS MADE TO THE EXCLUSIVE RIGHT TO USE "HEALTHCARE", APART FROM THE MARK AS SHOWN.

SER. NO. 85-469,633, FILED 11-10-2011.

YAT SYE, LEE, EXAMINING ATTORNEY



*David J. Kyffers*

Director of the United States Patent and Trademark Office

# United States of America

United States Patent and Trademark Office

## 100,000 JOBS MISSION

**Reg. No. 4,197,360**

JPMORGAN CHASE & CO. (DELAWARE CORPORATION)  
270 PARK AVENUE  
NEW YORK, NY 10017

**Registered Aug. 28, 2012**

**Int. Cl.: 35**

FOR: EMPLOYMENT COUNSELING AND RECRUITING FOR MILITARY VETERANS, IN CLASS 35 (U.S. CLS. 100, 101 AND 102).

**SERVICE MARK**

FIRST USE 3-9-2011; IN COMMERCE 3-9-2011.

**PRINCIPAL REGISTER**

THE MARK CONSISTS OF STANDARD CHARACTERS WITHOUT CLAIM TO ANY PARTICULAR FONT, STYLE, SIZE, OR COLOR.

NO CLAIM IS MADE TO THE EXCLUSIVE RIGHT TO USE "100,000 JOBS", APART FROM THE MARK AS SHOWN.

SER. NO. 85-469,738, FILED 11-10-2011.

BARBARA BROWN, EXAMINING ATTORNEY



*David J. Kybas*

Director of the United States Patent and Trademark Office



# United States of America

United States Patent and Trademark Office



**Reg. No. 4,197,361**

**Registered Aug. 28, 2012**

**Int. Cl.: 29**

**TRADEMARK**

**PRINCIPAL REGISTER**

JOHN B. SANFILIPPO & SON, INC. (DELAWARE CORPORATION)  
1703 N. RANDALL ROAD  
ELGIN, IL 601237820

FOR: POTATO CHIPS, IN CLASS 29 (U.S. CL. 46).

FIRST USE 7-22-2011; IN COMMERCE 7-22-2011.

OWNER OF U.S. REG. NOS. 3,923,226, 4,013,348, AND 4,013,699.

THE MARK CONSISTS OF A CAPITAL LETTER "A" WITH THE TOP AND MIDDLE CONNECTING PORTIONS BEING DIVIDED BY A SPACE AND PLACED OVER THE LETTERS "A", "R", "M", "A", WHICH LETTERS ARE FRAGMENTED AND OUTLINED, WITH ONLY THAT PORTION OF THE LETTER "M" THAT IS SLANTED TO THE LEFT BEING SOLID.

THE ENGLISH TRANSLATION OF THE WORD "ARMA" IN THE MARK IS WEAPON.

SER. NO. 85-469,741, FILED 11-10-2011.

DAVID TAYLOR, EXAMINING ATTORNEY



*David J. Kyffers*

Director of the United States Patent and Trademark Office

# United States of America

United States Patent and Trademark Office

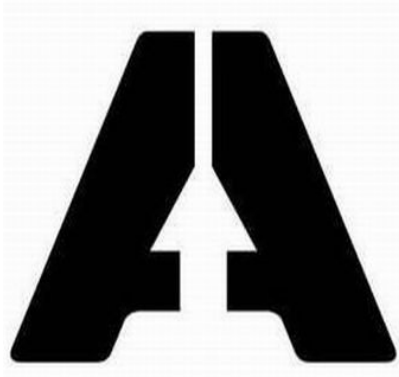

**Reg. No. 4,197,362**

**Registered Aug. 28, 2012**

**Int. Cl.: 29**

**TRADEMARK**

**PRINCIPAL REGISTER**

JOHN B. SANFILIPPO & SON, INC. (DELAWARE CORPORATION)  
1703 N. RANDALL ROAD  
ELGIN, IL 601237820

FOR: POTATO CHIPS, IN CLASS 29 (U.S. CL. 46).

FIRST USE 7-22-2011; IN COMMERCE 7-22-2011.

OWNER OF U.S. REG. NOS. 3,923,226, 4,013,348, AND 4,013,699.

THE MARK CONSISTS OF A STYLIZED CAPITAL LETTER "A" WITH THE INTERIOR THEREOF FORMING THE OUTLINE OF AN ARROWHEAD WITH THE TOP AND MIDDLE CONNECTING PORTIONS OF THE "A" BEING DIVIDED BY WHITE SPACE.

SER. NO. 85-469,749, FILED 11-10-2011.

DAVID TAYLOR, EXAMINING ATTORNEY



*David J. Kyffers*

Director of the United States Patent and Trademark Office

# United States of America

United States Patent and Trademark Office



**Reg. No. 4,197,363**

**Registered Aug. 28, 2012**

**Int. Cl.: 30**

**TRADEMARK**

**PRINCIPAL REGISTER**

CONFECTIONERY ARTS INTERNATIONAL, LLC (CONNECTICUT LIMITED LIABILITY COMPANY)  
332 WASHINGTON AVE  
NEW BRITAIN, CT 06051

FOR: CANDY CAKE DECORATIONS; EDIBLE CAKE DECORATIONS; EDIBLE ICINGS, CAKE MIX; EDIBLE FLAVORINGS FOR CAKES OTHER THAN ESSENTIAL OILS; EDIBLE FOOD DECORATIONS FOR CAKE AND PASTRY, NAMELY, CANDY SPRINKLES AND SUGARS; CANDY; CANDY PIECES FOR USE IN THE HOME PREPARATION OF OTHER CONFECTIONARIES; EDIBLE FAVORS FOR COOKIES, CANDY AND PASTRIES OTHER THAN ESSENTIAL OILS; CANDY FIGURINES AND DECORATIVE CANDY ORNAMENTS FOR FOODS; DESSERT MAKING KITS COMPRISED PRIMARILY OF CONFECTIONERY COATING SUGAR WAFERS FOR FOOD DECORATING AND MICROWAVEABLE BAGS; ACTIVITY KITS TO MAKE CANDY CONSISTING PRIMARILY OF PACKETS OF EDIBLE CANDY CLAY AND PLASTIC SCULPTING TOOLS, IN CLASS 30 (U.S. CL. 46).

FIRST USE 10-1-2010; IN COMMERCE 10-1-2010.

NO CLAIM IS MADE TO THE EXCLUSIVE RIGHT TO USE "CAKE DECORATORS", APART FROM THE MARK AS SHOWN.

THE MARK CONSISTS OF A CUPCAKE WITH THE WORD "CAKE" OVERLAYING THE CUPCAKE, AND THE WORD "DECORATORS" BELOW THE WORD "CAKE", A DECORATIVE BORDER AROUND THE CUPCAKE AND THE LITERAL ELEMENT.

SER. NO. 85-469,772, FILED 11-10-2011.

LINDA ORNDORFF, EXAMINING ATTORNEY



*David J. Kyffers*

Director of the United States Patent and Trademark Office

# United States of America

United States Patent and Trademark Office

## LILIA STOGOVA

**Reg. No. 4,197,364**

GENDELMAN, EDDIE (UNITED STATES INDIVIDUAL)  
8161 NEW UTRECHT AVE  
BROOKLYN, NY 11214

**Registered Aug. 28, 2012**

**Int. Cl.: 25**

FOR: CLOTHING, NAMELY, TOPS, BOTTOMS, SHIRTS, PANTS, SOCKS, UNDERWEAR, SWEATERS, SWEATSHIRTS, JACKETS, COATS, HATS, SHOES, BELTS, GLOVES, SCARVES, BLOUSES, SHORTS, SKIRTS, DRESSES, GOWNS, IN CLASS 25 (U.S. CLS. 22 AND 39).

**TRADEMARK**

**PRINCIPAL REGISTER**

FIRST USE 5-1-1996; IN COMMERCE 5-1-1996.

THE MARK CONSISTS OF STANDARD CHARACTERS WITHOUT CLAIM TO ANY PARTICULAR FONT, STYLE, SIZE, OR COLOR.

THE NAME(S), PORTRAIT(S), AND/OR SIGNATURE(S) SHOWN IN THE MARK IDENTIFIES "LILIA STOGOVA", WHOSE CONSENT(S) TO REGISTER IS MADE OF RECORD.

SER. NO. 85-470,047, FILED 11-11-2011.

DOMINIC FATHY, EXAMINING ATTORNEY



*David J. Kyros*

Director of the United States Patent and Trademark Office

# United States of America

United States Patent and Trademark Office

# ASKBOB

**Reg. No. 4,197,365**

**Registered Aug. 28, 2012**

**Int. Cl.: 38**

**SERVICE MARK**

**PRINCIPAL REGISTER**

AIRCRAFT TECHNICAL PUBLISHERS (CALIFORNIA CORPORATION)  
101 SOUTH HILL DRIVE  
BRISBANE, CA 940051251

FOR: PROVIDING AN ONLINE FORUM FOR AVIATION MAINTENANCE PROFESSIONALS FOR THE TRANSMISSION OF QUESTIONS, INFORMATION AND MESSAGES CONCERNING AIRCRAFT MAINTENANCE, IN CLASS 38 (U.S. CLS. 100, 101 AND 104).

FIRST USE 7-1-2008; IN COMMERCE 7-1-2008.

THE MARK CONSISTS OF STANDARD CHARACTERS WITHOUT CLAIM TO ANY PARTICULAR FONT, STYLE, SIZE, OR COLOR.

OWNER OF U.S. REG. NO. 3,456,172.

THE NAME(S), PORTRAIT(S), AND/OR SIGNATURE(S) SHOWN IN THE MARK IDENTIFIES BOB JONES, WHOSE CONSENT(S) TO REGISTER IS MADE OF RECORD.

SER. NO. 85-470,453, FILED 11-11-2011.

MARK RADEMACHER, EXAMINING ATTORNEY



*David J. Kyfos*

Director of the United States Patent and Trademark Office

# United States of America

United States Patent and Trademark Office



**Reg. No. 4,197,366**

**Registered Aug. 28, 2012**

**Int. Cl.: 28**

**TRADEMARK**

**PRINCIPAL REGISTER**

INC INTERNATIONAL COMPANY (PENNSYLVANIA CORPORATION)  
143 VIBURNUM DRIVE  
KENNETT SQUARE, PA 19348

FOR: ATHLETIC PROTECTIVE PADS, NAMELY, FOOTBALL SHOULDER PADS, BASKETBALL SHIN GUARDS, SOCCER SHIN GUARDS, LACROSSE SHOULDER PADS, SHIN PADS FOR EQUESTRIAN SPORTS, BASEBALL SHIN GUARDS, KARATE CHEST GUARDS, ELBOW PADS FOR SNOW SKIING, ELBOW AND KNEE PADS FOR SKATEBOARDING, ELBOW AND KNEE PADS FOR BIKING; PROTECTIVE PADDING FOR PLAYING FOOTBALL, BASKETBALL, SOCCER, LACROSSE, EQUESTRIAN SPORTS, BASEBALL, KARATE, SKIING, SKATEBOARDING, BIKING, SKYDIVING AND MOTORCYCLING; SAFETY PADDING FOR FOOTBALL, BASKETBALL, SOCCER, LACROSSE, EQUESTRIAN SPORTS, BASEBALL, KARATE, SKIING, SKATEBOARDING, BIKING, SKYDIVING AND MOTORCYCLING, IN CLASS 28 (U.S. CLS. 22, 23, 38 AND 50).

FIRST USE 1-3-2011; IN COMMERCE 1-3-2011.

THE MARK CONSISTS OF STYLIZED TERMS "EXO SKELETON" WITH "EXO" APPEARING IN A LARGE FONT THAT FORMS AN OVAL SHAPE THAT IS POSITIONED ABOVE THE SMALLER TERM "SKELETON", ALL OF WHICH ARE INSIDE A RECTANGLE.

SER. NO. 85-470,909, FILED 11-11-2011.

ANTHONY RINKER, EXAMINING ATTORNEY



*David J. Kybas*

Director of the United States Patent and Trademark Office

# United States of America

United States Patent and Trademark Office

## Circle 7

**Reg. No. 4,197,367**

**Registered Aug. 28, 2012**

**Int. Cl.: 41**

**SERVICE MARK**

**PRINCIPAL REGISTER**

HOLLICEASE MUSIC (CALIFORNIA PARTNERSHIP)  
#1  
9821 CASPI GARDENS DR.  
SANTEE, CA 92071

FOR: ENTERTAINMENT, NAMELY, LIVE PERFORMANCES BY A MUSICAL BAND, IN CLASS 41 (U.S. CLS. 100, 101 AND 107).

FIRST USE 10-21-2011; IN COMMERCE 10-21-2011.

THE MARK CONSISTS OF STANDARD CHARACTERS WITHOUT CLAIM TO ANY PARTICULAR FONT, STYLE, SIZE, OR COLOR.

SER. NO. 85-471,061, FILED 11-12-2011.

AISHA CLARKE, EXAMINING ATTORNEY



*David J. Kybas*

Director of the United States Patent and Trademark Office

# United States of America

United States Patent and Trademark Office

HI THERE FROM KAREN WALKER

**Reg. No. 4,197,368**

**Registered Aug. 28, 2012**

**Int. Cl.: 25**

**TRADEMARK**

**PRINCIPAL REGISTER**

KAREN WALKER LIMITED (NEW ZEALAND COMPANY)  
9 MAIDSTONE STREET, GREY LYNN  
AUCKLAND 1021, NEW ZEALAND

FOR: CLOTHING, NAMELY, PANTS, SHIRTS, T-SHIRTS, SINGLET, SHORTS, SWEAT-SHIRTS, SKIRTS, SUITS, SUIT JACKETS, SUIT PANTS, TROUSERS, DRESSES, BELTS, SWEAT SUITS, LINGERIE, BRAS, JACKETS, COATS, SCARVES, GLOVES, MITTENS, NIGHTGOWNS, PAJAMAS, TOPS, JEANS, SWEATERS, JUMPERS, BLOUSES, VESTS, SHAWLS, HOSIERY; HEADGEAR, NAMELY, HATS, CAPS, BEANIES; FOOTWEAR, NAMELY, SHOES, BOOTS, SANDALS AND SLIP ON SHOES, IN CLASS 25 (U.S. CLS. 22 AND 39).

THE MARK CONSISTS OF STANDARD CHARACTERS WITHOUT CLAIM TO ANY PARTICULAR FONT, STYLE, SIZE, OR COLOR.

OWNER OF NEW ZEALAND REG. NO. 774210, DATED 8-20-2007, EXPIRES 8-20-2017.

OWNER OF U.S. REG. NO. 4,031,031.

THE NAME(S), PORTRAIT(S), AND/OR SIGNATURE(S) SHOWN IN THE MARK IDENTIFIES "KAREN WALKER", WHOSE CONSENT(S) TO REGISTER IS MADE OF RECORD.

SER. NO. 85-471,083, FILED 11-12-2011.

DAVID COLLIER, EXAMINING ATTORNEY



*David J. Kyros*

Director of the United States Patent and Trademark Office



# United States of America

United States Patent and Trademark Office



**Reg. No. 4,197,369**

**Registered Aug. 28, 2012**

**Int. Cl.: 10**

**TRADEMARK**

**PRINCIPAL REGISTER**

MARTIN ROBINSON (UNITED KINGDOM LIMITED LIABILITY COMPANY)  
COLISEUM, WATCHMOOR PARK, RIVERSIDE WAY  
CAMBERLEY (SURREY), UNITED KINGDOM GU153YL

FOR: X-RAY APPARATUS FOR MEDICAL USE, IN CLASS 10 (U.S. CLS. 26, 39 AND 44).

FIRST USE 7-1-2010; IN COMMERCE 7-1-2010.

NO CLAIM IS MADE TO THE EXCLUSIVE RIGHT TO USE "XSTRAHL", APART FROM THE MARK AS SHOWN.

THE COLOR(S) PURPLE, WHITE IS/ARE CLAIMED AS A FEATURE OF THE MARK.

THE MARK CONSISTS OF "XSTRAHL" LOGO IN PURPLE WITH WHITE "X" ON PURPLE CIRCULAR BACKGROUND.

THE ENGLISH TRANSLATION OF "XSTRAHL" IN THE MARK IS "XRAY".

SER. NO. 85-471,366, FILED 11-14-2011.

INGA ERVIN, EXAMINING ATTORNEY



*David J. Kyffers*

Director of the United States Patent and Trademark Office

# United States of America

United States Patent and Trademark Office

## ONLY NATURAL PET

**Reg. No. 4,197,370**

ONLY NATURAL PET STORE, LLC (COLORADO LIMITED LIABILITY COMPANY)  
5541 CENTRAL AVENUE, SUITE 201  
BOULDER, CO 80301

**Registered Aug. 28, 2012**

**Int. Cls.: 3, 5 and 31**

FOR: HOME DENTAL CARE PRODUCTS FOR DOGS AND CATS, NAMELY, HERBAL DENTAL SPRAY; PET SHAMPOO AND CONDITIONER; NON-MEDICATED GROOMING PREPARATIONS FOR DOGS AND CATS, NAMELY, TEAR STAIN REMOVERS; ESSENTIAL OILS FOR PETS, IN CLASS 3 (U.S. CLS. 1, 4, 6, 50, 51 AND 52).

**TRADEMARK**

**PRINCIPAL REGISTER**

FIRST USE 6-16-2005; IN COMMERCE 6-16-2005.

FOR: DIETARY SUPPLEMENTS FOR PETS; DIETARY PET SUPPLEMENTS IN THE FORM OF PET TREATS; VITAMINS FOR PETS; MEDICINAL HERBAL PREPARATIONS FOR PETS; MEDICINAL HOMEOPATHIC PREPARATIONS AND MEDICINAL PREPARATIONS CONTAINING FLOWER ESSENCES FOR PETS FOR OVERALL HEALTH AND ENERGY AND STRESS RELIEF; HERBAL ANTI-ITCH AND SORE SKIN OINTMENT FOR PETS; FLEA AND TICK CONTROL PRODUCTS, NAMELY, POWDERS, SPRAYS, OILS, COLLARS, AND TAGS; EAR CARE PRODUCTS FOR DOGS AND CATS, NAMELY, MEDICINAL HERBAL PREPARATIONS FOR DISINFECTING; EYE CARE PRODUCTS FOR DOGS AND CATS, NAMELY, EYE WASHES, IN CLASS 5 (U.S. CLS. 6, 18, 44, 46, 51 AND 52).

FIRST USE 9-20-2004; IN COMMERCE 9-20-2004.

FOR: PET FOOD; EDIBLE PET TREATS; EDIBLE DOG CHEWS, IN CLASS 31 (U.S. CLS. 1 AND 46).

FIRST USE 10-27-2005; IN COMMERCE 10-27-2005.

THE MARK CONSISTS OF STANDARD CHARACTERS WITHOUT CLAIM TO ANY PARTICULAR FONT, STYLE, SIZE, OR COLOR.

OWNER OF U.S. REG. NO. 3,504,384.

NO CLAIM IS MADE TO THE EXCLUSIVE RIGHT TO USE "NATURAL PET", APART FROM THE MARK AS SHOWN.

SER. NO. 85-471,550, FILED 11-14-2011.



*David J. Kyffers*

Director of the United States Patent and Trademark Office

**Reg. No. 4,197,370** ALICIA COLLINS, EXAMINING ATTORNEY

# United States of America

United States Patent and Trademark Office

## Make Our Sanctuary Yours

**Reg. No. 4,197,371**

SANCTUARY PILATES, LLC (NEW YORK LIMITED LIABILITY COMPANY)  
316 E 84TH ST  
NEW YORK, NY 10028

**Registered Aug. 28, 2012**

**Int. Cl.: 41**

FOR: PROVIDING FITNESS AND EXERCISE STUDIO SERVICES, NAMELY, PILATES INSTRUCTION AND TRAINING, IN CLASS 41 (U.S. CLS. 100, 101 AND 107).

**SERVICE MARK**

FIRST USE 4-1-2006; IN COMMERCE 4-1-2006.

**PRINCIPAL REGISTER**

THE MARK CONSISTS OF STANDARD CHARACTERS WITHOUT CLAIM TO ANY PARTICULAR FONT, STYLE, SIZE, OR COLOR.

SER. NO. 85-471,635, FILED 11-14-2011.

WON TEAK OH, EXAMINING ATTORNEY



*David J. Kyffers*

Director of the United States Patent and Trademark Office

# United States of America

United States Patent and Trademark Office

# VITA JAVA

**Reg. No. 4,197,372**

DAVID T. HAILEY (UNITED STATES INDIVIDUAL)  
P.O. BOX 201416  
DENVER, CO 80220

**Registered Aug. 28, 2012**

**Int. Cl.: 5**

FOR: ANTIOXIDANT ENRICHED COFFEE; DIETARY AND NUTRITIONAL SUPPLEMENTS FOR USE IN SUPPLEMENTING COFFEE AND COFFEE BEVERAGES; VITAMIN AND MINERAL SUPPLEMENTS FOR USE IN SUPPLEMENTING COFFEE AND COFFEE BEVERAGES, IN CLASS 5 (U.S. CLS. 6, 18, 44, 46, 51 AND 52).

**TRADEMARK**

**PRINCIPAL REGISTER**

FIRST USE 11-11-2011; IN COMMERCE 11-11-2011.

THE MARK CONSISTS OF STANDARD CHARACTERS WITHOUT CLAIM TO ANY PARTICULAR FONT, STYLE, SIZE, OR COLOR.

NO CLAIM IS MADE TO THE EXCLUSIVE RIGHT TO USE "JAVA", APART FROM THE MARK AS SHOWN.

SER. NO. 85-471,803, FILED 11-14-2011.

MEGHAN REINHART, EXAMINING ATTORNEY



*David J. Kyros*

Director of the United States Patent and Trademark Office

# United States of America

United States Patent and Trademark Office

## THE JET SET PETS

**Reg. No. 4,197,373**

**Registered Aug. 28, 2012**

**Int. Cls.: 35 and 39**

**SERVICE MARK**

**PRINCIPAL REGISTER**

KELLY E. CARTER (UNITED STATES INDIVIDUAL), DBA THE JET SET PETS  
6709 LA TIJERA BLVD., NO. 361  
LOS ANGELES, CA 90045

FOR: INFORMATION SERVICES, NAMELY, PROVIDING A WEBSITE FEATURING CONSUMER INFORMATION IN THE FIELD OF PET PRODUCTS AND PET SERVICES, IN CLASS 35 (U.S. CLS. 100, 101 AND 102).

FIRST USE 2-21-2011; IN COMMERCE 2-21-2011.

FOR: PROVIDING A WEBSITE FEATURING INFORMATION ON PET TRAVEL, IN CLASS 39 (U.S. CLS. 100 AND 105).

FIRST USE 2-21-2011; IN COMMERCE 2-21-2011.

THE MARK CONSISTS OF STANDARD CHARACTERS WITHOUT CLAIM TO ANY PARTICULAR FONT, STYLE, SIZE, OR COLOR.

NO CLAIM IS MADE TO THE EXCLUSIVE RIGHT TO USE "PETS", APART FROM THE MARK AS SHOWN.

SER. NO. 85-471,881, FILED 11-14-2011.

ASMAT KHAN, EXAMINING ATTORNEY



*David J. Kybas*

Director of the United States Patent and Trademark Office

# United States of America

United States Patent and Trademark Office

# VHEIP

**Reg. No. 4,197,374**

**Registered Aug. 28, 2012**

**Int. Cl.: 36**

**SERVICE MARK**

**PRINCIPAL REGISTER**

VERMONT STUDENT ASSISTANCE CORPORATION (VERMONT CORPORATION)  
10 EAST ALLEN STREET, P.O. BOX 2000  
WINOOSKI, VT 054042601

FOR: FINANCIAL SERVICES, NAMELY, SAVINGS ACCOUNT AND INVESTMENT MANAGEMENT SERVICES TO ASSIST STUDENTS AND THEIR PARENTS TO PAY FOR POST-SECONDARY EDUCATION, IN CLASS 36 (U.S. CLS. 100, 101 AND 102).

FIRST USE 9-15-2001; IN COMMERCE 9-15-2001.

THE MARK CONSISTS OF STANDARD CHARACTERS WITHOUT CLAIM TO ANY PARTICULAR FONT, STYLE, SIZE, OR COLOR.

SER. NO. 85-472,512, FILED 11-15-2011.

ELISSA GARBER KON, EXAMINING ATTORNEY



*David J. Kyffers*

Director of the United States Patent and Trademark Office

# United States of America

United States Patent and Trademark Office



**Reg. No. 4,197,375**

**Registered Aug. 28, 2012**

**Int. Cl.: 25**

**TRADEMARK**

**PRINCIPAL REGISTER**

D.C. PREMIER SALES, INC. (NEW YORK CORPORATION), DBA SHOWAFLOPS  
P.O. BOX 309  
PORT WASHINGTON, NY 11050

FOR: ATHLETIC APPAREL, NAMELY, SHIRTS, PANTS, JACKETS, FOOTWEAR, HATS AND CAPS, ATHLETIC UNIFORMS; BEACH FOOTWEAR; FLIP FLOPS; FOOTWEAR; FOOTWEAR FOR MEN AND WOMEN, IN CLASS 25 (U.S. CLS. 22 AND 39).

FIRST USE 10-5-2010; IN COMMERCE 4-13-2011.

THE MARK CONSISTS OF THE LETTERS "S", "F" WITH THE TOP OF THE "F" FORMING A SHOWERHEAD WITH DROPLETS COMING OUT OF IT.

SER. NO. 85-472,667, FILED 11-15-2011.

SEAN CROWLEY, EXAMINING ATTORNEY



*David J. Kybas*

Director of the United States Patent and Trademark Office



# United States of America

United States Patent and Trademark Office

## System Outlook

**Reg. No. 4,197,376**

FORSYTH, ELENA (UNITED STATES INDIVIDUAL)  
PO BOX 2462

**Registered Aug. 28, 2012**

PALOS VERDES PENINSULA, CA 90274

**Int. Cl.: 41**

FOR: EDUCATIONAL SERVICES, NAMELY, PROVIDING LIVE AND ONLINE MENTORING, PERSONAL COACHING, CLASSES, SEMINARS, WORKSHOPS, GROUP TRAININGS, IN THE FIELD OF SELF HELP, PERSONAL DEVELOPMENT, SPIRITUALITY, RELATIONSHIP, THAT ENABLES INDIVIDUALS TO APPLY SYSTEMS TO ANY AREA OF LIFE WITH THE PURPOSE OF ACHIEVING DESIRED RESULTS, IN CLASS 41 (U.S. CLS. 100, 101 AND 107).

**SERVICE MARK**

**PRINCIPAL REGISTER**

FIRST USE 5-10-2009; IN COMMERCE 11-20-2009.

THE MARK CONSISTS OF STANDARD CHARACTERS WITHOUT CLAIM TO ANY PARTICULAR FONT, STYLE, SIZE, OR COLOR.

NO CLAIM IS MADE TO THE EXCLUSIVE RIGHT TO USE "SYSTEM", APART FROM THE MARK AS SHOWN.

SER. NO. 85-472,694, FILED 11-15-2011.

DANIEL CAPSHAW, EXAMINING ATTORNEY



*David J. Kyffers*

Director of the United States Patent and Trademark Office

# United States of America

United States Patent and Trademark Office

# AUTOAIM

**Reg. No. 4,197,377**

SANOFI (FRANCE CORPORATION)  
54 RUE LA BOÉTIE  
PARIS, FRANCE 75008

**Registered Aug. 28, 2012**

**Int. Cl.: 5**

FOR: SYRINGES SOLD FILLED WITH PHARMACEUTICAL PREPARATIONS FOR THE TREATMENT OF AUTO-IMMUNE DISEASE FOR HUMAN USE, IN CLASS 5 (U.S. CLS. 6, 18, 44, 46, 51 AND 52).

**TRADEMARK**

THE MARK CONSISTS OF STANDARD CHARACTERS WITHOUT CLAIM TO ANY PARTICULAR FONT, STYLE, SIZE, OR COLOR.

**PRINCIPAL REGISTER**

PRIORITY CLAIMED UNDER SEC. 44(D) ON FRANCE APPLICATION NO. 11/3832395, FILED 5-18-2011, REG. NO. 11/3832395, DATED 5-18-2011, EXPIRES 5-18-2021.

SER. NO. 85-472,726, FILED 11-15-2011.

AISHA SALEM, EXAMINING ATTORNEY



*David J. Kybas*

Director of the United States Patent and Trademark Office

# United States of America

United States Patent and Trademark Office



**Reg. No. 4,197,378**

**Registered Aug. 28, 2012**

**Int. Cl.: 29**

**TRADEMARK**

**PRINCIPAL REGISTER**

BBI, INC. (DELAWARE CORPORATION)  
300 DELAWARE AVE., SUITE 900  
WILMINGTON, DE 19801

FOR: CANNED BEANS; CANNED BEANS AND VEGETABLES, IN CLASS 29 (U.S. CL. 46).

FIRST USE 3-5-2012; IN COMMERCE 3-5-2012.

OWNER OF U.S. REG. NOS. 520,028, 2,381,034 AND OTHERS.

NO CLAIM IS MADE TO THE EXCLUSIVE RIGHT TO USE "SINCE 1908" OR "LATINA", APART FROM THE MARK AS SHOWN.

THE MARK CONSISTS OF THE WORDS "SINCE 1908 BUSH'S BEST" APPEARING INSIDE A STYLIZED DESIGN ABOVE THE WORDS "COCINA LATINA", ALL APPEARING INSIDE A STYLIZED SHIELD TYPE DESIGN.

THE ENGLISH TRANSLATION OF THE WORDS "COCINA LATINA" IN THE MARK IS "LATIN KITCHEN".

SEC. 2(F) AS TO "BEST".

SER. NO. 85-472,768, FILED 11-15-2011.

ANDREW LEASER, EXAMINING ATTORNEY



*David J. Kyffers*

Director of the United States Patent and Trademark Office

# United States of America

United States Patent and Trademark Office

# Delamar

**Reg. No. 4,197,379**

GREENWICH HOSPITALITY CORP. (CONNECTICUT CORPORATION)  
500 STEAMBOAT ROAD  
GREENWICH, CT 06830

**Registered Aug. 28, 2012**

**Int. Cls.: 41, 43 and 44**

FOR: HEALTH CLUB SERVICES, NAMELY, PROVIDING INSTRUCTION AND CONSULTATION IN THE FIELD OF PHYSICAL EXERCISE; PROVIDING USE OF EXERCISE EQUIPMENT; PROVIDING FITNESS AND EXERCISE FACILITIES, IN CLASS 41 (U.S. CLS. 100, 101 AND 107).

**SERVICE MARK**

**PRINCIPAL REGISTER**

FIRST USE 3-5-2002; IN COMMERCE 3-5-2002.

FOR: HOTEL SERVICES, MOTEL SERVICES, MOTOR INN LODGING SERVICES, RESORT LODGING SERVICES; RESTAURANT, BAR, CAFÉ AND COCKTAIL LOUNGE SERVICES; PROVISION OF FACILITIES FOR MEETINGS, CONFERENCES, BANQUETS, EXHIBITIONS AND SOCIAL FUNCTIONS FACILITIES FOR SPECIAL OCCASIONS, IN CLASS 43 (U.S. CLS. 100 AND 101).

FIRST USE 3-5-2002; IN COMMERCE 3-5-2002.

FOR: HEALTH SPA SERVICES, NAMELY, PROVIDING FACIAL, HAIR, SKIN AND BODY TREATMENTS, MANICURE AND PEDICURE SERVICES, MASSAGE SERVICES, BODY WAXING SERVICES AND BEAUTY SALON SERVICES, IN CLASS 44 (U.S. CLS. 100 AND 101).

FIRST USE 3-5-2002; IN COMMERCE 3-5-2002.

THE MARK CONSISTS OF STANDARD CHARACTERS WITHOUT CLAIM TO ANY PARTICULAR FONT, STYLE, SIZE, OR COLOR.

SEC. 2(F).

SER. NO. 85-472,785, FILED 11-15-2011.

LIEF MARTIN, EXAMINING ATTORNEY



*David J. Kyffers*

Director of the United States Patent and Trademark Office

# United States of America

United States Patent and Trademark Office



**Reg. No. 4,197,380**

**Registered Aug. 28, 2012**

**Int. Cl.: 30**

**TRADEMARK**

**PRINCIPAL REGISTER**

329985 ONTARIO INC. (CANADA CORPORATION), DBA KISKO PRODUCTS  
50 ROYAL GROUP CRESCENT, UNIT # 1  
WOODBIDGE, ONTARIO, CANADA L4H1X9

FOR: FROZEN CONFECTIONS AND FREEZABLE FLAVOURED CONFECTIONS, NAMELY, ICES, FREEZER POPS AND FREEZER BARS, IN CLASS 30 (U.S. CL. 46).

FIRST USE 4-0-2002; IN COMMERCE 4-0-2002.

PRIORITY CLAIMED UNDER SEC. 44(D) ON CANADA APPLICATION NO. 1529078, FILED 5-25-2011.

THE MARK CONSISTS OF A DEPICTION OF AN ALLIGATOR WITH LONG, CURLY HAIR WEARING SHORTS AND SANDALS. THE ALLIGATOR IS SITTING IN A CHAIR AND HAS ITS TONGUE OUT. THE ALLIGATOR'S RIGHT HAND IS MAKING A "THUMBS UP" GESTURE AND HIS LEFT HAND HOLDS A FROZEN CONFECTION.

SER. NO. 85-473,074, FILED 11-15-2011.

JANICE KIM, EXAMINING ATTORNEY



*David J. Kybas*

Director of the United States Patent and Trademark Office

# United States of America

United States Patent and Trademark Office

# MYHOLD

**Reg. No. 4,197,381**

SANOFI (FRANCE CORPORATION)  
54 RUE LA BOÉTIE  
PARIS, FRANCE 75008

**Registered Aug. 28, 2012**

**Int. Cl.: 5**

FOR: SYRINGES SOLD FILLED WITH PHARMACEUTICAL PREPARATIONS FOR THE TREATMENT OF AUTO-IMMUNE DISEASE FOR HUMAN USE, IN CLASS 5 (U.S. CLS. 6, 18, 44, 46, 51 AND 52).

**TRADEMARK**

THE MARK CONSISTS OF STANDARD CHARACTERS WITHOUT CLAIM TO ANY PARTICULAR FONT, STYLE, SIZE, OR COLOR.

**PRINCIPAL REGISTER**

PRIORITY CLAIMED UNDER SEC. 44(D) ON FRANCE APPLICATION NO. 11/3832467, FILED 5-18-2011, REG. NO. 11/3832467, DATED 5-18-2011, EXPIRES 5-18-2021.

OWNER OF U.S. REG. NO. 3,806,246.

SER. NO. 85-473,089, FILED 11-15-2011.

AISHA SALEM, EXAMINING ATTORNEY



*David J. Kybas*

Director of the United States Patent and Trademark Office

# United States of America

United States Patent and Trademark Office

# Tax Goddess

**Reg. No. 4,197,382**

TAX GODDESS BUSINESS SERVICES, PC (ARIZONA CORPORATION)  
5743 E. THOMAS ROAD, SUITE 6  
SCOTTSDALE, AZ 85251

**Registered Aug. 28, 2012**

**Int. Cls.: 35, 36, 41 and 45**

FOR: ACCOUNTANCY SERVICES; ACCOUNTING CONSULTATION; ADMINISTRATIVE ACCOUNTING; BOOKKEEPING; BUSINESS INFORMATION AND ACCOUNTING ADVISORY SERVICES; COMPUTERIZED ACCOUNTING SERVICES; CONSULTING AND INFORMATION CONCERNING ACCOUNTING; COST ACCOUNTING; INCOME TAX CONSULTATION; INCOME TAX PREPARATION; MANAGEMENT OF TAX FILES; PAYROLL ADMINISTRATION AND MANAGEMENT SERVICES; PROVIDING AN ON-LINE COMPUTER WEB SITE THAT PROVIDES COMMERCIAL FINANCIAL TRANSACTION DATA, ACCOUNT MANAGEMENT, FINANCIAL REPORTING, ACCOUNTING FEATURES AND RELATED REFERENCE INFORMATION; TAX ADVISORY SERVICES; TAX AND TAXATION PLANNING, ADVICE, INFORMATION AND CONSULTANCY SERVICES; TAX ASSESSMENT; TAX CONSULTATION; TAX DECLARATION PROCEDURE SERVICES; TAX FILING SERVICES; TAX PREPARATION, IN CLASS 35 (U.S. CLS. 100, 101 AND 102).

**SERVICE MARK**

**PRINCIPAL REGISTER**

FIRST USE 3-1-2007; IN COMMERCE 3-1-2007.

FOR: FIDUCIARY TAX PAYMENT PROCESSING SERVICES; ONLINE, REAL-TIME TAX PAYMENT PROCESSING, TAX PAYMENT MANAGEMENT, AND TAX PAYMENT ANALYSIS SERVICES; PAYROLL TAX DEBITING SERVICES; TAX PAYMENT PROCESSING SERVICES, IN CLASS 36 (U.S. CLS. 100, 101 AND 102).

FIRST USE 3-1-2007; IN COMMERCE 3-1-2007.

FOR: EDUCATIONAL SERVICES, NAMELY, CONDUCTING ONLINE SEMINARS, ONE ON ONE TRAINING, LIVE CLASSES, AND PHONE SEMINARS IN THE FIELDS OF ACCOUNTING, TAXES, PAYROLL, IRS NEGOTIATION FOR SETTLEMENT, BUDGETING, AND BUSINESS ACCOUNTING AND MANAGEMENT SOFTWARE TRAINING, AND DISTRIBUTION OF TRAINING MATERIALS IN CONNECTION THEREWITH, IN CLASS 41 (U.S. CLS. 100, 101 AND 107).

FIRST USE 3-1-2007; IN COMMERCE 3-1-2007.

FOR: REPRESENTATION OF CLIENTS IN TAX MATTERS BEFORE TAX AUTHORITIES, IN CLASS 45 (U.S. CLS. 100 AND 101).



*David J. Kyffers*

Director of the United States Patent and Trademark Office

**Reg. No. 4,197,382** FIRST USE 3-1-2007; IN COMMERCE 3-1-2007.

THE MARK CONSISTS OF STANDARD CHARACTERS WITHOUT CLAIM TO ANY PARTICULAR FONT, STYLE, SIZE, OR COLOR.

NO CLAIM IS MADE TO THE EXCLUSIVE RIGHT TO USE "TAX", APART FROM THE MARK AS SHOWN.

SER. NO. 85-473,103, FILED 11-15-2011.

CHERYL CLAYTON, EXAMINING ATTORNEY



# United States of America

United States Patent and Trademark Office

# VUECLICK

**Reg. No. 4,197,383**

SANOFI (FRANCE CORPORATION)  
54 RUE LA BOÉTIE  
PARIS, FRANCE 75008

**Registered Aug. 28, 2012**

**Int. Cl.: 5**

FOR: SYRINGES SOLD FILLED WITH PHARMACEUTICAL PREPARATIONS FOR THE TREATMENT OF AUTO-IMMUNE DISEASE FOR HUMAN USE, IN CLASS 5 (U.S. CLS. 6, 18, 44, 46, 51 AND 52).

**TRADEMARK**

THE MARK CONSISTS OF STANDARD CHARACTERS WITHOUT CLAIM TO ANY PARTICULAR FONT, STYLE, SIZE, OR COLOR.

**PRINCIPAL REGISTER**

PRIORITY CLAIMED UNDER SEC. 44(D) ON FRANCE APPLICATION NO. 11/3832510, FILED 5-18-2011, REG. NO. 11/3832510, DATED 5-18-2011, EXPIRES 5-18-2021.

OWNER OF U.S. REG. NOS. 3,183,983, 3,417,151 AND OTHERS.

SER. NO. 85-473,119, FILED 11-15-2011.

AISHA SALEM, EXAMINING ATTORNEY



*David J. Kyjars*

Director of the United States Patent and Trademark Office

# United States of America

United States Patent and Trademark Office



**Reg. No. 4,197,384**

**Registered Aug. 28, 2012**

**Int. Cl.: 41**

**SERVICE MARK**

**PRINCIPAL REGISTER**

SHOOT THE CENTERFOLD, INC. (FLORIDA CORPORATION)  
4912 PINETREE DRIVE  
MIAMI BEACH, FL 33140

FOR: PHOTOGRAPHY SERVICES, IN CLASS 41 (U.S. CLS. 100, 101 AND 107).

FIRST USE 8-10-2010; IN COMMERCE 8-10-2010.

NO CLAIM IS MADE TO THE EXCLUSIVE RIGHT TO USE "INC.", APART FROM THE MARK AS SHOWN.

THE MARK CONSISTS OF A SILHOUETTE OF A STANDING WOMAN. BELOW THERE IS THE STYLIZED TEXT "SHOOT THE CENTERFOLD INC.".

SER. NO. 85-473,554, FILED 11-15-2011.

REGINA DRUMMOND, EXAMINING ATTORNEY



*David J. Kybas*

Director of the United States Patent and Trademark Office

# United States of America

United States Patent and Trademark Office

# HYPLAND

**Reg. No. 4,197,385**

BENTLEY, JORDAN S (UNITED STATES INDIVIDUAL), DBA HYPLAND CLOTHING  
3740 W. 59TH PLACE  
LOS ANGELES, CA 90043 AND

**Registered Aug. 28, 2012**

**Int. Cl.: 25**

CARTER, STEPHANIE L (UNITED STATES INDIVIDUAL), DBA HYPLAND CLOTHING  
3740 W. 59TH PLACE  
LOS ANGELES, CA 90043

**TRADEMARK**

**PRINCIPAL REGISTER**

FOR: T-SHIRTS, HOODED SWEAT SHIRTS, HATS, BEANIES, CREW NECK SHIRTS, SOCKS, JEANS, AND OTHER FORMS OF CLOTHING ITEMS, NAMELY, SHIRTS, PANTS, SHORTS, PAJAMAS, JACKETS AND CAPS, IN CLASS 25 (U.S. CLS. 22 AND 39).

FIRST USE 1-1-2009; IN COMMERCE 1-1-2009.

THE MARK CONSISTS OF STANDARD CHARACTERS WITHOUT CLAIM TO ANY PARTICULAR FONT, STYLE, SIZE, OR COLOR.

SER. NO. 85-473,628, FILED 11-16-2011.

NATALIE POLZER, EXAMINING ATTORNEY



*David J. Kybas*

Director of the United States Patent and Trademark Office

# United States of America

United States Patent and Trademark Office

## INSPIRED BY AMBER

**Reg. No. 4,197,386**

ETTINGER, ROSEANN (UNITED STATES INDIVIDUAL)  
155 N. LAUREL STREET  
HAZLETON, PA 182015457 AND

**Registered Aug. 28, 2012**

**Int. Cl.: 14**

ETTINGER, AMBER (UNITED STATES INDIVIDUAL)  
155 N. LAUREL STREET  
HAZLETON, PA 182015457

**TRADEMARK**

**PRINCIPAL REGISTER**

FOR: JEWELRY, IN CLASS 14 (U.S. CLS. 2, 27, 28 AND 50).

FIRST USE 2-10-2009; IN COMMERCE 2-10-2009.

THE MARK CONSISTS OF STANDARD CHARACTERS WITHOUT CLAIM TO ANY PARTICULAR FONT, STYLE, SIZE, OR COLOR.

NO CLAIM IS MADE TO THE EXCLUSIVE RIGHT TO USE "AMBER", APART FROM THE MARK AS SHOWN.

SER. NO. 85-474,035, FILED 11-16-2011.

WILLIAM JACKSON, EXAMINING ATTORNEY



*David J. Kyffers*

Director of the United States Patent and Trademark Office

# United States of America

United States Patent and Trademark Office

# WINSLOW

## GAME ROOMS

**Reg. No. 4,197,387**

**Registered Aug. 28, 2012**

**Int. Cl.: 20**

**TRADEMARK**

**PRINCIPAL REGISTER**

CLB ASSETS LLC (MISSOURI LIMITED LIABILITY COMPANY), DBA C. L. BAILEY CO.  
PO BOX 290  
MARIONVILLE, MO 65705

FOR: FURNITURE, IN CLASS 20 (U.S. CLS. 2, 13, 22, 25, 32 AND 50).

FIRST USE 4-11-2010; IN COMMERCE 1-22-2011.

NO CLAIM IS MADE TO THE EXCLUSIVE RIGHT TO USE "GAME ROOMS", APART FROM THE MARK AS SHOWN.

THE COLOR(S) BURGUNDY IS/ARE CLAIMED AS A FEATURE OF THE MARK.

THE MARK CONSISTS OF "WINSLOW GAME ROOMS" IN BURGUNDY, ALL IN CAPITALIZED LETTERS. "WINSLOW" HAS THE BASE LINE SLIGHTLY ARCHED TO ENCLOSE THE WORDS "GAME ROOMS". "GAME ROOMS" IS IN A SMALLER FONT CENTERED BENEATH "WINSLOW".

SER. NO. 85-474,358, FILED 11-16-2011.

MARY ROSSMAN, EXAMINING ATTORNEY



*David J. Kyffers*

Director of the United States Patent and Trademark Office

**United States of America**  
United States Patent and Trademark Office

# VITUCCI'S

**Reg. No. 4,197,388**

**Registered Aug. 28, 2012**

**Int. Cl.: 43**

**SERVICE MARK**

**PRINCIPAL REGISTER**

VITUCCI'S, INC. (WISCONSIN CORPORATION)  
3540 EAST LAYTON AVENUE  
CUDAHY, WI 53110

FOR: BAR SERVICES, IN CLASS 43 (U.S. CLS. 100 AND 101).

FIRST USE 0-0-1959; IN COMMERCE 0-0-1959.

THE MARK CONSISTS OF STANDARD CHARACTERS WITHOUT CLAIM TO ANY PARTICULAR FONT, STYLE, SIZE, OR COLOR.

SEC. 2(F).

SER. NO. 85-474,388, FILED 11-16-2011.

MARLENE BELL, EXAMINING ATTORNEY



*David J. Kyffers*

Director of the United States Patent and Trademark Office

# United States of America

United States Patent and Trademark Office

## No Joke Artichoke Burger

**Reg. No. 4,197,389**

**Registered Aug. 28, 2012**

**Int. Cl.: 30**

**TRADEMARK**

**PRINCIPAL REGISTER**

AMC BURGERS, INC. (MICHIGAN CORPORATION)  
21751 W. ELEVEN MILE ROAD  
SOUTHFIELD, MI 48076

FOR: HAMBURGER SANDWICHES, IN CLASS 30 (U.S. CL. 46).

FIRST USE 10-5-2011; IN COMMERCE 10-31-2011.

THE MARK CONSISTS OF STANDARD CHARACTERS WITHOUT CLAIM TO ANY PARTICULAR FONT, STYLE, SIZE, OR COLOR.

NO CLAIM IS MADE TO THE EXCLUSIVE RIGHT TO USE "ARTICHOKE BURGER", APART FROM THE MARK AS SHOWN.

SER. NO. 85-474,883, FILED 11-17-2011.

AMY HELLA, EXAMINING ATTORNEY



*David J. Kyffers*

Director of the United States Patent and Trademark Office

# United States of America

United States Patent and Trademark Office



**Reg. No. 4,197,390**

THE FUN ZONE, LLC (NEVADA LIMITED LIABILITY COMPANY)  
90 CUMMINGS PARK  
WOBURN, MA 01801

**Registered Aug. 28, 2012**

**Int. Cl.: 41**

FOR: RENTAL OF INDOOR FACILITIES FOR PARTIES; PROVISION OF CHILDREN'S PLAYGROUNDS, IN CLASS 41 (U.S. CLS. 100, 101 AND 107).

**SERVICE MARK**

FIRST USE 0-0-2010; IN COMMERCE 0-0-2010.

**PRINCIPAL REGISTER**

NO CLAIM IS MADE TO THE EXCLUSIVE RIGHT TO USE "CLUBHOUSE", APART FROM THE MARK AS SHOWN.

THE COLOR(S) DARK BROWN, BROWN, YELLOW, BLUE, PINK, GREEN, AND RED IS/ARE CLAIMED AS A FEATURE OF THE MARK.

THE MARK CONSISTS OF THE WORD "THE" IN YELLOW STYLIZED FONT ON A BROWN WOODPLANK SIGN FASTENED TO A BROWN WOODPLANK POST, IN FRONT OF WHICH IS A GREEN PLANT IN A DARK BROWN POT. TO THE IMMEDIATE RIGHT IS THE WORDING "KLUBHOUSE" IN STYLIZED BROWN WOODPLANK LETTERS. THE "O" IS IN THE SHAPE OF A CHILDREN'S PLAY HOUSE WITH A RED DOOR, A YELLOW FOUR-SQUARE WINDOW PANE, AND FLAGS ON EITHER SIDE OF THE ROOF BEING BLUE AND PINK.

SER. NO. 85-474,921, FILED 11-17-2011.

H. M. FISHER, EXAMINING ATTORNEY



*David J. Kybas*

Director of the United States Patent and Trademark Office



# United States of America

United States Patent and Trademark Office

## Madison's "M" Sauce

**Reg. No. 4,197,391**

BMC SMILES LLC (ARIZONA LIMITED LIABILITY COMPANY)  
3764 S CUPERTINO DR.  
GILBERT, AZ 85297

**Registered Aug. 28, 2012**

**Int. Cl.: 30**

FOR: MARINADES; SAUCES, IN CLASS 30 (U.S. CL. 46).

**TRADEMARK**

FIRST USE 9-1-2011; IN COMMERCE 9-1-2011.

**PRINCIPAL REGISTER**

THE MARK CONSISTS OF STANDARD CHARACTERS WITHOUT CLAIM TO ANY PARTICULAR FONT, STYLE, SIZE, OR COLOR.

OWNER OF U.S. REG. NO. 3,639,244.

NO CLAIM IS MADE TO THE EXCLUSIVE RIGHT TO USE "SAUCE", APART FROM THE MARK AS SHOWN.

SER. NO. 85-474,926, FILED 11-17-2011.

WENDY JUN, EXAMINING ATTORNEY



*David J. Kyffers*

Director of the United States Patent and Trademark Office

# United States of America

United States Patent and Trademark Office

## ZIPPER WITH THE HOOK

**Reg. No. 4,197,392**

MATTRESS SAFE, INC. (GEORGIA CORPORATION)

**Registered Aug. 28, 2012**

P.O. BOX 2267  
CUMMING, GA 30041

**Int. Cl.: 24**

FOR: BED PRODUCTS, NAMELY, MATTRESS COVERS AND BOX SPRING COVERS, IN CLASS 24 (U.S. CLS. 42 AND 50).

**TRADEMARK**

FIRST USE 6-0-2006; IN COMMERCE 6-0-2006.

**PRINCIPAL REGISTER**

THE MARK CONSISTS OF STANDARD CHARACTERS WITHOUT CLAIM TO ANY PARTICULAR FONT, STYLE, SIZE, OR COLOR.

SEC. 2(F).

SER. NO. 85-474,961, FILED 11-17-2011.

JENNIFER VASQUEZ, EXAMINING ATTORNEY



*David J. Kybas*

Director of the United States Patent and Trademark Office

# United States of America

United States Patent and Trademark Office

## Numb Acai Mojito

**Reg. No. 4,197,393**

TASTY COCKTAILS LLC (NEVADA LIMITED LIABILITY COMPANY)  
1323 PANINI DR  
HENDERSON, NV 89052

**Registered Aug. 28, 2012**

**Int. Cl.: 33**

FOR: PREPARED ALCOHOLIC COCKTAIL, IN CLASS 33 (U.S. CLS. 47 AND 49).

**TRADEMARK**

FIRST USE 7-10-2010; IN COMMERCE 7-10-2010.

**PRINCIPAL REGISTER**

THE MARK CONSISTS OF STANDARD CHARACTERS WITHOUT CLAIM TO ANY PARTICULAR FONT, STYLE, SIZE, OR COLOR.

OWNER OF U.S. REG. NOS. 3,845,672 AND 3,874,408.

NO CLAIM IS MADE TO THE EXCLUSIVE RIGHT TO USE "ACAI MOJITO", APART FROM THE MARK AS SHOWN.

SER. NO. 85-475,269, FILED 11-17-2011.

JANICE KIM, EXAMINING ATTORNEY



*David J. Kyffers*

Director of the United States Patent and Trademark Office

# United States of America

United States Patent and Trademark Office

## Numb Nectar

**Reg. No. 4,197,394**

TASTY COCKTAILS LLC (NEVADA LIMITED LIABILITY COMPANY)  
1323 PANINI DR  
HENDERSON, NV 89052

**Registered Aug. 28, 2012**

**Int. Cl.: 33**

FOR: PREPARED ALCOHOLIC COCKTAIL, IN CLASS 33 (U.S. CLS. 47 AND 49).

**TRADEMARK**

FIRST USE 7-10-2010; IN COMMERCE 7-10-2010.

**PRINCIPAL REGISTER**

THE MARK CONSISTS OF STANDARD CHARACTERS WITHOUT CLAIM TO ANY PARTICULAR FONT, STYLE, SIZE, OR COLOR.

OWNER OF U.S. REG. NOS. 3,845,672 AND 3,874,408.

NO CLAIM IS MADE TO THE EXCLUSIVE RIGHT TO USE "NECTAR", APART FROM THE MARK AS SHOWN.

SER. NO. 85-475,295, FILED 11-17-2011.

JANICE KIM, EXAMINING ATTORNEY



*David J. Kyffers*

Director of the United States Patent and Trademark Office

# United States of America

United States Patent and Trademark Office

## Numb Blue Dream

**Reg. No. 4,197,395**

TASTY COCKTAILS LLC (NEVADA LIMITED LIABILITY COMPANY)  
1323 PANINI DR  
HENDERSON, NV 89052

**Registered Aug. 28, 2012**

**Int. Cl.: 33**

FOR: PREPARED ALCOHOLIC COCKTAIL, IN CLASS 33 (U.S. CLS. 47 AND 49).

**TRADEMARK**

FIRST USE 7-10-2010; IN COMMERCE 7-10-2010.

**PRINCIPAL REGISTER**

THE MARK CONSISTS OF STANDARD CHARACTERS WITHOUT CLAIM TO ANY PARTICULAR FONT, STYLE, SIZE, OR COLOR.

OWNER OF U.S. REG. NOS. 3,845,672 AND 3,874,408.

NO CLAIM IS MADE TO THE EXCLUSIVE RIGHT TO USE "BLUE", APART FROM THE MARK AS SHOWN.

SER. NO. 85-475,321, FILED 11-17-2011.

JANICE KIM, EXAMINING ATTORNEY



*David J. Kyffers*

Director of the United States Patent and Trademark Office

# United States of America

United States Patent and Trademark Office

# Numb Diablo

**Reg. No. 4,197,396**

TASTY COCKTAILS LLC (NEVADA LIMITED LIABILITY COMPANY)  
1323 PANINI DR  
HENDERSON, NV 89052

**Registered Aug. 28, 2012**

**Int. Cl.: 33**

FOR: PREPARED ALCOHOLIC COCKTAIL, IN CLASS 33 (U.S. CLS. 47 AND 49).

**TRADEMARK**

FIRST USE 7-10-2010; IN COMMERCE 7-10-2010.

**PRINCIPAL REGISTER**

THE MARK CONSISTS OF STANDARD CHARACTERS WITHOUT CLAIM TO ANY PARTICULAR FONT, STYLE, SIZE, OR COLOR.

OWNER OF U.S. REG. NOS. 3,845,672 AND 3,874,408.

THE ENGLISH TRANSLATION OF THE WORD "DIABLO" IN THE MARK IS "DEVIL".

SER. NO. 85-475,358, FILED 11-17-2011.

JANICE KIM, EXAMINING ATTORNEY



*David J. Kybas*

Director of the United States Patent and Trademark Office

# United States of America

United States Patent and Trademark Office

## E4D DENTIST

**Reg. No. 4,197,397**

**Registered Aug. 28, 2012**

**Int. Cl.: 10**

**TRADEMARK**

**PRINCIPAL REGISTER**

D4D TECHNOLOGIES, LLC (DELAWARE LIMITED LIABILITY COMPANY)  
650 INTERNATIONAL PARKWAY, SUITE 150  
RICHARDSON, TX 75081

FOR: DENTAL INSTRUMENTS, NAMELY, DENTAL TOOLS, IMAGING SYSTEMS, SOFTWARE AND MILLING MACHINES FOR MANUFACTURING DENTAL PROSTHETICS, IN CLASS 10 (U.S. CLS. 26, 39 AND 44).

FIRST USE 2-0-2008; IN COMMERCE 2-0-2008.

THE MARK CONSISTS OF STANDARD CHARACTERS WITHOUT CLAIM TO ANY PARTICULAR FONT, STYLE, SIZE, OR COLOR.

NO CLAIM IS MADE TO THE EXCLUSIVE RIGHT TO USE "DENTIST", APART FROM THE MARK AS SHOWN.

SER. NO. 85-475,468, FILED 11-17-2011.

SUSAN STIGLITZ, EXAMINING ATTORNEY



*David J. Kyjars*

Director of the United States Patent and Trademark Office

# United States of America

United States Patent and Trademark Office



**Reg. No. 4,197,398**

CAMBIA HEALTH SOLUTIONS, INC. (OREGON CORPORATION)  
100 SW MARKET STREET  
PORTLAND, OR 97201

**Registered Aug. 28, 2012**

**Int. Cls.: 36, 44 and 45**

FOR: INSURANCE SERVICES, NAMELY, UNDERWRITING, ISSUANCE AND ADMINISTRATION OF LIFE INSURANCE, HEALTH INSURANCE; PHARMACEUTICAL BENEFIT MANAGEMENT SERVICES, IN CLASS 36 (U.S. CLS. 100, 101 AND 102).

**SERVICE MARK**

FIRST USE 11-7-2011; IN COMMERCE 11-7-2011.

**PRINCIPAL REGISTER**

FOR: HEALTH CARE SERVICES, NAMELY, WELLNESS PROGRAMS, IN CLASS 44 (U.S. CLS. 100 AND 101).

FIRST USE 11-7-2011; IN COMMERCE 11-7-2011.

FOR: ON-LINE SOCIAL NETWORKING SERVICES, IN CLASS 45 (U.S. CLS. 100 AND 101).

FIRST USE 11-7-2011; IN COMMERCE 11-7-2011.

NO CLAIM IS MADE TO THE EXCLUSIVE RIGHT TO USE "HEALTH SOLUTIONS", APART FROM THE MARK AS SHOWN.

THE MARK CONSISTS OF A CIRCLE WITH SMALLER CIRCLES WITHIN EACH OTHER TOGETHER WITH THE WORDS "CAMBIA HEALTH SOLUTIONS".

THE ENGLISH TRANSLATION OF THE WORD "CAMBIA" IN THE MARK IS "CHANGE".

SER. NO. 85-475,507, FILED 11-17-2011.

KEVIN DINALLO, EXAMINING ATTORNEY



*David J. Kybas*

Director of the United States Patent and Trademark Office



# United States of America

United States Patent and Trademark Office

The logo for Earthport features the word "earthport" in a lowercase, blue, sans-serif font. To the right of the text is a curved yellow line that starts below the 't' and arches over the 'p' and 'o', resembling a stylized arc or a partial circle.

**Reg. No. 4,197,399**

EARTHPORT PLC (UNITED KINGDOM PUBLIC LIMITED COMPANY (PLC))  
21 NEW STREET

**Registered Aug. 28, 2012**

LONDON, UNITED KINGDOM EC2M 4TP

**Int. Cl.: 36**

FOR: ELECTRONIC PAYMENT SERVICES, NAMELY, ELECTRONIC PROCESSING AND TRANSMISSION OF BILL PAYMENT DATA VIA A GLOBAL COMPUTER NETWORK OR OTHER TELECOMMUNICATION NETWORKS, NAMELY, WIRELESS, FIXED AND MOBILE NETWORKS; PROVIDING INFORMATION IN THE FIELD OF ELECTRONIC PAYMENT PROCESSING AND TRANSMISSION VIA COMPUTER NETWORKS AND GLOBAL INFORMATION NETWORKS; FINANCIAL SERVICES, NAMELY, ELECTRONIC FUNDS TRANSFER VIA COMPUTER NETWORKS AND ELECTRONIC COMMUNICATIONS NETWORKS; CLEARING AND RECONCILING FINANCIAL TRANSACTIONS VIA ELECTRONIC COMMUNICATIONS NETWORKS; CREDIT CARD, DEBIT CARD, BANK CARD AND ELECTRONIC PAYMENT CARD SERVICES; PROCESSING AND TRANSMISSION OF BILLS AND PAYMENTS THEREOF, CONDUCTED VIA GLOBAL COMPUTER AND COMMUNICATIONS NETWORKS; PROVIDING FINANCIAL TRANSACTION PROCESSING SERVICES AND FINANCIAL INFORMATION BY ELECTRONIC MEANS VIA COMPUTER NETWORKS AND GLOBAL INFORMATION NETWORKS IN THE FIELD OF ELECTRONIC FUND TRANSFER AND PAYMENT PROCESSING SERVICES; ELECTRONIC FUNDS AND CURRENCY TRANSFER SERVICES; BANKING SERVICES, NAMELY, TRANSFER OF FUNDS FROM ACCOUNTS, IN CLASS 36 (U.S. CLS. 100, 101 AND 102).

**SERVICE MARK**

**PRINCIPAL REGISTER**



PRIORITY CLAIMED UNDER SEC. 44(D) ON ERPN CMNTY TM OFC APPLICATION NO. 010354231, FILED 10-19-2011, REG. NO. 010354231, DATED 3-5-2012, EXPIRES 10-19-2021.

THE COLOR(S) BLUE AND YELLOW IS/ARE CLAIMED AS A FEATURE OF THE MARK.

THE MARK CONSISTS OF THE WORD "EARTHPORT" IN BLUE WITH A CURVED YELLOW LINE ON THE RIGHT SIDE OF THE WORD "EARTHPORT".

SER. NO. 85-476,445, FILED 11-18-2011.

LINDA E. BLOHM, EXAMINING ATTORNEY

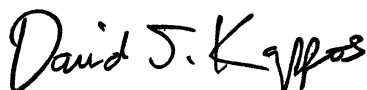
A handwritten signature in black ink that reads "David J. Kyffers".

Director of the United States Patent and Trademark Office

# United States of America

United States Patent and Trademark Office



**Reg. No. 4,197,400**

**Registered Aug. 28, 2012**

**Int. Cls.: 35 and 37**

**SERVICE MARK**

**PRINCIPAL REGISTER**

MEASUREMENT CONTROLS, INC. (NORTH CAROLINA CORPORATION)  
6131 OLD CONCORD ROAD  
CHARLOTTE, NC 28213

FOR: RETAIL AND WHOLESALE STORE SERVICES FEATURING UTILITY METERS;  
ONLINE RETAIL AND WHOLESALE STORE SERVICES FEATURING UTILITY METERS,  
DISTRIBUTORSHIP SERVICES FEATURING UTILITY METERS, IN CLASS 35 (U.S. CLS.  
100, 101 AND 102).

FIRST USE 5-1-2008; IN COMMERCE 5-1-2008.

FOR: REFURBISHING SERVICES IN THE FIELD OF UTILITY METERS, IN CLASS 37 (U.S.  
CLS. 100, 103 AND 106).

FIRST USE 5-1-2008; IN COMMERCE 5-1-2008.

THE MARK CONSISTS OF A CIRCLE HAVING AN OUTLINE OF A FIRST M-SHAPE SPACED  
ABOVE AN OUTLINE OF A SECOND M-SHAPE.

SER. NO. 85-476,892, FILED 11-18-2011.

JEFFREY LOOK, EXAMINING ATTORNEY



*David J. Kyffers*

Director of the United States Patent and Trademark Office

# United States of America

United States Patent and Trademark Office

## Inspiring Language Learners

**Reg. No. 4,197,401**

**Registered Aug. 28, 2012**

**Int. Cl.: 41**

**SERVICE MARK**

**PRINCIPAL REGISTER**

ROCKET LANGUAGES LTD (NEW ZEALAND LIMITED LIABILITY COMPANY), AKA  
LIBROS MEDIA LTD  
18 SEAMOUNT TERRACE  
CHRISTCHURCH, NEW ZEALAND 8081

FOR: INSTRUCTION IN THE FIELD OF LANGUAGE LEARNING, IN CLASS 41 (U.S. CLS.  
100, 101 AND 107).

FIRST USE 11-1-2011; IN COMMERCE 11-1-2011.

THE MARK CONSISTS OF STANDARD CHARACTERS WITHOUT CLAIM TO ANY PAR-  
TICULAR FONT, STYLE, SIZE, OR COLOR.

NO CLAIM IS MADE TO THE EXCLUSIVE RIGHT TO USE "LANGUAGE LEARNERS",  
APART FROM THE MARK AS SHOWN.

SER. NO. 85-477,302, FILED 11-20-2011.

SAMUEL E. SHARPER JR., EXAMINING ATTORNEY



*David J. Kyffers*

Director of the United States Patent and Trademark Office

# United States of America

United States Patent and Trademark Office

## GREEN MISSION

**Reg. No. 4,197,402**

**Registered Aug. 28, 2012**

**Int. Cl.: 3**

**TRADEMARK**

**PRINCIPAL REGISTER**

WHOLE FOODS MARKET IP, L.P. (DELAWARE LIMITED PARTNERSHIP)  
550 BOWIE STREET, 6TH FLOOR  
AUSTIN, TX 78703

FOR: HOUSEHOLD CLEANING PREPARATIONS, LAUNDRY DETERGENT, FABRIC SOFTENERS, DISHWASHING PREPARATIONS, ALL-PURPOSE CLEANING PREPARATIONS, TOILET CLEANING PREPARATIONS, PRE-MOISTENED DISPOSABLE HOUSEHOLD CLEANING WIPES, ALL BEING ENVIRONMENTALLY FRIENDLY, IN CLASS 3 (U.S. CLS. 1, 4, 6, 50, 51 AND 52).

FIRST USE 9-0-2011; IN COMMERCE 9-0-2011.

THE MARK CONSISTS OF STANDARD CHARACTERS WITHOUT CLAIM TO ANY PARTICULAR FONT, STYLE, SIZE, OR COLOR.

OWNER OF U.S. REG. NOS. 3,121,198, 3,264,496, AND 4,075,113.

NO CLAIM IS MADE TO THE EXCLUSIVE RIGHT TO USE "GREEN", APART FROM THE MARK AS SHOWN.

SER. NO. 85-477,449, FILED 11-21-2011.

RAUL CORDOVA, EXAMINING ATTORNEY



*David J. Kyros*

Director of the United States Patent and Trademark Office

# United States of America

United States Patent and Trademark Office

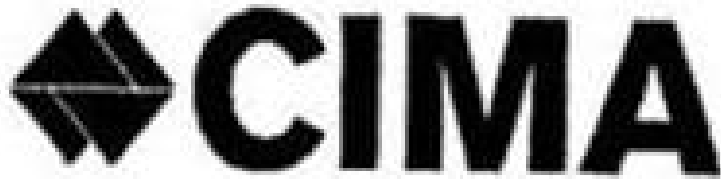

**Reg. No. 4,197,403**

**Registered Aug. 28, 2012**

**Int. Cl.: 36**

**SERVICE MARK**

**PRINCIPAL REGISTER**

THE CIMA COMPANIES, INC. (DELAWARE CORPORATION)  
2750 KILLARNEY DRIVE, SUITE 202  
WOODBIDGE, VA 22192

FOR: INSURANCE BROKERAGE AND INSURANCE ADMINISTRATION, IN CLASS 36  
(U.S. CLS. 100, 101 AND 102).

FIRST USE 11-15-2011; IN COMMERCE 11-15-2011.

OWNER OF U.S. REG. NOS. 960,105, 1,397,938, AND 1,958,659.

THE MARK CONSISTS OF THE WORD "CIMA" ADJACENT TO A DESIGN OF TWO INTER-  
SECTING DIAMOND SHAPES.

SER. NO. 85-477,776, FILED 11-21-2011.

AMY KELLY, EXAMINING ATTORNEY



*David J. Kyffers*

Director of the United States Patent and Trademark Office

# United States of America

United States Patent and Trademark Office



# ITLS

International Trauma Life Support

**Reg. No. 4,197,404**

**Registered Aug. 28, 2012**

**Int. Cl.: 41**

**SERVICE MARK**

**PRINCIPAL REGISTER**

BASIC TRAUMA LIFE SUPPORT INTERNATIONAL, INC. (ALABAMA NON-PROFIT CORPORATION), DBA INTERNATIONAL TRAUMA LIFE SUPPORT  
SUITE 200  
3000 WOODCREEK DRIVE  
DOWNERS GROVE, IL 60515

FOR: EDUCATIONAL SERVICES, NAMELY, CONDUCTING WORKSHOPS, COURSES, AND CONFERENCES IN THE FIELD OF EMERGENCY MEDICAL CARE AND LIFE SUPPORT, AND DISTRIBUTION OF BOOKS AND COURSE MATERIALS THEREWITH, IN CLASS 41 (U.S. CLS. 100, 101 AND 107).

FIRST USE 10-28-2005, THE MARK WAS FIRST USED ANYWHERE IN A DIFFERENT FORM OTHER THAN THAT SOUGHT TO BE REGISTERED AT LEAST AS EARLY AS 09/01/1992; IN COMMERCE 10-28-2005, THE MARK WAS FIRST USED IN COMMERCE IN A DIFFERENT FORM OTHER THAN THAT SOUGHT TO BE REGISTERED AT LEAST AS EARLY AS 09/01/1992.

OWNER OF U.S. REG. NOS. 1,928,942, 3,299,392, AND 3,958,597.

THE COLOR(S) BLUE-GRAY, LIGHTER SHADE BLUE-GRAY, LIGHT GOLDENROD AND WHITE IS/ARE CLAIMED AS A FEATURE OF THE MARK.

NO CLAIM IS MADE TO THE EXCLUSIVE RIGHT TO USE "INTERNATIONAL TRAUMA LIFE SUPPORT", APART FROM THE MARK AS SHOWN.

THE MARK CONSISTS OF A GRAPHIC COMPRISING A WHITE SERPENT AND STAFF (CADUCEUS) INSIDE A LIGHTER SHADE BLUE-GRAY 6-POINT "\*" SYMBOL OUTLINED IN BLUE-GRAY, ALL OF WHICH IS INSCRIBED WITHIN A CIRCLE HAVING TWELVE EQUI-SPACED TICK MARKS, AND AN AREA OF LIGHTER SHADE GOLDENROD COLOR FROM THE TICK MARK LOCATED AT TWO-O'CLOCK THROUGH THE TWELVE-O'CLOCK MARK; TO THE RIGHT OF THE BLUE-GRAY AND GOLDENROD CIRCULAR GRAPHIC ARE FOUR BOLD BLUE-GRAY UPPER-CASE LETTERS "ITLS", ABOVE THE WORDING "INTERNATIONAL TRAUMA LIFE SUPPORT" IN BLUE-GRAY LETTERS.



*David J. Kyffers*

Director of the United States Patent and Trademark Office

SER. NO. 85-478,187, FILED 11-21-2011.

JEFFREY LOOK, EXAMINING ATTORNEY

# United States of America

United States Patent and Trademark Office

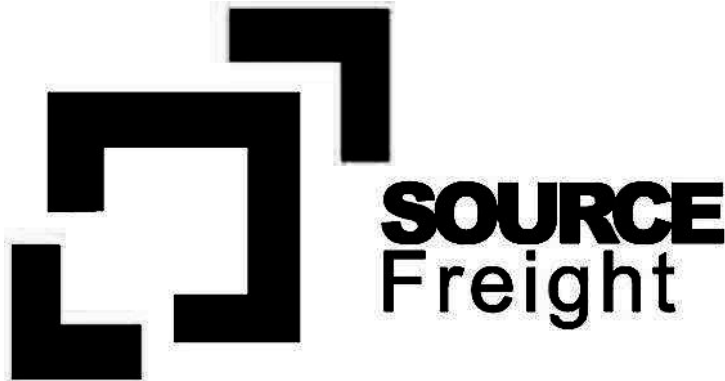

**Reg. No. 4,197,405**

**Registered Aug. 28, 2012**

**Int. Cl.: 39**

**SERVICE MARK**

**PRINCIPAL REGISTER**

SOURCE HOLDING DELAWARE, LLC (DELAWARE LIMITED LIABILITY COMPANY)  
812 UNION ST.  
MONTEBELLO, CA 90640

FOR: GLOBAL TRANSPORTATION OF FREIGHT FOR OTHERS BY ALL AVAILABLE MEANS; TRANSPORTATION OF PASSENGERS AND/OR GOODS BY TRAIN TRUCK OR AIR; WAREHOUSING SERVICES, NAMELY, STORAGE, DISTRIBUTION, PICK-UP, AND PACKING FOR SHIPMENT OF DOCUMENTS, PACKAGES, RAW MATERIALS, AND OTHER FREIGHT FOR OTHERS, IN CLASS 39 (U.S. CLS. 100 AND 105).

FIRST USE 11-21-2011; IN COMMERCE 11-21-2011.

OWNER OF U.S. REG. NO. 3,084,246.

NO CLAIM IS MADE TO THE EXCLUSIVE RIGHT TO USE "FREIGHT", APART FROM THE MARK AS SHOWN.

THE MARK CONSISTS OF RECTANGULAR SHAPES NEXT TO THE WORDS "SOURCE FREIGHT".

SER. NO. 85-478,199, FILED 11-21-2011.

SUE LAWRENCE, EXAMINING ATTORNEY



*David J. Kybas*

Director of the United States Patent and Trademark Office

# United States of America

United States Patent and Trademark Office

## BEASTIE BOYS

**Reg. No. 4,197,406**

**Registered Aug. 28, 2012**

**Int. Cls.: 9 and 25**

**TRADEMARK**

**PRINCIPAL REGISTER**

BEASTIE BOYS (NEW YORK PARTNERSHIP)  
SUITE 1600  
1880 CENTURY PARK EAST  
LOS ANGELES, CA 90067

FOR: MUSICAL SOUND RECORDINGS; VIDEO RECORDINGS FEATURING MUSICAL PERFORMANCES, IN CLASS 9 (U.S. CLS. 21, 23, 26, 36 AND 38).

FIRST USE 0-0-1982; IN COMMERCE 0-0-1982.

FOR: CAPS; T-SHIRTS, IN CLASS 25 (U.S. CLS. 22 AND 39).

FIRST USE 0-0-1985; IN COMMERCE 0-0-1985.

THE MARK CONSISTS OF STANDARD CHARACTERS WITHOUT CLAIM TO ANY PARTICULAR FONT, STYLE, SIZE, OR COLOR.

SER. NO. 85-478,275, FILED 11-21-2011.

BARBARA A. GOLD, EXAMINING ATTORNEY



*David J. Kybas*

Director of the United States Patent and Trademark Office



# United States of America

United States Patent and Trademark Office

A large, stylized cursive logo for the word "Howe". The letters are thick and fluid, with a long horizontal tail on the 'e'.

**Reg. No. 4,197,407**

HOWE, LLC (DELAWARE LIMITED LIABILITY COMPANY)  
1633 WESTLAKE AVENUE N.  
SEATTLE, WA 98109

**Registered Aug. 28, 2012**

**Int. Cl.: 9**

FOR: EYEWEAR, NAMELY, SUNGLASSES, EYEGASSES AND OPHTHALMIC FRAMES  
AND CASES THEREFOR, IN CLASS 9 (U.S. CLS. 21, 23, 26, 36 AND 38).

**TRADEMARK**

FIRST USE 11-21-2011; IN COMMERCE 11-21-2011.

**PRINCIPAL REGISTER**

OWNER OF U.S. REG. NOS. 2,670,569, 3,061,845, AND 3,487,455.

THE MARK CONSISTS OF A STYLIZED WORD "HOWE".

SEC. 2(F).

SER. NO. 85-478,360, FILED 11-21-2011.

JEAN IM, EXAMINING ATTORNEY



A handwritten signature in cursive script that reads "David J. Kyffers".

Director of the United States Patent and Trademark Office

# United States of America

United States Patent and Trademark Office

A large, stylized cursive logo for the word "Howe". The letters are thick and fluid, with a long horizontal tail on the 'e'.

**Reg. No. 4,197,408**

**Registered Aug. 28, 2012**

**Int. Cl.: 14**

**TRADEMARK**

**PRINCIPAL REGISTER**

HOWE, LLC (DELAWARE LIMITED LIABILITY COMPANY)  
1633 WESTLAKE AVENUE N.  
SEATTLE, WA 98109

FOR: WRIST WATCHES, IN CLASS 14 (U.S. CLS. 2, 27, 28 AND 50).

FIRST USE 11-21-2011; IN COMMERCE 11-21-2011.

OWNER OF U.S. REG. NOS. 2,670,569, 3,061,845, AND 3,487,455.

THE MARK CONSISTS OF A STYLIZED WORD "HOWE".

SEC. 2(F).

SER. NO. 85-478,384, FILED 11-21-2011.

JEAN IM, EXAMINING ATTORNEY



A handwritten signature in cursive script that reads "David J. Kyffers".

Director of the United States Patent and Trademark Office

# United States of America

United States Patent and Trademark Office



**Reg. No. 4,197,409**

**Registered Aug. 28, 2012**

**Int. Cl.: 43**

**SERVICE MARK**

**PRINCIPAL REGISTER**

ACH FOOD COMPANIES, INC. (DELAWARE CORPORATION)  
7171 GOODLETT FARMS PARKWAY  
CORDOVA, TN 38016

FOR: PROVIDING ONLINE INFORMATION SERVICES, NAMELY, PROVIDING A WEBSITE WITH INSTRUCTION ON BAKING TECHNIQUES, BAKING TIPS AND RECIPES, IN CLASS 43 (U.S. CLS. 100 AND 101).

FIRST USE 10-24-2011; IN COMMERCE 10-24-2011.

NO CLAIM IS MADE TO THE EXCLUSIVE RIGHT TO USE "BAKER", APART FROM THE MARK AS SHOWN.

THE MARK CONSISTS OF THE WORDS "BECOME A BETTER" IN SCRIPT ON THE FIRST LINE AND "BAKER" IN BOLDFACE TYPE ON THE SECOND LINE WITH A KITCHEN WHISK STANDING UPRIGHT AT THE LEFT SIDE OF THE WORDING.

SER. NO. 85-478,672, FILED 11-22-2011.

EMILY CHUO, EXAMINING ATTORNEY



*David J. Kybas*

Director of the United States Patent and Trademark Office

# United States of America

United States Patent and Trademark Office

## STATE AG MONITOR

**Reg. No. 4,197,410**

DICKSTEIN SHAPIRO LLP (D.C. LIMITED LIABILITY PARTNERSHIP)

**Registered Aug. 28, 2012**

1825 EYE ST., NW  
WASHINGTON, DC 20006

**Int. Cl.: 41**

FOR: ON-LINE JOURNAL, NAMELY, A BLOG FEATURING STATE ATTORNEY GENERAL ISSUES; PROVIDING ONLINE NEWSLETTERS IN THE FIELD OF STATE ATTORNEY GENERAL ISSUES, IN CLASS 41 (U.S. CLS. 100, 101 AND 107).

**SERVICE MARK**

FIRST USE 6-30-2011; IN COMMERCE 2-24-2012.

**PRINCIPAL REGISTER**

THE MARK CONSISTS OF STANDARD CHARACTERS WITHOUT CLAIM TO ANY PARTICULAR FONT, STYLE, SIZE, OR COLOR.

NO CLAIM IS MADE TO THE EXCLUSIVE RIGHT TO USE "STATE AG", APART FROM THE MARK AS SHOWN.

SER. NO. 85-478,794, FILED 11-22-2011.

KEVON CHISOLM, EXAMINING ATTORNEY



*David J. Kybas*

Director of the United States Patent and Trademark Office

# United States of America

United States Patent and Trademark Office

# ATIZ

**Reg. No. 4,197,411**

**Registered Aug. 28, 2012**

**Int. Cl.: 9**

**TRADEMARK**

**PRINCIPAL REGISTER**

ATIZ INNOVATION CO., LTD. (THAILAND LIMITED COMPANY (LTD.))  
729/26-27 RATCHADAPHISEK RD.  
YANNAWA, THAILAND

FOR: COMPUTER HARDWARE AND SOFTWARE FOR IMAGING PAGES OF DOCUMENTS AND BOOKS; SCANNERS; PERIPHERALS FOR COMPUTING DEVICES AND HAND-HELD DEVICES FOR VISUALLY RECORDING, IMAGING AND DISPLAYING TEXT, DOCUMENTS AND BOOKS, IN CLASS 9 (U.S. CLS. 21, 23, 26, 36 AND 38).

FIRST USE 1-1-2005; IN COMMERCE 1-5-2006.

THE MARK CONSISTS OF STANDARD CHARACTERS WITHOUT CLAIM TO ANY PARTICULAR FONT, STYLE, SIZE, OR COLOR.

SER. NO. 85-478,948, FILED 11-22-2011.

JOHN HWANG, EXAMINING ATTORNEY



*David J. Kyffers*

Director of the United States Patent and Trademark Office

# United States of America

United States Patent and Trademark Office

# CUISINART

**Reg. No. 4,197,412**

CONAIR CORPORATION (DELAWARE CORPORATION)  
ONE CUMMINGS POINT ROAD  
STAMFORD, CT 06902

**Registered Aug. 28, 2012**

**Int. Cls.: 9 and 21**

FOR: MEASURING CUPS; MEASURING SPOONS; THERMOMETER, IN CLASS 9 (U.S. CLS. 21, 23, 26, 36 AND 38).

**TRADEMARK**

FIRST USE 3-0-2011; IN COMMERCE 3-0-2011.

**PRINCIPAL REGISTER**

FOR: SERVING TONGS; NON-ELECTRIC FOOD BLENDER USED FOR DOUGH; MIXING BOWLS, IN CLASS 21 (U.S. CLS. 2, 13, 23, 29, 30, 33, 40 AND 50).

FIRST USE 8-0-2011; IN COMMERCE 8-0-2011.

THE MARK CONSISTS OF STANDARD CHARACTERS WITHOUT CLAIM TO ANY PARTICULAR FONT, STYLE, SIZE, OR COLOR.

OWNER OF U.S. REG. NOS. 1,183,520, 2,313,580 AND OTHERS.

SER. NO. 85-478,955, FILED 11-22-2011.

PAULA MAHONEY, EXAMINING ATTORNEY



*David J. Kyfos*

Director of the United States Patent and Trademark Office

# United States of America

United States Patent and Trademark Office



**EARLY LEARNING  
VILLAGE**

Making joyous connections.

**Reg. No. 4,197,413**

**Registered Aug. 28, 2012**

**Int. Cl.: 41**

**SERVICE MARK**

**PRINCIPAL REGISTER**

LOUISIANA CHILDREN'S MUSEUM (LOUISIANA NON-PROFIT CORPORATION)  
420 JULIA STREET  
NEW ORLEANS, LA 70130

FOR: EDUCATIONAL AND ENTERTAINMENT SERVICES FOR CHILDREN, NAMELY, PROVIDING INTERACTIVE PLAY AREAS, INSTRUCTIONAL CLASSES IN THE FIELD OF ART, MUSIC, EARLY LITERACY, LOCAL CULTURE, ENVIRONMENTAL STUDIES AND SOCIAL GATHERINGS FOR CHILDREN; MUSEUM SERVICES; MUSEUMS, IN CLASS 41 (U.S. CLS. 100, 101 AND 107).

FIRST USE 6-24-2010; IN COMMERCE 6-24-2010.

NO CLAIM IS MADE TO THE EXCLUSIVE RIGHT TO USE "EARLY LEARNING", APART FROM THE MARK AS SHOWN.

THE COLOR(S) YELLOW, GREEN, BLUE, MAGENTA, PURPLE AND BLACK IS/ARE CLAIMED AS A FEATURE OF THE MARK.

THE MARK CONSISTS OF FIVE OVERLAPPING CRAYON-SHAPED HOUSES IN THE COLORS YELLOW, GREEN, BLUE, MAGENTA AND PURPLE; EACH HOUSE HAS TRANSPARENT WINDOWS AND A TRANSPARENT DOOR; UNDERNEATH THE DESIGN THE WORDS "EARLY LEARNING VILLAGE MAKING JOYOUS CONNECTIONS." APPEARS ON TWO LINES IN THE COLOR BLACK.

SER. NO. 85-479,043, FILED 11-22-2011.

KATHRYN COWARD, EXAMINING ATTORNEY



*David J. Kyjars*

Director of the United States Patent and Trademark Office

# United States of America

United States Patent and Trademark Office



**Reg. No. 4,197,414**

ARMANI & ASSOCIATI, INC. (FLORIDA CORPORATION)  
C/O 150 SE 2ND AVENUE #1010  
MIAMI, FL 33131

**Registered Aug. 28, 2012**

**Int. Cl.: 30**

FOR: BREAD, FOCACCIA, BUNS, BREAD ROLLS, FLAT BREADS, PASTRY, BREAD STICKS, IN CLASS 30 (U.S. CL. 46).

**TRADEMARK**

FIRST USE 1-3-2011; IN COMMERCE 6-1-2011.

**PRINCIPAL REGISTER**

NO CLAIM IS MADE TO THE EXCLUSIVE RIGHT TO USE "FOCACCIA", APART FROM THE MARK AS SHOWN.

THE NAME "MAX FOCACCIA" DOES NOT IDENTIFY A LIVING INDIVIDUAL.

THE MARK CONSISTS OF AN ARTIST'S PALETTE WITH THE WORDS " MAX FOCACCIA".

SER. NO. 85-479,046, FILED 11-22-2011.

HOWARD B. LEVINE, EXAMINING ATTORNEY



*David J. Kybas*

Director of the United States Patent and Trademark Office



# United States of America

United States Patent and Trademark Office

# TYMENTRY

**Reg. No. 4,197,415**

**Registered Aug. 28, 2012**

**Int. Cl.: 35**

**SERVICE MARK**

**PRINCIPAL REGISTER**

KOOSHAREM, LLC (CALIFORNIA LIMITED LIABILITY COMPANY)  
3820 STATE ST  
SANTA BARBARA, CA 93105

FOR: BUSINESS INFORMATION SERVICES, NAMELY, PROVIDING ONLINE COMPILATION OF EMPLOYMENT DATA, NAMELY, EMPLOYEE TIME RECORDS AND EMPLOYEE JOB AND PROJECT TRACKING RECORDS AND PREPARATION OF BUSINESS REPORTS IN CONNECTION THEREWITH; SERVICES IN THE FIELD OF EMPLOYMENT MANAGEMENT, NAMELY, ONLINE BUSINESS RECORDS MANAGEMENT RELATING TO EMPLOYEE TIMEKEEPING, JOB AND PROJECT TRACKING AND PREPARATION OF BUSINESS REPORTS IN CONNECTION THEREWITH, IN CLASS 35 (U.S. CLS. 100, 101 AND 102).

FIRST USE 11-11-2011; IN COMMERCE 11-11-2011.

THE MARK CONSISTS OF STANDARD CHARACTERS WITHOUT CLAIM TO ANY PARTICULAR FONT, STYLE, SIZE, OR COLOR.

OWNER OF U.S. REG. NO. 3,714,323.

SER. NO. 85-479,111, FILED 11-22-2011.

MARY CRAWFORD, EXAMINING ATTORNEY



*David J. Kyros*

Director of the United States Patent and Trademark Office

# United States of America

United States Patent and Trademark Office

# Infologs

**Reg. No. 4,197,416**

**Registered Aug. 28, 2012**

**Int. Cl.: 42**

**SERVICE MARK**

**PRINCIPAL REGISTER**

DNA2.0 (CALIFORNIA CORPORATION)  
SUITE A  
1140 O'BRIEN DRIVE  
MENLO PARK, CA 94025

FOR: CONSULTING SERVICES IN THE FIELDS OF BIOTECHNOLOGY, PHARMACEUTICAL RESEARCH AND DEVELOPMENT AND GENETIC SCIENCE; PROVIDING INFORMATION ON THE SUBJECT OF SCIENTIFIC RESEARCH IN THE FIELD OF BIOCHEMISTRY AND BIOTECHNOLOGY; RESEARCH AND DEVELOPMENT IN THE PHARMACEUTICAL AND BIOTECHNOLOGY FIELDS; SCIENTIFIC RESEARCH CONSULTING IN THE FIELD OF BIOTECHNOLOGY AND BIOENGINEERING, IN CLASS 42 (U.S. CLS. 100 AND 101).

FIRST USE 11-0-2006; IN COMMERCE 9-0-2011.

THE MARK CONSISTS OF STANDARD CHARACTERS WITHOUT CLAIM TO ANY PARTICULAR FONT, STYLE, SIZE, OR COLOR.

SER. NO. 85-479,157, FILED 11-22-2011.

MICHAEL TANNER, EXAMINING ATTORNEY



*David J. Kybas*

Director of the United States Patent and Trademark Office

# United States of America

United States Patent and Trademark Office

## BUDGET CHALLENGE

**Reg. No. 4,197,417**

**Registered Aug. 28, 2012**

**Int. Cl.: 42**

**SERVICE MARK**

**PRINCIPAL REGISTER**

NEXT TEN (CALIFORNIA CORPORATION)  
SUITE 402  
300 BRANNAN STREET  
SAN FRANCISCO, CA 94107

FOR: ONLINE, NON-DOWNLOADABLE COMPUTER SOFTWARE WHICH ALLOWS USERS TO CREATE WEB SITES THAT ENABLE RESIDENTS WHO VISIT THE SITES TO VIEW BUDGET POLICY CHOICES, IN CLASS 42 (U.S. CLS. 100 AND 101).

FIRST USE 4-1-2007; IN COMMERCE 4-1-2007.

THE MARK CONSISTS OF STANDARD CHARACTERS WITHOUT CLAIM TO ANY PARTICULAR FONT, STYLE, SIZE, OR COLOR.

NO CLAIM IS MADE TO THE EXCLUSIVE RIGHT TO USE "BUDGET", APART FROM THE MARK AS SHOWN.

SER. NO. 85-479,493, FILED 11-22-2011.

EDWARD FENNESSY, EXAMINING ATTORNEY



*David J. Kyffers*

Director of the United States Patent and Trademark Office

# United States of America

United States Patent and Trademark Office

## CALIFORNIA BUDGET CHALLENGE

**Reg. No. 4,197,418**

**Registered Aug. 28, 2012**

**Int. Cl.: 42**

**SERVICE MARK**

**PRINCIPAL REGISTER**

NEXT TEN (CALIFORNIA CORPORATION)  
SUITE 402  
300 BRANNAN STREET  
SAN FRANCISCO, CA 94107

FOR: PROVIDING A WEB SITE FEATURING TEMPORARY USE OF NON-DOWNLOADABLE SOFTWARE THAT ALLOWS RESIDENTS TO VIEW STATE BUDGET POLICY CHOICES, IN CLASS 42 (U.S. CLS. 100 AND 101).

FIRST USE 4-5-2005; IN COMMERCE 4-5-2005.

THE MARK CONSISTS OF STANDARD CHARACTERS WITHOUT CLAIM TO ANY PARTICULAR FONT, STYLE, SIZE, OR COLOR.

NO CLAIM IS MADE TO THE EXCLUSIVE RIGHT TO USE "CALIFORNIA BUDGET", APART FROM THE MARK AS SHOWN.

SER. NO. 85-479,532, FILED 11-22-2011.

EDWARD FENNESSY, EXAMINING ATTORNEY



*David J. Kyros*

Director of the United States Patent and Trademark Office

# United States of America

United States Patent and Trademark Office

## FEDERAL BUDGET CHALLENGE

**Reg. No. 4,197,419**

**Registered Aug. 28, 2012**

**Int. Cl.: 42**

**SERVICE MARK**

**PRINCIPAL REGISTER**

NEXT TEN (CALIFORNIA CORPORATION)  
SUITE 402  
300 BRANNAN STREET  
SAN FRANCISCO, CA 94107

FOR: PROVIDING A WEB SITE FEATURING TEMPORARY USE OF NON-DOWNLOADABLE SOFTWARE THAT ALLOWS RESIDENTS TO VIEW FEDERAL BUDGET POLICY CHOICES, IN CLASS 42 (U.S. CLS. 100 AND 101).

FIRST USE 11-9-2009; IN COMMERCE 11-9-2009.

THE MARK CONSISTS OF STANDARD CHARACTERS WITHOUT CLAIM TO ANY PARTICULAR FONT, STYLE, SIZE, OR COLOR.

NO CLAIM IS MADE TO THE EXCLUSIVE RIGHT TO USE "FEDERAL BUDGET", APART FROM THE MARK AS SHOWN.

SER. NO. 85-479,536, FILED 11-22-2011.

EDWARD FENNESSY, EXAMINING ATTORNEY



*David J. Kyffers*

Director of the United States Patent and Trademark Office

# United States of America

United States Patent and Trademark Office

## LIFE IS COLOR

**Reg. No. 4,197,420**

ARZY COMPANY, INC. (CALIFORNIA CORPORATION)  
650 SOUTH HILL STREET #915  
LOS ANGELES, CA 90014

**Registered Aug. 28, 2012**

**Int. Cl.: 14**

FOR: BANGLES; BRACELETS; DIAMOND JEWELRY; DIAMONDS; EARRINGS; GEMSTONE JEWELRY; JEWELRY; NECKLACES; PEARLS; PENDANTS; RINGS; SILVER; WEDDING BANDS; WEDDING RINGS, IN CLASS 14 (U.S. CLS. 2, 27, 28 AND 50).

**TRADEMARK**

FIRST USE 6-3-2011; IN COMMERCE 6-3-2011.

**PRINCIPAL REGISTER**

THE MARK CONSISTS OF STANDARD CHARACTERS WITHOUT CLAIM TO ANY PARTICULAR FONT, STYLE, SIZE, OR COLOR.

SER. NO. 85-479,566, FILED 11-22-2011.

SUZANNE BLANE, EXAMINING ATTORNEY



*David J. Kyros*

Director of the United States Patent and Trademark Office

# United States of America

United States Patent and Trademark Office



**Reg. No. 4,197,421**

**Registered Aug. 28, 2012**

**Int. Cl.: 30**

**TRADEMARK**

**PRINCIPAL REGISTER**

PIERDANT DE LA MORA, PEDRO (MEXICO INDIVIDUAL), DBA LEMPAT FOODS  
COLONIA DOCTORES  
DR. LUCIO 158  
MEXICO, MEXICO 06720

FOR: CONDIMENT, NAMELY, PEPPER SAUCE; COOKING SAUCES; HOT CHILI PEPPER SAUCE; HOT SAUCE; SAUCES; COOKING SAUCES, IN CLASS 30 (U.S. CL. 46).

FIRST USE 1-1-2006; IN COMMERCE 5-1-2010.

THE MARK CONSISTS OF A STYLIZED ROOSTER ABOVE THE WORDING "TIERRA BRAVA".

THE ENGLISH TRANSLATION OF "TIERRA BRAVA" IN THE MARK IS "BRAVE LAND".

SER. NO. 85-479,583, FILED 11-22-2011.

JAMES LOVELACE, EXAMINING ATTORNEY



*David J. Kyfos*

Director of the United States Patent and Trademark Office

# United States of America

United States Patent and Trademark Office

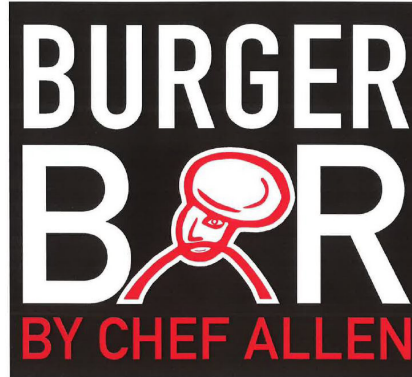

**Reg. No. 4,197,422**

**Registered Aug. 28, 2012**

**Int. Cl.: 43**

**SERVICE MARK**

**PRINCIPAL REGISTER**

5CENTS, LLC (FLORIDA LIMITED LIABILITY COMPANY)  
3660 N 34 AVE  
HOLLYWOOD, FL 33021

FOR: BAR SERVICES; RESTAURANT SERVICES, NAMELY, PROVIDING OF FOOD AND BEVERAGES FOR CONSUMPTION ON AND OFF THE PREMISES, IN CLASS 43 (U.S. CLS. 100 AND 101).

FIRST USE 10-15-2010; IN COMMERCE 10-15-2010.

OWNER OF U.S. REG. NO. 2,555,669.

THE COLOR(S) BLACK, RED AND WHITE IS/ARE CLAIMED AS A FEATURE OF THE MARK.

NO CLAIM IS MADE TO THE EXCLUSIVE RIGHT TO USE "BURGER BAR", APART FROM THE MARK AS SHOWN.

THE FICTITIOUS OR ASSUMED NAME "CHEF ALLEN" IDENTIFIES "ALLEN SUSSER", A LIVING INDIVIDUAL WHOSE CONSENT IS OF RECORD.

THE MARK CONSISTS OF A BLACK SQUARE BORDER CONTAINING THE STYLIZED WORDING "BURGER BAR" IN WHITE WHERE THE "A" IN "BAR" IS REPRESENTED BY A WHITE AND RED ONE-EYED CHEF WEARING A TOQUE, ABOVE THE WORDING "BY CHEF ALLEN" IN RED.

SER. NO. 85-479,683, FILED 11-23-2011.

ANDREA K. NADELMAN, EXAMINING ATTORNEY



*David J. Kyffers*

Director of the United States Patent and Trademark Office



# United States of America

United States Patent and Trademark Office

  
**GROW MOR**  
Growing More by Knowing More  

**Reg. No. 4,197,423**

PROGRESSIVE AG CENTER (MINNESOTA LIMITED LIABILITY COMPANY)  
113 4TH ST. SE

**Registered Aug. 28, 2012**

STEWARSVILLE, MN 55976

**Int. Cl.: 44**

FOR: AGRICULTURAL ADVICE, NAMELY, PROVIDING RECOMMENDATIONS FOR PLANT AND SOIL NUTRITION SUPPLEMENTS, IN CLASS 44 (U.S. CLS. 100 AND 101).

**SERVICE MARK**

FIRST USE 4-5-2012; IN COMMERCE 4-5-2012.

**PRINCIPAL REGISTER**

THE MARK CONSISTS OF THE WORD "GROWMOR" BLACK IN COLOR WITH A CURVED GREEN LINE ABOVE THE LETTERS "ROW" IN "GROW". TEXT "GROWING MORE BY KNOWING MORE" IN BLACK UNDER THE WORD "GROWMOR" WITH A SOLID GREEN LINE BELOW TEXT.

THE COLOR(S) BLACK AND GREEN IS/ARE CLAIMED AS A FEATURE OF THE MARK.

SER. NO. 85-479,727, FILED S.R. 11-23-2011 AM. P.R. 4-16-2012.

DAVID MURRAY, EXAMINING ATTORNEY



*David J. Kyffers*

Director of the United States Patent and Trademark Office

# United States of America

United States Patent and Trademark Office



**Reg. No. 4,197,424**

**Registered Aug. 28, 2012**

**Int. Cls.: 41 and 45**

**SERVICE MARK**

**PRINCIPAL REGISTER**

FAMILIES OF FANA-WNY, INC. (NEW YORK CORPORATION)  
6 PINE TERRACE  
ORCHARD PARK, NY 14127

FOR: EDUCATIONAL SERVICES, NAMELY, WORKSHOPS ABOUT HOW TO ADOPT, IN CLASS 41 (U.S. CLS. 100, 101 AND 107).

FIRST USE 10-27-2011; IN COMMERCE 11-1-2011.

FOR: PROVIDING A WEBSITE FEATURING INFORMATION ABOUT ADOPTION, IN CLASS 45 (U.S. CLS. 100 AND 101).

FIRST USE 10-27-2011; IN COMMERCE 11-1-2011.

THE MARK CONSISTS OF A CARTOON DRAWING OF TWO ADULTS IN PROFILE HOLDING HANDS, ONE CURVED LEFT, AND ONE CURVED RIGHT, SURROUNDING A CARTOON OF A CHILD FACING FORWARD WITH UPRAISED ARMS, ABOVE THE WORDS "FAMILIES OF FANA" IN UPPER CASE LETTERS, ALL IN THE COLOR GREEN.

THE COLOR(S) GREEN IS/ARE CLAIMED AS A FEATURE OF THE MARK.

SER. NO. 85-479,872, FILED 11-23-2011.

DAVID HOFFMAN, EXAMINING ATTORNEY



*David J. Kyffers*

Director of the United States Patent and Trademark Office

# United States of America

United States Patent and Trademark Office



**Reg. No. 4,197,425**

INDUSTRIAL MAGNETICS, INC. (MICHIGAN CORPORATION)  
1385 M-75 SOUTH  
BOYNE CITY, MI 49712

**Registered Aug. 28, 2012**

**Int. Cl.: 39**

FOR: EXPEDITED SHIPPING AND DELIVERY SERVICES, NAMELY, SAME DAY SHIPMENT SERVICES OF MAGNETS FOR HOLDING, LIFTING, FIXTUREING, WELDING AND SWEEPING APPLICATIONS, MAGNETS FOR AUTOMATED/ROBOTIC MATERIAL HANDLING AND MAGNETIC SEPARATION DEVICES FOR FERROUS METAL REMOVAL, ALL ORDERED VIA THE INTERNET OR VIA TELEPHONE, IN CLASS 39 (U.S. CLS. 100 AND 105).

**SERVICE MARK**

**PRINCIPAL REGISTER**

FIRST USE 1-21-2009; IN COMMERCE 1-21-2009.

OWNER OF U.S. REG. NO. 3,284,113.

NO CLAIM IS MADE TO THE EXCLUSIVE RIGHT TO USE "QUICK SHIP" OR "ORDER TODAY-SHIP TODAY" OR "INDUSTRIAL MAGNETICS, INC." OR "ESTABLISHED 1961", APART FROM THE MARK AS SHOWN.

THE MARK CONSISTS OF THE MARK IS THE WORD "QUICKSHIP" IN CONJUNCTION WITH A STYLIZED ARROW. THE SHAFT OF THE STYLIZED ARROW IS POSITIONED HORIZONTALLY BELOW THE WORD AND CONTAINS THE WORDS "ORDER TODAY-SHIP TODAY" AND THE HEAD OF THE ARROW IS POSITIONED TO THE RIGHT OF THE WORD AND VERTICALLY SPACED FROM THE SHAFT SUPERIMPOSED OF THE RIGHTMOST END OF THE SHAFT AND THE LEFTMOST END OF THE HEAD IS A STYLIZED SHADED CUBE BEARING A STYLISTIC DEPICTION OF A HORSESHOE MAGNET AND THE LETTERS "IMI" ENCLOSED WITHIN A CIRCULAR BACKGROUND. THE WORDS "INDUSTRIAL MAGNETICS, INC." AND "ESTABLISHED 1961" AND ANOTHER CIRCLE ARE CIRCUMSCRIBED WITHIN THE SHADED CUBE.



SER. NO. 85-480,196, FILED 11-23-2011.

STEVEN JACKSON, EXAMINING ATTORNEY

*David J. Kyffers*

Director of the United States Patent and Trademark Office

# United States of America

United States Patent and Trademark Office



**Reg. No. 4,197,426**

**Registered Aug. 28, 2012**

**Int. Cl.: 38**

**SERVICE MARK**

**PRINCIPAL REGISTER**

IMMS GMBH (SWITZERLAND CORPORATION)  
CHAMERSTRASSE 115  
ZUG, SWITZERLAND 6300

FOR: TELEVISION BROADCASTING SERVICES PROVIDED THROUGH A SATELLITE TELEVISION CHANNEL FEATURING GERMAN-LANGUAGE PROGRAMMING, IN CLASS 38 (U.S. CLS. 100, 101 AND 104).

FIRST USE 9-21-2011; IN COMMERCE 9-21-2011.

NO CLAIM IS MADE TO THE EXCLUSIVE RIGHT TO USE "GERMAN TV", APART FROM THE MARK AS SHOWN.

THE MARK CONSISTS OF THE STYLIZED WORDS "MY, GERMAN" AND "TV" INSIDE A RECTANGLE. THE WORD "MY" IS DRAWN ABOVE THE LETTERS "MA" OF THE WORD "GERMAN"; THE WORD "TV" IS DRAWN BELOW THE LETTERS "ER" OF THE WORD "GERMAN".

SER. NO. 85-481,267, FILED 11-28-2011.

TARAH HARDY, EXAMINING ATTORNEY



*David J. Kybas*

Director of the United States Patent and Trademark Office

# United States of America

United States Patent and Trademark Office

# Born Banner

**Reg. No. 4,197,427**

**Registered Aug. 28, 2012**

**Int. Cl.: 24**

**TRADEMARK**

**PRINCIPAL REGISTER**

RENEW MEDIA GROUP, INC. (TEXAS CORPORATION)  
817 SOUTH BRYAN STREET  
AMARILLO, TX 79106

FOR: BANNERS OF TEXTILE, IN CLASS 24 (U.S. CLS. 42 AND 50).

FIRST USE 11-7-2011; IN COMMERCE 11-7-2011.

THE MARK CONSISTS OF STANDARD CHARACTERS WITHOUT CLAIM TO ANY PARTICULAR FONT, STYLE, SIZE, OR COLOR.

NO CLAIM IS MADE TO THE EXCLUSIVE RIGHT TO USE "BANNER", APART FROM THE MARK AS SHOWN.

SER. NO. 85-481,308, FILED 11-28-2011.

NAAKWAMA ANKRAH, EXAMINING ATTORNEY



*David J. Kyffers*

Director of the United States Patent and Trademark Office

# United States of America

United States Patent and Trademark Office



**Reg. No. 4,197,428**

GLOBAL LYNX, INC (DELAWARE CORPORATION)  
5705 TIMBER STAR

**Registered Aug. 28, 2012**

SAN ANTONIO, TX 782505925

**Int. Cl.: 42**

FOR: INFORMATION TECHNOLOGY CONSULTATION, IN CLASS 42 (U.S. CLS. 100 AND 101).

**SERVICE MARK**

FIRST USE 9-1-2011; IN COMMERCE 9-1-2011.

**PRINCIPAL REGISTER**

OWNER OF U.S. REG. NO. 3,952,566.

THE COLOR(S) BLUE AND GREY IS/ARE CLAIMED AS A FEATURE OF THE MARK.

THE MARK CONSISTS OF THE GREY WORDS, "GLOBAL LYNX", IN UPPER AND LOWER CASE WITH A STYLIZED "X" IN WHICH "GLOBAL" APPEARS ABOVE "LYNX". TWO BLUE CURVED, OPPOSITE AND STYLIZED LINES ARE SET BESIDE THE TEXT. THE WHITE IN THE DRAWING IS BACKGROUND AND IS NOT CLAIMED AS A COLOR.

SER. NO. 85-481,472, FILED 11-28-2011.

STEVEN R. FINE, EXAMINING ATTORNEY



*David J. Kyffers*

Director of the United States Patent and Trademark Office

# United States of America

United States Patent and Trademark Office

## HARTSTRINGS

**Reg. No. 4,197,429**

PARIGI ENTERPRISES, LLC (DELAWARE LIMITED LIABILITY COMPANY)  
112 WEST 34TH STREET, 5TH FLOOR  
NEW YORK, NY 10120

**Registered Aug. 28, 2012**

**Int. Cls.: 25 and 35**

FOR: CHILDREN'S CLOTHING, FOOTWEAR, AND HEADWEAR, NAMELY, DRESSES, JUMPERS, SKIRTS, SKORTS, SHORTS, PANTS, SWIMWEAR, SHIRTS, T-SHIRTS, TURTLE-NECKS, SWEATERS, VESTS, SWEATSHIRTS WITH HOODS, COATS, RAIN COATS, JACKETS, BLAZERS, PONCHOS, TUNICS, LEGGINGS, TIGHTS, SOCKS, SHOES, RAIN BOOTS, ROMPERS, ONE-PIECE GARMENTS, OVERALLS, AND HATS, IN CLASS 25 (U.S. CLS. 22 AND 39).

**TRADEMARK**

**SERVICE MARK**

**PRINCIPAL REGISTER**

FIRST USE 3-27-1979; IN COMMERCE 3-27-1979.

FOR: RETAIL STORE AND ON-LINE RETAIL STORE SERVICES FEATURING CLOTHING, FOOTWEAR, AND HEADWEAR FOR CHILDREN, IN CLASS 35 (U.S. CLS. 100, 101 AND 102).

FIRST USE 12-31-1987; IN COMMERCE 12-31-1987.

THE MARK CONSISTS OF STANDARD CHARACTERS WITHOUT CLAIM TO ANY PARTICULAR FONT, STYLE, SIZE, OR COLOR.

SER. NO. 85-481,608, FILED 11-28-2011.

AMY KELLY, EXAMINING ATTORNEY



*David J. Kyros*

Director of the United States Patent and Trademark Office

# United States of America

United States Patent and Trademark Office



**Reg. No. 4,197,430**

**Registered Aug. 28, 2012**

**Int. Cl.: 36**

**SERVICE MARK**

**PRINCIPAL REGISTER**

CAPITAL COMMUNICATIONS FEDERAL CREDIT UNION (NEW YORK CORPORATION),  
AKA CAPITAL COMMUNICATIONS FCU OR CAP COM FCU  
18 COMPUTER DRIVE EAST  
ALBANY, NY 12205

FOR: BANKING AND FINANCING SERVICES; BANKING SERVICES, IN CLASS 36 (U.S. CLS. 100, 101 AND 102).

FIRST USE 3-30-2008; IN COMMERCE 3-30-2008.

NO CLAIM IS MADE TO THE EXCLUSIVE RIGHT TO USE "CAR BUYERS HELPLINE", APART FROM THE MARK AS SHOWN.

THE MARK CONSISTS OF TWO CONCENTRIC, SINGLE-LINE CIRCLES, RESEMBLING A TIRE. CUTTING ACROSS THE "TIRE" DIAGONALLY ARE THE WORDS "CAR BUYERS" IN LARGE, STYLIZED UPPER-AND-LOWER-CASE LETTERS AND JUST BELOW THE "ERS" IN "BUYERS" IS THE WORD "HELPLINE" IN MUCH SMALLER STYLIZED, UPPER-AND-LOWER-CASE LETTERS. ABOVE THE PHRASE "CAR BUYERS" AND WITHIN THE CONCENTRIC CIRCLES ARE THE WORDS "WE NEGOTIATE" AND BELOW THE PHRASE "CAR BUYERS" AND WITHIN THE CONCENTRIC CIRCLES ARE THE WORDS "YOU DRIVE".

SER. NO. 85-481,678, FILED 11-28-2011.

RAUL CORDOVA, EXAMINING ATTORNEY



*David J. Kyffers*

Director of the United States Patent and Trademark Office



# United States of America

United States Patent and Trademark Office

## Lacay Cho Lon

**Reg. No. 4,197,431**

TO, KIEN CAM (UNITED STATES INDIVIDUAL), TA LACAY CHO LON  
6793D WILSON BLVD.

**Registered Aug. 28, 2012**

FALLS CHURCH, VA 22044

**Int. Cl.: 43**

FOR: RESTAURANT SERVICES FEATURING VIETNAMESE FOOD; RESTAURANT SERVICES, INCLUDING SIT-DOWN SERVICE OF FOOD AND TAKE-OUT RESTAURANT SERVICES, IN CLASS 43 (U.S. CLS. 100 AND 101).

**SERVICE MARK**

FIRST USE 9-26-2009; IN COMMERCE 9-26-2009.

**PRINCIPAL REGISTER**

THE MARK CONSISTS OF STANDARD CHARACTERS WITHOUT CLAIM TO ANY PARTICULAR FONT, STYLE, SIZE, OR COLOR.

THE ENGLISH TRANSLATION OF THE WORDS "LACAY CHO LON" IN THE MARK IS "LACAY MARKET PLACE".

SER. NO. 85-481,823, FILED 11-28-2011.

BRENDAN MCCAULEY, EXAMINING ATTORNEY



*David J. Kyros*

Director of the United States Patent and Trademark Office

# United States of America

United States Patent and Trademark Office

## GEEZER GASSERS

**Reg. No. 4,197,432**

CHARLES H. LIPKA (UNITED STATES INDIVIDUAL)  
517 MAUREEN DR.  
EUREKA, MO 63025

**Registered Aug. 28, 2012**

**Int. Cls.: 35 and 41**

FOR: ASSOCIATION SERVICES, NAMELY, PROMOTING THE INTEREST OF VINTAGE AUTOMOBILE OWNERS, IN CLASS 35 (U.S. CLS. 100, 101 AND 102).

**SERVICE MARK**

FIRST USE 0-0-2006; IN COMMERCE 0-0-2006.

**PRINCIPAL REGISTER**

FOR: ENTERTAINMENT IN THE NATURE OF AUTOMOBILE DISPLAYS, EXHIBITIONS AND RACES, IN CLASS 41 (U.S. CLS. 100, 101 AND 107).

FIRST USE 0-0-2003; IN COMMERCE 0-0-2003.

THE MARK CONSISTS OF STANDARD CHARACTERS WITHOUT CLAIM TO ANY PARTICULAR FONT, STYLE, SIZE, OR COLOR.

SEC. 2(F) AS TO "GASSERS".

SER. NO. 85-481,831, FILED 11-28-2011.

CAROLINE WOOD, EXAMINING ATTORNEY



*David J. Kyros*

Director of the United States Patent and Trademark Office

# United States of America

United States Patent and Trademark Office

# All-Safe

**Reg. No. 4,197,433**

**Registered Aug. 28, 2012**

**Int. Cl.: 9**

**TRADEMARK**

**PRINCIPAL REGISTER**

ALL-FLO PUMP COMPANY, LIMITED (OHIO LIMITED LIABILITY COMPANY)  
7750 TYLER BLVD.  
MENTOR, OH 44060

FOR: ELECTRICAL LEAK DETECTION AND LEAK MANAGEMENT SYSTEM FOR USE WITH AIR OPERATED DOUBLE DIAPHRAGM PUMPS COMPRISED OF A PRIMARY LEAK DETECTION SENSOR INSTALLED IN THE AREA BETWEEN THE POLYTETRAFLUOROETHYLENE (PTFE) OVERLAY AND THE BACKUP DIAPHRAGM, A SECONDARY LEAK DETECTION SENSOR INSTALLED IN THE AIR SECTION OF THE PUMP, AN EXTERNAL COMPONENT CONNECTED TO THE AIR OPERATED DOUBLE DIAPHRAGM PUMP IN THE NATURE OF A VISUAL ALARM, AN AUDIBLE ALARM AND AN AUTOMATIC PUMP SHUT-OFF IN CASE OF LEAK DETECTION SOLD AS A UNIT, IN CLASS 9 (U.S. CLS. 21, 23, 26, 36 AND 38).

FIRST USE 10-1-2011; IN COMMERCE 11-1-2011.

THE MARK CONSISTS OF STANDARD CHARACTERS WITHOUT CLAIM TO ANY PARTICULAR FONT, STYLE, SIZE, OR COLOR.

SER. NO. 85-481,841, FILED 11-28-2011.

CAROLINE WOOD, EXAMINING ATTORNEY



*David J. Kyros*

Director of the United States Patent and Trademark Office

# United States of America

United States Patent and Trademark Office

LeadFrg

**Reg. No. 4,197,434**

TEAM CUMMINS, LLC (TEXAS LIMITED LIABILITY COMPANY)  
5103 SAGAIL PLACE  
SAN ANTONIO, TX 78249

**Registered Aug. 28, 2012**

**Int. Cl.: 42**

FOR: PROVIDING A MEMBERS-ONLY WEBSITE FEATURING TECHNOLOGY WHICH PROVIDES MEMBERS WITH THE ABILITY TO DESIGN, PLAN, IMPLEMENT AND TRACK BUSINESS AND PERSONAL GOALS WHILE EXTRACTING METRICS FOR THE ANALYSIS OF PERFORMANCE MANAGEMENT AND DEVELOPMENT, IN CLASS 42 (U.S. CLS. 100 AND 101).

**SERVICE MARK**

**PRINCIPAL REGISTER**

FIRST USE 7-1-2011; IN COMMERCE 7-1-2011.

OWNER OF U.S. REG. NO. 4,083,166.

THE COLOR(S) BLACK, WHITE, ORANGE AND LIGHT ORANGE IS/ARE CLAIMED AS A FEATURE OF THE MARK.

THE MARK CONSISTS OF THE WORDING "LEADFROG". ALL THE LETTERS, BUT FOR THE "O", ARE BLACK. THE LETTER "O" IS REPRESENTED BY AN ORANGE AND LIGHT ORANGE FOUR-PRONGED FROG PAD. THE LETTERS "L" AND "F" ARE CAPITALIZED. THE BACKGROUND IS WHITE.

SER. NO. 85-481,856, FILED 11-28-2011.

WENDY GOODMAN, EXAMINING ATTORNEY



*David J. Kybas*

Director of the United States Patent and Trademark Office

# United States of America

United States Patent and Trademark Office

# LUX\*

ISLAND RESORTS

**Reg. No. 4,197,435**

**Registered Aug. 28, 2012**

**Int. Cls.: 30, 41 and 43**

**TRADEMARK**

**SERVICE MARK**

**PRINCIPAL REGISTER**

POSEIDON LTÉE (MAURITIUS CORPORATION)  
58 PIERRE SIMONET STREET  
FLOREAL, MAURITIUS

FOR: COFFEE, TEA, COCOA, SUGAR, RICE, TAPIOCA, SAGO, ARTIFICIAL COFFEE; FLOUR AND FOOD PREPARATIONS MADE FROM CEREALS, BREAD, PASTRY, NAMELY, CEREAL BARS, SNACKS; CONFECTIONERY, NAMELY, CHOCOLATE, SWEETS; ICES; HONEY, TREACLE, YEAST, BAKING POWDER, SALT, MUSTARD; VINEGAR, SAUCES EXCEPT SALAD DRESSINGS; SPICES; ICE, IN CLASS 30 (U.S. CL. 46).

FOR: EDUCATION AND TRAINING SERVICES, NAMELY, PROVIDING TRAINING SERVICES IN INDUSTRIAL AND COMMERCIAL FIELDS; COACHING IN THE FIELDS OF LEADERSHIP DEVELOPMENT, TEAM DEVELOPMENT AND ORGANIZATIONAL CHANGE MANAGEMENT; PROVIDING LANGUAGE TUTORING; ONLINE ELECTRONIC PUBLISHING OF BOOKS, MAGAZINES; PRODUCTION OF FILMS, VIDEOS FOR EDUCATIONAL, TRAINING AND ENTERTAINMENT PURPOSES; RENTAL OF EDUCATIONAL MATERIALS OR EQUIPMENT AND APPARATUS; ORGANIZATION OF COMPETITIONS AND EXHIBITIONS FOR EDUCATION OR ENTERTAINMENT; HEALTH CLUB SERVICES, NAMELY, PROVIDING INSTRUCTIONS IN THE FIELD OF YOGA, EXERCISE, SPAS, SPORTING ACTIVITIES; PHOTOGRAPHY SERVICES; CONSULTANCY AND ADVISORY SERVICES IN THE FIELD OF EDUCATION AND ENTERTAINMENT, IN CLASS 41 (U.S. CLS. 100, 101 AND 107).

FOR: RESTAURANTS, CAFES, SNACK BARS AND FAST FOOD SERVICES; PROVISION OF MEALS TO THE PUBLIC; PROVISION OF TEMPORARY ACCOMMODATION; ACCOMMODATION RESERVATION SERVICES; CONSULTANCY AND ADVISORY SERVICES IN THE FIELD OF HOSPITALITY AND/OR RESTAURANTS, IN CLASS 43 (U.S. CLS. 100 AND 101).

PRIORITY CLAIMED UNDER SEC. 44(D) ON MAURITIUS APPLICATION NO. 11687/2011, FILED 6-8-2011, REG. NO. 11687/2011, DATED 9-5-2011, EXPIRES 6-8-2021.

NO CLAIM IS MADE TO THE EXCLUSIVE RIGHT TO USE "ISLAND RESORTS", APART FROM THE MARK AS SHOWN.

THE MARK CONSISTS OF THE WORD "LUX \*" IN LARGE BOLD LETTERS ABOVE THE WORDS "ISLAND RESORTS".



*David J. Kybas*

Director of the United States Patent and Trademark Office

**Reg. No. 4,197,435** SER. NO. 85-481,912, FILED 11-28-2011.

ZACHARY BELLO, EXAMINING ATTORNEY

# United States of America

United States Patent and Trademark Office

# NIXIT

**Reg. No. 4,197,436**

**Registered Aug. 28, 2012**

**Int. Cl.: 37**

**SERVICE MARK**

**PRINCIPAL REGISTER**

MIDDLETON, ADRIAN S. (UNITED STATES INDIVIDUAL)  
2630 NOBLE DR.  
TALLAHASSEE, FL 32308

FOR: TERMITE AND PEST CONTROL, IN CLASS 37 (U.S. CLS. 100, 103 AND 106).

FIRST USE 1-7-2007; IN COMMERCE 12-1-2007.

THE MARK CONSISTS OF STANDARD CHARACTERS WITHOUT CLAIM TO ANY PARTICULAR FONT, STYLE, SIZE, OR COLOR.

OWNER OF U.S. REG. NO. 3,581,366.

SER. NO. 85-482,040, FILED 11-28-2011.

TARAH HARDY, EXAMINING ATTORNEY



*David J. Kyffers*

Director of the United States Patent and Trademark Office

# United States of America

United States Patent and Trademark Office

# carcode.me

**Reg. No. 4,197,437**

**Registered Aug. 28, 2012**

**Int. Cl.: 12**

**TRADEMARK**

**PRINCIPAL REGISTER**

SNAPSHOT MOBILE INC. (DELAWARE CORPORATION)  
6805 WOODLAWN AVE NE #18  
SEATTLE, WA 98115

FOR: PROVIDING AN ONLINE WEBSITE FOR CREATING AND HOSTING MICRO WEBSITES WHICH ALLOWS EACH CAR IN AN AUTOMOBILE DEALER'S INVENTORY TO BE ACCESSED BY POTENTIAL CUSTOMERS VIA A NETWORK REFERENCE, OR QR CODE SCANNED FROM A TAG BY A MOBILE DEVICE, IN CLASS 12 (U.S. CLS. 19, 21, 23, 31, 35 AND 44).

FIRST USE 1-1-2011; IN COMMERCE 1-1-2011.

THE MARK CONSISTS OF STANDARD CHARACTERS WITHOUT CLAIM TO ANY PARTICULAR FONT, STYLE, SIZE, OR COLOR.

SER. NO. 85-482,227, FILED 11-29-2011.

TAMARA FRAZIER, EXAMINING ATTORNEY



*David J. Kybas*

Director of the United States Patent and Trademark Office



United States of America  
United States Patent and Trademark Office

**KAKAO**  
 **BERLIN**

**Reg. No. 4,197,438**

**Registered Aug. 28, 2012**

**Int. Cl.: 30**

**TRADEMARK**

**PRINCIPAL REGISTER**

PROGOURMET FOODS, LLC (WASHINGTON LIMITED LIABILITY COMPANY)  
3643 BEACH DRIVE  
PORT ORCHARD, WA 98366

FOR: CHOCOLATE; CHOCOLATE BARK CONTAINING GROUND COFFEE BEANS;  
CHOCOLATE BARS; CHOCOLATE CHIPS; CHOCOLATE CONFECTIONS; CHOCOLATE  
FOR CONFECTIONERY AND BREAD; CHOCOLATE POWDER, IN CLASS 30 (U.S. CL. 46).

FIRST USE 5-0-2009; IN COMMERCE 5-0-2009.

NO CLAIM IS MADE TO THE EXCLUSIVE RIGHT TO USE "KAKAO" AND "BERLIN",  
APART FROM THE MARK AS SHOWN.

THE MARK CONSISTS OF THE STYLIZED WORDING "KAKAO" WITH DASHED LINES  
APPEARING AT THE FOOT OF BOTH LETTERS "K" IN THE WORD "KAKAO" AND AT  
THE TOP OF THE LETTER "A" IN THE SAME WORD. UNDERNEATH THE FIRST LETTER  
"K" IN "KAKAO" AND BEFORE THE WORD "BERLIN" APPEARS A STYLIZED DEPICTION  
OF A COCOA BEAN. TO THE RIGHT OF THE SAME IS THE WORD "BERLIN".

THE ENGLISH TRANSLATION OF "KAKAO" IN THE MARK IS "COCOA".

SER. NO. 85-482,408, FILED 11-29-2011.

AHSEN KHAN, EXAMINING ATTORNEY



*David J. Kybas*

Director of the United States Patent and Trademark Office

# United States of America

United States Patent and Trademark Office

## JOINTBOND PM

**Reg. No. 4,197,439**

D & D EMULSIONS, INC. (OHIO CORPORATION)  
270 PARK AVENUE EAST  
MANSFIELD, OH 44902

**Registered Aug. 28, 2012**

**Int. Cl.: 1**

FOR: SYNTHETIC EMULSIFIED PETROLEUM RESIN FOR USE AS A POLYMER MODIFIED JOINT SEALER IN THE ROAD MAINTENANCE INDUSTRY, IN CLASS 1 (U.S. CLS. 1, 5, 6, 10, 26 AND 46).

**TRADEMARK**

FIRST USE 1-10-2011; IN COMMERCE 6-6-2011.

**PRINCIPAL REGISTER**

THE MARK CONSISTS OF STANDARD CHARACTERS WITHOUT CLAIM TO ANY PARTICULAR FONT, STYLE, SIZE, OR COLOR.

NO CLAIM IS MADE TO THE EXCLUSIVE RIGHT TO USE "PM", APART FROM THE MARK AS SHOWN.

SER. NO. 85-482,496, FILED 11-29-2011.

ANTHONY RINKER, EXAMINING ATTORNEY



*David J. Kyffers*

Director of the United States Patent and Trademark Office

# United States of America

United States Patent and Trademark Office

## Feather Touch

**Reg. No. 4,197,440**

**Registered Aug. 28, 2012**

**Int. Cl.: 9**

**TRADEMARK**

**PRINCIPAL REGISTER**

STARLIGHT INSTRUMENTS, LLC (INDIANA LIMITED LIABILITY COMPANY)  
2380 E CARDINAL DRIVE  
COLUMBIA CITY, IN 46725

FOR: TELESCOPES, IN CLASS 9 (U.S. CLS. 21, 23, 26, 36 AND 38).

FIRST USE 3-28-2000; IN COMMERCE 3-28-2000.

THE MARK CONSISTS OF STANDARD CHARACTERS WITHOUT CLAIM TO ANY PARTICULAR FONT, STYLE, SIZE, OR COLOR.

SEC. 2(F).

SER. NO. 85-482,732, FILED 11-29-2011.

SHAUNIA CARLYLE, EXAMINING ATTORNEY



*David J. Kyffers*

Director of the United States Patent and Trademark Office

# United States of America

United States Patent and Trademark Office



SCULTURA  
PLASTIC SURGERY

**Reg. No. 4,197,441**

**Registered Aug. 28, 2012**

**Int. Cl.: 44**

STRAWN, JON BRADLEY (UNITED STATES INDIVIDUAL), DBA SCULTURA PLASTIC SURGERY  
SUITE 501  
1401 AVOCADO AVENUE  
NEWPORT BEACH, CA 92660

**SERVICE MARK**

FOR: COSMETIC AND PLASTIC SURGERY, IN CLASS 44 (U.S. CLS. 100 AND 101).

**PRINCIPAL REGISTER**

FIRST USE 11-4-2011; IN COMMERCE 11-12-2011.

NO CLAIM IS MADE TO THE EXCLUSIVE RIGHT TO USE "SCULTURA PLASTIC SURGERY", APART FROM THE MARK AS SHOWN.

THE COLOR(S) WHITE, PURPLE, PINK, AND GREY IS/ARE CLAIMED AS A FEATURE OF THE MARK.

THE MARK CONSISTS OF A CIRCLE IS PRESENT ON THE LEFT SIDE WHICH IS SPLIT WITH AN "S" SHAPED WHITE LINE REPRESENTING A SUBTLE APPEARANCE OF A BREAST. THE LEFT HALF OF THE CIRCLE IS COLORED PURPLE, AND THE RIGHT HALF IS COLORED PINK. "SCULTURA" IS WRITTEN IN GREY TO THE RIGHT OF THE CIRCLE. "PLASTIC SURGERY" IS WRITTEN IN GREY BENEATH THE WORD "SCULTURA".

THE ENGLISH TRANSLATION OF "SCULTURA" IN THE MARK IS "SCULPTURE".

SER. NO. 85-482,828, FILED 11-29-2011.

MELISSA VALLILLO, EXAMINING ATTORNEY



*David J. Kyros*

Director of the United States Patent and Trademark Office

# United States of America

United States Patent and Trademark Office



**Reg. No. 4,197,442**

**Registered Aug. 28, 2012**

**Int. Cls.: 3, 5, 8, 16 and 21**

THE KROGER CO. OF MICHIGAN (MICHIGAN CORPORATION)  
40399 GRAND RIVER AVENUE  
NOVI, MI 48375

FOR: BABY WIPES, IN CLASS 3 (U.S. CLS. 1, 4, 6, 50, 51 AND 52).

FIRST USE 0-0-2007; IN COMMERCE 0-0-2007.

**TRADEMARK**

FOR: BABY FOOD, FORMULA, IN CLASS 5 (U.S. CLS. 6, 18, 44, 46, 51 AND 52).

**PRINCIPAL REGISTER**

FIRST USE 0-0-2006; IN COMMERCE 0-0-2006.

FOR: CUTLERY, NAMELY, KNIVES, FORKS, AND SPOONS, IN CLASS 8 (U.S. CLS. 23, 28 AND 44).

FIRST USE 6-9-2010; IN COMMERCE 6-9-2010.

FOR: DISPOSABLE TRAINING PANTS, IN CLASS 16 (U.S. CLS. 2, 5, 22, 23, 29, 37, 38 AND 50).

FIRST USE 5-0-2009; IN COMMERCE 5-0-2009.

FOR: BOWLS, PLATES, TRAINING CUPS FOR BABIES AND CHILDREN, INSULATED DRINKING CUPS WITH A STRAW FOR BABIES AND CHILDREN, IN CLASS 21 (U.S. CLS. 2, 13, 23, 29, 30, 33, 40 AND 50).

FIRST USE 6-4-2010; IN COMMERCE 6-4-2010.

OWNER OF U.S. REG. NOS. 3,942,702 AND 3,968,420.

THE COLOR(S) WHITE, BROWN, BLACK, LIGHT BLUE, DARK GREEN, LIGHT YELLOW, DARK YELLOW, AND GOLD IS/ARE CLAIMED AS A FEATURE OF THE MARK.

NO CLAIM IS MADE TO THE EXCLUSIVE RIGHT TO USE "FOR TODDLER", APART FROM THE MARK AS SHOWN.



*David J. Kybas*

Director of the United States Patent and Trademark Office

**Reg. No. 4,197,442** THE MARK CONSISTS OF A FLYING CARTOON FIREFLY WITH A GOLDEN BODY, BROWN HAIR AND FACIAL FEATURES, BLACK ANTENNAE, AND LIGHT BLUE AND WHITE WINGS, WEARING A GLOWING YELLOW DIAPER, ALL WITHIN A CIRCULAR LIGHT YELLOW BACKGROUND ENCLOSED WITHIN A DARK GREEN CIRCULAR BORDER. THE WORDING "COMFORTS" APPEARS IN THE COLOR WHITE CURVED DOWNWARD IN THE UPPER HALF OF THE DARK GREEN CIRCULAR BORDER AND THE WORDING "FOR TODDLER" APPEARS IN THE COLOR WHITE CURVED UPWARD IN THE LOWER HALF OF THE DARK GREEN CIRCULAR BORDER. CURVED WHITE DASHES APPEAR BEFORE AND AFTER "FOR TODDLER". THE WORDING APPEARS BETWEEN TWO SERIES OF WHITE POLKA DOTS FORMING CONCENTRIC CIRCLES WITHIN THE DARK GREEN BORDER. THE DARK GREEN CIRCULAR BORDER IS ENCLOSED WITHIN A WHITE SCALLOPED BORDER. THE MARK IS SHOWN ON A GRAY BACKGROUND THAT IS NOT A FEATURE OF THE MARK BUT INTENDED TO REPRESENT THE BACKGROUND OF THE MARK.

SER. NO. 85-482,880, FILED 11-29-2011.

KAREN BRACEY, EXAMINING ATTORNEY

# United States of America

United States Patent and Trademark Office

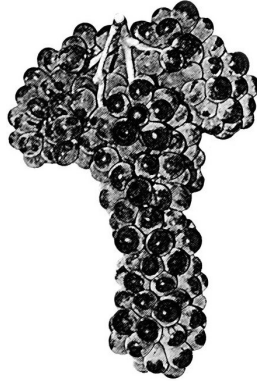

**Reg. No. 4,197,443**

**Registered Aug. 28, 2012**

**Int. Cl.: 33**

**TRADEMARK**

**PRINCIPAL REGISTER**

WILLIAM LEWIS VONDRASEK (UNITED STATES INDIVIDUAL)  
2749 BEAVER AVE.  
SIMI VALLEY, CA 93065 AND

DAVID ANTHONY VONDRASEK (UNITED STATES INDIVIDUAL)  
19524 CALVERT ST.  
TARZANA, CA 91335

FOR: WINE, IN CLASS 33 (U.S. CLS. 47 AND 49).

FIRST USE 10-1-2009; IN COMMERCE 11-1-2011.

THE MARK CONSISTS OF A STYLIZED CLUSTER OF GRAPES RESEMBLING A CROSS.

SER. NO. 85-482,895, FILED 11-29-2011.

KEVON CHISOLM, EXAMINING ATTORNEY



*David J. Kybas*

Director of the United States Patent and Trademark Office

# United States of America

United States Patent and Trademark Office

## currently obsessed

**Reg. No. 4,197,444**

**Registered Aug. 28, 2012**

**Int. Cl.: 35**

**SERVICE MARK**

**PRINCIPAL REGISTER**

NASTYGOAT CORPORATION (TEXAS CORPORATION)  
2651 NORTH HARWOOD STREET, SUITE 530  
DALLAS, TX 75201

FOR: WEB-BASED SERVICE TO HELP STYLE BLOGGERS MONETIZE THEIR CONTENT THROUGH PROMOTING THE GOODS OF OTHERS BY PROVIDING PRODUCT IMAGES AND LINKS TO CONNECT CONSUMERS TO PRODUCTS, AND THAT PROMOTES THE SALE OF STYLE APPAREL AND ACCESSORIES OF OTHERS, IN CLASS 35 (U.S. CLS. 100, 101 AND 102).

FIRST USE 11-23-2011; IN COMMERCE 11-23-2011.

THE MARK CONSISTS OF STANDARD CHARACTERS WITHOUT CLAIM TO ANY PARTICULAR FONT, STYLE, SIZE, OR COLOR.

SER. NO. 85-483,033, FILED 11-29-2011.

MARK RADEMACHER, EXAMINING ATTORNEY



*David J. Kyffers*

Director of the United States Patent and Trademark Office



# United States of America

United States Patent and Trademark Office

# STALK

**Reg. No. 4,197,445**

**Registered Aug. 28, 2012**

**Int. Cl.: 35**

**SERVICE MARK**

**PRINCIPAL REGISTER**

NASTYGOAT CORPORATION (TEXAS CORPORATION)  
2651 NORTH HARWOOD STREET, SUITE 530  
DALLAS, TX 75201

FOR: PROMOTING THE GOODS AND SERVICES OF OTHERS BY ENABLING CONSUMERS TO CONNECT WITH, FOLLOW, AND LINK TO ONLINE BLOGS AND BLOGGERS, IN CLASS 35 (U.S. CLS. 100, 101 AND 102).

FIRST USE 11-23-2011; IN COMMERCE 11-23-2011.

THE MARK CONSISTS OF STANDARD CHARACTERS WITHOUT CLAIM TO ANY PARTICULAR FONT, STYLE, SIZE, OR COLOR.

SER. NO. 85-483,049, FILED 11-29-2011.

MARK RADEMACHER, EXAMINING ATTORNEY



*David J. Kyffers*

Director of the United States Patent and Trademark Office

# United States of America

United States Patent and Trademark Office

## ASK MR. ROBOT

**Reg. No. 4,197,446**

TEAM ROBOT, INC. (DELAWARE CORPORATION)  
2101 CARLMONT DRIVE, SUITE 207  
BELMONT, CA 94002

**Registered Aug. 28, 2012**

**Int. Cls.: 41 and 42**

FOR: PROVIDING A WEBSITE FEATURING INFORMATION IN THE FIELD OF COMPUTER GAMES, IN CLASS 41 (U.S. CLS. 100, 101 AND 107).

**SERVICE MARK**

FIRST USE 0-0-2010; IN COMMERCE 0-0-2010.

**PRINCIPAL REGISTER**

FOR: COMPUTER SERVICES, NAMELY, CREATING AN ONLINE COMMUNITY FOR COMPUTER USERS TO PARTICIPATE IN DISCUSSIONS, SHARE INFORMATION AND SCORES, GET FEEDBACK FROM PEERS, FORM VIRTUAL COMMUNITIES, AND ENGAGE IN SOCIAL NETWORKING SERVICES IN THE FIELD OF COMPUTER GAMES, IN CLASS 42 (U.S. CLS. 100 AND 101).

FIRST USE 0-0-2010; IN COMMERCE 0-0-2010.

THE MARK CONSISTS OF STANDARD CHARACTERS WITHOUT CLAIM TO ANY PARTICULAR FONT, STYLE, SIZE, OR COLOR.

THE NAME SHOWN IN THE MARK DOES NOT IDENTIFY A PARTICULAR LIVING INDIVIDUAL.

SER. NO. 85-483,104, FILED 11-29-2011.

TINA BROWN, EXAMINING ATTORNEY



*David J. Kybas*

Director of the United States Patent and Trademark Office

# United States of America

United States Patent and Trademark Office

# IRIE TIME

**Reg. No. 4,197,447**

**Registered Aug. 28, 2012**

**Int. Cls.: 16 and 25**

**TRADEMARK**

**PRINCIPAL REGISTER**

SCHROEDER, DONALD W. (UNITED STATES INDIVIDUAL)  
PO BOX 22947  
HOUSTON, TX 772272947

FOR: ADHESIVE NOTE PAPER; ADVERTISING PAMPHLETS; ADVERTISING SIGNS OF PAPER OR CARDBOARD; ALL-IN-ONE PORTABLE CARDBOARD BOX THAT DISPENSES BOTH CUPS MADE OF PAPER, PLASTIC OR OTHER MATERIAL AND LIQUIDS, NAMELY, BEVERAGES FOR DOMESTIC, PERSONAL OR COMMERCIAL USE; ALUMINUM FOIL LAMINATED PAPER FOR PRINTING PURPOSES; BANNERS OF PAPER; BLANK OR PARTIALLY PRINTED PAPER LABELS; BLANK PAPER COMPUTER TAPES FOR RECORDING PROGRAMS; BLANK PAPER NOTEBOOKS; BROCHURES ABOUT MUSIC OR TRAVEL; BUSINESS CARD PAPER; CALENDAR-FINISHED PAPER; COASTERS MADE OF PAPER; COASTERS OF PAPER; COLLAPSIBLE BOXES OF PAPER; CONTAINERS FOR STORAGE OR TRANSPORT MADE OF PAPER OR CARDBOARD; CORRUGATED PAPER PANELS LAMINATED WITH BLEACHED WHITE PAPER PRIMARILY FOR APPLICATION OF PRINTED MEDIA FOR FURTHER USE IN SIGNAGE APPLICATIONS; CORRUGATED PAPER PANELS LAMINATED WITH KRAFT LINERBOARD PRIMARILY FOR LAMINATION WITH DECORATIVE OVERLAYS FOR FURTHER USE IN THE CONSTRUCTION OF WALL PARTITIONS, ROOM DIVIDERS, DESKTOPS AND TABLETOPS; DECORATIVE PAPER CENTERPIECES; EMBROIDERY DESIGN PATTERNS; FIGURES MADE OF PAPER; FLAGS AND PENNANTS OF PAPER; INFORMATIONAL FLYERS FEATURING MUSIC OR TRAVEL; LEAFLETS ABOUT MUSIC OR TRAVEL; MAGAZINE PAPER; PAPER AND CARDBOARD; PAPER BADGES; PAPER BANNERS; PAPER BOARD; PAPER BOARDS; PAPER DOILIES; PAPER DROP CLOTHS; PAPER FOR USE IN MAKING SIGNS; PAPER FOR USE IN THE GRAPHIC ARTS INDUSTRY; PAPER FOR USE IN THE MANUFACTURE OF WALLPAPER; PAPER FOR WRAPPING AND PACKAGING; PAPER GIFT BAGS; PAPER GIFT CARDS; PAPER GIFT WRAP; PAPER LABELS; PAPER MATS; PAPER NAPKINS; PAPER PARTY BAGS; PAPER PARTY DECORATIONS; PAPER PARTY FAVORS; PAPER PATCHES FOR CLOTHING; PAPER PENNANTS; PAPER PLACE MATS; PAPER POUCHES SOLD EMPTY FOR HOLDING CONDIMENTS; PAPER SIGNBOARDS; PAPER STATIONERY; PAPER STATIONERY WITH INSPIRATIONAL MESSAGES IMPRINTED THEREON; PAPER SUBSTRATES ONTO WHICH DIGITAL IMAGES ARE PRINTED; PAPER TAGS; PAPER WEIGHTS; PAPER WINE GIFT BAGS; PAPERS FOR USE IN THE GRAPHIC ARTS INDUSTRY; PLACARDS OF PAPER OR CARDBOARD; PLACE MATS OF PAPER; PLASTIC OR PAPER BAGS FOR MERCHANDISE PACKAGING; PORTABLE CARDBOARD BOX FOR DISPENSING PAPER, PLASTIC OR OTHER PREMEASURED CUPS AND DISPENSING LIQUIDS, NAMELY, BEVERAGES, FOR DOMESTIC, PERSONAL OR COMMERCIAL USE;



*David J. Kyros*

Director of the United States Patent and Trademark Office

**Reg. No. 4,197,447** POSTCARD PAPER; POSTERS MADE OF PAPER; PRINTED ADVERTISING BOARDS OF PAPER OR CARDBOARD; PRINTED COLLECTOR CARDS MADE PRIMARILY OF PAPER AND ALSO INCLUDING METAL; PRINTED COLLECTOR CARDS MADE PRIMARILY OF PAPER BUT ALSO INCLUDING METAL; PRINTED CONSUMER REPORTS FEATURING INFORMATION ON MUSIC OR TRAVEL; PRINTED MATTER, NAMELY, PAPER SIGNS, BOOKS, MANUALS, CURRICULUM, NEWSLETTERS, INFORMATIONAL CARDS AND BROCHURES IN THE FIELD OF MUSIC OR TRAVEL; PRINTED PAPER LABELS; PRINTED PAPER SIGNS; PRINTED PAPER SIGNS, NAMELY, TABLE TENTS; TABLE CLOTHS OF PAPER; TABLE LINENS OF PAPER; TABLE MATS OF PAPER; TABLE NAPKINS OF PAPER; WORKS OF ART MADE FROM CUSTOM MANUFACTURED PAPER; WRAPPING PAPER; WRITING PAPER; WRITING PAPER HOLDERS; WRITING PAPER PADS, IN CLASS 16 (U.S. CLS. 2, 5, 22, 23, 29, 37, 38 AND 50).

FIRST USE 1-1-1995; IN COMMERCE 2-24-1995.

FOR: ADULT NOVELTY GAG CLOTHING ITEM, NAMELY, SOCKS; BELTS; BELTS FOR CLOTHING; BELTS MADE OUT OF CLOTH; BIBS NOT OF CLOTH OR PAPER; BOTTOMS; CHILDREN'S AND INFANTS' CLOTH BIBS; CHILDREN'S CLOTH EATING BIBS; CLOTH BIBS; CLOTHING ITEMS, NAMELY, ADHESIVE POCKETS THAT MAY BE AFFIXED DIRECTLY TO THE BODY AS A DECORATIVE PIECE OF CLOTHING WITH UTILITY; CLOTHING ITEMS, NAMELY, ADHESIVE POCKETS THAT MAY BE AFFIXED DIRECTLY TO THE INSIDE OF CLOTHING FOR STORAGE AND SAFEKEEPING OF PERSONAL ITEMS; CLOTHING, NAMELY, CROPS; CLOTHING, NAMELY, HAND-WARMERS; CLOTHING, NAMELY, NECK TUBES; FABRIC SOLD AS AN INTEGRAL COMPONENT OF FINISHED CLOTHING ITEMS, NAMELY, SHIRTS, BLOUSES, PANTS AND SKIRTS; GLOVES AS CLOTHING; HEADBANDS FOR CLOTHING; HOODS; INFANT AND TODDLER ONE PIECE CLOTHING; JACKETS; JERSEYS; LEATHER BELTS; MANTLES; PAPER HATS FOR USE AS CLOTHING ITEMS; PARTY HATS; POCKET SQUARES; SHORT SETS; SUN PROTECTIVE CLOTHING, NAMELY, HATS, SCARVES, SHIRTS, BLOUSES, PANTS AND SKIRTS; TIES; TOPS; WEARABLE GARMENTS AND CLOTHING, NAMELY, SHIRTS; WOMEN'S CLOTHING, NAMELY, SHIRTS, DRESSES, SKIRTS, BLOUSES; WRAPS; WRIST BANDS; WRISTBANDS, IN CLASS 25 (U.S. CLS. 22 AND 39).

FIRST USE 1-1-1995; IN COMMERCE 2-24-1995.

THE MARK CONSISTS OF STANDARD CHARACTERS WITHOUT CLAIM TO ANY PARTICULAR FONT, STYLE, SIZE, OR COLOR.

OWNER OF U.S. REG. NOS. 1,966,577, 2,171,269 AND OTHERS.

THE ENGLISH TRANSLATION OF "IRIE" IN THE MARK IS "FEELING GOOD".

SER. NO. 85-483,136, FILED 11-29-2011.

JAY FLOWERS, EXAMINING ATTORNEY

# United States of America

United States Patent and Trademark Office

**AKSYON TV**  
**INTERNATIONAL**

**Reg. No. 4,197,448**

**Registered Aug. 28, 2012**

**Int. Cl.: 38**

**SERVICE MARK**

**PRINCIPAL REGISTER**

PILIPINAS GLOBAL NETWORK (US) LLC (DELAWARE LIMITED LIABILITY COMPANY)  
12TH FLOOR MARAJO TOWER 312-26 STREET W  
4TH AVENUE  
BONIFACIO GLOBAL CITY, PHILIPPINES

FOR: TELEVISION BROADCASTING SERVICES, IN CLASS 38 (U.S. CLS. 100, 101 AND 104).

FIRST USE 3-16-2001; IN COMMERCE 3-16-2001.

NO CLAIM IS MADE TO THE EXCLUSIVE RIGHT TO USE "TV INTERNATIONAL", APART FROM THE MARK AS SHOWN.

THE MARK CONSISTS OF THE WORD "AKSYON" WITH THE "A" STYLIZED AND ITS LEFT LEG EXTENDED. THE LETTERS "K" AND "O" HAVE THE LEFT PORTION OF THE LETTER CUT OFF. THE WORD "TV" IS HOUSED IN A CAPSULE-SHAPED BACKGROUND ATTACHED TO THE LETTER "N" IN "AKSYON". THE WORDING "AKSYON TV" IS BETWEEN TWO THIN LINES, WITH A THIN LINE UNDERNEATH THE TOTAL DESIGN. THE WORD "INTERNATIONAL" IS IN CAPITAL LETTERS BELOW THE LINE UNDERNEATH THE WORDING "AKSYON TV".

THE ENGLISH TRANSLATION OF "AKSYON" IN THE MARK IS "ACTION".

SER. NO. 85-483,191, FILED 11-29-2011.

LAURA KOVALSKY, EXAMINING ATTORNEY



*David J. Kyros*

Director of the United States Patent and Trademark Office

# United States of America

United States Patent and Trademark Office

## Freeway University

**Reg. No. 4,197,449**

MCCARTHY, FRANK J (UNITED STATES INDIVIDUAL)  
17884 ARBOR GREENE DRIVE  
TAMPA, FL 336473136

**Registered Aug. 28, 2012**

**Int. Cl.: 9**

FOR: AUDIO MATERIALS AND MEDIA, NAMELY, CASSETTE TAPES, CDS, DVDS, AND DOWNLOADABLE AUDIO FILES, PROVIDING SALES, PRODUCT, AND WORK RELATED IDEAS, IN CLASS 9 (U.S. CLS. 21, 23, 26, 36 AND 38).

**TRADEMARK**

FIRST USE 6-24-1996; IN COMMERCE 7-25-1996.

**PRINCIPAL REGISTER**

THE MARK CONSISTS OF STANDARD CHARACTERS WITHOUT CLAIM TO ANY PARTICULAR FONT, STYLE, SIZE, OR COLOR.

SER. NO. 85-483,408, FILED 11-30-2011.

WARREN L. OLANDRIA, EXAMINING ATTORNEY



*David J. Kyffers*

Director of the United States Patent and Trademark Office

# United States of America

United States Patent and Trademark Office

## ADAPTLY MOMENTUM

**Reg. No. 4,197,450**

**Registered Aug. 28, 2012**

**Int. Cls.: 35 and 42**

**SERVICE MARK**

**PRINCIPAL REGISTER**

ADAPTLY, INC. (DELAWARE CORPORATION)  
40 W. 23RD ST., FIFTH FLOOR  
NEW YORK, NY 10010

FOR: ON-LINE ADVERTISING AND MARKETING SERVICES; PLACING ADVERTISEMENTS FOR OTHERS; PROMOTING THE GOODS AND SERVICES OF OTHERS BY PLACING ADVERTISEMENTS IN ELECTRONIC MEDIA THROUGH A GLOBAL COMPUTER NETWORK; BRAND EVALUATION SERVICES, NAMELY, COMPILING AND ANALYZING AND MEASURING DATA ON THE EFFECTIVENESS AND PERFORMANCE OF BRANDS, IN CLASS 35 (U.S. CLS. 100, 101 AND 102).

FIRST USE 12-7-2011; IN COMMERCE 12-7-2011.

FOR: PROVIDING A WEBSITE FEATURING ONLINE NON-DOWNLOADABLE SOFTWARE THAT ENABLES USERS TO ASSESS AND MEASURE BRAND EFFECTIVENESS; COMPUTER SERVICES, NAMELY, HOSTING AN ONLINE WEBSITE LOCATION FOR OTHERS TO REMOTELY MANAGE, CREATE, DEPLOY, AND MONITOR THEIR MARKETING ACTIVITIES; APPLICATION SERVICE PROVIDER, NAMELY, HOSTING, MANAGING, DEVELOPING, AND MAINTAINING APPLICATIONS, SOFTWARE, AND WEBSITES, IN THE FIELDS OF ADVERTISING AND MARKETING FOR WIRELESS DELIVERY OF CONTENT TO HANDHELD COMPUTERS, LAPTOPS AND MOBILE ELECTRONIC DEVICES, IN CLASS 42 (U.S. CLS. 100 AND 101).

FIRST USE 12-7-2011; IN COMMERCE 12-7-2011.

THE MARK CONSISTS OF STANDARD CHARACTERS WITHOUT CLAIM TO ANY PARTICULAR FONT, STYLE, SIZE, OR COLOR.

SER. NO. 85-483,522, FILED 11-30-2011.

MARGARET POWER, EXAMINING ATTORNEY



*David J. Kyros*

Director of the United States Patent and Trademark Office

# United States of America

United States Patent and Trademark Office

## GET OUT OF THE MIRROR APPAREL

**Reg. No. 4,197,451**

DIGGS, JOJO (UNITED STATES INDIVIDUAL)  
11231 OTSEGO ST., #309  
NORTH HOLLYWOOD, CA 91601

**Registered Aug. 28, 2012**

**Int. Cl.: 25**

FOR: T-SHIRTS; TANK TOPS, IN CLASS 25 (U.S. CLS. 22 AND 39).

**TRADEMARK**

FIRST USE 11-16-2011; IN COMMERCE 11-16-2011.

**PRINCIPAL REGISTER**

THE MARK CONSISTS OF STANDARD CHARACTERS WITHOUT CLAIM TO ANY PARTICULAR FONT, STYLE, SIZE, OR COLOR.

NO CLAIM IS MADE TO THE EXCLUSIVE RIGHT TO USE "APPAREL", APART FROM THE MARK AS SHOWN.

SER. NO. 85-483,654, FILED 11-30-2011.

MARGERY A. TIERNEY, EXAMINING ATTORNEY



*David J. Kyffers*

Director of the United States Patent and Trademark Office



# United States of America

United States Patent and Trademark Office



**Reg. No. 4,197,452**

**Registered Aug. 28, 2012**

**Int. Cl.: 38**

**SERVICE MARK**

**PRINCIPAL REGISTER**

PILIPINAS GLOBAL NETWORK (US) LLC (DELAWARE LIMITED LIABILITY COMPANY)  
12TH FL, MARAJO TOWER  
312-26TH ST. W 4TH AVE. BONIFACIO GLOBAL CITY  
TAGUIG CITY 1634, PHILIPPINES

FOR: TELEVISION BROADCASTING SERVICES FEATURING FILIPINO AND TAGALOG PROGRAMS, IN CLASS 38 (U.S. CLS. 100, 101 AND 104).

FIRST USE 3-16-2011; IN COMMERCE 3-16-2011.

NO CLAIM IS MADE TO THE EXCLUSIVE RIGHT TO USE "TV5", APART FROM THE MARK AS SHOWN.

THE COLOR(S) RED, BLACK AND WHITE IS/ARE CLAIMED AS A FEATURE OF THE MARK.

THE MARK CONSISTS OF THE WORD "KAPALID", WITH THE LETTER "K" IN RED LOOKING LIKE A PERSON JUMPING WITH BOTH HANDS IN THE AIR, AND THE LETTERS "APALID" IN WHITE LOWER CASE LETTERS. TO THE RIGHT OF THE WORD, IN A RED CIRCLE, ARE THE LETTERS "TV" SITTING ON TOP THE NUMBER "5". THE CHARACTERS ARE ALL HOUSED IN A BLACK ROUNDED RECTANGLE.

THE ENGLISH TRANSLATION OF "KAPALID" IN THE MARK IS "SIBLING".

SER. NO. 85-483,783, FILED 11-30-2011.

LAURA KOVALSKY, EXAMINING ATTORNEY



*David J. Kybas*

Director of the United States Patent and Trademark Office

# United States of America

United States Patent and Trademark Office



**PASSPORT**  
CORPORATE

**Reg. No. 4,197,453**

**Registered Aug. 28, 2012**

**Int. Cl.: 35**

**SERVICE MARK**

**PRINCIPAL REGISTER**

PASSPORT UNLIMITED, INC. (WASHINGTON CORPORATION), DBA PASSPORT  
UNLIMITED  
PO BOX 727  
KIRKLAND, WA 98083

FOR: PROMOTING THE GOODS AND SERVICES OF OTHERS BY DISTRIBUTING PRINTED MATERIALS ABOUT SUCH GOODS AND SERVICES TO MEMBERS OF IDENTIFIED GROUPS, BY ADMINISTERING DISCOUNT PROGRAMS TO ENABLE MEMBERSHIP PARTICIPANTS TO OBTAIN DISCOUNTS FOR SUCH GOODS AND SERVICES, AND BY ADMINISTERING WEB SITES ON A GLOBAL COMPUTER NETWORK FEATURING ADVERTISEMENTS FOR SUCH GOOD AND SERVICES, IN CLASS 35 (U.S. CLS. 100, 101 AND 102).

FIRST USE 9-0-2008; IN COMMERCE 9-0-2008.

OWNER OF U.S. REG. NOS. 2,768,909, 3,992,067 AND OTHERS.

NO CLAIM IS MADE TO THE EXCLUSIVE RIGHT TO USE "CORPORATE", APART FROM THE MARK AS SHOWN.

THE MARK CONSISTS OF THE LITERAL ELEMENTS "PASSPORT CORPORATE" AND A STYLISTIC IMAGE CONSISTING OF A CIRCULAR FORM BOUNDING A PLURALITY OF CITY BUILDINGS AGAINST A CONTRASTING BACKGROUND.

SER. NO. 85-483,867, FILED 11-30-2011.

DAVID MURRAY, EXAMINING ATTORNEY



*David J. Kyfos*

Director of the United States Patent and Trademark Office

# United States of America

United States Patent and Trademark Office



## PASSPORT D I N I N G

**Reg. No. 4,197,454**

**Registered Aug. 28, 2012**

**Int. Cl.: 35**

**SERVICE MARK**

**PRINCIPAL REGISTER**

PASSPORT UNLIMITED, INC. (WASHINGTON CORPORATION), DBA PASSPORT  
UNLIMITED  
PO BOX 727  
KIRKLAND, WA 98083

FOR: PROMOTING THE GOODS AND SERVICES OF OTHERS BY DISTRIBUTING PRINTED MATERIALS ABOUT SUCH GOODS AND SERVICES TO MEMBERS OF IDENTIFIED GROUPS, BY ADMINISTERING DISCOUNT PROGRAMS TO ENABLE MEMBERSHIP PARTICIPANTS TO OBTAIN DISCOUNTS FOR SUCH GOODS AND SERVICES, AND BY ADMINISTERING WEB SITES ON A GLOBAL COMPUTER NETWORK FEATURING ADVERTISEMENTS FOR SUCH GOOD AND SERVICES, IN CLASS 35 (U.S. CLS. 100, 101 AND 102).

FIRST USE 6-0-2008; IN COMMERCE 6-0-2008.

OWNER OF U.S. REG. NOS. 2,768,909, 3,992,067 AND OTHERS.

NO CLAIM IS MADE TO THE EXCLUSIVE RIGHT TO USE "DINING", APART FROM THE MARK AS SHOWN.

THE MARK CONSISTS OF THE LITERAL ELEMENTS "PASSPORT DINING" AND A STYLISTIC IMAGE CONSISTING OF A CIRCULAR FORM BOUNDING A PLURALITY OF CITY BUILDINGS AGAINST A CONTRASTING BACKGROUND.

SER. NO. 85-483,905, FILED 11-30-2011.

DAVID MURRAY, EXAMINING ATTORNEY



*David J. Kyfos*

Director of the United States Patent and Trademark Office

# United States of America

United States Patent and Trademark Office



**Reg. No. 4,197,455**

**Registered Aug. 28, 2012**

**Int. Cl.: 19**

**TRADEMARK**

**PRINCIPAL REGISTER**

HIJOS DE FRANCISCO GAYA FORES, S.L. (SPAIN CORPORATION)  
CARRETERA BURRIANA, 8  
ONDA, CASTELLON, SPAIN 12200

FOR: GLAZED CERAMIC TILES, NON-METAL TILES, MATERIALS FOR WALL SURFACING, NAMELY, NON-METAL WALL TILES AND FLOOR TILES OF CERAMIC, SANDSTONE AND PORCELAIN, IN CLASS 19 (U.S. CLS. 1, 12, 33 AND 50).

OWNER OF ERPN CMNTY TM OFC REG. NO. 008971855, DATED 8-18-2010, EXPIRES 3-22-2020.

THE COLOR(S) DARK RED AND WHITE IS/ARE CLAIMED AS A FEATURE OF THE MARK.

OWNER OF U.S. REG. NO. 2,509,234.

THE MARK CONSISTS OF A DARK RED QUADRANGLE INSIDE OF WHICH ARE THE LETTERS "G", "F" IN WHITE STYLIZED FORM.

SER. NO. 85-483,952, FILED 11-30-2011.

AMY HELLA, EXAMINING ATTORNEY



*David J. Kyffers*

Director of the United States Patent and Trademark Office

# United States of America

United States Patent and Trademark Office

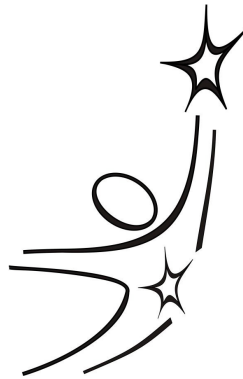

**Reg. No. 4,197,456**

**Registered Aug. 28, 2012**

**Int. Cl.: 41**

**SERVICE MARK**

**PRINCIPAL REGISTER**

KHASAY ALIEV (RUSSIAN FED. INDIVIDUAL)  
9456 CRYSTAL VIEW DRIVE  
TUJUNGA, CA 91042

FOR: ARRANGING AND CONDUCTING EDUCATIONAL CONFERENCES; CONTINUING EDUCATION SERVICES, NAMELY, PROVIDING LIVE AND ON-LINE CONTINUING PROFESSIONAL EDUCATION SEMINARS IN THE FIELD OF STRESS MANAGEMENT; DEVELOPING EDUCATIONAL MANUALS FOR OTHERS IN THE FIELD OF STRESS MANAGEMENT; DEVELOPMENT AND DISSEMINATION OF EDUCATIONAL MATERIALS FOR OTHERS IN THE FIELD OF STRESS MANAGEMENT; EDUCATING AT UNIVERSITY OR COLLEGES; EDUCATION SERVICES IN THE NATURE OF COURSES AT THE UNIVERSITY LEVEL; EDUCATION SERVICES, NAMELY, MENTORING IN THE FIELD OF STRESS MANAGEMENT; EDUCATION SERVICES, NAMELY, PROVIDING CAREER RE-TRAINING CLASSES, SEMINARS, AND WORKSHOPS IN THE FIELD OF STRESS MANAGEMENT; EDUCATIONAL AND ENTERTAINMENT SERVICES, NAMELY, A CONTINUING PROGRAM ABOUT STRESS MANAGEMENT ACCESSIBLE BY RADIO, TELEVISION, SATELLITE, AUDIO, VIDEO AND COMPUTER NETWORKS; EDUCATIONAL AND ENTERTAINMENT SERVICES, NAMELY, PROVIDING MOTIVATIONAL AND EDUCATIONAL SPEAKERS; EDUCATIONAL AND ENTERTAINMENT SERVICES, NAMELY, PROVIDING MOTIVATIONAL AND EDUCATIONAL SPEAKERS IN THE FIELD OF SELF- AND PERSONAL IMPROVEMENT; EDUCATIONAL AND ENTERTAINMENT SERVICES, NAMELY, PROVIDING MOTIVATIONAL SPEAKING SERVICES IN THE FIELD OF STRESS MANAGEMENT; EDUCATIONAL SERVICES IN THE NATURE OF STRESS MANAGEMENT SCHOOLS; EDUCATIONAL SERVICES, NAMELY, CONDUCTING DISTANCE LEARNING INSTRUCTION AT THE COLLEGE LEVEL; EDUCATIONAL SERVICES, NAMELY, CONDUCTING INFORMAL ON-LINE PROGRAMS IN THE FIELDS OF STRESS MANAGEMENT, AND PRINTABLE MATERIALS DISTRIBUTED THEREWITH; EDUCATIONAL SERVICES, NAMELY, CONDUCTING PROGRAMS IN THE FIELD OF STRESS MANAGEMENT; EDUCATIONAL SERVICES, NAMELY, CONDUCTING CLASSES IN THE FIELDS OF STRESS MANAGEMENT AND DISTRIBUTION OF TRAINING MATERIALS IN CONNECTION THEREWITH; EDUCATIONAL SERVICES, NAMELY, CONDUCTING SEMINARS IN THE FIELD OF STRESS MANAGEMENT; EDUCATIONAL SERVICES, NAMELY, CONDUCTING WORKSHOPS IN THE FIELD OF STRESS MANAGEMENT AND DISTRIBUTION OF TRAINING MATERIAL IN CONNECTION THEREWITH; EDUCATIONAL SERVICES, NAMELY, CONDUCTING LECTURES IN THE FIELD OF STRESS MANAGEMENT; EDUCATIONAL SERVICES, NAMELY, CONDUCTING COURSES IN THE FIELD OF STRESS MANAGEMENT AND DISTRIBUTION OF COURSE MATERIAL IN CONNECTION



*David J. Kybas*

Director of the United States Patent and Trademark Office

**Reg. No. 4,197,456** THEREWITH; EDUCATIONAL SERVICES, NAMELY, CONDUCTING CLASSES IN THE FIELD OF STRESS MANAGEMENT AND DISTRIBUTION OF EDUCATIONAL MATERIALS IN CONNECTION THEREWITH; EDUCATIONAL SERVICES, NAMELY, DEVELOPING CURRICULUM FOR EDUCATORS; EDUCATIONAL SERVICES, NAMELY, DEVELOPING CURRICULUM FOR OTHERS IN THE FIELD OF STRESS MANAGEMENT; EDUCATIONAL SERVICES, NAMELY, DEVELOPING, ARRANGING, AND CONDUCTING EDUCATIONAL CONFERENCES AND PROGRAMS AND PROVIDING COURSES OF INSTRUCTION IN THE FIELD OF STRESS MANAGEMENT; EDUCATIONAL SERVICES, NAMELY, PROFESSIONAL COACHING OF TEACHERS IN THE FIELD OF STRESS MANAGEMENT PROVIDED ON A REAL-TIME BASIS DURING CLASSROOM INSTRUCTION; EDUCATIONAL SERVICES, NAMELY, PROVIDING A CONTINUING PRERECORDED AUDIO PROGRAM IN THE FIELD OF STRESS MANAGEMENT ACCESSIBLE OVER THE INTERNET; EDUCATIONAL SERVICES, NAMELY, PROVIDING A LEARNING AND INNOVATION CENTER FEATURING FULLY CUSTOMIZED LEADERSHIP, MOTIVATIONAL, EDUCATIONAL, AND BRAINSTORMING TRAINING; EDUCATIONAL SERVICES, NAMELY, PROVIDING CONTINUING PROFESSIONAL EDUCATION COURSES IN THE FIELD OF STRESS MANAGEMENT; EDUCATIONAL SERVICES, NAMELY, PROVIDING COURSES OF INSTRUCTION AT THE COLLEGE LEVEL; EDUCATIONAL SERVICES, NAMELY, PROVIDING COURSES OF INSTRUCTION AT THE UNIVERSITY LEVEL AND DISTRIBUTION OF COURSE MATERIAL IN CONNECTION THEREWITH; EDUCATIONAL SERVICES, NAMELY, PROVIDING DISPLAYS AND EXHIBITS IN THE FIELD OF STRESS MANAGEMENT; EDUCATIONAL SERVICES, NAMELY, PROVIDING EDUCATIONAL SPEAKERS IN THE FIELD OF STRESS MANAGEMENT; EDUCATIONAL SERVICES, NAMELY, PROVIDING ON-LINE EDUCATION IN THE FIELD OF STRESS MANAGEMENT; EDUCATIONAL SERVICES, NAMELY, PROVIDING ONGOING TELEVISION PUBLIC SERVICE ANNOUNCEMENTS IN THE FIELD OF STRESS MANAGEMENT; EDUCATIONAL SERVICES, NAMELY, PROVIDING ONLINE INSTRUCTION IN THE FIELD OF STRESS MANAGEMENT; EDUCATIONAL SERVICES, NAMELY, PROVIDING ONLINE INSTRUCTION IN THE FIELD OF STRESS MANAGEMENT VIA AN ONLINE WEBSITE; EDUCATIONAL SERVICES, NAMELY, TEACHER TRAINING IN THE FIELD OF STRESS MANAGEMENT PROVIDED ON A REAL-TIME BASIS DURING CLASSROOM INSTRUCTION; PRODUCTION AND DISTRIBUTION OF VIDEOS IN THE FIELD OF STRESS MANAGEMENT; PROVIDING AN IN-PERSON EDUCATIONAL FORUM IN THE FIELD OF STRESS MANAGEMENT; PROVIDING COURSES OF INSTRUCTION AT THE POST-GRADUATE LEVEL; PROVIDING EDUCATION COURSES IN THE FIELD OF STRESS MANAGEMENT OFFERED THROUGH ONLINE, NON-DOWNLOADABLE VIDEOS AND INSTRUCTOR ASSISTANCE; PROVIDING EDUCATION IN THE FIELD OF STRESS MANAGEMENT RENDERED THROUGH VIDEO CONFERENCE; PROVIDING EDUCATION IN THE FIELD OF STRESS MANAGEMENT RENDERED THROUGH CORRESPONDENCE COURSES, IN CLASS 41 (U.S. CLS. 100, 101 AND 107).

FIRST USE 1-15-2008; IN COMMERCE 1-15-2008.

THE MARK CONSISTS OF HUMAN FORM WITH A STAR ON ITS CHEST REACHING FOR A STAR.

SER. NO. 85-484,030, FILED 11-30-2011.

APRIL HESIK, EXAMINING ATTORNEY

# United States of America

United States Patent and Trademark Office

## NABFEME SHERO

**Reg. No. 4,197,457**

HARRISON, JOHNNIE M. (UNITED STATES INDIVIDUAL)  
289 UNDERCLIFF AVENUE  
EDGEWATER, NJ 07020

**Registered Aug. 28, 2012**

**Int. Cl.: 41**

FOR: AWARDS PROGRAM FOR THE PRESENTATION OF AWARDS TO WOMEN HEROES  
IN RECOGNITION OF THEIR ACHIEVEMENTS AND QUALITIES, IN CLASS 41 (U.S. CLS.  
100, 101 AND 107).

**SERVICE MARK**

FIRST USE 11-19-1999; IN COMMERCE 11-19-1999.

**PRINCIPAL REGISTER**

THE MARK CONSISTS OF STANDARD CHARACTERS WITHOUT CLAIM TO ANY PAR-  
TICULAR FONT, STYLE, SIZE, OR COLOR.

OWNER OF U.S. REG. NO. 3,014,661.

SER. NO. 85-484,143, FILED 11-30-2011.

AMY C. KEAN, EXAMINING ATTORNEY



*David J. Kyffers*

Director of the United States Patent and Trademark Office

# United States of America

United States Patent and Trademark Office

## THE ROYAL FLUSH COLLECTION

**Reg. No. 4,197,458**

BERNARD NACHT & COMPANY, INC. (NEW YORK CORPORATION)  
589 FIFTH AVENUE, SUITE 1204  
NEW YORK, NY 10017

**Registered Aug. 28, 2012**

**Int. Cl.: 14**

FOR: JEWELRY, IN CLASS 14 (U.S. CLS. 2, 27, 28 AND 50).

**TRADEMARK**

FIRST USE 9-30-2001; IN COMMERCE 9-30-2001.

**PRINCIPAL REGISTER**

THE MARK CONSISTS OF STANDARD CHARACTERS WITHOUT CLAIM TO ANY PARTICULAR FONT, STYLE, SIZE, OR COLOR.

NO CLAIM IS MADE TO THE EXCLUSIVE RIGHT TO USE "COLLECTION", APART FROM THE MARK AS SHOWN.

SER. NO. 85-484,159, FILED 11-30-2011.

AMY C. KEAN, EXAMINING ATTORNEY



*David J. Kappas*

Director of the United States Patent and Trademark Office



# United States of America

United States Patent and Trademark Office

# Cloud<sup>n</sup>

**Reg. No. 4,197,459**

**Registered Aug. 28, 2012**

**Int. Cl.: 42**

**SERVICE MARK**

**PRINCIPAL REGISTER**

VERIO INC. (DELAWARE CORPORATION)  
8300 E. MAPLEWOOD AVENUE, SUITE 400  
GREENWOOD VILLAGE, CO 80111

FOR: COMPUTER SERVICES, NAMELY, CLOUD HOSTING PROVIDER SERVICES, IN CLASS 42 (U.S. CLS. 100 AND 101).

FIRST USE 3-29-2012; IN COMMERCE 3-29-2012.

THE MARK CONSISTS OF THE WORD "CLOUD" FOLLOWED BY A SUPERScript "N".

SER. NO. 85-484,261, FILED 11-30-2011.

NATALIE POLZER, EXAMINING ATTORNEY



*David J. Kybas*

Director of the United States Patent and Trademark Office

# United States of America

United States Patent and Trademark Office



**Reg. No. 4,197,460**

**Registered Aug. 28, 2012**

**Int. Cl.: 5**

**TRADEMARK**

**PRINCIPAL REGISTER**

LI, CHANG (UNITED STATES INDIVIDUAL), DBA YONG TAI COMPANY LLC  
1088 BISHOP STREET, STE# 1226  
HONOLULU, HI 96813

FOR: HERBAL PILLS FOR THE TREATMENT OF DIABETICS, IN CLASS 5 (U.S. CLS. 6, 18, 44, 46, 51 AND 52).

FIRST USE 12-20-1997; IN COMMERCE 12-20-1997.

NO CLAIM IS MADE TO THE EXCLUSIVE RIGHT TO USE "SHILIANHUA", "SEKIRANKA" OR THE CHINESE CHARACTERS THAT TRANSLITERATE TO "SHILIANHUA", APART FROM THE MARK AS SHOWN.

THE COLOR(S) RED, GREEN, WHITE AND BLACK IS/ARE CLAIMED AS A FEATURE OF THE MARK.

THE NON-LATIN CHARACTERS IN THE MARK TRANSLITERATE TO "SHILIANHUA", AND THIS MEANS "GHOST PLANTS" OR "MOTHER-OF-PEARL PLANTS" IN ENGLISH.

THE MARK CONSISTS OF THE RED STYLIZED WORDING "SHILIANHUA" ABOVE THREE WHITE CHINESE CHARACTERS AGAINST A RED RECTANGULAR BACKGROUND. THE CHINESE CHARACTERS TRANSLITERATE TO "SHILIANHUA". BELOW THESE IS THE RED STYLIZED WORDING "(SEKIRANKA)". ALL THESE WORDINGS MEAN "GHOST PLANTS" OR "MOTHER-OF-PEARL PLANTS" IN ENGLISH. BELOW THESE WORDINGS IS THE DESIGN OF A FLOWER-LIKE GHOST PLANT IN GREEN COLOR, OUTLINED IN BLACK.

THE ENGLISH TRANSLATIONS OF BOTH "SHILIANHUA" AND "SEKIRANKA" IN THE MARK ARE "GHOST PLANTS" OR "MOTHER-OF-PEARL PLANTS".

SER. NO. 85-484,311, FILED 11-30-2011.

DAWN HAN, EXAMINING ATTORNEY



*David J. Kappas*

Director of the United States Patent and Trademark Office

# United States of America

United States Patent and Trademark Office

## Triple Wellness

**Reg. No. 4,197,461**

BIG SKY GROWTH AND WELLNESS LLC (MONTANA LIMITED LIABILITY COMPANY)  
258 BUTTE CREEK ROAD  
PEERLESS, MT 59253

**Registered Aug. 28, 2012**

**Int. Cls.: 9, 16, 41 and 44**

FOR: DIGITAL MEDIA, NAMELY, DVDS, CDS, DOWNLOADABLE TEXT, AUDIO, AND VIDEO FILES, AND DOWNLOADABLE WEBINARS IN THE FIELDS OF HEALTH, WELLNESS, AND MENTAL HEALTH, IN CLASS 9 (U.S. CLS. 21, 23, 26, 36 AND 38).

**TRADEMARK**

FIRST USE 8-1-2010; IN COMMERCE 8-1-2010.

**SERVICE MARK**

FOR: EDUCATIONAL PUBLICATIONS, NAMELY, WORKBOOKS, BROCHURES, TRAINING MANUALS, TEXTBOOKS, WORKSHEETS, AND LETTERS IN THE FIELDS OF MENTAL HEALTH; WORKBOOKS DIRECTED TO HEALTH AND WELLNESS AND MENTAL HEALTH, IN CLASS 16 (U.S. CLS. 2, 5, 22, 23, 29, 37, 38 AND 50).

**PRINCIPAL REGISTER**

FIRST USE 8-1-2010; IN COMMERCE 8-1-2010.

FOR: EDUCATIONAL SERVICES, NAMELY, PROVIDING EDUCATIONAL PROGRAMS, SEMINARS, WORKSHOPS, CONFERENCES, AND NON-DOWNLOADABLE WEBINARS IN THE FIELDS OF HEALTH, WELLNESS, AND MENTAL HEALTH, IN CLASS 41 (U.S. CLS. 100, 101 AND 107).

FIRST USE 8-1-2010; IN COMMERCE 8-1-2010.

FOR: CONSULTING SERVICES IN THE FIELD OF HEALTH, WELLNESS, AND MENTAL HEALTH; WELLNESS AND HEALTH-RELATED CONSULTING SERVICES, IN CLASS 44 (U.S. CLS. 100 AND 101).

FIRST USE 8-1-2010; IN COMMERCE 8-1-2010.

THE MARK CONSISTS OF STANDARD CHARACTERS WITHOUT CLAIM TO ANY PARTICULAR FONT, STYLE, SIZE, OR COLOR.

NO CLAIM IS MADE TO THE EXCLUSIVE RIGHT TO USE "WELLNESS", APART FROM THE MARK AS SHOWN.

SER. NO. 85-484,333, FILED 11-30-2011.



*David J. Kyros*

Director of the United States Patent and Trademark Office

**Reg. No. 4,197,461** KIMBERLY FRYE, EXAMINING ATTORNEY

# United States of America

United States Patent and Trademark Office



**Reg. No. 4,197,462**

**Registered Aug. 28, 2012**

**Int. Cl.: 44**

**SERVICE MARK**

**PRINCIPAL REGISTER**

UNIVERSITY HEALTH SYSTEMS OF EASTERN CAROLINA, INC. (NORTH CAROLINA  
NON-PROFIT CORPORATION)  
P.O. BOX 6028  
2100 STANTONSBURG ROAD  
GREENVILLE, NC 27835

FOR: HOSPITALS; BEHAVIORAL HEALTH SERVICES; EMERGENCY MEDICAL ASSIST-  
ANCE; HEALTHCARE SERVICES; MEDICAL SERVICES; MEDICAL IMAGING SERVICES;  
MEDICAL CLINICS; PHYSICIAN SERVICES; PROVIDING A WEBSITE FEATURING  
MEDICAL INFORMATION; REHABILITATION PATIENT CARE SERVICES; SURGERY, IN  
CLASS 44 (U.S. CLS. 100 AND 101).

FIRST USE 1-25-2012; IN COMMERCE 1-25-2012.

THE MARK CONSISTS OF A STYLIZED LETTER "V" COMPRISED OF TWO OVERLAPPING  
POINTED-TIP OVALS THAT OVERLAP IN THE CENTER TO FORM A VENN DIAGRAM;  
THE COLOR TEAL GREEN APPEARS IN THE CENTER OVERLAPPING SECTION OF THE  
TWO OVERLAPPING POINTED-TIP OVALS; THE COLOR LIGHT BLUE APPEARS IN THE  
RIGHT POINTED-TIP OVAL; THE COLOR DARK BLUE APPEARS IN THE LEFT POINTED-  
TIP OVAL; THE COLOR WHITE REPRESENTS BACKGROUND AND IS NOT CLAIMED  
AS A FEATURE OF THE MARK.

THE COLOR(S) TEAL GREEN, LIGHT BLUE AND DARK BLUE IS/ARE CLAIMED AS A  
FEATURE OF THE MARK.

SER. NO. 85-484,554, FILED 12-1-2011.

MYRIAH HABEEB, EXAMINING ATTORNEY



*David J. Kypos*

Director of the United States Patent and Trademark Office

# United States of America

United States Patent and Trademark Office

# WISKULLSIN

**Reg. No. 4,197,463**

WISKULLSIN LLC (WISCONSIN LIMITED LIABILITY COMPANY)  
1726 E. NORTH AVENUE  
MILWAUKEE, WI 53202

**Registered Aug. 28, 2012**

**Int. Cl.: 25**

FOR: CLOTHING AND HEADWEAR, NAMELY, T-SHIRTS, SHIRTS, LONG-SLEEVED SHIRTS, HOODED SWEATSHIRTS, SWEATSHIRTS, UNDERWEAR, SHORTS, HATS AND JACKETS, IN CLASS 25 (U.S. CLS. 22 AND 39).

**TRADEMARK**

FIRST USE 3-1-2008; IN COMMERCE 7-1-2009.

**PRINCIPAL REGISTER**

THE MARK CONSISTS OF STANDARD CHARACTERS WITHOUT CLAIM TO ANY PARTICULAR FONT, STYLE, SIZE, OR COLOR.

THE WORDING "WISKULLSIN" HAS NO MEANING IN A FOREIGN LANGUAGE.

SER. NO. 85-484,661, FILED 12-1-2011.

JANICE KIM, EXAMINING ATTORNEY



*David J. Kybas*

Director of the United States Patent and Trademark Office

# United States of America

United States Patent and Trademark Office

## MURPHY-MEISGEIER TYPE INDICATOR FOR CHILDREN

**Reg. No. 4,197,464**

**Registered Aug. 28, 2012**

**Int. Cl.: 9**

**TRADEMARK**

**PRINCIPAL REGISTER**

MEISGEIER, CHARLES (UNITED STATES INDIVIDUAL)  
7218 ROLLING MEADOW DRIVE  
RICHMOND, TX 77469 AND

MURPHY, ELIZABETH (UNITED STATES INDIVIDUAL)  
2720 EDGEBROOK COURT  
KELLER, TX 76248

FOR: DOWNLOADABLE PUBLICATIONS IN THE NATURE OF DOWNLOADABLE PSYCHOLOGICAL TEST BOOKLETS AND ANSWER SHEETS FOR USE IN THE FIELD OF CHILDHOOD EDUCATION, IN CLASS 9 (U.S. CLS. 21, 23, 26, 36 AND 38).

FIRST USE 11-15-2007; IN COMMERCE 11-15-2007.

THE MARK CONSISTS OF STANDARD CHARACTERS WITHOUT CLAIM TO ANY PARTICULAR FONT, STYLE, SIZE, OR COLOR.

OWNER OF U.S. REG. NOS. 3,316,488 AND 3,632,157.

NO CLAIM IS MADE TO THE EXCLUSIVE RIGHT TO USE "TYPE INDICATOR FOR CHILDREN", APART FROM THE MARK AS SHOWN.

SER. NO. 85-484,684, FILED 12-1-2011.

MICHAEL TANNER, EXAMINING ATTORNEY



*David J. Kybas*

Director of the United States Patent and Trademark Office

# United States of America

United States Patent and Trademark Office

## Design Womb

**Reg. No. 4,197,465**

LAFAVE, NICOLE (UNITED STATES INDIVIDUAL)  
1588 SANCHEZ ST.

**Registered Aug. 28, 2012**

SAN FRANCISCO, CA 94131

**Int. Cls.: 35 and 42**

FOR: BRANDING SERVICES, NAMELY, CONSULTING, DEVELOPMENT, MANAGEMENT AND MARKETING OF BRANDS FOR BUSINESSES; CREATING CORPORATE LOGOS FOR OTHERS, IN CLASS 35 (U.S. CLS. 100, 101 AND 102).

**SERVICE MARK**

FIRST USE 3-29-2010; IN COMMERCE 7-0-2010.

**PRINCIPAL REGISTER**

FOR: GRAPHIC DESIGN, NAMELY, DESIGNING PACKAGING, PRINT COLLATERAL AND WEBSITES FOR OTHERS, IN CLASS 42 (U.S. CLS. 100 AND 101).

FIRST USE 3-29-2010; IN COMMERCE 7-0-2010.

THE MARK CONSISTS OF STANDARD CHARACTERS WITHOUT CLAIM TO ANY PARTICULAR FONT, STYLE, SIZE, OR COLOR.

NO CLAIM IS MADE TO THE EXCLUSIVE RIGHT TO USE "DESIGN", APART FROM THE MARK AS SHOWN.

SER. NO. 85-484,702, FILED 12-1-2011.

KRISTIN DAHLING, EXAMINING ATTORNEY



*David J. Kybas*

Director of the United States Patent and Trademark Office



# United States of America

United States Patent and Trademark Office

## MURPHY-MEISGEIER TYPE INDICATOR FOR CHILDREN

**Reg. No. 4,197,466**

**Registered Aug. 28, 2012**

**Int. Cl.: 41**

**SERVICE MARK**

**PRINCIPAL REGISTER**

MEISGEIER, CHARLES (UNITED STATES INDIVIDUAL)  
7218 ROLLING MEADOW DRIVE  
RICHMOND, TX 77469 AND

MURPHY, ELIZABETH (UNITED STATES INDIVIDUAL)  
2720 EDGEBROOK COURT  
KELLER, TX 76248

FOR: EDUCATIONAL SERVICES, NAMELY, PROVIDING COURSES, WORKSHOPS AND SEMINARS IN THE FIELDS OF CHILDHOOD EDUCATIONAL METHODS AND PSYCHOLOGICAL TESTING, IN CLASS 41 (U.S. CLS. 100, 101 AND 107).

FIRST USE 10-8-1987; IN COMMERCE 10-8-1987.

THE MARK CONSISTS OF STANDARD CHARACTERS WITHOUT CLAIM TO ANY PARTICULAR FONT, STYLE, SIZE, OR COLOR.

OWNER OF U.S. REG. NOS. 3,316,488 AND 3,632,157.

NO CLAIM IS MADE TO THE EXCLUSIVE RIGHT TO USE "TYPE INDICATOR FOR CHILDREN", APART FROM THE MARK AS SHOWN.

SER. NO. 85-484,704, FILED 12-1-2011.

MICHAEL TANNER, EXAMINING ATTORNEY



*David J. Kyffers*

Director of the United States Patent and Trademark Office

# United States of America

United States Patent and Trademark Office

## MURPHY-MEISGEIER TYPE INDICATOR FOR CHILDREN

**Reg. No. 4,197,467**

MEISGEIER, CHARLES (UNITED STATES INDIVIDUAL)  
7218 ROLLING MEADOW DRIVE  
RICHMOND, TX 77469 AND

**Registered Aug. 28, 2012**

**Int. Cl.: 44**

MURPHY, ELIZABETH (UNITED STATES INDIVIDUAL)  
2720 EDGEBROOK COURT  
KELLER, TX 76248

**SERVICE MARK**

**PRINCIPAL REGISTER**

FOR: ONLINE PSYCHOLOGICAL TESTING SERVICES FOR USE IN THE FIELD OF  
CHILDHOOD EDUCATION, IN CLASS 44 (U.S. CLS. 100 AND 101).

FIRST USE 8-1-2001; IN COMMERCE 8-1-2001.

THE MARK CONSISTS OF STANDARD CHARACTERS WITHOUT CLAIM TO ANY PAR-  
TICULAR FONT, STYLE, SIZE, OR COLOR.

OWNER OF U.S. REG. NOS. 3,316,488 AND 3,632,157.

NO CLAIM IS MADE TO THE EXCLUSIVE RIGHT TO USE "TYPE INDICATOR FOR  
CHILDREN", APART FROM THE MARK AS SHOWN.

SER. NO. 85-484,743, FILED 12-1-2011.

MICHAEL TANNER, EXAMINING ATTORNEY



*David J. Kybas*

Director of the United States Patent and Trademark Office

# United States of America

United States Patent and Trademark Office

## Hydraulink

---

### Hose and Fittings

**Reg. No. 4,197,468**

**Registered Aug. 28, 2012**

**Int. Cls.: 17 and 19**

**TRADEMARK**

**PRINCIPAL REGISTER**

HYDRAULINK FLUID CONNECTORS LIMITED (NEW ZEALAND COMPANY)  
222 STATION ROAD  
PENROSE, AUKLAND, NEW ZEALAND 1061

FOR: NON-METAL PLASTIC AND RUBBER FLEXIBLE TUBES AND NON-METAL COUPLINGS FOR USE THEREWITH, FOR USE IN INDUSTRIAL, SPECIALTY, PNEUMATIC, MOBILE AND STATIONARY PLANT EQUIPMENT AND IN COMPONENTS OF SUCH PLANT EQUIPMENT; NON-METAL FLEXIBLE HYDRAULIC HOSES MADE OF RUBBER AND PLASTIC AND NON-METAL HOSE COUPLINGS AND HOSE FITTINGS FOR USE THEREWITH, FOR USE IN INDUSTRIAL, SPECIALTY, PNEUMATIC, MOBILE AND STATIONARY PLANT EQUIPMENT AND IN COMPONENTS OF SUCH PLANT EQUIPMENT, IN CLASS 17 (U.S. CLS. 1, 5, 12, 13, 35 AND 50).

FOR: NON-METAL FLEXIBLE TUBING AND TUBING COUPLINGS FOR JOINING AND TERMINATING PIPES FOR USE IN INDUSTRIAL, SPECIALTY, PNEUMATIC, MOBILE AND STATIONARY PLANT EQUIPMENT AND IN COMPONENTS OF SUCH PLANT EQUIPMENT, IN CLASS 19 (U.S. CLS. 1, 12, 33 AND 50).

OWNER OF NEW ZEALAND REG. NO. 834581, DATED 6-10-2011, EXPIRES 12-9-2020.

NO CLAIM IS MADE TO THE EXCLUSIVE RIGHT TO USE "HOSE AND FITTINGS", APART FROM THE MARK AS SHOWN.

SER. NO. 85-484,944, FILED 12-1-2011.

REBECCA GILBERT, EXAMINING ATTORNEY



*David J. Kyros*

Director of the United States Patent and Trademark Office

# United States of America

United States Patent and Trademark Office

## Associate Record

**Reg. No. 4,197,469**

PORT NEXUS CORPORATION (DELAWARE CORPORATION)

**Registered Aug. 28, 2012**

2131 HOLLYWOOD BLVD.  
HOLLYWOOD, FL 33020

**Int. Cl.: 38**

FOR: TELECOMMUNICATIONS SERVICES, NAMELY, PROVIDING ADVANCED CALLING FEATURES IN THE NATURE OF SEAMLESS MOBILE PHONE VOICE CALL CAPTURE, NAMELY, PROVIDING THE ABILITY TO RECORD TELEPHONE CALLS AND TO SAVE RECORDED FILES ONLINE, IN CLASS 38 (U.S. CLS. 100, 101 AND 104).

**SERVICE MARK**

**PRINCIPAL REGISTER**

FIRST USE 11-7-2011; IN COMMERCE 11-7-2011.

THE MARK CONSISTS OF STANDARD CHARACTERS WITHOUT CLAIM TO ANY PARTICULAR FONT, STYLE, SIZE, OR COLOR.

NO CLAIM IS MADE TO THE EXCLUSIVE RIGHT TO USE "RECORD", APART FROM THE MARK AS SHOWN.

SER. NO. 85-485,149, FILED 12-1-2011.

ERIN FALK, EXAMINING ATTORNEY



*David J. Kyjars*

Director of the United States Patent and Trademark Office

# United States of America

United States Patent and Trademark Office

## UNIGROUP WORLDWIDE LOGISTICS

**Reg. No. 4,197,470**

**Registered Aug. 28, 2012**

**Int. Cls.: 35 and 39**

**SERVICE MARK**

**PRINCIPAL REGISTER**

UNIGROUP WORLDWIDE LOGISTICS, LLC (MISSOURI LIMITED LIABILITY COMPANY)  
ONE PREMIER DRIVE  
FENTON, MO 63026

FOR: BUSINESS MANAGEMENT SERVICES, NAMELY, MANAGEMENT OF TRANSPORTATION, STORAGE, DISTRIBUTION, SUPPLY CHAIN, AND LOGISTICS SERVICES; AND PROJECT MANAGEMENT SERVICES FOR OTHERS FOR BUSINESS PURPOSES IN THE FIELDS OF TRANSPORTATION, STORAGE, DISTRIBUTION, SUPPLY CHAIN, AND LOGISTICS, IN CLASS 35 (U.S. CLS. 100, 101 AND 102).

FIRST USE 8-2-2011; IN COMMERCE 8-2-2011.

FOR: TRANSPORTATION AND STORAGE OF GOODS, FREIGHT FORWARDING, LOGISTICS AND SUPPLY CHAIN SERVICES, IN CLASS 39 (U.S. CLS. 100 AND 105).

FIRST USE 8-2-2011; IN COMMERCE 8-2-2011.

THE MARK CONSISTS OF STANDARD CHARACTERS WITHOUT CLAIM TO ANY PARTICULAR FONT, STYLE, SIZE, OR COLOR.

OWNER OF U.S. REG. NOS. 2,206,766, 2,453,218 AND OTHERS.

NO CLAIM IS MADE TO THE EXCLUSIVE RIGHT TO USE "WORLDWIDE LOGISTICS", APART FROM THE MARK AS SHOWN.

SER. NO. 85-485,209, FILED 12-1-2011.

JAY FLOWERS, EXAMINING ATTORNEY



*David J. Kypos*

Director of the United States Patent and Trademark Office

# United States of America

United States Patent and Trademark Office



**UniGroup**  
Worldwide Logistics

**Reg. No. 4,197,471**

**Registered Aug. 28, 2012**

**Int. Cls.: 35 and 39**

**SERVICE MARK**

**PRINCIPAL REGISTER**

UNIGROUP WORLDWIDE LOGISTICS, LLC (MISSOURI LIMITED LIABILITY COMPANY)  
ONE PREMIER DRIVE  
FENTON, MO 63026

FOR: BUSINESS MANAGEMENT SERVICES, NAMELY, MANAGEMENT OF TRANSPORTATION, STORAGE, DISTRIBUTION, SUPPLY CHAIN, AND LOGISTICS SERVICES; AND PROJECT MANAGEMENT SERVICES FOR OTHERS FOR BUSINESS PURPOSES IN THE FIELDS OF TRANSPORTATION, STORAGE, DISTRIBUTION, SUPPLY CHAIN, AND LOGISTICS, IN CLASS 35 (U.S. CLS. 100, 101 AND 102).

FIRST USE 8-2-2011; IN COMMERCE 8-2-2011.

FOR: TRANSPORTATION AND STORAGE OF GOODS, FREIGHT FORWARDING, LOGISTICS AND SUPPLY CHAIN SERVICES, IN CLASS 39 (U.S. CLS. 100 AND 105).

FIRST USE 8-2-2011; IN COMMERCE 8-2-2011.

OWNER OF U.S. REG. NOS. 2,206,766, 2,453,218 AND OTHERS.

THE COLOR(S) RED AND BROWN IS/ARE CLAIMED AS A FEATURE OF THE MARK.

NO CLAIM IS MADE TO THE EXCLUSIVE RIGHT TO USE "WORLDWIDE LOGISTICS", APART FROM THE MARK AS SHOWN.

THE MARK CONSISTS OF A U-SHAPED DESIGN AND THE PHRASE "UNIGROUP WORLDWIDE LOGISTICS". THE U-SHAPED DESIGN AND THE PHRASE "WORLDWIDE LOGISTICS" ARE DISPLAYED IN BROWN, AND THE TERM "UNIGROUP" IS DISPLAYED IN RED.

SER. NO. 85-485,221, FILED 12-1-2011.

JAY FLOWERS, EXAMINING ATTORNEY



*David J. Kyffers*

Director of the United States Patent and Trademark Office

# United States of America

United States Patent and Trademark Office

## SOIL GUARD

**Reg. No. 4,197,472**

MAT, INC. (MINNESOTA CORPORATION)  
12402 HIGHWAY 2  
FLOODWOOD, MN 55738

**Registered Aug. 28, 2012**

**Int. Cl.: 19**

FOR: EROSION CONTROL MATRIX CONTAINING ORGANIC DEFIBRATED FIBERS, NAMELY, A THIN BLANKET OF BONDED FIBER FOR DOMESTIC, INDUSTRIAL AND CONSTRUCTION COVERING USES, IN CLASS 19 (U.S. CLS. 1, 12, 33 AND 50).

**TRADEMARK**

FIRST USE 3-6-1998; IN COMMERCE 3-6-1998.

**PRINCIPAL REGISTER**

THE MARK CONSISTS OF STANDARD CHARACTERS WITHOUT CLAIM TO ANY PARTICULAR FONT, STYLE, SIZE, OR COLOR.

NO CLAIM IS MADE TO THE EXCLUSIVE RIGHT TO USE "SOIL", APART FROM THE MARK AS SHOWN.

SER. NO. 85-485,245, FILED 12-1-2011.

ANNE E. GUSTASON, EXAMINING ATTORNEY



*David J. Kyffers*

Director of the United States Patent and Trademark Office

# United States of America

United States Patent and Trademark Office

## Upper Valley Computers

**Reg. No. 4,197,473**

UPPER VALLEY COMPUTERS (NEW HAMPSHIRE LIMITED LIABILITY COMPANY)  
6 GATES RD.  
ETNA, NH 03750

**Registered Aug. 28, 2012**

**Int. Cl.: 42**

FOR: CONSULTING SERVICES IN THE FIELD OF DESIGN, SELECTION, IMPLEMENTATION AND USE OF COMPUTER HARDWARE AND SOFTWARE SYSTEMS FOR OTHERS, IN CLASS 42 (U.S. CLS. 100 AND 101).

**SERVICE MARK**

FIRST USE 5-5-2009; IN COMMERCE 5-7-2009.

**PRINCIPAL REGISTER**

THE MARK CONSISTS OF STANDARD CHARACTERS WITHOUT CLAIM TO ANY PARTICULAR FONT, STYLE, SIZE, OR COLOR.

NO CLAIM IS MADE TO THE EXCLUSIVE RIGHT TO USE "COMPUTERS", APART FROM THE MARK AS SHOWN.

SER. NO. 85-485,267, FILED 12-1-2011.

Alice Benmaman, Examining Attorney



*David J. Kyffers*

Director of the United States Patent and Trademark Office



# United States of America

United States Patent and Trademark Office

**CHINA  BOWL**

**Reg. No. 4,197,474**

**Registered Aug. 28, 2012**

**Int. Cl.: 43**

**SERVICE MARK**

**PRINCIPAL REGISTER**

ASIAN FUSION FOOD INC. (CALIFORNIA CORPORATION), DBA CHINA BOWL EXPRESS  
11031 FIRESTONE BLVD  
STE 102  
NORWALK, CA 906502213

FOR: FAST-FOOD RESTAURANT SERVICES; FROZEN YOGURT SHOP SERVICES IN THE NATURE OF A RESTAURANT; RESTAURANT SERVICES FEATURING CHINESE FOOD, HAWAIIAN BBQ, FROZEN YOGURT, AND JUICE BAR; RESTAURANT SERVICES, INCLUDING SIT-DOWN SERVICE OF FOOD AND TAKE-OUT RESTAURANT SERVICES, IN CLASS 43 (U.S. CLS. 100 AND 101).

FIRST USE 10-1-2003; IN COMMERCE 10-1-2003.

OWNER OF U.S. REG. NO. 3,918,851.

THE COLOR(S) RED AND YELLOW IS/ARE CLAIMED AS A FEATURE OF THE MARK.

NO CLAIM IS MADE TO THE EXCLUSIVE RIGHT TO USE "CHINA" AND "EXPRESS", APART FROM THE MARK AS SHOWN.

THE MARK CONSISTS OF THE WORDS "CHINA BOWL" IN RED LETTERING WITH A STYLIZED BOWL IN THE MIDDLE AND UNDER THE WORDS "CHINA BOWL". THE BOWL IS YELLOW WITH THE WORD "EXPRESS" IN RED CENTERED INSIDE AND STYLIZED RED LINES. THE COLORS BLACK, WHITE, AND/OR GRAY REPRESENT BACKGROUND, OUTLINING, SHADING AND/OR TRANSPARENT AREAS AND ARE NOT PART OF THE MARK.

SER. NO. 85-485,291, FILED 12-1-2011.

LINDA ORNDORFF, EXAMINING ATTORNEY



*David J. Kyros*

Director of the United States Patent and Trademark Office

# United States of America

United States Patent and Trademark Office

# RF-BLOK

**Reg. No. 4,197,475**

TURN-LUCKILY INTERNATIONAL, INC. (CALIFORNIA CORPORATION)  
9710 RESEARCH DRIVE  
IRVINE, CA 92618

**Registered Aug. 28, 2012**

**Int. Cl.: 9**

FOR: ELECTRONIC COMPONENTS, NAMELY, CABLE CONNECTORS, CONNECTION CABLES AND POWER ADAPTERS, IN CLASS 9 (U.S. CLS. 21, 23, 26, 36 AND 38).

**TRADEMARK**

FIRST USE 4-1-2000; IN COMMERCE 4-1-2000.

**PRINCIPAL REGISTER**

THE MARK CONSISTS OF STANDARD CHARACTERS WITHOUT CLAIM TO ANY PARTICULAR FONT, STYLE, SIZE, OR COLOR.

SER. NO. 85-485,396, FILED 12-1-2011.

KAPIL BHANOT, EXAMINING ATTORNEY



*David J. Kybas*

Director of the United States Patent and Trademark Office

# United States of America

United States Patent and Trademark Office

## SLIMFUL CHOCOLATE DECADENCE OOLONG TEA

**Reg. No. 4,197,476**

**Registered Aug. 28, 2012**

**Int. Cl.: 30**

TEAVANA CORPORATION (GEORGIA CORPORATION)  
SUITE 1480  
3630 PEACHTREE ROAD  
ATLANTA, GA 30326

FOR: TEA, IN CLASS 30 (U.S. CL. 46).

**TRADEMARK**

FIRST USE 10-1-2011; IN COMMERCE 10-1-2011.

**PRINCIPAL REGISTER**

THE MARK CONSISTS OF STANDARD CHARACTERS WITHOUT CLAIM TO ANY PARTICULAR FONT, STYLE, SIZE, OR COLOR.

NO CLAIM IS MADE TO THE EXCLUSIVE RIGHT TO USE "CHOCOLATE" AND "OOLONG TEA", APART FROM THE MARK AS SHOWN.

SER. NO. 85-485,536, FILED 12-2-2011.

WILLIAM P. SHANAHAN, EXAMINING ATTORNEY



*David J. Kyffers*

Director of the United States Patent and Trademark Office

# United States of America

United States Patent and Trademark Office

## DANCE PASSPORT

**Reg. No. 4,197,477**

KRISTIN E. ORLOWSKI (UNITED STATES INDIVIDUAL), DBA DANCE PASSPORT LLC.  
226 W 17TH ST. APT 2A  
NEW YORK, NY 10011

**Registered Aug. 28, 2012**

**Int. Cl.: 41**

FOR: DANCE EVENTS; DANCE INSTRUCTION; DANCE INSTRUCTION FOR CHILDREN; DANCE RESERVATION SERVICES, NAMELY, ARRANGING FOR ADMISSION TO DANCE EVENTS; DANCE SCHOOLS; DANCE STUDIOS; EDUCATION SERVICES, NAMELY, PROVIDING CLASSES AND INSTRUCTION IN THE FIELD OF DANCE; ENTERTAINMENT IN THE NATURE OF DANCE PERFORMANCES; ORGANIZATION OF DANCING EVENTS; PHOTOGRAPHY; PHOTOGRAPHY SERVICES; TRAINING OF DANCE INSTRUCTORS, IN CLASS 41 (U.S. CLS. 100, 101 AND 107).

**SERVICE MARK**

**PRINCIPAL REGISTER**

FIRST USE 11-11-2011; IN COMMERCE 11-11-2011.

THE MARK CONSISTS OF STANDARD CHARACTERS WITHOUT CLAIM TO ANY PARTICULAR FONT, STYLE, SIZE, OR COLOR.

NO CLAIM IS MADE TO THE EXCLUSIVE RIGHT TO USE "DANCE", APART FROM THE MARK AS SHOWN.

SER. NO. 85-485,552, FILED 12-2-2011.

MARLENE BELL, EXAMINING ATTORNEY



*David J. Kybas*

Director of the United States Patent and Trademark Office

# United States of America

United States Patent and Trademark Office

 puridone

**Reg. No. 4,197,478**

**Registered Aug. 28, 2012**

**Int. Cl.: 44**

**SERVICE MARK**

**PRINCIPAL REGISTER**

PURICORP HOLDINGS, LLC (FLORIDA LIMITED LIABILITY COMPANY)  
7450 DR. PHILLIPS BLVD.  
SUITE 205  
ORLANDO, FL 32819

FOR: ADDICTION TREATMENT GOODS, NAMELY, PROVIDING PAINKILLER ADDICTION THERAPY, IN CLASS 44 (U.S. CLS. 100 AND 101).

FIRST USE 12-14-2011; IN COMMERCE 12-14-2011.

THE STIPLING IS FOR SHADING PURPOSES ONLY.

THE MARK CONSISTS OF THE STYLIZED WORD "PURIDONE". AN IMAGE OF A STYLIZED HELIX TO THE LEFT OF THE TEXT.

SER. NO. 85-485,597, FILED 12-2-2011.

SKYE YOUNG, EXAMINING ATTORNEY



*David J. Kyjars*

Director of the United States Patent and Trademark Office

# United States of America

United States Patent and Trademark Office

## WU XING TO

**Reg. No. 4,197,479**

ADAMO, H L (UNITED STATES INDIVIDUAL)  
200 W. 57TH ST., #808  
NEW YORK, NY 10019

**Registered Aug. 28, 2012**

**Int. Cl.: 41**

FOR: MARTIAL ARTS INSTRUCTION, IN CLASS 41 (U.S. CLS. 100, 101 AND 107).

**SERVICE MARK**

FIRST USE 7-0-2011; IN COMMERCE 7-0-2011.

**PRINCIPAL REGISTER**

THE MARK CONSISTS OF STANDARD CHARACTERS WITHOUT CLAIM TO ANY PARTICULAR FONT, STYLE, SIZE, OR COLOR.

NO CLAIM IS MADE TO THE EXCLUSIVE RIGHT TO USE "TO", APART FROM THE MARK AS SHOWN.

THE ENGLISH TRANSLATION OF "WU XING TO" IN THE MARK IS FIVE ELEMENTS USING SWORD.

SER. NO. 85-485,990, FILED 12-2-2011.

EMILY CARLSEN, EXAMINING ATTORNEY



*David J. Kyffers*

Director of the United States Patent and Trademark Office

# United States of America

United States Patent and Trademark Office



**Reg. No. 4,197,480**

**Registered Aug. 28, 2012**

**Int. Cls.: 35 and 37**

**SERVICE MARK**

**PRINCIPAL REGISTER**

MARK G. ANDERSON CONSULTANTS, INC. (D.C. CORPORATION)  
730 ELEVENTH STREET, NW  
WASHINGTON, DC 20001

FOR: BUSINESS MANAGEMENT CONSULTING SERVICES IN THE FIELD OF BUILDING DESIGN AND CONSTRUCTION; PROVIDING CONSULTATION SERVICES IN PROCUREMENT, NAMELY, PROCURING CONTRACTS AND PURCHASING GOODS AND SERVICES FOR OTHERS IN THE FIELD OF BUILDING DESIGN AND CONSTRUCTION; BUSINESS SERVICES, NAMELY, FACILITIES MANAGEMENT OF TECHNICAL OPERATIONS; PROJECT MANAGEMENT FOR BUSINESS PURPOSES IN THE FIELD OF BUILDING DESIGN, IN CLASS 35 (U.S. CLS. 100, 101 AND 102).

FIRST USE 11-1-2011; IN COMMERCE 11-1-2011.

FOR: PROJECT MANAGEMENT IN THE FIELD OF CONSTRUCTION, IN CLASS 37 (U.S. CLS. 100, 103 AND 106).

FIRST USE 11-1-2011; IN COMMERCE 11-1-2011.

THE MARKS CONSISTS OF THE WORDING "MGAC" IN STYLIZED FONT INSIDE A RECTANGULAR BACKGROUND.

SER. NO. 85-486,084, FILED 12-2-2011.

AMY KELLY, EXAMINING ATTORNEY



*David J. Kybas*

Director of the United States Patent and Trademark Office

# United States of America

United States Patent and Trademark Office

## SWAMP FOX TAVERN

**Reg. No. 4,197,481**

**Registered Aug. 28, 2012**

**Int. Cl.: 43**

**SERVICE MARK**

**PRINCIPAL REGISTER**

US FREEDOM FIGHTER CLOTHING, LLC (NORTH CAROLINA LIMITED LIABILITY COMPANY)

327 NORTH LOGAN STREET, MARION, NC 28752

327 NORTH LOGAN STREET

MARION, NC 28752

FOR: RESTAURANT AND BAR SERVICES, IN CLASS 43 (U.S. CLS. 100 AND 101).

FIRST USE 12-1-2011; IN COMMERCE 12-1-2011.

THE MARK CONSISTS OF STANDARD CHARACTERS WITHOUT CLAIM TO ANY PARTICULAR FONT, STYLE, SIZE, OR COLOR.

NO CLAIM IS MADE TO THE EXCLUSIVE RIGHT TO USE "TAVERN", APART FROM THE MARK AS SHOWN.

SER. NO. 85-486,404, FILED 12-2-2011.

KATHLEEN KOLACZ, EXAMINING ATTORNEY



*David J. Kyffers*

Director of the United States Patent and Trademark Office



# United States of America

United States Patent and Trademark Office

# PolyPlus

**Reg. No. 4,197,482**

ALO INVESTMENTS, LLC (CALIFORNIA LIMITED LIABILITY COMPANY)  
2794 W. TOLA AVENUE  
ANAHEIM, CA 92804

**Registered Aug. 28, 2012**

**Int. Cl.: 5**

FOR: DIETARY AND NUTRITIONAL SUPPLEMENTS FOR ANIMALS, IN CLASS 5 (U.S. CLS. 6, 18, 44, 46, 51 AND 52).

**TRADEMARK**

FIRST USE 6-23-2011; IN COMMERCE 6-23-2011.

**PRINCIPAL REGISTER**

THE MARK CONSISTS OF STANDARD CHARACTERS WITHOUT CLAIM TO ANY PARTICULAR FONT, STYLE, SIZE, OR COLOR.

SER. NO. 85-486,534, FILED 12-3-2011.

ANDREA HACK, EXAMINING ATTORNEY



*David J. Kyffers*

Director of the United States Patent and Trademark Office

# United States of America

United States Patent and Trademark Office

# AED LINK

**Reg. No. 4,197,483**

**Registered Aug. 28, 2012**

**Int. Cl.: 9**

**TRADEMARK**

**PRINCIPAL REGISTER**

ATRUS, INC. (FLORIDA CORPORATION)  
SUITE 400  
1814 N.E. MIAMI GARDENS DRIVE  
NORTH MIAMI BEACH, FL 33179

FOR: SYSTEM COMPRISED PRIMARILY OF COMPUTER HARDWARE, COMPUTER SOFTWARE PROGRAMS AND DATABASE MANAGEMENT SOFTWARE FOR PROVIDING INFORMATION ABOUT THE LOCATION OF ONE OR MORE AUTOMATIC EXTERNAL DEFIBRILLATORS TO PUBLIC SAFETY ANSWERING POINTS; SYSTEM COMPRISED PRIMARILY OF COMPUTER HARDWARE, COMPUTER SOFTWARE PROGRAMS AND DATABASE MANAGEMENT SOFTWARE FOR PROVIDING AND DISPLAYING THE LOCATION OF ONE OR MORE AUTOMATED EXTERNAL DEFIBRILLATORS ON PUBLIC SAFETY ANSWERING POINT COMPUTER-BASED GEOGRAPHIC INFORMATION SYSTEM MAP, IN CLASS 9 (U.S. CLS. 21, 23, 26, 36 AND 38).

FIRST USE 1-31-2006; IN COMMERCE 1-31-2006.

THE MARK CONSISTS OF STANDARD CHARACTERS WITHOUT CLAIM TO ANY PARTICULAR FONT, STYLE, SIZE, OR COLOR.

OWNER OF U.S. REG. NO. 3,473,914.

NO CLAIM IS MADE TO THE EXCLUSIVE RIGHT TO USE "AED", APART FROM THE MARK AS SHOWN.

SER. NO. 85-486,579, FILED 12-4-2011.

AMY C. KEAN, EXAMINING ATTORNEY



*David J. Kappas*

Director of the United States Patent and Trademark Office

# United States of America

United States Patent and Trademark Office

# Gym-N-Learn

**Reg. No. 4,197,484**

KOMARA, PATTI (INDIANA CORPORATION)  
1530 JOLIET STREET  
DYER, IN 46311

**Registered Aug. 28, 2012**

**Int. Cl.: 41**

FOR: INSTRUCTIONAL PRESCHOOL CLASS, IN CLASS 41 (U.S. CLS. 100, 101 AND 107).

**SERVICE MARK**

FIRST USE 1-3-2005; IN COMMERCE 1-3-2005.

**PRINCIPAL REGISTER**

THE MARK CONSISTS OF STANDARD CHARACTERS WITHOUT CLAIM TO ANY PARTICULAR FONT, STYLE, SIZE, OR COLOR.

SER. NO. 85-486,835, FILED 12-5-2011.

PAULA MAHONEY, EXAMINING ATTORNEY



*David J. Kybas*

Director of the United States Patent and Trademark Office

# United States of America

United States Patent and Trademark Office

# RUSSCO



**Reg. No. 4,197,485**

**Registered Aug. 28, 2012**

**Int. Cls.: 9 and 11**

**TRADEMARK**

**PRINCIPAL REGISTER**

RUSSCO LIGHTING TECHNOLOGIES, INC. (CALIFORNIA CORPORATION)  
2300 BETHELVIEW ROAD, SUITE 110-131  
CUMMING, GA 30040

FOR: LIGHTING BALLASTS, POWER SWITCHES, POWER SUPPLIES, TRANSFORMERS, LIGHTING CONTROL PANELS, LED ELECTRONIC DRIVERS, ELECTRIC STARTERS AND LAMP IGNITER UNITS FOR LIGHTING PURPOSES, ELECTRIC LIGHT DIMMERS, IN CLASS 9 (U.S. CLS. 21, 23, 26, 36 AND 38).

FIRST USE 11-14-2011; IN COMMERCE 11-14-2011.

FOR: LIGHTING FIXTURES; LED (LIGHT EMITTING DIODE) LIGHTING FIXTURES; HID (HIGH INTENSITY DISCHARGE) LIGHTING FIXTURES; ELECTRIC LIGHTING FIXTURES; LED LIGHTING FIXTURES FOR USE IN DISPLAY, COMMERCIAL, INDUSTRIAL, RESIDENTIAL, AND ARCHITECTURAL ACCENT LIGHTING APPLICATIONS; LED LIGHTING FIXTURES FOR INDOOR AND OUTDOOR LIGHTING APPLICATIONS, LIGHTING FIXTURES FOR USE IN PARKING DECKS AND GARAGES; LIGHTING FIXTURES FOR USE IN PARKING LOTS AND WALKWAYS; LIGHTING FIXTURES THAT INTEGRATE NATURAL DAYLIGHT AND FLUORESCENT LIGHTING INTO THE FIXTURE; LIGHTING FIXTURES WITH MOTION DETECTION; INDUCTION LIGHTING FIXTURES; LAMPS; LED LAMPS; ELECTRIC LAMPS; FLUORESCENT LAMP TUBES; FLUORESCENT LAMPS, INCANDESCENT LAMPS, LIGHT BULBS, IN CLASS 11 (U.S. CLS. 13, 21, 23, 31 AND 34).

FIRST USE 11-14-2011; IN COMMERCE 11-14-2011.

THE MARK CONSISTS OF THE WORD "RUSSCO" FOLLOWED BY THE STYLIZED IMAGE OF TWO LEAVES ON A LIGHT BULB. "RUSSCO" IS WRITTEN IN BLACK. THE LEAVES ARE COLORED LIGHT GREEN. THE LIGHT BULB IS OUTLINED IN LIGHT GREEN AND IS FILLED IN WITH WHITE.

THE COLOR(S) BLACK, LIGHT GREEN, AND WHITE IS/ARE CLAIMED AS A FEATURE OF THE MARK.

SER. NO. 85-487,109, FILED 12-5-2011.

KELLY BOULTON, EXAMINING ATTORNEY



*David J. Kyros*

Director of the United States Patent and Trademark Office

# United States of America

United States Patent and Trademark Office



## VIDANT HEALTH

**Reg. No. 4,197,486**

**Registered Aug. 28, 2012**

**Int. Cl.: 44**

UNIVERSITY HEALTH SYSTEMS OF EASTERN CAROLINA, INC. (NORTH CAROLINA  
NON-PROFIT CORPORATION)  
P.O. BOX 6028  
2100 STANTONSBURG ROAD  
GREENVILLE, NC 27835

**SERVICE MARK**

**PRINCIPAL REGISTER**

FOR: HOSPITALS; BEHAVIORAL HEALTH SERVICES; EMERGENCY MEDICAL ASSIST-  
ANCE; HEALTHCARE SERVICES; MEDICAL SERVICES; MEDICAL IMAGING SERVICES;  
MEDICAL CLINICS; PHYSICIAN SERVICES; PROVIDING A WEBSITE FEATURING  
MEDICAL INFORMATION; REHABILITATION PATIENT CARE SERVICES; SURGERY, IN  
CLASS 44 (U.S. CLS. 100 AND 101).

FIRST USE 1-25-2012; IN COMMERCE 1-25-2012.

NO CLAIM IS MADE TO THE EXCLUSIVE RIGHT TO USE "HEALTH", APART FROM THE  
MARK AS SHOWN.

THE COLOR(S) TEAL GREEN, LIGHT BLUE AND DARK BLUE IS/ARE CLAIMED AS A  
FEATURE OF THE MARK.

THE MARK CONSISTS OF THE STYLIZED PHRASE "VIDANT HEALTH" BENEATH A  
STYLIZED LETTER "V" COMPRISED OF TWO OVERLAPPING POINTED-TIP OVALS  
THAT OVERLAP IN THE CENTER TO FORM A VENN DIAGRAM; THE COLOR TEAL  
GREEN APPEARS IN THE CENTER OVERLAPPING SECTION OF THE TWO OVERLAPPING  
POINTED-TIP OVALS; THE COLOR LIGHT BLUE APPEARS IN THE RIGHT POINTED-TIP  
OVAL; THE COLOR DARK BLUE APPEARS IN THE LEFT POINTED-TIP OVAL AND IN  
THE STYLIZED PHRASE "VIDANT HEALTH"; THE COLOR WHITE REPRESENTS BACK-  
GROUND AND IS NOT CLAIMED AS A FEATURE OF THE MARK.

THE WORDING "VIDANT" HAS NO MEANING IN A FOREIGN LANGUAGE.

SER. NO. 85-487,185, FILED 12-5-2011.

MYRIAH HABEEB, EXAMINING ATTORNEY



*David J. Kyffers*

Director of the United States Patent and Trademark Office

# United States of America

United States Patent and Trademark Office



**Reg. No. 4,197,487**

MYFAVORITESCARD, INC. (TENNESSEE CORPORATION)  
1568 ROCKDALE RUN  
ANTIOCH, TN 37013

**Registered Aug. 28, 2012**

**Int. Cl.: 35**

FOR: COMPUTERIZED ON-LINE GIFT ORDERING SERVICE WHICH MATCHES THE GIFT GIVER'S REQUIREMENTS WITH THE GIFT RECIPIENT'S WANTS AND NEEDS, IN CLASS 35 (U.S. CLS. 100, 101 AND 102).

**SERVICE MARK**

FIRST USE 10-23-2011; IN COMMERCE 10-23-2011.

**PRINCIPAL REGISTER**

THE MARK CONSISTS OF A RED GIFT WRAPPED IN A BLUE RIBBON AND BLUE AND WHITE BOW WITH THE WHITE WORDING "GETMYFAVS.COM GET THE PERFECT GIFT...EVERYTIME!" SUPERIMPOSED THEREON. THE BLUE RIBBON APPEARS UNDER THE WORDING "GETMYFAVS.COM" AND THE BLUE AND WHITE BOW APPEARS ON THE TOP RIGHT OF THE GIFT BOX. AN IMAGE OF A BALLOON APPEARS IN THE MIDDLE OF THE GIFT BOX IN A LIGHTER SHADE OF RED. THE COLOR BLACK REPRESENTS BACKGROUND AND IS NOT PART OF THE MARK.

THE COLOR(S) RED, BLUE AND WHITE IS/ARE CLAIMED AS A FEATURE OF THE MARK.

SER. NO. 85-487,245, FILED 12-5-2011.

DANIEL BRODY, EXAMINING ATTORNEY



*David J. Kybas*

Director of the United States Patent and Trademark Office

# United States of America

United States Patent and Trademark Office

## Meet the Critters

**Reg. No. 4,197,488**

**Registered Aug. 28, 2012**

**Int. Cls.: 35 and 41**

**SERVICE MARK**

**PRINCIPAL REGISTER**

PETCO ANIMAL SUPPLIES STORES, INC. (DELAWARE CORPORATION)  
9125 REHCO ROAD  
SAN DIEGO, CA 92121

FOR: RETAIL AND ON-LINE STORE SERVICES FEATURING PET SUPPLIES, PET TOYS, PET FOOD, AND SPORTS AND SPORTING GOODS; PROMOTING SPORTS COMPETITIONS AND EVENTS OF OTHERS; ORGANIZATION OF EVENTS, EXHIBITIONS, FAIRS AND SHOWS FOR COMMERCIAL, PROMOTIONAL AND ADVERTISING PURPOSES; RETAIL STORE SERVICES IN THE FIELD OF ANIMAL AND PET SUPPLIES, IN CLASS 35 (U.S. CLS. 100, 101 AND 102).

FIRST USE 4-1-2010; IN COMMERCE 4-1-2010.

FOR: ENTERTAINMENT SERVICES, NAMELY, ORGANIZING COMMUNITY SPORTING AND CULTURAL EVENTS; ORGANIZING COMMUNITY FESTIVALS FEATURING A VARIETY OF ACTIVITIES, NAMELY, SPORTING EVENTS, ART EXHIBITIONS, FLEA MARKETS AND THE LIKE; ORGANIZING COMMUNITY CULTURAL EVENTS; ORGANIZATION OF EXHIBITIONS FOR CULTURAL OR EDUCATIONAL PURPOSES PROVIDING ONLINE ADVICE AND INFORMATION IN THE FIELD OF EDUCATIONAL AND ENTERTAINMENT ACTIVITIES AND EVENTS FOR CHILDREN; PROVIDING ONLINE INFORMATION RELATING TO EDUCATIONAL AND ENTERTAINMENT ACTIVITIES AND EVENTS FOR CHILDREN; PROVIDING INFORMATION RELATING TO SPORTS AND SPORTING EVENTS; PROVIDING ONLINE INFORMATION RELATING TO THE ORGANIZING OF EDUCATIONAL, CULTURAL, SPORTING OR ENTERTAINMENT EXHIBITIONS; PROVIDING AN INTERNET WEBSITE PORTAL IN THE FIELD OF ENTERTAINMENT, CULTURAL AND SPORTING EVENTS; PROVISION OF ONLINE INFORMATION RELATING TO LIVE MUSICAL PERFORMANCES, ROAD SHOWS, LIVE STAGE EVENTS, THEATRICAL PERFORMANCES, LIVE MUSIC CONCERTS AND AUDIENCE PARTICIPATION IN SUCH EVENTS, IN CLASS 41 (U.S. CLS. 100, 101 AND 107).

FIRST USE 4-1-2010; IN COMMERCE 4-1-2010.

THE MARK CONSISTS OF STANDARD CHARACTERS WITHOUT CLAIM TO ANY PARTICULAR FONT, STYLE, SIZE, OR COLOR.

SER. NO. 85-487,477, FILED 12-5-2011.



*David J. Kyjars*

Director of the United States Patent and Trademark Office

**Reg. No. 4,197,488** LOURDES AYALA, EXAMINING ATTORNEY



# United States of America

United States Patent and Trademark Office



WEST COAST CAREERS

**Reg. No. 4,197,489**

WEST COAST CAREERS INC (WASHINGTON CORPORATION)  
4100 194TH ST SW, SUITE 225  
LYNNWOOD, WA 98036

**Registered Aug. 28, 2012**

**Int. Cl.: 35**

FOR: PLACEMENT OF STAFF, IN CLASS 35 (U.S. CLS. 100, 101 AND 102).

**SERVICE MARK**

FIRST USE 4-1-2004; IN COMMERCE 4-1-2004.

**PRINCIPAL REGISTER**

NO CLAIM IS MADE TO THE EXCLUSIVE RIGHT TO USE "WEST COAST CAREERS", APART FROM THE MARK AS SHOWN.

THE COLOR(S) 3 SHADES OF BLUE AND 1 SHADE OF GRAY IS/ARE CLAIMED AS A FEATURE OF THE MARK.

THE MARK CONSISTS OF THE WORDING "WEST COAST CAREERS" IN THE COLOR BLUE OVERLAYING A DESIGN ELEMENT OF A GRAY SUN INTERSECTED BY A WAVY HORIZONTAL LINE THAT IS IN THE COLOR BLUE ON THE LEFT AND GRAY ON THE RIGHT.

SER. NO. 85-487,576, FILED 12-5-2011.

WENDY JUN, EXAMINING ATTORNEY



*David J. Kyjars*

Director of the United States Patent and Trademark Office

# United States of America

United States Patent and Trademark Office

# Koala Pal

**Reg. No. 4,197,490**

BRIGHT IDEAS, INC. (CALIFORNIA CORPORATION)  
30242 BELMONT COURT  
AGOURA HILLS, CA 91301

**Registered Aug. 28, 2012**

**Int. Cl.: 9**

FOR: AUDIO SPEAKERS; AUDIO SPEAKERS WITH CHARGING DOCK FOR MP3 PLAYERS, SMART PHONES, DVD PLAYERS, TABLETS DESKTOP COMPUTERS AND LAPTOP COMPUTERS, IN CLASS 9 (U.S. CLS. 21, 23, 26, 36 AND 38).

**TRADEMARK**

FIRST USE 5-1-2011; IN COMMERCE 5-1-2011.

**PRINCIPAL REGISTER**

THE MARK CONSISTS OF STANDARD CHARACTERS WITHOUT CLAIM TO ANY PARTICULAR FONT, STYLE, SIZE, OR COLOR.

SER. NO. 85-487,591, FILED 12-5-2011.

PRISCILLA MILTON, EXAMINING ATTORNEY



*David J. Kyjars*

Director of the United States Patent and Trademark Office

# United States of America

United States Patent and Trademark Office

## BADGER MAX

**Reg. No. 4,197,491**

BADGEN MAX, INC. (DELAWARE CORPORATION)  
1305 HANOVER CT.  
WAUNAKEE, WI 53597

**Registered Aug. 28, 2012**

**Int. Cl.: 32**

FOR: SPORTS DRINKS; ENERGY DRINKS; SPORTS ENERGY DRINKS, IN CLASS 32 (U.S. CLS. 45, 46 AND 48).

**TRADEMARK**

FIRST USE 11-0-2011; IN COMMERCE 11-0-2011.

**PRINCIPAL REGISTER**

THE MARK CONSISTS OF STANDARD CHARACTERS WITHOUT CLAIM TO ANY PARTICULAR FONT, STYLE, SIZE, OR COLOR.

OWNER OF U.S. REG. NO. 4,110,234.

SER. NO. 85-487,691, FILED 12-5-2011.

WARREN L. OLANDRIA, EXAMINING ATTORNEY



*David J. Kyffers*

Director of the United States Patent and Trademark Office

# United States of America

United States Patent and Trademark Office

## Just Add Shutters

**Reg. No. 4,197,492**

**Registered Aug. 28, 2012**

**Int. Cl.: 37**

**SERVICE MARK**

**PRINCIPAL REGISTER**

JUST ADD SHUTTERS, INC (ALABAMA CORPORATION)  
4620 12TH AVE E  
TUSCALOOSA, AL 35405

FOR: INSTALLATION AND MAINTENANCE OF SHUTTERS; INSTALLATION AND REPAIR OF BLINDS; INSTALLATION OF DOORS AND WINDOWS; INSTALLATION, REPAIR AND REPLACEMENT OF SHUTTERS; WINDOW BLIND INSTALLATION AND REPAIR, IN CLASS 37 (U.S. CLS. 100, 103 AND 106).

FIRST USE 1-1-2011; IN COMMERCE 1-1-2011.

THE MARK CONSISTS OF STANDARD CHARACTERS WITHOUT CLAIM TO ANY PARTICULAR FONT, STYLE, SIZE, OR COLOR.

SER. NO. 85-487,935, FILED 12-6-2011.

DAVID ELTON, EXAMINING ATTORNEY



*David J. Kyfos*

Director of the United States Patent and Trademark Office

# United States of America

United States Patent and Trademark Office

## EPCO Carbon Dioxide Products, Incorporated

**Reg. No. 4,197,493**

**Registered Aug. 28, 2012**

**Int. Cl.: 1**

**TRADEMARK**

**PRINCIPAL REGISTER**

EPCO CARBON DIOXIDE PRODUCTS, INCORPORATED (ILLINOIS CORPORATION)  
SUITE K  
1800 AUBURN AVENUE  
MONROE, LA 71201

FOR: LIQUIFIED CARBON DIOXIDE, IN CLASS 1 (U.S. CLS. 1, 5, 6, 10, 26 AND 46).

FIRST USE 10-14-1988; IN COMMERCE 10-14-1988.

THE MARK CONSISTS OF STANDARD CHARACTERS WITHOUT CLAIM TO ANY PARTICULAR FONT, STYLE, SIZE, OR COLOR.

NO CLAIM IS MADE TO THE EXCLUSIVE RIGHT TO USE "CARBON DIOXIDE PRODUCTS, INCORPORATED", APART FROM THE MARK AS SHOWN.

SER. NO. 85-488,116, FILED 12-6-2011.

JOHN DWYER, EXAMINING ATTORNEY



*David J. Kybas*

Director of the United States Patent and Trademark Office

# United States of America

United States Patent and Trademark Office

## STAGE MATE

**Reg. No. 4,197,494**

**Registered Aug. 28, 2012**

**Int. Cl.: 15**

**TRADEMARK**

**PRINCIPAL REGISTER**

SHS INTERNATIONAL, INC. (INDIANA CORPORATION)  
1922 WEST BANTA ROAD  
INDIANAPOLIS, IN 46217

FOR: MUSICAL INSTRUMENT ACCESSORIES, NAMELY, STANDS, MUSICAL INSTRUMENT STANDS, SHEET MUSIC STANDS, CAPOS AND GUITAR SLIDES, IN CLASS 15 (U.S. CLS. 2, 21 AND 36).

FIRST USE 4-30-2011; IN COMMERCE 4-30-2011.

THE MARK CONSISTS OF STANDARD CHARACTERS WITHOUT CLAIM TO ANY PARTICULAR FONT, STYLE, SIZE, OR COLOR.

SER. NO. 85-488,394, FILED 12-6-2011.

JACQUELINE A. LAVINE, EXAMINING ATTORNEY



*David J. Kyros*

Director of the United States Patent and Trademark Office

# United States of America

United States Patent and Trademark Office

## COMPLIANCEUPDATER

**Reg. No. 4,197,495**

**Registered Aug. 28, 2012**

**Int. Cl.: 45**

**SERVICE MARK**

**PRINCIPAL REGISTER**

COMPLIANCEUPDATER, INC. (FLORIDA CORPORATION)  
200 LESLIE DRIVE  
SUITE 820  
HALLANDALE, FL 33009

FOR: REGULATORY COMPLIANCE CONSULTING IN THE FIELD OF MORTGAGE FINANCE, IN CLASS 45 (U.S. CLS. 100 AND 101).

FIRST USE 11-1-2011; IN COMMERCE 11-1-2011.

THE MARK CONSISTS OF STANDARD CHARACTERS WITHOUT CLAIM TO ANY PARTICULAR FONT, STYLE, SIZE, OR COLOR.

SER. NO. 85-488,450, FILED 12-6-2011.

BENJAMIN OKEKE, EXAMINING ATTORNEY



*David J. Kyffers*

Director of the United States Patent and Trademark Office

# United States of America

United States Patent and Trademark Office

## KIMBERLY OVITZ

**Reg. No. 4,197,496**

KIM OVITZ DESIGN INC. (NEW YORK CORPORATION)  
401 BROADWAY, SUITE 1812  
NEW YORK, NY 10013

**Registered Aug. 28, 2012**

**Int. Cl.: 25**

FOR: DRESSES, SKIRTS, BLOUSES, T-SHIRTS, SWEATERS, SHIRTS, SWEATSHIRTS,  
BLOUSES, JACKETS, COATS, BELTS, SCARVES, PANTS, JEANS, IN CLASS 25 (U.S. CLS.  
22 AND 39).

**TRADEMARK**

FIRST USE 9-1-2008; IN COMMERCE 9-1-2008.

**PRINCIPAL REGISTER**

THE MARK CONSISTS OF STANDARD CHARACTERS WITHOUT CLAIM TO ANY PAR-  
TICULAR FONT, STYLE, SIZE, OR COLOR.

THE NAME(S), PORTRAIT(S), AND/OR SIGNATURE(S) SHOWN IN THE MARK IDENTIFIES  
"KIMBERLY OVITZ", WHOSE CONSENT(S) TO REGISTER IS MADE OF RECORD.

SER. NO. 85-488,454, FILED 12-6-2011.

ANNE MADDEN, EXAMINING ATTORNEY



*David J. Kybas*

Director of the United States Patent and Trademark Office



# United States of America

United States Patent and Trademark Office

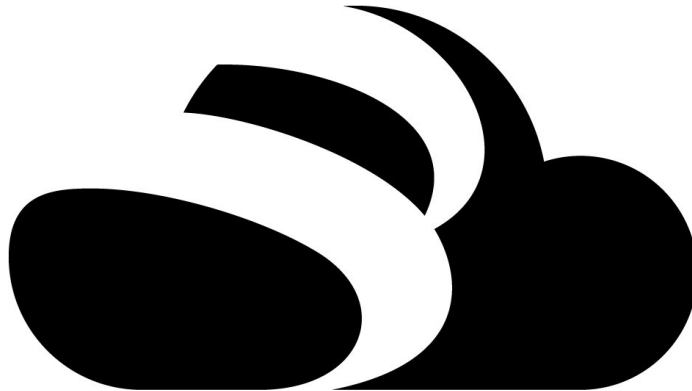

**Reg. No. 4,197,497**

**Registered Aug. 28, 2012**

**Int. Cl.: 42**

**SERVICE MARK**

**PRINCIPAL REGISTER**

BIZMO, LLC (COLORADO LIMITED LIABILITY COMPANY)  
P.O. BOX 270070  
FORT COLLINS, CO 805270070

FOR: APPLICATION SERVICE PROVIDER PROVIDING HOSTING, MANAGING, DEVELOPING, AND MAINTAINING COMPUTER SOFTWARE FOR BUSINESS ACCOUNTING AND FINANCIAL MANAGEMENT, NAMELY, ACCOUNTING, BILL PAYMENT, PROJECT MANAGEMENT, BILLING, EXPENSE REPORTING, INVENTORY MANAGEMENT, FIXED ASSET MANAGEMENT, AND CONTACT MANAGEMENT, PROVIDED TO CUSTOMERS THROUGH HOSTED SERVICES, IN CLASS 42 (U.S. CLS. 100 AND 101).

FIRST USE 11-2-2011; IN COMMERCE 11-2-2011.

THE MARK CONSISTS OF A CLOUD WITH PARTIAL CONCENTRIC RINGS.

SER. NO. 85-488,547, FILED 12-6-2011.

LINDSEY RUBIN, EXAMINING ATTORNEY



*David J. Kyffers*

Director of the United States Patent and Trademark Office

# United States of America

United States Patent and Trademark Office



**Reg. No. 4,197,498**

**Registered Aug. 28, 2012**

**Int. Cls.: 37 and 40**

**SERVICE MARK**

**PRINCIPAL REGISTER**

VENTURA FOODS, LLC (DELAWARE LIMITED LIABILITY COMPANY)  
40 POINTE DRIVE  
BREA, CA 92821

FOR: WASTE OIL COLLECTION FOR RECYCLING; COLLECTION OF VEGETABLE OIL OR COOKING OIL FOR RECYCLING; RECYCLING SERVICES, NAMELY, COLLECTING USED VEGETABLE OIL OR COOKING OIL FOR PURPOSES OF CONVERTING IT TO BIOFUEL, IN CLASS 37 (U.S. CLS. 100, 103 AND 106).

FIRST USE 9-0-2009; IN COMMERCE 9-0-2009.

FOR: COOKING OIL AND VEGETABLE OIL RECYCLING SERVICES; RECYCLING OF VEGETABLE OIL OR COOKING OIL INTO RENEWABLE FUEL, IN CLASS 40 (U.S. CLS. 100, 103 AND 106).

FIRST USE 9-0-2009; IN COMMERCE 9-0-2009.

THE MARK CONSISTS OF A LIGHT GREEN GLOBE WITH DARK GREEN CONTINENTS ALL ENCIRCLED BY THREE CURVED ARROWS THAT CAST A SHADOW ON THE GLOBE AND CONTINENTS. THE ARROWS AND GLOBE FEATURE ARTISTIC FADING FROM LIGHT GREEN TO DARK GREEN TO WHITE.

THE COLOR(S) LIGHT GREEN, GREEN, DARK GREEN, AND WHITE IS/ARE CLAIMED AS A FEATURE OF THE MARK.

SER. NO. 85-488,752, FILED 12-6-2011.

TEJBIR SINGH, EXAMINING ATTORNEY



*David J. Kybas*

Director of the United States Patent and Trademark Office

# United States of America

United States Patent and Trademark Office



**Reg. No. 4,197,499**

**Registered Aug. 28, 2012**

**Int. Cls.: 37 and 40**

**SERVICE MARK**

**PRINCIPAL REGISTER**

VENTURA FOODS, LLC (DELAWARE LIMITED LIABILITY COMPANY)  
40 POINTE DRIVE  
BREA, CA 92821

FOR: WASTE OIL COLLECTION FOR RECYCLING; COLLECTION OF VEGETABLE OIL OR COOKING OIL FOR RECYCLING; RECYCLING SERVICES, NAMELY, COLLECTING USED VEGETABLE OIL OR COOKING OIL FOR PURPOSES OF CONVERTING IT TO BIOFUEL, IN CLASS 37 (U.S. CLS. 100, 103 AND 106).

FIRST USE 9-0-2009; IN COMMERCE 9-0-2009.

FOR: COOKING OIL AND VEGETABLE OIL RECYCLING SERVICES; RECYCLING OF VEGETABLE OIL OR COOKING OIL INTO RENEWABLE FUEL, IN CLASS 40 (U.S. CLS. 100, 103 AND 106).

FIRST USE 9-0-2009; IN COMMERCE 9-0-2009.

NO CLAIM IS MADE TO THE EXCLUSIVE RIGHT TO USE THE RECYCLING SYMBOL, APART FROM THE MARK AS SHOWN.

THE COLOR(S) GREEN, LIGHT BLUE, MEDIUM BLUE, DARK BLUE AND WHITE IS/ARE CLAIMED AS A FEATURE OF THE MARK.

THE MARK CONSISTS OF A LIGHT BLUE GLOBE WITH MEDIUM BLUE AND DARK BLUE CONTINENTS ALL ENCIRCLED BY THREE CURVED ARROWS. THE ARROWS FEATURE ARTISTIC FADING FROM GREEN TO WHITE.

SER. NO. 85-488,776, FILED 12-6-2011.

TEJBIR SINGH, EXAMINING ATTORNEY



*David J. Kybas*

Director of the United States Patent and Trademark Office

# United States of America

United States Patent and Trademark Office

# NAVIGATOR

**Reg. No. 4,197,500**

**Registered Aug. 28, 2012**

**Int. Cl.: 19**

**TRADEMARK**

**PRINCIPAL REGISTER**

ALCO INDUSTRIES, INC (DELAWARE CORPORATION)  
SUITE 130  
820 ADAMS AVENUE  
TROOPER, PA 19403

FOR: WALL-MOUNTED NON-METAL DISPLAY UNITS COMPRISING NUMEROUS ACTUAL PAINT COLOR SWATCHES FOR AIDING THE USER IN MATCHING AUTOMOTIVE PAINT COLORS, IN CLASS 19 (U.S. CLS. 1, 12, 33 AND 50).

FIRST USE 7-11-2011; IN COMMERCE 7-11-2011.

THE MARK CONSISTS OF STANDARD CHARACTERS WITHOUT CLAIM TO ANY PARTICULAR FONT, STYLE, SIZE, OR COLOR.

SER. NO. 85-489,385, FILED 12-7-2011.

GINA HAYES, EXAMINING ATTORNEY



*David J. Kyffers*

Director of the United States Patent and Trademark Office

# United States of America

United States Patent and Trademark Office

## TOTAL DYNAMIC STORAGE

**Reg. No. 4,197,501**

SOUTHEASTERN TANK, INC. (TENNESSEE CORPORATION)  
60 VESTA ROAD  
LEBANON, TN 37090

**Registered Aug. 28, 2012**

**Int. Cl.: 6**

FOR: METAL WATER STORAGE AND DISTRIBUTION TANKS AND PUMP STATIONS  
SOLD AS A UNIT, IN CLASS 6 (U.S. CLS. 2, 12, 13, 14, 23, 25 AND 50).

**TRADEMARK**

FIRST USE 4-6-2011; IN COMMERCE 8-9-2011.

**PRINCIPAL REGISTER**

THE MARK CONSISTS OF STANDARD CHARACTERS WITHOUT CLAIM TO ANY PARTICULAR FONT, STYLE, SIZE, OR COLOR.

NO CLAIM IS MADE TO THE EXCLUSIVE RIGHT TO USE "STORAGE", APART FROM THE MARK AS SHOWN.

SER. NO. 85-489,431, FILED 12-7-2011.

MARGERY A. TIERNEY, EXAMINING ATTORNEY



*David J. Kybas*

Director of the United States Patent and Trademark Office

# United States of America

United States Patent and Trademark Office

## STROKE SURVIVORS EMPOWERING EACH OTHER

**Reg. No. 4,197,502**

**Registered Aug. 28, 2012**

**Int. Cl.: 41**

**SERVICE MARK**

**PRINCIPAL REGISTER**

STROKE SURVIVORS EMPOWERING EACH OTHER (ILLINOIS NON-PROFIT CORPORATION)  
1048 FOXWORTH BOULEVARD  
LOMBARD, IL 60148

FOR: EDUCATION AND SUPPORT SERVICES, NAMELY, CLASSES, SEMINARS AND WORKSHOPS FEATURING COUNSELING SERVICES AND INFORMATION ON STROKE REHABILITATION FOR STROKE SURVIVORS AND THEIR FAMILIES, IN CLASS 41 (U.S. CLS. 100, 101 AND 107).

FIRST USE 9-23-2008; IN COMMERCE 9-23-2008.

THE MARK CONSISTS OF STANDARD CHARACTERS WITHOUT CLAIM TO ANY PARTICULAR FONT, STYLE, SIZE, OR COLOR.

NO CLAIM IS MADE TO THE EXCLUSIVE RIGHT TO USE "STROKE SURVIVORS", APART FROM THE MARK AS SHOWN.

SER. NO. 85-489,455, FILED S.R. 12-7-2011 AM. P.R. 4-24-2012.

DEZMONA MIZELLE, EXAMINING ATTORNEY



*David J. Kyffers*

Director of the United States Patent and Trademark Office

# United States of America

United States Patent and Trademark Office

## EZ SHIPPER RACKS

**Reg. No. 4,197,503**

**Registered Aug. 28, 2012**

**Int. Cl.: 20**

**TRADEMARK**

**PRINCIPAL REGISTER**

EZ SHIPPER RACKS, INC. (CALIFORNIA CORPORATION)  
31336 VIA COLINAS, #101  
WESTLAKE VILLAGE, CA 91362

FOR: SHELVES, IN CLASS 20 (U.S. CLS. 2, 13, 22, 25, 32 AND 50).

FIRST USE 10-1-1981; IN COMMERCE 10-1-1981.

THE MARK CONSISTS OF STANDARD CHARACTERS WITHOUT CLAIM TO ANY PARTICULAR FONT, STYLE, SIZE, OR COLOR.

NO CLAIM IS MADE TO THE EXCLUSIVE RIGHT TO USE "SHIPPER RACKS", APART FROM THE MARK AS SHOWN.

SER. NO. 85-489,489, FILED 12-7-2011.

KHANH LE, EXAMINING ATTORNEY



*David J. Kyffers*

Director of the United States Patent and Trademark Office

# United States of America

United States Patent and Trademark Office

## Whimsy Cookie Co.

**Reg. No. 4,197,504**

**Registered Aug. 28, 2012**

**Int. Cl.: 30**

**TRADEMARK**

**PRINCIPAL REGISTER**

WHIMSY COOKIE CO., LLC (TENNESSEE LIMITED LIABILITY COMPANY)  
5632 FALCONWOOD DRIVE  
ARLINGTON, TN 38002

FOR: BAKERY GOODS, IN CLASS 30 (U.S. CL. 46).

FIRST USE 1-1-2008; IN COMMERCE 11-1-2011.

THE MARK CONSISTS OF STANDARD CHARACTERS WITHOUT CLAIM TO ANY PARTICULAR FONT, STYLE, SIZE, OR COLOR.

NO CLAIM IS MADE TO THE EXCLUSIVE RIGHT TO USE "COOKIE CO.", APART FROM THE MARK AS SHOWN.

SER. NO. 85-489,570, FILED 12-7-2011.

SOPHIA S. KIM, EXAMINING ATTORNEY



*David J. Kyffers*

Director of the United States Patent and Trademark Office



# United States of America

United States Patent and Trademark Office

# HIGHLAND

**Reg. No. 4,197,505**

HIGHLAND PACKAGING SOLUTIONS, INC. (FLORIDA CORPORATION)  
590 3RD STREET N.W.  
MULBERRY, FL 33860

**Registered Aug. 28, 2012**

**Int. Cl.: 20**

FOR: PACKAGING CONTAINERS MADE OF PLASTIC FOR FOOD PRODUCTS, NAMELY, PACKAGING CONSISTING OF THERMOFORMED CLAMSHELL PACKAGING, PLASTIC TRAYS, AND CORRUGATED CONTAINERS AND PLASTIC BOXES, IN CLASS 20 (U.S. CLS. 2, 13, 22, 25, 32 AND 50).

**TRADEMARK**

**PRINCIPAL REGISTER**

FIRST USE 3-18-2008; IN COMMERCE 3-18-2008.

THE MARK CONSISTS OF STANDARD CHARACTERS WITHOUT CLAIM TO ANY PARTICULAR FONT, STYLE, SIZE, OR COLOR.

SER. NO. 85-489,663, FILED 12-7-2011.

LESLEY LAMOTHE, EXAMINING ATTORNEY



*David J. Kybas*

Director of the United States Patent and Trademark Office

# United States of America

United States Patent and Trademark Office



**Reg. No. 4,197,506**

**Registered Aug. 28, 2012**

**Int. Cl.: 44**

**SERVICE MARK**

**PRINCIPAL REGISTER**

FRANKLIN BAER (UNITED STATES INDIVIDUAL), DBA SANRU  
326 7TH STREET  
HARRISONBURG, VA 22802

FOR: CHARITABLE SERVICES, NAMELY, PROVIDING HEALTH CARE EQUIPMENT; CONSULTING SERVICES TO HEALTH CARE PROVIDERS IN THE FIELD OF TREATING LIFE-CHANGING OR LIFE-THREATENING DISEASES; HEALTH CARE SERVICES, NAMELY, DISEASE MANAGEMENT PROGRAMS; HEALTH CARE SERVICES, NAMELY, WELLNESS PROGRAMS; HEALTHCARE SERVICES, NAMELY, INTEGRATED HEALTHCARE SERVICES WITH A NETWORK OF INTERNATIONAL HEALTHCARE PROVIDERS, IN CLASS 44 (U.S. CLS. 100 AND 101).

FIRST USE 6-22-1983; IN COMMERCE 6-22-1992.

OWNER OF U.S. REG. NOS. 3,821,067 AND 7,788,102.

THE COLOR(S) RED, BROWN, WHITE AND BLACK IS/ARE CLAIMED AS A FEATURE OF THE MARK.

THE MARK CONSISTS OF A SMILING YOUNG AFRICAN FATHER LOVINGLY CRADLES HIS INFANT CHILD IN HIS ARMS. THE SKIN OF THE BABY AND OF THE FATHER IS BROWN. THE FATHER HAS CLOSELY CROPPED BLACK HAIR AND IS WEARING A BRIGHT RED OPEN-COLLARED SHORT-SLEEVED SHIRT. THE CHILD, WHO COULD BE EITHER A BOY OR GIRL, IS DRESSED IN WHITE TOP AND PANTS WITH WHITE SOCKS AND SMILING WITH OPEN EYES UP AT HIS/HER FATHER. THE FATHER'S LEFT HAND SUPPORTS THE BOTTOM OF THE CHILD WHILE HIS RIGHT HAND IS CROSSED AND HIDDEN UNDER THE CHILD. THE WORD "SANRU" (ALL CAPS) APPEARS IN BRIGHT RED LETTERS BELOW THE FATHER AND CHILD IN BENGUIAT FONT.

THE ENGLISH TRANSLATION OF "SANRU" IN THE MARK IS "RURAL HEALTH".

SER. NO. 85-489,762, FILED 12-7-2011.

FLORENTINA BLANDU, EXAMINING ATTORNEY



*David J. Kyffers*

Director of the United States Patent and Trademark Office

# United States of America

United States Patent and Trademark Office

# DFWHC

**Reg. No. 4,197,507**

DALLAS-FORT WORTH HOSPITAL COUNCIL (TEXAS NON-PROFIT CORPORATION)  
250 DECKER DRIVE  
IRVING, TX 750622706

**Registered Aug. 28, 2012**

**Int. Cls.: 35, 41 and 42**

FOR: ELECTRONIC DATA COLLECTION AND DATA SUBMISSION SERVICES FOR BUSINESS PURPOSES IN THE FIELDS OF MEDICINE AND HEALTHCARE; EMPLOYMENT AGENCY SERVICES, NAMELY, TEMPORARY AND PERMANENT PLACEMENT OF HEALTH CARE PROFESSIONALS; RECRUITMENT AND PLACEMENT OF PERSONNEL IN THE HEALTH CARE INDUSTRY; MEDICAL PERSONNEL RECRUITMENT SERVICES AND CONSULTATION RELATED THERETO; PROMOTING COLLABORATION WITHIN THE SCIENTIFIC, RESEARCH AND MEDICAL COMMUNITIES TO ACHIEVE ADVANCES IN THE FIELD OF HEALTHCARE; PROMOTING THE EXCHANGE OF INFORMATION AND RESOURCES WITHIN THE SCIENTIFIC RESEARCH AND MEDICAL COMMUNITIES TO ACHIEVE ADVANCES IN THE FIELD OF HEALTHCARE, IN CLASS 35 (U.S. CLS. 100, 101 AND 102).

**SERVICE MARK**

**PRINCIPAL REGISTER**

FIRST USE 12-31-1978; IN COMMERCE 12-31-1978.

FOR: EDUCATION SERVICES, NAMELY, CONDUCTING CLASSES, SEMINARS AND WORKSHOPS FOR NURSES, DOCTORS AND HEALTHCARE PROFESSIONALS IN THE FIELD OF HOSPITAL QUALITY AND PATIENT SAFETY ISSUES, IN CLASS 41 (U.S. CLS. 100, 101 AND 107).

FIRST USE 12-31-1978; IN COMMERCE 12-31-1978.

FOR: MEDICAL AND SCIENTIFIC RESEARCH SERVICES, NAMELY, PROVIDING A DATABASE IN THE FIELD OF HOSPITAL OUTPATIENT AND INPATIENT DATA AND FEATURING INPUTTING AND COLLECTION OF DATA AND INFORMATION ALL REPORTING RESEARCH ANALYSIS; PROVIDING SCIENTIFIC AND MEDICAL RESEARCH AND ANALYSIS SERVICES IN THE HEALTHCARE INDUSTRY AND TO IMPROVE COMMUNITY HEALTH ISSUES, IN CLASS 42 (U.S. CLS. 100 AND 101).

FIRST USE 12-31-1978; IN COMMERCE 12-31-1978.

THE MARK CONSISTS OF STANDARD CHARACTERS WITHOUT CLAIM TO ANY PARTICULAR FONT, STYLE, SIZE, OR COLOR.



*David J. Kyffers*

Director of the United States Patent and Trademark Office

**Reg. No. 4,197,507** SER. NO. 85-489,788, FILED 12-7-2011.

KATHLEEN M. VANSTON, EXAMINING ATTORNEY

# United States of America

United States Patent and Trademark Office



**Reg. No. 4,197,508**

**Registered Aug. 28, 2012**

**Int. Cl.: 43**

**SERVICE MARK**

**PRINCIPAL REGISTER**

JBIRD DEVELOPMENT GROUP LLC (NEW YORK LIMITED LIABILITY COMPANY)  
37A BEDFORD STREET #44  
NEW YORK, NY 10014

FOR: BAR AND COCKTAIL LOUNGE SERVICES, IN CLASS 43 (U.S. CLS. 100 AND 101).

FIRST USE 8-4-2011; IN COMMERCE 8-4-2011.

NO CLAIM IS MADE TO THE EXCLUSIVE RIGHT TO USE "COCKTAILS", APART FROM THE MARK AS SHOWN.

THE MARK CONSISTS OF THE CURSIVE LETTER "J" WITH A BIRD PERCHED ON THE TAIL OF THE LETTER "J" OVER THE WORDS "JBIRD COCKTAILS".

SER. NO. 85-489,802, FILED 12-7-2011.

APRIL ROACH, EXAMINING ATTORNEY



*David J. Kybas*

Director of the United States Patent and Trademark Office

# United States of America

United States Patent and Trademark Office

# EMBI TEC

**Reg. No. 4,197,509**

**Registered Aug. 28, 2012**

**Int. Cl.: 9**

**TRADEMARK**

**PRINCIPAL REGISTER**

C.C. IMEX (CALIFORNIA CORPORATION), DBA EMBI TEC  
P.O. BOX 795  
LA JOLLA, CA 920380795

FOR: LABORATORY APPARATUS, DEVICES AND CONSUMABLES FOR CONDUCTING NUCLEIC ACID AND DNA ANALYSES, AND ELECTROPHORESIS EXPERIMENTS, NAMELY, ELECTROPHORESIS SYSTEMS, GEL RUNNING TANKS, POWER SUPPLIES, GEL COMBS, GEL TRAYS, GEL CASTING STANDS, GEL CLAMSHELLS, GEL EXTRACTION TOOLS, LIGHT BOXES AND ILLUMINATORS, IN CLASS 9 (U.S. CLS. 21, 23, 26, 36 AND 38).

FIRST USE 6-10-1996; IN COMMERCE 6-10-1996.

THE MARK CONSISTS OF STANDARD CHARACTERS WITHOUT CLAIM TO ANY PARTICULAR FONT, STYLE, SIZE, OR COLOR.

NO CLAIM IS MADE TO THE EXCLUSIVE RIGHT TO USE "TEC", APART FROM THE MARK AS SHOWN.

SER. NO. 85-489,929, FILED 12-7-2011.

TAMARA FRAZIER, EXAMINING ATTORNEY



*David J. Kyffers*

Director of the United States Patent and Trademark Office

# United States of America

United States Patent and Trademark Office

## Sophisticated Scraps

**Reg. No. 4,197,510**

THREE SQUARES PROPERTIES, LLC (FLORIDA LIMITED LIABILITY COMPANY)  
207 MORRISON ST.

**Registered Aug. 28, 2012**

SANTA ROSA BEACH, FL 32459

**Int. Cl.: 35**

FOR: ON-LINE RETAIL STORE SERVICES FEATURING VINTAGE PAPER, FABRICS, CLOTHING, ARTS AND CRAFTS; RETAIL STORE SERVICES FEATURING VINTAGE PAPER, FABRICS, CLOTHING, ARTS AND CRAFTS, IN CLASS 35 (U.S. CLS. 100, 101 AND 102).

**SERVICE MARK**

**PRINCIPAL REGISTER**

FIRST USE 7-1-2004; IN COMMERCE 11-1-2011.

THE MARK CONSISTS OF STANDARD CHARACTERS WITHOUT CLAIM TO ANY PARTICULAR FONT, STYLE, SIZE, OR COLOR.

NO CLAIM IS MADE TO THE EXCLUSIVE RIGHT TO USE "SCRAPS", APART FROM THE MARK AS SHOWN.

SER. NO. 85-489,941, FILED 12-7-2011.

SKYE YOUNG, EXAMINING ATTORNEY



*David J. Kybas*

Director of the United States Patent and Trademark Office

# United States of America

United States Patent and Trademark Office

## *1 Gulp – Itz Gon*

**Reg. No. 4,197,511**

ROSS, ROBERT GAYLON, SR. (UNITED STATES INDIVIDUAL)  
317 PECAN VALLEY RD.  
CENTER POINT, TX 780105546

**Registered Aug. 28, 2012**

**Int. Cl.: 5**

FOR: DIETARY AND NUTRITIONAL SUPPLEMENTS, IN CLASS 5 (U.S. CLS. 6, 18, 44, 46, 51 AND 52).

**TRADEMARK**

FIRST USE 10-15-2011; IN COMMERCE 10-15-2011.

**PRINCIPAL REGISTER**

THE MARK CONSISTS OF THE STYLIZED WORDING "1 GULP- ITZ GON".

SER. NO. 85-490,458, FILED 12-8-2011.

CIMMERIAN COLEMAN, EXAMINING ATTORNEY



*David J. Kyffers*

Director of the United States Patent and Trademark Office



# United States of America

United States Patent and Trademark Office



**Reg. No. 4,197,512**

**Registered Aug. 28, 2012**

**Int. Cl.: 9**

**TRADEMARK**

**PRINCIPAL REGISTER**

ZAGG INTELLECTUAL PROPERTY HOLDING CO., INC. (NEVADA CORPORATION)  
3855 SOUTH 500 WEST, STE. C  
SALT LAKE CITY, UT 84115

FOR: FITTED PLASTIC FILMS KNOWN AS SKINS FOR COVERING AND PROVIDING A SCRATCH PROOF BARRIER OR PROTECTION FOR ELECTRONIC DEVICES, NAMELY, MP3 PLAYERS, MOBILE TELEPHONES, SMART TELEPHONES, DIGITAL CAMERAS, GLOBAL POSITIONING SYSTEMS, PERSONAL DIGITAL ASSISTANTS AND TABLET COMPUTERS; FITTED PLASTIC FILMS FOR COVERING AND PROVIDING A SCRATCH PROOF BARRIER OR PROTECTION FOR ELECTRONIC DEVICES, NAMELY, MP3 PLAYERS, MOBILE TELEPHONES, SMART TELEPHONES, DIGITAL CAMERAS, GLOBAL POSITIONING SYSTEM, PERSONAL DIGITAL ASSISTANTS AND TABLET COMPUTERS, IN CLASS 9 (U.S. CLS. 21, 23, 26, 36 AND 38).

FIRST USE 12-0-2009; IN COMMERCE 12-0-2009.

NO CLAIM IS MADE TO THE EXCLUSIVE RIGHT TO USE "MILITARY GRADE", APART FROM THE MARK AS SHOWN.

THE MARK CONSISTS OF THE STYLIZED WORDING "MILITARY GRADE" APPEARING TO THE RIGHT OF A HELICOPTER ALL OF WHICH IS SURROUNDED BY A CONCENTRIC RECTANGLE. THE WORDING "MILITARY" APPEARS ABOVE THE WORDING "GRADE".

SER. NO. 85-490,915, FILED 12-8-2011.

MICHAEL TANNER, EXAMINING ATTORNEY



*David J. Kybas*

Director of the United States Patent and Trademark Office

United States of America  
United States Patent and Trademark Office

KINTOSOL

**Reg. No. 4,197,513**

GARCIA, MANUEL (MEXICO INDIVIDUAL)  
4522 W. GREENFIELD AVE.  
WEST MILWAUKEE, WI 53214

**Registered Aug. 28, 2012**

**Int. Cl.: 41**

FOR: ENTERTAINMENT IN THE NATURE OF LIVE PERFORMANCES BY A MUSICAL GROUP, IN CLASS 41 (U.S. CLS. 100, 101 AND 107).

**SERVICE MARK**

FIRST USE 9-21-1998; IN COMMERCE 9-21-1998.

**PRINCIPAL REGISTER**

THE MARK CONSISTS OF STANDARD CHARACTERS WITHOUT CLAIM TO ANY PARTICULAR FONT, STYLE, SIZE, OR COLOR.

THE ENGLISH TRANSLATION OF THE TERM "SOL" IN THE MARK IS "SUN". THE WORDING "KINTO" IN THE MARK HAS NO MEANING IN A FOREIGN LANGUAGE.

SER. NO. 85-491,038, FILED 12-8-2011.

MICHAEL TANNER, EXAMINING ATTORNEY



*David J. Kyffers*

Director of the United States Patent and Trademark Office

# United States of America

United States Patent and Trademark Office



**Reg. No. 4,197,514**

**Registered Aug. 28, 2012**

**Int. Cl.: 35**

**SERVICE MARK**

**PRINCIPAL REGISTER**

NATIONAL PANHELLENIC CONFERENCE, INC. (INDIANA CORPORATION)  
3901 WEST 86TH STREET, SUITE 398  
INDIANAPOLIS, IN 46268

FOR: ASSOCIATION SERVICES, NAMELY, PROMOTING THE INTERESTS OF COLLEGIATE FRATERNAL ORGANIZATIONS, NAMELY, SORORITIES, AND PROMOTING THE INTERESTS OF INDIVIDUAL MEMBERS THEREOF, IN CLASS 35 (U.S. CLS. 100, 101 AND 102).

FIRST USE 0-0-1957; IN COMMERCE 0-0-1957.

NO CLAIM IS MADE TO THE EXCLUSIVE RIGHT TO USE "NATIONAL PANHELLENIC", APART FROM THE MARK AS SHOWN.

THE MARK CONSISTS OF A COAT-OF-ARMS CONTAINING AN OIL LAMP ABOVE A SHIELD BEARING A LAUREL WREATH AND SWORD. THE SHIELD IS SUPPORTED BY MANTLING BEARING THE WORDS "NATIONAL PANHELLENIC CONFERENCE".

SEC. 2(F).

SER. NO. 85-491,295, FILED 12-9-2011.

JASON TURNER, EXAMINING ATTORNEY



*David J. Kybas*

Director of the United States Patent and Trademark Office

# United States of America

United States Patent and Trademark Office

## NATIONAL PANHELLENIC CONFERENCE

**Reg. No. 4,197,515**

NATIONAL PANHELLENIC CONFERENCE, INC. (INDIANA CORPORATION)  
3901 WEST 86TH STREET, SUITE 398  
INDIANAPOLIS, IN 46268

**Registered Aug. 28, 2012**

**Int. Cl.: 35**

FOR: ASSOCIATION SERVICES, NAMELY, PROMOTING THE INTERESTS OF COLLEGIATE FRATERNAL ORGANIZATIONS, NAMELY, SORORITIES, AND PROMOTING THE INTERESTS OF INDIVIDUAL MEMBERS THEREOF, IN CLASS 35 (U.S. CLS. 100, 101 AND 102).

**SERVICE MARK**

**PRINCIPAL REGISTER**

FIRST USE 0-0-1902; IN COMMERCE 0-0-1902.

THE MARK CONSISTS OF STANDARD CHARACTERS WITHOUT CLAIM TO ANY PARTICULAR FONT, STYLE, SIZE, OR COLOR.

NO CLAIM IS MADE TO THE EXCLUSIVE RIGHT TO USE "NATIONAL PANHELLENIC", APART FROM THE MARK AS SHOWN.

SEC. 2(F).

SER. NO. 85-491,298, FILED 12-9-2011.

JASON TURNER, EXAMINING ATTORNEY



*David J. Kyffers*

Director of the United States Patent and Trademark Office

# United States of America

United States Patent and Trademark Office

## LimousineGuard

**Reg. No. 4,197,516**

**Registered Aug. 28, 2012**

**Int. Cl.: 36**

**SERVICE MARK**

**PRINCIPAL REGISTER**

WILLIS NORTH AMERICA, INC. (DELAWARE CORPORATION)  
26 CENTURY BLVD, 7S  
NASHVILLE, TN 37214

FOR: INSURANCE SERVICES, NAMELY, INSURANCE AGENCY AND BROKERAGE SERVICES FOR LIMOUSINE SERVICES, LIVERY VEHICLES AND PRE-ARRANGED TRANSPORTATION SERVICES, IN CLASS 36 (U.S. CLS. 100, 101 AND 102).

FIRST USE 4-30-2010; IN COMMERCE 4-30-2010.

THE MARK CONSISTS OF STANDARD CHARACTERS WITHOUT CLAIM TO ANY PARTICULAR FONT, STYLE, SIZE, OR COLOR.

SER. NO. 85-491,384, FILED 12-9-2011.

FRED CARL, EXAMINING ATTORNEY



*David J. Kyffers*

Director of the United States Patent and Trademark Office

# United States of America

United States Patent and Trademark Office



**Reg. No. 4,197,517**

ZAGG INTELLECTUAL PROPERTY HOLDING CO., INC. (NEVADA CORPORATION)  
3855 SOUTH 500 WEST, STE. C  
SALT LAKE CITY, UT 84115

**Registered Aug. 28, 2012**

**Int. Cl.: 9**

FOR: FITTED PLASTIC FILMS KNOWN AS SKINS FOR COVERING AND PROVIDING A SCRATCH PROOF BARRIER OR PROTECTION FOR ELECTRONIC DEVICES, NAMELY, MP3 PLAYERS, MOBILE TELEPHONES, SMART TELEPHONES, DIGITAL CAMERAS, GLOBAL POSITIONING SYSTEMS, PERSONAL DIGITAL ASSISTANTS AND TABLET COMPUTERS; FITTED PLASTIC FILMS FOR COVERING AND PROVIDING A SCRATCH PROOF BARRIER OR PROTECTION FOR ELECTRONIC DEVICES, NAMELY, MP3 PLAYERS, MOBILE TELEPHONES, SMART TELEPHONES, DIGITAL CAMERAS, GLOBAL POSITIONING SYSTEM, PERSONAL DIGITAL ASSISTANTS AND TABLET COMPUTERS, IN CLASS 9 (U.S. CLS. 21, 23, 26, 36 AND 38).

**TRADEMARK**

**PRINCIPAL REGISTER**

FIRST USE 12-0-2009; IN COMMERCE 12-0-2009.

NO CLAIM IS MADE TO THE EXCLUSIVE RIGHT TO USE "TECHNOLOGY", APART FROM THE MARK AS SHOWN.

THE MARK CONSISTS OF THE STYLIZED WORDING "NANO-MEMORY TECHNOLOGY" AS WELL AS THE DEPICTION OF AN ATOMIC MODEL SURROUNDED BY A CONCENTRIC CIRCLE INTERSECTING A CONCENTRIC RECTANGLE. THE WORDING "NANO-MEMORY" APPEARS ABOVE THE WORDING "TECHNOLOGY" ALL OF WHICH APPEARS TO THE RIGHT OF THE DEPICTION OF AN ATOMIC MODEL AND IS SURROUNDED BY A CONCENTRIC RECTANGLE. THE DEPICTION OF THE ATOMIC MODEL APPEARS SURROUNDED BY A CONCENTRIC CIRCLE WHICH INTERSECTS THE CONCENTRIC RECTANGLE.



SER. NO. 85-491,435, FILED 12-9-2011.

MICHAEL TANNER, EXAMINING ATTORNEY

*David J. Kybas*

Director of the United States Patent and Trademark Office

# United States of America

United States Patent and Trademark Office



**Reg. No. 4,197,518**

TWIN CITIES FOOD TOURS, LLC (MINNESOTA LIMITED LIABILITY COMPANY)  
19 FIRST ST. SOUTH - UNIT B207  
MINNEAPOLIS, MN 55401

**Registered Aug. 28, 2012**

**Int. Cl.: 39**

FOR: ARRANGING OF TOURS, IN CLASS 39 (U.S. CLS. 100 AND 105).

**SERVICE MARK**

FIRST USE 9-21-2010; IN COMMERCE 9-21-2010.

**PRINCIPAL REGISTER**

NO CLAIM IS MADE TO THE EXCLUSIVE RIGHT TO USE "TWIN CITIES FOOD TOURS",  
APART FROM THE MARK AS SHOWN.

THE COLOR(S) DARK RED, LIGHT RED, AND GRAY IS/ARE CLAIMED AS A FEATURE  
OF THE MARK.

THE MARK CONSISTS OF THE CAPITALIZED WORDS "TWIN CITIES" IN DARK RED AT  
THE TOP OF THE MARK. THE WORDS "FOOD TOURS" IN STYLIZED GRAY LETTER  
FORM THE RIGHT SIDE OF THE MARK. THE STYLIZED LETTERS "T" AND "C" FORM  
THE LEFT SIDE OF THE MARK. THE "C" IS DARK RED. THE "T" IS LIGHT RED.

SER. NO. 85-491,481, FILED 12-9-2011.

REGINA DRUMMOND, EXAMINING ATTORNEY



*David J. Kybas*

Director of the United States Patent and Trademark Office

# United States of America

United States Patent and Trademark Office

## Tate's Bake Shop

**Reg. No. 4,197,519**

TATE'S BAKE SHOP, INC. (NEW YORK CORPORATION)  
43 NORTH SEA ROAD  
SOUTHAMPTON, NY 11968

**Registered Aug. 28, 2012**

**Int. Cls.: 18, 21, 25 and  
30**

FOR: BAGS, NAMELY, ALL-PURPOSE CARRYING BAGS, REUSABLE SHOPPING BAGS, TOTE BAGS, IN CLASS 18 (U.S. CLS. 1, 2, 3, 22 AND 41).

FIRST USE 4-1-2003; IN COMMERCE 4-1-2003.

**TRADEMARK**

FOR: WICKER BASKETS; COOKIE JARS, IN CLASS 21 (U.S. CLS. 2, 13, 23, 29, 30, 33, 40 AND 50).

**PRINCIPAL REGISTER**

FIRST USE 4-1-2003; IN COMMERCE 4-1-2003.

FOR: CLOTHING, NAMELY, T-SHIRTS AND APRONS, IN CLASS 25 (U.S. CLS. 22 AND 39).

FIRST USE 4-1-2003; IN COMMERCE 4-1-2003.

FOR: BAKERY GOODS; GIFT BOXES COMPRISED PRIMARILY OF BAKERY GOODS, IN CLASS 30 (U.S. CL. 46).

FIRST USE 4-1-2003; IN COMMERCE 4-1-2003.

THE MARK CONSISTS OF STANDARD CHARACTERS WITHOUT CLAIM TO ANY PARTICULAR FONT, STYLE, SIZE, OR COLOR.

OWNER OF U.S. REG. NOS. 3,003,958 AND 4,015,517.

NO CLAIM IS MADE TO THE EXCLUSIVE RIGHT TO USE "BAKE SHOP", APART FROM THE MARK AS SHOWN.

SER. NO. 85-491,501, FILED 12-9-2011.

B. PARADEWELAI, EXAMINING ATTORNEY



*David J. Kyros*

Director of the United States Patent and Trademark Office



# United States of America

United States Patent and Trademark Office

# EFCOR

**Reg. No. 4,197,520**

NEV, LLC (DELAWARE LIMITED LIABILITY COMPANY)  
800 DELAWARE AVE.  
WILMINGTON, DE 19801

**Registered Aug. 28, 2012**

**Int. Cl.: 35**

FOR: CATALOG ORDERING SERVICE FEATURING ELECTRICAL, COMMERCIAL, INSTITUTIONAL, AND INDUSTRIAL PRODUCTS AND SUPPLIES, NAMELY, ELECTRICAL COMPONENTS, CABLES, CABLE ACCESSORIES, PRODUCTS FOR CABLE MANAGEMENT, CONDUIT, ELECTRONIC CONTROL EQUIPMENT, AND WIRING ACCESSORIES; DISTRIBUTORSHIP SERVICES IN THE FIELD OF ELECTRICAL, COMMERCIAL, INSTITUTIONAL, AND INDUSTRIAL PRODUCTS AND SUPPLIES, NAMELY, ELECTRICAL COMPONENTS, CABLES, CABLE ACCESSORIES, PRODUCTS FOR CABLE MANAGEMENT, CONDUIT, ELECTRONIC CONTROL EQUIPMENT, AND WIRING ACCESSORIES; WEB-BASED CATALOG SERVICES FEATURING ELECTRICAL, COMMERCIAL, INSTITUTIONAL, AND INDUSTRIAL PRODUCTS AND SUPPLIES, NAMELY, ELECTRICAL COMPONENTS, CABLES, CABLE ACCESSORIES, PRODUCTS FOR CABLE MANAGEMENT, CONDUIT, ELECTRONIC CONTROL EQUIPMENT, AND WIRING ACCESSORIES, IN CLASS 35 (U.S. CLS. 100, 101 AND 102).

**SERVICE MARK**

**PRINCIPAL REGISTER**

FIRST USE 12-17-2009; IN COMMERCE 12-17-2009.

THE MARK CONSISTS OF STANDARD CHARACTERS WITHOUT CLAIM TO ANY PARTICULAR FONT, STYLE, SIZE, OR COLOR.

OWNER OF U.S. REG. NOS. 3,756,195 AND 3,756,196.

SER. NO. 85-491,736, FILED 12-9-2011.

STEVEN PEREZ, EXAMINING ATTORNEY



*David J. Kypos*

Director of the United States Patent and Trademark Office

# United States of America

United States Patent and Trademark Office

**Reg. No. 4,197,521**

**Registered Aug. 28, 2012**

**Int. Cl.: 35**

**SERVICE MARK**

**PRINCIPAL REGISTER**

NEV, LLC (DELAWARE LIMITED LIABILITY COMPANY)  
800 DELAWARE AVE.  
WILMINGTON, DE 19801

FOR: CATALOG ORDERING SERVICE FEATURING ELECTRICAL, COMMERCIAL, INSTITUTIONAL, AND INDUSTRIAL PRODUCTS AND SUPPLIES, NAMELY, ELECTRICAL COMPONENTS, CABLES, CABLE ACCESSORIES, PRODUCTS FOR CABLE MANAGEMENT, CONDUIT, ELECTRONIC CONTROL EQUIPMENT, AND WIRING ACCESSORIES; DISTRIBUTORSHIP SERVICES IN THE FIELD OF ELECTRICAL, COMMERCIAL, INSTITUTIONAL, AND INDUSTRIAL PRODUCTS AND SUPPLIES, NAMELY, ELECTRICAL COMPONENTS, CABLES, CABLE ACCESSORIES, PRODUCTS FOR CABLE MANAGEMENT, CONDUIT, ELECTRONIC CONTROL EQUIPMENT, AND WIRING ACCESSORIES; WEB-BASED CATALOG SERVICES FEATURING ELECTRICAL, COMMERCIAL, INSTITUTIONAL, AND INDUSTRIAL PRODUCTS AND SUPPLIES, NAMELY, ELECTRICAL COMPONENTS, CABLES, CABLE ACCESSORIES, PRODUCTS FOR CABLE MANAGEMENT, CONDUIT, ELECTRONIC CONTROL EQUIPMENT, AND WIRING ACCESSORIES, IN CLASS 35 (U.S. CLS. 100, 101 AND 102).

FIRST USE 12-17-2009; IN COMMERCE 12-17-2009.

OWNER OF U.S. REG. NOS. 3,756,195 AND 3,756,196.

THE MARK CONSISTS OF THE TERM "EFCOR" IN STYLIZED SCRIPT.

SER. NO. 85-491,771, FILED 12-9-2011.

STEVEN PEREZ, EXAMINING ATTORNEY



*David J. Kybas*

Director of the United States Patent and Trademark Office

# United States of America

United States Patent and Trademark Office

# MT<sup>2</sup>IT

your safe medical network

**Reg. No. 4,197,522**

**Registered Aug. 28, 2012**

**Int. Cls.: 35 and 42**

**SERVICE MARK**

**PRINCIPAL REGISTER**

MEYER, JÖRG-UWE (FED REP GERMANY INDIVIDUAL)  
GIESENDORFER WEG 20  
RATZEBURG, FED REP GERMANY 23909

FOR: ONLINE RETAIL STORE SERVICES FEATURING SOFTWARE; RETAIL STORE SERVICES FEATURING SOFTWARE, IN CLASS 35 (U.S. CLS. 100, 101 AND 102).

FOR: DEVELOPING COMPUTER SOFTWARE FOR USE WITH NETWORKING MEDICAL EQUIPMENT, MEDICAL INFORMATION SYSTEMS AND NETWORKED DEVICES; DESIGN, DEVELOPMENT AND IMPLEMENTATION OF SOFTWARE AND MONITORING EQUIPMENT IN THE NATURE OF COMPUTER MEDICAL NETWORKS, IN WHICH MEDICAL DEVICES NETWORKED DEVICES AND INFORMATION SYSTEMS ARE INTEGRATED, IN CLASS 42 (U.S. CLS. 100 AND 101).

PRIORITY CLAIMED UNDER SEC. 44(D) ON FED REP GERMANY APPLICATION NO. 302011038278, FILED 6-28-2011, REG. NO. 302011038278, DATED 3-11-2011, EXPIRES 6-30-2021.

THE COLOR(S) RED, GRAY, AND BLACK IS/ARE CLAIMED AS A FEATURE OF THE MARK.

NO CLAIM IS MADE TO THE EXCLUSIVE RIGHT TO USE "IT" OR "YOUR SAFE MEDICAL NETWORK", APART FROM THE MARK AS SHOWN.

THE MARK CONSISTS OF "MT" IN BLACK WITH THE NUMBER "2" IN RED FOLLOWED BY THE LETTERS "IT" IN BLACK. BELOW THE STYLIZED WORDING "MT 2 IT" IS THE STYLIZED PHRASE "YOUR SAFE MEDICAL NETWORK" IN GRAY.

SER. NO. 85-491,850, FILED 12-9-2011.

ALYSSA STEEL, EXAMINING ATTORNEY



*David J. Kybas*

Director of the United States Patent and Trademark Office

# United States of America

United States Patent and Trademark Office

## THE WORLD'S PREMIER CULINARY COLLEGE

**Reg. No. 4,197,523**

**Registered Aug. 28, 2012**

**Int. Cls.: 16 and 41**

**TRADEMARK**

**SERVICE MARK**

**PRINCIPAL REGISTER**

THE CULINARY INSTITUTE OF AMERICA (NEW YORK CORPORATION)  
1946 CAMPUS DRIVE  
HYDE PARK, NY 125381499

FOR: BOOKS AND PUBLICATIONS, NAMELY, PAMPHLETS, MAGAZINES, CATALOGS, BROCHURES AND NEWSLETTERS IN THE FIELD OF CULINARY ARTS, FOOD PREPARATION AND FOODSERVICE MANAGEMENT, IN CLASS 16 (U.S. CLS. 2, 5, 22, 23, 29, 37, 38 AND 50).

FIRST USE 12-31-2005; IN COMMERCE 12-31-2005.

FOR: EDUCATIONAL SERVICES, NAMELY, PROVIDING COURSES OF INSTRUCTIONS AT THE COLLEGE LEVEL WHICH OFFER BACHELOR'S AND ASSOCIATE'S DEGREES IN THE CULINARY ARTS, IN CLASS 41 (U.S. CLS. 100, 101 AND 107).

FIRST USE 9-30-2002; IN COMMERCE 9-30-2002.

THE MARK CONSISTS OF STANDARD CHARACTERS WITHOUT CLAIM TO ANY PARTICULAR FONT, STYLE, SIZE, OR COLOR.

SEC. 2(F).

SER. NO. 85-491,889, FILED 12-9-2011.

SHAILA SETTLES, EXAMINING ATTORNEY



*David J. Kypos*

Director of the United States Patent and Trademark Office

**United States of America**  
United States Patent and Trademark Office

**AQUATIX**

**Reg. No. 4,197,524**

ROBERT WILLIAMS (UNITED STATES INDIVIDUAL)  
40342 PADOVA DR.  
INDIO, CA 92203

**Registered Aug. 28, 2012**

**Int. Cl.: 21**

FOR: PLASTIC WATER BOTTLES SOLD EMPTY; EMPTY WATER BOTTLES FOR BICYCLES; REUSABLE PLASTIC WATER BOTTLES SOLD EMPTY, IN CLASS 21 (U.S. CLS. 2, 13, 23, 29, 30, 33, 40 AND 50).

**TRADEMARK**

FIRST USE 9-15-2011; IN COMMERCE 3-2-2012.

**PRINCIPAL REGISTER**

THE MARK CONSISTS OF STANDARD CHARACTERS WITHOUT CLAIM TO ANY PARTICULAR FONT, STYLE, SIZE, OR COLOR.

SER. NO. 85-492,098, FILED 12-9-2011.

SUSAN STIGLITZ, EXAMINING ATTORNEY



*David J. Kyros*

Director of the United States Patent and Trademark Office

# United States of America

United States Patent and Trademark Office



**Reg. No. 4,197,525**

**Registered Aug. 28, 2012**

**Int. Cl.: 32**

**TRADEMARK**

**PRINCIPAL REGISTER**

SNEAKY PETE'S BEVERAGE, LLC (NEW JERSEY LIMITED LIABILITY COMPANY)  
#161  
576 VALLEY ROAD  
WAYNE, NJ 07470

FOR: OAT-BASED NON-ALCOHOLIC BEVERAGES, IN CLASS 32 (U.S. CLS. 45, 46 AND 48).

FIRST USE 5-27-2010; IN COMMERCE 11-25-2011.

THE MARK CONSISTS OF A CARTOON BOY ABOVE A BANNER WITH THE WORDS "SNEAKY PETE'S" ACROSS THE BANNER.

SER. NO. 85-492,132, FILED 12-9-2011.

LESLIE RICHARDS, EXAMINING ATTORNEY



*David J. Kybas*

Director of the United States Patent and Trademark Office

# United States of America

United States Patent and Trademark Office

## Water N Sports

**Reg. No. 4,197,526**

**Registered Aug. 28, 2012**

**Int. Cl.: 35**

**SERVICE MARK**

**PRINCIPAL REGISTER**

HAMMETT, CLIFFORD, JAMES (FLORIDA LIMITED LIABILITY COMPANY), DBA WATER  
N SPORTS .LLC  
4718 9TH PLACE  
VERO BEACH, FL 32966

FOR: RETAIL SPORTING GOODS STORES, IN CLASS 35 (U.S. CLS. 100, 101 AND 102).

FIRST USE 1-1-2005; IN COMMERCE 1-1-2005.

THE MARK CONSISTS OF STANDARD CHARACTERS WITHOUT CLAIM TO ANY PARTICULAR FONT, STYLE, SIZE, OR COLOR.

SEC. 2(F).

SER. NO. 85-492,317, FILED 12-10-2011.

WARREN L. OLANDRIA, EXAMINING ATTORNEY



*David J. Kyffers*

Director of the United States Patent and Trademark Office

# United States of America

United States Patent and Trademark Office

# GOODIX

**Reg. No. 4,197,527**

**Registered Aug. 28, 2012**

**Int. Cl.: 9**

**TRADEMARK**

**PRINCIPAL REGISTER**

SHENZHEN GOODIX TECHNOLOGY CO.,LTD. (CHINA CORPORATION)  
FLOOR 13, PHASE B, TENGFEI INDUSTRIAL  
BUILDING, FUTIAN FREE TRADE ZONE,  
SHENZHEN, CHINA

FOR: APPARATUS FOR TRANSMISSION OF COMMUNICATION; AUTOMATIC SWITCHING APPARATUS; AUTOMATIC TELEPHONE EXCHANGE APPARATUS; CARDS AND MICRO-PROCESSORS FOR COMPUTERS; CENTRAL PROCESSING UNITS (CPU); COMPUTER CENTRAL PROCESSING UNITS; COMPUTER OPERATING PROGRAMS; DIGITAL TELEPHONE SWITCHING APPARATUS; DOWNLOADABLE COMPUTER GAME PROGRAMS; INTEGRATED CIRCUIT MODULES; INTEGRATED CIRCUITS; INTEGRATED CIRCUITS, INTEGRATED CIRCUIT CHIPS, AND INTEGRATED CIRCUIT MODULES FOR DIGITAL VIDEO COMPRESSION AND DECOMPRESSION; INTEGRATED CIRCUITS, INTEGRATED CIRCUIT CHIPS, AND INTEGRATED CIRCUIT MODULES FOR ENCODING AND DECODING DIGITAL VIDEO; MICROPROCESSOR-BASED HARDWARE SYSTEMS USED TO REDUCE POWER CONSUMPTION; MICROPROCESSORS; MICROPROCESSORS AND SEMI-CONDUCTORS; PRINTED CIRCUITS; RADIOTELEPHONY SETS; TELEPHONE APPARATUS, IN CLASS 9 (U.S. CLS. 21, 23, 26, 36 AND 38).

FIRST USE 8-15-2004; IN COMMERCE 8-15-2004.

THE MARK CONSISTS OF THE WORD "GOODIX" IN STYLIZED FORM, WITH THE "OO" INTERLOCKING AND A TRIANGLE FORMING THE DOT OVER THE "I".

THE WORDING "GOODIX" HAS NO MEANING IN A FOREIGN LANGUAGE.

SER. NO. 85-492,494, FILED 12-12-2011.

EUGENIA MARTIN, EXAMINING ATTORNEY



*David J. Kybas*

Director of the United States Patent and Trademark Office



# United States of America

United States Patent and Trademark Office

# Avroto

**Reg. No. 4,197,528**

**Registered Aug. 28, 2012**

**Int. Cl.: 7**

**TRADEMARK**

**PRINCIPAL REGISTER**

SCARTZ, JAMES P. (UNITED STATES INDIVIDUAL)  
72 INDUSTRIAL PARK PLACE  
POWELL, OH 43065

FOR: DURABLE BRUSHLESS MOTORS BUILT FOR MULTI-ROTOR UNMANNED AERIAL VEHICLES (UAVS) APPLICATIONS, IN CLASS 7 (U.S. CLS. 13, 19, 21, 23, 31, 34 AND 35).

FIRST USE 1-1-2011; IN COMMERCE 2-1-2011.

THE MARK CONSISTS OF STANDARD CHARACTERS WITHOUT CLAIM TO ANY PARTICULAR FONT, STYLE, SIZE, OR COLOR.

SER. NO. 85-492,548, FILED 12-12-2011.

LINDA ESTRADA, EXAMINING ATTORNEY



*David J. Kyffers*

Director of the United States Patent and Trademark Office

# United States of America

United States Patent and Trademark Office

## RASPBERRY RIOT LEMON MATE TEA

**Reg. No. 4,197,529**

**Registered Aug. 28, 2012**

**Int. Cl.: 30**

TEAVANA CORPORATION (GEORGIA CORPORATION)  
3630 PEACHTREE ROAD  
SUITE 1480  
ATLANTA, GA 30326

FOR: TEA, IN CLASS 30 (U.S. CL. 46).

**TRADEMARK**

FIRST USE 10-1-2009; IN COMMERCE 10-1-2009.

**PRINCIPAL REGISTER**

THE MARK CONSISTS OF STANDARD CHARACTERS WITHOUT CLAIM TO ANY PARTICULAR FONT, STYLE, SIZE, OR COLOR.

NO CLAIM IS MADE TO THE EXCLUSIVE RIGHT TO USE "RASPBERRY" AND "LEMON MATE TEA", APART FROM THE MARK AS SHOWN.

SER. NO. 85-492,551, FILED 12-12-2011.

KEVIN CORWIN, EXAMINING ATTORNEY



*David J. Kyffers*

Director of the United States Patent and Trademark Office

# United States of America

United States Patent and Trademark Office

## PEACH MOMOTARO ARTISAN TEA

**Reg. No. 4,197,530**

**Registered Aug. 28, 2012**

**Int. Cl.: 30**

TEAVANA CORPORATION (GEORGIA CORPORATION)  
SUITE 1480  
3630 PEACHTREE ROAD  
ATLANTA, GA 30326

FOR: TEA, IN CLASS 30 (U.S. CL. 46).

**TRADEMARK**

FIRST USE 10-1-2008; IN COMMERCE 10-1-2008.

**PRINCIPAL REGISTER**

THE MARK CONSISTS OF STANDARD CHARACTERS WITHOUT CLAIM TO ANY PARTICULAR FONT, STYLE, SIZE, OR COLOR.

OWNER OF U.S. REG. NO. 3,548,899.

NO CLAIM IS MADE TO THE EXCLUSIVE RIGHT TO USE "PEACH" AND "ARTISAN TEA", APART FROM THE MARK AS SHOWN.

THE WORDING "MOMOTARO" HAS NO MEANING IN A FOREIGN LANGUAGE.

SER. NO. 85-492,624, FILED 12-12-2011.

KEVIN CORWIN, EXAMINING ATTORNEY



*David J. Kyffers*

Director of the United States Patent and Trademark Office

# United States of America

United States Patent and Trademark Office

## KDT CENTER

**Reg. No. 4,197,531**

FT. WORTH REHABILITATION, INC. (TEXAS CORPORATION)  
4430 LAVON DR. STE 374-114  
GARLAND, TX 75040

**Registered Aug. 28, 2012**

**Int. Cl.: 44**

FOR: CONDUCTING MEDICAL EXAMINATIONS AND EVALUATIONS FOR INSURANCE PURPOSES, IN CLASS 44 (U.S. CLS. 100 AND 101).

**SERVICE MARK**

FIRST USE 9-1-2011; IN COMMERCE 9-12-2011.

**PRINCIPAL REGISTER**

THE MARK CONSISTS OF STANDARD CHARACTERS WITHOUT CLAIM TO ANY PARTICULAR FONT, STYLE, SIZE, OR COLOR.

NO CLAIM IS MADE TO THE EXCLUSIVE RIGHT TO USE "CENTER", APART FROM THE MARK AS SHOWN.

SER. NO. 85-492,765, FILED 12-12-2011.

TIMOTHY FINNEGAN, EXAMINING ATTORNEY



*David J. Kybas*

Director of the United States Patent and Trademark Office

# United States of America

United States Patent and Trademark Office



**Reg. No. 4,197,532**

**Registered Aug. 28, 2012**

**Int. Cl.: 41**

**SERVICE MARK**

**PRINCIPAL REGISTER**

THE ROBERT W. WOODRUFF LIBRARY OF THE ATLANTA UNIVERSITY CENTER, INC.  
(GEORGIA NON-PROFIT CORPORATION)  
111 JAMES P. BRAWLEY DRIVE SW  
ATLANTA, GA 303144207

FOR: LIBRARY SERVICES, NAMELY, LENDING AND RESEARCH LIBRARY SERVICES; EDUCATIONAL SERVICES, NAMELY, CONDUCTING LECTURES AND DISCUSSIONS, SYMPOSIA, COURSES, WORKSHOPS, READINGS, AND BOOK SIGNINGS IN THE FIELD OF AFRICANA STUDIES, ARCHIVES AND SPECIAL COLLECTIONS, ARTS AND HUMANITIES, BUSINESS AND ECONOMICS, EDUCATION, GENERAL REFERENCE, STATE OF GEORGIA, GOVERNMENT AND LAW, HEALTH SCIENCES, HISPANIC DATABASES, MULTI-DISCIPLINARY, NEWS AND CURRENT EVENTS, RELIGION AND PHILOSOPHY, SCIENCE AND TECHNOLOGY, SOCIAL SCIENCES, AND STATISTICS; CONDUCTING EDUCATIONAL AND ENTERTAINMENT EXHIBITIONS IN THE FIELD OF AFRICANA STUDIES, ARCHIVES AND SPECIAL COLLECTIONS, ARTS AND HUMANITIES, BUSINESS AND ECONOMICS, EDUCATION, GENERAL REFERENCE, STATE OF GEORGIA, GOVERNMENT AND LAW, HEALTH SCIENCES, HISPANIC DATABASES, MULTI-DISCIPLINARY, NEWS AND CURRENT EVENTS, RELIGION AND PHILOSOPHY, SCIENCE AND TECHNOLOGY, SOCIAL SCIENCES, AND STATISTICS, IN CLASS 41 (U.S. CLS. 100, 101 AND 107).

FIRST USE 3-1-2004; IN COMMERCE 3-1-2004.

THE MARK CONSISTS OF THE PETALS OF A LOTUS FLOWER BORDERED BY A COMPLETE CIRCLE BAND.

SER. NO. 85-492,956, FILED 12-12-2011.

DANNEAN HETZEL, EXAMINING ATTORNEY



*David J. Kyjars*

Director of the United States Patent and Trademark Office

# United States of America

United States Patent and Trademark Office

LEARN IT. SEE IT. LIVE  
IT.

**Reg. No. 4,197,533**

**Registered Aug. 28, 2012**

**Int. Cl.: 41**

**SERVICE MARK**

**PRINCIPAL REGISTER**

SCHOOL YEAR ABROAD, INC. (MASSACHUSETTS NON-PROFIT CORPORATION)  
439 SOUTH UNION STREET  
LAWRENCE, MA 01843

FOR: FULL-ACADEMIC-YEAR AND SUMMER EDUCATIONAL SERVICES IN THE NATURE  
OF INDEPENDENT SECONDARY SCHOOLS FOR AMERICAN STUDENTS OVERSEAS ,  
IN CLASS 41 (U.S. CLS. 100, 101 AND 107).

FIRST USE 8-0-2011; IN COMMERCE 8-0-2011.

THE MARK CONSISTS OF STANDARD CHARACTERS WITHOUT CLAIM TO ANY PAR-  
TICULAR FONT, STYLE, SIZE, OR COLOR.

SER. NO. 85-493,258, FILED 12-12-2011.

DAWN HAN, EXAMINING ATTORNEY



*David J. Kyffers*

Director of the United States Patent and Trademark Office

# United States of America

United States Patent and Trademark Office

## Mr. Long Island Leather

**Reg. No. 4,197,534**

LIRMC, INC. (NEW YORK CORPORATION)  
15 WELBOURN LANE  
CORAM, NY 11727

**Registered Aug. 28, 2012**

**Int. Cl.: 41**

FOR: ENTERTAINMENT SERVICES, NAMELY, CONDUCTING CONTESTS, IN CLASS 41  
(U.S. CLS. 100, 101 AND 107).

**SERVICE MARK**

FIRST USE 10-15-1996; IN COMMERCE 10-15-1996.

**PRINCIPAL REGISTER**

THE MARK CONSISTS OF STANDARD CHARACTERS WITHOUT CLAIM TO ANY PARTICULAR FONT, STYLE, SIZE, OR COLOR.

NO CLAIM IS MADE TO THE EXCLUSIVE RIGHT TO USE "LONG ISLAND", APART FROM THE MARK AS SHOWN.

SER. NO. 85-493,270, FILED 12-12-2011.

DAWN HAN, EXAMINING ATTORNEY



*David J. Kyffers*

Director of the United States Patent and Trademark Office

# United States of America

United States Patent and Trademark Office



**Reg. No. 4,197,535**

**Registered Aug. 28, 2012**

**Int. Cl.: 36**

**SERVICE MARK**

**PRINCIPAL REGISTER**

DRW FRANCHISE SYSTEMS LLC (WISCONSIN LIMITED LIABILITY COMPANY)  
106 E GRAND AVENUE  
EAU CLAIRE, WI 54701

FOR: REAL ESTATE BROKERAGE SERVICES, IN CLASS 36 (U.S. CLS. 100, 101 AND 102).

FIRST USE 1-1-2008; IN COMMERCE 4-1-2009.

NO CLAIM IS MADE TO THE EXCLUSIVE RIGHT TO USE "DISCOUNT REALTY" AND "REAL ESTATE SERVICES", APART FROM THE MARK AS SHOWN.

THE MARK CONSISTS OF A 5-SIDED POLYGON REPRESENTING THE ROOF OF A HOUSE WITH ELEVEN SHARP POINTS RADIATING OUTWARD AND UPWARD FROM IT. THE WORDS "DISCOUNT REALTY WORKS" APPEAR DIRECTLY UNDER THE IMAGE. IN SMALLER FONT, THE WORDS "INNOVATIVE REAL ESTATE SERVICES" APPEAR BELOW THE LARGER WORDS.

SER. NO. 85-493,293, FILED 12-12-2011.

EUGENIA MARTIN, EXAMINING ATTORNEY



*David J. Kybas*

Director of the United States Patent and Trademark Office



# United States of America

United States Patent and Trademark Office

ONE MOTHER, ONE DAUGHTER,  
ONE PROMISE!

**Reg. No. 4,197,536**

ARIELLE ANACKER CANCER FOUNDATION, INC. (FLORIDA CORPORATION)  
6664 N.W. 42ND TERRACE  
COCONUT CREEK, FL 33073

**Registered Aug. 28, 2012**

**Int. Cl.: 36**

FOR: CHARITABLE FUNDRAISING SERVICES, IN CLASS 36 (U.S. CLS. 100, 101 AND 102).

**SERVICE MARK**

FIRST USE 2-13-2010; IN COMMERCE 2-13-2011.

**PRINCIPAL REGISTER**

THE MARK CONSISTS OF STANDARD CHARACTERS WITHOUT CLAIM TO ANY PARTICULAR FONT, STYLE, SIZE, OR COLOR.

SER. NO. 85-493,342, FILED 12-12-2011.

TINA L. SNAPP, EXAMINING ATTORNEY



*David J. Kyffers*

Director of the United States Patent and Trademark Office

# United States of America

United States Patent and Trademark Office

## Toxic Relief Booster

**Reg. No. 4,197,537**

THORNE RESEARCH, INC. (IDAHO CORPORATION)  
25820 HIGHWAY 2 WEST  
SANDPOINT, ID 83864

**Registered Aug. 28, 2012**

**Int. Cl.: 5**

FOR: DIETARY AND NUTRITIONAL SUPPLEMENTS; DIETARY AND NUTRITIONAL SUPPLEMENTS CONTAINING NUTRIENTS AND BOTANICALS; DIETARY SUPPLEMENTS; DIETARY SUPPLEMENTS FOR PROVIDING GENERAL DETOXIFICATION SUPPORT; NUTRITIONAL SUPPLEMENT FOR ELIMINATING TOXINS FROM THE BODY; NUTRITIONAL SUPPLEMENTS, IN CLASS 5 (U.S. CLS. 6, 18, 44, 46, 51 AND 52).

**TRADEMARK**

**PRINCIPAL REGISTER**

FIRST USE 8-1-2006; IN COMMERCE 8-1-2006.

THE MARK CONSISTS OF STANDARD CHARACTERS WITHOUT CLAIM TO ANY PARTICULAR FONT, STYLE, SIZE, OR COLOR.

NO CLAIM IS MADE TO THE EXCLUSIVE RIGHT TO USE "TOXIC RELIEF", APART FROM THE MARK AS SHOWN.

SER. NO. 85-493,385, FILED 12-12-2011.

KATHERINE CONNOLLY, EXAMINING ATTORNEY



*David J. Kyros*

Director of the United States Patent and Trademark Office

# United States of America

United States Patent and Trademark Office

*Beautiful  
Sole* 

**Reg. No. 4,197,538**

WANDA STEWART (UNITED STATES INDIVIDUAL), DBA BEAUTIFUL SOLE  
PO BOX 753

**Registered Aug. 28, 2012**

LAKE CHARLES, LA 706020753

**Int. Cl.: 3**

FOR: AROMATIC BODY CARE PRODUCTS, NAMELY, BODY LOTION, SHOWER GEL, CUTICLE CREAM, SHAMPOO, CONDITIONER, NON-MEDICATED LIP BALM, SOAP, BODY POLISH, BODY AND FOOT SCRUB AND NON-MEDICATED FOOT CREAM, IN CLASS 3 (U.S. CLS. 1, 4, 6, 50, 51 AND 52).

**TRADEMARK**

**PRINCIPAL REGISTER**

FIRST USE 1-1-2007; IN COMMERCE 1-1-2007.

NO CLAIM IS MADE TO THE EXCLUSIVE RIGHT TO USE "SOLE", APART FROM THE MARK AS SHOWN.

THE COLOR(S) GOLD, BROWN, TAN, GREEN AND YELLOW ARE CLAIMED AS A FEATURE OF THE MARK IS/ARE CLAIMED AS A FEATURE OF THE MARK.

THE MARK CONSISTS OF STYLIZED WORD, "BEAUTIFUL SOLE", IN VARIOUS SHADES OF BROWN, GOLD, TAN AND YELLOW WITH A GREEN AND GOLD BUTTERFLY ON THE SIDE.

SER. NO. 85-493,531, FILED 12-13-2011.

ANGELA M. MICHELI, EXAMINING ATTORNEY



*David J. Kyros*

Director of the United States Patent and Trademark Office

# United States of America

United States Patent and Trademark Office

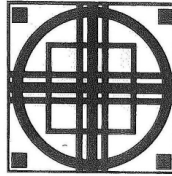

**Reg. No. 4,197,539**

**Registered Aug. 28, 2012**

**Int. Cls.: 35 and 41**

THE SCHAUMBURG TOWNSHIP DISTRICT PUBLIC LIBRARY (ILLINOIS ORGANIZED UNDER THE ILLINOIS PUBLIC LIBRARY DISTRICT ACT AN ILLINOIS MUNICIPAL CORPORATION AND A UNIT OF LOCAL GOVERNMENT (75 ILCS 16/1 ET SEQ.))  
130 SOUTH ROSELLE ROAD  
SCHAUMBURG, IL 60193

**SERVICE MARK**

FOR: BUSINESS SERVICES, NAMELY, ARRANGING AND CONDUCTING AN IN-PERSON FORUM FOR EXCHANGING, DONATING AND BUYING BOOKS AND PERIODICALS, IN CLASS 35 (U.S. CLS. 100, 101 AND 102).

**PRINCIPAL REGISTER**

FIRST USE 9-26-1998; IN COMMERCE 9-26-1998.

FOR: LIBRARIES; LENDING LIBRARIES, ONLINE LIBRARY SERVICES, NAMELY, PROVIDING ELECTRONIC LIBRARY SERVICES WHICH FEATURE NEWSPAPERS, MAGAZINES, BOOKS, PHOTOGRAPHS AND PICTURES VIA AN ONLINE COMPUTER NETWORK; MOBILE LIBRARY SERVICES, IN CLASS 41 (U.S. CLS. 100, 101 AND 107).

FIRST USE 9-26-1998; IN COMMERCE 9-26-1998.

THE MARK CONSISTS OF A GEOMETRIC PATTERN CONSISTING OF A SQUARE WITHIN WHICH ARE THREE SETS OF LINES FORMING A PLUS SIGN IN THE CENTER. THERE IS A CIRCLE WHICH TOUCHES THE FOUR SIDES OF THE OUTER SQUARE AND THERE IS A SMALLER SQUARE WITHIN THAT CIRCLE. A SMALL DARKENED SQUARE APPEARS IN EACH CORNER OF THE LARGER SQUARE.

SER. NO. 85-494,289, FILED 12-13-2011.

LINDA LAVACHE, EXAMINING ATTORNEY



*David J. Kybas*

Director of the United States Patent and Trademark Office

# United States of America

United States Patent and Trademark Office



**Reg. No. 4,197,540**

VITRA FURNITURE, INC. (CALIFORNIA CORPORATION)  
518 S. PALM AVE.  
ALHAMBRA, CA 91803

**Registered Aug. 28, 2012**

**Int. Cls.: 10 and 20**

FOR: MASSAGERS IN THE NATURE OF ELECTROMECHANICAL MASSAGE MECHANISM  
FOR CHAIRS, IN CLASS 10 (U.S. CLS. 26, 39 AND 44).

**TRADEMARK**

FIRST USE 5-31-2010; IN COMMERCE 10-15-2011.

**PRINCIPAL REGISTER**

FOR: FURNITURE, IN CLASS 20 (U.S. CLS. 2, 13, 22, 25, 32 AND 50).

FIRST USE 5-31-2010; IN COMMERCE 10-15-2011.

THE MARK CONSISTS OF THREE BOLD CAPITAL LETTERS OF "E", OVERLAPPING AND  
LEANING AGAINST EACH OTHER WITH THE BORDER FORMING AN ASYMMETRY  
HEXAGON.

SER. NO. 85-494,480, FILED 12-13-2011.

TAMARA FRAZIER, EXAMINING ATTORNEY



*David J. Kybas*

Director of the United States Patent and Trademark Office

# United States of America

United States Patent and Trademark Office

## Game Dude Rocks

**Reg. No. 4,197,541**

BEST BITS & BYTES, INC. (CALIFORNIA CORPORATION)  
12104 SHERMAN WAY

**Registered Aug. 28, 2012**

NORTH HOLLYWOOD, CA 91605

**Int. Cl.: 35**

FOR: RETAIL STORE SERVICES FEATURING NEW AND USED VIDEO GAME HARDWARE, SOFTWARE, AND ACCESSORIES, IN CLASS 35 (U.S. CLS. 100, 101 AND 102).

**SERVICE MARK**

FIRST USE 6-25-1991; IN COMMERCE 6-25-1991.

**PRINCIPAL REGISTER**

THE MARK CONSISTS OF STANDARD CHARACTERS WITHOUT CLAIM TO ANY PARTICULAR FONT, STYLE, SIZE, OR COLOR.

NO CLAIM IS MADE TO THE EXCLUSIVE RIGHT TO USE "GAME", APART FROM THE MARK AS SHOWN.

SER. NO. 85-494,592, FILED 12-13-2011.

MICHELLE DUBOIS, EXAMINING ATTORNEY



*David J. Kybas*

Director of the United States Patent and Trademark Office

# United States of America

United States Patent and Trademark Office



**Reg. No. 4,197,542**

WILLIAMS, ERVIN G. (UNITED STATES INDIVIDUAL), DBA DYNAMO AMPLIFICATION  
501 JEFFERSON LN  
LAKE DALLAS, TX 75065

**Registered Aug. 28, 2012**

**Int. Cl.: 9**

FOR: GUITAR AMPLIFIERS, IN CLASS 9 (U.S. CLS. 21, 23, 26, 36 AND 38).

**TRADEMARK**

FIRST USE 8-2-2010; IN COMMERCE 2-26-2011.

**PRINCIPAL REGISTER**

THE MARK CONSISTS OF THE WORDING "DYNAMO" IN A STYLIZED FONT.

SER. NO. 85-494,662, FILED 12-14-2011.

DAWN HAN, EXAMINING ATTORNEY



*David J. Kybas*

Director of the United States Patent and Trademark Office

# United States of America

United States Patent and Trademark Office

## RETO NORTEÑO BANDA

**Reg. No. 4,197,543**

BARBA OROZCO, JOSE ANTONIO (MEXICO INDIVIDUAL)  
8115 SENATOR ST  
DETROIT, MI 48209

**Registered Aug. 28, 2012**

**Int. Cl.: 41**

FOR: ENTERTAINMENT, NAMELY, LIVE PERFORMANCES BY A MUSICAL BAND, IN CLASS 41 (U.S. CLS. 100, 101 AND 107).

**SERVICE MARK**

FIRST USE 0-0-2008; IN COMMERCE 0-0-2008.

**PRINCIPAL REGISTER**

THE MARK CONSISTS OF STANDARD CHARACTERS WITHOUT CLAIM TO ANY PARTICULAR FONT, STYLE, SIZE, OR COLOR.

NO CLAIM IS MADE TO THE EXCLUSIVE RIGHT TO USE "BANDA", APART FROM THE MARK AS SHOWN.

THE ENGLISH TRANSLATION OF "RETO NORTEÑO BANDA" IN THE MARK IS "CHALLENGE NORTHERN BAND" OR "DARE NORTHERN BAND".

SER. NO. 85-494,665, FILED 12-14-2011.

DAWN HAN, EXAMINING ATTORNEY



*David J. Kybas*

Director of the United States Patent and Trademark Office



# United States of America

United States Patent and Trademark Office



**Reg. No. 4,197,544**

**Registered Aug. 28, 2012**

**Int. Cl.: 36**

**SERVICE MARK**

**PRINCIPAL REGISTER**

GLAXIS CAPITAL MANAGEMENT, LLC (FLORIDA LIMITED LIABILITY COMPANY)  
443 JOHN RINGLING BLVD, SUITE G  
SARASOTA, FL 34236

FOR: FINANCIAL SERVICES, NAMELY, INVESTMENT ADVICE, INVESTMENT MANAGEMENT, INVESTMENT CONSULTATION AND INVESTMENT OF FUNDS FOR OTHERS, INCLUDING PRIVATE AND PUBLIC EQUITY AND DEBT INVESTMENT SERVICES; INVESTMENT ADVISORY SERVICES; INVESTMENT MANAGEMENT, IN CLASS 36 (U.S. CLS. 100, 101 AND 102).

FIRST USE 0-0-2008; IN COMMERCE 0-0-2008.

NO CLAIM IS MADE TO THE EXCLUSIVE RIGHT TO USE "CAPITAL MANAGEMENT, LLC", APART FROM THE MARK AS SHOWN.

THE MARK CONSISTS OF A HIGHLY STYLIZED LETTER "G" TO THE LEFT OF THE STYLIZED WORDING "GLAXIS CAPITAL MANAGEMENT, LLC".

SER. NO. 85-494,667, FILED 12-14-2011.

DAWN HAN, EXAMINING ATTORNEY



*David J. Kyros*

Director of the United States Patent and Trademark Office

# United States of America

United States Patent and Trademark Office

# REALTYSYNC

**Reg. No. 4,197,545**

**Registered Aug. 28, 2012**

**Int. Cl.: 42**

**SERVICE MARK**

**PRINCIPAL REGISTER**

BROKER OFFICE SOLUTIONS, INC. (UTAH CORPORATION)  
11052 SHILLING AVE  
SOUTH JORDAN, UT 84095

FOR: PROVIDING AN ONLINE NON-DOWNLOADABLE INTERNET-BASED SYSTEM APPLICATION FEATURING TECHNOLOGY ENABLING USERS TO MANAGE REAL ESTATE TRANSACTIONS; PROVIDING TEMPORARY USE OF ON-LINE NON-DOWNLOADABLE SOFTWARE AND APPLICATIONS FOR REAL ESTATE BROKERS AND AGENTS TO MANAGE REAL ESTATE TRANSACTIONS, DATA AND DOCUMENTS, IN CLASS 42 (U.S. CLS. 100 AND 101).

FIRST USE 0-0-2009; IN COMMERCE 0-0-2009.

THE MARK CONSISTS OF STANDARD CHARACTERS WITHOUT CLAIM TO ANY PARTICULAR FONT, STYLE, SIZE, OR COLOR.

SER. NO. 85-494,669, FILED 12-14-2011.

DAWN HAN, EXAMINING ATTORNEY



*David J. Kyros*

Director of the United States Patent and Trademark Office

# United States of America

United States Patent and Trademark Office



**Reg. No. 4,197,546**

**Registered Aug. 28, 2012**

**Int. Cl.: 35**

**SERVICE MARK**

**PRINCIPAL REGISTER**

DREAMBOX (SINGAPORE CORPORATION), DBA DREAMBOX MUSIC PTE LTD  
65B PAGODA STREET  
SINGAPORE, SINGAPORE 059224

FOR: WHOLESALE AND RETAIL DISTRIBUTORSHIP SERVICES IN THE FIELD OF MUSICAL AND NON-MUSICAL SOUND RECORDINGS AND VIDEO RECORDINGS; ADVERTISING AND PROMOTION SERVICES AND RELATED CONSULTING SERVICES; ADVERTISING AND PUBLICITY SERVICES; ASSOCIATION SERVICES, NAMELY, PROMOTING THE INTERESTS OF MUSICIANS, SINGERS, SONGWRITERS, MUSICAL PERFORMERS AND ARTISTS; COMPUTERIZED ONLINE ORDERING SERVICES IN THE FIELD OF MUSIC AND ENTERTAINMENT; COMPUTERIZED ONLINE RETAIL STORE SERVICES IN THE FIELD OF MUSIC AND ENTERTAINMENT; ONLINE RETAIL STORE SERVICES FEATURING DOWNLOADABLE PRE-RECORDED MUSIC AND AUDIO-VISUAL CONTENT AND GENERAL MERCHANDISE; ORGANIZATION OF PROMOTIONS USING AUDIO-VISUAL MEDIA; PREPARING AUDIO-VISUAL DISPLAYS IN THE FIELD OF MUSIC; PREPARING AUDIO VISUAL PRESENTATIONS FOR USE IN ADVERTISING; ARRANGING AND CONDUCTING FAIRS AND EXHIBITIONS FOR BUSINESS AND ADVERTISING PURPOSES; PROMOTING THE CONCERTS OF OTHERS; PROMOTING THE GOODS AND SERVICES OF OTHERS BY ARRANGING FOR SPONSORS TO AFFILIATE THEIR GOODS AND SERVICES WITH CONCERTS, MUSICAL AND SPORTS EVENTS; PROMOTING THE GOODS OF OTHERS BY PREPARING AND PLACING ADVERTISEMENTS IN AN ELECTRONIC MAGAZINE ACCESSED THROUGH A GLOBAL COMPUTER NETWORK; PROVIDING INFORMATION ABOUT THE GOODS AND SERVICES OF OTHERS VIA A GLOBAL COMPUTER NETWORK, RETAIL STORE SERVICES AVAILABLE THROUGH COMPUTER COMMUNICATIONS FEATURING CD'S CASSETTES, DVD'S, VIDEOCASSETTES AND LICENSED MERCHANDISE; MANAGEMENT SERVICES FOR PROFESSIONAL AUDIO RECORDING ARTISTS; TALENT AGENCY SERVICES; ADVERTISING, INCLUDING PROMOTION OF PRODUCTS AND SERVICES OF THIRD PARTIES THROUGH SPONSORING ARRANGEMENTS AND LICENSE AGREEMENTS RELATING TO MUSIC EVENTS; PROMOTING MUSIC COMPETITIONS AND EVENTS FOR OTHERS. PROMOTING GOODS AND SERVICES OF OTHERS BY ARRANGING FOR SPONSORS TO AFFILIATE THEIR GOODS AND SERVICES WITH MUSIC COMPETITIONS; PROMOTING THE INTERESTS OF PEOPLE INVOLVED AND CONCERNED WITH MUSIC; PROVIDING ONLINE REGISTRATION SERVICES FOR MUSIC COMPETITIONS; COMMERCIAL ADMINISTRATION OF THE LICENSING OF MUSICAL AND NON-MUSICAL SOUND RECORDINGS, IN CLASS 35 (U.S. CLS. 100, 101 AND 102).



*David J. Kybas*

Director of the United States Patent and Trademark Office

**Reg. No. 4,197,546** FIRST USE 5-1-2007; IN COMMERCE 5-1-2007.

THE MARK CONSISTS OF LETTERS "D" AND "B" IN LOWER CASE ABOVE WORD "DREAMBOX". "DREAMBOX" BEARING CAPITAL LETTER FOR ENTIRE WORD "DREAMBOX" SPELT AS SINGLE WORD "DREAMBOX" LETTERS "D" AND "B" IN BIGGER FONT SIZE.

SER. NO. 85-494,725, FILED 12-14-2011.

SOPHIA S. KIM, EXAMINING ATTORNEY

# United States of America

United States Patent and Trademark Office

## AFRICAN MANGO FUSION

**Reg. No. 4,197,547**

**Registered Aug. 28, 2012**

**Int. Cl.: 5**

**TRADEMARK**

**PRINCIPAL REGISTER**

NUTRI-FUSION SYSTEMS, INC. (UTAH CORPORATION), DBA HCG FUSION  
9854 SOUTH 700 EAST, #2  
SANDY, UT 84070

FOR: DIETARY AND NUTRITIONAL SUPPLEMENTS CONTAINING AFRICAN MANGO; SUPPLEMENTS AND NUTRITIONAL PREPARATIONS FOR USE IN WEIGHT MANAGEMENT AND DIETING CONTAINING AFRICAN MANGO; VITAMINS, HERBS AND MINERALS FOR USE IN DIETARY AND NUTRITIONAL SUPPLEMENTS CONTAINING AFRICAN MANGO; NUTRITIONAL SUPPLEMENTS FOR USE AS A MEAL REPLACEMENT CONTAINING AFRICAN MANGO; DIETING CAPSULES, PILLS, AND POWDER PREPARATIONS CONTAINING AFRICAN MANGO TO PROMOTE WEIGHT LOSS, IN CLASS 5 (U.S. CLS. 6, 18, 44, 46, 51 AND 52).

FIRST USE 12-13-2011; IN COMMERCE 12-13-2011.

THE MARK CONSISTS OF STANDARD CHARACTERS WITHOUT CLAIM TO ANY PARTICULAR FONT, STYLE, SIZE, OR COLOR.

NO CLAIM IS MADE TO THE EXCLUSIVE RIGHT TO USE "AFRICAN MANGO", APART FROM THE MARK AS SHOWN.

SER. NO. 85-495,035, FILED 12-14-2011.

KELLY BOULTON, EXAMINING ATTORNEY



*David J. Kyffers*

Director of the United States Patent and Trademark Office

# United States of America

United States Patent and Trademark Office

# AIM MRO

**Reg. No. 4,197,548**

AIM MRO HOLDINGS, INC. (OHIO CORPORATION)  
8500 GLENDALE-MILFORD ROAD  
CAMP DENNISON, OH 45111

**Registered Aug. 28, 2012**

**Int. Cl.: 35**

FOR: BUSINESS SERVICES, NAMELY, PROVIDING INFORMATION IN RELATION TO RESOURCE PLANNING, REPAIR SCHEDULING, QUALITY MANAGEMENT, MATERIALS MANAGEMENT, VENDOR MANAGEMENT, AND SUPPLIER MANAGEMENT FOR THE MANUFACTURE AND REPAIR OF TURBINES, IN CLASS 35 (U.S. CLS. 100, 101 AND 102).

**SERVICE MARK**

**PRINCIPAL REGISTER**

FIRST USE 12-15-2006; IN COMMERCE 12-15-2006.

THE MARK CONSISTS OF STANDARD CHARACTERS WITHOUT CLAIM TO ANY PARTICULAR FONT, STYLE, SIZE, OR COLOR.

NO CLAIM IS MADE TO THE EXCLUSIVE RIGHT TO USE "MRO", APART FROM THE MARK AS SHOWN.

SER. NO. 85-495,095, FILED 12-14-2011.

SUNG IN, EXAMINING ATTORNEY



*David J. Kypos*

Director of the United States Patent and Trademark Office

# United States of America

United States Patent and Trademark Office

# AIM MRO

**Reg. No. 4,197,549**

AIM MRO HOLDINGS, INC. (OHIO CORPORATION)  
8500 GLENDALE-MILFORD ROAD  
CAMP DENNISON, OH 45111

**Registered Aug. 28, 2012**

**Int. Cl.: 42**

FOR: QUALITY CONTROL FOR OTHERS, IN CLASS 42 (U.S. CLS. 100 AND 101).

**SERVICE MARK**

FIRST USE 12-15-2006; IN COMMERCE 12-15-2006.

**PRINCIPAL REGISTER**

THE MARK CONSISTS OF STANDARD CHARACTERS WITHOUT CLAIM TO ANY PARTICULAR FONT, STYLE, SIZE, OR COLOR.

NO CLAIM IS MADE TO THE EXCLUSIVE RIGHT TO USE "MRO", APART FROM THE MARK AS SHOWN.

SER. NO. 85-495,104, FILED 12-14-2011.

SUNG IN, EXAMINING ATTORNEY



*David J. Kyffers*

Director of the United States Patent and Trademark Office

# United States of America

United States Patent and Trademark Office

# CHANTIQUE

**Reg. No. 4,197,550**

DEWI METRA (UNITED STATES INDIVIDUAL)  
1556 PINE CONE TRAIL  
PORT WASHINGTON, WI 53074

**Registered Aug. 28, 2012**

**Int. Cls.: 18 and 25**

FOR: BAGS, NAMELY, HANDBAGS, PURSES, WALLETS, BACKPACKS, TOTE BAGS, BRIEFCASES, IN CLASS 18 (U.S. CLS. 1, 2, 3, 22 AND 41).

**TRADEMARK**

FIRST USE 11-30-2004; IN COMMERCE 11-30-2004.

**PRINCIPAL REGISTER**

FOR: CLOTHING AND ACCESSORIES, NAMELY, TOPS, SHIRTS, TEE SHIRTS, T-SHIRTS, TANK TOPS, TUNICS, POLO SHIRTS, SWEATERS, HOODED SWEATSHIRTS, SWEATSHIRTS, SCRUB TOPS NOT FOR MEDICAL PURPOSES, CARDIGANS, SHRUGS, VESTS, JACKETS, BLAZERS; OUTERWEAR, NAMELY, JACKETS, BLAZERS, COATS, VESTS; BOTTOMS, SKIRTS, PANTS, CAPRIS, SHORTS, SKORTS, SCRUB BOTTOMS NOT FOR MEDICAL PURPOSES, DENIMS, JEANS, SUITS, JUMPSUITS, ROMPERS, DRESSES, GOWNS, WEDDING GOWNS, WEDDING DRESSES, LOUNGEWEAR, SLEEPWEAR, PAJAMAS, NIGHTGOWNS, CHEMISES, BABY DOLL PAJAMAS, SLEEPSHIRTS, ROBES, UNDERSHIRTS, CAMISOLES, UNDERWEAR, BRAS, SWIMWEAR; MATERNITY WEAR, NAMELY, TOPS, SHIRTS, SWEATERS, SWEATSHIRTS, PANTS, SHORTS, SKIRTS, DRESSES, PAJAMAS, NIGHTGOWNS; SCARVES, SHAWLS, WRAPS, BANDANAS, TIES, LEG WEAR, NAMELY, LEGGINGS, TIGHTS, SOCKS, PANTYHOSE; FOOTWEAR; HEADBANDS, HEADWEAR, HATS, CAPS, BELTS, APRONS, IN CLASS 25 (U.S. CLS. 22 AND 39).

FIRST USE 11-30-2004; IN COMMERCE 11-30-2004.

THE MARK CONSISTS OF STANDARD CHARACTERS WITHOUT CLAIM TO ANY PARTICULAR FONT, STYLE, SIZE, OR COLOR.

OWNER OF U.S. REG. NO. 2,428,392.

SER. NO. 85-495,175, FILED 12-14-2011.

RONALD DELGIZZI, EXAMINING ATTORNEY



*David J. Kyffers*

Director of the United States Patent and Trademark Office



# United States of America

United States Patent and Trademark Office

## Legends of Russian Ballet

**Reg. No. 4,197,551**

**Registered Aug. 28, 2012**

**Int. Cl.: 41**

**SERVICE MARK**

**PRINCIPAL REGISTER**

KRAOR MEAT, INC. (FLORIDA CORPORATION), DBA KRAOR PROMOTIONS, INC.  
SUITE A  
1483 LAKE BALDWIN LANE  
ORLANDO, FL 32814

FOR: ENTERTAINMENT IN THE NATURE OF BALLET PERFORMANCES, IN CLASS 41  
(U.S. CLS. 100, 101 AND 107).

FIRST USE 10-14-2011; IN COMMERCE 10-14-2011.

THE MARK CONSISTS OF STANDARD CHARACTERS WITHOUT CLAIM TO ANY PARTICULAR FONT, STYLE, SIZE, OR COLOR.

NO CLAIM IS MADE TO THE EXCLUSIVE RIGHT TO USE "RUSSIAN BALLET", APART FROM THE MARK AS SHOWN.

SER. NO. 85-495,352, FILED 12-14-2011.

NORA BUCHANAN WILL, EXAMINING ATTORNEY



*David J. Kyffers*

Director of the United States Patent and Trademark Office

# United States of America

United States Patent and Trademark Office

## American Funds Portfolio Resources

**Reg. No. 4,197,552**

**Registered Aug. 28, 2012**

**Int. Cl.: 36**

**SERVICE MARK**

**PRINCIPAL REGISTER**

AMERICAN FUNDS DISTRIBUTORS, INC. (CALIFORNIA CORPORATION)  
ATTN: DAVID M. GIVNER  
333 S. HOPE ST., 55TH FLOOR  
LOS ANGELES, CA 90071

FOR: FINANCIAL SERVICES, NAMELY, FINANCIAL ANALYSIS, EVALUATION AND CONSULTATION; INVESTMENT MANAGEMENT AND ADVICE; MUTUAL FUND INVESTMENT MANAGEMENT AND DISTRIBUTION; ANNUITY SERVICES, NAMELY, INVESTMENT MANAGEMENT AND DISTRIBUTION OF VARIABLE ANNUITIES; FIDUCIARY SERVICES, NAMELY, SERVING AS TRUSTEE FOR DIRECTED AND DISCRETIONARY TRUST ACCOUNTS; ESTATE PLANNING; AND FINANCIAL ADMINISTRATION OF EMPLOYEE BENEFIT, PENSION AND RETIREMENT PLANS IN CONNECTION THEREWITH, IN CLASS 36 (U.S. CLS. 100, 101 AND 102).

FIRST USE 5-12-2011; IN COMMERCE 5-12-2011.

THE MARK CONSISTS OF STANDARD CHARACTERS WITHOUT CLAIM TO ANY PARTICULAR FONT, STYLE, SIZE, OR COLOR.

OWNER OF U.S. REG. NOS. 2,627,929, 3,563,152 AND OTHERS.

NO CLAIM IS MADE TO THE EXCLUSIVE RIGHT TO USE "PORTFOLIO RESOURCES", APART FROM THE MARK AS SHOWN.

SEC. 2(F) AS TO "AMERICAN FUNDS".

SER. NO. 85-495,488, FILED 12-14-2011.

RAMONA ORTIGA, EXAMINING ATTORNEY



*David J. Kyffers*

Director of the United States Patent and Trademark Office

# United States of America

United States Patent and Trademark Office

## Giving To Those Who Give

**Reg. No. 4,197,553**

NATIONAL OBESITY FOUNDATION (CALIFORNIA CORPORATION)  
4333 ADMIRALTY WAY HELIX 9  
MARINA DEL REY, CA 90292

**Registered Aug. 28, 2012**

**Int. Cl.: 44**

FOR: CHARITABLE SERVICES, NAMELY, PROVIDING BARIATRIC MEDICAL AND SURGICAL SERVICES TO DESERVING INDIVIDUALS, IN CLASS 44 (U.S. CLS. 100 AND 101).

**SERVICE MARK**

FIRST USE 12-5-2011; IN COMMERCE 12-5-2011.

**PRINCIPAL REGISTER**

THE MARK CONSISTS OF STANDARD CHARACTERS WITHOUT CLAIM TO ANY PARTICULAR FONT, STYLE, SIZE, OR COLOR.

SER. NO. 85-495,707, FILED 12-14-2011.

ALYSSA STEEL, EXAMINING ATTORNEY



*David J. Kyjars*

Director of the United States Patent and Trademark Office

# United States of America

United States Patent and Trademark Office



**boys team**  
c h a r i t y

**Reg. No. 4,197,554**

**Registered Aug. 28, 2012**

**Int. Cl.: 35**

**SERVICE MARK**

**PRINCIPAL REGISTER**

BOYS TEAM CHARITY, INC. (ARIZONA CHARITABLE, NON-PROFIT CORPORATION)  
P.O. BOX 5145  
SCOTTSDALE, AZ 85261

FOR: CHARITABLE SERVICES, NAMELY, ORGANIZING, DEVELOPING AND CONDUCTING VOLUNTEER PROGRAMS, COMMUNITY SERVICE PROJECTS, AND COORDINATION OF NON-MONETARY CONTRIBUTIONS TO CHARITIES AND NON-PROFITS, AND ONLINE MEMBERSHIP RESOURCES IN THE NATURE OF A WEBSITE FOR CONNECTING PEOPLE WHO HAVE SERVICE NEEDS WITH PEOPLE WHO ARE WILLING TO PROVIDE VOLUNTEER SERVICES, IN CLASS 35 (U.S. CLS. 100, 101 AND 102).

FIRST USE 11-29-2001; IN COMMERCE 11-29-2001.

NO CLAIM IS MADE TO THE EXCLUSIVE RIGHT TO USE "BOYS TEAM CHARITY", APART FROM THE MARK AS SHOWN.

THE MARK CONSISTS OF THE WORDING "BOYS TEAM CHARITY" IN A STYLIZED FONT AND A DESIGN THAT CONSISTS OF TWO ENCIRCLING STYLIZED WINGS WITH FOUR FEATHERS EACH.

SER. NO. 85-495,886, FILED 12-15-2011.

RENEE MCCRAY, EXAMINING ATTORNEY



*David J. Kyffers*

Director of the United States Patent and Trademark Office

# United States of America

United States Patent and Trademark Office

## FloraMend Prime Probiotic

**Reg. No. 4,197,555**

THORNE RESEARCH, INC. (IDAHO CORPORATION)  
25820 HIGHWAY 2 WEST  
SANDPOINT, ID 83864

**Registered Aug. 28, 2012**

**Int. Cl.: 5**

FOR: DIETARY AND NUTRITIONAL SUPPLEMENTS; DIETARY AND NUTRITIONAL SUPPLEMENTS CONTAINING A PROPRIETARY BLEND OF PROBIOTIC BACTERIA; DIETARY SUPPLEMENTS; NUTRITIONAL SUPPLEMENTS; NUTRITIONAL SUPPLEMENTS FOR PROMOTING GASTROINTESTINAL HEALTH; NUTRITIONAL SUPPLEMENTS, NAMELY, PROBIOTIC COMPOSITIONS, IN CLASS 5 (U.S. CLS. 6, 18, 44, 46, 51 AND 52).

**TRADEMARK**

**PRINCIPAL REGISTER**

FIRST USE 12-5-2011; IN COMMERCE 12-5-2011.

THE MARK CONSISTS OF STANDARD CHARACTERS WITHOUT CLAIM TO ANY PARTICULAR FONT, STYLE, SIZE, OR COLOR.

NO CLAIM IS MADE TO THE EXCLUSIVE RIGHT TO USE "PROBIOTIC", APART FROM THE MARK AS SHOWN.

SER. NO. 85-496,139, FILED 12-15-2011.

KATHERINE CONNOLLY, EXAMINING ATTORNEY



*David J. Kyros*

Director of the United States Patent and Trademark Office

# United States of America

United States Patent and Trademark Office

# AYT

**Reg. No. 4,197,556**

**Registered Aug. 28, 2012**

**Int. Cl.: 37**

**SERVICE MARK**

**PRINCIPAL REGISTER**

GARY ZHU (UNITED STATES INDIVIDUAL)  
6135 BURNETT STREET  
ALEXANDRA, VA 22310

FOR: AUTO SERVICE, NAMELY, AUTOMOBILE REPAIR AND MAINTENANCE; AUTO BODY WORK, NAMELY, AUTOMOBILE BODY REPAIR AND FINISHING FOR OTHERS; AUTOMOBILE PAINTING; AUTOMOBILE CUSTOMIZATION SERVICES; AUTOMOBILE DETAILING; TIRE ROTATING AND BALANCING, IN CLASS 37 (U.S. CLS. 100, 103 AND 106).

FIRST USE 1-2-1992; IN COMMERCE 1-2-1992.

THE MARK CONSISTS OF STANDARD CHARACTERS WITHOUT CLAIM TO ANY PARTICULAR FONT, STYLE, SIZE, OR COLOR.

SER. NO. 85-496,194, FILED 12-15-2011.

GINA FINK, EXAMINING ATTORNEY



*David J. Kyffers*

Director of the United States Patent and Trademark Office

# United States of America

United States Patent and Trademark Office

my1Story

**Reg. No. 4,197,557**

MY1STORY, LLC (FLORIDA LIMITED LIABILITY COMPANY)  
6555 POWERLINE ROAD, SUITE 113  
FORT LAUDERDALE, FL 33309

**Registered Aug. 28, 2012**

**Int. Cls.: 16 and 28**

FOR: CHILDREN'S ACTIVITY BOOKS; CHILDREN'S BOOKS, IN CLASS 16 (U.S. CLS. 2, 5, 22, 23, 29, 37, 38 AND 50).

**TRADEMARK**

FIRST USE 6-1-2011; IN COMMERCE 6-1-2011.

**PRINCIPAL REGISTER**

FOR: PLUSH TOYS; PUZZLES, IN CLASS 28 (U.S. CLS. 22, 23, 38 AND 50).

FIRST USE 6-1-2011; IN COMMERCE 6-1-2011.

OWNER OF U.S. REG. NOS. 3,704,637 AND 3,809,076.

THE COLOR(S) LIME GREEN, PURPLE AND ORANGE IS/ARE CLAIMED AS A FEATURE OF THE MARK.

THE MARK CONSISTS OF THE STYLIZED LETTERS "MY1STORY" WITH "MY" IN LIME GREEN, "1ST" IN PURPLE AND "ORY" IN ORANGE.

SER. NO. 85-496,293, FILED 12-15-2011.

SUSAN RICHARDS, EXAMINING ATTORNEY



*David J. Kyffers*

Director of the United States Patent and Trademark Office

# United States of America

United States Patent and Trademark Office

## ArchitectureBoston

**Reg. No. 4,197,558**

**Registered Aug. 28, 2012**

**Int. Cl.: 16**

**TRADEMARK**

**PRINCIPAL REGISTER**

THE BOSTON SOCIETY OF ARCHITECTS (MASSACHUSETTS CORPORATION)  
290 CONGRESS STREET  
BOSTON, MA 022101033

FOR: MAGAZINES IN THE FIELD OF ARCHITECTURE, IN CLASS 16 (U.S. CLS. 2, 5, 22, 23, 29, 37, 38 AND 50).

FIRST USE 6-30-1998; IN COMMERCE 6-30-1998.

THE MARK CONSISTS OF STANDARD CHARACTERS WITHOUT CLAIM TO ANY PARTICULAR FONT, STYLE, SIZE, OR COLOR.

SEC. 2(F).

SER. NO. 85-496,308, FILED 12-15-2011.

HELENE LIWINSKI, EXAMINING ATTORNEY



*David J. Kybas*

Director of the United States Patent and Trademark Office



# United States of America

United States Patent and Trademark Office

# NUTRIBANK

**Reg. No. 4,197,559**

**Registered Aug. 28, 2012**

**Int. Cls.: 35 and 36**

**SERVICE MARK**

**PRINCIPAL REGISTER**

NUTRI/SYSTEM IPHC, INC. (DELAWARE CORPORATION)  
SUITE 322  
1011 CENTRE ROAD  
WILMINGTON, DE 19805

FOR: CHARITABLE SERVICES, NAMELY, COORDINATION OF NON-MONETARY CONTRIBUTIONS TO CHARITIES AND NON-PROFIT ORGANIZATIONS, IN CLASS 35 (U.S. CLS. 100, 101 AND 102).

FIRST USE 12-15-2011; IN COMMERCE 12-15-2011.

FOR: CHARITABLE SERVICES, NAMELY, COORDINATION OF MONETARY CONTRIBUTIONS TO CHARITIES AND NON-PROFIT ORGANIZATIONS, IN CLASS 36 (U.S. CLS. 100, 101 AND 102).

FIRST USE 12-15-2011; IN COMMERCE 12-15-2011.

THE MARK CONSISTS OF STANDARD CHARACTERS WITHOUT CLAIM TO ANY PARTICULAR FONT, STYLE, SIZE, OR COLOR.

SER. NO. 85-496,337, FILED 12-15-2011.

JAY FLOWERS, EXAMINING ATTORNEY



*David J. Kyfos*

Director of the United States Patent and Trademark Office

# United States of America

United States Patent and Trademark Office

## COLLEGE CHANGES EVERYTHING

**Reg. No. 4,197,560**

**Registered Aug. 28, 2012**

**Int. Cl.: 41**

**SERVICE MARK**

**PRINCIPAL REGISTER**

ILLINOIS STUDENT ASSISTANCE COMMISSION (ILLINOIS STATE AGENCY)  
1755 LAKE COOK ROAD  
DEERFIELD, IL 600155206

FOR: EDUCATIONAL SERVICES, NAMELY, CREATING CURRICULA, CONDUCTING CLASSES, LECTURES, SEMINARS, TRAINING PROGRAMS, PROFESSIONAL DEVELOPMENT PROGRAMS AND WORKSHOPS RELATING TO POSTSECONDARY FINANCING, POSTSECONDARY ENROLLMENT, POST SECONDARY EDUCATION AND POST SECONDARY COMPLETION, IN CLASS 41 (U.S. CLS. 100, 101 AND 107).

FIRST USE 3-17-2011; IN COMMERCE 7-21-2011.

THE MARK CONSISTS OF STANDARD CHARACTERS WITHOUT CLAIM TO ANY PARTICULAR FONT, STYLE, SIZE, OR COLOR.

SER. NO. 85-496,417, FILED 12-15-2011.

PAM WILLIS, EXAMINING ATTORNEY



*David J. Kyffers*

Director of the United States Patent and Trademark Office

# United States of America

United States Patent and Trademark Office



**Reg. No. 4,197,561**

**Registered Aug. 28, 2012**

**Int. Cl.: 41**

APEGA: SOCIEDAD PERUANA DE GASTRONOMIA ASOCIACION CIVIL (PERU CIVIL ASSOCIATION)  
AVENIDA DEL PARQUE NORTE NO. 829  
URBANIZACION CORPAC  
SAN ISIDRO, LIMA, PERU

**SERVICE MARK**

FOR: ORGANIZATION OF EVENTS, FAIRS, AND CONTESTS ALL FOR CULTURAL PURPOSES, IN CLASS 41 (U.S. CLS. 100, 101 AND 107).

**PRINCIPAL REGISTER**

OWNER OF PERU REG. NO. 63070, DATED 8-12-2010, EXPIRES 8-12-2020.

THE COLOR(S) YELLOW AND PINK IS/ARE CLAIMED AS A FEATURE OF THE MARK.

THE MARK CONSISTS OF THE WORDING "MISTURA" IN A STYLIZED FORMAT ABOVE A CURVED LINE, BOTH INSIDE A RECTANGLE. THE WORDING "MISTURA" AND THE CURVED LINE APPEAR IN YELLOW AND THE RECTANGLE APPEARS IN PINK.

THE ENGLISH TRANSLATION OF "MISTURA" IN THE MARK IS "MIXTURE".

SER. NO. 85-496,646, FILED 12-15-2011.

JESSICA FATHY, EXAMINING ATTORNEY



*David J. Kyffers*

Director of the United States Patent and Trademark Office

# United States of America

United States Patent and Trademark Office

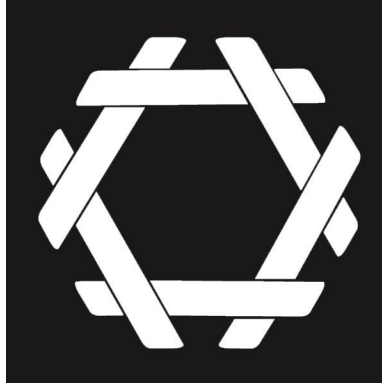

**Reg. No. 4,197,562**

**Registered Aug. 28, 2012**

**Int. Cl.: 9**

**TRADEMARK**

**PRINCIPAL REGISTER**

LIU, RICHARD C. (UNITED STATES INDIVIDUAL)  
520 NATOMA ST. #6  
SAN FRANCISCO, CA 94103

FOR: CAMERAS AND CAMERA ACCESSORIES, NAMELY, CASES, BAGS, STRAPS, AND  
CABLE RELEASES, IN CLASS 9 (U.S. CLS. 21, 23, 26, 36 AND 38).

FIRST USE 2-15-2011; IN COMMERCE 12-3-2011.

THE MARK CONSISTS OF A SINGLE HEXAGONAL SHAPE CREATED BY SIX OVERLAP-  
PING LINES THAT EXTEND OVER THE EDGES OF EACH CONNECTING LINES.

SER. NO. 85-496,947, FILED 12-16-2011.

SOPHIA S. KIM, EXAMINING ATTORNEY



*David J. Kyffers*

Director of the United States Patent and Trademark Office

# United States of America

United States Patent and Trademark Office

# DSPTCH

**Reg. No. 4,197,563**

LIU, RICHARD C. (UNITED STATES INDIVIDUAL)  
520 NATOMA ST. #6  
SAN FRANCISCO, CA 94103

**Registered Aug. 28, 2012**

**Int. Cl.: 9**

FOR: CAMERAS AND CAMERA ACCESSORIES, NAMELY, CASES, BAGS, STRAPS, AND CABLE RELEASES, IN CLASS 9 (U.S. CLS. 21, 23, 26, 36 AND 38).

**TRADEMARK**

FIRST USE 12-29-2010; IN COMMERCE 12-3-2011.

**PRINCIPAL REGISTER**

THE MARK CONSISTS OF STANDARD CHARACTERS WITHOUT CLAIM TO ANY PARTICULAR FONT, STYLE, SIZE, OR COLOR.

SER. NO. 85-496,957, FILED 12-16-2011.

SOPHIA S. KIM, EXAMINING ATTORNEY



*David J. Kyffers*

Director of the United States Patent and Trademark Office

# United States of America

United States Patent and Trademark Office

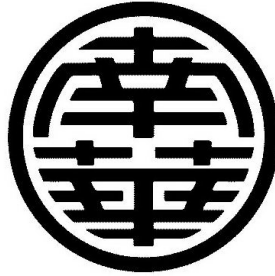

**Reg. No. 4,197,564**

**Registered Aug. 28, 2012**

**Int. Cl.: 43**

**SERVICE MARK**

**PRINCIPAL REGISTER**

NOM WAH DIM SUM PARLOR INC. (NEW YORK CORPORATION), DBA NOM WAH TEA  
PARLOR  
13 DOYERS STREET  
NEW YORK, NY 10013

FOR: RESTAURANT SERVICES, IN CLASS 43 (U.S. CLS. 100 AND 101).

FIRST USE 0-0-1920; IN COMMERCE 0-0-1920.

THE MARK CONSISTS OF A DESIGN OF CHINESE CHARACTERS.

THE NON-LATIN CHARACTERS IN THE MARK TRANSLITERATE TO "NOM WAH" AND  
THIS HAS NO MEANING IN A FOREIGN LANGUAGE.

SER. NO. 85-497,237, FILED 12-16-2011.

NANCY CLARKE, EXAMINING ATTORNEY



*David J. Kybas*

Director of the United States Patent and Trademark Office

# United States of America

United States Patent and Trademark Office



**Reg. No. 4,197,565**

**Registered Aug. 28, 2012**

**Int. Cl.: 36**

**SERVICE MARK**

**PRINCIPAL REGISTER**

GLENDONTODD CAPITAL LLC (TEXAS LIMITED LIABILITY COMPANY)  
2101 CEDAR SPRINGS ROAD, SUITE 1540  
DALLAS, TX 752012164

FOR: FINANCIAL SERVICES, NAMELY, PRIVATE AND PUBLIC EQUITY AND DEBT INVESTMENT, IN CLASS 36 (U.S. CLS. 100, 101 AND 102).

FIRST USE 1-12-2011; IN COMMERCE 1-12-2011.

NO CLAIM IS MADE TO THE EXCLUSIVE RIGHT TO USE "CAPITAL", APART FROM THE MARK AS SHOWN.

THE COLOR(S) GREEN, BLUE, BLACK AND WHITE IS/ARE CLAIMED AS A FEATURE OF THE MARK.

THE MARK CONSISTS OF A GREEN AND WHITE BULLS-EYE WITH BLUE ARROW IN CENTER TO THE LEFT OF BLACK UNDERLINED "GLENDONTODD" IN GREEN LETTERING WITH "CAPITAL" DIRECTLY BELOW IN BLUE.

SER. NO. 85-497,337, FILED 12-16-2011.

JACQUELINE A. LAVINE, EXAMINING ATTORNEY



*David J. Kybas*

Director of the United States Patent and Trademark Office

# United States of America

United States Patent and Trademark Office

## THE COMMUNAL PANTRY

**Reg. No. 4,197,566**

ZOBITZ, ELIZABETH ANN (UNITED STATES INDIVIDUAL)  
43 FERNWOOD ROAD  
SUMMIT, NJ 07901

**Registered Aug. 28, 2012**

**Int. Cl.: 41**

FOR: ENTERTAINMENT SERVICES, NAMELY, PROVIDING INFORMATION BY MEANS OF A GLOBAL COMPUTER NETWORK IN THE FIELDS OF CELEBRITIES, ENTERTAINMENT, AND POPULAR CULTURE; ENTERTAINMENT SERVICES, NAMELY, THE PROVISION OF CONTINUING PROGRAM FEATURING FOOD RELATED COMMENTARY DELIVERED BY INTERNET; INTERACTIVE ONLINE WEB JOURNALS FEATURING FOOD RELATED PERSONAL STORIES, RELATIONSHIPS AND TRAVEL; PROVIDING AN INTERNET WEBSITE PORTAL IN THE FIELD OF ENTERTAINMENT, CULTURAL AND SPORTING EVENTS; PROVIDING AN ONLINE MONTHLY COLUMN IN THE FIELD OF FOOD, BAKING AND COOKING IN COMBINATION WITH WORLD ADVENTURES AND EXPLORATION; PROVIDING INFORMATION RELATING TO ORGANIZING COMMUNITY SPORTING AND CULTURAL ACTIVITIES, CONTESTS AND GAMES; PROVIDING INFORMATION, NEWS AND COMMENTARY IN THE FIELD OF RECREATION AND LEISURE ACTIVITIES, IN CLASS 41 (U.S. CLS. 100, 101 AND 107).

**SERVICE MARK**

**PRINCIPAL REGISTER**

FIRST USE 1-1-2011; IN COMMERCE 9-1-2011.

THE MARK CONSISTS OF STANDARD CHARACTERS WITHOUT CLAIM TO ANY PARTICULAR FONT, STYLE, SIZE, OR COLOR.

SER. NO. 85-497,472, FILED 12-16-2011.

CURTIS FRENCH, EXAMINING ATTORNEY



*David J. Kyffers*

Director of the United States Patent and Trademark Office



# United States of America

United States Patent and Trademark Office

# MYDEALBAG

**Reg. No. 4,197,567**

**Registered Aug. 28, 2012**

**Int. Cls.: 35 and 42**

**SERVICE MARK**

**PRINCIPAL REGISTER**

7736568 CANADA INC. (CANADA CORPORATION), DBA MYDEALBAG MEDIA  
SUITE 2360  
555 WEST HASTINGS STREET  
VANCOUVER, CANADA V6B4N5

FOR: PROMOTING THE GOODS AND SERVICES OF OTHERS, NAMELY, COLLECTING, COMPILING AND DISSEMINATING INFORMATION REGARDING DISCOUNTS, DEALS, COUPONS, REBATES, VOUCHERS AND SPECIAL OFFERS FOR THE GOODS AND SERVICES OF OTHERS; ADVERTISING AND PROMOTIONAL SERVICES, NAMELY, PROMOTING GOODS AND SERVICES OF THIRD PARTY MERCHANTS AND VENDORS THROUGH THE INTERNET, WEBSITES, MOBILE APPLICATIONS; ADMINISTRATION OF A PROGRAM FOR ENABLING PARTICIPANTS TO OBTAIN DISCOUNTS ON PRODUCTS AND SERVICES; ADVERTISING, NAMELY, PROMOTING THE SALE OF ARTICLES AND SERVICES FOR THIRD PARTIES BY THE TRANSMISSION OF ADVERTISING MATERIAL AND THE DISSEMINATION OF ADVERTISING MESSAGES ON COMPUTER NETWORKS; BUSINESS CONSULTING IN THE FIELD OF BUSINESS NETWORKING; ADVERTISING THE WARES AND SERVICES OF OTHERS, NAMELY, DISSEMINATION OF ADVERTISING MATTER; ELECTRONIC COMMERCE SERVICES, NAMELY, PROVIDING INFORMATION ABOUT PRODUCTS VIA TELECOMMUNICATION NETWORKS FOR ADVERTISING AND SALES PURPOSES; GENERAL BUSINESS NETWORKING REFERRAL SERVICES, NAMELY, PROMOTING THE GOODS AND SERVICES OF OTHERS BY PASSING BUSINESS LEADS AND REFERRALS AMONG GROUP MEMBERS; ADVERTISING THE WARES AND SERVICES OF OTHERS, NAMELY, ONLINE ADVERTISING VIA A COMPUTER COMMUNICATIONS NETWORK; PREPARING AND PLACING OF ADVERTISEMENTS FOR OTHERS; PROVIDING A SEARCHABLE ON-LINE ADVERTISING WEBSITE AND GUIDE FEATURING THE GOODS AND SERVICES OF OTHER VENDORS VIA THE INTERNET; PROVIDING AN ON-LINE DIRECTORY INFORMATION SERVICE FEATURING INFORMATION REGARDING BARGAINS, DISCOUNTS, REBATES, COUPONS, SALE ITEMS AND GOODS AND SERVICES OF OTHERS; PROVIDING CONSUMER INFORMATION SERVICES AND MAKING REFERRALS IN THE FIELD OF ENTERTAINMENT SERVICES FOR PRODUCTS, SERVICES, EVENTS, ACTIVITIES, FACILITIES AND LOCATIONS; PROVIDING INFORMATION ABOUT COMMERCIAL BUSINESS AND COMMERCIAL INFORMATION VIA THE GLOBAL COMPUTER NETWORK, IN CLASS 35 (U.S. CLS. 100, 101 AND 102).

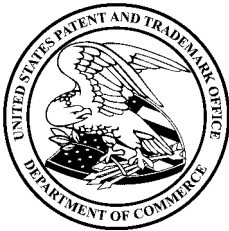

*David J. Kyjars*

FIRST USE 5-1-2011; IN COMMERCE 5-1-2011.

**Reg. No. 4,197,567** FOR: COMPUTER SERVICES IN THE NATURE OF CUSTOMIZED WEB PAGES FEATURING USER-DEFINED INFORMATION, PERSONAL PROFILES AND INFORMATION; PROVIDING A WEBSITE FEATURING A MEDIA AGGREGATOR AND SEARCH ENGINE FOR INTERNET CONTENT; PROVIDING INFORMATION AT THE SPECIFIC REQUEST OF END-USERS BY MEANS OF TELEPHONE OR GLOBAL COMPUTER NETWORKS, IN CLASS 42 (U.S. CLS. 100 AND 101).

FIRST USE 5-1-2011; IN COMMERCE 5-1-2011.

THE MARK CONSISTS OF STANDARD CHARACTERS WITHOUT CLAIM TO ANY PARTICULAR FONT, STYLE, SIZE, OR COLOR.

PRIORITY CLAIMED UNDER SEC. 44(D) ON CANADA APPLICATION NO. 1550265, FILED 11-1-2011.

SER. NO. 85-497,493, FILED 12-16-2011.

RONALD MCMORROW, EXAMINING ATTORNEY

# United States of America

United States Patent and Trademark Office

# Calorie Camp

**Reg. No. 4,197,568**

**Registered Aug. 28, 2012**

**Int. Cls.: 44 and 45**

**SERVICE MARK**

**PRINCIPAL REGISTER**

ABOUT, INC. (DELAWARE CORPORATION)  
620 EIGHTH AVENUE  
NEW YORK, NY 10018

FOR: PROVIDING A WEBSITE THAT OFFERS GUIDANCE, ADVICE AND INFORMATION IN THE FIELDS OF HEALTH, NUTRITION, WEIGHT LOSS DIETING, AND WELLNESS; PROVIDING INFORMATION IN THE FIELDS OF HEALTH, NUTRITION, WEIGHT LOSS, DIETING AND WELLNESS; PROVIDING INFORMATION, NEWS AND COMMENTARY IN THE FIELDS OF HEALTH, NUTRITION, WEIGHT LOSS, DIETING AND WELLNESS, IN CLASS 44 (U.S. CLS. 100 AND 101).

FIRST USE 12-16-2011; IN COMMERCE 12-16-2011.

FOR: ONLINE SOCIAL NETWORKING SERVICES; ONLINE SOCIAL NETWORKING SERVICES IN THE FIELDS OF HEALTH, NUTRITION, WEIGHT LOSS, DIETING AND WELLNESS; ORGANIZING AND CONDUCTING ONLINE WEBSITE-BASED SUPPORT GROUPS IN THE FIELDS OF HEALTH, NUTRITION, WEIGHT LOSS DIETING, AND WELLNESS, IN CLASS 45 (U.S. CLS. 100 AND 101).

FIRST USE 11-16-2011; IN COMMERCE 11-16-2011.

THE MARK CONSISTS OF STANDARD CHARACTERS WITHOUT CLAIM TO ANY PARTICULAR FONT, STYLE, SIZE, OR COLOR.

SER. NO. 85-497,534, FILED 12-16-2011.

BENJAMIN OKEKE, EXAMINING ATTORNEY



*David J. Kyros*

Director of the United States Patent and Trademark Office

# United States of America

United States Patent and Trademark Office

## NEW YORK CITY GUITAR SCHOOL

**Reg. No. 4,197,569**

**Registered Aug. 28, 2012**

**Int. Cl.: 41**

**SERVICE MARK**

**PRINCIPAL REGISTER**

NEW YORK CITY GUITAR SCHOOL, INC. (NEW YORK CORPORATION)  
11TH FLOOR  
251 WEST 30TH STREET  
NEW YORK, NY 10001

FOR: EDUCATIONAL SERVICES, NAMELY, CONDUCTING INDIVIDUAL LESSONS, GROUP CLASSES AND WORKSHOPS IN THE FIELDS OF GUITAR PLAYING AND DISTRIBUTION OF TRAINING MATERIALS IN CONNECTION THEREWITH, IN CLASS 41 (U.S. CLS. 100, 101 AND 107).

FIRST USE 7-1-2003; IN COMMERCE 9-1-2003.

THE MARK CONSISTS OF STANDARD CHARACTERS WITHOUT CLAIM TO ANY PARTICULAR FONT, STYLE, SIZE, OR COLOR.

OWNER OF U.S. REG. NO. 3,161,651.

NO CLAIM IS MADE TO THE EXCLUSIVE RIGHT TO USE "GUITAR SCHOOL", APART FROM THE MARK AS SHOWN.

SEC. 2(F).

SER. NO. 85-497,549, FILED 12-16-2011.

REGINA DRUMMOND, EXAMINING ATTORNEY



*David J. Kybas*

Director of the United States Patent and Trademark Office

# United States of America

United States Patent and Trademark Office

## HOME SAFETY COUNCIL

**Reg. No. 4,197,570**

CHILDREN'S NATIONAL MEDICAL CENTER (D.C. NON-PROFIT CORPORATION)  
111 MICHIGAN AVE., N.W.  
WASHINGTON, DC 20010

**Registered Aug. 28, 2012**

**Int. Cl.: 9**

FOR: PRE-RECORDED ELECTRONIC MEDIA PROMOTING HOME SAFETY AWARENESS AND INJURY PREVENTION; DOWNLOADABLE VIDEOS PROMOTING HOME SAFETY AWARENESS AND INJURY PREVENTION, IN CLASS 9 (U.S. CLS. 21, 23, 26, 36 AND 38).

**TRADEMARK**

FIRST USE 10-1-2005; IN COMMERCE 10-1-2005.

**PRINCIPAL REGISTER**

THE MARK CONSISTS OF STANDARD CHARACTERS WITHOUT CLAIM TO ANY PARTICULAR FONT, STYLE, SIZE, OR COLOR.

OWNER OF U.S. REG. NOS. 3,025,260 AND 3,038,940.

NO CLAIM IS MADE TO THE EXCLUSIVE RIGHT TO USE "COUNCIL", APART FROM THE MARK AS SHOWN.

SEC. 2(F) AS TO "HOME SAFETY".

SER. NO. 85-497,621, FILED 12-16-2011.

ZACHARY BELLO, EXAMINING ATTORNEY



*David J. Kyfos*

Director of the United States Patent and Trademark Office

# United States of America

United States Patent and Trademark Office

## DR. CHRISTOPHER'S

**Reg. No. 4,197,571**

R & D, LLC (UTAH LIMITED LIABILITY COMPANY)  
2696 NORTH UNIVERSITY AVE., SUITE 220  
PROVO, UT 84604

**Registered Aug. 28, 2012**

**Int. Cl.: 44**

FOR: DIETARY AND NUTRITIONAL GUIDANCE, IN CLASS 44 (U.S. CLS. 100 AND 101).

**SERVICE MARK**

FIRST USE 8-23-1976; IN COMMERCE 8-23-1976.

**PRINCIPAL REGISTER**

THE MARK CONSISTS OF STANDARD CHARACTERS WITHOUT CLAIM TO ANY PARTICULAR FONT, STYLE, SIZE, OR COLOR.

THE NAME(S), PORTRAIT(S), AND/OR SIGNATURE(S) SHOWN IN THE MARK DOES NOT IDENTIFY A PARTICULAR LIVING INDIVIDUAL.

SER. NO. 85-497,644, FILED 12-16-2011.

PAULA MAHONEY, EXAMINING ATTORNEY



*David J. Kyffers*

Director of the United States Patent and Trademark Office

# United States of America

United States Patent and Trademark Office

## POST COATS

**Reg. No. 4,197,572**

NIKITIS, LLC (FLORIDA LIMITED LIABILITY COMPANY)  
545 SW INDIAN RIVER COURT  
STUART, FL 34994

**Registered Aug. 28, 2012**

**Int. Cl.: 17**

FOR: PVC SHEETING FORMED INTO HEAT SHRINKABLE SLEEVES FOR COVERING WOOD OR METAL BEAMS AND POSTS, IN CLASS 17 (U.S. CLS. 1, 5, 12, 13, 35 AND 50).

**TRADEMARK**

FIRST USE 11-1-2011; IN COMMERCE 11-1-2011.

**PRINCIPAL REGISTER**

THE MARK CONSISTS OF STANDARD CHARACTERS WITHOUT CLAIM TO ANY PARTICULAR FONT, STYLE, SIZE, OR COLOR.

NO CLAIM IS MADE TO THE EXCLUSIVE RIGHT TO USE "POST", APART FROM THE MARK AS SHOWN.

SER. NO. 85-498,437, FILED 12-19-2011.

FRED CARL, EXAMINING ATTORNEY



*David J. Kyfos*

Director of the United States Patent and Trademark Office

# United States of America

United States Patent and Trademark Office

## SWEETIE PIE'S

**Reg. No. 4,197,573**

SWEETIE PIE'S RESTAURANT, INC. (MISSOURI CORPORATION)  
4270 MANCHESTER AVE.

**Registered Aug. 28, 2012**

ST. LOUIS, MO 63110

**Int. Cl.: 43**

FOR: RESTAURANT SERVICES, IN CLASS 43 (U.S. CLS. 100 AND 101).

**SERVICE MARK**

FIRST USE 11-12-1997; IN COMMERCE 11-12-1997.

**PRINCIPAL REGISTER**

THE MARK CONSISTS OF STANDARD CHARACTERS WITHOUT CLAIM TO ANY PARTICULAR FONT, STYLE, SIZE, OR COLOR.

SER. NO. 85-498,604, FILED 12-19-2011.

DAVID MURRAY, EXAMINING ATTORNEY



*David J. Kyfos*

Director of the United States Patent and Trademark Office



# United States of America

United States Patent and Trademark Office



**Reg. No. 4,197,574**

KMM TELECOMMUNICATIONS (CALIFORNIA CORPORATION)  
9 LAW DRIVE, SUITE 13  
FAIRFIELD, NJ 07004

**Registered Aug. 28, 2012**

**Int. Cl.: 35**

FOR: SUPPLY CHAIN INTEGRATION AND LOGISTICS SERVICES, NAMELY, BUSINESS CONSULTING AND SUPPLY CHAIN MANAGEMENT SERVICES REGARDING SOURCING OF PRODUCTS AND SERVICES, CONTRACT MANAGEMENT, INVENTORY PLANNING AND PROCUREMENT, COMMUNICATION MATERIAL SUPPLY MANAGEMENT AND DEPLOYMENT, WAREHOUSING OF SUPPLIES AND MATERIALS, CABLE-CUTTING SERVICES, AND INFORMATION TECHNOLOGY SYSTEMS INTEGRATION AND PROJECT MANAGEMENT, IN CLASS 35 (U.S. CLS. 100, 101 AND 102).

**SERVICE MARK**

**PRINCIPAL REGISTER**

FIRST USE 12-12-2011; IN COMMERCE 12-12-2011.

THE MARK CONSISTS OF THE LETTERS "K","M","M" IN TEAL WITH TWO CURVED LINES IN NAVY BLUE ABOVE AND TO THE LEFT OF THE LETTER "K" AND ONE CURVED LINE IN NAVY BLUE APPEARING BEHIND THE LETTERS "K","M","M".

THE COLOR(S) NAVY BLUE AND TEAL IS/ARE CLAIMED AS A FEATURE OF THE MARK.

SER. NO. 85-498,967, FILED 12-19-2011.

RAUL CORDOVA, EXAMINING ATTORNEY



*David J. Kyjars*

Director of the United States Patent and Trademark Office

# United States of America

United States Patent and Trademark Office

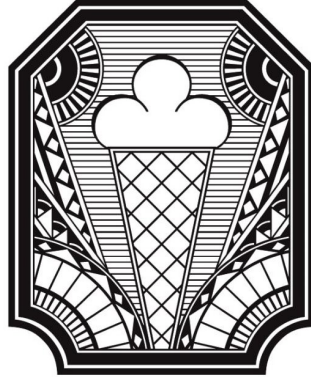

**Reg. No. 4,197,575**

**Registered Aug. 28, 2012**

**Int. Cls.: 30 and 43**

**TRADEMARK**

**SERVICE MARK**

**PRINCIPAL REGISTER**

THE WORLD'S GREATEST ICE CREAM COMPANY, INC. (FLORIDA CORPORATION)  
1626 MICHIGAN AVENUE  
MIAMI BEACH, FL 33139

FOR: ICE CREAM, FROZEN YOGURT, SORBET AND FROZEN CONFECTIONS, IN CLASS 30 (U.S. CL. 46).

FIRST USE 7-4-1987; IN COMMERCE 7-4-1987.

FOR: ICE CREAM PARLOR SERVICES, IN CLASS 43 (U.S. CLS. 100 AND 101).

FIRST USE 7-4-1987; IN COMMERCE 7-4-1987.

OWNER OF U.S. REG. NOS. 1,944,016 AND 1,952,901.

THE MARK CONSISTS OF THE IMAGE OF AN ICE CREAM CONE APPEARING WITHIN A STYLIZED QUADRILATERAL SHAPED FRAME WITH CURVED CUT CORNERS AT THE BOTTOM AND STRAIGHT CUT CORNERS AT THE TOP; THE BACKGROUND WITHIN THE FRAME IS MADE UP OF HORIZONTAL STRIPES AND ART DECO SEMI-CIRCLES AND DIAGONAL LINES APPEAR ON THE LEFT AND RIGHT OF THE ICE CREAM CONE WITH PATTERNS OF TRIANGLES AND QUADRILATERALS WITHIN THE SEMI-CIRCLES AND DIAGONAL LINES.

SER. NO. 85-499,450, FILED 12-20-2011.

CHARLOTTE CORWIN, EXAMINING ATTORNEY



*David J. Kybas*

Director of the United States Patent and Trademark Office

# United States of America

United States Patent and Trademark Office



**Reg. No. 4,197,576**

JPMORGAN CHASE & CO. (DELAWARE CORPORATION)  
270 PARK AVENUE  
NEW YORK, NY 10017

**Registered Aug. 28, 2012**

**Int. Cl.: 35**

FOR: EMPLOYMENT COUNSELING AND RECRUITING FOR MILITARY VETERANS, IN CLASS 35 (U.S. CLS. 100, 101 AND 102).

**SERVICE MARK**

FIRST USE 9-12-2011; IN COMMERCE 9-12-2011.

**PRINCIPAL REGISTER**

NO CLAIM IS MADE TO THE EXCLUSIVE RIGHT TO USE "100,000 JOBS", APART FROM THE MARK AS SHOWN.

THE MARK CONSISTS OF THE STYLIZED WORDING "100,000 JOBS MISSION", WITH THE COMMA IN THE NUMBERING "100,000" FORMED BY A FIVE POINTED STAR, ALL SET TO THE RIGHT OF A DESIGN ELEMENT COMPRISED OF A SILHOUETTE OF A SALUTING HUMAN SUPERIMPOSED OVER A CIRCULAR DESIGN ELEMENT, WITH THE RIGHT HALF OF THE CIRCULAR DESIGN ELEMENT FORMED BY HORIZONTAL STRIPES AND THE LEFT HALF OF THE CIRCULAR DESIGN ELEMENT FORMED BY A SOLID BACKGROUND WITH A PORTION OF A FIVE POINTED STAR SET IN THE UPPER LEFT PORTION OF THE CIRCULAR DESIGN ELEMENT. THREE FIVE POINTED STARS APPEAR TO THE LEFT OF THE CIRCULAR DESIGN ELEMENT.

SER. NO. 85-499,634, FILED 12-20-2011.

BARBARA BROWN, EXAMINING ATTORNEY



*David J. Kybas*

Director of the United States Patent and Trademark Office

# United States of America

United States Patent and Trademark Office

## RESPONSIBLE FUNDRAISING

**Reg. No. 4,197,577**

WHEELER, JR., GEORGE (UNITED STATES INDIVIDUAL)  
8547 E. ARAPAHOE ROAD, J-563  
GREENWOOD VILLAGE, CO 80112

**Registered Aug. 28, 2012**

**Int. Cl.: 36**

FOR: FUNDRAISING SERVICES, NAMELY, SHARING PROFITS FROM THE SALE OF SOCIALLY RESPONSIBLE PRODUCTS WITH NOT-FOR-PROFIT ORGANIZATIONS, SCHOOLS, AND CIVIC GROUPS, IN CLASS 36 (U.S. CLS. 100, 101 AND 102).

**SERVICE MARK**

FIRST USE 6-15-2011; IN COMMERCE 6-15-2011.

**PRINCIPAL REGISTER**

THE MARK CONSISTS OF STANDARD CHARACTERS WITHOUT CLAIM TO ANY PARTICULAR FONT, STYLE, SIZE, OR COLOR.

NO CLAIM IS MADE TO THE EXCLUSIVE RIGHT TO USE "FUNDRAISING", APART FROM THE MARK AS SHOWN.

SER. NO. 85-499,768, FILED 12-20-2011.

CURTIS FRENCH, EXAMINING ATTORNEY



*David J. Kyffers*

Director of the United States Patent and Trademark Office

# United States of America

United States Patent and Trademark Office



**Reg. No. 4,197,578**

**Registered Aug. 28, 2012**

**Int. Cl.: 43**

**SERVICE MARK**

**PRINCIPAL REGISTER**

LU, MEI LIN (UNITED STATES INDIVIDUAL)  
17829 COLIMA RD.  
CITY OF INDUSTRY, CA 91748 AND

LU, MEI HUI (UNITED STATES INDIVIDUAL)  
921 S. BALDWIN AVE, #G  
ARCADIA, CA 91007 AND

LU, MEI FEN (UNITED STATES INDIVIDUAL)  
121 N. VEGA ST.  
ALHAMBRA, CA 91801

FOR: RESTAURANT SERVICES, IN CLASS 43 (U.S. CLS. 100 AND 101).

FIRST USE 7-6-2011; IN COMMERCE 7-6-2011.

OWNER OF U.S. REG. NO. 2,986,966.

THE NON-LATIN CHARACTERS IN THE MARK TRANSLITERATE TO "HSIA LU TZU" AND THIS MEANS "LITTLE LU'S" IN ENGLISH.

NO CLAIM IS MADE TO THE EXCLUSIVE RIGHT TO USE "SINCE 1989", APART FROM THE MARK AS SHOWN.

THE MARK CONSISTS OF A SILHOUETTE OUTLINE OF A STYLIZED BOWL WITH A SPOON PLACED TO THE LEFT OF IT. THE PRINTING "LU'S GARDEN SINCE 1989" IS PRINTED WITHIN THE BOWL ON THE TOP. THREE CHINESE CHARACTERS ARE PRINTED WITHIN THE BOWL DESIGN NEAR ITS BOTTOM.

SER. NO. 85-499,827, FILED 12-20-2011.

KEVIN CORWIN, EXAMINING ATTORNEY



*David J. Kybas*

Director of the United States Patent and Trademark Office

# United States of America

United States Patent and Trademark Office

# **BENNETT** **Auto Supply**

**Reg. No. 4,197,579**

**Registered Aug. 28, 2012**

**Int. Cl.: 35**

**SERVICE MARK**

**PRINCIPAL REGISTER**

BENNETT AUTO SUPPLY INC. (FLORIDA CORPORATION), DBA BENNETT AUTO SUPPLY  
3141 S.W. 10TH STREET, POMPANO BEACH, FL  
3141 SW 10TH STREET  
POMPANO BEACH, FL 33069

FOR: RETAIL DISCOUNT STORE SERVICES IN THE FIELD OF AUTOMOBILE PARTS AND ACCESSORIES; RETAIL SHOPS FEATURING AUTOMOBILE PARTS AND ACCESSORIES; WHOLESALE STORE SERVICES FEATURING AUTOMOBILE PARTS AND ACCESSORIES, IN CLASS 35 (U.S. CLS. 100, 101 AND 102).

FIRST USE 1-1-2011; IN COMMERCE 1-1-2011.

OWNER OF U.S. REG. NOS. 3,182,250 AND 3,969,566.

THE COLOR(S) BLACK, WHITE, TAN, GOLD, AND YELLOW IS/ARE CLAIMED AS A FEATURE OF THE MARK.

NO CLAIM IS MADE TO THE EXCLUSIVE RIGHT TO USE "AUTO SUPPLY", APART FROM THE MARK AS SHOWN.

THE STIPLING IS FOR SHADING PURPOSES ONLY.

THE MARK CONSISTS OF THE WORDS "BENNETT AUTO SUPPLY" APPEARING IN ITALICIZED FONT WITH A SHADOWING EFFECT USING A WHITE AND BLACK BORDER, WITH THE ACTUAL LETTERS OF "BENNETT AUTO SUPPLY" COMPRISED OF THREE COLORS, TAN, GOLD AND YELLOW, CREATING A GRADIENT EFFECT GOING FROM THE DARKEST OF THESE COLORS AT THE TOP, YELLOW, TO THE LIGHTEST OF THESE COLORS AT THE BOTTOM, GOLD. THE LETTERS "NNETT" APPEARING IN "BENNETT" HAVE HEAT LINES IN THE SAME COLORS AS THE LETTERS DEPICTING SPEED, PROPULSION, HEAT OR WIND.

SER. NO. 85-499,849, FILED 12-20-2011.

SHAILA SETTLES, EXAMINING ATTORNEY



*David J. Kyffers*

Director of the United States Patent and Trademark Office

# United States of America

United States Patent and Trademark Office

# BIG BOSS

**Reg. No. 4,197,580**

**Registered Aug. 28, 2012**

**Int. Cl.: 21**

**TRADEMARK**

**PRINCIPAL REGISTER**

DISCO, INC. (PENNSYLVANIA CORPORATION)  
4626 NORTH FIFTEENTH STREET  
PHILADELPHIA, PA 19140

FOR: SCOURING PADS, IN CLASS 21 (U.S. CLS. 2, 13, 23, 29, 30, 33, 40 AND 50).

FIRST USE 12-31-1992; IN COMMERCE 12-31-1992.

THE MARK CONSISTS OF STANDARD CHARACTERS WITHOUT CLAIM TO ANY PARTICULAR FONT, STYLE, SIZE, OR COLOR.

OWNER OF U.S. REG. NOS. 717,303 AND 2,300,432.

SER. NO. 85-500,324, FILED 12-20-2011.

TEJBIR SINGH, EXAMINING ATTORNEY



*David J. Kyffers*

Director of the United States Patent and Trademark Office

# United States of America

United States Patent and Trademark Office



**PRANCING  
LEOPARD  
ORGANICS**

**Reg. No. 4,197,581**

**Registered Aug. 28, 2012**

**Int. Cl.: 25**

**TRADEMARK**

**PRINCIPAL REGISTER**

SEVDA E. HOLLAND (NEW JERSEY LIMITED LIABILITY COMPANY), DBA PRANCING LEOPARD LLC  
178 DOREMUS AVE.  
RIDGEWOOD, NJ 07450

FOR: BELTS; BELTS FOR CLOTHING; BELTS MADE OUT OF CLOTH; BOTTOMS; CLOTHING FOR ATHLETIC USE, NAMELY, PADDED PANTS; CLOTHING, NAMELY, ARM WARMERS; CLOTHING, NAMELY, COWLS AND SMOKE RING SCARVES; CLOTHING, NAMELY, HAND-WARMERS; CLOTHING, NAMELY, KNEE WARMERS; CLOTHING, NAMELY, NECK TUBES; CLOTHING, NAMELY, WRAP-AROUNDS; HOODS; JACKETS; JERSEYS; MUFFLERS; SHOULDER WRAPS; SHOULDER WRAPS FOR CLOTHING; WEARABLE GARMENTS AND CLOTHING, NAMELY, SHIRTS; WOMEN'S CLOTHING, NAMELY, SHIRTS, DRESSES, SKIRTS, BLOUSES; WRAPS; ALL OF THE AFORE-SAID GOODS MADE WITH SUBSTANTIALLY ORGANIC MATERIALS, IN CLASS 25 (U.S. CLS. 22 AND 39).

FIRST USE 4-1-2009; IN COMMERCE 5-1-2009.

NO CLAIM IS MADE TO THE EXCLUSIVE RIGHT TO USE "ORGANICS", APART FROM THE MARK AS SHOWN.

THE MARK CONSISTS OF THE DESIGN OF A SNOW LEOPARD ABOVE THE STYLIZED WORDING "PRANCING LEOPARD ORGANICS".

SER. NO. 85-500,331, FILED 12-20-2011.

DAWN HAN, EXAMINING ATTORNEY



*David J. Kyffers*

Director of the United States Patent and Trademark Office



# United States of America

United States Patent and Trademark Office

## A LASH THING

**Reg. No. 4,197,582**

BISHOP, JULIE (UNITED STATES INDIVIDUAL)  
27001 MOULTON PKWY.

**Registered Aug. 28, 2012**

LAGUNA HILLS, CA 92656

**Int. Cl.: 35**

FOR: ON-LINE RETAIL STORE SERVICES AND RETAIL STORE SERVICES FEATURING MASCARA, FALSE EYELASHES, TWEEZERS, SCISSORS, AIR COMPRESSORS, MASCARA WANDS, MICROFIBER BRUSHES, ADHESIVES, CLEANSERS, EYE GEL PADS, AND SURGICAL TAPE; WHOLESALE STORE SERVICES FEATURING MASCARA, FALSE EYELASHES, TWEEZERS, SCISSORS, AIR COMPRESSORS, MASCARA WANDS, MICROFIBER BRUSHES, ADHESIVES, CLEANSERS, EYE GEL PADS, AND SURGICAL TAPE, IN CLASS 35 (U.S. CLS. 100, 101 AND 102).

**SERVICE MARK**

**PRINCIPAL REGISTER**

FIRST USE 2-1-2011; IN COMMERCE 5-1-2011.

THE MARK CONSISTS OF STANDARD CHARACTERS WITHOUT CLAIM TO ANY PARTICULAR FONT, STYLE, SIZE, OR COLOR.

NO CLAIM IS MADE TO THE EXCLUSIVE RIGHT TO USE "LASH" , APART FROM THE MARK AS SHOWN.

SER. NO. 85-500,498, FILED 12-21-2011.

BRIDGETT SMITH, EXAMINING ATTORNEY



*David J. Kyros*

Director of the United States Patent and Trademark Office

# United States of America

United States Patent and Trademark Office

ME  
MICHAEL ELIE

**Reg. No. 4,197,583**

MICHAEL HALABI (UNITED STATES INDIVIDUAL)  
419 BROADWAY  
WESTWOOD, NJ 07675

**Registered Aug. 28, 2012**

**Int. Cl.: 3**

FOR: COSMETICS; NON-MEDICATED SKIN, HAIR AND SCALP CARE PREPARATIONS,  
IN CLASS 3 (U.S. CLS. 1, 4, 6, 50, 51 AND 52).

**TRADEMARK**

FIRST USE 12-7-2011; IN COMMERCE 12-7-2011.

**PRINCIPAL REGISTER**

THE NAME(S), PORTRAIT(S), AND/OR SIGNATURE(S) SHOWN IN THE MARK DOES NOT  
IDENTIFY A PARTICULAR LIVING INDIVIDUAL.

THE MARK CONSISTS OF THE WORDS "MICHAEL ELIE" CAPITALIZED BELOW LETTERS  
"ME" CAPITALIZED.

SER. NO. 85-500,818, FILED 12-21-2011.

GIANCARLO CASTRO, EXAMINING ATTORNEY



*David J. Kyffers*

Director of the United States Patent and Trademark Office

# United States of America

United States Patent and Trademark Office

## MEET ME IN THE CLOUD

**Reg. No. 4,197,584**

**Registered Aug. 28, 2012**

**Int. Cl.: 42**

**SERVICE MARK**

**PRINCIPAL REGISTER**

SUSAN MCEVILLY (UNITED STATES INDIVIDUAL), DBA MEET ME IN THE CLOUD  
1087 LEHIGH VALLEY CIRCLE  
DANVILLE, CA 94526

FOR: TECHNICAL CONSULTING SERVICES IN THE FIELD OF EVALUATION AND IMPLEMENTATION OF INTERNET TECHNOLOGY AND SERVICES; CONSULTING SERVICES IN THE FIELD OF HOSTING COMPUTER SOFTWARE APPLICATIONS; COMPUTER SOFTWARE CONSULTANCY, AND CONSULTING SERVICES IN THE FIELD OF CLOUD COMPUTING, IN CLASS 42 (U.S. CLS. 100 AND 101).

FIRST USE 5-30-2009; IN COMMERCE 7-1-2011.

THE MARK CONSISTS OF STANDARD CHARACTERS WITHOUT CLAIM TO ANY PARTICULAR FONT, STYLE, SIZE, OR COLOR.

SER. NO. 85-500,846, FILED 12-21-2011.

DARRYL SPRUILL, EXAMINING ATTORNEY



*David J. Kybas*

Director of the United States Patent and Trademark Office

# United States of America

United States Patent and Trademark Office

## NATURA PET

**Reg. No. 4,197,585**

**Registered Aug. 28, 2012**

**Int. Cl.: 31**

**TRADEMARK**

**PRINCIPAL REGISTER**

NATURA PET PRODUCTS INC. (DELAWARE CORPORATION)  
ONE PROCTER & GAMBLE PLAZA  
CINCINNATI, OH 45202

FOR: PET FOOD, IN CLASS 31 (U.S. CLS. 1 AND 46).

FIRST USE 11-15-2010; IN COMMERCE 11-15-2010.

THE MARK CONSISTS OF STANDARD CHARACTERS WITHOUT CLAIM TO ANY PARTICULAR FONT, STYLE, SIZE, OR COLOR.

OWNER OF U.S. REG. NOS. 3,748,883 AND 4,096,527.

NO CLAIM IS MADE TO THE EXCLUSIVE RIGHT TO USE "PET", APART FROM THE MARK AS SHOWN.

THE ENGLISH TRANSLATION OF "NATURA" IN THE MARK IS NATURE.

SER. NO. 85-500,969, FILED 12-21-2011.

RAMONA ORTIGA, EXAMINING ATTORNEY



*David J. Kyffers*

Director of the United States Patent and Trademark Office

# United States of America

United States Patent and Trademark Office

## NUBANI TRADING COMPANY

**Reg. No. 4,197,586**

NUBANI TRADING COMPANY (ILLINOIS CORPORATION)  
2850 OAK STREET, BUILDING A  
BELLWOOD, IL 60104

**Registered Aug. 28, 2012**

**Int. Cl.: 35**

FOR: WHOLESALE DISTRIBUTORSHIPS FEATURING CANDY, FOOD AND NOVELTY ITEMS, IN CLASS 35 (U.S. CLS. 100, 101 AND 102).

**SERVICE MARK**

FIRST USE 12-31-1986; IN COMMERCE 12-31-1986.

**PRINCIPAL REGISTER**

THE MARK CONSISTS OF STANDARD CHARACTERS WITHOUT CLAIM TO ANY PARTICULAR FONT, STYLE, SIZE, OR COLOR.

NO CLAIM IS MADE TO THE EXCLUSIVE RIGHT TO USE "TRADING COMPANY", APART FROM THE MARK AS SHOWN.

SER. NO. 85-501,567, FILED 12-21-2011.

SUNG IN, EXAMINING ATTORNEY



*David J. Kyfos*

Director of the United States Patent and Trademark Office

# United States of America

United States Patent and Trademark Office

## ORCHIDS ARE EASY

**Reg. No. 4,197,587**

COSTA FARMS, LLC (FLORIDA LIMITED LIABILITY COMPANY)  
22290 SW 162ND AVENUE  
GOULDS, FL 33170

**Registered Aug. 28, 2012**

**Int. Cl.: 31**

FOR: LIVE FLOWERS AND LIVING PLANTS, NAMELY, ORCHIDS, IN CLASS 31 (U.S. CLS. 1 AND 46).

**TRADEMARK**

FIRST USE 12-31-2009; IN COMMERCE 12-31-2009.

**PRINCIPAL REGISTER**

THE MARK CONSISTS OF STANDARD CHARACTERS WITHOUT CLAIM TO ANY PARTICULAR FONT, STYLE, SIZE, OR COLOR.

NO CLAIM IS MADE TO THE EXCLUSIVE RIGHT TO USE "ORCHIDS", APART FROM THE MARK AS SHOWN.

SER. NO. 85-501,635, FILED 12-21-2011.

DAVID HOFFMAN, EXAMINING ATTORNEY



*David J. Kyffers*

Director of the United States Patent and Trademark Office

# United States of America

United States Patent and Trademark Office

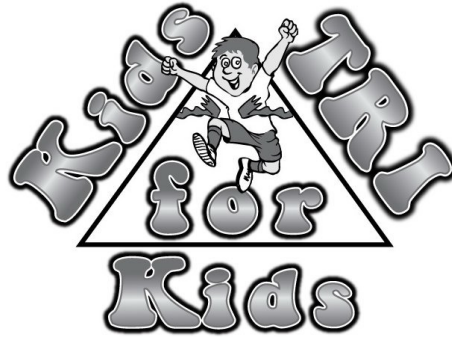

**Reg. No. 4,197,588**

**Registered Aug. 28, 2012**

**Int. Cl.: 41**

**SERVICE MARK**

**PRINCIPAL REGISTER**

KIDS TRI FOR KIDS, INC. (INDIANA CORPORATION)  
9875 LAKEWOOD DRIVE EAST  
INDIANAPOLIS, IN 46280

FOR: PLANNING, ORGANIZING, ARRANGING, PRODUCING, CONDUCTING, GOVERNING AND REGULATING SPORTING EVENTS, NAMELY, TRIATHLONS FOR CHILDREN, TO EDUCATE CHILDREN AND THEIR FAMILIES ABOUT FITNESS, GENERAL HEALTH, LIFE SKILLS AND THE VALUE OF ENGAGING IN ACTIVITIES TO BENEFIT OTHERS, IN CLASS 41 (U.S. CLS. 100, 101 AND 107).

FIRST USE 11-30-2010; IN COMMERCE 11-30-2010.

THE MARK CONSISTS OF THE WORDS "KIDS TRI FOR KIDS" SURROUNDING A TRIANGLE WITH A CHILD RUNNING THROUGH THE MIDDLE.

SER. NO. 85-501,797, FILED 12-22-2011.

JULIE VEPPUMTHARA, EXAMINING ATTORNEY



*David J. Kyffers*

Director of the United States Patent and Trademark Office

# United States of America

United States Patent and Trademark Office



**Reg. No. 4,197,589**

SELANDER, KARL (UNITED STATES INDIVIDUAL)  
15531 BRANCHCREST CIRCLE  
DALLAS, TX 75248

**Registered Aug. 28, 2012**

**Int. Cl.: 7**

FOR: PNEUMATIC FILING MACHINES AND BLADES THEREFOR, PNEUMATIC SANDERS,  
IN CLASS 7 (U.S. CLS. 13, 19, 21, 23, 31, 34 AND 35).

**TRADEMARK**

FIRST USE 8-21-1963; IN COMMERCE 8-21-1963.

**PRINCIPAL REGISTER**

NO CLAIM IS MADE TO THE EXCLUSIVE RIGHT TO USE "AIR TOOL CORP. OF AMERICA", APART FROM THE MARK AS SHOWN.

THE MARK CONSISTS OF A LARGE LETTER "A" WITH THE LETTERS "ATCOA" BELOW THE CROSS LINE IN THE "A", AND THE TEXT "AIR TOOL CORP. OF AMERICA" BELOW "ATCOA".

SER. NO. 85-501,907, FILED 12-22-2011.

MARK SHINER, EXAMINING ATTORNEY



*David J. Kybas*

Director of the United States Patent and Trademark Office



# United States of America

United States Patent and Trademark Office

## INLAND LAKES PRODUCTIONS

**Reg. No. 4,197,590**

INLAND LAKES PRODUCTIONS, LLC (MICHIGAN CORPORATION)  
6632 TELEGRAPH ROAD #123  
BLOOMFIELD HILLS, MI 48301

**Registered Aug. 28, 2012**

**Int. Cl.: 41**

FOR: FILM AND VIDEO PRODUCTION, IN CLASS 41 (U.S. CLS. 100, 101 AND 107).

**SERVICE MARK**

FIRST USE 2-15-2011; IN COMMERCE 2-15-2011.

**PRINCIPAL REGISTER**

THE MARK CONSISTS OF STANDARD CHARACTERS WITHOUT CLAIM TO ANY PARTICULAR FONT, STYLE, SIZE, OR COLOR.

NO CLAIM IS MADE TO THE EXCLUSIVE RIGHT TO USE "PRODUCTIONS", APART FROM THE MARK AS SHOWN.

SER. NO. 85-502,120, FILED 12-22-2011.

WON TEAK OH, EXAMINING ATTORNEY



*David J. Kyffers*

Director of the United States Patent and Trademark Office

# United States of America

United States Patent and Trademark Office

## THE DIFFERENCE IS IN THE EXPERIENCE

**Reg. No. 4,197,591**

**Registered Aug. 28, 2012**

**Int. Cl.: 35**

**SERVICE MARK**

**PRINCIPAL REGISTER**

NATIONAL ASSOCIATION OF MUTUAL INSURANCE COMPANIES, INC. (INDIANA CORPORATION)  
3601 VINCENNES ROAD  
INDIANAPOLIS, IN 46268

FOR: TRADE ASSOCIATION SERVICES, NAMELY, PROMOTING THE INTERESTS OF INSURANCE COMPANIES AND THE INSURANCE INDUSTRY, IN CLASS 35 (U.S. CLS. 100, 101 AND 102).

FIRST USE 9-18-2011; IN COMMERCE 9-18-2011.

THE MARK CONSISTS OF STANDARD CHARACTERS WITHOUT CLAIM TO ANY PARTICULAR FONT, STYLE, SIZE, OR COLOR.

SER. NO. 85-502,136, FILED 12-22-2011.

RUSS HERMAN, EXAMINING ATTORNEY



*David J. Kyffers*

Director of the United States Patent and Trademark Office

# United States of America

United States Patent and Trademark Office

## SITREN AIRVOID

**Reg. No. 4,197,592**

**Registered Aug. 28, 2012**

**Int. Cl.: 1**

**TRADEMARK**

**PRINCIPAL REGISTER**

EVONIK GOLDSCHMIDT GMBH (FED REP GERMANY GESELLSCHAFT MIT  
BESCHRÄNKTER HAFTUNG (GMBH))  
GOLDSCHMIDTSTRASSE 100  
ESSEN, FED REP GERMANY 45127

FOR: UNPROCESSED ARTIFICIAL RESINS AND CHEMICAL ADDITIVES, AUXILIARIES  
AND INGREDIENTS FOR THE MANUFACTURE AND PROCESSING OF BUILDING MA-  
TERIALS, ESPECIALLY OF CONCRETE, IN CLASS 1 (U.S. CLS. 1, 5, 6, 10, 26 AND 46).

FIRST USE 12-15-2011; IN COMMERCE 12-15-2011.

THE MARK CONSISTS OF STANDARD CHARACTERS WITHOUT CLAIM TO ANY PAR-  
TICULAR FONT, STYLE, SIZE, OR COLOR.

OWNER OF U.S. REG. NO. 2,326,663.

NO CLAIM IS MADE TO THE EXCLUSIVE RIGHT TO USE "AIR VOID", APART FROM  
THE MARK AS SHOWN.

SER. NO. 85-502,268, FILED 12-22-2011.

WON TEAK OH, EXAMINING ATTORNEY



*David J. Kyffers*

Director of the United States Patent and Trademark Office

# United States of America

United States Patent and Trademark Office

# ENHANCE

**Reg. No. 4,197,593**

HART SPECIALTIES, INC. (NEW YORK CORPORATION)  
5000 NEW HORIZONS BLVD  
AMITYVILLE, NY 11701

**Registered Aug. 28, 2012**

**Int. Cl.: 9**

FOR: EYEGLOSS FRAMES, EYEGLOSSES AND RELATED EYE GLASS ACCESSORIES, NAMELY, EYEGLOSS CHAINS, STRAPS, CORDS, AND EYEGLOSS FLOATS IN THE NATURE OF DEVICES ATTACHED TO THE SIDE OF THE FRAME TO AID IN FLOATATION; EYEGLOSS CASES, IN CLASS 9 (U.S. CLS. 21, 23, 26, 36 AND 38).

**TRADEMARK**

**PRINCIPAL REGISTER**

FIRST USE 3-17-2011; IN COMMERCE 3-17-2011.

THE MARK CONSISTS OF STANDARD CHARACTERS WITHOUT CLAIM TO ANY PARTICULAR FONT, STYLE, SIZE, OR COLOR.

SER. NO. 85-502,807, FILED 12-23-2011.

TARAH HARDY, EXAMINING ATTORNEY



*David J. Kyffers*

Director of the United States Patent and Trademark Office

# United States of America

United States Patent and Trademark Office

# Uniagros

**Reg. No. 4,197,594**

**Registered Aug. 28, 2012**

**Int. Cl.: 35**

**SERVICE MARK**

**PRINCIPAL REGISTER**

PILARQUIM (SHANGHAI) CO., LTD. (CHINA CORPORATION)  
1500 HANGTANG ROAD  
JINHUI TOWN, FENGXIAN DISTRICT  
SHANGHAI, CHINA 201405

FOR: ADVISORY SERVICES RELATING TO BUSINESS MANAGEMENT AND BUSINESS OPERATIONS; BUSINESS ADVICE AND COMMERCIAL INFORMATION; BUSINESS ADVICE AND INFORMATION; BUSINESS ADVICE, INQUIRIES OR INFORMATION; BUSINESS APPRAISALS; BUSINESS ASSISTANCE, MANAGEMENT AND INFORMATION SERVICES; BUSINESS CONSULTANCY; BUSINESS CONSULTING, INQUIRIES OR INFORMATION; BUSINESS INFORMATION AND INQUIRIES; BUSINESS INVESTIGATIONS; BUSINESS MANAGEMENT AND ENTERPRISE ORGANIZATION CONSULTANCY; BUSINESS MANAGEMENT ASSISTANCE TO INDUSTRIAL OR COMMERCIAL COMPANIES; BUSINESS MANAGEMENT CONSULTANCY AND ADVISORY SERVICES; BUSINESS MANAGEMENT CONSULTING AND ADVISORY SERVICES; BUSINESS ORGANIZATION AND OPERATION CONSULTANCY; BUSINESS RESEARCH; COMMERCIAL ASSISTANCE IN BUSINESS MANAGEMENT; COMMERCIAL INFORMATION AGENCIES; COMMERCIAL INFORMATION AND DIRECTORY AGENCY; CONSULTATION RELATING TO TRADE FAIRS; GOODS IMPORT-EXPORT AGENCIES; MANAGEMENT AND OPERATION ASSISTANCE TO COMMERCIAL BUSINESSES; MARKETING RESEARCH SERVICES; MARKETING SERVICES, NAMELY, CONSUMER MARKETING RESEARCH; PROCUREMENT, NAMELY, PURCHASING AGRICULTURAL PRODUCTS FOR OTHERS; PROVIDING INFORMATION AND NEWS IN THE FIELD OF BUSINESS; PUBLIC RELATIONS; PUBLICITY AND SALES PROMOTION SERVICES; PURCHASING AND PROCUREMENT SERVICES, NAMELY, PROCURING OF CONTRACTS FOR OTHERS FOR THE PURCHASE OF GOODS AND LABOR CONTRACTING SERVICES; SALES PROMOTION FOR OTHERS PROVIDED THROUGH THE DISTRIBUTION AND THE ADMINISTRATION OF PRIVILEGED USER CARDS; SALES PROMOTION SERVICES, IN CLASS 35 (U.S. CLS. 100, 101 AND 102).



FIRST USE 12-29-2003; IN COMMERCE 12-30-2003.

THE MARK CONSISTS OF STYLIZED WORDING "UNIAGROS" WITH SPECIAL DESIGN WHICH THE DOT OF THE LETTER "I" APPEARS LIKE A STAR.

*David J. Kypas*

SER. NO. 85-502,813, FILED 12-23-2011.

DEBORAH LOBO, EXAMINING ATTORNEY

# United States of America

United States Patent and Trademark Office

## IMAGINE ECO

**Reg. No. 4,197,595**

IMAGINE SURF, LLC (CALIFORNIA LIMITED LIABILITY COMPANY)  
924 B CALLE NEGOCIO  
SAN CLEMENTE, CA 92673

**Registered Aug. 28, 2012**

**Int. Cl.: 28**

FOR: SURFBOARDS, PADDLEBOARDS, AND STAND UP PADDLEBOARDS, IN CLASS 28  
(U.S. CLS. 22, 23, 38 AND 50).

**TRADEMARK**

FIRST USE 3-0-2006; IN COMMERCE 3-0-2006.

**PRINCIPAL REGISTER**

THE MARK CONSISTS OF STANDARD CHARACTERS WITHOUT CLAIM TO ANY PARTICULAR FONT, STYLE, SIZE, OR COLOR.

NO CLAIM IS MADE TO THE EXCLUSIVE RIGHT TO USE "ECO", APART FROM THE MARK AS SHOWN.

SER. NO. 85-502,823, FILED 12-23-2011.

YAT SYE, LEE, EXAMINING ATTORNEY



*David J. Kyffers*

Director of the United States Patent and Trademark Office

# United States of America

United States Patent and Trademark Office

## U-Du U-niversity

**Reg. No. 4,197,596**

**Registered Aug. 28, 2012**

**Int. Cl.: 25**

**TRADEMARK**

**PRINCIPAL REGISTER**

BRASWELL JR., ELROY (UNITED STATES INDIVIDUAL)  
#5 L  
170 E 4TH STREET  
BROOKLYN, NY 11218

FOR: SHORT-SLEEVED OR LONG-SLEEVED T-SHIRTS, IN CLASS 25 (U.S. CLS. 22 AND 39).

FIRST USE 5-15-2011; IN COMMERCE 5-31-2011.

THE MARK CONSISTS OF STANDARD CHARACTERS WITHOUT CLAIM TO ANY PARTICULAR FONT, STYLE, SIZE, OR COLOR.

SER. NO. 85-502,932, FILED 12-23-2011.

PRISCILLA MILTON, EXAMINING ATTORNEY



*David J. Kybas*

Director of the United States Patent and Trademark Office

# United States of America

United States Patent and Trademark Office

# THROTTLE

**Reg. No. 4,197,597**

**Registered Aug. 28, 2012**

**Int. Cls.: 38 and 42**

**SERVICE MARK**

**PRINCIPAL REGISTER**

CLASSIC FORMS & SYSTEMS, INC. (MARYLAND CORPORATION), DBA CLASSICPLUS  
95 MONOCACY BLVD., STE B20  
FREDERICK, MD 21701

FOR: TELECOMMUNICATION SERVICES, NAMELY, PROVIDING E-MAIL AND TEXT NOTIFICATION ALERTS FEATURING AUTOMATED SERVICE REMINDERS, SAFETY ALERTS, RECALL ALERTS, AND SPECIAL DISCOUNT OFFERS, IN CLASS 38 (U.S. CLS. 100, 101 AND 104).

FIRST USE 7-9-2008; IN COMMERCE 7-9-2008.

FOR: PROVIDING TEMPORARY USE OF ON-LINE NON-DOWNLOADABLE SOFTWARE FOR USE BY AUTOMOTIVE REPAIR FACILITIES IN PROVIDING VEHICLE REPAIR INFORMATION, MAINTENANCE SCHEDULES, AND GUIDANCE, IN CLASS 42 (U.S. CLS. 100 AND 101).

FIRST USE 7-9-2008; IN COMMERCE 7-9-2008.

THE MARK CONSISTS OF STANDARD CHARACTERS WITHOUT CLAIM TO ANY PARTICULAR FONT, STYLE, SIZE, OR COLOR.

SER. NO. 85-502,974, FILED 12-23-2011.

MARK SPARACINO, EXAMINING ATTORNEY



*David J. Kyffers*

Director of the United States Patent and Trademark Office



# United States of America

United States Patent and Trademark Office

# EZO POWER

**Reg. No. 4,197,598**

MAXWAVE HOLDING LIMITED (HONG KONG CORPORATION)  
1008-1012, 10/F, K.WAH CENTRE, 191 JAVA  
NORTH POINT, HONG KONG

**Registered Aug. 28, 2012**

**Int. Cl.: 9**

FOR: BATTERIES AND BATTERY CHARGERS; USB CABLES; VIDEO CABLES, IN CLASS  
9 (U.S. CLS. 21, 23, 26, 36 AND 38).

**TRADEMARK**

FIRST USE 12-20-2011; IN COMMERCE 12-22-2011.

**PRINCIPAL REGISTER**

THE MARK CONSISTS OF STANDARD CHARACTERS WITHOUT CLAIM TO ANY PAR-  
TICULAR FONT, STYLE, SIZE, OR COLOR.

NO CLAIM IS MADE TO THE EXCLUSIVE RIGHT TO USE "POWER", APART FROM THE  
MARK AS SHOWN.

SER. NO. 85-503,295, FILED 12-23-2011.

TARAH HARDY, EXAMINING ATTORNEY



*David J. Kyffers*

Director of the United States Patent and Trademark Office

# United States of America

United States Patent and Trademark Office

## IMAGINUTRITION

**Reg. No. 4,197,599**

**Registered Aug. 28, 2012**

**Int. Cl.: 42**

**SERVICE MARK**

**PRINCIPAL REGISTER**

IMAGINUTRITION, INC. (COLORADO CORPORATION)  
32545 B GOLDEN LANTERN PMB 477  
DANA POINT, FL 92629

FOR: CONSULTING SERVICES IN THE FIELD OF THE DESIGN OF FOODS, MEDICAL FOODS, BEVERAGES, COSMETICS AND DIETARY SUPPLEMENTS, AND CLINICAL TRIALS; DESIGN AND DEVELOPMENT OF FOODS, MEDICAL FOODS, BEVERAGES, COSMETICS AND DIETARY SUPPLEMENTS, AND CLINICAL TRIALS; PRODUCT DEVELOPMENT CONSULTATION; PRODUCT DEVELOPMENT IN THE FIELD OF FOODS, MEDICAL FOODS, BEVERAGES, COSMETICS AND DIETARY SUPPLEMENTS; PROVIDING MEDICAL AND SCIENTIFIC RESEARCH INFORMATION IN THE FIELD OF PHARMACEUTICALS AND CLINICAL TRIALS; RESEARCH AND DEVELOPMENT IN THE FIELD OF FOODS, MEDICAL FOODS, BEVERAGES, COSMETICS AND DIETARY SUPPLEMENTS; SCIENTIFIC RESEARCH AND DEVELOPMENT; TECHNICAL CONSULTANCY IN RELATION TO RESEARCH SERVICES RELATING TO FOODS AND DIETARY SUPPLEMENTS, IN CLASS 42 (U.S. CLS. 100 AND 101).

FIRST USE 7-13-1997; IN COMMERCE 7-13-1997.

THE MARK CONSISTS OF STANDARD CHARACTERS WITHOUT CLAIM TO ANY PARTICULAR FONT, STYLE, SIZE, OR COLOR.

SER. NO. 85-503,311, FILED 12-23-2011.

APRIL ROACH, EXAMINING ATTORNEY



*David J. Kyffers*

Director of the United States Patent and Trademark Office

# United States of America

United States Patent and Trademark Office

# GANGA

**Reg. No. 4,197,600**

**Registered Aug. 28, 2012**

**Int. Cls.: 25 and 28**

**TRADEMARK**

**PRINCIPAL REGISTER**

HILDA GRACIELA FUENTES (CALIFORNIA SOLE PROPRIETORSHIP), DBA GANGA  
SKATEBOARD  
2170 E WINSTON RD.  
ANAHEIM, CA 92806

FOR: ATHLETIC APPAREL, NAMELY, SHIRTS, PANTS, JACKETS, FOOTWEAR, HATS  
AND CAPS, ATHLETIC UNIFORMS, IN CLASS 25 (U.S. CLS. 22 AND 39).

FIRST USE 3-31-2011; IN COMMERCE 11-15-2011.

FOR: SKATEBOARD DECKS, IN CLASS 28 (U.S. CLS. 22, 23, 38 AND 50).

FIRST USE 3-31-2011; IN COMMERCE 11-15-2011.

THE MARK CONSISTS OF STANDARD CHARACTERS WITHOUT CLAIM TO ANY PAR-  
TICULAR FONT, STYLE, SIZE, OR COLOR.

THE ENGLISH TRANSLATION OF "GANGA" IS BARGAIN.

SER. NO. 85-503,327, FILED 12-23-2011.

FRED CARL, EXAMINING ATTORNEY



*David J. Kyfos*

Director of the United States Patent and Trademark Office

# United States of America

United States Patent and Trademark Office



**Reg. No. 4,197,601**

B CULTURE MEDIA L.L.C. (GEORGIA LIMITED LIABILITY COMPANY)  
695 PYLANT STREET  
ATLANTA, GA 30306

**Registered Aug. 28, 2012**

**Int. Cl.: 35**

FOR: ADVERTISING AND MARKETING SERVICES, NAMELY, PROMOTING THE GOODS AND SERVICES OF OTHERS, IN CLASS 35 (U.S. CLS. 100, 101 AND 102).

**SERVICE MARK**

FIRST USE 7-1-2011; IN COMMERCE 8-1-2011.

**PRINCIPAL REGISTER**

THE MARK CONSISTS OF A STYLIZED LETTER "B" INSIDE A CIRCLE WITH DOTS AROUND THE CIRCLE, AND THE WORD "CULTURE" ON A BANNER ACROSS THE BOTTOM PORTION OF THE CIRCLE.

SER. NO. 85-503,345, FILED 12-23-2011.

FRED CARL, EXAMINING ATTORNEY



*David J. Kybas*

Director of the United States Patent and Trademark Office

# United States of America

United States Patent and Trademark Office

## Curbside Couture

**Reg. No. 4,197,602**

BRONSON, LEAH (UNITED STATES INDIVIDUAL)  
40 SUMMERHILL WAY  
SAN RAFAEL, CA 94903

**Registered Aug. 28, 2012**

**Int. Cl.: 41**

FOR: ENTERTAINMENT SERVICE, NAMELY, MOBILE FASHION EVENT SERVICE FEATURING RUNWAY SHOWS, IN CLASS 41 (U.S. CLS. 100, 101 AND 107).

**SERVICE MARK**

FIRST USE 6-21-2011; IN COMMERCE 7-16-2011.

**PRINCIPAL REGISTER**

THE MARK CONSISTS OF STANDARD CHARACTERS WITHOUT CLAIM TO ANY PARTICULAR FONT, STYLE, SIZE, OR COLOR.

NO CLAIM IS MADE TO THE EXCLUSIVE RIGHT TO USE "COUTURE", APART FROM THE MARK AS SHOWN.

SER. NO. 85-503,350, FILED 12-23-2011.

FRED CARL, EXAMINING ATTORNEY



*David J. Kyffers*

Director of the United States Patent and Trademark Office

# United States of America

United States Patent and Trademark Office

For the ultimate  
expression of a bride...

**Reg. No. 4,197,603**

**Registered Aug. 28, 2012**

**Int. Cl.: 35**

**SERVICE MARK**

**PRINCIPAL REGISTER**

MON AMIE, INC (CALIFORNIA CORPORATION), DBA MON AMIE BRIDAL SALON  
355 BRISTOL STREET  
SUITE N  
COSTA MESA, CA 92626

FOR: ON-LINE RETAIL STORE SERVICES FEATURING BALL GOWNS; EVENING GOWNS;  
WEDDING DRESSES, WEDDING GOWNS, BRIDAL GOWNS, FORMAL WEAR AND RE-  
LATED ACCESSORY ITEMS; RETAIL STORE SERVICES FEATURING BALL GOWNS;  
EVENING GOWNS; WEDDING DRESSES, WEDDING GOWNS, BRIDAL GOWNS, FORMAL  
WEAR AND RELATED ACCESSORY ITEMS, IN CLASS 35 (U.S. CLS. 100, 101 AND 102).

FIRST USE 0-0-1993; IN COMMERCE 0-0-1993.

THE MARK CONSISTS OF STANDARD CHARACTERS WITHOUT CLAIM TO ANY PAR-  
TICULAR FONT, STYLE, SIZE, OR COLOR.

NO CLAIM IS MADE TO THE EXCLUSIVE RIGHT TO USE "BRIDE", APART FROM THE  
MARK AS SHOWN.

SER. NO. 85-503,411, FILED 12-23-2011.

SUNG IN, EXAMINING ATTORNEY



*David J. Kyfos*

Director of the United States Patent and Trademark Office

# United States of America

United States Patent and Trademark Office



**Reg. No. 4,197,604**

**Registered Aug. 28, 2012**

**Int. Cl.: 30**

**TRADEMARK**

**PRINCIPAL REGISTER**

E THINK, LLC (ARIZONA LIMITED LIABILITY COMPANY), DBA GO LB. SALT  
PO BOX 18866  
FOUNTAIN HILLS, AZ 85269

FOR: DRY SPICE RUB FOR MEATS AND FISH; EDIBLE SALT; EDIBLE SPICES; HERB SALT; MINERAL SALT FOR HUMAN CONSUMPTION; PEPPER; SALT FOR PRESERVING FOOD; SEA SALT FOR COOKING; SPICE BLENDS; SPICE RUBS; UNREFINED SUGAR, NAMELY, EVAPORATED SUGAR CANE JUICE, IN CLASS 30 (U.S. CL. 46).

FIRST USE 1-1-2011; IN COMMERCE 1-1-2011.

NO CLAIM IS MADE TO THE EXCLUSIVE RIGHT TO USE "SALT", APART FROM THE MARK AS SHOWN.

THE MARK CONSISTS OF THE STYLIZED WORDING "GO LB. SALT" APPEARING UPON SQUARE DESIGN ELEMENT WHICH IS SPLIT IN HALF HORIZONTALLY. THE UPPER PORTION OF THE DESIGN CONTAINS THE WORDING "GO LB." THE LOWER PORTION OF THE DESIGN CONTAINS THE WORD "SALT".

SER. NO. 85-503,597, FILED 12-24-2011.

GEOFFREY FOSDICK, EXAMINING ATTORNEY



*David J. Kyfos*

Director of the United States Patent and Trademark Office

# United States of America

United States Patent and Trademark Office

# ZIP KIT

**Reg. No. 4,197,605**

**Registered Aug. 28, 2012**

**Int. Cl.: 12**

**TRADEMARK**

**PRINCIPAL REGISTER**

SONNAX INDUSTRIES, INC. (VERMONT CORPORATION)  
AUTOMATIC DRIVE, P.O. BOX 440  
BELLOWS FALLS, VT 051010440

FOR: KITS COMPRISED OF TRANSMISSION REPLACEMENT PARTS USED TO REPAIR TRANSMISSIONS FOR LAND VEHICLES, SOLD AS A UNIT, IN CLASS 12 (U.S. CLS. 19, 21, 23, 31, 35 AND 44).

FIRST USE 9-15-2011; IN COMMERCE 9-15-2011.

THE MARK CONSISTS OF STANDARD CHARACTERS WITHOUT CLAIM TO ANY PARTICULAR FONT, STYLE, SIZE, OR COLOR.

NO CLAIM IS MADE TO THE EXCLUSIVE RIGHT TO USE "KIT", APART FROM THE MARK AS SHOWN.

SER. NO. 85-503,600, FILED 12-24-2011.

MICHAEL KEATING, EXAMINING ATTORNEY



*David J. Kybas*

Director of the United States Patent and Trademark Office



# United States of America

United States Patent and Trademark Office

## ANGEL IN A PICKLE

**Reg. No. 4,197,606**

NELOWET, SCOTT H. (UNITED STATES INDIVIDUAL)  
8144 SUMMIT RIDGE LANE  
JACKSONVILLE, FL 32256

**Registered Aug. 28, 2012**

**Int. Cl.: 29**

FOR: FRENCH FRY FOOD ITEM CONSISTING PRIMARILY OF FRENCH FRIES, BUT ALSO INCLUDING GRAVY AND TOPPINGS, IN CLASS 29 (U.S. CL. 46).

**TRADEMARK**

FIRST USE 11-1-2011; IN COMMERCE 11-1-2011.

**PRINCIPAL REGISTER**

THE MARK CONSISTS OF STANDARD CHARACTERS WITHOUT CLAIM TO ANY PARTICULAR FONT, STYLE, SIZE, OR COLOR.

SER. NO. 85-503,734, FILED 12-26-2011.

CHERYL CLAYTON, EXAMINING ATTORNEY



*David J. Kybas*

Director of the United States Patent and Trademark Office

# United States of America

United States Patent and Trademark Office

## ULTIMATE SMILE

**Reg. No. 4,197,607**

HOFFMAN, JOSEPH (UNITED STATES INDIVIDUAL)  
3381 N 40TH ST  
HOLLYWOOD, FL 33021

**Registered Aug. 28, 2012**

**Int. Cl.: 3**

FOR: TEETH WHITENING KITS; TOOTH WHITENING GELS; TOOTH WHITENING PASTES;  
TOOTH WHITENING PREPARATIONS; TEETH WHITENING STRIPS IMPREGNATED WITH  
TEETH WHITENING PREPARATIONS, IN CLASS 3 (U.S. CLS. 1, 4, 6, 50, 51 AND 52).

**TRADEMARK**

FIRST USE 6-6-2007; IN COMMERCE 6-6-2007.

**PRINCIPAL REGISTER**

THE MARK CONSISTS OF STANDARD CHARACTERS WITHOUT CLAIM TO ANY PAR-  
TICULAR FONT, STYLE, SIZE, OR COLOR.

SER. NO. 85-503,736, FILED 12-26-2011.

CHERYL CLAYTON, EXAMINING ATTORNEY



*David J. Kyros*

Director of the United States Patent and Trademark Office

# United States of America

United States Patent and Trademark Office

## FRENCH QUARTER ANGEL

**Reg. No. 4,197,608**

NELOWET, SCOTT H. (UNITED STATES INDIVIDUAL)  
8144 SUMMIT RIDGE LANE  
JACKSONVILLE, FL 32256

**Registered Aug. 28, 2012**

**Int. Cl.: 29**

FOR: FRENCH FRY FOOD ITEM CONSISTING PRIMARILY OF FRENCH FRIES, BUT ALSO INCLUDING GRAVY AND TOPPINGS, IN CLASS 29 (U.S. CL. 46).

**TRADEMARK**

FIRST USE 11-1-2011; IN COMMERCE 11-1-2011.

**PRINCIPAL REGISTER**

THE MARK CONSISTS OF STANDARD CHARACTERS WITHOUT CLAIM TO ANY PARTICULAR FONT, STYLE, SIZE, OR COLOR.

SER. NO. 85-503,738, FILED 12-26-2011.

CHERYL CLAYTON, EXAMINING ATTORNEY



*David J. Kyffers*

Director of the United States Patent and Trademark Office

# United States of America

United States Patent and Trademark Office

## SIMPLE SAINT

**Reg. No. 4,197,609**

NELOWET, SCOTT H. (UNITED STATES INDIVIDUAL)  
8144 SUMMIT RIDGE LANE  
JACKSONVILLE, FL 32256

**Registered Aug. 28, 2012**

**Int. Cl.: 29**

FOR: FRENCH FRY FOOD ITEM CONSISTING PRIMARILY OF FRENCH FRIES, BUT ALSO INCLUDING GRAVY AND TOPPINGS, IN CLASS 29 (U.S. CL. 46).

**TRADEMARK**

FIRST USE 11-1-2011; IN COMMERCE 11-1-2011.

**PRINCIPAL REGISTER**

THE MARK CONSISTS OF STANDARD CHARACTERS WITHOUT CLAIM TO ANY PARTICULAR FONT, STYLE, SIZE, OR COLOR.

SER. NO. 85-503,744, FILED 12-26-2011.

CHERYL CLAYTON, EXAMINING ATTORNEY



*David J. Kybas*

Director of the United States Patent and Trademark Office

# United States of America

United States Patent and Trademark Office

## ANGEL OF LOVE

**Reg. No. 4,197,610**

NELOWET, SCOTT H. (UNITED STATES INDIVIDUAL)  
8144 SUMMIT RIDGE LANE  
JACKSONVILLE, FL 32951

**Registered Aug. 28, 2012**

**Int. Cl.: 29**

FOR: FRENCH FRY FOOD ITEM CONSISTING PRIMARILY OF FRENCH FRIES, BUT ALSO INCLUDING GRAVY AND TOPPINGS, IN CLASS 29 (U.S. CL. 46).

**TRADEMARK**

FIRST USE 11-1-2011; IN COMMERCE 11-1-2011.

**PRINCIPAL REGISTER**

THE MARK CONSISTS OF STANDARD CHARACTERS WITHOUT CLAIM TO ANY PARTICULAR FONT, STYLE, SIZE, OR COLOR.

SER. NO. 85-503,754, FILED 12-26-2011.

CHERYL CLAYTON, EXAMINING ATTORNEY



*David J. Kyffers*

Director of the United States Patent and Trademark Office

# United States of America

United States Patent and Trademark Office

## SEDONA METHOD

**Reg. No. 4,197,611**

**Registered Aug. 28, 2012**

**Int. Cls.: 9, 41 and 44**

**TRADEMARK**

**SERVICE MARK**

**PRINCIPAL REGISTER**

SEDONA TRAINING ASSOCIATES, LLC (ARIZONA LIMITED LIABILITY COMPANY)  
53 PINON COURT  
SEDONA, AZ 86336

FOR: DOWNLOADABLE DIGITAL MEDIA, NAMELY, PODCASTS, MP3S, WEBINARS, DIGITAL AUDIO RECORDINGS, AND AUDIO FILES ALL FEATURING TRAINING, TEACHING AND EDUCATIONAL SUBJECT MATTER IN THE FIELD OF EMOTIONAL AND STRESS RELIEF METHODS AND PERSONAL GROWTH METHODS; PRERECORDED CDS FEATURING TRAINING, TEACHING AND EDUCATIONAL SUBJECT MATTER IN THE FIELD OF EMOTIONAL AND STRESS RELIEF METHODS AND PERSONAL GROWTH METHODS, IN CLASS 9 (U.S. CLS. 21, 23, 26, 36 AND 38).

FIRST USE 12-31-2000; IN COMMERCE 12-31-2000.

FOR: EDUCATIONAL SERVICES, NAMELY, PROVIDING ON-LINE E-LEARNING SEMINARS IN THE FIELD OF EMOTIONAL AND STRESS RELIEF METHODS AND PERSONAL GROWTH METHODS, IN CLASS 41 (U.S. CLS. 100, 101 AND 107).

FIRST USE 6-30-2010; IN COMMERCE 6-30-2010.

FOR: PROVIDING A WEBSITE FEATURING HEALTH INFORMATION REGARDING STRESS ELIMINATION, HEALTH AND WELLNESS, IN CLASS 44 (U.S. CLS. 100 AND 101).

FIRST USE 4-30-1996; IN COMMERCE 4-30-1996.

THE MARK CONSISTS OF STANDARD CHARACTERS WITHOUT CLAIM TO ANY PARTICULAR FONT, STYLE, SIZE, OR COLOR.

OWNER OF U.S. REG. NOS. 1,468,644, 2,495,644, AND 2,495,646.

SEC. 2(F).

SER. NO. 85-503,761, FILED 12-26-2011.

WON TEAK OH, EXAMINING ATTORNEY



*David J. Kypos*

Director of the United States Patent and Trademark Office

# United States of America

United States Patent and Trademark Office

# ORBIT

**Reg. No. 4,197,612**

HART SPECIALTIES, INC. (NEW YORK CORPORATION)  
5000 NEW HORIZONS BLVD  
AMITYVILLE, NY 11701

**Registered Aug. 28, 2012**

**Int. Cl.: 9**

FOR: EYEGLOSS FRAMES; EYEGLOSS CASES; EYEGLOSS ACCESSORIES, NAMELY, NOSE PADS, CORDS, CHAINS, CLIPON HARDWARE FOR EYEGASSES, IN CLASS 9 (U.S. CLS. 21, 23, 26, 36 AND 38).

**TRADEMARK**

FIRST USE 4-21-2011; IN COMMERCE 4-21-2011.

**PRINCIPAL REGISTER**

THE MARK CONSISTS OF STANDARD CHARACTERS WITHOUT CLAIM TO ANY PARTICULAR FONT, STYLE, SIZE, OR COLOR.

SER. NO. 85-503,769, FILED 12-26-2011.

TARAH HARDY, EXAMINING ATTORNEY



*David J. Kybas*

Director of the United States Patent and Trademark Office

# United States of America

United States Patent and Trademark Office



**Reg. No. 4,197,613**

SEDONA TRAINING ASSOCIATES, LLC (ARIZONA LIMITED LIABILITY COMPANY)  
53 PINON COURT  
SEDONA, AZ 86336

**Registered Aug. 28, 2012**

**Int. Cls.: 9, 16, 41 and 44**

FOR: DOWNLOADABLE DIGITAL MEDIA, NAMELY, PODCASTS, MP3S, WEBINARS, DIGITAL AUDIO RECORDINGS, AND AUDIO FILES ALL FEATURING TRAINING, TEACHING AND EDUCATIONAL SUBJECT MATTER IN THE FIELD OF EMOTIONAL AND STRESS RELIEF METHODS AND PERSONAL GROWTH METHODS; PRERECORDED CDS FEATURING TRAINING, TEACHING AND EDUCATIONAL SUBJECT MATTER IN THE FIELD OF EMOTIONAL AND STRESS RELIEF METHODS AND PERSONAL GROWTH METHODS, IN CLASS 9 (U.S. CLS. 21, 23, 26, 36 AND 38).

**TRADEMARK**

**SERVICE MARK**

**PRINCIPAL REGISTER**

FIRST USE 6-30-2008; IN COMMERCE 6-30-2008.

FOR: BOOKS AND WORKBOOKS FEATURING EMOTIONAL AND STRESS RELIEF METHODS AND PERSONAL GROWTH METHODS, IN CLASS 16 (U.S. CLS. 2, 5, 22, 23, 29, 37, 38 AND 50).

FIRST USE 6-30-1999; IN COMMERCE 6-30-1999.

FOR: EDUCATIONAL SERVICES, NAMELY, PROVIDING ON-LINE E-LEARNING SEMINARS IN THE FIELD OF EMOTIONAL AND STRESS RELIEF METHODS AND PERSONAL GROWTH METHODS; EDUCATIONAL SERVICES---NAMELY, CONDUCTING COURSES, SEMINARS AND WORKSHOPS RELATING TO EMOTIONAL AND STRESS RELIEF AND THE PERSONAL GROWTH RESULTING THEREFROM, IN CLASS 41 (U.S. CLS. 100, 101 AND 107).

FIRST USE 6-30-2010; IN COMMERCE 6-30-2010.

FOR: PROVIDING A WEBSITE FEATURING HEALTH INFORMATION REGARDING STRESS ELIMINATION, HEALTH AND WELLNESS, IN CLASS 44 (U.S. CLS. 100 AND 101).

FIRST USE 6-30-1999; IN COMMERCE 6-30-1999.

THE MARK CONSISTS OF A CIRCLE WITH A STYLIZED PHOENIX IN THE CENTER.

SER. NO. 85-503,772, FILED 12-26-2011.



*David J. Kybas*

Director of the United States Patent and Trademark Office



**Reg. No. 4,197,613** WON TEAK OH, EXAMINING ATTORNEY

# United States of America

United States Patent and Trademark Office

# MONO

**Reg. No. 4,197,614**

MONO CASES LLC (CALIFORNIA LIMITED LIABILITY COMPANY)  
62 HILLVIEW AVE  
SAN RAFAEL, CA 94901

**Registered Aug. 28, 2012**

**Int. Cl.: 15**

FOR: CARRYING CASES FOR MUSICAL INSTRUMENTS AND ACCESSORIES THEREFOR,  
NAMELY, MUSICAL INSTRUMENT STRAPS, IN CLASS 15 (U.S. CLS. 2, 21 AND 36).

**TRADEMARK**

FIRST USE 3-1-2007; IN COMMERCE 3-1-2007.

**PRINCIPAL REGISTER**

THE MARK CONSISTS OF STANDARD CHARACTERS WITHOUT CLAIM TO ANY PAR-  
TICULAR FONT, STYLE, SIZE, OR COLOR.

OWNER OF U.S. REG. NO. 3,296,606.

SER. NO. 85-503,798, FILED 12-26-2011.

DEBORAH LOBO, EXAMINING ATTORNEY



*David J. Kybas*

Director of the United States Patent and Trademark Office

# United States of America

United States Patent and Trademark Office

# GO PLAY

**Reg. No. 4,197,615**

MONO CASES LLC (CALIFORNIA LIMITED LIABILITY COMPANY)  
62 HILLVIEW AVE  
SAN RAFAEL, CA 94901

**Registered Aug. 28, 2012**

**Int. Cl.: 15**

FOR: CARRYING CASES FOR MUSICAL INSTRUMENTS AND ACCESSORIES THEREFOR,  
NAMELY, MUSICAL INSTRUMENT STRAPS, IN CLASS 15 (U.S. CLS. 2, 21 AND 36).

**TRADEMARK**

FIRST USE 3-1-2007; IN COMMERCE 3-1-2007.

**PRINCIPAL REGISTER**

THE MARK CONSISTS OF STANDARD CHARACTERS WITHOUT CLAIM TO ANY PAR-  
TICULAR FONT, STYLE, SIZE, OR COLOR.

SER. NO. 85-503,799, FILED 12-26-2011.

DEBORAH LOBO, EXAMINING ATTORNEY



*David J. Kybas*

Director of the United States Patent and Trademark Office

# United States of America

United States Patent and Trademark Office

# Recover It

**Reg. No. 4,197,616**

KJB SECURITY PRODUCTS, INC. (TENNESSEE CORPORATION)  
841-B FESSLERS PARKWAY  
NASHVILLE, TN 37210

**Registered Aug. 28, 2012**

**Int. Cl.: 9**

FOR: USB HARDWARE FOR COMPUTER MONITORING, IN CLASS 9 (U.S. CLS. 21, 23, 26, 36 AND 38).

**TRADEMARK**

FIRST USE 9-1-2011; IN COMMERCE 9-1-2011.

**PRINCIPAL REGISTER**

THE MARK CONSISTS OF STANDARD CHARACTERS WITHOUT CLAIM TO ANY PARTICULAR FONT, STYLE, SIZE, OR COLOR.

NO CLAIM IS MADE TO THE EXCLUSIVE RIGHT TO USE "IT", APART FROM THE MARK AS SHOWN.

SER. NO. 85-503,894, FILED 12-27-2011.

TRACY FLETCHER, EXAMINING ATTORNEY



*David J. Kyffers*

Director of the United States Patent and Trademark Office

# United States of America

United States Patent and Trademark Office

# EMSER TILE

**Reg. No. 4,197,617**

EMSER TILE LLC (CALIFORNIA LIMITED LIABILITY COMPANY)

**Registered Aug. 28, 2012**

8431 SANTA MONICA BLVD  
LOS ANGELES, CA 90069

**Int. Cl.: 35**

FOR: RETAIL AND WHOLESALE STORE SERVICES FEATURING FLOORING, IN CLASS 35 (U.S. CLS. 100, 101 AND 102).

**SERVICE MARK**

FIRST USE 0-0-1998; IN COMMERCE 0-0-1998.

**PRINCIPAL REGISTER**

THE MARK CONSISTS OF STANDARD CHARACTERS WITHOUT CLAIM TO ANY PARTICULAR FONT, STYLE, SIZE, OR COLOR.

NO CLAIM IS MADE TO THE EXCLUSIVE RIGHT TO USE "TILE", APART FROM THE MARK AS SHOWN.

SER. NO. 85-504,099, FILED 12-27-2011.

RAMONA ORTIGA, EXAMINING ATTORNEY



*David J. Kyffers*

Director of the United States Patent and Trademark Office

# United States of America

United States Patent and Trademark Office



**Reg. No. 4,197,618**

**Registered Aug. 28, 2012**

**Int. Cl.: 9**

**TRADEMARK**

**PRINCIPAL REGISTER**

TOMATOES EXTRAORDINAIRE, INC. (CALIFORNIA CORPORATION), DBA SPECIALTY PRODUCE  
1929 HANCOCK STREET, SUITE 150  
SAN DIEGO, CA 92110

FOR: COMPUTER APPLICATION SOFTWARE FOR MOBILE PHONES, HAND HELD COMPUTERS, AND PERSONAL COMPUTERS, NAMELY, SOFTWARE FOR REFERENCING INFORMATION AND DATA ON FRUITS AND VEGETABLES, IN CLASS 9 (U.S. CLS. 21, 23, 26, 36 AND 38).

FIRST USE 7-1-2010; IN COMMERCE 7-1-2010.

NO CLAIM IS MADE TO THE EXCLUSIVE RIGHT TO USE "SPECIALTY PRODUCE", APART FROM THE MARK AS SHOWN.

THE MARK CONSISTS OF THE WORDS "SPECIALTY PRODUCE" WITH AN APPLE IMAGE REPLACING THE "O" IN "PRODUCE", UNDERLINED IN AN ARC WITH A VARIETY OF FRUITS AND VEGETABLE IMAGES UNDERNEATH.

SER. NO. 85-504,230, FILED 12-27-2011.

KARANENDRA S. CHHINA, EXAMINING ATTORNEY



*David J. Kyros*

Director of the United States Patent and Trademark Office

# United States of America

United States Patent and Trademark Office



**Reg. No. 4,197,619**

**Registered Aug. 28, 2012**

**Int. Cl.: 31**

**TRADEMARK**

**PRINCIPAL REGISTER**

MONTEREY BAY BOUQUET ACQUISITION PARTNERS, LLC (CALIFORNIA LIMITED LIABILITY COMPANY)  
1750 SAN JUAN ROAD  
WATSONVILLE, CA 95077

FOR: FRESH CUT FLOWERS, IN CLASS 31 (U.S. CLS. 1 AND 46).

FIRST USE 5-31-2001; IN COMMERCE 5-31-2001.

NO CLAIM IS MADE TO THE EXCLUSIVE RIGHT TO USE "MONTEREY BAY BOUQUET", APART FROM THE MARK AS SHOWN.

THE MARK CONSISTS OF THE STYLIZED DESIGN OF A BAY OF WATER WITH CLOUDS IN THE BACKGROUND AND A SAILBOAT ON THE WATER, WITH TWO FLOWERS IN THE FOREGROUND LEANING TO THE RIGHT ACROSS THE WATER, ALL SET IN A RECTANGLE ABOVE THE WORDS "MONTEREY BAY BOUQUET" IN ALL CAPS, UNDERLINED.

SER. NO. 85-504,263, FILED 12-27-2011.

HEATHER THOMPSON, EXAMINING ATTORNEY



*David J. Kybas*

Director of the United States Patent and Trademark Office

# United States of America

United States Patent and Trademark Office



**Reg. No. 4,197,620**

**Registered Aug. 28, 2012**

**Int. Cl.: 28**

**TRADEMARK**

**PRINCIPAL REGISTER**

AHMET YUCE (TURKEY INDIVIDUAL)  
SUITE #117  
1055 WEST SAM HOUSTON PARKWAY NORTH  
HOUSTON, TX 77043

FOR: RADIO CONTROLLED TOY VEHICLES; RADIO TRANSMITTERS FOR USE WITH RADIO-CONTROLLED TOYS; REMOTE CONTROL TOY GLIDER, AIRPLANE AND SAILPLANE EQUIPMENT, NAMELY, REMOTE CONTROL SPARE PARTS, PROPELLERS, MOTORS, GEARS, BLADE SETS, CHARGERS, LANDING SKIDS, CABINS, REMOTES, TAIL MOTORS, TAIL MOTOR UNITS; REMOTE CONTROL TOYS, NAMELY, CARS, HELICOPTERS, TRUCKS, AIRPLANES, BOATS, BUGGIES, RACE CARS, RACE BOATS, RACE TRUCKS, ROBOTS, IN CLASS 28 (U.S. CLS. 22, 23, 38 AND 50).

FIRST USE 1-1-2007; IN COMMERCE 1-1-2007.

THE MARK CONSISTS OF THE WORD "YIBOO" IN BLUE APPEARING ON THE BLACK SCREEN OF A RED TELEVISION ON THE WHITE BACKGROUND.

THE COLOR(S) RED, BLACK, BLUE, AND WHITE IS/ARE CLAIMED AS A FEATURE OF THE MARK.

THE WORDING "YIBOO" HAS NO MEANING IN A FOREIGN LANGUAGE.

SER. NO. 85-504,414, FILED 12-27-2011.

MARTHA SANTOMARTINO, EXAMINING ATTORNEY



*David J. Kybas*

Director of the United States Patent and Trademark Office



# United States of America

United States Patent and Trademark Office

## Skills Pointer

**Reg. No. 4,197,621**

**Registered Aug. 28, 2012**

**Int. Cls.: 9 and 41**

**TRADEMARK**

**SERVICE MARK**

**PRINCIPAL REGISTER**

NORTHWEST EVALUATION ASSOCIATION (OREGON NON-PROFIT CORPORATION)  
121 NW EVERETT STREET  
PORTLAND, OR 97209

FOR: CHILDREN'S EDUCATIONAL SOFTWARE, IN CLASS 9 (U.S. CLS. 21, 23, 26, 36 AND 38).

FIRST USE 5-15-2009; IN COMMERCE 5-15-2009.

FOR: ANALYZING EDUCATIONAL TESTS SCORES AND DATA FOR OTHERS; CHILDREN'S EDUCATIONAL SERVICES, NAMELY, PROVIDING ACADEMIC PERFORMANCE EVALUATION, GUIDANCE AND MONITORING FOR CHILDREN PRE-KINDERGARTEN THROUGH GRADE 12 VIA THE INTERNET; CONSULTATION IN THE FIELD OF K-12 EDUCATIONAL SYSTEMS; EDUCATION SERVICES, NAMELY, PROVIDING KINDERGARTEN THROUGH 12TH GRADE (K-12) CLASSROOM INSTRUCTION; EDUCATION SERVICES, NAMELY, PROVIDING ONLINE COGNITIVE ASSESSMENTS AND TRAINING PROGRAMS THAT HELP IDENTIFY COGNITIVE STRENGTHS AND WEAKNESSES OF AN INDIVIDUAL; EDUCATIONAL SERVICES, NAMELY, DEVELOPING CURRICULUM FOR EDUCATORS; EDUCATIONAL TESTING SERVICES; PROVIDING EDUCATIONAL ASSESSMENT SERVICES; RESEARCH IN THE FIELD OF EDUCATION VIA THE INTERNET, IN CLASS 41 (U.S. CLS. 100, 101 AND 107).

FIRST USE 5-15-2009; IN COMMERCE 5-15-2009.

THE MARK CONSISTS OF STANDARD CHARACTERS WITHOUT CLAIM TO ANY PARTICULAR FONT, STYLE, SIZE, OR COLOR.

NO CLAIM IS MADE TO THE EXCLUSIVE RIGHT TO USE "SKILLS", APART FROM THE MARK AS SHOWN.

SER. NO. 85-504,420, FILED 12-27-2011.

SUSAN RICHARDS, EXAMINING ATTORNEY



*David J. Kyjars*

Director of the United States Patent and Trademark Office

# United States of America

United States Patent and Trademark Office



**Reg. No. 4,197,622**

**Registered Aug. 28, 2012**

**Int. Cl.: 45**

**SERVICE MARK**

**PRINCIPAL REGISTER**

DAYTIME DOGS, LLC (FLORIDA LIMITED LIABILITY COMPANY)  
PO BOX 357878  
GAINESVILLE, FL 32635

FOR: PET SITTING, IN CLASS 45 (U.S. CLS. 100 AND 101).

FIRST USE 10-1-2008; IN COMMERCE 10-1-2008.

NO CLAIM IS MADE TO THE EXCLUSIVE RIGHT TO USE "DOGS" , APART FROM THE MARK AS SHOWN.

THE MARK CONSISTS OF 2 STYLIZED DOGS, AND A SILHOUETTE OF A MAN WITH THE STYLIZED TEXT "DAYTIME DOGS".

SER. NO. 85-504,485, FILED 12-27-2011.

CHARISMA HAMPTON, EXAMINING ATTORNEY



*David J. Kyffers*

Director of the United States Patent and Trademark Office

# United States of America

United States Patent and Trademark Office

# BOOK LUST

**Reg. No. 4,197,623**

PEARL, NANCY (UNITED STATES INDIVIDUAL)  
4501 1/2 NE 55TH STREET  
SEATTLE, WA 98105

**Registered Aug. 28, 2012**

**Int. Cl.: 16**

FOR: PUBLICATIONS, NAMELY, BOOKS IN THE FIELD OF BOOK REVIEWS AND READING RECOMMENDATIONS ON FICTION AND NARRATIVE NON-FICTION TOPICS OF GENERAL INTEREST, IN CLASS 16 (U.S. CLS. 2, 5, 22, 23, 29, 37, 38 AND 50).

**TRADEMARK**

FIRST USE 3-1-2003; IN COMMERCE 9-1-2003.

**PRINCIPAL REGISTER**

THE MARK CONSISTS OF STANDARD CHARACTERS WITHOUT CLAIM TO ANY PARTICULAR FONT, STYLE, SIZE, OR COLOR.

NO CLAIM IS MADE TO THE EXCLUSIVE RIGHT TO USE "BOOK", APART FROM THE MARK AS SHOWN.

SER. NO. 85-504,538, FILED 12-27-2011.

JACLYN KIDWELL WALKER, EXAMINING ATTORNEY



*David J. Kybas*

Director of the United States Patent and Trademark Office

# United States of America

United States Patent and Trademark Office



**Reg. No. 4,197,624**

**Registered Aug. 28, 2012**

**Int. Cl.: 42**

**SERVICE MARK**

**PRINCIPAL REGISTER**

TRANSCEND INFORMATION, INC. (TAIWAN CORPORATION)  
NO. 70, XINGZHONG RD. TAIPEI, TAIWAN  
NO. 70, XINGZHONG RD.  
TAIPEI, TAIWAN 114

FOR: COMPUTER SOFTWARE DESIGN, DEVELOPMENT, UPDATING AND MAINTENANCE; COMPUTER SOFTWARE DEVELOPMENT IN THE FIELD OF MOBILE APPLICATIONS; CUSTOM DESIGN OF MEMORY AND STORAGE PRODUCTS BASED ON PERSONAL SELECTIONS MADE BY THE CUSTOMER; DESIGN AND DEVELOPMENT OF MULTIMEDIA PRODUCTS; DESIGN AND DEVELOPMENT OF ON-LINE COMPUTER SOFTWARE SYSTEMS; DESIGN AND DEVELOPMENT OF COMPUTER HARDWARE AND SOFTWARE; DESIGN AND DEVELOPMENT OF WIRELESS COMMUNICATION SYSTEMS FOR TRANSMISSION AND RECEPTION OF VOICE, DATA AND VIDEO; DESIGN AND DEVELOPMENT OF SOFTWARE AND HARDWARE FOR DATA EXCHANGE AND SHARING; CREATING, DESIGNING AND MAINTAINING HOME PAGES AND WEB SITES; INDUSTRIAL DESIGN; PACKAGING DESIGN; PRODUCT DESIGN AND DEVELOPMENT IN THE FIELD OF MEMORY AND STORAGE PRODUCTS; TECHNICAL SUPPORT SERVICES, NAMELY, TROUBLESHOOTING OF COMPUTER SOFTWARE PROBLEMS; COMPUTER SERVICES, NAMELY, CREATING AN ONLINE COMMUNITY FOR USERS TO GET FEEDBACK FROM THEIR PEERS, REQUEST FOR TECHNICAL SUPPORT, SEEK FOR OPERATION ASSISTANCE, IN CLASS 42 (U.S. CLS. 100 AND 101).

FIRST USE 11-16-2006; IN COMMERCE 11-16-2006.

OWNER OF U.S. REG. NOS. 3,290,430 AND 3,696,577.

THE MARK CONSISTS OF "T" IS SURROUNDED BY TWO ARCS WHICH ARE FORMED BY "T" AND LOOK LIKE A CIRCLE. "TRANSCEND" IS OUR COMPANY NAME.

SER. NO. 85-504,580, FILED 12-28-2011.

NATALIE POLZER, EXAMINING ATTORNEY



*David J. Kyros*

Director of the United States Patent and Trademark Office

**United States of America**  
United States Patent and Trademark Office

# Motochanic

**Reg. No. 4,197,625**

MOTOCHANIC, LLC (NEW JERSEY LIMITED LIABILITY COMPANY)  
5312 PARK AVE

**Registered Aug. 28, 2012**

WEST NEW YORK, NJ 07093

**Int. Cl.: 35**

FOR: RETAIL STORE SERVICES FEATURING MOTORCYCLE APPAREL, CLOTHING ACCESSORIES, AND MOTORCYCLE ACCESSORIES, IN CLASS 35 (U.S. CLS. 100, 101 AND 102).

**SERVICE MARK**

FIRST USE 4-1-2011; IN COMMERCE 4-1-2011.

**PRINCIPAL REGISTER**

THE MARK CONSISTS OF STANDARD CHARACTERS WITHOUT CLAIM TO ANY PARTICULAR FONT, STYLE, SIZE, OR COLOR.

SER. NO. 85-504,587, FILED 12-28-2011.

MARCIE MILONE, EXAMINING ATTORNEY



*David J. Kyffers*

Director of the United States Patent and Trademark Office

# United States of America

United States Patent and Trademark Office

# FrogAds

**Reg. No. 4,197,626**

FROGADS, INC. (NEVADA CORPORATION)

**Registered Aug. 28, 2012**

4946 HASKELL AVE  
ENCINO, CA 91436

**Int. Cl.: 35**

FOR: ONLINE CLASSIFIED ADVERTISING SERVICES, IN CLASS 35 (U.S. CLS. 100, 101 AND 102).

**SERVICE MARK**

FIRST USE 2-7-2010; IN COMMERCE 3-12-2011.

**PRINCIPAL REGISTER**

THE MARK CONSISTS OF STANDARD CHARACTERS WITHOUT CLAIM TO ANY PARTICULAR FONT, STYLE, SIZE, OR COLOR.

SER. NO. 85-504,593, FILED 12-28-2011.

MARTHA SANTOMARTINO, EXAMINING ATTORNEY



*David J. Kyffers*

Director of the United States Patent and Trademark Office

**United States of America**  
United States Patent and Trademark Office

**OSPREY**

**Reg. No. 4,197,627**

**Registered Aug. 28, 2012**

**Int. Cl.: 18**

**TRADEMARK**

**PRINCIPAL REGISTER**

OSPREY PACKS, INC. (COLORADO CORPORATION)  
115 W. PROGRESS CIRCLE  
CORTEZ, CO 81321

FOR: SPORTS BAGS; TRAVEL BAGS, IN CLASS 18 (U.S. CLS. 1, 2, 3, 22 AND 41).

FIRST USE 8-1-2000; IN COMMERCE 8-1-2000.

THE MARK CONSISTS OF STANDARD CHARACTERS WITHOUT CLAIM TO ANY PARTICULAR FONT, STYLE, SIZE, OR COLOR.

OWNER OF U.S. REG. NOS. 2,571,330, 3,054,327 AND OTHERS.

SER. NO. 85-504,797, FILED 12-28-2011.

DAVID ELTON, EXAMINING ATTORNEY



*David J. Kyffers*

Director of the United States Patent and Trademark Office

# United States of America

United States Patent and Trademark Office



STEINBERG  
*advisors, ltd.*

CERTIFIED PUBLIC ACCOUNTANTS

**Reg. No. 4,197,628**

**Registered Aug. 28, 2012**

**Int. Cl.: 35**

**SERVICE MARK**

**PRINCIPAL REGISTER**

STEINBERG ADVISORS, LTD. (ILLINOIS CORPORATION)  
SUITE 400  
5 REVERE DRIVE  
NORTHBROOK, IL 60062

FOR: ACCOUNTING ADVISORY AND BUSINESS CONSULTING SERVICES, IN CLASS 35  
(U.S. CLS. 100, 101 AND 102).

FIRST USE 4-1-2000; IN COMMERCE 4-1-2000.

NO CLAIM IS MADE TO THE EXCLUSIVE RIGHT TO USE "ADVISORS, LTD." AND  
"CERTIFIED PUBLIC ACCOUNTANTS", APART FROM THE MARK AS SHOWN.

THE COLOR(S) BLUE, BLACK AND WHITE IS/ARE CLAIMED AS A FEATURE OF THE  
MARK.

THE MARK CONSISTS OF STYLIZED LETTERS S AND A OUTLINED IN WHITE IN A  
BLUE BOX; A DARK BLUE LINE ABOVE AND BELOW THE WORD "STEINBERG" IN  
BLACK LETTERS; THE WORDS "ADVISORS, LTD." IN BLACK ITALICS; AND THE WORDS  
"CERTIFIED PUBLIC ACCOUNTANTS" IN BLUE LETTERS

SER. NO. 85-504,802, FILED 12-28-2011.

WON TEAK OH, EXAMINING ATTORNEY



*David J. Kybas*

Director of the United States Patent and Trademark Office



# United States of America

United States Patent and Trademark Office

## RentalBeacon.com

**Reg. No. 4,197,629**

RBC HOLDINGS INC. (DELAWARE CORPORATION)

**Registered Aug. 28, 2012**

361 LARCH  
ELMHURST, IL 60126

**Int. Cl.: 35**

FOR: MATCHING CONSUMERS WITH REAL ESTATE PROFESSIONALS IN THE FIELD OF REAL ESTATE SERVICES VIA COMPUTER NETWORK, IN CLASS 35 (U.S. CLS. 100, 101 AND 102).

**SERVICE MARK**

FIRST USE 6-15-2011; IN COMMERCE 6-15-2011.

**PRINCIPAL REGISTER**

THE MARK CONSISTS OF STANDARD CHARACTERS WITHOUT CLAIM TO ANY PARTICULAR FONT, STYLE, SIZE, OR COLOR.

SER. NO. 85-504,864, FILED 12-28-2011.

JENNIFER VASQUEZ, EXAMINING ATTORNEY



*David J. Kybas*

Director of the United States Patent and Trademark Office

# United States of America

United States Patent and Trademark Office



**Reg. No. 4,197,630**

**Registered Aug. 28, 2012**

**Int. Cl.: 35**

**SERVICE MARK**

**PRINCIPAL REGISTER**

TOMATOES EXTRAORDINAIRE, INC. (CALIFORNIA CORPORATION), DBA SPECIALTY PRODUCE  
1929 HANCOCK STREET, SUITE 150  
SAN DIEGO, CA 92110

FOR: ON-LINE RETAIL STORE SERVICES FEATURING A WIDE VARIETY OF CONSUMER GOODS OF OTHERS; ON-LINE WHOLESALE STORE SERVICES FEATURING A WIDE VARIETY OF CONSUMER GOODS OF OTHERS; WHOLESALE STORE SERVICES FEATURING A WIDE VARIETY OF CONSUMER GOODS OF OTHERS, IN CLASS 35 (U.S. CLS. 100, 101 AND 102).

FIRST USE 7-1-2000; IN COMMERCE 7-1-2000.

NO CLAIM IS MADE TO THE EXCLUSIVE RIGHT TO USE "SPECIALTY PRODUCE", APART FROM THE MARK AS SHOWN.

THE MARK CONSISTS OF THE WORDS "SPECIALTY PRODUCE" WITH AN APPLE IMAGE REPLACING THE "O" IN "PRODUCE", UNDERLINED IN AN ARC WITH A VARIETY OF FRUITS AND VEGETABLE IMAGES UNDERNEATH.

SER. NO. 85-504,895, FILED 12-28-2011.

KARANENDRA S. CHHINA, EXAMINING ATTORNEY



*David J. Kyjars*

Director of the United States Patent and Trademark Office

# United States of America

United States Patent and Trademark Office



**Reg. No. 4,197,631**

MCDERMOTT, DAVID D (UNITED STATES INDIVIDUAL)  
4747 LINCOLN MALL DR, STE 601  
MATTESON, IL 60443

**Registered Aug. 28, 2012**

**Int. Cl.: 41**

FOR: ENTERTAINMENT MEDIA PRODUCTION SERVICES FOR MOTION PICTURES,  
TELEVISION AND INTERNET, IN CLASS 41 (U.S. CLS. 100, 101 AND 107).

**SERVICE MARK**

FIRST USE 9-21-2011; IN COMMERCE 11-11-2011.

**PRINCIPAL REGISTER**

THE MARK CONSISTS OF A STYLIZED "NL".

SER. NO. 85-504,901, FILED 12-28-2011.

EUGENIA MARTIN, EXAMINING ATTORNEY



*David J. Kyffers*

Director of the United States Patent and Trademark Office

# United States of America

United States Patent and Trademark Office

## Moody Bitch Apothecary

**Reg. No. 4,197,632**

PRIMAK, HEATHER (UNITED STATES INDIVIDUAL)  
11845 OCEAN VIEW DRIVE  
SPARKS, NV 89441

**Registered Aug. 28, 2012**

**Int. Cl.: 3**

FOR: NON-MEDICATED SKIN CARE PREPARATIONS, NAMELY, SOAPS, BODY SCRUBS, BATH SALTS, AND LOTIONS; PERFUMES; REEDS AND SCENTED OILS SOLD AS A UNIT FOR USE IN ROOM SCENT DIFFUSERS , IN CLASS 3 (U.S. CLS. 1, 4, 6, 50, 51 AND 52).

**TRADEMARK**

FIRST USE 10-7-2011; IN COMMERCE 10-7-2011.

**PRINCIPAL REGISTER**

THE MARK CONSISTS OF STANDARD CHARACTERS WITHOUT CLAIM TO ANY PARTICULAR FONT, STYLE, SIZE, OR COLOR.

NO CLAIM IS MADE TO THE EXCLUSIVE RIGHT TO USE "APOTHECARY", APART FROM THE MARK AS SHOWN.

SER. NO. 85-504,975, FILED 12-28-2011.

MARCIE MILONE, EXAMINING ATTORNEY



*David J. Kyffers*

Director of the United States Patent and Trademark Office

# United States of America

United States Patent and Trademark Office

# PANTHER

**Reg. No. 4,197,633**

THE PANTHER AIR BOAT CORPORATION (FLORIDA CORPORATION)  
300 WILSON AVENUE  
COCOA, FL 32922

**Registered Aug. 28, 2012**

**Int. Cl.: 12**

FOR: WATERCRAFT, NAMELY, AIRBOATS AND STRUCTURAL PARTS THEREOF, IN CLASS 12 (U.S. CLS. 19, 21, 23, 31, 35 AND 44).

**TRADEMARK**

FIRST USE 12-31-1979; IN COMMERCE 12-31-1979.

**PRINCIPAL REGISTER**

THE MARK CONSISTS OF STANDARD CHARACTERS WITHOUT CLAIM TO ANY PARTICULAR FONT, STYLE, SIZE, OR COLOR.

SER. NO. 85-505,017, FILED 12-28-2011.

CHRISTOPHER BUONGIORNO, EXAMINING ATTORNEY



*David J. Kybas*

Director of the United States Patent and Trademark Office

# United States of America

United States Patent and Trademark Office

## Serving Christ Through Construction

**Reg. No. 4,197,634**

DALLAS 1 CORPORATION (FLORIDA CORPORATION)  
10328 MAIN STREET

**Registered Aug. 28, 2012**

THONOTOSASSA, FL 33592

**Int. Cl.: 37**

FOR: UNDERGROUND UTILITY CONTRACTOR SERVICES IN THE NATURE OF CONSTRUCTION OF UNDERGROUND UTILITIES, IN CLASS 37 (U.S. CLS. 100, 103 AND 106).

**SERVICE MARK**

FIRST USE 1-1-2010; IN COMMERCE 1-1-2010.

**PRINCIPAL REGISTER**

THE MARK CONSISTS OF STANDARD CHARACTERS WITHOUT CLAIM TO ANY PARTICULAR FONT, STYLE, SIZE, OR COLOR.

SER. NO. 85-505,163, FILED 12-28-2011.

BARBARA RUTLAND, EXAMINING ATTORNEY



*David J. Kyffers*

Director of the United States Patent and Trademark Office

# United States of America

United States Patent and Trademark Office

## 702 Series

**Reg. No. 4,197,635**

PAKZADIAN, AMIR (IRAN INDIVIDUAL)  
801 BURNETT AVE #6  
SAN FRANCISCO, CA 94131

**Registered Aug. 28, 2012**

**Int. Cl.: 41**

FOR: ENTERTAINMENT SERVICES, NAMELY, CONDUCTING PARTIES, IN CLASS 41 (U.S. CLS. 100, 101 AND 107).

**SERVICE MARK**

FIRST USE 12-10-2011; IN COMMERCE 12-10-2011.

**PRINCIPAL REGISTER**

THE MARK CONSISTS OF STANDARD CHARACTERS WITHOUT CLAIM TO ANY PARTICULAR FONT, STYLE, SIZE, OR COLOR.

NO CLAIM IS MADE TO THE EXCLUSIVE RIGHT TO USE "SERIES", APART FROM THE MARK AS SHOWN.

SER. NO. 85-505,207, FILED 12-28-2011.

AHSEN KHAN, EXAMINING ATTORNEY



*David J. Kybas*

Director of the United States Patent and Trademark Office

# United States of America

United States Patent and Trademark Office

# algaebits

**Reg. No. 4,197,636**

**Registered Aug. 28, 2012**

**Int. Cl.: 5**

**TRADEMARK**

**PRINCIPAL REGISTER**

ARNSTON, CATHARINE V. (CANADA INDIVIDUAL), DBA THE NAUGHTY NUTRITIONIST  
INC.  
9 HAWTHORNE PLACE, SUITE 6R  
BOSTON, MA 02114

FOR: DIETARY AND NUTRITIONAL SUPPLEMENTS CONTAINING ALGAE, IN CLASS 5  
(U.S. CLS. 6, 18, 44, 46, 51 AND 52).

FIRST USE 6-1-2010; IN COMMERCE 6-1-2010.

THE MARK CONSISTS OF STANDARD CHARACTERS WITHOUT CLAIM TO ANY PAR-  
TICULAR FONT, STYLE, SIZE, OR COLOR.

SER. NO. 85-505,254, FILED 12-28-2011.

SHAILA SETTLES, EXAMINING ATTORNEY



*David J. Kyros*

Director of the United States Patent and Trademark Office



# United States of America

United States Patent and Trademark Office

# PRIME

WORLD

**Reg. No. 4,197,637**

**Registered Aug. 28, 2012**

**Int. Cls.: 9 and 41**

**TRADEMARK**

**SERVICE MARK**

**PRINCIPAL REGISTER**

ZZIMA INTERNATIONAL (LUXEMBOURG SOCIÉTÉ À RESPONSABILITÉ LIMITÉE (SARL))  
75, PARC D'ACTIVITES  
MAMER/CAPELLEN, LUXEMBOURG L-8308

FOR: DOWNLOADABLE COMPUTER GAME SOFTWARE FOR USE ON WIRELESS DEVICES AND COMPUTERS; COMPUTER GAME PROGRAMS FOR COMPUTER, VIDEO, ONLINE AND BROWSER GAMES; COMPUTER SOFTWARE, NAMELY, GAME ENGINE SOFTWARE FOR VIDEO GAME DEVELOPMENT AND OPERATION, IN CLASS 9 (U.S. CLS. 21, 23, 26, 36 AND 38).

FIRST USE 12-30-2008; IN COMMERCE 10-4-2011.

FOR: INTERACTIVE GAME SERVICES PROVIDED ON-LINE OVER A COMPUTER NETWORK OR THE INTERNET, NAMELY, PROVIDING A COMPUTER GAME THAT MAY BE ACCESSED NETWORK-WIDE BY NETWORK USERS; INTERACTIVE GAMES, INTERACTIVE ENTERTAINMENT AND COMPETITION SERVICES, ALL IN THE NATURE OF ONLINE COMPUTER GAMES PROVIDED OVER A COMPUTER NETWORK OR THE INTERNET; PROVIDING ONLINE COMPUTER GAMES SERVICES ON COMPUTER NETWORKS; PROVIDING ONLINE COMPUTER GAMES, ONLINE VIDEO COMPUTER GAMES, ONLINE COMPUTER GAMES AND ONLINE BROWSER COMPUTER GAMES AND ONLINE COMPUTER GAMES FOR MOBILE TELEPHONES; ENTERTAINMENT SERVICES, NAMELY, PROVIDING VIRTUAL ENVIRONMENTS IN WHICH USERS CAN INTERACT THROUGH SOCIAL GAMES FOR RECREATIONAL, LEISURE OR ENTERTAINMENT PURPOSES; PRODUCTION OF ONLINE DIGITAL FILMS CONCERNING GAMES AND GAME STRATEGY; PROVIDING A WEB-BASED SYSTEM AND ONLINE PORTAL FOR CUSTOMERS TO PARTICIPATE IN ONLINE GAMING, IN CLASS 41 (U.S. CLS. 100, 101 AND 107).

FIRST USE 12-30-2008; IN COMMERCE 10-4-2011.

THE MARK CONSISTS OF THE WORDS "PRIME WORLD" IN A STYLIZED FONT AND THE "I" WITH A TEARDROP FORMING THE DOT. THE "I" LOOKS LIKE A DAGGER. THE TERM "WORLD" FALLS BELOW THE TERM "PRIME".

SER. NO. 85-505,284, FILED 12-28-2011.

LINDA MICKLEBURGH, EXAMINING ATTORNEY



*David J. Kyffers*

Director of the United States Patent and Trademark Office

# United States of America

United States Patent and Trademark Office

## Athens Consulting

**Reg. No. 4,197,638**

**Registered Aug. 28, 2012**

**Int. Cl.: 42**

**SERVICE MARK**

**PRINCIPAL REGISTER**

ATHENS CONSULTING, LLC (CALIFORNIA LIMITED LIABILITY COMPANY)  
SUITE 300  
225 SOUTH LAKE AVENUE  
PASADENA, CA 91101

FOR: ENGINEERING DESIGN SERVICES; PRODUCT DEVELOPMENT AND ENGINEERING SERVICES FOR OTHERS, IN CLASS 42 (U.S. CLS. 100 AND 101).

FIRST USE 12-18-2006; IN COMMERCE 12-18-2006.

THE MARK CONSISTS OF STANDARD CHARACTERS WITHOUT CLAIM TO ANY PARTICULAR FONT, STYLE, SIZE, OR COLOR.

NO CLAIM IS MADE TO THE EXCLUSIVE RIGHT TO USE "CONSULTING", APART FROM THE MARK AS SHOWN.

SER. NO. 85-505,292, FILED 12-28-2011.

ESTHER BELENKER, EXAMINING ATTORNEY



*David J. Kybas*

Director of the United States Patent and Trademark Office

# United States of America

United States Patent and Trademark Office

## Amazatto Foods

**Reg. No. 4,197,639**

**Registered Aug. 28, 2012**

**Int. Cl.: 30**

**TRADEMARK**

**PRINCIPAL REGISTER**

AMAZATTO FOODS & MARKETING, INC (MAINE CORPORATION)  
113 NORTH LANCEY ST., P.O. BOX 370  
PITTSFIELD, ME 04967

FOR: PASTA, IN CLASS 30 (U.S. CL. 46).

FIRST USE 2-15-2001; IN COMMERCE 10-20-2009.

THE MARK CONSISTS OF STANDARD CHARACTERS WITHOUT CLAIM TO ANY PARTICULAR FONT, STYLE, SIZE, OR COLOR.

NO CLAIM IS MADE TO THE EXCLUSIVE RIGHT TO USE "FOODS", APART FROM THE MARK AS SHOWN.

SER. NO. 85-505,310, FILED 12-29-2011.

PRISCILLA MILTON, EXAMINING ATTORNEY



*David J. Kyffers*

Director of the United States Patent and Trademark Office

# United States of America

United States Patent and Trademark Office

# ASSESSA

**Reg. No. 4,197,640**

**Registered Aug. 28, 2012**

**Int. Cl.: 42**

**SERVICE MARK**

**PRINCIPAL REGISTER**

COLUMBUS RESEARCH, INC. (CALIFORNIA CORPORATION), DBA WATSON EDUCATION  
1724 WASHINGTON PL  
SAN DIEGO, CA 92103

FOR: DESIGN AND DEVELOPMENT OF COMPUTER SOFTWARE FOR DATA COLLECTION;  
SOFTWARE AS A SERVICE (SAAS) SERVICES FEATURING SOFTWARE IN THE FIELD  
OF EDUCATIONAL DATA COLLECTION; SOFTWARE DEVELOPMENT CONSULTING IN  
THE FIELD OF EDUCATIONAL DATA COLLECTION, IN CLASS 42 (U.S. CLS. 100 AND  
101).

FIRST USE 10-24-2001; IN COMMERCE 10-24-2001.

THE MARK CONSISTS OF STANDARD CHARACTERS WITHOUT CLAIM TO ANY PAR-  
TICULAR FONT, STYLE, SIZE, OR COLOR.

THE WORDING "ASSESSA" HAS NO MEANING IN A FOREIGN LANGUAGE.

SER. NO. 85-505,317, FILED 12-29-2011.

JERI J. FICKES, EXAMINING ATTORNEY



*David J. Kybas*

Director of the United States Patent and Trademark Office

# United States of America

United States Patent and Trademark Office

## KITCHEN COUSINS

**Reg. No. 4,197,641**

**Registered Aug. 28, 2012**

**Int. Cl.: 41**

**SERVICE MARK**

**PRINCIPAL REGISTER**

SCRIPPS NETWORKS, LLC (DELAWARE LIMITED LIABILITY COMPANY)  
9721 SHERRILL BOULEVARD  
KNOXVILLE, TN 37932

FOR: EDUCATIONAL AND ENTERTAINMENT SERVICES, NAMELY, A CONTINUING PROGRAM ABOUT HOME IMPROVEMENT, HOME REPAIR, AND HOME RENOVATION, ACCESSIBLE BY RADIO, TELEVISION, CABLE, FIBER OPTIC NETWORKS, WIRELESS NETWORKS, SATELLITE, AUDIO VIDEO, AND COMPUTER NETWORKS, IN CLASS 41 (U.S. CLS. 100, 101 AND 107).

FIRST USE 10-29-2011; IN COMMERCE 10-29-2011.

THE MARK CONSISTS OF STANDARD CHARACTERS WITHOUT CLAIM TO ANY PARTICULAR FONT, STYLE, SIZE, OR COLOR.

NO CLAIM IS MADE TO THE EXCLUSIVE RIGHT TO USE "KITCHEN", APART FROM THE MARK AS SHOWN.

SER. NO. 85-505,400, FILED 12-29-2011.

SUZANNE BLANE, EXAMINING ATTORNEY



*David J. Kyffers*

Director of the United States Patent and Trademark Office

# United States of America

United States Patent and Trademark Office

## A1 PASSPORT & VISA SERVICES

**Reg. No. 4,197,642**

A 1 PASSPORT & VISA SERVICES INC. (NEW YORK CORPORATION)  
362 FIFTH AVE, SUITE 902  
NEW YORK, NY 10001

**Registered Aug. 28, 2012**

**Int. Cl.: 39**

FOR: ARRANGING FOR TRAVEL VISAS AND PASSPORTS AND RELATED CONSULTING SERVICES FOR PERSONS TRAVELING ABROAD, IN CLASS 39 (U.S. CLS. 100 AND 105).

**SERVICE MARK**

FIRST USE 7-6-2007; IN COMMERCE 7-6-2007.

**PRINCIPAL REGISTER**

THE MARK CONSISTS OF STANDARD CHARACTERS WITHOUT CLAIM TO ANY PARTICULAR FONT, STYLE, SIZE, OR COLOR.

NO CLAIM IS MADE TO THE EXCLUSIVE RIGHT TO USE "PASSPORT & VISA SERVICES", APART FROM THE MARK AS SHOWN.

SER. NO. 85-505,494, FILED 12-29-2011.

JULIE VEPPUMTHARA, EXAMINING ATTORNEY



*David J. Kybas*

Director of the United States Patent and Trademark Office

# United States of America

United States Patent and Trademark Office



**Reg. No. 4,197,643**

**Registered Aug. 28, 2012**

**Int. Cl.: 5**

**TRADEMARK**

**PRINCIPAL REGISTER**

AVON PRODUCTS, INC. (NEW YORK CORPORATION)  
LEGAL DEPARTMENT, 3RD FLOOR  
777 THIRD AVENUE  
NEW YORK, NY 10017

FOR: ACNE TREATMENT PREPARATIONS, IN CLASS 5 (U.S. CLS. 6, 18, 44, 46, 51 AND 52).

FIRST USE 1-1-2005; IN COMMERCE 1-1-2005.

OWNER OF U.S. REG. NOS. 3,046,726, 3,445,832, AND 3,446,056.

THE MARK CONSISTS OF THE WORD "MARK" FOLLOWED BY A ".". THE BLACK AND GREY SHOWN IN THE MARK IS FOR SHADING PURPOSES ONLY AND IS NOT A FEATURE OF THE MARK.

SER. NO. 85-505,495, FILED 12-29-2011.

SUSAN RICHARDS, EXAMINING ATTORNEY



*David J. Kybas*

Director of the United States Patent and Trademark Office

# United States of America

United States Patent and Trademark Office

## WEEKEND ANDREA JOVINE

**Reg. No. 4,197,644**

COOPERSMITH, ANDREA JOVINE (UNITED STATES INDIVIDUAL)  
60 WINDING LANE  
GREENWICH, CT 06831

**Registered Aug. 28, 2012**

**Int. Cl.: 25**

FOR: LADIES CLOTHING, NAMELY, PANTS, SHORTS, SKIRTS, CUT AND SEW TOPS, T-SHIRTS, DRESSES, JACKETS, LEGGINGS, IN CLASS 25 (U.S. CLS. 22 AND 39).

**TRADEMARK**

FIRST USE 4-1-2011; IN COMMERCE 4-1-2011.

**PRINCIPAL REGISTER**

THE MARK CONSISTS OF STANDARD CHARACTERS WITHOUT CLAIM TO ANY PARTICULAR FONT, STYLE, SIZE, OR COLOR.

OWNER OF U.S. REG. NO. 2,732,636.

NO CLAIM IS MADE TO THE EXCLUSIVE RIGHT TO USE "WEEKEND", APART FROM THE MARK AS SHOWN.

THE NAME "ANDREA JOVINE" IDENTIFIES A LIVING INDIVIDUAL WHOSE CONSENT IS OF RECORD.

SER. NO. 85-505,538, FILED 12-29-2011.

GRETТА YAO, EXAMINING ATTORNEY



*David J. Kyffers*

Director of the United States Patent and Trademark Office



# United States of America

United States Patent and Trademark Office



**Reg. No. 4,197,645**

ASCENDENT QUALITY GROUP INC (FLORIDA CORPORATION)  
5151 DORWIN PLACE  
ORLANDO, FL 32814

**Registered Aug. 28, 2012**

**Int. Cls.: 35 and 45**

FOR: BUSINESS CONSULTING SERVICES IN THE FIELD OF LIFE SCIENCES, NAMELY, MEDICAL DEVICE MANUFACTURERS AND PHARMACEUTICAL MANUFACTURERS; TOTAL QUALITY MANAGEMENT SERVICES, NAMELY, BUSINESS MANAGEMENT SERVICES FOR ESTABLISHING BUSINESS QUALITY POLICY AND DETERMINING BUSINESS MEANS FOR IMPLEMENTING THOSE POLICIES TO IMPROVE CUSTOMER SATISFACTION, IN CLASS 35 (U.S. CLS. 100, 101 AND 102).

**SERVICE MARK**

**PRINCIPAL REGISTER**

FIRST USE 1-21-2011; IN COMMERCE 1-21-2011.

FOR: REGULATORY COMPLIANCE CONSULTING IN THE FIELD OF LIFE SCIENCES, NAMELY, MEDICAL DEVICE MANUFACTURERS, PHARMACEUTICAL MANUFACTURERS, MEDICAL, BIOPHARMACEUTICAL AND BIOTECHNOLOGY COMPANIES, IN CLASS 45 (U.S. CLS. 100 AND 101).

FIRST USE 1-21-2011; IN COMMERCE 1-21-2011.

THE MARK CONSISTS OF A GREY BOX WITH A BLUE CHECK MARK LAYERED ON TOP OF THE GREY BOX, FOLLOWED HORIZONTALLY BY THE UPPERCASE LETTERS "A", "Q", "G" IN BLACK STYLIZED FONT, WITH A BLUE DESIGN MARK FORMING THE TAIL OF THE "Q".

THE COLOR(S) BLACK, BLUE, GREY IS/ARE CLAIMED AS A FEATURE OF THE MARK.

SER. NO. 85-505,569, FILED 12-29-2011.

MATTHEW MCDOWELL, EXAMINING ATTORNEY



*David J. Kyjars*

Director of the United States Patent and Trademark Office

# United States of America

United States Patent and Trademark Office

## AWAKEN TEEN LEADERSHIP

**Reg. No. 4,197,646**

LAWRENCE CARROLL (UNITED STATES INDIVIDUAL)  
PO BOX 1318

**Registered Aug. 28, 2012**

STOCKBRIDGE, MA 01262

**Int. Cl.: 41**

FOR: EDUCATION SERVICES, NAMELY, PROVIDING WORKSHOP, LECTURES, AND LIFE COACHING IN THE FIELD OF PERSONAL BETTERMENT AND LIFESTYLE WELLNESS FOR TEENS; YOGA INSTRUCTION, IN CLASS 41 (U.S. CLS. 100, 101 AND 107).

**SERVICE MARK**

FIRST USE 11-1-2011; IN COMMERCE 11-1-2011.

**PRINCIPAL REGISTER**

THE MARK CONSISTS OF STANDARD CHARACTERS WITHOUT CLAIM TO ANY PARTICULAR FONT, STYLE, SIZE, OR COLOR.

NO CLAIM IS MADE TO THE EXCLUSIVE RIGHT TO USE "TEEN LEADERSHIP", APART FROM THE MARK AS SHOWN.

SER. NO. 85-505,680, FILED 12-29-2011.

TARAH HARDY, EXAMINING ATTORNEY



*David J. Kybas*

Director of the United States Patent and Trademark Office

# United States of America

United States Patent and Trademark Office

## MYMAGIC MASSAGE

**Reg. No. 4,197,647**

NAYOYA WELLNESS CORP. (NEW YORK CORPORATION)  
2625 EAST 24TH STREET  
BROOKLYN, NY 11235

**Registered Aug. 28, 2012**

**Int. Cl.: 10**

FOR: MANUAL MASSAGE TOOLS, IN CLASS 10 (U.S. CLS. 26, 39 AND 44).

**TRADEMARK**

FIRST USE 12-28-2011; IN COMMERCE 12-28-2011.

**PRINCIPAL REGISTER**

THE MARK CONSISTS OF STANDARD CHARACTERS WITHOUT CLAIM TO ANY PARTICULAR FONT, STYLE, SIZE, OR COLOR.

NO CLAIM IS MADE TO THE EXCLUSIVE RIGHT TO USE "MASSAGE", APART FROM THE MARK AS SHOWN.

SER. NO. 85-505,684, FILED 12-29-2011.

HEATHER THOMPSON, EXAMINING ATTORNEY



*David J. Kyffers*

Director of the United States Patent and Trademark Office

# United States of America

United States Patent and Trademark Office



**Reg. No. 4,197,648**

**Registered Aug. 28, 2012**

**Int. Cl.: 9**

**TRADEMARK**

**PRINCIPAL REGISTER**

TIME PLAZA (CALIFORNIA CORPORATION)  
350 S. LOS ANGELES STREET  
LOS ANGELES, CA 90013

FOR: CASES FOR EYEGLASSES AND SUNGLASSES; CASES FOR SPECTACLES AND SUNGLASSES; CHAINS FOR SPECTACLES AND FOR SUNGLASSES; EYEWEAR, NAMELY, SUNGLASSES, EYEGLASSES AND OPHTHALMIC FRAMES AND CASES THEREFOR; EYEWEAR, NAMELY, SUNGLASSES; FRAMES FOR SPECTACLES AND SUNGLASSES; LENSES FOR SUNGLASSES; NOSE GUARDS WHICH CAN BE WORN BY ATTACHMENT TO EYEWEAR SUCH AS SUNGLASSES AND SKI GOGGLES; SPECTACLES AND SUNGLASSES; SUNGLASS CHAINS AND CORDS; SUNGLASS LENSES; SUNGLASSES; SUNGLASSES AND SPECTACLES, IN CLASS 9 (U.S. CLS. 21, 23, 26, 36 AND 38).

FIRST USE 3-1-2011; IN COMMERCE 7-15-2011.

OWNER OF U.S. REG. NOS. 3,825,100, 3,954,088 AND OTHERS.

THE MARK CONSISTS OF THE SILHOUETTES OF TWO WOMEN SITTING SUCH THAT EACH IS A MIRROR IMAGE OF THE OTHER ABOVE THE WORDING "UNIVERSAL SUN-V".

SER. NO. 85-505,717, FILED 12-29-2011.

JAMES LOVELACE, EXAMINING ATTORNEY



*David J. Kyffers*

Director of the United States Patent and Trademark Office

# United States of America

United States Patent and Trademark Office

## Explore it. Live it.

**Reg. No. 4,197,649**

**Registered Aug. 28, 2012**

**Int. Cl.: 35**

**SERVICE MARK**

**PRINCIPAL REGISTER**

BRAINERD LAKES AREA CHAMBERS OF COMMERCE (MINNESOTA CORPORATION),  
DBA BRAINERD LAKES CHAMBER  
124 N 6 STREET  
BRAINERD, MN 56401

FOR: CHAMBER OF COMMERCE SERVICES, NAMELY, PROMOTING BUSINESS AND  
TOURISM IN THE MINNESOTA BRAINERD LAKES AREA, IN CLASS 35 (U.S. CLS. 100,  
101 AND 102).

FIRST USE 12-19-2011; IN COMMERCE 12-19-2011.

THE MARK CONSISTS OF STANDARD CHARACTERS WITHOUT CLAIM TO ANY PAR-  
TICULAR FONT, STYLE, SIZE, OR COLOR.

SER. NO. 85-505,779, FILED 12-29-2011.

HEATHER THOMPSON, EXAMINING ATTORNEY



*David J. Kyffers*

Director of the United States Patent and Trademark Office

# United States of America

United States Patent and Trademark Office



**Reg. No. 4,197,650**

**Registered Aug. 28, 2012**

**Int. Cl.: 41**

**SERVICE MARK**

**PRINCIPAL REGISTER**

GAYLE III, JOE A. (UNITED STATES INDIVIDUAL)  
500 SOUTH E STREET  
EASLEY, SC 29640

FOR: TRAINING SERVICES IN THE FIELD OF BUILDING INSULATION, THE APPLICATION OF BUILDING INSULATION, AND THE USE OF INSULATION PRODUCTS AND ACCESSORIES, IN CLASS 41 (U.S. CLS. 100, 101 AND 107).

FIRST USE 2-15-2009; IN COMMERCE 2-15-2009.

THE MARK CONSISTS OF A STYLIZED CARTOON MAN WEARING A HAT, GLASSES AND A NECK BANDANA. THE MAN IS SPRAYING FOAM GUN WITH HIS LEFT HAND AND HOLDING THE HOSE OF THE GUN IN HIS RIGHT HAND. LINES AND CIRCLES ARE ERUPTING FROM THE GUN REPRESENTING A SPRAY.

SER. NO. 85-505,792, FILED 12-29-2011.

KIMBERLY FRYE, EXAMINING ATTORNEY



*David J. Kybas*

Director of the United States Patent and Trademark Office

# United States of America

United States Patent and Trademark Office



**Reg. No. 4,197,651**

**Registered Aug. 28, 2012**

**Int. Cl.: 39**

**SERVICE MARK**

**PRINCIPAL REGISTER**

TRAVEL CRAZY (KENTUCKY CORPORATION)  
SUITE 2  
709 MT. EDEN RD.  
SHELBYVILLE, KY 40065

FOR: ORGANIZATION OF EXCURSIONS, SIGHTSEEING TOURS, HOLIDAYS, TOURS,  
AND TRAVEL, IN CLASS 39 (U.S. CLS. 100 AND 105).

FIRST USE 3-15-1993; IN COMMERCE 3-15-1993.

NO CLAIM IS MADE TO THE EXCLUSIVE RIGHT TO USE "TRAVEL", APART FROM THE  
MARK AS SHOWN.

THE MARK CONSISTS OF A CIRCLE WITH A FORM OF MOTORCOACH INSIDE THE  
CIRCLE, THE TEXT "TRAVEL" LISTED TO THE RIGHT OF THE CIRCLE, AND "CRAZY"  
LISTED IMMEDIATELY BENEATH "TRAVEL".

SER. NO. 85-505,836, FILED 12-29-2011.

JOSETTE BEVERLY, EXAMINING ATTORNEY



*David J. Kyffers*

Director of the United States Patent and Trademark Office

# United States of America

United States Patent and Trademark Office

# Brybelly

**Reg. No. 4,197,652**

BRYBELLY HOLDINGS, INC. (INDIANA CORPORATION)  
3334 MESILLA CT  
INDIANAPOLIS, IN 46226

**Registered Aug. 28, 2012**

**Int. Cl.: 28**

FOR: GAMING EQUIPMENT, NAMELY, POKER CHIPS; PLAY SETS FOR ACTION FIGURES; PLUSH DOLLS; PLUSH TOYS; TOY CONSTRUCTION SETS; TOY TRAINS AND PARTS AND ACCESSORIES THEREFOR; TRAIN SET ACCESSORIES, NAMELY, ARTIFICIAL TREES, TURF, FOLIAGE, BALLAST, LICHEN AND GRASS, IN CLASS 28 (U.S. CLS. 22, 23, 38 AND 50).

**TRADEMARK**

**PRINCIPAL REGISTER**

FIRST USE 1-1-2005; IN COMMERCE 1-1-2005.

THE MARK CONSISTS OF STANDARD CHARACTERS WITHOUT CLAIM TO ANY PARTICULAR FONT, STYLE, SIZE, OR COLOR.

SER. NO. 85-505,949, FILED 12-29-2011.

CHERYL CLAYTON, EXAMINING ATTORNEY



*David J. Kybas*

Director of the United States Patent and Trademark Office



# United States of America

United States Patent and Trademark Office

## sock monkey family

**Reg. No. 4,197,653**

**Registered Aug. 28, 2012**

**Int. Cl.: 28**

**TRADEMARK**

**PRINCIPAL REGISTER**

BRYBELLY HOLDINGS, INC. (INDIANA CORPORATION)  
3334 MESILLA CT  
INDIANAPOLIS, IN 46226

FOR: PLUSH DOLLS; PLUSH TOYS; STUFFED AND PLUSH TOYS; STUFFED DOLLS AND ANIMALS; STUFFED PUPPETS; STUFFED TOY ANIMALS; STUFFED TOYS, IN CLASS 28 (U.S. CLS. 22, 23, 38 AND 50).

FIRST USE 11-30-2011; IN COMMERCE 11-30-2011.

THE MARK CONSISTS OF STANDARD CHARACTERS WITHOUT CLAIM TO ANY PARTICULAR FONT, STYLE, SIZE, OR COLOR.

NO CLAIM IS MADE TO THE EXCLUSIVE RIGHT TO USE "SOCK MONKEY", APART FROM THE MARK AS SHOWN.

SER. NO. 85-505,987, FILED 12-29-2011.

CHERYL CLAYTON, EXAMINING ATTORNEY



*David J. Kyros*

Director of the United States Patent and Trademark Office

# United States of America

United States Patent and Trademark Office

# giddyapp

**Reg. No. 4,197,654**

**Registered Aug. 28, 2012**

**Int. Cl.: 9**

**TRADEMARK**

**PRINCIPAL REGISTER**

FLECK.TV, LLC (CALIFORNIA LIMITED LIABILITY COMPANY)  
16654 SOLEDAD CANYON ROAD, #382  
CANYON COUNTRY, CA 91387

FOR: CHILDREN'S EDUCATIONAL SOFTWARE; COMPUTER APPLICATION SOFTWARE FOR MOBILE PHONES, NAMELY, SOFTWARE FOR AUGMENTED REALITY HORSE CARE AND RIDING; COMPUTER APPLICATION SOFTWARE FOR GAME PLAY, NAMELY, SOFTWARE FOR VIRTUAL PONIES; COMPUTER GAME SOFTWARE, IN CLASS 9 (U.S. CLS. 21, 23, 26, 36 AND 38).

FIRST USE 1-1-2011; IN COMMERCE 1-1-2011.

THE MARK CONSISTS OF STANDARD CHARACTERS WITHOUT CLAIM TO ANY PARTICULAR FONT, STYLE, SIZE, OR COLOR.

SER. NO. 85-506,023, FILED 12-29-2011.

GINA FINK, EXAMINING ATTORNEY



*David J. Kyffers*

Director of the United States Patent and Trademark Office

# United States of America

United States Patent and Trademark Office



*Nana's  
Candy LC*  
Old Fashioned Homemade Candy

**Reg. No. 4,197,655**

**Registered Aug. 28, 2012**

**Int. Cl.: 30**

**TRADEMARK**

**PRINCIPAL REGISTER**

NANA'S CANDY, LC (VIRGINIA LIMITED LIABILITY COMPANY)  
1804 COURTLAND ROAD  
ALEXANDRIA, VA 22306

FOR: CANDIES, IN CLASS 30 (U.S. CL. 46).

FIRST USE 9-13-2011; IN COMMERCE 9-13-2011.

NO CLAIM IS MADE TO THE EXCLUSIVE RIGHT TO USE "CANDY LC" AND "OLD FASHIONED HOMEMADE CANDY", APART FROM THE MARK AS SHOWN.

THE MARK CONSISTS OF A LADY IN A HALF APRON GIVING A TIN BOX OF CANDY WITH BOW AND THE WORDING "NANA'S CANDY LC OLD FASHIONED HOMEMADE CANDY".

SER. NO. 85-506,091, FILED 12-29-2011.

RAMONA ORTIGA, EXAMINING ATTORNEY



*David J. Kyffers*

Director of the United States Patent and Trademark Office

# United States of America

United States Patent and Trademark Office



**Reg. No. 4,197,656**

SX-POWERTECH LLC (NORTH CAROLINA LIMITED LIABILITY COMPANY)  
PO BOX 398  
NEW LONDON, NC 28127

**Registered Aug. 28, 2012**

**Int. Cl.: 35**

FOR: PREPARING AUDIOVISUAL PRESENTATIONS FOR USE IN ADVERTISING, IN CLASS 35 (U.S. CLS. 100, 101 AND 102).

**SERVICE MARK**

FIRST USE 12-15-2011; IN COMMERCE 12-15-2011.

**PRINCIPAL REGISTER**

THE MARK CONSISTS OF "S" WITHIN A RED CIRCLE WITH "X" NEXT TO IT IN BLUE STYLIZED FONT. BELOW IT IS "POWERTECH" IN BLACK STYLIZED LETTERS. THE COLOR WHITE REPRESENTS BACKGROUND AND IS NOT PART OF THE MARK.

THE COLOR(S) RED, BLUE AND BLACK IS/ARE CLAIMED AS A FEATURE OF THE MARK.

SER. NO. 85-506,206, FILED 12-30-2011.

DOUGLAS LEE, EXAMINING ATTORNEY



*David J. Kybas*

Director of the United States Patent and Trademark Office

# United States of America

United States Patent and Trademark Office

## PFD Rewards

**Reg. No. 4,197,657**

**Registered Aug. 28, 2012**

**Int. Cl.: 35**

**SERVICE MARK**

**PRINCIPAL REGISTER**

PET360, INC. (DELAWARE CORPORATION)  
SUITE 400  
2250 HICKORY ROAD  
PLYMOUTH MEETING, PA 19462

FOR: ARRANGING AND CONDUCTING INCENTIVE REWARD PROGRAMS TO PROMOTE THE SALE OF PET FOOD, PET NUTRITIONAL SUPPLEMENTS, PET PHARMACEUTICAL PRODUCTS AND PET CARE SUPPLIES , IN CLASS 35 (U.S. CLS. 100, 101 AND 102).

FIRST USE 12-7-2011; IN COMMERCE 12-7-2011.

THE MARK CONSISTS OF STANDARD CHARACTERS WITHOUT CLAIM TO ANY PARTICULAR FONT, STYLE, SIZE, OR COLOR.

NO CLAIM IS MADE TO THE EXCLUSIVE RIGHT TO USE "REWARDS", APART FROM THE MARK AS SHOWN.

SER. NO. 85-506,228, FILED 12-30-2011.

THEODORE MCBRIDE, EXAMINING ATTORNEY



*David J. Kybas*

Director of the United States Patent and Trademark Office

# United States of America

United States Patent and Trademark Office

HAIR  
NO  
MORE

**Reg. No. 4,197,658**

APEX MARKETING GROUP LLC (WYOMING LIMITED LIABILITY COMPANY)  
7835 S. RAINBOW BLVD. SUITE 4-300  
LAS VEGAS, NV 89139

**Registered Aug. 28, 2012**

**Int. Cl.: 3**

FOR: HAIR GROWTH INHIBITING SPRAY MIST AND GEL; DEPIATORIES IN CREAM FORM, IN CLASS 3 (U.S. CLS. 1, 4, 6, 50, 51 AND 52).

**TRADEMARK**

FIRST USE 10-8-1997; IN COMMERCE 10-8-1997.

**PRINCIPAL REGISTER**

NO CLAIM IS MADE TO THE EXCLUSIVE RIGHT TO USE "HAIR", APART FROM THE MARK AS SHOWN.

THE MARK CONSISTS OF THE WORDS "HAIR NO MORE". THE WORDS ARE PRESENTED IN A STYLIZED FONT. THE WORDS ARE PRESENTED VERTICALLY WITH "HAIR" AT THE TOP, "NO" IN THE MIDDLE AND "MORE" AT THE BOTTOM. THERE IS A HORIZONTAL LINE IN BETWEEN THE WORDS "NO" AND "MORE".

SER. NO. 85-506,438, FILED 12-30-2011.

JEFFREY LOOK, EXAMINING ATTORNEY



*David J. Kyffers*

Director of the United States Patent and Trademark Office

United States of America  
United States Patent and Trademark Office

# CHERRY'S

**Reg. No. 4,197,659**

CHERRY'S INDUSTRIAL EQUIPMENT CORP. (ILLINOIS CORPORATION)  
600 MORSE AVENUE

**Registered Aug. 28, 2012**

ELK GROVE VILLAGE, IL 60007

**Int. Cl.: 7**

FOR: MATERIAL HANDLING EQUIPMENT AND MATERIAL HANDLING MACHINES, NAMELY, AUTOMATIC PALLET DISPENSERS, AUTOMATED PALLET INVERTERS, PALLET/SPACER RECOVERY MACHINES, MACHINERY ROLLER SKIDS, AUTOMATED 90 DEGREE LOAD TIPPERS, AUTOMATED PALLET STRAIGHTENERS, AUTOMATED PALLET CHANGERS AND PALLET WASHING MACHINES, IN CLASS 7 (U.S. CLS. 13, 19, 21, 23, 31, 34 AND 35).

**TRADEMARK**

**PRINCIPAL REGISTER**

FIRST USE 12-30-1983; IN COMMERCE 12-30-1983.

THE MARK CONSISTS OF STANDARD CHARACTERS WITHOUT CLAIM TO ANY PARTICULAR FONT, STYLE, SIZE, OR COLOR.

SER. NO. 85-506,473, FILED 12-30-2011.

FONG HSU, EXAMINING ATTORNEY



*David J. Kyffers*

Director of the United States Patent and Trademark Office

# United States of America

United States Patent and Trademark Office

## GREEN OATH

**Reg. No. 4,197,660**

JOSEPHINE LORNA CHENG (UNITED STATES INDIVIDUAL)  
13840 MOUNTAIN AVENUE  
CHINO, CA 91710

**Registered Aug. 28, 2012**

**Int. Cl.: 16**

FOR: BINDERS; BOOK BINDINGS; ENVELOPES; FILE FOLDERS; PENCIL OR PEN BOXES; PROTECTIVE COVERS FOR SHEETS OR PAPER AND PAGES OF BOOKS AND THE LIKE; STATIONERY CASES; THREE-RING BINDERS, IN CLASS 16 (U.S. CLS. 2, 5, 22, 23, 29, 37, 38 AND 50).

**TRADEMARK**

**PRINCIPAL REGISTER**

FIRST USE 9-10-2010; IN COMMERCE 1-1-2011.

THE MARK CONSISTS OF STANDARD CHARACTERS WITHOUT CLAIM TO ANY PARTICULAR FONT, STYLE, SIZE, OR COLOR.

NO CLAIM IS MADE TO THE EXCLUSIVE RIGHT TO USE "GREEN", APART FROM THE MARK AS SHOWN.

SER. NO. 85-506,497, FILED 12-30-2011.

BRENDAN REGAN, EXAMINING ATTORNEY



*David J. Kybas*

Director of the United States Patent and Trademark Office



# United States of America

United States Patent and Trademark Office

# SVADA

**Reg. No. 4,197,661**

**Registered Aug. 28, 2012**

**Int. Cl.: 5**

**TRADEMARK**

**PRINCIPAL REGISTER**

LONDO, MICHEAL J. (UNITED STATES INDIVIDUAL)  
SUITE 150  
720 W CHEYENNE AVE  
NORTH LAS VEGAS, NV 89030

FOR: MINERAL, VITAMIN, OR NUTRITIONALLY ENHANCED WATER; NUTRITIONALLY FORTIFIED WATER; VITAMIN ENRICHED WATER, IN CLASS 5 (U.S. CLS. 6, 18, 44, 46, 51 AND 52).

FIRST USE 8-12-2011; IN COMMERCE 12-21-2011.

THE MARK CONSISTS OF STANDARD CHARACTERS WITHOUT CLAIM TO ANY PARTICULAR FONT, STYLE, SIZE, OR COLOR.

THE WORDING "SVADA" HAS NO MEANING IN A FOREIGN LANGUAGE.

SER. NO. 85-506,503, FILED 12-30-2011.

ALAIN LAPTER, EXAMINING ATTORNEY



*David J. Kyffers*

Director of the United States Patent and Trademark Office

# United States of America

United States Patent and Trademark Office

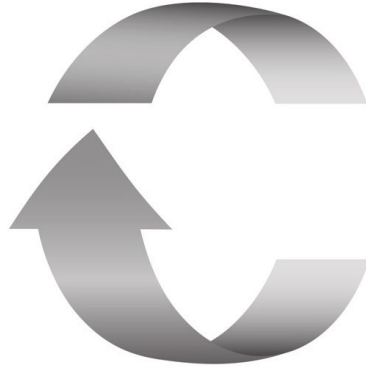

**Reg. No. 4,197,662**

**Registered Aug. 28, 2012**

**Int. Cl.: 7**

**TRADEMARK**

**PRINCIPAL REGISTER**

CHERRY'S INDUSTRIAL EQUIPMENT CORP. (ILLINOIS CORPORATION)  
600 MORSE AVENUE  
ELK GROVE VILLAGE, IL 60007

FOR: MATERIAL HANDLING EQUIPMENT AND MATERIAL HANDLING MACHINES, NAMELY, AUTOMATIC PALLET DISPENSERS, AUTOMATED PALLET INVERTERS, PALLET/SPACER RECOVERY MACHINES, MACHINERY ROLLER SKIDS, AUTOMATED 90 DEGREE LOAD TIPPERS, AUTOMATED PALLET STRAIGHTENERS, AUTOMATED PALLET CHANGERS AND PALLET WASHING MACHINES, IN CLASS 7 (U.S. CLS. 13, 19, 21, 23, 31, 34 AND 35).

FIRST USE 1-30-2011; IN COMMERCE 1-30-2011.

THE MARK CONSISTS OF CIRCULAR ARROW DESIGN.

SER. NO. 85-506,506, FILED 12-30-2011.

FONG HSU, EXAMINING ATTORNEY



*David J. Kyffers*

Director of the United States Patent and Trademark Office

# United States of America

United States Patent and Trademark Office

## STAT RESPONDER

**Reg. No. 4,197,663**

GRAPETREE MEDICAL STAFFING, INC. (IOWA CORPORATION)  
703 16TH STREET  
SPIRIT LAKE, IA 51360

**Registered Aug. 28, 2012**

**Int. Cl.: 35**

FOR: PERSONNEL PLACEMENT SERVICES IN THE FIELD OF HEALTHCARE AND EMERGENCY SERVICES; BUSINESS CONSULTING SERVICES IN THE FIELD OF HUMAN RESOURCES AND WORKFORCE MANAGEMENT , IN CLASS 35 (U.S. CLS. 100, 101 AND 102).

**SERVICE MARK**

**PRINCIPAL REGISTER**

FIRST USE 0-0-2006; IN COMMERCE 0-0-2006.

THE MARK CONSISTS OF STANDARD CHARACTERS WITHOUT CLAIM TO ANY PARTICULAR FONT, STYLE, SIZE, OR COLOR.

NO CLAIM IS MADE TO THE EXCLUSIVE RIGHT TO USE "RESPONDER", APART FROM THE MARK AS SHOWN.

SER. NO. 85-506,780, FILED 12-31-2011.

KRISTIN DAHLING, EXAMINING ATTORNEY



*David J. Kybas*

Director of the United States Patent and Trademark Office

# United States of America

United States Patent and Trademark Office

## Woman of La Mancha

**Reg. No. 4,197,664**

GOTHBERG FARMS L.L.C. (WASHINGTON LIMITED LIABILITY COMPANY)  
15203 SUNSET ROAD  
BOW, WA 98232

**Registered Aug. 28, 2012**

**Int. Cl.: 29**

FOR: CHEESE MADE FROM THE MILK OF LA MANCHA GOATS, IN CLASS 29 (U.S. CL. 46).

**TRADEMARK**

FIRST USE 7-1-2009; IN COMMERCE 7-1-2009.

**PRINCIPAL REGISTER**

THE MARK CONSISTS OF STANDARD CHARACTERS WITHOUT CLAIM TO ANY PARTICULAR FONT, STYLE, SIZE, OR COLOR.

SER. NO. 85-506,906, FILED 12-31-2011.

JIM RINGLE, EXAMINING ATTORNEY



*David J. Kybas*

Director of the United States Patent and Trademark Office

# United States of America

United States Patent and Trademark Office

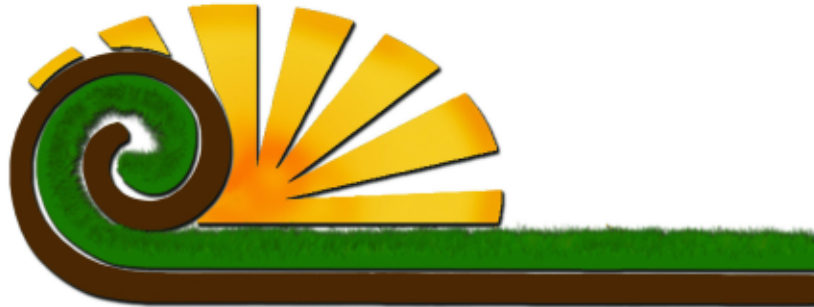

**Reg. No. 4,197,665**

MONDO GARDENS (TEXAS CORPORATION), DBA THOMAS TURFGRASS  
3931 CR 154

**Registered Aug. 28, 2012**

WHARTON, TX 77488

**Int. Cl.: 44**

FOR: HORTICULTURAL SERVICES; HORTICULTURAL SERVICES, NAMELY, INSTALLING SOD, IN CLASS 44 (U.S. CLS. 100 AND 101).

**SERVICE MARK**

FIRST USE 4-13-2002; IN COMMERCE 4-13-2002.

**PRINCIPAL REGISTER**

THE MARK CONSISTS OF A BROWN AND GREEN LINE RUNNING HORIZONTALLY WHICH THEN END IN A LOOP IN FRONT OF A STYLIZED SUN HAVING AN ORANGE BASE FROM WHICH EXTEND A SERIES OF YELLOW LINES REPRESENTING SUNRAYS. THE WHITE IN THE LOOP OF THE MARK REPRESENTS BACKGROUND AND IS NOT PART OF THE MARK.

THE COLOR(S) BROWN, GREEN, YELLOW AND ORANGE IS/ARE CLAIMED AS A FEATURE OF THE MARK.

SER. NO. 85-507,037, FILED 1-1-2012.

DEBORAH LOBO, EXAMINING ATTORNEY



*David J. Kybas*

Director of the United States Patent and Trademark Office

# United States of America

United States Patent and Trademark Office



**Reg. No. 4,197,666**

**Registered Aug. 28, 2012**

**Int. Cl.: 44**

**SERVICE MARK**

**PRINCIPAL REGISTER**

MONDO GARDENS (TEXAS CORPORATION), DBA THOMAS TURFGRASS  
3931 CR 154  
3931 CR 154  
WHARTON, TX 77488

FOR: HORTICULTURAL SERVICES; HORTICULTURAL SERVICES, NAMELY, INSTALLING SOD, IN CLASS 44 (U.S. CLS. 100 AND 101).

FIRST USE 11-18-2010; IN COMMERCE 11-18-2010.

NO CLAIM IS MADE TO THE EXCLUSIVE RIGHT TO USE "TURFGRASS" AND "GRASS & INSTALLATION", APART FROM THE MARK AS SHOWN.

THE COLOR(S) BROWN, GREEN, YELLOW, ORANGE, BLACK AND WHITE IS/ARE CLAIMED AS A FEATURE OF THE MARK.

THE NAME(S), PORTRAIT(S), AND/OR SIGNATURE(S) SHOWN IN THE MARK DOES NOT IDENTIFY A PARTICULAR LIVING INDIVIDUAL.

THE MARK CONSISTS OF A BROWN AND GREEN LINE RUNNING HORIZONTALLY WHICH THEN END IN A LOOP IN FRONT OF A STYLIZED SUN HAVING AN ORANGE BASE FROM WHICH EXTEND A SERIES OF YELLOW LINES REPRESENTING SUNRAYS. THE WORDS "THOMAS TURFGRASS" ARE SUPERIMPOSED OVER THE DESIGN IN GREEN LETTERS OUTLINED IN WHITE AND THE WORDS "GRASS & INSTALLATION" APPEAR BELOW THE DESIGN IN YELLOW LETTERS OUTLINED IN BLACK. THE WHITE THAT APPEARS IN THE LOOP REPRESENTS BACKGROUND AND IS NOT PART OF THE MARK.

SER. NO. 85-507,038, FILED 1-1-2012.

DEBORAH LOBO, EXAMINING ATTORNEY



*David J. Kyffers*

Director of the United States Patent and Trademark Office

# United States of America

United States Patent and Trademark Office

## Ocoee Rafting Center

**Reg. No. 4,197,667**

OCOEE RAFTING CENTER LLC (TENNESSEE LIMITED LIABILITY COMPANY)  
P.O. BOX 966 1548 HWY. 68  
DUCKTOWN, TN 37326

**Registered Aug. 28, 2012**

**Int. Cl.: 41**

FOR: ORGANIZING, ARRANGING, AND CONDUCTING WHITEWATER RAFTING EVENTS,  
IN CLASS 41 (U.S. CLS. 100, 101 AND 107).

**SERVICE MARK**

FIRST USE 4-1-2001; IN COMMERCE 4-1-2001.

**PRINCIPAL REGISTER**

THE MARK CONSISTS OF STANDARD CHARACTERS WITHOUT CLAIM TO ANY PARTICULAR FONT, STYLE, SIZE, OR COLOR.

OWNER OF U.S. REG. NO. 4,058,715.

NO CLAIM IS MADE TO THE EXCLUSIVE RIGHT TO USE "RAFTING CENTER", APART FROM THE MARK AS SHOWN.

SEC. 2(F).

SER. NO. 85-507,095, FILED 1-2-2012.

KATHERINE CHANG, EXAMINING ATTORNEY



*David J. Kyffers*

Director of the United States Patent and Trademark Office

# United States of America

United States Patent and Trademark Office



**Reg. No. 4,197,668**

**Registered Aug. 28, 2012**

**Int. Cl.: 41**

**SERVICE MARK**

**PRINCIPAL REGISTER**

SUBCAT, INC. (CALIFORNIA CORPORATION), DBA SUBCAT MARKETING  
271 E. IMPERIAL HWY, SUITE 641  
FULLERTON, CA 92835

FOR: ENTERTAINMENT SERVICES, NAMELY, PROVIDING ON-LINE COMPUTER GAMES;  
ENTERTAINMENT SERVICES, NAMELY, PROVIDING ON-LINE COMICS AND CARTOONS;  
ENTERTAINMENT SERVICES, NAMELY, PROVIDING PODCASTS IN THE FIELD OF  
MONEY; PROVIDING A WEB SITE FEATURING BLOGS AND NON-DOWNLOADABLE  
PUBLICATIONS IN THE NATURE OF ARTICLES IN THE FIELDS OF MONEY AND  
BUDGETING FOR CHILDREN, IN CLASS 41 (U.S. CLS. 100, 101 AND 107).

FIRST USE 0-0-2008; IN COMMERCE 0-0-2008.

NO CLAIM IS MADE TO THE EXCLUSIVE RIGHT TO USE "MONEY", APART FROM THE  
MARK AS SHOWN.

THE COLOR(S) GREEN, BLUE AND WHITE IS/ARE CLAIMED AS A FEATURE OF THE  
MARK.

THE MARK CONSISTS OF THE STYLIZED LETTERS "M3" IN GREEN, BLUE AND WHITE  
APPEARING ABOVE THE STYLIZED WORDS "MONEY CLUB" IN WHITE AND BLUE.

SER. NO. 85-507,232, FILED 1-2-2012.

ANN E. SAPPENFIELD, EXAMINING ATTORNEY



*David J. Kyros*

Director of the United States Patent and Trademark Office



# United States of America

United States Patent and Trademark Office



**Reg. No. 4,197,669**

**Registered Aug. 28, 2012**

**Int. Cl.: 41**

**SERVICE MARK**

**PRINCIPAL REGISTER**

TWIN CITIES TOXICOLOGY CONSORTIUM, LLC (MINNESOTA LIMITED LIABILITY COMPANY)  
32956 COUNTY 24 BLVD  
CANNON FALLS, MN 55009

FOR: EDUCATION SERVICES, NAMELY, PROVIDING LIVE AND ON-LINE CLASSES, SEMINARS, AND WORKSHOPS IN THE FIELD OF CLINICAL AND TACTICAL TOXICOLOGY, IN CLASS 41 (U.S. CLS. 100, 101 AND 107).

FIRST USE 1-1-2012; IN COMMERCE 1-1-2012.

NO CLAIM IS MADE TO THE EXCLUSIVE RIGHT TO USE "TOX TRENDS", APART FROM THE MARK AS SHOWN.

THE COLOR(S) BLACK, WHITE, RED, AND ORANGE IS/ARE CLAIMED AS A FEATURE OF THE MARK.

THE MARK CONSISTS OF THE WORDING "TOX TRENDS" IN WHITE ON A BLACK CIRCLE WITHIN AN ORANGE DIAMOND OVERLAYING A BLACK SQUARE, ALL WITHIN A RED CIRCLE.

SER. NO. 85-507,279, FILED 1-2-2012.

ROBIN MITTLER, EXAMINING ATTORNEY



*David J. Kyffers*

Director of the United States Patent and Trademark Office

# United States of America

United States Patent and Trademark Office



**Reg. No. 4,197,670**

**Registered Aug. 28, 2012**

**Int. Cl.: 36**

**SERVICE MARK**

**PRINCIPAL REGISTER**

FUNDACION TELETON I.A.P. (MEXICO INSTITUCION DE ASISTENCIA PRIVADA (IAP))  
COPERNICO NO. 51 COL. ANZURES  
MEXICO, MEXICO 11590

FOR: CHARITABLE FUNDRAISING; CHARITABLE FUNDRAISING SERVICES BY MEANS OF AN ENTERTAINMENT EVENT; CHARITABLE FUNDRAISING SERVICES BY MEANS OF MUSICAL CONCERTS; CHARITABLE FUNDRAISING SERVICES BY MEANS OF ORGANIZING AND CONDUCTING SPECIAL EVENTS; ELEEMOSYNARY SERVICES IN THE FIELD OF MONETARY DONATIONS, IN CLASS 36 (U.S. CLS. 100, 101 AND 102).

FIRST USE 1-1-1988; IN COMMERCE 7-7-2002.

OWNER OF U.S. REG. NOS. 2,972,929 AND 2,978,452.

THE COLOR(S) YELLOW AND PURPLE IS/ARE CLAIMED AS A FEATURE OF THE MARK.

THE MARK CONSISTS OF A YELLOW HEART WITH PURPLE HANDS SUPERIMPOSED OVER A PURPLE SQUARE.

SER. NO. 85-507,308, FILED 1-2-2012.

GISELLE AGOSTO, EXAMINING ATTORNEY



*David J. Kyffers*

Director of the United States Patent and Trademark Office

# United States of America

United States Patent and Trademark Office



**Reg. No. 4,197,671**

**Registered Aug. 28, 2012**

**Int. Cl.: 35**

**SERVICE MARK**

**PRINCIPAL REGISTER**

NEV, LLC (DELAWARE LIMITED LIABILITY COMPANY)  
800 DELAWARE AVE  
WILMINGTON, DE 19801

FOR: CATALOG ORDERING SERVICE FEATURING ELECTRICAL, COMMERCIAL, INSTITUTIONAL, AND INDUSTRIAL PRODUCTS AND SUPPLIES, NAMELY, ELECTRICAL COMPONENTS, CABLES, CABLE ACCESSORIES, PRODUCTS FOR CABLE MANAGEMENT, CONDUIT, ELECTRONIC CONTROL EQUIPMENT, AND WIRING ACCESSORIES; DISTRIBUTORSHIP SERVICES IN THE FIELD OF ELECTRICAL, COMMERCIAL, INSTITUTIONAL, AND INDUSTRIAL PRODUCTS AND SUPPLIES, NAMELY, ELECTRICAL COMPONENTS, CABLES, CABLE ACCESSORIES, PRODUCTS FOR CABLE MANAGEMENT, CONDUIT, ELECTRONIC CONTROL EQUIPMENT, AND WIRING ACCESSORIES; WEB-BASED CATALOG SERVICES FEATURING ELECTRICAL, COMMERCIAL, INSTITUTIONAL, AND INDUSTRIAL PRODUCTS AND SUPPLIES, NAMELY, ELECTRICAL COMPONENTS, CABLES, CABLE ACCESSORIES, PRODUCTS FOR CABLE MANAGEMENT, CONDUIT, ELECTRONIC CONTROL EQUIPMENT, AND WIRING ACCESSORIES, IN CLASS 35 (U.S. CLS. 100, 101 AND 102).

FIRST USE 12-17-2009; IN COMMERCE 12-17-2009.

OWNER OF U.S. REG. NO. 4,011,189.

THE MARK CONSISTS OF AN UPPER CASE LETTER "E" WITHIN THE OUTLINE OF A DIAMOND.

SER. NO. 85-507,349, FILED 1-3-2012.

STEVEN PEREZ, EXAMINING ATTORNEY



*David J. Kyffers*

Director of the United States Patent and Trademark Office

# United States of America

United States Patent and Trademark Office



**Reg. No. 4,197,672**

CLASSIC FORMS & SYSTEMS, INC. (MARYLAND CORPORATION), DBA CLASSICPLUS  
95 MONOCACY BLVD., STE B20  
FREDERICK, MD 21701

**Registered Aug. 28, 2012**

**Int. Cls.: 38 and 42**

FOR: TELECOMMUNICATION SERVICES, NAMELY, PROVIDING E-MAIL AND TEXT NOTIFICATION ALERTS FEATURING AUTOMATED SERVICE REMINDERS, SAFETY ALERTS, RECALL ALERTS, AND SPECIAL DISCOUNT OFFERS, IN CLASS 38 (U.S. CLS. 100, 101 AND 104).

**SERVICE MARK**

**PRINCIPAL REGISTER**

FIRST USE 7-9-2008; IN COMMERCE 7-9-2008.

FOR: PROVIDING TEMPORARY USE OF ON-LINE NON-DOWNLOADABLE SOFTWARE FOR USE BY AUTOMOTIVE REPAIR FACILITIES IN PROVIDING VEHICLE REPAIR INFORMATION, MAINTENANCE SCHEDULES, AND GUIDANCE, IN CLASS 42 (U.S. CLS. 100 AND 101).

FIRST USE 7-9-2008; IN COMMERCE 7-9-2008.

THE MARK CONSISTS OF THE WORD "THROTTLE" IN GRADED SHADES OF TEAL; THE "O" IN THE WORD IS A SPEEDOMETER, WITH THE DIAL DEPICTED IN BLACK, WHITE, AND GREY, AND THE NEEDLES DEPICTED IN ORANGE.

THE COLOR(S) TEAL, BLACK, WHITE, GREY, AND ORANGE IS/ARE CLAIMED AS A FEATURE OF THE MARK.

SER. NO. 85-507,377, FILED 1-3-2012.

MARK SPARACINO, EXAMINING ATTORNEY



*David J. Kybas*

Director of the United States Patent and Trademark Office

# United States of America

United States Patent and Trademark Office

## Fido Park Avenue Dog Boutique

**Reg. No. 4,197,673**

FIDO PARK AVENUE, LLC (VIRGINIA LIMITED LIABILITY COMPANY)  
854 DOGWOOD DELL LANE  
RICHMOND, VA 23113

**Registered Aug. 28, 2012**

**Int. Cl.: 35**

FOR: RETAIL STORE AND ON-LINE RETAIL STORE SERVICES FEATURING PRODUCTS FOR DOGS; RETAIL STORE AND ON-LINE RETAIL STORE SERVICES FEATURING PRODUCTS FOR DOG OWNERS, NAMELY, GIFTS AND NOVELTY ITEMS, IN CLASS 35 (U.S. CLS. 100, 101 AND 102).

**SERVICE MARK**

**PRINCIPAL REGISTER**

FIRST USE 11-16-2009; IN COMMERCE 11-16-2009.

THE MARK CONSISTS OF STANDARD CHARACTERS WITHOUT CLAIM TO ANY PARTICULAR FONT, STYLE, SIZE, OR COLOR.

NO CLAIM IS MADE TO THE EXCLUSIVE RIGHT TO USE "DOG BOUTIQUE", APART FROM THE MARK AS SHOWN.

SER. NO. 85-507,421, FILED 1-3-2012.

MARK SPARACINO, EXAMINING ATTORNEY



*David J. Kyffers*

Director of the United States Patent and Trademark Office

# United States of America

United States Patent and Trademark Office

# ARANJUEZ

**Reg. No. 4,197,674**

JUAN OROZCO CORPORATION (NEW YORK CORPORATION)  
P O BOX 812

**Registered Aug. 28, 2012**

MAUNABO, PUERTO RICO 007070812

**Int. Cl.: 15**

FOR: GUITAR STRINGS, CLASSICAL GUITARS, GUITAR CASES, UKULELE STRINGS,  
IN CLASS 15 (U.S. CLS. 2, 21 AND 36).

**TRADEMARK**

FIRST USE 1-0-1966; IN COMMERCE 1-0-1966.

**PRINCIPAL REGISTER**

THE MARK CONSISTS OF STANDARD CHARACTERS WITHOUT CLAIM TO ANY PAR-  
TICULAR FONT, STYLE, SIZE, OR COLOR.

OWNER OF U.S. REG. NO. 913,502.

SER. NO. 85-507,428, FILED 1-3-2012.

FRED CARL, EXAMINING ATTORNEY



*David J. Kyffers*

Director of the United States Patent and Trademark Office

# United States of America

United States Patent and Trademark Office



**Reg. No. 4,197,675**

WALKER, GUY L. (UNITED STATES INDIVIDUAL)  
1160 W. HIGHWAY 39  
BLACKFOOT, ID 83221

**Registered Aug. 28, 2012**

**Int. Cl.: 42**

FOR: INFORMATION TECHNOLOGY CONSULTATION, IN CLASS 42 (U.S. CLS. 100 AND 101).

**SERVICE MARK**

FIRST USE 3-0-2002; IN COMMERCE 3-0-2002.

**PRINCIPAL REGISTER**

THE MARK CONSISTS OF AN OUTLINE OF A HOUSE WITH A PICTURE WINDOW AND A COMPUTER MOUSE WITH CORD COMING FROM THE HOUSE.

SER. NO. 85-507,481, FILED 1-3-2012.

GEORGE LORENZO, EXAMINING ATTORNEY



*David J. Kyffers*

Director of the United States Patent and Trademark Office

# United States of America

United States Patent and Trademark Office



**Reg. No. 4,197,676**

**Registered Aug. 28, 2012**

**Int. Cl.: 28**

**TRADEMARK**

**PRINCIPAL REGISTER**

UNITED TRADEMARK HOLDINGS INC. (CALIFORNIA CORPORATION)  
141 S. LAPEER DR.  
BEVERLY HILLS, CA 90211

FOR: DOLLS, IN CLASS 28 (U.S. CLS. 22, 23, 38 AND 50).

FIRST USE 12-21-2011; IN COMMERCE 12-21-2011.

THE MARK CONSISTS OF A CROWN SITTING ON TOP OF THE WORD "TEENAGE", CENTERED, AND "PRINCESS" PRINTED LARGER AND CENTERED BELOW "TEENAGE".

SER. NO. 85-507,516, FILED 1-3-2012.

DAVID MURRAY, EXAMINING ATTORNEY



*David J. Kyfos*

Director of the United States Patent and Trademark Office



# United States of America

United States Patent and Trademark Office

# TECHONE

**Reg. No. 4,197,677**

**Registered Aug. 28, 2012**

**Int. Cls.: 9 and 28**

**TRADEMARK**

**PRINCIPAL REGISTER**

EGRANDBUY, INC (CALIFORNIA CORPORATION)  
321 VINELAND AVE  
INDUSTRY, CA 91746

FOR: RADIO TRANSMITTERS AND RECEIVERS FOR REMOTE CONTROLS AND RADIO CONTROLS FOR TOY AND MODEL VEHICLES, REMOTE CONTROL TRANSMITTER FOR RADIO-CONTROLLED TOY AND MODEL VEHICLES, ELECTRONIC AM AND FM RECEIVERS, BATTERIES AND CHARGERS FOR REMOTE CONTROL TOYS AND HOBBY MODEL VEHICLES, ELECTRONIC SERVO MOTOR CONTROLLERS AND ELECTRONIC SPEED CONTROLLERS ALL FOR USE WITH TOY AND MODEL VEHICLES, IN CLASS 9 (U.S. CLS. 21, 23, 26, 36 AND 38).

FIRST USE 6-1-2011; IN COMMERCE 6-1-2011.

FOR: REMOTE CONTROL TOYS, NAMELY, AIRPLANES, HELICOPTERS, CARS, TRUCKS, BUGGIES, AND ACCESSORIES THEREFOR; REMOTE CONTROLLED HOBBY MODEL AIRPLANES, HELICOPTERS, CARS, TRUCKS, BUGGIES, AND ACCESSORIES THEREFOR, IN CLASS 28 (U.S. CLS. 22, 23, 38 AND 50).

FIRST USE 6-1-2011; IN COMMERCE 6-1-2011.

THE MARK CONSISTS OF STANDARD CHARACTERS WITHOUT CLAIM TO ANY PARTICULAR FONT, STYLE, SIZE, OR COLOR.

SER. NO. 85-507,563, FILED 1-3-2012.

SARA BENJAMIN, EXAMINING ATTORNEY



*David J. Kyros*

Director of the United States Patent and Trademark Office

# United States of America

United States Patent and Trademark Office

*Classy  
Child*

**Reg. No. 4,197,678**

**Registered Aug. 28, 2012**

**Int. Cl.: 25**

**TRADEMARK**

**PRINCIPAL REGISTER**

CLASSY CHILD (TEXAS LIMITED LIABILITY COMPANY)  
6942 FM 1960 ROAD EAST, SUITE 116  
HUMBLE, TX 77346

FOR: CARDIGANS; CHILDREN'S AND INFANT'S APPAREL, NAMELY, JUMPERS, OVERALL SLEEPWEAR, PAJAMAS, ROMPERS AND ONE-PIECE GARMENTS; CHILDREN'S HEADWEAR; CREW NECK SWEATERS; HATS FOR INFANTS, BABIES, TODDLERS AND CHILDREN; HOODED SWEATSHIRTS FOR CHILDREN AND BABIES; MOCK TURTLE-NECK SWEATERS; ONE-PIECE GARMENTS FOR CHILDREN; SWEATERS; SWEATSHIRTS FOR CHILDREN AND BABIES; TURTLENECK SWEATERS; V-NECK SWEATERS, IN CLASS 25 (U.S. CLS. 22 AND 39).

FIRST USE 1-1-2012; IN COMMERCE 1-1-2012.

NO CLAIM IS MADE TO THE EXCLUSIVE RIGHT TO USE "CHILD", APART FROM THE MARK AS SHOWN.

SER. NO. 85-507,584, FILED 1-3-2012.

CHRISTINE MARTIN, EXAMINING ATTORNEY



*David J. Kybas*

Director of the United States Patent and Trademark Office

# United States of America

United States Patent and Trademark Office

## LOCKSMITH MAGIC

**Reg. No. 4,197,679**

**Registered Aug. 28, 2012**

**Int. Cls.: 37 and 45**

**SERVICE MARK**

**PRINCIPAL REGISTER**

LOCKSMITH MAGIC LLC (FLORIDA LIMITED LIABILITY COMPANY)  
SUITE 113-105  
13820 OLD ST. AUGUSTINE ROAD  
JACKSONVILLE, FL 32258

FOR: INSTALLATION, MAINTENANCE AND REPAIR OF CLOSED CIRCUIT TELEVISION (CCTV) SYSTEMS FOR SECURITY AND SURVEILLANCE, NAMELY, CAMERAS, SWITCHERS, MONITORS, MICROPHONES, AND RECORDERS; INSTALLATION, CHANGING, REPLACEMENT AND REPAIR OF LOCKS, IN CLASS 37 (U.S. CLS. 100, 103 AND 106).

FIRST USE 11-1-2009; IN COMMERCE 11-1-2009.

FOR: LOCKSMITHING, NAMELY, OPENING OF LOCKS, IN CLASS 45 (U.S. CLS. 100 AND 101).

FIRST USE 11-1-2009; IN COMMERCE 11-1-2009.

THE MARK CONSISTS OF STANDARD CHARACTERS WITHOUT CLAIM TO ANY PARTICULAR FONT, STYLE, SIZE, OR COLOR.

NO CLAIM IS MADE TO THE EXCLUSIVE RIGHT TO USE "LOCKSMITH", APART FROM THE MARK AS SHOWN.

SER. NO. 85-507,660, FILED 1-3-2012.

MARK RADEMACHER, EXAMINING ATTORNEY



*David J. Kypos*

Director of the United States Patent and Trademark Office

# United States of America

United States Patent and Trademark Office



**Reg. No. 4,197,680**

**Registered Aug. 28, 2012**

**Int. Cls.: 30 and 43**

**TRADEMARK**

**SERVICE MARK**

**PRINCIPAL REGISTER**

FRITANGA MONIMBO LITTLE HAVANA, INC. (FLORIDA CORPORATION)  
529 N.W. 12 AVENUE  
MIAMI, FL 33136

FOR: HOT SAUCE; FOOD SEASONINGS; CHIMICHURRI SAUCE; BAKERY DESSERTS,  
IN CLASS 30 (U.S. CL. 46).

FIRST USE 12-31-2010; IN COMMERCE 12-31-2010.

FOR: RESTAURANT SERVICES, IN CLASS 43 (U.S. CLS. 100 AND 101).

FIRST USE 1-31-1990; IN COMMERCE 1-31-1990.

OWNER OF U.S. REG. NO. 1,730,106.

THE COLOR(S) BLUE IS/ARE CLAIMED AS A FEATURE OF THE MARK.

NO CLAIM IS MADE TO THE EXCLUSIVE RIGHT TO USE "FRITANGA", "EST. 1988" OR  
"RESTAURANT", APART FROM THE MARK AS SHOWN.

THE MARK CONSISTS OF THE WORDS "FRITANGA MONIMBO" IN A BLUE UPPERCASE  
STYLIZED FONT WITHIN TWO BLUE CIRCLES. THERE IS A DESIGN OF A BLUE STYL-  
IZED HOUSE REPRESENTATION INSIDE THE SECOND BLUE INNER CIRCLE. THE  
LETTERS AND NUMBERS "EST. 1988" IN A BLUE STYLIZED FONT INSIDE A RECTAN-  
GULAR BLUE SHAPE BELOW THE OUTER BLUE CIRCLE. THE WORD "RESTAURANT"  
IN A BLUE STYLIZED FONT BELOW THE RECTANGULAR SHAPE.

THE ENGLISH TRANSLATION OF "FRITANGA" IN THE MARK IS FRIED SANDWICH.

SEC. 2(F) AS TO "MONIMBO".

SER. NO. 85-507,924, FILED 1-3-2012.

DAVID H. STINE, EXAMINING ATTORNEY



*David J. Kyjars*

Director of the United States Patent and Trademark Office

# United States of America

United States Patent and Trademark Office

## Aloha Systems

**Reg. No. 4,197,681**

**Registered Aug. 28, 2012**

**Int. Cl.: 35**

**SERVICE MARK**

**PRINCIPAL REGISTER**

ALOHA SYSTEMS INCORPORATED (CALIFORNIA CORPORATION)  
8539 BARNWOOD LANE  
RIVERSIDE, CA 925087126

FOR: BUSINESS CONSULTING AND ADVISORY SERVICES IN THE FIELD OF ENERGY EFFICIENCY; BUSINESS CONSULTING SERVICES FOR THE ELECTRIC ENERGY INDUSTRY; BUSINESS CONSULTING SERVICES IN THE FIELDS OF ENERGY MEASUREMENT TO IMPROVE ENERGY EFFICIENCY WITHIN RESIDENTIAL, COMMERCIAL, INDUSTRIAL AND INSTITUTIONAL FACILITIES; CONDUCTING ENERGY AUDITS OF COMMERCIAL AND INSTITUTIONAL FACILITIES FOR THE PURPOSE OF IMPROVING ENERGY EFFICIENCY; CONSULTATION IN THE FIELD OF ENERGY EFFICIENCY; CONSULTING SERVICES IN THE FIELD OF ENERGY EFFICIENCY FOR COMMERCIAL AND INSTITUTIONAL FACILITIES; CONSULTING SERVICES IN THE FIELD OF ENERGY USAGE MANAGEMENT AND ENERGY EFFICIENCY; CONSULTING SERVICES IN THE FIELDS OF ENERGY CONSUMPTION AND USAGE CONSERVATION TO IMPROVE ENERGY EFFICIENCY; ENERGY AUDITING; ENERGY USAGE MANAGEMENT; HOME ENERGY ASSESSMENT SERVICES FOR THE PURPOSE OF DETERMINING ENERGY EFFICIENCY OR USAGE MANAGEMENT; PROVISION OF INFORMATION, ADVICE AND CONSULTANCY IN RELATION TO ENERGY EFFICIENCY, IN CLASS 35 (U.S. CLS. 100, 101 AND 102).

FIRST USE 5-26-1988; IN COMMERCE 5-26-1988.

THE MARK CONSISTS OF STANDARD CHARACTERS WITHOUT CLAIM TO ANY PARTICULAR FONT, STYLE, SIZE, OR COLOR.

NO CLAIM IS MADE TO THE EXCLUSIVE RIGHT TO USE "SYSTEMS", APART FROM THE MARK AS SHOWN.

SER. NO. 85-508,030, FILED 1-3-2012.

MICHAEL WEBSTER, EXAMINING ATTORNEY



*David J. Kyros*

Director of the United States Patent and Trademark Office

# United States of America

United States Patent and Trademark Office



**Reg. No. 4,197,682**

BUYREPLY PTY LTD (AUSTRALIA CORPORATION)  
2 DAVIES AVE

**Registered Aug. 28, 2012**

VAUCLUSE, AUSTRALIA 2030

**Int. Cl.: 42**

FOR: PROVIDING TEMPORARY USE OF ONLINE NON-DOWNLOADABLE COMPUTER E-COMMERCE SOFTWARE TO ALLOW USERS TO PERFORM ELECTRONIC BUSINESS TRANSACTIONS VIA A GLOBAL COMPUTER NETWORK , IN CLASS 42 (U.S. CLS. 100 AND 101).

**SERVICE MARK**

**PRINCIPAL REGISTER**

FIRST USE 12-1-2011; IN COMMERCE 12-1-2011.

THE MARK CONSISTS OF AN ARROW WITHIN A BOX APPEARING TO THE LEFT OF THE WORDING "BUYREPLY".

SER. NO. 85-508,053, FILED 1-3-2012.

KATHERINE CHANG, EXAMINING ATTORNEY



*David J. Kyffers*

Director of the United States Patent and Trademark Office

# United States of America

United States Patent and Trademark Office

*Anchor Wear*

**Reg. No. 4,197,683**

SPENCER, JOANNE (UNITED STATES INDIVIDUAL), DBA ANCHOR WEAR BY JOANNE  
P.O. BOX 693024  
MIAMI, FL 33269

**Registered Aug. 28, 2012**

**Int. Cl.: 25**

FOR: PANTS, SHIRTS, JACKETS, SNEAKERS, HATS, CAPS, BELTS, SOCKS, PAJAMAS, INFANT CLOTHES, NAMELY, INFANT WEAR, BRAS, UNDERWEAR, SHOES, COATS, PANTIES, SKIRTS, TODDLER CLOTHES, NAMELY, ONE PIECE GARMENT FOR TODDLERS, HATS FOR TODDLERS AND SHIRTS FOR TODDLERS; UNIFORMS TOP AND BOTTOMS, NAMELY, SCRUBS NOT FOR MEDICAL PURPOSES, MITTENS, GLOVES, CLOTH BIBS, SLIPPERS, SHORTS, VISORS, TIES, BATHROBES, JEANS, BLOUSES, SCARVES, BATHING SUITS, NIGHTGOWNS, BOXER SHORTS, BRIEFS, DRESSES, TANK TOPS, EARMUFFS, SUSPENDERS, JOGGING SUITS, JUMPERS AND INFANT ONE PIECE CLOTHING, IN CLASS 25 (U.S. CLS. 22 AND 39).

**TRADEMARK**

**PRINCIPAL REGISTER**

FIRST USE 12-1-2011; IN COMMERCE 12-1-2011.

OWNER OF U.S. REG. NO. 3,880,127.

NO CLAIM IS MADE TO THE EXCLUSIVE RIGHT TO USE "WEAR", APART FROM THE MARK AS SHOWN.

THE MARK CONSISTS OF THE WORDS "ANCHOR WEAR" IN STYLIZED LETTERING.

SER. NO. 85-508,066, FILED 1-3-2012.

LAURIE KAUFMAN, EXAMINING ATTORNEY



*David J. Kyffers*

Director of the United States Patent and Trademark Office

# United States of America

United States Patent and Trademark Office

# TuneSmith

**Reg. No. 4,197,684**

**Registered Aug. 28, 2012**

**Int. Cl.: 9**

**TRADEMARK**

**PRINCIPAL REGISTER**

WIER, PETER MICHAEL (UNITED STATES INDIVIDUAL), DBA IDOLUMIC  
427  
201 E ANGELENO AVE.  
BURBANK, CA 91502

FOR: COMPUTER PROGRAMS FOR USE IN ELECTRONIC STORAGE OF DATA IN THE FIELD OF MUSICAL COMPOSITION; COMPUTER SOFTWARE FOR CREATING, EDITING, DISTRIBUTING, RECEIVING, STORING, ORGANIZING, MANAGING AND PITCHING LYRICS AND/OR MUSICAL COMPOSITIONS; COMPUTER SOFTWARE FOR THE AUTHORIZING AND PLAYBACK OF SONGS, IN CLASS 9 (U.S. CLS. 21, 23, 26, 36 AND 38).

FIRST USE 1-1-2012; IN COMMERCE 1-1-2012.

THE MARK CONSISTS OF STANDARD CHARACTERS WITHOUT CLAIM TO ANY PARTICULAR FONT, STYLE, SIZE, OR COLOR.

SER. NO. 85-508,072, FILED 1-3-2012.

KATHERINE M. DUBRAY, EXAMINING ATTORNEY



*David J. Kyros*

Director of the United States Patent and Trademark Office



# United States of America

United States Patent and Trademark Office

# Rhyme Genie

**Reg. No. 4,197,685**

**Registered Aug. 28, 2012**

**Int. Cl.: 9**

**TRADEMARK**

**PRINCIPAL REGISTER**

WIER, PETER MICHAEL (UNITED STATES INDIVIDUAL), DBA IDOLUMIC  
427  
201 E ANGELENO AVE.  
BURBANK, CA 91502

FOR: COMPUTER PROGRAMS FOR USE IN COMPOSING LYRICS AND/OR POETRY;  
COMPUTER SOFTWARE FOR MATCHING WORDS THAT ARE RELATED IN SOUND  
AND/OR MEANING; COMPUTER SOFTWARE FOR FINDING A VARIETY OF RHYMES,  
IN CLASS 9 (U.S. CLS. 21, 23, 26, 36 AND 38).

FIRST USE 5-9-2009; IN COMMERCE 5-9-2009.

THE MARK CONSISTS OF STANDARD CHARACTERS WITHOUT CLAIM TO ANY PAR-  
TICULAR FONT, STYLE, SIZE, OR COLOR.

NO CLAIM IS MADE TO THE EXCLUSIVE RIGHT TO USE "RHYME", APART FROM THE  
MARK AS SHOWN.

SER. NO. 85-508,083, FILED 1-3-2012.

KATHERINE M. DUBRAY, EXAMINING ATTORNEY



*David J. Kyffers*

Director of the United States Patent and Trademark Office

# United States of America

United States Patent and Trademark Office



*Beaver Glen*

**Reg. No. 4,197,686**

**Registered Aug. 28, 2012**

**Int. Cl.: 43**

**SERVICE MARK**

**PRINCIPAL REGISTER**

BEAVER GLEN BED AND BREAKFAST (VIRGINIA SOLE PROPRIETORSHIP)  
149 SLATEMONT RD SW  
MEADOWS OF DAN, VA 24120

FOR: BED AND BREAKFAST INN SERVICES, IN CLASS 43 (U.S. CLS. 100 AND 101).

FIRST USE 11-25-2011; IN COMMERCE 1-3-2012.

THE MARK CONSISTS OF A BEAVER GNAWING ON A TREE WITH THE WORDS "BEAVER GLEN" BENEATH IT.

SER. NO. 85-508,308, FILED 1-4-2012.

B. PARADEWELAI, EXAMINING ATTORNEY



*David J. Kyffers*

Director of the United States Patent and Trademark Office

# United States of America

United States Patent and Trademark Office

JOHN  
COPE'S

**Reg. No. 4,197,687**

NITTANY CORPORATION (DELAWARE CORPORATION)  
222 DELAWARE AVE.  
WILMINGTON, DE 19801

**Registered Aug. 28, 2012**

**Int. Cl.: 29**

FOR: VEGETABLES, NAMELY, PROCESSED CANNED AND FROZEN BEANS, BROCCOLI,  
CORN, AND PEAS, IN CLASS 29 (U.S. CL. 46).

**TRADEMARK**

FIRST USE 0-0-1950; IN COMMERCE 0-0-1950.

**PRINCIPAL REGISTER**

THE NAME "JOHN COPE'S" DOES NOT IDENTIFY A LIVING INDIVIDUAL.

THE MARK CONSISTS OF THE WORDS "JOHN COPE'S" IN STYLIZED FORM.

SER. NO. 85-508,385, FILED 1-4-2012.

FRED CARL, EXAMINING ATTORNEY



*David J. Kybas*

Director of the United States Patent and Trademark Office

# United States of America

United States Patent and Trademark Office

## JOHN COPE'S

**Reg. No. 4,197,688**

NITTANY CORPORATION (DELAWARE CORPORATION)  
222 DELAWARE AVE.  
WILMINGTON, DE 19801

**Registered Aug. 28, 2012**

**Int. Cl.: 29**

FOR: VEGETABLES, NAMELY, PROCESSED CANNED AND FROZEN BEANS, BROCCOLI, CORN, AND PEAS, IN CLASS 29 (U.S. CL. 46).

**TRADEMARK**

FIRST USE 0-0-1950; IN COMMERCE 0-0-1950.

**PRINCIPAL REGISTER**

THE MARK CONSISTS OF STANDARD CHARACTERS WITHOUT CLAIM TO ANY PARTICULAR FONT, STYLE, SIZE, OR COLOR.

THE NAME "JOHN COPE'S" DOES NOT IDENTIFY A LIVING INDIVIDUAL.

SER. NO. 85-508,386, FILED 1-4-2012.

FRED CARL, EXAMINING ATTORNEY



*David J. Kyffers*

Director of the United States Patent and Trademark Office

# United States of America

United States Patent and Trademark Office



**Reg. No. 4,197,689**

**Registered Aug. 28, 2012**

**Int. Cl.: 35**

**SERVICE MARK**

**PRINCIPAL REGISTER**

MEDIAPOP, LLC (TEXAS LIMITED LIABILITY COMPANY), FORMERLY MEDIAPOP, INC.  
1320 BROWN TRAIL  
BEDFORD, TX 76022

FOR: PROVIDING ADVERTISING, MARKETING AND PROMOTIONAL SERVICES, NAMELY, DEVELOPMENT OF ADVERTISING CAMPAIGNS FOR TELEVISION, WEB, PRINT, RADIO, AND DIRECT RESPONSE, IN CLASS 35 (U.S. CLS. 100, 101 AND 102).

FIRST USE 12-31-2002; IN COMMERCE 12-31-2002.

NO CLAIM IS MADE TO THE EXCLUSIVE RIGHT TO USE "CREATIVE" "MARKETING" "PRODUCTION", APART FROM THE MARK AS SHOWN.

THE COLOR(S) YELLOW, RED, BLACK, AND WHITE IS/ARE CLAIMED AS A FEATURE OF THE MARK.

THE MARK CONSISTS OF THE WORDING "MEDIAPOP" WITH "MEDIA" IN YELLOW AND OUTLINED IN BLACK AND "POP" IN RED, SHADED BLACK AT THE BOTTOM AND OUTLINED IN WHITE AND THEN BLACK. BEHIND "POP" IS A SOUND ARC CONSISTING OF A BLACK CIRCLE WITH BLACK AND WHITE HALF CIRCLES EMANATING FROM THE TOP. BELOW THAT IS THE WORDING "CREATIVE MARKETING PRODUCTION" ALL IN BLACK WITH BLACK DOTS SEPARATING THE TERMS.

SER. NO. 85-508,392, FILED 1-4-2012.

JESSICA A. POWERS, EXAMINING ATTORNEY



*David J. Kyffers*

Director of the United States Patent and Trademark Office

# United States of America

United States Patent and Trademark Office



**Reg. No. 4,197,690**

RICO, GILBERT J (UNITED STATES INDIVIDUAL), AKA BAMBA RICO  
13668 ALGRANTI AVE.  
SYLMAR, CA 91342

**Registered Aug. 28, 2012**

**Int. Cls.: 25 and 28**

FOR: ATHLETIC APPAREL, NAMELY, SHIRTS, PANTS, JACKETS, FOOTWEAR, HATS AND CAPS, ATHLETIC UNIFORMS, IN CLASS 25 (U.S. CLS. 22 AND 39).

**TRADEMARK**

FIRST USE 5-16-2011; IN COMMERCE 7-28-2011.

**PRINCIPAL REGISTER**

FOR: DISCS FOR PLAYING DISC GOLF, IN CLASS 28 (U.S. CLS. 22, 23, 38 AND 50).

FIRST USE 5-16-2011; IN COMMERCE 7-28-2011.

NO CLAIM IS MADE TO THE EXCLUSIVE RIGHT TO USE "DISCS", APART FROM THE MARK AS SHOWN.

THE MARK CONSISTS OF THE WORDS "LEGACY DISCS" WITH A SEMI-CIRCLE/ECLIPSE ELEMENT TO THE LEFT OF "LEGACY" AND A PARTIAL STAR WITH 5 VISIBLE RAYS APPEARING OVER THE ECLIPSE ELEMENT. "DISCS" APPEARS UNDER "LEGACY" ALIGNED TO THE RIGHT.

SER. NO. 85-508,435, FILED 1-4-2012.

STEVEN R. FINE, EXAMINING ATTORNEY



*David J. Kybas*

Director of the United States Patent and Trademark Office

# United States of America

United States Patent and Trademark Office

## HAYMAKERS FOR HOPE

**Reg. No. 4,197,691**

HAYMAKERS FOR HOPE INC. (MASSACHUSETTS CORPORATION)  
43 WOODRIDGE RD.

**Registered Aug. 28, 2012**

WELLESLEY, MA 02482

**Int. Cl.: 36**

FOR: CHARITABLE FUND RAISING SERVICES, BY MEANS OF ORGANIZING AND CONDUCTING FUNDRAISING AND BOXING EVENTS, IN CLASS 36 (U.S. CLS. 100, 101 AND 102).

**SERVICE MARK**

FIRST USE 11-18-2010; IN COMMERCE 11-18-2010.

**PRINCIPAL REGISTER**

THE MARK CONSISTS OF STANDARD CHARACTERS WITHOUT CLAIM TO ANY PARTICULAR FONT, STYLE, SIZE, OR COLOR.

SER. NO. 85-508,460, FILED 1-4-2012.

DEIRDRE ROBERTSON, EXAMINING ATTORNEY



*David J. Kyffers*

Director of the United States Patent and Trademark Office

# United States of America

United States Patent and Trademark Office

## NORMAN TOOL, INC.



**Reg. No. 4,197,692**

NORMAN TOOL, INC. (INDIANA CORPORATION)  
15415 OLD STATE ROAD  
EVANSVILLE, IN 47725

**Registered Aug. 28, 2012**

**Int. Cls.: 3 and 9**

FOR: ABRASIVE PAPER FOR USE WITH INSTRUMENTS FOR MEASURING WEAR USED FOR WEAR TESTS, IN CLASS 3 (U.S. CLS. 1, 4, 6, 50, 51 AND 52).

**TRADEMARK**

FIRST USE 11-18-2011; IN COMMERCE 11-18-2011.

**PRINCIPAL REGISTER**

FOR: INSTRUMENTS FOR MEASURING WEAR, DETERIORATION AND WEAR RESISTANCE OF PARTS, FINISHES, COATINGS, DYES, PAINTS AND INKS, WHETHER IMPRINTED, EMBEDDED OR STAMPED ON THE SURFACES OF GOODS AND PRODUCTS AND LABELS, IN CLASS 9 (U.S. CLS. 21, 23, 26, 36 AND 38).

FIRST USE 11-18-2011; IN COMMERCE 11-18-2011.

NO CLAIM IS MADE TO THE EXCLUSIVE RIGHT TO USE "TOOL, INC.", APART FROM THE MARK AS SHOWN.

THE MARK CONSISTS OF THE WORDS "NORMAN TOOL, INC." ARE LOCATED ABOVE THE LETTERS "N T I". THE TOP OF THE "T" FORMS A LINE BELOW THE WORDS "NORMAN TOOL, INC".

SER. NO. 85-508,488, FILED 1-4-2012.

JAMES GRIFFIN, EXAMINING ATTORNEY



*David J. Kyffers*

Director of the United States Patent and Trademark Office



United States of America  
United States Patent and Trademark Office

# SLIMVEST

**Reg. No. 4,197,693**

HASSLER, GERHARD (UNITED STATES INDIVIDUAL)  
7 LAYMAN ROAD

**Registered Aug. 28, 2012**

FRAMINGHAM, MA 01701

**Int. Cl.: 10**

FOR: APPARATUS FOR CELLULITE TREATMENT, REDUCTION AND ELIMINATION; STOMACH WRAP IN THE NATURE OF A SUPPORTIVE FOUNDATION GARMENT USED TO ASSIST IN WEIGHT LOSS, REDUCE POST PREGNANCY SWELLING AND SUPPORT THE MIDSECTION AFTER SURGERY; THERAPEUTIC APPARATUS, NAMELY, CHEMICALLY ACTIVATED ANTI-CELLULITE WRAPS, ICE PACKS, COMPRESSES, AND COMPRESSION BANDAGES, IN CLASS 10 (U.S. CLS. 26, 39 AND 44).

**TRADEMARK**

**PRINCIPAL REGISTER**

FIRST USE 5-21-2010; IN COMMERCE 5-21-2010.

THE MARK CONSISTS OF STANDARD CHARACTERS WITHOUT CLAIM TO ANY PARTICULAR FONT, STYLE, SIZE, OR COLOR.

SER. NO. 85-508,501, FILED 1-4-2012.

JAMES GRIFFIN, EXAMINING ATTORNEY



*David J. Kyffers*

Director of the United States Patent and Trademark Office

# United States of America

United States Patent and Trademark Office



**Reg. No. 4,197,694**

HAYMAKERS FOR HOPE INC. (MASSACHUSETTS CORPORATION)  
43 WOODRIDGE RD.

**Registered Aug. 28, 2012**

WELLESLEY, MA 02482

**Int. Cl.: 36**

FOR: CHARITABLE FUND RAISING SERVICES BY MEANS OF ORGANIZING AND CONDUCTING FUNDRAISING BOXING EVENTS, IN CLASS 36 (U.S. CLS. 100, 101 AND 102).

**SERVICE MARK**

FIRST USE 11-29-2011; IN COMMERCE 11-29-2011.

**PRINCIPAL REGISTER**

THE MARK CONSISTS OF THE WORDS "HAYMAKERS FOR HOPE" AND A TAPED FIST, WITH THE TAPE MAKE THE SHAPE OF TWO "H"'S.

SER. NO. 85-508,504, FILED 1-4-2012.

DEIRDRE ROBERTSON, EXAMINING ATTORNEY



*David J. Kybas*

Director of the United States Patent and Trademark Office

# United States of America

United States Patent and Trademark Office

## Triple-O Mechanical

**Reg. No. 4,197,695**

**Registered Aug. 28, 2012**

**Int. Cl.: 37**

**SERVICE MARK**

**PRINCIPAL REGISTER**

TRIPLE-O MECHANICAL, INC. (NEW YORK CORPORATION)  
6004 NORTH LAKE ROAD  
BERGEN, NY 14416

FOR: FURNACE INSTALLATION AND REPAIR; GENERAL CONTRACTOR SERVICES, NAMELY, PLUMBING, HEATING AND AIR CONDITIONING, CARPENTRY, DRYWALL, PAINTING, ELECTRICAL, BUILDING AND FRAMING CONTRACTOR SERVICES; HEATING CONTRACTOR SERVICES; HEATING EQUIPMENT INSTALLATION AND REPAIR; HVAC CONTRACTOR SERVICES; INSTALLATION AND REPAIR OF AIR CONDITIONING APPARATUS; INSTALLATION AND REPAIR OF FREEZING APPARATUS; INSTALLATION AND REPAIR OF HEATING, VENTILATING AND AIR CONDITIONING EQUIPMENT; INSTALLATION AND REPLACEMENT SERVICE FOR HEATING, VENTILATING AND AIR CONDITIONING SYSTEMS; INSTALLATION, MAINTENANCE AND REPAIR OF REFRIGERATION; INSTALLATION, REPAIR AND MAINTENANCE OF HEATING EQUIPMENT; MAINTENANCE AND REPAIR OF HEATING INSTALLATIONS; REFRIGERATOR REPAIR; REPAIR OF HOUSEHOLD APPLIANCES AND OF RESIDENTIAL HEATING, PLUMBING, AIR CONDITIONING, AND ELECTRICAL SYSTEMS, IN CLASS 37 (U.S. CLS. 100, 103 AND 106).

FIRST USE 1-1-2003; IN COMMERCE 1-1-2003.

THE MARK CONSISTS OF STANDARD CHARACTERS WITHOUT CLAIM TO ANY PARTICULAR FONT, STYLE, SIZE, OR COLOR.

NO CLAIM IS MADE TO THE EXCLUSIVE RIGHT TO USE "MECHANICAL", APART FROM THE MARK AS SHOWN.

SER. NO. 85-508,596, FILED 1-4-2012.

MATTHEW KLINE, EXAMINING ATTORNEY



*David J. Kypas*

Director of the United States Patent and Trademark Office

# United States of America

United States Patent and Trademark Office

# NAVSMART

**Reg. No. 4,197,696**

INVENTIOUS LTD (NEW ZEALAND LIMITED COMPANY (LTD.))  
8A HOBAY LN, MT PLEASANT  
CHRISTCHURCH, NEW ZEALAND

**Registered Aug. 28, 2012**

**Int. Cl.: 42**

FOR: PROVIDING ONLINE NON-DOWNLOADABLE INTERNET-BASED SYSTEM SOFTWARE APPLICATION THAT ALLOWS USERS TO NAVIGATE AND TO LOCATE SPECIFIC LOCATIONS USING A SMART PHONE'S GLOBAL POSITIONING SYSTEM, IN CLASS 42 (U.S. CLS. 100 AND 101).

**SERVICE MARK**

**PRINCIPAL REGISTER**

FIRST USE 11-1-2011; IN COMMERCE 12-22-2011.

THE MARK CONSISTS OF STANDARD CHARACTERS WITHOUT CLAIM TO ANY PARTICULAR FONT, STYLE, SIZE, OR COLOR.

SER. NO. 85-508,602, FILED 1-4-2012.

AHSEN KHAN, EXAMINING ATTORNEY



*David J. Kyffers*

Director of the United States Patent and Trademark Office

# United States of America

United States Patent and Trademark Office

# SOLDIERFIT

**Reg. No. 4,197,697**

**Registered Aug. 28, 2012**

**Int. Cl.: 41**

**SERVICE MARK**

**PRINCIPAL REGISTER**

DDT FITNESS (MARYLAND LIMITED LIABILITY COMPANY), DBA SOLDIERFIT  
18777 C N. FREDERICK AVE.  
GAITHERSBURG, MD 20879

FOR: CONDUCTING FITNESS CLASSES; PHYSICAL FITNESS CONDITIONING CLASSES; PHYSICAL FITNESS STUDIO SERVICES, NAMELY, PROVIDING EXERCISE CLASSES, BODY SCULPTING CLASSES, AND GROUP FITNESS CLASSES; PROVIDING A WEBSITE FOR PERSONS TO REGISTER FOR SURPRISE EVENTS AND CLASSES FOR THE PURPOSE OF ENTERTAINMENT; PROVIDING CLASSES, WORKSHOPS, SEMINARS AND CAMPS IN THE FIELDS OF FITNESS, EXERCISE, BOXING, KICK BOXING AND MIXED MARTIAL ARTS, IN CLASS 41 (U.S. CLS. 100, 101 AND 107).

FIRST USE 7-3-2007; IN COMMERCE 7-3-2007.

OWNER OF U.S. REG. NO. 3,854,234.

THE COLOR(S) YELLOW AND BLACK IS/ARE CLAIMED AS A FEATURE OF THE MARK.

THE STIPPLING IS A FEATURE OF THE MARK AND DOES NOT INDICATE COLOR.

THE MARK CONSISTS OF THE STYLIZED WORDING "SOLDIERFIT" IN THE COLOR YELLOW, OUTLINED IN BLACK, AND WITH BLACK STIPPLING, WHERE THE LETTER "I" CONSISTS OF A SILHOUETTE OF A SOLDIER IN THE COLOR YELLOW, OUTLINED IN BLACK, AND WITH BLACK STIPPLING.

SER. NO. 85-508,721, FILED 1-4-2012.

ADA HAN, EXAMINING ATTORNEY



*David J. Kybas*

Director of the United States Patent and Trademark Office

# United States of America

United States Patent and Trademark Office

# SOLIDA

**Reg. No. 4,197,698**

**Registered Aug. 28, 2012**

**Int. Cl.: 5**

**TRADEMARK**

**PRINCIPAL REGISTER**

CHEMINOVA, INC. (DELAWARE CORPORATION)  
ONE PARK DRIVE, SUITE 150  
RESEARCH TRIANGLE PARK, NC 27709

FOR: HERBICIDE, IN CLASS 5 (U.S. CLS. 6, 18, 44, 46, 51 AND 52).

FIRST USE 11-0-2010; IN COMMERCE 11-0-2010.

THE MARK CONSISTS OF STANDARD CHARACTERS WITHOUT CLAIM TO ANY PARTICULAR FONT, STYLE, SIZE, OR COLOR.

THE ENGLISH TRANSLATION OF "SOLIDA" IN THE MARK IS "SOLID".

SER. NO. 85-508,772, FILED 1-4-2012.

MATTHEW EINSTEIN, EXAMINING ATTORNEY



*David J. Kybas*

Director of the United States Patent and Trademark Office

# United States of America

United States Patent and Trademark Office

## Diamond Kitty

**Reg. No. 4,197,699**

**Registered Aug. 28, 2012**

**Int. Cl.: 41**

**SERVICE MARK**

**PRINCIPAL REGISTER**

GUTIERREZ, SUJAY MARIE (UNITED STATES INDIVIDUAL)  
#1205  
17000 NORTH BAY ROAD  
SUNNY ISLES BEACH, FL 33160

FOR: ENTERTAINMENT SERVICES IN THE NATURE OF LIVE ACTING PERFORMANCES AND MODELING FOR ADULT PERFORMANCES AND PUBLIC APPEARANCES, ALL OF THE AFOREMENTIONED BY A STAR OF ADULT MOVIES; ENTERTAINMENT SERVICES, NAMELY, PROVIDING A WEB SITE FEATURING NON-DOWNLOADABLE ADULT-THEMED PHOTOGRAPHS AND VIDEOS, IN CLASS 41 (U.S. CLS. 100, 101 AND 107).

FIRST USE 9-27-2007; IN COMMERCE 9-27-2007.

THE MARK CONSISTS OF STANDARD CHARACTERS WITHOUT CLAIM TO ANY PARTICULAR FONT, STYLE, SIZE, OR COLOR.

THE NAME "DIAMOND KITTY" IDENTIFIES THE STAGE NAME OF SUJAY MARIE GUTIERREZ, A LIVING INDIVIDUAL WHOSE CONSENT IS OF RECORD.

SER. NO. 85-508,818, FILED 1-4-2012.

JAY BESCH, EXAMINING ATTORNEY



*David J. Kyffers*

Director of the United States Patent and Trademark Office

# United States of America

United States Patent and Trademark Office

## PORTCO PACKAGING

**Reg. No. 4,197,700**

PORTCO CORPORATION (OREGON CORPORATION)  
3601 S.E. COLUMBIA WAY, SUITE 260  
VANCOUVER, WA 98661

**Registered Aug. 28, 2012**

**Int. Cl.: 40**

FOR: CUSTOM MANUFACTURE OF PACKAGING MATERIALS; LAMINATING OF PAPER, PLASTIC AND CARDBOARD PACKAGING; PRINTING SERVICES, IN CLASS 40 (U.S. CLS. 100, 103 AND 106).

**SERVICE MARK**

FIRST USE 12-31-1929; IN COMMERCE 12-31-1929.

**PRINCIPAL REGISTER**

THE MARK CONSISTS OF STANDARD CHARACTERS WITHOUT CLAIM TO ANY PARTICULAR FONT, STYLE, SIZE, OR COLOR.

OWNER OF U.S. REG. NO. 665,099.

NO CLAIM IS MADE TO THE EXCLUSIVE RIGHT TO USE "PACKAGING", APART FROM THE MARK AS SHOWN.

SER. NO. 85-508,834, FILED 1-4-2012.

BRENDAN REGAN, EXAMINING ATTORNEY



*David J. Kyffers*

Director of the United States Patent and Trademark Office



# United States of America

United States Patent and Trademark Office

# Swing Knits

**Reg. No. 4,197,701**

BZKNITTER, LLC (FLORIDA LIMITED LIABILITY COMPANY)  
5597 NE 33RD AVENUE

**Registered Aug. 28, 2012**

FORT LAUDERDALE, FL 33308

**Int. Cl.: 41**

FOR: INSTRUCTION IN THE FIELD OF KNITTING, IN CLASS 41 (U.S. CLS. 100, 101 AND 107).

**SERVICE MARK**

FIRST USE 1-4-2012; IN COMMERCE 1-4-2012.

**PRINCIPAL REGISTER**

THE MARK CONSISTS OF STANDARD CHARACTERS WITHOUT CLAIM TO ANY PARTICULAR FONT, STYLE, SIZE, OR COLOR.

NO CLAIM IS MADE TO THE EXCLUSIVE RIGHT TO USE "KNITS", APART FROM THE MARK AS SHOWN.

SER. NO. 85-508,905, FILED 1-4-2012.

JANICE KIM, EXAMINING ATTORNEY



*David J. Kyffers*

Director of the United States Patent and Trademark Office

# United States of America

United States Patent and Trademark Office

## GEOFFREY MILLER

**Reg. No. 4,197,702**

UNIVERSAL HOSIERY INC (CALIFORNIA CORPORATION), DBA UNIVERSAL HOSIERY  
26321 FERRY COURT  
SANTA CLARITA, CA 91350

**Registered Aug. 28, 2012**

**Int. Cl.: 25**

FOR: SOCKS, IN CLASS 25 (U.S. CLS. 22 AND 39).

**TRADEMARK**

FIRST USE 3-15-1999; IN COMMERCE 3-15-1999.

**PRINCIPAL REGISTER**

THE MARK CONSISTS OF STANDARD CHARACTERS WITHOUT CLAIM TO ANY PARTICULAR FONT, STYLE, SIZE, OR COLOR.

THE NAME "GEOFFREY MILLER" DOES NOT IDENTIFY A LIVING INDIVIDUAL.

SER. NO. 85-508,928, FILED 1-4-2012.

MATTHEW PAPPAS, EXAMINING ATTORNEY



*David J. Kyffers*

Director of the United States Patent and Trademark Office

# United States of America

United States Patent and Trademark Office



**Reg. No. 4,197,703**

MURRAY'S CHEESE LLC (NEW YORK LIMITED LIABILITY COMPANY)  
254 BLEECKER STREET  
NEW YORK, NY 10014

**Registered Aug. 28, 2012**

**Int. Cl.: 16**

FOR: PLASTIC SHOPPING BAGS, WRAPPING PAPER, AND OTHER PACKAGING, NAMELY, PAPER BAGS FOR PACKAGING, IN CLASS 16 (U.S. CLS. 2, 5, 22, 23, 29, 37, 38 AND 50).

**TRADEMARK**

FIRST USE 1-1-2010; IN COMMERCE 1-1-2010.

**PRINCIPAL REGISTER**

OWNER OF U.S. REG. NO. 3,527,535.

THE COLOR(S) YELLOW AND RED IS/ARE CLAIMED AS A FEATURE OF THE MARK.

NO CLAIM IS MADE TO THE EXCLUSIVE RIGHT TO USE "1940 EST.", APART FROM THE MARK AS SHOWN.

THE MARK CONSISTS OF THE WORDS "SAVORY", "AROMATIC", "LUSCIOUS", "SHARP", "FRUITY", "MUSHROOMY", "RICH", "MURRAY'S", "AGED", "BOLD", "TOASTY", "BITING", "NUTTY", "RIPE", "POWERFUL", "HERBACEOUS", "SPICY", "BUTTERY", "COMPLEX", "TANGY", "DELICATE", "CRUMBLY", "DECADENT", "FARMSTEAD", "&", "PERVASIVE", "SUBTLE", "LINGERING", "TART", "SMOKY", "CREAMY", "PUNGENT", "SOFT", "DELECTABLE", "SMOOTH", "STINKY" IN YELLOW STYLIZED FONT ON A RED BACKGROUND WITH YELLOW VERTICAL LINES. IN THE CENTER AREA OF THE MARK IS A YELLOW CIRCLE WITH THE WORDS "THE OLDEST THE BEST" IN RED STYLIZED FONT WITH TWO RED DOTS AND INSIDE THIS YELLOW CIRCLE ARE THE WORDS "1940 EST." IN YELLOW STYLIZED FONT ON A RED BACKGROUND.

SER. NO. 85-508,959, FILED 1-4-2012.

ERNEST SHOSHO, EXAMINING ATTORNEY



*David J. Kyros*

Director of the United States Patent and Trademark Office

# United States of America

United States Patent and Trademark Office

## Mindful Mothers

**Reg. No. 4,197,704**

LUCINDA K. JOHNSON (UNITED STATES INDIVIDUAL)  
1767 SOUTHWOOD DRIVE  
SAN LUIS OBISPO, CA 93401

**Registered Aug. 28, 2012**

**Int. Cls.: 35 and 36**

FOR: CHARITABLE SERVICES, NAMELY, ORGANIZING AND CONDUCTING VOLUNTEER PROGRAMS AND COMMUNITY SERVICE PROJECTS; CHARITABLE SERVICES, NAMELY, PROMOTING ENVIRONMENTAL AWARENESS TO CHILDREN, IN CLASS 35 (U.S. CLS. 100, 101 AND 102).

**SERVICE MARK**

**PRINCIPAL REGISTER**

FIRST USE 10-10-2010; IN COMMERCE 10-10-2010.

FOR: CHARITABLE FUNDRAISING SERVICES BY MEANS OF SELLING T-SHIRTS, ACCESSORIES TO RAISE FUNDS FOR ANNUAL HALLOWEEN PARADE; CHARITABLE FUNDRAISING SERVICES BY MEANS OF SELLING GOODS TO RAISE FUNDS, IN CLASS 36 (U.S. CLS. 100, 101 AND 102).

FIRST USE 10-10-2010; IN COMMERCE 10-10-2010.

THE MARK CONSISTS OF STANDARD CHARACTERS WITHOUT CLAIM TO ANY PARTICULAR FONT, STYLE, SIZE, OR COLOR.

NO CLAIM IS MADE TO THE EXCLUSIVE RIGHT TO USE "MOTHERS", APART FROM THE MARK AS SHOWN.

SER. NO. 85-508,982, FILED 1-5-2012.

BRENDAN REGAN, EXAMINING ATTORNEY



*David J. Kyros*

Director of the United States Patent and Trademark Office

# United States of America

United States Patent and Trademark Office



**Reg. No. 4,197,705**

**Registered Aug. 28, 2012**

**Int. Cls.: 35 and 36**

**SERVICE MARK**

**PRINCIPAL REGISTER**

LUCINDA K. JOHNSON (UNITED STATES INDIVIDUAL)  
1767 SOUTHWOOD DRIVE  
SAN LUIS OBISPO, NJ 93401

FOR: CHARITABLE SERVICES, NAMELY, ORGANIZING AND CONDUCTING VOLUNTEER PROGRAMS AND COMMUNITY SERVICE PROJECTS; CHARITABLE SERVICES, NAMELY, PROMOTING ENVIRONMENTAL AWARENESS TO CHILDREN, IN CLASS 35 (U.S. CLS. 100, 101 AND 102).

FIRST USE 10-10-2010; IN COMMERCE 10-10-2010.

FOR: CHARITABLE FUNDRAISING SERVICES BY MEANS OF SELLING T-SHIRTS, ACCESSORIES TO RAISE FUNDS FOR ANNUAL HALLOWEEN PARADE; CHARITABLE FUNDRAISING SERVICES BY MEANS OF SELLING GOODS TO RAISE FUNDS, IN CLASS 36 (U.S. CLS. 100, 101 AND 102).

FIRST USE 10-10-2010; IN COMMERCE 10-10-2010.

NO CLAIM IS MADE TO THE EXCLUSIVE RIGHT TO USE "MOTHERS" , APART FROM THE MARK AS SHOWN.

THE MARK CONSISTS OF AN IMAGE OF A TREE PROTRUDING OUT OF THE STYLIZED LETTERS "MM" WITH THE STYLIZED WORDS "MINDFUL MOTHERS" UNDERNEATH.

SER. NO. 85-508,995, FILED 1-5-2012.

BRENDAN REGAN, EXAMINING ATTORNEY



*David J. Kybas*

Director of the United States Patent and Trademark Office

# United States of America

United States Patent and Trademark Office

## TR2 TERROR RESPONSE TECHNOLOGY REPORT

**Reg. No. 4,197,706**

ACCESS INTELLIGENCE, LLC (DELAWARE LIMITED LIABILITY COMPANY)  
4 CHOKE CHERRY ROAD  
ROCKVILLE, MD 20850

**Registered Aug. 28, 2012**

**Int. Cl.: 41**

FOR: NON-DOWNLOADABLE ON-LINE ELECTRONIC NEWSLETTERS RELATING TO NEW BUSINESSES AND EMERGING TECHNOLOGIES CREATED FOR DEALING WITH GLOBAL TERRORISM AND HOMELAND DEFENSE, IN CLASS 41 (U.S. CLS. 100, 101 AND 107).

**SERVICE MARK**

**PRINCIPAL REGISTER**

FIRST USE 1-12-2005; IN COMMERCE 1-12-2005.

THE MARK CONSISTS OF STANDARD CHARACTERS WITHOUT CLAIM TO ANY PARTICULAR FONT, STYLE, SIZE, OR COLOR.

OWNER OF U.S. REG. NO. 3,065,657.

NO CLAIM IS MADE TO THE EXCLUSIVE RIGHT TO USE "TERROR RESPONSE TECHNOLOGY REPORT", APART FROM THE MARK AS SHOWN.

SER. NO. 85-509,041, FILED 1-5-2012.

JOHN GARTNER, EXAMINING ATTORNEY



*David J. Kyffers*

Director of the United States Patent and Trademark Office

# United States of America

United States Patent and Trademark Office

# APPTOPIA

**Reg. No. 4,197,707**

APPTOPIA LLC (DELAWARE LIMITED LIABILITY COMPANY)  
222 THIRD STREET, SUITE 2163  
CAMBRIDGE, MA 02142

**Registered Aug. 28, 2012**

**Int. Cl.: 36**

FOR: BROKERAGE SERVICES PERTAINING TO THE SALE AND EXCHANGE OF INTELLECTUAL PROPERTY AND RELATED RIGHTS IN COMPUTER APPLICATIONS FOR MOBILE PHONES, SMARTPHONES AND OTHER MOBILE COMPUTER DEVICES, IN CLASS 36 (U.S. CLS. 100, 101 AND 102).

**SERVICE MARK**

**PRINCIPAL REGISTER**

FIRST USE 4-16-2012; IN COMMERCE 4-16-2012.

THE MARK CONSISTS OF STANDARD CHARACTERS WITHOUT CLAIM TO ANY PARTICULAR FONT, STYLE, SIZE, OR COLOR.

SER. NO. 85-509,057, FILED 1-5-2012.

BRIDGETT SMITH, EXAMINING ATTORNEY



*David J. Kyffers*

Director of the United States Patent and Trademark Office

# United States of America

United States Patent and Trademark Office



**Reg. No. 4,197,708**

**Registered Aug. 28, 2012**

**Int. Cl.: 30**

**TRADEMARK**

**PRINCIPAL REGISTER**

BOTKA, CHRIS (UNITED STATES INDIVIDUAL)  
PO BOX 8  
RANGELEY, ME 04970

FOR: MAPLE SYRUP, IN CLASS 30 (U.S. CL. 46).

FIRST USE 2-28-2008; IN COMMERCE 2-28-2008.

NO CLAIM IS MADE TO THE EXCLUSIVE RIGHT TO USE "MAINE MOUNTAIN MAPLE",  
APART FROM THE MARK AS SHOWN.

THE MARK CONSISTS OF AN OVAL CONTAINING AN IMAGE OF A MOOSE AGAINST  
A BACKGROUND OF MOUNTAINS. BELOW THESE IMAGES INSIDE THE OVAL IS THE  
STYLIZED TEXT "MAINE MOUNTAIN" ABOVE THE STYLIZED TEXT "MAPLE" WITH A  
MAPLE LEAF ON EACH SIDE OF "MAPLE". A BORDER SURROUNDS THE OVAL.

SER. NO. 85-509,080, FILED 1-5-2012.

KATHLEEN M. VANSTON, EXAMINING ATTORNEY



*David J. Kybas*

Director of the United States Patent and Trademark Office



# United States of America

United States Patent and Trademark Office



# SOLARDOCK

*Going full tilt to bring you more power.*

**Reg. No. 4,197,709**

**Registered Aug. 28, 2012**

**Int. Cl.: 6**

**TRADEMARK**

**PRINCIPAL REGISTER**

BLUE SUNNY SKIES LLC (DELAWARE LIMITED LIABILITY COMPANY)  
201 W. 14TH STREET, SUITE 101  
WILMINGTON, DE 19801

FOR: SOLAR PANEL MOUNTING SYSTEMS COMPRISING METAL FRAMES ON WHICH SOLAR PANELS ARE MOUNTED, BALLAST FOR WEIGHTING THE FRAMES, METAL FASTENERS FOR SECURING SOLAR PANELS TO THE FRAMES, NAMELY, SCREWS, BOLTS AND CLIPS, DC-AC CONVERSION UNITS, AND GROUNDING CLIPS, IN CLASS 6 (U.S. CLS. 2, 12, 13, 14, 23, 25 AND 50).

FIRST USE 11-0-2011; IN COMMERCE 11-0-2011.

OWNER OF U.S. REG. NO. 2,918,896.

THE MARK CONSISTS OF THE WORDING "SOLARDOCK GOING FULL TILT TO BRING YOU MORE POWER." IN STYLIZED FONT, AND APPEARING ABOVE IS A DESIGN DEPICTING A RIGHT TRIANGLE WITH A RISING SUN FEATURING RADIATING RAYS SUPERIMPOSED OVER A SEMI-CIRCLE.

SER. NO. 85-509,118, FILED 1-5-2012.

AMY KELLY, EXAMINING ATTORNEY



*David J. Kyros*

Director of the United States Patent and Trademark Office

# United States of America

United States Patent and Trademark Office

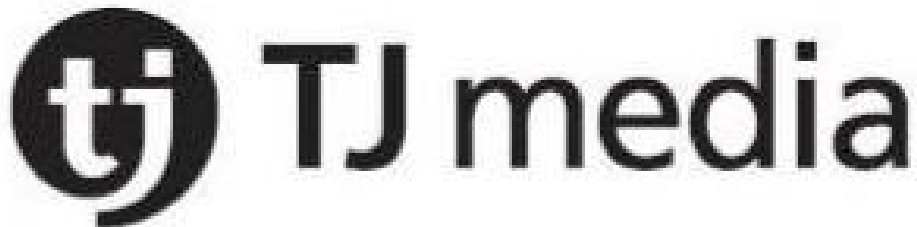

**Reg. No. 4,197,710**

**Registered Aug. 28, 2012**

**Int. Cl.: 9**

**TRADEMARK**

**PRINCIPAL REGISTER**

TJ MEDIA CO., LTD. (REPUBLIC OF KOREA CORPORATION)  
23 HWAGOK-RO 64-GIL, KANGSEO-GU  
SEOUL, REPUBLIC OF KOREA

FOR: KARAOKE MACHINES; ELECTRIC CONTROL PANELS AND SOFTWARE FOR CONTROLLING KARAOKE MACHINES; APPARATUS FOR DIVIDING IMAGE, NAMELY, DIVIDING AN INPUT VIDEO IMAGE SIGNAL INTO A PLURALITY OF IMAGE DIVISIONS; AMPLIFIER; AUDIO MIXERS; VIDEO MONITORS, TELEVISION MONITORS, FLAT PANEL DISPLAY SCREENS, LCD SCREENS DISPLAYING MULTIPLE CHANNELS AT ONCE; SET-TOP BOX FOR CONNECTING TO INTERNET; AUDIO SPEAKERS; ELECTRONIC CONTROL MODULE FOR CONTROLLING LIGHTING APPARATUS; SOUND REPRODUCTION APPARATUS HAVING A HANDHELD DIGITAL ELECTRONIC DEVICE FOR RECORDING, ORGANIZING, TRANSMITTING, MANIPULATING AND REVIEWING TEXT, DATA AND AUDIO; MICROPHONES FOR KARAOKE MACHINES, IN CLASS 9 (U.S. CLS. 21, 23, 26, 36 AND 38).

FIRST USE 5-1-2011; IN COMMERCE 12-15-2011.

OWNER OF U.S. REG. NO. 3,170,738.

NO CLAIM IS MADE TO THE EXCLUSIVE RIGHT TO USE "MEDIA", APART FROM THE MARK AS SHOWN.

THE MARK CONSISTS OF LETTERS "TJ" IN THE CIRCLE AND LETTERS "TJ MEDIA".

SER. NO. 85-509,147, FILED 1-5-2012.

MEGHAN REINHART, EXAMINING ATTORNEY



*David J. Kyros*

Director of the United States Patent and Trademark Office

# United States of America

United States Patent and Trademark Office



The Mended Hearts, Inc.

**Reg. No. 4,197,711**

**Registered Aug. 28, 2012**

**Int. Cl.: 36**

**SERVICE MARK**

**PRINCIPAL REGISTER**

THE MENDE HEARTS, INC. (MASSACHUSETTS NON-PROFIT CORPORATION)  
8150 N. CENTRAL EXPRESS WAY, M2075  
DALLAS, TX 75206

FOR: ACCEPTING AND ADMINISTERING MONETARY CHARITABLE CONTRIBUTIONS; ACCEPTING AND ADMINISTERING MONETARY CHARITABLE CONTRIBUTIONS TO FUND MEDICAL RESEARCH; CHARITABLE FOUNDATION SERVICES, NAMELY, PROVIDING FUNDRAISING ACTIVITIES TO SUPPORT MEDICAL RESEARCH AND PROCEDURES FOR THOSE IN NEED; CHARITABLE FOUNDATION SERVICES, NAMELY, PROVIDING FUNDRAISING ACTIVITIES, FUNDING, SCHOLARSHIPS AND/OR FINANCIAL ASSISTANCE FOR HEART PATIENTS; CHARITABLE FUNDRAISING; CHARITABLE FUNDRAISING SERVICES BY MEANS OF ORGANIZING AND CONDUCTING SPECIAL EVENTS; CHARITABLE FUNDRAISING SERVICES BY MEANS OF RUNNING AND WALKING EVENTS; CHARITABLE FUNDRAISING SERVICES FOR PROMOTING RESEARCH, EDUCATION AND OTHER ACTIVITIES RELATING TO SERVICES TO HEART PATIENTS THROUGH VISITING PROGRAMS, SUPPORT GROUP MEETINGS AND EDUCATIONAL FORUMS, IN CLASS 36 (U.S. CLS. 100, 101 AND 102).

FIRST USE 11-1-1955; IN COMMERCE 11-1-1955.

NO CLAIM IS MADE TO THE EXCLUSIVE RIGHT TO USE "INC.", APART FROM THE MARK AS SHOWN.

THE COLOR(S) RED, BLACK AND WHITE IS/ARE CLAIMED AS A FEATURE OF THE MARK.

THE MARK CONSISTS OF THE BLACK TEXT "THE MENDE HEARTS, INC." ADJACENT TO A RED HEART WITH WHITE STITCHING AND A FLAME WITH A RED OUTLINE EMANATING FROM THE TOP OF THE HEART.

SER. NO. 85-509,211, FILED 1-5-2012.

JAY FLOWERS, EXAMINING ATTORNEY



*David J. Kyros*

Director of the United States Patent and Trademark Office

# United States of America

United States Patent and Trademark Office



**Reg. No. 4,197,712**

**Registered Aug. 28, 2012**

**Int. Cl.: 14**

**TRADEMARK**

**PRINCIPAL REGISTER**

RADVANSKY, ANNETTE AMANDA (UNITED STATES INDIVIDUAL)  
38 TREESCAPE CIRCLE  
THE WOODLANDS, TX 77381

FOR: JEWELRY, IN CLASS 14 (U.S. CLS. 2, 27, 28 AND 50).

FIRST USE 10-19-2011; IN COMMERCE 10-19-2011.

NO CLAIM IS MADE TO THE EXCLUSIVE RIGHT TO USE "HANDWORK", APART FROM THE MARK AS SHOWN.

THE MARK CONSISTS OF THE LITERAL ELEMENT "HW" ABOVE "HANDWRAP", BOTH IN STYLIZED TEXT WITH A STYLIZED LINE DESIGN WITH AN ORNAMENTAL LEAF AT EACH END UNDERNEATH THE TEXT.

SER. NO. 85-509,231, FILED 1-5-2012.

JESSICA A. POWERS, EXAMINING ATTORNEY



*David J. Kyffers*

Director of the United States Patent and Trademark Office

# United States of America

United States Patent and Trademark Office

## Chandler Hill Vineyards

**Reg. No. 4,197,713**

CHANDLER HILL VINEYARDS, LLC (MISSOURI LIMITED LIABILITY COMPANY)  
596 DEFIANCE ROAD  
DEFIANCE, MO 63341

**Registered Aug. 28, 2012**

**Int. Cl.: 33**

FOR: GRAPE WINE; RED WINES; SPARKLING GRAPE WINE; TABLE WINES; WHITE WINE; WINE; WINES, IN CLASS 33 (U.S. CLS. 47 AND 49).

**TRADEMARK**

FIRST USE 4-9-2008; IN COMMERCE 4-9-2008.

**PRINCIPAL REGISTER**

THE MARK CONSISTS OF STANDARD CHARACTERS WITHOUT CLAIM TO ANY PARTICULAR FONT, STYLE, SIZE, OR COLOR.

NO CLAIM IS MADE TO THE EXCLUSIVE RIGHT TO USE "VINEYARDS", APART FROM THE MARK AS SHOWN.

SER. NO. 85-509,272, FILED 1-5-2012.

JAY BESCH, EXAMINING ATTORNEY



*David J. Kybas*

Director of the United States Patent and Trademark Office

# United States of America

United States Patent and Trademark Office

## TEAM HYBEAM STUDIO

**Reg. No. 4,197,714**

**Registered Aug. 28, 2012**

**Int. Cl.: 41**

**SERVICE MARK**

**PRINCIPAL REGISTER**

CRUZ, JEREMIAH (UNITED STATES INDIVIDUAL)  
2027 PECAN LANE  
DAWSONVILLE, GA 30534

FOR: RECORDING STUDIO SERVICES; MUSIC PRODUCTION SERVICES; POST-PRODUCTION EDITING SERVICES IN THE FIELD OF MUSIC, VIDEOS AND FILM; PRODUCTION OF SOUND AND MUSIC VIDEO RECORDINGS; MULTIMEDIA ENTERTAINMENT SERVICES IN THE NATURE OF RECORDING, PRODUCTION AND POST-PRODUCTION SERVICES IN THE FIELDS OF MUSIC, VIDEO, AND FILMS; MUSIC COMPOSITION FOR OTHERS; PROVIDING A WEBSITE FEATURING INFORMATION IN THE FIELD OF MUSIC AND ENTERTAINMENT, IN CLASS 41 (U.S. CLS. 100, 101 AND 107).

FIRST USE 1-1-2010; IN COMMERCE 1-3-2010.

THE MARK CONSISTS OF STANDARD CHARACTERS WITHOUT CLAIM TO ANY PARTICULAR FONT, STYLE, SIZE, OR COLOR.

NO CLAIM IS MADE TO THE EXCLUSIVE RIGHT TO USE "STUDIO", APART FROM THE MARK AS SHOWN.

SER. NO. 85-509,303, FILED 1-5-2012.

JIM RINGLE, EXAMINING ATTORNEY



*David J. Kyffers*

Director of the United States Patent and Trademark Office

# United States of America

United States Patent and Trademark Office

# BLUESTAR

**Reg. No. 4,197,715**

PRIZER-PAINTER STOVE WORKS, INC. (PENNSYLVANIA CORPORATION)  
600 ARLINGTON STREET  
READING, PA 19611

**Registered Aug. 28, 2012**

**Int. Cl.: 11**

FOR: RANGE HOODS, IN CLASS 11 (U.S. CLS. 13, 21, 23, 31 AND 34).

**TRADEMARK**

FIRST USE 10-0-2007; IN COMMERCE 10-0-2007.

**PRINCIPAL REGISTER**

THE MARK CONSISTS OF STANDARD CHARACTERS WITHOUT CLAIM TO ANY PARTICULAR FONT, STYLE, SIZE, OR COLOR.

OWNER OF U.S. REG. NOS. 3,509,134 AND 3,509,136.

SER. NO. 85-509,323, FILED 1-5-2012.

DOUGLAS LEE, EXAMINING ATTORNEY



*David J. Kyffers*

Director of the United States Patent and Trademark Office

# United States of America

United States Patent and Trademark Office



**Reg. No. 4,197,716**

FREEMAN, RICK EUGENE (UNITED STATES INDIVIDUAL)  
3515 SW 107TH  
SEATTLE, WA 98146

**Registered Aug. 28, 2012**

**Int. Cls.: 25 and 41**

FOR: SHIRTS; SHORT-SLEEVED OR LONG-SLEEVED T-SHIRTS; SWEAT SHIRTS; T-SHIRTS, IN CLASS 25 (U.S. CLS. 22 AND 39).

**TRADEMARK**

FIRST USE 12-0-2010; IN COMMERCE 12-0-2010.

**SERVICE MARK**

FOR: ON-LINE JOURNALS, NAMELY, BLOGS FEATURING INFORMATION ABOUT TRAVELING AND HIKING, IN CLASS 41 (U.S. CLS. 100, 101 AND 107).

**PRINCIPAL REGISTER**

FIRST USE 12-0-2010; IN COMMERCE 12-0-2010.

THE MARK CONSISTS OF THE STYLIZED TERMS "WANDER JUNKIE" IN RED FONT. ABOVE THE WORDING IS A STYLIZED BLACK CURVED LINE, AND TO THE RIGHT ARE STYLIZED CHINESE CHARACTERS IN BLACK FONT. NEXT TO THE BLACK CHINESE CHARACTERS IS A SMALLER, RED MARK CONTAINING A STYLIZED TRANSPARENT CHARACTER WITH NO ENGLISH MEANING. THE ENTIRE MARK IS SET AGAINST A TRANSPARENT BACKGROUND.

THE COLOR(S) BLACK AND RED IS/ARE CLAIMED AS A FEATURE OF THE MARK.

THE NON-LATIN CHARACTERS IN THE MARK TRANSLITERATE TO DA SHAN AND THIS MEANS BIG MOUNTAIN IN ENGLISH.

SER. NO. 85-509,351, FILED 1-5-2012.

TOBY BULLOFF, EXAMINING ATTORNEY



*David J. Kyffers*

Director of the United States Patent and Trademark Office



# United States of America

United States Patent and Trademark Office



**Reg. No. 4,197,717**

BREW BONES, LLC (COLORADO LIMITED LIABILITY COMPANY)  
2748 E. JAMISON AVENUE  
CENTENNIAL, CO 80122

**Registered Aug. 28, 2012**

**Int. Cl.: 31**

FOR: DOG BISCUITS, NAMELY, DOG BISCUITS MADE WITH HUMAN-GRADE, ORGANIC AND ALL-NATURAL INGREDIENTS, IN CLASS 31 (U.S. CLS. 1 AND 46).

**TRADEMARK**

FIRST USE 9-27-2010; IN COMMERCE 9-12-2011.

**PRINCIPAL REGISTER**

NO CLAIM IS MADE TO THE EXCLUSIVE RIGHT TO USE "BONES", APART FROM THE MARK AS SHOWN.

THE MARK CONSISTS OF A BOTTLE CONTAINING A BONE POSITIONED TO THE LEFT, POSITIONED IN THE MIDDLE ARE STRAIGHT HORIZONTAL LINES ABOVE AND BELOW THE WORDS "BREW BONES" AND TO THE RIGHT ARE TWO CONCENTRIC CIRCLES CONTAINING THE WORDS "PALE TAIL".

SER. NO. 85-509,472, FILED 1-5-2012.

GINA FINK, EXAMINING ATTORNEY



*David J. Kybas*

Director of the United States Patent and Trademark Office

# United States of America

United States Patent and Trademark Office

# SONOCO

**Reg. No. 4,197,718**

**Registered Aug. 28, 2012**

**Int. Cls.: 16, 19, 20 and 21**

**TRADEMARK**

**PRINCIPAL REGISTER**

SPC RESOURCES, INC. (DELAWARE CORPORATION)  
125 W HOME AVENUE  
HARTSVILLE, SC 29550

FOR: PAPER AND CARDBOARD; CONES, TUBES AND CORES MADE OF PAPER; POINT-OF-PURCHASE DISPLAYS MADE OF PAPER AND CARDBOARD; PAPERBOARD PROTECTIVE PACKAGING AND PACKAGING BASES FOR SHIPPING AND PRODUCT ASSEMBLY; PAPER CORNER POSTS FOR USE IN PACKAGING AND PROTECTING GOODS; CONTAINERS MADE OF SPIRALLY WOUND PAPER MATERIAL OR PAPER IN COMBINATION WITH METAL FOIL AND OTHER MATERIALS; COLLAPSIBLE BOXES AND CARTONS OF PAPER OR CARDBOARD, IN CLASS 16 (U.S. CLS. 2, 5, 22, 23, 29, 37, 38 AND 50).

FIRST USE 10-1-1915; IN COMMERCE 10-1-1915.

FOR: NON-METAL CASTING FORMS FOR CONCRETE, IN CLASS 19 (U.S. CLS. 1, 12, 33 AND 50).

FIRST USE 6-29-1944; IN COMMERCE 6-29-1944.

FOR: PLASTIC CONTAINERS FOR COMMERCIAL PACKAGING; COMMERCIAL PACKAGING MATERIALS, NAMELY, THERMOFORMED PLASTIC TRAYS, IN CLASS 20 (U.S. CLS. 2, 13, 22, 25, 32 AND 50).

FIRST USE 1-5-2012; IN COMMERCE 1-5-2012.

FOR: PLASTIC BOTTLES FOR COMMERCIAL PACKAGING SOLD EMPTY, IN CLASS 21 (U.S. CLS. 2, 13, 23, 29, 30, 33, 40 AND 50).

FIRST USE 8-18-2010; IN COMMERCE 8-18-2010.

THE MARK CONSISTS OF STANDARD CHARACTERS WITHOUT CLAIM TO ANY PARTICULAR FONT, STYLE, SIZE, OR COLOR.

OWNER OF U.S. REG. NOS. 552,840, 1,505,969 AND OTHERS.

SER. NO. 85-509,477, FILED 1-5-2012.



*David J. Kybas*

Director of the United States Patent and Trademark Office

**Reg. No. 4,197,718** JAMES LOVELACE, EXAMINING ATTORNEY

# United States of America

United States Patent and Trademark Office



**Reg. No. 4,197,719**

RED STAR TRADING INC. (CALIFORNIA CORPORATION)  
88 TRAILING VINE  
IRVINE, CA 92602

**Registered Aug. 28, 2012**

**Int. Cl.: 35**

FOR: ON-LINE RETAIL STORE SERVICES FEATURING CAMERA ACCESSORIES, IN CLASS 35 (U.S. CLS. 100, 101 AND 102).

**SERVICE MARK**

FIRST USE 8-0-2011; IN COMMERCE 8-0-2011.

**PRINCIPAL REGISTER**

THE MARK CONSISTS OF THE WORDS "REDSTAR SUPERMALL" IN A WHITE FONT. TO THE LEFT OF THE WORDS "REDSTAR SUPERMALL" IS THE IMAGE OF A LARGE WHITE STAR, WITHIN THE IMAGE OF THE WHITE STAR IS A SMALLER NAVY BLUE STAR PROJECTED AS A SHOOTING STAR. THE BACKGROUND OF THE MARK CONSISTS OF A RED RECTANGLE.

THE COLOR(S) RED, WHITE AND NAVY BLUE IS/ARE CLAIMED AS A FEATURE OF THE MARK.

SER. NO. 85-509,479, FILED 1-5-2012.

JAMES LOVELACE, EXAMINING ATTORNEY



*David J. Kyffers*

Director of the United States Patent and Trademark Office

# United States of America

United States Patent and Trademark Office



**Reg. No. 4,197,720**

GLOBAL PROCESS DIAGNOSTICS, INC. (LOUISIANA CORPORATION)  
26543 MISSION ST.

**Registered Aug. 28, 2012**

PRAIRIEVILLE, LA 70769

**Int. Cl.: 37**

FOR: AIR-COOLED HEAT EXCHANGER COIL CLEANING SERVICES, IN CLASS 37 (U.S. CLS. 100, 103 AND 106).

**SERVICE MARK**

FIRST USE 4-1-1999; IN COMMERCE 4-1-1999.

**PRINCIPAL REGISTER**

OWNER OF U.S. REG. NO. 4,070,331.

NO CLAIM IS MADE TO THE EXCLUSIVE RIGHT TO USE "FIN FOAM", APART FROM THE MARK AS SHOWN.

THE MARK CONSISTS OF THE TERM "FINFOAM" WITH THE LETTER "F" IN FOAM IN THE FORM OF A JUMPING PORPOISE-LIKE FISH. THE LETTERS "OAM" ARE SURROUNDED BY A RECTANGULAR DESIGN THAT IS DIVIDED INTO THIRDS. THE TOP AND BOTTOM THIRDS ARE MADE UP OF VERTICAL LINES AND THE MIDDLE THIRD IS SHADED.

SER. NO. 85-509,607, FILED 1-5-2012.

MICHAEL WEBSTER, EXAMINING ATTORNEY



*David J. Kypos*

Director of the United States Patent and Trademark Office

# United States of America

United States Patent and Trademark Office



**Reg. No. 4,197,721**

**Registered Aug. 28, 2012**

**Int. Cls.: 3 and 4**

**TRADEMARK**

**PRINCIPAL REGISTER**

ROSY RINGS, INC. (COLORADO CORPORATION)  
4477 GARFIELD ST.  
DENVER, CO 80216

FOR: POTPOURRI; REEDS AND SCENTED OILS SOLD AS A UNIT FOR USE IN ROOM SCENT DIFFUSERS; SCENTED CERAMIC STONES; SCENTED FABRIC REFRESHER SPRAY; SCENTED OILS USED TO PRODUCE AROMAS WHEN HEATED; SCENTED PINE CONES; SCENTED ROOM SPRAYS; SCENTED STICKS FOR ADDING SCENT TO A FLOWER BOUQUET OR FLOWERING POT PLANT, IN CLASS 3 (U.S. CLS. 1, 4, 6, 50, 51 AND 52).

FIRST USE 3-1-2011; IN COMMERCE 3-1-2011.

FOR: CANDLES; FRAGRANT WAX FOR USE IN POTPOURRI BURNERS; MELT TARTS, NAMELY, SCENTED WAX TO BE MELTED SLOWLY WITH A WARMER; SCENTED WAX FOR USE IN CANDLE WARMERS, IN CLASS 4 (U.S. CLS. 1, 6 AND 15).

FIRST USE 3-1-2011; IN COMMERCE 3-1-2011.

OWNER OF U.S. REG. NOS. 2,506,381 AND 2,506,382.

THE MARK CONSISTS OF A STYLIZED FLOWER BETWEEN THE WORDS "ROSY RINGS".

SER. NO. 85-509,650, FILED 1-5-2012.

JEFFREY LOOK, EXAMINING ATTORNEY



*David J. Kybas*

Director of the United States Patent and Trademark Office

# United States of America

United States Patent and Trademark Office



**Reg. No. 4,197,722**

FAB.COM, INC. (DELAWARE CORPORATION)  
330 W. 38TH STREET, SUITE 300  
NEW YORK, NY 10018

**Registered Aug. 28, 2012**

**Int. Cl.: 35**

FOR: PROVIDING INCENTIVE AWARD PROGRAMS FOR USERS THROUGH THE ISSU-  
ANCE OF CREDIT FOR REFERRALS, IN CLASS 35 (U.S. CLS. 100, 101 AND 102).

**SERVICE MARK**

FIRST USE 3-9-2011; IN COMMERCE 3-9-2011.

**PRINCIPAL REGISTER**

THE MARK CONSISTS OF THE WORDING "FAB" AND A HEART DESIGN IN LOWER  
POSITION OF A BOX.

SER. NO. 85-509,958, FILED 1-5-2012.

EMILY CHUO, EXAMINING ATTORNEY



*David J. Kyffers*

Director of the United States Patent and Trademark Office

# United States of America

United States Patent and Trademark Office

# NOBAC

**Reg. No. 4,197,723**

LAERA, VITO (UNITED STATES INDIVIDUAL)  
5960 SW 32 TERRACE  
FORT LAUDERDALE, FL 33312

**Registered Aug. 28, 2012**

**Int. Cls.: 11 and 20**

FOR: KITCHEN SINKS; PLUMBING SUPPLIES, NAMELY, SINK STRAINERS; SINK PED-  
ESTALS; SINKS; SINKS INTEGRATED INTO COUNTERS OR COUNTERTOPS; TAP WATER  
FAUCETS; TAPS; TAPS FOR WASHSTANDS, IN CLASS 11 (U.S. CLS. 13, 21, 23, 31 AND  
34).

**TRADEMARK**

**PRINCIPAL REGISTER**

FIRST USE 1-1-2006; IN COMMERCE 1-1-2006.

FOR: BATHROOM FURNITURE; BATHROOM VANITIES, IN CLASS 20 (U.S. CLS. 2, 13,  
22, 25, 32 AND 50).

FIRST USE 1-1-2006; IN COMMERCE 1-1-2006.

THE MARK CONSISTS OF STANDARD CHARACTERS WITHOUT CLAIM TO ANY PAR-  
TICULAR FONT, STYLE, SIZE, OR COLOR.

THE WORDING "NOBAC" HAS NO MEANING IN A FOREIGN LANGUAGE.

SER. NO. 85-509,970, FILED 1-5-2012.

WON TEAK OH, EXAMINING ATTORNEY



*David J. Kypos*

Director of the United States Patent and Trademark Office



# United States of America

United States Patent and Trademark Office

# Just Say Yes

**Reg. No. 4,197,724**

ALEXANDER J. SMALL, IV (UNITED STATES INDIVIDUAL)  
2122 SUTTER STREET  
DALLAS, TX 75216

**Registered Aug. 28, 2012**

**Int. Cl.: 41**

FOR: ENTERTAINMENT IN THE NATURE OF VISUAL AND AUDIO PERFORMANCES, NAMELY, MUSICAL BAND, ROCK GROUP, GYMNASTIC, DANCE, AND BALLET PERFORMANCES, IN CLASS 41 (U.S. CLS. 100, 101 AND 107).

**SERVICE MARK**

FIRST USE 9-1-2009; IN COMMERCE 9-1-2009.

**PRINCIPAL REGISTER**

THE MARK CONSISTS OF STANDARD CHARACTERS WITHOUT CLAIM TO ANY PARTICULAR FONT, STYLE, SIZE, OR COLOR.

SER. NO. 85-509,985, FILED S.R. 1-5-2012 AM. P.R. 4-16-2012.

WON TEAK OH, EXAMINING ATTORNEY



*David J. Kyffers*

Director of the United States Patent and Trademark Office

# United States of America

United States Patent and Trademark Office

# SheVapes

**Reg. No. 4,197,725**

INLIFE, LLC (CALIFORNIA LIMITED LIABILITY COMPANY)  
15771 VON KARMAN  
IRVINE, CA 92614

**Registered Aug. 28, 2012**

**Int. Cl.: 34**

FOR: ELECTRONIC CIGARETTES, NAMELY, ELECTRONIC NICOTINE DELIVERY DEVICE,  
IN CLASS 34 (U.S. CLS. 2, 8, 9 AND 17).

**TRADEMARK**

FIRST USE 7-1-2011; IN COMMERCE 7-1-2011.

**PRINCIPAL REGISTER**

THE MARK CONSISTS OF STANDARD CHARACTERS WITHOUT CLAIM TO ANY PARTICULAR FONT, STYLE, SIZE, OR COLOR.

SER. NO. 85-510,007, FILED 1-5-2012.

JORDAN BAKER, EXAMINING ATTORNEY



*David J. Kyffers*

Director of the United States Patent and Trademark Office

# United States of America

United States Patent and Trademark Office

# Power@Work

**Reg. No. 4,197,726**

**Registered Aug. 28, 2012**

**Int. Cl.: 35**

**SERVICE MARK**

**PRINCIPAL REGISTER**

NEIMARK, RONALD E (UNITED STATES INDIVIDUAL), DBA POWER@WORK  
1040 W GRANVILLE AVE APT 1005  
CHICAGO, IL 60660

FOR: PROVIDING LABOR RELATIONS SERVICES, NAMELY, ESTABLISHING COMMITTEES WITH UNIONS TO PROMOTE IMPROVED RELATIONS BETWEEN EMPLOYERS AND UNIONS, IN CLASS 35 (U.S. CLS. 100, 101 AND 102).

FIRST USE 8-1-2011; IN COMMERCE 9-1-2011.

THE MARK CONSISTS OF THE PHRASE "POWER@WORK".

SER. NO. 85-510,021, FILED 1-6-2012.

IRA J. GOODSaid, EXAMINING ATTORNEY



*David J. Kyffers*

Director of the United States Patent and Trademark Office

# United States of America

United States Patent and Trademark Office

## CHALLENGE ISLAND

**Reg. No. 4,197,727**

**Registered Aug. 28, 2012**

**Int. Cl.: 41**

**SERVICE MARK**

**PRINCIPAL REGISTER**

ESTROFF, SHARON DUKE (UNITED STATES INDIVIDUAL), DBA KIDSPLORATIONS  
SHARONESTROFF@GMAIL.COM  
4590 LASALLE COURT  
MARIETTA, GA 30062

FOR: DAY CAMP SERVICES; EDUCATION SERVICES, NAMELY, PROVIDING HANDS-ON OPPORTUNITIES FOR CHILDREN IN THE FIELD OF INTUITIVE ENGINEERING THROUGH LIVE, BROADCAST, AND ON-LINE CLASSES, SEMINARS, WORKSHOPS, TRAINING AND CURRICULUM DEVELOPMENT FOR CHILDREN, PARENTS AND EDUCATORS; EDUCATIONAL SERVICES, NAMELY, DEVELOPING CURRICULUM FOR EDUCATORS; ENTERTAINMENT SERVICES, NAMELY, CONDUCTING PARTIES; PROVIDING AFTER SCHOOL EDUCATIONAL PROGRAMS FOR CHILDREN IN GRADES PRE-K THROUGH 8, IN CLASS 41 (U.S. CLS. 100, 101 AND 107).

FIRST USE 7-1-2009; IN COMMERCE 8-1-2009.

THE MARK CONSISTS OF STANDARD CHARACTERS WITHOUT CLAIM TO ANY PARTICULAR FONT, STYLE, SIZE, OR COLOR.

SER. NO. 85-510,112, FILED 1-6-2012.

KATHLEEN LORENZO, EXAMINING ATTORNEY



*David J. Kyffers*

Director of the United States Patent and Trademark Office

# United States of America

United States Patent and Trademark Office



**Reg. No. 4,197,728**

**Registered Aug. 28, 2012**

**Int. Cl.: 35**

**SERVICE MARK**

**PRINCIPAL REGISTER**

NETTING SOLUTIONS, LLC. (FLORIDA LIMITED LIABILITY COMPANY)  
SUITE 1208  
175 SW 7TH STREET  
MIAMI, FL 33130

FOR: SOCIAL MEDIA STRATEGY AND MARKETING CONSULTANCY FOCUSING ON HELPING CLIENTS CREATE AND EXTEND THEIR PRODUCT AND BRAND STRATEGIES BY BUILDING VIRALLY ENGAGING MARKETING SOLUTIONS, IN CLASS 35 (U.S. CLS. 100, 101 AND 102).

FIRST USE 9-6-2011; IN COMMERCE 9-6-2011.

THE MARK CONSISTS OF A DEPICTION OF A SPEECH CLOUD WITH AN INNER OUTLINE WITH TWO BUBBLES WITH THE LETTERS "DB" WITHIN. THE WORDS "DIALOGUEBEAT" APPEARS ON THE RIGHT WITH CURVED LINES ABOVE THE "B" AND BELOW THE "T".

SER. NO. 85-510,179, FILED 1-6-2012.

ALEX KEAM, EXAMINING ATTORNEY



*David J. Kybas*

Director of the United States Patent and Trademark Office

# United States of America

United States Patent and Trademark Office

## RUSTIC WEDDING CHIC

**Reg. No. 4,197,729**

**Registered Aug. 28, 2012**

**Int. Cl.: 41**

**SERVICE MARK**

**PRINCIPAL REGISTER**

LORD, MARGARET M. (UNITED STATES INDIVIDUAL), DBA RUSTIC WEDDING CHIC  
4 RAMAPOO ROAD  
RIDGEFIELD, CT 06877

FOR: EDUCATION AND ENTERTAINMENT RELATING TO NUPTIALS AND RUSTIC WEDDINGS, NAMELY, ON-LINE JOURNALS, NAMELY, BLOGS, REPORTS, PHOTOGRAPHS; ADVICE ON RUSTIC WEDDINGS, NAMELY, WEDDING PLANNING SERVICES; PROVIDING INFORMATION ON RUSTIC WEDDING RESOURCES, NAMELY, RUSTIC WEDDING PLANNING AND CONSULTATION SERVICES, IN CLASS 41 (U.S. CLS. 100, 101 AND 107).

FIRST USE 6-1-2011; IN COMMERCE 6-1-2011.

THE MARK CONSISTS OF STANDARD CHARACTERS WITHOUT CLAIM TO ANY PARTICULAR FONT, STYLE, SIZE, OR COLOR.

NO CLAIM IS MADE TO THE EXCLUSIVE RIGHT TO USE "RUSTIC WEDDING", APART FROM THE MARK AS SHOWN.

SER. NO. 85-510,184, FILED 1-6-2012.

ALEX KEAM, EXAMINING ATTORNEY



*David J. Kybas*

Director of the United States Patent and Trademark Office

# United States of America

United States Patent and Trademark Office



**Reg. No. 4,197,730**

**Registered Aug. 28, 2012**

**Int. Cl.: 32**

**TRADEMARK**

**PRINCIPAL REGISTER**

GREEN BEE, LLC (MAINE LIMITED LIABILITY COMPANY)  
11 FIDDLEHEAD WAY  
HARPSWELL, ME 04079

FOR: SOFT DRINKS, NAMELY, SODAS, IN CLASS 32 (U.S. CLS. 45, 46 AND 48).

FIRST USE 3-1-2010; IN COMMERCE 6-20-2010.

NO CLAIM IS MADE TO THE EXCLUSIVE RIGHT TO USE "ALL NATURAL SODA", APART FROM THE MARK AS SHOWN.

THE MARK CONSISTS OF THE WORDS "GREEN BEE" ON A RECTANGULAR BACKGROUND, UNDERNEATH ARE THE WORDS "ALL NATURAL SODA", AND A BEE DESIGN APPEARING ABOVE THE WORDS IN A DASHED SWIRL TRAIL.

SER. NO. 85-510,255, FILED 1-6-2012.

CHRIS WELLS, EXAMINING ATTORNEY



*David J. Kyffers*

Director of the United States Patent and Trademark Office

# United States of America

United States Patent and Trademark Office

*Northeast Detailing*  
"Take Pride In Your Ride!"

**Reg. No. 4,197,731**

COOK, KRIS J. (UNITED STATES INDIVIDUAL)  
3 WHITEHALL RD.  
HOOKSETT, NH 03106

**Registered Aug. 28, 2012**

**Int. Cl.: 37**

FOR: AUTOMOBILE DETAILING; AUTOMOBILE RECONDITIONING SERVICES; CAR WASHING, IN CLASS 37 (U.S. CLS. 100, 103 AND 106).

**SERVICE MARK**

FIRST USE 8-1-2003; IN COMMERCE 3-0-2007.

**PRINCIPAL REGISTER**

NO CLAIM IS MADE TO THE EXCLUSIVE RIGHT TO USE "NORTHEAST DETAILING", APART FROM THE MARK AS SHOWN.

THE MARK CONSISTS OF AN OUTLINE SILHOUETTE OF A CAR ON TOP OF THE TEXT "NORTHEAST DETAILING" AND THE TEXT "'TAKE PRIDE IN YOUR RIDE!'" BELOW "NORTHEAST DETAILING".

SER. NO. 85-510,257, FILED 1-6-2012.

CHRIS WELLS, EXAMINING ATTORNEY



*David J. Kybas*

Director of the United States Patent and Trademark Office



# United States of America

United States Patent and Trademark Office

## BACKSTRETCH BUFFET

**Reg. No. 4,197,732**

**Registered Aug. 28, 2012**

**Int. Cl.: 43**

**SERVICE MARK**

**PRINCIPAL REGISTER**

MTR GAMING GROUP, INC. (DELAWARE CORPORATION)  
ROUTE 2  
CHESTER, WV 26034

FOR: BAR AND RESTAURANT SERVICES, IN CLASS 43 (U.S. CLS. 100 AND 101).

FIRST USE 10-31-2011; IN COMMERCE 10-31-2011.

THE MARK CONSISTS OF STANDARD CHARACTERS WITHOUT CLAIM TO ANY PARTICULAR FONT, STYLE, SIZE, OR COLOR.

NO CLAIM IS MADE TO THE EXCLUSIVE RIGHT TO USE "BUFFET", APART FROM THE MARK AS SHOWN.

SER. NO. 85-510,259, FILED 1-6-2012.

BRENDAN REGAN, EXAMINING ATTORNEY



*David J. Kyffers*

Director of the United States Patent and Trademark Office

# United States of America

United States Patent and Trademark Office



**Reg. No. 4,197,733**

**Registered Aug. 28, 2012**

**Int. Cl.: 41**

**SERVICE MARK**

**PRINCIPAL REGISTER**

UCHENDU, CHUKWUMA (UNITED STATES INDIVIDUAL)  
APT. 307  
25 SOUTH ST.  
LYNN, MA 01905

FOR: MULTIMEDIA ENTERTAINMENT SERVICES IN THE NATURE OF RECORDING, PRODUCTION AND POST-PRODUCTION SERVICES IN THE FIELDS OF MUSIC, VIDEO, AND FILMS, IN CLASS 41 (U.S. CLS. 100, 101 AND 107).

FIRST USE 10-0-2010; IN COMMERCE 7-0-2011.

NO CLAIM IS MADE TO THE EXCLUSIVE RIGHT TO USE "AFRICA", APART FROM THE MARK AS SHOWN.

THE STIPPLING IS FOR SHADING PURPOSES ONLY.

THE MARK CONSISTS OF THE TEXT "RIVER9JA OVERSEAS ENT!" AT THE TOP, BELOW IS AN OUTLINE OF THE MAP OF AFRICA WITH A HEADPHONE OVER IT AND THE TEXT "AFRICA" ON THE HEADPHONE, AND TO THE RIGHT OF THE MAP IS A MICROPHONE WITH ITS CORD WRAPPED AROUND THE LOWER PORTION OF THE MAP.

SER. NO. 85-510,262, FILED 1-6-2012.

CHRIS WELLS, EXAMINING ATTORNEY



*David J. Kyffers*

Director of the United States Patent and Trademark Office

# United States of America

United States Patent and Trademark Office

## BACKSTRETCH BAR

**Reg. No. 4,197,734**

**Registered Aug. 28, 2012**

**Int. Cl.: 43**

**SERVICE MARK**

**PRINCIPAL REGISTER**

MTR GAMING GROUP, INC. (DELAWARE CORPORATION)  
ROUTE 2  
CHESTER, WV 26034

FOR: BAR AND RESTAURANT SERVICES, IN CLASS 43 (U.S. CLS. 100 AND 101).

FIRST USE 10-31-2011; IN COMMERCE 10-31-2011.

THE MARK CONSISTS OF STANDARD CHARACTERS WITHOUT CLAIM TO ANY PARTICULAR FONT, STYLE, SIZE, OR COLOR.

NO CLAIM IS MADE TO THE EXCLUSIVE RIGHT TO USE "BAR", APART FROM THE MARK AS SHOWN.

SER. NO. 85-510,264, FILED 1-6-2012.

BRENDAN REGAN, EXAMINING ATTORNEY



*David J. Kyffers*

Director of the United States Patent and Trademark Office

# United States of America

United States Patent and Trademark Office



**Reg. No. 4,197,735**

**Registered Aug. 28, 2012**

**Int. Cls.: 14 and 35**

CANO, KARLA DIAZ (MEXICO INDIVIDUAL)  
UNIT M 502  
3301 NE FIRST AVENUE  
MIAMI, FL 33137

FOR: JEWELRY, IN CLASS 14 (U.S. CLS. 2, 27, 28 AND 50).

**TRADEMARK**

FIRST USE 10-2-2010; IN COMMERCE 10-2-2010.

**SERVICE MARK**

FOR: WHOLESALE AND RETAIL STORE SERVICES FEATURING JEWELRY, IN CLASS 35 (U.S. CLS. 100, 101 AND 102).

**PRINCIPAL REGISTER**

FIRST USE 10-2-2010; IN COMMERCE 10-2-2010.

THE MARK CONSISTS OF THE WORD "TIKLARI", IN LOWER CASE, DRAWN IN WHITE LETTERS AGAINST THE GRAY PORTION OF A RECTANGLE. THE RIGHT PORTION OF THE RECTANGLE IS COMPRISED OF VERTICAL STRIPES OF VARYING WIDTHS IN THE FOLLOWING ORDER: GREEN, BLUE, RED, YELLOW, PURPLE, BLUE, RED, GREEN, PURPLE, YELLOW.

THE COLOR(S) GRAY, WHITE, GREEN, BLUE, RED, YELLOW AND PURPLE IS/ARE CLAIMED AS A FEATURE OF THE MARK.

SER. NO. 85-510,277, FILED 1-6-2012.

BRENDAN REGAN, EXAMINING ATTORNEY



*David J. Kybas*

Director of the United States Patent and Trademark Office

# United States of America

United States Patent and Trademark Office

## BIG TWANG THEORY

**Reg. No. 4,197,736**

ROWAN, PETER H. (UNITED STATES INDIVIDUAL)  
401 GRAND AVENUE SUITE 300  
OAKLAND, CA 94610

**Registered Aug. 28, 2012**

**Int. Cl.: 41**

FOR: ENTERTAINMENT SERVICES IN THE NATURE OF LIVE MUSICAL PERFORMANCES,  
IN CLASS 41 (U.S. CLS. 100, 101 AND 107).

**SERVICE MARK**

FIRST USE 11-30-2011; IN COMMERCE 12-1-2011.

**PRINCIPAL REGISTER**

THE MARK CONSISTS OF STANDARD CHARACTERS WITHOUT CLAIM TO ANY PAR-  
TICULAR FONT, STYLE, SIZE, OR COLOR.

SER. NO. 85-510,304, FILED 1-6-2012.

BRENDAN REGAN, EXAMINING ATTORNEY



*David J. Kybas*

Director of the United States Patent and Trademark Office

# United States of America

United States Patent and Trademark Office



**Reg. No. 4,197,737**

**Registered Aug. 28, 2012**

**Int. Cls.: 39 and 41**

**SERVICE MARK**

**PRINCIPAL REGISTER**

BOSTON FOODIE TOURS, LLC (MASSACHUSETTS LIMITED LIABILITY COMPANY)  
#102  
100 BOATSWAIN WAY  
CHELSEA, MA 02150

FOR: ARRANGING OF TOURS; ARRANGING TRAVEL TOURS; CONDUCTING SIGHTSEEING TOURS FOR OTHERS; PERSONAL TOUR GUIDE SERVICES; TOUR CONDUCTING; TOUR GUIDE SERVICES; TOUR OPERATING AND ORGANISING, IN CLASS 39 (U.S. CLS. 100 AND 105).

FIRST USE 10-21-2011; IN COMMERCE 10-21-2011.

FOR: GUIDED TOURS OF FOOD-RELATED ESTABLISHMENTS, INCLUDING RESTAURANTS, GROCERS, BUTCHERIES, FROMAGGERIES, DELICATESSENS, WINE SHOPS AND BAKERIES.; ON-LINE JOURNALS, NAMELY, BLOGS FEATURING FOOD-RELATED INFORMATION, IN CLASS 41 (U.S. CLS. 100, 101 AND 107).

FIRST USE 10-21-2011; IN COMMERCE 10-21-2011.

NO CLAIM IS MADE TO THE EXCLUSIVE RIGHT TO USE "BOSTON FOODIE TOURS", "STROLL" OR "SAMPLE", APART FROM THE MARK AS SHOWN.

THE COLOR(S) BLACK, RED, AND WHITE IS/ARE CLAIMED AS A FEATURE OF THE MARK.

THE MARK CONSISTS OF A RECTANGLE WITH TWO RED OUTLINES ON ITS BORDERS, WITHIN WHICH RUNS THE BLACK WORDING "STROLL", "SAMPLE", "SAVOR", AND "REPEAT" SEPARATED BY RED DOTS ALL WITHIN A WHITE BACKGROUND. THE STYLIZED RED WORDING "BOSTON FOODIE TOURS" IS WITHIN THE WHITE INTERIOR OF THE RECTANGLE, WHICH ALSO CONTAINS A SMALLER RED RECTANGLE IN THE BOTTOM LEFT CORNER, WITHIN WHICH IS A WHITE SPOON AND FORK.

SER. NO. 85-510,306, FILED 1-6-2012.

BRIAN PINO, EXAMINING ATTORNEY



*David J. Kyppas*

Director of the United States Patent and Trademark Office

# United States of America

United States Patent and Trademark Office

# ULTRAMET

**Reg. No. 4,197,738**

CELPLAST METALLIZED PRODUCTS LIMITED (CANADA CORPORATION)  
67 COMMANDER BLVD., UNIT 4  
TORONTO, ON, CANADA M1S3M7

**Registered Aug. 28, 2012**

**Int. Cl.: 17**

FOR: PLASTIC FLEXIBLE PACKAGING FILM SOLD IN BULK TO INDUSTRIAL AND COMMERCIAL MANUFACTURERS, IN CLASS 17 (U.S. CLS. 1, 5, 12, 13, 35 AND 50).

**TRADEMARK**

FIRST USE 8-3-2011; IN COMMERCE 8-10-2011.

**PRINCIPAL REGISTER**

THE MARK CONSISTS OF STANDARD CHARACTERS WITHOUT CLAIM TO ANY PARTICULAR FONT, STYLE, SIZE, OR COLOR.

SER. NO. 85-510,340, FILED 1-6-2012.

ALLISON SCHRODY, EXAMINING ATTORNEY



*David J. Kyffers*

Director of the United States Patent and Trademark Office

# United States of America

United States Patent and Trademark Office



**Reg. No. 4,197,739**

MTR GAMING GROUP, INC. (DELAWARE CORPORATION)  
ROUTE 2  
CHESTER, WV 26034

**Registered Aug. 28, 2012**

**Int. Cl.: 43**

FOR: BAR AND RESTAURANT SERVICES, IN CLASS 43 (U.S. CLS. 100 AND 101).

**SERVICE MARK**

FIRST USE 10-31-2011; IN COMMERCE 10-31-2011.

**PRINCIPAL REGISTER**

NO CLAIM IS MADE TO THE EXCLUSIVE RIGHT TO USE "BAR" , APART FROM THE MARK AS SHOWN.

THE MARK CONSISTS OF THE WORDS "BACKSTRETCH" AND "BAR" IN A SINGLE, HORIZONTAL LINE WITH THE WORD "BAR" BEING LARGER THAN THE WORD "BACKSTRETCH".

SER. NO. 85-510,341, FILED 1-6-2012.

BRENDAN REGAN, EXAMINING ATTORNEY



*David J. Kybas*

Director of the United States Patent and Trademark Office



# United States of America

United States Patent and Trademark Office



**Reg. No. 4,197,740**

MTR GAMING GROUP, INC. (DELAWARE CORPORATION)  
ROUTE 2  
CHESTER, WV 26034

**Registered Aug. 28, 2012**

**Int. Cl.: 43**

FOR: BAR AND RESTAURANT SERVICES, IN CLASS 43 (U.S. CLS. 100 AND 101).

**SERVICE MARK**

FIRST USE 10-31-2011; IN COMMERCE 10-31-2011.

**PRINCIPAL REGISTER**

NO CLAIM IS MADE TO THE EXCLUSIVE RIGHT TO USE "BUFFET", APART FROM THE MARK AS SHOWN.

THE MARK CONSISTS OF THE WORD "BACKSTRETCH" OVER THE WORD "BUFFET" WITH THE "FFE" IN "BUFFET" HAVING THE IMAGE OF A FORK.

SER. NO. 85-510,348, FILED 1-6-2012.

BRENDAN REGAN, EXAMINING ATTORNEY



*David J. Kybas*

Director of the United States Patent and Trademark Office

# United States of America

United States Patent and Trademark Office

# UMBEL

**Reg. No. 4,197,741**

UMBEL CORP. (DELAWARE CORPORATION)  
2301 SHOAL CREEK BLVD.  
AUSTIN, TX 78705

**Registered Aug. 28, 2012**

**Int. Cl.: 42**

FOR: ONLINE COMPUTER SERVICES, NAMELY, ANALYZING AND REPORTING ON THE USER ACTIVITY OF COMPUTER NETWORKS OF OTHERS, IN CLASS 42 (U.S. CLS. 100 AND 101).

**SERVICE MARK**

FIRST USE 6-20-2011; IN COMMERCE 6-20-2011.

**PRINCIPAL REGISTER**

THE MARK CONSISTS OF STANDARD CHARACTERS WITHOUT CLAIM TO ANY PARTICULAR FONT, STYLE, SIZE, OR COLOR.

SER. NO. 85-510,364, FILED 1-6-2012.

LINDA LAVACHE, EXAMINING ATTORNEY



*David J. Kyffers*

Director of the United States Patent and Trademark Office

# United States of America

United States Patent and Trademark Office

## Kickstarting Confident Leaders

**Reg. No. 4,197,742**

**Registered Aug. 28, 2012**

**Int. Cl.: 41**

**SERVICE MARK**

**PRINCIPAL REGISTER**

KICK MASTERS KARATE, LLC (MARYLAND LIMITED LIABILITY COMPANY)  
16318 CLARYSVILLE ROAD  
FROSTBURG, MD 21532

FOR: EDUCATIONAL SERVICES, NAMELY, PROVIDING LIVE, AND ON-LINE PROGRAMS, CLASSES, SEMINARS, AND WORKSHOPS IN THE FIELDS OF FITNESS, BUSINESS APPLICATION, EXERCISE, LIFE COACHING, KARATE, AND MARTIAL ARTS AND DISTRIBUTING COURSE MATERIALS THEREWITH; EDUCATIONAL SERVICES, NAMELY, PROVIDING MOTIVATIONAL SPEAKERS IN THE FIELDS OF FITNESS, BUSINESS APPLICATION, EXERCISE, LIFE COACHING, KARATE, AND MARTIAL ARTS, IN CLASS 41 (U.S. CLS. 100, 101 AND 107).

FIRST USE 1-1-2005; IN COMMERCE 1-1-2005.

THE MARK CONSISTS OF STANDARD CHARACTERS WITHOUT CLAIM TO ANY PARTICULAR FONT, STYLE, SIZE, OR COLOR.

SER. NO. 85-510,391, FILED 1-6-2012.

MATTHEW KLINE, EXAMINING ATTORNEY



*David J. Kypas*

Director of the United States Patent and Trademark Office

# United States of America

United States Patent and Trademark Office

# SALADFACE

**Reg. No. 4,197,743**

MARK B. SOLOMON (UNITED STATES INDIVIDUAL)  
1454 WARNALL AVENUE  
LOS ANGELES, CA 90024

**Registered Aug. 28, 2012**

**Int. Cl.: 41**

FOR: ART EXHIBITIONS; EDUCATION SERVICES, NAMELY, PROVIDING CLASSES, SEMINARS, WORKSHOPS, AND LECTURES IN THE FIELD OF ART, NAMELY, CARVINGS, DRAWINGS, SCULPTING, AND PAINTINGS; EDUCATIONAL SERVICES, NAMELY, PROVIDING DISPLAYS AND EXHIBITS IN THE FIELD OF ART, NAMELY, CARVINGS, DRAWINGS, SCULPTING, AND PAINTINGS; INSTRUCTION IN THE FIELD OF ART, NAMELY, CARVINGS, DRAWINGS, SCULPTING, AND PAINTINGS, IN CLASS 41 (U.S. CLS. 100, 101 AND 107).

**SERVICE MARK**

**PRINCIPAL REGISTER**

FIRST USE 1-1-1970; IN COMMERCE 1-1-1970.

THE MARK CONSISTS OF STANDARD CHARACTERS WITHOUT CLAIM TO ANY PARTICULAR FONT, STYLE, SIZE, OR COLOR.

SER. NO. 85-510,414, FILED 1-6-2012.

MATTHEW PAPPAS, EXAMINING ATTORNEY



*David J. Kypas*

Director of the United States Patent and Trademark Office

# United States of America

United States Patent and Trademark Office

DISC  TEST

**Reg. No. 4,197,744**

DEVELOPMENTAL TESTING SERVICE, INC. (MASSACHUSETTS CORPORATION)  
35 SOUTH PARK TERRACE  
NORTHAMPTON, MA 01060

**Registered Aug. 28, 2012**

**Int. Cl.: 41**

FOR: ANALYZING EDUCATIONAL TESTS SCORES AND DATA FOR OTHERS; CHILDREN'S EDUCATIONAL SERVICES, NAMELY, PROVIDING ACADEMIC PERFORMANCE EVALUATION, GUIDANCE AND MONITORING FOR CHILDREN PRE-KINDERGARTEN THROUGH GRADE 12 VIA THE INTERNET; EDUCATIONAL EXAMINATION SERVICES; EDUCATIONAL SERVICES, NAMELY, DEVELOPING CURRICULUM FOR EDUCATORS; EDUCATIONAL TESTING SERVICES; PREPARING, ADMINISTERING, AND SCORING STANDARDIZED TESTS; PROVIDING EDUCATIONAL ASSESSMENT SERVICES; PROVIDING INFORMATION RELATING TO EDUCATIONAL SERVICES; RESEARCH IN THE FIELD OF EDUCATION VIA THE INTERNET; STANDARDIZED TESTING, IN CLASS 41 (U.S. CLS. 100, 101 AND 107).

**SERVICE MARK**

**PRINCIPAL REGISTER**

FIRST USE 9-1-2009; IN COMMERCE 9-1-2009.

THE MARK CONSISTS OF A DRAWING OF A DISCO BALL REPRESENTING THE LETTER "O" BETWEEN THE WORDS "DISC" AND "TEST".

SER. NO. 85-510,420, FILED 1-6-2012.

VIVIAN MICZNIK FIRST, EXAMINING ATTORNEY



*David J. Kyros*

Director of the United States Patent and Trademark Office

# United States of America

United States Patent and Trademark Office

# SIRUN

**Reg. No. 4,197,745**

MALY, ANDREW A. (UNITED STATES INDIVIDUAL)  
1000 SPRING LOOP, APT. 1105  
COLLEGE STATION, TX 77840

**Registered Aug. 28, 2012**

**Int. Cl.: 41**

FOR: RENTAL OF PORTABLE STEREO SOUND PACKS, IN CLASS 41 (U.S. CLS. 100, 101 AND 107).

**SERVICE MARK**

FIRST USE 10-23-2011; IN COMMERCE 10-23-2011.

**PRINCIPAL REGISTER**

THE MARK CONSISTS OF STANDARD CHARACTERS WITHOUT CLAIM TO ANY PARTICULAR FONT, STYLE, SIZE, OR COLOR.

SER. NO. 85-510,474, FILED 1-6-2012.

AMEEN IMAM, EXAMINING ATTORNEY



*David J. Kybas*

Director of the United States Patent and Trademark Office

# United States of America

United States Patent and Trademark Office

# HOT 97 FM

**Reg. No. 4,197,746**

**Registered Aug. 28, 2012**

**Int. Cls.: 9, 25 and 41**

**TRADEMARK**

**SERVICE MARK**

**PRINCIPAL REGISTER**

EMMIS RADIO, LLC (INDIANA LIMITED LIABILITY COMPANY)  
SUITE 700  
40 MONUMENT CIRCLE  
INDIANAPOLIS, IN 46204

FOR: DOWNLOADABLE SOFTWARE IN THE NATURE OF A MOBILE APPLICATION FOR TELECOMMUNICATIONS SERVICES FOR PROVIDING TRANSMISSION OF DATA, VIDEO, AND MEDIA CONTENT, IN CLASS 9 (U.S. CLS. 21, 23, 26, 36 AND 38).

FIRST USE 6-1-2009; IN COMMERCE 6-1-2009.

FOR: CLOTHING, NAMELY, T-SHIRTS, SWEATSHIRTS, JACKETS, HATS, IN CLASS 25 (U.S. CLS. 22 AND 39).

FIRST USE 6-1-2009; IN COMMERCE 6-1-2009.

FOR: ENTERTAINMENT SERVICES, NAMELY, PROVIDING A WEBSITE FEATURING MULTIMEDIA MATERIALS IN THE FIELDS OF MUSIC AND RADIO, IN CLASS 41 (U.S. CLS. 100, 101 AND 107).

FIRST USE 12-31-2001; IN COMMERCE 12-31-2001.

THE MARK CONSISTS OF STANDARD CHARACTERS WITHOUT CLAIM TO ANY PARTICULAR FONT, STYLE, SIZE, OR COLOR.

OWNER OF U.S. REG. NO. 2,477,364.

NO CLAIM IS MADE TO THE EXCLUSIVE RIGHT TO USE "97 FM", APART FROM THE MARK AS SHOWN.

SER. NO. 85-510,557, FILED 1-6-2012.

MATTHEW PAPPAS, EXAMINING ATTORNEY



*David J. Kyppas*

Director of the United States Patent and Trademark Office

# United States of America

United States Patent and Trademark Office



**Reg. No. 4,197,747**

AM PRODUCTS LLC (COLORADO LIMITED LIABILITY COMPANY)  
8035 LEE DRIVE #202  
ARVADA, CO 80005

**Registered Aug. 28, 2012**

**Int. Cls.: 3 and 5**

FOR: ALL-PURPOSE CLEANERS; BODY SPRAYS; DISPOSABLE WIPES IMPREGNATED WITH CLEANING CHEMICALS OR COMPOUNDS FOR INDUSTRIAL AND COMMERCIAL USE; DISPOSABLE WIPES IMPREGNATED WITH CLEANSING CHEMICALS OR COMPOUNDS FOR PERSONAL HYGIENE AND HOUSEHOLD USE; DISPOSABLE WIPES IMPREGNATED WITH CLEANSING COMPOUNDS FOR USE ON HOUSEHOLD SURFACES, IN CLASS 3 (U.S. CLS. 1, 4, 6, 50, 51 AND 52).

**TRADEMARK**

**PRINCIPAL REGISTER**

FIRST USE 1-1-2012; IN COMMERCE 1-1-2012.

FOR: ALL PURPOSE DISINFECTANTS FOR INHIBITING MICROBIAL GROWTH; ANTI-MICROBIAL HANDWASH; ANTIMICROBIAL COATINGS TO TREAT THE GROWTH OF MOLD, MILDEW, BACTERIA AND FUNGUS ON VARIOUS SURFACES; ANTIMICROBIALS FOR DERMATOLOGIC USE; HAND-SANITIZING PREPARATIONS; SANITIZING PREPARATIONS FOR HOSPITAL USE; SANITIZING PREPARATIONS FOR HOUSEHOLD USE; SPRAY SANITIZER FOR PERSONAL USE, IN CLASS 5 (U.S. CLS. 6, 18, 44, 46, 51 AND 52).

FIRST USE 1-1-2012; IN COMMERCE 1-1-2012.

NO CLAIM IS MADE TO THE EXCLUSIVE RIGHT TO USE "EXCLUSIVE MICROBE STOP TECHNOLOGY", APART FROM THE MARK AS SHOWN.

THE COLOR(S) ORANGE AND BLACK IS/ARE CLAIMED AS A FEATURE OF THE MARK.

THE MARK CONSISTS OF THE STYLIZED TERM "FEATURING" IN BLACK FONT, ABOVE A STYLIZED SHIELD DESIGN IN ORANGE. WITHIN THE ORANGE SHIELD, IS THE TERMS "MST" IN ORANGE FONT. BELOW, IS THE TERM "EXCLUSIVE" IN BLACK FONT. ABOVE, THE TERMS "MICROBE STOP TECHNOLOGY" IN WHITE FONT, OUTLINED IN ORANGE.

SER. NO. 85-510,559, FILED 1-6-2012.

WILLIAM VERHOSEK, EXAMINING ATTORNEY



*David J. Kybas*

Director of the United States Patent and Trademark Office



# United States of America

United States Patent and Trademark Office

## H&W PRINTING

**Reg. No. 4,197,748**

H&W PRINTING, INC. (GEORGIA CORPORATION)  
1724 SANDS PLACE  
MARIETTA, GA 30067

**Registered Aug. 28, 2012**

**Int. Cl.: 40**

FOR: PRINTING SERVICES; BINDERY SERVICES FOR OTHERS, NAMELY, COLLATING, FOLDING, STAPLING, PERFORATING, CUTTING AND BINDING OF PRINTED, PHOTOCOPIED AND TYPEWRITTEN MATERIALS; DIGITAL PRINTING SERVICES, IN CLASS 40 (U.S. CLS. 100, 103 AND 106).

**SERVICE MARK**

**PRINCIPAL REGISTER**

FIRST USE 0-0-1996; IN COMMERCE 0-0-1996.

THE MARK CONSISTS OF STANDARD CHARACTERS WITHOUT CLAIM TO ANY PARTICULAR FONT, STYLE, SIZE, OR COLOR.

OWNER OF U.S. REG. NO. 3,620,096.

NO CLAIM IS MADE TO THE EXCLUSIVE RIGHT TO USE "PRINTING", APART FROM THE MARK AS SHOWN.

SER. NO. 85-510,562, FILED 1-6-2012.

AMY KELLY, EXAMINING ATTORNEY



*David J. Kyffers*

Director of the United States Patent and Trademark Office

# United States of America

United States Patent and Trademark Office

## ALL LIKE APPAREL WORLDWIDE

**Reg. No. 4,197,749**

**Registered Aug. 28, 2012**

**Int. Cl.: 25**

**TRADEMARK**

**PRINCIPAL REGISTER**

LEADERSHIP MEDIA (NEW JERSEY LIMITED LIABILITY COMPANY)  
#32-205  
725 RIVER ROAD  
EDGEWATER, NJ 07020

FOR: BEACH COVER-UPS; COATS; FOOTWEAR; GLOVES; HEADWEAR; JACKETS;  
NECKWEAR; PANTS; SCARVES; SHIRTS; SHORTS; SWIMSUITS; UNDERGARMENTS, IN  
CLASS 25 (U.S. CLS. 22 AND 39).

FIRST USE 7-1-1965; IN COMMERCE 11-19-2011.

THE MARK CONSISTS OF STANDARD CHARACTERS WITHOUT CLAIM TO ANY PAR-  
TICULAR FONT, STYLE, SIZE, OR COLOR.

NO CLAIM IS MADE TO THE EXCLUSIVE RIGHT TO USE "APPAREL" AND "WORLD-  
WIDE", APART FROM THE MARK AS SHOWN.

SER. NO. 85-510,591, FILED 1-6-2012.

JOHN DALIER, EXAMINING ATTORNEY



*David J. Kybas*

Director of the United States Patent and Trademark Office

# United States of America

United States Patent and Trademark Office

# PC-Fit

**Reg. No. 4,197,750**

**Registered Aug. 28, 2012**

**Int. Cl.: 41**

**SERVICE MARK**

**PRINCIPAL REGISTER**

DR. RIBA'S HEALTH CLUB INC. (CALIFORNIA CORPORATION)  
#2  
2100 W. ALTON AVE.  
SANTA ANA, CA 92704

FOR: PROFESSIONAL COACHING SERVICES IN THE FIELD OF FAMILY EATING DYNAMICS AND THE PSYCHOLOGY OF FAMILY EATING DYNAMICS, IN CLASS 41 (U.S. CLS. 100, 101 AND 107).

FIRST USE 10-1-2008; IN COMMERCE 10-1-2008.

THE MARK CONSISTS OF STANDARD CHARACTERS WITHOUT CLAIM TO ANY PARTICULAR FONT, STYLE, SIZE, OR COLOR.

SER. NO. 85-510,596, FILED 1-6-2012.

JOHN DALIER, EXAMINING ATTORNEY



*David J. Kybas*

Director of the United States Patent and Trademark Office

# United States of America

United States Patent and Trademark Office

# YouCoach

**Reg. No. 4,197,751**

YOU FIT, INC. (FLORIDA CORPORATION)  
6475 1ST AVE. S.

**Registered Aug. 28, 2012**

ST. PETERSBURG, FL 33707

**Int. Cl.: 41**

FOR: HEALTH CLUB SERVICES, NAMELY, PROVIDING INSTRUCTION IN EXERCISE AND PHYSICAL FITNESS, IN CLASS 41 (U.S. CLS. 100, 101 AND 107).

**SERVICE MARK**

FIRST USE 1-5-2012; IN COMMERCE 1-5-2012.

**PRINCIPAL REGISTER**

THE MARK CONSISTS OF STANDARD CHARACTERS WITHOUT CLAIM TO ANY PARTICULAR FONT, STYLE, SIZE, OR COLOR.

SER. NO. 85-510,700, FILED 1-6-2012.

MICHAEL TANNER, EXAMINING ATTORNEY



*David J. Kyros*

Director of the United States Patent and Trademark Office

# United States of America

United States Patent and Trademark Office

## IT'S OUR EARTH

**Reg. No. 4,197,752**

IT'S OUR EARTH (ILLINOIS CORPORATION)  
125 N. MAIN STREET  
WHEATON, IL 60187

**Registered Aug. 28, 2012**

**Int. Cl.: 35**

FOR: RETAIL STORE SERVICES FEATURING GENERAL CONSUMER MERCHANDISE THAT HAS BEEN RECYCLED, IN CLASS 35 (U.S. CLS. 100, 101 AND 102).

**SERVICE MARK**

FIRST USE 6-1-2004; IN COMMERCE 6-1-2004.

**PRINCIPAL REGISTER**

THE MARK CONSISTS OF STANDARD CHARACTERS WITHOUT CLAIM TO ANY PARTICULAR FONT, STYLE, SIZE, OR COLOR.

SER. NO. 85-510,720, FILED 1-6-2012.

MARK SPARACINO, EXAMINING ATTORNEY



*David J. Kyffers*

Director of the United States Patent and Trademark Office

# United States of America

United States Patent and Trademark Office

The logo for STAR DONOR features the words "STAR DONOR" in a blue, serif font. The letter "O" in "DONOR" is replaced by a yellow five-pointed star with a blue outline. A yellow arch extends from the top of the star over the "O" in "DONOR".

**Reg. No. 4,197,753**

STRATMARK, LTD. (TEXAS LIMITED PARTNERSHIP)  
855 E. COLLINS BLVD.  
RICHARDSON, TX 75081

**Registered Aug. 28, 2012**

**Int. Cl.: 35**

FOR: BUSINESS CONSULTATION SERVICES TO ASSIST NON-PROFIT ORGANIZATIONS IN PLANNING, MANAGING, AND CONDUCTING FUNDRAISING ACTIVITIES, IN CLASS 35 (U.S. CLS. 100, 101 AND 102).

**SERVICE MARK**

FIRST USE 11-15-2010; IN COMMERCE 11-15-2010.

**PRINCIPAL REGISTER**

THE MARK CONSISTS OF THE WORD "STARDONOR" IN BLUE, WITH THE SECOND "O" IN "DONOR" AS A STAR WITH BLUE OUTLINE AND A YELLOW CENTER, AND A YELLOW ARCH EXTENDING OVER THE SECOND "O" IN "DONOR".

THE COLOR(S) BLUE AND YELLOW IS/ARE CLAIMED AS A FEATURE OF THE MARK.

SER. NO. 85-510,751, FILED 1-6-2012.

TARAH HARDY, EXAMINING ATTORNEY



*David J. Kyffers*

Director of the United States Patent and Trademark Office

# United States of America

United States Patent and Trademark Office

## Center Street: The Stephens CEO Summit

**Reg. No. 4,197,754**

STEPHENS INC. (ARKANSAS CORPORATION)  
111 CENTER STREET  
LITTLE ROCK, AR 72201

**Registered Aug. 28, 2012**

**Int. Cl.: 35**

FOR: PROMOTING COLLABORATION AMONG LEADERS IN THE FIELD OF BUSINESS,  
IN CLASS 35 (U.S. CLS. 100, 101 AND 102).

**SERVICE MARK**

FIRST USE 5-1-2011; IN COMMERCE 5-1-2011.

**PRINCIPAL REGISTER**

THE MARK CONSISTS OF STANDARD CHARACTERS WITHOUT CLAIM TO ANY PAR-  
TICULAR FONT, STYLE, SIZE, OR COLOR.

NO CLAIM IS MADE TO THE EXCLUSIVE RIGHT TO USE "CEO SUMMIT", APART FROM  
THE MARK AS SHOWN.

SER. NO. 85-510,797, FILED 1-6-2012.

ANDREW LEASER, EXAMINING ATTORNEY



*David J. Kybas*

Director of the United States Patent and Trademark Office

# United States of America

United States Patent and Trademark Office

# PRO GLIDER

**Reg. No. 4,197,755**

RADIO FLYER, INC. (ILLINOIS CORPORATION)  
6515 WEST GRAND AVENUE  
CHICAGO, IL 60707

**Registered Aug. 28, 2012**

**Int. Cl.: 12**

FOR: KICK SCOOTER, IN CLASS 12 (U.S. CLS. 19, 21, 23, 31, 35 AND 44).

**TRADEMARK**

FIRST USE 12-0-2011; IN COMMERCE 12-0-2011.

**PRINCIPAL REGISTER**

THE MARK CONSISTS OF STANDARD CHARACTERS WITHOUT CLAIM TO ANY PARTICULAR FONT, STYLE, SIZE, OR COLOR.

NO CLAIM IS MADE TO THE EXCLUSIVE RIGHT TO USE "PRO", APART FROM THE MARK AS SHOWN.

SER. NO. 85-510,827, FILED 1-6-2012.

DAVID COLLIER, EXAMINING ATTORNEY



*David J. Kyffers*

Director of the United States Patent and Trademark Office



# United States of America

United States Patent and Trademark Office

## ACCELERATED OIL TECHNOLOGIES

**Reg. No. 4,197,756**

ACCELERATED OIL TECHNOLOGIES, LLC (DELAWARE LIMITED LIABILITY COMPANY)  
140 WEST 57TH STREET, 11TH FLOOR  
NEW YORK, NY 10019

**Registered Aug. 28, 2012**

**Int. Cl.: 35**

FOR: BUSINESS MANAGEMENT IN THE FIELD OF IMPROVING AND OPTIMIZING OIL PRODUCTION AND RECOVERY, IN CLASS 35 (U.S. CLS. 100, 101 AND 102).

**SERVICE MARK**

FIRST USE 8-12-2010; IN COMMERCE 8-12-2010.

**PRINCIPAL REGISTER**

THE MARK CONSISTS OF STANDARD CHARACTERS WITHOUT CLAIM TO ANY PARTICULAR FONT, STYLE, SIZE, OR COLOR.

NO CLAIM IS MADE TO THE EXCLUSIVE RIGHT TO USE "OIL TECHNOLOGIES", APART FROM THE MARK AS SHOWN.

SER. NO. 85-510,829, FILED 1-6-2012.

DAVID YONTEF, EXAMINING ATTORNEY



*David J. Kyffers*

Director of the United States Patent and Trademark Office

# United States of America

United States Patent and Trademark Office

# AOT

**Reg. No. 4,197,757**

ACCELERATED OIL TECHNOLOGIES, LLC (DELAWARE LIMITED LIABILITY COMPANY)  
140 WEST 57TH STREET, 11TH FLOOR  
NEW YORK, NY 10019

**Registered Aug. 28, 2012**

**Int. Cl.: 35**

FOR: BUSINESS MANAGEMENT IN THE FIELD OF IMPROVING AND OPTIMIZING OIL PRODUCTION AND RECOVERY, IN CLASS 35 (U.S. CLS. 100, 101 AND 102).

**SERVICE MARK**

FIRST USE 8-12-2010; IN COMMERCE 8-12-2010.

**PRINCIPAL REGISTER**

THE MARK CONSISTS OF STANDARD CHARACTERS WITHOUT CLAIM TO ANY PARTICULAR FONT, STYLE, SIZE, OR COLOR.

SER. NO. 85-510,835, FILED 1-6-2012.

DAVID YONTEF, EXAMINING ATTORNEY



*David J. Kyffers*

Director of the United States Patent and Trademark Office

# United States of America

United States Patent and Trademark Office

# Bella Bun

**Reg. No. 4,197,758**

**Registered Aug. 28, 2012**

**Int. Cl.: 20**

**TRADEMARK**

**PRINCIPAL REGISTER**

JEDIAH P. LOGIODICE (UNITED STATES INDIVIDUAL), DBA AMANDA RACHAEL PHOTOGRAPHY  
758 HIGGINS ROAD  
PITTSFIELD, ME 04967 AND

AMANDA RACHAEL LOGIODICE (UNITED STATES INDIVIDUAL), DBA AMANDA RACHAEL PHOTOGRAPHY  
758 HIGGINS ROAD  
PITTSFIELD, ME 04967

FOR: PHOTOGRAPHY POSERS, NAMELY, PORTABLE CUSHIONS FOR SUPPORTING, POSITIONING AND POSING INFANTS FOR PHOTOGRAPHY AND STRUCTURAL PARTS THEREFOR, IN CLASS 20 (U.S. CLS. 2, 13, 22, 25, 32 AND 50).

FIRST USE 2-0-2011; IN COMMERCE 2-0-2011.

THE MARK CONSISTS OF STANDARD CHARACTERS WITHOUT CLAIM TO ANY PARTICULAR FONT, STYLE, SIZE, OR COLOR.

THE ENGLISH TRANSLATION OF "BELLA" IN THE MARK IS "BEAUTIFUL".

SER. NO. 85-510,848, FILED 1-6-2012.

DAVID YONTEF, EXAMINING ATTORNEY



*David J. Kyffers*

Director of the United States Patent and Trademark Office

# United States of America

United States Patent and Trademark Office



**Reg. No. 4,197,759**

**Registered Aug. 28, 2012**

**Int. Cl.: 39**

**SERVICE MARK**

**PRINCIPAL REGISTER**

TRAVEL CRAZY (KENTUCKY CORPORATION)  
SUITE 2  
709 MT. EDEN RD  
SHELBYVILLE, KY 40065

FOR: ORGANIZATION OF EXCURSIONS, SIGHTSEEING TOURS, HOLIDAYS, TOURS  
AND TRAVEL TO COLLEGE SPORTING EVENTS, IN CLASS 39 (U.S. CLS. 100 AND 105).

FIRST USE 3-15-1993; IN COMMERCE 3-15-1993.

NO CLAIM IS MADE TO THE EXCLUSIVE RIGHT TO USE "CARAVAN", APART FROM  
THE MARK AS SHOWN.

THE MARK CONSISTS OF A RECTANGULAR BOX WITH ROUND EDGES AND THE  
STYLIZED TEXT "CATFAN CARAVAN".

SER. NO. 85-510,897, FILED 1-6-2012.

JOSETTE BEVERLY, EXAMINING ATTORNEY



*David J. Kyffers*

Director of the United States Patent and Trademark Office

# United States of America

United States Patent and Trademark Office

## THE ANARCHIST'S GUIDE TO SELLING

**Reg. No. 4,197,760**

**Registered Aug. 28, 2012**

**Int. Cl.: 16**

**TRADEMARK**

**PRINCIPAL REGISTER**

AUTHENTIC SYSTEMS, LLC (CALIFORNIA LIMITED LIABILITY COMPANY)  
26362 CARMEL RANCHO LANE - SUITE 200  
CARMEL, CA 93921

FOR: EDUCATIONAL KITS SOLD AS A UNIT IN THE FIELD OF MOTIVATION RESEARCH AND DEVELOPMENT CONSISTING PRIMARILY OF PRINTED INSTRUCTIONAL MATERIALS AND ALSO INCLUDING AUDIO CDS; EDUCATIONAL KITS SOLD AS A UNIT IN THE FIELD OF MOTIVATION RESEARCH AND DEVELOPMENT CONSISTING PRIMARILY OF EDUCATIONAL BOOKS, FLASH CARDS AND WORKSHEETS, AND ALSO INCLUDING AN EDUCATIONAL DVD; EDUCATIONAL PUBLICATIONS, NAMELY, EDUCATIONAL LEARNING CARDS, FLASH CARDS, ACTIVITY CARDS, WORKBOOKS, TEXTBOOKS, ACTIVITY BOOKS, STORY BOOKS, PUZZLE BOOKS, PRINTED PUZZLES, TEACHER GUIDES, MANUALS, POSTERS AND EDUCATIONAL BOOKLETS IN THE FIELD OF MOTIVATION RESEARCH AND DEVELOPMENT; PAPER TEACHING MATERIALS IN THE FIELD OF MOTIVATION RESEARCH AND DEVELOPMENT; PRINTED INSTRUCTIONAL, EDUCATIONAL, AND TEACHING MATERIALS IN THE FIELD OF MOTIVATION RESEARCH AND DEVELOPMENT; PRINTED TEACHING MATERIALS IN THE FIELD OF MOTIVATION RESEARCH AND DEVELOPMENT; PRINTED VISUALS IN THE NATURE OF MOTIVATION RESEARCH AND DEVELOPMENT, IN CLASS 16 (U.S. CLS. 2, 5, 22, 23, 29, 37, 38 AND 50).

FIRST USE 5-1-2011; IN COMMERCE 5-1-2011.

THE MARK CONSISTS OF STANDARD CHARACTERS WITHOUT CLAIM TO ANY PARTICULAR FONT, STYLE, SIZE, OR COLOR.

NO CLAIM IS MADE TO THE EXCLUSIVE RIGHT TO USE "GUIDE TO SELLING", APART FROM THE MARK AS SHOWN.

SER. NO. 85-510,900, FILED 1-6-2012.

JASON BLAIR, EXAMINING ATTORNEY



*David J. Kyffers*

Director of the United States Patent and Trademark Office

# United States of America

United States Patent and Trademark Office

## SIMPLE FARMER

**Reg. No. 4,197,761**

BYRNE, JEFF (UNITED STATES INDIVIDUAL)  
2973 HARBOR BLVD., #60  
COSTA MESA, CA 92626

**Registered Aug. 28, 2012**

**Int. Cl.: 20**

FOR: PLASTIC STORAGE CONTAINERS FOR COMMERCIAL AND RETAIL USE, IN CLASS 20 (U.S. CLS. 2, 13, 22, 25, 32 AND 50).

**TRADEMARK**

FIRST USE 9-21-2008; IN COMMERCE 12-1-2009.

**PRINCIPAL REGISTER**

THE MARK CONSISTS OF STANDARD CHARACTERS WITHOUT CLAIM TO ANY PARTICULAR FONT, STYLE, SIZE, OR COLOR.

SER. NO. 85-510,910, FILED 1-6-2012.

JAMES STEIN, EXAMINING ATTORNEY



*David J. Kyffers*

Director of the United States Patent and Trademark Office

# United States of America

United States Patent and Trademark Office

# LA FUNGHI

**Reg. No. 4,197,762**

**Registered Aug. 28, 2012**

**Int. Cl.: 35**

**SERVICE MARK**

**PRINCIPAL REGISTER**

LA FUNGHI LLC (CALIFORNIA LIMITED LIABILITY COMPANY)  
556  
269 S.BEVERLY DR  
BEVERLY HILLS, CA 90212

FOR: ON-LINE RETAIL STORE SERVICES FEATURING MUSHROOMS OF ALL KINDS;  
RETAIL STORE SERVICES FEATURING MUSHROOMS OF ALL KINDS, IN CLASS 35 (U.S.  
CLS. 100, 101 AND 102).

FIRST USE 4-20-2009; IN COMMERCE 4-20-2009.

NO CLAIM IS MADE TO THE EXCLUSIVE RIGHT TO USE "LA FUNGHI", APART FROM  
THE MARK AS SHOWN.

THE MARK CONSISTS OF THE STYLIZED TEXT "LA FUNGHI" WITH THE LETTER "I"  
REPRESENTED BY A MUSHROOM.

THE ENGLISH TRANSLATION OF THE WORD "FUNGHI" IN THE MARK IS "FUNGUS"  
OR "MUSHROOM".

SER. NO. 85-510,990, FILED 1-6-2012.

LINDA M. KING, EXAMINING ATTORNEY



*David J. Kybas*

Director of the United States Patent and Trademark Office

# United States of America

United States Patent and Trademark Office

# D ' BELLA

**Reg. No. 4,197,763**

**Registered Aug. 28, 2012**

**Int. Cl.: 3**

**TRADEMARK**

**PRINCIPAL REGISTER**

SUN, HONG QIANG (CHINA INDIVIDUAL)  
24427 GOLDPOINT PLACE  
DIAMOND BAR, CA 91765 AND

AMETRADE INTERNATIONAL CORP. (CALIFORNIA CORPORATION)  
24427 GOLDPOINT PLACE  
DIAMOND BAR, CA 91765

FOR: HAIR CARE KITS COMPRISING NON-MEDICATED HAIR CARE PREPARATIONS, NAMELY, SHAMPOO, CONDITIONER, TREATMENT, GEL AND SPRAY, IN CLASS 3 (U.S. CLS. 1, 4, 6, 50, 51 AND 52).

FIRST USE 1-3-2012; IN COMMERCE 1-3-2012.

THE MARK CONSISTS OF STANDARD CHARACTERS WITHOUT CLAIM TO ANY PARTICULAR FONT, STYLE, SIZE, OR COLOR.

THE ENGLISH TRANSLATION OF THE WORD "D'BELLA" IN THE MARK IS "LOVELY".

SER. NO. 85-511,101, FILED 1-7-2012.

MEGHAN REINHART, EXAMINING ATTORNEY



*David J. Kyros*

Director of the United States Patent and Trademark Office



# United States of America

United States Patent and Trademark Office

# PARDI-GRAS

**Reg. No. 4,197,764**

JERRY DIAZ (UNITED STATES INDIVIDUAL)

**Registered Aug. 28, 2012**

P.O. BOX 1641  
NEDERLAND, TX 77627

**Int. Cl.: 41**

FOR: ENTERTAINMENT IN THE NATURE OF A FESTIVAL PRIMARILY FEATURING LIVE MUSIC, ENTERTAINMENT, ARTS, STREET PARADES, AND, MUSIC AND ALSO PROVIDING FOOD, ALL OF THE AFOREMENTIONED SERVICES EXCLUDING SERVICES RELATED TO PARTY AND SPECIAL EVENT PLANNING, CONSULTATION, AND RENTALS, IN CLASS 41 (U.S. CLS. 100, 101 AND 107).

**SERVICE MARK**

**PRINCIPAL REGISTER**

FIRST USE 11-30-1997; IN COMMERCE 11-30-1997.

THE MARK CONSISTS OF STANDARD CHARACTERS WITHOUT CLAIM TO ANY PARTICULAR FONT, STYLE, SIZE, OR COLOR.

SER. NO. 85-511,116, FILED 1-7-2012.

JENNIFER WILLISTON, EXAMINING ATTORNEY



*David J. Kybas*

Director of the United States Patent and Trademark Office

# United States of America

United States Patent and Trademark Office

## Meerkat Lighting

**Reg. No. 4,197,765**

**Registered Aug. 28, 2012**

**Int. Cl.: 11**

**TRADEMARK**

**PRINCIPAL REGISTER**

SPENCER, SCOTT DOUGLAS (NEW MEXICO SOLE PROPRIETORSHIP), DBA MEERKAT LIGHTING  
1201 CALLE LUNA  
SANTA FE, NM 87501

FOR: BICYCLE LAMPS; BICYCLE LIGHTS; BOOK LIGHTS; FLASHLIGHTS; LED LIGHTS FOR LIGHTING PURPOSES INCORPORATED INTO KEY CHAINS, SMALL TOYS OR OTHER SIMILAR PERSONAL ITEMS; LIGHTS FOR VEHICLES; MINIATURE ACCENT LIGHTS FOR ATTACHMENT TO THE BODY AND/OR SPORTS EQUIPMENT TO PROVIDE ACCENT LIGHTING TO PARTS OF THE BODY AND/OR THE SPORTS EQUIPMENT TO WHICH IT IS ATTACHED; PEN LIGHTS; POCKET SEARCH LIGHTS; PORTABLE BATTERY-OPERATED LIGHTS THAT CAN BE PLACED ON SURFACES WHERE OTHER LIGHT SOURCES ARE UNAVAILABLE; SOLAR-POWERED ALL-WEATHER LIGHTS; SPOT LIGHTS; WRIST LIGHTS FOR ILLUMINATION PURPOSES, IN CLASS 11 (U.S. CLS. 13, 21, 23, 31 AND 34).

FIRST USE 1-7-2012; IN COMMERCE 1-7-2012.

THE MARK CONSISTS OF STANDARD CHARACTERS WITHOUT CLAIM TO ANY PARTICULAR FONT, STYLE, SIZE, OR COLOR.

NO CLAIM IS MADE TO THE EXCLUSIVE RIGHT TO USE "LIGHTING", APART FROM THE MARK AS SHOWN.

SER. NO. 85-511,143, FILED 1-7-2012.

TINA MAI, EXAMINING ATTORNEY



*David J. Kyffers*

Director of the United States Patent and Trademark Office

# United States of America

United States Patent and Trademark Office

## Meercat Lighting

**Reg. No. 4,197,766**

**Registered Aug. 28, 2012**

**Int. Cl.: 11**

**TRADEMARK**

**PRINCIPAL REGISTER**

SPENCER, SCOTT DOUGLAS (NEW MEXICO SOLE PROPRIETORSHIP), DBA MEERCAT LIGHTING  
1201 CALLE LUNA  
SANTA FE, NM 87501

FOR: BICYCLE LAMPS; BICYCLE LIGHTS; BOOK LIGHTS; FLASHLIGHTS; LED LIGHTS FOR LIGHTING PURPOSES INCORPORATED INTO KEY CHAINS, SMALL TOYS OR OTHER SIMILAR PERSONAL ITEMS; LIGHTS FOR VEHICLES; MINIATURE ACCENT LIGHTS FOR ATTACHMENT TO THE BODY AND/OR SPORTS EQUIPMENT TO PROVIDE ACCENT LIGHTING TO PARTS OF THE BODY AND/OR THE SPORTS EQUIPMENT TO WHICH IT IS ATTACHED; PEN LIGHTS; POCKET SEARCH LIGHTS; PORTABLE BATTERY-OPERATED LIGHTS THAT CAN BE PLACED ON SURFACES WHERE OTHER LIGHT SOURCES ARE UNAVAILABLE; SOLAR-POWERED ALL-WEATHER LIGHTS; SPOT LIGHTS; WRIST LIGHTS FOR ILLUMINATION PURPOSES, IN CLASS 11 (U.S. CLS. 13, 21, 23, 31 AND 34).

FIRST USE 1-7-2012; IN COMMERCE 1-7-2012.

THE MARK CONSISTS OF STANDARD CHARACTERS WITHOUT CLAIM TO ANY PARTICULAR FONT, STYLE, SIZE, OR COLOR.

NO CLAIM IS MADE TO THE EXCLUSIVE RIGHT TO USE "LIGHTING", APART FROM THE MARK AS SHOWN.

SER. NO. 85-511,146, FILED 1-7-2012.

TINA MAI, EXAMINING ATTORNEY



*David J. Kyffers*

Director of the United States Patent and Trademark Office

# United States of America

United States Patent and Trademark Office

The logo for 'engsly' features the word in a lowercase, rounded, sans-serif font. Above the letter 'n' is a small, stylized outline of a dog's head.

**Reg. No. 4,197,767**

WEIKEL, ANDRIA (UNITED STATES INDIVIDUAL)  
230 SEXTON DRIVE  
BALL GROUND, GA 30107

**Registered Aug. 28, 2012**

**Int. Cls.: 14, 18 and 25**

FOR: BRACELETS; NYLON BRACELETS, IN CLASS 14 (U.S. CLS. 2, 27, 28 AND 50).

**TRADEMARK**

FIRST USE 4-19-2010; IN COMMERCE 7-31-2010.

**PRINCIPAL REGISTER**

FOR: ANIMAL LEASHES; COLLARS FOR ANIMALS; COLLARS FOR PETS; COLLARS FOR PETS BEARING MEDICAL INFORMATION; COLLARS OF ANIMALS; DOG COLLARS; DOG COLLARS AND LEADS; DOG LEASHES; LEASHES FOR ANIMALS; PET PRODUCTS, NAMELY, PET RESTRAINING DEVICES CONSISTING OF ANIMAL LEASHES, COLLARS, HARNESSSES, RESTRAINING STRAPS, AND LEASHES WITH LOCKING DEVICES; PET RESTRAINING DEVICES CONSISTING OF HARNESSSES AND/OR RESTRAINING STRAPS, FOR USE IN PET GROOMING OR VETERINARY CARE; PET RESTRAINING DEVICES CONSISTING OF LEASHES, COLLARS, HARNESSSES, RESTRAINING STRAP, LEASHES WITH LOCKING DEVICE FOR USE IN IDENTIFICATION AND PERSONALIZATION, IN CLASS 18 (U.S. CLS. 1, 2, 3, 22 AND 41).

FIRST USE 4-19-2010; IN COMMERCE 7-31-2010.

FOR: BELTS; BELTS FOR CLOTHING; BELTS MADE FROM IMITATION LEATHER; WAIST BELTS; WRISTBANDS, IN CLASS 25 (U.S. CLS. 22 AND 39).

FIRST USE 4-19-2010; IN COMMERCE 7-31-2010.

THE MARK CONSISTS OF AN OUTLINED ANIMAL DESIGN WITH WINGS ABOVE THE TEXT "ENGSly".

SER. NO. 85-511,221, FILED 1-7-2012.

DAWN HAN, EXAMINING ATTORNEY



*David J. Kybas*

Director of the United States Patent and Trademark Office

# United States of America

United States Patent and Trademark Office

## THE ANSWER BAND

**Reg. No. 4,197,768**

ROMANS ROAD, LLC (ILLINOIS LIMITED LIABILITY COMPANY)  
PO BOX 492

**Registered Aug. 28, 2012**

EDWARDSVILLE, IL 62025

**Int. Cl.: 14**

FOR: RUBBER OR SILICON WRISTBANDS IN THE NATURE OF A BRACELET, IN CLASS 14 (U.S. CLS. 2, 27, 28 AND 50).

**TRADEMARK**

FIRST USE 0-0-2011; IN COMMERCE 0-0-2011.

**PRINCIPAL REGISTER**

THE MARK CONSISTS OF STANDARD CHARACTERS WITHOUT CLAIM TO ANY PARTICULAR FONT, STYLE, SIZE, OR COLOR.

NO CLAIM IS MADE TO THE EXCLUSIVE RIGHT TO USE "BAND", APART FROM THE MARK AS SHOWN.

SER. NO. 85-511,306, FILED 1-8-2012.

VIVIAN MICZNIK FIRST, EXAMINING ATTORNEY



*David J. Kybas*

Director of the United States Patent and Trademark Office

# United States of America

United States Patent and Trademark Office

## mobile brain bank

**Reg. No. 4,197,769**

SÖDERLING, PETRA (FINLAND INDIVIDUAL)

**Registered Aug. 28, 2012**

MANNERHEIMINTIE 81 A 7  
HELSINKI, FINLAND 00270

**Int. Cl.: 42**

**SERVICE MARK**

**PRINCIPAL REGISTER**

FOR: APPLICATION SERVICE PROVIDER (ASP), NAMELY, HOSTING COMPUTER SOFTWARE APPLICATIONS OF OTHERS; APPLICATION SERVICE PROVIDER, NAMELY, HOSTING, MANAGING, DEVELOPING, ANALYZING, AND MAINTAINING APPLICATIONS, SOFTWARE, AND WEB SITES, OF OTHERS IN THE FIELDS OF ADVERTISING AND MARKETING; APPLICATION SERVICE PROVIDER, NAMELY, HOSTING, MANAGING, DEVELOPING, AND MAINTAINING APPLICATIONS, SOFTWARE, AND WEB SITES, IN THE FIELDS OF PERSONAL PRODUCTIVITY, WIRELESS COMMUNICATION, MOBILE INFORMATION ACCESS, AND REMOTE DATA MANAGEMENT FOR WIRELESS DELIVERY OF CONTENT TO HANDHELD COMPUTERS, LAPTOPS AND MOBILE ELECTRONIC DEVICES; APPLICATION SERVICE PROVIDER, NAMELY, HOSTING, MANAGING, DEVELOPING, ANALYZING, AND MAINTAINING APPLICATIONS, SOFTWARE AND WEB SITES OF OTHERS IN THE FIELDS OF COMMUNICATION TECHNOLOGY AND MOBILE DEVICES.; BUSINESS TECHNOLOGY SOFTWARE CONSULTATION SERVICES; COMPUTER AIDED DESIGN FOR OTHERS; COMPUTER CONSULTATION; COMPUTER GRAPHICS DESIGN SERVICES; COMPUTER HARDWARE AND SOFTWARE DESIGN; COMPUTER PROGRAMMING; COMPUTER PROGRAMMING AND SOFTWARE DESIGN; COMPUTER PROGRAMMING CONSULTANCY; COMPUTER PROGRAMMING SERVICES, NAMELY, CONTENT CREATION FOR VIRTUAL WORLDS AND THREE DIMENSIONAL PLATFORMS; COMPUTER PROJECT MANAGEMENT SERVICES IN THE FIELD OF TELECOMMUNICATIONS; COMPUTER SERVICES IN THE NATURE OF CUSTOMIZED WEB PAGES AND OTHER DATA FEED FORMATS FEATURING USER-DEFINED INFORMATION; COMPUTER SERVICES, NAMELY, ACTING AS AN APPLICATION SERVICE PROVIDER IN THE FIELD OF INFORMATION MANAGEMENT TO HOST COMPUTER APPLICATION SOFTWARE FOR THE PURPOSE OF MOBILE COMMUNICATIONS.; COMPUTER SERVICES, NAMELY, DESIGNING AND IMPLEMENTING WEB SITES FOR OTHERS; COMPUTER SERVICES, NAMELY, DESIGNING AND IMPLEMENTING MOBILE DEVICE SOFTWARE APPLICATIONS FOR OTHERS; COMPUTER SERVICES, NAMELY, MANAGING WEB SITES FOR OTHERS; COMPUTER SOFTWARE CONSULTANCY; COMPUTER SOFTWARE CONSULTING; COMPUTER SOFTWARE DESIGN; COMPUTER SOFTWARE DESIGN AND UPDATING; COMPUTER SOFTWARE DESIGN FOR OTHERS; COMPUTER SOFTWARE DEVELOPMENT; COMPUTER SOFTWARE DEVELOPMENT AND COMPUTER PROGRAMMING DEVELOPMENT FOR OTHERS; COMPUTER SOFTWARE DEVELOPMENT IN THE FIELD OF MOBILE APPLICATIONS; COMPUTER SYSTEM



*David J. Kyjars*

Director of the United States Patent and Trademark Office

**Reg. No. 4,197,769** DESIGN SERVICES; CONSULTANCY IN THE FIELD OF SOFTWARE DESIGN; CONSULTANCY WITH REGARD TO WEBPAGE DESIGN; CONSULTING IN THE FIELD OF CONFIGURATION MANAGEMENT FOR COMPUTER HARDWARE AND SOFTWARE; CONSULTING IN THE FIELD OF INFORMATION TECHNOLOGY; CONSULTING IN THE FIELD OF IT PROJECT MANAGEMENT; CONSULTING IN THE FIELD OF TELECOMMUNICATIONS TECHNOLOGY; CONSULTING IN THE FIELD OF VIRTUALIZATION TECHNOLOGIES FOR ENTERPRISES AND BUSINESSES; CONSULTING SERVICES IN THE DESIGN AND IMPLEMENTATION OF COMPUTER-BASED INFORMATION SYSTEMS FOR BUSINESSES; CONSULTING SERVICES IN THE FIELD OF CLOUD COMPUTING; CONSULTING SERVICES IN THE FIELD OF COMPUTER-BASED INFORMATION SYSTEMS FOR BUSINESSES; CONSULTING SERVICES IN THE FIELD OF DESIGN, SELECTION, IMPLEMENTATION AND USE OF COMPUTER HARDWARE AND SOFTWARE SYSTEMS FOR OTHERS; CONSULTING SERVICES IN THE FIELD OF HOSTING COMPUTER SOFTWARE APPLICATIONS; CONSULTING SERVICES IN THE FIELD OF PROVIDING ONLINE, NON-DOWNLOADABLE SOFTWARE AND APPLICATIONS; CREATING OF COMPUTER PROGRAMS; CREATING, MAINTAINING, AND MODERNIZING COMPUTER SOFTWARE; CREATION, DESIGN, DEVELOPMENT AND MAINTENANCE OF WEB SITES FOR THIRD PARTIES; CUSTOM DESIGN AND DEVELOPMENT OF MOBILE DEVICE SOFTWARE APPLICATIONS; DESIGN AND CREATING WEB SITES FOR OTHERS; DESIGN AND DEVELOPMENT OF COMPUTER GAME SOFTWARE AND VIRTUAL REALITY SOFTWARE; DESIGN AND DEVELOPMENT OF COMPUTER HARDWARE AND SOFTWARE; DESIGN AND DEVELOPMENT OF COMPUTER SOFTWARE; DESIGN AND DEVELOPMENT OF MULTIMEDIA PRODUCTS; DESIGN AND DEVELOPMENT OF ON-LINE COMPUTER SOFTWARE SYSTEMS; DESIGN AND DEVELOPMENT OF SOFTWARE AND HARDWARE FOR MOBILE COMMUNICATIONS; DESIGN AND TESTING FOR NEW PRODUCT DEVELOPMENT; DESIGN AND TESTING OF NEW PRODUCTS FOR OTHERS; DESIGN AND WRITING OF COMPUTER SOFTWARE; DESIGN FOR OTHERS IN THE FIELD OF MOBILE DEVICE APPLICATION DESIGN; DESIGN OF HOME PAGES, COMPUTER SOFTWARE AND WEB SITES; DESIGN OF MOBILE TELEPHONES; DESIGN, DEVELOPMENT AND IMPLEMENTATION OF SOFTWARE; DESIGN, DEVELOPMENT, AND CONSULTING SERVICES RELATED THERETO IN THE FIELD OF MOBILE DEVICE SOFTWARE DESIGN; DESIGN, DEVELOPMENT, AND IMPLEMENTATION OF SOFTWARE FOR MOBILE DEVICES; DESIGN, DEVELOPMENT, INSTALLATION AND MAINTENANCE OF COMPUTER SOFTWARE; DESIGN, INSTALLATION, UPDATING AND MAINTENANCE OF COMPUTER SOFTWARE; DESIGN, MAINTENANCE, DEVELOPMENT AND UPDATING OF COMPUTER SOFTWARE; DESIGNING AND DEVELOPING COMPUTER GAME SOFTWARE AND VIDEO GAME SOFTWARE FOR USE WITH COMPUTERS, VIDEO GAME PROGRAM SYSTEMS AND COMPUTER NETWORKS; DESIGNING AND DEVELOPING WEBPAGES ON THE INTERNET; DESIGNING WEBSITES FOR ADVERTISING PURPOSES; DESIGNING WEBSITES FOR OTHERS; DEVELOPING AND UPDATING COMPUTER SOFTWARE; DEVELOPING COMPUTER SOFTWARE; DEVELOPMENT, DESIGN AND UPDATING OF HOME PAGES; HOMEPAGE AND WEBPAGE DESIGN; INFORMATION TECHNOLOGY CONSULTATION; IT CONSULTING SERVICES; MULTIDISCIPLINARY GRAPHIC DESIGN SERVICES; MULTIDISCIPLINARY VISUAL DESIGN SERVICES; NEW PRODUCT DESIGN SERVICES; PLANNING, DESIGN, DEVELOPMENT, MAINTENANCE AND OPTIMIZATION OF ONLINE WEBSITES FOR THIRD PARTIES; PRODUCT RESEARCH AND DEVELOPMENT; PROGRAMMING OF COMPUTER SOFTWARE FOR OTHERS; PROGRAMMING OF MULTIMEDIA APPLICATIONS; RESEARCH AND DEVELOPMENT OF COMPUTER SOFTWARE; RESEARCH AND DEVELOPMENT OF NEW PRODUCTS; RESEARCH AND DEVELOPMENT OF NEW PRODUCTS FOR OTHERS; RESEARCH, DEVELOPMENT, DESIGN AND UPGRADING OF COMPUTER SOFTWARE; SOFTWARE DESIGN AND DEVELOPMENT; SOFTWARE DEVELOPMENT AND PRODUCT DEVELOPMENT IN THE FIELD OF MOBILE DEVICE SOFTWARE; SOFTWARE DEVELOPMENT CONSULTING IN THE FIELD OF MOBILE DEVICES.; TECHNOLOGICAL CONSULTATION IN THE TECHNOLOGY FIELD OF MOBILE DEVICES. UPDATING AND DESIGN OF COMPUTER SOFTWARE; VISUAL DESIGN SERVICES IN THE NATURE OF DESIGNING VISUAL ELEMENTS FOR ON-LINE, BROADCAST, PRINT, OUTDOOR AND OTHER COMMUNICATION MEDIA; WEB SITE DESIGN; WEBSITE DESIGN AND DEVELOPMENT

**Reg. No. 4,197,769** FOR OTHERS; WRITING AND UPDATING COMPUTER SOFTWARE, IN CLASS 42 (U.S. CLS. 100 AND 101).

FIRST USE 9-23-2011; IN COMMERCE 9-23-2011.

THE MARK CONSISTS OF STANDARD CHARACTERS WITHOUT CLAIM TO ANY PARTICULAR FONT, STYLE, SIZE, OR COLOR.

NO CLAIM IS MADE TO THE EXCLUSIVE RIGHT TO USE "MOBILE", APART FROM THE MARK AS SHOWN.

SER. NO. 85-511,317, FILED 1-8-2012.

GISELLE AGOSTO, EXAMINING ATTORNEY



# United States of America

United States Patent and Trademark Office

## Barrel Tender

**Reg. No. 4,197,770**

2 HANDS DISTRIBUTING, LLC (OREGON LIMITED LIABILITY COMPANY)  
4119 SE RIVER DR.

**Registered Aug. 28, 2012**

MILWAUKIE, OR 97267

**Int. Cl.: 13**

FOR: GUN MOUNTS, IN CLASS 13 (U.S. CLS. 2 AND 9).

**TRADEMARK**

FIRST USE 1-2-2012; IN COMMERCE 1-2-2012.

**PRINCIPAL REGISTER**

THE MARK CONSISTS OF STANDARD CHARACTERS WITHOUT CLAIM TO ANY PARTICULAR FONT, STYLE, SIZE, OR COLOR.

NO CLAIM IS MADE TO THE EXCLUSIVE RIGHT TO USE "BARREL", APART FROM THE MARK AS SHOWN.

SER. NO. 85-511,333, FILED 1-8-2012.

CHRISTINE MARTIN, EXAMINING ATTORNEY



*David J. Kyffers*

Director of the United States Patent and Trademark Office

# United States of America

United States Patent and Trademark Office

## Vodka Squeeze Sweet Tea

**Reg. No. 4,197,771**

SCOTT L. TEMPLIN (UNITED STATES INDIVIDUAL)  
11692 SKYHAWK CT.  
FISHERS, IN 46037

**Registered Aug. 28, 2012**

**Int. Cl.: 33**

FOR: LIQUOR AND LIQUEUR BEVERAGES, NAMELY, VODKA AND FRUIT JUICES;  
VODKA AND ICE TEA; VODKA, IN CLASS 33 (U.S. CLS. 47 AND 49).

**TRADEMARK**

FIRST USE 3-1-2010; IN COMMERCE 8-22-2010.

**PRINCIPAL REGISTER**

THE MARK CONSISTS OF STANDARD CHARACTERS WITHOUT CLAIM TO ANY PARTICULAR FONT, STYLE, SIZE, OR COLOR.

NO CLAIM IS MADE TO THE EXCLUSIVE RIGHT TO USE "VODKA" AND "SWEET TEA",  
APART FROM THE MARK AS SHOWN.

SER. NO. 85-511,353, FILED 1-8-2012.

JEFF DEFORD, EXAMINING ATTORNEY



*David J. Kyffers*

Director of the United States Patent and Trademark Office

# United States of America

United States Patent and Trademark Office

## Vodka Squeeze Orange

**Reg. No. 4,197,772**

SCOTT L. TEMPLIN (UNITED STATES INDIVIDUAL)  
11692 SKYHAWK CT.  
FISHERS, IN 46037

**Registered Aug. 28, 2012**

**Int. Cl.: 33**

FOR: LIQUOR AND LIQUEUR BEVERAGES, NAMELY, VODKA AND FRUIT JUICES;  
VODKA AND ORANGE JUICE; VODKA, IN CLASS 33 (U.S. CLS. 47 AND 49).

**TRADEMARK**

FIRST USE 3-1-2010; IN COMMERCE 8-22-2010.

**PRINCIPAL REGISTER**

THE MARK CONSISTS OF STANDARD CHARACTERS WITHOUT CLAIM TO ANY PARTICULAR FONT, STYLE, SIZE, OR COLOR.

NO CLAIM IS MADE TO THE EXCLUSIVE RIGHT TO USE "VODKA" AND "ORANGE", APART FROM THE MARK AS SHOWN.

SER. NO. 85-511,357, FILED 1-8-2012.

JEFF DEFORD, EXAMINING ATTORNEY



*David J. Kyffers*

Director of the United States Patent and Trademark Office

# United States of America

United States Patent and Trademark Office

## Beaus For Boobs Bachelor Auction to Benefit Breast Cancer Research, Awareness and Survivorship

**Reg. No. 4,197,773**

SHE CAN MAKE IT HAPPEN, LLC (GEORGIA LIMITED LIABILITY COMPANY)  
5751 BOREAL WAY SW  
ATLANTA, GA 30331

**Registered Aug. 28, 2012**

**Int. Cl.: 36**

FOR: CHARITABLE FUNDRAISING TO SUPPORT BREAST CANCER RESEARCH, AWARENESS AND SURVIVORSHIP; CHARITABLE SERVICES, NAMELY, ORGANIZING FUNDRAISING SERVICES AND EVENTS TO RAISE FUNDS IN THE FIELD OF BREAST CANCER RESEARCH, AWARENESS AND SURVIVORSHIP, IN CLASS 36 (U.S. CLS. 100, 101 AND 102).

**SERVICE MARK**

**PRINCIPAL REGISTER**

FIRST USE 8-9-2011; IN COMMERCE 8-9-2011.

THE MARK CONSISTS OF STANDARD CHARACTERS WITHOUT CLAIM TO ANY PARTICULAR FONT, STYLE, SIZE, OR COLOR.

NO CLAIM IS MADE TO THE EXCLUSIVE RIGHT TO USE "BACHELOR AUCTION TO BENEFIT BREAST CANCER RESEARCH, AWARENESS AND SURVIVORSHIP", APART FROM THE MARK AS SHOWN.

SER. NO. 85-511,384, FILED 1-9-2012.

LOURDES AYALA, EXAMINING ATTORNEY



*David J. Kyffers*

Director of the United States Patent and Trademark Office

# United States of America

United States Patent and Trademark Office

# GEZ LEWIEZ

**Reg. No. 4,197,774**

THOMAS, TERRENCE L. (UNITED STATES INDIVIDUAL)  
1249 N. AUSTIN BLVD., APT. 2  
CHICAGO, IL 60651 AND

**Registered Aug. 28, 2012**

**Int. Cl.: 41**

WILLIAMS, BRANDON D. (UNITED STATES INDIVIDUAL)  
26 WASHINGTON BLVD., APT. 1B  
OAK PARK, IL 60302

**SERVICE MARK**

**PRINCIPAL REGISTER**

FOR: ENTERTAINMENT IN THE NATURE OF LIVE PERFORMANCES BY A MUSICAL ARTIST, MUSICAL GROUP OR MUSICAL BAND; ENTERTAINMENT IN THE NATURE OF PERSONAL APPEARANCES BY A MUSICIAN, MUSICAL GROUP, MUSICAL BAND, ENTERTAINER, ACTOR, OR CELEBRITY; MUSIC PRODUCTION SERVICES; PRODUCTION OF SOUND AND MUSIC VIDEO RECORDINGS; MUSICAL COMPOSITION AND PRODUCTION OF MUSICAL SOUND RECORDINGS; ENTERTAINMENT SERVICES IN THE NATURE OF MUSIC RECORDING AND SOUND RECORDING STUDIO SERVICES; MUSIC COMPOSITION AND TRANSCRIPTION FOR OTHERS; PRODUCTION AND PUBLISHING OF MUSICAL COMPOSITIONS; MUSIC PUBLISHING; RECORD PRODUCTION; ARTIST DEVELOPMENT, NAMELY, EDUCATIONAL MENTORING IN THE FIELD OF SONGWRITING, COMPOSING, MUSIC PRODUCING, AND SUCCESSFUL MARKETING FOR THE NURTURING OF NEW ARTISTS; ARRANGING AND CONDUCTING OF CONCERTS; CONCERT BOOKING; ENTERTAINMENT IN THE NATURE OF TRAVELLING TOURS FEATURING MUSIC; ENTERTAINMENT SERVICES, NAMELY, PROVIDING A WEB SITE FEATURING NON-DOWNLOADABLE MUSICAL PERFORMANCES, MUSICAL VIDEOS, RELATED FILM CLIPS, AND PHOTOGRAPHS; PROVIDING A WEBSITE ON A GLOBAL COMPUTER NETWORK FEATURING INFORMATION ON ENTERTAINMENT, MUSICAL PERFORMERS AND PRODUCERS, AND RELATED MUSICAL PERFORMANCES, BIOGRAPHIES, PRODUCTIONS, SOUND AND VIDEO RECORDINGS, APPEARANCES, AND CONCERTS, IN CLASS 41 (U.S. CLS. 100, 101 AND 107).



FIRST USE 5-31-2005; IN COMMERCE 5-31-2005.

THE MARK CONSISTS OF STANDARD CHARACTERS WITHOUT CLAIM TO ANY PARTICULAR FONT, STYLE, SIZE, OR COLOR.

*David J. Kyros*

SER. NO. 85-511,400, FILED 1-9-2012.

KATHLEEN M. VANSTON, EXAMINING ATTORNEY

# United States of America

United States Patent and Trademark Office



**Reg. No. 4,197,775**

**Registered Aug. 28, 2012**

**Int. Cl.: 41**

**SERVICE MARK**

**PRINCIPAL REGISTER**

STEVEN M HACKER (UNITED STATES INDIVIDUAL)  
6898 NE 8TH DR  
BOCA RATON, FL 33487

FOR: EDUCATIONAL SERVICES, NAMELY, PROVIDING SYMPOSIUMS IN THE FIELD OF PHYSICIAN ENTREPRENEURSHIP AND MEDICAL BUSINESS; PROVIDING ON-LINE RESOURCES, NAMELY, NON-DOWNLOADABLE PUBLICATIONS IN THE NATURE OF BOOKS IN THE FIELD OF PHYSICIAN ENTREPRENEURSHIP AND MEDICAL BUSINESS, IN CLASS 41 (U.S. CLS. 100, 101 AND 107).

FIRST USE 11-5-2010; IN COMMERCE 11-5-2010.

OWNER OF U.S. REG. NO. 4,014,132.

THE COLOR(S) BLACK, WHITE, GREEN AND GRAY IS/ARE CLAIMED AS A FEATURE OF THE MARK.

NO CLAIM IS MADE TO THE EXCLUSIVE RIGHT TO USE "MEDICAL ENTREPRENEUR", APART FROM THE MARK AS SHOWN.

THE MARK CONSISTS OF A BLACK BRIEFCASE WITH A GREEN AND GRAY STETHOSCOPE ON THE BRIEFCASE. THE STETHOSCOPE IS SHAPED IN THE SHAPE OF AN ARROW. THE NAME "THE MEDICAL ENTREPRENEUR" IS IN WHITE AND ALSO ON THE BRIEFCASE.

SER. NO. 85-511,403, FILED 1-9-2012.

KATHLEEN M. VANSTON, EXAMINING ATTORNEY



*David J. Kyjars*

Director of the United States Patent and Trademark Office

# United States of America

United States Patent and Trademark Office

## BETTER THAN ALPACA?

**Reg. No. 4,197,776**

DAVID & YOUNG GROUP CORP. (NEW JERSEY CORPORATION)  
901 CASTLE ROAD, UNIT #2  
SECAUCUS, NJ 07094

**Registered Aug. 28, 2012**

**Int. Cl.: 25**

FOR: CLOTHING, NAMELY, HATS, SCARVES AND GLOVES, IN CLASS 25 (U.S. CLS. 22 AND 39).

**TRADEMARK**

FIRST USE 1-1-2012; IN COMMERCE 1-1-2012.

**PRINCIPAL REGISTER**

THE MARK CONSISTS OF STANDARD CHARACTERS WITHOUT CLAIM TO ANY PARTICULAR FONT, STYLE, SIZE, OR COLOR.

OWNER OF U.S. REG. NOS. 3,167,910, 3,736,342 AND OTHERS.

SER. NO. 85-511,417, FILED 1-9-2012.

KAREN K. BUSH, EXAMINING ATTORNEY



*David J. Kybas*

Director of the United States Patent and Trademark Office

# United States of America

United States Patent and Trademark Office

## BETTER THAN FOX?

**Reg. No. 4,197,777**

DAVID & YOUNG GROUP CORP. (NEW JERSEY CORPORATION)  
901 CASTLE ROAD, UNIT #2  
SECAUCUS, NJ 07094

**Registered Aug. 28, 2012**

**Int. Cl.: 25**

FOR: CLOTHING, NAMELY, HATS, SCARVES AND GLOVES, IN CLASS 25 (U.S. CLS. 22 AND 39).

**TRADEMARK**

FIRST USE 1-1-2012; IN COMMERCE 1-1-2012.

**PRINCIPAL REGISTER**

THE MARK CONSISTS OF STANDARD CHARACTERS WITHOUT CLAIM TO ANY PARTICULAR FONT, STYLE, SIZE, OR COLOR.

OWNER OF U.S. REG. NOS. 3,167,910, 3,736,342 AND OTHERS.

SER. NO. 85-511,426, FILED 1-9-2012.

KAREN K. BUSH, EXAMINING ATTORNEY



*David J. Kyffers*

Director of the United States Patent and Trademark Office



# United States of America

United States Patent and Trademark Office

## BETTER THAN MINK?

**Reg. No. 4,197,778**

DAVID & YOUNG GROUP CORP. (NEW JERSEY CORPORATION)  
901 CASTLE ROAD, UNIT #2  
SECAUCUS, NJ 07094

**Registered Aug. 28, 2012**

**Int. Cl.: 25**

FOR: CLOTHING, NAMELY, HATS, SCARVES AND GLOVES, IN CLASS 25 (U.S. CLS. 22 AND 39).

**TRADEMARK**

FIRST USE 1-1-2012; IN COMMERCE 1-1-2012.

**PRINCIPAL REGISTER**

THE MARK CONSISTS OF STANDARD CHARACTERS WITHOUT CLAIM TO ANY PARTICULAR FONT, STYLE, SIZE, OR COLOR.

OWNER OF U.S. REG. NOS. 3,167,910, 3,736,342 AND OTHERS.

SER. NO. 85-511,430, FILED 1-9-2012.

KAREN K. BUSH, EXAMINING ATTORNEY



*David J. Kyffers*

Director of the United States Patent and Trademark Office

# United States of America

United States Patent and Trademark Office

## BETTER THAN SABLE?

**Reg. No. 4,197,779**

DAVID & YOUNG GROUP CORP. (NEW JERSEY CORPORATION)  
901 CASTLE ROAD, UNIT #2  
SECAUCUS, NJ 07094

**Registered Aug. 28, 2012**

**Int. Cl.: 25**

FOR: CLOTHING, NAMELY, HATS, SCARVES AND GLOVES, IN CLASS 25 (U.S. CLS. 22 AND 39).

**TRADEMARK**

FIRST USE 1-1-2012; IN COMMERCE 1-1-2012.

**PRINCIPAL REGISTER**

THE MARK CONSISTS OF STANDARD CHARACTERS WITHOUT CLAIM TO ANY PARTICULAR FONT, STYLE, SIZE, OR COLOR.

OWNER OF U.S. REG. NOS. 3,167,910, 3,736,342 AND OTHERS.

SER. NO. 85-511,432, FILED 1-9-2012.

KAREN K. BUSH, EXAMINING ATTORNEY



*David J. Kyffers*

Director of the United States Patent and Trademark Office

# United States of America

United States Patent and Trademark Office

## SOFTER THAN FOX?

**Reg. No. 4,197,780**

DAVID & YOUNG GROUP CORP. (NEW JERSEY CORPORATION)  
901 CASTLE ROAD, UNIT #2  
SECAUCUS, NJ 07094

**Registered Aug. 28, 2012**

**Int. Cl.: 25**

FOR: CLOTHING, NAMELY, HATS, SCARVES AND GLOVES, IN CLASS 25 (U.S. CLS. 22 AND 39).

**TRADEMARK**

FIRST USE 1-1-2012; IN COMMERCE 1-1-2012.

**PRINCIPAL REGISTER**

THE MARK CONSISTS OF STANDARD CHARACTERS WITHOUT CLAIM TO ANY PARTICULAR FONT, STYLE, SIZE, OR COLOR.

OWNER OF U.S. REG. NOS. 3,167,910, 3,736,342 AND OTHERS.

SER. NO. 85-511,437, FILED 1-9-2012.

KAREN K. BUSH, EXAMINING ATTORNEY



*David J. Kybas*

Director of the United States Patent and Trademark Office

# United States of America

United States Patent and Trademark Office

## SOFTER THAN RABBIT?

**Reg. No. 4,197,781**

DAVID & YOUNG GROUP CORP. (NEW JERSEY CORPORATION)  
901 CASTLE ROAD, UNIT #2  
SECAUCUS, NJ 07094

**Registered Aug. 28, 2012**

**Int. Cl.: 25**

FOR: CLOTHING, NAMELY, HATS, SCARVES AND GLOVES, IN CLASS 25 (U.S. CLS. 22 AND 39).

**TRADEMARK**

FIRST USE 1-1-2012; IN COMMERCE 1-1-2012.

**PRINCIPAL REGISTER**

THE MARK CONSISTS OF STANDARD CHARACTERS WITHOUT CLAIM TO ANY PARTICULAR FONT, STYLE, SIZE, OR COLOR.

OWNER OF U.S. REG. NOS. 3,167,910, 3,736,342 AND OTHERS.

SER. NO. 85-511,443, FILED 1-9-2012.

KAREN K. BUSH, EXAMINING ATTORNEY



*David J. Kyffers*

Director of the United States Patent and Trademark Office

# United States of America

United States Patent and Trademark Office

## SOFTER THAN REAL FUR?

**Reg. No. 4,197,782**

DAVID & YOUNG GROUP CORP. (NEW JERSEY CORPORATION)  
901 CASTLE ROAD, UNIT #2  
SECAUCUS, NJ 07094

**Registered Aug. 28, 2012**

**Int. Cl.: 25**

FOR: CLOTHING, NAMELY, HATS, SCARVES AND GLOVES, IN CLASS 25 (U.S. CLS. 22 AND 39).

**TRADEMARK**

FIRST USE 1-1-2012; IN COMMERCE 1-1-2012.

**PRINCIPAL REGISTER**

THE MARK CONSISTS OF STANDARD CHARACTERS WITHOUT CLAIM TO ANY PARTICULAR FONT, STYLE, SIZE, OR COLOR.

OWNER OF U.S. REG. NOS. 3,167,910, 3,736,342 AND OTHERS.

SER. NO. 85-511,451, FILED 1-9-2012.

KAREN K. BUSH, EXAMINING ATTORNEY



*David J. Kyffers*

Director of the United States Patent and Trademark Office

# United States of America

United States Patent and Trademark Office

## SOFTER THAN ALPACA?

**Reg. No. 4,197,783**

DAVID & YOUNG GROUP CORP. (NEW JERSEY CORPORATION)  
901 CASTLE ROAD, UNIT #2  
SECAUCUS, NJ 07094

**Registered Aug. 28, 2012**

**Int. Cl.: 25**

FOR: CLOTHING, NAMELY, HATS, SCARVES AND GLOVES, IN CLASS 25 (U.S. CLS. 22 AND 39).

**TRADEMARK**

FIRST USE 1-1-2012; IN COMMERCE 1-1-2012.

**PRINCIPAL REGISTER**

THE MARK CONSISTS OF STANDARD CHARACTERS WITHOUT CLAIM TO ANY PARTICULAR FONT, STYLE, SIZE, OR COLOR.

OWNER OF U.S. REG. NOS. 3,167,910, 3,736,342 AND OTHERS.

SER. NO. 85-511,455, FILED 1-9-2012.

KAREN K. BUSH, EXAMINING ATTORNEY



*David J. Kybas*

Director of the United States Patent and Trademark Office

# United States of America

United States Patent and Trademark Office

explore  
WORKSHOP

**Reg. No. 4,197,784**

**Registered Aug. 28, 2012**

**Int. Cl.: 45**

**SERVICE MARK**

**PRINCIPAL REGISTER**

EVANGELICAL ALLIANCE MISSION (TEAM), THE (ILLINOIS CORPORATION)  
P.O. BOX 969  
WHEATON, IL 60187

FOR: RELIGIOUS MISSIONARY SERVICES, IN CLASS 45 (U.S. CLS. 100 AND 101).

FIRST USE 11-15-2011; IN COMMERCE 11-15-2011.

OWNER OF U.S. REG. NO. 2,534,066.

NO CLAIM IS MADE TO THE EXCLUSIVE RIGHT TO USE "WORKSHOP", APART FROM THE MARK AS SHOWN.

THE MARK CONSISTS OF THE WORDS "EXPLORE WORKSHOP" WITH A COMPASS INSIDE THE "O" IN "EXPLORE".

SER. NO. 85-511,456, FILED 1-9-2012.

ELISSA GARBER KON, EXAMINING ATTORNEY



*David J. Kyffers*

Director of the United States Patent and Trademark Office

# United States of America

United States Patent and Trademark Office



**Reg. No. 4,197,785**

**Registered Aug. 28, 2012**

**Int. Cl.: 18**

**TRADEMARK**

**PRINCIPAL REGISTER**

OSPREY PACKS, INC. (COLORADO CORPORATION)  
115 W. PROGRESS CIRCLE  
CORTEZ, CO 81321

FOR: BACKPACKS; HYDRATION PACKS, NAMELY, BACKPACKS FOR CARRYING A LIQUID STORAGE CONTAINER; BACKPACK COMPONENTS, NAMELY, HARNESSSES AND HIP BELTS; SPORT PACKS IN THE NATURE OF SKI PACKS, SNOWBOARD PACKS, AND CLIMBING PACKS; DAYPACKS; MESSENGER AND COURIER BAGS; SLING BAGS; BACKPACK COVERS; BACKPACK ACCESSORIES, NAMELY, BACK CUSHION PADS, PADDED BELTS, POUCHES SOLD EMPTY FOR ATTACHMENT TO BACKPACKS AND SPORTS BAGS, AND CARRYING CASES FOR MAPS; FITTED RAIN COVERS FOR BACKPACKS; FANNY PACKS; TRAVEL PACKS; WHEELED TRAVEL BAGS AND CARGO BAGS IN THE NATURE OF ALL-PURPOSE CARRYING BAGS AND LUGGAGE; BACKPACKS, TRAVEL PACKS, DUFFLE BAGS, SHOULDER BAGS, WHEELED BAGS, COURIER BAGS, SPORTS BAGS, AND TRAVEL BAGS, ALL WITH INTEGRAL ORGANIZER COMPARTMENTS; DUFFEL BAGS; SHOULDER BAGS; SPORTS BAGS; SPORTS PACKS; TRAVEL BAGS; BACK FRAMES FOR CARRYING CHILDREN; COMMUTER PACKS FOR BICYCLISTS IN THE NATURE OF BACKPACKS, IN CLASS 18 (U.S. CLS. 1, 2, 3, 22 AND 41).

FIRST USE 8-1-2000; IN COMMERCE 8-1-2000.

OWNER OF U.S. REG. NOS. 2,571,330, 4,119,126 AND OTHERS.

THE STIPLING IS A FEATURE OF THE MARK AND DOES NOT INDICATE COLOR.

THE MARK CONSISTS OF A STYLIZED BIRD WITH OUTSTRETCHED WINGS.

SER. NO. 85-511,473, FILED 1-9-2012.

DAVID ELTON, EXAMINING ATTORNEY



*David J. Kypos*

Director of the United States Patent and Trademark Office



# United States of America

United States Patent and Trademark Office

## Kitchen Mischief

**Reg. No. 4,197,786**

**Registered Aug. 28, 2012**

**Int. Cls.: 41 and 43**

**SERVICE MARK**

**PRINCIPAL REGISTER**

WARREN, MATTHEW (UNITED STATES INDIVIDUAL)  
5605 10TH AVENUE SOUTH  
BIRMINGHAM, AL 352224103 AND

MILLER, JOSH (UNITED STATES INDIVIDUAL)  
5605 10TH AVENUE SOUTH  
BIRMINGHAM, AL 352224103

FOR: ON-LINE JOURNALS, NAMELY, BLOGS FEATURING COOKING AND RECIPES, IN CLASS 41 (U.S. CLS. 100, 101 AND 107).

FIRST USE 5-26-2009; IN COMMERCE 5-26-2009.

FOR: CATERING SERVICES, IN CLASS 43 (U.S. CLS. 100 AND 101).

FIRST USE 5-26-2009; IN COMMERCE 5-26-2009.

THE MARK CONSISTS OF STANDARD CHARACTERS WITHOUT CLAIM TO ANY PARTICULAR FONT, STYLE, SIZE, OR COLOR.

NO CLAIM IS MADE TO THE EXCLUSIVE RIGHT TO USE "KITCHEN", APART FROM THE MARK AS SHOWN.

SER. NO. 85-511,484, FILED 1-9-2012.

PATRICIA EVANKO, EXAMINING ATTORNEY



*David J. Kyros*

Director of the United States Patent and Trademark Office

# United States of America

United States Patent and Trademark Office

## EARLY RELEASES

**Reg. No. 4,197,787**

**Registered Aug. 28, 2012**

**Int. Cl.: 42**

**SERVICE MARK**

**PRINCIPAL REGISTER**

NUMISMATIC GUARANTY CORPORATION OF AMERICA (FLORIDA CORPORATION)  
PO BOX 4776  
5501 COMMUNICATIONS PARKWAY  
SARASOTA, FL 34240

FOR: COIN GRADING AND AUTHENTICATION SERVICES, IN CLASS 42 (U.S. CLS. 100 AND 101).

FIRST USE 12-14-2006; IN COMMERCE 12-14-2006.

THE MARK CONSISTS OF STANDARD CHARACTERS WITHOUT CLAIM TO ANY PARTICULAR FONT, STYLE, SIZE, OR COLOR.

OWNER OF U.S. REG. NO. 3,424,834.

SEC. 2(F).

SER. NO. 85-511,515, FILED 1-9-2012.

MATTHEW KLINE, EXAMINING ATTORNEY



*David J. Kyffers*

Director of the United States Patent and Trademark Office

# United States of America

United States Patent and Trademark Office

## FAST FOOD, NOT FAT FOOD.

**Reg. No. 4,197,788**

**Registered Aug. 28, 2012**

**Int. Cl.: 43**

**SERVICE MARK**

**PRINCIPAL REGISTER**

ENERGY KITCHEN INC. (NEW YORK CORPORATION)  
SUITE 614  
71 WEST 23RD STREET  
NEW YORK, NY 10010

FOR: RESTAURANT SERVICES; RESTAURANT SERVICES, NAMELY, PROVIDING OF FOOD AND BEVERAGES FOR CONSUMPTION ON AND OFF THE PREMISES; TAKE-OUT RESTAURANT SERVICES, IN CLASS 43 (U.S. CLS. 100 AND 101).

FIRST USE 11-0-2011; IN COMMERCE 11-0-2011.

THE MARK CONSISTS OF STANDARD CHARACTERS WITHOUT CLAIM TO ANY PARTICULAR FONT, STYLE, SIZE, OR COLOR.

OWNER OF U.S. REG. NO. 4,088,319.

SER. NO. 85-511,521, FILED 1-9-2012.

KATHLEEN M. VANSTON, EXAMINING ATTORNEY



*David J. Kybas*

Director of the United States Patent and Trademark Office

# United States of America

United States Patent and Trademark Office

## CLINIC SOFIA

**Reg. No. 4,197,789**

CLINIC SOFIA OB-GYN, P.A. (MINNESOTA CORPORATION)  
600 RIVER STREET  
MINNEAPOLIS, MN 55401

**Registered Aug. 28, 2012**

**Int. Cl.: 44**

FOR: OBSTETRICAL AND GYNECOLOGICAL SERVICES; LASER TREATMENT FOR SKIN,  
IN CLASS 44 (U.S. CLS. 100 AND 101).

**SERVICE MARK**

FIRST USE 10-4-2004; IN COMMERCE 10-4-2004.

**PRINCIPAL REGISTER**

THE MARK CONSISTS OF STANDARD CHARACTERS WITHOUT CLAIM TO ANY PAR-  
TICULAR FONT, STYLE, SIZE, OR COLOR.

OWNER OF U.S. REG. NO. 3,141,833.

NO CLAIM IS MADE TO THE EXCLUSIVE RIGHT TO USE "CLINIC", APART FROM THE  
MARK AS SHOWN.

SER. NO. 85-511,533, FILED 1-9-2012.

KIMBERLY PERRY, EXAMINING ATTORNEY



*David J. Kyffers*

Director of the United States Patent and Trademark Office

# United States of America

United States Patent and Trademark Office

## Desert Critter Wear

**Reg. No. 4,197,790**

ROBERTS, MARCI (UNITED STATES INDIVIDUAL)  
206 N. AVE. D  
MARATHON, TX 79842

**Registered Aug. 28, 2012**

**Int. Cl.: 25**

FOR: DRESSES; HATS; JACKETS; PANTS; SCARVES; SHIRTS; SKIRTS; SLEEPWEAR; T-SHIRTS; UNDERWEAR; YOGA PANTS, IN CLASS 25 (U.S. CLS. 22 AND 39).

**TRADEMARK**

FIRST USE 10-28-2010; IN COMMERCE 10-28-2010.

**PRINCIPAL REGISTER**

THE MARK CONSISTS OF STANDARD CHARACTERS WITHOUT CLAIM TO ANY PARTICULAR FONT, STYLE, SIZE, OR COLOR.

NO CLAIM IS MADE TO THE EXCLUSIVE RIGHT TO USE "WEAR", APART FROM THE MARK AS SHOWN.

SER. NO. 85-511,551, FILED 1-9-2012.

SAMUEL E. SHARPER JR., EXAMINING ATTORNEY



*David J. Kyffers*

Director of the United States Patent and Trademark Office

# United States of America

United States Patent and Trademark Office



**Reg. No. 4,197,791**

NEWMAN, BARBARA G. (UNITED STATES INDIVIDUAL)  
2209 KENTUCKY AVENUE  
BALTIMORE, MD 21213

**Registered Aug. 28, 2012**

**Int. Cl.: 41**

FOR: ON-LINE JOURNALS, NAMELY, BLOGS FEATURING INFORMATION, OPINION, COMMENTARY, POETRY AND PROSE IN THE FIELD OF GENERAL INTEREST, IN CLASS 41 (U.S. CLS. 100, 101 AND 107).

**SERVICE MARK**

FIRST USE 12-22-2011; IN COMMERCE 12-22-2011.

**PRINCIPAL REGISTER**

THE MARK CONSISTS OF THE TOP HALF OF A BEAR'S HEAD, WHICH CONSISTS OF TWO EARS AND TWO EYES. THE FACE IS CUT OFF BELOW THE EYES. THE LETTERS "GB" APPEAR AT THE RIGHT BOTTOM SIDE OF THE FACE IN SMALL SCRIPT.

SER. NO. 85-511,552, FILED 1-9-2012.

RONALD MCMORROW, EXAMINING ATTORNEY



*David J. Kybas*

Director of the United States Patent and Trademark Office

# United States of America

United States Patent and Trademark Office

# BeeMap

**Reg. No. 4,197,792**

ATTSHAN, SHADI (JORDAN INDIVIDUAL)

**Registered Aug. 28, 2012**

IRSAL  
RAMALLAH, WEST BANK/GAZA

**Int. Cl.: 42**

FOR: PROVIDING A WEBSITE THAT GIVES USERS THE ABILITY TO REVIEW VARIOUS PRINT, PHOTOGRAPHIC, GRAPHIC IMAGE, AND AUDIO AND VIDEO CONTENT AND UTILIZE A CUSTOM TEMPLATE TO PROVIDE INPUT, LIKES, DISLIKES, EDITS, CHANGES, MODIFICATIONS, OPINIONS, SUGGESTIONS, AND COMMENTS AND ENGAGE IN SOCIAL, BUSINESS AND COMMUNITY NETWORKING, IN CLASS 42 (U.S. CLS. 100 AND 101).

**SERVICE MARK**

**PRINCIPAL REGISTER**

FIRST USE 11-11-2011; IN COMMERCE 11-11-2011.

THE MARK CONSISTS OF STANDARD CHARACTERS WITHOUT CLAIM TO ANY PARTICULAR FONT, STYLE, SIZE, OR COLOR.

SER. NO. 85-511,555, FILED 1-9-2012.

SAMUEL E. SHARPER JR., EXAMINING ATTORNEY



*David J. Kyffers*

Director of the United States Patent and Trademark Office

# United States of America

United States Patent and Trademark Office

## KEYBANK BUSINESS CAPITAL

**Reg. No. 4,197,793**

KEYCORP (OHIO CORPORATION)  
127 PUBLIC SQUARE  
CLEVELAND, OH 44114

**Registered Aug. 28, 2012**

**Int. Cl.: 36**

FOR: FINANCIAL SERVICES, NAMELY, ASSET BASED LENDING SERVICES, IN CLASS 36 (U.S. CLS. 100, 101 AND 102).

**SERVICE MARK**

FIRST USE 11-17-2011; IN COMMERCE 11-17-2011.

**PRINCIPAL REGISTER**

THE MARK CONSISTS OF STANDARD CHARACTERS WITHOUT CLAIM TO ANY PARTICULAR FONT, STYLE, SIZE, OR COLOR.

OWNER OF U.S. REG. NOS. 1,722,378, 2,802,389 AND OTHERS.

NO CLAIM IS MADE TO THE EXCLUSIVE RIGHT TO USE "BUSINESS CAPITAL", APART FROM THE MARK AS SHOWN.

SER. NO. 85-511,565, FILED 1-9-2012.

SAMUEL E. SHARPER JR., EXAMINING ATTORNEY



*David J. Kyffers*

Director of the United States Patent and Trademark Office



# United States of America

United States Patent and Trademark Office

# Hot Plot

**Reg. No. 4,197,794**

**Registered Aug. 28, 2012**

**Int. Cl.: 31**

**TRADEMARK**

**PRINCIPAL REGISTER**

TRUE NORTH OUTDOORS, LLC (WISCONSIN LIMITED LIABILITY COMPANY)  
C/O KYLE GUINN  
110 EAST THIRD ST  
NEW RICHMOND, WI 54017

FOR: AGRICULTURAL SEEDS; CROP SEEDS; GRASS SEEDS; HERB SEEDS FOR PLANTING; PLANT SEEDS; WILDLIFE SEED MIXTURES, IN CLASS 31 (U.S. CLS. 1 AND 46).

FIRST USE 1-1-2010; IN COMMERCE 1-1-2010.

THE MARK CONSISTS OF STANDARD CHARACTERS WITHOUT CLAIM TO ANY PARTICULAR FONT, STYLE, SIZE, OR COLOR.

NO CLAIM IS MADE TO THE EXCLUSIVE RIGHT TO USE "PLOT", APART FROM THE MARK AS SHOWN.

SER. NO. 85-511,586, FILED 1-9-2012.

AMEEN IMAM, EXAMINING ATTORNEY



*David J. Kyffers*

Director of the United States Patent and Trademark Office

# United States of America

United States Patent and Trademark Office



**Reg. No. 4,197,795**

**Registered Aug. 28, 2012**

**Int. Cl.: 41**

**SERVICE MARK**

**PRINCIPAL REGISTER**

WORLD POETRY MOVEMENT, LLC (DELAWARE LIMITED LIABILITY COMPANY)  
SUITE 4-176  
1776 PARK AVENUE  
PARK CITY, UT 84060

FOR: ENTERTAINMENT SERVICES, NAMELY, CONDUCTING CONTESTS, IN CLASS 41  
(U.S. CLS. 100, 101 AND 107).

FIRST USE 3-1-2011; IN COMMERCE 3-1-2011.

NO CLAIM IS MADE TO THE EXCLUSIVE RIGHT TO USE "WORLD POETRY MOVEMENT",  
APART FROM THE MARK AS SHOWN.

THE MARK CONSISTS OF THE WORDS "WORLD POETRY MOVEMENT" IN SCRIPT AND  
UNDERLINED, WITH A QUILL PEN OVER THE WORD "MOVEMENT".

SER. NO. 85-511,654, FILED 1-9-2012.

PRISCILLA MILTON, EXAMINING ATTORNEY



*David J. Kybas*

Director of the United States Patent and Trademark Office

# United States of America

United States Patent and Trademark Office



**Reg. No. 4,197,796**

**Registered Aug. 28, 2012**

**Int. Cl.: 29**

**TRADEMARK**

**PRINCIPAL REGISTER**

LIN, WENDY YUEH CHI (UNITED STATES INDIVIDUAL)  
16482 MONTE CRISTO DRIVE  
HACIENDA HEIGHTS, CA 91745

FOR: BEEF JERKY; DRIED FRUITS; PORK, IN CLASS 29 (U.S. CL. 46).

FIRST USE 12-31-1998; IN COMMERCE 12-31-1998.

THE MARK CONSISTS OF CHARACTERS FROM THE CHINESE LANGUAGE STYLED AS A CHOP, WHICH TRANSLITERATE TO "LAO ZI HAO" TRANSLATING TO ENGLISH AS "OLD NAME".

THE NON-LATIN CHARACTERS IN THE MARK TRANSLITERATE TO LAO ZI HAO AND THIS MEANS OLD NAME IN ENGLISH.

SER. NO. 85-511,661, FILED 1-9-2012.

KATINA MISTER, EXAMINING ATTORNEY



*David J. Kybas*

Director of the United States Patent and Trademark Office

# United States of America

United States Patent and Trademark Office

## Coco-Hydration

**Reg. No. 4,197,797**

AMAZON PRESERVATION PARTNERS (DELAWARE CORPORATION), DBA ZOLA ACAI  
1501-A VERMONT ST  
SAN FRANCISCO, CA 94107

**Registered Aug. 28, 2012**

**Int. Cl.: 32**

FOR: FRUIT DRINKS; FRUIT DRINKS AND FRUIT JUICES; FRUIT DRINKS AND JUICES;  
FRUIT JUICES AND FRUIT DRINKS, IN CLASS 32 (U.S. CLS. 45, 46 AND 48).

**TRADEMARK**

FIRST USE 11-11-2011; IN COMMERCE 11-11-2011.

**PRINCIPAL REGISTER**

THE MARK CONSISTS OF STANDARD CHARACTERS WITHOUT CLAIM TO ANY PAR-  
TICULAR FONT, STYLE, SIZE, OR COLOR.

SER. NO. 85-511,666, FILED 1-9-2012.

KATHERINE E. HALMEN, EXAMINING ATTORNEY



*David J. Kybas*

Director of the United States Patent and Trademark Office

# United States of America

United States Patent and Trademark Office

# VennGogh

**Reg. No. 4,197,798**

**Registered Aug. 28, 2012**

**Int. Cl.: 35**

**SERVICE MARK**

**PRINCIPAL REGISTER**

VENNGOGH, INC. (FLORIDA CORPORATION)  
433 PLAZA REAL, STE. 275  
BOCA RATON, FL 33432

FOR: ADVERTISING, MARKETING AND PROMOTIONAL SERVICES RELATED TO ALL INDUSTRIES FOR THE PURPOSE OF FACILITATING NETWORKING AND SOCIALIZING OPPORTUNITIES FOR BUSINESS PURPOSES , IN CLASS 35 (U.S. CLS. 100, 101 AND 102).

FIRST USE 8-18-2011; IN COMMERCE 11-18-2011.

THE MARK CONSISTS OF STANDARD CHARACTERS WITHOUT CLAIM TO ANY PARTICULAR FONT, STYLE, SIZE, OR COLOR.

THE NAME(S), PORTRAIT(S), AND/OR SIGNATURE(S) SHOWN IN THE MARK DOES NOT IDENTIFY A PARTICULAR LIVING INDIVIDUAL.

SER. NO. 85-511,711, FILED 1-9-2012.

ROBERT C. CLARK JR., EXAMINING ATTORNEY



*David J. Kyffers*

Director of the United States Patent and Trademark Office

# United States of America

United States Patent and Trademark Office

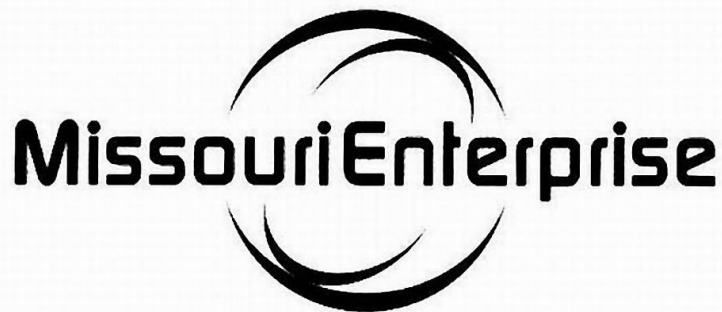

**Reg. No. 4,197,799**

**Registered Aug. 28, 2012**

**Int. Cl.: 35**

**SERVICE MARK**

**PRINCIPAL REGISTER**

MISSOURI INCUTECH FOUNDATION (MISSOURI CORPORATION)  
SUITE 215  
12125 WOODCREST EXECUTIVE DRIVE  
ST. LOUIS, MO 63141

FOR: BUSINESS CONSULTING AND INFORMATION SERVICES, IN CLASS 35 (U.S. CLS. 100, 101 AND 102).

FIRST USE 10-6-2010; IN COMMERCE 8-27-2011.

OWNER OF U.S. REG. NOS. 3,162,097 AND 3,308,785.

THE MARK CONSISTS OF "MISSOURIENTERPRISE" AS ONE WORD WITH CAPITAL "M" FOR "MISSOURI" AND CAPITAL "E" FOR "ENTERPRISE" WITH TWO CONCENTRIC CIRCLES CENTERED AND BEHIND "MISSOURIENTERPRISE".

SER. NO. 85-511,743, FILED 1-9-2012.

JULIE GUTTADAURO, EXAMINING ATTORNEY



*David J. Kybas*

Director of the United States Patent and Trademark Office

# United States of America

United States Patent and Trademark Office

# Spirit Winds

**Reg. No. 4,197,800**

**Registered Aug. 28, 2012**

**Int. Cl.: 20**

**TRADEMARK**

**PRINCIPAL REGISTER**

ROBERT VITAVEC (UNITED STATES INDIVIDUAL), DBA SPIRIT WINDS  
11186 WHITE OAK WAY  
NEVADA CITY, CA 95959

FOR: WIND CHIMES, IN CLASS 20 (U.S. CLS. 2, 13, 22, 25, 32 AND 50).

FIRST USE 0-0-1997; IN COMMERCE 0-0-1997.

THE MARK CONSISTS OF STANDARD CHARACTERS WITHOUT CLAIM TO ANY PARTICULAR FONT, STYLE, SIZE, OR COLOR.

SER. NO. 85-511,794, FILED 1-9-2012.

ZHALEH DELANEY, EXAMINING ATTORNEY



*David J. Kyffers*

Director of the United States Patent and Trademark Office

# United States of America

United States Patent and Trademark Office

## LEADING INNOVATION

**Reg. No. 4,197,801**

KAISER FOUNDATION HEALTH PLAN, INC. (CALIFORNIA CORPORATION)  
ONE KAISER PLAZA  
OAKLAND, CA 94612

**Registered Aug. 28, 2012**

**Int. Cl.: 28**

FOR: GAME EQUIPMENT DISTRIBUTED AS A UNIT COMPRISED OF A PLAYING BOARD, CARDS, STATUS SHEETS, AND RULES OF PLAY, FOR USE IN TRAINING MANAGERS AND EMPLOYEES OF ORGANIZATIONS, IN CLASS 28 (U.S. CLS. 22, 23, 38 AND 50).

**TRADEMARK**

FIRST USE 4-19-2011; IN COMMERCE 4-19-2011.

**PRINCIPAL REGISTER**

THE MARK CONSISTS OF STANDARD CHARACTERS WITHOUT CLAIM TO ANY PARTICULAR FONT, STYLE, SIZE, OR COLOR.

SER. NO. 85-511,809, FILED 1-9-2012.

ROBIN MITTLER, EXAMINING ATTORNEY



*David J. Kyffers*

Director of the United States Patent and Trademark Office



# United States of America

United States Patent and Trademark Office

# SHIELDZONE

**Reg. No. 4,197,802**

ZAGG INTELLECTUAL PROPERTY HOLDING CO., INC. (NEVADA CORPORATION)  
3855 SOUTH 500 WEST, SUITE J  
SALT LAKE CITY, UT 84115

**Registered Aug. 28, 2012**

**Int. Cl.: 9**

FOR: FITTED PLASTIC FILMS FOR COVERING AND PROVIDING A SCRATCH RESISTANT BARRIER OR PROTECTION FOR ELECTRONIC DEVICES, NAMELY, MEDIA PLAYERS, CELL PHONES, TELEPHONES, SMART PHONES, GLOBAL POSITIONING SYSTEMS, PERSONAL DIGITAL ASSISTANTS, COMPUTERS, TABLET COMPUTERS AND CAMERAS, IN CLASS 9 (U.S. CLS. 21, 23, 26, 36 AND 38).

**TRADEMARK**

**PRINCIPAL REGISTER**

FIRST USE 9-1-2006; IN COMMERCE 9-1-2006.

THE MARK CONSISTS OF STANDARD CHARACTERS WITHOUT CLAIM TO ANY PARTICULAR FONT, STYLE, SIZE, OR COLOR.

OWNER OF U.S. REG. NO. 4,096,424.

SER. NO. 85-511,820, FILED 1-9-2012.

MICHAEL TANNER, EXAMINING ATTORNEY



*David J. Kyffers*

Director of the United States Patent and Trademark Office

# United States of America

United States Patent and Trademark Office

## JAKE'S MINT CHEW

**Reg. No. 4,197,803**

JAKE'S MINT CHEW, LLC (MASSACHUSETTS LIMITED LIABILITY COMPANY)  
P.O. BOX 183  
PEABODY, MA 01960

**Registered Aug. 28, 2012**

**Int. Cl.: 34**

FOR: TOBACCO SUBSTITUTE, NAMELY, A NON-TOBACCO BASED FLAVORED CHEW,  
IN CLASS 34 (U.S. CLS. 2, 8, 9 AND 17).

**TRADEMARK**

FIRST USE 10-31-2010; IN COMMERCE 10-31-2010.

**PRINCIPAL REGISTER**

THE MARK CONSISTS OF STANDARD CHARACTERS WITHOUT CLAIM TO ANY PAR-  
TICULAR FONT, STYLE, SIZE, OR COLOR.

NO CLAIM IS MADE TO THE EXCLUSIVE RIGHT TO USE "MINT CHEW", APART FROM  
THE MARK AS SHOWN.

SER. NO. 85-511,847, FILED 1-9-2012.

LINDA POWELL, EXAMINING ATTORNEY



*David J. Kyffers*

Director of the United States Patent and Trademark Office

# United States of America

United States Patent and Trademark Office

CHEW HEALTHY, CHEW MINT!

**Reg. No. 4,197,804**

JAKE'S MINT CHEW, LLC (MASSACHUSETTS LIMITED LIABILITY COMPANY)  
P.O. BOX 183  
PEABODY, MA 01960

**Registered Aug. 28, 2012**

**Int. Cl.: 34**

FOR: TOBACCO SUBSTITUTE, NAMELY, A NON-TOBACCO BASED FLAVORED CHEW,  
IN CLASS 34 (U.S. CLS. 2, 8, 9 AND 17).

**TRADEMARK**

FIRST USE 10-31-2010; IN COMMERCE 10-31-2010.

**PRINCIPAL REGISTER**

THE MARK CONSISTS OF STANDARD CHARACTERS WITHOUT CLAIM TO ANY PAR-  
TICULAR FONT, STYLE, SIZE, OR COLOR.

SER. NO. 85-511,878, FILED 1-9-2012.

LINDA POWELL, EXAMINING ATTORNEY



*David J. Kybas*

Director of the United States Patent and Trademark Office

# United States of America

United States Patent and Trademark Office

## SHAPING THE ART OF DECOR SINCE 1967

**Reg. No. 4,197,805**

REN-WIL INC. (CANADA CORPORATION)  
9181 BOIVIN ST.

**Registered Aug. 28, 2012**

MONTREAL, QUEBEC, CANADA H8R2E8

**Int. Cl.: 35**

FOR: WHOLESALE STORE SERVICES FEATURING ART, FRAMES, HOME FURNISHINGS, HOME DECOR, HOME FURNISHING ACCESSORIES, MIRRORS, TABLES, LIGHTING, TABLE LAMPS, FLOOR LAMPS, LIGHTING FIXTURES, BATHROOM HARDWARE, IN CLASS 35 (U.S. CLS. 100, 101 AND 102).

**SERVICE MARK**

**PRINCIPAL REGISTER**

FIRST USE 1-1-2010; IN COMMERCE 1-1-2010.

THE MARK CONSISTS OF STANDARD CHARACTERS WITHOUT CLAIM TO ANY PARTICULAR FONT, STYLE, SIZE, OR COLOR.

NO CLAIM IS MADE TO THE EXCLUSIVE RIGHT TO USE "SINCE 1967", APART FROM THE MARK AS SHOWN.

SER. NO. 85-511,888, FILED 1-9-2012.

LIEF MARTIN, EXAMINING ATTORNEY



*David J. Kybas*

Director of the United States Patent and Trademark Office

# United States of America

## United States Patent and Trademark Office



**Reg. No. 4,197,806**

**Registered Aug. 28, 2012**

**Int. Cl.: 35**

**SERVICE MARK**

**PRINCIPAL REGISTER**

KAPPA PHI LAMBDA SORORITY, INC. (NEW YORK CORPORATION)  
P.O. BOX 4067  
NEW YORK, NY 10136

FOR: ASSOCIATION SERVICES, NAMELY, ORGANIZING CHAPTERS OF A SORORITY AND PROMOTING THE INTERESTS OF MEMBERS THEREOF, IN CLASS 35 (U.S. CLS. 100, 101 AND 102).

FIRST USE 0-0-1995; IN COMMERCE 0-0-1995.

OWNER OF U.S. REG. NO. 3,284,663.

THE MARK CONSISTS OF A CREST DESIGN CONTAINING A SHIELD DIVIDED INTO FOUR SECTIONS. THE TOP LEFT SECTION DISPLAYS A REPRESENTATION OF AN ORCHID, THE TOP RIGHT SECTION DISPLAYS A REPRESENTATION OF A DIAMOND SCEPTRE, THE LOWER LEFT SECTION DISPLAYS A REPRESENTATION OF TWO BURNING CANDLES, THE LOWER RIGHT SECTION CONTAINS A REPRESENTATION OF A GLOBE. SUPERIMPOSED OVER THE INTERSECTION OF THE FOUR SECTIONS IS A REPRESENTATION OF A CROWN BEARING THE GREEK ALPHABET LETTERS "KAPPA," "PHI," AND "LAMBDA" AND SUPERIMPOSED OVER THE BOTTOM OF THE SHIELD IS A BANNER BEARING THE WORDS "FRATERNITE SERVITIUM VARIETAS". THE SHIELD AND BANNER IS SUPERIMPOSED OVER A REPRESENTATION OF A PHOENIX WITH OUTSTRETCHED WINGS.

THE ENGLISH TRANSLATION OF "FRATERNITE SERVITIUM VARIETAS" IN THE MARK IS "SISTERHOOD SERVICE CULTURAL DIVERSITY".

SER. NO. 85-511,927, FILED 1-9-2012.

KATHERINE CONNOLLY, EXAMINING ATTORNEY



*David J. Kybas*

Director of the United States Patent and Trademark Office

# United States of America

United States Patent and Trademark Office

## INTEGRATED SCIENTIFIC INFORMATION SHARING

**Reg. No. 4,197,807**

**Registered Aug. 28, 2012**

**Int. Cl.: 35**

**SERVICE MARK**

**PRINCIPAL REGISTER**

MEDISYS HEALTH COMMUNICATIONS, LLC (NEW JERSEY LIMITED LIABILITY COMPANY)  
65 MAIN STREET  
HIGH BRIDGE, NJ 08829

FOR: CONSULTATION SERVICES, NAMELY, CREATIVE AND STRATEGIC CONSULTATION REGARDING DEVELOPMENT AND PRODUCTION OF MARKETING CAMPAIGNS, BRAND STRATEGIES, COMMUNICATIONS STRATEGIES AND COMMUNICATION PLATFORMS FOR OTHERS, IN CLASS 35 (U.S. CLS. 100, 101 AND 102).

FIRST USE 11-0-2010; IN COMMERCE 11-0-2010.

THE MARK CONSISTS OF STANDARD CHARACTERS WITHOUT CLAIM TO ANY PARTICULAR FONT, STYLE, SIZE, OR COLOR.

NO CLAIM IS MADE TO THE EXCLUSIVE RIGHT TO USE "SCIENTIFIC INFORMATION SHARING", APART FROM THE MARK AS SHOWN.

SER. NO. 85-511,932, FILED 1-9-2012.

JORDAN BAKER, EXAMINING ATTORNEY



*David J. Kyffers*

Director of the United States Patent and Trademark Office

# United States of America

United States Patent and Trademark Office

## THERMO-THIMBLE

**Reg. No. 4,197,808**

**Registered Aug. 28, 2012**

**Int. Cl.: 19**

**TRADEMARK**

**PRINCIPAL REGISTER**

THERMO MANUFACTURING, INC. (OHIO CORPORATION)  
3709 COLUMBUS ROAD NE  
CANTON, OH 44705

FOR: NON-METAL ELECTRICAL AND PLUMBING FITTINGS, NAMELY, A POKE THROUGH, IN THE NATURE OF A SPECIALIZED DUCT, FOR RUNNING AND SETTING ELECTRICAL WIRING, PLUMBING LINES, AND HVAC LINES, IN CLASS 19 (U.S. CLS. 1, 12, 33 AND 50).

FIRST USE 1-9-2012; IN COMMERCE 1-9-2012.

THE MARK CONSISTS OF STANDARD CHARACTERS WITHOUT CLAIM TO ANY PARTICULAR FONT, STYLE, SIZE, OR COLOR.

OWNER OF U.S. REG. NO. 2,970,589.

SER. NO. 85-512,022, FILED 1-9-2012.

HANNO RITTNER, EXAMINING ATTORNEY



*David J. Kyffers*

Director of the United States Patent and Trademark Office

# United States of America

United States Patent and Trademark Office

# OOSHIRTS

**Reg. No. 4,197,809**

**Registered Aug. 28, 2012**

**Int. Cl.: 25**

**TRADEMARK**

**PRINCIPAL REGISTER**

OOSHIRTS INC. (CALIFORNIA CORPORATION)  
#285  
64 SHATTUCK SQ  
BERKELEY, CA 94704

FOR: BOTTOMS; HOODED SWEATSHIRTS; PANTS; SHIRTS; SWEATPANTS; SWEATSHIRTS; T-SHIRTS; TOPS, IN CLASS 25 (U.S. CLS. 22 AND 39).

FIRST USE 1-1-2008; IN COMMERCE 1-1-2008.

THE MARK CONSISTS OF STANDARD CHARACTERS WITHOUT CLAIM TO ANY PARTICULAR FONT, STYLE, SIZE, OR COLOR.

SER. NO. 85-512,051, FILED 1-9-2012.

GISELLE AGOSTO, EXAMINING ATTORNEY



*David J. Kyffers*

Director of the United States Patent and Trademark Office



# United States of America

United States Patent and Trademark Office

## Pest Elimination Plus

**Reg. No. 4,197,810**

ECONOMY EXTERMINATORS, INC. (NORTH CAROLINA CORPORATION)  
2160 N. SALEM STREET  
APEX, NC 27502

**Registered Aug. 28, 2012**

**Int. Cl.: 37**

FOR: PEST CONTROL AND EXTERMINATION OTHER THAN FOR AGRICULTURAL PURPOSES, IN CLASS 37 (U.S. CLS. 100, 103 AND 106).

**SERVICE MARK**

FIRST USE 1-9-2012; IN COMMERCE 1-9-2012.

**PRINCIPAL REGISTER**

THE MARK CONSISTS OF STANDARD CHARACTERS WITHOUT CLAIM TO ANY PARTICULAR FONT, STYLE, SIZE, OR COLOR.

NO CLAIM IS MADE TO THE EXCLUSIVE RIGHT TO USE "PEST ELIMINATION", APART FROM THE MARK AS SHOWN.

SER. NO. 85-512,081, FILED 1-9-2012.

ANNE E. GUSTASON, EXAMINING ATTORNEY



*David J. Kybas*

Director of the United States Patent and Trademark Office

# United States of America

United States Patent and Trademark Office

**ONE WAY J**  
C O L L E C T I O N

**Reg. No. 4,197,811**

PAK, PAUL (UNITED STATES INDIVIDUAL), FORMERLY TYJ TRADING, INC.  
1926 N. OLYMPIC DRIVE  
VERNON HILLS, IL 60061

**Registered Aug. 28, 2012**

**Int. Cl.: 14**

FOR: COSTUME JEWELRY, IN CLASS 14 (U.S. CLS. 2, 27, 28 AND 50).

**TRADEMARK**

FIRST USE 12-1-2011; IN COMMERCE 12-1-2011.

**PRINCIPAL REGISTER**

NO CLAIM IS MADE TO THE EXCLUSIVE RIGHT TO USE "COLLECTION", APART FROM THE MARK AS SHOWN.

THE MARK CONSISTS OF THE WORDS "ONE WAY J COLLECTION" WRITTEN IN STYLIZED FORM IN WHICH THE WORDS OF "ONE WAY J" IN ON THE TOP LINE AND THE WORDS OF "COLLECTION" IS WRITTEN BENEATH IT. "J" IS ON A BLACK RECTANGULAR BACKGROUND, THE LETTER "ONE WAY" AND "COLLECTION" ARE BLACK AND "J" IS WHITE. WITHIN THE WORDING "COLLECTION" THE CHARACTER "T" DEPICTS A DESIGN OF A MEDIEVAL CROSS.

SER. NO. 85-512,127, FILED 1-9-2012.

JOHN E. MICHOS, EXAMINING ATTORNEY



*David J. Kyffers*

Director of the United States Patent and Trademark Office

# United States of America

United States Patent and Trademark Office



**Reg. No. 4,197,812**

DALLAS AREA HABITAT FOR HUMANITY INC. (TEXAS CORPORATION)  
2800 N. HAMPTON ROAD  
DALLAS, TX 75212

**Registered Aug. 28, 2012**

**Int. Cl.: 36**

FOR: CHARITABLE FUNDRAISING SERVICES BY MEANS OF AN ANNUAL DESIGN COMPETITION INTENDED TO RAISE AWARENESS OF THE ORGANIZATION'S RESALE STORES, IN CLASS 36 (U.S. CLS. 100, 101 AND 102).

**SERVICE MARK**

FIRST USE 7-22-2011; IN COMMERCE 7-22-2011.

**PRINCIPAL REGISTER**

NO CLAIM IS MADE TO THE EXCLUSIVE RIGHT TO USE "DESIGN" AND "INTERIOR DESIGN COMPETITION", APART FROM THE MARK AS SHOWN.

THE MARK CONSISTS OF THE WORDS "DESIGN DUEL" IN ALL CAPITAL LETTERS WITH CROSS-HATCH SHADING, WITH EACH WORD APPEARING IN A RECTANGLE WITH CROSS MARKS AT EACH CORNER, AND SEPARATED BY A SMALLER RECTANGLE WITH A LINE IN THE MIDDLE, WITH THE WORDS "INTERIOR DESIGN COMPETITION" WRITTEN BELOW THE RECTANGLE, ALL IN A STYLE WHICH SIMULATES CONSTRUCTION PLANS.

SER. NO. 85-512,129, FILED 1-9-2012.

JOHN E. MICHOS, EXAMINING ATTORNEY



*David J. Kyffers*

Director of the United States Patent and Trademark Office

# United States of America

United States Patent and Trademark Office



**Reg. No. 4,197,813**

**Registered Aug. 28, 2012**

**Int. Cl.: 27**

**TRADEMARK**

**PRINCIPAL REGISTER**

UNIMAT INDUSTRIES LLC (FLORIDA LIMITED LIABILITY COMPANY)  
6980 NW 43RD STREET  
MIAMI, FL 33166

FOR: FLOOR MATS, IN CLASS 27 (U.S. CLS. 19, 20, 37, 42 AND 50).

FIRST USE 12-1-2010; IN COMMERCE 1-1-2011.

THE MARK CONSISTS OF A STYLIZED LETTER "U" WITH TWO SWEEPING, CURVED LINES ACROSS IT, ABOVE THE WORD "UNIMAT" IN A STYLIZED FONT, WHICH IS IN TURN ABOVE THE PHRASE "INNOVATION IN SURFACES" IN A STYLIZED FONT.

SER. NO. 85-512,130, FILED 1-9-2012.

JAMES MACFARLANE, EXAMINING ATTORNEY



*David J. Kybas*

Director of the United States Patent and Trademark Office

# United States of America

United States Patent and Trademark Office



**Reg. No. 4,197,814**

**Registered Aug. 28, 2012**

**Int. Cls.: 35 and 41**

**SERVICE MARK**

**PRINCIPAL REGISTER**

DIAL GLOBAL, INC. (DELAWARE CORPORATION)  
220 W. 42ND STREET  
NEW YORK, NY 10036

FOR: PRODUCTION OF ADVERTISING AND PROMOTIONAL MATERIALS, IN CLASS 35 (U.S. CLS. 100, 101 AND 102).

FIRST USE 10-0-2011; IN COMMERCE 10-0-2011.

FOR: PRODUCTION AND DISTRIBUTION OF RADIO PROGRAMS; RADIO ENTERTAINMENT PRODUCTION; AND RADIO PROGRAM SYNDICATION, IN CLASS 41 (U.S. CLS. 100, 101 AND 107).

FIRST USE 10-0-2011; IN COMMERCE 10-0-2011.

THE MARK CONSISTS OF A BLUE CIRCLE CONTAINING THE LETTERS "DG" IN WHITE.

THE COLOR(S) BLUE AND WHITE IS/ARE CLAIMED AS A FEATURE OF THE MARK.

SER. NO. 85-512,153, FILED 1-9-2012.

NATALIE POLZER, EXAMINING ATTORNEY



*David J. Kybas*

Director of the United States Patent and Trademark Office

# United States of America

United States Patent and Trademark Office



**Reg. No. 4,197,815**

SHELBYVILLE INVESTMENT GROUP (TENNESSEE CORPORATION)  
295 BLUESTOCKING HOLLOW  
SHELBYVILLE, TN 37160

**Registered Aug. 28, 2012**

**Int. Cl.: 43**

FOR: RESTAURANT SERVICES, IN CLASS 43 (U.S. CLS. 100 AND 101).

**SERVICE MARK**

FIRST USE 9-1-1947; IN COMMERCE 9-1-1947.

**PRINCIPAL REGISTER**

NO CLAIM IS MADE TO THE EXCLUSIVE RIGHT TO USE "CAFÉ AIR CONDITIONED", APART FROM THE MARK AS SHOWN.

THE MARK CONSISTS OF THE FOLLOWING STYLIZED PHRASES WITH EACH STACKED UPON THE NEXT: "POPE'S", "CAFE", AND "AIR CONDITIONED" WITHIN A STYLIZED SHAPE WITH STAIR STEPS DOWN THE LEFT AND RIGHT. THE SHAPE RESEMBLES A VINTAGE NEON SIGN.

SER. NO. 85-512,163, FILED 1-9-2012.

ESTHER A. BORSUK, EXAMINING ATTORNEY



*David J. Kybas*

Director of the United States Patent and Trademark Office

# United States of America

United States Patent and Trademark Office

# HyperThetical

**Reg. No. 4,197,816**

GOLIATH TECHNOLOGIES, INC. (PENNSYLVANIA CORPORATION)  
2109 DELANCEY ST.

**Registered Aug. 28, 2012**

PHILADELPHIA, PA 19103

**Int. Cl.: 9**

FOR: COMPUTER APPLICATION SOFTWARE FOR DATACENTERS, NAMELY, SOFTWARE FOR CAPACITY PLANNING FOR VIRTUAL AND PHYSICAL MACHINES, IN CLASS 9 (U.S. CLS. 21, 23, 26, 36 AND 38).

**TRADEMARK**

FIRST USE 12-1-2011; IN COMMERCE 1-3-2012.

**PRINCIPAL REGISTER**

THE MARK CONSISTS OF STANDARD CHARACTERS WITHOUT CLAIM TO ANY PARTICULAR FONT, STYLE, SIZE, OR COLOR.

SER. NO. 85-512,169, FILED 1-9-2012.

MICHAEL WEBSTER, EXAMINING ATTORNEY



*David J. Kyros*

Director of the United States Patent and Trademark Office

# United States of America

United States Patent and Trademark Office

**POPE'S CAFE**  
**GOOD COFFEE**  
**FINE FOOD**  
*Hot* **BISCUITS**

**Reg. No. 4,197,817**

**Registered Aug. 28, 2012**

**Int. Cl.: 43**

**SERVICE MARK**

**PRINCIPAL REGISTER**

SHELBYVILLE INVESTMENT GROUP (TENNESSEE CORPORATION)  
295 BLUESTOCKING HOLLOW  
SHELBYVILLE, TN 37160

FOR: RESTAURANT SERVICES, IN CLASS 43 (U.S. CLS. 100 AND 101).

FIRST USE 9-1-1947; IN COMMERCE 9-1-1947.

NO CLAIM IS MADE TO THE EXCLUSIVE RIGHT TO USE "CAFE GOOD COFFEE FINE FOOD HOT BISCUITS", APART FROM THE MARK AS SHOWN.

THE MARK CONSISTS OF THE STYLIZED TEXT "POPE'S CAFE GOOD COFFEE FINE FOOD HOT BISCUITS".

SER. NO. 85-512,260, FILED 1-9-2012.

ESTHER A. BORSUK, EXAMINING ATTORNEY



*David J. Kyffers*

Director of the United States Patent and Trademark Office



# United States of America

United States Patent and Trademark Office

## Upper Echelon Sports Medicine and Training: "TRAIN. RACE. LIVE."

**Reg. No. 4,197,818**

**Registered Aug. 28, 2012**

**Int. Cl.: 41**

**SERVICE MARK**

**PRINCIPAL REGISTER**

CREE, RUSSELL WADE (OREGON LIMITED LIABILITY COMPANY), DBA UPPER  
ECHELON FITNESS & SPORTS MEDICINE  
1811 NW COUCH ST #404  
PORTLAND, OR 97209

FOR: COACHING IN THE FIELD OF SPORTS, IN CLASS 41 (U.S. CLS. 100, 101 AND 107).

FIRST USE 8-1-2008; IN COMMERCE 8-1-2008.

THE MARK CONSISTS OF STANDARD CHARACTERS WITHOUT CLAIM TO ANY PARTICULAR FONT, STYLE, SIZE, OR COLOR.

OWNER OF U.S. REG. NO. 4,033,715.

NO CLAIM IS MADE TO THE EXCLUSIVE RIGHT TO USE "SPORTS MEDICINE" AND "TRAINING", APART FROM THE MARK AS SHOWN.

SER. NO. 85-512,294, FILED 1-9-2012.

JACQUELINE A. LAVINE, EXAMINING ATTORNEY



*David J. Kybas*

Director of the United States Patent and Trademark Office

# United States of America

United States Patent and Trademark Office

## Chiva Culiona

**Reg. No. 4,197,819**

BBIP, LLC (FLORIDA LIMITED LIABILITY COMPANY)  
10840 SW 113 PLACE  
MIAMI, FL 33176

**Registered Aug. 28, 2012**

**Int. Cl.: 41**

FOR: ENTERTAINMENT SERVICES, NAMELY, PROVIDING A WEB SITE FEATURING PHOTOGRAPHIC, AUDIO, VIDEO AND PROSE PRESENTATIONS FEATURING ADULT-ORIENTED SUBJECT MATTER, IN CLASS 41 (U.S. CLS. 100, 101 AND 107).

**SERVICE MARK**

FIRST USE 11-18-2011; IN COMMERCE 11-18-2011.

**PRINCIPAL REGISTER**

THE MARK CONSISTS OF STANDARD CHARACTERS WITHOUT CLAIM TO ANY PARTICULAR FONT, STYLE, SIZE, OR COLOR.

OWNER OF U.S. REG. NOS. 2,810,145 AND 3,310,838.

SER. NO. 85-512,302, FILED 1-9-2012.

DAVID I, EXAMINING ATTORNEY



*David J. Kyffers*

Director of the United States Patent and Trademark Office

# United States of America

United States Patent and Trademark Office



**Reg. No. 4,197,820**

**Registered Aug. 28, 2012**

**Int. Cls.: 35 and 38**

**SERVICE MARK**

**PRINCIPAL REGISTER**

SOCIAL REALITY (DELAWARE CORPORATION)  
479 RODEO DRIVE  
BEVERLY HILLS, CA 90210

FOR: INTERNET ADVERTISING SERVICES, IN CLASS 35 (U.S. CLS. 100, 101 AND 102).

FIRST USE 4-1-2010; IN COMMERCE 4-1-2010.

FOR: BROADCASTING SERVICES, NAMELY, TRANSMISSION OF ADVERTISING PROGRAMS AND MEDIA ADVERTISING COMMUNICATIONS VIA DIGITAL COMMUNICATIONS NETWORKS, IN CLASS 38 (U.S. CLS. 100, 101 AND 104).

FIRST USE 4-1-2010; IN COMMERCE 4-1-2010.

NO CLAIM IS MADE TO THE EXCLUSIVE RIGHT TO USE "SOCIAL", APART FROM THE MARK AS SHOWN.

THE COLOR(S) GRAY, PINK, PURPLE, BLUE, GREEN, YELLOW, ORANGE AND RED IS/ARE CLAIMED AS A FEATURE OF THE MARK.

THE MARK CONSISTS OF THE WORD "SOCIAL" SPELLED OUT IN GRAY LETTERS ON THE LEFT SIDE FOLLOWED BY AN ARTISTICALLY SHAPED LETTER "S" WITH A GAP AT THE TOP RIGHT AND BOTTOM LEFT AND WITH THE COLORS OVERLAPPING EACH OTHER FROM TOP RIGHT TO BOTTOM LEFT INCLUDE PINK, PURPLE, BLUE, GREEN, YELLOW, ORANGE, AND RED FOLLOWED BY THE WORD "REALITY" SPELLED OUT IN GRAY LETTERS ON THE RIGHT SIDE OF THE IMAGE.

SER. NO. 85-512,352, FILED 1-9-2012.

JOHN WILKE, EXAMINING ATTORNEY



*David J. Kybas*

Director of the United States Patent and Trademark Office

# United States of America

United States Patent and Trademark Office

## ALL CITY ANIMAL TRAPPING & REMOVAL

**Reg. No. 4,197,821**

TRAPPER TREVOR, INC. (CALIFORNIA CORPORATION)  
1321 N ALAMEDA ST  
WILMINGTON, CA 90744

**Registered Aug. 28, 2012**

**Int. Cl.: 39**

FOR: ANIMAL REMOVAL SERVICES, IN CLASS 39 (U.S. CLS. 100 AND 105).

**SERVICE MARK**

FIRST USE 0-0-1995; IN COMMERCE 0-0-1995.

**PRINCIPAL REGISTER**

THE MARK CONSISTS OF STANDARD CHARACTERS WITHOUT CLAIM TO ANY PARTICULAR FONT, STYLE, SIZE, OR COLOR.

NO CLAIM IS MADE TO THE EXCLUSIVE RIGHT TO USE "ANIMAL TRAPPING & REMOVAL", APART FROM THE MARK AS SHOWN.

SER. NO. 85-512,363, FILED 1-9-2012.

MIDGE BUTLER, EXAMINING ATTORNEY



*David J. Kyffers*

Director of the United States Patent and Trademark Office

# United States of America

United States Patent and Trademark Office

# TK BURGERS

**Reg. No. 4,197,822**

**Registered Aug. 28, 2012**

**Int. Cl.: 43**

**SERVICE MARK**

**PRINCIPAL REGISTER**

TK'S FAST GRILL, INC. (CALIFORNIA CORPORATION)  
110 PACIFIC COAST HIGHWAY  
HUNTINGTON BEACH, CA 92660

FOR: RESTAURANT SERVICES, IN CLASS 43 (U.S. CLS. 100 AND 101).

FIRST USE 5-1-1995; IN COMMERCE 12-31-2000.

THE MARK CONSISTS OF STANDARD CHARACTERS WITHOUT CLAIM TO ANY PARTICULAR FONT, STYLE, SIZE, OR COLOR.

OWNER OF U.S. REG. NO. 3,810,905.

NO CLAIM IS MADE TO THE EXCLUSIVE RIGHT TO USE "BURGERS", APART FROM THE MARK AS SHOWN.

SER. NO. 85-512,422, FILED 1-10-2012.

JANICE KIM, EXAMINING ATTORNEY



*David J. Kyffers*

Director of the United States Patent and Trademark Office

# United States of America

United States Patent and Trademark Office

# The Maids

**Reg. No. 4,197,823**

THE MAIDS INTERNATIONAL, INC. (NEBRASKA CORPORATION)  
9394 WEST DODGE STREET, SUITE 140  
OMAHA, NE 68114

**Registered Aug. 28, 2012**

**Int. Cl.: 37**

FOR: RESIDENTIAL AND COMMERCIAL CLEANING SERVICES, IN CLASS 37 (U.S. CLS. 100, 103 AND 106).

**SERVICE MARK**

FIRST USE 4-15-2010; IN COMMERCE 4-15-2010.

**PRINCIPAL REGISTER**

OWNER OF U.S. REG. NOS. 1,184,135, 2,247,181, AND 2,928,853.

THE MARK CONSISTS OF THE STYLIZED WORDS "THE MAIDS" UNDER FOUR STYLIZED STARS.

SEC. 2(F) AS TO "THE MAIDS".

SER. NO. 85-512,456, FILED 1-10-2012.

MARILYN IZZI, EXAMINING ATTORNEY



*David J. Kyffers*

Director of the United States Patent and Trademark Office

# United States of America

United States Patent and Trademark Office



**Reg. No. 4,197,824**

**Registered Aug. 28, 2012**

**Int. Cl.: 30**

**TRADEMARK**

**PRINCIPAL REGISTER**

LITTLE BIRD ENTERPRISES LLC (MARYLAND LIMITED LIABILITY COMPANY)  
#115  
1810-J YORK ROAD  
LUTHERVILLE, MD 21093

FOR: POPCORN, IN CLASS 30 (U.S. CL. 46).

FIRST USE 5-29-2011; IN COMMERCE 10-17-2011.

NO CLAIM IS MADE TO THE EXCLUSIVE RIGHT TO USE "ORIGINAL POPCORN", APART FROM THE MARK AS SHOWN.

THE MARK CONSISTS OF THE STYLIZED TEXT "POP!" ABOVE THE STYLIZED TEXT "PIERSON'S ORIGINAL POPCORN". AROUND THE TEXT ARE CURVING BORDERS AND BEHIND THE TEXT IS A BACKGROUND OF VERTICAL LINES. THERE IS A CIRCLE IN THE CENTER OF THE LETTER "O" IN "POP!".

SER. NO. 85-512,474, FILED 1-10-2012.

KIMBERLY PERRY, EXAMINING ATTORNEY



*David J. Kybas*

Director of the United States Patent and Trademark Office

# United States of America

United States Patent and Trademark Office

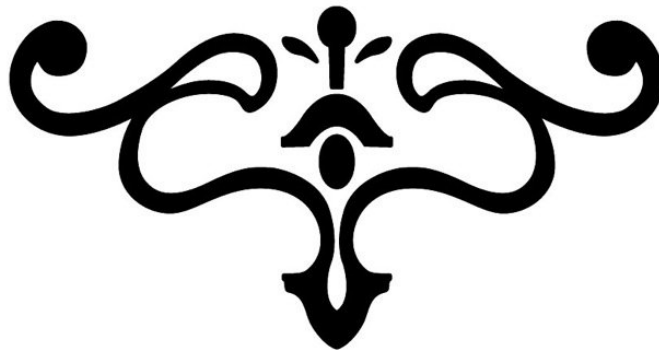

**Reg. No. 4,197,825**

**Registered Aug. 28, 2012**

**Int. Cl.: 30**

**TRADEMARK**

**PRINCIPAL REGISTER**

KILWIN'S CHOCOLATES FRANCHISE, INC. (MICHIGAN CORPORATION)  
355 NORTH DIVISION ROAD  
PETOSKEY, MI 49770

FOR: CANDY; ICE CREAM; FROZEN CONFECTIONS; CONFECTIONERY MADE OF SUGAR; CHOCOLATE AND CHOCOLATES; AND CHOCOLATE CANDY, IN CLASS 30 (U.S. CL. 46).

FIRST USE 5-26-2011; IN COMMERCE 5-26-2011.

THE MARK CONSISTS OF SCROLLWORK AND FLOURISH DESIGN.

SER. NO. 85-512,480, FILED 1-10-2012.

AMY ALFIERI, EXAMINING ATTORNEY



*David J. Kyffers*

Director of the United States Patent and Trademark Office



# United States of America

United States Patent and Trademark Office

## Advantage Hobby

**Reg. No. 4,197,826**

**Registered Aug. 28, 2012**

**Int. Cl.: 35**

**SERVICE MARK**

**PRINCIPAL REGISTER**

HOBBY LOGISTICS, LLC (ILLINOIS LIMITED LIABILITY COMPANY)  
2710D NORTH MATTIS AVE.  
CHAMPAIGN, IL 61822

FOR: ON-LINE RETAIL STORE SERVICES FEATURING REMOTE CONTROL TOYS, NAMELY, AIRPLANES, HELICOPTERS, CARS, TRUCKS, TRAINS, BOATS, AND ROBOTS.; RETAIL STORE SERVICES FEATURING REMOTE CONTROL TOYS, NAMELY, AIRPLANES, HELICOPTERS, CARS, TRUCKS, TRAINS, BOATS, AND ROBOTS. ACCESSIBLE ON-LINE AND BY TELEPHONE, FACSIMILE AND MAIL ORDER; RETAIL HOBBY STORES, IN CLASS 35 (U.S. CLS. 100, 101 AND 102).

FIRST USE 8-20-2006; IN COMMERCE 8-20-2006.

THE MARK CONSISTS OF STANDARD CHARACTERS WITHOUT CLAIM TO ANY PARTICULAR FONT, STYLE, SIZE, OR COLOR.

NO CLAIM IS MADE TO THE EXCLUSIVE RIGHT TO USE "HOBBY", APART FROM THE MARK AS SHOWN.

SER. NO. 85-512,508, FILED 1-10-2012.

KAPIL BHANOT, EXAMINING ATTORNEY



*David J. Kyffers*

Director of the United States Patent and Trademark Office

# United States of America

United States Patent and Trademark Office

## Eat. Drink. Be Murdered.

**Reg. No. 4,197,827**

**Registered Aug. 28, 2012**

**Int. Cl.: 41**

**SERVICE MARK**

**PRINCIPAL REGISTER**

MCCAFFERY MYSTERIES, INC. (PENNSYLVANIA DOMESTIC NONPROFIT CORP SECTION 5306)  
SUITE 103  
200 HIDDEN RIDGE CT.  
SOUTH PARK, PA 15129

FOR: ENTERTAINMENT AND EDUCATIONAL SERVICES, NAMELY, PRESENTATION OF LIVE COMEDY MURDER MYSTERY SHOWS, FOR THE PURPOSE OF TEACHING PROBLEM SOLVING SKILLS AND TEAM WORK, IN CLASS 41 (U.S. CLS. 100, 101 AND 107).

FIRST USE 1-1-2001; IN COMMERCE 1-1-2001.

THE MARK CONSISTS OF STANDARD CHARACTERS WITHOUT CLAIM TO ANY PARTICULAR FONT, STYLE, SIZE, OR COLOR.

NO CLAIM IS MADE TO THE EXCLUSIVE RIGHT TO USE "MURDERED", APART FROM THE MARK AS SHOWN.

SER. NO. 85-512,564, FILED 1-10-2012.

ERIN FALK, EXAMINING ATTORNEY



*David J. Kyffers*

Director of the United States Patent and Trademark Office

# United States of America

United States Patent and Trademark Office

## The Background Screening Lifeline

**Reg. No. 4,197,828**

SECURTEST, INC. (GEORGIA CORPORATION)  
1720 EPPS BRIDGE PARKWAY SUITE 108-380  
ATHENS, GA 30606

**Registered Aug. 28, 2012**

**Int. Cl.: 45**

FOR: EMPLOYMENT BACKGROUND SCREENING, NAMELY, BACKGROUND SCREENING OF CURRENT EMPLOYEES OF OTHERS, IN CLASS 45 (U.S. CLS. 100 AND 101).

**SERVICE MARK**

FIRST USE 12-31-2011; IN COMMERCE 12-31-2011.

**PRINCIPAL REGISTER**

THE MARK CONSISTS OF STANDARD CHARACTERS WITHOUT CLAIM TO ANY PARTICULAR FONT, STYLE, SIZE, OR COLOR.

NO CLAIM IS MADE TO THE EXCLUSIVE RIGHT TO USE "BACKGROUND SCREENING", APART FROM THE MARK AS SHOWN.

SER. NO. 85-512,574, FILED 1-10-2012.

LOURDES AYALA, EXAMINING ATTORNEY



*David J. Kybas*

Director of the United States Patent and Trademark Office

# United States of America

United States Patent and Trademark Office

## CENTERS FOR WORKING FAMILIES

**Reg. No. 4,197,829**

THE ANNIE E. CASEY FOUNDATION (DELAWARE NON-PROFIT CORPORATION)  
701 ST. PAUL STREET  
BALTIMORE, MD 21202

**Registered Aug. 28, 2012**

**Int. Cl.: 36**

FOR: FINANCIAL CONSULTING SERVICES TO LOW INCOME FAMILIES AT COMMUNITY CENTERS, IN CLASS 36 (U.S. CLS. 100, 101 AND 102).

**SERVICE MARK**

FIRST USE 4-0-2002; IN COMMERCE 4-0-2002.

**PRINCIPAL REGISTER**

THE MARK CONSISTS OF STANDARD CHARACTERS WITHOUT CLAIM TO ANY PARTICULAR FONT, STYLE, SIZE, OR COLOR.

OWNER OF U.S. REG. NO. 3,115,418.

NO CLAIM IS MADE TO THE EXCLUSIVE RIGHT TO USE "CENTERS", APART FROM THE MARK AS SHOWN.

SEC. 2(F).

SER. NO. 85-512,579, FILED 1-10-2012.

EMILY CHUO, EXAMINING ATTORNEY



*David J. Kybas*

Director of the United States Patent and Trademark Office

# United States of America

United States Patent and Trademark Office

con su fe todo es posible

**Reg. No. 4,197,830**

LUCUMIPRODUCTS INC. (TEXAS CORPORATION), DBA LUCUMI WHOLESALE & IMPORT  
25218 STERLING CLOUD LANE  
KATY, TX 77494

**Registered Aug. 28, 2012**

**Int. Cl.: 35**

FOR: ON-LINE RETAIL STORE SERVICES FEATURING RITUAL PERFUMES, OILS, LOTIONS, SCENTED WATERS, INCENSE, CANDLES, SPELLS, COLOGNES AND CLEANSERS, IN CLASS 35 (U.S. CLS. 100, 101 AND 102).

**SERVICE MARK**

FIRST USE 3-0-1984; IN COMMERCE 1-0-2000.

**PRINCIPAL REGISTER**

THE MARK CONSISTS OF STANDARD CHARACTERS WITHOUT CLAIM TO ANY PARTICULAR FONT, STYLE, SIZE, OR COLOR.

THE ENGLISH TRANSLATION OF "CON SU FE TODO ES POSIBLE" IN THE MARK IS "WITH YOUR FAITH ANYTHING IS POSSIBLE".

SER. NO. 85-512,681, FILED 1-10-2012.

RONALD MCMORROW, EXAMINING ATTORNEY



*David J. Kyffers*

Director of the United States Patent and Trademark Office

# United States of America

United States Patent and Trademark Office



**Reg. No. 4,197,831**

**Registered Aug. 28, 2012**

**Int. Cl.: 43**

**SERVICE MARK**

**PRINCIPAL REGISTER**

TK'S FAST GRILL, INC. (CALIFORNIA CORPORATION)  
110 PACIFIC COAST HIGHWAY  
HUNTINGTON BEACH, CA 92660

FOR: RESTAURANT SERVICES, IN CLASS 43 (U.S. CLS. 100 AND 101).

FIRST USE 10-31-2011; IN COMMERCE 10-31-2011.

OWNER OF U.S. REG. NO. 3,810,905.

NO CLAIM IS MADE TO THE EXCLUSIVE RIGHT TO USE "BURGERS", APART FROM THE MARK AS SHOWN.

THE MARK CONSISTS OF THE WORD "BURGERS" HAVING A TIKI TORCH MAN IN A RUNNING POSITION WHO IS HOLDING A SURFBOARD OVER THE LETTERS "BU" IN THE WORD "BURGERS" AND TO THE RIGHT OF THE TIKI TORCH MAN ARE THE LETTERS "TK" IN A TRIANGLE OVER THE LETTERS "RGE" IN THE WORD "BURGERS".

SER. NO. 85-512,792, FILED 1-10-2012.

JANICE KIM, EXAMINING ATTORNEY



*David J. Kyffers*

Director of the United States Patent and Trademark Office

# United States of America

United States Patent and Trademark Office

# Dayseam

**Reg. No. 4,197,832**

SEAMLESS RECORDS, LLC (PENNSYLVANIA LIMITED LIABILITY COMPANY)  
3605 BROWNSVILLE ROAD  
TREVOSE, PA 19053

**Registered Aug. 28, 2012**

**Int. Cl.: 41**

FOR: ENTERTAINMENT IN THE NATURE OF LIVE PERFORMANCES BY A MUSICAL GROUP, IN CLASS 41 (U.S. CLS. 100, 101 AND 107).

**SERVICE MARK**

FIRST USE 1-27-2009; IN COMMERCE 1-27-2009.

**PRINCIPAL REGISTER**

THE MARK CONSISTS OF STANDARD CHARACTERS WITHOUT CLAIM TO ANY PARTICULAR FONT, STYLE, SIZE, OR COLOR.

SER. NO. 85-512,817, FILED 1-10-2012.

GIANCARLO CASTRO, EXAMINING ATTORNEY



*David J. Kybas*

Director of the United States Patent and Trademark Office

# United States of America

United States Patent and Trademark Office



## Insight Principles

**Reg. No. 4,197,833**

**Registered Aug. 28, 2012**

**Int. Cl.: 35**

**SERVICE MARK**

**PRINCIPAL REGISTER**

INSIGHT PRINCIPLES, INC. (MASSACHUSETTS CORPORATION)  
9 BUTLER AVENUE  
LEXINGTON, MA 02421

FOR: ADVERTISING AND BUSINESS SERVICES, NAMELY, BUSINESS CONSULTATION SERVICES IN THE FIELD OF BUSINESS INNOVATION, ORGANIZATIONAL TRANSFORMATION, AND TALENT DEVELOPMENT STRATEGIES, IN CLASS 35 (U.S. CLS. 100, 101 AND 102).

FIRST USE 10-21-2010; IN COMMERCE 10-21-2010.

THE MARK CONSISTS OF TWO LARGE BLOCK LETTERS: A LARGE BLOCK LETTER "I", BLACK IN COLOR, FOLLOWED BY A LARGE BLOCK LETTER "P", RED IN COLOR, IN THE MIDDLE OF THE MARK, AND CENTERED WITHIN THE MARK. AN INCANDESCENT LIGHT BULB DESIGN ELEMENT APPEARS AT THE TOP, WHEREBY THE SOCKET PORTION OF THE BULB SITS DIRECTLY ATOP THE BLOCK LETTER "I" AND IS COLINEAR WITH BLOCK LETTER "I", HAVING BLACK THREADS AND A YELLOW BULB. AT THE BOTTOM OF THE MARK, BENEATH THE BLOCK LETTERS, LITERAL ELEMENTS "INSIGHT PRINCIPLES" APPEAR IN BLACK AS PLAIN TEXT.

THE COLOR(S) YELLOW, RED, AND BLACK IS/ARE CLAIMED AS A FEATURE OF THE MARK.

SER. NO. 85-512,824, FILED 1-10-2012.

LEIGH CAROLINE CASE, EXAMINING ATTORNEY



*David J. Kyros*

Director of the United States Patent and Trademark Office



# United States of America

United States Patent and Trademark Office

# X 3 SIXTY

**Reg. No. 4,197,834**

**Registered Aug. 28, 2012**

**Int. Cl.: 41**

**SERVICE MARK**

**PRINCIPAL REGISTER**

CLEARLY CONFUSED, INC. (CALIFORNIA CORPORATION)  
6520 PLATT AVE, SUITE 399  
WEST HILLS, CA 91307

FOR: CREATING AND DEVELOPING CONCEPTS FOR TELEVISION PROGRAMS; ENTERTAINMENT IN THE NATURE OF PRODUCTION OF SHORT FILMS AND MOTION PICTURES FOR RELEASE THROUGH VOD PLATFORMS AND GENERAL RELEASE, SPECIFICALLY FOCUSED ON NEWS AND ENTERTAINMENT PROGRAMMING; MULTIMEDIA ENTERTAINMENT SERVICES IN THE NATURE OF DEVELOPMENT, PRODUCTION AND POST-PRODUCTION SERVICES IN THE FIELDS OF VIDEO AND FILMS; PRODUCTION OF TELEVISION PROGRAMS; PROVISION OF NON-DOWNLOADABLE FILMS AND TELEVISION PROGRAMMES VIA A VIDEO-ON-DEMAND SERVICE, IN CLASS 41 (U.S. CLS. 100, 101 AND 107).

FIRST USE 6-2-2011; IN COMMERCE 6-2-2011.

THE MARK CONSISTS OF STANDARD CHARACTERS WITHOUT CLAIM TO ANY PARTICULAR FONT, STYLE, SIZE, OR COLOR.

SER. NO. 85-512,875, FILED 1-10-2012.

JENNY PARK, EXAMINING ATTORNEY



*David J. Kyffers*

Director of the United States Patent and Trademark Office

# United States of America

United States Patent and Trademark Office

## TenBridge Partners

**Reg. No. 4,197,835**

TENBRIDGE PARTNERS, LLC (OREGON LIMITED LIABILITY COMPANY)  
811 SW NAITO PKWY., SUITE 200  
PORTLAND, OR 97204

**Registered Aug. 28, 2012**

**Int. Cl.: 36**

FOR: INVESTMENT AND FINANCIAL RISK MANAGEMENT CONSULTING SERVICES,  
IN CLASS 36 (U.S. CLS. 100, 101 AND 102).

**SERVICE MARK**

FIRST USE 1-1-2012; IN COMMERCE 1-1-2012.

**PRINCIPAL REGISTER**

THE MARK CONSISTS OF STANDARD CHARACTERS WITHOUT CLAIM TO ANY PARTICULAR FONT, STYLE, SIZE, OR COLOR.

NO CLAIM IS MADE TO THE EXCLUSIVE RIGHT TO USE "PARTNERS", APART FROM THE MARK AS SHOWN.

SER. NO. 85-512,891, FILED 1-10-2012.

TARAH HARDY, EXAMINING ATTORNEY



*David J. Kybas*

Director of the United States Patent and Trademark Office

# United States of America

United States Patent and Trademark Office

## Handcrafted Ales & Lagers Brewed with Aloha

**Reg. No. 4,197,836**

**Registered Aug. 28, 2012**

**Int. Cl.: 32**

**TRADEMARK**

**PRINCIPAL REGISTER**

AUMAKUA HOLDINGS INC. (HAWAII CORPORATION), DBA MAUI BREWING CO.  
910 HONOAPIILANI HWY #55  
LAHAINA, HI 96761

FOR: BEER; BEER MAKING KIT; BEER, ALE AND LAGER; BEER, ALE AND PORTER;  
BEER, ALE, LAGER, STOUT AND PORTER; BEER, ALE, LAGER, STOUT, PORTER,  
SHANDY; BEER-BASED COOLERS; BEERS; BLACK BEER; BREWED MALT-BASED AL-  
COHOLIC BEVERAGE IN THE NATURE OF A BEER; COFFEE-FLAVORED BEER;  
FLAVORED BEERS; GINGER BEER; MALT BEER; PALE BEER; PORTER, IN CLASS 32  
(U.S. CLS. 45, 46 AND 48).

FIRST USE 1-1-2006; IN COMMERCE 1-1-2006.

THE MARK CONSISTS OF STANDARD CHARACTERS WITHOUT CLAIM TO ANY PAR-  
TICULAR FONT, STYLE, SIZE, OR COLOR.

NO CLAIM IS MADE TO THE EXCLUSIVE RIGHT TO USE "HANDCRAFTED ALES &  
LAGERS BREWED", APART FROM THE MARK AS SHOWN.

SEC. 2(F).

SER. NO. 85-512,895, FILED 1-10-2012.

TARAH HARDY, EXAMINING ATTORNEY



*David J. Kyros*

Director of the United States Patent and Trademark Office

**United States of America**  
United States Patent and Trademark Office

# BONEYARD

**Reg. No. 4,197,837**

FULL RUT.NET, INC. (FLORIDA CORPORATION)  
9031 NORTHWEST 162 TERRACE  
MIAMI LAKES, FL 33018

**Registered Aug. 28, 2012**

**Int. Cl.: 41**

FOR: ENTERTAINMENT SERVICES, NAMELY, TELEVISION PROGRAMS FEATURING OUTDOOR ACTIVITIES IN THE NATURE OF HUNTING AND FISHING, IN CLASS 41 (U.S. CLS. 100, 101 AND 107).

**SERVICE MARK**

FIRST USE 9-1-2011; IN COMMERCE 9-1-2011.

**PRINCIPAL REGISTER**

THE MARK CONSISTS OF STANDARD CHARACTERS WITHOUT CLAIM TO ANY PARTICULAR FONT, STYLE, SIZE, OR COLOR.

SER. NO. 85-512,901, FILED 1-10-2012.

JOHN WILKE, EXAMINING ATTORNEY



*David J. Kyffers*

Director of the United States Patent and Trademark Office

# United States of America

United States Patent and Trademark Office

## Thunder Creek Equipment

**Reg. No. 4,197,838**

LDJ MANUFACTURING, INC. (IOWA CORPORATION)  
1833 HWY 163  
PELLA, IA 50219

**Registered Aug. 28, 2012**

**Int. Cl.: 12**

FOR: FUEL TRAILERS AND SERVICE TRAILERS, IN CLASS 12 (U.S. CLS. 19, 21, 23, 31, 35 AND 44).

**TRADEMARK**

FIRST USE 3-1-2009; IN COMMERCE 3-1-2009.

**PRINCIPAL REGISTER**

THE MARK CONSISTS OF STANDARD CHARACTERS WITHOUT CLAIM TO ANY PARTICULAR FONT, STYLE, SIZE, OR COLOR.

NO CLAIM IS MADE TO THE EXCLUSIVE RIGHT TO USE "EQUIPMENT", APART FROM THE MARK AS SHOWN.

SER. NO. 85-512,904, FILED 1-10-2012.

MARILYN IZZI, EXAMINING ATTORNEY



*David J. Kyffers*

Director of the United States Patent and Trademark Office

# United States of America

United States Patent and Trademark Office

## Pro-Prep leather softener

**Reg. No. 4,197,839**

**Registered Aug. 28, 2012**

**Int. Cl.: 4**

**TRADEMARK**

**PRINCIPAL REGISTER**

WEBSTER'S SPORTING GOODS, INC. (INDIANA CORPORATION), DBA WEBSTER'S SPORTING GOODS, INC.  
5060 E. 62ND ST.  
INDIANAPOLIS, IN 46220

FOR: LEATHER PRESERVING OIL AND GREASE, IN CLASS 4 (U.S. CLS. 1, 6 AND 15).

FIRST USE 3-28-1988; IN COMMERCE 3-28-1988.

THE MARK CONSISTS OF STANDARD CHARACTERS WITHOUT CLAIM TO ANY PARTICULAR FONT, STYLE, SIZE, OR COLOR.

NO CLAIM IS MADE TO THE EXCLUSIVE RIGHT TO USE "LEATHER SOFTENER", APART FROM THE MARK AS SHOWN.

SER. NO. 85-512,910, FILED 1-10-2012.

KAREN K. BUSH, EXAMINING ATTORNEY



*David J. Kyffers*

Director of the United States Patent and Trademark Office

# United States of America

United States Patent and Trademark Office

## SHUT UP AND FISH

**Reg. No. 4,197,840**

FULL RUT.NET, INC. (FLORIDA CORPORATION)  
9031 NORTHWEST 162 TERRACE  
MIAMI LAKES, FL 33018

**Registered Aug. 28, 2012**

**Int. Cl.: 41**

FOR: ENTERTAINMENT SERVICES, NAMELY, TELEVISION PROGRAMS FEATURING OUTDOOR ACTIVITIES IN THE NATURE OF HUNTING AND FISHING, IN CLASS 41 (U.S. CLS. 100, 101 AND 107).

**SERVICE MARK**

FIRST USE 9-1-2011; IN COMMERCE 9-1-2011.

**PRINCIPAL REGISTER**

THE MARK CONSISTS OF STANDARD CHARACTERS WITHOUT CLAIM TO ANY PARTICULAR FONT, STYLE, SIZE, OR COLOR.

SER. NO. 85-512,920, FILED 1-10-2012.

JOHN WILKE, EXAMINING ATTORNEY



*David J. Kyffers*

Director of the United States Patent and Trademark Office

# United States of America

United States Patent and Trademark Office

# GEB

**Reg. No. 4,197,841**

**Registered Aug. 28, 2012**

**Int. Cl.: 9**

**TRADEMARK**

**PRINCIPAL REGISTER**

GENE ERA BIOTECH. CO., LTD. (CHINA CORPORATION)  
256 SOUTH JIANGHONG NAN ROAD  
BINJIANG DISTRICT, CHINA

FOR: GLASS TUBES FOR SCIENTIFIC PURPOSES; LABORATORY APPARATUS AND INSTRUMENTS, NAMELY, BOTTLE TOP FILTERS USED FOR THE PURIFICATION OF TISSUE CULTURE MEDIA; LABORATORY APPARATUS, NAMELY, CENTRIFUGES; LABORATORY CONSUMABLES, NAMELY, PIPETTE TIPS; LABORATORY EQUIPMENT AND SUPPLIES, NAMELY, TEST TUBES; PLATES, GLASS SLIDES OR CHIPS HAVING MULTI-WELL ARRAYS THAT CAN BE USED IN CHEMICAL ANALYSIS, BIOLOGICAL ANALYSIS OR PATTERNING FOR SCIENTIFIC, LABORATORY OR MEDICAL RESEARCH USE, IN CLASS 9 (U.S. CLS. 21, 23, 26, 36 AND 38).

FIRST USE 2-10-2011; IN COMMERCE 2-10-2011.

THE MARK CONSISTS OF STANDARD CHARACTERS WITHOUT CLAIM TO ANY PARTICULAR FONT, STYLE, SIZE, OR COLOR.

SER. NO. 85-512,931, FILED 1-10-2012.

TARAH HARDY, EXAMINING ATTORNEY



*David J. Kypos*

Director of the United States Patent and Trademark Office



# United States of America

United States Patent and Trademark Office

## SHUT UP AND HUNT

**Reg. No. 4,197,842**

FULL RUT.NET, INC. (FLORIDA CORPORATION)  
9031 NORTHWEST 162 TERRACE  
MIAMI LAKES, FL 33018

**Registered Aug. 28, 2012**

**Int. Cl.: 41**

FOR: ENTERTAINMENT SERVICES, NAMELY, TELEVISION PROGRAMS FEATURING OUTDOOR ACTIVITIES IN THE NATURE OF HUNTING AND FISHING, IN CLASS 41 (U.S. CLS. 100, 101 AND 107).

**SERVICE MARK**

FIRST USE 9-1-2011; IN COMMERCE 9-1-2011.

**PRINCIPAL REGISTER**

THE MARK CONSISTS OF STANDARD CHARACTERS WITHOUT CLAIM TO ANY PARTICULAR FONT, STYLE, SIZE, OR COLOR.

SER. NO. 85-512,936, FILED 1-10-2012.

JOHN WILKE, EXAMINING ATTORNEY



*David J. Kyffers*

Director of the United States Patent and Trademark Office

# United States of America

United States Patent and Trademark Office

# Ringinator

**Reg. No. 4,197,843**

MARTIN LEMIEUX (UNITED STATES INDIVIDUAL)  
POBOX 580692

**Registered Aug. 28, 2012**

MINNEAPOLIS, MN 55458

**Int. Cl.: 7**

FOR: METAL WORKING MACHINES, NAMELY, SAWS AND CUTTERS, IN CLASS 7 (U.S. CLS. 13, 19, 21, 23, 31, 34 AND 35).

**TRADEMARK**

FIRST USE 11-24-2008; IN COMMERCE 11-24-2008.

**PRINCIPAL REGISTER**

THE MARK CONSISTS OF STANDARD CHARACTERS WITHOUT CLAIM TO ANY PARTICULAR FONT, STYLE, SIZE, OR COLOR.

SER. NO. 85-512,950, FILED 1-10-2012.

GEORGE LORENZO, EXAMINING ATTORNEY



*David J. Kybas*

Director of the United States Patent and Trademark Office

# United States of America

United States Patent and Trademark Office

## Thunder Creek Customs

**Reg. No. 4,197,844**

LDJ MANUFACTURING, INC. (IOWA CORPORATION)  
1833 HWY 163  
PELLA, IA 50219

**Registered Aug. 28, 2012**

**Int. Cl.: 12**

FOR: MOTORCYCLE-MOUNTED ACCESSORY STORAGE ASSEMBLIES AND ACCESSORY RACKS FOR MOTORCYCLE EQUIPMENT; MOTORCYCLE TRAILERS, IN CLASS 12 (U.S. CLS. 19, 21, 23, 31, 35 AND 44).

**TRADEMARK**

FIRST USE 11-1-2008; IN COMMERCE 11-1-2008.

**PRINCIPAL REGISTER**

THE MARK CONSISTS OF STANDARD CHARACTERS WITHOUT CLAIM TO ANY PARTICULAR FONT, STYLE, SIZE, OR COLOR.

NO CLAIM IS MADE TO THE EXCLUSIVE RIGHT TO USE "CUSTOMS", APART FROM THE MARK AS SHOWN.

SER. NO. 85-512,969, FILED 1-10-2012.

MARILYN IZZI, EXAMINING ATTORNEY



*David J. Kyffers*

Director of the United States Patent and Trademark Office

# United States of America

United States Patent and Trademark Office

# LUCKY GI

**Reg. No. 4,197,845**

NELSON, SCOTT W. (UNITED STATES INDIVIDUAL)  
720 20TH STREET  
BEAUMONT, TX 77706

**Registered Aug. 28, 2012**

**Int. Cls.: 25 and 28**

FOR: T-SHIRTS, PANTS, HEAD WEAR, SWEAT SHIRTS, SWEAT PANTS, SHORTS, UNDERWEAR, BELTS, JACKETS, ATHLETIC UNIFORMS, BEACHWEAR, BATHING SUITS, MIXED MARTIAL ARTS SUITS, TANK-TOPS, TRACK SUITS, UNDER GARMENTS, YOGA PANTS, YOGA SHIRTS, IN CLASS 25 (U.S. CLS. 22 AND 39).

**TRADEMARK**

**PRINCIPAL REGISTER**

FIRST USE 0-0-2007; IN COMMERCE 0-0-2007.

FOR: SPORTS EQUIPMENT FOR BOXING AND MARTIAL ARTS, NAMELY, BOXING GLOVES, BOXING BAGS, PUNCHING MITTS, BELLY PROTECTORS, GROIN PROTECTORS AND SHIN GUARDS; MARTIAL ARTS TRAINING EQUIPMENT; MIXED MARTIAL ARTS GLOVES; SHIN GUARDS FOR ATHLETIC USE; ATHLETIC PROTECTIVE PADS FOR MARTIAL ARTS, IN CLASS 28 (U.S. CLS. 22, 23, 38 AND 50).

FIRST USE 0-0-2007; IN COMMERCE 0-0-2007.

THE MARK CONSISTS OF STANDARD CHARACTERS WITHOUT CLAIM TO ANY PARTICULAR FONT, STYLE, SIZE, OR COLOR.

OWNER OF U.S. REG. NO. 3,408,458.

NO CLAIM IS MADE TO THE EXCLUSIVE RIGHT TO USE "GI", APART FROM THE MARK AS SHOWN.

SER. NO. 85-512,977, FILED 1-10-2012.

DEBORAH LOBO, EXAMINING ATTORNEY



*David J. Kyffers*

Director of the United States Patent and Trademark Office

# United States of America

United States Patent and Trademark Office

## JIMMY CHEW

**Reg. No. 4,197,846**

**Registered Aug. 28, 2012**

**Int. Cls.: 9, 18 and 25**

**TRADEMARK**

**PRINCIPAL REGISTER**

J. CHOO LIMITED (ENGLAND CORPORATION)  
KENSINGTON CHURCH STREET  
4 LANCER SQUARE  
LONDON, ENGLAND W84EH

FOR: SUNGLASSES, SUNGLASS CASES AND FRAMES, IN CLASS 9 (U.S. CLS. 21, 23, 26, 36 AND 38).

FOR: TRAVELING BAGS; HANDBAGS; PURSES; WALLETS, IN CLASS 18 (U.S. CLS. 1, 2, 3, 22 AND 41).

FOR: FOOTWEAR; SCARVES, IN CLASS 25 (U.S. CLS. 22 AND 39).

THE MARK CONSISTS OF STANDARD CHARACTERS WITHOUT CLAIM TO ANY PARTICULAR FONT, STYLE, SIZE, OR COLOR.

OWNER OF ERPN CMNTY TM OFC REG. NO. 005067764, DATED 2-22-2007, EXPIRES 4-13-2016.

OWNER OF U.S. REG. NOS. 3,128,827, 4,021,226 AND OTHERS.

THE NAME(S), PORTRAIT(S), AND/OR SIGNATURE(S) SHOWN IN THE MARK DOES NOT IDENTIFY A PARTICULAR LIVING INDIVIDUAL.

SER. NO. 85-513,004, FILED 1-10-2012.

JUDITH HELFMAN, EXAMINING ATTORNEY



*David J. Kybas*

Director of the United States Patent and Trademark Office

# United States of America

United States Patent and Trademark Office

# SEW PRIDDY

**Reg. No. 4,197,847**

SEW PRIDDY LLC (TEXAS LIMITED LIABILITY COMPANY)  
2334 W BUCKINGHAM RD STE 230-120  
GARLAND, TX 75042

**Registered Aug. 28, 2012**

**Int. Cl.: 25**

FOR: WOMEN'S, CHILDREN'S, TODDLER'S AND BABY'S CLOTHING, NAMELY, DRESSES, SKIRTS, SWEATSHIRTS, HOODED SWEATSHIRTS, SHIRTS, PANTS, SHORTS, SOCKS, IN CLASS 25 (U.S. CLS. 22 AND 39).

**TRADEMARK**

FIRST USE 8-13-2011; IN COMMERCE 11-11-2011.

**PRINCIPAL REGISTER**

THE MARK CONSISTS OF STANDARD CHARACTERS WITHOUT CLAIM TO ANY PARTICULAR FONT, STYLE, SIZE, OR COLOR.

SER. NO. 85-513,017, FILED 1-10-2012.

KEVIN DINALLO, EXAMINING ATTORNEY



*David J. Kyffers*

Director of the United States Patent and Trademark Office

# United States of America

United States Patent and Trademark Office



**Reg. No. 4,197,848**

**Registered Aug. 28, 2012**

**Int. Cl.: 25**

**TRADEMARK**

**PRINCIPAL REGISTER**

AMERICAN PUBLIC UNIVERSITY SYSTEM, INC. (WEST VIRGINIA CORPORATION)  
111 W. CONGRESS STREET  
CHARLES TOWN, WV 25414

FOR: APRONS; HATS; T-SHIRTS; VISORS, IN CLASS 25 (U.S. CLS. 22 AND 39).

FIRST USE 6-17-2011; IN COMMERCE 6-17-2011.

THE MARK CONSISTS OF A STYLIZED DESIGN OF AN EAGLE HEAD BETWEEN THE WORDS "GOLDEN EAGLES". THE INITIALS "AMU" APPEAR ABOVE THE WORD "EAGLES".

SER. NO. 85-513,020, FILED 1-10-2012.

SHAILA SETTLES, EXAMINING ATTORNEY



*David J. Kyffers*

Director of the United States Patent and Trademark Office

# United States of America

United States Patent and Trademark Office



**Reg. No. 4,197,849**

AMERICAN PUBLIC UNIVERSITY SYSTEM, INC. (WEST VIRGINIA CORPORATION)  
111 W. CONGRESS STREET  
CHARLES TOWN, WV 25414

**Registered Aug. 28, 2012**

**Int. Cl.: 21**

FOR: PORTABLE BEVERAGE COOLERS; SPORTS BOTTLES SOLD EMPTY, IN CLASS 21  
(U.S. CLS. 2, 13, 23, 29, 30, 33, 40 AND 50).

**TRADEMARK**

FIRST USE 6-17-2011; IN COMMERCE 6-17-2011.

**PRINCIPAL REGISTER**

THE MARK CONSISTS OF A STYLIZED DESIGN OF AN EAGLE HEAD BETWEEN THE  
WORDS "GOLDEN" AND "EAGLES"; THE INITIALS "AMU" APPEAR ABOVE THE WORD  
"EAGLES".

SER. NO. 85-513,073, FILED 1-10-2012.

SHAILA SETTLES, EXAMINING ATTORNEY



*David J. Kybas*

Director of the United States Patent and Trademark Office



# United States of America

United States Patent and Trademark Office

# TPF

**Reg. No. 4,197,850**

**Registered Aug. 28, 2012**

**Int. Cl.: 36**

**SERVICE MARK**

**PRINCIPAL REGISTER**

TEXAS PRESBYTERIAN FOUNDATION (TEXAS NON-PROFIT CORPORATION)  
6100 COLWELL BLVD., STE. 250  
IRVING, TX 75039

FOR: CHARITABLE FOUNDATION SERVICES, NAMELY, PROVIDING FUNDS DEVELOPMENT SERVICES TO SUPPORT RELIGIOUS AND EDUCATIONAL INSTITUTIONS; FINANCIAL SERVICES, NAMELY, INVESTMENT MANAGEMENT, INVESTMENT CONSULTATION AND INVESTMENT OF FUNDS FOR OTHERS; ESTATE TRUST PLANNING AND MANAGEMENT, IN CLASS 36 (U.S. CLS. 100, 101 AND 102).

FIRST USE 12-31-1978; IN COMMERCE 12-31-1983.

THE MARK CONSISTS OF STANDARD CHARACTERS WITHOUT CLAIM TO ANY PARTICULAR FONT, STYLE, SIZE, OR COLOR.

SER. NO. 85-513,075, FILED 1-10-2012.

DOMINIC FATHY, EXAMINING ATTORNEY



*David J. Kybas*

Director of the United States Patent and Trademark Office

# United States of America

United States Patent and Trademark Office

# superbook

**Reg. No. 4,197,851**

**Registered Aug. 28, 2012**

**Int. Cls.: 9 and 38**

**TRADEMARK**

**SERVICE MARK**

**PRINCIPAL REGISTER**

CHRISTIAN BROADCASTING NETWORK, INC., THE (VIRGINIA CORPORATION)  
977 CENTERVILLE TURNPIKE  
VIRGINIA BEACH, VA 234630001

FOR: DIGITAL MEDIA, NAMELY, PRE-RECORDED VIDEO CASSETTES, COMPACT DISCS, DIGITAL VIDEO DISCS, DOWNLOADABLE AUDIO AND VIDEO RECORDINGS, DVDS, AND HIGH DEFINITION DIGITAL DISCS FEATURING ANIMATED CHILDREN'S PROGRAMMING, IN CLASS 9 (U.S. CLS. 21, 23, 26, 36 AND 38).

FIRST USE 10-15-1984; IN COMMERCE 10-15-1984.

FOR: STREAMING OF VIDEO MATERIAL ON THE INTERNET; CABLE TELEVISION BROADCASTING; TELEVISION BROADCASTING; SATELLITE BROADCASTING, IN CLASS 38 (U.S. CLS. 100, 101 AND 104).

FIRST USE 10-8-1982; IN COMMERCE 10-8-1982.

THE MARK CONSISTS OF STANDARD CHARACTERS WITHOUT CLAIM TO ANY PARTICULAR FONT, STYLE, SIZE, OR COLOR.

OWNER OF U.S. REG. NOS. 3,384,641 AND 3,865,690.

SER. NO. 85-513,081, FILED 1-10-2012.

ANDREW RHIM, EXAMINING ATTORNEY



*David J. Kyffers*

Director of the United States Patent and Trademark Office

# United States of America

United States Patent and Trademark Office



**Reg. No. 4,197,852**

AMERICAN PUBLIC UNIVERSITY SYSTEM, INC. (WEST VIRGINIA CORPORATION)  
111 W. CONGRESS STREET  
CHARLES TOWN, WV 25414

**Registered Aug. 28, 2012**

**Int. Cl.: 24**

FOR: BEACH TOWELS; BED BLANKETS; BLANKETS FOR OUTDOOR USE, IN CLASS 24  
(U.S. CLS. 42 AND 50).

**TRADEMARK**

FIRST USE 6-23-2011; IN COMMERCE 6-23-2011.

**PRINCIPAL REGISTER**

THE MARK CONSISTS OF A STYLIZED DESIGN OF AN EAGLE HEAD BETWEEN THE  
WORDS "GOLDEN" AND "EAGLES"; THE INITIALS "AMU" APPEAR ABOVE THE WORD  
"EAGLES".

SER. NO. 85-513,083, FILED 1-10-2012.

SHAILA SETTLES, EXAMINING ATTORNEY



*David J. Kybas*

Director of the United States Patent and Trademark Office

# United States of America

United States Patent and Trademark Office

# Savannah

**Reg. No. 4,197,853**

AMENDIA, INC. (GEORGIA CORPORATION)  
1755 WEST OAK PARKWAY  
MARIETTA, GA 30062

**Registered Aug. 28, 2012**

**Int. Cl.: 10**

FOR: BONE SCREWS; MEDICAL DEVICES, NAMELY, DEVICES FOR SPINAL DISC REPAIR IN THE NATURE OF AN APPARATUS USED IN SPINAL DISC REPAIR PROCEDURES, IN CLASS 10 (U.S. CLS. 26, 39 AND 44).

**TRADEMARK**

FIRST USE 3-4-2011; IN COMMERCE 3-4-2011.

**PRINCIPAL REGISTER**

THE MARK CONSISTS OF STANDARD CHARACTERS WITHOUT CLAIM TO ANY PARTICULAR FONT, STYLE, SIZE, OR COLOR.

SER. NO. 85-513,084, FILED 1-10-2012.

TEJBIR SINGH, EXAMINING ATTORNEY



*David J. Kybas*

Director of the United States Patent and Trademark Office

# United States of America

United States Patent and Trademark Office

## WAGGLETOPS

**Reg. No. 4,197,854**

BETH LARSEN (UNITED STATES INDIVIDUAL)  
61237 KING SOLOMON LANE  
BEND, OR 61237

**Registered Aug. 28, 2012**

**Int. Cl.: 24**

FOR: COVERS FOR CUSHIONS, PILLOWS AND BEDS FOR PETS, IN CLASS 24 (U.S. CLS. 42 AND 50).

**TRADEMARK**

FIRST USE 1-6-2012; IN COMMERCE 1-6-2012.

**PRINCIPAL REGISTER**

THE MARK CONSISTS OF STANDARD CHARACTERS WITHOUT CLAIM TO ANY PARTICULAR FONT, STYLE, SIZE, OR COLOR.

SER. NO. 85-513,086, FILED 1-10-2012.

ANDREW RHIM, EXAMINING ATTORNEY



*David J. Kybas*

Director of the United States Patent and Trademark Office

# United States of America

United States Patent and Trademark Office

# GALENIC

**Reg. No. 4,197,855**

**Registered Aug. 28, 2012**

**Int. Cls.: 3 and 5**

**TRADEMARK**

**PRINCIPAL REGISTER**

PIERRE FABRE DERMO-COSMETIQUE (FRANCE SOCIÉTÉ PAR ACTIONS SIMPLIFIÉE (SAS))  
45, PLACE ABEL GANCE  
BOULOGNE, FRANCE 92100

FOR: COSMETICS, NAMELY, CLEANSING GELS, MILKS, MAKE UP REMOVERS, SKIN MASKS, SKIN LOTIONS, BODY AND FACIAL EMULSIONS AND BODY OILS, IN CLASS 3 (U.S. CLS. 1, 4, 6, 50, 51 AND 52).

FOR: MEDICATED SKIN CARE PREPARATIONS FOR REPAIRING, MOISTURIZING AND PROTECTING, IN CLASS 5 (U.S. CLS. 6, 18, 44, 46, 51 AND 52).

THE MARK CONSISTS OF STANDARD CHARACTERS WITHOUT CLAIM TO ANY PARTICULAR FONT, STYLE, SIZE, OR COLOR.

OWNER OF FRANCE REG. NO. 932,385, DATED 10-1-1975, EXPIRES 9-24-2015.

OWNER OF U.S. REG. NOS. 1,120,806 AND 2,528,904.

SER. NO. 85-513,102, FILED 1-10-2012.

VIVIAN MICZNIK FIRST, EXAMINING ATTORNEY



*David J. Kybas*

Director of the United States Patent and Trademark Office

# United States of America

United States Patent and Trademark Office



**Reg. No. 4,197,856**

DOBYNS RODS, INC. (CALIFORNIA CORPORATION)  
1828 STABLER LANE, SUITE 630  
YUBA CITY, CA 95993

**Registered Aug. 28, 2012**

**Int. Cls.: 16, 25 and 28**

FOR: DECALS, STICKERS, IN CLASS 16 (U.S. CLS. 2, 5, 22, 23, 29, 37, 38 AND 50).

FIRST USE 12-31-2010; IN COMMERCE 12-31-2010.

**TRADEMARK**

FOR: CLOTHING, NAMELY, T-SHIRTS, HATS AND SWEATSHIRTS, IN CLASS 25 (U.S. CLS. 22 AND 39).

**PRINCIPAL REGISTER**

FIRST USE 12-31-2010; IN COMMERCE 12-31-2010.

FOR: FISHING RODS; COMPONENTS FOR FISHING RODS, NAMELY, GUIDES, REEL SEATS, AND HOOK HOLDERS, IN CLASS 28 (U.S. CLS. 22, 23, 38 AND 50).

FIRST USE 12-31-2010; IN COMMERCE 12-31-2010.

NO CLAIM IS MADE TO THE EXCLUSIVE RIGHT TO USE "RODS", APART FROM THE MARK AS SHOWN.

THE MARK CONSISTS OF A DESIGN OF A FISH WITH THE TERM "DOBYNS" OVER THE FISH. THE TERM "RODS" IS BELOW "DOBYNS" IN SMALLER FONT TO THE RIGHT.

SER. NO. 85-513,172, FILED 1-10-2012.

SALLY SHIH, EXAMINING ATTORNEY



*David J. Kybas*

Director of the United States Patent and Trademark Office

# United States of America

United States Patent and Trademark Office

# NxSeq

**Reg. No. 4,197,857**

**Registered Aug. 28, 2012**

**Int. Cl.: 1**

**TRADEMARK**

**PRINCIPAL REGISTER**

LUCIGEN CORPORATION (WISCONSIN CORPORATION)  
2120 W. GREENVIEW DRIVE  
MIDDLETON, WI 53562

FOR: ASSAYS AND REAGENTS FOR USE IN GENETIC RESEARCH; BIOCHEMICAL REAGENTS COMMONLY KNOWN AS PROBES, FOR DETECTING AND ANALYZING MOLECULES IN PROTEIN OR NUCLEOTIDE ARRAYS; CHEMICAL REAGENTS FOR NON-MEDICAL PURPOSES; NUCLEIC ACID SEQUENCES AND CHEMICAL REAGENTS FOR OTHER THAN MEDICAL AND VETERINARY PURPOSES; REAGENTS FOR RESEARCH PURPOSES; REAGENTS FOR SCIENTIFIC OR MEDICAL RESEARCH USE, IN CLASS 1 (U.S. CLS. 1, 5, 6, 10, 26 AND 46).

FIRST USE 11-15-2011; IN COMMERCE 11-15-2011.

THE MARK CONSISTS OF STANDARD CHARACTERS WITHOUT CLAIM TO ANY PARTICULAR FONT, STYLE, SIZE, OR COLOR.

SER. NO. 85-513,197, FILED 1-10-2012.

MAYUR VAGHANI, EXAMINING ATTORNEY



*David J. Kyros*

Director of the United States Patent and Trademark Office



# United States of America

United States Patent and Trademark Office

# PERMA LOCK

**Reg. No. 4,197,858**

DAVIE, JR., WARREN PAT (UNITED STATES INDIVIDUAL)  
#3 VETERANS MEMORIAL BLVD.  
KENNER, LA 70062

**Registered Aug. 28, 2012**

**Int. Cl.: 37**

FOR: CONSTRUCTION AND BUILDING REPAIR SERVICES, NAMELY, FOUNDATION UNDERPINNING SERVICES, IN CLASS 37 (U.S. CLS. 100, 103 AND 106).

**SERVICE MARK**

FIRST USE 1-1-2003; IN COMMERCE 1-1-2003.

**PRINCIPAL REGISTER**

THE MARK CONSISTS OF STANDARD CHARACTERS WITHOUT CLAIM TO ANY PARTICULAR FONT, STYLE, SIZE, OR COLOR.

SER. NO. 85-513,199, FILED 1-10-2012.

TASNEEM HUSSAIN, EXAMINING ATTORNEY



*David J. Kybas*

Director of the United States Patent and Trademark Office

# United States of America

United States Patent and Trademark Office

## WHATEVER IT TAKES!

**Reg. No. 4,197,859**

TRIWEST HEALTHCARE ALLIANCE CORP. (DELAWARE CORPORATION)

**Registered Aug. 28, 2012**

16010 N. 28TH AVENUE  
PHOENIX, AZ 85053

**Int. Cl.: 36**

FOR: MANAGING AND ADMINISTRATING HEALTH CARE PLANS, NAMELY, PREFERRED PROVIDER ORGANIZATION HEALTH CARE PLANS, HEALTH MAINTENANCE ORGANIZATIONS PLANS, AND FEE FOR SERVICE PLANS, IN CLASS 36 (U.S. CLS. 100, 101 AND 102).

**SERVICE MARK**

**PRINCIPAL REGISTER**

FIRST USE 8-21-1995; IN COMMERCE 8-21-1995.

THE MARK CONSISTS OF STANDARD CHARACTERS WITHOUT CLAIM TO ANY PARTICULAR FONT, STYLE, SIZE, OR COLOR.

SER. NO. 85-513,215, FILED 1-10-2012.

ESTHER A. BORSUK, EXAMINING ATTORNEY



*David J. Kybas*

Director of the United States Patent and Trademark Office

# United States of America

United States Patent and Trademark Office

# FICB

**Reg. No. 4,197,860**

ASSET BUILDERS OF AMERICA INC. (WISCONSIN CORPORATION)  
1213 N. SHERMAN AVE  
MADISON, WI 53704

**Registered Aug. 28, 2012**

**Int. Cl.: 41**

FOR: EDUCATION SERVICES, NAMELY, PROVIDING AN EDUCATIONAL QUESTION AND ANSWER GAME IN WHICH STUDENT TEAMS COMPETE AT A TOURNAMENT, WITH THE QUESTIONS TESTING THE STUDENTS' KNOWLEDGE IN THE FIELD OF PERSONAL FINANCE, IN CLASS 41 (U.S. CLS. 100, 101 AND 107).

**SERVICE MARK**

**PRINCIPAL REGISTER**

FIRST USE 0-0-2006; IN COMMERCE 0-0-2006.

THE MARK CONSISTS OF STANDARD CHARACTERS WITHOUT CLAIM TO ANY PARTICULAR FONT, STYLE, SIZE, OR COLOR.

SER. NO. 85-513,248, FILED 1-10-2012.

MATTHEW KLINE, EXAMINING ATTORNEY



*David J. Kyffers*

Director of the United States Patent and Trademark Office

# United States of America

United States Patent and Trademark Office

## RODEO UNCORKED!

**Reg. No. 4,197,861**

**Registered Aug. 28, 2012**

**Int. Cl.: 41**

**SERVICE MARK**

**PRINCIPAL REGISTER**

HOUSTON LIVESTOCK SHOW & RODEO, INC. (TEXAS CORPORATION)  
RELIANT CENTER  
8334 FANNIN STREET  
HOUSTON, TX 77054

FOR: ORGANIZING AND CONDUCTING MUSICAL ENTERTAINMENT EVENTS FEATURING FOOD AND BEVERAGES; ENTERTAINMENT SERVICES, NAMELY, FOOD AND BEVERAGE TASTINGS; ORGANIZING LIVE ENTERTAINMENT FEATURING WINE AUCTIONS AND DINNER, IN CLASS 41 (U.S. CLS. 100, 101 AND 107).

FIRST USE 12-31-2004; IN COMMERCE 12-31-2004.

THE MARK CONSISTS OF STANDARD CHARACTERS WITHOUT CLAIM TO ANY PARTICULAR FONT, STYLE, SIZE, OR COLOR.

SER. NO. 85-513,250, FILED 1-10-2012.

MATTHEW KLINE, EXAMINING ATTORNEY



*David J. Kybas*

Director of the United States Patent and Trademark Office

# United States of America

United States Patent and Trademark Office

# SEFC

**Reg. No. 4,197,862**

**Registered Aug. 28, 2012**

**Int. Cl.: 42**

**SERVICE MARK**

**PRINCIPAL REGISTER**

S.E.F.C. ENGINEERS, INC. (KENTUCKY CORPORATION)  
SUITE 215  
828 LANE ALLEN ROAD  
LEXINGTON, KY 40504

FOR: ENGINEERING SERVICES IN THE FIELD OF PLANNING, EVALUATING, DESIGNING, COST ESTIMATING, CONSTRUCTION DOCUMENTS, FORENSIC, RESEARCH AND TECHNICAL DOCUMENTS AND REPORTS IN THE RELATED SCIENTIFIC AND TECHNOLOGICAL FIELDS, TO DEVELOP COMPONENT ENGINEERING CONSTRUCTION DOCUMENTS FOR THE INDUSTRY, TO PERFORM FORENSIC ENGINEERING AND CONSULTING SERVICES TO DETERMINE ORIGIN AND CAUSATION, EVALUATION OF CLAIMS AND REMEDIATION STRATEGIES WITH OR WITHOUT CONSTRUCTION DOCUMENTS, TO PROVIDE RELATED EXPERT TESTIMONIES IN LITIGATION CASES, IN CLASS 42 (U.S. CLS. 100 AND 101).

FIRST USE 12-21-2011; IN COMMERCE 12-21-2011.

THE MARK CONSISTS OF STANDARD CHARACTERS WITHOUT CLAIM TO ANY PARTICULAR FONT, STYLE, SIZE, OR COLOR.

SER. NO. 85-513,270, FILED 1-10-2012.

THEODORE MCBRIDE, EXAMINING ATTORNEY



*David J. Kybas*

Director of the United States Patent and Trademark Office

# United States of America

United States Patent and Trademark Office



## RIVERBRIDGE

*Personal wealth advisors*

**Reg. No. 4,197,863**

**Registered Aug. 28, 2012**

**Int. Cl.: 36**

**SERVICE MARK**

**PRINCIPAL REGISTER**

RIVERBRIDGE PARTNERS, LLC (MINNESOTA LIMITED LIABILITY COMPANY)  
SUITE 1200  
527 MARQUETTE AVENUE SOUTH  
MINNEAPOLIS, MN 55402

FOR: FINANCIAL SERVICES, NAMELY, WEALTH MANAGEMENT SERVICES, IN CLASS  
36 (U.S. CLS. 100, 101 AND 102).

FIRST USE 12-19-2011; IN COMMERCE 1-10-2012.

OWNER OF U.S. REG. NO. 3,293,628.

THE COLOR(S) GOLD AND GRAY IS/ARE CLAIMED AS A FEATURE OF THE MARK.

NO CLAIM IS MADE TO THE EXCLUSIVE RIGHT TO USE "PERSONAL WEALTH AD-  
VISORS", APART FROM THE MARK AS SHOWN.

THE MARK CONSISTS OF THE WORD "RIVERBRIDGE" IN THE COLOR GRAY WITH AN  
ARCH IN THE COLOR GOLD APPEARING ABOVE THE WORD "RIVERBRIDGE" WITH  
THE WORDS "PERSONAL WEALTH ADVISORS" IN THE COLOR GOLD APPEARING  
BELOW THE WORD "RIVERBRIDGE".

SER. NO. 85-513,280, FILED 1-10-2012.

BILL DAWE, EXAMINING ATTORNEY



*David J. Kybas*

Director of the United States Patent and Trademark Office

# United States of America

United States Patent and Trademark Office

# **MOHAWK**

## **MEDICAL MALL**

**Reg. No. 4,197,864**

MOHAWK HOSPITAL EQUIPMENT (NEW YORK CORPORATION)  
335 COLUMBIA ST.  
UTICA, NY 13502

**Registered Aug. 28, 2012**

**Int. Cl.: 35**

FOR: ON-LINE WHOLESALE STORE SERVICES FEATURING MEDICAL EQUIPMENT  
AND MEDICAL SUPPLIES SALES, IN CLASS 35 (U.S. CLS. 100, 101 AND 102).

**SERVICE MARK**

FIRST USE 1-15-2005; IN COMMERCE 1-15-2005.

**PRINCIPAL REGISTER**

OWNER OF U.S. REG. NO. 4,059,605.

NO CLAIM IS MADE TO THE EXCLUSIVE RIGHT TO USE "MEDICAL MALL", APART  
FROM THE MARK AS SHOWN.

SER. NO. 85-513,327, FILED 1-10-2012.

ELLEN BURNS, EXAMINING ATTORNEY



*David J. Kyffers*

Director of the United States Patent and Trademark Office

# United States of America

United States Patent and Trademark Office

## THE HAIR TIMES

**Reg. No. 4,197,865**

THE HAIR TIMES, INC. (NEW YORK CORPORATION)  
109-72 FRANCIS BLVD.  
JAMAICA, NY 11429

**Registered Aug. 28, 2012**

**Int. Cl.: 41**

FOR: MAGAZINE PUBLISHING; MULTIMEDIA PUBLISHING OF BOOKS, MAGAZINES, JOURNALS, SOFTWARE, GAMES, MUSIC, AND ELECTRONIC PUBLICATIONS; PROVIDING ON-LINE MAGAZINES IN THE FIELD OF COSMETICS, SPECIFICALLY FOR HAIR PRODUCTS, WIGS AND HAIR CARE; PUBLICATION OF MAGAZINES; PUBLISHING OF WEB MAGAZINES, IN CLASS 41 (U.S. CLS. 100, 101 AND 107).

**SERVICE MARK**

**PRINCIPAL REGISTER**

FIRST USE 1-4-2012; IN COMMERCE 1-4-2012.

THE MARK CONSISTS OF STANDARD CHARACTERS WITHOUT CLAIM TO ANY PARTICULAR FONT, STYLE, SIZE, OR COLOR.

NO CLAIM IS MADE TO THE EXCLUSIVE RIGHT TO USE "HAIR", APART FROM THE MARK AS SHOWN.

SER. NO. 85-513,353, FILED 1-10-2012.

JEFFREY LOOK, EXAMINING ATTORNEY



*David J. Kyffers*

Director of the United States Patent and Trademark Office



# United States of America

United States Patent and Trademark Office

The logo for SWINN features the word "SWINN" in a bold, italicized, sans-serif font. Above the letter "N" is a stylized wing graphic consisting of three horizontal lines that curve upwards and to the right, ending in a pointed tip.

**Reg. No. 4,197,866**

**Registered Aug. 28, 2012**

**Int. Cl.: 40**

**SERVICE MARK**

**PRINCIPAL REGISTER**

SWINN EXHIBIT (TEXAS LIMITED LIABILITY COMPANY)

A  
5300 LEDESMA  
AUSTIN, TX 78721

FOR: CUSTOM IMPRINTING OF SPORTS BRAS, HATS, CANVAS BAGS, AND SHIRTS WITH DECORATIVE DESIGNS, IN CLASS 40 (U.S. CLS. 100, 103 AND 106).

FIRST USE 10-14-2011; IN COMMERCE 11-21-2011.

THE MARK CONSISTS OF THE STYLIZED TEXT "SWINN" WITH A WING ON TOP OF IT.

SER. NO. 85-513,384, FILED 1-10-2012.

JOHN WILKE, EXAMINING ATTORNEY



*David J. Kybas*

Director of the United States Patent and Trademark Office

# United States of America

United States Patent and Trademark Office



**Reg. No. 4,197,867**

**Registered Aug. 28, 2012**

**Int. Cl.: 35**

**SERVICE MARK**

**PRINCIPAL REGISTER**

SILICON VALLEY CORPORATE RELOCATION LLC (CALIFORNIA LIMITED LIABILITY COMPANY)  
SUITE C1 #405  
2310 HOMESTEAD RD  
LOS ALTOS, CA 94024

FOR: BUSINESS RELOCATION SERVICES, IN CLASS 35 (U.S. CLS. 100, 101 AND 102).

FIRST USE 12-1-2011; IN COMMERCE 1-3-2012.

NO CLAIM IS MADE TO THE EXCLUSIVE RIGHT TO USE "SILICON VALLEY CORPORATE RELOCATION", APART FROM THE MARK AS SHOWN.

THE MARK CONSISTS OF A BRIDGE WITH THE STYLIZED TEXT "SILICON VALLEY CORPORATE RELOCATION".

SER. NO. 85-513,387, FILED 1-10-2012.

ANNE E. GUSTASON, EXAMINING ATTORNEY



*David J. Kybas*

Director of the United States Patent and Trademark Office

# United States of America

United States Patent and Trademark Office

# PHILIPPIAN

**Reg. No. 4,197,868**

**Registered Aug. 28, 2012**

**Int. Cl.: 9**

**TRADEMARK**

**PRINCIPAL REGISTER**

MITCHELL, PHILIPPIAN (UNITED STATES INDIVIDUAL)  
PO BOX 1901  
TULSA, OK 741011901

FOR: MUSICAL RECORDINGS, IN CLASS 9 (U.S. CLS. 21, 23, 26, 36 AND 38).

FIRST USE 12-4-2006; IN COMMERCE 12-4-2006.

THE MARK CONSISTS OF STANDARD CHARACTERS WITHOUT CLAIM TO ANY PARTICULAR FONT, STYLE, SIZE, OR COLOR.

SER. NO. 85-513,397, FILED 1-10-2012.

SUE LAWRENCE, EXAMINING ATTORNEY



*David J. Kyffers*

Director of the United States Patent and Trademark Office

# United States of America

United States Patent and Trademark Office



**Reg. No. 4,197,869**

ROELLE, MICHAEL T (OREGON PARTNERSHIP), DBA GLACIER TANKS  
12518 NE AIRPORT WAY SUITE 148  
PORTLAND, OR 97230

**Registered Aug. 28, 2012**

**Int. Cl.: 6**

FOR: METAL FLUID STORAGE TANKS; METAL STORAGE TANKS AND ROOFS THEREFOR; WATER TANKS OF METAL FOR HOUSEHOLD PURPOSES, IN CLASS 6 (U.S. CLS. 2, 12, 13, 14, 23, 25 AND 50).

**TRADEMARK**

FIRST USE 6-1-2006; IN COMMERCE 6-4-2006.

**PRINCIPAL REGISTER**

NO CLAIM IS MADE TO THE EXCLUSIVE RIGHT TO USE "TANKS", APART FROM THE MARK AS SHOWN.

THE COLOR(S) DARK BLUE, LIGHT BLUE, WHITE AND BLACK IS/ARE CLAIMED AS A FEATURE OF THE MARK.

THE MARK CONSISTS OF DARK BLUE WORDS "GLACIER TANKS" OUTLINED IN BLACK WITH A LIGHT BLUE MOUNTAIN SCENE IN THE BACKGROUND THAT HAS RIDGES AND VALLEYS THAT ARE INDICATED WITH LINES THAT ARE DARK BLUE LIKE THE WORDS AND ARE OUTLINED IN DARK BLUE AND THE LIGHT BLUE OF THE MOUNTAIN FADES TO WHITE AT THE BOTTOM.

SER. NO. 85-513,450, FILED 1-10-2012.

REBECCA SMITH, EXAMINING ATTORNEY



*David J. Kybas*

Director of the United States Patent and Trademark Office

# United States of America

United States Patent and Trademark Office

## Grateful Heads

**Reg. No. 4,197,870**

TAYLOR, ANDREW, B (UNITED STATES INDIVIDUAL)  
2319 PEACH STREET  
SALEM, VA 24153

**Registered Aug. 28, 2012**

**Int. Cl.: 25**

FOR: TIE DYED HEADWEAR, IN CLASS 25 (U.S. CLS. 22 AND 39).

**TRADEMARK**

FIRST USE 1-8-2011; IN COMMERCE 1-9-2011.

**PRINCIPAL REGISTER**

THE MARK CONSISTS OF STANDARD CHARACTERS WITHOUT CLAIM TO ANY PARTICULAR FONT, STYLE, SIZE, OR COLOR.

SER. NO. 85-513,470, FILED 1-10-2012.

SHAILA SETTLES, EXAMINING ATTORNEY



*David J. Kyffers*

Director of the United States Patent and Trademark Office

# United States of America

United States Patent and Trademark Office

## BAD APPLE TATTOO

**Reg. No. 4,197,871**

**Registered Aug. 28, 2012**

**Int. Cl.: 44**

**SERVICE MARK**

**PRINCIPAL REGISTER**

BAD APPLE TATTOO, LLC (NEVADA LIMITED LIABILITY COMPANY)  
STE. B  
5640 WEST CHARLESTON BLVD.  
LAS VEGAS, NV 89146 AND

CROTSLEY, JACK EDWARD (UNITED STATES INDIVIDUAL)  
SUITE B  
5640 WEST CHARLESTON BLVD.  
LAS VEGAS, NV 89146

FOR: TATTOOING SERVICES , IN CLASS 44 (U.S. CLS. 100 AND 101).

FIRST USE 10-20-2009; IN COMMERCE 10-20-2009.

THE MARK CONSISTS OF STANDARD CHARACTERS WITHOUT CLAIM TO ANY PARTICULAR FONT, STYLE, SIZE, OR COLOR.

NO CLAIM IS MADE TO THE EXCLUSIVE RIGHT TO USE "TATTOO", APART FROM THE MARK AS SHOWN.

SER. NO. 85-513,526, FILED 1-11-2012.

ALEX KEAM, EXAMINING ATTORNEY



*David J. Kybas*

Director of the United States Patent and Trademark Office

# United States of America

United States Patent and Trademark Office

# NxGen

**Reg. No. 4,197,872**

**Registered Aug. 28, 2012**

**Int. Cl.: 1**

**TRADEMARK**

**PRINCIPAL REGISTER**

LUCIGEN CORPORATION (WISCONSIN CORPORATION)  
2120 W. GREENVIEW DRIVE  
MIDDLETON, WI 53562

FOR: ASSAYS AND REAGENTS FOR USE IN GENETIC RESEARCH; BIOCHEMICAL REAGENTS USED FOR NON-MEDICAL PURPOSES; CHEMICAL SOLUTIONS AND PREPARATIONS CONSISTING OF PRE-MIXED REACTANTS AND REAGENTS FOR SCIENTIFIC AND RESEARCH USE IN CONNECTION WITH AMPLIFICATION, ANALYSIS OR LABELING OF NUCLEIC ACID; REAGENT KITS COMPRISING GENERIC DNA CIRCLE, DNA PRIMERS, POLYMERASE AND BUFFERS FOR USE IN BIOTECHNOLOGY FIELDS; REAGENTS FOR RESEARCH PURPOSES; REAGENTS FOR SCIENTIFIC OR MEDICAL RESEARCH USE, IN CLASS 1 (U.S. CLS. 1, 5, 6, 10, 26 AND 46).

FIRST USE 5-15-2011; IN COMMERCE 5-15-2011.

THE MARK CONSISTS OF STANDARD CHARACTERS WITHOUT CLAIM TO ANY PARTICULAR FONT, STYLE, SIZE, OR COLOR.

SER. NO. 85-513,580, FILED 1-11-2012.

MAYUR VAGHANI, EXAMINING ATTORNEY



*David J. Kypos*

Director of the United States Patent and Trademark Office

# United States of America

United States Patent and Trademark Office

American **ED** tv

**Reg. No. 4,197,873**

AMERICAN EDUCATION TELEVISION NETWORK (OHIO LIMITED LIABILITY COMPANY)  
3691 GALE RD.  
GRANVILLE, OH 43023

**Registered Aug. 28, 2012**

**Int. Cl.: 38**

FOR: TELEVISION BROADCASTING, IN CLASS 38 (U.S. CLS. 100, 101 AND 104).

**SERVICE MARK**

FIRST USE 8-1-2010; IN COMMERCE 8-1-2010.

**PRINCIPAL REGISTER**

NO CLAIM IS MADE TO THE EXCLUSIVE RIGHT TO USE "AMERICAN ED TV", APART FROM THE MARK AS SHOWN.

THE STIPPLING IS FOR SHADING PURPOSES ONLY.

THE MARK CONSISTS OF THE STYLIZED TEXT "AMERICANEDTV" WHERE THE LETTERS "E", "D" ARE LARGER THAN THE REST OF THE TEXT. A GRADUATION CAP RESTS ON THE RIGHT UPPER CORNER OF THE LETTER "D".

SER. NO. 85-513,633, FILED 1-11-2012.

DAVID MURRAY, EXAMINING ATTORNEY



*David J. Kyffers*

Director of the United States Patent and Trademark Office



# United States of America

United States Patent and Trademark Office



**Reg. No. 4,197,874**

**Registered Aug. 28, 2012**

**Int. Cl.: 9**

**TRADEMARK**

**PRINCIPAL REGISTER**

SW GLOBAL CORP. (CALIFORNIA CORPORATION)  
#105  
15929 E. VALLEY BLVD.  
CITY OF INDUSTRY, CA 91744

FOR: EYEWEAR, IN CLASS 9 (U.S. CLS. 21, 23, 26, 36 AND 38).

FIRST USE 2-0-2011; IN COMMERCE 2-0-2011.

NO CLAIM IS MADE TO THE EXCLUSIVE RIGHT TO USE "EYEWEAR", APART FROM THE MARK AS SHOWN.

THE MARK CONSISTS OF A STYLIZED LETTER "S", FOLLOWED BY A STYLIZED LETTER "W", FOLLOWED BY A STYLIZED LETTER "G", EACH ON A SQUARE BACKGROUND, AND THE WORD "EYEWEAR" BELOW.

SER. NO. 85-513,650, FILED 1-11-2012.

KATHERINE CHANG, EXAMINING ATTORNEY



*David J. Kyffers*

Director of the United States Patent and Trademark Office

# United States of America

United States Patent and Trademark Office

# LOOKOUT

**Reg. No. 4,197,875**

**Registered Aug. 28, 2012**

**Int. Cl.: 30**

**TRADEMARK**

**PRINCIPAL REGISTER**

CHATTANOOGA BAKERY, INC. (TENNESSEE CORPORATION)  
900 MANUFACTURERS ROAD  
CHATTANOOGA, TN 37405

FOR: CHEESE FLAVORED PASTRY, IN CLASS 30 (U.S. CL. 46).

FIRST USE 5-1-2011; IN COMMERCE 5-1-2011.

THE MARK CONSISTS OF STANDARD CHARACTERS WITHOUT CLAIM TO ANY PARTICULAR FONT, STYLE, SIZE, OR COLOR.

OWNER OF U.S. REG. NOS. 604,020 AND 1,741,544.

SER. NO. 85-513,656, FILED 1-11-2012.

KATHERINE CHANG, EXAMINING ATTORNEY



*David J. Kyffers*

Director of the United States Patent and Trademark Office

# United States of America

United States Patent and Trademark Office



PURE DEAD BRILLIANT

[www.pdbjewelry.com](http://www.pdbjewelry.com)

**Reg. No. 4,197,876**

**Registered Aug. 28, 2012**

**Int. Cl.: 14**

**TRADEMARK**

**PRINCIPAL REGISTER**

NORA LOGAN (UNITED STATES INDIVIDUAL), DBA PDB JEWELRY  
260 W 72ND ST APT 9D  
260 W 72ND ST APT 9D  
NEW YORK, NY 10023

FOR: BRACELETS; GEMSTONE JEWELRY; JEWELRY; JEWELRY CHAINS; ORNAMENTS OF PRECIOUS METAL IN THE NATURE OF JEWELRY; RINGS BEING JEWELRY, IN CLASS 14 (U.S. CLS. 2, 27, 28 AND 50).

FIRST USE 2-25-2011; IN COMMERCE 3-1-2011.

NO CLAIM IS MADE TO THE EXCLUSIVE RIGHT TO USE "PURE", "BRILLIANT" AND "WWW.PDBJEWELRY.COM", APART FROM THE MARK AS SHOWN.

THE MARK CONSISTS OF THE STYLIZED LETTERS "PDB" WITH A DIAMOND INSERTED AT THE BASE OF THE "D" AND "B", WITH THE TAGLINE "PURE DEAD BRILLIANT" BELOW THE STYLIZED LETTERS. THE WEBSITE ADDRESS "WWW.PDBJEWELRY.COM" IS BELOW BOTH THE STYLIZED LETTERS AND THE TAGLINE.

SER. NO. 85-513,668, FILED 1-11-2012.

DAVID MURRAY, EXAMINING ATTORNEY



*David J. Kyros*

Director of the United States Patent and Trademark Office

# United States of America

United States Patent and Trademark Office

**FLY**   
**ALLDAY**

**Reg. No. 4,197,877**

**Registered Aug. 28, 2012**

**Int. Cl.: 25**

**TRADEMARK**

**PRINCIPAL REGISTER**

FLY ALL DAY TEES (NEW YORK CORPORATION)  
2803 WATCHILL AVENUE  
MEDFORD, NY 11763

FOR: CLOTHING, NAMELY, T-SHIRTS, PANTS, SHORTS, WOVEN SHIRTS, TANK TOPS, HOODED SWEAT SHIRTS, SWEAT SHIRTS, JEANS, COATS, JACKETS, SWEATERS, CAPS, AND HATS, IN CLASS 25 (U.S. CLS. 22 AND 39).

FIRST USE 5-27-2010; IN COMMERCE 6-0-2010.

NO CLAIM IS MADE TO THE EXCLUSIVE RIGHT TO USE "CLOTHING", APART FROM THE MARK AS SHOWN.

THE MARK CONSISTS OF THE WORD "FLY" ON THE LEFT, A PLANE ON THE RIGHT WITH THE WORD "CLOTHING" ON THE BOTTOM OF THE LOWER LEFT WING, AND THE WORD "ALLDAY" BELOW.

SER. NO. 85-513,670, FILED 1-11-2012.

KATHERINE CHANG, EXAMINING ATTORNEY



*David J. Kyjars*

Director of the United States Patent and Trademark Office

# United States of America

United States Patent and Trademark Office

# JADU

**Reg. No. 4,197,878**

**Registered Aug. 28, 2012**

**Int. Cl.: 9**

**TRADEMARK**

**PRINCIPAL REGISTER**

JADU, LTD (UNITED KINGDOM LIMITED COMPANY (LTD.))  
MERIDIAN BUSINESS PARK  
UNIVERSE HOUSE 1 MERUS COURT  
LEICESTER, UNITED KINGDOM LE191RJ

FOR: DOWNLOADABLE COMPUTER SOFTWARE FOR WEB CONTENT MANAGEMENT SYSTEMS USED FOR NON-TECHNICAL MANAGEMENT OF WEB BASED CONTENT, DATA AND ELECTRONIC DOCUMENTS, WEB APPLICATIONS RELATED TO DOCUMENT MANAGEMENT, SEARCHABLE DIRECTORIES, PRODUCTIVITY, WORKFLOW, HUMAN RESOURCES, E-PAYMENTS, RETAIL STORE MANAGEMENT, E-FORMS, DATA RECORDING, E-FILING, CONTENT MANAGEMENT, SOFTWARE AUTHENTICATION, SOCIAL NETWORKING, AND PUBLISHING, THE AFOREMENTIONED BEING FOR SCIENTIFIC AND TECHNOLOGICAL SERVICES AND RESEARCH AND DESIGN RELATING THERETO; DOWNLOADABLE COMPUTER SOFTWARE FOR DESIGN AND DEVELOPMENT OF COMPUTER HARDWARE AND SOFTWARE, AND INSTALLATION, MAINTENANCE AND REPAIR OF COMPUTER SOFTWARE; DOWNLOADABLE COMPUTER SOFTWARE FOR COMPUTER CONSULTANCY RELATED TO THE USE OF COMPUTER SOFTWARE AND USED FOR PROVIDING CONSULTING SERVICES IN THE FIELD OF WEB-BASED CONTENT MANAGEMENT, DESIGN, DRAWING AND COMMISSIONED WRITING; DOWNLOADABLE COMPUTER SOFTWARE FOR THE COMPILATION OF WEB SITES AND USED FOR CREATING, MAINTAINING AND HOSTING THE WEB SITES OF OTHERS; DOWNLOADABLE COMPUTER SOFTWARE FOR COMPILATION, CREATION AND MAINTENANCE OF A REGISTER OF DOMAIN NAMES; DOWNLOADABLE COMPUTER SOFTWARE FOR THE MANAGEMENT OF CONTENT ON A WEB SITE AND THE WEB SITES OF OTHERS; DOWNLOADABLE COMPUTER SOFTWARE FOR CONNECTIVITY TO BOTH PUBLIC FACING CONTENT AND BACK OFFICE SYSTEMS AND USED FOR ENSURING DATA ACCURACY AND EFFICIENT FORM PROCESSING, ON-LINE PAYMENTS, AND OVERALL WEB CONTENT MANAGEMENT, IN CLASS 9 (U.S. CLS. 21, 23, 26, 36 AND 38).



FIRST USE 4-4-2002; IN COMMERCE 7-20-2009.

THE MARK CONSISTS OF STANDARD CHARACTERS WITHOUT CLAIM TO ANY PARTICULAR FONT, STYLE, SIZE, OR COLOR.

"JADU" IS A SANSKRIT WORD MEANING "MAGIC".

SER. NO. 85-513,709, FILED 1-11-2012.

*David J. Kyros*

Director of the United States Patent and Trademark Office

**Reg. No. 4,197,878** KATHY DE JONGE, EXAMINING ATTORNEY

# United States of America

United States Patent and Trademark Office

## OPEN SKY SOFTWARE

**Reg. No. 4,197,879**

OPEN SKY SOFTWARE, INC. (TEXAS CORPORATION)  
7718 WOOD HOLLOW DR STE 106  
AUSTIN, TX 78731

**Registered Aug. 28, 2012**

**Int. Cl.: 42**

FOR: SOFTWARE DESIGN AND DEVELOPMENT, IN CLASS 42 (U.S. CLS. 100 AND 101).

**SERVICE MARK**

FIRST USE 9-1-2001; IN COMMERCE 9-1-2001.

**PRINCIPAL REGISTER**

THE MARK CONSISTS OF STANDARD CHARACTERS WITHOUT CLAIM TO ANY PARTICULAR FONT, STYLE, SIZE, OR COLOR.

NO CLAIM IS MADE TO THE EXCLUSIVE RIGHT TO USE "SOFTWARE", APART FROM THE MARK AS SHOWN.

SER. NO. 85-513,746, FILED 1-11-2012.

THOMAS MANOR, EXAMINING ATTORNEY



*David J. Kyros*

Director of the United States Patent and Trademark Office

# United States of America

United States Patent and Trademark Office



**Reg. No. 4,197,880**

**Registered Aug. 28, 2012**

**Int. Cl.: 9**

**TRADEMARK**

**PRINCIPAL REGISTER**

LIMMER CREATIVE, LLC (MAINE LIMITED LIABILITY COMPANY)  
STEPHANIE@LIMMERCREATIVE.COM  
1 SAYWARD STREET  
KENNEBUNK, ME 04043

FOR: EDUCATIONAL SOFTWARE FEATURING INSTRUCTION IN EMERGENCY MEDICAL  
TECHNICIAN TESTING AND PRACTICE, IN CLASS 9 (U.S. CLS. 21, 23, 26, 36 AND 38).

FIRST USE 8-23-2010; IN COMMERCE 8-23-2010.

NO CLAIM IS MADE TO THE EXCLUSIVE RIGHT TO USE "EMT REVIEW" AND THE  
REPRESENTATION OF THE UNIVERSAL MEDICAL ALERT SYMBOL, APART FROM THE  
MARK AS SHOWN.

THE COLOR(S) GREEN PANTONE 7489, BLUE PANTONE 660, BLUE PANTONE AND 661  
YELLOW PANTONE 803 IS/ARE CLAIMED AS A FEATURE OF THE MARK.

THE MARK CONSISTS OF THE WORDS "EMT REVIEW" IN A STYLIZED FONT IN YELLOW  
PANTONE 803, AND IN ALL CAPITAL LETTERS, ADJACENT TO A STYLIZED CHECK-  
MARK IN GREEN PANTONE 7489 SUPERIMPOSED OVER THE CENTER OF A UNIVERSAL  
MEDICAL ALERT SYMBOL COMPRISED OF A SIX POINTED STAR IN BLUE PANTONE  
660 AND BLUE PANTONE 661. THE COLOR BLACK IS FOR SHADING PURPOSES ONLY  
AND IS NOT PART OF THE MARK.

SER. NO. 85-513,766, FILED 1-11-2012.

LINDA LAVACHE, EXAMINING ATTORNEY



*David J. Kybas*

Director of the United States Patent and Trademark Office



# United States of America

United States Patent and Trademark Office

# OLAY

**Reg. No. 4,197,881**

**Registered Aug. 28, 2012**

**Int. Cl.: 3**

**TRADEMARK**

**PRINCIPAL REGISTER**

THE PROCTER & GAMBLE COMPANY (OHIO CORPORATION)  
ONE PROCTER & GAMBLE PLAZA  
CINCINNATI, OH 45202

FOR: NON-MEDICATED SKIN CARE PREPARATIONS; BODY WASH AND BAR SOAP, IN CLASS 3 (U.S. CLS. 1, 4, 6, 50, 51 AND 52).

FIRST USE 12-31-2010; IN COMMERCE 12-31-2010.

OWNER OF U.S. REG. NOS. 1,130,648, 3,066,692 AND OTHERS.

THE MARK CONSISTS OF THE WORD "OLAY" IN STYLIZED FORM.

SER. NO. 85-513,800, FILED 1-11-2012.

DAVID COLLIER, EXAMINING ATTORNEY



*David J. Kyffers*

Director of the United States Patent and Trademark Office

# United States of America

United States Patent and Trademark Office

## Quality First Roofing

**Reg. No. 4,197,882**

QUALITY FRIST ROOFING, INC. (NEBRASKA CORPORATION)

**Registered Aug. 28, 2012**

3716 D. STREET  
OMAHA, NE 68107

**Int. Cl.: 37**

FOR: CONSTRUCTION AND REPAIR SERVICES, NAMELY, ROOFING SERVICES, IN CLASS 37 (U.S. CLS. 100, 103 AND 106).

**SERVICE MARK**

FIRST USE 7-1-2009; IN COMMERCE 7-1-2009.

**PRINCIPAL REGISTER**

THE MARK CONSISTS OF STANDARD CHARACTERS WITHOUT CLAIM TO ANY PARTICULAR FONT, STYLE, SIZE, OR COLOR.

NO CLAIM IS MADE TO THE EXCLUSIVE RIGHT TO USE "ROOFING", APART FROM THE MARK AS SHOWN.

SER. NO. 85-513,825, FILED 1-11-2012.

KATHRYN COWARD, EXAMINING ATTORNEY



*David J. Kybas*

Director of the United States Patent and Trademark Office

# United States of America

United States Patent and Trademark Office



**AENC Annual Trade Show**  
Connecting People ~ Growing Business

December 13, 2012 • Raleigh, NC

**Reg. No. 4,197,883**

**Registered Aug. 28, 2012**

**Int. Cl.: 35**

**SERVICE MARK**

**PRINCIPAL REGISTER**

ASSOCIATION EXECUTIVES OF NORTH CAROLINA, INC. (NORTH CAROLINA CORPORATION), DBA AENC  
7511 MOURNING DOVE ROAD, SUITE 102  
RALEIGH, NC 27615

FOR: TRADE ASSOCIATION SERVICES, NAMELY, PROMOTING THE INTERESTS OF ASSOCIATION MANAGEMENT, IN CLASS 35 (U.S. CLS. 100, 101 AND 102).

FIRST USE 1-1-2011; IN COMMERCE 1-1-2011.

NO CLAIM IS MADE TO THE EXCLUSIVE RIGHT TO USE "ANNUAL TRADE SHOW", "DECEMBER 13, 2012" AND "RALEIGH, NC", APART FROM THE MARK AS SHOWN.

THE COLOR(S) RED, PURPLE, MAGENTA, YELLOW, BLUE, GREEN, AND GRAY IS/ARE CLAIMED AS A FEATURE OF THE MARK.

THE MARK CONSISTS OF SIX INTERLOCKING PIECES OF IDENTICAL SHAPE AND SIZE FORMING A SIX-POINTED "STAR" SHAPED FIGURE WITH ROUNDED POINTS. THE SIX INTERLOCKING PIECES ARE RED, PURPLE, MAGENTA, YELLOW, BLUE, AND GREEN, RESPECTIVELY. JUST ABOVE EACH OF THE SIX "POINTS", OUTSIDE THE DESIGN, IS A CIRCLE OF CORRESPONDING COLOR TO THE INTERLOCKING PIECE IT IS ADJACENT TO. THE WORDING "AENC ANNUAL TRADE SHOW" APPEARS IN PURPLE DIRECTLY BELOW THE DESIGN. IN SMALLER WORDING BELOW, IN BLUE, IS "CONNECTING PEOPLE GROWING BUSINESS", SEPARATED IN THE MIDDLE BY A SMALL BLUE SQUIGGLE LINE. IMMEDIATELY BELOW IS A PURPLE HORIZONTAL LINE, AND THEN AT THE BOTTOM OF THE MARK, IN GRAY, IS THE WORDING "DECEMBER 13, 2012" AND "RALEIGH, NC". BETWEEN THE TWO GROUPS OF WORDING IS A BLUE DOT.

SER. NO. 85-513,918, FILED 1-11-2012.

JORDAN BAKER, EXAMINING ATTORNEY



*David J. Kyjars*

Director of the United States Patent and Trademark Office

United States of America  
United States Patent and Trademark Office

**PERMA  
LOCK**

**Reg. No. 4,197,884**

DAVIE, JR., WARREN PAT (UNITED STATES INDIVIDUAL)  
#3 VETERANS MEMORIAL BLVD.  
KENNER, LA 70062

**Registered Aug. 28, 2012**

**Int. Cl.: 37**

FOR: CONSTRUCTION AND BUILDING REPAIR SERVICES, NAMELY, FOUNDATION UNDERPINNING SERVICES, IN CLASS 37 (U.S. CLS. 100, 103 AND 106).

**SERVICE MARK**

FIRST USE 9-19-2005; IN COMMERCE 9-19-2005.

**PRINCIPAL REGISTER**

THE MARK CONSISTS OF THE WORDS "PERMA LOCK" APPEARING IN BOLD BLACK CAPITAL LETTERS WITH "PERMA" BEING DIRECTLY ABOVE "LOCK".

SER. NO. 85-513,921, FILED 1-11-2012.

TASNEEM HUSSAIN, EXAMINING ATTORNEY



*David J. Kyffers*

Director of the United States Patent and Trademark Office

# United States of America

United States Patent and Trademark Office

## REUMOSAN PLUS USA

**Reg. No. 4,197,885**

JOSE DE JESUS GARCIA (UNITED STATES INDIVIDUAL)  
1701 MONTANA  
EL PASO, TX 79902

**Registered Aug. 28, 2012**

**Int. Cl.: 5**

FOR: DIETARY AND NUTRITIONAL SUPPLEMENTS MADE IN THE UNITED STATES, IN CLASS 5 (U.S. CLS. 6, 18, 44, 46, 51 AND 52).

**TRADEMARK**

FIRST USE 1-1-2012; IN COMMERCE 1-1-2012.

**PRINCIPAL REGISTER**

THE MARK CONSISTS OF STANDARD CHARACTERS WITHOUT CLAIM TO ANY PARTICULAR FONT, STYLE, SIZE, OR COLOR.

NO CLAIM IS MADE TO THE EXCLUSIVE RIGHT TO USE "USA", APART FROM THE MARK AS SHOWN.

THE WORDING "REUMOSAN" HAS NO MEANING IN A FOREIGN LANGUAGE.

SER. NO. 85-513,941, FILED 1-11-2012.

JOHN WILKE, EXAMINING ATTORNEY



*David J. Kybas*

Director of the United States Patent and Trademark Office

United States of America  
United States Patent and Trademark Office

TERRAPIN

**Reg. No. 4,197,886**

**Registered Aug. 28, 2012**

**Int. Cl.: 43**

**SERVICE MARK**

**PRINCIPAL REGISTER**

HUNTER-KRONER, LTD. (NEW YORK CORPORATION), DBA TERRAPIN RESTAURANT  
6426 MONTGOMERY STREET  
RHINEBECK, NY 12572

FOR: BISTRO SERVICES; CATERING SERVICES; RESTAURANT AND CATERING SERVICES; RESTAURANT SERVICES; TAKE-OUT RESTAURANT SERVICES, IN CLASS 43 (U.S. CLS. 100 AND 101).

FIRST USE 5-1-1998; IN COMMERCE 5-1-1998.

THE MARK CONSISTS OF STANDARD CHARACTERS WITHOUT CLAIM TO ANY PARTICULAR FONT, STYLE, SIZE, OR COLOR.

SER. NO. 85-513,969, FILED 1-11-2012.

JOHN GARTNER, EXAMINING ATTORNEY



*David J. Kyffers*

Director of the United States Patent and Trademark Office

# United States of America

United States Patent and Trademark Office

## THE MOLECULE

**Reg. No. 4,197,887**

THE MOLECULE INC. (NEW YORK CORPORATION)

**Registered Aug. 28, 2012**

594 BROADWAY, SUITE 906  
NEW YORK, NY 10012

**Int. Cl.: 41**

FOR: ENTERTAINMENT SERVICES, NAMELY, PRODUCTION OF VISUAL EFFECTS AND MOTION GRAPHICS FOR FILMS, TELEVISION, COMMERCIALS, MUSIC VIDEOS, DOCUMENTARIES, INTERNET WEBSITES, AND VISUAL INSTALLATIONS IN THE NATURE OF INTERACTIVE MEDIA, IN CLASS 41 (U.S. CLS. 100, 101 AND 107).

**SERVICE MARK**

**PRINCIPAL REGISTER**

FIRST USE 4-30-2005; IN COMMERCE 4-30-2005.

THE MARK CONSISTS OF STANDARD CHARACTERS WITHOUT CLAIM TO ANY PARTICULAR FONT, STYLE, SIZE, OR COLOR.

SER. NO. 85-513,990, FILED 1-11-2012.

MICHAEL WIENER, EXAMINING ATTORNEY



*David J. Kyjars*

Director of the United States Patent and Trademark Office

# United States of America

United States Patent and Trademark Office

## SANTA FE STAR

**Reg. No. 4,197,888**

**Registered Aug. 28, 2012**

**Int. Cls.: 29 and 30**

**TRADEMARK**

**PRINCIPAL REGISTER**

PROVEEDORES DE INGENIERIA ALIMENTARIA S.A. DE C.V. (MEXICO CORPORATION)  
AVENIDA INDUSTRIAS NO. 140  
COLONIA FRACC. PIMSA OTE.  
APODACA, NUEVO LEÓN, MEXICO 66600

FOR: EXTRACTS FOR SOUPS; INSTANT OR PRE-COOKED MISO SOUP; PREPARATIONS FOR MAKING SOUPS; SOUP MIXES; SOUP PASTES; SOUPS, IN CLASS 29 (U.S. CL. 46).

FIRST USE 11-3-2011; IN COMMERCE 11-3-2011.

FOR: FLAVOURINGS FOR SOUPS; PASTA FOR SOUPS; SPICES, IN CLASS 30 (U.S. CL. 46).

FIRST USE 11-3-2011; IN COMMERCE 11-3-2011.

THE MARK CONSISTS OF STANDARD CHARACTERS WITHOUT CLAIM TO ANY PARTICULAR FONT, STYLE, SIZE, OR COLOR.

NO CLAIM IS MADE TO THE EXCLUSIVE RIGHT TO USE "SANTA FE", APART FROM THE MARK AS SHOWN.

THE ENGLISH TRANSLATION OF "SANTA FE" IN THE MARK IS "SAINT FAITH".

SER. NO. 85-514,035, FILED 1-11-2012.

FONG HSU, EXAMINING ATTORNEY



*David J. Kyffers*

Director of the United States Patent and Trademark Office



# United States of America

United States Patent and Trademark Office

# HERCULITE

**Reg. No. 4,197,889**

**Registered Aug. 28, 2012**

**Int. Cl.: 5**

**TRADEMARK**

**PRINCIPAL REGISTER**

KERR CORPORATION (DELAWARE CORPORATION)  
1717 WEST COLLINS AVENUE  
ORANGE, CA 92867

FOR: DENTAL COMPOSITE MATERIALS, IN CLASS 5 (U.S. CLS. 6, 18, 44, 46, 51 AND 52).

FIRST USE 0-0-1986; IN COMMERCE 0-0-1986.

THE MARK CONSISTS OF STANDARD CHARACTERS WITHOUT CLAIM TO ANY PARTICULAR FONT, STYLE, SIZE, OR COLOR.

OWNER OF U.S. REG. NO. 1,447,094.

SER. NO. 85-514,054, FILED 1-11-2012.

JENNY PARK, EXAMINING ATTORNEY



*David J. Kyffers*

Director of the United States Patent and Trademark Office

# United States of America

United States Patent and Trademark Office



**Reg. No. 4,197,890**

HESS AIR (TEXAS CORPORATION), DBA HESS AIR  
P.O. BOX 910  
MCALLEN, TX 78516

**Registered Aug. 28, 2012**

**Int. Cl.: 37**

FOR: AIR CONDITIONING CONTRACTOR SERVICES, IN CLASS 37 (U.S. CLS. 100, 103 AND 106).

**SERVICE MARK**

FIRST USE 1-1-2011; IN COMMERCE 1-1-2011.

**PRINCIPAL REGISTER**

THE MARK CONSISTS OF THE LETTER "H" APPEARING ABOVE "HESSAIR", WITH THE CROSS SECTION IN THE LETTER "H" BEING A WAVY BAR THAT EXTENDS BEYOND BOTH VERTICAL SIDES OF THE LETTER.

SER. NO. 85-514,094, FILED 1-11-2012.

JOHN DWYER, EXAMINING ATTORNEY



*David J. Kyros*

Director of the United States Patent and Trademark Office

# United States of America

United States Patent and Trademark Office



**Reg. No. 4,197,891**

**Registered Aug. 28, 2012**

**Int. Cls.: 35 and 36**

**SERVICE MARK**

**PRINCIPAL REGISTER**

HORAN ASSOCIATES, INC. (OHIO CORPORATION)  
4990 EAST GALBRAITH ROAD, SUITE 102  
CINCINNATI, OH 45236

FOR: ASSISTANCE WITH BUSINESS MANAGEMENT AND PLANNING; BUSINESS SUCCESSION PLANNING; COST MANAGEMENT FOR THE HEALTH BENEFIT PLANS OF OTHERS; COST MANAGEMENT FOR THE HEALTH CARE BENEFIT PLANS OF OTHERS, IN CLASS 35 (U.S. CLS. 100, 101 AND 102).

FIRST USE 1-1-2012; IN COMMERCE 1-1-2012.

FOR: ADMINISTRATION OF EMPLOYEE BENEFIT PLANS CONCERNING INSURANCE AND FINANCE; BROKERAGE IN THE FIELD OF HEALTH INSURANCE, IN CLASS 36 (U.S. CLS. 100, 101 AND 102).

FIRST USE 1-1-2012; IN COMMERCE 1-1-2012.

OWNER OF U.S. REG. NOS. 3,246,820 AND 4,008,671.

THE COLOR(S) BLUE, BLACK, GREEN AND WHITE IS/ARE CLAIMED AS A FEATURE OF THE MARK IS/ARE CLAIMED AS A FEATURE OF THE MARK.

NO CLAIM IS MADE TO THE EXCLUSIVE RIGHT TO USE "HEALTH MANAGEMENT", APART FROM THE MARK AS SHOWN.

THE MARK CONSISTS OF A STYLIZED CIRCULAR DESIGN IN BLUE, WITH A WHITE DIAMOND CENTER. THE WORD "HORAN", WITH AN APPLE IN GREEN USED FOR THE "O" IS LOCATED TO THE RIGHT OF THE CIRCULAR DESIGN AND THE WORDS "HEALTH MANAGEMENT" ARE CENTERED UNDERNEATH THE WORD "HORAN". ALL OF THE WORDING EXCEPT FOR THE LETTER "O" APPEARS IN BLACK.

SER. NO. 85-514,098, FILED 1-11-2012.

DORITT L. CARROLL, EXAMINING ATTORNEY



*David J. Kyjars*

Director of the United States Patent and Trademark Office

# United States of America

United States Patent and Trademark Office

## DSC UNPLUGGED

**Reg. No. 4,197,892**

**Registered Aug. 28, 2012**

**Int. Cls.: 9 and 42**

**TRADEMARK**

**SERVICE MARK**

**PRINCIPAL REGISTER**

DEALER SERVICES CORPORATION (DELAWARE CORPORATION)  
SUITE 100  
1320 CITY CENTER DRIVE  
CARMEL, IN 46032

FOR: DOWNLOADABLE SOFTWARE IN THE NATURE OF A MOBILE APPLICATION FOR WHOLESALE AND RETAIL MARKET DATA COLLECTION, ANALYSIS AND MANAGEMENT, NAMELY, APPRAISAL AND MARKET CONDITION ANALYTICS, FINANCING VEHICLE INVENTORY AND VEHICLE INVENTORY MANAGEMENT, IN CLASS 9 (U.S. CLS. 21, 23, 26, 36 AND 38).

FIRST USE 12-0-2010; IN COMMERCE 12-0-2010.

FOR: PROVIDING TEMPORARY USE OF A WEB-BASED SOFTWARE APPLICATION FOR WHOLESALE AND RETAIL MARKET DATA COLLECTION, ANALYSIS AND MANAGEMENT, NAMELY, APPRAISAL AND MARKET CONDITION ANALYTICS, FINANCING VEHICLE INVENTORY AND VEHICLE INVENTORY MANAGEMENT, IN CLASS 42 (U.S. CLS. 100 AND 101).

FIRST USE 12-0-2010; IN COMMERCE 12-0-2010.

THE MARK CONSISTS OF STANDARD CHARACTERS WITHOUT CLAIM TO ANY PARTICULAR FONT, STYLE, SIZE, OR COLOR.

OWNER OF U.S. REG. NO. 3,821,266.

SER. NO. 85-514,106, FILED 1-11-2012.

WILLIAM JACKSON, EXAMINING ATTORNEY



*David J. Kypos*

Director of the United States Patent and Trademark Office

# United States of America

United States Patent and Trademark Office



**Reg. No. 4,197,893**

CARR ENVIRONMENTAL GROUP, INC. (TEXAS CORPORATION)  
504 SPRING HILL DR., STE. 300  
SPRING, TX 77386

**Registered Aug. 28, 2012**

**Int. Cls.: 40, 42 and 45**

FOR: ENVIRONMENTAL REMEDIATION SERVICES, NAMELY, TREATMENT OF SOIL AND WATER, IN CLASS 40 (U.S. CLS. 100, 103 AND 106).

**SERVICE MARK**

FIRST USE 10-3-2005; IN COMMERCE 10-3-2005.

**PRINCIPAL REGISTER**

FOR: CONSULTING SERVICES IN THE FIELD OF ENVIRONMENTAL ASSESSMENT AND PLANNING; ENGINEERING SERVICES IN THE FIELD OF ENVIRONMENTAL COMPLIANCE; ENVIRONMENTAL SERVICES, NAMELY, DESIGN FOR OTHERS IN THE FIELD OF ENVIRONMENTAL ENGINEERING; ENVIRONMENTAL SERVICES, NAMELY, TECHNICAL CONSULTATION IN THE FIELD OF ENVIRONMENTAL SCIENCE; ENVIRONMENTAL SERVICES, NAMELY, TECHNICAL CONSULTATION IN THE FIELD OF ENVIRONMENTAL SCIENCE, ENGINEERING SERVICES AND DESIGN FOR OTHERS IN THE FIELD OF ENVIRONMENTAL ENGINEERING; ENVIRONMENTAL TESTING AND INSPECTION SERVICES, IN CLASS 42 (U.S. CLS. 100 AND 101).

FIRST USE 10-3-2005; IN COMMERCE 10-3-2005.

FOR: REVIEWING ENVIRONMENTAL DATA, ANALYZING THE DATA IN CONNECTION WITH ENVIRONMENTAL LAWS AND REGULATIONS, AND PREPARING ENVIRONMENTAL COMPLIANCE REPORTS; REVIEWING STANDARDS AND PRACTICES TO ASSURE COMPLIANCE WITH ENVIRONMENTAL LAWS AND REGULATIONS, IN CLASS 45 (U.S. CLS. 100 AND 101).

FIRST USE 1-1-1995; IN COMMERCE 1-1-1995.

THE MARK CONSISTS OF THE CAPITAL LETTERS "C", "E" AND "G" IN A BLACK STYLIZED FONT TO THE RIGHT OF THREE HORIZONTAL LINES OF GRADUATED SIZE WHICH ARE COLORED FROM TOP TO BOTTOM BLUE, GREEN AND BROWN, AND SAID HORIZONTAL LINES BEING INTERSECTED BY A VERTICAL BLACK LINE.

THE COLOR(S) BLUE, GREEN, BROWN AND BLACK IS/ARE CLAIMED AS A FEATURE OF THE MARK.



*David J. Kyros*

Director of the United States Patent and Trademark Office

**Reg. No. 4,197,893** SER. NO. 85-514,117, FILED 1-11-2012.

BRENDAN MCCAULEY, EXAMINING ATTORNEY

# United States of America

United States Patent and Trademark Office

# MYDSC

**Reg. No. 4,197,894**

**Registered Aug. 28, 2012**

**Int. Cl.: 42**

**SERVICE MARK**

**PRINCIPAL REGISTER**

DEALER SERVICES CORPORATION (DELAWARE CORPORATION)  
SUITE 100  
1320 CITY CENTER DRIVE  
CARMEL, IN 46032

FOR: PROVIDING TEMPORARY USE OF A WEB-BASED SOFTWARE APPLICATION FOR VEHICLE INVENTORY FINANCING AND ACCOUNT MANAGEMENT, IN CLASS 42 (U.S. CLS. 100 AND 101).

FIRST USE 7-0-2005; IN COMMERCE 7-0-2005.

THE MARK CONSISTS OF STANDARD CHARACTERS WITHOUT CLAIM TO ANY PARTICULAR FONT, STYLE, SIZE, OR COLOR.

OWNER OF U.S. REG. NO. 3,821,266.

SER. NO. 85-514,120, FILED 1-11-2012.

WILLIAM JACKSON, EXAMINING ATTORNEY



*David J. Kyffers*

Director of the United States Patent and Trademark Office

# United States of America

United States Patent and Trademark Office

# CARETAKER

**Reg. No. 4,197,895**

**Registered Aug. 28, 2012**

**Int. Cl.: 10**

**TRADEMARK**

**PRINCIPAL REGISTER**

EMPIRICAL TECHNOLOGIES CORPORATION (VIRGINIA CORPORATION)  
PO BOX 8175  
CHARLOTTESVILLE, VA 229068175

FOR: MEDICAL APPARATUS, SOFTWARE, AND INSTRUMENTS SOLD AS A UNIT,  
NAMELY, METER FOR MEASURING AND MONITORING PHYSIOLOGICAL LIFE SIGNS,  
IN CLASS 10 (U.S. CLS. 26, 39 AND 44).

FIRST USE 2-19-2008; IN COMMERCE 2-19-2008.

THE MARK CONSISTS OF STANDARD CHARACTERS WITHOUT CLAIM TO ANY PAR-  
TICULAR FONT, STYLE, SIZE, OR COLOR.

SER. NO. 85-514,123, FILED 1-11-2012.

WILLIAM JACKSON, EXAMINING ATTORNEY



*David J. Kyffers*

Director of the United States Patent and Trademark Office



# United States of America

United States Patent and Trademark Office

# CARMODY

**Reg. No. 4,197,896**

**Registered Aug. 28, 2012**

**Int. Cl.: 42**

**SERVICE MARK**

**PRINCIPAL REGISTER**

CHARLES SCOTT CARMODY (UNITED STATES INDIVIDUAL)  
P.O. BOX 434  
409 TRAIL SIDE DR.  
DE FOREST, WI 53532

FOR: COMPUTER PROGRAMMING SERVICES, NAMELY, MANAGEMENT SOFTWARE AS A SERVICES; CONSULTING IN THE FIELD OF DESIGNING MANAGEMENT SOFTWARE AS A SERVICES; CONSULTING IN THE FIELD OF MANAGEMENT SOFTWARE AS A SERVICE DESIGN; GRAPHIC ILLUSTRATION AND DRAWING SERVICES, NAMELY, MANAGEMENT SOFTWARE AS A SERVICES, IN CLASS 42 (U.S. CLS. 100 AND 101).

FIRST USE 2-2-1999; IN COMMERCE 2-2-1999.

THE MARK CONSISTS OF STANDARD CHARACTERS WITHOUT CLAIM TO ANY PARTICULAR FONT, STYLE, SIZE, OR COLOR.

SEC. 2(F).

SER. NO. 85-514,128, FILED 1-11-2012.

JOHN HWANG, EXAMINING ATTORNEY



*David J. Kyffers*

Director of the United States Patent and Trademark Office

# United States of America

United States Patent and Trademark Office

## Kubaba Books

**Reg. No. 4,197,897**

**Registered Aug. 28, 2012**

**Int. Cl.: 16**

**TRADEMARK**

**PRINCIPAL REGISTER**

JOHN BIGELOW TAYLOR, LLC (NEW YORK LIMITED LIABILITY COMPANY), DBA  
KUBABA BOOKS  
223 OLD STATE RD  
HIGHLAND FALLS, NY 10928

FOR: NON-FICTION BOOKS ON A VARIETY OF TOPICS, EXCLUDING THE TOPIC OF  
ANCIENT GODS AND GODDESSES, IN CLASS 16 (U.S. CLS. 2, 5, 22, 23, 29, 37, 38 AND  
50).

FIRST USE 6-1-1991; IN COMMERCE 6-1-1991.

THE MARK CONSISTS OF STANDARD CHARACTERS WITHOUT CLAIM TO ANY PAR-  
TICULAR FONT, STYLE, SIZE, OR COLOR.

NO CLAIM IS MADE TO THE EXCLUSIVE RIGHT TO USE "BOOKS", APART FROM THE  
MARK AS SHOWN.

SER. NO. 85-514,150, FILED 1-11-2012.

ZHALEH DELANEY, EXAMINING ATTORNEY



*David J. Kybas*

Director of the United States Patent and Trademark Office

# United States of America

United States Patent and Trademark Office

## Dutchman Brand

**Reg. No. 4,197,898**

**Registered Aug. 28, 2012**

**Int. Cl.: 1**

**TRADEMARK**

**PRINCIPAL REGISTER**

DAVIS, MITCHELL (UNITED STATES INDIVIDUAL)  
P.O. BOX 345  
WESTLEY, CA 95387 AND

DAVIS, CONOR (UNITED STATES INDIVIDUAL)  
P.O. BOX 345  
WESTLEY, CA 95387

FOR: POTTING SOIL, IN CLASS 1 (U.S. CLS. 1, 5, 6, 10, 26 AND 46).

FIRST USE 11-4-2011; IN COMMERCE 11-4-2011.

THE MARK CONSISTS OF STANDARD CHARACTERS WITHOUT CLAIM TO ANY PARTICULAR FONT, STYLE, SIZE, OR COLOR.

NO CLAIM IS MADE TO THE EXCLUSIVE RIGHT TO USE "BRAND", APART FROM THE MARK AS SHOWN.

SER. NO. 85-514,284, FILED 1-11-2012.

PAUL E. FAHRENKOPF, EXAMINING ATTORNEY



*David J. Kyffers*

Director of the United States Patent and Trademark Office

# United States of America

United States Patent and Trademark Office



**Reg. No. 4,197,899**

**Registered Aug. 28, 2012**

**Int. Cl.: 41**

**SERVICE MARK**

**PRINCIPAL REGISTER**

KINGSLEE PURCELL (UNITED STATES INDIVIDUAL)  
#285 326 N WESTERN AVENUE  
LOS ANGELES, CA 90004

FOR: FILM AND VIDEO PRODUCTION; VIDEOTAPE FILM PRODUCTION, IN CLASS 41  
(U.S. CLS. 100, 101 AND 107).

FIRST USE 9-15-2010; IN COMMERCE 9-15-2010.

THE MARK CONSISTS OF THE FOLLOWING: THE WORD "KINGSPEI" IS WRITTEN IN  
A BROWN COLOR WITH AN OUTLINE IN THE COLOR GRAY, WITH A WHITE FLOWER  
WITH A YELLOW CENTER BELOW IT. THIS IS ALL SET ON A BLACK BACKGROUND.

THE COLOR(S) BROWN, GRAY, WHITE, YELLOW, AND BLACK IS/ARE CLAIMED AS A  
FEATURE OF THE MARK.

SER. NO. 85-514,362, FILED 1-11-2012.

ANNE E. GUSTASON, EXAMINING ATTORNEY



*David J. Kybas*

Director of the United States Patent and Trademark Office

# United States of America

United States Patent and Trademark Office

**village**  
**nurseries**

ROOTED IN QUALITY

**Reg. No. 4,197,900**

VILLAGE NURSERIES WHOLESALÉ, LLC (CALIFORNIA LIMITED LIABILITY COMPANY)  
1589 N. MAIN ST.  
ORANGE, CA 92867

**Registered Aug. 28, 2012**

**Int. Cls.: 31 and 35**

FOR: LIVE PLANTS, IN CLASS 31 (U.S. CLS. 1 AND 46).

**TRADEMARK**

FIRST USE 1-1-2004; IN COMMERCE 1-1-2004.

**SERVICE MARK**

FOR: WHOLESALE AND RETAIL STORE SERVICES FEATURING LIVE PLANTS, IN CLASS 35 (U.S. CLS. 100, 101 AND 102).

**PRINCIPAL REGISTER**

FIRST USE 1-1-2004; IN COMMERCE 1-1-2004.

OWNER OF U.S. REG. NO. 4,041,522.

NO CLAIM IS MADE TO THE EXCLUSIVE RIGHT TO USE "NURSERIES", APART FROM THE MARK AS SHOWN.

THE MARK CONSISTS OF "VILLAGE NURSERIES ROOTED IN QUALITY", WITH THE "G" IN "VILLAGE" REPRESENTED BY A DRAWING OF A POT.

SER. NO. 85-514,392, FILED 1-11-2012.

KRISTIN DAHLING, EXAMINING ATTORNEY



*David J. Kyffers*

Director of the United States Patent and Trademark Office

# United States of America

United States Patent and Trademark Office

## Pacific Auxiliary Fire Alarm Co.

**Reg. No. 4,197,901**

**Registered Aug. 28, 2012**

**Int. Cl.: 9**

**TRADEMARK**

**PRINCIPAL REGISTER**

PACIFIC AUXILIARY FIRE ALARM COMPANY (CALIFORNIA CORPORATION), AKA  
PAFA  
95 BOUTWELL STREET  
SAN FRANCISCO, CA 94124

FOR: ALARM INSTALLATIONS AND ALARMS; ALARM MONITORING SYSTEMS; FIRE ALARM AND EMERGENCY EVACUATION DEVICES, NAMELY, FIRE ALARM CONTROL PANELS, SMOKE DETECTORS, HEAT DETECTORS, ALARM PULL STATIONS, AUDIBLE AND VISIBLE NOTIFICATION APPLIANCES, STROBES, SIRENS, BELLS, HORNS, AND SPEAKERS; FIRE ALARMS; SECURITY AND FIRE ALARMS, IN CLASS 9 (U.S. CLS. 21, 23, 26, 36 AND 38).

FIRST USE 1-1-1957; IN COMMERCE 1-1-1957.

THE MARK CONSISTS OF STANDARD CHARACTERS WITHOUT CLAIM TO ANY PARTICULAR FONT, STYLE, SIZE, OR COLOR.

NO CLAIM IS MADE TO THE EXCLUSIVE RIGHT TO USE "AUXILIARY FIRE ALARM CO.", APART FROM THE MARK AS SHOWN.

SER. NO. 85-514,453, FILED 1-11-2012.

ELLEN B. AWRICH, EXAMINING ATTORNEY



*David J. Kyffers*

Director of the United States Patent and Trademark Office

# United States of America

United States Patent and Trademark Office



**Reg. No. 4,197,902**

JOSEPH, DELORES (UNITED STATES INDIVIDUAL)  
1805 SW 101 TERRACE  
MIRAMAR, FL 33025

**Registered Aug. 28, 2012**

**Int. Cl.: 41**

FOR: PHYSICAL FITNESS CONDITIONING CLASSES; PROVIDING FITNESS AND EXERCISE STUDIO SERVICES, NAMELY, PILATES INSTRUCTION AND TRAINING; PROVIDING PHYSICAL FITNESS AND EXERCISE SERVICE, NAMELY, INDOOR CYCLING AND YOGA INSTRUCTION, IN CLASS 41 (U.S. CLS. 100, 101 AND 107).

**SERVICE MARK**

**PRINCIPAL REGISTER**

FIRST USE 11-17-2011; IN COMMERCE 11-17-2011.

NO CLAIM IS MADE TO THE EXCLUSIVE RIGHT TO USE "CYCLING AND YOGA STUDIO", APART FROM THE MARK AS SHOWN.

THE MARK CONSISTS OF A BODY POSING IN A KNEELING POSITION WITH THE LEFT KNEE FORWARD AND THE RIGHT LEG BACK. THE ARMS ARE SWEEPED BACK OVER THE HEAD AND HOLDING THE WHEEL OF A BICYCLE. BEHIND THE BODY ARE THE STYLIZED TEXT "MY ADDICTION". BELOW THERE IS THE STYLIZED TEXT "CYCLING AND YOGA STUDIO".

SER. NO. 85-514,470, FILED 1-11-2012.

AMY ALFIERI, EXAMINING ATTORNEY



*David J. Kybas*

Director of the United States Patent and Trademark Office

# United States of America

United States Patent and Trademark Office



**Reg. No. 4,197,903**

**Registered Aug. 28, 2012**

**Int. Cl.: 39**

**SERVICE MARK**

**PRINCIPAL REGISTER**

GOLDEN GATE BRIDGE, HIGHWAY AND TRANSPORTATION DISTRICT (CALIFORNIA  
PUBLIC CORPORATION AND POLITICAL SUBDIVISION)  
P.O. BOX 9000 PRESIDIO STATION  
SAN FRANCISCO, CA 94129

FOR: BRIDGE OPERATION SERVICES; PROVIDING INFORMATION ABOUT BRIDGE  
OPERATION SERVICES AND BRIDGE TRANSPORTATION SERVICES, IN CLASS 39 (U.S.  
CLS. 100 AND 105).

FIRST USE 5-27-2011; IN COMMERCE 5-27-2011.

OWNER OF U.S. REG. NOS. 2,662,471, 3,695,454 AND OTHERS.

NO CLAIM IS MADE TO THE EXCLUSIVE RIGHT TO USE "BRIDGE", "1937", "2012" AND  
"75TH ANNIVERSARY", APART FROM THE MARK AS SHOWN.

THE MARK CONSISTS OF A STYLIZED CIRCLE DESIGN WITH SCALLOPED EDGES  
FEATURING THE WORDING "GOLDEN GATE BRIDGE" AT THE TOP, THE YEAR "1937"  
APPEARS BENEATH THE LETTER "G" IN "GOLDEN" AND THE YEAR "2012" APPEARS  
BELOW THE LETTER "E" IN THE WORD "BRIDGE", AT THE BOTTOM OF THE CIRCLE  
THE WORDING "75TH ANNIVERSARY" APPEARS AND AT THE CENTER OF THE CIRCLE  
IS A DESIGN OF A BRIDGE WITH SUN RAYS EXTENDING FROM THE CENTER.

SER. NO. 85-514,483, FILED 1-11-2012.

JASON TURNER, EXAMINING ATTORNEY



*David J. Kypos*

Director of the United States Patent and Trademark Office



# United States of America

United States Patent and Trademark Office

## StatusHumor.com

**Reg. No. 4,197,904**

**Registered Aug. 28, 2012**

**Int. Cl.: 45**

**SERVICE MARK**

**PRINCIPAL REGISTER**

IMEDIA PARTNERS, LLC (CALIFORNIA LIMITED LIABILITY COMPANY)  
#401  
3419 E CHAPMAN AVE  
ORANGE, CA 92869

FOR: PROVIDING A WEBSITE FEATURING A COMPILATION OF STATUS UPDATES FROM SOCIAL NETWORKING SITES, IN CLASS 45 (U.S. CLS. 100 AND 101).

FIRST USE 4-1-2010; IN COMMERCE 4-1-2010.

THE MARK CONSISTS OF STANDARD CHARACTERS WITHOUT CLAIM TO ANY PARTICULAR FONT, STYLE, SIZE, OR COLOR.

SER. NO. 85-514,497, FILED 1-11-2012.

JOHN DALIER, EXAMINING ATTORNEY



*David J. Kyjars*

Director of the United States Patent and Trademark Office

# United States of America

United States Patent and Trademark Office

# Pick Life

**Reg. No. 4,197,905**

ROB STEPHANI (UNITED STATES INDIVIDUAL)  
838 JURY COURT  
SAN JOSE, CA 95112

**Registered Aug. 28, 2012**

**Int. Cls.: 14 and 15**

FOR: JEWELRY, NAMELY, JEWELRY SHAPED AS GUITAR PICKS, IN CLASS 14 (U.S. CLS. 2, 27, 28 AND 50).

**TRADEMARK**

FIRST USE 1-11-2012; IN COMMERCE 1-11-2012.

**PRINCIPAL REGISTER**

FOR: GUITAR ACCESSORIES, NAMELY, GUITAR PICKS, IN CLASS 15 (U.S. CLS. 2, 21 AND 36).

FIRST USE 1-11-2012; IN COMMERCE 1-11-2012.

THE MARK CONSISTS OF STANDARD CHARACTERS WITHOUT CLAIM TO ANY PARTICULAR FONT, STYLE, SIZE, OR COLOR.

NO CLAIM IS MADE TO THE EXCLUSIVE RIGHT TO USE "PICK", APART FROM THE MARK AS SHOWN.

SER. NO. 85-514,532, FILED 1-11-2012.

KIM MONINGHOFF, EXAMINING ATTORNEY



*David J. Kybas*

Director of the United States Patent and Trademark Office

# United States of America

United States Patent and Trademark Office

## Universal Dream

**Reg. No. 4,197,906**

RICE DAPHNE D. (UNITED STATES INDIVIDUAL)  
2230 WOODVIEW DRIVE APT 341  
YPSILANTI, MI 48198

**Registered Aug. 28, 2012**

**Int. Cl.: 41**

FOR: ENTERTAINMENT IN THE NATURE OF BEAUTY PAGEANTS, IN CLASS 41 (U.S. CLS. 100, 101 AND 107).

**SERVICE MARK**

FIRST USE 1-11-2012; IN COMMERCE 1-17-2012.

**PRINCIPAL REGISTER**

THE MARK CONSISTS OF STANDARD CHARACTERS WITHOUT CLAIM TO ANY PARTICULAR FONT, STYLE, SIZE, OR COLOR.

SER. NO. 85-514,574, FILED 1-11-2012.

BARNEY CHARLON, EXAMINING ATTORNEY



*David J. Kyffers*

Director of the United States Patent and Trademark Office

# United States of America

United States Patent and Trademark Office

## CHANNELFIX

**Reg. No. 4,197,907**

CHANNELFIX.COM, LLC (FLORIDA LIMITED LIABILITY COMPANY)  
7950 NW 53RD STREET - SUITE 215  
MIAMI, FL 33166

**Registered Aug. 28, 2012**

**Int. Cls.: 9, 35, 38, 41  
and 42**

FOR: COMPUTER SOFTWARE FOR UPLOADING, POSTING, SHOWING, DISPLAYING, TAGGING, BLOGGING, SHARING OR OTHERWISE PROVIDING ELECTRONIC MEDIA OR INFORMATION IN THE FIELD OF COMMUNICATIONS NETWORKS VIA THE INTERNET OR OTHER COMMUNICATIONS NETWORKS WITH THIRD PARTIES, IN CLASS 9 (U.S. CLS. 21, 23, 26, 36 AND 38).

**TRADEMARK**

**SERVICE MARK**

FIRST USE 1-1-2011; IN COMMERCE 1-1-2011.

**PRINCIPAL REGISTER**

FOR: AD SERVING, NAMELY, PLACING ADVERTISEMENTS ON WEBSITES FOR OTHERS USING SPECIALIZED COMPUTER SOFTWARE, IN CLASS 35 (U.S. CLS. 100, 101 AND 102).

FIRST USE 1-1-2011; IN COMMERCE 1-1-2011.

FOR: AUDIO AND VIDEO BROADCASTING SERVICES OVER THE INTERNET IN THE FIELD OF COMMUNICATIONS NETWORK, NAMELY, UPLOADING, POSTING, SHOWING, DISPLAYING, TAGGING AND ELECTRONICALLY TRANSMITTING INFORMATION, AUDIO, AND VIDEO CLIPS; PROVIDING ACCESS TO INFORMATION, AUDIO, AND VIDEO VIA WEBSITES, ONLINE FORUMS, CHAT ROOMS, LISTSERVS AND BLOGS OVER THE INTERNET; PROVIDING ON-LINE CHAT ROOMS AND ELECTRONIC BULLETIN BOARDS FOR TRANSMISSION OF MESSAGES AMONG USERS IN THE FIELD OF GENERAL INTEREST, IN CLASS 38 (U.S. CLS. 100, 101 AND 104).

FIRST USE 1-1-2011; IN COMMERCE 1-1-2011.

FOR: EDUCATIONAL AND ENTERTAINMENT SERVICES, NAMELY, A CONTINUING PROGRAM ABOUT PROVIDING A WEBSITE FEATURING AUDIO CLIPS, VIDEO CLIPS, MUSICAL PERFORMANCES, MUSICAL VIDEOS, FILM CLIPS, PHOTOGRAPHS, OTHER MULTIMEDIA MATERIALS, AND INFORMATION IN THE FIELD OF AUDIO CLIPS, VIDEO CLIPS, MUSICAL PERFORMANCES, MUSICAL VIDEOS, FILM CLIPS, PHOTOGRAPHS, AND OTHER MULTIMEDIA MATERIALS ACCESSIBLE BY RADIO, TELEVISION, SATELLITE, AUDIO, VIDEO AND COMPUTER NETWORKS; ON-LINE JOURNALS, NAMELY, BLOGS FEATURING INFORMATION IN THE FIELD OF AUDIO CLIPS, VIDEO



*David J. Kyffers*

Director of the United States Patent and Trademark Office

**Reg. No. 4,197,907** CLIPS, MUSICAL PERFORMANCES, MUSICAL VIDEOS, FILM CLIPS, PHOTOGRAPHS, AND OTHER MULTIMEDIA MATERIALS ACCESSIBLE BY RADIO, TELEVISION, SATELLITE, AUDIO, VIDEO AND COMPUTER NETWORKS, IN CLASS 41 (U.S. CLS. 100, 101 AND 107).

FIRST USE 1-1-2011; IN COMMERCE 1-1-2011.

FOR: APPLICATION SERVICE PROVIDER (ASP) FEATURING SOFTWARE FOR USE TO ENABLE UPLOADING, POSTING, SHOWING, DISPLAYING, TAGGING, BLOGGING, SHARING OR OTHERWISE PROVIDING ELECTRONIC MEDIA OR INFORMATION IN THE FIELD OF COMMUNICATIONS NETWORKS OVER THE INTERNET OR OTHER COMMUNICATIONS NETWORK, IN CLASS 42 (U.S. CLS. 100 AND 101).

FIRST USE 1-1-2011; IN COMMERCE 1-1-2011.

THE MARK CONSISTS OF STANDARD CHARACTERS WITHOUT CLAIM TO ANY PARTICULAR FONT, STYLE, SIZE, OR COLOR.

SER. NO. 85-514,609, FILED 1-12-2012.

RENEE MCCRAY, EXAMINING ATTORNEY

# United States of America

United States Patent and Trademark Office

## TRIAL LAWYERS COLLEGE

**Reg. No. 4,197,908**

**Registered Aug. 28, 2012**

**Int. Cl.: 41**

**SERVICE MARK**

**PRINCIPAL REGISTER**

THE TRIAL LAWYERS COLLEGE (WYOMING CORPORATION)  
P.O. BOX 1249  
LARAMIE, WY 82073

FOR: PROVIDING CONTINUING LEGAL EDUCATION SERVICES, NAMELY, CONDUCTING SEMINARS AND OTHER TRAINING PROGRAMS FOR LAWYERS AND JUDGES, IN CLASS 41 (U.S. CLS. 100, 101 AND 107).

FIRST USE 8-1-1994; IN COMMERCE 8-1-1994.

THE MARK CONSISTS OF STANDARD CHARACTERS WITHOUT CLAIM TO ANY PARTICULAR FONT, STYLE, SIZE, OR COLOR.

OWNER OF U.S. REG. NO. 2,596,366.

NO CLAIM IS MADE TO THE EXCLUSIVE RIGHT TO USE "COLLEGE", APART FROM THE MARK AS SHOWN.

SEC. 2(F).

SER. NO. 85-514,661, FILED 1-12-2012.

KIM MONINGHOFF, EXAMINING ATTORNEY



*David J. Kyffers*

Director of the United States Patent and Trademark Office

# United States of America

United States Patent and Trademark Office

## GOTTASHOPIT

**Reg. No. 4,197,909**

**Registered Aug. 28, 2012**

**Int. Cl.: 42**

**SERVICE MARK**

**PRINCIPAL REGISTER**

GOTTASHOPIT.COM LLC (WISCONSIN LIMITED LIABILITY COMPANY)  
751 RESERVE COURT  
SOUTH ELGIN, IL 60177

FOR: PROVIDING ON-LINE NON-DOWNLOADABLE SOFTWARE VIA A WEBSITE TO ENABLE CONSUMERS TO LOCATE CONTRACTORS AND SERVICES PROVIDERS; PROVIDING ON-LINE NON-DOWNLOADABLE SOFTWARE VIA A WEBSITE TO ENABLE CONSUMERS TO OBTAIN BIDS FROM CONTRACTORS AND SERVICES PROVIDERS AND ENABLE CONTRACTORS AND SERVICE PROVIDERS TO BID ON PROJECTS SUBMITTED BY CONSUMERS; PROVIDING ON-LINE NON-DOWNLOADABLE SOFTWARE VIA A WEBSITE TO FACILITATE THE BUYING AND SELLING OF GOODS AND SERVICES, IN CLASS 42 (U.S. CLS. 100 AND 101).

FIRST USE 12-1-2011; IN COMMERCE 12-1-2011.

THE MARK CONSISTS OF STANDARD CHARACTERS WITHOUT CLAIM TO ANY PARTICULAR FONT, STYLE, SIZE, OR COLOR.

SER. NO. 85-514,677, FILED 1-12-2012.

LEIGH CAROLINE CASE, EXAMINING ATTORNEY



*David J. Kypos*

Director of the United States Patent and Trademark Office

# United States of America

United States Patent and Trademark Office

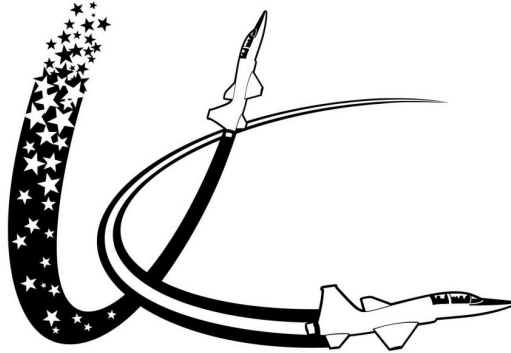

**Reg. No. 4,197,910**

CITY OF UNIVERSAL CITY (TEXAS MUNICIPAL CORPORATION)  
2150 UNIVERSAL CITY BLVD.  
UNIVERSAL CITY, TX 78148

**Registered Aug. 28, 2012**

**Int. Cls.: 35, 37 and 41**

FOR: PROMOTING TOURISM, BUSINESS AND CULTURAL EVENTS IN THE UNIVERSAL CITY AREA, IN CLASS 35 (U.S. CLS. 100, 101 AND 102).

**SERVICE MARK**

FIRST USE 11-0-2010; IN COMMERCE 11-0-2010.

**PRINCIPAL REGISTER**

FOR: CONSTRUCTION AND MAINTENANCE REPAIR OF STREETS AND SIDEWALKS AND STREET CLEANING AND SWEEPING, IN CLASS 37 (U.S. CLS. 100, 103 AND 106).

FIRST USE 1-7-2011; IN COMMERCE 1-7-2011.

FOR: RECREATIONAL PARK SERVICES; ENTERTAINMENT AND RECREATIONAL SERVICES, NAMELY, OPERATING A PUBLIC PARK FEATURING A GOLF COURSE, WALKING TRAILS, AND DISC GOLF COURSE; AND ORGANIZING RECREATIONAL EVENTS IN THE NATURE OF A FAMILY ORIENTED FUN DAY , IN CLASS 41 (U.S. CLS. 100, 101 AND 107).

FIRST USE 11-0-2011; IN COMMERCE 11-0-2011.

THE MARK CONSISTS OF A JET FLYING UPWARD WITH A VERTICALLY ARCHED JET STREAM CONTAINING STARS, A SECOND JET FLYING HORIZONTALLY WITH AN ARCHED JET STREAM MADE UP OF THREE ADJACENT LINES, WITH THE TWO JET STREAMS INTERSECTING.

SER. NO. 85-514,786, FILED 1-12-2012.

REBECCA SMITH, EXAMINING ATTORNEY



*David J. Kybas*

Director of the United States Patent and Trademark Office



# United States of America

United States Patent and Trademark Office

# Remarlé

**Reg. No. 4,197,911**

RENÉE MARIE LEMASNEY (UNITED STATES INDIVIDUAL)

**Registered Aug. 28, 2012**

1024 OHIO AVE  
BENSALEM, PA 19020

**Int. Cl.: 3**

FOR: AROMATIC BODY CARE PRODUCTS, NAMELY, BODY LOTION, SHOWER GEL, CUTICLE CREAM, SHAMPOO, CONDITIONER, NON-MEDICATED LIP BALM, SOAP, BODY POLISH, BODY AND FOOT SCRUB AND NON-MEDICATED FOOT CREAM; BODY SCRUB; FACIAL SCRUBS; FOOT SCRUBS; HAND SCRUBS, IN CLASS 3 (U.S. CLS. 1, 4, 6, 50, 51 AND 52).

**TRADEMARK**

**PRINCIPAL REGISTER**

FIRST USE 12-12-2011; IN COMMERCE 12-12-2011.

THE MARK CONSISTS OF STANDARD CHARACTERS WITHOUT CLAIM TO ANY PARTICULAR FONT, STYLE, SIZE, OR COLOR.

THE WORDING "REMARLÉ" HAS NO MEANING IN A FOREIGN LANGUAGE.

SER. NO. 85-514,790, FILED 1-12-2012.

JUDITH HELFMAN, EXAMINING ATTORNEY



*David J. Kyffers*

Director of the United States Patent and Trademark Office

# United States of America

United States Patent and Trademark Office



**Reg. No. 4,197,912**

**Registered Aug. 28, 2012**

**Int. Cl.: 35**

**SERVICE MARK**

**PRINCIPAL REGISTER**

WISCONSIN MILK MARKETING BOARD, INC. (WISCONSIN CORPORATION)  
8414 EXCELSIOR DRIVE  
MADISON, WI 53717

FOR: PROMOTING THE SALE OF GOODS OF OTHERS, NAMELY, CHEESE, THROUGH THE DISTRIBUTION OF PRINTED AND WEBSITE MATERIALS, MENUS, AND BROCHURES , IN CLASS 35 (U.S. CLS. 100, 101 AND 102).

FIRST USE 7-1-2009; IN COMMERCE 7-1-2009.

OWNER OF U.S. REG. NO. 3,870,645.

THE COLOR(S) RED, WHITE, TAN, BROWN AND GOLD IS/ARE CLAIMED AS A FEATURE OF THE MARK.

NO CLAIM IS MADE TO THE EXCLUSIVE RIGHT TO USE "CHEESE", APART FROM THE MARK AS SHOWN.

THE MARK CONSISTS OF A GOLD SHIELD OUTLINED IN TAN AND BROWN, WITH A WHITE OUTLINING OF THE SHAPE INSIDE OF THE SHIELD INSIDE OF THE SHIELD WITH A WHITE CROWN. THERE IS A RED BANNER ACROSS THE SHIELD OUTLINED IN TAN AND BROWN. THE WORDING "CHEESE & BURGER" APPEARS IN WHITE CROSS THE BANNER AND THE TERM "SOCIETY" APPEARS IN WHITE INSIDE OF THE SHIELD. THERE ARE TWO TRIANGULAR DESIGN ELEMENTS IN RED OUTLINED IN TAN BENEATH THE BANNER ELEMENT AND TWO SWIRLS IN RED, TAN, AND BROWN BELOW THE TRIANGULAR DESIGN ELEMENTS.

SER. NO. 85-514,830, FILED 1-12-2012.

LINDSEY RUBIN, EXAMINING ATTORNEY



*David J. Kyffers*

Director of the United States Patent and Trademark Office

# United States of America

United States Patent and Trademark Office



**Reg. No. 4,197,913**

**Registered Aug. 28, 2012**

**Int. Cl.: 25**

**TRADEMARK**

**PRINCIPAL REGISTER**

ROJAS, SURLEY (UNITED STATES INDIVIDUAL)  
P.O. BOX 6206  
FULLERTON, CA 92834

FOR: BEANIES; BOARD SHORTS; HATS; HOODED SWEATSHIRTS; JACKETS; JEANS;  
PANTS; SWIMSUITS; T-SHIRTS; WARM UP OUTFITS, IN CLASS 25 (U.S. CLS. 22 AND  
39).

FIRST USE 12-1-2011; IN COMMERCE 12-1-2011.

THE MARK CONSISTS OF THE STYLIZED TEXT "OODEX" WITH A DASH/ARROW BELOW  
THE TEXT.

SER. NO. 85-514,860, FILED 1-12-2012.

LAURIE MAYES, EXAMINING ATTORNEY



*David J. Kyffers*

Director of the United States Patent and Trademark Office

# United States of America

United States Patent and Trademark Office

## PIPELINEOPTIMIZER

**Reg. No. 4,197,914**

**Registered Aug. 28, 2012**

**Int. Cl.: 9**

**TRADEMARK**

**PRINCIPAL REGISTER**

ENERGY SOLUTIONS INTERNATIONAL, INC. (TEXAS CORPORATION)  
SUITE 200  
7904 N. SAM HOUSTON PARKWAY WEST  
HOUSTON, TX 77064

FOR: COMPUTER PROGRAMS FOR ENGINEERING ANALYSIS, MODELING, AND OPTIMIZATION FOR USE IN PIPELINE OPERATIONS AND CONTROL IN THE ENERGY INDUSTRY, IN CLASS 9 (U.S. CLS. 21, 23, 26, 36 AND 38).

FIRST USE 12-21-2005; IN COMMERCE 12-21-2005.

THE MARK CONSISTS OF STANDARD CHARACTERS WITHOUT CLAIM TO ANY PARTICULAR FONT, STYLE, SIZE, OR COLOR.

OWNER OF U.S. REG. NOS. 2,946,947, 3,900,175 AND OTHERS.

SEC. 2(F).

SER. NO. 85-515,039, FILED 1-12-2012.

THOMAS MANOR, EXAMINING ATTORNEY



*David J. Kyffers*

Director of the United States Patent and Trademark Office

# United States of America

United States Patent and Trademark Office



**Reg. No. 4,197,915**

JESSE BELLAVANCE (UNITED STATES INDIVIDUAL)  
108 BUCKINGHAM ROAD  
CHARLOTTESVILLE, VA 22903

**Registered Aug. 28, 2012**

**Int. Cl.: 25**

FOR: BELTS MADE OUT OF CLOTH; MARTIAL ARTS UNIFORMS, NAMELY, GIS; SHORT-SLEEVED OR LONG-SLEEVED T-SHIRTS, IN CLASS 25 (U.S. CLS. 22 AND 39).

**TRADEMARK**

FIRST USE 1-1-2010; IN COMMERCE 1-1-2010.

**PRINCIPAL REGISTER**

NO CLAIM IS MADE TO THE EXCLUSIVE RIGHT TO USE "BRAZILIAN JIU-JITSU KIMONOS", APART FROM THE MARK AS SHOWN.

THE MARK CONSISTS OF A FORWARD-FACING BEE POSITIONED UNDER THE WORDS "KILLER BEE" AND "BRAZILIAN JIU-JITSU KIMONOS".

SER. NO. 85-515,074, FILED 1-12-2012.

JORDAN BAKER, EXAMINING ATTORNEY



*David J. Kybas*

Director of the United States Patent and Trademark Office

# United States of America

United States Patent and Trademark Office

# Laxmi

**Reg. No. 4,197,916**

**Registered Aug. 28, 2012**

**Int. Cl.: 14**

**TRADEMARK**

**PRINCIPAL REGISTER**

SUBERI BROTHERS LLC (NEW YORK LIMITED LIABILITY COMPANY)  
902 BROADWAY, 14TH FLOOR  
NEW YORK, NY 10010

FOR: DIAMOND JEWELRY; DIAMONDS, IN CLASS 14 (U.S. CLS. 2, 27, 28 AND 50).

FIRST USE 4-1-2004; IN COMMERCE 4-1-2004.

THE MARK CONSISTS OF STANDARD CHARACTERS WITHOUT CLAIM TO ANY PARTICULAR FONT, STYLE, SIZE, OR COLOR.

THE ENGLISH TRANSLATION OF "LAXMI" IN THE MARK IS "PROSPERITY".

SER. NO. 85-515,096, FILED 1-12-2012.

AMY KERTGATE, EXAMINING ATTORNEY



*David J. Kyffers*

Director of the United States Patent and Trademark Office

# United States of America

United States Patent and Trademark Office

## Laxmi Diamond

**Reg. No. 4,197,917**

SUBERI BROTHERS LLC (NEW YORK LIMITED LIABILITY COMPANY)  
902 BROADWAY, 14TH FLOOR  
NEW YORK, NY 10010

**Registered Aug. 28, 2012**

**Int. Cl.: 14**

FOR: DIAMOND JEWELRY; DIAMONDS, IN CLASS 14 (U.S. CLS. 2, 27, 28 AND 50).

**TRADEMARK**

FIRST USE 4-1-2004; IN COMMERCE 4-1-2004.

**PRINCIPAL REGISTER**

THE MARK CONSISTS OF STANDARD CHARACTERS WITHOUT CLAIM TO ANY PARTICULAR FONT, STYLE, SIZE, OR COLOR.

NO CLAIM IS MADE TO THE EXCLUSIVE RIGHT TO USE "DIAMOND", APART FROM THE MARK AS SHOWN.

THE ENGLISH TRANSLATION OF "LAXMI" IN THE MARK IS "PROSPERITY".

SER. NO. 85-515,103, FILED 1-12-2012.

AMY KERTGATE, EXAMINING ATTORNEY



*David J. Kyffers*

Director of the United States Patent and Trademark Office

# United States of America

United States Patent and Trademark Office

# SMARTFLOW

**Reg. No. 4,197,918**

BURGER & BROWN ENGINEERING, INCORPORATED (KANSAS CORPORATION)  
4500 EAST 142ND STREET  
GRANDVIEW, MO 64030

**Registered Aug. 28, 2012**

**Int. Cl.: 9**

FOR: TEMPERATURE GAUGES, TEMPERATURE REGULATORS, FLOW METERS, FLOW RATE GAUGES, FLOW REGULATORS, FLOW DISTRIBUTION MANIFOLDS AND CONTROL VALVES FOR REGULATING THE FLOW OF LIQUIDS, ALL FOR LIQUID COOLING SYSTEMS, IN CLASS 9 (U.S. CLS. 21, 23, 26, 36 AND 38).

**TRADEMARK**

**PRINCIPAL REGISTER**

FIRST USE 2-28-1992; IN COMMERCE 2-28-1992.

THE MARK CONSISTS OF STANDARD CHARACTERS WITHOUT CLAIM TO ANY PARTICULAR FONT, STYLE, SIZE, OR COLOR.

OWNER OF U.S. REG. NO. 1,797,618.

SER. NO. 85-515,172, FILED 1-12-2012.

JORDAN BAKER, EXAMINING ATTORNEY



*David J. Kyffers*

Director of the United States Patent and Trademark Office



# United States of America

United States Patent and Trademark Office



**Reg. No. 4,197,919**

**Registered Aug. 28, 2012**

**Int. Cl.: 36**

**SERVICE MARK**

**PRINCIPAL REGISTER**

THE CALIFORNIA GROCERS ASSOCIATION EDUCATIONAL FOUNDATION (CALIFORNIA CORPORATION)  
1215 K STREET, SUITE 700  
SACRAMENTO, CA 95814

FOR: PROVIDING EDUCATIONAL SCHOLARSHIPS, IN CLASS 36 (U.S. CLS. 100, 101 AND 102).

FIRST USE 10-18-2010; IN COMMERCE 10-18-2010.

NO CLAIM IS MADE TO THE EXCLUSIVE RIGHT TO USE "CALIFORNIA GROCERS ASSOCIATION" AND "EDUCATIONAL FOUNDATION", APART FROM THE MARK AS SHOWN.

THE COLOR(S) BLACK, WHITE, GREEN, YELLOW AND GRAY IS/ARE CLAIMED AS A FEATURE OF THE MARK.

THE MARK CONSISTS OF A DEPICTION OF AN OPEN BLACK LAPTOP COMPUTER WITH A GREEN SCREEN ON WHICH A DEPICTION OF AN OPEN BOOK WITH YELLOW HALF-SUN COMING OUT OF IT APPEARS. THE WHITE LETTERS "CGA" APPEARS ON THE BOOK COVER. THE BOOK COVER IS IN BLACK AND THE BOOK PAGES ARE IN WHITE. UNDER THE LAPTOP DEPICTION ARE THE WORDS "CALIFORNIA GROCERS ASSOCIATION" IN THE COLOR GRAY AGAINST A WHITE BACKGROUND. UNDER THOSE WORDS ARE THE WORDS "EDUCATIONAL FOUNDATION" IN BLACK AGAINST A YELLOW BACKGROUND. A BLACK LINE FORMS THE RECTANGULAR OUTER BORDER OF THE LAPTOP AND THE WORDS "CALIFORNIA GROCERS ASSOCIATION" AND ANOTHER BLACK LINE FORMS A CONNECTING HORIZONTAL BORDER AROUND THE WORDS "EDUCATIONAL FOUNDATION".

SER. NO. 85-515,180, FILED 1-12-2012.

EDWARD NELSON, EXAMINING ATTORNEY



*David J. Kyffers*

Director of the United States Patent and Trademark Office

# United States of America

United States Patent and Trademark Office

## ART OF THE CARD

**Reg. No. 4,197,920**

HERO ARTS RUBBER STAMPS, INC. (CALIFORNIA CORPORATION)  
1200 HARBOUR WAY S., STE. 201  
RICHMOND, CA 94804

**Registered Aug. 28, 2012**

**Int. Cl.: 16**

FOR: INK STAMPS; RUBBER STAMPS, IN CLASS 16 (U.S. CLS. 2, 5, 22, 23, 29, 37, 38 AND 50).

**TRADEMARK**

FIRST USE 12-15-2011; IN COMMERCE 12-15-2011.

**PRINCIPAL REGISTER**

THE MARK CONSISTS OF STANDARD CHARACTERS WITHOUT CLAIM TO ANY PARTICULAR FONT, STYLE, SIZE, OR COLOR.

SER. NO. 85-515,187, FILED 1-12-2012.

ODESSA BIBBINS, EXAMINING ATTORNEY



*David J. Kybas*

Director of the United States Patent and Trademark Office

# United States of America

United States Patent and Trademark Office

## For Perfect Wine

**Reg. No. 4,197,921**

HEWY WINE CHILLERS, LLC (FLORIDA LIMITED LIABILITY COMPANY)  
2147 ALAMEDA AVE  
ORLANDO, FL 32804

**Registered Aug. 28, 2012**

**Int. Cl.: 21**

FOR: BOTTLE STOPPERS SPECIALLY ADAPTED FOR USE WITH WINE BOTTLES;  
COOLERS FOR WINE, IN CLASS 21 (U.S. CLS. 2, 13, 23, 29, 30, 33, 40 AND 50).

**TRADEMARK**

FIRST USE 9-20-2011; IN COMMERCE 9-20-2011.

**PRINCIPAL REGISTER**

THE MARK CONSISTS OF STANDARD CHARACTERS WITHOUT CLAIM TO ANY PARTICULAR FONT, STYLE, SIZE, OR COLOR.

NO CLAIM IS MADE TO THE EXCLUSIVE RIGHT TO USE "WINE", APART FROM THE MARK AS SHOWN.

SER. NO. 85-515,242, FILED 1-12-2012.

JOHN WILKE, EXAMINING ATTORNEY



*David J. Kyffers*

Director of the United States Patent and Trademark Office

# United States of America

United States Patent and Trademark Office

# TRIPYIP

**Reg. No. 4,197,922**

**Registered Aug. 28, 2012**

**Int. Cl.: 39**

**SERVICE MARK**

**PRINCIPAL REGISTER**

TRIPYIP, LLC (NEVADA LIMITED LIABILITY COMPANY)  
SUITE # E-520  
2505 ANTHEM VILLAGE DRIVE  
HENDERSON, NV 89052

FOR: TRAVEL INFORMATION SERVICES; PROVIDING AN ON-LINE COMPUTER DATABASE IN THE FIELD OF TRAVEL INFORMATION SERVICES; PROVIDING TRAVEL INFORMATION OF WORLDWIDE TRAVEL DESTINATIONS AND LOCAL ATTRACTIONS VIA A GLOBAL COMPUTER NETWORK, IN CLASS 39 (U.S. CLS. 100 AND 105).

FIRST USE 10-1-2011; IN COMMERCE 12-22-2011.

THE MARK CONSISTS OF STANDARD CHARACTERS WITHOUT CLAIM TO ANY PARTICULAR FONT, STYLE, SIZE, OR COLOR.

SER. NO. 85-515,335, FILED 1-12-2012.

KRISTIN DAHLING, EXAMINING ATTORNEY



*David J. Kybas*

Director of the United States Patent and Trademark Office

# United States of America

United States Patent and Trademark Office

**Reg. No. 4,197,923**

JESSIE GEORGINA, LLC (CONNECTICUT LIMITED LIABILITY COMPANY)  
220 12520 HIGH BLUFF DR  
SAN DIEGO, CA 92130

**Registered Aug. 28, 2012**

**Int. Cl.: 18**

FOR: TRAVEL BAGS, IN CLASS 18 (U.S. CLS. 1, 2, 3, 22 AND 41).

**TRADEMARK**

FIRST USE 12-1-2011; IN COMMERCE 12-31-2011.

**PRINCIPAL REGISTER**

THE MARK CONSISTS OF THE STYLIZED LETTERS "JG" SHOWN AS TWO REVERSED, MIRROR IMAGE FIGURES WITH A LONG AND SHORT ROUGHLY STRAIGHT SECTION, WITH EACH SECTION ENDING IN A ROUNDED TIP.

SER. NO. 85-515,339, FILED 1-12-2012.

WILLIAM VERHOSEK, EXAMINING ATTORNEY



*David J. Kybas*

Director of the United States Patent and Trademark Office

# United States of America

United States Patent and Trademark Office

## CHRISTIAN BOOK AWARD

**Reg. No. 4,197,924**

EVANGELICAL CHRISTIAN PUBLISHERS ASSOCIATION (ARIZONA CORPORATION)  
9633 SO. 48TH ST. SUITE 195  
PHOENIX, AZ 85044

**Registered Aug. 28, 2012**

**Int. Cl.: 41**

FOR: PROVIDING RECOGNITION BY WAY OF AWARDS TO DEMONSTRATE EXCELLENCE IN THE FIELD OF CHRISTIAN LITERATURE, IN CLASS 41 (U.S. CLS. 100, 101 AND 107).

**SERVICE MARK**

FIRST USE 7-10-2006; IN COMMERCE 7-10-2006.

**PRINCIPAL REGISTER**

THE MARK CONSISTS OF STANDARD CHARACTERS WITHOUT CLAIM TO ANY PARTICULAR FONT, STYLE, SIZE, OR COLOR.

NO CLAIM IS MADE TO THE EXCLUSIVE RIGHT TO USE "BOOK AWARD", APART FROM THE MARK AS SHOWN.

SEC. 2(F).

SER. NO. 85-515,347, FILED 1-12-2012.

KRISTIN DAHLING, EXAMINING ATTORNEY



*David J. Kyffers*

Director of the United States Patent and Trademark Office

# United States of America

United States Patent and Trademark Office



**Reg. No. 4,197,925**

**Registered Aug. 28, 2012**

**Int. Cl.: 43**

BAD DADDY'S INTERNATIONAL, LLC (NORTH CAROLINA LIMITED LIABILITY COMPANY)  
601 SOUTH KINGS DRIVE  
SUITE HH  
CHARLOTTE, NC 28204

**SERVICE MARK**

FOR: RESTAURANT SERVICES, IN CLASS 43 (U.S. CLS. 100 AND 101).

**PRINCIPAL REGISTER**

FIRST USE 8-10-2011; IN COMMERCE 8-10-2011.

OWNER OF U.S. REG. NO. 4,031,969.

NO CLAIM IS MADE TO THE EXCLUSIVE RIGHT TO USE "BURGER BAR" AND "EST. 2007", APART FROM THE MARK AS SHOWN.

THE MARK CONSISTS OF THE IMAGE OF A BOTTLE CAP WITH THE WORDING "BAD DADDY'S" WITH INITIAL CAPS STYLIZED IN A BLACK BANNER AND THE WORDING "BURGER BAR" CENTERED BELOW IN BLACK CAPITAL LETTERS WITH THE LETTERS "EST." AND NUMBERS "2007" CENTERED BENEATH WITH A STAR IN BETWEEN.

SER. NO. 85-515,365, FILED 1-12-2012.

BRIAN NEVILLE, EXAMINING ATTORNEY



*David J. Kyffers*

Director of the United States Patent and Trademark Office

# United States of America

United States Patent and Trademark Office

## GATEWAYS TO OPPORTUNITY

**Reg. No. 4,197,926**

**Registered Aug. 28, 2012**

**Int. Cls.: 35, 36 and 45**

**SERVICE MARK**

**PRINCIPAL REGISTER**

ILLINOIS NETWORK OF CHILD CARE RESOURCE & REFERRAL AGENCIES (ILLINOIS CORPORATION)  
1226 TOWANDA PLAZA  
BLOOMINGTON, IL 61701

FOR: PROVIDING CAREER INFORMATION, NAMELY, JOB-READINESS AND CAREER DEVELOPMENT INFORMATION; PROVIDING CAREER INFORMATION; CAREER NETWORKING SERVICES; PROVIDING AN ON-LINE SEARCHABLE DATABASE FEATURING EMPLOYMENT OPPORTUNITIES; PROVIDING A WEBSITE FEATURING CAREER INFORMATION AND JOB LISTINGS, IN CLASS 35 (U.S. CLS. 100, 101 AND 102).

FIRST USE 1-24-2005; IN COMMERCE 1-24-2005.

FOR: PROVIDING EDUCATIONAL SCHOLARSHIPS, IN CLASS 36 (U.S. CLS. 100, 101 AND 102).

FIRST USE 1-24-2005; IN COMMERCE 1-24-2005.

FOR: VERIFYING THE BACKGROUND CREDENTIALS OF PRACTITIONERS IN THE FIELDS OF EARLY CHILD CARE AND DEVELOPMENT AND SCHOOL AGE AND YOUTH DEVELOPMENT, IN CLASS 45 (U.S. CLS. 100 AND 101).

FIRST USE 1-24-2005; IN COMMERCE 1-24-2005.

THE MARK CONSISTS OF STANDARD CHARACTERS WITHOUT CLAIM TO ANY PARTICULAR FONT, STYLE, SIZE, OR COLOR.

SER. NO. 85-515,480, FILED 1-12-2012.

ROBIN MITTLER, EXAMINING ATTORNEY



*David J. Kyffers*

Director of the United States Patent and Trademark Office



# United States of America

United States Patent and Trademark Office

# RESCUE

**Reg. No. 4,197,927**

**Registered Aug. 28, 2012**

**Int. Cls.: 37 and 42**

**SERVICE MARK**

**PRINCIPAL REGISTER**

STERLING INTERNATIONAL INC. (WASHINGTON CORPORATION)  
3808 NORTH SULLIVAN ROAD, BLDG. 16BV  
SPOKANE, WA 992161630

FOR: INDUSTRIAL, AGRICULTURAL, COMMERCIAL, AND RESIDENTIAL PEST CONTROL SERVICES FOR OTHERS, NAMELY, THE SELECTION, IMPLEMENTATION, AND USE OF PEST CONTROL TECHNOLOGY; PROVIDING ONLINE INFORMATION IN THE FIELD OF PEST CONTROL, IN CLASS 37 (U.S. CLS. 100, 103 AND 106).

FIRST USE 2-16-2007; IN COMMERCE 2-16-2007.

FOR: DESIGN AND DEVELOPMENT OF PEST CONTROL TECHNOLOGY, IN CLASS 42 (U.S. CLS. 100 AND 101).

FIRST USE 2-16-2007; IN COMMERCE 2-16-2007.

THE MARK CONSISTS OF STANDARD CHARACTERS WITHOUT CLAIM TO ANY PARTICULAR FONT, STYLE, SIZE, OR COLOR.

OWNER OF U.S. REG. NOS. 2,536,089, 3,558,921 AND OTHERS.

SER. NO. 85-515,487, FILED 1-12-2012.

AMY HELLA, EXAMINING ATTORNEY



*David J. Kybas*

Director of the United States Patent and Trademark Office

# United States of America

United States Patent and Trademark Office

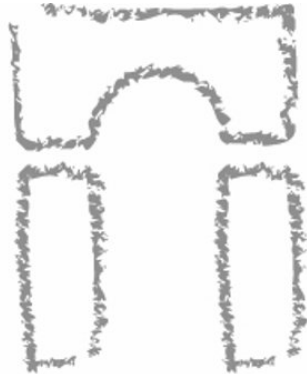

**Reg. No. 4,197,928**

**Registered Aug. 28, 2012**

**Int. Cls.: 35, 36 and 45**

**SERVICE MARK**

**PRINCIPAL REGISTER**

ILLINOIS NETWORK OF CHILD CARE RESOURCE & REFERRAL AGENCIES (ILLINOIS CORPORATION)  
1226 TOWANDA PLAZA  
BLOOMINGTON, IL 61701

FOR: PROVIDING CAREER INFORMATION, NAMELY, JOB-READINESS AND CAREER DEVELOPMENT INFORMATION; PROVIDING CAREER INFORMATION; CAREER NETWORKING SERVICES; PROVIDING AN ON-LINE SEARCHABLE DATABASE FEATURING EMPLOYMENT OPPORTUNITIES; PROVIDING A WEBSITE FEATURING CAREER INFORMATION AND JOB LISTINGS, IN CLASS 35 (U.S. CLS. 100, 101 AND 102).

FIRST USE 1-24-2005; IN COMMERCE 1-24-2005.

FOR: PROVIDING EDUCATIONAL SCHOLARSHIPS, IN CLASS 36 (U.S. CLS. 100, 101 AND 102).

FIRST USE 1-24-2005; IN COMMERCE 1-24-2005.

FOR: VERIFYING THE BACKGROUND CREDENTIALS OF PRACTITIONERS IN THE FIELDS OF EARLY CHILD CARE AND DEVELOPMENT AND SCHOOL AGE AND YOUTH DEVELOPMENT, IN CLASS 45 (U.S. CLS. 100 AND 101).

FIRST USE 1-24-2005; IN COMMERCE 1-24-2005.

THE MARK CONSISTS OF A HAND DRAWN GATE.

SER. NO. 85-515,500, FILED 1-12-2012.

ROBIN MITTLER, EXAMINING ATTORNEY



*David J. Kybas*

Director of the United States Patent and Trademark Office

# United States of America

United States Patent and Trademark Office

The logo for SUREFIRE features the word "SUREFIRE" in a bold, black, sans-serif font. The letters are centered within a large, black, stylized circular shape that is open at the top and bottom, resembling a partial ring or a stylized 'C'.

**Reg. No. 4,197,929**

SUREFIRE, LLC (CALIFORNIA LIMITED LIABILITY COMPANY)  
18300 MOUNT BALDY CIRCLE  
FOUNTAIN VALLEY, CA 92708

**Registered Aug. 28, 2012**

**Int. Cl.: 11**

FOR: ILLUMINATION PRODUCTS, NAMELY, WEAPON-MOUNTED LIGHTS, IN CLASS 11 (U.S. CLS. 13, 21, 23, 31 AND 34).

**TRADEMARK**

FIRST USE 3-17-2011; IN COMMERCE 3-17-2011.

**PRINCIPAL REGISTER**

OWNER OF U.S. REG. NOS. 2,657,142, 3,820,152 AND OTHERS.

THE MARK CONSISTS OF THE WORD "SUREFIRE" IN BLOCK LETTERS, WITH HORIZONTAL PARENTHESES ABOVE AND BELOW THE WORD, SPANNING FROM THE FIRST "R" TO THE "I".

SER. NO. 85-515,504, FILED 1-12-2012.

JUSTINE D. PARKER, EXAMINING ATTORNEY



*David J. Kybas*

Director of the United States Patent and Trademark Office

# United States of America

United States Patent and Trademark Office

## Wax On Wax Off Hand Car Wash & Detail

**Reg. No. 4,197,930**

KHAN, MOHAMMED IMRAN (UNITED STATES INDIVIDUAL)  
3405 HENLEY ST.  
GLENVIEW, IL 60025

**Registered Aug. 28, 2012**

**Int. Cl.: 37**

FOR: AUTOMOBILE CLEANING AND CAR WASHING; AUTOMOBILE DETAILING; CAR WASHING; VEHICLE DETAILING, IN CLASS 37 (U.S. CLS. 100, 103 AND 106).

**SERVICE MARK**

FIRST USE 1-5-2010; IN COMMERCE 1-5-2010.

**PRINCIPAL REGISTER**

THE MARK CONSISTS OF STANDARD CHARACTERS WITHOUT CLAIM TO ANY PARTICULAR FONT, STYLE, SIZE, OR COLOR.

NO CLAIM IS MADE TO THE EXCLUSIVE RIGHT TO USE "HAND CAR WASH & DETAIL", APART FROM THE MARK AS SHOWN.

SER. NO. 85-515,508, FILED 1-12-2012.

KIMBERLY PERRY, EXAMINING ATTORNEY



*David J. Kybas*

Director of the United States Patent and Trademark Office

# United States of America

United States Patent and Trademark Office

## Epiphany Media Group

**Reg. No. 4,197,931**

**Registered Aug. 28, 2012**

**Int. Cl.: 41**

**SERVICE MARK**

**PRINCIPAL REGISTER**

PYLE, GEORGE RUSSELL (UNITED STATES INDIVIDUAL), DBA EPIPHANY MEDIA GROUP  
2640 KENNINGTON DR.  
GLENDALE, CA 91206 AND

MARION MACKENZIE PYLE (UNITED STATES INDIVIDUAL), DBA EPIPHANY MEDIA GROUP  
2640 KENNINGTON DR.  
GLENDALE, CA 91206



*David J. Kybas*

Director of the United States Patent and Trademark Office

FOR: CREATING AND DEVELOPING CONCEPTS FOR TELEVISION PROGRAMS; EDUCATIONAL SERVICES, NAMELY, PROVIDING ONGOING TELEVISION PUBLIC SERVICE ANNOUNCEMENTS IN THE FIELD OF NON-PROFIT CAUSES, ENVIRONMENTAL SUSTAINABILITY, WATER AND ENERGY EFFICIENCY, HEALTH AND WELLNESS, CHILDHOOD DEVELOPMENT, FAITH AND FAMILY; EDUCATIONAL SERVICES, NAMELY, PROVIDING ONLINE INSTRUCTION IN THE FIELD OF SPOKESPERSON TRAINING, MEDIA TRAINING, GROUP FACILITATION, THEATRE SET AND LIGHTING DESIGN, ACTING FOR FILM, TELEVISION AND STAGE, PUBLIC SPEAKING VIA AN ONLINE WEBSITE; ENTERTAINMENT IN THE NATURE OF THEATER PRODUCTIONS; ENTERTAINMENT IN THE NATURE OF VISUAL AND AUDIO PERFORMANCES BY AN ACTOR; ENTERTAINMENT SERVICES, NAMELY, PROVIDING A WEB SITE FEATURING PHOTOGRAPHIC, AUDIO, VIDEO AND PROSE PRESENTATIONS FEATURING FICTION AND NON FICTION EDIFYING STORIES OF THE HUMAN EXPERIENCE; ENTERTAINMENT SERVICES, NAMELY, PROVIDING ON-GOING WEBISODES FEATURING FICTION AND NON FICTION EDIFYING STORIES OF THE HUMAN EXPERIENCE, FAITH AND FAMILY, GREEN HOMES AND GARDENS VIA A GLOBAL COMPUTER NETWORK; ENTERTAINMENT SERVICES, NAMELY, PROVIDING VIDEO PODCASTS IN THE FIELD OF ART AND CULTURE, LITERATURE, MUSIC, PERFORMANCES, LECTURES; ENTERTAINMENT SERVICES, NAMELY, STORYTELLING; FILM AND VIDEO FILM PRODUCTION; FILM AND VIDEO PRODUCTION CONSULTING SERVICES; FILM PRODUCTION; MOTION PICTURE FILM PRODUCTION; MULTIMEDIA ENTERTAINMENT SERVICES IN THE NATURE OF DEVELOPMENT, PRODUCTION AND POST-PRODUCTION SERVICES IN THE FIELDS OF VIDEO AND FILMS; MULTIMEDIA PUBLISHING OF BOOKS, MAGAZINES, JOURNALS, SOFTWARE, GAMES, MUSIC, AND ELECTRONIC PUBLICATIONS; OPERATION OF VIDEO EQUIPMENT OR AUDIO EQUIPMENT ETC. FOR PRODUCTION OF RADIO OR TELEVISION PROGRAMS; ORGANISATION OF FASHION SHOWS FOR ENTERTAINMENT PURPOSES; ORGANIZATION OF EXHIBITIONS FOR CULTURAL OR EDUCATIONAL

**Reg. No. 4,197,931** PURPOSES; ORGANIZATION OF EXHIBITIONS FOR MUSICAL ENTERTAINMENT; ORGANIZATION OF FASHION SHOWS FOR ENTERTAINMENT PURPOSES; ORGANIZING AND ARRANGING EXHIBITIONS FOR ENTERTAINMENT PURPOSES; PHOTOGRAPHIC AND VIDEO SERVICES, NAMELY, PHOTOGRAPHIC AND VIDEO CAPTURE; POST-PRODUCTION EDITING SERVICES IN THE FIELD OF MUSIC, VIDEOS AND FILM; PRODUCTION AND DISTRIBUTION OF INDEPENDENT MOTION PICTURES; PRODUCTION AND DISTRIBUTION OF RADIO PROGRAMS; PRODUCTION AND DISTRIBUTION OF TELEVISION SHOWS AND MOVIES; PRODUCTION AND DISTRIBUTION OF VIDEOS IN THE FIELD OF EDUCATION AND ENTERTAINMENT; PRODUCTION OF AUDIO RECORDING; PRODUCTION OF CABLE TELEVISION PROGRAMS; PRODUCTION OF DVDS, VIDEOTAPES AND TELEVISION PROGRAMS FEATURING FICTION AND NON FICTION EDIFYING STORIES OF THE HUMAN EXPERIENCE, MEDIA TECHNOLOGY, THEATRE ARTS, GREEN LIVING, SUSTAINABLE USE OF WATER AND ENERGY, CHILDHOOD DEVELOPMENT, NON-PROFIT CAUSES, CROSS CULTURAL MISSIONS, FAITH AND FAMILY ISSUES, SPIRITUAL GROWTH; PRODUCTION OF FILMS; PRODUCTION OF TELEVISION PROGRAMS; PRODUCTION OF VIDEO DISCS FOR OTHERS; RENTAL OF VIDEO CAMERAS; TELEVISION SHOW PRODUCTION; VIDEO EDITING; VIDEO PRODUCTION SERVICES , IN CLASS 41 (U.S. CLS. 100, 101 AND 107).

FIRST USE 10-29-2007; IN COMMERCE 1-6-2008.

THE MARK CONSISTS OF STANDARD CHARACTERS WITHOUT CLAIM TO ANY PARTICULAR FONT, STYLE, SIZE, OR COLOR.

OWNER OF U.S. REG. NO. 3,496,867.

NO CLAIM IS MADE TO THE EXCLUSIVE RIGHT TO USE "MEDIA GROUP", APART FROM THE MARK AS SHOWN.

SER. NO. 85-515,598, FILED S.R. 1-13-2012 AM. P.R. 1-13-2012.

DAVID TOOLEY, EXAMINING ATTORNEY

# United States of America

United States Patent and Trademark Office

## CHALLENGE WHAT'S POSSIBLE

**Reg. No. 4,197,932**

**Registered Aug. 28, 2012**

**Int. Cl.: 3**

**TRADEMARK**

**PRINCIPAL REGISTER**

THE PROCTER & GAMBLE COMPANY (OHIO CORPORATION)  
ONE PROCTER & GAMBLE PLAZA  
CINCINNATI, OH 45202

FOR: BODY WASH AND BAR SOAP, IN CLASS 3 (U.S. CLS. 1, 4, 6, 50, 51 AND 52).

FIRST USE 9-30-2011; IN COMMERCE 9-30-2011.

THE MARK CONSISTS OF STANDARD CHARACTERS WITHOUT CLAIM TO ANY PARTICULAR FONT, STYLE, SIZE, OR COLOR.

OWNER OF U.S. REG. NO. 4,071,895.

SER. NO. 85-515,685, FILED 1-13-2012.

DAVID COLLIER, EXAMINING ATTORNEY



*David J. Kyffers*

Director of the United States Patent and Trademark Office

# United States of America

United States Patent and Trademark Office

## CHALLENGE WHAT'S POSSIBLE

**Reg. No. 4,197,933**

**Registered Aug. 28, 2012**

**Int. Cl.: 5**

**TRADEMARK**

**PRINCIPAL REGISTER**

THE PROCTER & GAMBLE COMPANY (OHIO CORPORATION)  
ONE PROCTER & GAMBLE PLAZA  
CINCINNATI, OH 45202

FOR: MEDICATED SKIN CARE PREPARATIONS, IN CLASS 5 (U.S. CLS. 6, 18, 44, 46, 51 AND 52).

FIRST USE 9-30-2011; IN COMMERCE 9-30-2011.

THE MARK CONSISTS OF STANDARD CHARACTERS WITHOUT CLAIM TO ANY PARTICULAR FONT, STYLE, SIZE, OR COLOR.

OWNER OF U.S. REG. NO. 4,071,895.

SER. NO. 85-515,697, FILED 1-13-2012.

DAVID COLLIER, EXAMINING ATTORNEY



*David J. Kyffers*

Director of the United States Patent and Trademark Office



# United States of America

United States Patent and Trademark Office

## CHALLENGE WHAT'S POSSIBLE

**Reg. No. 4,197,934**

**Registered Aug. 28, 2012**

**Int. Cl.: 21**

**TRADEMARK**

**PRINCIPAL REGISTER**

THE PROCTER & GAMBLE COMPANY (OHIO CORPORATION)  
299 E. SIXTH STREET  
CINCINNATI, OH 45202

FOR: POWERED FACIAL BRUSH USED TO CLEAN THE SKIN, IN CLASS 21 (U.S. CLS. 2, 13, 23, 29, 30, 33, 40 AND 50).

FIRST USE 9-30-2011; IN COMMERCE 9-30-2011.

THE MARK CONSISTS OF STANDARD CHARACTERS WITHOUT CLAIM TO ANY PARTICULAR FONT, STYLE, SIZE, OR COLOR.

OWNER OF U.S. REG. NO. 4,071,895.

SER. NO. 85-515,741, FILED 1-13-2012.

DAVID COLLIER, EXAMINING ATTORNEY



*David J. Kyffers*

Director of the United States Patent and Trademark Office

# United States of America

United States Patent and Trademark Office

## A NETBALLISTICS COMPANY

**Reg. No. 4,197,935**

NETBALLISTICS, LLC (KENTUCKY LIMITED LIABILITY COMPANY)  
P.O. BOX 3222

**Registered Aug. 28, 2012**

LOUISVILLE, KY 40201

**Int. Cl.: 35**

FOR: RETAIL STORE SERVICES AND ON-LINE RETAIL STORE SERVICES FEATURING AMMUNITION, FIREARMS, CLIPS AND MAGAZINES, SCOPES, LASER AND NIGHT VISION EQUIPMENT, GUN PARTS AND ACCESSORIES, HAND CUFFS AND LEG IRONS, HOLSTERS AND ACCESSORIES, FIREARM CLEANING AND CARE PRODUCTS, SLINGS, SWIVELS, GUN RESTS, BIPODS AND TRIPODS, EYE AND HEARING PROTECTION, RELOADING EQUIPMENT, MUZZLE LOADING EQUIPMENT, BLACK POWDER, KNIVES, TOOLS AND ACCESSORIES, SAFETY AND STORAGE EQUIPMENT, TARGETS AND TARGET TRAINING EQUIPMENT, CLOTHING AND TACTICAL WEAR, HUNTING SUPPLIES AND GEAR, SURVIVAL GEAR, ATV PARTS AND ACCESSORIES, AIR GUNS, ARCHERY EQUIPMENT AND ACCESSORIES, BOOKS AND VIDEOS ABOUT FIREARMS, SHOOTING SKILLS AND TRAINING, GUN CARE, HUNTING, WILD GAME PROCESSING, HUNTING AND GUN SPORTS, RELOADING, AND GUN SAFETY, IN CLASS 35 (U.S. CLS. 100, 101 AND 102).

**SERVICE MARK**

**PRINCIPAL REGISTER**

FIRST USE 10-12-2009; IN COMMERCE 1-5-2010.

THE MARK CONSISTS OF STANDARD CHARACTERS WITHOUT CLAIM TO ANY PARTICULAR FONT, STYLE, SIZE, OR COLOR.

NO CLAIM IS MADE TO THE EXCLUSIVE RIGHT TO USE "COMPANY", APART FROM THE MARK AS SHOWN.

SER. NO. 85-515,757, FILED 1-13-2012.

RUSS HERMAN, EXAMINING ATTORNEY



*David J. Kyros*

Director of the United States Patent and Trademark Office

# United States of America

United States Patent and Trademark Office

## **FEA Professor**

**Reg. No. 4,197,936**

BAILEY, JEFFREY H. (UNITED STATES INDIVIDUAL)  
8111 W. BRADLEY ROAD  
MILWAUKEE, WI 53223

**Registered Aug. 28, 2012**

**Int. Cl.: 42**

FOR: ENGINEERING, IN CLASS 42 (U.S. CLS. 100 AND 101).

**SERVICE MARK**

FIRST USE 10-1-2011; IN COMMERCE 10-1-2011.

**PRINCIPAL REGISTER**

NO CLAIM IS MADE TO THE EXCLUSIVE RIGHT TO USE "FEA" , APART FROM THE MARK AS SHOWN.

THE MARK CONSISTS OF THE STYLIZED TEXT "FEA PROFESSOR".

SER. NO. 85-515,812, FILED 1-13-2012.

BARBARA A. GOLD, EXAMINING ATTORNEY



*David J. Kybas*

Director of the United States Patent and Trademark Office

# United States of America

United States Patent and Trademark Office

## COOKIE PRO ULTRA II

**Reg. No. 4,197,937**

WILTON INDUSTRIES, INC. (DELAWARE CORPORATION)  
2240 W. 75TH ST.  
WOODRIDGE, IL 60517

**Registered Aug. 28, 2012**

**Int. Cl.: 21**

FOR: COOKIE CUTTERS, IN CLASS 21 (U.S. CLS. 2, 13, 23, 29, 30, 33, 40 AND 50).

**TRADEMARK**

FIRST USE 1-1-2007; IN COMMERCE 1-1-2007.

**PRINCIPAL REGISTER**

THE MARK CONSISTS OF STANDARD CHARACTERS WITHOUT CLAIM TO ANY PARTICULAR FONT, STYLE, SIZE, OR COLOR.

OWNER OF U.S. REG. NO. 3,867,709.

NO CLAIM IS MADE TO THE EXCLUSIVE RIGHT TO USE "COOKIE", APART FROM THE MARK AS SHOWN.

SER. NO. 85-515,888, FILED 1-13-2012.

MARK SHINER, EXAMINING ATTORNEY



*David J. Kyffers*

Director of the United States Patent and Trademark Office

# United States of America

United States Patent and Trademark Office

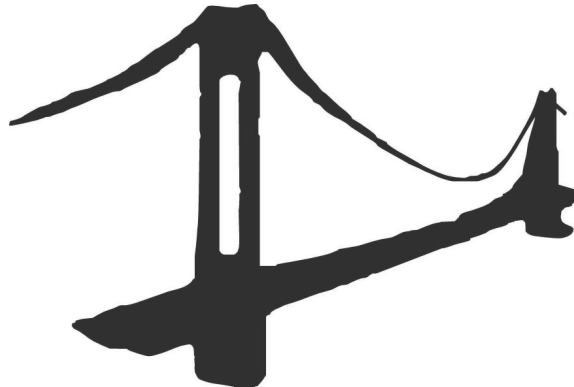

**Reg. No. 4,197,938**

**Registered Aug. 28, 2012**

**Int. Cl.: 36**

**SERVICE MARK**

**PRINCIPAL REGISTER**

MAPFRE FAMILIAR, COMPAÑIA DE SEGUROS Y REASEGUROS, S.A. (SPAIN SOCIEDAD ANONIMA)  
MAJADAHONDA  
CARRETERA DE POZUELO A MAJADAHONDA NO 50  
MADRID, SPAIN

FOR: INSURANCE UNDERWRITING SERVICES FOR ALL TYPES OF INSURANCE; INSURANCE ADMINISTRATION; INSURANCE AGENCY AND BROKERAGE; CLAIMS ADJUSTMENT AND CLAIMS ADMINISTRATION IN THE FIELD OF INSURANCE; INSURANCE CONSULTATION, IN CLASS 36 (U.S. CLS. 100, 101 AND 102).

FIRST USE 1-6-2008; IN COMMERCE 1-6-2008.

THE MARK CONSISTS OF A STYLIZED DRAWING OF A SUSPENSION BRIDGE WITH A SINGLE TOWER, THE DECK AND SUSPENSION CABLES OF WHICH CUT OFF MIDWAY THROUGH THE BRIDGE.

SER. NO. 85-515,907, FILED 1-13-2012.

MAUREEN DALL, EXAMINING ATTORNEY



*David J. Kyffers*

Director of the United States Patent and Trademark Office

# United States of America

United States Patent and Trademark Office

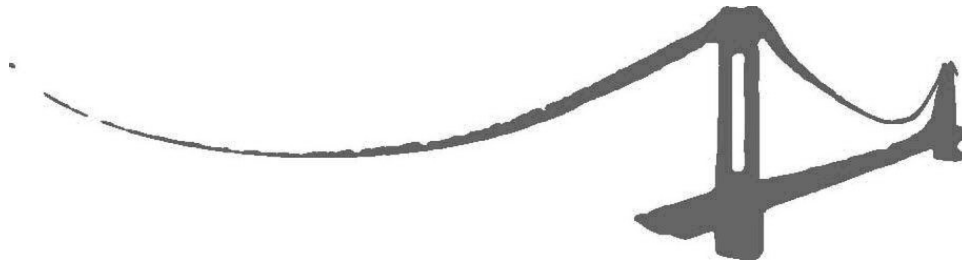

**Reg. No. 4,197,939**

**Registered Aug. 28, 2012**

**Int. Cl.: 36**

MAPFRE FAMILIAR, COMPAÑIA DE SEGUROS Y REASEGUROS, S.A. (SPAIN SOCIEDAD ANONIMA)  
MAJADAHONDA  
CARRETERA DE POZUELO A MAJADAHONDA NO 50  
MADRID, SPAIN

**SERVICE MARK**

**PRINCIPAL REGISTER**

FOR: INSURANCE UNDERWRITING SERVICES FOR ALL TYPES OF INSURANCE; INSURANCE ADMINISTRATION; INSURANCE AGENCY AND BROKERAGE; CLAIMS ADJUSTMENT AND CLAIMS ADMINISTRATION IN THE FIELD OF INSURANCE; INSURANCE CONSULTATION, IN CLASS 36 (U.S. CLS. 100, 101 AND 102).

FIRST USE 8-4-2006; IN COMMERCE 8-4-2006.

THE MARK CONSISTS OF A STYLIZED DRAWING OF A SUSPENSION BRIDGE, THE DECK OF WHICH CUTS OFF MIDWAY THROUGH THE BRIDGE, BUT IN WHICH THE SUSPENSION CABLES CONTINUE ON AND TO THE LEFT.

SER. NO. 85-515,929, FILED 1-13-2012.

MAUREEN DALL, EXAMINING ATTORNEY



*David J. Kyffers*

Director of the United States Patent and Trademark Office

# United States of America

United States Patent and Trademark Office

# **SUREFIRE**

**Reg. No. 4,197,940**

SUREFIRE, LLC (CALIFORNIA LIMITED LIABILITY COMPANY)  
18300 MOUNT BALDY CIRCLE  
FOUNTAIN VALLEY, CA 92708

**Registered Aug. 28, 2012**

**Int. Cl.: 11**

FOR: ILLUMINATION PRODUCTS, NAMELY WEAPON-MOUNTED LIGHTS, IN CLASS 11 (U.S. CLS. 13, 21, 23, 31 AND 34).

**TRADEMARK**

FIRST USE 1-1-2004; IN COMMERCE 1-1-2004.

**PRINCIPAL REGISTER**

OWNER OF U.S. REG. NOS. 2,657,142, 3,820,152 AND OTHERS.

THE MARK CONSISTS OF THE WORD "SUREFIRE" IN ITALICIZED BLOCK LETTERS, WITH HORIZONTAL ORIENTED PARENTHESES ABOVE AND BELOW THE MARK, SPANNING BETWEEN THE FIRST "R" AND THE "F".

SER. NO. 85-515,953, FILED 1-13-2012.

JUSTINE D. PARKER, EXAMINING ATTORNEY



*David J. Kybas*

Director of the United States Patent and Trademark Office

# United States of America

United States Patent and Trademark Office

# Infinite-Win

**Reg. No. 4,197,941**

**Registered Aug. 28, 2012**

**Int. Cl.: 41**

**SERVICE MARK**

**PRINCIPAL REGISTER**

BUSINESS WORLD RISING, INC. (CALIFORNIA CORPORATION), DBA BUSINESS WOMEN RISING, INC.  
3334 EAST COAST HWY, SUITE 417  
NEWPORT BEACH, CA 92625

FOR: BUSINESS TRAINING IN THE FIELD OF PROFESSIONAL DEVELOPMENT, MANAGEMENT DEVELOPMENT, EXECUTIVE DEVELOPMENT AND LEADERSHIP DEVELOPMENT; PEER TO PEER COACHING SERVICES IN THE FIELD OF MANAGEMENT, LEADERSHIP AND EXECUTIVE DEVELOPMENT; PROVIDING EDUCATIONAL MENTORING SERVICES AND PROGRAMS IN THE FIELD OF MANAGEMENT, LEADERSHIP AND EXECUTIVE DEVELOPMENT; PROVIDING GROUP COACHING IN THE FIELD OF MANAGEMENT, LEADERSHIP AND EXECUTIVE DEVELOPMENT, IN CLASS 41 (U.S. CLS. 100, 101 AND 107).

FIRST USE 12-22-2011; IN COMMERCE 1-4-2012.

THE MARK CONSISTS OF STANDARD CHARACTERS WITHOUT CLAIM TO ANY PARTICULAR FONT, STYLE, SIZE, OR COLOR.

SER. NO. 85-515,962, FILED 1-13-2012.

JAMES LOVELACE, EXAMINING ATTORNEY



*David J. Kyfos*

Director of the United States Patent and Trademark Office



# United States of America

United States Patent and Trademark Office

# **SURE** **FIRE**

**Reg. No. 4,197,942**

SUREFIRE, LLC (CALIFORNIA LIMITED LIABILITY COMPANY)  
18300 MOUNT BALDY CIRCLE  
FOUNTAIN VALLEY, CA 92708

**Registered Aug. 28, 2012**

**Int. Cl.: 11**

FOR: ILLUMINATION PRODUCTS, NAMELY, WEAPON-MOUNTED LIGHTS, IN CLASS 11 (U.S. CLS. 13, 21, 23, 31 AND 34).

**TRADEMARK**

FIRST USE 8-0-1998; IN COMMERCE 8-0-1998.

**PRINCIPAL REGISTER**

OWNER OF U.S. REG. NOS. 2,657,142, 3,820,152 AND OTHERS.

THE MARK CONSISTS OF THE WORDS "SURE" AND "FIRE" IN ITALICIZED BLOCK FORM WITH CROSSHAIRS BETWEEN THE WORDS.

SER. NO. 85-515,988, FILED 1-13-2012.

JUSTINE D. PARKER, EXAMINING ATTORNEY



*David J. Kybas*

Director of the United States Patent and Trademark Office

# United States of America

United States Patent and Trademark Office



**Reg. No. 4,197,943**

**Registered Aug. 28, 2012**

**Int. Cl.: 35**

**SERVICE MARK**

**PRINCIPAL REGISTER**

MODERN MUFFIN, LLC (NORTH CAROLINA LIMITED LIABILITY COMPANY)  
5931 MARSAILLES COURT  
CHARLOTTE, NC 28277

FOR: RETAIL BAKERY SHOP, IN CLASS 35 (U.S. CLS. 100, 101 AND 102).

FIRST USE 7-1-2011; IN COMMERCE 7-1-2011.

NO CLAIM IS MADE TO THE EXCLUSIVE RIGHT TO USE "MUFFIN", APART FROM THE MARK AS SHOWN.

THE MARK CONSISTS OF A DRAWING OF A MUFFIN WITH THE STYLIZED WORD "MODERN" ABOVE THE STYLIZED WORD "MUFFIN" ABOVE THE PHRASE "A HEALTHFUL INDULGENCE", ALL INSIDE THE MUFFIN DRAWING.

SER. NO. 85-516,106, FILED 1-13-2012.

TRACY FLETCHER, EXAMINING ATTORNEY



*David J. Kyffers*

Director of the United States Patent and Trademark Office

# United States of America

United States Patent and Trademark Office

# SUPATHA

**Reg. No. 4,197,944**

**Registered Aug. 28, 2012**

**Int. Cls.: 41 and 44**

**SERVICE MARK**

**PRINCIPAL REGISTER**

DONNAMARIE GIAIME (UNITED STATES INDIVIDUAL), DBA SUPATHA YOGA  
205 HARRISON STREET  
FRENCHTOWN, NJ 08825

FOR: ARRANGING AND CONDUCTING INCENTIVE AWARD PROGRAMS TO ENCOURAGE THE FREQUENT, CONTINUED AND EFFECTIVE PRACTICE OF PHYSICAL EXERCISE; COUNSELING SERVICES IN THE FIELD OF PHYSICAL FITNESS; LIFE COACHING SERVICES IN THE FIELD OF YOGA, REIKI AND PERSONAL FITNESS; MEDITATION TRAINING; PEER TO PEER COACHING SERVICES IN THE FIELD OF YOGA, REIKI AND PERSONAL FITNESS; PERSONAL COACHING SERVICES IN THE FIELD OF YOGA, REIKI AND PERSONAL FITNESS; PHYSICAL EDUCATION SERVICES; PHYSICAL FITNESS CONDITIONING CLASSES; PHYSICAL FITNESS CONSULTATION; PHYSICAL FITNESS INSTRUCTION; PHYSICAL FITNESS STUDIO SERVICES, NAMELY, PROVIDING EXERCISE CLASSES, BODY SCULPTING CLASSES, AND GROUP FITNESS CLASSES; PHYSICAL FITNESS STUDIO SERVICES, NAMELY, PROVIDING GROUP EXERCISE INSTRUCTION, EQUIPMENT, AND FACILITIES; PHYSICAL FITNESS TRAINING OF INDIVIDUALS AND GROUPS; PHYSICAL FITNESS TRAINING SERVICES; PROFESSIONAL COACHING SERVICES IN THE FIELD OF YOGA, REIKI AND PERSONAL FITNESS; PROVIDING FITNESS AND EXERCISE STUDIO SERVICES, NAMELY, PILATES INSTRUCTION AND TRAINING; PROVIDING GROUP COACHING IN THE FIELD OF YOGA, REIKI AND PERSONAL FITNESS; PROVIDING PHYSICAL FITNESS AND EXERCISE SERVICE, NAMELY, INDOOR CYCLING AND YOGA INSTRUCTION; YOGA INSTRUCTION, IN CLASS 41 (U.S. CLS. 100, 101 AND 107).

FIRST USE 2-1-2004; IN COMMERCE 2-1-2004.

FOR: ENERGY HEALING SERVICES, NAMELY, STRESS MANAGEMENT AND STRESS REDUCTION COUNSELING FOR INDIVIDUALS TO ENHANCE THEIR LIVES; PHYSICAL THERAPY EVALUATION, IDENTIFICATION, AND MANAGEMENT OF MOVEMENT DYSFUNCTION TO RESTORE, MAINTAIN, AND PROMOTE OPTIMAL PHYSICAL FUNCTION PREVENTING THE ONSET, SYMPTOMS AND PROGRESSION OF IMPAIRMENTS, FUNCTIONAL LIMITATIONS, AND DISABILITIES RESULTING FROM DISEASE, DISORDERS, CONDITIONS, OR INJURIES; REIKI HEALING SERVICES; STRESS REDUCTION THERAPY, IN CLASS 44 (U.S. CLS. 100 AND 101).

FIRST USE 2-1-2004; IN COMMERCE 2-1-2004.



*David J. Kyros*

Director of the United States Patent and Trademark Office

**Reg. No. 4,197,944** THE MARK CONSISTS OF STANDARD CHARACTERS WITHOUT CLAIM TO ANY PARTICULAR FONT, STYLE, SIZE, OR COLOR.

OWNER OF U.S. REG. NO. 2,966,791.

THE ENGLISH TRANSLATION OF THE WORD "SUPATHA" IN THE MARK IS "HE WHO FOLLOWS A VIRTUOUS PATH".

SER. NO. 85-516,118, FILED 1-13-2012.

DORITT L. CARROLL, EXAMINING ATTORNEY

# United States of America

United States Patent and Trademark Office

The logo for B. Young RV features the text "B. Young RV" in a bold, outlined, sans-serif font. The letter "Y" is stylized to resemble a human figure with its arms raised in a V-shape, positioned above the "O" in "Young".

**Reg. No. 4,197,945**

BY RV, INC. (MONTANA CORPORATION), DBA B. YOUNG RV  
16803 SE MCLOUGHLIN BLVD.  
MILWAUKIE, OR 97267

**Registered Aug. 28, 2012**

**Int. Cl.: 35**

FOR: RETAIL STORE SERVICES FEATURING NEW AND PRE-OWNED RECREATIONAL VEHICLES IN MULTIPLE RV CLASSES, PLUS AFTER-MARKET SERVICE AND PARTS FOR SAME, IN CLASS 35 (U.S. CLS. 100, 101 AND 102).

**SERVICE MARK**

FIRST USE 1-4-2010; IN COMMERCE 3-22-2010.

**PRINCIPAL REGISTER**

NO CLAIM IS MADE TO THE EXCLUSIVE RIGHT TO USE "RV", APART FROM THE MARK AS SHOWN.

THE MARK CONSISTS OF CHARACTERS COMPRISING THE LETTERS AND PUNCTUATION "B. YOUNG RV" IN OUTLINE FORM, WITH A STYLIZED "Y" DEPICTING A CHARACTERIZATION OF A HUMAN FIGURE STANDING WITH UPRAISED ARMS.

SER. NO. 85-516,381, FILED 1-13-2012.

DEIRDRE ROBERTSON, EXAMINING ATTORNEY



*David J. Kyffers*

Director of the United States Patent and Trademark Office

# United States of America

## United States Patent and Trademark Office

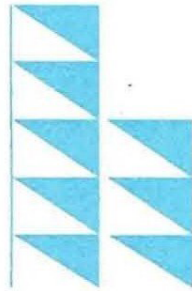

**Reg. No. 4,197,946**

**Registered Aug. 28, 2012**

**Int. Cls.: 36 and 37**

**SERVICE MARK**

**PRINCIPAL REGISTER**

HUMPHREY ASSOCIATES, INC. (MARYLAND CORPORATION)  
7170 RIVERWOOD DRIVE  
COLUMBIA, MD 21046

FOR: REAL ESTATE MANAGEMENT SERVICES, IN CLASS 36 (U.S. CLS. 100, 101 AND 102).

FIRST USE 4-19-1976; IN COMMERCE 4-19-1976.

FOR: REAL ESTATE DEVELOPMENT, IN CLASS 37 (U.S. CLS. 100, 103 AND 106).

FIRST USE 4-19-1976; IN COMMERCE 4-19-1976.

THE MARK CONSISTS OF FIVE VERTICAL BLUE TRIANGLES TO THE LEFT OF THREE VERTICAL BLUE TRIANGLES. TO THE LEFT OF THE TRIANGLES IS A VERTICAL BLUE LINE.

THE COLOR(S) BLUE IS/ARE CLAIMED AS A FEATURE OF THE MARK.

SER. NO. 85-516,390, FILED 1-13-2012.

MICHAEL WEBSTER, EXAMINING ATTORNEY



*David J. Kybas*

Director of the United States Patent and Trademark Office

# United States of America

United States Patent and Trademark Office

## THE GODLY NETWORK

**Reg. No. 4,197,947**

PROPHETIC OUTPOUR CHURCH (MICHIGAN CORPORATION)  
PO BOX 806471

**Registered Aug. 28, 2012**

ST CLAIR SHORES, MI 480806471

**Int. Cl.: 38**

FOR: BROADCASTING OF CABLE TELEVISION, TELEVISION, WEBCAST PROGRAMS,  
IN CLASS 38 (U.S. CLS. 100, 101 AND 104).

**SERVICE MARK**

FIRST USE 10-15-2004; IN COMMERCE 10-15-2004.

**PRINCIPAL REGISTER**

THE MARK CONSISTS OF STANDARD CHARACTERS WITHOUT CLAIM TO ANY PAR-  
TICULAR FONT, STYLE, SIZE, OR COLOR.

NO CLAIM IS MADE TO THE EXCLUSIVE RIGHT TO USE "NETWORK", APART FROM  
THE MARK AS SHOWN.

SER. NO. 85-516,391, FILED 1-13-2012.

MICHAEL WEBSTER, EXAMINING ATTORNEY



*David J. Kybas*

Director of the United States Patent and Trademark Office

# United States of America

United States Patent and Trademark Office

# CHT

**Reg. No. 4,197,948**

BIO-RAD LABORATORIES, INC. (DELAWARE CORPORATION)  
1000 ALFRED NOBEL DRIVE  
HERCULES, CA 94547

**Registered Aug. 28, 2012**

**Int. Cl.: 1**

FOR: CHROMATOGRAPHY CHEMICALS, IN CLASS 1 (U.S. CLS. 1, 5, 6, 10, 26 AND 46).

**TRADEMARK**

FIRST USE 12-31-2002; IN COMMERCE 12-31-2002.

**PRINCIPAL REGISTER**

THE MARK CONSISTS OF STANDARD CHARACTERS WITHOUT CLAIM TO ANY PARTICULAR FONT, STYLE, SIZE, OR COLOR.

SER. NO. 85-516,405, FILED 1-13-2012.

TASNEEM HUSSAIN, EXAMINING ATTORNEY



*David J. Kyjars*

Director of the United States Patent and Trademark Office



# United States of America

United States Patent and Trademark Office

# CFT

**Reg. No. 4,197,949**

BIO-RAD LABORATORIES, INC. (DELAWARE CORPORATION)  
1000 ALFRED NOBEL DRIVE  
HERCULES, CA 94547

**Registered Aug. 28, 2012**

**Int. Cl.: 1**

FOR: CHROMATOGRAPHY CHEMICALS, IN CLASS 1 (U.S. CLS. 1, 5, 6, 10, 26 AND 46).

**TRADEMARK**

FIRST USE 12-31-2005; IN COMMERCE 12-31-2005.

**PRINCIPAL REGISTER**

THE MARK CONSISTS OF STANDARD CHARACTERS WITHOUT CLAIM TO ANY PARTICULAR FONT, STYLE, SIZE, OR COLOR.

SER. NO. 85-516,406, FILED 1-13-2012.

TASNEEM HUSSAIN, EXAMINING ATTORNEY



*David J. Kybas*

Director of the United States Patent and Trademark Office

# United States of America

United States Patent and Trademark Office

## DECIDING MOMENT:

**Reg. No. 4,197,950**

**Registered Aug. 28, 2012**

**Int. Cls.: 35 and 44**

**SERVICE MARK**

**PRINCIPAL REGISTER**

THE HENRY J. KAISER FAMILY FOUNDATION (CALIFORNIA CHARITABLE TRUST)  
2400 SAND HILL ROAD  
MENLO PARK, CA 94025

FOR: PROMOTING PUBLIC AWARENESS OF HIV/AIDS AND THE NEED FOR LEADERSHIP, ACTION, RESPONSIBILITY, AND MOBILIZATION TO STRENGTHEN RESPONSES TO HIV/AIDS, PARTICULARLY IN THE BLACK AMERICAN COMMUNITY, WITH THE GOALS OF REDUCING THE SPREAD OF HIV/AIDS AND THE STIGMA ASSOCIATED WITH HIV/AIDS, IN CLASS 35 (U.S. CLS. 100, 101 AND 102).

FIRST USE 10-5-2010; IN COMMERCE 10-5-2010.

FOR: PROVIDING HEALTH INFORMATION IN THE FIELD OF HIV/AIDS WITH THE GOALS OF REDUCING THE SPREAD OF HIV/AIDS AND THE STIGMA ASSOCIATED WITH HIV/AIDS, IN CLASS 44 (U.S. CLS. 100 AND 101).

FIRST USE 10-5-2010; IN COMMERCE 10-5-2010.

OWNER OF U.S. REG. NOS. 3,865,390, 3,868,324, AND 3,868,325.

THE MARK CONSISTS OF THE WORDS "DECIDING MOMENT" CONTAINING THE "GREATER THAN" SIGN WITHIN THE LETTER "O" IN THE WORD "MOMENT," WITH A COLON APPEARING AT THE END OF MARK.

SER. NO. 85-516,408, FILED 1-13-2012.

MARC LEIPZIG, EXAMINING ATTORNEY



*David J. Kypos*

Director of the United States Patent and Trademark Office

# United States of America

United States Patent and Trademark Office

## DECIDING MOMENT

**Reg. No. 4,197,951**

**Registered Aug. 28, 2012**

**Int. Cls.: 35 and 44**

**SERVICE MARK**

**PRINCIPAL REGISTER**

THE HENRY J. KAISER FAMILY FOUNDATION (CALIFORNIA CHARITABLE TRUST)  
2400 SAND HILL ROAD  
MENLO PARK, CA 94025

FOR: PROMOTING PUBLIC AWARENESS OF HIV/AIDS AND THE NEED FOR LEADERSHIP, ACTION, RESPONSIBILITY, AND MOBILIZATION TO STRENGTHEN RESPONSES TO HIV/AIDS, PARTICULARLY IN THE BLACK AMERICAN COMMUNITY, WITH THE GOALS OF REDUCING THE SPREAD OF HIV/AIDS AND THE STIGMA ASSOCIATED WITH HIV/AIDS, IN CLASS 35 (U.S. CLS. 100, 101 AND 102).

FIRST USE 10-5-2010; IN COMMERCE 10-5-2010.

FOR: PROVIDING HEALTH INFORMATION IN THE FIELD OF HIV/AIDS WITH THE GOALS OF REDUCING THE SPREAD OF HIV/AIDS AND THE STIGMA ASSOCIATED WITH HIV/AIDS, IN CLASS 44 (U.S. CLS. 100 AND 101).

FIRST USE 10-5-2010; IN COMMERCE 10-5-2010.

THE MARK CONSISTS OF STANDARD CHARACTERS WITHOUT CLAIM TO ANY PARTICULAR FONT, STYLE, SIZE, OR COLOR.

SER. NO. 85-516,419, FILED 1-13-2012.

MARC LEIPZIG, EXAMINING ATTORNEY



*David J. Kybas*

Director of the United States Patent and Trademark Office

# United States of America

United States Patent and Trademark Office

## DECIDING MOMENTS

**Reg. No. 4,197,952**

**Registered Aug. 28, 2012**

**Int. Cls.: 35 and 44**

**SERVICE MARK**

**PRINCIPAL REGISTER**

THE HENRY J. KAISER FAMILY FOUNDATION (CALIFORNIA CHARITABLE TRUST)  
2400 SAND HILL ROAD  
MENLO PARK, CA 94025

FOR: PROMOTING PUBLIC AWARENESS OF HIV/AIDS AND THE NEED FOR LEADERSHIP, ACTION, RESPONSIBILITY, AND MOBILIZATION TO STRENGTHEN RESPONSES TO HIV/AIDS, PARTICULARLY IN THE BLACK AMERICAN COMMUNITY, WITH THE GOALS OF REDUCING THE SPREAD OF HIV/AIDS AND THE STIGMA ASSOCIATED WITH HIV/AIDS, IN CLASS 35 (U.S. CLS. 100, 101 AND 102).

FIRST USE 10-5-2010; IN COMMERCE 10-5-2010.

FOR: PROVIDING HEALTH INFORMATION IN THE FIELD OF HIV/AIDS WITH THE GOALS OF REDUCING THE SPREAD OF HIV/AIDS AND THE STIGMA ASSOCIATED WITH HIV/AIDS, IN CLASS 44 (U.S. CLS. 100 AND 101).

FIRST USE 10-5-2010; IN COMMERCE 10-5-2010.

THE MARK CONSISTS OF STANDARD CHARACTERS WITHOUT CLAIM TO ANY PARTICULAR FONT, STYLE, SIZE, OR COLOR.

SER. NO. 85-516,428, FILED 1-13-2012.

MARC LEIPZIG, EXAMINING ATTORNEY



*David J. Kyjars*

Director of the United States Patent and Trademark Office

# United States of America

United States Patent and Trademark Office

# SABA

**Reg. No. 4,197,953**

**Registered Aug. 28, 2012**

**Int. Cl.: 29**

**TRADEMARK**

**PRINCIPAL REGISTER**

CHATTRADE DEVELOPMENT CORPORATION (PHILIPPINES CORPORATION), DBA  
CHATTRADE ENTERPRISES  
822 ELCANO STREET, SAN NICOLAS  
MANILA 1010, PHILIPPINES

FOR: SEAFOOD, IN CLASS 29 (U.S. CL. 46).

FIRST USE 6-0-2000; IN COMMERCE 6-0-2000.

THE MARK CONSISTS OF STANDARD CHARACTERS WITHOUT CLAIM TO ANY PARTICULAR FONT, STYLE, SIZE, OR COLOR.

SER. NO. 85-516,437, FILED 1-13-2012.

TASNEEM HUSSAIN, EXAMINING ATTORNEY



*David J. Kybas*

Director of the United States Patent and Trademark Office

# United States of America

United States Patent and Trademark Office

## Christian Women Lifestyle xPress Online Magazine

**Reg. No. 4,197,954**

THOMPSON, DEANETTA (UNITED STATES INDIVIDUAL)

**Registered Aug. 28, 2012**

P.O. BOX 090135  
BROOKLYN, NY 11209

**Int. Cl.: 41**

FOR: PROVIDING ON-LINE MAGAZINES IN THE FIELD OF CHRISTIANITY, IN CLASS 41 (U.S. CLS. 100, 101 AND 107).

**SERVICE MARK**

FIRST USE 4-1-2010; IN COMMERCE 4-1-2010.

**PRINCIPAL REGISTER**

THE MARK CONSISTS OF STANDARD CHARACTERS WITHOUT CLAIM TO ANY PARTICULAR FONT, STYLE, SIZE, OR COLOR.

OWNER OF U.S. REG. NO. 4,111,457.

NO CLAIM IS MADE TO THE EXCLUSIVE RIGHT TO USE "CHRISTIAN WOMEN LIFESTYLE" AND "ONLINE MAGAZINE", APART FROM THE MARK AS SHOWN.

SER. NO. 85-516,455, FILED 1-13-2012.

EDWARD NELSON, EXAMINING ATTORNEY



*David J. Kyros*

Director of the United States Patent and Trademark Office

# United States of America

United States Patent and Trademark Office

# Sharktech

**Reg. No. 4,197,955**

TIMRAWI, TIM (UNITED STATES INDIVIDUAL)  
100 PINEHURST  
MISSOULA, MT 59803

**Registered Aug. 28, 2012**

**Int. Cl.: 42**

FOR: COMPUTER CO-LOCATION SERVICES, NAMELY, PROVIDING FACILITIES FOR THE LOCATION OF COMPUTER SERVERS WITH THE EQUIPMENT OF OTHERS; HOSTING WEBSITES ON THE INTERNET, IN CLASS 42 (U.S. CLS. 100 AND 101).

**SERVICE MARK**

FIRST USE 8-13-2003; IN COMMERCE 8-13-2003.

**PRINCIPAL REGISTER**

THE MARK CONSISTS OF STANDARD CHARACTERS WITHOUT CLAIM TO ANY PARTICULAR FONT, STYLE, SIZE, OR COLOR.

SER. NO. 85-516,464, FILED 1-13-2012.

PRISCILLA MILTON, EXAMINING ATTORNEY



*David J. Kybas*

Director of the United States Patent and Trademark Office

# United States of America

United States Patent and Trademark Office

# Hargress

**Reg. No. 4,197,956**

HARGRESS, MICAH (UNITED STATES INDIVIDUAL)  
19421 FARIMAN DR.  
CARSON, CA 90746

**Registered Aug. 28, 2012**

**Int. Cl.: 18**

FOR: TOTE BAGS; LEATHER LUXURY HAND BAGS; PURSES; BACKPACKS, IN CLASS 18 (U.S. CLS. 1, 2, 3, 22 AND 41).

**TRADEMARK**

FIRST USE 11-7-2003; IN COMMERCE 11-7-2003.

**PRINCIPAL REGISTER**

THE MARK CONSISTS OF STANDARD CHARACTERS WITHOUT CLAIM TO ANY PARTICULAR FONT, STYLE, SIZE, OR COLOR.

SEC. 2(F).

SER. NO. 85-516,471, FILED 1-13-2012.

VIVIAN MICZNIK FIRST, EXAMINING ATTORNEY



*David J. Kybas*

Director of the United States Patent and Trademark Office



# United States of America

United States Patent and Trademark Office



**Reg. No. 4,197,957**

**Registered Aug. 28, 2012**

**Int. Cls.: 35 and 42**

**SERVICE MARK**

**PRINCIPAL REGISTER**

BYTEKNIGHT COMPUTERS (UTAH LIMITED LIABILITY COMPANY)  
938 SPRING CREEK LANE  
FARMINGTON, UT 84025

FOR: BUSINESS SERVICES, NAMELY, PROVIDING COMPUTER DATABASES REGARDING THE PURCHASE AND SALE OF A WIDE VARIETY OF PRODUCTS AND SERVICES OF OTHERS; COMPILING OF INFORMATION INTO COMPUTER DATABASES; DATABASE MANAGEMENT; ON-LINE RETAIL STORE SERVICES FEATURING CUSTOM COMPUTERS, SERVERS, PARTS AND SOFTWARE, IN CLASS 35 (U.S. CLS. 100, 101 AND 102).

FIRST USE 1-1-2001; IN COMMERCE 1-1-2001.

FOR: TECHNICAL SUPPORT SERVICES, NAMELY, TROUBLESHOOTING OF COMPUTER SOFTWARE PROBLEMS, IN CLASS 42 (U.S. CLS. 100 AND 101).

FIRST USE 1-1-2001; IN COMMERCE 1-1-2001.

NO CLAIM IS MADE TO THE EXCLUSIVE RIGHT TO USE "COMPUTERS", APART FROM THE MARK AS SHOWN.

THE MARK CONSISTS OF A KNIGHT WITH HELMET, THE TEXT "BYTEKNIGHT" BELOW THE DESIGN, AND "COMPUTERS" BELOW "BYTEKNIGHT" BETWEEN THE LETTERS "Y" AND "G".

SER. NO. 85-516,474, FILED 1-13-2012.

VIVIAN MICZNIK FIRST, EXAMINING ATTORNEY



*David J. Kypos*

Director of the United States Patent and Trademark Office

# United States of America

United States Patent and Trademark Office



**KIKU**  
**JAPANESE FUSION**

**Reg. No. 4,197,958**

**Registered Aug. 28, 2012**

**Int. Cl.: 43**

**SERVICE MARK**

**PRINCIPAL REGISTER**

KIKU JAPANESE FUSION (FLORIDA LIMITED LIABILITY COMPANY)  
3491 SUITE 12 THOMASVILLE RD.  
TALLAHASSEE, FL 32309

FOR: RESTAURANT SERVICES, IN CLASS 43 (U.S. CLS. 100 AND 101).

FIRST USE 5-1-2009; IN COMMERCE 6-1-2009.

NO CLAIM IS MADE TO THE EXCLUSIVE RIGHT TO USE "JAPANESE FUSION", APART FROM THE MARK AS SHOWN.

THE NON-LATIN CHARACTERS IN THE MARK TRANSLITERATE TO "XIANG JU" AND THIS MEANS "CHRYSANTHEMUM" IN ENGLISH.

THE MARK CONSISTS OF A RECTANGULAR DESIGN WITH A JAPANESE CHARACTER WITHIN THE RECTANGULAR DESIGN. DIRECTLY TO THE RIGHT IS THE WORDING "KIKU" IN STYLIZED FONT. THERE ARE TWO DOTS PLACED ABOVE THE CHARACTER "U". DIRECTLY BELOW, IS A RECTANGULAR DESIGN WITH THE WORDING "JAPANESE FUSION" IN STYLIZED FONT PLACED WITHIN THE RECTANGULAR DESIGN.

THE ENGLISH TRANSLATION OF "KIKU" IN THE MARK IS "CHRYSANTHEMUM".

SER. NO. 85-516,476, FILED 1-13-2012.

VIVIAN MICZNIK FIRST, EXAMINING ATTORNEY



*David J. Kybas*

Director of the United States Patent and Trademark Office

# United States of America

United States Patent and Trademark Office

# danistyle

**Reg. No. 4,197,959**

**Registered Aug. 28, 2012**

**Int. Cl.: 45**

**SERVICE MARK**

**PRINCIPAL REGISTER**

STONE, DANIELLE (UNITED STATES INDIVIDUAL), DBA DANISTYLE  
2965 CALLE NOGUERA  
SANTA BARBARA, CA 93105

FOR: FASHION CONSULTING SERVICES, IN CLASS 45 (U.S. CLS. 100 AND 101).

FIRST USE 12-18-2001; IN COMMERCE 12-18-2001.

THE MARK CONSISTS OF STANDARD CHARACTERS WITHOUT CLAIM TO ANY PARTICULAR FONT, STYLE, SIZE, OR COLOR.

SER. NO. 85-516,477, FILED 1-13-2012.

MAYUR VAGHANI, EXAMINING ATTORNEY



*David J. Kyffers*

Director of the United States Patent and Trademark Office

# United States of America

United States Patent and Trademark Office

# Punk Muffin

**Reg. No. 4,197,960**

BRIAN LOVE (UNITED STATES INDIVIDUAL)  
7313 FOSTER CT SW  
ALBUQUERQUE, NM 87121 AND

**Registered Aug. 28, 2012**

**Int. Cl.: 25**

ELLEN LOVE (UNITED STATES INDIVIDUAL)  
7313 FOSTER CT SW  
ALBUQUERQUE, NM 87111

**TRADEMARK**

**PRINCIPAL REGISTER**

FOR: ATHLETIC APPAREL, NAMELY, SHIRTS, PANTS, JACKETS, FOOTWEAR, HATS AND CAPS, ATHLETIC UNIFORMS; BABIES' PANTS; BODY SHIRTS; BUTTON DOWN SHIRTS; DENIM JACKETS; DRESS SHIRTS; HEAVY JACKETS; HOODED SWEAT SHIRTS; JACKETS; JACKETS AND SOCKS; LONG-SLEEVED SHIRTS; PANTS; POLO SHIRTS; RUGBY SHIRTS; SHIRTS; SHIRTS AND SHORT-SLEEVED SHIRTS; SHIRTS FOR INFANTS, BABIES, TODDLERS AND CHILDREN; SHORT-SLEEVED OR LONG-SLEEVED T-SHIRTS; SHORT-SLEEVED SHIRTS; SLEEVES WORN SEPARATE AND APART FROM BLOUSES, SHIRTS AND OTHER TOPS; SPORT SHIRTS; SPORTS SHIRTS; SPORTS SHIRTS WITH SHORT SLEEVES; SWEAT PANTS; SWEAT SHIRTS; T-SHIRTS; TEE SHIRTS; TRACK PANTS; WEARABLE GARMENTS AND CLOTHING, NAMELY, SHIRTS; WIND PANTS; WOMEN'S CLOTHING, NAMELY, SHIRTS, DRESSES, SKIRTS, BLOUSES, IN CLASS 25 (U.S. CLS. 22 AND 39).

FIRST USE 1-1-2012; IN COMMERCE 1-1-2012.

THE MARK CONSISTS OF STANDARD CHARACTERS WITHOUT CLAIM TO ANY PARTICULAR FONT, STYLE, SIZE, OR COLOR.

SER. NO. 85-516,481, FILED 1-13-2012.

GEORGE LORENZO, EXAMINING ATTORNEY



*David J. Kyros*

Director of the United States Patent and Trademark Office

# United States of America

United States Patent and Trademark Office

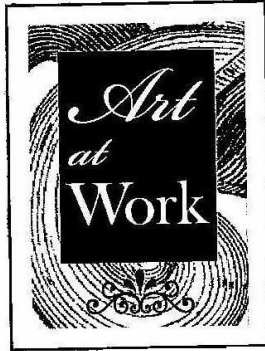

**Reg. No. 4,197,961**

**Registered Aug. 28, 2012**

**Int. Cl.: 41**

**SERVICE MARK**

**PRINCIPAL REGISTER**

MARKS, ANNE (UNITED STATES INDIVIDUAL)  
7940 H WRENWOOD BOULEVARD  
BATON ROUGE, LA 70809

FOR: EDUCATIONAL SERVICES, NAMELY, CONDUCTING MOTIVATIONAL AND CREATIVE WORKSHOPS IN SMALL GROUP SESSIONS IN THE BUSINESS PLACE USING THE ARTISTIC DISCIPLINES, NAMELY, VISUAL, MUSIC, MOVEMENT, THEATRE, AND WRITING, IN ORDER TO EXPAND CREATIVITY, IMPROVE FOCUS, INCREASE PRODUCTIVITY, AND ACHIEVE GREATER SUCCESS IN LIFE AND BUSINESS, IN CLASS 41 (U.S. CLS. 100, 101 AND 107).

FIRST USE 9-0-2010; IN COMMERCE 9-0-2010.

THE MARK CONSISTS OF THE WORDING "ART AT WORK" IN STYLIZED FONT INSIDE A RECTANGLE SUPERIMPOSED OVER A RECTANGLE FEATURING A FILIGREE DESIGN AT THE BOTTOM WITH A SWIRL DESIGN IN THE BACKGROUND.

SER. NO. 85-516,487, FILED 1-13-2012.

AMY KELLY, EXAMINING ATTORNEY



*David J. Kyffers*

Director of the United States Patent and Trademark Office

# United States of America

United States Patent and Trademark Office

## WARM HEARTS CARE

**Reg. No. 4,197,962**

**Registered Aug. 28, 2012**

**Int. Cl.: 44**

**SERVICE MARK**

**PRINCIPAL REGISTER**

MARI INVESTMENTS LLP (TENNESSEE LIMITED PARTNERSHIP), DBA WARM HEARTS CARE  
1321 MURFREESBORO PIKE, SUITE 606  
NASHVILLE, TN 37217

FOR: HEALTH CARE SERVICES, NAMELY, WELLNESS PROGRAMS; HOME HEALTH CARE SERVICES; HOME NURSING AID SERVICES; HOME-VISIT NURSING CARE; NURSING HOMES; PROVIDING ASSISTANCE, FITNESS EVALUATION AND CONSULTATION TO INDIVIDUALS TO HELP THEM MAKE HEALTH, WELLNESS AND NUTRITIONAL CHANGES IN THEIR DAILY LIVING TO IMPROVE HEALTH; PROVIDING HEALTHY LIFESTYLE AND NUTRITION SERVICES, NAMELY, PERSONAL ASSESSMENTS, PERSONALIZED ROUTINES, MAINTENANCE SCHEDULES, AND COUNSELING; PROVIDING WELLNESS SERVICES, NAMELY, PERSONAL ASSESSMENTS, PERSONALIZED ROUTINES, MAINTENANCE SCHEDULES, AND COUNSELING; WELLNESS AND HEALTH-RELATED CONSULTING SERVICES, IN CLASS 44 (U.S. CLS. 100 AND 101).

FIRST USE 1-1-2001; IN COMMERCE 2-1-2001.

THE MARK CONSISTS OF STANDARD CHARACTERS WITHOUT CLAIM TO ANY PARTICULAR FONT, STYLE, SIZE, OR COLOR.

NO CLAIM IS MADE TO THE EXCLUSIVE RIGHT TO USE "CARE", APART FROM THE MARK AS SHOWN.

SER. NO. 85-516,496, FILED 1-13-2012.

JENNIFER VASQUEZ, EXAMINING ATTORNEY



*David J. Kyffers*

Director of the United States Patent and Trademark Office

# United States of America

United States Patent and Trademark Office

## YOUR HAPPY PLACE

**Reg. No. 4,197,963**

FARR'S FRESH INC. (UTAH CORPORATION)  
2575 SOUTH 300 WEST  
SALT LAKE CITY, UT 84115

**Registered Aug. 28, 2012**

**Int. Cl.: 35**

FOR: RETAIL STORE SERVICES FEATURING FROZEN DESSERTS, IN CLASS 35 (U.S. CLS. 100, 101 AND 102).

**SERVICE MARK**

FIRST USE 10-1-2011; IN COMMERCE 10-1-2011.

**PRINCIPAL REGISTER**

THE MARK CONSISTS OF STANDARD CHARACTERS WITHOUT CLAIM TO ANY PARTICULAR FONT, STYLE, SIZE, OR COLOR.

SER. NO. 85-516,507, FILED 1-13-2012.

REGINA DRUMMOND, EXAMINING ATTORNEY



*David J. Kybas*

Director of the United States Patent and Trademark Office

# United States of America

United States Patent and Trademark Office

## Hate Now Vomit Later

**Reg. No. 4,197,964**

BRIAN LOVE (UNITED STATES INDIVIDUAL)  
7313 FOSTER CT SW  
ALBUQUERQUE, NM 87121 AND

**Registered Aug. 28, 2012**

**Int. Cl.: 25**

ELLEN LOVE (UNITED STATES INDIVIDUAL)  
7313 FOSTER CT SW  
ALBUQUERQUE, NM 87111

**TRADEMARK**

**PRINCIPAL REGISTER**

FOR: ANKLE SOCKS; BUTTON DOWN SHIRTS; DRESS SHIRTS; HOODED SWEAT SHIRTS; LONG-SLEEVED SHIRTS; POLO SHIRTS; RUGBY SHIRTS; SHIRTS; SHIRTS AND SHORT-SLEEVED SHIRTS; SHIRTS FOR INFANTS, BABIES, TODDLERS AND CHILDREN; SHORT-SLEEVED OR LONG-SLEEVED T-SHIRTS; SHORT-SLEEVED SHIRTS; SPORT SHIRTS; SPORTS SHIRTS; SPORTS SHIRTS WITH SHORT SLEEVES; SWEAT SHIRTS; T-SHIRTS; TEE SHIRTS, IN CLASS 25 (U.S. CLS. 22 AND 39).

FIRST USE 9-1-2011; IN COMMERCE 9-1-2011.

THE MARK CONSISTS OF STANDARD CHARACTERS WITHOUT CLAIM TO ANY PARTICULAR FONT, STYLE, SIZE, OR COLOR.

SER. NO. 85-516,546, FILED 1-13-2012.

GEORGE LORENZO, EXAMINING ATTORNEY



*David J. Kybas*

Director of the United States Patent and Trademark Office



# United States of America

United States Patent and Trademark Office

## LANGUAGE LITTLES

**Reg. No. 4,197,965**

**Registered Aug. 28, 2012**

**Int. Cl.: 28**

**TRADEMARK**

**PRINCIPAL REGISTER**

BRIAN CAPITAL CORPORATION (NEW YORK CORPORATION), DBA LANGUAGE LITTLES  
SUITE 9A  
167 EAST 82ND STREET  
NEW YORK, NY 10028

FOR: DOLLS, IN CLASS 28 (U.S. CLS. 22, 23, 38 AND 50).

FIRST USE 7-1-2000; IN COMMERCE 7-1-2000.

THE MARK CONSISTS OF STANDARD CHARACTERS WITHOUT CLAIM TO ANY PARTICULAR FONT, STYLE, SIZE, OR COLOR.

SER. NO. 85-516,553, FILED 1-13-2012.

JACLYN KIDWELL WALKER, EXAMINING ATTORNEY



*David J. Kybas*

Director of the United States Patent and Trademark Office

# United States of America

United States Patent and Trademark Office

## SKIN EQUIPMENT

**Reg. No. 4,197,966**

TRUE BALANCE ATHLETICS, LLC (ARKANSAS LIMITED LIABILITY COMPANY)  
1710 SADDLEBROOK DRIVE  
ROGERS, AR 72758

**Registered Aug. 28, 2012**

**Int. Cl.: 5**

FOR: SKIN LUBRICANTS AND POWDERS FOR ATHLETES TO PREVENT SKIN CHAFING,  
IN CLASS 5 (U.S. CLS. 6, 18, 44, 46, 51 AND 52).

**TRADEMARK**

FIRST USE 9-30-2011; IN COMMERCE 9-30-2011.

**PRINCIPAL REGISTER**

THE MARK CONSISTS OF STANDARD CHARACTERS WITHOUT CLAIM TO ANY PAR-  
TICULAR FONT, STYLE, SIZE, OR COLOR.

NO CLAIM IS MADE TO THE EXCLUSIVE RIGHT TO USE "SKIN", APART FROM THE  
MARK AS SHOWN.

SER. NO. 85-516,554, FILED 1-13-2012.

JACLYN KIDWELL WALKER, EXAMINING ATTORNEY



*David J. Kybas*

Director of the United States Patent and Trademark Office

# United States of America

United States Patent and Trademark Office

## NUTRINATIVE

**Reg. No. 4,197,967**

NUTRINATIVE (NEW YORK CORPORATION)  
4100 MOORPARK AVE, STE 216  
SAN JOSE, CA 95117

**Registered Aug. 28, 2012**

**Int. Cl.: 5**

FOR: DIETARY SUPPLEMENTS, IN CLASS 5 (U.S. CLS. 6, 18, 44, 46, 51 AND 52).

**TRADEMARK**

FIRST USE 9-14-2011; IN COMMERCE 10-1-2011.

**PRINCIPAL REGISTER**

THE MARK CONSISTS OF STANDARD CHARACTERS WITHOUT CLAIM TO ANY PARTICULAR FONT, STYLE, SIZE, OR COLOR.

SER. NO. 85-516,556, FILED 1-13-2012.

JACLYN KIDWELL WALKER, EXAMINING ATTORNEY



*David J. Kyffers*

Director of the United States Patent and Trademark Office

# United States of America

United States Patent and Trademark Office

## CREATE TO HEAL

**Reg. No. 4,197,968**

CONSCIOUS COMMUNICATION INC (CALIFORNIA CORPORATION)  
224 N FAIR OAKS AVE STE 300  
PASADENA, CA 91103

**Registered Aug. 28, 2012**

**Int. Cl.: 41**

FOR: PROVIDING EDUCATIONAL PROGRAMS, TRAINING AND MENTORING IN THE FIELDS OF LEADERSHIP, PERSONAL DEVELOPMENT, SELF EMPOWERMENT, SELF HEALING, CREATIVE EXPRESSION AND SOCIAL CHANGE, IN CLASS 41 (U.S. CLS. 100, 101 AND 107).

**SERVICE MARK**

**PRINCIPAL REGISTER**

FIRST USE 6-1-2011; IN COMMERCE 6-1-2011.

THE MARK CONSISTS OF STANDARD CHARACTERS WITHOUT CLAIM TO ANY PARTICULAR FONT, STYLE, SIZE, OR COLOR.

SER. NO. 85-516,561, FILED 1-13-2012.

JACLYN KIDWELL WALKER, EXAMINING ATTORNEY



*David J. Kyffers*

Director of the United States Patent and Trademark Office

# United States of America

United States Patent and Trademark Office

# Charlene K

**Reg. No. 4,197,969**

**Registered Aug. 28, 2012**

**Int. Cl.: 14**

**TRADEMARK**

**PRINCIPAL REGISTER**

CHARLENE K CORPORATION (CALIFORNIA CORPORATION)  
#A1093  
110 E 9TH ST.  
LOS ANGELES, CA 90079

FOR: JEWELRY, IN CLASS 14 (U.S. CLS. 2, 27, 28 AND 50).

FIRST USE 1-1-2006; IN COMMERCE 1-1-2006.

THE MARK CONSISTS OF STANDARD CHARACTERS WITHOUT CLAIM TO ANY PARTICULAR FONT, STYLE, SIZE, OR COLOR.

SER. NO. 85-516,563, FILED 1-13-2012.

JACLYN KIDWELL WALKER, EXAMINING ATTORNEY



*David J. Kybas*

Director of the United States Patent and Trademark Office

# United States of America

United States Patent and Trademark Office



**Reg. No. 4,197,970**

**Registered Aug. 28, 2012**

**Int. Cl.: 42**

**SERVICE MARK**

**PRINCIPAL REGISTER**

HOLT CONSULTING SERVICES, LLC (OKLAHOMA LIMITED LIABILITY COMPANY)  
SUITE B  
9524 E. 81ST STREET  
TULSA, OK 74133

FOR: ARCHEOLOGICAL EXPLORATION AND RESEARCH, IN CLASS 42 (U.S. CLS. 100 AND 101).

FIRST USE 11-10-2009; IN COMMERCE 3-1-2010.

NO CLAIM IS MADE TO THE EXCLUSIVE RIGHT TO USE "CONSULTING" AND "SERVICES, LLC", APART FROM THE MARK AS SHOWN.

THE MARK CONSISTS OF AN OVAL SURROUNDING A NATIVE AMERICAN ARROWHEAD WITH A STYLIZED "H" IN THE CENTER. ARCHING ABOVE THE OVAL IS THE STYLIZED TEXT "HOLT CONSULTING" AND ARCHING BELOW THE OVAL IS THE STYLIZED TEXT "SERVICES, LLC".

SER. NO. 85-516,573, FILED 1-13-2012.

JACLYN KIDWELL WALKER, EXAMINING ATTORNEY



*David J. Kybas*

Director of the United States Patent and Trademark Office

# United States of America

United States Patent and Trademark Office

## Catch Like a Local

**Reg. No. 4,197,971**

**Registered Aug. 28, 2012**

**Int. Cl.: 42**

**SERVICE MARK**

**PRINCIPAL REGISTER**

SCREEN3NETWORK LLC (CALIFORNIA LIMITED LIABILITY COMPANY)  
9555 COZYCROFT AVENUE  
CHATSWORTH, CA 91311

FOR: PROVIDING A WEBSITE FEATURING METEOROLOGICAL AND GEOLOGICAL INFORMATION SERVICES, NAMELY, PROVIDING FISHERMAN, MARINE INTERESTS AND THE GENERAL PUBLIC WITH FISHING CONDITION FORECASTS, ENTOMOLOGY INFORMATION, SPECIES INFORMATION IN THE NATURE OF SCIENTIFIC STUDY AND RESEARCH IN THE FIELD OF REPRODUCTION, HUSBANDRY, AND GENERAL HEALTH OF ALL SPORT FISHING SPECIES, AND WEATHER CONDITIONS BY GLOBAL COMPUTER INFORMATION NETWORKS, IN CLASS 42 (U.S. CLS. 100 AND 101).

FIRST USE 9-1-2009; IN COMMERCE 9-1-2009.

THE MARK CONSISTS OF STANDARD CHARACTERS WITHOUT CLAIM TO ANY PARTICULAR FONT, STYLE, SIZE, OR COLOR.

OWNER OF U.S. REG. NO. 3,945,346.

SER. NO. 85-516,584, FILED 1-13-2012.

WILLIAM JACKSON, EXAMINING ATTORNEY



*David J. Kyros*

Director of the United States Patent and Trademark Office

# United States of America

United States Patent and Trademark Office

## PLANK SKATEBOARDS

**Reg. No. 4,197,972**

**Registered Aug. 28, 2012**

**Int. Cls.: 25 and 28**

**TRADEMARK**

**PRINCIPAL REGISTER**

PLANK SKATEBOARDS, LLC (CALIFORNIA LIMITED LIABILITY COMPANY)  
3650 JOY ROAD  
OCCIDENTAL, CA 95465

FOR: CLOTHING, NAMELY, T-SHIRTS, IN CLASS 25 (U.S. CLS. 22 AND 39).

FIRST USE 1-4-2005; IN COMMERCE 1-30-2005.

FOR: SKATEBOARDS, SKATEBOARD ACCESSORIES, NAMELY HARDWOOD LAMINATED SKATEBOARD DECKS, SKATEBOARD DECKS, GRIP TAPE, IN CLASS 28 (U.S. CLS. 22, 23, 38 AND 50).

FIRST USE 1-4-2005; IN COMMERCE 1-30-2005.

THE MARK CONSISTS OF STANDARD CHARACTERS WITHOUT CLAIM TO ANY PARTICULAR FONT, STYLE, SIZE, OR COLOR.

NO CLAIM IS MADE TO THE EXCLUSIVE RIGHT TO USE "SKATEBOARDS", APART FROM THE MARK AS SHOWN.

SER. NO. 85-516,588, FILED 1-13-2012.

APRIL HESIK, EXAMINING ATTORNEY



*David J. Kyros*

Director of the United States Patent and Trademark Office



# United States of America

United States Patent and Trademark Office

# TEAM DIRTY

**Reg. No. 4,197,973**

GUEVARA, VICTOR M. (UNITED STATES INDIVIDUAL)  
10225 RIO CAMINO  
LAKESIDE, CA 92040

**Registered Aug. 28, 2012**

**Int. Cl.: 25**

FOR: BEANIES; BOTTOMS; HATS; JACKETS; PANTS; SHIRTS; SWEATSHIRTS; TANK  
TOPS; TOPS, IN CLASS 25 (U.S. CLS. 22 AND 39).

**TRADEMARK**

FIRST USE 5-0-2004; IN COMMERCE 5-0-2004.

**PRINCIPAL REGISTER**

THE MARK CONSISTS OF STANDARD CHARACTERS WITHOUT CLAIM TO ANY PAR-  
TICULAR FONT, STYLE, SIZE, OR COLOR.

SER. NO. 85-516,592, FILED 1-13-2012.

CURTIS FRENCH, EXAMINING ATTORNEY



*David J. Kybas*

Director of the United States Patent and Trademark Office

# United States of America

United States Patent and Trademark Office

## THE VELVET CACTUS

**Reg. No. 4,197,974**

**Registered Aug. 28, 2012**

**Int. Cl.: 43**

**SERVICE MARK**

**PRINCIPAL REGISTER**

THE VELVET CACTUS LLC (LOUISIANA LIMITED LIABILITY COMPANY)  
6300 ARGONNE BOULEVARD  
NEW ORLEANS, LA 70124

FOR: RESTAURANT SERVICES, IN CLASS 43 (U.S. CLS. 100 AND 101).

FIRST USE 5-21-2011; IN COMMERCE 5-21-2011.

THE MARK CONSISTS OF STANDARD CHARACTERS WITHOUT CLAIM TO ANY PARTICULAR FONT, STYLE, SIZE, OR COLOR.

SER. NO. 85-516,611, FILED 1-13-2012.

AMEEN IMAM, EXAMINING ATTORNEY



*David J. Kybas*

Director of the United States Patent and Trademark Office

# United States of America

United States Patent and Trademark Office

## METRO DADE K-9

**Reg. No. 4,197,975**

METRO DADE K-9 GUARD DOG SERVICES, INC. (FLORIDA CORPORATION)  
17940 S.W. 168TH STREET  
MIAMI, FL 33187

**Registered Aug. 28, 2012**

**Int. Cl.: 35**

FOR: RETAIL STORE SERVICES FEATURING DOGS, NAMELY, POLICE DOGS, CANINES, HOME PROTECTION DOGS, EXECUTIVE PROTECTION DOGS, PUPPIES, AND GERMAN SHEPARDS , IN CLASS 35 (U.S. CLS. 100, 101 AND 102).

**SERVICE MARK**

FIRST USE 3-0-1990; IN COMMERCE 3-0-1990.

**PRINCIPAL REGISTER**

THE MARK CONSISTS OF STANDARD CHARACTERS WITHOUT CLAIM TO ANY PARTICULAR FONT, STYLE, SIZE, OR COLOR.

OWNER OF U.S. REG. NO. 2,966,910.

NO CLAIM IS MADE TO THE EXCLUSIVE RIGHT TO USE "K-9", APART FROM THE MARK AS SHOWN.

SEC. 2(F).

SER. NO. 85-516,625, FILED 1-13-2012.

HELENE LIWINSKI, EXAMINING ATTORNEY



*David J. Kybas*

Director of the United States Patent and Trademark Office

# United States of America

United States Patent and Trademark Office

# Retreads

**Reg. No. 4,197,976**

**Registered Aug. 28, 2012**

**Int. Cl.: 28**

**TRADEMARK**

**PRINCIPAL REGISTER**

CYCLE DOG LLC (OREGON LIMITED LIABILITY COMPANY), DBA CYCLE DOG  
2434 NW RALEIGH ST  
PORTLAND, OR 97210

FOR: DISC TOSS TOYS; DOG TOYS; PET TOYS; PET TOYS MADE OF ROPE; PLUSH TOYS;  
PULL TOYS; RUBBER CHARACTER TOYS; SQUEEZABLE SQUEAKING TOYS; SQUEEZE  
TOYS; STUFFED AND PLUSH TOYS; STUFFED TOYS; TOY ANIMALS; TOYS FOR DO-  
MESTIC PETS; WATER TOYS, IN CLASS 28 (U.S. CLS. 22, 23, 38 AND 50).

FIRST USE 1-7-2011; IN COMMERCE 1-11-2012.

THE MARK CONSISTS OF STANDARD CHARACTERS WITHOUT CLAIM TO ANY PAR-  
TICULAR FONT, STYLE, SIZE, OR COLOR.

SER. NO. 85-516,634, FILED 1-13-2012.

JENNIFER VASQUEZ, EXAMINING ATTORNEY



*David J. Kyffers*

Director of the United States Patent and Trademark Office

# United States of America

United States Patent and Trademark Office

## GARRISON & SLOAN

**Reg. No. 4,197,977**

GARRISON & SLOAN, INC. (FLORIDA CORPORATION)

**Registered Aug. 28, 2012**

17940 S.W. 168TH STREET  
MIAMI, FL 33187

**Int. Cl.: 45**

FOR: AIRPORT BAGGAGE SECURITY INSPECTION SERVICES; BAGGAGE INSPECTION SERVICES FOR SECURITY PURPOSES; BAGGAGE SECURITY INSPECTIONS FOR AIRLINES; BOMB DETECTION SERVICES; DETECTIVE INVESTIGATIONS; SECURITY CONTROL OF PERSONS AND LUGGAGE IN AIRPORTS; SECURITY INSPECTION SERVICES FOR OTHERS; SECURITY SERVICES, NAMELY, CONDUCTING RECOVERY OPERATIONS FOR THE RECOVERY OF PROPERTY AND PERSONNEL; SECURITY SERVICES, NAMELY, PROVIDING EXECUTIVE PROTECTION; SECURITY SERVICES, NAMELY, PROVIDING SECURITY ASSESSMENTS FOR BUSINESSES AND GOVERNMENTAL AGENCIES, IN CLASS 45 (U.S. CLS. 100 AND 101).

**SERVICE MARK**

**PRINCIPAL REGISTER**

FIRST USE 8-16-2000; IN COMMERCE 12-0-2000.

THE MARK CONSISTS OF STANDARD CHARACTERS WITHOUT CLAIM TO ANY PARTICULAR FONT, STYLE, SIZE, OR COLOR.

SER. NO. 85-516,639, FILED 1-13-2012.

COLLEEN DOMBROW, EXAMINING ATTORNEY



*David J. Kybas*

Director of the United States Patent and Trademark Office

# United States of America

United States Patent and Trademark Office



**Reg. No. 4,197,978**

**Registered Aug. 28, 2012**

**Int. Cl.: 44**

**SERVICE MARK**

**PRINCIPAL REGISTER**

CHESAPEAKE WEIGHT LOSS CONSULTANTS, PLLC (VIRGINIA LIMITED LIABILITY COMPANY)

SUITE D  
680 KINGSBOROUGH SQUARE  
CHESAPEAKE, VA 23320

FOR: MEDICAL SERVICES; PHYSICIAN SERVICES, IN CLASS 44 (U.S. CLS. 100 AND 101).

FIRST USE 12-1-2010; IN COMMERCE 7-14-2011.

THE MARK CONSISTS OF A BUTTERFLY WITH "C" AND "L" ON THE WINGS AND THE CENTER FORMED BY A "W".

SER. NO. 85-516,649, FILED 1-13-2012.

JENNIFER VASQUEZ, EXAMINING ATTORNEY



*David J. Kybas*

Director of the United States Patent and Trademark Office

# United States of America

United States Patent and Trademark Office

## CHAINBUILDER

**Reg. No. 4,197,979**

**Registered Aug. 28, 2012**

**Int. Cl.: 42**

**SERVICE MARK**

**PRINCIPAL REGISTER**

BOSTECH CORPORATION (INDIANA CORPORATION)  
6100 WEST 96TH STREET  
INDIANAPOLIS, IN 46204

FOR: SOFTWARE AS A SERVICE (SAAS) SERVICES FEATURING SOFTWARE FOR ALLOWING DISPARATE APPLICATIONS AND BACKEND SYSTEMS TO TRANSFER DATA BY TRANSLATING MESSAGE TYPES, FORMATS, AND USING DIFFERENT PROTOCOLS TO SEND MESSAGES AND SOFTWARE FOR PROVIDING MESSAGE COMMUNICATION, MESSAGE PARSING/CREATION, DATA TRANSLATION/MAPPING, RECOVERABILITY OF MESSAGES, ROUTING MESSAGES, AND GUARANTEED DELIVERY OF MESSAGES BETWEEN SYSTEMS; AND COMPUTER SERVICES, NAMELY, DESIGNING, DEVELOPING, AND MAINTAINING COMPUTER SOFTWARE APPLICATIONS FOR OTHERS AND CONSULTING SERVICES RELATED THERETO, IN CLASS 42 (U.S. CLS. 100 AND 101).

FIRST USE 12-0-2005; IN COMMERCE 12-0-2005.

THE MARK CONSISTS OF STANDARD CHARACTERS WITHOUT CLAIM TO ANY PARTICULAR FONT, STYLE, SIZE, OR COLOR.

OWNER OF U.S. REG. NO. 2,605,699.

SER. NO. 85-516,669, FILED 1-13-2012.

JOSETTE BEVERLY, EXAMINING ATTORNEY



*David J. Kybas*

Director of the United States Patent and Trademark Office

# United States of America

United States Patent and Trademark Office

# flowfold

**Reg. No. 4,197,980**

**Registered Aug. 28, 2012**

**Int. Cl.: 18**

**TRADEMARK**

**PRINCIPAL REGISTER**

LIFETHEREAL LLC (MAINE LIMITED LIABILITY COMPANY), DBA FLOWFOLD  
PO BOX 12  
PEAKS ISLAND, ME 04108

FOR: BUSINESS CARD HOLDERS IN THE NATURE OF WALLETS AND POCKET CARD  
HOLDERS; WALLETS AND WALLET INSERTS; WALLETS WITH CARD COMPARTMENTS,  
IN CLASS 18 (U.S. CLS. 1, 2, 3, 22 AND 41).

FIRST USE 3-12-2011; IN COMMERCE 3-12-2011.

THE MARK CONSISTS OF STANDARD CHARACTERS WITHOUT CLAIM TO ANY PAR-  
TICULAR FONT, STYLE, SIZE, OR COLOR.

SER. NO. 85-516,676, FILED 1-13-2012.

AISHA SALEM, EXAMINING ATTORNEY



*David J. Kyffers*

Director of the United States Patent and Trademark Office



United States of America  
United States Patent and Trademark Office

# PROCELLIX

**Reg. No. 4,197,981**

DERMAL MEDS INC. (NEVADA CORPORATION)  
7477 WEST LAKE MEADE BLVD., SUITE 170  
LAS VEGAS, NV 89128

**Registered Aug. 28, 2012**

**Int. Cl.: 3**

FOR: BEAUTY CREAMS; BEAUTY CREAMS FOR BODY CARE; BODY CREAM; CREAMS FOR CELLULITE REDUCTION, IN CLASS 3 (U.S. CLS. 1, 4, 6, 50, 51 AND 52).

**TRADEMARK**

FIRST USE 11-1-2009; IN COMMERCE 6-1-2010.

**PRINCIPAL REGISTER**

THE MARK CONSISTS OF STANDARD CHARACTERS WITHOUT CLAIM TO ANY PARTICULAR FONT, STYLE, SIZE, OR COLOR.

SER. NO. 85-516,685, FILED 1-14-2012.

LINDA M. KING, EXAMINING ATTORNEY



*David J. Kybas*

Director of the United States Patent and Trademark Office

# United States of America

United States Patent and Trademark Office

# HiStory

**Reg. No. 4,197,982**

LIFE ARMOUR, LLC (NORTH CAROLINA LIMITED LIABILITY COMPANY)  
214 CHARTER DRIVE  
WILMINGTON, NC 28403

**Registered Aug. 28, 2012**

**Int. Cl.: 14**

FOR: RUBBER OR SILICON WRISTBANDS IN THE NATURE OF A BRACELET, IN CLASS 14 (U.S. CLS. 2, 27, 28 AND 50).

**TRADEMARK**

FIRST USE 9-24-2011; IN COMMERCE 11-4-2011.

**PRINCIPAL REGISTER**

THE MARK CONSISTS OF STANDARD CHARACTERS WITHOUT CLAIM TO ANY PARTICULAR FONT, STYLE, SIZE, OR COLOR.

SER. NO. 85-516,689, FILED 1-14-2012.

RICHARD WHITE, EXAMINING ATTORNEY



*David J. Kyffers*

Director of the United States Patent and Trademark Office

# United States of America

United States Patent and Trademark Office

## NUTRITIONFIX

**Reg. No. 4,197,983**

ARLANWEB INC. (CANADA CORPORATION)

**Registered Aug. 28, 2012**

5610 BOIS-FRANC  
MONTREAL, CANADA H4S1A9

**Int. Cl.: 35**

FOR: ON-LINE RETAIL STORE SERVICES FEATURING DIETARY AND NUTRITIONAL SUPPLEMENTS, HEALTH FOOD SUPPLEMENTS, PROTEIN SUPPLEMENTS, VITAMIN AND MINERAL SUPPLEMENTS, AND WEIGHT MANAGEMENT SUPPLEMENTS; ON-LINE RETAIL STORE SERVICES FEATURING ATHLETIC APPAREL, NAMELY, SHIRTS, PANTS, JACKETS, FOOTWEAR, HATS AND CAPS; AND ON-LINE RETAIL STORE SERVICES FEATURING ATHLETIC EQUIPMENT, NAMELY, KNEE BRACES, ELBOW BRACES, EXERCISE BALLS, JUMP ROPE, SPORTS BALLS, AND SPORTS GLOVES, IN CLASS 35 (U.S. CLS. 100, 101 AND 102).

**SERVICE MARK**

**PRINCIPAL REGISTER**

FIRST USE 1-6-2012; IN COMMERCE 1-6-2012.

THE MARK CONSISTS OF STANDARD CHARACTERS WITHOUT CLAIM TO ANY PARTICULAR FONT, STYLE, SIZE, OR COLOR.

SER. NO. 85-516,701, FILED 1-14-2012.

RICHARD WHITE, EXAMINING ATTORNEY



*David J. Kypos*

Director of the United States Patent and Trademark Office

# United States of America

United States Patent and Trademark Office



**Reg. No. 4,197,984**

**Registered Aug. 28, 2012**

**Int. Cl.: 3**

**TRADEMARK**

**PRINCIPAL REGISTER**

VERITAS BEAUTY, LLC (NEVADA LIMITED LIABILITY COMPANY)  
200 SOUTH VIRGINIA, 8TH FLOOR  
RENO, NV 89501

FOR: COLOGNES, PERFUMES AND COSMETICS; COSMETIC CREAMS; COSMETIC CREAMS FOR SKIN CARE; COSMETIC HAIR DRESSING PREPARATIONS; COSMETIC HAND CREAMS; COSMETIC MASSAGE CREAMS; COSMETIC PREPARATIONS; COSMETIC PREPARATIONS FOR BATH AND SHOWER; COSMETIC PREPARATIONS FOR BODY CARE; COSMETIC PREPARATIONS FOR SKIN CARE; COSMETIC PREPARATIONS FOR SKIN RENEWAL; COSMETIC PREPARATIONS FOR THE HAIR AND SCALP; COSMETIC SKIN FRESHENERS; COSMETICS AND COSMETIC PREPARATIONS; COSMETICS IN GENERAL, INCLUDING PERFUMES; FACE CREAMS FOR COSMETIC USE; LOTIONS FOR COSMETIC PURPOSES; PRIVATE LABEL COSMETICS; SKIN AND BODY TOPICAL LOTIONS, CREAMS AND OILS FOR COSMETIC USE; SKIN CONDITIONING CREAMS FOR COSMETIC PURPOSES; SKIN FRESHENERS; TOPICAL SKIN SPRAYS FOR COSMETIC PURPOSES, IN CLASS 3 (U.S. CLS. 1, 4, 6, 50, 51 AND 52).

FIRST USE 10-29-2011; IN COMMERCE 10-29-2011.

THE MARK CONSISTS OF A SPIRAL OF TWO RIBBONS (OF DIFFERENT LENGTHS) IN A STYLIZED FIGURE 8 WITH AN OVAL AT ONE END OF THE SPIRAL AND ONE RIBBON (SHORTER THAN THE OTHER) MEETING AT THE MIDPOINT OF THE LONGER RIBBON TO CLOSE THE EIGHT. THE LONGER RIBBON CONTINUES TO CURVE AS IF CLOSING THE FIGURE EIGHT BUT STOPS AT A POINT PARALLEL TO THE BASE OF THE SHORTER RIBBON.

SER. NO. 85-516,710, FILED 1-14-2012.

BRENDAN REGAN, EXAMINING ATTORNEY



*David J. Kybas*

Director of the United States Patent and Trademark Office

# United States of America

United States Patent and Trademark Office

## CARITA DE ANGEL

**Reg. No. 4,197,985**

**Registered Aug. 28, 2012**

**Int. Cl.: 41**

**SERVICE MARK**

**PRINCIPAL REGISTER**

TELEVISA, S.A. DE C.V. (MEXICO CORPORATION)  
AVENIDA VASCO DE QUIROGA 2000  
EDIFICIO A PISO 4, COLONIA ZEDEC  
SANTA FE, MEXICO 01210

FOR: ENTERTAINMENT SERVICES IN THE NATURE OF A CONTINUING DRAMATIC SHOW BROADCAST OVER THE INTERNET AND AN ONGOING DRAMATIC TELEVISION SHOW, IN CLASS 41 (U.S. CLS. 100, 101 AND 107).

THE MARK CONSISTS OF STANDARD CHARACTERS WITHOUT CLAIM TO ANY PARTICULAR FONT, STYLE, SIZE, OR COLOR.

OWNER OF MEXICO REG. NO. 875156, DATED 2-1-2005, EXPIRES 2-1-2015.

THE ENGLISH TRANSLATION OF "CARITA DE ANGEL" IN THE MARK IS "LITTLE ANGEL FACE".

SER. NO. 85-516,724, FILED 1-14-2012.

SANDRA BUJA, EXAMINING ATTORNEY



*David J. Kyffers*

Director of the United States Patent and Trademark Office

# United States of America

United States Patent and Trademark Office

# Fontalina

**Reg. No. 4,197,986**

**Registered Aug. 28, 2012**

**Int. Cl.: 18**

**TRADEMARK**

**PRINCIPAL REGISTER**

LIGHTER CORP (CONNECTICUT CORPORATION)  
36 MAYFAIR LANE  
GREENWICH, CT 06831

FOR: BACKPACKS, BOOK BAGS, SPORTS BAGS, BUM BAGS, WALLETS AND HANDBAGS; EVENING HANDBAGS; FASHION HANDBAGS; FITTED PROTECTIVE COVERS FOR HANDBAGS, BRIEFCASES, VALISES, SUITCASES, AND BRIEFCASE-LIKE PORTFOLIOS; GENTLEMEN'S HANDBAGS; HANDBAG FRAMES; HANDBAGS; HANDBAGS FOR LADIES; HANDBAGS FOR MEN; HANDBAGS, PURSES AND WALLETS; INTERCHANGEABLE DECORATIVE COVERS FOR ACCESSORIZATION PURPOSES THAT ARE SPECIALLY ADAPTED TO HANDBAGS; LEATHER HANDBAGS; STRAPS FOR HANDBAGS, IN CLASS 18 (U.S. CLS. 1, 2, 3, 22 AND 41).

FIRST USE 8-12-2011; IN COMMERCE 8-12-2011.

THE MARK CONSISTS OF STANDARD CHARACTERS WITHOUT CLAIM TO ANY PARTICULAR FONT, STYLE, SIZE, OR COLOR.

SER. NO. 85-516,726, FILED 1-14-2012.

APRIL ROACH, EXAMINING ATTORNEY



*David J. Kyffers*

Director of the United States Patent and Trademark Office

# United States of America

United States Patent and Trademark Office

## AMOR SIN MAQUILLAJE

**Reg. No. 4,197,987**

**Registered Aug. 28, 2012**

**Int. Cl.: 41**

**SERVICE MARK**

**PRINCIPAL REGISTER**

TELEVISA, S.A. DE C.V. (MEXICO CORPORATION)  
EDIFICIO A PISO 4, COLONIA ZEDEC  
AVENIDA VASCO DE QUIROGA 2000  
SANTA FE, MEXICO 01210

FOR: ENTERTAINMENT SERVICES IN THE NATURE OF A CONTINUING DRAMATIC SHOW BROADCAST OVER THE INTERNET AND AN ONGOING DRAMATIC TELEVISION SHOW, IN CLASS 41 (U.S. CLS. 100, 101 AND 107).

THE MARK CONSISTS OF STANDARD CHARACTERS WITHOUT CLAIM TO ANY PARTICULAR FONT, STYLE, SIZE, OR COLOR.

OWNER OF MEXICO REG. NO. 1004711, DATED 9-4-2007, EXPIRES 9-4-2017.

OWNER OF U.S. REG. NO. 3,597,061.

THE ENGLISH TRANSLATION OF "AMOR SIN MAQUILLAJE" IN THE MARK IS "LOVE WITHOUT MAKE UP".

SER. NO. 85-516,730, FILED 1-14-2012.

SANDRA BUJA, EXAMINING ATTORNEY



*David J. Kyffers*

Director of the United States Patent and Trademark Office

# United States of America

United States Patent and Trademark Office



**Reg. No. 4,197,988**

**Registered Aug. 28, 2012**

**Int. Cl.: 41**

**SERVICE MARK**

**PRINCIPAL REGISTER**

TELEVISA, S.A. DE C.V. (MEXICO CORPORATION)  
EDIFICIO A PISO 4, COLONIA ZEDEC  
AVENIDA VASCO DE QUIROGA 2000  
SANTA FE, MEXICO 01210

FOR: ENTERTAINMENT SERVICES IN THE NATURE OF A CONTINUING DRAMATIC SHOW BROADCAST OVER THE INTERNET FEATURING FICTIONAL STORIES ABOUT PEOPLE WHO SUFFER ADDICTIONS TO DRUGS, FOOD, ACTIVITIES LIKE SHOPPING, EXERCISE, SEX, AMONG OTHERS; AND AN ONGOING DRAMATIC TELEVISION SHOW FEATURING FICTIONAL STORIES ABOUT PEOPLE WHO SUFFER ADDICTIONS TO DRUGS, FOOD, ACTIVITIES LIKE SHOPPING, EXERCISE, SEX, AMONG OTHERS, IN CLASS 41 (U.S. CLS. 100, 101 AND 107).

FIRST USE 2-12-2012; IN COMMERCE 2-12-2012.

NO CLAIM IS MADE TO THE EXCLUSIVE RIGHT TO USE "ADICTOS", APART FROM THE MARK AS SHOWN.

THE MARK CONSISTS OF THE DESIGNATION "ADICTOS" IN WHICH THE LETTER "I" HAS THE APPEARANCE OF A STYLIZED BURNING CIGARETTE WITH SMOKE EMANATING FROM THE TOP PORTION THEREOF, THE LETTER "T" HAS THE APPEARANCE OF A STYLIZED SYRINGE, AND THE LETTER "O" HAS A RECTANGULAR LINE BISECTING IT AT AN ANGLE.

THE ENGLISH TRANSLATION OF "ADICTOS" IN THE MARK IS "ADDICTED".

SER. NO. 85-516,740, FILED 1-14-2012.

SANDRA BUJA, EXAMINING ATTORNEY



*David J. Kyffers*

Director of the United States Patent and Trademark Office



# United States of America

United States Patent and Trademark Office

## EL PRIVILEGIO DE MANDAR

**Reg. No. 4,197,989**

**Registered Aug. 28, 2012**

**Int. Cl.: 41**

**SERVICE MARK**

**PRINCIPAL REGISTER**

TELEVISA, S.A. DE C.V. (MEXICO CORPORATION)  
AVENIDA VASCO DE QUIROGA 2000  
EDIFICIO A PISO 4, COLONIA ZEDEC  
SANTA FE, MEXICO 01210

FOR: ENTERTAINMENT SERVICES IN THE NATURE OF A CONTINUING COMEDY SHOW BROADCAST OVER THE INTERNET AND AN ONGOING COMEDY TELEVISION SHOW, IN CLASS 41 (U.S. CLS. 100, 101 AND 107).

THE MARK CONSISTS OF STANDARD CHARACTERS WITHOUT CLAIM TO ANY PARTICULAR FONT, STYLE, SIZE, OR COLOR.

OWNER OF MEXICO REG. NO. 874987, DATED 1-24-2005, EXPIRES 1-24-2015.

THE ENGLISH TRANSLATION OF "EL PRIVILEGIO DE MANDAR" IN THE MARK IS "THE PRIVILEGE OF LEADING".

SER. NO. 85-516,744, FILED 1-14-2012.

SANDRA BUJA, EXAMINING ATTORNEY



*David J. Kyffers*

Director of the United States Patent and Trademark Office

United States of America  
United States Patent and Trademark Office

# Psychictribe

**Reg. No. 4,197,990**

PENDREY, JASON LEE (UNITED STATES INDIVIDUAL)  
80 TRISTAN ROAD  
CLIFTON, NJ 07013

**Registered Aug. 28, 2012**

**Int. Cl.: 45**

FOR: INTERNET-BASED SOCIAL NETWORKING SERVICES, IN CLASS 45 (U.S. CLS. 100 AND 101).

**SERVICE MARK**

FIRST USE 1-12-2012; IN COMMERCE 1-12-2012.

**PRINCIPAL REGISTER**

THE MARK CONSISTS OF STANDARD CHARACTERS WITHOUT CLAIM TO ANY PARTICULAR FONT, STYLE, SIZE, OR COLOR.

SER. NO. 85-516,777, FILED 1-14-2012.

ESTHER A. BORSUK, EXAMINING ATTORNEY



*David J. Kybas*

Director of the United States Patent and Trademark Office

# United States of America

United States Patent and Trademark Office

## Spring Thaw

**Reg. No. 4,197,991**

ALLENTOWN TRAIN MEET ASSOCIATES (PENNSYLVANIA PARTNERSHIP)  
1120 SOUTH JEFFERSON ST.  
ALLENTOWN, PA 18103

**Registered Aug. 28, 2012**

**Int. Cl.: 35**

FOR: CONDUCTING TRADE SHOWS IN THE FIELD OF MODEL TRAINS, IN CLASS 35  
(U.S. CLS. 100, 101 AND 102).

**SERVICE MARK**

FIRST USE 2-1-1979; IN COMMERCE 2-1-1979.

**PRINCIPAL REGISTER**

THE MARK CONSISTS OF STANDARD CHARACTERS WITHOUT CLAIM TO ANY PARTICULAR FONT, STYLE, SIZE, OR COLOR.

SER. NO. 85-516,835, FILED 1-15-2012.

JUDITH HELFMAN, EXAMINING ATTORNEY



*David J. Kyffers*

Director of the United States Patent and Trademark Office

# United States of America

United States Patent and Trademark Office

# OffersHQ

**Reg. No. 4,197,992**

FORUM COMMUNICATIONS COMPANY (NORTH DAKOTA CORPORATION)  
101 5TH ST. N.  
FARGO, ND 58107

**Registered Aug. 28, 2012**

**Int. Cl.: 9**

FOR: COMPUTER APPLICATION SOFTWARE FOR COMPUTERS, MOBILE PHONES, HANDHELD COMPUTERS AND OTHER MOBILE DEVICES, NAMELY, SOFTWARE FOR AGGREGATING AND ACCESSING DISCOUNTS, COUPONS, OFFERS, DEALS AND OTHER PROMOTIONS, IN CLASS 9 (U.S. CLS. 21, 23, 26, 36 AND 38).

**TRADEMARK**

**PRINCIPAL REGISTER**

FIRST USE 11-6-2011; IN COMMERCE 11-6-2011.

THE MARK CONSISTS OF STANDARD CHARACTERS WITHOUT CLAIM TO ANY PARTICULAR FONT, STYLE, SIZE, OR COLOR.

SER. NO. 85-516,851, FILED 1-15-2012.

JANICE L. MCMORROW, EXAMINING ATTORNEY



*David J. Kybas*

Director of the United States Patent and Trademark Office

# United States of America

United States Patent and Trademark Office

# Intelli**joint**

**Reg. No. 4,197,993**

**Registered Aug. 28, 2012**

**Int. Cl.: 9**

**TRADEMARK**

**PRINCIPAL REGISTER**

THE JONES GROUP APC (LOUISIANA CORPORATION), DBA JONES GROUP FORENSIC ENGINEERS  
305 LOST CREEK DRIVE NW  
KENNESAW, GA 30152

FOR: AUTOMATED MONITORING SYSTEM, NAMELY, MICROPROCESSOR BASED HARDWARE AND SOFTWARE USED TO MONITOR THE CONDITION OF ELECTRICAL BUSWAY AND ITS JOINTS AND TAPS, IN CLASS 9 (U.S. CLS. 21, 23, 26, 36 AND 38).

FIRST USE 10-15-2011; IN COMMERCE 10-15-2011.

THE MARK CONSISTS OF THE WORD INTELLIJOINT IN MIXED CASE. "INTELLI" IS IN GRAY FONT; "JOINT" IS IN ORANGE BOLD FONT. THE DOT OF THE "J" AND "I" IN JOINT ARE GRAY CIRCLES.

THE COLOR(S) GRAY AND ORANGE IS/ARE CLAIMED AS A FEATURE OF THE MARK.

SER. NO. 85-516,870, FILED 1-15-2012.

CAROLINE WOOD, EXAMINING ATTORNEY



*David J. Kyffers*

Director of the United States Patent and Trademark Office

# United States of America

United States Patent and Trademark Office

## Dons of Debonair

**Reg. No. 4,197,994**

**Registered Aug. 28, 2012**

**Int. Cl.: 18**

**TRADEMARK**

**PRINCIPAL REGISTER**

DONS OF DEBONAIR (ILLINOIS CORPORATION)  
954 E 164TH COURT  
SOUTH HOLLAND, IL 60473

FOR: BACK PACKS, IN CLASS 18 (U.S. CLS. 1, 2, 3, 22 AND 41).

FIRST USE 9-14-2011; IN COMMERCE 9-14-2011.

THE MARK CONSISTS OF STANDARD CHARACTERS WITHOUT CLAIM TO ANY PARTICULAR FONT, STYLE, SIZE, OR COLOR.

SER. NO. 85-516,879, FILED 1-15-2012.

STEVEN R. FINE, EXAMINING ATTORNEY



*David J. Kybas*

Director of the United States Patent and Trademark Office

# United States of America

United States Patent and Trademark Office

## Be Positive Mom

**Reg. No. 4,197,995**

STEPHANIE LEMA (UNITED STATES INDIVIDUAL), DBA BE POSITIVE MOM  
5338 KUNKEL DRIVE  
SAN JOSE, CA 95124

**Registered Aug. 28, 2012**

**Int. Cl.: 45**

FOR: PROVIDING A MOTIVATIONAL WEBSITE THE PRIMARY MISSION OF WHICH IS TO INCREASE PERSONAL HAPPINESS IN TERMS OF PERSONAL RELATIONSHIPS, PERSONAL GROWTH AND MOTIVATION, AND SELF-FULFILLMENT, IN CLASS 45 (U.S. CLS. 100 AND 101).

**SERVICE MARK**

**PRINCIPAL REGISTER**

FIRST USE 6-10-2010; IN COMMERCE 6-10-2010.

THE MARK CONSISTS OF STANDARD CHARACTERS WITHOUT CLAIM TO ANY PARTICULAR FONT, STYLE, SIZE, OR COLOR.

SER. NO. 85-516,890, FILED 1-15-2012.

CHRISTOPHER SIDOTI, EXAMINING ATTORNEY



*David J. Kyffers*

Director of the United States Patent and Trademark Office

# United States of America

United States Patent and Trademark Office

# NanCakes

**Reg. No. 4,197,996**

NANCAKES, LLC (OHIO LIMITED LIABILITY COMPANY)  
8405 INDIAN HILL RD.  
CINCINNATI, OH 45243

**Registered Aug. 28, 2012**

**Int. Cl.: 30**

FOR: ICED CAKES, IN CLASS 30 (U.S. CL. 46).

**TRADEMARK**

FIRST USE 2-15-2010; IN COMMERCE 2-15-2010.

**PRINCIPAL REGISTER**

THE MARK CONSISTS OF STANDARD CHARACTERS WITHOUT CLAIM TO ANY PARTICULAR FONT, STYLE, SIZE, OR COLOR.

SER. NO. 85-516,905, FILED 1-15-2012.

JAMES GRIFFIN, EXAMINING ATTORNEY



*David J. Kyffers*

Director of the United States Patent and Trademark Office



# United States of America

United States Patent and Trademark Office

## Romulus Capital

**Reg. No. 4,197,997**

ROMULUS CAPITAL, LLC (FLORIDA LIMITED LIABILITY COMPANY)  
1213 WINDWARD DRIVE  
APOPKA, FL 32703

**Registered Aug. 28, 2012**

**Int. Cl.: 36**

FOR: MANAGEMENT OF A CAPITAL INVESTMENT FUND; MANAGEMENT OF PRIVATE EQUITY FUNDS, IN CLASS 36 (U.S. CLS. 100, 101 AND 102).

**SERVICE MARK**

FIRST USE 8-1-2011; IN COMMERCE 8-1-2011.

**PRINCIPAL REGISTER**

THE MARK CONSISTS OF STANDARD CHARACTERS WITHOUT CLAIM TO ANY PARTICULAR FONT, STYLE, SIZE, OR COLOR.

NO CLAIM IS MADE TO THE EXCLUSIVE RIGHT TO USE "CAPITAL", APART FROM THE MARK AS SHOWN.

SER. NO. 85-516,920, FILED 1-15-2012.

TRICIA SONNEBORN, EXAMINING ATTORNEY



*David J. Kybas*

Director of the United States Patent and Trademark Office

# United States of America

United States Patent and Trademark Office



**Reg. No. 4,197,998**

**Registered Aug. 28, 2012**

**Int. Cl.: 18**

**TRADEMARK**

**PRINCIPAL REGISTER**

L. & LEUNG HANDBAGS MANUFACTORY LIMITED (HONG KONG LIMITED LIABILITY COMPANY)  
6TH FLOOR, BONSUN INDUSTRIAL BUILDING,  
364-366 SHA TSUI ROAD, TSUEN WAN, N.T.  
HONG KONG, HONG KONG

FOR: HANDBAGS, IN CLASS 18 (U.S. CLS. 1, 2, 3, 22 AND 41).

FIRST USE 1-3-2012; IN COMMERCE 1-3-2012.

THE MARK CONSISTS OF REAR SIDE OF A FOX.

SER. NO. 85-516,963, FILED 1-16-2012.

ELISSA GARBER KON, EXAMINING ATTORNEY



*David J. Kybas*

Director of the United States Patent and Trademark Office

United States of America  
United States Patent and Trademark Office

**BROCK**

**Reg. No. 4,197,999**

BROCK USA, LLC (COLORADO LIMITED LIABILITY COMPANY)  
2840 WILDERNESS PLACE  
BOULDER, CO 80301

**Registered Aug. 28, 2012**

**Int. Cl.: 19**

FOR: SYNTHETIC BASE FOR PLACEMENT UNDERNEATH PAVERS, IN CLASS 19 (U.S. CLS. 1, 12, 33 AND 50).

**TRADEMARK**

FIRST USE 7-16-2010; IN COMMERCE 7-16-2010.

**PRINCIPAL REGISTER**

THE MARK CONSISTS OF STANDARD CHARACTERS WITHOUT CLAIM TO ANY PARTICULAR FONT, STYLE, SIZE, OR COLOR.

OWNER OF U.S. REG. NO. 3,179,714.

SER. NO. 85-517,032, FILED 1-16-2012.

DAVID TOOLEY, EXAMINING ATTORNEY



*David J. Kyffers*

Director of the United States Patent and Trademark Office

# United States of America

United States Patent and Trademark Office

## WE THE BEST

**Reg. No. 4,198,000**

**Registered Aug. 28, 2012**

**Int. Cls.: 9 and 41**

**TRADEMARK**

**SERVICE MARK**

**PRINCIPAL REGISTER**

KHALED, KHALED M. (UNITED STATES INDIVIDUAL)  
C/O SEDLMAYR & ASSOCIATES, P.C.  
200 PARK AVENUE SOUTH, SUITE 1408  
NEW YORK, NY 10003

FOR: MUSICAL SOUND RECORDINGS; DOWNLOADABLE MUSICAL SOUND RECORDINGS, IN CLASS 9 (U.S. CLS. 21, 23, 26, 36 AND 38).

FIRST USE 6-12-2007; IN COMMERCE 11-0-2007.

FOR: ENTERTAINMENT SERVICES IN THE NATURE OF RECORDING, PRODUCTION, AND POST PRODUCTION SERVICES IN THE FIELD OF MUSIC; PRODUCTION OF MUSICAL SOUND RECORDINGS; MUSIC PRODUCTION SERVICES; ENTERTAINMENT SERVICES IN THE NATURE OF PRESENTING LIVE MUSICAL PERFORMANCES, IN CLASS 41 (U.S. CLS. 100, 101 AND 107).

FIRST USE 0-0-2007; IN COMMERCE 0-0-2007.

THE MARK CONSISTS OF STANDARD CHARACTERS WITHOUT CLAIM TO ANY PARTICULAR FONT, STYLE, SIZE, OR COLOR.

SER. NO. 85-517,034, FILED 1-16-2012.

JEFF DEFORD, EXAMINING ATTORNEY



*David J. Kyros*

Director of the United States Patent and Trademark Office

# United States of America

United States Patent and Trademark Office

## Get to Know Your Breasts

**Reg. No. 4,198,001**

ROCK PINK INC. (FLORIDA CORPORATION)  
POB 683317

**Registered Aug. 28, 2012**

ORLANDO, FL 32868

**Int. Cl.: 35**

FOR: PROMOTING PUBLIC AWARENESS OF BREAST HEALTH AND BREAST CANCER,  
IN CLASS 35 (U.S. CLS. 100, 101 AND 102).

**SERVICE MARK**

FIRST USE 7-1-2009; IN COMMERCE 7-1-2009.

**PRINCIPAL REGISTER**

THE MARK CONSISTS OF STANDARD CHARACTERS WITHOUT CLAIM TO ANY PAR-  
TICULAR FONT, STYLE, SIZE, OR COLOR.

SER. NO. 85-517,041, FILED 1-16-2012.

JEFF DEFORD, EXAMINING ATTORNEY



*David J. Kyffers*

Director of the United States Patent and Trademark Office

# United States of America

United States Patent and Trademark Office

## CONSTRULEGAL

**Reg. No. 4,198,002**

**Registered Aug. 28, 2012**

**Int. Cl.: 45**

**SERVICE MARK**

**PRINCIPAL REGISTER**

CORPORACIÓN MEXICANA DE ASESORES EN DERECHO S.C. (MEXICO SOCIEDAD CORPORATIVA)  
FEBO 29. COL. CRÉDITO CONSTRUCTOR  
MÉXICO, D.F., MEXICO 03940 AND

ABOGADOS CONSULTORES S.A. (PERU SOCIEDAD ANÓNIMA), DBA NPG ABOGADOS  
AV. CANAVAL Y MOREYRA 452 - PISO 13  
SAN ISIDRO, LIMA 27, PERU AND

PECKAR & ABRAMSON, P.C. (NEW JERSEY PROFESSIONAL CORPORATION)  
70 GRAND AVE  
RIVER EDGE, NJ 07661

FOR: LEGAL SERVICES, IN CLASS 45 (U.S. CLS. 100 AND 101).

FIRST USE 10-31-2011; IN COMMERCE 10-31-2011.

THE MARK CONSISTS OF STANDARD CHARACTERS WITHOUT CLAIM TO ANY PARTICULAR FONT, STYLE, SIZE, OR COLOR.

SER. NO. 85-517,069, FILED 1-16-2012.

TOBY BULLOFF, EXAMINING ATTORNEY



*David J. Kybas*

Director of the United States Patent and Trademark Office

# United States of America

United States Patent and Trademark Office



**Reg. No. 4,198,003**

**Registered Aug. 28, 2012**

**Int. Cl.: 45**

**SERVICE MARK**

**PRINCIPAL REGISTER**

CORPORACIÓN MEXICANA DE ASESORES EN DERECHO S.C. (MEXICO SOCIEDAD CORPORATIVA)  
FEBO 29. COL. CRÉDITO CONSTRUCTOR  
MÉXICO, D.F., MEXICO 03940 AND

ABOGADOS CONSULTORES S.A. (PERU SOCIEDAD ANÓNIMA), DBA NPG ABOGADOS  
AV. CANAVAL Y MOREYRA 452 - PISO 13  
SAN ISIDRO, LIMA 27, PERU AND

PECKAR & ABRAMSON, P.C. (NEW JERSEY PROFESSIONAL CORPORATION)  
70 GRAND AVE  
RIVER EDGE, NJ 07661

FOR: LEGAL SERVICES, IN CLASS 45 (U.S. CLS. 100 AND 101).

FIRST USE 10-31-2011; IN COMMERCE 10-31-2011.

THE MARK CONSISTS OF THE WORD "CONSTRULEGAL" WITH A MAP OF THE AMERICAS INSIDE THE LETTER "C".

SER. NO. 85-517,072, FILED 1-16-2012.

TOBY BULLOFF, EXAMINING ATTORNEY



*David J. Kybas*

Director of the United States Patent and Trademark Office

# United States of America

United States Patent and Trademark Office

# S-LOCK

**Reg. No. 4,198,004**

**Registered Aug. 28, 2012**

**Int. Cl.: 26**

**TRADEMARK**

**PRINCIPAL REGISTER**

PASKAL ZIPPERS (ISRAEL CORPORATION)  
KIBBUTZ YIRON  
D. N. MEROM HAGALIL, ISRAEL 13855

FOR: ZIPPERS, IN CLASS 26 (U.S. CLS. 37, 39, 40, 42 AND 50).

FIRST USE 1-31-2005; IN COMMERCE 1-31-2005.

THE MARK CONSISTS OF STANDARD CHARACTERS WITHOUT CLAIM TO ANY PARTICULAR FONT, STYLE, SIZE, OR COLOR.

SER. NO. 85-517,078, FILED 1-16-2012.

MICHAEL KEATING, EXAMINING ATTORNEY



*David J. Keating*

Director of the United States Patent and Trademark Office



# United States of America

United States Patent and Trademark Office

## THE WISDOM OF NATURE & THE POWER OF SCIENCE

**Reg. No. 4,198,005**

SALEM BOTANICALS CORPORATION (NEW JERSEY CORPORATION)  
100 CENTRAL SCHOOLHOUSE RD.  
CARNEYS POINT, NJ 08069

**Registered Aug. 28, 2012**

**Int. Cls.: 3 and 5**

FOR: SKIN AND BODY TOPICAL LOTIONS, CREAMS AND OILS FOR COSMETIC USE,  
IN CLASS 3 (U.S. CLS. 1, 4, 6, 50, 51 AND 52).

**TRADEMARK**

FIRST USE 0-0-2006; IN COMMERCE 0-0-2006.

**PRINCIPAL REGISTER**

FOR: DIETARY SUPPLEMENTS; HERBAL TEAS FOR MEDICINAL PURPOSES; NUTRI-  
TIONAL SUPPLEMENTS; VITAMIN OILS FOR HUMAN CONSUMPTION, IN CLASS 5 (U.S.  
CLS. 6, 18, 44, 46, 51 AND 52).

FIRST USE 0-0-2006; IN COMMERCE 0-0-2006.

THE MARK CONSISTS OF STANDARD CHARACTERS WITHOUT CLAIM TO ANY PAR-  
TICULAR FONT, STYLE, SIZE, OR COLOR.

SER. NO. 85-517,101, FILED 1-16-2012.

KRISTIN DAHLING, EXAMINING ATTORNEY



*David J. Kybas*

Director of the United States Patent and Trademark Office

# United States of America

United States Patent and Trademark Office

## SALEM BOTANICALS

**Reg. No. 4,198,006**

**Registered Aug. 28, 2012**

**Int. Cls.: 3 and 5**

**TRADEMARK**

**PRINCIPAL REGISTER**

SALEM BOTANICALS CORPORATION (NEW JERSEY CORPORATION)  
100 CENTRAL SCHOOLHOUSE RD.  
CARNEYS POINT, NJ 08069

FOR: SKIN AND BODY TOPICAL LOTIONS, CREAMS AND OILS FOR COSMETIC USE, ALL OF THE AFOREMENTIONED MADE FROM BOTANICALS, IN CLASS 3 (U.S. CLS. 1, 4, 6, 50, 51 AND 52).

FIRST USE 0-0-2006; IN COMMERCE 0-0-2006.

FOR: DIETARY SUPPLEMENTS MADE FROM BOTANICALS; HERBAL TEAS FOR MEDICINAL PURPOSES MADE FROM BOTANICALS; NUTRITIONAL SUPPLEMENTS MADE FROM BOTANICALS; VITAMIN OILS MADE FROM BOTANICALS FOR HUMAN CONSUMPTION, IN CLASS 5 (U.S. CLS. 6, 18, 44, 46, 51 AND 52).

FIRST USE 0-0-2006; IN COMMERCE 0-0-2006.

THE MARK CONSISTS OF STANDARD CHARACTERS WITHOUT CLAIM TO ANY PARTICULAR FONT, STYLE, SIZE, OR COLOR.

NO CLAIM IS MADE TO THE EXCLUSIVE RIGHT TO USE "BOTANICALS", APART FROM THE MARK AS SHOWN.

SEC. 2(F).

SER. NO. 85-517,110, FILED 1-16-2012.

KRISTIN DAHLING, EXAMINING ATTORNEY



*David J. Kyros*

Director of the United States Patent and Trademark Office

# United States of America

United States Patent and Trademark Office

# Frames

**Reg. No. 4,198,007**

TECH4LEARNING, INC. (CALIFORNIA CORPORATION)  
10981 SAN DIEGO MISSION RD. STE 120  
SAN DIEGO, CA 92108

**Registered Aug. 28, 2012**

**Int. Cl.: 9**

FOR: COMPUTER SOFTWARE FOR USE IN RELATION TO DIGITAL ANIMATION AND SPECIAL EFFECTS OF IMAGES, IN CLASS 9 (U.S. CLS. 21, 23, 26, 36 AND 38).

**TRADEMARK**

FIRST USE 8-1-2006; IN COMMERCE 9-18-2006.

**PRINCIPAL REGISTER**

THE MARK CONSISTS OF STANDARD CHARACTERS WITHOUT CLAIM TO ANY PARTICULAR FONT, STYLE, SIZE, OR COLOR.

SER. NO. 85-517,111, FILED 1-16-2012.

FONG HSU, EXAMINING ATTORNEY



*David J. Kybas*

Director of the United States Patent and Trademark Office

# United States of America

United States Patent and Trademark Office

## JUST THINK DYNAMICS

**Reg. No. 4,198,008**

CYNTHIA B. LAKE (UNITED STATES INDIVIDUAL)

**Registered Aug. 28, 2012**

960 LA VISTA COURT  
MORGAN HILL, CA 95037

**Int. Cl.: 35**

FOR: BUSINESS CONSULTATION SERVICES, IN CLASS 35 (U.S. CLS. 100, 101 AND 102).

**SERVICE MARK**

FIRST USE 7-1-2011; IN COMMERCE 7-1-2011.

**PRINCIPAL REGISTER**

THE MARK CONSISTS OF STANDARD CHARACTERS WITHOUT CLAIM TO ANY PARTICULAR FONT, STYLE, SIZE, OR COLOR.

SER. NO. 85-517,120, FILED 1-16-2012.

FONG HSU, EXAMINING ATTORNEY



*David J. Kyffers*

Director of the United States Patent and Trademark Office

# United States of America

United States Patent and Trademark Office

# Trello

**Reg. No. 4,198,009**

FOG CREEK SOFTWARE, INC. (DELAWARE CORPORATION)  
55 BROADWAY FLOOR 25  
NEW YORK, NY 10006

**Registered Aug. 28, 2012**

**Int. Cl.: 42**

FOR: COMPUTER SERVICES, NAMELY, PROVIDING CUSTOMIZED ONLINE WEB PAGES FEATURING USER-DEFINED INFORMATION; COMPUTER SERVICES, NAMELY, HOSTING A WEBPAGE FOR USERS TO CREATE NOTES AND UPLOAD FILE ATTACHMENTS INCLUDING IMAGES, ALLOW OTHER USERS TO SEE THE INFORMATION AND CHANGES IN THE INFORMATION THE MOMENT THE INFORMATION IS SUBMITTED OR CHANGED, PROVIDING SEARCH ENGINES FOR OBTAINING INFORMATION REQUESTED BY USERS ON A GLOBAL COMPUTER NETWORK, PROVIDING CUSTOMIZED SEARCHING OF A WEBPAGE TO LOCATE SPECIFIC INFORMATION REQUESTED BY USERS; APPLICATION SERVICE PROVIDER FEATURING APPLICATION PROGRAMMING INTERFACE (API) SOFTWARE FOR USE IN BUILDING SOFTWARE APPLICATIONS, IN CLASS 42 (U.S. CLS. 100 AND 101).

**SERVICE MARK**

**PRINCIPAL REGISTER**

FIRST USE 9-1-2011; IN COMMERCE 9-1-2011.

THE MARK CONSISTS OF STANDARD CHARACTERS WITHOUT CLAIM TO ANY PARTICULAR FONT, STYLE, SIZE, OR COLOR.

SER. NO. 85-517,127, FILED 1-16-2012.

FONG HSU, EXAMINING ATTORNEY



*David J. Kybas*

Director of the United States Patent and Trademark Office

# United States of America

United States Patent and Trademark Office

## TACKLE THE WORLD

**Reg. No. 4,198,010**

MOTBN, INC. (GEORGIA CORPORATION)

**Registered Aug. 28, 2012**

P.O. BOX 1900  
FAYETTEVILLE, GA 30214

**Int. Cl.: 45**

FOR: PROVIDING A WEB SITE FEATURING INFORMATION ABOUT RELIGION, IN CLASS 45 (U.S. CLS. 100 AND 101).

**SERVICE MARK**

FIRST USE 1-9-2012; IN COMMERCE 1-9-2012.

**PRINCIPAL REGISTER**

THE MARK CONSISTS OF STANDARD CHARACTERS WITHOUT CLAIM TO ANY PARTICULAR FONT, STYLE, SIZE, OR COLOR.

SER. NO. 85-517,139, FILED 1-16-2012.

DAVID TOOLEY, EXAMINING ATTORNEY



*David J. Kyffers*

Director of the United States Patent and Trademark Office

# United States of America

United States Patent and Trademark Office

# ORINAN

**Reg. No. 4,198,011**

**Registered Aug. 28, 2012**

**Int. Cl.: 18**

**TRADEMARK**

**PRINCIPAL REGISTER**

YIN JIANG (CHINA INDIVIDUAL)  
10260 WILLIAMS ROAD  
RICHMOND, BC, CANADA V7A1H4

FOR: BACKPACKS, BOOK BAGS, SPORTS BAGS, BUM BAGS, WALLETS AND HANDBAGS; EVENING HANDBAGS; FASHION HANDBAGS; FITTED PROTECTIVE COVERS FOR HANDBAGS, BRIEFCASES, VALISES, SUITCASES, AND BRIEFCASE-LIKE PORTFOLIOS; GENTLEMEN'S HANDBAGS; HANDBAGS; HANDBAGS FOR LADIES; HANDBAGS FOR MEN; HANDBAGS, PURSES AND WALLETS; LEATHER HANDBAGS; LUGGAGE; LUGGAGE AND TRUNKS; LUGGAGE TAGS; STRAPS FOR HANDBAGS, IN CLASS 18 (U.S. CLS. 1, 2, 3, 22 AND 41).

THE MARK CONSISTS OF STANDARD CHARACTERS WITHOUT CLAIM TO ANY PARTICULAR FONT, STYLE, SIZE, OR COLOR.

OWNER OF CANADA REG. NO. 1480366, DATED 11-25-2011, EXPIRES 11-24-2026.

SER. NO. 85-517,141, FILED 1-16-2012.

MARK SHINER, EXAMINING ATTORNEY



*David J. Kyffers*

Director of the United States Patent and Trademark Office

United States of America  
United States Patent and Trademark Office

**C-STAR**

**Reg. No. 4,198,012**

CHANG STAR CORPORATION (TAIWAN CORPORATION)  
NO. 10-1, HSING YEH RD., FU HSING  
CHANG HWA HSIEN, TAIWAN

**Registered Aug. 28, 2012**

**Int. Cl.: 12**

FOR: BICYCLE PARTS, NAMELY, BRAKES, BRAKE LEVERS, HANDLE BARS, HANDLE BAR STEMS, SEAT POSTS, BRAKE CABLES AND PEDALS, IN CLASS 12 (U.S. CLS. 19, 21, 23, 31, 35 AND 44).

**TRADEMARK**

FIRST USE 5-20-2000; IN COMMERCE 4-16-2004.

**PRINCIPAL REGISTER**

THE MARK CONSISTS OF THE WORD "C-STAR" IN STYLIZED PRINT, WITH A FIVE-POINTED STAR DESIGN APPEARING INSIDE THE LETTER "A".

SER. NO. 85-517,143, FILED 1-16-2012.

MICHAEL SOUDERS, EXAMINING ATTORNEY



*David J. Kyjars*

Director of the United States Patent and Trademark Office



United States of America  
United States Patent and Trademark Office

# NEYCRAFT

**Reg. No. 4,198,013**

**Registered Aug. 28, 2012**

**Int. Cl.: 7**

**TRADEMARK**

**PRINCIPAL REGISTER**

DENTSPLY INTERNATIONAL INC. (DELAWARE CORPORATION)  
221 WEST PHILADELPHIA STREET  
YORK, PA 174050872

FOR: CASTING MACHINES, IN CLASS 7 (U.S. CLS. 13, 19, 21, 23, 31, 34 AND 35).

FIRST USE 1-1-1988; IN COMMERCE 1-1-1988.

THE MARK CONSISTS OF STANDARD CHARACTERS WITHOUT CLAIM TO ANY PARTICULAR FONT, STYLE, SIZE, OR COLOR.

OWNER OF U.S. REG. NOS. 2,026,735 AND 2,857,985.

SER. NO. 85-517,173, FILED 1-16-2012.

LUCY ARANT, EXAMINING ATTORNEY



*David J. Kyffers*

Director of the United States Patent and Trademark Office

# United States of America

United States Patent and Trademark Office

## Wags N' Kisses

**Reg. No. 4,198,014**

**Registered Aug. 28, 2012**

**Int. Cl.: 31**

**TRADEMARK**

**PRINCIPAL REGISTER**

CALLI, SIMONE D. (UNITED STATES INDIVIDUAL)  
85 MIDWOOD ROAD  
GLEN ROCK, NJ 07452 AND

CALLI, LAWRENCE A. (UNITED STATES INDIVIDUAL)  
85 MIDWOOD ROAD  
GLEN ROCK, NJ 07452

FOR: PET FOOD; PET TREATS, IN CLASS 31 (U.S. CLS. 1 AND 46).

FIRST USE 5-18-2011; IN COMMERCE 5-18-2011.

THE MARK CONSISTS OF STANDARD CHARACTERS WITHOUT CLAIM TO ANY PARTICULAR FONT, STYLE, SIZE, OR COLOR.

SER. NO. 85-517,181, FILED 1-16-2012.

KATHLEEN KOLACZ, EXAMINING ATTORNEY



*David J. Kybas*

Director of the United States Patent and Trademark Office

# United States of America

United States Patent and Trademark Office

## KANDEE JOHNSON

**Reg. No. 4,198,015**

KANDEE JOHNSON (UNITED STATES INDIVIDUAL)

**Registered Aug. 28, 2012**

P.O. BOX 700  
MINDEN, NV 89423

**Int. Cl.: 41**

FOR: EDUCATION SERVICES, NAMELY, PROVIDING LIVE AND ON-LINE CLASSES, SEMINARS AND INSTRUCTION IN THE FIELD OF PERSONAL GROWTH AND MOTIVATION, PERSONAL IMAGE DEVELOPMENT, AND PERSONAL DEVELOPMENT, NAMELY, SELF-IMPROVEMENT, SELF-FULFILLMENT, AND INTERPERSONAL COMMUNICATION; EDUCATION SERVICES, NAMELY, PROVIDING LIVE AND ON-LINE CLASSES, SEMINARS AND INSTRUCTION IN THE FIELD OF MAKE-UP APPLICATION AND ARTISTRY; ENTERTAINMENT SERVICES, NAMELY, PERSONAL APPEARANCES BY A PUBLIC FIGURE; ENTERTAINMENT, NAMELY, A CONTINUING MOTIVATIONAL SHOW BROADCAST OVER INTERNET AND TELEVISION; PRODUCTION OF DVDS FEATURING MAKE-UP AND PERSONAL GROWTH AND MOTIVATION, PERSONAL IMAGE DEVELOPMENT, AND PERSONAL DEVELOPMENT, NAMELY, SELF-IMPROVEMENT, SELF-FULFILLMENT, AND INTERPERSONAL COMMUNICATION; PROVIDING A WEBSITE FEATURING BLOGS AND NON-DOWNLOADABLE PUBLICATIONS IN THE NATURE OF ARTICLES AND COMMENTARY IN THE FIELD(S) OF COSMETICS AND MAKE-UP AND PERSONAL GROWTH AND MOTIVATION, PERSONAL IMAGE DEVELOPMENT, AND PERSONAL DEVELOPMENT, NAMELY, SELF-IMPROVEMENT, SELF-FULFILLMENT, AND INTERPERSONAL COMMUNICATION; WRITING OF TEXTS, IN CLASS 41 (U.S. CLS. 100, 101 AND 107).

**SERVICE MARK**

**PRINCIPAL REGISTER**



FIRST USE 6-19-2009; IN COMMERCE 6-19-2009.

THE MARK CONSISTS OF STANDARD CHARACTERS WITHOUT CLAIM TO ANY PARTICULAR FONT, STYLE, SIZE, OR COLOR.

THE NAME "KANDEE JOHNSON" IDENTIFIES A LIVING INDIVIDUAL WHOSE CONSENT IS OF RECORD.

SER. NO. 85-517,190, FILED 1-16-2012.

ROSELLE HERRERA, EXAMINING ATTORNEY

*David J. Kyffers*

Director of the United States Patent and Trademark Office

# United States of America

United States Patent and Trademark Office

# HipChicksOut

**Reg. No. 4,198,016**

HIPCHICKSOUT LLC (COLORADO LIMITED LIABILITY COMPANY)  
2421 W. DUNKELD PLACE  
DENVER, CO 80211

**Registered Aug. 28, 2012**

**Int. Cl.: 41**

FOR: ARRANGING AND CONDUCTING SPECIAL EVENTS FOR SOCIAL ENTERTAINMENT PURPOSES, IN CLASS 41 (U.S. CLS. 100, 101 AND 107).

**SERVICE MARK**

FIRST USE 2-17-2005; IN COMMERCE 6-19-2010.

**PRINCIPAL REGISTER**

THE MARK CONSISTS OF STANDARD CHARACTERS WITHOUT CLAIM TO ANY PARTICULAR FONT, STYLE, SIZE, OR COLOR.

SER. NO. 85-517,191, FILED 1-16-2012.

ROSELLE HERRERA, EXAMINING ATTORNEY



*David J. Kybas*

Director of the United States Patent and Trademark Office

# United States of America

United States Patent and Trademark Office

# ENSIDIO

**Reg. No. 4,198,017**

ENSIDIO, INC. (FLORIDA CORPORATION)  
810 W COUNTRY VIEW  
LA HABRA, CA 90631

**Registered Aug. 28, 2012**

**Int. Cl.: 9**

FOR: IP (INTERNET PROTOCOL) CAMERAS; IP (INTERNET PROTOCOL) SPEED DOME CAMERAS, IN CLASS 9 (U.S. CLS. 21, 23, 26, 36 AND 38).

**TRADEMARK**

FIRST USE 12-21-2011; IN COMMERCE 12-21-2011.

**PRINCIPAL REGISTER**

THE MARK CONSISTS OF "ENSIDIO" IN STYLIZED FONT FOR A DOT IN THE "O".

THE WORDING "ENSIDIO" HAS NO MEANING IN A FOREIGN LANGUAGE.

SER. NO. 85-517,201, FILED 1-16-2012.

TRICIA SONNEBORN, EXAMINING ATTORNEY



*David J. Kybas*

Director of the United States Patent and Trademark Office

**United States of America**  
United States Patent and Trademark Office

**BIGVINE**

**Reg. No. 4,198,018**

**Registered Aug. 28, 2012**

**Int. Cl.: 33**

**TRADEMARK**

**PRINCIPAL REGISTER**

BIGVINE WINES LLC (DELAWARE LIMITED LIABILITY COMPANY)  
728 FIRST STREET  
NAPA, CA 94559

FOR: WINES, IN CLASS 33 (U.S. CLS. 47 AND 49).

FIRST USE 3-17-2009; IN COMMERCE 11-12-2009.

THE MARK CONSISTS OF STANDARD CHARACTERS WITHOUT CLAIM TO ANY PARTICULAR FONT, STYLE, SIZE, OR COLOR.

SER. NO. 85-517,221, FILED 1-16-2012.

ALAIN LAPTER, EXAMINING ATTORNEY



*David J. Kybas*

Director of the United States Patent and Trademark Office

# United States of America

United States Patent and Trademark Office

# AirFlo

**Reg. No. 4,198,019**

ANODYNE MEDICAL DEVICE (FLORIDA CORPORATION)  
4200 NW 120TH AVE  
CORAL SPRINGS, FL 33065

**Registered Aug. 28, 2012**

**Int. Cl.: 10**

FOR: MEDICAL PRODUCTS, NAMELY, THERAPEUTIC MATTRESSES, BEDS, SEATS AND CUSHIONS, IN CLASS 10 (U.S. CLS. 26, 39 AND 44).

**TRADEMARK**

FIRST USE 10-15-2011; IN COMMERCE 12-28-2011.

**PRINCIPAL REGISTER**

THE MARK CONSISTS OF STANDARD CHARACTERS WITHOUT CLAIM TO ANY PARTICULAR FONT, STYLE, SIZE, OR COLOR.

SER. NO. 85-517,253, FILED 1-16-2012.

JENNY PARK, EXAMINING ATTORNEY



*David J. Kybas*

Director of the United States Patent and Trademark Office

# United States of America

United States Patent and Trademark Office

BE HEARD. BE SEEN. BE  
INSPIRED.

**Reg. No. 4,198,020**

SPECTRIO LLC (DELAWARE LIMITED LIABILITY COMPANY)  
720 BROOKER CREEK BLVD. SUITE 215  
OLDSMAR, FL 34677

**Registered Aug. 28, 2012**

**Int. Cl.: 37**

FOR: INSTALLATION AND MAINTENANCE OF DIGITAL SIGNAGE AND AUDIO VISUAL PRODUCTS SOLD THEREWITH; INSTALLATION OF BACKGROUND MUSIC SYSTEMS, AUDIO COMMUNICATION SYSTEMS, AND VIDEO DISPLAY SYSTEMS, IN CLASS 37 (U.S. CLS. 100, 103 AND 106).

**SERVICE MARK**

**PRINCIPAL REGISTER**

FIRST USE 11-15-2011; IN COMMERCE 11-15-2011.

THE MARK CONSISTS OF STANDARD CHARACTERS WITHOUT CLAIM TO ANY PARTICULAR FONT, STYLE, SIZE, OR COLOR.

SER. NO. 85-517,281, FILED 1-16-2012.

DORITT L. CARROLL, EXAMINING ATTORNEY



*David J. Kyffers*

Director of the United States Patent and Trademark Office



**United States of America**  
United States Patent and Trademark Office

# CANDIRU

**Reg. No. 4,198,021**

TRANSEQUATORIAL SOLUTIONS, INC. (ALABAMA CORPORATION)  
60 RANDALL ROAD  
GALLANT, AL 35972

**Registered Aug. 28, 2012**

**Int. Cl.: 8**

FOR: KNIVES, NAMELY, FIXED-BLADE KNIVES AND FOLDING KNIVES, IN CLASS 8  
(U.S. CLS. 23, 28 AND 44).

**TRADEMARK**

FIRST USE 1-13-2012; IN COMMERCE 1-13-2012.

**PRINCIPAL REGISTER**

THE MARK CONSISTS OF STANDARD CHARACTERS WITHOUT CLAIM TO ANY PARTICULAR FONT, STYLE, SIZE, OR COLOR.

SER. NO. 85-517,282, FILED 1-16-2012.

IRA J. GOODSaid, EXAMINING ATTORNEY



*David J. Kybas*

Director of the United States Patent and Trademark Office

# United States of America

United States Patent and Trademark Office

## The Dirt Dealer

**Reg. No. 4,198,022**

JEFFREY T. OBRECHT (UNITED STATES INDIVIDUAL)  
615 WASHINGTON AVENUE

**Registered Aug. 28, 2012**

IOWA FALLS, IA 50126

**Int. Cl.: 35**

FOR: REAL ESTATE ADVERTISING SERVICES, IN CLASS 35 (U.S. CLS. 100, 101 AND 102).

**SERVICE MARK**

FIRST USE 1-1-2006; IN COMMERCE 1-1-2006.

**PRINCIPAL REGISTER**

THE MARK CONSISTS OF STANDARD CHARACTERS WITHOUT CLAIM TO ANY PARTICULAR FONT, STYLE, SIZE, OR COLOR.

SER. NO. 85-517,284, FILED 1-16-2012.

LUCY ARANT, EXAMINING ATTORNEY



*David J. Kybas*

Director of the United States Patent and Trademark Office

# United States of America

United States Patent and Trademark Office

BE HEARD. BE SEEN. BE  
INSPIRED.

**Reg. No. 4,198,023**

SPECTRIO LLC (DELAWARE LIMITED LIABILITY COMPANY)  
720 BROOKER CREEK BLVD. SUITE 215  
OLDSMAR, FL 34677

**Registered Aug. 28, 2012**

**Int. Cl.: 38**

FOR: ELECTRONIC MESSAGING; TELEPHONE VOICE MESSAGING SERVICES; VOICE MAIL SERVICES, IN CLASS 38 (U.S. CLS. 100, 101 AND 104).

**SERVICE MARK**

FIRST USE 11-15-2011; IN COMMERCE 11-15-2011.

**PRINCIPAL REGISTER**

THE MARK CONSISTS OF STANDARD CHARACTERS WITHOUT CLAIM TO ANY PARTICULAR FONT, STYLE, SIZE, OR COLOR.

SER. NO. 85-517,285, FILED 1-16-2012.

DORITT L. CARROLL, EXAMINING ATTORNEY



*David J. Kybas*

Director of the United States Patent and Trademark Office

# United States of America

United States Patent and Trademark Office

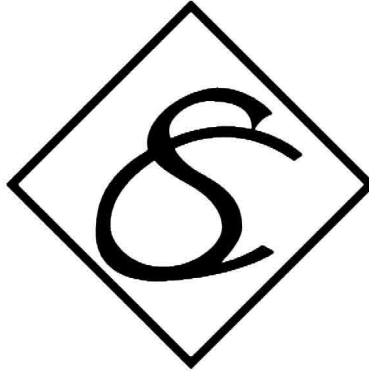

**Reg. No. 4,198,024**

**Registered Aug. 28, 2012**

**Int. Cl.: 18**

**TRADEMARK**

**PRINCIPAL REGISTER**

C & S TRADING, INC. (TEXAS CORPORATION)  
11034 GRISSOM LANE  
DALLAS, TX 75229

FOR: HANDBAGS; LUGGAGE; WALLETS, IN CLASS 18 (U.S. CLS. 1, 2, 3, 22 AND 41).

FIRST USE 9-1-2011; IN COMMERCE 9-1-2011.

THE MARK CONSISTS OF THE LETTERS "C" AND "S". THE LETTERS ARE PRESENTED INTERSECTING IN A DIAMOND LIKE SHAPE.

SER. NO. 85-517,292, FILED 1-16-2012.

MARK SPARACINO, EXAMINING ATTORNEY



*David J. Kyffers*

Director of the United States Patent and Trademark Office

# United States of America

United States Patent and Trademark Office

WE'LL STRAIGHTEN OUT YOUR  
TEENAGER.

**Reg. No. 4,198,025**

**Registered Aug. 28, 2012**

**Int. Cl.: 44**

**SERVICE MARK**

**PRINCIPAL REGISTER**

AUSTIN NO LIMITS CREATIVE, LLC (TEXAS LIMITED LIABILITY COMPANY), DBA  
PERZAGO  
6305 PLUM HOLLOW OVERLOOK  
AUSTIN, TX 78746

FOR: ORTHODONTIC SERVICES, IN CLASS 44 (U.S. CLS. 100 AND 101).

FIRST USE 12-8-2011; IN COMMERCE 12-8-2011.

THE MARK CONSISTS OF STANDARD CHARACTERS WITHOUT CLAIM TO ANY PARTICULAR FONT, STYLE, SIZE, OR COLOR.

SER. NO. 85-517,301, FILED 1-16-2012.

LUCY ARANT, EXAMINING ATTORNEY



*David J. Kyffers*

Director of the United States Patent and Trademark Office

# United States of America

United States Patent and Trademark Office

# VoiceMe

**Reg. No. 4,198,026**

VOICEME, LLC (NEVADA LIMITED LIABILITY COMPANY)  
6040 SOUTH DURANGO DR., #105  
LAS VEGAS, NV 89113

**Registered Aug. 28, 2012**

**Int. Cl.: 9**

FOR: DOWNLOADABLE SOFTWARE IN THE NATURE OF A MOBILE APPLICATION FOR A VOICE OPERATED SEARCH ENGINE, IN CLASS 9 (U.S. CLS. 21, 23, 26, 36 AND 38).

**TRADEMARK**

FIRST USE 12-22-2011; IN COMMERCE 12-22-2011.

**PRINCIPAL REGISTER**

THE MARK CONSISTS OF STANDARD CHARACTERS WITHOUT CLAIM TO ANY PARTICULAR FONT, STYLE, SIZE, OR COLOR.

SER. NO. 85-517,310, FILED 1-16-2012.

JOHN WILKE, EXAMINING ATTORNEY



*David J. Kybas*

Director of the United States Patent and Trademark Office

# United States of America

United States Patent and Trademark Office

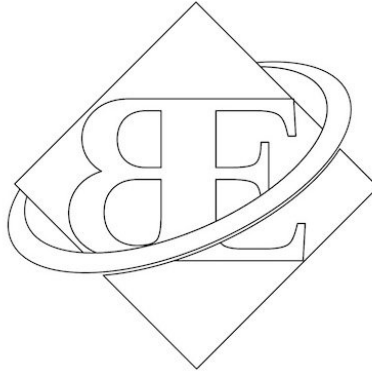

**Reg. No. 4,198,027**

**Registered Aug. 28, 2012**

**Int. Cl.: 44**

**SERVICE MARK**

**PRINCIPAL REGISTER**

LORIC ENTERPRISES, LLC (ARIZONA LIMITED LIABILITY COMPANY)  
4960 SOUTH GILBERT ROAD, SUITE 1-185  
CHANDLER, AZ 85249

FOR: PROVIDING ASSISTANCE, FITNESS EVALUATION AND CONSULTATION TO INDIVIDUALS TO HELP THEM MAKE HEALTH, WELLNESS AND NUTRITIONAL CHANGES IN THEIR DAILY LIVING TO IMPROVE HEALTH, IN CLASS 44 (U.S. CLS. 100 AND 101).

FIRST USE 1-1-2010; IN COMMERCE 1-1-2010.

THE MARK CONSISTS OF A DIAMOND WITH THE LETTERS "B" AND "E" CONTAINED THEREIN. THE LETTER "B" APPEARS BACKWARDS AND A CIRCULAR SWOOSH OVERLAID AT AN ANGLE.

SER. NO. 85-517,328, FILED 1-16-2012.

LINDA POWELL, EXAMINING ATTORNEY



*David J. Kyffers*

Director of the United States Patent and Trademark Office

# United States of America

United States Patent and Trademark Office

# TILT 'N MIX

**Reg. No. 4,198,028**

WILTON INDUSTRIES, INC. (DELAWARE CORPORATION)  
2240 W. 75TH ST.  
WOODRIDGE, IL 60517

**Registered Aug. 28, 2012**

**Int. Cl.: 21**

FOR: MIXING BOWLS, IN CLASS 21 (U.S. CLS. 2, 13, 23, 29, 30, 33, 40 AND 50).

**TRADEMARK**

FIRST USE 1-1-2008; IN COMMERCE 1-1-2008.

**PRINCIPAL REGISTER**

THE MARK CONSISTS OF STANDARD CHARACTERS WITHOUT CLAIM TO ANY PARTICULAR FONT, STYLE, SIZE, OR COLOR.

SER. NO. 85-517,351, FILED 1-16-2012.

MARK SHINER, EXAMINING ATTORNEY



*David J. Kybas*

Director of the United States Patent and Trademark Office



# United States of America

United States Patent and Trademark Office

WE DON'T HAVE CASES. WE  
HAVE CLIENTS.

**Reg. No. 4,198,029**

SANCHELIMA & ASSOCIATES, P.A. (FLORIDA CORPORATION)  
235 SW LE JEUNE ROAD  
MIAMI, FL 33134

**Registered Aug. 28, 2012**

**Int. Cl.: 45**

FOR: LEGAL SERVICES, IN CLASS 45 (U.S. CLS. 100 AND 101).

**SERVICE MARK**

FIRST USE 12-31-2010; IN COMMERCE 12-31-2010.

**PRINCIPAL REGISTER**

THE MARK CONSISTS OF STANDARD CHARACTERS WITHOUT CLAIM TO ANY PARTICULAR FONT, STYLE, SIZE, OR COLOR.

SER. NO. 85-517,356, FILED 1-16-2012.

MARGERY A. TIERNEY, EXAMINING ATTORNEY



*David J. Kyffers*

Director of the United States Patent and Trademark Office

# United States of America

United States Patent and Trademark Office

## READY SET ROCKET

**Reg. No. 4,198,030**

**Registered Aug. 28, 2012**

**Int. Cls.: 35 and 42**

**SERVICE MARK**

**PRINCIPAL REGISTER**

READY SET ROCKET (NEW YORK LIMITED LIABILITY COMPANY)  
SUITE 1219  
636 BROADWAY  
NEW YORK, NY 10012

FOR: BUSINESS CONSULTING SERVICES IN THE FIELD OF ADVERTISING AND MARKETING; ADVERTISING AND MARKETING MANAGEMENT AGENCY SERVICES, NAMELY, THE CREATION, DEVELOPMENT AND DISSEMINATION OF ADVERTISING AND PROMOTIONAL MATERIALS THROUGH INTERNET MARKETING, SEARCH ENGINE MARKETING, SOCIAL MEDIA MARKETING, MOBILE MARKETING, DISPLAY ADVERTISING, BLOGGING AND OTHER FORMS OF PASSIVE, SHARABLE OR VIRAL COMMUNICATIONS CHANNELS, IN CLASS 35 (U.S. CLS. 100, 101 AND 102).

FIRST USE 7-23-2010; IN COMMERCE 7-23-2010.

FOR: DESIGN, CREATION, AND MAINTENANCE OF WEBSITES FOR OTHERS, NAMELY, WEBSITE, WEBSITE APPLICATION, MOBILE APPLICATION, AND COMPUTER APPLICATION DESIGN AND DEVELOPMENT IN THE FIELD OF ONLINE MARKETING AND ADVERTISING FOR OTHERS; WEBSITE CONTENT DEVELOPMENT SERVICES FOR OTHERS, NAMELY, COPYWRITING, DESIGN, ANIMATION, PHOTOGRAPHY AND VIDEO SERVICES, IN CLASS 42 (U.S. CLS. 100 AND 101).

FIRST USE 7-23-2010; IN COMMERCE 7-23-2010.

THE MARK CONSISTS OF STANDARD CHARACTERS WITHOUT CLAIM TO ANY PARTICULAR FONT, STYLE, SIZE, OR COLOR.

SER. NO. 85-517,361, FILED 1-16-2012.

INGA ERVIN, EXAMINING ATTORNEY



*David J. Kypos*

Director of the United States Patent and Trademark Office

# United States of America

United States Patent and Trademark Office

## UPDRAFT JACK

**Reg. No. 4,198,031**

ALLIANCE METAVERSAL STUDIO (DELAWARE LIMITED LIABILITY COMPANY)  
60 LEO M. BIRMINGHAM PARKWAY, SUITE 1L  
BRIGHTON, MA 02135

**Registered Aug. 28, 2012**

**Int. Cl.: 9**

FOR: VIDEO AND COMPUTER GAME PROGRAMS, IN CLASS 9 (U.S. CLS. 21, 23, 26, 36 AND 38).

**TRADEMARK**

FIRST USE 1-10-2012; IN COMMERCE 1-10-2012.

**PRINCIPAL REGISTER**

THE MARK CONSISTS OF STANDARD CHARACTERS WITHOUT CLAIM TO ANY PARTICULAR FONT, STYLE, SIZE, OR COLOR.

SER. NO. 85-517,380, FILED 1-16-2012.

JEAN IM, EXAMINING ATTORNEY



*David J. Kyffers*

Director of the United States Patent and Trademark Office

# United States of America

United States Patent and Trademark Office

## STELLAR PHOENIX

**Reg. No. 4,198,032**

STELLAR INFORMATION SYSTEMS LTD. (INDIA CORPORATION)  
D-18, INFOCITY PHASE 2, SEC-33  
GURGAON, DELHI, INDIA

**Registered Aug. 28, 2012**

**Int. Cl.: 9**

FOR: COMPUTER SOFTWARE FOR DATA RECOVERY, EMAIL REPAIR, FILE REPAIR, DATABASE REPAIR, DATA SAFETY AND ERASURE, AND PASSWORD RECOVERY , IN CLASS 9 (U.S. CLS. 21, 23, 26, 36 AND 38).

**TRADEMARK**

FIRST USE 3-3-2004; IN COMMERCE 3-3-2004.

**PRINCIPAL REGISTER**

THE MARK CONSISTS OF STANDARD CHARACTERS WITHOUT CLAIM TO ANY PARTICULAR FONT, STYLE, SIZE, OR COLOR.

SER. NO. 85-517,387, FILED 1-16-2012.

EUGENIA MARTIN, EXAMINING ATTORNEY



*David J. Kyffers*

Director of the United States Patent and Trademark Office

# United States of America

United States Patent and Trademark Office

## LAWYEROLOGY

**Reg. No. 4,198,033**

SULLIVAN, ROBERT (UNITED STATES INDIVIDUAL)  
3004 SW COACHLIGHT PLACE  
LEES SUMMIT, MO 64081

**Registered Aug. 28, 2012**

**Int. Cl.: 41**

FOR: PROVIDING A WEBSITE FEATURING BLOGS AND NON-DOWNLOADABLE PUBLICATIONS IN THE NATURE OF ARTICLES IN THE FIELD(S) OF THE LAW, IN CLASS 41 (U.S. CLS. 100, 101 AND 107).

**SERVICE MARK**

FIRST USE 12-20-2011; IN COMMERCE 1-12-2012.

**PRINCIPAL REGISTER**

THE MARK CONSISTS OF STANDARD CHARACTERS WITHOUT CLAIM TO ANY PARTICULAR FONT, STYLE, SIZE, OR COLOR.

SER. NO. 85-517,406, FILED 1-16-2012.

VIVIAN MICZNIK FIRST, EXAMINING ATTORNEY



*David J. Kybas*

Director of the United States Patent and Trademark Office

**United States of America**  
United States Patent and Trademark Office

# TOADLICK

**Reg. No. 4,198,034**

TOADLICK ENTERTAINMENT, LLC (ALABAMA LIMITED LIABILITY COMPANY)  
P.O. BOX 752

**Registered Aug. 28, 2012**

DOTHAN, AL 36302

**Int. Cl.: 41**

FOR: ENTERTAINMENT SERVICES, NAMELY, MUSIC FESTIVALS, IN CLASS 41 (U.S. CLS. 100, 101 AND 107).

**SERVICE MARK**

FIRST USE 11-4-2011; IN COMMERCE 11-4-2011.

**PRINCIPAL REGISTER**

THE MARK CONSISTS OF STANDARD CHARACTERS WITHOUT CLAIM TO ANY PARTICULAR FONT, STYLE, SIZE, OR COLOR.

SER. NO. 85-517,411, FILED 1-16-2012.

CHRISTINE MARTIN, EXAMINING ATTORNEY



*David J. Kybas*

Director of the United States Patent and Trademark Office

# United States of America

United States Patent and Trademark Office

## STRATEGIC MEETINGS SOLUTIONS

**Reg. No. 4,198,035**

**Registered Aug. 28, 2012**

**Int. Cl.: 35**

**SERVICE MARK**

**PRINCIPAL REGISTER**

STRATEGIC MEETINGS SOLUTIONS, INC. (TEXAS CORPORATION)  
SUITE 600  
3333 LEE PARKWAY  
DALLAS, TX 75219

FOR: BUSINESS MEETING PLANNING, BUSINESS CONFERENCE PLANNING, PROVIDING FACILITIES FOR BUSINESS MEETINGS, SPECIAL EVENT PLANNING FOR BUSINESS PURPOSES, PROVIDING TRAVEL MANAGEMENT SERVICES, IN CLASS 35 (U.S. CLS. 100, 101 AND 102).

FIRST USE 3-0-2008; IN COMMERCE 3-0-2008.

THE MARK CONSISTS OF STANDARD CHARACTERS WITHOUT CLAIM TO ANY PARTICULAR FONT, STYLE, SIZE, OR COLOR.

NO CLAIM IS MADE TO THE EXCLUSIVE RIGHT TO USE "MEETINGS SOLUTIONS", APART FROM THE MARK AS SHOWN.

SER. NO. 85-517,450, FILED 1-16-2012.

FRANK LATTUCA, EXAMINING ATTORNEY



*David J. Kyffers*

Director of the United States Patent and Trademark Office

# United States of America

United States Patent and Trademark Office

# SIGNEX

**Reg. No. 4,198,036**

GOEX CORPORATION (WISCONSIN CORPORATION)  
2532 FOSTER AVENUE  
JANESVILLE, WI 53545

**Registered Aug. 28, 2012**

**Int. Cl.: 17**

FOR: PLASTIC IN EXTRUDED FORM FOR GENERAL INDUSTRIAL USE, IN CLASS 17  
(U.S. CLS. 1, 5, 12, 13, 35 AND 50).

**TRADEMARK**

FIRST USE 9-1-2007; IN COMMERCE 9-1-2007.

**PRINCIPAL REGISTER**

THE MARK CONSISTS OF STANDARD CHARACTERS WITHOUT CLAIM TO ANY PARTICULAR FONT, STYLE, SIZE, OR COLOR.

SER. NO. 85-517,470, FILED 1-16-2012.

KIMBERLY FRYE, EXAMINING ATTORNEY



*David J. Kybas*

Director of the United States Patent and Trademark Office



# United States of America

United States Patent and Trademark Office



**Reg. No. 4,198,037**

**Registered Aug. 28, 2012**

**Int. Cl.: 45**

**SERVICE MARK**

**PRINCIPAL REGISTER**

MUSICIANS REVOLUTIONARY NETWORK LLC (FLORIDA LIMITED LIABILITY COMPANY)  
600 WEST LAS OLAS BLVD. #1508  
FORT LAUDERDALE, FL 33312

FOR: ONLINE SOCIAL NETWORKING SERVICES IN THE FIELD OF MUSIC , IN CLASS 45 (U.S. CLS. 100 AND 101).

FIRST USE 8-4-2011; IN COMMERCE 4-2-2012.

THE MARK CONSISTS OF A TREBLE CLEF ARTFULLY MERGED WITH A CONDUCTOR HOLDING A BATON.

SER. NO. 85-517,478, FILED 1-16-2012.

KIMBERLY PERRY, EXAMINING ATTORNEY



*David J. Kybas*

Director of the United States Patent and Trademark Office

# United States of America

United States Patent and Trademark Office

## MOTHER NATURE'S WORKFORCE

**Reg. No. 4,198,038**

**Registered Aug. 28, 2012**

**Int. Cl.: 35**

**SERVICE MARK**

**PRINCIPAL REGISTER**

OPERATIONAL TECHNOLOGIES CORP. (TEXAS CORPORATION)  
SUITE 230  
4100 NW LOOP 410  
SAN ANTONIO, TX 78229

FOR: TRANSPORTATION LOGISTICS SERVICES, NAMELY, ARRANGING THE TRANSPORTATION OF MATERIALS FOR OTHERS; PROMOTING RECYCLING BY PROVIDING AND PROCESSING REBATES FOR RECYCLABLE MATERIALS, IN CLASS 35 (U.S. CLS. 100, 101 AND 102).

FIRST USE 5-1-2011; IN COMMERCE 5-1-2011.

THE MARK CONSISTS OF STANDARD CHARACTERS WITHOUT CLAIM TO ANY PARTICULAR FONT, STYLE, SIZE, OR COLOR.

SER. NO. 85-517,494, FILED 1-16-2012.

JOHN WILKE, EXAMINING ATTORNEY



*David J. Kyffers*

Director of the United States Patent and Trademark Office

**United States of America**  
United States Patent and Trademark Office

# AmbuPak

**Reg. No. 4,198,039**

IMPERIAL LAUNDRY SERVICES, LLC (DELAWARE LIMITED LIABILITY COMPANY)  
1236 13TH STREET  
RACINE, WI 53403

**Registered Aug. 28, 2012**

**Int. Cl.: 24**

FOR: BED BLANKETS; BED SHEETS; PILLOW CASES; TOWELS, IN CLASS 24 (U.S. CLS. 42 AND 50).

**TRADEMARK**

FIRST USE 9-30-2011; IN COMMERCE 9-30-2011.

**PRINCIPAL REGISTER**

THE MARK CONSISTS OF STANDARD CHARACTERS WITHOUT CLAIM TO ANY PARTICULAR FONT, STYLE, SIZE, OR COLOR.

SER. NO. 85-517,502, FILED 1-16-2012.

GEORGE LORENZO, EXAMINING ATTORNEY



*David J. Kybas*

Director of the United States Patent and Trademark Office

# United States of America

United States Patent and Trademark Office

# SHIPQWEST

**Reg. No. 4,198,040**

THE TNT GROUP OF LOUISIANA (LOUISIANA LIMITED LIABILITY COMPANY)  
8501 JO LEE DR.

**Registered Aug. 28, 2012**

DENHAM SPRINGS, LA 70706

**Int. Cl.: 35**

FOR: BUSINESS MANAGEMENT CONSULTATION AND SERVICES, NAMELY, SHIPMENT PROCESSING, IN CLASS 35 (U.S. CLS. 100, 101 AND 102).

**SERVICE MARK**

FIRST USE 12-1-2011; IN COMMERCE 12-1-2011.

**PRINCIPAL REGISTER**

THE MARK CONSISTS OF STANDARD CHARACTERS WITHOUT CLAIM TO ANY PARTICULAR FONT, STYLE, SIZE, OR COLOR.

SER. NO. 85-517,508, FILED 1-16-2012.

GEORGE LORENZO, EXAMINING ATTORNEY



*David J. Kybas*

Director of the United States Patent and Trademark Office

# United States of America

United States Patent and Trademark Office

## MOTHER NATURE'S WORKFORCE

**Reg. No. 4,198,041**

**Registered Aug. 28, 2012**

**Int. Cl.: 37**

**SERVICE MARK**

**PRINCIPAL REGISTER**

OPERATIONAL TECHNOLOGIES CORP. (TEXAS CORPORATION)  
SUITE 230  
4100 NW LOOP 410  
SAN ANTONIO, TX 78229

FOR: RECYCLING SERVICES, NAMELY, COLLECTION OF RECYCLABLE MATERIALS, SUCH AS GLASS, PAPER, PLASTIC, ALUMINUM, PAPER, CARDBOARD, AND ELECTRONICS; AND WASTE DISPOSAL FOR OTHERS, IN CLASS 37 (U.S. CLS. 100, 103 AND 106).

FIRST USE 5-1-2011; IN COMMERCE 5-1-2011.

THE MARK CONSISTS OF STANDARD CHARACTERS WITHOUT CLAIM TO ANY PARTICULAR FONT, STYLE, SIZE, OR COLOR.

SER. NO. 85-517,510, FILED 1-16-2012.

JOHN WILKE, EXAMINING ATTORNEY



*David J. Kyffers*

Director of the United States Patent and Trademark Office

# United States of America

United States Patent and Trademark Office

## MOTHER NATURE'S WORKFORCE

**Reg. No. 4,198,042**

**Registered Aug. 28, 2012**

**Int. Cl.: 40**

**SERVICE MARK**

**PRINCIPAL REGISTER**

OPERATIONAL TECHNOLOGIES CORP. (TEXAS CORPORATION)  
SUITE 230  
4100 NW LOOP 410  
SAN ANTONIO, TX 78229

FOR: WASTE MANAGEMENT; PROVISION OF INFORMATION, ADVICE AND CONSULTANCY IN RELATION TO THE PRODUCTION OF ENERGY, AND THE TREATMENT, MANAGEMENT, RECYCLING, TRANSFORMATION AND INCINERATION OF WASTE; RECYCLING, RECLAMATION, AND PROCESSING OF USABLE MATERIALS FROM WASTE AND TRASH; AND DOCUMENT DESTRUCTION, IN CLASS 40 (U.S. CLS. 100, 103 AND 106).

FIRST USE 5-1-2011; IN COMMERCE 5-1-2011.

THE MARK CONSISTS OF STANDARD CHARACTERS WITHOUT CLAIM TO ANY PARTICULAR FONT, STYLE, SIZE, OR COLOR.

SER. NO. 85-517,512, FILED 1-16-2012.

JOHN WILKE, EXAMINING ATTORNEY



*David J. Kyffers*

Director of the United States Patent and Trademark Office

# United States of America

United States Patent and Trademark Office

## THE WALLFLOWERS

**Reg. No. 4,198,043**

**Registered Aug. 28, 2012**

**Int. Cls.: 9 and 41**

DYLAN, JAKOB (UNITED STATES INDIVIDUAL)  
C/O LOEB & LOEB LLP, SUITE 2200  
10100 SANTA MONICA BLVD.  
LOS ANGELES, CA 90067

FOR: MUSICAL SOUND RECORDINGS, IN CLASS 9 (U.S. CLS. 21, 23, 26, 36 AND 38).

**TRADEMARK**

FIRST USE 0-0-1992; IN COMMERCE 0-0-1992.

**SERVICE MARK**

FOR: ENTERTAINMENT SERVICES, NAMELY, PROVIDING NON-DOWNLOADABLE MUSICAL SOUND RECORDINGS AND AUDIOVISUAL RECORDINGS FEATURING MUSICAL PERFORMANCES OVER THE INTERNET, IN CLASS 41 (U.S. CLS. 100, 101 AND 107).

**PRINCIPAL REGISTER**

FIRST USE 0-0-2007; IN COMMERCE 0-0-2007.

THE MARK CONSISTS OF STANDARD CHARACTERS WITHOUT CLAIM TO ANY PARTICULAR FONT, STYLE, SIZE, OR COLOR.

SER. NO. 85-517,519, FILED 1-16-2012.

LINDSEY RUBIN, EXAMINING ATTORNEY



*David J. Kybas*

Director of the United States Patent and Trademark Office

# United States of America

United States Patent and Trademark Office

# BioXter

**Reg. No. 4,198,044**

**Registered Aug. 28, 2012**

**Int. Cl.: 5**

**TRADEMARK**

**PRINCIPAL REGISTER**

PIVEG, INC. (CALIFORNIA CORPORATION), DBA PIVEG  
11760 SORRENTO VALLEY ROAD, SUITE L  
SAN DIEGO, CA 92121

FOR: AGRICULTURAL PESTICIDES; ANIMAL REPELLENTS; DOMESTIC PESTICIDES;  
INSECT REPELLENTS; INSECTICIDES; INSECTICIDES FOR AGRICULTURAL USE; IN-  
SECTICIDES FOR DOMESTIC USE; PREPARATIONS FOR REPELLING ANIMAL PESTS,  
NAMELY, BIRDS, DEER AND RODENTS, IN CLASS 5 (U.S. CLS. 6, 18, 44, 46, 51 AND 52).

FIRST USE 11-30-2007; IN COMMERCE 11-30-2007.

THE MARK CONSISTS OF STANDARD CHARACTERS WITHOUT CLAIM TO ANY PAR-  
TICULAR FONT, STYLE, SIZE, OR COLOR.

SER. NO. 85-517,523, FILED 1-16-2012.

JAY FLOWERS, EXAMINING ATTORNEY



*David J. Kyffers*

Director of the United States Patent and Trademark Office



# United States of America

United States Patent and Trademark Office

TheNewtonProject

**Reg. No. 4,198,045**

**Registered Aug. 28, 2012**

**Int. Cl.: 35**

**SERVICE MARK**

**PRINCIPAL REGISTER**

THE NEWTON PROJECT, INC. (LOUISIANA CORPORATION)  
11207 PROVERBS AVE  
BATON ROUGE, LA 70816

FOR: CHARITABLE SERVICES, NAMELY, PROMOTING PUBLIC AWARENESS OF THE SIGNIFICANT IMPACT THAT AN INDIVIDUAL CAN HAVE IN LIVES OF OTHERS BY THEIR GOOD DEEDS AND THE POSITIVE MOMENTUM CREATED BY ONE'S ACTIONS; CHARITABLE SERVICES, NAMELY, PROMOTING PUBLIC AWARENESS OF THE IMPORTANCE OF VOLUNTEERISM, COMMUNITY SERVICE AND COMMUNITY OUTREACH, IN CLASS 35 (U.S. CLS. 100, 101 AND 102).

FIRST USE 3-31-2011; IN COMMERCE 4-22-2011.

NO CLAIM IS MADE TO THE EXCLUSIVE RIGHT TO USE "PROJECT", APART FROM THE MARK AS SHOWN.

THE MARK CONSISTS OF THE LITERAL ELEMENTS THE NEWTON PROJECT WHEREIN THE LETTER O OF NEWTON REPRESENTS AN IMAGE OF A FINGERPRINT AS SHOWN IN THE MARK.

SER. NO. 85-517,529, FILED 1-16-2012.

JAY FLOWERS, EXAMINING ATTORNEY



*David J. Kybas*

Director of the United States Patent and Trademark Office

# United States of America

United States Patent and Trademark Office

## THE TRIBAL BLUES BAND

**Reg. No. 4,198,046**

ZION, RAYA (UNITED STATES INDIVIDUAL)  
70 DARTMOUTH AVENUE  
SAN CARLOS, CA 94070

**Registered Aug. 28, 2012**

**Int. Cl.: 41**

FOR: ENTERTAINMENT IN THE NATURE OF VISUAL AND AUDIO PERFORMANCES, NAMELY, MUSICAL BAND, ROCK GROUP, GYMNASTIC, DANCE, AND BALLET PERFORMANCES; ENTERTAINMENT SERVICES IN THE NATURE OF LIVE MUSICAL PERFORMANCES; ENTERTAINMENT SERVICES IN THE NATURE OF PRESENTING LIVE MUSICAL PERFORMANCES; ENTERTAINMENT SERVICES IN THE NATURE OF MUSICAL PERFORMANCES; ENTERTAINMENT, NAMELY, LIVE PERFORMANCES BY A MUSICAL BAND, IN CLASS 41 (U.S. CLS. 100, 101 AND 107).

**SERVICE MARK**

**PRINCIPAL REGISTER**

FIRST USE 7-15-2007; IN COMMERCE 7-15-2007.

THE MARK CONSISTS OF STANDARD CHARACTERS WITHOUT CLAIM TO ANY PARTICULAR FONT, STYLE, SIZE, OR COLOR.

NO CLAIM IS MADE TO THE EXCLUSIVE RIGHT TO USE "BLUES BAND", APART FROM THE MARK AS SHOWN.

SER. NO. 85-517,534, FILED 1-16-2012.

JAY FLOWERS, EXAMINING ATTORNEY



*David J. Kyffers*

Director of the United States Patent and Trademark Office

# United States of America

United States Patent and Trademark Office

# AMERICUS

**Reg. No. 4,198,047**

LABELLE WINERY, LLC (NEW HAMPSHIRE LIMITED LIABILITY COMPANY)  
100 CHESTUNT HILL ROAD  
AMHERST, NH 03031

**Registered Aug. 28, 2012**

**Int. Cl.: 33**

FOR: WINE, IN CLASS 33 (U.S. CLS. 47 AND 49).

**TRADEMARK**

FIRST USE 12-1-2010; IN COMMERCE 12-1-2010.

**PRINCIPAL REGISTER**

THE MARK CONSISTS OF STANDARD CHARACTERS WITHOUT CLAIM TO ANY PARTICULAR FONT, STYLE, SIZE, OR COLOR.

SER. NO. 85-517,541, FILED 1-16-2012.

JAY FLOWERS, EXAMINING ATTORNEY



*David J. Kyffers*

Director of the United States Patent and Trademark Office

# United States of America

United States Patent and Trademark Office



**Reg. No. 4,198,048**

**Registered Aug. 28, 2012**

**Int. Cl.: 41**

**SERVICE MARK**

**PRINCIPAL REGISTER**

FINAL VISION ENTERTAINMENT, INC. (WASHINGTON CORPORATION), DBA  
BANDOGZ.COM  
SUITE 405  
3230 SW AVALON WAY  
SEATTLE, WA 98126

FOR: ENTERTAINMENT SERVICES, NAMELY, PROVIDING A WEB SITE FEATURING PHOTOGRAPHIC, AUDIO, VIDEO AND PROSE PRESENTATIONS FEATURING MUSICAL BANDS, IN CLASS 41 (U.S. CLS. 100, 101 AND 107).

FIRST USE 7-12-2010; IN COMMERCE 7-12-2010.

THE MARK CONSISTS OF LARGE BLUE CAPITAL LETTERS "B, A, N, D, O, G, Z," A BLUE PERIOD, AND SMALLER BLUE LOWER-CASE LETTERS "C, O, M", ALL OUTLINED IN LIGHT BLUE, WRITTEN OVER A BLACK CITYSCAPE SILHOUETTED OVER A ROW OF ORANGE BRICKS, A LARGE WHITE CIRCULAR MOON, AND A BLUE AND ORANGE GRADIENT BACKGROUND.

THE COLOR(S) ORANGE, BLUE, LIGHT BLUE, BLACK, AND WHITE IS/ARE CLAIMED AS A FEATURE OF THE MARK.

SER. NO. 85-517,591, FILED 1-16-2012.

REBECCA SMITH, EXAMINING ATTORNEY



*David J. Kyffers*

Director of the United States Patent and Trademark Office

# United States of America

United States Patent and Trademark Office

# Sunphosate

**Reg. No. 4,198,049**

**Registered Aug. 28, 2012**

**Int. Cl.: 5**

**TRADEMARK**

**PRINCIPAL REGISTER**

ZHEJIANG XINAN CHEMICAL INDUSTRIAL GROUP CO., LTD. (CHINA LIMITED COMPANY (LTD.))  
XIN'ANJIANG TOWN, JIANDE CITY  
ZHEJIANG PROVINCE, CHINA

FOR: CHEMICAL PREPARATIONS TO TREAT WHEAT SMUT; CHEMICAL REAGENTS FOR MEDICAL OR VETERINARY PURPOSES; DEPURATIVES FOR THE BODY; FUNGICIDES; HERBAL TEAS FOR MEDICINAL PURPOSES; HERBICIDES; PREPARATIONS FOR DESTROYING PARASITES; PREPARATIONS FOR DESTROYING VERMIN; PREPARATIONS FOR REPELLING ANIMALS, BIRDS AND INSECTS; STERILISING PREPARATIONS, IN CLASS 5 (U.S. CLS. 6, 18, 44, 46, 51 AND 52).

FIRST USE 5-12-2009; IN COMMERCE 8-7-2009.

THE MARK CONSISTS OF STANDARD CHARACTERS WITHOUT CLAIM TO ANY PARTICULAR FONT, STYLE, SIZE, OR COLOR.

THE WORDING "SUNPHOSATE" HAS NO MEANING IN A FOREIGN LANGUAGE.

SER. NO. 85-517,621, FILED 1-17-2012.

TEJBIR SINGH, EXAMINING ATTORNEY



*David J. Kyros*

Director of the United States Patent and Trademark Office

# United States of America

United States Patent and Trademark Office

**Laphier**  
**耐斐尔**

**Reg. No. 4,198,050**

**Registered Aug. 28, 2012**

**Int. Cl.: 4**

**TRADEMARK**

**PRINCIPAL REGISTER**

USA LAPHIER INTERNATIONAL PETROCHEMICAL LLC (NEVADA LIMITED LIABILITY COMPANY)  
1805 N CAR SIN STREET  
SUITE S CARSON CITY, NV 89721

FOR: CUTTING FLUIDS; INDUSTRIAL OILS; LEATHER PRESERVING OIL AND GREASE; MOTOR OIL; NAPHTHA, IN CLASS 4 (U.S. CLS. 1, 6 AND 15).

FIRST USE 8-13-2010; IN COMMERCE 8-13-2010.

THE MARK CONSISTS OF STYLIZED WORD "LAPHIER" AND THREE CHINESE CHARACTERS WHICH ARE UNDER THE WORD "LAPHIER".

THE NON-LATIN CHARACTERS IN THE MARK TRANSLITERATE TO "NAI FEI ER" AND THIS HAS NO MEANING IN A FOREIGN LANGUAGE.

THE WORDING "NAI FEI ER" HAS NO MEANING IN A FOREIGN LANGUAGE.

SER. NO. 85-517,643, FILED 1-17-2012.

IRA J. GOODSAY, EXAMINING ATTORNEY



*David J. Kypos*

Director of the United States Patent and Trademark Office

# United States of America

United States Patent and Trademark Office



**Reg. No. 4,198,051**

**Registered Aug. 28, 2012**

**Int. Cl.: 9**

**TRADEMARK**

**PRINCIPAL REGISTER**

COPFER, DANIEL (UNITED STATES INDIVIDUAL)  
#400  
1382 W. 9TH ST.  
CLEVELAND, OH 44113

FOR: COMPUTER SOFTWARE FOR BROWSING ELECTRONIC RECORDS WITH A LARGE DATA VOLUME; COMPUTER SOFTWARE THAT PROVIDES WEB-BASED ACCESS TO APPLICATIONS AND SERVICES THROUGH A WEB OPERATING SYSTEM OR PORTAL INTERFACE; COMPUTER SOFTWARE FOR MONITORING AND CONTROLLING COMMUNICATION BETWEEN COMPUTERS AND AUTOMATED MACHINE SYSTEMS, IN CLASS 9 (U.S. CLS. 21, 23, 26, 36 AND 38).

FIRST USE 11-1-2011; IN COMMERCE 11-1-2011.

NO CLAIM IS MADE TO THE EXCLUSIVE RIGHT TO USE "EDISCOVERY", APART FROM THE MARK AS SHOWN.

THE COLOR(S) RED, GREY AND WHITE IS/ARE CLAIMED AS A FEATURE OF THE MARK.

THE MARK CONSISTS OF THE LITERAL ELEMENTS "VEDISCOVERY" WRITTEN IN STYLIZED FORM WHEREIN THE WORD "DISCOVERY" IS WRITTEN IN GREY COLOR BESIDES THE RED COLORED LETTER "V" AND OVER THE LETTER "V" THE LETTER "E" IS SUPERSCRIPED IN LOWERCASE IN WHITE COLOR AS SHOWN IN THE MARK.

SER. NO. 85-517,645, FILED 1-17-2012.

MORGAN WYNNE, EXAMINING ATTORNEY



*David J. Kyffers*

Director of the United States Patent and Trademark Office

# United States of America

United States Patent and Trademark Office

# NUTUYU

**Reg. No. 4,198,052**

**Registered Aug. 28, 2012**

**Int. Cl.: 41**

**SERVICE MARK**

**PRINCIPAL REGISTER**

GEE DAVEY PRODUCTIONS (NEW YORK LIMITED LIABILITY COMPANY)  
35 RAINER STREET  
MELVILLE, NY 11747

FOR: ARRANGING AND CONDUCTING OF CONCERTS; ENTERTAINMENT, NAMELY, LIVE MUSIC CONCERTS; ARRANGING AND CONDUCTING OF CONFERENCES FOR ENTERTAINMENT PURPOSES, FESTIVALS AND MUSICAL SHOWCASES; ENTERTAINMENT SERVICES, NAMELY, ARRANGING AND CONDUCTING MUSICAL FESTIVALS, IN CLASS 41 (U.S. CLS. 100, 101 AND 107).

FIRST USE 5-1-2011; IN COMMERCE 8-20-2011.

THE MARK CONSISTS OF STANDARD CHARACTERS WITHOUT CLAIM TO ANY PARTICULAR FONT, STYLE, SIZE, OR COLOR.

SER. NO. 85-517,650, FILED 1-17-2012.

TOBY BULLOFF, EXAMINING ATTORNEY



*David J. Kyros*

Director of the United States Patent and Trademark Office



# United States of America

United States Patent and Trademark Office

## TICKETINGBOX

**Reg. No. 4,198,053**

**Registered Aug. 28, 2012**

**Int. Cl.: 41**

7 PLUS ENTERTAINMENT, LLC (GEORGIA LIMITED LIABILITY COMPANY), DBA  
TICKETINGBOX  
SUITE 210  
3311 N BERKELEY LAKE ROAD  
DULUTH, GA 30096

**SERVICE MARK**

**PRINCIPAL REGISTER**

FOR: ARRANGING FOR TICKET RESERVATIONS FOR SHOWS AND OTHER ENTERTAINMENT EVENTS; BOOKING OF SEATS FOR SHOWS AND BOOKING OF THEATRE TICKETS; ENTERTAINMENT TICKET AGENCY SERVICES; ON-LINE ADMISSION TICKET AGENCY SERVICES FOR ENTERTAINMENT, EDUCATIONAL, SPORTING AND CULTURAL EVENTS; ON-LINE ENTERTAINMENT TICKET AGENCY SERVICES; PROVIDING AN INTERNET WEBSITE PORTAL FEATURING LINKS TO MUSICAL ARTIST WEBSITES AND MUSIC PERFORMANCE TICKET INFORMATION; PROVIDING WILL-CALL TICKET SERVICES; THEATRICAL TICKET AGENCIES; TICKET AGENCY SERVICES FOR ENTERTAINMENT EVENTS; TICKET RESERVATION AND BOOKING SERVICES FOR ENTERTAINMENT, SPORTING AND CULTURAL EVENTS, IN CLASS 41 (U.S. CLS. 100, 101 AND 107).

FIRST USE 9-19-2011; IN COMMERCE 9-19-2011.

THE MARK CONSISTS OF STANDARD CHARACTERS WITHOUT CLAIM TO ANY PARTICULAR FONT, STYLE, SIZE, OR COLOR.

SER. NO. 85-517,653, FILED 1-17-2012.

DAWN FELDMAN, EXAMINING ATTORNEY



*David J. Kyffers*

Director of the United States Patent and Trademark Office

# United States of America

United States Patent and Trademark Office



**Reg. No. 4,198,054**

**Registered Aug. 28, 2012**

**Int. Cl.: 41**

**SERVICE MARK**

**PRINCIPAL REGISTER**

THE TRIAL LAWYERS COLLEGE (WYOMING CORPORATION)  
P.O. BOX 1249  
LARAMIE, WY 82073

FOR: PROVIDING CONTINUING LEGAL EDUCATION SERVICES, NAMELY, CONDUCTING SEMINARS AND OTHER TRAINING PROGRAMS FOR LAWYERS AND JUDGES, IN CLASS 41 (U.S. CLS. 100, 101 AND 107).

FIRST USE 1-1-1997; IN COMMERCE 1-1-1997.

THE MARK CONSISTS OF A STYLIZED DESIGN OF A CLOUD WITH A BOLT OF LIGHTNING.

SER. NO. 85-517,685, FILED 1-17-2012.

KIM MONINGHOFF, EXAMINING ATTORNEY



*David J. Kyffers*

Director of the United States Patent and Trademark Office

# United States of America

United States Patent and Trademark Office

## EFAQ MESSENDER

**Reg. No. 4,198,055**

**Registered Aug. 28, 2012**

**Int. Cl.: 9**

**TRADEMARK**

**PRINCIPAL REGISTER**

J2 GLOBAL, INC. (DELAWARE CORPORATION)  
6922 HOLLYWOOD BLVD., 5TH FLOOR  
HOLLYWOOD, CA 90028

FOR: COMPUTER SOFTWARE FOR USE IN FACILITATING ELECTRONIC COMMUNICATIONS, NAMELY TRANSMISSION OF DOCUMENTS, AUDIO TEXT AND/OR IMAGES VIA EMAIL; COMPUTER SOFTWARE USED FOR ACCESSING, MANAGING, TRANSMITTING, EDITING, ANALYZING, ARCHIVING AND SORTING ELECTRONIC MESSAGES AND DOCUMENTS; AND USER MANUALS SOLD AS A UNIT THEREWITH, IN CLASS 9 (U.S. CLS. 21, 23, 26, 36 AND 38).

FIRST USE 0-0-1999; IN COMMERCE 0-0-1999.

THE MARK CONSISTS OF STANDARD CHARACTERS WITHOUT CLAIM TO ANY PARTICULAR FONT, STYLE, SIZE, OR COLOR.

OWNER OF U.S. REG. NOS. 2,530,979, 3,930,606 AND OTHERS.

SEC. 2(F) AS TO EFAQ.

SER. NO. 85-517,697, FILED 1-17-2012.

JENNIFER WILLISTON, EXAMINING ATTORNEY



*David J. Kybas*

Director of the United States Patent and Trademark Office

# United States of America

United States Patent and Trademark Office

## ALLDATA MARKET

**Reg. No. 4,198,056**

**Registered Aug. 28, 2012**

**Int. Cl.: 42**

**SERVICE MARK**

**PRINCIPAL REGISTER**

ALLDATA LLC (NEVADA LIMITED LIABILITY COMPANY)  
SUITE 100  
9650 WEST TARON DRIVE  
ELK GROVE, CA 95757

FOR: COMPUTER SERVICES, NAMELY, HOSTING AND MAINTAINING AN ON-LINE WEBSITE FOR OTHERS TO USE IN CUSTOMER RELATIONSHIP MANAGEMENT , IN CLASS 42 (U.S. CLS. 100 AND 101).

FIRST USE 11-16-2007; IN COMMERCE 11-16-2007.

THE MARK CONSISTS OF STANDARD CHARACTERS WITHOUT CLAIM TO ANY PARTICULAR FONT, STYLE, SIZE, OR COLOR.

OWNER OF U.S. REG. NOS. 1,556,655, 2,571,052, AND 3,500,617.

SER. NO. 85-517,732, FILED 1-17-2012.

KAREN K. BUSH, EXAMINING ATTORNEY



*David J. Kybas*

Director of the United States Patent and Trademark Office

# United States of America

United States Patent and Trademark Office



**Reg. No. 4,198,057**

MOTIVATION MOVEMENT, LLC (NEW YORK LIMITED LIABILITY COMPANY)  
229 VLY RD.

**Registered Aug. 28, 2012**

SCHENECTADY, NY 12309

**Int. Cl.: 25**

FOR: CAPS; COATS; HATS; HEADWEAR; HOODED SWEATSHIRTS; JACKETS; JEANS; PANTS; SHIRTS; SHORTS; SWEATERS; T-SHIRTS; TANK TOPS, IN CLASS 25 (U.S. CLS. 22 AND 39).

**TRADEMARK**

FIRST USE 11-8-2011; IN COMMERCE 11-8-2011.

**PRINCIPAL REGISTER**

THE MARK CONSISTS OF A CAPITAL "M" WITH ONE VERTICAL LINE TO THE LEFT OF IT, ONE VERTICAL LINE TO THE RIGHT OF IT, AND TWO SMALL DIAGONAL LINES OVER THE TOP OF IT FACING INWARD TO THE "M". THE DIAGONAL LINES HAVE A LOOK OF EYEBROWS OVER THE CAPITAL "M", AND THE TEXT "MOTIVATION MOVEMENT" BELOW, ALL ON A SQUARE BACKGROUND.

SER. NO. 85-517,739, FILED 1-17-2012.

ALAIN LAPTER, EXAMINING ATTORNEY



*David J. Kyffers*

Director of the United States Patent and Trademark Office

# United States of America

United States Patent and Trademark Office

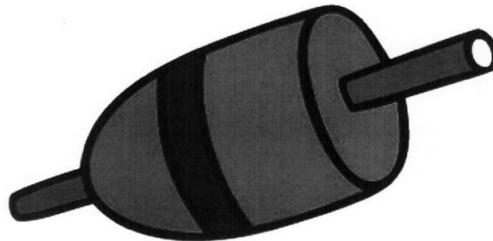

**Reg. No. 4,198,058**

**Registered Aug. 28, 2012**

**Int. Cl.: 25**

**TRADEMARK**

**PRINCIPAL REGISTER**

BUOY APPAREL, LLC (MAINE LIMITED LIABILITY COMPANY)  
30 MILK STREET, 5TH FLOOR  
PORTLAND, ME 04101

FOR: BASEBALL CAPS; BELTS; CAP VISORS; HATS; HOODED SWEATSHIRTS; JERSEYS;  
SANDALS; TIES; WEARABLE GARMENTS AND CLOTHING, NAMELY, SHIRTS, IN CLASS  
25 (U.S. CLS. 22 AND 39).

FIRST USE 9-1-2008; IN COMMERCE 9-1-2008.

THE MARK CONSISTS OF A LOBSTER BUOY BEARING A SINGLE HORIZONTAL STRIPE  
AROUND THE CENTRAL PORTION OF ITS BODY, A FLAT TOP AND CYLINDRICAL  
SHAPE. THE BODY OF THE BUOY TAPERS TOWARD THE BOTTOM, AT WHICH POINT,  
A SPINDLE MEMBER PROTRUDES THE BODY. AT THE FLAT TOP OF THE BUOY, AN-  
OTHER CIRCULAR SPINDLE MEMBER PROTRUDES FROM THE CENTER.

SER. NO. 85-517,757, FILED 1-17-2012.

ELI HELLMAN, EXAMINING ATTORNEY



*David J. Kyffers*

Director of the United States Patent and Trademark Office

# United States of America

United States Patent and Trademark Office

## SCENTSABILITY

**Reg. No. 4,198,059**

**Registered Aug. 28, 2012**

**Int. Cl.: 4**

**TRADEMARK**

**PRINCIPAL REGISTER**

SCENTSABILITY, INC. (FLORIDA CORPORATION)  
503 N.W. 118TH WAY  
CORAL SPRINGS, FL 33071

FOR: CANDLES, IN CLASS 4 (U.S. CLS. 1, 6 AND 15).

FIRST USE 5-18-2009; IN COMMERCE 5-18-2009.

THE MARK CONSISTS OF STANDARD CHARACTERS WITHOUT CLAIM TO ANY PARTICULAR FONT, STYLE, SIZE, OR COLOR.

SER. NO. 85-517,761, FILED 1-17-2012.

CHRISTINA SOBRAL, EXAMINING ATTORNEY



*David J. Kyffers*

Director of the United States Patent and Trademark Office

# United States of America

United States Patent and Trademark Office

## LUCKY 7 SNOOSE

**Reg. No. 4,198,060**

MALLARD MOTEL, LLC (WISCONSIN LIMITED LIABILITY COMPANY)  
3601 COMMERCE COURT, SUITE 4  
APPLETON, WI 54911

**Registered Aug. 28, 2012**

**Int. Cl.: 28**

FOR: HUNTING ACCESSORIES, NAMELY, STANDS FOR DECOYS, IN CLASS 28 (U.S. CLS. 22, 23, 38 AND 50).

**TRADEMARK**

FIRST USE 1-17-2012; IN COMMERCE 1-17-2012.

**PRINCIPAL REGISTER**

THE MARK CONSISTS OF STANDARD CHARACTERS WITHOUT CLAIM TO ANY PARTICULAR FONT, STYLE, SIZE, OR COLOR.

SER. NO. 85-517,764, FILED 1-17-2012.

ALAIN LAPTER, EXAMINING ATTORNEY



*David J. Kybas*

Director of the United States Patent and Trademark Office



# United States of America

United States Patent and Trademark Office

## PEOPLE OF FAITH AGAINST THE DEATH PENALTY

**Reg. No. 4,198,061**

PEOPLE OF FAITH AGAINST THE DEATH PENALTY (NORTH CAROLINA CORPORATION)  
110 WEST MAIN STREET, SUITE 2-G  
CARRBORO, NC 27510

**Registered Aug. 28, 2012**

**Int. Cl.: 35**

FOR: CHARITABLE SERVICES, NAMELY, PROMOTING PUBLIC AWARENESS OF THE DEATH PENALTY AND REASONS WHY IT SHOULD BE ABOLISHED; LOBBYING SERVICES, NAMELY, PROMOTING THE INTERESTS OF THOSE OPPOSING THE DEATH PENALTY IN THE FIELDS OF LEGISLATION AND REGULATION, IN CLASS 35 (U.S. CLS. 100, 101 AND 102).

**SERVICE MARK**

**PRINCIPAL REGISTER**

FIRST USE 2-1-1994; IN COMMERCE 2-1-1994.

THE MARK CONSISTS OF STANDARD CHARACTERS WITHOUT CLAIM TO ANY PARTICULAR FONT, STYLE, SIZE, OR COLOR.

SER. NO. 85-517,767, FILED 1-17-2012.

ELI HELLMAN, EXAMINING ATTORNEY



*David J. Kyffers*

Director of the United States Patent and Trademark Office

# United States of America

United States Patent and Trademark Office

## ANN TAYLOR

**Reg. No. 4,198,062**

ANSCO, INC. (DELAWARE CORPORATION)  
7 TIMES SQUARE  
NEW YORK, NY 10036

**Registered Aug. 28, 2012**

**Int. Cl.: 9**

FOR: MAGNETIC CODED GIFT CARDS AND ELECTRONIC ENCODED GIFT CERTIFICATES WHICH MAY THEN BE REDEEMED FOR GOODS OR SERVICES, IN CLASS 9 (U.S. CLS. 21, 23, 26, 36 AND 38).

**TRADEMARK**

FIRST USE 4-1-2003; IN COMMERCE 4-1-2003.

**PRINCIPAL REGISTER**

THE MARK CONSISTS OF STANDARD CHARACTERS WITHOUT CLAIM TO ANY PARTICULAR FONT, STYLE, SIZE, OR COLOR.

OWNER OF U.S. REG. NO. 3,876,692.

THE NAME "ANN TAYLOR" DOES NOT IDENTIFY A LIVING INDIVIDUAL.

SER. NO. 85-517,794, FILED 1-17-2012.

KATHY DE JONGE, EXAMINING ATTORNEY



*David J. Kyffers*

Director of the United States Patent and Trademark Office

# United States of America

United States Patent and Trademark Office

# WOOP!WEAR

**Reg. No. 4,198,063**

**Registered Aug. 28, 2012**

**Int. Cl.: 25**

**TRADEMARK**

**PRINCIPAL REGISTER**

WOOP!WEAR LLC (WASHINGTON LIMITED LIABILITY COMPANY)  
45 LAKE ROAD  
TROUT LAKE, WA 986502018

FOR: ACTIVEWEAR CLOTHING AND CLOTHING ACCESSORIES MADE IN WHOLE OR SUBSTANTIAL PART OF ALPACA FIBERS FOR WOMEN AND MEN, NAMELY, BASE LAYERS, SHIRTS, LONG-SLEEVED SHIRTS, T-SHIRTS, POLO SHIRTS, PANTS, LEGGINGS, LONG UNDERWEAR, THERMAL UNDERWEAR, SWEATPANTS, SWEATSHIRTS, HOODED SWEATSHIRTS, JACKETS, SWEATERS, PULLOVERS, HOODED PULLOVERS, TURTLE-NECK PULLOVERS, SKIWEAR, SKI HATS, KNITTED CAPS, BEANIES, HOODS, AND SCARVES, IN CLASS 25 (U.S. CLS. 22 AND 39).

FIRST USE 1-5-2012; IN COMMERCE 1-5-2012.

THE MARK CONSISTS OF STANDARD CHARACTERS WITHOUT CLAIM TO ANY PARTICULAR FONT, STYLE, SIZE, OR COLOR.

SER. NO. 85-517,803, FILED 1-17-2012.

JORDAN BAKER, EXAMINING ATTORNEY



*David J. Kyffers*

Director of the United States Patent and Trademark Office

# United States of America

United States Patent and Trademark Office



**Reg. No. 4,198,064**

DESOUZA, ALEXANDRE S. (UNITED STATES INDIVIDUAL)  
1440 CHARLESTON RD.  
SPENCER, WV 25276

**Registered Aug. 28, 2012**

**Int. Cl.: 41**

FOR: EDUCATION SERVICES, NAMELY, PROVIDING LIVE AND ON-LINE CLASSES AND COURSES IN THE FIELD OF MEDICINE, IN CLASS 41 (U.S. CLS. 100, 101 AND 107).

**SERVICE MARK**

FIRST USE 11-0-2011; IN COMMERCE 11-0-2011.

**PRINCIPAL REGISTER**

NO CLAIM IS MADE TO THE EXCLUSIVE RIGHT TO USE "THE FIRST WORLD SURGICAL ANATOMY SCHOOL! ANATOMY MIAMI INTERNATIONAL SURGICAL ANATOMY COURSE", APART FROM THE MARK AS SHOWN.

THE COLOR(S) LIGHT BLUE, DARK BLUE, WHITE, BLACK AND GRAY IS/ARE CLAIMED AS A FEATURE OF THE MARK.

THE MARK CONSISTS OF A GLOBE WITH DARK BLUE AND LIGHT BLUE CONTINENTS. THE OCEANS ON THE GLOBE FADES FROM LIGHT BLUE TO WHITE. THERE IS A LIGHT BLUE OVAL OVER THE TOP HALF OF THE GLOBE COVERING SOME CONTINENTS AND OCEAN. THERE IS A BLACK OUTLINE OF A NUDE MAN OVER THE BOTTOM RIGHT OF THE OVAL EXTENDING DOWN INTO THE BOTTOM HALF OF THE GLOBE. THE GRAY WORDS "ANATOMY MIAMI" APPEARS ACROSS THE BOTTOM HALF OF THE GLOBE. THE MAN'S LEGS APPEAR IN BETWEEN "ANATOMY" AND "MIAMI". ABOVE THE GLOBE APPEARS THE BLACK WORDS "THE FIRST WORLD SURGICAL ANATOMY SCHOOL!" BELOW THE GLOBE ARE THE BLACK WORDS "INTERNATIONAL SURGICAL ANATOMY COURSE". THERE IS A HALF BLACK RECTANGLE OUTLINE EMERGING FROM EITHER SIDE OF THE GLOBE AND A HALF DARK BLUE RECTANGLE ON THE RIGHT SIDE OF THE GLOBE. THERE IS A HALF DARK BLUE CIRCLE ON THE LEFT SIDE OF THE GLOBE, SLIGHTLY OVERLAPPING THE LEFT SIDE OF THE GLOBE. THE REMAINDER OF THE WHITE IN THE MARK IS BACKGROUND AREA WHICH IS NOT A PART OF THE MARK.



SER. NO. 85-517,825, FILED 1-17-2012.

*David J. Kyros*

REBECCA GILBERT, EXAMINING ATTORNEY

# United States of America

United States Patent and Trademark Office

# INNOVARA

**Reg. No. 4,198,065**

**Registered Aug. 28, 2012**

**Int. Cls.: 35 and 41**

**SERVICE MARK**

**PRINCIPAL REGISTER**

INNOVARA, INC. (VIRGINIA CORPORATION)  
105 MIDDLE STREET  
HADLEY, MA 01035

FOR: BUSINESS CONSULTING AND INFORMATION SERVICES; BUSINESS DEVELOPMENT CONSULTING SERVICES; BUSINESS MANAGEMENT CONSULTANCY AND ADVISORY SERVICES; BUSINESS MANAGEMENT CONSULTING AND ADVISORY SERVICES; BUSINESS MARKETING CONSULTING SERVICES, IN CLASS 35 (U.S. CLS. 100, 101 AND 102).

FIRST USE 12-1-1983; IN COMMERCE 12-1-1983.

FOR: BUSINESS TRAINING; EDUCATIONAL SERVICES, NAMELY, CONDUCTING CLASSES, SEMINARS, CONFERENCES AND WORKSHOPS IN THE FIELD OF SALES, MARKETING, BUSINESS AND MANAGEMENT DEVELOPMENT, AND BUSINESS MARKETING AND DISTRIBUTION OF TRAINING MATERIAL IN CONNECTION THEREWITH, IN CLASS 41 (U.S. CLS. 100, 101 AND 107).

FIRST USE 12-1-1983; IN COMMERCE 12-1-1983.

THE MARK CONSISTS OF STANDARD CHARACTERS WITHOUT CLAIM TO ANY PARTICULAR FONT, STYLE, SIZE, OR COLOR.

OWNER OF U.S. REG. NO. 1,705,364.

SER. NO. 85-517,856, FILED 1-17-2012.

ALYSSA STEEL, EXAMINING ATTORNEY



*David J. Kyffers*

Director of the United States Patent and Trademark Office

# United States of America

United States Patent and Trademark Office

# Mixing Map

**Reg. No. 4,198,066**

AUMMA, LLC (NEVADA LIMITED LIABILITY COMPANY)  
9553 IRIS FLAT CT.

**Registered Aug. 28, 2012**

LAS VEGAS, NV 89179

**Int. Cl.: 27**

FOR: RUBBER MATS, IN CLASS 27 (U.S. CLS. 19, 20, 37, 42 AND 50).

**TRADEMARK**

FIRST USE 11-6-2010; IN COMMERCE 11-6-2010.

**PRINCIPAL REGISTER**

THE MARK CONSISTS OF STANDARD CHARACTERS WITHOUT CLAIM TO ANY PARTICULAR FONT, STYLE, SIZE, OR COLOR.

SER. NO. 85-517,888, FILED 1-17-2012.

MARILYN IZZI, EXAMINING ATTORNEY



*David J. Kyffers*

Director of the United States Patent and Trademark Office

# United States of America

United States Patent and Trademark Office

## IPARENT SA

**Reg. No. 4,198,067**

THE CHILDREN'S SHELTER (TEXAS NON-PROFIT CORPORATION)  
2939 W. WOODLAWN  
SAN ANTONIO, TX 78228

**Registered Aug. 28, 2012**

**Int. Cls.: 35 and 43**

FOR: CHARITABLE SERVICES, NAMELY, EMPLOYMENT COUNSELING SERVICES FOR THOSE LIVING IN POVERTY IN THE AREAS OF PREPARING FOR, OBTAINING, MAINTAINING AND ADVANCING IN EMPLOYMENT OPPORTUNITIES; CHARITABLE SERVICES, NAMELY, ORGANIZING AND CONDUCTING VOLUNTEER PROGRAMS AND COMMUNITY SERVICE PROJECTS; CHARITABLE SERVICES, NAMELY, ORGANIZING AND DEVELOPING PROJECTS THAT AIM TO IMPROVE THE LIVES OF UNDERPRIVILEGED AND IMPOVERISHED PEOPLE; CHARITABLE SERVICES, NAMELY, ORGANIZING YOUTH GROUPS TO UNDERTAKE PROJECTS TO BENEFIT THE NEEDY AND THE COMMUNITY TO ENCOURAGE LEADERSHIP, CHARACTER, COMPASSION, AND GOOD CITIZENSHIP, IN CLASS 35 (U.S. CLS. 100, 101 AND 102).

**SERVICE MARK**

**PRINCIPAL REGISTER**

FIRST USE 12-1-2010; IN COMMERCE 12-1-2010.

FOR: CHARITABLE SERVICES, NAMELY, PROVIDING CHILD CARE FOR CHILDREN IN NEED OF EMERGENCY SHELTER; EMERGENCY SHELTER SERVICES, IN CLASS 43 (U.S. CLS. 100 AND 101).

FIRST USE 12-1-2010; IN COMMERCE 12-1-2010.

THE MARK CONSISTS OF STANDARD CHARACTERS WITHOUT CLAIM TO ANY PARTICULAR FONT, STYLE, SIZE, OR COLOR.

NO CLAIM IS MADE TO THE EXCLUSIVE RIGHT TO USE "SA", APART FROM THE MARK AS SHOWN.

SER. NO. 85-517,891, FILED 1-17-2012.

JENNIFER VASQUEZ, EXAMINING ATTORNEY



*David J. Kyros*

Director of the United States Patent and Trademark Office

# United States of America

United States Patent and Trademark Office

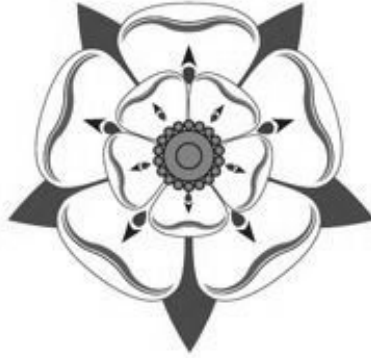

**Reg. No. 4,198,068**

YORKSHIRE EQUITY, LLC (COLORADO LIMITED LIABILITY COMPANY)  
100 FILLMORE PLACE, SUITE 500  
DENVER, CO 80206

**Registered Aug. 28, 2012**

**Int. Cl.: 36**

FOR: PRIVATE EQUITY INVESTMENT SERVICES, IN CLASS 36 (U.S. CLS. 100, 101 AND 102).

**SERVICE MARK**

FIRST USE 1-0-2009; IN COMMERCE 1-0-2009.

**PRINCIPAL REGISTER**

THE MARK CONSISTS OF A STYLIZED ROSE.

SER. NO. 85-517,924, FILED 1-17-2012.

EVELYN BRADLEY, EXAMINING ATTORNEY



*David J. Kybas*

Director of the United States Patent and Trademark Office



# United States of America

United States Patent and Trademark Office

## BLOCK BREAD ENTERTAINMENT

**Reg. No. 4,198,069**

BLOCK BREAD ENTERTAINMENT LLC (FLORIDA LIMITED LIABILITY COMPANY)  
825 SW 10TH AVE

**Registered Aug. 28, 2012**

DELRAY BEACH, FL 33444

**Int. Cl.: 9**

FOR: COMPACT DISCS FEATURING MUSIC; DIGITAL MUSIC DOWNLOADABLE FROM THE INTERNET; DOWNLOADABLE VIDEO RECORDINGS FEATURING MUSIC; MOTION PICTURE FILMS ABOUT MUSIC AND MUSIC ARTISTS; MUSICAL VIDEO RECORDINGS, IN CLASS 9 (U.S. CLS. 21, 23, 26, 36 AND 38).

**TRADEMARK**

**PRINCIPAL REGISTER**

FIRST USE 6-0-2006; IN COMMERCE 6-0-2006.

THE MARK CONSISTS OF STANDARD CHARACTERS WITHOUT CLAIM TO ANY PARTICULAR FONT, STYLE, SIZE, OR COLOR.

NO CLAIM IS MADE TO THE EXCLUSIVE RIGHT TO USE "ENTERTAINMENT", APART FROM THE MARK AS SHOWN.

SER. NO. 85-517,941, FILED 1-17-2012.

BRIAN PINO, EXAMINING ATTORNEY



*David J. Kyffers*

Director of the United States Patent and Trademark Office

# United States of America

United States Patent and Trademark Office

## BRIDGING THE GAP BETWEEN DREAMS & ACHIEVEMENT

**Reg. No. 4,198,070**

STOCKDALE RESOURCE GROUP INCORPORATED (MINNESOTA CORPORATION)  
5116 BENTON AVE S  
EDINA, MN 55436

**Registered Aug. 28, 2012**

**Int. Cl.: 41**

FOR: EDUCATION SERVICES, NAMELY, PROVIDING LIVE AND ON-LINE CLASSES, WORKSHOPS AND SEMINARS IN THE FIELD OF PERSONAL DEVELOPMENT; EDUCATIONAL SERVICES, NAMELY, CONDUCTING CLASSES, WORKSHOPS AND SEMINARS IN THE FIELDS OF PERSONAL DEVELOPMENT AND DISTRIBUTION OF TRAINING MATERIALS IN CONNECTION THEREWITH, IN CLASS 41 (U.S. CLS. 100, 101 AND 107).

**SERVICE MARK**

**PRINCIPAL REGISTER**

FIRST USE 10-16-2010; IN COMMERCE 10-16-2010.

THE MARK CONSISTS OF STANDARD CHARACTERS WITHOUT CLAIM TO ANY PARTICULAR FONT, STYLE, SIZE, OR COLOR.

SER. NO. 85-517,947, FILED 1-17-2012.

GISELLE AGOSTO, EXAMINING ATTORNEY



*David J. Kyffers*

Director of the United States Patent and Trademark Office

# United States of America

United States Patent and Trademark Office



**Reg. No. 4,198,071**

ZEIHAN, JOHN (UNITED STATES INDIVIDUAL)  
107 ELMSHIRE DR  
LANCASTER, PA 17603

**Registered Aug. 28, 2012**

**Int. Cl.: 36**

FOR: CHARITABLE FUNDRAISING SERVICES, IN CLASS 36 (U.S. CLS. 100, 101 AND 102).

**SERVICE MARK**

FIRST USE 1-1-2011; IN COMMERCE 1-1-2011.

**PRINCIPAL REGISTER**

THE STIPPLING IS FOR SHADING PURPOSES ONLY.

THE MARK CONSISTS OF AN ANIMAL PAW WITH THE STYLIZED TEXT "CRITTER NATION".

SER. NO. 85-517,949, FILED 1-17-2012.

LAURIE KAUFMAN, EXAMINING ATTORNEY



*David J. Kyffers*

Director of the United States Patent and Trademark Office

# United States of America

United States Patent and Trademark Office



**Reg. No. 4,198,072**

**Registered Aug. 28, 2012**

**Int. Cl.: 41**

**SERVICE MARK**

**PRINCIPAL REGISTER**

THE GOOD BOSS (NEVADA TRUST)  
#104  
PO BOX 7172-371, 195 HWY 50  
STATELINE, NV 894497172

FOR: PROFESSIONAL COACHING SERVICES IN THE FIELD OF BUSINESS, IN CLASS 41  
(U.S. CLS. 100, 101 AND 107).

FIRST USE 9-13-2011; IN COMMERCE 9-13-2011.

THE MARK CONSISTS OF A PYRAMID VIEWED FROM THE CORNER WITH THE SIDES LOOKING LIKE ARROWS POINTING LEFT AND RIGHT. THE CORNER IS PART OF A LIGHT BEAM THAT TRAVELS TO THE CAP STONE OF THE PYRAMID WHICH HAS A LIGHT ON TOP. TO THE RIGHT THERE IS THE STYLIZED TEXT "WE DEVELOP HIGH PERFORMING MASTER EXECUTIVES THE GOOD BOSS".

SER. NO. 85-517,952, FILED 1-17-2012.

KELLEY WELLS, EXAMINING ATTORNEY



*David J. Kybas*

Director of the United States Patent and Trademark Office

# United States of America

United States Patent and Trademark Office

# SUPERBOOK

**Reg. No. 4,198,073**

**Registered Aug. 28, 2012**

**Int. Cls.: 9 and 38**

**TRADEMARK**

**SERVICE MARK**

**PRINCIPAL REGISTER**

CHRISTIAN BROADCASTING NETWORK, INC., THE (VIRGINIA CORPORATION)  
977 CENTERVILLE TURNPIKE  
VIRGINIA BEACH, VA 234630001

FOR: DIGITAL MEDIA, NAMELY, PRE-RECORDED VIDEO CASSETTES, COMPACT DISCS, DIGITAL VIDEO DISCS, DOWNLOADABLE AUDIO AND VIDEO RECORDINGS, DVDS, AND HIGH DEFINITION DIGITAL DISCS FEATURING ANIMATED CHILDREN'S PROGRAMMING, IN CLASS 9 (U.S. CLS. 21, 23, 26, 36 AND 38).

FIRST USE 4-0-2008; IN COMMERCE 4-0-2008.

FOR: STREAMING OF VIDEO MATERIAL ON THE INTERNET; CABLE TELEVISION BROADCASTING; TELEVISION BROADCASTING; SATELLITE BROADCASTING, IN CLASS 38 (U.S. CLS. 100, 101 AND 104).

FIRST USE 4-0-2008; IN COMMERCE 4-0-2008.

OWNER OF U.S. REG. NOS. 3,384,641 AND 3,865,690.

THE MARK CONSISTS OF THE WORD "SUPERBOOK" IN STYLIZED LETTERING.

SER. NO. 85-517,968, FILED 1-17-2012.

ANDREW RHIM, EXAMINING ATTORNEY



*David J. Kyffers*

Director of the United States Patent and Trademark Office

# United States of America

United States Patent and Trademark Office

## Beau & Luxey

**Reg. No. 4,198,074**

**Registered Aug. 28, 2012**

**Int. Cl.: 3**

**TRADEMARK**

**PRINCIPAL REGISTER**

BEAU & LUXEY, INC. (GEORGIA CORPORATION)  
3378  
2451 CUMBERLAND PARKWAY  
ATLANTA, GA 30339

FOR: SUGAR AND OIL BODY SCRUBS, BODY CREMES, SOAPS, BATH OILS, AND HAIR CARE PREPARATIONS, IN CLASS 3 (U.S. CLS. 1, 4, 6, 50, 51 AND 52).

FIRST USE 10-0-2011; IN COMMERCE 10-0-2011.

THE MARK CONSISTS OF STANDARD CHARACTERS WITHOUT CLAIM TO ANY PARTICULAR FONT, STYLE, SIZE, OR COLOR.

SER. NO. 85-518,032, FILED 1-17-2012.

HANNO RITTNER, EXAMINING ATTORNEY



*David J. Kyffers*

Director of the United States Patent and Trademark Office

# United States of America

United States Patent and Trademark Office



**Reg. No. 4,198,075**

**Registered Aug. 28, 2012**

**Int. Cl.: 41**

**SERVICE MARK**

**PRINCIPAL REGISTER**

THE DISTRICT BOARD OF TRUSTEES OF BROWARD COMMUNITY COLLEGE (FLORIDA  
A FLORIDA EDUCATIONAL INSTITUTION)  
225 EAST LAS OLAS BOULEVARD  
FORT LAUDERDALE, FL 33301

FOR: EDUCATIONAL SERVICES, NAMELY, PROVIDING COURSES OF INSTRUCTION  
AT THE COMMUNITY AND STATE COLLEGE LEVEL AND DISTRIBUTING COURSE  
MATERIAL IN CONNECTION THEREWITH; CONDUCTING DISTANCE LEARNING IN-  
STRUCTION AT THE COMMUNITY AND STATE COLLEGE LEVEL AND DISTRIBUTING  
COURSE MATERIALS IN CONNECTION THEREWITH, IN CLASS 41 (U.S. CLS. 100, 101  
AND 107).

FIRST USE 7-1-2008; IN COMMERCE 7-1-2008.

OWNER OF U.S. REG. NOS. 3,495,012 AND 3,689,012.

THE MARK CONSISTS OF THE LETTERS "B" AND "C" IN LOWERCASE AND WITH THE  
"C" INSIDE OF THE "B" AND BOTH LETTERS INSIDE A BOX WITH THE TOP AND BOTH  
SIDES OF THE BOX SLANTING TO THE LEFT WITH THE BOTTOM OF THE BOX BEING  
HORIZONTAL.

SER. NO. 85-518,055, FILED 1-17-2012.

WILLIAM ROSSMAN, EXAMINING ATTORNEY



*David J. Kyffers*

Director of the United States Patent and Trademark Office

# United States of America

United States Patent and Trademark Office

IF YOU ARE STILL TYING  
KNOTS, YOU DON'T KNOW JACK

**Reg. No. 4,198,076**

KARL BEITZEL (UNITED STATES INDIVIDUAL)  
5046 JOHNNYCAKE RIDGE NE  
CANTON, OH 44705

**Registered Aug. 28, 2012**

**Int. Cl.: 28**

FOR: FISHING TACKLE CAPABLE OF KNOTLESS CONNECTION TO A FISHING LINE,  
IN CLASS 28 (U.S. CLS. 22, 23, 38 AND 50).

**TRADEMARK**

FIRST USE 12-22-2010; IN COMMERCE 7-15-2011.

**PRINCIPAL REGISTER**

THE MARK CONSISTS OF STANDARD CHARACTERS WITHOUT CLAIM TO ANY PAR-  
TICULAR FONT, STYLE, SIZE, OR COLOR.

SER. NO. 85-518,067, FILED 1-17-2012.

SUSAN LESLIE DUBOIS, EXAMINING ATTORNEY



*David J. Kybas*

Director of the United States Patent and Trademark Office



# United States of America

United States Patent and Trademark Office

## BE YOUNG HAVE FUN!

**Reg. No. 4,198,077**

BY RV, INC. (MONTANA CORPORATION), DBA B. YOUNG RV  
16803 SE MCLOUGHLIN BLVD.

**Registered Aug. 28, 2012**

MILWAUKIE, OR 97267

**Int. Cl.: 35**

FOR: RETAIL STORE SERVICES FEATURING NEW AND PRE-OWNED RECREATIONAL VEHICLES IN MULTIPLE RV CLASSES, PLUS AFTER-MARKET SERVICE AND PARTS FOR SAME, IN CLASS 35 (U.S. CLS. 100, 101 AND 102).

**SERVICE MARK**

FIRST USE 1-4-2010; IN COMMERCE 3-22-2010.

**PRINCIPAL REGISTER**

THE MARK CONSISTS OF STANDARD CHARACTERS WITHOUT CLAIM TO ANY PARTICULAR FONT, STYLE, SIZE, OR COLOR.

SER. NO. 85-518,085, FILED 1-17-2012.

DEIRDRE ROBERTSON, EXAMINING ATTORNEY



*David J. Kyffers*

Director of the United States Patent and Trademark Office

# United States of America

United States Patent and Trademark Office

# SUPER-U

**Reg. No. 4,198,078**

ABRAHAM, THOMAS G. (UNITED STATES INDIVIDUAL)  
6600 SW 57TH AVENUE, SUITE 300  
MIAMI, FL 33143

**Registered Aug. 28, 2012**

**Int. Cl.: 20**

FOR: STATUES MADE OF POLY RESIN AND STARCH BASED POWDER; FIGURINES MADE OF POLY RESIN AND STARCH BASED POWDER, IN CLASS 20 (U.S. CLS. 2, 13, 22, 25, 32 AND 50).

**TRADEMARK**

FIRST USE 3-25-2011; IN COMMERCE 3-25-2011.

**PRINCIPAL REGISTER**

THE MARK CONSISTS OF THE TERM "SUPER-U" IN A FANCIFUL FONT.

SER. NO. 85-518,097, FILED 1-17-2012.

KATHLEEN LORENZO, EXAMINING ATTORNEY



*David J. Kyffers*

Director of the United States Patent and Trademark Office

# United States of America

United States Patent and Trademark Office

red apple  
lipstick 

**Reg. No. 4,198,079**

**Registered Aug. 28, 2012**

**Int. Cl.: 3**

**TRADEMARK**

**PRINCIPAL REGISTER**

T TECHNOLOGY INC. (TEXAS CORPORATION)  
9211 WEST ROAD STE 143-176  
77064, TX 77064

FOR: LIP GLOSS; LIPSTICKS, IN CLASS 3 (U.S. CLS. 1, 4, 6, 50, 51 AND 52).

FIRST USE 5-12-2011; IN COMMERCE 5-12-2011.

NO CLAIM IS MADE TO THE EXCLUSIVE RIGHT TO USE "LIPSTICK", APART FROM THE MARK AS SHOWN.

THE COLOR(S) GREEN, LIGHT GREEN, RED, BROWN AND WHITE IS/ARE CLAIMED AS A FEATURE OF THE MARK.

THE MARK CONSISTS OF THE STYLIZED WHITE WORDING "RED APPLE LIPSTICK", AND A GREEN AND LIGHT GREEN APPLE, WITH THE DEPICTION OF RED LIPS ON ITS SKIN, A BROWN STEM, AND A GREEN LEAF. THE BLACK IN THE MARK IS OUTLINING WHICH IS NOT A PART OF THE MARK AND THE REMAINDER OF THE WHITE IN THE MARK IS BACKGROUND AREA WHICH IS NOT A PART OF THE MARK.

SER. NO. 85-518,106, FILED 1-17-2012.

REBECCA GILBERT, EXAMINING ATTORNEY



*David J. Kybas*

Director of the United States Patent and Trademark Office

# United States of America

United States Patent and Trademark Office

## LEGAL RESIDENT OF THE UNITED STATES

**Reg. No. 4,198,080**

DELISLE, FRANK (UNITED STATES INDIVIDUAL)  
156 OAKHURST COURT  
COPPEROPLIS, CA 95228

**Registered Aug. 28, 2012**

**Int. Cl.: 25**

FOR: CLOTHING, NAMELY, BASEBALL CAPS, T-SHIRTS, PANTS, SHIRTS, JACKETS, SWEATERS, HATS, VISORS, DRESSES AND SKIRTS, IN CLASS 25 (U.S. CLS. 22 AND 39).

**TRADEMARK**

FIRST USE 6-1-2011; IN COMMERCE 1-1-2012.

**PRINCIPAL REGISTER**

THE MARK CONSISTS OF STANDARD CHARACTERS WITHOUT CLAIM TO ANY PARTICULAR FONT, STYLE, SIZE, OR COLOR.

OWNER OF U.S. REG. NO. 3,847,714.

SER. NO. 85-518,122, FILED 1-17-2012.

BRIAN PINO, EXAMINING ATTORNEY



*David J. Kyffers*

Director of the United States Patent and Trademark Office

# United States of America

United States Patent and Trademark Office

## SOHO APPAREL

**Reg. No. 4,198,081**

**Registered Aug. 28, 2012**

**Int. Cl.: 25**

**TRADEMARK**

**PRINCIPAL REGISTER**

BILLION INTERNATIONAL TRADING, INC (CALIFORNIA CORPORATION)  
11221 E. RUSH STREET #D  
SOUTH EL MONTE, CA 91733

FOR: COATS; FOOTWEAR; GLOVES; GYM SUITS; HEADBANDS; JACKETS; JEANS;  
JOGGING SUITS; PAJAMAS; PANTS; RAIN COATS; SCARVES; SHIRTS; SHORTS; SOCKS;  
SUITS; SPORTS PANTS; SPORTS SHIRTS; SWEATERS; SWEAT PANTS; SWEAT SUITS;  
SWIMWEAR; TIES; T-SHIRTS; UNDERWEAR; AND WAIST BELTS, IN CLASS 25 (U.S.  
CLS. 22 AND 39).

FIRST USE 11-14-2011; IN COMMERCE 11-14-2011.

THE MARK CONSISTS OF STANDARD CHARACTERS WITHOUT CLAIM TO ANY PARTICULAR FONT, STYLE, SIZE, OR COLOR.

OWNER OF U.S. REG. NOS. 3,578,179, 3,942,457 AND OTHERS.

NO CLAIM IS MADE TO THE EXCLUSIVE RIGHT TO USE "APPAREL", APART FROM THE MARK AS SHOWN.

SER. NO. 85-518,170, FILED 1-17-2012.

CHRIS WELLS, EXAMINING ATTORNEY



*David J. Kyros*

Director of the United States Patent and Trademark Office

# United States of America

United States Patent and Trademark Office

## PURE HARMONY

**Reg. No. 4,198,082**

**Registered Aug. 28, 2012**

**Int. Cl.: 30**

**TRADEMARK**

**PRINCIPAL REGISTER**

GOLDEN HERITAGE FOODS, LLC (DELAWARE LIMITED LIABILITY COMPANY)  
120 SANTA FE STREET  
HILLSBORO, KS 67063

FOR: HONEY, IN CLASS 30 (U.S. CL. 46).

FIRST USE 1-0-2011; IN COMMERCE 1-0-2011.

THE MARK CONSISTS OF STANDARD CHARACTERS WITHOUT CLAIM TO ANY PARTICULAR FONT, STYLE, SIZE, OR COLOR.

SER. NO. 85-518,174, FILED 1-17-2012.

DORITT L. CARROLL, EXAMINING ATTORNEY



*David J. Kyffers*

Director of the United States Patent and Trademark Office

# United States of America

United States Patent and Trademark Office

YOUR CONTROLS, YOUR WAY

**Reg. No. 4,198,083**

UTAK LABORATORIES, INC. (CALIFORNIA CORPORATION)  
25020 AVENUE TIBBETTS  
VALENCIA, CA 91355

**Registered Aug. 28, 2012**

**Int. Cl.: 42**

FOR: CUSTOM DESIGN AND DEVELOPMENT OF CHEMICAL REAGENTS FOR USE IN THE FIELDS OF THERAPEUTIC DRUG MONITORING, CLINICAL TOXICOLOGY, FORENSIC TOXICOLOGY AND INDUSTRIAL TOXICOLOGY, IN CLASS 42 (U.S. CLS. 100 AND 101).

**SERVICE MARK**

**PRINCIPAL REGISTER**

FIRST USE 8-1-2009; IN COMMERCE 8-1-2009.

THE MARK CONSISTS OF STANDARD CHARACTERS WITHOUT CLAIM TO ANY PARTICULAR FONT, STYLE, SIZE, OR COLOR.

NO CLAIM IS MADE TO THE EXCLUSIVE RIGHT TO USE "CONTROLS", APART FROM THE MARK AS SHOWN.

SER. NO. 85-518,200, FILED 1-17-2012.

LAKEISHA LEWIS, EXAMINING ATTORNEY



*David J. Kyffers*

Director of the United States Patent and Trademark Office

# United States of America

United States Patent and Trademark Office



**Reg. No. 4,198,084**

**Registered Aug. 28, 2012**

**Int. Cls.: 25 and 41**

**TRADEMARK**

**SERVICE MARK**

**PRINCIPAL REGISTER**

ORLANDO HOOPS, INC. (FLORIDA CORPORATION), AKA OHOOPS  
4620 MISTY WAY  
OVIEDO, FL 32765

FOR: ATHLETIC APPAREL, NAMELY, SHIRTS, PANTS, JACKETS, FOOTWEAR, HATS AND CAPS, ATHLETIC UNIFORMS; CLOTHING FOR ATHLETIC USE, NAMELY, PADDED ELBOW COMPRESSION SLEEVES BEING PART OF AN ATHLETIC GARMENT; HOODED SWEAT SHIRTS; JOGGING PANTS; LONG-SLEEVED SHIRTS; MOISTURE-WICKING SPORTS PANTS; MOISTURE-WICKING SPORTS SHIRTS; POLO SHIRTS; SHORT-SLEEVED OR LONG-SLEEVED T-SHIRTS; SOCKS; SWEAT PANTS, IN CLASS 25 (U.S. CLS. 22 AND 39).

FIRST USE 3-27-2009; IN COMMERCE 3-27-2009.

FOR: ATHLETIC TRAINING SERVICES; BASKETBALL CAMPS; CHARITABLE SERVICES, NAMELY, PROVIDING TRAINING IN THE FIELD OF BASKETBALL SKILLS; PERSONAL TRAINING SERVICES, NAMELY, STRENGTH AND CONDITIONING TRAINING AND SPEED TRAINING; PHYSICAL FITNESS TRAINING OF INDIVIDUALS AND GROUPS; TRAINING SERVICES IN THE FIELD OF BASKETBALL, IN CLASS 41 (U.S. CLS. 100, 101 AND 107).

FIRST USE 3-27-2009; IN COMMERCE 3-27-2009.

THE MARK CONSISTS OF THE DESIGN OF A CIRCLE WITH CURVED LINES THAT REPRESENT THE LETTERS "O" AND "H", WITH THE LETTER "H" BEING WITHIN THE CIRCUMFERENCE OF THE LETTER "O".

SER. NO. 85-518,204, FILED 1-17-2012.

DEIRDRE ROBERTSON, EXAMINING ATTORNEY



*David J. Kyros*

Director of the United States Patent and Trademark Office



# United States of America

United States Patent and Trademark Office



**Reg. No. 4,198,085**

**Registered Aug. 28, 2012**

**Int. Cl.: 41**

**SERVICE MARK**

**PRINCIPAL REGISTER**

MCNEIL, ROBERT ARTHUR (UNITED STATES INDIVIDUAL)  
4529 WEST WATROUS AVENUE  
TAMPA, FL 33629

FOR: EDUCATIONAL AND ENTERTAINMENT SERVICES, NAMELY, PROVIDING MOTIVATIONAL SPEAKING SERVICES IN THE FIELD OF LEADERSHIP AND MANAGEMENT; ON-LINE JOURNALS, NAMELY, BLOGS FEATURING LEADERSHIP AND MANAGEMENT; PROFESSIONAL COACHING SERVICES IN THE FIELD OF LEADERSHIP AND MANAGEMENT, IN CLASS 41 (U.S. CLS. 100, 101 AND 107).

FIRST USE 9-0-1978; IN COMMERCE 9-0-1978.

THE NAME SHOWN IN THE MARK IDENTIFIES A LIVING INDIVIDUAL WHOSE CONSENT IS OF RECORD

THE MARK CONSISTS OF A STYLIZED LETTER "A" WITH AN ARROW IN THE CENTER, FOLLOWED BY THE STYLIZED TEXT "RT MCNEIL" RUNNING FROM THE RIGHT SIDE OF THE STYLIZED LETTER "A" AND PRESENTED IN BOTH UPPER AND LOWER CASE LETTERING. A THIN LINE RUNS BENEATH AND IS EXTENDED BEYOND THE LETTERING "RT MCNEIL". BELOW THE LINE, APPEARING IN UPPER AND LOWER CASE LETTERING BUT IN SMALLER SIZE FONT, IS THE STYLIZED TEXT "WHEN THEORY IS NOT ENOUGH".

SER. NO. 85-518,232, FILED 1-17-2012.

RAUL CORDOVA, EXAMINING ATTORNEY



*David J. Kybas*

Director of the United States Patent and Trademark Office

# United States of America

United States Patent and Trademark Office

# Electrum

**Reg. No. 4,198,086**

RONALD AMERAL (UNITED STATES INDIVIDUAL)  
13465 CAMINO CANADA, SUITE 106-139  
EL CAJON, CA 92021

**Registered Aug. 28, 2012**

**Int. Cl.: 5**

FOR: FOOD SUPPLEMENTS; NUTRITIONAL SUPPLEMENTS; VITAMIN AND MINERAL SUPPLEMENTS; VITAMINS, IN CLASS 5 (U.S. CLS. 6, 18, 44, 46, 51 AND 52).

**TRADEMARK**

FIRST USE 3-20-2002; IN COMMERCE 3-20-2002.

**PRINCIPAL REGISTER**

THE MARK CONSISTS OF STANDARD CHARACTERS WITHOUT CLAIM TO ANY PARTICULAR FONT, STYLE, SIZE, OR COLOR.

SER. NO. 85-518,242, FILED 1-17-2012.

DEZMONA MIZELLE, EXAMINING ATTORNEY



*David J. Kybas*

Director of the United States Patent and Trademark Office

# United States of America

United States Patent and Trademark Office

# CSP

**Reg. No. 4,198,087**

SCRUM ALLIANCE, INC. (COLORADO CORPORATION)

**Registered Aug. 28, 2012**

P.O. BOX 40097  
INDIANAPOLIS, IN 462400097

**CERTIFICATION MARK**

FOR: PROVIDING INFORMATION IN THE FIELDS OF PRODUCT DEVELOPMENT, PRODUCT DESIGN AND PRODUCT MANUFACTURING; PROJECT MANAGEMENT SERVICES, PRODUCT DEVELOPMENT SERVICES, PRODUCT DESIGN SERVICES, AND PRODUCT MANUFACTURING SERVICES, IN CLASS B (U.S. CL. B).

**PRINCIPAL REGISTER**

FIRST USE 0-0-2010; IN COMMERCE 0-0-2010.

THE MARK CONSISTS OF STANDARD CHARACTERS WITHOUT CLAIM TO ANY PARTICULAR FONT, STYLE, SIZE, OR COLOR.

THE CERTIFICATION MARK, AS USED BY AUTHORIZED PERSONS, CERTIFIES THAT THE PERSON DISPLAYING THE MARK HAS DEMONSTRATED QUALIFICATIONS IN THE USE OF SPECIFIED PRODUCT DEVELOPMENT PROCESSES IN ACCORDANCE WITH STANDARDS ESTABLISHED BY THE CERTIFIER.

SER. NO. 85-518,244, FILED 1-17-2012.

DEZMONA MIZELLE, EXAMINING ATTORNEY



*David J. Kyffers*

Director of the United States Patent and Trademark Office

# United States of America

United States Patent and Trademark Office

# q.ACO

**Reg. No. 4,198,088**

**Registered Aug. 28, 2012**

**Int. Cl.: 42**

**SERVICE MARK**

**PRINCIPAL REGISTER**

HEALTHCARE DATA SOLUTIONS, LLC (FLORIDA LIMITED LIABILITY COMPANY)  
23464 GLENRIDGE DRIVE  
NEWHALL, CA 91321

FOR: PROVIDING TEMPORARY USE OF A WEB-BASED SOFTWARE APPLICATION FOR COLLECTING, MANAGING, AND ANALYZING HEALTHCARE DATA, IN CLASS 42 (U.S. CLS. 100 AND 101).

FIRST USE 10-3-2011; IN COMMERCE 12-19-2011.

THE MARK CONSISTS OF STANDARD CHARACTERS WITHOUT CLAIM TO ANY PARTICULAR FONT, STYLE, SIZE, OR COLOR.

SER. NO. 85-518,258, FILED 1-17-2012.

JEAN IM, EXAMINING ATTORNEY



*David J. Kyffers*

Director of the United States Patent and Trademark Office

# United States of America

United States Patent and Trademark Office

## CHENMKO

**Reg. No. 4,198,089**

**Registered Aug. 28, 2012**

**Int. Cl.: 9**

**TRADEMARK**

**PRINCIPAL REGISTER**

CHENMKO ENTERPRISE CO., LTD (TAIWAN LIMITED LIABILITY COMPANY)  
5FL-2, NO. 190, SEC. 2  
CHUNG HSING RD., HSIN TIEN DIST  
NEW TAIPEI CITY, TAIWAN

FOR: SEMICONDUCTORS; SEMICONDUCTOR COMPONENTS, NAMELY, CONVERTERS, WAFERS, POWER TRANSISTORS, SILICON CRYSTALLINE CHIPS, SEMICONDUCTOR CHIPS, INTEGRATED CIRCUITS, AND RECTIFIERS; MICROPROCESSOR CHIPS, IN CLASS 9 (U.S. CLS. 21, 23, 26, 36 AND 38).

FIRST USE 1-12-2002; IN COMMERCE 10-9-2011.

THE MARK CONSISTS OF THE STYLIZED WORDING "CHENMKO" WITH A RHOMBUS IN THE LETTER "E".

THE WORD(S) "CHENMKO" HAS NO MEANING IN A FOREIGN LANGUAGE.

SER. NO. 85-518,272, FILED 1-17-2012.

MELISSA VALLILLO, EXAMINING ATTORNEY



*David J. Kyfos*

Director of the United States Patent and Trademark Office

# United States of America

United States Patent and Trademark Office

# MTD4LYFE

**Reg. No. 4,198,090**

TOBIAS, MICHAEL (UNITED STATES INDIVIDUAL)  
3 LAUREN CT  
KINGSTON, NY 12401

**Registered Aug. 28, 2012**

**Int. Cl.: 35**

FOR: CHARITABLE SERVICES, NAMELY, PROMOTING PUBLIC AWARENESS AND HELP FOR MUSICIANS IN NEED, IN CLASS 35 (U.S. CLS. 100, 101 AND 102).

**SERVICE MARK**

FIRST USE 10-0-2006; IN COMMERCE 10-0-2006.

**PRINCIPAL REGISTER**

THE MARK CONSISTS OF STANDARD CHARACTERS WITHOUT CLAIM TO ANY PARTICULAR FONT, STYLE, SIZE, OR COLOR.

SER. NO. 85-518,287, FILED 1-17-2012.

ALEX KEAM, EXAMINING ATTORNEY



*David J. Kybas*

Director of the United States Patent and Trademark Office

# United States of America

United States Patent and Trademark Office

## NEVER STOP MOVING 365

**Reg. No. 4,198,091**

SCHIRONE, CHRISTINA (UNITED STATES INDIVIDUAL)  
65 THIRD STREET  
PELHAM, NY 10803

**Registered Aug. 28, 2012**

**Int. Cl.: 41**

FOR: CONDUCTING FITNESS CLASSES; CONSULTING SERVICES IN THE FIELDS OF FITNESS AND EXERCISE; PERSONAL FITNESS TRAINING SERVICES AND CONSULTANCY; PERSONAL TRAINER SERVICES; PHYSICAL FITNESS CONDITIONING CLASSES; PHYSICAL FITNESS INSTRUCTION; PHYSICAL FITNESS STUDIO SERVICES, NAMELY, PROVIDING EXERCISE CLASSES, BODY SCULPTING CLASSES, AND GROUP FITNESS CLASSES; PHYSICAL FITNESS TRAINING SERVICES; PROVIDING A WEBSITE FEATURING INFORMATION ON EXERCISE AND FITNESS; PROVIDING ASSISTANCE, PERSONAL TRAINING AND PHYSICAL FITNESS CONSULTATION TO INDIVIDUALS TO HELP THEM MAKE PHYSICAL FITNESS, STRENGTH, CONDITIONING, AND EXERCISE IMPROVEMENT IN THEIR DAILY LIVING; PROVIDING INFORMATION IN THE FIELD OF EXERCISE TRAINING; PROVIDING INFORMATION ON PHYSICAL EXERCISE, IN CLASS 41 (U.S. CLS. 100, 101 AND 107).

**SERVICE MARK**

**PRINCIPAL REGISTER**

FIRST USE 7-31-2009; IN COMMERCE 7-31-2009.

THE MARK CONSISTS OF STANDARD CHARACTERS WITHOUT CLAIM TO ANY PARTICULAR FONT, STYLE, SIZE, OR COLOR.

SER. NO. 85-518,301, FILED 1-17-2012.

ALEX KEAM, EXAMINING ATTORNEY



*David J. Kybas*

Director of the United States Patent and Trademark Office

# United States of America

United States Patent and Trademark Office

## LIFEFORWARD

**Reg. No. 4,198,092**

ZIRLIN, RACHEL M. (UNITED STATES INDIVIDUAL)  
219 SOLAR DRIVE

**Registered Aug. 28, 2012**

WALKERSVILLE, MD 27193

**Int. Cls.: 41 and 44**

FOR: LIFE COACHING SERVICES IN THE FIELD OF PERSONAL AND PROFESSIONAL GROWTH AND DEVELOPMENT, IN CLASS 41 (U.S. CLS. 100, 101 AND 107).

**SERVICE MARK**

FIRST USE 11-0-2011; IN COMMERCE 11-0-2011.

**PRINCIPAL REGISTER**

FOR: HYPNOSIS SERVICES, IN CLASS 44 (U.S. CLS. 100 AND 101).

FIRST USE 11-0-2011; IN COMMERCE 11-0-2011.

THE MARK CONSISTS OF STANDARD CHARACTERS WITHOUT CLAIM TO ANY PARTICULAR FONT, STYLE, SIZE, OR COLOR.

SER. NO. 85-518,320, FILED 1-17-2012.

JEAN IM, EXAMINING ATTORNEY



*David J. Kybas*

Director of the United States Patent and Trademark Office



# United States of America

United States Patent and Trademark Office

# SLA SENTRY

**Reg. No. 4,198,093**

**Registered Aug. 28, 2012**

**Int. Cl.: 9**

**TRADEMARK**

**PRINCIPAL REGISTER**

VIGILENT CORPORATION (DELAWARE CORPORATION)  
712 EL CERRITO PLAZA  
EL CERRITO, CA 94530

FOR: COMPUTER HARDWARE AND SOFTWARE SYSTEM FOR REMOTELY MONITORING ENVIRONMENTAL CONDITIONS AND CONTROLLING DEVICES WITHIN A BUILDING, FACILITY, GROUNDS, OR DESIGNATED SPATIAL AREA; COMPUTER HARDWARE AND SOFTWARE SYSTEMS FOR MONITORING ENVIRONMENTAL AND DEVICE ATTRIBUTES AND CONTROLLING DEVICES.; COMPUTER SOFTWARE AND HARDWARE FOR AUTOMATED PROCESS CONTROL, IN CLASS 9 (U.S. CLS. 21, 23, 26, 36 AND 38).

FIRST USE 9-30-2010; IN COMMERCE 9-30-2010.

THE MARK CONSISTS OF STANDARD CHARACTERS WITHOUT CLAIM TO ANY PARTICULAR FONT, STYLE, SIZE, OR COLOR.

SER. NO. 85-518,327, FILED 1-17-2012.

HENRY S. ZAK, EXAMINING ATTORNEY



*David J. Kyros*

Director of the United States Patent and Trademark Office

# United States of America

United States Patent and Trademark Office

## UPTIME ADVISOR

**Reg. No. 4,198,094**

VIGILENT CORPORATION (DELAWARE CORPORATION)

**Registered Aug. 28, 2012**

712 EL CERRITO PLAZA  
EL CERRITO, CA 94530

**Int. Cl.: 9**

FOR: COMPUTER HARDWARE AND SOFTWARE SYSTEM FOR REMOTELY MONITORING ENVIRONMENTAL CONDITIONS AND CONTROLLING DEVICES WITHIN A BUILDING, FACILITY, GROUNDS, OR DESIGNATED SPATIAL AREA; COMPUTER HARDWARE AND SOFTWARE SYSTEMS FOR MONITORING ENVIRONMENTAL AND DEVICE ATTRIBUTES AND CONTROLLING DEVICES.; COMPUTER SOFTWARE AND HARDWARE FOR AUTOMATED PROCESS CONTROL, IN CLASS 9 (U.S. CLS. 21, 23, 26, 36 AND 38).

**TRADEMARK**

**PRINCIPAL REGISTER**

FIRST USE 9-30-2010; IN COMMERCE 9-30-2010.

THE MARK CONSISTS OF STANDARD CHARACTERS WITHOUT CLAIM TO ANY PARTICULAR FONT, STYLE, SIZE, OR COLOR.

SER. NO. 85-518,334, FILED 1-17-2012.

HENRY S. ZAK, EXAMINING ATTORNEY



*David J. Kybas*

Director of the United States Patent and Trademark Office

# United States of America

United States Patent and Trademark Office

## KASEY FRAMEZ

**Reg. No. 4,198,095**

**Registered Aug. 28, 2012**

**Int. Cl.: 9**

**TRADEMARK**

**PRINCIPAL REGISTER**

MERCHANT, JOHN K (UNITED STATES INDIVIDUAL), DBA KASEY FRAMEZ  
6295 RIVERSTONE DR.  
COLUMBUS, OH 43228

FOR: AUDIO AND VIDEO RECORDINGS FEATURING MUSIC AND ARTISTIC PERFORMANCES; COMPACT DISCS FEATURING MUSIC, IN CLASS 9 (U.S. CLS. 21, 23, 26, 36 AND 38).

FIRST USE 9-17-2011; IN COMMERCE 12-17-2011.

THE MARK CONSISTS OF STANDARD CHARACTERS WITHOUT CLAIM TO ANY PARTICULAR FONT, STYLE, SIZE, OR COLOR.

THE NAME "KASEY FRAMEZ" IDENTIFIES A LIVING INDIVIDUAL WHOSE CONSENT IS OF RECORD.

SER. NO. 85-518,368, FILED 1-17-2012.

JENNIFER VASQUEZ, EXAMINING ATTORNEY



*David J. Kybas*

Director of the United States Patent and Trademark Office

# United States of America

United States Patent and Trademark Office

## JULIETTE LONGUET

**Reg. No. 4,198,096**

MADEMOISELLE PAPILLON LTD (NEW YORK CORPORATION), DBA JULIETTE LONGUET  
116 CENTRAL PARK SOUTH SUITE 12 N  
NEW YORK, NY 10019

**Registered Aug. 28, 2012**

**Int. Cl.: 25**

FOR: WOMEN'S CLOTHING, NAMELY, SHIRTS, DRESSES, SKIRTS, BLOUSES, IN CLASS  
25 (U.S. CLS. 22 AND 39).

**TRADEMARK**

FIRST USE 5-10-2004; IN COMMERCE 5-10-2004.

**PRINCIPAL REGISTER**

THE MARK CONSISTS OF STANDARD CHARACTERS WITHOUT CLAIM TO ANY PAR-  
TICULAR FONT, STYLE, SIZE, OR COLOR.

THE NAME JULIETTE LONGUET IDENTIFIES A LIVING INDIVIDUAL WHOSE CONSENT  
IS OF RECORD.

SER. NO. 85-518,375, FILED 1-17-2012.

COLLEEN DOMBROW, EXAMINING ATTORNEY



*David J. Kybas*

Director of the United States Patent and Trademark Office

# United States of America

United States Patent and Trademark Office

# ClubBody

**Reg. No. 4,198,097**

**Registered Aug. 28, 2012**

**Int. Cl.: 35**

**SERVICE MARK**

**PRINCIPAL REGISTER**

CLUBBODY.COM, LLC (FLORIDA LIMITED LIABILITY COMPANY)  
SUITE 640  
1675 LARIMER STREET  
DENVER, CO 80202

FOR: PROMOTING THE GOODS AND SERVICES OF OTHERS BY PROVIDING A WEBSITE FEATURING RATINGS, REVIEWS AND RECOMMENDATIONS ON PRODUCTS THAT ARE OFFERED BY THIRD PARTIES FOR COMMERCIAL PURPOSES, IN CLASS 35 (U.S. CLS. 100, 101 AND 102).

FIRST USE 6-22-2010; IN COMMERCE 6-22-2010.

THE MARK CONSISTS OF STANDARD CHARACTERS WITHOUT CLAIM TO ANY PARTICULAR FONT, STYLE, SIZE, OR COLOR.

SER. NO. 85-518,393, FILED 1-17-2012.

DANIEL CAPSHAW, EXAMINING ATTORNEY



*David J. Kyffers*

Director of the United States Patent and Trademark Office

# United States of America

United States Patent and Trademark Office



**Reg. No. 4,198,098**

**Registered Aug. 28, 2012**

**Int. Cl.: 41**

**SERVICE MARK**

**PRINCIPAL REGISTER**

ORLANDO HOOPS, INC. (FLORIDA CORPORATION), AKA OHOOPS  
4620 MISTY WAY  
OVIEDO, FL 32765

FOR: ATHLETIC TRAINING SERVICES; BASKETBALL CAMPS; CHARITABLE SERVICES, NAMELY, PROVIDING TRAINING IN THE FIELD OF BASKETBALL SKILLS; PERSONAL TRAINING SERVICES, NAMELY, STRENGTH AND CONDITIONING TRAINING AND SPEED TRAINING; PHYSICAL FITNESS TRAINING OF INDIVIDUALS AND GROUPS; TRAINING SERVICES IN THE FIELD OF BASKETBALL, IN CLASS 41 (U.S. CLS. 100, 101 AND 107).

FIRST USE 3-27-2009; IN COMMERCE 3-27-2009.

THE MARK CONSISTS OF A STYLIZED WORD "OHOOPS" WITH THE INITIAL LETTER "O" CAPITALIZED AND TURNED BACKWARD.

SER. NO. 85-518,412, FILED 1-17-2012.

DEIRDRE ROBERTSON, EXAMINING ATTORNEY



*David J. Kyros*

Director of the United States Patent and Trademark Office

# United States of America

United States Patent and Trademark Office



**Reg. No. 4,198,099**

ACCEL FIRE SYSTEMS, INC. (ALASKA CORPORATION)  
4510 GAMBELL STREET  
ANCHORAGE, AK 99524

**Registered Aug. 28, 2012**

**Int. Cls.: 9, 37 and 42**

FOR: FIRE SPRINKLERS; FIRE-EXTINGUISHING SYSTEMS; SPRINKLER SYSTEMS FOR FIRE PROTECTION, IN CLASS 9 (U.S. CLS. 21, 23, 26, 36 AND 38).

**TRADEMARK**

FIRST USE 7-30-1995; IN COMMERCE 7-30-1995.

**SERVICE MARK**

FOR: FIRE ALARM INSTALLATION AND REPAIR; INSTALLATION AND MAINTENANCE OF FIRE ALARM, DETECTION AND SUPPRESSION SYSTEMS; REPAIR OR MAINTENANCE OF FIRE ALARMS, IN CLASS 37 (U.S. CLS. 100, 103 AND 106).

**PRINCIPAL REGISTER**

FIRST USE 7-30-1995; IN COMMERCE 7-30-1995.

FOR: DESIGN AND INSPECTION OF FIRE ALARM, DETECTION AND SUPPRESSION SYSTEMS, IN CLASS 42 (U.S. CLS. 100 AND 101).

FIRST USE 7-30-1995; IN COMMERCE 7-30-1995.

OWNER OF U.S. REG. NO. 3,456,713.

THE COLOR(S) BLACK AND RED IS/ARE CLAIMED AS A FEATURE OF THE MARK.

THE MARK CONSISTS OF A STYLIZED IMAGE OF FIRE SPRINKLER IN BLACK, WITH DIAGONAL BLACK LINES RADIATING OUT FROM IT, APPEARING ABOVE STYLIZED IMAGE OF FLAMES IN RED, WITH THE WORD "ACCEL" IN CAPITAL LETTERS BELOW IT.

SER. NO. 85-518,414, FILED 1-17-2012.

GEORGE LORENZO, EXAMINING ATTORNEY



*David J. Kypos*

Director of the United States Patent and Trademark Office

# United States of America

United States Patent and Trademark Office

# Biomiga

**Reg. No. 4,198,100**

**Registered Aug. 28, 2012**

**Int. Cl.: 1**

**TRADEMARK**

**PRINCIPAL REGISTER**

SHI, JINGYU (UNITED STATES INDIVIDUAL)  
7256 CAYNON GLEN COURT  
SAN DIEGO, CA 92129

FOR: REAGENT KIT CONTAINING PRE-MADE COLUMNS, BUFFERS, PRE-MADE BUFFER CONCENTRATES, SYRINGES AND INSTRUCTIONAL MANUAL FOR THE PURIFICATION OF NUCLEIC ACIDS (DNA AND RNA) FOR IN VITRO USE IN THE BIOTECHNOLOGY FIELD; REAGENT KIT CONTAINING PRE-MADE COLUMNS, BUFFERS, PRE-MADE BUFFER CONCENTRATES, SYRINGES AND INSTRUCTIONAL MANUAL FOR THE PURIFICATION OF VIRUSES FOR IN VITRO USE IN THE BIOTECHNOLOGY FIELD, IN CLASS 1 (U.S. CLS. 1, 5, 6, 10, 26 AND 46).

FIRST USE 5-18-2003; IN COMMERCE 11-18-2003.

THE MARK CONSISTS OF STANDARD CHARACTERS WITHOUT CLAIM TO ANY PARTICULAR FONT, STYLE, SIZE, OR COLOR.

SER. NO. 85-518,418, FILED 1-17-2012.

ELLEN B. AWRICH, EXAMINING ATTORNEY



*David J. Kyffers*

Director of the United States Patent and Trademark Office



# United States of America

United States Patent and Trademark Office

## Learning Treasures

**Reg. No. 4,198,101**

TOTKIT, INC. (INDIANA CORPORATION), DBA LEARNING TREASURES  
223 SOUTH PETE ELLIS DRIVE #18  
BLOOMINGTON, IN 47408

**Registered Aug. 28, 2012**

**Int. Cl.: 35**

FOR: RETAIL STORE SERVICES FEATURING EDUCATIONAL PRODUCTS, TEACHING SUPPLIES, AND TOYS, IN CLASS 35 (U.S. CLS. 100, 101 AND 102).

**SERVICE MARK**

FIRST USE 7-31-1982; IN COMMERCE 7-31-1982.

**PRINCIPAL REGISTER**

THE MARK CONSISTS OF STANDARD CHARACTERS WITHOUT CLAIM TO ANY PARTICULAR FONT, STYLE, SIZE, OR COLOR.

SER. NO. 85-518,419, FILED 1-17-2012.

LAURIE KAUFMAN, EXAMINING ATTORNEY



*David J. Kybas*

Director of the United States Patent and Trademark Office

# United States of America

United States Patent and Trademark Office

# FILM NOIR

**Reg. No. 4,198,102**

KINGDOM ANIMALIA, LLC (CALIFORNIA LIMITED LIABILITY COMPANY)  
1401 MAIN STREET  
VENICE, CA 90291

**Registered Aug. 28, 2012**

**Int. Cl.: 3**

FOR: COSMETICS, NAMELY, A LIQUID LACQUER TO DARKEN, THICKEN AND LENGTHEN EYELASHES; MASCARA, IN CLASS 3 (U.S. CLS. 1, 4, 6, 50, 51 AND 52).

**TRADEMARK**

FIRST USE 7-0-2010; IN COMMERCE 7-0-2010.

**PRINCIPAL REGISTER**

THE MARK CONSISTS OF STANDARD CHARACTERS WITHOUT CLAIM TO ANY PARTICULAR FONT, STYLE, SIZE, OR COLOR.

SER. NO. 85-518,443, FILED 1-17-2012.

MARILYN IZZI, EXAMINING ATTORNEY



*David J. Kybas*

Director of the United States Patent and Trademark Office

# United States of America

United States Patent and Trademark Office

# AMP

**Reg. No. 4,198,103**

HUMANA INC. (DELAWARE CORPORATION)  
500 WEST MAIN STREET  
LOUISVILLE, KY 40202

**Registered Aug. 28, 2012**

**Int. Cl.: 9**

FOR: MEDICAL SOFTWARE TO ASSIST IN DEVELOPING A PATIENT'S MEDICAL PROFILE THROUGH ANALYSIS OF CURRENT PROCEDURES, CURRENT LAB VALUES, CLINICAL DATA, ACTIVE MEDICATIONS AND ACTIVE DIAGNOSES, IN CLASS 9 (U.S. CLS. 21, 23, 26, 36 AND 38).

**TRADEMARK**

**PRINCIPAL REGISTER**

FIRST USE 1-5-2012; IN COMMERCE 1-5-2012.

THE MARK CONSISTS OF STANDARD CHARACTERS WITHOUT CLAIM TO ANY PARTICULAR FONT, STYLE, SIZE, OR COLOR.

SER. NO. 85-518,445, FILED 1-17-2012.

SUE LAWRENCE, EXAMINING ATTORNEY



*David J. Kyffers*

Director of the United States Patent and Trademark Office

# United States of America

United States Patent and Trademark Office

# SCRIPT

**Reg. No. 4,198,104**

KINGDOM ANIMALIA, LLC (CALIFORNIA LIMITED LIABILITY COMPANY)  
1401 MAIN STREET  
VENICE, CA 90291

**Registered Aug. 28, 2012**

**Int. Cl.: 3**

FOR: COSMETICS, NAMELY, LIQUID EYELINER, IN CLASS 3 (U.S. CLS. 1, 4, 6, 50, 51 AND 52).

**TRADEMARK**

FIRST USE 3-0-2011; IN COMMERCE 3-0-2011.

**PRINCIPAL REGISTER**

THE MARK CONSISTS OF STANDARD CHARACTERS WITHOUT CLAIM TO ANY PARTICULAR FONT, STYLE, SIZE, OR COLOR.

SER. NO. 85-518,457, FILED 1-17-2012.

MARILYN IZZI, EXAMINING ATTORNEY



*David J. Kyffers*

Director of the United States Patent and Trademark Office

# United States of America

United States Patent and Trademark Office

# 2GO

**Reg. No. 4,198,105**

POCKET CARD NETWORKS, LLC (DELAWARE LIMITED LIABILITY COMPANY)  
213 SOLANO CAY CIRCLE  
PONTE VEDRA, FL 32082

**Registered Aug. 28, 2012**

**Int. Cl.: 35**

FOR: ADVERTISING AND ADVERTISEMENT SERVICES, IN CLASS 35 (U.S. CLS. 100, 101 AND 102).

**SERVICE MARK**

FIRST USE 10-0-2008; IN COMMERCE 10-0-2008.

**PRINCIPAL REGISTER**

THE MARK CONSISTS OF STANDARD CHARACTERS WITHOUT CLAIM TO ANY PARTICULAR FONT, STYLE, SIZE, OR COLOR.

OWNER OF U.S. REG. NOS. 3,622,962 AND 3,653,855.

SER. NO. 85-518,470, FILED 1-17-2012.

BRENDAN REGAN, EXAMINING ATTORNEY



*David J. Kyffers*

Director of the United States Patent and Trademark Office

# United States of America

United States Patent and Trademark Office

# PARTRADE

**Reg. No. 4,198,106**

**Registered Aug. 28, 2012**

**Int. Cl.: 35**

**SERVICE MARK**

**PRINCIPAL REGISTER**

PARTRADE TRADING COMPANY, LLC (NORTH CAROLINA LIMITED LIABILITY COMPANY)  
3801 COMMERCE DRIVE  
KINSTON, NC 28504

FOR: ON-LINE RETAIL STORE SERVICES FEATURING GOODS DESIGNED FOR USE WITH DOGS OR HORSES; WHOLESALE STORE SERVICES FEATURING GOODS DESIGNED FOR USE WITH DOGS OR HORSES, IN CLASS 35 (U.S. CLS. 100, 101 AND 102).

FIRST USE 12-31-2002; IN COMMERCE 12-31-2002.

THE MARK CONSISTS OF STANDARD CHARACTERS WITHOUT CLAIM TO ANY PARTICULAR FONT, STYLE, SIZE, OR COLOR.

OWNER OF U.S. REG. NO. 3,045,143.

SER. NO. 85-518,477, FILED 1-17-2012.

JOHN GARTNER, EXAMINING ATTORNEY



*David J. Kyffers*

Director of the United States Patent and Trademark Office

# United States of America

United States Patent and Trademark Office

# Jubei

**Reg. No. 4,198,107**

**Registered Aug. 28, 2012**

**Int. Cl.: 8**

**TRADEMARK**

**PRINCIPAL REGISTER**

INFINITY ETRADING INC. (CALIFORNIA CORPORATION)  
UNIT H  
5160 RICHTON STREET  
MONTCLAIR, CA 91763

FOR: CUTLERY, NAMELY, SWORDS, FIXED BLADE DAGGERS, KITCHEN KNIVES, AND  
DAGGERS, IN CLASS 8 (U.S. CLS. 23, 28 AND 44).

FIRST USE 8-16-2011; IN COMMERCE 9-6-2011.

THE MARK CONSISTS OF STANDARD CHARACTERS WITHOUT CLAIM TO ANY PAR-  
TICULAR FONT, STYLE, SIZE, OR COLOR.

SER. NO. 85-518,478, FILED 1-17-2012.

JOHN GARTNER, EXAMINING ATTORNEY



*David J. Kyffers*

Director of the United States Patent and Trademark Office

# United States of America

United States Patent and Trademark Office

# Treadsmith

**Reg. No. 4,198,108**

**Registered Aug. 28, 2012**

**Int. Cl.: 28**

**TRADEMARK**

**PRINCIPAL REGISTER**

ONEFASTBUFFALO CORP (TEXAS CORPORATION)  
SUITE 333-19  
9661 AUDELIA RD.  
DALLAS, TX 75238

FOR: PADDLE SURFBOARDS; SKATEBOARDS; SNOWBOARDS; SURFBOARDS, IN CLASS  
28 (U.S. CLS. 22, 23, 38 AND 50).

FIRST USE 10-15-2011; IN COMMERCE 1-1-2012.

THE MARK CONSISTS OF STANDARD CHARACTERS WITHOUT CLAIM TO ANY PAR-  
TICULAR FONT, STYLE, SIZE, OR COLOR.

SER. NO. 85-518,490, FILED 1-17-2012.

JOHN GARTNER, EXAMINING ATTORNEY



*David J. Kyfos*

Director of the United States Patent and Trademark Office



# United States of America

United States Patent and Trademark Office

## RIVER TREE BISTRO

**Reg. No. 4,198,109**

RIVER TREE GRAINS, LLC (TEXAS LIMITED LIABILITY COMPANY)  
16350 BLANCO ROAD SUITE 103  
SAN ANTONIO, TX 78232

**Registered Aug. 28, 2012**

**Int. Cl.: 43**

FOR: RESTAURANT SERVICES, IN CLASS 43 (U.S. CLS. 100 AND 101).

**SERVICE MARK**

FIRST USE 11-16-2009; IN COMMERCE 11-16-2009.

**PRINCIPAL REGISTER**

THE MARK CONSISTS OF STANDARD CHARACTERS WITHOUT CLAIM TO ANY PARTICULAR FONT, STYLE, SIZE, OR COLOR.

NO CLAIM IS MADE TO THE EXCLUSIVE RIGHT TO USE "BISTRO", APART FROM THE MARK AS SHOWN.

SER. NO. 85-518,491, FILED 1-17-2012.

JOHN GARTNER, EXAMINING ATTORNEY



*David J. Kyffers*

Director of the United States Patent and Trademark Office

# United States of America

United States Patent and Trademark Office

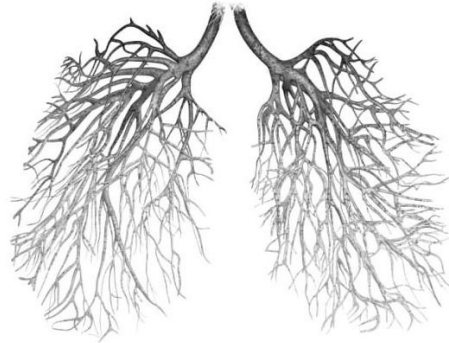

**Reg. No. 4,198,110**

**Registered Aug. 28, 2012**

**Int. Cl.: 16**

**TRADEMARK**

**PRINCIPAL REGISTER**

SUNOVION PHARMACEUTICALS INC. (DELAWARE CORPORATION)  
84 WATERFORD DRIVE  
MARLBOROUGH, MA 01752

FOR: PRINTED MATERIALS, NAMELY, BROCHURES, BOOKLETS, AND PHARMACEUTICAL INFORMATION LEAFLETS IN THE FIELD OF RESPIRATORY HEALTH AND RESPIRATORY DISEASES AND CONDITIONS, IN CLASS 16 (U.S. CLS. 2, 5, 22, 23, 29, 37, 38 AND 50).

FIRST USE 1-16-2012; IN COMMERCE 1-16-2012.

THE MARK CONSISTS OF A REPRESENTATION OF LUNGS CREATED BY A DEPICTION OF TREE ROOTS WHICH BRANCH INTO BRONCHI.

SER. NO. 85-518,515, FILED 1-17-2012.

MATTHEW PAPPAS, EXAMINING ATTORNEY



*David J. Kappas*

Director of the United States Patent and Trademark Office

# United States of America

United States Patent and Trademark Office

## THROUGHOUT THE LUNG

**Reg. No. 4,198,111**

SUNOVION PHARMACEUTICALS INC. (DELAWARE CORPORATION)

**Registered Aug. 28, 2012**

84 WATERFORD DRIVE  
MARLBOROUGH, MA 01752

**Int. Cl.: 16**

FOR: PRINTED MATERIALS, NAMELY, BROCHURES, BOOKLETS, AND PHARMACEUTICAL INFORMATION LEAFLETS IN THE FIELD OF RESPIRATORY HEALTH AND RESPIRATORY DISEASES AND CONDITIONS, IN CLASS 16 (U.S. CLS. 2, 5, 22, 23, 29, 37, 38 AND 50).

**TRADEMARK**

**PRINCIPAL REGISTER**

FIRST USE 1-16-2012; IN COMMERCE 1-16-2012.

THE MARK CONSISTS OF STANDARD CHARACTERS WITHOUT CLAIM TO ANY PARTICULAR FONT, STYLE, SIZE, OR COLOR.

SER. NO. 85-518,519, FILED 1-17-2012.

MATTHEW PAPPAS, EXAMINING ATTORNEY



*David J. Kypas*

Director of the United States Patent and Trademark Office

# United States of America

United States Patent and Trademark Office

## SHORTSTACK

**Reg. No. 4,198,112**

PANCAKE LABORATORIES, INC. (NEVADA CORPORATION)  
201 W. LIBERTY STREET, SUITE LL-1  
RENO, NV 89501

**Registered Aug. 28, 2012**

**Int. Cl.: 9**

FOR: COMPUTER SOFTWARE, NAMELY, SOFTWARE DEVELOPMENT TOOLS FOR THE CREATION AND CUSTOMIZATION OF SOCIAL MEDIA WEBPAGES AND WEBSITES , IN CLASS 9 (U.S. CLS. 21, 23, 26, 36 AND 38).

**TRADEMARK**

FIRST USE 11-1-2010; IN COMMERCE 11-1-2010.

**PRINCIPAL REGISTER**

THE MARK CONSISTS OF STANDARD CHARACTERS WITHOUT CLAIM TO ANY PARTICULAR FONT, STYLE, SIZE, OR COLOR.

SER. NO. 85-518,531, FILED 1-17-2012.

MATTHEW PAPPAS, EXAMINING ATTORNEY



*David J. Kypas*

Director of the United States Patent and Trademark Office

# United States of America

United States Patent and Trademark Office



**Reg. No. 4,198,113**

DISNEY ENTERPRISES, INC. (DELAWARE CORPORATION)  
500 SOUTH BUENA VISTA STREET  
BURBANK, CA 91521

**Registered Aug. 28, 2012**

**Int. Cl.: 16**

FOR: PRINTED MATERIALS AND PUBLICATIONS, NAMELY, COMIC BOOKS, IN CLASS 16 (U.S. CLS. 2, 5, 22, 23, 29, 37, 38 AND 50).

**TRADEMARK**

FIRST USE 3-9-2011; IN COMMERCE 3-9-2011.

**PRINCIPAL REGISTER**

THE MARK CONSISTS OF TWO CRESCENTS ENCIRCLING A SMALL CIRCLE.

SER. NO. 85-518,549, FILED 1-17-2012.

KATHERINE CHANG, EXAMINING ATTORNEY



*David J. Kybas*

Director of the United States Patent and Trademark Office

# United States of America

United States Patent and Trademark Office

## THE SANCTUARY

**Reg. No. 4,198,114**

**Registered Aug. 28, 2012**

**Int. Cl.: 35**

**SERVICE MARK**

**PRINCIPAL REGISTER**

NOEL STUDIO, INC. (INDIANA CORPORATION)  
75 N. MAIN STREET  
ZIONSVILLE, IN 46077

FOR: ART GALLERY SERVICES, IN CLASS 35 (U.S. CLS. 100, 101 AND 102).

FIRST USE 3-1-2006; IN COMMERCE 3-1-2006.

THE MARK CONSISTS OF STANDARD CHARACTERS WITHOUT CLAIM TO ANY PARTICULAR FONT, STYLE, SIZE, OR COLOR.

SER. NO. 85-518,550, FILED 1-17-2012.

AMY KELLY, EXAMINING ATTORNEY



*David J. Kyffers*

Director of the United States Patent and Trademark Office

# United States of America

United States Patent and Trademark Office

## Bitches Who Brunch

**Reg. No. 4,198,115**

**Registered Aug. 28, 2012**

**Int. Cl.: 43**

**SERVICE MARK**

**PRINCIPAL REGISTER**

BITCHES WHO BRUNCH LLC (D.C. LIMITED LIABILITY COMPANY)  
UNIT 210  
1300 N STREET NW  
WASHINGTON, DC 20005

FOR: PROVIDING ON-LINE REVIEWS OF RESTAURANTS AND HOTELS, IN CLASS 43  
(U.S. CLS. 100 AND 101).

FIRST USE 3-15-2010; IN COMMERCE 12-19-2011.

THE MARK CONSISTS OF STANDARD CHARACTERS WITHOUT CLAIM TO ANY PARTICULAR FONT, STYLE, SIZE, OR COLOR.

SER. NO. 85-518,553, FILED 1-17-2012.

AMY KELLY, EXAMINING ATTORNEY



*David J. Kyffers*

Director of the United States Patent and Trademark Office

# United States of America

United States Patent and Trademark Office

# MyWIN

**Reg. No. 4,198,116**

**Registered Aug. 28, 2012**

**Int. Cl.: 42**

**SERVICE MARK**

**PRINCIPAL REGISTER**

WEICHERT CO. (NEW JERSEY CORPORATION)  
1625 STATE ROUTE 10 EAST  
MORRIS PLAINS, NJ 07950

FOR: COMPUTER SERVICES, NAMELY, PROVIDING AN ONLINE, NON-DOWNLOADABLE SOFTWARE APPLICATION FOR USE BY OTHERS TO PROCESS, REVIEW, AND DEVELOP REPORTS ON EMPLOYEE RELOCATIONS, JOB ASSIGNMENTS, AND RELATED RELOCATION AND EXPENSE DOCUMENTATION IN REGARD TO RELOCATIONS AND JOB ASSIGNMENTS, IN CLASS 42 (U.S. CLS. 100 AND 101).

FIRST USE 11-15-2010; IN COMMERCE 11-15-2010.

THE MARK CONSISTS OF STANDARD CHARACTERS WITHOUT CLAIM TO ANY PARTICULAR FONT, STYLE, SIZE, OR COLOR.

SER. NO. 85-518,554, FILED 1-17-2012.

AMY KELLY, EXAMINING ATTORNEY



*David J. Kybas*

Director of the United States Patent and Trademark Office



# United States of America

United States Patent and Trademark Office

## NORTH STAR

**Reg. No. 4,198,117**

ATRIUM WINDOWS AND DOORS, INC. (DELAWARE CORPORATION)  
3890 WEST NORTHWEST HIGHWAY, SUITE 500  
DALLAS, TX 75220

**Registered Aug. 28, 2012**

**Int. Cls.: 6 and 19**

FOR: METAL ENTRANCE DOORS, IN CLASS 6 (U.S. CLS. 2, 12, 13, 14, 23, 25 AND 50).

**TRADEMARK**

FOR: VINYL WINDOWS, NON-METAL PATIO DOORS , IN CLASS 19 (U.S. CLS. 1, 12, 33 AND 50).

**PRINCIPAL REGISTER**

THE MARK CONSISTS OF STANDARD CHARACTERS WITHOUT CLAIM TO ANY PARTICULAR FONT, STYLE, SIZE, OR COLOR.

OWNER OF CANADA REG. NO. TMA530542, DATED 7-26-2000, EXPIRES 7-26-2015.

SER. NO. 85-518,577, FILED 1-17-2012.

ELIZABETH KAJUBI, EXAMINING ATTORNEY



*David J. Kybas*

Director of the United States Patent and Trademark Office

# United States of America

United States Patent and Trademark Office

## NATURAL AT NIGHT

**Reg. No. 4,198,118**

TOO FACED COSMETICS, LLC (DELAWARE LIMITED LIABILITY COMPANY)  
17361 ARMSTRONG AVENUE  
IRVINE, CA 92614

**Registered Aug. 28, 2012**

**Int. Cl.: 3**

FOR: COSMETICS, IN CLASS 3 (U.S. CLS. 1, 4, 6, 50, 51 AND 52).

**TRADEMARK**

FIRST USE 6-15-2011; IN COMMERCE 12-15-2011.

**PRINCIPAL REGISTER**

THE MARK CONSISTS OF STANDARD CHARACTERS WITHOUT CLAIM TO ANY PARTICULAR FONT, STYLE, SIZE, OR COLOR.

SER. NO. 85-518,612, FILED 1-17-2012.

LINDA POWELL, EXAMINING ATTORNEY



*David J. Kybas*

Director of the United States Patent and Trademark Office

# United States of America

United States Patent and Trademark Office

## SKULLEBRITIES

**Reg. No. 4,198,119**

**Registered Aug. 28, 2012**

**Int. Cl.: 16**

**TRADEMARK**

**PRINCIPAL REGISTER**

FALLEN IDOL, LLC, DBA, SKULLEBRITIES (RHODE ISLAND LIMITED LIABILITY COMPANY)  
572 SMITHFIELD ROAD, UNIT 4  
572 SMITHFIELD ROAD, U, RI 02904

FOR: ART PRINTS; GRAPHIC ART PRINTS; LITHOGRAPHIC WORKS OF ART; PRINTED ART REPRODUCTIONS; STICKERS, IN CLASS 16 (U.S. CLS. 2, 5, 22, 23, 29, 37, 38 AND 50).

FIRST USE 9-18-2009; IN COMMERCE 9-18-2009.

THE MARK CONSISTS OF STANDARD CHARACTERS WITHOUT CLAIM TO ANY PARTICULAR FONT, STYLE, SIZE, OR COLOR.

OWNER OF U.S. REG. NO. 3,827,513.

SER. NO. 85-518,618, FILED 1-17-2012.

MICHELLE DUBOIS, EXAMINING ATTORNEY



*David J. Kyffers*

Director of the United States Patent and Trademark Office

# United States of America

United States Patent and Trademark Office

## Let's Get Healthy California

**Reg. No. 4,198,120**

**Registered Aug. 28, 2012**

**Int. Cl.: 35**

**SERVICE MARK**

**PRINCIPAL REGISTER**

SEIU UNITED HEALTHCARE WORKERS WEST LOCAL 2005 (CALIFORNIA NON-PROFIT ASSOCIATION), AKA SEIU-UHW WEST  
560 THOMAS L. BERKLEY WAY  
OAKLAND, CA 94612

FOR: PROMOTING THE INTERESTS OF PEOPLE CONCERNED WITH HEALTH, COMMUNITY AND ENVIRONMENTAL SUSTAINABILITY ISSUES , IN CLASS 35 (U.S. CLS. 100, 101 AND 102).

FIRST USE 11-17-2011; IN COMMERCE 11-17-2011.

THE MARK CONSISTS OF STANDARD CHARACTERS WITHOUT CLAIM TO ANY PARTICULAR FONT, STYLE, SIZE, OR COLOR.

SER. NO. 85-518,631, FILED 1-17-2012.

NATALIE POLZER, EXAMINING ATTORNEY



*David J. Kybas*

Director of the United States Patent and Trademark Office

# United States of America

United States Patent and Trademark Office

## WEALTH YOU CAN TOUCH

**Reg. No. 4,198,121**

ATLAS GOLD GROUP (NEVADA CORPORATION)  
28015 SMYTH DRIVE  
VALENCIA, CA 91355

**Registered Aug. 28, 2012**

**Int. Cl.: 36**

FOR: FINANCIAL SERVICES, NAMELY, GOLD TRADING, IN CLASS 36 (U.S. CLS. 100, 101 AND 102).

**SERVICE MARK**

FIRST USE 8-9-1997; IN COMMERCE 8-9-1997.

**PRINCIPAL REGISTER**

THE MARK CONSISTS OF STANDARD CHARACTERS WITHOUT CLAIM TO ANY PARTICULAR FONT, STYLE, SIZE, OR COLOR.

SER. NO. 85-518,634, FILED 1-17-2012.

JOHN DWYER, EXAMINING ATTORNEY



*David J. Kyffers*

Director of the United States Patent and Trademark Office

# United States of America

United States Patent and Trademark Office



**Reg. No. 4,198,122**

ELITE SALES PROFESSIONALS, INC. (GEORGIA CORPORATION)  
2715 WINSLEY DRIVR SW, SUITE 100  
MARIETTA, GA 30064

**Registered Aug. 28, 2012**

**Int. Cl.: 35**

FOR: CONSULTING IN THE FIELD OF SALES METHODS, SALES MANAGEMENT, AND SALES IMPROVEMENT; EXECUTIVE RECRUITING SERVICES, IN CLASS 35 (U.S. CLS. 100, 101 AND 102).

**SERVICE MARK**

FIRST USE 5-5-2002; IN COMMERCE 5-5-2002.

**PRINCIPAL REGISTER**

THE MARK CONSISTS OF AN ENCIRCLED STYLIZED WOLF.

SER. NO. 85-518,640, FILED 1-17-2012.

KIMBERLY FRYE, EXAMINING ATTORNEY



*David J. Kyffers*

Director of the United States Patent and Trademark Office

# United States of America

United States Patent and Trademark Office

## SUSTAINABILITY AT WORK

**Reg. No. 4,198,123**

**Registered Aug. 28, 2012**

**Int. Cl.: 40**

**SERVICE MARK**

**PRINCIPAL REGISTER**

TRADEBE ENVIRONMENTAL SERVICES, LLC (DELAWARE LIMITED LIABILITY COMPANY)

SUITE 500  
1301 WEST 22ND ST.  
OAK BROOK, IL 60523

FOR: WASTE MANAGEMENT SERVICES, IN CLASS 40 (U.S. CLS. 100, 103 AND 106).

FIRST USE 5-0-2011; IN COMMERCE 5-0-2011.

THE MARK CONSISTS OF STANDARD CHARACTERS WITHOUT CLAIM TO ANY PARTICULAR FONT, STYLE, SIZE, OR COLOR.

SER. NO. 85-518,691, FILED 1-18-2012.

APRIL ROACH, EXAMINING ATTORNEY



*David J. Kyffers*

Director of the United States Patent and Trademark Office

# United States of America

United States Patent and Trademark Office

## DOCTOR PUNCH

**Reg. No. 4,198,124**

LAU, TED C (UNITED STATES INDIVIDUAL), DBA DOCTOR PUNCH  
10421 DEL NORTE WAY  
LOS ALAMITOS, CA 90720

**Registered Aug. 28, 2012**

**Int. Cl.: 16**

FOR: COMICS, IN CLASS 16 (U.S. CLS. 2, 5, 22, 23, 29, 37, 38 AND 50).

**TRADEMARK**

FIRST USE 1-11-2003; IN COMMERCE 10-20-2008.

**PRINCIPAL REGISTER**

THE MARK CONSISTS OF STANDARD CHARACTERS WITHOUT CLAIM TO ANY PARTICULAR FONT, STYLE, SIZE, OR COLOR.

SER. NO. 85-518,702, FILED 1-18-2012.

SANDRA BUJA, EXAMINING ATTORNEY



*David J. Kyffers*

Director of the United States Patent and Trademark Office



**United States of America**  
United States Patent and Trademark Office

# CRÄCKIES

**Reg. No. 4,198,125**

KUPCAKE'S FOODS, DIVISION OF SCENIC MEDIA, INC. (CALIFORNIA CORPORATION)  
6122 SCENIC AVE  
LOS ANGELES, CA 90068

**Registered Aug. 28, 2012**

**Int. Cl.: 30**

FOR: CRACKERS, CRISP BREADS, IN CLASS 30 (U.S. CL. 46).

**TRADEMARK**

FIRST USE 7-5-2011; IN COMMERCE 10-7-2011.

**PRINCIPAL REGISTER**

THE MARK CONSISTS OF STANDARD CHARACTERS WITHOUT CLAIM TO ANY PARTICULAR FONT, STYLE, SIZE, OR COLOR.

SER. NO. 85-518,710, FILED 1-18-2012.

LAURIE KAUFMAN, EXAMINING ATTORNEY



*David J. Kyffers*

Director of the United States Patent and Trademark Office

# United States of America

United States Patent and Trademark Office

## Restoring Lives

**Reg. No. 4,198,126**

WILSON KEHOE & WININGHAM LLC (INDIANA LIMITED LIABILITY COMPANY)  
2859 NORTH MERIDIAN STREET  
INDIANAPOLIS, IN 46208

**Registered Aug. 28, 2012**

**Int. Cl.: 45**

FOR: LEGAL SERVICES, IN CLASS 45 (U.S. CLS. 100 AND 101).

**SERVICE MARK**

FIRST USE 12-15-2010; IN COMMERCE 12-15-2010.

**PRINCIPAL REGISTER**

THE MARK CONSISTS OF STANDARD CHARACTERS WITHOUT CLAIM TO ANY PARTICULAR FONT, STYLE, SIZE, OR COLOR.

SER. NO. 85-518,749, FILED 1-18-2012.

LAURIE KAUFMAN, EXAMINING ATTORNEY



*David J. Kyffers*

Director of the United States Patent and Trademark Office

# United States of America

United States Patent and Trademark Office

## TUCKADREAM

**Reg. No. 4,198,127**

TUCKADREAM, LLC (CONNECTICUT LIMITED LIABILITY COMPANY)  
4 BURCHARD LANE  
ROWAYTON, CT 06853

**Registered Aug. 28, 2012**

**Int. Cl.: 20**

FOR: PILLOWS; PILLOWS WITH POCKETS FOR STORING NOTES AND OTHER MATERIALS, IN CLASS 20 (U.S. CLS. 2, 13, 22, 25, 32 AND 50).

**TRADEMARK**

FIRST USE 6-13-2011; IN COMMERCE 6-13-2011.

**PRINCIPAL REGISTER**

THE MARK CONSISTS OF STANDARD CHARACTERS WITHOUT CLAIM TO ANY PARTICULAR FONT, STYLE, SIZE, OR COLOR.

SER. NO. 85-518,781, FILED 1-18-2012.

SUNG IN, EXAMINING ATTORNEY



*David J. Kyfos*

Director of the United States Patent and Trademark Office

# United States of America

United States Patent and Trademark Office

# RAVALIA'S

**Reg. No. 4,198,128**

RAVALIA'S INTERNATIONAL LLC (FLORIDA LIMITED LIABILITY COMPANY)  
704 FOX VALLEY DRIVE  
LONGWOOD, FL 32779

**Registered Aug. 28, 2012**

**Int. Cl.: 43**

FOR: RESTAURANT SERVICES, IN CLASS 43 (U.S. CLS. 100 AND 101).

**SERVICE MARK**

FIRST USE 9-15-2011; IN COMMERCE 9-15-2011.

**PRINCIPAL REGISTER**

THE MARK CONSISTS OF STANDARD CHARACTERS WITHOUT CLAIM TO ANY PARTICULAR FONT, STYLE, SIZE, OR COLOR.

SER. NO. 85-518,789, FILED 1-18-2012.

SUNG IN, EXAMINING ATTORNEY



*David J. Kyfos*

Director of the United States Patent and Trademark Office

# United States of America

United States Patent and Trademark Office

## Infogix Perceive

**Reg. No. 4,198,129**

INFOGIX, INC. (DELAWARE CORPORATION)  
1240 E. DIEHL ROAD, SUITE 400  
NAPERVILLE, IL 60563

**Registered Aug. 28, 2012**

**Int. Cl.: 9**

FOR: COMPUTER SOFTWARE PLATFORMS FOR ENTERPRISE REPORTING WITHIN OTHER COMPUTER SOFTWARE AND COMPUTER SYSTEMS TO REPORT ON INACCURATE, INCONSISTENT, AND INCOMPLETE INFORMATION, AS WELL AS THE MANUALS DISTRIBUTED THEREWITH, IN CLASS 9 (U.S. CLS. 21, 23, 26, 36 AND 38).

**TRADEMARK**

**PRINCIPAL REGISTER**

FIRST USE 1-1-2010; IN COMMERCE 1-1-2010.

THE MARK CONSISTS OF STANDARD CHARACTERS WITHOUT CLAIM TO ANY PARTICULAR FONT, STYLE, SIZE, OR COLOR.

OWNER OF U.S. REG. NOS. 3,152,257, 3,498,547 AND OTHERS.

SER. NO. 85-518,794, FILED 1-18-2012.

ANDREA K. NADELMAN, EXAMINING ATTORNEY



*David J. Kyros*

Director of the United States Patent and Trademark Office

# United States of America

United States Patent and Trademark Office

## POSITIVE THOUGHTS, POSITIVE DREAMS

**Reg. No. 4,198,130**

TUCKADREAM, LLC (CONNECTICUT LIMITED LIABILITY COMPANY)  
4 BURCHARD LANE  
ROWAYTON, CT 06853

**Registered Aug. 28, 2012**

**Int. Cl.: 20**

FOR: PILLOWS; PILLOWS WITH POCKETS FOR STORING NOTES AND OTHER MATERIALS, IN CLASS 20 (U.S. CLS. 2, 13, 22, 25, 32 AND 50).

**TRADEMARK**

FIRST USE 6-13-2011; IN COMMERCE 6-13-2011.

**PRINCIPAL REGISTER**

THE MARK CONSISTS OF STANDARD CHARACTERS WITHOUT CLAIM TO ANY PARTICULAR FONT, STYLE, SIZE, OR COLOR.

SER. NO. 85-518,797, FILED 1-18-2012.

SUNG IN, EXAMINING ATTORNEY



*David J. Kyffers*

Director of the United States Patent and Trademark Office

# United States of America

United States Patent and Trademark Office

## DIZZY WHIZZ

**Reg. No. 4,198,131**

DIZZY WHIZZ, INC. (KENTUCKY CORPORATION)  
217 W. ST. CATHERINE ST.  
LOUISVILLE, KY 40203

**Registered Aug. 28, 2012**

**Int. Cl.: 43**

FOR: RESTAURANT SERVICES, IN CLASS 43 (U.S. CLS. 100 AND 101).

**SERVICE MARK**

FIRST USE 12-31-1947; IN COMMERCE 12-31-1947.

**PRINCIPAL REGISTER**

THE MARK CONSISTS OF STANDARD CHARACTERS WITHOUT CLAIM TO ANY PARTICULAR FONT, STYLE, SIZE, OR COLOR.

SER. NO. 85-518,810, FILED 1-18-2012.

SETH A. RAPPAPORT, EXAMINING ATTORNEY



*David J. Kyffers*

Director of the United States Patent and Trademark Office

# United States of America

United States Patent and Trademark Office

# KGfit

**Reg. No. 4,198,132**

**Registered Aug. 28, 2012**

**Int. Cl.: 41**

**SERVICE MARK**

**PRINCIPAL REGISTER**

GRUNING, KAJ (FED REP GERMANY INDIVIDUAL)  
#9202  
5125 PALM SPRINGS BLVD.  
TAMPA, FL 33647

FOR: LIFE COACHING SERVICES IN THE FIELD OF FITNESS; PERSONAL TRAINER SERVICES; PERSONAL TRAINING PROVIDED IN CONNECTION WITH WEIGHT LOSS AND EXERCISE PROGRAMS; PHYSICAL FITNESS CONSULTATION, IN CLASS 41 (U.S. CLS. 100, 101 AND 107).

FIRST USE 1-1-2011; IN COMMERCE 10-1-2011.

THE MARK CONSISTS OF STANDARD CHARACTERS WITHOUT CLAIM TO ANY PARTICULAR FONT, STYLE, SIZE, OR COLOR.

SER. NO. 85-518,822, FILED 1-18-2012.

COURTNEY ALVAREZ, EXAMINING ATTORNEY



*David J. Kybas*

Director of the United States Patent and Trademark Office



# United States of America

United States Patent and Trademark Office

## You Speak We Listen Report Cards

**Reg. No. 4,198,133**

CLEAN COUNTRY, INC. (MINNESOTA CORPORATION)  
14126 WEST CENTER ROAD  
OMAHA, NE 68144

**Registered Aug. 28, 2012**

**Int. Cl.: 37**

FOR: JANITORIAL SERVICES, IN CLASS 37 (U.S. CLS. 100, 103 AND 106).

**SERVICE MARK**

FIRST USE 11-11-2011; IN COMMERCE 11-11-2011.

**PRINCIPAL REGISTER**

THE MARK CONSISTS OF STANDARD CHARACTERS WITHOUT CLAIM TO ANY PARTICULAR FONT, STYLE, SIZE, OR COLOR.

SER. NO. 85-518,842, FILED 1-18-2012.

THEODORE MCBRIDE, EXAMINING ATTORNEY



*David J. Kyffers*

Director of the United States Patent and Trademark Office

# United States of America

United States Patent and Trademark Office

# CARIVIN

**Reg. No. 4,198,134**

**Registered Aug. 28, 2012**

**Int. Cl.: 33**

**TRADEMARK**

**PRINCIPAL REGISTER**

T & BEER, INC (NEW YORK CORPORATION), DBA SIMONE INTERNATIONAL  
136 WILLOW DRIVE  
OLD TAPPAN, NJ 07675

FOR: WINE, IN CLASS 33 (U.S. CLS. 47 AND 49).

FIRST USE 2-26-2009; IN COMMERCE 2-26-2009.

THE MARK CONSISTS OF STANDARD CHARACTERS WITHOUT CLAIM TO ANY PARTICULAR FONT, STYLE, SIZE, OR COLOR.

SER. NO. 85-518,851, FILED 1-18-2012.

THEODORE MCBRIDE, EXAMINING ATTORNEY



*David J. Kybas*

Director of the United States Patent and Trademark Office

# United States of America

United States Patent and Trademark Office

## LET'S INNOVATE

**Reg. No. 4,198,135**

**Registered Aug. 28, 2012**

**Int. Cl.: 42**

**SERVICE MARK**

**PRINCIPAL REGISTER**

SUMMIT CONSULTING GROUP, INC. (MARYLAND CORPORATION), DBA SUMMIT  
GLOBAL TESTING  
138 MAIN STREET, 2ND FLOOR  
ANNAPOLIS, MD 21401

FOR: DESIGN, DEVELOPMENT AND IMPLEMENTATION OF SOFTWARE, HARDWARE  
AND TECHNOLOGY SOLUTIONS, AND CONSULTING SERVICES RELATED THERETO,  
IN THE FIELD OF COMPUTER-BASED EDUCATIONAL AND STANDARDIZED TESTING,  
IN CLASS 42 (U.S. CLS. 100 AND 101).

FIRST USE 12-15-2011; IN COMMERCE 12-15-2011.

THE MARK CONSISTS OF STANDARD CHARACTERS WITHOUT CLAIM TO ANY PAR-  
TICULAR FONT, STYLE, SIZE, OR COLOR.

SER. NO. 85-518,863, FILED 1-18-2012.

THEODORE MCBRIDE, EXAMINING ATTORNEY



*David J. Kyffers*

Director of the United States Patent and Trademark Office

# United States of America

United States Patent and Trademark Office

## ON SIGHT FILMS

**Reg. No. 4,198,136**

JOSEPH ERIC BREFO-SARPONG (UNITED STATES INDIVIDUAL)  
2360 FIRST AVENUE - SUITE 16G  
NEW YORK, NY 10035

**Registered Aug. 28, 2012**

**Int. Cl.: 41**

FOR: PRODUCTION AND DISTRIBUTION OF MOTION PICTURES, IN CLASS 41 (U.S. CLS. 100, 101 AND 107).

**SERVICE MARK**

FIRST USE 6-1-2011; IN COMMERCE 6-1-2011.

**PRINCIPAL REGISTER**

THE MARK CONSISTS OF STANDARD CHARACTERS WITHOUT CLAIM TO ANY PARTICULAR FONT, STYLE, SIZE, OR COLOR.

NO CLAIM IS MADE TO THE EXCLUSIVE RIGHT TO USE "FILMS", APART FROM THE MARK AS SHOWN.

SER. NO. 85-518,906, FILED 1-18-2012.

KATHLEEN LORENZO, EXAMINING ATTORNEY



*David J. Kyffers*

Director of the United States Patent and Trademark Office

# United States of America

United States Patent and Trademark Office

*Dynamic*  *Marriage II*

**Reg. No. 4,198,137**

**Registered Aug. 28, 2012**

**Int. Cl.: 41**

FAMILY DYNAMICS INSTITUTE, INC. (GEORGIA CORPORATION), AKA FAMILY DYNAMICS  
SUITE 316  
318 SEABOARD LANE  
FRANKLIN, TN 37067

**SERVICE MARK**

**PRINCIPAL REGISTER**

FOR: EDUCATION AND TRAINING SERVICES, NAMELY, PROVIDING SEMINARS, CLASSES AND WORKSHOPS REGARDING TROUBLED MARRIAGES AND FAMILY INTERACTION SOCIAL SKILLS, AND DISTRIBUTING COURSE MATERIAL IN CONNECTION THEREWITH; EDUCATION AND TRAINING SERVICES FOR FACILITATORS THAT WILL PROVIDE SEMINARS, CLASSES AND WORKSHOPS REGARDING TROUBLED MARRIAGES AND FAMILY INTERACTION SOCIAL SKILLS, AND DISTRIBUTING COURSE MATERIAL IN CONNECTION THEREWITH, IN CLASS 41 (U.S. CLS. 100, 101 AND 107).

FIRST USE 4-29-2010, THE MARK WAS FIRST USED ANYWHERE IN A DIFFERENT FORM OTHER THAN THAT SOUGHT TO BE REGISTERED AT LEAST AS EARLY AS 09/13/2006. ; IN COMMERCE 6-2-2010, THE MARK WAS FIRST USED IN COMMERCE IN A DIFFERENT FORM OTHER THAN THAT SOUGHT TO BE REGISTERED AT LEAST AS EARLY AS 09/13/2006..

OWNER OF U.S. REG. NO. 4,066,188.

NO CLAIM IS MADE TO THE EXCLUSIVE RIGHT TO USE "MARRIAGE II", APART FROM THE MARK AS SHOWN.

THE MARK CONSISTS OF THE STYLIZED WORDING "DYNAMIC MARRIAGE II" WITH TWO OVERLAID WEDDING BANDS PLACED BETWEEN THE WORDS "DYNAMIC" AND "MARRIAGE".

SER. NO. 85-518,908, FILED 1-18-2012.

LINDA POWELL, EXAMINING ATTORNEY



*David J. Kyffers*

Director of the United States Patent and Trademark Office

# United States of America

United States Patent and Trademark Office

## Doing a world of good.

**Reg. No. 4,198,138**

**Registered Aug. 28, 2012**

**Int. Cls.: 36 and 41**

**SERVICE MARK**

**PRINCIPAL REGISTER**

THE JEWISH FEDERATIONS OF NORTH AMERICA, INC. (NEW YORK CORPORATION)  
25 BROADWAY  
NEW YORK, NY 10004

FOR: CHARITABLE FUND RAISING SERVICES; CHARITABLE FUND RAISING SERVICES IN VIEW OF DISASTER PRECAUTIONS AND PREVENTION; PHILANTHROPIC SERVICES CONSISTING OF MONETARY DONATIONS; PROVIDING EDUCATIONAL SCHOLARSHIPS; PROVIDING INTERACTIVE WEB SITES CONTAINING INFORMATION RELATED TO THE FOREGOING SERVICES; AND FINANCIAL PLANNING, IN CLASS 36 (U.S. CLS. 100, 101 AND 102).

FIRST USE 5-1-2011; IN COMMERCE 5-1-2011.

FOR: EDUCATIONAL SERVICES, NAMELY, CONDUCTING SEMINARS, COURSES AND PROGRAMS IN THE FIELDS OF ART, HISTORY, JEWISH CULTURE AND FINANCES TO ASSIST LOCAL COMMUNITIES IN BUILDING, STRENGTHENING AND MAINTAINING THE CONTINUITY OF JEWISH LIFE, IN CLASS 41 (U.S. CLS. 100, 101 AND 107).

FIRST USE 5-1-2011; IN COMMERCE 5-1-2011.

THE MARK CONSISTS OF STANDARD CHARACTERS WITHOUT CLAIM TO ANY PARTICULAR FONT, STYLE, SIZE, OR COLOR.

OWNER OF U.S. REG. NO. 3,153,184.

SER. NO. 85-518,922, FILED 1-18-2012.

GEOFFREY FOSDICK, EXAMINING ATTORNEY



*David J. Kyffers*

Director of the United States Patent and Trademark Office

# United States of America

United States Patent and Trademark Office

# Mamacon

**Reg. No. 4,198,139**

**Registered Aug. 28, 2012**

**Int. Cl.: 41**

**SERVICE MARK**

**PRINCIPAL REGISTER**

MAMACON, LLC (WASHINGTON LIMITED LIABILITY COMPANY)  
#123  
15127 NE 24TH ST  
REDMOND, WA 98052

FOR: EDUCATIONAL SERVICES, NAMELY, CONDUCTING CONFERENCES AND EVENTS FOR PROVIDING MOTHERS WITH PARENTING DEVELOPMENT AND EDUCATION, IN CLASS 41 (U.S. CLS. 100, 101 AND 107).

FIRST USE 9-1-2011; IN COMMERCE 9-1-2011.

THE MARK CONSISTS OF STANDARD CHARACTERS WITHOUT CLAIM TO ANY PARTICULAR FONT, STYLE, SIZE, OR COLOR.

SER. NO. 85-518,933, FILED 1-18-2012.

MARK SHINER, EXAMINING ATTORNEY



*David J. Kyffers*

Director of the United States Patent and Trademark Office

# United States of America

United States Patent and Trademark Office

# Infogix Nexix

**Reg. No. 4,198,140**

INFOGIX, INC. (DELAWARE CORPORATION)

**Registered Aug. 28, 2012**

1240 E. DIEHL ROAD, SUITE 400  
NAPERVILLE, IL 60563

**Int. Cl.: 9**

FOR: COMPUTER SOFTWARE PLATFORMS FOR MONITORING, REPORTING, AND MODELING INFORMATION WITHIN OTHER COMPUTER SOFTWARE AND COMPUTER SYSTEMS TO DETECT AND REPORT ON INACCURATE, INCONSISTENT, AND INCOMPLETE INFORMATION, AS WELL AS THE MANUALS DISTRIBUTED THEREWITH, IN CLASS 9 (U.S. CLS. 21, 23, 26, 36 AND 38).

**TRADEMARK**

**PRINCIPAL REGISTER**

FIRST USE 6-1-2010; IN COMMERCE 6-1-2010.

THE MARK CONSISTS OF STANDARD CHARACTERS WITHOUT CLAIM TO ANY PARTICULAR FONT, STYLE, SIZE, OR COLOR.

OWNER OF U.S. REG. NOS. 3,152,257, 3,498,547 AND OTHERS.

SER. NO. 85-518,965, FILED 1-18-2012.

ANDREA K. NADELMAN, EXAMINING ATTORNEY



*David J. Kyffers*

Director of the United States Patent and Trademark Office



# United States of America

United States Patent and Trademark Office

## Glamorously Healthy

**Reg. No. 4,198,141**

RUMPH, ANTHONY (UNITED STATES INDIVIDUAL)  
1333 HARVARD STREET #36  
SANTA MONICA, CA 90404

**Registered Aug. 28, 2012**

**Int. Cl.: 44**

FOR: PROVIDING A WEBSITE FEATURING INFORMATION ABOUT HEALTH, WELLNESS AND NUTRITION, IN CLASS 44 (U.S. CLS. 100 AND 101).

**SERVICE MARK**

FIRST USE 3-1-2010; IN COMMERCE 3-1-2010.

**PRINCIPAL REGISTER**

THE MARK CONSISTS OF STANDARD CHARACTERS WITHOUT CLAIM TO ANY PARTICULAR FONT, STYLE, SIZE, OR COLOR.

SER. NO. 85-518,977, FILED 1-18-2012.

ANNE E. GUSTASON, EXAMINING ATTORNEY



*David J. Kybas*

Director of the United States Patent and Trademark Office

# United States of America

United States Patent and Trademark Office

## ARMORED HAWK

**Reg. No. 4,198,142**

ARMORED HAWK CORPORATION (CALIFORNIA CORPORATION)  
8775 COSTA VERDE BOULEVARD SUITE 113  
SAN DIEGO, CA 921225339

**Registered Aug. 28, 2012**

**Int. Cl.: 42**

FOR: DESIGN AND DEVELOPMENT OF COMPUTER HARDWARE AND SOFTWARE, IN CLASS 42 (U.S. CLS. 100 AND 101).

**SERVICE MARK**

FIRST USE 8-10-2011; IN COMMERCE 8-10-2011.

**PRINCIPAL REGISTER**

THE MARK CONSISTS OF STANDARD CHARACTERS WITHOUT CLAIM TO ANY PARTICULAR FONT, STYLE, SIZE, OR COLOR.

SER. NO. 85-518,989, FILED 1-18-2012.

CHRISTOPHER LAW, EXAMINING ATTORNEY



*David J. Kybas*

Director of the United States Patent and Trademark Office

# United States of America

United States Patent and Trademark Office



**Reg. No. 4,198,143**

ERIK OSBERG (UNITED STATES INDIVIDUAL), DBA WHISKEY CREEK PRODUCTION  
512 IRVING AVE SW  
WADENA, MN 56482

**Registered Aug. 28, 2012**

**Int. Cl.: 41**

FOR: PROVIDING INFORMATION, NEWS AND COMMENTARY IN THE FIELD OF RECREATION AND LEISURE ACTIVITIES, IN CLASS 41 (U.S. CLS. 100, 101 AND 107).

**SERVICE MARK**

FIRST USE 8-1-2011; IN COMMERCE 8-1-2011.

**PRINCIPAL REGISTER**

NO CLAIM IS MADE TO THE EXCLUSIVE RIGHT TO USE "OUTDOOR REPORT", APART FROM THE MARK AS SHOWN.

THE COLOR(S) BLUE, GREEN, AND WHITE IS/ARE CLAIMED AS A FEATURE OF THE MARK.

THE MARK CONSISTS OF THE WORDS "THE OUTDOOR REPORT" WITH "OUTDOOR" IN GREEN LETTERS WITH A WHITE SHADOW AND "REPORT" IN BLUE LETTERS WITH A WHITE SHADOW. THE "O" IN "OUTDOOR" HAS RIFLE SCOPE CROSSHAIRS IN IT AND THE TAIL OF THE "R" IN "REPORT" IS SHAPED LIKE A FISH HOOK.

SER. NO. 85-519,000, FILED 1-18-2012.

IRA J. GOODSaid, EXAMINING ATTORNEY



*David J. Kyffers*

Director of the United States Patent and Trademark Office

# United States of America

United States Patent and Trademark Office

## FOOTHILL FARMS

**Reg. No. 4,198,144**

PRECISION FOODS, INC. (IOWA CORPORATION)  
11457 OLDE CABIN ROAD  
ST. LOUIS, MO 63141

**Registered Aug. 28, 2012**

**Int. Cl.: 30**

FOR: SALAD DRESSINGS, SALAD DRESSING MIXES, SAUCE MIXES AND SEASONING MIXES, IN CLASS 30 (U.S. CL. 46).

**TRADEMARK**

FIRST USE 9-1-1984; IN COMMERCE 9-1-1984.

**PRINCIPAL REGISTER**

THE MARK CONSISTS OF STANDARD CHARACTERS WITHOUT CLAIM TO ANY PARTICULAR FONT, STYLE, SIZE, OR COLOR.

SER. NO. 85-519,033, FILED 1-18-2012.

KELLY TRUSILO, EXAMINING ATTORNEY



*David J. Kybas*

Director of the United States Patent and Trademark Office

# United States of America

United States Patent and Trademark Office

# NORTHCAPE

**Reg. No. 4,198,145**

**Registered Aug. 28, 2012**

**Int. Cls.: 20 and 35**

**TRADEMARK**

**SERVICE MARK**

**PRINCIPAL REGISTER**

CHICAGO WICKER & TRADING COMPANY (ILLINOIS CORPORATION)  
5151 WEST 73RD STREET, SUITE B  
BEDFORD PARK, IL 60638

FOR: FURNITURE, IN CLASS 20 (U.S. CLS. 2, 13, 22, 25, 32 AND 50).

FIRST USE 1-0-2009; IN COMMERCE 1-0-2009.

FOR: WHOLESALE DISTRIBUTORSHIPS FEATURING FURNITURE, IN CLASS 35 (U.S. CLS. 100, 101 AND 102).

FIRST USE 1-0-2009; IN COMMERCE 1-0-2009.

THE MARK CONSISTS OF STANDARD CHARACTERS WITHOUT CLAIM TO ANY PARTICULAR FONT, STYLE, SIZE, OR COLOR.

OWNER OF U.S. REG. NOS. 3,189,187 AND 3,189,188.

SER. NO. 85-519,041, FILED 1-18-2012.

WILLIAM P. SHANAHAN, EXAMINING ATTORNEY



*David J. Kyffers*

Director of the United States Patent and Trademark Office

# United States of America

United States Patent and Trademark Office

# WDFX

**Reg. No. 4,198,146**

**Registered Aug. 28, 2012**

**Int. Cl.: 38**

**SERVICE MARK**

**PRINCIPAL REGISTER**

RAYCOM MEDIA, INC. (DELAWARE CORPORATION)  
RSA TOWER 20TH FLOOR  
201 MONROE STREET  
MONTGOMERY, AL 36104

FOR: TELEVISION BROADCASTING SERVICES, IN CLASS 38 (U.S. CLS. 100, 101 AND 104).

FIRST USE 8-31-1995; IN COMMERCE 8-31-1995.

THE MARK CONSISTS OF STANDARD CHARACTERS WITHOUT CLAIM TO ANY PARTICULAR FONT, STYLE, SIZE, OR COLOR.

SER. NO. 85-519,044, FILED 1-18-2012.

CHRISTOPHER SIDOTI, EXAMINING ATTORNEY



*David J. Kybas*

Director of the United States Patent and Trademark Office

# United States of America

United States Patent and Trademark Office

## One Billion Care

**Reg. No. 4,198,147**

HEART FOR THE WORLD MINISTRIES, INC. (TEXAS NON-PROFIT CORPORATION)  
2118 GRANT AVENUE  
EL PASO, TX 79930

**Registered Aug. 28, 2012**

**Int. Cl.: 36**

FOR: CHARITABLE FUNDRAISING, IN CLASS 36 (U.S. CLS. 100, 101 AND 102).

**SERVICE MARK**

FIRST USE 7-0-2011; IN COMMERCE 7-0-2011.

**PRINCIPAL REGISTER**

THE MARK CONSISTS OF STANDARD CHARACTERS WITHOUT CLAIM TO ANY PARTICULAR FONT, STYLE, SIZE, OR COLOR.

SER. NO. 85-519,058, FILED 1-18-2012.

PAM WILLIS, EXAMINING ATTORNEY



*David J. Kyffers*

Director of the United States Patent and Trademark Office

# United States of America

United States Patent and Trademark Office

# PERRY'S

**Reg. No. 4,198,148**

APB ENTERPRISES, INC. (CALIFORNIA CORPORATION)  
1944 UNION STREET  
SAN FRANCISCO, CA 94123

**Registered Aug. 28, 2012**

**Int. Cl.: 43**

FOR: RESTAURANT, BAR AND CATERING SERVICES, IN CLASS 43 (U.S. CLS. 100 AND 101).

**SERVICE MARK**

FIRST USE 8-20-1990; IN COMMERCE 8-20-1990.

**PRINCIPAL REGISTER**

THE MARK CONSISTS OF THE WORD "PERRY'S" IN STYLIZED LETTERS.

SER. NO. 85-519,100, FILED 1-18-2012.

BRIAN PINO, EXAMINING ATTORNEY



*David J. Kyros*

Director of the United States Patent and Trademark Office



# United States of America

United States Patent and Trademark Office



**Reg. No. 4,198,149**

**Registered Aug. 28, 2012**

**Int. Cl.: 43**

**SERVICE MARK**

**PRINCIPAL REGISTER**

APB ENTERPRISES, INC. (CALIFORNIA CORPORATION)  
1944 UNION STREET  
SAN FRANCISCO, CA 94123

FOR: RESTAURANT, BAR AND CATERING SERVICES, IN CLASS 43 (U.S. CLS. 100 AND 101).

FIRST USE 8-20-1990; IN COMMERCE 8-20-1990.

THE MARK CONSISTS OF DESIGN CONSISTING OF CIRCLE ENCOMPASSING HAND HOLDING TRAY OF FOOD AND WINE WITH A BOTTOM BORDER CONSISTING OF STYLIZED WORD "PERRY'S".

SER. NO. 85-519,109, FILED 1-18-2012.

BRIAN PINO, EXAMINING ATTORNEY



*David J. Kyffers*

Director of the United States Patent and Trademark Office

# United States of America

United States Patent and Trademark Office

## LUKE BRYAN

**Reg. No. 4,198,150**

**Registered Aug. 28, 2012**

**Int. Cl.: 25**

**TRADEMARK**

**PRINCIPAL REGISTER**

BRYAN, THOMAS LUTHER (UNITED STATES INDIVIDUAL), AKA LUKE BRYAN  
C/O MILOM HORSNELL CROW ROSE KELLEY PLC  
3310 WEST END AVENUE, SUITE 610  
NASHVILLE, TN 37203

FOR: CAPS; HATS; HEADWEAR; CASUAL CLOTHING, NAMELY, TOPS FOR MEN AND WOMEN; SHIRTS; T-SHIRTS, IN CLASS 25 (U.S. CLS. 22 AND 39).

FIRST USE 11-18-2005; IN COMMERCE 11-18-2005.

THE MARK CONSISTS OF STANDARD CHARACTERS WITHOUT CLAIM TO ANY PARTICULAR FONT, STYLE, SIZE, OR COLOR.

THE NAME(S), PORTRAIT(S), AND/OR SIGNATURE(S) SHOWN IN THE MARK IDENTIFIES THOMAS LUTHER BRYAN, P/K/A LUKE BRYAN, WHOSE CONSENT(S) TO REGISTER IS MADE OF RECORD.

SER. NO. 85-519,113, FILED 1-18-2012.

CHRISTINA SOBRAL, EXAMINING ATTORNEY



*David J. Kybas*

Director of the United States Patent and Trademark Office

# United States of America

United States Patent and Trademark Office

## KIDS CAPS & CASH

**Reg. No. 4,198,151**

DEAN FOODS COMPANY (DELAWARE CORPORATION)  
2711 NORTH HASKELL AVENUE, SUITE 3400  
DALLAS, TX 75204

**Registered Aug. 28, 2012**

**Int. Cl.: 29**

FOR: DAIRY PRODUCTS EXCLUDING ICE CREAM, ICE MILK AND FROZEN YOGURT,  
IN CLASS 29 (U.S. CL. 46).

**TRADEMARK**

FIRST USE 10-23-2003; IN COMMERCE 10-25-2003.

**PRINCIPAL REGISTER**

THE MARK CONSISTS OF STANDARD CHARACTERS WITHOUT CLAIM TO ANY PAR-  
TICULAR FONT, STYLE, SIZE, OR COLOR.

SER. NO. 85-519,126, FILED 1-18-2012.

MEGHAN REINHART, EXAMINING ATTORNEY



*David J. Kybas*

Director of the United States Patent and Trademark Office

# United States of America

United States Patent and Trademark Office

## LUKE BRYAN

**Reg. No. 4,198,152**

**Registered Aug. 28, 2012**

**Int. Cl.: 41**

**SERVICE MARK**

**PRINCIPAL REGISTER**

BRYAN, THOMAS LUTHER (UNITED STATES INDIVIDUAL), AKA LUKE BRYAN  
C/O MILOM HORSNELL CROW ROSE KELLEY PLC  
3310 WEST END AVENUE, SUITE 610  
NASHVILLE, TN 37203

FOR: ENTERTAINMENT SERVICES IN THE NATURE OF LIVE MUSICAL PERFORMANCES;  
ENTERTAINMENT, NAMELY, LIVE MUSIC CONCERTS; ENTERTAINMENT, NAMELY,  
LIVE STAGE PERFORMANCES AND PUBLIC APPEARANCES BY A MUSICAL ARTIST,  
IN CLASS 41 (U.S. CLS. 100, 101 AND 107).

FIRST USE 0-0-1995; IN COMMERCE 0-0-1995.

THE MARK CONSISTS OF STANDARD CHARACTERS WITHOUT CLAIM TO ANY PAR-  
TICULAR FONT, STYLE, SIZE, OR COLOR.

THE NAME(S), PORTRAIT(S), AND/OR SIGNATURE(S) SHOWN IN THE MARK IDENTIFIES  
THOMAS LUTHER BRYAN, P/K/A "LUKE BRYAN", WHOSE CONSENT(S) TO REGISTER  
IS MADE OF RECORD.

SER. NO. 85-519,130, FILED 1-18-2012.

CHRISTINA SOBRAL, EXAMINING ATTORNEY



*David J. Kybas*

Director of the United States Patent and Trademark Office

# United States of America

United States Patent and Trademark Office

# MORE BEER

**Reg. No. 4,198,153**

COULTAS, CONRAD H. (UNITED STATES INDIVIDUAL)  
9630 WILLOW LANE  
MOKENA, IL 60448

**Registered Aug. 28, 2012**

**Int. Cl.: 25**

FOR: CLOTHING NAMELY SHIRTS, HATS, SHORTS, T-SHIRTS, SWEATSHIRTS, SWEATERS, PANTS, IN CLASS 25 (U.S. CLS. 22 AND 39).

**TRADEMARK**

FIRST USE 6-0-1986; IN COMMERCE 6-0-1986.

**PRINCIPAL REGISTER**

THE MARK CONSISTS OF STANDARD CHARACTERS WITHOUT CLAIM TO ANY PARTICULAR FONT, STYLE, SIZE, OR COLOR.

SER. NO. 85-519,137, FILED 1-18-2012.

JULIE VEPPUMTHARA, EXAMINING ATTORNEY



*David J. Kybas*

Director of the United States Patent and Trademark Office

# United States of America

United States Patent and Trademark Office

# LBTV

**Reg. No. 4,198,154**

**Registered Aug. 28, 2012**

**Int. Cl.: 41**

**SERVICE MARK**

**PRINCIPAL REGISTER**

BRYAN, THOMAS LUTHER (UNITED STATES INDIVIDUAL), AKA LUKE BRYAN  
C/O MILOM HORSNELL CROW ROSE KELLEY PLC  
3310 WEST END AVENUE, SUITE 610  
NASHVILLE, TN 37203

FOR: PROVIDING NON-DOWNLOADABLE VIDEOS AND AUDIO-VISUAL CONTENT IN THE FIELDS OF ENTERTAINMENT, MUSIC, AND MUSICAL ENTERTAINMENT VIA ELECTRONIC COMMUNICATIONS, TELEPHONE COMMUNICATIONS AND DIGITAL TRANSMISSION; PROVIDING NON-DOWNLOADABLE ON-GOING WEBISODES IN THE FIELDS OF ENTERTAINMENT, MUSIC, AND MUSICAL ENTERTAINMENT VIA ELECTRONIC COMMUNICATIONS, TELEPHONE COMMUNICATIONS AND DIGITAL TRANSMISSION, IN CLASS 41 (U.S. CLS. 100, 101 AND 107).

FIRST USE 8-5-2008; IN COMMERCE 8-5-2008.

THE MARK CONSISTS OF STANDARD CHARACTERS WITHOUT CLAIM TO ANY PARTICULAR FONT, STYLE, SIZE, OR COLOR.

SER. NO. 85-519,138, FILED 1-18-2012.

CHRISTINA SOBRAL, EXAMINING ATTORNEY



*David J. Kypos*

Director of the United States Patent and Trademark Office

# United States of America

United States Patent and Trademark Office

## METAPLAYER

**Reg. No. 4,198,155**

**Registered Aug. 28, 2012**

**Int. Cl.: 42**

**SERVICE MARK**

**PRINCIPAL REGISTER**

RAMP HOLDINGS INC. (DELAWARE CORPORATION)  
27 WORMWOOD STREET  
BOSTON, MA 02210

FOR: PROVIDING TEMPORARY USE OF NON-DOWNLOADABLE SOFTWARE FOR VIEWING AUDIO AND VIDEO CONTENT, ADVERTISEMENTS, AND RELATED INFORMATION; PROVIDING TEMPORARY USE OF NON-DOWNLOADABLE SOFTWARE FOR SEARCHING AUDIO AND VIDEO CONTENT, AND FOR FINDING AND VIEWING RELATED CONTENT, IN CLASS 42 (U.S. CLS. 100 AND 101).

FIRST USE 10-22-2008; IN COMMERCE 10-22-2008.

THE MARK CONSISTS OF STANDARD CHARACTERS WITHOUT CLAIM TO ANY PARTICULAR FONT, STYLE, SIZE, OR COLOR.

SER. NO. 85-519,174, FILED 1-18-2012.

ELLEN B. AWRICH, EXAMINING ATTORNEY



*David J. Kyffers*

Director of the United States Patent and Trademark Office

# United States of America

United States Patent and Trademark Office

## DOES THIS TASTE FUNNY TO YOU?

**Reg. No. 4,198,156**

MCMANN, TATE & STEVENS, LLC (NORTH CAROLINA LIMITED LIABILITY COMPANY)  
1009 D HUNTING RIDGE RD.

**Registered Aug. 28, 2012**

RALEIGH, NC 27615

**Int. Cl.: 41**

FOR: ENTERTAINMENT SERVICES, NAMELY, AN ON-GOING SERIES FEATURING A COOKING SHOW PROVIDED THROUGH TELEVISION, SATELLITE AND INTERNET; ENTERTAINMENT SERVICES, NAMELY, PROVIDING ON-GOING TELEVISION PROGRAMS IN THE FIELD OF COOKING VIA A GLOBAL COMPUTER NETWORK; ENTERTAINMENT, NAMELY, A CONTINUING COOKING SHOW BROADCAST OVER TELEVISION, SATELLITE, AUDIO, AND VIDEO MEDIA, IN CLASS 41 (U.S. CLS. 100, 101 AND 107).

**SERVICE MARK**

**PRINCIPAL REGISTER**

FIRST USE 11-0-2009; IN COMMERCE 11-0-2009.

THE MARK CONSISTS OF STANDARD CHARACTERS WITHOUT CLAIM TO ANY PARTICULAR FONT, STYLE, SIZE, OR COLOR.

SER. NO. 85-519,207, FILED 1-18-2012.

ERIN FALK, EXAMINING ATTORNEY



*David J. Kyffers*

Director of the United States Patent and Trademark Office



# United States of America

United States Patent and Trademark Office

## BSW BEAUTY

**Reg. No. 4,198,157**

PPF BEAUTY INC. (NEW YORK CORPORATION)

**Registered Aug. 28, 2012**

351 S. SALINA ST.  
SYRACUSE, NY 13202

**Int. Cl.: 35**

FOR: ON-LINE RETAIL STORE SERVICES FEATURING BEAUTY SUPPLIES; RETAIL STORE SERVICES FEATURING BEAUTY SUPPLIES, IN CLASS 35 (U.S. CLS. 100, 101 AND 102).

**SERVICE MARK**

FIRST USE 4-0-2010; IN COMMERCE 4-0-2010.

**PRINCIPAL REGISTER**

THE MARK CONSISTS OF STANDARD CHARACTERS WITHOUT CLAIM TO ANY PARTICULAR FONT, STYLE, SIZE, OR COLOR.

NO CLAIM IS MADE TO THE EXCLUSIVE RIGHT TO USE "BEAUTY", APART FROM THE MARK AS SHOWN.

SER. NO. 85-519,211, FILED 1-18-2012.

ERIN FALK, EXAMINING ATTORNEY



*David J. Kybas*

Director of the United States Patent and Trademark Office

# United States of America

United States Patent and Trademark Office

## IT'S ALL ABOUT EVOLUTION

**Reg. No. 4,198,158**

FGS-WI, LLC (WISCONSIN LIMITED LIABILITY COMPANY)  
1101 S. JANESVILLE ST.  
MILTON, WI 53563

**Registered Aug. 28, 2012**

**Int. Cl.: 35**

FOR: DIRECT MAIL MARKETING SERVICES, IN CLASS 35 (U.S. CLS. 100, 101 AND 102).

**SERVICE MARK**

FIRST USE 8-31-2011; IN COMMERCE 10-0-2011.

**PRINCIPAL REGISTER**

THE MARK CONSISTS OF STANDARD CHARACTERS WITHOUT CLAIM TO ANY PARTICULAR FONT, STYLE, SIZE, OR COLOR.

SER. NO. 85-519,221, FILED 1-18-2012.

KRISTINA MORRIS, EXAMINING ATTORNEY



*David J. Kyffers*

Director of the United States Patent and Trademark Office

# United States of America

United States Patent and Trademark Office

# RCPM

**Reg. No. 4,198,159**

EYETRACKSHOP AB (SWEDEN CORPORATION)  
KUNGSGATAN 44

**Registered Aug. 28, 2012**

STOCKHOLM, SWEDEN 11135

**Int. Cl.: 35**

FOR: BUSINESS ASSISTANCE, ADVISORY AND CONSULTING SERVICES IN THE FIELD OF MARKET RESEARCH VIA ONLINE SURVEYS USING WEBCAMS; MARKETING SERVICES, NAMELY, CONSUMER MARKETING RESEARCH, IN CLASS 35 (U.S. CLS. 100, 101 AND 102).

**SERVICE MARK**

**PRINCIPAL REGISTER**

FIRST USE 1-17-2012; IN COMMERCE 1-17-2012.

THE MARK CONSISTS OF STANDARD CHARACTERS WITHOUT CLAIM TO ANY PARTICULAR FONT, STYLE, SIZE, OR COLOR.

SER. NO. 85-519,266, FILED 1-18-2012.

NICHOLAS COLEMAN, EXAMINING ATTORNEY



*David J. Kyffers*

Director of the United States Patent and Trademark Office

# United States of America

United States Patent and Trademark Office

# NetBSD

**Reg. No. 4,198,160**

THE NETBSD FOUNDATION (DELAWARE CORPORATION)  
235 W. 48TH ST., #22A  
NEW YORK, NY 10036

**Registered Aug. 28, 2012**

**Int. Cl.: 9**

FOR: COMPUTER OPERATING SYSTEMS, IN CLASS 9 (U.S. CLS. 21, 23, 26, 36 AND 38).

**TRADEMARK**

FIRST USE 4-21-1993; IN COMMERCE 4-21-1993.

**PRINCIPAL REGISTER**

THE MARK CONSISTS OF STANDARD CHARACTERS WITHOUT CLAIM TO ANY PARTICULAR FONT, STYLE, SIZE, OR COLOR.

SER. NO. 85-519,282, FILED 1-18-2012.

VERNA BETH RIRIE, EXAMINING ATTORNEY



*David J. Kyffers*

Director of the United States Patent and Trademark Office

# United States of America

United States Patent and Trademark Office

## RED DOGS & ROOSTERS

**Reg. No. 4,198,161**

WALDEN, WILFORD (UNITED STATES INDIVIDUAL)  
1110 NEWPORT STREET  
DENVER, CO 80220

**Registered Aug. 28, 2012**

**Int. Cl.: 41**

FOR: ORGANIZING SPORTING EVENTS, NAMELY, RECREATIONAL HUNTING; PRODUCTION OF TELEVISION PROGRAMS, IN CLASS 41 (U.S. CLS. 100, 101 AND 107).

**SERVICE MARK**

FIRST USE 9-0-2009; IN COMMERCE 9-0-2009.

**PRINCIPAL REGISTER**

THE MARK CONSISTS OF STANDARD CHARACTERS WITHOUT CLAIM TO ANY PARTICULAR FONT, STYLE, SIZE, OR COLOR.

NO CLAIM IS MADE TO THE EXCLUSIVE RIGHT TO USE "DOGS", APART FROM THE MARK AS SHOWN.

SER. NO. 85-519,291, FILED 1-18-2012.

HENRY S. ZAK, EXAMINING ATTORNEY



*David J. Kybas*

Director of the United States Patent and Trademark Office

# United States of America

United States Patent and Trademark Office

# LIFELANE180

**Reg. No. 4,198,162**

LIFELANE (ALASKA CORPORATION)  
4524 PECAN STREET  
SPRINGDALE, AR 72762

**Registered Aug. 28, 2012**

**Int. Cl.: 45**

FOR: PROVIDING A WEBSITE FEATURING INFORMATION ABOUT RELIGIOUS BELIEF SYSTEMS, IN CLASS 45 (U.S. CLS. 100 AND 101).

**SERVICE MARK**

FIRST USE 9-0-2008; IN COMMERCE 8-0-2009.

**PRINCIPAL REGISTER**

THE MARK CONSISTS OF STANDARD CHARACTERS WITHOUT CLAIM TO ANY PARTICULAR FONT, STYLE, SIZE, OR COLOR.

SER. NO. 85-519,310, FILED 1-18-2012.

ROBERT C. CLARK JR., EXAMINING ATTORNEY



*David J. Kybas*

Director of the United States Patent and Trademark Office

# United States of America

United States Patent and Trademark Office

# NUTRI-STIX

**Reg. No. 4,198,163**

LORRAINE LOUISE PICKETT (UNITED STATES INDIVIDUAL)  
166 HIGH KNOLL RD.  
JASPER, GA 30143

**Registered Aug. 28, 2012**

**Int. Cl.: 5**

FOR: NUTRITIONAL SUPPLEMENTS FOR ANIMALS, IN CLASS 5 (U.S. CLS. 6, 18, 44, 46, 51 AND 52).

**TRADEMARK**

FIRST USE 9-30-2011; IN COMMERCE 9-30-2011.

**PRINCIPAL REGISTER**

THE MARK CONSISTS OF STANDARD CHARACTERS WITHOUT CLAIM TO ANY PARTICULAR FONT, STYLE, SIZE, OR COLOR.

SER. NO. 85-519,324, FILED 1-18-2012.

CHRISTOPHER SIDOTI, EXAMINING ATTORNEY



*David J. Kybas*

Director of the United States Patent and Trademark Office

# United States of America

United States Patent and Trademark Office

# PAMPA

**Reg. No. 4,198,164**

**Registered Aug. 28, 2012**

**Int. Cl.: 29**

**TRADEMARK**

**PRINCIPAL REGISTER**

TRANSNATIONAL FOODS, INC. (FLORIDA CORPORATION)  
1110 BRICKELL AVENUE, SUITE 808  
MIAMI, FL 33131

FOR: PROCESSED PEANUTS, NAMELY, HONEY ROASTED PEANUTS, DRY ROASTED PEANUTS, SALTED PEANUTS, IN CLASS 29 (U.S. CL. 46).

FIRST USE 9-19-2011; IN COMMERCE 9-19-2011.

THE MARK CONSISTS OF STANDARD CHARACTERS WITHOUT CLAIM TO ANY PARTICULAR FONT, STYLE, SIZE, OR COLOR.

OWNER OF U.S. REG. NOS. 2,805,877, 3,743,672 AND OTHERS.

SER. NO. 85-519,328, FILED 1-18-2012.

DAVID YONTEF, EXAMINING ATTORNEY



*David J. Kyffers*

Director of the United States Patent and Trademark Office



**United States of America**  
United States Patent and Trademark Office

**PAMPA**

**Reg. No. 4,198,165**

**Registered Aug. 28, 2012**

**Int. Cl.: 29**

**TRADEMARK**

**PRINCIPAL REGISTER**

TRANSNATIONAL FOODS, INC. (FLORIDA CORPORATION)  
1110 BRICKELL AVENUE, SUITE 808  
MIAMI, FL 33131

FOR: CHEESE SPREADS, IN CLASS 29 (U.S. CL. 46).

FIRST USE 1-11-2011; IN COMMERCE 1-11-2011.

THE MARK CONSISTS OF STANDARD CHARACTERS WITHOUT CLAIM TO ANY PARTICULAR FONT, STYLE, SIZE, OR COLOR.

OWNER OF U.S. REG. NOS. 2,805,877, 3,743,672 AND OTHERS.

SER. NO. 85-519,347, FILED 1-18-2012.

DAVID YONTEF, EXAMINING ATTORNEY



*David J. Kyffers*

Director of the United States Patent and Trademark Office

# United States of America

United States Patent and Trademark Office

# MICROJOBS

**Reg. No. 4,198,166**

SCHNEIDER, DAVID L. (UNITED STATES INDIVIDUAL)  
PO BOX 9272

**Registered Aug. 28, 2012**

RANCHO SANTA FE, CA 92067

**Int. Cl.: 35**

FOR: PROVIDING ONLINE PRICE COMPARISONS OF EMPLOYMENT AND JOB PLACEMENT SERVICES; MARKETING SERVICES, NAMELY, PROVIDING QUALIFIED SALES LEADS TO OTHERS, ONLINE REFERRAL SERVICES IN THE EMPLOYMENT AND JOB PLACEMENT SERVICES INDUSTRY; PROVIDING A SEARCHABLE DIRECTORY OF EMPLOYMENT AGENCIES AND JOB PLACEMENT INFORMATION FOR OBTAINING DATA AND INFORMATION FROM OTHERS VIA THE INTERNET; ADVERTISING SERVICES, NAMELY, PROVIDING ONLINE MARKETING SERVICES IN THE NATURE OF BANNER ADVERTISING, DISPLAY ADVERTISING, LINK EXCHANGES AND SEARCH ENGINE PLACEMENT SERVICES FOR THE EMPLOYMENT AND JOB PLACEMENT SERVICES INDUSTRY; EMPLOYMENT AGENCY SERVICES; PROVIDING EMPLOYMENT INFORMATION; PROVIDING ON-LINE EMPLOYMENT PLACEMENT SERVICES, NAMELY, MATCHING RESUMES AND POTENTIAL EMPLOYERS VIA A GLOBAL COMPUTER NETWORK, IN CLASS 35 (U.S. CLS. 100, 101 AND 102).

**SERVICE MARK**

**PRINCIPAL REGISTER**

FIRST USE 7-5-2002; IN COMMERCE 7-5-2002.

THE MARK CONSISTS OF STANDARD CHARACTERS WITHOUT CLAIM TO ANY PARTICULAR FONT, STYLE, SIZE, OR COLOR.

SER. NO. 85-519,353, FILED 1-18-2012.

JAMES GRIFFIN, EXAMINING ATTORNEY



*David J. Kyffers*

Director of the United States Patent and Trademark Office

# United States of America

United States Patent and Trademark Office

# iGenConnect

**Reg. No. 4,198,167**

SANDERS, SAM (UNITED STATES INDIVIDUAL)  
2 MONTE ALTO LANE  
SANTA FE, NM 87508 AND

**Registered Aug. 28, 2012**

**Int. Cl.: 38**

O'SULLIVAN-SANDERS, PATRICA (UNITED STATES INDIVIDUAL)  
2 MONTE ALTO LANE  
2 MONTE ALTO LANE  
SANTA FE, NM 87508

**SERVICE MARK**

**PRINCIPAL REGISTER**

FOR: EDUCATIONAL TEXT MESSAGING SERVICES FOR TRANSMISSION OF EDUCATIONAL CONTENT VIA SMS, IN CLASS 38 (U.S. CLS. 100, 101 AND 104).

FIRST USE 10-1-2011; IN COMMERCE 10-1-2011.

THE MARK CONSISTS OF STANDARD CHARACTERS WITHOUT CLAIM TO ANY PARTICULAR FONT, STYLE, SIZE, OR COLOR.

SER. NO. 85-519,369, FILED 1-18-2012.

TINA BROWN, EXAMINING ATTORNEY



*David J. Kyjars*

Director of the United States Patent and Trademark Office

# United States of America

United States Patent and Trademark Office

## CLOWN SHOES

**Reg. No. 4,198,168**

**Registered Aug. 28, 2012**

**Int. Cl.: 32**

**TRADEMARK**

**PRINCIPAL REGISTER**

ARBORWAY IMPORTS, INC. (MASSACHUSETTS CORPORATION)  
141 MIDDLESEX TURNPIKE  
BURLINGTON, MA 01803

FOR: BEER, IN CLASS 32 (U.S. CLS. 45, 46 AND 48).

FIRST USE 12-0-2009; IN COMMERCE 12-0-2009.

THE MARK CONSISTS OF STANDARD CHARACTERS WITHOUT CLAIM TO ANY PARTICULAR FONT, STYLE, SIZE, OR COLOR.

SER. NO. 85-519,373, FILED 1-18-2012.

DAVID YONTEF, EXAMINING ATTORNEY



*David J. Kyffers*

Director of the United States Patent and Trademark Office

# United States of America

United States Patent and Trademark Office

# REPORT.NET

**Reg. No. 4,198,169**

**Registered Aug. 28, 2012**

**Int. Cl.: 35**

**SERVICE MARK**

**PRINCIPAL REGISTER**

WNC INSURANCE SERVICES, INC. (CALIFORNIA CORPORATION)  
899 EL CENTRO  
SOUTH PASADENA, CA 91030

FOR: INSURANCE CLAIMS AUDITING SERVICES; MANAGING THE OPERATIONS OF INSURANCE AGENCIES AND BROKERS ON AN OUTSOURCING BASIS; TRACKING AND MONITORING INSURANCE COMPLIANCE, IN CLASS 35 (U.S. CLS. 100, 101 AND 102).

FIRST USE 5-0-2000; IN COMMERCE 5-0-2000.

THE MARK CONSISTS OF STANDARD CHARACTERS WITHOUT CLAIM TO ANY PARTICULAR FONT, STYLE, SIZE, OR COLOR.

SEC. 2(F).

SER. NO. 85-519,382, FILED 1-18-2012.

ELLEN PERKINS, EXAMINING ATTORNEY



*David J. Kyffers*

Director of the United States Patent and Trademark Office

# United States of America

United States Patent and Trademark Office

# RIMAS

**Reg. No. 4,198,170**

THE SHARED LOGIC GROUP, INC. (OHIO CORPORATION)  
6904 SPRING VALLEY DRIVE, SUITE 305  
HOLLAND, OH 43528

**Registered Aug. 28, 2012**

**Int. Cl.: 9**

FOR: COMPUTER SOFTWARE FOR ACCOUNTING, RECORDKEEPING AND BUSINESS MANAGEMENT, IN CLASS 9 (U.S. CLS. 21, 23, 26, 36 AND 38).

**TRADEMARK**

FIRST USE 3-0-1982; IN COMMERCE 3-0-1982.

**PRINCIPAL REGISTER**

THE MARK CONSISTS OF STANDARD CHARACTERS WITHOUT CLAIM TO ANY PARTICULAR FONT, STYLE, SIZE, OR COLOR.

SER. NO. 85-519,410, FILED 1-18-2012.

FRANK LATTUCA, EXAMINING ATTORNEY



*David J. Kyffers*

Director of the United States Patent and Trademark Office

# United States of America

United States Patent and Trademark Office

## TECHNOLOGY NEVER TASTED SO GOOD

**Reg. No. 4,198,171**

IBREWMASTER, INC. (ILLINOIS CORPORATION)  
425 SNOW DRIFT CIRCLE  
BARTLETT, IL 60103

**Registered Aug. 28, 2012**

**Int. Cl.: 9**

FOR: COMPUTER APPLICATION SOFTWARE FOR MOBILE PHONES, NAMELY, SOFTWARE FOR THE USE OF CREATING, MANAGING, AND TRACKING THE BREWING PROCESS INCLUDING RECIPE CREATION, BATCH CREATION, RECIPE SHARING AND TRACKING OF ALL THE STEPS OF THE BEER, MEAD, AND CIDER BREWING PROCESS; COMPUTER APPLICATION SOFTWARE FOR MOBILE PHONES, PORTABLE MEDIA PLAYERS, TABLET COMPUTERS, HANDHELD COMPUTERS AND DESKTOP COMPUTERS, NAMELY, SOFTWARE FOR THE USE OF CREATING, MANAGING, AND TRACKING THE BREWING PROCESS INCLUDING RECIPE CREATION, BATCH CREATION, RECIPE SHARING AND TRACKING OF ALL THE STEPS OF THE BEER, MEAD, AND CIDER BREWING PROCESS, IN CLASS 9 (U.S. CLS. 21, 23, 26, 36 AND 38).

**TRADEMARK**

**PRINCIPAL REGISTER**

FIRST USE 2-0-2011; IN COMMERCE 2-0-2011.

THE MARK CONSISTS OF STANDARD CHARACTERS WITHOUT CLAIM TO ANY PARTICULAR FONT, STYLE, SIZE, OR COLOR.

SER. NO. 85-519,419, FILED 1-18-2012.

SUE LAWRENCE, EXAMINING ATTORNEY



*David J. Kyffers*

Director of the United States Patent and Trademark Office

# United States of America

United States Patent and Trademark Office



**Reg. No. 4,198,172**

**Registered Aug. 28, 2012**

**Int. Cls.: 9 and 16**

**TRADEMARK**

**PRINCIPAL REGISTER**

SIMPLEPONS INC. (DELAWARE CORPORATION)  
220 CONGRESS PARK DRIVE #304  
DELRAY BEACH, FL 33445

FOR: CONSUMER COUPONS DOWNLOADED FROM A GLOBAL COMPUTER NETWORK,  
IN CLASS 9 (U.S. CLS. 21, 23, 26, 36 AND 38).

FIRST USE 9-1-2011; IN COMMERCE 9-1-2011.

FOR: COUPON BOOKS, IN CLASS 16 (U.S. CLS. 2, 5, 22, 23, 29, 37, 38 AND 50).

FIRST USE 9-1-2011; IN COMMERCE 9-1-2011.

THE MARK CONSISTS OF THE LETTERS "SP" INSIDE OF A TEAL SQUARE WITH A  
RAISED LETTER "S" APPEARING IN ORANGE AND THE LETTER "P" APPEARING IN  
TEAL.

THE COLOR(S) ORANGE AND TEAL IS/ARE CLAIMED AS A FEATURE OF THE MARK.

SER. NO. 85-519,438, FILED 1-18-2012.

ROBERT C. CLARK JR., EXAMINING ATTORNEY



*David J. Kybas*

Director of the United States Patent and Trademark Office



# United States of America

United States Patent and Trademark Office



**Reg. No. 4,198,173**

EAGLES NEST MASSAGE THERAPY (MINNESOTA CORPORATION)  
1114 E 9TH ST.  
DULUTH, MN 55805

**Registered Aug. 28, 2012**

**Int. Cl.: 44**

FOR: BODYWORK THERAPY; MASSAGE THERAPY SERVICES, IN CLASS 44 (U.S. CLS. 100 AND 101).

**SERVICE MARK**

FIRST USE 6-1-1990; IN COMMERCE 6-1-1990.

**PRINCIPAL REGISTER**

THE MARK CONSISTS OF A STYLIZED DESIGN THAT IS A NATIVE AMERICAN STYLIZED EAGLE SURROUNDED BY A CIRCLE. THERE ARE HAND PRINTS ALL THE WAY AROUND THE PERIMETER.

SER. NO. 85-519,452, FILED 1-18-2012.

DOMINICK J. SALEMI, EXAMINING ATTORNEY



*David J. Kyffers*

Director of the United States Patent and Trademark Office

# United States of America

United States Patent and Trademark Office

Making the world a better  
place, one job at a time.

**Reg. No. 4,198,174**

**Registered Aug. 28, 2012**

**Int. Cl.: 35**

**SERVICE MARK**

**PRINCIPAL REGISTER**

ATR INTERNATIONAL, INC. (CALIFORNIA CORPORATION)  
SUITE 110  
1230 OAKMEAD PARKWAY  
SUNNYVALE, CA 94085

FOR: EMPLOYMENT AGENCY SERVICES, NAMELY, FILLING THE TEMPORARY AND PERMANENT STAFFING NEEDS OF BUSINESSES, IN CLASS 35 (U.S. CLS. 100, 101 AND 102).

FIRST USE 2-11-2011; IN COMMERCE 2-11-2011.

THE MARK CONSISTS OF STANDARD CHARACTERS WITHOUT CLAIM TO ANY PARTICULAR FONT, STYLE, SIZE, OR COLOR.

SER. NO. 85-519,459, FILED 1-18-2012.

DOMINICK J. SALEMI, EXAMINING ATTORNEY



*David J. Kybas*

Director of the United States Patent and Trademark Office

# United States of America

United States Patent and Trademark Office

## VENICE ALE HOUSE

**Reg. No. 4,198,175**

VENICE ALE HOUSE, LLC (CALIFORNIA LIMITED LIABILITY COMPANY)  
2 ROSE AVENUE  
VENICE, CA 90291

**Registered Aug. 28, 2012**

**Int. Cl.: 25**

FOR: CHILDREN'S AND INFANT'S APPAREL, NAMELY, JUMPERS, OVERALL SLEEPWEAR, PAJAMAS, ROMPERS AND ONE-PIECE GARMENTS; HATS; PANTS; SWIM WEAR; TANK TOPS; TEE SHIRTS; TOPS; WEARABLE GARMENTS AND CLOTHING, NAMELY, SHIRTS, IN CLASS 25 (U.S. CLS. 22 AND 39).

**TRADEMARK**

**PRINCIPAL REGISTER**

FIRST USE 8-1-2010; IN COMMERCE 8-1-2010.

THE MARK CONSISTS OF STANDARD CHARACTERS WITHOUT CLAIM TO ANY PARTICULAR FONT, STYLE, SIZE, OR COLOR.

OWNER OF U.S. REG. NO. 4,094,805.

SER. NO. 85-519,460, FILED 1-18-2012.

IRA J. GOODSaid, EXAMINING ATTORNEY



*David J. Kyffers*

Director of the United States Patent and Trademark Office

# United States of America

United States Patent and Trademark Office



**Reg. No. 4,198,176**

**Registered Aug. 28, 2012**

**Int. Cl.: 43**

**SERVICE MARK**

**PRINCIPAL REGISTER**

CAKE AFFAIR INC. (VIRGINIA CORPORATION)  
6548C LITTLE RIVER TURNPIKE  
ALEXANDRIA, VA 22312

FOR: RESTAURANT AND CATERING SERVICES, IN CLASS 43 (U.S. CLS. 100 AND 101).

FIRST USE 1-1-2009; IN COMMERCE 6-20-2009.

THE MARK CONSISTS OF A COMBINATION OF FOUR WAVY LINES FOLLOWED BY THE STYLIZED TEXT "INDAROMA".

SER. NO. 85-519,468, FILED 1-18-2012.

JOHN GARTNER, EXAMINING ATTORNEY



*David J. Kybas*

Director of the United States Patent and Trademark Office

# United States of America

United States Patent and Trademark Office

## AromaTheraPutty

**Reg. No. 4,198,177**

AROMATHERAPUTTY CORP. (CALIFORNIA CORPORATION)

**Registered Aug. 28, 2012**

1925 DE LA PENA AVE  
SANTA CLARA, CA 95050

**Int. Cl.: 28**

FOR: AROMATHERAPY PRODUCT, NAMELY, SCENTED COLORED PUTTY USED FOR HAND EXERCISE, STRESS RELIEF, FOCUS, THINKING, AND RELAXATION, IN CLASS 28 (U.S. CLS. 22, 23, 38 AND 50).

**TRADEMARK**

FIRST USE 4-1-2007; IN COMMERCE 4-1-2007.

**PRINCIPAL REGISTER**

THE MARK CONSISTS OF STANDARD CHARACTERS WITHOUT CLAIM TO ANY PARTICULAR FONT, STYLE, SIZE, OR COLOR.

SER. NO. 85-519,469, FILED 1-18-2012.

BRIAN PINO, EXAMINING ATTORNEY



*David J. Kyffers*

Director of the United States Patent and Trademark Office

# United States of America

United States Patent and Trademark Office

MADEINEARTH

**Reg. No. 4,198,178**

HUKMAI LLC (CALIFORNIA LIMITED LIABILITY COMPANY)  
1627 ABBOT KINNEY BLVD  
VENICE, CA 90291

**Registered Aug. 28, 2012**

**Int. Cl.: 14**

FOR: JEWELRY, IN CLASS 14 (U.S. CLS. 2, 27, 28 AND 50).

**TRADEMARK**

FIRST USE 6-6-2011; IN COMMERCE 6-6-2011.

**PRINCIPAL REGISTER**

THE MARK CONSISTS OF THE STYLIZED TEXT "MADEINEARTH".

SER. NO. 85-519,473, FILED 1-18-2012.

KAREN K. BUSH, EXAMINING ATTORNEY



*David J. Kyffers*

Director of the United States Patent and Trademark Office

# United States of America

United States Patent and Trademark Office

# HD

**Reg. No. 4,198,179**

**Registered Aug. 28, 2012**

**Int. Cl.: 9**

**TRADEMARK**

**PRINCIPAL REGISTER**

NLU PRODUCTS, L.L.C. (UTAH LIMITED LIABILITY COMPANY)  
1103 E. LONE PEAK LANE  
DRAPER, UT 84020

FOR: ACCESSORIES FOR ELECTRONIC DEVICES, NAMELY SCREEN PROTECTORS, BODY WRAPS, COVERS, OVERLAYS, AND CASES ALL OF THE FOREGOING FOR USE IN CONNECTION WITH CELL PHONES, TABLET COMPUTERS, PORTABLE MEDIA PLAYERS, CAMERAS, AND GAMING CONSOLES, IN CLASS 9 (U.S. CLS. 21, 23, 26, 36 AND 38).

FIRST USE 5-31-2006; IN COMMERCE 5-31-2006.

THE MARK CONSISTS OF STANDARD CHARACTERS WITHOUT CLAIM TO ANY PARTICULAR FONT, STYLE, SIZE, OR COLOR.

SER. NO. 85-519,478, FILED 1-18-2012.

KAREN K. BUSH, EXAMINING ATTORNEY



*David J. Kybas*

Director of the United States Patent and Trademark Office

# United States of America

United States Patent and Trademark Office

# WELLCRAFT

**Reg. No. 4,198,180**

**Registered Aug. 28, 2012**

**Int. Cl.: 19**

**TRADEMARK**

**PRINCIPAL REGISTER**

TAPCO INTERNATIONAL CORPORATION (MICHIGAN CORPORATION)  
29797 BECK ROAD  
WIXON, MI 48393

FOR: NON-METAL EGRESS WINDOW WELL SYSTEMS USED FOR WINDOW WELL ESCAPE, NAMELY, WINDOW WELLS AND COVERS, IN CLASS 19 (U.S. CLS. 1, 12, 33 AND 50).

FIRST USE 5-1-2002; IN COMMERCE 5-1-2002.

THE MARK CONSISTS OF STANDARD CHARACTERS WITHOUT CLAIM TO ANY PARTICULAR FONT, STYLE, SIZE, OR COLOR.

SER. NO. 85-519,479, FILED 1-18-2012.

KAREN K. BUSH, EXAMINING ATTORNEY



*David J. Kyffers*

Director of the United States Patent and Trademark Office



# United States of America

United States Patent and Trademark Office

# JBM75

**Reg. No. 4,198,181**

**Registered Aug. 28, 2012**

**Int. Cl.: 17**

**TRADEMARK**

**PRINCIPAL REGISTER**

JBM SOLUTIONS, INC. (MARYLAND CORPORATION)  
162 BAY CLUB PARKWAY  
NORTH EAST, MD 21901

FOR: SOUND BARRIER PANELS FOR USE ALONG HIGHWAYS AND OTHER TRANSPORTATION CORRIDORS; INSULATING MATERIALS, NAMELY, MINERALIZED CELLULOSIC WOOD FIBER CEMENT; INSULATION MATERIAL, NOT OF METAL, FOR SOUND PROTECTION; ACOUSTIC INSULATION MATERIAL FOR USE IN THE RESIDENTIAL, COMMERCIAL AND INDUSTRIAL INDUSTRIES; SOUND INSULATING PANELS, WALLS, SLABS AND ENCLOSURES, NAMELY, SOUND INSULATING MATERIALS FOR RESIDENTIAL, COMMERCIAL AND INDUSTRIAL STRUCTURES AND FACILITIES AND FOR RETROFITTING RESIDENTIAL, COMMERCIAL AND INDUSTRIAL STRUCTURES AND FACILITIES; CONSTRUCTION MATERIALS, NAMELY, ACOUSTIC INSULATION MATERIALS FOR RESIDENTIAL, COMMERCIAL AND INDUSTRIAL STRUCTURES AND FACILITIES AND FOR RETROFITTING RESIDENTIAL, COMMERCIAL AND INDUSTRIAL STRUCTURES AND FACILITIES, IN CLASS 17 (U.S. CLS. 1, 5, 12, 13, 35 AND 50).

FIRST USE 4-1-2007; IN COMMERCE 4-1-2007.

THE MARK CONSISTS OF STANDARD CHARACTERS WITHOUT CLAIM TO ANY PARTICULAR FONT, STYLE, SIZE, OR COLOR.

SER. NO. 85-519,490, FILED 1-18-2012.

KATHLEEN M. VANSTON, EXAMINING ATTORNEY



*David J. Kyffers*

Director of the United States Patent and Trademark Office

United States of America  
United States Patent and Trademark Office

# TINEFCON

**Reg. No. 4,198,182**

**Registered Aug. 28, 2012**

**Int. Cl.: 5**

**TRADEMARK**

**PRINCIPAL REGISTER**

PIRAMAL HEALTHCARE LIMITED (INDIA LIMITED LIABILITY COMPANY)  
PIRAMAL TOWER, PENINSULA CORPORATE PARK  
GANPATRAO KADAM MARG, LOWER PAREL  
MUMBAI, INDIA 400013

FOR: DIETARY SUPPLEMENTS, IN CLASS 5 (U.S. CLS. 6, 18, 44, 46, 51 AND 52).

FIRST USE 10-0-2009; IN COMMERCE 10-0-2009.

THE MARK CONSISTS OF STANDARD CHARACTERS WITHOUT CLAIM TO ANY PARTICULAR FONT, STYLE, SIZE, OR COLOR.

SER. NO. 85-519,497, FILED 1-18-2012.

JOHN GARTNER, EXAMINING ATTORNEY



*David J. Kybas*

Director of the United States Patent and Trademark Office

# United States of America

United States Patent and Trademark Office

## LUXURY WITH A PURPOSE

**Reg. No. 4,198,183**

THE PILLOW BAR, LLC (TEXAS LIMITED LIABILITY COMPANY)  
122 HOWELL STREET, SUITE 260  
DALLAS, TX 75207

**Registered Aug. 28, 2012**

**Int. Cl.: 20**

FOR: HEAD SUPPORTING PILLOWS; NECK-SUPPORTING PILLOWS; PILLOWS, IN CLASS 20 (U.S. CLS. 2, 13, 22, 25, 32 AND 50).

**TRADEMARK**

FIRST USE 10-10-2011; IN COMMERCE 10-10-2011.

**PRINCIPAL REGISTER**

THE MARK CONSISTS OF STANDARD CHARACTERS WITHOUT CLAIM TO ANY PARTICULAR FONT, STYLE, SIZE, OR COLOR.

SER. NO. 85-519,516, FILED 1-18-2012.

GIANCARLO CASTRO, EXAMINING ATTORNEY



*David J. Kyffers*

Director of the United States Patent and Trademark Office

# United States of America

United States Patent and Trademark Office



**Reg. No. 4,198,184**

**Registered Aug. 28, 2012**

**Int. Cl.: 41**

**SERVICE MARK**

**PRINCIPAL REGISTER**

THE REDHEAD COMPANIES, INC. (MARYLAND CORPORATION)  
6011 UNIVERSITY BOULEVARD, SUITE 210  
ELLCOTT CITY, MD 21043

FOR: LIFE COACHING SERVICES IN THE FIELD OF BUSINESS PRACTICES, IN CLASS  
41 (U.S. CLS. 100, 101 AND 107).

FIRST USE 11-14-2011; IN COMMERCE 11-14-2011.

THE MARK CONSISTS OF A DESIGN ELEMENT DEPICTING A CONVERTIBLE AUTO-  
MOBILE AND DRIVER WHICH APPEARS ABOVE THE LOWERCASE WORD "TOPDOWN".

SER. NO. 85-519,517, FILED 1-18-2012.

GIANCARLO CASTRO, EXAMINING ATTORNEY



*David J. Kybas*

Director of the United States Patent and Trademark Office

# United States of America

United States Patent and Trademark Office



**Reg. No. 4,198,185**

**Registered Aug. 28, 2012**

**Int. Cl.: 25**

**TRADEMARK**

**PRINCIPAL REGISTER**

STICK & BALL LLC (CALIFORNIA LIMITED LIABILITY COMPANY)  
324 E. STRAWBERRY DR.  
MILL VALLEY, CA 94941

FOR: PONCHOS, IN CLASS 25 (U.S. CLS. 22 AND 39).

FIRST USE 12-1-2011; IN COMMERCE 12-1-2011.

THE MARK CONSISTS OF THE LETTER S ABOVE AND TO THE LEFT OF THE LETTER B WITH A MALLET AND BALL BETWEEN THE TWO LETTERS.

SER. NO. 85-519,526, FILED 1-18-2012.

JEFFREY LOOK, EXAMINING ATTORNEY



*David J. Kyffers*

Director of the United States Patent and Trademark Office

# United States of America

United States Patent and Trademark Office

## HAWTHORN SUITES

**Reg. No. 4,198,186**

U.S. FRANCHISE SYSTEMS, INC. (DELAWARE CORPORATION)  
22 SYLVAN WAY

**Registered Aug. 28, 2012**

PARSIPPANY, NJ 07054

**Int. Cl.: 43**

FOR: HOTEL AND MOTEL SERVICES, MAKING LODGING RESERVATIONS FOR OTHERS,  
IN CLASS 43 (U.S. CLS. 100 AND 101).

**SERVICE MARK**

FIRST USE 10-7-1985; IN COMMERCE 10-7-1985.

**PRINCIPAL REGISTER**

THE MARK CONSISTS OF STANDARD CHARACTERS WITHOUT CLAIM TO ANY PARTICULAR FONT, STYLE, SIZE, OR COLOR.

OWNER OF U.S. REG. NOS. 1,531,365, 2,614,720 AND OTHERS.

NO CLAIM IS MADE TO THE EXCLUSIVE RIGHT TO USE "SUITES", APART FROM THE MARK AS SHOWN.

SER. NO. 85-519,550, FILED 1-18-2012.

STEVEN R. FINE, EXAMINING ATTORNEY



*David J. Kyffers*

Director of the United States Patent and Trademark Office

# United States of America

United States Patent and Trademark Office

## PoolSupplyWorld

**Reg. No. 4,198,187**

XPEM, INC. (CALIFORNIA CORPORATION)  
2351 SUNSET BOULEVARD, SUITE 170  
ROCKLIN, CA 95765

**Registered Aug. 28, 2012**

**Int. Cl.: 35**

FOR: RETAIL SHOPS FEATURING POOL AND SPA SUPPLIES, EQUIPMENT AND ACCESSORIES, IN CLASS 35 (U.S. CLS. 100, 101 AND 102).

**SERVICE MARK**

FIRST USE 9-1-2006; IN COMMERCE 9-1-2006.

**PRINCIPAL REGISTER**

THE MARK CONSISTS OF STANDARD CHARACTERS WITHOUT CLAIM TO ANY PARTICULAR FONT, STYLE, SIZE, OR COLOR.

OWNER OF U.S. REG. NOS. 3,813,307 AND 3,904,311.

SER. NO. 85-519,554, FILED 1-18-2012.

STEVEN R. FINE, EXAMINING ATTORNEY



*David J. Kybas*

Director of the United States Patent and Trademark Office

# United States of America

United States Patent and Trademark Office

## Discover the Captain in You

**Reg. No. 4,198,188**

BROWN, MICHAEL (UNITED STATES INDIVIDUAL)  
311 SOCIETY PLACE  
NEWTOWN, PA 18940

**Registered Aug. 28, 2012**

**Int. Cl.: 41**

FOR: EDUCATION SERVICES, NAMELY, PROVIDING CLASSES, SEMINARS, AND WORKSHOPS IN THE FIELD OF SAILING, IN CLASS 41 (U.S. CLS. 100, 101 AND 107).

**SERVICE MARK**

FIRST USE 8-1-2008; IN COMMERCE 8-1-2008.

**PRINCIPAL REGISTER**

THE MARK CONSISTS OF STANDARD CHARACTERS WITHOUT CLAIM TO ANY PARTICULAR FONT, STYLE, SIZE, OR COLOR.

SER. NO. 85-519,564, FILED 1-18-2012.

LUCY ARANT, EXAMINING ATTORNEY



*David J. Kyffers*

Director of the United States Patent and Trademark Office



# United States of America

United States Patent and Trademark Office



## KWIK POWER

**Reg. No. 4,198,189**

**Registered Aug. 28, 2012**

**Int. Cl.: 20**

**TRADEMARK**

**PRINCIPAL REGISTER**

YING-CHIEH LIAO (TAIWAN INDIVIDUAL)  
3F.-5, NO. 262, SEC. 2, HENAN RD.,  
SITUN DISTRICT  
TAICHUNG CITY, TAIWAN 407

FOR: NON-METAL TOOL BOXES; FREE-STANDING TOOL RACKS; PLASTIC BINS; STORAGE AND ORGANIZATION SYSTEMS COMPRISING SHELVES, DRAWERS, CUPBOARDS, BASKETS AND CLOTHES RODS, SOLD AS A UNIT; SHELVING AND COMPONENT PARTS THEREOF, NAMELY, SHELVES AND BRACKETS SOLD AS A UNIT, IN CLASS 20 (U.S. CLS. 2, 13, 22, 25, 32 AND 50).

FIRST USE 2-15-2008; IN COMMERCE 2-1-2009.

THE MARK CONSISTS OF A BAT DESIGN OVER THE WORDING "KWIK POWER".

SER. NO. 85-519,570, FILED 1-18-2012.

APRIL HESIK, EXAMINING ATTORNEY



*David J. Kyffers*

Director of the United States Patent and Trademark Office

# United States of America

United States Patent and Trademark Office

# SEA LEVEL

**Reg. No. 4,198,190**

**Registered Aug. 28, 2012**

**Int. Cl.: 16**

**TRADEMARK**

**PRINCIPAL REGISTER**

MUSSO, CARLOS (UNITED STATES INDIVIDUAL)  
125  
6701 NW 7TH STREET  
MIAMI, FL 33126

FOR: ART PRINTS; MAGAZINES FEATURING OCEAN SPORTS, SURFING, ART, AND PHOTOGRAPHY; PENS; POSTERS; STICKERS, IN CLASS 16 (U.S. CLS. 2, 5, 22, 23, 29, 37, 38 AND 50).

FIRST USE 1-1-2009; IN COMMERCE 1-1-2009.

THE MARK CONSISTS OF STANDARD CHARACTERS WITHOUT CLAIM TO ANY PARTICULAR FONT, STYLE, SIZE, OR COLOR.

SER. NO. 85-519,571, FILED 1-18-2012.

MICHAEL ENGEL, EXAMINING ATTORNEY



*David J. Kyffers*

Director of the United States Patent and Trademark Office

# United States of America

United States Patent and Trademark Office

# Altavra

**Reg. No. 4,198,191**

**Registered Aug. 28, 2012**

**Int. Cl.: 36**

**SERVICE MARK**

**PRINCIPAL REGISTER**

ALTAVRA INC. (FLORIDA CORPORATION)  
#1809  
390 SE MIZNER BLVD  
BOCA RATON, FL 33432

FOR: FINANCIAL PLANNING; INVESTMENT ADVISORY SERVICES; INVESTMENT BROKERAGE; INVESTMENT CONSULTATION, IN CLASS 36 (U.S. CLS. 100, 101 AND 102).

FIRST USE 8-4-2004; IN COMMERCE 8-4-2004.

THE MARK CONSISTS OF STANDARD CHARACTERS WITHOUT CLAIM TO ANY PARTICULAR FONT, STYLE, SIZE, OR COLOR.

SER. NO. 85-519,578, FILED 1-18-2012.

COLLEEN DOMBROW, EXAMINING ATTORNEY



*David J. Kyffers*

Director of the United States Patent and Trademark Office

# United States of America

United States Patent and Trademark Office

## tidytilt

**Reg. No. 4,198,192**

**Registered Aug. 28, 2012**

**Int. Cl.: 9**

**TRADEMARK**

**PRINCIPAL REGISTER**

TT DESIGN LABS LLC (ILLINOIS LIMITED LIABILITY COMPANY)  
#2204  
474 N LAKE SHORE DR.  
CHICAGO, IL 60611

FOR: MOBILE PHONE MOUNT ; EARPHONE CORD WRAP ; MOBILE PHONE STAND, IN CLASS 9 (U.S. CLS. 21, 23, 26, 36 AND 38).

FIRST USE 11-1-2011; IN COMMERCE 12-20-2011.

THE MARK CONSISTS OF THE TEXT "TIDYTILT" WITH STYLIZED LETTER "I'S THAT RESEMBLE EARBUDS.

SER. NO. 85-519,584, FILED 1-18-2012.

JOHN HWANG, EXAMINING ATTORNEY



*David J. Kybas*

Director of the United States Patent and Trademark Office

# United States of America

United States Patent and Trademark Office

# Pixelkeet

**Reg. No. 4,198,193**

**Registered Aug. 28, 2012**

**Int. Cl.: 42**

**SERVICE MARK**

**PRINCIPAL REGISTER**

GREENWALT, JESSICA (UNITED STATES INDIVIDUAL)  
APT. 8  
1538 FILBERT STREET  
SAN FRANCISCO, CA 94123

FOR: PLANNING, DESIGN, DEVELOPMENT, MAINTENANCE AND OPTIMIZATION OF  
ONLINE WEBSITES FOR THIRD PARTIES, IN CLASS 42 (U.S. CLS. 100 AND 101).

FIRST USE 1-0-2008; IN COMMERCE 1-0-2011.

THE MARK CONSISTS OF STANDARD CHARACTERS WITHOUT CLAIM TO ANY PAR-  
TICULAR FONT, STYLE, SIZE, OR COLOR.

SER. NO. 85-519,592, FILED 1-18-2012.

NAAKWAMA ANKRAH, EXAMINING ATTORNEY



*David J. Kyffers*

Director of the United States Patent and Trademark Office

# United States of America

United States Patent and Trademark Office



**TechConnectOhio**

**Reg. No. 4,198,194**

HARRIS, DANNY (UNITED STATES INDIVIDUAL)  
8101 TREE LAKE BLVD.  
POWELL, OH 43065

**Registered Aug. 28, 2012**

**Int. Cl.: 35**

FOR: ORGANIZING AND CONDUCTING JOB FAIRS, IN CLASS 35 (U.S. CLS. 100, 101 AND 102).

**SERVICE MARK**

FIRST USE 11-20-2010; IN COMMERCE 3-1-2011.

**PRINCIPAL REGISTER**

THE MARK CONSISTS OF THE STYLIZED TEXT "TECHCONNECTOHIO" BELOW A STYLIZED STAR MADE OF SIX INWARD-POINTING ARROWS.

SER. NO. 85-519,621, FILED 1-18-2012.

JENNIFER VASQUEZ, EXAMINING ATTORNEY



*David J. Kybas*

Director of the United States Patent and Trademark Office

# United States of America

United States Patent and Trademark Office

# IMMUNOCET

**Reg. No. 4,198,195**

HERMAN, STEPHEN (UNITED STATES INDIVIDUAL)  
19199 S. E. DANIEL LANE  
TEQUESTA, FL 33469

**Registered Aug. 28, 2012**

**Int. Cl.: 5**

FOR: NUTRITIONAL SUPPLEMENTS; MEDICINAL CREAMS FOR SKIN CARE; MEDICATED SKIN CARE PREPARATIONS, NAMELY, CREAMS, LOTIONS, GELS, TONERS, CLEANERS AND PEELS; TOPICAL ANALGESIC CREAMS, IN CLASS 5 (U.S. CLS. 6, 18, 44, 46, 51 AND 52).

**TRADEMARK**

**PRINCIPAL REGISTER**

FIRST USE 1-1-2010; IN COMMERCE 1-1-2010.

THE MARK CONSISTS OF STANDARD CHARACTERS WITHOUT CLAIM TO ANY PARTICULAR FONT, STYLE, SIZE, OR COLOR.

SER. NO. 85-519,625, FILED 1-18-2012.

DAVID MURRAY, EXAMINING ATTORNEY



*David J. Kyffers*

Director of the United States Patent and Trademark Office

# United States of America

United States Patent and Trademark Office

## RK2 SYSTEMS

**Reg. No. 4,198,196**

RK2 SYSTEMS, INC. (CALIFORNIA CORPORATION)  
421A SOUTH ANDREASEN DRIVE  
ESCONDIDO, CA 92029

**Registered Aug. 28, 2012**

**Int. Cl.: 11**

FOR: WATER FILTRATION SYSTEMS CONSISTING OF FLUIDIZED BEDS, IN THE NATURE OF A BED OF FILTERS THROUGH WHICH WATER IS CHANNLED FOR FILTRATION, AND PROTEIN FRACTIONATORS, ALL SOLD AS A UNIT, IN CLASS 11 (U.S. CLS. 13, 21, 23, 31 AND 34).

**TRADEMARK**

**PRINCIPAL REGISTER**

FIRST USE 11-1-1992; IN COMMERCE 11-1-1992.

THE MARK CONSISTS OF STANDARD CHARACTERS WITHOUT CLAIM TO ANY PARTICULAR FONT, STYLE, SIZE, OR COLOR.

NO CLAIM IS MADE TO THE EXCLUSIVE RIGHT TO USE "SYSTEMS", APART FROM THE MARK AS SHOWN.

SER. NO. 85-519,672, FILED 1-18-2012.

BRIAN CALLAGHAN, EXAMINING ATTORNEY



*David J. Kyffers*

Director of the United States Patent and Trademark Office



# United States of America

United States Patent and Trademark Office

## Firefly Kitchens

**Reg. No. 4,198,197**

FIREFLY KITCHENS, LLC (WASHINGTON LIMITED LIABILITY COMPANY)  
844 NW 49TH STREET  
SEATTLE, WA 98107

**Registered Aug. 28, 2012**

**Int. Cl.: 29**

FOR: FERMENTED VEGETABLES; SAUERKRAUT, IN CLASS 29 (U.S. CL. 46).

**TRADEMARK**

FIRST USE 5-19-2010; IN COMMERCE 5-19-2010.

**PRINCIPAL REGISTER**

THE MARK CONSISTS OF STANDARD CHARACTERS WITHOUT CLAIM TO ANY PARTICULAR FONT, STYLE, SIZE, OR COLOR.

SER. NO. 85-519,681, FILED 1-18-2012.

THEODORE MCBRIDE, EXAMINING ATTORNEY



*David J. Kybas*

Director of the United States Patent and Trademark Office

# United States of America

United States Patent and Trademark Office



**Reg. No. 4,198,198**

**Registered Aug. 28, 2012**

**Int. Cls.: 30 and 43**

**TRADEMARK**

**SERVICE MARK**

**PRINCIPAL REGISTER**

DOGTOWN COFFEE, LLC (CALIFORNIA LIMITED LIABILITY COMPANY)  
434 N. VENICE BLVD.  
VENICE, CA 90291

FOR: BEVERAGES MADE OF COFFEE; COFFEE; UNROASTED COFFEE, IN CLASS 30 (U.S. CL. 46).

FIRST USE 12-21-2010; IN COMMERCE 12-21-2010.

FOR: COFFEE SHOPS, IN CLASS 43 (U.S. CLS. 100 AND 101).

FIRST USE 12-21-2010; IN COMMERCE 12-21-2010.

THE MARK CONSISTS OF A CIRCLE WITH THE LETTERS "DTC" INSIDE THE CIRCLE.

SER. NO. 85-519,690, FILED 1-18-2012.

BRIAN NEVILLE, EXAMINING ATTORNEY



*David J. Kybas*

Director of the United States Patent and Trademark Office

# United States of America

United States Patent and Trademark Office

## TWO GREY HILLS

**Reg. No. 4,198,199**

**Registered Aug. 28, 2012**

**Int. Cls.: 35 and 41**

**SERVICE MARK**

**PRINCIPAL REGISTER**

TWO GRAY HILLS TRADING CO. (NEW MEXICO CORPORATION), DBA TWO GREY HILLS TRADING POST  
HCR 330, BOX 70  
TOHATCHI, NM 87326

FOR: RETAIL STORE FEATURING GROCERIES AND OTHER GENERAL MERCHANDISE, INCLUDING WEAVINGS AND RUGS, IN CLASS 35 (U.S. CLS. 100, 101 AND 102).

FIRST USE 0-0-1897; IN COMMERCE 7-29-1944.

FOR: MUSEUM SERVICES, NAMELY, SAFEKEEPING AND CARE OF A HISTORIC TRADING POST, IN CLASS 41 (U.S. CLS. 100, 101 AND 107).

FIRST USE 0-0-1897; IN COMMERCE 7-29-1944.

THE MARK CONSISTS OF STANDARD CHARACTERS WITHOUT CLAIM TO ANY PARTICULAR FONT, STYLE, SIZE, OR COLOR.

SER. NO. 85-519,693, FILED 1-18-2012.

BRIAN NEVILLE, EXAMINING ATTORNEY



*David J. Kybas*

Director of the United States Patent and Trademark Office

# United States of America

United States Patent and Trademark Office

## DIVA-for-Rhino

**Reg. No. 4,198,200**

SOLEMMA LLC (MASSACHUSETTS LIMITED LIABILITY COMPANY)  
2 REED STREET COURT  
CAMBRIDGE, MA 02140

**Registered Aug. 28, 2012**

**Int. Cl.: 9**

FOR: COMPUTER SOFTWARE FOR USE IN THE ENVIRONMENTAL PERFORMANCE ANALYSIS OF CAD MODELS, IN CLASS 9 (U.S. CLS. 21, 23, 26, 36 AND 38).

**TRADEMARK**

FIRST USE 8-3-2010; IN COMMERCE 1-24-2010.

**PRINCIPAL REGISTER**

THE MARK CONSISTS OF STANDARD CHARACTERS WITHOUT CLAIM TO ANY PARTICULAR FONT, STYLE, SIZE, OR COLOR.

SER. NO. 85-519,717, FILED 1-18-2012.

THEODORE MCBRIDE, EXAMINING ATTORNEY



*David J. Kybas*

Director of the United States Patent and Trademark Office

# United States of America

United States Patent and Trademark Office

## Let's write together.

**Reg. No. 4,198,201**

**Registered Aug. 28, 2012**

**Int. Cl.: 42**

**SERVICE MARK**

**PRINCIPAL REGISTER**

WEBSISTANT, L.L.C. (CALIFORNIA LIMITED LIABILITY COMPANY)  
233 NORTH BRAND BLVD.  
GLENDALE, CA 91203

FOR: PROVIDING A WEB SITE FEATURING TECHNOLOGY THAT ENABLES INTERNET USERS TO CREATE, BOOKMARK, ANNOTATE, AND PUBLICLY SHARE DATA; PROVIDING A WEB SITE FEATURING TECHNOLOGY THAT ENABLES USERS TO UPLOAD, EDIT, AND SHARE DIGITAL CONTENT, IN CLASS 42 (U.S. CLS. 100 AND 101).

FIRST USE 1-2-2012; IN COMMERCE 1-2-2012.

THE MARK CONSISTS OF STANDARD CHARACTERS WITHOUT CLAIM TO ANY PARTICULAR FONT, STYLE, SIZE, OR COLOR.

SER. NO. 85-519,721, FILED 1-18-2012.

MARK SPARACINO, EXAMINING ATTORNEY



*David J. Kyffers*

Director of the United States Patent and Trademark Office

# United States of America

United States Patent and Trademark Office

## QUICKTHOTICS

**Reg. No. 4,198,202**

**Registered Aug. 28, 2012**

**Int. Cl.: 10**

**TRADEMARK**

**PRINCIPAL REGISTER**

ANTHONY, RAYMOND J. (UNITED KINGDOM INDIVIDUAL)  
SOLE SOLUTIONS  
7 EUCALYPTUS BLD. PRINTER WAY  
GEORGE TOWN, CAYMAN ISLANDS KY1-1003

FOR: ORTHOTICS FOR FOOT, IN CLASS 10 (U.S. CLS. 26, 39 AND 44).

FIRST USE 12-22-2011; IN COMMERCE 12-22-2011.

THE MARK CONSISTS OF STANDARD CHARACTERS WITHOUT CLAIM TO ANY PARTICULAR FONT, STYLE, SIZE, OR COLOR.

SER. NO. 85-519,738, FILED 1-18-2012.

DAVID I, EXAMINING ATTORNEY



*David J. Kyfos*

Director of the United States Patent and Trademark Office

# United States of America

United States Patent and Trademark Office

## Amber Chase

**Reg. No. 4,198,203**

**Registered Aug. 28, 2012**

**Int. Cl.: 41**

**SERVICE MARK**

**PRINCIPAL REGISTER**

HENDRICKSON, LILLIAN (UNITED STATES INDIVIDUAL), AKA AMBER CHASE  
P.O. BOX 72  
438 N. 4TH ST.  
KALAMA, WA 98625

FOR: ENTERTAINMENT IN THE NATURE OF DANCE PERFORMANCES; ENTERTAINMENT IN THE NATURE OF LIVE PERFORMANCES BY AN ACTOR IN ADULT MOVIES; ENTERTAINMENT IN THE NATURE OF PRERECORDED ADULT-THEMED, SEX-ORIENTED, INSULT-ORIENTED, ROLEPLAY-ORIENTED, AND NON-SEXUAL CHAT MESSAGES BY TELEPHONE; ENTERTAINMENT IN THE NATURE OF VISUAL AND AUDIO PERFORMANCES BY AN ACTOR IN ADULT MOVIES; ENTERTAINMENT IN THE NATURE OF VISUAL AND AUDIO PERFORMANCES BY AN ACTOR; ENTERTAINMENT SERVICES, NAMELY, PERSONAL APPEARANCES BY A ARTIST, DANCER, MODEL, ADULT-ENTERTAINMENT PERFORMER, ONLINE PERSONA; ENTERTAINMENT SERVICES, NAMELY, PROVIDING A WEB SITE FEATURING NON-DOWNLOADABLE ADULT-THEMED PHOTOGRAPHS AND VIDEOS; MODELING FOR ARTISTS; PRODUCTION OF DVDS FEATURING ADULT MOVIES, IN CLASS 41 (U.S. CLS. 100, 101 AND 107).

FIRST USE 8-1-2003; IN COMMERCE 7-1-2007.

THE MARK CONSISTS OF STANDARD CHARACTERS WITHOUT CLAIM TO ANY PARTICULAR FONT, STYLE, SIZE, OR COLOR.

THE NAME "AMBER CHASE" IDENTIFIES A LIVING INDIVIDUAL WHOSE CONSENT IS OF RECORD.

SER. NO. 85-519,760, FILED 1-19-2012.

TASHIA BUNCH, EXAMINING ATTORNEY



*David J. Kyffers*

Director of the United States Patent and Trademark Office

United States of America  
United States Patent and Trademark Office

**GoldMax** 

**Reg. No. 4,198,204**

**Registered Aug. 28, 2012**

**Int. Cl.: 5**

HAINAN GUOJIAN HIGHTECH MILK INDUSTRY CO., LTD (CHINA LIMITED LIABILITY COMPANY)  
BLOCK D, DIAMOND BUILDING  
42 LONG KUN SOUTH ROAD  
HAIKOU CITY, HAINAN, CHINA

**TRADEMARK**

**PRINCIPAL REGISTER**

FOR: FOOD FOR BABIES; MEDICATED DERMATOLOGICAL PREPARATIONS AND SUBSTANCES; NUTRITIVE SUBSTANCES FOR MICROORGANISM CULTURES; POWDERED MILK FOR BABIES; PROCESSED FOOD ADAPTED FOR MEDICAL PURPOSES, IN CLASS 5 (U.S. CLS. 6, 18, 44, 46, 51 AND 52).

FIRST USE 11-21-2009; IN COMMERCE 2-3-2010.

THE MARK CONSISTS OF THE LETTERS OF "GOLDMAX" AND TWO CHINESE CHARACTERS IN AN ARROW. AROUND THE WORDING ARE THREE FOUR-POINT STARS AND THREE SOLID CIRCLES

THE NON-LATIN CHARACTERS IN THE MARK TRANSLITERATE TO "GAO""PEI" AND THIS HAS NO MEANING IN A FOREIGN LANGUAGE.

THE WORDING "GOLDMAX" HAS NO MEANING IN A FOREIGN LANGUAGE.

SER. NO. 85-519,772, FILED 1-19-2012.

TASHIA BUNCH, EXAMINING ATTORNEY



*David J. Kybas*

Director of the United States Patent and Trademark Office



# United States of America

United States Patent and Trademark Office

# GPR

**Reg. No. 4,198,205**

**Registered Aug. 28, 2012**

**Int. Cl.: 5**

**TRADEMARK**

**PRINCIPAL REGISTER**

GPR NUTRITION, INC. (WYOMING CORPORATION)  
SUITE 1402-585  
347 5TH AVE.  
NEW YORK, NY 10016

FOR: DIETARY AND NUTRITIONAL SUPPLEMENTS, IN CLASS 5 (U.S. CLS. 6, 18, 44, 46, 51 AND 52).

FIRST USE 9-23-2011; IN COMMERCE 11-4-2011.

THE MARK CONSISTS OF STANDARD CHARACTERS WITHOUT CLAIM TO ANY PARTICULAR FONT, STYLE, SIZE, OR COLOR.

SER. NO. 85-519,814, FILED 1-19-2012.

FRANK LATTUCA, EXAMINING ATTORNEY



*David J. Kyros*

Director of the United States Patent and Trademark Office

# United States of America

United States Patent and Trademark Office

## BRYANT CUSTOM PRECISION RIFLESMITHING

**Reg. No. 4,198,206**

BRYANT CUSTOM LLC (TEXAS LIMITED LIABILITY COMPANY)  
7761 FM 592  
WHEELER, TX 79096

**Registered Aug. 28, 2012**

**Int. Cl.: 37**

FOR: CUSTOM REPAIR, REBUILDING, RESTOCKING, REFINISHING, REBARRELING, RELINING, CHAMBERING, PILLAR BEDDING, AND ACCURIZING OF SHOTGUNS AND RIFLES, IN CLASS 37 (U.S. CLS. 100, 103 AND 106).

**SERVICE MARK**

FIRST USE 1-0-1997; IN COMMERCE 1-0-1997.

**PRINCIPAL REGISTER**

THE MARK CONSISTS OF STANDARD CHARACTERS WITHOUT CLAIM TO ANY PARTICULAR FONT, STYLE, SIZE, OR COLOR.

NO CLAIM IS MADE TO THE EXCLUSIVE RIGHT TO USE "CUSTOM PRECISION RIFLESMITHING", APART FROM THE MARK AS SHOWN.

THE NAME(S), PORTRAIT(S), AND/OR SIGNATURE(S) SHOWN IN THE MARK IDENTIFIES THOMAS BRYANT, WHOSE CONSENT(S) TO REGISTER IS MADE OF RECORD.

SEC. 2(F).

SER. NO. 85-519,815, FILED 1-19-2012.

FRANK LATTUCA, EXAMINING ATTORNEY



*David J. Kybas*

Director of the United States Patent and Trademark Office

# United States of America

United States Patent and Trademark Office

# PrintGiant

**Reg. No. 4,198,207**

**Registered Aug. 28, 2012**

**Int. Cls.: 35 and 40**

**SERVICE MARK**

**PRINCIPAL REGISTER**

PRINTGIANT, LLC (NEW JERSEY LIMITED LIABILITY COMPANY)  
9 OLD HOMESTEAD ROAD  
WAYNE, NJ 07470

FOR: DESIGN OF ADVERTISING MATERIALS FOR OTHERS, IN CLASS 35 (U.S. CLS. 100, 101 AND 102).

FIRST USE 12-1-2005; IN COMMERCE 4-1-2009.

FOR: PRINTING OF ADVERTISING MATTER, IN CLASS 40 (U.S. CLS. 100, 103 AND 106).

FIRST USE 12-1-2005; IN COMMERCE 4-1-2009.

THE MARK CONSISTS OF STANDARD CHARACTERS WITHOUT CLAIM TO ANY PARTICULAR FONT, STYLE, SIZE, OR COLOR.

SER. NO. 85-519,817, FILED 1-19-2012.

FRANK LATTUCA, EXAMINING ATTORNEY



*David J. Kybas*

Director of the United States Patent and Trademark Office

# United States of America

United States Patent and Trademark Office

# TITANIA

**Reg. No. 4,198,208**

**Registered Aug. 28, 2012**

**Int. Cls.: 3 and 8**

**TRADEMARK**

**PRINCIPAL REGISTER**

TITANIA FABRIK GMBH (FED REP GERMANY GESELLSCHAFT MIT BESCHRÄNKTER HAFTUNG (GMBH))  
FORTUNASTRAßE 10-14  
WÜLFRATH, FED REP GERMANY 42489

FOR: COSMETICS; PERFUMERY, IN CLASS 3 (U.S. CLS. 1, 4, 6, 50, 51 AND 52).

FIRST USE 1-1-1999; IN COMMERCE 1-1-1999.

FOR: CALLUS CUTTERS; CALLUS RASPS; CUTICLE SCISSORS; DEPILATORY APPLIANCES; DISPOSABLE RAZORS; ELECTRIC AND BATTERY-POWERED HAIR CLIPPERS; ELECTRIC AND BATTERY-POWERED HAIR TRIMMERS; ELECTRIC FINGERNAIL POLISHERS; ELECTRIC HAIR CLIPPERS; ELECTRIC HAIR CUTTERS; ELECTRIC HAIR TRIMMERS; ELECTRIC MANICURE SETS; ELECTRIC PEDICURE SETS; ELECTRIC SHAVERS; EPILATORY APPLIANCES; EYELASH CURLERS; EYELASH SEPARATORS; FILES; FINGERNAIL CLIPPERS; FOOT CARE IMPLEMENTS, NAMELY, FOOT FILES; HAIR CLIPPERS; HAIR CUTTING SCISSORS; HAIR TRIMMERS; HAND-OPERATED HAIR CLIPPERS; MANICURE IMPLEMENTS, NAMELY, NAIL FILES, NAIL CLIPPERS, CUTICLE PUSHERS, TWEEZERS, NAIL AND CUTICLE SCISSORS; MANICURE SETS; MUSTACHE AND BEARD TRIMMERS; NAIL BUFFERS; NAIL CLIPPERS; NAIL FILES; NAIL NIPPERS; NAIL SCISSORS; NAIL SKIN TREATMENT TRIMMERS; NON-ELECTRIC FINGERNAIL POLISHERS; NON-ELECTRIC HAIR CLIPPERS; NON-ELECTRIC RAZORS; NON-ELECTRIC SHAVERS; PEDICURE IMPLEMENTS, NAMELY, NAIL FILES, NAIL CLIPPERS, CUTICLE PUSHERS, TWEEZERS, NAIL AND CUTICLE SCISSORS; PEDICURE SETS; TWEEZERS, IN CLASS 8 (U.S. CLS. 23, 28 AND 44).

FIRST USE 1-1-1999; IN COMMERCE 1-1-1999.

THE MARK CONSISTS OF STANDARD CHARACTERS WITHOUT CLAIM TO ANY PARTICULAR FONT, STYLE, SIZE, OR COLOR.

OWNER OF U.S. REG. NO. 3,042,036.

SER. NO. 85-519,823, FILED 1-19-2012.

KELLEY WELLS, EXAMINING ATTORNEY



*David J. Kelley*

Director of the United States Patent and Trademark Office

# United States of America

United States Patent and Trademark Office

## A BETTER SYSTEM

**Reg. No. 4,198,209**

**Registered Aug. 28, 2012**

**Int. Cl.: 41**

**SERVICE MARK**

**PRINCIPAL REGISTER**

ELECTRONIC INK, INC. (PENNSYLVANIA CORPORATION)  
19TH FLOOR  
ONE SOUTH BROAD STREET  
PHILADELPHIA, PA 19107

FOR: ON-LINE JOURNALS, NAMELY, BLOGS FEATURING INFORMATION IN THE FIELD OF BUSINESS SOFTWARE SYSTEMS, TECHNOLOGY AND DESIGN, IN CLASS 41 (U.S. CLS. 100, 101 AND 107).

FIRST USE 7-7-2009; IN COMMERCE 7-7-2009.

THE MARK CONSISTS OF STANDARD CHARACTERS WITHOUT CLAIM TO ANY PARTICULAR FONT, STYLE, SIZE, OR COLOR.

SER. NO. 85-519,831, FILED 1-19-2012.

WILLIAM P. SHANAHAN, EXAMINING ATTORNEY



*David J. Kybas*

Director of the United States Patent and Trademark Office

United States of America  
United States Patent and Trademark Office

xfinity

**Reg. No. 4,198,210**

**Registered Aug. 28, 2012**

**Int. Cl.: 38**

**SERVICE MARK**

**PRINCIPAL REGISTER**

COMCAST CORPORATION (PENNSYLVANIA CORPORATION)  
1701 JOHN F. KENNEDY BOULEVARD  
PHILADELPHIA, PA 19103

FOR: CABLE TELEVISION BROADCASTING SERVICES; PROVISION OF TELECOMMUNICATION ACCESS TO VIDEO AND AUDIO CONTENT PROVIDED VIA VIDEO-ON-DEMAND, INTERACTIVE TELEVISION, PAY PER VIEW AND PAY TELEVISION SUBSCRIPTION SERVICES; PROVIDING HIGH SPEED ACCESS TO THE INTERNET AND OTHER ELECTRONIC COMMUNICATIONS NETWORKS; STREAMING OF VIDEO AND AUDIO MATERIAL VIA THE INTERNET AND OTHER ELECTRONIC COMMUNICATIONS NETWORKS; PROVIDING ELECTRONIC MAIL, INSTANT MESSAGING, WEB MESSAGING AND WIRELESS DIGITAL MESSAGING SERVICES; TELECOMMUNICATION ACCESS SERVICES; PERSONAL COMMUNICATIONS SERVICES; ELECTRONIC, LOCAL AND LONG DISTANCE TRANSMISSION OF VOICE, DATA AND GRAPHICS BY MEANS OF CABLE, TELEPHONE, WIRELESS, ISDN AND SATELLITE TECHNOLOGIES; PROVIDING FIBER OPTIC NETWORK SERVICES; PROVIDING VOICE COMMUNICATION SERVICES VIA THE INTERNET AND OTHER ELECTRONIC COMMUNICATIONS NETWORKS; PROVIDING TELECOMMUNICATIONS SERVICES VIA PREPAID TELEPHONE CALLING CARDS; VOICE-OVER IP SERVICES; AND LEASING OR RENTAL OF TELECOMMUNICATIONS EQUIPMENT, IN CLASS 38 (U.S. CLS. 100, 101 AND 104).

FIRST USE 2-12-2010; IN COMMERCE 2-12-2010.

OWNER OF U.S. REG. NOS. 3,850,803, 3,944,290, AND 3,951,529.

THE MARK CONSISTS OF THE STYLIZED LETTERS "XFINITY".

SER. NO. 85-519,850, FILED 1-19-2012.

DOUGLAS LEE, EXAMINING ATTORNEY



*David J. Kybas*

Director of the United States Patent and Trademark Office

# United States of America

United States Patent and Trademark Office

## PERFECTING THE BALANCE OF MAINTENANCE

**Reg. No. 4,198,211**

**Registered Aug. 28, 2012**

**Int. Cls.: 37, 40 and 42**

**SERVICE MARK**

**PRINCIPAL REGISTER**

SOLUTIONS MANAGEMENT, INC. (NEW YORK CORPORATION)  
P. O. BOX 1027  
REMSENBURG, NY 119601027

FOR: JANITORIAL SERVICES; POWER WASHING SERVICES; RESTORATION SERVICES  
IN THE FIELD OF WATER, SMOKE AND FIRE DAMAGE; WINDOW CLEANING, IN CLASS  
37 (U.S. CLS. 100, 103 AND 106).

FIRST USE 9-10-2011; IN COMMERCE 9-10-2011.

FOR: MOLD REMEDIATION SERVICES, IN CLASS 40 (U.S. CLS. 100, 103 AND 106).

FIRST USE 9-10-2011; IN COMMERCE 9-10-2011.

FOR: INSPECTING BUILDINGS FOR THE EXISTENCE OF MOLD, IN CLASS 42 (U.S. CLS.  
100 AND 101).

FIRST USE 9-10-2011; IN COMMERCE 9-10-2011.

THE MARK CONSISTS OF STANDARD CHARACTERS WITHOUT CLAIM TO ANY PAR-  
TICULAR FONT, STYLE, SIZE, OR COLOR.

SER. NO. 85-519,851, FILED 1-19-2012.

KEVIN DINALLO, EXAMINING ATTORNEY



*David J. Kybas*

Director of the United States Patent and Trademark Office

# United States of America

United States Patent and Trademark Office

## BUGS DO IT BETTER

**Reg. No. 4,198,212**

BUGS DO IT BETTER LLC (ARIZONA LIMITED LIABILITY COMPANY)  
5025 N. CENTRAL AVENUE SUITE # 538  
PHOENIX, AZ 85012

**Registered Aug. 28, 2012**

**Int. Cl.: 1**

FOR: CHEMICAL PREPARATIONS IN THE NATURE OF ACTUATORS AND ENHANCERS OF THE NATURAL ORGANIC DECOMPOSITION OF FAT, OILS, AND GREASES, IN CLASS 1 (U.S. CLS. 1, 5, 6, 10, 26 AND 46).

**TRADEMARK**

FIRST USE 5-17-2011; IN COMMERCE 5-17-2011.

**PRINCIPAL REGISTER**

THE MARK CONSISTS OF STANDARD CHARACTERS WITHOUT CLAIM TO ANY PARTICULAR FONT, STYLE, SIZE, OR COLOR.

SER. NO. 85-519,852, FILED 1-19-2012.

DOUGLAS LEE, EXAMINING ATTORNEY



*David J. Kyffers*

Director of the United States Patent and Trademark Office



# United States of America

United States Patent and Trademark Office

# ACCELSPINE

**Reg. No. 4,198,213**

ACCEL BIOMEDICS, LLC (DELAWARE LIMITED LIABILITY COMPANY)  
10455 N. CENTRAL EXPRESSWAY, STE 109-324  
DALLAS, TX 75231

**Registered Aug. 28, 2012**

**Int. Cl.: 10**

FOR: SURGICAL AND MEDICAL APPARATUS AND INSTRUMENTS FOR USE IN SPINAL SURGERY, IN CLASS 10 (U.S. CLS. 26, 39 AND 44).

**TRADEMARK**

FIRST USE 3-11-2011; IN COMMERCE 6-8-2011.

**PRINCIPAL REGISTER**

THE MARK CONSISTS OF STANDARD CHARACTERS WITHOUT CLAIM TO ANY PARTICULAR FONT, STYLE, SIZE, OR COLOR.

SER. NO. 85-519,868, FILED 1-19-2012.

ELI HELLMAN, EXAMINING ATTORNEY



*David J. Kybas*

Director of the United States Patent and Trademark Office

# United States of America

United States Patent and Trademark Office

## WE GOT YOUR BACK!

**Reg. No. 4,198,214**

**Registered Aug. 28, 2012**

**Int. Cls.: 35 and 44**

**SERVICE MARK**

**PRINCIPAL REGISTER**

ACCIDENT INJURY CENTERS OF ATLANTA, INC. (GEORGIA CORPORATION)  
SUITE C  
1132 HIGHTOWER TRAIL  
SANDY SPRINGS, GA 30350

FOR: ADVERTISING AND MARKETING SERVICES FOR THE HEALTH CARE INDUSTRY,  
IN CLASS 35 (U.S. CLS. 100, 101 AND 102).

FIRST USE 12-1-2004; IN COMMERCE 12-1-2004.

FOR: HEALTH CARE SERVICES, NAMELY MEDICAL, CHIROPRACTIC, PHYSICAL  
THERAPY, DIAGNOSTIC TESTING AND IMAGING SERVICES, IN CLASS 44 (U.S. CLS.  
100 AND 101).

FIRST USE 12-1-2004; IN COMMERCE 12-1-2004.

THE MARK CONSISTS OF STANDARD CHARACTERS WITHOUT CLAIM TO ANY PAR-  
TICULAR FONT, STYLE, SIZE, OR COLOR.

OWNER OF U.S. REG. NO. 3,271,803.

SER. NO. 85-519,889, FILED 1-19-2012.

ANNE E. GUSTASON, EXAMINING ATTORNEY



*David J. Kybas*

Director of the United States Patent and Trademark Office

# United States of America

United States Patent and Trademark Office

## MOHONK PRESERVE

**Reg. No. 4,198,215**

MOHONK PRESERVE, INC. (NEW YORK CORPORATION)

**Registered Aug. 28, 2012**

P.O. BOX 715  
NEW PALTZ, NY 12561

**Int. Cl.: 16**

FOR: PUBLICATIONS, NAMELY, BOOKS, NEWSLETTERS, BROCHURES, FLYERS, BOOKLETS, INFORMATIONAL SHEETS AND PAMPHLETS IN THE FIELDS OF NATURE, AND OUTDOOR EDUCATION PROGRAM, IN CLASS 16 (U.S. CLS. 2, 5, 22, 23, 29, 37, 38 AND 50).

**TRADEMARK**

**PRINCIPAL REGISTER**

FIRST USE 3-30-1978; IN COMMERCE 3-30-1978.

THE MARK CONSISTS OF STANDARD CHARACTERS WITHOUT CLAIM TO ANY PARTICULAR FONT, STYLE, SIZE, OR COLOR.

SER. NO. 85-519,894, FILED 1-19-2012.

ANDREA HACK, EXAMINING ATTORNEY



*David J. Kyffers*

Director of the United States Patent and Trademark Office

# United States of America

United States Patent and Trademark Office

# 40 EAST

**Reg. No. 4,198,216**

MCINTYRE, DANIEL (UNITED STATES INDIVIDUAL)  
205 GAZEBO COURT  
WILMINGTON, NC 28409

**Registered Aug. 28, 2012**

**Int. Cl.: 41**

FOR: ENTERTAINMENT, NAMELY, LIVE PERFORMANCES BY A MUSICAL BAND, IN CLASS 41 (U.S. CLS. 100, 101 AND 107).

**SERVICE MARK**

FIRST USE 1-9-2012; IN COMMERCE 1-9-2012.

**PRINCIPAL REGISTER**

THE MARK CONSISTS OF STANDARD CHARACTERS WITHOUT CLAIM TO ANY PARTICULAR FONT, STYLE, SIZE, OR COLOR.

SER. NO. 85-519,913, FILED 1-19-2012.

KEVIN DINALLO, EXAMINING ATTORNEY



*David J. Kybas*

Director of the United States Patent and Trademark Office

# United States of America

United States Patent and Trademark Office



**Reg. No. 4,198,217**

**Registered Aug. 28, 2012**

**Int. Cls.: 37, 40 and 42**

**SERVICE MARK**

**PRINCIPAL REGISTER**

SOLUTIONS MANAGEMENT, INC. (NEW YORK CORPORATION)  
P. O. BOX 1027  
REMSENBURG, NY 119601027

FOR: JANITORIAL SERVICES; POWER WASHING SERVICES; RESTORATION SERVICES IN THE FIELD OF WATER, SMOKE AND FIRE DAMAGE; WINDOW CLEANING, IN CLASS 37 (U.S. CLS. 100, 103 AND 106).

FIRST USE 9-10-2011; IN COMMERCE 9-10-2011.

FOR: MOLD REMEDIATION SERVICES, IN CLASS 40 (U.S. CLS. 100, 103 AND 106).

FIRST USE 9-10-2011; IN COMMERCE 9-10-2011.

FOR: INSPECTING BUILDINGS FOR THE EXISTENCE OF MOLD, IN CLASS 42 (U.S. CLS. 100 AND 101).

FIRST USE 9-10-2011; IN COMMERCE 9-10-2011.

THE MARK CONSISTS OF THE LETTERS "SM" AND STYLIZED "I" ABOVE THE WORDS "SOLUTIONS MANAGEMENT".

SER. NO. 85-519,920, FILED 1-19-2012.

KEVIN DINALLO, EXAMINING ATTORNEY



*David J. Kybas*

Director of the United States Patent and Trademark Office

# United States of America

United States Patent and Trademark Office

 SELECTUSA

**Reg. No. 4,198,218**

**Registered Aug. 28, 2012**

**Int. Cl.: 35**

**SERVICE MARK**

**PRINCIPAL REGISTER**

U.S. DEPARTMENT OF COMMERCE, INTERNATIONAL TRADE ADMINISTRATION  
(UNITED STATES FEDERAL AGENCY)  
1401 CONSTITUTION AVENUE, NW  
WASHINGTON, DC 20230

FOR: PROVIDING BUSINESS INFORMATION, NAMELY, INFORMATION ABOUT FEDERAL PROGRAMS AVAILABLE TO BUSINESSES LOCATED IN OR INTERESTED IN BEING LOCATED IN THE UNITED STATES, IN CLASS 35 (U.S. CLS. 100, 101 AND 102).

FIRST USE 6-15-2011; IN COMMERCE 6-15-2011.

THE MARK CONSISTS OF A STAR CONTAINING A CHECKMARK THROUGH IT, FOLLOWED BY THE WORD SELECTUSA.

SER. NO. 85-519,930, FILED 1-19-2012.

ROBERT C. CLARK JR., EXAMINING ATTORNEY



*David J. Kyffers*

Director of the United States Patent and Trademark Office

United States of America  
United States Patent and Trademark Office

# SLIMROCK

**Reg. No. 4,198,219**

PURE CALIFORNIA BEVERAGES INC. (CALIFORNIA CORPORATION)  
318 GEORGINA AVENUE  
SANTA MONICA, CA 90402

**Registered Aug. 28, 2012**

**Int. Cl.: 32**

FOR: NON-ALCOHOLIC COCKTAIL MIXES, IN CLASS 32 (U.S. CLS. 45, 46 AND 48).

**TRADEMARK**

FIRST USE 8-8-2011; IN COMMERCE 8-8-2011.

**PRINCIPAL REGISTER**

THE MARK CONSISTS OF STANDARD CHARACTERS WITHOUT CLAIM TO ANY PARTICULAR FONT, STYLE, SIZE, OR COLOR.

SER. NO. 85-519,945, FILED 1-19-2012.

JORDAN BAKER, EXAMINING ATTORNEY



*David J. Kybas*

Director of the United States Patent and Trademark Office

# United States of America

United States Patent and Trademark Office

## PARCHMENT

**Reg. No. 4,198,220**

**Registered Aug. 28, 2012**

**Int. Cl.: 41**

**SERVICE MARK**

**PRINCIPAL REGISTER**

PARCHMENT INC. (DELAWARE CORPORATION)  
6263 NORTH SCOTTSDALE ROAD, SUITE 170  
SCOTTSDALE, AZ 85250

FOR: EDUCATIONAL SERVICES, NAMELY, OBTAINING, MANAGING, PROVIDING, AND EXCHANGING EDUCATION-RELATED CREDENTIALS, TRANSCRIPTS, STUDENT RECORDS AND DOCUMENTS, AND SCHOOL AND UNIVERSITY RECORDS AND DOCUMENTS, FOR OTHERS, IN CLASS 41 (U.S. CLS. 100, 101 AND 107).

FIRST USE 3-10-2011; IN COMMERCE 3-10-2011.

THE MARK CONSISTS OF STANDARD CHARACTERS WITHOUT CLAIM TO ANY PARTICULAR FONT, STYLE, SIZE, OR COLOR.

SER. NO. 85-519,975, FILED 1-19-2012.

MICHAEL WIENER, EXAMINING ATTORNEY



*David J. Kyffers*

Director of the United States Patent and Trademark Office



# United States of America

United States Patent and Trademark Office

# TESHMONT

**Reg. No. 4,198,221**

TESHMONT CONSULTANTS LP (CANADA LIMITED PARTNERSHIP)  
1190 WAVERLEY STREET

**Registered Aug. 28, 2012**

WINNIPEG, MANITOBA, CANADA R3TOP4

**Int. Cl.: 42**

FOR: ENGINEERING SERVICES IN THE FIELD OF HIGH VOLTAGE POWER TRANSMISSION, IN CLASS 42 (U.S. CLS. 100 AND 101).

**SERVICE MARK**

FIRST USE 12-1-1966; IN COMMERCE 5-15-1970.

**PRINCIPAL REGISTER**

THE MARK CONSISTS OF STANDARD CHARACTERS WITHOUT CLAIM TO ANY PARTICULAR FONT, STYLE, SIZE, OR COLOR.

SER. NO. 85-519,987, FILED 1-19-2012.

THEODORE MCBRIDE, EXAMINING ATTORNEY



*David J. Kybas*

Director of the United States Patent and Trademark Office

# United States of America

United States Patent and Trademark Office

## StopThinkChange

**Reg. No. 4,198,222**

HELENA NORD LEE (SWEDEN INDIVIDUAL)  
168 WEBSTER ROAD  
SCARSDALE, NY 10583

**Registered Aug. 28, 2012**

**Int. Cl.: 41**

FOR: PROFESSIONAL COACHING SERVICES IN THE FIELD OF HEALTH AND PERSONAL DEVELOPMENT, IN CLASS 41 (U.S. CLS. 100, 101 AND 107).

**SERVICE MARK**

FIRST USE 1-1-2012; IN COMMERCE 1-1-2012.

**PRINCIPAL REGISTER**

THE MARK CONSISTS OF STANDARD CHARACTERS WITHOUT CLAIM TO ANY PARTICULAR FONT, STYLE, SIZE, OR COLOR.

SER. NO. 85-519,994, FILED 1-19-2012.

SUSAN STIGLITZ, EXAMINING ATTORNEY



*David J. Kybas*

Director of the United States Patent and Trademark Office

# United States of America

United States Patent and Trademark Office

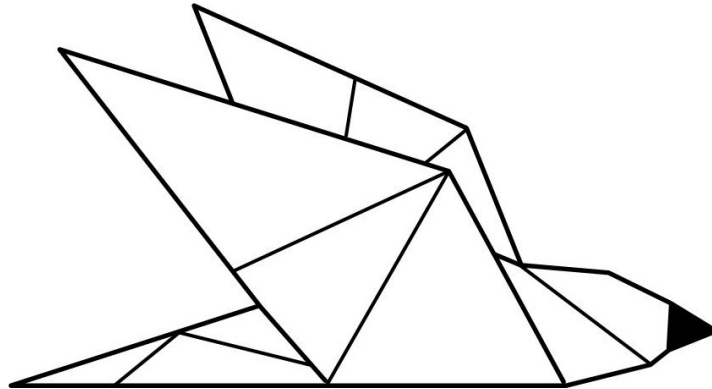

**Reg. No. 4,198,223**

**Registered Aug. 28, 2012**

**Int. Cl.: 41**

**SERVICE MARK**

**PRINCIPAL REGISTER**

PARCHMENT INC. (DELAWARE CORPORATION)  
6263 NORTH SCOTTSDALE ROAD, SUITE 170  
SCOTTSDALE, AZ 85250

FOR: EDUCATIONAL SERVICES, NAMELY, OBTAINING, MANAGING, PROVIDING, AND EXCHANGING EDUCATION-RELATED CREDENTIALS, TRANSCRIPTS, STUDENT RECORDS AND DOCUMENTS, AND SCHOOL AND UNIVERSITY RECORDS AND DOCUMENTS, FOR OTHERS, IN CLASS 41 (U.S. CLS. 100, 101 AND 107).

FIRST USE 3-10-2011; IN COMMERCE 3-10-2011.

THE MARK CONSISTS OF AN ORIGAMI BIRD.

SER. NO. 85-520,001, FILED 1-19-2012.

MICHAEL WIENER, EXAMINING ATTORNEY



*David J. Kybas*

Director of the United States Patent and Trademark Office

# United States of America

United States Patent and Trademark Office

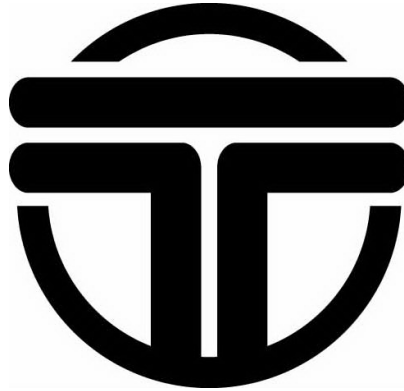

**Reg. No. 4,198,224**

**Registered Aug. 28, 2012**

**Int. Cl.: 42**

**SERVICE MARK**

**PRINCIPAL REGISTER**

TESHMONT CONSULTANTS LP (CANADA LIMITED PARTNERSHIP)  
1190 WAVERLEY STREET  
WINNIPEG, MANITOBA, CANADA R3TOP4

FOR: ENGINEERING SERVICES IN THE FIELD OF HIGH VOLTAGE POWER TRANSMISSION, IN CLASS 42 (U.S. CLS. 100 AND 101).

FIRST USE 12-31-1995; IN COMMERCE 12-31-1995.

THE MARK CONSISTS OF STYLIZED CAPITAL LETTER "T" SUPERIMPOSED ON A CIRCLE.

SER. NO. 85-520,004, FILED 1-19-2012.

THEODORE MCBRIDE, EXAMINING ATTORNEY



*David J. Kybas*

Director of the United States Patent and Trademark Office

# United States of America

United States Patent and Trademark Office

# S'WELL

**Reg. No. 4,198,225**

SONGMASTERS LLC (NEW YORK LIMITED LIABILITY COMPANY)  
110 WEST 96TH STREET STE 11A  
NEW YORK, NY 10025

**Registered Aug. 28, 2012**

**Int. Cl.: 41**

FOR: DEVELOPMENT AND DISSEMINATION OF EDUCATIONAL INFORMATION AND MATERIALS IN THE FIELD OF WOMEN'S HEALTH AND WELLNESS, IN CLASS 41 (U.S. CLS. 100, 101 AND 107).

**SERVICE MARK**

FIRST USE 11-0-2011; IN COMMERCE 11-0-2011.

**PRINCIPAL REGISTER**

THE MARK CONSISTS OF STANDARD CHARACTERS WITHOUT CLAIM TO ANY PARTICULAR FONT, STYLE, SIZE, OR COLOR.

SER. NO. 85-520,024, FILED 1-19-2012.

THEODORE MCBRIDE, EXAMINING ATTORNEY



*David J. Kybas*

Director of the United States Patent and Trademark Office

# United States of America

United States Patent and Trademark Office

## Almost perfect

**Reg. No. 4,198,226**

MILES, AARON L. (UNITED STATES INDIVIDUAL)  
27 WEIRFIELD STREET  
BROOKLYN, NY 11221

**Registered Aug. 28, 2012**

**Int. Cl.: 25**

FOR: HATS; JACKETS; PANTS; SHOES; SNEAKERS; SWEATSHIRTS; T-SHIRTS, IN CLASS 25 (U.S. CLS. 22 AND 39).

**TRADEMARK**

FIRST USE 10-14-2002; IN COMMERCE 7-0-2007.

**PRINCIPAL REGISTER**

THE MARK CONSISTS OF STANDARD CHARACTERS WITHOUT CLAIM TO ANY PARTICULAR FONT, STYLE, SIZE, OR COLOR.

SER. NO. 85-520,035, FILED 1-19-2012.

DANNEAN HETZEL, EXAMINING ATTORNEY



*David J. Kybas*

Director of the United States Patent and Trademark Office

# United States of America

United States Patent and Trademark Office

## Adorable Mouse Doors

**Reg. No. 4,198,227**

ADOORABLE (CALIFORNIA LIMITED LIABILITY COMPANY)  
114 MACKIE DRIVE  
MARTINEZ, CA 94553

**Registered Aug. 28, 2012**

**Int. Cl.: 20**

FOR: NOVELTY MOUSE DOORS MADE OF WOOD, AND HAVE SMALL-HINGED DOORS THAT OPEN UP BY A PERSON'S HANDS TO REVEAL GRAPHICS AND TEXT CARDS THAT ARE INSERT FROM THE TOP OF THE DOOR FRAME, IN CLASS 20 (U.S. CLS. 2, 13, 22, 25, 32 AND 50).

**TRADEMARK**

**PRINCIPAL REGISTER**

FIRST USE 12-25-2010; IN COMMERCE 11-27-2011.

THE MARK CONSISTS OF STANDARD CHARACTERS WITHOUT CLAIM TO ANY PARTICULAR FONT, STYLE, SIZE, OR COLOR.

NO CLAIM IS MADE TO THE EXCLUSIVE RIGHT TO USE "MOUSE DOORS", APART FROM THE MARK AS SHOWN.

SER. NO. 85-520,048, FILED 1-19-2012.

LINDA MICKLEBURGH, EXAMINING ATTORNEY



*David J. Kyfos*

Director of the United States Patent and Trademark Office

# United States of America

United States Patent and Trademark Office

*blue hour designs*

**Reg. No. 4,198,228**

BLUE HOUR DESIGNS, LLC (COLORADO LIMITED LIABILITY COMPANY)  
367 LODGEWOOD LN.  
LAFAYETTE, CO 80026

**Registered Aug. 28, 2012**

**Int. Cl.: 14**

FOR: JEWELRY, IN CLASS 14 (U.S. CLS. 2, 27, 28 AND 50).

**TRADEMARK**

FIRST USE 1-1-2010; IN COMMERCE 1-1-2010.

**PRINCIPAL REGISTER**

NO CLAIM IS MADE TO THE EXCLUSIVE RIGHT TO USE "DESIGNS" , APART FROM THE MARK AS SHOWN.

THE MARK CONSISTS OF THE WORDING "BLUE HOUR DESIGNS" IN A STYLIZED MANNER.

SER. NO. 85-520,052, FILED 1-19-2012.

DAVID MURRAY, EXAMINING ATTORNEY



*David J. Kyros*

Director of the United States Patent and Trademark Office



# United States of America

United States Patent and Trademark Office

## ADVANTAGE CAPITAL FUNDS

**Reg. No. 4,198,229**

**Registered Aug. 28, 2012**

**Int. Cl.: 36**

**SERVICE MARK**

**PRINCIPAL REGISTER**

ADVANTAGE CAPITAL FUNDS LLC (CALIFORNIA LIMITED LIABILITY COMPANY)  
SUITE 515  
5900 SEPULVEDA BLVD  
VAN NUYS, CA 91411

FOR: EQUITY CAPITAL INVESTMENT; MANAGEMENT OF A CAPITAL INVESTMENT FUND; PROVIDING WORKING CAPITAL; PROVIDING WORKING CAPITAL FINANCING TO SMALL BUSINESSES AND SMALL BUSINESS OWNERS; VENTURE CAPITAL ADVISORY SERVICES; VENTURE CAPITAL FINANCING; VENTURE CAPITAL FUND MANAGEMENT, IN CLASS 36 (U.S. CLS. 100, 101 AND 102).

FIRST USE 9-0-2008; IN COMMERCE 9-0-2008.

THE MARK CONSISTS OF STANDARD CHARACTERS WITHOUT CLAIM TO ANY PARTICULAR FONT, STYLE, SIZE, OR COLOR.

NO CLAIM IS MADE TO THE EXCLUSIVE RIGHT TO USE "CAPITAL FUNDS", APART FROM THE MARK AS SHOWN.

SER. NO. 85-520,058, FILED 1-19-2012.

JIM RINGLE, EXAMINING ATTORNEY



*David J. Kybas*

Director of the United States Patent and Trademark Office

# United States of America

United States Patent and Trademark Office

# LRK

**Reg. No. 4,198,230**

**Registered Aug. 28, 2012**

**Int. Cl.: 25**

**TRADEMARK**

**PRINCIPAL REGISTER**

INTELLEXUAL PROPERTY (CONNECTICUT LIMITED LIABILITY COMPANY)  
#700R  
1266 EAST MAIN ST.  
STAMFORD, CT 06902

FOR: DRESS SHIRTS; DRESSES; JACKETS; PANTS, IN CLASS 25 (U.S. CLS. 22 AND 39).

FIRST USE 10-3-2011; IN COMMERCE 10-10-2011.

THE MARK CONSISTS OF THE STYLIZED LETTERS "LRK".

SER. NO. 85-520,071, FILED 1-19-2012.

BRIAN PINO, EXAMINING ATTORNEY



*David J. Kyffers*

Director of the United States Patent and Trademark Office

# United States of America

United States Patent and Trademark Office

# SECO SEALS

**Reg. No. 4,198,231**

**Registered Aug. 28, 2012**

**Int. Cl.: 6**

**TRADEMARK**

**PRINCIPAL REGISTER**

SECO SEALS, INC. (CALIFORNIA CORPORATION)  
UNIT K  
1370 LOGAN AVENUE  
COSTA MESA, CA 92626

FOR: METAL TUBE FITTING GASKETS, IN CLASS 6 (U.S. CLS. 2, 12, 13, 14, 23, 25 AND 50).

FIRST USE 1-0-1969; IN COMMERCE 1-0-1969.

THE MARK CONSISTS OF STANDARD CHARACTERS WITHOUT CLAIM TO ANY PARTICULAR FONT, STYLE, SIZE, OR COLOR.

NO CLAIM IS MADE TO THE EXCLUSIVE RIGHT TO USE "SEALS", APART FROM THE MARK AS SHOWN.

SER. NO. 85-520,072, FILED 1-19-2012.

MATTHEW KLINE, EXAMINING ATTORNEY



*David J. Kypas*

Director of the United States Patent and Trademark Office

# United States of America

United States Patent and Trademark Office

# CEEMSA

**Reg. No. 4,198,232**

WIFER WORLDWIDE LLC (TEXAS LIMITED LIABILITY COMPANY), DBA CEEMSA  
63N SHIMMERING ASPEN CR  
SPRING, TX 77389

**Registered Aug. 28, 2012**

**Int. Cl.: 9**

FOR: CURRENT RECTIFIERS, IN CLASS 9 (U.S. CLS. 21, 23, 26, 36 AND 38).

**TRADEMARK**

FIRST USE 1-1-2012; IN COMMERCE 1-1-2012.

**PRINCIPAL REGISTER**

THE MARK CONSISTS OF STANDARD CHARACTERS WITHOUT CLAIM TO ANY PARTICULAR FONT, STYLE, SIZE, OR COLOR.

SER. NO. 85-520,077, FILED 1-19-2012.

MICHAEL ENGEL, EXAMINING ATTORNEY



*David J. Kyffers*

Director of the United States Patent and Trademark Office

# United States of America

United States Patent and Trademark Office

# WINC

**Reg. No. 4,198,233**

**Registered Aug. 28, 2012**

**Int. Cl.: 41**

**SERVICE MARK**

**PRINCIPAL REGISTER**

WOMEN IN COMMUNITY, LLC (COLORADO LIMITED LIABILITY COMPANY)  
3815 NORTHBROOK DR., UNIT C  
BOULDER, CO 80304

FOR: PROVIDING EDUCATIONAL MENTORING SERVICES AND PROGRAMS IN THE FIELD OF BUSINESS GROWTH, BUSINESS MANAGEMENT AND BUSINESS DEVELOPMENT, IN CLASS 41 (U.S. CLS. 100, 101 AND 107).

FIRST USE 1-16-2011; IN COMMERCE 1-18-2012.

THE MARK CONSISTS OF STANDARD CHARACTERS WITHOUT CLAIM TO ANY PARTICULAR FONT, STYLE, SIZE, OR COLOR.

SER. NO. 85-520,078, FILED 1-19-2012.

BARBARA RUTLAND, EXAMINING ATTORNEY



*David J. Kybas*

Director of the United States Patent and Trademark Office

# United States of America

United States Patent and Trademark Office

## U.S. VINTAGE

**Reg. No. 4,198,234**

EXIST, INC. (FLORIDA CORPORATION)

**Registered Aug. 28, 2012**

1650 N.W. 23RD AVE., BAY A  
FT. LAUDERDALE, FL 33311

**Int. Cl.: 25**

FOR: SHIRTS, T-SHIRTS, TANK TOPS, SHORT SETS, JOGGING PANTS, CAPRI PANTS, DRESSES, PANTS, SWEATSHIRTS, SWEATERS, CREWNECK SWEATERS, FLEECE SWEATSHIRTS, POLO SHIRTS, HAWAIIAN SHIRTS, IN CLASS 25 (U.S. CLS. 22 AND 39).

**TRADEMARK**

FIRST USE 9-21-2005; IN COMMERCE 9-21-2005.

**PRINCIPAL REGISTER**

THE MARK CONSISTS OF STANDARD CHARACTERS WITHOUT CLAIM TO ANY PARTICULAR FONT, STYLE, SIZE, OR COLOR.

OWNER OF U.S. REG. NO. 3,099,559.

NO CLAIM IS MADE TO THE EXCLUSIVE RIGHT TO USE "VINTAGE", APART FROM THE MARK AS SHOWN.

SEC. 2(F).

SER. NO. 85-520,133, FILED 1-19-2012.

WILLIAM P. SHANAHAN, EXAMINING ATTORNEY



*David J. Kyffers*

Director of the United States Patent and Trademark Office

# United States of America

United States Patent and Trademark Office

# KGMB

**Reg. No. 4,198,235**

**Registered Aug. 28, 2012**

**Int. Cl.: 38**

**SERVICE MARK**

**PRINCIPAL REGISTER**

RAYCOM MEDIA, INC. (DELAWARE CORPORATION)  
RSA TOWER 20TH FLOOR  
201 MONROE STREET  
MONTGOMERY, AL 36104

FOR: TELEVISION BROADCASTING SERVICES, IN CLASS 38 (U.S. CLS. 100, 101 AND 104).

FIRST USE 12-1-1952; IN COMMERCE 12-1-1952.

THE MARK CONSISTS OF STANDARD CHARACTERS WITHOUT CLAIM TO ANY PARTICULAR FONT, STYLE, SIZE, OR COLOR.

SER. NO. 85-520,137, FILED 1-19-2012.

CHRISTOPHER SIDOTI, EXAMINING ATTORNEY



*David J. Kybas*

Director of the United States Patent and Trademark Office

# United States of America

United States Patent and Trademark Office

# TRIALOY

**Reg. No. 4,198,236**

**Registered Aug. 28, 2012**

**Int. Cls.: 16 and 21**

**TRADEMARK**

**PRINCIPAL REGISTER**

PAINT BRUSH CORPORATION (SOUTH DAKOTA CORPORATION)  
P.O. BOX 371  
27 WEST CHERRY STREET  
VERMILLION, SD 57069

FOR: PAINT BRUSHES, IN CLASS 16 (U.S. CLS. 2, 5, 22, 23, 29, 37, 38 AND 50).

FIRST USE 11-17-2011; IN COMMERCE 11-17-2011.

FOR: BRUSHES FOR CLEANING MACHINERY AND EQUIPMENT; FILAMENTS FOR MAKING BRUSHES, IN CLASS 21 (U.S. CLS. 2, 13, 23, 29, 30, 33, 40 AND 50).

FIRST USE 5-14-2004; IN COMMERCE 5-19-2004.

THE MARK CONSISTS OF STANDARD CHARACTERS WITHOUT CLAIM TO ANY PARTICULAR FONT, STYLE, SIZE, OR COLOR.

OWNER OF U.S. REG. NO. 3,030,581.

SER. NO. 85-520,138, FILED 1-19-2012.

WILLIAM P. SHANAHAN, EXAMINING ATTORNEY



*David J. Kybas*

Director of the United States Patent and Trademark Office



# United States of America

United States Patent and Trademark Office

# BINDU

**Reg. No. 4,198,237**

**Registered Aug. 28, 2012**

**Int. Cl.: 20**

**TRADEMARK**

**PRINCIPAL REGISTER**

STEELCASE INC. (MICHIGAN CORPORATION)  
901 44TH ST SE, PO BOX 1967  
GRAND RAPIDS, MI 49501

FOR: SEATING FURNITURE, IN CLASS 20 (U.S. CLS. 2, 13, 22, 25, 32 AND 50).

FIRST USE 7-17-2009; IN COMMERCE 7-17-2009.

THE MARK CONSISTS OF STANDARD CHARACTERS WITHOUT CLAIM TO ANY PARTICULAR FONT, STYLE, SIZE, OR COLOR.

SER. NO. 85-520,162, FILED 1-19-2012.

JANICE L. MCMORROW, EXAMINING ATTORNEY



*David J. Kybas*

Director of the United States Patent and Trademark Office

United States of America  
United States Patent and Trademark Office

# STACKATO

**Reg. No. 4,198,238**

**Registered Aug. 28, 2012**

**Int. Cl.: 42**

**SERVICE MARK**

**PRINCIPAL REGISTER**

ACTIVESTATE SOFTWARE INC. (CANADA CORPORATION)  
409 GRANVILLE STREET, SUITE 1700  
VANCOUVER, BC, CANADA V6C-1T2

FOR: PLATFORM AS A SERVICE (PAAS) FEATURING COMPUTER SOFTWARE APPLICATION PLATFORM FOR USE IN THE AUTOMATED DEPLOYMENT, CONFIGURATION, SCALING AND MONITORING OF APPLICATIONS TO PUBLIC OR PRIVATE CLOUD, INCLUDING A LANGUAGE INTERPRETER, WEB FRAMEWORK, PREREQUISITE MODULES AND DATABASE, IN CLASS 42 (U.S. CLS. 100 AND 101).

FIRST USE 5-5-2011; IN COMMERCE 5-5-2011.

THE MARK CONSISTS OF STANDARD CHARACTERS WITHOUT CLAIM TO ANY PARTICULAR FONT, STYLE, SIZE, OR COLOR.

SER. NO. 85-520,200, FILED 1-19-2012.

ERIN FALK, EXAMINING ATTORNEY



*David J. Kybas*

Director of the United States Patent and Trademark Office

# United States of America

United States Patent and Trademark Office



**Reg. No. 4,198,239**

**Registered Aug. 28, 2012**

**Int. Cl.: 25**

**TRADEMARK**

**PRINCIPAL REGISTER**

BLUME, KRIS (UNITED STATES INDIVIDUAL)  
10431 N. FAIR DESERT DRIVE  
ORO VALLEY, AZ 85737

FOR: HATS; JACKETS; PANTS; SHIRTS; SHORT-SLEEVED OR LONG-SLEEVED T-SHIRTS;  
SOCKS; SWEAT PANTS; SWEAT SHIRTS; T-SHIRTS; UNDERWEAR, IN CLASS 25 (U.S.  
CLS. 22 AND 39).

FIRST USE 12-0-2008; IN COMMERCE 12-0-2008.

THE MARK CONSISTS OF THE STYLIZED LETTER "P", AND THE STYLIZED LETTER  
"H". THE LETTER "H" GOES THROUGH THE OPEN PORTION OF THE LETTER "P".

SER. NO. 85-520,205, FILED 1-19-2012.

AMEEN IMAM, EXAMINING ATTORNEY



*David J. Kyffers*

Director of the United States Patent and Trademark Office

# United States of America

United States Patent and Trademark Office

# ZIPPYKID

**Reg. No. 4,198,240**

ZIPPYKID INC (DELAWARE CORPORATION), AKA ZIPPYKID WORDPRESS HOSTING  
112 E. PECAN ST., SUITE 1100  
SAN ANTONIO, TX 78205

**Registered Aug. 28, 2012**

**Int. Cl.: 42**

FOR: COMPUTER SERVICES, NAMELY, HOSTING AND MAINTAINING AN ON-LINE  
WEB SITE FOR OTHERS FOR ONLINE COMMUNICATION, IN CLASS 42 (U.S. CLS. 100  
AND 101).

**SERVICE MARK**

FIRST USE 5-28-2010; IN COMMERCE 6-1-2010.

**PRINCIPAL REGISTER**

THE MARK CONSISTS OF STANDARD CHARACTERS WITHOUT CLAIM TO ANY PAR-  
TICULAR FONT, STYLE, SIZE, OR COLOR.

SER. NO. 85-520,246, FILED 1-19-2012.

JEFFREY LOOK, EXAMINING ATTORNEY



*David J. Kyffers*

Director of the United States Patent and Trademark Office

# United States of America

United States Patent and Trademark Office

## CRAZY CUBES

**Reg. No. 4,198,241**

**Registered Aug. 28, 2012**

**Int. Cl.: 30**

**TRADEMARK**

**PRINCIPAL REGISTER**

PELICAN ICE & COLD STORAGE, L.L.C. (LOUISIANA LIMITED LIABILITY COMPANY),  
FORMERLY PELICAN ICE & COLD STORAGE, INC.  
711 OXLEY STREET  
KENNER, LA 70062

FOR: ICE, IN CLASS 30 (U.S. CL. 46).

FIRST USE 1-1-1960; IN COMMERCE 1-1-1960.

THE MARK CONSISTS OF STANDARD CHARACTERS WITHOUT CLAIM TO ANY PARTICULAR FONT, STYLE, SIZE, OR COLOR.

NO CLAIM IS MADE TO THE EXCLUSIVE RIGHT TO USE "CUBES", APART FROM THE MARK AS SHOWN.

SER. NO. 85-520,263, FILED 1-19-2012.

JOHN WILKE, EXAMINING ATTORNEY



*David J. Kyffers*

Director of the United States Patent and Trademark Office

# United States of America

United States Patent and Trademark Office

## FEMME FATALE V.I.P.

**Reg. No. 4,198,242**

ENDIA ABRANTE (UNITED STATES INDIVIDUAL)

**Registered Aug. 28, 2012**

A149  
10624 S. EASTERN AVENUE  
HENDERSON, NV 89052

**Int. Cl.: 41**

FOR: PARTY PLANNING; SPECIAL EVENT PLANNING FOR SOCIAL ENTERTAINMENT PURPOSES, IN CLASS 41 (U.S. CLS. 100, 101 AND 107).

**SERVICE MARK**

FIRST USE 1-12-2012; IN COMMERCE 1-12-2012.

**PRINCIPAL REGISTER**

THE MARK CONSISTS OF STANDARD CHARACTERS WITHOUT CLAIM TO ANY PARTICULAR FONT, STYLE, SIZE, OR COLOR.

SER. NO. 85-520,269, FILED 1-19-2012.

TINA BROWN, EXAMINING ATTORNEY



*David J. Kyffers*

Director of the United States Patent and Trademark Office

# United States of America

United States Patent and Trademark Office

# SPICY CITY

**Reg. No. 4,198,243**

ZHENG, LAN (UNITED STATES INDIVIDUAL)  
402 TERRA BELLA  
IRVINE, CA 92602

**Registered Aug. 28, 2012**

**Int. Cl.: 43**

FOR: RESTAURANT SERVICES FEATURING CHINESE FOOD, IN CLASS 43 (U.S. CLS. 100 AND 101).

**SERVICE MARK**

FIRST USE 5-1-2010; IN COMMERCE 5-1-2010.

**PRINCIPAL REGISTER**

THE MARK CONSISTS OF STANDARD CHARACTERS WITHOUT CLAIM TO ANY PARTICULAR FONT, STYLE, SIZE, OR COLOR.

SER. NO. 85-520,282, FILED 1-19-2012.

KATHERINE CONNOLLY, EXAMINING ATTORNEY



*David J. Kybas*

Director of the United States Patent and Trademark Office

# United States of America

United States Patent and Trademark Office

## Credit Union ONE

**Reg. No. 4,198,244**

CREDIT UNION ONE (MICHIGAN CORPORATION)  
400 EAST NINE MILE ROAD  
FERNDALE, MI 48220

**Registered Aug. 28, 2012**

**Int. Cl.: 36**

FOR: CREDIT UNION SERVICES; CREDIT UNION SERVICES PROVIDED BY MOBILE TELEPHONE CONNECTIONS; CREDIT UNIONS, IN CLASS 36 (U.S. CLS. 100, 101 AND 102).

**SERVICE MARK**

FIRST USE 4-28-1985; IN COMMERCE 4-28-1985.

**PRINCIPAL REGISTER**

THE MARK CONSISTS OF STANDARD CHARACTERS WITHOUT CLAIM TO ANY PARTICULAR FONT, STYLE, SIZE, OR COLOR.

NO CLAIM IS MADE TO THE EXCLUSIVE RIGHT TO USE "CREDIT UNION", APART FROM THE MARK AS SHOWN.

SER. NO. 85-520,314, FILED 1-19-2012.

BRIAN PINO, EXAMINING ATTORNEY



*David J. Kyffers*

Director of the United States Patent and Trademark Office



# United States of America

United States Patent and Trademark Office

## MUNICIPAL WINEMAKERS

**Reg. No. 4,198,245**

MUNICIPAL WINEMAKERS, LLC (CALIFORNIA LIMITED LIABILITY COMPANY)  
2642 INDUSTRIAL PARKWAY, SUITE H  
SANTA MARIA, CA 93455

**Registered Aug. 28, 2012**

**Int. Cls.: 21, 33, 35, 39  
and 41**

FOR: DRINKING GLASSES, IN CLASS 21 (U.S. CLS. 2, 13, 23, 29, 30, 33, 40 AND 50).

FIRST USE 7-26-2007; IN COMMERCE 7-26-2007.

**TRADEMARK**

FOR: WINE, IN CLASS 33 (U.S. CLS. 47 AND 49).

**SERVICE MARK**

FIRST USE 7-26-2007; IN COMMERCE 7-26-2007.

**PRINCIPAL REGISTER**

FOR: ON-LINE RETAIL STORE SERVICES FEATURING WINE, IN CLASS 35 (U.S. CLS. 100, 101 AND 102).

FIRST USE 7-26-2007; IN COMMERCE 7-26-2007.

FOR: WINE CLUB SERVICES FEATURING PERIODIC SHIPMENTS OF WINE TO MEMBERS, IN CLASS 39 (U.S. CLS. 100 AND 105).

FIRST USE 7-26-2007; IN COMMERCE 7-26-2007.

FOR: ENTERTAINMENT SERVICES, NAMELY, WINE TASTINGS, IN CLASS 41 (U.S. CLS. 100, 101 AND 107).

FIRST USE 7-26-2007; IN COMMERCE 7-26-2007.

THE MARK CONSISTS OF STANDARD CHARACTERS WITHOUT CLAIM TO ANY PARTICULAR FONT, STYLE, SIZE, OR COLOR.

NO CLAIM IS MADE TO THE EXCLUSIVE RIGHT TO USE "WINEMAKERS", APART FROM THE MARK AS SHOWN.

SER. NO. 85-520,360, FILED 1-19-2012.

DAVID YONTEF, EXAMINING ATTORNEY



*David J. Kyffers*

Director of the United States Patent and Trademark Office

# United States of America

United States Patent and Trademark Office

## AQUA CHEMPACS

**Reg. No. 4,198,246**

AQUACHEMPACS, LLC (DELAWARE LIMITED LIABILITY COMPANY)  
515 ANDREWS ROAD  
TREVOSE, PA 19053

**Registered Aug. 28, 2012**

**Int. Cl.: 3**

FOR: WATER-SOLUBLE PACKETS CONTAINING MULTI-PURPOSE CLEANERS, IN CLASS 3 (U.S. CLS. 1, 4, 6, 50, 51 AND 52).

**TRADEMARK**

FIRST USE 1-18-2012; IN COMMERCE 1-18-2012.

**PRINCIPAL REGISTER**

THE MARK CONSISTS OF STANDARD CHARACTERS WITHOUT CLAIM TO ANY PARTICULAR FONT, STYLE, SIZE, OR COLOR.

SER. NO. 85-520,371, FILED 1-19-2012.

KATHERINE CHANG, EXAMINING ATTORNEY



*David J. Kybas*

Director of the United States Patent and Trademark Office

# United States of America

United States Patent and Trademark Office

# vpulse

**Reg. No. 4,198,247**

VELODYNE ACOUSTICS, INC. (CALIFORNIA CORPORATION)  
600 UNIVERSITY AVE. STE. 278  
SACRAMENTO, CA 95825

**Registered Aug. 28, 2012**

**Int. Cl.: 9**

FOR: AUDIO HEADPHONES, IN CLASS 9 (U.S. CLS. 21, 23, 26, 36 AND 38).

**TRADEMARK**

FIRST USE 11-1-2011; IN COMMERCE 11-24-2011.

**PRINCIPAL REGISTER**

THE MARK CONSISTS OF STANDARD CHARACTERS WITHOUT CLAIM TO ANY PARTICULAR FONT, STYLE, SIZE, OR COLOR.

SER. NO. 85-520,373, FILED 1-19-2012.

KAPIL BHANOT, EXAMINING ATTORNEY



*David J. Kybas*

Director of the United States Patent and Trademark Office

# United States of America

United States Patent and Trademark Office



**Reg. No. 4,198,248**

**Registered Aug. 28, 2012**

**Int. Cl.: 41**

**SERVICE MARK**

**PRINCIPAL REGISTER**

TELEVISA, S.A. DE C.V. (MEXICO CORPORATION)  
EDIFICIO A PISO 4, COLONIA ZEDEC  
AVENIDA VASCO DE QUIROGA 2000  
SANTA FE, MEXICO 01210

FOR: ENTERTAINMENT SERVICES IN THE NATURE OF A CONTINUING DRAMATIC SHOW BROADCAST OVER THE INTERNET AND AN ONGOING DRAMATIC TELEVISION SHOW, IN CLASS 41 (U.S. CLS. 100, 101 AND 107).

OWNER OF MEXICO REG. NO. 712626, DATED 5-10-2001, EXPIRES 5-10-2021.

THE COLOR(S) BLUE, YELLOW, WHITE AND PURPLE IS/ARE CLAIMED AS A FEATURE OF THE MARK.

THE MARK CONSISTS OF THE DESIGNATION "AMIGAS" IN BLUE WITH INTERSPERSED WHITE AND YELLOW FLOWER DESIGNS, THE LETTER "Y" IN YELLOW, AND THE DESIGNATION "RIVALES" IN PURPLE WITH AN IRREGULAR WHITE LINE THROUGH THE MIDDLE OF THE LETTERS.

THE ENGLISH TRANSLATION OF "AMIGAS Y RIVALES" IN THE MARK IS "FRIENDS AND RIVALS".

SER. NO. 85-520,384, FILED 1-19-2012.

SANDRA BUJA, EXAMINING ATTORNEY



*David J. Kybas*

Director of the United States Patent and Trademark Office

# United States of America

United States Patent and Trademark Office

## CLUB AWESOME

**Reg. No. 4,198,249**

MUNICIPAL WINEMAKERS, LLC (CALIFORNIA LIMITED LIABILITY COMPANY)  
2642 INDUSTRIAL PARKWAY, SUITE H  
SANTA MARIA, CA 93455

**Registered Aug. 28, 2012**

**Int. Cl.: 39**

FOR: WINE CLUB SERVICES FEATURING PERIODIC SHIPMENTS OF WINE TO MEMBERS,  
IN CLASS 39 (U.S. CLS. 100 AND 105).

**SERVICE MARK**

FIRST USE 7-26-2007; IN COMMERCE 7-26-2007.

**PRINCIPAL REGISTER**

THE MARK CONSISTS OF STANDARD CHARACTERS WITHOUT CLAIM TO ANY PARTICULAR FONT, STYLE, SIZE, OR COLOR.

NO CLAIM IS MADE TO THE EXCLUSIVE RIGHT TO USE "CLUB", APART FROM THE MARK AS SHOWN.

SER. NO. 85-520,386, FILED 1-19-2012.

DAVID YONTEF, EXAMINING ATTORNEY



*David J. Kyffers*

Director of the United States Patent and Trademark Office

# United States of America

United States Patent and Trademark Office

# FREEDA

**Reg. No. 4,198,250**

**Registered Aug. 28, 2012**

**Int. Cl.: 26**

**TRADEMARK**

**PRINCIPAL REGISTER**

FREEDA, INC. (NEW YORK CORPORATION)  
107 MIDDLE NECK ROAD, \*\*1  
GREAT NECK, NY 11021

FOR: WIGS AND HAIRPIECES, IN CLASS 26 (U.S. CLS. 37, 39, 40, 42 AND 50).

FIRST USE 0-0-1965; IN COMMERCE 0-0-1965.

THE MARK CONSISTS OF STANDARD CHARACTERS WITHOUT CLAIM TO ANY PARTICULAR FONT, STYLE, SIZE, OR COLOR.

SER. NO. 85-520,388, FILED 1-19-2012.

CURTIS FRENCH, EXAMINING ATTORNEY



*David J. Kybas*

Director of the United States Patent and Trademark Office

# United States of America

United States Patent and Trademark Office

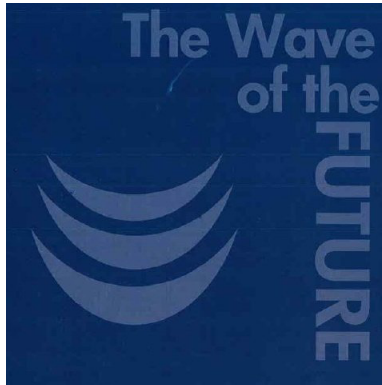

**Reg. No. 4,198,251**

**Registered Aug. 28, 2012**

**Int. Cl.: 42**

**SERVICE MARK**

**PRINCIPAL REGISTER**

AMARAPEX CORPORATION (TEXAS CORPORATION)  
9800 NORTHWEST FREEWAY, SUITE 301  
HOUSTON, TX 77092

FOR: INSPECTIONS OF PETROCHEMICAL, OIL AND NATURAL GAS, AND POWER GENERATION INDUSTRIES; MATERIALS TESTING AND ANALYSING; PRODUCT TESTING; SCIENTIFIC AND TECHNOLOGICAL SERVICES, NAMELY, TESTING AND INSPECTION IN THE FIELD OF PETROCHEMICAL, OIL AND NATURAL GAS, AND POWER GENERATION INDUSTRIES; TESTING, ANALYSIS, AND EVALUATION OF PETROCHEMICAL, OIL AND NATURAL GAS AND POWER GENERATION TO ASSURE COMPLIANCE WITH INDUSTRY STANDARDS, IN CLASS 42 (U.S. CLS. 100 AND 101).

FIRST USE 6-0-2011; IN COMMERCE 6-0-2011.

THE MARK CONSISTS OF THE LIGHT BLUE STYLIZED WORDS "THE WAVE", ABOVE THE LIGHT BLUE STYLIZED WORDS "OF THE" ABOVE THE LIGHT BLUE STYLIZED WORD "FUTURE", DEMONSTRATED VERTICALLY DOWN THE RIGHT SIDE OF THE MARK. TO THE LEFT OF THE VERTICAL WORD ARE THREE LIGHT BLUE WAVE DESIGNS, STACKED FROM SMALLEST TO LARGEST. THE LOGO APPEARS ON A DARK BLUE BACKGROUND.

THE COLOR(S) DARK BLUE AND LIGHT BLUE IS/ARE CLAIMED AS A FEATURE OF THE MARK.

SER. NO. 85-520,390, FILED 1-19-2012.

CURTIS FRENCH, EXAMINING ATTORNEY



*David J. Kyjars*

Director of the United States Patent and Trademark Office

# United States of America

United States Patent and Trademark Office

## DREAMCATCHER.COM

**Reg. No. 4,198,252**

DREAMCATCHER.COM, INC. (FLORIDA CORPORATION)

**Registered Aug. 28, 2012**

1521 ALTON ROAD, #362  
MIAMI BEACH, FL 33139

**Int. Cl.: 35**

FOR: ON-LINE RETAIL STORE SERVICES FEATURING CULTURAL, INDIAN AND NATIVE AMERICAN CRAFTS, IN CLASS 35 (U.S. CLS. 100, 101 AND 102).

**SERVICE MARK**

FIRST USE 1-1-2003; IN COMMERCE 1-1-2003.

**PRINCIPAL REGISTER**

THE MARK CONSISTS OF STANDARD CHARACTERS WITHOUT CLAIM TO ANY PARTICULAR FONT, STYLE, SIZE, OR COLOR.

OWNER OF U.S. REG. NO. 3,092,358.

SEC. 2(F).

SER. NO. 85-520,402, FILED 1-19-2012.

ANNE E. GUSTASON, EXAMINING ATTORNEY



*David J. Kybas*

Director of the United States Patent and Trademark Office



# United States of America

United States Patent and Trademark Office

## Color Watcher

**Reg. No. 4,198,253**

**Registered Aug. 28, 2012**

**Int. Cl.: 9**

**TRADEMARK**

**PRINCIPAL REGISTER**

INTRAVIS, INC. (DELAWARE CORPORATION)  
3070 BUSINESS PARK DR., SUITE H  
NORCROSS, GA 30071

FOR: OPTICAL METROLOGY SYSTEM FOR QUALITY ASSURANCE INSPECTION OF COLOR AND BRIGHTNESS IN THE VISIBLE UV AND INFRARED SPECTRUM OF PRE-FORMS, CONSISTING OF COMPUTER SOFTWARE FOR CONTROLLING THE OPERATIONS OF COLORPHOTOSPECTROMETER, PERSONAL COMPUTER, DATA PROCESSING EQUIPMENT FOR SEQUENCE CONTROL, COMPUTER MONITORS, LIGHT SOURCES AND MECHANICAL INSPECTION FRAMES WHICH ARE USED TO PRESENT THE PRE-FORMS TO THE COLORPHOTOSPECTROMETER IN AN ACCURATE AND TIMELY MANNER, ALL OF THE FORGOING SOLD AS A UNIT, IN CLASS 9 (U.S. CLS. 21, 23, 26, 36 AND 38).

FIRST USE 12-0-2005; IN COMMERCE 12-0-2005.

THE MARK CONSISTS OF STANDARD CHARACTERS WITHOUT CLAIM TO ANY PARTICULAR FONT, STYLE, SIZE, OR COLOR.

OWNER OF U.S. REG. NO. 3,793,743.

SER. NO. 85-520,429, FILED 1-19-2012.

SAMUEL E. SHARPER JR., EXAMINING ATTORNEY



*David J. Kyffers*

Director of the United States Patent and Trademark Office

# United States of America

United States Patent and Trademark Office

## AUSTRONAUTA

**Reg. No. 4,198,254**

STEVEN B. PARKER (UNITED STATES INDIVIDUAL)  
4299 GOLDENWOOD DRIVE  
OKEMOS, MI 48864 AND

**Registered Aug. 28, 2012**

**Int. Cl.: 42**

CARL R. RUBINO (UNITED STATES INDIVIDUAL)  
4304 OAKTREE ROAD  
ROCKVILLE, MD 20853

**SERVICE MARK**

**PRINCIPAL REGISTER**

FOR: DESIGN, DEVELOPMENT AND CONSULTING SERVICES RELATED THERETO IN THE FIELD OF COMPUTER SOFTWARE, NAMELY, SOFTWARE USED TO PROCESS NATURAL LANGUAGE QUERIES PROVIDING MULTILINGUAL SUPPORT, IN CLASS 42 (U.S. CLS. 100 AND 101).

FIRST USE 9-21-2010; IN COMMERCE 4-18-2011.

THE MARK CONSISTS OF STANDARD CHARACTERS WITHOUT CLAIM TO ANY PARTICULAR FONT, STYLE, SIZE, OR COLOR.

SER. NO. 85-520,442, FILED 1-19-2012.

DAVID YONTEF, EXAMINING ATTORNEY



*David J. Kyfos*

Director of the United States Patent and Trademark Office

# United States of America

United States Patent and Trademark Office

# DX-3

**Reg. No. 4,198,255**

**Registered Aug. 28, 2012**

**Int. Cl.: 28**

**TRADEMARK**

**PRINCIPAL REGISTER**

MUZZY OUTDOORS, LLC (DELAWARE LIMITED LIABILITY COMPANY)  
62 WALNUT STREET  
FLOOR 3  
WELLESLEY HILLS, MA 02481

FOR: ARROW TIPS FOR ARCHERY BOWS AND ARROWS, IN CLASS 28 (U.S. CLS. 22, 23, 38 AND 50).

FIRST USE 1-9-2012; IN COMMERCE 1-9-2012.

THE MARK CONSISTS OF STANDARD CHARACTERS WITHOUT CLAIM TO ANY PARTICULAR FONT, STYLE, SIZE, OR COLOR.

SER. NO. 85-520,462, FILED 1-19-2012.

JANICE L. MCMORROW, EXAMINING ATTORNEY



*David J. Kyffers*

Director of the United States Patent and Trademark Office

# United States of America

United States Patent and Trademark Office

# TRURENDI

**Reg. No. 4,198,256**

CHANG XIN INC. (CALIFORNIA CORPORATION)  
215 E 7TH STREET, STE A  
LOS ANGELES, CA 90014 AND

**Registered Aug. 28, 2012**

**Int. Cl.: 9**

WEIHUA ZHANG (UNITED STATES INDIVIDUAL)  
215 E 7TH STREET, STE A  
LOS ANGELES, CA 90014

**TRADEMARK**

**PRINCIPAL REGISTER**

FOR: CARRYING CASES FOR ELECTRONIC EQUIPMENT, NAMELY, CELL PHONES, TABLET COMPUTERS, PORTABLE GAMING DEVICES, MOBILE COMPUTERS, IN CLASS 9 (U.S. CLS. 21, 23, 26, 36 AND 38).

FIRST USE 11-1-2011; IN COMMERCE 11-1-2011.

THE MARK CONSISTS OF STANDARD CHARACTERS WITHOUT CLAIM TO ANY PARTICULAR FONT, STYLE, SIZE, OR COLOR.

SER. NO. 85-520,464, FILED 1-19-2012.

JANICE L. MCMORROW, EXAMINING ATTORNEY



*David J. Kyros*

Director of the United States Patent and Trademark Office

# United States of America

United States Patent and Trademark Office

## Brain Blankets

**Reg. No. 4,198,257**

WESTFALL, KATE JO (UNITED STATES INDIVIDUAL)  
20 1/2 PARK ST. S.  
MANSFIELD, OH 44902

**Registered Aug. 28, 2012**

**Int. Cl.: 25**

FOR: HATS; HATS FOR INFANTS, BABIES, TODDLERS AND CHILDREN, IN CLASS 25 (U.S. CLS. 22 AND 39).

**TRADEMARK**

FIRST USE 12-21-2001; IN COMMERCE 12-20-2006.

**PRINCIPAL REGISTER**

THE MARK CONSISTS OF STANDARD CHARACTERS WITHOUT CLAIM TO ANY PARTICULAR FONT, STYLE, SIZE, OR COLOR.

SER. NO. 85-520,471, FILED 1-19-2012.

BILL DAWE, EXAMINING ATTORNEY



*David J. Kybas*

Director of the United States Patent and Trademark Office

# United States of America

United States Patent and Trademark Office



**Reg. No. 4,198,258**

ACTR INC. (UTAH CORPORATION)  
1374 WEST 200 SOUTH  
LONDON, UT 84042

**Registered Aug. 28, 2012**

**Int. Cl.: 40**

FOR: MANUFACTURING SERVICES FOR OTHERS IN THE FIELD OF CARBON FIBER TOWERS, IN CLASS 40 (U.S. CLS. 100, 103 AND 106).

**SERVICE MARK**

FIRST USE 11-8-2011; IN COMMERCE 12-15-2011.

**PRINCIPAL REGISTER**

THE MARK CONSISTS OF MULTIPLE GEOMETRIC SHAPES FORMING A DIAMOND WITH INTERSECTING LINES. THE INTERSECTING LINES CREATE AN X WITH A VERTICAL LINE GOING THROUGH THE CENTER OF THE X.

SER. NO. 85-520,483, FILED 1-19-2012.

BARBARA BROWN, EXAMINING ATTORNEY



*David J. Kyffers*

Director of the United States Patent and Trademark Office

# United States of America

United States Patent and Trademark Office

# Faithviews

**Reg. No. 4,198,259**

**Registered Aug. 28, 2012**

**Int. Cl.: 41**

**SERVICE MARK**

**PRINCIPAL REGISTER**

BROYLES AND ASSOCIATES, LLC (OHIO LIMITED LIABILITY COMPANY)  
2216 WOODACRE DRIVE  
CINCINNATI, OH 45231

FOR: EDUCATIONAL SERVICES, NAMELY, PROVIDING ONLINE INSTRUCTION IN THE FIELD OF RELIGION AND SPIRITUALITY VIA AN ONLINE WEBSITE; PROVIDING A WEB SITE THAT FEATURES INFORMAL INSTRUCTION ON RELIGION AND SPIRITUALITY; PROVIDING A WEBSITE FOR ENTERTAINMENT PURPOSES WHERE USERS CAN VIEW AND POST ONLINE VIDEOS FEATURING RELIGION AND SPIRITUALITY, IN CLASS 41 (U.S. CLS. 100, 101 AND 107).

FIRST USE 5-15-2011; IN COMMERCE 6-10-2011.

THE MARK CONSISTS OF STANDARD CHARACTERS WITHOUT CLAIM TO ANY PARTICULAR FONT, STYLE, SIZE, OR COLOR.

SER. NO. 85-520,488, FILED 1-19-2012.

BARBARA BROWN, EXAMINING ATTORNEY



*David J. Kyffers*

Director of the United States Patent and Trademark Office

# United States of America

United States Patent and Trademark Office

# QUIET-STUD

**Reg. No. 4,198,260**

**Registered Aug. 28, 2012**

**Int. Cl.: 6**

**TRADEMARK**

**PRINCIPAL REGISTER**

L.J. AVALON LLC (FLORIDA LIMITED LIABILITY COMPANY)  
ATTN: LAHNIE JOHNSON  
6900 INTERBAY BLVD  
TAMPA, FL 33616

FOR: BUILDING WALL FRAMING MADE PRIMARILY OF METAL, IN CLASS 6 (U.S. CLS. 2, 12, 13, 14, 23, 25 AND 50).

FIRST USE 1-12-2009; IN COMMERCE 1-12-2009.

THE MARK CONSISTS OF STANDARD CHARACTERS WITHOUT CLAIM TO ANY PARTICULAR FONT, STYLE, SIZE, OR COLOR.

SER. NO. 85-520,503, FILED 1-19-2012.

KIM MONINGHOFF, EXAMINING ATTORNEY



*David J. Kyffers*

Director of the United States Patent and Trademark Office



# United States of America

United States Patent and Trademark Office



**Reg. No. 4,198,261**

BERKICH, KIMBERLEY JADE (UNITED STATES INDIVIDUAL)  
P.O. BOX 213  
LIVERPOOL, PA 17045

**Registered Aug. 28, 2012**

**Int. Cl.: 14**

FOR: BRACELETS; EARRINGS; JEWELRY; JEWELRY BROOCHES; JEWELRY, NAMELY, CROSSES; PENDANTS; RINGS, IN CLASS 14 (U.S. CLS. 2, 27, 28 AND 50).

**TRADEMARK**

FIRST USE 9-1-2010; IN COMMERCE 9-1-2010.

**PRINCIPAL REGISTER**

THE MARK CONSISTS OF THE STYLIZED TEXT REFINING ABOVE THE STYLIZED TEXT FIRE. TO THE RIGHT IS A STYLIZED FLAME. BELOW THE ABOVE TEXT IS THE STYLIZED TEXT SOLI DEO GLORIA.

THE ENGLISH TRANSLATION OF "SOLI DEO GLORIA" IN THE MARK IS "GLORY TO GOD ALONE".

SER. NO. 85-520,515, FILED 1-19-2012.

JULIE WATSON, EXAMINING ATTORNEY



*David J. Kybas*

Director of the United States Patent and Trademark Office

# United States of America

United States Patent and Trademark Office

## PRIME POPLAR

**Reg. No. 4,198,262**

GLEN OAK LUMBER & MILLING, INC. (WISCONSIN CORPORATION)  
N2885 COUNTY F  
MONTELLO, WI 53949

**Registered Aug. 28, 2012**

**Int. Cl.: 19**

FOR: HARDWOOD LUMBER AND MILLWORK PRODUCTS, NAMELY, DOOR JAMBS, WOOD MOLDING, WOOD TRIM AND WOOD FINISH BOARDS, IN CLASS 19 (U.S. CLS. 1, 12, 33 AND 50).

**TRADEMARK**

FIRST USE 9-0-1996; IN COMMERCE 9-0-1996.

**PRINCIPAL REGISTER**

THE MARK CONSISTS OF STANDARD CHARACTERS WITHOUT CLAIM TO ANY PARTICULAR FONT, STYLE, SIZE, OR COLOR.

OWNER OF U.S. REG. NO. 2,551,232.

SEC. 2(F).

SER. NO. 85-520,528, FILED 1-19-2012.

NAAKWAMA ANKRAH, EXAMINING ATTORNEY



*David J. Kyffers*

Director of the United States Patent and Trademark Office

# United States of America

United States Patent and Trademark Office

## Don't Just Do It... Do It Dirty

**Reg. No. 4,198,263**

DIRTY LIL DETAILS LLC (COLORADO LIMITED LIABILITY COMPANY)  
8496 SWEETCLOVER WAY  
PARKER, CO 80134

**Registered Aug. 28, 2012**

**Int. Cl.: 5**

FOR: AIR DEODORANT; AIR DEODORIZER; CAR DEODORANT; CAR DEODORIZER;  
DEODORIZERS FOR AUTOMOBILES, IN CLASS 5 (U.S. CLS. 6, 18, 44, 46, 51 AND 52).

**TRADEMARK**

FIRST USE 3-21-2011; IN COMMERCE 6-10-2011.

**PRINCIPAL REGISTER**

THE MARK CONSISTS OF STANDARD CHARACTERS WITHOUT CLAIM TO ANY PARTICULAR FONT, STYLE, SIZE, OR COLOR.

SER. NO. 85-520,537, FILED 1-19-2012.

NICHOLAS COLEMAN, EXAMINING ATTORNEY



*David J. Kybas*

Director of the United States Patent and Trademark Office

# United States of America

United States Patent and Trademark Office

# Intra Watcher

**Reg. No. 4,198,264**

**Registered Aug. 28, 2012**

**Int. Cl.: 9**

**TRADEMARK**

**PRINCIPAL REGISTER**

INTRAVIS, INC (DELAWARE CORPORATION)  
3070 BUSINESS PARK DR., SUITE H  
NORCROSS, GA 30071

FOR: GENERAL MULTI-PURPOSE OPTICAL METROLOGY SYSTEM FOR QUALITY ASSURANCE INSPECTION OF PLASTIC CONTAINERS AND ITS DECORATION, CONSISTING OF COMPUTER SOFTWARE FOR CONTROLLING THE OPERATIONS OF CAMERAS, PERSONAL COMPUTER, DATA PROCESSING EQUIPMENT FOR SEQUENCE CONTROL, COMPUTER MONITORS, LIGHT SOURCES AND MECHANICAL INSPECTION FRAMES WHICH ARE USED TO PRESENT THE PLASTIC CONTAINERS TO THE CAMERAS IN AN ACCURATE AND TIMELY MANNER, ALL OF THE FORGOING SOLD AS A UNIT, IN CLASS 9 (U.S. CLS. 21, 23, 26, 36 AND 38).

FIRST USE 6-0-2005; IN COMMERCE 6-0-2005.

THE MARK CONSISTS OF STANDARD CHARACTERS WITHOUT CLAIM TO ANY PARTICULAR FONT, STYLE, SIZE, OR COLOR.

OWNER OF U.S. REG. NO. 3,793,743.

SER. NO. 85-520,544, FILED 1-19-2012.

NICHOLAS COLEMAN, EXAMINING ATTORNEY



*David J. Kyros*

Director of the United States Patent and Trademark Office

# United States of America

United States Patent and Trademark Office

PATORUZÚ



**Reg. No. 4,198,265**

**Registered Aug. 28, 2012**

**Int. Cl.: 30**

**TRADEMARK**

**PRINCIPAL REGISTER**

ARGOS S.A. (ARGENTINA JOINT STOCK COMPANY)  
SANTA FÉ 1460, 2ND FLOOR  
BUENOS AIRES, ARGENTINA

FOR: TEA; YERBA MATE, IN CLASS 30 (U.S. CL. 46).

FIRST USE 2-0-2010; IN COMMERCE 2-0-2010.

THE MARK CONSISTS OF THE WORD "PATORUZÚ" ABOVE A CARTOON IMAGE OF A NATIVE MAN WEARING A FEATHER AND HOLDING A KETTLE AND A CUP.

SER. NO. 85-520,545, FILED 1-19-2012.

NICHOLAS COLEMAN, EXAMINING ATTORNEY



*David J. Kybas*

Director of the United States Patent and Trademark Office

# United States of America

United States Patent and Trademark Office

## dirty lil details

**Reg. No. 4,198,266**

DIRTY LIL DETAILS LLC (COLORADO LIMITED LIABILITY COMPANY)  
8496 SWEETCLOVER WAY  
PARKER, CO 80134

**Registered Aug. 28, 2012**

**Int. Cl.: 5**

FOR: AIR DEODORANT; AIR DEODORIZER; CAR DEODORANT; CAR DEODORIZER;  
DEODORIZERS FOR AUTOMOBILES, IN CLASS 5 (U.S. CLS. 6, 18, 44, 46, 51 AND 52).

**TRADEMARK**

FIRST USE 3-21-2011; IN COMMERCE 6-10-2011.

**PRINCIPAL REGISTER**

THE MARK CONSISTS OF STANDARD CHARACTERS WITHOUT CLAIM TO ANY PARTICULAR FONT, STYLE, SIZE, OR COLOR.

SER. NO. 85-520,548, FILED 1-19-2012.

NICHOLAS COLEMAN, EXAMINING ATTORNEY



*David J. Kybas*

Director of the United States Patent and Trademark Office

# United States of America

United States Patent and Trademark Office

## KERRY WOOD HEALTHY FOODS

**Reg. No. 4,198,267**

KERRY WOOD HEALTHY FOODS, LLC (CONNECTICUT LIMITED LIABILITY COMPANY)  
2 HIDEAWAY LANE  
WESTPORT, CT 06880

**Registered Aug. 28, 2012**

**Int. Cl.: 30**

FOR: SALAD DRESSINGS AND MARINADES, IN CLASS 30 (U.S. CL. 46).

FIRST USE 10-1-2008; IN COMMERCE 10-1-2008.

**TRADEMARK**

THE MARK CONSISTS OF STANDARD CHARACTERS WITHOUT CLAIM TO ANY PARTICULAR FONT, STYLE, SIZE, OR COLOR.

**PRINCIPAL REGISTER**

NO CLAIM IS MADE TO THE EXCLUSIVE RIGHT TO USE "HEALTHY FOODS", APART FROM THE MARK AS SHOWN.

THE NAME(S), PORTRAIT(S), AND/OR SIGNATURE(S) SHOWN IN THE MARK IDENTIFIES KERRY WOOD, WHOSE CONSENT(S) TO REGISTER IS MADE OF RECORD.

SER. NO. 85-520,559, FILED 1-19-2012.

JOHN GARTNER, EXAMINING ATTORNEY



*David J. Kyffers*

Director of the United States Patent and Trademark Office

# United States of America

United States Patent and Trademark Office

# EZ-VRC

**Reg. No. 4,198,268**

**Registered Aug. 28, 2012**

**Int. Cl.: 9**

**TRADEMARK**

**PRINCIPAL REGISTER**

FARKOUH, STEPHEN (DELAWARE LIMITED LIABILITY COMPANY), DBA VIRTUAL  
REMOTE CONTROLS, LLC  
62 SILVERCREST DRIVE  
TINTON FALLS, NJ 07712

FOR: HOME AND OFFICE AUTOMATION SYSTEMS COMPRISING WIRELESS AND WIRED  
CONTROLLERS, CONTROLLED DEVICES, AND SOFTWARE FOR LIGHTING, HVAC,  
SECURITY, SAFETY AND OTHER HOME AND OFFICE MONITORING AND CONTROL  
APPLICATIONS, IN CLASS 9 (U.S. CLS. 21, 23, 26, 36 AND 38).

FIRST USE 4-15-2011; IN COMMERCE 4-15-2011.

THE MARK CONSISTS OF STANDARD CHARACTERS WITHOUT CLAIM TO ANY PAR-  
TICULAR FONT, STYLE, SIZE, OR COLOR.

SER. NO. 85-520,609, FILED 1-19-2012.

ANTHONY RINKER, EXAMINING ATTORNEY



*David J. Kybas*

Director of the United States Patent and Trademark Office



# United States of America

United States Patent and Trademark Office

# CAM

**Reg. No. 4,198,269**

C.A.M. SUPPLY, INC. (CALIFORNIA CORPORATION)  
490 EAST MENLO AVENUE  
HEMET, CA 92543

**Registered Aug. 28, 2012**

**Int. Cl.: 8**

FOR: APPARATUS FOR TATTOOING; TATTOO MACHINES; TATTOO NEEDLES, IN CLASS 8 (U.S. CLS. 23, 28 AND 44).

**TRADEMARK**

FIRST USE 0-0-1994; IN COMMERCE 0-0-1994.

**PRINCIPAL REGISTER**

THE MARK CONSISTS OF STANDARD CHARACTERS WITHOUT CLAIM TO ANY PARTICULAR FONT, STYLE, SIZE, OR COLOR.

SER. NO. 85-520,628, FILED 1-19-2012.

ARETHA SOMERVILLE, EXAMINING ATTORNEY



*David J. Kyffers*

Director of the United States Patent and Trademark Office

# United States of America

United States Patent and Trademark Office

# MATRIX

**Reg. No. 4,198,270**

DIAB INTERNATIONAL AB (SWEDEN CORPORATION)  
BOX 201

**Registered Aug. 28, 2012**

312 22 LAHOLM, SWEDEN

**Int. Cl.: 17**

FOR: SEMI-MANUFACTURED FOAMED PLASTICS FOR USE IN CONSTRUCTION OF WIND POWER APPARATUS, BOATS, TRAINS, BUSES, AIRCRAFT, SPACECRAFT, SUBSEA BUOYANCY, AND PORTABLE HOUSING , IN CLASS 17 (U.S. CLS. 1, 5, 12, 13, 35 AND 50).

**TRADEMARK**

**PRINCIPAL REGISTER**

FIRST USE 9-0-2010; IN COMMERCE 9-0-2010.

THE MARK CONSISTS OF STANDARD CHARACTERS WITHOUT CLAIM TO ANY PARTICULAR FONT, STYLE, SIZE, OR COLOR.

SER. NO. 85-520,634, FILED 1-19-2012.

KRISTIN DAHLING, EXAMINING ATTORNEY



*David J. Kyffers*

Director of the United States Patent and Trademark Office

United States of America  
United States Patent and Trademark Office

SHAGGO

**Reg. No. 4,198,271**

**Registered Aug. 28, 2012**

**Int. Cl.: 28**

**TRADEMARK**

**PRINCIPAL REGISTER**

ATKINSON, JEFFREY P. (UNITED STATES INDIVIDUAL)  
SHAGGO001TM  
332 FIRST PLACE  
MANHATTAN BEACH, CA 90266

FOR: SPORTS EQUIPMENT FOR SNOWBOARDING, SURFING, AND SKATEBOARDS  
NAMELY, BAGS FOR SNOWBOARDS; BAGS FOR SURFBOARDS; BAGS FOR SKATE-  
BOARDS; BAGS FOR WINDSURFING EQUIPMENT; SNOWBOARDS; SKATEBOARDS;  
SURFBOARDS; PADDLE BOARDS; SNOWBOARD BINDINGS; SNOWBOARD DECKS;  
SKATEBOARD DECKS; SKATEBOARD GRIP TAPES; SKATEBOARD TRUCKS, SKATE-  
BOARD WHEELS, SKATEBOARD DECKS, AND SKATEBOARD DECK COVERINGS, IN  
CLASS 28 (U.S. CLS. 22, 23, 38 AND 50).

FIRST USE 9-29-2010; IN COMMERCE 11-18-2011.

THE MARK CONSISTS OF STANDARD CHARACTERS WITHOUT CLAIM TO ANY PAR-  
TICULAR FONT, STYLE, SIZE, OR COLOR.

SER. NO. 85-520,637, FILED 1-19-2012.

CURTIS FRENCH, EXAMINING ATTORNEY



*David J. Kypos*

Director of the United States Patent and Trademark Office

# United States of America

United States Patent and Trademark Office

## BE INDEPENDENT

**Reg. No. 4,198,272**

STANDER INC. (UTAH CORPORATION)

**Registered Aug. 28, 2012**

1615 QUAIL WAY  
LOGAN, UT 84321

**Int. Cls.: 10 and 20**

FOR: WALKERS TO AID IN MOBILITY; CRUTCHES; MEDICAL APPARATUS, NAMELY, HANDLE-TYPE DEVICE TO ASSIST MOBILITY-IMPAIRED INDIVIDUALS IN SUPPORTING THEIR WEIGHT WHEN TRANSFERRING FROM SITTING OR PRONE POSITIONS INTO OR FROM A STANDING POSITION, IN CLASS 10 (U.S. CLS. 26, 39 AND 44).

**TRADEMARK**

**PRINCIPAL REGISTER**

FIRST USE 11-30-2011; IN COMMERCE 11-30-2011.

FOR: BED RAILS; MOBILITY ASSISTANCE DEVICES, NAMELY, BATHTUB, SHOWER AND TOILET GRAB BARS NOT OF METAL, IN CLASS 20 (U.S. CLS. 2, 13, 22, 25, 32 AND 50).

FIRST USE 11-30-2011; IN COMMERCE 11-30-2011.

THE MARK CONSISTS OF STANDARD CHARACTERS WITHOUT CLAIM TO ANY PARTICULAR FONT, STYLE, SIZE, OR COLOR.

SER. NO. 85-520,645, FILED 1-19-2012.

ROBIN MITTLER, EXAMINING ATTORNEY



*David J. Kyros*

Director of the United States Patent and Trademark Office

# United States of America

United States Patent and Trademark Office

i4

**Reg. No. 4,198,273**

MICHAEL E. ZALETEL (UNITED STATES INDIVIDUAL)  
378 E. CLIFTON COURT  
GILBERT, AZ 85296

**Registered Aug. 28, 2012**

**Int. Cl.: 9**

FOR: PHOTOGRAPHIC ACCESSORIES---NAMELY, CAMERA HOLDERS, TRIPODS, AND CASES THEREFOR, IN CLASS 9 (U.S. CLS. 21, 23, 26, 36 AND 38).

**TRADEMARK**

FIRST USE 0-0-1999; IN COMMERCE 0-0-1999.

**PRINCIPAL REGISTER**

THE MARK CONSISTS OF STANDARD CHARACTERS WITHOUT CLAIM TO ANY PARTICULAR FONT, STYLE, SIZE, OR COLOR.

SER. NO. 85-520,655, FILED 1-19-2012.

FONG HSU, EXAMINING ATTORNEY



*David J. Kybas*

Director of the United States Patent and Trademark Office

# United States of America

United States Patent and Trademark Office

## Deliciously Nutritious

**Reg. No. 4,198,274**

**Registered Aug. 28, 2012**

**Int. Cl.: 41**

**SERVICE MARK**

**PRINCIPAL REGISTER**

DELICIOUSLY NUTRITIOUS, LLC (MARYLAND LIMITED LIABILITY COMPANY)  
4 ROCKWELL COURT  
ANNAPOLIS, MD 21403

FOR: EDUCATION SERVICES, NAMELY, PROVIDING LIVE AND ON-LINE CLASSES, CAMPS, SEMINARS AND OUTREACH PROGRAMS IN THE NATURE OF ON-SITE EDUCATIONAL CLASSES, PRODUCTION AND DISTRIBUTION OF EDUCATIONAL TELEVISION PROGRAMS, AND NON-DOWNLOADABLE INTERNET VIDEOS, ALL IN THE FIELD OF HEALTH, NUTRITION AND COOKING; EDUCATIONAL SERVICES, NAMELY, DEVELOPING CURRICULUM FOR OTHERS IN THE FIELD OF HEALTH AND NUTRITION; PROVIDING AFTER SCHOOL EDUCATIONAL PROGRAMS FOR CHILDREN IN GRADES PRE K-12; PROVIDING EDUCATIONAL DEMONSTRATIONS, IN CLASS 41 (U.S. CLS. 100, 101 AND 107).

FIRST USE 6-1-2007; IN COMMERCE 7-21-2008.

THE MARK CONSISTS OF STANDARD CHARACTERS WITHOUT CLAIM TO ANY PARTICULAR FONT, STYLE, SIZE, OR COLOR.

NO CLAIM IS MADE TO THE EXCLUSIVE RIGHT TO USE "NUTRITIOUS", APART FROM THE MARK AS SHOWN.

SER. NO. 85-520,658, FILED 1-19-2012.

ANDREA HACK, EXAMINING ATTORNEY



*David J. Kyffers*

Director of the United States Patent and Trademark Office

# United States of America

United States Patent and Trademark Office

# COSMOS

**Reg. No. 4,198,275**

**Registered Aug. 28, 2012**

**Int. Cl.: 9**

**TRADEMARK**

**PRINCIPAL REGISTER**

SUPPORT.COM, INC. (DELAWARE CORPORATION)  
LEGAL DEPARTMENT  
1900 SEAPORT BLVD, 3RD FLOOR  
REDWOOD CITY, CA 94063

FOR: COMPUTER SOFTWARE AND DOWNLOADABLE COMPUTER SOFTWARE, NAMELY, COMPUTER UTILITY SOFTWARE; COMPUTER SOFTWARE FOR USE IN DIAGNOSIS, REPAIR AND CONFIGURATION OF COMPUTERS, COMPUTER SOFTWARE AND COMPUTER PERIPHERALS; AND USER AND INSTRUCTION MANUALS SUPPLIED AS A UNIT WITH EACH OF THE FOREGOING, IN CLASS 9 (U.S. CLS. 21, 23, 26, 36 AND 38).

FIRST USE 4-13-2012; IN COMMERCE 4-13-2012.

THE MARK CONSISTS OF STANDARD CHARACTERS WITHOUT CLAIM TO ANY PARTICULAR FONT, STYLE, SIZE, OR COLOR.

SER. NO. 85-520,664, FILED 1-19-2012.

BRENDAN MCCAULEY, EXAMINING ATTORNEY



*David J. Kyjars*

Director of the United States Patent and Trademark Office

# United States of America

United States Patent and Trademark Office

## ICH BIN KEIN

**Reg. No. 4,198,276**

**Registered Aug. 28, 2012**

**Int. Cl.: 32**

**TRADEMARK**

**PRINCIPAL REGISTER**

MAD SCIENTISTS BREWING PARTNERS LLC (NEW YORK LIMITED LIABILITY COMPANY), DBA SIXPOINT CRAFT ALES  
40 VAN DYKE STREET  
BROOKLYN, NY 11231

FOR: BEER, IN CLASS 32 (U.S. CLS. 45, 46 AND 48).

FIRST USE 1-5-2012; IN COMMERCE 1-5-2012.

THE MARK CONSISTS OF STANDARD CHARACTERS WITHOUT CLAIM TO ANY PARTICULAR FONT, STYLE, SIZE, OR COLOR.

THE ENGLISH TRANSLATION OF "ICH BIN KEIN" IN THE MARK IS "I AM NOT".

SER. NO. 85-520,678, FILED 1-19-2012.

FONG HSU, EXAMINING ATTORNEY



*David J. Kybas*

Director of the United States Patent and Trademark Office



# United States of America

United States Patent and Trademark Office

# CAM

**Reg. No. 4,198,277**

C.A.M. SUPPLY, INC. (CALIFORNIA CORPORATION)  
490 EAST MENLO AVENUE  
HEMET, CA 92543

**Registered Aug. 28, 2012**

**Int. Cl.: 35**

FOR: ON-LINE RETAIL STORE SERVICES FEATURING TATTOO EQUIPMENT AND SUPPLIES; ON-LINE WHOLESALE STORE SERVICES FEATURING TATTOO EQUIPMENT AND SUPPLIES, IN CLASS 35 (U.S. CLS. 100, 101 AND 102).

**SERVICE MARK**

FIRST USE 0-0-1996; IN COMMERCE 0-0-1996.

**PRINCIPAL REGISTER**

THE MARK CONSISTS OF STANDARD CHARACTERS WITHOUT CLAIM TO ANY PARTICULAR FONT, STYLE, SIZE, OR COLOR.

SER. NO. 85-520,686, FILED 1-19-2012.

ARETHA SOMERVILLE, EXAMINING ATTORNEY



*David J. Kyffers*

Director of the United States Patent and Trademark Office

# United States of America

United States Patent and Trademark Office

# SKADI

**Reg. No. 4,198,278**

**Registered Aug. 28, 2012**

**Int. Cl.: 43**

**SERVICE MARK**

**PRINCIPAL REGISTER**

SKADI CORP. (CALIFORNIA CORPORATION)  
587 OLD MAMMOTH ROAD  
MAMMOTH LAKES, CA 93546

FOR: RESTAURANT SERVICES, IN CLASS 43 (U.S. CLS. 100 AND 101).

FIRST USE 12-24-1995; IN COMMERCE 12-24-1995.

THE MARK CONSISTS OF STANDARD CHARACTERS WITHOUT CLAIM TO ANY PARTICULAR FONT, STYLE, SIZE, OR COLOR.

SER. NO. 85-520,689, FILED 1-19-2012.

FONG HSU, EXAMINING ATTORNEY



*David J. Kybas*

Director of the United States Patent and Trademark Office

# United States of America

United States Patent and Trademark Office

## CANNON FISH

**Reg. No. 4,198,279**

CANNON FISH COMPANY (WASHINGTON CORPORATION)  
5512 17TH AVE NW  
SEATTLE, WA 98107

**Registered Aug. 28, 2012**

**Int. Cls.: 29 and 35**

FOR: PROCESSED SEAFOOD, NAMELY, FISH; SEAFOOD, NAMELY, SALMON, HALIBUT, TUNA, MAHI MAHI, SWORDFISH, BLACK COD, COD, DUNGENESS CRAB, FIN FISH, FLOUNDER, KING CRAB, LINGCOD, GROUPER, PANGASIUS, SNOW CRAB, SOLE, TILAPIA, WHITING, BARRAMUNDI, SNAPPER, IN CLASS 29 (U.S. CL. 46).

**TRADEMARK**

**SERVICE MARK**

FIRST USE 12-0-1991; IN COMMERCE 12-0-1991.

**PRINCIPAL REGISTER**

FOR: WHOLESALE FOOD DISTRIBUTORSHIP SERVICES, IN CLASS 35 (U.S. CLS. 100, 101 AND 102).

FIRST USE 12-0-1991; IN COMMERCE 12-0-1991.

THE MARK CONSISTS OF STANDARD CHARACTERS WITHOUT CLAIM TO ANY PARTICULAR FONT, STYLE, SIZE, OR COLOR.

OWNER OF U.S. REG. NO. 4,044,149.

NO CLAIM IS MADE TO THE EXCLUSIVE RIGHT TO USE "FISH", APART FROM THE MARK AS SHOWN.

SER. NO. 85-520,697, FILED 1-19-2012.

STEVEN R. FINE, EXAMINING ATTORNEY



*David J. Kypos*

Director of the United States Patent and Trademark Office

# United States of America

United States Patent and Trademark Office

## Pints For Peace

**Reg. No. 4,198,280**

**Registered Aug. 28, 2012**

**Int. Cl.: 36**

**SERVICE MARK**

**PRINCIPAL REGISTER**

FRIENDS FOREVER INCORPORATED (NEW HAMPSHIRE CORPORATION)  
#10  
31 RAYNES AVENUE  
PORTSMOUTH, NH 03801

FOR: CHARITABLE FUNDRAISING SERVICES IN THE NATURE OF BEVERAGE CONSUMPTION, FESTIVAL ATTENDANCE AND OTHER EVENTS, WHEREIN THE PROCEEDS FROM THOSE WHO PARTICIPATE GO TO CHARITY, IN CLASS 36 (U.S. CLS. 100, 101 AND 102).

FIRST USE 7-18-2009; IN COMMERCE 7-18-2009.

THE MARK CONSISTS OF STANDARD CHARACTERS WITHOUT CLAIM TO ANY PARTICULAR FONT, STYLE, SIZE, OR COLOR.

SER. NO. 85-520,717, FILED 1-19-2012.

CHRISIE B. KING, EXAMINING ATTORNEY



*David J. Kybas*

Director of the United States Patent and Trademark Office

# United States of America

United States Patent and Trademark Office

# Magic Flight

**Reg. No. 4,198,281**

**Registered Aug. 28, 2012**

**Int. Cl.: 28**

**TRADEMARK**

**PRINCIPAL REGISTER**

CASTALIA OUTDOORS, INC. (FLORIDA CORPORATION)  
117 REEDY CREEK DR  
FROSTPROOF, FL 33843

FOR: FISHING REELS, IN CLASS 28 (U.S. CLS. 22, 23, 38 AND 50).

FIRST USE 12-1-2011; IN COMMERCE 1-4-2012.

THE MARK CONSISTS OF STANDARD CHARACTERS WITHOUT CLAIM TO ANY PARTICULAR FONT, STYLE, SIZE, OR COLOR.

SER. NO. 85-520,719, FILED 1-19-2012.

HEATHER BIDDULPH, EXAMINING ATTORNEY



*David J. Kybas*

Director of the United States Patent and Trademark Office

# United States of America

United States Patent and Trademark Office

# ORDER

**Reg. No. 4,198,282**

KEIDEL JR., JOHN F. (UNITED STATES INDIVIDUAL)  
209 E 4TH ST.  
BRIDGEPORT, PA 19405

**Registered Aug. 28, 2012**

**Int. Cl.: 9**

FOR: COMPUTER SOFTWARE FOR USE IN DATABASE MANAGEMENT AND ORDER PROCESSING, IN CLASS 9 (U.S. CLS. 21, 23, 26, 36 AND 38).

**TRADEMARK**

FIRST USE 5-15-2004; IN COMMERCE 5-15-2004.

**PRINCIPAL REGISTER**

THE MARK CONSISTS OF STANDARD CHARACTERS WITHOUT CLAIM TO ANY PARTICULAR FONT, STYLE, SIZE, OR COLOR.

SER. NO. 85-520,724, FILED 1-19-2012.

MARK SPARACINO, EXAMINING ATTORNEY



*David J. Kybas*

Director of the United States Patent and Trademark Office

# United States of America

United States Patent and Trademark Office

# Kolbu

**Reg. No. 4,198,283**

AAA SUPER DEALS, INC. (NEW YORK CORPORATION)  
19 W 9TH STREET  
BROOKLYN, NY 11231

**Registered Aug. 28, 2012**

**Int. Cls.: 7 and 18**

FOR: AUTOMATED PET APPLIANCES, NAMELY, FEEDERS AND WATERERS, IN CLASS 7 (U.S. CLS. 13, 19, 21, 23, 31, 34 AND 35).

**TRADEMARK**

FIRST USE 5-5-2011; IN COMMERCE 5-5-2011.

**PRINCIPAL REGISTER**

FOR: ANIMAL LEASHES; COLLARS FOR PETS; ELECTRONIC PET COLLARS; PET CLOTHING, IN CLASS 18 (U.S. CLS. 1, 2, 3, 22 AND 41).

FIRST USE 5-5-2011; IN COMMERCE 5-5-2011.

THE MARK CONSISTS OF STANDARD CHARACTERS WITHOUT CLAIM TO ANY PARTICULAR FONT, STYLE, SIZE, OR COLOR.

THE ENGLISH TRANSLATION OF "KOLBU" IN THE MARK IS "FLASK".

SER. NO. 85-520,757, FILED 1-19-2012.

STEVEN R. FINE, EXAMINING ATTORNEY



*David J. Kyros*

Director of the United States Patent and Trademark Office

# United States of America

United States Patent and Trademark Office



**Reg. No. 4,198,284**

**Registered Aug. 28, 2012**

**Int. Cl.: 38**

**SERVICE MARK**

**PRINCIPAL REGISTER**

ALIENTO VISION HISPANIC FAMILY NETWORK, INC (NEW YORK CORPORATION)  
PO BOX 680008  
CORONA, CA 11368

FOR: SIMULCASTING BROADCAST TELEVISION OVER GLOBAL COMMUNICATION NETWORKS, THE INTERNET AND WIRELESS NETWORKS, IN CLASS 38 (U.S. CLS. 100, 101 AND 104).

FIRST USE 1-1-2010; IN COMMERCE 1-1-2010.

NO CLAIM IS MADE TO THE EXCLUSIVE RIGHT TO USE "AV", APART FROM THE MARK AS SHOWN.

THE COLOR(S) BLUE AND GREEN IS/ARE CLAIMED AS A FEATURE OF THE MARK.

THE MARK CONSISTS OF THE STYLIZED LETTERS "A" AND "V". THE LETTER "A" IS BLUE, THE "V" IS GREEN. THE COLOR WHITE REPRESENTS BACKGROUND, OUTLINING, SHADING AND/OR TRANSPARENT AREAS AND IS NOT PART OF THE MARK

SER. NO. 85-520,761, FILED 1-19-2012.

BRIAN PINO, EXAMINING ATTORNEY



*David J. Kyffers*

Director of the United States Patent and Trademark Office



# United States of America

United States Patent and Trademark Office

## Mr. Blue Shoes

**Reg. No. 4,198,285**

**Registered Aug. 28, 2012**

**Int. Cl.: 41**

**SERVICE MARK**

**PRINCIPAL REGISTER**

MICHAEL GREGORY DYSON (UNITED STATES INDIVIDUAL), AKA MR. BLUE SHOES  
PO BOX 1375  
COLLEYVILLE, TX 76034

FOR: ENTERTAINMENT SERVICES IN THE NATURE OF LIVE MUSICAL PERFORMANCES; MUSIC PRODUCTION SERVICES; PRODUCTION OF SOUND AND MUSIC VIDEO RECORDINGS; PROVIDING A WEBSITE FEATURING PRE-RECORDED MUSICAL AUDIO AND AUDIO-VISUAL CLIPS, PHOTOGRAPHS, MUSICAL AND ENTERTAINMENT NEWS, ON-LINE ELECTRONIC GAMES, AND BLOGS FEATURING INFORMATION ABOUT MUSIC, ENTERTAINMENT, AND ONLINE ELECTRONIC GAMES, IN CLASS 41 (U.S. CLS. 100, 101 AND 107).

FIRST USE 12-15-2009; IN COMMERCE 1-29-2010.

THE MARK CONSISTS OF STANDARD CHARACTERS WITHOUT CLAIM TO ANY PARTICULAR FONT, STYLE, SIZE, OR COLOR.

THE NAME "MR. BLUE SHOES" IDENTIFIES A LIVING INDIVIDUAL WHOSE CONSENT IS OF RECORD.

SER. NO. 85-520,811, FILED 1-19-2012.

EUGENIA MARTIN, EXAMINING ATTORNEY



*David J. Kyffers*

Director of the United States Patent and Trademark Office

# United States of America

United States Patent and Trademark Office

## Natural Culture

**Reg. No. 4,198,286**

WASHINGTON, NATALIE C. (UNITED STATES INDIVIDUAL), DBA NATURAL CULTURE  
P.O. BOX 60119

**Registered Aug. 28, 2012**

WASHINGTON, DC 200390119

**Int. Cl.: 9**

FOR: AUDIO DIGITAL TAPES FEATURING POSITIVE MUSIC AND SPIRITUAL CLASSES;  
DIGITAL MATERIALS, NAMELY, DOWNLOADABLE FILES FEATURING POSITIVE MUSIC  
AND SPIRITUAL CLASSES; DIGITAL MUSIC DOWNLOADABLE FROM THE INTERNET,  
IN CLASS 9 (U.S. CLS. 21, 23, 26, 36 AND 38).

**TRADEMARK**

**PRINCIPAL REGISTER**

FIRST USE 10-1-2010; IN COMMERCE 10-1-2010.

THE MARK CONSISTS OF STANDARD CHARACTERS WITHOUT CLAIM TO ANY PAR-  
TICULAR FONT, STYLE, SIZE, OR COLOR.

SER. NO. 85-520,864, FILED 1-19-2012.

JOHN DALIER, EXAMINING ATTORNEY



*David J. Kybas*

Director of the United States Patent and Trademark Office

# United States of America

United States Patent and Trademark Office

# MOTA

**Reg. No. 4,198,287**

**Registered Aug. 28, 2012**

**Int. Cl.: 28**

**TRADEMARK**

**PRINCIPAL REGISTER**

UNORTH LLC (CALIFORNIA LIMITED LIABILITY COMPANY)  
PO BOX 1116  
CAMPBELL, CA 950091116

FOR: ACTION FIGURE TOYS; BATTERY OPERATED ACTION TOYS; CASES FOR TOY VEHICLES; CHILDREN'S EDUCATIONAL TOYS FOR DEVELOPING MOTORIZED TOYS; CHILDREN'S MULTIPLE ACTIVITY TOYS; DOG TOYS; ELECTRIC ACTION TOYS; ELECTRIC TOY TRAIN TRANSFORMERS; ELECTRONIC ACTION TOYS; ELECTRONIC LEARNING TOYS; ELECTRONIC TOY VEHICLES; ELECTRONICALLY OPERATED TOY MOTOR VEHICLES; HAND-POWERED NON-MECHANICAL FLYING TOY; INFANT TOYS; INFLATABLE TOYS; MECHANICAL ACTION TOYS; MECHANICAL TOYS; MODEL TOY VEHICLES; NON-ELECTRONIC TOY VEHICLES; NON-RIDING TRANSPORTATION TOYS; PET TOYS; PLASTIC CHARACTER TOYS; PLUSH TOYS; PUSH TOYS; RADIO CONTROLLED TOY VEHICLES; RADIO TRANSMITTERS FOR USE WITH RADIO-CONTROLLED TOYS; REMOTE CONTROL TOYS, NAMELY, CARS, HELICOPTERS, VEHICLES, AIRPLANES, BOATS, BIRDS, ANIMALS, ROBOTS, DOLLS.; RIDE-ON TOYS AND ACCESSORIES THEREFOR; RIDEABLE TOYS AND ACCESSORIES THEREFOR; STUFFED AND PLUSH TOYS; STUFFED TOY ANIMALS; TALKING TOYS; TOY AIRPLANES; TOY ANIMALS; TOY ANIMALS AND ACCESSORIES THEREFOR; TOY BOATS; TOY BUILDING STRUCTURES AND TOY VEHICLE TRACKS; TOY CARS; TOY FURNITURE; TOY GUNS; TOY MASKS; TOY MICROSCOPES; TOY MODEL CARS; TOY ROBOTS; TOY TOOLS; TOY TRAINS AND PARTS AND ACCESSORIES THEREFOR; TOY VEHICLES; TOY VEHICLES AND ACCESSORIES THEREFOR; TOY VEHICLES WITH TRANSFORMING PARTS; TOY WEAPONS; TRANSFORMING ROBOTIC TOY VEHICLES; WATER TOYS, IN CLASS 28 (U.S. CLS. 22, 23, 38 AND 50).



FIRST USE 11-28-2011; IN COMMERCE 11-28-2011.

THE MARK CONSISTS OF STANDARD CHARACTERS WITHOUT CLAIM TO ANY PARTICULAR FONT, STYLE, SIZE, OR COLOR.

SER. NO. 85-520,879, FILED 1-20-2012.

GINA HAYES, EXAMINING ATTORNEY

*David J. Kyros*

Director of the United States Patent and Trademark Office

# United States of America

United States Patent and Trademark Office

# SMP-LOCK

**Reg. No. 4,198,288**

**Registered Aug. 28, 2012**

**Int. Cl.: 9**

**TRADEMARK**

**PRINCIPAL REGISTER**

RADIALL USA (ARIZONA CORPORATION), TA RADIALL  
STE 401  
8950 SOUTH 52ND STREET  
TEMPE, AZ 85284

FOR: ELECTRICAL AND ELECTRONIC CONNECTORS, IN CLASS 9 (U.S. CLS. 21, 23, 26,  
36 AND 38).

FIRST USE 1-25-2011; IN COMMERCE 7-7-2011.

THE MARK CONSISTS OF STANDARD CHARACTERS WITHOUT CLAIM TO ANY PAR-  
TICULAR FONT, STYLE, SIZE, OR COLOR.

SER. NO. 85-520,901, FILED 1-20-2012.

HEATHER SAPP, EXAMINING ATTORNEY



*David J. Kyffers*

Director of the United States Patent and Trademark Office

# United States of America

United States Patent and Trademark Office



**Reg. No. 4,198,289**

**Registered Aug. 28, 2012**

**Int. Cl.: 38**

**SERVICE MARK**

**PRINCIPAL REGISTER**

CHUNGHWA INTERNATIONAL COMMUNICATION NETWORK CO., LTD. (TAIWAN CORPORATION)  
22F, NO. 100  
SEC. 1, HSIN-TAI 5TH RD., XIZHI DIST.,  
NEW TAIPEI CITY, TAIWAN 221

FOR: TELEPHONE COMMUNICATIONS; CELLULAR TELEPHONE COMMUNICATION; VOICE MAIL SERVICES; TELECOMMUNICATION TRANSMISSION FOR VALUE ADDED NETWORK; PROVIDING TELECOMMUNICATIONS CONNECTIONS TO A GLOBAL COMPUTER DATA NETWORK; PROVIDING TELECOMMUNICATION CONNECTIONS TO THE INTERNET OR DATABASES; ONLINE TRANSMISSION OF INFORMATION; ELECTRONIC MAIL; COMPUTER AIDED TRANSMISSION OF INFORMATION AND IMAGES; PROVIDING TELECOMMUNICATIONS CONNECTIONS TO A GLOBAL COMPUTER NETWORK; TELECOMMUNICATIONS ROUTING AND JUNCTION SERVICES; TRANSMISSION OF CHATROOM INFORMATION; PROVIDING TELECOMMUNICATION CHANNELS FOR TEleshopping SERVICES; PROVIDING INTERNET CHATROOMS; PROVIDING ACCESS TO DATABASES; PROVIDING INFORMATION ACCESS TO ELECTRONIC LINKING NETWORKS; STREAMING OF AUDIO, VISUAL AND AUDIOVISUAL MATERIAL ON THE INTERNET; TELECONFERENCING SERVICES; INFORMATION SERVICES RELATING TO TELECOMMUNICATIONS; RENTAL OF MESSAGE SENDING APPARATUS, IN CLASS 38 (U.S. CLS. 100, 101 AND 104).

FIRST USE 6-28-2011; IN COMMERCE 12-16-2011.

THE MARK CONSISTS OF THE STYLIZED WORD "MOFREE" IN BLUE, THE LETTER "O" IN "MOFREE" HAS A GREEN PLANET DESIGN WITHIN THE LETTER.

THE COLOR(S) BLUE AND GREEN IS/ARE CLAIMED AS A FEATURE OF THE MARK.

SER. NO. 85-520,906, FILED 1-20-2012.

HEATHER SAPP, EXAMINING ATTORNEY



*David J. Kyffers*

Director of the United States Patent and Trademark Office

# United States of America

United States Patent and Trademark Office



**Reg. No. 4,198,290**

**Registered Aug. 28, 2012**

**Int. Cl.: 9**

CAPPSU CULTURE TECHNOLOGY (HK) LIMITED (HONG KONG LIMITED COMPANY (LTD.))  
9/F, KAM CHUNG COMMERCIAL BUILDING  
19-21 HENNESSY ROAD  
WANCHAI, HONG KONG

**TRADEMARK**

**PRINCIPAL REGISTER**

FOR: APPARATUS FOR TRANSMISSION OF COMMUNICATION; COMPUTER GAME PROGRAMMES DOWNLOADABLE VIA THE INTERNET; COMPUTER GAME PROGRAMS; COMPUTER PERIPHERAL DEVICES; DOWNLOADABLE ELECTRONIC PUBLICATIONS IN THE NATURE OF A MANUAL IN THE FIELD OF COMPUTER APPLICATIONS; MOBILE PHONES; OPTICAL CHARACTER READERS; PERSONAL STEREOS; VISUAL RECORDINGS AND AUDIOVISUAL RECORDINGS FEATURING MUSIC AND ANIMATION; WORD PROCESSORS, IN CLASS 9 (U.S. CLS. 21, 23, 26, 36 AND 38).

FIRST USE 2-8-2011; IN COMMERCE 2-8-2011.

THE MARK CONSISTS OF THE STYLIZED WORD "CAPPSU" AND SHADING THEREOF.

THE WORDING "CAPPSU" HAS NO MEANING IN A FOREIGN LANGUAGE.

SER. NO. 85-520,913, FILED 1-20-2012.

HEATHER SAPP, EXAMINING ATTORNEY



*David J. Kybas*

Director of the United States Patent and Trademark Office

# United States of America

United States Patent and Trademark Office



**Reg. No. 4,198,291**

**Registered Aug. 28, 2012**

**Int. Cl.: 9**

**TRADEMARK**

**PRINCIPAL REGISTER**

CHEN, KEVIN (UNITED STATES INDIVIDUAL)  
646 RADBURY PL  
DIAMOND BAR, CA 91765

FOR: BATTERIES; BATTERIES FOR VEHICLES; PROTECTIVE HELMETS; MOTORCYCLE HELMETS; PROTECTIVE MOTORCYCLE GLOVES; PROTECTIVE MOTORCYCLE KNEE GUARDS; PROTECTIVE CHIN GUARDS; NECK PROTECTOR; PROTECTIVE NECK COLLAR; PROTECTIVE ARMOR FOR MOTORCYCLES; PROTECTIVE FACE MASKS NOT FOR MEDICAL PURPOSES; PROTECTIVE SPORTS HELMET ACCESSORIES THAT ATTACH TO THE HELMETS, NAMELY, MOUTH GUARDS, EAR PADS, THROAT PROTECTORS, CHIN STRAPS, FACE MASKS, JAW PADS AND EYE SHIELDS, IN CLASS 9 (U.S. CLS. 21, 23, 26, 36 AND 38).

FIRST USE 12-1-2010; IN COMMERCE 3-2-2011.

THE MARK CONSISTS OF AN IMAGE OF A ROCKET WITH BURST FIRE EMERGING FROM A THREE RINGS CIRCLE WHICH INDICATES A SONIC BOOM AND THE WORDS "ROCKET FUZE" ARE WRITTEN TO THE RIGHT HAND SIDE AS SHOWN IN THE MARK.

SER. NO. 85-520,921, FILED 1-20-2012.

MORGAN WYNNE, EXAMINING ATTORNEY



*David J. Kyros*

Director of the United States Patent and Trademark Office

# United States of America

United States Patent and Trademark Office

# AVEO

**Reg. No. 4,198,292**

**Registered Aug. 28, 2012**

**Int. Cl.: 5**

**TRADEMARK**

**PRINCIPAL REGISTER**

AVEO PHARMACEUTICALS, INC. (DELAWARE CORPORATION)  
75 SIDNEY STREET  
CAMBRIDGE, MA 02139

FOR: MEDICINAL PREPARATIONS FOR USE IN ONCOLOGY; PHARMACEUTICAL PREPARATIONS FOR THE TREATMENT OF CANCER, IN CLASS 5 (U.S. CLS. 6, 18, 44, 46, 51 AND 52).

FIRST USE 11-29-2006; IN COMMERCE 11-29-2006.

THE MARK CONSISTS OF STANDARD CHARACTERS WITHOUT CLAIM TO ANY PARTICULAR FONT, STYLE, SIZE, OR COLOR.

OWNER OF U.S. REG. NOS. 3,276,293 AND 3,276,709.

SER. NO. 85-520,940, FILED 1-20-2012.

WON TEAK OH, EXAMINING ATTORNEY



*David J. Kybas*

Director of the United States Patent and Trademark Office



# United States of America

United States Patent and Trademark Office

## The Richter Reco

**Reg. No. 4,198,293**

**Registered Aug. 28, 2012**

**Int. Cl.: 44**

RICHTER, SHARON J. (UNITED STATES INDIVIDUAL), DBA SHARON RICHTER  
REGISTERED DIETITIAN PLLC  
SUITE 1400  
200 W. 57TH STREET  
NEW YORK, NY 10019

**SERVICE MARK**

**PRINCIPAL REGISTER**

FOR: CONSULTING SERVICES IN THE FIELDS OF HEALTH AND NUTRITION; COUNSELING SERVICES IN THE FIELDS OF HEALTH, NUTRITION AND LIFESTYLE WELLNESS; DIETARY AND NUTRITIONAL GUIDANCE; FOOD NUTRITION CONSULTATION; NUTRITION COUNSELING; PROVIDING A WEB SITE FEATURING INFORMATION ON HEALTH AND NUTRITION; PROVIDING ASSISTANCE, FITNESS EVALUATION AND CONSULTATION TO INDIVIDUALS TO HELP THEM MAKE HEALTH, WELLNESS AND NUTRITIONAL CHANGES IN THEIR DAILY LIVING TO IMPROVE HEALTH; PROVIDING HEALTHY LIFESTYLE AND NUTRITION SERVICES, NAMELY, PERSONAL ASSESSMENTS, PERSONALIZED ROUTINES, MAINTENANCE SCHEDULES, AND COUNSELING; PROVIDING INFORMATION ABOUT DIETARY SUPPLEMENTS AND NUTRITION; PROVIDING INFORMATION, NEWS AND COMMENTARY IN THE FIELD OF NUTRITION, HEALTH AND WELLNESS, IN CLASS 44 (U.S. CLS. 100 AND 101).

FIRST USE 1-1-2012; IN COMMERCE 1-1-2012.

THE MARK CONSISTS OF STANDARD CHARACTERS WITHOUT CLAIM TO ANY PARTICULAR FONT, STYLE, SIZE, OR COLOR.

SER. NO. 85-520,947, FILED 1-20-2012.

DORITT L. CARROLL, EXAMINING ATTORNEY



*David J. Kyjars*

Director of the United States Patent and Trademark Office

# United States of America

United States Patent and Trademark Office

# Tool Tamer

**Reg. No. 4,198,294**

SONNIER, TROY S. (UNITED STATES INDIVIDUAL)  
669 RAPIDES ST.

**Registered Aug. 28, 2012**

BATON ROUGE, LA 70806

**Int. Cl.: 18**

FOR: TOOL POUCHES, SOLD EMPTY, IN CLASS 18 (U.S. CLS. 1, 2, 3, 22 AND 41).

**TRADEMARK**

FIRST USE 12-21-2011; IN COMMERCE 12-21-2011.

**PRINCIPAL REGISTER**

THE MARK CONSISTS OF STANDARD CHARACTERS WITHOUT CLAIM TO ANY PARTICULAR FONT, STYLE, SIZE, OR COLOR.

NO CLAIM IS MADE TO THE EXCLUSIVE RIGHT TO USE "TOOL", APART FROM THE MARK AS SHOWN.

SER. NO. 85-520,949, FILED 1-20-2012.

DOUGLAS LEE, EXAMINING ATTORNEY



*David J. Kyffers*

Director of the United States Patent and Trademark Office

# United States of America

United States Patent and Trademark Office



**Reg. No. 4,198,295**

**Registered Aug. 28, 2012**

**Int. Cl.: 41**

**SERVICE MARK**

**PRINCIPAL REGISTER**

GOODING III, WILLIAM RONEL (UNITED STATES INDIVIDUAL), DBA HUNTING WITH A HERO  
1207 SAYLORS AVE.  
MONCKS CORNER, SC 29461

FOR: HUNTING GUIDE SERVICES; PROVIDING INFORMATION IN THE FIELD OF HUNTING AND FISHING VIA THE INTERNET; RECREATIONAL SERVICES, NAMELY, PROVIDING HUNTING PRESERVES, IN CLASS 41 (U.S. CLS. 100, 101 AND 107).

FIRST USE 3-15-2009; IN COMMERCE 3-15-2009.

NO CLAIM IS MADE TO THE EXCLUSIVE RIGHT TO USE "HUNTING", APART FROM THE MARK AS SHOWN.

THE COLOR(S) BLACK, WHITE AND LIGHT BROWN IS/ARE CLAIMED AS A FEATURE OF THE MARK.

THE MARK CONSISTS OF THE WORDS "HUNTING WITH A HERO" IN A STYLIZED LIGHT BROWN FONT. THE OUTSIDE OF THE WORDS "HUNTING WITH A HERO" ARE PRESENTED IN WHITE. THE CENTER OF THE MARK PRESENTS THE IMAGE OF WHITE SILHOUETTED MEN HUNTING. TO THE RIGHT OF THE IMAGE OF THE MEN ARE THE LETTERS "HWAH" IN WHITE. THE BACKGROUND OF THE MARK IS BLACK.

SER. NO. 85-520,959, FILED 1-20-2012.

KAREN K. BUSH, EXAMINING ATTORNEY



*David J. Kybas*

Director of the United States Patent and Trademark Office

**United States of America**  
United States Patent and Trademark Office

**AVEO**

**Reg. No. 4,198,296**

AVEO PHARMACEUTICALS, INC. (DELAWARE CORPORATION)  
75 SIDNEY STREET  
CAMBRIDGE, MA 02139

**Registered Aug. 28, 2012**

**Int. Cl.: 5**

FOR: MEDICINAL PREPARATIONS FOR USE IN ONCOLOGY; PHARMACEUTICAL PREPARATIONS FOR THE TREATMENT OF CANCER, IN CLASS 5 (U.S. CLS. 6, 18, 44, 46, 51 AND 52).

**TRADEMARK**

FIRST USE 11-29-2006; IN COMMERCE 11-29-2006.

**PRINCIPAL REGISTER**

OWNER OF U.S. REG. NOS. 3,276,293 AND 3,276,709.

THE MARK CONSISTS OF THE WORD "AVEO" IN WHICH THE HORIZONTAL PORTION OF THE LETTER "A" IS SHOWN AS A CURVED TRIANGULAR SHAPE.

SER. NO. 85-520,963, FILED 1-20-2012.

WON TEAK OH, EXAMINING ATTORNEY



*David J. Kyros*

Director of the United States Patent and Trademark Office

# United States of America

United States Patent and Trademark Office

# YOUNGZINE

**Reg. No. 4,198,297**

YOUNGZINE (DELAWARE CORPORATION)

**Registered Aug. 28, 2012**

P.O. BOX 10704  
SAN JOSE, CA 95157

**Int. Cl.: 41**

FOR: PROVIDING A WEB SITE FEATURING ON-LINE PUBLICATIONS IN THE FIELD OF NEWS ARTICLES FOR CHILDREN, IN CLASS 41 (U.S. CLS. 100, 101 AND 107).

**SERVICE MARK**

FIRST USE 4-0-2010; IN COMMERCE 4-0-2010.

**PRINCIPAL REGISTER**

THE MARK CONSISTS OF STANDARD CHARACTERS WITHOUT CLAIM TO ANY PARTICULAR FONT, STYLE, SIZE, OR COLOR.

SER. NO. 85-520,968, FILED 1-20-2012.

LOURDES AYALA, EXAMINING ATTORNEY



*David J. Kybas*

Director of the United States Patent and Trademark Office

# United States of America

United States Patent and Trademark Office



**Reg. No. 4,198,298**

ACCEL BIOMEDICS, LLC (DELAWARE LIMITED LIABILITY COMPANY)  
10455 N. CENTRAL EXPRESSWAY, STE 109-324  
DALLAS, TX 75231

**Registered Aug. 28, 2012**

**Int. Cl.: 10**

FOR: SURGICAL AND MEDICAL APPARATUS AND INSTRUMENTS FOR USE IN SPINAL SURGERY, IN CLASS 10 (U.S. CLS. 26, 39 AND 44).

**TRADEMARK**

FIRST USE 4-20-2011; IN COMMERCE 6-8-2011.

**PRINCIPAL REGISTER**

THE MARK CONSISTS OF A CIRCULAR SHAPE SURROUNDED BY TWO RINGS LOCATED TO THE LEFT OF THE WORD ACCELSPINE.

SER. NO. 85-520,980, FILED 1-20-2012.

ELI HELLMAN, EXAMINING ATTORNEY



*David J. Kybas*

Director of the United States Patent and Trademark Office

# United States of America

United States Patent and Trademark Office

## LIFE TIME ATHLETIC

**Reg. No. 4,198,299**

**Registered Aug. 28, 2012**

**Int. Cl.: 41**

**SERVICE MARK**

**PRINCIPAL REGISTER**

LIFE TIME FITNESS, INC. (MINNESOTA CORPORATION)  
2902 CORPORATE PLACE  
CHANHASSEN, MN 55317

FOR: PHYSICAL FITNESS INSTRUCTION AND HEALTH CLUB SERVICES, NAMELY, PROVIDING INSTRUCTION AND ACCESS TO EQUIPMENT IN THE FIELD OF PHYSICAL EXERCISE, AND PROVIDING RECREATION FACILITIES WITH COMPUTERS AND PLAY AREAS FOR CHILDREN, IN CLASS 41 (U.S. CLS. 100, 101 AND 107).

FIRST USE 12-0-2006; IN COMMERCE 12-0-2006.

THE MARK CONSISTS OF STANDARD CHARACTERS WITHOUT CLAIM TO ANY PARTICULAR FONT, STYLE, SIZE, OR COLOR.

OWNER OF U.S. REG. NOS. 2,140,172, 2,689,399 AND OTHERS.

NO CLAIM IS MADE TO THE EXCLUSIVE RIGHT TO USE "ATHLETIC", APART FROM THE MARK AS SHOWN.

SER. NO. 85-520,989, FILED 1-20-2012.

APRIL ROACH, EXAMINING ATTORNEY



*David J. Kyffers*

Director of the United States Patent and Trademark Office

# United States of America

United States Patent and Trademark Office

# NANO-BOND

**Reg. No. 4,198,300**

**Registered Aug. 28, 2012**

**Int. Cl.: 5**

**TRADEMARK**

**PRINCIPAL REGISTER**

PENTRON CLINICAL TECHNOLOGIES, LLC (CONNECTICUT LIMITED LIABILITY COMPANY)  
1717 WEST COLLINS AVENUE  
ORANGE, CA 92867

FOR: COMPOSITE, BONDING, CEMENTING AND LUTING ADHESIVES FOR DENTAL USE, IN CLASS 5 (U.S. CLS. 6, 18, 44, 46, 51 AND 52).

FIRST USE 10-2-2002; IN COMMERCE 10-2-2002.

THE MARK CONSISTS OF STANDARD CHARACTERS WITHOUT CLAIM TO ANY PARTICULAR FONT, STYLE, SIZE, OR COLOR.

SER. NO. 85-520,996, FILED 1-20-2012.

TINA MAI, EXAMINING ATTORNEY



*David J. Kyffers*

Director of the United States Patent and Trademark Office



# United States of America

United States Patent and Trademark Office

## ESSENTIAL WAVE

**Reg. No. 4,198,301**

**Registered Aug. 28, 2012**

**Int. Cl.: 20**

**TRADEMARK**

**PRINCIPAL REGISTER**

INTEX RECREATION CORP. (CALIFORNIA CORPORATION)  
SUITE 210  
4001 VIA ORO AVENUE  
LONG BEACH, CA 90810

FOR: INFLATABLE AIR MATTRESSES AND AIR BEDS FOR HOME USE AND FURNITURE,  
IN CLASS 20 (U.S. CLS. 2, 13, 22, 25, 32 AND 50).

FIRST USE 11-28-2011; IN COMMERCE 3-14-2012.

THE MARK CONSISTS OF STANDARD CHARACTERS WITHOUT CLAIM TO ANY PAR-  
TICULAR FONT, STYLE, SIZE, OR COLOR.

SER. NO. 85-521,041, FILED 1-20-2012.

HEATHER THOMPSON, EXAMINING ATTORNEY



*David J. Kybas*

Director of the United States Patent and Trademark Office

# United States of America

United States Patent and Trademark Office

## BRISTLECONE

**Reg. No. 4,198,302**

TWIN TOWERS, INC. (MINNESOTA CORPORATION)  
1537 HOLLYBROOK ROAD  
WAYZATA, MN 55391

**Registered Aug. 28, 2012**

**Int. Cl.: 41**

FOR: HEALTH CLUB SERVICES, NAMELY, PROVIDING INSTRUCTION AND EQUIPMENT  
IN THE FIELD OF PHYSICAL EXERCISE, IN CLASS 41 (U.S. CLS. 100, 101 AND 107).

**SERVICE MARK**

FIRST USE 5-1-2008; IN COMMERCE 5-1-2008.

**PRINCIPAL REGISTER**

THE MARK CONSISTS OF STANDARD CHARACTERS WITHOUT CLAIM TO ANY PAR-  
TICULAR FONT, STYLE, SIZE, OR COLOR.

OWNER OF U.S. REG. NO. 3,721,583.

SER. NO. 85-521,051, FILED 1-20-2012.

AMY HELLA, EXAMINING ATTORNEY



*David J. Kyffers*

Director of the United States Patent and Trademark Office

# United States of America

United States Patent and Trademark Office

# clementine

**Reg. No. 4,198,303**

**Registered Aug. 28, 2012**

**Int. Cl.: 12**

**TRADEMARK**

**PRINCIPAL REGISTER**

CLEMENTINE BICYCLE WORKS, LLC (SOUTH CAROLINA LIMITED LIABILITY COMPANY)  
220 N. CHURCH STREET, SUITE 4  
SPARTANBURG, SC 29306

FOR: BICYCLES, IN CLASS 12 (U.S. CLS. 19, 21, 23, 31, 35 AND 44).

FIRST USE 11-30-2011; IN COMMERCE 11-30-2011.

THE MARK CONSISTS OF STANDARD CHARACTERS WITHOUT CLAIM TO ANY PARTICULAR FONT, STYLE, SIZE, OR COLOR.

SER. NO. 85-521,055, FILED 1-20-2012.

CHRISTINE MARTIN, EXAMINING ATTORNEY



*David J. Kyffers*

Director of the United States Patent and Trademark Office

# United States of America

United States Patent and Trademark Office

# B.O.B.

**Reg. No. 4,198,304**

TWIN TOWERS, INC. (MINNESOTA CORPORATION)  
1537 HOLLYBROOK ROAD  
WAYZATA, MN 55391

**Registered Aug. 28, 2012**

**Int. Cl.: 44**

FOR: WEIGHT MANAGEMENT SERVICES, NAMELY, PROVIDING WEIGHT LOSS AND/OR WEIGHT MAINTENANCE PROGRAMS, IN CLASS 44 (U.S. CLS. 100 AND 101).

**SERVICE MARK**

FIRST USE 9-1-2007; IN COMMERCE 9-1-2007.

**PRINCIPAL REGISTER**

THE MARK CONSISTS OF STANDARD CHARACTERS WITHOUT CLAIM TO ANY PARTICULAR FONT, STYLE, SIZE, OR COLOR.

SER. NO. 85-521,056, FILED 1-20-2012.

AMY HELLA, EXAMINING ATTORNEY



*David J. Kybas*

Director of the United States Patent and Trademark Office

# United States of America

United States Patent and Trademark Office

## Mutual Action Planning

**Reg. No. 4,198,305**

PAUL R. PEASE, INC (CALIFORNIA CORPORATION), DBA THE PEASE GROUP  
230-28TH STREET

**Registered Aug. 28, 2012**

HERMOSA BEACH, CA 90254

**Int. Cl.: 35**

FOR: CONSULTING IN THE FIELD OF SALES METHODS, SALES MANAGEMENT, AND SALES IMPROVEMENT, IN CLASS 35 (U.S. CLS. 100, 101 AND 102).

**SERVICE MARK**

FIRST USE 3-1-1996; IN COMMERCE 3-1-1996.

**PRINCIPAL REGISTER**

THE MARK CONSISTS OF STANDARD CHARACTERS WITHOUT CLAIM TO ANY PARTICULAR FONT, STYLE, SIZE, OR COLOR.

NO CLAIM IS MADE TO THE EXCLUSIVE RIGHT TO USE "ACTION PLANNING", APART FROM THE MARK AS SHOWN.

SER. NO. 85-521,060, FILED 1-20-2012.

WENDY JUN, EXAMINING ATTORNEY



*David J. Kyffers*

Director of the United States Patent and Trademark Office

# United States of America

United States Patent and Trademark Office

# BUNDLE

**Reg. No. 4,198,306**

TWIN TOWERS, INC. (MINNESOTA CORPORATION)  
1537 HOLLYBROOK ROAD  
WAYZATA, MN 55391

**Registered Aug. 28, 2012**

**Int. Cl.: 44**

FOR: HEALTH ASSESSMENT SERVICES, NAMELY, PROVIDING HORMONE AND METABOLIC EVALUATIONS FOR CLIENTS IN ORDER TO ASSIST IN REACHING WEIGHT LOSS, SPORTS PERFORMANCE, HEALTH, FITNESS, AND WELLNESS-RELATED GOALS, IN CLASS 44 (U.S. CLS. 100 AND 101).

**SERVICE MARK**

**PRINCIPAL REGISTER**

FIRST USE 9-1-2007; IN COMMERCE 9-1-2007.

THE MARK CONSISTS OF STANDARD CHARACTERS WITHOUT CLAIM TO ANY PARTICULAR FONT, STYLE, SIZE, OR COLOR.

SER. NO. 85-521,061, FILED 1-20-2012.

AMY HELLA, EXAMINING ATTORNEY



*David J. Kybas*

Director of the United States Patent and Trademark Office

**United States of America**  
United States Patent and Trademark Office

# TRAKREF

**Reg. No. 4,198,307**

POLAR TECHNOLOGY, LLC (TENNESSEE LIMITED LIABILITY COMPANY)  
1360 FOSTER AVENUE  
NASHVILLE, TN 37210

**Registered Aug. 28, 2012**

**Int. Cl.: 42**

FOR: SOFTWARE AS A SERVICE (SAAS) SERVICES FEATURING SOFTWARE FOR INVENTORY CONTROL, IN CLASS 42 (U.S. CLS. 100 AND 101).

**SERVICE MARK**

FIRST USE 6-1-2011; IN COMMERCE 6-1-2011.

**PRINCIPAL REGISTER**

THE MARK CONSISTS OF STANDARD CHARACTERS WITHOUT CLAIM TO ANY PARTICULAR FONT, STYLE, SIZE, OR COLOR.

SER. NO. 85-521,075, FILED 1-20-2012.

AMY HELLA, EXAMINING ATTORNEY



*David J. Kybas*

Director of the United States Patent and Trademark Office

# United States of America

United States Patent and Trademark Office

# FranBrag

**Reg. No. 4,198,308**

**Registered Aug. 28, 2012**

**Int. Cl.: 9**

**TRADEMARK**

**PRINCIPAL REGISTER**

BIZBRAG (MARYLAND CORPORATION)  
SUITE 100D  
909 RIDGEBROOK ROAD  
SPARKS, MD 21152

FOR: COMPUTER SOFTWARE FOR ALLOWING FRANCHISES TO MANAGE SOCIAL MEDIA AND SOCIAL WEB ACTIVITIES, IN CLASS 9 (U.S. CLS. 21, 23, 26, 36 AND 38).

FIRST USE 12-28-2011; IN COMMERCE 12-29-2011.

THE MARK CONSISTS OF STANDARD CHARACTERS WITHOUT CLAIM TO ANY PARTICULAR FONT, STYLE, SIZE, OR COLOR.

SER. NO. 85-521,103, FILED 1-20-2012.

MARC LEIPZIG, EXAMINING ATTORNEY



*David J. Kyffers*

Director of the United States Patent and Trademark Office



United States of America  
United States Patent and Trademark Office

NOBCCHE

**Reg. No. 4,198,309**

**Registered Aug. 28, 2012**

**Int. Cl.: 35**

NATIONAL ORGANIZATION FOR THE PROFESSIONAL ADVANCEMENT OF BLACK  
CHEMISTS AND CHEMICAL ENGINEERS, INC. (GEORGIA CORPORATION), AKA  
NOBCCHE  
2426 GREENSIDE COURT  
AUSTELL, GA 30106

**SERVICE MARK**

FOR: ASSOCIATION SERVICES, NAMELY, PROMOTING THE INTERESTS OF AFRICAN-  
AMERICAN CHEMISTS, CHEMICAL ENGINEERS AND STUDENTS OF THOSE DISCIP-  
LINES, IN CLASS 35 (U.S. CLS. 100, 101 AND 102).

**PRINCIPAL REGISTER**

FIRST USE 4-0-1972; IN COMMERCE 3-0-1974.

THE MARK CONSISTS OF STANDARD CHARACTERS WITHOUT CLAIM TO ANY PAR-  
TICULAR FONT, STYLE, SIZE, OR COLOR.

OWNER OF U.S. REG. NO. 3,168,025.

SER. NO. 85-521,175, FILED 1-20-2012.

TARAH HARDY, EXAMINING ATTORNEY



*David J. Kyffers*

Director of the United States Patent and Trademark Office

# United States of America

United States Patent and Trademark Office



**Reg. No. 4,198,310**

**Registered Aug. 28, 2012**

**Int. Cl.: 12**

**TRADEMARK**

**PRINCIPAL REGISTER**

CLEMENTINE BICYCLE WORKS, LLC (SOUTH CAROLINA LIMITED LIABILITY COMPANY)  
220 N. CHURCH STREET, SUITE 4  
SPARTANBURG, SC 29306

FOR: BICYCLES, IN CLASS 12 (U.S. CLS. 19, 21, 23, 31, 35 AND 44).

FIRST USE 11-30-2011; IN COMMERCE 11-30-2011.

THE MARK CONSISTS OF AN OVAL BACKGROUND WITH THE LETTER "C" APPEARING TWICE, ONE "C" BEING A MIRROR IMAGE OF THE OTHER, AND TWO STARS EACH POSITIONED AT THE TOP AND BOTTOM OF THE OVAL BACKGROUND.

SER. NO. 85-521,178, FILED 1-20-2012.

CHRISTINE MARTIN, EXAMINING ATTORNEY



*David J. Kybas*

Director of the United States Patent and Trademark Office

# United States of America

United States Patent and Trademark Office

## BOOKER AND DAX

**Reg. No. 4,198,311**

**Registered Aug. 28, 2012**

**Int. Cl.: 43**

**SERVICE MARK**

**PRINCIPAL REGISTER**

BOOKER & DAX LLC (DELAWARE LIMITED LIABILITY COMPANY)  
SUITE 1211  
853 BROADWAY  
NEW YORK, NY 10003

FOR: BAR SERVICES; COCKTAIL LOUNGE SERVICES; WINE BARS, IN CLASS 43 (U.S. CLS. 100 AND 101).

FIRST USE 1-20-2012; IN COMMERCE 1-20-2012.

THE MARK CONSISTS OF STANDARD CHARACTERS WITHOUT CLAIM TO ANY PARTICULAR FONT, STYLE, SIZE, OR COLOR.

SER. NO. 85-521,179, FILED 1-20-2012.

JESSICA A. POWERS, EXAMINING ATTORNEY



*David J. Kyffers*

Director of the United States Patent and Trademark Office

# United States of America

United States Patent and Trademark Office

## NOBCCHE SCIENCE BOWL

**Reg. No. 4,198,312**

**Registered Aug. 28, 2012**

**Int. Cl.: 41**

**SERVICE MARK**

**PRINCIPAL REGISTER**

NATIONAL ORGANIZATION FOR THE PROFESSIONAL ADVANCEMENT OF BLACK CHEMISTS AND CHEMICAL ENGINEERS, INC. (GEORGIA CORPORATION), AKA NOBCCHE  
2426 GREENSIDE COURT  
AUSTELL, GA 30106

FOR: EDUCATIONAL SERVICES, NAMELY, CONDUCTING LOCAL, REGIONAL AND NATIONAL SCIENCE FAIRS AND ACADEMIC COMPETITIONS FOR STUDENTS IN THE FIELD OF CHEMISTRY, CHEMICAL ENGINEERING, SCIENCE, MATH, AND AFRICAN-AMERICAN HISTORY, IN CLASS 41 (U.S. CLS. 100, 101 AND 107).

FIRST USE 3-0-1989; IN COMMERCE 3-0-1989.

THE MARK CONSISTS OF STANDARD CHARACTERS WITHOUT CLAIM TO ANY PARTICULAR FONT, STYLE, SIZE, OR COLOR.

OWNER OF U.S. REG. NO. 3,168,025.

NO CLAIM IS MADE TO THE EXCLUSIVE RIGHT TO USE "SCIENCE BOWL", APART FROM THE MARK AS SHOWN.

SER. NO. 85-521,206, FILED 1-20-2012.

TARAH HARDY, EXAMINING ATTORNEY



*David J. Kyffers*

Director of the United States Patent and Trademark Office

# United States of America

United States Patent and Trademark Office

# TEL-TIME

**Reg. No. 4,198,313**

**Registered Aug. 28, 2012**

**Int. Cl.: 14**

**TRADEMARK**

**PRINCIPAL REGISTER**

MAXI-AIDS, INC. (NEW YORK CORPORATION)  
42 EXECUTIVE BOULEVARD  
FARMINGDALE, NY 11735

FOR: CLOCKS AND WATCHES, IN CLASS 14 (U.S. CLS. 2, 27, 28 AND 50).

FIRST USE 0-0-1995; IN COMMERCE 0-0-1995.

THE MARK CONSISTS OF STANDARD CHARACTERS WITHOUT CLAIM TO ANY PARTICULAR FONT, STYLE, SIZE, OR COLOR.

SER. NO. 85-521,217, FILED 1-20-2012.

TARAH HARDY, EXAMINING ATTORNEY



*David J. Kyros*

Director of the United States Patent and Trademark Office

# United States of America

United States Patent and Trademark Office

## Core 3

**Reg. No. 4,198,314**

**Registered Aug. 28, 2012**

**Int. Cl.: 9**

**TRADEMARK**

**PRINCIPAL REGISTER**

CRESTRON ELECTRONICS, INC. (NEW JERSEY CORPORATION)  
BRADLEY M. MARAZAS  
15 VOLVO DRIVE  
ROCKLEIGH, NJ 07647

FOR: REMOTE CONTROLS AND USER INTERFACES FOR REMOTE CONTROLS FOR MULTIMEDIA DEVICES, HOME THEATER SYSTEMS, AND HOME AUTOMATION SYSTEMS FOR LIGHTING, AUDIO/VIDEO, HVAC, SECURITY, APPLIANCES, WATER, AND SHADES, IN CLASS 9 (U.S. CLS. 21, 23, 26, 36 AND 38).

FIRST USE 6-16-2010; IN COMMERCE 6-16-2010.

THE MARK CONSISTS OF STANDARD CHARACTERS WITHOUT CLAIM TO ANY PARTICULAR FONT, STYLE, SIZE, OR COLOR.

SER. NO. 85-521,278, FILED 1-20-2012.

LINDA MICKLEBURGH, EXAMINING ATTORNEY



*David J. Kybas*

Director of the United States Patent and Trademark Office

# United States of America

United States Patent and Trademark Office

# QUICK ROOF

**Reg. No. 4,198,315**

COFAIR PRODUCTS, INC. (ILLINOIS CORPORATION)  
7301 ST. LOUIS AVENUE  
SKOKIE, IL 60076

**Registered Aug. 28, 2012**

**Int. Cl.: 17**

FOR: SELF-ADHESIVE SEALING TAPES FOR MAKING WATERPROOF REPAIRS ON ROOFS OF BUILDINGS AND VEHICLES, IN CLASS 17 (U.S. CLS. 1, 5, 12, 13, 35 AND 50).

**TRADEMARK**

FIRST USE 5-0-1993; IN COMMERCE 5-0-1993.

**PRINCIPAL REGISTER**

THE MARK CONSISTS OF STANDARD CHARACTERS WITHOUT CLAIM TO ANY PARTICULAR FONT, STYLE, SIZE, OR COLOR.

OWNER OF U.S. REG. NO. 3,094,680.

NO CLAIM IS MADE TO THE EXCLUSIVE RIGHT TO USE "ROOF", APART FROM THE MARK AS SHOWN.

SER. NO. 85-521,283, FILED 1-20-2012.

MARY ROSSMAN, EXAMINING ATTORNEY



*David J. Kyffers*

Director of the United States Patent and Trademark Office

# United States of America

United States Patent and Trademark Office

## May Day... Calling All Cars

**Reg. No. 4,198,316**

RIZZI, RON (UNITED STATES INDIVIDUAL)  
118 LATHEMS MILL LN  
BALL GROUND, GA 30107

**Registered Aug. 28, 2012**

**Int. Cl.: 41**

FOR: PROVIDING INFORMATION RELATING TO THE ORGANIZING OF EDUCATIONAL, CULTURAL, SPORTING, OR ENTERTAINMENT EXHIBITIONS, IN CLASS 41 (U.S. CLS. 100, 101 AND 107).

**SERVICE MARK**

FIRST USE 1-20-2012; IN COMMERCE 1-20-2012.

**PRINCIPAL REGISTER**

THE MARK CONSISTS OF STANDARD CHARACTERS WITHOUT CLAIM TO ANY PARTICULAR FONT, STYLE, SIZE, OR COLOR.

NO CLAIM IS MADE TO THE EXCLUSIVE RIGHT TO USE "CARS", APART FROM THE MARK AS SHOWN.

SER. NO. 85-521,290, FILED 1-20-2012.

NAKIA HENRY, EXAMINING ATTORNEY



*David J. Kyffers*

Director of the United States Patent and Trademark Office



# United States of America

United States Patent and Trademark Office

# Cuppow

**Reg. No. 4,198,317**

**Registered Aug. 28, 2012**

**Int. Cl.: 20**

**TRADEMARK**

**PRINCIPAL REGISTER**

RESNIKOFF, JOSHUA AND PANONE, AARON B. (UNITED STATES INDIVIDUAL), DBA  
CUPPOW  
9 OLIVE SQUARE  
SOMERVILLE, MA 02143

FOR: PLASTIC LIDS, IN CLASS 20 (U.S. CLS. 2, 13, 22, 25, 32 AND 50).

FIRST USE 1-10-2012; IN COMMERCE 1-10-2012.

THE MARK CONSISTS OF STANDARD CHARACTERS WITHOUT CLAIM TO ANY PARTICULAR FONT, STYLE, SIZE, OR COLOR.

SER. NO. 85-521,318, FILED 1-20-2012.

H. M. FISHER, EXAMINING ATTORNEY



*David J. Kybas*

Director of the United States Patent and Trademark Office

# United States of America

United States Patent and Trademark Office

# 12 Wt.

**Reg. No. 4,198,318**

**Registered Aug. 28, 2012**

**Int. Cl.: 25**

**TRADEMARK**

**PRINCIPAL REGISTER**

12 WT., LLC (DELAWARE LIMITED LIABILITY COMPANY)  
SUITE 449  
20 PARK PLAZA  
BOSTON, MA 02116

FOR: OUTDOOR RECREATIONAL CLOTHING, NAMELY, GLOVES, IN CLASS 25 (U.S. CLS. 22 AND 39).

FIRST USE 11-15-2010; IN COMMERCE 11-15-2010.

THE MARK CONSISTS OF STANDARD CHARACTERS WITHOUT CLAIM TO ANY PARTICULAR FONT, STYLE, SIZE, OR COLOR.

SER. NO. 85-521,320, FILED 1-20-2012.

LINDA MICKLEBURGH, EXAMINING ATTORNEY



*David J. Kyffers*

Director of the United States Patent and Trademark Office

# United States of America

United States Patent and Trademark Office

## INSIDE THE CAGE

**Reg. No. 4,198,319**

**Registered Aug. 28, 2012**

**Int. Cl.: 41**

**SERVICE MARK**

**PRINCIPAL REGISTER**

GREG DELONG (UNITED STATES INDIVIDUAL)  
#196  
18124 WEDGE PARKWAY  
RENO, NV 89511

FOR: ENTERTAINMENT SERVICES, NAMELY, THE PROVISION OF CONTINUING PROGRAMS FEATURING NEWS, INTERVIEWS, AND COMMENTARY ON COMBAT SPORTS AND MIXED MARTIAL ARTS DELIVERED BY RADIO AND THE INTERNET, IN CLASS 41 (U.S. CLS. 100, 101 AND 107).

FIRST USE 5-31-2008; IN COMMERCE 5-31-2008.

THE MARK CONSISTS OF STANDARD CHARACTERS WITHOUT CLAIM TO ANY PARTICULAR FONT, STYLE, SIZE, OR COLOR.

SER. NO. 85-521,332, FILED 1-20-2012.

NAAKWAMA ANKRAH, EXAMINING ATTORNEY



*David J. Kyffers*

Director of the United States Patent and Trademark Office

# United States of America

United States Patent and Trademark Office

# Rentler

**Reg. No. 4,198,320**

**Registered Aug. 28, 2012**

**Int. Cl.: 36**

**SERVICE MARK**

**PRINCIPAL REGISTER**

RENTLER, LLC (UTAH LIMITED LIABILITY COMPANY)  
36 SO. STATE STREET, SUITE 1400  
SALT LAKE CITY, UT 84111

FOR: REAL ESTATE RENTAL SERVICES, NAMELY, PROVIDING AN ONLINE DATABASE FOR LANDLORDS AND TENANTS THAT FEATURES INFORMATION AND TOOLS FOR THE LEASING OF RENTAL PROPERTIES, IN CLASS 36 (U.S. CLS. 100, 101 AND 102).

FIRST USE 1-19-2012; IN COMMERCE 1-19-2012.

THE MARK CONSISTS OF STANDARD CHARACTERS WITHOUT CLAIM TO ANY PARTICULAR FONT, STYLE, SIZE, OR COLOR.

SER. NO. 85-521,335, FILED 1-20-2012.

THOMAS MANOR, EXAMINING ATTORNEY



*David J. Kyffers*

Director of the United States Patent and Trademark Office

# United States of America

United States Patent and Trademark Office



**Reg. No. 4,198,321**

**Registered Aug. 28, 2012**

**Int. Cl.: 9**

**TRADEMARK**

**PRINCIPAL REGISTER**

AMCREST TECHNOLOGIES LLC (TEXAS LIMITED LIABILITY COMPANY)  
10810 KATY FWY SUITE 110  
HOUSTON, TX 77043

FOR: ANTENNAS FOR WIRELESS COMMUNICATIONS APPARATUS; AUDIO CABLES; AUDIO-RECEIVERS AND VIDEO-RECEIVERS; AUDIO-VIDEO RECEIVERS; BABY MONITORS; BLANK ELECTRONIC STORAGE MEDIA; CLOSED CIRCUIT TV SYSTEMS FOR SECURITY AND SURVEILLANCE, NAMELY, CAMERAS, SWITCHES, MONITORS, MICROPHONES, AND RECORDERS; COMBINATION VIDEO PLAYERS AND RECORDERS; COMPUTER HARDWARE FOR COMMUNICATING AUDIO, VIDEO AND DATA BETWEEN COMPUTERS VIA A GLOBAL COMPUTER NETWORK, WIDE-AREA COMPUTER NETWORKS, AND PEER-TO-PEER COMPUTER NETWORKS; COMPUTER HARDWARE FOR UPLOAD, STORAGE, RETRIEVAL, DOWNLOAD, TRANSMISSION AND DELIVERY OF DIGITAL CONTENT; CONSUMER ELECTRONIC PRODUCTS, NAMELY, AUDIO AMPLIFIERS, AUDIO SPEAKERS, AUDIO RECEIVERS, ELECTRICAL AUDIO AND SPEAKER CABLES AND CONNECTORS, HOME THEATER SYSTEMS, AUDIO DECODERS, VIDEO DECODERS, SPEAKERS, POWER CONVERSION DEVICES, POWER CONVERTERS, AND POWER INVERTERS; DIGITAL AUDIO PLAYERS; DIGITAL CAMCORDERS; DIGITAL CAMERAS; DIGITAL ENTERTAINMENT SYSTEMS FOR WATCHING, STORING AND SHARING DIGITAL CONTENT ON A HOME COMPUTER NETWORK; DIGITAL MEDIA RECEIVERS; DIGITAL MEDIA SERVERS; DIGITAL MEDIA STREAMING DEVICES; DIGITAL VIDEO RECORDERS; INTERNET DIGITAL VIDEO RECORDERS; IP (INTERNET PROTOCOL) CAMERAS; KEYBOARDS; MEDIA PLAYERS; NETWORK ROUTERS AND SWITCHES, NETWORK SECURITY CAMERAS; NETWORK VIDEO RECORDERS; PORTABLE DVD PLAYERS; PORTABLE INTERNET DEVICES; PORTABLE MEDIA PLAYERS; PORTABLE PERSONAL COMPUTERS; PORTABLE TABLET COMPUTERS; POWER OVER ETHERNET SWITCHES, INJECTORS AND SPLITTERS; PROTECTIVE COVERS AND CASES FOR CELL PHONES, PORTABLE PERSONAL COMPUTERS AND PORTABLE MEDIA PLAYERS; RECEIVERS FOR RECEIVING CABLE TELEVISION; RECEIVERS FOR SATELLITES; RECORD PLAYERS; SATELLITE RECEIVERS; STEREO CABLES; USB (UNIVERSAL SERIAL BUS) HARDWARE; VIDEO CABLES; VIDEO RECEIVERS; VIDEO RECORDERS; WIRELESS COMPUTER MICE; WIRELESS COMPUTER PERIPHERALS; WIRELESS RECEIVERS AND TRANSMITTERS FOR PORTABLE MEDIA PLAYERS; WIRELESS TRANSMITTERS AND RECEIVERS, IN CLASS 9 (U.S. CLS. 21, 23, 26, 36 AND 38).



*David J. Kyros*

Director of the United States Patent and Trademark Office

FIRST USE 6-1-2011; IN COMMERCE 7-4-2011.

**Reg. No. 4,198,321** THE MARK CONSISTS OF AN OVERALL INCOMPLETE TRIANGULAR SHAPE COMPOSED BY AN INCOMPLETE TRIANGLE SEPARATED BY TWO CURVED LINES FORMING AN INCOMPLETE OVAL WITH A SOLID CIRCLE IN THE CENTER. CENTERED BELOW THE IMAGE IS THE WORD "AGASIO" IN STYLIZED FONT.

SER. NO. 85-521,339, FILED 1-20-2012.

DANNEAN HETZEL, EXAMINING ATTORNEY

# United States of America

United States Patent and Trademark Office

# phanero

**Reg. No. 4,198,322**

AGILEX TECHNOLOGIES, INC. (FLORIDA CORPORATION), DBA AGILEX  
5155 PARKSTONE DRIVE  
CHANTILLY, VA 20151

**Registered Aug. 28, 2012**

**Int. Cl.: 9**

FOR: COMPUTER SOFTWARE FOR ANALYZING STRUCTURED AND UNSTRUCTURED DATA, IN CLASS 9 (U.S. CLS. 21, 23, 26, 36 AND 38).

**TRADEMARK**

FIRST USE 12-5-2011; IN COMMERCE 12-5-2011.

**PRINCIPAL REGISTER**

THE MARK CONSISTS OF STANDARD CHARACTERS WITHOUT CLAIM TO ANY PARTICULAR FONT, STYLE, SIZE, OR COLOR.

SER. NO. 85-521,349, FILED 1-20-2012.

MICHAEL WIENER, EXAMINING ATTORNEY



*David J. Kybas*

Director of the United States Patent and Trademark Office

# United States of America

United States Patent and Trademark Office

# 12 WT.

**Reg. No. 4,198,323**

**Registered Aug. 28, 2012**

**Int. Cl.: 25**

**TRADEMARK**

**PRINCIPAL REGISTER**

12 WT., LLC (DELAWARE LIMITED LIABILITY COMPANY)  
SUITE 449  
20 PARK PLAZA  
BOSTON, MA 02116

FOR: OUTDOOR RECREATIONAL CLOTHING, NAMELY, GLOVES, IN CLASS 25 (U.S. CLS. 22 AND 39).

FIRST USE 11-15-2010; IN COMMERCE 11-15-2010.

THE MARK CONSISTS OF THE STYLIZED NUMBER "12" OVER THE LETTERS "WT." IN SQUARE SHAPED SETTING.

SER. NO. 85-521,350, FILED 1-20-2012.

LINDA MICKLEBURGH, EXAMINING ATTORNEY



*David J. Kyffers*

Director of the United States Patent and Trademark Office



# United States of America

United States Patent and Trademark Office

## Creepy Works

**Reg. No. 4,198,324**

CREEPY WORKS LLC (ARKANSAS LIMITED LIABILITY COMPANY)  
150 HIGHWAY 286 EAST  
CONWAY, AR 72032

**Registered Aug. 28, 2012**

**Int. Cl.: 41**

FOR: ENTERTAINMENT IN THE NATURE OF A THEMED AMUSEMENT FACILITY, IN CLASS 41 (U.S. CLS. 100, 101 AND 107).

**SERVICE MARK**

FIRST USE 1-20-2012; IN COMMERCE 1-20-2012.

**PRINCIPAL REGISTER**

THE MARK CONSISTS OF STANDARD CHARACTERS WITHOUT CLAIM TO ANY PARTICULAR FONT, STYLE, SIZE, OR COLOR.

SER. NO. 85-521,364, FILED 1-20-2012.

THOMAS MANOR, EXAMINING ATTORNEY



*David J. Kyros*

Director of the United States Patent and Trademark Office

# United States of America

United States Patent and Trademark Office

# FACINOROUS

**Reg. No. 4,198,325**

MICHAEL STOWE (UNITED STATES INDIVIDUAL)  
9540 SANTA BARBARA ROAD  
ATASCADERO, CA 93422

**Registered Aug. 28, 2012**

**Int. Cl.: 41**

FOR: ENTERTAINMENT SERVICES IN THE NATURE OF LIVE MUSICAL PERFORMANCES,  
IN CLASS 41 (U.S. CLS. 100, 101 AND 107).

**SERVICE MARK**

FIRST USE 6-1-1993; IN COMMERCE 6-1-1994.

**PRINCIPAL REGISTER**

THE MARK CONSISTS OF STANDARD CHARACTERS WITHOUT CLAIM TO ANY PARTICULAR FONT, STYLE, SIZE, OR COLOR.

SER. NO. 85-521,372, FILED 1-20-2012.

THOMAS MANOR, EXAMINING ATTORNEY



*David J. Kyfos*

Director of the United States Patent and Trademark Office

# United States of America

United States Patent and Trademark Office



THE  
**London Manhattan**  
COMPANY

---

FINANCIAL SPECIALISTS

**Reg. No. 4,198,326**

**Registered Aug. 28, 2012**

**Int. Cl.: 36**

**SERVICE MARK**

**PRINCIPAL REGISTER**

THE LONDON MANHATTAN COMPANY (NEVADA CORPORATION)  
693 OCEAN AVE.  
PORTLAND, ME 04103

FOR: LOAN INTERMEDIATION SERVICES; PROCURING LOANS AND FINANCING FOR BUSINESSES, IN CLASS 36 (U.S. CLS. 100, 101 AND 102).

FIRST USE 4-0-2011, THE MARK WAS FIRST USED ANYWHERE IN A DIFFERENT FORM OTHER THAN THAT SOUGHT TO BE REGISTERED AT LEAST AS EARLY AS 12/00/1989; IN COMMERCE 4-0-2011, THE MARK WAS FIRST USED IN COMMERCE IN A DIFFERENT FORM OTHER THAN THAT SOUGHT TO BE REGISTERED AT LEAST AS EARLY AS 12/00/1989.

NO CLAIM IS MADE TO THE EXCLUSIVE RIGHT TO USE "COMPANY" AND "FINANCIAL SPECIALISTS", APART FROM THE MARK AS SHOWN.

THE MARK CONSISTS OF THE WORDS "THE LONDON MANHATTAN COMPANY" AND "FINANCIAL SPECIALISTS" SEPARATED BY A HORIZONTAL LINE, ALL OF WHICH IS TO THE RIGHT OF A CREST CONTAINING A DOLLAR SIGN IN ONE QUADRANT, AN ENGLISH POUND SIGN IN ONE QUADRANT, AN ABSTRACT WAVE DESIGN IN ONE QUADRANT, AND DARKNESS IN ONE QUADRANT.

SER. NO. 85-521,413, FILED 1-20-2012.

AMY KELLY, EXAMINING ATTORNEY



*David J. Kyjars*

Director of the United States Patent and Trademark Office

# United States of America

United States Patent and Trademark Office

## GOING KINETIC MOVING BEYOND POTENTIAL

**Reg. No. 4,198,327**

WILLIAMS, SONYA (UNITED STATES INDIVIDUAL)  
9406 PINE VIEW LN.  
CLINTON, MD 20735

**Registered Aug. 28, 2012**

**Int. Cl.: 35**

FOR: BUSINESS CONSULTATION; BUSINESS DEVELOPMENT SERVICES; BUSINESS STRATEGIC PLANNING SERVICES, IN CLASS 35 (U.S. CLS. 100, 101 AND 102).

**SERVICE MARK**

FIRST USE 1-10-2012; IN COMMERCE 1-10-2012.

**PRINCIPAL REGISTER**

THE MARK CONSISTS OF STANDARD CHARACTERS WITHOUT CLAIM TO ANY PARTICULAR FONT, STYLE, SIZE, OR COLOR.

SER. NO. 85-521,414, FILED 1-20-2012.

AMY KELLY, EXAMINING ATTORNEY



*David J. Kybas*

Director of the United States Patent and Trademark Office

# United States of America

United States Patent and Trademark Office

# GRAFTOBIAN

**Reg. No. 4,198,328**

**Registered Aug. 28, 2012**

**Int. Cl.: 3**

**TRADEMARK**

**PRINCIPAL REGISTER**

GRAFTOBIAN, LTD. (WISCONSIN CORPORATION)  
510 TASMAN STREET  
MADISON, WI 53714

FOR: MAKE-UP, IN CLASS 3 (U.S. CLS. 1, 4, 6, 50, 51 AND 52).

FIRST USE 3-31-1978; IN COMMERCE 3-31-1978.

THE MARK CONSISTS OF STANDARD CHARACTERS WITHOUT CLAIM TO ANY PARTICULAR FONT, STYLE, SIZE, OR COLOR.

SER. NO. 85-521,447, FILED 1-20-2012.

CURTIS FRENCH, EXAMINING ATTORNEY



*David J. Kyffers*

Director of the United States Patent and Trademark Office

# United States of America

United States Patent and Trademark Office



**Reg. No. 4,198,329**

SEVILLA, FERLY (UNITED STATES INDIVIDUAL)  
2406 NW 20 ST  
MIAMI, FL 33142

**Registered Aug. 28, 2012**

**Int. Cl.: 24**

FOR: BABY BEDDING, NAMELY, BUNDLE BAGS, SWADDLING BLANKETS, CRIB BUMPERS, FITTED CRIB SHEETS, CRIB SKIRTS, CRIB BLANKETS, AND DIAPER CHANGING PAD COVERS NOT OF PAPER; BED BLANKETS, IN CLASS 24 (U.S. CLS. 42 AND 50).

**TRADEMARK**

**PRINCIPAL REGISTER**

FIRST USE 1-1-2004; IN COMMERCE 1-1-2004.

THE STIPPLING IS FOR SHADING PURPOSES ONLY.

THE MARK CONSISTS OF THE THREE WORDS "TWO THREE BEAR" ON TWO LINES, WITH "TWO THREE" ON THE FIRST LINE AND "BEAR" ON THE SECOND LINE. THE LOGO HAS A TEDDY BEAR CLINGING ONTO EACH ONE OF THE WORDS. THE WORD "TWO" HAS A TEDDY BEAR SITTING ON THE "W" AND "O", HOLDING ONTO THE "T". THE WORD "THREE" HAS A TEDDY BEAR STANDING ON ONE LEG ON FIRST LETTER "E" AND HOLDING ONTO THE "T". THE WORD "BEAR" HAS A TEDDY BEAR STANDING WITH ONE FOOT ON THE FLOOR AND ONE FOOT ON THE "B", WHILE HOLDING ONTO THE LETTER.

SER. NO. 85-521,455, FILED 1-20-2012.

TAMARA FRAZIER, EXAMINING ATTORNEY



*David J. Kyros*

Director of the United States Patent and Trademark Office

# United States of America

United States Patent and Trademark Office

# SHIP TO

**Reg. No. 4,198,330**

**Registered Aug. 28, 2012**

**Int. Cl.: 9**

**TRADEMARK**

**PRINCIPAL REGISTER**

SALES PAD, LLC (MICHIGAN LIMITED LIABILITY COMPANY), DBA SALES PAD SOLUTIONS  
3200 EAGLE PARK DRIVE, SE  
GRAND RAPIDS, MI 49341

FOR: COMPUTER APPLICATION SOFTWARE FOR USE IN COLLECTING, INTEGRATING AND MANAGING FREIGHT SHIPPING AND TRACKING INFORMATION, IN CLASS 9 (U.S. CLS. 21, 23, 26, 36 AND 38).

FIRST USE 3-1-2008; IN COMMERCE 3-1-2008.

THE MARK CONSISTS OF STANDARD CHARACTERS WITHOUT CLAIM TO ANY PARTICULAR FONT, STYLE, SIZE, OR COLOR.

SER. NO. 85-521,456, FILED 1-20-2012.

STEVEN PEREZ, EXAMINING ATTORNEY



*David J. Kybas*

Director of the United States Patent and Trademark Office

# United States of America

United States Patent and Trademark Office

## Stageunderground

**Reg. No. 4,198,331**

**Registered Aug. 28, 2012**

**Int. Cl.: 41**

**SERVICE MARK**

**PRINCIPAL REGISTER**

STAGEUNDERGROUND, LLC. (GEORGIA LIMITED LIABILITY COMPANY)  
2918 GREYHAWK LN.  
CUMMING, GA 30040

FOR: SOUND RECORDING STUDIOS, IN CLASS 41 (U.S. CLS. 100, 101 AND 107).

FIRST USE 12-21-2005; IN COMMERCE 12-21-2005.

THE MARK CONSISTS OF STANDARD CHARACTERS WITHOUT CLAIM TO ANY PARTICULAR FONT, STYLE, SIZE, OR COLOR.

SER. NO. 85-521,477, FILED 1-20-2012.

LINDA POWELL, EXAMINING ATTORNEY



*David J. Kybas*

Director of the United States Patent and Trademark Office



# United States of America

United States Patent and Trademark Office

## A SUSTAINABLE REALITY

**Reg. No. 4,198,332**

**Registered Aug. 28, 2012**

**Int. Cl.: 41**

**SERVICE MARK**

**PRINCIPAL REGISTER**

MICHAEL R. SILBERMAN (UNITED STATES INDIVIDUAL)  
UNIT 1E  
1360 WEST HUBBARD STREET  
CHICAGO, IL 60642

FOR: PRODUCTION AND DISTRIBUTION OF VIDEOS IN THE FIELD OF ENVIRONMENTALLY SUSTAINABLE LIVING; ORGANIZING AND HOSTING EVENTS PROMOTING ENVIRONMENTALLY SUSTAINABLE LIVING; AND PROVIDING AN INTERNET WEBSITE FEATURING VIDEOS AND INFORMATION ABOUT ENVIRONMENTALLY SUSTAINABLE LIVING, IN CLASS 41 (U.S. CLS. 100, 101 AND 107).

FIRST USE 6-1-2011; IN COMMERCE 6-1-2011.

THE MARK CONSISTS OF STANDARD CHARACTERS WITHOUT CLAIM TO ANY PARTICULAR FONT, STYLE, SIZE, OR COLOR.

SER. NO. 85-521,483, FILED 1-20-2012.

LUCY ARANT, EXAMINING ATTORNEY



*David J. Kyffers*

Director of the United States Patent and Trademark Office

# United States of America

United States Patent and Trademark Office

## Because Dogs Are People Too

**Reg. No. 4,198,333**

**Registered Aug. 28, 2012**

**Int. Cl.: 31**

**TRADEMARK**

**PRINCIPAL REGISTER**

ZOE'S PREMIUM PEOPLE FOOD (NEW YORK LIMITED LIABILITY COMPANY)  
3RD FLOOR  
131 SAINT MARKS PLACE  
BROOKLYN, NY 11217

FOR: PET FOOD, IN CLASS 31 (U.S. CLS. 1 AND 46).

FIRST USE 8-30-2010; IN COMMERCE 10-4-2010.

THE MARK CONSISTS OF STANDARD CHARACTERS WITHOUT CLAIM TO ANY PARTICULAR FONT, STYLE, SIZE, OR COLOR.

SER. NO. 85-521,486, FILED 1-20-2012.

TOBY BULLOFF, EXAMINING ATTORNEY



*David J. Kybas*

Director of the United States Patent and Trademark Office

# United States of America

United States Patent and Trademark Office



**Reg. No. 4,198,334**

**Registered Aug. 28, 2012**

**Int. Cl.: 35**

**SERVICE MARK**

**PRINCIPAL REGISTER**

B. GLOWING LLC (OREGON LIMITED LIABILITY COMPANY)  
1133 NW 11TH AVENUE SUITE 401  
PORTLAND, OR 97209

FOR: ONLINE RETAIL STORE SERVICES IN THE FIELD OF COSMETICS, FRAGRANCES, SKIN CARE PRODUCTS, NAMELY, SKIN CLEANSER, SKIN MOISTURIZER, SKIN SERUM, EYE GEL, SKIN MASK AND SKIN TONER, BATH AND BEAUTY PRODUCTS, NAMELY, BATH AND SHOWER GEL, BATH OIL, BODY OIL, SOLID SOAPS, BUBBLE BATH, BODY BUTTER, SUGAR SCRUB, BATH SALTS AND BATH SPONGE, AND CANDLES, IN CLASS 35 (U.S. CLS. 100, 101 AND 102).

FIRST USE 10-1-2004; IN COMMERCE 10-1-2004.

OWNER OF U.S. REG. NO. 3,133,623.

THE MARK CONSISTS OF A LOWER CASE LETTER "B" WITH A TILDE SET IMMEDIATELY TO ITS RIGHT BOTH WITHIN A CIRCLE.

SER. NO. 85-521,534, FILED 1-20-2012.

WENDY JUN, EXAMINING ATTORNEY



*David J. Kyffers*

Director of the United States Patent and Trademark Office

**United States of America**  
United States Patent and Trademark Office

# GIORGIO

**Reg. No. 4,198,335**

**Registered Aug. 28, 2012**

**Int. Cl.: 30**

**TRADEMARK**

**PRINCIPAL REGISTER**

GIORGIFRED COMPANY (DELAWARE CORPORATION)  
NEMOURS BUILDING, 1007 ORANGE STREET  
SUITE 1414  
WILMINGTON, DE 19801

FOR: DOUGH WRAPPED FOOD PRODUCTS CONSISTING OF A DOUGH-BASED WRAPPER WITH FILLINGS CONSISTING PRIMARILY OF MEATS, POULTRY, SEA FOODS, EGGS, FRUITS, VEGETABLES AND CHEESE; SANDWICHES; PIEROGIES, IN CLASS 30 (U.S. CL. 46).

FIRST USE 10-22-2010; IN COMMERCE 10-22-2010.

THE MARK CONSISTS OF STANDARD CHARACTERS WITHOUT CLAIM TO ANY PARTICULAR FONT, STYLE, SIZE, OR COLOR.

OWNER OF U.S. REG. NOS. 2,230,769 AND 3,344,186.

THE ENGLISH TRANSLATION OF "GIORGIO" IN THE MARK IS "GEORGE".

SER. NO. 85-521,539, FILED 1-20-2012.

MARK SPARACINO, EXAMINING ATTORNEY



*David J. Kybas*

Director of the United States Patent and Trademark Office

# United States of America

United States Patent and Trademark Office

# Noblemirada

**Reg. No. 4,198,336**

**Registered Aug. 28, 2012**

**Int. Cl.: 20**

**TRADEMARK**

**PRINCIPAL REGISTER**

THE KITCHEN & BATH DEPOT INC. (DELAWARE CORPORATION), DBA GRAND KITCHEN  
STONEWORKS  
2660 MERCANTILE DR., STE. A1  
RANCHO CORDOVA, CA 95742

FOR: KITCHEN CABINETS, IN CLASS 20 (U.S. CLS. 2, 13, 22, 25, 32 AND 50).

FIRST USE 11-11-2011; IN COMMERCE 11-11-2011.

THE MARK CONSISTS OF STANDARD CHARACTERS WITHOUT CLAIM TO ANY PARTICULAR FONT, STYLE, SIZE, OR COLOR.

THE ENGLISH TRANSLATION OF "MIRADA" IN THE MARK IS "LOOK".

SER. NO. 85-521,543, FILED 1-20-2012.

SUSAN STIGLITZ, EXAMINING ATTORNEY



*David J. Kybas*

Director of the United States Patent and Trademark Office

# United States of America

United States Patent and Trademark Office

## FREEZE FOR FUN!

**Reg. No. 4,198,337**

SCHLOTTERBECK & FOSS COMPANY (MAINE CORPORATION)  
117 PREBLE STREET  
PORTLAND, ME 04101

**Registered Aug. 28, 2012**

**Int. Cl.: 31**

FOR: PET TREATS, IN CLASS 31 (U.S. CLS. 1 AND 46).

**TRADEMARK**

FIRST USE 9-6-2011; IN COMMERCE 9-6-2011.

**PRINCIPAL REGISTER**

THE MARK CONSISTS OF STANDARD CHARACTERS WITHOUT CLAIM TO ANY PARTICULAR FONT, STYLE, SIZE, OR COLOR.

SER. NO. 85-521,546, FILED 1-20-2012.

TOBY BULLOFF, EXAMINING ATTORNEY



*David J. Kyffers*

Director of the United States Patent and Trademark Office

# United States of America

United States Patent and Trademark Office

# SC13

**Reg. No. 4,198,338**

**Registered Aug. 28, 2012**

**Int. Cl.: 9**

**TRADEMARK**

**PRINCIPAL REGISTER**

NOVITA TECHNOLOGIES INC. (TENNESSEE CORPORATION)  
166 MOLLY WALTON DRIVE  
HENDERSONVILLE, TN 37075

FOR: ELECTRICAL SOCKETS, IN CLASS 9 (U.S. CLS. 21, 23, 26, 36 AND 38).

FIRST USE 4-1-2011; IN COMMERCE 9-1-2011.

THE MARK CONSISTS OF STANDARD CHARACTERS WITHOUT CLAIM TO ANY PARTICULAR FONT, STYLE, SIZE, OR COLOR.

SER. NO. 85-521,560, FILED 1-20-2012.

HELENE LIWINSKI, EXAMINING ATTORNEY



*David J. Kybas*

Director of the United States Patent and Trademark Office

# United States of America

United States Patent and Trademark Office

# Mini-Pearls

**Reg. No. 4,198,339**

FEDERATED MILLS, INC. (FLORIDA CORPORATION)  
3620 TAMiami TRAIL NORTH  
NAPLES, FL 34103

**Registered Aug. 28, 2012**

**Int. Cl.: 1**

FOR: CHEMICALS, NAMELY, CALCIUM PROPIONATE, IN CLASS 1 (U.S. CLS. 1, 5, 6, 10, 26 AND 46).

**TRADEMARK**

FIRST USE 12-24-2011; IN COMMERCE 12-24-2011.

**PRINCIPAL REGISTER**

THE MARK CONSISTS OF STANDARD CHARACTERS WITHOUT CLAIM TO ANY PARTICULAR FONT, STYLE, SIZE, OR COLOR.

SER. NO. 85-521,576, FILED 1-20-2012.

MARK SPARACINO, EXAMINING ATTORNEY



*David J. Kyffers*

Director of the United States Patent and Trademark Office



# United States of America

United States Patent and Trademark Office

## Hostile Duck Iron Power Sports

**Reg. No. 4,198,340**

APPLIED PROCESS, INC. (MICHIGAN CORPORATION)  
12238 NEWBURGH ROAD  
LIVONIA, MI 481501046

**Registered Aug. 28, 2012**

**Int. Cl.: 40**

FOR: METAL HEAT TREATING SERVICES BY MEANS OF AUSTEMPERING, SALT BATH QUENCH, TO PRODUCE HARDENED METALS FOR USE IN MOTORIZED VEHICLES, POWER SPORT VEHICLES, TRUCKS, MOTORCYCLES, BOATS, AND TRAILERS, IN CLASS 40 (U.S. CLS. 100, 103 AND 106).

**SERVICE MARK**

**PRINCIPAL REGISTER**

FIRST USE 0-0-2011; IN COMMERCE 0-0-2011.

THE MARK CONSISTS OF STANDARD CHARACTERS WITHOUT CLAIM TO ANY PARTICULAR FONT, STYLE, SIZE, OR COLOR.

NO CLAIM IS MADE TO THE EXCLUSIVE RIGHT TO USE "IRON POWER SPORTS", APART FROM THE MARK AS SHOWN.

SER. NO. 85-521,579, FILED 1-20-2012.

ROBIN MITTLER, EXAMINING ATTORNEY



*David J. Kyffers*

Director of the United States Patent and Trademark Office

# United States of America

United States Patent and Trademark Office

*Giorgio*

**Reg. No. 4,198,341**

**Registered Aug. 28, 2012**

**Int. Cl.: 30**

**TRADEMARK**

**PRINCIPAL REGISTER**

GIORGIFRED COMPANY (DELAWARE CORPORATION)  
NEMOURS BUILDING, 1007 ORANGE STREET  
SUITE 1414  
WILMINGTON, DE 19801

FOR: DOUGH WRAPPED FOOD PRODUCTS CONSISTING OF A DOUGH-BASED WRAPPER WITH FILLINGS CONSISTING PRIMARILY OF MEATS, POULTRY, SEA FOODS, EGGS, FRUITS, VEGETABLES AND CHEESE; SANDWICHES; PIEROGIES, IN CLASS 30 (U.S. CL. 46).

FIRST USE 10-22-2010; IN COMMERCE 10-22-2010.

OWNER OF U.S. REG. NOS. 2,230,769 AND 3,344,186.

THE MARK CONSISTS OF THE STYLIZED WORDING "GIORGIO".

THE ENGLISH TRANSLATION OF "GIORGIO" IN THE MARK IS "GEORGE".

SER. NO. 85-521,582, FILED 1-20-2012.

MARK SPARACINO, EXAMINING ATTORNEY



*David J. Kyffers*

Director of the United States Patent and Trademark Office

# United States of America

United States Patent and Trademark Office

# ManageWell

**Reg. No. 4,198,342**

**Registered Aug. 28, 2012**

**Int. Cl.: 42**

**SERVICE MARK**

**PRINCIPAL REGISTER**

WELLVATION LLC (MINNESOTA LIMITED LIABILITY COMPANY)  
SUITE 200  
15600 36TH AVE NORTH  
MINNEAPOLIS, MN 55446

FOR: PROVIDING ON-LINE NON-DOWNLOADABLE SOFTWARE FOR DATABASE MANAGEMENT IN THE FIELD OF ADMINISTRATION AND MANAGEMENT OF AN EMPLOYER SPONSORED WELLNESS PROGRAM, IN CLASS 42 (U.S. CLS. 100 AND 101).

FIRST USE 1-15-2011; IN COMMERCE 1-15-2011.

THE MARK CONSISTS OF STANDARD CHARACTERS WITHOUT CLAIM TO ANY PARTICULAR FONT, STYLE, SIZE, OR COLOR.

SER. NO. 85-521,584, FILED 1-20-2012.

JEAN IM, EXAMINING ATTORNEY



*David J. Kyffers*

Director of the United States Patent and Trademark Office

# United States of America

United States Patent and Trademark Office

# BareSkins

**Reg. No. 4,198,343**

COOK, TIMOTHY (UNITED STATES INDIVIDUAL)  
5320 CAMPO ROAD

**Registered Aug. 28, 2012**

WOODLAND HILLS, CA 91364

**Int. Cl.: 9**

FOR: COMPUTER SOFTWARE FOR USE AS VIRTUAL CHARACTERS FOR USE IN COMPUTER GAMES, IN CLASS 9 (U.S. CLS. 21, 23, 26, 36 AND 38).

**TRADEMARK**

FIRST USE 2-1-2010; IN COMMERCE 2-1-2010.

**PRINCIPAL REGISTER**

THE MARK CONSISTS OF STANDARD CHARACTERS WITHOUT CLAIM TO ANY PARTICULAR FONT, STYLE, SIZE, OR COLOR.

SER. NO. 85-521,588, FILED 1-20-2012.

JENNIFER WILLISTON, EXAMINING ATTORNEY



*David J. Kybas*

Director of the United States Patent and Trademark Office

# United States of America

United States Patent and Trademark Office

## MONSTER PARTS

**Reg. No. 4,198,344**

**Registered Aug. 28, 2012**

**Int. Cl.: 40**

**SERVICE MARK**

**PRINCIPAL REGISTER**

APPLIED PROCESS, INC. (MICHIGAN CORPORATION)  
12238 NEWBURGH ROAD  
LIVONIA, MI 481501046

FOR: METAL HEAT TREATING SERVICES BY MEANS OF AUSTEMPERING, SALT BATH QUENCH, TO PRODUCE HARDENED METALS FOR USE IN MOTORIZED VEHICLES, TRUCKING, CONSTRUCTION, MINING, RAILWAY, SHIPPING, WIND TURBINES, WEAPONS, HEAVING EQUIPMENT, BRIDGES, AERONAUTICS, DRILLING POWER TOOLS, AND RIGGING, IN CLASS 40 (U.S. CLS. 100, 103 AND 106).

FIRST USE 0-0-2011; IN COMMERCE 0-0-2011.

THE MARK CONSISTS OF STANDARD CHARACTERS WITHOUT CLAIM TO ANY PARTICULAR FONT, STYLE, SIZE, OR COLOR.

NO CLAIM IS MADE TO THE EXCLUSIVE RIGHT TO USE "PARTS", APART FROM THE MARK AS SHOWN.

SER. NO. 85-521,604, FILED 1-20-2012.

ROBIN MITTLER, EXAMINING ATTORNEY



*David J. Kybas*

Director of the United States Patent and Trademark Office

# United States of America

United States Patent and Trademark Office

# ArboRisk

**Reg. No. 4,198,345**

AMERICAN ADVANTAGE-PETERSEN & ASSOCIATES, INC. (WISCONSIN CORPORATION)  
15171 WEST NATIONAL AVENUE  
NEW BERLIN, WI 53151

**Registered Aug. 28, 2012**

**Int. Cl.: 36**

FOR: INSURANCE SERVICES IN THE NATURE OF LOSS CONTROL MANAGEMENT FOR OTHERS, IN CLASS 36 (U.S. CLS. 100, 101 AND 102).

**SERVICE MARK**

FIRST USE 12-0-2011; IN COMMERCE 12-0-2011.

**PRINCIPAL REGISTER**

THE MARK CONSISTS OF STANDARD CHARACTERS WITHOUT CLAIM TO ANY PARTICULAR FONT, STYLE, SIZE, OR COLOR.

SER. NO. 85-521,608, FILED 1-20-2012.

RICHARD WHITE, EXAMINING ATTORNEY



*David J. Kybas*

Director of the United States Patent and Trademark Office

# United States of America

United States Patent and Trademark Office

## Miss Ladyfinger

**Reg. No. 4,198,346**

**Registered Aug. 28, 2012**

**Int. Cl.: 41**

**SERVICE MARK**

**PRINCIPAL REGISTER**

TARYN MULTACK (UNITED STATES INDIVIDUAL)  
8B  
44 E.12TH ST.  
NEW YORK, NY 10003

FOR: INSTRUCTION IN THE FIELD OF FASHION; ON-LINE JOURNALS, NAMELY, BLOGS FEATURING FASHION; PROVIDING A WEBSITE FEATURING BLOGS AND NON-DOWNLOADABLE PUBLICATIONS IN THE NATURE OF FASHION IN THE FIELD(S) OF FASHION; TEACHING OF BEAUTY SKILLS, IN CLASS 41 (U.S. CLS. 100, 101 AND 107).

FIRST USE 5-1-2011; IN COMMERCE 5-1-2011.

THE MARK CONSISTS OF STANDARD CHARACTERS WITHOUT CLAIM TO ANY PARTICULAR FONT, STYLE, SIZE, OR COLOR.

SER. NO. 85-521,620, FILED 1-20-2012.

WON TEAK OH, EXAMINING ATTORNEY



*David J. Kyffers*

Director of the United States Patent and Trademark Office

# United States of America

United States Patent and Trademark Office

# T4i

**Reg. No. 4,198,347**

YT PRODUCTS, LLC (OREGON LIMITED LIABILITY COMPANY)  
251 W BARCLAY DR, STE C  
SISTERS, OR 97759

**Registered Aug. 28, 2012**

**Int. Cl.: 9**

FOR: GUN SCOPES; RIFLE SCOPES; RIFLESCOPES, IN CLASS 9 (U.S. CLS. 21, 23, 26, 36 AND 38).

**TRADEMARK**

FIRST USE 1-16-2012; IN COMMERCE 1-16-2012.

**PRINCIPAL REGISTER**

THE MARK CONSISTS OF STANDARD CHARACTERS WITHOUT CLAIM TO ANY PARTICULAR FONT, STYLE, SIZE, OR COLOR.

SER. NO. 85-521,622, FILED 1-20-2012.

WON TEAK OH, EXAMINING ATTORNEY



*David J. Kyffers*

Director of the United States Patent and Trademark Office



# United States of America

United States Patent and Trademark Office

# memorytrend

**Reg. No. 4,198,348**

BILLS, KELLY R (UNITED STATES INDIVIDUAL)  
125 EAST MAIN STREET #231  
AMERICAN FORK, UT 84003

**Registered Aug. 28, 2012**

**Int. Cl.: 20**

FOR: MATTRESSES, MATTRESS TOPPERS, PILLOWS, IN CLASS 20 (U.S. CLS. 2, 13, 22, 25, 32 AND 50).

**TRADEMARK**

FIRST USE 1-16-2012; IN COMMERCE 1-16-2012.

**PRINCIPAL REGISTER**

THE MARK CONSISTS OF STANDARD CHARACTERS WITHOUT CLAIM TO ANY PARTICULAR FONT, STYLE, SIZE, OR COLOR.

SER. NO. 85-521,628, FILED 1-20-2012.

RAUL CORDOVA, EXAMINING ATTORNEY



*David J. Kyffers*

Director of the United States Patent and Trademark Office

# United States of America

United States Patent and Trademark Office

## CLEANGUARD

**Reg. No. 4,198,349**

**Registered Aug. 28, 2012**

**Int. Cl.: 5**

**TRADEMARK**

**PRINCIPAL REGISTER**

TAMBRANDS, INC. (DELAWARE CORPORATION)  
ONE PROCTER & GAMBLE PLAZA  
CINCINNATI, OH 45202

FOR: TAMPONS, IN CLASS 5 (U.S. CLS. 6, 18, 44, 46, 51 AND 52).

FIRST USE 2-28-2011; IN COMMERCE 2-28-2011.

THE MARK CONSISTS OF STANDARD CHARACTERS WITHOUT CLAIM TO ANY PARTICULAR FONT, STYLE, SIZE, OR COLOR.

SER. NO. 85-521,643, FILED 1-20-2012.

ELI HELLMAN, EXAMINING ATTORNEY



*David J. Kybas*

Director of the United States Patent and Trademark Office

United States of America  
United States Patent and Trademark Office

# AMORUS

**Reg. No. 4,198,350**

AJ WHOLESALE MART (CALIFORNIA SOLE PROPRIETORSHIP)  
1444 30TH STREET, #A  
SAN DIEGO, CA 92154

**Registered Aug. 28, 2012**

**Int. Cl.: 3**

FOR: COSMETIC PREPARATIONS FOR EYE LASHES; EYE MAKE-UP; EYE PENCILS; EYE SHADOWS; FALSE NAILS; NAIL ART STICKERS; NAIL BUFFING PREPARATIONS; NAIL ENAMEL; NAIL GROOMING PRODUCTS, NAMELY, TIPS, GLUE, LACQUER AND GLITTER; NAIL POLISH; NAIL POLISH REMOVER, IN CLASS 3 (U.S. CLS. 1, 4, 6, 50, 51 AND 52).

**TRADEMARK**

**PRINCIPAL REGISTER**

FIRST USE 1-3-2012; IN COMMERCE 1-3-2012.

THE MARK CONSISTS OF STANDARD CHARACTERS WITHOUT CLAIM TO ANY PARTICULAR FONT, STYLE, SIZE, OR COLOR.

SER. NO. 85-521,660, FILED 1-20-2012.

JIM RINGLE, EXAMINING ATTORNEY



*David J. Kyffers*

Director of the United States Patent and Trademark Office

# United States of America

United States Patent and Trademark Office

## LEOLINDA BOWERS

**Reg. No. 4,198,351**

LEOLINDA BOWERS (UNITED STATES INDIVIDUAL)  
16470 W. CENTURY PLANT DR.  
SURPRISE, AZ 85387

**Registered Aug. 28, 2012**

**Int. Cl.: 36**

FOR: REAL ESTATE BROKERAGE, IN CLASS 36 (U.S. CLS. 100, 101 AND 102).

**SERVICE MARK**

FIRST USE 5-17-2007; IN COMMERCE 5-17-2007.

**PRINCIPAL REGISTER**

THE MARK CONSISTS OF STANDARD CHARACTERS WITHOUT CLAIM TO ANY PARTICULAR FONT, STYLE, SIZE, OR COLOR.

THE NAME(S), PORTRAIT(S), AND/OR SIGNATURE(S) SHOWN IN THE MARK IDENTIFIES LEOLINDA BOWERS, WHOSE CONSENT(S) TO REGISTER IS MADE OF RECORD.

SER. NO. 85-521,668, FILED 1-20-2012.

DEBORAH LOBO, EXAMINING ATTORNEY



*David J. Kyffers*

Director of the United States Patent and Trademark Office

# United States of America

United States Patent and Trademark Office

## GOT CHARGES?

**Reg. No. 4,198,352**

GARY M. WILSON (UNITED STATES INDIVIDUAL)  
18404 MACK AVENUE  
GROSSE POINTE FARMS, MI 48236

**Registered Aug. 28, 2012**

**Int. Cl.: 45**

FOR: LEGAL SERVICES, IN CLASS 45 (U.S. CLS. 100 AND 101).

**SERVICE MARK**

FIRST USE 11-30-2011; IN COMMERCE 11-30-2011.

**PRINCIPAL REGISTER**

THE MARK CONSISTS OF STANDARD CHARACTERS WITHOUT CLAIM TO ANY PARTICULAR FONT, STYLE, SIZE, OR COLOR.

SER. NO. 85-521,688, FILED 1-20-2012.

DAWN HAN, EXAMINING ATTORNEY



*David J. Kyffers*

Director of the United States Patent and Trademark Office

# United States of America

United States Patent and Trademark Office

## EnerGel Sleep Cooler

**Reg. No. 4,198,353**

KELLY BILLS (UNITED STATES INDIVIDUAL)  
125 E. MAIN ST. #231

**Registered Aug. 28, 2012**

AMERICAN FORK, UT 84003

**Int. Cl.: 20**

FOR: MATTRESSES, MATTRESS TOPPERS, PILLOWS, IN CLASS 20 (U.S. CLS. 2, 13, 22, 25, 32 AND 50).

**TRADEMARK**

FIRST USE 1-16-2011; IN COMMERCE 1-16-2011.

**PRINCIPAL REGISTER**

THE MARK CONSISTS OF STANDARD CHARACTERS WITHOUT CLAIM TO ANY PARTICULAR FONT, STYLE, SIZE, OR COLOR.

SER. NO. 85-521,689, FILED 1-20-2012.

RICHARD WHITE, EXAMINING ATTORNEY



*David J. Kyffers*

Director of the United States Patent and Trademark Office

# United States of America

United States Patent and Trademark Office

# Turlio

**Reg. No. 4,198,354**

**Registered Aug. 28, 2012**

**Int. Cl.: 30**

**TRADEMARK**

**PRINCIPAL REGISTER**

TURLIO LLC (CALIFORNIA LIMITED PARTNERSHIP)  
2620 W. LA PALMA AVE.  
ANAHEIM, CA 92801

FOR: COOKIES, IN CLASS 30 (U.S. CL. 46).

FIRST USE 1-7-2012; IN COMMERCE 1-7-2012.

THE MARK CONSISTS OF STANDARD CHARACTERS WITHOUT CLAIM TO ANY PARTICULAR FONT, STYLE, SIZE, OR COLOR.

THE WORDING TURLIO HAS NO MEANING IN A FOREIGN LANGUAGE.

SER. NO. 85-521,709, FILED 1-20-2012.

CHRISTOPHER SIDOTI, EXAMINING ATTORNEY



*David J. Kyffers*

Director of the United States Patent and Trademark Office

# United States of America

United States Patent and Trademark Office

# LAMP

**Reg. No. 4,198,355**

**Registered Aug. 28, 2012**

**Int. Cl.: 36**

**SERVICE MARK**

**PRINCIPAL REGISTER**

L.A.M.P. - LUTHERAN ASSOCIATION OF MISSIONARIES AND PILOTS INC. (CANADA CORPORATION)  
4966 - 92 AVENUE NW  
EDMONTON, CANADA T6B2V4

FOR: FINANCIAL SPONSORSHIP OF MISSIONARY PROGRAMS, CHARITABLE FUND RAISING, IN CLASS 36 (U.S. CLS. 100, 101 AND 102).

FIRST USE 5-8-1976; IN COMMERCE 5-8-1976.

THE MARK CONSISTS OF STANDARD CHARACTERS WITHOUT CLAIM TO ANY PARTICULAR FONT, STYLE, SIZE, OR COLOR.

SER. NO. 85-521,711, FILED 1-20-2012.

MATTHEW EINSTEIN, EXAMINING ATTORNEY



*David J. Kybas*

Director of the United States Patent and Trademark Office



# United States of America

United States Patent and Trademark Office

# SilrynPure

**Reg. No. 4,198,356**

BEWICKE, CAL (UNITED STATES INDIVIDUAL)  
330 F SIR FRANCIS DRAKE BLVD  
SAN ANSELMO, CA 94960

**Registered Aug. 28, 2012**

**Int. Cl.: 5**

FOR: DIETARY AND NUTRITIONAL SUPPLEMENTS, IN CLASS 5 (U.S. CLS. 6, 18, 44, 46, 51 AND 52).

**TRADEMARK**

FIRST USE 1-3-2010; IN COMMERCE 2-7-2010.

**PRINCIPAL REGISTER**

THE MARK CONSISTS OF STANDARD CHARACTERS WITHOUT CLAIM TO ANY PARTICULAR FONT, STYLE, SIZE, OR COLOR.

SER. NO. 85-521,725, FILED 1-20-2012.

DANIEL CAPSHAW, EXAMINING ATTORNEY



*David J. Kyros*

Director of the United States Patent and Trademark Office

# United States of America

United States Patent and Trademark Office

# Nature-Fil

**Reg. No. 4,198,357**

FAIRFIELD PROCESSING CORPORATION (CONNECTICUT CORPORATION)  
88 ROSE HILL AVENUE  
DANBURY, CT 06810

**Registered Aug. 28, 2012**

**Int. Cl.: 22**

FOR: RAW FIBROUS TEXTILE MATERIALS, DERIVED FROM PLANTS, INTENDED FOR USE AS FIBER OR STUFFING MATERIALS, IN CLASS 22 (U.S. CLS. 1, 2, 7, 19, 22, 42 AND 50).

**TRADEMARK**

FIRST USE 1-1-2006; IN COMMERCE 1-23-2007.

**PRINCIPAL REGISTER**

THE MARK CONSISTS OF STANDARD CHARACTERS WITHOUT CLAIM TO ANY PARTICULAR FONT, STYLE, SIZE, OR COLOR.

SER. NO. 85-521,739, FILED 1-20-2012.

DEBORAH LOBO, EXAMINING ATTORNEY



*David J. Kyffers*

Director of the United States Patent and Trademark Office

# United States of America

United States Patent and Trademark Office

## Printed Fresh Daily

**Reg. No. 4,198,358**

STORYVILLE APPAREL LLC (LOUISIANA LIMITED LIABILITY COMPANY)  
3029 MAGAZINE STREET  
NEW ORLEANS, LA 70115

**Registered Aug. 28, 2012**

**Int. Cls.: 25 and 40**

FOR: DRESSES; HOODED SWEATSHIRTS; SCARVES; T-SHIRTS, IN CLASS 25 (U.S. CLS. 22 AND 39).

**TRADEMARK**

FIRST USE 12-11-2011; IN COMMERCE 12-11-2011.

**SERVICE MARK**

FOR: SCREEN PRINTING, IN CLASS 40 (U.S. CLS. 100, 103 AND 106).

**PRINCIPAL REGISTER**

FIRST USE 12-11-2011; IN COMMERCE 12-11-2011.

THE MARK CONSISTS OF STANDARD CHARACTERS WITHOUT CLAIM TO ANY PARTICULAR FONT, STYLE, SIZE, OR COLOR.

SER. NO. 85-521,747, FILED 1-20-2012.

DEBORAH LOBO, EXAMINING ATTORNEY



*David J. Kybas*

Director of the United States Patent and Trademark Office

# United States of America

United States Patent and Trademark Office

# M.O.M.

**Reg. No. 4,198,359**

**Registered Aug. 28, 2012**

**Int. Cl.: 37**

**SERVICE MARK**

**PRINCIPAL REGISTER**

M.O.M. MONTREAL OFFICE MAINTENANCE (CANADA CORPORATION), AKA M.O.M. ENTRETIEN DE BUREAU MONTRÉAL INC.  
4225 ST. DOMINIQUE APT 602  
3449 AVE. DU MUSÉE  
MONTREAL, QUEBEC, CANADA H3G2C8

FOR: AIR CONDITIONING CONTRACTOR SERVICES; AIR DUCT CLEANING SERVICES; BUILDING MAINTENANCE AND REPAIR; CARPET AND RUG CLEANING; CARPET CLEANING; CLEANING OF BUILDINGS; CLEANING OF COMMERCIAL PREMISES; CLEANING OF EXTERNAL SURFACES OF BUILDINGS; CLEANING OF INDUSTRIAL PREMISES; CLEANING OF RESIDENTIAL HOUSES; CLEANING OF FLOORS; CONCRETE POLISHING; DEGREASING AND CLEANING SERVICES USING SOLVENT AND VAPOR TECHNOLOGY; DISINFECTING; DISINFECTING OF TELEPHONE HAND-SETS; DOOR REPAIR SERVICES; DRAIN AND SEWER CLEANING AND ROOTERING SERVICES; DRAIN CLEANING SERVICES; FLOOR POLISHING; FLOOR SANDING; FLOOR TREATMENT SERVICES, NAMELY, APPLICATION OF CHEMICAL PREPARATIONS TO FLOORS TO MAKE THEM SLIP-RESISTANT FOR SAFETY PURPOSES; FURNACE INSTALLATION AND REPAIR; FURNITURE MAINTENANCE; GAS TURBINE ENGINE CLEANING SERVICES; GAS TURBINE ENGINE REPAIR; GEM AND JEWELRY REPAIR AND CLEANING SERVICES; GENERAL BUILDING CONTRACTOR SERVICES; GENERAL CONTRACTOR SERVICES, NAMELY, PLUMBING, HEATING AND AIR CONDITIONING, CARPENTRY, DRYWALL, PAINTING, ELECTRICAL, BUILDING AND FRAMING CONTRACTOR SERVICES; HANDYMAN SERVICE, NAMELY, BUILDING REPAIR AND MAINTENANCE; HEATING CONTRACTOR SERVICES; HVAC CONTRACTOR SERVICES; INSTALLATION AND REPAIR OF AIR CONDITIONING APPARATUS; INSTALLATION AND REPAIR OF HEATING, VENTILATING AND AIR CONDITIONING EQUIPMENT; INSTALLATION AND REPLACEMENT SERVICE FOR HEATING, VENTILATING AND AIR CONDITIONING SYSTEMS; JANITORIAL SERVICES; MAID SERVICES; MAINTENANCE AND REPAIR OF BUILDINGS; PAINTING; POLISHING OF CONCRETE FLOORS; POLISHING OF FLOORS; PRESSURE WASHING SERVICES; RENTAL OF CLEANING EQUIPMENT; RENTAL OF CLEANING MACHINES; RENTAL OF DEGREASING MACHINES; RENTAL OF FLOOR CLEANING MACHINES; RENTAL OF VACUUM CLEANERS; REPAIR OR MAINTENANCE OF AIR-CONDITIONING APPARATUS; REPAIR OR MAINTENANCE OF INDUSTRIAL FURNACES; RESTROOM MAINTENANCE SERVICES; RUG CLEANING; RUG SHAMPOOING; SANITATION CONSULTATION; STREET CLEANING; STREET SWEEPING SERVICES; WASTE DISPOSAL FOR OTHERS; WINDOW CLEANING, IN CLASS 37 (U.S. CLS. 100, 103 AND 106).



*David J. Kypos*

Director of the United States Patent and Trademark Office

**Reg. No. 4,198,359** FIRST USE 1-31-2005; IN COMMERCE 8-19-2010.

THE MARK CONSISTS OF STANDARD CHARACTERS WITHOUT CLAIM TO ANY PARTICULAR FONT, STYLE, SIZE, OR COLOR.

SER. NO. 85-521,762, FILED 1-20-2012.

SUSAN LESLIE DUBOIS, EXAMINING ATTORNEY

# United States of America

United States Patent and Trademark Office

## DIAMOND REEF

**Reg. No. 4,198,360**

PETER A. WALLINGFORD (UNITED STATES INDIVIDUAL)  
236 S.W. 171ST ST.  
SEATTLE, WA 98166

**Registered Aug. 28, 2012**

**Int. Cl.: 28**

FOR: SCUBA DIVING INSTRUCTIONAL APPARATUS, NAMELY, UNDERWATER GRIDS,  
IN CLASS 28 (U.S. CLS. 22, 23, 38 AND 50).

**TRADEMARK**

FIRST USE 9-1-1989; IN COMMERCE 11-1-1989.

**PRINCIPAL REGISTER**

THE MARK CONSISTS OF STANDARD CHARACTERS WITHOUT CLAIM TO ANY PAR-  
TICULAR FONT, STYLE, SIZE, OR COLOR.

SER. NO. 85-521,782, FILED 1-20-2012.

SHAILA SETTLES, EXAMINING ATTORNEY



*David J. Kyffers*

Director of the United States Patent and Trademark Office

# United States of America

United States Patent and Trademark Office

## Caring for caregivers, for the future is in their hands

**Reg. No. 4,198,361**

**Registered Aug. 28, 2012**

**Int. Cls.: 9 and 16**

**TRADEMARK**

**PRINCIPAL REGISTER**

THE CARE COURSES SCHOOL, INC. (VIRGINIA CORPORATION), DBA CARE COURSES  
P.O. BOX 10526  
MCLEAN, VA 22102

FOR: DOWNLOADABLE ELECTRONIC PUBLICATIONS IN THE NATURE OF E-BOOKS  
AND DOWNLOADABLE DOCUMENTS IN THE FIELD OF CHILDCARE EDUCATION, IN  
CLASS 9 (U.S. CLS. 21, 23, 26, 36 AND 38).

FIRST USE 12-1-2005; IN COMMERCE 12-1-2005.

FOR: CATALOGS IN THE FIELD OF CHILDCARE EDUCATION; EDUCATIONAL PUBLIC-  
ATIONS, NAMELY, BOOKS AND WORKBOOKS IN THE FIELDS OF CHILDCARE EDUCA-  
TION, IN CLASS 16 (U.S. CLS. 2, 5, 22, 23, 29, 37, 38 AND 50).

FIRST USE 12-1-2005; IN COMMERCE 12-1-2005.

THE MARK CONSISTS OF STANDARD CHARACTERS WITHOUT CLAIM TO ANY PAR-  
TICULAR FONT, STYLE, SIZE, OR COLOR.

SER. NO. 85-521,807, FILED 1-20-2012.

BRIAN PINO, EXAMINING ATTORNEY



*David J. Kybas*

Director of the United States Patent and Trademark Office

# United States of America

United States Patent and Trademark Office

H E F F E R N A N



G R O U P

**Reg. No. 4,198,362**

**Registered Aug. 28, 2012**

**Int. Cl.: 36**

**SERVICE MARK**

**PRINCIPAL REGISTER**

HEFFERNAN INSURANCE BROKERS (CALIFORNIA CORPORATION)  
1350 CARLBACK AVENUE, SUITE 200  
WALNUT CREEK, CA 94596

FOR: INSURANCE BROKERAGE SERVICES, INSURANCE ADMINISTRATION, INSURANCE CLAIMS ADMINISTRATION AND PROCESSING, INSURANCE CONSULTATION, LOSS CONTROL, IN CLASS 36 (U.S. CLS. 100, 101 AND 102).

FIRST USE 11-13-2000; IN COMMERCE 11-13-2000.

NO CLAIM IS MADE TO THE EXCLUSIVE RIGHT TO USE "GROUP", APART FROM THE MARK AS SHOWN.

THE COLOR(S) YELLOW, BLACK, WHITE IS/ARE CLAIMED AS A FEATURE OF THE MARK.

THE MARK CONSISTS OF A LOWER CASE, WHITE LETTER "H" IN THE CENTER OF A BLACK BOX WITH A YELLOW CIRCLE IN THE CENTER OF THE "H". "HEFFERNAN" APPEARS TO THE UPPER LEFT OF THE BOX, WHILE "GROUP" APPEARS AT THE LOWER RIGHT OF THE BOX.

SER. NO. 85-521,810, FILED 1-20-2012.

MICHAEL W. BAIRD, EXAMINING ATTORNEY



*David J. Kybas*

Director of the United States Patent and Trademark Office



# United States of America

United States Patent and Trademark Office

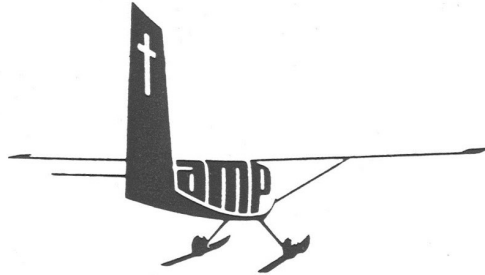

**Reg. No. 4,198,363**

**Registered Aug. 28, 2012**

**Int. Cl.: 36**

**SERVICE MARK**

**PRINCIPAL REGISTER**

L.A.M.P. - LUTHERAN ASSOCIATION OF MISSIONARIES AND PILOTS INC. (CANADA CORPORATION)  
4966 - 92 AVENUE NW  
EDMONTON, ALBERTA, CANADA T6B2V4

FOR: FINANCIAL SUPPORT OF MISSIONARY PROGRAMS, CHARITABLE FUND RAISING, IN CLASS 36 (U.S. CLS. 100, 101 AND 102).

FIRST USE 5-8-1976; IN COMMERCE 5-8-1976.

THE MARK CONSISTS OF THE IMAGE OF A FLOAT PLANE WITH THE WORD "LAMP" MAKING UP THE BODY OF THE PLANE AND A LATIN CROSS APPEARING ON THE TAIL FIN.

SER. NO. 85-521,820, FILED 1-20-2012.

MATTHEW EINSTEIN, EXAMINING ATTORNEY



*David J. Kybas*

Director of the United States Patent and Trademark Office

# United States of America

United States Patent and Trademark Office

# Silryn

**Reg. No. 4,198,364**

BEWICKE, CAL (UNITED STATES INDIVIDUAL)  
330 F SIR FRANCIS DRAKE BLVD  
SAN ANSELMO, CA 94960

**Registered Aug. 28, 2012**

**Int. Cl.: 5**

FOR: DIETARY AND NUTRITIONAL SUPPLEMENTS, IN CLASS 5 (U.S. CLS. 6, 18, 44, 46, 51 AND 52).

**TRADEMARK**

FIRST USE 1-3-2010; IN COMMERCE 2-7-2010.

**PRINCIPAL REGISTER**

THE MARK CONSISTS OF STANDARD CHARACTERS WITHOUT CLAIM TO ANY PARTICULAR FONT, STYLE, SIZE, OR COLOR.

SER. NO. 85-521,822, FILED 1-20-2012.

DANIEL CAPSHAW, EXAMINING ATTORNEY



*David J. Kyffers*

Director of the United States Patent and Trademark Office

# United States of America

United States Patent and Trademark Office

# Cardstick

**Reg. No. 4,198,365**

**Registered Aug. 28, 2012**

**Int. Cl.: 16**

**TRADEMARK**

**PRINCIPAL REGISTER**

ALISON WONG (CALIFORNIA LIMITED LIABILITY COMPANY), DBA INTEGRAL DESIGN  
LLC  
934 OAK LANE #3  
MENLO PARK, CA 94025

FOR: DECALS; STICKERS, IN CLASS 16 (U.S. CLS. 2, 5, 22, 23, 29, 37, 38 AND 50).

FIRST USE 6-24-2011; IN COMMERCE 8-3-2011.

THE MARK CONSISTS OF STANDARD CHARACTERS WITHOUT CLAIM TO ANY PARTICULAR FONT, STYLE, SIZE, OR COLOR.

SER. NO. 85-521,828, FILED 1-20-2012.

SUSAN STIGLITZ, EXAMINING ATTORNEY



*David J. Kybas*

Director of the United States Patent and Trademark Office

# United States of America

United States Patent and Trademark Office



**Reg. No. 4,198,366**

**Registered Aug. 28, 2012**

**Int. Cl.: 15**

**TRADEMARK**

**PRINCIPAL REGISTER**

KHS MUSICAL INSTRUMENTS LTD (TAIWAN LIMITED LIABILITY COMPANY)  
10TH FLOOR  
NO. 162, ZHONGSHAN 2ND RD., LUZHOU DIST.  
NEW TAIPEI CITY, TAIWAN 24756

FOR: FLUTES, GUITARS, BASS DRUMS, BASS DRUM SPURS, TOM TOMS, TIMBALES, FLOOR TOM TOMS, MELODIC TOM TOMS, TOM TOM STANDS, TOM TOM HOLDERS, WOODEN SNARE DRUMS, METAL SNARE DRUMS, SNARE DRUM STANDS, SNARE KITS, CYMBALS, CYMBAL BOOM STANDS, CYMBAL HOLDERS, CYMBAL STANDS, DRUM PEDALS, DRUM STICKS, HI-HAT STANDS, TRUMPETS, CORNETS, MELLOPHONES, FLUGEL HORNS, TROMBONES, EUPHONIUMS, SAXHORNS, SOUSAPHONES, PICCOLOS, UKULELES, CLARINETS, SAXOPHONES, COWBELLS, COWBELL HOLDERS, TAMBOURINES, BONGOS, CONGOS, BELL LYRES, VIOLINS, GONGS, PERCUSSION INSTRUMENTS, MARACAS, HARMONICAS, PITCH PIPES, TUNING FORKS, GUITAR HANGERS, CAPOES, GUITAR MACHINE HEADS, GUITAR STRAPS AND STANDS, AND INSTRUMENT CASES THEREFOR, IN CLASS 15 (U.S. CLS. 2, 21 AND 36).

FIRST USE 12-23-2011; IN COMMERCE 12-23-2011.

THE MARK CONSISTS OF A COIN DISPLAYING THE PROFILE OF A ROMAN GOD, FACING TO THE RIGHT WITH A BEARD AND LONG WAVY HAIR.

SER. NO. 85-521,847, FILED 1-20-2012.

HENRY S. ZAK, EXAMINING ATTORNEY



*David J. Kyffers*

Director of the United States Patent and Trademark Office

# United States of America

United States Patent and Trademark Office

## FEED YOUR FELINES LIKE THE CARNIVORES THEY ARE

**Reg. No. 4,198,367**

RADAGAST PET FOOD, INC. (OREGON CORPORATION), DBA RAD CAT  
3617 SE 17TH AVENUE  
PORTLAND, OR 97202

**Registered Aug. 28, 2012**

**Int. Cl.: 31**

FOR: PET FOOD, IN CLASS 31 (U.S. CLS. 1 AND 46).

**TRADEMARK**

FIRST USE 4-11-2005; IN COMMERCE 5-8-2006.

**PRINCIPAL REGISTER**

THE MARK CONSISTS OF STANDARD CHARACTERS WITHOUT CLAIM TO ANY PARTICULAR FONT, STYLE, SIZE, OR COLOR.

SER. NO. 85-521,856, FILED 1-20-2012.

ZHALEH DELANEY, EXAMINING ATTORNEY



*David J. Kybas*

Director of the United States Patent and Trademark Office

# United States of America

United States Patent and Trademark Office

# Dishoom

**Reg. No. 4,198,368**

DISHOOM LLC (DELAWARE LIMITED LIABILITY COMPANY)  
1221 S. EADS ST. #1506  
ARLINGTON, VA 22202

**Registered Aug. 28, 2012**

**Int. Cl.: 41**

FOR: ENTERTAINMENT IN THE NATURE OF PROVIDING AN INFORMATIONAL AND ENTERTAINMENT WEBSITE FEATURING AUDIO, VIDEO, PHOTOGRAPHIC AND PROSE PRESENTATIONS IN THE FIELD OF ENTERTAINMENT, IN CLASS 41 (U.S. CLS. 100, 101 AND 107).

**SERVICE MARK**

**PRINCIPAL REGISTER**

FIRST USE 1-14-2012; IN COMMERCE 1-14-2012.

THE MARK CONSISTS OF STANDARD CHARACTERS WITHOUT CLAIM TO ANY PARTICULAR FONT, STYLE, SIZE, OR COLOR.

SER. NO. 85-521,857, FILED 1-20-2012.

ZHALEH DELANEY, EXAMINING ATTORNEY



*David J. Kyffers*

Director of the United States Patent and Trademark Office

# United States of America

United States Patent and Trademark Office

## L.P.R LIQUID PANTY REMOVER

**Reg. No. 4,198,369**

**Registered Aug. 28, 2012**

**Int. Cl.: 3**

**TRADEMARK**

**PRINCIPAL REGISTER**

ALL STAR MOTIVATION.COM (NEVADA CORPORATION)  
3110 POLARIS AVENUE, SUITE 20  
LAS VEGAS, NV 89102

FOR: COLOGNE; FRAGRANCES, IN CLASS 3 (U.S. CLS. 1, 4, 6, 50, 51 AND 52).

FIRST USE 7-31-2010; IN COMMERCE 7-31-2010.

THE MARK CONSISTS OF STANDARD CHARACTERS WITHOUT CLAIM TO ANY PARTICULAR FONT, STYLE, SIZE, OR COLOR.

SER. NO. 85-521,883, FILED 1-20-2012.

MATTHEW PAPPAS, EXAMINING ATTORNEY



*David J. Kappas*

Director of the United States Patent and Trademark Office

# United States of America

United States Patent and Trademark Office

# FAT BUN

**Reg. No. 4,198,370**

**Registered Aug. 28, 2012**

**Int. Cl.: 43**

**SERVICE MARK**

**PRINCIPAL REGISTER**

NABHAN, ALBERT (UNITED STATES INDIVIDUAL)  
SUITE F  
1590 LOMALAND  
EL PASO, TX 79935

FOR: FAST-FOOD RESTAURANT SERVICES, IN CLASS 43 (U.S. CLS. 100 AND 101).

FIRST USE 12-13-2011; IN COMMERCE 12-13-2011.

THE MARK CONSISTS OF STANDARD CHARACTERS WITHOUT CLAIM TO ANY PARTICULAR FONT, STYLE, SIZE, OR COLOR.

NO CLAIM IS MADE TO THE EXCLUSIVE RIGHT TO USE "BUN", APART FROM THE MARK AS SHOWN.

SER. NO. 85-521,884, FILED 1-20-2012.

MATTHEW MCDOWELL, EXAMINING ATTORNEY



*David J. Kybas*

Director of the United States Patent and Trademark Office



# United States of America

United States Patent and Trademark Office



**Reg. No. 4,198,371**

**Registered Aug. 28, 2012**

**Int. Cl.: 43**

**SERVICE MARK**

**PRINCIPAL REGISTER**

NABHAN, ALBERT (UNITED STATES INDIVIDUAL)  
SUITE F  
1590 LOMALAND  
EL PASO, TX 77242

FOR: FAST-FOOD RESTAURANT SERVICES, IN CLASS 43 (U.S. CLS. 100 AND 101).

FIRST USE 12-13-2011; IN COMMERCE 12-13-2011.

NO CLAIM IS MADE TO THE EXCLUSIVE RIGHT TO USE "BUN HAMBURGERS", APART FROM THE MARK AS SHOWN.

THE COLOR(S) YELLOW, BLACK, RED, AND WHITE IS/ARE CLAIMED AS A FEATURE OF THE MARK.

THE MARK CONSISTS OF THE WORDING "FAT BUN HAMBURGERS" WITH "FAT" ABOVE "BUN" IN LARGE YELLOW LETTERS OUTLINED IN BLACK, AND THE WORD "HAMBURGERS" BELOW IN WHITE TYPEFACE LETTERS ENCASED IN A RED RECTANGLE OUTLINED IN BLACK.

SER. NO. 85-521,898, FILED 1-20-2012.

MATTHEW MCDOWELL, EXAMINING ATTORNEY



*David J. Kyros*

Director of the United States Patent and Trademark Office

# United States of America

United States Patent and Trademark Office

## Bonnie and Clyde

**Reg. No. 4,198,372**

**Registered Aug. 28, 2012**

**Int. Cl.: 41**

**SERVICE MARK**

**PRINCIPAL REGISTER**

CHOATE JR., EARL WAYNE (UNITED STATES INDIVIDUAL)  
1634 RIVERVIEW DRIVE  
NORFORK, AR 72658 AND

CHOATE, LINDA JO (UNITED STATES INDIVIDUAL)  
1634 RIVERVIEW DRIVE  
NORFORK, AR 72658

FOR: ENTERTAINMENT SERVICES, NAMELY, THE PRESENTATION OF LIVE MUSICAL PERFORMANCES AND PUBLIC APPEARANCES BY A RECORDING ARTIST(S), IN CLASS 41 (U.S. CLS. 100, 101 AND 107).

FIRST USE 4-1-2011; IN COMMERCE 4-1-2011.

THE MARK CONSISTS OF STANDARD CHARACTERS WITHOUT CLAIM TO ANY PARTICULAR FONT, STYLE, SIZE, OR COLOR.

SER. NO. 85-521,907, FILED 1-20-2012.

KATHLEEN LORENZO, EXAMINING ATTORNEY



*David J. Kyros*

Director of the United States Patent and Trademark Office

# United States of America

United States Patent and Trademark Office

## TSA Fast Pass

**Reg. No. 4,198,373**

KC PET PRODUCTS LLC (OREGON LIMITED LIABILITY COMPANY)  
12503 SE DIVISION ST STE D  
PORTLAND, OR 97236

**Registered Aug. 28, 2012**

**Int. Cl.: 18**

FOR: ANIMAL LEASHES; DOG LEASHES; LEASHES FOR ANIMALS; LEATHER LEASHES; PET PRODUCTS, NAMELY, PET RESTRAINING DEVICES CONSISTING OF LEASHES, COLLARS, HARNESSES, RESTRAINING STRAPS, AND LEASHES WITH LOCKING DEVICES, IN CLASS 18 (U.S. CLS. 1, 2, 3, 22 AND 41).

**TRADEMARK**

**PRINCIPAL REGISTER**

FIRST USE 10-17-2011; IN COMMERCE 1-15-2012.

THE MARK CONSISTS OF STANDARD CHARACTERS WITHOUT CLAIM TO ANY PARTICULAR FONT, STYLE, SIZE, OR COLOR.

SER. NO. 85-521,921, FILED 1-20-2012.

MARGERY A. TIERNEY, EXAMINING ATTORNEY



*David J. Kybas*

Director of the United States Patent and Trademark Office

United States of America  
United States Patent and Trademark Office

PRIZMEYEZ

**Reg. No. 4,198,374**

NICKELL, CAROLYN E (UNITED STATES INDIVIDUAL), DBA PRIZMEYEZ  
325 AUSTIN ST.  
SAN FRANCISCO, CA 94109

**Registered Aug. 28, 2012**

**Int. Cls.: 9 and 28**

FOR: EYEWEAR; SUNGLASSES, IN CLASS 9 (U.S. CLS. 21, 23, 26, 36 AND 38).

FIRST USE 8-14-2009; IN COMMERCE 9-14-2009.

**TRADEMARK**

FOR: TOY PRISM GLASSES, IN CLASS 28 (U.S. CLS. 22, 23, 38 AND 50).

**PRINCIPAL REGISTER**

FIRST USE 8-14-2009; IN COMMERCE 9-14-2009.

THE MARK CONSISTS OF STANDARD CHARACTERS WITHOUT CLAIM TO ANY PARTICULAR FONT, STYLE, SIZE, OR COLOR.

SER. NO. 85-521,934, FILED 1-21-2012.

MARIA-VICTORIA SUAREZ, EXAMINING ATTORNEY



*David J. Kybas*

Director of the United States Patent and Trademark Office

# United States of America

United States Patent and Trademark Office

# Medi-Wash

**Reg. No. 4,198,375**

MEDI-WASH (NEW JERSEY LIMITED LIABILITY COMPANY)  
12 FALLS RD.

**Registered Aug. 28, 2012**

MEDFORD, NJ 08055

**Int. Cl.: 37**

FOR: JANITORIAL SERVICES, IN CLASS 37 (U.S. CLS. 100, 103 AND 106).

**SERVICE MARK**

FIRST USE 4-8-2008; IN COMMERCE 4-8-2008.

**PRINCIPAL REGISTER**

THE MARK CONSISTS OF STANDARD CHARACTERS WITHOUT CLAIM TO ANY PARTICULAR FONT, STYLE, SIZE, OR COLOR.

SER. NO. 85-521,977, FILED 1-21-2012.

ALICE BENMAMAN, EXAMINING ATTORNEY



*David J. Kyffers*

Director of the United States Patent and Trademark Office

# United States of America

United States Patent and Trademark Office

## SPANISH FOR UNITED STATESERS A SECOND LANGUAGE OPENS A SECOND WORLD OF OPPORTUNITIES

**Reg. No. 4,198,376**

ACOSTA, SILAS (UNITED STATES INDIVIDUAL)  
11127 NC HIGHWAY 41 W.

**Registered Aug. 28, 2012**

BLADENBORO, NC 28320

**Int. Cl.: 16**

FOR: SERIES OF NON-FICTION BOOKS IN THE FIELD OF LANGUAGE, SOCIOLOGY, HUMANITIES AND PSYCHOLOGY, IN CLASS 16 (U.S. CLS. 2, 5, 22, 23, 29, 37, 38 AND 50).

**TRADEMARK**

FIRST USE 9-0-2000; IN COMMERCE 9-0-2000.

**PRINCIPAL REGISTER**

THE MARK CONSISTS OF STANDARD CHARACTERS WITHOUT CLAIM TO ANY PARTICULAR FONT, STYLE, SIZE, OR COLOR.

SER. NO. 85-521,979, FILED 1-21-2012.

JACQUELINE A. LAVINE, EXAMINING ATTORNEY



*David J. Kybas*

Director of the United States Patent and Trademark Office

# United States of America

United States Patent and Trademark Office

# ZTS

**Reg. No. 4,198,377**

**Registered Aug. 28, 2012**

**Int. Cl.: 42**

**SERVICE MARK**

**PRINCIPAL REGISTER**

ZIEGLER, DAVID WILLIAM (NEW YORK SOLE PROPRIETORSHIP), DBA ZIEGLER  
TECHNICAL SOLUTIONS  
PO BOX 2014  
NEW CITY, NY 109562014

FOR: COMPUTER CONSULTATION; COMPUTER WEBSITE DESIGN; CONSULTING IN THE FIELD OF INFORMATION TECHNOLOGY; DESIGN OF HOMEPAGES AND WEBSITES; DESIGNING WEBSITES FOR OTHERS; INFORMATION TECHNOLOGY CONSULTATION; MAINTENANCE OF WEBSITES AND HOSTING ON-LINE WEB FACILITIES FOR OTHERS; WEBSITE DESIGN AND DEVELOPMENT FOR OTHERS, IN CLASS 42 (U.S. CLS. 100 AND 101).

FIRST USE 1-18-2012; IN COMMERCE 1-18-2012.

THE MARK CONSISTS OF STANDARD CHARACTERS WITHOUT CLAIM TO ANY PARTICULAR FONT, STYLE, SIZE, OR COLOR.

SER. NO. 85-521,980, FILED 1-21-2012.

JACQUELINE A. LAVINE, EXAMINING ATTORNEY



*David J. Kybas*

Director of the United States Patent and Trademark Office

# United States of America

United States Patent and Trademark Office

# shuitar

**Reg. No. 4,198,378**

**Registered Aug. 28, 2012**

**Int. Cl.: 15**

**TRADEMARK**

**PRINCIPAL REGISTER**

GLASSMEYER, MATTHEW W (UNITED STATES INDIVIDUAL)  
1203 GARTLAND AVENUE  
NASHVILLE, TN 37206

FOR: MUSICAL INSTRUMENTS; PERCUSSION INSTRUMENTS; STRING INSTRUMENTS,  
IN CLASS 15 (U.S. CLS. 2, 21 AND 36).

FIRST USE 3-1-1999; IN COMMERCE 2-1-2009.

THE MARK CONSISTS OF STANDARD CHARACTERS WITHOUT CLAIM TO ANY PAR-  
TICULAR FONT, STYLE, SIZE, OR COLOR.

SER. NO. 85-522,029, FILED 1-21-2012.

JEFFREY LOOK, EXAMINING ATTORNEY



*David J. Kyffers*

Director of the United States Patent and Trademark Office



# United States of America

United States Patent and Trademark Office

## DARLIN'S DARLINS

**Reg. No. 4,198,379**

DARLIN LLC (IDAHO LIMITED LIABILITY COMPANY)  
PO BOX 2916

**Registered Aug. 28, 2012**

SUN VALLEY, ID 83353

**Int. Cl.: 41**

FOR: PROFESSIONAL COACHING SERVICES IN THE FIELD OF FIGURE SKATING; SPORTS INSTRUCTION SERVICES, IN CLASS 41 (U.S. CLS. 100, 101 AND 107).

**SERVICE MARK**

FIRST USE 5-1-2000; IN COMMERCE 5-1-2000.

**PRINCIPAL REGISTER**

THE MARK CONSISTS OF STANDARD CHARACTERS WITHOUT CLAIM TO ANY PARTICULAR FONT, STYLE, SIZE, OR COLOR.

SER. NO. 85-522,031, FILED 1-21-2012.

JEFFREY LOOK, EXAMINING ATTORNEY



*David J. Kyros*

Director of the United States Patent and Trademark Office

# United States of America

United States Patent and Trademark Office

## MEAMORPHISM

**Reg. No. 4,198,380**

**Registered Aug. 28, 2012**

**Int. Cl.: 42**

**SERVICE MARK**

**PRINCIPAL REGISTER**

ALI MEAMAR (UNITED STATES INDIVIDUAL)  
ART PEOPLE GALLERY  
50 POST STREET #41  
SAN FRANCISCO, CA 94104

FOR: CUSTOM DESIGN AND DEVELOPMENT OF MIXED MEDIA AND MULTIMEDIA  
ARTWORK, IN CLASS 42 (U.S. CLS. 100 AND 101).

FIRST USE 1-1-2012; IN COMMERCE 1-1-2012.

THE MARK CONSISTS OF STANDARD CHARACTERS WITHOUT CLAIM TO ANY PAR-  
TICULAR FONT, STYLE, SIZE, OR COLOR.

SER. NO. 85-522,042, FILED 1-21-2012.

ALICE BENMAMAN, EXAMINING ATTORNEY



*David J. Kyffers*

Director of the United States Patent and Trademark Office

# United States of America

United States Patent and Trademark Office



**Reg. No. 4,198,381**

**Registered Aug. 28, 2012**

**Int. Cl.: 43**

**SERVICE MARK**

**PRINCIPAL REGISTER**

PINNACLE ENTERTAINMENT, INC. (DELAWARE CORPORATION)  
8918 SPANISH RIDGE AVENUE  
LAS VEGAS, NV 89148

FOR: BAR SERVICES; PROVIDING BANQUET AND SOCIAL FUNCTION FACILITIES FOR SPECIAL OCCASIONS; RESTAURANT AND CATERING SERVICES, IN CLASS 43 (U.S. CLS. 100 AND 101).

FIRST USE 1-28-2011; IN COMMERCE 1-28-2011.

OWNER OF U.S. REG. NOS. 4,041,157 AND 4,082,604.

THE MARK CONSISTS OF A DRAWING OF A HORSE HEAD FEATURING A BRIDLE AND FLYING MANE WHERE THE MANE IS COMPOSED OF THREE SOLID BANDS WHICH EXTEND OUTWARD FROM THE HORSE'S NECK. THE HORSE HEAD DRAWING IS CENTERED OVER THE STYLIZED WORD "RIVER" WHICH IS CENTERED OVER THE STYLIZED WORD "DOWNS" ALL OF WHICH IS CENTERED WITHIN A RIGHT-SLANTING OVAL.

SER. NO. 85-522,045, FILED 1-21-2012.

VERNA BETH RIRIE, EXAMINING ATTORNEY



*David J. Kybas*

Director of the United States Patent and Trademark Office

# United States of America

United States Patent and Trademark Office

## AuctionMyAuto.com

**Reg. No. 4,198,382**

HAMER JR, ROBERT E (UNITED STATES INDIVIDUAL)  
1895 IXORA ROAD

**Registered Aug. 28, 2012**

NORTH MIAMI, FL 33181

**Int. Cl.: 35**

FOR: ARRANGING AND CONDUCTING AUCTIONS; ON-LINE AUCTIONEERING SERVICES VIA THE INTERNET, IN CLASS 35 (U.S. CLS. 100, 101 AND 102).

**SERVICE MARK**

FIRST USE 10-20-2009; IN COMMERCE 11-21-2009.

**PRINCIPAL REGISTER**

THE MARK CONSISTS OF STANDARD CHARACTERS WITHOUT CLAIM TO ANY PARTICULAR FONT, STYLE, SIZE, OR COLOR.

SER. NO. 85-522,056, FILED 1-21-2012.

FRED CARL, EXAMINING ATTORNEY



*David J. Kybas*

Director of the United States Patent and Trademark Office

United States of America  
United States Patent and Trademark Office

# LADYPILOT

**Reg. No. 4,198,383**

**Registered Aug. 28, 2012**

**Int. Cl.: 9**

**TRADEMARK**

**PRINCIPAL REGISTER**

NEKO CASE (UNITED STATES INDIVIDUAL)  
C/O HERTZ & LICHTENSTEIN LLP  
450 N. ROXBURY DR., 8TH FL.  
BEVERLY HILLS, CA 90210

FOR: MUSICAL SOUND RECORDINGS, IN CLASS 9 (U.S. CLS. 21, 23, 26, 36 AND 38).

FIRST USE 8-20-2002; IN COMMERCE 8-20-2002.

THE MARK CONSISTS OF STANDARD CHARACTERS WITHOUT CLAIM TO ANY PARTICULAR FONT, STYLE, SIZE, OR COLOR.

SER. NO. 85-522,065, FILED 1-21-2012.

FRED CARL, EXAMINING ATTORNEY



*David J. Kyffers*

Director of the United States Patent and Trademark Office

# United States of America

United States Patent and Trademark Office

## GET GUSSIED UP

**Reg. No. 4,198,384**

SCHUMACHER, KYLEE D (UNITED STATES INDIVIDUAL)

**Registered Aug. 28, 2012**

PO BOX 50451  
AMARILLO, TX 79159

**Int. Cl.: 35**

FOR: ON-LINE RETAIL STORE SERVICES FEATURING CLOTHING AND RELATED ACCESSORIES; RETAIL STORE SERVICES FEATURING CLOTHING AND RELATED ACCESSORIES, IN CLASS 35 (U.S. CLS. 100, 101 AND 102).

**SERVICE MARK**

FIRST USE 0-0-2006; IN COMMERCE 0-0-2006.

**PRINCIPAL REGISTER**

THE MARK CONSISTS OF STANDARD CHARACTERS WITHOUT CLAIM TO ANY PARTICULAR FONT, STYLE, SIZE, OR COLOR.

SER. NO. 85-522,067, FILED 1-21-2012.

FRED CARL, EXAMINING ATTORNEY



*David J. Kyffers*

Director of the United States Patent and Trademark Office

# United States of America

United States Patent and Trademark Office

Support. Connect. Empower.

**Reg. No. 4,198,385**

**Registered Aug. 28, 2012**

**Int. Cl.: 35**

**SERVICE MARK**

**PRINCIPAL REGISTER**

BLUE STAR FAMILIES, INC. (GEORGIA CORPORATION)  
PO BOX 322  
FALLS CHURCH, VA 22040

FOR: CHARITABLE SERVICES, NAMELY, ORGANIZING AND CONDUCTING VOLUNTEER PROGRAMS AND COMMUNITY SERVICE PROJECTS AIMED AT INCREASING SUPPORT AND MORALE OF FAMILIES OF DECEASED WAR VETERANS, WAR VETERANS, CURRENT MEMBERS AND FUTURE MEMBERS OF THE U.S. MILITARY, IN CLASS 35 (U.S. CLS. 100, 101 AND 102).

FIRST USE 7-27-2009; IN COMMERCE 7-27-2009.

THE MARK CONSISTS OF STANDARD CHARACTERS WITHOUT CLAIM TO ANY PARTICULAR FONT, STYLE, SIZE, OR COLOR.

SER. NO. 85-522,095, FILED 1-21-2012.

JAY FLOWERS, EXAMINING ATTORNEY



*David J. Kybas*

Director of the United States Patent and Trademark Office

United States of America  
United States Patent and Trademark Office

# POOP-OFF

**Reg. No. 4,198,386**

LIFE'S GREAT PRODUCTS, LLC (NEVADA LIMITED LIABILITY COMPANY)  
155 NORTH BALBOA STREET, SUITE D1  
SAN MARCOS, CA 92069

**Registered Aug. 28, 2012**

**Int. Cl.: 3**

FOR: CLEANING PREPARATIONS FOR REMOVAL OF BIRD DROPPINGS, IN CLASS 3  
(U.S. CLS. 1, 4, 6, 50, 51 AND 52).

**TRADEMARK**

FIRST USE 5-3-1994; IN COMMERCE 5-3-1994.

**PRINCIPAL REGISTER**

THE MARK CONSISTS OF STANDARD CHARACTERS WITHOUT CLAIM TO ANY PARTICULAR FONT, STYLE, SIZE, OR COLOR.

OWNER OF U.S. REG. NO. 2,674,030.

SER. NO. 85-522,127, FILED 1-21-2012.

JAY FLOWERS, EXAMINING ATTORNEY



*David J. Kyffers*

Director of the United States Patent and Trademark Office



# United States of America

United States Patent and Trademark Office

## Initially Amy Fay

**Reg. No. 4,198,387**

INITIALLY AMY FAY, LLC (TENNESSEE LIMITED LIABILITY COMPANY)  
5400 HOMBERG DRIVE  
KNOXVILLE, TN 37919

**Registered Aug. 28, 2012**

**Int. Cl.: 35**

FOR: RETAIL STORE SERVICES AND ONLINE RETAIL STORE SERVICES FEATURING CLOTHING, CLOTHING ACCESSORIES, HOME GOODS, HOME DECOR, HOUSEWARES, HOLIDAY ITEMS, GIFT ITEMS, NAMELY, BABY GIFTS, TEACHER GIFTS, HOLIDAY GIFTS, CORPORATE GIFTS, WEDDING GIFTS, GIFTS FOR WOMEN AND GIFTS FOR MEN, IN CLASS 35 (U.S. CLS. 100, 101 AND 102).

**SERVICE MARK**

**PRINCIPAL REGISTER**

FIRST USE 10-17-2002; IN COMMERCE 10-17-2002.

THE MARK CONSISTS OF STANDARD CHARACTERS WITHOUT CLAIM TO ANY PARTICULAR FONT, STYLE, SIZE, OR COLOR.

THE NAME(S), PORTRAIT(S), AND/OR SIGNATURE(S) SHOWN IN THE MARK IDENTIFIES AMY FAY CHANDLER, WHOSE CONSENT(S) TO REGISTER IS MADE OF RECORD.

SER. NO. 85-522,143, FILED 1-21-2012.

JAY FLOWERS, EXAMINING ATTORNEY



*David J. Kyros*

Director of the United States Patent and Trademark Office

# United States of America

United States Patent and Trademark Office

# FaithLifts

**Reg. No. 4,198,388**

MACON, TASHION (UNITED STATES INDIVIDUAL)  
12712 MOORPARK ST. #102  
STUDIO CITY, CA 91604

**Registered Aug. 28, 2012**

**Int. Cl.: 41**

FOR: EDUCATIONAL SERVICES, NAMELY, CONDUCTING SEMINARS AND TRAINING IN THE FIELD OF SPIRITUALITY, CHRISTIANITY, PERSONAL IMPROVEMENT AND DISTRIBUTION OF COURSE MATERIAL IN CONNECTION THEREWITH, IN CLASS 41 (U.S. CLS. 100, 101 AND 107).

**SERVICE MARK**

**PRINCIPAL REGISTER**

FIRST USE 1-19-2012; IN COMMERCE 1-19-2012.

THE MARK CONSISTS OF STANDARD CHARACTERS WITHOUT CLAIM TO ANY PARTICULAR FONT, STYLE, SIZE, OR COLOR.

SER. NO. 85-522,165, FILED 1-22-2012.

PAM WILLIS, EXAMINING ATTORNEY



*David J. Kyffers*

Director of the United States Patent and Trademark Office

# United States of America

United States Patent and Trademark Office

## Electric Threads

**Reg. No. 4,198,389**

**Registered Aug. 28, 2012**

**Int. Cl.: 25**

**TRADEMARK**

**PRINCIPAL REGISTER**

ELECTRIC THREADS LLC (VIRGINIA LIMITED LIABILITY COMPANY), AKA ELECTRIC  
THREADS  
214 HARDING AVENUE  
BLACKSBURG, VA 24060

FOR: BEANIES; HATS; HOODED SWEATSHIRTS; SWEATSHIRTS; T-SHIRTS, IN CLASS  
25 (U.S. CLS. 22 AND 39).

FIRST USE 8-1-2011; IN COMMERCE 8-31-2011.

THE MARK CONSISTS OF STANDARD CHARACTERS WITHOUT CLAIM TO ANY PAR-  
TICULAR FONT, STYLE, SIZE, OR COLOR.

NO CLAIM IS MADE TO THE EXCLUSIVE RIGHT TO USE "THREADS", APART FROM  
THE MARK AS SHOWN.

SER. NO. 85-522,166, FILED 1-22-2012.

PAM WILLIS, EXAMINING ATTORNEY



*David J. Kyffers*

Director of the United States Patent and Trademark Office

# United States of America

United States Patent and Trademark Office

## HILLCREST GLASS

**Reg. No. 4,198,390**

**Registered Aug. 28, 2012**

**Int. Cl.: 37**

**SERVICE MARK**

**PRINCIPAL REGISTER**

SILICA PARTNERS, LLC (COLORADO LIMITED LIABILITY COMPANY)  
4047 NEVIS ST  
BOULDER, CO 80301

FOR: INSTALLATION, REPAIR AND REPLACEMENT OF FLAT GLASS, NAMELY WINDOWS, DOORS, MIRRORS, PANELS AND SHOWERS; PLATE GLASS INSTALLATION AND REPAIR SERVICES, IN CLASS 37 (U.S. CLS. 100, 103 AND 106).

FIRST USE 12-31-1969; IN COMMERCE 12-31-1969.

THE MARK CONSISTS OF STANDARD CHARACTERS WITHOUT CLAIM TO ANY PARTICULAR FONT, STYLE, SIZE, OR COLOR.

NO CLAIM IS MADE TO THE EXCLUSIVE RIGHT TO USE "GLASS", APART FROM THE MARK AS SHOWN.

SER. NO. 85-522,194, FILED 1-22-2012.

JULIE WATSON, EXAMINING ATTORNEY



*David J. Kyffers*

Director of the United States Patent and Trademark Office

# United States of America

United States Patent and Trademark Office

## I BUY MY MUSIC

**Reg. No. 4,198,391**

**Registered Aug. 28, 2012**

**Int. Cl.: 25**

**TRADEMARK**

**PRINCIPAL REGISTER**

ISHAM, MARK (UNITED STATES INDIVIDUAL)  
C/O HERTZ & LICHTENSTEIN LLP  
450 N. ROXBURY DR., 8TH FL.  
BEVERLY HILLS, CA 90210 AND

ISHAM, DONNA (UNITED STATES INDIVIDUAL)  
C/O HERTZ & LICHTENSTEIN LLP  
450 N. ROXBURY DR., 8TH FL.  
BEVERLY HILLS, CA 90210

FOR: CLOTHING, NAMELY, T-SHIRTS, IN CLASS 25 (U.S. CLS. 22 AND 39).

FIRST USE 5-3-2011; IN COMMERCE 5-3-2011.

THE MARK CONSISTS OF STANDARD CHARACTERS WITHOUT CLAIM TO ANY PARTICULAR FONT, STYLE, SIZE, OR COLOR.

SER. NO. 85-522,204, FILED 1-22-2012.

BARBARA RUTLAND, EXAMINING ATTORNEY



*David J. Kyffers*

Director of the United States Patent and Trademark Office

# United States of America

United States Patent and Trademark Office

# KnitPurlGurl

**Reg. No. 4,198,392**

STEINMETZ, KARRIE L. (UNITED STATES INDIVIDUAL), DBA KNITPURLGURL  
235 MCFANN RD  
VALENCIA, PA 16059

**Registered Aug. 28, 2012**

**Int. Cl.: 41**

FOR: ENTERTAINMENT SERVICES, NAMELY, PROVIDING VIDEO PODCASTS IN THE FIELD OF KNITTING; ON-LINE JOURNALS, NAMELY, BLOGS FEATURING KNITTING , IN CLASS 41 (U.S. CLS. 100, 101 AND 107).

**SERVICE MARK**

FIRST USE 1-2-2008; IN COMMERCE 1-2-2008.

**PRINCIPAL REGISTER**

THE MARK CONSISTS OF STANDARD CHARACTERS WITHOUT CLAIM TO ANY PARTICULAR FONT, STYLE, SIZE, OR COLOR.

SER. NO. 85-522,209, FILED 1-22-2012.

BARBARA RUTLAND, EXAMINING ATTORNEY



*David J. Kybas*

Director of the United States Patent and Trademark Office

# United States of America

United States Patent and Trademark Office



i luminate

**Reg. No. 4,198,393**

**Registered Aug. 28, 2012**

**Int. Cl.: 37**

**SERVICE MARK**

**PRINCIPAL REGISTER**

ILUMINATE, LLC (FLORIDA LIMITED LIABILITY COMPANY)  
18126 BAL HARBOUR DRIVE  
HOUSTON, TX 77058

FOR: RENTAL AND LEASING OF LIGHTING APPARATUS, LIGHTING INSTRUMENTS AND LIGHTING SYSTEMS FOR USE IN DANCE AND MUSICAL PERFORMANCES; TECHNICAL CONSULTATION IN THE FIELD OF INSTALLATION AND USE OF LIGHTING APPARATUS, LIGHTING INSTRUMENTS AND LIGHTING SYSTEMS IN DANCE AND MUSICAL PERFORMANCES, IN CLASS 37 (U.S. CLS. 100, 103 AND 106).

FIRST USE 2-28-2010; IN COMMERCE 6-7-2010.

THE MARK CONSISTS OF THE WORD "I LUMINATE" UNDERNEATH A STYLIZED CIRCLE.

SER. NO. 85-522,233, FILED 1-22-2012.

JAY FLOWERS, EXAMINING ATTORNEY



*David J. Kybas*

Director of the United States Patent and Trademark Office

# United States of America

United States Patent and Trademark Office



iLUMINATE

**Reg. No. 4,198,394**

**Registered Aug. 28, 2012**

**Int. Cl.: 9**

**TRADEMARK**

**PRINCIPAL REGISTER**

ILUMINATE, LLC (FLORIDA LIMITED LIABILITY COMPANY)  
18126 BAL HARBOUR DRIVE  
HOUSTON, TX 77058

FOR: LIGHT SYSTEMS COMPRISING WIRELESS DEVICES THAT POWER LIGHTS, LIGHTS AND COMMUNICATIONS SOFTWARE FOR CONTROLLING SAID WIRELESS DEVICES, IN CLASS 9 (U.S. CLS. 21, 23, 26, 36 AND 38).

FIRST USE 2-28-2010; IN COMMERCE 6-7-2010.

THE MARK CONSISTS OF THE WORD "I LUMINATE" UNDERNEATH A STYLIZED CIRCLE.

SER. NO. 85-522,234, FILED 1-22-2012.

JAY FLOWERS, EXAMINING ATTORNEY



*David J. Kybas*

Director of the United States Patent and Trademark Office



# United States of America

United States Patent and Trademark Office

## Once a Cheerleader Always a Cheerleader

**Reg. No. 4,198,395**

**Registered Aug. 28, 2012**

**Int. Cl.: 25**

**TRADEMARK**

**PRINCIPAL REGISTER**

CRAWFORD, MICHELE A (GEORGIA LIMITED LIABILITY COMPANY), DBA ALUMNI  
CHEERLEADERS, LCC  
8010 ST. CHARLES SQUARE  
ROSWELL, GA 30075

FOR: ANKLETS; ATHLETIC UNIFORMS; BABY BOTTOMS; BABY TOPS; BALLOON PANTS; BANDANAS; BASEBALL CAPS; BATHING COSTUMES FOR WOMEN; BATHING SUITS; BATHING TRUNKS; BATHROBES; BEACH COVERUPS; BEACH FOOTWEAR; BEACH SHOES; BEACHWEAR; BELTS; BELTS MADE OF LEATHER; BERETS; BERMUDA SHORTS; BIB OVERALLS; BIKINIS; BLAZERS; BLOOMERS; BLOUSES; BOARD SHORTS; BOARDSHORTS; BODY SUITS; BOLEROS; BOOTIES; BOOTS; BOTTOMS; BOXER BRIEFS; BOXER SHORTS; BRALETTES; BRAS; BRASSIERES; BRIEFS; BUSTIERS; BUTTON-FRONT ALOHA SHIRTS; CAMISETTES; CAMISOLES; CAMP SHIRTS; CAP VISORS; CAPRI PANTS; CAPRIS; CAPS; CAPS WITH VISORS; CARDIGANS; A-SHIRTS; ANKLE BOOTS; ANKLE SOCKS; APRONS; ATHLETIC FOOTWEAR; ATHLETIC SHOES; BABY BIBS NOT OF PAPER; CARGO PANTS; CHEF'S HATS; CHEMISES; CHILDREN'S HEADWEAR; CLOGS; CLOTH BIBS FOR ADULT DINERS; COATS; COATS FOR MEN AND WOMEN; COATS MADE OF COTTON; COATS OF DENIM; CORSETS; COVERALLS; CREWNECK SWEATERS; CREWNECKS; CROP TOPS; CULOTTES; DENIM JACKETS; DENIMS; DOWN JACKETS; DRESS SHIRTS; DRESS SUITS; DRESSES; EAR MUFFS; EAR WARMERS; EARBANDS; FABRIC BELTS; FLEECE PULLOVERS; FLEECE SHORTS; FLIP FLOPS; FOOTWEAR FOR MEN AND WOMEN; FOOTWEAR, NAMELY, RUBBERS; FUR COATS AND JACKETS; G-STRINGS; GARTER BELTS; GARTERS; GAUCHOS; GLOVES; GOLF CAPS; GOLF SHIRTS; GYM SHORTS; GYM SUITS; HALLOWEEN COSTUMES; HALTER TOPS; HAT BANDS; HATS; HEAD SCARVES; HEAD SWEATBANDS; HEADBANDS; HEADWEAR; HEAVY JACKETS; HOODS; INFANT AND TODDLER ONE PIECE CLOTHING; INFANT SLEEPERS; INFANTS' SHOES AND BOOTS; INFANTWEAR; INSOLES; JACKETS; JEANS; JERSEYS; JOGGING OUTFITS; JOGGING PANTS; JOGGING SUITS; JUMPSUITS; KNICKERS; KNITTED CAPS; LAB COATS; LADIES' BOOTS; LADIES' SUITS; LADIES' UNDERWEAR; LEATHER BELTS; LEATHER COATS; LEATHER HEADWEAR; LEATHER JACKETS; LEATHER PANTS; LEATHER SHOES; LEGGINGS. LEOTARDS AND TIGHTS FOR WOMEN, MEN AND CHILDREN OF NYLON, COTTON OR OTHER TEXTILE FIBERS; LINGERIE; LONG JACKETS; LONG SLEEVED VESTS; LOUNGEWEAR; MATERNITY SLEEPWEAR; MEN AND WOMEN JACKETS, COATS, TROUSERS, VESTS; MEN'S SUITS, WOMEN'S SUITS; MINISKIRTS; MITTENS; MOCK TURTLE-NECK SWEATERS; MOCKNECKS; MULES; NECKTIES; NIGHT GOWNS; NIGHTWEAR; NURSE PANTS; OPEN-NECKED SHIRTS; OVER COATS; OVERCOATS; PAJAMAS; PANTIES, SHORTS AND BRIEFS; PANTS; PEDAL



*David J. Kyros*

Director of the United States Patent and Trademark Office

**Reg. No. 4,198,395** PUSHERS; PEDICURE SANDALS; PLAY SUITS; POLO SHIRTS; PONCHOS; PULLOVERS; RAIN BOOTS; RAIN JACKETS; RAIN SLICKERS; RAINCOATS; RAINWEAR; ROBES; ROMPERS; SANDALS; SARONGS; SASHES; SCARVES; SCRUBS NOT FOR MEDICAL PURPOSES; SHIRTS; SHIRTS FOR SUITS; SHOES; SHORT SETS; SHORT-SLEEVED OR LONG-SLEEVED T-SHIRTS; SHORT-SLEEVED SHIRTS; SHORTS; SILK SCARVES; SKI JACKETS; SKI PANTS; SKI SUITS; SKIRT SUITS; SKIRTS AND DRESSES; SKORTS; SKULLIES; SLACKS; SLEEP MASKS; SLEEP SHIRTS; SLEEPWEAR; SLEEVED OR SLEEVELESS JACKETS; SLEEVELESS JERSEYS; SLIPPERS; SNEAKERS; SOCKS; SOLES; SPORT COATS; SPORTS BRA; SPORTS JERSEYS; SPORTS SHIRTS; SPORTS SHIRTS WITH SHORT SLEEVES; STRAPS FOR BRAS; SUEDE JACKETS; SUITS; SUITS OF LEATHER; SUN VISORS; SUSPENDER BELTS FOR WOMEN; SUSPENDERS; SWEAT BANDS; SWEAT PANTS; SWEAT SHIRTS; SWEAT SUITS; SWEATSOCKS; SWIM WEAR; SWIM WEAR FOR GENTLEMEN AND LADIES; SWIMSUITS; SWIMWEAR; T-SHIRTS; TANK TOPS; TANK-TOPS; TEDDIES; TEE SHIRTS; TENNIS WEAR; THONGS; TIES; TONGUE OR PULLSTRAP FOR SHOES AND BOOTS; TOP COATS; TOPS; TRACK PANTS; TRACK SUITS; TRACK-SUITS; TRENCH COATS; TUBE TOPS; TUNICS; TURTLENECK SWEATERS; TURTLE-NECKS; UNDER GARMENTS; UNDERGARMENTS; UNDERWEAR; UNIFORMS; UNITARDS; V-NECK SWEATERS; VESTS; VISORS; WAIST BELTS; WAISTBANDS; WALKING SHORTS; WARM UP SUITS; WATERPROOF JACKETS AND PANTS; WEDDING DRESSES; WIND PANTS; WIND-JACKETS; WOMEN'S SHOES; WOMEN'S UNDERWEAR; WRAPS; WRIST-BANDS; YOGA PANTS. YOGA SHIRTS; MUSCLE TOPS; SWEATERS; CANVAS SHOES; DANCE COSTUMES; FOOTWEAR; FOOTWEAR FOR WOMEN; MONEY BELTS; ONE PIECE GARMENT FOR INFANTS AND TODDLERS; PANTIES; PANTSUITS; RUGBY TOPS; SHOULDER WRAPS; SKI BOOT BAGS; SKI GLOVES, IN CLASS 25 (U.S. CLS. 22 AND 39).

FIRST USE 1-1-2008; IN COMMERCE 6-15-2010.

THE MARK CONSISTS OF STANDARD CHARACTERS WITHOUT CLAIM TO ANY PARTICULAR FONT, STYLE, SIZE, OR COLOR.

NO CLAIM IS MADE TO THE EXCLUSIVE RIGHT TO USE "CHEERLEADER" , APART FROM THE MARK AS SHOWN.

SER. NO. 85-522,236, FILED 1-22-2012.

CHRIS WELLS, EXAMINING ATTORNEY

# United States of America

United States Patent and Trademark Office

# Synthesia

**Reg. No. 4,198,396**

SYNTHESIA LLC (MICHIGAN LIMITED LIABILITY COMPANY)  
8681 INDIGO LN  
YPSILANTI, MI 48197

**Registered Aug. 28, 2012**

**Int. Cl.: 9**

FOR: EDUCATIONAL SOFTWARE FEATURING INSTRUCTION IN MUSIC, IN CLASS 9  
(U.S. CLS. 21, 23, 26, 36 AND 38).

**TRADEMARK**

FIRST USE 4-30-2007; IN COMMERCE 6-5-2008.

**PRINCIPAL REGISTER**

THE MARK CONSISTS OF STANDARD CHARACTERS WITHOUT CLAIM TO ANY PARTICULAR FONT, STYLE, SIZE, OR COLOR.

SER. NO. 85-522,238, FILED 1-22-2012.

SUSAN LESLIE DUBOIS, EXAMINING ATTORNEY



*David J. Kybas*

Director of the United States Patent and Trademark Office

# United States of America

United States Patent and Trademark Office

## Healthy is the new Skinny

**Reg. No. 4,198,397**

**Registered Aug. 28, 2012**

**Int. Cls.: 25 and 41**

**TRADEMARK**

**SERVICE MARK**

**PRINCIPAL REGISTER**

HEALTHY IS THE NEW SKINNY (CALIFORNIA LIMITED LIABILITY COMPANY)  
#9  
1120 N. EL CENTRO AVE.  
LOS ANGELES, CA 90038

FOR: T-SHIRTS, IN CLASS 25 (U.S. CLS. 22 AND 39).

FIRST USE 8-10-2010; IN COMMERCE 8-10-2010.

FOR: CONDUCTING WORKSHOPS AND SEMINARS IN HEALTH, WELLNESS, SELF-ESTEEM AND BODY IMAGE; EDUCATIONAL AND ENTERTAINMENT SERVICES, NAMELY, PROVIDING MOTIVATIONAL SPEAKING SERVICES IN THE FIELD OF HEALTH, WELLNESS, SELF-ESTEEM AND BODY IMAGE.; PROVIDING A WEBSITE FEATURING ENTERTAINMENT INFORMATION, IN CLASS 41 (U.S. CLS. 100, 101 AND 107).

FIRST USE 12-8-2010; IN COMMERCE 12-8-2010.

THE MARK CONSISTS OF STANDARD CHARACTERS WITHOUT CLAIM TO ANY PARTICULAR FONT, STYLE, SIZE, OR COLOR.

SER. NO. 85-522,249, FILED 1-22-2012.

KAREN BRACEY, EXAMINING ATTORNEY



*David J. Kyros*

Director of the United States Patent and Trademark Office

# United States of America

United States Patent and Trademark Office

# TouchTrainer

**Reg. No. 4,198,398**

**Registered Aug. 28, 2012**

**Int. Cl.: 9**

**TRADEMARK**

**PRINCIPAL REGISTER**

FLYTHISSIM L.L.C. (CALIFORNIA LIMITED LIABILITY COMPANY)  
1702 DEVAUL RANCH DR.  
SAN LUIS OBISPO, CA 93405

FOR: FLIGHT SIMULATORS, IN CLASS 9 (U.S. CLS. 21, 23, 26, 36 AND 38).

FIRST USE 8-16-2011; IN COMMERCE 9-21-2011.

THE MARK CONSISTS OF STANDARD CHARACTERS WITHOUT CLAIM TO ANY PARTICULAR FONT, STYLE, SIZE, OR COLOR.

SER. NO. 85-522,255, FILED 1-22-2012.

ALAIN LAPTER, EXAMINING ATTORNEY



*David J. Kyffers*

Director of the United States Patent and Trademark Office

# United States of America

United States Patent and Trademark Office



**Reg. No. 4,198,399**

SEEKING ADRENALINE, LLC (PENNSYLVANIA LIMITED LIABILITY COMPANY)  
611 NEEDLE ST  
PHOENIXVILLE, PA 19460

**Registered Aug. 28, 2012**

**Int. Cl.: 35**

FOR: ADVERTISEMENT FOR OTHERS ON THE INTERNET; ADVERTISING AND DIRECTORY SERVICES, NAMELY, PROMOTING THE SERVICES OF OTHERS BY PROVIDING A WEB PAGE FEATURING LINKS TO THE WEBSITES OF OTHERS, IN CLASS 35 (U.S. CLS. 100, 101 AND 102).

**SERVICE MARK**

**PRINCIPAL REGISTER**

FIRST USE 1-1-2011; IN COMMERCE 1-1-2011.

THE MARK CONSISTS OF A RED TRIANGLE WITH A HEART BEAT MONITOR WITHIN IT. SEEKING IS LISTED ON THE TOP IN BLACK. ADRENALINE IS LISTED BELOW THIS IN RED.

THE COLOR(S) RED AND BLACK IS/ARE CLAIMED AS A FEATURE OF THE MARK.

SER. NO. 85-522,268, FILED 1-22-2012.

ALAIN LAPTER, EXAMINING ATTORNEY



*David J. Kyffers*

Director of the United States Patent and Trademark Office

# United States of America

United States Patent and Trademark Office

# SpendDown

**Reg. No. 4,198,400**

SPEND DOWN LLC (OREGON LIMITED LIABILITY COMPANY)  
541 WILLAMETTE ST. SUITE 215  
EUGENE, OR 97401

**Registered Aug. 28, 2012**

**Int. Cl.: 35**

FOR: THE BRINGING TOGETHER, FOR THE BENEFIT OF OTHERS, OF A VARIETY OF GOODS AND SERVICES, ENABLING CUSTOMERS TO CONVENIENTLY VIEW AND PURCHASE THOSE GOODS AND SERVICES FROM AN INTERNET WEB SITE PARTICULARLY SPECIALIZING IN THE MARKETING OF THE SALE OF GOODS AND SERVICES OF OTHERS, IN CLASS 35 (U.S. CLS. 100, 101 AND 102).

**SERVICE MARK**

**PRINCIPAL REGISTER**

FIRST USE 9-1-2011; IN COMMERCE 1-10-2012.

THE MARK CONSISTS OF STANDARD CHARACTERS WITHOUT CLAIM TO ANY PARTICULAR FONT, STYLE, SIZE, OR COLOR.

SER. NO. 85-522,283, FILED 1-22-2012.

MARIA-VICTORIA SUAREZ, EXAMINING ATTORNEY



*David J. Kyjars*

Director of the United States Patent and Trademark Office

# United States of America

United States Patent and Trademark Office

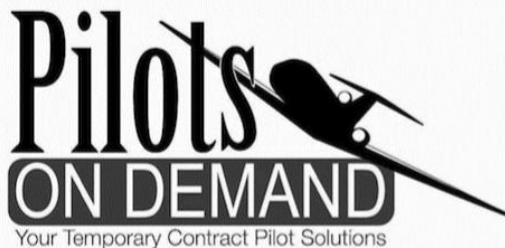

**Reg. No. 4,198,401**

**Registered Aug. 28, 2012**

**Int. Cl.: 35**

**SERVICE MARK**

**PRINCIPAL REGISTER**

PILOTS ON DEMAND, L.L.C. (MICHIGAN LIMITED LIABILITY COMPANY)  
237 EAST FRONT STREET, SUITE 202  
TRAVERSE CITY, MI 49684

FOR: RECRUITMENT AND PLACEMENT OF PERSONNEL IN THE FIELD OF AVIATION,  
IN CLASS 35 (U.S. CLS. 100, 101 AND 102).

FIRST USE 1-1-2010; IN COMMERCE 2-1-2010.

NO CLAIM IS MADE TO THE EXCLUSIVE RIGHT TO USE "PILOTS ON DEMAND" AND  
"YOUR TEMPORARY CONTRACT PILOT SOLUTIONS", APART FROM THE MARK AS  
SHOWN.

THE MARK CONSISTS OF THE WORDS "PILOTS ON DEMAND" WITH THE WORDS "ON  
DEMAND" IN A RECTANGLE, THE WORDING "YOUR TEMPORARY CONTRACT PILOT  
SOLUTIONS", AND AN AIRPLANE SILHOUETTE.

SER. NO. 85-522,311, FILED 1-23-2012.

DAVID C. REIHNER, EXAMINING ATTORNEY



*David J. Kybas*

Director of the United States Patent and Trademark Office



**United States of America**  
United States Patent and Trademark Office

# CHILLING

**Reg. No. 4,198,402**

ZOLL CIRCULATION, INC. (DELAWARE CORPORATION)  
650 ALMANOR AVENUE  
SUNNYVALE, CA 94085

**Registered Aug. 28, 2012**

**Int. Cl.: 41**

FOR: EDUCATIONAL SERVICES, NAMELY DEVELOPING, ARRANGING AND CONDUCTING MEDICAL CONFERENCES, IN CLASS 41 (U.S. CLS. 100, 101 AND 107).

**SERVICE MARK**

FIRST USE 2-24-2011; IN COMMERCE 2-24-2011.

**PRINCIPAL REGISTER**

THE MARK CONSISTS OF STANDARD CHARACTERS WITHOUT CLAIM TO ANY PARTICULAR FONT, STYLE, SIZE, OR COLOR.

SER. NO. 85-522,314, FILED 1-23-2012.

ANDREA HACK, EXAMINING ATTORNEY



*David J. Kyffers*

Director of the United States Patent and Trademark Office

# United States of America

United States Patent and Trademark Office

# supervegan

**Reg. No. 4,198,403**

**Registered Aug. 28, 2012**

**Int. Cl.: 35**

**SERVICE MARK**

**PRINCIPAL REGISTER**

SUPERVEGAN, LLC (NEW YORK LIMITED LIABILITY COMPANY)  
263 EASTERN PARKWAY, #41  
BROOKLYN, NY 11238

FOR: PROVIDING A SEARCHABLE ONLINE ADVERTISING WEBSITE AND INFORMATIONAL GUIDE FEATURING THE GOODS AND SERVICES OF OTHER VENDORS VIA THE INTERNET IN THE FIELD OF FOOD; PROVIDING A WEBSITE WHERE USERS CAN POST RATINGS, REVIEWS AND RECOMMENDATIONS ON RESTAURANTS, FOOD AND WINE FOR COMMERCIAL PURPOSES, IN CLASS 35 (U.S. CLS. 100, 101 AND 102).

FIRST USE 5-1-2006; IN COMMERCE 5-1-2006.

THE MARK CONSISTS OF STANDARD CHARACTERS WITHOUT CLAIM TO ANY PARTICULAR FONT, STYLE, SIZE, OR COLOR.

SER. NO. 85-522,325, FILED 1-23-2012.

DAVID TAYLOR, EXAMINING ATTORNEY



*David J. Kyffers*

Director of the United States Patent and Trademark Office

# United States of America

United States Patent and Trademark Office

## 20,000 DIALOGUES

**Reg. No. 4,198,404**

UNITY PRODUCTIONS FOUNDATION (CALIFORNIA CORPORATION), AKA UPF  
1200 29TH ST. NW  
WASHINGTON, DC 20007

**Registered Aug. 28, 2012**

**Int. Cl.: 35**

FOR: PROMOTING PUBLIC AWARENESS OF THE NEED AND MEANS OF PURSUING PEACE AND CULTURAL UNDERSTANDING THROUGH MEDIA, IN CLASS 35 (U.S. CLS. 100, 101 AND 102).

**SERVICE MARK**

FIRST USE 9-1-2005; IN COMMERCE 9-1-2005.

**PRINCIPAL REGISTER**

THE MARK CONSISTS OF STANDARD CHARACTERS WITHOUT CLAIM TO ANY PARTICULAR FONT, STYLE, SIZE, OR COLOR.

SER. NO. 85-522,327, FILED 1-23-2012.

DAVID TAYLOR, EXAMINING ATTORNEY



*David J. Kyffers*

Director of the United States Patent and Trademark Office

**United States of America**  
United States Patent and Trademark Office

# RIOMAX

**Reg. No. 4,198,405**

RIO RANCH SUPPLY INC. (MINNESOTA CORPORATION)  
165 HIGHWAY 195  
VESTA, MN 56292

**Registered Aug. 28, 2012**

**Int. Cl.: 5**

FOR: ANIMAL FEED SUPPLEMENTS; DIETARY SUPPLEMENTS FOR ANIMALS, IN CLASS 5 (U.S. CLS. 6, 18, 44, 46, 51 AND 52).

**TRADEMARK**

FIRST USE 1-1-2005; IN COMMERCE 1-1-2005.

**PRINCIPAL REGISTER**

THE MARK CONSISTS OF STANDARD CHARACTERS WITHOUT CLAIM TO ANY PARTICULAR FONT, STYLE, SIZE, OR COLOR.

SER. NO. 85-522,328, FILED 1-23-2012.

KEVIN DINALLO, EXAMINING ATTORNEY



*David J. Kybas*

Director of the United States Patent and Trademark Office

# United States of America

United States Patent and Trademark Office

# STILGUT

**Reg. No. 4,198,406**

APLICA, JOHN (UNITED STATES INDIVIDUAL)  
1608 S ASHLAND AVE  
CHICAGO, IL 60608

**Registered Aug. 28, 2012**

**Int. Cl.: 9**

FOR: CARRYING CASES FOR ELECTRONIC EQUIPMENT, NAMELY, TABLET COMPUTERS; CARRYING CASES FOR MOBILE COMPUTERS; NOTEBOOK COMPUTER CARRYING CASES, IN CLASS 9 (U.S. CLS. 21, 23, 26, 36 AND 38).

**TRADEMARK**

FIRST USE 12-5-2011; IN COMMERCE 12-5-2011.

**PRINCIPAL REGISTER**

THE MARK CONSISTS OF STANDARD CHARACTERS WITHOUT CLAIM TO ANY PARTICULAR FONT, STYLE, SIZE, OR COLOR.

SER. NO. 85-522,363, FILED 1-23-2012.

LINDSEY RUBIN, EXAMINING ATTORNEY



*David J. Kybas*

Director of the United States Patent and Trademark Office

United States of America  
United States Patent and Trademark Office

# PROCOAT

**Reg. No. 4,198,407**

BRASSCRAFT MANUFACTURING COMPANY (MICHIGAN CORPORATION)  
39600 ORCHARD HILL PLACE  
NOVI, MI 48375

**Registered Aug. 28, 2012**

**Int. Cl.: 2**

FOR: PROTECTIVE FINISH COATING SOLD AS AN INTEGRAL COMPONENT OF FLUID CONDUCTING PIPES AND TUBING, IN CLASS 2 (U.S. CLS. 6, 11 AND 16).

**TRADEMARK**

FIRST USE 7-0-2001; IN COMMERCE 7-0-2001.

**PRINCIPAL REGISTER**

THE MARK CONSISTS OF STANDARD CHARACTERS WITHOUT CLAIM TO ANY PARTICULAR FONT, STYLE, SIZE, OR COLOR.

OWNER OF U.S. REG. NO. 2,948,663.

SER. NO. 85-522,366, FILED 1-23-2012.

MIDGE BUTLER, EXAMINING ATTORNEY



*David J. Kyffers*

Director of the United States Patent and Trademark Office

# United States of America

United States Patent and Trademark Office

## CHANGE IS NATURAL

**Reg. No. 4,198,408**

**Registered Aug. 28, 2012**

**Int. Cl.: 14**

**TRADEMARK**

**PRINCIPAL REGISTER**

JEWELPOP, INC. (CANADA CORPORATION), DBA KAMELEON JEWELRY  
SUITE 100  
63 TACOMA DRIVE  
DARTMOUTH, CANADA B2W6E2

FOR: JEWELRY, IN CLASS 14 (U.S. CLS. 2, 27, 28 AND 50).

FIRST USE 1-31-2007; IN COMMERCE 1-31-2007.

THE MARK CONSISTS OF STANDARD CHARACTERS WITHOUT CLAIM TO ANY PARTICULAR FONT, STYLE, SIZE, OR COLOR.

SER. NO. 85-522,379, FILED 1-23-2012.

JOHN WILKE, EXAMINING ATTORNEY



*David J. Kyffers*

Director of the United States Patent and Trademark Office

# United States of America

United States Patent and Trademark Office

## INDIAN MADE EASY

**Reg. No. 4,198,409**

**Registered Aug. 28, 2012**

**Int. Cls.: 29 and 30**

**TRADEMARK**

**PRINCIPAL REGISTER**

PATAK (SPICES) LIMITED (GREAT BRITAIN CORPORATION)  
WESTON CENTRE, 10 GROSVENOR STREET  
LONDON, GREAT BRITAIN W1K4QY

FOR: FISH, MEAT, POULTRY AND GAME; PRESERVED FRUITS AND VEGETABLES;  
SHELF-STABLE AND FROZEN PREPARED AND PACKAGED INDIAN-STYLE MEALS  
CONSISTING PRIMARILY OF VEGETABLES, MEAT, FISH, POULTRY OR GAME, IN CLASS  
29 (U.S. CL. 46).

FIRST USE 5-15-2011; IN COMMERCE 6-3-2011.

FOR: CURRY PASTE; SAUCES; CHUTNEYS; RELISHES, IN CLASS 30 (U.S. CL. 46).

FIRST USE 5-15-2011; IN COMMERCE 6-3-2011.

THE MARK CONSISTS OF STANDARD CHARACTERS WITHOUT CLAIM TO ANY PAR-  
TICULAR FONT, STYLE, SIZE, OR COLOR.

SER. NO. 85-522,384, FILED 1-23-2012.

LAURIE MAYES, EXAMINING ATTORNEY



*David J. Kypos*

Director of the United States Patent and Trademark Office



# United States of America

United States Patent and Trademark Office

## Marination 101

**Reg. No. 4,198,410**

TWINS, LLC (WYOMING LIMITED LIABILITY COMPANY)  
710 SHILOH ROAD  
CORINTH, KY 41010

**Registered Aug. 28, 2012**

**Int. Cl.: 41**

FOR: EDUCATIONAL SERVICES, NAMELY, CONDUCTING WORKSHOPS IN THE FIELDS OF THE FOOD INDUSTRY AND DISTRIBUTION OF TRAINING MATERIALS IN CONNECTION THEREWITH, IN CLASS 41 (U.S. CLS. 100, 101 AND 107).

**SERVICE MARK**

FIRST USE 2-12-2002; IN COMMERCE 2-12-2002.

**PRINCIPAL REGISTER**

THE MARK CONSISTS OF STANDARD CHARACTERS WITHOUT CLAIM TO ANY PARTICULAR FONT, STYLE, SIZE, OR COLOR.

SER. NO. 85-522,387, FILED 1-23-2012.

LAURIE MAYES, EXAMINING ATTORNEY



*David J. Kyffers*

Director of the United States Patent and Trademark Office

# United States of America

United States Patent and Trademark Office

# QM-710

**Reg. No. 4,198,411**

SUNRISE MEDICAL (US) LLC (DELAWARE CORPORATION)  
2842 BUSINESS PARK AVENUE  
FRESNO, CA 937271328

**Registered Aug. 28, 2012**

**Int. Cl.: 12**

FOR: MOTORISED WHEELCHAIRS FOR THE DISABLED AND THOSE WITH MOBILITY DIFFICULTIES; WHEELCHAIRS, IN CLASS 12 (U.S. CLS. 19, 21, 23, 31, 35 AND 44).

**TRADEMARK**

FIRST USE 11-28-2011; IN COMMERCE 11-28-2011.

**PRINCIPAL REGISTER**

THE MARK CONSISTS OF STANDARD CHARACTERS WITHOUT CLAIM TO ANY PARTICULAR FONT, STYLE, SIZE, OR COLOR.

SER. NO. 85-522,455, FILED 1-23-2012.

KIMBERLY PERRY, EXAMINING ATTORNEY



*David J. Kybas*

Director of the United States Patent and Trademark Office

# United States of America

United States Patent and Trademark Office

WE'RE DIFFERENT. WE'RE  
BETTER. BELIEVE IT.

**Reg. No. 4,198,412**

WEBSTER FIVE CENTS SAVINGS BANK (MASSACHUSETTS CHARTERED BANK)  
36 THOMPSON ROAD  
WEBSTER, MA 01570

**Registered Aug. 28, 2012**

**Int. Cl.: 36**

FOR: BANKING SERVICES, IN CLASS 36 (U.S. CLS. 100, 101 AND 102).

**SERVICE MARK**

FIRST USE 5-1-2001; IN COMMERCE 5-1-2003.

**PRINCIPAL REGISTER**

THE MARK CONSISTS OF STANDARD CHARACTERS WITHOUT CLAIM TO ANY PARTICULAR FONT, STYLE, SIZE, OR COLOR.

SER. NO. 85-522,480, FILED 1-23-2012.

SHAUNIA CARLYLE, EXAMINING ATTORNEY



*David J. Kyffers*

Director of the United States Patent and Trademark Office

# United States of America

United States Patent and Trademark Office

# ABLE TREE

**Reg. No. 4,198,413**

**Registered Aug. 28, 2012**

**Int. Cl.: 10**

**TRADEMARK**

**PRINCIPAL REGISTER**

ABLE TREE, INC. (OREGON CORPORATION)  
5200 SW MEADOWS RD, SUITE 150  
LAKE OSWEGO, OR 97035

FOR: DENTAL PROSTHESES, IN CLASS 10 (U.S. CLS. 26, 39 AND 44).

FIRST USE 1-19-2012; IN COMMERCE 1-19-2012.

THE MARK CONSISTS OF STANDARD CHARACTERS WITHOUT CLAIM TO ANY PARTICULAR FONT, STYLE, SIZE, OR COLOR.

SER. NO. 85-522,481, FILED 1-23-2012.

PAM WILLIS, EXAMINING ATTORNEY



*David J. Kyffers*

Director of the United States Patent and Trademark Office

# United States of America

United States Patent and Trademark Office

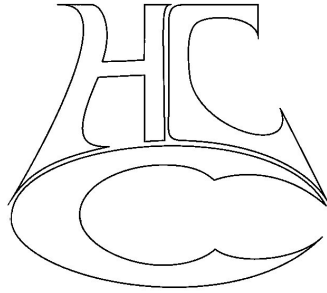

**Reg. No. 4,198,414**

HC3 ENTERPRISES, LLC (TEXAS LIMITED LIABILITY COMPANY)  
3101 TABLETOP MOUNTAIN DR.  
SPICEWOOD, TX 78669

**Registered Aug. 28, 2012**

**Int. Cl.: 40**

FOR: MANUFACTURE OF MOTORCYCLE PARTS TO ORDER AND/OR SPECIFICATION OF OTHERS, IN CLASS 40 (U.S. CLS. 100, 103 AND 106).

**SERVICE MARK**

FIRST USE 10-24-2008; IN COMMERCE 10-24-2008.

**PRINCIPAL REGISTER**

THE MARK CONSISTS OF A DESIGN WHICH IS MORE LIKE A BRAND OF THE ACRONYM "HCC".

SER. NO. 85-522,482, FILED 1-23-2012.

PAM WILLIS, EXAMINING ATTORNEY



*David J. Kyffers*

Director of the United States Patent and Trademark Office

# United States of America

United States Patent and Trademark Office

# WhisperVault

**Reg. No. 4,198,415**

**Registered Aug. 28, 2012**

**Int. Cl.: 42**

**SERVICE MARK**

**PRINCIPAL REGISTER**

PIERCE, WILLIAM (UNITED STATES INDIVIDUAL)  
PMB 114  
3377 BETHEL RD SE, SUITE 107  
PORT ORCHARD, WA 983665608

FOR: PROVIDING A SECURE, WEB-BASED SOFTWARE AS A SERVICE ENABLING INDIVIDUALS TO REMOTELY CREATE AND MANAGE THEIR OWN ACCOUNTS SO THAT WHATEVER PRIVATE CONTENT THEY UPLOAD NOW CAN BE ENCRYPTED, THEN DELIVERED TO THEIR INTENDED RECIPIENTS, AT THE TIME AND IN THE MANNER REQUESTED, IN CLASS 42 (U.S. CLS. 100 AND 101).

FIRST USE 5-4-2008; IN COMMERCE 5-4-2008.

THE MARK CONSISTS OF STANDARD CHARACTERS WITHOUT CLAIM TO ANY PARTICULAR FONT, STYLE, SIZE, OR COLOR.

SER. NO. 85-522,483, FILED 1-23-2012.

PAM WILLIS, EXAMINING ATTORNEY



*David J. Kyffers*

Director of the United States Patent and Trademark Office

# United States of America

United States Patent and Trademark Office

# Dogtails

**Reg. No. 4,198,416**

**Registered Aug. 28, 2012**

**Int. Cl.: 3**

**TRADEMARK**

**PRINCIPAL REGISTER**

LAZAR, ALI (UNITED STATES INDIVIDUAL)  
#511  
6000 COLLINS AVE.  
MIAMI BEACH, FL 33140 AND

LAZAR, JONATHAN (UNITED STATES INDIVIDUAL)  
#511  
6000 COLLINS AVE.  
MIAMI BEACH, FL 33140

FOR: AROMATIC BODY CARE PRODUCTS, NAMELY, BODY LOTION, SHOWER GEL, CUTICLE CREAM, SHAMPOO, CONDITIONER, NON-MEDICATED LIP BALM, SOAP, BODY POLISH, BODY AND FOOT SCRUB AND NON-MEDICATED FOOT CREAM; BODY WASH; DEODORANTS FOR ANIMALS; DEODORIZERS FOR PETS; DISPOSABLE WIPES IMPREGNATED WITH CLEANSING CHEMICALS OR COMPOUNDS FOR ANIMAL HYGIENE; HOME DENTAL CARE PRODUCTS FOR DOGS AND CATS, NAMELY, NON-MEDICATED DENTAL SPRAY; LAUNDRY DETERGENTS; NON-MEDICATED GROOMING PREPARATIONS FOR DOGS AND PETS, NAMELY, DETANGLER; ODOR REMOVERS FOR PETS; PET CARE KITS COMPRISING SHAMPOO, CONDITIONER, BODY SPRAY; PET FRAGRANCES; PET SHAMPOO; PET SHAMPOO AND CONDITIONER; ROOM FRAGRANCES; SKIN CLEANSER IN LIQUID SPRAY FORM FOR USE AS A BABY WIPE ALTERNATIVE, IN CLASS 3 (U.S. CLS. 1, 4, 6, 50, 51 AND 52).

FIRST USE 2-15-2011; IN COMMERCE 1-16-2012.

THE MARK CONSISTS OF THE TEXT "DOGTAILS" ON THE LEFT AND AN IMAGE OF A RIGHT-FACING DOG ON THE RIGHT.

SER. NO. 85-522,493, FILED 1-23-2012.

EMILY CARLSEN, EXAMINING ATTORNEY



*David J. Kyros*

Director of the United States Patent and Trademark Office

# United States of America

United States Patent and Trademark Office

## You Rake It We'll Take It

**Reg. No. 4,198,417**

TALLMAN, XAVIER (UNITED STATES INDIVIDUAL), DBA XAVIER LANDSCAPING  
P.O. BOX 522

**Registered Aug. 28, 2012**

WEST HYANNISPORT, MA 02672

**Int. Cl.: 44**

FOR: LAWN CARE SERVICES, LANDSCAPE GARDENING AND DESIGN SERVICES, TREE  
REMOVAL SERVICES, IN CLASS 44 (U.S. CLS. 100 AND 101).

**SERVICE MARK**

FIRST USE 11-15-2011; IN COMMERCE 11-15-2011.

**PRINCIPAL REGISTER**

THE MARK CONSISTS OF STANDARD CHARACTERS WITHOUT CLAIM TO ANY PAR-  
TICULAR FONT, STYLE, SIZE, OR COLOR.

NO CLAIM IS MADE TO THE EXCLUSIVE RIGHT TO USE "RAKE", APART FROM THE  
MARK AS SHOWN.

SER. NO. 85-522,512, FILED 1-23-2012.

JOHN E. MICHOS, EXAMINING ATTORNEY



*David J. Kyffers*

Director of the United States Patent and Trademark Office



# United States of America

United States Patent and Trademark Office



**Reg. No. 4,198,418**

FALCON MOTOR SPORTS INC. (MICHIGAN CORPORATION)  
255 ELM STREET  
HOLLY, MI 48442

**Registered Aug. 28, 2012**

**Int. Cl.: 12**

FOR: AUTOMOBILE AND STRUCTURAL PARTS THEREFOR, IN CLASS 12 (U.S. CLS. 19, 21, 23, 31, 35 AND 44).

**TRADEMARK**

FIRST USE 1-8-2011; IN COMMERCE 1-8-2011.

**PRINCIPAL REGISTER**

THE MARK CONSISTS OF A BIRD DESIGN.

SER. NO. 85-522,537, FILED 1-23-2012.

KHANH LE, EXAMINING ATTORNEY



*David J. Kyffers*

Director of the United States Patent and Trademark Office

# United States of America

United States Patent and Trademark Office

BE HEARD. BE SEEN. BE  
INSPIRED.

**Reg. No. 4,198,419**

**Registered Aug. 28, 2012**

**Int. Cl.: 35**

**SERVICE MARK**

**PRINCIPAL REGISTER**

SPECTRIO LLC (DELAWARE LIMITED LIABILITY COMPANY)  
720 BROOKER CREEK BLVD. SUITE 215  
OLDSMAR, FL 34677

FOR: ADVERTISING, MARKETING AND PROMOTION SERVICES; DEVELOPMENT, OPERATION AND ADMINISTRATION OF DIGITAL SIGNAGE SYSTEMS AND DIGITAL ADVERTISING SYSTEMS FOR OTHERS, NAMELY, PROVIDING ADVERTISING SPACE BY ELECTRONIC MEANS AND GLOBAL COMPUTER INFORMATION NETWORKS; ADVERTISING SERVICES, NAMELY, PROVISION OF BACKGROUND MUSIC SERVICES FOR BUSINESSES FOR USE TO DELIVER ADVERTISING MESSAGES AND PROMOTIONS; ON-HOLD MARKETING MESSAGE SERVICES FOR OTHERS, NAMELY, PROVIDING CUSTOMIZED RECORDED MESSAGES TO BE PLAYED WHILE TELEPHONE CALLERS ARE PLACED ON HOLD FOR ADVERTISING PURPOSES AND CUSTOMIZED RECORDED MESSAGES TO PROMOTE THE GOODS AND SERVICES OF OTHERS; ADVERTISING AND BRANDED MESSAGING FOR OTHERS, NAMELY, CREATION AND MANAGEMENT OF IN-STORE DIGITAL SIGNAGE AND MUSIC FOR USE IN ADVERTISING AND TELEPHONE RECORDINGS, IN CLASS 35 (U.S. CLS. 100, 101 AND 102).

FIRST USE 11-15-2011; IN COMMERCE 11-15-2011.

THE MARK CONSISTS OF STANDARD CHARACTERS WITHOUT CLAIM TO ANY PARTICULAR FONT, STYLE, SIZE, OR COLOR.

SER. NO. 85-522,539, FILED 1-23-2012.

DORITT L. CARROLL, EXAMINING ATTORNEY



*David J. Kybas*

Director of the United States Patent and Trademark Office

# United States of America

United States Patent and Trademark Office

# KPTS

**Reg. No. 4,198,420**

**Registered Aug. 28, 2012**

**Int. Cl.: 38**

**SERVICE MARK**

**PRINCIPAL REGISTER**

KANSAS PUBLIC TELECOMMUNICATIONS SERVICE, INCORPORATED (KANSAS  
NON-PROFIT CORPORATION)  
320 W. 21ST STREET N.  
WICHITA, KS 67203

FOR: TELEVISION BROADCASTING SERVICES, IN CLASS 38 (U.S. CLS. 100, 101 AND  
104).

FIRST USE 1-5-1970; IN COMMERCE 1-5-1970.

THE MARK CONSISTS OF STANDARD CHARACTERS WITHOUT CLAIM TO ANY PAR-  
TICULAR FONT, STYLE, SIZE, OR COLOR.

SER. NO. 85-522,573, FILED 1-23-2012.

AHSEN KHAN, EXAMINING ATTORNEY



*David J. Kyjars*

Director of the United States Patent and Trademark Office

# United States of America

United States Patent and Trademark Office



**Reg. No. 4,198,421**

MS DE LA PIEDAD, S.A. DE C.V. (MEXICO CORPORATION)  
KM. 5.5 CARR. A ZAMORA - LA PIEDAD  
MICHOCAN, MEXICO 59300

**Registered Aug. 28, 2012**

**Int. Cl.: 25**

FOR: CAPS; PANTS; SHOES; SHORTS; SOCKS; T-SHIRTS, IN CLASS 25 (U.S. CLS. 22 AND 39).

**TRADEMARK**

FIRST USE 6-30-2005; IN COMMERCE 1-16-2006.

**PRINCIPAL REGISTER**

THE MARK CONSISTS OF A RECTANGLE WITH SLANTED LEFT AND RIGHT SIDES INSIDE OF WHICH APPEARS AN ABSTRACT DESIGN FORMED BY TWO CAPITAL LETTERS "M" POSITIONED SIDEWAYS AGAINST EACH OTHER BELOW OF WHICH APPEARS THE WORD "MARVAL" IN LOWER CASE STYLIZED LETTERS.

THE WORDING "MARVAL" HAS NO MEANING IN A FOREIGN LANGUAGE.

SER. NO. 85-522,610, FILED 1-23-2012.

SHANNON TWOHIG, EXAMINING ATTORNEY



*David J. Kyffers*

Director of the United States Patent and Trademark Office

**United States of America**  
United States Patent and Trademark Office

**LIVESAVVY**

**Reg. No. 4,198,422**

LIVE SAVVY DESIGN, LLC (MINNESOTA LIMITED LIABILITY COMPANY)  
2615 BURNHAM ROAD  
MINNEAPOLIS, MN 55416

**Registered Aug. 28, 2012**

**Int. Cl.: 25**

FOR: HEADBANDS, IN CLASS 25 (U.S. CLS. 22 AND 39).

**TRADEMARK**

FIRST USE 6-0-2009; IN COMMERCE 8-0-2009.

**PRINCIPAL REGISTER**

THE MARK CONSISTS OF STANDARD CHARACTERS WITHOUT CLAIM TO ANY PARTICULAR FONT, STYLE, SIZE, OR COLOR.

SER. NO. 85-522,621, FILED 1-23-2012.

BILL DAWE, EXAMINING ATTORNEY



*David J. Kyffers*

Director of the United States Patent and Trademark Office

# United States of America

United States Patent and Trademark Office

## BEHIND THE SEAMS

**Reg. No. 4,198,423**

**Registered Aug. 28, 2012**

**Int. Cl.: 41**

**SERVICE MARK**

**PRINCIPAL REGISTER**

BUILD-A-BEAR RETAIL MANAGEMENT, INC. (DELAWARE CORPORATION)  
1954 INNERBELT BUSINESS CENTER DRIVE  
ST. LOUIS, MO 631145760

FOR: ON-LINE JOURNALS, NAMELY, BLOGS FEATURING PRODUCT REVIEWS, HISTORICAL DATA, COMMUNITY INVOLVEMENT, ENTERTAINMENT, FAMILY ACTIVITIES, INSTRUCTIONAL GUIDES, CHILDREN'S EDUCATION, AND TOPICS OF DISCUSSION OF GENERAL INTEREST TO CHILDREN AND FAMILIES, IN CLASS 41 (U.S. CLS. 100, 101 AND 107).

FIRST USE 2-15-2012; IN COMMERCE 2-15-2012.

THE MARK CONSISTS OF STANDARD CHARACTERS WITHOUT CLAIM TO ANY PARTICULAR FONT, STYLE, SIZE, OR COLOR.

SER. NO. 85-522,655, FILED 1-23-2012.

TINA L. SNAPP, EXAMINING ATTORNEY



*David J. Kyffers*

Director of the United States Patent and Trademark Office

# United States of America

United States Patent and Trademark Office

# CHIMPANESE

**Reg. No. 4,198,424**

WELLNESS, INC. (MASSACHUSETTS CORPORATION)  
790 BOYLSTON STREET  
BOSTON, MA 02199

**Registered Aug. 28, 2012**

**Int. Cl.: 9**

FOR: PRINTING FONTS THAT CAN BE DOWNLOADED PROVIDED BY MEANS OF ELECTRONIC TRANSMISSION, IN CLASS 9 (U.S. CLS. 21, 23, 26, 36 AND 38).

**TRADEMARK**

FIRST USE 8-1-2007; IN COMMERCE 8-1-2007.

**PRINCIPAL REGISTER**

THE MARK CONSISTS OF STANDARD CHARACTERS WITHOUT CLAIM TO ANY PARTICULAR FONT, STYLE, SIZE, OR COLOR.

OWNER OF U.S. REG. NOS. 3,060,215 AND 3,091,330.

SER. NO. 85-522,656, FILED 1-23-2012.

TINA L. SNAPP, EXAMINING ATTORNEY



*David J. Kybas*

Director of the United States Patent and Trademark Office

# United States of America

United States Patent and Trademark Office

# SR45

**Reg. No. 4,198,425**

SUNRISE MEDICAL (US) LLC (DELAWARE CORPORATION)  
2842 BUSINESS PARK AVENUE  
FRESNO, CA 937271328

**Registered Aug. 28, 2012**

**Int. Cl.: 12**

FOR: WHEELCHAIRS, IN CLASS 12 (U.S. CLS. 19, 21, 23, 31, 35 AND 44).

**TRADEMARK**

FIRST USE 10-5-2011; IN COMMERCE 10-5-2011.

**PRINCIPAL REGISTER**

THE MARK CONSISTS OF STANDARD CHARACTERS WITHOUT CLAIM TO ANY PARTICULAR FONT, STYLE, SIZE, OR COLOR.

SER. NO. 85-522,659, FILED 1-23-2012.

KIMBERLY PERRY, EXAMINING ATTORNEY



*David J. Kyffers*

Director of the United States Patent and Trademark Office



# United States of America

United States Patent and Trademark Office

# BUILT-4-ME

**Reg. No. 4,198,426**

SUNRISE MEDICAL (US) LLC (DELAWARE CORPORATION)  
2842 BUSINESS PARK AVENUE  
FRESNO, CA 937271328

**Registered Aug. 28, 2012**

**Int. Cl.: 40**

FOR: CUSTOM BUILDING OF WHEELCHAIRS, IN CLASS 40 (U.S. CLS. 100, 103 AND 106).

**SERVICE MARK**

FIRST USE 12-31-2011; IN COMMERCE 12-31-2011.

**PRINCIPAL REGISTER**

THE MARK CONSISTS OF STANDARD CHARACTERS WITHOUT CLAIM TO ANY PARTICULAR FONT, STYLE, SIZE, OR COLOR.

SER. NO. 85-522,687, FILED 1-23-2012.

KIMBERLY PERRY, EXAMINING ATTORNEY



*David J. Kyffers*

Director of the United States Patent and Trademark Office

# United States of America

United States Patent and Trademark Office

# ON TARGET

**Reg. No. 4,198,427**

**Registered Aug. 28, 2012**

**Int. Cl.: 41**

**SERVICE MARK**

**PRINCIPAL REGISTER**

SECOND AMENDMENT FOUNDATION FOR EDUCATION & RESEARCH USA INC.  
(ILLINOIS CORPORATION)  
1113 S RAVEN RD  
SHOREWOOD, IL 60404

FOR: ON-LINE ELECTRONIC NEWSLETTERS DELIVERED BY E-MAIL IN THE FIELD OF FIREARM EDUCATION AND INDUSTRY DEVELOPMENTS; PROVIDING ON-LINE NEWSLETTERS IN THE FIELD OF FIREARM EDUCATION AND INDUSTRY DEVELOPMENTS, IN CLASS 41 (U.S. CLS. 100, 101 AND 107).

FIRST USE 1-6-2012; IN COMMERCE 1-6-2012.

THE MARK CONSISTS OF STANDARD CHARACTERS WITHOUT CLAIM TO ANY PARTICULAR FONT, STYLE, SIZE, OR COLOR.

SER. NO. 85-522,709, FILED 1-23-2012.

TOBY BULLOFF, EXAMINING ATTORNEY



*David J. Kyffers*

Director of the United States Patent and Trademark Office

# United States of America

United States Patent and Trademark Office

## IS TODAY SOON ENOUGH?

**Reg. No. 4,198,428**

**Registered Aug. 28, 2012**

**Int. Cl.: 37**

**SERVICE MARK**

**PRINCIPAL REGISTER**

PRECISION PLUMBING SERVICES, INC. (ILLINOIS CORPORATION)  
1051 N. MAIN STREET., SUITE E  
LOMBARD, IL 60148

FOR: INSTALLATION AND REPAIR OF HEATING, VENTILATING AND AIR CONDITIONING EQUIPMENT; PLUMBING SERVICES; MUNICIPAL, INDUSTRIAL AND DOMESTIC SEWER, DRAIN AND PIPE CLEANING AND REPAIRS; INSTALLATION AND REPAIR OF RESIDENTIAL WATER TREATMENT EQUIPMENT, IN CLASS 37 (U.S. CLS. 100, 103 AND 106).

FIRST USE 10-17-2002; IN COMMERCE 6-9-2004.

THE MARK CONSISTS OF STANDARD CHARACTERS WITHOUT CLAIM TO ANY PARTICULAR FONT, STYLE, SIZE, OR COLOR.

SER. NO. 85-522,711, FILED 1-23-2012.

TOBY BULLOFF, EXAMINING ATTORNEY



*David J. Kyffers*

Director of the United States Patent and Trademark Office

# United States of America

United States Patent and Trademark Office

# UTULSA

**Reg. No. 4,198,429**

**Registered Aug. 28, 2012**

**Int. Cl.: 38**

**SERVICE MARK**

**PRINCIPAL REGISTER**

THE UNIVERSITY OF TULSA (OKLAHOMA NON-PROFIT EDUCATIONAL CORPORATION)  
800 SOUTH TUCKER DRIVE  
TULSA, OK 74104

FOR: PROVIDING TELECOMMUNICATIONS CONNECTIONS TO A GLOBAL COMPUTER NETWORK, NAMELY, WEBSITE, IN CLASS 38 (U.S. CLS. 100, 101 AND 104).

FIRST USE 0-0-1988; IN COMMERCE 0-0-1988.

THE MARK CONSISTS OF STANDARD CHARACTERS WITHOUT CLAIM TO ANY PARTICULAR FONT, STYLE, SIZE, OR COLOR.

OWNER OF U.S. REG. NO. 2,075,741.

SER. NO. 85-522,718, FILED 1-23-2012.

LAURIE KAUFMAN, EXAMINING ATTORNEY



*David J. Kyffers*

Director of the United States Patent and Trademark Office

# United States of America

United States Patent and Trademark Office

# Rewindiet

**Reg. No. 4,198,430**

BENEFICIAL INTERNATIONAL, INC. (UTAH CORPORATION)  
1780 WEST 500 SOUTH  
SALT LAKE CITY, UT 84104

**Registered Aug. 28, 2012**

**Int. Cl.: 5**

FOR: HERBAL SUPPLEMENTS, IN CLASS 5 (U.S. CLS. 6, 18, 44, 46, 51 AND 52).

**TRADEMARK**

FIRST USE 11-23-2011; IN COMMERCE 11-23-2011.

**PRINCIPAL REGISTER**

THE MARK CONSISTS OF STANDARD CHARACTERS WITHOUT CLAIM TO ANY PARTICULAR FONT, STYLE, SIZE, OR COLOR.

SER. NO. 85-522,731, FILED 1-23-2012.

LAURIE KAUFMAN, EXAMINING ATTORNEY



*David J. Kybas*

Director of the United States Patent and Trademark Office

# United States of America

United States Patent and Trademark Office

## FOCUS MY SEARCH

**Reg. No. 4,198,431**

**Registered Aug. 28, 2012**

**Int. Cl.: 42**

**SERVICE MARK**

**PRINCIPAL REGISTER**

KIRKEGAARD, SHEILA (UNITED STATES INDIVIDUAL)  
7618 SNOWBERRY AVENUE SE  
SNOQUALMIE, WA 98065 AND

KIRKEGAARD, NIELS (DENMARK INDIVIDUAL)  
7618 SNOWBERRY AVE SE  
SNOQUALMIE, WA 98065

FOR: PROVIDING A SEARCH ENGINE WEBSITE LISTING CAMPS, ACTIVITIES, TEAM AND CLUB SCHEDULES, IN CLASS 42 (U.S. CLS. 100 AND 101).

FIRST USE 11-1-2011; IN COMMERCE 11-1-2011.

THE MARK CONSISTS OF STANDARD CHARACTERS WITHOUT CLAIM TO ANY PARTICULAR FONT, STYLE, SIZE, OR COLOR.

SER. NO. 85-522,735, FILED 1-23-2012.

MARK T. MULLEN, EXAMINING ATTORNEY



*David J. Kyffers*

Director of the United States Patent and Trademark Office

# United States of America

United States Patent and Trademark Office

## BLANCA NIEVES

**Reg. No. 4,198,432**

**Registered Aug. 28, 2012**

**Int. Cl.: 3**

**TRADEMARK**

**PRINCIPAL REGISTER**

FABRICA DE JABON LA CORONA S.A. DE C.V. (MEXICO CORPORATION)  
CARLOS B. ZETINA #80  
PARQUE INDUSTRIAL XALOSTOC  
ECATEPEC DE MORELOS, MEXICO

FOR: BLEACHING PREPARATIONS FOR HOUSEHOLD USE; CLEANING AND POLISHING PREPARATIONS; DEGREASING PREPARATIONS FOR HOUSEHOLD USE; DENTIFRICES; ESSENTIAL OILS; HAIR LOTIONS; LAUNDRY BLEACH; LAUNDRY DETERGENT; LAUNDRY SOAP; PERFUMES; SOAPS AND DETERGENTS; STAIN REMOVING PREPARATIONS, IN CLASS 3 (U.S. CLS. 1, 4, 6, 50, 51 AND 52).

FIRST USE 11-21-1988; IN COMMERCE 10-3-2006.

THE MARK CONSISTS OF STANDARD CHARACTERS WITHOUT CLAIM TO ANY PARTICULAR FONT, STYLE, SIZE, OR COLOR.

OWNER OF U.S. REG. NO. 2,890,950.

THE ENGLISH TRANSLATION OF "BLANCA NIEVES" IN THE MARK IS "SNOW WHITE".

SER. NO. 85-522,741, FILED 1-23-2012.

GIANCARLO CASTRO, EXAMINING ATTORNEY



*David J. Kyffers*

Director of the United States Patent and Trademark Office

# United States of America

United States Patent and Trademark Office

## ATTACK VS DEFENCE MATCH

**Reg. No. 4,198,433**

**Registered Aug. 28, 2012**

**Int. Cl.: 28**

**TRADEMARK**

**PRINCIPAL REGISTER**

KAHANOFF, ALEJANDRO JAVIER (ARGENTINA INDIVIDUAL)  
VIRREY DEL PINO 2081, 1426  
BUENOS AIRES, ARGENTINA

FOR: SPORT BALLS; BOARD GAMES; TABLES FOR TABLE FOOTBALL; PUZZLES; BALLOONS; INFLATABLE TOYS; PLAYING CARDS; CONFETTI; SOCCER EQUIPMENT, NAMELY, SOCCER BALLS, GLOVES, KNEE PADS, ELBOW PADS, SHOULDER PADS, SHIN GUARDS, SOCCER GOALS, SOCCER GOAL WALLS; SPORTING BAGS AND CONTAINERS ADAPTED FOR CARRYING SPORTS ARTICLES; PAPER AND PLASTIC PARTY HATS; HAND-HELD ELECTRONIC GAMES OTHER THAN THOSE ADAPTED FOR USE WITH TELEVISION RECEIVERS ONLY; TOY FOAM NOVELTY ITEMS, NAMELY, FOAM HANDS; TOY ROBOTS FOR ENTERTAINMENT USE, ARCADE GAMES, IN CLASS 28 (U.S. CLS. 22, 23, 38 AND 50).

THE MARK CONSISTS OF STANDARD CHARACTERS WITHOUT CLAIM TO ANY PARTICULAR FONT, STYLE, SIZE, OR COLOR.

OWNER OF ARGENTINA REG. NO. 2354788, DATED 3-26-2010, EXPIRES 3-26-2020.

SER. NO. 85-522,759, FILED 1-23-2012.

PRISCILLA MILTON, EXAMINING ATTORNEY



*David J. Kyros*

Director of the United States Patent and Trademark Office



# United States of America

United States Patent and Trademark Office

# REVOLUTION

**Reg. No. 4,198,434**

AQUATROLS CORPORATION OF AMERICA, INC. (DELAWARE CORPORATION)  
1273 IMPERIAL WAY

**Registered Aug. 28, 2012**

PAULSBORO, NJ 08066

**Int. Cl.: 1**

FOR: SURFACTANTS FOR USE IN SOIL-WATER MANAGEMENT TO PROMOTE UNIFORM MOVEMENT OF WATER IN THE SOIL, IN CLASS 1 (U.S. CLS. 1, 5, 6, 10, 26 AND 46).

**TRADEMARK**

FIRST USE 9-1-2004; IN COMMERCE 9-1-2004.

**PRINCIPAL REGISTER**

THE MARK CONSISTS OF STANDARD CHARACTERS WITHOUT CLAIM TO ANY PARTICULAR FONT, STYLE, SIZE, OR COLOR.

SER. NO. 85-522,800, FILED 1-23-2012.

JESSICA A. POWERS, EXAMINING ATTORNEY



*David J. Kybas*

Director of the United States Patent and Trademark Office

# United States of America

United States Patent and Trademark Office

# RAFFENE

**Reg. No. 4,198,435**

**Registered Aug. 28, 2012**

**Int. Cl.: 4**

**TRADEMARK**

**PRINCIPAL REGISTER**

SAN JOAQUIN REFINING CO., INC. (CALIFORNIA CORPORATION)  
3129 STANDARD STREET  
BAKERSFIELD, CA 93308

FOR: ENGINE OILS; INDUSTRIAL LUBRICANTS, IN CLASS 4 (U.S. CLS. 1, 6 AND 15).

FIRST USE 6-12-1989; IN COMMERCE 6-12-1989.

THE MARK CONSISTS OF STANDARD CHARACTERS WITHOUT CLAIM TO ANY PARTICULAR FONT, STYLE, SIZE, OR COLOR.

SER. NO. 85-522,818, FILED 1-23-2012.

YAT SYE, LEE, EXAMINING ATTORNEY



*David J. Kyffers*

Director of the United States Patent and Trademark Office

# United States of America

United States Patent and Trademark Office



**Reg. No. 4,198,436**

MIRANI MOTOR INC. (CALIFORNIA CORPORATION)  
7343 CAMBY AVE.  
RESEDA, CA 91335

**Registered Aug. 28, 2012**

**Int. Cl.: 35**

FOR: AUTOMOBILE DEALERSHIPS; DEALERSHIPS IN THE FIELD OF USED CARS, IN CLASS 35 (U.S. CLS. 100, 101 AND 102).

**SERVICE MARK**

FIRST USE 10-5-2011; IN COMMERCE 10-5-2011.

**PRINCIPAL REGISTER**

NO CLAIM IS MADE TO THE EXCLUSIVE RIGHT TO USE "MOTORS", APART FROM THE MARK AS SHOWN.

THE COLOR(S) BLACK, GRAY, WHITE AND RED IS/ARE CLAIMED AS A FEATURE OF THE MARK.

THE NAME(S), PORTRAIT(S), AND/OR SIGNATURE(S) SHOWN IN THE MARK DOES NOT IDENTIFY A PARTICULAR LIVING INDIVIDUAL.

THE MARK CONSISTS OF THE STYLIZED LETTERS "M M" IN GRAY ENCLOSED BY A GRAY OVAL. BELOW THE "M M" IS THE STYLIZED WORDING "MIRANI MOTORS". THE "MIRANI" IS IN RED. THE "MOTORS" IS IN WHITE AND GRAY. THE "T" IN "MOTORS" IS CREATED FROM THE SECOND "M" ABOVE. ALL TERMS ARE ENCLOSED BY A SECOND GRAY AND WHITE OVAL AND ARE ON A BLACK BACKGROUND.



SER. NO. 85-522,826, FILED 1-23-2012.

TASNEEM HUSSAIN, EXAMINING ATTORNEY

*David J. Kybas*

Director of the United States Patent and Trademark Office

**United States of America**  
United States Patent and Trademark Office

**STAFFPAK**

**Reg. No. 4,198,437**

**Registered Aug. 28, 2012**

**Int. Cl.: 36**

**SERVICE MARK**

**PRINCIPAL REGISTER**

U.S. RISK INSURANCE GROUP, INC. (DELAWARE CORPORATION)  
SUITE 500  
10210 NORTH CENTRAL EXPRESSWAY  
DALLAS, TX 75231

FOR: INSURANCE BROKERAGE AND INSURANCE UNDERWRITING SERVICES IN THE  
FIELDS OF PROPERTY, CASUALTY, AND PROFESSIONAL LIABILITY INSURANCE , IN  
CLASS 36 (U.S. CLS. 100, 101 AND 102).

FIRST USE 1-1-2005; IN COMMERCE 1-1-2005.

THE MARK CONSISTS OF STANDARD CHARACTERS WITHOUT CLAIM TO ANY PAR-  
TICULAR FONT, STYLE, SIZE, OR COLOR.

SER. NO. 85-522,830, FILED 1-23-2012.

MICHAEL KEATING, EXAMINING ATTORNEY



*David J. Kybas*

Director of the United States Patent and Trademark Office

# United States of America

United States Patent and Trademark Office

## Press...the Show

**Reg. No. 4,198,438**

**Registered Aug. 28, 2012**

**Int. Cl.: 35**

**SERVICE MARK**

**PRINCIPAL REGISTER**

M KAY B LLC (NEW YORK LIMITED LIABILITY COMPANY)  
SUITE 1 ARANEO  
27 EAST MERRICK ROAD  
VALLEY STREAM, NY 11580

FOR: ARRANGING AND CONDUCTING TRADE SHOWS IN THE FIELD OF FASHION, IN CLASS 35 (U.S. CLS. 100, 101 AND 102).

FIRST USE 12-1-2011; IN COMMERCE 12-1-2011.

THE MARK CONSISTS OF STANDARD CHARACTERS WITHOUT CLAIM TO ANY PARTICULAR FONT, STYLE, SIZE, OR COLOR.

NO CLAIM IS MADE TO THE EXCLUSIVE RIGHT TO USE "THE SHOW", APART FROM THE MARK AS SHOWN.

SER. NO. 85-522,889, FILED 1-23-2012.

GIANCARLO CASTRO, EXAMINING ATTORNEY



*David J. Kyffers*

Director of the United States Patent and Trademark Office

# United States of America

United States Patent and Trademark Office

# OZ

**Reg. No. 4,198,439**

TANGO HOLDING, LLC (TENNESSEE LIMITED LIABILITY COMPANY)  
101 DUNHAM SPRINGS LANE  
NASHVILLE, TN 37205

**Registered Aug. 28, 2012**

**Int. Cl.: 41**

FOR: CIGAR LOUNGE SERVICES; ART EXHIBITIONS; OPERATION OF ART STUDIO, IN CLASS 41 (U.S. CLS. 100, 101 AND 107).

**SERVICE MARK**

FIRST USE 1-28-2012; IN COMMERCE 1-28-2012.

**PRINCIPAL REGISTER**

THE MARK CONSISTS OF STANDARD CHARACTERS WITHOUT CLAIM TO ANY PARTICULAR FONT, STYLE, SIZE, OR COLOR.

SER. NO. 85-523,083, FILED 1-23-2012.

TEJBIR SINGH, EXAMINING ATTORNEY



*David J. Kyffers*

Director of the United States Patent and Trademark Office

# United States of America

United States Patent and Trademark Office



**Reg. No. 4,198,440**

**Registered Aug. 28, 2012**

**Int. Cl.: 30**

**TRADEMARK**

**PRINCIPAL REGISTER**

NANCAKES, LLC (OHIO LIMITED LIABILITY COMPANY)  
8405 INDIAN HILL RD.  
CINCINNATI, OH 45243

FOR: ICED CAKES, IN CLASS 30 (U.S. CL. 46).

FIRST USE 2-15-2010; IN COMMERCE 2-15-2010.

THE MARK CONSISTS OF A SMILING WOMAN HOLDING A SPOON IN HER RIGHT HAND AND A CARROT IN HER LEFT ABOVE THE LITERAL ELEMENT "NANCAKES" IN SCRIPT LETTERING.

SER. NO. 85-523,273, FILED 1-23-2012.

JAMES GRIFFIN, EXAMINING ATTORNEY



*David J. Kyfos*

Director of the United States Patent and Trademark Office

# United States of America

United States Patent and Trademark Office



**Reg. No. 4,198,441**

**Registered Aug. 28, 2012**

**Int. Cl.: 41**

**SERVICE MARK**

**PRINCIPAL REGISTER**

AMERICAN ACADEMY OF HOSPITALITY SCIENCES, INC. (NEVADA CORPORATION)  
240 CENTRAL PARK SOUTH  
NEW YORK, NY 10019

FOR: PROVIDING RECOGNITION AND INCENTIVES BY THE WAY OF AWARDS TO DEMONSTRATE EXCELLENCE IN THE FIELD OF THE HOSPITALITY INDUSTRY, INCLUDING HOTELS, RESTAURANTS AND RESORTS, AND MANUFACTURERS AND SELLERS OF OTHER PRODUCTS AND SERVICES, IN CLASS 41 (U.S. CLS. 100, 101 AND 107).

FIRST USE 1-31-2000; IN COMMERCE 1-31-2000.

OWNER OF U.S. REG. NOS. 2,667,791, 3,178,571, AND 3,755,650.

NO CLAIM IS MADE TO THE EXCLUSIVE RIGHT TO USE "AWARD", APART FROM THE MARK AS SHOWN.

THE MARK CONSISTS OF A CIRCLE WITH THE UPPER PORTION OF THE APPLIED-FOR MARK COMPRISING FIVE FIVE-POINTED STARS WHICH ARE LOCATED ABOVE A FOUR-PARTITIONED FLAT REPRESENTATION OF THE EARTH SHOWING THE CONTINENTS AND LAND MASSES WITH SOME PARALLELS OF LATITUDE AND LONGITUDE ALSO BEING DEPICTED. BELOW THAT IS THE WORDING "STAR DIAMOND AWARD" IN STYLIZED CHARACTERS.

SER. NO. 85-523,436, FILED 1-24-2012.

JESSICA A. POWERS, EXAMINING ATTORNEY



*David J. Kybas*

Director of the United States Patent and Trademark Office



# United States of America

United States Patent and Trademark Office



**Reg. No. 4,198,442**

**Registered Aug. 28, 2012**

**Int. Cl.: 35**

**SERVICE MARK**

**PRINCIPAL REGISTER**

ANGIE'S LIST, INC. (DELAWARE CORPORATION)  
1030 E. WASHINGTON STREET  
INDIANAPOLIS, IN 46202

FOR: PROVIDING CONSUMER INFORMATION SERVICES REGARDING HOME CONTRACTORS, PRODUCT AND SERVICE PROVIDERS, CAR SPECIALISTS AND HEALTH CARE PROVIDERS, NAMELY, PROVIDING CONSUMER RATING INFORMATION, CONSUMER REFERRAL INFORMATION, CONSUMER RECOMMENDATIONS, COUPONS AND PRICE DISCOUNT INFORMATION, IN CLASS 35 (U.S. CLS. 100, 101 AND 102).

FIRST USE 10-18-2011; IN COMMERCE 10-18-2011.

OWNER OF U.S. REG. NOS. 2,083,451, 3,255,446 AND OTHERS.

THE MARK CONSISTS OF THE WORD "ANGIE" INSIDE OF A SPEECH BUBBLE DESIGN.

SER. NO. 85-523,442, FILED 1-24-2012.

BRIDGETT SMITH, EXAMINING ATTORNEY



*David J. Kybas*

Director of the United States Patent and Trademark Office

# United States of America

United States Patent and Trademark Office

## GERAUD COLLECTION

**Reg. No. 4,198,443**

GOLD N DIAMONDS, INC. (GEORGIA CORPORATION)  
250 SPRING STREET NW SUITE 6E320  
ATLANTA, GA 30303

**Registered Aug. 28, 2012**

**Int. Cl.: 14**

FOR: DIAMOND JEWELRY; JEWELRY, IN CLASS 14 (U.S. CLS. 2, 27, 28 AND 50).

**TRADEMARK**

FIRST USE 10-1-2011; IN COMMERCE 10-1-2011.

**PRINCIPAL REGISTER**

THE MARK CONSISTS OF STANDARD CHARACTERS WITHOUT CLAIM TO ANY PARTICULAR FONT, STYLE, SIZE, OR COLOR.

NO CLAIM IS MADE TO THE EXCLUSIVE RIGHT TO USE "COLLECTION", APART FROM THE MARK AS SHOWN.

SER. NO. 85-523,454, FILED 1-24-2012.

LUCY ARANT, EXAMINING ATTORNEY



*David J. Kyffers*

Director of the United States Patent and Trademark Office

# United States of America

United States Patent and Trademark Office

## FRAME CARE

**Reg. No. 4,198,444**

**Registered Aug. 28, 2012**

**Int. Cl.: 9**

**TRADEMARK**

**PRINCIPAL REGISTER**

BK FRAMES, CORP. (FLORIDA CORPORATION)  
5700 COLLINS AVENUE  
MIAMI BEACH, FL 33140

FOR: EYEGLOSS FRAMES; EYEGLOSSSES, IN CLASS 9 (U.S. CLS. 21, 23, 26, 36 AND 38).

FIRST USE 10-1-2010; IN COMMERCE 10-1-2010.

THE MARK CONSISTS OF STANDARD CHARACTERS WITHOUT CLAIM TO ANY PARTICULAR FONT, STYLE, SIZE, OR COLOR.

NO CLAIM IS MADE TO THE EXCLUSIVE RIGHT TO USE "FRAME", APART FROM THE MARK AS SHOWN.

SER. NO. 85-523,654, FILED 1-24-2012.

JERI J. FICKES, EXAMINING ATTORNEY



*David J. Kyffers*

Director of the United States Patent and Trademark Office

# United States of America

United States Patent and Trademark Office



**Reg. No. 4,198,445**

WALLACE, TARA M. (UNITED STATES INDIVIDUAL)  
33 WEST END AVENUE  
NEW YORK, NY 10023

**Registered Aug. 28, 2012**

**Int. Cl.: 41**

FOR: PROVIDING FITNESS AND EXERCISE FACILITIES, IN CLASS 41 (U.S. CLS. 100, 101 AND 107).

**SERVICE MARK**

FIRST USE 2-1-2011; IN COMMERCE 2-1-2011.

**PRINCIPAL REGISTER**

NO CLAIM IS MADE TO THE EXCLUSIVE RIGHT TO USE "NYC", APART FROM THE MARK AS SHOWN.

THE STIPPLING SHOWN IN THE DRAWING IS A FEATURE OF THE MARK.

THE MARK CONSISTS OF A FANCIFUL BICYCLE RIDER AND BICYCLE WITH LINES FOR MOTION, THE WORD "PEDAL" AND ABBREVIATION "NYC" ON THE HORIZONTAL PORTION OF THE LETTER "L".

SER. NO. 85-523,727, FILED 1-24-2012.

DAVID C. REIHNER, EXAMINING ATTORNEY



*David J. Kyros*

Director of the United States Patent and Trademark Office

# United States of America

United States Patent and Trademark Office

## FENCING WITH A TWIST

**Reg. No. 4,198,446**

**Registered Aug. 28, 2012**

**Int. Cls.: 6 and 19**

**TRADEMARK**

**PRINCIPAL REGISTER**

PREFORMED LINE PRODUCTS COMPANY (OHIO CORPORATION)  
660 BETA DRIVE  
MAYFIELD VILLAGE, OH 44143

FOR: METAL FENCING PRODUCTS, NAMELY, DEAD-END BRACES, CONNECTORS, ANCHORS AND SPLICES FOR FENCING WIRE, IN CLASS 6 (U.S. CLS. 2, 12, 13, 14, 23, 25 AND 50).

FIRST USE 3-31-2011; IN COMMERCE 3-31-2011.

FOR: NON-METAL FENCING PRODUCTS, NAMELY, INSULATORS AND TREE-GUARDS FOR FENCING WIRE, IN CLASS 19 (U.S. CLS. 1, 12, 33 AND 50).

FIRST USE 3-31-2011; IN COMMERCE 3-31-2011.

THE MARK CONSISTS OF STANDARD CHARACTERS WITHOUT CLAIM TO ANY PARTICULAR FONT, STYLE, SIZE, OR COLOR.

NO CLAIM IS MADE TO THE EXCLUSIVE RIGHT TO USE "FENCING", APART FROM THE MARK AS SHOWN.

SER. NO. 85-523,754, FILED 1-24-2012.

SUSAN LESLIE DUBOIS, EXAMINING ATTORNEY



*David J. Kyjars*

Director of the United States Patent and Trademark Office

# United States of America

United States Patent and Trademark Office

## HAWAIIAN RUBY GUAVA

**Reg. No. 4,198,447**

PACIFICA, INC. (OREGON CORPORATION)  
3139 NW INDUSTRIAL STREET  
PORTLAND, OR 97210

**Registered Aug. 28, 2012**

**Int. Cl.: 3**

FOR: PERFUMES, IN CLASS 3 (U.S. CLS. 1, 4, 6, 50, 51 AND 52).

**TRADEMARK**

FIRST USE 1-1-2007; IN COMMERCE 1-1-2007.

**PRINCIPAL REGISTER**

THE MARK CONSISTS OF STANDARD CHARACTERS WITHOUT CLAIM TO ANY PARTICULAR FONT, STYLE, SIZE, OR COLOR.

OWNER OF U.S. REG. NOS. 3,226,193, 3,596,861, AND 3,853,544.

SEC. 2(F).

SER. NO. 85-523,863, FILED 1-24-2012.

RON FAIRBANKS, EXAMINING ATTORNEY



*David J. Kyffers*

Director of the United States Patent and Trademark Office

# United States of America

United States Patent and Trademark Office

## LESS-STRESS WEIGHT SUPPORT

**Reg. No. 4,198,448**

**Registered Aug. 28, 2012**

**Int. Cl.: 5**

**TRADEMARK**

**PRINCIPAL REGISTER**

PRIMARY INVESTMENTS GROUP LIMITED (BR. VIRGIN ISLANDS CORPORATION)  
P. O. BOX 3444  
C/O TRUSTNET CHAMBERS  
ROAD TOWN, TORTOLA, BR. VIRGIN ISLANDS

FOR: DIETARY SUPPLEMENTS; FOOD SUPPLEMENTS; HERBAL SUPPLEMENTS; NUTRITIONAL SUPPLEMENTS; VITAMIN SUPPLEMENTS; MINERAL SUPPLEMENTS; MULTI-VITAMIN AND MINERAL SUPPLEMENTS, IN CLASS 5 (U.S. CLS. 6, 18, 44, 46, 51 AND 52).

FIRST USE 12-21-2011; IN COMMERCE 12-21-2011.

THE MARK CONSISTS OF STANDARD CHARACTERS WITHOUT CLAIM TO ANY PARTICULAR FONT, STYLE, SIZE, OR COLOR.

OWNER OF U.S. REG. NO. 3,252,167.

NO CLAIM IS MADE TO THE EXCLUSIVE RIGHT TO USE "WEIGHT SUPPORT", APART FROM THE MARK AS SHOWN.

SER. NO. 85-523,909, FILED 1-24-2012.

RAMONA ORTIGA, EXAMINING ATTORNEY



*David J. Kyros*

Director of the United States Patent and Trademark Office

# United States of America

United States Patent and Trademark Office

## DIZZY DOGG'S

**Reg. No. 4,198,449**

**Registered Aug. 28, 2012**

**Int. Cl.: 18**

**TRADEMARK**

**PRINCIPAL REGISTER**

D.D. INDUSTRIES, INC. (ILLINOIS CORPORATION)  
4040 S. NORMAL  
CHICAGO, IL 60609

FOR: RAWHIDE CHEWS FOR DOGS, IN CLASS 18 (U.S. CLS. 1, 2, 3, 22 AND 41).

FIRST USE 0-0-1996; IN COMMERCE 0-0-1996.

THE MARK CONSISTS OF STANDARD CHARACTERS WITHOUT CLAIM TO ANY PARTICULAR FONT, STYLE, SIZE, OR COLOR.

NO CLAIM IS MADE TO THE EXCLUSIVE RIGHT TO USE "DOGG'S", APART FROM THE MARK AS SHOWN.

SER. NO. 85-523,970, FILED 1-24-2012.

DEZMONA MIZELLE, EXAMINING ATTORNEY



*David J. Kyffers*

Director of the United States Patent and Trademark Office



# United States of America

United States Patent and Trademark Office



**Reg. No. 4,198,450**

**Registered Aug. 28, 2012**

**Int. Cl.: 43**

**SERVICE MARK**

**PRINCIPAL REGISTER**

KONA ICE, INC. (KENTUCKY CORPORATION)  
5945 CENTENNIAL CIRCLE  
FLORENCE, KY 41042

FOR: PROVIDING OF FOOD AND DRINK VIA A MOBILE TRUCK, IN CLASS 43 (U.S. CLS. 100 AND 101).

FIRST USE 6-23-2007; IN COMMERCE 6-23-2007.

THE MARK CONSISTS OF TWO GRAY SMILING DOLPHINS WITH WHITE IRIS AND BLACK EYEBALLS WITH RED TONGUES WITH LOWER PART OF DOLPHINS IN DARK BLUE WATER WITH LIGHTER BLUE WATER WITH WHITE HIGHLIGHTS SPLASHING ABOVE THE BLUE SPLASHING WATER.

THE COLOR(S) GRAY, RED, DARK BLUE, WHITE, AND BLACK IS/ARE CLAIMED AS A FEATURE OF THE MARK.

SER. NO. 85-524,004, FILED 1-24-2012.

CAROLYN CATALDO, EXAMINING ATTORNEY



*David J. Kybas*

Director of the United States Patent and Trademark Office

# United States of America

United States Patent and Trademark Office



**Reg. No. 4,198,451**

**Registered Aug. 28, 2012**

**Int. Cl.: 35**

**SERVICE MARK**

**PRINCIPAL REGISTER**

ULTRA COLD STORAGE, L.L.C. (TEXAS LIMITED LIABILITY COMPANY), DBA  
PLANTATION PRODUCE CO.  
805 TRINITY RD.  
MISSION, TX 78572

FOR: DISTRIBUTORSHIP SERVICES IN THE FIELD OF FRESH FRUITS AND VEGETABLES,  
IN CLASS 35 (U.S. CLS. 100, 101 AND 102).

FIRST USE 1-0-2010; IN COMMERCE 1-0-2010.

NO CLAIM IS MADE TO THE EXCLUSIVE RIGHT TO USE "PRODUCE CO.", APART FROM  
THE MARK AS SHOWN.

THE MARK CONSISTS OF A DRAWING OF THREE PALM TREES DIRECTLY ABOVE THE  
PHRASE "PLANTATION PRODUCE CO." IN STYLIZED LETTERING AND UNDERLINED.  
DIRECTLY BENEATH THE WORDING IN THE MARK IS AN ABSTRACT DRAWING OF  
SUN RAYS IN A SEMICIRCULAR SHAPE.

SER. NO. 85-524,025, FILED 1-24-2012.

ADA HAN, EXAMINING ATTORNEY



*David J. Kyffers*

Director of the United States Patent and Trademark Office

# United States of America

United States Patent and Trademark Office

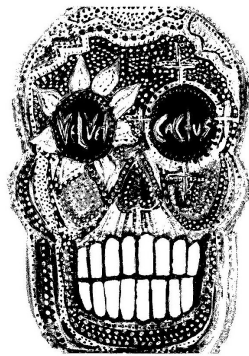

**Reg. No. 4,198,452**

**Registered Aug. 28, 2012**

**Int. Cl.: 43**

**SERVICE MARK**

**PRINCIPAL REGISTER**

THE VELVET CACTUS LLC (LOUISIANA LIMITED LIABILITY COMPANY)  
6300 ARGONNE BOULEVARD  
NEW ORLEANS, LA 70124

FOR: RESTAURANT SERVICES, IN CLASS 43 (U.S. CLS. 100 AND 101).

FIRST USE 5-21-2011; IN COMMERCE 5-21-2011.

THE MARK CONSISTS OF A BEADED MASK RESEMBLING A HUMAN SKULL HAVING THE LITERAL ELEMENT "VELVET" WITHIN THE EYEHOLE ON THE LEFT, WHICH IS SURROUNDED BY A STYLIZED DRAWING OF A DAISY, AND THE LITERAL ELEMENT "CACTUS" WITHIN THE EYEHOLE ON THE RIGHT SURROUNDED BY FOUR CROSSES.

SER. NO. 85-524,077, FILED 1-24-2012.

AMEEN IMAM, EXAMINING ATTORNEY



*David J. Kybas*

Director of the United States Patent and Trademark Office

# United States of America

United States Patent and Trademark Office



**Reg. No. 4,198,453**

**Registered Aug. 28, 2012**

**Int. Cl.: 45**

**SERVICE MARK**

**PRINCIPAL REGISTER**

BRAVO ZULU NETWORK, L.L.C. (GEORGIA LIMITED LIABILITY COMPANY)  
3406 SPINDLETOP DR.  
KENNESAW, GA 30144

FOR: ON-LINE SOCIAL NETWORKING SERVICES, IN CLASS 45 (U.S. CLS. 100 AND 101).

FIRST USE 7-5-2010; IN COMMERCE 7-5-2010.

NO CLAIM IS MADE TO THE EXCLUSIVE RIGHT TO USE "NETWORK", APART FROM THE MARK AS SHOWN.

THE MARK CONSISTS OF A FADING CIRCLE SET, AND PARTIALLY HIDDEN, ON A HORIZON, BOTH IN THE BACKGROUND, WITH A SWOOPING ROW OF 8 BOLD STARS IN FRONT AND TO THE LEFT OF THE BACKGROUND IMAGES, ALONG WITH A SWOOPING ROW OF 8 BOLD STARS IN FRONT OF THE BACKGROUND IMAGES, TO THE RIGHT. BENEATH THE STARS, CIRCLE, AND HORIZON ARE THE WORDS, "BRAVO ZULU NETWORK" IN BOLD WITH A SLIGHT SHADOW BEHIND EACH WORD SIMULATING SOMEWHAT OF A 3D IMAGE OF THE WORDS. BENEATH "BRAVO ZULU NETWORK" IS A LONG, RECTANGULAR, DARK BOX WITH THE WORDS "HEROES MOVING FORWARD" PRINTED IN ALL CAPITAL LETTERS INSIDE THE RECTANGULAR, DARK BOX.

SER. NO. 85-524,184, FILED 1-24-2012.

KEVON CHISOLM, EXAMINING ATTORNEY



*David J. Kyffers*

Director of the United States Patent and Trademark Office

# United States of America

United States Patent and Trademark Office

## BEACHCASTLE SWEETS

**Reg. No. 4,198,454**

BEACHCASTLE SWEETS (WASHINGTON SOLE PROPRIETORSHIP)  
1715 L AVENUE  
ANACORTES, WA 98221

**Registered Aug. 28, 2012**

**Int. Cl.: 30**

FOR: CHOCOLATE; CHOCOLATE CANDIES; CHOCOLATE CONFECTIONS, NAMELY, ALMOND TOFFEE AND SEA SALT CARAMELS; CHOCOLATE TRUFFLES; FILLED CHOCOLATE, IN CLASS 30 (U.S. CL. 46).

**TRADEMARK**

FIRST USE 3-6-2009; IN COMMERCE 3-6-2009.

**PRINCIPAL REGISTER**

THE MARK CONSISTS OF STANDARD CHARACTERS WITHOUT CLAIM TO ANY PARTICULAR FONT, STYLE, SIZE, OR COLOR.

NO CLAIM IS MADE TO THE EXCLUSIVE RIGHT TO USE "SWEETS", APART FROM THE MARK AS SHOWN.

SER. NO. 85-524,248, FILED 1-24-2012.

SAIMA MAKHDOOM, EXAMINING ATTORNEY



*David J. Kyffers*

Director of the United States Patent and Trademark Office

# United States of America

United States Patent and Trademark Office

## CAJUNDILLAS

**Reg. No. 4,198,455**

LAST IN CONCEPTS, LLC (LOUISIANA LIMITED LIABILITY COMPANY)  
460 MAIN STREET

**Registered Aug. 28, 2012**

BATON ROUGE, LA 70801

**Int. Cl.: 29**

FOR: PREPARED ENTREE CONSISTING PRIMARILY OF CHICKEN, SAUSAGE AND CHEESE FOR CONSUMPTION ON OR OFF PREMISES, IN CLASS 29 (U.S. CL. 46).

**TRADEMARK**

FIRST USE 9-9-2003; IN COMMERCE 9-9-2003.

**PRINCIPAL REGISTER**

THE MARK CONSISTS OF STANDARD CHARACTERS WITHOUT CLAIM TO ANY PARTICULAR FONT, STYLE, SIZE, OR COLOR.

SER. NO. 85-524,570, FILED 1-25-2012.

ALEX KEAM, EXAMINING ATTORNEY



*David J. Kyros*

Director of the United States Patent and Trademark Office

# United States of America

United States Patent and Trademark Office

## EVERYONE NEEDS A LITTLE PLAYING TIME

**Reg. No. 4,198,456**

**Registered Aug. 28, 2012**

**Int. Cl.: 43**

**SERVICE MARK**

**PRINCIPAL REGISTER**

LAST IN CONCEPTS, LLC (LOUISIANA LIMITED LIABILITY COMPANY)  
460 MAIN STREET  
BATON ROUGE, LA 70801

FOR: RESTAURANT AND BAR SERVICES, IN CLASS 43 (U.S. CLS. 100 AND 101).

FIRST USE 10-1-2008; IN COMMERCE 10-1-2008.

THE MARK CONSISTS OF STANDARD CHARACTERS WITHOUT CLAIM TO ANY PARTICULAR FONT, STYLE, SIZE, OR COLOR.

SER. NO. 85-524,581, FILED 1-25-2012.

ALEX KEAM, EXAMINING ATTORNEY



*David J. Kybas*

Director of the United States Patent and Trademark Office

# United States of America

United States Patent and Trademark Office

## LA CONSENTIDA

**Reg. No. 4,198,457**

COMUNICACIONES SAN MILLAN S.A. DE C.V. (MEXICO CORPORATION)  
PO BOX 759  
SAN LUIS, AZ 853490759

**Registered Aug. 28, 2012**

**Int. Cl.: 38**

FOR: BROADCASTING OF RADIO PROGRAMMES, IN CLASS 38 (U.S. CLS. 100, 101 AND 104).

**SERVICE MARK**

FIRST USE 6-7-1952; IN COMMERCE 6-8-1990.

**PRINCIPAL REGISTER**

THE MARK CONSISTS OF STANDARD CHARACTERS WITHOUT CLAIM TO ANY PARTICULAR FONT, STYLE, SIZE, OR COLOR.

THE ENGLISH TRANSLATION OF "LA CONSENTIDA" IN THE MARK IS "THE ALLOWED ONE".

SER. NO. 85-524,772, FILED 1-25-2012.

STEVEN R. FINE, EXAMINING ATTORNEY



*David J. Kybas*

Director of the United States Patent and Trademark Office



# United States of America

United States Patent and Trademark Office

# KMGH

**Reg. No. 4,198,458**

**Registered Aug. 28, 2012**

**Int. Cl.: 38**

**SERVICE MARK**

**PRINCIPAL REGISTER**

SCRIPPS MEDIA, INC. (DELAWARE CORPORATION)  
SUITE 2800  
312 WALNUT STREET  
CINCINNATI, OH 45202

FOR: TELEVISION BROADCASTING SERVICES, IN CLASS 38 (U.S. CLS. 100, 101 AND 104).

FIRST USE 0-0-1972; IN COMMERCE 0-0-1972.

THE MARK CONSISTS OF STANDARD CHARACTERS WITHOUT CLAIM TO ANY PARTICULAR FONT, STYLE, SIZE, OR COLOR.

SER. NO. 85-524,867, FILED 1-25-2012.

WILLIAM VERHOSEK, EXAMINING ATTORNEY



*David J. Kyjars*

Director of the United States Patent and Trademark Office

# United States of America

United States Patent and Trademark Office



**Reg. No. 4,198,459**

YOU FIT, INC. (FLORIDA CORPORATION)  
6475 1ST AVE. S.

**Registered Aug. 28, 2012**

ST. PETERSBURG, FL 33707

**Int. Cl.: 41**

FOR: HEALTH CLUB SERVICES, NAMELY, PROVIDING INSTRUCTION IN EXERCISE AND PHYSICAL FITNESS, IN CLASS 41 (U.S. CLS. 100, 101 AND 107).

**SERVICE MARK**

FIRST USE 1-6-2012; IN COMMERCE 1-6-2012.

**PRINCIPAL REGISTER**

OWNER OF U.S. REG. NO. 3,683,711.

THE COLOR(S) WHITE, GREEN, AND PURPLE IS/ARE CLAIMED AS A FEATURE OF THE MARK.

THE MARK CONSISTS OF THE STYLIZED LETTERS "YF", THE STYLIZED WORDING "YOUCOACH", THE DESIGN OF A DOT APPEARING IN THE CENTER OF THE LETTER "O" OF "YOU" AND THE DEPICTION OF A SINGLE LINE CIRCLE SURROUNDING THE LETTERS "YF". THE COLOR GREEN APPEARS IN THE WORDING "YOU" AS WELL AS IN THE DEPICTION OF THE SINGLE LINE CIRCLE SURROUNDING THE "YF" LETTERS AND THE BACKGROUND BEHIND THE "Y" LETTER IN THE "YF" LETTERING. THE COLOR PURPLE APPEARS IN THE "F" LETTER OF THE "YF" LETTERING AND THE WORDING "COACH" AS WELL AS IN THE DEPICTION OF THE DOT APPEARING IN THE LETTER "O" OF "YOU". THE COLOR WHITE APPEARS IN THE "Y" LETTER OF THE "YF" LETTERING. BUT FOR THE COLOR WHITE APPEARING IN THE LETTER "Y" OF THE "YF" LETTERING, THE COLOR WHITE APPEARING IN THE MARK REPRESENTS BACKGROUND OR TRANSPARENT AREAS AND ARE NOT PART OF THE MARK.

SER. NO. 85-524,876, FILED 1-25-2012.

MICHAEL TANNER, EXAMINING ATTORNEY



*David J. Kyjars*

Director of the United States Patent and Trademark Office

# United States of America

United States Patent and Trademark Office

# WRTV

**Reg. No. 4,198,460**

**Registered Aug. 28, 2012**

**Int. Cl.: 38**

**SERVICE MARK**

**PRINCIPAL REGISTER**

SCRIPPS MEDIA, INC. (DELAWARE CORPORATION)  
SUITE 2800  
312 WALNUT STREET  
CINCINNATI, OH 45202

FOR: TELEVISION BROADCASTING SERVICES, IN CLASS 38 (U.S. CLS. 100, 101 AND 104).

FIRST USE 0-0-1972; IN COMMERCE 0-0-1972.

THE MARK CONSISTS OF STANDARD CHARACTERS WITHOUT CLAIM TO ANY PARTICULAR FONT, STYLE, SIZE, OR COLOR.

SER. NO. 85-524,891, FILED 1-25-2012.

WILLIAM VERHOSEK, EXAMINING ATTORNEY



*David J. Kybas*

Director of the United States Patent and Trademark Office

# United States of America

United States Patent and Trademark Office

The logo for AltiusEd features a stylized arch design above the word "AltiusEd". The arch is composed of a thick line on the inside, two thin lines in the middle, and radiating geometric shapes of various sizes around the outside. The word "AltiusEd" is written in a serif font.

**Reg. No. 4,198,461**

ALTIUS EDUCATION, INC. (DELAWARE CORPORATION)

**Registered Aug. 28, 2012**

345 CALIFORNIA STREET, SUITE 1200  
SAN FRANCISCO, CA 94104

**Int. Cl.: 35**

**SERVICE MARK**

**PRINCIPAL REGISTER**

FOR: BUSINESS MANAGEMENT CONSULTING, STRATEGIC PLANNING AND BUSINESS ADVISORY SERVICES FOR UNIVERSITIES, COLLEGES AND EDUCATIONAL INSTITUTIONS IN THE FIELD OF ESTABLISHING, MANAGING AND ADMINISTERING ONLINE UNIVERSITIES AND EDUCATIONAL PROGRAMS; ADVERTISING AND MARKETING SERVICES, NAMELY, ADVERTISING AND MARKETING FOR ONLINE EDUCATIONAL PROGRAMS AND ONLINE UNIVERSITIES; BRANDING SERVICES, NAMELY, CONSULTING, DEVELOPMENT, MANAGEMENT AND MARKETING OF BRANDS FOR ONLINE UNIVERSITIES AND EDUCATIONAL PROGRAMS; BUSINESS VENTURE DEVELOPMENT AND FORMATION CONSULTING SERVICES FOR UNIVERSITIES, COLLEGES AND EDUCATIONAL INSTITUTIONS SEEKING TO ESTABLISH ONLINE UNIVERSITIES AND EDUCATIONAL PROGRAMS, IN CLASS 35 (U.S. CLS. 100, 101 AND 102).

FIRST USE 9-23-2009; IN COMMERCE 9-23-2009.

OWNER OF U.S. REG. NOS. 3,971,306, 3,982,090 AND OTHERS.

THE MARK CONSISTS OF WORD "ALTIUSED" WITH ARCH DESIGN ABOVE "LTIUS" AND DESIGN CONSISTING OF THICK LINE INSIDE ARCH, FOLLOWED BY TWO THIN LINES IN THE MIDDLE OF ARCH AND RADIATING GEOMETRIC DESIGNS OF VARIOUS SIZES AROUND OUTSIDE OF ARCH.

SER. NO. 85-524,991, FILED 1-25-2012.

KAREN K. BUSH, EXAMINING ATTORNEY



*David J. Kyros*

Director of the United States Patent and Trademark Office

# United States of America

United States Patent and Trademark Office

The logo for AltiusEd features a stylized arch design above the word "AltiusEd". The arch is composed of a thick line inside, followed by two thin lines in the middle, and radiating geometric designs of various sizes around the outside. The word "AltiusEd" is written in a serif font.

**Reg. No. 4,198,462**

ALTIUS EDUCATION, INC. (DELAWARE CORPORATION)  
345 CALIFORNIA STREET, SUITE 1200  
SAN FRANCISCO, CA 94104

**Registered Aug. 28, 2012**

**Int. Cl.: 41**

FOR: EDUCATIONAL SERVICES, NAMELY, PROVIDING ONLINE UNIVERSITIES, COLLEGES AND EDUCATIONAL PROGRAMS, NAMELY, COURSES OF INSTRUCTION AT THE POST SECONDARY LEVEL; EDUCATIONAL SERVICES, NAMELY, CONDUCTING DISTANCE LEARNING INSTRUCTION AT THE UNIVERSITY LEVEL, IN CLASS 41 (U.S. CLS. 100, 101 AND 107).

**SERVICE MARK**

**PRINCIPAL REGISTER**

FIRST USE 9-23-2009; IN COMMERCE 9-23-2009.

OWNER OF U.S. REG. NOS. 3,971,306, 3,982,090 AND OTHERS.

THE MARK CONSISTS OF WORD "ALTIUSED" WITH ARCH DESIGN ABOVE "LTIUS" AND DESIGN CONSISTING OF THICK LINE INSIDE ARCH, FOLLOWED BY TWO THIN LINES IN THE MIDDLE OF ARCH AND RADIATING GEOMETRIC DESIGNS OF VARIOUS SIZES AROUND OUTSIDE OF ARCH.

SER. NO. 85-524,995, FILED 1-25-2012.

KAREN K. BUSH, EXAMINING ATTORNEY



*David J. Kyjars*

Director of the United States Patent and Trademark Office

# United States of America

United States Patent and Trademark Office



**Reg. No. 4,198,463**

ATLAS ROOFING CORPORATION (MISSISSIPPI CORPORATION)  
2564 VALLEY ROAD  
MERIDIAN, MS 39307

**Registered Aug. 28, 2012**

**Int. Cl.: 17**

FOR: BUILDING INSULATION IN THE FORM OF POLYURETHANE FOAM SHEET COMBINED WITH A BOARD CAPABLE OF HOLDING NAILS, IN CLASS 17 (U.S. CLS. 1, 5, 12, 13, 35 AND 50).

**TRADEMARK**

FIRST USE 3-1-2003; IN COMMERCE 3-1-2003.

**PRINCIPAL REGISTER**

OWNER OF U.S. REG. NOS. 3,009,708 AND 3,052,220.

THE MARK CONSISTS OF THE WORD "CROSSVENT" IN BLOCK PRINT PLACED OVER A DESIGN OF TWO CROSSED ARROWS WITH THE POINT OF ONE TOUCHING THE BASE OF THE LETTER "C" AND THE POINT OF THE OTHER TOUCHING THE BASE OF THE LETTER "T".

SEC. 2(F) AS TO CROSSVENT.

SER. NO. 85-525,190, FILED 1-25-2012.

EDWARD FENNESSY, EXAMINING ATTORNEY



*David J. Kyros*

Director of the United States Patent and Trademark Office

# United States of America

United States Patent and Trademark Office

**PIZZA  
FELLAS**

**Reg. No. 4,198,464**

HASHEM, THOMAS (UNITED STATES INDIVIDUAL)  
348 REBECCA AVE  
SCRANTON, PA 18504

**Registered Aug. 28, 2012**

**Int. Cl.: 43**

FOR: RESTAURANT SERVICES, INCLUDING SIT-DOWN SERVICE OF FOOD AND TAKE-OUT RESTAURANT SERVICES; RESTAURANT SERVICES, NAMELY, PROVIDING OF FOOD AND BEVERAGES FOR CONSUMPTION ON AND OFF THE PREMISES, IN CLASS 43 (U.S. CLS. 100 AND 101).

**SERVICE MARK**

**PRINCIPAL REGISTER**

FIRST USE 1-1-2002; IN COMMERCE 1-1-2002.

NO CLAIM IS MADE TO THE EXCLUSIVE RIGHT TO USE "PIZZA", APART FROM THE MARK AS SHOWN.

THE MARK CONSISTS OF THE WORD "PIZZA" IN BUBBLE LETTERS IN A CURVE SHAPE OVER THE WORD "FELLAS" IN A CURVE SHAPE.

SER. NO. 85-525,278, FILED 1-25-2012.

JACQUELINE A. LAVINE, EXAMINING ATTORNEY



*David J. Kyffers*

Director of the United States Patent and Trademark Office

# United States of America

United States Patent and Trademark Office

## THE WORK THE WORK THE WORK

**Reg. No. 4,198,465**

BBDO WORLDWIDE INC. (NEW YORK CORPORATION)  
1285 AVENUE OF THE AMERICAS  
NEW YORK, NY 10019

**Registered Aug. 28, 2012**

**Int. Cl.: 35**

FOR: ADVERTISING AGENCIES, PREPARING ADVERTISEMENTS FOR OTHERS, PLACING ADVERTISEMENTS FOR OTHERS, COOPERATIVE ADVERTISING AND MARKETING, MARKET ANALYSIS, MARKET RESEARCH AND PUBLIC RELATIONS SERVICES, IN CLASS 35 (U.S. CLS. 100, 101 AND 102).

**SERVICE MARK**

**PRINCIPAL REGISTER**

FIRST USE 1-0-1999; IN COMMERCE 1-0-1999.

THE MARK CONSISTS OF STANDARD CHARACTERS WITHOUT CLAIM TO ANY PARTICULAR FONT, STYLE, SIZE, OR COLOR.

OWNER OF U.S. REG. NO. 2,488,382.

SEC. 2(F).

SER. NO. 85-525,288, FILED 1-25-2012.

JANICE KIM, EXAMINING ATTORNEY



*David J. Kyffers*

Director of the United States Patent and Trademark Office



# United States of America

United States Patent and Trademark Office

## SAFEPRO AUTO GLASS

**Reg. No. 4,198,466**

**Registered Aug. 28, 2012**

**Int. Cl.: 37**

**SERVICE MARK**

**PRINCIPAL REGISTER**

SAFEPRO GLASS, LLC (ARIZONA LIMITED LIABILITY COMPANY)  
34501 S OLD BLACK CANYON HWY  
BLACK CANYON CITY, AZ 85284

FOR: INSTALLATION, REPAIR AND REPLACEMENT OF GLASS IN AUTOMOTIVE TYPE VEHICLES, NAMELY, AUTOMOBILES AND TRUCKS, IN CLASS 37 (U.S. CLS. 100, 103 AND 106).

FIRST USE 10-1-2002; IN COMMERCE 10-1-2002.

THE MARK CONSISTS OF STANDARD CHARACTERS WITHOUT CLAIM TO ANY PARTICULAR FONT, STYLE, SIZE, OR COLOR.

NO CLAIM IS MADE TO THE EXCLUSIVE RIGHT TO USE "AUTO GLASS", APART FROM THE MARK AS SHOWN.

SER. NO. 85-525,813, FILED 1-26-2012.

CAROLYN CATALDO, EXAMINING ATTORNEY



*David J. Kyffers*

Director of the United States Patent and Trademark Office

# United States of America

United States Patent and Trademark Office

# POWER'S

**Reg. No. 4,198,467**

**Registered Aug. 28, 2012**

**Int. Cl.: 43**

**SERVICE MARK**

**PRINCIPAL REGISTER**

POWER ENTERPRISES, INC. (CALIFORNIA CORPORATION)  
SUITE 200  
11090 SAN PABLO AVENUE  
EL CERRITO, CA 94530

FOR: RESTAURANT SERVICES, IN CLASS 43 (U.S. CLS. 100 AND 101).

FIRST USE 2-13-2004; IN COMMERCE 2-13-2004.

THE MARK CONSISTS OF STANDARD CHARACTERS WITHOUT CLAIM TO ANY PARTICULAR FONT, STYLE, SIZE, OR COLOR.

OWNER OF U.S. REG. NO. 1,449,931.

SER. NO. 85-526,077, FILED 1-26-2012.

ELISSA GARBER KON, EXAMINING ATTORNEY



*David J. Kybas*

Director of the United States Patent and Trademark Office

# United States of America

United States Patent and Trademark Office

## The Attraction Agency

**Reg. No. 4,198,468**

THE ATTRACTION AGENCY LLC (MASSACHUSETTS LIMITED LIABILITY COMPANY)  
148 CROSS ROAD  
WEST STOCKBRIDGE, MA 01266

**Registered Aug. 28, 2012**

**Int. Cl.: 45**

FOR: MATCHMAKING SERVICES; CONSULTATION SERVICES IN THE FIELD OF DATING,  
IN CLASS 45 (U.S. CLS. 100 AND 101).

**SERVICE MARK**

FIRST USE 1-1-2012; IN COMMERCE 1-1-2012.

**PRINCIPAL REGISTER**

THE MARK CONSISTS OF STANDARD CHARACTERS WITHOUT CLAIM TO ANY PAR-  
TICULAR FONT, STYLE, SIZE, OR COLOR.

NO CLAIM IS MADE TO THE EXCLUSIVE RIGHT TO USE "AGENCY", APART FROM THE  
MARK AS SHOWN.

SER. NO. 85-526,547, FILED 1-26-2012.

LUCY ARANT, EXAMINING ATTORNEY



*David J. Kyffers*

Director of the United States Patent and Trademark Office

# United States of America

United States Patent and Trademark Office

## STAPLES NIKO

**Reg. No. 4,198,469**

STAPLES THE OFFICE SUPERSTORE, LLC (DELAWARE LIMITED LIABILITY COMPANY)  
500 STAPLES DRIVE  
FRAMINGHAM, MA 01702

**Registered Aug. 28, 2012**

**Int. Cl.: 16**

FOR: WRITING INSTRUMENTS, IN CLASS 16 (U.S. CLS. 2, 5, 22, 23, 29, 37, 38 AND 50).

**TRADEMARK**

FIRST USE 7-17-2011; IN COMMERCE 10-7-2011.

**PRINCIPAL REGISTER**

THE MARK CONSISTS OF STANDARD CHARACTERS WITHOUT CLAIM TO ANY PARTICULAR FONT, STYLE, SIZE, OR COLOR.

OWNER OF U.S. REG. NOS. 1,438,390, 3,385,468 AND OTHERS.

SER. NO. 85-527,055, FILED 1-27-2012.

JASON BLAIR, EXAMINING ATTORNEY



*David J. Kyffers*

Director of the United States Patent and Trademark Office

# United States of America

United States Patent and Trademark Office

## TORRELONGARES

**Reg. No. 4,198,470**

COVINCA SDAD.COOP (SPAIN CORPORATION)

**Registered Aug. 28, 2012**

CTRA. VALENCIA, S/N  
ZARAGOSA, SPAIN

**Int. Cl.: 33**

FOR: WINES, IN CLASS 33 (U.S. CLS. 47 AND 49).

**TRADEMARK**

THE MARK CONSISTS OF STANDARD CHARACTERS WITHOUT CLAIM TO ANY PARTICULAR FONT, STYLE, SIZE, OR COLOR.

**PRINCIPAL REGISTER**

OWNER OF SPAIN REG. NO. 1.058.553, DATED 3-5-1987, RENEWED AS REG. NO. 1.058.553, DATED 12-5-2006, EXPIRES 1-26-2014.

THE WORDING "TORRELONGARES" HAS NO MEANING IN A FOREIGN LANGUAGE.

SER. NO. 85-527,174, FILED 1-27-2012.

STEVEN R. FINE, EXAMINING ATTORNEY



*David J. Kyffers*

Director of the United States Patent and Trademark Office

# United States of America

United States Patent and Trademark Office

## Signature Series Ron Rizzi's Cars And Coffee

**Reg. No. 4,198,471**

RIZZI, RON (UNITED STATES INDIVIDUAL)  
118 LATHEMS MILL LN  
BALL GROUND, GA 30107

**Registered Aug. 28, 2012**

**Int. Cl.: 35**

FOR: ADVERTISING, PROMOTION, AND MARKETING SERVICES IN THE NATURE OF CREATING, ARRANGING AND PROVIDING SPECIAL CAUSE RELATED EVENT MARKETING PROGRAMS FOR OTHERS; BUSINESS SERVICES, NAMELY, DEVELOPING FUND RAISING CAMPAIGNS FOR OTHERS; COOPERATIVE ADVERTISING AND MARKETING PROGRAMS; DEVELOPMENT OF CAUSE MARKETING STRATEGIES AND CAUSE RELATED CONCEPTS; MARKETING CONSULTING FOR SPECIALTY COFFEE RETAILERS AND DISTRIBUTORS, IN CLASS 35 (U.S. CLS. 100, 101 AND 102).

**SERVICE MARK**

**PRINCIPAL REGISTER**

FIRST USE 1-27-2012; IN COMMERCE 1-27-2012.

THE MARK CONSISTS OF STANDARD CHARACTERS WITHOUT CLAIM TO ANY PARTICULAR FONT, STYLE, SIZE, OR COLOR.

OWNER OF U.S. REG. NOS. 3,539,866, 3,539,905 AND OTHERS.

NO CLAIM IS MADE TO THE EXCLUSIVE RIGHT TO USE "SERIES", APART FROM THE MARK AS SHOWN.

SER. NO. 85-527,291, FILED 1-27-2012.

NAKIA HENRY, EXAMINING ATTORNEY



*David J. Kybas*

Director of the United States Patent and Trademark Office

# United States of America

United States Patent and Trademark Office

## BEAUTYRETIC

**Reg. No. 4,198,472**

MENTIS, DIMITRIOS (UNITED STATES INDIVIDUAL)  
1000 NW 105TH AVENUE  
PLANTATION, FL 33322

**Registered Aug. 28, 2012**

**Int. Cl.: 5**

FOR: DIURETICS, IN CLASS 5 (U.S. CLS. 6, 18, 44, 46, 51 AND 52).

**TRADEMARK**

FIRST USE 9-1-2011; IN COMMERCE 9-1-2011.

**PRINCIPAL REGISTER**

THE MARK CONSISTS OF STANDARD CHARACTERS WITHOUT CLAIM TO ANY PARTICULAR FONT, STYLE, SIZE, OR COLOR.

SER. NO. 85-527,363, FILED 1-27-2012.

ROSELLE HERRERA, EXAMINING ATTORNEY



*David J. Kyffers*

Director of the United States Patent and Trademark Office

United States of America  
United States Patent and Trademark Office

# FRICTION

**Reg. No. 4,198,473**

ERIC HUANG (UNITED STATES INDIVIDUAL)  
5527 RYLAND AVE  
TEMPLE CITY, CA 91780

**Registered Aug. 28, 2012**

**Int. Cls.: 8 and 35**

FOR: APPARATUS FOR TATTOOING; TATTOO MACHINE PARTS, NAMELY, SPRINGS AND ARMATURE BARS; TATTOO MACHINES; TATTOO NEEDLES, IN CLASS 8 (U.S. CLS. 23, 28 AND 44).

**TRADEMARK**

FIRST USE 2-17-2011; IN COMMERCE 2-17-2011.

**SERVICE MARK**

FOR: ON-LINE RETAIL CONSIGNMENT STORES FEATURING TATTOO SUPPLIES, EQUIPMENT, FURNITURE AND APPAREL, IN CLASS 35 (U.S. CLS. 100, 101 AND 102).

**PRINCIPAL REGISTER**

FIRST USE 2-17-2011; IN COMMERCE 2-17-2011.

THE MARK CONSISTS OF STANDARD CHARACTERS WITHOUT CLAIM TO ANY PARTICULAR FONT, STYLE, SIZE, OR COLOR.

SER. NO. 85-527,738, FILED 1-27-2012.

JOHN WILKE, EXAMINING ATTORNEY



*David J. Kypos*

Director of the United States Patent and Trademark Office



# United States of America

United States Patent and Trademark Office

## We Make Math Make Sense

**Reg. No. 4,198,474**

**Registered Aug. 28, 2012**

**Int. Cl.: 41**

**SERVICE MARK**

**PRINCIPAL REGISTER**

MATHNASIUM, LLC (CALIFORNIA LIMITED LIABILITY COMPANY)  
5120 W. GOLDLEAF CIRCLE, SUITE 300  
LOS ANGELES, CA 90056

FOR: EDUCATIONAL AND ONLINE EDUCATIONAL SERVICES, NAMELY, PROVIDING COURSES OF INSTRUCTION TO CHILDREN IN THE FIELD OF MATHEMATICS AND DISSEMINATING COURSE MATERIALS IN CONNECTION THEREWITH; PROVIDING INFORMATION IN THE FIELD OF INSTRUCTIONAL MATHEMATICS OR MATHEMATICS INSTRUCTION VIA A GLOBAL COMPUTER NETWORK, IN CLASS 41 (U.S. CLS. 100, 101 AND 107).

FIRST USE 8-1-2010; IN COMMERCE 8-1-2010.

THE MARK CONSISTS OF STANDARD CHARACTERS WITHOUT CLAIM TO ANY PARTICULAR FONT, STYLE, SIZE, OR COLOR.

SER. NO. 85-528,047, FILED 1-29-2012.

DEBORAH LOBO, EXAMINING ATTORNEY



*David J. Kybas*

Director of the United States Patent and Trademark Office

# United States of America

United States Patent and Trademark Office

## WHERE THE FUTURE OF INSURANCE HAS ITS VOICE

**Reg. No. 4,198,475**

**Registered Aug. 28, 2012**

**Int. Cl.: 35**

**SERVICE MARK**

**PRINCIPAL REGISTER**

NATIONAL ASSOCIATION OF MUTUAL INSURANCE COMPANIES, INC. (INDIANA CORPORATION)  
3601 VINCENNES ROAD  
INDIANAPOLIS, IN 46268

FOR: TRADE ASSOCIATION SERVICES, NAMELY, PROMOTING THE INTERESTS OF INSURANCE COMPANIES AND THE INSURANCE INDUSTRY, IN CLASS 35 (U.S. CLS. 100, 101 AND 102).

FIRST USE 11-8-2011; IN COMMERCE 11-8-2011.

THE MARK CONSISTS OF STANDARD CHARACTERS WITHOUT CLAIM TO ANY PARTICULAR FONT, STYLE, SIZE, OR COLOR.

SER. NO. 85-528,588, FILED 1-30-2012.

RUSS HERMAN, EXAMINING ATTORNEY



*David J. Kyjars*

Director of the United States Patent and Trademark Office

# United States of America

United States Patent and Trademark Office

# KEPSTAN

**Reg. No. 4,198,476**

**Registered Aug. 28, 2012**

**Int. Cls.: 1 and 17**

**TRADEMARK**

**PRINCIPAL REGISTER**

ARKEMA FRANCE (FRANCE CORPORATION)  
420 RUE D'ESTIENNE D'ORVES  
COLOMBES, FRANCE 92700

FOR: CHEMICAL PRODUCTS FOR USE IN INDUSTRY, NAMELY, POLYETHER KETONE KETONE, POLYARYL ETHER KETONE; TECHNICAL POLYMERS; UNPROCESSED PLASTICS, IN CLASS 1 (U.S. CLS. 1, 5, 6, 10, 26 AND 46).

FOR: PLASTICS IN EXTRUDED FORM FOR USE IN MANUFACTURE; SYNTHETIC AND ARTIFICIAL RESINS (SEMI-PROCESSED); THERMOPLASTIC MATERIALS USED IN THE MANUFACTURE OF COMPOSITE MATERIALS, OF ANTI-CORROSION COATINGS, OF INJECTED MOLDED PARTS, OF FIRE AND CHEMICAL RESISTANT FILMS AND SHEETS, IN CLASS 17 (U.S. CLS. 1, 5, 12, 13, 35 AND 50).

THE MARK CONSISTS OF STANDARD CHARACTERS WITHOUT CLAIM TO ANY PARTICULAR FONT, STYLE, SIZE, OR COLOR.

PRIORITY CLAIMED UNDER SEC. 44(D) ON FRANCE APPLICATION NO. 11/3857573, FILED 9-9-2011, REG. NO. 11/3857573, DATED 9-9-2011, EXPIRES 9-9-2021.

SER. NO. 85-528,679, FILED 1-30-2012.

JACQUELINE A. LAVINE, EXAMINING ATTORNEY



*David J. Kyjars*

Director of the United States Patent and Trademark Office

# United States of America

United States Patent and Trademark Office

## CSET

**Reg. No. 4,198,477**

**Registered Aug. 28, 2012**

**Int. Cls.: 9, 41 and 42**

U.S. DEPARTMENT OF HOMELAND SECURITY (UNITED STATES AGENCY OF THE  
UNITED STATES GOVERNMENT)  
S&T AGC MAIL STOP 0205  
245 MURRAY LANE  
WASHINGTON, D.C., DC 205280205

**TRADEMARK**

**SERVICE MARK**

**PRINCIPAL REGISTER**

FOR: DOWNLOADABLE COMPUTER SOFTWARE FOR ASSESSING INFORMATION TECHNOLOGY AND INDUSTRIAL CONTROL SYSTEMS AND NETWORKS AGAINST INDUSTRY STANDARDS AND BEST PRACTICES TO ENHANCE AND/OR PROTECT CYBERSECURITY ASSETS, IN CLASS 9 (U.S. CLS. 21, 23, 26, 36 AND 38).

FIRST USE 9-1-2009; IN COMMERCE 9-1-2009.

FOR: TRAINING IN THE FIELD OF COMPUTER SOFTWARE, NAMELY, PROVIDING ONSITE TRAINING TO INDUSTRIAL CONTROL SYSTEM OWNERS, OPERATORS, INTEGRATORS, AND VENDORS IN USING COMPUTER SOFTWARE FOR ASSESSING INFORMATION TECHNOLOGY AND INDUSTRIAL CONTROL SYSTEMS AND NETWORKS AGAINST INDUSTRY STANDARDS AND BEST PRACTICES TO ENHANCE AND/OR PROTECT CYBERSECURITY ASSETS, IN CLASS 41 (U.S. CLS. 100, 101 AND 107).

FIRST USE 9-1-2009; IN COMMERCE 9-1-2009.

FOR: COMPUTER SOFTWARE CONSULTING IN THE FIELD OF COMPUTER SOFTWARE FOR ASSESSING INFORMATION TECHNOLOGY AND INDUSTRIAL CONTROL SYSTEMS AND NETWORKS AGAINST INDUSTRY STANDARDS AND BEST PRACTICES TO ENHANCE AND/OR PROTECT CYBERSECURITY ASSETS, IN CLASS 42 (U.S. CLS. 100 AND 101).

FIRST USE 9-1-2009; IN COMMERCE 9-1-2009.

THE MARK CONSISTS OF STANDARD CHARACTERS WITHOUT CLAIM TO ANY PARTICULAR FONT, STYLE, SIZE, OR COLOR.

SER. NO. 85-528,685, FILED 1-30-2012.

ROBIN CHOSID, EXAMINING ATTORNEY



*David J. Kyffers*

Director of the United States Patent and Trademark Office

# United States of America

United States Patent and Trademark Office

## DAYANI COLLECTION

**Reg. No. 4,198,478**

**Registered Aug. 28, 2012**

**Int. Cl.: 14**

**TRADEMARK**

**PRINCIPAL REGISTER**

SHY CREATION (CALIFORNIA CORPORATION)  
650 S HILL ST  
428  
LOS ANGELES, CA 90014

FOR: BRACELETS; BROACHES; BROOCHES; CHARMS; CHARMS FOR COLLAR JEWELRY AND BRACELET; DIAMOND JEWELRY; GEMSTONE JEWELRY; GOLD; GOLD, UNWORKED OR SEMI-WORKED; JEWELRY; JEWELRY AND IMITATION JEWELRY; JEWELRY BROOCHES; JEWELRY CHAINS; JEWELRY FOR ATTACHMENT TO CLOTHING; JEWELRY FOR THE HEAD; JEWELRY, NAMELY, CROSSES; JEWELRY, NAMELY, STONE PENDANTS; PINS BEING JEWELRY; PLATINUM; PRECIOUS AND SEMI-PRECIOUS CRYSTAL STONES AND BEADS FOR USE IN JEWELRY; RINGS; RINGS BEING JEWELRY; SILVER; STAINLESS STEEL JEWELRY BRACELETS; WATCHES AND JEWELRY; WOMEN'S JEWELRY, IN CLASS 14 (U.S. CLS. 2, 27, 28 AND 50).

FIRST USE 1-9-2012; IN COMMERCE 1-9-2012.

THE MARK CONSISTS OF STANDARD CHARACTERS WITHOUT CLAIM TO ANY PARTICULAR FONT, STYLE, SIZE, OR COLOR.

NO CLAIM IS MADE TO THE EXCLUSIVE RIGHT TO USE "COLLECTION", APART FROM THE MARK AS SHOWN.

SER. NO. 85-528,896, FILED 1-30-2012.

LEIGH CAROLINE CASE, EXAMINING ATTORNEY



*David J. Kypos*

Director of the United States Patent and Trademark Office

# United States of America

United States Patent and Trademark Office

# RoofLook

**Reg. No. 4,198,479**

WARDLAW CLAIMS SERVICE LLP (TEXAS PARTNERSHIP)  
2725 TEXAS CENTRAL PKWY  
WACO, TX 76712

**Registered Aug. 28, 2012**

**Int. Cl.: 36**

FOR: CLAIMS ADJUSTMENT IN THE FIELD OF INSURANCE, IN CLASS 36 (U.S. CLS. 100, 101 AND 102).

**SERVICE MARK**

FIRST USE 11-21-2011; IN COMMERCE 11-21-2011.

**PRINCIPAL REGISTER**

THE MARK CONSISTS OF STANDARD CHARACTERS WITHOUT CLAIM TO ANY PARTICULAR FONT, STYLE, SIZE, OR COLOR.

SER. NO. 85-529,079, FILED 1-30-2012.

REGINA DRUMMOND, EXAMINING ATTORNEY



*David J. Kybas*

Director of the United States Patent and Trademark Office

# United States of America

United States Patent and Trademark Office

# HYDRA-OIL

**Reg. No. 4,198,480**

**Registered Aug. 28, 2012**

**Int. Cl.: 3**

**TRADEMARK**

**PRINCIPAL REGISTER**

STANMAR INTERNATIONAL USA INC. (DELAWARE CORPORATION)  
F108  
6370 LUSK BLVD  
SAN DIEGO, CA 92121

FOR: PERSONAL CARE PRODUCTS, NAMELY, BODY OILS, NON-MEDICATED SKIN LOTIONS, SHOWER GEL, BEAUTY CREAMS FOR BODY CARE, BODY LOTIONS, ESSENTIAL OILS FOR USE AS NON-MEDICATED SKIN CARE PREPARATIONS AND FACIAL OILS, SKIN EMOLLIENTS, SCENTED BODY SPRAYS, SUNLESS TANNING LOTION FOR THE BODY, IN CLASS 3 (U.S. CLS. 1, 4, 6, 50, 51 AND 52).

FIRST USE 1-1-2012; IN COMMERCE 1-1-2012.

THE MARK CONSISTS OF STANDARD CHARACTERS WITHOUT CLAIM TO ANY PARTICULAR FONT, STYLE, SIZE, OR COLOR.

SER. NO. 85-529,106, FILED 1-30-2012.

MICHAEL WEBSTER, EXAMINING ATTORNEY



*David J. Kyffers*

Director of the United States Patent and Trademark Office

# United States of America

United States Patent and Trademark Office

## WHAT'S YOUR RATIO?

**Reg. No. 4,198,481**

**Registered Aug. 28, 2012**

**Int. Cl.: 5**

**TRADEMARK**

**PRINCIPAL REGISTER**

ANTI-AGING ESSENTIALS, INC. (PENNSYLVANIA CORPORATION), DBA METRA GENIX CORPORATION  
4010 MUIRFIELD DRIVE  
PRESTO, PA 15142

FOR: DIETARY AND NUTRITIONAL SUPPLEMENTS; NUTRITIONAL SUPPLEMENT ENERGY BARS; NUTRITIONAL SUPPLEMENTS; PROTEIN SUPPLEMENTS, IN CLASS 5 (U.S. CLS. 6, 18, 44, 46, 51 AND 52).

FIRST USE 1-9-2012; IN COMMERCE 1-9-2012.

THE MARK CONSISTS OF STANDARD CHARACTERS WITHOUT CLAIM TO ANY PARTICULAR FONT, STYLE, SIZE, OR COLOR.

SER. NO. 85-529,692, FILED 1-31-2012.

ANDREA K. NADELMAN, EXAMINING ATTORNEY



*David J. Kyffers*

Director of the United States Patent and Trademark Office



# United States of America

United States Patent and Trademark Office

## CODE BLUE

**Reg. No. 4,198,482**

STARBUZZ TOBACCO, INC. (CALIFORNIA CORPORATION)  
2116 W. LINCOLN AVENUE  
ANAHEIM, CA 92801

**Registered Aug. 28, 2012**

**Int. Cl.: 34**

FOR: PIPE TOBACCO; MOLASSES TOBACCO; TOBACCO; SMOKING TOBACCO;  
FLAVORED TOBACCO, IN CLASS 34 (U.S. CLS. 2, 8, 9 AND 17).

**TRADEMARK**

FIRST USE 1-26-2012; IN COMMERCE 1-26-2012.

**PRINCIPAL REGISTER**

THE MARK CONSISTS OF STANDARD CHARACTERS WITHOUT CLAIM TO ANY PARTICULAR FONT, STYLE, SIZE, OR COLOR.

OWNER OF U.S. REG. NOS. 3,619,407, 3,815,043 AND OTHERS.

SER. NO. 85-529,856, FILED 1-31-2012.

SAIMA MAKHDOOM, EXAMINING ATTORNEY



*David J. Kybas*

Director of the United States Patent and Trademark Office

# United States of America

United States Patent and Trademark Office

# AREALAV

**Reg. No. 4,198,483**

LAERA, VITO (UNITED STATES INDIVIDUAL)  
5960 SW 32 TERRACE

**Registered Aug. 28, 2012**

FORT LAUDERDALE, FL 33312

**Int. Cl.: 11**

FOR: ANTI-SPLASH TAP NOZZLES; AUTOMATIC FAUCETS; BATH TUB JETS; BATH TUBS; BATH TUBS AND SHOWER TRAYS; BATHROOM EXHAUST FANS; BATHS, BATHTUBS, WHIRLPOOL BATHS AND BATH INSTALLATIONS; FAUCET AERATORS; FAUCET HANDLES; FAUCET SPRAYERS; FAUCETS; HOT TUB JETS; HOT TUBS; KITCHEN SINK SPRAYERS; KITCHEN SINKS; LAVATORIES; LAVATORY BOWLS; LAVATORY SEATS; MIXER FAUCETS FOR WATER PIPES; PLUMBING FITTINGS, NAMELY, AERATORS FOR FAUCETS; PLUMBING FITTINGS, NAMELY, FAUCET FILTERS; PLUMBING FITTINGS, NAMELY, SINK STRAINERS; PLUMBING FITTINGS, NAMELY, TUB CONTROL VALVES; PLUMBING FIXTURES, NAMELY, SINK SPRAYERS; PLUMBING FIXTURES, NAMELY, SINK TRAPS; PLUMBING SUPPLIES, NAMELY, SINK STRAINERS; SAUNA BATH INSTALLATIONS; SHOWER AND BATH CUBICLES; SHOWER FAUCET EXTENSIONS; SHOWER TUBS; SINGLE LEVER FIXTURES FOR LAVATORIES AND SINKS; SINK DRAINER SYSTEM COMPRISED OF A DRAIN TRAY, SINK MOUNT, KICK STAND AND ROD; SINK PEDESTALS; SINKS; SINKS INTEGRATED INTO COUNTERS OR COUNTER-TOPS; STAINLESS STEEL BOTTOM GRIDS SPECIALLY ADAPTED AND SHAPED FOR USE IN SINKS; TAP WATER FAUCETS; TAP-WATER PURIFYING APPARATUS; TAPS; TAPS FOR WASHSTANDS; TUB PARTS, NAMELY, TUB OVERFLOWS; TUB PARTS, NAMELY, TUB WASTES; TUB SPOUTS; WATER FAUCET SPOUT; WHIRLPOOL BATHS, IN CLASS 11 (U.S. CLS. 13, 21, 23, 31 AND 34).

**TRADEMARK**

**PRINCIPAL REGISTER**



FIRST USE 1-1-2007; IN COMMERCE 1-1-2007.

THE MARK CONSISTS OF STANDARD CHARACTERS WITHOUT CLAIM TO ANY PARTICULAR FONT, STYLE, SIZE, OR COLOR.

THE WORDING "AREALAV" HAS NO MEANING IN A FOREIGN LANGUAGE.

SER. NO. 85-530,905, FILED 2-1-2012.

WON TEAK OH, EXAMINING ATTORNEY

*David J. Kypos*

Director of the United States Patent and Trademark Office

# United States of America

United States Patent and Trademark Office

# YTRANSFER

**Reg. No. 4,198,484**

ALTIUS EDUCATION, INC. (DELAWARE CORPORATION)  
345 CALIFORNIA STREET, SUITE 1200  
SAN FRANCISCO, CA 94104

**Registered Aug. 28, 2012**

**Int. Cl.: 41**

FOR: EDUCATIONAL SERVICES, NAMELY, PROVIDING ON-LINE INFORMATION AND COUNSELING ABOUT ENROLLING IN COLLEGE AND TRANSFERRING BETWEEN COLLEGES AND UNIVERSITIES, IN CLASS 41 (U.S. CLS. 100, 101 AND 107).

**SERVICE MARK**

FIRST USE 11-29-2011; IN COMMERCE 11-29-2011.

**PRINCIPAL REGISTER**

THE MARK CONSISTS OF STANDARD CHARACTERS WITHOUT CLAIM TO ANY PARTICULAR FONT, STYLE, SIZE, OR COLOR.

SER. NO. 85-530,938, FILED 2-1-2012.

KAREN K. BUSH, EXAMINING ATTORNEY



*David J. Kybas*

Director of the United States Patent and Trademark Office

United States of America  
United States Patent and Trademark Office

yTransfer

**Reg. No. 4,198,485**

ALTIVUS EDUCATION, INC. (DELAWARE CORPORATION)  
345 CALIFORNIA STREET, SUITE 1200  
SAN FRANCISCO, CA 94104

**Registered Aug. 28, 2012**

**Int. Cl.: 41**

FOR: EDUCATIONAL SERVICES, NAMELY, PROVIDING ON-LINE INFORMATION AND COUNSELING ABOUT ENROLLING IN COLLEGE AND TRANSFERRING BETWEEN COLLEGES AND UNIVERSITIES, IN CLASS 41 (U.S. CLS. 100, 101 AND 107).

**SERVICE MARK**

FIRST USE 11-29-2011; IN COMMERCE 11-29-2011.

**PRINCIPAL REGISTER**

THE MARK CONSISTS OF STYLIZED LOWER CASE "Y" IN FRONT OF WORD "TRANSFER" WITH TOP OF CAPITAL LETTER "T" BEING AN ARROW FACING LEFT AND TOP RIGHT PART OF LOWER CASE "R" BEING AN ARROW FACING RIGHT.

SER. NO. 85-530,940, FILED 2-1-2012.

KAREN K. BUSH, EXAMINING ATTORNEY



*David J. Kyffers*

Director of the United States Patent and Trademark Office

# United States of America

United States Patent and Trademark Office

## ELLA CYCLE

**Reg. No. 4,198,486**

**Registered Aug. 28, 2012**

**Int. Cls.: 5, 29, 30, 32  
and 40**

**TRADEMARK**

**SERVICE MARK**

**PRINCIPAL REGISTER**

ELLA'S KITCHEN (IP) LIMITED (UNITED KINGDOM COMPANY)  
C/O 2020 CHARTERED ACCOUNTANTS  
1 ST. ANDREW'S HILL  
LONDON, UNITED KINGDOM EC4V5BY

FOR: FOOD FOR BABIES; CEREALS FOR BABIES; BEVERAGES FOR BABIES, IN CLASS 5 (U.S. CLS. 6, 18, 44, 46, 51 AND 52).

FOR: MEAT, FISH, POULTRY AND GAME; MEAT EXTRACTS; PRESERVED, DRIED AND COOKED FRUITS AND VEGETABLES; JELLIES, JAMS, COMPOTES; EGGS, MILK AND MILK PRODUCTS, EXCLUDING ICE CREAM, ICE MILK AND FROZEN YOGURTS; EDIBLE OILS AND FATS; PREPARED MEALS CONSISTING PRIMARILY OF MEAT, FISH, POULTRY OR VEGETABLES; SOUPS AND POTATO CRISPS; PRESERVED, FROZEN, DRIED AND COOKED FRUITS AND VEGETABLES; FRUIT PUREES; VEGETABLE PUREES; PREPARED MEALS AND SNACKS CONTAINING ANY OF THE AFORESAID GOODS, NAMELY FRUIT-BASED SNACK FOODS, VEGETABLE-BASED SNACK FOODS, IN CLASS 29 (U.S. CL. 46).

FOR: COFFEE, TEA, COCOA, SUGAR, RICE, TAPIOCA, SAGO, ARTIFICIAL COFFEE; PREPARATIONS MADE FROM CEREALS, NAMELY, READY TO EAT CEREALS; BREAD, PASTRY AND CONFECTIONERY MADE OF SUGAR, EDIBLE ICES; HONEY, TREACLE; YEAST, BAKING-POWDER; SALT, MUSTARD; VINEGAR, SAUCES AS CONDIMENTS, NAMELY, KETCHUP, SALSA; SPICES; ICE; ICE-CREAM; CHOCOLATE; BISCUITS; COOKIES; PIES; PIZZAS; PASTA; PASTA SAUCES; FROZEN, PREPARED OR PACKAGED PASTA DISHES CONSISTING PRIMARILY OF PASTA; ICE-CREAM BARS; COOKING SAUCES; SANDWICHES; PREPARED MEALS CONSISTING PRIMARILY OF PASTA OR RICE; MAIZE, CORN AND RICE-BASED SNACK FOODS; PREPARATIONS MADE FROM RICE, NAMELY RICE-BASED SNACK FOODS, BREAKFAST CEREALS MADE FROM RICE; RICE FLOUR; PREPARATIONS MADE FROM RICE FLOUR, NAMELY, PASTA; BREAKFAST CEREALS; CEREAL BASED FOODSTUFFS, NAMELY CEREAL-DERIVED FOOD BARS; BREAKFAST CEREAL CONTAINING FRUIT; PREPARED MEALS AND SNACKS CONTAINING ANY OF THE AFORESAID GOODS, IN CLASS 30 (U.S. CL. 46).

FOR: MINERAL AND AERATED WATER; FRUIT DRINKS AND FRUIT JUICES; CONCENTRATES, SYRUPS OR POWDERS USED IN THE PREPARATION OF SOFT DRINKS; FRUIT SMOOTHIES; LEMONADES; COLAS; NON-ALCOHOLIC CORDIALS; BARLEY WATERS, IN CLASS 32 (U.S. CLS. 45, 46 AND 48).



*David J. Kyffers*

Director of the United States Patent and Trademark Office

**Reg. No. 4,198,486** FOR: TREATMENT OF MATERIALS IN CONNECTION WITH RECYCLING; TREATMENT OF MATERIALS IN CONNECTION WITH RECYCLING AS A CHARITABLE SERVICE FOR CHARITY; INFORMATION, ADVISORY AND CONSULTANCY SERVICES IN CONNECTION WITH ALL OF THE AFORESAID SERVICES, IN CLASS 40 (U.S. CLS. 100, 103 AND 106).

THE MARK CONSISTS OF STANDARD CHARACTERS WITHOUT CLAIM TO ANY PARTICULAR FONT, STYLE, SIZE, OR COLOR.

OWNER OF UNITED KINGDOM REG. NO. 010134674, DATED 12-22-2011, EXPIRES 7-19-2021.

OWNER OF U.S. REG. NOS. 3,784,824 AND 4,014,812.

SER. NO. 85-531,134, FILED 2-1-2012.

CARYN GLASSER, EXAMINING ATTORNEY

# United States of America

United States Patent and Trademark Office

## HODGES TRUCKING COMPANY

**Reg. No. 4,198,487**

CHESAPEAKE ENERGY CORPORATION (OKLAHOMA CORPORATION)  
6100 N. WESTERN AVENUE  
OKLAHOMA CITY, OK 73118

**Registered Aug. 28, 2012**

**Int. Cl.: 39**

FOR: OILFIELD AND HEAVY HAUL TRANSPORTATION, NAMELY, TRANSPORT BY TRUCK AND MOVING GOODS BY CRANE, IN CLASS 39 (U.S. CLS. 100 AND 105).

**SERVICE MARK**

FIRST USE 1-5-2006; IN COMMERCE 1-5-2006.

**PRINCIPAL REGISTER**

THE MARK CONSISTS OF STANDARD CHARACTERS WITHOUT CLAIM TO ANY PARTICULAR FONT, STYLE, SIZE, OR COLOR.

NO CLAIM IS MADE TO THE EXCLUSIVE RIGHT TO USE "TRUCKING COMPANY", APART FROM THE MARK AS SHOWN.

SEC. 2(F).

SER. NO. 85-532,601, FILED 2-2-2012.

KATHERINE CHANG, EXAMINING ATTORNEY



*David J. Kyffers*

Director of the United States Patent and Trademark Office

# United States of America

United States Patent and Trademark Office



**Reg. No. 4,198,488**

**Registered Aug. 28, 2012**

**Int. Cl.: 42**

**SERVICE MARK**

**PRINCIPAL REGISTER**

ATHENS CONSULTING, LLC (CALIFORNIA LIMITED LIABILITY COMPANY)  
SUITE 300  
225 SOUTH LAKE AVENUE  
PASADENA, CA 91101

FOR: ENGINEERING DESIGN SERVICES; PRODUCT DEVELOPMENT AND ENGINEERING SERVICES FOR OTHERS, IN CLASS 42 (U.S. CLS. 100 AND 101).

FIRST USE 10-24-2008; IN COMMERCE 10-24-2008.

THE MARK CONSISTS OF A STYLIZED LETTER "A".

SER. NO. 85-532,613, FILED 2-2-2012.

ESTHER BELENKER, EXAMINING ATTORNEY



*David J. Kyjars*

Director of the United States Patent and Trademark Office



# United States of America

United States Patent and Trademark Office

# SCENTREND

**Reg. No. 4,198,489**

SCENTSY, INC. (IDAHO CORPORATION)  
P. O. BOX 1335  
MERIDIAN, ID 83680

**Registered Aug. 28, 2012**

**Int. Cl.: 4**

FOR: SCENTED WAX IN THE FORM OF BARS AND CHIPS FOR USE IN CANDLE WARMERS, IN CLASS 4 (U.S. CLS. 1, 6 AND 15).

**TRADEMARK**

FIRST USE 2-1-2012; IN COMMERCE 2-1-2012.

**PRINCIPAL REGISTER**

NO CLAIM IS MADE TO THE EXCLUSIVE RIGHT TO USE "SCENT TREND", APART FROM THE MARK AS SHOWN.

THE MARK CONSISTS OF A STYLIZED DESIGN OF A RECTANGLE WITH A CURVED STRIPE IN THE CENTER, TO THE RIGHT OF THE RECTANGLE IS THE STYLIZED WORD "SCENTREND".

SER. NO. 85-532,645, FILED 2-2-2012.

MARY CRAWFORD, EXAMINING ATTORNEY



*David J. Kybas*

Director of the United States Patent and Trademark Office

# United States of America

United States Patent and Trademark Office

# HIDDEN

**Reg. No. 4,198,490**

KINGDOM ANIMALIA, LLC (CALIFORNIA LIMITED LIABILITY COMPANY)  
1401 MAIN STREET  
VENICE, CA 90291

**Registered Aug. 28, 2012**

**Int. Cl.: 3**

FOR: COSMETICS, NAMELY, A TINTED FACIAL CREAM TO CONCEAL FACIAL LINES, CIRCLES AND BLEMISHES, IN CLASS 3 (U.S. CLS. 1, 4, 6, 50, 51 AND 52).

**TRADEMARK**

FIRST USE 0-0-2004; IN COMMERCE 0-0-2004.

**PRINCIPAL REGISTER**

THE MARK CONSISTS OF STANDARD CHARACTERS WITHOUT CLAIM TO ANY PARTICULAR FONT, STYLE, SIZE, OR COLOR.

SER. NO. 85-533,087, FILED 2-3-2012.

MARILYN IZZI, EXAMINING ATTORNEY



*David J. Kyffers*

Director of the United States Patent and Trademark Office

# United States of America

United States Patent and Trademark Office

# CONTROL IT.

**Reg. No. 4,198,491**

**Registered Aug. 28, 2012**

**Int. Cl.: 36**

**SERVICE MARK**

**PRINCIPAL REGISTER**

T. ROWE PRICE GROUP, INC. (MARYLAND CORPORATION)  
100 EAST PRATT STREET  
BALTIMORE, MD 21202

FOR: FINANCIAL ADMINISTRATION OF RETIREMENT PLANS FOR RETIREMENT PLAN PROVIDERS AND RETIREMENT PLAN PARTICIPANTS, IN CLASS 36 (U.S. CLS. 100, 101 AND 102).

FIRST USE 2-15-2012; IN COMMERCE 2-15-2012.

THE MARK CONSISTS OF STANDARD CHARACTERS WITHOUT CLAIM TO ANY PARTICULAR FONT, STYLE, SIZE, OR COLOR.

SER. NO. 85-533,190, FILED 2-3-2012.

ELIZABETH HUGHITT, EXAMINING ATTORNEY



*David J. Kyffers*

Director of the United States Patent and Trademark Office

# United States of America

United States Patent and Trademark Office

# 846

**Reg. No. 4,198,492**

CHROMAFLO TECHNOLOGIES CORPORATION (OHIO CORPORATION)  
2600 MICHIGAN AVENUE  
ASHTABULA, OH 44004

**Registered Aug. 28, 2012**

**Int. Cl.: 2**

FOR: COLORANT DISPERSIONS FOR USE IN SURFACE COATING COMPOSITIONS, IN CLASS 2 (U.S. CLS. 6, 11 AND 16).

**TRADEMARK**

FIRST USE 8-10-2011; IN COMMERCE 8-10-2011.

**PRINCIPAL REGISTER**

THE MARK CONSISTS OF STANDARD CHARACTERS WITHOUT CLAIM TO ANY PARTICULAR FONT, STYLE, SIZE, OR COLOR.

SER. NO. 85-533,367, FILED 2-3-2012.

AMY KELLY, EXAMINING ATTORNEY



*David J. Kyros*

Director of the United States Patent and Trademark Office

# United States of America

United States Patent and Trademark Office

# 897

**Reg. No. 4,198,493**

CHROMAFLO TECHNOLOGIES CORPORATION (OHIO CORPORATION)  
2600 MICHIGAN AVENUE  
ASHTABULA, OH 44004

**Registered Aug. 28, 2012**

**Int. Cl.: 2**

FOR: COLORANT DISPERSIONS FOR USE IN SURFACE COATING COMPOSITIONS, IN CLASS 2 (U.S. CLS. 6, 11 AND 16).

**TRADEMARK**

FIRST USE 9-27-2011; IN COMMERCE 9-27-2011.

**PRINCIPAL REGISTER**

THE MARK CONSISTS OF STANDARD CHARACTERS WITHOUT CLAIM TO ANY PARTICULAR FONT, STYLE, SIZE, OR COLOR.

SER. NO. 85-533,415, FILED 2-3-2012.

AMY KELLY, EXAMINING ATTORNEY



*David J. Kyros*

Director of the United States Patent and Trademark Office

# United States of America

United States Patent and Trademark Office

# Vignette

**Reg. No. 4,198,494**

**Registered Aug. 28, 2012**

**Int. Cl.: 33**

**TRADEMARK**

**PRINCIPAL REGISTER**

SPARKLING OREGON, LLC (OREGON LIMITED LIABILITY COMPANY), DBA R. STUART  
& CO.  
SUITE #100  
845 NE FIFTH STREET  
MCMINNVILLE, OR 97128

FOR: GRAPE WINE; RED WINE; RED WINES; WINE; WINES, IN CLASS 33 (U.S. CLS. 47  
AND 49).

FIRST USE 1-15-2012; IN COMMERCE 1-15-2012.

THE MARK CONSISTS OF STANDARD CHARACTERS WITHOUT CLAIM TO ANY PAR-  
TICULAR FONT, STYLE, SIZE, OR COLOR.

SER. NO. 85-535,072, FILED S.R. 2-6-2012 AM. P.R. 4-18-2012.

BARBARA A. GOLD, EXAMINING ATTORNEY



*David J. Kyffers*

Director of the United States Patent and Trademark Office

**United States of America**  
United States Patent and Trademark Office

# GO-STAT

**Reg. No. 4,198,495**

GOEX CORPORATION (WISCONSIN CORPORATION)  
2532 FOSTER AVENUE  
JANESVILLE, WI 53545

**Registered Aug. 28, 2012**

**Int. Cl.: 2**

FOR: COATINGS IN THE NATURE OF ELECTRICAL STATIC DISSIPATE COATING FOR PLASTICS, IN CLASS 2 (U.S. CLS. 6, 11 AND 16).

**TRADEMARK**

FIRST USE 9-8-2000; IN COMMERCE 9-8-2000.

**PRINCIPAL REGISTER**

THE MARK CONSISTS OF STANDARD CHARACTERS WITHOUT CLAIM TO ANY PARTICULAR FONT, STYLE, SIZE, OR COLOR.

SER. NO. 85-535,155, FILED 2-6-2012.

KIMBERLY FRYE, EXAMINING ATTORNEY



*David J. Kybas*

Director of the United States Patent and Trademark Office

# United States of America

United States Patent and Trademark Office

## WHERE SUSTAINABLE CHEMISTRY MAKES THE DIFFERENCE

**Reg. No. 4,198,496**

**Registered Aug. 28, 2012**

**Int. Cls.: 17 and 19**

**TRADEMARK**

**PRINCIPAL REGISTER**

COOLEY GROUP HOLDINGS, INC. (DELAWARE CORPORATION)  
50 ESTEN AVENUE  
PAWTUCKET, RI 02862

FOR: POLYMER MATERIALS AND MEMBRANES AND REINFORCED POLYMER SUBSTRATES IN THE FORM OF SHEETS, RODS, FILMS, USED IN THE MANUFACTURE OF PROTECTIVE COVERINGS AND LINERS, LINERS FOR INDUSTRIAL TANKS, RESERVOIRS, PONDS, GROUND COVERS, GRAIN COVERS, INDUSTRIAL CURTAINS, ENVIRONMENTAL LINERS, AND THE LIKE; POLYMER MATERIALS AND MEMBRANES AND REINFORCED POLYMER SUBSTRATES IN THE FORM OF SHEETS, RODS, FILMS, FOR GENERAL INDUSTRIAL USE AND FOR USE IN THE MANUFACTURE OF SAFETY EQUIPMENT AND MEDICAL DEVICES; POLYMER SUBSTRATES FOR USE IN THE MANUFACTURE OF AWNINGS, SIGNS AND BILLBOARDS, BANNERS, DIGITAL IMAGING AND PRINTING APPLICATIONS, IN CLASS 17 (U.S. CLS. 1, 5, 12, 13, 35 AND 50).

FIRST USE 1-0-2012; IN COMMERCE 1-0-2012.

FOR: ROOFING MEMBRANES, IN CLASS 19 (U.S. CLS. 1, 12, 33 AND 50).

FIRST USE 1-0-2012; IN COMMERCE 1-0-2012.

THE MARK CONSISTS OF STANDARD CHARACTERS WITHOUT CLAIM TO ANY PARTICULAR FONT, STYLE, SIZE, OR COLOR.

OWNER OF U.S. REG. NO. 3,159,327.

SER. NO. 85-535,729, FILED 2-7-2012.

COURTNEY ALVAREZ, EXAMINING ATTORNEY



*David J. Kyffers*

Director of the United States Patent and Trademark Office



# United States of America

United States Patent and Trademark Office



**Reg. No. 4,198,497**

ISLE OF CAPRI CASINOS, INC. (DELAWARE CORPORATION)  
600 EMERSON ROAD, SUITE 300  
ST. LOUIS, MO 63141

**Registered Aug. 28, 2012**

**Int. Cl.: 43**

FOR: BAR SERVICES; RESTAURANT SERVICES, IN CLASS 43 (U.S. CLS. 100 AND 101).

**SERVICE MARK**

FIRST USE 7-3-2009; IN COMMERCE 7-3-2009.

**PRINCIPAL REGISTER**

NO CLAIM IS MADE TO THE EXCLUSIVE RIGHT TO USE "BUFFET", APART FROM THE MARK AS SHOWN.

THE MARK CONSISTS OF THE WORDS "THE BUFFET" WITH THE WORD BUFFET UNDERLINED AND THE IMAGE OF A KNIFE REPRESENTING EACH LETTER "F" IN THE WORD "BUFFET".

SER. NO. 85-535,932, FILED 2-7-2012.

RAMONA ORTIGA, EXAMINING ATTORNEY



*David J. Kyffers*

Director of the United States Patent and Trademark Office

# United States of America

United States Patent and Trademark Office

## DORMA PURE

**Reg. No. 4,198,498**

**Registered Aug. 28, 2012**

**Int. Cl.: 6**

**TRADEMARK**

**PRINCIPAL REGISTER**

DORMA DOOR CONTROLS, INC. (PENNSYLVANIA CORPORATION)  
DORMA DRIVE  
REAMSTOWN, PA 17567

FOR: GLASS DOOR HARDWARE, NAMELY, METAL RAILS, FRAMES AND CLAMPS;  
DOOR AND WINDOW HARDWARE, NAMELY, HINGES, SLIDES, DAMPERS, IN CLASS  
6 (U.S. CLS. 2, 12, 13, 14, 23, 25 AND 50).

FIRST USE 1-30-2012; IN COMMERCE 1-30-2012.

THE MARK CONSISTS OF STANDARD CHARACTERS WITHOUT CLAIM TO ANY PAR-  
TICULAR FONT, STYLE, SIZE, OR COLOR.

OWNER OF U.S. REG. NOS. 1,557,624, 2,655,540 AND OTHERS.

SER. NO. 85-535,962, FILED 2-7-2012.

BARBARA BROWN, EXAMINING ATTORNEY



*David J. Kyffers*

Director of the United States Patent and Trademark Office

# United States of America

United States Patent and Trademark Office

## SMASHBOX CLICK YOU'RE IT

**Reg. No. 4,198,499**

DJF ENTERPRISES (CALIFORNIA CORPORATION)  
767 FIFTH AVENUE  
NEW YORK, NY 10153

**Registered Aug. 28, 2012**

**Int. Cl.: 3**

FOR: COSMETICS, IN CLASS 3 (U.S. CLS. 1, 4, 6, 50, 51 AND 52).

**TRADEMARK**

FIRST USE 9-8-2011; IN COMMERCE 9-8-2011.

**PRINCIPAL REGISTER**

THE MARK CONSISTS OF STANDARD CHARACTERS WITHOUT CLAIM TO ANY PARTICULAR FONT, STYLE, SIZE, OR COLOR.

OWNER OF U.S. REG. NOS. 2,392,373, 4,088,078 AND OTHERS.

SER. NO. 85-536,000, FILED 2-7-2012.

BARBARA BROWN, EXAMINING ATTORNEY



*David J. Kyffers*

Director of the United States Patent and Trademark Office

**United States of America**  
United States Patent and Trademark Office

# ECO CLOUD

**Reg. No. 4,198,500**

**Registered Aug. 28, 2012**

**Int. Cl.: 22**

**TRADEMARK**

**PRINCIPAL REGISTER**

ENCOMPASS GROUP, LLC (DELAWARE LIMITED LIABILITY COMPANY), DBA THE  
PILLOW FACTORY  
165 MACON STREET  
MCDONOUGH, GA 30253

FOR: FIBERFILL, IN CLASS 22 (U.S. CLS. 1, 2, 7, 19, 22, 42 AND 50).

FIRST USE 1-0-2012; IN COMMERCE 1-0-2012.

THE MARK CONSISTS OF STANDARD CHARACTERS WITHOUT CLAIM TO ANY PARTICULAR FONT, STYLE, SIZE, OR COLOR.

SER. NO. 85-536,226, FILED 2-7-2012.

ROBIN MITTLER, EXAMINING ATTORNEY



*David J. Kybas*

Director of the United States Patent and Trademark Office

# United States of America

United States Patent and Trademark Office

## GABA SOOTHE

**Reg. No. 4,198,501**

JARROW FORMULAS, INC. (CALIFORNIA CORPORATION)  
1824 SOUTH ROBERTSON BLVD.  
LOS ANGELES, CA 90035

**Registered Aug. 28, 2012**

**Int. Cl.: 5**

FOR: DIETARY AND NUTRITIONAL SUPPLEMENTS CONTAINING GAMMA-AMINOBUTYRIC ACID (GABA), IN CLASS 5 (U.S. CLS. 6, 18, 44, 46, 51 AND 52).

**TRADEMARK**

FIRST USE 6-0-2010; IN COMMERCE 6-0-2010.

**PRINCIPAL REGISTER**

THE MARK CONSISTS OF STANDARD CHARACTERS WITHOUT CLAIM TO ANY PARTICULAR FONT, STYLE, SIZE, OR COLOR.

NO CLAIM IS MADE TO THE EXCLUSIVE RIGHT TO USE "GABA", APART FROM THE MARK AS SHOWN.

SER. NO. 85-537,156, FILED 2-8-2012.

TOBY BULLOFF, EXAMINING ATTORNEY



*David J. Kyffers*

Director of the United States Patent and Trademark Office

# United States of America

United States Patent and Trademark Office

# Safe-Lok

**Reg. No. 4,198,502**

ZIRC COMPANY (MINNESOTA CORPORATION)  
3918 HIGHWAY 55 SE  
BUFFALO, MN 55313

**Registered Aug. 28, 2012**

**Int. Cl.: 10**

FOR: PLASTIC COVERS THAT LOCK ONTO DENTAL SET-UP TRAYS AND PROCEDURE TUBS TO CONTAIN ITEMS DURING TRANSPORT BETWEEN OPERATORY AND STERILIZATION AREAS, IN CLASS 10 (U.S. CLS. 26, 39 AND 44).

**TRADEMARK**

FIRST USE 12-14-2011; IN COMMERCE 12-14-2011.

**PRINCIPAL REGISTER**

THE MARK CONSISTS OF STANDARD CHARACTERS WITHOUT CLAIM TO ANY PARTICULAR FONT, STYLE, SIZE, OR COLOR.

SER. NO. 85-537,302, FILED 2-8-2012.

WENDY JUN, EXAMINING ATTORNEY



*David J. Kyfos*

Director of the United States Patent and Trademark Office

# United States of America

United States Patent and Trademark Office

## KEY COMMUNITY MORTGAGE

**Reg. No. 4,198,503**

KEYCORP (OHIO CORPORATION)  
127 PUBLIC SQUARE  
CLEVELAND, OH 44114

**Registered Aug. 28, 2012**

**Int. Cl.: 36**

FOR: MORTGAGE SERVICES, NAMELY, MORTGAGE LENDING AND MORTGAGE CONSULTATION SERVICES, IN CLASS 36 (U.S. CLS. 100, 101 AND 102).

**SERVICE MARK**

FIRST USE 9-12-2008; IN COMMERCE 9-12-2008.

**PRINCIPAL REGISTER**

THE MARK CONSISTS OF STANDARD CHARACTERS WITHOUT CLAIM TO ANY PARTICULAR FONT, STYLE, SIZE, OR COLOR.

OWNER OF U.S. REG. NOS. 3,133,175, 3,378,224 AND OTHERS.

NO CLAIM IS MADE TO THE EXCLUSIVE RIGHT TO USE "COMMUNITY MORTGAGE", APART FROM THE MARK AS SHOWN.

SER. NO. 85-537,584, FILED 2-8-2012.

SAMUEL E. SHARPER JR., EXAMINING ATTORNEY



*David J. Kyffers*

Director of the United States Patent and Trademark Office

# United States of America

United States Patent and Trademark Office

## TIGER & BONE

**Reg. No. 4,198,504**

**Registered Aug. 28, 2012**

**Int. Cl.: 5**

**TRADEMARK**

**PRINCIPAL REGISTER**

OCHO RIOS HOLDING CORP. (FLORIDA CORPORATION)  
9956 SW 155 CT  
MIAMI, FL 33196

FOR: DIETARY SUPPLEMENTS, IN CLASS 5 (U.S. CLS. 6, 18, 44, 46, 51 AND 52).

FIRST USE 6-12-1998; IN COMMERCE 6-12-1998.

THE MARK CONSISTS OF STANDARD CHARACTERS WITHOUT CLAIM TO ANY PARTICULAR FONT, STYLE, SIZE, OR COLOR.

SER. NO. 85-537,585, FILED 2-8-2012.

ALYSSA STEEL, EXAMINING ATTORNEY



*David J. Kyffers*

Director of the United States Patent and Trademark Office



United States of America  
United States Patent and Trademark Office

# HEADSHED

**Reg. No. 4,198,505**

HEADBLADE, INC. (CALIFORNIA CORPORATION)  
3623 EASTHAM DRIVE  
CULVER CITY, CA 90232

**Registered Aug. 28, 2012**

**Int. Cl.: 3**

FOR: TOILETRIES, NAMELY, SHAVING CREAM, MOISTURIZING CREAM, SOAPS, SUNSCREEN CREAM, BODY WASH, SELF-TANNING PREPARATIONS, WIPES IMPREGNATED WITH A CLEANING PREPARATION AND AFTER-TAN MOISTURIZER, IN CLASS 3 (U.S. CLS. 1, 4, 6, 50, 51 AND 52).

**TRADEMARK**

**PRINCIPAL REGISTER**

FIRST USE 10-0-2006; IN COMMERCE 10-0-2006.

THE MARK CONSISTS OF STANDARD CHARACTERS WITHOUT CLAIM TO ANY PARTICULAR FONT, STYLE, SIZE, OR COLOR.

SER. NO. 85-537,703, FILED 2-8-2012.

PAM WILLIS, EXAMINING ATTORNEY



*David J. Kyffers*

Director of the United States Patent and Trademark Office

# United States of America

United States Patent and Trademark Office

# KUDOCASE

**Reg. No. 4,198,506**

WIRELESS NRG, LLC (FLORIDA LIMITED LIABILITY COMPANY)  
1890 NW 95TH AVENUE  
MIAMI, FL 33172

**Registered Aug. 28, 2012**

**Int. Cl.: 9**

FOR: CARRYING CASES FOR ELECTRONIC EQUIPMENT, NAMELY, TABLET COMPUTERS, ELECTRONIC READERS, AND CELL PHONES; CARRYING CASES, HOLDERS, PROTECTIVE CASES AND STANDS FEATURING POWER SUPPLY CONNECTORS, ADAPTORS, SPEAKERS AND BATTERY CHARGING DEVICES, SPECIALLY ADAPTED FOR USE WITH HANDHELD DIGITAL ELECTRONIC DEVICES; PHOTOVOLTAIC SOLAR MODULES FOR PRODUCTION OF ELECTRICITY; RENEWABLE BATTERY SYSTEM TO PROVIDE BACKUP POWER, IN CLASS 9 (U.S. CLS. 21, 23, 26, 36 AND 38).

**TRADEMARK**

**PRINCIPAL REGISTER**

FIRST USE 1-20-2012; IN COMMERCE 2-2-2012.

THE MARK CONSISTS OF STANDARD CHARACTERS WITHOUT CLAIM TO ANY PARTICULAR FONT, STYLE, SIZE, OR COLOR.

SER. NO. 85-537,743, FILED 2-8-2012.

ROBERT C. CLARK JR., EXAMINING ATTORNEY



*David J. Kyffers*

Director of the United States Patent and Trademark Office

# United States of America

United States Patent and Trademark Office



**Reg. No. 4,198,507**

**Registered Aug. 28, 2012**

**COLLECTIVE  
MEMBERSHIP**

**PRINCIPAL REGISTER**

IPC INTERNATIONAL, INC. (NEW YORK NON-PROFIT CORPORATION)  
SUITE 309 S  
3000 LAKE SIDE DRIVE  
BANNOCKBURN, IL 60015

FOR: INDICATING MEMBERSHIP IN AN ORGANIZATION THAT PROMOTES THE INTERESTS OF THE PRINTED CIRCUIT BOARD MANUFACTURING AND DESIGN INDUSTRY AND THE ELECTRONICS MANUFACTURING INDUSTRY, IN CLASS 200 (U.S. CL. 200).

FIRST USE 1-0-2009; IN COMMERCE 1-0-2009.

OWNER OF U.S. REG. NOS. 2,324,147, 3,040,611 AND OTHERS.

THE MARK CONSISTS OF A CURVED SWOOSH DESIGN FOLLOWED BY THE WORDING "IPC".

SER. NO. 85-538,778, FILED 2-9-2012.

JEFFREY LOOK, EXAMINING ATTORNEY



*David J. Kybas*

Director of the United States Patent and Trademark Office

# United States of America

United States Patent and Trademark Office

# UFOCUS

**Reg. No. 4,198,508**

**Registered Aug. 28, 2012**

**Int. Cl.: 9**

**TRADEMARK**

**PRINCIPAL REGISTER**

METTLER-TOLEDO AG (SWITZERLAND CORPORATION)  
IM LANGACHER 44  
GREIFENSEE, SWITZERLAND 8606

FOR: ELECTRODES, ELECTRONIC MEASURING DEVICES AND PARTS THEREFOR, NAMELY, ELECTRONIC CONTROLS, ELECTRONIC DISPLAY INTERFACES, SENSORS, HOLDERS SPECIFICALLY ADAPTED FOR SAID MEASURING DEVICES, HOUSINGS AND ARMATURES, FOR MEASURING, TESTING AND CONTROL OF PH IN A LABORATORY OR IN PROCESS CONTROL FOR LIQUIDS, IN CLASS 9 (U.S. CLS. 21, 23, 26, 36 AND 38).

FIRST USE 9-1-2011; IN COMMERCE 9-1-2011.

THE MARK CONSISTS OF STANDARD CHARACTERS WITHOUT CLAIM TO ANY PARTICULAR FONT, STYLE, SIZE, OR COLOR.

PRIORITY CLAIMED UNDER SEC. 44(D) ON SWITZERLAND APPLICATION NO. 59181/2011, FILED 8-11-2011, REG. NO. 620088, DATED 9-12-2011, EXPIRES 8-11-2021.

SER. NO. 85-539,015, FILED 2-10-2012.

DAVID ELTON, EXAMINING ATTORNEY



*David J. Kybas*

Director of the United States Patent and Trademark Office

# United States of America

United States Patent and Trademark Office

# UPLACE

**Reg. No. 4,198,509**

**Registered Aug. 28, 2012**

**Int. Cl.: 9**

**TRADEMARK**

**PRINCIPAL REGISTER**

METTLER-TOLEDO AG (SWITZERLAND CORPORATION)  
IM LANGACHER 44  
GREIFENSEE, SWITZERLAND 8606

FOR: ELECTRODES, ELECTRONIC MEASURING DEVICES AND PARTS THEREFOR, NAMELY, ELECTRONIC CONTROLS, ELECTRONIC DISPLAY INTERFACES, SENSORS, HOLDERS SPECIFICALLY ADAPTED FOR SAID MEASURING DEVICES, HOUSINGS AND ARMATURES, FOR MEASURING, TESTING AND CONTROL OF PH IN A LABORATORY OR IN PROCESS CONTROL FOR LIQUIDS, IN CLASS 9 (U.S. CLS. 21, 23, 26, 36 AND 38).

FIRST USE 9-1-2011; IN COMMERCE 9-1-2011.

THE MARK CONSISTS OF STANDARD CHARACTERS WITHOUT CLAIM TO ANY PARTICULAR FONT, STYLE, SIZE, OR COLOR.

PRIORITY CLAIMED UNDER SEC. 44(D) ON SWITZERLAND APPLICATION NO. 59183/2011, FILED 8-11-2011, REG. NO. 620089, DATED 9-12-2011, EXPIRES 8-11-2021.

SER. NO. 85-539,016, FILED 2-10-2012.

DAVID ELTON, EXAMINING ATTORNEY



*David J. Kypos*

Director of the United States Patent and Trademark Office

# United States of America

United States Patent and Trademark Office

# RESCUE

**Reg. No. 4,198,510**

**Registered Aug. 28, 2012**

**Int. Cl.: 5**

**TRADEMARK**

**PRINCIPAL REGISTER**

STERLING INTERNATIONAL INC. (WASHINGTON CORPORATION)  
3808 NORTH SULLIVAN ROAD, BLDG. 16BV  
SPOKANE, WA 992161630

FOR: BIOPESTICIDES FOR DOMESTIC USE; INSECT ATTRACTANTS FOR USE IN PEST CONTROL, IN CLASS 5 (U.S. CLS. 6, 18, 44, 46, 51 AND 52).

FIRST USE 3-0-2007; IN COMMERCE 3-0-2007.

THE MARK CONSISTS OF STANDARD CHARACTERS WITHOUT CLAIM TO ANY PARTICULAR FONT, STYLE, SIZE, OR COLOR.

OWNER OF U.S. REG. NOS. 2,536,089, 3,558,921 AND OTHERS.

SER. NO. 85-539,801, FILED 2-10-2012.

AMY HELLA, EXAMINING ATTORNEY



*David J. Kybas*

Director of the United States Patent and Trademark Office

# United States of America

United States Patent and Trademark Office

# QUADRASET

**Reg. No. 4,198,511**

**Registered Aug. 28, 2012**

**Int. Cl.: 19**

**TRADEMARK**

**PRINCIPAL REGISTER**

OLDCASTLE BUILDING PRODUCTS, INC. (DELAWARE CORPORATION)  
C/O OLDCASTLE LAW GROUP  
900 ASHWOOD PARKWAY  
ATLANTA, GA 30338

FOR: CONCRETE, IN CLASS 19 (U.S. CLS. 1, 12, 33 AND 50).

FIRST USE 10-30-2006; IN COMMERCE 10-30-2006.

THE MARK CONSISTS OF STANDARD CHARACTERS WITHOUT CLAIM TO ANY PARTICULAR FONT, STYLE, SIZE, OR COLOR.

SER. NO. 85-539,882, FILED 2-10-2012.

LAKEISHA LEWIS, EXAMINING ATTORNEY



*David J. Kybas*

Director of the United States Patent and Trademark Office

# United States of America

United States Patent and Trademark Office

## INHERITANCE CREATOR

**Reg. No. 4,198,512**

AMERICAN INTERNATIONAL GROUP, INC. (DELAWARE CORPORATION)  
180 MAIDEN LANE  
NEW YORK, NY 10005

**Registered Aug. 28, 2012**

**Int. Cl.: 36**

FOR: LIFE INSURANCE UNDERWRITING, IN CLASS 36 (U.S. CLS. 100, 101 AND 102).

**SERVICE MARK**

FIRST USE 3-26-2012; IN COMMERCE 3-26-2012.

**PRINCIPAL REGISTER**

THE MARK CONSISTS OF STANDARD CHARACTERS WITHOUT CLAIM TO ANY PARTICULAR FONT, STYLE, SIZE, OR COLOR.

OWNER OF U.S. REG. NOS. 3,351,898 AND 3,687,409.

SER. NO. 85-540,670, FILED 2-13-2012.

NANCY CLARKE, EXAMINING ATTORNEY



*David J. Kyffers*

Director of the United States Patent and Trademark Office



# United States of America

United States Patent and Trademark Office

## INSIDE THE SHOWROOM

**Reg. No. 4,198,513**

TSI ACCESSORY GROUP, INC. (MISSOURI CORPORATION)  
1031 EXECUTIVE PARKWAY DRIVE  
ST. LOUIS, MO 63141

**Registered Aug. 28, 2012**

**Int. Cl.: 41**

FOR: ON-LINE JOURNALS, NAMELY, BLOGS FEATURING INFORMATION AND COMMENTARY IN THE FIELD OF FASHION AND FASHION ACCESSORIES, IN CLASS 41 (U.S. CLS. 100, 101 AND 107).

**SERVICE MARK**

FIRST USE 1-26-2012; IN COMMERCE 1-26-2012.

**PRINCIPAL REGISTER**

THE MARK CONSISTS OF STANDARD CHARACTERS WITHOUT CLAIM TO ANY PARTICULAR FONT, STYLE, SIZE, OR COLOR.

SER. NO. 85-540,694, FILED 2-13-2012.

CHRISTINE MARTIN, EXAMINING ATTORNEY



*David J. Kybas*

Director of the United States Patent and Trademark Office

# United States of America

United States Patent and Trademark Office

# 844

**Reg. No. 4,198,514**

CHROMAFLO TECHNOLOGIES CORPORATION (OHIO CORPORATION)  
2600 MICHIGAN AVENUE  
ASHTABULA, OH 44004

**Registered Aug. 28, 2012**

**Int. Cl.: 2**

FOR: COLORANT DISPERSIONS FOR USE IN SURFACE COATING COMPOSITIONS, IN CLASS 2 (U.S. CLS. 6, 11 AND 16).

**TRADEMARK**

FIRST USE 1-30-1986; IN COMMERCE 1-30-1986.

**PRINCIPAL REGISTER**

THE MARK CONSISTS OF STANDARD CHARACTERS WITHOUT CLAIM TO ANY PARTICULAR FONT, STYLE, SIZE, OR COLOR.

SER. NO. 85-541,122, FILED 2-13-2012.

AMY KELLY, EXAMINING ATTORNEY



*David J. Kyffers*

Director of the United States Patent and Trademark Office

# United States of America

United States Patent and Trademark Office

# SecondLook

**Reg. No. 4,198,515**

WARDLAW CLAIMS SERVICE LLP (TEXAS LIMITED LIABILITY PARTNERSHIP)  
2725 TEXAS CENTRAL PKWY  
WACO, TX 76712

**Registered Aug. 28, 2012**

**Int. Cl.: 36**

FOR: APPRAISALS FOR INSURANCE CLAIMS OF REAL ESTATE, IN CLASS 36 (U.S. CLS. 100, 101 AND 102).

**SERVICE MARK**

FIRST USE 11-21-2011; IN COMMERCE 12-1-2011.

**PRINCIPAL REGISTER**

THE MARK CONSISTS OF STANDARD CHARACTERS WITHOUT CLAIM TO ANY PARTICULAR FONT, STYLE, SIZE, OR COLOR.

SER. NO. 85-541,841, FILED 2-14-2012.

REGINA DRUMMOND, EXAMINING ATTORNEY



*David J. Kyffers*

Director of the United States Patent and Trademark Office

# United States of America

United States Patent and Trademark Office

## LIVE YOUR DASH

**Reg. No. 4,198,516**

**Registered Aug. 28, 2012**

**Int. Cl.: 14**

**TRADEMARK**

**PRINCIPAL REGISTER**

ELLIS, LINDA M. (UNITED STATES INDIVIDUAL), DBA LINDA'S LYRICS  
ATTN.: LINDA M. ELLIS  
1050 E. PIEDMONT ROAD, SUITE E-135  
MARIETTA, GA 30062

FOR: RUBBER OR SILICON WRISTBANDS IN THE NATURE OF A BRACELET, IN CLASS  
14 (U.S. CLS. 2, 27, 28 AND 50).

FIRST USE 2-3-2012; IN COMMERCE 2-3-2012.

THE MARK CONSISTS OF STANDARD CHARACTERS WITHOUT CLAIM TO ANY PAR-  
TICULAR FONT, STYLE, SIZE, OR COLOR.

OWNER OF U.S. REG. NO. 4,042,342.

SER. NO. 85-542,356, FILED 2-14-2012.

IRA J. GOODSaid, EXAMINING ATTORNEY



*David J. Kyffers*

Director of the United States Patent and Trademark Office

# United States of America

United States Patent and Trademark Office

## SIGN TRACK

**Reg. No. 4,198,517**

KAPS, THERESA (UNITED STATES INDIVIDUAL)  
2 CREST ROAD  
JACKSON, NJ 08527 AND

**Registered Aug. 28, 2012**

**Int. Cl.: 37**

KAPS, THOMAS (FED REP GERMANY INDIVIDUAL)  
2 CREST ROAD  
JACKSON, NJ 08527 AND

**SERVICE MARK**

**PRINCIPAL REGISTER**

ROSARIO, JEANNE (UNITED STATES INDIVIDUAL)  
64 WINDJAMMER COURT  
BAYVILLE, NJ 08721 AND

ROSARIO, PAUL (UNITED STATES INDIVIDUAL)  
64 WINDJAMMER COURT  
BAYVILLE, NJ 08721

FOR: INSTALLATION, MAINTENANCE AND REPAIR OF PEST CONTROL AND BIRD CONTROL SYSTEMS, PEST REMOVAL AND BIRD REMOVAL SYSTEMS; PEST CONTROL; PEST CONTROL AND EXTERMINATION OTHER THAN FOR AGRICULTURAL PURPOSES; TERMITE AND PEST CONTROL, IN CLASS 37 (U.S. CLS. 100, 103 AND 106).

FIRST USE 2-14-2012; IN COMMERCE 2-14-2012.

THE MARK CONSISTS OF STANDARD CHARACTERS WITHOUT CLAIM TO ANY PARTICULAR FONT, STYLE, SIZE, OR COLOR.

SER. NO. 85-542,391, FILED 2-14-2012.

LOURDES AYALA, EXAMINING ATTORNEY



*David J. Kybas*

Director of the United States Patent and Trademark Office

# United States of America

United States Patent and Trademark Office

# 808

**Reg. No. 4,198,518**

CHROMAFLO TECHNOLOGIES CORPORATION (OHIO CORPORATION)  
2600 MICHIGAN AVENUE  
ASHTABULA, OH 44004

**Registered Aug. 28, 2012**

**Int. Cl.: 2**

FOR: COLORANT DISPERSIONS FOR USE IN SURFACE COATING COMPOSITIONS, IN CLASS 2 (U.S. CLS. 6, 11 AND 16).

**TRADEMARK**

FIRST USE 3-27-2009; IN COMMERCE 3-27-2009.

**PRINCIPAL REGISTER**

THE MARK CONSISTS OF STANDARD CHARACTERS WITHOUT CLAIM TO ANY PARTICULAR FONT, STYLE, SIZE, OR COLOR.

SER. NO. 85-542,972, FILED 2-15-2012.

AMY KELLY, EXAMINING ATTORNEY



*David J. Kyffers*

Director of the United States Patent and Trademark Office

# United States of America

United States Patent and Trademark Office



**Reg. No. 4,198,519**

108 (TEXAS LIMITED LIABILITY COMPANY)  
25903 PEPPER RIDGE LN  
SPRING, TX 77373

**Registered Aug. 28, 2012**

**Int. Cl.: 25**

FOR: ATHLETIC APPAREL, NAMELY, SHIRTS, PANTS, JACKETS, FOOTWEAR, HATS AND CAPS, ATHLETIC UNIFORMS, IN CLASS 25 (U.S. CLS. 22 AND 39).

**TRADEMARK**

FIRST USE 2-14-2012; IN COMMERCE 2-14-2012.

**PRINCIPAL REGISTER**

THE MARK CONSISTS OF THREE RINGS VERTICALLY STACKED WITH THE TOP RING BEING GOLD AND THE TWO RINGS BELOW BEING WHITE. THERE ARE TWO WHITE LINES BEGINNING FROM ABOVE AND BELOW THE RINGS BUT DO NOT CONNECT TO THE RINGS. THE RINGS AND LINES ARE SITTING ON A SOLID BLACK POLYGON.

THE COLOR(S) GOLD, BLACK AND WHITE IS/ARE CLAIMED AS A FEATURE OF THE MARK.

SER. NO. 85-543,089, FILED 2-15-2012.

LINDA E. BLOHM, EXAMINING ATTORNEY



*David J. Kybas*

Director of the United States Patent and Trademark Office

# United States of America

United States Patent and Trademark Office

## ART IN THE AGE

**Reg. No. 4,198,520**

**Registered Aug. 28, 2012**

**Int. Cl.: 33**

**TRADEMARK**

**PRINCIPAL REGISTER**

WILLIAM GRANT & SONS IRISH BRANDS LIMITED (IRELAND CORPORATION)  
3D FLOOR, UNIT C, THE PLAZA  
BLOCK 71, PARK WEST BUSINESS PARK  
DUBLIN, IRELAND 12

FOR: ALCOHOLIC BEVERAGES EXCEPT BEERS, IN CLASS 33 (U.S. CLS. 47 AND 49).

FIRST USE 1-1-2009; IN COMMERCE 3-1-2009.

THE MARK CONSISTS OF STANDARD CHARACTERS WITHOUT CLAIM TO ANY PARTICULAR FONT, STYLE, SIZE, OR COLOR.

SER. NO. 85-543,131, FILED 2-15-2012.

TRACY WHITTAKER-BROWN, EXAMINING ATTORNEY



*David J. Kyros*

Director of the United States Patent and Trademark Office



# United States of America

United States Patent and Trademark Office

## HUNABKU HEALING

**Reg. No. 4,198,521**

HARPER, WENDY (MEXICO INDIVIDUAL)

**Registered Aug. 28, 2012**

9214 PERFECT HOUR  
COLUMBIA, MD 21045

**Int. Cl.: 44**

FOR: PROVIDING A WEBSITE FEATURING INFORMATION ON ALTERNATIVE HEALTH AND HEALING; PROVIDING BOTH IN-PERSON AND ON-LINE VIBRATIONAL ENERGY HEALING SERVICES; REIKI HEALING SERVICES; AROMATHERAPY SERVICES; PSYCHOTHERAPY SERVICES AND HOLISTIC HEALTH SERVICES, IN CLASS 44 (U.S. CLS. 100 AND 101).

**SERVICE MARK**

**PRINCIPAL REGISTER**

FIRST USE 1-1-2009; IN COMMERCE 12-15-2010.

THE MARK CONSISTS OF STANDARD CHARACTERS WITHOUT CLAIM TO ANY PARTICULAR FONT, STYLE, SIZE, OR COLOR.

NO CLAIM IS MADE TO THE EXCLUSIVE RIGHT TO USE "HEALING", APART FROM THE MARK AS SHOWN.

SER. NO. 85-543,174, FILED 2-15-2012.

TINA BROWN, EXAMINING ATTORNEY



*David J. Kyffers*

Director of the United States Patent and Trademark Office

# United States of America

United States Patent and Trademark Office

## MILLER LITE FREE RIDES

**Reg. No. 4,198,522**

**Registered Aug. 28, 2012**

**Int. Cl.: 35**

**SERVICE MARK**

**PRINCIPAL REGISTER**

MILLERCOORS LLC (DELAWARE LIMITED LIABILITY COMPANY)  
SUITE 800  
250 SOUTH WACKER DRIVE  
CHICAGO, IL 606065888

FOR: PROMOTING PUBLIC AWARENESS OF THE NEED FOR MODERATION AND RESPONSIBILITY IN DRINKING ALCOHOLIC BEVERAGES BY ARRANGING FOR FREE TRANSPORTATION TO THE PUBLIC, IN CLASS 35 (U.S. CLS. 100, 101 AND 102).

FIRST USE 10-1-2009; IN COMMERCE 10-1-2009.

THE MARK CONSISTS OF STANDARD CHARACTERS WITHOUT CLAIM TO ANY PARTICULAR FONT, STYLE, SIZE, OR COLOR.

OWNER OF U.S. REG. NOS. 1,385,379, 3,723,562 AND OTHERS.

NO CLAIM IS MADE TO THE EXCLUSIVE RIGHT TO USE "FREE RIDES", APART FROM THE MARK AS SHOWN.

SER. NO. 85-543,833, FILED 2-15-2012.

ELISSA GARBER KON, EXAMINING ATTORNEY



*David J. Kyffers*

Director of the United States Patent and Trademark Office

# United States of America

United States Patent and Trademark Office

# LASER-FREE

**Reg. No. 4,198,523**

**Registered Aug. 28, 2012**

**Int. Cl.: 3**

**TRADEMARK**

**PRINCIPAL REGISTER**

PETER THOMAS ROTH LABS, LLC (NEW YORK LIMITED LIABILITY COMPANY)  
16TH FLOOR  
460 PARK AVENUE  
NEW YORK, NY 10022

FOR: NON-MEDICATED SKIN CARE PREPARATIONS, IN CLASS 3 (U.S. CLS. 1, 4, 6, 50, 51 AND 52).

FIRST USE 11-0-2010; IN COMMERCE 11-0-2010.

THE MARK CONSISTS OF STANDARD CHARACTERS WITHOUT CLAIM TO ANY PARTICULAR FONT, STYLE, SIZE, OR COLOR.

SER. NO. 85-543,917, FILED 2-15-2012.

JASON BLAIR, EXAMINING ATTORNEY



*David J. Kybas*

Director of the United States Patent and Trademark Office

# United States of America

United States Patent and Trademark Office

# GlowStrike

**Reg. No. 4,198,524**

NELSON, JASON (UNITED STATES INDIVIDUAL)  
9201 SW 21ST STREET  
OKLAHOMA CITY, OK 73128

**Registered Aug. 28, 2012**

**Int. Cl.: 28**

FOR: BITE INDICATORS; BITE SENSORS; FISH BITE ALARM AND STRIKE INDICATOR; FISHING EQUIPMENT, NAMELY, CLAMPS FOR SECURING FISHING EQUIPMENT ON BODY; FISHING LINES; FISHING POLES; FISHING RODS; FISHING TACKLE; ICE FISHING STRIKE INDICATOR; RODS FOR FISHING, IN CLASS 28 (U.S. CLS. 22, 23, 38 AND 50).

**TRADEMARK**

**PRINCIPAL REGISTER**

FIRST USE 2-13-2012; IN COMMERCE 2-13-2012.

THE MARK CONSISTS OF STANDARD CHARACTERS WITHOUT CLAIM TO ANY PARTICULAR FONT, STYLE, SIZE, OR COLOR.

SER. NO. 85-544,085, FILED 2-15-2012.

KATHLEEN KOLACZ, EXAMINING ATTORNEY



*David J. Kybas*

Director of the United States Patent and Trademark Office

# United States of America

United States Patent and Trademark Office



**Reg. No. 4,198,525**

**Registered Aug. 28, 2012**

**Int. Cls.: 35 and 39**

**SERVICE MARK**

**PRINCIPAL REGISTER**

YRC WORLDWIDE INC. (DELAWARE CORPORATION)  
10990 ROE AVENUE  
OVERLAND PARK, KS 66211

FOR: BUSINESS CONSULTING SERVICES RELATING TO PRODUCT DISTRIBUTION, OPERATIONS MANAGEMENT SERVICES, LOGISTICS, REVERSE LOGISTICS, SUPPLY CHAIN, AND PRODUCTION SYSTEMS AND DISTRIBUTION SOLUTIONS; BUSINESS MANAGEMENT SERVICES, NAMELY, MANAGING LOGISTICS, REVERSE LOGISTICS, SUPPLY CHAIN SERVICES, SUPPLY CHAIN VISIBILITY AND SYNCHRONIZATION, SUPPLY AND DEMAND FORECASTING AND PRODUCT DISTRIBUTION PROCESSES FOR OTHERS; TRANSPORTATION LOGISTICS SERVICES, NAMELY, ARRANGING THE TRANSPORTATION OF GOODS FOR OTHERS; TRANSPORTATION LOGISTICS SERVICES, NAMELY, PLANNING AND SCHEDULING SHIPMENTS FOR USERS OF TRANSPORTATION SERVICES; COMPUTERIZED TRACKING AND TRACING OF PACKAGES IN TRANSIT; INFORMATION MANAGEMENT SERVICES, NAMELY, SHIPMENT PROCESSING, PREPARING SHIPPING DOCUMENTS AND INVOICES, TRACKING DOCUMENTS, PACKAGES AND FREIGHT OVER COMPUTER NETWORKS, INTRANETS AND INTERNETS; MONITORING AND TRACKING OF PACKAGE SHIPMENTS; PROVIDING ELECTRONIC TRACKING OF FREIGHT INFORMATION TO OTHERS; TRACKING, LOCATING AND MONITORING OF VEHICLES, MARITIME VESSELS AND AIRCRAFT SERVICES FOR COMMERCIAL PURPOSES; CUSTOMS CLEARANCE SERVICES; ARRANGING FOR PICKUP, DELIVERY, STORAGE AND TRANSPORTATION OF DOCUMENTS, PACKAGES, FREIGHT AND PARCELS VIA GROUND AND AIR CARRIERS; ORDER FULFILLMENT SERVICES, IN CLASS 35 (U.S. CLS. 100, 101 AND 102).

FIRST USE 2-1-2012; IN COMMERCE 2-1-2012.

FOR: DOMESTIC AND INTERNATIONAL COMMON CARRIER FREIGHT TRANSPORTATION BY MEANS OF TRUCK, AIR, OR SEA, AND DOMESTIC AND INTERNATIONAL FREIGHT FORWARDING SERVICES; SUPPLY CHAIN, LOGISTICS AND REVERSE LOGISTICS SERVICES, NAMELY, STORAGE, TRANSPORTATION AND DELIVERY OF DOCUMENTS, PACKAGES, RAW MATERIALS, AND OTHER FREIGHT FOR OTHERS BY AIR, RAIL, SHIP OR TRUCK; WAREHOUSING SERVICES, NAMELY, STORAGE, DISTRIBUTION, PICK-UP, AND PACKING FOR SHIPMENT OF DOCUMENTS, PACKAGES, RAW MATERIALS, AND OTHER FREIGHT FOR OTHERS, IN CLASS 39 (U.S. CLS. 100 AND 105).

FIRST USE 2-1-2012; IN COMMERCE 2-1-2012.



*David J. Kyffers*

Director of the United States Patent and Trademark Office

**Reg. No. 4,198,525** OWNER OF U.S. REG. NOS. 3,272,882, 3,776,056 AND OTHERS.

THE MARK CONSISTS OF THE LETTERS "YRC" ABOVE A TRILATERAL DESIGN THAT IS DIVIDED INTO TWO PARTS BY A SMALLER TRILATERAL DESIGN, WITH THE WORD "REIMER" BELOW THE TRILATERAL DESIGNS.

SER. NO. 85-544,719, FILED 2-16-2012.

BRIAN NEVILLE, EXAMINING ATTORNEY

# United States of America

United States Patent and Trademark Office

## ACTION CCSS

**Reg. No. 4,198,526**

AMERICAN READING COMPANY (PENNSYLVANIA CORPORATION)

**Registered Aug. 28, 2012**

201 S. GULPH ROAD  
KING OF PRUSSIA, PA 19406

**Int. Cl.: 41**

FOR: EDUCATIONAL SERVICES, NAMELY, A READING AND WRITING PROGRAM FOR PRE-KINDERGARTEN THROUGH SECONDARY SCHOOL STUDENTS; A PROGRAM FOR ASSESSING THE LEVEL OF DIFFICULTY OF BOOKS AS PART OF A READING PROGRAM; A READING INTERVENTION PROGRAM THAT COMBINES NONFICTION READING AND WRITING THAT DEVELOPS VOCABULARY, BACKGROUND KNOWLEDGE AND TEST PREPAREDNESS, IN CLASS 41 (U.S. CLS. 100, 101 AND 107).

**SERVICE MARK**

**PRINCIPAL REGISTER**

FIRST USE 12-1-2011; IN COMMERCE 12-1-2011.

THE MARK CONSISTS OF STANDARD CHARACTERS WITHOUT CLAIM TO ANY PARTICULAR FONT, STYLE, SIZE, OR COLOR.

OWNER OF U.S. REG. NOS. 3,821,141 AND 3,821,145.

NO CLAIM IS MADE TO THE EXCLUSIVE RIGHT TO USE "CCSS" , APART FROM THE MARK AS SHOWN.

SER. NO. 85-544,824, FILED 2-16-2012.

MATTHEW KLINE, EXAMINING ATTORNEY



*David J. Kyros*

Director of the United States Patent and Trademark Office

# United States of America

United States Patent and Trademark Office

## ROCK FLIGHT

**Reg. No. 4,198,527**

LIVE NATION WORLDWIDE, INC. (DELAWARE CORPORATION)  
9348 CIVIC CENTER DRIVE  
BEVERLY HILLS, CA 90210

**Registered Aug. 28, 2012**

**Int. Cl.: 35**

FOR: PROMOTING THE GOODS AND SERVICES OF OTHERS BY AWARDING ENTERTAINMENT RELATED TRAVEL PACKAGES CONSISTING OF CONCERT TICKETS, AIR AND GROUND TRANSPORTATION, HOTEL ACCOMMODATIONS AND/OR OTHER AWARDS, IN CLASS 35 (U.S. CLS. 100, 101 AND 102).

**SERVICE MARK**

**PRINCIPAL REGISTER**

FIRST USE 5-18-2009; IN COMMERCE 5-18-2009.

THE MARK CONSISTS OF STANDARD CHARACTERS WITHOUT CLAIM TO ANY PARTICULAR FONT, STYLE, SIZE, OR COLOR.

SER. NO. 85-545,088, FILED 2-16-2012.

KAREN K. BUSH, EXAMINING ATTORNEY



*David J. Kyjars*

Director of the United States Patent and Trademark Office



# United States of America

United States Patent and Trademark Office

## SELENIUM SYNERGY

**Reg. No. 4,198,528**

JARROW FORMULAS, INC. (CALIFORNIA CORPORATION)  
1824 SOUTH ROBERTSON BLVD.  
LOS ANGELES, CA 90035

**Registered Aug. 28, 2012**

**Int. Cl.: 5**

FOR: DIETARY AND NUTRITIONAL SUPPLEMENTS CONTAINING SELENIUM, IN CLASS 5 (U.S. CLS. 6, 18, 44, 46, 51 AND 52).

**TRADEMARK**

FIRST USE 10-0-1995; IN COMMERCE 10-0-1995.

**PRINCIPAL REGISTER**

THE MARK CONSISTS OF STANDARD CHARACTERS WITHOUT CLAIM TO ANY PARTICULAR FONT, STYLE, SIZE, OR COLOR.

OWNER OF U.S. REG. NO. 3,826,921.

NO CLAIM IS MADE TO THE EXCLUSIVE RIGHT TO USE "SELENIUM", APART FROM THE MARK AS SHOWN.

SER. NO. 85-545,245, FILED 2-16-2012.

TOBY BULLOFF, EXAMINING ATTORNEY



*David J. Kyffers*

Director of the United States Patent and Trademark Office

# United States of America

United States Patent and Trademark Office

## NATIONWIDE SURETY STARTER

**Reg. No. 4,198,529**

**Registered Aug. 28, 2012**

**Int. Cl.: 36**

**SERVICE MARK**

**PRINCIPAL REGISTER**

NATIONWIDE MUTUAL INSURANCE COMPANY (OHIO CORPORATION)  
OFFICE OF GENERAL COUNSEL 1-35-204  
ONE NATIONWIDE PLAZA  
COLUMBUS, OH 43215

FOR: FINANCIAL SERVICES, NAMELY, UNDERWRITING AND ADMINISTRATION OF SURETY BONDS, IN CLASS 36 (U.S. CLS. 100, 101 AND 102).

FIRST USE 9-12-2011; IN COMMERCE 9-12-2011.

THE MARK CONSISTS OF STANDARD CHARACTERS WITHOUT CLAIM TO ANY PARTICULAR FONT, STYLE, SIZE, OR COLOR.

OWNER OF U.S. REG. NOS. 1,793,850, 2,371,088 AND OTHERS.

NO CLAIM IS MADE TO THE EXCLUSIVE RIGHT TO USE "SURETY", APART FROM THE MARK AS SHOWN.

SER. NO. 85-545,683, FILED 2-17-2012.

TINA BROWN, EXAMINING ATTORNEY



*David J. Kyffers*

Director of the United States Patent and Trademark Office

# United States of America

United States Patent and Trademark Office

# inControl

**Reg. No. 4,198,530**

**Registered Aug. 28, 2012**

**Int. Cl.: 5**

**TRADEMARK**

**PRINCIPAL REGISTER**

HEB GROCERY COMPANY LP (TEXAS LIMITED PARTNERSHIP)  
CORPORATE LAW DEPARTMENT  
646 SOUTH MAIN  
SAN ANTONIO, TX 78204

FOR: ANTISEPTIC WIPES, MEDICATED LOZENGES, IN CLASS 5 (U.S. CLS. 6, 18, 44, 46, 51 AND 52).

FIRST USE 2-13-2008; IN COMMERCE 2-13-2008.

THE MARK CONSISTS OF STANDARD CHARACTERS WITHOUT CLAIM TO ANY PARTICULAR FONT, STYLE, SIZE, OR COLOR.

OWNER OF U.S. REG. NOS. 2,875,244 AND 3,105,225.

SER. NO. 85-546,258, FILED 2-17-2012.

JUDITH HELFMAN, EXAMINING ATTORNEY



*David J. Kyffers*

Director of the United States Patent and Trademark Office

# United States of America

United States Patent and Trademark Office

## GO SMILE SMILE WHITENING LIGHT

**Reg. No. 4,198,531**

**Registered Aug. 28, 2012**

**Int. Cls.: 3 and 10**

**TRADEMARK**

**PRINCIPAL REGISTER**

GOSMILE, INC. (DELAWARE CORPORATION)  
715 HEARST AVENUE, SUITE 300  
BERKELEY, CA 94710

FOR: KITS COMPRISED PRIMARILY OF TEETH WHITENING PREPARATIONS, IN CLASS 3 (U.S. CLS. 1, 4, 6, 50, 51 AND 52).

FIRST USE 12-22-2010; IN COMMERCE 12-22-2010.

FOR: DENTAL APPARATUS, NAMELY, INTRA-ORAL LIGHT SYSTEMS, IN CLASS 10 (U.S. CLS. 26, 39 AND 44).

FIRST USE 11-24-2010; IN COMMERCE 11-24-2010.

THE MARK CONSISTS OF STANDARD CHARACTERS WITHOUT CLAIM TO ANY PARTICULAR FONT, STYLE, SIZE, OR COLOR.

OWNER OF U.S. REG. NOS. 2,566,285, 4,077,264 AND OTHERS.

NO CLAIM IS MADE TO THE EXCLUSIVE RIGHT TO USE "WHITENING LIGHT", APART FROM THE MARK AS SHOWN.

SER. NO. 85-546,266, FILED 2-17-2012.

CAROLYN CATALDO, EXAMINING ATTORNEY



*David J. Kybas*

Director of the United States Patent and Trademark Office

# United States of America

United States Patent and Trademark Office

## Shave Time. Shave Money.

**Reg. No. 4,198,532**

DOLLAR SHAVE CLUB, INC. (DELAWARE CORPORATION)  
PO BOX 5481

**Registered Aug. 28, 2012**

SANTA MONICA, CA 904095481

**Int. Cl.: 35**

FOR: COMPUTERIZED ON-LINE ORDERING SERVICES IN THE FIELD OF SHAVING PRODUCTS AND ACCESSORIES; COMPUTERIZED ON-LINE RETAIL STORE SERVICES IN THE FIELD OF SHAVING PRODUCTS AND ACCESSORIES; ON-LINE RETAIL STORE SERVICES FEATURING SHAVING PRODUCTS AND ACCESSORIES, IN CLASS 35 (U.S. CLS. 100, 101 AND 102).

**SERVICE MARK**

**PRINCIPAL REGISTER**

FIRST USE 2-16-2012; IN COMMERCE 2-17-2012.

THE MARK CONSISTS OF STANDARD CHARACTERS WITHOUT CLAIM TO ANY PARTICULAR FONT, STYLE, SIZE, OR COLOR.

SER. NO. 85-546,320, FILED 2-17-2012.

KIMBERLY FRYE, EXAMINING ATTORNEY



*David J. Kyffers*

Director of the United States Patent and Trademark Office

# United States of America

United States Patent and Trademark Office

When to go. Where to go.  
What to throw.

**Reg. No. 4,198,533**

SCREEN3NETWORK LLC (CALIFORNIA LIMITED LIABILITY COMPANY)  
9555 COZYCROFT AVENUE  
CHATSWORTH, CA 91311

**Registered Aug. 28, 2012**

**Int. Cl.: 41**

FOR: PROVIDING A WEBSITE FOR FISHERS, FEATURING FISHING-RELATED INFORMATION, NAMELY, PROVIDING INFORMATION ON RECREATIONAL FISHING HOTSPOTS TO HELP THEM PLAN AND EXECUTE THEIR FISHING TRIPS, IN CLASS 41 (U.S. CLS. 100, 101 AND 107).

**SERVICE MARK**

**PRINCIPAL REGISTER**

FIRST USE 11-1-2011; IN COMMERCE 11-1-2011.

THE MARK CONSISTS OF STANDARD CHARACTERS WITHOUT CLAIM TO ANY PARTICULAR FONT, STYLE, SIZE, OR COLOR.

SER. NO. 85-546,546, FILED 2-17-2012.

WILLIAM JACKSON, EXAMINING ATTORNEY



*David J. Kyffers*

Director of the United States Patent and Trademark Office

# United States of America

United States Patent and Trademark Office

## QUANTUM EMOTIONAL CLEARING

**Reg. No. 4,198,534**

LEE BEYMER (UNITED STATES INDIVIDUAL)  
406 MEADOW COURT  
BASALT, CO 81621

**Registered Aug. 28, 2012**

**Int. Cl.: 41**

FOR: EDUCATIONAL SERVICES, NAMELY, CONDUCTING CLASSES, WORKSHOPS, PRIVATE TUTORING AND TRAINING SERVICES IN THE FIELD OF SELF-ADMINISTERED ACUPUNCTURE TECHNIQUES AND DISTRIBUTION OF TRAINING MATERIAL IN CONNECTION THEREWITH, IN CLASS 41 (U.S. CLS. 100, 101 AND 107).

**SERVICE MARK**

**PRINCIPAL REGISTER**

FIRST USE 12-1-2002; IN COMMERCE 12-1-2002.

THE MARK CONSISTS OF STANDARD CHARACTERS WITHOUT CLAIM TO ANY PARTICULAR FONT, STYLE, SIZE, OR COLOR.

NO CLAIM IS MADE TO THE EXCLUSIVE RIGHT TO USE "EMOTIONAL CLEARING", APART FROM THE MARK AS SHOWN.

SER. NO. 85-547,650, FILED 2-20-2012.

RUSS HERMAN, EXAMINING ATTORNEY



*David J. Kyffers*

Director of the United States Patent and Trademark Office

# United States of America

United States Patent and Trademark Office

# oneOeight

**Reg. No. 4,198,535**

108 (TEXAS LIMITED LIABILITY COMPANY)  
25903 PEPPER RIDGE LN  
SPRING, TX 77373

**Registered Aug. 28, 2012**

**Int. Cl.: 25**

FOR: ATHLETIC APPAREL, NAMELY, SHIRTS, PANTS, JACKETS, FOOTWEAR, HATS AND CAPS, ATHLETIC UNIFORMS, IN CLASS 25 (U.S. CLS. 22 AND 39).

**TRADEMARK**

FIRST USE 2-14-2012; IN COMMERCE 2-14-2012.

**PRINCIPAL REGISTER**

THE MARK CONSISTS OF STANDARD CHARACTERS WITHOUT CLAIM TO ANY PARTICULAR FONT, STYLE, SIZE, OR COLOR.

SER. NO. 85-548,215, FILED 2-21-2012.

LINDA E. BLOHM, EXAMINING ATTORNEY



*David J. Kyros*

Director of the United States Patent and Trademark Office



# United States of America

United States Patent and Trademark Office

## Organization Starts Here

**Reg. No. 4,198,536**

**Registered Aug. 28, 2012**

**Int. Cl.: 20**

**TRADEMARK**

**PRINCIPAL REGISTER**

THE STOW COMPANY (MICHIGAN CORPORATION), FORMERLY WINDQUEST COMPANIES, INC  
3311 WINDQUEST DRIVE  
HOLLAND, MI 49424

FOR: STORAGE AND ORGANIZATION SYSTEMS COMPRISING SHELVES, DRAWERS, CUPBOARDS, BASKETS AND CLOTHES RODS, SOLD AS A UNIT, IN CLASS 20 (U.S. CLS. 2, 13, 22, 25, 32 AND 50).

FIRST USE 2-10-2012; IN COMMERCE 2-10-2012.

THE MARK CONSISTS OF STANDARD CHARACTERS WITHOUT CLAIM TO ANY PARTICULAR FONT, STYLE, SIZE, OR COLOR.

SER. NO. 85-549,100, FILED 2-22-2012.

KELLY TRUSILO, EXAMINING ATTORNEY



*David J. Kybas*

Director of the United States Patent and Trademark Office

# United States of America

United States Patent and Trademark Office

# Courtlandt

**Reg. No. 4,198,537**

**Registered Aug. 28, 2012**

**Int. Cl.: 19**

**TRADEMARK**

**PRINCIPAL REGISTER**

GLASSCRAFT DOOR I (TEXAS LIMITED PARTNERSHIP), DBA GLASSCRAFT DOOR COMPANY  
2002 BRITTMOORE ROAD  
HOUSTON, TX 77043

FOR: INSULATED GLASS, IN CLASS 19 (U.S. CLS. 1, 12, 33 AND 50).

FIRST USE 12-1-1984; IN COMMERCE 12-1-1984.

THE MARK CONSISTS OF STANDARD CHARACTERS WITHOUT CLAIM TO ANY PARTICULAR FONT, STYLE, SIZE, OR COLOR.

SER. NO. 85-549,392, FILED 2-22-2012.

CURTIS FRENCH, EXAMINING ATTORNEY



*David J. Kybas*

Director of the United States Patent and Trademark Office

# United States of America

United States Patent and Trademark Office

## America's Energy Partner

**Reg. No. 4,198,538**

AMERICAN ELECTRIC POWER COMPANY, INC. (NEW YORK CORPORATION)  
1 RIVERSIDE PLAZA  
COLUMBUS, OH 43215

**Registered Aug. 28, 2012**

**Int. Cl.: 39**

FOR: DISTRIBUTION AND TRANSMISSION OF ELECTRICITY, IN CLASS 39 (U.S. CLS. 100 AND 105).

**SERVICE MARK**

FIRST USE 3-21-1996; IN COMMERCE 3-21-1996.

**PRINCIPAL REGISTER**

THE MARK CONSISTS OF STANDARD CHARACTERS WITHOUT CLAIM TO ANY PARTICULAR FONT, STYLE, SIZE, OR COLOR.

NO CLAIM IS MADE TO THE EXCLUSIVE RIGHT TO USE "AMERICA'S ENERGY", APART FROM THE MARK AS SHOWN.

SER. NO. 85-549,643, FILED 2-22-2012.

DEBORAH LOBO, EXAMINING ATTORNEY



*David J. Kyffers*

Director of the United States Patent and Trademark Office

United States of America  
United States Patent and Trademark Office

# CHINET

**Reg. No. 4,198,539**

**Registered Aug. 28, 2012**

**Int. Cl.: 21**

**TRADEMARK**

**PRINCIPAL REGISTER**

HUHTAMAKI, INC. (KANSAS CORPORATION)  
9201 PACKAGING DRIVE  
DESOTO, KS 66018

FOR: DISPOSABLE DINNERWARE, NAMELY, PLASTIC PLATES, BOWLS, CUPS, PAPER-BOARD CUPS, BOWLS, SERVING PLATTERS, SERVING TRAYS AND COOKING PANS, IN CLASS 21 (U.S. CLS. 2, 13, 23, 29, 30, 33, 40 AND 50).

FIRST USE 5-0-2000; IN COMMERCE 5-0-2000.

THE MARK CONSISTS OF STANDARD CHARACTERS WITHOUT CLAIM TO ANY PARTICULAR FONT, STYLE, SIZE, OR COLOR.

OWNER OF U.S. REG. NOS. 684,589, 2,539,447 AND OTHERS.

SER. NO. 85-550,183, FILED 2-22-2012.

JULIE WATSON, EXAMINING ATTORNEY



*David J. Kyffers*

Director of the United States Patent and Trademark Office

# United States of America

United States Patent and Trademark Office

## NATIONWIDE RETIREMENT FLEXIBLE ADVANTAGE

**Reg. No. 4,198,540**

**Registered Aug. 28, 2012**

**Int. Cl.: 36**

**SERVICE MARK**

**PRINCIPAL REGISTER**

NATIONWIDE MUTUAL INSURANCE COMPANY (OHIO CORPORATION)  
OFFICE OF GENERAL COUNSEL 1-35-204  
ONE NATIONWIDE PLAZA  
COLUMBUS, OH 43215

FOR: FINANCIAL SERVICES, NAMELY, BROKERAGE, ADMINISTRATION, AND DISTRIBUTION OF MUTUAL FUNDS, MONEY MARKET FUNDS, PENSION PLANS, AND RETIREMENT PLANS; INVESTMENT ADVISORY AND FINANCIAL ASSET MANAGEMENT SERVICES, IN CLASS 36 (U.S. CLS. 100, 101 AND 102).

FIRST USE 9-30-2011; IN COMMERCE 9-30-2011.

THE MARK CONSISTS OF STANDARD CHARACTERS WITHOUT CLAIM TO ANY PARTICULAR FONT, STYLE, SIZE, OR COLOR.

OWNER OF U.S. REG. NOS. 2,017,147, 3,832,553 AND OTHERS.

NO CLAIM IS MADE TO THE EXCLUSIVE RIGHT TO USE "RETIREMENT", APART FROM THE MARK AS SHOWN.

SER. NO. 85-550,629, FILED 2-23-2012.

TINA BROWN, EXAMINING ATTORNEY



*David J. Kybas*

Director of the United States Patent and Trademark Office

# United States of America

United States Patent and Trademark Office

## AG GATEWAY

**Reg. No. 4,198,541**

AMERICAN INTERNATIONAL GROUP, INC. (DELAWARE CORPORATION)  
180 MAIDEN LANE  
NEW YORK, NY 10038

**Registered Aug. 28, 2012**

**Int. Cl.: 42**

FOR: PROVIDING ON-LINE NON-DOWNLOADABLE SOFTWARE FOR AGENTS AND PRODUCERS TO ACCESS LIFE INSURANCE QUOTES AND CUSTOMER INFORMATION, IN CLASS 42 (U.S. CLS. 100 AND 101).

**SERVICE MARK**

FIRST USE 2-14-2012; IN COMMERCE 2-14-2012.

**PRINCIPAL REGISTER**

THE MARK CONSISTS OF STANDARD CHARACTERS WITHOUT CLAIM TO ANY PARTICULAR FONT, STYLE, SIZE, OR COLOR.

OWNER OF U.S. REG. NOS. 2,895,825, 3,077,573 AND OTHERS.

NO CLAIM IS MADE TO THE EXCLUSIVE RIGHT TO USE "GATEWAY", APART FROM THE MARK AS SHOWN.

SER. NO. 85-550,816, FILED 2-23-2012.

NANCY CLARKE, EXAMINING ATTORNEY



*David J. Kyjars*

Director of the United States Patent and Trademark Office

# United States of America

United States Patent and Trademark Office

## JOHN HANCOCK INVESTOR SENTIMENT INDEX

**Reg. No. 4,198,542**

JOHN HANCOCK LIFE INSURANCE COMPANY (U.S.A.) (MICHIGAN CORPORATION)  
601 CONGRESS STREET  
BOSTON, MA 02210

**Registered Aug. 28, 2012**

**Int. Cl.: 36**

FOR: PROVIDING INFORMATION IN THE FIELD OF FINANCE AND FINANCIAL INVESTMENTS; PROVIDING A WEBSITE FEATURING INFORMATION IN THE FIELD OF FINANCE AND FINANCIAL INVESTMENTS, IN CLASS 36 (U.S. CLS. 100, 101 AND 102).

**SERVICE MARK**

FIRST USE 1-0-2011; IN COMMERCE 1-0-2011.

**PRINCIPAL REGISTER**

THE MARK CONSISTS OF STANDARD CHARACTERS WITHOUT CLAIM TO ANY PARTICULAR FONT, STYLE, SIZE, OR COLOR.

OWNER OF U.S. REG. NOS. 557,033, 3,742,440 AND OTHERS.

NO CLAIM IS MADE TO THE EXCLUSIVE RIGHT TO USE "INVESTOR SENTIMENT INDEX", APART FROM THE MARK AS SHOWN.

THE NAME(S), PORTRAIT(S), AND/OR SIGNATURE(S) SHOWN IN THE MARK DOES NOT IDENTIFY A PARTICULAR LIVING INDIVIDUAL.

SER. NO. 85-551,114, FILED 2-23-2012.

DEIRDRE ROBERTSON, EXAMINING ATTORNEY



*David J. Kyjars*

Director of the United States Patent and Trademark Office

# United States of America

United States Patent and Trademark Office

## INDULGENT CREATIONS

**Reg. No. 4,198,543**

PREVO'S FAMILY MARKETS, INC. (MICHIGAN CORPORATION)  
850 76TH ST SW  
GRAND RAPIDS, MI 49518

**Registered Aug. 28, 2012**

**Int. Cl.: 30**

FOR: ICE CREAM, IN CLASS 30 (U.S. CL. 46).

**TRADEMARK**

FIRST USE 11-7-2010; IN COMMERCE 11-7-2010.

**PRINCIPAL REGISTER**

THE MARK CONSISTS OF STANDARD CHARACTERS WITHOUT CLAIM TO ANY PARTICULAR FONT, STYLE, SIZE, OR COLOR.

SER. NO. 85-553,495, FILED 2-27-2012.

HANNO RITTNER, EXAMINING ATTORNEY



*David J. Kyffers*

Director of the United States Patent and Trademark Office



# United States of America

United States Patent and Trademark Office



**Reg. No. 4,198,544**

**Registered Aug. 28, 2012**

**Int. Cl.: 35**

**SERVICE MARK**

**PRINCIPAL REGISTER**

EMMIS RADIO, LLC (INDIANA LIMITED LIABILITY COMPANY)  
SUITE 700  
40 MONUMENT CIRCLE  
INDIANAPOLIS, IN 46204

FOR: ORGANIZING VOTER REGISTRATION DRIVES; PROVIDING INFORMATION REGARDING POLITICAL ISSUES, KNOWING HOW TO VOTE AND KNOWING HOW TO REGISTER TO VOTE, IN CLASS 35 (U.S. CLS. 100, 101 AND 102).

FIRST USE 4-30-2004; IN COMMERCE 4-30-2004.

OWNER OF U.S. REG. NOS. 2,477,364, 2,611,930, AND 3,123,677.

THE COLOR(S) BLACK WHITE, RED, BLUE AND YELLOW IS/ARE CLAIMED AS A FEATURE OF THE MARK.

NO CLAIM IS MADE TO THE EXCLUSIVE RIGHT TO USE "VOTES", APART FROM THE MARK AS SHOWN.

THE MARK CONSISTS OF A BLUE OUTER CIRCLE CONTAINING AN AMERICAN FLAG OVERLAID BY WORDING, WITH VISIBLE PORTIONS OF THE FLAG CONSISTING OF A BLUE STRIP WITH WHITE STARS IN ADDITION TO PATCHES OF RED AND WHITE, WITH THE WORDS "HIP HOP VOTES" WRITTEN OVER THE FLAG AND CIRCLE, WITH "HIP HOP" IN BLACK LETTERS OUTLINED IN WHITE, EXCEPT FOR THE LETTER "O" IN "HOP", WHICH IS COMPRISED OF A YELLOW CIRCLE OUTLINED IN WHITE FOLLOWED BY A BLACK OUTLINE CONTAINING THE PHRASE "HOT 97" WRITTEN IN WHITE LETTERS WITH A BLACK OUTLINE AND BLACK SHADING, AND "FM" WRITTEN IN BLACK LETTERS IN A SMALLER WHITE CIRCLE OUTLINED IN BLACK, WHICH IS LOCATED AT THE BOTTOM RIGHT OF THE NUMBER "7", AND APPEARING BELOW "HIP HOP" IS THE WORD "VOTES" WRITTEN IN WHITE WITH A RED OUTLINE AND RED SHADING, EXCEPT FOR THE LETTER "V" WHICH IS COMPRISED OF A SOLID RED CHECK MARK, THE BOTTOM AND UNDERSIDE OF WHICH CONTAIN A BLACK OUTLINE, AND THREE WHITE STARS OUTLINED IN BLACK AT THE UPPER LEFT OF THE OUTER CIRCLE, ONE WHITE STAR OUTLINED IN BLACK AT THE UPPER RIGHT OF THE OUTER CIRCLE AND TWO WHITE STARS OUTLINED IN BLACK AT THE LOWER RIGHT OF THE OUTER CIRCLE, WITH THE REMAINING AREAS WITHIN THE OUTER CIRCLE BEING WHITE.



*David J. Kappas*

Director of the United States Patent and Trademark Office

**Reg. No. 4,198,544** SEC. 2(F) AS TO "HIP HOP VOTES".

SER. NO. 85-554,073, FILED 2-27-2012.

MATTHEW PAPPAS, EXAMINING ATTORNEY

# United States of America

United States Patent and Trademark Office

## LOVE IS FREE

**Reg. No. 4,198,545**

ROTH WHITMAN GROUP, INC. (ILLINOIS CORPORATION)  
300 N LASALLE ST. SUITE 4925  
CHICAGO, IL 60654

**Registered Aug. 28, 2012**

**Int. Cl.: 45**

FOR: COMPUTER DATING SERVICES; DATING SERVICES, IN CLASS 45 (U.S. CLS. 100 AND 101).

**SERVICE MARK**

FIRST USE 2-16-2012; IN COMMERCE 2-16-2012.

**PRINCIPAL REGISTER**

THE MARK CONSISTS OF STANDARD CHARACTERS WITHOUT CLAIM TO ANY PARTICULAR FONT, STYLE, SIZE, OR COLOR.

SER. NO. 85-554,293, FILED 2-27-2012.

WILLIAM VERHOSEK, EXAMINING ATTORNEY



*David J. Kybas*

Director of the United States Patent and Trademark Office

# United States of America

United States Patent and Trademark Office

# HERSHEY

**Reg. No. 4,198,546**

**Registered Aug. 28, 2012**

**Int. Cl.: 41**

HERSHEY CHOCOLATE & CONFECTIONERY CORPORATION (DELAWARE CORPORATION)  
SUITE 204  
4860 ROBB STREET  
WHEAT RIDGE, CO 80033

**SERVICE MARK**

**PRINCIPAL REGISTER**

FOR: ENTERTAINMENT SERVICES, NAMELY, ORGANIZING AND CONDUCTING HALF MARATHON AND 10K RACES AND BICYCLE RACES; ARRANGING AND CONDUCTING ATHLETIC COMPETITIONS, NAMELY, A HALF MARATHON AND 10K RACE AND BICYCLE RACE, IN CLASS 41 (U.S. CLS. 100, 101 AND 107).

FIRST USE 10-3-2010; IN COMMERCE 10-3-2010.

THE MARK CONSISTS OF STANDARD CHARACTERS WITHOUT CLAIM TO ANY PARTICULAR FONT, STYLE, SIZE, OR COLOR.

OWNER OF U.S. REG. NOS. 1,161,379, 1,648,189 AND OTHERS.

SEC. 2(F) AS TO "HERSHEY".

SER. NO. 85-554,410, FILED 2-28-2012.

SAMUEL E. SHARPER JR., EXAMINING ATTORNEY



*David J. Kyffers*

Director of the United States Patent and Trademark Office

# United States of America

United States Patent and Trademark Office



**Reg. No. 4,198,547**

**Registered Aug. 28, 2012**

**Int. Cl.: 25**

**TRADEMARK**

**PRINCIPAL REGISTER**

GRENDENE S.A. (BRAZIL CORPORATION)  
AV. DUQUE DE CAXIAS, 131-A C.POSTAL, 230  
95.180 FARROUPILHA RS, BRAZIL

FOR: SHOES, IN CLASS 25 (U.S. CLS. 22 AND 39).

FIRST USE 7-8-2010; IN COMMERCE 7-8-2010.

THE MARK CONSISTS OF "M:ZERO" WITH A CIRCLE AROUND THE WORDS AND BOTH ARE SUPERIMPOSED ON A RECTANGULAR BACKGROUND.

SER. NO. 85-554,539, FILED 2-28-2012.

JAMES LOVELACE, EXAMINING ATTORNEY



*David J. Kyffers*

Director of the United States Patent and Trademark Office

# United States of America

United States Patent and Trademark Office

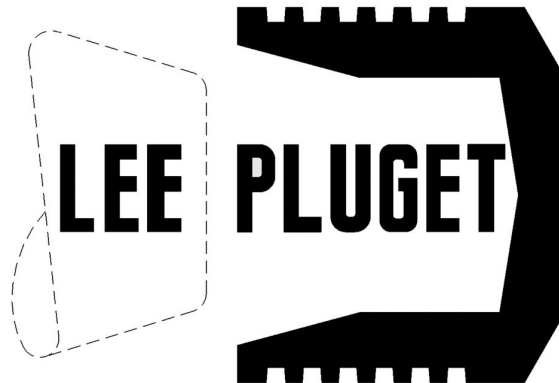

**Reg. No. 4,198,548**

**Registered Aug. 28, 2012**

**Int. Cl.: 6**

**TRADEMARK**

**PRINCIPAL REGISTER**

THE LEE COMPANY (CONNECTICUT CORPORATION)  
HTTP://WWW.THELEECO.COM  
2 PETTIPAUG ROAD  
WESTBROOK, CT 06498

FOR: METALLIC HYDRAULIC SYSTEM SEALING PLUGS, IN CLASS 6 (U.S. CLS. 2, 12, 13, 14, 23, 25 AND 50).

FIRST USE 0-0-1970; IN COMMERCE 0-0-1970.

OWNER OF U.S. REG. NOS. 898,105 AND 900,584.

THE MARK CONSISTS OF "LEE" WITHIN OUTLINED FRUSTACONICAL SHAPE AND "PLUGET" WITHIN THREE SIDED FIGURE WITH HORIZONTAL UPPER AND LOWER SIDES HAVING RECTANGULAR INDENTS AND WITH SOLID VERTICAL END SIDE.

SER. NO. 85-556,199, FILED 2-29-2012.

ANDREW LEASER, EXAMINING ATTORNEY



*David J. Kyros*

Director of the United States Patent and Trademark Office

# United States of America

United States Patent and Trademark Office



**Reg. No. 4,198,549**

**Registered Aug. 28, 2012**

**Int. Cl.: 25**

**TRADEMARK**

**PRINCIPAL REGISTER**

UNIVERSAL HOSIERY INC (CALIFORNIA CORPORATION), DBA UNIVERSAL HOSIERY  
26321 FERRY COURT  
SANTA CLARITA, CA 91350

FOR: SOCKS, IN CLASS 25 (U.S. CLS. 22 AND 39).

FIRST USE 8-10-1994; IN COMMERCE 8-10-1994.

THE MARK CONSISTS OF THE BLACK SILHOUETTE OF A MAN IN A BLACK TUXEDO WITH A WHITE SHIRT CONTAINING A SINGLE BLACK BUTTON, AND A RED BOW TIE CONTAINING WHITE SHADING, WITH A WHITE HAND HOLDING A WHITE TOP HAT CONTAINING BLACK OUTLINING AND CONTAINING BLACK SHADED CIRCLES IN A VERTICAL PATTERN ALONG THE CENTER PORTION.

THE COLOR(S) BLACK, WHITE, AND RED IS/ARE CLAIMED AS A FEATURE OF THE MARK.

SER. NO. 85-556,939, FILED 2-29-2012.

MATTHEW PAPPAS, EXAMINING ATTORNEY



*David J. Kappas*

Director of the United States Patent and Trademark Office

# United States of America

United States Patent and Trademark Office

# BETAPLUG

**Reg. No. 4,198,550**

THE LEE COMPANY (CONNECTICUT CORPORATION)  
2 PETTIPAUG ROAD  
WESTBROOK, CT 06498

**Registered Aug. 28, 2012**

**Int. Cl.: 6**

FOR: METAL SEALING PLUGS FOR USE IN HYDRAULIC SYSTEMS, IN CLASS 6 (U.S. CLS. 2, 12, 13, 14, 23, 25 AND 50).

**TRADEMARK**

FIRST USE 3-31-1990; IN COMMERCE 3-31-1990.

**PRINCIPAL REGISTER**

THE MARK CONSISTS OF STANDARD CHARACTERS WITHOUT CLAIM TO ANY PARTICULAR FONT, STYLE, SIZE, OR COLOR.

SER. NO. 85-557,356, FILED 3-1-2012.

ANDREW LEASER, EXAMINING ATTORNEY



*David J. Kyffers*

Director of the United States Patent and Trademark Office



# United States of America

United States Patent and Trademark Office

## BACONREADER

**Reg. No. 4,198,551**

**Registered Aug. 28, 2012**

**Int. Cls.: 9 and 42**

**TRADEMARK**

**SERVICE MARK**

**PRINCIPAL REGISTER**

ONELOUDER APPS, INC. (DELAWARE CORPORATION)  
SUITE 400  
909 WALNUT STREET  
KANSAS CITY, MO 64106

FOR: SOFTWARE AND DOWNLOADABLE SOFTWARE FOR ACCESSING INFORMATION ON GLOBAL COMPUTER NETWORKS; SOFTWARE AND DOWNLOADABLE SOFTWARE THAT ALLOWS FOR INTERACTION BETWEEN AND AMONG USERS OF COMPUTERS, MOBILE AND HANDHELD COMPUTERS, AND WIRED AND WIRELESS COMMUNICATION DEVICES AND PROVIDES THE MEANS TO TRANSMIT, SYNDICATE, DISTRIBUTE, PUBLISH, TAG, ORGANIZE, AGGREGATE AND MANAGE WEB LINKS, BLOGS, NEWS CONTENT, SOCIAL MEDIA CONTENT, TEXT MESSAGES, IMAGES, AUDIO, VIDEO AND AGGREGATED CONTENT FEEDS, OVER THE INTERNET, WIRELESS AND OTHER COMMUNICATIONS NETWORKS, IN CLASS 9 (U.S. CLS. 21, 23, 26, 36 AND 38).

FIRST USE 4-13-2011; IN COMMERCE 4-13-2011.

FOR: SOFTWARE AS A SERVICE (SAAS) SERVICES FEATURING SOFTWARE FOR INTERACTION BETWEEN AND AMONG USERS OF COMPUTERS, MOBILE AND HANDHELD COMPUTERS, AND WIRED AND WIRELESS COMMUNICATION DEVICES AND PROVIDES THE MEANS TO TRANSMIT, SYNDICATE, DISTRIBUTE, PUBLISH, TAG, ORGANIZE, AGGREGATE AND MANAGE WEB LINKS, BLOGS, SOCIAL MEDIA CONTENT, TEXT MESSAGES, IMAGES, AUDIO, VIDEO AND AGGREGATED CONTENT FEEDS, OVER THE INTERNET, WIRELESS AND OTHER COMMUNICATIONS NETWORKS, IN CLASS 42 (U.S. CLS. 100 AND 101).

FIRST USE 4-13-2011; IN COMMERCE 4-13-2011.

THE MARK CONSISTS OF STANDARD CHARACTERS WITHOUT CLAIM TO ANY PARTICULAR FONT, STYLE, SIZE, OR COLOR.

SER. NO. 85-557,472, FILED 3-1-2012.

MIDGE BUTLER, EXAMINING ATTORNEY



*David J. Kyros*

Director of the United States Patent and Trademark Office

# United States of America

United States Patent and Trademark Office

# Infocrossing

**Reg. No. 4,198,552**

INFOCROSSING, INC. (DELAWARE CORPORATION)  
2 CHRISTIE HEIGHTS STREET  
LEONIA, NJ 07605

**Registered Aug. 28, 2012**

**Int. Cl.: 42**

FOR: DESIGN OF COMPUTER NETWORKS AND SOFTWARE FOR OTHERS FOR THE DEPLOYMENT, HOSTING, MANAGEMENT AND SUPPORT OF COMPUTER NETWORKS, DATA AND SYSTEM SOFTWARE FOR OTHERS IN VIRTUAL, REMOTE OR LOCAL COMPUTING ENVIRONMENTS, IN CLASS 42 (U.S. CLS. 100 AND 101).

**SERVICE MARK**

**PRINCIPAL REGISTER**

FIRST USE 8-15-2011; IN COMMERCE 8-15-2011.

THE MARK CONSISTS OF STANDARD CHARACTERS WITHOUT CLAIM TO ANY PARTICULAR FONT, STYLE, SIZE, OR COLOR.

OWNER OF U.S. REG. NO. 2,732,496.

SEC. 2(F).

SER. NO. 85-557,617, FILED 3-1-2012.

JOHN DWYER, EXAMINING ATTORNEY



*David J. Kyros*

Director of the United States Patent and Trademark Office

# United States of America

United States Patent and Trademark Office

## BREATH FOR LIFE

**Reg. No. 4,198,553**

**Registered Aug. 28, 2012**

**Int. Cl.: 44**

**SERVICE MARK**

**PRINCIPAL REGISTER**

CARENEXT, LLC (NEW YORK LIMITED LIABILITY COMPANY)  
4TH FLOOR  
2500 WESTCHESTER AVENUE  
PURCHASE, NY 10577

FOR: MEDICAL PULMONARY SERVICES, IN CLASS 44 (U.S. CLS. 100 AND 101).

FIRST USE 3-0-2005; IN COMMERCE 3-0-2005.

THE MARK CONSISTS OF STANDARD CHARACTERS WITHOUT CLAIM TO ANY PARTICULAR FONT, STYLE, SIZE, OR COLOR.

SER. NO. 85-558,371, FILED 3-2-2012.

KATHRYN COWARD, EXAMINING ATTORNEY



*David J. Kyros*

Director of the United States Patent and Trademark Office

# United States of America

United States Patent and Trademark Office

## GALERIA MELISSA

**Reg. No. 4,198,554**

**Registered Aug. 28, 2012**

**Int. Cl.: 35**

**SERVICE MARK**

**PRINCIPAL REGISTER**

GRENDENE S.A. (BRAZIL CORPORATION)  
AV. DUQUE DE CAXIAS, 131-A C.POSTAL, 230  
95.180 FARROUPILHA RS, BRAZIL

FOR: RETAIL STORE SERVICES IN THE FIELD OF FOOTWEAR AND ACCESSORIES, IN CLASS 35 (U.S. CLS. 100, 101 AND 102).

FIRST USE 2-8-2012; IN COMMERCE 2-8-2012.

THE MARK CONSISTS OF STANDARD CHARACTERS WITHOUT CLAIM TO ANY PARTICULAR FONT, STYLE, SIZE, OR COLOR.

OWNER OF U.S. REG. NOS. 2,526,595, 2,737,154, AND 3,047,672.

THE ENGLISH TRANSLATION OF THE WORD "GALERIA" IN THE MARK IS "GALLERY".

SER. NO. 85-558,453, FILED 3-2-2012.

JAMES LOVELACE, EXAMINING ATTORNEY



*David J. Kyffers*

Director of the United States Patent and Trademark Office

# United States of America

United States Patent and Trademark Office



**Reg. No. 4,198,555**

FAB.COM, INC. (DELAWARE CORPORATION)  
330 W. 38TH STREET, SUITE 300  
NEW YORK, NY 10018

**Registered Aug. 28, 2012**

**Int. Cl.: 45**

FOR: INTERNET-BASED SOCIAL NETWORKING SERVICES; INTERNET BASED SOCIAL NETWORKING SERVICES ALLOWING USERS TO COMMUNICATE AND SHARE, STORE, TRANSMIT, VIEW, AND DOWNLOAD TEXT, IMAGES, AUDIO AND VIDEO CONTENT, AND OTHER MULTIMEDIA MATERIALS, IN CLASS 45 (U.S. CLS. 100 AND 101).

**SERVICE MARK**

**PRINCIPAL REGISTER**

FIRST USE 1-5-2012; IN COMMERCE 1-5-2012.

THE MARK CONSISTS OF THE WORDING "FAB" AND HEART DESIGN IN LOWER POSITION OF A BOX.

SER. NO. 85-560,161, FILED 3-5-2012.

EMILY CHUO, EXAMINING ATTORNEY



*David J. Kyffers*

Director of the United States Patent and Trademark Office

# United States of America

United States Patent and Trademark Office



**Reg. No. 4,198,556**

FAB.COM, INC. (DELAWARE CORPORATION)  
330 W. 38TH STREET, SUITE 300  
NEW YORK, NY 10018

**Registered Aug. 28, 2012**

**Int. Cl.: 9**

FOR: COMPUTER APPLICATION SOFTWARE FOR MOBILE PHONES OR HANDHELD COMPUTERS, NAMELY, SOFTWARE FOR ONLINE RETAIL SHOPPING, IN CLASS 9 (U.S. CLS. 21, 23, 26, 36 AND 38).

**TRADEMARK**

FIRST USE 10-16-2011; IN COMMERCE 10-16-2011.

**PRINCIPAL REGISTER**

THE MARK CONSISTS OF THE WORDING "FAB" AND HEART DESIGN IN LOWER POSITION OF A BOX.

SER. NO. 85-560,197, FILED 3-5-2012.

EMILY CHUO, EXAMINING ATTORNEY



*David J. Kyffers*

Director of the United States Patent and Trademark Office

# United States of America

United States Patent and Trademark Office

## GET IT NAKED

**Reg. No. 4,198,557**

HAMILTON, SUSAN (UNITED STATES INDIVIDUAL)  
1420 LONGMEADOW DRIVE  
GILROY, CA 95020

**Registered Aug. 28, 2012**

**Int. Cl.: 35**

FOR: PROMOTING PUBLIC AWARENESS OF CELIAC SPRUE DISEASE, GLUTEN-INDUCED SENSITIVITIES AND GLUTEN FREE DIETS, IN CLASS 35 (U.S. CLS. 100, 101 AND 102).

**SERVICE MARK**

FIRST USE 3-1-2012; IN COMMERCE 3-1-2012.

**PRINCIPAL REGISTER**

THE MARK CONSISTS OF STANDARD CHARACTERS WITHOUT CLAIM TO ANY PARTICULAR FONT, STYLE, SIZE, OR COLOR.

SER. NO. 85-560,240, FILED 3-5-2012.

YAT SYE, LEE, EXAMINING ATTORNEY



*David J. Kybas*

Director of the United States Patent and Trademark Office

# United States of America

United States Patent and Trademark Office

# RESTART

**Reg. No. 4,198,558**

**Registered Aug. 28, 2012**

**Int. Cl.: 44**

**SERVICE MARK**

**PRINCIPAL REGISTER**

RESTART INTERNET ADDICTION RECOVERY PROGRAM, LLC. (WASHINGTON LIMITED LIABILITY COMPANY)  
PO BOX 490  
FALL CITY, WA 980240490

FOR: ADDICTION TREATMENT SERVICES, IN CLASS 44 (U.S. CLS. 100 AND 101).

FIRST USE 6-30-2009; IN COMMERCE 6-30-2009.

THE MARK CONSISTS OF STANDARD CHARACTERS WITHOUT CLAIM TO ANY PARTICULAR FONT, STYLE, SIZE, OR COLOR.

SER. NO. 85-560,874, FILED 3-5-2012.

KERI CANTONE, EXAMINING ATTORNEY



*David J. Kyffers*

Director of the United States Patent and Trademark Office



# United States of America

United States Patent and Trademark Office

## PRAIRIE FARMS

**Reg. No. 4,198,559**

**Registered Aug. 28, 2012**

**Int. Cl.: 29**

**TRADEMARK**

**PRINCIPAL REGISTER**

PRAIRIE FARMS DAIRY, INC. (ILLINOIS CORPORATION)  
1100 BROADWAY  
CARLINVILLE, IL 62626

FOR: MILK, FLAVORED MILK, CREAM, WHIPPED CREAM, HALF AND HALF, BUTTER-MILK, NON-ALCOHOLIC EGGNOG, BUTTER, COTTAGE CHEESE, YOGURT, SOUR CREAM, EGG SUBSTITUTE, MARGARINE AND DIPS , IN CLASS 29 (U.S. CL. 46).

FIRST USE 1-1-1939; IN COMMERCE 1-1-1939.

THE MARK CONSISTS OF STANDARD CHARACTERS WITHOUT CLAIM TO ANY PARTICULAR FONT, STYLE, SIZE, OR COLOR.

OWNER OF U.S. REG. NOS. 1,286,158, 3,871,025 AND OTHERS.

NO CLAIM IS MADE TO THE EXCLUSIVE RIGHT TO USE "FARM", APART FROM THE MARK AS SHOWN.

SER. NO. 85-561,269, FILED 3-6-2012.

DAVID MURRAY, EXAMINING ATTORNEY



*David J. Kyfos*

Director of the United States Patent and Trademark Office

# United States of America

United States Patent and Trademark Office

## PRAIRIE FARMS

**Reg. No. 4,198,560**

PRAIRIE FARMS DAIRY, INC. (ILLINOIS CORPORATION)  
1100 BROADWAY  
CARLINVILLE, IL 62626

**Registered Aug. 28, 2012**

**Int. Cl.: 30**

FOR: ICE CREAM, FROZEN YOGURT, SHERBERT, ICED TEA, IN CLASS 30 (U.S. CL. 46).

**TRADEMARK**

FIRST USE 1-1-1939; IN COMMERCE 1-1-1939.

**PRINCIPAL REGISTER**

THE MARK CONSISTS OF STANDARD CHARACTERS WITHOUT CLAIM TO ANY PARTICULAR FONT, STYLE, SIZE, OR COLOR.

OWNER OF U.S. REG. NOS. 1,286,158, 3,871,025 AND OTHERS.

SER. NO. 85-561,293, FILED 3-6-2012.

DAVID MURRAY, EXAMINING ATTORNEY



*David J. Kyffers*

Director of the United States Patent and Trademark Office

# United States of America

United States Patent and Trademark Office

## PRAIRIE FARMS

**Reg. No. 4,198,561**

PRAIRIE FARMS DAIRY, INC. (ILLINOIS CORPORATION)

**Registered Aug. 28, 2012**

1100 BROADWAY  
CARLINVILLE, IL 61701

**Int. Cl.: 32**

FOR: ORANGE JUICE, FRUIT FLAVORED DRINKS, IN CLASS 32 (U.S. CLS. 45, 46 AND 48).

**TRADEMARK**

FIRST USE 1-1-1939; IN COMMERCE 1-1-1939.

**PRINCIPAL REGISTER**

THE MARK CONSISTS OF STANDARD CHARACTERS WITHOUT CLAIM TO ANY PARTICULAR FONT, STYLE, SIZE, OR COLOR.

OWNER OF U.S. REG. NOS. 1,286,158, 3,871,024, AND 3,871,025.

SER. NO. 85-561,307, FILED 3-6-2012.

DAVID MURRAY, EXAMINING ATTORNEY



*David J. Kyros*

Director of the United States Patent and Trademark Office

# United States of America

United States Patent and Trademark Office

# CAT CHEF

**Reg. No. 4,198,562**

**Registered Aug. 28, 2012**

**Int. Cl.: 9**

**TRADEMARK**

**PRINCIPAL REGISTER**

PLAYTIKA LTD. (ISRAEL LIMITED COMPANY (LTD.))  
16 TIOMKIN STREET  
TEL AVIV, ISRAEL 65783

FOR: COMPUTER GAME SOFTWARE; VIDEO GAME PROGRAMS; AND COMPUTER SOFTWARE PLATFORMS FOR SOCIAL NETWORKING; INTERACTIVE VIDEO GAME PROGRAMS; DOWNLOADABLE GAME PROGRAMS AND COMPUTER SOFTWARE PLATFORMS FOR SOCIAL NETWORKING THAT MAY BE ACCESSED VIA THE INTERNET, COMPUTERS AND WIRELESS DEVICES; COMPUTER SOFTWARE TO ENABLE UPLOADING, POSTING, SHOWING, DISPLAYING, TAGGING, BLOGGING, SHARING OR OTHERWISE PROVIDING MEDIA OR INFORMATION IN THE FIELDS OF VIRTUAL COMMUNITIES, GAMING, ENTERTAINMENT, AND GENERAL INTEREST VIA THE INTERNET OR OTHER COMMUNICATIONS NETWORKS WITH THIRD PARTIES; DOWNLOADABLE GAME SOFTWARE FOR CELLULAR TELEPHONES; DOWNLOADABLE GAME SOFTWARE FOR WIRELESS DEVICES; AND DOWNLOADABLE GAME SOFTWARE FOR USE WITH SOCIAL NETWORKING APPLICATIONS AND ON SOCIAL NETWORKING WEBSITES, IN CLASS 9 (U.S. CLS. 21, 23, 26, 36 AND 38).

FIRST USE 2-17-2011; IN COMMERCE 2-17-2011.

THE MARK CONSISTS OF STANDARD CHARACTERS WITHOUT CLAIM TO ANY PARTICULAR FONT, STYLE, SIZE, OR COLOR.

SER. NO. 85-561,541, FILED 3-6-2012.

WILLIAM VERHOSEK, EXAMINING ATTORNEY



*David J. Kyffers*

Director of the United States Patent and Trademark Office

# United States of America

United States Patent and Trademark Office

## FARM FORTUNE

**Reg. No. 4,198,563**

**Registered Aug. 28, 2012**

**Int. Cl.: 9**

**TRADEMARK**

**PRINCIPAL REGISTER**

PLAYTIKA LTD. (ISRAEL LIMITED COMPANY (LTD.))  
16 TIOMKIN STREET  
TEL AVIV, ISRAEL 65783

FOR: COMPUTER GAME SOFTWARE; VIDEO GAME PROGRAMS; AND COMPUTER SOFTWARE PLATFORMS FOR SOCIAL NETWORKING; INTERACTIVE VIDEO GAME PROGRAMS; DOWNLOADABLE GAME PROGRAMS AND COMPUTER SOFTWARE PLATFORMS FOR SOCIAL NETWORKING THAT MAY BE ACCESSED VIA THE INTERNET, COMPUTERS AND WIRELESS DEVICES; COMPUTER SOFTWARE TO ENABLE UPLOADING, POSTING, SHOWING, DISPLAYING, TAGGING, BLOGGING, SHARING OR OTHERWISE PROVIDING MEDIA OR INFORMATION IN THE FIELDS OF VIRTUAL COMMUNITIES, GAMING, ENTERTAINMENT, AND GENERAL INTEREST VIA THE INTERNET OR OTHER COMMUNICATIONS NETWORKS WITH THIRD PARTIES; DOWNLOADABLE GAME SOFTWARE FOR CELLULAR TELEPHONES; DOWNLOADABLE GAME SOFTWARE FOR WIRELESS DEVICES; AND DOWNLOADABLE GAME SOFTWARE FOR USE WITH SOCIAL NETWORKING APPLICATIONS AND ON SOCIAL NETWORKING WEBSITES, IN CLASS 9 (U.S. CLS. 21, 23, 26, 36 AND 38).

FIRST USE 12-16-2010; IN COMMERCE 12-16-2010.

THE MARK CONSISTS OF STANDARD CHARACTERS WITHOUT CLAIM TO ANY PARTICULAR FONT, STYLE, SIZE, OR COLOR.

SER. NO. 85-561,560, FILED 3-6-2012.

WILLIAM VERHOSEK, EXAMINING ATTORNEY



*David J. Kyffers*

Director of the United States Patent and Trademark Office

# United States of America

United States Patent and Trademark Office

## BUBBLE RUMBLE

**Reg. No. 4,198,564**

**Registered Aug. 28, 2012**

**Int. Cl.: 9**

**TRADEMARK**

**PRINCIPAL REGISTER**

PLAYTIKA LTD. (ISRAEL LIMITED COMPANY (LTD.))  
16 TIOMKIN STREET  
TEL AVIV, ISRAEL 65783

FOR: COMPUTER GAME SOFTWARE; VIDEO GAME PROGRAMS; AND COMPUTER SOFTWARE PLATFORMS FOR SOCIAL NETWORKING; INTERACTIVE VIDEO GAME PROGRAMS; DOWNLOADABLE GAME PROGRAMS AND COMPUTER SOFTWARE PLATFORMS FOR SOCIAL NETWORKING THAT MAY BE ACCESSED VIA THE INTERNET, COMPUTERS AND WIRELESS DEVICES; COMPUTER SOFTWARE TO ENABLE UPLOADING, POSTING, SHOWING, DISPLAYING, TAGGING, BLOGGING, SHARING OR OTHERWISE PROVIDING MEDIA OR INFORMATION IN THE FIELDS OF VIRTUAL COMMUNITIES, GAMING, ENTERTAINMENT, AND GENERAL INTEREST VIA THE INTERNET OR OTHER COMMUNICATIONS NETWORKS WITH THIRD PARTIES; DOWNLOADABLE GAME SOFTWARE FOR CELLULAR TELEPHONES; DOWNLOADABLE GAME SOFTWARE FOR WIRELESS DEVICES; AND DOWNLOADABLE GAME SOFTWARE FOR USE WITH SOCIAL NETWORKING APPLICATIONS AND ON SOCIAL NETWORKING WEBSITES, IN CLASS 9 (U.S. CLS. 21, 23, 26, 36 AND 38).

FIRST USE 12-16-2010; IN COMMERCE 12-16-2010.

THE MARK CONSISTS OF STANDARD CHARACTERS WITHOUT CLAIM TO ANY PARTICULAR FONT, STYLE, SIZE, OR COLOR.

SER. NO. 85-561,572, FILED 3-6-2012.

WILLIAM VERHOSEK, EXAMINING ATTORNEY



*David J. Kyffers*

Director of the United States Patent and Trademark Office

# United States of America

United States Patent and Trademark Office

## CIVILITREASURES

**Reg. No. 4,198,565**

**Registered Aug. 28, 2012**

**Int. Cl.: 9**

**TRADEMARK**

**PRINCIPAL REGISTER**

PLAYTIKA LTD. (ISRAEL LIMITED COMPANY (LTD.))  
16 TIOMKIN STREET  
TEL AVIV, ISRAEL 65783

FOR: COMPUTER GAME SOFTWARE; VIDEO GAME PROGRAMS; AND COMPUTER SOFTWARE PLATFORMS FOR SOCIAL NETWORKING; INTERACTIVE VIDEO GAME PROGRAMS; DOWNLOADABLE GAME PROGRAMS AND COMPUTER SOFTWARE PLATFORMS FOR SOCIAL NETWORKING THAT MAY BE ACCESSED VIA THE INTERNET, COMPUTERS AND WIRELESS DEVICES; COMPUTER SOFTWARE TO ENABLE UPLOADING, POSTING, SHOWING, DISPLAYING, TAGGING, BLOGGING, SHARING OR OTHERWISE PROVIDING MEDIA OR INFORMATION IN THE FIELDS OF VIRTUAL COMMUNITIES, GAMING, ENTERTAINMENT, AND GENERAL INTEREST VIA THE INTERNET OR OTHER COMMUNICATIONS NETWORKS WITH THIRD PARTIES; DOWNLOADABLE GAME SOFTWARE FOR CELLULAR TELEPHONES; DOWNLOADABLE GAME SOFTWARE FOR WIRELESS DEVICES; AND DOWNLOADABLE GAME SOFTWARE FOR USE WITH SOCIAL NETWORKING APPLICATIONS AND ON SOCIAL NETWORKING WEBSITES, IN CLASS 9 (U.S. CLS. 21, 23, 26, 36 AND 38).

FIRST USE 12-16-2010; IN COMMERCE 12-16-2010.

THE MARK CONSISTS OF STANDARD CHARACTERS WITHOUT CLAIM TO ANY PARTICULAR FONT, STYLE, SIZE, OR COLOR.

SER. NO. 85-561,580, FILED 3-6-2012.

WILLIAM VERHOSEK, EXAMINING ATTORNEY



*David J. Kyffers*

Director of the United States Patent and Trademark Office

# United States of America

United States Patent and Trademark Office

## FOREST OF MAGIC

**Reg. No. 4,198,566**

**Registered Aug. 28, 2012**

**Int. Cl.: 9**

**TRADEMARK**

**PRINCIPAL REGISTER**

PLAYTIKA LTD. (ISRAEL LIMITED COMPANY (LTD.))  
16 TIOMKIN STREET  
TEL AVIV, ISRAEL 65783

FOR: COMPUTER GAME SOFTWARE; VIDEO GAME PROGRAMS; AND COMPUTER SOFTWARE PLATFORMS FOR SOCIAL NETWORKING; INTERACTIVE VIDEO GAME PROGRAMS; DOWNLOADABLE GAME PROGRAMS AND COMPUTER SOFTWARE PLATFORMS FOR SOCIAL NETWORKING THAT MAY BE ACCESSED VIA THE INTERNET, COMPUTERS AND WIRELESS DEVICES; COMPUTER SOFTWARE TO ENABLE UPLOADING, POSTING, SHOWING, DISPLAYING, TAGGING, BLOGGING, SHARING OR OTHERWISE PROVIDING MEDIA OR INFORMATION IN THE FIELDS OF VIRTUAL COMMUNITIES, GAMING, ENTERTAINMENT, AND GENERAL INTEREST VIA THE INTERNET OR OTHER COMMUNICATIONS NETWORKS WITH THIRD PARTIES; DOWNLOADABLE GAME SOFTWARE FOR CELLULAR TELEPHONES; DOWNLOADABLE GAME SOFTWARE FOR WIRELESS DEVICES; AND DOWNLOADABLE GAME SOFTWARE FOR USE WITH SOCIAL NETWORKING APPLICATIONS AND ON SOCIAL NETWORKING WEBSITES, IN CLASS 9 (U.S. CLS. 21, 23, 26, 36 AND 38).

FIRST USE 12-16-2010; IN COMMERCE 12-16-2010.

THE MARK CONSISTS OF STANDARD CHARACTERS WITHOUT CLAIM TO ANY PARTICULAR FONT, STYLE, SIZE, OR COLOR.

SER. NO. 85-561,596, FILED 3-6-2012.

WILLIAM VERHOSEK, EXAMINING ATTORNEY



*David J. Kyffers*

Director of the United States Patent and Trademark Office



# United States of America

United States Patent and Trademark Office

# DEEP SEEK

**Reg. No. 4,198,567**

**Registered Aug. 28, 2012**

**Int. Cl.: 9**

**TRADEMARK**

**PRINCIPAL REGISTER**

PLAYTIKA LTD. (ISRAEL LIMITED COMPANY (LTD.))  
16 TIOMKIN STREET  
TEL AVIV, ISRAEL 65783

FOR: COMPUTER GAME SOFTWARE; VIDEO GAME PROGRAMS; AND COMPUTER SOFTWARE PLATFORMS FOR SOCIAL NETWORKING; INTERACTIVE VIDEO GAME PROGRAMS; DOWNLOADABLE GAME PROGRAMS AND COMPUTER SOFTWARE PLATFORMS FOR SOCIAL NETWORKING THAT MAY BE ACCESSED VIA THE INTERNET, COMPUTERS AND WIRELESS DEVICES; COMPUTER SOFTWARE TO ENABLE UPLOADING, POSTING, SHOWING, DISPLAYING, TAGGING, BLOGGING, SHARING OR OTHERWISE PROVIDING MEDIA OR INFORMATION IN THE FIELDS OF VIRTUAL COMMUNITIES, GAMING, ENTERTAINMENT, AND GENERAL INTEREST VIA THE INTERNET OR OTHER COMMUNICATIONS NETWORKS WITH THIRD PARTIES; DOWNLOADABLE GAME SOFTWARE FOR CELLULAR TELEPHONES; DOWNLOADABLE GAME SOFTWARE FOR WIRELESS DEVICES; AND DOWNLOADABLE GAME SOFTWARE FOR USE WITH SOCIAL NETWORKING APPLICATIONS AND ON SOCIAL NETWORKING WEBSITES, IN CLASS 9 (U.S. CLS. 21, 23, 26, 36 AND 38).

FIRST USE 4-14-2011; IN COMMERCE 4-14-2011.

THE MARK CONSISTS OF STANDARD CHARACTERS WITHOUT CLAIM TO ANY PARTICULAR FONT, STYLE, SIZE, OR COLOR.

SER. NO. 85-561,609, FILED 3-6-2012.

WILLIAM VERHOSEK, EXAMINING ATTORNEY



*David J. Kyffers*

Director of the United States Patent and Trademark Office

# United States of America

United States Patent and Trademark Office

## CHALLENGE WHAT'S POSSIBLE

**Reg. No. 4,198,568**

**Registered Aug. 28, 2012**

**Int. Cl.: 3**

**TRADEMARK**

**PRINCIPAL REGISTER**

THE PROCTER & GAMBLE COMPANY (OHIO CORPORATION)  
ONE PROCTER & GAMBLE PLAZA  
CINCINNATI, OH 45202

FOR: NON-MEDICATED SKIN CARE PREPARATIONS AND DEPILATORIES, IN CLASS 3  
(U.S. CLS. 1, 4, 6, 50, 51 AND 52).

FIRST USE 9-30-2011; IN COMMERCE 9-30-2011.

THE MARK CONSISTS OF STANDARD CHARACTERS WITHOUT CLAIM TO ANY PARTICULAR FONT, STYLE, SIZE, OR COLOR.

OWNER OF U.S. REG. NO. 4,071,895.

SER. NO. 85-561,693, FILED 3-6-2012.

DAVID COLLIER, EXAMINING ATTORNEY



*David J. Kybas*

Director of the United States Patent and Trademark Office

# United States of America

United States Patent and Trademark Office

## COAGRASPER

**Reg. No. 4,198,569**

OLYMPUS MEDICAL SYSTEMS CORP. (JAPAN JOINT STOCK COMPANY)  
43-2, HATAGAYA 2-CHOME, SHIBUYA-KU  
TOKYO, JAPAN

**Registered Aug. 28, 2012**

**Int. Cl.: 10**

FOR: TREATMENT INSTRUMENTS FOR USE WITH MEDICAL AND SURGICAL ENDO-  
SCOPES, NAMELY, HEMOSTATIC FORCEPS, IN CLASS 10 (U.S. CLS. 26, 39 AND 44).

**TRADEMARK**

FIRST USE 5-1-2007; IN COMMERCE 5-1-2007.

**PRINCIPAL REGISTER**

THE MARK CONSISTS OF STANDARD CHARACTERS WITHOUT CLAIM TO ANY PAR-  
TICULAR FONT, STYLE, SIZE, OR COLOR.

SER. NO. 85-561,725, FILED 3-6-2012.

CAROLYN CATALDO, EXAMINING ATTORNEY



*David J. Kybas*

Director of the United States Patent and Trademark Office

# United States of America

United States Patent and Trademark Office

# Design Duel

**Reg. No. 4,198,570**

DALLAS AREA HABITAT FOR HUMANITY INC. (TEXAS CORPORATION)  
2800 N. HAMPTON ROAD  
DALLAS, TX 75212

**Registered Aug. 28, 2012**

**Int. Cl.: 36**

FOR: CHARITABLE FUNDRAISING SERVICES BY MEANS OF AN ANNUAL DESIGN COMPETITION INTENDED TO RAISE AWARENESS OF THE ORGANIZATION'S RESALE STORES, IN CLASS 36 (U.S. CLS. 100, 101 AND 102).

**SERVICE MARK**

FIRST USE 7-22-2011; IN COMMERCE 7-22-2011.

**PRINCIPAL REGISTER**

THE MARK CONSISTS OF STANDARD CHARACTERS WITHOUT CLAIM TO ANY PARTICULAR FONT, STYLE, SIZE, OR COLOR.

NO CLAIM IS MADE TO THE EXCLUSIVE RIGHT TO USE "DESIGN", APART FROM THE MARK AS SHOWN.

SER. NO. 85-561,921, FILED 3-6-2012.

JOHN E. MICHOS, EXAMINING ATTORNEY



*David J. Kyffers*

Director of the United States Patent and Trademark Office

United States of America  
United States Patent and Trademark Office

# IRONSORB

**Reg. No. 4,198,571**

JARROW FORMULAS, INC. (CALIFORNIA CORPORATION)  
1824 SOUTH ROBERTSON BLVD.  
LOS ANGELES, CA 90035

**Registered Aug. 28, 2012**

**Int. Cl.: 5**

FOR: DIETARY AND NUTRITIONAL SUPPLEMENTS CONTAINING IRON, IN CLASS 5  
(U.S. CLS. 6, 18, 44, 46, 51 AND 52).

**TRADEMARK**

FIRST USE 5-0-2002; IN COMMERCE 5-0-2002.

**PRINCIPAL REGISTER**

THE MARK CONSISTS OF STANDARD CHARACTERS WITHOUT CLAIM TO ANY PARTICULAR FONT, STYLE, SIZE, OR COLOR.

OWNER OF U.S. REG. NOS. 2,507,906, 4,032,207 AND OTHERS.

SER. NO. 85-562,505, FILED 3-7-2012.

TOBY BULLOFF, EXAMINING ATTORNEY



*David J. Kybas*

Director of the United States Patent and Trademark Office

# United States of America

United States Patent and Trademark Office

## JARROW PAK

**Reg. No. 4,198,572**

JARROW FORMULAS, INC. (CALIFORNIA CORPORATION)  
1824 SOUTH ROBERTSON BLVD.  
LOS ANGELES, CA 90035

**Registered Aug. 28, 2012**

**Int. Cl.: 5**

FOR: DIETARY AND NUTRITIONAL SUPPLEMENTS, IN CLASS 5 (U.S. CLS. 6, 18, 44, 46, 51 AND 52).

**TRADEMARK**

FIRST USE 5-0-2002; IN COMMERCE 5-0-2002.

**PRINCIPAL REGISTER**

THE MARK CONSISTS OF STANDARD CHARACTERS WITHOUT CLAIM TO ANY PARTICULAR FONT, STYLE, SIZE, OR COLOR.

OWNER OF U.S. REG. NOS. 2,468,898, 3,911,837 AND OTHERS.

NO CLAIM IS MADE TO THE EXCLUSIVE RIGHT TO USE "PAK", APART FROM THE MARK AS SHOWN.

SER. NO. 85-562,542, FILED 3-7-2012.

TOBY BULLOFF, EXAMINING ATTORNEY



*David J. Kyffers*

Director of the United States Patent and Trademark Office

# United States of America

United States Patent and Trademark Office

# TOM

**Reg. No. 4,198,573**

**Registered Aug. 28, 2012**

**Int. Cls.: 42 and 45**

**SERVICE MARK**

**PRINCIPAL REGISTER**

GENESISTEMS, INC. (NEW YORK CORPORATION)  
1900 W BLOOMFIELD RD  
HONEOYE FALLS, NY 14472

FOR: COMPUTER SOFTWARE DEVELOPMENT AND CONSULTING SERVICES, IN CLASS 42 (U.S. CLS. 100 AND 101).

FIRST USE 11-1-1974; IN COMMERCE 11-1-1974.

FOR: COMPUTER SOFTWARE LICENSING SERVICES, IN CLASS 45 (U.S. CLS. 100 AND 101).

FIRST USE 11-1-1974; IN COMMERCE 11-1-1974.

THE MARK CONSISTS OF STANDARD CHARACTERS WITHOUT CLAIM TO ANY PARTICULAR FONT, STYLE, SIZE, OR COLOR.

OWNER OF U.S. REG. NO. 1,183,557.

SER. NO. 85-562,596, FILED 3-7-2012.

DEIRDRE ROBERTSON, EXAMINING ATTORNEY



*David J. Kybas*

Director of the United States Patent and Trademark Office

# United States of America

United States Patent and Trademark Office

## REDDI-RESPONSE

**Reg. No. 4,198,574**

**Registered Aug. 28, 2012**

**Int. Cl.: 36**

**SERVICE MARK**

**PRINCIPAL REGISTER**

ZIONS BANCORPORATION (UTAH CORPORATION)  
SUITE 700  
ONE SOUTH MAIN STREET  
SALT LAKE CITY, UT 84133

FOR: BANKING AND FINANCIAL SERVICES, IN CLASS 36 (U.S. CLS. 100, 101 AND 102).

FIRST USE 6-5-1992; IN COMMERCE 6-5-1992.

THE MARK CONSISTS OF STANDARD CHARACTERS WITHOUT CLAIM TO ANY PARTICULAR FONT, STYLE, SIZE, OR COLOR.

SER. NO. 85-562,688, FILED 3-7-2012.

ODESSA BIBBINS, EXAMINING ATTORNEY



*David J. Kyffers*

Director of the United States Patent and Trademark Office



# United States of America

United States Patent and Trademark Office

## The Total Firearms Experience

**Reg. No. 4,198,575**

**Registered Aug. 28, 2012**

**Int. Cl.: 41**

**SERVICE MARK**

**PRINCIPAL REGISTER**

FRISCO FIREARMS & ACADEMY LLC (TEXAS LIMITED LIABILITY COMPANY), DBA  
FRISCO GUN CLUB & ACADEMY D/B/A FRISCO GUN CLUB D/B/A FGC  
1607 WEST MOCKINGBIRD LANE  
DALLAS, TX 75235

FOR: GUN FIRING RANGES, IN CLASS 41 (U.S. CLS. 100, 101 AND 107).

FIRST USE 2-1-2012; IN COMMERCE 2-1-2012.

THE MARK CONSISTS OF STANDARD CHARACTERS WITHOUT CLAIM TO ANY PARTICULAR FONT, STYLE, SIZE, OR COLOR.

NO CLAIM IS MADE TO THE EXCLUSIVE RIGHT TO USE "FIREARMS", APART FROM THE MARK AS SHOWN.

SER. NO. 85-562,722, FILED S.R. 3-7-2012 AM. P.R. 4-24-2012.

JAMES GRIFFIN, EXAMINING ATTORNEY



*David J. Kyffers*

Director of the United States Patent and Trademark Office

# United States of America

United States Patent and Trademark Office



**Reg. No. 4,198,576**

FIRST DESCENTS (COLORADO NON-PROFIT CORPORATION)  
767 SANTA FE DRIVE  
DENVER, CO 80204

**Registered Aug. 28, 2012**

**Int. Cls.: 16, 25 and 36**

FOR: STICKERS, IN CLASS 16 (U.S. CLS. 2, 5, 22, 23, 29, 37, 38 AND 50).

**TRADEMARK**

FIRST USE 10-17-2011; IN COMMERCE 10-19-2011.

**SERVICE MARK**

FOR: T-SHIRTS, HOODED SWEATSHIRTS, IN CLASS 25 (U.S. CLS. 22 AND 39).

**PRINCIPAL REGISTER**

FIRST USE 10-17-2011; IN COMMERCE 10-19-2011.

FOR: CHARITABLE FUNDRAISING SERVICES, IN CLASS 36 (U.S. CLS. 100, 101 AND 102).

FIRST USE 10-17-2011; IN COMMERCE 10-19-2011.

OWNER OF U.S. REG. NO. 2,695,260.

THE COLOR(S) BLUE IS/ARE CLAIMED AS A FEATURE OF THE MARK.

THE MARK CONSISTS OF A STYLIZED CIRCLE DESIGN OF TWO INTERLOCKED PATTERNS FOLLOWED BY THE WORD "FIRST" ABOVE THE WORD "DESCENTS" ALL IN BLUE.

SER. NO. 85-563,193, FILED 3-7-2012.

FONG HSU, EXAMINING ATTORNEY



*David J. Kybas*

Director of the United States Patent and Trademark Office

# United States of America

United States Patent and Trademark Office

**HEART**  **Respond**

**Reg. No. 4,198,577**

**Registered Aug. 28, 2012**

**Int. Cl.: 35**

**SERVICE MARK**

**PRINCIPAL REGISTER**

WHEELER, JR., GEORGE (UNITED STATES INDIVIDUAL)  
8547 E. ARAPAHOE BLVD  
J-563  
GREENWOOD VILLAGE, CO 80112

FOR: PUBLIC ADVOCACY TO PROMOTE AWARENESS FOR RESPONSIVE LIFE SAVING AND FIRST AID, IN CLASS 35 (U.S. CLS. 100, 101 AND 102).

FIRST USE 11-1-2011; IN COMMERCE 11-1-2011.

THE MARK CONSISTS OF THE WORD "HEART" IN CAPITAL LETTERS, IN RED; A DEPICTION OF A CLOCK, IN BLACK WITH A THE HOUR BETWEEN 12 & 1 DESIGNATED IN RED; THE WORD "RESPOND" IN TITLE CASE, IN BLACK.

THE COLOR(S) RED AND BLACK IS/ARE CLAIMED AS A FEATURE OF THE MARK.

SER. NO. 85-563,279, FILED 3-7-2012.

CURTIS FRENCH, EXAMINING ATTORNEY



*David J. Kyros*

Director of the United States Patent and Trademark Office

# United States of America

United States Patent and Trademark Office

# icab2go

**Reg. No. 4,198,578**

**Registered Aug. 28, 2012**

**Int. Cl.: 9**

**TRADEMARK**

**PRINCIPAL REGISTER**

ICAB LLC (DELAWARE LIMITED LIABILITY COMPANY)  
SUITE 516  
1835 E HALLANDALE BEACH BLVD  
HALLANDALE, FL 33009

FOR: AUTOMATED SYSTEMS, NAMELY, SOFTWARE, HARDWARE AND COMMUNICATIONS DEVICES FOR PLANNING, SCHEDULING, CONTROLLING, MONITORING AND PROVIDING INFORMATION ON TRANSPORTATION ASSETS AND PARTS THEREOF; COMPUTER APPLICATION SOFTWARE FOR MOBILE PHONES, NAMELY, SOFTWARE FOR HAILING A TAXI; COMPUTER APPLICATION SOFTWARE FOR HAILING A TAXI, NAMELY, SOFTWARE FOR REQUESTING A TAXI ON THE WEB; COMPUTER COMMUNICATIONS SOFTWARE TO ALLOW CUSTOMERS TO ACCESS BANK ACCOUNT INFORMATION AND TRANSACT BANK BUSINESS; COMPUTER HARDWARE AND SOFTWARE SYSTEM FOR TRACKING PEOPLE, OBJECTS AND PETS USING GPS DATA ON A DEVICE ON THE TRACKED PEOPLE, OBJECTS AND PETS; COMPUTER SOFTWARE FOR USE IN CUSTOMER RELATIONSHIP MANAGEMENT (CRM); COMPUTER SOFTWARE FOR WIRELESS CONTENT DELIVERY; COMPUTER SOFTWARE PLATFORMS FOR HAILING A TAXI AND DISPLAY MEDIA CONTENT; COMPUTER SOFTWARE THAT PROVIDES REAL-TIME, INTEGRATED BUSINESS MANAGEMENT INTELLIGENCE BY COMBINING INFORMATION FROM VARIOUS DATABASES AND PRESENTING IT IN AN EASY-TO-UNDERSTAND USER INTERFACE; COMPUTER SOFTWARE THAT PROVIDES WEB-BASED ACCESS TO APPLICATIONS AND SERVICES THROUGH A WEB OPERATING SYSTEM OR PORTAL INTERFACE; COMPUTER SOFTWARE, NAMELY, ELECTRONIC FINANCIAL PLATFORM THAT ACCOMMODATES MULTIPLE TYPES OF PAYMENT AND DEBT TRANSACTIONS IN AN INTEGRATED MOBILE PHONE, PDA, AND WEB BASED ENVIRONMENT; GLOBAL POSITIONING SYSTEM (GPS) CONSISTING OF COMPUTERS, COMPUTER SOFTWARE, TRANSMITTERS, RECEIVERS, AND NETWORK INTERFACE DEVICES; VEHICLE DETECTION EQUIPMENT, NAMELY, DISPLAY MONITORS, COMPUTERS, IMAGE SENSORS, VIDEO CAMERAS, AND OPERATING SYSTEM AND APPLICATION SOFTWARE TO DETECT VEHICLE LOCATION; VEHICLE TRACKING DEVICES COMPRISED OF CELLULAR RADIO MODULES, COMPUTER SOFTWARE AND COMPUTER HARDWARE, SENSORS, TRANSMITTERS, RECEIVERS AND GLOBAL POSITIONING SATELLITE RECEIVERS, ALL FOR USE IN CONNECTION WITH VEHICLE TRACKING, VEHICLE MONITORING AND ANTI-THEFT VEHICLE ALARMS, IN CLASS 9 (U.S. CLS. 21, 23, 26, 36 AND 38).



*David J. Kyros*

Director of the United States Patent and Trademark Office

FIRST USE 2-1-2012; IN COMMERCE 2-1-2012.

**Reg. No. 4,198,578** THE MARK CONSISTS OF STANDARD CHARACTERS WITHOUT CLAIM TO ANY PARTICULAR FONT, STYLE, SIZE, OR COLOR.

SER. NO. 85-563,707, FILED 3-8-2012.

VIVIAN MICZNIK FIRST, EXAMINING ATTORNEY

# United States of America

United States Patent and Trademark Office

## RASPBERRY KETONE FUSION

**Reg. No. 4,198,579**

NUTRI-FUSION SYSTEMS, INC. (UTAH CORPORATION)  
9854 SOUTH 700 EAST, #2  
SANDY, UT 84070

**Registered Aug. 28, 2012**

**Int. Cl.: 5**

FOR: DIETARY SUPPLEMENTS CONTAINING RASPBERRY KETONE, IN CLASS 5 (U.S. CLS. 6, 18, 44, 46, 51 AND 52).

**TRADEMARK**

FIRST USE 2-4-2012; IN COMMERCE 2-4-2012.

**PRINCIPAL REGISTER**

THE MARK CONSISTS OF STANDARD CHARACTERS WITHOUT CLAIM TO ANY PARTICULAR FONT, STYLE, SIZE, OR COLOR.

NO CLAIM IS MADE TO THE EXCLUSIVE RIGHT TO USE "RASPBERRY KETONE", APART FROM THE MARK AS SHOWN.

SER. NO. 85-564,308, FILED 3-8-2012.

KELLY BOULTON, EXAMINING ATTORNEY



*David J. Kyffers*

Director of the United States Patent and Trademark Office

# United States of America

United States Patent and Trademark Office

## REALPAGE CLOUD

**Reg. No. 4,198,580**

**Registered Aug. 28, 2012**

**Int. Cl.: 42**

**SERVICE MARK**

**PRINCIPAL REGISTER**

REALPAGE, INC. (DELAWARE CORPORATION)  
4000 INTERNATIONAL PARKWAY  
CARROLLTON, TX 75007

FOR: CLOUD COMPUTING FEATURING SOFTWARE FOR USE IN MARKETING, LEASING, RENTING, MANAGING, AND ACCOUNTING OF APARTMENTS AND OTHER HOUSING PROPERTIES; SOFTWARE AS A SERVICE (SAAS) SERVICES, NAMELY, HOSTING SOFTWARE FOR USE BY OTHERS FOR USE IN MARKETING, LEASING, RENTING, MANAGING, AND ACCOUNTING OF APARTMENTS AND OTHER HOUSING PROPERTIES, IN CLASS 42 (U.S. CLS. 100 AND 101).

FIRST USE 8-1-2009; IN COMMERCE 8-1-2009.

THE MARK CONSISTS OF STANDARD CHARACTERS WITHOUT CLAIM TO ANY PARTICULAR FONT, STYLE, SIZE, OR COLOR.

OWNER OF U.S. REG. NO. 2,700,712.

NO CLAIM IS MADE TO THE EXCLUSIVE RIGHT TO USE "CLOUD", APART FROM THE MARK AS SHOWN.

SER. NO. 85-564,461, FILED 3-8-2012.

ADA HAN, EXAMINING ATTORNEY



*David J. Kyjars*

Director of the United States Patent and Trademark Office

# United States of America

United States Patent and Trademark Office



**Reg. No. 4,198,581**

QINGSONG LI (CHINA INDIVIDUAL)  
5328 SPICEWOOD LANE  
FRISCO, TX 75034

**Registered Aug. 28, 2012**

**Int. Cl.: 35**

FOR: ON-LINE RETAIL STORE SERVICES FEATURING LED LIGHTS, IN CLASS 35 (U.S. CLS. 100, 101 AND 102).

**SERVICE MARK**

FIRST USE 1-24-2012; IN COMMERCE 1-24-2012.

**PRINCIPAL REGISTER**

NO CLAIM IS MADE TO THE EXCLUSIVE RIGHT TO USE "LED DEPOT", APART FROM THE MARK AS SHOWN.

THE COLOR(S) GREEN, BLACK IS/ARE CLAIMED AS A FEATURE OF THE MARK.

THE MARK CONSISTS OF A STACK OF 4 X 4 GREEN DOTS TO THE LEFT OF THE WORD "LED" IN GREEN, NEXT TO THE WORD "DEPOT" IN BLACK.

SER. NO. 85-564,489, FILED 3-8-2012.

DORITT L. CARROLL, EXAMINING ATTORNEY



*David J. Kybas*

Director of the United States Patent and Trademark Office



# United States of America

United States Patent and Trademark Office



**Reg. No. 4,198,582**

**Registered Aug. 28, 2012**

**Int. Cl.: 41**

**SERVICE MARK**

**PRINCIPAL REGISTER**

THE DISTRICT BOARD OF TRUSTEES OF BROWARD COMMUNITY COLLEGE (FLORIDA  
EDUCATIONAL INSTITUTION)  
225 EAST LAS OLAS BOULEVARD  
FORT LAUDERDALE, FL 33301

FOR: ENTERTAINMENT SERVICES, NAMELY, ARRANGING, ORGANIZING, OPERATING  
AND CONDUCTING ATHLETIC EVENTS, TOURNAMENTS AND EXHIBITIONS, IN CLASS  
41 (U.S. CLS. 100, 101 AND 107).

FIRST USE 1-31-2008; IN COMMERCE 1-31-2008.

THE MARK CONSISTS OF A DRAWING OF A HAWK'S HEAD AND NECK FACING RIGHT,  
WITH THE AREA AROUND THE EYE AND CHEEK IN BLACK AND BLUE, THE BEAK IN  
BLACK, THE REMAINDER OF THE HEAD AND NECK IN WHITE AND FEATHERS  
STANDING UP AT THE BACK OF THE HEAD IN BLACK AND BLUE AND THE ENTIRE  
DRAWING OUTLINED IN WHITE.

THE COLOR(S) BLUE, BLACK, AND WHITE IS/ARE CLAIMED AS A FEATURE OF THE  
MARK.

SER. NO. 85-565,157, FILED 3-9-2012.

WILLIAM ROSSMAN, EXAMINING ATTORNEY



*David J. Kyfos*

Director of the United States Patent and Trademark Office

# United States of America

United States Patent and Trademark Office

# PF STORE

**Reg. No. 4,198,583**

PFIP, LLC (NEW HAMPSHIRE LIMITED LIABILITY COMPANY)  
26 FOX RUN ROAD  
NEWINGTON, NH 03801

**Registered Aug. 28, 2012**

**Int. Cl.: 35**

FOR: ONLINE RETAIL STORE SERVICES IN THE FIELD OF APPAREL, BAGS, ACCESSORIES, DRINKWARE, FURNITURE, BLANKETS, TOWELS, AND SPORTING GOODS, IN CLASS 35 (U.S. CLS. 100, 101 AND 102).

**SERVICE MARK**

FIRST USE 3-6-2012; IN COMMERCE 3-6-2012.

**PRINCIPAL REGISTER**

THE MARK CONSISTS OF STANDARD CHARACTERS WITHOUT CLAIM TO ANY PARTICULAR FONT, STYLE, SIZE, OR COLOR.

OWNER OF U.S. REG. NO. 3,566,624.

NO CLAIM IS MADE TO THE EXCLUSIVE RIGHT TO USE "STORE", APART FROM THE MARK AS SHOWN.

SER. NO. 85-565,315, FILED 3-9-2012.

ANDREW RHIM, EXAMINING ATTORNEY



*David J. Kyffers*

Director of the United States Patent and Trademark Office

# United States of America

United States Patent and Trademark Office

# 1 WEATHER

**Reg. No. 4,198,584**

**Registered Aug. 28, 2012**

**Int. Cls.: 9 and 42**

**TRADEMARK**

**SERVICE MARK**

**PRINCIPAL REGISTER**

ONELOUDER APPS, INC. (DELAWARE CORPORATION)  
SUITE 400  
909 WALNUT STREET  
KANSAS CITY, MO 64106

FOR: SOFTWARE AND DOWNLOADABLE SOFTWARE FOR ACCESSING INFORMATION ON GLOBAL COMPUTER NETWORKS; SOFTWARE AND DOWNLOADABLE SOFTWARE THAT ALLOWS FOR INTERACTION BETWEEN AND AMONG USERS OF COMPUTERS, MOBILE AND HANDHELD COMPUTERS, AND WIRED AND WIRELESS COMMUNICATION DEVICES AND PROVIDES THE MEANS TO TRANSMIT, SYNDICATE, DISTRIBUTE, PUBLISH, TAG, ORGANIZE, AGGREGATE AND MANAGE WEB LINKS, BLOGS, NEWS CONTENT, SOCIAL MEDIA CONTENT, TEXT MESSAGES, IMAGES, AUDIO, VIDEO AND AGGREGATED CONTENT FEEDS, OVER THE INTERNET, WIRELESS AND OTHER COMMUNICATIONS NETWORKS, IN CLASS 9 (U.S. CLS. 21, 23, 26, 36 AND 38).

FIRST USE 3-3-2012; IN COMMERCE 3-3-2012.

FOR: SOFTWARE AS A SERVICE (SAAS) SERVICES FEATURING SOFTWARE FOR INTERACTION BETWEEN AND AMONG USERS OF COMPUTERS, MOBILE AND HANDHELD COMPUTERS, AND WIRED AND WIRELESS COMMUNICATION DEVICES AND PROVIDES THE MEANS TO TRANSMIT, SYNDICATE, DISTRIBUTE, PUBLISH, TAG, ORGANIZE, AGGREGATE AND MANAGE WEB LINKS, BLOGS, SOCIAL MEDIA CONTENT, TEXT MESSAGES, IMAGES, AUDIO, VIDEO AND AGGREGATED CONTENT FEEDS, OVER THE INTERNET, WIRELESS AND OTHER COMMUNICATIONS NETWORKS, IN CLASS 42 (U.S. CLS. 100 AND 101).

FIRST USE 3-3-2012; IN COMMERCE 3-3-2012.

THE MARK CONSISTS OF STANDARD CHARACTERS WITHOUT CLAIM TO ANY PARTICULAR FONT, STYLE, SIZE, OR COLOR.

SER. NO. 85-565,786, FILED 3-9-2012.

MIDGE BUTLER, EXAMINING ATTORNEY



*David J. Kyffers*

Director of the United States Patent and Trademark Office

# United States of America

United States Patent and Trademark Office

# BRONZEYE

**Reg. No. 4,198,585**

**Registered Aug. 28, 2012**

**Int. Cl.: 28**

**TRADEMARK**

**PRINCIPAL REGISTER**

SPRO CORP. (GEORGIA CORPORATION)  
3900 KENNESAW 75 PKWY., SUITE 140  
KENNESAW, GA 30144

FOR: FISHING LURES, IN CLASS 28 (U.S. CLS. 22, 23, 38 AND 50).

FIRST USE 10-0-2005; IN COMMERCE 10-0-2005.

THE MARK CONSISTS OF STANDARD CHARACTERS WITHOUT CLAIM TO ANY PARTICULAR FONT, STYLE, SIZE, OR COLOR.

SER. NO. 85-565,917, FILED 3-9-2012.

SUSAN LESLIE DUBOIS, EXAMINING ATTORNEY



*David J. Kyffers*

Director of the United States Patent and Trademark Office

# United States of America

United States Patent and Trademark Office

## LITTLE JOHN

**Reg. No. 4,198,586**

SPRO CORP. (GEORGIA CORPORATION)  
3900 KENNESAW 75 PKWY., SUITE 140  
KENNESAW, GA 30144

**Registered Aug. 28, 2012**

**Int. Cl.: 28**

FOR: FISHING LURES, IN CLASS 28 (U.S. CLS. 22, 23, 38 AND 50).

**TRADEMARK**

FIRST USE 10-0-2007; IN COMMERCE 10-0-2007.

**PRINCIPAL REGISTER**

THE MARK CONSISTS OF STANDARD CHARACTERS WITHOUT CLAIM TO ANY PARTICULAR FONT, STYLE, SIZE, OR COLOR.

SER. NO. 85-565,920, FILED 3-9-2012.

SUSAN LESLIE DUBOIS, EXAMINING ATTORNEY



*David J. Kyffers*

Director of the United States Patent and Trademark Office

# United States of America

United States Patent and Trademark Office

# FAT JOHN

**Reg. No. 4,198,587**

**Registered Aug. 28, 2012**

**Int. Cl.: 28**

**TRADEMARK**

**PRINCIPAL REGISTER**

SPRO CORP. (GEORGIA CORPORATION)  
3900 KENNESAW 75 PKWY., SUITE 140  
KENNESAW, GA 30144

FOR: FISHING LURES, IN CLASS 28 (U.S. CLS. 22, 23, 38 AND 50).

FIRST USE 12-0-2010; IN COMMERCE 12-0-2010.

THE MARK CONSISTS OF STANDARD CHARACTERS WITHOUT CLAIM TO ANY PARTICULAR FONT, STYLE, SIZE, OR COLOR.

SER. NO. 85-565,937, FILED 3-9-2012.

SUSAN LESLIE DUBOIS, EXAMINING ATTORNEY



*David J. Kyffers*

Director of the United States Patent and Trademark Office

# United States of America

United States Patent and Trademark Office

# Dial Global

**Reg. No. 4,198,588**

DIAL GLOBAL, INC. (DELAWARE CORPORATION)  
220 WEST 42ND STREET  
NEW YORK, NY 10036

**Registered Aug. 28, 2012**

**Int. Cls.: 35 and 41**

FOR: PRODUCTION OF ADVERTISING AND PROMOTIONAL MATERIALS, IN CLASS 35 (U.S. CLS. 100, 101 AND 102).

**SERVICE MARK**

FIRST USE 0-0-2008; IN COMMERCE 0-0-2008.

**PRINCIPAL REGISTER**

FOR: PRODUCTION AND DISTRIBUTION OF RADIO PROGRAMS; RADIO ENTERTAINMENT PRODUCTION; RADIO PROGRAM SYNDICATION, IN CLASS 41 (U.S. CLS. 100, 101 AND 107).

FIRST USE 0-0-2008; IN COMMERCE 0-0-2008.

THE MARK CONSISTS OF STANDARD CHARACTERS WITHOUT CLAIM TO ANY PARTICULAR FONT, STYLE, SIZE, OR COLOR.

NO CLAIM IS MADE TO THE EXCLUSIVE RIGHT TO USE "GLOBAL", APART FROM THE MARK AS SHOWN.

SER. NO. 85-566,010, FILED 3-9-2012.

NATALIE POLZER, EXAMINING ATTORNEY



*David J. Kybas*

Director of the United States Patent and Trademark Office

United States of America  
United States Patent and Trademark Office

ИЗРАИЛСКИЙ  
ISRAELSKY

**Reg. No. 4,198,589**

**Registered Aug. 28, 2012**

**Int. Cl.: 29**

**TRADEMARK**

**PRINCIPAL REGISTER**

NATIONWIDE DAIRY INC. (NEW YORK CORPORATION)  
792 EAST 93RD STREET  
BROOKLYN, NY 11236

FOR: BRINZA, CHEESE, COTTAGE CHEESE, CREAM CHEESE, CURD CHEESE, FARMER CHEESE, FETA CHEESE, FRESH CHEESE, MARGARINE, EDIBLE OILS AND FATS, VEGETABLE OIL SPREAD, VEGETABLE EXTRACTS FOR FOOD, YOGURT, KEFIR, HARD CHEESE, MOZZARELLA CHEESE, POT CHEESE, SOFT CHEESE, SOUR CREAM, BUTTER, BUTTER BLEND, MILK, CONDENSED WHOLE MILK, DAIRY PRODUCTS EXCLUDING ICE CREAM, ICE MILK AND FROZEN YOGURT, IN CLASS 29 (U.S. CL. 46).

FIRST USE 11-20-2003; IN COMMERCE 11-20-2003.

NO CLAIM IS MADE TO THE EXCLUSIVE RIGHT TO USE THE CYRILLIC CHARACTERS THAT TRANSLITERATE TO "ISRAELI", APART FROM THE MARK AS SHOWN.

THE MARK CONSISTS OF A RUSSIAN WORD IN STANDARD CYRILLIC CHARACTERS ABOVE THE TERM "ISRAELSKY".

THE ENGLISH TRANSLATION OF THE CYRILLIC CHARACTERS IN THE MARK IS "ISRAELI".

SER. NO. 85-566,110, FILED 3-10-2012.

SAMUEL E. SHARPER JR., EXAMINING ATTORNEY



*David J. Kappas*

Director of the United States Patent and Trademark Office



# United States of America

United States Patent and Trademark Office

## FULL HARVEST

**Reg. No. 4,198,590**

**Registered Aug. 28, 2012**

**Int. Cl.: 30**

**TRADEMARK**

**PRINCIPAL REGISTER**

FOODFORCE ENTERPRISE, INC. (MISSOURI CORPORATION)  
617 CEPI DR.  
CHESTERFIELD, MO 63005

FOR: RICE, IN CLASS 30 (U.S. CL. 46).

FIRST USE 3-0-2003; IN COMMERCE 3-0-2003.

THE MARK CONSISTS OF STANDARD CHARACTERS WITHOUT CLAIM TO ANY PARTICULAR FONT, STYLE, SIZE, OR COLOR.

SER. NO. 85-566,253, FILED 3-11-2012.

JENNY PARK, EXAMINING ATTORNEY



*David J. Kyffers*

Director of the United States Patent and Trademark Office

# United States of America

United States Patent and Trademark Office

# Duracraft

**Reg. No. 4,198,591**

**Registered Aug. 28, 2012**

**Int. Cl.: 8**

**TRADEMARK**

**PRINCIPAL REGISTER**

BLAIN SUPPLY, INC. (WISCONSIN CORPORATION)  
3507 E. RACINE ST., P.O. BOX 5391  
JANESVILLE, WI 53547

FOR: TOOL APRONS, IN CLASS 8 (U.S. CLS. 23, 28 AND 44).

FIRST USE 3-31-2003; IN COMMERCE 3-31-2003.

THE MARK CONSISTS OF STANDARD CHARACTERS WITHOUT CLAIM TO ANY PARTICULAR FONT, STYLE, SIZE, OR COLOR.

OWNER OF U.S. REG. NOS. 3,042,726, 3,502,944 AND OTHERS.

SER. NO. 85-566,494, FILED 3-12-2012.

BRIAN PINO, EXAMINING ATTORNEY



*David J. Kyffers*

Director of the United States Patent and Trademark Office

# United States of America

United States Patent and Trademark Office

## Ultimate Test Drive

**Reg. No. 4,198,592**

AVIS BUDGET CAR RENTAL LLC (DELAWARE LIMITED LIABILITY COMPANY)  
6 SYLVAN WAY

**Registered Aug. 28, 2012**

PARSIPPANY, NJ 07054

**Int. Cls.: 35 and 39**

FOR: RETAIL OUTLETS FEATURING AUTOMOBILES, VANS, AND TRUCKS, IN CLASS 35 (U.S. CLS. 100, 101 AND 102).

**SERVICE MARK**

FIRST USE 2-28-2012; IN COMMERCE 2-28-2012.

**PRINCIPAL REGISTER**

FOR: LEASING OF VEHICLES; RENTAL OF VEHICLES, IN CLASS 39 (U.S. CLS. 100 AND 105).

FIRST USE 2-28-2012; IN COMMERCE 2-28-2012.

NO CLAIM IS MADE TO THE EXCLUSIVE RIGHT TO USE "ULTIMATE TEST DRIVE", APART FROM THE MARK AS SHOWN.

THE MARK CONSISTS OF THE WORDING "ULTIMATE TESTDRIVE", WITH THE WORDS "TEST" AND "DRIVE" JOINED TO FORM ONE ELEMENT, AND WITH A STYLIZED DEPICTION OF A CHECK MARK FORMING THE LETTER "V" IN THE WORD "DRIVE".

SER. NO. 85-566,500, FILED 3-12-2012.

DOUGLAS LEE, EXAMINING ATTORNEY



*David J. Kybas*

Director of the United States Patent and Trademark Office

# United States of America

United States Patent and Trademark Office

# Duracraft Pro

**Reg. No. 4,198,593**

BLAIN SUPPLY, INC. (WISCONSIN CORPORATION)

**Registered Aug. 28, 2012**

3507 E. RACINE ST., P. O. BOX 5391  
JANESVILLE, WI 535475391

**Int. Cl.: 6**

FOR: METAL CHEST CABINET TOOL BOXES ON WHEELS; METAL TOOL BOXES AND METAL CHEST CABINET TOOL BOXES; METAL SAWHORSE BRACKETS, IN CLASS 6 (U.S. CLS. 2, 12, 13, 14, 23, 25 AND 50).

**TRADEMARK**

FIRST USE 10-0-2004; IN COMMERCE 10-0-2004.

**PRINCIPAL REGISTER**

THE MARK CONSISTS OF STANDARD CHARACTERS WITHOUT CLAIM TO ANY PARTICULAR FONT, STYLE, SIZE, OR COLOR.

OWNER OF U.S. REG. NOS. 3,042,726, 3,502,944 AND OTHERS.

NO CLAIM IS MADE TO THE EXCLUSIVE RIGHT TO USE "PRO", APART FROM THE MARK AS SHOWN.

SER. NO. 85-566,556, FILED 3-12-2012.

BRIAN PINO, EXAMINING ATTORNEY



*David J. Kyffers*

Director of the United States Patent and Trademark Office

# United States of America

United States Patent and Trademark Office

## Duracraft Pro

**Reg. No. 4,198,594**

BLAIN SUPPLY, INC. (WISCONSIN CORPORATION)

**Registered Aug. 28, 2012**

3507 E. RACINE ST., P. O. BOX 5391  
JANESVILLE, WI 535475391

**Int. Cl.: 8**

**TRADEMARK**

**PRINCIPAL REGISTER**

FOR: HAND TOOLS, NAMELY, DRIVE SPINNER HANDLES, PLIERS SETS, CHISEL SETS, PUNCH SETS, PUNCH AND CHISEL SETS, WOOD CHISEL SETS, UTILITY KNIVES, PLIERS, CHISELS, PUNCHES, WRENCH SETS, BENCH VISES, SCREWDRIVERS, SCREWDRIVER SETS, HAMMERS, SOCKET SETS, SOCKET AND WRENCH SETS CONSISTING OF SOCKETS, EXTENSIONS, ADAPTERS, RATCHETS, SPINNER HANDLES, COMBINATION WRENCHES, COMBINATION WRENCH SETS, AND COMBINATION WRENCHES, SOCKET CLIP RAILS, SOCKET EXTENSIONS, ADAPTERS, WRENCHES, SOCKETS, FLEXIBLE HANDLES, RATCHETS, UNIVERSAL JOINTS, NUT SPLITTER SETS, REVERSIBLE IMPACT DRIVER SETS, PIPE WRENCHES, LOCKING PLIERS, SNIPS, AVIATION SNIPS WITH HOLSTERS, BOLT CUTTERS, TORQUE WRENCHES, IMPACT DRIVER BIT SETS, DRIVE SOCKET ADAPTERS, "T" HANDLES, SPRING CLAMPS, BAR CLAMPS, MECHANIC'S TOOL SETS CONSISTING OF ITEMS SUCH AS PLIERS, WRENCHES, SOCKETS, AND SCREWDRIVERS, SOCKET AND TOOL SETS CONSISTING OF SOCKETS, EXTENSIONS, ADAPTERS, RATCHETS, AND SPINNER HANDLES, NUT DRIVERS AND NUT DRIVER SETS, TELESCOPING FLEXIBLE DRIVER SETS, END NIPPERS, CABLE CUTTERS, HEX KEY SETS, ELECTRICIAN'S SHEARS, MULTIPLE-PURPOSE SHEARS, IN CLASS 8 (U.S. CLS. 23, 28 AND 44).

FIRST USE 7-0-1999; IN COMMERCE 7-0-1999.

THE MARK CONSISTS OF STANDARD CHARACTERS WITHOUT CLAIM TO ANY PARTICULAR FONT, STYLE, SIZE, OR COLOR.

OWNER OF U.S. REG. NOS. 3,042,726, 3,502,944 AND OTHERS.

NO CLAIM IS MADE TO THE EXCLUSIVE RIGHT TO USE "PRO", APART FROM THE MARK AS SHOWN.

SER. NO. 85-566,619, FILED 3-12-2012.

BRIAN PINO, EXAMINING ATTORNEY



*David J. Kypos*

Director of the United States Patent and Trademark Office

# United States of America

United States Patent and Trademark Office

# Duracraft Pro

**Reg. No. 4,198,595**

BLAIN SUPPLY, INC. (WISCONSIN CORPORATION)

**Registered Aug. 28, 2012**

3507 E. RACINE ST., P. O. BOX 5391  
JANESVILLE, WI 535475391

**Int. Cl.: 20**

FOR: WORK BENCHES AND SAW HORSES, IN CLASS 20 (U.S. CLS. 2, 13, 22, 25, 32 AND 50).

**TRADEMARK**

FIRST USE 4-30-2008; IN COMMERCE 4-30-2008.

**PRINCIPAL REGISTER**

THE MARK CONSISTS OF STANDARD CHARACTERS WITHOUT CLAIM TO ANY PARTICULAR FONT, STYLE, SIZE, OR COLOR.

OWNER OF U.S. REG. NOS. 3,042,726, 3,502,944 AND OTHERS.

NO CLAIM IS MADE TO THE EXCLUSIVE RIGHT TO USE "PRO", APART FROM THE MARK AS SHOWN.

SER. NO. 85-566,661, FILED 3-12-2012.

BRIAN PINO, EXAMINING ATTORNEY



*David J. Kyffers*

Director of the United States Patent and Trademark Office

# United States of America

United States Patent and Trademark Office

## WINDOW WORLD CARES

**Reg. No. 4,198,596**

**Registered Aug. 28, 2012**

**Int. Cl.: 36**

**SERVICE MARK**

**PRINCIPAL REGISTER**

WINDOW WORLD INTERNATIONAL, LLC (NORTH CAROLINA LIMITED LIABILITY COMPANY)  
118 SHAVER STREET  
NORTH WILKESBORO, NC 28659

FOR: CHARITABLE FUNDRAISING, IN CLASS 36 (U.S. CLS. 100, 101 AND 102).

FIRST USE 9-7-2008; IN COMMERCE 9-7-2008.

THE MARK CONSISTS OF STANDARD CHARACTERS WITHOUT CLAIM TO ANY PARTICULAR FONT, STYLE, SIZE, OR COLOR.

OWNER OF U.S. REG. NOS. 2,331,991, 3,997,287, AND 3,998,196.

SER. NO. 85-566,886, FILED 3-12-2012.

ELLEN B. AWRICH, EXAMINING ATTORNEY



*David J. Kybas*

Director of the United States Patent and Trademark Office

# United States of America

United States Patent and Trademark Office



**Reg. No. 4,198,597**

**Registered Aug. 28, 2012**

**Int. Cl.: 36**

**SERVICE MARK**

**PRINCIPAL REGISTER**

WINDOW WORLD INTERNATIONAL, LLC (NORTH CAROLINA LIMITED LIABILITY COMPANY)  
118 SHAVER STREET  
NORTH WILKESBORO, NC 28659

FOR: CHARITABLE FUNDRAISING, IN CLASS 36 (U.S. CLS. 100, 101 AND 102).

FIRST USE 12-1-2008; IN COMMERCE 12-1-2008.

OWNER OF U.S. REG. NOS. 2,331,991, 3,997,287, AND 3,998,196.

THE MARK CONSISTS OF THE WORDS "WINDOW WORLD CARES" OVER THE WORDS "COMMITTED TO HELPING OTHERS IN NEED". THERE IS THE IMAGE OF A HEART WHERE THE LEFT AND RIGHT TOP PORTIONS OF THE HEART APPEAR TO HAVE THE HEADS OF PEOPLE. THE LEFT SIDE OF THE HEART IS PLACED ACROSS THE LETTER "S" IN THE WORD "CARES".

SER. NO. 85-566,903, FILED 3-12-2012.

ELLEN B. AWRICH, EXAMINING ATTORNEY



*David J. Kyffers*

Director of the United States Patent and Trademark Office



# United States of America

United States Patent and Trademark Office

# PHTHRIVE

**Reg. No. 4,198,598**

JOURNEY VENTURES, LLC (MISSOURI LIMITED LIABILITY COMPANY), DBA PH LIFE  
2733 E. BATTLEFIELD #129  
SPRINGFIELD, MO 65804

**Registered Aug. 28, 2012**

**Int. Cl.: 5**

FOR: MINERAL SUPPLEMENTS, NAMELY, MINERAL DROPS; LIQUID NUTRITIONAL SUPPLEMENTS, NAMELY, PH DROPS; LIQUID NUTRITIONAL SUPPLEMENTS, NAMELY, ALKALIZING DROPS; LIQUID NUTRITIONAL SUPPLEMENTS, NAMELY, DROPS FOR INCREASING PH LEVELS, IN CLASS 5 (U.S. CLS. 6, 18, 44, 46, 51 AND 52).

**TRADEMARK**

**PRINCIPAL REGISTER**

FIRST USE 2-0-2012; IN COMMERCE 2-0-2012.

THE MARK CONSISTS OF STANDARD CHARACTERS WITHOUT CLAIM TO ANY PARTICULAR FONT, STYLE, SIZE, OR COLOR.

SER. NO. 85-566,940, FILED 3-12-2012.

TASHIA BUNCH, EXAMINING ATTORNEY



*David J. Kypos*

Director of the United States Patent and Trademark Office

# United States of America

United States Patent and Trademark Office

## QUANTUM BIOTEK

**Reg. No. 4,198,599**

**Registered Aug. 28, 2012**

**Int. Cls.: 11 and 40**

**TRADEMARK**

**SERVICE MARK**

**PRINCIPAL REGISTER**

QUANTUM BIOTEK PTY LTD (AUSTRALIA PROPRIETARY LIMITED COMPANY (P/L OR PTY. LTD.))  
PO BOX 363  
HORSLEY PARK, AUSTRALIA

FOR: APPARATUS FOR ENVIRONMENTAL CONTROL, NAMELY, AN APPARATUS FOR STRUCTURALLY ALTERING WATER MOLECULAR STRUCTURES, INCREASING WATER AND LIQUID PRODUCTIVITY, AND WATER PURIFICATION; WATER PURIFICATION MACHINES, IN CLASS 11 (U.S. CLS. 13, 21, 23, 31 AND 34).

FIRST USE 2-5-2010; IN COMMERCE 2-5-2010.

FOR: WATER TREATMENT AND PURIFICATION; WATER TREATMENT SERVICES, NAMELY, TREATMENT OF WATER AND SALT WATER, IN CLASS 40 (U.S. CLS. 100, 103 AND 106).

FIRST USE 2-5-2010; IN COMMERCE 2-5-2010.

THE MARK CONSISTS OF STANDARD CHARACTERS WITHOUT CLAIM TO ANY PARTICULAR FONT, STYLE, SIZE, OR COLOR.

PRIORITY CLAIMED UNDER SEC. 44(D) ON AUSTRALIA APPLICATION NO. 1478253, FILED 3-7-2012.

NO CLAIM IS MADE TO THE EXCLUSIVE RIGHT TO USE "BIOTECH", APART FROM THE MARK AS SHOWN.

SER. NO. 85-567,365, FILED 3-12-2012.

MARK T. MULLEN, EXAMINING ATTORNEY



*David J. Kypos*

Director of the United States Patent and Trademark Office

# United States of America

United States Patent and Trademark Office

## TWEET ZILLA

**Reg. No. 4,198,600**

KAPS, THERESA (UNITED STATES INDIVIDUAL)  
2 CREST ROAD  
JACKSON, NJ 08527 AND

**Registered Aug. 28, 2012**

**Int. Cl.: 37**

KAPS, THOMAS (FED REP GERMANY INDIVIDUAL)  
2 CREST ROAD  
JACKSON, NJ 08527 AND

**SERVICE MARK**

**PRINCIPAL REGISTER**

ROSARIO, JEANNE (UNITED STATES INDIVIDUAL)  
64 WINDJAMMER COURT  
BAYVILLE, NJ 08721 AND

ROSARIO, PAUL (UNITED STATES INDIVIDUAL)  
64 WINDJAMMER COURT  
BAYVILLE, NJ 08721

FOR: REMOVING BIRDS FROM RESIDENTIAL AND COMMERCIAL BUILDINGS, IN CLASS 37 (U.S. CLS. 100, 103 AND 106).

FIRST USE 12-29-2011; IN COMMERCE 12-29-2011.

THE MARK CONSISTS OF STANDARD CHARACTERS WITHOUT CLAIM TO ANY PARTICULAR FONT, STYLE, SIZE, OR COLOR.

OWNER OF U.S. REG. NO. 3,663,594.

SER. NO. 85-568,039, FILED 3-13-2012.

REBECCA SMITH, EXAMINING ATTORNEY



*David J. Kyros*

Director of the United States Patent and Trademark Office

# United States of America

United States Patent and Trademark Office

# BIG MONEY

**Reg. No. 4,198,601**

ECLIPSE GAMING SYSTEMS, LLC (TEXAS LIMITED LIABILITY COMPANY)  
575-G OLD NORCROSS ROAD  
LAWRENCEVILLE, GA 30045

**Registered Aug. 28, 2012**

**Int. Cl.: 28**

FOR: GAMING EQUIPMENT, NAMELY, SLOT MACHINES WITH OR WITHOUT VIDEO OUTPUT; SLOT MACHINES, IN CLASS 28 (U.S. CLS. 22, 23, 38 AND 50).

**TRADEMARK**

FIRST USE 8-6-2009; IN COMMERCE 8-6-2009.

**PRINCIPAL REGISTER**

THE MARK CONSISTS OF STANDARD CHARACTERS WITHOUT CLAIM TO ANY PARTICULAR FONT, STYLE, SIZE, OR COLOR.

SER. NO. 85-568,523, FILED 3-13-2012.

DAVID C. REIHNER, EXAMINING ATTORNEY



*David J. Kybas*

Director of the United States Patent and Trademark Office

# United States of America

United States Patent and Trademark Office

# DIRECT FIT

**Reg. No. 4,198,602**

DEWITTS REPRODUCTIONS, INC. (MICHIGAN CORPORATION)  
1275 GRAND OAKS DRIVE  
HOWELL, MI 48843

**Registered Aug. 28, 2012**

**Int. Cl.: 7**

FOR: REPLACEMENT ALUMINUM RADIATORS FOR AUTOMOTIVE MOTORS AND ENGINES, IN CLASS 7 (U.S. CLS. 13, 19, 21, 23, 31, 34 AND 35).

**TRADEMARK**

FIRST USE 6-15-2004; IN COMMERCE 6-15-2004.

**PRINCIPAL REGISTER**

THE MARK CONSISTS OF STANDARD CHARACTERS WITHOUT CLAIM TO ANY PARTICULAR FONT, STYLE, SIZE, OR COLOR.

NO CLAIM IS MADE TO THE EXCLUSIVE RIGHT TO USE "FIT", APART FROM THE MARK AS SHOWN.

SEC. 2(F).

SER. NO. 85-569,799, FILED 3-14-2012.

JASON TURNER, EXAMINING ATTORNEY



*David J. Kyffers*

Director of the United States Patent and Trademark Office

# United States of America

United States Patent and Trademark Office

## 22-STEP HEALTHY TOUCH

**Reg. No. 4,198,603**

THE MAIDS INTERNATIONAL, INC. (NEBRASKA CORPORATION)  
9394 WEST DODGE STREET, SUITE 140  
OMAHA, NE 68114

**Registered Aug. 28, 2012**

**Int. Cl.: 37**

FOR: RESIDENTIAL AND COMMERCIAL CLEANING SERVICES, IN CLASS 37 (U.S. CLS. 100, 103 AND 106).

**SERVICE MARK**

FIRST USE 8-28-1995; IN COMMERCE 8-28-1995.

**PRINCIPAL REGISTER**

THE MARK CONSISTS OF STANDARD CHARACTERS WITHOUT CLAIM TO ANY PARTICULAR FONT, STYLE, SIZE, OR COLOR.

OWNER OF U.S. REG. NOS. 2,013,614, 2,178,325, AND 3,285,083.

NO CLAIM IS MADE TO THE EXCLUSIVE RIGHT TO USE "22-STEP", APART FROM THE MARK AS SHOWN.

SER. NO. 85-570,179, FILED 3-15-2012.

MARILYN IZZI, EXAMINING ATTORNEY



*David J. Kyffers*

Director of the United States Patent and Trademark Office

# United States of America

United States Patent and Trademark Office

# TWEETZILLA

**Reg. No. 4,198,604**

KAPS, THERESA (UNITED STATES INDIVIDUAL)  
2 CREST ROAD  
JACKSON, NJ 08527 AND

**Registered Aug. 28, 2012**

**Int. Cl.: 11**

KAPS, THOMAS (FED REP GERMANY INDIVIDUAL)  
2 CREST ROAD  
JACKSON, NJ 08527 AND

**TRADEMARK**

**PRINCIPAL REGISTER**

ROSARIO, JEANNE (UNITED STATES INDIVIDUAL)  
64 WINDJAMMER COURT  
BAYVILLE, NJ 08721 AND

ROSARIO, PAUL (UNITED STATES INDIVIDUAL)  
64 WINDJAMMER COURT  
BAYVILLE, NJ 08721

FOR: ELECTRICAL DEVICES TO BE PLUGGED INTO WALL OUTLETS HAVING A HEATING ELEMENT AND WHICH DISPENSES A FOG; A HAZE; OR A MIST.; FOG GENERATORS; FOG MACHINES; FOG MAKING MACHINES; OUTDOOR AUTOMATED MIST SYSTEM FOR INSECT AND PEST CONTROL COMPRISING A FOG GENERATOR; A HAZE GENERATOR; OR A MIST GENERATOR, IN CLASS 11 (U.S. CLS. 13, 21, 23, 31 AND 34).

FIRST USE 3-9-2012; IN COMMERCE 3-9-2012.

THE MARK CONSISTS OF STANDARD CHARACTERS WITHOUT CLAIM TO ANY PARTICULAR FONT, STYLE, SIZE, OR COLOR.

OWNER OF U.S. REG. NO. 3,663,594.

SER. NO. 85-570,543, FILED 3-15-2012.

REBECCA SMITH, EXAMINING ATTORNEY



*David J. Kyros*

Director of the United States Patent and Trademark Office

# United States of America

United States Patent and Trademark Office

# B & F

**Reg. No. 4,198,605**

**Registered Aug. 28, 2012**

**Int. Cls.: 24, 26 and 27**

**TRADEMARK**

**PRINCIPAL REGISTER**

BRUNSCHWIG & FILS LLC (NEW YORK LIMITED LIABILITY COMPANY)  
245 CENTRAL AVENUE SOUTH  
BETHPAGE, NY 11714

FOR: FABRICS AND TEXTILES FOR USE IN THE MANUFACTURE OF HOME FURNISHINGS, NAMELY, UPHOLSTERY, FURNITURE, DRAPERIES, CURTAINS, WALL COVERINGS, LINENS, SLIPCOVERS, BEDSPREADS, PILLOWS, BEDSHEETS, QUILTS AND CURTAIN TIE-BACKS; WOVEN, PRINTED, NATURAL AND SYNTHETIC FIBER DECORATIVE FABRICS, IN CLASS 24 (U.S. CLS. 42 AND 50).

FIRST USE 4-30-2011; IN COMMERCE 4-30-2011.

FOR: FABRIC AND FURNISHING TRIMMINGS, NAMELY, ORNAMENTAL RIBBONS MADE OF TEXTILES, LACE TRIMMING, BRAIDS, TASSELS, FRINGES AND DECORATIVE CORDS, IN CLASS 26 (U.S. CLS. 37, 39, 40, 42 AND 50).

FIRST USE 4-30-2011; IN COMMERCE 4-30-2011.

FOR: WALLPAPER; NON-TEXTILE WALL COVERINGS, NAMELY, WALL COVERINGS MADE OF PAPER, GRASSCLOTH, VINYL, POLYMERS OR FABRIC, IN CLASS 27 (U.S. CLS. 19, 20, 37, 42 AND 50).

FIRST USE 4-30-2011; IN COMMERCE 4-30-2011.

THE MARK CONSISTS OF STANDARD CHARACTERS WITHOUT CLAIM TO ANY PARTICULAR FONT, STYLE, SIZE, OR COLOR.

OWNER OF U.S. REG. NO. 1,024,931.

SER. NO. 85-570,806, FILED 3-15-2012.

DEZMONA MIZELLE, EXAMINING ATTORNEY



*David J. Kyffers*

Director of the United States Patent and Trademark Office



# United States of America

United States Patent and Trademark Office

# QS

**Reg. No. 4,198,606**

SPC RESOURCES, INC. (DELAWARE CORPORATION)  
125 W HOME AVENUE  
HARTSVILLE, SC 29550

**Registered Aug. 28, 2012**

**Int. Cl.: 16**

FOR: PAPER BASED CORES FOR WINDING SENSITIVE OR SPECIALIZED FILM PRODUCTS, IN CLASS 16 (U.S. CLS. 2, 5, 22, 23, 29, 37, 38 AND 50).

**TRADEMARK**

FIRST USE 1-1-2002; IN COMMERCE 1-1-2002.

**PRINCIPAL REGISTER**

THE MARK CONSISTS OF STANDARD CHARACTERS WITHOUT CLAIM TO ANY PARTICULAR FONT, STYLE, SIZE, OR COLOR.

SER. NO. 85-570,862, FILED 3-15-2012.

JAMES LOVELACE, EXAMINING ATTORNEY



*David J. Kyffers*

Director of the United States Patent and Trademark Office

# United States of America

United States Patent and Trademark Office

# TINY ADDR

**Reg. No. 4,198,607**

NAIM, KHALED (UNITED STATES INDIVIDUAL)  
555 SALVATIERRA WALK, APT. 445  
STANFORD, CA 94305

**Registered Aug. 28, 2012**

**Int. Cl.: 42**

FOR: COMPUTER SERVICES, NAMELY, PROVIDING SEARCH PLATFORMS TO ALLOW USERS TO ENTER AN ADDRESS AND PINPOINT A LOCATION ON A MAP TO CREATE A URL, IN CLASS 42 (U.S. CLS. 100 AND 101).

**SERVICE MARK**

FIRST USE 1-22-2012; IN COMMERCE 2-1-2012.

**PRINCIPAL REGISTER**

THE MARK CONSISTS OF STANDARD CHARACTERS WITHOUT CLAIM TO ANY PARTICULAR FONT, STYLE, SIZE, OR COLOR.

SER. NO. 85-570,966, FILED 3-15-2012.

BILL DAWE, EXAMINING ATTORNEY



*David J. Kyros*

Director of the United States Patent and Trademark Office

# United States of America

United States Patent and Trademark Office

## SANI-CLOTH

**Reg. No. 4,198,608**

**Registered Aug. 28, 2012**

**Int. Cl.: 5**

**TRADEMARK**

**PRINCIPAL REGISTER**

PROFESSIONAL DISPOSABLES INTERNATIONAL, INC. (DELAWARE CORPORATION)  
TWO NICE-PAK PARK  
ORANGEBURG, NY 109621376

FOR: ANTISEPTIC WIPES; ANTISEPTICS; DISPOSABLE WIPES IMPREGNATED WITH DISINFECTING CHEMICALS OR COMPOUNDS THEREFOR FOR USE IN HOSPITALS, CLINICS, MEDICAL OFFICES, MEDICAL FACILITIES, PATIENT CARE FACILITIES, BATHROOMS, RESTAURANTS, AND FOOD PREPARATION FACILITIES; DISPOSABLE WIPES IMPREGNATED WITH DISINFECTING CHEMICALS OR COMPOUNDS THEREFOR FOR USE ON HANDS OR SKIN, OR ON SOLID SURFACES, NAMELY, FURNITURE, WHEELCHAIRS, SHOPPING CARTS, REST ROOM FIXTURES AND COUNTERS, TOILET SEATS, DOOR-KNOBS, SINKS, RESTAURANT TABLES, SEATING, BOOSTER SEATS, HIGH CHAIRS, MENUS, CASH REGISTERS, TELEPHONES, AND FOOD PREPARATION AND KITCHEN EQUIPMENT AND TOOLS; MICROFIBER TOWEL IMPREGNATED WITH AN ANTIMICROBIAL TREATMENT; SANITIZING WIPES, IN CLASS 5 (U.S. CLS. 6, 18, 44, 46, 51 AND 52).

FIRST USE 10-22-1987; IN COMMERCE 10-22-1987.

THE MARK CONSISTS OF STANDARD CHARACTERS WITHOUT CLAIM TO ANY PARTICULAR FONT, STYLE, SIZE, OR COLOR.

OWNER OF U.S. REG. NOS. 1,665,082, 3,826,009 AND OTHERS.

SER. NO. 85-571,569, FILED 3-16-2012.

MARC LEIPZIG, EXAMINING ATTORNEY



*David J. Kypos*

Director of the United States Patent and Trademark Office

# United States of America

United States Patent and Trademark Office

## ON YOUR SIDE AUTO REPAIR NETWORK

**Reg. No. 4,198,609**

**Registered Aug. 28, 2012**

**Int. Cl.: 36**

**SERVICE MARK**

**PRINCIPAL REGISTER**

NATIONWIDE MUTUAL INSURANCE COMPANY (OHIO CORPORATION)  
OFFICE OF GENERAL COUNSEL 1-35-204  
ONE NATIONWIDE PLAZA  
COLUMBUS, OH 43215

FOR: INSURANCE SERVICES, NAMELY, INSURANCE CLAIMS ADMINISTRATION,  
PROCESSING, AND ADJUSTING, IN CLASS 36 (U.S. CLS. 100, 101 AND 102).

FIRST USE 9-15-2011; IN COMMERCE 9-15-2011.

THE MARK CONSISTS OF STANDARD CHARACTERS WITHOUT CLAIM TO ANY PAR-  
TICULAR FONT, STYLE, SIZE, OR COLOR.

OWNER OF U.S. REG. NOS. 1,793,850, 3,331,297 AND OTHERS.

NO CLAIM IS MADE TO THE EXCLUSIVE RIGHT TO USE "AUTO REPAIR NETWORK",  
APART FROM THE MARK AS SHOWN.

SER. NO. 85-571,935, FILED 3-16-2012.

TINA BROWN, EXAMINING ATTORNEY



*David J. Kyffers*

Director of the United States Patent and Trademark Office

# United States of America

United States Patent and Trademark Office

ROYAL WAGON



**Reg. No. 4,198,610**

**Registered Aug. 28, 2012**

**Int. Cl.: 30**

**TRADEMARK**

**PRINCIPAL REGISTER**

FOODFORCE ENTERPRISE, INC. (MISSOURI CORPORATION)  
617 CEPI DR.  
CHESTERFIELD, MO 63005

FOR: FOOD STARCH, IN CLASS 30 (U.S. CL. 46).

FIRST USE 5-0-2005; IN COMMERCE 5-0-2005.

THE MARK CONSISTS OF THE WORDS "ROYAL WAGON" ABOVE A STYLIZED DEPICTION OF A MAN RIDING ON A HORSE AND CHARIOT.

SER. NO. 85-572,604, FILED 3-18-2012.

JENNY PARK, EXAMINING ATTORNEY



*David J. Kyffers*

Director of the United States Patent and Trademark Office

# United States of America

United States Patent and Trademark Office

## Lean and Mean

**Reg. No. 4,198,611**

PARISI, JOSEPH A (UNITED STATES INDIVIDUAL)  
1000 ROUTE 29

**Registered Aug. 28, 2012**

MIDDLE GROVE, NY 12850

**Int. Cl.: 30**

FOR: ICE CREAM DESSERTS, IN CLASS 30 (U.S. CL. 46).

FIRST USE 9-12-1996; IN COMMERCE 9-12-1996.

**TRADEMARK**

THE MARK CONSISTS OF STANDARD CHARACTERS WITHOUT CLAIM TO ANY PARTICULAR FONT, STYLE, SIZE, OR COLOR.

**PRINCIPAL REGISTER**

SER. NO. 85-572,803, FILED 3-19-2012.

HANNO RITTNER, EXAMINING ATTORNEY



*David J. Kyffers*

Director of the United States Patent and Trademark Office

United States of America  
United States Patent and Trademark Office

KALVA

**Reg. No. 4,198,612**

SENSORYEFFECTS FLAVOR COMPANY (DELAWARE CORPORATION)  
231 ROCK INDUSTRIAL PARK DRIVE  
BRIDGETON, MO 63044

**Registered Aug. 28, 2012**

**Int. Cl.: 30**

FOR: CONFECTIONER'S COATINGS IN THE NATURE OF EDIBLE SHELLAC COATING  
FOR FOODS AND CHOCOLATE FLAVORING, IN CLASS 30 (U.S. CL. 46).

**TRADEMARK**

FIRST USE 8-13-1935; IN COMMERCE 8-13-1935.

**PRINCIPAL REGISTER**

THE MARK CONSISTS OF STANDARD CHARACTERS WITHOUT CLAIM TO ANY PAR-  
TICULAR FONT, STYLE, SIZE, OR COLOR.

OWNER OF U.S. REG. NO. 397,838.

SER. NO. 85-574,190, FILED 3-20-2012.

KAREN K. BUSH, EXAMINING ATTORNEY



*David J. Kyffers*

Director of the United States Patent and Trademark Office

# United States of America

United States Patent and Trademark Office

# TreePro

**Reg. No. 4,198,613**

**Registered Aug. 28, 2012**

**Int. Cl.: 36**

**SERVICE MARK**

**PRINCIPAL REGISTER**

NIP GROUP, INC. (NEW JERSEY CORPORATION)  
900 ROUTE 9 NORTH  
SUITE 503  
WOODBIDGE, NJ 070951003

FOR: INSURANCE AGENCIES IN THE FIELD OF LANDSCAPE GARDENING, LAWN CARE AND TREE SERVICES INDUSTRIES; INSURANCE SERVICES, NAMELY, UNDERWRITING, ISSUANCE AND ADMINISTRATION OF LANDSCAPE GARDENING, LAWN CARE AND TREE SERVICES INDUSTRIES; INSURANCE SERVICES, NAMELY, WRITING PROPERTY AND CASUALTY INSURANCE, IN CLASS 36 (U.S. CLS. 100, 101 AND 102).

FIRST USE 7-8-2001; IN COMMERCE 7-8-2001.

THE MARK CONSISTS OF STANDARD CHARACTERS WITHOUT CLAIM TO ANY PARTICULAR FONT, STYLE, SIZE, OR COLOR.

SER. NO. 85-576,207, FILED 3-21-2012.

JOHN DALIER, EXAMINING ATTORNEY



*David J. Kybas*

Director of the United States Patent and Trademark Office



# United States of America

United States Patent and Trademark Office

## Dare To Wear

**Reg. No. 4,198,614**

**Registered Aug. 28, 2012**

**Int. Cl.: 3**

**TRADEMARK**

**PRINCIPAL REGISTER**

MEGA CREATIONS INC (CALIFORNIA CORPORATION), DBA LECHAT CORPORATION  
CALIFORNIA  
228 LINUS PAULING DR.  
HERCULES, CA 94547

FOR: NAIL GROOMING PRODUCTS, NAMELY, NAIL LACQUER, GLITTER, NAIL HARDENERS, NAIL POLISH, NAIL POLISH BASE COAT, NAIL POLISH REMOVERS, NAIL POLISH TOP COAT, NAIL REPAIR PRODUCTS, NAIL VARNISHES, NAIL CARE PREPARATIONS, NAMELY, NAIL SOFTENERS, NAIL ENAMEL, COSMETICS AND COSMETIC PREPARATIONS; CUTICLE REMOVERS, COSMETIC PREPARATIONS FOR NAIL DRYING, NAIL CARE KITS COMPRISING NAIL POLISH, NAIL CARE PREPARATIONS, IN CLASS 3 (U.S. CLS. 1, 4, 6, 50, 51 AND 52).

FIRST USE 5-12-2006; IN COMMERCE 7-1-2006.

THE MARK CONSISTS OF STANDARD CHARACTERS WITHOUT CLAIM TO ANY PARTICULAR FONT, STYLE, SIZE, OR COLOR.

SER. NO. 85-577,305, FILED 3-22-2012.

MIDGE BUTLER, EXAMINING ATTORNEY



*David J. Kypos*

Director of the United States Patent and Trademark Office

# United States of America

United States Patent and Trademark Office

## THE BEST LITTLE STILLHOUSE IN TEXAS

**Reg. No. 4,198,615**

LONE STAR DISTILLERY, LLC (TEXAS LIMITED LIABILITY COMPANY)  
P.O. BOX 5932  
AUSTIN, TX 78763

**Registered Aug. 28, 2012**

**Int. Cl.: 40**

FOR: WHISKY DISTILLERY SERVICES, IN CLASS 40 (U.S. CLS. 100, 103 AND 106).

**SERVICE MARK**

FIRST USE 1-8-2008; IN COMMERCE 1-8-2008.

**PRINCIPAL REGISTER**

THE MARK CONSISTS OF STANDARD CHARACTERS WITHOUT CLAIM TO ANY PARTICULAR FONT, STYLE, SIZE, OR COLOR.

SER. NO. 85-577,441, FILED 3-22-2012.

KATINA MISTER, EXAMINING ATTORNEY



*David J. Kyffers*

Director of the United States Patent and Trademark Office

# United States of America

United States Patent and Trademark Office

## PRIMAL WEAR

**Reg. No. 4,198,616**

**Registered Aug. 28, 2012**

**Int. Cl.: 25**

**TRADEMARK**

**PRINCIPAL REGISTER**

PRIMAL WEAR, INC. (COLORADO CORPORATION)  
7700 CHERRY CREEK SOUTH DRIVE, SUITE 106  
DENVER, CO 80206

FOR: ATHLETIC APPAREL, NAMELY, SHIRTS, PANTS, JACKETS, FOOTWEAR, HATS AND CAPS, ATHLETIC UNIFORMS; CLOTHING, NAMELY, ARM WARMERS; CYCLING SHORTS; CYCLISTS' JERSEYS; LEG WARMERS; SKULLIES; SOCKS; TRIATHLON CLOTHING, NAMELY, TRIATHLON TIGHTS, TRIATHLON SHORTS, TRIATHLON SING-LETS, TRIATHLON SHIRTS, TRIATHLON SUITS, IN CLASS 25 (U.S. CLS. 22 AND 39).

FIRST USE 9-20-1992; IN COMMERCE 9-20-1992.

THE MARK CONSISTS OF STANDARD CHARACTERS WITHOUT CLAIM TO ANY PARTICULAR FONT, STYLE, SIZE, OR COLOR.

OWNER OF U.S. REG. NOS. 3,213,870, 3,494,801 AND OTHERS.

NO CLAIM IS MADE TO THE EXCLUSIVE RIGHT TO USE "WEAR", APART FROM THE MARK AS SHOWN.

SER. NO. 85-577,857, FILED 3-23-2012.

MARK T. MULLEN, EXAMINING ATTORNEY



*David J. Kyffers*

Director of the United States Patent and Trademark Office

# United States of America

United States Patent and Trademark Office



**Reg. No. 4,198,617**

**Registered Aug. 28, 2012**

**Int. Cl.: 30**

**TRADEMARK**

**PRINCIPAL REGISTER**

GENERAL MILLS IP HOLDINGS I, LLC (DELAWARE LIMITED LIABILITY COMPANY)  
NUMBER ONE GENERAL MILLS BLVD.  
MINNEAPOLIS, MN 55426

FOR: PROCESSED CEREAL-BASED FOOD TO BE USED AS A BREAKFAST FOOD, SNACK  
FOOD OR INGREDIENT FOR MAKING OTHER FOODS, IN CLASS 30 (U.S. CL. 46).

FIRST USE 1-0-2004; IN COMMERCE 1-0-2004.

THE MARK CONSISTS OF THE STYLIZED DESIGN OF A BAKER WEARING A CHEF'S  
HAT, GLASSES AND APRON AND HOLDING A BAKING SHEET BEARING A SLICED  
LOAF OF SWIRLED BREAD.

SER. NO. 85-578,225, FILED 3-23-2012.

RAUL CORDOVA, EXAMINING ATTORNEY



*David J. Kybas*

Director of the United States Patent and Trademark Office

# United States of America

United States Patent and Trademark Office



**Reg. No. 4,198,618**

**Registered Aug. 28, 2012**

**Int. Cls.: 38 and 41**

**SERVICE MARK**

**PRINCIPAL REGISTER**

DIRECTV, LLC (CALIFORNIA LIMITED LIABILITY COMPANY)  
2230 EAST IMPERIAL HWY  
EL SEGUNDO, CA 90245

FOR: SATELLITE TELEVISION BROADCASTING; SATELLITE TRANSMISSION SERVICES; BROADCASTING PROGRAMS VIA A GLOBAL COMPUTER NETWORK; VIDEO-ON-DEMAND TRANSMISSION SERVICES; PAY-PER-VIEW TELEVISION TRANSMISSION SERVICES; STREAMING OF AUDIO AND VIDEO CONTENT ON THE INTERNET; ELECTRONIC TRANSMISSION OF DATA VIA GLOBAL COMPUTER NETWORKS, WIRELESS NETWORKS AND ELECTRONIC COMMUNICATION NETWORKS; PROVIDING ACCESS TO GLOBAL COMPUTER NETWORKS, WIRELESS NETWORKS AND TELECOMMUNICATION NETWORKS FOR TRANSMISSION OR RECEIPT OF DATA; SATELLITE TELEVISION BROADCASTING AND TRANSMISSION SERVICES FEATURING INTERACTIVE TELEVISION VIEWING FUNCTIONS THAT PERMIT USERS TO VIEW AND SHARE AUDIO FILES, VIDEO FILES, PHOTOGRAPHS, IMAGES AND OTHER MULTIMEDIA CONTENT BETWEEN AND AMONG COMPUTERS, SET-TOP-BOXES, AND OTHER AUDIOVISUAL DEVICES, ALL OF THE AFOREMENTIONED SERVICES EXCLUDING THE TRANSMISSION OF GAMES OVER SATELLITE, BROADCAST AND GLOBAL COMPUTER NETWORKS, CELLULAR-BASED ENTERTAINMENT SERVICES, AND GAMING SERVICES, IN CLASS 38 (U.S. CLS. 100, 101 AND 104).

FIRST USE 10-7-2010; IN COMMERCE 10-7-2010.



*David J. Kyffers*

Director of the United States Patent and Trademark Office

FOR: DISTRIBUTION OF TELEVISION PROGRAMS FOR OTHERS; TELEVISION PROGRAMMING; PROGRAMMING ON A GLOBAL COMPUTER NETWORK; ENTERTAINMENT SERVICES, NAMELY, PROVIDING ONGOING TELEVISION PROGRAMS FEATURING MUSIC, MUSICAL ENTERTAINMENT, INFORMATION ABOUT MUSIC AND ENTERTAINMENT IN THE FIELD OF MUSIC, ALL VIA SATELLITE; PROVIDING ON-LINE INTERACTIVE COMPUTER DATABASES IN THE FIELD OF ENTERTAINMENT INFORMATION FEATURING TELEVISION PROGRAMMING LISTS, PROGRAM SCHEDULES AND PROGRAM-RELATED INFORMATION; PROVIDING ON-LINE INTERACTIVE COMPUTER DATABASES FEATURING ENTERTAINMENT INFORMATION AND SCHEDULES ABOUT TELEVISION PROGRAMMING, MOVIES, AND OTHER DIGITAL IMAGES, AUDIO, VIDEO AND OTHER MULTIMEDIA MATERIALS; ENTERTAINMENT SERVICES, NAMELY, PROVIDING ON-LINE COMPUTER GAMES; PROVIDING COMPUTER GAMES VIA SATELLITE TRANSMISSION; PROVIDING A COMPUTER GAME FOR USE NETWORK-WIDE BY NETWORK USERS; ENTERTAINMENT SERVICES, NAMELY, PROVIDING ON-

**Reg. No. 4,198,618** GOING TELEVISION PROGRAMS FEATURING GENERAL NEWS AND LOCAL NEWS THAT ALSO INCLUDE INTERACTIVE FUNCTIONS THAT PERMIT VIEWERS TO VIEW MULTIPLE IMAGES AND SOURCES OF TELEVISION PROGRAMMING SIMULTANEOUSLY; ENTERTAINMENT SERVICES, NAMELY, PROVIDING ONGOING TELEVISION PROGRAMS FEATURING GENERAL NEWS AND LOCAL NEWS AS WELL AS A VARIETY OF INFORMATION OF INTEREST TO SPECIFIC GEOGRAPHIC AREAS THAT ALSO INCLUDE INTERACTIVE COMPONENTS THAT LET VIEWERS CHOOSE WHAT TO WATCH AT VARIOUS TIMES, TO OBTAIN INFORMATION ABOUT POPULAR PROGRAMS IN THEIR LOCAL VIEWING AREA AND TO MORE NARROWLY DEFINE THE TYPES OF RELATED INFORMATION THEY RECEIVE AND PROGRAMS THEY VIEW; ENTERTAINMENT SERVICES, NAMELY, ONGOING TELEVISION PROGRAMS IN THE FIELD OF GEOGRAPHICAL, CATEGORICAL, REAL-TIME PROGRAMMING RATINGS THAT ALSO INCLUDE INTERACTIVE COMPONENTS THAT LET VIEWERS MORE NARROWLY DEFINE THE TYPES OF RELATED INFORMATION THEY RECEIVE AND PROGRAMS THEY VIEW. ENTERTAINMENT SERVICES, NAMELY, PROVIDING ONGOING TELEVISION PROGRAMS FEATURING GENERAL INFORMATION RELATING TO SATELLITE TELEVISION SERVICE, SATELLITE TELEVISION EQUIPMENT AND HARDWARE, SATELLITE TELEVISION PROGRAMMING AND AUDIO, VISUAL AND OTHER MULTIMEDIA CONTENT THAT ALSO INCLUDE INTERACTIVE COMPONENTS THAT ALLOW USERS TO DEFINE THEIR VIEWING PREFERENCE; ON-LINE, NONDOWNLOADABLE NEWSLETTERS FEATURING GENERAL INFORMATION RELATING TO ENTERTAINMENT, NAMELY, TELEVISION, MOVIES AND OTHER MULTIMEDIA ENTERTAINMENT-RELATED CONTENT; ON-LINE, NONDOWNLOADABLE NEWSLETTERS FEATURING GENERAL INFORMATION RELATING TO SATELLITE TELECOMMUNICATION SERVICES AND SATELLITE TELECOMMUNICATIONS HARDWARE; AND ENTERTAINMENT SERVICES, NAMELY, PROVIDING ONGOING TELEVISION PROGRAMS IN A WIDE VARIETY OF FIELDS THAT ALSO FEATURE INTERACTIVE TELEVISION VIEWING FUNCTIONS THAT PERMIT VIEWERS TO VIEW AND USE COMPUTER APPLICATIONS SIMULTANEOUSLY WHILE VIEWING TELEVISION PROGRAMS, IN CLASS 41 (U.S. CLS. 100, 101 AND 107).

FIRST USE 10-7-2010; IN COMMERCE 10-7-2010.

THE MARK CONSISTS OF CYCLONE DESIGN ADJACENT AND TO THE LEFT OF THE WORD "DIRECTV" IN AN OVERALL HORIZONTAL CONFIGURATION.

SER. NO. 85-580,882, FILED 3-27-2012.

ELIZABETH KAJUBI, EXAMINING ATTORNEY

# United States of America

United States Patent and Trademark Office

galeria  
melissa

**Reg. No. 4,198,619**

GRENDENE S.A. (BRAZIL CORPORATION)  
AV. DUQUE DE CAXIAS, 131-A C.POSTAL, 230  
95.180 FARROUPILHA RS, BRAZIL

**Registered Aug. 28, 2012**

**Int. Cl.: 35**

FOR: RETAIL STORE SERVICES IN THE FIELD OF FOOTWEAR AND ACCESSORIES, IN CLASS 35 (U.S. CLS. 100, 101 AND 102).

**SERVICE MARK**

FIRST USE 2-8-2012; IN COMMERCE 2-8-2012.

**PRINCIPAL REGISTER**

OWNER OF U.S. REG. NOS. 2,526,595, 2,737,154, AND 3,047,672.

THE MARK CONSISTS OF THE PHRASE "GALERIA MELISSA" IN LOWERCASE LETTERING. THE TERM "GALERIA" IS DEPICTED IN SMALL LETTERING AND IS PLACED ABOVE THE LEFT SIDE OF THE TERM "MELISSA" WHICH IS DEPICTED IN LARGE LETTERING.

THE ENGLISH TRANSLATION OF THE WORD "GALERIA" IN THE MARK IS "GALLERY".

SER. NO. 85-581,023, FILED 3-27-2012.

JAMES LOVELACE, EXAMINING ATTORNEY



*David J. Kypos*

Director of the United States Patent and Trademark Office

# United States of America

United States Patent and Trademark Office

WAVE  ONE

**Reg. No. 4,198,620**

DENTSPLY INTERNATIONAL INC. (DELAWARE CORPORATION)  
221 WEST PHILADELPHIA STREET  
YORK, PA 174050872

**Registered Aug. 28, 2012**

**Int. Cl.: 10**

FOR: ENDODONTIC APPARATUS, IN CLASS 10 (U.S. CLS. 26, 39 AND 44).

**TRADEMARK**

FIRST USE 6-8-2011; IN COMMERCE 6-8-2011.

**PRINCIPAL REGISTER**

OWNER OF U.S. REG. NO. 4,064,570.

THE COLOR(S) GREY, BLUE, AND BLACK IS/ARE CLAIMED AS A FEATURE OF THE MARK.

THE MARK CONSISTS OF THE WORD "WAVE" IN GREY COUPLED WITH THE WORD ONE WHEREIN THE LETTER "O" CONSISTS OF 2 ARROW FORMS, ONE BLACK AND ONE BLUE, MEETING AT THE TOP, AND THE REMAINING LETTERS "NE" IN BLACK.

SER. NO. 85-581,092, FILED 3-27-2012.

LUCY ARANT, EXAMINING ATTORNEY



*David J. Kyffers*

Director of the United States Patent and Trademark Office



# United States of America

United States Patent and Trademark Office

## BABY POWDER

**Reg. No. 4,198,621**

DEMETER F.L., INC. (NEW YORK CORPORATION)  
12 NORTH GATE ROAD  
GREAT NECK, NY 11023

**Registered Aug. 28, 2012**

**Int. Cl.: 3**

FOR: FRAGRANCE FOR PERSONAL USE, ROOM FRAGRANCE, COLOGNE, BATH OIL,  
BATH GEL, BODY LOTION, IN CLASS 3 (U.S. CLS. 1, 4, 6, 50, 51 AND 52).

**TRADEMARK**

FIRST USE 9-30-2006; IN COMMERCE 9-30-2006.

**PRINCIPAL REGISTER**

THE MARK CONSISTS OF STANDARD CHARACTERS WITHOUT CLAIM TO ANY PAR-  
TICULAR FONT, STYLE, SIZE, OR COLOR.

SEC. 2(F).

SER. NO. 85-581,836, FILED 3-28-2012.

STEVEN R. FINE, EXAMINING ATTORNEY



*David J. Kybas*

Director of the United States Patent and Trademark Office

# United States of America

United States Patent and Trademark Office

## USPS PS LIGHTWEIGHT

**Reg. No. 4,198,622**

**Registered Aug. 28, 2012**

**Int. Cl.: 16**

**TRADEMARK**

**PRINCIPAL REGISTER**

UNITED STATES POSTAL SERVICE (UNITED STATES INDEPENDENT ESTABLISHMENT OF THE EXECUTIVE BRANCH OF THE GOVERNMENT OF THE UNITED STATES OF AMERICA)

475 L'ENFANT PLAZA, SW  
WASHINGTON, DC 202601136

FOR: SHIPPING LABELS, IN CLASS 16 (U.S. CLS. 2, 5, 22, 23, 29, 37, 38 AND 50).

FIRST USE 1-22-2012; IN COMMERCE 1-22-2012.

THE MARK CONSISTS OF STANDARD CHARACTERS WITHOUT CLAIM TO ANY PARTICULAR FONT, STYLE, SIZE, OR COLOR.

OWNER OF U.S. REG. NOS. 2,709,084, 3,854,015 AND OTHERS.

NO CLAIM IS MADE TO THE EXCLUSIVE RIGHT TO USE "LIGHTWEIGHT", APART FROM THE MARK AS SHOWN.

SER. NO. 85-582,344, FILED 3-28-2012.

JEFFERY COWARD, EXAMINING ATTORNEY



*David J. Kyffers*

Director of the United States Patent and Trademark Office

# United States of America

United States Patent and Trademark Office

# EPACKET

**Reg. No. 4,198,623**

**Registered Aug. 28, 2012**

**Int. Cl.: 16**

**TRADEMARK**

**PRINCIPAL REGISTER**

UNITED STATES POSTAL SERVICE (UNITED STATES INDEPENDENT ESTABLISHMENT OF THE EXECUTIVE BRANCH OF THE GOVERNMENT OF THE UNITED STATES OF AMERICA)

475 L'ENFANT PLAZA, SW  
WASHINGTON, DC 202601136

FOR: SHIPPING LABELS, IN CLASS 16 (U.S. CLS. 2, 5, 22, 23, 29, 37, 38 AND 50).

FIRST USE 10-1-2010; IN COMMERCE 10-1-2010.

THE MARK CONSISTS OF STANDARD CHARACTERS WITHOUT CLAIM TO ANY PARTICULAR FONT, STYLE, SIZE, OR COLOR.

OWNER OF U.S. REG. NO. 4,078,262.

SER. NO. 85-583,132, FILED 3-29-2012.

JEFFERY COWARD, EXAMINING ATTORNEY



*David J. Kyffers*

Director of the United States Patent and Trademark Office

# United States of America

United States Patent and Trademark Office



**Reg. No. 4,198,624**

**Registered Aug. 28, 2012**

**Int. Cls.: 35 and 41**

**SERVICE MARK**

**PRINCIPAL REGISTER**

CHICAGO COSMETOLOGISTS ASSOCIATION, INC. (ILLINOIS CORPORATION)  
401 N. MICHIGAN AVENUE  
CHICAGO, IL 60611

FOR: ASSOCIATION SERVICES, NAMELY, PROMOTING THE INTERESTS OF COSMETOLOGISTS, IN CLASS 35 (U.S. CLS. 100, 101 AND 102).

FIRST USE 12-1-2008; IN COMMERCE 12-1-2008.

FOR: EDUCATION SERVICES, NAMELY, CONDUCTING WORKSHOPS, SEMINARS AND CLASSES IN THE FIELD OF COSMETOLOGY, IN CLASS 41 (U.S. CLS. 100, 101 AND 107).

FIRST USE 12-1-2008; IN COMMERCE 12-1-2008.

THE MARK CONSISTS OF SCRIPT LETTERS "AAE".

SER. NO. 85-583,180, FILED 3-29-2012.

EMILY CHUO, EXAMINING ATTORNEY



*David J. Kybas*

Director of the United States Patent and Trademark Office

# United States of America

United States Patent and Trademark Office

## USPS EPACKET

**Reg. No. 4,198,625**

**Registered Aug. 28, 2012**

**Int. Cl.: 16**

**TRADEMARK**

**PRINCIPAL REGISTER**

UNITED STATES POSTAL SERVICE (UNITED STATES INDEPENDENT ESTABLISHMENT OF THE EXECUTIVE BRANCH OF THE GOVERNMENT OF THE UNITED STATES OF AMERICA)

475 L'ENFANT PLAZA, SW  
WASHINGTON, DC 202601136

FOR: SHIPPING LABELS, IN CLASS 16 (U.S. CLS. 2, 5, 22, 23, 29, 37, 38 AND 50).

FIRST USE 3-13-2012; IN COMMERCE 3-13-2012.

THE MARK CONSISTS OF STANDARD CHARACTERS WITHOUT CLAIM TO ANY PARTICULAR FONT, STYLE, SIZE, OR COLOR.

OWNER OF U.S. REG. NOS. 2,709,084, 4,078,262 AND OTHERS.

SER. NO. 85-583,652, FILED 3-29-2012.

JEFFERY COWARD, EXAMINING ATTORNEY



*David J. Kyffers*

Director of the United States Patent and Trademark Office

United States of America  
United States Patent and Trademark Office

**SHOE DEPT.**  
**—ENCORE—**

**Reg. No. 4,198,626**

SHOE SHOW, INC. (NORTH CAROLINA CORPORATION)  
2201 TRINITY CHURCH ROAD  
CONCORD, NC 28027

**Registered Aug. 28, 2012**

**Int. Cl.: 35**

FOR: RETAIL SHOE STORE SERVICES, IN CLASS 35 (U.S. CLS. 100, 101 AND 102).

**SERVICE MARK**

FIRST USE 2-26-2010; IN COMMERCE 2-26-2010.

**PRINCIPAL REGISTER**

OWNER OF U.S. REG. NO. 1,720,873.

NO CLAIM IS MADE TO THE EXCLUSIVE RIGHT TO USE "SHOE", APART FROM THE MARK AS SHOWN.

THE MARK CONSISTS OF THE WORDS "SHOE DEPT." WHICH APPEAR IN CAPITAL LETTERS CENTERED ABOVE THE WORD "ENCORE", WHICH ALSO APPEARS IN CAPITAL LETTERS CENTERED BETWEEN TWO HORIZONTAL LINES.

SEC. 2(F) AS TO "SHOE DEPT."

SER. NO. 85-584,646, FILED 3-30-2012.

ELLEN PERKINS, EXAMINING ATTORNEY



*David J. Kyfos*

Director of the United States Patent and Trademark Office

United States of America  
United States Patent and Trademark Office

**SHOE DEPT.**  

---

**ENCORE**

**Reg. No. 4,198,627**

**Registered Aug. 28, 2012**

**Int. Cl.: 35**

**SERVICE MARK**

**PRINCIPAL REGISTER**

SHOE SHOW, INC. (NORTH CAROLINA CORPORATION)  
2201 TRINITY CHURCH ROAD  
CONCORD, NC 28027

FOR: RETAIL SHOE STORE SERVICES, IN CLASS 35 (U.S. CLS. 100, 101 AND 102).

FIRST USE 0-0-2008; IN COMMERCE 0-0-2008.

OWNER OF U.S. REG. NO. 1,720,873.

NO CLAIM IS MADE TO THE EXCLUSIVE RIGHT TO USE "SHOE", APART FROM THE MARK AS SHOWN.

THE MARK CONSISTS OF THE WORDS "SHOE DEPT." WHICH APPEAR CENTERED OVER A HORIZONTAL LINE WITH THE WORD "ENCORE" CENTERED BELOW THE HORIZONTAL LINE.

SEC. 2(F) AS TO "SHOE DEPT."

SER. NO. 85-584,659, FILED 3-30-2012.

ELLEN PERKINS, EXAMINING ATTORNEY



*David J. Kyros*

Director of the United States Patent and Trademark Office

# United States of America

United States Patent and Trademark Office

## EZ Pistol Holder

**Reg. No. 4,198,628**

**Registered Aug. 28, 2012**

**Int. Cl.: 13**

**TRADEMARK**

**PRINCIPAL REGISTER**

PARISI, JOSEPH A (UNITED STATES INDIVIDUAL)  
1000 ROUTE 29  
1000 ROUTE 29  
MIDDLE GROVE, NY 12850

FOR: GUN CASES; PISTOL CASES; PISTOL HOLSTERS, IN CLASS 13 (U.S. CLS. 2 AND 9).

FIRST USE 9-14-2011; IN COMMERCE 1-13-2012.

THE MARK CONSISTS OF STANDARD CHARACTERS WITHOUT CLAIM TO ANY PARTICULAR FONT, STYLE, SIZE, OR COLOR.

NO CLAIM IS MADE TO THE EXCLUSIVE RIGHT TO USE "PISTOL HOLDER", APART FROM THE MARK AS SHOWN.

SER. NO. 85-584,686, FILED 3-30-2012.

HANNO RITTNER, EXAMINING ATTORNEY



*David J. Kyffers*

Director of the United States Patent and Trademark Office



# United States of America

United States Patent and Trademark Office



**Reg. No. 4,198,629**

**Registered Aug. 28, 2012**

**Int. Cl.: 34**

**TRADEMARK**

**PRINCIPAL REGISTER**

SANTA FE NATURAL TOBACCO COMPANY, INC. (NEW MEXICO CORPORATION)  
ONE PLAZA LA PRENSA  
SANTA FE, NM 87507

FOR: CIGARETTES, IN CLASS 34 (U.S. CLS. 2, 8, 9 AND 17).

FIRST USE 7-31-2010; IN COMMERCE 7-31-2010.

OWNER OF U.S. REG. NOS. 1,718,559, 2,692,958 AND OTHERS.

THE COLOR(S) RED, WHITE, NAVY BLUE AND BLACK IS/ARE CLAIMED AS A FEATURE OF THE MARK.

THE MARK CONSISTS OF THE STYLIZED WORDING "NATURAL AMERICAN SPIRIT" STACKED ABOVE A DESIGN COMPRISING THE ENCIRCLED PROFILE OF A NATIVE AMERICAN CHIEFTAIN WEARING A FEATHERED WAR BONNET AND SMOKING A PEACE PIPE. THE WORD "NATURAL" APPEARS IN WHITE LETTERING. THE WORDS "AMERICAN SPIRIT" ARE IN WHITE LETTERING OUTLINED IN RED. THE SILHOUETTE OF THE CHIEFTAIN IS BLACK. THE PEACE PIPE AND HEADDRESS ARE WHITE WITH BLACK ACCENTS. THE INTERIOR OF THE CIRCLE IS RED WITH A WHITE BORDER. THE ENTIRE DESIGN IS ON A NAVY BLUE BACKGROUND.

SEC. 2(F) AS TO "NATURAL".

SER. NO. 85-584,858, FILED 3-30-2012.

KATHLEEN M. VANSTON, EXAMINING ATTORNEY



*David J. Kybas*

Director of the United States Patent and Trademark Office

# United States of America

United States Patent and Trademark Office

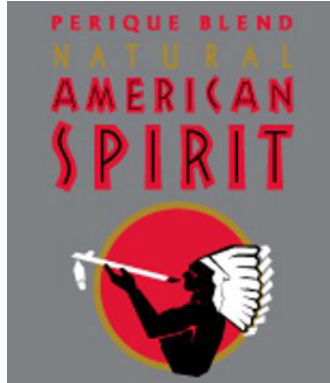

**Reg. No. 4,198,630**

**Registered Aug. 28, 2012**

**Int. Cl.: 34**

**TRADEMARK**

**PRINCIPAL REGISTER**

SANTA FE NATURAL TOBACCO COMPANY, INC. (NEW MEXICO CORPORATION)  
ONE PLAZA LA PRENSA  
SANTA FE, NM 87507

FOR: CIGARETTES, IN CLASS 34 (U.S. CLS. 2, 8, 9 AND 17).

FIRST USE 7-31-2010; IN COMMERCE 7-31-2010.

OWNER OF U.S. REG. NOS. 1,718,559, 2,692,958 AND OTHERS.

THE COLOR(S) RED, WHITE, BLACK, GOLD AND GRAY IS/ARE CLAIMED AS A FEATURE OF THE MARK.

NO CLAIM IS MADE TO THE EXCLUSIVE RIGHT TO USE "PERIQUE BLEND", APART FROM THE MARK AS SHOWN.

THE MARK CONSISTS OF THE STYLIZED WORDING "PERIQUE BLEND NATURAL AMERICAN SPIRIT" STACKED ABOVE A DESIGN COMPRISING THE ENCIRCLED PROFILE OF A NATIVE AMERICAN CHIEFTAIN WEARING A FEATHERED WAR BONNET AND SMOKING A PEACE PIPE. THE WORDING "PERIQUE BLEND" APPEARS IN RED LETTERING. THE WORD "NATURAL" APPEARS IN GOLD LETTERING. THE WORDS "AMERICAN SPIRIT" ARE IN BLACK LETTERING OUTLINED IN RED. THE SILHOUETTE OF THE CHIEFTAIN IS BLACK. THE PEACE PIPE AND HEADDRESS ARE WHITE WITH BLACK ACCENTS. THE INTERIOR OF THE CIRCLE IS RED WITH A GOLD BORDER. THE ENTIRE DESIGN IS ON A GRAY BACKGROUND.

SEC. 2(F) AS TO "NATURAL".

SER. NO. 85-584,868, FILED 3-30-2012.

KATHLEEN M. VANSTON, EXAMINING ATTORNEY



*David J. Kybas*

Director of the United States Patent and Trademark Office

# United States of America

United States Patent and Trademark Office



**Reg. No. 4,198,631**

**Registered Aug. 28, 2012**

**Int. Cl.: 41**

**SERVICE MARK**

**PRINCIPAL REGISTER**

SEMINOLE TRIBE OF FLORIDA (UNITED STATES FEDERALLY-RECOGNIZED INDIAN TRIBE)  
6300 STIRLING ROAD  
HOLLYWOOD, FL 33024

FOR: CASINOS, IN CLASS 41 (U.S. CLS. 100, 101 AND 107).

FIRST USE 10-31-2011; IN COMMERCE 10-31-2011.

NO CLAIM IS MADE TO THE EXCLUSIVE RIGHT TO USE "POKER LOUNGE", APART FROM THE MARK AS SHOWN.

THE MARK CONSISTS OF THE STYLIZED WORDS "STAX" ABOVE THE WORD "POKER" WHICH IS ABOVE THE WORD "LOUNGE", WITH TWO HORIZONTAL LINES REPRESENTING POKER CHIPS ABOVE AND BELOW THE WORD "STAX", AND FOUR LINES/CHIPS BELOW THE WORD "LOUNGE".

SER. NO. 85-586,611, FILED 4-2-2012.

KATHY DE JONGE, EXAMINING ATTORNEY



*David J. Kybas*

Director of the United States Patent and Trademark Office

# United States of America

United States Patent and Trademark Office



**Reg. No. 4,198,632**

SEMINOLE TRIBE OF FLORIDA (UNITED STATES FEDERALLY-RECOGNIZED INDIAN TRIBE)

**Registered Aug. 28, 2012**

6300 STIRLING ROAD  
HOLLYWOOD, FL 33024

**Int. Cl.: 41**

FOR: CASINOS, IN CLASS 41 (U.S. CLS. 100, 101 AND 107).

**SERVICE MARK**

FIRST USE 10-31-2011; IN COMMERCE 10-31-2011.

**PRINCIPAL REGISTER**

NO CLAIM IS MADE TO THE EXCLUSIVE RIGHT TO USE "POKER LOUNGE", APART FROM THE MARK AS SHOWN.

THE MARK CONSISTS OF THE STYLIZED WORD "STAX" TO THE LEFT OF THE WORDS "POKER LOUNGE" WITH "POKER" ABOVE "LOUNGE", ABOVE THE WORDS "STAX" AND "POKER" ARE TWO HORIZONTAL LINES REPRESENTING POKER CHIPS, WITH TWO LINES/CHIPS BELOW THE WORDS "STAX" AND "LOUNGE" AS WELL.

SER. NO. 85-586,650, FILED 4-2-2012.

KATHLEEN M. VANSTON, EXAMINING ATTORNEY



*David J. Kybas*

Director of the United States Patent and Trademark Office

# United States of America

United States Patent and Trademark Office



**Reg. No. 4,198,633**

**Registered Aug. 28, 2012**

**Int. Cl.: 14**

**TRADEMARK**

**PRINCIPAL REGISTER**

ELDIB, KENNETH O (UNITED STATES INDIVIDUAL)  
10874 GOLF VIEW DRIVE  
INDIANAPOLIS, IN 46234

FOR: JEWELRY, IN CLASS 14 (U.S. CLS. 2, 27, 28 AND 50).

FIRST USE 4-3-2012; IN COMMERCE 4-3-2012.

THIS MARK CONSISTS OF AN ANKH WITH A PEACE SIGN INSIDE THE CIRCULAR PART OF THE ANKH.

SER. NO. 85-587,264, FILED 4-3-2012.

LOURDES AYALA, EXAMINING ATTORNEY



*David J. Kyffers*

Director of the United States Patent and Trademark Office

# United States of America

United States Patent and Trademark Office

C<sup>2</sup>

STEAK ■ SEAFOOD

**Reg. No. 4,198,634**

**Registered Aug. 28, 2012**

**Int. Cl.: 43**

CACHE CREEK CASINO RESORT (UNITED STATES A WHOLLY OWNED TRIBAL ENTERPRISE OF THE YOCHA DEHE WINTUN NATION, A FEDERALLY - RECOGNIZED INDIAN TRIBE)  
14455 HIGHWAY 16  
BROOKS, CA 95606

**SERVICE MARK**

**PRINCIPAL REGISTER**

FOR: RESTAURANT SERVICES, IN CLASS 43 (U.S. CLS. 100 AND 101).

FIRST USE 8-19-2004; IN COMMERCE 8-19-2004.

OWNER OF U.S. REG. NO. 3,161,524.

NO CLAIM IS MADE TO THE EXCLUSIVE RIGHT TO USE "STEAK SEAFOOD", APART FROM THE MARK AS SHOWN.

THE MARK CONSISTS OF A STYLIZED LETTER "C" WITH A RAISED NUMBER "2" FOLLOWED BY THE WORDS UNDERNEATH OF "STEAK" AND "SEAFOOD" SEPARATED BY A DOT.

SER. NO. 85-587,947, FILED 4-3-2012.

KATHY DE JONGE, EXAMINING ATTORNEY



*David J. Kyros*

Director of the United States Patent and Trademark Office

# United States of America

United States Patent and Trademark Office

## MARKETING INSIDER

**Reg. No. 4,198,635**

**Registered Aug. 28, 2012**

**Int. Cl.: 16**

**TRADEMARK**

**PRINCIPAL REGISTER**

ALLEGRA HOLDINGS LLC (MICHIGAN LIMITED LIABILITY COMPANY)  
47585 GALLEON DRIVE  
PLYMOUTH, MI 48170

FOR: NEWSLETTERS IN THE FIELDS OF ADVERTISING, MARKETING AND PROMOTION SERVICES, GRAPHICS AND SIGNS, IN CLASS 16 (U.S. CLS. 2, 5, 22, 23, 29, 37, 38 AND 50).

FIRST USE 3-0-2010; IN COMMERCE 3-0-2010.

THE MARK CONSISTS OF STANDARD CHARACTERS WITHOUT CLAIM TO ANY PARTICULAR FONT, STYLE, SIZE, OR COLOR.

NO CLAIM IS MADE TO THE EXCLUSIVE RIGHT TO USE "MARKETING", APART FROM THE MARK AS SHOWN.

SER. NO. 85-587,982, FILED 4-3-2012.

ESTHER A. BORSUK, EXAMINING ATTORNEY



*David J. Kyjars*

Director of the United States Patent and Trademark Office

# United States of America

United States Patent and Trademark Office

## PASTURE PLUS

**Reg. No. 4,198,636**

RIO RANCH SUPPLY INC. (MINNESOTA CORPORATION)  
165 HIGHWAY 195  
VESTA, MN 56292

**Registered Aug. 28, 2012**

**Int. Cl.: 5**

FOR: ANIMAL FEED SUPPLEMENTS; DIETARY SUPPLEMENTS FOR ANIMALS, IN CLASS 5 (U.S. CLS. 6, 18, 44, 46, 51 AND 52).

**TRADEMARK**

FIRST USE 1-1-2008; IN COMMERCE 1-1-2008.

**PRINCIPAL REGISTER**

THE MARK CONSISTS OF STANDARD CHARACTERS WITHOUT CLAIM TO ANY PARTICULAR FONT, STYLE, SIZE, OR COLOR.

NO CLAIM IS MADE TO THE EXCLUSIVE RIGHT TO USE "PASTURE", APART FROM THE MARK AS SHOWN.

SER. NO. 85-588,129, FILED 4-3-2012.

KEVIN DINALLO, EXAMINING ATTORNEY



*David J. Kybas*

Director of the United States Patent and Trademark Office



# United States of America

United States Patent and Trademark Office



**Reg. No. 4,198,637**

RIO RANCH SUPPLY INC. (MINNESOTA CORPORATION)  
165 HIGHWAY 195  
VESTA, MN 56292

**Registered Aug. 28, 2012**

**Int. Cl.: 5**

FOR: ANIMAL FEED SUPPLEMENTS; DIETARY SUPPLEMENTS FOR ANIMALS, IN CLASS 5 (U.S. CLS. 6, 18, 44, 46, 51 AND 52).

**TRADEMARK**

FIRST USE 1-1-2005; IN COMMERCE 1-1-2005.

**PRINCIPAL REGISTER**

NO CLAIM IS MADE TO THE EXCLUSIVE RIGHT TO USE "ENHANCED NUTRITION", APART FROM THE MARK AS SHOWN.

THE MARK CONSISTS OF THE STYLIZED TEXT "RIOMAX" WRITTEN ABOVE THE STYLIZED TEXT "ENHANCED NUTRITION". A STYLIZED HAT IS DISPLAYED ON TOP OF THE LETTER "R" IN "RIOMAX". A STYLIZED CURVED LINE WITH A STAR AT THE END CROSSES THE TEXT "RIOMAX" AND ENDS BETWEEN THE TEXT "ENHANCED" AND "NUTRITION".

SER. NO. 85-588,135, FILED 4-3-2012.

KEVIN DINALLO, EXAMINING ATTORNEY



*David J. Kybas*

Director of the United States Patent and Trademark Office

# United States of America

United States Patent and Trademark Office

# Aeroblades

**Reg. No. 4,198,638**

**Registered Aug. 28, 2012**

**Int. Cl.: 8**

**TRADEMARK**

**PRINCIPAL REGISTER**

NEPTUNE TRADING INC. (CALIFORNIA CORPORATION)  
MICHAEL LU  
4021 GREYSTONE DR.  
ONTARIO, CA 91761

FOR: KNIVES; KNIVES FOR HOBBY USE; SPORT KNIVES; THROWING KNIVES, IN CLASS 8 (U.S. CLS. 23, 28 AND 44).

FIRST USE 8-19-2011; IN COMMERCE 9-27-2011.

THE MARK CONSISTS OF STANDARD CHARACTERS WITHOUT CLAIM TO ANY PARTICULAR FONT, STYLE, SIZE, OR COLOR.

SER. NO. 85-588,256, FILED 4-3-2012.

ADA HAN, EXAMINING ATTORNEY



*David J. Kybas*

Director of the United States Patent and Trademark Office

# United States of America

United States Patent and Trademark Office

## We've Done The Research For You

**Reg. No. 4,198,639**

**Registered Aug. 28, 2012**

**Int. Cl.: 16**

**TRADEMARK**

**PRINCIPAL REGISTER**

HOME CONTRACTORS REVIEW, LLC (GEORGIA LIMITED LIABILITY COMPANY), DBA  
HOME SERVICES REVIEW AND FIVE STAR RATED  
4230 GRAND TETON PKWY  
SUWANEE, GA 30024

FOR: MAGAZINES IN THE FIELD OF CONTRACTOR RESEARCH, RATING AND  
HOMEOWNER REFERRAL, IN CLASS 16 (U.S. CLS. 2, 5, 22, 23, 29, 37, 38 AND 50).

FIRST USE 1-25-2007; IN COMMERCE 1-25-2007.

THE MARK CONSISTS OF STANDARD CHARACTERS WITHOUT CLAIM TO ANY PAR-  
TICULAR FONT, STYLE, SIZE, OR COLOR.

SER. NO. 85-588,896, FILED 4-4-2012.

JEFF DEFORD, EXAMINING ATTORNEY



*David J. Kyffers*

Director of the United States Patent and Trademark Office

# United States of America

United States Patent and Trademark Office

# KeepSight

**Reg. No. 4,198,640**

KEEPSIGHT LLC (CONNECTICUT LIMITED LIABILITY COMPANY)  
515 OLD SLOCUM RD.  
HEBRON, CT 06248

**Registered Aug. 28, 2012**

**Int. Cl.: 44**

FOR: MEDICAL TESTING FOR DIAGNOSTIC OR TREATMENT PURPOSES, IN CLASS 44  
(U.S. CLS. 100 AND 101).

**SERVICE MARK**

FIRST USE 5-4-2006; IN COMMERCE 7-15-2006.

**PRINCIPAL REGISTER**

THE MARK CONSISTS OF STANDARD CHARACTERS WITHOUT CLAIM TO ANY PARTICULAR FONT, STYLE, SIZE, OR COLOR.

SER. NO. 85-589,320, FILED 4-4-2012.

DARRYL SPRUILL, EXAMINING ATTORNEY



*David J. Kybas*

Director of the United States Patent and Trademark Office

# United States of America

United States Patent and Trademark Office

## PACIFIC PRIME

**Reg. No. 4,198,641**

PACIFIC LIFE INSURANCE COMPANY (NEBRASKA CORPORATION)  
700 NEWPORT CENTER DRIVE  
NEWPORT BEACH, CA 92660

**Registered Aug. 28, 2012**

**Int. Cl.: 36**

FOR: INSURANCE AND FINANCIAL SERVICES, NAMELY, LIFE INSURANCE UNDERWRITING AND ADMINISTRATION, IN CLASS 36 (U.S. CLS. 100, 101 AND 102).

**SERVICE MARK**

FIRST USE 8-30-2010; IN COMMERCE 8-30-2010.

**PRINCIPAL REGISTER**

THE MARK CONSISTS OF STANDARD CHARACTERS WITHOUT CLAIM TO ANY PARTICULAR FONT, STYLE, SIZE, OR COLOR.

OWNER OF U.S. REG. NOS. 2,168,494, 3,764,968 AND OTHERS.

SER. NO. 85-589,566, FILED 4-4-2012.

MICHAEL SOUDERS, EXAMINING ATTORNEY



*David J. Kyffers*

Director of the United States Patent and Trademark Office

# United States of America

United States Patent and Trademark Office

## THREAT MATRIX

**Reg. No. 4,198,642**

**Registered Aug. 28, 2012**

**Int. Cl.: 42**

**SERVICE MARK**

**PRINCIPAL REGISTER**

BARON SERVICES, INC. (DELAWARE CORPORATION)  
4930 RESEARCH DRIVE  
HUNTSVILLE, AL 35805

FOR: PROVIDING REAL-TIME AND HISTORICAL WEATHER INFORMATION TO STATIONARY AND MOBILE USERS, VIA SATELLITE, RADIO, AND CELLULAR PHONE TRANSMITTERS AND VIA LOCAL AND GLOBAL COMPUTERS; PROVIDING WEATHER-RELATED DATA AND INFORMATION AND WEATHER-RELATED IMAGES THROUGH A DISTRIBUTION NETWORK; PROVIDING REAL-TIME AND HISTORICAL WEATHER INFORMATION, NAMELY, PROVIDING WEATHER INFORMATION THAT FEATURES THE GRAPHICAL DISPLAY OF RADAR, LIGHTNING, THUNDERSTORMS, WIND VELOCITY, WIND SHEAR, WIND ROTATION, PRECIPITATION, STORM LOCATION, STORM TRACKING, AND OTHER WEATHER PHENOMENON AND WEATHER DATA; PROVIDING WEATHER INFORMATION SERVICES, IN CLASS 42 (U.S. CLS. 100 AND 101).

FIRST USE 4-27-2010; IN COMMERCE 4-27-2010.

THE MARK CONSISTS OF STANDARD CHARACTERS WITHOUT CLAIM TO ANY PARTICULAR FONT, STYLE, SIZE, OR COLOR.

SER. NO. 85-590,356, FILED 4-5-2012.

RENEE MCCRAY, EXAMINING ATTORNEY



*David J. Kyros*

Director of the United States Patent and Trademark Office

# United States of America

United States Patent and Trademark Office

# ROOM KEY

**Reg. No. 4,198,643**

HOTEL JV SERVICES, LLC (DELAWARE LIMITED LIABILITY COMPANY)  
3811 TURTLE CREEK BLVD., STE. 1450  
DALLAS, TX 75219

**Registered Aug. 28, 2012**

**Int. Cl.: 43**

FOR: PROVIDING A WEBSITE FEATURING INFORMATION IN THE FIELD OF HOTELS AND TEMPORARY ACCOMMODATIONS; RESERVATIONS AND BOOKINGS FOR HOTELS AND TEMPORARY ACCOMMODATIONS, IN CLASS 43 (U.S. CLS. 100 AND 101).

**SERVICE MARK**

FIRST USE 1-11-2012; IN COMMERCE 1-11-2012.

**PRINCIPAL REGISTER**

THE MARK CONSISTS OF STANDARD CHARACTERS WITHOUT CLAIM TO ANY PARTICULAR FONT, STYLE, SIZE, OR COLOR.

SER. NO. 85-976,503, FILED 9-22-2011.

JAMES GRIFFIN, EXAMINING ATTORNEY



*David J. Kyffers*

Director of the United States Patent and Trademark Office

# United States of America

United States Patent and Trademark Office

# ROOMKEY.COM

**Reg. No. 4,198,644**

HOTEL JV SERVICES, LLC (DELAWARE LIMITED LIABILITY COMPANY)  
3811 TURTLE CREEK BLVD., STE. 1450  
DALLAS, TX 75219

**Registered Aug. 28, 2012**

**Int. Cl.: 43**

FOR: PROVIDING A WEBSITE FEATURING INFORMATION IN THE FIELD OF HOTELS AND TEMPORARY ACCOMMODATIONS; RESERVATIONS AND BOOKINGS FOR HOTELS AND TEMPORARY ACCOMMODATIONS, IN CLASS 43 (U.S. CLS. 100 AND 101).

**SERVICE MARK**

FIRST USE 1-11-2012; IN COMMERCE 1-11-2012.

**PRINCIPAL REGISTER**

THE MARK CONSISTS OF STANDARD CHARACTERS WITHOUT CLAIM TO ANY PARTICULAR FONT, STYLE, SIZE, OR COLOR.

SER. NO. 85-976,690, FILED 9-22-2011.

JAMES GRIFFIN, EXAMINING ATTORNEY



*David J. Kyffers*

Director of the United States Patent and Trademark Office



# United States of America

United States Patent and Trademark Office



**Reg. No. 4,198,645**

ASSOCIATIONS, INC. (TEXAS CORPORATION)  
5401 N. CENTRAL EXPRESSWAY, SUITE 300  
DALLAS, TX 75205

**Registered Aug. 28, 2012**

**Int. Cl.: 42**

FOR: PROVIDING TEMPORARY USE OF NON-DOWNLOADABLE COMPUTER SOFTWARE TO PERMIT OTHERS TO PROVIDE INFORMATION PROCESSING SERVICES AND FINANCIAL ACCOUNTING SERVICES TO COMMUNITY ASSOCIATIONS, IN CLASS 42 (U.S. CLS. 100 AND 101).

**SERVICE MARK**

**PRINCIPAL REGISTER**

FIRST USE 5-5-2012; IN COMMERCE 5-5-2012.

THE MARK CONSISTS OF THE WORD "AIMS" SUPERIMPOSED ON A BULLS-EYE TARGET, THE TARGET CONSISTING OF A CENTER CIRCLE WITH 4 PROGRESSIVELY LARGER RINGS, THE RINGS ALTERNATING IN LIGHT.

SN 76-680,964, FILED 8-21-2007.

DEZMONA MIZELLE, EXAMINING ATTORNEY



*David J. Kyffers*

Director of the United States Patent and Trademark Office

# United States of America

United States Patent and Trademark Office

## STOREMYBOXES.COM

**Reg. No. 4,198,646**

STOREMYBOXES.COM, LLC (CALIFORNIA LIMITED LIABILITY COMPANY)  
777 S FLAGLER DRIVE  
WEST PALM BEACH, FL 33401

**Registered Aug. 28, 2012**

**Int. Cl.: 39**

FOR: PHYSICAL RELOCATION AND DELIVERY SERVICES OF CONTAINERS, IN CLASS 39 (U.S. CLS. 100 AND 105).

**SERVICE MARK**

FIRST USE 6-29-2012; IN COMMERCE 6-29-2012.

**PRINCIPAL REGISTER**

THE MARK CONSISTS OF STANDARD CHARACTERS WITHOUT CLAIM TO ANY PARTICULAR FONT, STYLE, SIZE, OR COLOR.

SN 76-682,469, FILED 10-1-2007.

DAVID MURRAY, EXAMINING ATTORNEY



*David J. Kybas*

Director of the United States Patent and Trademark Office

# United States of America

United States Patent and Trademark Office

**MAKE FUN WORK. MAKE WORK FUN. MAKE ZUCA WORK FOR YOU**

**Reg. No. 4,198,647**

ZUCA, INC. (CALIFORNIA CORPORATION)  
645 EAST MCGLINCY LANE, UNIT C  
CAMPBELL, CA 95008

**Registered Aug. 28, 2012**

**Int. Cl.: 18**

FOR: LUGGAGE, BACKPACKS AND BAGS, NAMELY, ROLLING LUGGAGE, SCHOOL BAGS, ROLLING BRIEFCASES AND ROLLING BACKPACKS, IN CLASS 18 (U.S. CLS. 1, 2, 3, 22 AND 41).

**TRADEMARK**

FIRST USE 12-31-2007; IN COMMERCE 12-31-2007.

**PRINCIPAL REGISTER**

THE MARK CONSISTS OF STANDARD CHARACTERS WITHOUT CLAIM TO ANY PARTICULAR FONT, STYLE, SIZE, OR COLOR.

SN 76-683,942, FILED 11-13-2007.

RAUL CORDOVA, EXAMINING ATTORNEY



*David J. Kybas*

Director of the United States Patent and Trademark Office

# United States of America

United States Patent and Trademark Office

## EPs 7630

**Reg. No. 4,198,648**

**Registered Aug. 28, 2012**

**Int. Cl.: 5**

**TRADEMARK**

**PRINCIPAL REGISTER**

DR. WILLMAR SCHWABE GMBH & CO. KG (FED REP GERMANY CORPORATION)  
WILLMAR-SCHWABE-STRASSE 4  
D-76227 KARLSRUHE, FED REP GERMANY

FOR: PLANT-BASED PHARMACEUTICALS FOR THE TREATMENT OF RESPIRATORY DISEASES, NAMELY, THOSE BASED ON AN ETHANOLIC EXTRACT OF THE ROOTS OF PELARGONIUM SIDOIDES, IN CLASS 5 (U.S. CLS. 6, 18, 44, 46, 51 AND 52).

FIRST USE 8-24-2009; IN COMMERCE 8-24-2009.

THE MARK CONSISTS OF STANDARD CHARACTERS WITHOUT CLAIM TO ANY PARTICULAR FONT, STYLE, SIZE, OR COLOR.

SN 76-690,276, FILED 6-5-2008.

SUZANNE BLANE, EXAMINING ATTORNEY



*David J. Kyjars*

Director of the United States Patent and Trademark Office

United States of America  
United States Patent and Trademark Office

AM<sup>2</sup>P

**Reg. No. 4,198,649**

ABSI CORPORATION (VIRGINIA CORPORATION)  
9210 CORPORATE BOULEVARD, SUITE 150  
ROCKVILLE, MD 20850

**Registered Aug. 28, 2012**

**Int. Cl.: 42**

FOR: APPLICATION SERVICE PROVIDER (ASP) HOSTING COMPUTER SOFTWARE APPLICATIONS FOR WIRELESS CONTENT DELIVERY, INCLUSIVE OF SOFTWARE FOR WIRELESS APPLICATION INTEGRATION, IN CLASS 42 (U.S. CLS. 100 AND 101).

**SERVICE MARK**

FIRST USE 6-10-2008; IN COMMERCE 6-2-2012.

**PRINCIPAL REGISTER**

THE MARK CONSISTS OF THE CAPITAL LETTERS "AM" AND "P" WITH THE NUMBER "2" IN SUPERSCRIPT BETWEEN THE LETTERS "M" AND "P".

SN 76-692,895, FILED 9-16-2008.

RAMONA ORTIGA, EXAMINING ATTORNEY



*David J. Kyros*

Director of the United States Patent and Trademark Office

# United States of America

United States Patent and Trademark Office

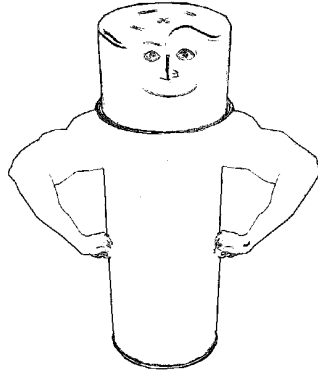

**Reg. No. 4,198,650**

**Registered Aug. 28, 2012**

**Int. Cl.: 4**

**TRADEMARK**

**PRINCIPAL REGISTER**

SYNCO CHEMICAL CORPORATION (NEW YORK CORPORATION)  
P.O. BOX 405, 24  
DAVINCI DRIVE  
BOHEMIA, NY 11716

FOR: LUBRICANTS, NAMELY, ALL-PURPOSE LUBRICANTS, GREASE, NAMELY, GENERAL PURPOSE GREASE, IN CLASS 4 (U.S. CLS. 1, 6 AND 15).

FIRST USE 2-15-2012; IN COMMERCE 2-15-2012.

THE MARK CONSISTS OF A STYLIZED REPRESENTATION OF A MAN FORMED BY AN AEROSOL CAN WITH A MAN'S EYE, NOSE, SMILING MOUTH AND CHIN AS THE CAP OF THE CAN AND MUSCULAR ARMS ON EITHER SIDE OF THE CAN WITH FISTS RESTING ON EITHER SIDE OF THE CAN.

SN 76-702,286, FILED 3-29-2010.

AMY ALFIERI, EXAMINING ATTORNEY



*David J. Kybas*

Director of the United States Patent and Trademark Office

# United States of America

United States Patent and Trademark Office

## WORTH MORE

**Reg. No. 4,198,651**

**Registered Aug. 28, 2012**

**Int. Cl.: 35**

**SERVICE MARK**

**PRINCIPAL REGISTER**

CIRCA INC. (NEW YORK CORPORATION)  
415 MADISON AVENUE, 19TH FLOOR  
NEW YORK, NY 10017

FOR: PROCUREMENT SERVICES, NAMELY, PURCHASING ESTATE JEWELRY AND JEWELRY FROM SIMILAR SOURCES FOR OTHERS, IN CLASS 35 (U.S. CLS. 100, 101 AND 102).

FIRST USE 12-31-2010; IN COMMERCE 12-31-2010.

THE MARK CONSISTS OF STANDARD CHARACTERS WITHOUT CLAIM TO ANY PARTICULAR FONT, STYLE, SIZE, OR COLOR.

SN 76-703,479, FILED 6-22-2010.

MICHAEL ENGEL, EXAMINING ATTORNEY



*David J. Kyffers*

Director of the United States Patent and Trademark Office

# United States of America

United States Patent and Trademark Office

# TRIDRIVER

**Reg. No. 4,198,652**

**Registered Aug. 28, 2012**

**Int. Cl.: 7**

**TRADEMARK**

**PRINCIPAL REGISTER**

IBT HOLDINGS, LLC (FLORIDA LIMITED LIABILITY COMPANY)  
624 SOUTH MILITARY TRAIL  
DEERFIELD BEACH, FL 33442

FOR: POWER TOOLS, NAMELY, DRILLS, DRIVERS, SAWS, SCREW DRIVERS, CUTTERS, GRINDERS, WRENCHES AND SANDERS; POWER-OPERATED TOOLS, NAMELY, DRILLS, DRIVERS, SAWS, SCREW DRIVERS, CUTTERS, GRINDERS, WRENCHES AND SANDERS; ELECTRIC SCREWDRIVERS; AIR POWERED TOOLS, NAMELY, DRILLS, DRIVERS, SAWS, SCREW DRIVERS, CUTTERS, GRINDERS, WRENCHES AND SANDERS, IN CLASS 7 (U.S. CLS. 13, 19, 21, 23, 31, 34 AND 35).

FIRST USE 5-1-2011; IN COMMERCE 5-1-2011.

THE MARK CONSISTS OF STANDARD CHARACTERS WITHOUT CLAIM TO ANY PARTICULAR FONT, STYLE, SIZE, OR COLOR.

SN 76-703,527, FILED 6-25-2010.

KAREN K. BUSH, EXAMINING ATTORNEY



*David J. Kyros*

Director of the United States Patent and Trademark Office



# United States of America

United States Patent and Trademark Office

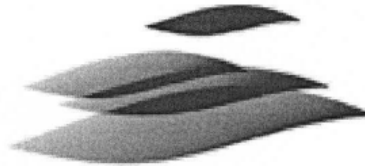

## Full Life

**Reg. No. 4,198,653**

FULL LIFE CARE (WASHINGTON CORPORATION)  
800 JEFFERSON STREET, SUITE 620  
SEATTLE, WA 98104

**Registered Aug. 28, 2012**

**Int. Cls.: 41, 44, and 45**

FOR: PROVIDING SOCIAL ACTIVITIES IN THE NATURE OF DAY PROGRAMS, NAMELY, ARRANGING, ORGANIZING AND HOSTING SOCIAL EVENTS FOR ADULTS WITH PHYSICAL AND MENTAL DISABILITIES AND CHRONIC HEALTH CONDITIONS, IN CLASS 41 (U.S. CLS. 100, 101 AND 107).

**SERVICE MARK**

**PRINCIPAL REGISTER**

FIRST USE 11-7-2011; IN COMMERCE 11-7-2011.

FOR: PROVIDING HEALTH CARE IN THE NATURE OF WELLNESS DAY PROGRAMS FOR ADULTS WITH PHYSICAL AND MENTAL DISABILITIES AND CHRONIC HEALTH CONDITIONS; SUPPORTED LIVING HOME SERVICES FOR ADULTS WITH ALZHEIMERS AND DEMENTIA, NAMELY, REST HOMES, IN CLASS 44 (U.S. CLS. 100 AND 101).

FIRST USE 11-7-2011; IN COMMERCE 11-7-2011.

FOR: IN-HOME SUPPORT SERVICES TO ADULTS WITH PHYSICAL AND MENTAL DISABILITIES AND CHRONIC HEALTH CONDITIONS IN THE NATURE OF THE COORDINATION OF NECESSARY PERSONAL SERVICES AND PERSONAL CARE; SOCIAL SERVICES, NAMELY, VOLUNTEER COMPANIONSHIP SERVICES FOR SOCIALLY ISOLATED ELDERS, NAMELY, PROVIDING NON-MEDICAL IN-HOME PERSONAL SERVICES, INCLUDING CHECKING HOME CONDITION, SUPPLIES AND INDIVIDUAL WELL BEING, SCHEDULE APPOINTMENTS, RUNNING ERRANDS, MAKING SAFETY CHECKS AND PROVIDING ONLINE INFORMATION RELATED THESE PERSONAL SERVICES , IN CLASS 45 (U.S. CLS. 100 AND 101).

FIRST USE 11-7-2011; IN COMMERCE 11-7-2011.

THE MARK CONSISTS OF THE EMPHASIZED WORDS "FULL LIFE" OFFSET TO THE LEFT AND UNDER FOUR STYLIZED BRUSH MARKS.

SN 76-704,278, FILED 8-27-2010.

JEAN IM, EXAMINING ATTORNEY



*David J. Kyros*

Director of the United States Patent and Trademark Office

United States of America  
United States Patent and Trademark Office

**LUNCHPRO**

**Reg. No. 4,198,654**

CARLTON, MATT (UNITED STATES INDIVIDUAL)  
P.O. BOX 38445  
DALLAS, TX 75238

**Registered Aug. 28, 2012**

**Int. Cl.: 35**

FOR: ONLINE ORDERING SERVICES FEATURING RESTAURANT TAKE-OUT AND DELIVERY FOR GROUPS AND MEETINGS, IN CLASS 35 (U.S. CLS. 100, 101 AND 102).

**SERVICE MARK**

FIRST USE 2-8-2002; IN COMMERCE 2-23-2011.

**PRINCIPAL REGISTER**

THE MARK CONSISTS OF STANDARD CHARACTERS WITHOUT CLAIM TO ANY PARTICULAR FONT, STYLE, SIZE, OR COLOR.

SN 76-706,142, FILED 1-26-2011.

PATRICIA EVANKO, EXAMINING ATTORNEY



*David J. Kybas*

Director of the United States Patent and Trademark Office

# United States of America

United States Patent and Trademark Office

# GardenQuest

**Reg. No. 4,198,655**

**Registered Aug. 28, 2012**

**Int. Cl.: 41**

**SERVICE MARK**

**PRINCIPAL REGISTER**

10-20 MEDIA, INC. (MARYLAND CORPORATION)  
16005 FREDERICK ROAD  
WOODBINE, MD 21797

FOR: ENTERTAINMENT AND EDUCATIONAL SERVICES, NAMELY, INTERACTIVE SOCIAL GARDENING GAME, PROVIDED VIA THE INTERNET FOR REGISTERED USERS, NAMELY, ON-LINE, NON-DOWNLOADABLE GAME, FEATURING PROGRAMS AND SOFTWARE ABOUT GARDENING, ALL PLAYED FOR ENTERTAINMENT AND EDUCATIONAL SERVICES, NAMELY, PROVIDING VIRTUAL ENVIRONMENTS IN WHICH USERS CAN INTERACT USING VIRTUAL GARDENING PRODUCTS AND VIRTUAL CURRENCY FOR PURCHASING GOODS, AS WELL AS REAL WORLD GARDENING INFORMATION, IN CLASS 41 (U.S. CLS. 100, 101 AND 107).

FIRST USE 6-5-2012; IN COMMERCE 6-5-2012.

THE MARK CONSISTS OF STANDARD CHARACTERS WITHOUT CLAIM TO ANY PARTICULAR FONT, STYLE, SIZE, OR COLOR.

SN 76-706,806, FILED 3-15-2011.

WILLIAM BRECKENFELD, EXAMINING ATTORNEY



*David J. Kypos*

Director of the United States Patent and Trademark Office

**United States of America**  
United States Patent and Trademark Office

# IRONUP

**Reg. No. 4,198,656**

YASOO HEALTH, INC. (TENNESSEE CORPORATION)  
2109 MARKET ST.

**Registered Aug. 28, 2012**

JOHNSON CITY, TN 37604

**Int. Cl.: 5**

FOR: PHARMACEUTICALS IN THE NATURE OF DIETARY IRON SUPPLEMENTS FOR MEDICAL USE, IN CLASS 5 (U.S. CLS. 6, 18, 44, 46, 51 AND 52).

**TRADEMARK**

FIRST USE 4-5-2011; IN COMMERCE 8-2-2011.

**PRINCIPAL REGISTER**

THE MARK CONSISTS OF STANDARD CHARACTERS WITHOUT CLAIM TO ANY PARTICULAR FONT, STYLE, SIZE, OR COLOR.

NO CLAIM IS MADE TO THE EXCLUSIVE RIGHT TO USE "IRON", APART FROM THE MARK AS SHOWN.

SN 76-707,116, FILED 4-5-2011.

SEAN CROWLEY, EXAMINING ATTORNEY



*David J. Kybas*

Director of the United States Patent and Trademark Office

# United States of America

United States Patent and Trademark Office

## WESTERN STAR

**Reg. No. 4,198,657**

OLDE GRANDDAD INDUSTRIES, INC. (NEW JERSEY CORPORATION)  
160 PASSAIC AVENUE, BLDG. 31 B  
KEARNY, NJ 07032

**Registered Aug. 28, 2012**

**Int. Cl.: 5**

FOR: FRAGRANCE AND DEODORIZING PRODUCTS FOR LAND VEHICLES, AIRCRAFT, MARINE CRAFT, PERSONAL, COMMERCIAL, INDUSTRIAL AND HOME USE, NAMELY, AIR FRESHENERS, IN CLASS 5 (U.S. CLS. 6, 18, 44, 46, 51 AND 52).

**TRADEMARK**

FIRST USE 5-25-2012; IN COMMERCE 5-25-2012.

**PRINCIPAL REGISTER**

THE MARK CONSISTS OF STANDARD CHARACTERS WITHOUT CLAIM TO ANY PARTICULAR FONT, STYLE, SIZE, OR COLOR.

SN 76-707,182, FILED 4-8-2011.

CURTIS FRENCH, EXAMINING ATTORNEY



*David J. Kyffers*

Director of the United States Patent and Trademark Office

# United States of America

United States Patent and Trademark Office

GO OUT MORE...FOR LESS

**Reg. No. 4,198,658**

VOOMERANG LLC (CALIFORNIA LIMITED LIABILITY COMPANY)  
132 S. LASKY DR.

**Registered Aug. 28, 2012**

BEVERLY HILLS, CA 90212

**Int. Cl.: 35**

FOR: PROMOTING THE GOODS AND SERVICES OF OTHERS BY PROVIDING A WEBSITE WHICH FEATURES COUPONS, PRICE COMPARISONS, CONSUMER PRODUCT AND SERVICE REVIEWS, LINKS TO RETAIL WEBSITES OF OTHERS, DISCOUNTS ON PURCHASES OF PRODUCTS OR SERVICES, SPECIAL DISCOUNTS TO REPEAT CUSTOMERS AND FOR CUSTOMER REFERRALS, AND E-MAIL NOTICE OF PRODUCT OR SERVICE DISCOUNT OFFERS, IN CLASS 35 (U.S. CLS. 100, 101 AND 102).

**SERVICE MARK**

**PRINCIPAL REGISTER**

FIRST USE 5-15-2012; IN COMMERCE 5-15-2012.

THE MARK CONSISTS OF STANDARD CHARACTERS WITHOUT CLAIM TO ANY PARTICULAR FONT, STYLE, SIZE, OR COLOR.

SN 76-707,409, FILED 4-27-2011.

BARNEY CHARLON, EXAMINING ATTORNEY



*David J. Kyffers*

Director of the United States Patent and Trademark Office

# United States of America

United States Patent and Trademark Office

# DECIMUS

**Reg. No. 4,198,659**

**Registered Aug. 28, 2012**

**Int. Cl.: 33**

**TRADEMARK**

**PRINCIPAL REGISTER**

TITHE WINES, L.L.C. (TEXAS LIMITED LIABILITY COMPANY)  
16110 CHASEMORE DRIVE  
SPRING, TX 77379

FOR: WINES, IN CLASS 33 (U.S. CLS. 47 AND 49).

FIRST USE 4-19-2012; IN COMMERCE 4-19-2012.

THE MARK CONSISTS OF STANDARD CHARACTERS WITHOUT CLAIM TO ANY PARTICULAR FONT, STYLE, SIZE, OR COLOR.

THE ENGLISH TRANSLATION OF THE LATIN WORD "DECIMUS" IN THE MARK IS "A TENTH".

SN 76-707,538, FILED 5-9-2011.

MATTHEW KLINE, EXAMINING ATTORNEY



*David J. Kyffers*

Director of the United States Patent and Trademark Office

# United States of America

United States Patent and Trademark Office

## DAKOTA SCRUBS

**Reg. No. 4,198,660**

ARMOUTH INTERNATIONAL INC. (NEW YORK CORPORATION)  
18 WEST 33RD STREET  
NEW YORK, NY 10001

**Registered Aug. 28, 2012**

**Int. Cl.: 25**

FOR: CLOTHING, NAMELY, SCHOOL UNIFORMS, SHIRTS, BLOUSES, PANTS, SKIRTS, SOCKS, JACKETS, SWEATERS, SHORTS, FOOTWEAR, LADIES SLEEPWEAR, BATH ROBES, LOUNGE PANTS, SCRUBS NOT FOR MEDICAL PURPOSES, AND INTIMATES, NAMELY, BRAS AND PANTIES, IN CLASS 25 (U.S. CLS. 22 AND 39).

**TRADEMARK**

**PRINCIPAL REGISTER**

FIRST USE 6-30-2011; IN COMMERCE 6-30-2011.

THE MARK CONSISTS OF STANDARD CHARACTERS WITHOUT CLAIM TO ANY PARTICULAR FONT, STYLE, SIZE, OR COLOR.

NO CLAIM IS MADE TO THE EXCLUSIVE RIGHT TO USE "SCRUBS", APART FROM THE MARK AS SHOWN.

SN 76-707,602, FILED 5-13-2011.

LESLIE RICHARDS, EXAMINING ATTORNEY



*David J. Kyffers*

Director of the United States Patent and Trademark Office



# United States of America

United States Patent and Trademark Office

## POLKADOG

**Reg. No. 4,198,661**

POLKA DOG DESIGNS, LLC (MASSACHUSETTS LIMITED LIABILITY COMPANY)  
256 SHAWMUT AVENUE  
BOSTON, MA 02118

**Registered Aug. 28, 2012**

**Int. Cls.: 18 and 28**

FOR: PET COLLARS, PET LEASHES, IN CLASS 18 (U.S. CLS. 1, 2, 3, 22 AND 41).

**TRADEMARK**

FIRST USE 12-11-2011; IN COMMERCE 12-11-2011.

**PRINCIPAL REGISTER**

FOR: PET TOYS, IN CLASS 28 (U.S. CLS. 22, 23, 38 AND 50).

FIRST USE 12-11-2011; IN COMMERCE 12-11-2011.

THE MARK CONSISTS OF STANDARD CHARACTERS WITHOUT CLAIM TO ANY PARTICULAR FONT, STYLE, SIZE, OR COLOR.

OWNER OF U.S. REG. NOS. 3,161,374 AND 3,839,591.

SN 76-708,152, FILED 6-27-2011.

TIMOTHY FINNEGAN, EXAMINING ATTORNEY



*David J. Kybas*

Director of the United States Patent and Trademark Office

# United States of America

United States Patent and Trademark Office

## IONTOPATCH EXTRA STRENGTH

**Reg. No. 4,198,662**

THE TAPEMARK COMPANY (MINNESOTA CORPORATION)  
1685 MARTHALER LANE  
WEST ST. PAUL, MN 55118

**Registered Aug. 28, 2012**

**Int. Cl.: 10**

FOR: TRANSDERMAL DRUG DELIVERY PATCHES SOLD WITHOUT MEDICATION, IN CLASS 10 (U.S. CLS. 26, 39 AND 44).

**TRADEMARK**

FIRST USE 12-0-2011; IN COMMERCE 12-0-2011.

**PRINCIPAL REGISTER**

THE MARK CONSISTS OF STANDARD CHARACTERS WITHOUT CLAIM TO ANY PARTICULAR FONT, STYLE, SIZE, OR COLOR.

OWNER OF U.S. REG. NOS. 2,571,142, 2,632,478, AND 3,342,496.

NO CLAIM IS MADE TO THE EXCLUSIVE RIGHT TO USE "EXTRA STRENGTH", APART FROM THE MARK AS SHOWN.

SN 76-708,483, FILED 7-26-2011.

DAWN FELDMAN, EXAMINING ATTORNEY



*David J. Kyros*

Director of the United States Patent and Trademark Office

# United States of America

United States Patent and Trademark Office

## POOL HIBERNATION

**Reg. No. 4,198,663**

KING TECHNOLOGY, INC. (MINNESOTA CORPORATION)  
530 11TH AVENUE SOUTH  
HOPKINS, MN 55343

**Registered Aug. 28, 2012**

**Int. Cl.: 5**

FOR: ALGAECIDES AND BACTERICIDES FOR SWIMMING POOLS, IN CLASS 5 (U.S. CLS. 6, 18, 44, 46, 51 AND 52).

**TRADEMARK**

FIRST USE 9-7-2011; IN COMMERCE 6-22-2012.

**PRINCIPAL REGISTER**

THE MARK CONSISTS OF STANDARD CHARACTERS WITHOUT CLAIM TO ANY PARTICULAR FONT, STYLE, SIZE, OR COLOR.

NO CLAIM IS MADE TO THE EXCLUSIVE RIGHT TO USE "POOL", APART FROM THE MARK AS SHOWN.

SN 76-708,977, FILED 9-6-2011.

ESTHER BELENKER, EXAMINING ATTORNEY



*David J. Kyfos*

Director of the United States Patent and Trademark Office

# United States of America

United States Patent and Trademark Office



**Reg. No. 4,198,664**

**Registered Aug. 28, 2012**

**Int. Cl.: 25**

**TRADEMARK**

**PRINCIPAL REGISTER**

BELLEVILLE SHOE MANUFACTURING CO. (DELAWARE CORPORATION)  
100 PREMIER DRIVE  
BELLEVILLE, IL 62222

FOR: FOOTWEAR, IN CLASS 25 (U.S. CLS. 22 AND 39).

FIRST USE 12-15-2011; IN COMMERCE 12-15-2011.

OWNER OF U.S. REG. NO. 2,646,418.

NO CLAIM IS MADE TO THE EXCLUSIVE RIGHT TO USE "BELLEVILLE", APART FROM THE MARK AS SHOWN.

THE MARK CONSISTS OF A STYLIZED LETTER "B" WITH A STAR IN THE CENTER, POSITIONED TO THE LEFT OF THREE WAVY HORIZONTAL LINES. IMMEDIATELY BELOW IS THE STYLIZED WORDING "BELLEVILLE", AND BELOW AND JUSTIFIED TO THE RIGHT IS THE STYLIZED WORDING "ARM YOUR FEET".

SN 76-709,096, FILED 9-16-2011.

JORDAN BAKER, EXAMINING ATTORNEY



*David J. Kyffers*

Director of the United States Patent and Trademark Office

# United States of America

United States Patent and Trademark Office

## BLUE LAGOON

**Reg. No. 4,198,665**

SOFINA CORP. (FLORIDA CORPORATION)  
201 CIRCLE DRIVE NORTH, UNIT #107  
PISCATAWAY, NJ 08854

**Registered Aug. 28, 2012**

**Int. Cl.: 28**

FOR: INFLATABLE POOL TOYS, NAMELY, AN INFLATABLE FLOATING ISLAND, IN CLASS 28 (U.S. CLS. 22, 23, 38 AND 50).

**TRADEMARK**

FIRST USE 2-15-2012; IN COMMERCE 2-15-2012.

**PRINCIPAL REGISTER**

THE MARK CONSISTS OF STANDARD CHARACTERS WITHOUT CLAIM TO ANY PARTICULAR FONT, STYLE, SIZE, OR COLOR.

SN 76-709,203, FILED 9-26-2011.

SUZANNE BLANE, EXAMINING ATTORNEY



*David J. Kyffers*

Director of the United States Patent and Trademark Office

**United States of America**  
United States Patent and Trademark Office

**FINANCIAL  
SURCURITY!**

**Reg. No. 4,198,666**

PARKER, ROBERT L. (UNITED STATES INDIVIDUAL)  
601 PRESSLEY STR. APT# 416  
PITTSBURGH, PA 15212

**Registered Aug. 28, 2012**

**Int. Cl.: 41**

FOR: PRODUCTION OF MOVIES, IN CLASS 41 (U.S. CLS. 100, 101 AND 107).

**SERVICE MARK**

FIRST USE 4-3-2012; IN COMMERCE 4-3-2012.

**PRINCIPAL REGISTER**

THE MARK CONSISTS OF STANDARD CHARACTERS WITHOUT CLAIM TO ANY PARTICULAR FONT, STYLE, SIZE, OR COLOR.

SN 76-709,437, FILED 10-18-2011.

AISHA CLARKE, EXAMINING ATTORNEY



*David J. Kyffers*

Director of the United States Patent and Trademark Office

# United States of America

United States Patent and Trademark Office



**Reg. No. 4,198,667**

**Registered Aug. 28, 2012**

**Int. Cls.: 41 and 44**

**SERVICE MARK**

**PRINCIPAL REGISTER**

DIABETES CARE ASSOCIATES, INC. (DELAWARE CORPORATION)  
4525 HARDING ROAD, SUITE 103  
NASHVILLE, TN 37205

FOR: PROVIDING EDUCATIONAL AND ENTERTAINMENT SERVICES IN THE NATURE OF PODCASTS, WEBCASTS IN THE FIELD OF DIABETES EDUCATION, DIABETES TREATMENT, DIABETES MANAGEMENT, DIABETES PREVENTION, AND CARING FOR OTHERS WITH DIABETES; EDUCATIONAL AND ENTERTAINMENT SERVICES, NAMELY, THE PRESENTATION AND CONDUCTING OF SEMINARS, LECTURES, WORKSHOPS AND PANEL DISCUSSIONS IN THE FIELDS OF DISEASE PREVENTION AND LIFESTYLE CHOICES AND IN THE FIELDS OF DIABETES EDUCATION, DIABETES TREATMENT, DIABETES MANAGEMENT, DIABETES PREVENTION, AND CARING FOR OTHERS WITH DIABETES; PERSONAL COACHING SERVICES IN THE FIELDS OF DISEASE PREVENTION AND LIFESTYLE CHOICES AND IN THE FIELDS OF DIABETES EDUCATION, DIABETES TREATMENT, DIABETES CONTROL, DIABETES MANAGEMENT, DIABETES PREVENTION, AND CARING FOR OTHERS WITH DIABETES, IN CLASS 41 (U.S. CLS. 100, 101 AND 107).

FIRST USE 12-29-2011; IN COMMERCE 12-29-2011.



FOR: PROVIDING A WEB SITE FEATURING PHOTOGRAPHIC, AUDIO, VIDEO AND PROSE PRESENTATIONS FEATURING DIABETES EDUCATION, DIABETES TREATMENT, DIABETES MANAGEMENT, DIABETES PREVENTION, AND CARING FOR OTHERS WITH DIABETES; MEDICAL AND HEALTHCARE SERVICES, NAMELY, TREATMENT, CONTROL AND MANAGEMENT OF DIABETES AND DIABETES-RELATED MEDICAL PROBLEMS; PROVIDING A WEB SITE WITH ONLINE INFORMATION ON NUTRITION, HEALTH, HEALTHY LIFESTYLES, PHYSICAL WELLNESS, DIABETES PREVENTION, DISEASE MANAGEMENT, IN THE FIELDS OF DIABETES, DIABETES TREATMENT, DIABETES MANAGEMENT, DIABETES PREVENTION, AND CARING FOR OTHERS WITH DIABETES; PROVIDING ONLINE ELECTRONIC INTERACTIVE INFORMATION SERVICES IN THE FIELDS OF DIABETES, DIABETES TREATMENT, DIABETES MANAGEMENT, DIABETES PREVENTION, AND CARING FOR OTHERS WITH DIABETES, IN CLASS 44 (U.S. CLS. 100 AND 101).

FIRST USE 12-29-2011; IN COMMERCE 12-29-2011.

*David J. Kappas*

Director of the United States Patent and Trademark Office

**Reg. No. 4,198,667** NO CLAIM IS MADE TO THE EXCLUSIVE RIGHT TO USE "DIABETES CARE GROUP",  
APART FROM THE MARK AS SHOWN.

THE MARK CONSISTS OF THE WORDING "DIABETES CARE GROUP" TO THE RIGHT  
OF THE DESIGN OF AN APPLE.

SN 76-979,086, FILED 11-27-2009.

MICHAEL WEBSTER, EXAMINING ATTORNEY



# United States of America

United States Patent and Trademark Office

# PChome

**Reg. No. 4,198,668**

PCHOME ONLINE INC (TAIWAN CORPORATION)  
12F., NO. 105, SEC.2, TUN HUA S. RD.  
TAIPEI, TAIWAN 106

**Registered Aug. 28, 2012**

**Int. Cl.: 35**

**SERVICE MARK**

**PRINCIPAL REGISTER**

FOR: PROVIDING PURCHASE SERVICES FOR OTHERS, NAMELY, BUSINESS SERVICES, NAMELY, PROVIDING COMPUTER DATABASES REGARDING THE PURCHASE AND SALE OF A WIDE VARIETY OF PRODUCTS AND SERVICES OF OTHERS; PROVIDING ON-LINE AUCTION SERVICES; ADVERTISING SERVICES, NAMELY, DISSEMINATION OF ADVERTISING FOR OTHERS VIA AN ONLINE ELECTRONIC COMMUNICATIONS NETWORK; DISSEMINATION OF ADVERTISING FOR OTHERS VIA AN ON-LINE COMMUNICATIONS; ON-LINE ADVERTISING ON COMPUTER COMMUNICATION NETWORKS; ELECTRONIC BILLBOARD ADVERTISING; PROMOTING THE GOODS AND SERVICES OF OTHERS BY MEANS OF OPERATING AN ON-LINE SHOPPING MALL WITH LINKS TO THE RETAIL WEB SITES OF OTHERS; ON-LINE RETAIL STORE SERVICES FEATURING A WIDE VARIETY OF CONSUMER GOODS OF OTHERS; PROVIDING BUSINESS INFORMATION VIA COMPUTER DATABANKS AND THE INTERNET; PROVIDING INFORMATION ABOUT COMMERCIAL BUSINESS AND COMMERCIAL INFORMATION VIA THE GLOBAL COMPUTER NETWORK; COMPUTERIZED ONLINE RETAIL STORE SERVICES FEATURING GENERAL CONSUMER GOODS WHICH ALLOWS CONSUMERS TO SEARCH AND ORDER GOODS; COMPUTERIZED ON-LINE RETAIL STORE SERVICES FEATURING GENERAL MERCHANDISE AND GENERAL CONSUMER GOODS; PROVIDING CONSUMER PRODUCT INFORMATION VIA THE INTERNET OR OTHER COMPUTER OR COMMUNICATIONS NETWORKS; PROVIDING CONSUMER PRODUCT INFORMATION VIA THE INTERNET; PROVIDING AN ONLINE SEARCHABLE DATABASE FEATURING CONSUMER INFORMATION AND/OR COMMERCIAL INFORMATION IN THE FIELD OF CONSUMER GOODS; PROVIDING A SEARCHABLE ON-LINE ADVERTISING WEBSITE AND GUIDE FEATURING THE GOODS AND SERVICES OF OTHER VENDORS VIA THE INTERNET; PROVIDING A SEARCHABLE WEBSITE FEATURING THE GOODS AND SERVICES OF OTHER VENDORS; PURCHASING INFORMATION SERVICES VIA THE INTERNET, NAMELY, PROVIDING AN ON-LINE COMMERCIAL INFORMATION DIRECTORY ON THE INTERNET AND/OR PROVIDING COMMERCIAL INFORMATION AND ADVICE FOR CONSUMERS; PROVIDING INFORMATION PERTAINING TO PROCUREMENT, BUYING, SELLING AND TENDERING INFORMATION AND OPPORTUNITIES RELATING TO GOODS, SERVICES, AND CONSTRUCTION VIA COMPUTER, COMPUTER NETWORKS, TELEPHONE, THE INTERNET OR ELECTRONIC MAIL; ON-LINE RETAIL STORE SERVICES FEATURING COMPUTER SOFTWARE AND HARDWARE; PROVIDING BUSINESS INFORMATION VIA THE GLOBAL COMPUTER NETWORK OR COMPUTER NETWORKS;



*David J. Kybas*

Director of the United States Patent and Trademark Office

**Reg. No. 4,198,668** PROVIDING COMMERCIAL INFORMATION UPDATES ONLINE AND OVER A GLOBAL COMPUTER NETWORK IN THE FIELDS OF BUSINESS, COMMERCE, AND INDUSTRY; PROVIDING COMMERCIAL INFORMATION ABOUT THE GOODS AND SERVICES OF OTHERS VIA THE GLOBAL COMPUTER NETWORK OR COMPUTER NETWORKS; ONLINE ADVERTISING AND PROMOTION SERVICES; ON-LINE ADVERTISING SERVICES FOR OTHERS; ON-LINE ADVERTISING AND MARKETING SERVICES; RENTAL OF ADVERTISING SPACE; ADVERTISEMENT FOR OTHERS ON THE INTERNET; ADVERTISING VIA ELECTRONIC MEDIA AND SPECIFICALLY THE INTERNET; ADVERTISING, NAMELY, ON-LINE ADVERTISING ON A COMPUTER NETWORK; INTERNET ADVERTISING SERVICES; ONLINE ADVERTISEMENTS, IN CLASS 35 (U.S. CLS. 100, 101 AND 102).

FIRST USE 4-1-2012; IN COMMERCE 4-1-2012.

SN 76-979,153, FILED 6-10-2011.

ANGELA DUONG, EXAMINING ATTORNEY

# United States of America

United States Patent and Trademark Office

# PChome ONLINE

**Reg. No. 4,198,669**

**Registered Aug. 28, 2012**

**Int. Cl.: 35**

**SERVICE MARK**

**PRINCIPAL REGISTER**

PCHOME ONLINE INC (TAIWAN CORPORATION)  
12F., NO. 105, SEC.2, TUN HUA S. RD  
TAIPEI, TAIWAN 106

FOR: PROVIDING PURCHASE SERVICES FOR OTHERS, NAMELY, BUSINESS SERVICES, NAMELY, PROVIDING COMPUTER DATABASES REGARDING THE PURCHASE AND SALE OF A WIDE VARIETY OF PRODUCTS AND SERVICES OF OTHERS; PROVIDING ON-LINE AUCTION SERVICES; ADVERTISING SERVICES, NAMELY, DISSEMINATION OF ADVERTISING FOR OTHERS VIA AN ONLINE ELECTRONIC COMMUNICATIONS NETWORK; DISSEMINATION OF ADVERTISING FOR OTHERS VIA AN ON-LINE COMMUNICATIONS; ON-LINE ADVERTISING ON COMPUTER COMMUNICATION NETWORKS; ELECTRONIC BILLBOARD ADVERTISING; PROMOTING THE GOODS AND SERVICES OF OTHERS BY MEANS OF OPERATING AN ON-LINE SHOPPING MALL WITH LINKS TO THE RETAIL WEB SITES OF OTHERS; ON-LINE RETAIL STORE SERVICES FEATURING A WIDE VARIETY OF CONSUMER GOODS OF OTHERS; PROVIDING BUSINESS INFORMATION VIA COMPUTER DATABANKS AND THE INTERNET; PROVIDING INFORMATION ABOUT COMMERCIAL BUSINESS AND COMMERCIAL INFORMATION VIA THE GLOBAL COMPUTER NETWORK; COMPUTERIZED ONLINE RETAIL STORE SERVICES FEATURING GENERAL CONSUMER GOODS WHICH ALLOWS CONSUMERS TO SEARCH AND ORDER GOODS; COMPUTERIZED ON-LINE RETAIL STORE SERVICES FEATURING GENERAL MERCHANDISE AND GENERAL CONSUMER GOODS; PROVIDING CONSUMER PRODUCT INFORMATION VIA THE INTERNET OR OTHER COMPUTER OR COMMUNICATIONS NETWORKS; PROVIDING CONSUMER PRODUCT INFORMATION VIA THE INTERNET; PROVIDING AN ONLINE SEARCHABLE DATABASE FEATURING CONSUMER INFORMATION AND/OR COMMERCIAL INFORMATION IN THE FIELD OF CONSUMER GOODS; PROVIDING A SEARCHABLE ON-LINE ADVERTISING WEBSITE AND GUIDE FEATURING THE GOODS AND SERVICES OF OTHER VENDORS VIA THE INTERNET; PROVIDING A SEARCHABLE WEBSITE FEATURING THE GOODS AND SERVICES OF OTHER VENDORS; PURCHASING INFORMATION SERVICES VIA THE INTERNET, NAMELY, PROVIDING AN ON-LINE COMMERCIAL INFORMATION DIRECTORY ON THE INTERNET AND/OR PROVIDING COMMERCIAL INFORMATION AND ADVICE FOR CONSUMERS; PROVIDING INFORMATION PERTAINING TO PROCUREMENT, BUYING, SELLING AND TENDERING INFORMATION AND OPPORTUNITIES RELATING TO GOODS, SERVICES, AND CONSTRUCTION VIA COMPUTER, COMPUTER NETWORKS, TELEPHONE, THE INTERNET OR ELECTRONIC MAIL; ON-LINE RETAIL STORE SERVICES FEATURING COMPUTER SOFTWARE AND HARDWARE; PROVIDING BUSINESS INFORMATION VIA THE GLOBAL COMPUTER NETWORK OR COMPUTER NETWORKS;



*David J. Kyros*

Director of the United States Patent and Trademark Office

**Reg. No. 4,198,669** PROVIDING COMMERCIAL INFORMATION UPDATES ONLINE AND OVER A GLOBAL COMPUTER NETWORK IN THE FIELDS OF BUSINESS, COMMERCE, AND INDUSTRY; PROVIDING COMMERCIAL INFORMATION ABOUT THE GOODS AND SERVICES OF OTHERS VIA THE GLOBAL COMPUTER NETWORK OR COMPUTER NETWORKS; ONLINE ADVERTISING AND PROMOTION SERVICES; ON-LINE ADVERTISING SERVICES FOR OTHERS; ON-LINE ADVERTISING AND MARKETING SERVICES; RENTAL OF ADVERTISING SPACE; ADVERTISEMENT FOR OTHERS ON THE INTERNET; ADVERTISING VIA ELECTRONIC MEDIA AND SPECIFICALLY THE INTERNET; ADVERTISING, NAMELY, ON-LINE ADVERTISING ON A COMPUTER NETWORK; INTERNET ADVERTISING SERVICES; ONLINE ADVERTISEMENTS, IN CLASS 35 (U.S. CLS. 100, 101 AND 102).

FIRST USE 4-4-2012; IN COMMERCE 4-4-2012.

NO CLAIM IS MADE TO THE EXCLUSIVE RIGHT TO USE "ONLINE", APART FROM THE MARK AS SHOWN.

SN 76-979,157, FILED 6-10-2011.

ANGELA DUONG, EXAMINING ATTORNEY

# United States of America

United States Patent and Trademark Office

# INFINITI

**Reg. No. 4,198,670**

**Registered Aug. 28, 2012**

**Int. Cls.: 9 and 28**

**TRADEMARK**

**PRINCIPAL REGISTER**

NISSAN JIDOSHA KABUSHIKI KAISHA (JAPAN CORPORATION), DBA NISSAN MOTOR CO., LTD.,  
NO. 2 TAKARACHO, KANAGAWA-KU  
YOKOHAMA-SHI, KANAGAWA-KEN, JAPAN 2208623

FOR: SUNGLASSES, IN CLASS 9 (U.S. CLS. 21, 23, 26, 36 AND 38).

FIRST USE 9-1-2011; IN COMMERCE 9-1-2011.

FOR: TOYS AND PLAYTHINGS, NAMELY, MINIATURE DIE CAST VEHICLES, BATTERY OPERATED REMOTE CONTROL LAND VEHICLES; TOY PLASTIC MODEL HOBBY CRAFT KITS, SIT-IN AND RIDE-ON TOY VEHICLES, LIGHT AND SOUND TOYS IN THE NATURE OF MINIATURE CARS WITH LED LIGHTS, PLUSH TOYS, STUFFED TOYS; STAND ALONE COMPUTER GAMES AND COIN-OPERATED VIDEO GAMES, IN CLASS 28 (U.S. CLS. 22, 23, 38 AND 50).

THE MARK CONSISTS OF STANDARD CHARACTERS WITHOUT CLAIM TO ANY PARTICULAR FONT, STYLE, SIZE, OR COLOR.

PRIORITY CLAIMED UNDER SEC. 44(D) ON JAPAN APPLICATION NO. 2004-049420, FILED 5-28-2004, REG. NO. 4849859, DATED 3-25-2005, EXPIRES 3-25-2015.

OWNER OF U.S. REG. NOS. 2,160,715, 2,894,822, AND OTHERS.

SN 76-979,195, FILED 8-10-2004.

JEFFERY COWARD, EXAMINING ATTORNEY



*David J. Kypos*

Director of the United States Patent and Trademark Office

# United States of America

United States Patent and Trademark Office

## BON APPETIT

**Reg. No. 4,198,671**

ADVANCE MAGAZINE PUBLISHERS INC. (NEW YORK CORPORATION)  
4 TIMES SQUARE  
NEW YORK, NY 10036

**Registered Aug. 28, 2012**

**Int. Cls.: 8 and 21**

FOR: FLATWARE, NAMELY, FORKS, KNIVES, SPOONS, SOLD SEPARATELY OR IN SETS; SPOONS; HOUSEHOLD KNIVES, NAMELY, CHEFS KNIVES, STEAK KNIVES, KNIVES FOR BREAD, PREP KNIVES, SERRATED AND NON-SERRATED KNIVES, IN CLASS 8 (U.S. CLS. 23, 28 AND 44).

**TRADEMARK**

**PRINCIPAL REGISTER**

FIRST USE 1-31-2012; IN COMMERCE 1-31-2012.

FOR: WHISKS; SPICE RACKS; PLASTIC FOOD STORAGE CONTAINERS FOR HOUSEHOLD USE; PLANTERS FOR FLOWERS AND PLANTS FOR OUTDOOR USE; COOKWARE, NAMELY, POTS AND PANS, MADE OF STAINLESS, ENAMEL, COPPER AND OTHER MATERIALS; CUTTING BOARDS, PREP BOWLS, COLANDERS; BAKEWARE, NAMELY, COOKIE SHEETS, CAKE AND LOAF PANS, MUFFIN TINS, SOUFFLÉ DISHES, DUTCH OVENS; SERVING PIECES, NAMELY, TRAYS, CAKE PLATES, PLATTERS, BOWLS, SALAD BOWLS; PAPER CUPS; BEVERAGE GLASSWARE MADE OF ACRYLIC, IN CLASS 21 (U.S. CLS. 2, 13, 23, 29, 30, 33, 40 AND 50).

FIRST USE 1-31-2012; IN COMMERCE 1-31-2012.

THE MARK CONSISTS OF STANDARD CHARACTERS WITHOUT CLAIM TO ANY PARTICULAR FONT, STYLE, SIZE, OR COLOR.

OWNER OF U.S. REG. NOS. 653,791, 1,283,423, AND OTHERS.

THE ENGLISH TRANSLATION OF THE WORD "BON APPETIT" IN THE MARK IS GOOD APPETITE.

SN 76-979,210, FILED 7-5-2007.

SEAN CROWLEY, EXAMINING ATTORNEY



*David J. Kyros*

Director of the United States Patent and Trademark Office

# United States of America

United States Patent and Trademark Office



**Reg. No. 4,198,672**

SALSBURY, SCOTT (UNITED STATES INDIVIDUAL)  
63 ATLANTIC AVENUE, APT. 9C  
BOSTON, MA 02110

**Registered Aug. 28, 2012**

**Int. Cls.: 18 and 25**

FOR: TRAVEL BAGS, NAMELY, BAGS, TOTE BAGS, SACHELS, MESSENGER BAGS AND PROTECTIVE FITTED LINERS THEREFOR, IN CLASS 18 (U.S. CLS. 1, 2, 3, 22 AND 41).

**TRADEMARK**

FIRST USE 3-5-2012; IN COMMERCE 3-5-2012.

**PRINCIPAL REGISTER**

FOR: CLOTHING, NAMELY, SHIRTS, IN CLASS 25 (U.S. CLS. 22 AND 39).

FIRST USE 3-5-2012; IN COMMERCE 3-5-2012.

THE MARK CONSISTS OF A ROUNDED SIDEWAYS TRAPEZOID WITH A COILED CURLY-"Q" TO ONE SIDE AND A SINGLE HELICAL LOOP CURLY-"Q" WITH CURVED EXTENSION TO THE OTHER SIDE.

SN 76-979,211, FILED 10-7-2010.

LINDSEY RUBIN, EXAMINING ATTORNEY



*David J. Kybas*

Director of the United States Patent and Trademark Office

# United States of America

United States Patent and Trademark Office

## GOOD ENOUGH MOTHER

**Reg. No. 4,198,673**

**Registered Aug. 28, 2012**

**Int. Cls.: 16, 25, 35, and 41**

**TRADEMARK**

**SERVICE MARK**

**PRINCIPAL REGISTER**

SYLER, RENE (UNITED STATES INDIVIDUAL)  
6 BEDFORD ROAD  
CHAPPAQUA, NY 10514

FOR: ALBUMS, NAMELY, PHOTOGRAPH AND SCRAPBOOK; BOOKMARKS; BROCHURES, PAMPHLETS AND NEWSLETTERS FEATURING TOPICS OF INTEREST TO WOMEN, NAMELY, HEALTH AND FITNESS, FOOD AND NUTRITION, BEAUTY, FAMILY, RELATIONSHIPS, PREGNANCY, CHILD DEVELOPMENT AND CHILD CARD; BUMPER STICKERS, CALENDARS, COOKBOOKS, DAY PLANNERS, DECALS AND STICKERS, GREETING CARDS, MAGAZINES FEATURING TOPICS OF INTEREST TO WOMEN; WIRE-BOUND NOTEBOOKS, POSTCARDS, POSTERS, SERIES OF BOOKS FEATURING TOPICS OF INTEREST TO WOMEN; STATIONERY, SYNDICATED COLUMN FEATURING TOPICS OF INTEREST TO WOMEN, WRITING PADS, IN CLASS 16 (U.S. CLS. 2, 5, 22, 23, 29, 37, 38 AND 50).

FIRST USE 2-2-2006; IN COMMERCE 2-2-2006.

FOR: WEARING APPAREL FOR WOMEN AND CHILDREN, NAMELY, SHIRTS, TANKTOPS, T-SHIRTS; HEADWEAR, NAMELY, CAPS, HATS AND VISORS, IN CLASS 25 (U.S. CLS. 22 AND 39).

FIRST USE 2-2-2006; IN COMMERCE 2-2-2006.



FOR: DEMONSTRATION OF GOODS AND SERVICES BY ELECTRONIC MEANS, ALSO FOR THE BENEFIT OF THE SO-CALLED TEleshopping AND HOME SHOPPING SERVICES; DIRECT MAIL ADVERTISING; ARRANGING AND CONDUCTING TRADE SHOW EXHIBITIONS, FASHION SHOWS AND FAIRS FEATURING TOPICS OF INTEREST TO WOMEN ALL FOR BUSINESS AND COMMERCIAL PURPOSES; MAIL ORDER, RETAIL STORE AND ON-LINE RETAIL STORE SERVICES FEATURING CLOTHING ACCESSORIES, HOUSEHOLD ACCESSORIES, BOOKS, CLOTHING, COSMETICS, GIFT ITEMS AND PAPER GOODS; RADIO AND TELEVISION ADVERTISING AND COMMERCIALS; DEMOGRAPHIC CONSULTATION SERVICES AND MARKET RESEARCH; PROMOTING THE GOODS AND SERVICES OF OTHERS VIA A COMPUTERIZED, ONLINE GLOBAL COMMUNICATIONS NETWORK; DISSEMINATING ADVERTISEMENT MATERIAL FOR OTHERS VIA AN ON-LINE GLOBAL NETWORK, IN CLASS 35 (U.S. CLS. 100, 101 AND 102).

FIRST USE 2-2-2006; IN COMMERCE 2-2-2006.

*David J. Kyros*

Director of the United States Patent and Trademark Office



**Reg. No. 4,198,673** FOR: EDUCATIONAL SERVICES, NAMELY, ARRANGING AND CONDUCTING EDUCATIONAL CONFERENCES, SEMINARS AND WORKSHOPS FEATURING TOPICS OF INTEREST TO WOMEN; ENTERTAINMENT SERVICES, NAMELY, PRODUCTION OF RADIO AND TELEVISION PROGRAMMING AND VIDEOTAPES, IN CLASS 41 (U.S. CLS. 100, 101 AND 107).

FIRST USE 2-2-2006; IN COMMERCE 2-2-2006.

THE MARK CONSISTS OF STANDARD CHARACTERS WITHOUT CLAIM TO ANY PARTICULAR FONT, STYLE, SIZE, OR COLOR.

SN 77-028,457, FILED 10-24-2006.

JANICE KIM, EXAMINING ATTORNEY

# United States of America

United States Patent and Trademark Office

# KASTLE

**Reg. No. 4,198,674**

**Registered Aug. 28, 2012**

**Int. Cls.: 25 and 28**

**TRADEMARK**

**PRINCIPAL REGISTER**

KASTLE GMBH (AUSTRIA CORPORATION)  
EDISONSTRASSE 2  
WELS, AUSTRIA 4600

FOR: CLOTHING AND SPORTSWEAR, NAMELY, SKI SUITS, SKI JACKETS, SKI PANTS, SKI HATS, SKI CAPS, SKI UNDERWEAR, SKI PULLOVERS, SKI-BELT, IN CLASS 25 (U.S. CLS. 22 AND 39).

FIRST USE 12-3-2009; IN COMMERCE 3-3-2010.

FOR: SPORTS EQUIPMENT, NAMELY, SKIS, SKI BINDINGS, SKI POLES, SKI BAGS, SKI STRAPS, IN CLASS 28 (U.S. CLS. 22, 23, 38 AND 50).

FIRST USE 12-3-2007; IN COMMERCE 12-3-2007.

THE MARK CONSISTS OF STANDARD CHARACTERS WITHOUT CLAIM TO ANY PARTICULAR FONT, STYLE, SIZE, OR COLOR.

SN 77-064,412, FILED 12-14-2006.

MICHELLE DUBOIS, EXAMINING ATTORNEY



*David J. Kybas*

Director of the United States Patent and Trademark Office

# United States of America

United States Patent and Trademark Office

# Synapse

**Reg. No. 4,198,675**

**Registered Aug. 28, 2012**

**Int. Cl.: 33**

**TRADEMARK**

**PRINCIPAL REGISTER**

HIGH VIEW VINEYARDS, LLC (CALIFORNIA LIMITED LIABILITY COMPANY)  
9913 NORTH SEDONA CIRCLE  
FRESNO, CA 937201406

FOR: WINES, IN CLASS 33 (U.S. CLS. 47 AND 49).

FIRST USE 12-31-2007; IN COMMERCE 12-31-2007.

THE MARK CONSISTS OF STANDARD CHARACTERS WITHOUT CLAIM TO ANY PARTICULAR FONT, STYLE, SIZE, OR COLOR.

SN 77-072,560, FILED 12-28-2006.

LINDA LAVACHE, EXAMINING ATTORNEY



*David J. Kyffers*

Director of the United States Patent and Trademark Office

**United States of America**  
United States Patent and Trademark Office

# AQUARIA

**Reg. No. 4,198,676**

BIT BLOT, LLC (CALIFORNIA LIMITED LIABILITY COMPANY)  
1180 OAK GROVE AVENUE  
SAN MARINO, CA 91108

**Registered Aug. 28, 2012**

**Int. Cl.: 9**

FOR: COMPUTER GAME PROGRAM; VIDEO GAME PROGRAM FOR USE IN HAND-HELD UNITS, IN CLASS 9 (U.S. CLS. 21, 23, 26, 36 AND 38).

**TRADEMARK**

FIRST USE 12-7-2007; IN COMMERCE 12-7-2007.

**PRINCIPAL REGISTER**

THE MARK CONSISTS OF STANDARD CHARACTERS WITHOUT CLAIM TO ANY PARTICULAR FONT, STYLE, SIZE, OR COLOR.

SN 77-147,765, FILED 4-3-2007.

LESLIE RICHARDS, EXAMINING ATTORNEY



*David J. Kybas*

Director of the United States Patent and Trademark Office

# United States of America

United States Patent and Trademark Office

## CONCIERGE CATARACT SURGERY

**Reg. No. 4,198,677**

**Registered Aug. 28, 2012**

**Int. Cl.: 44**

**SERVICE MARK**

**PRINCIPAL REGISTER**

BRECKSVILLE LASER EYE CENTER, LLC (OHIO LIMITED LIABILITY COMPANY)  
SUITE D  
7001 S. EDGERTON ROAD  
BRECKSVILLE, OH 44141

FOR: EYE SURGERY SERVICES, IN CLASS 44 (U.S. CLS. 100 AND 101).

FIRST USE 6-0-2011; IN COMMERCE 6-0-2011.

THE MARK CONSISTS OF STANDARD CHARACTERS WITHOUT CLAIM TO ANY PARTICULAR FONT, STYLE, SIZE, OR COLOR.

NO CLAIM IS MADE TO THE EXCLUSIVE RIGHT TO USE "CATARACT SURGERY", APART FROM THE MARK AS SHOWN.

SN 77-183,363, FILED 5-17-2007.

MELISSA VALLILLO, EXAMINING ATTORNEY



*David J. Kybas*

Director of the United States Patent and Trademark Office

# United States of America

United States Patent and Trademark Office

## GIRLFRIENDS' GUIDE

**Reg. No. 4,198,678**

VICKI IOVINE (UNITED STATES INDIVIDUAL)  
277 N. TIGRETAIL ROAD  
LOS ANGELES, CA 90049

**Registered Aug. 28, 2012**

**Int. Cl.: 9**

FOR: AUDIO RECORDINGS FEATURING SELF-IMPROVEMENT TOPICS; AUDIO RECORDINGS FEATURING INFORMATION ABOUT PREGNANCY, MOTHERHOOD, CHILD-REARING, HOMEMAKING, MARITAL RELATIONS, ROMANTIC RELATIONSHIPS, FRIENDSHIP RELATIONSHIPS, HEALTH, AND TOPICS OF INTEREST TO WOMEN, IN CLASS 9 (U.S. CLS. 21, 23, 26, 36 AND 38).

**TRADEMARK**

**PRINCIPAL REGISTER**

FIRST USE 10-31-1997; IN COMMERCE 10-31-1997.

THE MARK CONSISTS OF STANDARD CHARACTERS WITHOUT CLAIM TO ANY PARTICULAR FONT, STYLE, SIZE, OR COLOR.

NO CLAIM IS MADE TO THE EXCLUSIVE RIGHT TO USE "GUIDE", APART FROM THE MARK AS SHOWN.

SN 77-186,478, FILED 5-21-2007.

SUNG IN, EXAMINING ATTORNEY



*David J. Kyfos*

Director of the United States Patent and Trademark Office

# United States of America

United States Patent and Trademark Office

# BUG B GON

**Reg. No. 4,198,679**

OMS INVESTMENTS, INC. (DELAWARE CORPORATION)  
10250 CONSTELLATION BLVD., SUITE 2800  
LOS ANGELES, CA 90067

**Registered Aug. 28, 2012**

**Int. Cl.: 5**

FOR: PESTICIDES, INSECTICIDES FOR DOMESTIC USE, IN CLASS 5 (U.S. CLS. 6, 18, 44, 46, 51 AND 52).

**TRADEMARK**

FIRST USE 1-31-1996; IN COMMERCE 1-31-1996.

**PRINCIPAL REGISTER**

THE MARK CONSISTS OF STANDARD CHARACTERS WITHOUT CLAIM TO ANY PARTICULAR FONT, STYLE, SIZE, OR COLOR.

OWNER OF U.S. REG. NOS. 2,073,033 AND 2,980,869.

SN 77-187,581, FILED 5-22-2007.

ODESSA BIBBINS, EXAMINING ATTORNEY



*David J. Kyffers*

Director of the United States Patent and Trademark Office

# United States of America

United States Patent and Trademark Office

# ULTRASHARP

**Reg. No. 4,198,680**

**Registered Aug. 28, 2012**

**Int. Cl.: 9**

**TRADEMARK**

**PRINCIPAL REGISTER**

KLA-TENCOR CORPORATION (DELAWARE CORPORATION)  
ONE TECHNOLOGY DRIVE  
MILPITAS, CA 95035

FOR: SEMICONDUCTOR TOPOGRAPHY EQUIPMENT, NAMELY, HIGH RESOLUTION SURFACE PROFILING HARDWARE, SOFTWARE, STYLI AND USER MANUALS SOLD AS A UNIT, ALL FOR ENHANCED SEMICONDUCTOR MANUFACTURE AND INSPECTION PURPOSES THAT ARE SOLD ONLY TO CHIPMAKERS, IN CLASS 9 (U.S. CLS. 21, 23, 26, 36 AND 38).

FIRST USE 7-31-2007; IN COMMERCE 7-31-2007.

THE MARK CONSISTS OF STANDARD CHARACTERS WITHOUT CLAIM TO ANY PARTICULAR FONT, STYLE, SIZE, OR COLOR.

SN 77-193,599, FILED 5-30-2007.

STEPHANIE ALI, EXAMINING ATTORNEY



*David J. Kyffers*

Director of the United States Patent and Trademark Office



# United States of America

United States Patent and Trademark Office

## SEX FIFTH AVENUE

**Reg. No. 4,198,681**

**Registered Aug. 28, 2012**

**Int. Cl.: 10**

**TRADEMARK**

**PRINCIPAL REGISTER**

RADCLIFFE, MICHAEL (UNITED STATES INDIVIDUAL)  
PO BOX 180  
ELKA PARK, NY 12427

FOR: ADULT SEXUAL AIDS, NAMELY, CONDOMS, SEX DOLLS; NIPPLE CLAMPS, NIPPLE RINGS, ERECTION RINGS, STIMULATOR RINGS, CUT BUMPERS, HAND PADDLES, SEX SWINGS, SEX CHAIRS, DONGS, DILDOS, VIBRATORS, VIBRATING EGGS; MASTURBATORS, ARTIFICIAL VAGINAS, BULLETS FOR SEXUAL STIMULATION PURPOSES; ARTIFICIAL PENISES, PENIS ENLARGERS, BENWA BALLS; ANAL PROBES; SEX MACHINES IN THE NATURE OF MOTORIZED DILDOS, IN CLASS 10 (U.S. CLS. 26, 39 AND 44).

FIRST USE 7-8-1995; IN COMMERCE 7-8-1995.

THE MARK CONSISTS OF STANDARD CHARACTERS WITHOUT CLAIM TO ANY PARTICULAR FONT, STYLE, SIZE, OR COLOR.

NO CLAIM IS MADE TO THE EXCLUSIVE RIGHT TO USE "SEX", APART FROM THE MARK AS SHOWN.

SN 77-196,779, FILED 6-4-2007.

MARLENE BELL, EXAMINING ATTORNEY



*David J. Kyros*

Director of the United States Patent and Trademark Office

# United States of America

United States Patent and Trademark Office

## SULZER BINGHAM

**Reg. No. 4,198,682**

**Registered Aug. 28, 2012**

**Int. Cls.: 7 and 37**

**TRADEMARK**

**SERVICE MARK**

**PRINCIPAL REGISTER**

SULZER MANAGEMENT A.G. (SWITZERLAND CORPORATION)  
ZURCHER STR. 12  
WINTERTHUR, SWITZERLAND CH-8401

FOR: PUMPS, NAMELY, CENTRIFUGAL PUMPS, STRUCTURAL AND REPLACEMENT PARTS THEREFOR, IN CLASS 7 (U.S. CLS. 13, 19, 21, 23, 31, 34 AND 35).

FIRST USE 6-1-1988; IN COMMERCE 6-1-1988.

FOR: PUMP REPAIR AND MAINTENANCE SERVICES, IN CLASS 37 (U.S. CLS. 100, 103 AND 106).

FIRST USE 6-1-1988; IN COMMERCE 6-1-1988.

THE MARK CONSISTS OF STANDARD CHARACTERS WITHOUT CLAIM TO ANY PARTICULAR FONT, STYLE, SIZE, OR COLOR.

OWNER OF U.S. REG. NOS. 616,842, 944,021, AND 2,070,948.

THE NAME "SULZER BINGHAM" DOES NOT IDENTIFY A LIVING INDIVIDUAL.

SN 77-209,057, FILED 6-18-2007.

GISELLE AGOSTO, EXAMINING ATTORNEY



*David J. Kybas*

Director of the United States Patent and Trademark Office

# United States of America

United States Patent and Trademark Office

## SMART LIVING

**Reg. No. 4,198,683**

**Registered Aug. 28, 2012**

**Int. Cl.: 29**

**TRADEMARK**

**PRINCIPAL REGISTER**

PERDUE HOLDINGS, INC. (DELAWARE CORPORATION)  
31149 OLD OCEAN CITY ROAD  
SALISBURY, MD 21804

FOR: POULTRY, IN CLASS 29 (U.S. CL. 46).

FIRST USE 5-0-2012; IN COMMERCE 5-0-2012.

THE MARK CONSISTS OF STANDARD CHARACTERS WITHOUT CLAIM TO ANY PARTICULAR FONT, STYLE, SIZE, OR COLOR.

SN 77-209,357, FILED 6-19-2007.

JORDAN BAKER, EXAMINING ATTORNEY



*David J. Kyffers*

Director of the United States Patent and Trademark Office

# United States of America

United States Patent and Trademark Office

# HONEYVILLE

**Reg. No. 4,198,684**

**Registered Aug. 28, 2012**

**Int. Cls.: 29, 30, 32, and 35**

HONEYVILLE GRAIN, INC. (UTAH CORPORATION)  
11600 DAYTON DRIVE  
RANCHO CUCAMONGA, CA 91730

FOR: SOUP MIXES; FREEZE DRIED AND DEHYDRATED FRUITS, IN CLASS 29 (U.S. CL. 46).

FIRST USE 3-0-1986; IN COMMERCE 3-0-1986.

**TRADEMARK**

**SERVICE MARK**

**PRINCIPAL REGISTER**

FOR: FLAVORED HOT CHOCOLATE; POWDERED SOFT ICE CREAM BLENDS FOR MAKING ICE-CREAM; FREEZE DRIED AND DEHYDRATED VEGETABLES; BAKERY DESSERTS; POWDERED YOGURT BLENDS FOR MAKING SOFT SERVE FROZEN YOGURT; MILKSHAKE MIXES; CHOCOLATE FLAVORED DRINK MIXES, INCLUDING CHAMPUR-RADO MEXICAN DRINK MIXES, IN CLASS 30 (U.S. CL. 46).

FIRST USE 6-0-1988; IN COMMERCE 6-0-1988.

FOR: FRUIT PUNCHES; POWDER BASED SPORTS DRINKS; POWDER BASED SMOOTHIES; POWDER BASED DESSERT DRINKS, NAMELY, LEMONADE MIXES, FRUIT-FLAVORED DRINK MIXES, SLUSH DRINK MIXES, COFFEE DRINK MIXES, FLAVORED TEA DRINK MIXES, MARGARITA BASE DRINK MIXES, FLAVORED PROTEIN DRINK MIXES, HORCHATA DRINK MIXES, APPLE CIDER MIXES, AND FRUIT FLAVORED MEXICAN DRINK MIXES, INCLUDING JAMAICA DRINK MIXES, LICUADO DRINK MIXES, IN CLASS 32 (U.S. CLS. 45, 46 AND 48).

FIRST USE 7-0-1992; IN COMMERCE 7-0-1992.

FOR: RETAIL CATALOG ORDERING SERVICES, ONLINE STORE SERVICES, AND RETAIL STORE SERVICES FEATURING FOOD PRODUCTS AND BEVERAGES, IN CLASS 35 (U.S. CLS. 100, 101 AND 102).

FIRST USE 8-0-2002; IN COMMERCE 8-0-2002.

THE MARK CONSISTS OF STANDARD CHARACTERS WITHOUT CLAIM TO ANY PARTICULAR FONT, STYLE, SIZE, OR COLOR.

OWNER OF U.S. REG. NOS. 2,195,903 AND 2,782,828.



*David J. Kyros*

Director of the United States Patent and Trademark Office

**Reg. No. 4,198,684** SN 77-222,479, FILED 7-5-2007.

HENRY S. ZAK, EXAMINING ATTORNEY

# United States of America

United States Patent and Trademark Office



**Reg. No. 4,198,685**

**Registered Aug. 28, 2012**

**Int. Cl.: 25**

**TRADEMARK**

**PRINCIPAL REGISTER**

ALREADY, LLC (TEXAS LIMITED LIABILITY COMPANY)  
3501 STATE HIGHWAY 157, SUITE 101  
EULESS, TX 76040

FOR: PANTS; SHORTS; BATHING SUITS, IN CLASS 25 (U.S. CLS. 22 AND 39).

FIRST USE 5-15-2012; IN COMMERCE 5-15-2012.

THE MARK CONSISTS OF A CIRCLE FACE WITH LEFT VERTICAL OVAL-SHAPED EYE AND RIGHT ESSENTIALLY HORIZONTAL EYE WHICH TAPERS FROM AN INNER OVAL SHAPE TO AN OUTER POINT WHICH POINTS SLIGHTLY UPWARDLY, EYES, MOUTH, A LEFT EYEBROW ARCHING UPWARDLY, A TONGUE EMANATING FROM THE MOUTH UPWARDLY.

SN 77-248,900, FILED 8-7-2007.

DANNEAN HETZEL, EXAMINING ATTORNEY



*David J. Kybas*

Director of the United States Patent and Trademark Office

# United States of America

United States Patent and Trademark Office

## THE BENEFITS

**Reg. No. 4,198,686**

**Registered Aug. 28, 2012**

**Int. Cl.: 41**

**SERVICE MARK**

**PRINCIPAL REGISTER**

LUMHOLT, ILANGUAQ DAVID (DENMARK INDIVIDUAL)  
FRANKRIGSHUSENE 9, 1.TH  
2300 KØBENHAVN S, DENMARK AND

PETERSEN, THOMAS STENGAARD (DENMARK INDIVIDUAL)  
FRANKRIGSHUSENE 9, 1.TH  
2300 KØBENHAVN S, DENMARK

FOR: ENTERTAINMENT SERVICES IN THE NATURE OF LIVE MUSICAL PERFORMANCES BY A MUSICAL BAND; PROVIDING A WEBSITE FEATURING MUSICAL PERFORMANCES, MUSICAL VIDEOS, PHOTOGRAPHS, AND OTHER MULTIMEDIA MATERIALS, IN CLASS 41 (U.S. CLS. 100, 101 AND 107).

FIRST USE 9-0-2007; IN COMMERCE 9-0-2007.

THE MARK CONSISTS OF STANDARD CHARACTERS WITHOUT CLAIM TO ANY PARTICULAR FONT, STYLE, SIZE, OR COLOR.

SN 77-264,237, FILED 8-24-2007.

CHRISTINA SOBRAL, EXAMINING ATTORNEY



*David J. Kyros*

Director of the United States Patent and Trademark Office

# United States of America

United States Patent and Trademark Office

# COR

**Reg. No. 4,198,687**

**Registered Aug. 28, 2012**

**Int. Cl.: 5**

**TRADEMARK**

**PRINCIPAL REGISTER**

COR NUTRITION, LLC (NEW YORK LIMITED LIABILITY COMPANY)  
315 MADISON AVENUE  
SUITE 1306  
NEW YORK, NY 10017

FOR: NUTRITIONAL PRODUCTS, NAMELY, DIETARY FOOD SUPPLEMENTS, DIETARY LIQUID SUPPLEMENTS AND DAIRY-BASED DIETARY LIQUID SUPPLEMENTS , IN CLASS 5 (U.S. CLS. 6, 18, 44, 46, 51 AND 52).

FIRST USE 4-16-2012; IN COMMERCE 4-16-2012.

THE MARK CONSISTS OF STANDARD CHARACTERS WITHOUT CLAIM TO ANY PARTICULAR FONT, STYLE, SIZE, OR COLOR.

SN 77-266,704, FILED 8-28-2007.

REGINA DRUMMOND, EXAMINING ATTORNEY



*David J. Kybas*

Director of the United States Patent and Trademark Office



# United States of America

United States Patent and Trademark Office

## UNIVERSIDAD MAYOR

**Reg. No. 4,198,688**

**Registered Aug. 28, 2012**

**Int. Cl.: 41**

**SERVICE MARK**

**PRINCIPAL REGISTER**

INVERSIONES RIO PUELO S.A. (CHILE CORPORATION)  
AV. EL VALLE N° 961, OF. 2702  
HUECHURABA, CHILE

FOR: EDUCATIONAL SERVICES, NAMELY, CONDUCTING CLASSES, SEMINARS, CONFERENCES AND WORKSHOPS IN ALL FIELDS OF EDUCATION; ARRANGING AND CONDUCTING EDUCATIONAL CONFERENCES; EDUCATIONAL SERVICES IN THE NATURE OF CORRESPONDENCE SCHOOLS; TEACHING IN THE FIELDS OF TECHNOLOGY AND ECONOMICS; LIBRARIES; ORGANIZING AND CONDUCTING INTERCOLLEGIATE SPORTS EXHIBITIONS; ORGANIZING AND CONDUCTING EDUCATIONAL CULTURAL EXHIBITIONS; COMPUTER SERVICES, NAMELY, PROVIDING ON-LINE ARTICLES, BOOKS AND MAGAZINES IN THE FIELD OF TECHNOLOGY AND ECONOMICS, IN CLASS 41 (U.S. CLS. 100, 101 AND 107).

FIRST USE 8-0-2011; IN COMMERCE 8-0-2011.

THE MARK CONSISTS OF STANDARD CHARACTERS WITHOUT CLAIM TO ANY PARTICULAR FONT, STYLE, SIZE, OR COLOR.

NO CLAIM IS MADE TO THE EXCLUSIVE RIGHT TO USE "UNIVERSIDAD", APART FROM THE MARK AS SHOWN.

THE FOREIGN WORDING IN THE MARK TRANSLATES INTO ENGLISH AS UNIVERSITY.

SN 77-276,884, FILED 9-11-2007.

MARLENE BELL, EXAMINING ATTORNEY



*David J. Kyros*

Director of the United States Patent and Trademark Office

# United States of America

United States Patent and Trademark Office



**Reg. No. 4,198,689**

**Registered Aug. 28, 2012**

**Int. Cl.: 43**

**SERVICE MARK**

**PRINCIPAL REGISTER**

SCHRAML, SCOTT (UNITED STATES INDIVIDUAL)  
N31W23577 ROUGH HILL ROAD  
PEWAUKEE, WI 53072

FOR: RESTAURANTS, IN CLASS 43 (U.S. CLS. 100 AND 101).

FIRST USE 5-15-2011; IN COMMERCE 5-15-2011.

THE MARK CONSISTS OF STYLIZED WORDS "MOJO BOWL" INSIDE A BOX.

SN 77-286,037, FILED 9-21-2007.

WANDA KAY PRICE, EXAMINING ATTORNEY



*David J. Kyffers*

Director of the United States Patent and Trademark Office

# United States of America

United States Patent and Trademark Office

# Blue Quench

**Reg. No. 4,198,690**

RENOVO MANAGEMENT LLC (CONNECTICUT LIMITED LIABILITY COMPANY)  
15 OLD STONE CROSSING  
WEST SIMSBURY, CT 06092

**Registered Aug. 28, 2012**

**Int. Cl.: 11**

FOR: THERMOELECTRIC COOLER/HEATER FOR FOOD AND BEVERAGES; WATER COOLERS; ELECTRIC REFRIGERATORS; ICE-COOLING REFRIGERATORS; REFRIGERATED BEVERAGE DISPENSING UNITS; REFRIGERATED DISPENSING UNITS FOR BEVERAGES, IN CLASS 11 (U.S. CLS. 13, 21, 23, 31 AND 34).

**TRADEMARK**

**PRINCIPAL REGISTER**

FIRST USE 10-14-2007; IN COMMERCE 10-14-2007.

THE MARK CONSISTS OF STANDARD CHARACTERS WITHOUT CLAIM TO ANY PARTICULAR FONT, STYLE, SIZE, OR COLOR.

NO CLAIM IS MADE TO THE EXCLUSIVE RIGHT TO USE "BLUE", APART FROM THE MARK AS SHOWN.

SN 77-304,556, FILED 10-15-2007.

MICHAEL WIENER, EXAMINING ATTORNEY



*David J. Kyros*

Director of the United States Patent and Trademark Office

# United States of America

United States Patent and Trademark Office

# KING

**Reg. No. 4,198,691**

PARFUMS DE COEUR, LTC. (CONNECTICUT CORPORATION)  
85 OLD KINGS HIGHWAY  
DARIEN, CT 06820

**Registered Aug. 28, 2012**

**Int. Cl.: 3**

FOR: MEN'S FRAGRANCES, NAMELY, COLOGNE, AND SCENTED BODY SPRAYS, IN CLASS 3 (U.S. CLS. 1, 4, 6, 50, 51 AND 52).

**TRADEMARK**

FIRST USE 1-22-2008; IN COMMERCE 1-22-2008.

**PRINCIPAL REGISTER**

THE MARK CONSISTS OF STANDARD CHARACTERS WITHOUT CLAIM TO ANY PARTICULAR FONT, STYLE, SIZE, OR COLOR.

SN 77-314,208, FILED 10-26-2007.

BARBARA BROWN, EXAMINING ATTORNEY



*David J. Kybas*

Director of the United States Patent and Trademark Office

# United States of America

United States Patent and Trademark Office

# WHET

**Reg. No. 4,198,692**

**Registered Aug. 28, 2012**

**Int. Cl.: 25**

**TRADEMARK**

**PRINCIPAL REGISTER**

ENTREPRENEURIAL VENTURES CAPITAL CO, LLC (PENNSYLVANIA LIMITED LIABILITY COMPANY)  
C/O TEV LAW GROUP PC  
PO BOX 113345  
PITTSBURGH, PA 15241

FOR: CLOTHING, NAMELY, EXERCISE CLOTHING; UNDER-GARMENTS; TEE SHIRTS; CAPS; HEADWEAR, IN CLASS 25 (U.S. CLS. 22 AND 39).

FIRST USE 8-18-2008; IN COMMERCE 8-18-2008.

THE MARK CONSISTS OF STANDARD CHARACTERS WITHOUT CLAIM TO ANY PARTICULAR FONT, STYLE, SIZE, OR COLOR.

SN 77-322,269, FILED 11-6-2007.

KYLE PEETE, EXAMINING ATTORNEY



*David J. Kyffers*

Director of the United States Patent and Trademark Office

# United States of America

United States Patent and Trademark Office

## ELECTROCRAFT

**Reg. No. 4,198,693**

ELECTROCRAFT, INC. (DELAWARE CORPORATION)  
1 PROGRESS DRIVE  
DOVER, NH 03820

**Registered Aug. 28, 2012**

**Int. Cls.: 7, 9, 12, 37, and 40**

FOR: (BASED ON USE IN COMMERCE)) AC MOTORS; DC MOTORS; BRUSHLESS MOTORS; SERVO MOTORS; MOTOR GENERATORS; AC GEAR MOTORS; DC GEAR MOTORS; MACHINE TRANSAXLE DRIVES; GEARBOXES, OTHER THAN FOR LAND VEHICLES; BRUSHLESS GEAR MOTORS; STEPPING MOTORS; LINEAR ACTUATORS; INTEGRATED MOTOR DRIVES, OTHER THAN FOR LAND VEHICLES, IN CLASS 7 (U.S. CLS. 13, 19, 21, 23, 31, 34 AND 35).

**TRADEMARK**

**SERVICE MARK**

**PRINCIPAL REGISTER**

FIRST USE 2-0-1961; IN COMMERCE 2-0-1961.

FOR: (BASED ON USE IN COMMERCE)) ELECTRIC CIRCUITS FOR THE CONTROL AND REGULATION OF ELECTRIC MOTORS; ELECTRIC CONTROLS FOR ELECTRIC MOTORS; MOTOR SPEED CONTROLS; SERVO DRIVES, NAMELY, ELECTRONIC SERVO MOTOR CONTROLS; AMPLIFIERS FOR ELECTRIC MOTORS; POSITION CONTROLS FOR ELECTRIC MOTORS; ELECTRIC MOTOR SPEED SENSORS; STEPPING CONTROLS FOR ELECTRIC MOTORS; STEPPING DRIVES, NAMELY, ELECTRONIC STEPPER MOTOR CONTROLS, IN CLASS 9 (U.S. CLS. 21, 23, 26, 36 AND 38).

FIRST USE 2-0-1961; IN COMMERCE 2-0-1961.

FOR: (BASED ON USE IN COMMERCE)) DC MOTORS; BRUSHLESS MOTORS; DC GEAR MOTORS; MACHINE TRANSAXLE DRIVES; GEARBOXES; BRUSHLESS GEAR MOTORS; INTEGRATED MOTOR DRIVES, FOR LAND VEHICLES; STEPPING MOTORS, FOR LAND VEHICLES, IN CLASS 12 (U.S. CLS. 19, 21, 23, 31, 35 AND 44).

FIRST USE 7-7-2007; IN COMMERCE 7-7-2007.

FOR: REPAIR SERVICES RENDERED TO OTHERS, NAMELY, REPAIR OF ELECTRIC MOTORS, GEAR MOTORS, SERVO MOTORS, SERVO DRIVES, POSITION CONTROLS FOR ELECTRIC MOTORS, STEPPER DRIVES, STEPPER CONTROLS, LINEAR ACTUATORS, MACHINE TRANSAXLE DRIVES, INTEGRATED MOTOR DRIVES, GEARBOXES, MOTOR GENERATORS, MOTOR SPEED CONTROLS, ELECTRIC MOTOR SPEED SENSORS, ELECTRIC CIRCUITS FOR THE CONTROL AND REGULATION OF ELECTRIC MOTORS,



*David J. Kyffers*

Director of the United States Patent and Trademark Office

**Reg. No. 4,198,693** ELECTRIC CONTROLS FOR ELECTRIC MOTORS, AMPLIFIERS FOR ELECTRIC MOTORS, IN CLASS 37 (U.S. CLS. 100, 103 AND 106).

FIRST USE 4-16-2012; IN COMMERCE 4-16-2012.

FOR: (BASED ON USE IN COMMERCE)) CUSTOM MANUFACTURE OF THE FOLLOWING FOR THIRD PARTIES: AC MOTORS, DC MOTORS, BRUSHLESS MOTORS, MACHINE TRANSAXLE DRIVES, GEARBOXES, SERVO MOTORS, AC GEAR MOTORS, DC GEAR MOTORS, BRUSHLESS GEAR MOTORS, STEPPING MOTORS, LINEAR ACTUATORS, INTEGRATED MOTOR DRIVES, MOTOR GENERATORS, MOTOR SPEED CONTROLS, SERVO DRIVES, STEPPING DRIVES, ELECTRIC CIRCUITS FOR THE CONTROL AND REGULATION OF ELECTRIC MOTORS, ELECTRIC CONTROLS FOR ELECTRIC MOTORS, AMPLIFIERS FOR ELECTRIC MOTORS, POSITION CONTROLS FOR ELECTRIC MOTORS, STEPPING CONTROLS FOR ELECTRIC MOTORS, ELECTRIC MOTOR SPEED SENSORS, IN CLASS 40 (U.S. CLS. 100, 103 AND 106).

FIRST USE 11-23-2001; IN COMMERCE 11-23-2001.

THE MARK CONSISTS OF STANDARD CHARACTERS WITHOUT CLAIM TO ANY PARTICULAR FONT, STYLE, SIZE, OR COLOR.

OWNER OF U.S. REG. NOS. 1,572,910, 2,752,092, AND 2,758,207.

SN 77-322,653, FILED 11-6-2007.

SANI KHOURI, EXAMINING ATTORNEY

# United States of America

United States Patent and Trademark Office

# HeliTrak

**Reg. No. 4,198,694**

DIGITAL CONTROL INCORPORATED (WASHINGTON CORPORATION)  
19625 - 62ND AVENUE, SUITE B-103  
KENT, WA 98032

**Registered Aug. 28, 2012**

**Int. Cl.: 9**

FOR: COMPUTER SOFTWARE FOR USE IN STABILITY CONTROL AND AUTO PILOT SYSTEMS FOR HELICOPTERS AND AVIATION EQUIPMENT, IN CLASS 9 (U.S. CLS. 21, 23, 26, 36 AND 38).

**TRADEMARK**

FIRST USE 6-0-2012; IN COMMERCE 6-0-2012.

**PRINCIPAL REGISTER**

THE MARK CONSISTS OF STANDARD CHARACTERS WITHOUT CLAIM TO ANY PARTICULAR FONT, STYLE, SIZE, OR COLOR.

SN 77-324,767, FILED 11-8-2007.

SUSAN RICHARDS, EXAMINING ATTORNEY



*David J. Kyffers*

Director of the United States Patent and Trademark Office



# United States of America

United States Patent and Trademark Office

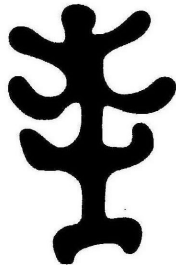

## Step by Step

**Reg. No. 4,198,695**

**Registered Aug. 28, 2012**

**Int. Cl.: 16**

**TRADEMARK**

**PRINCIPAL REGISTER**

STARRY LTD. (HONG KONG PRIVATE LIMITED COMPANY)  
4B, 12 SHIPYARD LANE  
QUARRY BAY, HONG KONG

FOR: PRINTED MATTER, NAMELY, PHOTOGRAPHS, BOOKLETS, GREETING CARDS, GIFT CARDS, STATIONERY FOR CHILDREN'S EDUCATIONAL ACTIVITIES, POSTCARDS, CALENDARS, DESK CALENDARS; PAPER, CARDBOARD AND GOODS MADE FROM THESE MATERIALS, NAMELY, COLOURED PAPER FOR DECORATIVE USE, PAPER RIBBONS, ARTICLES OF CARDBOARD OR PAPER FOR PACKAGING, NAMELY, CARDBOARD PACKAGING, AND PAPER PACKAGING MATERIALS, NAMELY, PAPER FOR WRAPPING AND PACKAGING; BOOKBINDING MATERIAL; STATIONERY; INSTRUCTIONAL AND TEACHING MATERIAL, NAMELY, PRINTED INSTRUCTIONAL, EDUCATIONAL, AND TEACHING MATERIALS IN THE FIELD OF CHILDREN'S EDUCATION, AND RELATED GOODS, NAMELY, ADHESIVES FOR STATIONERY OR HOUSEHOLD PURPOSES, IN CLASS 16 (U.S. CLS. 2, 5, 22, 23, 29, 37, 38 AND 50).

FIRST USE 12-14-2002; IN COMMERCE 12-22-2011.

THE MARK CONSISTS OF THE WORDS "STEP BY STEP" UNDER A MISCELLANEOUS DESIGN HAVING AN OVERALL RECTANGULAR SHAPE.

SN 77-339,791, FILED 11-29-2007.

BRIAN NEVILLE, EXAMINING ATTORNEY



*David J. Kybas*

Director of the United States Patent and Trademark Office

# United States of America

United States Patent and Trademark Office



**SINGLE**

**Reg. No. 4,198,696**

DISTILLERIE FRANCIACORTA S.P.A. (ITALY JOINT STOCK COMPANY)  
VIA MANDOLOSSA, 80  
25064 GUSSAGO (BS), ITALY

**Registered Aug. 28, 2012**

**Int. Cl.: 33**

FOR: VODKA, IN CLASS 33 (U.S. CLS. 47 AND 49).

**TRADEMARK**

FIRST USE 11-28-2006; IN COMMERCE 3-3-2008.

**PRINCIPAL REGISTER**

THE MARK CONSISTS OF A STALK OF WHEAT WITH A LEAF ABOVE THE WORD "SINGLE".

SN 77-357,056, FILED 12-20-2007.

ANNE E. GUSTASON, EXAMINING ATTORNEY



*David J. Kyffers*

Director of the United States Patent and Trademark Office

# United States of America

United States Patent and Trademark Office

## Independent Heel System

**Reg. No. 4,198,697**

NORTHWEST PODIATRIC LABORATORY, INC. (WASHINGTON CORPORATION)  
1091 FIR AVENUE  
BLAINE, WA 98230

**Registered Aug. 28, 2012**

**Int. Cl.: 10**

FOR: ORTHOTIC INSERTS FOR FOOTWEAR, IN CLASS 10 (U.S. CLS. 26, 39 AND 44).

FIRST USE 4-24-2012; IN COMMERCE 4-24-2012.

**TRADEMARK**

THE MARK CONSISTS OF STANDARD CHARACTERS WITHOUT CLAIM TO ANY PARTICULAR FONT, STYLE, SIZE, OR COLOR.

**PRINCIPAL REGISTER**

NO CLAIM IS MADE TO THE EXCLUSIVE RIGHT TO USE "HEEL SYSTEM", APART FROM THE MARK AS SHOWN.

SN 77-362,060, FILED 12-31-2007.

JEFFERY COWARD, EXAMINING ATTORNEY



*David J. Kyffers*

Director of the United States Patent and Trademark Office

# United States of America

United States Patent and Trademark Office

## POWER to Move the World

**Reg. No. 4,198,698**

**Registered Aug. 28, 2012**

**Int. Cl.: 25**

**TRADEMARK**

**PRINCIPAL REGISTER**

DELAWARE CAPITAL FORMATION, INC. (DELAWARE CORPORATION)  
SUITE 5  
501 SILVERSIDE ROAD  
WILMINGTON, DE 19809

FOR: POLO SHIRTS, IN CLASS 25 (U.S. CLS. 22 AND 39).

FIRST USE 3-0-2008; IN COMMERCE 3-0-2008.

THE MARK CONSISTS OF STANDARD CHARACTERS WITHOUT CLAIM TO ANY PARTICULAR FONT, STYLE, SIZE, OR COLOR.

SN 77-368,661, FILED 1-10-2008.

JACLYN KIDWELL WALKER, EXAMINING ATTORNEY



*David J. Kybas*

Director of the United States Patent and Trademark Office

# United States of America

United States Patent and Trademark Office

# INGENUITY

**Reg. No. 4,198,699**

**Registered Aug. 28, 2012**

**Int. Cls.: 6 and 7**

**TRADEMARK**

**PRINCIPAL REGISTER**

ILLINOIS TOOL WORKS INC. (DELAWARE CORPORATION)  
3600 WEST LAKE AVENUE  
GLENVIEW, IL 60026

FOR: METAL FASTENERS FOR CONSTRUCTION AND INDUSTRIAL USE, NAMELY, STAPLES, PINS, AND BRADS, IN CLASS 6 (U.S. CLS. 2, 12, 13, 14, 23, 25 AND 50).

FIRST USE 10-30-2010; IN COMMERCE 10-30-2010.

FOR: POWER OPERATED HAND TOOLS FOR AFFIXING METAL FASTENERS, FOR CONSTRUCTION AND INDUSTRIAL USE, IN CLASS 7 (U.S. CLS. 13, 19, 21, 23, 31, 34 AND 35).

FIRST USE 10-30-2010; IN COMMERCE 10-30-2010.

THE MARK CONSISTS OF STANDARD CHARACTERS WITHOUT CLAIM TO ANY PARTICULAR FONT, STYLE, SIZE, OR COLOR.

SN 77-370,606, FILED 1-14-2008.

MICHELLE DUBOIS, EXAMINING ATTORNEY



*David J. Kyffers*

Director of the United States Patent and Trademark Office

# United States of America

United States Patent and Trademark Office



**Reg. No. 4,198,700**

CLEATSKINS, INC. (DELAWARE CORPORATION)  
2240 ENCINITAS BLVD., SUITE D-250  
ENCINITAS, CA 92024

**Registered Aug. 28, 2012**

**Int. Cl.: 25**

FOR: SPORTSWEAR AND LEISURE WEAR, NAMELY, SHIRTS, T-SHIRTS, JERSEYS, PULLOVERS, JACKETS, COATS, CAPS, HATS; NON-METAL CLEATS FOR ATTACHMENT TO SPORTS SHOES, IN CLASS 25 (U.S. CLS. 22 AND 39).

**TRADEMARK**

FIRST USE 8-0-2009; IN COMMERCE 8-0-2009.

**PRINCIPAL REGISTER**

THE MARK CONSISTS OF TWO STYLIZED OPPOSING LETTER "C"'S.

SN 77-371,196, FILED 1-14-2008.

CHARLES L. JENKINS, EXAMINING ATTORNEY



*David J. Kyffers*

Director of the United States Patent and Trademark Office

# United States of America

United States Patent and Trademark Office

# ACCELON

**Reg. No. 4,198,701**

KEYNETIK, INC. (VIRGINIA CORPORATION)  
2883 FRANKLIN OAKS DRIVE  
HERNDON, VA 201712265

**Registered Aug. 28, 2012**

**Int. Cl.: 9**

FOR: SOFTWARE FOR USE IN CONTROLLING, MONITORING, AND DETECTING PHYSICAL MOTION OF A PHYSICAL OBJECT, AND TO PROVIDE INFORMATION IN THE NATURE OF COLLECTED DATA ON THE PHYSICAL MOTION OF A PHYSICAL OBJECT; SOFTWARE, NAMELY, SOFTWARE FOR CONTROLLING, MONITORING AND PROVIDING INFORMATION IN THE NATURE OF COLLECTED DATA ON PHYSICAL MOTION OF A PHYSICAL OBJECT AND PARTS THEREOF; SOFTWARE FOR USE IN CONTROLLING, MONITORING, AND DETECTING PHYSICAL MOTION OF A PHYSICAL OBJECT, AND TO PROVIDE INFORMATION IN THE NATURE OF COLLECTED DATA ON THE PHYSICAL MOTION OF A PHYSICAL OBJECT, IN CLASS 9 (U.S. CLS. 21, 23, 26, 36 AND 38).

**TRADEMARK**

**PRINCIPAL REGISTER**

FIRST USE 7-6-2012; IN COMMERCE 7-6-2012.

THE MARK CONSISTS OF STANDARD CHARACTERS WITHOUT CLAIM TO ANY PARTICULAR FONT, STYLE, SIZE, OR COLOR.

SN 77-392,277, FILED 2-8-2008.

ADA HAN, EXAMINING ATTORNEY



*David J. Kyffers*

Director of the United States Patent and Trademark Office

# United States of America

United States Patent and Trademark Office

# MY SHARE

**Reg. No. 4,198,702**

MILKY WAY INTERNATIONAL TRADING CORPORATION (CALIFORNIA CORPORATION)  
15203 SHOEMAKER AVENUE  
NORWALK, CA 90650

**Registered Aug. 28, 2012**

**Int. Cls.: 16 and 21**

FOR: PAPER PRODUCTS MADE FROM SUGAR CANE FIBER, NAMELY, PAPER FOOD CONTAINERS, IN CLASS 16 (U.S. CLS. 2, 5, 22, 23, 29, 37, 38 AND 50).

**TRADEMARK**

FIRST USE 11-19-2011; IN COMMERCE 4-8-2012.

**PRINCIPAL REGISTER**

FOR: PAPER PRODUCTS MADE FROM SUGAR CANE FIBER, NAMELY, PAPER PLATES, PAPER BOWLS AND PAPER TRAYS, IN CLASS 21 (U.S. CLS. 2, 13, 23, 29, 30, 33, 40 AND 50).

FIRST USE 6-15-2011; IN COMMERCE 7-6-2011.

THE MARK CONSISTS OF STANDARD CHARACTERS WITHOUT CLAIM TO ANY PARTICULAR FONT, STYLE, SIZE, OR COLOR.

SN 77-397,674, FILED 2-14-2008.

MICHELLE DUBOIS, EXAMINING ATTORNEY



*David J. Kybas*

Director of the United States Patent and Trademark Office



# United States of America

United States Patent and Trademark Office

I ♥ SHOES

**Reg. No. 4,198,703**

PAYLESS SHOESOURCE WORLDWIDE, INC. (KANSAS CORPORATION)  
JAYHAWK TOWERS, 700 SW JACKSON, STE. 202  
TOPEKA, KS 66603

**Registered Aug. 28, 2012**

**Int. Cl.: 35**

FOR: RETAIL SHOE AND FASHION ACCESSORIES STORE SERVICES; COMPUTERIZED ON-LINE RETAIL STORE SERVICES IN THE FIELD OF FOOTWEAR, APPAREL, PURSES, HANDBAGS, AND BACKPACKS, ACCESSIBLE VIA GLOBAL COMPUTER NETWORKS, IN CLASS 35 (U.S. CLS. 100, 101 AND 102).

**SERVICE MARK**

**PRINCIPAL REGISTER**

FIRST USE 5-0-2007; IN COMMERCE 5-0-2007.

OWNER OF U.S. REG. NO. 2,646,852.

NO CLAIM IS MADE TO THE EXCLUSIVE RIGHT TO USE "SHOES", APART FROM THE MARK AS SHOWN.

THE MARK CONSISTS OF THE WORD "I" IN A STYLIZED FORMAT FOLLOWED BY THE STYLIZED DESIGN OF A HEART FOLLOWED BY THE WORD "SHOES" IN A STYLIZED FORMAT.

SN 77-398,389, FILED 2-15-2008.

WANDA KAY PRICE, EXAMINING ATTORNEY



*David J. Kyffers*

Director of the United States Patent and Trademark Office

# United States of America

United States Patent and Trademark Office

# JOHNNY X

**Reg. No. 4,198,704**

JOHNNY X, INC. (FLORIDA CORPORATION)

**Registered Aug. 28, 2012**

P.O. BOX 970762  
COCONUT CREEK, FL 33097

**Int. Cls.: 25, 28, and 41**

FOR: CLOTHING, NAMELY, UNDERWEAR, TRACKSUITS, SHELL SUITS, OVERALLS, COATS, MANTLES, SUITS, JACKETS, WAIST COATS, BATH ROBES, BELTS FOR CLOTHING, GLOVES, JUMPERS, TROUSERS, SKIRTS, SHORTS, SHIRTS, POLO SHIRTS, T-SHIRTS, SWEAT SHIRTS, SWEAT BANDS, SCARVES, NECKWEAR, FOOTWEAR HEADGEAR, NAMELY, HATS, CAPS, CAP PEAKS, VISORS, BASEBALL CAPS, AND HEADBANDS, IN CLASS 25 (U.S. CLS. 22 AND 39).

**TRADEMARK**

**SERVICE MARK**

**PRINCIPAL REGISTER**

FIRST USE 2-5-2012; IN COMMERCE 2-5-2012.

FOR: TOYS, NAMELY, POKER CHIPS, CARD GAME TABLES AND GAMING TABLES, PLUSH TOYS, STUFFED TOYS, DOLLS, TOY FIGURINES, KITES, TOY VEHICLES AND RELATED ACCESSORIES SOLD AS UNITS, PAPER TOYS, NAMELY, PAPER AIRPLANES, PAPER DOLLS, PAPER MOBILES, RIDE-ON OR IN TOYS, NAMELY, TOY BICYCLES AND TOY VEHICLES, TOY VEHICLE TRACKS AND RACING SETS, TOY MOTORCYCLES, REMOTE-CONTROL TOYS, NAMELY, MOTORCYCLES, CARS, RACE CARS, AIRPLANES, AND BOATS, TOY ACTION FIGURES, TOY FIGURES, BALLS FOR GAMES, SOFT TOYS, CRIB TOYS, SQUEEZE TOYS, TOYS FOR INFANTS, IN CLASS 28 (U.S. CLS. 22, 23, 38 AND 50).

FIRST USE 2-5-2012; IN COMMERCE 2-5-2012.

FOR: ENTERTAINMENT SERVICES, NAMELY, FAN CLUBS FOR POKER GAMES; ENTERTAINMENT SERVICES, NAMELY, ORGANIZING, CONDUCTING, PRODUCING AND EXHIBITING POKER EVENTS RENDERED LIVE; SPONSORING, ORGANIZING AND CONDUCTING POKER GAMES AND TOURNAMENTS; ENTERTAINMENT SERVICES, NAMELY, PROVIDING CORPORATE PARTIES AND CELEBRATIONS; ORGANIZING ENTERTAINMENT BEFORE AND AFTER POKER EVENTS; PROVIDING INFORMATION IN THE FIELD OF POKER RELATED TIPS AND STRATEGY; PROVIDING NEWS AND INFORMATION IN THE FIELD OF POKER EVENTS, TOURNAMENTS, SCHEDULES, PLAYERS AND OTHER RELATED TOPICS OF INTEREST TO THE POKER PLAYER COMMUNITY, NAMELY, POKER STRATEGY; ORGANIZING AND CONDUCTING SEMINARS, CONFERENCES AND TRAINING SESSIONS RELATING TO POKER, DEVELOPMENT AND DISSEMINATION OF EDUCATIONAL TRAINING MATERIALS IN CONNECTION THEREWITH,



*David J. Kyros*

Director of the United States Patent and Trademark Office

**Reg. No. 4,198,704** IN CD ROM, AND OTHER DIGITAL AND/OR ELECTRONIC MEDIA, AND PRINT FORMAT; FAN CLUBS FOR MOTOR RACING ENTERTAINMENT AND SPORTING ACTIVITIES, ORGANIZING MOTOR RACING EVENTS, ENTERTAINMENT IN THE NATURE OF MOTOR RACING EVENTS, ENTERTAINMENT IN THE NATURE OF COMPETITIONS IN THE FIELD OF MOTOR RACING CONTESTS, ORGANIZING ENTERTAINMENT AND SOCIAL EVENTS, NAMELY, POST RACING PARTIES, IN CLASS 41 (U.S. CLS. 100, 101 AND 107).

FIRST USE 2-5-2012; IN COMMERCE 2-5-2012.

THE MARK CONSISTS OF STANDARD CHARACTERS WITHOUT CLAIM TO ANY PARTICULAR FONT, STYLE, SIZE, OR COLOR.

THE NAME(S), PORTRAIT(S), AND/OR SIGNATURE(S) SHOWN IN THE MARK IDENTIFIES A LIVING INDIVIDUAL, WHOSE CONSENT(S) TO REGISTER IS SUBMITTED.

SN 77-399,939, FILED 2-19-2008.

ROBIN CHOSID, EXAMINING ATTORNEY

# United States of America

United States Patent and Trademark Office

## MY FIRST TEE

**Reg. No. 4,198,705**

**Registered Aug. 28, 2012**

**Int. Cl.: 25**

**TRADEMARK**

**PRINCIPAL REGISTER**

FRANCO APPAREL GROUP, INC. (NEW YORK CORPORATION)  
1407 BROADWAY  
30TH FLOOR  
NEW YORK, NY 10018

FOR: T-SHIRTS, IN CLASS 25 (U.S. CLS. 22 AND 39).

FIRST USE 11-0-2005; IN COMMERCE 11-0-2005.

THE MARK CONSISTS OF STANDARD CHARACTERS WITHOUT CLAIM TO ANY PARTICULAR FONT, STYLE, SIZE, OR COLOR.

NO CLAIM IS MADE TO THE EXCLUSIVE RIGHT TO USE "TEE", APART FROM THE MARK AS SHOWN.

SN 77-401,263, FILED 2-20-2008.

ADA HAN, EXAMINING ATTORNEY



*David J. Kybas*

Director of the United States Patent and Trademark Office

# United States of America

United States Patent and Trademark Office

## The Great American

**Reg. No. 4,198,706**

ALLEN, BENJAMIN L. (UNITED STATES INDIVIDUAL)  
HC 73 BOX-115-C  
DRURY, MO 85244

**Registered Aug. 28, 2012**

**Int. Cl.: 35**

FOR: RETAIL STORE SERVICES FEATURING AMERICAN-MADE GOODS, AND TEMPORARY RETAIL STORE SERVICES SET-UP ONSITE AT TRADESHOWS, FEATURING AMERICAN-MADE GOODS FEATURING MAGNETS, SIGNS, CARDS, GAMES, AND PUZZLES, IN CLASS 35 (U.S. CLS. 100, 101 AND 102).

**SERVICE MARK**

**PRINCIPAL REGISTER**

FIRST USE 6-14-2012; IN COMMERCE 6-14-2012.

THE MARK CONSISTS OF STANDARD CHARACTERS WITHOUT CLAIM TO ANY PARTICULAR FONT, STYLE, SIZE, OR COLOR.

NO CLAIM IS MADE TO THE EXCLUSIVE RIGHT TO USE "AMERICAN", APART FROM THE MARK AS SHOWN.

SN 77-410,527, FILED 3-1-2008.

ALICE BENMAMAN, EXAMINING ATTORNEY



*David J. Kybas*

Director of the United States Patent and Trademark Office

# United States of America

United States Patent and Trademark Office

# GAMESCREEN

**Reg. No. 4,198,707**

**Registered Aug. 28, 2012**

**Int. Cl.: 41**

**SERVICE MARK**

**PRINCIPAL REGISTER**

GAMESCREEN, INC. (CALIFORNIA CORPORATION)  
17TH FLOOR  
1100 GLENDON AVE  
LOS ANGELES, CA 90024

FOR: ENTERTAINMENT SERVICES, NAMELY, PROVIDING ON-LINE INTERACTIVE COMPUTER GAMES PLAYED OVER COMPUTER NETWORKS, SATELLITE NETWORKS, WIRELESS NETWORKS AND GLOBAL COMMUNICATION NETWORKS; ENTERTAINMENT IN THE NATURE OF BASKETBALL, BASEBALL, CRICKET, FOOTBALL, SOCCER, HOCKEY, GOLF, TENNIS, TRACK AND FIELD, EQUESTRIAN, POLO, SNOW SKIING, ICE SKATING, WATER SKIING, BOAT AND YACHT RACING, AIR RACING, HORSE RACING, AUTO RACING, BICYCLE RACING, MOTORCYCLE RACING, DOG RACING, BOXING AND VOLLEYBALL GAMES, PROVIDED BY VIEWING OVER COMPUTER NETWORKS, SATELLITE NETWORKS, WIRELESS NETWORKS AND GLOBAL COMMUNICATION NETWORKS; PRODUCTION OF TELEVISION PROGRAMS , IN CLASS 41 (U.S. CLS. 100, 101 AND 107).

FIRST USE 4-26-2000; IN COMMERCE 6-3-2012.

THE MARK CONSISTS OF STANDARD CHARACTERS WITHOUT CLAIM TO ANY PARTICULAR FONT, STYLE, SIZE, OR COLOR.

SN 77-428,855, FILED 3-22-2008.

ANNE FARRELL, EXAMINING ATTORNEY



*David J. Kyffers*

Director of the United States Patent and Trademark Office

# United States of America

United States Patent and Trademark Office

# STRATYS-3

**Reg. No. 4,198,708**

CONOPCO, INC. (NEW YORK CORPORATION)  
700 SYLVAN AVENUE  
ENGLEWOOD CLIFFS, NJ 07632

**Registered Aug. 28, 2012**

**Int. Cl.: 3**

FOR: NON-MEDICATED SKIN CARE PREPARATIONS, NAMELY, OILS, CREAMS AND LOTIONS, IN CLASS 3 (U.S. CLS. 1, 4, 6, 50, 51 AND 52).

**TRADEMARK**

FIRST USE 0-0-2009; IN COMMERCE 0-0-2009.

**PRINCIPAL REGISTER**

THE MARK CONSISTS OF STANDARD CHARACTERS WITHOUT CLAIM TO ANY PARTICULAR FONT, STYLE, SIZE, OR COLOR.

SN 77-433,249, FILED 3-27-2008.

MARC LEIPZIG, EXAMINING ATTORNEY



*David J. Kyffers*

Director of the United States Patent and Trademark Office

# United States of America

United States Patent and Trademark Office

## PROMETRIC



**Reg. No. 4,198,709**

**Registered Aug. 28, 2012**

**Int. Cl.: 16**

**TRADEMARK**

**PRINCIPAL REGISTER**

PROMETRIC INC. (DELAWARE CORPORATION)  
1501 S. CLINTON STREET  
BALTIMORE, MD 21224

FOR: PRINTED EDUCATIONAL PUBLICATIONS FOR USE IN TECHNICAL TRAINING SKILLS ASSESSMENT PROGRAM, NAMELY, HANDBOOKS, BROCHURES, PAMPHLETS, PRINTED FORMS, SCORE-REPORTING FORMS, PRINTED REPORTS, BULLETINS, NEWSLETTERS, MAGAZINES, STUDY GUIDES, PRINTED INFORMATIONAL FOLDERS, AND PRINTED INFORMATIONAL BINDERS, ALL IN THE FIELD OF VOCATIONAL SKILLS TESTING, VOCATIONAL SKILLS TEST DEVELOPMENT, VOCATIONAL SKILLS TEST DELIVERY AND VOCATIONAL SKILLS TEST ASSESSMENT, IN CLASS 16 (U.S. CLS. 2, 5, 22, 23, 29, 37, 38 AND 50).

FIRST USE 4-0-2008; IN COMMERCE 4-0-2008.

OWNER OF U.S. REG. NO. 2,276,211.

SN 77-435,464, FILED 3-31-2008.

B. PARADEWELAI, EXAMINING ATTORNEY



*David J. Kyffers*

Director of the United States Patent and Trademark Office



# United States of America

United States Patent and Trademark Office

# AVEDRO

**Reg. No. 4,198,710**

AVEDRO INC. (DELAWARE CORPORATION)  
230 THIRD AVENUE  
WALTHAM, MA 02451

**Registered Aug. 28, 2012**

**Int. Cl.: 44**

FOR: SURGERY; LASER VISION SURGERY SERVICES, IN CLASS 44 (U.S. CLS. 100 AND 101).

**SERVICE MARK**

FIRST USE 11-0-2010; IN COMMERCE 11-0-2010.

**PRINCIPAL REGISTER**

THE MARK CONSISTS OF STANDARD CHARACTERS WITHOUT CLAIM TO ANY PARTICULAR FONT, STYLE, SIZE, OR COLOR.

SN 77-442,851, FILED 4-8-2008.

CAROLYN CATALDO, EXAMINING ATTORNEY



*David J. Kyffers*

Director of the United States Patent and Trademark Office

# United States of America

United States Patent and Trademark Office

# KERAFLEX

**Reg. No. 4,198,711**

AVEDRO INC. (DELAWARE CORPORATION)  
230 THIRD AVENUE  
WALTHAM, MA 02451

**Registered Aug. 28, 2012**

**Int. Cl.: 44**

FOR: SURGERY; LASER VISION SURGERY SERVICES, IN CLASS 44 (U.S. CLS. 100 AND 101).

**SERVICE MARK**

FIRST USE 11-0-2010; IN COMMERCE 11-0-2010.

**PRINCIPAL REGISTER**

THE MARK CONSISTS OF STANDARD CHARACTERS WITHOUT CLAIM TO ANY PARTICULAR FONT, STYLE, SIZE, OR COLOR.

SN 77-442,853, FILED 4-8-2008.

CAROLYN CATALDO, EXAMINING ATTORNEY



*David J. Kybas*

Director of the United States Patent and Trademark Office

United States of America  
United States Patent and Trademark Office

易游行

**Reg. No. 4,198,712**

PAYEASE CORP. (DELAWARE CORPORATION)  
2332-A WALSH AVENUE  
SANTA CLARA, CA 95051

**Registered Aug. 28, 2012**

**Int. Cl.: 39**

FOR: TRAVEL GUIDE AND TRAVEL INFORMATION SERVICES; TRAVEL AND TOUR TICKET RESERVATION SERVICES; TRANSPORT AND DELIVERY OF GOODS, IN CLASS 39 (U.S. CLS. 100 AND 105).

**SERVICE MARK**

FIRST USE 2-0-2008; IN COMMERCE 2-0-2008.

**PRINCIPAL REGISTER**

NO CLAIM IS MADE TO THE EXCLUSIVE RIGHT TO USE THE NON-LATIN CHARACTERS THAT MEAN TRAVEL, APART FROM THE MARK AS SHOWN.

THE NON-LATIN CHARACTER(S) IN THE MARK TRANSLITERATE INTO "YIYOU XING", AND THIS MEANS "TRAVEL FUN ENTERTAINMENT LEISURE" IN ENGLISH.

THE MARK CONSISTS OF CHINESE CHARACTERS.

SN 77-446,646, FILED 4-11-2008.

MICHAEL TANNER, EXAMINING ATTORNEY



*David J. Kybas*

Director of the United States Patent and Trademark Office

# United States of America

United States Patent and Trademark Office

# 首信易支付

**Reg. No. 4,198,713**

**Registered Aug. 28, 2012**

**Int. Cls.: 36 and 38**

**SERVICE MARK**

**PRINCIPAL REGISTER**

PAYEASE CORP. (DELAWARE CORPORATION)  
2332-A WALSH AVENUE  
SANTA CLARA, CA 95051

FOR: FINANCIAL TRANSACTION SERVICES, NAMELY, PROVIDING SECURE COMMERCIAL TRANSACTIONS AND PAYMENT OPTIONS FOR ONLINE AND OFFLINE PURCHASES USING MOBILE ELECTRONIC DEVICES AND ELECTRONIC AND OPTICAL COMMUNICATIONS NETWORKS; PAYMENT PROCESSING SERVICES, NAMELY, CREDIT CARD AND DEBIT CARD TRANSACTION SERVICES; ELECTRONIC PAYMENT SERVICES, NAMELY, ELECTRONIC PROCESSING AND TRANSMISSION OF BILL PAYMENT DATA; BILL PAYMENT SERVICES; INSURANCE INFORMATION, IN CLASS 36 (U.S. CLS. 100, 101 AND 102).

FIRST USE 7-0-2006; IN COMMERCE 7-0-2006.

FOR: PROVIDING ELECTRONIC AND OPTICAL TRANSMISSION OF FINANCIAL TRANSACTION AND PAYMENT DATA VIA A GLOBAL COMPUTER NETWORK; PROVIDING E-MAIL SERVICES; PROVIDING MULTIPLE-USER ACCESS TO A GLOBAL COMPUTER INFORMATION NETWORK; INFORMATION ABOUT TELECOMMUNICATIONS; PROVIDING ACCESS TO TELECOMMUNICATIONS NETWORKS; PROVIDING ELECTRONIC BULLETIN BOARDS FOR TRANSMISSION OF MESSAGES AMONG COMPUTER USERS CONCERNING FINANCIAL TRANSACTIONS, IN CLASS 38 (U.S. CLS. 100, 101 AND 104).

FIRST USE 7-0-2006; IN COMMERCE 7-0-2006.

NO CLAIM IS MADE TO THE EXCLUSIVE RIGHT TO USE THE NON-LATIN CHARACTERS THAT MEAN INFORMATION TECHNOLOGY PAYMENT, APART FROM THE MARK AS SHOWN.

THE NON-LATIN CHARACTER(S) IN THE MARK TRANSLITERATE INTO "SHOU XIN YI ZHI FU", AND THIS MEANS "CAPITAL INFORMATION TECHNOLOGY PAYMENT MADE EASY" IN ENGLISH.

THE MARK CONSISTS OF CHINESE CHARACTERS.

SN 77-446,656, FILED 4-11-2008.



*David J. Kyros*

Director of the United States Patent and Trademark Office

**Reg. No. 4,198,713** MICHAEL TANNER, EXAMINING ATTORNEY

# United States of America

United States Patent and Trademark Office

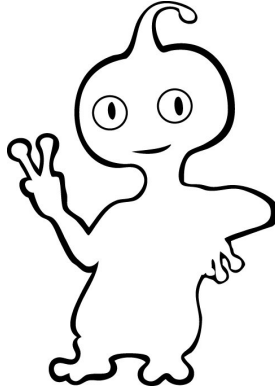

**Reg. No. 4,198,714**

**Registered Aug. 28, 2012**

**Int. Cl.: 39**

**SERVICE MARK**

**PRINCIPAL REGISTER**

PAYEASE CORP. (DELAWARE CORPORATION)  
2332-A WALSH AVENUE  
SANTA CLARA, CA 95051

FOR: TRAVEL GUIDE AND TRAVEL INFORMATION SERVICES; TRAVEL AND TOUR TICKET RESERVATION SERVICES; TRANSPORT AND DELIVERY OF GOODS, IN CLASS 39 (U.S. CLS. 100 AND 105).

FIRST USE 10-0-2007; IN COMMERCE 10-0-2007.

THE MARK CONSISTS OF AN ALIEN BEING.

SN 77-446,661, FILED 4-11-2008.

MICHAEL TANNER, EXAMINING ATTORNEY



*David J. Kybas*

Director of the United States Patent and Trademark Office

# United States of America

United States Patent and Trademark Office



**Reg. No. 4,198,715**

PAYEASE CORP. (DELAWARE CORPORATION)  
2332-A WALSH AVENUE  
SANTA CLARA, CA 95051

**Registered Aug. 28, 2012**

**Int. Cls.: 36 and 38**

FOR: FINANCIAL TRANSACTION SERVICES, NAMELY, PROVIDING SECURE COMMERCIAL TRANSACTIONS AND PAYMENT OPTIONS FOR ONLINE AND OFFLINE PURCHASES USING MOBILE ELECTRONIC DEVICES AND ELECTRONIC AND OPTICAL COMMUNICATIONS NETWORKS; PAYMENT PROCESSING SERVICES, NAMELY, CREDIT CARD AND DEBIT CARD TRANSACTION SERVICES; ELECTRONIC PAYMENT SERVICES, NAMELY, ELECTRONIC PROCESSING AND TRANSMISSION OF BILL PAYMENT DATA; BILL PAYMENT SERVICES; INSURANCE INFORMATION, IN CLASS 36 (U.S. CLS. 100, 101 AND 102).

**SERVICE MARK**

**PRINCIPAL REGISTER**

FIRST USE 7-0-2006; IN COMMERCE 7-0-2006.

FOR: PROVIDING ELECTRONIC AND OPTICAL TRANSMISSION OF FINANCIAL TRANSACTION AND PAYMENT DATA VIA A GLOBAL COMPUTER NETWORK; PROVIDING E-MAIL SERVICES; PROVIDING MULTIPLE-USER ACCESS TO A GLOBAL COMPUTER INFORMATION NETWORK; INFORMATION ABOUT TELECOMMUNICATIONS; PROVIDING ACCESS TO TELECOMMUNICATIONS NETWORKS; PROVIDING ELECTRONIC BULLETIN BOARDS FOR TRANSMISSION OF MESSAGES AMONG COMPUTER USERS CONCERNING FINANCIAL TRANSACTIONS, IN CLASS 38 (U.S. CLS. 100, 101 AND 104).

FIRST USE 7-0-2006; IN COMMERCE 7-0-2006.

NO CLAIM IS MADE TO THE EXCLUSIVE RIGHT TO USE THE NON-LATIN CHARACTERS THAT MEAN "PAYMENT", APART FROM THE MARK AS SHOWN.

THE NON-LATIN CHARACTER(S) IN THE MARK TRANSLITERATE INTO "YI ZHI FU", AND THIS MEANS "PAYMENT MADE INTELLIGENT AND EASIER" IN ENGLISH.

THE MARK CONSISTS OF A STYLIZED LOWER CASE LETTER "E" AND CHINESE CHARACTERS.

SN 77-446,668, FILED 4-11-2008.



*David J. Kyros*

Director of the United States Patent and Trademark Office

**Reg. No. 4,198,715** MICHAEL TANNER, EXAMINING ATTORNEY



# United States of America

United States Patent and Trademark Office



**Reg. No. 4,198,716**

PAYEASE CORP. (DELAWARE CORPORATION)  
2332-A WALSH AVENUE  
SANTA CLARA, CA 95051

**Registered Aug. 28, 2012**

**Int. Cl.: 39**

FOR: TRAVEL GUIDE AND TRAVEL INFORMATION SERVICES; TRAVEL AND TOUR TICKET RESERVATION SERVICES; TRANSPORT AND DELIVERY OF GOODS, IN CLASS 39 (U.S. CLS. 100 AND 105).

**SERVICE MARK**

FIRST USE 10-0-2007; IN COMMERCE 10-0-2007.

**PRINCIPAL REGISTER**

NO CLAIM IS MADE TO THE EXCLUSIVE RIGHT TO USE THE NON-LATIN CHARACTERS THAT MEAN TRAVEL, APART FROM THE MARK AS SHOWN.

THE NON-LATIN CHARACTER(S) IN THE MARK TRANSLITERATE INTO "YIYOU XING", AND THIS MEANS "TRAVEL FUN ENTERTAINMENT LEISURE" IN ENGLISH.

THE MARK CONSISTS OF CHINESE CHARACTERS ON A BACKGROUND OF WAVY LINES.

SN 77-446,670, FILED 4-11-2008.

MICHAEL TANNER, EXAMINING ATTORNEY



*David J. Kyjars*

Director of the United States Patent and Trademark Office

# United States of America

United States Patent and Trademark Office

# CONVIVA

## EXPERIENCE LIVE

**Reg. No. 4,198,717**

**Registered Aug. 28, 2012**

**Int. Cl.: 38**

**SERVICE MARK**

**PRINCIPAL REGISTER**

CONVIVA INC. (DELAWARE CORPORATION)  
305 CORNWALL DR.  
PITTSBURGH, PA 15238

FOR: TELECOMMUNICATIONS AND MULTIMEDIA SERVICES, NAMELY, TRANSMISSION, DISTRIBUTION AND DELIVERY OF MULTIMEDIA CONTENT VIA A GLOBAL COMPUTER NETWORK; TELECOMMUNICATIONS CONSULTING IN THE FIELD OF MULTIMEDIA CONTENT TRANSMISSION; CONSULTING IN THE FIELD OF MULTIMEDIA CONTENT TRANSMISSION; TECHNICAL SUPPORT SERVICES IN THE FIELD OF MULTIMEDIA CONTENT TRANSMISSION, IN CLASS 38 (U.S. CLS. 100, 101 AND 104).

FIRST USE 6-14-2012; IN COMMERCE 6-14-2012.

NO CLAIM IS MADE TO THE EXCLUSIVE RIGHT TO USE "LIVE", APART FROM THE MARK AS SHOWN.

THE MARK CONSISTS OF THE LITERAL ELEMENT "CONVIVA EXPERIENCE LIVE", THE LETTER "O" IN "CONVIVA" APPEARING IN A STYLIZED FORMAT.

THE ENGLISH TRANSLATION OF "CONVIVA" IN THE MARK IS "TO LIVE TOGETHER" OR "COEXIST".

SN 77-450,947, FILED 4-17-2008.

KAREN SEVERSON, EXAMINING ATTORNEY



*David J. Kyros*

Director of the United States Patent and Trademark Office

# United States of America

United States Patent and Trademark Office

## IN A CLASS BY ITSELF

**Reg. No. 4,198,718**

LB BRANDS, LLC (MAINE LIMITED LIABILITY COMPANY)  
PO BOX 239

**Registered Aug. 28, 2012**

PORT CLYDE, ME 04855

**Int. Cl.: 25**

FOR: CLOTHING, NAMELY, TOPS, BOTTOMS, HEADWEAR AND FOOTWEAR, IN CLASS 25 (U.S. CLS. 22 AND 39).

**TRADEMARK**

FIRST USE 7-1-2011; IN COMMERCE 7-1-2011.

**PRINCIPAL REGISTER**

THE MARK CONSISTS OF STANDARD CHARACTERS WITHOUT CLAIM TO ANY PARTICULAR FONT, STYLE, SIZE, OR COLOR.

SN 77-452,890, FILED 4-20-2008.

TIMOTHY FINNEGAN, EXAMINING ATTORNEY



*David J. Kyffers*

Director of the United States Patent and Trademark Office

# United States of America

United States Patent and Trademark Office

## POINT BLANK

**Reg. No. 4,198,719**

ANTHONY WILLIAMS (UNITED STATES INDIVIDUAL)  
4518 NORTHWOOD DRIVE  
BALTIMORE, MD 21239

**Registered Aug. 28, 2012**

**Int. Cl.: 35**

FOR: ONLINE RETAIL STORE SERVICES FEATURING GREETING CARDS, POSTCARDS, NOTECARDS AND STATIONERY, IN CLASS 35 (U.S. CLS. 100, 101 AND 102).

**SERVICE MARK**

FIRST USE 6-25-2012; IN COMMERCE 6-25-2012.

**PRINCIPAL REGISTER**

THE MARK CONSISTS OF STANDARD CHARACTERS WITHOUT CLAIM TO ANY PARTICULAR FONT, STYLE, SIZE, OR COLOR.

SN 77-457,478, FILED 4-24-2008.

SHAILA SETTLES, EXAMINING ATTORNEY



*David J. Kybas*

Director of the United States Patent and Trademark Office

# United States of America

United States Patent and Trademark Office

## CONTEMPO SPA

**Reg. No. 4,198,720**

PLANET BEACH BRANDS, LLC (LOUISIANA LIMITED LIABILITY COMPANY)  
920 POEYFARRE, PH. 3

**Registered Aug. 28, 2012**

NEW ORLEANS, LA 70130

**Int. Cl.: 44**

FOR: TANNING SALON SERVICES; HEALTH SPA SERVICES FOR HEALTH AND WELLNESS OF THE BODY AND SPIRIT, NAMELY, FACIAL AND BODY TREATMENT SERVICES, COSMETIC BODY CARE SERVICES; COUNSELING SERVICES IN THE FIELD OF HEALTH, NUTRITION AND LIFESTYLE WELLNESS, IN CLASS 44 (U.S. CLS. 100 AND 101).

**SERVICE MARK**

**PRINCIPAL REGISTER**

FIRST USE 2-8-2009; IN COMMERCE 2-9-2009.

THE MARK CONSISTS OF STANDARD CHARACTERS WITHOUT CLAIM TO ANY PARTICULAR FONT, STYLE, SIZE, OR COLOR.

OWNER OF U.S. REG. NO. 3,299,750.

NO CLAIM IS MADE TO THE EXCLUSIVE RIGHT TO USE "SPA", APART FROM THE MARK AS SHOWN.

SN 77-463,420, FILED 5-1-2008.

STEVEN PEREZ, EXAMINING ATTORNEY



*David J. Kyfos*

Director of the United States Patent and Trademark Office

# United States of America

United States Patent and Trademark Office



**Reg. No. 4,198,721**

**Registered Aug. 28, 2012**

**Int. Cl.: 9**

**TRADEMARK**

**PRINCIPAL REGISTER**

O2 HOLDINGS, LLC (DELAWARE LIMITED LIABILITY COMPANY)  
75 NINTH AVENUE  
NEW YORK, NY 10011

FOR: PRE-RECORDED CDS AND DVDS FEATURING TELEVISION PROGRAMMING AND  
DOWNLOADABLE TELEVISION SHOWS IN THE NATURE OF REALITY PROGRAMMING,  
IN CLASS 9 (U.S. CLS. 21, 23, 26, 36 AND 38).

FIRST USE 12-14-2010; IN COMMERCE 12-14-2010.

OWNER OF U.S. REG. NO. 2,805,115.

THE MARK CONSISTS OF THE WORD "OXYGEN" WITHIN A CIRCLE.

SN 77-464,036, FILED 5-2-2008.

TIMOTHY FINNEGAN, EXAMINING ATTORNEY



*David J. Kybas*

Director of the United States Patent and Trademark Office

# United States of America

United States Patent and Trademark Office

## DETECTING CHANGES FASTER IN THE CRITICALLY ILL PATIENT

**Reg. No. 4,198,722**

OPTISCAN BIOMEDICAL CORPORATION (DELAWARE CORPORATION)

**Registered Aug. 28, 2012**

21021 CORSAIR BLVD  
HAYWARD, CA 94545

**Int. Cl.: 44**

FOR: PROVIDING MEDICAL INFORMATION IN THE FIELDS OF MANAGEMENT AND MEASUREMENT OF GLUCOSE AND OTHER CONSTITUENTS IN THE HUMAN BODY AND IN THE DIAGNOSIS AND TREATMENT OF DIABETES, IN CLASS 44 (U.S. CLS. 100 AND 101).

**SERVICE MARK**

**PRINCIPAL REGISTER**

FIRST USE 6-20-2012; IN COMMERCE 6-20-2012.

THE MARK CONSISTS OF STANDARD CHARACTERS WITHOUT CLAIM TO ANY PARTICULAR FONT, STYLE, SIZE, OR COLOR.

SN 77-464,409, FILED 5-2-2008.

KAREN SEVERSON, EXAMINING ATTORNEY



*David J. Kyjars*

Director of the United States Patent and Trademark Office

United States of America  
United States Patent and Trademark Office

# ECOMAX

**Reg. No. 4,198,723**

ROCK-TENN SHARED SERVICES, LLC (GEORGIA LIMITED LIABILITY COMPANY)  
504 THRASHER STREET  
NORCROSS, GA 30071

**Registered Aug. 28, 2012**

**Int. Cl.: 16**

FOR: PACKAGING MADE PRIMARILY OF PAPERBOARD, IN CLASS 16 (U.S. CLS. 2, 5, 22, 23, 29, 37, 38 AND 50).

**TRADEMARK**

FIRST USE 12-28-2009; IN COMMERCE 12-28-2009.

**PRINCIPAL REGISTER**

THE MARK CONSISTS OF STANDARD CHARACTERS WITHOUT CLAIM TO ANY PARTICULAR FONT, STYLE, SIZE, OR COLOR.

SN 77-465,563, FILED 5-5-2008.

PAULA MAHONEY, EXAMINING ATTORNEY



*David J. Kybas*

Director of the United States Patent and Trademark Office



# United States of America

United States Patent and Trademark Office

## ROOLY RESISTANCE

**Reg. No. 4,198,724**

**Registered Aug. 28, 2012**

**Int. Cl.: 9**

**TRADEMARK**

**PRINCIPAL REGISTER**

I.E. MANUFACTURING LLC (NEVADA LIMITED LIABILITY COMPANY)  
3998 INLAND EMPIRE BLVD., SUITE 300  
ONTARIO, CA 91764

FOR: OPTICAL LENSES; LENSES FOR SUNGLASSES AND GOGGLES; SUNGLASSES;  
AND SPORT GOGGLES, IN CLASS 9 (U.S. CLS. 21, 23, 26, 36 AND 38).

FIRST USE 4-1-2009; IN COMMERCE 5-1-2009.

THE MARK CONSISTS OF STANDARD CHARACTERS WITHOUT CLAIM TO ANY PAR-  
TICULAR FONT, STYLE, SIZE, OR COLOR.

OWNER OF U.S. REG. NO. 2,756,051.

SN 77-466,607, FILED 5-6-2008.

AISHA CLARKE, EXAMINING ATTORNEY



*David J. Kyffers*

Director of the United States Patent and Trademark Office

# United States of America

United States Patent and Trademark Office

## GIVE YOUR MACHINES A VOICE

**Reg. No. 4,198,725**

MEI, INC. (DELAWARE CORPORATION)  
1301 WILSON DRIVE  
WEST CHESTER, PA 19380

**Registered Aug. 28, 2012**

**Int. Cl.: 9**

FOR: TELEMETERS; ELECTRONIC AND OPTICAL DEVICES FOR ACCEPTING, SORTING, IDENTIFYING, VERIFYING, VALIDATING, QUANTIFYING, TESTING, DISPENSING AND REJECTING CURRENCY INCLUDING PAPER MONEY, COINS, BANK NOTES, TICKETS, COUPONS AND VOUCHERS; ELECTRONIC AND OPTICAL DEVICES FOR RECOGNIZING MONEY IN COIN AND BILL FORM, MAKING CHANGE IN COIN AND BILL FORM, AND RECOGNIZING COUNTERFEIT CURRENCY; COMPUTER HARDWARE AND SOFTWARE FOR REMOTELY COLLECTING ELECTRONIC DATA, NAMELY, TELEMETRIC DATA FROM CURRENCY COUNTERS, CURRENCY SORTERS, CURRENCY VALIDATORS, VENDING MACHINES, UNATTENDED PAYMENT SYSTEMS, SLOT MACHINES, CASINO GAMING MACHINES, BILL AND COIN OPERATED MACHINES AND CHANGE-MAKING MACHINES, IN CLASS 9 (U.S. CLS. 21, 23, 26, 36 AND 38).

**TRADEMARK**

**PRINCIPAL REGISTER**

FIRST USE 1-0-2012; IN COMMERCE 1-0-2012.

THE MARK CONSISTS OF STANDARD CHARACTERS WITHOUT CLAIM TO ANY PARTICULAR FONT, STYLE, SIZE, OR COLOR.

SN 77-467,163, FILED 5-6-2008.

JENNY PARK, EXAMINING ATTORNEY



*David J. Kybas*

Director of the United States Patent and Trademark Office

# United States of America

United States Patent and Trademark Office

# lumina sphere

**Reg. No. 4,198,726**

LUMINA SPHERE LLC (ARIZONA LIMITED LIABILITY COMPANY)  
3655 W. ANTHEM WAY, SUITE A109-419  
ANTHEM, AZ 85086

**Registered Aug. 28, 2012**

**Int. Cl.: 9**

FOR: SOUND RECORDINGS FEATURING ORIGINAL MUSIC; COMPACT DISCS FEATURING ORIGINAL MUSIC; PRE-RECORDED CDS FEATURING ORIGINAL MUSIC, IN CLASS 9 (U.S. CLS. 21, 23, 26, 36 AND 38).

**TRADEMARK**

FIRST USE 1-7-2009; IN COMMERCE 9-30-2011.

**PRINCIPAL REGISTER**

THE MARK CONSISTS OF STANDARD CHARACTERS WITHOUT CLAIM TO ANY PARTICULAR FONT, STYLE, SIZE, OR COLOR.

SN 77-468,214, FILED 5-7-2008.

KIM MONINGHOFF, EXAMINING ATTORNEY



*David J. Kybas*

Director of the United States Patent and Trademark Office

# United States of America

United States Patent and Trademark Office

## MY STROKE OF INSIGHT

**Reg. No. 4,198,727**

**Registered Aug. 28, 2012**

**Int. Cl.: 38**

**SERVICE MARK**

**PRINCIPAL REGISTER**

MY STROKE OF INSIGHT INC. (INDIANA CORPORATION)  
PO BOX 1181  
BLOOMINGTON, IN 47402

FOR: STREAMING OF AUDIO MATERIAL ON THE INTERNET; STREAMING OF VIDEO MATERIAL ON THE INTERNET; PROVIDING ON-LINE ELECTRONIC BULLETIN BOARDS FOR TRANSMISSION OF MESSAGES AMONG COMPUTER USERS CONCERNING THINKING, REASONING, ACQUIRING AND APPLYING KNOWLEDGE, THE BRAIN, THE MIND, NEUROLOGY, HEALTH, WELLNESS, SPIRITUALITY, REHABILITATION, AND MEDICINE, IN CLASS 38 (U.S. CLS. 100, 101 AND 104).

FIRST USE 6-9-2008; IN COMMERCE 6-9-2008.

THE MARK CONSISTS OF STANDARD CHARACTERS WITHOUT CLAIM TO ANY PARTICULAR FONT, STYLE, SIZE, OR COLOR.

SN 77-469,233, FILED 5-8-2008.

LAURIE MAYES, EXAMINING ATTORNEY



*David J. Kyffers*

Director of the United States Patent and Trademark Office

# United States of America

United States Patent and Trademark Office

# [bu:st]

**Reg. No. 4,198,728**

**Registered Aug. 28, 2012**

**Int. Cls.: 9 and 35**

**TRADEMARK**

**SERVICE MARK**

**PRINCIPAL REGISTER**

[BU:ST] GMBH (FED REP GERMANY CORPORATION)  
BERATUNGSUNTERNEHMEN FÜR SYSTEME UND TEC  
HERRN TIM SIEVERS MARCEL-BREUER-STRASSE 15  
MUNCHEN, FED REP GERMANY 80807

FOR: COMPUTER SOFTWARE FOR BUSINESS PROCESS AND INFORMATION MANAGEMENT STORED ON DATA CARRIERS, IN CLASS 9 (U.S. CLS. 21, 23, 26, 36 AND 38).

FIRST USE 8-1-2009; IN COMMERCE 8-1-2009.

FOR: ADVERTISING, OFFICE WORK, NAMELY, PROJECT MANAGEMENT SERVICES TO ACHIEVE BUSINESS TARGETS OR IMPLEMENT PROCESSES OR PRODUCT IMPROVEMENTS, BUSINESS ADMINISTRATION AND MANAGEMENT, BUSINESS CONSULTING WITH REGARD TO ORGANIZATION AND RUNNING OF COMPANIES AND BUSINESS MARKETING SERVICES OF TECHNOLOGY, ALL IN THE AUTOMOBILE INDUSTRY AND AUTOMOBILE-SUPPLY INDUSTRY AND IN THE FIELDS OF TELECOMMUNICATIONS, ELECTRICAL ENGINEERING, MECHANICAL ENGINEERING AND PLANT ENGINEERING, IN CLASS 35 (U.S. CLS. 100, 101 AND 102).

FIRST USE 8-1-2009; IN COMMERCE 8-1-2009.

THE MARK CONSISTS OF STANDARD CHARACTERS WITHOUT CLAIM TO ANY PARTICULAR FONT, STYLE, SIZE, OR COLOR.

SN 77-476,574, FILED 5-16-2008.

BARBARA BROWN, EXAMINING ATTORNEY



*David J. Kyjars*

Director of the United States Patent and Trademark Office

# United States of America

United States Patent and Trademark Office

[ə]

**Reg. No. 4,198,729**

**Registered Aug. 28, 2012**

**Int. Cls.: 9 and 35**

**TRADEMARK**

**SERVICE MARK**

**PRINCIPAL REGISTER**

[BU:ST] GMBH (FED REP GERMANY CORPORATION)  
BERATUNGSUNTERNEHMEN FÜR SYSTEME UND TEC  
HERRN TIM SIEVERS MARCEL-BREUER-STRASSE15  
MUNCHEN, FED REP GERMANY 80807

FOR: COMPUTER SOFTWARE FOR BUSINESS PROCESS AND INFORMATION MANAGEMENT STORED ON DATA CARRIERS, IN CLASS 9 (U.S. CLS. 21, 23, 26, 36 AND 38).

FIRST USE 8-1-2009; IN COMMERCE 8-1-2009.

FOR: ADVERTISING, OFFICE WORK, NAMELY, PROJECT MANAGEMENT SERVICES TO ACHIEVE BUSINESS TARGETS OR IMPLEMENT PROCESSES OR PRODUCT IMPROVEMENTS, BUSINESS ADMINISTRATION AND MANAGEMENT, BUSINESS CONSULTING WITH REGARD TO ORGANIZATION AND RUNNING OF COMPANIES AND BUSINESS MARKETING SERVICES OF TECHNOLOGY, ALL IN THE AUTOMOBILE INDUSTRY AND AUTOMOBILE-SUPPLY INDUSTRY AND IN THE FIELDS OF TELECOMMUNICATIONS, ELECTRICAL ENGINEERING, MECHANICAL ENGINEERING AND PLANT ENGINEERING, IN CLASS 35 (U.S. CLS. 100, 101 AND 102).

FIRST USE 8-1-2009; IN COMMERCE 8-1-2009.

THE MARK CONSISTS OF AN THE UPSIDEDOWN LETTER "E" WITHIN BRACKETS.

SN 77-476,713, FILED 5-16-2008.

BARBARA BROWN, EXAMINING ATTORNEY



*David J. Kyffers*

Director of the United States Patent and Trademark Office

# United States of America

United States Patent and Trademark Office



**Reg. No. 4,198,730**

**Registered Aug. 28, 2012**

**Int. Cl.: 14**

**TRADEMARK**

**PRINCIPAL REGISTER**

PUSSYCAT DOLLS, LLC (DELAWARE LIMITED LIABILITY COMPANY)  
2220 COLORADO AVENUE  
C/O UMG RECORDINGS, INC.  
SANTA MONICA, CA 90404

FOR: JEWELRY, IN CLASS 14 (U.S. CLS. 2, 27, 28 AND 50).

FIRST USE 9-1-2005; IN COMMERCE 9-1-2005.

THE MARK CONSISTS OF THE WORDS "PUSSYCAT DOLLS" WITHIN A HEART, WITH THE WORD "PUSSYCAT" PLACED ON A BANNER DISPLAYED ACROSS THE UPPER PART OF THE HEART, THE WORD "DOLLS" DISPLAYED ON THE HEART UNDER THE BANNER AND AN ORNAMENTAL DESIGN ON THE TOP OF THE HEART.

SN 77-480,368, FILED 5-21-2008.

RAMONA ORTIGA, EXAMINING ATTORNEY



*David J. Kybas*

Director of the United States Patent and Trademark Office

# United States of America

United States Patent and Trademark Office

## ECOMOTORS INTERNATIONAL

**Reg. No. 4,198,731**

**Registered Aug. 28, 2012**

**Int. Cl.: 12**

**TRADEMARK**

**PRINCIPAL REGISTER**

ECOMOTORS, INC. (DELAWARE CORPORATION)  
SUITE 100  
2401 W. BIG BEAVER ROAD  
TROY, MI 48084

FOR: LAND VEHICLES AND STRUCTURAL PARTS THEREFORE; LAND VEHICLES, NAMELY, AUTOMOBILES, TRUCKS, MOTORCYCLES; ENGINES FOR LAND VEHICLES; PARTS AND COMPONENTS FOR LAND VEHICLES, NAMELY, AXLES, DRIVE GEARS, AND TRANSMISSIONS; LAND VEHICLE POWER TRAIN SYSTEMS COMPRISED OF ENGINES, DRIVESHAFTS, AXLES, AND TRANSMISSIONS, IN CLASS 12 (U.S. CLS. 19, 21, 23, 31, 35 AND 44).

FIRST USE 5-31-2012; IN COMMERCE 5-31-2012.

THE MARK CONSISTS OF STANDARD CHARACTERS WITHOUT CLAIM TO ANY PARTICULAR FONT, STYLE, SIZE, OR COLOR.

NO CLAIM IS MADE TO THE EXCLUSIVE RIGHT TO USE "INTERNATIONAL", APART FROM THE MARK AS SHOWN.

SN 77-485,029, FILED 5-28-2008.

MARILYN IZZI, EXAMINING ATTORNEY



*David J. Kybas*

Director of the United States Patent and Trademark Office



# United States of America

United States Patent and Trademark Office

# LIVIBRANCE

**Reg. No. 4,198,732**

**Registered Aug. 28, 2012**

**Int. Cls.: 14 and 25**

**TRADEMARK**

**PRINCIPAL REGISTER**

LIVIBRANCE CENTER, LLC (FLORIDA LIMITED LIABILITY COMPANY)  
200 BEACH DRIVE NE UNIT #9  
ST. PETERSBURG, FL 33701

FOR: JEWELRY, IN CLASS 14 (U.S. CLS. 2, 27, 28 AND 50).

FIRST USE 6-10-2012; IN COMMERCE 6-10-2012.

FOR: CLOTHING, NAMELY, SHIRTS, T-SHIRTS, HATS, CAPS AND BANDANAS, IN CLASS 25 (U.S. CLS. 22 AND 39).

FIRST USE 6-10-2012; IN COMMERCE 6-10-2012.

THE MARK CONSISTS OF STANDARD CHARACTERS WITHOUT CLAIM TO ANY PARTICULAR FONT, STYLE, SIZE, OR COLOR.

SN 77-496,203, FILED 6-11-2008.

PAUL E. FAHRENKOPF, EXAMINING ATTORNEY



*David J. Kyffers*

Director of the United States Patent and Trademark Office

# United States of America

United States Patent and Trademark Office

## TIOGA ENERGY

**Reg. No. 4,198,733**

**Registered Aug. 28, 2012**

**Int. Cl.: 40**

**SERVICE MARK**

**PRINCIPAL REGISTER**

TIOGA ENERGY, INC. (DELAWARE CORPORATION)  
123 MISSION STREET  
9TH FLOOR  
SAN FRANCISCO, CA 94105

FOR: PRODUCTION OF ENERGY IN THE FIELDS OF RENEWABLE ENERGY, ENERGY EFFICIENCY, ENERGY MANAGEMENT, AND DISTRIBUTED POWER GENERATION SYSTEMS; LEASING ELECTRICITY GENERATING SYSTEMS, IN CLASS 40 (U.S. CLS. 100, 103 AND 106).

FIRST USE 12-0-2008; IN COMMERCE 7-0-2010.

THE MARK CONSISTS OF STANDARD CHARACTERS WITHOUT CLAIM TO ANY PARTICULAR FONT, STYLE, SIZE, OR COLOR.

NO CLAIM IS MADE TO THE EXCLUSIVE RIGHT TO USE "ENERGY", APART FROM THE MARK AS SHOWN.

SN 77-500,298, FILED 6-16-2008.

PAUL E. FAHRENKOPF, EXAMINING ATTORNEY



*David J. Kyffers*

Director of the United States Patent and Trademark Office

# United States of America

United States Patent and Trademark Office

## TIOGA ENERGY

**Reg. No. 4,198,734**

**Registered Aug. 28, 2012**

**Int. Cl.: 39**

**SERVICE MARK**

**PRINCIPAL REGISTER**

TIOGA ENERGY, INC. (DELAWARE CORPORATION)  
123 MISSION STREET  
9TH FLOOR  
SAN FRANCISCO, CA 94105

FOR: TRANSMITTING AND DISTRIBUTING POWER UTILIZING RENEWABLE ENERGY, ENERGY EFFICIENCY, ENERGY MANAGEMENT, AND DISTRIBUTED POWER GENERATION SYSTEMS, IN CLASS 39 (U.S. CLS. 100 AND 105).

FIRST USE 12-0-2008; IN COMMERCE 7-0-2010.

THE MARK CONSISTS OF STANDARD CHARACTERS WITHOUT CLAIM TO ANY PARTICULAR FONT, STYLE, SIZE, OR COLOR.

NO CLAIM IS MADE TO THE EXCLUSIVE RIGHT TO USE "ENERGY", APART FROM THE MARK AS SHOWN.

SN 77-500,307, FILED 6-16-2008.

PAUL E. FAHRENKOPF, EXAMINING ATTORNEY



*David J. Kyros*

Director of the United States Patent and Trademark Office

# United States of America

United States Patent and Trademark Office

# SUREPATH

**Reg. No. 4,198,735**

**Registered Aug. 28, 2012**

**Int. Cl.: 40**

**SERVICE MARK**

**PRINCIPAL REGISTER**

TIOGA ENERGY, INC. (DELAWARE CORPORATION)  
123 MISSION STREET  
9TH FLOOR  
SAN FRANCISCO, CA 94105

FOR: OPERATION OF RENEWABLE ENERGY, ENERGY EFFICIENCY, ENERGY MANAGEMENT, AND DISTRIBUTED POWER GENERATION SYSTEMS; LEASING ELECTRICITY GENERATING SYSTEMS, IN CLASS 40 (U.S. CLS. 100, 103 AND 106).

FIRST USE 12-0-2008; IN COMMERCE 7-0-2010.

THE MARK CONSISTS OF STANDARD CHARACTERS WITHOUT CLAIM TO ANY PARTICULAR FONT, STYLE, SIZE, OR COLOR.

SN 77-500,311, FILED 6-16-2008.

PAUL E. FAHRENKOPF, EXAMINING ATTORNEY



*David J. Kybas*

Director of the United States Patent and Trademark Office

# United States of America

United States Patent and Trademark Office

# SUREPATH

**Reg. No. 4,198,736**

**Registered Aug. 28, 2012**

**Int. Cl.: 39**

**SERVICE MARK**

**PRINCIPAL REGISTER**

TIOGA ENERGY, INC. (DELAWARE CORPORATION)  
123 MISSION STREET  
9TH FLOOR  
SAN FRANCISCO, CA 94105

FOR: TRANSMITTING AND DISTRIBUTING POWER UTILIZING RENEWABLE ENERGY, ENERGY EFFICIENCY, ENERGY MANAGEMENT, AND DISTRIBUTED POWER GENERATION SYSTEMS, IN CLASS 39 (U.S. CLS. 100 AND 105).

FIRST USE 12-0-2008; IN COMMERCE 7-0-2010.

THE MARK CONSISTS OF STANDARD CHARACTERS WITHOUT CLAIM TO ANY PARTICULAR FONT, STYLE, SIZE, OR COLOR.

SN 77-500,315, FILED 6-16-2008.

PAUL E. FAHRENKOPF, EXAMINING ATTORNEY



*David J. Kybas*

Director of the United States Patent and Trademark Office

# United States of America

United States Patent and Trademark Office

## WORDSPOTTER

**Reg. No. 4,198,737**

**Registered Aug. 28, 2012**

**Int. Cls.: 9, 38, and 42**

**TRADEMARK**

**SERVICE MARK**

**PRINCIPAL REGISTER**

SCTI HOLDINGS, INC. (DELAWARE CORPORATION)  
8630 FENTON STREET  
#520  
SILVER SPRING, MD 20910

FOR: COMPUTER HARDWARE, SOFTWARE AND PROGRAMS FOR MANAGEMENT, RECORDING AND DELIVERY OF AUDIO FOR LIVE CONTINUOUS SPEECH, IN CLASS 9 (U.S. CLS. 21, 23, 26, 36 AND 38).

FIRST USE 6-15-2012; IN COMMERCE 6-15-2012.

FOR: PROVIDING EQUIPMENT FOR THE ELECTRONIC AND DIGITAL TRANSMISSION OF AUDIO SIGNALS FOR LIVE CONTINUOUS SPEECH, IN CLASS 38 (U.S. CLS. 100, 101 AND 104).

FIRST USE 6-15-2012; IN COMMERCE 6-15-2012.

FOR: COMPUTER SERVICES, NAMELY, REMOTE AND ON-SITE MANAGEMENT OF COMPUTER APPLICATIONS FOR OTHERS IN THE FIELD OF MANAGEMENT, RECORDING AND DELIVERY OF AUDIO FOR LIVE CONTINUOUS SPEECH , IN CLASS 42 (U.S. CLS. 100 AND 101).

FIRST USE 6-15-2012; IN COMMERCE 6-15-2012.

THE MARK CONSISTS OF STANDARD CHARACTERS WITHOUT CLAIM TO ANY PARTICULAR FONT, STYLE, SIZE, OR COLOR.

SN 77-503,012, FILED 6-19-2008.

GEOFFREY FOSDICK, EXAMINING ATTORNEY



*David J. Kypos*

Director of the United States Patent and Trademark Office

# United States of America

United States Patent and Trademark Office



**Reg. No. 4,198,738**

**Registered Aug. 28, 2012**

**Int. Cl.: 40**

**SERVICE MARK**

**PRINCIPAL REGISTER**

TIOGA ENERGY, INC. (DELAWARE CORPORATION)  
123 MISSION STREET  
9TH FLOOR  
SAN FRANCISCO, CA 94105

FOR: PRODUCTION OF ENERGY IN THE FIELDS OF RENEWABLE ENERGY, ENERGY EFFICIENCY, ENERGY MANAGEMENT, AND DISTRIBUTED POWER GENERATION SYSTEMS; LEASING ELECTRICITY GENERATING SYSTEMS, IN CLASS 40 (U.S. CLS. 100, 103 AND 106).

FIRST USE 12-0-2008; IN COMMERCE 7-0-2010.

THE MARK CONSISTS OF A SQUARE BOX DIVIDED VERTICALLY INTO 4 SEPARATE CURVED SECTIONS.

SN 77-504,190, FILED 6-20-2008.

PAUL E. FAHRENKOPF, EXAMINING ATTORNEY



*David J. Kybas*

Director of the United States Patent and Trademark Office

# United States of America

United States Patent and Trademark Office

# Wellosophy

**Reg. No. 4,198,739**

WELLOSOPHY CORPORATION (FLORIDA CORPORATION)  
2795 E. BIDWELL STREET, SUITE 100-220  
FOLSOM, CA 95630

**Registered Aug. 28, 2012**

**Int. Cl.: 5**

FOR: THERAPEUTIC AGENTS FOR WEIGHT CONTROL AND APPETITE SUPPRESSION,  
IN CLASS 5 (U.S. CLS. 6, 18, 44, 46, 51 AND 52).

**TRADEMARK**

FIRST USE 7-1-2008; IN COMMERCE 7-1-2008.

**PRINCIPAL REGISTER**

THE MARK CONSISTS OF STANDARD CHARACTERS WITHOUT CLAIM TO ANY PAR-  
TICULAR FONT, STYLE, SIZE, OR COLOR.

SN 77-506,084, FILED 6-24-2008.

ALEXANDER L. POWERS, EXAMINING ATTORNEY



*David J. Kybas*

Director of the United States Patent and Trademark Office



# United States of America

United States Patent and Trademark Office

## MIRACLE ON ICE

**Reg. No. 4,198,740**

USA HOCKEY, INC. (D.C. NON-PROFIT CORPORATION)  
1775 BOB JOHNSON DRIVE  
COLORADO SPRINGS, CO 80906

**Registered Aug. 28, 2012**

**Int. Cl.: 28**

FOR: HOCKEY EQUIPMENT IN THE NATURE OF STICKS, PUCKS, IN CLASS 28 (U.S. CLS. 22, 23, 38 AND 50).

**TRADEMARK**

FIRST USE 6-1-2012; IN COMMERCE 6-1-2012.

**PRINCIPAL REGISTER**

THE MARK CONSISTS OF STANDARD CHARACTERS WITHOUT CLAIM TO ANY PARTICULAR FONT, STYLE, SIZE, OR COLOR.

OWNER OF U.S. REG. NO. 3,101,193.

SN 77-506,795, FILED 6-24-2008.

ANN E. SAPPENFIELD, EXAMINING ATTORNEY



*David J. Kybas*

Director of the United States Patent and Trademark Office

# United States of America

United States Patent and Trademark Office

## PROMETRIC



**Reg. No. 4,198,741**

**Registered Aug. 28, 2012**

**Int. Cl.: 16**

**TRADEMARK**

**PRINCIPAL REGISTER**

PROMETRIC INC. (DELAWARE CORPORATION)  
1501 S. CLINTON STREET  
BALTIMORE, MD 21224

FOR: PRINTED EDUCATIONAL PUBLICATIONS FOR USE IN TECHNICAL TRAINING SKILLS ASSESSMENT PROGRAM, NAMELY, HANDBOOKS, BROCHURES, PAMPHLETS, PRINTED FORMS, SCORE-REPORTING FORMS, PRINTED REPORTS, BULLETINS, NEWSLETTERS, MAGAZINES, STUDY GUIDES, PRINTED INFORMATIONAL FOLDERS, AND PRINTED INFORMATIONAL BINDERS, ALL IN THE FIELD OF VOCATIONAL SKILLS TESTING, VOCATIONAL SKILLS TEST DEVELOPMENT, VOCATIONAL SKILLS TEST DELIVERY AND VOCATIONAL SKILLS TEST ASSESSMENT, IN CLASS 16 (U.S. CLS. 2, 5, 22, 23, 29, 37, 38 AND 50).

FIRST USE 4-0-2008; IN COMMERCE 4-0-2008.

OWNER OF U.S. REG. NO. 2,276,211.

THE COLOR(S) GRAY AND GREEN IS/ARE CLAIMED AS A FEATURE OF THE MARK.

THE MARK CONSISTS OF THE MARK "PROMETRIC" IN GRAY AND THE RADIANT BURST IN GREEN.

SN 77-508,657, FILED 6-26-2008.

B. PARADEWELAI, EXAMINING ATTORNEY



*David J. Kyffers*

Director of the United States Patent and Trademark Office

# United States of America

United States Patent and Trademark Office

## CELFIN CAPITAL

**Reg. No. 4,198,742**

**Registered Aug. 28, 2012**

**Int. Cl.: 36**

**SERVICE MARK**

**PRINCIPAL REGISTER**

INVERSIONES CELFIN CAPITAL S.A. (CHILE CORPORATION)  
PISO 19  
APOQUINDO NO. 3721  
LAS CONDES, CHILE

FOR: FINANCIAL AND INVESTMENT SERVICES, NAMELY, MANAGEMENT AND BROKERAGE IN THE FIELDS OF STOCKS, BONDS, OPTIONS, COMMODITIES, FUTURES AND OTHER SECURITIES, INVESTMENT OF FUNDS OF OTHERS, IN CLASS 36 (U.S. CLS. 100, 101 AND 102).

FIRST USE 11-30-2011; IN COMMERCE 11-30-2011.

THE MARK CONSISTS OF STANDARD CHARACTERS WITHOUT CLAIM TO ANY PARTICULAR FONT, STYLE, SIZE, OR COLOR.

NO CLAIM IS MADE TO THE EXCLUSIVE RIGHT TO USE "CAPITAL", APART FROM THE MARK AS SHOWN.

THE WORDING "CELFIN" HAS NO MEANING IN A FOREIGN LANGUAGE.

SN 77-512,643, FILED 7-1-2008.

JACQUELINE A. LAVINE, EXAMINING ATTORNEY



*David J. Kybas*

Director of the United States Patent and Trademark Office

# United States of America

United States Patent and Trademark Office

# CELFIN

**Reg. No. 4,198,743**

**Registered Aug. 28, 2012**

**Int. Cl.: 36**

**SERVICE MARK**

**PRINCIPAL REGISTER**

INVERSIONES CELFIN CAPITAL S.A. (CHILE CORPORATION)  
PISO 19  
APOQUINDO NO. 3721  
LAS CONDES, CHILE

FOR: FINANCIAL AND INVESTMENT SERVICES, NAMELY, MANAGEMENT AND BROKERAGE IN THE FIELDS OF STOCKS, BONDS, OPTIONS, COMMODITIES, FUTURES AND OTHER SECURITIES, INVESTMENT OF FUNDS OF OTHERS, IN CLASS 36 (U.S. CLS. 100, 101 AND 102).

FIRST USE 11-0-2011; IN COMMERCE 11-0-2011.

THE MARK CONSISTS OF STANDARD CHARACTERS WITHOUT CLAIM TO ANY PARTICULAR FONT, STYLE, SIZE, OR COLOR.

THE MARK "CELFIN" HAS NO MEANING IN A FOREIGN LANGUAGE.

SN 77-512,659, FILED 7-1-2008.

JACQUELINE A. LAVINE, EXAMINING ATTORNEY



*David J. Kybas*

Director of the United States Patent and Trademark Office

# United States of America

United States Patent and Trademark Office

# ROO

**Reg. No. 4,198,744**

EDWARDS, LUKE J (AUSTRALIA INDIVIDUAL)  
6/30 SEYMOUR ROAD, HAMILTON  
BRISBANE, QUEENSLAND, AUSTRALIA 4007

**Registered Aug. 28, 2012**

**Int. Cl.: 9**

FOR: CASES FOR SPECTACLES AND SUNGLASSES, IN CLASS 9 (U.S. CLS. 21, 23, 26, 36 AND 38).

**TRADEMARK**

FIRST USE 6-11-2012; IN COMMERCE 6-11-2012.

**PRINCIPAL REGISTER**

THE MARK CONSISTS OF STANDARD CHARACTERS WITHOUT CLAIM TO ANY PARTICULAR FONT, STYLE, SIZE, OR COLOR.

SN 77-523,127, FILED 7-16-2008.

KAPIL BHANOT, EXAMINING ATTORNEY



*David J. Kybas*

Director of the United States Patent and Trademark Office

# United States of America

United States Patent and Trademark Office

# ROAD RAGE

**Reg. No. 4,198,745**

**Registered Aug. 28, 2012**

**Int. Cl.: 37**

**SERVICE MARK**

**PRINCIPAL REGISTER**

MELLION, MICHAEL (UNITED STATES INDIVIDUAL)  
7028 MEANDERING STREAM WAY  
FULTON, MD 20759

FOR: AUTOMOBILE DETAILING; INSTALLATION, MAINTENANCE AND REPAIR OF AUTOMOBILES, AUTO PARTS, AND AUTO ACCESSORIES, IN CLASS 37 (U.S. CLS. 100, 103 AND 106).

FIRST USE 5-14-2012; IN COMMERCE 5-14-2012.

THE MARK CONSISTS OF STANDARD CHARACTERS WITHOUT CLAIM TO ANY PARTICULAR FONT, STYLE, SIZE, OR COLOR.

SN 77-527,180, FILED 7-21-2008.

GINA HAYES, EXAMINING ATTORNEY



*David J. Kyffers*

Director of the United States Patent and Trademark Office

# United States of America

United States Patent and Trademark Office



**Reg. No. 4,198,746**

**Registered Aug. 28, 2012**

**Int. Cl.: 30**

**TRADEMARK**

**PRINCIPAL REGISTER**

REVOLUTION FOODS, INC. (DELAWARE CORPORATION)  
8383 CAPWELL DRIVE  
OAKLAND, CA 94621

FOR: FOOD PRODUCTS, NAMELY, BREAKFAST CEREALS, PREPARED MEALS, PROCESSED MEALS, DRIED MEALS, COOKED MEALS CONSISTING PRIMARILY OF RICE, NOODLES, DUMPLINGS AND PASTA, IN CLASS 30 (U.S. CL. 46).

FIRST USE 8-27-2007; IN COMMERCE 4-1-2008.

OWNER OF U.S. REG. NO. 3,473,564.

NO CLAIM IS MADE TO THE EXCLUSIVE RIGHT TO USE "FOODS", APART FROM THE MARK AS SHOWN.

THE MARK CONSISTS OF A HUMAN FIGURE AND AN APPLE, WITH THE WORDS "REVOLUTION FOODS".

SN 77-528,487, FILED 7-22-2008.

VIVIAN MICZNIK FIRST, EXAMINING ATTORNEY



*David J. Kybas*

Director of the United States Patent and Trademark Office

# United States of America

United States Patent and Trademark Office

## THREE RUBYS

**Reg. No. 4,198,747**

ELSENER, PAUL (UNITED STATES INDIVIDUAL)

**Registered Aug. 28, 2012**

63 SOUTH ROAD  
FARMINGTON, CT 06030

**Int. Cl.: 14**

FOR: GEMSTONES, NAMELY, RUBIES SOLD AS A COMPONENT OF JEWELRY, WHICH MAY CONTAIN OTHER PRECIOUS OR NON-PRECIOUS STONES, IN CLASS 14 (U.S. CLS. 2, 27, 28 AND 50).

**TRADEMARK**

FIRST USE 8-13-2011; IN COMMERCE 8-25-2011.

**PRINCIPAL REGISTER**

THE MARK CONSISTS OF STANDARD CHARACTERS WITHOUT CLAIM TO ANY PARTICULAR FONT, STYLE, SIZE, OR COLOR.

NO CLAIM IS MADE TO THE EXCLUSIVE RIGHT TO USE "RUBIES", APART FROM THE MARK AS SHOWN.

SN 77-538,050, FILED 8-4-2008.

HEATHER THOMPSON, EXAMINING ATTORNEY



*David J. Kyffers*

Director of the United States Patent and Trademark Office



# United States of America

United States Patent and Trademark Office

# CL

**Reg. No. 4,198,748**

CRAIGSLIST, INC. (DELAWARE CORPORATION)  
1381 9TH AVENUE  
SAN FRANCISCO, CA 94122

**Registered Aug. 28, 2012**

**Int. Cl.: 38**

FOR: PROVIDING ONLINE INTERACTIVE BULLETIN BOARDS FOR TRANSMISSION OF MESSAGES AMONG COMPUTER USERS CONCERNING CLASSIFIED LISTINGS AND LISTINGS FOR ANNOUNCEMENTS, EVENTS, CLASSES, MEETINGS, ACTIVITIES, HOUSING, REAL ESTATE, ROOMMATES, RENTALS, FOR SALE ADVERTISEMENTS, WANT ADS, EMPLOYMENT, RESUMES, VOLUNTEERISM, SERVICES, COMMUNITY, PERSONALS, POLITICS, FAMILY, ARTS AND INFORMATION ON A WIDE VARIETY OF TOPICS OF GENERAL INTEREST TO THE PUBLIC; PROVIDING ON-LINE FORUMS AND DISCUSSION GROUPS FOR TRANSMISSION OF MESSAGES AMONG COMPUTER USERS CONCERNING HEALTH, FAMILY, ARTS, POLITICS, LEISURE, ROMANCE, WORK, AND INFORMATION ON A WIDE VARIETY OF TOPICS OF GENERAL INTEREST TO THE PUBLIC; ELECTRONIC MAIL SERVICES; ELECTRONIC MAIL SUBSCRIPTION SERVICES; AND ELECTRONIC TRANSMISSION OF MESSAGES, DATA AND IMAGES, IN CLASS 38 (U.S. CLS. 100, 101 AND 104).

**SERVICE MARK**

**PRINCIPAL REGISTER**

FIRST USE 11-4-2005; IN COMMERCE 11-4-2005.

THE MARK CONSISTS OF STANDARD CHARACTERS WITHOUT CLAIM TO ANY PARTICULAR FONT, STYLE, SIZE, OR COLOR.

SN 77-539,831, FILED 8-5-2008.

BRENDAN MCCAULEY, EXAMINING ATTORNEY



*David J. Kyjars*

Director of the United States Patent and Trademark Office

# United States of America

United States Patent and Trademark Office

## VERDANT COUTURE

**Reg. No. 4,198,749**

WATKINS, MICHAEL (UNITED STATES INDIVIDUAL)  
27 RODE DRIVE  
ROCHESTER, NY 14622

**Registered Aug. 28, 2012**

**Int. Cls.: 18 and 25**

FOR: PURSES, HANDBAGS, IN CLASS 18 (U.S. CLS. 1, 2, 3, 22 AND 41).

**TRADEMARK**

FIRST USE 5-31-2012; IN COMMERCE 5-31-2012.

**PRINCIPAL REGISTER**

FOR: CLOTHING, NAMELY, SKIRTS, SHIRTS, SWEATSHIRTS, VESTS, BLAZERS, DRESSES, JEANS; CLOTHING ACCESSORIES, NAMELY, BELTS, SCARVES AND SHAWLS, IN CLASS 25 (U.S. CLS. 22 AND 39).

FIRST USE 5-31-2012; IN COMMERCE 5-31-2012.

THE MARK CONSISTS OF STANDARD CHARACTERS WITHOUT CLAIM TO ANY PARTICULAR FONT, STYLE, SIZE, OR COLOR.

NO CLAIM IS MADE TO THE EXCLUSIVE RIGHT TO USE "COUTURE", APART FROM THE MARK AS SHOWN.

SN 77-549,388, FILED 8-18-2008.

BILL DAWE, EXAMINING ATTORNEY



*David J. Kyffers*

Director of the United States Patent and Trademark Office

# United States of America

United States Patent and Trademark Office



**Reg. No. 4,198,750**

DENTALAPPOINTMENT.COM LLC (TEXAS LIMITED LIABILITY COMPANY)  
6527 HOLDEN MILLS DRIVE  
SPRING, TX 77389

**Registered Aug. 28, 2012**

**Int. Cl.: 35**

FOR: PROVIDING A WEB SITE FOR DENTAL PROFESSIONALS TO MANAGE SCHEDULES AND APPOINTMENTS AND FOR PATIENTS TO LOCATE DENTISTS AND SCHEDULE APPOINTMENTS, IN CLASS 35 (U.S. CLS. 100, 101 AND 102).

**SERVICE MARK**

FIRST USE 5-24-2012; IN COMMERCE 5-24-2012.

**PRINCIPAL REGISTER**

NO CLAIM IS MADE TO THE EXCLUSIVE RIGHT TO USE "DENTALAPPOINTMENT.COM", APART FROM THE MARK AS SHOWN.

THE STIPPLING IS FOR SHADING PURPOSES ONLY.

THE MARK CONSISTS OF THE STYLIZED WORDS "DENTALAPPOINTMENT.COM". TO THE LEFT OF THE STYLIZED WORDS IS AN IMAGE OF A TOOTH WITH A COMPUTER AND A STYLIZED PEN POINTING ON THE TOOTH WITH A BACKGROUND PAPER.

SN 77-552,301, FILED 8-21-2008.

REBECCA SMITH, EXAMINING ATTORNEY



*David J. Kyros*

Director of the United States Patent and Trademark Office

# United States of America

United States Patent and Trademark Office

## AVALANCHE TECHNOLOGY

**Reg. No. 4,198,751**

**Registered Aug. 28, 2012**

**Int. Cls.: 9 and 42**

**TRADEMARK**

**SERVICE MARK**

**PRINCIPAL REGISTER**

AVALANCHE TECHNOLOGY, INC. (DELAWARE CORPORATION)  
48371 FREMONT BLVD.  
SUITE 101  
FREMONT, CA 94538

FOR: ELECTRONIC MEMORY UNITS AND PRODUCTS, NAMELY, MAGNETIC MEMORY UNITS, NON-VOLATILE MEMORY UNITS, VOLATILE MEMORY UNITS; COMPUTER MEMORY HARDWARE; SOFTWARE FOR CONTROLLING UNITS EMPLOYING ELECTRONIC MEMORY; SOFTWARE FOR CONTROLLING ELECTRONIC MEMORY UNITS; SOFTWARE FOR CONTROLLING MAGNETIC MEMORY UNITS; COMPUTER HARDWARE USING ELECTRONIC MEMORY UNITS; ELECTRONIC STORAGE USING ELECTRONIC MEMORY UNITS, NAMELY, MAGNETIC MEMORY, NON-VOLATILE MEMORY, AND VOLATILE MEMORY; ELECTRONIC MEMORY MEDIA, NAMELY, MAGNETIC MEMORY, NON-VOLATILE MEMORY AND VOLATILE MEMORY, IN CLASS 9 (U.S. CLS. 21, 23, 26, 36 AND 38).

FIRST USE 11-28-2011; IN COMMERCE 11-28-2011.

FOR: SEMICONDUCTOR SERVICES, NAMELY, DESIGN AND DEVELOPMENT OF COMPUTER HARDWARE, NAMELY, DESIGN AND DEVELOPMENT OF ELECTRONIC MEMORY UNITS AND PRODUCTS, NAMELY, MAGNETIC MEMORY UNITS, NON-VOLATILE MEMORY UNITS, VOLATILE MEMORY UNITS; DESIGN AND DEVELOPMENT OF COMPUTER MEMORY HARDWARE; DESIGN AND DEVELOPMENT OF SOFTWARE FOR CONTROLLING UNITS EMPLOYING ELECTRONIC MEMORY; DESIGN AND DEVELOPMENT OF SOFTWARE FOR CONTROLLING ELECTRONIC MEMORY UNITS; DESIGN AND DEVELOPMENT OF SOFTWARE FOR CONTROLLING MAGNETIC MEMORY UNITS; DESIGN AND DEVELOPMENT OF COMPUTER HARDWARE USING ELECTRONIC MEMORY UNITS; DESIGN AND DEVELOPMENT OF ELECTRONIC STORAGE USING ELECTRONIC MEMORY UNITS, NAMELY, MAGNETIC MEMORY, NON-VOLATILE MEMORY, AND VOLATILE MEMORY; DESIGN AND DEVELOPMENT OF ELECTRONIC MEMORY MEDIA, NAMELY, MAGNETIC MEMORY, NON-VOLATILE MEMORY, AND VOLATILE MEMORY, IN CLASS 42 (U.S. CLS. 100 AND 101).

FIRST USE 4-20-2010; IN COMMERCE 4-20-2010.

THE MARK CONSISTS OF STANDARD CHARACTERS WITHOUT CLAIM TO ANY PARTICULAR FONT, STYLE, SIZE, OR COLOR.



*David J. Kappas*

Director of the United States Patent and Trademark Office

**Reg. No. 4,198,751** NO CLAIM IS MADE TO THE EXCLUSIVE RIGHT TO USE "TECHNOLOGIES", APART FROM THE MARK AS SHOWN.

SN 77-555,366, FILED 8-25-2008.

SUSAN LESLIE DUBOIS, EXAMINING ATTORNEY

# United States of America

United States Patent and Trademark Office



**Reg. No. 4,198,752**

**Registered Aug. 28, 2012**

**Int. Cl.: 3**

**TRADEMARK**

**PRINCIPAL REGISTER**

HOEFLER, CHRISTINA (UNITED STATES INDIVIDUAL)  
11625 FOWLERS MILL ROAD  
CHARDON, OH 44024

FOR: COSMETICS AND MAKE-UP; FRAGRANCES, IN CLASS 3 (U.S. CLS. 1, 4, 6, 50, 51 AND 52).

FIRST USE 4-3-2012; IN COMMERCE 4-3-2012.

THE STIPLING IS FOR SHADING PURPOSES ONLY.

THE MARK CONSISTS OF AN IMAGE OF A BANNER WITH THE STYLIZED WORDS "SOUL OF THE ROSE" ON IT. ABOVE THE BANNER IS AN IMAGE OF A HEART AS BACKGROUND TO A GUITAR WITH WINGS. THE GUITAR HAS A ROSE VINE THAT WRAPS AROUND THE BODY AND HANDLE.

SN 77-556,608, FILED 8-27-2008.

LINDA ESTRADA, EXAMINING ATTORNEY



*David J. Kybas*

Director of the United States Patent and Trademark Office

# United States of America

United States Patent and Trademark Office

# ELS STUDIO

**Reg. No. 4,198,753**

PANASONIC CORPORATION OF NORTH AMERICA (DELAWARE CORPORATION)  
ONE PANASONIC WAY - PANAZIP 3B-6  
SECAUCUS, NJ 07094

**Registered Aug. 28, 2012**

**Int. Cl.: 9**

FOR: AUTOMOTIVE AUDIO SYSTEMS, PRIMARILY COMPRISING AMPLIFIERS AND  
SPEAKERS, IN CLASS 9 (U.S. CLS. 21, 23, 26, 36 AND 38).

**TRADEMARK**

FIRST USE 10-15-2011; IN COMMERCE 3-1-2012.

**PRINCIPAL REGISTER**

THE MARK CONSISTS OF STANDARD CHARACTERS WITHOUT CLAIM TO ANY PAR-  
TICULAR FONT, STYLE, SIZE, OR COLOR.

OWNER OF U.S. REG. NO. 2,977,368.

SN 77-565,904, FILED 9-9-2008.

STEVEN R. FINE, EXAMINING ATTORNEY



*David J. Kybas*

Director of the United States Patent and Trademark Office

# United States of America

United States Patent and Trademark Office

## EZ Tax Forms

**Reg. No. 4,198,754**

COMPUTER FORMS, INC. (OREGON CORPORATION)  
PO BOX 23456  
PORTLAND, OR 97223

**Registered Aug. 28, 2012**

**Int. Cl.: 40**

FOR: PRINTING OF TAX FORMS, IN CLASS 40 (U.S. CLS. 100, 103 AND 106).

**SERVICE MARK**

FIRST USE 5-30-2012; IN COMMERCE 5-30-2012.

**PRINCIPAL REGISTER**

THE MARK CONSISTS OF STANDARD CHARACTERS WITHOUT CLAIM TO ANY PARTICULAR FONT, STYLE, SIZE, OR COLOR.

NO CLAIM IS MADE TO THE EXCLUSIVE RIGHT TO USE "TAX FORMS", APART FROM THE MARK AS SHOWN.

SN 77-566,468, FILED 9-10-2008.

LINDA MICKLEBURGH, EXAMINING ATTORNEY



*David J. Kyffers*

Director of the United States Patent and Trademark Office



# United States of America

United States Patent and Trademark Office

## GREEN BY CHOICE

**Reg. No. 4,198,755**

BLUE OCEAN PRESS, INC. (FLORIDA CORPORATION)  
6299 NW 27TH WAY

**Registered Aug. 28, 2012**

FORT LAUDERDALE, FL 33309

**Int. Cl.: 40**

FOR: CUSTOM MANUFACTURE OF PROMOTIONAL GOODS OF OTHERS SUCH AS COFFEE MUGS, KEY CHAINS, T-SHIRTS AND PENS, PRINTED MATTER, NAMELY, BOOKS, BROCHURES, MANUALS, LETTERHEAD, STATIONARY, AND BUSINESS CARDS USING ENVIRONMENTALLY FRIENDLY MANUFACTURING PROCESSES, IN CLASS 40 (U.S. CLS. 100, 103 AND 106).

**SERVICE MARK**

**PRINCIPAL REGISTER**

FIRST USE 0-0-2008; IN COMMERCE 0-0-2008.

THE MARK CONSISTS OF STANDARD CHARACTERS WITHOUT CLAIM TO ANY PARTICULAR FONT, STYLE, SIZE, OR COLOR.

NO CLAIM IS MADE TO THE EXCLUSIVE RIGHT TO USE "GREEN", APART FROM THE MARK AS SHOWN.

SN 77-567,373, FILED 9-11-2008.

EVELYN BRADLEY, EXAMINING ATTORNEY



*David J. Kyros*

Director of the United States Patent and Trademark Office

# United States of America

United States Patent and Trademark Office

## CRYOGENICS TECHNOLOGY MANAGEMENT

**Reg. No. 4,198,756**

WELDING COMPANY OF AMERICA (ILLINOIS CORPORATION)  
335 E. SULLIVAN ROAD  
AURORA, IL 60505

**Registered Aug. 28, 2012**

**Int. Cls.: 35 and 37**

FOR: WHOLESALE AND RETAIL STORE SERVICES FEATURING CRYOGENIC PUMPS, CRYOGENIC PUMP PARTS AND VAPORIZERS, IN CLASS 35 (U.S. CLS. 100, 101 AND 102).

**SERVICE MARK**

FIRST USE 1-0-2009; IN COMMERCE 1-0-2009.

**PRINCIPAL REGISTER**

FOR: INSTALLATION, REPAIR AND MAINTENANCE OF CRYOGENIC PUMPS, CRYOGENIC PUMP PARTS AND VAPORIZERS, IN CLASS 37 (U.S. CLS. 100, 103 AND 106).

FIRST USE 1-0-2009; IN COMMERCE 1-0-2009.

THE MARK CONSISTS OF STANDARD CHARACTERS WITHOUT CLAIM TO ANY PARTICULAR FONT, STYLE, SIZE, OR COLOR.

NO CLAIM IS MADE TO THE EXCLUSIVE RIGHT TO USE "CRYOGENICS", APART FROM THE MARK AS SHOWN.

SN 77-568,763, FILED 9-12-2008.

PAULA MAHONEY, EXAMINING ATTORNEY



*David J. Kybas*

Director of the United States Patent and Trademark Office

# United States of America

United States Patent and Trademark Office

## CHRISTIAN LACROIX

**Reg. No. 4,198,757**

**Registered Aug. 28, 2012**

**Int. Cl.: 27**

**TRADEMARK**

**PRINCIPAL REGISTER**

CHRISTIAN LACROIX, SNC (FRANCE SOCIÉTÉ EN NOM COLLECTIF (SNC))  
7 RUE HENRI ROCHEFORT  
CHRISTIAN LACROIX, SNC  
PARIS, FRANCE 75017

FOR: FABRIC WALL COVERINGS, NAMELY, CLOTH WALL COVERINGS, WALLPAPER,  
IN CLASS 27 (U.S. CLS. 19, 20, 37, 42 AND 50).

FIRST USE 1-31-2012; IN COMMERCE 1-31-2012.

THE MARK CONSISTS OF STANDARD CHARACTERS WITHOUT CLAIM TO ANY PAR-  
TICULAR FONT, STYLE, SIZE, OR COLOR.

OWNER OF U.S. REG. NO. 1,499,154.

THE NAME "CHRISTIAN LACROIX" IDENTIFIES A LIVING INDIVIDUAL WHOSE CON-  
SENT IS OF RECORD.

SN 77-571,030, FILED 9-16-2008.

ELIZABETH KAJUBI, EXAMINING ATTORNEY



*David J. Kybas*

Director of the United States Patent and Trademark Office

# United States of America

United States Patent and Trademark Office

# FRESH V

**Reg. No. 4,198,758**

**Registered Aug. 28, 2012**

**Int. Cl.: 32**

**TRADEMARK**

**PRINCIPAL REGISTER**

JOSEPH J. NORTON (UNITED STATES INDIVIDUAL)  
SUITE 2  
7701 GRAND RIVER  
BRIGHTON, MI 48114

FOR: BOTTLED WATER, FRUIT JUICE, VEGETABLE JUICE BEVERAGES AND FRUIT FLAVORED WATER, IN CLASS 32 (U.S. CLS. 45, 46 AND 48).

FIRST USE 1-1-2007; IN COMMERCE 1-1-2007.

THE MARK CONSISTS OF STANDARD CHARACTERS WITHOUT CLAIM TO ANY PARTICULAR FONT, STYLE, SIZE, OR COLOR.

NO CLAIM IS MADE TO THE EXCLUSIVE RIGHT TO USE "FRESH", APART FROM THE MARK AS SHOWN.

SN 77-573,387, FILED 9-18-2008.

CHRISTOPHER BUONGIORNO, EXAMINING ATTORNEY



*David J. Kybas*

Director of the United States Patent and Trademark Office

# United States of America

United States Patent and Trademark Office

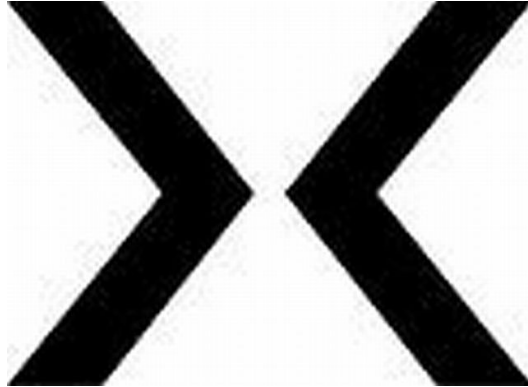

**Reg. No. 4,198,759**

**Registered Aug. 28, 2012**

**Int. Cl.: 9**

**TRADEMARK**

**PRINCIPAL REGISTER**

XACTWARE SOLUTIONS, INC. (DELAWARE CORPORATION)  
545 WASHINGTON BOULEVARD  
JERSEY CITY, NJ 07310

FOR: DOWNLOADABLE COMPUTER SOFTWARE THAT IS USED IN INSURANCE CLAIMS HANDLING AND THAT ALLOWS FOR INSURANCE CLAIMS PERSONNEL AND INSURANCE POLICYHOLDERS, NAMELY, TO PREPARE INSURANCE CLAIMS ESTIMATES FOR THE RESTORATION, REPAIR AND REPLACEMENT OF PROPERTY, TO AUDIT REPAIR ESTIMATES FOR ERRORS, TO PERFORM REAL-TIME EXCHANGE AND ANALYSIS OF PROPERTY VALUATION DATA AND INSURANCE CLAIMS ESTIMATES, TO COMPILE ACCURATE PROPERTY VALUATIONS BY CREATING REPLACEMENT COST ESTIMATES; COST ESTIMATION SOFTWARE TO ESTIMATE THE COST OF BUILDING, REMODELING, REPLACING OR REPAIRING STRUCTURES AND PROPERTY AND FOR THE INSURED REAL AND PERSONAL PROPERTY OF HOME OWNERS; GRAPHICS-BASED CONSTRUCTION ESTIMATION SOFTWARE TO ESTIMATE THE COST OF BUILDING OR REPAIRING STRUCTURES FOR USE BY THE CONSTRUCTION AND INSURANCE INDUSTRIES, IN CLASS 9 (U.S. CLS. 21, 23, 26, 36 AND 38).

FIRST USE 2-27-2012; IN COMMERCE 2-27-2012.

THE MARK CONSISTS OF THE LETTER "X" DEPICTED GEOMETRICALLY.

SN 77-574,794, FILED 9-19-2008.

CHERYL CLAYTON, EXAMINING ATTORNEY



*David J. Kyffers*

Director of the United States Patent and Trademark Office

# United States of America

United States Patent and Trademark Office

## VERY CHERRY

**Reg. No. 4,198,760**

MINT STUDIO LLC (OHIO LIMITED LIABILITY COMPANY)  
180 VARICK STREET  
NEW YORK, NY 10014

**Registered Aug. 28, 2012**

**Int. Cl.: 25**

FOR: FOOTWEAR, IN CLASS 25 (U.S. CLS. 22 AND 39).

**TRADEMARK**

FIRST USE 5-1-2012; IN COMMERCE 5-1-2012.

**PRINCIPAL REGISTER**

THE MARK CONSISTS OF STANDARD CHARACTERS WITHOUT CLAIM TO ANY PARTICULAR FONT, STYLE, SIZE, OR COLOR.

SN 77-576,777, FILED 9-23-2008.

ROBIN CHOSID, EXAMINING ATTORNEY



*David J. Kyffers*

Director of the United States Patent and Trademark Office

**United States of America**  
United States Patent and Trademark Office

**YUM YUM**

**Reg. No. 4,198,761**

BLUNT WRAP U.S.A., INC. (LOUISIANA CORPORATION)  
P.O. BOX 1935

**Registered Aug. 28, 2012**

MANDEVILLE, LA 70470

**Int. Cl.: 34**

FOR: TOBACCO PRODUCTS, ACCESSORIES, AND SMOKING ARTICLES, NAMELY, CIGARS, IN CLASS 34 (U.S. CLS. 2, 8, 9 AND 17).

**TRADEMARK**

FIRST USE 5-16-2012; IN COMMERCE 5-16-2012.

**PRINCIPAL REGISTER**

THE MARK CONSISTS OF STANDARD CHARACTERS WITHOUT CLAIM TO ANY PARTICULAR FONT, STYLE, SIZE, OR COLOR.

SN 77-582,751, FILED 9-30-2008.

CHERYL CLAYTON, EXAMINING ATTORNEY



*David J. Kyffers*

Director of the United States Patent and Trademark Office

# United States of America

United States Patent and Trademark Office

## CLEAN THE HANDS THAT TREAT THE WOUND

**Reg. No. 4,198,762**

GOJO INDUSTRIES, INC. (OHIO CORPORATION)  
ONE GOJO PLAZA, SUITE 500  
AKRON, OH 44311

**Registered Aug. 28, 2012**

**Int. Cl.: 5**

FOR: HAND SANITIZING AND DISINFECTING PREPARATION WITH ANTI-BACTERIAL AND ANTI-MICROBIAL PROPERTIES, IN CLASS 5 (U.S. CLS. 6, 18, 44, 46, 51 AND 52).

**TRADEMARK**

FIRST USE 10-29-2010; IN COMMERCE 3-16-2012.

**PRINCIPAL REGISTER**

THE MARK CONSISTS OF STANDARD CHARACTERS WITHOUT CLAIM TO ANY PARTICULAR FONT, STYLE, SIZE, OR COLOR.

SN 77-586,871, FILED 10-7-2008.

SANI KHOURI, EXAMINING ATTORNEY



*David J. Kyffers*

Director of the United States Patent and Trademark Office



# United States of America

United States Patent and Trademark Office

## VERICREST FINANCIAL

**Reg. No. 4,198,763**

**Registered Aug. 28, 2012**

**Int. Cl.: 36**

**SERVICE MARK**

**PRINCIPAL REGISTER**

VERICREST FINANCIAL, INC. (DELAWARE CORPORATION)  
2711 N. HASKELL AVENUE, SUITE 2150  
DALLAS, TX 75204

FOR: MORTGAGE BANKING; FINANCIAL VALUATION SERVICES, NAMELY, VALUATION AND APPRAISAL OF REAL ESTATE LOANS, REAL ESTATE AND PERSONAL PROPERTY SECURING LOANS, AND REAL ESTATE LOAN PORTFOLIOS; MORTGAGE BANKING SERVICES, NAMELY, ACQUISITION, SERVICING, SECURITIZATION OF MORTGAGE LOANS, IN CLASS 36 (U.S. CLS. 100, 101 AND 102).

FIRST USE 3-17-2009; IN COMMERCE 3-17-2009.

THE MARK CONSISTS OF STANDARD CHARACTERS WITHOUT CLAIM TO ANY PARTICULAR FONT, STYLE, SIZE, OR COLOR.

NO CLAIM IS MADE TO THE EXCLUSIVE RIGHT TO USE "FINANCIAL", APART FROM THE MARK AS SHOWN.

SN 77-591,594, FILED 10-13-2008.

DARRYL SPRUILL, EXAMINING ATTORNEY



*David J. Kyfos*

Director of the United States Patent and Trademark Office

United States of America  
United States Patent and Trademark Office

# VERICREST

**Reg. No. 4,198,764**

VERICREST FINANCIAL, INC. (DELAWARE CORPORATION)

**Registered Aug. 28, 2012**

2711 N. HASKELL AVENUE, SUITE 2150  
DALLAS, TX 75204

**Int. Cl.: 36**

FOR: MORTGAGE BANKING; FINANCIAL VALUATION SERVICES, NAMELY, VALUATION AND APPRAISAL OF REAL ESTATE LOANS, REAL ESTATE AND PERSONAL PROPERTY SECURING LOANS, AND REAL ESTATE LOAN PORTFOLIOS; MORTGAGE BANKING SERVICES, NAMELY, ACQUISITION, SERVICING, SECURITIZATION OF MORTGAGE LOANS, IN CLASS 36 (U.S. CLS. 100, 101 AND 102).

**SERVICE MARK**

**PRINCIPAL REGISTER**

FIRST USE 3-17-2009; IN COMMERCE 3-17-2009.

THE MARK CONSISTS OF STANDARD CHARACTERS WITHOUT CLAIM TO ANY PARTICULAR FONT, STYLE, SIZE, OR COLOR.

SN 77-591,596, FILED 10-13-2008.

DARRYL SPRUILL, EXAMINING ATTORNEY



*David J. Kyffers*

Director of the United States Patent and Trademark Office

# United States of America

United States Patent and Trademark Office

# ARTMINDS

**Reg. No. 4,198,765**

**Registered Aug. 28, 2012**

**Int. Cl.: 28**

**TRADEMARK**

**PRINCIPAL REGISTER**

MICHAELS STORES PROCUREMENT COMPANY, INC. (DELAWARE CORPORATION)  
8000 BENT BRANCH DRIVE  
IRVING, TX 75063

FOR: HOBBY CRAFT KITS COMPRISED IN WHOLE OR IN PART OF CLAY, FOAM, WOOD ITEMS FOR PAINTING AND DECORATING INCLUDING LETTERS, NUMBERS, AND SHAPES, INSTRUCTION BOOKS, AND TOOLS, IN CLASS 28 (U.S. CLS. 22, 23, 38 AND 50).

FIRST USE 5-0-2011; IN COMMERCE 5-0-2011.

THE MARK CONSISTS OF STANDARD CHARACTERS WITHOUT CLAIM TO ANY PARTICULAR FONT, STYLE, SIZE, OR COLOR.

SN 77-595,921, FILED 10-20-2008.

DARRYL SPRUILL, EXAMINING ATTORNEY



*David J. Kyffers*

Director of the United States Patent and Trademark Office

# United States of America

United States Patent and Trademark Office

# ARTMINDS

**Reg. No. 4,198,766**

**Registered Aug. 28, 2012**

**Int. Cl.: 20**

**TRADEMARK**

**PRINCIPAL REGISTER**

MICHAELS STORES PROCUREMENT COMPANY, INC. (DELAWARE CORPORATION)  
8000 BENT BRANCH DRIVE  
IRVING, TX 75063

FOR: DECORATIVE GLITTER; WOOD CRAFT ITEMS IN THE NATURE OF TABLES, STOOLS AND CHAIRS; ROCKING CHAIRS; BENCHES; SHELVES; COAT RACKS; MAGAZINE RACKS; WOOD CRATES; WOOD BOXES; WOOD FURNITURE CHESTS; TOY CHESTS; FIGURINES OF WOOD; AND WORKS OF ART MADE OF WOOD, IN CLASS 20 (U.S. CLS. 2, 13, 22, 25, 32 AND 50).

FIRST USE 5-0-2012; IN COMMERCE 5-0-2012.

THE MARK CONSISTS OF STANDARD CHARACTERS WITHOUT CLAIM TO ANY PARTICULAR FONT, STYLE, SIZE, OR COLOR.

SN 77-595,936, FILED 10-20-2008.

DARRYL SPRUILL, EXAMINING ATTORNEY



*David J. Kyffers*

Director of the United States Patent and Trademark Office

# United States of America

United States Patent and Trademark Office

# ARTMINDS

**Reg. No. 4,198,767**

**Registered Aug. 28, 2012**

**Int. Cl.: 16**

**TRADEMARK**

**PRINCIPAL REGISTER**

MICHAELS STORES PROCUREMENT COMPANY, INC. (DELAWARE CORPORATION)  
8000 BENT BRANCH DRIVE  
IRVING, TX 75063

FOR: ART SUPPLIES, NAMELY, ARTISTS' BRUSHES, ARTISAN GLUE, ART AND CRAFT PAINT KITS; STICKERS; STENCILS; ARTS AND CRAFTS CLAY KITS, MODELING CLAY, ADHESIVE TAPE FOR STATIONERY OR HOUSEHOLD PURPOSES, GLUE FOR STATIONERY OR HOUSEHOLD USE, WORD PUZZLES IN THE NATURE OF CROSSWORD AND REBUS PUZZLES, IN CLASS 16 (U.S. CLS. 2, 5, 22, 23, 29, 37, 38 AND 50).

FIRST USE 8-0-2011; IN COMMERCE 8-0-2011.

THE MARK CONSISTS OF STANDARD CHARACTERS WITHOUT CLAIM TO ANY PARTICULAR FONT, STYLE, SIZE, OR COLOR.

SN 77-595,951, FILED 10-20-2008.

DARRYL SPRUILL, EXAMINING ATTORNEY



*David J. Kyros*

Director of the United States Patent and Trademark Office

# United States of America

United States Patent and Trademark Office

## LITTLEMISSMATCHED

**Reg. No. 4,198,768**

**Registered Aug. 28, 2012**

**Int. Cl.: 26**

**TRADEMARK**

**PRINCIPAL REGISTER**

MISS MATCHED, INC. (DELAWARE CORPORATION)  
SUITE 501  
307 7TH AVENUE  
NEW YORK, NY 10001

FOR: HAIR ACCESSORIES, NAMELY, HAIR BANDS, HAIR WRAPS AND HAIR TIES, IN CLASS 26 (U.S. CLS. 37, 39, 40, 42 AND 50).

FIRST USE 4-9-2011; IN COMMERCE 4-9-2011.

THE MARK CONSISTS OF STANDARD CHARACTERS WITHOUT CLAIM TO ANY PARTICULAR FONT, STYLE, SIZE, OR COLOR.

OWNER OF U.S. REG. NOS. 3,475,092, 3,565,831, AND OTHERS.

SN 77-597,659, FILED 10-22-2008.

DARRYL SPRUILL, EXAMINING ATTORNEY



*David J. Kybas*

Director of the United States Patent and Trademark Office

# United States of America

United States Patent and Trademark Office

## LITTLEMISSMATCHED

**Reg. No. 4,198,769**

**Registered Aug. 28, 2012**

**Int. Cl.: 3**

**TRADEMARK**

**PRINCIPAL REGISTER**

MISS MATCHED, INC. (DELAWARE CORPORATION)  
SUITE 501  
307 7TH AVENUE  
NEW YORK, NY 10001

FOR: COSMETICS AND MAKE-UP; LIP GLOSS AND LIP BALM; NAIL POLISH; PERFUME  
AND BODY SPRAY, IN CLASS 3 (U.S. CLS. 1, 4, 6, 50, 51 AND 52).

FIRST USE 8-8-2011; IN COMMERCE 8-8-2011.

THE MARK CONSISTS OF STANDARD CHARACTERS WITHOUT CLAIM TO ANY PAR-  
TICULAR FONT, STYLE, SIZE, OR COLOR.

OWNER OF U.S. REG. NOS. 3,475,092, 3,565,830, AND 3,565,831.

SN 77-597,762, FILED 10-22-2008.

DARRYL SPRUILL, EXAMINING ATTORNEY



*David J. Kybas*

Director of the United States Patent and Trademark Office

# United States of America

United States Patent and Trademark Office

## AGING AS A SPIRITUAL PRACTICE

**Reg. No. 4,198,770**

RICHMOND, LEWIS (UNITED STATES INDIVIDUAL)

**Registered Aug. 28, 2012**

PO BOX 856  
SAUSALITO, CA 94966

**Int. Cl.: 16**

FOR: PRINTED INSTRUCTIONAL, EDUCATIONAL, AND TEACHING MATERIALS IN THE FIELD OF AGING, IN CLASS 16 (U.S. CLS. 2, 5, 22, 23, 29, 37, 38 AND 50).

**TRADEMARK**

FIRST USE 4-14-2012; IN COMMERCE 4-14-2012.

**PRINCIPAL REGISTER**

THE MARK CONSISTS OF STANDARD CHARACTERS WITHOUT CLAIM TO ANY PARTICULAR FONT, STYLE, SIZE, OR COLOR.

NO CLAIM IS MADE TO THE EXCLUSIVE RIGHT TO USE "AGING" AND "SPIRITUAL", APART FROM THE MARK AS SHOWN.

SN 77-598,055, FILED 10-22-2008.

RUSS HERMAN, EXAMINING ATTORNEY



*David J. Kyffers*

Director of the United States Patent and Trademark Office



# United States of America

United States Patent and Trademark Office

# ALION

**Reg. No. 4,198,771**

BAYER AKTIENGESELLSCHAFT (FED REP GERMANY JOINT STOCK COMPANY)  
D-51368

**Registered Aug. 28, 2012**

LEVERKUSEN-BAYERWERK, FED REP GERMANY

**Int. Cl.: 5**

FOR: PREPARATIONS FOR KILLING WEEDS, HERBICIDES, IN CLASS 5 (U.S. CLS. 6, 18, 44, 46, 51 AND 52).

**TRADEMARK**

FIRST USE 6-14-2011; IN COMMERCE 6-14-2011.

**PRINCIPAL REGISTER**

THE MARK CONSISTS OF STANDARD CHARACTERS WITHOUT CLAIM TO ANY PARTICULAR FONT, STYLE, SIZE, OR COLOR.

SN 77-599,281, FILED 10-23-2008.

SUZANNE BLANE, EXAMINING ATTORNEY



*David J. Kyffers*

Director of the United States Patent and Trademark Office

# United States of America

United States Patent and Trademark Office

# TRINITY

**Reg. No. 4,198,772**

**Registered Aug. 28, 2012**

**Int. Cl.: 9**

**TRADEMARK**

**PRINCIPAL REGISTER**

ITT CORPORATION (INDIANA CORPORATION)  
1133 WESTCHESTER AVENUE  
WHITE PLAINS, NY 10604

FOR: ELECTRICAL CONNECTORS, IN CLASS 9 (U.S. CLS. 21, 23, 26, 36 AND 38).

FIRST USE 11-1-2008; IN COMMERCE 12-1-2008.

THE MARK CONSISTS OF STANDARD CHARACTERS WITHOUT CLAIM TO ANY PARTICULAR FONT, STYLE, SIZE, OR COLOR.

SN 77-599,837, FILED 10-24-2008.

ANN E. SAPPENFIELD, EXAMINING ATTORNEY



*David J. Kybas*

Director of the United States Patent and Trademark Office

# United States of America

United States Patent and Trademark Office

## WARREN DIGITAL 4D

**Reg. No. 4,198,773**

WARREN THEATRES, LLC (KANSAS LIMITED LIABILITY COMPANY)  
P.O. BOX 782560  
WICHITA, KS 672782560

**Registered Aug. 28, 2012**

**Int. Cl.: 41**

FOR: MOVIE THEATERS, IN CLASS 41 (U.S. CLS. 100, 101 AND 107).

**SERVICE MARK**

FIRST USE 6-4-2012; IN COMMERCE 6-4-2012.

**PRINCIPAL REGISTER**

THE MARK CONSISTS OF STANDARD CHARACTERS WITHOUT CLAIM TO ANY PARTICULAR FONT, STYLE, SIZE, OR COLOR.

OWNER OF U.S. REG. NOS. 2,116,148, 2,116,273, AND 3,034,033.

NO CLAIM IS MADE TO THE EXCLUSIVE RIGHT TO USE "DIGITAL 4D", APART FROM THE MARK AS SHOWN.

SN 77-602,059, FILED 10-28-2008.

DAVID HOFFMAN, EXAMINING ATTORNEY



*David J. Kyffers*

Director of the United States Patent and Trademark Office

# United States of America

United States Patent and Trademark Office

## WARREN DIGITAL MEGA SCREENS

**Reg. No. 4,198,774**

WARREN THEATRES, LLC (KANSAS LIMITED LIABILITY COMPANY)  
P.O. BOX 782560  
WICHITA, KS 672782560

**Registered Aug. 28, 2012**

**Int. Cl.: 41**

FOR: MOVIE THEATERS, IN CLASS 41 (U.S. CLS. 100, 101 AND 107).

**SERVICE MARK**

FIRST USE 6-4-2012; IN COMMERCE 6-4-2012.

**PRINCIPAL REGISTER**

THE MARK CONSISTS OF STANDARD CHARACTERS WITHOUT CLAIM TO ANY PARTICULAR FONT, STYLE, SIZE, OR COLOR.

OWNER OF U.S. REG. NOS. 2,116,148, 2,116,273, AND 3,034,033.

NO CLAIM IS MADE TO THE EXCLUSIVE RIGHT TO USE "DIGITAL MEGA SCREENS", APART FROM THE MARK AS SHOWN.

SN 77-602,135, FILED 10-28-2008.

DAVID HOFFMAN, EXAMINING ATTORNEY



*David J. Kyffers*

Director of the United States Patent and Trademark Office

# United States of America

United States Patent and Trademark Office

## connectivitynet.com

**Reg. No. 4,198,775**

BEECHER, AUDREAN (UNITED STATES INDIVIDUAL)  
616 MILLPOND ROAD  
LEXINGTON, KY 40514

**Registered Aug. 28, 2012**

**Int. Cl.: 35**

FOR: BUSINESS CONSULTATION IN THE FIELD OF NON-PROFIT ASSET MANAGEMENT,  
IN CLASS 35 (U.S. CLS. 100, 101 AND 102).

**SERVICE MARK**

FIRST USE 6-21-2012; IN COMMERCE 6-21-2012.

**PRINCIPAL REGISTER**

THE MARK CONSISTS OF STANDARD CHARACTERS WITHOUT CLAIM TO ANY PAR-  
TICULAR FONT, STYLE, SIZE, OR COLOR.

SN 77-604,664, FILED 10-30-2008.

JACLYN KIDWELL WALKER, EXAMINING ATTORNEY



*David J. Kybas*

Director of the United States Patent and Trademark Office

# United States of America

United States Patent and Trademark Office

# connectivitynet.org

**Reg. No. 4,198,776**

BEECHER, AUDREAN (UNITED STATES INDIVIDUAL)  
616 MILLPOND ROAD  
LEXINGTON, KY 40514

**Registered Aug. 28, 2012**

**Int. Cl.: 35**

FOR: BUSINESS CONSULTATION IN THE FIELD OF NON-PROFIT ASSET MANAGEMENT,  
IN CLASS 35 (U.S. CLS. 100, 101 AND 102).

**SERVICE MARK**

FIRST USE 6-22-2012; IN COMMERCE 6-22-2012.

**PRINCIPAL REGISTER**

THE MARK CONSISTS OF STANDARD CHARACTERS WITHOUT CLAIM TO ANY PAR-  
TICULAR FONT, STYLE, SIZE, OR COLOR.

SN 77-604,714, FILED 10-31-2008.

JACLYN KIDWELL WALKER, EXAMINING ATTORNEY



*David J. Kyros*

Director of the United States Patent and Trademark Office

# United States of America

United States Patent and Trademark Office

## TOUR DE FOOD

**Reg. No. 4,198,777**

**Registered Aug. 28, 2012**

**Int. Cl.: 41**

**SERVICE MARK**

**PRINCIPAL REGISTER**

BLUE RIBBON IP, LLC (NEW YORK LIMITED LIABILITY COMPANY)  
166 MERCER STREET  
SUITE 6C  
NEW YORK, NY 10012

FOR: ENTERTAINMENT SERVICES, NAMELY, AN ON-GOING AUDIO-VISUAL PROGRAM DISTRIBUTED OVER TELEVISION AND AUDIO AND VISUAL MEDIA IN THE FIELDS OF FOOD, COOKING AND TRAVEL, IN CLASS 41 (U.S. CLS. 100, 101 AND 107).

FIRST USE 11-0-2009; IN COMMERCE 11-0-2009.

THE MARK CONSISTS OF STANDARD CHARACTERS WITHOUT CLAIM TO ANY PARTICULAR FONT, STYLE, SIZE, OR COLOR.

NO CLAIM IS MADE TO THE EXCLUSIVE RIGHT TO USE "FOOD", APART FROM THE MARK AS SHOWN.

SN 77-604,958, FILED 10-31-2008.

LINDA E. BLOHM, EXAMINING ATTORNEY



*David J. Kybas*

Director of the United States Patent and Trademark Office

# United States of America

United States Patent and Trademark Office

## EVERY NIGHT MATTERS

**Reg. No. 4,198,778**

KING KOIL LICENSING COMPANY, INC. (DELAWARE CORPORATION)  
7501 S. QUINCY STREET, SUITE 130  
WILLOWBROOK, IL 60527

**Registered Aug. 28, 2012**

**Int. Cl.: 20**

FOR: BEDS; BOX SPRINGS; MATTRESSES, IN CLASS 20 (U.S. CLS. 2, 13, 22, 25, 32 AND 50).

**TRADEMARK**

FIRST USE 1-31-2009; IN COMMERCE 1-31-2009.

**PRINCIPAL REGISTER**

THE MARK CONSISTS OF STANDARD CHARACTERS WITHOUT CLAIM TO ANY PARTICULAR FONT, STYLE, SIZE, OR COLOR.

SN 77-606,623, FILED 11-4-2008.

DORITT L. CARROLL, EXAMINING ATTORNEY



*David J. Kybas*

Director of the United States Patent and Trademark Office



# United States of America

United States Patent and Trademark Office

# BIOCIPHER

**Reg. No. 4,198,779**

**Registered Aug. 28, 2012**

**Int. Cl.: 5**

**TRADEMARK**

**PRINCIPAL REGISTER**

ALLOZYNE, INC. (DELAWARE CORPORATION)  
1600 FAIRVIEW AVENUE EAST  
SUITE 300  
SEATTLE, WA 98102

FOR: PROTEIN-BASED PHARMACEUTICALS FOR THE TREATMENT OF VARIOUS CONDITIONS; AMINO ACIDS FOR MEDICAL OR VETERINARY PURPOSES, IN CLASS 5 (U.S. CLS. 6, 18, 44, 46, 51 AND 52).

FIRST USE 6-14-2012; IN COMMERCE 6-14-2012.

THE MARK CONSISTS OF STANDARD CHARACTERS WITHOUT CLAIM TO ANY PARTICULAR FONT, STYLE, SIZE, OR COLOR.

SN 77-610,294, FILED 11-7-2008.

FLORENTINA BLANDU, EXAMINING ATTORNEY



*David J. Kyjars*

Director of the United States Patent and Trademark Office

# United States of America

United States Patent and Trademark Office



**Reg. No. 4,198,780**

**Registered Aug. 28, 2012**

**Int. Cl.: 28**

**TRADEMARK**

**PRINCIPAL REGISTER**

SUNRISE INC. (JAPAN CORPORATION)  
2-44-10 KAMIIGUSA  
SUGINAMI-KU, TOKYO, JAPAN 167-0023

FOR: DOLL CASES; DOLL CLOTHING; DOLLS AND ACCESSORIES THEREFOR; DOLLS AND PLAYSETS THEREFOR; DOLLS' CLOTHES; HOBBY CRAFT KIT COMPRISING FABRICS; HOBBY CRAFT SETS FOR DESIGNING AND MAKING DOLL FASHIONS, FASHION ACCESSORIES, PLAYSETS FOR DOLLS COMPRISED OF DOLL FURNITURE, INCLUDING BEDS, CLOSET, WARDROBES, RUNWAYS; PHOTOGRAPHY STUDIO PLAYSETS FOR DOLLS INCLUDING TOY ACCESSORIES THEREFOR; SHOES FOR DOLLS, IN CLASS 28 (U.S. CLS. 22, 23, 38 AND 50).

FIRST USE 7-1-2009; IN COMMERCE 7-1-2009.

THE MARK CONSISTS OF THE LETTER "H" IN STYLIZED SCRIPT WITH A DESIGN OF A HEART ABOVE THE "H".

SN 77-611,807, FILED 11-11-2008.

WARREN L. OLANDRIA, EXAMINING ATTORNEY



*David J. Kybas*

Director of the United States Patent and Trademark Office

# United States of America

United States Patent and Trademark Office

## TOTAL INVOLVEMENT EXPERIENCE

**Reg. No. 4,198,781**

ARTISON, LLC (NEVADA LIMITED LIABILITY COMPANY)  
774 MAYS BLVD

**Registered Aug. 28, 2012**

INCLINE VILLAGE, NV 89451

**Int. Cl.: 9**

FOR: AUDIO SPEAKER SYSTEMS, NAMELY, SPEAKERS, POWERED SUBWOOFERS, AMPLIFIERS, PREAMPLIFIERS, AND COMPACT DISC PLAYERS, IN CLASS 9 (U.S. CLS. 21, 23, 26, 36 AND 38).

**TRADEMARK**

FIRST USE 6-1-2012; IN COMMERCE 6-1-2012.

**PRINCIPAL REGISTER**

THE MARK CONSISTS OF STANDARD CHARACTERS WITHOUT CLAIM TO ANY PARTICULAR FONT, STYLE, SIZE, OR COLOR.

SN 77-615,963, FILED 11-17-2008.

FRANK LATTUCA, EXAMINING ATTORNEY



*David J. Kyffers*

Director of the United States Patent and Trademark Office

# United States of America

United States Patent and Trademark Office

# WITH YOU

**Reg. No. 4,198,782**

**Registered Aug. 28, 2012**

**Int. Cl.: 45**

**SERVICE MARK**

**PRINCIPAL REGISTER**

SPECTRUM HEALTH INNOVATIONS, LLC (UNITED STATES LIMITED LIABILITY COMPANY)  
100 MICHIGAN STREET, N.E.  
GRAND RAPIDS, MI 49503

FOR: HEALTH CARE SERVICES, NAMELY, MATCHING INDIVIDUALS WITH A LIFE-CHANGING OR LIFE-THREATENING HEALTH CONDITION WITH OTHER INDIVIDUALS WHO HAVE EXPERIENCED THAT HEALTH CONDITION, FOR EMOTIONAL SUPPORT PURPOSES, IN CLASS 45 (U.S. CLS. 100 AND 101).

FIRST USE 3-0-2008; IN COMMERCE 3-0-2008.

THE MARK CONSISTS OF STANDARD CHARACTERS WITHOUT CLAIM TO ANY PARTICULAR FONT, STYLE, SIZE, OR COLOR.

SN 77-616,562, FILED 11-18-2008.

WANDA KAY PRICE, EXAMINING ATTORNEY



*David J. Kyffers*

Director of the United States Patent and Trademark Office

# United States of America

United States Patent and Trademark Office

## THIRD ESTATE

**Reg. No. 4,198,783**

LANGER JUICE COMPANY, INC. (CALIFORNIA CORPORATION)  
16195 STEPHENS STREET  
CITY OF INDUSTRY, CA 91745

**Registered Aug. 28, 2012**

**Int. Cl.: 33**

FOR: ALCOHOLIC BEVERAGES, NAMELY, SPARKLING WINES AND SPARKLING WINE ENERGY DRINKS, IN CLASS 33 (U.S. CLS. 47 AND 49).

**TRADEMARK**

FIRST USE 3-4-2012; IN COMMERCE 3-4-2012.

**PRINCIPAL REGISTER**

THE MARK CONSISTS OF STANDARD CHARACTERS WITHOUT CLAIM TO ANY PARTICULAR FONT, STYLE, SIZE, OR COLOR.

NO CLAIM IS MADE TO THE EXCLUSIVE RIGHT TO USE "ESTATE", APART FROM THE MARK AS SHOWN.

SN 77-617,436, FILED 11-19-2008.

ASMAT KHAN, EXAMINING ATTORNEY



*David J. Kyffers*

Director of the United States Patent and Trademark Office

# United States of America

United States Patent and Trademark Office

## Collegiate Icon

**Reg. No. 4,198,784**

CHRISTOPHER E. BENGYAK (UNITED STATES INDIVIDUAL)  
3030 10TH COURT  
VERO BEACH, FL 32960

**Registered Aug. 28, 2012**

**Int. Cl.: 25**

FOR: ATHLETIC APPAREL, NAMELY, SHIRTS, PANTS, JACKETS, FOOTWEAR, HATS AND CAPS, ATHLETIC UNIFORMS, IN CLASS 25 (U.S. CLS. 22 AND 39).

**TRADEMARK**

FIRST USE 7-3-2012; IN COMMERCE 7-3-2012.

**PRINCIPAL REGISTER**

THE MARK CONSISTS OF STANDARD CHARACTERS WITHOUT CLAIM TO ANY PARTICULAR FONT, STYLE, SIZE, OR COLOR.

NO CLAIM IS MADE TO THE EXCLUSIVE RIGHT TO USE "COLLEGIATE", APART FROM THE MARK AS SHOWN.

SN 77-627,364, FILED 12-5-2008.

TRACY CROSS, EXAMINING ATTORNEY



*David J. Kyffers*

Director of the United States Patent and Trademark Office

# United States of America

United States Patent and Trademark Office



**Reg. No. 4,198,785**

SIZZLER USA FRANCHISE, INC. (DELAWARE CORPORATION)  
25910 ACERO DRIVE  
MISSION VIEJO, CA 92691

**Registered Aug. 28, 2012**

**Int. Cl.: 29**

FOR: FOOD PRODUCTS, NAMELY, A PREPARED ENTRÉE DISH CONSISTING PRIMARILY OF SHRIMP, FOR CONSUMPTION ON OR OFF PREMISES, IN CLASS 29 (U.S. CL. 46).

**TRADEMARK**

FIRST USE 7-2-2012; IN COMMERCE 7-2-2012.

**PRINCIPAL REGISTER**

NO CLAIM IS MADE TO THE EXCLUSIVE RIGHT TO USE "SHRIMP", APART FROM THE MARK AS SHOWN.

THE MARK CONSISTS OF A SHRIMP, THE WORD "SHRIMP" ADJACENT TO IT, THE WORD "UNLIMITED" ABOVE ON THE LEFT-HAND SIDE.

SN 77-629,315, FILED 12-9-2008.

LEIGH CAROLINE CASE, EXAMINING ATTORNEY



*David J. Kybas*

Director of the United States Patent and Trademark Office

# United States of America

United States Patent and Trademark Office

## RESPECT YOUR UNIVERSE

**Reg. No. 4,198,786**

RESPECT YOUR UNIVERSE, INC. (NEVADA CORPORATION)

**Registered Aug. 28, 2012**

818 N. RUSSELL STREET  
PORTLAND, OR 97227

**Int. Cl.: 25**

FOR: ATHLETIC BRAS, ATHLETIC UNDERWEAR, BEACHWEAR, BOTTOMS, BOXER SHORTS, COMPRESSION SHORTS FOR ATHLETIC USE, SHORTS, SWEAT PANTS, SWEATSHIRTS, AND WARM-UP SUITS, IN CLASS 25 (U.S. CLS. 22 AND 39).

**TRADEMARK**

FIRST USE 2-0-2012; IN COMMERCE 2-0-2012.

**PRINCIPAL REGISTER**

THE MARK CONSISTS OF STANDARD CHARACTERS WITHOUT CLAIM TO ANY PARTICULAR FONT, STYLE, SIZE, OR COLOR.

SN 77-630,779, FILED 12-10-2008.

JOHN DWYER, EXAMINING ATTORNEY



*David J. Kybas*

Director of the United States Patent and Trademark Office



# United States of America

United States Patent and Trademark Office



**Reg. No. 4,198,787**

PANAMA JACK INTERNATIONAL, INC. (FLORIDA CORPORATION)  
230 ERNESTINE STREET  
ORLANDO, FL 32801

**Registered Aug. 28, 2012**

**Int. Cl.: 25**

FOR: CLOTHING, NAMELY, SHIRTS, SWEATSHIRTS, T-SHIRTS, FOOTWEAR, HEADWEAR, VISORS, CAPS, SHORTS, AND CAMP SHIRTS, IN CLASS 25 (U.S. CLS. 22 AND 39).

**TRADEMARK**

FIRST USE 0-0-1987; IN COMMERCE 0-0-1987.

**PRINCIPAL REGISTER**

OWNER OF U.S. REG. NO. 3,284,348.

THE NAME(S), PORTRAIT(S), AND/OR SIGNATURE(S) SHOWN IN THE MARK DOES NOT IDENTIFY A PARTICULAR LIVING INDIVIDUAL.

THE MARK CONSISTS OF THE DESIGN OF A MAN WITH A MUSTACHE WEARING A HAT AND A MONOCLE ENCLOSED IN AN OVAL OUTLINED WITH A ROPE.

SN 77-634,154, FILED 12-16-2008.

PAUL MORENO, EXAMINING ATTORNEY



*David J. Kybas*

Director of the United States Patent and Trademark Office

# United States of America

United States Patent and Trademark Office

# KAT EYE

**Reg. No. 4,198,788**

**Registered Aug. 28, 2012**

**Int. Cl.: 9**

**TRADEMARK**

**PRINCIPAL REGISTER**

ELBIT SYSTEMS OF AMERICA, LLC (DELAWARE LIMITED LIABILITY COMPANY)  
4700 MARINE CREEK PARKWAY  
FORT WORTH, TX 76179

FOR: LAND- VEHICLE MOUNTABLE AND STATIONARY ENHANCED LONG RANGE SURVEILLANCE EQUIPMENT, NAMELY, LONG RANGE CAMERAS HAVING ENHANCED OPTICAL SENSORS THAT OPERATE IN LOW VISIBILITY CONDITIONS SUCH AS NIGHT, FOG, HAZE, AND DUST, AND PROVIDE AN ENHANCED IMAGE THAT IS TRANSMITTED TO THE OPERATOR'S MONITOR, IN CLASS 9 (U.S. CLS. 21, 23, 26, 36 AND 38).

FIRST USE 9-24-2009; IN COMMERCE 9-24-2009.

THE MARK CONSISTS OF STANDARD CHARACTERS WITHOUT CLAIM TO ANY PARTICULAR FONT, STYLE, SIZE, OR COLOR.

SN 77-634,412, FILED 12-16-2008.

MARIAM MAHMOUDI, EXAMINING ATTORNEY



*David J. Kybas*

Director of the United States Patent and Trademark Office

# United States of America

United States Patent and Trademark Office

# VITATOMIC

**Reg. No. 4,198,789**

KUBIUK, CARL (UNITED STATES INDIVIDUAL)  
415 DANA LANE  
BARRINGTON, IL 60010

**Registered Aug. 28, 2012**

**Int. Cl.: 32**

FOR: SPORTS DRINKS, IN CLASS 32 (U.S. CLS. 45, 46 AND 48).

**TRADEMARK**

FIRST USE 7-13-2012; IN COMMERCE 7-13-2012.

**PRINCIPAL REGISTER**

THE MARK CONSISTS OF STANDARD CHARACTERS WITHOUT CLAIM TO ANY PARTICULAR FONT, STYLE, SIZE, OR COLOR.

SN 77-635,163, FILED 12-17-2008.

KRISTINA MORRIS, EXAMINING ATTORNEY



*David J. Kybas*

Director of the United States Patent and Trademark Office

# United States of America

United States Patent and Trademark Office

## GRIFFIN CLUB

**Reg. No. 4,198,790**

MARRIOTT INTERNATIONAL, INC. (DELAWARE CORPORATION)  
10400 FERNWOOD ROAD  
BETHESDA, MD 20817

**Registered Aug. 28, 2012**

**Int. Cl.: 43**

FOR: HOTEL, RESTAURANT AND BAR SERVICES; RESORT LODGING SERVICES, IN CLASS 43 (U.S. CLS. 100 AND 101).

**SERVICE MARK**

FIRST USE 1-16-2012; IN COMMERCE 1-16-2012.

**PRINCIPAL REGISTER**

THE MARK CONSISTS OF STANDARD CHARACTERS WITHOUT CLAIM TO ANY PARTICULAR FONT, STYLE, SIZE, OR COLOR.

NO CLAIM IS MADE TO THE EXCLUSIVE RIGHT TO USE "CLUB", APART FROM THE MARK AS SHOWN.

SN 77-641,993, FILED 12-31-2008.

ANTHONY RINKER, EXAMINING ATTORNEY



*David J. Kyffers*

Director of the United States Patent and Trademark Office

# United States of America

United States Patent and Trademark Office

# CONSERT

**Reg. No. 4,198,791**

**Registered Aug. 28, 2012**

**Int. Cl.: 9**

**TRADEMARK**

**PRINCIPAL REGISTER**

CONSERT, INC. (DELAWARE CORPORATION)  
SUITES 340  
4700 FALLS OF NEUSE ROAD  
RALEIGH, NC 27609

FOR: ENERGY MANAGEMENT SOFTWARE, NAMELY, COMPUTER SOFTWARE FOR USE BY UTILITIES AND THEIR BUSINESS AND RESIDENTIAL CUSTOMERS IN THE OPERATION OF ELECTRICITY-MONITORING DEVICES, ENERGY CONSUMPTION-REPORTING DEVICES, ELECTRICAL ENERGY MANAGEMENT DEVICES AND ELECTRICAL LOAD-SHEDDING DEVICES, IN CLASS 9 (U.S. CLS. 21, 23, 26, 36 AND 38).

FIRST USE 7-16-2010; IN COMMERCE 7-16-2010.

THE MARK CONSISTS OF STANDARD CHARACTERS WITHOUT CLAIM TO ANY PARTICULAR FONT, STYLE, SIZE, OR COLOR.

SN 77-647,571, FILED 1-12-2009.

KHANH LE, EXAMINING ATTORNEY



*David J. Kyjars*

Director of the United States Patent and Trademark Office

United States of America  
United States Patent and Trademark Office

# Play Proud

**Reg. No. 4,198,792**

PALMER, GARY (UNITED STATES INDIVIDUAL)  
1500 BILTMORE DRIVE  
CHARLOTTE, NC 28207

**Registered Aug. 28, 2012**

**Int. Cl.: 25**

FOR: HATS; JACKETS; PANTS; SHIRTS; SWEAT SHIRTS, IN CLASS 25 (U.S. CLS. 22 AND 39).

**TRADEMARK**

FIRST USE 5-30-2012; IN COMMERCE 5-30-2012.

**PRINCIPAL REGISTER**

THE MARK CONSISTS OF STANDARD CHARACTERS WITHOUT CLAIM TO ANY PARTICULAR FONT, STYLE, SIZE, OR COLOR.

SN 77-648,123, FILED 1-13-2009.

ESTHER A. BORSUK, EXAMINING ATTORNEY



*David J. Kyffers*

Director of the United States Patent and Trademark Office

# United States of America

United States Patent and Trademark Office

## OUR JOB IS FUN

**Reg. No. 4,198,793**

**Registered Aug. 28, 2012**

**Int. Cl.: 41**

**SERVICE MARK**

**PRINCIPAL REGISTER**

CHURCHILL DOWNS INCORPORATED (KENTUCKY CORPORATION)  
600 N. HURSTBOURNE PARKWAY  
SUITE 400  
LOUISVILLE, KY 40222

FOR: PROVIDING INFORMATION IN THE FIELD OF ENTERTAINMENT FEATURING HORSE RACES, HORSE RACING, WAGERING ON HORSE RACES AND GAMING, AND RELATED NEWS, VIA A GLOBAL OR OTHER WIDE AREA COMPUTER NETWORK OR VIA TELECOMMUNICATIONS DEVICES, IN CLASS 41 (U.S. CLS. 100, 101 AND 107).

FIRST USE 2-15-2012; IN COMMERCE 2-15-2012.

THE MARK CONSISTS OF STANDARD CHARACTERS WITHOUT CLAIM TO ANY PARTICULAR FONT, STYLE, SIZE, OR COLOR.

SN 77-649,059, FILED 1-14-2009.

JEAN IM, EXAMINING ATTORNEY



*David J. Kyffers*

Director of the United States Patent and Trademark Office

# United States of America

United States Patent and Trademark Office

## INTELLIGENT INTEGRATION

**Reg. No. 4,198,794**

SANTUR CORPORATION (DELAWARE CORPORATION)  
40931 ENCYCLOPEDIA CIRCLE  
FREMONT, CA 94538

**Registered Aug. 28, 2012**

**Int. Cl.: 9**

FOR: TELECOMMUNICATIONS PRODUCTS, NAMELY, TUNABLE LASERS, FIXED WAVELENGTH LASERS, PUMP LASERS, TUNABLE LASER MODULES FOR FIBER OPTIC NETWORKS, LASER SOURCES PACKAGED WITH CONTROL ELECTRONICS, THERMALLY TUNED LASER SOURCES, TUNABLE OPTICAL TRANSMITTER MODULES, FIBER GRATINGS, WAVELENGTH DIVISION MULTIPLEXERS, TRANSPONDERS, PHOTONIC INTEGRATED CIRCUITS; ELECTRO-OPTIC COMPONENTS FOR USE IN DATA COMMUNICATION SYSTEMS, IN CLASS 9 (U.S. CLS. 21, 23, 26, 36 AND 38).

**TRADEMARK**

**PRINCIPAL REGISTER**

FIRST USE 3-23-2010; IN COMMERCE 3-23-2010.

THE MARK CONSISTS OF STANDARD CHARACTERS WITHOUT CLAIM TO ANY PARTICULAR FONT, STYLE, SIZE, OR COLOR.

NO CLAIM IS MADE TO THE EXCLUSIVE RIGHT TO USE "INTELLIGENT", APART FROM THE MARK AS SHOWN.

SN 77-652,966, FILED 1-20-2009.

DOMINICK J. SALEMI, EXAMINING ATTORNEY



*David J. Kyffers*

Director of the United States Patent and Trademark Office



# United States of America

United States Patent and Trademark Office

# SENTRYCOM

**Reg. No. 4,198,795**

LOGICMARK, LLC (DELAWARE LIMITED LIABILITY COMPANY)  
1359 BARCLAY BLVD.

**Registered Aug. 28, 2012**

BUFFALO GROVE, IL 60654

**Int. Cl.: 9**

FOR: ELECTRONIC PERSONAL EMERGENCY RESPONSE SYSTEM TO NOTIFY OTHERS IN THE EVENT OF AN EMERGENCY COMPRISED OF A RADIO TRANSCEIVER BASE STATION AND A RADIO TRANSCEIVER PENDANT WORN BY THE USER, FOR USE IN THE HOME HEALTH CARE INDUSTRY, IN CLASS 9 (U.S. CLS. 21, 23, 26, 36 AND 38).

**TRADEMARK**

**PRINCIPAL REGISTER**

FIRST USE 6-15-2012; IN COMMERCE 6-15-2012.

THE MARK CONSISTS OF STANDARD CHARACTERS WITHOUT CLAIM TO ANY PARTICULAR FONT, STYLE, SIZE, OR COLOR.

SN 77-656,904, FILED 1-26-2009.

JORDAN BAKER, EXAMINING ATTORNEY



*David J. Kybas*

Director of the United States Patent and Trademark Office

# United States of America

United States Patent and Trademark Office

# EXGEL

**Reg. No. 4,198,796**

**Registered Aug. 28, 2012**

**Int. Cls.: 1, 7, 10, 12, 17,  
and 20**

**TRADEMARK**

**PRINCIPAL REGISTER**

KAJI CO., LTD. (JAPAN CORPORATION)  
11408 GREY COLT LANE  
1295-3 MINARI OKUIZUMO-CHO NITA-GUN  
SHIMANE, 699-1511, JAPAN 20850

FOR: SILICON RESIN; URETHANE RESIN; PLASTIC IN PRIMARY FORMS; GLUE AND ADHESIVE AGENT, EXCEPT FOR OFFICE USE, NAMELY, ADHESIVES AND GLUES FOR INDUSTRIAL PURPOSES; SILICON; NON-FERROUS METAL, NAMELY, RARE EARTH METALS; PLASTIC BASIC PRODUCTS, NAMELY, UNPROCESSED PLASTICS, IN CLASS 1 (U.S. CLS. 1, 5, 6, 10, 26 AND 46).

FIRST USE 4-1-1998; IN COMMERCE 4-15-2011.

FOR: RUBBER SHOCK ABSORBERS FOR INDUSTRIAL MACHINERY; SILICON RESIN SHOCK ABSORBERS FOR INDUSTRIAL MACHINERY; URETHANE RESIN SHOCK ABSORBERS FOR INDUSTRIAL MACHINERY; PLASTIC SHOCK ABSORBERS FOR INDUSTRIAL MACHINERY, IN CLASS 7 (U.S. CLS. 13, 19, 21, 23, 31, 34 AND 35).

FIRST USE 4-1-1998; IN COMMERCE 4-15-2011.

FOR: PILLOWS FOR MEDICAL USE, NAMELY, FACE PILLOWS AND BUST PILLOWS USED IN THERAPEUTIC FACILITIES; STRETCHER; PACIFIER FOR BABIES, BABY BOTTLE NIPPLE; BANDAGE, NAMELY, ELASTIC BANDAGES, COMPRESSION BANDAGES, SUPPORTIVE BANDAGES; CRUTCHES; MEDICAL MACHINERY AND APPLIANCES, NAMELY, CATHETERS, MEDICAL INTRODUCERS, SURGICAL STAPLERS; MEDICAL SUPPORTERS; MEDICAL FOOTWEAR, NAMELY, ORTHOPEDIC FOOTWEAR; MEDICAL INSOLE FOR SHOES OR SHOE SOLE, NAMELY, ORTHOTIC INSERTS FOR FOOTWEAR; MEDICAL BELTS; CORSETRY, NAMELY, ABDOMINAL CORSETS, CORSETS FOR THERAPEUTIC USE; THERAPEUTIC BEDS FOR MEDICAL USE, NAMELY, HOSPITAL BEDS FOR USE BY BURN PATIENTS AND PRESSURE SORE PREVENTION MEDICAL BEDS; SURGICAL TABLES, NAMELY, SURGICAL TABLE EQUIPPED WITH GEL CUSHIONS TO COMFORTABLY SUPPORT FOR PATIENTS EXPECTING LONG HOURS OF SURGERIES; STRAIT JACKETS FOR MEDICAL USE; CUSHIONS FOR RELIEF OF PRESSURE SORE FOR MEDICAL PURPOSES, NAMELY, CUSHIONS DESIGNED TO PREVENT PRESSURE SORE OR EASE PAIN FROM EXISTING PRESSURE SORE, AND CUSHIONS DESIGNED TO REDUCE PRESSURE ONTO PATIENT'S BODY FROM CUSHION SURFACE; MATTRESSES FOR RELIEF OF PRESSURE SORE FOR MEDICAL PURPOSES, NAMELY,



*David J. Kybas*

Director of the United States Patent and Trademark Office

**Reg. No. 4,198,796** GEL MATTRESS FOR MEDICAL PURPOSES, GEL SUPPORT MATTRESSES FOR MEDICAL USE; HOSPITAL BEDS WITH PRESSURE SORE RELIEF FUNCTION FOR MEDICAL PURPOSES, NAMELY, HOSPITAL BEDS FOR PATIENTS WITH SERIOUS INJURIES OR COMA, HOSPITAL BEDS FOR PATIENTS INCAPABLE OF ROLLING OVER OR CHANGING POSTURES TO PREVENT PRESSURE SORES OR EASE PAIN FROM EXISTING PRESSURE SORES; CUSHIONS FOR MEDICAL USE, NAMELY, CUSHIONS DESIGNED TO REDUCE PRESSURE ONTO PATIENT'S BODY FROM CUSHION SURFACE; PILLOWS FOR MEDICAL USE, NAMELY, PILLOWS DESIGNED TO REDUCE PRESSURE ONTO PATIENT'S BODY PARTS WHILE PATIENT RECEIVING TREATMENTS, IN CLASS 10 (U.S. CLS. 26, 39 AND 44).

FIRST USE 4-1-1998; IN COMMERCE 4-15-2011.

FOR: SHOCK ABSORBING PAD FOR MEDICAL USE, NAMELY, WHEEL CHAIR PAD AND WHEEL CHAIR ARMS PAD; CUSHIONS FOR MEDICAL USE, NAMELY, SUPPORT CUSHION FOR WHEEL CHAIR; VEHICLE PARTS, NAMELY, RUBBER SHOCK ABSORBERS FOR AUTOMOTIVES; VEHICLE PARTS, NAMELY, SILICON RESIN SHOCK ABSORBERS FOR AUTOMOTIVES; VEHICLE PARTS, NAMELY, URETHANE RESIN SHOCK ABSORBERS FOR AUTOMOTIVES; VEHICLE PARTS, NAMELY, PLASTIC SHOCK ABSORBERS FOR AUTOMOTIVES, IN CLASS 12 (U.S. CLS. 19, 21, 23, 31, 35 AND 44).

FIRST USE 4-1-1998; IN COMMERCE 4-15-2011.

FOR: RUBBER; PLASTIC BASIC PRODUCTS, NAMELY, SEMI-PROCESSED PLASTICS; SILICON RESIN BASIC PRODUCTS, NAMELY, SILICONE RESIN BASED SEALANTS AND ADHESIVES; URETHANE RESIN BASIC PRODUCTS, NAMELY, URETHANE RESINS IN EXTRUDED FORM FOR GENERAL INDUSTRIAL AND AUTOMOTIVE USE, IN CLASS 17 (U.S. CLS. 1, 5, 12, 13, 35 AND 50).

FIRST USE 4-1-1998; IN COMMERCE 4-15-2011.

FOR: CUSHIONS FOR RELIEF OF PRESSURE SORE NOT FOR MEDICAL PURPOSES; MATTRESSES FOR RELIEF OF PRESSURE SORE NOT FOR MEDICAL PURPOSES; CHAIRS WITH PRESSURE SORE RELIEF CUSHION NOT FOR MEDICAL PURPOSES; CRADLES WITH PRESSURE SORE RELIEF BEDDING NOT FOR MEDICAL PURPOSES; BEDS WITH PRESSURE SORE RELIEF FUNCTION NOT FOR MEDICAL PURPOSES; FURNITURE WITH PRESSURE SORE RELIEF FUNCTION NOT FOR MEDICAL PURPOSES; SOFAS WITH PRESSURE RELIEF FUNCTION NOT FOR MEDICAL PURPOSES; BEDS FOR PET ANIMALS; MASSAGE TABLE FOR MEDICAL USE; CUSHIONS FOR MEDICAL USE, NAMELY, CUSHION FOR TAKING BATH FOR PATIENTS AND IMPAIRED PERSONS IN THE NATURE OF SHOWER CHAIR CUSHIONS; CUSHIONS FOR SHOWER CHAIRS, IN CLASS 20 (U.S. CLS. 2, 13, 22, 25, 32 AND 50).

FIRST USE 4-1-1998; IN COMMERCE 4-15-2011.

THE MARK CONSISTS OF STANDARD CHARACTERS WITHOUT CLAIM TO ANY PARTICULAR FONT, STYLE, SIZE, OR COLOR.

SN 77-663,352, FILED 2-4-2009.

TINA BROWN, EXAMINING ATTORNEY

# United States of America

United States Patent and Trademark Office



**Reg. No. 4,198,797**

**Registered Aug. 28, 2012**

ICC EVALUATION SERVICE, LLC (DELAWARE LIMITED LIABILITY COMPANY)  
5360 WORKMAN MILL ROAD  
WHITTIER, CA 90601

**CERTIFICATION MARK  
GOODS**

FOR: BUILDING AND CONSTRUCTION PRODUCTS AND COMPONENTS, IN CLASS A  
(U.S. CL. A).

**PRINCIPAL REGISTER**

FIRST USE 9-30-2010; IN COMMERCE 9-30-2010.

OWNER OF U.S. REG. NOS. 2,952,145, 3,042,240, AND OTHERS.

THE MARK CONSISTS OF AN INCOMPLETE OVAL SURROUNDING THE CAPITAL LETTERS "E" AND "S", WITH THE CAPITAL LETTERS "ICC" APPEARING AT THE UPPER LEFT BOUNDARY OF THE OVAL.

THE CERTIFICATION MARK, AS INTENDED TO BE USED BY AUTHORIZED PERSONS, IS INTENDED TO CERTIFY THAT THE GOODS MEET CONSTRUCTION, BUILDING AND SAFETY CODE REQUIREMENTS AND/OR ACCEPTANCE CRITERIA ESTABLISHED OR ADOPTED BY THE CERTIFIER.

SN 77-663,582, FILED 2-4-2009.

ELIZABETH KAJUBI, EXAMINING ATTORNEY



*David J. Kyffers*

Director of the United States Patent and Trademark Office

# United States of America

United States Patent and Trademark Office

# INSPO

**Reg. No. 4,198,798**

**Registered Aug. 28, 2012**

**Int. Cl.: 25**

**TRADEMARK**

**PRINCIPAL REGISTER**

NEW BALANCE ATHLETIC SHOE, INC. (MASSACHUSETTS CORPORATION)  
20 GUEST STREET  
BRIGHTON LANDING  
BOSTON, MA 02135

FOR: FOOTWEAR, IN CLASS 25 (U.S. CLS. 22 AND 39).

FIRST USE 5-25-2012; IN COMMERCE 5-25-2012.

THE MARK CONSISTS OF STANDARD CHARACTERS WITHOUT CLAIM TO ANY PARTICULAR FONT, STYLE, SIZE, OR COLOR.

OWNER OF U.S. REG. NO. 2,847,272.

SN 77-664,001, FILED 2-5-2009.

BARNEY CHARLON, EXAMINING ATTORNEY



*David J. Kyffers*

Director of the United States Patent and Trademark Office

# United States of America

United States Patent and Trademark Office



**Reg. No. 4,198,799**

**Registered Aug. 28, 2012**

**Int. Cl.: 9**

**TRADEMARK**

**PRINCIPAL REGISTER**

TECOM INDUSTRIES, INC. (CALIFORNIA CORPORATION)  
375 CONEJO RIDGE AVENUE  
THOUSAND OAKS, CA 91361

FOR: BROADBAND ANTENNA SYSTEM CONSISTING OF KU BAND TRANSMIT/RECEIVE ANTENNA ASSEMBLY, HIGH POWER TRANSCEIVER, ANTENNA CONTROL UNIT, AND INTERCONNECT AND POWER CABLES, FOR USE WITH AIRPLANES, TRAINS, SHIPS, AND VEHICLES, IN CLASS 9 (U.S. CLS. 21, 23, 26, 36 AND 38).

FIRST USE 7-23-2010; IN COMMERCE 7-23-2010.

NO CLAIM IS MADE TO THE EXCLUSIVE RIGHT TO USE "KUSTREAM", APART FROM THE MARK AS SHOWN.

THE MARK CONSISTS OF THE WORD "KUSTREAM". A CIRCLE WITH SMALL OVALS MOVING IN A SPHERICAL MANNER APPEARS TO THE LEFT OF THE WORD "KUSTREAM".

SN 77-667,675, FILED 2-10-2009.

ANDREW RHIM, EXAMINING ATTORNEY



*David J. Kyjars*

Director of the United States Patent and Trademark Office

# United States of America

United States Patent and Trademark Office

# NAILICIOUS

**Reg. No. 4,198,800**

**Registered Aug. 28, 2012**

**Int. Cl.: 3**

**TRADEMARK**

**PRINCIPAL REGISTER**

BATH & BODY WORKS BRAND MANAGEMENT, INC. (DELAWARE CORPORATION)  
7 LIMITED PARKWAY EAST  
REYNOLDBURG, OH 43068

FOR: PERSONAL CARE PRODUCTS, NAMELY, CUTICLE CONDITIONERS, CUTICLE CREAM, CUTICLE REMOVING PREPARATIONS, EMERY BOARDS, LOTIONS FOR STRENGTHENING THE NAILS, NAIL BUFFING PREPARATIONS, NAIL CARE PREPARATIONS, NAIL CARE PREPARATIONS, NAMELY, NAIL SOFTENERS, NAIL CREAM, NAIL ENAMEL, NAIL POLISH, NAIL POLISH REMOVERS, IN CLASS 3 (U.S. CLS. 1, 4, 6, 50, 51 AND 52).

FIRST USE 11-1-2011; IN COMMERCE 11-1-2011.

THE MARK CONSISTS OF STANDARD CHARACTERS WITHOUT CLAIM TO ANY PARTICULAR FONT, STYLE, SIZE, OR COLOR.

SN 77-675,791, FILED 2-23-2009.

RICHARD WHITE, EXAMINING ATTORNEY



*David J. Kyffers*

Director of the United States Patent and Trademark Office

# United States of America

United States Patent and Trademark Office

# Dream Farm

**Reg. No. 4,198,801**

ALAWAR ENTERTAINMENT, INC (VIRGINIA CORPORATION)  
901 N. PITT STREET, SUITE 325  
ALEXANDRIA, VA 22314

**Registered Aug. 28, 2012**

**Int. Cl.: 9**

FOR: COMPUTER GAME SOFTWARE; DOWNLOADABLE COMPUTER SOFTWARE FOR USE AS AN ENTERTAINMENT MULTIMEDIA GAME VIA THE WIRELESS DEVICES AND INTERNET; ELECTRONIC GAME SOFTWARE, IN CLASS 9 (U.S. CLS. 21, 23, 26, 36 AND 38).

**TRADEMARK**

**PRINCIPAL REGISTER**

FIRST USE 7-10-2009; IN COMMERCE 7-10-2009.

THE MARK CONSISTS OF STANDARD CHARACTERS WITHOUT CLAIM TO ANY PARTICULAR FONT, STYLE, SIZE, OR COLOR.

NO CLAIM IS MADE TO THE EXCLUSIVE RIGHT TO USE "FARM", APART FROM THE MARK AS SHOWN.

SN 77-683,839, FILED 3-5-2009.

JESSICA FATHY, EXAMINING ATTORNEY



*David J. Kyros*

Director of the United States Patent and Trademark Office



# United States of America

United States Patent and Trademark Office



**Reg. No. 4,198,802**

**Registered Aug. 28, 2012**

**Int. Cl.: 41**

**SERVICE MARK**

**PRINCIPAL REGISTER**

VALE NATIONAL TRAINING CENTERS, INC. (TEXAS CORPORATION)  
2424 RANDOL MILL ROAD  
ARLINGTON, TX 76011

FOR: TRAINING IN THE FIELD OF ECOLOGICALLY SOUND PROPERTY INSURANCE ADJUSTMENT SPECIFICALLY TRAINING IN THE FIELDS OF IDENTIFICATION AND EVALUATION OF ECOLOGICALLY SOUND BUILDINGS AND ECOLOGICALLY SOUND PRODUCTS, ECOLOGICALLY SOUND PRODUCT RATING SYSTEM, ECOLOGICALLY SOUND BUILDING CONSTRUCTION, AND UNDERWRITING AND ADJUSTMENT OF ECOLOGICALLY SOUND BUILDINGS AND PRODUCT CLAIMS, IN CLASS 41 (U.S. CLS. 100, 101 AND 107).

FIRST USE 1-0-2009; IN COMMERCE 1-0-2009.

THE MARK CONSISTS OF STYLIZED TREE WITH CHAIN LINK DESIGN.

SN 77-689,167, FILED 3-12-2009.

SUSAN HAYASH, EXAMINING ATTORNEY



*David J. Kybas*

Director of the United States Patent and Trademark Office

# United States of America

United States Patent and Trademark Office

## JUNIPER NETWORKS

**Reg. No. 4,198,803**

**Registered Aug. 28, 2012**

**Int. Cl.: 16**

**TRADEMARK**

**PRINCIPAL REGISTER**

JUNIPER NETWORKS, INC. (DELAWARE CORPORATION)  
1194 NORTH MATHILDA AVENUE  
SUNNYVALE, CA 94089

FOR: PRINTED PUBLICATIONS, NAMELY, BOOKS IN THE FIELD OF COMPUTERS, NETWORKING, TELECOMMUNICATIONS, COMMUNICATIONS, AND NETWORK SECURITY, IN CLASS 16 (U.S. CLS. 2, 5, 22, 23, 29, 37, 38 AND 50).

FIRST USE 4-1-2010; IN COMMERCE 4-1-2010.

THE MARK CONSISTS OF STANDARD CHARACTERS WITHOUT CLAIM TO ANY PARTICULAR FONT, STYLE, SIZE, OR COLOR.

OWNER OF U.S. REG. NOS. 2,255,921, 3,089,694, AND OTHERS.

NO CLAIM IS MADE TO THE EXCLUSIVE RIGHT TO USE "NETWORKS", APART FROM THE MARK AS SHOWN.

SN 77-690,688, FILED 3-13-2009.

SUSAN RICHARDS, EXAMINING ATTORNEY



*David J. Kyros*

Director of the United States Patent and Trademark Office

# United States of America

United States Patent and Trademark Office

# SKINAMINS

**Reg. No. 4,198,804**

RADOJEVIC, DANA (CANADA INDIVIDUAL)  
231 INDIAN GROVE

**Registered Aug. 28, 2012**

TORONTO, ONTARIO, CANADA M6P2H4

**Int. Cl.: 5**

FOR: INGESTIBLE VITAMINS, INGESTIBLE ANTI-AGING VITAMINS FOR SKIN, INGESTIBLE ANTI-INFLAMMATORY VITAMINS FOR SKIN, VITAMINS FOR HEALTHY SKIN, NUTRITIONAL SUPPLEMENTS FOR IMPROVED SKIN CONDITIONS, IN CLASS 5 (U.S. CLS. 6, 18, 44, 46, 51 AND 52).

**TRADEMARK**

**PRINCIPAL REGISTER**

FIRST USE 6-10-2008; IN COMMERCE 6-10-2008.

THE MARK CONSISTS OF STANDARD CHARACTERS WITHOUT CLAIM TO ANY PARTICULAR FONT, STYLE, SIZE, OR COLOR.

PRIORITY CLAIMED UNDER SEC. 44(D) ON CANADA APPLICATION NO. 1419761, FILED 11-27-2008.

SN 77-707,074, FILED 4-5-2009.

BARBARA RUTLAND, EXAMINING ATTORNEY



*David J. Kybas*

Director of the United States Patent and Trademark Office

# United States of America

United States Patent and Trademark Office

## DERMAL DIET

**Reg. No. 4,198,805**

RADOJEVIC, DANA (CANADA INDIVIDUAL)  
231 INDIAN GROVE

**Registered Aug. 28, 2012**

TORONTO, ONTARIO, CANADA M6P2H4

**Int. Cl.: 5**

FOR: INGESTIBLE VITAMINS, INGESTIBLE ANTI-AGING VITAMINS FOR SKIN, INGESTIBLE ANTI-INFLAMMATORY VITAMINS FOR SKIN, VITAMINS FOR HEALTHY SKIN, NUTRITIONAL SUPPLEMENTS FOR IMPROVED SKIN CONDITIONS, IN CLASS 5 (U.S. CLS. 6, 18, 44, 46, 51 AND 52).

**TRADEMARK**

**PRINCIPAL REGISTER**

FIRST USE 8-28-2008; IN COMMERCE 8-28-2008.

THE MARK CONSISTS OF STANDARD CHARACTERS WITHOUT CLAIM TO ANY PARTICULAR FONT, STYLE, SIZE, OR COLOR.

PRIORITY CLAIMED UNDER SEC. 44(D) ON CANADA APPLICATION NO. 1419764, FILED 11-27-2008.

NO CLAIM IS MADE TO THE EXCLUSIVE RIGHT TO USE "DERMAL", APART FROM THE MARK AS SHOWN.

SN 77-707,077, FILED 4-5-2009.

BARBARA RUTLAND, EXAMINING ATTORNEY



*David J. Kyjars*

Director of the United States Patent and Trademark Office

# United States of America

United States Patent and Trademark Office

# Happy Knees

**Reg. No. 4,198,806**

WILSON VERBATEEN (NEWYORK SOLE PROPRIETORSHIP), DBA VERBATEEN WILSON,  
219 13TH STREET APT 8  
BROOKLYN, NY 11215

**Registered Aug. 28, 2012**

**Int. Cl.: 3**

FOR: MOISTURIZING CREAMS, IN CLASS 3 (U.S. CLS. 1, 4, 6, 50, 51 AND 52).

**TRADEMARK**

FIRST USE 5-29-2012; IN COMMERCE 5-29-2012.

**PRINCIPAL REGISTER**

THE MARK CONSISTS OF STANDARD CHARACTERS WITHOUT CLAIM TO ANY PARTICULAR FONT, STYLE, SIZE, OR COLOR.

NO CLAIM IS MADE TO THE EXCLUSIVE RIGHT TO USE "KNEES", APART FROM THE MARK AS SHOWN.

SN 77-708,781, FILED 4-7-2009.

MYRIAH HABEEB, EXAMINING ATTORNEY



*David J. Kyffers*

Director of the United States Patent and Trademark Office

# United States of America

United States Patent and Trademark Office

## THE ADVISOR LAB

**Reg. No. 4,198,807**

**Registered Aug. 28, 2012**

**Int. Cls.: 35, 36, and 41**

**SERVICE MARK**

**PRINCIPAL REGISTER**

THE ADVISOR LAB, LLC (PENNSYLVANIA LIMITED LIABILITY COMPANY)  
1500 MARKET STREET, SUITE 3310E  
PHILADELPHIA, PA 19102

FOR: OFFICE FUNCTIONS IN THE NATURE OF MAINTAINING RECORDS OF OWNERSHIP AND SETTLEMENTS FOR TRANSFERS OF STOCKS, SHARES AND SECURITIES; RECORD KEEPING SERVICES FOR USE IN REGULATORY COMPLIANCE IN CONNECTIONS WITH FINANCIAL INVESTMENTS; CUSTOMER RELATIONSHIP MANAGEMENT (CMR) SERVICES; ADMINISTRATIVE PROCESSING OF STOCK PURCHASE ORDERS FOR OTHERS; BILLING SERVICES; BUSINESS MANAGEMENT SERVICES FOR THE FINANCIAL INVESTMENT BUSINESS OF OTHERS, IN CLASS 35 (U.S. CLS. 100, 101 AND 102).

FIRST USE 1-6-2009; IN COMMERCE 1-6-2009.

FOR: FINANCIAL ASSET MANAGEMENT; FINANCIAL ADVISORY SERVICES; INVESTMENT ADVISORY SERVICES; FINANCIAL PORTFOLIO ANALYSIS SERVICES; FINANCIAL PORTFOLIO MANAGEMENT, IN CLASS 36 (U.S. CLS. 100, 101 AND 102).

FIRST USE 1-6-2009; IN COMMERCE 1-6-2009.

FOR: INVESTMENT BROKER SALES TRAINING; CONDUCTING SEMINARS AND WORKSHOPS IN THE FIELD OF FINANCIAL INVESTMENT FOR INVESTMENT BROKERS, IN CLASS 41 (U.S. CLS. 100, 101 AND 107).

FIRST USE 1-6-2009; IN COMMERCE 1-6-2009.

THE MARK CONSISTS OF STANDARD CHARACTERS WITHOUT CLAIM TO ANY PARTICULAR FONT, STYLE, SIZE, OR COLOR.

NO CLAIM IS MADE TO THE EXCLUSIVE RIGHT TO USE "ADVISOR", APART FROM THE MARK AS SHOWN.

SN 77-708,897, FILED 4-7-2009.

BRENDAN MCCAULEY, EXAMINING ATTORNEY



*David J. Kyffers*

Director of the United States Patent and Trademark Office

# United States of America

United States Patent and Trademark Office



**Reg. No. 4,198,808**

**Registered Aug. 28, 2012**

**Int. Cl.: 36**

**SERVICE MARK**

**PRINCIPAL REGISTER**

SOCIETY TO BENEFIT EVERYONE, INC. (MASSACHUSETTS CORPORATION)  
P.O. BOX 21  
ASHFIELD, MA 01330

FOR: BANKING CONSULTATION; CURRENCY ADVICE; FINANCIAL CONSULTING; CONSULTING SERVICES IN THE FIELD OF CURRENCY, MONEY MANAGEMENT, AND BANKING; FINANCIAL LOAN CONSULTATION; PROVIDING INFORMATION AND ADVICE IN THE FIELD OF FINANCE; PROVIDING INFORMATION AND ADVICE IN THE FIELD OF THE FINANCIAL ASPECTS OF RETIREMENT; PROVIDING GRANTS TO LOCAL COMMUNITY ORGANIZATIONS AND BUSINESSES, IN CLASS 36 (U.S. CLS. 100, 101 AND 102).

FIRST USE 4-22-2008; IN COMMERCE 4-22-2008.

THE MARK CONSISTS OF A CIRCLE WITH A SWIRL IN THE CENTER.

SN 77-712,350, FILED 4-13-2009.

LAKEISHA LEWIS, EXAMINING ATTORNEY



*David J. Kybas*

Director of the United States Patent and Trademark Office

# United States of America

United States Patent and Trademark Office

## THE DAVID BOWIE ARCHIVE

**Reg. No. 4,198,809**

RISKY FOLIO, INC. (DELAWARE CORPORATION)

**Registered Aug. 28, 2012**

C/O RZO COMPANIES 250 W. 57TH ST.  
NEW YORK, NY 10107

**Int. Cls.: 35, 39, and 41**

FOR: COMMERCIAL ADMINISTRATION OF THE LICENSING AND RENTAL OF THE INFORMATION, MATERIALS AND PRODUCTS RELATING TO THE MUSICAL WORKS, LYRIC SHEETS, COSTUMES, EPHEMERA, ARTWORK, ALBUMS, PROPS, SET DESIGNS, PHOTOGRAPHS, VIDEO CLIPS, AUDIO FILES, SOUND RECORDINGS, AUDIOVISUAL RECORDINGS, OTHER MULTIMEDIA MATERIAL, AND RELATED WORKS, INFORMATION AND MATERIAL OF OTHERS, NAMELY, A PERFORMING ARTIST, IN CLASS 35 (U.S. CLS. 100, 101 AND 102).

**SERVICE MARK**

**PRINCIPAL REGISTER**

FIRST USE 12-3-2010; IN COMMERCE 2-24-2011.

FOR: ARCHIVAL STORAGE SERVICES, NAMELY, PROVIDING ARCHIVAL STORAGE SPACE FOR THE MUSICAL WORKS, LYRIC SHEETS, COSTUMES, EPHEMERA, ARTWORK, ALBUMS, PROPS, SET DESIGNS, PHOTOGRAPHS, VIDEO CLIPS, AUDIO FILES, SOUND RECORDINGS, AUDIOVISUAL RECORDINGS, OTHER MULTIMEDIA MATERIAL, AND RELATED WORKS, INFORMATION AND MATERIAL OF A PERFORMING ARTIST, IN CLASS 39 (U.S. CLS. 100 AND 105).

FIRST USE 12-3-2010; IN COMMERCE 2-24-2011.



FOR: ENTERTAINMENT AND EDUCATIONAL SERVICES, NAMELY, PROVIDING A LIBRARY AND ARCHIVE OF INFORMATION, MATERIALS AND PRODUCTS RELATING TO THE MUSICAL WORKS, LYRIC SHEETS, COSTUMES, EPHEMERA, ARTWORK, ALBUMS, PROPS, SET DESIGNS, PHOTOGRAPHS, VIDEO CLIPS, AUDIO FILES, SOUND RECORDINGS, AUDIOVISUAL RECORDINGS, OTHER MULTIMEDIA MATERIAL, AND RELATED WORKS, INFORMATION AND MATERIAL OF A PERFORMING ARTIST; ARCHIVE LIBRARY SERVICES, NAMELY, A REFERENCE LIBRARY OF INFORMATION, MATERIALS AND PRODUCTS RELATING TO THE MUSICAL WORKS, LYRIC SHEETS, COSTUMES, EPHEMERA, ARTWORK, ALBUMS, PROPS, SET DESIGNS, PHOTOGRAPHS, VIDEO CLIPS, AUDIO FILES, SOUND RECORDINGS, AUDIOVISUAL RECORDINGS, OTHER MULTIMEDIA MATERIAL, AND RELATED WORKS, INFORMATION AND MATERIAL OF A PERFORMING ARTIST, IN CLASS 41 (U.S. CLS. 100, 101 AND 107).

*David J. Kyjars*

Director of the United States Patent and Trademark Office

FIRST USE 12-3-2010; IN COMMERCE 2-24-2011.



**Reg. No. 4,198,809** THE MARK CONSISTS OF STANDARD CHARACTERS WITHOUT CLAIM TO ANY PARTICULAR FONT, STYLE, SIZE, OR COLOR.

NO CLAIM IS MADE TO THE EXCLUSIVE RIGHT TO USE "ARCHIVE", APART FROM THE MARK AS SHOWN.

"DAVID BOWIE" IDENTIFIES A LIVING INDIVIDUAL WHOSE CONSENT IS OF RECORD.

SN 77-713,413, FILED 4-14-2009.

SUZANNE BLANE, EXAMINING ATTORNEY

# United States of America

United States Patent and Trademark Office

## THE THRILLIONAIRES

**Reg. No. 4,198,810**

MONEY MASTERS LIMITED (CYPRUS LIMITED LIABILITY COMPANY)

**Registered Aug. 28, 2012**

1ST FLOOR, OFFICE 1  
LARNACA, CYPRUS

**Int. Cl.: 41**

FOR: ENTERTAINMENT IN THE NATURE OF PRERECORDED SELF-EMPOWERMENT, SELF-ACTUALIZATION, FINANCE, TRAVEL, HEALTH AND WELL BEING MESSAGES BY TELEPHONE; FILM AND VIDEO PRODUCTION; PRODUCTION OF TELEVISION PROGRAMS; PROVIDING A WEB SITE FEATURING NON-DOWNLOADABLE INSTRUCTIONAL VIDEOS IN THE FIELD OF FINANCE; PROVIDING A WEB SITE THAT FEATURES INFORMAL INSTRUCTION ON SELF-EMPOWERMENT, SELF-ACTUALIZATION, FINANCES, TRAVEL, HEALTH AND WELL BEING, IN CLASS 41 (U.S. CLS. 100, 101 AND 107).

**SERVICE MARK**

**PRINCIPAL REGISTER**

FIRST USE 9-30-2011; IN COMMERCE 9-30-2011.

THE MARK CONSISTS OF STANDARD CHARACTERS WITHOUT CLAIM TO ANY PARTICULAR FONT, STYLE, SIZE, OR COLOR.

OWNER OF U.S. REG. NO. 3,673,198.

SN 77-717,422, FILED 4-20-2009.

CHARLOTTE CORWIN, EXAMINING ATTORNEY



*David J. Kyros*

Director of the United States Patent and Trademark Office

# United States of America

United States Patent and Trademark Office

# WINCHESTER

**Reg. No. 4,198,811**

OLIN CORPORATION (VIRGINIA CORPORATION)  
190 CARONDELET PLAZA, SUITE 1530  
ST. LOUIS, MO 63105

**Registered Aug. 28, 2012**

**Int. Cl.: 33**

FOR: TEQUILA, IN CLASS 33 (U.S. CLS. 47 AND 49).

**TRADEMARK**

FIRST USE 2-28-2011; IN COMMERCE 2-28-2011.

**PRINCIPAL REGISTER**

THE MARK CONSISTS OF STANDARD CHARACTERS WITHOUT CLAIM TO ANY PARTICULAR FONT, STYLE, SIZE, OR COLOR.

OWNER OF U.S. REG. NOS. 2,269,474, 3,078,588, AND OTHERS.

SN 77-722,139, FILED 4-24-2009.

ELLEN BURNS, EXAMINING ATTORNEY



*David J. Kyffers*

Director of the United States Patent and Trademark Office

# United States of America

United States Patent and Trademark Office

## WE MAKE PATIENTS SAFER

**Reg. No. 4,198,812**

SPECTRUM SURGICAL INSTRUMENTS CORP. (OHIO CORPORATION)  
4575 HUDSON DRIVE  
STOW, OH 44224

**Registered Aug. 28, 2012**

**Int. Cls.: 10, 16, 35, and 37**

FOR: SURGICAL APPARATUS AND INSTRUMENTS FOR MEDICAL, DENTAL OR VETERINARY USE, SURGICAL DEVICES AND INSTRUMENTS, SURGICAL INSTRUMENTS AND APPARATUS, IN CLASS 10 (U.S. CLS. 26, 39 AND 44).

**TRADEMARK**

FIRST USE 0-0-2010; IN COMMERCE 0-0-2010.

**SERVICE MARK**

FOR: PUBLICATIONS, NAMELY, BOOKS, BROCHURES, BOOKLETS, AND TEACHING MATERIALS IN THE FIELD OF THE CLEANING, SHARPENING AND CARE OF SURGICAL, MEDICAL, DENTAL AND VETERINARY INSTRUMENTS, IN CLASS 16 (U.S. CLS. 2, 5, 22, 23, 29, 37, 38 AND 50).

**PRINCIPAL REGISTER**

FIRST USE 12-0-2008; IN COMMERCE 12-0-2008.

FOR: MAIL ORDER CATALOG SERVICES FEATURING MEDICAL INSTRUMENTS, SURGICAL INSTRUMENTS, TOOLS FOR CLEANING MEDICAL AND SURGICAL INSTRUMENTS, SUPPLIES FOR CLEANING MEDICAL AND SURGICAL INSTRUMENTS, MEDICAL AND SURGICAL INSTRUMENT ACCESSORIES; INTERNET BASED RETAIL STORE SERVICES FEATURING MEDICAL INSTRUMENTS, SURGICAL INSTRUMENTS, TOOLS FOR CLEANING MEDICAL AND SURGICAL INSTRUMENTS, SUPPLIES FOR CLEANING MEDICAL AND SURGICAL INSTRUMENTS, MEDICAL AND SURGICAL INSTRUMENT ACCESSORIES; PHONE ORDER CATALOG SERVICES FEATURING MEDICAL INSTRUMENTS, SURGICAL INSTRUMENTS, TOOLS FOR CLEANING MEDICAL AND SURGICAL INSTRUMENTS, SUPPLIES FOR CLEANING MEDICAL AND SURGICAL INSTRUMENTS, IN CLASS 35 (U.S. CLS. 100, 101 AND 102).

FIRST USE 12-0-2008; IN COMMERCE 12-0-2008.

FOR: REPAIR SERVICES FOR SURGICAL, MEDICAL, DENTAL AND VETERINARY INSTRUMENTS; SHARPENING SERVICES FOR SURGICAL, MEDICAL, DENTAL AND VETERINARY INSTRUMENTS, IN CLASS 37 (U.S. CLS. 100, 103 AND 106).

FIRST USE 12-0-2008; IN COMMERCE 12-0-2008.



*David J. Kyjars*

Director of the United States Patent and Trademark Office

**Reg. No. 4,198,812** THE MARK CONSISTS OF STANDARD CHARACTERS WITHOUT CLAIM TO ANY PARTICULAR FONT, STYLE, SIZE, OR COLOR.

SN 77-722,973, FILED 4-27-2009.

MARY CRAWFORD, EXAMINING ATTORNEY

# United States of America

United States Patent and Trademark Office

# FIRST ZR

**Reg. No. 4,198,813**

SAGEMAX BIOCERAMICS, INC. (WASHINGTON CORPORATION)  
34210 9TH AVENUE SOUTH, SUITE 118  
FEDERAL WAY, WA 98003

**Registered Aug. 28, 2012**

**Int. Cl.: 5**

FOR: DENTAL CERAMIC BLANKS MADE IN PART OF ZIRCONIUM, IN CLASS 5 (U.S. CLS. 6, 18, 44, 46, 51 AND 52).

**TRADEMARK**

FIRST USE 1-10-2009; IN COMMERCE 1-10-2009.

**PRINCIPAL REGISTER**

THE MARK CONSISTS OF STANDARD CHARACTERS WITHOUT CLAIM TO ANY PARTICULAR FONT, STYLE, SIZE, OR COLOR.

NO CLAIM IS MADE TO THE EXCLUSIVE RIGHT TO USE "ZR", APART FROM THE MARK AS SHOWN.

SN 77-730,435, FILED 5-6-2009.

EDWARD NELSON, EXAMINING ATTORNEY



*David J. Kyffers*

Director of the United States Patent and Trademark Office

# United States of America

United States Patent and Trademark Office

## LIVE CHURCH TOGETHER

**Reg. No. 4,198,814**

**Registered Aug. 28, 2012**

**Int. Cl.: 42**

**SERVICE MARK**

**PRINCIPAL REGISTER**

THE TABLE PROJECT (MINNESOTA NON-PROFIT CORPORATION)  
3530 E. 28TH STREET  
MINNEAPOLIS, MN 55406

FOR: PROVIDING AN ONLINE NON-DOWNLOADABLE SOFTWARE APPLICATION TO FACILITATE CONNECTION, COMMUNICATION, AND SHARING OF CONTENT BETWEEN AND AMONG MEMBERS OF CHURCH GROUPS; COMPUTER SERVICES, NAMELY, HOSTING ONLINE WEB FACILITIES FOR OTHERS FOR ORGANIZING AND CONDUCTING ONLINE MEETINGS, GATHERINGS, AND INTERACTIVE DISCUSSIONS; COMPUTER SERVICES, NAMELY, CREATING AN ONLINE COMMUNITY FOR REGISTERED USERS TO PARTICIPATE IN DISCUSSIONS, GET FEEDBACK FROM THEIR PEERS, FORM VIRTUAL COMMUNITIES, AND ENGAGE IN SOCIAL NETWORKING; PROVIDING A WEB SITE FEATURING TEMPORARY USE OF NON-DOWNLOADABLE SOFTWARE ALLOWING WEB SITE USERS TO UPLOAD ONLINE VIDEOS, PHOTOS, AND OTHER SHARED FILES FOR SHARING WITH OTHERS FOR ENTERTAINMENT PURPOSES, IN CLASS 42 (U.S. CLS. 100 AND 101).

FIRST USE 6-15-2012; IN COMMERCE 6-15-2012.

THE MARK CONSISTS OF STANDARD CHARACTERS WITHOUT CLAIM TO ANY PARTICULAR FONT, STYLE, SIZE, OR COLOR.

NO CLAIM IS MADE TO THE EXCLUSIVE RIGHT TO USE "CHURCH", APART FROM THE MARK AS SHOWN.

SN 77-732,888, FILED 5-8-2009.

SHAILA SETTLES, EXAMINING ATTORNEY



*David J. Kyffers*

Director of the United States Patent and Trademark Office

# United States of America

United States Patent and Trademark Office

# SMEAK

**Reg. No. 4,198,815**

**Registered Aug. 28, 2012**

**Int. Cl.: 38**

**SERVICE MARK**

**PRINCIPAL REGISTER**

SMEAK, INC. (CALIFORNIA CORPORATION)  
13386 SURREY LANE  
SARATOGA, CA 95070

FOR: TELECOMMUNICATION ACCESS SERVICES, NAMELY, PROVIDING ONLINE AND TELECOMMUNICATION FACILITIES FOR REALTIME INTERACTION BETWEEN AND AMONG USERS OF COMPUTERS, MOBILE AND HANDHELD COMPUTERS, WIRED AND WIRELESS COMMUNICATION DEVICES, AND AUTONOMOUS CENTRAL SERVERS, ENABLING INDIVIDUALS TO SEND AND RECEIVE MESSAGES VIA EMAIL AND INSTANT MESSAGING OR BY AN INTERACTIVE WEBSITE; PROVIDING ON-LINE CHAT ROOMS AND ELECTRONIC BULLETIN BOARDS FOR TRANSMISSION OF MESSAGES AMONG USERS IN THE FIELD OF GENERAL INTEREST; PROVIDING AN ONLINE COMMUNITY FORUM FOR USERS TO SHARE INFORMATION, PHOTOS, AUDIO AND VIDEO CONTENT ABOUT THEMSELVES, THEIR LIKES AND DISLIKES AND DAILY ACTIVITIES, TO GET FEEDBACK FROM THEIR PEERS, IN CLASS 38 (U.S. CLS. 100, 101 AND 104).

FIRST USE 5-5-2009; IN COMMERCE 6-29-2012.

THE MARK CONSISTS OF STANDARD CHARACTERS WITHOUT CLAIM TO ANY PARTICULAR FONT, STYLE, SIZE, OR COLOR.

SN 77-735,380, FILED 5-12-2009.

TIMOTHY FINNEGAN, EXAMINING ATTORNEY



*David J. Kybas*

Director of the United States Patent and Trademark Office



# United States of America

United States Patent and Trademark Office



**Reg. No. 4,198,816**

CENGAGE LEARNING, INC. (NEW YORK CORPORATION)  
200 FIRST STAMFORD PLACE  
STAMFORD, CT 06902

**Registered Aug. 28, 2012**

**Int. Cls.: 9, 16, 37, and 41**

FOR: COMPUTER SOFTWARE PROVIDING INSTRUCTION AND INFORMATION ON THE TOPIC OF CONSTRUCTION AND ENVIRONMENTALLY FRIENDLY CONSTRUCTION, IN CLASS 9 (U.S. CLS. 21, 23, 26, 36 AND 38).

**TRADEMARK**

FIRST USE 10-0-2011; IN COMMERCE 10-0-2011.

**SERVICE MARK**

FOR: PRINTED PRODUCTS, NAMELY, BOOKS, MANUALS AND PRINTED COURSE MATERIALS PROVIDING INSTRUCTION AND INFORMATION ON THE TOPIC OF CONSTRUCTION AND ENVIRONMENTALLY FRIENDLY CONSTRUCTION, IN CLASS 16 (U.S. CLS. 2, 5, 22, 23, 29, 37, 38 AND 50).

**PRINCIPAL REGISTER**

FIRST USE 9-0-2009; IN COMMERCE 9-0-2009.

FOR: ONLINE SERVICES, NAMELY, PROVIDING INFORMATION ON THE TOPIC OF BUILDING CONSTRUCTION AND ENVIRONMENTALLY FRIENDLY BUILDING CONSTRUCTION VIA THE INTERNET, IN CLASS 37 (U.S. CLS. 100, 103 AND 106).

FIRST USE 2-0-2012; IN COMMERCE 2-0-2012.

FOR: ONLINE SERVICES, NAMELY, PROVIDING INSTRUCTION ON THE TOPIC OF CONSTRUCTION AND ENVIRONMENTALLY FRIENDLY CONSTRUCTION VIA THE INTERNET, IN CLASS 41 (U.S. CLS. 100, 101 AND 107).

FIRST USE 2-0-2012; IN COMMERCE 2-0-2012.

NO CLAIM IS MADE TO THE EXCLUSIVE RIGHT TO USE "INNOVATION QUALITY SUSTAINABILITY", APART FROM THE MARK AS SHOWN.

THE COLOR(S) GREEN, GRAY, SILVER, BLACK AND WHITE IS/ARE CLAIMED AS A FEATURE OF THE MARK.

THE MARK CONSISTS OF A TRIANGLE (WITH A GRAY, SILVER AND BLACK OUTLINE) IN DIFFERENT SHADES OF GREEN WITH A GREEN LEAF IN THE MIDDLE AND THE



*David J. Kyffers*

Director of the United States Patent and Trademark Office

**Reg. No. 4,198,816** WORD "INNOVATION", "QUALITY" AND "SUSTAINABILITY" (IN WHITE) ON THE SIDES, AS WELL AS THE TERM "WWW.THEGREENDESTINATION" (IN GREEN) INCLUDED UNDERNEATH THE TRIANGLE. THE WHITE INTERIOR PORTION OF THE TRIANGLE IS BACKGROUND AND NOT PART OF THE MARK.

SN 77-736,194, FILED 5-13-2009.

MICHAEL ENGEL, EXAMINING ATTORNEY

# United States of America

United States Patent and Trademark Office



## Crédit Andorrà

**Reg. No. 4,198,817**

CREDIT ANDORRA, S.A. (ANDORRA CORPORATION)  
AVENIDA MERITXELL, 80

**Registered Aug. 28, 2012**

ANDORRA LA VELLA, ANDORRA AD500

**Int. Cl.: 36**

FOR: INSURANCE BROKERAGE; INSURANCE INFORMATION; FINANCIAL ADVICE;  
FINANCIAL CONSULTANCY; MONETARY AFFAIRS, NAMELY, MONETARY EXCHANGE  
AND MONETARY STRATEGY CONSULTATION; BANKING; REAL ESTATE BROKERAGE;  
REAL ESTATE CONSULTATION, IN CLASS 36 (U.S. CLS. 100, 101 AND 102).

**SERVICE MARK**

**PRINCIPAL REGISTER**

FIRST USE 12-31-2011; IN COMMERCE 12-31-2011.

NO CLAIM IS MADE TO THE EXCLUSIVE RIGHT TO USE "CRÈDIT ANDORRÀ", APART  
FROM THE MARK AS SHOWN.

THE COLOR(S) COLORS GREEN, WHITE AND BLACK IS/ARE CLAIMED AS A FEATURE  
OF THE MARK.

THE MARK CONSISTS OF A GREEN CIRCLE INSIDE OF WHICH ARE TWO WHITE KEYS,  
ONE BELOW THE OTHER; TO THE RIGHT SIDE OF THIS DESIGN IS THE WORDING  
"CRÈDIT ANDORRÀ" IN STYLIZED BLACK LETTERING.

SN 77-740,230, FILED 5-19-2009.

JOHN GARTNER, EXAMINING ATTORNEY



*David J. Kybas*

Director of the United States Patent and Trademark Office

# United States of America

United States Patent and Trademark Office

## Michael Di Maulo

**Reg. No. 4,198,818**

DIMAULO, MICHAEL ANTHONY (UNITED STATES INDIVIDUAL)  
56 ELM STREET

**Registered Aug. 28, 2012**

ENGLEWOOD CLIFFS, NJ 07632

**Int. Cl.: 41**

FOR: ENTERTAINMENT IN THE NATURE OF LIVE PERFORMANCES BY A PROFESSIONAL SINGER, IN CLASS 41 (U.S. CLS. 100, 101 AND 107).

**SERVICE MARK**

FIRST USE 12-10-2010; IN COMMERCE 12-10-2010.

**PRINCIPAL REGISTER**

THE MARK CONSISTS OF STANDARD CHARACTERS WITHOUT CLAIM TO ANY PARTICULAR FONT, STYLE, SIZE, OR COLOR.

THE NAME IN THE MARK IDENTIFIES A LIVING INDIVIDUAL WHOSE CONSENT IS OF RECORD.

SN 77-741,883, FILED 5-21-2009.

LESLEY LAMOTHE, EXAMINING ATTORNEY



*David J. Kyffers*

Director of the United States Patent and Trademark Office

# United States of America

United States Patent and Trademark Office

## IN THE ZONE

**Reg. No. 4,198,819**

**Registered Aug. 28, 2012**

**Int. Cl.: 28**

**TRADEMARK**

**PRINCIPAL REGISTER**

REGENT SPORTS CORPORATION (NEW YORK CORPORATION)  
P.O. BOX 11357  
HAUPPAUGE, NY 11788

FOR: INFLATABLE SPORT BALLS, IN CLASS 28 (U.S. CLS. 22, 23, 38 AND 50).

FIRST USE 3-1-2012; IN COMMERCE 3-1-2012.

THE MARK CONSISTS OF STANDARD CHARACTERS WITHOUT CLAIM TO ANY PARTICULAR FONT, STYLE, SIZE, OR COLOR.

SN 77-742,821, FILED 5-22-2009.

KEVIN CORWIN, EXAMINING ATTORNEY



*David J. Kyffers*

Director of the United States Patent and Trademark Office

# United States of America

United States Patent and Trademark Office

## DOS ARMADILLOS

**Reg. No. 4,198,820**

INTERNATIONAL PREMIUM SPIRITS, CORP. (TEXAS CORPORATION)  
3801 W. URSULA AVENUE  
MCALLEN, TX 78503

**Registered Aug. 28, 2012**

**Int. Cl.: 33**

FOR: LIQUOR AND LIQUEUR BEVERAGES, NAMELY, TEQUILAS, IN CLASS 33 (U.S. CLS. 47 AND 49).

**TRADEMARK**

FIRST USE 2-8-2012; IN COMMERCE 2-8-2012.

**PRINCIPAL REGISTER**

THE MARK CONSISTS OF STANDARD CHARACTERS WITHOUT CLAIM TO ANY PARTICULAR FONT, STYLE, SIZE, OR COLOR.

THE ENGLISH TRANSLATION OF "DOS" IN THE MARK IS TWO.

SN 77-743,526, FILED 5-22-2009.

CHRISTOPHER BUONGIORNO, EXAMINING ATTORNEY



*David J. Kyffers*

Director of the United States Patent and Trademark Office

# United States of America

United States Patent and Trademark Office

## SIMPLY SECURE

**Reg. No. 4,198,821**

ALLIANCEBERNSTEIN L.P. (DELAWARE LIMITED PARTNERSHIP)  
1345 AVENUE OF THE AMERICAS

**Registered Aug. 28, 2012**

NEW YORK, NY 10105

**Int. Cl.: 36**

FOR: FINANCIAL SERVICES, NAMELY, INVESTMENT MANAGEMENT AND INVESTMENT CONSULTING SERVICES FOR OTHERS; STOCK BROKERAGE; INVESTMENT BROKERAGE; INVESTMENT ADVICE; WEALTH MANAGEMENT; MUTUAL FUND MANAGEMENT; FINANCIAL PLANNING, IN CLASS 36 (U.S. CLS. 100, 101 AND 102).

**SERVICE MARK**

**PRINCIPAL REGISTER**

FIRST USE 1-0-2011; IN COMMERCE 1-0-2011.

THE MARK CONSISTS OF STANDARD CHARACTERS WITHOUT CLAIM TO ANY PARTICULAR FONT, STYLE, SIZE, OR COLOR.

SN 77-745,820, FILED 5-27-2009.

MARC LEIPZIG, EXAMINING ATTORNEY



*David J. Kybas*

Director of the United States Patent and Trademark Office

# United States of America

United States Patent and Trademark Office

# SPARC64



**Reg. No. 4,198,822**

SPARC INTERNATIONAL, INC. (CALIFORNIA CORPORATION)  
1671 DELL AVENUE, SUITE 204  
CAMPBELL, CA 95008

**Registered Aug. 28, 2012**

**Int. Cl.: 9**

FOR: COMPUTER HARDWARE, NAMELY, MICROPROCESSORS, CENTRAL PROCESSING UNITS, CIRCUIT BOARDS AND INTEGRATED CIRCUITS; COMPUTER PROGRAMS FOR OPERATING SYSTEMS AND MANUALS SOLD THEREWITH, IN CLASS 9 (U.S. CLS. 21, 23, 26, 36 AND 38).

**TRADEMARK**

**PRINCIPAL REGISTER**

FIRST USE 6-29-2012; IN COMMERCE 6-29-2012.

OWNER OF U.S. REG. NOS. 1,591,728, 1,715,120, AND 2,188,380.

THE MARK CONSISTS OF THE WORDING "SPARC64" AND DESIGNS. THE DESIGNS CONSIST OF INTERLOCKING TRIANGLES OR ARROWS THAT ARE THEMSELVES FORMED OF REPEATED SERIES OF LINES. THE LINES GIVE THE TRIANGLES THE APPEARANCE OF FEATHERED EDGES, BUT MERGE INTO MORE SOLID FORMS. THE TRIANGLES INTERLOCK AND TWIST TO GIVE THE APPEARANCE OF A LIGHTNING BOLT OR EVEN THE LETTER S.

SN 77-745,849, FILED 5-27-2009.

CORY BOONE, EXAMINING ATTORNEY



*David J. Kybas*

Director of the United States Patent and Trademark Office



United States of America  
United States Patent and Trademark Office

DUDE

**Reg. No. 4,198,823**

KONISZCZUK, STEVEN JOHN (UNITED STATES INDIVIDUAL)  
5751 WILENA PLACE  
SARASOTA, FL 34238

**Registered Aug. 28, 2012**

**Int. Cl.: 3**

FOR: BEAUTY BEVERAGES, NAMELY, FRUIT JUICES AND ENERGY DRINK CONTAINING NUTRITIONAL SUPPLEMENTS, VITAMIN AND MINERAL SUPPLEMENTS, NUTRITIONAL ADDITIVES FOR USE IN FOODS AND DIETARY SUPPLEMENTS FOR HUMAN CONSUMPTION, PLANT AND HERB EXTRACTS FOR COSMETIC PURPOSES AND MADE AVAILABLE THROUGH HEALTH CARE AND BEAUTY PRODUCT CATEGORIES, IN CLASS 3 (U.S. CLS. 1, 4, 6, 50, 51 AND 52).

**TRADEMARK**

**PRINCIPAL REGISTER**

FIRST USE 1-10-2012; IN COMMERCE 3-26-2012.

THE MARK CONSISTS OF STANDARD CHARACTERS WITHOUT CLAIM TO ANY PARTICULAR FONT, STYLE, SIZE, OR COLOR.

SN 77-747,323, FILED 5-29-2009.

ANGELA M. MICHELI, EXAMINING ATTORNEY



*David J. Kyros*

Director of the United States Patent and Trademark Office

# United States of America

United States Patent and Trademark Office

## CYPRESS COAST

**Reg. No. 4,198,824**

**Registered Aug. 28, 2012**

**Int. Cl.: 36**

**SERVICE MARK**

**PRINCIPAL REGISTER**

CYPRESS COAST PARTNERS, LLC (DELAWARE LIMITED LIABILITY COMPANY)  
225 CROSSROADS BLVD  
CARMEL, CA 93923

FOR: EQUITY CAPITAL INVESTMENT; FINANCIAL ADVICE AND CONSULTANCY SERVICES; FINANCIAL AND INVESTMENT SERVICES, NAMELY, MANAGEMENT AND BROKERAGE IN THE FIELDS OF STOCKS, BONDS, OPTIONS, COMMODITIES, FUTURES AND OTHER SECURITIES, AND THE INVESTMENT OF FUNDS OF OTHERS; FINANCIAL INVESTMENT IN THE FIELD OF REAL ESTATE AND SECURITIES; FINANCIAL SERVICES, NAMELY, INVESTMENT ADVICE, INVESTMENT MANAGEMENT, INVESTMENT CONSULTATION AND INVESTMENT OF FUNDS FOR OTHERS, INCLUDING PRIVATE AND PUBLIC EQUITY AND DEBT INVESTMENT SERVICES; FUNDS INVESTMENT; HEDGE FUND INVESTMENT SERVICES; INVESTMENT ADVISORY SERVICES; INVESTMENT OF FUNDS FOR OTHERS, IN CLASS 36 (U.S. CLS. 100, 101 AND 102).

FIRST USE 6-1-2010; IN COMMERCE 1-1-2011.

THE MARK CONSISTS OF STANDARD CHARACTERS WITHOUT CLAIM TO ANY PARTICULAR FONT, STYLE, SIZE, OR COLOR.

SN 77-747,616, FILED 5-29-2009.

WENDY GOODMAN, EXAMINING ATTORNEY



*David J. Kyros*

Director of the United States Patent and Trademark Office

# United States of America

United States Patent and Trademark Office

## MOLTO BENE

**Reg. No. 4,198,825**

**Registered Aug. 28, 2012**

**Int. Cl.: 33**

**TRADEMARK**

**PRINCIPAL REGISTER**

THE WINE GROUP LLC (DELAWARE LIMITED LIABILITY COMPANY)  
4596 S. TRACY BOULEVARD  
TRACY, CA 95377

FOR: WINE, IN CLASS 33 (U.S. CLS. 47 AND 49).

FIRST USE 6-12-2012; IN COMMERCE 6-12-2012.

THE MARK CONSISTS OF STANDARD CHARACTERS WITHOUT CLAIM TO ANY PARTICULAR FONT, STYLE, SIZE, OR COLOR.

THE ENGLISH TRANSLATION OF "MOLTO BENE" IN THE MARK IS VERY WELL.

SN 77-748,961, FILED 6-1-2009.

ANDREA HACK, EXAMINING ATTORNEY



*David J. Kyffers*

Director of the United States Patent and Trademark Office

# United States of America

United States Patent and Trademark Office

## RESEARCH!AMERICA

**Reg. No. 4,198,826**

**Registered Aug. 28, 2012**

**Int. Cls.: 35 and 42**

**SERVICE MARK**

**PRINCIPAL REGISTER**

RESEARCH!AMERICA (D.C. CORPORATION)  
SUITE 520  
1101 KING STREET  
ALEXANDRIA, VA 22314

FOR: PROMOTING PUBLIC AWARENESS OF THE NEED FOR MEDICAL AND SCIENTIFIC RESEARCH; PUBLIC ADVOCACY TO PROMOTE AWARENESS OF THE NEED FOR MEDICAL AND SCIENTIFIC RESEARCH, IN CLASS 35 (U.S. CLS. 100, 101 AND 102).

FIRST USE 5-22-1989; IN COMMERCE 5-22-1989.

FOR: INFORMATION DISSEMINATION, NAMELY, PROVIDING INFORMATION IN THE FIELD OF MEDICAL RESEARCH AND SCIENCE, IN CLASS 42 (U.S. CLS. 100 AND 101).

FIRST USE 5-22-1989; IN COMMERCE 5-22-1989.

THE MARK CONSISTS OF STANDARD CHARACTERS WITHOUT CLAIM TO ANY PARTICULAR FONT, STYLE, SIZE, OR COLOR.

OWNER OF U.S. REG. NOS. 2,359,064, 2,479,856, AND 2,638,234.

SN 77-756,353, FILED 6-10-2009.

BRENDAN MCCAULEY, EXAMINING ATTORNEY



*David J. Kyros*

Director of the United States Patent and Trademark Office

# United States of America

United States Patent and Trademark Office

# ROCKET

**Reg. No. 4,198,827**

**Registered Aug. 28, 2012**

**Int. Cls.: 28, 37, and 40**

**TRADEMARK**

**SERVICE MARK**

**PRINCIPAL REGISTER**

PROSLIDE TECHNOLOGY INC. (CANADA CORPORATION)  
2650 QUEENSVIEW DRIVE, SUITE 150  
OTTAWA, ONTARIO, CANADA K2B8H6

FOR: AMUSEMENT PARK RIDES; AMUSEMENT PARK WATER RIDES; WATERSLIDES;  
WATERSLIDE RAFTS, IN CLASS 28 (U.S. CLS. 22, 23, 38 AND 50).

FIRST USE 5-31-2005; IN COMMERCE 5-31-2005.

FOR: INSTALLATION AND MAINTENANCE OF AMUSEMENT PARK RIDES, AMUSEMENT  
PARK WATER RIDES, WATERSLIDES, AMUSEMENT PARK RIDE CONTROL SYSTEMS,  
AND WATERSLIDE RAFTS, IN CLASS 37 (U.S. CLS. 100, 103 AND 106).

FIRST USE 12-31-2005; IN COMMERCE 12-31-2005.

FOR: CUSTOM MANUFACTURE OF AMUSEMENT PARK RIDES, AMUSEMENT PARK  
WATER RIDES, WATERSLIDES, AMUSEMENT PARK RIDE CONTROL SYSTEMS, AND  
WATERSLIDE RAFTS, IN CLASS 40 (U.S. CLS. 100, 103 AND 106).

FIRST USE 12-31-2005; IN COMMERCE 12-31-2005.

THE MARK CONSISTS OF STANDARD CHARACTERS WITHOUT CLAIM TO ANY PAR-  
TICULAR FONT, STYLE, SIZE, OR COLOR.

SN 77-757,629, FILED 6-11-2009.

WILLIAM BRECKENFELD, EXAMINING ATTORNEY



*David J. Kyros*

Director of the United States Patent and Trademark Office

# United States of America

United States Patent and Trademark Office

## BIO2 SOLUTION

**Reg. No. 4,198,828**

AGSMART, INC. (COLORADO CORPORATION)

**Registered Aug. 28, 2012**

P.O. BOX 329  
STRASBURG, CO 80136

**Int. Cls.: 37 and 42**

FOR: CONSULTING SERVICES FOR THE CONSTRUCTION OF WASTE WATER REMEDIATION LAGOONS, IN CLASS 37 (U.S. CLS. 100, 103 AND 106).

**SERVICE MARK**

FIRST USE 3-10-2012; IN COMMERCE 3-10-2012.

**PRINCIPAL REGISTER**

FOR: ENGINEERING, RESEARCH, DESIGN, AND DEVELOPMENT OF TECHNOLOGIES FOR THE CONSTRUCTION AND IMPLEMENTATION OF WASTE WATER REMEDIATION LAGOONS, IN CLASS 42 (U.S. CLS. 100 AND 101).

FIRST USE 5-15-2012; IN COMMERCE 5-15-2012.

THE MARK CONSISTS OF STANDARD CHARACTERS WITHOUT CLAIM TO ANY PARTICULAR FONT, STYLE, SIZE, OR COLOR.

OWNER OF U.S. REG. NO. 2,620,047.

NO CLAIM IS MADE TO THE EXCLUSIVE RIGHT TO USE "SOLUTION", APART FROM THE MARK AS SHOWN.

SN 77-760,756, FILED 6-16-2009.

JOHN DWYER, EXAMINING ATTORNEY



*David J. Kyros*

Director of the United States Patent and Trademark Office

# United States of America

United States Patent and Trademark Office

## EXTEND-A-CLEAN

**Reg. No. 4,198,829**

S. C. JOHNSON & SON, INC. (WISCONSIN CORPORATION)  
1525 HOWE STREET  
RACINE, WI 53403

**Registered Aug. 28, 2012**

**Int. Cl.: 3**

FOR: TOILET BOWL CLEANERS, IN CLASS 3 (U.S. CLS. 1, 4, 6, 50, 51 AND 52).

**TRADEMARK**

FIRST USE 1-19-2011; IN COMMERCE 1-19-2011.

**PRINCIPAL REGISTER**

THE MARK CONSISTS OF STANDARD CHARACTERS WITHOUT CLAIM TO ANY PARTICULAR FONT, STYLE, SIZE, OR COLOR.

SN 77-762,029, FILED 6-17-2009.

INGRID C. EULIN, EXAMINING ATTORNEY



*David J. Kyffers*

Director of the United States Patent and Trademark Office

# United States of America

United States Patent and Trademark Office

## WHERE THE PLANET OPENS UP TO TELL ITS STORY

**Reg. No. 4,198,830**

**Registered Aug. 28, 2012**

**Int. Cl.: 43**

**SERVICE MARK**

**PRINCIPAL REGISTER**

HENDRICKS INVESTMENT HOLDINGS, LLC (DELAWARE LIMITED LIABILITY COMPANY)  
8484 GEORGIA AVENUE  
SILVER SPRING, MD 20910

FOR: HOTELS; MOTOR INNS; RESORT LODGING SERVICES; HEALTH RESORT SERVICES, NAMELY, PROVIDING FOOD AND LODGING THAT SPECIALIZE IN PROMOTING PATRONS' GENERAL HEALTH AND WELL-BEING, IN CLASS 43 (U.S. CLS. 100 AND 101).

FIRST USE 5-29-2012; IN COMMERCE 5-29-2012.

THE MARK CONSISTS OF STANDARD CHARACTERS WITHOUT CLAIM TO ANY PARTICULAR FONT, STYLE, SIZE, OR COLOR.

SN 77-763,900, FILED 6-19-2009.

LINDA ESTRADA, EXAMINING ATTORNEY



*David J. Kybas*

Director of the United States Patent and Trademark Office



# United States of America

United States Patent and Trademark Office

# SOLAIS

**Reg. No. 4,198,831**

SOLAIS LIGHTING, INC. (DELAWARE CORPORATION)  
470 WEST AVENUE  
STAMFORD, CT 069026359

**Registered Aug. 28, 2012**

**Int. Cl.: 11**

FOR: LIGHTING, NAMELY, LAMPS AND LIGHTING FIXTURES, IN CLASS 11 (U.S. CLS. 13, 21, 23, 31 AND 34).

**TRADEMARK**

FIRST USE 7-31-2010; IN COMMERCE 7-31-2010.

**PRINCIPAL REGISTER**

NO CLAIM IS MADE TO THE EXCLUSIVE RIGHT TO USE "SOLAIS", APART FROM THE MARK AS SHOWN.

THE MARK CONSISTS OF THE SHADED LETTERS "SOLAIS", WHERE THE LETTER "O" IS REPLACED BY A LIGHTER SHADED TURBINE-STYLE CIRCULAR FAN BLADE CONSISTING OF FIVE INDIVIDUAL FAN BLADES.

THE ENGLISH TRANSLATION OF "SOLAIS" IS "OF LIGHT".

SN 77-770,967, FILED 6-30-2009.

ODESSA BIBBINS, EXAMINING ATTORNEY



*David J. Kyffers*

Director of the United States Patent and Trademark Office

# United States of America

United States Patent and Trademark Office

# TINY TOOT

**Reg. No. 4,198,832**

LIVING MAP, LLC (SOUTH DAKOTA LIMITED LIABILITY COMPANY)  
163 WEST MAIN  
LEAD, SD 57754

**Registered Aug. 28, 2012**

**Int. Cls.: 25 and 28**

FOR: CLOTHING, NAMELY, T-SHIRTS, SHIRTS, BLOUSES, SWEATSHIRTS, JACKETS, SWEATERS, DRESSES, JUMPERS, PANTS, SLACKS, SHORTS, SLEEPWEAR, SWIMWEAR, SNOWSUITS, RAINWEAR, SCARVES, INFANTWEAR, PLAY SUITS AND CLOTH BIBS; FOOTWEAR, NAMELY, SHOES, SNEAKERS, SANDALS, SLIPPERS, BOOTS; HEADGEAR, NAMELY, CAPS, HATS, HEAD BANDS, EAR MUFFS, IN CLASS 25 (U.S. CLS. 22 AND 39).

**TRADEMARK**

**PRINCIPAL REGISTER**

FIRST USE 7-9-2012; IN COMMERCE 7-9-2012.

FOR: TOYS, NAMELY, MUSICAL TOYS, TALKING TOYS, BATTERY OPERATED TOYS, MECHANICAL TOYS, TRAINS, VEHICLES, STUFFED TOYS, PLUSH TOYS, JIGSAW PUZZLES, IN CLASS 28 (U.S. CLS. 22, 23, 38 AND 50).

FIRST USE 7-9-2012; IN COMMERCE 7-9-2012.

THE MARK CONSISTS OF STANDARD CHARACTERS WITHOUT CLAIM TO ANY PARTICULAR FONT, STYLE, SIZE, OR COLOR.

SN 77-774,611, FILED 7-6-2009.

KIMBERLY PERRY, EXAMINING ATTORNEY



*David J. Kyffers*

Director of the United States Patent and Trademark Office

# United States of America

United States Patent and Trademark Office

## GINNY WEASLEY

**Reg. No. 4,198,833**

WARNER BROS. ENTERTAINMENT INC. (DELAWARE CORPORATION)  
4000 WARNER BOULEVARD  
BURBANK, CA 91522

**Registered Aug. 28, 2012**

**Int. Cl.: 28**

FOR: TOYS AND PLAYTHINGS, NAMELY, ACTION FIGURES; DOLLS, IN CLASS 28 (U.S. CLS. 22, 23, 38 AND 50).

**TRADEMARK**

FIRST USE 5-1-2009; IN COMMERCE 5-1-2009.

**PRINCIPAL REGISTER**

THE MARK CONSISTS OF STANDARD CHARACTERS WITHOUT CLAIM TO ANY PARTICULAR FONT, STYLE, SIZE, OR COLOR.

OWNER OF U.S. REG. NO. 2,456,416.

THE NAME(S), PORTRAIT(S), AND/OR SIGNATURE(S) SHOWN IN THE MARK DOES NOT IDENTIFY A PARTICULAR LIVING INDIVIDUAL.

SN 77-774,776, FILED 7-6-2009.

LAURIE MAYES, EXAMINING ATTORNEY



*David J. Kyros*

Director of the United States Patent and Trademark Office

# United States of America

United States Patent and Trademark Office

## EQUISENTIAL

**Reg. No. 4,198,834**

**Registered Aug. 28, 2012**

**Int. Cls.: 10 and 18**

**TRADEMARK**

**PRINCIPAL REGISTER**

PROFESSIONAL'S CHOICE SPORTS MEDICINE PRODUCTS, INC. (CALIFORNIA CORPORATION)  
SUITE 106  
EL CAJON, CA 92020

FOR: ORTHOPEDIC BRACES AND STRAPS FOR EQUINE JOINTS AND LIMBS, IN CLASS 10 (U.S. CLS. 26, 39 AND 44).

FIRST USE 4-1-2010; IN COMMERCE 4-1-2010.

FOR: HORSE TACK, NAMELY, SADDLERY, FEEDERS, WRAPS, CINCHES, IN CLASS 18 (U.S. CLS. 1, 2, 3, 22 AND 41).

FIRST USE 4-1-2010; IN COMMERCE 4-1-2010.

THE MARK CONSISTS OF STANDARD CHARACTERS WITHOUT CLAIM TO ANY PARTICULAR FONT, STYLE, SIZE, OR COLOR.

SN 77-784,146, FILED 7-17-2009.

CHRISTINE COOPER, EXAMINING ATTORNEY



*David J. Kypos*

Director of the United States Patent and Trademark Office

# United States of America

United States Patent and Trademark Office

# XQD

**Reg. No. 4,198,835**

**Registered Aug. 28, 2012**

**Int. Cl.: 10**

**TRADEMARK**

**PRINCIPAL REGISTER**

SONY CORPORATION (JAPAN CORPORATION)  
1-7-1 KONAN, MINATO-KU  
TOKYO, JAPAN

FOR: IC MEMORY CARDS, IN CLASS 10 (U.S. CLS. 26, 39 AND 44).

FIRST USE 1-31-2012; IN COMMERCE 1-31-2012.

THE MARK CONSISTS OF STANDARD CHARACTERS WITHOUT CLAIM TO ANY PARTICULAR FONT, STYLE, SIZE, OR COLOR.

SN 77-786,883, FILED 7-22-2009.

MARILYN IZZI, EXAMINING ATTORNEY



*David J. Kybas*

Director of the United States Patent and Trademark Office

# United States of America

United States Patent and Trademark Office

## Addison Papers

**Reg. No. 4,198,836**

MOORMAN-GREENE, YASMIN (UNITED STATES INDIVIDUAL)  
875 W. 181 ST, #3D

**Registered Aug. 28, 2012**

NEW YORK, NY 10033

**Int. Cl.: 41**

FOR: PROVIDING A WEBSITE FEATURING EDUCATIONAL INFORMATION IN THE FIELD OF LAW, NAMELY, STUDY GUIDES, FICTIONAL STORIES, ESSAYS AND ONLINE TRAINING IN THE FIELD OF TEST PREPARATION, IN CLASS 41 (U.S. CLS. 100, 101 AND 107).

**SERVICE MARK**

**PRINCIPAL REGISTER**

FIRST USE 8-1-2010; IN COMMERCE 8-30-2010.

THE MARK CONSISTS OF STANDARD CHARACTERS WITHOUT CLAIM TO ANY PARTICULAR FONT, STYLE, SIZE, OR COLOR.

NO CLAIM IS MADE TO THE EXCLUSIVE RIGHT TO USE "PAPERS", APART FROM THE MARK AS SHOWN.

THE NAME "ADDISON PAPERS" DOES NOT IDENTIFY A LIVING INDIVIDUAL.

SN 77-787,535, FILED 7-22-2009.

RENEE MCCRAY, EXAMINING ATTORNEY



*David J. Kyros*

Director of the United States Patent and Trademark Office

# United States of America

United States Patent and Trademark Office

## PURSE CANDY

**Reg. No. 4,198,837**

SICURA DESIGNS, INC. (NEW YORK CORPORATION)  
107 NEW YORK AVENUE  
JERSEY CITY, NJ 07307

**Registered Aug. 28, 2012**

**Int. Cls.: 3 and 20**

FOR: COMPACTS CONTAINING MAKE-UP; COSMETICS, NAMELY, COMPACTS; LIPSTICK CASES, IN CLASS 3 (U.S. CLS. 1, 4, 6, 50, 51 AND 52).

**TRADEMARK**

FIRST USE 1-1-2007; IN COMMERCE 1-1-2007.

**PRINCIPAL REGISTER**

FOR: PERSONAL COMPACT MIRRORS, IN CLASS 20 (U.S. CLS. 2, 13, 22, 25, 32 AND 50).

FIRST USE 1-1-2007; IN COMMERCE 1-1-2007.

THE MARK CONSISTS OF STANDARD CHARACTERS WITHOUT CLAIM TO ANY PARTICULAR FONT, STYLE, SIZE, OR COLOR.

SN 77-790,825, FILED 7-28-2009.

LINDA POWELL, EXAMINING ATTORNEY



*David J. Kybas*

Director of the United States Patent and Trademark Office

# United States of America

United States Patent and Trademark Office

# OWL POST

**Reg. No. 4,198,838**

WARNER BROS. ENTERTAINMENT INC. (DELAWARE CORPORATION)  
4000 WARNER BOULEVARD  
BURBANK, CA 91522

**Registered Aug. 28, 2012**

**Int. Cl.: 16**

FOR: PRINTED MATTER AND PAPER GOODS, NAMELY, STATIONERY, WRITING PAPER, ENVELOPES, IN CLASS 16 (U.S. CLS. 2, 5, 22, 23, 29, 37, 38 AND 50).

**TRADEMARK**

FIRST USE 6-18-2010; IN COMMERCE 6-18-2010.

**PRINCIPAL REGISTER**

THE MARK CONSISTS OF STANDARD CHARACTERS WITHOUT CLAIM TO ANY PARTICULAR FONT, STYLE, SIZE, OR COLOR.

SN 77-792,203, FILED 7-29-2009.

JOHN SCHUYLER YARD, EXAMINING ATTORNEY



*David J. Kybas*

Director of the United States Patent and Trademark Office



# United States of America

United States Patent and Trademark Office

## ACCELERATE PRP SPORT

**Reg. No. 4,198,839**

EXACTECH, INC. (FLORIDA CORPORATION)  
2320 NORTH WEST 66TH COURT  
GAINESVILLE, FL 32653

**Registered Aug. 28, 2012**

**Int. Cl.: 5**

FOR: BIOLOGICAL PREPARATIONS FOR MEDICAL PURPOSES, IN CLASS 5 (U.S. CLS. 6, 18, 44, 46, 51 AND 52).

**TRADEMARK**

FIRST USE 1-0-2010; IN COMMERCE 1-0-2010.

**PRINCIPAL REGISTER**

THE MARK CONSISTS OF STANDARD CHARACTERS WITHOUT CLAIM TO ANY PARTICULAR FONT, STYLE, SIZE, OR COLOR.

NO CLAIM IS MADE TO THE EXCLUSIVE RIGHT TO USE "PRP SPORT", APART FROM THE MARK AS SHOWN.

SN 77-793,062, FILED 7-30-2009.

JENNIFER VASQUEZ, EXAMINING ATTORNEY



*David J. Kybas*

Director of the United States Patent and Trademark Office

# United States of America

United States Patent and Trademark Office

# ESTIVATION

**Reg. No. 4,198,840**

MAGAT, EDITH (UNITED STATES INDIVIDUAL)  
1960 ALTAMONT PLACE  
SAN DIEGO, CA 92139

**Registered Aug. 28, 2012**

**Int. Cl.: 25**

FOR: SHORT-SLEEVED OR LONG-SLEEVED T-SHIRTS, IN CLASS 25 (U.S. CLS. 22 AND 39).

**TRADEMARK**

FIRST USE 3-1-2012; IN COMMERCE 3-1-2012.

**PRINCIPAL REGISTER**

THE MARK CONSISTS OF STANDARD CHARACTERS WITHOUT CLAIM TO ANY PARTICULAR FONT, STYLE, SIZE, OR COLOR.

SN 77-793,190, FILED 7-30-2009.

FRED CARL, EXAMINING ATTORNEY



*David J. Kyffers*

Director of the United States Patent and Trademark Office

# United States of America

United States Patent and Trademark Office



**Reg. No. 4,198,841**

**Registered Aug. 28, 2012**

**Int. Cl.: 9**

**TRADEMARK**

**PRINCIPAL REGISTER**

MASTRAN MUSIC GROUP, INC. (TENNESSEE CORPORATION), DBA GRANDVISTA,  
1706 GRAND AVENUE  
NASHVILLE, TN 37212

FOR: CHILDREN'S EDUCATIONAL MUSIC CDS AND DVDS, IN CLASS 9 (U.S. CLS. 21,  
23, 26, 36 AND 38).

FIRST USE 5-31-2011; IN COMMERCE 5-31-2011.

NO CLAIM IS MADE TO THE EXCLUSIVE RIGHT TO USE "MUSIC", APART FROM THE  
MARK AS SHOWN.

THE MARK CONSISTS OF THE WORDS "QUAVER'S MARVELOUS WORLD OF MUSIC"  
OVER THE DESIGN OF A PIANO KEYBOARD.

SN 77-796,959, FILED 8-4-2009.

WON TEAK OH, EXAMINING ATTORNEY



*David J. Kyffers*

Director of the United States Patent and Trademark Office

# United States of America

United States Patent and Trademark Office

## In My Corner

**Reg. No. 4,198,842**

JOSEPH ORRACH (UNITED STATES INDIVIDUAL)  
1924 WASHINGTON STREET #2  
SAN FRANCISCO, CA 94109

**Registered Aug. 28, 2012**

**Int. Cl.: 41**

FOR: ENTERTAINMENT SERVICES IN THE NATURE OF ON-GOING THEATRICAL SHOWS FEATURING LIVE THEATER AND DANCE PERFORMANCES AT PERFORMANCE VENUES; EDUCATIONAL SERVICES, NAMELY, WORKSHOPS IN THE FIELDS OF PRODUCTION OF LIVE THEATER, DANCE, ACTING, AND STORY TELLING, IN CLASS 41 (U.S. CLS. 100, 101 AND 107).

**SERVICE MARK**

**PRINCIPAL REGISTER**

FIRST USE 7-20-2008; IN COMMERCE 5-15-2009.

THE MARK CONSISTS OF STANDARD CHARACTERS WITHOUT CLAIM TO ANY PARTICULAR FONT, STYLE, SIZE, OR COLOR.

SN 77-804,831, FILED 8-14-2009.

ASMAT KHAN, EXAMINING ATTORNEY



*David J. Kyffers*

Director of the United States Patent and Trademark Office

# United States of America

United States Patent and Trademark Office

# SPARTACUS

**Reg. No. 4,198,843**

**Registered Aug. 28, 2012**

**Int. Cls.: 9, 16, and 41**

**TRADEMARK**

**SERVICE MARK**

**PRINCIPAL REGISTER**

STARZ ENTERTAINMENT, LLC (COLORADO LIMITED LIABILITY COMPANY)  
8900 LIBERTY CIRCLE  
ENGLEWOOD, CO 80112

FOR: PRERECORDED VIDEO RECORDINGS, DVDS AND CDS FEATURING A TELEVISION SERIES; COMPUTER GAME PROGRAMS; COMPUTER GAME SOFTWARE; DOWNLOADABLE MULTIMEDIA FILES CONTAINING ARTWORK, TEXT, AUDIO, VIDEO, GAMES AND INTERNET WEB LINKS, ALL FEATURING CONTENT FROM OR RELATING TO A TELEVISION SERIES; DOWNLOADABLE VIDEO GAMES ACCESSIBLE VIA THE INTERNET, COMPUTERS AND WIRELESS DEVICES ALL FEATURING CONTENT FROM OR RELATING TO A TELEVISION SERIES, IN CLASS 9 (U.S. CLS. 21, 23, 26, 36 AND 38).

FIRST USE 1-22-2010; IN COMMERCE 1-22-2010.

FOR: PRINTED MATTER AND PAPER GOODS, NAMELY, BOOKS FEATURING COMIC MATERIAL FEATURING CONTENT FROM OR RELATING TO A TELEVISION SERIES ONLY AND NOT RELATING TO TRAVEL; A SERIES OF BOOKS OF FICTION FEATURING CONTENT FROM OR RELATING TO A TELEVISION SERIES ONLY AND NOT RELATING TO TRAVEL, POSTERS FEATURING CONTENT FROM OR RELATING TO A TELEVISION SERIES ONLY AND NOT RELATING TO TRAVEL; NEWSLETTERS FEATURING CONTENT FROM OR RELATING TO A TELEVISION SERIES ONLY AND NOT RELATING TO TRAVEL, PHOTOGRAPHS, AND TRADING CARDS ALL FEATURING CONTENT FROM OR RELATING TO A TELEVISION SERIES ONLY AND NOT RELATING TO TRAVEL, IN CLASS 16 (U.S. CLS. 2, 5, 22, 23, 29, 37, 38 AND 50).

FIRST USE 1-22-2010; IN COMMERCE 1-22-2010.

FOR: ENTERTAINMENT SERVICES IN THE NATURE OF A DRAMATIC TELEVISION SERIES; PROVIDING INFORMATION ONLINE FEATURING NON-DOWNLOADABLE CONTENT FROM OR RELATING TO A TELEVISION SERIES; PROVIDING ONLINE NON-DOWNLOADABLE INTERACTIVE AND NON-INTERACTIVE COMIC BOOKS FEATURING CONTENT FROM OR RELATING TO A TELEVISION SERIES; NON-DOWNLOADABLE VIDEO GAMES ACCESSIBLE VIA THE INTERNET, COMPUTERS AND WIRELESS DEVICES ALL FEATURING CONTENT FROM OR RELATING TO A TELEVISION SERIES, IN CLASS 41 (U.S. CLS. 100, 101 AND 107).

FIRST USE 1-22-2010; IN COMMERCE 1-22-2010.



*David J. Kyffers*

Director of the United States Patent and Trademark Office

**Reg. No. 4,198,843** THE MARK CONSISTS OF STANDARD CHARACTERS WITHOUT CLAIM TO ANY PARTICULAR FONT, STYLE, SIZE, OR COLOR.

SN 77-807,901, FILED 8-19-2009.

RON FAIRBANKS, EXAMINING ATTORNEY

# United States of America

United States Patent and Trademark Office

# STORM

**Reg. No. 4,198,844**

**Registered Aug. 28, 2012**

**Int. Cl.: 31**

**TRADEMARK**

**PRINCIPAL REGISTER**

LAND O'LAKES PURINA FEED LLC (MINNESOTA LIMITED LIABILITY COMPANY)  
1080 COUNTY ROAD F WEST  
SHOREVIEW, MN 55126

FOR: ANIMAL FEED, IN CLASS 31 (U.S. CLS. 1 AND 46).

FIRST USE 2-21-2012; IN COMMERCE 2-21-2012.

THE MARK CONSISTS OF STANDARD CHARACTERS WITHOUT CLAIM TO ANY PARTICULAR FONT, STYLE, SIZE, OR COLOR.

SN 77-811,144, FILED 8-24-2009.

APRIL HESIK, EXAMINING ATTORNEY



*David J. Kybas*

Director of the United States Patent and Trademark Office

# United States of America

United States Patent and Trademark Office

# Eco-telligent

**Reg. No. 4,198,845**

**Registered Aug. 28, 2012**

**Int. Cl.: 7**

**TRADEMARK**

**PRINCIPAL REGISTER**

INTERNATIONAL ENVIRONMENTAL CORPORATION (OKLAHOMA CORPORATION)  
LEGAL DEPARTMENT  
5000 S.W. 7TH STREET  
OKLAHOMA CITY, OK 73128

FOR: CUSTOM-PROGRAMMED MOTORS AND MOTOR CONTROLLERS, SOLD AS A UNIT, FOR USE IN HEATING AND AIR CONDITIONING EQUIPMENT, IN CLASS 7 (U.S. CLS. 13, 19, 21, 23, 31, 34 AND 35).

FIRST USE 5-18-2012; IN COMMERCE 5-18-2012.

THE MARK CONSISTS OF STANDARD CHARACTERS WITHOUT CLAIM TO ANY PARTICULAR FONT, STYLE, SIZE, OR COLOR.

SN 77-811,874, FILED 8-25-2009.

CHRISTINE COOPER, EXAMINING ATTORNEY



*David J. Kybas*

Director of the United States Patent and Trademark Office



# United States of America

United States Patent and Trademark Office

# BAD BOY

**Reg. No. 4,198,846**

**Registered Aug. 28, 2012**

**Int. Cl.: 9**

**TRADEMARK**

**PRINCIPAL REGISTER**

PLATYPUS WEAR, INC. (NEVADA CORPORATION)  
2411 SECOND AVENUE  
SAN DIEGO, CA 92101

FOR: DOWNLOADABLE AUDIO AND VIDEO RECORDINGS FEATURING DOCUMENTARIES OF ATHLETES, INSTRUCTION IN RELATION TO FIGHTING AND MIXED MARTIAL ARTS, INTERVIEWS WITH ATHLETIC TRAINERS AND COACHES, AND INTERVIEWS WITH ATHLETES AND OTHER PERSONALITIES, IN CLASS 9 (U.S. CLS. 21, 23, 26, 36 AND 38).

FIRST USE 4-12-2012; IN COMMERCE 4-12-2012.

THE MARK CONSISTS OF STANDARD CHARACTERS WITHOUT CLAIM TO ANY PARTICULAR FONT, STYLE, SIZE, OR COLOR.

OWNER OF U.S. REG. NOS. 1,469,124, 2,060,484, AND OTHERS.

SN 77-816,252, FILED 8-31-2009.

ANGELA DUONG, EXAMINING ATTORNEY



*David J. Kyffers*

Director of the United States Patent and Trademark Office

# United States of America

United States Patent and Trademark Office

## INNOVAPHASE

**Reg. No. 4,198,847**

**Registered Aug. 28, 2012**

**Int. Cls.: 1 and 30**

**TRADEMARK**

**PRINCIPAL REGISTER**

CLABBER GIRL CORPORATION (INDIANA CORPORATION)  
900 WABASH AVENUE  
TERRE HAUTE, IN 47807

FOR: ENCAPSULATED FOOD PRESERVATIVES FOR USE IN THE MANUFACTURE OF FOODSTUFFS; ENCAPSULATED DOUGH CONDITIONERS AND STABILIZERS COMPRISED OF THICKENING AND PRESERVING ADDITIVES FOR NON-NUTRITIONAL PURPOSES, NAMELY, GUAR GUM AND FUMARIC ACID; FRYING OIL ADDITIVE FOR NON-NUTRITIONAL PURPOSES MADE FROM MINERALS AND ORGANIC ACIDS, IN CLASS 1 (U.S. CLS. 1, 5, 6, 10, 26 AND 46).

FIRST USE 1-31-2009; IN COMMERCE 1-31-2009.

FOR: SODIUM FREE BAKING POWDER, IN CLASS 30 (U.S. CL. 46).

FIRST USE 1-31-2009; IN COMMERCE 1-31-2009.

THE MARK CONSISTS OF STANDARD CHARACTERS WITHOUT CLAIM TO ANY PARTICULAR FONT, STYLE, SIZE, OR COLOR.

SN 77-821,864, FILED 9-8-2009.

SANJEEV VOHRA, EXAMINING ATTORNEY



*David J. Kyros*

Director of the United States Patent and Trademark Office

# United States of America

United States Patent and Trademark Office



**Reg. No. 4,198,848**

**Registered Aug. 28, 2012**

**Int. Cl.: 32**

**TRADEMARK**

**PRINCIPAL REGISTER**

VILLA DE ODON S.A.C. (PERU CORPORATION)  
SANTIAGO DE SURCO AV  
LA ENCALADA 197, INT. B  
LIMA, PERU

FOR: NON-ALCOHOLIC BEVERAGES, NAMELY, SODAS, IN CLASS 32 (U.S. CLS. 45, 46 AND 48).

FIRST USE 6-24-2006; IN COMMERCE 3-20-2012.

THE MARK CONSISTS OF A RED SWIRL BACKGROUND WITH RED DROPLETS, SUPERIMPOSED OVER THE RED BACKGROUND APPEARS THE LETTERS "K", "R" IN GREEN SURROUNDED BY A WHITE BORDER, IN BETWEEN THE LETTERS "K" AND "R" APPEAR A YELLOW DROP BENEATH WHICH APPEARS A DEPICTION OF A YELLOW LEMON WEDGE.

THE COLOR(S) RED, GREEN, YELLOW AND WHITE IS/ARE CLAIMED AS A FEATURE OF THE MARK.

SN 77-826,007, FILED 9-14-2009.

AISHA CLARKE, EXAMINING ATTORNEY



*David J. Kybas*

Director of the United States Patent and Trademark Office

United States of America  
United States Patent and Trademark Office

GRÜ-V

**Reg. No. 4,198,849**

WINE GROUP LLC., THE (DELAWARE LIMITED LIABILITY COMPANY)  
4596 S. TRACY BOULEVARD  
TRACY, CA 95377

**Registered Aug. 28, 2012**

**Int. Cl.: 33**

FOR: WINE, IN CLASS 33 (U.S. CLS. 47 AND 49).

**TRADEMARK**

FIRST USE 6-20-2012; IN COMMERCE 6-20-2012.

**PRINCIPAL REGISTER**

THE MARK CONSISTS OF STANDARD CHARACTERS WITHOUT CLAIM TO ANY PARTICULAR FONT, STYLE, SIZE, OR COLOR.

SN 77-829,099, FILED 9-17-2009.

ANDREA BUTLER, EXAMINING ATTORNEY



*David J. Kybas*

Director of the United States Patent and Trademark Office

# United States of America

United States Patent and Trademark Office

# STEAMACTIV

**Reg. No. 4,198,850**

KAO KABUSHIKI KAISHA (JAPAN CORPORATION), TA KAO CORPORATION,  
14-10, NIHONBASHI KAYABACHO, 1-CHOME  
CHUO-KU, TOKYO, JAPAN 103-8210

**Registered Aug. 28, 2012**

**Int. Cl.: 3**

FOR: COSMETIC INGREDIENT USED AS AN INTEGRAL COMPONENT OF NON-MEDICATED SKIN CARE PREPARATIONS, IN CLASS 3 (U.S. CLS. 1, 4, 6, 50, 51 AND 52).

**TRADEMARK**

FIRST USE 12-31-2009; IN COMMERCE 12-31-2009.

**PRINCIPAL REGISTER**

THE MARK CONSISTS OF STANDARD CHARACTERS WITHOUT CLAIM TO ANY PARTICULAR FONT, STYLE, SIZE, OR COLOR.

SN 77-842,558, FILED 10-6-2009.

LESLEY LAMOTHE, EXAMINING ATTORNEY



*David J. Kybas*

Director of the United States Patent and Trademark Office

# United States of America

United States Patent and Trademark Office

## UNICORNMEDIA

**Reg. No. 4,198,851**

**Registered Aug. 28, 2012**

**Int. Cl.: 35**

**SERVICE MARK**

**PRINCIPAL REGISTER**

UNICORN MEDIA, INC. (DELAWARE CORPORATION)  
24 WEST 5TH STREET  
TEMPE, AZ 85281

FOR: BUSINESS MONITORING SERVICES, NAMELY, TRACKING WEB SITES OF OTHERS TO PROVIDE DETAILS ABOUT VISITS TO WEB SITES AND THE USE OF DATA OR AUDIO VISUAL IMAGES DISPLAYED AND DISTRIBUTED ON THOSE WEB SITES AND PREPARING BUSINESS AND MARKET REPORTS WITH RESPECT TO THAT INFORMATION, IN CLASS 35 (U.S. CLS. 100, 101 AND 102).

FIRST USE 6-15-2008; IN COMMERCE 6-15-2008.

THE MARK CONSISTS OF STANDARD CHARACTERS WITHOUT CLAIM TO ANY PARTICULAR FONT, STYLE, SIZE, OR COLOR.

SN 77-842,803, FILED 10-6-2009.

SETH A. RAPPAPORT, EXAMINING ATTORNEY



*David J. Kybas*

Director of the United States Patent and Trademark Office

# United States of America

United States Patent and Trademark Office

# ASE

**Reg. No. 4,198,852**

ADVANCED SEMICONDUCTOR ENGINEERING, INC. (TAIWAN CORPORATION)  
NO.26, JINGSAN RD., NANTZ CHIU  
KAOHSIUN, TAIWAN 811

**Registered Aug. 28, 2012**

**Int. Cls.: 9, 40, and 42**

FOR: INTEGRATED CIRCUIT CHIPS; CIRCUIT BOARDS; SEMICONDUCTORS; SEMICONDUCTOR DEVICES; INTEGRATED CIRCUITS; ELECTRONIC INTEGRATED CIRCUITS; PRINTED CIRCUIT BOARDS; SEMICONDUCTORS CHIPS; INTEGRATED CIRCUIT BOARDS AND SEMICONDUCTOR WAFERS, IN CLASS 9 (U.S. CLS. 21, 23, 26, 36 AND 38).

**TRADEMARK**

**SERVICE MARK**

FIRST USE 5-1-2012; IN COMMERCE 5-1-2012.

**PRINCIPAL REGISTER**

FOR: CUSTOM MANUFACTURE OF SEMICONDUCTORS, SEMICONDUCTOR WAFERS AND INTEGRATED CIRCUIT BOARDS, IN CLASS 40 (U.S. CLS. 100, 103 AND 106).

FIRST USE 5-1-2012; IN COMMERCE 5-1-2012.

FOR: RESEARCH AND DEVELOPMENT FOR OTHERS OF SEMICONDUCTORS; SEMICONDUCTOR PACKAGING DESIGN; INTEGRATED CIRCUIT DESIGN FOR OTHERS; QUALITY EVALUATION FOR OTHERS OF SEMICONDUCTORS AND RELATED PRODUCTS; TESTING OF SEMICONDUCTORS AND RELATED PRODUCTS; PROVIDING QUALITY ASSURANCE IN THE FIELD OF SEMICONDUCTORS AND RELATED PRODUCTS; CONSULTING IN THE FIELD OF SEMICONDUCTOR PACKAGING TECHNOLOGY, IN CLASS 42 (U.S. CLS. 100 AND 101).

FIRST USE 5-1-2012; IN COMMERCE 5-1-2012.

THE MARK CONSISTS OF STANDARD CHARACTERS WITHOUT CLAIM TO ANY PARTICULAR FONT, STYLE, SIZE, OR COLOR.

SN 77-843,397, FILED 10-7-2009.

ESTHER A. BORSUK, EXAMINING ATTORNEY



*David J. Kyffers*

Director of the United States Patent and Trademark Office

# United States of America

United States Patent and Trademark Office



**BELCORP**

**LO IMAGINAMOS, LO HACEMOS**

**Reg. No. 4,198,853**

EBEL INTERNATIONAL LIMITED (BERMUDA CORPORATION)  
CEDAR HOUSE, 41 CEDAR AVENUE  
HAMILTON, BERMUDA HM12

**Registered Aug. 28, 2012**

**Int. Cl.: 35**

FOR: DIRECT MARKETING SERVICES FEATURING COSMETICS, FRAGRANCES, SKIN CARE PRODUCTS, BODY CARE PRODUCTS; ONLINE RETAIL STORE SERVICES FEATURING COSMETICS, FRAGRANCES, SKIN CARE PRODUCTS, BODY CARE PRODUCTS, IN CLASS 35 (U.S. CLS. 100, 101 AND 102).

**SERVICE MARK**

**PRINCIPAL REGISTER**

FIRST USE 1-19-2012; IN COMMERCE 1-19-2012.

THE MARK CONSISTS OF A STYLIZED REPRESENTATION OF THE LETTER "B", WITH THE WORDING "BELCORP" APPEARING BENEATH THE LETTER "B" AND THE WORDING "LO IMAGINAMOS LO HACEMOS" APPEARING BENEATH THE WORDING "BELCORP". THE COLORS PURPLE AND BLUE APPEAR IN PARTS OF THE STYLIZED LETTER "B". THE COLOR BLUE APPEARS IN THE WORDING "BELCORP". THE COLOR RED APPEARS IN THE WORDING "LO IMAGINAMOS LO HACEMOS".

THE COLOR(S) PURPLE, BLUE, AND RED IS/ARE CLAIMED AS A FEATURE OF THE MARK.

THE ENGLISH TRANSLATION OF "LO IMAGINAMOS, LO HACEMOS" IN THE MARK IS WE IMAGINE IT, WE DO IT.

SN 77-843,830, FILED 10-7-2009.

RONALD MCMORROW, EXAMINING ATTORNEY



*David J. Kybas*

Director of the United States Patent and Trademark Office



# United States of America

United States Patent and Trademark Office

# Evitan

**Reg. No. 4,198,854**

**Registered Aug. 28, 2012**

**Int. Cl.: 3**

**TRADEMARK**

**PRINCIPAL REGISTER**

EVITAN LLC (CALIFORNIA LIMITED LIABILITY COMPANY)  
16133 VENTURA BLVD STE 310  
ENCINO, CA 91436

FOR: SKIN CREAMS; LOTIONS, NAMELY, BODY AND FACIAL LOTIONS; BODY WASH; TONER, NAMELY, SKIN TONERS; LIP BALM; SHAMPOO; CONDITIONER, NAMELY, HAIR CONDITIONER; NON-MEDICATED DIAPER RASH CREAM; PREGNANCY LOTION, NAMELY, NON-MEDICATED SKIN LOTION FOR SKIN CARE DURING PREGNANCY; CLEANING PREPARATIONS FOR HOUSEHOLD PURPOSES, IN CLASS 3 (U.S. CLS. 1, 4, 6, 50, 51 AND 52).

FIRST USE 6-11-2012; IN COMMERCE 6-11-2012.

THE MARK CONSISTS OF STANDARD CHARACTERS WITHOUT CLAIM TO ANY PARTICULAR FONT, STYLE, SIZE, OR COLOR.

THE ENGLISH TRANSLATION OF "EVITAN" IN THE MARK IS "AVOID".

SN 77-848,814, FILED 10-14-2009.

APRIL ROACH, EXAMINING ATTORNEY



*David J. Kyffers*

Director of the United States Patent and Trademark Office

# United States of America

United States Patent and Trademark Office



**Reg. No. 4,198,855**

**Registered Aug. 28, 2012**

**Int. Cl.: 35**

**SERVICE MARK**

**PRINCIPAL REGISTER**

EASTERN NATIONAL (VIRGINIA NON-PROFIT CORPORATION)  
SUITE 1  
470 MARYLAND DRIVE  
FORT WASHINGTON, PA 19034

FOR: COMPUTERIZED ONLINE RETAIL STORE SERVICES FEATURING GIFTS, ARTS AND CRAFTS, CLOTHING, BOOKS, PERIODICALS, MAPS, PRINTS, POSTERS, POSTCARDS, STATIONERY, GAMES, TOYS, COLLECTIBLES, AND AUDIO AND VIDEO RECORDINGS; PROMOTIONAL SERVICES, NAMELY, PROMOTING GREATER PUBLIC AWARENESS OF THE IMPORTANCE OF NATIONAL PARKS, IN CLASS 35 (U.S. CLS. 100, 101 AND 102).

FIRST USE 7-1-2008; IN COMMERCE 7-1-2008.

OWNER OF U.S. REG. NO. 2,707,551.

NO CLAIM IS MADE TO THE EXCLUSIVE RIGHT TO USE "AMERICA'S NATIONAL PARKS" FOR PROMOTIONAL SERVICES, NAMELY, PROMOTING GREATER PUBLIC AWARENESS OF THE IMPORTANCE OF NATIONAL PARKS AND "THE OFFICIAL ONLINE STORE OF AMERICA'S NATIONAL PARKS" FOR COMPUTERIZED ONLINE RETAIL SERVICES FEATURING GIFTS, ARTS AND CRAFTS, CLOTHING, BOOKS, PERIODICALS, MAPS, PRINTS, POSTERS, POSTCARDS, STATIONERY, GAMES, TOYS, COLLECTIBLES, AND AUDIO AND VIDEO RECORDINGS, APART FROM THE MARK AS SHOWN.

SN 77-849,821, FILED 10-15-2009.

ELLEN BURNS, EXAMINING ATTORNEY



*David J. Kyjars*

Director of the United States Patent and Trademark Office

# United States of America

United States Patent and Trademark Office



**Reg. No. 4,198,856**

MIRON, NICHOLAS (UNITED STATES INDIVIDUAL)  
23 KHAKUM WOOD RD.  
GREENWICH, CT 06831

**Registered Aug. 28, 2012**

**Int. Cl.: 18**

FOR: PET COLLARS; PET LEASHES, IN CLASS 18 (U.S. CLS. 1, 2, 3, 22 AND 41).

**TRADEMARK**

FIRST USE 11-21-2010; IN COMMERCE 11-21-2010.

**PRINCIPAL REGISTER**

THE MARK CONSISTS OF A CIRCLE CONTAINING TWO SMALLER CIRCLES THAT ARE TOUCHING AND BELOW THAT THE LETTERS "N", "N".

SN 77-850,116, FILED 10-16-2009.

MICHELLE DUBOIS, EXAMINING ATTORNEY



*David J. Kyffers*

Director of the United States Patent and Trademark Office

# United States of America

United States Patent and Trademark Office

# TRANSFLU

**Reg. No. 4,198,857**

BOGOCH FAMILY LLC (DELAWARE LIMITED LIABILITY COMPANY)  
46 EAST 91 STREET  
NEW YORK, NY 10128

**Registered Aug. 28, 2012**

**Int. Cl.: 5**

FOR: VACCINES; PREPARATIONS FOR TREATING COUGHS, COLDS AND FLU; DIAGNOSTIC AGENTS, PREPARATIONS AND SUBSTANCES FOR MEDICAL PURPOSES , IN CLASS 5 (U.S. CLS. 6, 18, 44, 46, 51 AND 52).

**TRADEMARK**

FIRST USE 11-23-2001; IN COMMERCE 11-23-2011.

**PRINCIPAL REGISTER**

THE MARK CONSISTS OF STANDARD CHARACTERS WITHOUT CLAIM TO ANY PARTICULAR FONT, STYLE, SIZE, OR COLOR.

SN 77-855,190, FILED 10-22-2009.

INGRID C. EULIN, EXAMINING ATTORNEY



*David J. Kybas*

Director of the United States Patent and Trademark Office

# United States of America

United States Patent and Trademark Office

## MY FIRST WRANGLER

**Reg. No. 4,198,858**

WRANGLER APPAREL CORP. (DELAWARE CORPORATION)  
3411 SILVERSIDE ROAD  
WILMINGTON, DE 19810

**Registered Aug. 28, 2012**

**Int. Cl.: 25**

FOR: BOTTOMS; JACKETS, IN CLASS 25 (U.S. CLS. 22 AND 39).

**TRADEMARK**

FIRST USE 10-24-2011; IN COMMERCE 10-25-2011.

**PRINCIPAL REGISTER**

THE MARK CONSISTS OF STANDARD CHARACTERS WITHOUT CLAIM TO ANY PARTICULAR FONT, STYLE, SIZE, OR COLOR.

OWNER OF U.S. REG. NOS. 809,323, 3,517,580, AND OTHERS.

SN 77-855,650, FILED 10-23-2009.

SHAILA SETTLES, EXAMINING ATTORNEY



*David J. Kyffers*

Director of the United States Patent and Trademark Office

# United States of America

United States Patent and Trademark Office

# NEW MOON

**Reg. No. 4,198,859**

**Registered Aug. 28, 2012**

**Int. Cl.: 22**

**TRADEMARK**

**PRINCIPAL REGISTER**

SUMMIT ENTERTAINMENT, LLC (DELAWARE LIMITED LIABILITY COMPANY)  
1630 STEWART STREET, SUITE 120  
SANTA MONICA, CA 90404

FOR: MULTI-PURPOSE CLOTH BAGS, IN CLASS 22 (U.S. CLS. 1, 2, 7, 19, 22, 42 AND 50).

FIRST USE 10-0-2009; IN COMMERCE 10-0-2009.

THE MARK CONSISTS OF STANDARD CHARACTERS WITHOUT CLAIM TO ANY PARTICULAR FONT, STYLE, SIZE, OR COLOR.

SN 77-859,380, FILED 10-28-2009.

ALLISON HOLTZ, EXAMINING ATTORNEY



*David J. Kyffers*

Director of the United States Patent and Trademark Office

# United States of America

United States Patent and Trademark Office

# ASIAN BOX

**Reg. No. 4,198,860**

**Registered Aug. 28, 2012**

**Int. Cl.: 43**

**SERVICE MARK**

**PRINCIPAL REGISTER**

ASIAN BOX HOLDINGS, LLC (CALIFORNIA LIMITED LIABILITY COMPANY)  
1442 HARKER AVENUE  
PALO ALTO, CA 94301

FOR: RESTAURANT AND CATERING SERVICES, IN CLASS 43 (U.S. CLS. 100 AND 101).

FIRST USE 2-2-2012; IN COMMERCE 3-2-2012.

THE MARK CONSISTS OF STANDARD CHARACTERS WITHOUT CLAIM TO ANY PARTICULAR FONT, STYLE, SIZE, OR COLOR.

NO CLAIM IS MADE TO THE EXCLUSIVE RIGHT TO USE "ASIAN", APART FROM THE MARK AS SHOWN.

SN 77-860,236, FILED 10-29-2009.

PATRICIA EVANKO, EXAMINING ATTORNEY



*David J. Kyffers*

Director of the United States Patent and Trademark Office

# United States of America

United States Patent and Trademark Office

## Life with Bills

**Reg. No. 4,198,861**

**Registered Aug. 28, 2012**

**Int. Cls.: 41 and 42**

**SERVICE MARK**

**PRINCIPAL REGISTER**

LIFE WITH BILLS, LLC (NORTH CAROLINA LIMITED LIABILITY COMPANY)  
177 NORTH MAIN STREET  
MOORESVILLE, NC 28115

FOR: EDUCATIONAL SERVICES FEATURING ON-LINE CLASSES, TRAINING, AND CURRICULUM IN THE FIELD OF PERSONAL FINANCE FOR CHILDREN, PARENTS, AND EDUCATORS, IN CLASS 41 (U.S. CLS. 100, 101 AND 107).

FIRST USE 6-1-2008; IN COMMERCE 9-1-2009.

FOR: PROVIDING ON-LINE, NON-DOWNLOADABLE SOFTWARE FOR EDUCATIONAL INSTRUCTION AND TRAINING IN THE UTILIZATION AND MANAGEMENT OF PERSONAL FINANCES, IN CLASS 42 (U.S. CLS. 100 AND 101).

FIRST USE 6-1-2008; IN COMMERCE 9-1-2009.

THE MARK CONSISTS OF STANDARD CHARACTERS WITHOUT CLAIM TO ANY PARTICULAR FONT, STYLE, SIZE, OR COLOR.

NO CLAIM IS MADE TO THE EXCLUSIVE RIGHT TO USE "BILLS" , APART FROM THE MARK AS SHOWN.

SN 77-860,259, FILED 10-29-2009.

MARY CRAWFORD, EXAMINING ATTORNEY



*David J. Kybas*

Director of the United States Patent and Trademark Office



# United States of America

United States Patent and Trademark Office

## WANT ORGANIC

**Reg. No. 4,198,862**

**Registered Aug. 28, 2012**

**Int. Cls.: 9 and 18**

**TRADEMARK**

**PRINCIPAL REGISTER**

WANT HOLDINGS, INC. (CANADA CORPORATION)  
225 CHABANEL STREET WEST, SUITE 915  
MONTREAL QUEBEC, CANADA H2N2C9

FOR: CARRYING CASES FOR MP3 PLAYERS, CELL PHONES, AND LAPTOPS, ALL MADE WHOLLY OR IN SUBSTANTIAL PART FROM ORGANIC MATERIALS, IN CLASS 9 (U.S. CLS. 21, 23, 26, 36 AND 38).

FIRST USE 9-25-2009; IN COMMERCE 9-25-2009.

FOR: VALISES, TRAVELING BAGS, TRAVELING SETS IN THE NATURE OF EMPTY COSMETIC BAGS FOR CARRYING COSMETICS, POUCHES FOR HOLDING MAKE-UP, KEYS AND OTHER PERSONAL ITEMS, GARMENT BAGS FOR TRAVEL, VANITY CASES SOLD EMPTY, RUCKSACKS, HANDBAGS, BEACH BAGS, CANVAS AND TEXTILE SHOPPING BAGS, SHOULDER BAGS, AND BRIEF CASES, ALL MADE WHOLLY OR IN SUBSTANTIAL PART FROM ORGANIC MATERIALS; ORGANIC LEATHER GOODS, NAMELY, LEATHER POUCHES FOR TRAVEL, BRIEF CASES, BRIEFCASE-TYPE PORTFOLIOS, BILLFOLDS, AND BUSINESS CARD CASES, IN CLASS 18 (U.S. CLS. 1, 2, 3, 22 AND 41).

FIRST USE 9-25-2009; IN COMMERCE 9-25-2009.

THE MARK CONSISTS OF STANDARD CHARACTERS WITHOUT CLAIM TO ANY PARTICULAR FONT, STYLE, SIZE, OR COLOR.

NO CLAIM IS MADE TO THE EXCLUSIVE RIGHT TO USE "ORGANIC", APART FROM THE MARK AS SHOWN.

SN 77-860,844, FILED 10-29-2009.

AMY KELLY, EXAMINING ATTORNEY



*David J. Kyros*

Director of the United States Patent and Trademark Office

# United States of America

United States Patent and Trademark Office

## WRANGLER NATIONAL PATRIOT

**Reg. No. 4,198,863**

**Registered Aug. 28, 2012**

**Int. Cls.: 25 and 36**

**TRADEMARK**

**SERVICE MARK**

**PRINCIPAL REGISTER**

WRANGLER APPAREL CORP. (DELAWARE CORPORATION)  
3411 SILVERSIDE ROAD  
WILMINGTON, DE 19810

FOR: TOPS; HEADWEAR, IN CLASS 25 (U.S. CLS. 22 AND 39).

FIRST USE 5-5-2010; IN COMMERCE 5-6-2010.

FOR: CHARITABLE FUND RAISING , IN CLASS 36 (U.S. CLS. 100, 101 AND 102).

FIRST USE 7-3-2010; IN COMMERCE 7-3-2010.

THE MARK CONSISTS OF STANDARD CHARACTERS WITHOUT CLAIM TO ANY PARTICULAR FONT, STYLE, SIZE, OR COLOR.

OWNER OF U.S. REG. NOS. 809,323, 3,558,946, AND OTHERS.

SN 77-861,736, FILED 10-30-2009.

SHAILA SETTLES, EXAMINING ATTORNEY



*David J. Kybas*

Director of the United States Patent and Trademark Office

# United States of America

United States Patent and Trademark Office

## SAPPHIRE SERIES

**Reg. No. 4,198,864**

**Registered Aug. 28, 2012**

**Int. Cl.: 7**

**TRADEMARK**

**PRINCIPAL REGISTER**

BSH HOME APPLIANCES CORPORATION (DELAWARE CORPORATION)  
SUITE 600  
1901 MAIN STREET  
IRVINE, CA 92614

FOR: HOUSEHOLD AND KITCHEN MACHINES AND EQUIPMENT, NAMELY, ELECTRIC KITCHEN MACHINES AND EQUIPMENT, NAMELY, DISHWASHERS; STRUCTURAL PARTS OF ALL AFOREMENTIONED GOODS, IN CLASS 7 (U.S. CLS. 13, 19, 21, 23, 31, 34 AND 35).

FIRST USE 7-6-2012; IN COMMERCE 7-6-2012.

THE MARK CONSISTS OF STANDARD CHARACTERS WITHOUT CLAIM TO ANY PARTICULAR FONT, STYLE, SIZE, OR COLOR.

NO CLAIM IS MADE TO THE EXCLUSIVE RIGHT TO USE "SERIES", APART FROM THE MARK AS SHOWN.

SN 77-863,007, FILED 11-2-2009.

ROBERT C. CLARK JR., EXAMINING ATTORNEY



*David J. Kyffers*

Director of the United States Patent and Trademark Office

# United States of America

United States Patent and Trademark Office



**Reg. No. 4,198,865**

**Registered Aug. 28, 2012**

**Int. Cl.: 35**

**SERVICE MARK**

**PRINCIPAL REGISTER**

GILMER COUNTY CHAMBER OF COMMERCE, INC. (GEORGIA CORPORATION)  
PO BOX 505  
ELLIJAY, GA 30539

FOR: CHAMBER OF COMMERCE SERVICES, NAMELY, PROMOTING BUSINESS AND TOURISM IN THE GILMER COUNTY GEORGIA AREA, IN CLASS 35 (U.S. CLS. 100, 101 AND 102).

FIRST USE 12-0-2010; IN COMMERCE 12-0-2010.

NO CLAIM IS MADE TO THE EXCLUSIVE RIGHT TO USE "GILMER COUNTY GA", APART FROM THE MARK AS SHOWN.

THE MARK CONSISTS OF THE WORDS "GILMER COUNTY GA" AND AN APPLE IMPOSED UPON A FRAMED MOUNTAINOUS BACKGROUND WITH A SUN AND RAYS.

SN 77-866,635, FILED 11-6-2009.

GISELLE AGOSTO, EXAMINING ATTORNEY



*David J. Kybas*

Director of the United States Patent and Trademark Office

# United States of America

United States Patent and Trademark Office

## ICON BY OLEG CASSINI

**Reg. No. 4,198,866**

OLEG CASSINI, INC. (NEW YORK CORPORATION)  
313 MCCOUNS LANE  
OYSTER BAY COVE, NY 11771

**Registered Aug. 28, 2012**

**Int. Cl.: 3**

FOR: PERFUME, COLOGNE, EAU DE TOILETTE, IN CLASS 3 (U.S. CLS. 1, 4, 6, 50, 51 AND 52).

**TRADEMARK**

FIRST USE 3-15-2005; IN COMMERCE 3-15-2005.

**PRINCIPAL REGISTER**

THE MARK CONSISTS OF STANDARD CHARACTERS WITHOUT CLAIM TO ANY PARTICULAR FONT, STYLE, SIZE, OR COLOR.

OWNER OF U.S. REG. NOS. 885,856, 3,491,539, AND OTHERS.

THE NAME(S), PORTRAIT(S), AND/OR SIGNATURE(S) SHOWN IN THE MARK DOES NOT IDENTIFY A PARTICULAR LIVING INDIVIDUAL.

SN 77-867,198, FILED 11-6-2009.

TARAH HARDY, EXAMINING ATTORNEY



*David J. Kybas*

Director of the United States Patent and Trademark Office

# United States of America

United States Patent and Trademark Office

## INSPIRED MEDICINE

**Reg. No. 4,198,867**

MONTEFIORE MEDICAL CENTER (NEW YORK NON-PROFIT CORPORATION)  
111 EAST 210TH STREET  
BRONX, NY 104672490

**Registered Aug. 28, 2012**

**Int. Cls.: 35, 36, 39, 41,  
42, and 45**

FOR: PROFESSIONAL REFERRAL SERVICES IN THE FIELD OF HEALTH AND MEDICINE;  
MEDICAL TRANSCRIPTION SERVICES; MEDICAL BILLING SERVICES FOR OTHERS;  
RETAIL PHARMACY SERVICES, IN CLASS 35 (U.S. CLS. 100, 101 AND 102).

**SERVICE MARK**

FIRST USE 9-1-2009; IN COMMERCE 9-26-2011.

**PRINCIPAL REGISTER**

FOR: ACCEPTING AND ADMINISTERING MONETARY CONTRIBUTIONS TO FUND  
MEDICAL RESEARCH, MEDICAL EDUCATION AND/OR MEDICAL SERVICES, IN CLASS  
36 (U.S. CLS. 100, 101 AND 102).

FIRST USE 9-1-2009; IN COMMERCE 9-26-2011.

FOR: STORAGE OF HUMAN CELLS FOR MEDICAL USE, IN CLASS 39 (U.S. CLS. 100 AND  
105).

FIRST USE 9-1-2009; IN COMMERCE 9-26-2011.

FOR: EDUCATIONAL SERVICES, NAMELY, SEMINARS, WORKSHOPS AND TRAINING  
PROGRAMS IN THE FIELDS OF HEALTH AND MEDICINE, IN CLASS 41 (U.S. CLS. 100,  
101 AND 107).

FIRST USE 9-1-2009; IN COMMERCE 9-26-2011.

FOR: MEDICAL RESEARCH, NAMELY, CONDUCTING CLINICAL TRIALS; MEDICAL  
LABORATORY SERVICES, IN CLASS 42 (U.S. CLS. 100 AND 101).

FIRST USE 9-1-2009; IN COMMERCE 9-26-2011.

FOR: CASE MANAGEMENT SERVICES, NAMELY, THE COORDINATION OF MEDICAL  
AND SOCIAL SERVICES FOR PATIENTS AND THEIR CAREGIVERS AND FAMILIES, IN  
CLASS 45 (U.S. CLS. 100 AND 101).

FIRST USE 9-1-2009; IN COMMERCE 9-26-2011.



*David J. Kyjars*

Director of the United States Patent and Trademark Office

**Reg. No. 4,198,867** THE MARK CONSISTS OF STANDARD CHARACTERS WITHOUT CLAIM TO ANY PARTICULAR FONT, STYLE, SIZE, OR COLOR.

NO CLAIM IS MADE TO THE EXCLUSIVE RIGHT TO USE "MEDICINE", APART FROM THE MARK AS SHOWN.

SN 77-867,266, FILED 11-6-2009.

MICHELE SWAIN, EXAMINING ATTORNEY

# United States of America

United States Patent and Trademark Office

## EL TINIEBLO

**Reg. No. 4,198,868**

**Registered Aug. 28, 2012**

**Int. Cls.: 25 and 33**

**TRADEMARK**

**PRINCIPAL REGISTER**

MEZCALES DE TAMAULIPAS S DE RLMI (MEXICO LIMITED LIABILITY COMPANY)  
MUNICIPIO DE JIMENEZ  
CARRETERA VICTORIA - MATAMOROS KM 106  
TAMAULIPAS, MEXICO

FOR: CLOTHING AND APPAREL, NAMELY, SHIRTS, T-SHIRTS, SWEATSHIRTS, SWEATERS, PANTS, SWEATPANTS, SHORTS, SKIRTS, DRESSES, OUTERWEAR, NAMELY, JACKETS AND COATS, HEADGEAR, NAMELY, CAPS AND HATS, FOOTWEAR, SOCKS, SCARVES, SLEEPWEAR, SWIMWEAR, AND UNDERWEAR, IN CLASS 25 (U.S. CLS. 22 AND 39).

FIRST USE 9-1-2009; IN COMMERCE 10-1-2011.

FOR: ALCOHOLIC BEVERAGES, NAMELY, MEZCAL; DISTILLED SPIRITS OF AGAVE AND CREAM MEZCALS, IN CLASS 33 (U.S. CLS. 47 AND 49).

FIRST USE 9-1-2009; IN COMMERCE 10-1-2011.

THE MARK CONSISTS OF STANDARD CHARACTERS WITHOUT CLAIM TO ANY PARTICULAR FONT, STYLE, SIZE, OR COLOR.

THE ENGLISH TRANSLATION OF "EL TINIEBLO" IN THE MARK IS "THE DARKNESS".

SN 77-867,451, FILED 11-6-2009.

STEPHANIE ALI, EXAMINING ATTORNEY



*David J. Kybas*

Director of the United States Patent and Trademark Office



# United States of America

United States Patent and Trademark Office

## VIE: VIRTUAL ISLAND OF ENTERTAINMENT

**Reg. No. 4,198,869**

**Registered Aug. 28, 2012**

**Int. Cl.: 41**

**SERVICE MARK**

**PRINCIPAL REGISTER**

ENVIE INTERACTIVE LLC (CALIFORNIA LIMITED LIABILITY COMPANY)  
1503 GRANT ROAD  
SUITE 150  
MOUNTAIN VIEW, CA 94040

FOR: ONLINE COMPUTER GAME FOR ADULTS, IN CLASS 41 (U.S. CLS. 100, 101 AND 107).

FIRST USE 6-21-2011; IN COMMERCE 6-21-2011.

THE MARK CONSISTS OF STANDARD CHARACTERS WITHOUT CLAIM TO ANY PARTICULAR FONT, STYLE, SIZE, OR COLOR.

NO CLAIM IS MADE TO THE EXCLUSIVE RIGHT TO USE "VIRTUAL" AND "ENTERTAINMENT", APART FROM THE MARK AS SHOWN.

SN 77-870,387, FILED 11-11-2009.

MARIAM MAHMOUDI, EXAMINING ATTORNEY



*David J. Kyffers*

Director of the United States Patent and Trademark Office

# United States of America

United States Patent and Trademark Office

## VIRTUAL ISLAND OF ENTERTAINMENT

**Reg. No. 4,198,870**

**Registered Aug. 28, 2012**

**Int. Cl.: 41**

**SERVICE MARK**

**PRINCIPAL REGISTER**

ENVIE INTERACTIVE LLC (CALIFORNIA LIMITED LIABILITY COMPANY)  
1503 GRANT ROAD  
SUITE 150  
MOUNTAIN VIEW, CA 94040

FOR: ONLINE COMPUTER GAME FOR ADULTS, IN CLASS 41 (U.S. CLS. 100, 101 AND 107).

FIRST USE 6-21-2011; IN COMMERCE 6-21-2011.

THE MARK CONSISTS OF STANDARD CHARACTERS WITHOUT CLAIM TO ANY PARTICULAR FONT, STYLE, SIZE, OR COLOR.

NO CLAIM IS MADE TO THE EXCLUSIVE RIGHT TO USE "VIRTUAL" AND "ENTERTAINMENT", APART FROM THE MARK AS SHOWN.

SN 77-870,445, FILED 11-11-2009.

MARIAM MAHMOUDI, EXAMINING ATTORNEY



*David J. Kybas*

Director of the United States Patent and Trademark Office

United States of America  
United States Patent and Trademark Office

# KERACALM

**Reg. No. 4,198,871**

ATLANTIC COAST MEDIA GROUP, LLC (VIRGINIA LIMITED LIABILITY COMPANY)  
499 WASHINGTON BLVD  
JERSEY CITY, NJ 09310

**Registered Aug. 28, 2012**

**Int. Cl.: 3**

FOR: SKIN LOTION, IN CLASS 3 (U.S. CLS. 1, 4, 6, 50, 51 AND 52).

**TRADEMARK**

FIRST USE 8-11-2011; IN COMMERCE 8-11-2011.

**PRINCIPAL REGISTER**

THE MARK CONSISTS OF STANDARD CHARACTERS WITHOUT CLAIM TO ANY PARTICULAR FONT, STYLE, SIZE, OR COLOR.

SN 77-878,986, FILED 11-23-2009.

JESSICA A. POWERS, EXAMINING ATTORNEY



*David J. Kyffers*

Director of the United States Patent and Trademark Office

# United States of America

United States Patent and Trademark Office

# ZIPWIK

**Reg. No. 4,198,872**

ABBOTT LABORATORIES (ILLINOIS CORPORATION)  
100 ABBOTT PARK ROAD  
ABBOTT PARK, IL 60064

**Registered Aug. 28, 2012**

**Int. Cl.: 5**

FOR: MEDICAL DIAGNOSTIC STRIPS FOR USE IN MONITORING GLUCOSE LEVELS, IN CLASS 5 (U.S. CLS. 6, 18, 44, 46, 51 AND 52).

**TRADEMARK**

FIRST USE 8-31-2010; IN COMMERCE 8-31-2010.

**PRINCIPAL REGISTER**

THE MARK CONSISTS OF STANDARD CHARACTERS WITHOUT CLAIM TO ANY PARTICULAR FONT, STYLE, SIZE, OR COLOR.

SN 77-879,062, FILED 11-23-2009.

KATHERINE CONNOLLY, EXAMINING ATTORNEY



*David J. Kybas*

Director of the United States Patent and Trademark Office

# United States of America

United States Patent and Trademark Office

## JUSTIN DULGE

**Reg. No. 4,198,873**

LYONS, DEVON (UNITED STATES INDIVIDUAL)  
103 LEFFERTS AVENUE  
BROOKLYN, NY 11225

**Registered Aug. 28, 2012**

**Int. Cl.: 3**

FOR: BATH GEL; BATH LOTION; BEAUTY LOTIONS; BODY LOTIONS; COSMETIC PREPARATIONS, NAMELY, FIRING LOTIONS; FACE AND BODY LOTIONS; LIP BALM; SHOWER AND BATH GEL; SKIN TONERS, IN CLASS 3 (U.S. CLS. 1, 4, 6, 50, 51 AND 52).

**TRADEMARK**

FIRST USE 10-12-2011; IN COMMERCE 10-12-2011.

**PRINCIPAL REGISTER**

THE MARK CONSISTS OF STANDARD CHARACTERS WITHOUT CLAIM TO ANY PARTICULAR FONT, STYLE, SIZE, OR COLOR.

THE NAME SHOWN IN THE MARK DOES NOT IDENTIFY A PARTICULAR LIVING INDIVIDUAL.

SN 77-879,384, FILED 11-24-2009.

KHANH LE, EXAMINING ATTORNEY



*David J. Kyjars*

Director of the United States Patent and Trademark Office

United States of America  
United States Patent and Trademark Office

YOUNGZ

**Reg. No. 4,198,874**

FLIPOTICS TECHNOLOGY, LLC (TEXAS LIMITED LIABILITY COMPANY)  
2103 RUE DE ST. GERMAINE  
AUSTIN, TX 78746

**Registered Aug. 28, 2012**

**Int. Cl.: 25**

FOR: ATHLETIC APPAREL, NAMELY, CAPS; FLIP FLOPS; FOOTWEAR; HATS, IN CLASS  
25 (U.S. CLS. 22 AND 39).

**TRADEMARK**

FIRST USE 3-28-2012; IN COMMERCE 5-25-2012.

**PRINCIPAL REGISTER**

THE MARK CONSISTS OF STANDARD CHARACTERS WITHOUT CLAIM TO ANY PAR-  
TICULAR FONT, STYLE, SIZE, OR COLOR.

SN 77-880,279, FILED 11-24-2009.

KATHLEEN M. VANSTON, EXAMINING ATTORNEY



*David J. Kybas*

Director of the United States Patent and Trademark Office

United States of America  
United States Patent and Trademark Office

RX GEAR

**Reg. No. 4,198,875**

RX GEAR, LLC (DELAWARE LIMITED LIABILITY COMPANY)  
2300 CROWN COLONY DRIVE, STE. 300  
QUINCY, MA 02169

**Registered Aug. 28, 2012**

**Int. Cl.: 35**

FOR: RETAIL STORE SERVICES FEATURING MEDICAL APPAREL AND ACCESSORIES,  
IN CLASS 35 (U.S. CLS. 100, 101 AND 102).

**SERVICE MARK**

FIRST USE 0-0-2007; IN COMMERCE 0-0-2007.

**PRINCIPAL REGISTER**

THE MARK CONSISTS OF STANDARD CHARACTERS WITHOUT CLAIM TO ANY PAR-  
TICULAR FONT, STYLE, SIZE, OR COLOR.

OWNER OF U.S. REG. NOS. 2,613,016 AND 3,586,201.

NO CLAIM IS MADE TO THE EXCLUSIVE RIGHT TO USE "GEAR", APART FROM THE  
MARK AS SHOWN.

SN 77-882,222, FILED 11-30-2009.

ARETHA SOMERVILLE, EXAMINING ATTORNEY



*David J. Kybas*

Director of the United States Patent and Trademark Office

# United States of America

United States Patent and Trademark Office

# iRunway

**Reg. No. 4,198,876**

THE WET SEAL, INC. (DELAWARE CORPORATION)  
26972 BURBANK

**Registered Aug. 28, 2012**

FOOTHILL RANCH, CA 92610

**Int. Cl.: 42**

FOR: PROVIDING FASHION DESIGN INFORMATION BY MEANS OF AN ELECTRONIC SERVICE DELIVERED VIA COMPUTER AND WIRELESS DEVICES BY MEANS OF A GLOBAL COMPUTER NETWORK, IN CLASS 42 (U.S. CLS. 100 AND 101).

**SERVICE MARK**

FIRST USE 9-1-2009; IN COMMERCE 9-1-2009.

**PRINCIPAL REGISTER**

THE MARK CONSISTS OF STANDARD CHARACTERS WITHOUT CLAIM TO ANY PARTICULAR FONT, STYLE, SIZE, OR COLOR.

SN 77-882,427, FILED 11-30-2009.

KHANH LE, EXAMINING ATTORNEY



*David J. Kyffers*

Director of the United States Patent and Trademark Office



# United States of America

United States Patent and Trademark Office

## REVIVE YOUR SLEEP

**Reg. No. 4,198,877**

FREDMAN BROS. FURNITURE COMPANY, INC. (ILLINOIS CORPORATION)  
8226 LACKLAND ROAD  
ST. LOUIS, MO 63114

**Registered Aug. 28, 2012**

**Int. Cl.: 20**

FOR: BEDS, MATTRESSES, MATTRESS FOUNDATIONS, BOX SPRINGS, ADJUSTABLE  
BED BASES, PILLOWS, IN CLASS 20 (U.S. CLS. 2, 13, 22, 25, 32 AND 50).

**TRADEMARK**

FIRST USE 6-0-2010; IN COMMERCE 6-0-2010.

**PRINCIPAL REGISTER**

THE MARK CONSISTS OF STANDARD CHARACTERS WITHOUT CLAIM TO ANY PAR-  
TICULAR FONT, STYLE, SIZE, OR COLOR.

SN 77-884,636, FILED 12-2-2009.

JUDITH HELFMAN, EXAMINING ATTORNEY



*David J. Kyffers*

Director of the United States Patent and Trademark Office

# United States of America

United States Patent and Trademark Office

# JOURNEY

**Reg. No. 4,198,878**

**Registered Aug. 28, 2012**

**Int. Cl.: 16**

**TRADEMARK**

**PRINCIPAL REGISTER**

THE JOHN HENRY COMPANY, A MULTI PACKAGING SOLUTIONS COMPANY (MICHIGAN CORPORATION)  
5800 W. GRAND RIVER AVENUE  
LANSING, MI 48901

FOR: HOLDERS FOR PLANTS AND FLOWERS, NAMELY, PAPER OR CARDBOARD OR FIBERBOARD CONTAINERS USED AS PACKAGING FOR HOLDING LIVE FLOWERS AND PLANTS DURING TRANSPORTATION, IN CLASS 16 (U.S. CLS. 2, 5, 22, 23, 29, 37, 38 AND 50).

FIRST USE 4-13-2010; IN COMMERCE 4-13-2010.

THE MARK CONSISTS OF STANDARD CHARACTERS WITHOUT CLAIM TO ANY PARTICULAR FONT, STYLE, SIZE, OR COLOR.

SN 77-886,136, FILED 12-4-2009.

WILLIAM VERHOSEK, EXAMINING ATTORNEY



*David J. Kyffers*

Director of the United States Patent and Trademark Office

# United States of America

United States Patent and Trademark Office

## THE LARYNGOSPASMS

**Reg. No. 4,198,879**

**Registered Aug. 28, 2012**

**Int. Cls.: 9, 16, 25, and  
35**

**TRADEMARK**

**SERVICE MARK**

**PRINCIPAL REGISTER**

THE LARYNGOSPASMS, LLC (MINNESOTA LIMITED LIABILITY COMPANY)  
C/O GARY COZINE  
3 IRIS WAY  
BERLIN, CT 06037

FOR: MUSICAL VIDEO RECORDINGS, NAMELY, VIDEO DISCS FEATURING MUSIC AND MUSICAL PERFORMANCES; (BASED ON USE IN COMMERCE) MUSICAL AUDIO RECORDINGS, NAMELY, AUDIO DISCS FEATURING MUSIC AND MUSICAL PERFORMANCES; COMPACT DISCS FEATURING MUSIC AND MUSICAL PERFORMANCES; PRE-RECORDED CD'S AND LASER DISCS FEATURING MUSIC AND MUSICAL PERFORMANCES; MOUSE PADS, IN CLASS 9 (U.S. CLS. 21, 23, 26, 36 AND 38).

FIRST USE 8-0-1993; IN COMMERCE 8-0-1993.

FOR: PROMOTIONAL ITEMS, NAMELY, STICKERS; POSTERS; PHOTOS; SOUVENIR PROGRAMS FEATURING IMAGES, WORDS, AND DESIGNS OF A MUSICAL, RECORDING, AND PERFORMING GROUP (BASED ON USE IN COMMERCE) SHEET MUSIC, IN CLASS 16 (U.S. CLS. 2, 5, 22, 23, 29, 37, 38 AND 50).

FIRST USE 8-28-2009; IN COMMERCE 8-28-2009.

FOR: PROMOTIONAL APPAREL, IN EACH CASE TO PROMOTE THE SERVICES OF A MUSICAL BAND, NAMELY, BASEBALL CAPS; HATS; SURGICAL TOPS, SURGICAL JACKETS; UNDERWEAR FEATURING IMAGES, WORDS, AND DESIGNS OF A MUSICAL, RECORDING, AND PERFORMING GROUP; (BASED ON USE IN COMMERCE) PROMOTIONAL APPAREL, IN EACH CASE TO PROMOTE THE SERVICES OF A MUSICAL BAND, NAMELY, HOODED SWEAT SHIRTS, LONG-SLEEVED T-SHIRTS, SHORT-SLEEVED T-SHIRTS, AND A-SHIRTS, FEATURING IMAGES, WORDS, AND DESIGNS OF A MUSICAL, RECORDING, AND PERFORMING GROUP, IN CLASS 25 (U.S. CLS. 22 AND 39).

FIRST USE 8-28-2009; IN COMMERCE 8-28-2009.

FOR: ON-LINE RETAIL STORE SERVICES FEATURING DVDS, STICKERS, POSTERS, SOUVENIR PROGRAMS, CDS, (BASED ON USE IN COMMERCE) ELECTRONIC AND DIGITAL FILES, NOVELTY ITEMS, AND CLOTHING OF AND ABOUT A PERFORMING AND RECORDING MUSICAL GROUP, IN CLASS 35 (U.S. CLS. 100, 101 AND 102).



*David J. Kyros*

Director of the United States Patent and Trademark Office

**Reg. No. 4,198,879** FIRST USE 9-4-2009; IN COMMERCE 9-4-2009.

THE MARK CONSISTS OF STANDARD CHARACTERS WITHOUT CLAIM TO ANY PARTICULAR FONT, STYLE, SIZE, OR COLOR.

SN 77-886,692, FILED 12-4-2009.

GEOFFREY FOSDICK, EXAMINING ATTORNEY

# United States of America

United States Patent and Trademark Office

## BOMB LAGER

**Reg. No. 4,198,880**

**Registered Aug. 28, 2012**

**Int. Cl.: 32**

**TRADEMARK**

**PRINCIPAL REGISTER**

BOMB BREWING COMPANY LLC (NEW YORK LIMITED LIABILITY COMPANY)  
648 BROADWAY  
NEW YORK, NY 10012

FOR: BEER, IN CLASS 32 (U.S. CLS. 45, 46 AND 48).

FIRST USE 5-23-2011; IN COMMERCE 2-16-2012.

THE MARK CONSISTS OF STANDARD CHARACTERS WITHOUT CLAIM TO ANY PARTICULAR FONT, STYLE, SIZE, OR COLOR.

NO CLAIM IS MADE TO THE EXCLUSIVE RIGHT TO USE "LAGER", APART FROM THE MARK AS SHOWN.

SN 77-887,238, FILED 12-7-2009.

ANDREA HACK, EXAMINING ATTORNEY



*David J. Kyffers*

Director of the United States Patent and Trademark Office

# United States of America

United States Patent and Trademark Office

## SELF-INSURED'S... WE'RE WIRED DIFFERENTLY

**Reg. No. 4,198,881**

**Registered Aug. 28, 2012**

**Int. Cl.: 45**

**SERVICE MARK**

**PRINCIPAL REGISTER**

FLOYD, SKEREN & KELLY, LLP (CALIFORNIA LIMITED LIABILITY PARTNERSHIP)  
SUITE 2025  
23801 CALABASAS ROAD  
CALABASAS, CA 91302

FOR: LEGAL SERVICES, IN CLASS 45 (U.S. CLS. 100 AND 101).

FIRST USE 3-1-2009; IN COMMERCE 3-1-2009.

THE MARK CONSISTS OF STANDARD CHARACTERS WITHOUT CLAIM TO ANY PARTICULAR FONT, STYLE, SIZE, OR COLOR.

SN 77-887,831, FILED 12-7-2009.

LINDSEY RUBIN, EXAMINING ATTORNEY



*David J. Kybas*

Director of the United States Patent and Trademark Office

# United States of America

United States Patent and Trademark Office

# ECO-CLICK

**Reg. No. 4,198,882**

XIAMEN LOTA INTERNATIONAL CO., LTD. (CHINA CORPORATION)  
NO. 61, XINGNAN ROAD  
JIMEI, XIAMEN, 361022, CHINA

**Registered Aug. 28, 2012**

**Int. Cl.: 11**

FOR: CARTRIDGE VALVE PERMITTING MULTI-POSITION FLOW FROM A FAUCET, IN CLASS 11 (U.S. CLS. 13, 21, 23, 31 AND 34).

**TRADEMARK**

FIRST USE 6-13-2012; IN COMMERCE 6-13-2012.

**PRINCIPAL REGISTER**

THE MARK CONSISTS OF STANDARD CHARACTERS WITHOUT CLAIM TO ANY PARTICULAR FONT, STYLE, SIZE, OR COLOR.

SN 77-889,197, FILED 12-9-2009.

JAMES STEIN, EXAMINING ATTORNEY



*David J. Kybas*

Director of the United States Patent and Trademark Office

# United States of America

United States Patent and Trademark Office

# CHLORONEX

**Reg. No. 4,198,883**

BOEHRINGER INGELHEIM VETMEDICA, INC. (DELAWARE CORPORATION)  
2621 NORTH BELT HIGHWAY  
ST. JOSEPH, MO 645062002

**Registered Aug. 28, 2012**

**Int. Cl.: 5**

FOR: VETERINARY ANTIBIOTICS, IN CLASS 5 (U.S. CLS. 6, 18, 44, 46, 51 AND 52).

**TRADEMARK**

FIRST USE 6-15-2012; IN COMMERCE 6-15-2012.

**PRINCIPAL REGISTER**

THE MARK CONSISTS OF STANDARD CHARACTERS WITHOUT CLAIM TO ANY PARTICULAR FONT, STYLE, SIZE, OR COLOR.

SN 77-890,538, FILED 12-10-2009.

ALLISON SCHRODY, EXAMINING ATTORNEY



*David J. Kybas*

Director of the United States Patent and Trademark Office



# United States of America

United States Patent and Trademark Office



**Reg. No. 4,198,884**

CHARTWELL PROPERTIES, INC. (CALIFORNIA CORPORATION)  
5900 WILSHIRE BLVD, SUITE 400  
LOS ANGELES, CA 90036

**Registered Aug. 28, 2012**

**Int. Cl.: 36**

FOR: LEASING OF SHOPPING MALL SPACE, IN CLASS 36 (U.S. CLS. 100, 101 AND 102).

**SERVICE MARK**

FIRST USE 5-2-2012; IN COMMERCE 5-2-2012.

**PRINCIPAL REGISTER**

NO CLAIM IS MADE TO THE EXCLUSIVE RIGHT TO USE "THE SHOPS ON EL PASEO", APART FROM THE MARK AS SHOWN.

THE MARK CONSISTS OF THE STYLIZED LETTERS "E" AND "P" INTERTWINED, WITH A VERTICAL LINE TO THE RIGHT OF THE "E" AND "P", AND THE WORDS "THE SHOPS ON EL PASEO" TO THE RIGHT OF THE VERTICAL LINE.

SN 77-891,328, FILED 12-11-2009.

TARAH HARDY, EXAMINING ATTORNEY



*David J. Kybas*

Director of the United States Patent and Trademark Office

# United States of America

United States Patent and Trademark Office

## CARE COMMUNICATIONS PRESS

**Reg. No. 4,198,885**

**Registered Aug. 28, 2012**

**Int. Cl.: 41**

**SERVICE MARK**

**PRINCIPAL REGISTER**

CARE COMMUNICATIONS, INC. (ILLINOIS CORPORATION)  
SUITE 1900  
205 W. WACKER DRIVE  
CHICAGO, IL 60606

FOR: BOOK PUBLISHING, IN CLASS 41 (U.S. CLS. 100, 101 AND 107).

FIRST USE 10-1-2009; IN COMMERCE 10-1-2009.

THE MARK CONSISTS OF STANDARD CHARACTERS WITHOUT CLAIM TO ANY PARTICULAR FONT, STYLE, SIZE, OR COLOR.

OWNER OF U.S. REG. NOS. 2,788,067 AND 2,864,063.

NO CLAIM IS MADE TO THE EXCLUSIVE RIGHT TO USE "PRESS", APART FROM THE MARK AS SHOWN.

SN 77-891,821, FILED 12-11-2009.

SUSAN RICHARDS, EXAMINING ATTORNEY



*David J. Kybas*

Director of the United States Patent and Trademark Office

# United States of America

United States Patent and Trademark Office

## STONEWALKER

**Reg. No. 4,198,886**

**Registered Aug. 28, 2012**

**Int. Cl.: 33**

**TRADEMARK**

**PRINCIPAL REGISTER**

BELLINGHAM ESTATES (PROPRIETARY) LIMITED (SOUTH AFRICA COMPANY), TA  
DOUGLAS GREEN BELLINGHAM,  
GROOT DRAKENSTEIN  
FRANSCHHOEK VALLEY, SOUTH AFRICA 7680

FOR: WINES, IN CLASS 33 (U.S. CLS. 47 AND 49).

FIRST USE 8-29-2011; IN COMMERCE 8-29-2011.

THE MARK CONSISTS OF STANDARD CHARACTERS WITHOUT CLAIM TO ANY PARTICULAR FONT, STYLE, SIZE, OR COLOR.

SN 77-893,013, FILED 12-14-2009.

JOHN SCHUYLER YARD, EXAMINING ATTORNEY



*David J. Kybas*

Director of the United States Patent and Trademark Office

# United States of America

United States Patent and Trademark Office

## Nokian eNTYRE

**Reg. No. 4,198,887**

NOKIAN TYRES (FINLAND PUBLIC LIMITED COMPANY (PLC))  
PIRKKALAISTIE FI-37100  
NOKIA, FINLAND

**Registered Aug. 28, 2012**

**Int. Cl.: 12**

FOR: TIRES, IN CLASS 12 (U.S. CLS. 19, 21, 23, 31, 35 AND 44).

**TRADEMARK**

FIRST USE 10-9-2009; IN COMMERCE 10-9-2009.

**PRINCIPAL REGISTER**

THE MARK CONSISTS OF STANDARD CHARACTERS WITHOUT CLAIM TO ANY PARTICULAR FONT, STYLE, SIZE, OR COLOR.

SEC. 2(F) AS TO "NOKIAN".

OWNER OF U.S. REG. NOS. 2,593,508, 3,086,418, AND OTHERS.

THE WORDING "NOKIAN ENTYRE" HAS NO MEANING IN A FOREIGN LANGUAGE.

SN 77-893,180, FILED 12-14-2009.

ALICIA COLLINS, EXAMINING ATTORNEY



*David J. Kyffers*

Director of the United States Patent and Trademark Office

# United States of America

United States Patent and Trademark Office

# KTFO'D

**Reg. No. 4,198,888**

**Registered Aug. 28, 2012**

**Int. Cl.: 33**

DIABLO SPIRITS, LLC (NEVADA LIMITED LIABILITY COMPANY)  
SUITE 101  
2900 S RANCHO DR  
LAS VEGAS, NV 89102

FOR: DISTILLED SPIRITS, IN CLASS 33 (U.S. CLS. 47 AND 49).

**TRADEMARK**

FIRST USE 6-1-2012; IN COMMERCE 6-1-2012.

**PRINCIPAL REGISTER**

THE MARK CONSISTS OF STANDARD CHARACTERS WITHOUT CLAIM TO ANY PARTICULAR FONT, STYLE, SIZE, OR COLOR.

OWNER OF U.S. REG. NO. 4,088,567.

SN 77-893,327, FILED 12-14-2009.

TASNEEM HUSSAIN, EXAMINING ATTORNEY



*David J. Kyffers*

Director of the United States Patent and Trademark Office

# United States of America

United States Patent and Trademark Office

## YOUNG THE GIANT

**Reg. No. 4,198,889**

**Registered Aug. 28, 2012**

**Int. Cl.: 25**

**TRADEMARK**

**PRINCIPAL REGISTER**

JUNGLE YOUTH RECORDINGS, INC (CALIFORNIA CORPORATION)  
16830 VENTURA BLVD, SUITE 501  
C/O HABER CORP.  
ENCINO, CA 91436

FOR: T-SHIRTS; SWEAT SHIRTS; HOODED SWEAT SHIRTS, IN CLASS 25 (U.S. CLS. 22 AND 39).

FIRST USE 1-0-2010; IN COMMERCE 1-0-2010.

THE MARK CONSISTS OF STANDARD CHARACTERS WITHOUT CLAIM TO ANY PARTICULAR FONT, STYLE, SIZE, OR COLOR.

SN 77-894,758, FILED 12-16-2009.

INGRID C. EULIN, EXAMINING ATTORNEY



*David J. Kyffers*

Director of the United States Patent and Trademark Office

# United States of America

United States Patent and Trademark Office

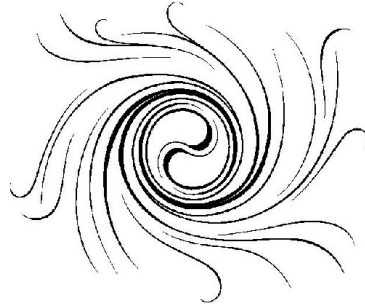

**Reg. No. 4,198,890**

FREDMAN BROS. FURNITURE COMPANY, INC. (ILLINOIS CORPORATION)  
8226 LACKLAND ROAD  
ST. LOUIS, MO 63114

**Registered Aug. 28, 2012**

**Int. Cl.: 20**

FOR: BEDS, MATTRESSES, MATTRESS FOUNDATIONS, BOX SPRINGS, ADJUSTABLE  
BED BASES, PILLOWS, IN CLASS 20 (U.S. CLS. 2, 13, 22, 25, 32 AND 50).

**TRADEMARK**

FIRST USE 6-0-2010; IN COMMERCE 6-0-2010.

**PRINCIPAL REGISTER**

THE MARK CONSISTS OF A CURVED LINE DESIGN.

SN 77-894,892, FILED 12-16-2009.

JUDITH HELFMAN, EXAMINING ATTORNEY



*David J. Kyffers*

Director of the United States Patent and Trademark Office

# United States of America

United States Patent and Trademark Office

# VRPower

**Reg. No. 4,198,891**

SILICONIX INCORPORATED (DELAWARE CORPORATION)  
2201 LAURELWOOD ROAD  
SANTA CLARA, CA 95054

**Registered Aug. 28, 2012**

**Int. Cl.: 9**

FOR: SEMICONDUCTOR DEVICES, NAMELY, VOLTAGE REGULATORS, IN CLASS 9  
(U.S. CLS. 21, 23, 26, 36 AND 38).

**TRADEMARK**

FIRST USE 7-0-2009; IN COMMERCE 4-0-2012.

**PRINCIPAL REGISTER**

THE MARK CONSISTS OF STANDARD CHARACTERS WITHOUT CLAIM TO ANY PARTICULAR FONT, STYLE, SIZE, OR COLOR.

SN 77-896,876, FILED 12-18-2009.

JANET LEE, EXAMINING ATTORNEY



*David J. Kyfos*

Director of the United States Patent and Trademark Office



# United States of America

United States Patent and Trademark Office

# BICEPTACLE

**Reg. No. 4,198,892**

**Registered Aug. 28, 2012**

**Int. Cl.: 9**

**TRADEMARK**

**PRINCIPAL REGISTER**

KCSM, INC. (CALIFORNIA CORPORATION)  
24971 EATON LANE  
LAGUNA NIGUEL, CA 92677

FOR: ELECTRICAL SOCKETS, IN CLASS 9 (U.S. CLS. 21, 23, 26, 36 AND 38).

FIRST USE 5-8-2012; IN COMMERCE 5-8-2012.

THE MARK CONSISTS OF STANDARD CHARACTERS WITHOUT CLAIM TO ANY PARTICULAR FONT, STYLE, SIZE, OR COLOR.

SN 77-898,623, FILED 12-21-2009.

ROBIN CHOSID, EXAMINING ATTORNEY



*David J. Kyffers*

Director of the United States Patent and Trademark Office

# United States of America

United States Patent and Trademark Office

## OPERATIONAL ENERGY

**Reg. No. 4,198,893**

**Registered Aug. 28, 2012**

**Int. Cl.: 9**

**TRADEMARK**

**PRINCIPAL REGISTER**

SUNDIAL POWER PODS, LLC (DELAWARE LIMITED LIABILITY COMPANY)  
SUITE 450  
100 CRESCENT COURT  
DALLAS, TX 75201

FOR: FIXED AND MOBILE PHOTOVOLTAIC SOLAR SYSTEMS COMPRISING PHOTOVOLTAIC SOLAR CELLS AND ARRAYS INTERCONNECTED IN A PANEL, BATTERIES, AND CLIMATE CONTROL UNITS CONSISTING OF DIGITAL THERMOSTATS, PHOTOVOLTAIC INVERTERS, AND COMMUNICATION PLATFORMS FOR WI-FI ACCESS FOR CONVERTING SOLAR ENERGY INTO ELECTRICAL ENERGY FOR THE PURPOSE OF PROVIDING POWER TO REMOTE AREAS, IN CLASS 9 (U.S. CLS. 21, 23, 26, 36 AND 38).

FIRST USE 10-19-2011; IN COMMERCE 10-19-2011.

THE MARK CONSISTS OF STANDARD CHARACTERS WITHOUT CLAIM TO ANY PARTICULAR FONT, STYLE, SIZE, OR COLOR.

NO CLAIM IS MADE TO THE EXCLUSIVE RIGHT TO USE "ENERGY" , APART FROM THE MARK AS SHOWN.

SN 77-901,928, FILED 12-29-2009.

LESLEY LAMOTHE, EXAMINING ATTORNEY



*David J. Kyffers*

Director of the United States Patent and Trademark Office

# United States of America

United States Patent and Trademark Office

## HARD BITTEN

**Reg. No. 4,198,894**

**Registered Aug. 28, 2012**

**Int. Cl.: 25**

**TRADEMARK**

**PRINCIPAL REGISTER**

GAMBLE, LA'MAR DELANEO (UNITED STATES INDIVIDUAL), DBA DELANEO CLOTHING,  
511 SORRELL DRIVE  
GEORGETOWN, SC 29440

FOR: ATHLETIC APPAREL, NAMELY, SHIRTS, PANTS, JACKETS, FOOTWEAR, HATS AND CAPS, ATHLETIC UNIFORMS; CAPRI PANTS; DENIMS; G-STRINGS; HATS; HOODED SWEAT SHIRTS; LONG-SLEEVED SHIRTS; OPEN-NECKED SHIRTS; OVER SHIRTS; PANTS; POLO SHIRTS; SHIRTS; SHIRTS AND SHORT-SLEEVED SHIRTS; SHORT-SLEEVED OR LONG-SLEEVED T-SHIRTS; SHORT-SLEEVED SHIRTS; SPORTS SHIRTS WITH SHORT SLEEVES; SWEAT PANTS; SWEAT SHIRTS; T-SHIRTS; TEE SHIRTS; WEARABLE GARMENTS AND CLOTHING, NAMELY, SHIRTS; WIND PANTS; WIND SHIRTS; WOMEN'S HATS AND HOODS, IN CLASS 25 (U.S. CLS. 22 AND 39).

FIRST USE 3-15-2009; IN COMMERCE 7-15-2009.

THE MARK CONSISTS OF STANDARD CHARACTERS WITHOUT CLAIM TO ANY PARTICULAR FONT, STYLE, SIZE, OR COLOR.

SN 77-904,900, FILED 1-5-2010.

JAY FLOWERS, EXAMINING ATTORNEY



*David J. Kypos*

Director of the United States Patent and Trademark Office

# United States of America

United States Patent and Trademark Office

# Academy

**Reg. No. 4,198,895**

WPP PROPERTIES (DELAWARE PARTNERSHIP)  
100 PARK AVENUE  
NEW YORK, NY 10017

**Registered Aug. 28, 2012**

**Int. Cls.: 35, 41, and 42**

FOR: BUSINESS CONSULTING SERVICES, NAMELY, PROVIDING ASSISTANCE IN DEVELOPMENT OF BUSINESS STRATEGIES AND CREATIVE IDEATION; ONLINE ADVERTISING AND MARKETING SERVICES, IN CLASS 35 (U.S. CLS. 100, 101 AND 102).

**SERVICE MARK**

FIRST USE 6-12-2009; IN COMMERCE 6-12-2009.

**PRINCIPAL REGISTER**

FOR: FILM AND VIDEO PRODUCTION AND EDITING, AND EDITING OF SOUNDS; PHOTOGRAPHY SERVICES; PHOTOGRAPH EDITING, IN CLASS 41 (U.S. CLS. 100, 101 AND 107).

FIRST USE 6-12-2009; IN COMMERCE 6-12-2009.

FOR: COMPUTER HARDWARE AND SOFTWARE CONSULTING SERVICES; COMPUTER PROGRAMMING; DEVELOPMENT OF CD-ROM PROGRAMS; DESIGN AND DEVELOPMENT OF ONLINE WEBSITES FOR THIRD PARTIES; IT INTEGRATION SERVICES; RESEARCH AND DEVELOPMENT OF 3D ANIMATION AND MOTION GRAPHICS TECHNOLOGY; VIDEO PRODUCTION AND EDITING AND SOUND PRODUCTION AND EDITING, 3D ANIMATION DEVELOPMENT AND MOTION GRAPHICS DEVELOPMENT, PHOTOGRAPHY, PHOTOGRAPH PRODUCTION AND EDITING, IN CLASS 42 (U.S. CLS. 100 AND 101).

FIRST USE 6-12-2009; IN COMMERCE 6-12-2009.

PRIORITY CLAIMED UNDER SEC. 44(D) ON CANADA APPLICATION NO. 1444044, FILED 7-8-2009, REG. NO. TMA798,368, DATED 5-25-2011, EXPIRES 5-25-2026.

THE MARK CONSISTS OF STYLIZED "A" IN FRONT OF THE LETTERS "CADEM" AND ENDING WITH A STYLIZED "Y".

SN 77-907,752, FILED 1-8-2010.

SUSAN LESLIE DUBOIS, EXAMINING ATTORNEY



*David J. Kyros*

Director of the United States Patent and Trademark Office

# United States of America

United States Patent and Trademark Office

# ISYS

**Reg. No. 4,198,896**

**Registered Aug. 28, 2012**

**Int. Cl.: 11**

**TRADEMARK**

**PRINCIPAL REGISTER**

APPLIED MATERIALS, INC. (DELAWARE CORPORATION)  
3050 BOWERS AVENUE  
M/S 1241  
SANTA CLARA, CA 95054

FOR: ENVIRONMENTAL CONTROL APPARATUS, NAMELY, HEAT PUMPS AND PROCESS CHILLERS THAT PROVIDE TEMPERATURE CONTROLLED FLUID TO THE TREATMENT AND ABATEMENT OF PROCESS GASES, FUMES, EFFLUENTS, AND LIQUIDS IN THE SEMICONDUCTOR WAFER FABRICATION PROCESS FOR POLLUTION CONTROL PURPOSES, IN CLASS 11 (U.S. CLS. 13, 21, 23, 31 AND 34).

FIRST USE 3-31-2010; IN COMMERCE 3-31-2010.

THE MARK CONSISTS OF STANDARD CHARACTERS WITHOUT CLAIM TO ANY PARTICULAR FONT, STYLE, SIZE, OR COLOR.

SN 77-912,433, FILED 1-14-2010.

JASON TURNER, EXAMINING ATTORNEY



*David J. Kyros*

Director of the United States Patent and Trademark Office

# United States of America

United States Patent and Trademark Office

## Save The Buzz

**Reg. No. 4,198,897**

ENTERPRISING BEE COMPANY (CALIFORNIA LIMITED LIABILITY COMPANY)  
7432 ETON AVE.

**Registered Aug. 28, 2012**

CANOGA PARK, CA 91303

**Int. Cl.: 44**

FOR: BEEKEEPING SERVICES, IN CLASS 44 (U.S. CLS. 100 AND 101).

**SERVICE MARK**

FIRST USE 8-8-2011; IN COMMERCE 8-8-2011.

**PRINCIPAL REGISTER**

THE MARK CONSISTS OF STANDARD CHARACTERS WITHOUT CLAIM TO ANY PARTICULAR FONT, STYLE, SIZE, OR COLOR.

SN 77-913,576, FILED 1-16-2010.

TEJBIR SINGH, EXAMINING ATTORNEY



*David J. Kyros*

Director of the United States Patent and Trademark Office

# United States of America

United States Patent and Trademark Office

# TPMG

**Reg. No. 4,198,898**

**Registered Aug. 28, 2012**

**Int. Cls.: 41, 42, and 44**

**SERVICE MARK**

**PRINCIPAL REGISTER**

THE PERMANENTE MEDICAL GROUP, INC. (CALIFORNIA CORPORATION)  
1800 HARRISON STREET, SUITE 2350  
OAKLAND, CA 94612

FOR: EDUCATIONAL SERVICES, NAMELY, ON-LINE AND WEB-BASED WORKSHOPS, LEARNING MODULES, COURSES AND SEMINARS AND TRAINING IN THE FIELDS OF MEDICAL ANALYSIS, DIAGNOSIS AND RESEARCH AND CLINICAL ANALYSIS, DIAGNOSIS AND RESEARCH; TRAINING SERVICES, NAMELY, DEVELOPMENT AND DISSEMINATION OF EDUCATIONAL MATERIALS OF OTHERS IN THE FIELDS OF MEDICINE, HEALTHCARE AND MEDICAL RESEARCH; ARRANGING AND CONDUCTING EDUCATIONAL COLLOQUIUMS, CONFERENCES, LECTURES, SEMINARS AND WORKSHOPS IN THE FIELD OF MEDICINE, HEALTHCARE, AND MEDICAL RESEARCH; ONLINE PUBLICATION OF REPORTS, ARTICLES AND STUDIES IN THE FIELD OF MEDICINE, HEALTHCARE, AND MEDICAL RESEARCH, IN CLASS 41 (U.S. CLS. 100, 101 AND 107).

FIRST USE 4-30-2012; IN COMMERCE 4-30-2012.

FOR: PROVIDING AN INTERACTIVE WEBSITE FEATURING TECHNOLOGY THAT ENABLES USERS TO INPUT DATA FOR HEALTHCARE MANAGEMENT PURPOSES; PROVIDING THE TEMPORARY USE OF ONLINE NONDOWNLOADABLE SOFTWARE AND COMPUTER PROGRAMS FOR OBTAINING MEDICAL DATA AND HEALTH CARE INFORMATION, AND MANAGING CHRONIC DISEASES, MEDICAL CONDITIONS, AND HEALTH RISKS; PROVIDING AN INTERACTIVE WEBSITE THAT ENABLES USERS TO ENTER, ACCESS, TRACK, MONITOR AND GENERATE HEALTH AND MEDICAL INFORMATION AND REPORTS, AND TO MANAGE CHRONIC DISEASES, MEDICAL CONDITIONS, AND HEALTH RISKS; PROVIDING AN INTERACTIVE WEBSITE FEATURING TECHNOLOGY ALLOWING USERS TO MANAGE AND ADMINISTER MEDICAL DATA; PROVIDING A WEBSITE FEATURING THE TEMPORARY USE OF ONLINE NONDOWNLOADABLE SOFTWARE FOR MANAGING AND ADMINISTERING MEDICAL DATA, IN CLASS 42 (U.S. CLS. 100 AND 101).

FIRST USE 4-30-2012; IN COMMERCE 4-30-2012.

FOR: MEDICAL SERVICES, NAMELY, PROVIDING MEDICAL INFORMATION, CONSULTANCY AND ADVISORY SERVICES, AND DIAGNOSIS AND TREATMENT IN THE FIELDS OF MEDICINE AND HEALTHCARE, IN-PERSON AND VIA TELEPHONE AND THE INTERNET; PROVIDING AN ONLINE COMPUTER DATABASE FEATURING INFORMATION



*David J. Kyjars*

Director of the United States Patent and Trademark Office

**Reg. No. 4,198,898** REGARDING HEALTH AND NUTRITION, HEALTHCARE SERVICES, AND TREATMENT OF CHRONIC DISEASES, MEDICAL CONDITIONS, AND HEALTH RISKS; HEALTH CARE SERVICES, NAMELY, PROVIDING A DATABASE IN THE FIELD OF MEDICAL AND HEALTHCARE INFORMATION AND MANAGING CHRONIC DISEASES, MEDICAL CONDITIONS AND HEALTH RISKS AND FEATURING INPUTTING AND COLLECTION OF DATA AND INFORMATION, ALL FOR INFORMATIONAL AND TREATMENT PURPOSES, IN CLASS 44 (U.S. CLS. 100 AND 101).

FIRST USE 4-30-2012; IN COMMERCE 4-30-2012.

THE MARK CONSISTS OF STANDARD CHARACTERS WITHOUT CLAIM TO ANY PARTICULAR FONT, STYLE, SIZE, OR COLOR.

SN 77-916,684, FILED 1-21-2010.

REBECCA POVARCHUK, EXAMINING ATTORNEY



# United States of America

United States Patent and Trademark Office

## FAMILY GAME NIGHT

**Reg. No. 4,198,899**

**Registered Aug. 28, 2012**

**Int. Cl.: 41**

**SERVICE MARK**

**PRINCIPAL REGISTER**

HASBRO, INC. (RHODE ISLAND CORPORATION)  
1027 NEWPORT AVENUE  
PAWTUCKET, RI 02862

FOR: ENTERTAINMENT SERVICES, NAMELY, AN ON-GOING TELEVISION GAME SHOW;  
ENTERTAINMENT SERVICES, NAMELY, AN ON-GOING TELEVISION GAME SHOW  
SEGMENT, IN CLASS 41 (U.S. CLS. 100, 101 AND 107).

FIRST USE 10-10-2010; IN COMMERCE 10-10-2010.

THE MARK CONSISTS OF STANDARD CHARACTERS WITHOUT CLAIM TO ANY PARTICULAR FONT, STYLE, SIZE, OR COLOR.

SEC. 2(F).

OWNER OF U.S. REG. NO. 2,242,143.

NO CLAIM IS MADE TO THE EXCLUSIVE RIGHT TO USE "GAME", APART FROM THE MARK AS SHOWN.

SN 77-918,640, FILED 1-23-2010.

CHRISTOPHER BUONGIORNO, EXAMINING ATTORNEY



*David J. Kyros*

Director of the United States Patent and Trademark Office

# United States of America

United States Patent and Trademark Office

## 1337 INDUSTRIES

**Reg. No. 4,198,900**

**Registered Aug. 28, 2012**

**Int. Cl.: 9**

**TRADEMARK**

**PRINCIPAL REGISTER**

1337 INDUSTRIES S.L. (SPAIN CORPORATION)  
RONDA DE LA BOBILA S/N  
POL. IND. PLA DE ROMANI, 08180 MOIÀ,  
BARCELONA, SPAIN

FOR: APPARATUS FOR RECORDING, TRANSMISSION OR REPRODUCTION OF SOUND OR IMAGES, NAMELY, HEADPHONES, HEADSETS, SOUND CARDS; COMPUTERS; COMPUTER HARDWARE; COMPUTER ACCESSORIES, NAMELY, KEYBOARDS, MOUSE PADS, JOYSTICKS; DATA PROCESSING EQUIPMENT, NAMELY, COMPUTER MICE, INTERACTIVE GAME PADS FOR PLAYING VIDEO GAMES; GAMING CONSOLE PERIPHERALS, NAMELY, HEADSETS, HEADPHONES, GAME PADS SPECIALLY ADAPTED FOR HOLDING GAMING CONSOLES, INTERACTIVE GLOVES THAT ARE SPECIALLY ADAPTED FOR PLAYING COMPUTER GAMES, IN CLASS 9 (U.S. CLS. 21, 23, 26, 36 AND 38).

FIRST USE 2-1-2012; IN COMMERCE 2-1-2012.

THE MARK CONSISTS OF STANDARD CHARACTERS WITHOUT CLAIM TO ANY PARTICULAR FONT, STYLE, SIZE, OR COLOR.

NO CLAIM IS MADE TO THE EXCLUSIVE RIGHT TO USE "INDUSTRIES", APART FROM THE MARK AS SHOWN.

SN 77-920,548, FILED 1-26-2010.

KIMBERLY FRYE, EXAMINING ATTORNEY



*David J. Kyros*

Director of the United States Patent and Trademark Office

# United States of America

United States Patent and Trademark Office

# ECLIPSE

**Reg. No. 4,198,901**

**Registered Aug. 28, 2012**

**Int. Cl.: 5**

**TRADEMARK**

**PRINCIPAL REGISTER**

SUMMIT ENTERTAINMENT, LLC (DELAWARE LIMITED LIABILITY COMPANY)  
1630 STEWART STREET, SUITE 120  
SANTA MONICA, CA 90404

FOR: BANDAGES FOR SKIN WOUNDS, IN CLASS 5 (U.S. CLS. 6, 18, 44, 46, 51 AND 52).

FIRST USE 6-1-2010; IN COMMERCE 6-1-2010.

THE MARK CONSISTS OF STANDARD CHARACTERS WITHOUT CLAIM TO ANY PARTICULAR FONT, STYLE, SIZE, OR COLOR.

SN 77-921,981, FILED 1-28-2010.

JESSICA FATHY, EXAMINING ATTORNEY



*David J. Kyffers*

Director of the United States Patent and Trademark Office

# United States of America

United States Patent and Trademark Office

# GAUCHO

**Reg. No. 4,198,902**

**Registered Aug. 28, 2012**

**Int. Cls.: 9 and 42**

**TRADEMARK**

**SERVICE MARK**

**PRINCIPAL REGISTER**

GAUCHO, INC. (NEVADA CORPORATION)  
7260 W. AZURE DRIVE, SUITE 140-892  
LAS VEGAS, NV 89130

FOR: COMPUTER SOFTWARE DEVELOPMENT TOOLS FOR SOCIAL NETWORKING, BUILDING SOCIAL NETWORKING APPLICATIONS AND FOR ALLOWING DATA RETRIEVAL, UPLOAD, ACCESS, AND MANAGEMENT; APPLICATION PROGRAMMING SOFTWARE INTERFACE USED WITH THIRD-PARTY SOFTWARE AND ONLINE SERVICES FOR SOCIAL NETWORKING, BUILDING SOCIAL NETWORKING APPLICATIONS AND FOR ALLOWING DATA RETRIEVAL, UPLOAD, ACCESS, AND MANAGEMENT; SOFTWARE TO ENABLE UPLOADING, POSTING, SHOWING, DISPLAYING, TAGGING, BLOGGING, SHARING, OR OTHERWISE PROVIDING ELECTRONIC MEDIA OR INFORMATION OVER THE INTERNET OR OTHER COMMUNICATIONS NETWORK; COMPUTER SOFTWARE FOR CREATING INDEXES OF INFORMATION, INDEXES OF WEB SITES AND INDEXES OF OTHER INFORMATION RESOURCES; COMPUTER SOFTWARE FOR BUSINESS, HOME, EDUCATION, AND DEVELOPER USE, FOR PROVIDING COMPUTER GAMES AND MULTIMEDIA ENCYCLOPEDIAS AND REFERENCE PRODUCTS STORED ON ELECTRONIC MEDIA; COMPUTER PROGRAMS FOR USE IN AUTOMOBILES, NAMELY, COMPUTER PROGRAMS FOR MONITORING AUTOMOBILE PERFORMANCE, FOR MAPPING AND NAVIGATION, FOR ELECTRONIC MAIL AND WIRELESS COMMUNICATION, FOR MAINTAINING PERSONAL DIRECTORIES, CONTACT LISTS, ADDRESS AND TELEPHONE NUMBER LISTS; COMPUTER OPERATING SYSTEM PROGRAMS AND COMPUTER UTILITIES; COMPUTER PROGRAMS FOR USE IN THE DEVELOPMENT OF OTHER COMPUTER PROGRAMS FOR USE IN AUTOMOBILE COMPUTERS; COMPUTER OPERATING SYSTEM PROGRAMS; COMPUTER PROGRAMS FOR PROVIDING TRAFFIC INFORMATION, NEWS; COMPUTER PROGRAMS FOR WALLET-SIZED PERSONAL COMPUTERS, NAMELY, PERSONAL INFORMATION MANAGER COMPUTER PROGRAMS WITH CALENDARS, CONTACT INFORMATION FILES AND TO-DO LISTS; COMPUTER NOTE TAKING PROGRAMS; COMPUTER PROGRAMS FOR FACILITATING VOICE, TEXT AND PEN INPUT TO A COMPUTER; ELECTRONIC MAIL COMPUTER PROGRAMS; ACCESS PROGRAMS FOR GLOBAL COMMUNICATION NETWORKS; COMPUTER PROGRAMS FOR WIRELESS COMMUNICATIONS; COMPUTER PROGRAMS FOR USE IN DEVELOPING OTHER COMPUTER PROGRAMS FOR USE ON WALLET-SIZED PERSONAL COMPUTERS; COMPUTER PROGRAMS FOR ACCESSING GLOBAL COMMUNICATION NETWORKS AND DISPLAYING CONTENT THEREFROM; COMPUTER PROGRAMS FOR ELECTRONIC PAGERS; COMPUTER PROGRAMS FOR PROVIDING PAGING AND WIRELESS COMMUNICATION FUNCTIONS; COMPUTER PROGRAMS FOR USE WITH HAND-HELD COM-



*David J. Kyffers*

Director of the United States Patent and Trademark Office

**Reg. No. 4,198,902** PUTERS, BUSINESS APPLICATION COMPUTER PROGRAMS FOR USE WITH HAND-HELD COMPUTERS, AND COMPUTER MOBILE DEVICES, IN CLASS 9 (U.S. CLS. 21, 23, 26, 36 AND 38).

FIRST USE 1-29-2010; IN COMMERCE 1-29-2010.

FOR: COMPUTER SERVICES, NAMELY, PROVIDING INTERNET SEARCH ENGINE SERVICES; COMPUTER SERVICES, NAMELY, ACTING AS APPLICATION SERVICE PROVIDER TO HOST, MANAGE, DEVELOP, AND MAINTAIN APPLICATIONS, SOFTWARE, WEBSITES, AND DATABASES IN THE FIELD OF IN PERSONAL PRODUCTIVITY, COLLABORATION, COMMUNICATION, AND PUBLISHING; COMPUTER SERVICES, NAMELY, MONITORING, TRACKING, AND REPORTING ON THE PERFORMANCE OF THE WEBSITE AND ONLINE CONTENT OF OTHERS FOR TECHNICAL PURPOSES; COMPUTER SERVICES IN THE NATURE OF CUSTOMIZED WEB PAGES FEATURING USER DEFINED INFORMATION, PERSONAL PROFILES, AND INFORMATION; PROVIDING ONLINE NON-DOWNLOADABLE SOFTWARE FOR USE IN PERSONAL PRODUCTIVITY, COLLABORATION, COMMUNICATION, AND PUBLISHING; PROVIDING ON-LINE NON-DOWNLOADABLE SOFTWARE FOR USE IN DATABASE MANAGEMENT, FOR USE AS A SPREADSHEET, AND FOR WORD PROCESSING; PROVIDING ON-LINE NON-DOWNLOADABLE COMPUTER SOFTWARE FOR TRACKING DOCUMENTS OVER COMPUTER NETWORKS, INTRANETS AND THE INTERNET; PROVIDING ON-LINE NON-DOWNLOADABLE SOFTWARE FOR CREATING AND MAINTAINING WEBSITES AND BLOGS; PROVIDING ON-LINE NON-DOWNLOADABLE SOFTWARE FOR DOCUMENT COLLABORATION AND REVISION TRACKING; PROVIDING ON-LINE NON-DOWNLOADABLE SOFTWARE FOR GRANTING AND CONTROLLING ACCESS TO DOCUMENTS; PROVIDING ON-LINE NON-DOWNLOADABLE SOFTWARE FOR MANAGING INDIVIDUAL AND GROUP CALENDARS AND SCHEDULES; PROVIDING ONLINE NON-DOWNLOADABLE SOFTWARE FEATURING ONLINE STORAGE OF DOCUMENTS AND DATABASES; PROVIDING ON-LINE NON-DOWNLOADABLE SOFTWARE FOR LANGUAGE TRANSLATION; PROVIDING ON-LINE COMPUTER MAPPING SERVICES; MAPPING SERVICES, NAMELY, PROVIDING A WEBSITE AND WEBSITE LINKS TO GEOGRAPHIC INFORMATION, MAP IMAGES, AND TRIP ROUTING; PROVIDING ON-LINE NON-DOWNLOADABLE SOFTWARE FOR TRACKING, MANAGING, AND OPTIMIZING ADVERTISING AND PROMOTIONAL CAMPAIGNS, AND CALCULATING RETURN ON INVESTMENT IN CONNECTION WITH THE SAME; PROVIDING ONLINE NON-DOWNLOADABLE SOFTWARE FOR TRACKING WEBSITE TRAFFIC, E-COMMERCE ACTIVITY, CUSTOMER LOYALTY, AND SALES CONVERSION RATES; PROVIDING ON-LINE NON-DOWNLOADABLE SOFTWARE FOR OPTIMIZING WEBSITE NAVIGATION; PROVIDING ON-LINE NON-DOWNLOADABLE SOFTWARE FOR MANAGING, COLLECTING, MONITORING, AND ANALYZING WEB, BLOG, AND OTHER ONLINE SITE TRAFFIC, USER PREFERENCES, USER COMMUNICATIONS AND CHAT AND LINKS IN REAL TIME; TECHNICAL SUPPORT SERVICES, NAMELY, TROUBLESHOOTING IN THE NATURE OF DIAGNOSING COMPUTER HARDWARE AND SOFTWARE PROBLEMS IN MANAGING, COLLECTING, MONITORING, AND ANALYZING WEB, BLOG, AND OTHER ONLINE SITE TRAFFIC, USER PREFERENCES AND LINKS; DESIGN AND DEVELOPMENT SERVICES FOR OTHERS OF SOFTWARE FOR MANAGING, COLLECTING, MONITORING, AND ANALYZING WEB, BLOG, AND OTHER ONLINE SITE TRAFFIC, USER PREFERENCES AND LINKS; TECHNICAL SUPPORT SERVICES, NAMELY, TROUBLESHOOTING OF COMPUTER HARDWARE FOR DIAGNOSTIC PROGRAMS; COMPUTER AND COMPUTER SOFTWARE CONSULTATION SERVICES; COMPUTER SERVICES, NAMELY, APPLICATION SERVICE PROVIDER FEATURING APPLICATION PROGRAM INTERFACE FOR USE IN BUILDING SOFTWARE APPLICATIONS, NAMELY, MANAGING, COLLECTING, MONITORING, AND ANALYZING WEB, BLOG, AND OTHER ONLINE SITE TRAFFIC, USER PREFERENCES AND LINKS; PROVIDING INFORMATION FROM SEARCHABLE INDEXES AND DATABASES OF INFORMATION, INCLUDING TEXT, ELECTRONIC DOCUMENTS, DATABASES, GRAPHICS, AND AUDIO VISUAL INFORMATION, BY MEANS OF GLOBAL COMPUTER INFORMATION NETWORKS; PROVIDING REFERENCE INFORMATION OVER COMPUTER NETWORKS AND GLOBAL COMMUNICATION NETWORKS; AND PROVIDING INFORMATION

**Reg. No. 4,198,902** CONCERNING COMPUTERS AND COMPUTER SOFTWARE OVER COMPUTER NETWORKS AND GLOBAL COMMUNICATION NETWORKS; LEASING COMPUTER FACILITIES TO OTHERS FOR THE PURPOSE OF THEIR PROVIDING INTERACTIVE RETAILING, ON-LINE ORDERING, AND RESTAURANT AND TRAVEL INFORMATION AND RESERVATIONS, ON A COMPUTER SERVER FOR A GLOBAL COMMUNICATION NETWORK, IN CLASS 42 (U.S. CLS. 100 AND 101).

FIRST USE 1-29-2010; IN COMMERCE 1-29-2010.

THE MARK CONSISTS OF STANDARD CHARACTERS WITHOUT CLAIM TO ANY PARTICULAR FONT, STYLE, SIZE, OR COLOR.

SN 77-922,315, FILED 1-28-2010.

DAVID C. REIHNER, EXAMINING ATTORNEY

# United States of America

United States Patent and Trademark Office

# ALTOP

**Reg. No. 4,198,903**

**Registered Aug. 28, 2012**

**Int. Cl.: 20**

**TRADEMARK**

**PRINCIPAL REGISTER**

L'AIR LIQUIDE, SOCIETE ANONYME POUR L'ETUDE ET L'EXPLOITATION DES  
PROCEDES GEORGES CLAUDE CORPORATION FRANCE (FRANCE CORPORATION)  
75, QUAI D'ORSAY  
PARIS, FRANCE 75007

FOR: PLASTIC CYLINDER CAP CONTAINING A BUILT-IN REGULATOR AND A PRESSURE  
RELIEF VALVE AS COMPONENTS THEREOF, FITTED TO INDUSTRIAL METAL GAS  
CYLINDERS, IN CLASS 20 (U.S. CLS. 2, 13, 22, 25, 32 AND 50).

FIRST USE 1-1-2000; IN COMMERCE 9-1-2010.

THE MARK CONSISTS OF STANDARD CHARACTERS WITHOUT CLAIM TO ANY PAR-  
TICULAR FONT, STYLE, SIZE, OR COLOR.

SN 77-923,157, FILED 1-29-2010.

CAROLYN CATALDO, EXAMINING ATTORNEY



*David J. Kyffers*

Director of the United States Patent and Trademark Office

# United States of America

United States Patent and Trademark Office

## GO AUTHENTICO

**Reg. No. 4,198,904**

CACIQUE, INC. (CALIFORNIA CORPORATION)  
14940 PROCTOR AVENUE  
CITY OF INDUSTRY, CA 91744

**Registered Aug. 28, 2012**

**Int. Cl.: 29**

FOR: DAIRY PRODUCTS EXCLUDING ICE CREAM, ICE MILK AND FROZEN YOGURT;  
SAUSAGES, IN CLASS 29 (U.S. CL. 46).

**TRADEMARK**

FIRST USE 6-0-2010; IN COMMERCE 6-0-2010.

**PRINCIPAL REGISTER**

THE MARK CONSISTS OF STANDARD CHARACTERS WITHOUT CLAIM TO ANY PARTICULAR FONT, STYLE, SIZE, OR COLOR.

SN 77-926,149, FILED 2-2-2010.

JUDITH HELFMAN, EXAMINING ATTORNEY



*David J. Kybas*

Director of the United States Patent and Trademark Office



# United States of America

United States Patent and Trademark Office



**Reg. No. 4,198,905**

TEXAS EDUCATION AGENCY (TEXAS STATE AGENCY)  
1701 NORTH CONGRESS AVENUE  
AUSTIN, TX 787011494

**Registered Aug. 28, 2012**

**Int. Cl.: 16**

FOR: PRINTED INSTRUCTIONAL, EDUCATIONAL, AND TEACHING MATERIALS FOR THE ASSESSMENT OF THE EDUCATIONAL DEVELOPMENT IN CHILDREN, IN CLASS 16 (U.S. CLS. 2, 5, 22, 23, 29, 37, 38 AND 50).

**TRADEMARK**

FIRST USE 1-26-2010; IN COMMERCE 3-26-2012.

**PRINCIPAL REGISTER**

NO CLAIM IS MADE TO THE EXCLUSIVE RIGHT TO USE "STATE OF TEXAS ASSESSMENTS OF ACADEMIC READINESS", APART FROM THE MARK AS SHOWN.

THE MARK CONSISTS OF THE WORDS "STAAR STATE OF TEXAS ASSESSMENTS OF ACADEMIC READINESS" OVER A TEXAS FLAG DESIGN.

SN 77-930,539, FILED 2-8-2010.

TRACY FLETCHER, EXAMINING ATTORNEY



*David J. Kybas*

Director of the United States Patent and Trademark Office

# United States of America

United States Patent and Trademark Office



**Reg. No. 4,198,906**

TEXAS EDUCATION AGENCY (TEXAS STATE AGENCY)  
1701 NORTH CONGRESS AVENUE  
AUSTIN, TX 787011494

**Registered Aug. 28, 2012**

**Int. Cl.: 41**

FOR: EDUCATIONAL AND TRAINING SERVICES, NAMELY, CONDUCTING CLASSES AND WORKSHOPS IN THE FIELD OF THE ASSESSMENT OF THE EDUCATIONAL DEVELOPMENT IN CHILDREN, IN CLASS 41 (U.S. CLS. 100, 101 AND 107).

**SERVICE MARK**

FIRST USE 1-26-2010; IN COMMERCE 3-26-2012.

**PRINCIPAL REGISTER**

NO CLAIM IS MADE TO THE EXCLUSIVE RIGHT TO USE "STATE OF TEXAS ASSESSMENTS OF ACADEMIC READINESS", APART FROM THE MARK AS SHOWN.

THE MARK CONSISTS OF THE WORDS "STAAR STATE OF TEXAS ASSESSMENTS OF ACADEMIC READINESS" OVER A TEXAS FLAG DESIGN.

SN 77-930,546, FILED 2-8-2010.

TRACY FLETCHER, EXAMINING ATTORNEY



*David J. Kybas*

Director of the United States Patent and Trademark Office

# United States of America

United States Patent and Trademark Office

# KING

**Reg. No. 4,198,907**

**Registered Aug. 28, 2012**

**Int. Cl.: 28**

**TRADEMARK**

**PRINCIPAL REGISTER**

WARRIOR SPORTS, INC. (MICHIGAN CORPORATION), DBA BRINE,  
32125 HOLLINGSWORTH AVE  
WARREN, MI 48092

FOR: GOALKEEPERS' GLOVES; SHIN GUARDS FOR ATHLETIC USE; SOCCER BALLS,  
IN CLASS 28 (U.S. CLS. 22, 23, 38 AND 50).

FIRST USE 2-1-2012; IN COMMERCE 2-1-2012.

THE MARK CONSISTS OF STANDARD CHARACTERS WITHOUT CLAIM TO ANY PAR-  
TICULAR FONT, STYLE, SIZE, OR COLOR.

OWNER OF U.S. REG. NOS. 3,419,775, 3,733,456, AND OTHERS.

SN 77-931,125, FILED 2-9-2010.

KATHLEEN M. VANSTON, EXAMINING ATTORNEY



*David J. Kybas*

Director of the United States Patent and Trademark Office

# United States of America

United States Patent and Trademark Office

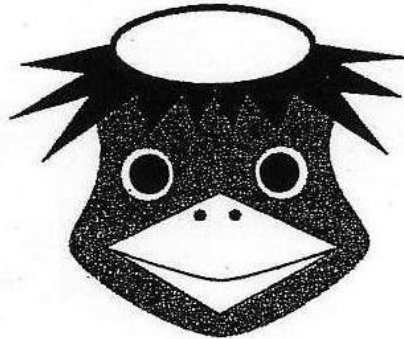

**Reg. No. 4,198,908**

DOHITOMI & CO., LTD. (JAPAN CORPORATION)  
382-3, SHINJO

**Registered Aug. 28, 2012**

KATO-SHI, HYOGO-KEN, JAPAN

**Int. Cl.: 28**

FOR: FISHING HOOKS AND FISHING TACKLES, IN CLASS 28 (U.S. CLS. 22, 23, 38 AND 50).

**TRADEMARK**

FIRST USE 6-20-2012; IN COMMERCE 6-20-2012.

**PRINCIPAL REGISTER**

THE MARK CONSISTS OF A STYLIZED DESIGN OF THE HEAD OF A JAPANESE MYTHICAL CREATURE

SN 77-932,072, FILED 2-9-2010.

RUSS HERMAN, EXAMINING ATTORNEY



*David J. Kypos*

Director of the United States Patent and Trademark Office

# United States of America

United States Patent and Trademark Office

# RADISPHERE

**Reg. No. 4,198,909**

RADISPHERE NATIONAL RADIOLOGY GROUP, INC. (DELAWARE CORPORATION)  
23625 COMMERCE PARK, SUITE 204  
BEACHWOOD, OH 44122

**Registered Aug. 28, 2012**

**Int. Cl.: 41**

FOR: TRAINING IN THE FIELD OF RADIOLOGY, COMPUTING, PROCESSING, AND ASSESSING OF X-RAYS, ULTRA SOUND SCANS AND MEDICAL DIGITAL IMAGING , IN CLASS 41 (U.S. CLS. 100, 101 AND 107).

**SERVICE MARK**

FIRST USE 6-18-2010; IN COMMERCE 6-18-2010.

**PRINCIPAL REGISTER**

THE MARK CONSISTS OF STANDARD CHARACTERS WITHOUT CLAIM TO ANY PARTICULAR FONT, STYLE, SIZE, OR COLOR.

SN 77-937,068, FILED 2-16-2010.

DARRYL SPRUILL, EXAMINING ATTORNEY



*David J. Kyffers*

Director of the United States Patent and Trademark Office

# United States of America

United States Patent and Trademark Office

# RADISPHERE

**Reg. No. 4,198,910**

**Registered Aug. 28, 2012**

**Int. Cl.: 42**

**SERVICE MARK**

**PRINCIPAL REGISTER**

RADISPHERE NATIONAL RADIOLOGY GROUP, INC. (DELAWARE CORPORATION)  
23625 COMMERCE PARK, SUITE 204  
BEACHWOOD, OH 44122

FOR: APPLICATION SERVICE PROVIDER (ASP) FEATURING SOFTWARE FOR USE IN MEDICAL IMAGING EVALUATION, ASSESSMENT, AND REPORTING; COMPUTER PROGRAMMING IN THE MEDICAL FIELD; COMPUTER SERVICES, NAMELY, ACTING AS AN APPLICATION SERVICE PROVIDER IN THE FIELD OF KNOWLEDGE MANAGEMENT TO HOST COMPUTER APPLICATION SOFTWARE FOR CREATING SEARCHABLE DATABASES OF INFORMATION AND DATA IN THE FIELDS OF RADIOLOGY AND MEDICAL IMAGING; MEDICAL AND SCIENTIFIC RESEARCH IN THE FIELD OF MEDICAL IMAGING; TECHNICAL CONSULTING IN THE FIELD OF INFORMATION TECHNOLOGY AND APPLICATION OF INFORMATION TECHNOLOGY, ALL IN THE FIELD OF MEDICAL DIGITAL RADIOLOGY; RESEARCH, DEVELOPMENT AND DESIGN SERVICES IN THE TECHNOLOGICAL AND SCIENTIFIC FIELD OF DIGITAL RADIOLOGY APPARATUS; INDUSTRIAL ANALYSIS AND RESEARCH IN THE FIELD OF DIGITAL RADIOLOGY APPARATUS; DESIGN AND DEVELOPMENT OF COMPUTER AND COMPUTER PROGRAMS, IN CLASS 42 (U.S. CLS. 100 AND 101).

FIRST USE 4-7-2010; IN COMMERCE 4-7-2010.

THE MARK CONSISTS OF STANDARD CHARACTERS WITHOUT CLAIM TO ANY PARTICULAR FONT, STYLE, SIZE, OR COLOR.

SN 77-937,078, FILED 2-16-2010.

DARRYL SPRUILL, EXAMINING ATTORNEY



*David J. Kypos*

Director of the United States Patent and Trademark Office

# United States of America

United States Patent and Trademark Office

# conversion

**Reg. No. 4,198,911**

**Registered Aug. 28, 2012**

**Int. Cl.: 35**

**SERVICE MARK**

**PRINCIPAL REGISTER**

E-REWARDS, INC. (DELAWARE CORPORATION)  
5800 TENNYSON PARKWAY, SUITE 600  
PLANO, TX 75024

FOR: MARKET RESEARCH SERVICES, NAMELY, THE ON-LINE COLLECTION, AGGREGATION AND ANALYSIS OF MARKET RESEARCH INFORMATION AND DATA COLLECTED FROM THE INTERNET AND REPORTING THE RESULTS OF SUCH ANALYSIS; CONSULTING SERVICES IN THE FIELD OF MARKET RESEARCH, IN CLASS 35 (U.S. CLS. 100, 101 AND 102).

FIRST USE 8-31-2009; IN COMMERCE 8-31-2009.

THE MARK CONSISTS OF THE COINED MARK "CONVERSION" WITH THE LETTER "I" IN SUCH MARK TAKING THE SHAPE OF AN ELONGATED TRIANGLE AND A SPHERE, WITH AN ARC OF SPHERES RANGING IN SIZE AND SPANNING FROM THE TWO LETTER "I"'S IN "CONVERSION".

THE WORDING "CONVERSION" HAS NO MEANING IN A FOREIGN LANGUAGE.

SN 77-939,885, FILED 2-19-2010.

BILL DAWE, EXAMINING ATTORNEY



*David J. Kyffers*

Director of the United States Patent and Trademark Office

# United States of America

United States Patent and Trademark Office



**Reg. No. 4,198,912**

**Registered Aug. 28, 2012**

**Int. Cls.: 9, 11, 14, and 42**

**TRADEMARK**

**SERVICE MARK**

**PRINCIPAL REGISTER**

FHF FUNKE + HUSTER FERNSIG GMBH (FED REP GERMANY LIMITED LIABILITY COMPANY)  
GEWERBEALLEE 15-19  
MUELHEIM AN DER RUHR, FED REP GERMANY 45441

FOR: WARNING SIGNALING LIGHTS, REVOLVING WARNING MIRROR LIGHTS; EXPLOSION-PROOF OPTICAL SIGNALING APPARATUS, IN PARTICULAR EXPLOSION-PROOF ELECTRICAL LIGHTS, EXPLOSION-PROOF WARNING BEACONS, EXPLOSION-PROOF ELECTRIC LIGHTS AND WARNING BEACONS FOR MOORING BOLLARDS OF METAL AND MOORING BOLLARDS OF CONCRETE, IN CLASS 9 (U.S. CLS. 21, 23, 26, 36 AND 38).

FIRST USE 5-10-2010; IN COMMERCE 10-5-2011.

FOR: LIGHTING APPARATUS, IN PARTICULAR FOR USE IN AREAS VULNERABLE TO EXPLOSIONS, NAMELY, LIGHTS AND LIGHTING FIXTURES; EXPLOSION-PROOF OPTICAL SIGNALING APPARATUS, IN PARTICULAR EXPLOSION-PROOF FLASH LIGHTS, EXPLOSION PROOF FLASH LIGHTS FOR MOORING BOLLARDS OF METAL AND MOORING BOLLARDS OF CONCRETE, IN CLASS 11 (U.S. CLS. 13, 21, 23, 31 AND 34).

FIRST USE 5-10-2010; IN COMMERCE 10-5-2011.

FOR: (BASED ON 44(E)) ALARM CLOCKS, IN CLASS 14 (U.S. CLS. 2, 27, 28 AND 50).

FOR: (BASED ON 44(E)) SCIENTIFIC RESEARCH, IN PARTICULAR IN THE FIELD OF EXPLOSION PROTECTION FOR LIGHTING FIXTURES AND OPTICAL SIGNALING APPARATUSES; DESIGN AND DEVELOPMENT OF COMPUTER HARDWARE AND SOFTWARE; COMPUTER PROGRAMMING, IN PARTICULAR IN THE FIELD OF EXPLOSION PROTECTION FOR LIGHTING FIXTURES AND OPTICAL SIGNALING APPARATUSES, IN CLASS 42 (U.S. CLS. 100 AND 101).

OWNER OF ERPN CMNTY TM OFC REG. NO. 007054018, DATED 2-16-2009, EXPIRES 7-1-2018.

THE COLOR(S) BLACK, YELLOW, GREY, RED, WHITE IS/ARE CLAIMED AS A FEATURE OF THE MARK.



*David J. Kyros*

Director of the United States Patent and Trademark Office



**Reg. No. 4,198,912** THE MARK CONSISTS OF THE TERM "EXPERTLINE" WITH "EXPERT" IN GRAY AND "LINE" IN RED, WITH THE FIRST LETTER "E" IN EXPERT HAVING A WHITE BORDER ON ITS UPPER ASPECTS AND A BLACK BORDER ON ITS LOWER ASPECTS, AND THE REMAINING LETTERS "X", "P", "E", "R" AND "T" IN "EXPERT" HAVING A BLACK BORDER ON THEIR LOWER ASPECTS, AND THE BORDER OF A HALF HEXAGON IN BLACK CONTAINING A YELLOW BACKGROUND.

SN 77-941,136, FILED 2-22-2010.

DAVID C. REIHNER, EXAMINING ATTORNEY

# United States of America

United States Patent and Trademark Office

# EVERLOOP

**Reg. No. 4,198,913**

**Registered Aug. 28, 2012**

**Int. Cl.: 42**

**SERVICE MARK**

**PRINCIPAL REGISTER**

EVERLOOP, INC. (CALIFORNIA CORPORATION)  
9000 CROW CANYON ROAD  
SUITE S #240  
DANVILLE, CA 94506

FOR: PROVIDING AND HOSTING AN INTERACTIVE WEBSITE ALLOWING USERS THE ABILITY TO UPLOAD, EXCHANGE AND SHARE PHOTOS, VIDEOS, MUSIC; FILE SHARING SERVICES, NAMELY, PROVIDING A WEBSITE FEATURING TECHNOLOGY ENABLING USERS TO UPLOAD AND DOWNLOAD ELECTRONIC FILES, IN CLASS 42 (U.S. CLS. 100 AND 101).

FIRST USE 10-0-2010; IN COMMERCE 10-0-2010.

THE MARK CONSISTS OF STANDARD CHARACTERS WITHOUT CLAIM TO ANY PARTICULAR FONT, STYLE, SIZE, OR COLOR.

SN 77-943,055, FILED 2-23-2010.

BRENDAN MCCAULEY, EXAMINING ATTORNEY



*David J. Kybas*

Director of the United States Patent and Trademark Office

# United States of America

United States Patent and Trademark Office



**Reg. No. 4,198,914**

RACK ASSASSIN LLC (TEXAS LIMITED LIABILITY COMPANY)  
118 HUMMINGBIRD LANE  
WEATHERFORD, TX 76088

**Registered Aug. 28, 2012**

**Int. Cl.: 25**

FOR: CAPS; JACKETS, AND SHIRTS, ALL FOR HUNTERS AND OUTDOOR ENTHUSIASTS,  
IN CLASS 25 (U.S. CLS. 22 AND 39).

**TRADEMARK**

FIRST USE 4-15-2010; IN COMMERCE 4-15-2010.

**PRINCIPAL REGISTER**

NO CLAIM IS MADE TO THE EXCLUSIVE RIGHT TO USE "RACK", APART FROM THE  
MARK AS SHOWN.

THE MARK CONSISTS OF A DEER'S SKULL WITH THE STYLIZED TEXT "RACK ASSA  
SSIN".

SN 77-946,348, FILED 2-26-2010.

EMILY CARLSEN, EXAMINING ATTORNEY



*David J. Kybas*

Director of the United States Patent and Trademark Office

# United States of America

United States Patent and Trademark Office



**Reg. No. 4,198,915**

**Registered Aug. 28, 2012**

**Int. Cls.: 20 and 24**

**TRADEMARK**

**PRINCIPAL REGISTER**

ORQUIDEA MARIA ANTONIETA ALONSO ESPINOSA DE LOS MONTEROS (MEXICO  
INDIVIDUAL)  
PROL. BOSQUE DE REFORMA 1440 TORRE 1-902  
MEXICO D.F, MEXICO 11700

FOR: BED PILLOWS, IN CLASS 20 (U.S. CLS. 2, 13, 22, 25, 32 AND 50).

FIRST USE 5-25-1997; IN COMMERCE 5-25-1997.

FOR: PILLOW CASES, IN CLASS 24 (U.S. CLS. 42 AND 50).

FIRST USE 5-25-1998; IN COMMERCE 5-25-1998.

THE MARK CONSISTS OF THE WORDING "MOTHER ORCHID" SEPARATED BY A DESIGN  
OF AN ORCHID.

SN 77-946,574, FILED 2-27-2010.

ANDREW LEASER, EXAMINING ATTORNEY



*David J. Kybas*

Director of the United States Patent and Trademark Office

# United States of America

United States Patent and Trademark Office

# POINTSPLUS

**Reg. No. 4,198,916**

WEIGHT WATCHERS INTERNATIONAL, INC. (VIRGINIA CORPORATION)  
11 MADISON AVENUE  
NEW YORK, NY 10010

**Registered Aug. 28, 2012**

**Int. Cl.: 41**

FOR: PHYSICAL FITNESS CONSULTATION; PROVISION OF INFORMATION IN THE FIELD OF PHYSICAL FITNESS; PROVIDING A WEBSITE AND ONLINE DATABASE FEATURING INFORMATION CONCERNING PHYSICAL FITNESS, IN CLASS 41 (U.S. CLS. 100, 101 AND 107).

**SERVICE MARK**

**PRINCIPAL REGISTER**

FIRST USE 11-28-2010; IN COMMERCE 11-28-2010.

THE MARK CONSISTS OF STANDARD CHARACTERS WITHOUT CLAIM TO ANY PARTICULAR FONT, STYLE, SIZE, OR COLOR.

OWNER OF U.S. REG. NOS. 2,139,767, 3,163,684, AND 3,346,918.

SN 77-948,576, FILED 3-2-2010.

KELLY TRUSILO, EXAMINING ATTORNEY



*David J. Kyros*

Director of the United States Patent and Trademark Office

# United States of America

United States Patent and Trademark Office



**Reg. No. 4,198,917**

HAPPY SOLES (NEVADA SOLE PROPRIETORSHIP)  
225 KENNEDY DR.  
RENO, NV 89506

**Registered Aug. 28, 2012**

**Int. Cl.: 25**

FOR: HEEL INSERTS; INSOLES; INSOLES; INSOLES FOR FOOTWEAR; POLYMER CUSTOM CUSHIONED SHOE INSERTS FOR PRIMARILY NON-ORTHOPEDIC PURPOSES; SHOE INSERTS FOR PRIMARILY NON-ORTHOPEDIC PURPOSES , IN CLASS 25 (U.S. CLS. 22 AND 39).

**TRADEMARK**

**PRINCIPAL REGISTER**

FIRST USE 12-14-2009; IN COMMERCE 12-14-2009.

NO CLAIM IS MADE TO THE EXCLUSIVE RIGHT TO USE SMILEY FACE DESIGN OR "SOLES", APART FROM THE MARK AS SHOWN.

THE COLOR(S) RED, YELLOW AND BLACK IS/ARE CLAIMED AS A FEATURE OF THE MARK.

THE MARK CONSISTS OF THE STYLIZED WORDING "HAPPY SOLES" IN THE COLOR RED SEPARATED BY THE DESIGN OF TWO BLACK FOOTPRINTS ON EITHER SIDE OF A YELLOW SMILEY FACE DESIGN WITH BLACK EYES AND A BLACK MOUTH.

SN 77-952,626, FILED 3-7-2010.

JEFFERY COWARD, EXAMINING ATTORNEY



*David J. Kyros*

Director of the United States Patent and Trademark Office

United States of America  
United States Patent and Trademark Office

RHINO

**Reg. No. 4,198,918**

**Registered Aug. 28, 2012**

**Int. Cl.: 9**

**TRADEMARK**

**PRINCIPAL REGISTER**

PSC, LLC (DELAWARE LIMITED LIABILITY COMPANY)  
5151 SAN FELIPE, SUITE 1600  
HOUSTON, TX 77056

FOR: ELECTRONIC FIELD MANAGEMENT SYSTEM, NAMELY, COMPUTER HARDWARE AND SOFTWARE BUSINESS APPLICATIONS USED AS A SYSTEM TO PROVIDE VALUE ADDED BUSINESS SOLUTIONS, PROJECT MANAGEMENT AND CONTRACT ADMINISTRATION SERVICES UTILIZING HAND HELD COMPUTERS AND COMPUTER TABLETS IN THE FIELDS OF HYDRO-BLASTING, AIR/LIQUID VACUUM AND TANK CLEANING, IN CLASS 9 (U.S. CLS. 21, 23, 26, 36 AND 38).

FIRST USE 8-1-2011; IN COMMERCE 8-1-2011.

THE MARK CONSISTS OF STANDARD CHARACTERS WITHOUT CLAIM TO ANY PARTICULAR FONT, STYLE, SIZE, OR COLOR.

SN 77-954,382, FILED 3-9-2010.

STEPHANIE ALI, EXAMINING ATTORNEY



*David J. Kyfos*

Director of the United States Patent and Trademark Office

# United States of America

United States Patent and Trademark Office



**Reg. No. 4,198,919**

**Registered Aug. 28, 2012**

**Int. Cl.: 33**

**TRADEMARK**

**PRINCIPAL REGISTER**

CHASE DISTILLERY LIMITED (UNITED KINGDOM CORPORATION)  
ROSEMAUND COTTAGE  
PRESTON WYNNE  
HEREFORD, UNITED KINGDOM HR13PG

FOR: VODKA; GIN; AND FRUIT LIQUORS, IN CLASS 33 (U.S. CLS. 47 AND 49).

FIRST USE 9-20-2010; IN COMMERCE 9-20-2010.

THE NAME(S), PORTRAIT(S), AND/OR SIGNATURE(S) SHOWN IN THE MARK DOES NOT IDENTIFY A PARTICULAR LIVING INDIVIDUAL.

THE MARK CONSISTS OF THE WORDS "WILLIAMS WC CHASE" SURROUNDED BY A STYLIZED OVAL DESIGN WITH A VINE AND LEAF DESIGN SURROUNDING THE OVAL.

SN 77-954,452, FILED 3-9-2010.

WANDA KAY PRICE, EXAMINING ATTORNEY



*David J. Kyros*

Director of the United States Patent and Trademark Office



# United States of America

United States Patent and Trademark Office

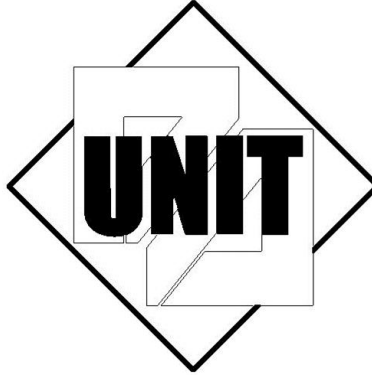

**Reg. No. 4,198,920**

**Registered Aug. 28, 2012**

**Int. Cl.: 9**

**TRADEMARK**

**PRINCIPAL REGISTER**

PUNITA LEATHERS INC. (VIRGINIA CORPORATION)  
SUITE #A-108  
3935 AVION PARK CT.  
CHANTILLY, VA 20151

FOR: BATTERIES; BATTERIES FOR LIGHTING; BATTERIES FOR POCKET LAMPS;  
BATTERIES, ELECTRIC, IN CLASS 9 (U.S. CLS. 21, 23, 26, 36 AND 38).

FIRST USE 5-10-2012; IN COMMERCE 5-10-2012.

THE MARK CONSISTS OF A SQUARE DESIGN AND THE STYLIZED TEXT "P UNIT A".

SN 77-956,522, FILED 3-11-2010.

ARETHA SOMERVILLE, EXAMINING ATTORNEY



*David J. Kyffers*

Director of the United States Patent and Trademark Office

# United States of America

United States Patent and Trademark Office

## LIVE ELECTRONIC BOOKS

**Reg. No. 4,198,921**

**Registered Aug. 28, 2012**

**Int. Cl.: 9**

**TRADEMARK**

**PRINCIPAL REGISTER**

OBSHESTVO S OGRANICHENNOY OTVETSTVENNOSTJU "FB MEDIA SOLUTIONS"  
(RUSSIAN FED. LIMITED LIABILITY COMPANY), DBA OOO "FB MRDIA SOLUTIONS",  
12 MEDIKOV  
MOSCOW, RUSSIAN FED. 115304

FOR: COMPUTER GAME PROGRAMS; COMPUTER GAME SOFTWARE; COMPUTER GAME SOFTWARE FOR PERSONAL COMPUTERS AND HOME VIDEO GAME CONSOLES; COMPUTER GAME SOFTWARE FOR USE WITH PERSONAL COMPUTERS, HOME VIDEO GAME CONSOLES USED WITH TELEVISIONS, AND FOR ARCADE-BASED VIDEO GAME CONSOLES; COMPUTER PROGRAMS FOR PRE-RECORDED GAMES; COMPUTER PROGRAMS FOR CONVERTING DOCUMENTS CREATED BY ONE COMPUTER PROGRAM TO ANOTHER FORMAT; COMPUTER-GAMING SOFTWARE; DOWNLOADABLE AUDIO FILES, MULTIMEDIA FILES, TEXT FILES, E-MAILS, WRITTEN DOCUMENTS, AUDIO MATERIAL, VIDEO MATERIAL AND GAMES FEATURING INFORMATION IN THE FORM OF DOWNLOADABLE SHORT EDUCATIONAL/TRAINING COMMUNICATIONS IN THE FIELD OF HUMAN RESOURCE DEVELOPMENT FOR THE PROMOTION OF EMPLOYEE RETENTION, CAREER GROWTH AND INCREASED PRODUCTIVITY FOR EMPLOYEES AND EMPLOYERS; DOWNLOADABLE COMPUTER GAME PROGRAMS; DOWNLOADABLE COMPUTER PROGRAMS FEATURING POSITIONABLE GAME PIECE FIGURES FOR USE IN THE FIELD OF COMPUTER GAMES; DOWNLOADABLE MULTIMEDIA FILE CONTAINING ARTWORK, TEXT, AUDIO, VIDEO, GAMES, AND INTERNET WEB LINKS RELATING TO EDUCATIONAL BOOKS AND TRAINING IN FIELDS OF ADVERTISEMENT AND EDUCATION; INTERACTIVE MULTIMEDIA COMPUTER GAME PROGRAM; INTERACTIVE MULTIMEDIA COMPUTER PROGRAM FOR GAMES AND ELECTRONIC DESIGN AUTOMATION; INTERACTIVE VIDEO GAMES OF VIRTUAL REALITY COMPRISED OF COMPUTER HARDWARE FOR USE WITH AN EXTERNAL MONITOR AND SOFTWARE, IN CLASS 9 (U.S. CLS. 21, 23, 26, 36 AND 38).

FIRST USE 5-25-2009; IN COMMERCE 5-25-2009.

THE MARK CONSISTS OF STANDARD CHARACTERS WITHOUT CLAIM TO ANY PARTICULAR FONT, STYLE, SIZE, OR COLOR.

NO CLAIM IS MADE TO THE EXCLUSIVE RIGHT TO USE "ELECTRONIC BOOKS", APART FROM THE MARK AS SHOWN.

SN 77-958,458, FILED 3-14-2010.



*David J. Kyros*

Director of the United States Patent and Trademark Office

**Reg. No. 4,198,921** JEAN IM, EXAMINING ATTORNEY

# United States of America

United States Patent and Trademark Office

## JERSEY SHORE MTV

**Reg. No. 4,198,922**

VIACOM INTERNATIONAL INC. (DELAWARE CORPORATION)  
1515 BROADWAY

**Registered Aug. 28, 2012**

NEW YORK, NY 10036

**Int. Cl.: 25**

FOR: MENS, WOMENS, AND CHILDRENS CLOTHING, NAMELY, SHIRTS, PANTS, UNDERWEAR, PAJAMAS; JACKETS, SUITS, SKIRTS, STOCKINGS, TIGHTS, TROUSERS, SWEATERS, DRESSES, BLOUSES; FOOTWEAR, HEADWEAR, OUTERWEAR, NAMELY, JACKETS, COATS, HATS, GLOVES, SCARVES, VESTS; SWIMWEAR; SHIRTS, T-SHIRTS, SWEATSHIRTS; JEANS, TROUSERS; HATS, CAPS; BOOTS; SHOES, SANDALS, SLIPPERS; BELTS, SOCKS; TIES; NECKTIES, IN CLASS 25 (U.S. CLS. 22 AND 39).

**TRADEMARK**

**PRINCIPAL REGISTER**

FIRST USE 12-31-2009; IN COMMERCE 12-31-2009.

THE MARK CONSISTS OF STANDARD CHARACTERS WITHOUT CLAIM TO ANY PARTICULAR FONT, STYLE, SIZE, OR COLOR.

OWNER OF U.S. REG. NOS. 1,372,705 AND 1,373,948.

NO CLAIM IS MADE TO THE EXCLUSIVE RIGHT TO USE "JERSEY SHORE", APART FROM THE MARK AS SHOWN.

SN 77-960,135, FILED 3-16-2010.

MICHAEL WEBSTER, EXAMINING ATTORNEY



*David J. Kyffers*

Director of the United States Patent and Trademark Office

# United States of America

United States Patent and Trademark Office

# AQUA SOLES

**Reg. No. 4,198,923**

PORTER, VERNON (UNITED STATES INDIVIDUAL)  
1023 BRINKLEY ROAD  
MURFREESBORO, TN 37128

**Registered Aug. 28, 2012**

**Int. Cl.: 10**

FOR: LIQUID ORTHOTIC MASSAGING INSOLES, IN CLASS 10 (U.S. CLS. 26, 39 AND 44).

**TRADEMARK**

FIRST USE 3-23-2010; IN COMMERCE 4-30-2010.

**PRINCIPAL REGISTER**

THE MARK CONSISTS OF STANDARD CHARACTERS WITHOUT CLAIM TO ANY PARTICULAR FONT, STYLE, SIZE, OR COLOR.

NO CLAIM IS MADE TO THE EXCLUSIVE RIGHT TO USE "SOLES", APART FROM THE MARK AS SHOWN.

SN 77-965,985, FILED 3-23-2010.

LINDA MICKLEBURGH, EXAMINING ATTORNEY



*David J. Kyffers*

Director of the United States Patent and Trademark Office

# United States of America

United States Patent and Trademark Office

# LA ALTEÑA

**Reg. No. 4,198,924**

**Registered Aug. 28, 2012**

**Int. Cl.: 31**

**TRADEMARK**

**PRINCIPAL REGISTER**

JUAN CARLOS BARAJAS PLASCENCIA (MEXICO INDIVIDUAL)  
AV.ARBOLEDAS 1101 COL. MDO DE ABASTOS  
GUADALAJARA, JALISCO, MEXICO 44540

FOR: NATURAL AGRICULTURAL PRODUCTS, NAMELY, AGRICULTURAL, HORTICULTURAL AND FORESTRY PRODUCTS, NAMELY, UNPROCESSED GRAINS, LIVE ANIMALS, FRESH FRUITS AND VEGETABLES, AGRICULTURAL SEEDS, NATURAL PLANTS AND FLOWERS, FOODSTUFFS FOR ANIMALS, MALT FOR BREWING AND DISTILLING, IN CLASS 31 (U.S. CLS. 1 AND 46).

FIRST USE 6-16-2011; IN COMMERCE 6-16-2011.

THE MARK CONSISTS OF STANDARD CHARACTERS WITHOUT CLAIM TO ANY PARTICULAR FONT, STYLE, SIZE, OR COLOR.

THE WORDING "LA ALTEÑA " HAS NO MEANING IN A FOREIGN LANGUAGE.

SN 77-967,371, FILED 3-24-2010.

TARA PATE, EXAMINING ATTORNEY



*David J. Kyffers*

Director of the United States Patent and Trademark Office

# United States of America

United States Patent and Trademark Office

## Mommaz Boy Couture

**Reg. No. 4,198,925**

CUSHMAN, VANESSA (UNITED STATES INDIVIDUAL)  
2 HILLSIDE CRESCENT

**Registered Aug. 28, 2012**

NEW ROCHELLE, NY 10804

**Int. Cl.: 18**

FOR: PET CLOTHING; COLLARS FOR PETS; PET COLLAR ACCESSORIES, NAMELY, BOWS AND CHARMS; PET ACCESSORIES, NAMELY, CANVAS, VINYL AND LEATHER BAGS IN THE NATURE OF PET CARRIERS, IN CLASS 18 (U.S. CLS. 1, 2, 3, 22 AND 41).

**TRADEMARK**

FIRST USE 7-17-2006; IN COMMERCE 9-21-2006.

**PRINCIPAL REGISTER**

THE MARK CONSISTS OF STANDARD CHARACTERS WITHOUT CLAIM TO ANY PARTICULAR FONT, STYLE, SIZE, OR COLOR.

NO CLAIM IS MADE TO THE EXCLUSIVE RIGHT TO USE "COUTURE", APART FROM THE MARK AS SHOWN.

SN 77-968,238, FILED 3-25-2010.

CHRISIE B. KING, EXAMINING ATTORNEY



*David J. Kybas*

Director of the United States Patent and Trademark Office

# United States of America

United States Patent and Trademark Office

## BLACK HILLS VINYA

**Reg. No. 4,198,926**

RIDDLE'S GROUP, INC. (SOUTH DAKOTA CORPORATION)  
2707 MT RUSHMORE ROAD  
RAPID CITY, SD 57701

**Registered Aug. 28, 2012**

**Int. Cl.: 14**

FOR: JEWELRY, IN CLASS 14 (U.S. CLS. 2, 27, 28 AND 50).

**TRADEMARK**

FIRST USE 6-30-2010; IN COMMERCE 6-30-2010.

**PRINCIPAL REGISTER**

THE MARK CONSISTS OF STANDARD CHARACTERS WITHOUT CLAIM TO ANY PARTICULAR FONT, STYLE, SIZE, OR COLOR.

NO CLAIM IS MADE TO THE EXCLUSIVE RIGHT TO USE "BLACK HILLS", APART FROM THE MARK AS SHOWN.

THE ENGLISH TRANSLATION OF "VINYA" IN THE MARK IS "VINE".

SN 77-969,020, FILED 3-25-2010.

PAM WILLIS, EXAMINING ATTORNEY



*David J. Kyffers*

Director of the United States Patent and Trademark Office



# United States of America

United States Patent and Trademark Office

# SIGMA4NET

**Reg. No. 4,198,927**

TREETECH SISTEMAS DIGITAIS LTDA. (BRAZIL LIMITED COMPANY (LTD.))  
PRACA CLAUDINO ALVES, 141 - CENTRO  
ATIBAIA/SP, BRAZIL

**Registered Aug. 28, 2012**

**Int. Cl.: 9**

FOR: COMPUTER PROGRAMS RECORDED ON DATA MEDIA (SOFTWARE) DESIGNED FOR USE IN MAINTENANCE, MONITORING, OPERATING, PLANNING, AND CONSTRUCTION OF POWER SUBSTATIONS; DOWNLOADABLE COMPUTER PROGRAMS FOR MAINTENANCE, MONITORING, OPERATING, PLANNING AND CONSTRUCTION OF POWER SUBSTATIONS, IN CLASS 9 (U.S. CLS. 21, 23, 26, 36 AND 38).

**TRADEMARK**

**PRINCIPAL REGISTER**

FIRST USE 1-0-2007; IN COMMERCE 6-0-2010.

THE MARK CONSISTS OF STANDARD CHARACTERS WITHOUT CLAIM TO ANY PARTICULAR FONT, STYLE, SIZE, OR COLOR.

SN 77-969,482, FILED 3-26-2010.

WENDY JUN, EXAMINING ATTORNEY



*David J. Kyffers*

Director of the United States Patent and Trademark Office

# United States of America

United States Patent and Trademark Office

# SIGMA4WEB

**Reg. No. 4,198,928**

TREETECH SISTEMAS DIGITAIS LTDA. (BRAZIL LIMITED COMPANY (LTD.))  
PRACA CLAUDINO ALVES, 141 - CENTRO  
ATIBAIA/SP, BRAZIL

**Registered Aug. 28, 2012**

**Int. Cl.: 9**

FOR: COMPUTER PROGRAMS RECORDED ON DATA MEDIA (SOFTWARE) DESIGNED FOR USE IN MAINTENANCE, MONITORING, OPERATING, PLANNING, AND CONSTRUCTION OF POWER SUBSTATIONS; DOWNLOADABLE COMPUTER PROGRAMS FOR MAINTENANCE, MONITORING, OPERATING, PLANNING AND CONSTRUCTION OF POWER SUBSTATIONS, IN CLASS 9 (U.S. CLS. 21, 23, 26, 36 AND 38).

**TRADEMARK**

**PRINCIPAL REGISTER**

FIRST USE 1-0-2007; IN COMMERCE 6-0-2010.

THE MARK CONSISTS OF STANDARD CHARACTERS WITHOUT CLAIM TO ANY PARTICULAR FONT, STYLE, SIZE, OR COLOR.

SN 77-969,490, FILED 3-26-2010.

WENDY JUN, EXAMINING ATTORNEY



*David J. Kybas*

Director of the United States Patent and Trademark Office

United States of America  
United States Patent and Trademark Office

# BIOSHOCK

**Reg. No. 4,198,929**

TAKE-TWO INTERACTIVE SOFTWARE, INC. (DELAWARE CORPORATION)  
622 BROADWAY

**Registered Aug. 28, 2012**

NEW YORK, NY 10012

**Int. Cls.: 9, 16, and 41**

FOR: PROVIDING DOWNLOADABLE MOTION PICTURES FEATURING ACTION AND ADVENTURE, IN CLASS 9 (U.S. CLS. 21, 23, 26, 36 AND 38).

**TRADEMARK**

FIRST USE 9-25-2006; IN COMMERCE 9-25-2006.

**SERVICE MARK**

FOR: PRINTED MATTER, NAMELY, PERIODICALS, MAGAZINES IN THE FIELD OF VIDEO GAMES AND COMPUTER SOFTWARE; CALENDARS, COMIC BOOKS; POSTERS; PICTURES; AND PHOTOGRAPHS, IN CLASS 16 (U.S. CLS. 2, 5, 22, 23, 29, 37, 38 AND 50).

**PRINCIPAL REGISTER**

FIRST USE 8-21-2007; IN COMMERCE 8-21-2007.

FOR: PROVIDING ONLINE VIDEO GAMES AND COMPUTER GAME SOFTWARE VIA THE INTERNET, IN CLASS 41 (U.S. CLS. 100, 101 AND 107).

FIRST USE 8-21-2007; IN COMMERCE 8-21-2007.

THE MARK CONSISTS OF STANDARD CHARACTERS WITHOUT CLAIM TO ANY PARTICULAR FONT, STYLE, SIZE, OR COLOR.

SN 77-975,655, FILED 8-14-2007.

HOWARD SMIGA, EXAMINING ATTORNEY



*David J. Kyros*

Director of the United States Patent and Trademark Office

# United States of America

United States Patent and Trademark Office

# Intermotor

**Reg. No. 4,198,930**

STANDARD MOTOR PRODUCTS, INC. (NEW YORK CORPORATION)  
37-18 NORTHERN BOULEVARD  
LONG ISLAND CITY, NY 11101

**Registered Aug. 28, 2012**

**Int. Cls.: 6, 7, 9, and 11**

FOR: MOTOR VEHICLE LOCKS OF METAL, NAMELY, MOTOR VEHICLE IGNITION LOCKS SOLD SEPARATELY FROM THE IGNITION SYSTEM, IN CLASS 6 (U.S. CLS. 2, 12, 13, 14, 23, 25 AND 50).

**TRADEMARK**

FIRST USE 6-30-2009; IN COMMERCE 6-30-2009.

**PRINCIPAL REGISTER**

FOR: LAND VEHICLE PARTS, NAMELY, FUEL INJECTORS; IGNITION PARTS, NAMELY, IGNITION SWITCHES, DISTRIBUTOR CAPS, DISTRIBUTOR POINTS, DISTRIBUTOR CONDENSERS, DISTRIBUTOR ROTORS, DISTRIBUTOR MODULES, DISTRIBUTOR PICK UPS COILS, DISTRIBUTOR TIMERS, DISTRIBUTOR REDUCTORS, IGNITION COILS, IGNITION POINTS, IGNITION CONDENSERS, STARTER DRIVES, STARTER CLUTCHES, STARTER BUSHINGS, IGNITION WIRES, IGNITION WIRE TERMINALS, IGNITION WIRE BOOTS, IGNITION WIRE NIPPLES; INTERNAL COMBUSTION ENGINES LAND VEHICLE PARTS, NAMELY, DISTRIBUTOR CAPS AND ROTORS; AUTOMOTIVE SPARK PLUG PROTECTORS; MOTOR VEHICLE LOCKS, NAMELY, MOTOR VEHICLE IGNITION LOCK INCORPORATED INTO THE IGNITION SYSTEM, IN CLASS 7 (U.S. CLS. 13, 19, 21, 23, 31, 34 AND 35).

FIRST USE 6-30-2009; IN COMMERCE 6-30-2009.



*David J. Kyros*

FOR: COMPUTER PERIPHERALS, NAMELY, COMPUTER CONTROL DEVICES IN THE NATURE OF ENGINE SENSOR CONTROL DEVICES THAT PROVIDE INFORMATION TO ON-BOARD COMPUTERS, NAMELY, RELAYS, SENSORS AND ACTUATORS; ELECTRICAL WIRE, BATTERY CABLES, AUTOMOTIVE SWITCHES, FOR EMISSION AND COMPUTERIZED ENGINE CONTROLS, NAMELY, ELECTRICAL SWITCHES USED FOR IGNITION, COMBINATION, HEADLIGHT, DIMMER, CRUISE CONTROL, DOOR JAMB, CLUTCH, NEUTRAL SAFETY, HEADLAMP, IGNITION LOCK, OIL PRESSURE, RADIATOR FAN, AND STOPLIGHT; TURN SIGNAL SWITCHES FOR VEHICLE ELECTRICAL SYSTEMS, ELECTRONIC ENGINE MANAGEMENT SYSTEMS COMPRISED OF CONTROL MODULES, SENSORS, ON-BOARD COMPUTERS, ACTUATORS, SOLENOIDS, VOLTAGE REGULATORS, AUTOMOTIVE RELAYS, AUTOMOTIVE RESISTANCE UNITS, NAMELY, COIL RESISTORS AND BLOWER MOTOR RESISTORS WHICH LIMIT THE VOLTAGE TO THE

**Reg. No. 4,198,930** COIL TO PREVENT EARLY BURN OUT FAILURE, AND ELECTRICAL VACUUM CONTROLS, IN CLASS 9 (U.S. CLS. 21, 23, 26, 36 AND 38).

FIRST USE 6-30-2009; IN COMMERCE 6-30-2009.

FOR: REPAIR AND REPLACEMENT PARTS FOR AIR CONDITIONERS AND HEATERS FOR VEHICLES, NAMELY, AIR CONDITIONING SWITCHES , IN CLASS 11 (U.S. CLS. 13, 21, 23, 31 AND 34).

FIRST USE 6-30-2009; IN COMMERCE 6-30-2009.

THE MARK CONSISTS OF STANDARD CHARACTERS WITHOUT CLAIM TO ANY PARTICULAR FONT, STYLE, SIZE, OR COLOR.

SN 77-982,813, FILED 12-12-2008.

SUE LAWRENCE, EXAMINING ATTORNEY

# United States of America

United States Patent and Trademark Office

# CYPHER

**Reg. No. 4,198,931**

**Registered Aug. 28, 2012**

**Int. Cls.: 16 and 28**

**TRADEMARK**

**PRINCIPAL REGISTER**

COLD FUSION ENTERTAINMENT, LLC (NEW YORK LIMITED LIABILITY COMPANY)  
10 WEST 33RD STREET  
SUITE 220  
NEW YORK, NY 10001

FOR: TRADING CARDS; PAPER, IN CLASS 16 (U.S. CLS. 2, 5, 22, 23, 29, 37, 38 AND 50).

FIRST USE 12-30-2010; IN COMMERCE 12-30-2010.

FOR: PLAYING CARDS; ELECTRONIC LEARNING TOYS, IN CLASS 28 (U.S. CLS. 22, 23, 38 AND 50).

FIRST USE 12-30-2011; IN COMMERCE 12-30-2011.

THE MARK CONSISTS OF STANDARD CHARACTERS WITHOUT CLAIM TO ANY PARTICULAR FONT, STYLE, SIZE, OR COLOR.

SN 77-982,834, FILED 1-28-2008.

JAY BESCH, EXAMINING ATTORNEY



*David J. Kyros*

Director of the United States Patent and Trademark Office

# United States of America

United States Patent and Trademark Office

## GARDENING MAMA

**Reg. No. 4,198,932**

COOKING MAMA LIMITED (CHINA CORPORATION)  
113 ARGYLE STREET, ROOM 501, 5F, MONGKOK  
KOWLOON, HONG KONG, CHINA

**Registered Aug. 28, 2012**

**Int. Cl.: 41**

FOR: PROVIDING ON-LINE COMPUTER GAMES, IN CLASS 41 (U.S. CLS. 100, 101 AND 107).

**SERVICE MARK**

FIRST USE 12-31-2011; IN COMMERCE 12-31-2011.

**PRINCIPAL REGISTER**

THE MARK CONSISTS OF STANDARD CHARACTERS WITHOUT CLAIM TO ANY PARTICULAR FONT, STYLE, SIZE, OR COLOR.

NO CLAIM IS MADE TO THE EXCLUSIVE RIGHT TO USE "GARDENING", APART FROM THE MARK AS SHOWN.

SN 77-982,913, FILED 4-30-2008.

CHARLOTTE CORWIN, EXAMINING ATTORNEY



*David J. Kybas*

Director of the United States Patent and Trademark Office

# United States of America

United States Patent and Trademark Office

## BLUE STATE

**Reg. No. 4,198,933**

**Registered Aug. 28, 2012**

**Int. Cls.: 21, 25, 32, 33,  
and 43**

**TRADEMARK**

**SERVICE MARK**

**PRINCIPAL REGISTER**

RUBEN, MARSHALL (UNITED STATES INDIVIDUAL)  
249 PEARL ST.  
3RD FLOOR  
HARTFORD, CT 06103

FOR: COFFEE CUPS, TEA CUPS AND MUGS; CUPS AND MUGS; MUGS; PORCELAIN MUGS; CUPS; INSULATED CONTAINERS FOR FOOD OR BEVERAGE FOR DOMESTIC USE; INSULATING SLEEVE HOLDER FOR BEVERAGE CUPS, IN CLASS 21 (U.S. CLS. 2, 13, 23, 29, 30, 33, 40 AND 50).

FIRST USE 5-1-2008; IN COMMERCE 5-1-2008.

FOR: SHIRTS; SHORT-SLEEVED OR LONG-SLEEVED T-SHIRTS; T-SHIRTS; BELTS; BOW TIES; GOLF SHIRTS; HATS; POLO SHIRTS; SOCKS; TIES, IN CLASS 25 (U.S. CLS. 22 AND 39).

FIRST USE 5-1-2008; IN COMMERCE 5-1-2008.

FOR: BEER; BOTTLED WATER; CARBONATED WATERS; COLAS; CONCENTRATES, SYRUPS OR POWDERS USED IN THE PREPARATION OF SOFT DRINKS; DRINKING WATER; FLAVORED BOTTLED WATER; FLAVORED WATERS; MINERAL AND AERATED WATERS; MINERAL AND CARBONATED WATERS; PURIFIED BOTTLED DRINKING WATER; SYRUPS FOR BEVERAGES, IN CLASS 32 (U.S. CLS. 45, 46 AND 48).

FIRST USE 7-25-2011; IN COMMERCE 7-25-2011.

FOR: ALCOHOLIC BEVERAGES, NAMELY, VODKA; COFFEE-BASED LIQUEURS; DISTILLED SPIRITS; LIQUEURS, IN CLASS 33 (U.S. CLS. 47 AND 49).

FIRST USE 11-21-2011; IN COMMERCE 11-21-2011.

FOR: RESTAURANT AND CAFE SERVICES; RESTAURANT SERVICES, NAMELY, PROVIDING OF FOOD AND BEVERAGES FOR CONSUMPTION ON AND OFF THE PREMISES, IN CLASS 43 (U.S. CLS. 100 AND 101).

FIRST USE 8-1-2007; IN COMMERCE 8-1-2007.



*David J. Kyjars*

Director of the United States Patent and Trademark Office



**Reg. No. 4,198,933** THE MARK CONSISTS OF STANDARD CHARACTERS WITHOUT CLAIM TO ANY PARTICULAR FONT, STYLE, SIZE, OR COLOR.

OWNER OF U.S. REG. NOS. 3,230,366 AND 3,477,087.

SN 77-983,055, FILED 11-5-2009.

MARY I. SPARROW, EXAMINING ATTORNEY

# United States of America

United States Patent and Trademark Office

# SNOOPY'S

**Reg. No. 4,198,934**

**Registered Aug. 28, 2012**

**Int. Cl.: 9**

**TRADEMARK**

**PRINCIPAL REGISTER**

PEANUTS WORLDWIDE, LLC (DELAWARE LIMITED LIABILITY COMPANY)  
3RD FLOOR  
1450 BROADWAY  
NEW YORK, NY 10018

FOR: DOWNLOADABLE ELECTRONIC GAMES VIA THE INTERNET AND WIRELESS DEVICES, IN CLASS 9 (U.S. CLS. 21, 23, 26, 36 AND 38).

FIRST USE 11-30-2011; IN COMMERCE 11-30-2011.

THE MARK CONSISTS OF STANDARD CHARACTERS WITHOUT CLAIM TO ANY PARTICULAR FONT, STYLE, SIZE, OR COLOR.

OWNER OF U.S. REG. NOS. 1,254,632, 1,300,520, AND 2,970,744.

SN 77-983,073, FILED 2-16-2010.

JAMES GRIFFIN, EXAMINING ATTORNEY



*David J. Kyffers*

Director of the United States Patent and Trademark Office

# United States of America

United States Patent and Trademark Office

# REMOTEMD

**Reg. No. 4,198,935**

REMOTE MD, L.L.C. (LOUISIANA LIMITED LIABILITY COMPANY)  
1525 DICKORY AVENUE  
HARAHAN, LA 70123

**Registered Aug. 28, 2012**

**Int. Cl.: 44**

FOR: HEALTH CARE SERVICES, NAMELY, PROVIDING HEALTHCARE SERVICES BY HEALTHCARE PROFESSIONALS OVER TELECOMMUNICATIONS NETWORKS, IN CLASS 44 (U.S. CLS. 100 AND 101).

**SERVICE MARK**

FIRST USE 11-1-2011; IN COMMERCE 11-1-2011.

**PRINCIPAL REGISTER**

THE MARK CONSISTS OF STANDARD CHARACTERS WITHOUT CLAIM TO ANY PARTICULAR FONT, STYLE, SIZE, OR COLOR.

SN 77-983,154, FILED 2-19-2010.

STEPHANIE ALI, EXAMINING ATTORNEY



*David J. Kyfos*

Director of the United States Patent and Trademark Office

# United States of America

United States Patent and Trademark Office

# COLORINES

**Reg. No. 4,198,936**

**Registered Aug. 28, 2012**

**Int. Cl.: 30**

**TRADEMARK**

**PRINCIPAL REGISTER**

FERNANDO NUÑEZ ROMERO (MEXICO INDIVIDUAL)  
COLONIA EL MIRADOR  
PRIVADA 29 ORIENTE # 1812  
PUEBLA, PUEBLA, MEXICO C.P72540 AND

MARIO NUÑEZ ROMERO (MEXICO INDIVIDUAL)  
COLONIA EL MIRADOR  
PRIVADA 29 ORIENTE # 1812  
PUEBLA, PUEBLA, MEXICO C.P72540

FOR: POWDER FOR THE PREPARATION OF FLAVORED AND SWEETENED GELATINS AND CUSTARD; SALSAS; SPICES; COOKIES PREPARED FROM WHEAT FLOUR, IN CLASS 30 (U.S. CL. 46).

FIRST USE 4-5-2012; IN COMMERCE 4-5-2012.

THE MARK CONSISTS OF STANDARD CHARACTERS WITHOUT CLAIM TO ANY PARTICULAR FONT, STYLE, SIZE, OR COLOR.

THE ENGLISH TRANSLATION OF "COLORINES" IN THE MARK IS "BRIGHT COLORS".

SN 77-983,180, FILED 8-20-2009.

ESTHER A. BORSUK, EXAMINING ATTORNEY



*David J. Kybas*

Director of the United States Patent and Trademark Office

# United States of America

United States Patent and Trademark Office

# IBEATS

**Reg. No. 4,198,937**

**Registered Aug. 28, 2012**

**Int. Cl.: 9**

**TRADEMARK**

**PRINCIPAL REGISTER**

BEATS ELECTRONICS, LLC (DELAWARE LIMITED LIABILITY COMPANY)  
1601 CLOVERFIELD BLVD  
SANTA MONICA, CA 90404

FOR: HEADSETS FOR MOBILE TELEPHONES; HEADPHONES; PERSONAL HEADPHONES  
FOR USE WITH SOUND TRANSMITTING SYSTEMS, IN CLASS 9 (U.S. CLS. 21, 23, 26, 36  
AND 38).

FIRST USE 10-14-2010; IN COMMERCE 10-14-2010.

THE MARK CONSISTS OF STANDARD CHARACTERS WITHOUT CLAIM TO ANY PAR-  
TICULAR FONT, STYLE, SIZE, OR COLOR.

OWNER OF U.S. REG. NO. 3,532,627.

SN 77-983,208, FILED 12-17-2009.

RONALD AIKENS, EXAMINING ATTORNEY



*David J. Kyffers*

Director of the United States Patent and Trademark Office

**United States of America**  
United States Patent and Trademark Office

**MASTER**

**Reg. No. 4,198,938**

**Registered Aug. 28, 2012**

**Int. Cl.: 9**

**TRADEMARK**

**PRINCIPAL REGISTER**

MASTER LOCK COMPANY LLC (DELAWARE LIMITED LIABILITY COMPANY)  
P.O. BOX 927  
137 W. FOREST HILL AVENUE  
OAK CREEK, WI 53154

FOR: ELECTRONIC COMBINATION LOCKS, ELECTRONIC PADLOCKS, IN CLASS 9 (U.S. CLS. 21, 23, 26, 36 AND 38).

FIRST USE 5-24-2012; IN COMMERCE 5-24-2012.

THE MARK CONSISTS OF STANDARD CHARACTERS WITHOUT CLAIM TO ANY PARTICULAR FONT, STYLE, SIZE, OR COLOR.

OWNER OF U.S. REG. NOS. 218,153, 745,127, AND OTHERS.

SN 77-983,256, FILED 6-28-2007.

CHERYL CLAYTON, EXAMINING ATTORNEY



*David J. Kyffers*

Director of the United States Patent and Trademark Office

# United States of America

United States Patent and Trademark Office

## MASTER LOCK

**Reg. No. 4,198,939**

**Registered Aug. 28, 2012**

**Int. Cl.: 9**

**TRADEMARK**

**PRINCIPAL REGISTER**

MASTER LOCK COMPANY LLC (DELAWARE LIMITED LIABILITY COMPANY)  
P.O. BOX 927  
137 W. FOREST HILL AVENUE  
OAK CREEK, WI 53154

FOR: ELECTRONIC COMBINATION LOCKS, ELECTRONIC PADLOCKS, IN CLASS 9 (U.S. CLS. 21, 23, 26, 36 AND 38).

FIRST USE 5-24-2012; IN COMMERCE 5-24-2012.

THE MARK CONSISTS OF STANDARD CHARACTERS WITHOUT CLAIM TO ANY PARTICULAR FONT, STYLE, SIZE, OR COLOR.

OWNER OF U.S. REG. NOS. 218,153, 230,311, AND 745,127.

NO CLAIM IS MADE TO THE EXCLUSIVE RIGHT TO USE "LOCK", APART FROM THE MARK AS SHOWN.

SN 77-983,257, FILED 6-28-2007.

CHERYL CLAYTON, EXAMINING ATTORNEY



*David J. Kyffers*

Director of the United States Patent and Trademark Office

# United States of America

United States Patent and Trademark Office



**Reg. No. 4,198,940**

**Registered Aug. 28, 2012**

UL LLC (DELAWARE LIMITED LIABILITY COMPANY)  
333 PFINGSTEN ROAD  
NORTHBROOK, IL 60062

**CERTIFICATION MARK**

**GOODS**

**PRINCIPAL REGISTER**

FOR: ELECTRICAL EQUIPMENT, USUALLY NOT OF A VOLTAGE EXCEEDING 600 V; CHEMICALS NAMELY, ADHESIVES; BUILDING MATERIALS AND EQUIPMENT; AIR CONDITIONERS; REFRIGERATION EQUIPMENT; FABRICS; LIGHTING EQUIPMENT; HEATING EQUIPMENT; OFFICE APPLIANCES AND BUSINESS EQUIPMENT; ROOFING MATERIALS AND SYSTEMS; ELECTRICAL APPLIANCES AND UTILIZATION EQUIPMENT; CONSUMER AND HOUSEHOLD ELECTRONICS, IN CLASS A (U.S. CL. A).

FIRST USE 1-4-2010; IN COMMERCE 1-4-2010.

OWNER OF U.S. REG. NOS. 782,589 AND 2,391,140.

THE MARK CONSISTS OF THE OUTLINE OF A LEAF WITH THE LETTERS "UL" INSIDE.

THE CERTIFICATION MARK, AS INTENDED TO BE USED BY AUTHORIZED PERSONS, IS INTENDED TO CERTIFY THAT THE GOODS AND/OR SERVICES PROVIDED HERE HAVE COMPLIED WITH ESTABLISHED GUIDELINES AND STANDARDS FOR ENVIRONMENTAL SUSTAINABILITY AND/OR ENERGY EFFICIENCY.

SN 77-983,259, FILED 11-25-2009.

DAVID H. STINE, EXAMINING ATTORNEY



*David J. Kybas*

Director of the United States Patent and Trademark Office



# United States of America

United States Patent and Trademark Office

# WAVESENSE

**Reg. No. 4,198,941**

**Registered Aug. 28, 2012**

**Int. Cl.: 10**

**TRADEMARK**

**PRINCIPAL REGISTER**

AGAMATRIX, INC. (DELAWARE CORPORATION)  
7C RAYMOND AVENUE  
SALEM, NH 03079

FOR: METER FOR THE MEDICAL PURPOSE OF ELECTROCHEMICAL MONITORING OF ANALYTES IN BIOLOGICAL FLUIDS DIRECTLY INVOLVED IN THE DIAGNOSIS, MONITORING, TREATMENT, AND MANAGEMENT OF DIABETES; DISPOSABLE TEST STRIPS FOR USE IN CONJUNCTION WITH A METER FOR ELECTROCHEMICAL MONITORING OF ANALYTES IN BIOLOGICAL FLUIDS DIRECTLY INVOLVED IN THE DIAGNOSIS, MONITORING, TREATMENT, AND MANAGEMENT OF DIABETES; CUTTING DEVICES/LANCETS FOR ACQUISITION OF BLOOD SAMPLES FOR USE IN ELECTROCHEMICAL DETECTION OF ANALYTES IN BLOOD DIRECTLY INVOLVED IN THE DIAGNOSIS, MONITORING, TREATMENT, AND MANAGEMENT OF DIABETES; METER FOR THE MEDICAL PURPOSE OF ELECTROCHEMICAL MONITORING OF GLUCOSE IN BIOLOGICAL FLUIDS FOR THE DIAGNOSIS, MONITORING, TREATMENT, AND MANAGEMENT OF DIABETES; AND DISPOSABLE TESTS STRIPS FOR USE IN CONJUNCTION WITH A METER FOR ELECTROCHEMICAL MONITORING OF GLUCOSE IN BIOLOGICAL FLUIDS FOR THE DIAGNOSIS, MONITORING, TREATMENT, AND MANAGEMENT OF DIABETES; CUTTING DEVICES/LANCETS FOR ACQUISITION OF BLOOD SAMPLES FOR USE IN ELECTROCHEMICAL DETECTION OF GLUCOSE IN BLOOD FOR THE DIAGNOSIS, MONITORING, TREATMENT, AND MANAGEMENT OF DIABETES, IN CLASS 10 (U.S. CLS. 26, 39 AND 44).

FIRST USE 4-30-2008; IN COMMERCE 4-30-2008.

THE MARK CONSISTS OF STANDARD CHARACTERS WITHOUT CLAIM TO ANY PARTICULAR FONT, STYLE, SIZE, OR COLOR.

SN 78-374,149, FILED 2-25-2004.

CHARLES L. JENKINS, EXAMINING ATTORNEY



*David J. Kypos*

Director of the United States Patent and Trademark Office

# United States of America

United States Patent and Trademark Office

# Indian

**Reg. No. 4,198,942**

**Registered Aug. 28, 2012**

**Int. Cls.: 12, 14, 18, 25,  
and 28**

**TRADEMARK**

**PRINCIPAL REGISTER**

INDIAN MOTORCYCLE INTERNATIONAL, LLC (DELAWARE LIMITED LIABILITY COMPANY)  
2100 HIGHWAY 55  
MEDINA, FL 553409770

FOR: MOTORCYCLES AND STRUCTURAL PARTS THEREFORE; MOTORCYCLE SADDLEBAGS; LEATHER MOTORCYCLE BAGS, IN CLASS 12 (U.S. CLS. 19, 21, 23, 31, 35 AND 44).

FIRST USE 0-0-1999; IN COMMERCE 0-0-1999.

FOR: JEWELRY; ORNAMENTAL PINS; CLOCKS, IN CLASS 14 (U.S. CLS. 2, 27, 28 AND 50).

FIRST USE 0-0-1999; IN COMMERCE 0-0-1999.

FOR: WALLETS; LEATHER KEY CHAINS; LUGGAGE; TRAVEL BAGS, IN CLASS 18 (U.S. CLS. 1, 2, 3, 22 AND 41).

FIRST USE 0-0-1999; IN COMMERCE 0-0-1999.

FOR: CLOTHING, NAMELY, JACKETS, SWEATERS, SHIRTS, VESTS, PANTS, GLOVES, CHAPS, SWEATSHIRTS, T-SHIRTS, BELTS; HEADWEAR, NAMELY, CAPS, HATS, SKULL CAPS, BEANIES, KNIT HATS, HEAD BANDS, AND BANDANAS; FOOTWEAR, NAMELY, SHOES AND BOOTS; LEATHER CLOTHING, NAMELY, LEATHER JACKETS, LEATHER PANTS, LEATHER CHAPS, LEATHER GLOVES, LEATHER SHIRTS, AND LEATHER BELTS, IN CLASS 25 (U.S. CLS. 22 AND 39).

FIRST USE 0-0-1999; IN COMMERCE 0-0-1999.

FOR: SCALE MODEL VEHICLES; MODEL TOY MOTORCYCLES; MINIATURE MOTORCYCLE REPLICAS, IN CLASS 28 (U.S. CLS. 22, 23, 38 AND 50).

FIRST USE 0-0-1999; IN COMMERCE 0-0-1999.

OWNER OF U.S. REG. NOS. 652,777, 2,813,224, AND OTHERS.



*David J. Kybas*

Director of the United States Patent and Trademark Office

**Reg. No. 4,198,942** THE MARK CONSISTS OF THE WORD "INDIAN" IN A STYLIZED FORMAT.

SN 78-487,298, FILED 9-21-2004.

MARY I. SPARROW, EXAMINING ATTORNEY

# United States of America

United States Patent and Trademark Office

# RED SPIDER

**Reg. No. 4,198,943**

**Registered Aug. 28, 2012**

**Int. Cls.: 6, 7, 9, and 37**

**TRADEMARK**

**SERVICE MARK**

**PRINCIPAL REGISTER**

RED SPIDER TECHNOLOGY LIMITED (SCOTLAND LIMITED COMPANY)  
WESTHILL BUSINESS CENTRE  
PEREGRINE ROAD, WESTHILL  
WESTHILL, UNITED KINGDOM AB32 6UF

FOR: OIL WELL COMPLETION EQUIPMENT, NAMELY, MANUALLY OPERATED METAL VALVES IN THE NATURE OF CONTROLLED FLUID AND GAS FLOW CONTROL VALVES AND SUBSURFACE VALVES; METAL EXPANDABLE OIL WELL LINERS; MANUALLY OPERATED METAL VALVES, NAMELY, RESERVOIR ISOLATION VALVES FOR PROVIDING A FLUID LOSS BARRIER AND A CHEMICAL INJECTION POINT FOR USE IN A WELLBORE, IN CLASS 6 (U.S. CLS. 2, 12, 13, 14, 23, 25 AND 50).

FIRST USE 2-28-2008; IN COMMERCE 7-31-2011.

FOR: OIL WELL EQUIPMENT, NAMELY, DOWNHOLE PACKERS FOR USE IN CONTROLLING THE FLOW AND MOVEMENT OF FLUIDS; OIL FIELD APPARATUS, NAMELY, POWER-OPERATED EXPANDABLE TUBULAR SYSTEMS COMPRISED OF EXPANDABLE LINERS AND LINER HANGERS; OILFIELD TOOLS AND WELL CONTROL EQUIPMENT FOR WELLBORES, NAMELY, POWER-OPERATED PACKERS FOR ZONAL ISOLATION IN WELLBORES; POWER-OPERATED OIL WELL COMPLETION TOOLS, NAMELY, LINER DEPLOYMENT TOOLS FOR USE IN WELLBORES, DRILLSTRING RETRIEVAL TOOLS IN THE NATURE OF PULLING TOOLS FOR USE IN WELLBORES, SAND EXCLUDERS FOR USE IN CONJUNCTION WITH COILED TUBING IN WELLBORES, IN CLASS 7 (U.S. CLS. 13, 19, 21, 23, 31, 34 AND 35).

FIRST USE 2-28-2008; IN COMMERCE 7-31-2011.

FOR: OIL WELL COMPLETION EQUIPMENT, NAMELY, AUTOMATIC VALVES IN THE NATURE OF CONTROLLED FLUID AND GAS FLOW CONTROL VALVES AND SUBSURFACE VALVES; OIL WELL COMPLETION EQUIPMENT, NAMELY, CONTROL VALVES FOR REGULATING THE FLOW OF GASES AND LIQUIDS; REMOTELY ACTUATED DOWNHOLE TOOLS, NAMELY, OIL AND GAS WELL DOWNHOLE SURVEY AND MEASUREMENT EQUIPMENT; AUTOMATIC VALVES IN THE NATURE OF RESERVOIR ISOLATION VALVES FOR PROVIDING A FLUID LOSS BARRIER AND A CHEMICAL INJECTION POINT FOR USE IN A WELLBORE, IN CLASS 9 (U.S. CLS. 21, 23, 26, 36 AND 38).

FIRST USE 2-28-2008; IN COMMERCE 7-31-2011.



*David J. Kyffers*

Director of the United States Patent and Trademark Office

**Reg. No. 4,198,943** FOR: OIL AND GAS WELL DRILLING SERVICES; WELL COMPLETION AND REMEDIAL SERVICES, NAMELY, INSTALLATION OF CONTROLLED FLUID AND GAS FLOW CONTROL VALVES; WELL CLEAN-UP AND DEBRIS REMOVAL SERVICES; RENTAL REPAIR, CONDITIONING AND INSTALLATION OF TOOLS FOR USE IN THE CONSTRUCTION, OPERATION, REPAIR ROUTINE MAINTENANCE AND INSPECTION OF OIL AND GAS WELLS; RENTAL, REPAIR, CONDITIONING AND INSTALLATION OF WELL CLEAN-UP, FLUID DISPLACEMENT, FLUID SAMPLING, FILTRATION, ZONAL ISOLATION AND CIRCULATION EQUIPMENT; CLEANING OF WELL BORES, CASING STRINGS, LINERS AND OTHER WELL TUBING; ADVISORY AND CONSULTANCY SERVICES RELATING TO ALL THE AFORESAID SERVICES, IN CLASS 37 (U.S. CLS. 100, 103 AND 106).

FIRST USE 2-28-2008; IN COMMERCE 7-31-2011.

THE MARK CONSISTS OF STANDARD CHARACTERS WITHOUT CLAIM TO ANY PARTICULAR FONT, STYLE, SIZE, OR COLOR.

OWNER OF UNITED KINGDOM REG. NO. 2356397, DATED 2-20-2004, EXPIRES 2-20-2014.

SN 78-910,110, FILED 6-16-2006.

KRISTIN DAHLING, EXAMINING ATTORNEY

# United States of America

United States Patent and Trademark Office

## THE MILLIONAIRE MAKER

**Reg. No. 4,198,944**

CHOICE PERFORMANCE, INC. (NEVADA CORPORATION)

**Registered Aug. 28, 2012**

PO BOX 36, 195 HWY 50  
ZEPHYR COVE, NV 89448

**Int. Cl.: 16**

FOR: SERIES OF NON-FICTION BOOKS IN THE FIELD OF WEALTH DEVELOPMENT AND PERSONAL DEVELOPMENT AND SUCCESS, IN CLASS 16 (U.S. CLS. 2, 5, 22, 23, 29, 37, 38 AND 50).

**TRADEMARK**

FIRST USE 0-0-2007; IN COMMERCE 0-0-2007.

**PRINCIPAL REGISTER**

THE MARK CONSISTS OF STANDARD CHARACTERS WITHOUT CLAIM TO ANY PARTICULAR FONT, STYLE, SIZE, OR COLOR.

SN 78-963,190, FILED 8-29-2006.

KATHY DE JONGE, EXAMINING ATTORNEY



*David J. Kyros*

Director of the United States Patent and Trademark Office

# United States of America

United States Patent and Trademark Office

# Campfire Ministries

**Reg. No. 4,198,945**

**Registered Aug. 28, 2012**

**Int. Cl.: 45**

**SERVICE MARK**

**PRINCIPAL REGISTER**

DENBO, ROBERT (UNITED STATES INDIVIDUAL)  
7303 WEST COUNTY ROAD 175 SOUTH  
FRENCH LICK, IN 47432 AND

STEWART, STANLEY (UNITED STATES INDIVIDUAL)  
836 WEST HAYSVILLE ROAD  
JASPER, IN 47546

FOR: PROVIDING FAITH-BASED DEVOTIONALS VIA SOCIAL NETWORKS , IN CLASS  
45 (U.S. CLS. 100 AND 101).

FIRST USE 10-18-2009; IN COMMERCE 10-18-2009.

NO CLAIM IS MADE TO THE EXCLUSIVE RIGHT TO USE "MINISTRIES", APART FROM  
THE MARK AS SHOWN.

THE COLOR(S) RED AND BLACK IS/ARE CLAIMED AS A FEATURE OF THE MARK.

THE MARK CONSISTS OF THE WORDING "CAMPFIRE MINISTRIES" IN BLACK STYLIZED  
FONT EXCEPT FOR THE LETTER "T" IN MINISTRIES, WHICH APPEARS AS A RED CROSS.

SN 85-004,199, FILED 4-1-2010.

SUZANNE BLANE, EXAMINING ATTORNEY



*David J. Kyffers*

Director of the United States Patent and Trademark Office

# United States of America

United States Patent and Trademark Office

## BECAUSE EVERY BABY DESERVES A FIRST BIRTHDAY

**Reg. No. 4,198,946**

**Registered Aug. 28, 2012**

**Int. Cl.: 35**

**SERVICE MARK**

**PRINCIPAL REGISTER**

THE SUDDEN INFANT DEATH SYNDROME ALLIANCE, INC. (MARYLAND CORPORATION), TA FIRST CANDLE,  
1314 BEDFORD AVENUE  
BALTIMORE, MD 21208

FOR: CHARITABLE SERVICES, NAMELY, PROMOTING PUBLIC AWARENESS OF SUDDEN INFANT DEATH SYNDROME, IN CLASS 35 (U.S. CLS. 100, 101 AND 102).

FIRST USE 4-0-2010; IN COMMERCE 4-0-2010.

THE MARK CONSISTS OF STANDARD CHARACTERS WITHOUT CLAIM TO ANY PARTICULAR FONT, STYLE, SIZE, OR COLOR.

SN 85-004,896, FILED 4-2-2010.

HEATHER THOMPSON, EXAMINING ATTORNEY



*David J. Kyjars*

Director of the United States Patent and Trademark Office



# United States of America

United States Patent and Trademark Office

## GET WRECKED

**Reg. No. 4,198,947**

GET WRECKED, LLC. (FLORIDA LIMITED LIABILITY COMPANY)  
1706 OAK PARK COURT  
TARPON SPRINGS, FL 34689

**Registered Aug. 28, 2012**

**Int. Cl.: 35**

FOR: SPECIALTY MERCHANDISING SERVICES, NAMELY, PROMOTING THE GOODS AND SERVICES OF OTHERS THROUGH THE DISTRIBUTION OF CUSTOMIZED ADVERTISING MATERIALS, NAMELY, STICKERS, BOTTLE OPENERS, FLAGS, BAGS, AND T-SHIRTS, IN CLASS 35 (U.S. CLS. 100, 101 AND 102).

**SERVICE MARK**

**PRINCIPAL REGISTER**

FIRST USE 7-30-2010; IN COMMERCE 8-15-2010.

THE MARK CONSISTS OF STANDARD CHARACTERS WITHOUT CLAIM TO ANY PARTICULAR FONT, STYLE, SIZE, OR COLOR.

SEC. 2(F).

SN 85-006,233, FILED 4-5-2010.

ANNE E. GUSTASON, EXAMINING ATTORNEY



*David J. Kybas*

Director of the United States Patent and Trademark Office

# United States of America

United States Patent and Trademark Office

## FARM-FRESH GOODNESS

**Reg. No. 4,198,948**

**Registered Aug. 28, 2012**

**Int. Cl.: 43**

**SERVICE MARK**

**PRINCIPAL REGISTER**

BOB EVANS FARMS, INC. (OHIO CORPORATION)  
3776 SOUTH HIGH STREET  
COLUMBUS, OH 43207

FOR: RESTAURANT SERVICES, IN CLASS 43 (U.S. CLS. 100 AND 101).

FIRST USE 4-20-2012; IN COMMERCE 4-20-2012.

THE MARK CONSISTS OF STANDARD CHARACTERS WITHOUT CLAIM TO ANY PARTICULAR FONT, STYLE, SIZE, OR COLOR.

OWNER OF U.S. REG. NOS. 2,898,942 AND 3,112,053.

NO CLAIM IS MADE TO THE EXCLUSIVE RIGHT TO USE "FARM-FRESH", APART FROM THE MARK AS SHOWN.

SN 85-008,574, FILED 4-7-2010.

SOPHIA S. KIM, EXAMINING ATTORNEY



*David J. Kyros*

Director of the United States Patent and Trademark Office

# United States of America

United States Patent and Trademark Office

## XTREME KLEAN

**Reg. No. 4,198,949**

FRY'S ELECTRONICS, INC. (CALIFORNIA CORPORATION)  
600 E. BROKAW ROAD  
SAN JOSE, CA 95112

**Registered Aug. 28, 2012**

**Int. Cls.: 3, 5, 16, and 21**

FOR: CLEANING PRODUCTS FOR USE ON ELECTRONIC EQUIPMENT, NAMELY, DISPOSABLE CLEANING, DUSTING, OR POLISHING WIPES AND CLOTHS IMPREGNATED WITH CLEANING COMPOUNDS, CLEANING SWABS FOR HOUSEHOLD PURPOSES, AND CANNED PRESSURIZED AIR, IN CLASS 3 (U.S. CLS. 1, 4, 6, 50, 51 AND 52).

**TRADEMARK**

**PRINCIPAL REGISTER**

FIRST USE 7-19-2010; IN COMMERCE 7-19-2010.

FOR: SANITIZING WIPES, IN CLASS 5 (U.S. CLS. 6, 18, 44, 46, 51 AND 52).

FIRST USE 1-28-2012; IN COMMERCE 1-28-2012.

FOR: DISPOSABLE CLEANING, DUSTING, OR POLISHING WIPES NOT IMPREGNATED WITH CLEANING COMPOUNDS, IN CLASS 16 (U.S. CLS. 2, 5, 22, 23, 29, 37, 38 AND 50).

FIRST USE 12-20-2011; IN COMMERCE 12-20-2011.

FOR: DISPOSABLE CLEANING, DUSTING, OR POLISHING CLOTHS; SANITIZING CLOTHS; CLEANING SWABS FOR COMMERCIAL USES, IN CLASS 21 (U.S. CLS. 2, 13, 23, 29, 30, 33, 40 AND 50).

FIRST USE 11-16-2011; IN COMMERCE 11-16-2011.

THE MARK CONSISTS OF STANDARD CHARACTERS WITHOUT CLAIM TO ANY PARTICULAR FONT, STYLE, SIZE, OR COLOR.

NO CLAIM IS MADE TO THE EXCLUSIVE RIGHT TO USE "CLEAN", APART FROM THE MARK AS SHOWN.

SN 85-009,758, FILED 4-8-2010.

CHERYL CLAYTON, EXAMINING ATTORNEY



*David J. Kyros*

Director of the United States Patent and Trademark Office

# United States of America

United States Patent and Trademark Office



**Reg. No. 4,198,950**

FRY'S ELECTRONICS, INC. (CALIFORNIA CORPORATION)  
600 E. BROKAW ROAD  
SAN JOSE, CA 95112

**Registered Aug. 28, 2012**

**Int. Cls.: 3, 5, 16, and 21**

FOR: CLEANING PRODUCTS FOR USE ON ELECTRONIC EQUIPMENT, NAMELY, DISPOSABLE CLEANING, DUSTING, OR POLISHING WIPES AND CLOTHS IMPREGNATED WITH CLEANING COMPOUNDS, CLEANING SWABS FOR HOUSEHOLD PURPOSES, AND CANNED PRESSURIZED AIR, IN CLASS 3 (U.S. CLS. 1, 4, 6, 50, 51 AND 52).

**TRADEMARK**

**PRINCIPAL REGISTER**

FIRST USE 7-19-2010; IN COMMERCE 7-19-2010.

FOR: SANITIZING WIPES, IN CLASS 5 (U.S. CLS. 6, 18, 44, 46, 51 AND 52).

FIRST USE 1-28-2012; IN COMMERCE 1-28-2012.

FOR: DISPOSABLE CLEANING, DUSTING, OR POLISHING WIPES NOT IMPREGNATED WITH CLEANING COMPOUNDS, IN CLASS 16 (U.S. CLS. 2, 5, 22, 23, 29, 37, 38 AND 50).

FIRST USE 12-20-2011; IN COMMERCE 12-20-2011.

FOR: DISPOSABLE CLEANING, DUSTING, OR POLISHING CLOTHS; SANITIZING CLOTHS; CLEANING SWABS FOR COMMERCIAL USES, IN CLASS 21 (U.S. CLS. 2, 13, 23, 29, 30, 33, 40 AND 50).

FIRST USE 11-16-2011; IN COMMERCE 11-16-2011.

NO CLAIM IS MADE TO THE EXCLUSIVE RIGHT TO USE "CLEAN", APART FROM THE MARK AS SHOWN.

THE MARK CONSISTS OF A LARGE SIDEWAYS FORWARD POINTING CHEVRON IN ALIGNMENT WITH THE WORD "XTREME". DIRECTLY BELOW AND ASKEW A LARGE SIDEWAYS BACKWARD POINTING CHEVRON IN ALIGNMENT WITH THE WORD "KLEAN".



*David J. Kyros*

SN 85-009,781, FILED 4-8-2010.

CHERYL CLAYTON, EXAMINING ATTORNEY

Director of the United States Patent and Trademark Office

# United States of America

United States Patent and Trademark Office

## ON DUTY, OFF DUTY, WE'VE GOT YOU COVERED

**Reg. No. 4,198,951**

FLYING CIRCLE BAG COMPANY (TEXAS CORPORATION)  
10045 JOHNS ROAD  
BOERNE, TX 78006

**Registered Aug. 28, 2012**

**Int. Cl.: 18**

FOR: BACKPACKS; BOOK BAGS; DUFFEL BAGS; GARMENT BAGS FOR TRAVEL;  
SHOULDER BAGS; SPORTS BAGS; TOTE BAGS, IN CLASS 18 (U.S. CLS. 1, 2, 3, 22 AND  
41).

**TRADEMARK**

FIRST USE 3-0-2010; IN COMMERCE 3-0-2010.

**PRINCIPAL REGISTER**

THE MARK CONSISTS OF STANDARD CHARACTERS WITHOUT CLAIM TO ANY PAR-  
TICULAR FONT, STYLE, SIZE, OR COLOR.

SN 85-012,610, FILED 4-13-2010.

CHARLOTTE CORWIN, EXAMINING ATTORNEY



*David J. Kyffers*

Director of the United States Patent and Trademark Office

# United States of America

United States Patent and Trademark Office

# MEMORAH

**Reg. No. 4,198,952**

ARI BABAKNIA (UNITED STATES INDIVIDUAL), AKA ARDESHIR BABAKNIA, M.D.,  
1 SAN SEBASTIAN

**Registered Aug. 28, 2012**

NEWPORT BEACH, CA 92660

**Int. Cl.: 41**

FOR: EDUCATIONAL SERVICES, NAMELY, PROVIDING A WEBSITE FEATURING HISTORICAL INFORMATION ABOUT THE HOLOCAUST; PUBLISHING OF BOOKS AND ELECTRONIC PUBLICATIONS RELATED TO THE HOLOCAUST; PROVIDING ON-LINE PUBLICATIONS, NAMELY, EBOOKS, BROCHURES, NEWSLETTERS, AND MAGAZINES, IN THE FIELD OF THE HOLOCAUST, IN CLASS 41 (U.S. CLS. 100, 101 AND 107).

**SERVICE MARK**

**PRINCIPAL REGISTER**

FIRST USE 4-15-2012; IN COMMERCE 4-15-2012.

THE MARK CONSISTS OF STANDARD CHARACTERS WITHOUT CLAIM TO ANY PARTICULAR FONT, STYLE, SIZE, OR COLOR.

THE WORDING "MEMORAH" HAS NO MEANING IN A FOREIGN LANGUAGE.

SN 85-012,759, FILED 4-13-2010.

KIM MONINGHOFF, EXAMINING ATTORNEY



*David J. Kyros*

Director of the United States Patent and Trademark Office

# United States of America

United States Patent and Trademark Office

# Y2L

**Reg. No. 4,198,953**

**Registered Aug. 28, 2012**

**Int. Cls.: 16 and 41**

**TRADEMARK**

**SERVICE MARK**

**PRINCIPAL REGISTER**

MUSCO CORPORATION (IOWA CORPORATION)  
100 1ST AVENUE WEST  
OSKALOOSA, IA 52577

FOR: PUBLICATION AND PRINTED MATTER, NAMELY, BOOKS, BOOKLETS, WORKBOOKS, WORKSHEETS, ACTIVITY BOOKS, HANDOUTS, ARTICLES, COLUMNS, CIRCULARS, PAMPHLETS, BROCHURES, NEWSLETTERS, LEAFLETS, INFORMATIONAL FLYERS, LETTERS AND SHEETS, TEACHING MATERIALS, CURRICULUM, CURRICULUM TEMPLATES, DIRECTORIES, TEACHING ACTIVITY GUIDES, POSTERS, TRAINING MANUALS, TRAINING MATERIALS, GUIDE BOOKS, INSTRUCTION SHEETS, ASSESSMENT SHEETS, QUESTIONNAIRES, DEVELOPMENTAL CHECKLISTS, PACKAGED KITS COMPOSED PRIMARILY OF PRINTED INSTRUCTIONAL, EDUCATIONAL, AND TEACHING MATERIALS AND ALSO INCLUDING AN EDUCATIONAL ELECTRONIC OR DIGITAL MEDIA, IN THE FIELD OF EARLY CHILDHOOD LEARNING AND DEVELOPMENT, IN CLASS 16 (U.S. CLS. 2, 5, 22, 23, 29, 37, 38 AND 50).

FIRST USE 8-12-2011; IN COMMERCE 8-12-2011.

FOR: DEVELOPING TRAINING SYSTEMS AND LEARNING METHODOLOGIES FOR OTHERS; DEVELOPING CURRICULUM, AND EDUCATIONAL MANUALS AND SUPPORT MATERIALS FOR OTHERS IN THE FIELD OF EARLY CHILDHOOD LEARNING AND DEVELOPMENT; PROVIDING A WEBSITE FEATURING INFORMATION IN THE FIELD OF EDUCATION OF CHILDREN; EDUCATION AND TRAINING SERVICES, NAMELY, DEVELOPING, AND FACILITATING IN-HOUSE PROGRAMS FOR MANAGERS AND WORKERS IN DAYCARE AND EARLY CHILDHOOD LEARNING SETTINGS, PROVIDING COACHING SERVICES, AND PROVIDING PUBLIC AND IN-HOUSE TRAINING, SEMINARS, AND PRESENTATIONS TO MANAGERS AND WORKERS IN DAYCARE AND EARLY CHILDHOOD LEARNING; CONSULTANCY IN THE FIELD OF EARLY CHILDHOOD LEARNING AND DEVELOPMENT; EDUCATION SERVICES, NAMELY, TRAINING EARLY CHILDHOOD EDUCATORS AND CARETAKERS IN THE FIELD OF EARLY CHILDHOOD LEARNING AND DEVELOPMENT AND PROVIDING PRINTED MATERIAL IN CONNECTION THEREWITH; PROVIDING GROUP COACHING AND LEARNING FORUMS IN THE FIELD OF LEADERSHIP DEVELOPMENT FOR EARLY CHILDHOOD LEARNING AND DEVELOPMENT INITIATIVES; ORGANIZING OF, DEVELOPING OF, AND EVALUATING THE EFFECTIVENESS OF CURRICULUM, AND EDUCATIONAL PROGRAMS AND PROJECTS OF OTHERS THAT AIM TO IMPROVE EARLY CHILDHOOD LEARNING AND DEVELOPMENT; PROVIDING A WEBSITE FEATURING INFORMATION AND RESOURCES



*David J. Kyjars*

Director of the United States Patent and Trademark Office

**Reg. No. 4,198,953** ABOUT EDUCATION, NAMELY, EARLY CHILDHOOD LEARNING AND LEARNING DEVELOPMENT; PROVIDING INFORMATION ON THE TOPIC OF EARLY CHILDHOOD EDUCATION AND LEARNING DEVELOPMENT; PROVIDING A WEB SITE FEATURING INFORMATION FOR FAMILIES ABOUT EARLY CHILDHOOD LEARNING AND LEARNING DEVELOPMENT INITIATIVES AND RESOURCES; EDUCATIONAL SERVICES, NAMELY, LEARNING CENTERS FOR EARLY CHILDHOOD LEARNING AND DEVELOPMENT, IN CLASS 41 (U.S. CLS. 100, 101 AND 107).

FIRST USE 11-2-2010; IN COMMERCE 11-2-2010.

THE MARK CONSISTS OF STANDARD CHARACTERS WITHOUT CLAIM TO ANY PARTICULAR FONT, STYLE, SIZE, OR COLOR.

SN 85-013,556, FILED 4-14-2010.

ELLEN PERKINS, EXAMINING ATTORNEY



# United States of America

United States Patent and Trademark Office

## YEARS TO LEARN

**Reg. No. 4,198,954**

MUSCO CORPORATION (IOWA CORPORATION)

**Registered Aug. 28, 2012**

100 1ST AVENUE WEST  
OSKALOOSA, IA 52577

**Int. Cl.: 41**

**SERVICE MARK**

**PRINCIPAL REGISTER**

FOR: DEVELOPING TRAINING SYSTEMS AND LEARNING METHODOLOGIES FOR OTHERS; DEVELOPING CURRICULUM, AND EDUCATIONAL MANUALS AND SUPPORT MATERIALS FOR OTHERS IN THE FIELD OF EARLY CHILDHOOD LEARNING AND DEVELOPMENT; PROVIDING A WEBSITE FEATURING INFORMATION IN THE FIELD OF EDUCATION OF CHILDREN; EDUCATION AND TRAINING SERVICES, NAMELY, DEVELOPING, AND FACILITATING IN-HOUSE PROGRAMS FOR MANAGERS AND WORKERS IN DAYCARE AND EARLY CHILDHOOD LEARNING SETTINGS, PROVIDING COACHING SERVICES, AND PROVIDING PUBLIC AND IN-HOUSE TRAINING, SEMINARS, AND PRESENTATIONS TO MANAGERS AND WORKERS IN DAYCARE AND EARLY CHILDHOOD LEARNING; CONSULTANCY IN THE FIELD OF EARLY CHILDHOOD LEARNING AND DEVELOPMENT; EDUCATION SERVICES, NAMELY, TRAINING EARLY CHILDHOOD EDUCATORS AND CARETAKERS IN THE FIELD OF EARLY CHILDHOOD LEARNING AND DEVELOPMENT AND PROVIDING PRINTED MATERIAL IN CONNECTION THEREWITH; PROVIDING GROUP COACHING AND LEARNING FORUMS IN THE FIELD OF LEADERSHIP DEVELOPMENT FOR EARLY CHILDHOOD LEARNING AND DEVELOPMENT INITIATIVES; ORGANIZING OF, DEVELOPING OF, AND EVALUATING THE EFFECTIVENESS OF CURRICULUM, AND EDUCATIONAL PROGRAMS AND PROJECTS OF OTHERS THAT AIM TO IMPROVE EARLY CHILDHOOD LEARNING AND DEVELOPMENT; PROVIDING A WEBSITE FEATURING INFORMATION AND RESOURCES ABOUT EDUCATION, NAMELY, EARLY CHILDHOOD LEARNING AND LEARNING DEVELOPMENT; PROVIDING INFORMATION ON THE TOPIC OF EARLY CHILDHOOD EDUCATION AND LEARNING DEVELOPMENT; PROVIDING A WEB SITE FEATURING INFORMATION FOR FAMILIES ABOUT EARLY CHILDHOOD LEARNING AND LEARNING DEVELOPMENT INITIATIVES AND RESOURCES; EDUCATIONAL SERVICES, NAMELY, LEARNING CENTERS FOR EARLY CHILDHOOD LEARNING AND DEVELOPMENT, IN CLASS 41 (U.S. CLS. 100, 101 AND 107).



FIRST USE 11-2-2010; IN COMMERCE 11-2-2010.

*David J. Kyros*

THE MARK CONSISTS OF STANDARD CHARACTERS WITHOUT CLAIM TO ANY PARTICULAR FONT, STYLE, SIZE, OR COLOR.

**Reg. No. 4,198,954** NO CLAIM IS MADE TO THE EXCLUSIVE RIGHT TO USE "LEARN", APART FROM THE MARK AS SHOWN.

SN 85-013,566, FILED 4-14-2010.

ELLEN PERKINS, EXAMINING ATTORNEY

# United States of America

United States Patent and Trademark Office

## WOULDN'T YOU RATHER LATHER

**Reg. No. 4,198,955**

LATHER, INC. (CALIFORNIA CORPORATION)  
76 N. FAIR OAKS AVENUE  
PASADENA, CA 91103

**Registered Aug. 28, 2012**

**Int. Cl.: 35**

FOR: RETAIL STORE SERVICES FEATURING HEALTH AND BEAUTY AID PRODUCTS,  
IN CLASS 35 (U.S. CLS. 100, 101 AND 102).

**SERVICE MARK**

FIRST USE 1-1-2007; IN COMMERCE 1-1-2007.

**PRINCIPAL REGISTER**

THE MARK CONSISTS OF STANDARD CHARACTERS WITHOUT CLAIM TO ANY PAR-  
TICULAR FONT, STYLE, SIZE, OR COLOR.

SN 85-015,336, FILED 4-15-2010.

RONALD AIKENS, EXAMINING ATTORNEY



*David J. Kybas*

Director of the United States Patent and Trademark Office

# United States of America

United States Patent and Trademark Office

# BATLSKIN

**Reg. No. 4,198,956**

**Registered Aug. 28, 2012**

**Int. Cl.: 9**

**TRADEMARK**

**PRINCIPAL REGISTER**

REVISION EYEWEAR S.A.R.L. (LUXEMBOURG CORPORATION)  
412F, ROUTE D'ESCH  
LUXEMBOURG, LUXEMBOURG L-2086

FOR: MODULAR PROTECTION AND ATTACHMENT SYSTEMS FOR COMBAT HELMET WITH OR WITHOUT A VISOR AND MANDIBLE GUARD AND ALLOWING FOR THE ATTACHMENT OF A RANGE OF CAPABILITY ENHANCING DEVICES SUCH AS FLASH-LIGHTS, CAMERAS, ELECTRO-OPTICAL SURVEILLANCE DEVICES AND RELATED ACCESSORIES, IN CLASS 9 (U.S. CLS. 21, 23, 26, 36 AND 38).

FIRST USE 4-17-2012; IN COMMERCE 4-17-2012.

THE MARK CONSISTS OF STANDARD CHARACTERS WITHOUT CLAIM TO ANY PARTICULAR FONT, STYLE, SIZE, OR COLOR.

PRIORITY CLAIMED UNDER SEC. 44(D) ON CANADA APPLICATION NO. 1,474,844, FILED 3-29-2010.

SN 85-020,701, FILED 4-22-2010.

LEIGH CAROLINE CASE, EXAMINING ATTORNEY



*David J. Kyffers*

Director of the United States Patent and Trademark Office

# United States of America

United States Patent and Trademark Office

# 베라클루드

**Reg. No. 4,198,957**

BRISTOL-MYERS SQUIBB COMPANY (DELAWARE CORPORATION)  
345 PARK AVENUE  
NEW YORK, NY 10154

**Registered Aug. 28, 2012**

**Int. Cl.: 16**

FOR: PRINTED MATERIALS, NAMELY, NEWSLETTERS, BROCHURES, FLYERS AND PACKETS ON THE SUBJECT OF HEPATITIS, IN CLASS 16 (U.S. CLS. 2, 5, 22, 23, 29, 37, 38 AND 50).

**TRADEMARK**

FIRST USE 11-15-2010; IN COMMERCE 11-15-2010.

**PRINCIPAL REGISTER**

OWNER OF U.S. REG. NOS. 3,022,352 AND 3,204,519.

THE NON-LATIN CHARACTERS IN THE MARK TRANSLITERATE TO "BARACLUDGE" AND THIS HAS NO MEANING IN A FOREIGN LANGUAGE.

THE MARK CONSISTS OF THE WORD "BARACLUDGE" IN KOREAN CHARACTERS.

SN 85-021,465, FILED 4-23-2010.

DEZMONA MIZELLE, EXAMINING ATTORNEY



*David J. Kyjars*

Director of the United States Patent and Trademark Office

United States of America  
United States Patent and Trademark Office

貝樂克

**Reg. No. 4,198,958**

BRISTOL-MYERS SQUIBB COMPANY (DELAWARE CORPORATION)  
345 PARK AVENUE  
NEW YORK, NY 10154

**Registered Aug. 28, 2012**

**Int. Cl.: 16**

FOR: PRINTED MATERIALS, NAMELY, NEWSLETTERS, BROCHURES, FLYERS AND PACKETS ON THE SUBJECT OF HEPATITIS, IN CLASS 16 (U.S. CLS. 2, 5, 22, 23, 29, 37, 38 AND 50).

**TRADEMARK**

FIRST USE 11-15-2010; IN COMMERCE 11-15-2010.

**PRINCIPAL REGISTER**

OWNER OF U.S. REG. NOS. 3,022,352 AND 3,204,519.

THE NON-LATIN CHARACTERS IN THE MARK TRANSLITERATE TO "BARACLUDE" AND THIS HAS NO MEANING IN A FOREIGN LANGUAGE.

THE MARK CONSISTS OF THE WORD "BARACLUDE" IN TRADITIONAL CHINESE CHARACTERS.

SN 85-021,469, FILED 4-23-2010.

DEZMONA MIZELLE, EXAMINING ATTORNEY



*David J. Kyros*

Director of the United States Patent and Trademark Office

# United States of America

United States Patent and Trademark Office

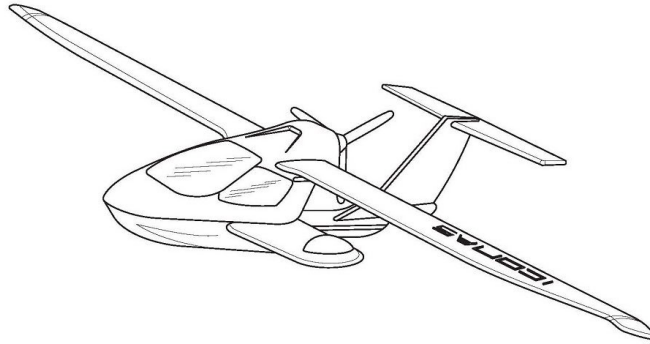

**Reg. No. 4,198,959**

**Registered Aug. 28, 2012**

**Int. Cl.: 28**

**TRADEMARK**

**PRINCIPAL REGISTER**

ICON AIRCRAFT, INC. (DELAWARE CORPORATION)  
12511 BEATRICE STREET  
LOS ANGELES, CA 90066

FOR: BATTERY OPERATED ACTION TOY AIRPLANES; ELECTRONIC TOY AIRPLANES; ELECTRONICALLY OPERATED TOY MOTOR AIRPLANES; NON-ELECTRONIC TOY AIRPLANES; RADIO CONTROLLED MODEL AIRPLANES; RADIO CONTROLLED TOY AIRPLANES; REMOTE CONTROL TOYS, NAMELY, AIRPLANES; SCALE MODEL AIRPLANES; SCALE MODEL AIRPLANE KITS; TOY AIRPLANES; TOY MODEL AIRPLANE HOBBYCRAFT KITS; TOY MODEL AIRPLANES AND RELATED ACCESSORIES SOLD AS UNITS, IN CLASS 28 (U.S. CLS. 22, 23, 38 AND 50).

FIRST USE 7-25-2011; IN COMMERCE 1-24-2012.

THE MARK CONSISTS OF A CONFIGURATION OF THE GOODS. IT IS COMPRISED OF THE THREE-DIMENSIONAL DESIGN OF A TOY OR MODEL AIRPLANE (WHICH IS A REPLICA OF A REAL AIRPLANE). THE MARK CONSISTS OF THE LITERAL ELEMENT OF THE MARK, "ICON A5", IN STANDARD CHARACTERS ON THE TOP OF THE LEFT WING OF THE TOY OR MODEL AIRPLANE. EVERYTHING SHOWN IN THE DRAWING IS CLAIMED AS PART OF THE MARK.

SN 85-023,567, FILED 4-26-2010.

ESTHER A. BORSUK, EXAMINING ATTORNEY



*David J. Kyjars*

Director of the United States Patent and Trademark Office

# United States of America

United States Patent and Trademark Office

## SMART SHOT

**Reg. No. 4,198,960**

KIMBERLY-CLARK WORLDWIDE, INC. (DELAWARE CORPORATION)  
2300 WINCHESTER ROAD  
NEENAH, WI 54956

**Registered Aug. 28, 2012**

**Int. Cl.: 21**

FOR: TOUCH FREE ADJUSTABLE ELECTRONIC SENSOR THAT ALLOWS THE USER TO CUSTOMIZE DISPENSING SETTINGS, SOLD AS A COMPONENT OF LIQUID SOAP DISPENSERS, IN CLASS 21 (U.S. CLS. 2, 13, 23, 29, 30, 33, 40 AND 50).

**TRADEMARK**

FIRST USE 11-3-2011; IN COMMERCE 11-3-2011.

**PRINCIPAL REGISTER**

THE MARK CONSISTS OF STANDARD CHARACTERS WITHOUT CLAIM TO ANY PARTICULAR FONT, STYLE, SIZE, OR COLOR.

NO CLAIM IS MADE TO THE EXCLUSIVE RIGHT TO USE "SMART", APART FROM THE MARK AS SHOWN.

SN 85-023,796, FILED 4-27-2010.

DAVID ELTON, EXAMINING ATTORNEY



*David J. Kyros*

Director of the United States Patent and Trademark Office



# United States of America

United States Patent and Trademark Office

## RHYTHM & RHYME

**Reg. No. 4,198,961**

DONCHEZ, RONALD E. (UNITED STATES INDIVIDUAL)  
20 WEST 36TH STREET, 12TH FLOOR  
NEW YORK, NY 10018 AND

**Registered Aug. 28, 2012**

**Int. Cl.: 18**

WANG, CHUNG CHIEH (UNITED STATES INDIVIDUAL)  
20 WEST 36TH STREET, 12TH FLOOR  
NEW YORK, NY 10018

**TRADEMARK**

**PRINCIPAL REGISTER**

FOR: LUXURY AND HIGH-END HANDBAGS, LUGGAGE, AND LEATHER GOODS, NAMELY, SHOULDER BAGS, ALL FOR WOMEN, IN CLASS 18 (U.S. CLS. 1, 2, 3, 22 AND 41).

FIRST USE 4-0-2010; IN COMMERCE 5-0-2010.

THE MARK CONSISTS OF STANDARD CHARACTERS WITHOUT CLAIM TO ANY PARTICULAR FONT, STYLE, SIZE, OR COLOR.

SN 85-024,175, FILED 4-27-2010.

GENE MACIOL, EXAMINING ATTORNEY



*David J. Kyros*

Director of the United States Patent and Trademark Office

# United States of America

United States Patent and Trademark Office

## FURRY NIGHT LIVE

**Reg. No. 4,198,962**

SPANGLER, ANTHONY (UNITED STATES INDIVIDUAL)  
4887 WELLINGTON PARK DRIVE  
SAN JOSE, CA 95136

**Registered Aug. 28, 2012**

**Int. Cl.: 41**

FOR: PRESENTATION OF LIVE SHOW PERFORMANCES, IN CLASS 41 (U.S. CLS. 100, 101 AND 107).

**SERVICE MARK**

FIRST USE 4-27-2010; IN COMMERCE 2-23-2011.

**PRINCIPAL REGISTER**

THE MARK CONSISTS OF STANDARD CHARACTERS WITHOUT CLAIM TO ANY PARTICULAR FONT, STYLE, SIZE, OR COLOR.

NO CLAIM IS MADE TO THE EXCLUSIVE RIGHT TO USE "NIGHT LIVE", APART FROM THE MARK AS SHOWN.

SN 85-024,713, FILED 4-27-2010.

LESLEY LAMOTHE, EXAMINING ATTORNEY



*David J. Kyffers*

Director of the United States Patent and Trademark Office

# United States of America

United States Patent and Trademark Office



**Reg. No. 4,198,963**

**Registered Aug. 28, 2012**

**Int. Cls.: 2 and 37**

**TRADEMARK**

**SERVICE MARK**

**PRINCIPAL REGISTER**

THE TRUSTEES OF THE SKUDO INTELLECTUAL PROPERTY TRUST (AUSTRALIA TRUST)  
PO BOX 148  
ROBINA, QUEENSLAND, AUSTRALIA 4226

FOR: PROTECTIVE COATINGS, FOR INTERIOR AND EXTERIOR SURFACES OF BUILDINGS AND IN SURROUNDING LANDSCAPE AND HARDSCAPE, IN CLASS 2 (U.S. CLS. 6, 11 AND 16).

FIRST USE 1-0-2010; IN COMMERCE 5-0-2010.

FOR: TREATMENT OF SURFACES BEING THE APPLICATION OF PROTECTION COATINGS NOT INCLUDING PAINT, IN CLASS 37 (U.S. CLS. 100, 103 AND 106).

FIRST USE 1-0-2010; IN COMMERCE 5-0-2010.

PRIORITY CLAIMED UNDER SEC. 44(D) ON AUSTRALIA APPLICATION NO. 1342564, FILED 1-27-2010.

THE COLOR(S) BLACK AND ORANGE IS/ARE CLAIMED AS A FEATURE OF THE MARK.

THE MARK CONSISTS OF THE WORD "SKUDO" IN WHICH THE LETTERS "S","K","U","D" APPEAR IN BLACK AND THE LETTER "O" APPEARS IN ORANGE, WITH A BUBBLE DESIGN FORMING THE SHAPE OF A CURVED ARROW IN ORANGE FRAMING THE TOP OF THE LETTERS.

SN 85-025,058, FILED 4-28-2010.

MICHAEL WEBSTER, EXAMINING ATTORNEY



*David J. Kybas*

Director of the United States Patent and Trademark Office

# United States of America

United States Patent and Trademark Office

# EGG2CAKE

**Reg. No. 4,198,964**

EGG2CAKE, LLC (OHIO LIMITED LIABILITY COMPANY)

**Registered Aug. 28, 2012**

P.O. BOX 53733  
CINCINNATI, OH 45253

**Int. Cls.: 16 and 35**

FOR: BOOK MARKS; BOOKS IN THE FIELD OF MATERNITY AND CHILDCARE; CALENDARS AND DIARIES; COASTERS OF PAPER; GREETING CARDS; NOTE BOOKS; NOTE PADS; POST CARDS; PRINTED CHARTS; PRINTED PAPER SIGNS; STATIONERY; STICKERS, IN CLASS 16 (U.S. CLS. 2, 5, 22, 23, 29, 37, 38 AND 50).

**TRADEMARK**

**SERVICE MARK**

FIRST USE 5-0-2010; IN COMMERCE 5-0-2010.

**PRINCIPAL REGISTER**

FOR: WHOLESALE STORE SERVICES FEATURING STATIONERY PRODUCTS, IN CLASS 35 (U.S. CLS. 100, 101 AND 102).

FIRST USE 5-0-2010; IN COMMERCE 5-0-2010.

THE MARK CONSISTS OF STANDARD CHARACTERS WITHOUT CLAIM TO ANY PARTICULAR FONT, STYLE, SIZE, OR COLOR.

SN 85-026,617, FILED 4-29-2010.

BERYL GARDNER, EXAMINING ATTORNEY



*David J. Kyfos*

Director of the United States Patent and Trademark Office

# United States of America

United States Patent and Trademark Office



**Reg. No. 4,198,965**

**Registered Aug. 28, 2012**

**Int. Cls.: 12 and 37**

**TRADEMARK**

**SERVICE MARK**

**PRINCIPAL REGISTER**

ECOFAB COVERS INTERNATIONAL INC. (BARBADOS CORPORATION)  
WHITEPARK HOUSE, WHITE PARK ROAD  
BRIDGETOWN, BARBADOS

FOR: FITTED COVERS FOR VEHICLES, NAMELY, FITTED COVERS FOR RAIL VEHICLES;  
STRUCTURAL PARTS FOR RAIL VEHICLES, IN CLASS 12 (U.S. CLS. 19, 21, 23, 31, 35 AND  
44).

FIRST USE 4-16-2010; IN COMMERCE 4-16-2010.

FOR: INSTALLATION, REMOVAL, AND MAINTENANCE OF RAIL VEHICLE COVERS;  
RAIL VEHICLE FLEET MANAGEMENT, NAMELY, VEHICLE REPAIR AND MAINTENANCE,  
IN CLASS 37 (U.S. CLS. 100, 103 AND 106).

FIRST USE 3-4-2010; IN COMMERCE 3-4-2010.

THE MARK CONSISTS OF THE WORDING "ECOFAB" IN LOWERCASE LETTERS WITH  
AN ARC CURVED AROUND THE BEGINNING OF THE WORDING TO THE LEFT. TO THE  
RIGHT OF THE WORDING "ECOFAB" IS THE WORDING "FLEXCOVER" IN CAPITAL  
LETTERS. CENTERED ABOVE ALL OF THE WORDING ARE THREE CONJOINED CURVED  
PLANAR ELEMENTS.

SN 85-027,614, FILED 4-30-2010.

KATINA MISTER, EXAMINING ATTORNEY



*David J. Kybas*

Director of the United States Patent and Trademark Office

# United States of America

United States Patent and Trademark Office

## Culligan Cares

**Reg. No. 4,198,966**

**Registered Aug. 28, 2012**

**Int. Cl.: 35**

**SERVICE MARK**

**PRINCIPAL REGISTER**

CULLIGAN INTERNATIONAL COMPANY (DELAWARE CORPORATION)  
SUITE 1100  
9399 W. HIGGINS ROAD  
ROSEMONT, IL 60018

FOR: CHARITABLE SERVICES, NAMELY, ORGANIZING AND CONDUCTING VOLUNTEER PROGRAMS AND COMMUNITY SERVICE PROJECTS, IN CLASS 35 (U.S. CLS. 100, 101 AND 102).

FIRST USE 4-30-2010; IN COMMERCE 12-1-2010.

THE MARK CONSISTS OF STANDARD CHARACTERS WITHOUT CLAIM TO ANY PARTICULAR FONT, STYLE, SIZE, OR COLOR.

OWNER OF U.S. REG. NOS. 1,008,612, 1,588,702, AND OTHERS.

SN 85-027,726, FILED 4-30-2010.

JULIE VEPPUMTHARA, EXAMINING ATTORNEY



*David J. Kybas*

Director of the United States Patent and Trademark Office

# United States of America

United States Patent and Trademark Office

## CONSTELLATION

**Reg. No. 4,198,967**

**Registered Aug. 28, 2012**

**Int. Cls.: 9, 41, and 42**

**TRADEMARK**

**SERVICE MARK**

**PRINCIPAL REGISTER**

BRIDGEPOINT EDUCATION, INC. (DELAWARE CORPORATION)  
13500 EVENING CREEK DRIVE N.  
SUITE 600  
SAN DIEGO, CA 92128

FOR: EDUCATIONAL PUBLICATIONS, NAMELY, ELECTRONIC DOWNLOADABLE TEXT BOOKS, WORKBOOKS AND WRITTEN COURSE MATERIALS FOR USE WITH COURSES OF INSTRUCTION IN THE FIELDS OF BUSINESS, MANAGEMENT, EDUCATION, PSYCHOLOGY, SOCIAL SCIENCES AND HEALTH SCIENCES AT THE POST-SECONDARY, UNDERGRADUATE AND GRADUATE LEVEL FOR DOWNLOAD TO WEB-ENABLED CELL PHONES AND OTHER PORTABLE ELECTRONIC DEVICES AS WELL AS COMPUTER HARD DRIVES, IN CLASS 9 (U.S. CLS. 21, 23, 26, 36 AND 38).

FIRST USE 7-1-2011; IN COMMERCE 7-1-2011.

FOR: EDUCATIONAL SERVICES IN THE NATURE OF PROVIDING ELECTRONIC NON-DOWNLOADABLE TEXT BOOKS, WORKBOOKS AND WRITTEN COURSE MATERIALS FOR USE WITH COURSES OF INSTRUCTIONS IN THE FIELDS OF BUSINESS, MANAGEMENT, EDUCATION, PSYCHOLOGY, SOCIAL SCIENCES AND HEALTH SCIENCES AT THE POST-SECONDARY, UNDERGRADUATE AND GRADUATE LEVEL, IN CLASS 41 (U.S. CLS. 100, 101 AND 107).

FIRST USE 4-29-2010; IN COMMERCE 4-29-2010.

FOR: PROVIDING TEMPORARY USE OF ONLINE NON-DOWNLOADABLE SOFTWARE IN THE NATURE OF A BROWSER-BASED NON-DOWNLOADABLE READER WHICH DISPLAYS, AND ALLOWS THE DOWNLOAD OF, WEB-BASED TEXTBOOKS AND WORKBOOKS AT THE POST-SECONDARY, UNDERGRADUATE AND GRADUATE LEVELS, IN CLASS 42 (U.S. CLS. 100 AND 101).

FIRST USE 4-29-2010; IN COMMERCE 4-29-2010.

THE MARK CONSISTS OF STANDARD CHARACTERS WITHOUT CLAIM TO ANY PARTICULAR FONT, STYLE, SIZE, OR COLOR.

SN 85-027,917, FILED 4-30-2010.



*David J. Kyffers*

Director of the United States Patent and Trademark Office

**Reg. No. 4,198,967** BARBARA BROWN, EXAMINING ATTORNEY



# United States of America

United States Patent and Trademark Office

POWERED BY ALGAE.  
APPROVED BY NATURE.

**Reg. No. 4,198,968**

AGSMART, INC. (COLORADO CORPORATION)

**Registered Aug. 28, 2012**

P.O. BOX 329  
STRASBURG, CO 80136

**Int. Cl.: 42**

FOR: ENGINEERING, RESEARCH, DESIGN AND DEVELOPMENT OF TECHNOLOGIES FOR THE IMPLEMENTATION OF WASTE WATER TREATMENT SOLUTIONS, AND CONSULTATION SERVICES RELATED THERETO , IN CLASS 42 (U.S. CLS. 100 AND 101).

**SERVICE MARK**

FIRST USE 5-15-2012; IN COMMERCE 5-15-2012.

**PRINCIPAL REGISTER**

THE MARK CONSISTS OF STANDARD CHARACTERS WITHOUT CLAIM TO ANY PARTICULAR FONT, STYLE, SIZE, OR COLOR.

SN 85-030,532, FILED 5-5-2010.

BRENDAN MCCAULEY, EXAMINING ATTORNEY



*David J. Kyffers*

Director of the United States Patent and Trademark Office

# United States of America

United States Patent and Trademark Office

# Knocksteady

**Reg. No. 4,198,969**

**Registered Aug. 28, 2012**

**Int. Cls.: 25 and 41**

**TRADEMARK**

**SERVICE MARK**

**PRINCIPAL REGISTER**

KNOCKSTEADY (CALIFORNIA PARTNERSHIP)  
#101  
2505 W 6TH STREET  
LOS ANGELES, CA 90057

FOR: CLOTHING, NAMELY, BASEBALL CAPS AND HATS, BEANIES, CREW NECK SWEATERS, CREW NECKS, DENIMS, HEADWEAR, HOODED PULLOVERS, HOODED SWEAT SHIRTS, HOODS, JACKETS, KNIT SHIRTS, KNITTED CAPS, PANTS, POLO KNIT TOPS, POLO SHIRTS, SHIRTS, SHIRTS AND SHORT-SLEEVED SHIRTS, SHORTS, SHORT-SLEEVED OR LONG-SLEEVED T-SHIRTS, SKULL CAPS, SKULLIES, SWEAT JACKETS, SWEAT SHIRTS, SWEATERS, TANK TOPS, IN CLASS 25 (U.S. CLS. 22 AND 39).

FIRST USE 8-7-2010; IN COMMERCE 10-29-2010.

FOR: MUSIC PRODUCTION SERVICES; PRODUCTION OF MUSICAL SOUND RECORDING; RECORDING STUDIO SERVICES; MUSIC PUBLISHING SERVICES; MULTIMEDIA ENTERTAINMENT SERVICES IN THE NATURE OF RECORDING, PRODUCTION AND POST-PRODUCTION SERVICES IN THE FIELDS OF MUSIC, VIDEO, AND FILMS; FAN CLUBS; PROVIDING AN INTERNET WEBSITE PORTAL FEATURING LINKS TO MUSICAL ARTIST WEBSITES AND MUSIC PERFORMANCE TICKET INFORMATION; ENTERTAINMENT SERVICES, NAMELY, PROVIDING A WEB SITE FEATURING NON-DOWNLOADABLE MUSICAL PERFORMANCES, MUSICAL VIDEOS, RELATED FILM CLIPS, PHOTOGRAPHS, AND OTHER MULTIMEDIA MATERIALS FEATURING MUSIC, IN CLASS 41 (U.S. CLS. 100, 101 AND 107).

FIRST USE 8-7-2010; IN COMMERCE 10-29-2010.

THE MARK CONSISTS OF STANDARD CHARACTERS WITHOUT CLAIM TO ANY PARTICULAR FONT, STYLE, SIZE, OR COLOR.

SN 85-033,527, FILED 5-7-2010.

Laurie Kaufman, Examining Attorney



*David J. Kyffers*

Director of the United States Patent and Trademark Office

# United States of America

United States Patent and Trademark Office

## LIVING COLOR

**Reg. No. 4,198,970**

JOHNSON & JOHNSON (NEW JERSEY CORPORATION)  
ONE JOHNSON & JOHNSON PLAZA  
NEW BRUNSWICK, NJ 089337001

**Registered Aug. 28, 2012**

**Int. Cl.: 3**

FOR: HAIR CARE PREPARATIONS, NAMELY, SHAMPOO, CONDITIONER, IN CLASS 3  
(U.S. CLS. 1, 4, 6, 50, 51 AND 52).

**TRADEMARK**

FIRST USE 1-12-2011; IN COMMERCE 1-12-2011.

**PRINCIPAL REGISTER**

THE MARK CONSISTS OF STANDARD CHARACTERS WITHOUT CLAIM TO ANY PARTICULAR FONT, STYLE, SIZE, OR COLOR.

NO CLAIM IS MADE TO THE EXCLUSIVE RIGHT TO USE "COLOR", APART FROM THE MARK AS SHOWN.

SN 85-033,870, FILED 5-10-2010.

BRENDAN MCCAULEY, EXAMINING ATTORNEY



*David J. Kyffers*

Director of the United States Patent and Trademark Office

# United States of America

United States Patent and Trademark Office

## FLIGHT CENTER.com

the world's airfare experts

**Reg. No. 4,198,971**

FLIGHT CENTRE LIMITED (AUSTRALIA LIMITED COMPANY (LTD.))  
LEVEL 2, 545 QUEEN STREET

**Registered Aug. 28, 2012**

BRISBANE, QUEENSLAND, AUSTRALIA 4000

**Int. Cls.: 39 and 43**

FOR: TRAVEL SERVICES BEING SERVICES OFFERED BY TRAVEL AGENTS, NAMELY, PASSENGER TRANSPORT SERVICES; AIR TRAVEL SERVICES, NAMELY, ARRANGING AIR TRANSPORTATION; CAR HIRE SERVICES, NAMELY, ARRANGING CAR TRANSPORT AND RENTAL OF CARS; ROAD TRANSPORT SERVICES, NAMELY, ARRANGING BUS TRANSPORT AND BUS CHARTERING; RAILWAY TRANSPORT SERVICES; SEA TRANSPORT SERVICES, NAMELY, ARRANGING OF BOAT CRUISES, ORGANISING CRUISES, BOAT CHARTERING, PASSENGER SHIP TRANSPORT, FERRY-BOAT TRANSPORT AND RENTAL OF BOATS; TRAVEL AGENCY SERVICES, NAMELY, BOOKING AND RESERVATION OF TRAVEL SERVICES FOR TRANSPORTATION; TRAVEL TICKET RESERVATION SERVICES; TOURIST AGENCY SERVICES, NAMELY, PROVIDING TRAVEL AND TOUR INFORMATION; ORGANIZING SIGHTSEEING TOUR AND CRUISE ARRANGING SERVICES; ARRANGING TRAVEL, CAR RENTAL, TOURS AND CRUISES FOR PACKAGE HOLIDAYS; AIR TRANSPORT SERVICES; TRANSPORT AND DELIVERY OF GOODS; TRAVEL AND TOURIST AGENCY SERVICES, NAMELY, ONLINE SERVICES OF SEARCHING FOR, RESERVING AND BOOKING TRAVEL; TRAVEL AND TOUR INFORMATION SERVICES, IN CLASS 39 (U.S. CLS. 100 AND 105).

**SERVICE MARK**

**PRINCIPAL REGISTER**

FIRST USE 3-1-2010; IN COMMERCE 3-1-2010.



FOR: TRAVEL AND TOURIST AGENCY SERVICES, NAMELY, ONLINE SERVICES OF SEARCHING FOR, RESERVING AND BOOKING ACCOMMODATION FOR TEMPORARY LODGING; TRAVEL AGENCY SERVICES, NAMELY, ARRANGING TEMPORARY ACCOMMODATION FOR PACKAGE HOLIDAYS; PROVIDING TRAVEL LODGING INFORMATION SERVICES AND TRAVEL LODGING BOOKING AGENCY SERVICES FOR TRAVELLERS, IN CLASS 43 (U.S. CLS. 100 AND 101).

FIRST USE 3-1-2010; IN COMMERCE 3-1-2010.

OWNER OF U.S. REG. NOS. 3,242,588 AND 3,382,244.

*David J. Kyffers*

NO CLAIM IS MADE TO THE EXCLUSIVE RIGHT TO USE "FLIGHT CENTER.COM", APART FROM THE MARK AS SHOWN.

**Reg. No. 4,198,971** THE MARK CONSISTS OF THE WORDS "FLIGHT CENTER.COM THE WORLD'S AIRFARE EXPERTS" WITH THE TERM ".COM" POSITIONED VERTICALLY TO THE RIGHT OF THE WORD "CENTER" AND THE WORDS "THE WORLD'S AIRFARE EXPERTS" RIGHT JUSTIFIED AND POSITIONED UNDERNEATH THE WORDS "FLIGHT CENTER.COM".

SN 85-036,053, FILED 5-12-2010.

CHRISTINA SOBRAL, EXAMINING ATTORNEY

# United States of America

United States Patent and Trademark Office



**Reg. No. 4,198,972**

ID SOFTWARE LLC (DELAWARE LIMITED LIABILITY COMPANY)  
1500 NORTH GREENVILLE AVE, FLOOR 7  
RICHARDSON, TX 75081

**Registered Aug. 28, 2012**

**Int. Cls.: 9 and 16**

FOR: DOWNLOADABLE PUBLICATIONS, NAMELY, COMPUTER AND VIDEO GAME STRATEGY GUIDES, IN CLASS 9 (U.S. CLS. 21, 23, 26, 36 AND 38).

**TRADEMARK**

FIRST USE 10-4-2011; IN COMMERCE 10-4-2011.

**PRINCIPAL REGISTER**

FOR: COMPUTER AND VIDEO GAME USER INSTRUCTION MANUALS; MAGAZINES, BOOKS, AND PAMPHLETS CONCERNING VIDEO GAMES; PRINTED GUIDES FEATURING COMPUTER AND VIDEO GAME STRATEGY, IN CLASS 16 (U.S. CLS. 2, 5, 22, 23, 29, 37, 38 AND 50).

FIRST USE 10-4-2011; IN COMMERCE 10-4-2011.

THE MARK CONSISTS OF THE STYLIZED WORD "RAGE" WHERE THE LETTER "A" APPEARS TO BE THE CENTER OF AN IMPACT THAT CREATES A SHATTERING OR CRACKING EFFECT UPON THE OTHER LETTERS IN THE MARK.

SN 85-037,275, FILED 5-13-2010.

CHRISTINE COOPER, EXAMINING ATTORNEY



*David J. Kyros*

Director of the United States Patent and Trademark Office

# United States of America

United States Patent and Trademark Office

# MARIKO

**Reg. No. 4,198,973**

**Registered Aug. 28, 2012**

**Int. Cl.: 30**

**TRADEMARK**

**PRINCIPAL REGISTER**

MARIKO FOOD CORPORATION (WASHINGTON CORPORATION)  
P.O. BOX 1724  
MERCER ISLAND, WA 98040

FOR: CHILI PASTE FOR USE AS A SEASONING; CHILI SAUCE; CONDIMENT, NAMELY, PEPPER SAUCE; DIPPING SAUCES; FRUIT SAUCES EXCLUDING CRANBERRY SAUCE AND APPLESAUCE; HOT SAUCE; MARINADES; PASTA SAUCE; RELISH; SAUCES; SEASONING PASTES; SPAGHETTI SAUCE; TEA; TOMATO SAUCE, IN CLASS 30 (U.S. CL. 46).

FIRST USE 7-0-2010; IN COMMERCE 11-0-2010.

THE MARK CONSISTS OF STANDARD CHARACTERS WITHOUT CLAIM TO ANY PARTICULAR FONT, STYLE, SIZE, OR COLOR.

THE WORDING "MARIKO" HAS NO MEANING IN A FOREIGN LANGUAGE.

SN 85-037,593, FILED 5-13-2010.

PAM WILLIS, EXAMINING ATTORNEY



*David J. Kypos*

Director of the United States Patent and Trademark Office

# United States of America

United States Patent and Trademark Office

## TRANSFORMING THE LANDSCAPE OF PRINT

**Reg. No. 4,198,974**

**Registered Aug. 28, 2012**

**Int. Cls.: 40 and 41**

**SERVICE MARK**

**PRINCIPAL REGISTER**

HERITAGE PRESERVATION CORPORATION (SOUTH CAROLINA CORPORATION)  
145 N. CHURCH STREET, #32  
SPARTANBURG, SC 29306

FOR: PROVIDING CUSTOMIZED DIGITAL ON-DEMAND PRINTING SERVICES OF DOCUMENTS IN THE FIELD OF COMMERCIAL PRINTING, IN CLASS 40 (U.S. CLS. 100, 103 AND 106).

FIRST USE 5-2-2012; IN COMMERCE 5-2-2012.

FOR: PUBLICATION OF CUSTOMIZED, PRINTED DOCUMENTS FOR OTHERS, IN CLASS 41 (U.S. CLS. 100, 101 AND 107).

FIRST USE 5-2-2012; IN COMMERCE 5-2-2012.

THE MARK CONSISTS OF STANDARD CHARACTERS WITHOUT CLAIM TO ANY PARTICULAR FONT, STYLE, SIZE, OR COLOR.

SN 85-038,874, FILED 5-14-2010.

ANN E. SAPPENFIELD, EXAMINING ATTORNEY



*David J. Kybas*

Director of the United States Patent and Trademark Office



# United States of America

United States Patent and Trademark Office

## GUEST FOCUSED CARE

**Reg. No. 4,198,975**

HKS, INC. (TEXAS CORPORATION)  
1919 MCKINNEY AVENUE  
DALLAS, TX 75201

**Registered Aug. 28, 2012**

**Int. Cl.: 42**

FOR: ARCHITECTURAL AND ENGINEERING SERVICES, IN CLASS 42 (U.S. CLS. 100 AND 101).

**SERVICE MARK**

FIRST USE 6-7-2012; IN COMMERCE 6-7-2012.

**PRINCIPAL REGISTER**

THE MARK CONSISTS OF STANDARD CHARACTERS WITHOUT CLAIM TO ANY PARTICULAR FONT, STYLE, SIZE, OR COLOR.

SN 85-041,494, FILED 5-18-2010.

SKYE YOUNG, EXAMINING ATTORNEY



*David J. Kybas*

Director of the United States Patent and Trademark Office

# United States of America

United States Patent and Trademark Office

## SMARTPHONE LOCKER

**Reg. No. 4,198,976**

WITZ SPORT CASES, INC. (CALIFORNIA CORPORATION)  
11282 PYRITES WAY  
GOLD RIVER, CA 95670

**Registered Aug. 28, 2012**

**Int. Cl.: 9**

FOR: PLASTIC BUOYANT WATERPROOF CASES FOR SMARTPHONES AND VALUABLES IN THE NATURE OF CAMERAS AND PORTABLE AUDIO PLAYERS, IN CLASS 9 (U.S. CLS. 21, 23, 26, 36 AND 38).

**TRADEMARK**

FIRST USE 6-18-2012; IN COMMERCE 6-18-2012.

**PRINCIPAL REGISTER**

THE MARK CONSISTS OF STANDARD CHARACTERS WITHOUT CLAIM TO ANY PARTICULAR FONT, STYLE, SIZE, OR COLOR.

OWNER OF U.S. REG. NO. 2,552,097.

NO CLAIM IS MADE TO THE EXCLUSIVE RIGHT TO USE "SMARTPHONE", APART FROM THE MARK AS SHOWN.

SN 85-041,820, FILED 5-18-2010.

MICHAEL KEATING, EXAMINING ATTORNEY



*David J. Kybas*

Director of the United States Patent and Trademark Office

# United States of America

United States Patent and Trademark Office

## KANSAS CITY SARSAPARILLA

**Reg. No. 4,198,977**

C-B BEVERAGE CORPORATION (MINNESOTA CORPORATION)  
1523 ALUM CREEK DRIVE  
COLUMBUS, OH 43209

**Registered Aug. 28, 2012**

**Int. Cl.: 32**

FOR: SOFT DRINK SYRUP, IN CLASS 32 (U.S. CLS. 45, 46 AND 48).

**TRADEMARK**

FIRST USE 11-2-1988; IN COMMERCE 11-2-1988.

**PRINCIPAL REGISTER**

THE MARK CONSISTS OF STANDARD CHARACTERS WITHOUT CLAIM TO ANY PARTICULAR FONT, STYLE, SIZE, OR COLOR.

NO CLAIM IS MADE TO THE EXCLUSIVE RIGHT TO USE "SARSAPARILLA", APART FROM THE MARK AS SHOWN.

SN 85-043,875, FILED 5-20-2010.

LAURIE MAYES, EXAMINING ATTORNEY



*David J. Kyffers*

Director of the United States Patent and Trademark Office

# United States of America

United States Patent and Trademark Office

## FOODPOLIS

**Reg. No. 4,198,978**

**Registered Aug. 28, 2012**

**Int. Cls.: 35 and 42**

**SERVICE MARK**

**PRINCIPAL REGISTER**

MINISTRY FOR FOOD, AGRICULTURE, FORESTRY AND FISHERIES OF REPUBLIC OF KOREA (REPUBLIC OF KOREA DEPARTMENT OF REPUBLIC OF KOREA)  
2-DONG, GUANMUN-RO 88, GWACHEON  
GYEONGGI-DO, REPUBLIC OF KOREA

FOR: MODELING FOR ADVERTISING OR SALES PROMOTION; DISTRIBUTION OF ADVERTISEMENTS AND COMMERCIAL ANNOUNCEMENTS; LAYOUT SERVICES FOR ADVERTISING PURPOSES; BUSINESS MARKETING CONSULTING SERVICES; CORPORATE ADVERTISEMENT AND PROMOTION; MARKETING CONSULTING; BUSINESS MARKETING SERVICES; ORGANIZATION OF TRADE FAIRS FOR COMMERCIAL OR ADVERTISING PURPOSES; ORGANIZATION OF EXHIBITIONS FOR COMMERCIAL OR ADVERTISING PURPOSES; DISTRIBUTION OF SAMPLES FOR ADVERTISING PURPOSES; DEMONSTRATION OF GOODS, NAMELY, PRODUCT DEMONSTRATION; PUBLIC RELATIONS; PRESENTATION OF GOODS ON COMMUNICATION MEDIA, FOR RETAIL PURPOSES; SHOP WINDOW DRESSING; DISTRIBUTION OF PROSPECTUSES AND SAMPLES; RENTAL OF ADVERTISING SPACE ON WEB SITES; SALES PROMOTION FOR OTHERS; CONSULTANCY RELATING TO PUBLIC RELATIONS; PRICE COMPARISON SERVICES; BUSINESS MANAGEMENT ASSISTANCE; BUSINESS MANAGEMENT CONSULTANCY; RELOCATION SERVICES FOR BUSINESSES; COST PRICE ANALYSIS; COST ASSESSMENT SERVICES; PROVIDING OF BUSINESS INFORMATION; COMMERCIAL ADMINISTRATION OF THE LICENSING OF THE GOODS AND SERVICES OF OTHERS; PROVISION OF COMMERCIAL INFORMATION VIA THE INTERNET; ADMINISTRATIVE PROCESSING OF PURCHASE ORDERS; IMPORT-EXPORT AGENCIES, IN CLASS 35 (U.S. CLS. 100, 101 AND 102).

FIRST USE 1-1-2010; IN COMMERCE 12-1-2011.

FOR: STANDARD AUTHENTICATION, NAMELY, DEVELOPING AND TESTING STANDARDS FOR FOODSTUFFS FOR THE PURPOSES OF ACCREDITATION; INSPECTION OF FOODSTUFFS; INSPECTION OF FOODSTUFFS MATERIALS; PRODUCT SAFETY TESTING; ANALYSIS OF FOOD INGREDIENTS; FOOD RESEARCH, IN CLASS 42 (U.S. CLS. 100 AND 101).

FIRST USE 1-1-2010; IN COMMERCE 12-1-2011.

THE MARK CONSISTS OF THE WORDING "FOODPOLIS" IN CHOCOLATE BROWN BLOCK LETTERING.



*David J. Kyffers*

Director of the United States Patent and Trademark Office

**Reg. No. 4,198,978** THE COLOR(S) CHOCOLATE BROWN IS/ARE CLAIMED AS A FEATURE OF THE MARK.

SN 85-043,886, FILED 5-20-2010.

SEAN CROWLEY, EXAMINING ATTORNEY

# United States of America

United States Patent and Trademark Office



**Reg. No. 4,198,979**

**Registered Aug. 28, 2012**

**Int. Cls.: 35 and 42**

**SERVICE MARK**

**PRINCIPAL REGISTER**

MINISTRY FOR FOOD, AGRICULTURE, FORESTRY AND FISHERIES OF REPUBLIC OF KOREA (REPUBLIC OF KOREA DEPARTMENT OF REPUBLIC OF KOREA)  
2-DONG, GUANMUN-RO 88, GWACHEON  
GYEONGGI-DO, REPUBLIC OF KOREA

FOR: MODELING FOR ADVERTISING OR SALES PROMOTION; DISTRIBUTION OF ADVERTISEMENTS AND COMMERCIAL ANNOUNCEMENTS; LAYOUT SERVICES FOR ADVERTISING PURPOSES; BUSINESS MARKETING CONSULTING SERVICES; CORPORATE ADVERTISEMENT AND PROMOTION; MARKETING CONSULTING; BUSINESS MARKETING SERVICES; ORGANIZATION OF TRADE FAIRS FOR COMMERCIAL OR ADVERTISING PURPOSES; ORGANIZATION OF EXHIBITIONS FOR COMMERCIAL OR ADVERTISING PURPOSES; DISTRIBUTION OF SAMPLES FOR ADVERTISING PURPOSES; DEMONSTRATION OF GOODS, NAMELY, PRODUCT DEMONSTRATION; PUBLIC RELATIONS; PRESENTATION OF GOODS ON COMMUNICATION MEDIA, FOR RETAIL PURPOSES; SHOP WINDOW DRESSING; DISTRIBUTION OF PROSPECTUSES AND SAMPLES; RENTAL OF ADVERTISING SPACE ON WEB SITES; SALES PROMOTION FOR OTHERS; CONSULTANCY RELATING TO PUBLIC RELATIONS; PRICE COMPARISON SERVICES; BUSINESS MANAGEMENT ASSISTANCE; BUSINESS MANAGEMENT CONSULTANCY; RELOCATION SERVICES FOR BUSINESSES; COST PRICE ANALYSIS; COST ASSESSMENT SERVICES; PROVIDING OF BUSINESS INFORMATION; COMMERCIAL ADMINISTRATION OF THE LICENSING OF THE GOODS AND SERVICES OF OTHERS; PROVISION OF COMMERCIAL INFORMATION VIA THE INTERNET; ADMINISTRATIVE PROCESSING OF PURCHASE ORDERS; IMPORT-EXPORT AGENCIES, IN CLASS 35 (U.S. CLS. 100, 101 AND 102).

FIRST USE 1-1-2010; IN COMMERCE 12-1-2011.

FOR: STANDARD AUTHENTICATION, NAMELY, DEVELOPING AND TESTING STANDARDS FOR FOODSTUFFS FOR THE PURPOSES OF ACCREDITATION; INSPECTION OF FOODSTUFFS; INSPECTION OF FOODSTUFFS MATERIALS; PRODUCT SAFETY TESTING; ANALYSIS OF FOOD INGREDIENTS; FOOD RESEARCH, IN CLASS 42 (U.S. CLS. 100 AND 101).

FIRST USE 1-1-2010; IN COMMERCE 12-1-2011.

THE MARK CONSISTS OF A DEVICE THAT REPRESENTS SIX PANEL SECTIONS OF AN OPENED ORIENTAL STYLE HAND FAN OR SIMILAR TO AN UPPER HALF MOON SHAPE



*David J. Kyjars*

Director of the United States Patent and Trademark Office

**Reg. No. 4,198,979** WITH A NOTCH AT ITS BASE. THE FIRST FAN SECTION APPEARS IN SALMON AND RED; THE SECOND SECTION APPEARS IN YELLOW AND DARK ORANGE; THE THIRD SECTION APPEARS IN GREEN AND FOREST GREEN; THE FOURTH SECTION APPEARS IN CORNFLOWER BLUE AND STEEL BLUE; THE FIFTH SECTION APPEARS IN ROYAL BLUE AND BLUE; AND, THE SIXTH SECTION APPEARS IN MAGENTA AND CHOCOLATE BROWN.

THE COLOR(S) SALMON AND RED, YELLOW AND DARK ORANGE, GREEN AND FOREST GREEN, CORNFLOWER BLUE AND STEEL BLUE, ROYAL BLUE AND BLUE, MAGENTA AND DEEP MAGENTA AND CHOCOLATE BROWN IS/ARE CLAIMED AS A FEATURE OF THE MARK.

SN 85-043,958, FILED 5-20-2010.

SEAN CROWLEY, EXAMINING ATTORNEY

# United States of America

United States Patent and Trademark Office



## FOODPOLIS

KOREA NATIONAL FOOD CLUSTER

**Reg. No. 4,198,980**

**Registered Aug. 28, 2012**

**Int. Cls.: 35 and 42**

**SERVICE MARK**

**PRINCIPAL REGISTER**

MINISTRY FOR FOOD, AGRICULTURE, FORESTRY AND FISHERIES OF REPUBLIC OF KOREA (REPUBLIC OF KOREA DEPARTMENT OF REPUBLIC OF KOREA)  
2-DONG, GUANMUN-RO 88, GWACHEON  
GYEONGGI-DO, REPUBLIC OF KOREA

FOR: MODELING FOR ADVERTISING OR SALES PROMOTION; DISTRIBUTION OF ADVERTISEMENTS AND COMMERCIAL ANNOUNCEMENTS; LAYOUT SERVICES FOR ADVERTISING PURPOSES; BUSINESS MARKETING CONSULTING SERVICES; CORPORATE ADVERTISEMENT AND PROMOTION; MARKETING CONSULTING; BUSINESS MARKETING SERVICES; ORGANIZATION OF TRADE FAIRS FOR COMMERCIAL OR ADVERTISING PURPOSES; ORGANIZATION OF EXHIBITIONS FOR COMMERCIAL OR ADVERTISING PURPOSES; DISTRIBUTION OF SAMPLES FOR ADVERTISING PURPOSES; DEMONSTRATION OF GOODS, NAMELY, PRODUCT DEMONSTRATION; PUBLIC RELATIONS; PRESENTATION OF GOODS ON COMMUNICATION MEDIA, FOR RETAIL PURPOSES; SHOP WINDOW DRESSING; DISTRIBUTION OF PROSPECTUSES AND SAMPLES; RENTAL OF ADVERTISING SPACE ON WEB SITES; SALES PROMOTION FOR OTHERS; CONSULTANCY RELATING TO PUBLIC RELATIONS; PRICE COMPARISON SERVICES; BUSINESS MANAGEMENT ASSISTANCE; BUSINESS MANAGEMENT CONSULTANCY; RELOCATION SERVICES FOR BUSINESSES; COST PRICE ANALYSIS; COST ASSESSMENT SERVICES; PROVIDING OF BUSINESS INFORMATION; COMMERCIAL ADMINISTRATION OF THE LICENSING OF THE GOODS AND SERVICES OF OTHERS; PROVISION OF COMMERCIAL INFORMATION VIA THE INTERNET; ADMINISTRATIVE PROCESSING OF PURCHASE ORDERS; IMPORT-EXPORT AGENCIES, IN CLASS 35 (U.S. CLS. 100, 101 AND 102).

FIRST USE 1-1-2010; IN COMMERCE 12-1-2011.

FOR: STANDARD AUTHENTICATION, NAMELY, DEVELOPING AND TESTING STANDARDS FOR FOODSTUFFS FOR THE PURPOSES OF ACCREDITATION; INSPECTION OF FOODSTUFFS; INSPECTION OF FOODSTUFFS MATERIALS; PRODUCT SAFETY TESTING; ANALYSIS OF FOOD INGREDIENTS; FOOD RESEARCH, IN CLASS 42 (U.S. CLS. 100 AND 101).

FIRST USE 1-1-2010; IN COMMERCE 12-1-2011.

NO CLAIM IS MADE TO THE EXCLUSIVE RIGHT TO USE "KOREA NATIONAL FOOD CLUSTER", APART FROM THE MARK AS SHOWN.



*David J. Kyjars*

Director of the United States Patent and Trademark Office



**Reg. No. 4,198,980** THE COLOR(S) SALMON AND RED, YELLOW AND DARK ORANGE, GREEN AND FOREST GREEN, CORNFLOWER BLUE AND STEEL BLUE, ROYAL BLUE AND BLUE, MAGENTA AND DEEP MAGENTA AND CHOCOLATE BROWN IS/ARE CLAIMED AS A FEATURE OF THE MARK.

THE MARK CONSISTS OF A DEVICE THAT REPRESENTS SIX PANEL SECTIONS OF AN OPENED ORIENTAL STYLE HAND FAN OR SIMILAR TO AN UPPER HALF MOON SHAPE WITH A NOTCH AT ITS BASE. THE SIX SECTIONS ARE SEPARATED FROM EACH OTHER BY A THIN VERTICAL WHITE SPACE OR RAY. STARTING FROM LEFT NO. 1 TO RIGHT NO. 6, EACH OF THE SIX PANELS IS PANTONE BI-COLORED IN UPPER AND LOWER SECTIONS RESPECTIVELY AS FOLLOWS: NO. 1 SALMON/RED, NO. 2 YELLOW/DARK ORANGE, NO. 3 GREEN/FOREST GREEN, NO. 4 CORNFLOWER BLUE/STEEL BLUE, NO. 5 ROYAL BLUE/BLUE, AND NO. 6 MAGENTA/DEEP MAGENTA. FINALLY, AN IRREGULAR CURVING LINE BISECTS ALL SIX SECTIONS INTO THE RESPECTIVE TWO PANTONES PER SECTION. THE BISECTING CURVE STARTS AT SECTION NO. 1 AND PROGRESSES TO NO. 6 AS FOLLOWS: IT STARTS IN THE LEFT CORNER OF NO. 1 AND CURVES SLIGHTLY CONCAVE THROUGH THE LOWER SECTIONS OF NOS. 2 AND 3. FROM NO. 4 THROUGH NO. 6 SECTIONS THE CURVE IS CONVEX STARTING AT THE MIDDLE NO. 3 AND FINISHING THE RIGHT MOST TIP OF NO. 6. THE WORDS "FOOD-POLIS KOREA NATIONAL FOOD CLUSTER" ARE CHOCOLATE BROWN .

SN 85-043,994, FILED 5-20-2010.

SEAN CROWLEY, EXAMINING ATTORNEY

# United States of America

United States Patent and Trademark Office

## PRO CONTROL

**Reg. No. 4,198,981**

**Registered Aug. 28, 2012**

**Int. Cl.: 9**

**TRADEMARK**

**PRINCIPAL REGISTER**

REMOTE TECHNOLOGIES INCORPORATED (MINNESOTA CORPORATION)  
5775 12TH AVE. EAST  
SUITE 180  
SHAKOPEE, MN 55379

FOR: HOME AUTOMATION SYSTEMS COMPRISING WIRELESS AND WIRED CONTROLLERS, CONTROL PROCESSORS, CONTROLLED DEVICES, AND SOFTWARE FOR LIGHTING, HVAC, SECURITY, SAFETY, AUDIO, VISUAL, AND OTHER HOME CONTROL APPLICATIONS, SPECIFICALLY EXCLUDING ENERGY AND UTILITIES, INDUSTRIAL, AND MANUFACTURING USES, IN CLASS 9 (U.S. CLS. 21, 23, 26, 36 AND 38).

FIRST USE 12-23-2011; IN COMMERCE 12-23-2011.

THE MARK CONSISTS OF STANDARD CHARACTERS WITHOUT CLAIM TO ANY PARTICULAR FONT, STYLE, SIZE, OR COLOR.

NO CLAIM IS MADE TO THE EXCLUSIVE RIGHT TO USE "CONTROL", APART FROM THE MARK AS SHOWN.

SN 85-044,681, FILED 5-21-2010.

NAPOLEON SHARMA, EXAMINING ATTORNEY



*David J. Kyros*

Director of the United States Patent and Trademark Office

# United States of America

United States Patent and Trademark Office

# AMIGO

**Reg. No. 4,198,982**

**Registered Aug. 28, 2012**

**Int. Cl.: 10**

**TRADEMARK**

**PRINCIPAL REGISTER**

CATHETER ROBOTICS, INC. (NEW JERSEY CORPORATION)  
SUITE 255  
500 INTERNATIONAL DRIVE  
BUDD LAKE, NJ 07828

FOR: MEDICAL DEVICE NOT FOR USE WITH INSULIN PUMPS, NAMELY, A TELE-ROBOTIC SYSTEM CONSISTING OF A MOTORIZED CATHETER POSITIONER HAVING ROTATIONAL AND TRANSLATIONAL MOVEMENT CAPABILITY AND A TELE-ROBOTIC CONTROLLER WITH ROTATION, TRANSLATION AND DEFLECTION CONTROL BUTTONS, TO FACILITATE REMOTE CATHETERIZATIONS, IN CLASS 10 (U.S. CLS. 26, 39 AND 44).

FIRST USE 6-18-2012; IN COMMERCE 6-18-2012.

THE MARK CONSISTS OF STANDARD CHARACTERS WITHOUT CLAIM TO ANY PARTICULAR FONT, STYLE, SIZE, OR COLOR.

SN 85-045,034, FILED 5-21-2010.

SUZANNE BLANE, EXAMINING ATTORNEY



*David J. Kyros*

Director of the United States Patent and Trademark Office

# United States of America

United States Patent and Trademark Office

# CARDBUILD

**Reg. No. 4,198,983**

HAROLD WELLS ASSOCIATES, INC. (CALIFORNIA CORPORATION)  
2101 W. CRESCENT AVE. #J  
ANAHEIM, CA 92801

**Registered Aug. 28, 2012**

**Int. Cl.: 42**

FOR: COMPUTER SERVICES, NAMELY, PROVIDING SOFTWARE CONFIGURATION SERVICES FOR OIL AND NATURAL GAS PRODUCTION EQUIPMENT, IN CLASS 42 (U.S. CLS. 100 AND 101).

**SERVICE MARK**

FIRST USE 10-24-2011; IN COMMERCE 10-24-2011.

**PRINCIPAL REGISTER**

THE MARK CONSISTS OF STANDARD CHARACTERS WITHOUT CLAIM TO ANY PARTICULAR FONT, STYLE, SIZE, OR COLOR.

SN 85-046,346, FILED 5-24-2010.

ALEX KEAM, EXAMINING ATTORNEY



*David J. Kyfos*

Director of the United States Patent and Trademark Office

# United States of America

United States Patent and Trademark Office



## TEVA WOMEN'S HEALTH

**Reg. No. 4,198,984**

**Registered Aug. 28, 2012**

**Int. Cl.: 5**

**TRADEMARK**

**PRINCIPAL REGISTER**

TEVA WOMEN'S HEALTH INC. (DELAWARE CORPORATION)  
LEGAL AFFAIRS - TRADEMARK DEPT.  
400 CHESTNUT RIDGE ROAD  
WOODCLIFF LAKE, NJ 07677

FOR: PHARMACEUTICAL PREPARATIONS IN THE FIELD OF WOMEN'S HEALTH, NAMELY, CONTRACEPTIVES, HORMONE REPLACEMENT THERAPIES AND PHARMACEUTICALS FOR TREATING MENOPAUSE AND ITS SYMPTOMS, IN CLASS 5 (U.S. CLS. 6, 18, 44, 46, 51 AND 52).

FIRST USE 4-13-2010; IN COMMERCE 4-13-2010.

OWNER OF U.S. REG. NOS. 2,730,118, 3,733,175, AND OTHERS.

THE COLOR(S) GREEN, WHITE AND BLACK IS/ARE CLAIMED AS A FEATURE OF THE MARK.

NO CLAIM IS MADE TO THE EXCLUSIVE RIGHT TO USE "WOMEN'S HEALTH", APART FROM THE MARK AS SHOWN.

THE MARK CONSISTS OF THE WORD "TEVA" IN STYLIZED LETTERS OUTLINED IN GREEN WITH WHITE FILL. UNDER THE STYLIZED GREEN LETTERS ARE THE WORDS "TEVA WOMEN'S HEALTH" IN BLACK BLOCK LETTERS.

THE ENGLISH TRANSLATION OF "TEVA" IN THE MARK IS "NATURE".

SN 85-048,938, FILED 5-27-2010.

KELLY TRUSILO, EXAMINING ATTORNEY



*David J. Kyjars*

Director of the United States Patent and Trademark Office

# United States of America

United States Patent and Trademark Office



TEVA WOMEN'S HEALTH

**Reg. No. 4,198,985**

**Registered Aug. 28, 2012**

**Int. Cl.: 5**

**TRADEMARK**

**PRINCIPAL REGISTER**

TEVA WOMEN'S HEALTH, INC. (DELAWARE CORPORATION)  
LEGAL AFFAIRS - TRADEMARK DEPT.  
400 CHESTNUT RIDGE ROAD  
WOODCLIFF LAKE, NJ 07677

FOR: PHARMACEUTICAL PREPARATIONS IN THE FIELD OF WOMEN'S HEALTH, NAMELY, CONTRACEPTIVES, HORMONE REPLACEMENT THERAPIES AND PHARMACEUTICALS FOR TREATING MENOPAUSE AND ITS SYMPTOMS, IN CLASS 5 (U.S. CLS. 6, 18, 44, 46, 51 AND 52).

FIRST USE 4-1-2012; IN COMMERCE 4-1-2012.

OWNER OF U.S. REG. NOS. 2,730,118, 3,733,175, AND OTHERS.

NO CLAIM IS MADE TO THE EXCLUSIVE RIGHT TO USE "WOMEN'S HEALTH", APART FROM THE MARK AS SHOWN.

THE ENGLISH TRANSLATION OF "TEVA" IN THE MARK IS "NATURE".

SN 85-049,058, FILED 5-27-2010.

KELLY TRUSILO, EXAMINING ATTORNEY



*David J. Kyffers*

Director of the United States Patent and Trademark Office

# United States of America

United States Patent and Trademark Office



**Reg. No. 4,198,986**

LAMETRA M. GRAY (UNITED STATES INDIVIDUAL)  
1604 W. 103RD STREET  
CHICAGO, IL 60643

**Registered Aug. 28, 2012**

**Int. Cl.: 16**

FOR: GIFT BAGS; GREETING CARDS; SEALS, IN CLASS 16 (U.S. CLS. 2, 5, 22, 23, 29, 37, 38 AND 50).

**TRADEMARK**

FIRST USE 3-28-2010; IN COMMERCE 3-28-2010.

**PRINCIPAL REGISTER**

THE MARK CONSISTS OF THE COLOR BLUE APPEARING IN A HEART DESIGN CONNECTING TO THE LETTER "M" IN SCRIPT FONT.

THE COLOR(S) BLUE IS/ARE CLAIMED AS A FEATURE OF THE MARK.

SN 85-049,295, FILED 5-27-2010.

WANDA KAY PRICE, EXAMINING ATTORNEY



*David J. Kybas*

Director of the United States Patent and Trademark Office

# United States of America

United States Patent and Trademark Office

**nonmyd** *WX*

**Reg. No. 4,198,987**

KOWA COMPANY, LTD. (JAPAN CORPORATION)  
6-29, NISHIKI 3-CHOME, NAKA-KU  
NAGOYA, JAPAN

**Registered Aug. 28, 2012**

**Int. Cl.: 10**

FOR: FUNDUS CAMERAS; OPHTHALMIC CAMERAS, IN CLASS 10 (U.S. CLS. 26, 39 AND 44).

**TRADEMARK**

FIRST USE 3-0-2011; IN COMMERCE 3-0-2011.

**PRINCIPAL REGISTER**

OWNER OF U.S. REG. NO. 3,253,946.

THE COLOR(S) BLACK, GREY AND WHITE IS/ARE CLAIMED AS A FEATURE OF THE MARK.

THE MARK CONSISTS OF THE COLOR BLACK ON "NONMYD", THE COLOR GREY ON THE "W" AND ON THE OUTLINE OF THE "X", AND THE COLOR WHITE ON THE INTERIOR OF THE "X".

SN 85-050,069, FILED 5-28-2010.

DOMINICK J. SALEMI, EXAMINING ATTORNEY



*David J. Kyffers*

Director of the United States Patent and Trademark Office



# United States of America

United States Patent and Trademark Office

# OFM

**Reg. No. 4,198,988**

**Registered Aug. 28, 2012**

**Int. Cl.: 36**

**SERVICE MARK**

**PRINCIPAL REGISTER**

BELLROSE, R. BRUCE (UNITED STATES INDIVIDUAL)  
1512 STERLING DRIVE  
FLORHAM PARK, NJ 079323034 AND

BELLROSE, SUSAN (UNITED STATES INDIVIDUAL)  
1512 STERLING DRIVE  
FLORHAM PARK, NJ 079323034

FOR: FINANCIAL MANAGEMENT SERVICES, IN CLASS 36 (U.S. CLS. 100, 101 AND 102).

FIRST USE 10-18-2011; IN COMMERCE 10-18-2011.

THE MARK CONSISTS OF STANDARD CHARACTERS WITHOUT CLAIM TO ANY PARTICULAR FONT, STYLE, SIZE, OR COLOR.

SN 85-050,463, FILED 5-28-2010.

BARBARA GAYNOR, EXAMINING ATTORNEY



*David J. Kybas*

Director of the United States Patent and Trademark Office

# United States of America

United States Patent and Trademark Office



CITIZENS  
PRIVATE BANK & TRUST

**Reg. No. 4,198,989**

CITIZENS FINANCIAL GROUP, INC. (DELAWARE CORPORATION)  
ONE CITIZENS PLAZA  
PROVIDENCE, RI 02903

**Registered Aug. 28, 2012**

**Int. Cl.: 36**

FOR: BANKING SERVICES; FINANCIAL ADVISORY AND CONSULTATION SERVICES,  
IN CLASS 36 (U.S. CLS. 100, 101 AND 102).

**SERVICE MARK**

FIRST USE 3-0-2010; IN COMMERCE 3-0-2010.

**PRINCIPAL REGISTER**

OWNER OF U.S. REG. NOS. 2,634,833, 3,269,714, AND OTHERS.

NO CLAIM IS MADE TO THE EXCLUSIVE RIGHT TO USE "PRIVATE BANK & TRUST",  
APART FROM THE MARK AS SHOWN.

THE MARK CONSISTS OF THE WORDING "CITIZENS PRIVATE BANK & TRUST"  
BETWEEN HORIZONTAL LINES, ALL BELOW A FLEUR-DE-LIS DESIGN.

SN 85-052,039, FILED 6-1-2010.

PATRICIA EVANKO, EXAMINING ATTORNEY



*David J. Kyros*

Director of the United States Patent and Trademark Office

# United States of America

United States Patent and Trademark Office

# EXPANDIA

**Reg. No. 4,198,990**

**Registered Aug. 28, 2012**

**Int. Cl.: 20**

**TRADEMARK**

**PRINCIPAL REGISTER**

BLUE SKY INNOVATION GROUP, INC. (OHIO CORPORATION)  
SUITE 202  
26210 EMORY ROAD  
CLEVELAND, OH 44128

FOR: FURNITURE, NAMELY, TABLES, EXPANDABLE TABLES, COFFEE TABLES, END TABLES AND SIDE TABLES, IN CLASS 20 (U.S. CLS. 2, 13, 22, 25, 32 AND 50).

FIRST USE 3-1-2012; IN COMMERCE 3-1-2012.

THE MARK CONSISTS OF STANDARD CHARACTERS WITHOUT CLAIM TO ANY PARTICULAR FONT, STYLE, SIZE, OR COLOR.

SN 85-052,763, FILED 6-2-2010.

SANI KHOURI, EXAMINING ATTORNEY



*David J. Kybas*

Director of the United States Patent and Trademark Office

# United States of America

United States Patent and Trademark Office

# KBS

**Reg. No. 4,198,991**

**Registered Aug. 28, 2012**

**Int. Cl.: 36**

**SERVICE MARK**

**PRINCIPAL REGISTER**

KBS REALTY ADVISORS, LLC (DELAWARE LIMITED LIABILITY COMPANY)  
SUITE 1300  
620 NEWPORT CENTER DRIVE  
NEWPORT BEACH, CA 92660

FOR: FINANCIAL INVESTMENT SERVICES IN THE FIELD OF REAL ESTATE, NAMELY, OFFERING COMMERCIAL REAL ESTATE INVESTMENT PRODUCTS; COMMERCIAL REAL ESTATE INVESTMENT; MANAGEMENT OF COMMERCIAL REAL ESTATE INVESTMENT FUNDS; INVESTMENT ADVISORY SERVICES IN THE FIELD OF COMMERCIAL REAL ESTATE; REAL ESTATE EQUITY SHARING, NAMELY, MANAGING AND ARRANGING THE OWNERSHIP AND CO-OWNERSHIP OF REAL ESTATE; REAL ESTATE FINANCING CONSULTATION; REAL ESTATE INVESTMENT CONSULTATION; FINANCIAL INVESTMENT SERVICES IN THE FIELD OF REAL ESTATE, NAMELY, OFFERING STRUCTURED FINANCIAL PRODUCTS, IN CLASS 36 (U.S. CLS. 100, 101 AND 102).

FIRST USE 7-0-1999; IN COMMERCE 7-0-1999.

THE MARK CONSISTS OF STANDARD CHARACTERS WITHOUT CLAIM TO ANY PARTICULAR FONT, STYLE, SIZE, OR COLOR.

OWNER OF U.S. REG. NOS. 3,586,307, 3,594,355, AND OTHERS.

SN 85-054,121, FILED 6-3-2010.

CARYN GLASSER, EXAMINING ATTORNEY



*David J. Kyffers*

Director of the United States Patent and Trademark Office

# United States of America

United States Patent and Trademark Office



**Reg. No. 4,198,992**

**Registered Aug. 28, 2012**

**Int. Cls.: 18 and 25**

**TRADEMARK**

**PRINCIPAL REGISTER**

NIKE, INC. (OREGON CORPORATION)  
ONE BOWERMAN DRIVE, DF-4  
BEAVERTON, OR 97005

FOR: BAGS, NAMELY, ALL-PURPOSE SPORTS BAGS, TOTE BAGS, DUFFLE BAGS, MESSENGER BAGS, BACKPACKS, AND BAGS FOR CARRYING SHOES, IN CLASS 18 (U.S. CLS. 1, 2, 3, 22 AND 41).

FIRST USE 4-30-2011; IN COMMERCE 4-30-2011.

FOR: CLOTHING, NAMELY, SHORTS, PANTS, SHIRTS, T-SHIRTS, TANK TOPS, JERSEYS, HOODED TOPS; SWEATSHIRTS, PULLOVERS, JACKETS, SWEATPANTS, AND GLOVES, IN CLASS 25 (U.S. CLS. 22 AND 39).

FIRST USE 6-30-2011; IN COMMERCE 6-30-2011.

THE MARK CONSISTS OF A SHIELD COMPOSED OF THREE PYRAMIDS OVERLAPPING A TRIANGLE.

SN 85-054,371, FILED 6-3-2010.

SUSAN LESLIE DUBOIS, EXAMINING ATTORNEY



*David J. Kybas*

Director of the United States Patent and Trademark Office

# United States of America

United States Patent and Trademark Office



**Reg. No. 4,198,993**

**Registered Aug. 28, 2012**

**Int. Cl.: 35**

**SERVICE MARK**

**PRINCIPAL REGISTER**

CROSS POND MEDIA, LLC. (DELAWARE LIMITED LIABILITY COMPANY)  
23RD FLOOR  
1440 BROADWAY  
NEW YORK, NY 10018

FOR: ADVERTISING SERVICES, PUBLIC RELATIONS AND MARKETING SERVICES, NAMELY, PROMOTING AND MARKETING THE GOODS AND SERVICES OF OTHERS THROUGH ALL PUBLIC COMMUNICATION MEANS, IN CLASS 35 (U.S. CLS. 100, 101 AND 102).

FIRST USE 1-1-2010; IN COMMERCE 1-1-2010.

THE MARK CONSISTS OF THE WORDING "CROSSPOND MEDIA", WITH "CROSSPOND" APPEARING IN DARK BLUE AND "MEDIA" APPEARING IN RED AND WITH THE "P" DROPPING INTO LIGHT BLUE CONCENTRIC CIRCLES. THE WORDING "BRIDGE THE GAP" APPEARS IN BLACK BELOW THE TERM "MEDIA".

THE COLOR(S) DARK BLUE, LIGHT BLUE, RED, AND BLACK IS/ARE CLAIMED AS A FEATURE OF THE MARK.

SN 85-054,691, FILED 6-4-2010.

KAREN SEVERSON, EXAMINING ATTORNEY



*David J. Kyros*

Director of the United States Patent and Trademark Office

# United States of America

United States Patent and Trademark Office

## THE OUT NYC

**Reg. No. 4,198,994**

42 STREET HOLDINGS LLC (DELAWARE LIMITED LIABILITY COMPANY)  
230 CENTRAL PARK SOUTH, SUITE 16C  
NEW YORK, NY 10019

**Registered Aug. 28, 2012**

**Int. Cls.: 43 and 44**

FOR: RESORT LODGING SERVICES; HOTEL, RESTAURANT, AND BAR SERVICES, IN CLASS 43 (U.S. CLS. 100 AND 101).

**SERVICE MARK**

FIRST USE 12-31-2011; IN COMMERCE 3-1-2012.

**PRINCIPAL REGISTER**

FOR: HEALTH SPA SERVICES FOR HEALTH AND WELLNESS OF THE BODY AND SPIRIT, IN CLASS 44 (U.S. CLS. 100 AND 101).

FIRST USE 12-31-2011; IN COMMERCE 3-1-2012.

THE MARK CONSISTS OF STANDARD CHARACTERS WITHOUT CLAIM TO ANY PARTICULAR FONT, STYLE, SIZE, OR COLOR.

NO CLAIM IS MADE TO THE EXCLUSIVE RIGHT TO USE "NYC", APART FROM THE MARK AS SHOWN.

SN 85-054,971, FILED 6-4-2010.

ADA HAN, EXAMINING ATTORNEY



*David J. Kyros*

Director of the United States Patent and Trademark Office

# United States of America

United States Patent and Trademark Office

## HAND HELD HISTORY

**Reg. No. 4,198,995**

**Registered Aug. 28, 2012**

**Int. Cl.: 9**

**TRADEMARK**

**PRINCIPAL REGISTER**

PATRIOT ART, INC. (NORTH CAROLINA CORPORATION)  
15923 PRESCOTT HILL AVENUE  
CHARLOTTE, NC 28277

FOR: A SERIES OF DOWNLOADABLE COMPUTER SOFTWARE FOR MOBILE MEDIA DEVICES FOR PROVIDING INFORMATION REGARDING TOURISM, IN CLASS 9 (U.S. CLS. 21, 23, 26, 36 AND 38).

FIRST USE 1-15-2012; IN COMMERCE 1-15-2012.

THE MARK CONSISTS OF STANDARD CHARACTERS WITHOUT CLAIM TO ANY PARTICULAR FONT, STYLE, SIZE, OR COLOR.

NO CLAIM IS MADE TO THE EXCLUSIVE RIGHT TO USE "HAND HELD", APART FROM THE MARK AS SHOWN.

SN 85-056,200, FILED 6-7-2010.

MIDGE BUTLER, EXAMINING ATTORNEY



*David J. Kyffers*

Director of the United States Patent and Trademark Office



# United States of America

United States Patent and Trademark Office

# Sisters

**Reg. No. 4,198,996**

**Registered Aug. 28, 2012**

**Int. Cls.: 9, 16, 18, and 21**

THE LONGABERGER COMPANY (OHIO CORPORATION)  
1500 E. MAIN STREET  
NEWARK, OH 43055

FOR: EYEGLASS CASES; CARRYING CASES FOR CELL PHONES AND MOBILE COMMUNICATIONS DEVICES, IN CLASS 9 (U.S. CLS. 21, 23, 26, 36 AND 38).

FIRST USE 8-1-2011; IN COMMERCE 8-1-2011.

**TRADEMARK**

**PRINCIPAL REGISTER**

FOR: LUNCH BAGS; LUNCH BAGS MADE OF TEXTILE, IN CLASS 16 (U.S. CLS. 2, 5, 22, 23, 29, 37, 38 AND 50).

FIRST USE 8-1-2011; IN COMMERCE 8-1-2011.

FOR: FABRIC HANDBAGS, LUGGAGE, TRAVEL BAGS, TOTE BAGS, SACHELS, BACKPACKS, SPORT BAGS, DUFFEL BAGS, SHOULDER BAGS, TOILETRY CASES SOLD EMPTY, COSMETIC CASES AND BAGS SOLD EMPTY, WALLETS, WRISTLETS, IN CLASS 18 (U.S. CLS. 1, 2, 3, 22 AND 41).

FIRST USE 8-1-2011; IN COMMERCE 8-1-2011.

FOR: TRAVEL MUGS; INSULATED COOLER BAGS FOR FOOD OR BEVERAGE, IN CLASS 21 (U.S. CLS. 2, 13, 23, 29, 30, 33, 40 AND 50).

FIRST USE 8-1-2011; IN COMMERCE 8-1-2011.

THE MARK CONSISTS OF THE WORD "SISTERS" IN STYLIZED FORMAT WITH THE DOT OVER THE "I" BEING A FLOWER.

SN 85-056,225, FILED 6-7-2010.

RENEE SERVANCE, EXAMINING ATTORNEY



*David J. Kybas*

Director of the United States Patent and Trademark Office

# United States of America

United States Patent and Trademark Office

# AQUACIRCUS

**Reg. No. 4,198,997**

EMPEX PRODUCTIONS LIMITED (CANADA CORPORATION)

**Registered Aug. 28, 2012**

591 ALBRIGHT ROAD  
UXBRIDGE, CANADA L9P1R4

**Int. Cl.: 28**

FOR: STRUCTURES, NAMELY, PERMANENTLY MOUNTED WATER PARK STRUCTURES AND COMPONENTS, NAMELY, ROCKING RIDES, WATER CURTAINS, WATERSLIDES, WATER PARK WATER BIKES, PULL SHOWERS, WATER CANNONS, WATER SHOOTERS, TEETER TOTTERS, BUNGEE SEATS; WATER PLAY STRUCTURES AND COMPONENTS, NAMELY, FOUNTAINS AND PIPES IN A VARIETY OF SHAPES, PERMANENTLY MOUNTED WATER PARK SPRAY UMBRELLAS, IN CLASS 28 (U.S. CLS. 22, 23, 38 AND 50).

**TRADEMARK**

**PRINCIPAL REGISTER**

FIRST USE 3-31-2011; IN COMMERCE 5-9-2012.

THE MARK CONSISTS OF STANDARD CHARACTERS WITHOUT CLAIM TO ANY PARTICULAR FONT, STYLE, SIZE, OR COLOR.

PRIORITY CLAIMED UNDER SEC. 44(D) ON CANADA APPLICATION NO. 1483091, FILED 5-31-2010, REG. NO. TMA795707, DATED 4-15-2011, EXPIRES 4-15-2026.

SN 85-056,265, FILED 6-7-2010.

NAAKWAMA ANKRAH, EXAMINING ATTORNEY



*David J. Kyros*

Director of the United States Patent and Trademark Office

# United States of America

United States Patent and Trademark Office

# CREW CHIEF

**Reg. No. 4,198,998**

BIG TIME HOLDINGS, INC. (GEORGIA CORPORATION)  
2 WILBANKS ROAD  
ROME, GA 30161

**Registered Aug. 28, 2012**

**Int. Cl.: 21**

FOR: WORK GLOVES, IN CLASS 21 (U.S. CLS. 2, 13, 23, 29, 30, 33, 40 AND 50).

**TRADEMARK**

FIRST USE 1-15-2012; IN COMMERCE 1-15-2012.

**PRINCIPAL REGISTER**

THE MARK CONSISTS OF STANDARD CHARACTERS WITHOUT CLAIM TO ANY PARTICULAR FONT, STYLE, SIZE, OR COLOR.

SN 85-057,838, FILED 6-8-2010.

RICHARD WHITE, EXAMINING ATTORNEY



*David J. Kyffers*

Director of the United States Patent and Trademark Office

# United States of America

United States Patent and Trademark Office

# ENCORE

**Reg. No. 4,198,999**

**Registered Aug. 28, 2012**

**Int. Cl.: 1**

**TRADEMARK**

**PRINCIPAL REGISTER**

W. R. GRACE & CO.-CONN. (CONNECTICUT CORPORATION)  
ATTN: PATENT DEPARTMENT  
7500 GRACE DRIVE  
COLUMBIA, MD 21044

FOR: CHEMICALS, NAMELY, FRESH AND/OR EQUILIBRIUM FLUID CRACKING CATALYSTS AND FLUID CRACKING CATALYST ADDITIVES FOR USE IN THE PETROLEUM REFINING INDUSTRY, IN CLASS 1 (U.S. CLS. 1, 5, 6, 10, 26 AND 46).

FIRST USE 10-18-2010; IN COMMERCE 10-18-2010.

THE MARK CONSISTS OF STANDARD CHARACTERS WITHOUT CLAIM TO ANY PARTICULAR FONT, STYLE, SIZE, OR COLOR.

SN 85-058,073, FILED 6-9-2010.

FRED CARL, EXAMINING ATTORNEY



*David J. Kyffers*

Director of the United States Patent and Trademark Office

# United States of America

United States Patent and Trademark Office

## EXPECT BETTER BANKING

**Reg. No. 4,199,000**

**Registered Aug. 28, 2012**

**Int. Cls.: 35 and 36**

**SERVICE MARK**

**PRINCIPAL REGISTER**

WEBSTER FINANCIAL CORPORATION (DELAWARE CORPORATION)  
145 BANK STREET  
WATERBURY, CT 06702

FOR: RECORD KEEPING AND REPORTING SERVICES, NAMELY, CORPORATE FINANCIAL ACTION REPORTING AND MANAGEMENT, TRACKING AND REPORTING FINANCIAL ACCOUNT, ASSET AND FINANCIAL TRANSACTION INFORMATION, PREPARING FINANCIAL ACCOUNT STATEMENTS AND SUMMARIES FOR BUSINESSES, IN CLASS 35 (U.S. CLS. 100, 101 AND 102).

FIRST USE 4-1-2010; IN COMMERCE 4-1-2010.

FOR: FINANCIAL SERVICES, NAMELY, BANKING SERVICES; INTERNET AND ONLINE BANKING SERVICES; PERSONAL AND COMMERCIAL BANKING SERVICES; CHECKING ACCOUNT SERVICES; SAVINGS ACCOUNT SERVICES; DIRECT DEPOSIT SERVICES; DEPOSIT SERVICES; SAFETY DEPOSIT BOX SERVICES; CERTIFICATES OF DEPOSIT; ONLINE BANKING; ONLINE BILL PAYMENT SERVICES; WIRE TRANSFER SERVICES; AUTOMATED TELLER MACHINE SERVICES; ELECTRONIC FUNDS TRANSFER SERVICES; CERTIFIED CHECK SERVICES; PROVIDING BANK ACCOUNT INFORMATION BY TELEPHONE AND OTHER MEANS; CREDIT CARD, DEBIT CARD AND CASH CARD SERVICES; RELATIONSHIP BANKING SERVICES THAT OFFER CUSTOMERS THE OPPORTUNITY TO RECEIVE A VARIETY OF MONEY SAVING, WEALTH ACCUMULATION AND CONVENIENCE FEATURES; RELATIONSHIP BANKING SERVICES THAT OFFER CUSTOMERS THE OPPORTUNITY TO RECEIVE A VARIETY OF MONEY SAVING, WEALTH ACCUMULATION AND CONVENIENCE FEATURES, INCLUDING FREE FOREIGN ATM AND ATM SURCHARGE REBATES, FREE CHECKS AND CHECKING, FREE TRAVELERS CHECKS, FREE ONLINE BANKING, FREE ONLINE BILL PAYING, DISCOUNTED RATES ON HOME EQUITY LINES, LOANS AND OTHER TYPES OF CONSUMER LOANS, AUTOMATIC LOAN DEDUCTIONS FROM ACCOUNTS, SPECIAL DEPOSIT RATE OFFERS, SPECIAL RATES ON SAVINGS ACCOUNTS, AND ONE COMBINED ACCOUNT STATEMENT WITH LINKS TO CUSTOMERS' OTHER ACCOUNTS, INCLUDING CHECKING, SAVINGS, MONEY MARKET, CERTIFICATES OF DEPOSIT, LINES AND/OR LOANS; CASH MANAGEMENT SERVICES, INCLUDING, ACCOUNT RECONCILIATION, AGENT DEPOSIT REPORTING, AUTOMATED CLEARING HOUSE, CONTROLLED DISBURSEMENT, FINANCIAL ELECTRONIC DATA INTERCHANGE REPORTING, LOCKBOX PROCESSING, WIRE TRANSFERS AND ZERO BALANCE ACCOUNTS FOR MANUFACTURING, DISTRIBUTION, WHOLESALE, RETAIL, AND SERVICE ENTITIES AND OTHERS; INVESTMENT BANKING



*David J. Kybas*

Director of the United States Patent and Trademark Office

**Reg. No. 4,199,000** SERVICES; ONLINE INVESTMENT BANKING SERVICES; PROVIDING BANKING AND SECURITIES UNDERWRITING AND BROKERAGE SERVICES; LOAN FINANCING; PERSONAL LOANS; COMMERCIAL LOANS; LINES OF CREDIT; MORTGAGE LENDING SERVICES; MORTGAGE LOANS; HOME EQUITY LINES AND LOANS; MORTGAGE PLANNING; MAINTAINING MORTGAGE ESCROW ACCOUNTS; MORTGAGE BANKING; MORTGAGE BANKING SERVICES, NAMELY, ORIGINATION, ACQUISITION, SERVICING, SECURITIZATION AND BROKERAGE OF CONSUMER AND MORTGAGE LOANS; SELLING AND PURCHASING OF LOAN PORTFOLIOS FOR OTHERS; MORTGAGE BROKERAGE; MORTGAGE LENDING; MORTGAGE PROCUREMENT FOR OTHERS; MORTGAGE SERVICES, NAMELY, BUYER PRE-QUALIFICATION OF MORTGAGES FOR MORTGAGE BROKERS AND BANKS; REAL ESTATE FINANCING SERVICES; PROVIDING LOANS SECURED BY COMMERCIAL PAPER; PROVIDING TEMPORARY LOANS; INSTALLMENT LOANS; LEASE-PURCHASE FINANCING SERVICES; ASSET-BASED LENDING SERVICES; COMMERCIAL LENDING SERVICES; FINANCING SERVICES; STRUCTURED FINANCING SERVICES; RETAIL FINANCING SERVICES; TRADE FINANCING SERVICES; PROVIDING WORKING CAPITAL LOANS; REVOLVING WORKING CAPITAL LOANS; TERM LOAN FACILITIES; CREDIT FACILITIES; CAPITAL EXPENDITURE LINES OF CREDIT AND LETTERS OF CREDIT; OFFERING FINANCING IN THE FORM OF EQUITY SERVICES; EQUIPMENT FINANCING SERVICES, STRUCTURED FINANCE SERVICES, MONEY LENDING SERVICES, AND CUSTOMIZED FINANCING PROGRAMS FOR PURCHASING AND LEASING OF EQUIPMENT; FINANCIAL PLANNING; FINANCIAL ADVISORY SERVICES; FINANCIAL MANAGEMENT SERVICES; CUSTOMIZED FINANCIAL MANAGEMENT; ASSET MANAGEMENT; INVESTMENT MANAGEMENT; INVESTMENT CONSULTATION; FUND INVESTMENT SERVICES; ONLINE FUND INVESTMENT SERVICES; INVESTMENT BROKERAGE SERVICES; ONLINE INVESTMENT BROKERAGE SERVICES; FINANCIAL ASSET VALUATION SERVICES; MONEY MARKET ACCOUNT SERVICES; MUTUAL FUND ADMINISTRATION AND BROKERAGE SERVICES; INVESTMENT AND TRUST COMPANY SERVICES; FIDUCIARY SERVICES, NAMELY, TRUST AND ESTATE PLANNING, TRUST AND ESTATE PLAN CONSULTATION, ESTATE SETTLEMENT; TRUST, ESTATE AND INVESTMENT CUSTODY AND ADMINISTRATION SERVICES, NAMELY, INVESTING AND MANAGEMENT OF FINANCIAL ASSETS, EXECUTING AND SETTLING SECURITIES TRADES, CORPORATE FINANCIAL ACTION MANAGEMENT, FINANCIAL TRANSACTION PROCESSING, BILL PAYMENT, ONLINE FINANCIAL ACCOUNT SERVICES, NAMELY, TRADING OF FINANCIAL INSTRUMENTS, SHARES, OPTIONS AND OTHER DERIVATIVE PRODUCTS; FINANCIAL PLANNING FOR RETIREMENT; COLLEGE TUITION PLANNING; FUND INVESTMENT SERVICES IN THE NATURE OF PROVIDING INDIVIDUAL RETIREMENT ACCOUNTS, 529 EDUCATION SAVINGS PLANS, AND UNIFORM GIFTS TO MINORS ACT ACCOUNTS; ERISA, TAFT-HARTLEY, EMPLOYEE BENEFIT AND EMPLOYEE PENSION PLAN ADMINISTRATION AND CONSULTATION; BILL PAYMENT SERVICES; CHECK PROCESSING; CONSUMER LENDING SERVICES; ELECTRONIC CASH TRANSACTIONS; ELECTRONIC DEBIT TRANSACTIONS; ELECTRONIC PAYMENT, NAMELY, ELECTRONIC PROCESSING AND TRANSMISSION OF BILL PAYMENT DATA; ELECTRONIC TRANSFER OF MONEY; ASSISTING OTHERS WITH THE COMPLETION OF FINANCIAL TRANSACTIONS FOR STOCKS, BONDS, SECURITIES AND EQUITIES; PROVIDING ON-LINE FINANCIAL CALCULATORS; HEALTH SAVINGS ACCOUNT SERVICES, NAMELY, PROVIDING BANKING SERVICES AND SAVINGS ACCOUNT ADMINISTRATION FOR CONSUMER-DRIVEN HEALTH CARE PLANS AND DEFINED CONTRIBUTION HEALTH CARE PLANS; CUSTODIAL SERVICES, AND TRUSTEE SERVICES FOR HEALTH SAVINGS ACCOUNTS; INVESTMENT MANAGEMENT AND DISTRIBUTION OF ANNUITIES; PROVIDING INTEREST RATE PROTECTION AGAINST FLUCTUATIONS IN INTEREST RATES; SUBMISSION AND ACCEPTANCE OF ELECTRONIC DEPOSITS VIA WEB-BASED PORTAL; SUBMISSION, ACCEPTANCE AND PROCESSING OF IMAGED CHECKS VIA WEB-BASED PORTAL; ELECTRONIC LOCK BOX SERVICES THAT ENABLE ACCEPTANCE OF ONLINE PAYMENTS VIA WEB-BASED PORTAL, ELECTRONIC LINK TO BILL IMAGES, ELECTRONIC CREDIT CARD AUTHORIZATIONS AND DECLINES, ELECTRONIC CONSOLIDATED RECEIVABLES REPORTING, AND ELECTRONIC FINANCIAL TRANSACTION SETTLEMENT SERVICES BETWEEN BILLERS' FINANCIAL INSTITUTIONS AND BILLERS' ACCOUNTS; ONLINE CASH MANAGEMENT,

**Reg. No. 4,199,000** FINANCIAL ACCOUNT MANAGEMENT, AND FINANCIAL INFORMATION AND INVESTMENT REPORTING SERVICES; LOCKBOX SERVICES, NAMELY, LOCKBOX PROCESSING AND ELECTRONIC LOCKBOX SERVICES THAT ENABLE ACCEPTANCE OF ONLINE PAYMENTS VIA WEB-BASED PORTAL; PAYROLL TAX DEBITING SERVICES; PROVIDING ELECTRONIC PROCESSING OF ELECTRONIC FUNDS TRANSFER, ACH, CREDIT CARD, DEBIT CARD, ELECTRONIC TRANSACTIONS, ELECTRONIC CHECKS AND ELECTRONIC PAYMENTS; AND PROVIDING INFORMATION IN THE FIELDS OF BANKING, FINANCE, TRUSTS, ESTATES, INVESTMENTS, ASSET MANAGEMENT, MORTGAGES, FINANCIAL PLANNING, EMPLOYEE BENEFIT PLANS, AND EMPLOYEE PENSION PLANS VIA THE INTERNET, GLOBAL NETWORKS, TELEPHONE, FACSIMILE OR OTHER MEANS, IN CLASS 36 (U.S. CLS. 100, 101 AND 102).

FIRST USE 4-1-2010; IN COMMERCE 4-1-2010.

THE MARK CONSISTS OF STANDARD CHARACTERS WITHOUT CLAIM TO ANY PARTICULAR FONT, STYLE, SIZE, OR COLOR.

NO CLAIM IS MADE TO THE EXCLUSIVE RIGHT TO USE "BANKING", APART FROM THE MARK AS SHOWN.

SN 85-059,113, FILED 6-10-2010.

ANTHONY RINKER, EXAMINING ATTORNEY

# United States of America

United States Patent and Trademark Office



**Reg. No. 4,199,001**

**Registered Aug. 28, 2012**

**Int. Cl.: 30**

**TRADEMARK**

**PRINCIPAL REGISTER**

MARS, INCORPORATED (DELAWARE CORPORATION)  
6885 ELM STREET  
MCLEAN, VA 221013883

FOR: CANDY, IN CLASS 30 (U.S. CL. 46).

FIRST USE 11-22-2010; IN COMMERCE 11-22-2010.

NO CLAIM IS MADE TO THE EXCLUSIVE RIGHT TO USE THE DESIGN OF THE PICTURE OF THE CANDY, APART FROM THE MARK AS SHOWN.

THE COLOR(S) BROWN, LIGHT BROWN, DARK BROWN, TAN, YELLOW, RED AND WHITE IS/ARE CLAIMED AS A FEATURE OF THE MARK.

THE MARK CONSISTS OF A PODIUM WITH RED SIDES AND A YELLOW TOP WITH A CANDY SITTING ON TOP OF THE PODIUM. THE WORD "SQUARED" IS DISPLAYED IN WHITE LETTERING ON THE RED SIDES OF THE PODIUM. THE CANDY HAS A BITE TAKEN OUT SHOWING THREE LAYERS WITHIN THE CANDY, NAMELY, A TOP BROWN LAYER, A MIDDLE LIGHT BROWN LAYER CONTAINING FOUR TAN-COLORED PEANUT SHAPES, AND A BOTTOM TAN LAYER. THE BACKGROUND CONSISTS OF YELLOW AND LIGHT BROWN GEOMETRIC SHAPES.

SN 85-059,239, FILED 6-10-2010.

LOURDES AYALA, EXAMINING ATTORNEY



*David J. Kyffers*

Director of the United States Patent and Trademark Office



# United States of America

United States Patent and Trademark Office

## CHOICEHOMELOANS.COM

**Reg. No. 4,199,002**

**Registered Aug. 28, 2012**

**Int. Cl.: 36**

**SERVICE MARK**

**PRINCIPAL REGISTER**

REPUBLIC MORTGAGE HOME LOANS, LLC (UTAH LIMITED LIABILITY COMPANY)  
SUITE 2  
5241 SOUTH STATE STREET  
MURRAY, UT 84107

FOR: MORTGAGE LENDING, IN CLASS 36 (U.S. CLS. 100, 101 AND 102).

FIRST USE 1-31-2012; IN COMMERCE 3-1-2012.

THE MARK CONSISTS OF STANDARD CHARACTERS WITHOUT CLAIM TO ANY PARTICULAR FONT, STYLE, SIZE, OR COLOR.

SN 85-059,414, FILED 6-10-2010.

PAULA MAHONEY, EXAMINING ATTORNEY



*David J. Kybas*

Director of the United States Patent and Trademark Office

# United States of America

United States Patent and Trademark Office

# K-SERIES

**Reg. No. 4,199,003**

**Registered Aug. 28, 2012**

**Int. Cl.: 9**

**TRADEMARK**

**PRINCIPAL REGISTER**

ENTERASYS NETWORKS, INC. (DELAWARE CORPORATION)  
50 MINUTEMAN ROAD  
ANDOVER, MA 018101008

FOR: COMPUTER HARDWARE AND SOFTWARE FOR USE IN INTERCONNECTING,  
MANAGING AND OPERATING LOCAL, WIDE AREA, GLOBAL AND OPTICAL NETWORKS,  
IN CLASS 9 (U.S. CLS. 21, 23, 26, 36 AND 38).

FIRST USE 3-29-2012; IN COMMERCE 3-29-2012.

THE MARK CONSISTS OF STANDARD CHARACTERS WITHOUT CLAIM TO ANY PAR-  
TICULAR FONT, STYLE, SIZE, OR COLOR.

SN 85-060,997, FILED 6-11-2010.

PAUL E. FAHRENKOPF, EXAMINING ATTORNEY



*David J. Kyffers*

Director of the United States Patent and Trademark Office

# United States of America

United States Patent and Trademark Office

## OPERATE WITH CONFIDENCE

**Reg. No. 4,199,004**

AERONAUTICAL SYSTEMS, INCORPORATED (VIRGINIA CORPORATION)  
43671 TRADE CENTER PLACE, SUITE 100  
STERLING, VA 20166

**Registered Aug. 28, 2012**

**Int. Cls.: 40 and 42**

FOR: MANUFACTURING SERVICES FOR OTHERS IN THE FIELD OF AIRCRAFT PARTS AND ACCESSORIES, IN CLASS 40 (U.S. CLS. 100, 103 AND 106).

**SERVICE MARK**

FIRST USE 3-14-2010; IN COMMERCE 3-14-2010.

**PRINCIPAL REGISTER**

FOR: ENGINEERING; DESIGN FOR OTHERS IN THE FIELD OF ENGINEERING; CUSTOM DESIGN AND ENGINEERING OF AIRCRAFT PARTS AND ACCESSORIES, IN CLASS 42 (U.S. CLS. 100 AND 101).

FIRST USE 3-14-2010; IN COMMERCE 3-14-2010.

THE MARK CONSISTS OF STANDARD CHARACTERS WITHOUT CLAIM TO ANY PARTICULAR FONT, STYLE, SIZE, OR COLOR.

OWNER OF U.S. REG. NO. 3,956,026.

SN 85-061,319, FILED 6-12-2010.

JAY FLOWERS, EXAMINING ATTORNEY



*David J. Kyffers*

Director of the United States Patent and Trademark Office

# United States of America

United States Patent and Trademark Office

## AVAILABILITY DELIVERED

**Reg. No. 4,199,005**

AERONAUTICAL SYSTEMS, INCORPORATED (VIRGINIA CORPORATION)  
43671 TRADE CENTER PLACE, SUITE 100  
STERLING, VA 20166

**Registered Aug. 28, 2012**

**Int. Cls.: 40 and 42**

FOR: MANUFACTURING SERVICES FOR OTHERS IN THE FIELD OF AIRCRAFT PARTS AND ACCESSORIES, IN CLASS 40 (U.S. CLS. 100, 103 AND 106).

**SERVICE MARK**

FIRST USE 3-14-2010; IN COMMERCE 3-14-2010.

**PRINCIPAL REGISTER**

FOR: ENGINEERING; DESIGN FOR OTHERS IN THE FIELD OF ENGINEERING; CUSTOM DESIGN AND ENGINEERING OF AIRCRAFT PARTS AND ACCESSORIES, IN CLASS 42 (U.S. CLS. 100 AND 101).

FIRST USE 3-14-2010; IN COMMERCE 3-14-2010.

THE MARK CONSISTS OF STANDARD CHARACTERS WITHOUT CLAIM TO ANY PARTICULAR FONT, STYLE, SIZE, OR COLOR.

OWNER OF U.S. REG. NO. 3,956,027.

SN 85-061,323, FILED 6-12-2010.

JAY FLOWERS, EXAMINING ATTORNEY



*David J. Kybas*

Director of the United States Patent and Trademark Office

# United States of America

United States Patent and Trademark Office

## Park N Pedal

**Reg. No. 4,199,006**

**Registered Aug. 28, 2012**

**Int. Cl.: 39**

**SERVICE MARK**

**PRINCIPAL REGISTER**

DEVAKI A. MURCH (UTAH SOLE PROPRIETORSHIP), DBA PARK N PEDAL,  
1358 SWAN STREET  
OGDEN, UT 84401

FOR: RENTAL OF BICYCLES; VALET PARKING, IN CLASS 39 (U.S. CLS. 100 AND 105).

FIRST USE 8-10-2009; IN COMMERCE 8-10-2009.

THE MARK CONSISTS OF STANDARD CHARACTERS WITHOUT CLAIM TO ANY PARTICULAR FONT, STYLE, SIZE, OR COLOR.

NO CLAIM IS MADE TO THE EXCLUSIVE RIGHT TO USE "PARK", APART FROM THE MARK AS SHOWN.

SN 85-061,440, FILED 6-12-2010.

ASMAT KHAN, EXAMINING ATTORNEY



*David J. Kybas*

Director of the United States Patent and Trademark Office

# United States of America

United States Patent and Trademark Office

## LUNCH TEACHERS

**Reg. No. 4,199,007**

KATHLEEN ANN ADAMICK-DIAZ (UNITED STATES INDIVIDUAL), AKA KATE ADAMICK,  
42 W. 13TH STREET #6E  
NEW YORK, NY 10011

**Registered Aug. 28, 2012**

**Int. Cls.: 41 and 43**

FOR: VOCATIONAL EDUCATION IN THE FIELDS OF CULINARY ARTS AND SCIENCES,  
IN CLASS 41 (U.S. CLS. 100, 101 AND 107).

**SERVICE MARK**

FIRST USE 5-31-2012; IN COMMERCE 5-31-2012.

**PRINCIPAL REGISTER**

FOR: CONSULTING SERVICES IN THE FIELD OF CULINARY ARTS, IN CLASS 43 (U.S.  
CLS. 100 AND 101).

FIRST USE 5-31-2012; IN COMMERCE 5-31-2012.

THE MARK CONSISTS OF STANDARD CHARACTERS WITHOUT CLAIM TO ANY PAR-  
TICULAR FONT, STYLE, SIZE, OR COLOR.

SN 85-061,511, FILED 6-13-2010.

BARBARA BROWN, EXAMINING ATTORNEY



*David J. Kyros*

Director of the United States Patent and Trademark Office

# United States of America

United States Patent and Trademark Office

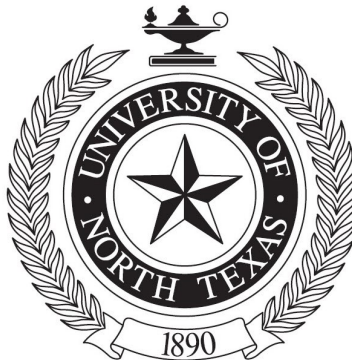

**Reg. No. 4,199,008**

**Registered Aug. 28, 2012**

**Int. Cls.: 16 and 41**

**TRADEMARK**

**SERVICE MARK**

**PRINCIPAL REGISTER**

UNIVERSITY OF NORTH TEXAS (TEXAS STATE UNIVERSITY)  
1501 W. CHESTNUT STREET  
DENTON, TX 76201

FOR: PAPER GOODS AND PRINTED MATERIALS, NAMELY, BALLOONS, GREETING CARDS, NOTE CARDS, NOTEPADS, POST CARDS, STICKERS, PAPER LABELS, STATIONERY, BUSINESS CARDS, GRADUATION ANNOUNCEMENT CARDS; RUBBER STAMPS; PHOTO ALBUMS, SCRAPBOOKS AND ACCESSORIES, NAMELY, DECORATIVE PAPER; DECALS; AND MONEY CLIPS, IN CLASS 16 (U.S. CLS. 2, 5, 22, 23, 29, 37, 38 AND 50).

FIRST USE 11-0-2005; IN COMMERCE 11-0-2005.

FOR: EDUCATIONAL SERVICES, NAMELY, PROVIDING COLLEGE AND GRADUATE LEVEL COURSES OF INSTRUCTION AND SEMINARS, AND EDUCATIONAL OPPORTUNITIES TO PARTICIPATE IN RESEARCH PROGRAMS; AND ENTERTAINMENT SERVICES, NAMELY, PROVIDING COLLEGE SPORT GAMES AND EVENTS, MUSICAL CONCERTS AND ENTERTAINMENT AND PERFORMANCES OF DRAMATIC WORKS, IN CLASS 41 (U.S. CLS. 100, 101 AND 107).

FIRST USE 5-0-1988; IN COMMERCE 5-0-1988.

OWNER OF U.S. REG. NO. 3,780,422.

SEC. 2(F) AS TO "UNIVERSITY OF NORTH TEXAS".

NO CLAIM IS MADE TO THE EXCLUSIVE RIGHT TO USE "UNIVERSITY" AND "1890", APART FROM THE MARK AS SHOWN.

THE MARK CONSISTS OF A CIRCULAR SEAL HAVING AN OUTER AND INNER BORDER WITHIN WHICH THE WORDING "UNIVERSITY OF NORTH TEXAS" APPEARS. WITHIN THE INNER BORDER APPEARS A BEVELED LONE STAR. OUTSIDE THE OUTER BORDER, A LAMP OF LEARNING WITH AN ETERNAL FLAME ON TOP OF A BOOK APPEARS AT THE TOP OF THE SEAL, THE WORDING "1890" WITHIN A BANNER APPEARS AT THE BOTTOM OF THE SEAL, AND BRANCHES EXTEND FROM EACH END OF THE BANNER ALONG THE OUTER BORDER TO THE OIL LAMP.



*David J. Kybas*

Director of the United States Patent and Trademark Office

SN 85-061,556, FILED 6-13-2010.

**Reg. No. 4,199,008** THOMAS MANOR, EXAMINING ATTORNEY



# United States of America

United States Patent and Trademark Office

# Gunlife

**Reg. No. 4,199,009**

GREENWOOD, LONALD A. (UNITED STATES INDIVIDUAL), DBA GUNLIFE,  
6675 STATE ROAD 16

**Registered Aug. 28, 2012**

ST. AUGUSTINE, FL 32092

**Int. Cls.: 13, 16, and 25**

FOR: GUN AND RIFLE CASES; GUN BELTS; GUN CASES; HOLSTERS; PISTOL HOLSTERS,  
IN CLASS 13 (U.S. CLS. 2 AND 9).

**TRADEMARK**

FIRST USE 5-4-2010; IN COMMERCE 7-30-2010.

**PRINCIPAL REGISTER**

FOR: (BASED ON USE IN COMMERCE) BUMPER STICKERS; DECORATIVE STICKERS  
FOR HELMETS; STICKERS; STICKERS AND TRANSFERS, IN CLASS 16 (U.S. CLS. 2, 5,  
22, 23, 29, 37, 38 AND 50).

FIRST USE 4-15-2010; IN COMMERCE 5-15-2010.

FOR: ATHLETIC APPAREL, NAMELY, SHIRTS, PANTS, JACKETS, FOOTWEAR, HATS  
AND CAPS, ATHLETIC UNIFORMS; BASEBALL CAPS AND HATS; CAMOUFLAGE SHIRTS;  
CAMP SHIRTS; DRESS SHIRTS; GOLF SHIRTS; HATS; HOODED SWEAT SHIRTS; OPEN-  
NECKED SHIRTS; PIQUE SHIRTS; POLO SHIRTS; RUGBY SHIRTS; SHORT-SLEEVED  
SHIRTS; SPORT SHIRTS; SPORTS CAPS AND HATS; SPORTS SHIRTS; SWEAT SHIRTS;  
T-SHIRTS; TEE SHIRTS, IN CLASS 25 (U.S. CLS. 22 AND 39).

FIRST USE 5-4-2010; IN COMMERCE 7-30-2010.

THE MARK CONSISTS OF STANDARD CHARACTERS WITHOUT CLAIM TO ANY PAR-  
TICULAR FONT, STYLE, SIZE, OR COLOR.

SN 85-062,154, FILED 6-14-2010.

ANGELA M. MICHELI, EXAMINING ATTORNEY



*David J. Kyros*

Director of the United States Patent and Trademark Office

# United States of America

United States Patent and Trademark Office

## ALICE: MADNESS RETURNS

**Reg. No. 4,199,010**

**Registered Aug. 28, 2012**

**Int. Cl.: 28**

**TRADEMARK**

**PRINCIPAL REGISTER**

ELECTRONIC ARTS INC. (DELAWARE CORPORATION)  
LEGAL DEPARTMENT  
209 REDWOOD SHORES PARKWAY  
REDWOOD CITY, CA 94065

FOR: COLLECTABLE TOY FIGURES, IN CLASS 28 (U.S. CLS. 22, 23, 38 AND 50).

FIRST USE 6-14-2011; IN COMMERCE 6-14-2011.

THE MARK CONSISTS OF STANDARD CHARACTERS WITHOUT CLAIM TO ANY PARTICULAR FONT, STYLE, SIZE, OR COLOR.

SN 85-063,671, FILED 6-15-2010.

DORITT L. CARROLL, EXAMINING ATTORNEY



*David J. Kyffers*

Director of the United States Patent and Trademark Office

# United States of America

United States Patent and Trademark Office

# MILSIGHT

**Reg. No. 4,199,011**

FLIR SYSTEMS, INC. (OREGON CORPORATION)  
27700 SW PARKWAY AVENUE  
WILSONVILLE, OR 97070

**Registered Aug. 28, 2012**

**Int. Cl.: 9**

FOR: MOUNTING NIGHT VISION DEVICES, NAMELY, HIGH-RESOLUTION NIGHT VISION SIGHTS FOR USE WITH WEAPONS, IN CLASS 9 (U.S. CLS. 21, 23, 26, 36 AND 38).

**TRADEMARK**

FIRST USE 6-1-2010; IN COMMERCE 6-1-2010.

**PRINCIPAL REGISTER**

THE MARK CONSISTS OF STANDARD CHARACTERS WITHOUT CLAIM TO ANY PARTICULAR FONT, STYLE, SIZE, OR COLOR.

SN 85-064,271, FILED 6-16-2010.

REGINA DRUMMOND, EXAMINING ATTORNEY



*David J. Kyffers*

Director of the United States Patent and Trademark Office

# United States of America

United States Patent and Trademark Office

# FLIP

**Reg. No. 4,199,012**

SONIC INNOVATIONS, INC. (DELAWARE CORPORATION)  
4246 SOUTH RIVERBOAT ROAD, SUITE 300  
SALT LAKE CITY, UT 84123

**Registered Aug. 28, 2012**

**Int. Cl.: 10**

FOR: HEARING AIDS, IN CLASS 10 (U.S. CLS. 26, 39 AND 44).

**TRADEMARK**

FIRST USE 1-2-2012; IN COMMERCE 1-2-2012.

**PRINCIPAL REGISTER**

THE MARK CONSISTS OF STANDARD CHARACTERS WITHOUT CLAIM TO ANY PARTICULAR FONT, STYLE, SIZE, OR COLOR.

SN 85-064,461, FILED 6-16-2010.

JOHN KELLY, EXAMINING ATTORNEY



*David J. Kybas*

Director of the United States Patent and Trademark Office

# United States of America

United States Patent and Trademark Office

# Rock Spirit

**Reg. No. 4,199,013**

CHRISTINA, MELISSA (UNITED STATES INDIVIDUAL)

**Registered Aug. 28, 2012**

P.O. BOX 6061-544  
SHERMAN OAKS, CA 91413

**Int. Cl.: 25**

FOR: CLOTHING, NAMELY, SHIRTS FOR MEN AND WOMEN, HOODED SWEATSHIRTS, SWEATERS, JACKETS AND BELTS, IN CLASS 25 (U.S. CLS. 22 AND 39).

**TRADEMARK**

FIRST USE 10-7-2011; IN COMMERCE 3-16-2012.

**PRINCIPAL REGISTER**

THE MARK CONSISTS OF STANDARD CHARACTERS WITHOUT CLAIM TO ANY PARTICULAR FONT, STYLE, SIZE, OR COLOR.

SN 85-064,743, FILED 6-16-2010.

BARNEY CHARLON, EXAMINING ATTORNEY



*David J. Kyffers*

Director of the United States Patent and Trademark Office

# United States of America

United States Patent and Trademark Office

## REFURBISHED EQUIPMENT FROM THE LIFESAVING INNOVATORS

**Reg. No. 4,199,014**

PHYSIO-CONTROL, INC. (WASHINGTON CORPORATION)  
11811 WILLOWS ROAD NE  
REDMOND, WA 98052

**Registered Aug. 28, 2012**

**Int. Cl.: 37**

FOR: MAINTENANCE, REPAIR AND REFURBISHMENT OF MEDICAL EQUIPMENT, IN CLASS 37 (U.S. CLS. 100, 103 AND 106).

**SERVICE MARK**

FIRST USE 9-15-2010; IN COMMERCE 9-27-2010.

**PRINCIPAL REGISTER**

THE MARK CONSISTS OF STANDARD CHARACTERS WITHOUT CLAIM TO ANY PARTICULAR FONT, STYLE, SIZE, OR COLOR.

NO CLAIM IS MADE TO THE EXCLUSIVE RIGHT TO USE "REFURBISHED EQUIPMENT", APART FROM THE MARK AS SHOWN.

SN 85-067,409, FILED 6-21-2010.

WILLIAM ROSSMAN, EXAMINING ATTORNEY



*David J. Kyffers*

Director of the United States Patent and Trademark Office

# United States of America

United States Patent and Trademark Office

## GET THIS WRITE

**Reg. No. 4,199,015**

**Registered Aug. 28, 2012**

**Int. Cl.: 41**

**SERVICE MARK**

**PRINCIPAL REGISTER**

CHRISTIANS, JOELLEN M. (UNITED STATES INDIVIDUAL)  
7425 N. 42ND STREET  
MILWAUKEE, WI 53209 AND

KIRCHNER, CHERYL A. (UNITED STATES INDIVIDUAL)  
2482 S. WENTWORTH AVE.  
MILWAUKEE, WI 53207

FOR: EDUCATION SERVICES, NAMELY, PROVIDING ON-LINE COURSES AND LESSONS IN THE FIELDS OF WRITING AND GRAMMAR, AND PRINTABLE EDUCATIONAL MATERIAL DISTRIBUTED THEREWITH, IN CLASS 41 (U.S. CLS. 100, 101 AND 107).

FIRST USE 7-3-2012; IN COMMERCE 7-3-2012.

THE MARK CONSISTS OF STANDARD CHARACTERS WITHOUT CLAIM TO ANY PARTICULAR FONT, STYLE, SIZE, OR COLOR.

SN 85-067,759, FILED 6-21-2010.

KELLEY WELLS, EXAMINING ATTORNEY



*David J. Kybas*

Director of the United States Patent and Trademark Office

# United States of America

United States Patent and Trademark Office

## VANILLA DREAM

**Reg. No. 4,199,016**

**Registered Aug. 28, 2012**

**Int. Cl.: 5**

**TRADEMARK**

**PRINCIPAL REGISTER**

OSMEGEN, INC. (PENNSYLVANIA CORPORATION)  
C/O THE HOMAX GROUP, INC.  
200 WESTERLY ROAD  
BELLINGHAM, WA 98226

FOR: AIR FRESHENERS; CARPET FRESHENERS AND ODOR ELIMINATORS; DEODORIZERS FOR HOUSEHOLD PET LITTER BOXES; DEODORIZING PRODUCTS, NAMELY, ALL PURPOSE DEODORIZER PREPARATIONS FOR HOUSEHOLD, COMMERCIAL AND INDUSTRIAL USE, IN CLASS 5 (U.S. CLS. 6, 18, 44, 46, 51 AND 52).

FIRST USE 9-0-2011; IN COMMERCE 9-0-2011.

THE MARK CONSISTS OF STANDARD CHARACTERS WITHOUT CLAIM TO ANY PARTICULAR FONT, STYLE, SIZE, OR COLOR.

NO CLAIM IS MADE TO THE EXCLUSIVE RIGHT TO USE "VANILLA", APART FROM THE MARK AS SHOWN.

SN 85-068,255, FILED 6-22-2010.

JACQUELINE A. LAVINE, EXAMINING ATTORNEY



*David J. Kybas*

Director of the United States Patent and Trademark Office



# United States of America

United States Patent and Trademark Office

# Eco-Green

**Reg. No. 4,199,017**

AALADIN INDUSTRIES, INC. (SOUTH DAKOTA CORPORATION)  
32584 477TH AVENUE  
ELK POINT, SD 57025

**Registered Aug. 28, 2012**

**Int. Cl.: 7**

FOR: MULTI-PURPOSE HIGH PRESSURE WASHERS; PRESSURE WASHING MACHINES,  
IN CLASS 7 (U.S. CLS. 13, 19, 21, 23, 31, 34 AND 35).

**TRADEMARK**

FIRST USE 4-0-2012; IN COMMERCE 4-0-2012.

**PRINCIPAL REGISTER**

THE MARK CONSISTS OF STANDARD CHARACTERS WITHOUT CLAIM TO ANY PAR-  
TICULAR FONT, STYLE, SIZE, OR COLOR.

SN 85-068,480, FILED 6-22-2010.

SCOTT BIBB, EXAMINING ATTORNEY



*David J. Kybas*

Director of the United States Patent and Trademark Office

# United States of America

United States Patent and Trademark Office

## RADIAN PERFORMANCE PLUS

**Reg. No. 4,199,018**

RADIAN GROUP INC. (DELAWARE CORPORATION)

**Registered Aug. 28, 2012**

1601 MARKET STREET  
PHILADELPHIA, PA 19103

**Int. Cl.: 36**

FOR: MORTGAGE INSURANCE UNDERWRITING SERVICES, IN CLASS 36 (U.S. CLS. 100, 101 AND 102).

**SERVICE MARK**

FIRST USE 6-4-2012; IN COMMERCE 6-4-2012.

**PRINCIPAL REGISTER**

THE MARK CONSISTS OF STANDARD CHARACTERS WITHOUT CLAIM TO ANY PARTICULAR FONT, STYLE, SIZE, OR COLOR.

OWNER OF U.S. REG. NOS. 2,513,095, 2,932,319, AND OTHERS.

SN 85-068,899, FILED 6-22-2010.

RICHARD WHITE, EXAMINING ATTORNEY



*David J. Kyjars*

Director of the United States Patent and Trademark Office

# United States of America

United States Patent and Trademark Office

## Mahco Outdoors

**Reg. No. 4,199,019**

**Registered Aug. 28, 2012**

**Int. Cl.: 20**

**TRADEMARK**

**PRINCIPAL REGISTER**

MAHCO, INC. (ARKANSAS CORPORATION)  
1202 MELISSA DRIVE  
BENTONVILLE, AR 72712

FOR: FURNITURE, CAMPING FURNITURE AND OUTDOOR FURNITURE, NAMELY, CAMPING CHAIRS, BEACH CHAIRS, TABLES AND FOLDING COTS, IN CLASS 20 (U.S. CLS. 2, 13, 22, 25, 32 AND 50).

FIRST USE 3-31-2011; IN COMMERCE 3-31-2011.

THE MARK CONSISTS OF STANDARD CHARACTERS WITHOUT CLAIM TO ANY PARTICULAR FONT, STYLE, SIZE, OR COLOR.

NO CLAIM IS MADE TO THE EXCLUSIVE RIGHT TO USE "OUTDOORS", APART FROM THE MARK AS SHOWN.

SN 85-069,120, FILED 6-22-2010.

MARLENE BELL, EXAMINING ATTORNEY



*David J. Kyffers*

Director of the United States Patent and Trademark Office

# United States of America

United States Patent and Trademark Office

# MAG&E

**Reg. No. 4,199,020**

**Registered Aug. 28, 2012**

**Int. Cl.: 35**

**SERVICE MARK**

**PRINCIPAL REGISTER**

US GAS & ELECTRIC, INC. (DELAWARE CORPORATION)  
PH5  
290 N.W. 165TH STREET  
NORTH MIAMI BEACH, FL 33169

FOR: ENERGY MANAGEMENT SERVICES, NAMELY, PROVIDING A SERVICE THAT  
ALLOWS CUSTOMERS TO PURCHASE ENERGY, NAMELY, ELECTRICITY AND NATURAL  
GAS, AT VARIABLE PRICES, IN CLASS 35 (U.S. CLS. 100, 101 AND 102).

FIRST USE 4-28-2011; IN COMMERCE 4-28-2011.

THE MARK CONSISTS OF STANDARD CHARACTERS WITHOUT CLAIM TO ANY PAR-  
TICULAR FONT, STYLE, SIZE, OR COLOR.

OWNER OF U.S. REG. NO. 3,800,175.

SN 85-070,105, FILED 6-23-2010.

KATHERINE STOIDES, EXAMINING ATTORNEY



*David J. Kyffers*

Director of the United States Patent and Trademark Office

# United States of America

United States Patent and Trademark Office

# CTG&E

**Reg. No. 4,199,021**

**Registered Aug. 28, 2012**

**Int. Cl.: 35**

**SERVICE MARK**

**PRINCIPAL REGISTER**

US GAS & ELECTRIC, INC. (DELAWARE CORPORATION)  
PH5  
290 N.W. 165TH STREET  
NORTH MIAMI BEACH, FL 33169

FOR: ENERGY MANAGEMENT SERVICES, NAMELY, PROVIDING A SERVICE THAT  
ALLOWS CUSTOMERS TO PURCHASE ENERGY, NAMELY, ELECTRICITY AND NATURAL  
GAS, AT VARIABLE PRICES, IN CLASS 35 (U.S. CLS. 100, 101 AND 102).

FIRST USE 4-28-2011; IN COMMERCE 4-28-2011.

THE MARK CONSISTS OF STANDARD CHARACTERS WITHOUT CLAIM TO ANY PAR-  
TICULAR FONT, STYLE, SIZE, OR COLOR.

OWNER OF U.S. REG. NO. 3,800,175.

SN 85-070,109, FILED 6-23-2010.

KATHERINE STOIDES, EXAMINING ATTORNEY



*David J. Kyffers*

Director of the United States Patent and Trademark Office

# United States of America

United States Patent and Trademark Office

# BizPak

**Reg. No. 4,199,022**

THE LAW FIRM OF JEFFREY L. SOLOMON, PLLC (NEW YORK CORPORATION)  
180 FROELICH FARM BOULEVARD  
WOODBURY, NY 11797

**Registered Aug. 28, 2012**

**Int. Cl.: 45**

FOR: LEGAL SERVICES, NAMELY, PRE-PACKAGED LEGAL SERVICES FOR INDIVIDUALS AND COMPANIES, IN CLASS 45 (U.S. CLS. 100 AND 101).

**SERVICE MARK**

FIRST USE 5-7-2012; IN COMMERCE 5-7-2012.

**PRINCIPAL REGISTER**

THE MARK CONSISTS OF STANDARD CHARACTERS WITHOUT CLAIM TO ANY PARTICULAR FONT, STYLE, SIZE, OR COLOR.

SN 85-071,365, FILED 6-25-2010.

STEVEN R. FINE, EXAMINING ATTORNEY



*David J. Kybas*

Director of the United States Patent and Trademark Office

# United States of America

United States Patent and Trademark Office

# Myorisan

**Reg. No. 4,199,023**

VERSAPHARM INCORPORATED (GEORGIA CORPORATION)  
1775 WEST OAK PARKWAY, SUITE 800  
MARIETTA, GA 300622260

**Registered Aug. 28, 2012**

**Int. Cl.: 5**

FOR: PHARMACEUTICAL PREPARATIONS FOR THE TREATMENT AND PREVENTION OF ACNE, IN CLASS 5 (U.S. CLS. 6, 18, 44, 46, 51 AND 52).

**TRADEMARK**

FIRST USE 6-4-2012; IN COMMERCE 6-4-2012.

**PRINCIPAL REGISTER**

THE MARK CONSISTS OF STANDARD CHARACTERS WITHOUT CLAIM TO ANY PARTICULAR FONT, STYLE, SIZE, OR COLOR.

SN 85-071,559, FILED 6-25-2010.

JOHN SCHUYLER YARD, EXAMINING ATTORNEY



*David J. Kyfos*

Director of the United States Patent and Trademark Office

# United States of America

United States Patent and Trademark Office

## RAID EARTH OPTIONS

**Reg. No. 4,199,024**

S. C. JOHNSON & SON, INC. (WISCONSIN CORPORATION)  
1525 HOWE STREET  
RACINE, WI 53403

**Registered Aug. 28, 2012**

**Int. Cl.: 21**

FOR: DISPOSABLE INSECT TRAP, IN CLASS 21 (U.S. CLS. 2, 13, 23, 29, 30, 33, 40 AND 50).

**TRADEMARK**

FIRST USE 6-16-2012; IN COMMERCE 6-16-2012.

**PRINCIPAL REGISTER**

THE MARK CONSISTS OF STANDARD CHARACTERS WITHOUT CLAIM TO ANY PARTICULAR FONT, STYLE, SIZE, OR COLOR.

OWNER OF U.S. REG. NOS. 628,506, 2,971,203, AND OTHERS.

SN 85-073,084, FILED 6-28-2010.

CHRISTINE COOPER, EXAMINING ATTORNEY



*David J. Kyffers*

Director of the United States Patent and Trademark Office



# United States of America

United States Patent and Trademark Office

## MUGGS MOTORSPORTS



## SUCK MY EXHAUST

**Reg. No. 4,199,025**

**Registered Aug. 28, 2012**

**Int. Cl.: 35**

**SERVICE MARK**

**PRINCIPAL REGISTER**

MUGGSMOTORSPORTS (GEORGIA LIMITED LIABILITY COMPANY)  
235 CHADWYCK LANE  
CANTON, GA 30115

FOR: RETAIL STORE SERVICES FEATURING MOTORCYCLE PARTS; ONLINE RETAIL STORE SERVICES FEATURING MOTORCYCLE PARTS, IN CLASS 35 (U.S. CLS. 100, 101 AND 102).

FIRST USE 1-1-2010; IN COMMERCE 1-1-2010.

NO CLAIM IS MADE TO THE EXCLUSIVE RIGHT TO USE "MOTORSPORTS", APART FROM THE MARK AS SHOWN.

THE MARK CONSISTS OF THE STYLIZED WORDS "MUGGS MOTORSPORTS SUCK MY EXHAUST". AN IMAGE OF A CHARACTER RIDING A MOTORCYCLE IS IN BETWEEN THE WORDS "MUGGS MOTORSPORTS" AND "SUCK MY EXHAUST".

SN 85-073,316, FILED 6-28-2010.

TOBY BULLOFF, EXAMINING ATTORNEY



*David J. Kyros*

Director of the United States Patent and Trademark Office

# United States of America

United States Patent and Trademark Office

# ONTD

**Reg. No. 4,199,026**

LIVE JOURNAL INC. (CALIFORNIA CORPORATION)  
580 MARKET STREET, SUITE 500  
SAN FRANCISCO, CA 94104

**Registered Aug. 28, 2012**

**Int. Cl.: 41**

FOR: ENTERTAINMENT SERVICES, NAMELY, PROVIDING COLUMNS FEATURING ONLINE INFORMATION IN THE FIELDS OF CELEBRITY GOSSIP, SPORTS, COMPUTER GAMES, AND CULTURAL ACTIVITIES; ENTERTAINMENT, NAMELY, CONDUCTING CONTESTS AND SWEEPSTAKES; ENTERTAINMENT SERVICES, NAMELY, PROVIDING ONLINE COMPUTER GAMES, IN CLASS 41 (U.S. CLS. 100, 101 AND 107).

**SERVICE MARK**

**PRINCIPAL REGISTER**

FIRST USE 6-26-2004; IN COMMERCE 6-26-2004.

THE MARK CONSISTS OF STANDARD CHARACTERS WITHOUT CLAIM TO ANY PARTICULAR FONT, STYLE, SIZE, OR COLOR.

SN 85-074,338, FILED 6-29-2010.

JOHN DWYER, EXAMINING ATTORNEY



*David J. Kybas*

Director of the United States Patent and Trademark Office

# United States of America

United States Patent and Trademark Office



**Reg. No. 4,199,027**

**Registered Aug. 28, 2012**

**Int. Cl.: 41**

**SERVICE MARK**

**PRINCIPAL REGISTER**

LIVE JOURNAL INC. (CALIFORNIA CORPORATION)  
580 MARKET STREET, SUITE 500  
SAN FRANCISCO, CA 94104

FOR: ENTERTAINMENT SERVICES, NAMELY, PROVIDING COLUMNS FEATURING ONLINE INFORMATION IN THE FIELDS OF CELEBRITY GOSSIP, SPORTS, COMPUTER GAMES, AND CULTURAL ACTIVITIES; ENTERTAINMENT, NAMELY, CONDUCTING CONTESTS AND SWEEPSTAKES; ENTERTAINMENT SERVICES, NAMELY, PROVIDING ONLINE COMPUTER GAMES, IN CLASS 41 (U.S. CLS. 100, 101 AND 107).

FIRST USE 12-31-2008; IN COMMERCE 12-31-2008.

THE MARK CONSISTS OF THE DESIGN OF AN EXCLAMATION POINT IN A DIALOG BUBBLE.

SN 85-074,377, FILED 6-29-2010.

JOHN DWYER, EXAMINING ATTORNEY



*David J. Kybas*

Director of the United States Patent and Trademark Office

# United States of America

United States Patent and Trademark Office



**Reg. No. 4,199,028**

DIESEL PRO POWER INC. (FLORIDA CORPORATION)  
760 NW 4TH. STREET, SUITE 100  
MIAMI, FL 33128

**Registered Aug. 28, 2012**

**Int. Cl.: 25**

FOR: FISHING SHIRTS; SHIRTS AND SHORT-SLEEVED SHIRTS, IN CLASS 25 (U.S. CLS. 22 AND 39).

**TRADEMARK**

FIRST USE 11-0-2011; IN COMMERCE 11-0-2011.

**PRINCIPAL REGISTER**

NO CLAIM IS MADE TO THE EXCLUSIVE RIGHT TO USE "USA", APART FROM THE MARK AS SHOWN.

THE COLOR(S) BLACK, BLUE, AND WHITE IS/ARE CLAIMED AS A FEATURE OF THE MARK.

THE MARK CONSISTS OF THE BLACK SILHOUETTE OF A SHARK WITH A WHITE LINE COMING OUT OF ITS MOUTH AND PASSING THROUGH THE WORD "BULLBUSTER" APPEARING TO THE RIGHT, THE WORD "USA" APPEARS SMALLER AND BENEATH THE FIRST LETTER "B" IN "BULLBUSTER"; THE WORDING APPEARS IN BLACK, AND THE SHARK HAS A BLUE PARALLELOGRAM IN ITS BACKGROUND.

SN 85-077,920, FILED 7-5-2010.

RON FAIRBANKS, EXAMINING ATTORNEY



*David J. Kypos*

Director of the United States Patent and Trademark Office

# United States of America

United States Patent and Trademark Office

## Patricia's Closet

**Reg. No. 4,199,029**

BLAIN SUPPLY, INC. (WISCONSIN CORPORATION)

**Registered Aug. 28, 2012**

3507 E. RACINE ST., P. O. BOX 5391  
JANESVILLE, WI 535475391

**Int. Cl.: 25**

FOR: WOMEN'S CLOTHING, NAMELY, WOVEN TOPS, KNIT TOPS, FLEECE TOPS, BLOUSES, SWEATERS, VESTS; WOMEN'S ACTIVEWEAR, NAMELY, FLEECE SETS OF PANTS AND TOPS, IN CLASS 25 (U.S. CLS. 22 AND 39).

**TRADEMARK**

FIRST USE 8-11-2011; IN COMMERCE 8-11-2011.

**PRINCIPAL REGISTER**

THE MARK CONSISTS OF STANDARD CHARACTERS WITHOUT CLAIM TO ANY PARTICULAR FONT, STYLE, SIZE, OR COLOR.

SN 85-078,141, FILED 7-6-2010.

JAY BESCH, EXAMINING ATTORNEY



*David J. Kyffers*

Director of the United States Patent and Trademark Office

# United States of America

United States Patent and Trademark Office



## CLEARSTORY

**Reg. No. 4,199,030**

WATANABE, DEBARA MEDINA (UNITED STATES INDIVIDUAL)  
8320 MIRAMAR MALL  
SAN DIEGO, CA 92121

**Registered Aug. 28, 2012**

**Int. Cls.: 39, 41, and 42**

FOR: ELECTRONIC STORAGE OF ELECTRONIC DATA; CONSULTING SERVICES IN THE FIELD OF STORAGE OF PHOTOGRAPHIC, VIDEO AND MULTIMEDIA DATA, IN CLASS 39 (U.S. CLS. 100 AND 105).

**SERVICE MARK**

FIRST USE 3-30-2012; IN COMMERCE 3-30-2012.

**PRINCIPAL REGISTER**

FOR: DIGITAL PHOTOGRAPHIC, VIDEO, PRINT AND MULTIMEDIA PUBLISHING SERVICES; EDUCATIONAL SERVICES, NAMELY, PROVIDING CLASSES AND WORKSHOPS IN THE FIELD OF PERSONAL DIGITAL PHOTOGRAPHY, VIDEO AND MULTIMEDIA PUBLISHING; CONSULTING SERVICES IN THE FIELD OF PERSONAL DIGITAL PHOTOGRAPHIC, VIDEO AND MULTIMEDIA PUBLISHING AND EDITING AND ORGANIZATION OF PHOTOGRAPHIC, VIDEO AND MULTIMEDIA DATA, IN CLASS 41 (U.S. CLS. 100, 101 AND 107).

FIRST USE 3-30-2012; IN COMMERCE 3-30-2012.

FOR: GRAPHIC DESIGN SERVICES; PROVIDING TEMPORARY USE OF NON-DOWNLOADABLE COMPUTER SOFTWARE AND HARDWARE FOR IMAGE EDITING; COMPUTER SERVICES, NAMELY, ELECTRONIC IMAGING OF VISUAL MATERIAL, NAMELY, PHOTOGRAPHS AND VIDEO CONTENT IN THE FIELDS OF PERSONAL DIGITAL PHOTOGRAPHY, VIDEO AND MULTIMEDIA PUBLISHING, AND RECORDING DATA FOR OTHERS ON OPTICAL, DIGITAL AND MAGNETIC MEDIA FOR ELECTRONIC STORAGE OF PERSONAL DIGITAL AND VIDEO PHOTOGRAPHY; TEMPORARY USE OF NON-DOWNLOADABLE SOFTWARE FOR DESKTOP PUBLISHING IN THE FIELD OF BOOK CREATION, FORMATTING AND PUBLISHING, IN CLASS 42 (U.S. CLS. 100 AND 101).

FIRST USE 3-30-2012; IN COMMERCE 3-30-2012.

THE MARK CONSISTS OF FOUR INTERSECTING CIRCLES WITH STYLIZED CAPITAL LETTERS "CS" IN THE CENTER OF THE CIRCLES WITH THE WORD "CLEARSTORY" IN CAPITAL LETTERS CENTERED ON THE LINE UNDERNEATH.



*David J. Kybas*

Director of the United States Patent and Trademark Office

SN 85-078,816, FILED 7-6-2010.

**Reg. No. 4,199,030** RICHARD WHITE, EXAMINING ATTORNEY

# United States of America

United States Patent and Trademark Office

# CROSSOVER

**Reg. No. 4,199,031**

TIPPMANN SPORTS, LLC (DELAWARE LIMITED LIABILITY COMPANY)  
975 WEILAND ROAD, SUITE 120  
BUFFALO GROVE, IL 60089

**Registered Aug. 28, 2012**

**Int. Cl.: 28**

FOR: PAINTBALL MARKERS AND ACCESSORIES, IN CLASS 28 (U.S. CLS. 22, 23, 38 AND 50).

**TRADEMARK**

FIRST USE 2-28-2012; IN COMMERCE 5-21-2012.

**PRINCIPAL REGISTER**

THE MARK CONSISTS OF STANDARD CHARACTERS WITHOUT CLAIM TO ANY PARTICULAR FONT, STYLE, SIZE, OR COLOR.

SN 85-079,391, FILED 7-7-2010.

MARGARET POWER, EXAMINING ATTORNEY



*David J. Kybas*

Director of the United States Patent and Trademark Office



# United States of America

United States Patent and Trademark Office

# chooze

**Reg. No. 4,199,032**

**Registered Aug. 28, 2012**

**Int. Cl.: 25**

**TRADEMARK**

**PRINCIPAL REGISTER**

DEGANI DESIGNS, LLC (TEXAS LIMITED LIABILITY COMPANY)  
13101 PRESTON ROAD, SUITE 550  
DALLAS, TX 75240

FOR: 100% VEGAN FOOTWEAR DESIGNED SUCH THAT THE RIGHT SHOE CONTAINS A DIFFERENT PATTERN OR DESIGN AS COMPARED TO THE LEFT SHOE; HATS, WEARABLE GARMENTS AND CLOTHING, NAMELY, SHIRTS EACH OF WHICH IS DESIGNED SUCH THAT THEY CONTAIN DIFFERENT PATTERNS OR DESIGNS, IN CLASS 25 (U.S. CLS. 22 AND 39).

FIRST USE 9-0-2011; IN COMMERCE 9-0-2011.

THE MARK CONSISTS OF STANDARD CHARACTERS WITHOUT CLAIM TO ANY PARTICULAR FONT, STYLE, SIZE, OR COLOR.

SN 85-080,910, FILED 7-9-2010.

JENNIFER VASQUEZ, EXAMINING ATTORNEY



*David J. Kybas*

Director of the United States Patent and Trademark Office

# United States of America

United States Patent and Trademark Office

# MIGHTY-B

**Reg. No. 4,199,033**

**Registered Aug. 28, 2012**

**Int. Cl.: 9**

**TRADEMARK**

**PRINCIPAL REGISTER**

BRIDGEPORT FITTINGS, INC. (CONNECTICUT CORPORATION)  
705 LORDSHIP BOULEVARD  
STRATFORD, CT 06615

FOR: ELECTRICAL FITTINGS AND PARTS FOR SUCH FITTINGS, NAMELY, ELECTRICAL CONNECTORS, ELECTRICAL CONDUITS, RAIN-TIGHT ELECTRIC CONNECTORS, ELECTRICAL COUPLINGS, ELECTRICAL CONDUIT AND CABLE STRAPS, BUSHINGS FOR USE IN ELECTRICAL CONNECTORS, ELECTRICAL CONDUIT EXPANSION FITTINGS, CONNECTION FITTINGS FOR ELECTRICAL CABLES, ELECTRICAL GROUNDING FITTINGS AND CLAMPS THEREFOR; ELECTRICAL EQUIPMENT, NAMELY, ELECTRICAL CONNECTORS, PLASTIC CONDUITS FOR ELECTRICAL USE, CONDUIT HANGERS FOR ELECTRICAL USE, SWITCH BOXES, BOX EXTENDERS; ELECTRICAL WIRE HOLDERS, NAMELY, REELS FOR ELECTRIC WIRE; COVER PLATES, NAMELY, ELECTRICAL OUTLET PLATES AND ELECTRIC SWITCH PLATES, AND MOUNTING BRACKETS FOR ELECTRICAL CABLES, IN CLASS 9 (U.S. CLS. 21, 23, 26, 36 AND 38).

FIRST USE 3-0-2011; IN COMMERCE 1-0-2012.

THE MARK CONSISTS OF STANDARD CHARACTERS WITHOUT CLAIM TO ANY PARTICULAR FONT, STYLE, SIZE, OR COLOR.

OWNER OF U.S. REG. NO. 2,859,244.

SN 85-081,104, FILED 7-9-2010.

ANDREW RHIM, EXAMINING ATTORNEY



*David J. Kypos*

Director of the United States Patent and Trademark Office

# United States of America

United States Patent and Trademark Office



**Reg. No. 4,199,034**

**Registered Aug. 28, 2012**

**Int. Cls.: 1, 6, and 11**

**TRADEMARK**

**PRINCIPAL REGISTER**

EASTERN LIGHTING AND TRUSS, LLC (VIRGINIA LIMITED LIABILITY COMPANY)  
2220 ZIA DRIVE  
VIRGINIA BEACH, VA 23456

FOR: CHEMICALS, NAMELY, SMOKE GENERATING FLUID FOR USE WITH FOG MACHINES AND CHEMICALS FOR USE IN THE MANUFACTURE OF ARTIFICIAL SNOW AND BUBBLE-MAKING SOLUTION FOR USE WITH SNOW AND BUBBLE MAKING MACHINES, IN CLASS 1 (U.S. CLS. 1, 5, 6, 10, 26 AND 46).

FIRST USE 11-6-2009; IN COMMERCE 12-1-2010.

FOR: LIGHTING ACCESSORIES, NAMELY, METAL CLAMPS, IN CLASS 6 (U.S. CLS. 2, 12, 13, 14, 23, 25 AND 50).

FIRST USE 11-6-2009; IN COMMERCE 12-1-2010.

FOR: FOG MAKING MACHINES; SNOW MAKING MACHINES; SMOKE GENERATING MACHINES FOR CREATING HAZY SPECIAL THEATRICAL EFFECTS, IN CLASS 11 (U.S. CLS. 13, 21, 23, 31 AND 34).

FIRST USE 11-6-2009; IN COMMERCE 12-1-2010.

THE MARK CONSISTS OF A STYLIZED LETTER "E" WITHIN A LIGHT BULB DESIGN FEATURING TEN LINES RESEMBLING ILLUMINATION ALONGSIDE THE LETTERS "LT" IN STYLIZED FONT AND TWO VERTICAL LINES.

SN 85-081,825, FILED 7-9-2010.

DAVID YONTEF, EXAMINING ATTORNEY



*David J. Kybas*

Director of the United States Patent and Trademark Office

# United States of America

United States Patent and Trademark Office

## ULTRASMART

**Reg. No. 4,199,035**

TIME WARNER CABLE INC. (DELAWARE CORPORATION)  
60 COLUMBUS CIRCLE  
NEW YORK, NY 10023

**Registered Aug. 28, 2012**

**Int. Cls.: 9 and 38**

FOR: TELEPHONES; WIRELESS COMMUNICATIONS DEVICES FOR VOICE, DATA OR IMAGE TRANSMISSION THAT FEATURE A SPEAKERPHONE, ADDRESS BOOK, DIRECTORY INFORMATION AND INTERNET CONNECTIVITY, IN CLASS 9 (U.S. CLS. 21, 23, 26, 36 AND 38).

**TRADEMARK**

**SERVICE MARK**

FIRST USE 7-0-2011; IN COMMERCE 7-0-2011.

**PRINCIPAL REGISTER**

FOR: TEXT AND NUMERIC WIRELESS DIGITAL MESSAGING SERVICES; WIRELESS ELECTRONIC TRANSMISSION OF VOICE SIGNALS, MESSAGES, DATA AND INFORMATION; TELEPHONE VOICE MESSAGING SERVICES; WEB MESSAGING, IN CLASS 38 (U.S. CLS. 100, 101 AND 104).

FIRST USE 7-0-2011; IN COMMERCE 7-0-2011.

THE MARK CONSISTS OF STANDARD CHARACTERS WITHOUT CLAIM TO ANY PARTICULAR FONT, STYLE, SIZE, OR COLOR.

SN 85-082,244, FILED 7-12-2010.

IRA J. GOODSID, EXAMINING ATTORNEY



*David J. Kyros*

Director of the United States Patent and Trademark Office

# United States of America

United States Patent and Trademark Office



**Reg. No. 4,199,036**

PD & PD, LLC (RHODE ISLAND LIMITED LIABILITY COMPANY)  
1177 AUBURN AVENUE  
JOHNSTON, RI 02919

**Registered Aug. 28, 2012**

**Int. Cl.: 35**

FOR: RETAIL STORE SERVICES FEATURING CLOTHING, IN CLASS 35 (U.S. CLS. 100, 101 AND 102).

**SERVICE MARK**

FIRST USE 7-1-2011; IN COMMERCE 7-1-2011.

**PRINCIPAL REGISTER**

THE MARK CONSISTS OF A FIRST FIVE-POINTED STAR, OUTLINED BY A SECOND FIVE POINTED STAR, WHICH IS OUTLINED BY A THIRD FIVE-POINTED STAR.

SN 85-083,518, FILED 7-13-2010.

TEJBIR SINGH, EXAMINING ATTORNEY



*David J. Kybas*

Director of the United States Patent and Trademark Office

# United States of America

United States Patent and Trademark Office

# KYG&E

**Reg. No. 4,199,037**

**Registered Aug. 28, 2012**

**Int. Cl.: 35**

**SERVICE MARK**

**PRINCIPAL REGISTER**

U.S. GAS & ELECTRIC, INC. (DELAWARE CORPORATION)  
PH5  
290 N.W. 165TH STREET  
NORTH MIAMI BEACH, FL 33169

FOR: ENERGY MANAGEMENT SERVICES, NAMELY, PROVIDING A SERVICE THAT ALLOWS CUSTOMERS TO PURCHASE ENERGY, NAMELY, ELECTRICITY AND NATURAL GAS, AT VARIABLE PRICES, IN CLASS 35 (U.S. CLS. 100, 101 AND 102).

FIRST USE 4-28-2011; IN COMMERCE 4-28-2011.

THE MARK CONSISTS OF STANDARD CHARACTERS WITHOUT CLAIM TO ANY PARTICULAR FONT, STYLE, SIZE, OR COLOR.

OWNER OF U.S. REG. NO. 3,800,175.

SN 85-083,689, FILED 7-13-2010.

KATHERINE STOIDES, EXAMINING ATTORNEY



*David J. Kyffers*

Director of the United States Patent and Trademark Office

# United States of America

United States Patent and Trademark Office

# Fun Bits

**Reg. No. 4,199,038**

**Registered Aug. 28, 2012**

**Int. Cls.: 9 and 42**

**TRADEMARK**

**SERVICE MARK**

**PRINCIPAL REGISTER**

FUN BITS INTERACTIVE LLC (WASHINGTON LIMITED LIABILITY COMPANY)  
605 FIRST AVENUE SUITE 220  
SEATTLE, WA 98104

FOR: COMPUTER GAME SOFTWARE DOWNLOADABLE FROM A GLOBAL COMPUTER NETWORK, IN CLASS 9 (U.S. CLS. 21, 23, 26, 36 AND 38).

FIRST USE 2-15-2012; IN COMMERCE 2-15-2012.

FOR: COMPUTER SOFTWARE DEVELOPMENT IN THE FIELD OF COMPUTER GAMES AND VIDEO GAMES; CUSTOMIZED SOFTWARE DEVELOPMENT SERVICES; DESIGN AND DEVELOPMENT OF COMPUTER GAME SOFTWARE AND VIRTUAL REALITY SOFTWARE; DESIGNING AND DEVELOPING COMPUTER GAME SOFTWARE AND VIDEO GAME SOFTWARE FOR USE WITH COMPUTERS, VIDEO GAME PROGRAM SYSTEMS AND COMPUTER NETWORKS, IN CLASS 42 (U.S. CLS. 100 AND 101).

FIRST USE 2-15-2012; IN COMMERCE 2-15-2012.

THE MARK CONSISTS OF STANDARD CHARACTERS WITHOUT CLAIM TO ANY PARTICULAR FONT, STYLE, SIZE, OR COLOR.

SN 85-083,775, FILED 7-13-2010.

KAREN SEVERSON, EXAMINING ATTORNEY



*David J. Kyros*

Director of the United States Patent and Trademark Office

# United States of America

United States Patent and Trademark Office

# INFALIBLE

**Reg. No. 4,199,039**

**Registered Aug. 28, 2012**

**Int. Cl.: 3**

**TRADEMARK**

**PRINCIPAL REGISTER**

JAFER LIMITED (BERMUDA CORPORATION)  
WATERFRONT DRIVE, P.O. BOX 3175  
3RD FLOOR, GENEVA PLACE  
ROAD TOWN, TORTOLA, BR. VIRGIN ISLANDS

FOR: FRAGRANCES FOR PERSONAL USE, TOILET WATER, COLOGNE, IN CLASS 3 (U.S. CLS. 1, 4, 6, 50, 51 AND 52).

FIRST USE 5-21-2012; IN COMMERCE 5-21-2012.

THE MARK CONSISTS OF STANDARD CHARACTERS WITHOUT CLAIM TO ANY PARTICULAR FONT, STYLE, SIZE, OR COLOR.

SN 85-084,832, FILED 7-14-2010.

MARLENE BELL, EXAMINING ATTORNEY



*David J. Kyffers*

Director of the United States Patent and Trademark Office



# United States of America

United States Patent and Trademark Office

# AireBarrier

**Reg. No. 4,199,040**

COLLINS, WILLIAM (UNITED STATES INDIVIDUAL)  
1736 BUCKLEY DRIVE  
FAYETTEVILLE, AR 72701

**Registered Aug. 28, 2012**

**Int. Cl.: 17**

FOR: SEALANTS, NAMELY, POLYURETHANE SPRAY FOAMS FOR APPLICATION ON CONDITIONED AND UNCONDITIONED WALLS, IN CLASS 17 (U.S. CLS. 1, 5, 12, 13, 35 AND 50).

**TRADEMARK**

FIRST USE 8-25-2010; IN COMMERCE 8-25-2010.

**PRINCIPAL REGISTER**

NO CLAIM IS MADE TO THE EXCLUSIVE RIGHT TO USE "AIR BARRIER", APART FROM THE MARK AS SHOWN.

THE COLOR(S) BLACK, GREEN, BLUE AND GRAY IS/ARE CLAIMED AS A FEATURE OF THE MARK.

THE MARK CONSISTS OF BLACK LETTERS "AIREBARRIER" CENTERED ON TOP OF AN INFINITY SYMBOL IN BACKGROUND, THE INFINITY SYMBOL HAVING A LEFT HALF THAT IS GREEN AND A RIGHT HALF THAT IS BLUE, ALL BEING REFLECTED IN LIGHT GRAY PARTIAL SHADOW BELOW. THE COLOR WHITE REPRESENTS BACKGROUND AND IS NOT PART OF THE MARK.

SN 85-085,354, FILED 7-15-2010.

CHRISTINE COOPER, EXAMINING ATTORNEY



*David J. Kybas*

Director of the United States Patent and Trademark Office

# United States of America

United States Patent and Trademark Office

# AireSealants

**Reg. No. 4,199,041**

COLLINS, WILLIAM (UNITED STATES INDIVIDUAL)  
1736 BUCKLEY DRIVE  
FAYETTEVILLE, AR 72701

**Registered Aug. 28, 2012**

**Int. Cl.: 17**

FOR: SEALANTS, NAMELY, POLYURETHANE SPRAY FOAM FOR APPLICATION ON CONDITIONED OR UNCONDITIONED WALLS, IN CLASS 17 (U.S. CLS. 1, 5, 12, 13, 35 AND 50).

**TRADEMARK**

FIRST USE 7-1-2011; IN COMMERCE 7-1-2011.

**PRINCIPAL REGISTER**

NO CLAIM IS MADE TO THE EXCLUSIVE RIGHT TO USE "AIR SEALANTS", APART FROM THE MARK AS SHOWN.

THE COLOR(S) GREEN, BLUE, BLACK AND GRAY IS/ARE CLAIMED AS A FEATURE OF THE MARK.

THE MARK CONSISTS OF BLACK LETTERS "AIRESEALANTS" CENTERED ON TOP OF AN INFINITY SYMBOL IN BACKGROUND, THE INFINITY SYMBOL HAVING A LEFT HALF THAT IS GREEN AND A RIGHT HALF THAT IS BLUE, ALL BEING REFLECTED IN LIGHT GRAY PARTIAL SHADOW BELOW. THE COLOR WHITE REPRESENTS BACKGROUND, OUTLINING, SHADING AND/OR TRANSPARENT AREAS THAT ARE NOT PART OF THE MARK.

SN 85-085,362, FILED 7-15-2010.

CHRISTINE COOPER, EXAMINING ATTORNEY



*David J. Kybas*

Director of the United States Patent and Trademark Office

# United States of America

United States Patent and Trademark Office



**Reg. No. 4,199,042**

**Registered Aug. 28, 2012**

**Int. Cl.: 9**

**TRADEMARK**

**PRINCIPAL REGISTER**

CRESTWOOD FILMS (CALIFORNIA CORPORATION)  
379  
1171 S. ROBERTSON BLVD  
LOS ANGELES, CA 90035

FOR: DIGITAL MEDIA, NAMELY, MP3S AND DOWNLOADABLE AUDIO FILES FEATURING MUSIC, IN CLASS 9 (U.S. CLS. 21, 23, 26, 36 AND 38).

FIRST USE 1-1-2010; IN COMMERCE 1-1-2010.

THE STIPLING IS FOR SHADING PURPOSES ONLY.

THE MARK CONSISTS OF THE STYLIZED TEXT "MICHAEL COLTON" IN FRONT OF A GUITAR.

SN 85-085,908, FILED 7-15-2010.

NICHOLAS COLEMAN, EXAMINING ATTORNEY



*David J. Kybas*

Director of the United States Patent and Trademark Office

# United States of America

United States Patent and Trademark Office

# KleenLine

**Reg. No. 4,199,043**

WAXIE'S ENTERPRISES, INC. (ARIZONA CORPORATION)

**Registered Aug. 28, 2012**

9353 WAXIE WAY  
SAN DIEGO, CA 92123

**Int. Cl.: 16**

FOR: TOILET TISSUE AND PAPER TOWELS, IN CLASS 16 (U.S. CLS. 2, 5, 22, 23, 29, 37, 38 AND 50).

**TRADEMARK**

FIRST USE 12-7-2010; IN COMMERCE 12-7-2010.

**PRINCIPAL REGISTER**

THE MARK CONSISTS OF STANDARD CHARACTERS WITHOUT CLAIM TO ANY PARTICULAR FONT, STYLE, SIZE, OR COLOR.

SN 85-086,712, FILED 7-16-2010.

CARYN GLASSER, EXAMINING ATTORNEY



*David J. Kybas*

Director of the United States Patent and Trademark Office

# United States of America

United States Patent and Trademark Office

## RUSSELL Investment Discipline ETFs

**Reg. No. 4,199,044**

FRANK RUSSELL COMPANY (WASHINGTON CORPORATION)  
1301 SECOND AVENUE, 18TH FLOOR  
SEATTLE, WA 98101

**Registered Aug. 28, 2012**

**Int. Cls.: 9, 16, 36, 41,  
and 42**

FOR: DOWNLOADABLE ELECTRONIC PUBLICATIONS, NAMELY, PROSPECTUSES, FACTSHEETS, FINANCIAL REPORTS, FINANCIAL BOOKLETS, FINANCIAL NEWSLETTERS, AND FINANCIAL BROCHURES, ALL IN THE FINANCIAL AND INVESTMENT FIELDS; DOWNLOADABLE ELECTRONIC PUBLICATIONS, NAMELY, LISTINGS OF INVESTMENT SECURITIES AND AN INDEX BASED ON SECURITIES VALUES; DOWNLOADABLE ELECTRONIC DATA FILES RELATING TO AN INDEX OF SECURITIES VALUES; DOWNLOADABLE ELECTRONIC PUBLICATIONS, NAMELY, LISTINGS OF SECURITIES WITHIN AN EXCHANGE TRADED FUND AND RELATED METRICS; DOWNLOADABLE ELECTRONIC DATA FILES RELATING TO AN EXCHANGE TRADED FUND AND RELATED METRICS, IN CLASS 9 (U.S. CLS. 21, 23, 26, 36 AND 38).

**TRADEMARK**

**SERVICE MARK**

**PRINCIPAL REGISTER**

FIRST USE 5-0-2011; IN COMMERCE 5-0-2011.

FOR: PRINTED FINANCIAL PUBLICATIONS, NAMELY, PROSPECTUSES, FACTSHEETS, FINANCIAL REPORTS, FINANCIAL BOOKLETS, FINANCIAL NEWSLETTERS, FINANCIAL BROCHURES, AND FINANCIAL BOOKS, ALL IN THE FINANCIAL AND INVESTMENT FIELDS; PRINTED MATERIALS, NAMELY, PRINTED LISTINGS OF INVESTMENT SECURITIES AND AN INDEX BASED ON SECURITIES VALUES; PRINTED PUBLICATIONS IN THE NATURE OF LISTINGS OF SECURITIES WITHIN AND EXCHANGE TRADED FUND PORTFOLIOS AND RELATED METRICS, IN CLASS 16 (U.S. CLS. 2, 5, 22, 23, 29, 37, 38 AND 50).

FIRST USE 10-0-2011; IN COMMERCE 10-0-2011.

FOR: FINANCIAL SERVICES IN THE NATURE OF AN INVESTMENT SECURITY; FINANCIAL CONSULTING; TRUST, FIDUCIARY AND INVESTMENT MANAGEMENT SERVICES; INVESTMENT FUND ADMINISTRATION SERVICES; PROVIDING FINANCIAL INFORMATION BY ELECTRONIC MEANS; PROVIDING AND UPDATING INFORMATION RELATING TO AN INDEX OF SECURITIES VALUES FOR OTHERS AND PROVIDING RULES AS TO THE MAKEUP OF THE INDEX; PROVIDING AND UPDATING INFORMATION RELATING TO PORTFOLIOS OF SECURITIES AND RELATED METRICS, IN CLASS 36 (U.S. CLS. 100, 101 AND 102).



*David J. Kyffers*

Director of the United States Patent and Trademark Office

**Reg. No. 4,199,044** FIRST USE 5-0-2011; IN COMMERCE 5-0-2011.

FOR: EDUCATIONAL SERVICES, NAMELY, CONDUCTING CLASSES, CONFERENCES, TELECONFERENCES, SEMINARS, WORKSHOPS AND TUTORIAL SESSIONS, ALL IN THE FINANCIAL AND INVESTMENT FIELDS, IN CLASS 41 (U.S. CLS. 100, 101 AND 107).

FIRST USE 8-0-2011; IN COMMERCE 8-0-2011.

FOR: PROVIDING ONLINE NON-DOWNLOADABLE SOFTWARE FOR FINANCIAL ANALYSIS AND MEASUREMENT AND FOR GRAPHICAL PRESENTATION, ALL IN THE FINANCIAL AND INVESTMENT FIELD, IN CLASS 42 (U.S. CLS. 100 AND 101).

FIRST USE 5-0-2011; IN COMMERCE 5-0-2011.

THE MARK CONSISTS OF STANDARD CHARACTERS WITHOUT CLAIM TO ANY PARTICULAR FONT, STYLE, SIZE, OR COLOR.

OWNER OF U.S. REG. NOS. 1,576,348, 3,792,722, AND OTHERS.

NO CLAIM IS MADE TO THE EXCLUSIVE RIGHT TO USE "INVESTMENT DISCIPLINE ETFS", APART FROM THE MARK AS SHOWN.

SN 85-086,954, FILED 7-16-2010.

JANICE L. MCMORROW, EXAMINING ATTORNEY

# United States of America

United States Patent and Trademark Office

## INVESTABLE VOL INDEX

**Reg. No. 4,199,045**

**Registered Aug. 28, 2012**

**Int. Cl.: 36**

**SERVICE MARK**

**PRINCIPAL REGISTER**

BANK OF AMERICA CORPORATION (DELAWARE CORPORATION)  
100 NORTH TRYON STREET  
CHARLOTTE, NC 28255

FOR: FINANCIAL SERVICES, NAMELY, PROVIDING INFORMATION IN THE FIELD OF MARKET VOLATILITY IN THE AREA OF FINANCIAL STOCK AND EQUITY MARKETS, IN CLASS 36 (U.S. CLS. 100, 101 AND 102).

FIRST USE 3-0-2010; IN COMMERCE 3-0-2010.

THE MARK CONSISTS OF STANDARD CHARACTERS WITHOUT CLAIM TO ANY PARTICULAR FONT, STYLE, SIZE, OR COLOR.

NO CLAIM IS MADE TO THE EXCLUSIVE RIGHT TO USE "INVESTABLE" AND "INDEX", APART FROM THE MARK AS SHOWN.

SN 85-088,600, FILED 7-20-2010.

MARC LEIPZIG, EXAMINING ATTORNEY



*David J. Kyfos*

Director of the United States Patent and Trademark Office

# United States of America

United States Patent and Trademark Office

## PHOSPHORESCENCE

**Reg. No. 4,199,046**

BHAROOCHA, HISHAM AKIRA (JAPAN INDIVIDUAL)  
520 LEONARD STREET, NO. 3  
BROOKLYN, NY 11223206

**Registered Aug. 28, 2012**

**Int. Cl.: 9**

FOR: EYEGLASSES AND SUNGLASSES, IN CLASS 9 (U.S. CLS. 21, 23, 26, 36 AND 38).

**TRADEMARK**

FIRST USE 9-1-2010; IN COMMERCE 9-1-2010.

**PRINCIPAL REGISTER**

THE MARK CONSISTS OF STANDARD CHARACTERS WITHOUT CLAIM TO ANY PARTICULAR FONT, STYLE, SIZE, OR COLOR.

SN 85-089,935, FILED 7-21-2010.

DAVID TAYLOR, EXAMINING ATTORNEY



*David J. Kyffers*

Director of the United States Patent and Trademark Office



# United States of America

United States Patent and Trademark Office

# Skinny Life

**Reg. No. 4,199,047**

**Registered Aug. 28, 2012**

**Int. Cls.: 41 and 44**

**SERVICE MARK**

**PRINCIPAL REGISTER**

CRYSTAL VISION LTD (ARIZONA LIMITED LIABILITY COMPANY), DBA CRYSTAL VISION LTD,  
5122 EAST ROCKRIDGE RD  
PHOENIX, AZ 85018

FOR: LIFE COACHING SERVICES IN THE FIELD OF WEIGHT LOSS VIA HYPNOTHERAPY, IN CLASS 41 (U.S. CLS. 100, 101 AND 107).

FIRST USE 1-1-2010; IN COMMERCE 1-1-2010.

FOR: PROVIDING A WEB SITE FEATURING INFORMATION IN THE FIELD OF MENTAL HEALTH AND PHYSICAL HEALTH, INCLUDING LIVING A HEALTHY AND DISEASE FREE LIFE, IN CLASS 44 (U.S. CLS. 100 AND 101).

FIRST USE 2-1-2012; IN COMMERCE 2-1-2012.

THE MARK CONSISTS OF STANDARD CHARACTERS WITHOUT CLAIM TO ANY PARTICULAR FONT, STYLE, SIZE, OR COLOR.

NO CLAIM IS MADE TO THE EXCLUSIVE RIGHT TO USE "LIFE", APART FROM THE MARK AS SHOWN.

SN 85-090,942, FILED 7-22-2010.

DAWN FELDMAN, EXAMINING ATTORNEY



*David J. Kyros*

Director of the United States Patent and Trademark Office

# United States of America

United States Patent and Trademark Office

## EP Telesis

**Reg. No. 4,199,048**

**Registered Aug. 28, 2012**

**Int. Cl.: 9**

**TRADEMARK**

**PRINCIPAL REGISTER**

DISC INTELLECTUAL PROPERTIES, LLC (CALIFORNIA LIMITED LIABILITY COMPANY)  
2835 NORTH NAOMI STREET  
ENTERTAINMENT PARTNERS  
BURBANK, CA 91504

FOR: COMPUTER SOFTWARE FOR USE IN FINANCIAL MANAGEMENT ASSOCIATED  
WITH COMMERCIAL PRODUCTIONS IN THE ENTERTAINMENT INDUSTRY, IN CLASS  
9 (U.S. CLS. 21, 23, 26, 36 AND 38).

FIRST USE 12-15-2011; IN COMMERCE 12-15-2011.

THE MARK CONSISTS OF STANDARD CHARACTERS WITHOUT CLAIM TO ANY PAR-  
TICULAR FONT, STYLE, SIZE, OR COLOR.

SN 85-091,540, FILED 7-23-2010.

TRICIA SONNEBORN, EXAMINING ATTORNEY



*David J. Kyros*

Director of the United States Patent and Trademark Office

# United States of America

United States Patent and Trademark Office



**Reg. No. 4,199,049**

**Registered Aug. 28, 2012**

**Int. Cl.: 25**

**TRADEMARK**

**PRINCIPAL REGISTER**

KWADWO BEDIAKO (OHIO JOINT VENTURE), DBA ADIKANFO MMRANTIE,  
225 OVERLOOK DR  
RITTMAN, OH 44270

FOR: A-SHIRTS; BASEBALL CAPS AND HATS; DRESS PANTS; HEADGEAR, NAMELY,  
TRUCKER HATS, BASEBALL CAPS; HOODED SWEAT SHIRTS; POLO SHIRTS; T-SHIRTS;  
V-NECK SWEATERS, IN CLASS 25 (U.S. CLS. 22 AND 39).

FIRST USE 3-12-2008; IN COMMERCE 5-7-2010.

THE MARK CONSISTS OF THE LETTER "I" ABOVE A BIRD DESIGN FEATURING THE  
WORDING "I AM" REPRESENTING THE BODY OF THE BIRD WITH WINGS.

SN 85-092,262, FILED 7-24-2010.

MICHELE SWAIN, EXAMINING ATTORNEY



*David J. Kybas*

Director of the United States Patent and Trademark Office

# United States of America

United States Patent and Trademark Office



**Reg. No. 4,199,050**

**Registered Aug. 28, 2012**

**Int. Cl.: 25**

**TRADEMARK**

**PRINCIPAL REGISTER**

COOPER'S AT BEAR LAKE WEST (IDAHO CORPORATION)  
554 LEWIS LOOP  
FISH HAVEN, ID 83287

FOR: HATS; SHIRTS, IN CLASS 25 (U.S. CLS. 22 AND 39).

FIRST USE 5-27-2010; IN COMMERCE 5-27-2010.

NO CLAIM IS MADE TO THE EXCLUSIVE RIGHT TO USE "BEAR LAKE WEST" AND "RESTAURANT & SPORTS BAR", APART FROM THE MARK AS SHOWN.

THE MARK CONSISTS OF THE STYLIZED WORDS "COOPER'S @ BEAR LAKE WEST RESTAURANT & SPORTS BAR". AN IMAGE OF A LITTLE BOY WITH A FISHING POLE SITTING ON TOP OF THE WORD "COOPER'S".

SN 85-093,314, FILED 7-26-2010.

PAM WILLIS, EXAMINING ATTORNEY



*David J. Kybas*

Director of the United States Patent and Trademark Office

# United States of America

United States Patent and Trademark Office

## HEAD FOR THE SUN

**Reg. No. 4,199,051**

SUNKIST GROWERS, INC. (CALIFORNIA CORPORATION)  
14130 RIVERSIDE DRIVE  
SHERMAN OAKS, CA 91423

**Registered Aug. 28, 2012**

**Int. Cl.: 32**

FOR: SOFT DRINKS, IN CLASS 32 (U.S. CLS. 45, 46 AND 48).

**TRADEMARK**

FIRST USE 6-30-2010; IN COMMERCE 2-14-2012.

**PRINCIPAL REGISTER**

THE MARK CONSISTS OF STANDARD CHARACTERS WITHOUT CLAIM TO ANY PARTICULAR FONT, STYLE, SIZE, OR COLOR.

SN 85-093,621, FILED 7-27-2010.

HENRY S. ZAK, EXAMINING ATTORNEY



*David J. Kybas*

Director of the United States Patent and Trademark Office

# United States of America

United States Patent and Trademark Office

# MOTOACTV

**Reg. No. 4,199,052**

**Registered Aug. 28, 2012**

**Int. Cl.: 9**

**TRADEMARK**

**PRINCIPAL REGISTER**

MOTOROLA TRADEMARK HOLDINGS, LLC (DELAWARE LIMITED LIABILITY COMPANY)  
600 NORTH US HIGHWAY 45  
LIBERTYVILLE, IL 60048

FOR: GLOBAL POSITIONING SYSTEMS, BATTERIES, BATTERY CHARGERS, POWER ADAPTERS, AND ELECTRONIC NON-MEDICAL PORTABLE DEVICES PRIMARILY FOR MEASURING, STORING, TRANSFERRING AND SYNCHRONIZING INFORMATION ABOUT AN INDIVIDUAL'S PHYSICAL EXERCISE AND ACTIVITY LEVELS, NAMELY, DATE, TIME, GLOBAL POSITIONING, DIRECTION, ALTITUDE, SPEED, DISTANCE, AND CALORIES, IN CLASS 9 (U.S. CLS. 21, 23, 26, 36 AND 38).

FIRST USE 10-18-2011; IN COMMERCE 12-21-2011.

THE MARK CONSISTS OF STANDARD CHARACTERS WITHOUT CLAIM TO ANY PARTICULAR FONT, STYLE, SIZE, OR COLOR.

OWNER OF U.S. REG. NOS. 3,402,839, 3,490,367, AND OTHERS.

SN 85-094,604, FILED 7-28-2010.

ELLEN B. AWRICH, EXAMINING ATTORNEY



*David J. Kyros*

Director of the United States Patent and Trademark Office

# United States of America

United States Patent and Trademark Office



**Reg. No. 4,199,053**

SCENTSY, INC. (IDAHO CORPORATION)  
P. O. BOX 1335  
MERIDIAN, ID 83680

**Registered Aug. 28, 2012**

**Int. Cl.: 4**

FOR: FRAGRANT, PERFUMED, AND SCENTED WICKLESS CANDLES; FRAGRANT, PERFUMED, AND SCENTED WAX BARS AND CHIPS FOR USE IN FRAGRANCE WARMERS, IN CLASS 4 (U.S. CLS. 1, 6 AND 15).

**TRADEMARK**

FIRST USE 4-25-2012; IN COMMERCE 4-25-2012.

**PRINCIPAL REGISTER**

OWNER OF U.S. REG. NOS. 3,417,399 AND 3,542,934.

NO CLAIM IS MADE TO THE EXCLUSIVE RIGHT TO USE "WICKLESS", APART FROM THE MARK AS SHOWN.

THE MARK CONSISTS OF A STYLIZED DESIGN FOR A LOGO CONTAINING THE WORD "SCENTSY" SHOWN IN LARGE CURSIVE LETTERING, AND THE WORD "WICKLESS" IN SMALLER BLOCK CAPITAL LETTERING BELOW THE CENTER PORTION OF THE WORD "SCENTSY". THERE ARE TWO FIVE-POINT STARS, ONE SHOWN ON THE LEFT OF THE DESIGN AT THE BOTTOM OF THE CAPITAL "S" IN THE WORD "SCENTSY", AND THE SECOND SHOWN ON THE RIGHT OF THE DESIGN ABOVE THE "Y" IN THE WORD "SCENTSY".

SN 85-094,718, FILED 7-28-2010.

JOHN GARTNER, EXAMINING ATTORNEY



*David J. Kyros*

Director of the United States Patent and Trademark Office

# United States of America

United States Patent and Trademark Office

# rightster

**Reg. No. 4,199,054**

**Registered Aug. 28, 2012**

**Int. Cl.: 35**

**SERVICE MARK**

**PRINCIPAL REGISTER**

RIGHTSTER LIMITED (UNITED KINGDOM LIMITED COMPANY)  
GILMOORA HOUSE  
57-61 MORTIMER STREET  
LONDON, UNITED KINGDOM W1W 8HS

FOR: CONTENT RIGHTS EXCHANGE, NAMELY, PROVIDING COMMERCIAL BARTER AND TRADE EXCHANGE OF LIVE VIDEO STREAMS, VIDEO CLIPS, PHOTOGRAPHIC AND AUDIO FILES OF OTHERS VIA AN ONLINE WEBSITE; BUSINESS MONITORING SERVICES, NAMELY, TRACKING ONLINE VIDEO STREAMS AND VIDEO CLIPS OF OTHERS IN THE ONLINE VIDEO INDUSTRY TO PROVIDE STRATEGY, INSIGHT, MARKETING, SALES, OPERATION, PRODUCT DESIGN, PARTICULARLY SPECIALIZING IN THE USE OF ANALYTIC AND STATISTIC MODELS FOR THE UNDERSTANDING AND PREDICTING OF CONSUMERS, BUSINESSES, AND MARKET TRENDS AND ACTIONS, IN CLASS 35 (U.S. CLS. 100, 101 AND 102).

FIRST USE 2-0-2011; IN COMMERCE 2-0-2011.

THE MARK CONSISTS OF STANDARD CHARACTERS WITHOUT CLAIM TO ANY PARTICULAR FONT, STYLE, SIZE, OR COLOR.

SN 85-096,590, FILED 7-30-2010.

AMY HELLA, EXAMINING ATTORNEY



*David J. Kybas*

Director of the United States Patent and Trademark Office



# United States of America

United States Patent and Trademark Office

## Original Play Pants BY Dot Dot Couture

**Reg. No. 4,199,055**

AMYS WARDROBE CORPORATION (CALIFORNIA CORPORATION)  
7853 AIRPORT BLVD  
LOS ANGELES, CA 90045

**Registered Aug. 28, 2012**

**Int. Cl.: 25**

FOR: INFANT AND TODDLER PANTS, TOPS AND FOOTWEAR, IN CLASS 25 (U.S. CLS. 22 AND 39).

**TRADEMARK**

FIRST USE 10-29-2010; IN COMMERCE 10-29-2010.

**PRINCIPAL REGISTER**

THE MARK CONSISTS OF STANDARD CHARACTERS WITHOUT CLAIM TO ANY PARTICULAR FONT, STYLE, SIZE, OR COLOR.

NO CLAIM IS MADE TO THE EXCLUSIVE RIGHT TO USE "ORIGINAL PLAY PANTS" OR "COUTURE", APART FROM THE MARK AS SHOWN.

SN 85-098,227, FILED 8-2-2010.

GRETCHEN ULRICH, EXAMINING ATTORNEY



*David J. Kybas*

Director of the United States Patent and Trademark Office

# United States of America

United States Patent and Trademark Office

## HOUSE & HOME

**Reg. No. 4,199,056**

LAFCO ENTERPRISES INC. (NEW YORK CORPORATION)  
285 LAFAYETTE STREET  
NEW YORK, NY 10012

**Registered Aug. 28, 2012**

**Int. Cl.: 3**

FOR: SOAPS, IN CLASS 3 (U.S. CLS. 1, 4, 6, 50, 51 AND 52).

**TRADEMARK**

FIRST USE 6-4-2012; IN COMMERCE 6-4-2012.

**PRINCIPAL REGISTER**

THE MARK CONSISTS OF STANDARD CHARACTERS WITHOUT CLAIM TO ANY PARTICULAR FONT, STYLE, SIZE, OR COLOR.

SN 85-099,530, FILED 8-3-2010.

MIDGE BUTLER, EXAMINING ATTORNEY



*David J. Kyffers*

Director of the United States Patent and Trademark Office

# United States of America

United States Patent and Trademark Office

## Pretty by Caren Original

**Reg. No. 4,199,057**

CAREN PRODUCTS, LLC (GEORGIA LIMITED LIABILITY COMPANY)  
3080 NORTHFIELD PLACE, SUITE 106  
ROSWELL, GA 30076

**Registered Aug. 28, 2012**

**Int. Cl.: 3**

FOR: SKIN CARE PRODUCTS, NAMELY, SKIN LOTION, HAND LOTION AND MOISTURIZING CREAM; SKIN CLEANSER; HAND SOAP; BAR SOAP; NON-MEDICATED FOOT LOTION, IN CLASS 3 (U.S. CLS. 1, 4, 6, 50, 51 AND 52).

**TRADEMARK**

FIRST USE 6-20-2012; IN COMMERCE 6-20-2012.

**PRINCIPAL REGISTER**

THE MARK CONSISTS OF STANDARD CHARACTERS WITHOUT CLAIM TO ANY PARTICULAR FONT, STYLE, SIZE, OR COLOR.

OWNER OF U.S. REG. NO. 3,783,999.

NO CLAIM IS MADE TO THE EXCLUSIVE RIGHT TO USE "ORIGINAL", APART FROM THE MARK AS SHOWN.

SN 85-100,107, FILED 8-4-2010.

JENNIFER DIXON, EXAMINING ATTORNEY



*David J. Kyffers*

Director of the United States Patent and Trademark Office

# United States of America

United States Patent and Trademark Office

Once-weekly   
**BYDUREON** **STEADY**  
**SUPPORT**

**Reg. No. 4,199,058**

AMYLIN PHARMACEUTICALS, INC. (DELAWARE CORPORATION)  
9360 TOWNE CENTREDRIVE  
SAN DIEGO, CA 92121

**Registered Aug. 28, 2012**

**Int. Cl.: 44**

FOR: MEDICAL INFORMATION SERVICES IN THE FIELD OF DIABETES, IN CLASS 44  
(U.S. CLS. 100 AND 101).

**SERVICE MARK**

FIRST USE 3-31-2012; IN COMMERCE 3-31-2012.

**PRINCIPAL REGISTER**

NO CLAIM IS MADE TO THE EXCLUSIVE RIGHT TO USE "ONCE-WEEKLY", APART  
FROM THE MARK AS SHOWN.

THE COLOR(S) GREEN AND ORANGE IS/ARE CLAIMED AS A FEATURE OF THE MARK.

THE MARK CONSISTS OF THE WORD "BYDUREON" IN ALL CAPITAL LETTERS IN A  
LARGE FONT IN THE COLOR GREEN. ABOVE THE WORD "BYDUREON" IN A SMALLER  
FONT ARE THE WORDS "ONCE WEEKLY" IN THE COLOR GREEN. THERE IS A HYPHEN  
BETWEEN THE WORDS "ONCE" AND "WEEKLY". TO THE RIGHT OF THE WORDS "ONCE  
WEEKLY" AND ALSO ABOVE THE WORD "BYDUREON" IS A DESIGN IMAGE IN THE  
SHAPE OF A STYLIZED CATERPILLAR. THE DESIGN IMAGE IS SEPARATED INTO  
SEVEN SECTIONS. THE FIRST SECTION OF THE DESIGN IMAGE CONSISTS OF THREE  
OVERLAPPING CIRCLES. EACH OF THE REMAINING SIX SECTIONS OF THE DESIGN  
IMAGE CONSIST OF TWO AND A HALF OVERLAPPING CIRCLES. THE 1ST, 2ND, 3RD,  
4TH, 6TH, AND 7TH SECTIONS OF THE DESIGN IMAGE ARE IN THE COLOR ORANGE.  
THE 5TH SECTION OF THE DESIGN IMAGE IS IN THE COLOR GREEN. TO THE RIGHT  
OF THE WORDS "BYDUREON ONCE WEEKLY" AND THE DESIGN IMAGE ARE THE  
WORDS "STEADY SUPPORT". THE WORD "STEADY" IS IN ALL CAPITAL LETTERS IN  
BOLD FONT IN THE COLOR GREEN AND IS PLACED ABOVE THE WORD "SUPPORT".  
THE WORD "SUPPORT" IS ALSO IN ALL CAPITAL LETTERS IN THE COLOR GREEN.  
THERE IS AN ORANGE LINE BETWEEN THE WORDS "STEADY" AND "SUPPORT".



SN 85-103,095, FILED 8-9-2010.

*David J. Kybas*

SCOTT BIBB, EXAMINING ATTORNEY

# United States of America

United States Patent and Trademark Office

# SEATSNOB

**Reg. No. 4,199,059**

**Registered Aug. 28, 2012**

**Int. Cl.: 41**

MURTHY ASSOCIATES, LLC (FLORIDA LIMITED LIABILITY COMPANY), DBA  
SEATSNOB,  
#910  
1800 PURDY AVE.  
MIAMI BEACH, FL 33139

**SERVICE MARK**

**PRINCIPAL REGISTER**

FOR: ARRANGING FOR TICKET RESERVATIONS FOR SHOWS AND OTHER ENTERTAINMENT EVENTS; BOOKING OF SEATS FOR SHOWS AND BOOKING OF THEATRE TICKETS; ENTERTAINMENT TICKET AGENCY SERVICES; ON-LINE ADMISSION TICKET AGENCY SERVICES FOR ENTERTAINMENT, EDUCATIONAL, SPORTING AND CULTURAL EVENTS; ON-LINE ENTERTAINMENT TICKET AGENCY SERVICES; PROVIDING AN INTERNET WEBSITE PORTAL FEATURING LINKS TO MUSICAL ARTIST WEBSITES AND MUSIC PERFORMANCE TICKET INFORMATION; THEATRICAL TICKET AGENCIES; TICKET AGENCY SERVICES FOR ENTERTAINMENT EVENTS; TICKET RESERVATION AND BOOKING SERVICES FOR ENTERTAINMENT, SPORTING AND CULTURAL EVENTS, IN CLASS 41 (U.S. CLS. 100, 101 AND 107).

FIRST USE 6-0-2010; IN COMMERCE 6-0-2010.

THE MARK CONSISTS OF STANDARD CHARACTERS WITHOUT CLAIM TO ANY PARTICULAR FONT, STYLE, SIZE, OR COLOR.

SN 85-104,216, FILED 8-10-2010.

SIMON TENG, EXAMINING ATTORNEY



*David J. Kyffers*

Director of the United States Patent and Trademark Office

# United States of America

United States Patent and Trademark Office

# CCE

**Reg. No. 4,199,060**

**Registered Aug. 28, 2012**

**Int. Cls.: 41 and 45**

**SERVICE MARK**

**PRINCIPAL REGISTER**

UNIVERSITY OF LANCASTER (UNITED KINGDOM UNIVERSITY)  
UNIVERSITY HOUSE  
BAILRIGG  
LANCASTER LA1 4YW, UNITED KINGDOM 015246520

FOR: TRAINING SERVICES IN THE FIELD OF SECURITY OPERATIONS AND SERVICE, NAMELY, ARRANGING AND CONDUCTING TRAINING IN THE FIELD OF SECURITY OPERATIONS AND SERVICE, AT THE END OF WHICH STUDENTS RECEIVE A CERTIFICATE NOTING TRAINING COMPLETION; CONSULTANCY SERVICES RELATING TO TRAINING IN THE FIELD OF SECURITY OPERATIONS AND SERVICE; TRAINING SERVICES RELATING TO SECURITY SERVICES; TRAINING TRAINERS IN THE FIELD OF SECURITY OPERATIONS AND SERVICE, IN CLASS 41 (U.S. CLS. 100, 101 AND 107).

FIRST USE 12-1-2011; IN COMMERCE 12-1-2011.

FOR: SECURITY INSPECTION SERVICES FOR OTHERS; SECURITY CONSULTANCY; PERSONAL SECURITY CONSULTANCY; AIRPORT BAGGAGE SECURITY INSPECTION SERVICES; FRAUD AND IDENTITY THEFT PROTECTION SERVICES; AIRPORT SECURITY SERVICES, NAMELY, SECURITY CONTROL OF PERSONS AND LUGGAGE IN AIRPORTS; AUDIT OF SECURITY SERVICES, ALSO KNOWN AS, SECURITY INSPECTION AUDITS TO IMPROVE THE SECURITY OF PERSONS AND LUGGAGE IN AIRPORTS; BORDER SECURITY SERVICES; FRAUD DETECTION SERVICES IN THE FIELD OF AIRPORTS AND LUGGAGE; EMPLOYMENT BACKGROUND SCREENING, NAMELY, BACKGROUND SCREENING OF CURRENT EMPLOYEES OF OTHERS; PASSENGER SECURITY SCREENING; PERSONNEL SECURITY SCREENING; SECURITY ADVISORY SERVICES IN THE FIELD OF AIRPORT SECURITY SYSTEMS; SECURITY CONSULTANCY IN THE FIELD OF RISK ASSESSMENT PERTAINING TO AIRPORT LAYOUTS AND SECURITY DEPLOYMENT, IN CLASS 45 (U.S. CLS. 100 AND 101).

FIRST USE 12-1-2011; IN COMMERCE 12-1-2011.

THE MARK CONSISTS OF STANDARD CHARACTERS WITHOUT CLAIM TO ANY PARTICULAR FONT, STYLE, SIZE, OR COLOR.

SN 85-107,912, FILED 8-16-2010.

RONALD AIKENS, EXAMINING ATTORNEY



*David J. Kyffers*

Director of the United States Patent and Trademark Office

# United States of America

United States Patent and Trademark Office

## FRENCH WRAP PLUS

**Reg. No. 4,199,061**

KMC EXIM CORP. (NEW YORK CORPORATION)

**Registered Aug. 28, 2012**

1 HARBOR PARK ROAD  
PORT WASHINGTON, NY 11050

**Int. Cl.: 3**

FOR: ARTIFICIAL FINGERNAILS AND NAIL CARE PREPARATIONS, IN CLASS 3 (U.S. CLS. 1, 4, 6, 50, 51 AND 52).

**TRADEMARK**

FIRST USE 5-0-2009; IN COMMERCE 5-0-2009.

**PRINCIPAL REGISTER**

THE MARK CONSISTS OF STANDARD CHARACTERS WITHOUT CLAIM TO ANY PARTICULAR FONT, STYLE, SIZE, OR COLOR.

OWNER OF U.S. REG. NO. 3,858,532.

NO CLAIM IS MADE TO THE EXCLUSIVE RIGHT TO USE "FRENCH WRAP", APART FROM THE MARK AS SHOWN.

SN 85-108,386, FILED 8-16-2010.

ANDREA HACK, EXAMINING ATTORNEY



*David J. Kyffers*

Director of the United States Patent and Trademark Office

# United States of America

United States Patent and Trademark Office



**Reg. No. 4,199,062**

**Registered Aug. 28, 2012**

**Int. Cl.: 9**

**TRADEMARK**

**PRINCIPAL REGISTER**

ACCELERATED PAYMENT SOLUTIONS, LLC (WASHINGTON LIMITED LIABILITY COMPANY)  
P.O. BOX 2038  
FERNDALE, WA 98248

FOR: DOWNLOADABLE COMPUTER SOFTWARE FOR USE WITH MOBILE DEVICES AND MOBILE COMPUTERS, FOR FINANCIAL ANALYSIS, IN CLASS 9 (U.S. CLS. 21, 23, 26, 36 AND 38).

FIRST USE 12-1-2010; IN COMMERCE 12-1-2010.

THE MARK CONSISTS OF THE STYLIZED LETTERS "CM". THE COLOR GREEN APPEARS IN THE LETTER "C", IN THE TOP PORTION OF THE LETTER "M" AND IN THE ARROW. THE COLORS BLUE AND WHITE APPEAR IN THE LOWER PORTION OF THE LETTER "M". THE LETTER "M" IS DIVIDED HORIZONTALLY WITH A ZIGZAG PROFIT GRAPH IN THE COLORS WHITE AND GREEN.

THE COLOR(S) GREEN, BLUE, AND WHITE IS/ARE CLAIMED AS A FEATURE OF THE MARK.

SN 85-109,509, FILED 8-17-2010.

EVELYN BRADLEY, EXAMINING ATTORNEY



*David J. Kybas*

Director of the United States Patent and Trademark Office



# United States of America

United States Patent and Trademark Office

## BOW COMMANDER

**Reg. No. 4,199,063**

TRONE, DAVID (UNITED STATES INDIVIDUAL)  
10 BIRCH ROAD  
COLUMBIA, NJ 07832

**Registered Aug. 28, 2012**

**Int. Cl.: 28**

FOR: ARCHERY BOWS, IN CLASS 28 (U.S. CLS. 22, 23, 38 AND 50).

**TRADEMARK**

FIRST USE 8-1-2010; IN COMMERCE 8-1-2010.

**PRINCIPAL REGISTER**

THE MARK CONSISTS OF STANDARD CHARACTERS WITHOUT CLAIM TO ANY PARTICULAR FONT, STYLE, SIZE, OR COLOR.

NO CLAIM IS MADE TO THE EXCLUSIVE RIGHT TO USE "BOW", APART FROM THE MARK AS SHOWN.

SN 85-109,759, FILED 8-17-2010.

SALLY SHIH, EXAMINING ATTORNEY



*David J. Kybas*

Director of the United States Patent and Trademark Office

# United States of America

United States Patent and Trademark Office

FEEL GOOD ABOUT EVERYDAY

**Reg. No. 4,199,064**

**Registered Aug. 28, 2012**

**Int. Cl.: 30**

**TRADEMARK**

**PRINCIPAL REGISTER**

RALCORP HOLDINGS, INC. (MISSOURI CORPORATION)  
SUITE 2900  
800 MARKET STREET  
ST. LOUIS, MO 63101

FOR: BREAKFAST CEREALS, IN CLASS 30 (U.S. CL. 46).

FIRST USE 1-17-2012; IN COMMERCE 1-17-2012.

THE MARK CONSISTS OF STANDARD CHARACTERS WITHOUT CLAIM TO ANY PARTICULAR FONT, STYLE, SIZE, OR COLOR.

SN 85-110,938, FILED 8-19-2010.

JUDITH HELFMAN, EXAMINING ATTORNEY



*David J. Kyffers*

Director of the United States Patent and Trademark Office

# United States of America

United States Patent and Trademark Office

## FEEL GOOD ABOUT BREAKFAST

**Reg. No. 4,199,065**

**Registered Aug. 28, 2012**

**Int. Cl.: 30**

**TRADEMARK**

**PRINCIPAL REGISTER**

RALCORP HOLDINGS, INC. (MISSOURI CORPORATION)  
SUITE 2900  
800 MARKET STREET  
ST. LOUIS, MO 63101

FOR: BREAKFAST CEREALS, IN CLASS 30 (U.S. CL. 46).

FIRST USE 1-17-2012; IN COMMERCE 1-17-2012.

THE MARK CONSISTS OF STANDARD CHARACTERS WITHOUT CLAIM TO ANY PARTICULAR FONT, STYLE, SIZE, OR COLOR.

SN 85-110,941, FILED 8-19-2010.

JUDITH HELFMAN, EXAMINING ATTORNEY



*David J. Kybas*

Director of the United States Patent and Trademark Office

# United States of America

United States Patent and Trademark Office

## MAXIMIZE YOUR BENEFIT

**Reg. No. 4,199,066**

HUMANA INC. (DELAWARE CORPORATION)  
500 WEST MAIN STREET  
LOUISVILLE, KY 40202

**Registered Aug. 28, 2012**

**Int. Cls.: 35, 36, and 41**

FOR: COST CONTAINMENT IN THE FIELD OF CONSUMER PRESCRIPTION MEDICATIONS, IN CLASS 35 (U.S. CLS. 100, 101 AND 102).

**SERVICE MARK**

FIRST USE 1-0-2004; IN COMMERCE 3-0-2005.

**PRINCIPAL REGISTER**

FOR: UNDERWRITING, ORGANIZING AND ADMINISTRATION OF PRE-PAID AND SELF-FUNDED HEALTH CARE AND PRESCRIPTION DRUG SERVICES AND PLANS; ADMINISTRATION OF PRESCRIPTION DRUG PROGRAMS FOR DRUG COVERAGE INSURERS, IN CLASS 36 (U.S. CLS. 100, 101 AND 102).

FIRST USE 1-0-2004; IN COMMERCE 3-0-2005.

FOR: EDUCATIONAL SERVICES, NAMELY, PROVIDING CLASSES AND SEMINARS IN THE FIELDS OF COST-EFFECTIVE PHARMACEUTICALS AND PRESCRIPTION DRUG COMPLIANCE, IN CLASS 41 (U.S. CLS. 100, 101 AND 107).

FIRST USE 1-0-2004; IN COMMERCE 3-0-2005.

THE MARK CONSISTS OF STANDARD CHARACTERS WITHOUT CLAIM TO ANY PARTICULAR FONT, STYLE, SIZE, OR COLOR.

OWNER OF U.S. REG. NOS. 3,386,959 AND 3,390,267.

SN 85-112,407, FILED 8-20-2010.

STEPHANIE ALI, EXAMINING ATTORNEY



*David J. Kyros*

Director of the United States Patent and Trademark Office

# United States of America

United States Patent and Trademark Office

## STM ECONOMY

**Reg. No. 4,199,067**

HCC INSURANCE HOLDINGS, INC. (DELAWARE CORPORATION)  
13403 NORTHWEST FREEWAY  
HOUSTON, TX 77040

**Registered Aug. 28, 2012**

**Int. Cl.: 36**

FOR: INSURANCE SERVICES, NAMELY, UNDERWRITING, ISSUING, AND ADMINISTRATION OF MEDICAL INSURANCE, IN CLASS 36 (U.S. CLS. 100, 101 AND 102).

**SERVICE MARK**

FIRST USE 4-0-2012; IN COMMERCE 4-0-2012.

**PRINCIPAL REGISTER**

THE MARK CONSISTS OF STANDARD CHARACTERS WITHOUT CLAIM TO ANY PARTICULAR FONT, STYLE, SIZE, OR COLOR.

NO CLAIM IS MADE TO THE EXCLUSIVE RIGHT TO USE "STM", APART FROM THE MARK AS SHOWN.

SN 85-113,851, FILED 8-23-2010.

FRED CARL, EXAMINING ATTORNEY



*David J. Kybas*

Director of the United States Patent and Trademark Office

# United States of America

United States Patent and Trademark Office



**Reg. No. 4,199,068**

**Registered Aug. 28, 2012**

**Int. Cl.: 7**

**TRADEMARK**

**PRINCIPAL REGISTER**

CHANGXING WIND POWER TECHNOLOGY CO., LTD. (CHINA CORPORATION)  
SAN LI HE CHANG SHAN TOWN  
ZOUPIING COUNTY  
SHANDONG PROVINCE, CHINA

FOR: WINDMILLS; WIND-OPERATED MACHINES FOR GENERATING POWER AND PARTS AND ACCESSORIES THEREFOR; WIND TURBINES AND PARTS AND ACCESSORIES THEREFOR; MILL TOWERS, HOUSINGS AND MASTS FOR USE IN PROVIDING A SUPPORTING STRUCTURE FOR WINDMILLS; WINDMILL PARTS AND ACCESSORIES, NAMELY, BLADES, BLADE HUBS, MACHINE BEDS, ROTATION DEVICES, YAW RINGS AND GEARS; PITCH CONTROL DEVICES FOR SETTING THE PITCH OF WINGS, NAMELY, BLADES, BRAKES AND BRAKING DEVICES, ALL BEING PARTS AND COMPONENTS OF WINDMILLS; MAIN SHAFTS, NAMELY, CAM SHAFTS AND SHAFTS FOR PUMPS; UNIVERSAL JOINTS AND TRANSMISSION CASES BEING PARTS OF WINDMILLS; CLUTCHES FOR MACHINES AND ELECTRIC GENERATORS, IN CLASS 7 (U.S. CLS. 13, 19, 21, 23, 31, 34 AND 35).

FIRST USE 1-25-2010; IN COMMERCE 1-25-2010.

THE MARK CONSISTS OF AN OVAL.

SN 85-115,930, FILED 8-25-2010.

CHRISTINA SOBRAL, EXAMINING ATTORNEY



*David J. Kyjars*

Director of the United States Patent and Trademark Office

# United States of America

United States Patent and Trademark Office

## CX WINDTECH

**Reg. No. 4,199,069**

**Registered Aug. 28, 2012**

**Int. Cl.: 7**

**TRADEMARK**

**PRINCIPAL REGISTER**

CHANGXING WIND POWER TECHNOLOGY CO., LTD. (CHINA CORPORATION)  
SAN LI HE CHANG SHAN TOWN  
ZOUPIING COUNTY  
SHANDONG PROVINCE, CHINA

FOR: WINDMILLS; WIND-OPERATED MACHINES FOR GENERATING POWER AND PARTS AND ACCESSORIES THEREFOR; WIND TURBINES AND PARTS AND ACCESSORIES THEREFOR; MILL TOWERS, HOUSINGS AND MASTS FOR USE IN PROVIDING A SUPPORTING STRUCTURE FOR WINDMILLS; WINDMILL PARTS AND ACCESSORIES, NAMELY, BLADES, BLADE HUBS, MACHINE BEDS, ROTATION DEVICES, YAW RINGS AND GEARS; PITCH CONTROL DEVICES FOR SETTING THE PITCH OF WINGS, NAMELY, BLADES, BRAKES AND BRAKING DEVICES, ALL BEING PARTS AND COMPONENTS OF WINDMILLS; MAIN SHAFTS, NAMELY, CAM SHAFTS AND SHAFTS FOR PUMPS; UNIVERSAL JOINTS AND TRANSMISSION CASES BEING PARTS OF WINDMILLS; CLUTCHES FOR MACHINES AND ELECTRIC GENERATORS, IN CLASS 7 (U.S. CLS. 13, 19, 21, 23, 31, 34 AND 35).

FIRST USE 1-25-2010; IN COMMERCE 1-25-2010.

THE MARK CONSISTS OF STANDARD CHARACTERS WITHOUT CLAIM TO ANY PARTICULAR FONT, STYLE, SIZE, OR COLOR.

SN 85-115,934, FILED 8-25-2010.

CHRISTINA SOBRAL, EXAMINING ATTORNEY



*David J. Kyffers*

Director of the United States Patent and Trademark Office

# United States of America

United States Patent and Trademark Office

# TRENDLINE

**Reg. No. 4,199,070**

**Registered Aug. 28, 2012**

**Int. Cls.: 10 and 21**

**TRADEMARK**

**PRINCIPAL REGISTER**

NUK USA LLC (DELAWARE CORPORATION)  
CORPORATION TRUST CO., CORP TRUST CTR.  
1209 ORANGE STREET  
WILMINGTON, DE 19801

FOR: FEEDING BOTTLES; FEEDING BOTTLE NIPPLES; DUMMIES FOR BABIES IN THE FORM OF NIPPLES; PACIFIERS FOR BABIES, IN CLASS 10 (U.S. CLS. 26, 39 AND 44).

FIRST USE 5-13-2010; IN COMMERCE 5-13-2010.

FOR: TABLEWARE FOR BABIES, NAMELY, CUPS, IN CLASS 21 (U.S. CLS. 2, 13, 23, 29, 30, 33, 40 AND 50).

FIRST USE 5-13-2010; IN COMMERCE 5-13-2010.

THE MARK CONSISTS OF STANDARD CHARACTERS WITHOUT CLAIM TO ANY PARTICULAR FONT, STYLE, SIZE, OR COLOR.

SN 85-118,140, FILED 8-28-2010.

DAWN FELDMAN, EXAMINING ATTORNEY



*David J. Kypos*

Director of the United States Patent and Trademark Office



# United States of America

United States Patent and Trademark Office

## FIRST ALERT

**Reg. No. 4,199,071**

**Registered Aug. 28, 2012**

**Int. Cls.: 6, 16, and 20**

**TRADEMARK**

**PRINCIPAL REGISTER**

THE TRUSTEES OF THE FIRST ALERT TRUST (MINNESOTA TRUST)  
THE TRUSTEES OF THE FIRST ALERT TRUST  
60 LIVINGSTON AVENUE  
ST. PAUL, MN 55107

FOR: METAL SECURITY CHESTS, IN CLASS 6 (U.S. CLS. 2, 12, 13, 14, 23, 25 AND 50).

FIRST USE 6-30-2009; IN COMMERCE 6-30-2009.

FOR: PAPER SHREDDERS; FILE BOXES FOR STORAGE OF BUSINESS AND PERSONAL RECORDS, IN CLASS 16 (U.S. CLS. 2, 5, 22, 23, 29, 37, 38 AND 50).

FIRST USE 6-30-2009; IN COMMERCE 6-30-2009.

FOR: PLASTIC SAFES FOR HOUSEHOLD USE; NON-METAL SECURITY CHESTS, IN CLASS 20 (U.S. CLS. 2, 13, 22, 25, 32 AND 50).

FIRST USE 6-30-2009; IN COMMERCE 6-30-2009.

THE MARK CONSISTS OF STANDARD CHARACTERS WITHOUT CLAIM TO ANY PARTICULAR FONT, STYLE, SIZE, OR COLOR.

OWNER OF U.S. REG. NOS. 1,909,171, 3,887,275, AND OTHERS.

SN 85-121,728, FILED 9-2-2010.

BARBARA RUTLAND, EXAMINING ATTORNEY



*David J. Kybas*

Director of the United States Patent and Trademark Office

# United States of America

United States Patent and Trademark Office

## MEDIG MEDICAL INJURY GROUP

**Reg. No. 4,199,072**

MEDIG PROPRIETARY HOLDINGS, L.L.C. (FLORIDA LIMITED LIABILITY COMPANY)  
4410 NEWBERRY ROAD, SUITE A-3  
GAINESVILLE, FL 32607

**Registered Aug. 28, 2012**

**Int. Cl.: 44**

FOR: MEDICAL SERVICES, IN CLASS 44 (U.S. CLS. 100 AND 101).

**SERVICE MARK**

FIRST USE 11-30-2010; IN COMMERCE 11-30-2010.

**PRINCIPAL REGISTER**

THE MARK CONSISTS OF STANDARD CHARACTERS WITHOUT CLAIM TO ANY PARTICULAR FONT, STYLE, SIZE, OR COLOR.

NO CLAIM IS MADE TO THE EXCLUSIVE RIGHT TO USE "MEDICAL INJURY GROUP", APART FROM THE MARK AS SHOWN.

SN 85-121,918, FILED 9-2-2010.

TINA BROWN, EXAMINING ATTORNEY



*David J. Kyffers*

Director of the United States Patent and Trademark Office

# United States of America

United States Patent and Trademark Office

## CF Select

**Reg. No. 4,199,073**

**Registered Aug. 28, 2012**

**Int. Cls.: 38 and 41**

**SERVICE MARK**

**PRINCIPAL REGISTER**

LIBERTY MEDIA HOLDINGS (CALIFORNIA LIMITED LIABILITY COMPANY), DBA  
CORBIN FISHER,  
10620 S. HIGHLANDS PKWY., SUITE 110-454  
C/O RANDAZZA LEGAL GROUP  
LAS VEGAS, NV 89141

FOR: BROADCASTING SERVICES AND PROVISION OF TELECOMMUNICATION ACCESS  
TO VIDEO AND AUDIO CONTENT FEATURING ADULT-ORIENTED SUBJECT MATTER  
PROVIDED VIA A VIDEO-ON-DEMAND SERVICE VIA THE INTERNET, IN CLASS 38 (U.S.  
CLS. 100, 101 AND 104).

FIRST USE 7-15-2011; IN COMMERCE 8-15-2011.

FOR: ENTERTAINMENT SERVICES, NAMELY, PROVIDING A WEB SITE FEATURING  
PHOTOGRAPHIC, AUDIO, VIDEO AND PROSE PRESENTATIONS FEATURING ADULT-  
ORIENTED SUBJECT MATTER, IN CLASS 41 (U.S. CLS. 100, 101 AND 107).

FIRST USE 7-15-2011; IN COMMERCE 8-15-2011.

THE MARK CONSISTS OF STANDARD CHARACTERS WITHOUT CLAIM TO ANY PAR-  
TICULAR FONT, STYLE, SIZE, OR COLOR.

OWNER OF U.S. REG. NO. 4,008,769.

NO CLAIM IS MADE TO THE EXCLUSIVE RIGHT TO USE "SELECT", APART FROM THE  
MARK AS SHOWN.

SN 85-122,085, FILED 9-2-2010.

BERYL GARDNER, EXAMINING ATTORNEY



*David J. Kypos*

Director of the United States Patent and Trademark Office

# United States of America

United States Patent and Trademark Office

# Lookit

**Reg. No. 4,199,074**

**Registered Aug. 28, 2012**

**Int. Cls.: 9, 41, 42, and 45**

**TRADEMARK**

**SERVICE MARK**

**PRINCIPAL REGISTER**

SPENCER HUNT (UNITED STATES INDIVIDUAL)  
1012 PEARL ST  
SANTA MONICA, CA 90405

FOR: COMPUTER APPLICATION SOFTWARE FOR MOBILE PHONES, NAMELY, SOFTWARE FOR DISPLAYING AND SHARING WHAT A USER IS LOOKING AT OR EVENT THEY ARE ATTENDING, AND FINDING, LOCATING, AND INTERACTING WITH OTHER USERS, THINGS TO LOOK AT AND EVENTS, IN CLASS 9 (U.S. CLS. 21, 23, 26, 36 AND 38).

FIRST USE 6-1-2010; IN COMMERCE 10-1-2011.

FOR: ENTERTAINMENT SERVICES, NAMELY, PROVIDING AN ON-LINE COMPUTER GAME, IN CLASS 41 (U.S. CLS. 100, 101 AND 107).

FIRST USE 6-1-2010; IN COMMERCE 10-1-2011.

FOR: PROVIDING A WEBSITE FEATURING NON-DOWNLOADABLE SOFTWARE FOR DISPLAYING AND SHARING WHAT A USER IS LOOKING AT OR EVENT THEY ARE ATTENDING AND FINDING, LOCATING, AND INTERACTING WITH OTHER USERS AND THINGS TO LOOK AT AND EVENTS, IN CLASS 42 (U.S. CLS. 100 AND 101).

FIRST USE 6-1-2010; IN COMMERCE 10-1-2011.

FOR: ON-LINE SOCIAL NETWORKING SERVICES, IN CLASS 45 (U.S. CLS. 100 AND 101).

FIRST USE 6-1-2010; IN COMMERCE 10-1-2011.

THE MARK CONSISTS OF STANDARD CHARACTERS WITHOUT CLAIM TO ANY PARTICULAR FONT, STYLE, SIZE, OR COLOR.

SN 85-122,418, FILED 9-3-2010.

TINA BROWN, EXAMINING ATTORNEY



*David J. Kyffers*

Director of the United States Patent and Trademark Office

# United States of America

United States Patent and Trademark Office



**Reg. No. 4,199,075**

**Registered Aug. 28, 2012**

**Int. Cl.: 39**

**SERVICE MARK**

**PRINCIPAL REGISTER**

THE TERRY GROUP OF GEORGIA, LLC (GEORGIA LIMITED LIABILITY COMPANY)  
1123 ASCOTT VALLEY DR.  
JOHNS CREEK, GA 30097

FOR: PROVIDING A WEBSITE FEATURING INFORMATION, NEWS AND COMMENTARY IN THE FIELD OF TRAVEL; TRAVEL INFORMATION SERVICES, NAMELY, PROVISION OF GEOGRAPHIC INFORMATION, MAP IMAGES AND TRIP ROUTING INFORMATION IN THE NATURE OF AVIATION AND NAUTICAL CHARTS, AND PROVIDING INFORMATION RELATING TO MARINA SERVICES, IN CLASS 39 (U.S. CLS. 100 AND 105).

FIRST USE 3-1-2011; IN COMMERCE 3-1-2011.

THE MARK CONSISTS OF THE STYLIZED WORDING "THE SALTY PIRATES", AND THE DESIGN OF A SKULL WEARING A COWBOY HAT WITH TWO SWORDS CROSSED BENEATH THE SKULL, ALL DESIGN ELEMENTS ABOVE THE WORDING IN THE MARK.

SN 85-123,083, FILED 9-3-2010.

JAY BESCH, EXAMINING ATTORNEY



*David J. Kyffers*

Director of the United States Patent and Trademark Office

# United States of America

United States Patent and Trademark Office

# MEGA-STOP

**Reg. No. 4,199,076**

EBAA IRON INC. (TEXAS CORPORATION)

**Registered Aug. 28, 2012**

P.O. BOX 877  
EASTLAND, TX 76448

**Int. Cl.: 6**

FOR: METAL ASSEMBLIES FOR PROTECTION FROM OVER-INSERTION OF PVC PIPE JOINTS, COMPRISED OF SPRINGS AND METAL STOP RINGS, IN CLASS 6 (U.S. CLS. 2, 12, 13, 14, 23, 25 AND 50).

**TRADEMARK**

FIRST USE 9-28-2011; IN COMMERCE 9-28-2011.

**PRINCIPAL REGISTER**

THE MARK CONSISTS OF STANDARD CHARACTERS WITHOUT CLAIM TO ANY PARTICULAR FONT, STYLE, SIZE, OR COLOR.

OWNER OF U.S. REG. NOS. 1,807,041, 3,347,535, AND OTHERS.

SN 85-123,795, FILED 9-7-2010.

AISHA SALEM, EXAMINING ATTORNEY



*David J. Kybas*

Director of the United States Patent and Trademark Office

# United States of America

United States Patent and Trademark Office

## GREEN EATS

**Reg. No. 4,199,077**

**Registered Aug. 28, 2012**

**Int. Cls.: 8 and 21**

**TRADEMARK**

**PRINCIPAL REGISTER**

GREEN TOYS INCORPORATED (CALIFORNIA CORPORATION)  
912 COLE STREET, SUITE 283  
SAN FRANCISCO, CA 94117

FOR: TABLEWARE, NAMELY, FORKS AND SPOONS; CUTLERY FOR FEEDING INFANTS AND TODDLERS, NAMELY, SPOONS, IN CLASS 8 (U.S. CLS. 23, 28 AND 44).

FIRST USE 6-1-2011; IN COMMERCE 6-1-2011.

FOR: DINNERWARE, NAMELY, PLATES, CUPS, SAUCERS, BOWLS, SERVING PLATTERS, TRAYS, AND DRINKING GLASSES; MEAL TRAYS FOR INFANTS AND TODDLERS, IN CLASS 21 (U.S. CLS. 2, 13, 23, 29, 30, 33, 40 AND 50).

FIRST USE 6-1-2011; IN COMMERCE 6-1-2011.

THE MARK CONSISTS OF STANDARD CHARACTERS WITHOUT CLAIM TO ANY PARTICULAR FONT, STYLE, SIZE, OR COLOR.

NO CLAIM IS MADE TO THE EXCLUSIVE RIGHT TO USE "GREEN", APART FROM THE MARK AS SHOWN.

SN 85-123,804, FILED 9-7-2010.

WENDY JUN, EXAMINING ATTORNEY



*David J. Kyros*

Director of the United States Patent and Trademark Office

# United States of America

United States Patent and Trademark Office



**Reg. No. 4,199,078**

**Registered Aug. 28, 2012**

**Int. Cl.: 35**

**SERVICE MARK**

**PRINCIPAL REGISTER**

SECRET TEA SOCIETY (OHIO LIMITED LIABILITY COMPANY)  
30 DIVISION STREET  
HUDSON, OH 44236

FOR: CONSULTING SERVICES IN THE FIELD OF PROVIDING PEOPLE WITH CONSUMER INFORMATION ABOUT AND ADVICE ON SELECTION OF VARIOUS TYPES OF TEA, IN CLASS 35 (U.S. CLS. 100, 101 AND 102).

FIRST USE 4-19-2011; IN COMMERCE 4-19-2011.

NO CLAIM IS MADE TO THE EXCLUSIVE RIGHT TO USE "TEA SOCIETY", APART FROM THE MARK AS SHOWN.

THE MARK CONSISTS OF THE STYLIZED TERMS "SECRET TEA SOCIETY", WITH WAVY LINES REPRESENTING SMOKE ABOVE AND BELOW THE WORDS.

SN 85-124,929, FILED 9-8-2010.

HELENE LIWINSKI, EXAMINING ATTORNEY



*David J. Kyjars*

Director of the United States Patent and Trademark Office



# United States of America

United States Patent and Trademark Office



**Reg. No. 4,199,079**

**Registered Aug. 28, 2012**

**Int. Cls.: 21 and 25**

**TRADEMARK**

**PRINCIPAL REGISTER**

STARR, PAUL (UNITED STATES INDIVIDUAL)  
602 N. GRACE ST.  
LANSING, MI 48917

FOR: BEER BOTTLE OPENERS, BEER MUGS, AND INSULATED CONTAINERS FOR BEER CANS FOR DOMESTIC USE, IN CLASS 21 (U.S. CLS. 2, 13, 23, 29, 30, 33, 40 AND 50).

FIRST USE 7-1-2010; IN COMMERCE 8-1-2010.

FOR: CLOTHING PRODUCTS, NAMELY, T-SHIRTS, HATS AND SWEATSHIRTS, IN CLASS 25 (U.S. CLS. 22 AND 39).

FIRST USE 7-1-2010; IN COMMERCE 8-1-2010.

THE MARK CONSISTS OF A PICTURE OF A BROWN AND WHITE COLOR DOG WITH A GRAY COLOR NOSE AND RED COLOR TONGUE AND FEATURES OUTLINED IN BLACK. THE DOG IS WITHIN A CIRCLE IN LIGHT ORANGE COLOR. THE WORDS "I'M A BEER HOUND" ARE WRITTEN IN YELLOW COLOR, AND OUTLINED IN BLACK. THEY APPEAR AROUND THE ORANGE CIRCLE IN AN ORANGE BORDER THAT IS OUTLINED IN WHITE AND CONTAINS LIGHT YELLOW LEAVES AT EITHER END. THE DOG IS HOLDING A BROWN COLOR GLASS OF BEER WITH WHITE FOAM. THE DOG IS WEARING AN ORANGE COLOR COLLAR WITH A YELLOW BOTTLE CAP THAT HAS THE LETTERS "B" AND "H" WRITTEN IN BLACK COLOR ON IT. THERE IS AN ORANGE COLOR BANNER OUTLINED IN BLACK JUST BELOW THE PICTURE OF THE DOG WITH THE WORDS "A LOVE AFFAIR WITH BEER" WRITTEN IN YELLOW AND OUTLINED IN BLACK ON IT.

THE COLOR(S) ORANGE, YELLOW, GRAY, BLACK, WHITE, RED AND BROWN IS/ARE CLAIMED AS A FEATURE OF THE MARK.

SN 85-125,534, FILED 9-9-2010.

MICHELLE DUBOIS, EXAMINING ATTORNEY



*David J. Kybas*

Director of the United States Patent and Trademark Office

# United States of America

United States Patent and Trademark Office



**Reg. No. 4,199,080**

MIKAEL NILSSON (SWEDEN INDIVIDUAL)  
STORA GATAN 2 D 1TR  
VÄSTERÅS, SWEDEN SE-72209

**Registered Aug. 28, 2012**

**Int. Cl.: 21**

FOR: NON-ELECTRIC FOOD, BEVERAGE AND DRINK MIXERS FOR HOUSEHOLD, KITCHEN, DOMESTIC OR OUTDOOR USE; BOTTLES, SOLD EMPTY; CONTAINERS FOR HOUSEHOLD OR KITCHEN USE; SPORTS BOTTLES, SOLD EMPTY, FOR THE PURPOSE OF MIXING SUPPLEMENTS, IN CLASS 21 (U.S. CLS. 2, 13, 23, 29, 30, 33, 40 AND 50).

**TRADEMARK**

**PRINCIPAL REGISTER**

FIRST USE 12-5-2009; IN COMMERCE 9-24-2010.

THE MARK CONSISTS OF STYLIZED "S" TO THE LEFT OF THE WORD "SMARTSHAKE".

SN 85-130,447, FILED 9-15-2010.

JACQUELINE A. LAVINE, EXAMINING ATTORNEY



*David J. Kyros*

Director of the United States Patent and Trademark Office

# United States of America

United States Patent and Trademark Office



**Reg. No. 4,199,081**

**Registered Aug. 28, 2012**

**Int. Cls.: 21, 25, and 28**

**TRADEMARK**

**PRINCIPAL REGISTER**

CRUZ DEVELOPMENT & DESIGN (CALIFORNIA CORPORATION), DBA LIL' MELON,  
SUITE 1107  
3250 WILSHIRE BLVD. SUITE 1107  
LOS ANGELES, CA 90010

FOR: MULTIPURPOSE WIPING CLOTH FOR USE WITH INFANTS AND TODDLERS;  
DINNERWARE; DINNERWARE, NAMELY, PLATES, BOWLS AND CUPS; PLASTIC PLATES;  
TRAINING CUPS FOR BABIES AND CHILDREN, IN CLASS 21 (U.S. CLS. 2, 13, 23, 29, 30,  
33, 40 AND 50).

FIRST USE 1-1-2008; IN COMMERCE 1-1-2008.

FOR: CHILDREN'S AND INFANT'S APPAREL, NAMELY, JUMPERS, OVERALL SLEEP-  
WEAR, PAJAMAS, ROMPERS AND ONE-PIECE GARMENTS; CHILDREN'S HEADWEAR;  
HATS FOR INFANTS, BABIES, TODDLERS AND CHILDREN; LEG WARMERS; SHIRTS  
FOR INFANTS, BABIES, TODDLERS AND CHILDREN, IN CLASS 25 (U.S. CLS. 22 AND  
39).

FIRST USE 6-1-2008; IN COMMERCE 1-1-2009.

FOR: PROTECTIVE KNEE PADS FOR BABIES IN THE NATURE OF KNEE WARMERS  
FEATURING BUILT-IN PADS, IN CLASS 28 (U.S. CLS. 22, 23, 38 AND 50).

FIRST USE 1-1-2008; IN COMMERCE 1-1-2008.

THE MARK CONSISTS OF A MELON WITH BROWN SEEDS, YELLOW BODY, LIME GREEN  
RIND WITH BROWN CURSIVE LETTERING OF "LIL' MELON" TO THE LEFT.

THE COLOR(S) BROWN, YELLOW, LIME GREEN IS/ARE CLAIMED AS A FEATURE OF  
THE MARK.

SN 85-132,575, FILED 9-17-2010.

ANN E. SAPPENFIELD, EXAMINING ATTORNEY



*David J. Kyffers*

Director of the United States Patent and Trademark Office

# United States of America

United States Patent and Trademark Office

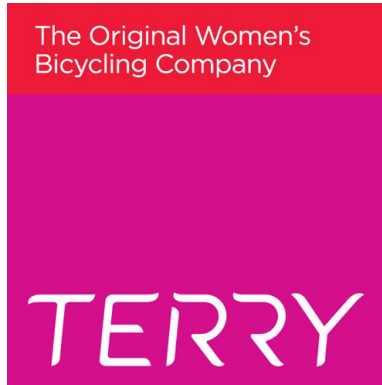

**Reg. No. 4,199,082**

**Registered Aug. 28, 2012**

**Int. Cls.: 25 and 35**

**TRADEMARK**

**SERVICE MARK**

**PRINCIPAL REGISTER**

TERRY PRECISION BICYCLES FOR WOMEN, INC. (NEW YORK CORPORATION)  
47 MAPLE STREET  
BURLINGTON, VT 05401

FOR: BICYCLE GLOVES; BICYCLING GLOVES; BOLEROS; BRAS; CLOTHING FOR ATHLETIC USE, NAMELY, PADDED SHORTS; CLOTHING, NAMELY, BASE LAYERS; CYCLISTS' JERSEYS; GLOVES; KNICKERS; LADIES' UNDERWEAR; LEGGINGS; PERSPIRATION ABSORBENT UNDERWEAR CLOTHING; RIDING GLOVES; SHORTS; SKORTS; SPORTS BRAS; TANK TOPS; TIGHTS; UNDERWEAR; WOMEN'S UNDERWEAR, IN CLASS 25 (U.S. CLS. 22 AND 39).

FIRST USE 1-15-2011; IN COMMERCE 1-15-2011.

FOR: WHOLESALE AND RETAIL STORE SERVICES AND ON-LINE RETAIL AND WHOLESALE STORE SERVICES FEATURING CYCLING ACCESSORIES, NAMELY, HELMETS, EYEGLASSES, SADDLE BAGS, PANNIERS AND APPAREL; MAIL ORDER CATALOG SERVICES FEATURING CYCLING ACCESSORIES, NAMELY, HELMETS, EYEGLASSES, SADDLE BAGS, PANNIERS AND APPAREL, IN CLASS 35 (U.S. CLS. 100, 101 AND 102).

FIRST USE 5-1-2010; IN COMMERCE 5-1-2010.

NO CLAIM IS MADE TO THE EXCLUSIVE RIGHT TO USE "ORIGINAL WOMEN'S BICYCLING COMPANY", APART FROM THE MARK AS SHOWN.

THE COLOR(S) ORANGE, WHITE AND PINK IS/ARE CLAIMED AS A FEATURE OF THE MARK.

THE MARK CONSISTS OF A RECTANGLE CONSISTING OF AN UPPER ORANGE RECTANGULAR REGION WITHIN WHICH THE FOLLOWING WORDS ARE CONTAINED IN WHITE BLOCK LETTERS WITH INITIAL CAPS: "THE ORIGINAL WOMEN'S BICYCLING COMPANY" AND A SECOND LOWER PINK RECTANGULAR REGION WITH THE WORD "TERRY" AT ITS BOTTOM IN WHITE SCRIPT WITH THE SECOND "R" MISSING ITS VERTICAL BAR.



*David J. Kyros*

Director of the United States Patent and Trademark Office

SN 85-132,947, FILED 9-19-2010.

CHARLES L. JENKINS, EXAMINING ATTORNEY

# United States of America

United States Patent and Trademark Office

# INSTAT RX

**Reg. No. 4,199,083**

GRANE SUPPLY, INC. (PENNSYLVANIA CORPORATION)  
105 GAMMA DRIVE  
PITTSBURGH, PA 15238

**Registered Aug. 28, 2012**

**Int. Cl.: 44**

FOR: ADVICE CONCERNING PHARMACEUTICAL DISPENSING TO MEDICAL PROFESSIONALS, IN CLASS 44 (U.S. CLS. 100 AND 101).

**SERVICE MARK**

FIRST USE 6-12-2012; IN COMMERCE 6-12-2012.

**PRINCIPAL REGISTER**

THE MARK CONSISTS OF STANDARD CHARACTERS WITHOUT CLAIM TO ANY PARTICULAR FONT, STYLE, SIZE, OR COLOR.

NO CLAIM IS MADE TO THE EXCLUSIVE RIGHT TO USE "RX", APART FROM THE MARK AS SHOWN.

SN 85-133,541, FILED 9-20-2010.

ELIZABETH KAJUBI, EXAMINING ATTORNEY



*David J. Kybas*

Director of the United States Patent and Trademark Office

# United States of America

United States Patent and Trademark Office

# STEP

**Reg. No. 4,199,084**

**Registered Aug. 28, 2012**

**Int. Cl.: 35**

**SERVICE MARK**

**PRINCIPAL REGISTER**

SUSTAINABLE TECHNOLOGY ENVIRONMENTS PROGRAM, INC. (VIRGINIA CORPORATION)

STE 200  
11242 WAPLES MILL ROAD  
FAIRFAX, VA 22030

FOR: BUSINESS SERVICES, NAMELY, FORMULATION OF BEST PRACTICES FOR DESIGNING, INTEGRATING, CONSTRUCTING AND OPERATING ENVIRONMENTALLY SUSTAINABLE IN-BUILDING AUDIO-VISUAL SYSTEMS, IN CLASS 35 (U.S. CLS. 100, 101 AND 102).

FIRST USE 6-15-2011; IN COMMERCE 6-15-2011.

THE MARK CONSISTS OF STANDARD CHARACTERS WITHOUT CLAIM TO ANY PARTICULAR FONT, STYLE, SIZE, OR COLOR.

SN 85-133,599, FILED 9-20-2010.

AISHA CLARKE, EXAMINING ATTORNEY



*David J. Kybas*

Director of the United States Patent and Trademark Office

# United States of America

United States Patent and Trademark Office

## SUSTAINABLE TECHNOLOGY ENVIRONMENTS PROGRAM

**Reg. No. 4,199,085**

**Registered Aug. 28, 2012**

**Int. Cl.: 35**

**SERVICE MARK**

**PRINCIPAL REGISTER**

SUSTAINABLE TECHNOLOGY ENVIRONMENTS PROGRAM, INC. (VIRGINIA CORPORATION)

11242 WAPLES MILL ROAD

STE 200

FAIRFAX, VA 22030

FOR: BUSINESS SERVICES, NAMELY, FORMULATION OF BEST PRACTICES FOR DESIGNING, INTEGRATING, CONSTRUCTING, AND OPERATING ENVIRONMENTALLY SUSTAINABLE IN-BUILDING AUDIO-VISUAL SYSTEMS, IN CLASS 35 (U.S. CLS. 100, 101 AND 102).

FIRST USE 6-15-2011; IN COMMERCE 6-15-2011.

THE MARK CONSISTS OF STANDARD CHARACTERS WITHOUT CLAIM TO ANY PARTICULAR FONT, STYLE, SIZE, OR COLOR.

NO CLAIM IS MADE TO THE EXCLUSIVE RIGHT TO USE "PROGRAM", APART FROM THE MARK AS SHOWN.

SN 85-133,622, FILED 9-20-2010.

AISHA CLARKE, EXAMINING ATTORNEY



*David J. Kybas*

Director of the United States Patent and Trademark Office

# United States of America

United States Patent and Trademark Office

## STRANGE SEX

**Reg. No. 4,199,086**

**Registered Aug. 28, 2012**

**Int. Cl.: 41**

**SERVICE MARK**

**PRINCIPAL REGISTER**

DISCOVERY COMMUNICATIONS, LLC (DELAWARE LIMITED LIABILITY COMPANY)  
ONE DISCOVERY PLACE  
SILVER SPRING, MD 20910

FOR: ENTERTAINMENT AND EDUCATIONAL SERVICES IN THE NATURE OF TELEVISION AND MULTIMEDIA PROGRAM SERIES FEATURING SUBJECTS OF GENERAL HUMAN INTEREST DISTRIBUTED VIA VARIOUS PLATFORMS ACROSS MULTIPLE FORMS OF TRANSMISSION MEDIA; PROVIDING ENTERTAINMENT INFORMATION TO OTHERS VIA A GLOBAL COMPUTER NETWORK, IN CLASS 41 (U.S. CLS. 100, 101 AND 107).

FIRST USE 11-4-2009; IN COMMERCE 11-4-2009.

THE MARK CONSISTS OF STANDARD CHARACTERS WITHOUT CLAIM TO ANY PARTICULAR FONT, STYLE, SIZE, OR COLOR.

NO CLAIM IS MADE TO THE EXCLUSIVE RIGHT TO USE "SEX", APART FROM THE MARK AS SHOWN.

SN 85-133,996, FILED 9-20-2010.

SAIMA MAKHDOOM, EXAMINING ATTORNEY



*David J. Kyffers*

Director of the United States Patent and Trademark Office



# United States of America

United States Patent and Trademark Office

## PASTURE GEL MAT

**Reg. No. 4,199,087**

**Registered Aug. 28, 2012**

**Int. Cl.: 18**

**TRADEMARK**

**PRINCIPAL REGISTER**

PROMAT INC. (CANADA CORPORATION)  
594711 COUNTY ROAD 59 SOUTH, R.R. #4  
WOODSTOCK, CANADA N4S7V8

FOR: ANIMAL BEDDING PRODUCTS, NAMELY, MATTRESSES, MATS, PILLOWS AND PADS FOR USE IN STALLS, PENS AND TRAILERS, IN CLASS 18 (U.S. CLS. 1, 2, 3, 22 AND 41).

FIRST USE 3-23-2011; IN COMMERCE 3-23-2011.

THE MARK CONSISTS OF STANDARD CHARACTERS WITHOUT CLAIM TO ANY PARTICULAR FONT, STYLE, SIZE, OR COLOR.

OWNER OF U.S. REG. NO. 2,166,642.

NO CLAIM IS MADE TO THE EXCLUSIVE RIGHT TO USE "GEL MAT", APART FROM THE MARK AS SHOWN.

SN 85-134,927, FILED 9-21-2010.

AISHA CLARKE, EXAMINING ATTORNEY



*David J. Kyffers*

Director of the United States Patent and Trademark Office

# United States of America

United States Patent and Trademark Office



**Reg. No. 4,199,088**

**Registered Aug. 28, 2012**

**Int. Cl.: 30**

**TRADEMARK**

**PRINCIPAL REGISTER**

COLOMBINA S.A. (COLOMBIA CORPORATION)  
LA PAILA  
ZARZAL, VALLE, COLOMBIA

FOR: CONFECTIONERY, NAMELY, MARSHMALLOWS COVERED WITH CHOCOLATE,  
IN CLASS 30 (U.S. CL. 46).

FIRST USE 9-30-2010; IN COMMERCE 9-30-2011.

OWNER OF U.S. REG. NOS. 2,246,891 AND 3,105,972.

THE COLOR(S) RED, BLUE, WHITE AND BROWN IS/ARE CLAIMED AS A FEATURE OF  
THE MARK.

NO CLAIM IS MADE TO THE EXCLUSIVE RIGHT TO USE THE DEPICTION OF  
CHOCOLATE AND CANDY, APART FROM THE MARK AS SHOWN.

THE MARK CONSISTS OF A RED RECTANGULAR DESIGN. IN THE LOWER PORTION  
OF THE DESIGN ARE BROWN AND WHITE CHOCOLATE COVERED MARSHMALLOW  
CANDIES IN A SEA OF BROWN CHOCOLATE. IN THE UPPER LEFT OF THE DESIGN  
AGAINST THE RED BACKGROUND IS A BLUE BANNER OUTLINED IN WHITE WITH  
THE WORD "COLOMBINA" WITHIN IN WHITE. ADJOINING THE BANNER ON THE RIGHT  
IS A RED DIAMOND DESIGN CONTAINING A WHITE CRESCENT MOON WITH A GIRL  
IN BLUE SITTING ON THE MOON. BELOW THE BANNER ARE THE TERMS "CHOC  
MELOS" IN STYLIZED LETTERS IN WHITE ON TWO LINES WITH THE "O" IN "CHOC"  
DEPICTED AS A CHOCOLATE CANDY IN BROWN AND WHITE.

THE ENGLISH TRANSLATION OF "COLOMBINA" IN THE MARK IS COLUMBINE. THE  
WORDING "CHOC MELOS" HAS NO MEANING IN A FOREIGN LANGUAGE.

SN 85-135,249, FILED 9-22-2010.

PAM WILLIS, EXAMINING ATTORNEY



*David J. Kybas*

Director of the United States Patent and Trademark Office

# United States of America

United States Patent and Trademark Office

## ABC GLOBAL SERVICES

**Reg. No. 4,199,089**

ABC GLOBAL SERVICES, INC. (DELAWARE CORPORATION)

**Registered Aug. 28, 2012**

6400 SHAFER COURT, SUITE 310  
ROSEMONT, IL 60018

**Int. Cl.: 39**

FOR: PROVIDING TRAVEL PROGRAMS TO TRAVEL AGENCIES, THE TRAVEL MANAGEMENT COMMUNITY, CORPORATE TRAVEL DEPARTMENTS AND THEIR CUSTOMERS, IN CLASS 39 (U.S. CLS. 100 AND 105).

**SERVICE MARK**

FIRST USE 11-24-2010; IN COMMERCE 11-24-2010.

**PRINCIPAL REGISTER**

THE MARK CONSISTS OF STANDARD CHARACTERS WITHOUT CLAIM TO ANY PARTICULAR FONT, STYLE, SIZE, OR COLOR.

OWNER OF U.S. REG. NO. 3,571,935.

NO CLAIM IS MADE TO THE EXCLUSIVE RIGHT TO USE "GLOBAL SERVICES", APART FROM THE MARK AS SHOWN.

SN 85-135,474, FILED 9-22-2010.

STEPHANIE ALI, EXAMINING ATTORNEY



*David J. Kyffers*

Director of the United States Patent and Trademark Office

# United States of America

United States Patent and Trademark Office

# ABC

**Reg. No. 4,199,090**

ABC GLOBAL SERVICES, INC. (DELAWARE CORPORATION)  
6400 SHAFER COURT, SUITE 310  
ROSEMONT, IL 60018

**Registered Aug. 28, 2012**

**Int. Cl.: 39**

FOR: PROVIDING TRAVEL PROGRAMS TO TRAVEL AGENCIES, THE TRAVEL MANAGEMENT COMMUNITY, CORPORATE TRAVEL DEPARTMENTS AND THEIR CUSTOMERS, IN CLASS 39 (U.S. CLS. 100 AND 105).

**SERVICE MARK**

FIRST USE 11-24-2010; IN COMMERCE 11-24-2010.

**PRINCIPAL REGISTER**

THE MARK CONSISTS OF STANDARD CHARACTERS WITHOUT CLAIM TO ANY PARTICULAR FONT, STYLE, SIZE, OR COLOR.

SN 85-135,516, FILED 9-22-2010.

STEPHANIE ALI, EXAMINING ATTORNEY



*David J. Kyffers*

Director of the United States Patent and Trademark Office

# United States of America

United States Patent and Trademark Office

# WH

**Reg. No. 4,199,091**

**Registered Aug. 28, 2012**

**Int. Cl.: 34**

**TRADEMARK**

**PRINCIPAL REGISTER**

PREMIER MANUFACTURING, INC (MISSOURI CORPORATION)  
17998 CHESTERFIELD AIRPORT ROAD  
CHESTERFIELD, MO 63005

FOR: PIPE TOBACCO, IN CLASS 34 (U.S. CLS. 2, 8, 9 AND 17).

FIRST USE 3-21-2012; IN COMMERCE 3-21-2012.

THE MARK CONSISTS OF THE LETTERS "W" AND "H" WHICH BOTH APPEAR IN CAPITAL LETTERS. THE LETTER "W" APPEARS SLIGHTLY ABOVE AND TO THE LEFT OF THE LETTER "H".

SN 85-136,793, FILED 9-23-2010.

ADA HAN, EXAMINING ATTORNEY



*David J. Kybas*

Director of the United States Patent and Trademark Office

# United States of America

United States Patent and Trademark Office



## condorcama

Get the bird's eye view.

**Reg. No. 4,199,092**

CONDORCAM LLC (COLORADO LIMITED LIABILITY COMPANY)

**Registered Aug. 28, 2012**

8855 W. 32ND AVE  
WHEAT RIDGE, CO 80033

**Int. Cl.: 41**

FOR: FILM AND VIDEO PRODUCTION, IN CLASS 41 (U.S. CLS. 100, 101 AND 107).

**SERVICE MARK**

FIRST USE 12-1-2010; IN COMMERCE 12-1-2010.

**PRINCIPAL REGISTER**

THE MARK CONSISTS OF A CONDOR BIRD WITH THE STYLIZED TEXT "CONDORCAM GET THE BIRD'S EYE VIEW".

SN 85-137,044, FILED 9-23-2010.

PAM WILLIS, EXAMINING ATTORNEY



*David J. Kyffers*

Director of the United States Patent and Trademark Office

# United States of America

United States Patent and Trademark Office

## SCHWARTZ CENTER CONNECTIONS

**Reg. No. 4,199,093**

COHEN, ELLEN (UNITED STATES INDIVIDUAL)  
34 MONADNOCK ROAD  
CHESTNUT HILL, MA 02467

**Registered Aug. 28, 2012**

**Int. Cl.: 41**

FOR: EDUCATIONAL SERVICES, NAMELY, A PROGRAM IN THE FIELD OF ENHANCING COMPASSION, COMMUNICATION, AND COLLABORATION AMONG HEALTH CARE PROVIDERS AND BETWEEN PROVIDERS AND PATIENTS, IN CLASS 41 (U.S. CLS. 100, 101 AND 107).

**SERVICE MARK**

**PRINCIPAL REGISTER**

FIRST USE 11-30-2010; IN COMMERCE 11-30-2010.

THE MARK CONSISTS OF STANDARD CHARACTERS WITHOUT CLAIM TO ANY PARTICULAR FONT, STYLE, SIZE, OR COLOR.

OWNER OF U.S. REG. NOS. 2,596,926, 2,697,003, AND OTHERS.

NO CLAIM IS MADE TO THE EXCLUSIVE RIGHT TO USE "CENTER", APART FROM THE MARK AS SHOWN.

SN 85-137,215, FILED 9-24-2010.

ANDREW LEASER, EXAMINING ATTORNEY



*David J. Kybas*

Director of the United States Patent and Trademark Office

# United States of America

United States Patent and Trademark Office

## IRON SPRINGS

**Reg. No. 4,199,094**

**Registered Aug. 28, 2012**

**Int. Cls.: 6 and 19**

**TRADEMARK**

**PRINCIPAL REGISTER**

MASONITE INTERNATIONAL CORPORATION (CANADA CORPORATION)  
1820 MATHESON BOULEVARD, UNIT B4  
MISSISSAUGA, CANADA L4W0B3

FOR: DOOR LITES, SIDE LITES, TRANSOM LITES IN THE NATURE OF GLASS AND PLASTIC PANELS WHICH ARE SOLD AS AN INTEGRAL COMPONENT OF METAL ENTRY DOORS AND DOOR ENTRANCEWAYS, IN CLASS 6 (U.S. CLS. 2, 12, 13, 14, 23, 25 AND 50).

FIRST USE 4-8-2011; IN COMMERCE 4-8-2011.

FOR: DOOR LITES, SIDE LITES AND TRANSOM LITES, ALL IN THE NATURE OF GLASS AND PLASTIC PANELS FOR DOORS AND DOOR ENTRANCEWAYS; DOOR LITES, SIDE LITES, TRANSOM LITES IN THE NATURE OF GLASS AND PLASTIC PANELS WHICH ARE SOLD AS AN INTEGRAL COMPONENT OF NON-METAL ENTRY DOORS AND DOOR ENTRANCEWAYS, IN CLASS 19 (U.S. CLS. 1, 12, 33 AND 50).

FIRST USE 4-8-2011; IN COMMERCE 4-8-2011.

THE MARK CONSISTS OF STANDARD CHARACTERS WITHOUT CLAIM TO ANY PARTICULAR FONT, STYLE, SIZE, OR COLOR.

NO CLAIM IS MADE TO THE EXCLUSIVE RIGHT TO USE "IRON", APART FROM THE MARK AS SHOWN.

SN 85-137,568, FILED 9-24-2010.

MARK RADEMACHER, EXAMINING ATTORNEY



*David J. Kyfos*

Director of the United States Patent and Trademark Office



# United States of America

United States Patent and Trademark Office



**We're The Future!**

**Reg. No. 4,199,095**

**Registered Aug. 28, 2012**

**Int. Cl.: 38**

**SERVICE MARK**

**PRINCIPAL REGISTER**

BROWN, DONALD E. (UNITED STATES INDIVIDUAL)  
P.O. BOX 531222  
LOS ANGELES, CA 900531222 AND

SAWYER, CHRISTOPHER (UNITED STATES INDIVIDUAL)  
P.O. BOX 531222  
LOS ANGELES, CA 900531222

FOR: INTERNET RADIO BROADCASTING SERVICES, IN CLASS 38 (U.S. CLS. 100, 101 AND 104).

FIRST USE 6-15-2010; IN COMMERCE 6-15-2010.

NO CLAIM IS MADE TO THE EXCLUSIVE RIGHT TO USE THE DESIGN OF THE GLOBE, APART FROM THE MARK AS SHOWN.

THE COLOR(S) BLUE, WHITE, RED, GRAY AND BLACK IS/ARE CLAIMED AS A FEATURE OF THE MARK.

THE MARK CONSISTS OF LETTERS "KGFI" WITH THE COLORS BLUE, WHITE, RED APPEARING IN EACH LETTER; THERE IS A GLOBE IN THE BACKGROUND WITH THE COLORS GRAY, BLACK AND WHITE IN THE GLOBE; THE NORTH AMERICAN CONTINENT IS BLACK; THE PARTS OF THE CONTINENTS TO THE LEFT AND RIGHT OF NORTH AMERICA ARE IN THE COLOR WHITE; THE WATER REGIONS OF THE GLOBE APPEAR IN THE COLOR GRAY; THERE ARE BLACK VERTICAL RAYS EXTENDING FROM THE GLOBE TO THE LETTERS "KGFI" IN FRONT OF THE GLOBE; THE WORDING "WE'RE THE FUTURE!" IS BENEATH THE LETTERS "KGFI" AND APPEARS IN THE COLOR BLACK.

SN 85-138,281, FILED 9-25-2010.

GINA HAYES, EXAMINING ATTORNEY



*David J. Kybas*

Director of the United States Patent and Trademark Office

# United States of America

United States Patent and Trademark Office

# SEEDCAMP

**Reg. No. 4,199,096**

SEEDCAMP LIMITED (UNITED KINGDOM LIMITED COMPANY (LTD.))  
2ND FLOOR, CARDIFF HOUSE, TILLING ROAD  
LONDON, UNITED KINGDOM NW21LJ

**Registered Aug. 28, 2012**

**Int. Cls.: 35, 36, 41, and  
45**

FOR: BUSINESS MANAGEMENT; BUSINESS COLLABORATION SERVICES; BUSINESS AND PROFESSIONAL NETWORKING SERVICES; BUSINESS AND PROFESSIONAL NETWORKING EVENTS, IN CLASS 35 (U.S. CLS. 100, 101 AND 102).

**SERVICE MARK**

FIRST USE 7-31-2007; IN COMMERCE 7-31-2007.

**PRINCIPAL REGISTER**

FOR: INVESTMENT SERVICES, NAMELY, INVESTING IN START-UP BUSINESSES; FUNDING FOR START-UP BUSINESSES, IN CLASS 36 (U.S. CLS. 100, 101 AND 102).

FIRST USE 7-31-2007; IN COMMERCE 9-30-2008.

FOR: NON-DOWNLOADABLE ELECTRONIC PUBLICATIONS IN THE NATURE OF BROCHURES AND ELECTRONIC BOOKS IN THE FIELD OF ENTREPRENEURSHIP; ARRANGING AND CONDUCTING ELECTRONIC SEMINARS; AND EDUCATION SERVICE, NAMELY, PROVIDING MENTORING, TUTORING, CLASSES, SEMINARS AND WORKSHOPS IN THE FIELD OF ENTREPRENEURSHIP; PROVIDING TRAINING SERVICES IN THE FIELD OF ENTREPRENEURSHIP; ORGANIZING EDUCATIONAL EXHIBITIONS IN THE FIELD OF ENTREPRENEURSHIP; EXHIBITIONS IN THE FIELD OF ENTREPRENEURSHIP; PRODUCTION AND PRESENTATION OF COMPETITIONS, IN CLASS 41 (U.S. CLS. 100, 101 AND 107).

FIRST USE 7-31-2007; IN COMMERCE 7-31-2007.

FOR: SOCIAL NETWORKING SERVICES; ADVISORY, CONSULTANCY AND INFORMATION SERVICES RELATING TO THE AFORESAID PROVIDED ONLINE VIA THE INTERNET, IN CLASS 45 (U.S. CLS. 100 AND 101).

FIRST USE 7-31-2007; IN COMMERCE 7-31-2007.

THE MARK CONSISTS OF STANDARD CHARACTERS WITHOUT CLAIM TO ANY PARTICULAR FONT, STYLE, SIZE, OR COLOR.



*David J. Kyros*

Director of the United States Patent and Trademark Office

**Reg. No. 4,199,096** PRIORITY CLAIMED UNDER SEC. 44(D) ON ERPN CMNTY TM OFC APPLICATION NO. 008982423, FILED 3-25-2010, REG. NO. 008982423, DATED 9-20-2010, EXPIRES 3-25-2020.

SN 85-138,737, FILED 9-27-2010.

NAAKWAMA ANKRAH, EXAMINING ATTORNEY

# United States of America

United States Patent and Trademark Office

## HEALTH IS EVERYTHING

**Reg. No. 4,199,097**

**Registered Aug. 28, 2012**

**Int. Cl.: 41**

**SERVICE MARK**

**PRINCIPAL REGISTER**

ARTAMONOV, MIKHAIL (UNITED STATES INDIVIDUAL)  
225 ERDMAN AVENUE,  
BANGOR, PA 18013

FOR: ON-LINE PUBLICATION OF A MAGAZINE AND NEWSLETTER PERTAINING TO HEALTHCARE; PROVIDING NEWSLETTERS IN THE FIELD OF HEALTHCARE VIA E-MAIL; CONDUCTING WORKSHOPS, CONFERENCES, CLASSES, SEMINARS IN THE FIELD OF MEDICAL DIAGNOSTICS AND THE DISTRIBUTION OF COURSE MATERIALS IN CONNECTION THEREWITH; HEALTH RELATED EDUCATIONAL SERVICES, NAMELY, CONDUCTING CLASSES AND PUBLISHING BOOKS, MAGAZINES, ELECTRONIC PUBLICATIONS, WEB MAGAZINES IN THE FIELD OF HEALTH MAINTENANCE, IN CLASS 41 (U.S. CLS. 100, 101 AND 107).

FIRST USE 3-11-2011; IN COMMERCE 3-11-2011.

THE MARK CONSISTS OF STANDARD CHARACTERS WITHOUT CLAIM TO ANY PARTICULAR FONT, STYLE, SIZE, OR COLOR.

NO CLAIM IS MADE TO THE EXCLUSIVE RIGHT TO USE "HEALTH", APART FROM THE MARK AS SHOWN.

SN 85-139,189, FILED 9-27-2010.

KAREN K. BUSH, EXAMINING ATTORNEY



*David J. Kyjars*

Director of the United States Patent and Trademark Office

# United States of America

United States Patent and Trademark Office

## LIFE LENSES

**Reg. No. 4,199,098**

LEE-ANNE RAGAN (CANADA INDIVIDUAL)  
9018 LYRA PLACE

**Registered Aug. 28, 2012**

BURNABY, BC, CANADA V3J1B1

**Int. Cl.: 41**

FOR: PROVIDING GROUP COACHING FOR CORPORATIONS AND ORGANIZATIONS IN THE FIELDS OF LEADERSHIP DEVELOPMENT AND MANAGEMENT SKILLS, IN CLASS 41 (U.S. CLS. 100, 101 AND 107).

**SERVICE MARK**

FIRST USE 2-9-2009; IN COMMERCE 7-9-2010.

**PRINCIPAL REGISTER**

THE MARK CONSISTS OF STANDARD CHARACTERS WITHOUT CLAIM TO ANY PARTICULAR FONT, STYLE, SIZE, OR COLOR.

SN 85-140,249, FILED 9-28-2010.

PATRICIA EVANKO, EXAMINING ATTORNEY



*David J. Kyros*

Director of the United States Patent and Trademark Office

# United States of America

United States Patent and Trademark Office

# LIVIN XL

**Reg. No. 4,199,099**

**Registered Aug. 28, 2012**

**Int. Cl.: 25**

**TRADEMARK**

**PRINCIPAL REGISTER**

STUSSY, INC. (CALIFORNIA CORPORATION)  
17426 DAIMLER STREET  
IRVINE, CA 92614

FOR: BASEBALL CAPS; BATHING SUITS; BELTS; BOARD SHORTS; CAPS; COATS; DRESSES; HATS; JACKETS; JERSEYS; PAJAMAS; PANTS; RAIN COATS; SHIRTS; SHORT-SLEEVED SHIRTS; SHORTS; SOCKS; SWEAT SHIRTS; SWEATERS; SWEATPANTS; SWIMSUITS; T-SHIRTS; TANK-TOPS; UNDERWEAR; VISORS; WIND RESISTANT JACKETS, IN CLASS 25 (U.S. CLS. 22 AND 39).

FIRST USE 11-30-1989; IN COMMERCE 11-30-1989.

THE MARK CONSISTS OF STANDARD CHARACTERS WITHOUT CLAIM TO ANY PARTICULAR FONT, STYLE, SIZE, OR COLOR.

NO CLAIM IS MADE TO THE EXCLUSIVE RIGHT TO USE "XL", APART FROM THE MARK AS SHOWN.

SN 85-140,436, FILED 9-28-2010.

STEPHANIE ALI, EXAMINING ATTORNEY



*David J. Kyffers*

Director of the United States Patent and Trademark Office

# United States of America

United States Patent and Trademark Office

# HYDRARAMP

**Reg. No. 4,199,100**

SUPER LAWN TRUCK, INC. (GEORGIA CORPORATION)  
1434 PEACH PARKWAY  
FORT VALLEY, GA 31030

**Registered Aug. 28, 2012**

**Int. Cl.: 12**

FOR: A HINGED REAR DOOR FOR A CARGO TRUCK THAT ALSO OPERATES AS A LOADING RAMP, IN CLASS 12 (U.S. CLS. 19, 21, 23, 31, 35 AND 44).

**TRADEMARK**

FIRST USE 2-28-2002; IN COMMERCE 2-28-2002.

**PRINCIPAL REGISTER**

THE MARK CONSISTS OF STANDARD CHARACTERS WITHOUT CLAIM TO ANY PARTICULAR FONT, STYLE, SIZE, OR COLOR.

SN 85-142,602, FILED 9-30-2010.

STEVEN R. FINE, EXAMINING ATTORNEY



*David J. Kybas*

Director of the United States Patent and Trademark Office

# United States of America

United States Patent and Trademark Office

## VOYAGER HEALTH TECHNOLOGIES

**Reg. No. 4,199,101**

**Registered Aug. 28, 2012**

**Int. Cl.: 5**

**TRADEMARK**

**PRINCIPAL REGISTER**

VOYAGER HEALTH TECHNOLOGIES CORP. (NEVADA CORPORATION)  
SUITE 100  
2190 EAST PEBBLE ROAD  
LAS VEGAS, NV 89123

FOR: DIETARY AND NUTRITIONAL SUPPLEMENTS, IN CLASS 5 (U.S. CLS. 6, 18, 44, 46, 51 AND 52).

FIRST USE 2-10-2011; IN COMMERCE 2-10-2011.

THE MARK CONSISTS OF STANDARD CHARACTERS WITHOUT CLAIM TO ANY PARTICULAR FONT, STYLE, SIZE, OR COLOR.

NO CLAIM IS MADE TO THE EXCLUSIVE RIGHT TO USE "HEALTH TECHNOLOGIES", APART FROM THE MARK AS SHOWN.

SN 85-143,422, FILED 10-1-2010.

MICHELLE DUBOIS, EXAMINING ATTORNEY



*David J. Kyffers*

Director of the United States Patent and Trademark Office



# United States of America

United States Patent and Trademark Office

# Cybele's

**Reg. No. 4,199,102**

**Registered Aug. 28, 2012**

**Int. Cl.: 5**

**TRADEMARK**

**PRINCIPAL REGISTER**

FREE TO EAT, INC. (CALIFORNIA CORPORATION)  
ARTISTS FINANCIAL MANAGEMENT  
75 NINTH AVE. 5TH FL.  
NEW YORK, NY 10011

FOR: GLUTEN-FREE, ALLERGEN-FREE BAKERY GOODS, COOKIES, CAKES, BREADS, CONFECTIONARY, SAUCES, PROCESSED CEREALS TO ACCOMMODATE SPECIAL MEDICAL AND HEALTH CONDITIONS, IN CLASS 5 (U.S. CLS. 6, 18, 44, 46, 51 AND 52).

FIRST USE 3-9-2012; IN COMMERCE 3-9-2012.

THE MARK CONSISTS OF STANDARD CHARACTERS WITHOUT CLAIM TO ANY PARTICULAR FONT, STYLE, SIZE, OR COLOR.

SN 85-144,261, FILED 10-4-2010.

MARLENE BELL, EXAMINING ATTORNEY



*David J. Kyffers*

Director of the United States Patent and Trademark Office

# United States of America

United States Patent and Trademark Office

## SENIOR ADVANTAGE

### PALMDALE REGIONAL MEDICAL CENTER

**Reg. No. 4,199,103**

UHS OF DELAWARE, INC. (DELAWARE CORPORATION)  
367 SOUTH GULPH ROAD  
KING OF PRUSSIA, PA 194060958

**Registered Aug. 28, 2012**

**Int. Cl.: 35**

FOR: ADMINISTRATION OF A DISCOUNT PROGRAM ENABLING PARTICIPANTS TO OBTAIN FREE AND DISCOUNTED GOODS AND SERVICES THAT HELP ENHANCE THE HEALTH AND WELL-BEING OF ADULTS, THROUGH THE USE OF A DISCOUNT MEMBERSHIP CARD, IN CLASS 35 (U.S. CLS. 100, 101 AND 102).

**SERVICE MARK**

**PRINCIPAL REGISTER**

FIRST USE 11-0-2010; IN COMMERCE 11-0-2010.

OWNER OF U.S. REG. NO. 3,554,063.

NO CLAIM IS MADE TO THE EXCLUSIVE RIGHT TO USE "SENIOR" AND "PALMDALE REGIONAL MEDICAL CENTER", APART FROM THE MARK AS SHOWN.

THE MARK CONSISTS OF THE WORDS "SENIOR ADVANTAGE PALMDALE REGIONAL MEDICAL CENTER" WITH A CIRCULAR DESIGN HAVING A SILHOUETTE OF PALM LEAVES THEREIN IN BETWEEN THE WORDS "SENIOR" AND "ADVANTAGE".

SN 85-144,401, FILED 10-4-2010.

SUE LAWRENCE, EXAMINING ATTORNEY



*David J. Kybas*

Director of the United States Patent and Trademark Office

# United States of America

United States Patent and Trademark Office

# KELLAN

**Reg. No. 4,199,104**

**Registered Aug. 28, 2012**

**Int. Cl.: 9**

**TRADEMARK**

**PRINCIPAL REGISTER**

INNOVATIVE WIRELESS TECHNOLOGIES, INC. (DELAWARE CORPORATION)  
306 N. WEST EL NORTE PKWY  
ESCONDIDO, CA 92026

FOR: AUTOMATED SELF CONTAINED ELECTRONIC SURVEILLANCE DEVICES THAT CAN BE DEPLOYED TO GATHER EVIDENCE OR INTELLIGENCE IN REMOTE LOCATIONS; ELECTRONIC REGULATING AND CONTROL DEVICES FOR THE OPERATION OF LIGHT EMITTING DIODES; WIRELESS COMMUNICATION DEVICES FOR TRANSMITTING IMAGES TAKEN BY A CAMERA; WIRELESS COMMUNICATION DEVICES FOR VOICE, DATA OR IMAGE TRANSMISSION; WIRELESS CONTROLLER TO MONITOR AND CONTROL THE FUNCTIONING OF OTHER ELECTRONIC DEVICES; WIRELESS TRANSMITTERS AND RECEIVERS, IN CLASS 9 (U.S. CLS. 21, 23, 26, 36 AND 38).

FIRST USE 12-0-2011; IN COMMERCE 12-0-2011.

THE MARK CONSISTS OF STANDARD CHARACTERS WITHOUT CLAIM TO ANY PARTICULAR FONT, STYLE, SIZE, OR COLOR.

THE NAME "KELLAN" DOES NOT IDENTIFY A LIVING INDIVIDUAL.

SN 85-145,987, FILED 10-6-2010.

JAY BESCH, EXAMINING ATTORNEY



*David J. Kypos*

Director of the United States Patent and Trademark Office

# United States of America

United States Patent and Trademark Office



**Reg. No. 4,199,105**

**Registered Aug. 28, 2012**

**Int. Cl.: 25**

**TRADEMARK**

**PRINCIPAL REGISTER**

BOARD OF REGENTS OF THE UNIVERSITY SYSTEM OF GEORGIA (GEORGIA STATE AGENCY)  
270 WASHINGTON STREET, SW  
ATLANTA, GA 30334

FOR: T-SHIRTS, IN CLASS 25 (U.S. CLS. 22 AND 39).

FIRST USE 9-30-2011; IN COMMERCE 10-12-2011.

OWNER OF U.S. REG. NOS. 2,334,549, 3,725,163, AND OTHERS.

SEC. 2(F) AS TO "GEORGIA COLLEGE".

NO CLAIM IS MADE TO THE EXCLUSIVE RIGHT TO USE "COLLEGE", APART FROM THE MARK AS SHOWN.

THE MARK CONSISTS OF THE WORDS "GEORGIA COLLEGE" ARCHED ON TWO LINES FORMING AN OVAL SHAPE, AND AN IMAGE OF A BOBCAT FACE IN THE CENTER OF THE OVAL SHAPED "GEORGIA COLLEGE".

SN 85-145,993, FILED 10-6-2010.

SUSAN RICHARDS, EXAMINING ATTORNEY



*David J. Kybas*

Director of the United States Patent and Trademark Office

# United States of America

United States Patent and Trademark Office

# Yogurt by U

**Reg. No. 4,199,106**

**Registered Aug. 28, 2012**

**Int. Cl.: 43**

**SERVICE MARK**

**PRINCIPAL REGISTER**

MONTEPALMA USA, LLC (FLORIDA LIMITED LIABILITY COMPANY)  
SUITE 1010  
2665 SOUTH BAYSHORE DRIVE  
COCONUT GROVE, FL 33133

FOR: FROZEN YOGURT SHOP SERVICES IN THE NATURE OF A RESTAURANT, IN CLASS  
43 (U.S. CLS. 100 AND 101).

FIRST USE 11-1-2011; IN COMMERCE 11-1-2011.

THE MARK CONSISTS OF STANDARD CHARACTERS WITHOUT CLAIM TO ANY PAR-  
TICULAR FONT, STYLE, SIZE, OR COLOR.

NO CLAIM IS MADE TO THE EXCLUSIVE RIGHT TO USE "YOGURT", APART FROM THE  
MARK AS SHOWN.

SN 85-146,151, FILED 10-6-2010.

TINA BROWN, EXAMINING ATTORNEY



*David J. Kyros*

Director of the United States Patent and Trademark Office

# United States of America

United States Patent and Trademark Office

## SIRA ULO NASYON

**Reg. No. 4,199,107**

FREDERICK, DAVID I. (UNITED STATES INDIVIDUAL)  
2106 GULLANE WAY  
GILROY, CA 95020

**Registered Aug. 28, 2012**

**Int. Cl.: 25**

FOR: CAPS; HATS; SHIRTS; T-SHIRTS, IN CLASS 25 (U.S. CLS. 22 AND 39).

**TRADEMARK**

FIRST USE 9-7-2011; IN COMMERCE 5-10-2012.

**PRINCIPAL REGISTER**

THE MARK CONSISTS OF STANDARD CHARACTERS WITHOUT CLAIM TO ANY PARTICULAR FONT, STYLE, SIZE, OR COLOR.

SN 85-146,199, FILED 10-6-2010.

RAMONA ORTIGA, EXAMINING ATTORNEY



*David J. Kybas*

Director of the United States Patent and Trademark Office

# United States of America

United States Patent and Trademark Office

# ISWARM

**Reg. No. 4,199,108**

**Registered Aug. 28, 2012**

**Int. Cl.: 42**

**SERVICE MARK**

**PRINCIPAL REGISTER**

CEIBA SOLUTIONS INC (DELAWARE CORPORATION)  
SUITE 310  
485 MASSACHUSETTS AVE  
CAMBRIDGE, MA 02139

FOR: COMPUTER AND TECHNOLOGICAL PROFESSIONAL SERVICES, NAMELY, PROVIDING TEMPORARY USE OF ONLINE NON-DOWNLOADABLE SOFTWARE FOR ALLOWING USERS TO MANAGE ALL OF THEIR SOCIAL MEDIA SITES THROUGH A SINGLE LOG-IN, IN CLASS 42 (U.S. CLS. 100 AND 101).

FIRST USE 12-14-2010; IN COMMERCE 12-14-2010.

THE MARK CONSISTS OF STANDARD CHARACTERS WITHOUT CLAIM TO ANY PARTICULAR FONT, STYLE, SIZE, OR COLOR.

SN 85-146,979, FILED 10-7-2010.

MICHELLE DUBOIS, EXAMINING ATTORNEY



*David J. Kybas*

Director of the United States Patent and Trademark Office

# United States of America

United States Patent and Trademark Office

## FROM ONE HEART TO ANOTHER... WITH LOVE

**Reg. No. 4,199,109**

JOHNSON & JOHNSON (NEW JERSEY CORPORATION)  
ONE JOHNSON & JOHNSON PLAZA  
NEW BRUNSWICK, NJ 089337001

**Registered Aug. 28, 2012**

**Int. Cl.: 3**

FOR: GIFT BOX CONTAINING BABY PRODUCTS, NAMELY, BODY WASH AND SKIN CLEANSER, HAIR SHAMPOO, BODY LOTION, NON-MEDICATED DIAPER RASH CREAM, AND POWDER, IN CLASS 3 (U.S. CLS. 1, 4, 6, 50, 51 AND 52).

**TRADEMARK**

FIRST USE 5-8-2012; IN COMMERCE 5-8-2012.

**PRINCIPAL REGISTER**

THE MARK CONSISTS OF STANDARD CHARACTERS WITHOUT CLAIM TO ANY PARTICULAR FONT, STYLE, SIZE, OR COLOR.

SN 85-146,984, FILED 10-7-2010.

LAKEISHA LEWIS, EXAMINING ATTORNEY



*David J. Kybas*

Director of the United States Patent and Trademark Office



# United States of America

United States Patent and Trademark Office



**Reg. No. 4,199,110**

**Registered Aug. 28, 2012**

**Int. Cl.: 3**

**TRADEMARK**

**PRINCIPAL REGISTER**

JOHNSON & JOHNSON (NEW JERSEY CORPORATION)  
ONE JOHNSON & JOHNSON PLAZA  
NEW BRUNSWICK, NJ 089337001

FOR: GIFT BOX CONTAINING BABY PRODUCTS, NAMELY, BODY WASH AND SKIN CLEANSER, HAIR SHAMPOO, BODY LOTION, NON-MEDICATED DIAPER RASH CREAM, AND POWDER, IN CLASS 3 (U.S. CLS. 1, 4, 6, 50, 51 AND 52).

FIRST USE 5-8-2012; IN COMMERCE 5-8-2012.

THE MARK CONSISTS OF THE STYLIZED PHRASE "FROM ONE HEART TO ANOTHER..." APPEARING IN A HEART NEXT TO THE PHRASE "WITH LOVE" APPEARING IN A SMALLER HEART NEXT TO IT.

SN 85-146,997, FILED 10-7-2010.

LAKEISHA LEWIS, EXAMINING ATTORNEY



*David J. Kybas*

Director of the United States Patent and Trademark Office

# United States of America

United States Patent and Trademark Office

## LCI COLLABORATION NETWORK

**Reg. No. 4,199,111**

**Registered Aug. 28, 2012**

**Int. Cl.: 42**

**SERVICE MARK**

**PRINCIPAL REGISTER**

LCI GLOBAL SUPPLY CHAIN MANAGEMENT SOLUTIONS, INC. (TEXAS CORPORATION)  
3925 W. BRAKER LANE  
AUSTIN, TX 78759

FOR: SOFTWARE AS A SERVICE (SAAS) SERVICES FEATURING SOFTWARE FOR A SUPPLY CHAIN EXECUTION AND COLLABORATION SYSTEM WITH APPLICATIONS FOR MANAGING INVENTORY, SUPPLY CHAINS, TRADE ZONES, ORDERS, ACCOUNTS PAYABLE, VENDORS, BUSINESS NETWORKS, TRANSPORTATION, TRADE TRANSACTIONS, AND IMPORT-EXPORT OPERATIONS, IN CLASS 42 (U.S. CLS. 100 AND 101).

FIRST USE 9-10-2010; IN COMMERCE 9-10-2010.

THE MARK CONSISTS OF STANDARD CHARACTERS WITHOUT CLAIM TO ANY PARTICULAR FONT, STYLE, SIZE, OR COLOR.

NO CLAIM IS MADE TO THE EXCLUSIVE RIGHT TO USE "COLLABORATION NETWORK", APART FROM THE MARK AS SHOWN.

SN 85-147,011, FILED 10-7-2010.

MICHELLE DUBOIS, EXAMINING ATTORNEY



*David J. Kybas*

Director of the United States Patent and Trademark Office

# United States of America

United States Patent and Trademark Office

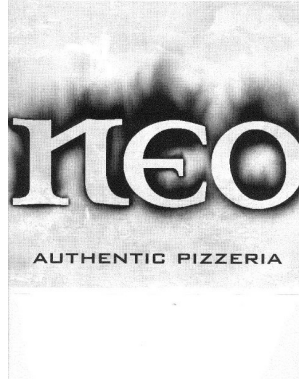

**Reg. No. 4,199,112**

PIZZERIA NEO INC (ILLINOIS CORPORATION)  
31 S. FIRST STREET  
ST. CHARLES, IL 60174

**Registered Aug. 28, 2012**

**Int. Cl.: 43**

FOR: RESTAURANT SERVICES FEATURING ITALIAN, MEDITERRANEAN, AND PIZZA,  
IN CLASS 43 (U.S. CLS. 100 AND 101).

**SERVICE MARK**

FIRST USE 7-1-2010; IN COMMERCE 7-1-2010.

**PRINCIPAL REGISTER**

NO CLAIM IS MADE TO THE EXCLUSIVE RIGHT TO USE "AUTHENTIC PIZZERIA",  
APART FROM THE MARK AS SHOWN.

THE MARK CONSISTS OF THE LITERAL ELEMENTS "NEO AUTHENTIC PIZZERIA"  
AGAINST A MARBLEIZED WALLPAPER BACKGROUND. THE TERM "NEO" APPEARS  
IN LARGE STYLIZED FONT IN THE CENTER WITH A BURNING DESIGN QUALITY, SUCH  
THAT THE LETTERS APPEAR TO BE BURNING. THE TERMS "AUTHENTIC PIZZERIA"  
APPEAR IN VERTICAL CONFIGURATION BELOW "NEO" IN CAPITAL LETTERS IN A  
STYLIZED FONT.

SN 85-148,030, FILED 10-8-2010.

WARREN L. OLANDRIA, EXAMINING ATTORNEY



*David J. Kyros*

Director of the United States Patent and Trademark Office

# United States of America

United States Patent and Trademark Office

## LAVENDER RETREAT

**Reg. No. 4,199,113**

LAVENDER RETREAT INC. (VIRGINIA CORPORATION)  
4321 RIDGEWOOD CENTER DRIVE  
LAKE RIDGE, VA 22192

**Registered Aug. 28, 2012**

**Int. Cls.: 35, 39, 43, and 44**

FOR: PROVIDING ASSISTANCE, FITNESS EVALUATION AND CONSULTATION TO CORPORATE CLIENTS TO HELP THEIR EMPLOYEES MAKE HEALTH, WELLNESS AND NUTRITIONAL CHANGES IN THEIR DAILY LIVING TO INCREASE PRODUCTIVITY AND LOWER HEALTH CARE COSTS, IN CLASS 35 (U.S. CLS. 100, 101 AND 102).

**SERVICE MARK**

FIRST USE 2-28-2011; IN COMMERCE 2-28-2011.

**PRINCIPAL REGISTER**

FOR: ARRANGING AND COORDINATING TRAVEL ARRANGEMENTS FOR INDIVIDUALS AND GROUPS, NAMELY, DESTINATIONS STAYS, HONEYMOONS, FAMILY VACATIONS, IN CLASS 39 (U.S. CLS. 100 AND 105).

FIRST USE 1-31-2011; IN COMMERCE 1-31-2011.

FOR: SPA SERVICES, NAMELY, PROVIDING TEMPORARY ACCOMMODATIONS AND FOOD AND BEVERAGES TO CLIENTS OF A HEALTH SPA, IN CLASS 43 (U.S. CLS. 100 AND 101).

FIRST USE 5-31-2011; IN COMMERCE 5-31-2011.

FOR: HEALTH SPA SERVICES FOR HEALTH AND WELLNESS OF THE BODY AND SPIRIT, NAMELY, PROVIDING MASSAGE, FACIAL AND BODY TREATMENT SERVICES, COSMETIC BODY CARE SERVICES; MASSAGE THERAPY SERVICES; WELLNESS AND HEALTH-RELATED CONSULTING SERVICES; PROVIDING INFORMATION IN THE FIELD OF NUTRITION, HEALTH AND WELLNESS; PROVIDING WELLNESS SERVICES, NAMELY, PERSONAL ASSESSMENTS, PERSONALIZED ROUTINES, MAINTENANCE SCHEDULES, AND COUNSELING; PROVIDING A WEBSITE FEATURING CONTENT REGARDING HEALTHY LIVING, MENTAL HEALTH AND LIFESTYLE WELLNESS; HEALTH SPA SERVICES FOR HEALTH AND WELLNESS OF THE BODY AND SPIRIT; ENERGY HEALING SERVICES, NAMELY, STRESS MANAGEMENT AND STRESS REDUCTION COUNSELING FOR INDIVIDUALS TO ENHANCE THEIR LIVES; NUTRITIONAL COUNSELING; HEALTH SPA SERVICES, NAMELY, PROVIDING ROOMS CONSISTING OF A SELECTION OF ARTWORK, LIGHTING, SOUND AND FURNISHINGS FOR AN ENVIRONMENT DESIGNED TO HELP ACHIEVE MENTAL WELLNESS, INCLUDING STRESS MANAGEMENT AND



*David J. Kyros*

Director of the United States Patent and Trademark Office

**Reg. No. 4,199,113** RELAXATION WITHOUT THE USE OF COMPUTERS OR ELECTRONIC AUTOMATED SYSTEMS; AROMATHERAPY SERVICES, IN CLASS 44 (U.S. CLS. 100 AND 101).

FIRST USE 12-31-2010; IN COMMERCE 12-31-2010.

THE MARK CONSISTS OF STANDARD CHARACTERS WITHOUT CLAIM TO ANY PARTICULAR FONT, STYLE, SIZE, OR COLOR.

NO CLAIM IS MADE TO THE EXCLUSIVE RIGHT TO USE "RETREAT", APART FROM THE MARK AS SHOWN.

SN 85-149,421, FILED 10-11-2010.

ANTHONY RINKER, EXAMINING ATTORNEY

# United States of America

United States Patent and Trademark Office

## LOS SUPER SEVEN

**Reg. No. 4,199,114**

**Registered Aug. 28, 2012**

**Int. Cl.: 41**

**SERVICE MARK**

**PRINCIPAL REGISTER**

STEVEN BERLIN (UNITED STATES INDIVIDUAL)  
SUITE 224  
3439 N.E.SANDY BLVD.  
PORTLAND, OR 97232

FOR: ENTERTAINMENT SERVICES IN THE NATURE OF LIVE MUSICAL PERFORMANCES,  
IN CLASS 41 (U.S. CLS. 100, 101 AND 107).

FIRST USE 4-29-2012; IN COMMERCE 4-29-2012.

THE MARK CONSISTS OF STANDARD CHARACTERS WITHOUT CLAIM TO ANY PAR-  
TICULAR FONT, STYLE, SIZE, OR COLOR.

THE ENGLISH TRANSLATION OF "LOS" IN THE MARK IS "THE".

SN 85-149,454, FILED 10-11-2010.

STEVEN PEREZ, EXAMINING ATTORNEY



*David J. Kyffers*

Director of the United States Patent and Trademark Office

# United States of America

United States Patent and Trademark Office

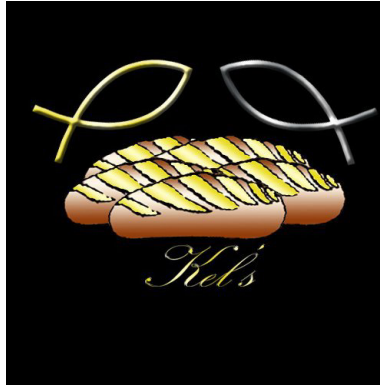

**Reg. No. 4,199,115**

**Registered Aug. 28, 2012**

**Int. Cl.: 43**

**SERVICE MARK**

**PRINCIPAL REGISTER**

KELSEY, DYWON D. (UNITED STATES INDIVIDUAL)  
300 STAUNTON COURT  
WILLIAMSTOWN, NJ 08094

FOR: RESTAURANT, IN CLASS 43 (U.S. CLS. 100 AND 101).

FIRST USE 11-1-2010; IN COMMERCE 3-10-2011.

THE MARK CONSISTS OF TWO FISH, FIVE BUTTERED LOAVES AND THE NAME "KEL'S". THE FISH APPEAR ABOVE THE LOAVES AND THE LEFT FISH IS GOLD AND THE RIGHT SILVER. BELOW THE FISH ARE FIVE BROWN LOAVES WITH GOLD BUTTER OUTLINED IN BLACK AND BENEATH THE LOAVES IS THE SILVER WORDING "KEL'S". THE MARK APPEARS ON A BLACK BACKGROUND.

THE COLOR(S) BLACK, BROWN, SILVER AND GOLD IS/ARE CLAIMED AS A FEATURE OF THE MARK.

SN 85-149,915, FILED 10-11-2010.

RENEE MCCRAY, EXAMINING ATTORNEY



*David J. Kybas*

Director of the United States Patent and Trademark Office

United States of America  
United States Patent and Trademark Office

# TRISHIELD

**Reg. No. 4,199,116**

**Registered Aug. 28, 2012**

**Int. Cl.: 4**

**TRADEMARK**

**PRINCIPAL REGISTER**

CASTROL LIMITED (UNITED KINGDOM LIMITED LIABILITY COMPANY)  
WAKEFIELD HOUSE, PIPERS WAY  
SWINDON, WILTSHIRE, UNITED KINGDOM SN31RE

FOR: A COMPONENT INGREDIENT OF LUBRICANTS FOR VEHICLES, IN CLASS 4 (U.S. CLS. 1, 6 AND 15).

FIRST USE 3-31-2011; IN COMMERCE 3-31-2011.

THE MARK CONSISTS OF STANDARD CHARACTERS WITHOUT CLAIM TO ANY PARTICULAR FONT, STYLE, SIZE, OR COLOR.

SN 85-150,345, FILED 10-12-2010.

ELI HELLMAN, EXAMINING ATTORNEY



*David J. Kyffers*

Director of the United States Patent and Trademark Office



# United States of America

United States Patent and Trademark Office

## GOURMET | 45

**Reg. No. 4,199,117**

**Registered Aug. 28, 2012**

**Int. Cl.: 43**

**SERVICE MARK**

**PRINCIPAL REGISTER**

GOURMET 45, INC. (ILLINOIS CORPORATION)  
2420 EAST OAKTON STREET, UNIT A  
ARLINGTON HEIGHTS, IL 60005

FOR: CATERING, IN CLASS 43 (U.S. CLS. 100 AND 101).

FIRST USE 11-1-2010; IN COMMERCE 1-1-2011.

THE MARK CONSISTS OF STANDARD CHARACTERS WITHOUT CLAIM TO ANY PARTICULAR FONT, STYLE, SIZE, OR COLOR.

NO CLAIM IS MADE TO THE EXCLUSIVE RIGHT TO USE "GOURMET", APART FROM THE MARK AS SHOWN.

SN 85-152,869, FILED 10-14-2010.

WANDA KAY PRICE, EXAMINING ATTORNEY



*David J. Kyffers*

Director of the United States Patent and Trademark Office

# United States of America

United States Patent and Trademark Office

# OptiLift

**Reg. No. 4,199,118**

**Registered Aug. 28, 2012**

**Int. Cl.: 42**

**SERVICE MARK**

**PRINCIPAL REGISTER**

VMONITOR, LLC (TEXAS CORPORATION)  
RAED ABDALLAH  
4321 W. SAM HOUSTON PARKWAY, SUITE 110  
HOUSTON, TX 77043

FOR: REMOTE MONITORING OF ASSETS IN OIL AND GAS FIELD TO PROVIDE FOR ARTIFICIAL LIFT OPTIMIZATION FOR ELECTRIC SUBMERSIBLE PUMPS, GAS LIFTS, PLUNGER LIFTING, ROB PUMPING, AND ARTIFICIAL LIFTING OF HYDROCARBONS FOR WELL OPTIMIZATION, HYDROCARBONS FLOW OPTIMIZATION, AND ARTIFICIAL LIFT OPTIMIZATION FOR MULTIPHASE DATA ESTIMATES, IN CLASS 42 (U.S. CLS. 100 AND 101).

FIRST USE 5-22-2012; IN COMMERCE 5-22-2012.

THE MARK CONSISTS OF STANDARD CHARACTERS WITHOUT CLAIM TO ANY PARTICULAR FONT, STYLE, SIZE, OR COLOR.

SN 85-153,513, FILED 10-15-2010.

PAUL E. FAHRENKOPF, EXAMINING ATTORNEY



*David J. Kybas*

Director of the United States Patent and Trademark Office

# United States of America

United States Patent and Trademark Office

# SHORE CHIC

**Reg. No. 4,199,119**

SHORE CHIC LLC (NEW JERSEY LIMITED LIABILITY COMPANY)  
98 DIVISION STREET  
KEYPORT, NJ 07735

**Registered Aug. 28, 2012**

**Int. Cl.: 40**

FOR: CUSTOM MANUFACTURE OF WEDDING DECORATIONS AND WEDDING DECOR ITEMS TO THE ORDER AND SPECIFICATION OF OTHERS, IN CLASS 40 (U.S. CLS. 100, 103 AND 106).

**SERVICE MARK**

FIRST USE 12-1-2003; IN COMMERCE 12-1-2003.

**PRINCIPAL REGISTER**

THE MARK CONSISTS OF STANDARD CHARACTERS WITHOUT CLAIM TO ANY PARTICULAR FONT, STYLE, SIZE, OR COLOR.

SN 85-153,971, FILED 10-15-2010.

DAVID H. STINE, EXAMINING ATTORNEY



*David J. Kyffers*

Director of the United States Patent and Trademark Office

# United States of America

United States Patent and Trademark Office

## 24-7 COACHING

**Reg. No. 4,199,120**

**Registered Aug. 28, 2012**

**Int. Cls.: 16 and 41**

**TRADEMARK**

**SERVICE MARK**

**PRINCIPAL REGISTER**

COLLEAGUE CONSULTING, LLC (MARYLAND LIMITED LIABILITY COMPANY)  
7500 GREENWAY CIRCLE DRIVE SUITE 200  
GREENBELT, MD 20770

FOR: PRINTED EDUCATIONAL MATERIALS IN THE FIELD OF BUSINESS COACHING, MENTORING, AND TRAINING IN CAREER COUNSELING, IN CLASS 16 (U.S. CLS. 2, 5, 22, 23, 29, 37, 38 AND 50).

FIRST USE 11-3-2010; IN COMMERCE 11-3-2010.

FOR: EDUCATIONAL SERVICES, NAMELY, PROVIDING CLASSES IN THE FIELDS OF BUSINESS COACHING, MENTORING, AND TRAINING IN CAREER COUNSELING, IN CLASS 41 (U.S. CLS. 100, 101 AND 107).

FIRST USE 11-3-2010; IN COMMERCE 11-3-2010.

THE MARK CONSISTS OF STANDARD CHARACTERS WITHOUT CLAIM TO ANY PARTICULAR FONT, STYLE, SIZE, OR COLOR.

NO CLAIM IS MADE TO THE EXCLUSIVE RIGHT TO USE "COACHING", APART FROM THE MARK AS SHOWN.

SN 85-154,026, FILED 10-15-2010.

B. PARADEWELAI, EXAMINING ATTORNEY



*David J. Kyffers*

Director of the United States Patent and Trademark Office

# United States of America

United States Patent and Trademark Office

## ONE PRICE, ONE HOUR

**Reg. No. 4,199,121**

GATEWAY CHEVROLET, INC. (DELAWARE CORPORATION)

**Registered Aug. 28, 2012**

9901 WEST PAPAGO FREEWAY  
AVONDALE, AZ 85353

**Int. Cl.: 35**

FOR: AUTOMOBILE DEALERSHIP SERVICES, IN CLASS 35 (U.S. CLS. 100, 101 AND 102).

**SERVICE MARK**

FIRST USE 1-0-2011; IN COMMERCE 1-0-2011.

**PRINCIPAL REGISTER**

THE MARK CONSISTS OF STANDARD CHARACTERS WITHOUT CLAIM TO ANY PARTICULAR FONT, STYLE, SIZE, OR COLOR.

SN 85-154,164, FILED 10-15-2010.

KAREN BRACEY, EXAMINING ATTORNEY



*David J. Kybas*

Director of the United States Patent and Trademark Office

# United States of America

United States Patent and Trademark Office

# SWEAT SHIELD

**Reg. No. 4,199,122**

HYGIENICS INDUSTRIES, INC. (FLORIDA CORPORATION)  
3968 194TH TRAIL  
MIAMI, FL 33160

**Registered Aug. 28, 2012**

**Int. Cl.: 25**

FOR: UNDERSHIRTS AND TEE-SHIRTS; DRESS SHIELDS IN THE NATURE OF PERSPIRATION BARRIERS FOR GARMENTS FABRICATED WITH HYDROPHOBIC MATERIAL FOR PERSPIRATION PROTECTION, IN CLASS 25 (U.S. CLS. 22 AND 39).

**TRADEMARK**

FIRST USE 5-14-2012; IN COMMERCE 5-14-2012.

**PRINCIPAL REGISTER**

NO CLAIM IS MADE TO THE EXCLUSIVE RIGHT TO USE "SHIELD", APART FROM THE MARK AS SHOWN.

THE MARK CONSISTS OF THE WORDING "SWEAT SHIELD" IN STYLIZED LETTERING.

SN 85-154,720, FILED 10-18-2010.

KAREN K. BUSH, EXAMINING ATTORNEY



*David J. Kyffers*

Director of the United States Patent and Trademark Office

# United States of America

United States Patent and Trademark Office

## PRETZ-A-BAGELS

**Reg. No. 4,199,123**

**Registered Aug. 28, 2012**

**Int. Cl.: 30**

**TRADEMARK**

**PRINCIPAL REGISTER**

GRUPO BIMBO, S.A. B. DE C.V. (MEXICO CORPORATION)  
NO. 1000, COL. PENA BLANCA SANTA FE  
PROLONGACION PASEO DE LA REFORMA  
MEXICO CITY, MEXICO 01210

FOR: BAKERY PRODUCTS, NAMELY, BAGELS, IN CLASS 30 (U.S. CL. 46).

FIRST USE 2-28-2011; IN COMMERCE 2-28-2011.

THE MARK CONSISTS OF STANDARD CHARACTERS WITHOUT CLAIM TO ANY PARTICULAR FONT, STYLE, SIZE, OR COLOR.

SN 85-155,691, FILED 10-19-2010.

JACQUELINE A. LAVINE, EXAMINING ATTORNEY



*David J. Kybas*

Director of the United States Patent and Trademark Office

United States of America  
United States Patent and Trademark Office

# NutriV<sup>an</sup>

**Reg. No. 4,199,124**

CARAVAN INGREDIENTS INC. (GEORGIA CORPORATION)  
7905 QUIVIRA  
LENEXA, KS 66215

**Registered Aug. 28, 2012**

**Int. Cl.: 5**

FOR: FOOD AND BEVERAGE SUPPLEMENTS, NAMELY, VITAMIN AND MINERAL SUPPLEMENT PREMIXES; FORTIFICATION PRODUCTS FOR FUNCTIONAL FOODS AND BEVERAGES OF ALL VARIETIES, NAMELY, VITAMIN PREPARATIONS, MINERAL PREPARATIONS, DIETARY FIBER AS AN ADDITIVE FOR FOOD PRODUCTS, BOTANICAL NUTRITIONAL SUPPLEMENTS, HERBAL SUPPLEMENTS, FOOD SUPPLEMENTS, NAMELY, ANTI-OXIDANTS, PROTEIN SUPPLEMENTS AND CALCIUM SUPPLEMENTS FOR USE AS INGREDIENTS IN THE FOOD AND BEVERAGE INDUSTRIES, IN CLASS 5 (U.S. CLS. 6, 18, 44, 46, 51 AND 52).

**TRADEMARK**

**PRINCIPAL REGISTER**

FIRST USE 1-1-2009, THE MARK WAS FIRST USED ANYWHERE IN A DIFFERENT FORM OTHER THAN THAT SOUGHT TO BE REGISTERED AT LEAST AS EARLY AS 09/00/2008. ; IN COMMERCE 1-1-2009, THE MARK WAS FIRST USED IN COMMERCE IN A DIFFERENT FORM OTHER THAN THAT SOUGHT TO BE REGISTERED AT LEAST AS EARLY AS 09/00/2008..

OWNER OF U.S. REG. NO. 3,800,346.

THE COLOR(S) BLACK AND GREEN IS/ARE CLAIMED AS A FEATURE OF THE MARK.

THE COLOR BLACK APPEARS IN ALL THE LETTERS OF THE WORDING "NUTRIVAN", WHILE THE COLOR GREEN APPEARS INSIDE THE LETTER "V" WHICH IS OUTLINED IN THE COLOR BLACK.

SN 85-156,305, FILED 10-19-2010.

EVELYN BRADLEY, EXAMINING ATTORNEY



*David J. Kypos*

Director of the United States Patent and Trademark Office



# United States of America

United States Patent and Trademark Office

# AVA

**Reg. No. 4,199,125**

**Registered Aug. 28, 2012**

**Int. Cls.: 16, 36, 37, and  
41**

AVALONBAY COMMUNITIES, INC. (MARYLAND CORPORATION)  
BALLSTON TOWER  
671 N. GLEBE ROAD, SUITE 800  
ARLINGTON, VA 22203

FOR: PRINTED GUIDES FOR RESIDENTIAL SERVICES, IN CLASS 16 (U.S. CLS. 2, 5, 22, 23, 29, 37, 38 AND 50).

**TRADEMARK**

FIRST USE 10-1-2011; IN COMMERCE 10-1-2011.

**SERVICE MARK**

FOR: REAL ESTATE BUILDING MANAGEMENT AND LEASING; RENTAL OF APARTMENTS AND RETAIL BUILDINGS; PROVIDING INFORMATION VIA THE INTERNET IN THE FIELD OF REAL ESTATE BUILDING MANAGEMENT AND LEASING; PROVIDING ONLINE INFORMATION FOR RENTERS AND PROSPECTIVE RENTERS IN THE FIELD OF REAL ESTATE, IN CLASS 36 (U.S. CLS. 100, 101 AND 102).

**PRINCIPAL REGISTER**

FIRST USE 10-1-2011; IN COMMERCE 10-1-2011.

FOR: REAL ESTATE APARTMENT CONSTRUCTION; REPAIR OF BUILDINGS; MAINTENANCE OF REAL ESTATE BUILDINGS, IN CLASS 37 (U.S. CLS. 100, 103 AND 106).

FIRST USE 10-1-2011; IN COMMERCE 10-1-2011.

FOR: PROVIDING FACILITIES FOR RECREATION ACTIVITIES; PROVIDING EXERCISE FACILITIES; PROVIDING INFORMATION TO AN APARTMENT COMMUNITY IN THE FIELD OF RECREATION AND LEISURE ACTIVITIES, IN CLASS 41 (U.S. CLS. 100, 101 AND 107).

FIRST USE 10-1-2011; IN COMMERCE 10-1-2011.

THE MARK CONSISTS OF STANDARD CHARACTERS WITHOUT CLAIM TO ANY PARTICULAR FONT, STYLE, SIZE, OR COLOR.

SN 85-156,771, FILED 10-20-2010.

BERNICE MIDDLETON, EXAMINING ATTORNEY



*David J. Kyros*

Director of the United States Patent and Trademark Office

# United States of America

United States Patent and Trademark Office

# MAGNET

**Reg. No. 4,199,126**

ESMERALDA FARMS, INC. (FLORIDA CORPORATION)  
1800 N.W. 89TH PLACE  
DORAL, FL 33172

**Registered Aug. 28, 2012**

**Int. Cl.: 31**

FOR: FRESH CUT FLOWERS, IN CLASS 31 (U.S. CLS. 1 AND 46).

**TRADEMARK**

FIRST USE 10-16-2011; IN COMMERCE 10-16-2011.

**PRINCIPAL REGISTER**

THE MARK CONSISTS OF STANDARD CHARACTERS WITHOUT CLAIM TO ANY PARTICULAR FONT, STYLE, SIZE, OR COLOR.

SN 85-156,964, FILED 10-20-2010.

KAREN SEVERSON, EXAMINING ATTORNEY



*David J. Kybas*

Director of the United States Patent and Trademark Office

# United States of America

United States Patent and Trademark Office



**Reg. No. 4,199,127**

**Registered Aug. 28, 2012**

**Int. Cls.: 35 and 36**

**SERVICE MARK**

**PRINCIPAL REGISTER**

ENTERTAINMENT PUBLICATIONS LLC (DELAWARE LIMITED LIABILITY COMPANY)  
1414 E. MAPLE ROAD  
TROY, MI 48083

FOR: ADVERTISING AND PROMOTIONAL SERVICES, NAMELY, PROMOTING THE GOODS AND SERVICES OF OTHERS THROUGH THE DISTRIBUTION OF COUPONS, AND DISCOUNT OFFERS WHICH ENTITLE THE HOLDER TO RECEIVE DISCOUNTS ON DINING, HOTEL ACCOMMODATIONS, CONSUMER MERCHANDISE, TRAVEL, MOVIES, SPORTS, THEATER AND OTHER LEISURE ACTIVITIES; PROVIDING ADVERTISING SERVICE THROUGH THE DISTRIBUTION OF ADVERTISEMENTS, COUPONS AND DISCOUNT OFFERS FOR DISPLAY ON INTERNET, NAMELY, IN WEBSITES, E-MAILS AND MULTI-MEDIA MESSAGES; PROVIDING VIA ON-LINE COMPUTER SERVICES A MEMBERSHIP PROGRAM ENTITLING THE PARTICIPANTS TO RECEIVE DISCOUNTS ON DINING, HOTEL ACCOMMODATIONS, CONSUMER MERCHANDISE, TRAVEL, MOVIES, SPORTS, THEATER AND OTHER LEISURE ACTIVITIES, AND PROVIDING IN CONNECTION THEREWITH AN ON-LINE DIRECTORY OF INFORMATION ABOUT THE DISCOUNT PROGRAM AND PARTICIPATING BUSINESSES, IN CLASS 35 (U.S. CLS. 100, 101 AND 102).

FIRST USE 8-8-2009; IN COMMERCE 8-8-2009.

FOR: CHARITABLE FUNDRAISING SERVICES EFFECTED THROUGH A MEMBERSHIP PROGRAM WHICH ENTITLES THE PARTICIPANTS TO DISTRIBUTE COUPONS AND DISCOUNT OFFERS WHICH ALLOWS THE HOLDER TO RECEIVE DISCOUNTS ON DINING, HOTEL ACCOMMODATION, CONSUMER MERCHANDISE, TRAVEL, MOVIES, SPORTS, THEATER AND OTHER LEISURE ACTIVITIES, IN CLASS 36 (U.S. CLS. 100, 101 AND 102).

FIRST USE 8-8-2009; IN COMMERCE 8-8-2009.

OWNER OF U.S. REG. NOS. 998,252, 3,863,005, AND OTHERS.

SEC. 2(F) AS TO "ENTERTAINMENT".

NO CLAIM IS MADE TO THE EXCLUSIVE RIGHT TO USE "FUNDRAISING", APART FROM THE MARK AS SHOWN.



*David J. Kyjars*

Director of the United States Patent and Trademark Office

**Reg. No. 4,199,127** THE MARK CONSISTS OF THE WORDS "ENTERTAINMENT" IN SCRIPT OVER THE WORD "EXTREME" WITH THE "X" IN "EXTREME" IN THE SHAPE OF A PERSON ALL OVER THE WORD "FUNDRAISING".

SN 85-157,086, FILED 10-20-2010.

CHRISTINE MARTIN, EXAMINING ATTORNEY

# United States of America

United States Patent and Trademark Office

## Business School of Happiness

**Reg. No. 4,199,128**

**Registered Aug. 28, 2012**

**Int. Cl.: 16**

**TRADEMARK**

**PRINCIPAL REGISTER**

THE BUSINESS SCHOOL OF HAPPINESS, INC. (CONNECTICUT CORPORATION)  
231 ROMFORD ROAD  
WASHINGTON DEPOT, CT 06794

FOR: MAGAZINES, BOOKS, AND PUBLICATIONS IN THE NATURE OF BOOKLETS AND PRINTED PERIODIC REPORTS, ALL OF THE FOREGOING FEATURING INFORMATION IN THE FIELD OF PHYSICAL HEALTH AND WELL BEING, IN CLASS 16 (U.S. CLS. 2, 5, 22, 23, 29, 37, 38 AND 50).

FIRST USE 6-9-2010; IN COMMERCE 6-9-2010.

THE MARK CONSISTS OF STANDARD CHARACTERS WITHOUT CLAIM TO ANY PARTICULAR FONT, STYLE, SIZE, OR COLOR.

SN 85-157,164, FILED 10-20-2010.

NANCY CLARKE, EXAMINING ATTORNEY



*David J. Kyffers*

Director of the United States Patent and Trademark Office

# United States of America

United States Patent and Trademark Office

# KLINT

**Reg. No. 4,199,129**

**Registered Aug. 28, 2012**

**Int. Cl.: 28**

**TRADEMARK**

**PRINCIPAL REGISTER**

BOINNARD, LUDOVIC (FRANCE INDIVIDUAL)  
818 NANTASKET COURT  
SAN DIEGO, CA 92109

FOR: SKIS, IN CLASS 28 (U.S. CLS. 22, 23, 38 AND 50).

FIRST USE 12-13-2010; IN COMMERCE 12-13-2010.

THE MARK CONSISTS OF STANDARD CHARACTERS WITHOUT CLAIM TO ANY PARTICULAR FONT, STYLE, SIZE, OR COLOR.

SN 85-157,530, FILED 10-20-2010.

DAVID ELTON, EXAMINING ATTORNEY



*David J. Kybas*

Director of the United States Patent and Trademark Office

# United States of America

United States Patent and Trademark Office

# BLAZON

**Reg. No. 4,199,130**

ARDENT PRODUCTS CORPORATION (DELAWARE CORPORATION)  
3021 SCARBOROUGH ROAD  
CLEVELAND HEIGHTS, OH 44118

**Registered Aug. 28, 2012**

**Int. Cl.: 9**

FOR: DIGITAL PHOTO FRAMES AND VIDEO MONITORS FOR DISPLAYING 3D IMAGES,  
IN CLASS 9 (U.S. CLS. 21, 23, 26, 36 AND 38).

**TRADEMARK**

FIRST USE 1-0-2011; IN COMMERCE 1-0-2011.

**PRINCIPAL REGISTER**

THE MARK CONSISTS OF STANDARD CHARACTERS WITHOUT CLAIM TO ANY PAR-  
TICULAR FONT, STYLE, SIZE, OR COLOR.

SN 85-158,073, FILED 10-21-2010.

CHRISTINE COOPER, EXAMINING ATTORNEY



*David J. Kybas*

Director of the United States Patent and Trademark Office

# United States of America

United States Patent and Trademark Office

# CACHATTO

**Reg. No. 4,199,131**

E-JAN NETWORKS CO. (JAPAN CORPORATION)

**Registered Aug. 28, 2012**

1-7-20 HIRAKAWA-CHO, CHIYODA-KU  
TOKYO, JAPAN

**Int. Cls.: 9, 38, and 42**

FOR: COMPUTER SOFTWARE IN THE FIELDS OF WIRELESS COMMUNICATION, PERSONAL PRODUCTIVITY, MOBILE INFORMATION ACCESS, MARKETING AND ADVERTISING, AND REMOTE DATA MANAGEMENT AND DATA SEARCHING FOR WIRELESS DELIVERY OF CONTENT TO COMPUTERS, LAPTOPS, MOBILE ELECTRONIC TERMINALS, TABLET COMPUTERS, MOBILE PHONES AND SMART PHONES, IN CLASS 9 (U.S. CLS. 21, 23, 26, 36 AND 38).

**TRADEMARK**

**SERVICE MARK**

**PRINCIPAL REGISTER**

FIRST USE 12-31-2005; IN COMMERCE 8-31-2011.

FOR: TRANSMISSION OF VOICE, AUDIO, VISUAL IMAGES, TEXTS AND DATA THROUGH THE INTERNET, TELECOMMUNICATIONS NETWORKS, WIRELESS COMMUNICATION NETWORKS, INFORMATION SERVICE NETWORKS, DATA NETWORKS AND DATABASES; TELECOMMUNICATIONS CONSULTING; PROVIDING ACCESS TO THE INTERNET AND TELECOMMUNICATIONS NETWORK, IN CLASS 38 (U.S. CLS. 100, 101 AND 104).

FIRST USE 12-31-2005; IN COMMERCE 8-31-2011.

FOR: DESIGN, CREATION AND MAINTENANCE OF COMPUTER PROGRAMS; CONSULTING RELATING TO DESIGN, CREATION AND MAINTENANCE OF COMPUTER PROGRAMS, AND PROVIDING INFORMATION THEREON; DESIGN, FORMULATION AND MAINTENANCE OF COMMUNICATION NETWORK SYSTEMS; CONSULTING RELATING TO DESIGN, FORMULATION AND MAINTENANCE OF COMMUNICATION NETWORK SYSTEMS, AND PROVIDING INFORMATION THEREON; REMOTE OPERATION OF COMPUTERS AND COMPUTER PROGRAMS; REMOTE MONITORING OF COMPUTERS AND COMMUNICATION NETWORK SYSTEMS; VERSION UPGRADE OF COMPUTER PROGRAMS, NAMELY, UPDATING OF COMPUTER PROGRAMS FOR OTHERS; TECHNICAL ADVICE RELATING TO PERFORMANCE AND OPERATION OF COMPUTERS, COMPUTER PROGRAMS, COMMUNICATION NETWORK AND TELECOMMUNICATION; PROVIDING TEMPORARY USE OF NON-DOWNLOADABLE COMPUTER PROGRAMS IN THE FIELDS OF WIRELESS COMMUNICATION, PERSONAL PRODUCTIVITY, MOBILE INFORMATION ACCESS, MARKETING AND ADVERTISING, AND REMOTE DATA MANAGEMENT AND DATA SEARCHING FOR WIRELESS DELIVERY OF CONTENT TO COMPUTERS, LAPTOPS, MOBILE ELECTRONIC TERMINALS, TABLET COMPUTERS,



*David J. Kyros*

Director of the United States Patent and Trademark Office



**Reg. No. 4,199,131** MOBILE PHONES AND SMART PHONES; APPLICATION SERVICE PROVIDER, NAMELY, HOSTING, MANAGING, DEVELOPING, AND MAINTAINING APPLICATIONS, SOFTWARE, AND WEB SITES, IN THE FIELDS OF PERSONAL PRODUCTIVITY, WIRELESS COMMUNICATION, MOBILE INFORMATION ACCESS, AND REMOTE DATA MANAGEMENT FOR WIRELESS DELIVERY OF CONTENT TO HANDHELD COMPUTERS, LAPTOPS AND MOBILE ELECTRONIC DEVICES, IN CLASS 42 (U.S. CLS. 100 AND 101).

FIRST USE 12-31-2005; IN COMMERCE 8-31-2011.

THE MARK CONSISTS OF STANDARD CHARACTERS WITHOUT CLAIM TO ANY PARTICULAR FONT, STYLE, SIZE, OR COLOR.

THE WORDING "CACHATTO" HAS NO MEANING IN A FOREIGN LANGUAGE.

SN 85-158,169, FILED 10-21-2010.

JANICE L. MCMORROW, EXAMINING ATTORNEY

# United States of America

United States Patent and Trademark Office



**Reg. No. 4,199,132**

**Registered Aug. 28, 2012**

**Int. Cl.: 35**

**SERVICE MARK**

**PRINCIPAL REGISTER**

FLORIDA DEPARTMENT OF CITRUS (FLORIDA STATE AGENCY)  
P.O. BOX 9010  
BARTOW, FL 338319010

FOR: ADVERTISING, MARKETING AND PROMOTING SALES BY WAY OF TELEVISION AND RADIO BROADCASTS AND WEBCASTS THROUGH AN ONLINE GLOBAL COMPUTER NETWORK AND WEBSITES; PRODUCTION OF TELEVISION COMMERCIALS, IN CLASS 35 (U.S. CLS. 100, 101 AND 102).

FIRST USE 6-1-2010; IN COMMERCE 3-24-2011.

OWNER OF U.S. REG. NOS. 982,104, 2,594,792, AND OTHERS.

THE COLOR(S) GREEN, YELLOW, ORANGE, BROWN, AND WHITE IS/ARE CLAIMED AS A FEATURE OF THE MARK.

NO CLAIM IS MADE TO THE EXCLUSIVE RIGHT TO USE "FLORIDA CITRUS", APART FROM THE MARK AS SHOWN.

THE MARK CONSISTS OF AN IMAGE OF A STYLIZED CITRUS TREE WITH ORANGE AND YELLOW FRUIT, GREEN LEAVES AND A BROWN TRUNK. THE WORDS "FLORIDA", IN ORANGE FONT, AND "CITRUS", IN GREEN FONT, ARE BELOW THE TREE, AND THE ENTIRE IMAGE AND WORDS ARE ENCLOSED BY A GREEN RECTANGULAR BORDER. THE BACKGROUND WITHIN THE RECTANGLE BEHIND THE TREE IMAGE AND WORDS IS WHITE.

SN 85-158,229, FILED 10-21-2010.

MICHELLE DUBOIS, EXAMINING ATTORNEY



*David J. Kyros*

Director of the United States Patent and Trademark Office

# United States of America

United States Patent and Trademark Office

# SOAW

**Reg. No. 4,199,133**

SVELTE MEDICAL SYSTEMS, INC. (DELAWARE CORPORATION)  
675 CENTRAL AVENUE  
NEW PROVIDENCE, NJ 07974

**Registered Aug. 28, 2012**

**Int. Cl.: 10**

FOR: MEDICAL DEVICES, NAMELY, STENT SYSTEMS COMPRISING STENTS, GUIDEWIRES, AND DILATION BALLOONS, IN CLASS 10 (U.S. CLS. 26, 39 AND 44).

**TRADEMARK**

FIRST USE 1-31-2008; IN COMMERCE 1-31-2009.

**PRINCIPAL REGISTER**

THE MARK CONSISTS OF STANDARD CHARACTERS WITHOUT CLAIM TO ANY PARTICULAR FONT, STYLE, SIZE, OR COLOR.

SN 85-159,410, FILED 10-22-2010.

AISHA SALEM, EXAMINING ATTORNEY



*David J. Kybas*

Director of the United States Patent and Trademark Office

# United States of America

United States Patent and Trademark Office

# PAGAN'S

**Reg. No. 4,199,134**

**Registered Aug. 28, 2012**

**COLLECTIVE  
MEMBERSHIP**

**PRINCIPAL REGISTER**

PAGAN'S MOTORCYCLE CLUB, WORLDWIDE, INC. (DELAWARE CORPORATION)  
P.O. BOX 88  
SOMERS POINT, NJ 08244

FOR: INDICATING MEMBERSHIP IN A MOTORCYCLE CLUB, IN CLASS 200 (U.S. CL. 200).

FIRST USE 12-31-1959; IN COMMERCE 12-31-1959.

THE MARK CONSISTS OF STANDARD CHARACTERS WITHOUT CLAIM TO ANY PARTICULAR FONT, STYLE, SIZE, OR COLOR.

OWNER OF U.S. REG. NOS. 3,385,849 AND 3,996,335.

SN 85-159,545, FILED 10-22-2010.

SUSAN LESLIE DUBOIS, EXAMINING ATTORNEY



*David J. Kyffers*

Director of the United States Patent and Trademark Office

# United States of America

United States Patent and Trademark Office

## I'll tell you why

**Reg. No. 4,199,135**

**Registered Aug. 28, 2012**

**Int. Cl.: 16**

**TRADEMARK**

**PRINCIPAL REGISTER**

KROGSGAARD, NOREEN MARGARET (UNITED STATES INDIVIDUAL), DBA NOREEN O'SULLIVAN, KRATHUSVEJ 32 CHARLOTTENLUND, DENMARK DK-2920

FOR: A SERIES OF BOOKS AND WRITTEN ARTICLES IN THE FIELD OF CHILDREN'S BOOKS; A SERIES OF BOOKS, WRITTEN ARTICLES, HANDOUTS AND WORKSHEETS IN THE FIELD OF CHILDREN'S BOOK; BOOKS IN THE FIELD OF CHILDREN'S BOOKS; CHILDREN'S ACTIVITY BOOKS; CHILDREN'S BOOKS; CHILDREN'S INTERACTIVE EDUCATIONAL BOOKS; COLORING BOOKS; EDUCATIONAL BOOKS FEATURING CHILD DEVELOPMENT; SERIES OF NON-FICTION BOOKS IN THE FIELD OF CHILD DEVELOPMENT; SKETCH BOOKS; BABY BOOKS; CUSTOMIZABLE JOURNAL BOOKS; EDUCATIONAL KITS SOLD AS A UNIT IN THE FIELD OF CHILD DEVELOPMENT CONSISTING PRIMARILY OF EDUCATIONAL BOOKS AND ALSO INCLUDING DVDS AND T-SHIRTS; EDUCATIONAL KITS SOLD AS A UNIT IN THE FIELD OF CHILD DEVELOPMENT CONSISTING PRIMARILY OF EDUCATIONAL BOOKS, FLASH CARDS AND WORKSHEETS, AND ALSO INCLUDING AN EDUCATIONAL DVD; EDUCATIONAL PUBLICATIONS, NAMELY, BOOKS, HAND-OUTS, WORKBOOKS, JOURNALS, PLAYBOOKS, WORKSHEETS AND CARDS IN THE FIELD OF RIGHT-BRAIN FITNESS; EDUCATIONAL PUBLICATIONS, NAMELY, EDUCATIONAL LEARNING CARDS, FLASH CARDS, ACTIVITY CARDS, WORKBOOKS, TEXTBOOKS, ACTIVITY BOOKS, STORY BOOKS, PUZZLE BOOKS, PRINTED PUZZLES, TEACHER GUIDES, MANUALS, POSTERS AND EDUCATIONAL BOOKLETS IN THE FIELD OF CHILD DEVELOPMENT; NON-FICTION BOOKS ON A VARIETY OF TOPICS; NON-FICTION BOOKS ON A VARIETY OF TOPICS; NOTE BOOKS; PICTURE BOOKS; PUBLICATIONS, NAMELY, BOOKS IN THE FIELDS OF CHILD DEVELOPMENT; ROLE PLAYING GAME EQUIPMENT IN THE NATURE OF GAME BOOK MANUALS; SCHOLARLY BOOKS ON VARIOUS TOPICS, NAMELY, CHILD DEVELOPMENT. SCHOOL SUPPLY KITS CONTAINING VARIOUS COMBINATIONS OF SELECTED SCHOOL SUPPLIES, NAMELY, WRITING INSTRUMENTS, PENS, PENCILS, MECHANICAL PENCILS, ERASERS, MARKERS, CRAYONS, HIGHLIGHTER PENS, FOLDERS, NOTEBOOKS, PAPER, PROTRACTORS, PAPER CLIPS, PENCIL SHARPENERS, WRITING GRIPS, GLUE AND BOOK MARKS; SCHOOL WRITING BOOKS; SERIES OF FICTION AND NON-FICTION BOOKS ON A VARIETY OF TOPICS; SERIES OF FICTION AND NON-FICTION BOOKS ON A VARIETY OF TOPICS; STORY BOOKS; TALKING CHILDREN'S BOOKS, IN CLASS 16 (U.S. CLS. 2, 5, 22, 23, 29, 37, 38 AND 50).



*David J. Kappas*

Director of the United States Patent and Trademark Office

FIRST USE 12-1-2009; IN COMMERCE 6-1-2010.

**Reg. No. 4,199,135** THE MARK CONSISTS OF STANDARD CHARACTERS WITHOUT CLAIM TO ANY PARTICULAR FONT, STYLE, SIZE, OR COLOR.

SN 85-159,667, FILED 10-23-2010.

LINDA POWELL, EXAMINING ATTORNEY

# United States of America

United States Patent and Trademark Office

## JUNOS PULSE

**Reg. No. 4,199,136**

**Registered Aug. 28, 2012**

**Int. Cl.: 9**

**TRADEMARK**

**PRINCIPAL REGISTER**

JUNIPER NETWORKS, INC. (DELAWARE CORPORATION)  
1194 NORTH MATHILDA AVENUE  
SUNNYVALE, CA 94089

FOR: COMPUTER SOFTWARE, NAMELY, NETWORK CLIENT THAT PROVIDES CONNECTIVITY, ACCESS, SECURITY, AND ACCELERATION OF SECURE NETWORK INFORMATION, DATA, AND APPLICATIONS THROUGH COMPUTERS, MOBILE DEVICES, AND SMARTPHONES, IN CLASS 9 (U.S. CLS. 21, 23, 26, 36 AND 38).

FIRST USE 7-0-2009; IN COMMERCE 7-0-2009.

THE MARK CONSISTS OF STANDARD CHARACTERS WITHOUT CLAIM TO ANY PARTICULAR FONT, STYLE, SIZE, OR COLOR.

SN 85-159,975, FILED 10-25-2010.

ZACHARY BELLO, EXAMINING ATTORNEY



*David J. Kyjars*

Director of the United States Patent and Trademark Office

# United States of America

United States Patent and Trademark Office

## ORTHO FITTERS

**Reg. No. 4,199,137**

**Registered Aug. 28, 2012**

**Int. Cls.: 41 and 44**

**SERVICE MARK**

**PRINCIPAL REGISTER**

ATLANTIC COAST ORTHOPAEDICS RESOURCES, INC. (NORTH CAROLINA CORPORATION)  
2205-A DISTRIBUTION CENTER DRIVE  
CHARLOTTE, NC 28269

FOR: PATIENT EDUCATION AND TRAINING SERVICES, NAMELY, ONE-ON-ONE COUNSELING, CLASSES AND WORKSHOPS IN THE FIELD OF ORTHOPEDIC DEVICES, IN CLASS 41 (U.S. CLS. 100, 101 AND 107).

FIRST USE 11-0-2011; IN COMMERCE 11-0-2011.

FOR: FITTING FOR ORTHOPEDIC DEVICES; MEDICAL SERVICES, NAMELY, FOLLOW-UP CARE FOR PATIENTS RECEIVING ORTHOPEDIC DEVICES; ORTHOPEDIC PATIENT CARE SERVICES, IN CLASS 44 (U.S. CLS. 100 AND 101).

FIRST USE 11-0-2011; IN COMMERCE 11-0-2011.

THE MARK CONSISTS OF STANDARD CHARACTERS WITHOUT CLAIM TO ANY PARTICULAR FONT, STYLE, SIZE, OR COLOR.

SN 85-160,486, FILED 10-25-2010.

ALICIA COLLINS, EXAMINING ATTORNEY



*David J. Kyjars*

Director of the United States Patent and Trademark Office



# United States of America

United States Patent and Trademark Office

## MOM BRANDS

**Reg. No. 4,199,138**

**Registered Aug. 28, 2012**

**Int. Cls.: 30 and 35**

**TRADEMARK**

**SERVICE MARK**

**PRINCIPAL REGISTER**

MOM BRANDS COMPANY (MINNESOTA CORPORATION)  
2700 IDS CENTER 80 S. 8TH STREET  
MINNEAPOLIS, MN 55402

FOR: BREAKFAST CEREAL AND CEREAL BASED SNACK FOODS, IN CLASS 30 (U.S. CL. 46).

FIRST USE 2-1-2012; IN COMMERCE 2-1-2012.

FOR: PROMOTION SERVICES AND BUSINESS ADMINISTRATION SERVICES FOR PROCESSING SALES MADE ON THE INTERNET, IN CLASS 35 (U.S. CLS. 100, 101 AND 102).

FIRST USE 12-26-2011; IN COMMERCE 12-26-2011.

THE MARK CONSISTS OF STANDARD CHARACTERS WITHOUT CLAIM TO ANY PARTICULAR FONT, STYLE, SIZE, OR COLOR.

OWNER OF U.S. REG. NOS. 3,121,925 AND 3,379,585.

NO CLAIM IS MADE TO THE EXCLUSIVE RIGHT TO USE "BRANDS", APART FROM THE MARK AS SHOWN.

SN 85-161,176, FILED 10-26-2010.

AISHA CLARKE, EXAMINING ATTORNEY



*David J. Kyffers*

Director of the United States Patent and Trademark Office

# United States of America

United States Patent and Trademark Office



Summit  
Media  
Group

**Reg. No. 4,199,139**

**Registered Aug. 28, 2012**

**Int. Cl.: 16**

**TRADEMARK**

**PRINCIPAL REGISTER**

SUMMIT MEDIA GROUP, INC. (ILLINOIS CORPORATION)  
SUITE 2401  
330 NORTH WABASH AVENUE  
CHICAGO, IL 60611

FOR: PUBLICATIONS, NAMELY, TRADE JOURNALS AND NEWSLETTERS IN THE FIELDS OF MANUFACTURING, PROCESSING AND PACKAGING, IN CLASS 16 (U.S. CLS. 2, 5, 22, 23, 29, 37, 38 AND 50).

FIRST USE 10-0-2010; IN COMMERCE 10-10-2010.

NO CLAIM IS MADE TO THE EXCLUSIVE RIGHT TO USE "MEDIA GROUP", APART FROM THE MARK AS SHOWN.

THE COLOR(S) BLACK AND BLUE IS/ARE CLAIMED AS A FEATURE OF THE MARK.

THE MARK CONSISTS OF A STYLIZED LETTER "S" IN A SHADED BLUE CIRCLE TO THE LEFT OF THE TEXT "SUMMIT MEDIA GROUP" APPEARING IN THE COLOR BLACK.

SN 85-161,286, FILED 10-26-2010.

RONALD AIKENS, EXAMINING ATTORNEY



*David J. Kybas*

Director of the United States Patent and Trademark Office

# United States of America

United States Patent and Trademark Office

## SEX AND THE CITY FABULOUS!

**Reg. No. 4,199,140**

HOME BOX OFFICE, INC. (DELAWARE CORPORATION)  
1100 AVENUE OF THE AMERICAS  
NEW YORK, NY 10036

**Registered Aug. 28, 2012**

**Int. Cl.: 9**

FOR: GAMING DEVICES, NAMELY, GAMING MACHINES, SLOT MACHINES, WITH OR WITHOUT VIDEO OUTPUT; MACHINES FOR PLAYING GAMES OF CHANCE, IN CLASS 9 (U.S. CLS. 21, 23, 26, 36 AND 38).

**TRADEMARK**

FIRST USE 1-23-2012; IN COMMERCE 1-23-2012.

**PRINCIPAL REGISTER**

THE MARK CONSISTS OF STANDARD CHARACTERS WITHOUT CLAIM TO ANY PARTICULAR FONT, STYLE, SIZE, OR COLOR.

OWNER OF U.S. REG. NOS. 2,513,906, 3,829,634, AND OTHERS.

SN 85-161,748, FILED 10-26-2010.

FRANK LATTUCA, EXAMINING ATTORNEY



*David J. Kyffers*

Director of the United States Patent and Trademark Office

# United States of America

United States Patent and Trademark Office

## LEVEL-CORRECT BRACKET

**Reg. No. 4,199,141**

**Registered Aug. 28, 2012**

**Int. Cl.: 6**

**TRADEMARK**

**PRINCIPAL REGISTER**

MARIAK INDUSTRIES, INC. (CALIFORNIA CORPORATION)  
575 W. MANVILLE STREET  
RANCHO DOMINGUEZ, CA 90220

FOR: METAL BRACKETS FOR RETAINING FASCIA BOARDS FOR WINDOW TREATMENTS, IN CLASS 6 (U.S. CLS. 2, 12, 13, 14, 23, 25 AND 50).

FIRST USE 8-15-2010; IN COMMERCE 8-15-2010.

THE MARK CONSISTS OF STANDARD CHARACTERS WITHOUT CLAIM TO ANY PARTICULAR FONT, STYLE, SIZE, OR COLOR.

NO CLAIM IS MADE TO THE EXCLUSIVE RIGHT TO USE "BRACKET", APART FROM THE MARK AS SHOWN.

SN 85-161,918, FILED 10-26-2010.

PATRICIA EVANKO, EXAMINING ATTORNEY



*David J. Kybas*

Director of the United States Patent and Trademark Office

# United States of America

United States Patent and Trademark Office

## SHORE CHIC

**Reg. No. 4,199,142**

SHORE CHIC LLC (NEW JERSEY LIMITED LIABILITY COMPANY)  
50 ENGLISH PLAZA  
RED BANK, NJ 07701

**Registered Aug. 28, 2012**

**Int. Cls.: 35 and 41**

FOR: ON-LINE WHOLESALE AND RETAIL STORE SERVICES FEATURING WEDDING PRODUCTS AND BEACH-RELATED HOME DECOR ITEMS; RETAIL STORE AND ON-LINE RETAIL STORE SERVICES FEATURING WEDDING PRODUCTS AND BEACH-RELATED HOME DECOR ITEMS, IN CLASS 35 (U.S. CLS. 100, 101 AND 102).

**SERVICE MARK**

**PRINCIPAL REGISTER**

FIRST USE 12-1-2003; IN COMMERCE 12-1-2003.

FOR: WEDDING PLANNING AND COORDINATION SERVICES, IN CLASS 41 (U.S. CLS. 100, 101 AND 107).

FIRST USE 12-1-2003; IN COMMERCE 12-1-2003.

THE MARK CONSISTS OF STANDARD CHARACTERS WITHOUT CLAIM TO ANY PARTICULAR FONT, STYLE, SIZE, OR COLOR.

NO CLAIM IS MADE TO THE EXCLUSIVE RIGHT TO USE "SHORE", APART FROM THE MARK AS SHOWN.

SN 85-162,710, FILED 10-27-2010.

DAVID H. STINE, EXAMINING ATTORNEY



*David J. Kyros*

Director of the United States Patent and Trademark Office

# United States of America

United States Patent and Trademark Office



**Reg. No. 4,199,143**

**Registered Aug. 28, 2012**

**Int. Cl.: 25**

**TRADEMARK**

**PRINCIPAL REGISTER**

CABLE, WENDY (UNITED STATES INDIVIDUAL)  
PO BOX 1510  
ROBBINSVILLE, NC 28771

FOR: BIB SHORTS; CLOTH BIBS; HATS; INFANT AND TODDLER ONE PIECE CLOTHING;  
PAJAMAS; PANTS; POLO SHIRTS; SHIRTS; SHORTS; SOCKS; SWEAT SHIRTS; T-SHIRTS;  
TANK TOPS; UNDERSHIRTS; UNDERWEAR, IN CLASS 25 (U.S. CLS. 22 AND 39).

FIRST USE 6-1-2012; IN COMMERCE 6-1-2012.

THE MARK CONSISTS OF AN INCOMPLETE CIRCLE CONTAINING A BUTTERFLY TO  
THE RIGHT, FACING IT'S COCOON, WHICH IS ON THE LEFT SIDE OF THE CIRCLE. THE  
STYLIZED TEXT "SECRET" CUTS INTO THE LEFT SIDE OF THE CIRCLE AND THE  
STYLIZED TERM "BLESSINGS" CUTS INTO THE RIGHT SIDE OF THE CIRCLE.

SN 85-162,737, FILED 10-27-2010.

TRACY WHITTAKER-BROWN, EXAMINING ATTORNEY



*David J. Kyffers*

Director of the United States Patent and Trademark Office

# United States of America

United States Patent and Trademark Office

# FERNRIDGE

**Reg. No. 4,199,144**

**Registered Aug. 28, 2012**

**Int. Cl.: 33**

**TRADEMARK**

**PRINCIPAL REGISTER**

FERN RIDGE LIMITED (NEW ZEALAND LIMITED LIABILITY COMPANY)  
27 NAPIER ROAD, HAVELOCK NORTH  
HAWKES BAY, NEW ZEALAND 4130

FOR: WINES AND SPIRITS, IN CLASS 33 (U.S. CLS. 47 AND 49).

FIRST USE 4-13-2004; IN COMMERCE 4-13-2004.

THE MARK CONSISTS OF STANDARD CHARACTERS WITHOUT CLAIM TO ANY PARTICULAR FONT, STYLE, SIZE, OR COLOR.

SN 85-162,775, FILED 10-27-2010.

ELI HELLMAN, EXAMINING ATTORNEY



*David J. Kybas*

Director of the United States Patent and Trademark Office

# United States of America

United States Patent and Trademark Office

## COUNTRY KITCHEN

**Reg. No. 4,199,145**

PET BRANDS, INC. (OHIO CORPORATION)  
4338 JANITROL ROAD  
COLUMBUS, OH 43228

**Registered Aug. 28, 2012**

**Int. Cl.: 31**

FOR: PET TREATS; DOG TREATS, NAMELY, JERKY PRODUCTS FOR DOGS, IN CLASS 31 (U.S. CLS. 1 AND 46).

**TRADEMARK**

FIRST USE 5-22-2012; IN COMMERCE 5-22-2012.

**PRINCIPAL REGISTER**

THE MARK CONSISTS OF STANDARD CHARACTERS WITHOUT CLAIM TO ANY PARTICULAR FONT, STYLE, SIZE, OR COLOR.

SN 85-163,270, FILED 10-28-2010.

JULIE WATSON, EXAMINING ATTORNEY



*David J. Kybas*

Director of the United States Patent and Trademark Office



# United States of America

United States Patent and Trademark Office

# SUDOKUPDQ

**Reg. No. 4,199,146**

SUDOKUPDQ(TM) LLC (KANSAS LIMITED LIABILITY COMPANY)  
1920 SW WEST UNION ROAD  
TOPEKA, KS 66615

**Registered Aug. 28, 2012**

**Int. Cls.: 9 and 41**

FOR: DOWNLOADABLE COMPUTER GAME PROGRAMS; COMPUTER GAME PROGRAMS  
DOWNLOADABLE VIA THE INTERNET; COMPUTER GAME SOFTWARE FOR GAMING  
MACHINES, NAMELY, MACHINES FOR GAMES AND GAMES ON TERMINALS, IN CLASS  
9 (U.S. CLS. 21, 23, 26, 36 AND 38).

**TRADEMARK**

**SERVICE MARK**

FIRST USE 5-18-2012; IN COMMERCE 5-18-2012.

**PRINCIPAL REGISTER**

FOR: ENTERTAINMENT SERVICES, NAMELY, PROVIDING ONLINE ELECTRONIC GAMES;  
ENTERTAINMENT SERVICES, NAMELY, PROVIDING ONLINE VIDEO GAMES, IN CLASS  
41 (U.S. CLS. 100, 101 AND 107).

FIRST USE 5-18-2012; IN COMMERCE 5-18-2012.

THE MARK CONSISTS OF STANDARD CHARACTERS WITHOUT CLAIM TO ANY PAR-  
TICULAR FONT, STYLE, SIZE, OR COLOR.

SN 85-163,272, FILED 10-28-2010.

MARTHA FROMM, EXAMINING ATTORNEY



*David J. Kyros*

Director of the United States Patent and Trademark Office

# United States of America

United States Patent and Trademark Office

## Voice of Reason

**Reg. No. 4,199,147**

**Registered Aug. 28, 2012**

**Int. Cls.: 35, 36, and 41**

**SERVICE MARK**

**PRINCIPAL REGISTER**

NORTHWEST FEDERAL CREDIT UNION (UNITED STATES FEDERALLY CHARTERED CREDIT UNION)  
200 SPRING STREET  
HERNDON, VA 20170

FOR: LOCATING NEW AND PRE-OWNED VEHICLES FOR PURCHASE OR LEASE, IN CLASS 35 (U.S. CLS. 100, 101 AND 102).

FIRST USE 2-1-2010; IN COMMERCE 2-1-2010.

FOR: LOAN FINANCING, NAMELY, TERM LOANS, HOME EQUITY LOANS, COMMERCIAL REAL ESTATE LOANS, LINES OF CREDIT, AND SMALL BUSINESS LOANS; FINANCIAL SERVICES, NAMELY, SAVINGS PROGRAMS FOR YOUTHS AND CHECKING ACCOUNTS; SAVINGS ACCOUNT SERVICES; STUDENT LOAN SERVICES, ELECTRONIC BANKING VIA GLOBAL COMPUTER NETWORK; INTERNET BANKING; BANKING SERVICES PROVIDED BY MOBILE TELEPHONE CONNECTIONS; TELEPHONE BANKING SERVICES; FINANCIAL PLANNING AND INVESTMENT ADVISORY SERVICES; BANKING SERVICES FEATURING THE PROVISION OF CERTIFICATES OF DEPOSIT; CHECKING ACCOUNT SERVICES FEATURING OVERDRAFT PROTECTION SERVICES; INVESTMENT BANKING SERVICES; CREDIT UNION SERVICES; BANKING SERVICES; LOAN FINANCING; FINANCING SERVICES; AUTOMOBILE LOAN FINANCING; INSTALLMENT LOANS; PROVIDING CASH AND OTHER REBATES AS PART OF A CUSTOMER LOYALTY PROGRAM FOR CREDIT CARD USE AND MORTGAGE LOAN USE; MORTGAGE LENDING; MORTGAGE BANKING SERVICES; LOAN FINANCING, NAMELY, AUTOMOBILE LOANS; CHECKING ACCOUNT SERVICES, ELECTRONIC REMOTE CHECK DEPOSIT SERVICES; ATM BANKING SERVICES; ISSUING OF CHECKS AND LETTERS OF CREDIT; CORPORATE SAVINGS ACCOUNT SERVICES; MERCHANT BANKING SERVICES; REVOLVING LOANS; CREDIT AND DEBIT CARD-SERVICES, IN CLASS 36 (U.S. CLS. 100, 101 AND 102).

FIRST USE 2-1-2010; IN COMMERCE 2-1-2010.

FOR: EDUCATIONAL SERVICES, NAMELY, CONDUCTING CLASSES, SEMINARS, WEBINARS, CONFERENCES, AND WORKSHOPS, IN FINANCIAL AND BANKING FIELDS AND DISTRIBUTION OF COURSE AND EDUCATIONAL MATERIAL IN CONNECTION THEREWITH, IN CLASS 41 (U.S. CLS. 100, 101 AND 107).

FIRST USE 8-14-2010; IN COMMERCE 8-14-2010.



*David J. Kyjars*

Director of the United States Patent and Trademark Office

**Reg. No. 4,199,147** THE MARK CONSISTS OF STANDARD CHARACTERS WITHOUT CLAIM TO ANY PARTICULAR FONT, STYLE, SIZE, OR COLOR.

SN 85-163,524, FILED 10-28-2010.

JOHN SCHUYLER YARD, EXAMINING ATTORNEY

# United States of America

United States Patent and Trademark Office

# GCA

**Reg. No. 4,199,148**

GLOBAL CASH ACCESS, INC. (DELAWARE CORPORATION)

**Registered Aug. 28, 2012**

3525 EAST POST ROAD, SUITE 120  
LAS VEGAS, NV 89120

**Int. Cl.: 9**

FOR: AUTOMATED TELLER MACHINES (ATM); INTERNET-BASED STAND-ALONE KIOSKS COMPRISING COMPUTERS, COMPUTER HARDWARE, COMPUTER PERIPHERALS AND COMPUTER OPERATING SOFTWARE FEATURING A TOUCH-SCREEN INTERFACE FOR PROCESSING FINANCIAL MONETARY TRANSACTIONS; COMPUTER PERIPHERALS, NAMELY, ATM DEBIT CARD KEYPADS AND CARD READERS USED IN CASINOS FOR ELECTRONIC MONEY TRANSFERS BY CONSUMERS; ELECTRONIC TERMINALS WHICH GENERATE CASINO VOUCHERS FOR GAMING PATRONS, IN CLASS 9 (U.S. CLS. 21, 23, 26, 36 AND 38).

**TRADEMARK**

**PRINCIPAL REGISTER**

FIRST USE 7-0-1997; IN COMMERCE 7-0-1997.

THE MARK CONSISTS OF STANDARD CHARACTERS WITHOUT CLAIM TO ANY PARTICULAR FONT, STYLE, SIZE, OR COLOR.

SN 85-164,038, FILED 10-28-2010.

AMEEN IMAM, EXAMINING ATTORNEY



*David J. Kyffers*

Director of the United States Patent and Trademark Office

# United States of America

United States Patent and Trademark Office

# GCA

**Reg. No. 4,199,149**

GLOBAL CASH ACCESS, INC. (DELAWARE CORPORATION)

**Registered Aug. 28, 2012**

3525 EAST POST ROAD, SUITE 120  
LAS VEGAS, NV 89120

**Int. Cl.: 36**

FOR: MONEY TRANSFER SERVICES VIA A GLOBAL COMPUTER NETWORK, AUTOMATED TELLER MACHINES (ATM) AND TELEPHONE; ELECTRONIC MONEY TRANSFER SERVICES; PROCESSING OF FINANCIAL TRANSACTIONS, NAMELY, ELECTRONIC CASH TRANSACTIONS, ELECTRONIC CREDIT CARD TRANSACTIONS, ELECTRONIC DEBIT TRANSACTIONS, ELECTRONIC FUNDS TRANSFER; FINANCIAL ADVISORY AND CONSULTANCY SERVICES RELATING TO MONEY TRANSFER SERVICES IN THE GAMING AND WAGERING INDUSTRY, IN CLASS 36 (U.S. CLS. 100, 101 AND 102).

**SERVICE MARK**

**PRINCIPAL REGISTER**

FIRST USE 7-0-1997; IN COMMERCE 7-0-1997.

THE MARK CONSISTS OF STANDARD CHARACTERS WITHOUT CLAIM TO ANY PARTICULAR FONT, STYLE, SIZE, OR COLOR.

SN 85-164,082, FILED 10-28-2010.

AMEEN IMAM, EXAMINING ATTORNEY



*David J. Kyffers*

Director of the United States Patent and Trademark Office

# United States of America

United States Patent and Trademark Office

# SuDoKuPDQ!

**Reg. No. 4,199,150**

SUDOKUPDQ(TM) LLC (KANSAS LIMITED LIABILITY COMPANY)  
1920 SW WEST UNION ROAD  
TOPEKA, KS 66615

**Registered Aug. 28, 2012**

**Int. Cls.: 9 and 41**

FOR: DOWNLOADABLE COMPUTER GAME PROGRAMS; COMPUTER GAME PROGRAMS  
DOWNLOADABLE VIA THE INTERNET; COMPUTER GAME SOFTWARE FOR GAMING  
MACHINES, NAMELY, MACHINES FOR GAMES AND GAMES ON TERMINALS, IN CLASS  
9 (U.S. CLS. 21, 23, 26, 36 AND 38).

**TRADEMARK**

**SERVICE MARK**

FIRST USE 5-18-2012; IN COMMERCE 5-18-2012.

**PRINCIPAL REGISTER**

FOR: ENTERTAINMENT SERVICES, NAMELY, PROVIDING ONLINE ELECTRONIC GAMES;  
ENTERTAINMENT SERVICES, NAMELY, PROVIDING ONLINE VIDEO GAMES, IN CLASS  
41 (U.S. CLS. 100, 101 AND 107).

FIRST USE 5-18-2012; IN COMMERCE 5-18-2012.

THE MARK CONSISTS OF THE TERM "SUDOKUPDQ" WITH THE "S", "D", "K", "P", "D"  
AND "Q" CAPITALIZED AND THE "U", "O" AND SECOND "U" LOWER CASE WITH AN  
EXCLAMATION POINT AT THE END OF THE MARK.

SN 85-164,095, FILED 10-28-2010.

MARTHA FROMM, EXAMINING ATTORNEY



*David J. Kyros*

Director of the United States Patent and Trademark Office

# United States of America

United States Patent and Trademark Office

# HOLT LENS

**Reg. No. 4,199,151**

CSFB HOLT LLC (DELAWARE LIMITED LIABILITY COMPANY)

**Registered Aug. 28, 2012**

11 MADISON AVENUE  
NEW YORK, NY 10010

**Int. Cl.: 42**

FOR: PROVIDING TEMPORARY USE OF NON-DOWNLOADABLE SOFTWARE THAT COMBINES A DATABASE OF PUBLICLY REPORTED FINANCIAL INFORMATION OF COMPANIES WITH ANALYTIC TOOLS AND A CALCULATION ENGINE FOR THE PURPOSE OF EVALUATING AND DETERMINING INVESTMENT OPPORTUNITIES, AND CREATING REPORTS AND CHARTS OF SUCH INVESTMENT OPPORTUNITIES, IN CLASS 42 (U.S. CLS. 100 AND 101).

**SERVICE MARK**

**PRINCIPAL REGISTER**

FIRST USE 10-20-2010; IN COMMERCE 11-15-2010.

THE MARK CONSISTS OF STANDARD CHARACTERS WITHOUT CLAIM TO ANY PARTICULAR FONT, STYLE, SIZE, OR COLOR.

SN 85-164,861, FILED 10-29-2010.

SKYE YOUNG, EXAMINING ATTORNEY



*David J. Kyros*

Director of the United States Patent and Trademark Office

# United States of America

United States Patent and Trademark Office

# EHD

**Reg. No. 4,199,152**

**Registered Aug. 28, 2012**

**Int. Cl.: 7**

**TRADEMARK**

**PRINCIPAL REGISTER**

HARRIS WASTE MANAGEMENT GROUP, INC. (DELAWARE CORPORATION)  
215 MARKET ROAD  
SUITE 1-A  
TYRONE, GA 30290

FOR: POWER OPERATED EQUIPMENT FOR SIZE REDUCTION OF RECYCLABLE MATERIAL, NAMELY, SHREDDERS FOR SCRAP METAL AND AUTOMOBILE SHEARS FOR HEAVY SCRAP METAL, BALERS FOR SCRAP METAL AND AUTOMOBILES, BALERS FOR SCRAP PAPER STOCK, PLASTIC CONTAINERS AND CORRUGATED CARDBOARD, AND HIGH DENSITY BALERS FOR SOLID RECYCLABLE MATERIAL, IN CLASS 7 (U.S. CLS. 13, 19, 21, 23, 31, 34 AND 35).

FIRST USE 6-25-2010; IN COMMERCE 10-13-2011.

THE MARK CONSISTS OF STANDARD CHARACTERS WITHOUT CLAIM TO ANY PARTICULAR FONT, STYLE, SIZE, OR COLOR.

SN 85-164,981, FILED 10-29-2010.

KATHY DE JONGE, EXAMINING ATTORNEY



*David J. Kyffers*

Director of the United States Patent and Trademark Office



United States of America  
United States Patent and Trademark Office

# CHILDISH

**Reg. No. 4,199,153**

**Registered Aug. 28, 2012**

**Int. Cl.: 14**

**TRADEMARK**

**PRINCIPAL REGISTER**

CHILDISH CLOTHING, INC. (CALIFORNIA CORPORATION)  
6310 SAN VICENTE BLVD., SUITE 501  
LOS ANGELES, CA 90048

FOR: JEWELRY, IN CLASS 14 (U.S. CLS. 2, 27, 28 AND 50).

FIRST USE 12-5-2007; IN COMMERCE 12-5-2007.

THE MARK CONSISTS OF STANDARD CHARACTERS WITHOUT CLAIM TO ANY PARTICULAR FONT, STYLE, SIZE, OR COLOR.

OWNER OF U.S. REG. NO. 2,886,459.

SN 85-165,126, FILED 10-29-2010.

DAWN HAN, EXAMINING ATTORNEY



*David J. Kyffers*

Director of the United States Patent and Trademark Office

# United States of America

United States Patent and Trademark Office



**Reg. No. 4,199,154**

WD-40 MANUFACTURING COMPANY (CALIFORNIA CORPORATION)  
1061 CUDAHY PLACE  
SAN DIEGO, CA 92110

**Registered Aug. 28, 2012**

**Int. Cl.: 35**

FOR: RETAIL SALES BY DIRECT SOLICITATION BY SALES AGENTS IN THE FIELD OF LUBRICANTS AND ANTI-RUST PRODUCTS; RETAIL SALES BY DIRECT SOLICITATION BY SALES AGENTS IN THE FIELD OF HOUSEHOLD CLEANING PRODUCTS, IN CLASS 35 (U.S. CLS. 100, 101 AND 102).

**SERVICE MARK**

**PRINCIPAL REGISTER**

FIRST USE 12-31-2009; IN COMMERCE 12-31-2009.

OWNER OF U.S. REG. NOS. 670,503, 3,010,487, AND OTHERS.

THE COLOR(S) WHITE, BLUE, YELLOW AND GRAY IS/ARE CLAIMED AS A FEATURE OF THE MARK.

NO CLAIM IS MADE TO THE EXCLUSIVE RIGHT TO USE "COMPANY", APART FROM THE MARK AS SHOWN.

THE MARK CONSISTS OF WHITE OUTLINED LETTERS "WD-40" WITH THE WORD "COMPANY" IN YELLOW CENTERED UNDERNEATH, ALL INSIDE A BLUE RECTANGLE WITH A THIN GRAY OUTLINE WITH CURVED EDGES.

SN 85-165,206, FILED 10-29-2010.

ANTHONY RINKER, EXAMINING ATTORNEY



*David J. Kybas*

Director of the United States Patent and Trademark Office

# United States of America

United States Patent and Trademark Office



**Reg. No. 4,199,155**

**Registered Aug. 28, 2012**

**Int. Cl.: 9**

**TRADEMARK**

**PRINCIPAL REGISTER**

MAYWEATHER, GEORGE (UNITED STATES INDIVIDUAL)  
10069 PRAIRIE DUNES WAY  
SACRAMENTO, CA 95758

FOR: COMPUTER APPLICATION SOFTWARE FOR MOBILE PHONES AND HANDHELD COMPUTERS, NAMELY, SOFTWARE FOR USE IN DATABASE MANAGEMENT, IN CLASS 9 (U.S. CLS. 21, 23, 26, 36 AND 38).

FIRST USE 2-28-2010; IN COMMERCE 9-14-2011.

THE MARK CONSISTS OF A MAN HUNCHED OVER HOLDING A MAGNIFYING GLASS WHICH IS BLACK WITH A PARTIAL THIN WHITE LINE ON THE INNER AND OUTER RIM AND WHITE MARK ON THE TOP PORTION OF THE HANDLE. THE MAN IS BROWN IN COLOR WITH BLACK HAIR AND BLACK MUSTACHE. HE HAS A LARGE WHITE EYE WITH A SMALL GRAY PUPIL. HE IS WEARING BLACK PANTS, BLACK SHOES AND A BLACK HAT WITH A WHITE LINE. HE HAS ON A LIGHT GRAY TRENCH COAT WITH A LIGHT BROWN BELT AND WHITE BUCKLE. HIS SHIRT SLEEVE IS WHITE. HE IS OUTLINED IN BLACK. HE IS CENTERED IN A SQUARE WITH ROUNDED CORNERS. THE SQUARE IS SHADED WITH OVERLAPPING SHADES OF LIGHT BLUE AND BLUE IN A SEMI-CIRCULAR PATTERN. CENTERED BELOW THE SQUARE ARE THE WORDS "FINDTHEBIZ" IN WHITE. THE ENTIRE MARK APPEARS ON A BLACK BACKGROUND.

THE COLOR(S) BLACK, WHITE, BROWN, GRAY, LIGHT GRAY, LIGHT BROWN, LIGHT BLUE, AND BLUE IS/ARE CLAIMED AS A FEATURE OF THE MARK.

SN 85-165,290, FILED 10-29-2010.

KATHERINE E. HALMEN, EXAMINING ATTORNEY



*David J. Kyjars*

Director of the United States Patent and Trademark Office

# United States of America

United States Patent and Trademark Office

# PowersportsU

**Reg. No. 4,199,156**

MOTORSPORT AFTERMARKET GROUP, INC. (DELAWARE CORPORATION)  
17771 MITCHELL NORTH  
IRVINE, CA 92614

**Registered Aug. 28, 2012**

**Int. Cl.: 35**

FOR: PROMOTING THE BRANDS, GOODS AND SERVICES OF OTHERS THROUGH ONLINE PROMOTION OF KNOWLEDGE OF INFORMATION ABOUT BRANDED PRODUCTS, INCLUDING THE TECHNICAL FEATURES AND BENEFITS OF SUCH PRODUCTS AND HOW TO DISPLAY AND SELL SUCH PRODUCTS, IN CLASS 35 (U.S. CLS. 100, 101 AND 102).

**SERVICE MARK**

**PRINCIPAL REGISTER**

FIRST USE 5-20-2012; IN COMMERCE 5-20-2012.

THE MARK CONSISTS OF STANDARD CHARACTERS WITHOUT CLAIM TO ANY PARTICULAR FONT, STYLE, SIZE, OR COLOR.

SN 85-165,306, FILED 10-29-2010.

WILLIAM BRECKENFELD, EXAMINING ATTORNEY



*David J. Kyffers*

Director of the United States Patent and Trademark Office

# United States of America

United States Patent and Trademark Office

## Powersports University

**Reg. No. 4,199,157**

MOTORSPORT AFTERMARKET GROUP, INC. (DELAWARE CORPORATION)  
17771 MITCHELL NORTH  
IRVINE, CA 92614

**Registered Aug. 28, 2012**

**Int. Cl.: 35**

FOR: PROMOTING THE BRANDS, GOODS AND SERVICES OF OTHERS THROUGH ONLINE PROMOTION OF KNOWLEDGE OF INFORMATION ABOUT BRANDED PRODUCTS, INCLUDING THE TECHNICAL FEATURES AND BENEFITS OF SUCH PRODUCTS AND HOW TO DISPLAY AND SELL SUCH PRODUCTS, IN CLASS 35 (U.S. CLS. 100, 101 AND 102).

**SERVICE MARK**

**PRINCIPAL REGISTER**

FIRST USE 12-31-2011; IN COMMERCE 12-31-2011.

THE MARK CONSISTS OF STANDARD CHARACTERS WITHOUT CLAIM TO ANY PARTICULAR FONT, STYLE, SIZE, OR COLOR.

NO CLAIM IS MADE TO THE EXCLUSIVE RIGHT TO USE "POWERSPORTS", APART FROM THE MARK AS SHOWN.

SN 85-165,313, FILED 10-29-2010.

WILLIAM BRECKENFELD, EXAMINING ATTORNEY



*David J. Kyfos*

Director of the United States Patent and Trademark Office

# United States of America

United States Patent and Trademark Office

## Lamella EcoFlow

**Reg. No. 4,199,158**

**Registered Aug. 28, 2012**

**Int. Cl.: 11**

**TRADEMARK**

**PRINCIPAL REGISTER**

PARKSON CORPORATION (DELAWARE CORPORATION)  
SUITE 100  
1401 W. CYPRESS CREEK ROAD  
FORT LAUDERDALE, FL 33309

FOR: WASTE AND WASTEWATER TREATMENT APPARATUS, NAMELY, GRAVITY  
SETTLERS FOR LIQUID AND SOLIDS SEPARATION FOR INDUSTRIAL AND MUNICIPAL  
USE, IN CLASS 11 (U.S. CLS. 13, 21, 23, 31 AND 34).

FIRST USE 8-22-2011; IN COMMERCE 8-22-2011.

THE MARK CONSISTS OF STANDARD CHARACTERS WITHOUT CLAIM TO ANY PAR-  
TICULAR FONT, STYLE, SIZE, OR COLOR.

OWNER OF U.S. REG. NO. 1,184,461.

SN 85-165,798, FILED 11-1-2010.

SUSAN LESLIE DUBOIS, EXAMINING ATTORNEY



*David J. Kyros*

Director of the United States Patent and Trademark Office

# United States of America

United States Patent and Trademark Office

## MX Stay Cool

**Reg. No. 4,199,159**

MULLINIX PACKAGES, INC. (INDIANA CORPORATION)  
3511 ENGLE RD.

**Registered Aug. 28, 2012**

FORT WAYNE, IN 46809

**Int. Cl.: 20**

FOR: PLASTIC BEVERAGE, CONFECTION AND FANCY AND STAPLE FOODSTUFF CONTAINERS FOR THE FOOD INDUSTRY, IN CLASS 20 (U.S. CLS. 2, 13, 22, 25, 32 AND 50).

**TRADEMARK**

FIRST USE 1-17-2011; IN COMMERCE 7-23-2011.

**PRINCIPAL REGISTER**

THE MARK CONSISTS OF STANDARD CHARACTERS WITHOUT CLAIM TO ANY PARTICULAR FONT, STYLE, SIZE, OR COLOR.

SN 85-165,949, FILED 11-1-2010.

JAMES A. RAUEN, EXAMINING ATTORNEY



*David J. Kyffers*

Director of the United States Patent and Trademark Office

# United States of America

United States Patent and Trademark Office



**Reg. No. 4,199,160**

**Registered Aug. 28, 2012**

**Int. Cl.: 1**

**TRADEMARK**

**PRINCIPAL REGISTER**

ROEBIC LABORATORIES, INC. (CONNECTICUT CORPORATION)  
P.O. BOX 927  
25 CONNAIR ROAD  
ORANGE, CT 06477

FOR: CLEANING PREPARATIONS IN THE NATURE OF NATURAL BACTERIA TO CLEAN SEPTIC AND SEWAGE TANKS AND PIPES AND TO PREVENT ODORS AND REDUCE NATURAL WASTE; BIOLOGICALLY ACTIVE MICROORGANISMS AND ENZYMES FOR USE IN DEGRADING SURFACTANTS, HYDROCARBONS, AMMONIA AND OTHER CHEMICALS IN MIXED WASTEWATERS; PREPARATIONS IN THE NATURE OF NATURAL BACTERIA AND ENZYMES USED TO AID AND ACCELERATE THE COMPOSTING OF ANIMAL WASTES, HUMAN WASTES, AND OTHER ORGANIC MATERIALS; BIOLOGICALLY ACTIVE MICROORGANISMS AND ENZYMES FOR TREATMENT OF BOVINE, PORCINE, ORNITHIC, AND OTHER MANURES AND THEIR ASSOCIATED WASTEWATER AND WASTEWATER SYSTEMS; BIOLOGICALLY ACTIVE MICROORGANISMS AND ENZYMES FOR THE TREATMENT OF WATER BODIES AND WASTEWATERS BURDENED WITH ELEVATED BIOLOGICAL OXYGEN DEMANDS (BOD), CHEMICAL OXYGEN DEMANDS (COD), OR NITRATE LEVELS; BIOLOGICALLY ACTIVE MICROORGANISMS AND ENZYMES FOR USE IN DEGRADING ORGANIC MATERIALS, AMMONIA, NITROGEN COMPOUNDS, SULFUR COMPOUNDS, HYDROCARBONS, AND OTHER CHEMICALS FOUND IN WASTE WATER AND WASTE WATER SYSTEMS; BIOLOGICALLY ACTIVE MICROORGANISMS AND ENZYMES FOR REDUCING SLUDGE VOLUMES AND SUSPENDED SOLIDS CONCENTRATIONS IN WATER BODIES, WASTE WATER, AND WASTE WATER TREATMENT SYSTEMS; BIOLOGICALLY ACTIVE MICROORGANISMS AND ENZYMES FOR THE TREATMENT OF WATERS AND LANDS POLLUTED WITH PETROLEUM BASED HYDROCARBONS, AND FOR THE TREATMENT OF PETROLEUM LADEN WASTE WATERS; BIOLOGICALLY ACTIVE MICROORGANISMS AND ENZYMES TO AID IN, AND TO INCREASE THE EFFICIENCIES OF, ANAEROBIC DIGESTERS AND BIOGAS PRODUCTION; BIOLOGICALLY ACTIVE MICROORGANISMS AND ENZYMES FOR THE TREATMENT OF FOOD SERVICE AND FOOD PROCESSING WASTES, AND ASSOCIATED TREATMENT SYSTEMS; BIOLOGICALLY ACTIVE MICROORGANISMS AND ENZYMES FOR THE TREATMENT OF WASTEWATERS HIGH IN FATS, OILS, AND GREASE (FOG), IN CLASS 1 (U.S. CLS. 1, 5, 6, 10, 26 AND 46).



*David J. Kyjars*

Director of the United States Patent and Trademark Office

FIRST USE 2-0-2012; IN COMMERCE 2-0-2012.

OWNER OF U.S. REG. NO. 3,856,435.



**Reg. No. 4,199,160** THE MARK CONSISTS OF AN OVAL SHAPE WITH THE TERM "ROETECH" IN THE CENTER.

SN 85-167,211, FILED 11-2-2010.

DOUGLAS LEE, EXAMINING ATTORNEY

# United States of America

United States Patent and Trademark Office

## IT'S COOL TO BE GREEN

**Reg. No. 4,199,161**

YOU FIT, INC. (FLORIDA CORPORATION)

**Registered Aug. 28, 2012**

6161 9TH AVE. NORTH  
ST. PETERSBURG, FL 33710

**Int. Cl.: 41**

FOR: HEALTH CLUB SERVICES, NAMELY, PROVIDING INSTRUCTION, FACILITIES, AND EQUIPMENT IN THE FIELD OF PHYSICAL EXERCISE UTILIZING ENVIRONMENTALLY-FRIENDLY PRACTICES, IN CLASS 41 (U.S. CLS. 100, 101 AND 107).

**SERVICE MARK**

FIRST USE 12-1-2010; IN COMMERCE 12-1-2010.

**PRINCIPAL REGISTER**

THE MARK CONSISTS OF STANDARD CHARACTERS WITHOUT CLAIM TO ANY PARTICULAR FONT, STYLE, SIZE, OR COLOR.

SN 85-167,762, FILED 11-3-2010.

MELISSA VALLILLO, EXAMINING ATTORNEY



*David J. Kyros*

Director of the United States Patent and Trademark Office

# United States of America

United States Patent and Trademark Office

## VOLCANO SURF

**Reg. No. 4,199,162**

SALTER, BRADLEY (UNITED STATES INDIVIDUAL)  
24 MALIALANI PLACE  
LAHAINA, HI 96761

**Registered Aug. 28, 2012**

**Int. Cl.: 25**

FOR: BOARD SHORTS; FOOTWEAR; HATS; HEADWEAR; JACKETS; PANTS; SCARVES; SHIRTS; SHORTS; SKI AND SNOWBOARD SHOES AND PARTS THEREOF; SNOW BOARDING SUITS; SNOWBOARD BOOTS; SNOWBOARD GLOVES; SNOWBOARD JACKETS; SNOWBOARD MITTENS; SNOWBOARD PANTS; SURF WEAR; T-SHIRTS, IN CLASS 25 (U.S. CLS. 22 AND 39).

**TRADEMARK**

**PRINCIPAL REGISTER**

FIRST USE 6-30-1989; IN COMMERCE 6-15-2001.

THE MARK CONSISTS OF STANDARD CHARACTERS WITHOUT CLAIM TO ANY PARTICULAR FONT, STYLE, SIZE, OR COLOR.

NO CLAIM IS MADE TO THE EXCLUSIVE RIGHT TO USE "SURF", APART FROM THE MARK AS SHOWN.

SN 85-168,243, FILED 11-3-2010.

WARREN L. OLANDRIA, EXAMINING ATTORNEY



*David J. Kyffers*

Director of the United States Patent and Trademark Office

# United States of America

United States Patent and Trademark Office

# BUTT HUNT

**Reg. No. 4,199,163**

MADBROOK PUBLISHING LLC (DELAWARE LIMITED LIABILITY COMPANY)  
550 9TH STREET  
BROOKLYN, NY 11215

**Registered Aug. 28, 2012**

**Int. Cl.: 9**

FOR: CHILDREN'S EDUCATIONAL SOFTWARE, IN CLASS 9 (U.S. CLS. 21, 23, 26, 36 AND 38).

**TRADEMARK**

FIRST USE 11-15-2011; IN COMMERCE 11-15-2011.

**PRINCIPAL REGISTER**

THE MARK CONSISTS OF STANDARD CHARACTERS WITHOUT CLAIM TO ANY PARTICULAR FONT, STYLE, SIZE, OR COLOR.

SN 85-168,557, FILED 11-3-2010.

MELISSA VALLILLO, EXAMINING ATTORNEY



*David J. Kybas*

Director of the United States Patent and Trademark Office

# United States of America

United States Patent and Trademark Office

## WE SEND JOY

**Reg. No. 4,199,164**

**Registered Aug. 28, 2012**

**Int. Cl.: 35**

**SERVICE MARK**

**PRINCIPAL REGISTER**

STEAL NETWORK, LLC (UTAH LIMITED LIABILITY COMPANY)  
2181 CALIFORNIA AVE SUITE 400  
SALT LAKE CITY, UT 84104

FOR: ON-LINE RETAIL STORE SERVICES AND MAIL ORDER SERVICES FEATURING QUALITY BABY AND MATERNITY PRODUCTS; ON-LINE RETAIL STORE SERVICES AND MAIL ORDER SERVICES FEATURING SCRAPBOOK AND CRAFT PRODUCTS AND SUPPLIES, NAMELY, PAPERS, NOTEPADS, CARDSTOCK, RUB ON TRANSFERS, FRAMES, ACRYLIC STAMPS, TRANSPARENCIES, BLOCKS, STATIONERY, CARDS AND ENVELOPES, ADHESIVES AND OTHER MOUNTING SUPPLIES, ADHESIVE CARTRIDGES, PHOTO MATS, PAGE PROTECTORS, TEMPLATES, STENCILS, BRADS, MAGNETS, BADGES, ALPHABET STICKERS, GLITTER STICKERS, EMBOSSED STICKERS, NUMBERS STICKERS AND STICKER MAKERS, PUNCH OUT GLITTER CUTS, CHIPBOARD, LAMINATORS, LABEL MAKERS, MAGNET MAKERS, PORTABLE PRINTER AND DISK BUBBLES, GLITTER, CARD MAKING KITS, ALBUM KITS, AND KITS FOR MAKING HAIR BOWS AND HEADBANDS, EMBELLISHMENTS, NAMELY, TAGS, JEWELS, BUTTONS, FLOWERS, BUTTERFLIES, BLOSSOMS, STONES, RIBBONS, AND FOIL LACE, AND SCRAPBOOK AND CRAFT TOOLS, NAMELY, LETTERING TOOLS, DIE CUTS, PUNCHES, MARKERS, CUTTING MATS, FLEX RULERS, RULERS, STAPLERS, SCISSORS, AND PENCILS, WOODEN BASE BOARDS, MAGNETIC SHEETS, SCRAPBOOK AND CRAFT STORAGE, DISPLAY, AND ORGANIZATION PRODUCTS, NAMELY, JOURNALING CARDS AND BOOKS, DISPLAY ALBUMS, DISPLAY RACKS, DISPLAY SHELVES, TAGS AND TITLES FOR DISPLAY AND ORGANIZATION PRODUCTS, CARRYING CASES, TOTE BAGS, MESSENGER BAGS, AND CAMERA BAGS; ONLINE RETAIL STORE SERVICES AND MAIL ORDER SERVICES FEATURING CHILDREN'S APPAREL, NAMELY, FOOTWEAR, HEADWEAR, EYEWEAR, OUTERWEAR, BELTS, SHIRTS, SOCKS, SHORTS, JACKETS, COATS, PLAYWEAR, COSTUMES, LEGGINGS, MITTENS, SCARVES, PLAY SMOCKS AND APRONS, HAIR ACCESSORIES, NAMELY, HEAD WRAPS, HAIR CLIPS, HAIR BOWS, HAIR FLOWERS, HEADBANDS AND PONY TAIL LOOPS, JEWELRY, NAMELY, BRACELETS AND NECKLACES, SCHOOL SUPPLIES, NAMELY, BOOK BAGS AND LUNCH SACKS, TOYS NAMELY, DARTS GAMES, CARD GAMES, CRAYONS, COLORING SETS, STACKABLE BLOCKS, STUFFED TOYS, COOKING TOYS, OUTDOOR GAMES, AND TOY POSTAL SETS, NAMELY, MINIATURE MAIL BOXES, MINIATURE LETTERS, AND MINIATURE STAMPS, BEDDING, NAMELY, LAP BLANKETS, CHILDREN'S BLANKETS, BED PILLOWS, NECK PILLOWS, AND TRAVEL PILLOWS, ENTERTAINMENT, NAMELY, BOOKS, DVDS AND CDS, WALL ART AND DÉCOR AND ACCESSORIES, NAMELY, ARTWORK AND LIGHT SWITCH EXTENDER AND ADAPTORS, PERSONAL ITEMS,



*David J. Kyros*

Director of the United States Patent and Trademark Office

**Reg. No. 4,199,164** NAMELY, FACIAL TISSUE, HAND SANITIZER AND LIP BALM, STATIONERY, SEWING SUPPLIES, NAMELY, WOODEN BEADS, THREADING LACE, WOODEN THREADER AND STORAGE AND CARRYING CASE, CHILD GROWTH CHARTS, AND STICKERS; RETAIL STORE SERVICES FEATURING QUALITY BABY AND MATERNITY PRODUCTS; RETAIL STORE SERVICES FEATURING SCRAPBOOK AND CRAFT PRODUCTS AND SUPPLIES, NAMELY, PAPERS, NOTEPADS, CARDSTOCK, RUB ON TRANSFERS, FRAMES, ACRYLIC STAMPS, TRANSPARENCIES, BLOCKS, STATIONERY, CARDS AND ENVELOPES, ADHESIVES AND OTHER MOUNTING SUPPLIES, ADHESIVE CARTRIDGES, PHOTO MATS, PAGE PROTECTORS, TEMPLATES, STENCILS, BRADS, MAGNETS, BADGES, ALPHABET STICKERS, GLITTER STICKERS, EMBOSSED STICKERS, NUMBERS STICKERS AND STICKER MAKERS, PUNCH OUT GLITTER CUTS, CHIPBOARD, LAMINATORS, LABEL MAKERS, MAGNET MAKERS, PORTABLE PRINTER AND DISK BUBBLES, GLITTER, CARD MAKING KITS, ALBUM KITS, AND KITS FOR MAKING HAIR BOWS AND HEADBANDS, EMBELLISHMENTS, NAMELY, TAGS, JEWELS, BUTTONS, FLOWERS, BUTTERFLIES, BLOSSOMS, STONES, RIBBONS, AND FOIL LACE, AND SCRAPBOOK AND CRAFT TOOLS, NAMELY, LETTERING TOOLS, DIE CUTS, PUNCHES, MARKERS, PENS, CUTTING MATS, FLEX RULERS, RULERS, STAPLERS, SCISSORS, AND PENCILS, WOODEN BASE BOARDS, MAGNETIC SHEETS, SCRAPBOOK AND CRAFT STORAGE, DISPLAY, AND ORGANIZATION PRODUCTS, NAMELY, JOURNALING CARDS AND BOOKS, DISPLAY ALBUMS, DISPLAY RACKS, DISPLAY SHELVES, TAGS AND TITLES FOR DISPLAY AND ORGANIZATION PRODUCTS, CARRYING CASES, TOTE BAGS, MESSENGER BAGS, AND CAMERA BAGS; RETAIL STORE SERVICES FEATURING CHILDREN'S APPAREL, NAMELY, FOOTWEAR, HEADWEAR, EYEWEAR, OUTERWEAR, BELTS, SHIRTS, SOCKS, SHORTS, JACKETS, COATS, PLAYWEAR, COSTUMES, LEGGINGS, MITTENS, SCARVES, PLAY SMOCKS AND APRONS, HAIR ACCESSORIES, NAMELY, HEAD WRAPS, HAIR CLIPS, HAIR BOWS, HAIR FLOWERS, HEADBANDS AND PONY TAIL LOOPS, JEWELRY, NAMELY, BRACELETS AND NECKLACES, SCHOOL SUPPLIES, NAMELY, BOOK BAGS AND LUNCH SACKS, TOYS NAMELY, DARTS GAMES, CARD GAMES, CRAYONS, COLORING SETS, STACKABLE BLOCKS, STUFFED TOYS, COOKING TOYS, OUTDOOR GAMES, AND BEDDING, NAMELY, LAP BLANKETS, CHILDREN'S BLANKETS, BED PILLOWS, NECK PILLOWS, AND TRAVEL PILLOWS, ENTERTAINMENT, NAMELY, BOOKS, DVDS AND CDS, WALL ART AND DÉCOR AND ACCESSORIES, NAMELY, ARTWORK AND LIGHT SWITCH EXTENDER AND ADAPTORS, PERSONAL ITEMS, NAMELY, FACIAL TISSUE, HAND SANITIZER AND LIP BALM, STATIONERY, SEWING SUPPLIES, NAMELY, WOODEN BEADS, THREADING LACE, WOODEN THREADER AND STORAGE AND CARRYING CASE, CHILD GROWTH CHARTS, AND STICKERS; ON-LINE RETAIL STORE, MAIL ORDER, AND RETAIL STORE SERVICES FEATURING SCRAPBOOK AND CRAFT PRODUCTS AND SUPPLIES, NAMELY, STAMP PADS AND PAINT, AND SCRAPBOOK AND CRAFT TOOLS, NAMELY, TRIMMERS; ONLINE RETAIL STORE SERVICES AND MAIL ORDER SERVICES FEATURING CHILDREN'S APPAREL, NAMELY, SWIMWEAR, SCHOOL SUPPLIES, NAMELY, BACKPACKS, TOYS, NAMELY, BOARD GAMES, ENTERTAINMENT, NAMELY, VIDEOS, WALL ART AND DÉCOR AND ACCESSORIES, NAMELY, PHOTOGRAPHS, TOWELS; PROMOTING THE GOODS AND SERVICES OF OTHERS BY PLACING ADVERTISEMENTS ON A WEBSITE ACCESSED THROUGH A GLOBAL COMPUTER NETWORK, IN CLASS 35 (U.S. CLS. 100, 101 AND 102).

FIRST USE 9-9-2010; IN COMMERCE 9-9-2010.

THE MARK CONSISTS OF STANDARD CHARACTERS WITHOUT CLAIM TO ANY PARTICULAR FONT, STYLE, SIZE, OR COLOR.

SN 85-168,610, FILED 11-3-2010.

ANDREA BUTLER, EXAMINING ATTORNEY

# United States of America

United States Patent and Trademark Office

# TRUE STAR

**Reg. No. 4,199,165**

**Registered Aug. 28, 2012**

**Int. Cl.: 11**

**TRADEMARK**

**PRINCIPAL REGISTER**

SPECIALIZED COMPONENT PARTS LIMITED, INC. (INDIANA CORPORATION)  
P.O. BOX 560  
1700 S. INDIANA AVE.  
AUBURN, IN 46706

FOR: IGNITERS FOR GAS AND LP COMMERCIAL AND RESIDENTIAL OVENS, FURNACES, DRYERS, POOLS, HOT WATER HEATERS, BOILERS, INFRARED HEATERS, GARAGE HEATERS, AND SPACE HEATERS, IN CLASS 11 (U.S. CLS. 13, 21, 23, 31 AND 34).

FIRST USE 6-1-2011; IN COMMERCE 6-1-2012.

THE MARK CONSISTS OF STANDARD CHARACTERS WITHOUT CLAIM TO ANY PARTICULAR FONT, STYLE, SIZE, OR COLOR.

SN 85-168,846, FILED 11-4-2010.

TEJBIR SINGH, EXAMINING ATTORNEY



*David J. Kyffers*

Director of the United States Patent and Trademark Office

# United States of America

United States Patent and Trademark Office

## MARTHA STEWART CRAFTS

**Reg. No. 4,199,166**

MARTHA STEWART LIVING OMNIMEDIA, INC. (DELAWARE CORPORATION)  
601 WEST 26TH STREET, 10TH FLOOR  
NEW YORK, NY 10001

**Registered Aug. 28, 2012**

**Int. Cl.: 16**

FOR: PAPER-BASED ARTS AND CRAFTS PAINT KITS, IN CLASS 16 (U.S. CLS. 2, 5, 22, 23, 29, 37, 38 AND 50).

**TRADEMARK**

FIRST USE 8-0-2011; IN COMMERCE 8-0-2011.

**PRINCIPAL REGISTER**

THE MARK CONSISTS OF STANDARD CHARACTERS WITHOUT CLAIM TO ANY PARTICULAR FONT, STYLE, SIZE, OR COLOR.

OWNER OF U.S. REG. NOS. 3,455,782 AND 3,730,165.

NO CLAIM IS MADE TO THE EXCLUSIVE RIGHT TO USE "CRAFTS", APART FROM THE MARK AS SHOWN.

THE NAME "MARTHA STEWART" IDENTIFIES A LIVING INDIVIDUAL WHOSE CONSENT IS OF RECORD.

SN 85-168,989, FILED 11-4-2010.

ALYSSA STEEL, EXAMINING ATTORNEY



*David J. Kyffers*

Director of the United States Patent and Trademark Office



# United States of America

United States Patent and Trademark Office

## Dr. Collectors

**Reg. No. 4,199,167**

GRASSET, OLIVIER, JEAN-MARIE (FRANCE INDIVIDUAL)  
2800 NICHOLS CANYON PLACE  
LOS ANGELES, CA 90046

**Registered Aug. 28, 2012**

**Int. Cls.: 18 and 25**

FOR: LUGGAGE, HANDBAGS, TOTE BAGS, BACKPACKS, TRAVEL BAGS, ALL-PURPOSE CARRYING BAGS, UMBRELLAS, IN CLASS 18 (U.S. CLS. 1, 2, 3, 22 AND 41).

**TRADEMARK**

FIRST USE 7-1-2010; IN COMMERCE 7-1-2010.

**PRINCIPAL REGISTER**

FOR: CLOTHING, NAMELY, BATHING SUITS, SARONGS, PAREOS, TUNICS, T-SHIRTS, TANK TOPS, BLOUSES, DRESSES, SHIRTS, SWEATERS, PULLOVERS, SWEATSHIRTS, HOODED SWEATSHIRTS, HALTER TOPS, JEANS, JERSEYS, JUMPERS, JUMPSUITS, OVERALLS, SHORTS, TROUSERS, SUITS, PAJAMAS, ROBES, UNDERWEAR, HOSIERY, COATS, BLAZERS, FUR JACKETS AND STOLES, JACKETS, SPORT COATS, CLOTHING ACCESSORIES, NAMELY, BELT, SASHES, SCARVES, SHAWLS, CAPS AND HATS, SUSPENDERS, GLOVES, MUFFLERS, TIES, BOW TIES, FOOTWEAR, BOOTS, SHOES, SLIPPERS, LOAFERS, ANKLE BOOTS, SANDALS, FLIP-FLOPS, STOCKING AND SOCKS, IN CLASS 25 (U.S. CLS. 22 AND 39).

FIRST USE 6-1-2012; IN COMMERCE 6-1-2012.

THE MARK CONSISTS OF STANDARD CHARACTERS WITHOUT CLAIM TO ANY PARTICULAR FONT, STYLE, SIZE, OR COLOR.

THE NAME "DR.COLLECTORS" DOES NOT IDENTIFY A LIVING INDIVIDUAL.

SN 85-169,104, FILED 11-4-2010.

MICHELLE DUBOIS, EXAMINING ATTORNEY



*David J. Kybas*

Director of the United States Patent and Trademark Office

# United States of America

United States Patent and Trademark Office

## DOMINICAN CLUB

**Reg. No. 4,199,168**

SHAW-ROSS INTERNATIONAL IMPORTERS, INC. (FLORIDA CORPORATION)  
1600 N.W. 163RD STREET  
MIAMI, FL 33169

**Registered Aug. 28, 2012**

**Int. Cl.: 33**

FOR: RUM, IN CLASS 33 (U.S. CLS. 47 AND 49).

**TRADEMARK**

FIRST USE 4-16-2012; IN COMMERCE 4-16-2012.

**PRINCIPAL REGISTER**

THE MARK CONSISTS OF STANDARD CHARACTERS WITHOUT CLAIM TO ANY PARTICULAR FONT, STYLE, SIZE, OR COLOR.

NO CLAIM IS MADE TO THE EXCLUSIVE RIGHT TO USE "DOMINICAN", APART FROM THE MARK AS SHOWN.

SN 85-169,864, FILED 11-4-2010.

BARBARA RUTLAND, EXAMINING ATTORNEY



*David J. Kyffers*

Director of the United States Patent and Trademark Office

# United States of America

United States Patent and Trademark Office

# FILTERMAX

**Reg. No. 4,199,169**

**Registered Aug. 28, 2012**

**Int. Cl.: 11**

**TRADEMARK**

**PRINCIPAL REGISTER**

FILTERMAX TECHNOLOGIES, LLC (CALIFORNIA LIMITED LIABILITY COMPANY)  
31915 RANCHO CALIFORNIA ROAD  
SUITE 200-231  
TEMECULA, CA 92591

FOR: WATER TREATMENT EQUIPMENT, NAMELY, WATER FILTRATION MEMBRANE UNITS, WATER FILTRATION UNITS, FIBROUS FILTERING MEDIA UNITS FOR WATER PURIFICATION, WATER FILTER CARTRIDGES, MEMBRANE FILTER CARTRIDGES AND STRUCTURAL COMPONENT PARTS UTILIZED THEREWITH, IN CLASS 11 (U.S. CLS. 13, 21, 23, 31 AND 34).

FIRST USE 10-1-2010; IN COMMERCE 3-25-2011.

THE MARK CONSISTS OF STANDARD CHARACTERS WITHOUT CLAIM TO ANY PARTICULAR FONT, STYLE, SIZE, OR COLOR.

SN 85-170,223, FILED 11-5-2010.

WILLIAM VERHOSEK, EXAMINING ATTORNEY



*David J. Kybas*

Director of the United States Patent and Trademark Office

**United States of America**  
United States Patent and Trademark Office

# NANOFIL

**Reg. No. 4,199,170**

PURE FISHING, INC. (IOWA CORPORATION)  
1900 18TH STREET  
SPIRIT LAKE, IA 51360

**Registered Aug. 28, 2012**

**Int. Cl.: 28**

FOR: FISHING LINE; FISHING TACKLE, IN CLASS 28 (U.S. CLS. 22, 23, 38 AND 50).

**TRADEMARK**

FIRST USE 6-0-2011; IN COMMERCE 6-0-2011.

**PRINCIPAL REGISTER**

THE MARK CONSISTS OF STANDARD CHARACTERS WITHOUT CLAIM TO ANY PARTICULAR FONT, STYLE, SIZE, OR COLOR.

SN 85-170,302, FILED 11-5-2010.

JOHN DALIER, EXAMINING ATTORNEY



*David J. Kyffers*

Director of the United States Patent and Trademark Office

# United States of America

United States Patent and Trademark Office

# PV-POD

**Reg. No. 4,199,171**

METALAB STUDIOS INC. (TEXAS CORPORATION)

**Registered Aug. 28, 2012**

2003 KANE STREET  
HOUSTON, TX 77007

**Int. Cl.: 20**

FOR: NON-METAL SOLAR PANEL MOUNTS, IN CLASS 20 (U.S. CLS. 2, 13, 22, 25, 32 AND 50).

**TRADEMARK**

FIRST USE 6-1-2011; IN COMMERCE 6-1-2011.

**PRINCIPAL REGISTER**

THE MARK CONSISTS OF STANDARD CHARACTERS WITHOUT CLAIM TO ANY PARTICULAR FONT, STYLE, SIZE, OR COLOR.

SN 85-170,550, FILED 11-5-2010.

BERYL GARDNER, EXAMINING ATTORNEY



*David J. Kyffers*

Director of the United States Patent and Trademark Office

# United States of America

United States Patent and Trademark Office

## JUICE FOR LIFE

**Reg. No. 4,199,172**

NUTRIFASTER, INC. (WASHINGTON CORPORATION)  
209 S. BENNETT STREET  
SEATTLE, WA 98108

**Registered Aug. 28, 2012**

**Int. Cl.: 7**

FOR: ELECTRIC JUICE EXTRACTORS, IN CLASS 7 (U.S. CLS. 13, 19, 21, 23, 31, 34 AND 35).

**TRADEMARK**

FIRST USE 5-12-2012; IN COMMERCE 5-12-2012.

**PRINCIPAL REGISTER**

THE MARK CONSISTS OF STANDARD CHARACTERS WITHOUT CLAIM TO ANY PARTICULAR FONT, STYLE, SIZE, OR COLOR.

NO CLAIM IS MADE TO THE EXCLUSIVE RIGHT TO USE "JUICE", APART FROM THE MARK AS SHOWN.

SN 85-170,560, FILED 11-5-2010.

DORITT L. CARROLL, EXAMINING ATTORNEY



*David J. Kyffers*

Director of the United States Patent and Trademark Office

# United States of America

United States Patent and Trademark Office

## LEGENDARY HOSPITALITY WITH A SOFTER FOOTPRINT

**Reg. No. 4,199,173**

**Registered Aug. 28, 2012**

**Int. Cls.: 35, 41, 43, and  
44**

**SERVICE MARK**

**PRINCIPAL REGISTER**

XANTERRA PARKS & RESORTS, INC. (DELAWARE CORPORATION)  
SUITE 600 NORTH  
6312 SOUTH FIDDLERS GREEN CIRCLE  
GREENWOOD VILLAGE, CO 80111

FOR: MANAGEMENT OF PARKS, HOTELS, LODGES, RESORTS, CONCESSIONS AND RESTAURANTS FOR OTHERS; RETAIL GIFT SHOPS; RETAIL SOUVENIR STORES; RETAIL CONVENIENCE STORES; RETAIL SPORTING GOODS STORES; AND PROVIDING CONCESSION STANDS FEATURING FOOD AND SOUVENIRS, IN CLASS 35 (U.S. CLS. 100, 101 AND 102).

FIRST USE 1-24-2012; IN COMMERCE 1-24-2010.

FOR: RECREATIONAL PARK SERVICES; RECREATIONAL SERVICES IN THE NATURE OF GOLF AND TENNIS FACILITIES; PROVIDING FACILITIES FOR RECREATION ACTIVITIES; PROVIDING FITNESS AND EXERCISE FACILITIES, IN CLASS 41 (U.S. CLS. 100, 101 AND 107).

FIRST USE 1-24-2012; IN COMMERCE 1-24-2012.

FOR: HOTEL, RESORT LODGING AND RESTAURANT SERVICES; PROVIDING CONVENTION FACILITIES; PROVIDING CAMPGROUND FACILITIES, IN CLASS 43 (U.S. CLS. 100 AND 101).

FIRST USE 1-24-2012; IN COMMERCE 1-24-2012.

FOR: HEALTH SPA SERVICES FOR HEALTH AND WELLNESS OF THE BODY AND SPIRIT; HEALTH SPA SERVICES, NAMELY, COSMETIC BODY CARE SERVICES, AND MASSAGE, FACIAL AND BODY TREATMENT SERVICES, IN CLASS 44 (U.S. CLS. 100 AND 101).

FIRST USE 1-24-2012; IN COMMERCE 1-24-2012.

THE MARK CONSISTS OF STANDARD CHARACTERS WITHOUT CLAIM TO ANY PARTICULAR FONT, STYLE, SIZE, OR COLOR.

SN 85-170,856, FILED 11-6-2010.



*David J. Kyffers*

Director of the United States Patent and Trademark Office

**Reg. No. 4,199,173** DAWN FELDMAN, EXAMINING ATTORNEY



# United States of America

United States Patent and Trademark Office

## OPEN CIRCLE

**Reg. No. 4,199,174**

**Registered Aug. 28, 2012**

**Int. Cl.: 36**

**SERVICE MARK**

**PRINCIPAL REGISTER**

OPEN CIRCLE ADVISORS, LLC (CONNECTICUT LIMITED LIABILITY COMPANY)  
9 TWIN BROOK DRIVE  
WOODBIDGE, CT 06525

FOR: INVESTMENT ADVISORY SERVICES, IN CLASS 36 (U.S. CLS. 100, 101 AND 102).

FIRST USE 11-0-2011; IN COMMERCE 6-12-2012.

THE MARK CONSISTS OF STANDARD CHARACTERS WITHOUT CLAIM TO ANY PARTICULAR FONT, STYLE, SIZE, OR COLOR.

SN 85-171,188, FILED 11-8-2010.

JAY FLOWERS, EXAMINING ATTORNEY



*David J. Kyros*

Director of the United States Patent and Trademark Office

# United States of America

United States Patent and Trademark Office

## CHOMPERS! BRINGING DENTAL CARE TO KIDS

**Reg. No. 4,199,175**

**Registered Aug. 28, 2012**

**Int. Cls.: 35 and 44**

**SERVICE MARK**

**PRINCIPAL REGISTER**

COMMUNITY HEALTH FOUNDATION OF WESTERN AND CENTRAL NEW YORK, INC.  
(NEW YORK NOT-FOR-PROFIT CORPORATION)  
726 EXCHANGE STREET, SUITE 518  
BUFFALO, NY 14210

FOR: PROMOTING PUBLIC AWARENESS OF DENTAL EDUCATION, PREVENTION, AND TREATMENT TO CHILDREN LIVING IN POVERTY IN THE FORM OF A HEALTH INITIATIVE; PROMOTING AWARENESS AMONG PEDIATRIC MEDICAL PROVIDERS OF ORAL HEALTH PRIORITY DURING OFFICE VISITS IN THE FORM OF A HEALTH INITIATIVE, IN CLASS 35 (U.S. CLS. 100, 101 AND 102).

FIRST USE 5-27-2010; IN COMMERCE 5-27-2010.

FOR: PORTABLE DENTAL CARE SERVICES, IN CLASS 44 (U.S. CLS. 100 AND 101).

FIRST USE 5-27-2010; IN COMMERCE 5-27-2010.

THE MARK CONSISTS OF STANDARD CHARACTERS WITHOUT CLAIM TO ANY PARTICULAR FONT, STYLE, SIZE, OR COLOR.

SN 85-171,560, FILED 11-8-2010.

ANGELA DUONG, EXAMINING ATTORNEY



*David J. Kyjars*

Director of the United States Patent and Trademark Office

# United States of America

United States Patent and Trademark Office

## CELEBRITY IMPACT

**Reg. No. 4,199,176**

**Registered Aug. 28, 2012**

**Int. Cl.: 35**

**SERVICE MARK**

**PRINCIPAL REGISTER**

CELEBRITY IMPACT, INC. (GEORGIA CORPORATION)  
P.O. BOX 177  
DECATUR, GA 300310177

FOR: BUSINESS CONSULTING SERVICES FOR NONPROFIT ORGANIZATIONS OWNED BY CELEBRITIES, NAMELY, BOARD DEVELOPMENT, STRATEGIC PLANNING, BUSINESS RESOURCE DEVELOPMENT, GRANT WRITING, FINANCIAL RECORDS MANAGEMENT, FUND DEVELOPMENT IN THE NATURE OF MATCHING POTENTIAL INVESTORS WITH NONPROFIT ORGANIZATIONS NEEDING FUNDING, ORGANIZATIONAL DEVELOPMENT CONSULTING AND MARKETING CONSULTING, IN CLASS 35 (U.S. CLS. 100, 101 AND 102).

FIRST USE 2-26-2009; IN COMMERCE 4-0-2009.

THE MARK CONSISTS OF STANDARD CHARACTERS WITHOUT CLAIM TO ANY PARTICULAR FONT, STYLE, SIZE, OR COLOR.

NO CLAIM IS MADE TO THE EXCLUSIVE RIGHT TO USE "CELEBRITY", APART FROM THE MARK AS SHOWN.

SN 85-172,174, FILED 11-9-2010.

AISHA SALEM, EXAMINING ATTORNEY



*David J. Kyffers*

Director of the United States Patent and Trademark Office

# United States of America

United States Patent and Trademark Office

## THE GLORIOUS

**Reg. No. 4,199,177**

WICKS, CHRISTOPHER (UNITED STATES INDIVIDUAL)  
3131 SOUTH BROADWAY  
LOS ANGELES, CA 90007 AND

**Registered Aug. 28, 2012**

**Int. Cl.: 41**

ROSSI, MICK (UNITED STATES INDIVIDUAL)  
3131 SOUTH BROADWAY  
LOS ANGELES, CA 90007

**SERVICE MARK**

**PRINCIPAL REGISTER**

FOR: ENTERTAINMENT SERVICES IN THE NATURE OF LIVE MUSICAL PERFORMANCES;  
LIVE PERFORMANCES BY A MUSICAL GROUP; PROVIDING A WEBSITE FEATURING  
INFORMATION IN THE FIELD OF MUSIC AND ENTERTAINMENT, IN CLASS 41 (U.S.  
CLS. 100, 101 AND 107).

FIRST USE 5-28-2011; IN COMMERCE 5-28-2011.

THE MARK CONSISTS OF STANDARD CHARACTERS WITHOUT CLAIM TO ANY PAR-  
TICULAR FONT, STYLE, SIZE, OR COLOR.

SN 85-172,639, FILED 11-9-2010.

SUSAN STIGLITZ, EXAMINING ATTORNEY



*David J. Kypos*

Director of the United States Patent and Trademark Office

# United States of America

United States Patent and Trademark Office

## DUNDAS DASHBOARD

**Reg. No. 4,199,178**

**Registered Aug. 28, 2012**

**Int. Cls.: 9 and 42**

**TRADEMARK**

**SERVICE MARK**

**PRINCIPAL REGISTER**

DUNDAS DATA VISUALIZATION INC. (CANADA CORPORATION)  
500 - 250 FERRAND DRIVE  
TORONTO, ONTARIO, CANADA M3C3G8

FOR: COMPUTER SOFTWARE FOR CONNECTING TO DATA STORED IN RELATIONAL AND MULTIDIMENSIONAL DATABASES AND OTHER DATA REPOSITORIES, FOR FACILITATION OF THE CREATION OF KEY PERFORMANCE INDICATORS (KPIs) FROM THE DATA, FOR DESIGNING INTERACTIVE VIEWS AND VISUAL REPRESENTATIONS OF THE KPIs USING CHARTS, GAUGES, MAPS, GRIDS AND OTHER VISUALIZATION TYPES, AND FOR PUBLISHING AND INTEGRATING THESE DESIGNS INTO VARIOUS WEB-BASED AND OTHER BUSINESS APPLICATIONS, IN CLASS 9 (U.S. CLS. 21, 23, 26, 36 AND 38).

FIRST USE 11-9-2011; IN COMMERCE 11-9-2011.

FOR: PROVIDING NON-DOWNLOADABLE WEB-BASED COMPUTER SOFTWARE FOR CONNECTING TO DATA STORED IN RELATIONAL AND MULTIDIMENSIONAL DATABASES AND OTHER DATA REPOSITORIES, FOR FACILITATION OF THE CREATION OF KEY PERFORMANCE INDICATORS (KPIs) FROM THE DATA, FOR DESIGNING INTERACTIVE VIEWS AND VISUAL REPRESENTATIONS OF THE KPIs USING CHARTS, GAUGES, MAPS, GRIDS AND OTHER VISUALIZATION TYPES, AND FOR PUBLISHING AND INTEGRATING THESE DESIGNS INTO VARIOUS WEB-BASED AND OTHER BUSINESS APPLICATIONS, IN CLASS 42 (U.S. CLS. 100 AND 101).

FIRST USE 11-9-2011; IN COMMERCE 11-9-2011.

THE MARK CONSISTS OF STANDARD CHARACTERS WITHOUT CLAIM TO ANY PARTICULAR FONT, STYLE, SIZE, OR COLOR.

PRIORITY CLAIMED UNDER SEC. 44(D) ON CANADA APPLICATION NO. 1487095, FILED 6-30-2010, REG. NO. TMA797366, DATED 5-12-2011, EXPIRES 5-12-2026.

NO CLAIM IS MADE TO THE EXCLUSIVE RIGHT TO USE "DASHBOARD", APART FROM THE MARK AS SHOWN.

SN 85-172,742, FILED 11-9-2010.



*David J. Kyjars*

Director of the United States Patent and Trademark Office

**Reg. No. 4,199,178** TRACY FLETCHER, EXAMINING ATTORNEY

# United States of America

United States Patent and Trademark Office

**FOUR**  
*Loko*

**Reg. No. 4,199,179**

**Registered Aug. 28, 2012**

**Int. Cl.: 25**

**TRADEMARK**

**PRINCIPAL REGISTER**

PHUSION PROJECTS, LLC (DELAWARE LIMITED LIABILITY COMPANY)  
# 424  
1658 MILWAUKEE AVENUE  
CHICAGO, IL 60647

FOR: CLOTHING AND HEADGEAR, NAMELY, SHIRTS, HATS AND CAPS, IN CLASS 25  
(U.S. CLS. 22 AND 39).

FIRST USE 11-18-2011; IN COMMERCE 11-18-2011.

OWNER OF U.S. REG. NOS. 3,988,581 AND 4,038,908.

THE MARK CONSISTS OF THE WORDS "FOUR" AND "LOKO" IN STYLIZED FONT.

SN 85-172,847, FILED 11-9-2010.

ANDREA K. NADELMAN, EXAMINING ATTORNEY



*David J. Kybas*

Director of the United States Patent and Trademark Office

# United States of America

United States Patent and Trademark Office

# G'D Y USA

**Reg. No. 4,199,180**

**Registered Aug. 28, 2012**

**Int. Cls.: 9, 16, 35, 36, 39,  
41, and 45**

**TRADEMARK**

**SERVICE MARK**

**PRINCIPAL REGISTER**

THE COMMONWEALTH OF AUSTRALIA AS REPRESENTED BY THE DEPARTMENT OF FOREIGN AFFAIRS AND TRADE (AUSTRALIA JOINT APPLICANTS)  
RG CASEY BUILDING, JOHN MCEWEN CRESCENT  
BARTON, AUSTRALIA ACT0221 AND

THE COMMONWEALTH OF AUSTRALIA REPRESENTED BY THE AUSTRALIAN TRADE COMMISSION (AUSTRALIA JOINT APPLICANTS)  
MINTER ELLISON BUILDING, 2ND FLOOR  
25 NATIONAL CIRCUIT  
FORREST, AUSTRALIA ACT2603 AND

QANTAS AIRWAYS LIMITED (AUSTRALIA JOINT APPLICANTS)  
203 COWARD STREET  
MASCOT, AUSTRALIA NSW2020 AND

TOURISM AUSTRALIA (AUSTRALIA JOINT APPLICANTS)  
GPO BOX 2721  
SYDNEY, AUSTRALIA NSW1006

FOR: DOWNLOADABLE ELECTRONIC PUBLICATIONS, NAMELY, MAGAZINES, NEWSLETTERS AND NEWSPAPERS, BOOKLETS, PROGRAMS, BROCHURES, HANDOUTS, FLYERS, POSTCARDS, POSTERS, INVITATIONS, ITINERARIES, CALENDARS AND ADVERTISEMENTS IN RELATION TO EVENTS, AUSTRALIAN GOODS AND SERVICES, AUSTRALIA AND AUSTRALIAN RELATED BUSINESSES AND ORGANIZATIONS, SPONSORSHIP AND ENDORSEMENTS, IN CLASS 9 (U.S. CLS. 21, 23, 26, 36 AND 38).

FIRST USE 11-13-2006; IN COMMERCE 11-13-2006.

FOR: PRINTED MATERIALS, NAMELY, MAGAZINES, NEWSLETTERS AND NEWSPAPERS, BOOKLETS, PROGRAMS, BROCHURES, HANDOUTS, FLYERS, POSTCARDS, POSTERS, INVITATIONS, ITINERARIES, CALENDARS AND ADVERTISEMENTS IN RELATION TO EVENTS, AUSTRALIAN GOODS AND SERVICES, AUSTRALIA AND AUSTRALIAN RELATED BUSINESSES AND ORGANIZATIONS, SPONSORSHIP AND ENDORSEMENTS; EVENT CALENDARS, IN CLASS 16 (U.S. CLS. 2, 5, 22, 23, 29, 37, 38 AND 50).

FIRST USE 11-13-2006; IN COMMERCE 11-13-2006.



*David J. Kappas*

Director of the United States Patent and Trademark Office



**Reg. No. 4,199,180** FOR: ADVERTISING SERVICES; PROMOTION AND ADVERTISING SERVICES FOR OTHERS IN RELATION TO AUSTRALIAN GOODS AND SERVICES; SPONSORSHIPS OF GOODS AND SERVICES FOR OTHERS THROUGH PROMOTION AND MARKETING SERVICES; INFORMATION SERVICES RELATING TO BUSINESSES; INFORMATION SERVICES RELATING TO TRADE; PROVIDING PROMOTIONAL SERVICES IN THE NATURE OF PRODUCT SAMPLING ACTIVITIES; MARKET RESEARCH AND MARKET ANALYSIS SERVICES FOR OTHERS; EVENT MANAGEMENT SERVICES, NAMELY, ORGANIZING AND CONDUCTING BUSINESS EXHIBITIONS, TRADE SHOWS AND EVENTS; INFORMATION AND CONSULTANCY SERVICES RELATING TO THE AFOREMENTIONED SERVICES; PROVISION OF BUSINESS INFORMATION, NOT DOWNLOADABLE, OVER A GLOBAL COMPUTER NETWORK IN THE FIELD OF AUSTRALIAN GOODS AND SERVICES AND AUSTRALIA AND AUSTRALIAN RELATED BUSINESSES AND ORGANIZATIONS, IN CLASS 35 (U.S. CLS. 100, 101 AND 102).

FIRST USE 11-13-2006; IN COMMERCE 11-13-2006.

FOR: PROVISION OF INFORMATION RELATING TO FINANCE AND INVESTMENT, IN CLASS 36 (U.S. CLS. 100, 101 AND 102).

FIRST USE 11-13-2006; IN COMMERCE 11-13-2006.

FOR: PROVISION OF INFORMATION RELATING TO TOURISM , IN CLASS 39 (U.S. CLS. 100 AND 105).

FIRST USE 11-13-2006; IN COMMERCE 11-13-2006.

FOR: EDUCATION SERVICES FEATURING SEMINARS, LECTURES, FORUMS, SYMPOSIUMS, CONFERENCES AND PANEL DISCUSSIONS RELATING TO EVENTS, AUSTRALIAN GOODS AND SERVICES, AUSTRALIA AND AUSTRALIAN RELATED BUSINESSES AND ORGANIZATIONS, SPONSORSHIP AND ENDORSEMENTS; PROVIDING TRAINING IN THE FIELD OF AUSTRALIAN GOODS AND SERVICES, AUSTRALIA AND AUSTRALIAN RELATED BUSINESSES AND ORGANIZATIONS; ENTERTAINMENT SERVICES, NAMELY, FILM SCREENINGS, FOOD AND BEVERAGE EVENTS, WINE TASTING, COOKING DEMONSTRATIONS, GALA EVENTS, FASHION AND JEWELER SHOWS, ART EXHIBITIONS, MUSIC EVENTS AND DANCE EVENTS; ORGANIZING SPORTING AND CULTURAL EVENTS; INFORMATION AND CONSULTANCY SERVICES RELATING TO THE AFOREMENTIONED SERVICES, IN CLASS 41 (U.S. CLS. 100, 101 AND 107).

FIRST USE 11-13-2006; IN COMMERCE 11-13-2006.

FOR: PROVISION OF INFORMATION RELATING TO FASHION, IN CLASS 45 (U.S. CLS. 100 AND 101).

FIRST USE 11-13-2006; IN COMMERCE 11-13-2006.

NO CLAIM IS MADE TO THE EXCLUSIVE RIGHT TO USE "USA", APART FROM THE MARK AS SHOWN.

THE MARK CONSISTS OF THE WORDING "G'DAY USA" AND A SIGN INCORPORATING A GRAPHIC OF A JUMPING KANGAROO.

SN 85-172,986, FILED 11-9-2010.

ZACHARY BELLO, EXAMINING ATTORNEY

# United States of America

United States Patent and Trademark Office

## STUDIO BY SOFFT

**Reg. No. 4,199,181**

**Registered Aug. 28, 2012**

**Int. Cl.: 25**

**TRADEMARK**

**PRINCIPAL REGISTER**

COLUMBIA INSURANCE COMPANY (NEBRASKA CORPORATION)  
3024 HARNEY STREET  
OMAHA, NE 68131

FOR: FOOTWEAR; CLOTHING, NAMELY, BELTS, DRESSES, GLOVES, JACKETS, NECKWEAR, NIGHTWEAR, PANTS, SUITS, SWIMWEAR, SKIRTS, TOPS, BOTTOMS, UNDERWEAR, HEADWEAR, UNIFORMS, SHIRTS, WRISTBANDS, SOCKS, HOSIERY, T-SHIRTS, SWEATSHIRTS, SWEATPANTS, SHORTS, SWEATERS, COATS, SCARVES, CAPS, PULLOVERS, VESTS, IN CLASS 25 (U.S. CLS. 22 AND 39).

FIRST USE 5-10-2011; IN COMMERCE 5-10-2011.

THE MARK CONSISTS OF STANDARD CHARACTERS WITHOUT CLAIM TO ANY PARTICULAR FONT, STYLE, SIZE, OR COLOR.

OWNER OF U.S. REG. NOS. 3,059,058 AND 3,663,078.

NO CLAIM IS MADE TO THE EXCLUSIVE RIGHT TO USE "STUDIO", APART FROM THE MARK AS SHOWN.

SN 85-173,302, FILED 11-10-2010.

ELLEN BURNS, EXAMINING ATTORNEY



*David J. Kyros*

Director of the United States Patent and Trademark Office

# United States of America

United States Patent and Trademark Office

# SERT

**Reg. No. 4,199,182**

**Registered Aug. 28, 2012**

**Int. Cls.: 42 and 45**

**SERVICE MARK**

**PRINCIPAL REGISTER**

PHILLIPS 66 COMPANY (DELAWARE CORPORATION)  
P. O. BOX 4428  
INTELLECTUAL PROPERTY - LEGAL  
HOUSTON, TX 77210

FOR: TECHNOLOGY CONSULTATION IN THE FIELD OF HEAVY METAL SEPARATION PROCESSES, IN CLASS 42 (U.S. CLS. 100 AND 101).

FIRST USE 10-3-2011; IN COMMERCE 10-3-2011.

FOR: LICENSING OF TECHNOLOGY IN THE FIELD OF HEAVY METAL SEPARATION PROCESSES, IN CLASS 45 (U.S. CLS. 100 AND 101).

FIRST USE 10-3-2011; IN COMMERCE 10-3-2011.

THE MARK CONSISTS OF STANDARD CHARACTERS WITHOUT CLAIM TO ANY PARTICULAR FONT, STYLE, SIZE, OR COLOR.

SN 85-173,615, FILED 11-10-2010.

ZACHARY BELLO, EXAMINING ATTORNEY



*David J. Kypos*

Director of the United States Patent and Trademark Office

# United States of America

United States Patent and Trademark Office



**Reg. No. 4,199,183**

G3 ENTERPRISES, INC. (DELAWARE CORPORATION)  
502 EAST WHITEMORE AVENUE  
MODESTO, CA 95358

**Registered Aug. 28, 2012**

**Int. Cls.: 6, 16, 20, 35, 39, 40, and 41** FOR: BOTTLE CLOSURES OF METAL, IN CLASS 6 (U.S. CLS. 2, 12, 13, 14, 23, 25 AND 50).

FIRST USE 11-30-2009; IN COMMERCE 11-30-2009.

**TRADEMARK**

FOR: PRINTED PAPER LABELS; PAPER PRESSURE SENSITIVE LABELS, IN CLASS 16 (U.S. CLS. 2, 5, 22, 23, 29, 37, 38 AND 50).

**SERVICE MARK**

FIRST USE 11-30-2009; IN COMMERCE 11-30-2009.

**PRINCIPAL REGISTER**

FOR: CORKS FOR BOTTLES, IN CLASS 20 (U.S. CLS. 2, 13, 22, 25, 32 AND 50).

FIRST USE 11-30-2009; IN COMMERCE 11-30-2009.

FOR: TRANSPORTATION LOGISTICS SERVICES, NAMELY, ARRANGING THE TRANSPORTATION OF GOODS FOR OTHERS AND PLANNING AND SCHEDULING SHIPMENTS FOR USERS OF TRANSPORTATION SERVICES, IN CLASS 35 (U.S. CLS. 100, 101 AND 102).

FIRST USE 11-30-2009; IN COMMERCE 11-30-2009.

FOR: RENTAL OF WAREHOUSE SPACE; MOBILE BOTTLING SERVICES, IN CLASS 39 (U.S. CLS. 100 AND 105).

FIRST USE 11-30-2009; IN COMMERCE 11-30-2009.

FOR: WINERY SERVICES; PRINTING, IN CLASS 40 (U.S. CLS. 100, 103 AND 106).

FIRST USE 6-30-2010; IN COMMERCE 6-30-2010.

FOR: DIGITAL IMAGING SERVICES, IN CLASS 41 (U.S. CLS. 100, 101 AND 107).

FIRST USE 11-30-2009; IN COMMERCE 11-30-2009.



*David J. Kyffers*

Director of the United States Patent and Trademark Office

**Reg. No. 4,199,183** OWNER OF U.S. REG. NO. 3,009,326.

THE MARK CONSISTS OF A STYLIZED LETTER "G" AND THE NUMBER "3".

SN 85-174,389, FILED 11-11-2010.

TEJBIR SINGH, EXAMINING ATTORNEY

# United States of America

United States Patent and Trademark Office

# AWNGUARD

**Reg. No. 4,199,184**

**Registered Aug. 28, 2012**

**Int. Cl.: 6**

**TRADEMARK**

**PRINCIPAL REGISTER**

AWNEX, INC. (GEORGIA CORPORATION)  
260 VALLEY STREET  
SUITE 100  
BALL GROUND, GA 30107

FOR: ARCHITECTURAL CANOPY SYSTEM, NAMELY, METAL CANOPIES AND METAL AWNINGS, IN CLASS 6 (U.S. CLS. 2, 12, 13, 14, 23, 25 AND 50).

FIRST USE 6-11-2012; IN COMMERCE 6-11-2012.

THE MARK CONSISTS OF STANDARD CHARACTERS WITHOUT CLAIM TO ANY PARTICULAR FONT, STYLE, SIZE, OR COLOR.

SN 85-174,432, FILED 11-11-2010.

MARGERY A. TIERNEY, EXAMINING ATTORNEY



*David J. Kyffers*

Director of the United States Patent and Trademark Office

# United States of America

United States Patent and Trademark Office

# 1333 MINNA

**Reg. No. 4,199,185**

GOORIN BROS., INC. (CALIFORNIA CORPORATION)  
1269 HOWARD STREET  
SAN FRANCISCO, CA 94103

**Registered Aug. 28, 2012**

**Int. Cl.: 25**

FOR: HATS, HEADGEAR, NAMELY, CAPS, BEANIES, SHAPED HATS, IN CLASS 25 (U.S. CLS. 22 AND 39).

**TRADEMARK**

FIRST USE 12-0-2005; IN COMMERCE 12-0-2005.

**PRINCIPAL REGISTER**

THE MARK CONSISTS OF STANDARD CHARACTERS WITHOUT CLAIM TO ANY PARTICULAR FONT, STYLE, SIZE, OR COLOR.

SN 85-174,529, FILED 11-11-2010.

SETH A. RAPPAPORT, EXAMINING ATTORNEY



*David J. Kybas*

Director of the United States Patent and Trademark Office

# United States of America

United States Patent and Trademark Office

# Clam Club

**Reg. No. 4,199,186**

S GARAY & CO LLC (CALIFORNIA LIMITED LIABILITY COMPANY)  
P.O. BOX 210276  
CHULA VISTA, CA 91921

**Registered Aug. 28, 2012**

**Int. Cl.: 32**

FOR: TOMATO JUICE; TOMATO JUICE BEVERAGES (NON CARBONATED); VEGETABLE JUICES, IN CLASS 32 (U.S. CLS. 45, 46 AND 48).

**TRADEMARK**

FIRST USE 3-21-2012; IN COMMERCE 3-21-2012.

**PRINCIPAL REGISTER**

THE MARK CONSISTS OF STANDARD CHARACTERS WITHOUT CLAIM TO ANY PARTICULAR FONT, STYLE, SIZE, OR COLOR.

SN 85-175,130, FILED 11-12-2010.

ANN E. SAPPENFIELD, EXAMINING ATTORNEY



*David J. Kybas*

Director of the United States Patent and Trademark Office



# United States of America

United States Patent and Trademark Office



**Reg. No. 4,199,187**

**Registered Aug. 28, 2012**

**Int. Cl.: 25**

**TRADEMARK**

**PRINCIPAL REGISTER**

TO THE 9'S KIDS, LLC (GEORGIA LIMITED LIABILITY COMPANY)  
20 SHERWOOD LANE  
MARIETTA, GA 30067

FOR: CLOTHING, NAMELY, PANTS, COATS, SWEATSHIRTS, SUITS, JEANS, VESTS, SWEATERS, JACKETS, HOSIERY, TIGHTS, BELTS, GLOVES, MITTENS, SCARVES AND HATS, IN CLASS 25 (U.S. CLS. 22 AND 39).

FIRST USE 8-0-2011; IN COMMERCE 8-0-2011.

THE MARK CONSISTS OF THE WORDING "9'S" WITH A CROWN ON TOP OF THE NUMBER "9", ALL BENEATH A SERIES OF EIGHT-POINTED STARS

SN 85-175,303, FILED 11-12-2010.

LIEF MARTIN, EXAMINING ATTORNEY



*David J. Kyffers*

Director of the United States Patent and Trademark Office

# United States of America

United States Patent and Trademark Office

## WHERE HEALTHCARE AND SCIENCE CONVERGE

**Reg. No. 4,199,188**

**Registered Aug. 28, 2012**

**Int. Cls.: 35, 36, 41, and  
42**

**SERVICE MARK**

**PRINCIPAL REGISTER**

UNIVERSITY OF THE SCIENCES IN PHILADELPHIA (PENNSYLVANIA NON-PROFIT CORPORATION)  
600 43RD STREET  
PHILADELPHIA, PA 19104

FOR: BUSINESS CONSULTING SERVICES FOR THE PHARMACEUTICAL AND HEALTH CARE INDUSTRIES, NAMELY, PHARMACEUTICAL CARE MANAGEMENT PROGRAMS IN THE NATURE OF COST MANAGEMENT AND DRUG UTILIZATION REVIEW FOR PHARMACEUTICAL BENEFIT PLANS FOR PRIVATE AND PUBLIC AGENCIES, ORGANIZATIONS, INSTITUTIONS, AND INDIVIDUALS; BUSINESS RESEARCH SERVICES, NAMELY, PROVIDING AND FACILITATING PHARMACOECONOMICS RESEARCH PROJECTS AND RESEARCH TEAMS FOR IMPROVING DRUG THERAPY UTILIZATION AND COSTS REIMBURSEMENTS THROUGH APPLIED PHARMACOECONOMICS FOR THE PHARMACEUTICAL AND HEALTH CARE INDUSTRIES; AND PROVIDING AND FACILITATING GERIATRICS-FOCUSED RESEARCH PROGRAMS DEDICATED TO ASSESSING HEALTH CARE OF THE ELDERLY, NAMELY, DRUG UTILIZATION REVIEW RESEARCH FOR THE PHARMACEUTICAL AND HEALTH CARE INDUSTRIES, IN CLASS 35 (U.S. CLS. 100, 101 AND 102).

FIRST USE 9-1-2010; IN COMMERCE 9-1-2010.



FOR: PROVIDING AND FACILITATING PHARMACOECONOMICS RESEARCH PROJECTS AND RESEARCH TEAMS FOR IMPROVING DRUG THERAPY REIMBURSEMENTS THROUGH APPLIED PHARMACOECONOMICS FOR THE PHARMACEUTICAL AND HEALTH CARE INDUSTRIES, NAMELY, RESEARCH ABOUT PATIENT REIMBURSEMENT FOR PHARMACEUTICALS AND FINANCING THE RESEARCH OF OTHERS IN THE FIELD OF PHARMACOECONOMICS; AND PROVIDING AND FACILITATING GERIATRICS-FOCUSED RESEARCH PROGRAMS DEDICATED TO ASSESSING HEALTH CARE OF THE ELDERLY BY OUTCOMES ASSESSMENT AND DRUG USE AND UTILIZATION FOR THE PHARMACEUTICAL AND HEALTH CARE INDUSTRIES, NAMELY, FINANCING THE RESEARCH OF OTHERS, IN CLASS 36 (U.S. CLS. 100, 101 AND 102).

FIRST USE 9-1-2010; IN COMMERCE 9-1-2010.

*David J. Kyjars*

Director of the United States Patent and Trademark Office

FOR: EDUCATIONAL SERVICES, NAMELY, PROVIDING COURSES OF INSTRUCTION AT THE UNDERGRADUATE, GRADUATE, AND POST-GRADUATE LEVELS; EDUCATIONAL SERVICES, NAMELY, PROVIDING EDUCATIONAL UNDERGRADUATE, GRADUATE,

**Reg. No. 4,199,188** AND POST-GRADUATE LEVEL RESEARCH PROGRAMS FOR ALL ASPECTS OF PHARMACEUTICAL STUDY; PROVIDING CONTINUING EDUCATION CONFERENCES, SEMINARS AND WORKSHOPS IN THE FIELDS OF PHARMACEUTICAL STUDY, HEALTH CARE, AND HEALTH SCIENCES; CONDUCTING EDUCATIONAL CONFERENCES AND SEMINARS IN THE FIELDS OF THE STUDY OF PHARMACY AND THE PHARMACEUTICAL AND HEALTH CARE INDUSTRIES; PUBLICATION OF NEWSLETTERS, NEWS BRIEFS, AND MONOGRAPHS FOR PHARMACISTS AND HEALTH CARE PROFESSIONALS; ENTERTAINMENT SERVICES IN THE NATURE OF PRESENTATION OF A VARIETY OF INTERCOLLEGIATE SPORTING EVENTS, NAMELY, CROSS-COUNTRY RUNNING, CHEERLEADING, RIFLE, BASKETBALL, BASEBALL, GOLF, TENNIS, SOFTBALL, AND VOLLEYBALL, IN CLASS 41 (U.S. CLS. 100, 101 AND 107).

FIRST USE 9-1-2010; IN COMMERCE 9-1-2010.

FOR: TECHNICAL CONSULTING SERVICES IN THE NATURE OF PHARMACEUTICAL TECHNOLOGY CONSULTING FOR PHARMACEUTICAL CARE MANAGEMENT PROGRAMS PROVIDED TO PRIVATE AND PUBLIC AGENCIES, ORGANIZATIONS, INSTITUTIONS, AND INDIVIDUALS FOR THE PHARMACEUTICAL AND HEALTH CARE INDUSTRIES; RESEARCH CONSULTING SERVICES IN THE NATURE OF PHARMACEUTICAL RESEARCH SERVICES FOR PHARMACEUTICAL CARE MANAGEMENT PROGRAMS FOR PRIVATE AND PUBLIC AGENCIES, ORGANIZATIONS, INSTITUTIONS, AND INDIVIDUALS IN THE PHARMACEUTICAL AND HEALTH CARE INDUSTRIES; PROVIDING AND FACILITATING PHARMACOECONOMICS RESEARCH PROJECTS AND RESEARCH TEAMS FOR IMPROVING DRUG THERAPY SELECTION, UTILIZATION, COSTS, AND REIMBURSEMENTS THROUGH APPLIED PHARMACOECONOMICS FOR THE PHARMACEUTICAL AND HEALTH CARE INDUSTRIES, NAMELY, PHARMACEUTICAL RESEARCH SERVICES; AND PROVIDING AND FACILITATING GERIATRICS-FOCUSED RESEARCH PROGRAMS DEDICATED TO ASSESSING HEALTH CARE OF THE ELDERLY BY OUTCOMES ASSESSMENT AND DRUG USE AND UTILIZATION FOR THE PHARMACEUTICAL AND HEALTH CARE INDUSTRIES, NAMELY, RESEARCH IN THE FIELD OF PHARMACEUTICALS, IN CLASS 42 (U.S. CLS. 100 AND 101).

FIRST USE 9-1-2010; IN COMMERCE 9-1-2010.

THE MARK CONSISTS OF STANDARD CHARACTERS WITHOUT CLAIM TO ANY PARTICULAR FONT, STYLE, SIZE, OR COLOR.

SN 85-175,434, FILED 11-12-2010.

BARNEY CHARLON, EXAMINING ATTORNEY

# United States of America

United States Patent and Trademark Office

# USSCIENCES

**Reg. No. 4,199,189**

**Registered Aug. 28, 2012**

**Int. Cls.: 35, 36, 41, and  
42**

**SERVICE MARK**

**PRINCIPAL REGISTER**

UNIVERSITY OF THE SCIENCES IN PHILADELPHIA (PENNSYLVANIA NON-PROFIT CORPORATION)  
600 43RD STREET  
PHILADELPHIA, PA 19104

FOR: BUSINESS CONSULTING SERVICES FOR THE PHARMACEUTICAL AND HEALTH CARE INDUSTRIES, NAMELY, PHARMACEUTICAL CARE MANAGEMENT PROGRAMS IN THE NATURE OF COST MANAGEMENT AND DRUG UTILIZATION REVIEW FOR PHARMACEUTICAL BENEFIT PLANS FOR PRIVATE AND PUBLIC AGENCIES, ORGANIZATIONS, INSTITUTIONS, AND INDIVIDUALS; BUSINESS RESEARCH SERVICES, NAMELY, PROVIDING AND FACILITATING PHARMACOECONOMICS RESEARCH PROJECTS AND RESEARCH TEAMS FOR IMPROVING DRUG THERAPY UTILIZATION AND COSTS REIMBURSEMENTS THROUGH APPLIED PHARMACOECONOMICS FOR THE PHARMACEUTICAL AND HEALTH CARE INDUSTRIES; AND PROVIDING AND FACILITATING GERIATRICS-FOCUSED RESEARCH PROGRAMS DEDICATED TO ASSESSING HEALTH CARE OF THE ELDERLY, NAMELY, DRUG UTILIZATION REVIEW RESEARCH FOR THE PHARMACEUTICAL AND HEALTH CARE INDUSTRIES, IN CLASS 35 (U.S. CLS. 100, 101 AND 102).

FIRST USE 9-1-2010; IN COMMERCE 9-1-2010.



FOR: PROVIDING AND FACILITATING PHARMACOECONOMICS RESEARCH PROJECTS AND RESEARCH TEAMS FOR IMPROVING DRUG THERAPY REIMBURSEMENTS THROUGH APPLIED PHARMACOECONOMICS FOR THE PHARMACEUTICAL AND HEALTH CARE INDUSTRIES, NAMELY, RESEARCH ABOUT PATIENT REIMBURSEMENT FOR PHARMACEUTICALS AND FINANCING THE RESEARCH OF OTHERS IN THE FIELD OF PHARMACOECONOMICS; AND PROVIDING AND FACILITATING GERIATRICS-FOCUSED RESEARCH PROGRAMS DEDICATED TO ASSESSING HEALTH CARE OF THE ELDERLY BY OUTCOMES ASSESSMENT AND DRUG USE AND UTILIZATION FOR THE PHARMACEUTICAL AND HEALTH CARE INDUSTRIES, NAMELY, FINANCING THE RESEARCH OF OTHERS, IN CLASS 36 (U.S. CLS. 100, 101 AND 102).

FIRST USE 9-1-2010; IN COMMERCE 9-1-2010.

*David J. Kyffers*

Director of the United States Patent and Trademark Office

FOR: EDUCATIONAL SERVICES, NAMELY, PROVIDING COURSES OF INSTRUCTION AT THE UNDERGRADUATE, GRADUATE, AND POST-GRADUATE LEVELS; EDUCATIONAL SERVICES, NAMELY, PROVIDING EDUCATIONAL UNDERGRADUATE, GRADUATE,

**Reg. No. 4,199,189** AND POST-GRADUATE LEVEL RESEARCH PROGRAMS FOR ALL ASPECTS OF PHARMACEUTICAL STUDY; PROVIDING CONTINUING EDUCATION CONFERENCES, SEMINARS AND WORKSHOPS IN THE FIELDS OF PHARMACEUTICAL STUDY, HEALTH CARE, AND HEALTH SCIENCES; CONDUCTING EDUCATIONAL CONFERENCES AND SEMINARS IN THE FIELDS OF THE STUDY OF PHARMACY AND THE PHARMACEUTICAL AND HEALTH CARE INDUSTRIES; PUBLICATION OF NEWSLETTERS, NEWS BRIEFS, AND MONOGRAPHS FOR PHARMACISTS AND HEALTH CARE PROFESSIONALS; ENTERTAINMENT SERVICES IN THE NATURE OF PRESENTATION OF A VARIETY OF INTERCOLLEGIATE SPORTING EVENTS, NAMELY, CROSS-COUNTRY RUNNING, CHEERLEADING, RIFLE, BASKETBALL, BASEBALL, GOLF, TENNIS, SOFTBALL, AND VOLLEYBALL, IN CLASS 41 (U.S. CLS. 100, 101 AND 107).

FIRST USE 9-1-2010; IN COMMERCE 9-1-2010.

FOR: TECHNICAL CONSULTING SERVICES IN THE NATURE OF PHARMACEUTICAL TECHNOLOGY CONSULTING FOR PHARMACEUTICAL CARE MANAGEMENT PROGRAMS PROVIDED TO PRIVATE AND PUBLIC AGENCIES, ORGANIZATIONS, INSTITUTIONS, AND INDIVIDUALS FOR THE PHARMACEUTICAL AND HEALTH CARE INDUSTRIES; RESEARCH CONSULTING SERVICES IN THE NATURE OF PHARMACEUTICAL RESEARCH SERVICES FOR PHARMACEUTICAL CARE MANAGEMENT PROGRAMS FOR PRIVATE AND PUBLIC AGENCIES, ORGANIZATIONS, INSTITUTIONS, AND INDIVIDUALS IN THE PHARMACEUTICAL AND HEALTH CARE INDUSTRIES; PROVIDING AND FACILITATING PHARMACOECONOMICS RESEARCH PROJECTS AND RESEARCH TEAMS FOR IMPROVING DRUG THERAPY SELECTION, UTILIZATION, COSTS, AND REIMBURSEMENTS THROUGH APPLIED PHARMACOECONOMICS FOR THE PHARMACEUTICAL AND HEALTH CARE INDUSTRIES, NAMELY, PHARMACEUTICAL RESEARCH SERVICES; AND PROVIDING AND FACILITATING GERIATRICS-FOCUSED RESEARCH PROGRAMS DEDICATED TO ASSESSING HEALTH CARE OF THE ELDERLY BY OUTCOMES ASSESSMENT AND DRUG USE AND UTILIZATION FOR THE PHARMACEUTICAL AND HEALTH CARE INDUSTRIES, NAMELY, RESEARCH IN THE FIELD OF PHARMACEUTICALS, IN CLASS 42 (U.S. CLS. 100 AND 101).

FIRST USE 9-1-2010; IN COMMERCE 9-1-2010.

THE MARK CONSISTS OF STANDARD CHARACTERS WITHOUT CLAIM TO ANY PARTICULAR FONT, STYLE, SIZE, OR COLOR.

OWNER OF U.S. REG. NO. 2,390,738.

SN 85-175,448, FILED 11-12-2010.

BARNEY CHARLON, EXAMINING ATTORNEY

**United States of America**  
United States Patent and Trademark Office

# FLORQUIST

**Reg. No. 4,199,190**

VESPERLIND LLC (DELAWARE LIMITED LIABILITY COMPANY), DBA FLORQUIST,  
1756 MORTIE STREET  
SPRINGDALE, AR 72764

**Registered Aug. 28, 2012**

**Int. Cl.: 35**

FOR: CONSULTING SERVICES IN THE FIELD OF IMPORTATION AND EXPORTATION  
OF GOODS, IN CLASS 35 (U.S. CLS. 100, 101 AND 102).

**SERVICE MARK**

FIRST USE 2-8-2011; IN COMMERCE 2-8-2011.

**PRINCIPAL REGISTER**

THE MARK CONSISTS OF STANDARD CHARACTERS WITHOUT CLAIM TO ANY PAR-  
TICULAR FONT, STYLE, SIZE, OR COLOR.

SN 85-175,523, FILED 11-12-2010.

NICHOLAS ALTREE, EXAMINING ATTORNEY



*David J. Kybas*

Director of the United States Patent and Trademark Office

# United States of America

United States Patent and Trademark Office

## MY GLOBAL BOX NETWORK

**Reg. No. 4,199,191**

KENNETH J. BAGAN (UNITED STATES INDIVIDUAL)  
5727 W. HOWARD ST.  
NILES, IL 60714

**Registered Aug. 28, 2012**

**Int. Cls.: 9 and 38**

FOR: INTERACTIVE COMPUTER KIOSKS COMPRISING COMPUTERS, COMPUTER HARDWARE, COMPUTER PERIPHERALS, AND COMPUTER OPERATING SOFTWARE, FOR USE IN MEASURING USERS' BLOOD PRESSURE AND WEIGHT, IN CLASS 9 (U.S. CLS. 21, 23, 26, 36 AND 38).

**TRADEMARK**

**SERVICE MARK**

FIRST USE 5-30-2012; IN COMMERCE 5-30-2012.

**PRINCIPAL REGISTER**

FOR: COMMUNICATION SERVICES, NAMELY, TRANSMITTING RESULTS OF BLOOD PRESSURE AND WEIGHT TESTS TO OTHERS OVER THE INTERNET, IN CLASS 38 (U.S. CLS. 100, 101 AND 104).

FIRST USE 5-30-2012; IN COMMERCE 5-30-2012.

THE MARK CONSISTS OF STANDARD CHARACTERS WITHOUT CLAIM TO ANY PARTICULAR FONT, STYLE, SIZE, OR COLOR.

NO CLAIM IS MADE TO THE EXCLUSIVE RIGHT TO USE "GLOBAL" "NETWORK", APART FROM THE MARK AS SHOWN.

SN 85-175,939, FILED 11-12-2010.

ALLISON HOLTZ, EXAMINING ATTORNEY



*David J. Kyros*

Director of the United States Patent and Trademark Office

# United States of America

United States Patent and Trademark Office

## THE SOLUTION

**Reg. No. 4,199,192**

**Registered Aug. 28, 2012**

**Int. Cls.: 9, 16, and 28**

**TRADEMARK**

**PRINCIPAL REGISTER**

BODY BY JAKE GLOBAL, LLC (DELAWARE LIMITED LIABILITY COMPANY)  
11611 SAN VICENTE BLVD., SUITE 610  
LOS ANGELES, CA 90049

FOR: DVDS FEATURING INFORMATION IN THE FIELDS OF HEALTH, FITNESS, MOTIVATION, EXERCISE, WELLNESS, NUTRITION AND HEALTHY LIFESTYLES, IN CLASS 9 (U.S. CLS. 21, 23, 26, 36 AND 38).

FIRST USE 9-1-2011; IN COMMERCE 9-1-2011.

FOR: BOOKS IN THE FIELD OF HEALTH, FITNESS, MOTIVATION, EXERCISE, WELLNESS, NUTRITION AND HEALTHY LIFESTYLES; MANUALS IN THE FIELD OF HEALTH, FITNESS, MOTIVATION, EXERCISE, WELLNESS, NUTRITION AND HEALTHY LIFESTYLES; POSTERS, IN CLASS 16 (U.S. CLS. 2, 5, 22, 23, 29, 37, 38 AND 50).

FIRST USE 9-1-2011; IN COMMERCE 9-1-2011.

FOR: MANUALLY-OPERATED EXERCISE EQUIPMENT , IN CLASS 28 (U.S. CLS. 22, 23, 38 AND 50).

FIRST USE 9-1-2011; IN COMMERCE 9-1-2011.

THE MARK CONSISTS OF STANDARD CHARACTERS WITHOUT CLAIM TO ANY PARTICULAR FONT, STYLE, SIZE, OR COLOR.

SN 85-176,067, FILED 11-12-2010.

DAWN HAN, EXAMINING ATTORNEY



*David J. Kyros*

Director of the United States Patent and Trademark Office



# United States of America

United States Patent and Trademark Office

# EVERGREEN

**Reg. No. 4,199,193**

ASPEN MEDICAL PRODUCTS, INC. (CALIFORNIA CORPORATION)  
6481 OAK CANYON  
IRVINE, CA 92618

**Registered Aug. 28, 2012**

**Int. Cl.: 10**

FOR: LOWER SPINE BRACING PRODUCTS, IN CLASS 10 (U.S. CLS. 26, 39 AND 44).

**TRADEMARK**

FIRST USE 4-4-2011; IN COMMERCE 4-4-2011.

**PRINCIPAL REGISTER**

THE MARK CONSISTS OF STANDARD CHARACTERS WITHOUT CLAIM TO ANY PARTICULAR FONT, STYLE, SIZE, OR COLOR.

SN 85-176,722, FILED 11-15-2010.

C. DIONNE CLYBURN, EXAMINING ATTORNEY



*David J. Kyffers*

Director of the United States Patent and Trademark Office

# United States of America

United States Patent and Trademark Office

I TAKE MY PIECES OF  
YESTERDAY AND PUT THEM  
INTO MY PUZZLE OF TOMORROW

**Reg. No. 4,199,194**

ALLIED MATERIALS AND EQUIPMENT COMPANY, INC. (KANSAS CORPORATION)  
1420 KANSAS AVENUE  
KANSAS CITY, MO 64127

**Registered Aug. 28, 2012**

**Int. Cl.: 28**

FOR: JIGSAW PUZZLES, IN CLASS 28 (U.S. CLS. 22, 23, 38 AND 50).

**TRADEMARK**

FIRST USE 5-17-2012; IN COMMERCE 5-17-2012.

**PRINCIPAL REGISTER**

THE MARK CONSISTS OF STANDARD CHARACTERS WITHOUT CLAIM TO ANY PARTICULAR FONT, STYLE, SIZE, OR COLOR.

SN 85-177,032, FILED 11-15-2010.

LAKEISHA LEWIS, EXAMINING ATTORNEY



*David J. Kyffers*

Director of the United States Patent and Trademark Office

# United States of America

United States Patent and Trademark Office



**Reg. No. 4,199,195**

**Registered Aug. 28, 2012**

**Int. Cl.: 41**

**SERVICE MARK**

**PRINCIPAL REGISTER**

SHUFFLE MASTER, INC. (MINNESOTA CORPORATION)  
1106 PALMS AIRPORT DRIVE  
LAS VEGAS, NV 89119

FOR: ENTERTAINMENT SERVICES, NAMELY, PROVIDING A LIVE GAME OF CHANCE ON A GAMING TABLE THAT ENABLES CREDIT WAGERING, IN CLASS 41 (U.S. CLS. 100, 101 AND 107).

FIRST USE 7-16-2010; IN COMMERCE 7-16-2010.

OWNER OF U.S. REG. NOS. 2,233,569, 2,397,403, AND 2,650,060.

NO CLAIM IS MADE TO THE EXCLUSIVE RIGHT TO USE "THREE CARD POKER", APART FROM THE MARK AS SHOWN.

THE MARK CONSISTS OF THE OUTLINE OF THREE PLAYING CARDS WITH A DIAMOND DESIGN ON THE FACE OF EACH CARD AND THE WORDS "THREE CARD POKER" UNDER THE PLAYING CARDS.

SN 85-177,370, FILED 11-15-2010.

NAPOLEON SHARMA, EXAMINING ATTORNEY



*David J. Kyffers*

Director of the United States Patent and Trademark Office

# United States of America

United States Patent and Trademark Office

# DEFENDER

**Reg. No. 4,199,196**

**Registered Aug. 28, 2012**

**Int. Cl.: 12**

**TRADEMARK**

**PRINCIPAL REGISTER**

MICHELIN NORTH AMERICA, INC. (NEW YORK CORPORATION)  
ONE PARKWAY SOUTH  
GREENVILLE, SC 29615

FOR: PNEUMATIC TIRES FOR PASSENGER CARS, IN CLASS 12 (U.S. CLS. 19, 21, 23, 31, 35 AND 44).

FIRST USE 3-1-2012; IN COMMERCE 3-1-2012.

THE MARK CONSISTS OF STANDARD CHARACTERS WITHOUT CLAIM TO ANY PARTICULAR FONT, STYLE, SIZE, OR COLOR.

SN 85-177,604, FILED 11-16-2010.

CURTIS FRENCH, EXAMINING ATTORNEY



*David J. Kybas*

Director of the United States Patent and Trademark Office

# United States of America

United States Patent and Trademark Office

## LUNCHABLES PROJECT POTENTIAL

**Reg. No. 4,199,197**

**Registered Aug. 28, 2012**

**Int. Cl.: 41**

**SERVICE MARK**

**PRINCIPAL REGISTER**

KRAFT FOODS GLOBAL BRANDS LLC (DELAWARE LIMITED LIABILITY COMPANY)  
THREE LAKES DRIVE  
NORTHFIELD, IL 60093

FOR: ARRANGING CONTESTS AND AWARDED FIELD TRIPS TO THE WINNERS  
THEREOF TO ENCOURAGE ACADEMIC ACHIEVEMENT, IN CLASS 41 (U.S. CLS. 100,  
101 AND 107).

FIRST USE 8-31-2010; IN COMMERCE 8-31-2010.

THE MARK CONSISTS OF STANDARD CHARACTERS WITHOUT CLAIM TO ANY PAR-  
TICULAR FONT, STYLE, SIZE, OR COLOR.

OWNER OF U.S. REG. NOS. 1,488,700, 1,664,231, AND OTHERS.

NO CLAIM IS MADE TO THE EXCLUSIVE RIGHT TO USE "PROJECT", APART FROM THE  
MARK AS SHOWN.

SN 85-178,020, FILED 11-16-2010.

RONALD MCMORROW, EXAMINING ATTORNEY



*David J. Kyffers*

Director of the United States Patent and Trademark Office

# United States of America

United States Patent and Trademark Office

# PRESTOR

**Reg. No. 4,199,198**

CELLULAR BIOENGINEERING, INC. (DELAWARE CORPORATION)

**Registered Aug. 28, 2012**

1946 YOUNG STREET, SUITE 288  
HONOLULU, HI 96826

**Int. Cl.: 3**

FOR: SKIN CLEANSERS; HAIR CLEANSERS; CLEANING PREPARATIONS FOR REMOVAL OF PARTICULATE CONTAMINANTS FROM SKIN AND HAIR; CLEANING PREPARATIONS FOR REMOVAL OF BIOLOGICAL, CHEMICAL, RADIOLOGICAL, RADIOACTIVE, AND NUCLEAR MATERIAL FROM SKIN AND HAIR; CLEANING PREPARATIONS FOR NEUTRALIZING AND DECONTAMINATING BIOLOGICAL, CHEMICAL, RADIOLOGICAL, RADIOACTIVE, AND NUCLEAR MATERIAL AND OTHER CONTAMINANTS; CLEANING PREPARATIONS FOR REMOVAL OF RADIOACTIVE PARTICLES FROM SURFACES; CLEANING PREPARATIONS FOR REMOVAL OF BIOLOGICAL, CHEMICAL, RADIOLOGICAL, RADIOACTIVE, AND NUCLEAR MATERIAL FROM TEXTILES AND CLOTHING, IN CLASS 3 (U.S. CLS. 1, 4, 6, 50, 51 AND 52).

**TRADEMARK**

**PRINCIPAL REGISTER**

FIRST USE 6-1-2010; IN COMMERCE 9-27-2010.

THE MARK CONSISTS OF STANDARD CHARACTERS WITHOUT CLAIM TO ANY PARTICULAR FONT, STYLE, SIZE, OR COLOR.

SN 85-178,515, FILED 11-17-2010.

RENEE MCCRAY, EXAMINING ATTORNEY



*David J. Kyros*

Director of the United States Patent and Trademark Office

# United States of America

United States Patent and Trademark Office



**Reg. No. 4,199,199**

**Registered Aug. 28, 2012**

**Int. Cl.: 14**

**TRADEMARK**

**PRINCIPAL REGISTER**

BULLTORO WATCH COMPANY LLC (CONNECTICUT LIMITED LIABILITY COMPANY)  
1 NETTLETON DRIVE  
WOODBIDGE, CT 06525

FOR: WATCHES, IN CLASS 14 (U.S. CLS. 2, 27, 28 AND 50).

FIRST USE 5-24-2012; IN COMMERCE 5-24-2012.

THE MARK CONSISTS OF A SHIELD WITH THE LETTER "B" SUPERIMPOSED ON THE LETTER "T".

SN 85-179,185, FILED 11-17-2010.

FRED CARL, EXAMINING ATTORNEY



*David J. Kyffers*

Director of the United States Patent and Trademark Office

United States of America  
United States Patent and Trademark Office

SOKOTA

**Reg. No. 4,199,200**

1ST SELECT SEED, INC. (IDAHO CORPORATION)  
640 DOOLEY LANE  
NAMPA, ID 83686

**Registered Aug. 28, 2012**

**Int. Cl.: 31**

FOR: SEEDS FOR PLANTING, NAMELY, ALFALFA, CORN, SORGHUM AND SOYBEANS,  
IN CLASS 31 (U.S. CLS. 1 AND 46).

**TRADEMARK**

FIRST USE 5-4-2012; IN COMMERCE 5-18-2012.

**PRINCIPAL REGISTER**

THE MARK CONSISTS OF STANDARD CHARACTERS WITHOUT CLAIM TO ANY PAR-  
TICULAR FONT, STYLE, SIZE, OR COLOR.

SN 85-179,295, FILED 11-17-2010.

TRACY CROSS, EXAMINING ATTORNEY



*David J. Kybas*

Director of the United States Patent and Trademark Office



# United States of America

United States Patent and Trademark Office



**Reg. No. 4,199,201**

BAYER AG (FED REP GERMANY AKTIENGESELLSCHAFT)  
KAISER WILHELM ALLEE  
LEVERKUSEN, FED REP GERMANY 51373

**Registered Aug. 28, 2012**

**Int. Cls.: 16, 41, and 44**

FOR: PRINTED EDUCATIONAL MATERIALS, NAMELY, INSTRUCTIONAL AND TEACHING MATERIALS ABOUT HEMOPHILIA FOR DISTRIBUTION TO HEMOPHILIA PATIENTS AND TO PERSONS TREATING HEMOPHILIA, IN CLASS 16 (U.S. CLS. 2, 5, 22, 23, 29, 37, 38 AND 50).

**TRADEMARK**

**SERVICE MARK**

FIRST USE 10-30-2009; IN COMMERCE 10-30-2009.

**PRINCIPAL REGISTER**

FOR: EDUCATIONAL SERVICES, NAMELY, CONDUCTING WORKSHOPS, CONFERENCES, SEMINARS, IN THE FIELD OF HEMOPHILIA, IN CLASS 41 (U.S. CLS. 100, 101 AND 107).

FIRST USE 10-30-2009; IN COMMERCE 10-30-2009.

FOR: PROVIDING HEALTH INFORMATION ABOUT HEMOPHILIA FOR HEMOPHILIA PATIENTS AND FOR PERSONS TREATING HEMOPHILIA, IN CLASS 44 (U.S. CLS. 100 AND 101).

FIRST USE 10-30-2009; IN COMMERCE 10-30-2009.

THE MARK CONSISTS OF THE WORDS "LIVING FIT" EXCLAMATION MARK "!" AND THE WORDS "A JOINT EFFORT" STYLIZED.

SN 85-179,670, FILED 11-18-2010.

HOWARD B. LEVINE, EXAMINING ATTORNEY



*David J. Kybas*

Director of the United States Patent and Trademark Office

# United States of America

United States Patent and Trademark Office

## LOLABEE'S HARVEST

**Reg. No. 4,199,202**

LOLABEE'S HARVEST, LLC (DELAWARE LIMITED LIABILITY COMPANY)  
1333 GOUGH STREET, APT. 12A  
SAN FRANCISCO, CA 94109

**Registered Aug. 28, 2012**

**Int. Cl.: 35**

FOR: RETAIL AND ONLINE RETAIL STORE SERVICES IN THE FIELD OF PRODUCE, MEAT, EGGS, DAIRY PRODUCTS, DRIED FRUITS, PRESERVED OR PICKLED FRUIT AND VEGETABLES, JAMS, HONEY, NUTS, OLIVE OIL AND GIFT BASKETS OF THE AFORESAID ITEMS, IN CLASS 35 (U.S. CLS. 100, 101 AND 102).

**SERVICE MARK**

**PRINCIPAL REGISTER**

FIRST USE 11-3-2011; IN COMMERCE 11-3-2011.

THE MARK CONSISTS OF STANDARD CHARACTERS WITHOUT CLAIM TO ANY PARTICULAR FONT, STYLE, SIZE, OR COLOR.

SN 85-180,218, FILED 11-18-2010.

GENE MACIOL, EXAMINING ATTORNEY



*David J. Kyffers*

Director of the United States Patent and Trademark Office

# United States of America

United States Patent and Trademark Office



**PREMIER**  
*Orthopedic Supply*

**Reg. No. 4,199,203**

**Registered Aug. 28, 2012**

**Int. Cl.: 10**

**TRADEMARK**

**PRINCIPAL REGISTER**

PREMIER ORTHOPEDIC SUPPLY (NEW YORK CORPORATION)  
1042 COMMACK ROAD  
DIX HILLS, NY 11746

FOR: ORTHOPEDIC BRACES, IN CLASS 10 (U.S. CLS. 26, 39 AND 44).

FIRST USE 1-15-2012; IN COMMERCE 1-15-2012.

NO CLAIM IS MADE TO THE EXCLUSIVE RIGHT TO USE "ORTHOPEDIC SUPPLY",  
APART FROM THE MARK AS SHOWN.

THE MARK CONSISTS OF THE STYLIZED TERM "PREMIER" IN ALL CAPITAL LETTERS  
IN FRONT OF A STYLIZED EARTH. BELOW THE TERM "PREMIER" ARE THE STYLIZED  
TERMS "ORTHOPEDIC SUPPLY".

SN 85-180,596, FILED 11-18-2010.

TEJBIR SINGH, EXAMINING ATTORNEY



*David J. Kybas*

Director of the United States Patent and Trademark Office

# United States of America

United States Patent and Trademark Office

# AIRBOX

**Reg. No. 4,199,204**

**Registered Aug. 28, 2012**

**Int. Cls.: 9, 35, 38, and 41**

**TRADEMARK**

**SERVICE MARK**

**PRINCIPAL REGISTER**

AIRBOX TELEVISION, INC. (FLORIDA CORPORATION)  
601 CLEARWATER PARK ROAD  
WEST PALM BEACH, FL 33401

FOR: RECEIVERS, NAMELY, TELEVISION RECEIVERS AND RADIO RECEIVERS; SET-TOP BOXES, DIGITAL VIDEO RECORDERS; ANTENNAS AND SATELLITE DISHES; REMOTE CONTROL UNITS FOR TELEVISIONS, SET TOP BOXES; ALL FOR USE FOR VIDEO, AUDIO AND DATA SERVICES VIA DIGITAL BROADCAST AND INTERNET DISTRIBUTION BY TERRESTRIAL, SATELLITE AND WIRELESS NETWORKS TO VIDEO DISPLAY DEVICES, NAMELY, TELEVISIONS, VIDEO PROJECTORS AND VIDEO MONITORS; AND VIDEO DISPLAY DEVICES, NAMELY, TELEVISIONS, VIDEO PROJECTORS AND VIDEO MONITORS, IN CLASS 9 (U.S. CLS. 21, 23, 26, 36 AND 38).

FIRST USE 2-20-2012; IN COMMERCE 2-20-2012.

FOR: COMPUTERIZED ON-LINE ORDERING AND DATA PROCESSING SERVICES IN THE FIELDS OF TELEVISION, FILM, RADIO, VIDEO, AUDIO, MUSIC, PHOTOS, TEXT, DATA AND MULTI-MEDIA CONTENT, IN CLASS 35 (U.S. CLS. 100, 101 AND 102).

FIRST USE 2-20-2012; IN COMMERCE 2-20-2012.

FOR: TRANSMISSION OF VIDEO, AUDIO AND DATA PROGRAMMING AND OTHER VIDEO, AUDIO AND DATA SERVICES, NAMELY, RADIO AND VIDEO BROADCASTING SERVICES; SUBSCRIPTION VIDEO AND AUDIO TRANSMISSION SERVICES; PAY-PER-VIEW VIDEO AND AUDIO TRANSMISSION SERVICES; VIDEO-ON-DEMAND TRANSMISSION SERVICES; SUBSCRIPTION VIDEO-ON-DEMAND TRANSMISSION SERVICES; ALL DELIVERED TO VIDEO DISPLAY DEVICES, NAMELY, TELEVISIONS, COMPUTERS, MOBILE DEVICES, VIDEO PROJECTORS AND VIDEO MONITORS VIA DIGITAL BROADCAST AND INTERNET DISTRIBUTION BY TERRESTRIAL, SATELLITE AND WIRELESS NETWORKS; DISTRIBUTION OF SUCH PROGRAMMING AND SERVICES FOR OTHERS, NAMELY, RADIO AND VIDEO BROADCASTING SERVICES, IN CLASS 38 (U.S. CLS. 100, 101 AND 104).

FIRST USE 2-20-2012; IN COMMERCE 2-20-2012.

FOR: ENTERTAINMENT IN THE NATURE OF ON-GOING TELEVISION PROGRAMS IN THE FIELD OF SPORTS, COMEDY, TRAVEL, DRAMA, VARIETY, HEALTH RELATED



*David J. Kyffers*

Director of the United States Patent and Trademark Office

**Reg. No. 4,199,204** ISSUES, CHILDREN'S PROGRAMMING, WEATHER AND NEWS ALL DELIVERED TO VIDEO DISPLAY DEVICES, NAMELY, TELEVISIONS, COMPUTERS, MOBILE DEVICES, VIDEO PROJECTORS AND VIDEO MONITORS VIA DIGITAL BROADCAST AND INTERNET DISTRIBUTION BY TERRESTRIAL, SATELLITE AND WIRELESS NETWORKS; DISTRIBUTION OF TELEVISION PROGRAMMING TO CABLE TELEVISION SYSTEMS FOR BROADCAST TO VIDEO DISPLAY DEVICES, NAMELY, TELEVISIONS, COMPUTERS, MOBILE DEVICES, VIDEO PROJECTORS AND VIDEO MONITORS VIA DIGITAL BROADCAST AND INTERNET DISTRIBUTION BY TERRESTRIAL, SATELLITE AND WIRELESS NETWORKS, IN CLASS 41 (U.S. CLS. 100, 101 AND 107).

FIRST USE 2-20-2012; IN COMMERCE 2-20-2012.

THE MARK CONSISTS OF STANDARD CHARACTERS WITHOUT CLAIM TO ANY PARTICULAR FONT, STYLE, SIZE, OR COLOR.

SN 85-180,761, FILED 11-19-2010.

KRISTINA MORRIS, EXAMINING ATTORNEY

# United States of America

United States Patent and Trademark Office

## ULTRAFASTSIGE

**Reg. No. 4,199,205**

**Registered Aug. 28, 2012**

**Int. Cls.: 16 and 42**

**TRADEMARK**

**SERVICE MARK**

**PRINCIPAL REGISTER**

MICRAM MICROELECTRONIC GMBH LIMITED (FED REP GERMANY GESELLSCHAFT MIT BESCHRÄNKTER HAFTUNG (GMBH))  
KONRAD-ZUSE-STRASSE, 10 44801  
BOCHUM, FED REP GERMANY

FOR: PRINTED MATTER, NAMELY, MANUALS IN THE FIELD OF INTEGRATED CIRCUITS, BUT EXCLUDING THOSE IN THE FIELDS OF DATA STORAGE AND IMAGING APPLICATIONS; INSTRUCTIONAL AND TEACHING MATERIAL, EXCEPT APPARATUS, IN THE FORM OF PRINTED MATTER, MODELS, BLACKBOARDS, DRAWING INSTRUMENTS AND REPRESENTATION INSTRUMENTS IN THE FIELD OF INTEGRATED CIRCUITS, BUT EXCLUDING THOSE IN THE FIELDS OF DATA STORAGE AND IMAGING APPLICATIONS, IN CLASS 16 (U.S. CLS. 2, 5, 22, 23, 29, 37, 38 AND 50).

FIRST USE 8-0-2010; IN COMMERCE 8-0-2010.

FOR: ENGINEERING SERVICES, EXCLUDING SERVICES IN THE FIELDS OF DATA STORAGE AND IMAGING APPLICATIONS; COMPUTER PROGRAMMING FOR OTHERS, EXCLUDING SERVICES IN THE FIELDS OF DATA STORAGE AND IMAGING APPLICATIONS; DEVELOPMENT OF ELECTROTECHNICAL AND/OR OPTICAL DEVICES AND APPARATUS, IN PARTICULAR OF APPLICATION SPECIFIC INTEGRATED CIRCUITS, EXCLUDING DATA STORAGE AND IMAGING APPLICATIONS; DESIGN AND DEVELOPMENT OF ELECTROTECHNICAL AND/OR ELECTRONIC AND/OR OPTOELECTRONIC ELEMENTS, CIRCUITS AND PRINTED CIRCUIT BOARDS, IN PARTICULAR APPLICATION SPECIFIC INTEGRATED CIRCUITS, EXCLUDING DATA STORAGE AND IMAGING APPLICATIONS; TECHNICAL CONSULTANCY AND PROVIDING OF TECHNICAL EXPERTISE IN THE FIELDS OF DEVELOPMENT AND PRODUCTION OF ELECTRONIC AND OPTOELECTRONIC COMPONENTS, ESPECIALLY OF INTEGRATED CIRCUITS, BUT EXCLUDING DATA STORAGE AND IMAGING APPLICATIONS, IN CLASS 42 (U.S. CLS. 100 AND 101).

FIRST USE 8-10-2010; IN COMMERCE 8-10-2010.

THE MARK CONSISTS OF STANDARD CHARACTERS WITHOUT CLAIM TO ANY PARTICULAR FONT, STYLE, SIZE, OR COLOR.

SN 85-181,176, FILED 11-19-2010.



*David J. Kyros*

Director of the United States Patent and Trademark Office

**Reg. No. 4,199,205** PAM WILLIS, EXAMINING ATTORNEY

United States of America  
United States Patent and Trademark Office

# LoungeLux

**Reg. No. 4,199,206**

**Registered Aug. 28, 2012**

**Int. Cl.: 25**

**TRADEMARK**

**PRINCIPAL REGISTER**

ELOISE CARR LLC (NEW YORK LIMITED LIABILITY COMPANY)  
SUITE 8D  
81 IRVING PLACE  
NEW YORK, NY 10003

FOR: WOMENS APPAREL, NAMELY, LOUNGEWEAR, DRESSES, PANTS, JACKETS, SWEATERS, SKIRTS, SHORTS, TOPS, SLEEPWEAR, NIGHTWEAR, IN CLASS 25 (U.S. CLS. 22 AND 39).

FIRST USE 3-26-2011; IN COMMERCE 9-30-2011.

THE MARK CONSISTS OF STANDARD CHARACTERS WITHOUT CLAIM TO ANY PARTICULAR FONT, STYLE, SIZE, OR COLOR.

SN 85-181,188, FILED 11-19-2010.

JULIE WATSON, EXAMINING ATTORNEY



*David J. Kyffers*

Director of the United States Patent and Trademark Office



# United States of America

United States Patent and Trademark Office



**Reg. No. 4,199,207**

**Registered Aug. 28, 2012**

**Int. Cls.: 35 and 44**

**SERVICE MARK**

**PRINCIPAL REGISTER**

COMMUNITY HEALTH FOUNDATION OF WESTERN AND CENTRAL NEW YORK, INC.  
(NEW YORK NOT-FOR-PROFIT CORPORATION)  
726 EXCHANGE STREET, SUITE 518  
BUFFALO, NY 14210

FOR: PROMOTING PUBLIC AWARENESS OF DENTAL EDUCATION, PREVENTION, AND TREATMENT TO CHILDREN LIVING IN POVERTY IN THE FORM OF A HEALTH INITIATIVE; PROMOTING AWARENESS AMONG PEDIATRIC MEDICAL PROVIDERS OF ORAL HEALTH PRIORITY DURING OFFICE VISITS IN THE FORM OF A HEALTH INITIATIVE, IN CLASS 35 (U.S. CLS. 100, 101 AND 102).

FIRST USE 5-27-2010; IN COMMERCE 5-27-2010.

FOR: PORTABLE DENTAL CARE SERVICES, IN CLASS 44 (U.S. CLS. 100 AND 101).

FIRST USE 5-27-2010; IN COMMERCE 5-27-2010.

THE MARK CONSISTS OF AN ILLUSTRATION OF A GREEN ALLIGATOR WITH WHITE TEETH OUTLINED IN BLACK AND WHITE EYES WITH BLACK PUPILS, WEARING AN ORANGE T-SHIRT BEARING THE LETTER "C" IN WHITE THAT IS HOLDING AN ORANGE TOOTHBRUSH WITH WHITE BRISTLES.

THE COLOR(S) GREEN, ORANGE, WHITE, AND BLACK IS/ARE CLAIMED AS A FEATURE OF THE MARK.

SN 85-182,308, FILED 11-22-2010.

ANGELA DUONG, EXAMINING ATTORNEY



*David J. Kyjars*

Director of the United States Patent and Trademark Office

# United States of America

United States Patent and Trademark Office

## TRIBE OF STYLE

**Reg. No. 4,199,208**

**Registered Aug. 28, 2012**

**COLLECTIVE  
MEMBERSHIP**

**PRINCIPAL REGISTER**

SEXY HAIR CONCEPTS, LLC (DELAWARE LIMITED LIABILITY COMPANY)  
21551 PRAIRIE STREET  
CHATSWORTH, CA 91311

FOR: INDICATING MEMBERSHIP IN AN ORGANIZATION OF STYLISTS WHO HAVE ATTENDED OR COMPLETED EDUCATIONAL AND ENTERTAINMENT PROGRAMS IN THE FIELD OF HAIR CARE SERVICES, IN CLASS 200 (U.S. CL. 200).

FIRST USE 1-1-2011; IN COMMERCE 1-1-2011.

THE MARK CONSISTS OF STANDARD CHARACTERS WITHOUT CLAIM TO ANY PARTICULAR FONT, STYLE, SIZE, OR COLOR.

OWNER OF U.S. REG. NO. 3,120,069.

SN 85-183,084, FILED 11-23-2010.

COLLEEN DOMBROW, EXAMINING ATTORNEY



*David J. Kybas*

Director of the United States Patent and Trademark Office

# United States of America

United States Patent and Trademark Office

## BEER'S BEST FRIEND

**Reg. No. 4,199,209**

EARLY TIMES DISTILLERS COMPANY (DELAWARE CORPORATION)  
2921 DIXIE HIGHWAY  
LOUISVILLE, KY 40216

**Registered Aug. 28, 2012**

**Int. Cl.: 33**

FOR: DISTILLED SPIRITS, IN CLASS 33 (U.S. CLS. 47 AND 49).

**TRADEMARK**

FIRST USE 5-31-2011; IN COMMERCE 5-31-2011.

**PRINCIPAL REGISTER**

THE MARK CONSISTS OF STANDARD CHARACTERS WITHOUT CLAIM TO ANY PARTICULAR FONT, STYLE, SIZE, OR COLOR.

SN 85-183,204, FILED 11-23-2010.

LAURA KOVALSKY, EXAMINING ATTORNEY



*David J. Kybas*

Director of the United States Patent and Trademark Office

# United States of America

United States Patent and Trademark Office

## A LIFETIME OF PLEASURE

**Reg. No. 4,199,210**

SUSSMAN-AUTOMATIC CORPORATION (NEW YORK CORPORATION)  
43-20 34TH STREET

**Registered Aug. 28, 2012**

LONG ISLAND CITY, NY 11101

**Int. Cls.: 9 and 11**

FOR: ELECTRONIC CONTROLS FOR COMMERCIAL AND RESIDENTIAL STEAMBATHS,  
STEAM GENERATORS AND SAUNAS, IN CLASS 9 (U.S. CLS. 21, 23, 26, 36 AND 38).

**TRADEMARK**

FIRST USE 4-5-2002; IN COMMERCE 4-5-2002.

**PRINCIPAL REGISTER**

FOR: COMMERCIAL AND RESIDENTIAL STEAMBATHS, STEAM GENERATORS AND  
SAUNAS, IN CLASS 11 (U.S. CLS. 13, 21, 23, 31 AND 34).

FIRST USE 4-5-2002; IN COMMERCE 4-5-2002.

THE MARK CONSISTS OF STANDARD CHARACTERS WITHOUT CLAIM TO ANY PAR-  
TICULAR FONT, STYLE, SIZE, OR COLOR.

SN 85-183,369, FILED 11-23-2010.

DAYNA BROWNE, EXAMINING ATTORNEY



*David J. Kyfos*

Director of the United States Patent and Trademark Office

# United States of America

United States Patent and Trademark Office

# ORTHO

**Reg. No. 4,199,211**

JOHNSON & JOHNSON (NEW JERSEY CORPORATION)  
ONE JOHNSON & JOHNSON PLAZA  
NEW BRUNSWICK, NJ 089337001

**Registered Aug. 28, 2012**

**Int. Cls.: 1, 5, 9, and 10**

FOR: ASSAYS AND REAGENTS FOR BLOOD AND PLASMA RESEARCH PURPOSES, IN CLASS 1 (U.S. CLS. 1, 5, 6, 10, 26 AND 46).

**TRADEMARK**

FIRST USE 12-31-1950; IN COMMERCE 12-31-1950.

**PRINCIPAL REGISTER**

FOR: MEDICAL DIAGNOSTIC ASSAYS AND REAGENTS FOR TESTING AND SCREENING OF BLOOD AND PLASMA, IN CLASS 5 (U.S. CLS. 6, 18, 44, 46, 51 AND 52).

FIRST USE 12-31-1950; IN COMMERCE 12-31-1950.

FOR: COMPUTER SOFTWARE FOR USE IN DIAGNOSTIC TESTING, SCREENING, AND MANAGEMENT OF BLOOD AND PLASMA, NAMELY, SOFTWARE THAT ALLOWS BLOOD AND PLASMA INFORMATION TO BE RECORDED AND MAINTAINED, INSTRUMENTS TO BE MONITORED, AND QUALITY CONTROL TO BE MANAGED, IN CLASS 9 (U.S. CLS. 21, 23, 26, 36 AND 38).

FIRST USE 12-31-1987; IN COMMERCE 12-31-1987.

FOR: MEDICAL EQUIPMENT, NAMELY, CHEMISTRY ANALYZER APPARATUS USED TO GENERATE DIAGNOSTIC TEST RESULTS FROM BLOOD AND OTHER BODY FLUIDS BY PROFESSIONALS IN HOSPITALS, LABORATORIES, CLINICS AND DOCTORS' OFFICES, IN CLASS 10 (U.S. CLS. 26, 39 AND 44).

FIRST USE 12-31-1987; IN COMMERCE 12-31-1987.

THE MARK CONSISTS OF STANDARD CHARACTERS WITHOUT CLAIM TO ANY PARTICULAR FONT, STYLE, SIZE, OR COLOR.

OWNER OF U.S. REG. NOS. 387,080, 698,176, AND OTHERS.

SN 85-183,412, FILED 11-23-2010.

JIM RINGLE, EXAMINING ATTORNEY



*David J. Kyros*

Director of the United States Patent and Trademark Office

# United States of America

United States Patent and Trademark Office

## THEODORA & CALLUM

**Reg. No. 4,199,212**

**Registered Aug. 28, 2012**

**Int. Cls.: 3, 18, 25, and  
35**

**TRADEMARK**

**SERVICE MARK**

**PRINCIPAL REGISTER**

THEODORA & CALLUM, LLC (UNITED STATES LIMITED LIABILITY COMPANY)  
915 BROADWAY  
20TH FLOOR  
NEW YORK, NY 10010

FOR: BAR SOAP; BATH OILS AND BATH SALTS; BODY LOTION; COLOGNES, PERFUMES AND COSMETICS; HAIR CONDITIONERS; SHAMPOOS; SHOWER AND BATH GEL, IN CLASS 3 (U.S. CLS. 1, 4, 6, 50, 51 AND 52).

FIRST USE 5-25-2012; IN COMMERCE 5-25-2012.

FOR: WALLETS, IN CLASS 18 (U.S. CLS. 1, 2, 3, 22 AND 41).

FIRST USE 5-25-2012; IN COMMERCE 5-25-2012.

FOR: BATHING SUITS; BELTS; BOTTOMS; BRAS; JEANS; JOGGING SUITS; LEGGINGS; LINGERIE; PAJAMAS; PANTS; SHIRTS; SHORTS; SKORTS; SUITS; SWEATERS; TOPS; UNDERWEAR, IN CLASS 25 (U.S. CLS. 22 AND 39).

FIRST USE 5-25-2012; IN COMMERCE 5-25-2012.

FOR: ON-LINE RETAIL STORE SERVICES FEATURING COLOGNES, PERFUMES, COSMETICS, BATH AND BODY PRODUCTS AND BELTS; RETAIL STORE SERVICES FEATURING COLOGNES, PERFUMES, COSMETICS, BATH AND BODY PRODUCTS AND BELTS, IN CLASS 35 (U.S. CLS. 100, 101 AND 102).

FIRST USE 5-25-2012; IN COMMERCE 5-25-2012.

THE MARK CONSISTS OF STANDARD CHARACTERS WITHOUT CLAIM TO ANY PARTICULAR FONT, STYLE, SIZE, OR COLOR.

SN 85-183,730, FILED 11-23-2010.

FLORENTINA BLANDU, EXAMINING ATTORNEY



*David J. Kyros*

Director of the United States Patent and Trademark Office

# United States of America

United States Patent and Trademark Office

*Theodora  
& Callum*

**Reg. No. 4,199,213**

**Registered Aug. 28, 2012**

**Int. Cls.: 3, 18, 25, and  
35**

**TRADEMARK**

**SERVICE MARK**

**PRINCIPAL REGISTER**

THEODORA & CALLUM, LLC (UNITED STATES LIMITED LIABILITY COMPANY)  
915 BROADWAY  
20TH FLOOR  
NEW YORK, NY 10010

FOR: BAR SOAP; BATH OILS AND BATH SALTS; BODY LOTION; COLOGNES, PERFUMES AND COSMETICS; HAIR CONDITIONERS; SHAMPOOS; SHOWER AND BATH GEL, IN CLASS 3 (U.S. CLS. 1, 4, 6, 50, 51 AND 52).

FIRST USE 5-25-2012; IN COMMERCE 5-25-2012.

FOR: WALLETS, IN CLASS 18 (U.S. CLS. 1, 2, 3, 22 AND 41).

FIRST USE 5-25-2012; IN COMMERCE 5-25-2012.

FOR: BATHING SUITS; BELTS; BOTTOMS; BRAS; JEANS; JOGGING SUITS; LEGGINGS; LINGERIE; PAJAMAS; PANTS; SHIRTS; SHORTS; SKORTS; SUITS; SWEATERS; TOPS; UNDERWEAR, IN CLASS 25 (U.S. CLS. 22 AND 39).

FIRST USE 5-25-2012; IN COMMERCE 5-25-2012.

FOR: ON-LINE RETAIL STORE SERVICES FEATURING COLOGNES, PERFUMES, COSMETICS, BATH AND BODY PRODUCTS AND BELTS; RETAIL STORE SERVICES FEATURING COLOGNES, PERFUMES, COSMETICS, BATH AND BODY PRODUCTS AND BELTS, IN CLASS 35 (U.S. CLS. 100, 101 AND 102).

FIRST USE 5-25-2012; IN COMMERCE 5-25-2012.

THE MARK CONSISTS OF THE WORD "THEODORA" ABOVE THE WORDS "& CALLUM".

SN 85-183,822, FILED 11-23-2010.

FLORENTINA BLANDU, EXAMINING ATTORNEY



*David J. Kyros*

Director of the United States Patent and Trademark Office

# United States of America

United States Patent and Trademark Office



**Reg. No. 4,199,214**

**Registered Aug. 28, 2012**

**Int. Cl.: 20**

**TRADEMARK**

**PRINCIPAL REGISTER**

EVERGREEN PACKAGING INC. (DELAWARE CORPORATION)  
5350 POPLAR AVENUE, SUITE 600  
MEMPHIS, TN 38119

FOR: NON-METALLIC AND NON-PAPER CLOSURES AND CAPS FOR CARTONS, CONTAINERS, AND BOTTLES; PLASTIC LIDS; PLASTIC PACKAGING COMPONENTS FOR CONTAINERS AND CARTONS, NAMELY, DISPENSING AND CLOSABLE POUR SPOUTS AND CONTAINER AND CARTON CLOSURES, IN CLASS 20 (U.S. CLS. 2, 13, 22, 25, 32 AND 50).

FIRST USE 4-20-2012; IN COMMERCE 4-20-2012.

OWNER OF U.S. REG. NOS. 1,880,374, 3,796,017, AND OTHERS.

NO CLAIM IS MADE TO THE EXCLUSIVE RIGHT TO USE "PACKAGING", APART FROM THE MARK AS SHOWN.

THE MARK CONSISTS OF A HEXAGON DESIGN AND THE WORDS "EVERGREEN PACKAGING".

SN 85-183,975, FILED 11-23-2010.

HOWARD B. LEVINE, EXAMINING ATTORNEY



*David J. Kyffers*

Director of the United States Patent and Trademark Office



# United States of America

United States Patent and Trademark Office

## LOVE STRINGS

**Reg. No. 4,199,215**

**Registered Aug. 28, 2012**

**Int. Cl.: 14**

**TRADEMARK**

**PRINCIPAL REGISTER**

MR. DAVID FRIEDMAN (UNITED STATES INDIVIDUAL)  
11 REGENT DRIVE  
LAWRENCE, NY 11559

FOR: JEWELRY, IN CLASS 14 (U.S. CLS. 2, 27, 28 AND 50).

FIRST USE 9-15-2010; IN COMMERCE 9-15-2010.

THE MARK CONSISTS OF STANDARD CHARACTERS WITHOUT CLAIM TO ANY PARTICULAR FONT, STYLE, SIZE, OR COLOR.

NO CLAIM IS MADE TO THE EXCLUSIVE RIGHT TO USE "STRINGS", APART FROM THE MARK AS SHOWN.

SN 85-184,402, FILED 11-24-2010.

KATHLEEN LORENZO, EXAMINING ATTORNEY



*David J. Kyffers*

Director of the United States Patent and Trademark Office

# United States of America

United States Patent and Trademark Office

## TINY TOWNE

**Reg. No. 4,199,216**

TINY TOWNE, LLC (GEORGIA LIMITED LIABILITY COMPANY)  
1800 WILLOW TRAIL PARKWAY  
NORTHCROSS, GA 30093

**Registered Aug. 28, 2012**

**Int. Cl.: 41**

FOR: AMUSEMENT PARKS; VEHICLE DRIVING INSTRUCTION, IN CLASS 41 (U.S. CLS. 100, 101 AND 107).

**SERVICE MARK**

FIRST USE 6-15-2011; IN COMMERCE 6-15-2011.

**PRINCIPAL REGISTER**

THE MARK CONSISTS OF STANDARD CHARACTERS WITHOUT CLAIM TO ANY PARTICULAR FONT, STYLE, SIZE, OR COLOR.

SN 85-184,636, FILED 11-24-2010.

KIMBERLY FRYE, EXAMINING ATTORNEY



*David J. Kybas*

Director of the United States Patent and Trademark Office

# United States of America

United States Patent and Trademark Office

## PENNY MUSTARD

**Reg. No. 4,199,217**

**Registered Aug. 28, 2012**

**Int. Cl.: 35**

**SERVICE MARK**

**PRINCIPAL REGISTER**

HUTH BEDROOMS, INC. (WISCONSIN CORPORATION)  
6800 INDUSTRIAL LOOP  
GREENDALE, WI 53129

FOR: RETAIL STORE SERVICE, WHOLESALE FURNITURE STORES, ON-LINE RETAIL STORE SERVICES, MAIL ORDER AND MAIL ORDER CATALOGUE SERVICES, AND TELEPHONE SHOP AT HOME RETAIL SERVICES, ALL FEATURING BEDS, BED FRAMES, FUTONS, FUTON FRAMES, HEADBOARDS, FOOTBOARDS, ADJUSTABLE FOUNDATIONS FOR BEDS AND MATTRESSES, ADJUSTABLE BEDS, TRUNDLE BEDS, BUNK BEDS, SOFA BEDS, CRIBS, METAL AND NON-METAL BED FITTINGS, ARMOIRES, CABINETS, BOOKCASES, CHESTS, DRESSERS, BUREAUS, NIGHTSTANDS, DESKS, FILE CABINETS, STEP STOOLS, FOOT STOOLS, VANITIES, TABLES, CHAIRS, BENCHES, MIRRORS, MATTRESSES, BOX SPRINGS, FEATHERBEDS, MATTRESS PADS, MATTRESS COVERS, MATTRESS PROTECTORS, BED LINENS, BED SHEETS, BEDSPREADS, COVERLETS, COMFORTERS, COMFORTER COVERS, DUVET COVERS, BLANKETS, THROWS, PILLOW CASES, PILLOW SHAMS, PILLOW PROTECTORS, BED SKIRTS, PILLOWS, BOLSTERS AND RUGS, LAMPS, CLOCKS, AND DECORATIVE ACCESSORIES, NAMELY, FRAMED PICTURES, FRAMED PHOTOS AND FRAMED ARTWORK, METAL WALL ART, VASES, STATUES, STATUETTES, FIGURINES, CANDLES, CANDLE HOLDERS, FINIALS, CHARGERS, PERFUME BOTTLES, JARS, URNS, BOWLS, TRAYS, ENTERTAINMENT CENTERS, SOFAS, SECTIONALS, RECLINERS, OTTOMANS, SOFA TABLES, COFFEE TABLES, END TABLES, CHAISES, CUBES, DAYBEDS, MEDIA STORAGE, DINING TABLES, DINING CHAIRS, BARSTOOLS, DINING BENCHES, BUFFETS, HUTCHES, CURIOS, OFFICE CHAIRS, FILING CABINETS, CONSOLES, COUNTERS, ISLANDS, LIGHTING, COMPUTER STANDS, MURPHY BEDS, WALL BEDS, DRY BARS, WET BARS, TRELIS, ROOM DIVIDER, KITCHEN CABINETS, WINE RACKS, WALL SCONCES, COAT RACKS, SLEEPER SOFAS, EASELS, STORAGE BEDS, PIER WALLS, PLATFORM BEDS, IRON BEDS, FABRIC BEDS, MIRROR PANES, COMPONENT DECKS, TOVIDIA, VANITIES, GUN CABINETS, HUTCHES, STOOLS, LAMPS, RUGS, CURTAINS, TOWELS, TV STANDS, TV STORAGE, LOVESEATS, BASKETS, FLOWERS, PLANTS, TREES, CLOSET COMPONENTS, SERVERS, SIDEBARDS AND QUILT RACKS, IN CLASS 35 (U.S. CLS. 100, 101 AND 102).



*David J. Kybas*

Director of the United States Patent and Trademark Office

FIRST USE 1-1-2011; IN COMMERCE 1-15-2011.

THE MARK CONSISTS OF STANDARD CHARACTERS WITHOUT CLAIM TO ANY PARTICULAR FONT, STYLE, SIZE, OR COLOR.

**Reg. No. 4,199,217** SN 85-184,801, FILED 11-24-2010.

DAYNA BROWNE, EXAMINING ATTORNEY

# United States of America

United States Patent and Trademark Office

## BUILDING ATHLETES FROM THE INSIDE OUT

**Reg. No. 4,199,218**

**Registered Aug. 28, 2012**

**Int. Cls.: 5, 29, and 32**

**TRADEMARK**

**PRINCIPAL REGISTER**

CYTOSPORT, INC. (CALIFORNIA CORPORATION)  
4795 INDUSTRIAL WAY  
BENICIA, CA 94510

FOR: DIETARY AND NUTRITIONAL SUPPLEMENTS; MEAL REPLACEMENT AND DIETARY SUPPLEMENT DRINKS; MEAL REPLACEMENT AND DIETARY SUPPLEMENT DRINK MIXES; PRE-MIXED LIQUID MEAL REPLACEMENT BEVERAGES; PRE-MIXED NUTRITIONALLY FORTIFIED BEVERAGES; DIETARY AND NUTRITIONAL SUPPLEMENTS IN POWDERED FORM; PROTEIN-BASED, NUTRIENT DENSE MEAL REPLACEMENT BARS, IN CLASS 5 (U.S. CLS. 6, 18, 44, 46, 51 AND 52).

FIRST USE 12-1-2010; IN COMMERCE 12-1-2010.

FOR: NUTRITIONALLY FORTIFIED SNACK BARS, NAMELY, PROTEIN BASED, NUTRIENT-DENSE SNACK BARS, IN CLASS 29 (U.S. CL. 46).

FIRST USE 5-1-2011; IN COMMERCE 5-1-2011.

FOR: SPORTS DRINKS; POWDER SPORTS DRINK MIXES, IN CLASS 32 (U.S. CLS. 45, 46 AND 48).

FIRST USE 12-1-2010; IN COMMERCE 12-1-2010.

THE MARK CONSISTS OF STANDARD CHARACTERS WITHOUT CLAIM TO ANY PARTICULAR FONT, STYLE, SIZE, OR COLOR.

SN 85-184,911, FILED 11-24-2010.

SALLY SHIH, EXAMINING ATTORNEY



*David J. Kyros*

Director of the United States Patent and Trademark Office

# United States of America

United States Patent and Trademark Office

# DURA FIT

**Reg. No. 4,199,219**

CAN-AMERICAN CORRUGATING CO. LTD. (CANADA CORPORATION)  
BOX 9, 1 CANAM ROAD

**Registered Aug. 28, 2012**

MARGARET, MANITOBA, CANADA R0K1J0

**Int. Cl.: 6**

FOR: METAL CLADDING FOR BUILDINGS, IN CLASS 6 (U.S. CLS. 2, 12, 13, 14, 23, 25 AND 50).

**TRADEMARK**

FIRST USE 5-23-2012; IN COMMERCE 5-23-2012.

**PRINCIPAL REGISTER**

THE MARK CONSISTS OF STANDARD CHARACTERS WITHOUT CLAIM TO ANY PARTICULAR FONT, STYLE, SIZE, OR COLOR.

PRIORITY CLAIMED UNDER SEC. 44(D) ON CANADA APPLICATION NO. 1505136, FILED 11-23-2010.

SN 85-184,988, FILED 11-24-2010.

CHARLOTTE CORWIN, EXAMINING ATTORNEY



*David J. Kybas*

Director of the United States Patent and Trademark Office

# United States of America

United States Patent and Trademark Office

## Millennial Generation



**Reg. No. 4,199,220**

**Registered Aug. 28, 2012**

**Int. Cl.: 25**

**TRADEMARK**

**PRINCIPAL REGISTER**

JENKINS BUSINESS INVESTMENTS INC./ MILLENNIAL GENERATION (ILLINOIS CORPORATION)  
P.O. BOX 335  
TOMAH, WI 54660

FOR: DRESSES; FLEECE BOTTOMS; FLEECE TOPS; GLOVES; HATS; JACKETS; SANDALS; SCARVES; SOCKS; T-SHIRTS, IN CLASS 25 (U.S. CLS. 22 AND 39).

FIRST USE 11-23-2011; IN COMMERCE 11-23-2011.

THE MARK CONSISTS OF THE STYLIZED WORDS "MILLENNIAL GENERATION" ABOVE AN ABSTRACT DESIGN THAT GENERALLY APPEARS AS A FIVE POINT STAR WITH CHEVRONS ON EACH SIDE THAT BEND INWARD TOWARDS THE STAR.

SN 85-185,762, FILED 11-28-2010.

DAVID TAYLOR, EXAMINING ATTORNEY



*David J. Kyffers*

Director of the United States Patent and Trademark Office

# United States of America

United States Patent and Trademark Office

# HOMEMAX

**Reg. No. 4,199,221**

**Registered Aug. 28, 2012**

**Int. Cl.: 35**

**SERVICE MARK**

**PRINCIPAL REGISTER**

BETTER BUY WHOLESALE HOLDINGS, LLC (NEW YORK LIMITED LIABILITY COMPANY)  
P.O. BOX 670264  
FLUSHING, NY 11367

FOR: RETAIL STORE SERVICES FEATURING CONSUMER GOODS, HOUSEWARES, HARDWARE, TOYS, RUGS, TELEPHONES, LUGGAGE, PERFUME, HEALTH AND BEAUTY AIDES, PET SUPPLIES, KITCHENWARE, IN CLASS 35 (U.S. CLS. 100, 101 AND 102).

FIRST USE 3-1-2011; IN COMMERCE 3-1-2011.

THE MARK CONSISTS OF STANDARD CHARACTERS WITHOUT CLAIM TO ANY PARTICULAR FONT, STYLE, SIZE, OR COLOR.

SN 85-186,024, FILED 11-29-2010.

BARBARA BROWN, EXAMINING ATTORNEY



*David J. Kybas*

Director of the United States Patent and Trademark Office



# United States of America

United States Patent and Trademark Office

# PRODUSEAL

**Reg. No. 4,199,222**

EUROFRESH, INC. (DELAWARE CORPORATION)  
26050 SOUTH EUROFRESH AVENUE  
WILLCOX, AZ 85643

**Registered Aug. 28, 2012**

**Int. Cl.: 31**

FOR: FRESH PRODUCE, NAMELY, CUCUMBERS, IN CLASS 31 (U.S. CLS. 1 AND 46).

**TRADEMARK**

FIRST USE 3-15-2012; IN COMMERCE 3-15-2012.

**PRINCIPAL REGISTER**

THE MARK CONSISTS OF STANDARD CHARACTERS WITHOUT CLAIM TO ANY PARTICULAR FONT, STYLE, SIZE, OR COLOR.

SN 85-186,100, FILED 11-29-2010.

LINDA ORNDORFF, EXAMINING ATTORNEY



*David J. Kyffers*

Director of the United States Patent and Trademark Office

# United States of America

United States Patent and Trademark Office

## AMERICAN PANTRY FOOD, EQUIPMENT & KNOWLEDGE FOR THE UNEXPECTED

**Reg. No. 4,199,223**

AMERICAN PANTRY, LLC (MINNESOTA LIMITED LIABILITY COMPANY)  
1660 SOUTH HIGHWAY 100, SUITE 130  
ST. LOUIS PARK, MN 55416

**Registered Aug. 28, 2012**

**Int. Cls.: 35 and 45**

FOR: ONLINE RETAIL STORE SERVICES FEATURING SUPPLIES FOR EMERGENCY AND DISASTER PREPAREDNESS, IN CLASS 35 (U.S. CLS. 100, 101 AND 102).

**SERVICE MARK**

FIRST USE 4-28-2010; IN COMMERCE 6-3-2010.

**PRINCIPAL REGISTER**

FOR: PROVIDING A WEBSITE FEATURING INFORMATION IN THE FIELD OF EMERGENCY AND DISASTER PREPAREDNESS, IN CLASS 45 (U.S. CLS. 100 AND 101).

FIRST USE 4-28-2010; IN COMMERCE 6-3-2010.

THE MARK CONSISTS OF STANDARD CHARACTERS WITHOUT CLAIM TO ANY PARTICULAR FONT, STYLE, SIZE, OR COLOR.

NO CLAIM IS MADE TO THE EXCLUSIVE RIGHT TO USE "AMERICAN", APART FROM THE MARK AS SHOWN.

SN 85-186,168, FILED 11-29-2010.

MARK SPARACINO, EXAMINING ATTORNEY



*David J. Kyros*

Director of the United States Patent and Trademark Office

# United States of America

United States Patent and Trademark Office

# GLU

**Reg. No. 4,199,224**

**Registered Aug. 28, 2012**

**Int. Cl.: 44**

**SERVICE MARK**

**PRINCIPAL REGISTER**

TID FIRST, INC. (DELAWARE CORPORATION)  
11 AVENUE DE LAFAYETTE  
5TH FLOOR  
BOSTON, MA 02111

FOR: PROVIDING INFORMATION TO MOBILE DEVICE USERS IN THE FIELD OF DIABETES; PROVIDING INFORMATION OVER THE INTERNET IN THE FIELD OF DIABETES, IN CLASS 44 (U.S. CLS. 100 AND 101).

FIRST USE 11-29-2010; IN COMMERCE 6-5-2012.

THE MARK CONSISTS OF STANDARD CHARACTERS WITHOUT CLAIM TO ANY PARTICULAR FONT, STYLE, SIZE, OR COLOR.

SN 85-186,742, FILED 11-29-2010.

ROSELLE HERRERA, EXAMINING ATTORNEY



*David J. Kybas*

Director of the United States Patent and Trademark Office

# United States of America

United States Patent and Trademark Office

## GENXTRAORDINARY

**Reg. No. 4,199,225**

**Registered Aug. 28, 2012**

**Int. Cl.: 41**

**SERVICE MARK**

**PRINCIPAL REGISTER**

HUMAN RESOURCES ASSOCIATION OF NEW YORK (NEW YORK NON-PROFIT CORPORATION)  
1255 WHITEHORSE-MERCERVILLE ROAD  
BUILDING B-SUITE 514  
TRENTON, NJ 08619

FOR: EDUCATION SERVICES, NAMELY, MENTORING IN THE FIELD OF HUMAN RESOURCES; EDUCATIONAL SERVICES, NAMELY, CONDUCTING MEETINGS, TRAINING PROGRAMS, SEMINARS AND WORKSHOPS IN THE FIELD OF HUMAN RESOURCES; WORKSHOPS AND SEMINARS IN THE FIELD OF HUMAN RESOURCES, IN CLASS 41 (U.S. CLS. 100, 101 AND 107).

FIRST USE 5-31-2011; IN COMMERCE 5-31-2011.

THE MARK CONSISTS OF STANDARD CHARACTERS WITHOUT CLAIM TO ANY PARTICULAR FONT, STYLE, SIZE, OR COLOR.

SN 85-187,028, FILED 11-30-2010.

COLLEEN KEARNEY, EXAMINING ATTORNEY



*David J. Kyros*

Director of the United States Patent and Trademark Office

# United States of America

United States Patent and Trademark Office

## LIVING SALAD

**Reg. No. 4,199,226**

**Registered Aug. 28, 2012**

**Int. Cl.: 31**

**TRADEMARK**

**PRINCIPAL REGISTER**

THE GRACIOUS LIVING GROUP, LLC (CALIFORNIA LIMITED LIABILITY COMPANY)  
19951 GLEN HAVEN DRIVE  
YORBA LINDA, CA 92886

FOR: LIVE FISH FOR FOOD PURPOSES; LIVE PLANTS, NAMELY, LETTUCE, SPINACH, ARUGULA, GREENS, NAMELY, CRESS, ENDIVE, ESCAROLE, MICRO-GREENS, SPROUTS, WHEATGRASS, MUSTARD GREENS, CHARD, BROCCOLI, FRESH HERBS, CARROTS, TOMATOES, VEGETABLES, NAMELY, CARROTS, CUCUMBERS, SQUASH, PEAS, BEANS, EGGPLANTS, ZUCCHINI, PEPPERS, AND CABBAGES; LIVE LOBSTERS; LIVE OYSTERS; LIVE SHRIMP; UNPROCESSED ANCHOVIES; UNPROCESSED APPLES; UNPROCESSED APRICOTS; UNPROCESSED ARTICHOKE; UNPROCESSED ASPARAGUS; UNPROCESSED AVOCADOS; UNPROCESSED BEAN SPROUTS; UNPROCESSED BEANS; UNPROCESSED BEETS; UNPROCESSED BLUEBERRIES; UNPROCESSED CABBAGE; UNPROCESSED COLLARD GREENS; UNPROCESSED CORN; UNPROCESSED DATES; UNPROCESSED FRUITS; UNPROCESSED GINGER; UNPROCESSED HEARTS OF PALM; UNPROCESSED HERBS; UNPROCESSED LETTUCE; UNPROCESSED MUSHROOMS; UNPROCESSED OLIVES; UNPROCESSED ONIONS; UNPROCESSED ORANGES; UNPROCESSED PEACHES; UNPROCESSED PEPPERS; UNPROCESSED POTATOES; UNPROCESSED TOMATOES; UNPROCESSED VEGETABLES; UNPROCESSED ZUCCHINI, IN CLASS 31 (U.S. CLS. 1 AND 46).

FIRST USE 3-1-2012; IN COMMERCE 3-1-2012.

THE MARK CONSISTS OF STANDARD CHARACTERS WITHOUT CLAIM TO ANY PARTICULAR FONT, STYLE, SIZE, OR COLOR.

NO CLAIM IS MADE TO THE EXCLUSIVE RIGHT TO USE "SALAD", APART FROM THE MARK AS SHOWN.

SN 85-187,415, FILED 11-30-2010.

KATHLEEN M. VANSTON, EXAMINING ATTORNEY



*David J. Kybas*

Director of the United States Patent and Trademark Office

# United States of America

United States Patent and Trademark Office

# 丸亀製麺

**Reg. No. 4,199,227**

TORIDOLL USA CORPORATION (HAWAII CORPORATION)  
2310 KUHIO AVENUE  
HONOLULU, HI 96815

**Registered Aug. 28, 2012**

**Int. Cl.: 43**

FOR: RESTAURANT AND CAFE SERVICES, NAMELY, RESTAURANTS AND CAFES THAT SERVE JAPANESE-STYLE NOODLES SUCH AS UDON; CATERING OF FOOD AND DRINKS; SNACK BAR AND CANTEEN SERVICES; SELF-SERVICE RESTAURANTS; MOBILE RESTAURANT SERVICES, IN CLASS 43 (U.S. CLS. 100 AND 101).

**SERVICE MARK**

**PRINCIPAL REGISTER**

FIRST USE 4-1-2011; IN COMMERCE 4-1-2011.

NO CLAIM IS MADE TO THE EXCLUSIVE RIGHT TO USE THE NON-LATIN CHARACTERS WHICH TRANSLITERATE TO "SEIMEN, APART FROM THE MARK AS SHOWN.

THE NON-LATIN CHARACTERS IN THE MARK TRANSLITERATE TO "MARUKAME SEIMEN" AND THE WORDING "MARUKAME" HAS NO MEANING IN A FOREIGN LANGUAGE AND THE WORDING "SEIMEN" MEANS "NOODLE MAKING" IN ENGLISH.

THE MARK CONSISTS OF FOUR JAPANESE CHARACTERS.

SN 85-187,627, FILED 11-30-2010.

BILL DAWE, EXAMINING ATTORNEY



*David J. Kyros*

Director of the United States Patent and Trademark Office

# United States of America

United States Patent and Trademark Office

# MARUKAME

**Reg. No. 4,199,228**

TORIDOLL USA CORPORATION (HAWAII CORPORATION)  
2310 KUHIO AVENUE  
HONOLULU, HI 96815

**Registered Aug. 28, 2012**

**Int. Cl.: 43**

FOR: RESTAURANT AND CAFE SERVICES, NAMELY, RESTAURANTS AND CAFES THAT SERVE JAPANESE-STYLE NOODLES SUCH AS UDON; CATERING OF FOOD AND DRINKS; SNACK BAR AND CANTEEN SERVICES; SELF-SERVICE RESTAURANTS; MOBILE RESTAURANT SERVICES, IN CLASS 43 (U.S. CLS. 100 AND 101).

**SERVICE MARK**

**PRINCIPAL REGISTER**

FIRST USE 4-1-2011; IN COMMERCE 4-1-2011.

THE MARK CONSISTS OF STANDARD CHARACTERS WITHOUT CLAIM TO ANY PARTICULAR FONT, STYLE, SIZE, OR COLOR.

THE WORDING "MARUKAME" HAS NO MEANING IN A FOREIGN LANGUAGE.

SN 85-187,629, FILED 11-30-2010.

BILL DAWE, EXAMINING ATTORNEY



*David J. Kyffers*

Director of the United States Patent and Trademark Office

# United States of America

United States Patent and Trademark Office



**Reg. No. 4,199,229**

**Registered Aug. 28, 2012**

**Int. Cl.: 43**

**SERVICE MARK**

**PRINCIPAL REGISTER**

TORIDOLL USA CORPORATION (HAWAII CORPORATION)  
2310 KUHIO AVENUE  
HONOLULU, HI 96815

FOR: RESTAURANT AND CAFE SERVICES, NAMELY, RESTAURANTS AND CAFES THAT SERVE JAPANESE-STYLE NOODLES SUCH AS UDON; CATERING OF FOOD AND DRINKS; SNACK BAR AND CANTEEN SERVICES; SELF-SERVICE RESTAURANTS; MOBILE RESTAURANT SERVICES, IN CLASS 43 (U.S. CLS. 100 AND 101).

FIRST USE 4-1-2011; IN COMMERCE 4-1-2011.

NO CLAIM IS MADE TO THE EXCLUSIVE RIGHT TO USE "JAPANESE NOODLE" OR "UDON" OR "TEMPURA OR MUSUBI" OR THE NON-LATIN CHARACTERS WHICH TRANSLITERATE TO SEIMEN, APART FROM THE MARK AS SHOWN.

THE NON-LATIN CHARACTERS IN THE MARK TRANSLITERATE TO "MARUKAME SEIMEN" AND THE WORDING "MARUKAME" HAS NO MEANING IN A FOREIGN LANGUAGE AND THE WORDING "SEIMEN" MEANS "NOODLE MAKING" IN ENGLISH.

THE MARK CONSISTS OF A SQUARE WHICH CONTAINS THE WORDING "JAPANESE NOODLE" FOLLOWED BY THE WORD "MARUKAME", SEPARATED TO HIGHLIGHT THE SYLLABLES "MA", "RU", "KA", AND "ME", PLUS FOUR JAPANESE CHARACTERS, ALONG WITH THE WORDS "UDON", "TEMPURA", AND "MUSUBI", AND AN ORNAMENTAL BACKGROUND SHOWING STYLIZED WAVES OF WATER.

THE WORDING "MA RU KA ME" HAS NO MEANING IN A FOREIGN LANGUAGE.

SN 85-187,632, FILED 11-30-2010.

BILL DAWE, EXAMINING ATTORNEY



*David J. Kyros*

Director of the United States Patent and Trademark Office



# United States of America

United States Patent and Trademark Office

# WEIDT

**Reg. No. 4,199,230**

THE WEIDT GROUP, INC. (MINNESOTA CORPORATION)  
5800 BAKER ROAD  
MINNETONKA, MN 55345

**Registered Aug. 28, 2012**

**Int. Cl.: 35**

FOR: PROVIDING INFORMATION IN THE FIELD OF ENERGY EFFICIENCY; ENERGY USAGE MANAGEMENT INFORMATION SERVICES; ENERGY USAGE MANAGEMENT; ENERGY AUDITING; VALUE ENGINEERING, NAMELY, COST ANALYSIS; COST/PRICE ANALYSIS; AND COST ANALYSES, IN CLASS 35 (U.S. CLS. 100, 101 AND 102).

**SERVICE MARK**

**PRINCIPAL REGISTER**

FIRST USE 2-23-2012; IN COMMERCE 2-23-2012.

THE MARK CONSISTS OF STANDARD CHARACTERS WITHOUT CLAIM TO ANY PARTICULAR FONT, STYLE, SIZE, OR COLOR.

SEC. 2(F).

OWNER OF U.S. REG. NOS. 3,338,694, 3,434,052, AND OTHERS.

SN 85-187,989, FILED 12-1-2010.

TINA BROWN, EXAMINING ATTORNEY



*David J. Kybas*

Director of the United States Patent and Trademark Office

# United States of America

United States Patent and Trademark Office

## FORMYCHILDREN

**Reg. No. 4,199,231**

**Registered Aug. 28, 2012**

**Int. Cl.: 39**

**SERVICE MARK**

**PRINCIPAL REGISTER**

FORMYCHILDREN, LLC (MINNESOTA LIMITED LIABILITY COMPANY)  
C/O MICHAEL WRIGHT  
4060 PIPEWOOD LANE  
CHANHASSEN, MN 55331

FOR: ELECTRONIC STORAGE OF DIGITAL CONTENT INCLUDING TEXT, PHOTOGRAPHS, IMAGES, VIDEO, AND AUDIO, IN CLASS 39 (U.S. CLS. 100 AND 105).

FIRST USE 4-28-2012; IN COMMERCE 4-28-2012.

THE MARK CONSISTS OF STANDARD CHARACTERS WITHOUT CLAIM TO ANY PARTICULAR FONT, STYLE, SIZE, OR COLOR.

SN 85-188,022, FILED 12-1-2010.

DOUGLAS LEE, EXAMINING ATTORNEY



*David J. Kyffers*

Director of the United States Patent and Trademark Office

# United States of America

United States Patent and Trademark Office

# BELLAFILL

**Reg. No. 4,199,232**

SUNEVA MEDICAL, INC. (DELAWARE CORPORATION)  
5870 PACIFIC CENTER BLVD.  
SAN DIEGO, CA 92121

**Registered Aug. 28, 2012**

**Int. Cls.: 5 and 10**

FOR: INJECTABLE DERMAL FILLERS, IN CLASS 5 (U.S. CLS. 6, 18, 44, 46, 51 AND 52).

FIRST USE 5-0-2012; IN COMMERCE 5-0-2012.

**TRADEMARK**

FOR: MEDICAL DEVICES, ACCESSORIES, AND PREPARATIONS, NAMELY, MEDICAL, SURGICAL, AND ORTHOPEDIC IMPLANTS MADE OF ARTIFICIAL MATERIALS, IN CLASS 10 (U.S. CLS. 26, 39 AND 44).

**PRINCIPAL REGISTER**

FIRST USE 5-0-2012; IN COMMERCE 5-0-2012.

THE MARK CONSISTS OF STANDARD CHARACTERS WITHOUT CLAIM TO ANY PARTICULAR FONT, STYLE, SIZE, OR COLOR.

SN 85-188,311, FILED 12-1-2010.

DAWN FELDMAN, EXAMINING ATTORNEY



*David J. Kybas*

Director of the United States Patent and Trademark Office

# United States of America

United States Patent and Trademark Office

## NYA NATIONAL YOGURT ASSOCIATION CULTURES FOR LIFE

**Reg. No. 4,199,233**

**Registered Aug. 28, 2012**

**Int. Cl.: 35**

**SERVICE MARK**

**PRINCIPAL REGISTER**

NATIONAL YOGURT ASSOCIATION (D.C. NON-PROFIT CORPORATION)  
2000 CORPORATE RIDGE, SUITE 1000  
MCLEAN, VA 22102

FOR: ASSOCIATION SERVICES, NAMELY, PROMOTING THE INTERESTS OF PRODUCERS AND SELLERS OF YOGURT AND FOOD OR BEVERAGES CONTAINING LIVE CULTURES; GOVERNMENT RELATIONS CONSULTANCY; ADVERTISING AND PROMOTING THE GOODS OF OTHERS, NAMELY, YOGURT AND FOOD OR BEVERAGES CONTAINING LIVE CULTURES; PROMOTING PUBLIC AWARENESS OF FOOD NUTRITION AND SAFETY; PROVIDING A WEBSITE FEATURING INFORMATION ABOUT GOVERNMENT RELATIONS AND CONSUMERS AFFAIRS RELATING TO THE YOGURT INDUSTRY AND INFORMATION PROMOTING THE SALE AND USE OF YOGURT AND FOOD OR BEVERAGES CONTAINING LIVE CULTURES, IN CLASS 35 (U.S. CLS. 100, 101 AND 102).

FIRST USE 5-17-2012; IN COMMERCE 5-17-2012.

THE MARK CONSISTS OF STANDARD CHARACTERS WITHOUT CLAIM TO ANY PARTICULAR FONT, STYLE, SIZE, OR COLOR.

SEC. 2(F) AS TO "NATIONAL YOGURT ASSOCIATION".

NO CLAIM IS MADE TO THE EXCLUSIVE RIGHT TO USE "ASSOCIATION", APART FROM THE MARK AS SHOWN.

SN 85-188,332, FILED 12-1-2010.

PATRICIA EVANKO, EXAMINING ATTORNEY



*David J. Kyros*

Director of the United States Patent and Trademark Office

# United States of America

United States Patent and Trademark Office

# ILOMYS

**Reg. No. 4,199,234**

**Registered Aug. 28, 2012**

**Int. Cl.: 3**

**TRADEMARK**

**PRINCIPAL REGISTER**

DEUG GON MOON (REPUBLIC OF KOREA INDIVIDUAL)  
114-501 DAELIM GANGBYEON APT.  
EUNGBONG-DONG, SEONGDONG-GU  
SEOUL, REPUBLIC OF KOREA

FOR: COSMETICS; COSMETICS AND MAKE-UP; BODY LOTIONS; COSMETIC PREPARATIONS FOR SKIN CARE; SKIN CLEANSERS; COSMETIC SUN-PROTECTING PREPARATIONS; COSMETIC PREPARATIONS FOR SLIMMING PURPOSES; FOUNDATIONS; FACE AND BODY CREAMS; MASK PACK FOR COSMETIC PURPOSES; BEAUTY MASKS; BEAUTY SOAP, IN CLASS 3 (U.S. CLS. 1, 4, 6, 50, 51 AND 52).

FIRST USE 12-2-2008; IN COMMERCE 5-26-2010.

THE MARK CONSISTS OF STANDARD CHARACTERS WITHOUT CLAIM TO ANY PARTICULAR FONT, STYLE, SIZE, OR COLOR.

THE WORDING "ILOMYS" HAS NO MEANING IN A FOREIGN LANGUAGE.

SN 85-188,587, FILED 12-1-2010.

JOHN WILKE, EXAMINING ATTORNEY



*David J. Kyffers*

Director of the United States Patent and Trademark Office

# United States of America

United States Patent and Trademark Office

## CHILLI BEANS

**Reg. No. 4,199,235**

BALGLOW FINANCE S/A (URUGUAY CORPORATION)

**Registered Aug. 28, 2012**

AV. GENERAL FLORES, 2422  
MONTEVIDEO, URUGUAY

**Int. Cl.: 25**

FOR: CLOTHING, NAMELY, T-SHIRTS, BEACH-WEAR, SWIMWEAR, SWIMTRUNKS,  
SHORTS, SHIRTS, FOOTWEAR, NAMELY, THONGS, IN CLASS 25 (U.S. CLS. 22 AND 39).

**TRADEMARK**

FIRST USE 9-1-2011; IN COMMERCE 9-1-2011.

**PRINCIPAL REGISTER**

THE MARK CONSISTS OF STANDARD CHARACTERS WITHOUT CLAIM TO ANY PAR-  
TICULAR FONT, STYLE, SIZE, OR COLOR.

SN 85-188,943, FILED 12-2-2010.

JOHN WILKE, EXAMINING ATTORNEY



*David J. Kyros*

Director of the United States Patent and Trademark Office

# United States of America

United States Patent and Trademark Office

## SCADE SYSTEM

**Reg. No. 4,199,236**

**Registered Aug. 28, 2012**

**Int. Cl.: 9**

**TRADEMARK**

**PRINCIPAL REGISTER**

ESTEREL TECHNOLOGIES, INC. (CALIFORNIA CORPORATION)  
SUITE 818  
444 CASTRO STREE  
MOUNTAIN VIEW, CA 94041

FOR: COMPUTER SOFTWARE DEVELOPMENT TOOLS; COMPUTER SOFTWARE PLATFORMS FOR CREATING EMBEDDED SOFTWARE USED FOR CRITICAL FUNCTIONS AND TO CREATE EXECUTABLE SPECIFICATIONS, FORMAL TESTS, AND AUTOMATICALLY GENERATED CODE, IN CLASS 9 (U.S. CLS. 21, 23, 26, 36 AND 38).

FIRST USE 2-22-2012; IN COMMERCE 2-22-2012.

THE MARK CONSISTS OF STANDARD CHARACTERS WITHOUT CLAIM TO ANY PARTICULAR FONT, STYLE, SIZE, OR COLOR.

OWNER OF U.S. REG. NOS. 3,020,031, 3,575,709, AND OTHERS.

NO CLAIM IS MADE TO THE EXCLUSIVE RIGHT TO USE "SYSTEM", APART FROM THE MARK AS SHOWN.

SN 85-189,440, FILED 12-2-2010.

CHRISTINE COOPER, EXAMINING ATTORNEY



*David J. Kyros*

Director of the United States Patent and Trademark Office

# United States of America

United States Patent and Trademark Office

## BECAUSE LIFE IS SHORT

**Reg. No. 4,199,237**

**Registered Aug. 28, 2012**

**Int. Cl.: 25**

**TRADEMARK**

**PRINCIPAL REGISTER**

JADEN LAM, LLC (NEW YORK LIMITED LIABILITY COMPANY)  
SUITE 900  
750 THIRD AVENUE  
NEW YORK, NY 10017

FOR: MEN'S CLOTHING, NAMELY, SHIRTS, BLAZERS, SUITS, VESTS, PANTS, SHORTS, SWEATERS, BELTS, HATS, TIES, SOCKS, SHOES, OUTERWEAR IN THE NATURE OF OVERCOATS, JACKETS AND RAINCOATS AND SPORTSWEAR IN THE NATURE OF SWEAT SHIRTS, SWEAT PANTS AND SWEAT SHORTS, IN CLASS 25 (U.S. CLS. 22 AND 39).

FIRST USE 4-2-2012; IN COMMERCE 4-2-2012.

THE MARK CONSISTS OF STANDARD CHARACTERS WITHOUT CLAIM TO ANY PARTICULAR FONT, STYLE, SIZE, OR COLOR.

SN 85-189,488, FILED 12-2-2010.

DAVID YONTEF, EXAMINING ATTORNEY



*David J. Kybas*

Director of the United States Patent and Trademark Office



# United States of America

United States Patent and Trademark Office

# NEOFACE

**Reg. No. 4,199,238**

**Registered Aug. 28, 2012**

**Int. Cl.: 9**

**TRADEMARK**

**PRINCIPAL REGISTER**

NIPPON DENKI KABUSHIKI KAISHA (JAPAN CORPORATION), DBA NEC CORPORATION,  
7-1, SHIBA 5-CHOME, MINATO-KU  
TOKYO, JAPAN

FOR: ELECTRONIC FACE RECOGNITION UNITS WHICH VERIFY AND IDENTIFY PERSONS/USERS IN THE FIELD OF PERSONAL AUTHENTICATION; COMPUTER HARDWARE; COMPUTER SOFTWARE FOR USE IN PROCESSING, STORING AND ACCESSING INFORMATION OF FACES IN ORDER TO VERIFY AND IDENTIFY THE PERSONS/USERS IN THE FIELD OF PERSONAL AUTHENTICATION; COMPUTER SOFTWARE FOR USE IN FACE RECOGNITION, IN CLASS 9 (U.S. CLS. 21, 23, 26, 36 AND 38).

FIRST USE 4-24-2012; IN COMMERCE 4-24-2012.

THE MARK CONSISTS OF STANDARD CHARACTERS WITHOUT CLAIM TO ANY PARTICULAR FONT, STYLE, SIZE, OR COLOR.

SN 85-190,123, FILED 12-3-2010.

TINA BROWN, EXAMINING ATTORNEY



*David J. Kyros*

Director of the United States Patent and Trademark Office

# United States of America

United States Patent and Trademark Office

# Lenstar Plus

**Reg. No. 4,199,239**

EASTMAN CHEMICAL COMPANY (DELAWARE CORPORATION)  
200 SOUTH WILCOX DRIVE  
KINGSPORT, TN 37660

**Registered Aug. 28, 2012**

**Int. Cl.: 1**

FOR: UNPROCESSED ARTIFICIAL RESINS FOR USE IN THE MANUFACTURE OF PLASTICS, IN CLASS 1 (U.S. CLS. 1, 5, 6, 10, 26 AND 46).

**TRADEMARK**

FIRST USE 1-26-2011; IN COMMERCE 1-26-2011.

**PRINCIPAL REGISTER**

THE MARK CONSISTS OF STANDARD CHARACTERS WITHOUT CLAIM TO ANY PARTICULAR FONT, STYLE, SIZE, OR COLOR.

OWNER OF U.S. REG. NO. 2,754,497.

SN 85-190,153, FILED 12-3-2010.

ALYSSA STEEL, EXAMINING ATTORNEY



*David J. Kyffers*

Director of the United States Patent and Trademark Office

# United States of America

United States Patent and Trademark Office

## THE ZING LINE

**Reg. No. 4,199,240**

AAKRON RULE CORP. (NEW YORK CORPORATION)  
8 INDIANOLA AVENUE  
AKRON, NY 14001

**Registered Aug. 28, 2012**

**Int. Cl.: 40**

FOR: CUSTOM IMPRINTING OF PROMOTIONAL PRODUCTS, NAMELY, EMPTY BOTTLES, WRITING INSTRUMENTS, KEY-TAGS, KEY-CHAINS, BOTTLE OPENERS, ANTI-BACTERIAL PRODUCTS, HEADPHONES, HIGHLIGHTERS, BADGE HOLDERS, AND PENS, IN CLASS 40 (U.S. CLS. 100, 103 AND 106).

**SERVICE MARK**

**PRINCIPAL REGISTER**

FIRST USE 12-31-2011; IN COMMERCE 12-31-2011.

THE MARK CONSISTS OF STANDARD CHARACTERS WITHOUT CLAIM TO ANY PARTICULAR FONT, STYLE, SIZE, OR COLOR.

SN 85-190,669, FILED 12-3-2010.

DAWN FELDMAN, EXAMINING ATTORNEY



*David J. Kyffers*

Director of the United States Patent and Trademark Office

# United States of America

United States Patent and Trademark Office



**Reg. No. 4,199,241**

AAKRON RULE CORP. (NEW YORK CORPORATION)  
8 INDIANOLA AVENUE  
AKRON, NY 14001

**Registered Aug. 28, 2012**

**Int. Cl.: 40**

FOR: CUSTOM IMPRINTING OF PROMOTIONAL PRODUCTS, NAMELY, STATIONARY PRODUCTS, PENCILS, PENS, EMPTY WATER BOTTLES, KEY CHAINS, DRINKWARE, CUPS, MUGS AND BALLS, IN CLASS 40 (U.S. CLS. 100, 103 AND 106).

**SERVICE MARK**

FIRST USE 12-31-2003; IN COMMERCE 12-31-2003.

**PRINCIPAL REGISTER**

NO CLAIM IS MADE TO THE EXCLUSIVE RIGHT TO USE "PRODUCTS", APART FROM THE MARK AS SHOWN.

THE MARK CONSISTS OF THE WORDING "HOME OF THE MOOD PRODUCTS" IN STYLIZED LETTERING ON TOP OF AN OVAL DESIGN WITH ALTERNATING LIGHT AND DARK STRIPS IN A STARBURST PATTERN.

SN 85-190,671, FILED 12-3-2010.

DAWN FELDMAN, EXAMINING ATTORNEY



*David J. Kyros*

Director of the United States Patent and Trademark Office

# United States of America

United States Patent and Trademark Office

# MASS

**Reg. No. 4,199,242**

**Registered Aug. 28, 2012**

**Int. Cl.: 9**

**TRADEMARK**

**PRINCIPAL REGISTER**

DATA CENTER TRANSITIONS, INC. (NEW MEXICO CORPORATION)  
87 EL DORADO ROAD  
CORRALES, NM 87048

FOR: RACK ENCLOSURES FOR COMPUTER EQUIPMENT, IN CLASS 9 (U.S. CLS. 21, 23, 26, 36 AND 38).

FIRST USE 12-7-2010; IN COMMERCE 3-16-2012.

THE MARK CONSISTS OF STANDARD CHARACTERS WITHOUT CLAIM TO ANY PARTICULAR FONT, STYLE, SIZE, OR COLOR.

SN 85-192,580, FILED 12-7-2010.

PRISCILLA MILTON, EXAMINING ATTORNEY



*David J. Kybas*

Director of the United States Patent and Trademark Office

# United States of America

United States Patent and Trademark Office

## Challah-looyah

**Reg. No. 4,199,243**

KOSHER FOODS UNLIMITED, INC. (CALIFORNIA CORPORATION), DBA GOT KOSHER?,  
1410 S. LIVONIA AVE.

**Registered Aug. 28, 2012**

LOS ANGELES, CA 90035

**Int. Cl.: 30**

FOR: BREAD AND BUNS; FROZEN BREADS; FROZEN DOUGH FOR USE AS PIZZA, BREAD  
OR OTHER BREAD-TYPE PRODUCTS, IN CLASS 30 (U.S. CL. 46).

**TRADEMARK**

FIRST USE 5-15-2012; IN COMMERCE 5-15-2012.

**PRINCIPAL REGISTER**

THE MARK CONSISTS OF STANDARD CHARACTERS WITHOUT CLAIM TO ANY PAR-  
TICULAR FONT, STYLE, SIZE, OR COLOR.

SN 85-193,271, FILED 12-8-2010.

KEVIN CORWIN, EXAMINING ATTORNEY



*David J. Kyros*

Director of the United States Patent and Trademark Office

# United States of America

United States Patent and Trademark Office

# BLACK BOA

**Reg. No. 4,199,244**

**Registered Aug. 28, 2012**

**Int. Cl.: 34**

**TRADEMARK**

**PRINCIPAL REGISTER**

INTERNATIONAL ODDITIES, INC. (CALIFORNIA CORPORATION)  
SUITE 163  
927 DEEP VALLEY DRIVE  
ROLLING HILLS, CA 90274

FOR: HERBS FOR SMOKING, IN CLASS 34 (U.S. CLS. 2, 8, 9 AND 17).

FIRST USE 5-30-2012; IN COMMERCE 5-30-2012.

THE MARK CONSISTS OF STANDARD CHARACTERS WITHOUT CLAIM TO ANY PARTICULAR FONT, STYLE, SIZE, OR COLOR.

SN 85-193,342, FILED 12-8-2010.

JOHN SCHUYLER YARD, EXAMINING ATTORNEY



*David J. Kybas*

Director of the United States Patent and Trademark Office

# United States of America

United States Patent and Trademark Office

## THE CAR WHISPERER

**Reg. No. 4,199,245**

**Registered Aug. 28, 2012**

**Int. Cl.: 35**

**SERVICE MARK**

**PRINCIPAL REGISTER**

ITHINK CONSULTING LLC (COLORADO LIMITED LIABILITY COMPANY)  
SUITE E  
9836 W. FREIBURG DR.  
LITTLETON, CO 80127

FOR: PROVIDING A WEBSITE FEATURING INFORMATION IN THE FIELD OF AUTOMOBILES FOR SALE BY MEANS OF THE INTERNET; PROVIDING A SEARCHABLE ONLINE ADVERTISING WEBSITE AND INFORMATIONAL GUIDE FEATURING THE GOODS AND SERVICES OF OTHER VENDORS VIA THE INTERNET IN THE FIELD OF AUTOMOBILES; PROMOTING THE GOODS AND SERVICES OF OTHERS BY PROVIDING A WEBSITE FEATURING COUPONS, REBATES, PRICE-COMPARISON INFORMATION, PRODUCT REVIEWS, LINKS TO THE RETAIL WEBSITES OF OTHERS, AND DISCOUNT INFORMATION, IN CLASS 35 (U.S. CLS. 100, 101 AND 102).

FIRST USE 12-30-2009; IN COMMERCE 7-19-2011.

THE MARK CONSISTS OF STANDARD CHARACTERS WITHOUT CLAIM TO ANY PARTICULAR FONT, STYLE, SIZE, OR COLOR.

NO CLAIM IS MADE TO THE EXCLUSIVE RIGHT TO USE "CAR", APART FROM THE MARK AS SHOWN.

SN 85-193,520, FILED 12-8-2010.

LAURIE MAYES, EXAMINING ATTORNEY



*David J. Kyros*

Director of the United States Patent and Trademark Office



# United States of America

United States Patent and Trademark Office

## NANNI BANELLE

**Reg. No. 4,199,246**

JANELLE, LLC (NEW JERSEY LIMITED LIABILITY COMPANY)  
PO BOX 808

**Registered Aug. 28, 2012**

NORTH BERGEN, NJ 070470808

**Int. Cl.: 14**

FOR: JEWELRY, IN CLASS 14 (U.S. CLS. 2, 27, 28 AND 50).

**TRADEMARK**

FIRST USE 2-0-2012; IN COMMERCE 2-0-2012.

**PRINCIPAL REGISTER**

THE MARK CONSISTS OF STANDARD CHARACTERS WITHOUT CLAIM TO ANY PARTICULAR FONT, STYLE, SIZE, OR COLOR.

THE NAME(S), PORTRAIT(S), AND/OR SIGNATURE(S) SHOWN IN THE MARK DOES NOT IDENTIFY A PARTICULAR LIVING INDIVIDUAL.

SN 85-194,127, FILED 12-9-2010.

ANGELA M. MICHELI, EXAMINING ATTORNEY



*David J. Kyffers*

Director of the United States Patent and Trademark Office

# United States of America

United States Patent and Trademark Office

# RDZN

**Reg. No. 4,199,247**

**Registered Aug. 28, 2012**

**Int. Cl.: 14**

**TRADEMARK**

**PRINCIPAL REGISTER**

ROGUE DESIGN, LLC (CALIFORNIA LIMITED LIABILITY COMPANY)  
P. O. BOX 4956  
LAGUNA BEACH, CA 926524956

FOR: JEWELRY, IN CLASS 14 (U.S. CLS. 2, 27, 28 AND 50).

FIRST USE 12-31-2010; IN COMMERCE 12-31-2010.

THE MARK CONSISTS OF STANDARD CHARACTERS WITHOUT CLAIM TO ANY PARTICULAR FONT, STYLE, SIZE, OR COLOR.

SN 85-194,188, FILED 12-9-2010.

FRED CARL, EXAMINING ATTORNEY



*David J. Kyfos*

Director of the United States Patent and Trademark Office

# United States of America

United States Patent and Trademark Office

## LIGHTNING LOAD

**Reg. No. 4,199,248**

BLOUNT, INC. (DELAWARE CORPORATION)  
4909 SE INTERNATIONAL WAY  
PORTLAND, OR 97222

**Registered Aug. 28, 2012**

**Int. Cl.: 7**

FOR: TRIMMER HEADS FOR POWER TRIMMERS, IN CLASS 7 (U.S. CLS. 13, 19, 21, 23, 31, 34 AND 35).

**TRADEMARK**

FIRST USE 1-0-2012; IN COMMERCE 1-0-2012.

**PRINCIPAL REGISTER**

THE MARK CONSISTS OF STANDARD CHARACTERS WITHOUT CLAIM TO ANY PARTICULAR FONT, STYLE, SIZE, OR COLOR.

SN 85-194,247, FILED 12-9-2010.

MIDGE BUTLER, EXAMINING ATTORNEY



*David J. Kyffers*

Director of the United States Patent and Trademark Office

# United States of America

United States Patent and Trademark Office

# DBO

**Reg. No. 4,199,249**

DEBOTTY ELECTRIC CO., LTD (ILLINOIS LIMITED LIABILITY COMPANY)  
6050 W. EASTWOOD AVE., #201  
CHICAGO, IL 60630

**Registered Aug. 28, 2012**

**Int. Cl.: 9**

FOR: CIRCUIT BREAKERS; ELECTRIC CONNECTORS; ELECTRIC CONVERTERS;  
ELECTRIC RELAYS; ELECTRICAL DUCTS; ELECTRICAL FUSES; LIGHTNING ARRESTERS;  
POWER SUPPLIES; SWITCHBOARDS; VOLTAGE SURGE PROTECTORS, IN CLASS 9 (U.S.  
CLS. 21, 23, 26, 36 AND 38).

**TRADEMARK**

**PRINCIPAL REGISTER**

FIRST USE 10-8-2009; IN COMMERCE 12-28-2010.

THE WORDING "DBO" HAS NO MEANING IN A FOREIGN LANGUAGE.

SN 85-194,731, FILED 12-9-2010.

EVIN L. KOZAK, EXAMINING ATTORNEY



*David J. Kyros*

Director of the United States Patent and Trademark Office

# United States of America

United States Patent and Trademark Office

# SABER

**Reg. No. 4,199,250**

**Registered Aug. 28, 2012**

**Int. Cl.: 28**

**TRADEMARK**

**PRINCIPAL REGISTER**

SABER WEIGHT SYSTEMS, LLC (DELAWARE CORPORATION)  
2222 NORTH PACKER ROAD  
SPRINGFIELD, MO 65803

FOR: EXERCISE WEIGHTS, IN CLASS 28 (U.S. CLS. 22, 23, 38 AND 50).

FIRST USE 3-22-2012; IN COMMERCE 3-22-2012.

THE MARK CONSISTS OF STANDARD CHARACTERS WITHOUT CLAIM TO ANY PARTICULAR FONT, STYLE, SIZE, OR COLOR.

SN 85-195,689, FILED 12-10-2010.

MARK T. MULLEN, EXAMINING ATTORNEY



*David J. Kybas*

Director of the United States Patent and Trademark Office

# United States of America

United States Patent and Trademark Office

## WARFIGHTER

**Reg. No. 4,199,251**

MILO AFONG (UNITED STATES INDIVIDUAL)

**Registered Aug. 28, 2012**

94-644 MELE PLACE  
WAIPAHU, HI 967974318

**Int. Cl.: 25**

FOR: CAPS; COATS; COMBATIVE SPORTS UNIFORMS; GYM SHORTS; HATS; JACKETS; MARTIAL ARTS UNIFORMS; MARTIAL ARTS UNIFORMS, NAMELY, GIS; MIXED MARTIAL ARTS SUITS; SHIRTS; SHIRTS AND SHORT-SLEEVED SHIRTS; SHORTS; SPORT COATS; SPORT SHIRTS; SPORTS CAPS AND HATS; SPORTS JACKETS; SPORTS JERSEYS; SPORTS PANTS; SPORTS SHIRTS; SPORTS SHIRTS WITH SHORT SLEEVES; SWEAT JACKETS; SWEAT PANTS; SWEAT SHIRTS; SWEAT SHORTS; T-SHIRTS; WIND COATS; WIND PANTS; WIND RESISTANT JACKETS; WIND SHIRTS; WIND-JACKETS, IN CLASS 25 (U.S. CLS. 22 AND 39).

**TRADEMARK**

**PRINCIPAL REGISTER**

FIRST USE 4-30-2012; IN COMMERCE 4-30-2012.

THE MARK CONSISTS OF STANDARD CHARACTERS WITHOUT CLAIM TO ANY PARTICULAR FONT, STYLE, SIZE, OR COLOR.

SN 85-195,883, FILED 12-11-2010.

MARGERY A. TIERNEY, EXAMINING ATTORNEY



*David J. Kyros*

Director of the United States Patent and Trademark Office

# United States of America

United States Patent and Trademark Office

## PLAYFUL MINDS

**Reg. No. 4,199,252**

GAMELOFT S.A. (FRANCE CORPORATION)  
14 RUE AUBER  
PARIS 75009, FRANCE

**Registered Aug. 28, 2012**

**Int. Cl.: 9**

FOR: COMPUTER SOFTWARE FOR ELECTRONIC GAMES AND ENTERTAINMENT, NAMELY, COMPUTER GAME SOFTWARE USED AND PLAYED ON MOBILE AND CELLULAR TELEPHONES, HANDHELD COMPUTERS, HANDHELD CONSOLES, HOME CONSOLES, PERSONAL COMPUTERS AND PERSONAL DIGITAL ASSISTANTS; DOWNLOADABLE ELECTRONIC GAME PROGRAMS, IN CLASS 9 (U.S. CLS. 21, 23, 26, 36 AND 38).

**TRADEMARK**

**PRINCIPAL REGISTER**

FIRST USE 1-0-2012; IN COMMERCE 1-0-2012.

THE MARK CONSISTS OF STANDARD CHARACTERS WITHOUT CLAIM TO ANY PARTICULAR FONT, STYLE, SIZE, OR COLOR.

SN 85-196,312, FILED 12-13-2010.

TINA L. SNAPP, EXAMINING ATTORNEY



*David J. Kyros*

Director of the United States Patent and Trademark Office

# United States of America

United States Patent and Trademark Office

## CREED AVENTUS

**Reg. No. 4,199,253**

EROL SARL (LUXEMBOURG CORPORATION)  
9, RUE DU LABORATOIRE  
LUXEMBOURG, LUXEMBOURG L-1911

**Registered Aug. 28, 2012**

**Int. Cl.: 3**

FOR: PERFUMES, TOILET WATERS, AFTER SHAVE, SHOWER GELS AND BATH GELS,  
DEODORANTS, IN CLASS 3 (U.S. CLS. 1, 4, 6, 50, 51 AND 52).

**TRADEMARK**

FIRST USE 4-6-2010; IN COMMERCE 4-6-2010.

**PRINCIPAL REGISTER**

THE MARK CONSISTS OF STANDARD CHARACTERS WITHOUT CLAIM TO ANY PAR-  
TICULAR FONT, STYLE, SIZE, OR COLOR.

OWNER OF U.S. REG. NO. 2,810,521.

SN 85-196,827, FILED 12-13-2010.

WILLIAM VERHOSEK, EXAMINING ATTORNEY



*David J. Kybas*

Director of the United States Patent and Trademark Office



# United States of America

United States Patent and Trademark Office

## TRICO FACTORY REPLACEMENT CENTER

**Reg. No. 4,199,254**

TRICO PRODUCTS CORPORATION (NEW YORK CORPORATION)  
3255 WEST HAMLIN RD.

**Registered Aug. 28, 2012**

ROCHESTER HILLS, MI 48309

**Int. Cl.: 12**

FOR: WINDSHIELD WIPER BLADES FOR VEHICLES, IN CLASS 12 (U.S. CLS. 19, 21, 23, 31, 35 AND 44).

**TRADEMARK**

FIRST USE 10-30-2011; IN COMMERCE 10-30-2011.

**PRINCIPAL REGISTER**

THE MARK CONSISTS OF STANDARD CHARACTERS WITHOUT CLAIM TO ANY PARTICULAR FONT, STYLE, SIZE, OR COLOR.

OWNER OF U.S. REG. NOS. 167,037, 2,292,526, AND OTHERS.

NO CLAIM IS MADE TO THE EXCLUSIVE RIGHT TO USE "FACTORY REPLACEMENT CENTER", APART FROM THE MARK AS SHOWN.

SN 85-197,248, FILED 12-14-2010.

JULIE GUTTADAURO, EXAMINING ATTORNEY



*David J. Kybas*

Director of the United States Patent and Trademark Office

# United States of America

United States Patent and Trademark Office

# WICKED

**Reg. No. 4,199,255**

**Registered Aug. 28, 2012**

**Int. Cl.: 4**

**TRADEMARK**

**PRINCIPAL REGISTER**

WICKED CANDLES LLC (CALIFORNIA LIMITED LIABILITY COMPANY)  
8908 MELROSE AVENUE  
WEST HOLLYWOOD, CA 90069

FOR: CANDLES, IN CLASS 4 (U.S. CLS. 1, 6 AND 15).

FIRST USE 8-6-2010; IN COMMERCE 8-6-2010.

THE MARK CONSISTS OF THE STYLIZED TEXT "WICK ED" WITH AN ABSTRACT DESIGN.

SN 85-197,250, FILED 12-14-2010.

TINA L. SNAPP, EXAMINING ATTORNEY



*David J. Kyffers*

Director of the United States Patent and Trademark Office

# United States of America

United States Patent and Trademark Office

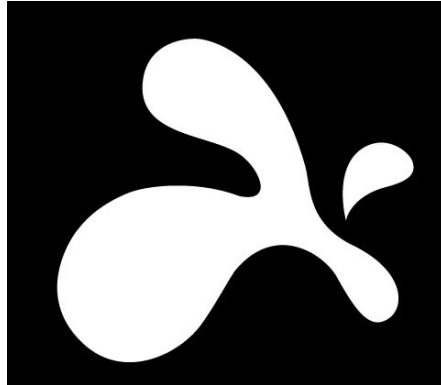

**Reg. No. 4,199,256**

**Registered Aug. 28, 2012**

**Int. Cl.: 9**

**TRADEMARK**

**PRINCIPAL REGISTER**

SPLASHTOP INC. (DELAWARE CORPORATION)  
1054 S. DE ANZA BLVD. #200  
SAN JOSE, CA 95129

FOR: BIOS COMPUTER PROGRAMS BIOS COMPUTER PROGRAM COMPUTER E-COMMERCE SOFTWARE TO ALLOW USERS TO PERFORM ELECTRONIC BUSINESS TRANSACTIONS VIA A GLOBAL COMPUTER NETWORK COMPUTER GAME PROGRAMS COMPUTER GAME SOFTWARE COMPUTER GRAPHICS SOFTWARE COMPUTER HARDWARE AND COMPUTER SOFTWARE PROGRAMS FOR THE INTEGRATION OF TEXT, AUDIO, GRAPHICS, STILL IMAGES AND MOVING PICTURES INTO AN INTERACTIVE DELIVERY FOR MULTIMEDIA APPLICATIONS COMPUTER HARDWARE AND SOFTWARE FOR SETTING UP AND CONFIGURING LOCAL AREA NETWORKS COMPUTER HARDWARE AND SOFTWARE USED FOR THE CONTROL OF VOICE CONTROLLED INFORMATION AND COMMUNICATION DEVICES COMPUTER OPERATING PROGRAMS COMPUTER OPERATING SYSTEMS COMPUTER PROGRAMS FOR THE ENABLING OF ACCESS OR ENTRANCE CONTROL COMPUTER SEARCH ENGINE SOFTWARE COMPUTER SERVERS COMPUTER SOFTWARE FOR ACCESSING INFORMATION DIRECTORIES THAT MAY BE DOWNLOADED FROM THE GLOBAL COMPUTER NETWORK COMPUTER SOFTWARE FOR ADMINISTRATION OF COMPUTER LOCAL AREA NETWORKS COMPUTER SOFTWARE FOR ADMINISTRATION OF COMPUTER NETWORKS COMPUTER SOFTWARE FOR APPLICATION AND DATABASE INTEGRATION COMPUTER SOFTWARE FOR COMMUNICATING WITH USERS OF HAND-HELD COMPUTERS COMPUTER SOFTWARE FOR COMPUTER SYSTEM AND APPLICATION DEVELOPMENT, DEPLOYMENT AND MANAGING ACCESS SERVER APPLICATIONS COMPUTER SOFTWARE FOR MANIPULATING DIGITAL AUDIO INFORMATION FOR USE IN AUDIO MEDIA APPLICATIONS COMPUTER SOFTWARE FOR ORGANIZING AND VIEWING DIGITAL IMAGES AND PHOTOGRAPHS COMPUTER SOFTWARE FOR PROCESSING DIGITAL MUSIC FILES COMPUTER SOFTWARE FOR THE COLLECTION, EDITING, ORGANIZING, MODIFYING, BOOK MARKING, TRANSMISSION, STORAGE AND SHARING OF DATA AND INFORMATION, IN CLASS 9 (U.S. CLS. 21, 23, 26, 36 AND 38).



FIRST USE 4-30-2011; IN COMMERCE 4-30-2011.

THE MARK CONSISTS OF A STYLIZED DESIGN OF WATER SPLASHING.

SN 85-197,386, FILED 12-14-2010.

*David J. Kybas*

Director of the United States Patent and Trademark Office

**Reg. No. 4,199,256** WILLIAM BRECKENFELD, EXAMINING ATTORNEY

# United States of America

United States Patent and Trademark Office

# BIOFORTIS

**Reg. No. 4,199,257**

**Registered Aug. 28, 2012**

**Int. Cls.: 35, 41, and 42**

**SERVICE MARK**

**PRINCIPAL REGISTER**

MERIEUX NUTRISCIENCES CORPORATION (DELAWARE CORPORATION)  
FL. 23  
111 E. WACKER DRIVE  
CHICAGO, IL 60601

FOR: BUSINESS MANAGEMENT CONSULTING SERVICES; BUSINESS MARKETING CONSULTING AND RESEARCH SERVICES, NAMELY, DESIGNING, CONDUCTING AND ANALYZING MARKET AND PRODUCT VIABILITY STUDIES, CONSUMER FOCUS GROUP STUDIES, BRAND AND PRODUCT AWARENESS STUDIES, PACKAGING DESIGNS, CONSUMER PROFILING AND OPINION POLLING FOR NEW PRODUCTS, IN CLASS 35 (U.S. CLS. 100, 101 AND 102).

FIRST USE 4-5-2011; IN COMMERCE 4-5-2011.

FOR: EDUCATIONAL SERVICES, NAMELY, CONDUCTING TRAINING CLASSES AND SEMINARS IN THE FIELD OF NUTRITIONAL SCIENCES AND SENSORY ANALYSIS, IN CLASS 41 (U.S. CLS. 100, 101 AND 107).

FIRST USE 4-5-2011; IN COMMERCE 4-5-2011.

FOR: SCIENTIFIC AND TECHNICAL RESEARCH SERVICES, NAMELY, DESIGNING, CONDUCTING AND ANALYZING SCIENTIFIC STUDIES AND SURVEYS ABOUT THE SENSORY IMPACT OF PRODUCTS AND BRANDS ON CONSUMERS, PACKAGING DESIGNS AND QUALITY CONTROL; CONDUCTING NEW PRODUCT RESEARCH AND DEVELOPMENT SERVICES FOR OTHERS, IN CLASS 42 (U.S. CLS. 100 AND 101).

FIRST USE 4-5-2011; IN COMMERCE 4-5-2011.

THE MARK CONSISTS OF STANDARD CHARACTERS WITHOUT CLAIM TO ANY PARTICULAR FONT, STYLE, SIZE, OR COLOR.

SN 85-197,573, FILED 12-14-2010.

AMY C. KEAN, EXAMINING ATTORNEY



*David J. Kyjars*

Director of the United States Patent and Trademark Office

# United States of America

United States Patent and Trademark Office

# HALLMOTO

**Reg. No. 4,199,258**

NOVATEK INC. (UTAH CORPORATION)  
2185 SOUTH LARSEN PARKWAY  
PROVO, UT 84606

**Registered Aug. 28, 2012**

**Int. Cl.: 12**

FOR: MOTOR VEHICLES, NAMELY, CONCEPT MOTOR VEHICLES, IN CLASS 12 (U.S. CLS. 19, 21, 23, 31, 35 AND 44).

**TRADEMARK**

FIRST USE 12-14-2010; IN COMMERCE 6-21-2011.

**PRINCIPAL REGISTER**

THE MARK CONSISTS OF STANDARD CHARACTERS WITHOUT CLAIM TO ANY PARTICULAR FONT, STYLE, SIZE, OR COLOR.

SN 85-197,585, FILED 12-14-2010.

CHARLOTTE CORWIN, EXAMINING ATTORNEY



*David J. Kyffers*

Director of the United States Patent and Trademark Office

# United States of America

United States Patent and Trademark Office

# globalphile

**Reg. No. 4,199,259**

**Registered Aug. 28, 2012**

**Int. Cl.: 39**

**SERVICE MARK**

**PRINCIPAL REGISTER**

WEYBRIDGE CAPITAL INVESTORS, INC. (ILLINOIS CORPORATION)  
SUITE 230  
2502 NORTH CLARK STREET  
CHICAGO, IL 60614

FOR: PROVIDING A WEBSITE FEATURING INFORMATION, PHOTOGRAPHS, AND VIDEO CONCERNING TRAVEL, IN CLASS 39 (U.S. CLS. 100 AND 105).

FIRST USE 3-0-2012; IN COMMERCE 3-0-2012.

THE MARK CONSISTS OF STANDARD CHARACTERS WITHOUT CLAIM TO ANY PARTICULAR FONT, STYLE, SIZE, OR COLOR.

SN 85-198,389, FILED 12-15-2010.

KATHRYN COWARD, EXAMINING ATTORNEY



*David J. Kyros*

Director of the United States Patent and Trademark Office

# United States of America

United States Patent and Trademark Office



**Reg. No. 4,199,260**

**Registered Aug. 28, 2012**

**Int. Cls.: 9, 35, 38, and 41**

**TRADEMARK**

**SERVICE MARK**

**PRINCIPAL REGISTER**

AIRBOX TELEVISION, INC. (FLORIDA CORPORATION)  
601 CLEARWATER PARK ROAD  
WEST PALM BEACH, FL 33401

FOR: RECEIVERS, NAMELY, TELEVISION RECEIVERS AND RADIO RECEIVERS; SET-TOP BOXES, DIGITAL VIDEO RECORDERS; ANTENNAS AND SATELLITE DISHES; REMOTE CONTROL UNITS FOR TELEVISIONS, SET TOP BOXES; ALL FOR USE FOR VIDEO, AUDIO AND DATA SERVICES VIA DIGITAL BROADCAST AND INTERNET DISTRIBUTION BY TERRESTRIAL, SATELLITE AND WIRELESS NETWORKS TO VIDEO DISPLAY DEVICES, NAMELY, TELEVISIONS, VIDEO PROJECTORS AND VIDEO MONITORS; AND VIDEO DISPLAY DEVICES, NAMELY, TELEVISIONS, VIDEO PROJECTORS AND VIDEO MONITORS, IN CLASS 9 (U.S. CLS. 21, 23, 26, 36 AND 38).

FIRST USE 2-20-2012; IN COMMERCE 2-20-2012.

FOR: COMPUTERIZED ON-LINE ORDERING AND DATA PROCESSING SERVICES IN THE FIELDS OF TELEVISION, FILM, RADIO, VIDEO, AUDIO, MUSIC, PHOTOS, TEXT, DATA AND MULTI-MEDIA CONTENT, IN CLASS 35 (U.S. CLS. 100, 101 AND 102).

FIRST USE 2-20-2012; IN COMMERCE 2-20-2012.

FOR: TRANSMISSION OF VIDEO, AUDIO AND DATA PROGRAMMING AND OTHER VIDEO, AUDIO AND DATA SERVICES, NAMELY, RADIO AND VIDEO BROADCASTING SERVICES; SUBSCRIPTION VIDEO AND AUDIO TRANSMISSION SERVICES; PAY-PER-VIEW VIDEO AND AUDIO TRANSMISSION SERVICES; VIDEO-ON-DEMAND TRANSMISSION SERVICES; SUBSCRIPTION VIDEO-ON-DEMAND TRANSMISSION SERVICES; ALL DELIVERED TO VIDEO DISPLAY DEVICES, NAMELY, TELEVISIONS, COMPUTERS, MOBILE DEVICES, VIDEO PROJECTORS AND VIDEO MONITORS VIA DIGITAL BROADCAST AND INTERNET DISTRIBUTION BY TERRESTRIAL, SATELLITE AND WIRELESS NETWORKS; DISTRIBUTION OF SUCH PROGRAMMING AND SERVICES FOR OTHERS, NAMELY, RADIO AND VIDEO BROADCASTING SERVICES, IN CLASS 38 (U.S. CLS. 100, 101 AND 104).

FIRST USE 2-20-2012; IN COMMERCE 2-20-2012.

FOR: ENTERTAINMENT IN THE NATURE OF ON-GOING TELEVISION PROGRAMS IN THE FIELD OF SPORTS, COMEDY, TRAVEL, DRAMA, VARIETY, HEALTH RELATED



*David J. Kyjars*

Director of the United States Patent and Trademark Office



**Reg. No. 4,199,260** ISSUES, CHILDREN'S PROGRAMMING, WEATHER AND NEWS ALL DELIVERED TO VIDEO DISPLAY DEVICES, NAMELY, TELEVISIONS, COMPUTERS, MOBILE DEVICES, VIDEO PROJECTORS AND VIDEO MONITORS VIA DIGITAL BROADCAST AND INTERNET DISTRIBUTION BY TERRESTRIAL, SATELLITE AND WIRELESS NETWORKS; DISTRIBUTION OF TELEVISION PROGRAMMING TO CABLE TELEVISION SYSTEMS FOR BROADCAST TO VIDEO DISPLAY DEVICES, NAMELY, TELEVISIONS, COMPUTERS, MOBILE DEVICES, VIDEO PROJECTORS AND VIDEO MONITORS VIA DIGITAL BROADCAST AND INTERNET DISTRIBUTION BY TERRESTRIAL, SATELLITE AND WIRELESS NETWORKS, IN CLASS 41 (U.S. CLS. 100, 101 AND 107).

FIRST USE 2-20-2012; IN COMMERCE 2-20-2012.

THE MARK CONSISTS OF THE WORD "AIR" SURROUNDED BY A RECTANGULAR BOX. THE DOT ON THE LETTER "I" IS A BALL WITH "WAVES" EMANATING UPWARD. THE WORD "BOX" APPEARS TO THE RIGHT, WITH THE LETTER "B" ON THE RIGHT SIDE OF THE RECTANGLE.

SN 85-198,775, FILED 12-15-2010.

KRISTINA MORRIS, EXAMINING ATTORNEY

# United States of America

United States Patent and Trademark Office

## Bridgetown Collection

**Reg. No. 4,199,261**

BRANDED, LLC (GEORGIA LIMITED LIABILITY COMPANY)  
3333 LEE PARKWAY 6TH FLOOR  
DALLAS, TX 75219

**Registered Aug. 28, 2012**

**Int. Cl.: 25**

FOR: CLOTHING, NAMELY, T-SHIRTS, SHIRTS, BLOUSES, SWEATERS, TOPS, PANTS, SHORTS, JEANS, DRESSES, SKIRTS, JACKETS, BLAZERS, SUITS, COATS, LOUNGEWEAR, SWEATSHIRTS, SOCKS, BELTS, SCARVES; FOOTWEAR; HEADWEAR, IN CLASS 25 (U.S. CLS. 22 AND 39).

**TRADEMARK**

**PRINCIPAL REGISTER**

FIRST USE 6-20-2012; IN COMMERCE 6-20-2012.

THE MARK CONSISTS OF STANDARD CHARACTERS WITHOUT CLAIM TO ANY PARTICULAR FONT, STYLE, SIZE, OR COLOR.

NO CLAIM IS MADE TO THE EXCLUSIVE RIGHT TO USE "COLLECTION", APART FROM THE MARK AS SHOWN.

SN 85-198,895, FILED 12-15-2010.

SAIMA MAKHDOOM, EXAMINING ATTORNEY



*David J. Kybas*

Director of the United States Patent and Trademark Office

# United States of America

United States Patent and Trademark Office

# TRUE

**Reg. No. 4,199,262**

STANBIO LABORATORY (TEXAS CORPORATION)  
1261 NORTH MAIN STREET  
BOERNE, TX 78006

**Registered Aug. 28, 2012**

**Int. Cl.: 5**

FOR: PREGNANCY TEST KITS FOR HOME USE, IN CLASS 5 (U.S. CLS. 6, 18, 44, 46, 51 AND 52).

**TRADEMARK**

FIRST USE 4-30-2012; IN COMMERCE 4-30-2012.

**PRINCIPAL REGISTER**

THE MARK CONSISTS OF STANDARD CHARACTERS WITHOUT CLAIM TO ANY PARTICULAR FONT, STYLE, SIZE, OR COLOR.

SN 85-199,121, FILED 12-16-2010.

RICHARD WHITE, EXAMINING ATTORNEY



*David J. Kybas*

Director of the United States Patent and Trademark Office

# United States of America

United States Patent and Trademark Office

## Plan. Book. Share.

**Reg. No. 4,199,263**

**Registered Aug. 28, 2012**

**Int. Cl.: 39**

**SERVICE MARK**

**PRINCIPAL REGISTER**

GEORAMA, INC. (ILLINOIS CORPORATION)  
508 W FONTENAY WAY  
PALATINE, IL 60067

FOR: COORDINATING TRAVEL ARRANGEMENTS FOR INDIVIDUALS AND FOR GROUPS; ON-LINE TRANSPORTATION RESERVATION AND TRAVEL TICKET RESERVATION SERVICES; ONLINE TRIP AND TRAVEL RESERVATION SERVICES; ORGANISATION OF TRAVEL; ORGANIZATION OF EXCURSIONS, SIGHTSEEING TOURS, HOLIDAYS, TOURS AND TRAVEL; ORGANIZATION OF TRAVEL AND BOAT TRIPS; ORGANIZATION OF TRIPS; ORGANIZATION, BOOKING AND ARRANGEMENT OF EXCURSIONS, DAY TRIPS AND SIGHTSEEING TOURS; PROVIDING A WEB SITE AND WEB SITE LINKS TO GEOGRAPHIC INFORMATION, MAP IMAGES, AND TRIP ROUTING; PROVIDING A WEB SITE FEATURING TRAVEL INFORMATION AND COMMENTARY; PROVIDING A WEBSITE FEATURING INFORMATION ON TRAVEL; PROVIDING AN ON-LINE COMPUTER DATABASE IN THE FIELD OF TRAVEL INFORMATION SERVICES; PROVIDING AN ON-LINE SEARCHABLE COMPUTER DATABASE FEATURING INFORMATION ON TRAVEL; PROVIDING INFORMATION ABOUT AUTOMOBILES FOR LEASE BY MEAN OF THE INTERNET; PROVIDING INFORMATION, NEWS AND COMMENTARY IN THE FIELD OF TRAVEL; PROVIDING LINKS TO WEB SITES OF OTHERS FEATURING TRAVEL; PROVIDING REVIEWS OF TRAVEL SERVICE PROVIDERS; PROVIDING TRAVEL INFORMATION TO TRAVELERS REGARDING FARES, TIMETABLES AND PUBLIC TRANSPORT, IN CLASS 39 (U.S. CLS. 100 AND 105).

FIRST USE 5-1-2012; IN COMMERCE 5-1-2012.

THE MARK CONSISTS OF STANDARD CHARACTERS WITHOUT CLAIM TO ANY PARTICULAR FONT, STYLE, SIZE, OR COLOR.

SN 85-200,200, FILED 12-17-2010.

JACQUELINE A. LAVINE, EXAMINING ATTORNEY



*David J. Kyjars*

Director of the United States Patent and Trademark Office

# United States of America

United States Patent and Trademark Office

# CLEARCARE

**Reg. No. 4,199,264**

**Registered Aug. 28, 2012**

**Int. Cl.: 1**

**TRADEMARK**

**PRINCIPAL REGISTER**

ARCH CHEMICALS, INC. (VIRGINIA CORPORATION)  
501 MERRITT 7, P.O. BOX 5204  
NORWALK, CT 068565204

FOR: CHEMICALS USED TO SANITIZE AND TO TREAT POTABLE WATER, DRINKING WATER, WASTE WATER, INDUSTRIAL WASTE WATER, AND SWIMMING POOL, SPA AND HOT TUB WATER; WATER TEST KITS, NAMELY, CHEMICAL ANALYSIS KIT FOR TESTING SWIMMING POOL, SPA AND HOT TUB WATER; WATER TEST KIT REAGENT REFILLS, IN CLASS 1 (U.S. CLS. 1, 5, 6, 10, 26 AND 46).

FIRST USE 1-15-2011; IN COMMERCE 1-15-2011.

THE MARK CONSISTS OF STANDARD CHARACTERS WITHOUT CLAIM TO ANY PARTICULAR FONT, STYLE, SIZE, OR COLOR.

SN 85-201,948, FILED 12-20-2010.

KIMBERLY PERRY, EXAMINING ATTORNEY



*David J. Kybas*

Director of the United States Patent and Trademark Office

# United States of America

United States Patent and Trademark Office

## GOODCOUPONS

**Reg. No. 4,199,265**

**Registered Aug. 28, 2012**

**Int. Cls.: 35 and 42**

**SERVICE MARK**

**PRINCIPAL REGISTER**

GOODSEARCH, LLC (DELAWARE LIMITED LIABILITY COMPANY)  
P.O. BOX 492176  
LOS ANGELES, CA 90049

FOR: PROMOTING THE GOODS AND SERVICES OF OTHERS BY PROVIDING A WEB SITE FEATURING COUPONS, REBATES, PRICE-COMPARISON INFORMATION, PRODUCT REVIEWS, LINKS TO THE RETAIL WEB SITES OF OTHERS, AND DISCOUNT INFORMATION; PROMOTING THE GOODS OF OTHERS, NAMELY, PROVIDING INFORMATION REGARDING DISCOUNTS, COUPONS, REBATES, VOUCHERS AND SPECIAL OFFERS FOR THE GOODS AND SERVICES OF OTHERS; PROMOTIONAL SERVICES, NAMELY, PROMOTING THE GOODS AND SERVICES OF OTHERS BY MEANS OF PROVIDING ON-LINE COUPONS; PROMOTING THE GOODS AND SERVICES OF OTHERS VIA A GLOBAL COMPUTER NETWORK; INFOMEDIARY SERVICES, NAMELY, FACILITATING TRANSACTIONS BETWEEN BUYERS AND SELLERS THROUGH PROVIDING BUYERS WITH INFORMATION ABOUT SELLERS, GOODS, AND/OR SERVICES; PROMOTING SALE OF GOODS AND SERVICES OF OTHERS BY PROVIDING A WEBSITE AT WHICH USERS CAN LINK TO THE COMMERCIAL WEBSITES OF SELLERS; PROMOTING THE SALE OF GOODS AND SERVICES OF OTHERS THROUGH ONLINE PROMOTIONAL CONTESTS; PROVIDING AN ON-LINE COMMERCIAL INFORMATION DIRECTORY; DISSEMINATION OF ADVERTISING FOR OTHERS VIA AN ON-LINE ELECTRONIC COMMUNICATIONS NETWORK; PROVIDING A SEARCHABLE ON-LINE ADVERTISING GUIDE FEATURING THE GOODS AND SERVICE OF OTHER ON-LINE VENDORS; ALL OF THE FOREGOING SERVICES FEATURING AN OPTION FOR CONSUMERS TO DONATE A PORTION OR PERCENTAGE OF PROCEEDS TO CHARITIES, NOT-FOR-PROFIT AND PHILANTHROPIC ORGANIZATIONS AND ASSOCIATIONS, SCHOOLS, AND CIVIC GROUPS, IN CLASS 35 (U.S. CLS. 100, 101 AND 102).

FIRST USE 3-23-2011; IN COMMERCE 3-23-2011.

FOR: PROVIDING A SEARCH ENGINE ON THE INTERNET FOR OBTAINING INFORMATION ON CONSUMER PRODUCTS AND MERCHANTS; PROVIDING CUSTOMIZED ON-LINE WEB PAGES FEATURING USER-DEFINED INFORMATION, WHICH INCLUDES SEARCH ENGINES AND ON-LINE WEB LINKS TO OTHER WEB SITES; COMPUTER SERVICES, NAMELY, CREATING INDEXES OF INFORMATION, SITES AND OTHER RESOURCES AVAILABLE ON A GLOBAL COMPUTER NETWORK; COMPUTER SERVICES, NAMELY, PROVIDING INFORMATION FROM SEARCHABLE INDEXES AND DATABASES OF INFORMATION, INCLUDING TEXT, ELECTRONIC DOCUMENTS, AND DATABASES



*David J. Kyffers*

Director of the United States Patent and Trademark Office

**Reg. No. 4,199,265** BY MEANS OF A GLOBAL COMPUTER NETWORK; COMPUTER SERVICES, NAMELY, PROVIDING SEARCH ENGINES FOR OBTAINING DATA ON A GLOBAL COMPUTER NETWORK; AND COMPUTER SERVICES, NAMELY, PROVIDING INFORMATION AT THE SPECIFIC REQUEST OF END-USERS BY MEANS OF A GLOBAL COMPUTER NETWORK; ALL OF THE FOREGOING SERVICES FEATURING AN OPTION FOR CONSUMERS TO DONATE A PORTION OR PERCENTAGE OF PROCEEDS TO CHARITIES, NOT-FOR-PROFIT AND PHILANTHROPIC ORGANIZATIONS AND ASSOCIATIONS, SCHOOLS, AND CIVIC GROUPS, IN CLASS 42 (U.S. CLS. 100 AND 101).

FIRST USE 3-23-2011; IN COMMERCE 3-23-2011.

THE MARK CONSISTS OF STANDARD CHARACTERS WITHOUT CLAIM TO ANY PARTICULAR FONT, STYLE, SIZE, OR COLOR.

OWNER OF U.S. REG. NOS. 3,424,170, 3,743,390, AND OTHERS.

SN 85-202,284, FILED 12-20-2010.

TRACY FLETCHER, EXAMINING ATTORNEY

# United States of America

United States Patent and Trademark Office

# PCPI

**Reg. No. 4,199,266**

**Registered Aug. 28, 2012**

**Int. Cls.: 9, 16, and 44**

**TRADEMARK**

**SERVICE MARK**

**PRINCIPAL REGISTER**

AMERICAN MEDICAL ASSOCIATION (ILLINOIS CORPORATION)  
515 NORTH STATE STREET  
CHICAGO, IL 60654

FOR: DOWNLOADABLE ELECTRONIC PUBLICATIONS, IN THE NATURE OF BROCHURES, NEWSLETTERS, MEASURES OF PERFORMANCE, AND INSTRUCTIONAL MATERIALS, ALL IN THE FIELD OF HEALTHCARE, REGARDING MEASURING HEALTHCARE PROVIDERS' PERFORMANCE FOR IMPROVED MANAGEMENT OF HEALTH CARE CONDITIONS, IN CLASS 9 (U.S. CLS. 21, 23, 26, 36 AND 38).

FIRST USE 10-31-2007; IN COMMERCE 10-31-2007.

FOR: PRINTED PUBLICATIONS, IN THE NATURE OF BROCHURES, NEWSLETTERS, MEASURES OF PERFORMANCE, AND INSTRUCTIONAL MATERIALS, ALL IN THE FIELD OF HEALTHCARE, REGARDING MEASURING HEALTHCARE PROVIDERS' PERFORMANCE FOR IMPROVED MANAGEMENT OF HEALTH CARE CONDITIONS, IN CLASS 16 (U.S. CLS. 2, 5, 22, 23, 29, 37, 38 AND 50).

FIRST USE 5-31-2008; IN COMMERCE 5-31-2008.

FOR: PROVIDING HEALTHCARE INFORMATION REGARDING MEASURING HEALTHCARE PROVIDERS' PERFORMANCE FOR IMPROVED MANAGEMENT OF HEALTH CARE CONDITIONS, IN CLASS 44 (U.S. CLS. 100 AND 101).

FIRST USE 5-31-2008; IN COMMERCE 5-31-2008.

THE MARK CONSISTS OF STANDARD CHARACTERS WITHOUT CLAIM TO ANY PARTICULAR FONT, STYLE, SIZE, OR COLOR.

SN 85-202,614, FILED 12-21-2010.

AISHA CLARKE, EXAMINING ATTORNEY



*David J. Kyjars*

Director of the United States Patent and Trademark Office



# United States of America

United States Patent and Trademark Office

**SOLGLIDE**  
Bearings

**Reg. No. 4,199,267**

**Registered Aug. 28, 2012**

**Int. Cl.: 7**

**TRADEMARK**

**PRINCIPAL REGISTER**

SAINT-GOBAIN PERFORMANCE PLASTICS PAMPUS GMBH (FED REP GERMANY CORPORATION)  
AM NORDKANAL 37, POSTFACH 80  
WILLICH, FED REP GERMANY D47862

FOR: MACHINE PARTS, NAMELY, BEARINGS AND BUSHINGS, IN CLASS 7 (U.S. CLS. 13, 19, 21, 23, 31, 34 AND 35).

FIRST USE 2-13-2012; IN COMMERCE 2-13-2012.

NO CLAIM IS MADE TO THE EXCLUSIVE RIGHT TO USE "BEARINGS", APART FROM THE MARK AS SHOWN.

THE MARK CONSISTS OF THE STYLIZED PRESENTATION OF THE WORDS "SOLGLIDE BEARINGS", WITH A STYLIZED SUN LOGO AS THE "O" IN THE WORD "SOLGLIDE".

SN 85-202,837, FILED 12-21-2010.

DOMINICK J. SALEMI, EXAMINING ATTORNEY



*David J. Kybas*

Director of the United States Patent and Trademark Office

# United States of America

United States Patent and Trademark Office

## SYNERGISTIC SOLUTIONS FOR PROGRESSIVE ORTHODONTICS

**Reg. No. 4,199,268**

**Registered Aug. 28, 2012**

**Int. Cls.: 10, 16, and 44**

RMO, INC. (COLORADO CORPORATION)  
650 W. COLFAX AVENUE  
DENVER, CO 80204

FOR: ORTHODONTIC APPLIANCES, IN CLASS 10 (U.S. CLS. 26, 39 AND 44).

FIRST USE 12-0-2010; IN COMMERCE 12-0-2010.

**TRADEMARK**

**SERVICE MARK**

**PRINCIPAL REGISTER**

FOR: PRINTED MATTER, NAMELY, PRINTED INSTRUCTIONS IN THE FIELD OF ORTHODONTICS, PEDIATRIC DENTISTRY AND GENERAL DENTISTRY; PRINTED GUIDES, PRINTED INSTRUCTIONAL AND EDUCATIONAL MATERIALS, INFORMATIONAL FLYERS, NEWSLETTERS, BOOKLETS, POSTERS, PAMPHLETS, PRINTED INFORMATION SHEETS, PRODUCT GUIDES, CATALOGS, REPORTS, BROCHURES, BOOKS, LEAFLETS, BULLETINS AND JOURNALS ALL IN THE FIELD OF ORTHODONTICS, PEDIATRIC DENTISTRY AND GENERAL DENTISTRY, IN CLASS 16 (U.S. CLS. 2, 5, 22, 23, 29, 37, 38 AND 50).

FIRST USE 12-0-2010; IN COMMERCE 12-0-2010.

FOR: PROVIDING A WEBSITE IN THE FIELD OF ORTHODONTICS, IN CLASS 44 (U.S. CLS. 100 AND 101).

FIRST USE 12-0-2010; IN COMMERCE 12-0-2010.

THE MARK CONSISTS OF STANDARD CHARACTERS WITHOUT CLAIM TO ANY PARTICULAR FONT, STYLE, SIZE, OR COLOR.

OWNER OF U.S. REG. NOS. 3,364,950, 3,521,552, AND OTHERS.

SN 85-202,989, FILED 12-21-2010.

TOBY BULLOFF, EXAMINING ATTORNEY



*David J. Kypos*

Director of the United States Patent and Trademark Office

# United States of America

United States Patent and Trademark Office



nanokeratin  
S Y S T E M

**Reg. No. 4,199,269**

**Registered Aug. 28, 2012**

**Int. Cl.: 3**

**TRADEMARK**

**PRINCIPAL REGISTER**

HAIR EXPRESS LTD. (ISRAEL CORPORATION)  
53 SRLOZOROV STREET  
TEL AVIV, ISRAEL

FOR: NON-MEDICATED HAIR TREATMENT PREPARATIONS FOR COSMETIC PURPOSES; HAIR CARE PREPARATIONS; PREPARATIONS FOR SMOOTHING AND STRAIGHTENING OF HAIR; PREPARATIONS FOR RESTORATION OF HAIR; GELS, SPRAYS AND MOUSSES AND PREPARATIONS FOR HAIR STYLING AND HAIR CARE; HAIR CONDITIONERS AND HAIR LOTIONS, IN CLASS 3 (U.S. CLS. 1, 4, 6, 50, 51 AND 52).

FIRST USE 1-16-2012; IN COMMERCE 1-16-2012.

OWNER OF U.S. REG. NO. 3,604,733.

NO CLAIM IS MADE TO THE EXCLUSIVE RIGHT TO USE "NANO KERATIN SYSTEM", APART FROM THE MARK AS SHOWN.

THE MARK CONSISTS OF A EIGHT POINTED MOLECULAR OR FLOWER DESIGN. THE WORDS "NANOKERATIN SYSTEM" APPEAR BELOW.

SN 85-203,109, FILED 12-21-2010.

ELIZABETH KAJUBI, EXAMINING ATTORNEY



*David J. Kybas*

Director of the United States Patent and Trademark Office

# United States of America

United States Patent and Trademark Office

## OGILVY FUSION

**Reg. No. 4,199,270**

**Registered Aug. 28, 2012**

**Int. Cl.: 35**

**SERVICE MARK**

**PRINCIPAL REGISTER**

WPP PROPERTIES (DELAWARE PARTNERSHIP)  
4TH FLOOR  
100 PARK AVENUE  
NEW YORK, NY 10017

FOR: ADVERTISING AGENCY SERVICES; PUBLIC RELATIONS SERVICES; DIRECT MARKETING ADVERTISING SERVICES FOR OTHERS; MARKETING CONSULTING; MARKET RESEARCH, SURVEYS AND ANALYSIS; MEDIA PLANNING AND BUYING SERVICES, NAMELY, CONSULTING AND ADVISING ON THE APPROPRIATE MEDIA TO ADVERTISE IN, AND PURCHASING MEDIA TIME AND SPACE; PLACING ADVERTISEMENTS FOR OTHERS; SALES PROMOTION SERVICES; NAMELY, PROMOTING THE GOODS AND SERVICES OF VARIOUS INDUSTRIES THROUGH THE DISTRIBUTION OF PROMOTIONAL MATERIALS AND BY RENDERING SALES PROMOTION ADVICE; CUSTOMER RELATIONSHIP MANAGEMENT SERVICES; BUSINESS AND MARKETING CONSULTING SERVICES RELATED TO ADVERTISING, MARKETING AND BRAND DEVELOPMENT; EVENT MARKETING, NAMELY, ARRANGING AND CONDUCTING MARKETING PROMOTIONAL EVENTS FOR OTHERS; BUSINESS MARKETING CONSULTING SERVICES RELATING TO BRANDS AND BRAND DEVELOPMENT, ASSESSMENT, ANALYSIS, EXPLOITATION AND PROMOTION, IN CLASS 35 (U.S. CLS. 100, 101 AND 102).

FIRST USE 12-0-2010; IN COMMERCE 12-0-2010.

THE MARK CONSISTS OF STANDARD CHARACTERS WITHOUT CLAIM TO ANY PARTICULAR FONT, STYLE, SIZE, OR COLOR.

OWNER OF U.S. REG. NOS. 2,276,623, 3,366,964, AND OTHERS.

SN 85-203,822, FILED 12-22-2010.

LINDA ORNDORFF, EXAMINING ATTORNEY



*David J. Kyros*

Director of the United States Patent and Trademark Office

# United States of America

United States Patent and Trademark Office

# HDHF

**Reg. No. 4,199,271**

**Registered Aug. 28, 2012**

**Int. Cl.: 9**

**TRADEMARK**

**PRINCIPAL REGISTER**

CAPE EVOLUTION LTD (CHINA CORPORATION)  
ROOM 1206-7 12FL, NEW VICTORY HOUSE  
93-103 WING LOK STREET  
CENTRAL, HONG KONG, CHINA

FOR: HIGH DEFINITION, POINT OF VIEW, HANDS FREE DIGITAL VIDEO RECORDING APPARATUS FOR VIDEO AND STILL IMAGE CAPTURE EMBEDDED IN VARIOUS STYLES OF EYEWEAR AND SUNGLASSES FOR PROFESSIONAL USE, RECREATIONAL USE, DRIVING, SPORTS, AND INDOOR USE, IN CLASS 9 (U.S. CLS. 21, 23, 26, 36 AND 38).

FIRST USE 12-27-2010; IN COMMERCE 6-4-2012.

THE MARK CONSISTS OF STANDARD CHARACTERS WITHOUT CLAIM TO ANY PARTICULAR FONT, STYLE, SIZE, OR COLOR.

SN 85-205,907, FILED 12-27-2010.

AMEEN IMAM, EXAMINING ATTORNEY



*David J. Kyffers*

Director of the United States Patent and Trademark Office

# United States of America

United States Patent and Trademark Office



**Reg. No. 4,199,272**

**Registered Aug. 28, 2012**

**Int. Cl.: 5**

**TRADEMARK**

**PRINCIPAL REGISTER**

GOWAN COMPANY, L.L.C. (ARIZONA LIMITED LIABILITY COMPANY)  
370 S. MAIN STREET  
YUMA, AZ 85364

FOR: AGRICULTURAL PESTICIDES, IN CLASS 5 (U.S. CLS. 6, 18, 44, 46, 51 AND 52).

FIRST USE 3-13-2012; IN COMMERCE 3-13-2012.

OWNER OF U.S. REG. NO. 1,928,282.

NO CLAIM IS MADE TO THE EXCLUSIVE RIGHT TO USE "HERBICIDE", APART FROM THE MARK AS SHOWN.

THE MARK CONSISTS OF THE WORDS "SCYTHE" AND "HERBICIDE" OVER A REPRESENTATION OF A SCYTHE BLADE.

SN 85-206,156, FILED 12-27-2010.

CORY BOONE, EXAMINING ATTORNEY



*David J. Kyffers*

Director of the United States Patent and Trademark Office

# United States of America

United States Patent and Trademark Office

## EGISTICS CLOUDDOCS

**Reg. No. 4,199,273**

**Registered Aug. 28, 2012**

**Int. Cl.: 42**

**SERVICE MARK**

**PRINCIPAL REGISTER**

EGISTICS, INC. (DELAWARE CORPORATION)  
SUITE 550  
17304 PRESTON RD  
DALLAS, TX 75252

FOR: APPLICATION SERVICE PROVIDERS (ASP) SERVICES FEATURING SOFTWARE FOR USE IN THE STORAGE AND ACCESS OF DATA AND INFORMATION, NAMELY, UPLOAD, SCAN, INDEX AND SEARCH DOCUMENTS WITHIN THE APPLICATION, IN CLASS 42 (U.S. CLS. 100 AND 101).

FIRST USE 1-16-2012; IN COMMERCE 1-16-2012.

THE MARK CONSISTS OF STANDARD CHARACTERS WITHOUT CLAIM TO ANY PARTICULAR FONT, STYLE, SIZE, OR COLOR.

OWNER OF U.S. REG. NO. 3,291,559.

NO CLAIM IS MADE TO THE EXCLUSIVE RIGHT TO USE "CLOUD DOCS", APART FROM THE MARK AS SHOWN.

THE WORD "EGISTICS" HAS NO MEANING IN A FOREIGN LANGUAGE.

SN 85-206,295, FILED 12-28-2010.

BILL DAWE, EXAMINING ATTORNEY



*David J. Kyffers*

Director of the United States Patent and Trademark Office

# United States of America

United States Patent and Trademark Office

## ASCENTIA REAL ESTATE INVESTMENT

**Reg. No. 4,199,274**

**Registered Aug. 28, 2012**

**Int. Cl.: 36**

**SERVICE MARK**

**PRINCIPAL REGISTER**

COLORADO REAL ESTATE AND INVESTMENT COMPANY (COLORADO CORPORATION)  
TWO WEST DRY CREEK CIRCLE, SUITE 200  
LITTLETON, CO 80120

FOR: REAL ESTATE INVESTMENT SERVICES AND PROPERTY MANAGEMENT SERVICES  
FOR CONDOMINIUM ASSOCIATIONS, HOMEOWNER ASSOCIATIONS, APARTMENT  
BUILDINGS AND MOBILE HOME PARKS, IN CLASS 36 (U.S. CLS. 100, 101 AND 102).

FIRST USE 6-5-2012; IN COMMERCE 6-5-2012.

THE MARK CONSISTS OF STANDARD CHARACTERS WITHOUT CLAIM TO ANY PAR-  
TICULAR FONT, STYLE, SIZE, OR COLOR.

NO CLAIM IS MADE TO THE EXCLUSIVE RIGHT TO USE "REAL ESTATE INVESTMENT",  
APART FROM THE MARK AS SHOWN.

SN 85-206,770, FILED 12-28-2010.

NATALIE POLZER, EXAMINING ATTORNEY



*David J. Kybas*

Director of the United States Patent and Trademark Office



# United States of America

United States Patent and Trademark Office

## 3D SCALPEL

**Reg. No. 4,199,275**

**Registered Aug. 28, 2012**

**Int. Cl.: 10**

**TRADEMARK**

**PRINCIPAL REGISTER**

WU, JUNG (TAIWAN INDIVIDUAL)  
7-3, NO.166, SEC. 4, ZHONGXIAO E. RD.  
TAIPEI CITY 110, TAIWAN

FOR: SURGICAL INSTRUMENTS, NAMELY, BLADES, STAPLERS, SURGICAL SAWS, SURGICAL KNIVES, SURGICAL SCISSORS, SURGICAL MIRRORS, SURGICAL STAPLERS, SURGICAL SKIN STAPLERS, SURGICAL PERFORATORS, SURGICAL PLIERS, SURGICAL CLIPS; ARTIFICIAL BREASTS; ARTIFICIAL JAWS; SURGICAL SUTURES; SURGICAL IMPLANTS COMPRISING ARTIFICIAL MATERIAL AND ASSOCIATED SURGICAL INSTRUMENT SETS; SURGICAL GLOVES; SURGICAL GOWNS; SURGICAL DRAPES; SURGICAL CAPS; ELECTRIC SCALPELS FOR SURGICAL PURPOSES; ARTIFICIAL SKIN FOR SURGICAL PURPOSES; MEDICAL BAGS ADAPTED FOR AND SOLD WITH MEDICAL, SURGICAL AND VETERINARY INSTRUMENTS; MEDICAL AND SURGICAL APPARATUS AND INSTRUMENTS, NAMELY, ORTHOPEDIC FIXATION DEVICE USED IN ORTHOPEDIC TRANSPLANT AND/OR IMPLANT SURGERY; INJECTION SYRINGES FOR SURGICAL USE, IN CLASS 10 (U.S. CLS. 26, 39 AND 44).

FIRST USE 1-6-2011; IN COMMERCE 1-6-2011.

THE MARK CONSISTS OF STANDARD CHARACTERS WITHOUT CLAIM TO ANY PARTICULAR FONT, STYLE, SIZE, OR COLOR.

NO CLAIM IS MADE TO THE EXCLUSIVE RIGHT TO USE "SCALPEL", APART FROM THE MARK AS SHOWN.

SN 85-208,641, FILED 12-31-2010.

LAURIE KAUFMAN, EXAMINING ATTORNEY



*David J. Kyros*

Director of the United States Patent and Trademark Office

# United States of America

United States Patent and Trademark Office

# FIREWORKS

**Reg. No. 4,199,276**

PARFUMS DE COEUR, LTD. (CONNECTICUT CORPORATION)  
85 OLD KINGS HIGHWAY  
DARIEN, CT 06820

**Registered Aug. 28, 2012**

**Int. Cl.: 3**

FOR: WOMEN'S FRAGRANCES, NAMELY, PERFUME, BODY SPRAYS AND BODY LOTIONS, IN CLASS 3 (U.S. CLS. 1, 4, 6, 50, 51 AND 52).

**TRADEMARK**

FIRST USE 2-0-2009; IN COMMERCE 2-0-2009.

**PRINCIPAL REGISTER**

THE MARK CONSISTS OF STANDARD CHARACTERS WITHOUT CLAIM TO ANY PARTICULAR FONT, STYLE, SIZE, OR COLOR.

SN 85-209,055, FILED 1-3-2011.

KRISTINA MORRIS, EXAMINING ATTORNEY



*David J. Kybas*

Director of the United States Patent and Trademark Office

# United States of America

United States Patent and Trademark Office

## SLOW DANCE

**Reg. No. 4,199,277**

PARFUMS DE COEUR, LTD. (CONNECTICUT CORPORATION)  
85 OLD KINGS HIGHWAY  
DARIEN, CT 06820

**Registered Aug. 28, 2012**

**Int. Cl.: 3**

FOR: PERFUMES AND BODY SPRAYS USED AS A FRAGRANCE, IN CLASS 3 (U.S. CLS. 1, 4, 6, 50, 51 AND 52).

**TRADEMARK**

FIRST USE 2-0-2009; IN COMMERCE 2-0-2009.

**PRINCIPAL REGISTER**

THE MARK CONSISTS OF STANDARD CHARACTERS WITHOUT CLAIM TO ANY PARTICULAR FONT, STYLE, SIZE, OR COLOR.

SN 85-209,063, FILED 1-3-2011.

KRISTINA MORRIS, EXAMINING ATTORNEY



*David J. Kyjars*

Director of the United States Patent and Trademark Office

# United States of America

United States Patent and Trademark Office

## TOM FORD JASMIN ROUGE

**Reg. No. 4,199,278**

FORD, THOMAS C. (UNITED STATES INDIVIDUAL)  
C/O SHAPIRO & COMPANY, C.P.A.  
9229 SUNSET BOULEVARD, SUITE 607  
LOS ANGELES, CA 90069

**Registered Aug. 28, 2012**

**Int. Cl.: 3**

FOR: FRAGRANCES FOR PERSONAL USE, IN CLASS 3 (U.S. CLS. 1, 4, 6, 50, 51 AND 52).

**TRADEMARK**

FIRST USE 8-31-2011; IN COMMERCE 8-31-2011.

**PRINCIPAL REGISTER**

THE MARK CONSISTS OF STANDARD CHARACTERS WITHOUT CLAIM TO ANY PARTICULAR FONT, STYLE, SIZE, OR COLOR.

OWNER OF U.S. REG. NOS. 3,076,975, 3,544,448, AND OTHERS.

NO CLAIM IS MADE TO THE EXCLUSIVE RIGHT TO USE "JASMIN", APART FROM THE MARK AS SHOWN.

THE NAME "TOM FORD" IN THE MARK IDENTIFIES THOMAS C. FORD, A LIVING INDIVIDUAL WHOSE CONSENT IS OF RECORD.

THE ENGLISH TRANSLATION OF "JASMIN" IN THE MARK IS "JASMINE".

SN 85-210,099, FILED 1-4-2011.

DAVID H. STINE, EXAMINING ATTORNEY



*David J. Kybas*

Director of the United States Patent and Trademark Office

# United States of America

United States Patent and Trademark Office

## TOM FORD SANTAL BLUSH

**Reg. No. 4,199,279**

FORD, THOMAS C. (UNITED STATES INDIVIDUAL)  
C/O SHAPIRO & COMPANY, C.P.A.  
9229 SUNSET BOULEVARD  
LOS ANGELES, CA 90069

**Registered Aug. 28, 2012**

**Int. Cl.: 3**

FOR: FRAGRANCES FOR PERSONAL USE, IN CLASS 3 (U.S. CLS. 1, 4, 6, 50, 51 AND 52).

**TRADEMARK**

FIRST USE 8-31-2011; IN COMMERCE 8-31-2011.

**PRINCIPAL REGISTER**

THE MARK CONSISTS OF STANDARD CHARACTERS WITHOUT CLAIM TO ANY PARTICULAR FONT, STYLE, SIZE, OR COLOR.

OWNER OF U.S. REG. NOS. 3,076,975, 3,544,448, AND OTHERS.

NO CLAIM IS MADE TO THE EXCLUSIVE RIGHT TO USE "SANTAL", APART FROM THE MARK AS SHOWN.

THE NAME "TOM FORD" IN THE MARK IDENTIFIES THOMAS C. FORD, A LIVING INDIVIDUAL WHOSE CONSENT IS OF RECORD.

THE ENGLISH TRANSLATION OF "SANTAL" IN THE MARK IS "SANDALWOOD".

SN 85-210,159, FILED 1-4-2011.

DAVID H. STINE, EXAMINING ATTORNEY



*David J. Kyros*

Director of the United States Patent and Trademark Office

# United States of America

United States Patent and Trademark Office

## Dark Hundred

**Reg. No. 4,199,280**

PURPLE WINE PRODUCTION COMPANY (CALIFORNIA CORPORATION)  
9119 GRATON RD.  
GRATON, CA 95444

**Registered Aug. 28, 2012**

**Int. Cl.: 33**

FOR: WINE; WINES, IN CLASS 33 (U.S. CLS. 47 AND 49).

**TRADEMARK**

FIRST USE 5-4-2012; IN COMMERCE 5-4-2012.

**PRINCIPAL REGISTER**

THE MARK CONSISTS OF STANDARD CHARACTERS WITHOUT CLAIM TO ANY PARTICULAR FONT, STYLE, SIZE, OR COLOR.

SN 85-210,311, FILED 1-4-2011.

CHERYL CLAYTON, EXAMINING ATTORNEY



*David J. Kybas*

Director of the United States Patent and Trademark Office

# United States of America

United States Patent and Trademark Office

# CONTEMASSI

**Reg. No. 4,199,281**

BRONCO WINE COMPANY (CALIFORNIA CORPORATION)  
6342 BYSTRUM ROAD  
CERES, CA 95307

**Registered Aug. 28, 2012**

**Int. Cl.: 33**

FOR: WINE, IN CLASS 33 (U.S. CLS. 47 AND 49).

**TRADEMARK**

FIRST USE 4-12-2011; IN COMMERCE 4-12-2011.

**PRINCIPAL REGISTER**

THE MARK CONSISTS OF STANDARD CHARACTERS WITHOUT CLAIM TO ANY PARTICULAR FONT, STYLE, SIZE, OR COLOR.

SN 85-210,796, FILED 1-5-2011.

KAREN K. BUSH, EXAMINING ATTORNEY



*David J. Kybas*

Director of the United States Patent and Trademark Office

# United States of America

United States Patent and Trademark Office

## SUPREME HATTERS

**Reg. No. 4,199,282**

DENCIGER, SHNIOR (UNITED STATES INDIVIDUAL)  
4380 UNIVERSITY PARKWAY  
UNIVERSITY HEIGHTS, OH 44118

**Registered Aug. 28, 2012**

**Int. Cl.: 25**

FOR: CLOTHING, NAMELY, HATS, JACKETS, SUITS, PANTS, SWEATERS, SHIRTS, SHOES,  
IN CLASS 25 (U.S. CLS. 22 AND 39).

**TRADEMARK**

FIRST USE 4-1-2011; IN COMMERCE 1-1-2012.

**PRINCIPAL REGISTER**

THE MARK CONSISTS OF STANDARD CHARACTERS WITHOUT CLAIM TO ANY PARTICULAR FONT, STYLE, SIZE, OR COLOR.

NO CLAIM IS MADE TO THE EXCLUSIVE RIGHT TO USE "HATTERS", APART FROM THE MARK AS SHOWN.

SN 85-211,541, FILED 1-6-2011.

RAUL CORDOVA, EXAMINING ATTORNEY



*David J. Kybas*

Director of the United States Patent and Trademark Office



# United States of America

United States Patent and Trademark Office

# LITTER ZAP

**Reg. No. 4,199,283**

LOVENVIRTH, STEWART J. (UNITED STATES INDIVIDUAL)  
24 CHESTNUT RIDGE DRIVE  
INMAN, SC 29349

**Registered Aug. 28, 2012**

**Int. Cl.: 21**

FOR: ANIMAL LITTER BOXES, IN CLASS 21 (U.S. CLS. 2, 13, 23, 29, 30, 33, 40 AND 50).

**TRADEMARK**

FIRST USE 4-18-2012; IN COMMERCE 4-18-2012.

**PRINCIPAL REGISTER**

THE MARK CONSISTS OF STANDARD CHARACTERS WITHOUT CLAIM TO ANY PARTICULAR FONT, STYLE, SIZE, OR COLOR.

NO CLAIM IS MADE TO THE EXCLUSIVE RIGHT TO USE "LITTER", APART FROM THE MARK AS SHOWN.

SN 85-211,576, FILED 1-6-2011.

JOHN GARTNER, EXAMINING ATTORNEY



*David J. Kyffers*

Director of the United States Patent and Trademark Office

# United States of America

United States Patent and Trademark Office

# PARSE.LY

**Reg. No. 4,199,284**

PARSELY, INC. (DELAWARE CORPORATION), AKA PARSE.LY,  
989 6TH AVE., 3RD FLOOR  
NEW YORK, NY 10018

**Registered Aug. 28, 2012**

**Int. Cls.: 9, 35, and 39**

FOR: COMPUTER PROGRAMS FOR USING THE INTERNET AND THE WORLD WIDE WEB, IN CLASS 9 (U.S. CLS. 21, 23, 26, 36 AND 38).

**TRADEMARK**

FIRST USE 8-20-2009; IN COMMERCE 8-20-2009.

**SERVICE MARK**

**PRINCIPAL REGISTER**

FOR: ADVERTISEMENT FOR OTHERS ON THE INTERNET; ADVERTISING AND COMMERCIAL INFORMATION SERVICES, VIA THE INTERNET; ADVERTISING AND MARKETING SERVICES PROVIDED BY MEANS OF INDIRECT METHODS OF MARKETING COMMUNICATIONS, NAMELY, SOCIAL MEDIA, SEARCH ENGINE MARKETING, INQUIRY MARKETING, INTERNET MARKETING, MOBILE MARKETING, BLOGGING AND OTHER FORMS OF PASSIVE, SHARABLE OR VIRAL COMMUNICATIONS CHANNELS; ADVERTISING ON THE INTERNET FOR OTHERS; ADVERTISING SERVICES, NAMELY, PROMOTING PROPERTIES FOR SALE BY OWNER VIA THE INTERNET; ADVERTISING VIA ELECTRONIC MEDIA AND SPECIFICALLY THE INTERNET; ADVICE AND INFORMATION ABOUT CUSTOMER SERVICES AND PRODUCT MANAGEMENT AND PRICES ON INTERNET SITES IN CONNECTION WITH PURCHASES MADE OVER THE INTERNET; AN INTERACTIVE WEB SITE FOR USERS TO REVIEW AND RATE INTERNET CONTENT, PEOPLE, COMPANIES, PRODUCTS AND/OR SERVICES UTILIZING A SOFTWARE APPLICATION TO AWARD POINTS WHEREBY WEB SITE USERS ARE ELIGIBLE TO EXCHANGE POINTS EARNED FOR PROMOTIONAL ITEMS CONSISTING OF COUPONS, REBATES, DISCOUNTS OR SPECIAL OFFERINGS ON GOODS AND/OR SERVICE PROVIDED BY WEB SITE SPONSORS; AUCTIONEERING PROVIDED ON THE INTERNET; BUSINESS ADMINISTRATION SERVICES FOR PROCESSING SALES MADE ON THE INTERNET; COMPILATION OF ADVERTISEMENTS FOR USE AS WEB PAGES ON THE INTERNET; CONSULTING SERVICES IN THE FIELD OF INTERNET MARKETING; DESIGN OF INTERNET ADVERTISING; DISSEMINATION OF ADVERTISING FOR OTHERS VIA AN ON-LINE COMMUNICATIONS NETWORK ON THE INTERNET; DISSEMINATION OF ADVERTISING FOR OTHERS VIA THE INTERNET; FACILITATING THE EXCHANGE OF NEEDED INFORMATION FOR FINANCIAL COMPENSATION VIA THE INTERNET; INFORMATION, ADVISORY AND CONSULTANCY SERVICES RELATING TO BUSINESS AND MANAGEMENT OR BUSINESS ADMINISTRATION, INCLUDING SUCH SERVICES PROVIDED ON LINE OR VIA THE INTERNET; INFORMATION, ADVISORY, CONSULTING, BUSINESS RESEARCH AND PLANNING SERVICES RELATING TO PUBLICITY, MARKETING



*David J. Kyros*

Director of the United States Patent and Trademark Office

**Reg. No. 4,199,284** COMMUNICATIONS, REPUTATION MANAGEMENT OR BUSINESS ADMINISTRATION, INCLUDING SUCH SERVICES PROVIDED ONLINE OR VIA THE INTERNET; INTERNET ADVERTISING SERVICES, IN CLASS 35 (U.S. CLS. 100, 101 AND 102).

FIRST USE 8-20-2009; IN COMMERCE 8-20-2009.

FOR: ON-LINE COMPUTER SERVICES FOR STORING CONTENT ITEMS SELECTED BY USERS FROM INTERNET WEB PAGES, IN CLASS 39 (U.S. CLS. 100 AND 105).

FIRST USE 8-20-2009; IN COMMERCE 8-20-2009.

THE MARK CONSISTS OF STANDARD CHARACTERS WITHOUT CLAIM TO ANY PARTICULAR FONT, STYLE, SIZE, OR COLOR.

SN 85-211,733, FILED 1-6-2011.

STEPHANIE ALI, EXAMINING ATTORNEY

# United States of America

United States Patent and Trademark Office

## Destination Cuisine

**Reg. No. 4,199,285**

DESTINATION CUISINE (FLORIDA LIMITED LIABILITY COMPANY)  
3793 EAGLE HAMMOCK DRIVE  
SARASOTA, FL 34240

**Registered Aug. 28, 2012**

**Int. Cl.: 42**

FOR: HOSTING AN ON-LINE COMMUNITY WEB SITE FEATURING SHARED COMMUNICATIONS BETWEEN COMMUNITY MEMBERS INTERESTED IN CUISINE AND TRAVEL, NAMELY, LIVING COOKBOOKS, RESTAURANTS AND A CULINARY FOCUSED TRAVEL PORTAL, IN CLASS 42 (U.S. CLS. 100 AND 101).

**SERVICE MARK**

**PRINCIPAL REGISTER**

FIRST USE 5-23-2012; IN COMMERCE 5-23-2012.

THE MARK CONSISTS OF STANDARD CHARACTERS WITHOUT CLAIM TO ANY PARTICULAR FONT, STYLE, SIZE, OR COLOR.

NO CLAIM IS MADE TO THE EXCLUSIVE RIGHT TO USE "CUISINE", APART FROM THE MARK AS SHOWN.

SN 85-211,735, FILED 1-6-2011.

STEPHANIE ALI, EXAMINING ATTORNEY



*David J. Kybas*

Director of the United States Patent and Trademark Office

# United States of America

United States Patent and Trademark Office

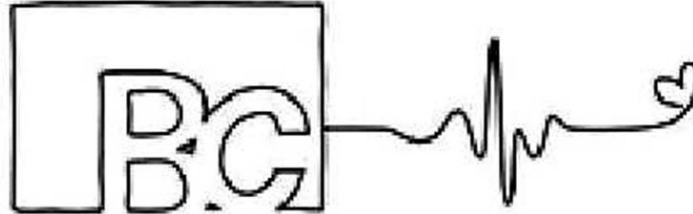

**Reg. No. 4,199,286**

**Registered Aug. 28, 2012**

**Int. Cl.: 25**

**TRADEMARK**

**PRINCIPAL REGISTER**

SEYCHELLES IMPORTS, LLC (CALIFORNIA LIMITED LIABILITY COMPANY)  
800 NORTH SEPULVEDA BOULEVARD  
EL SEGUNDO, CA 90245

FOR: FOOTWEAR, IN CLASS 25 (U.S. CLS. 22 AND 39).

FIRST USE 7-0-2010; IN COMMERCE 7-0-2010.

OWNER OF U.S. REG. NO. 3,004,155.

THE MARK CONSISTS OF THE STYLIZED LETTERS "BC" WITHIN A BOX WITH A FANCIFUL GEOMETRIC DESIGN WITH A HEART TO THE FAR RIGHT.

SN 85-211,742, FILED 1-6-2011.

STEPHANIE ALI, EXAMINING ATTORNEY



*David J. Kyffers*

Director of the United States Patent and Trademark Office

# United States of America

United States Patent and Trademark Office

## STAR OF JOY

**Reg. No. 4,199,287**

KAMA-SCHACHTER JEWELRY (PVT.) LTD. (INDIA LIMITED LIABILITY COMPANY)  
203 & 204, BLOCK NO. II, SEEPZ  
ANDHERI (E), MUMBAI, INDIA 400096

**Registered Aug. 28, 2012**

**Int. Cl.: 14**

FOR: JEWELRY, IN CLASS 14 (U.S. CLS. 2, 27, 28 AND 50).

**TRADEMARK**

FIRST USE 5-0-2012; IN COMMERCE 5-0-2012.

**PRINCIPAL REGISTER**

THE MARK CONSISTS OF STANDARD CHARACTERS WITHOUT CLAIM TO ANY PARTICULAR FONT, STYLE, SIZE, OR COLOR.

SN 85-212,256, FILED 1-6-2011.

JOHN WILKE, EXAMINING ATTORNEY



*David J. Kybas*

Director of the United States Patent and Trademark Office

# United States of America

United States Patent and Trademark Office

## HAPPINESS IN STORE

**Reg. No. 4,199,288**

**Registered Aug. 28, 2012**

**Int. Cls.: 35, 43, and 44**

**SERVICE MARK**

**PRINCIPAL REGISTER**

PETSMART STORE SUPPORT GROUP, INC. (DELAWARE CORPORATION)  
LEGAL DEPARTMENT  
19601 NORTH 27TH AVENUE  
PHOENIX, AZ 85027

FOR: RETAIL STORE SERVICES AND ON-LINE RETAIL STORE SERVICES, FEATURING PET FOOD, PET SUPPLIES AND PET ACCESSORIES, IN CLASS 35 (U.S. CLS. 100, 101 AND 102).

FIRST USE 5-2-2011; IN COMMERCE 5-2-2011.

FOR: BOARDING FOR PETS; PET DAY CARE SERVICES; PROVIDING INFORMATION ABOUT PET BOARDING AND PET DAY CARE, IN CLASS 43 (U.S. CLS. 100 AND 101).

FIRST USE 5-2-2011; IN COMMERCE 5-2-2011.

FOR: PET GROOMING SERVICES; PROVIDING INFORMATION ABOUT PET GROOMING SERVICES, IN CLASS 44 (U.S. CLS. 100 AND 101).

FIRST USE 5-2-2011; IN COMMERCE 5-2-2011.

THE MARK CONSISTS OF STANDARD CHARACTERS WITHOUT CLAIM TO ANY PARTICULAR FONT, STYLE, SIZE, OR COLOR.

SN 85-212,293, FILED 1-6-2011.

WILLIAM BRECKENFELD, EXAMINING ATTORNEY



*David J. Kyros*

Director of the United States Patent and Trademark Office

# United States of America

United States Patent and Trademark Office

# HEAT N EAT

**Reg. No. 4,199,289**

ROBBIE MANUFACTURING, INC. (KANSAS CORPORATION)  
10810 MID-AMERICA AVENUE  
LENEXA, KS 66219

**Registered Aug. 28, 2012**

**Int. Cl.: 16**

FOR: PLASTIC FOOD STORAGE BAGS FOR INDUSTRIAL AND COMMERCIAL USE, IN CLASS 16 (U.S. CLS. 2, 5, 22, 23, 29, 37, 38 AND 50).

**TRADEMARK**

FIRST USE 2-29-2012; IN COMMERCE 2-29-2012.

**PRINCIPAL REGISTER**

THE MARK CONSISTS OF STANDARD CHARACTERS WITHOUT CLAIM TO ANY PARTICULAR FONT, STYLE, SIZE, OR COLOR.

SN 85-212,677, FILED 1-7-2011.

HENRY S. ZAK, EXAMINING ATTORNEY



*David J. Kyffers*

Director of the United States Patent and Trademark Office



# United States of America

United States Patent and Trademark Office

# EMERGE

**Reg. No. 4,199,290**

BOSTON SCIENTIFIC SCIMED, INC. (MINNESOTA CORPORATION)  
ONE SCIMED PLACE  
MAPLE GROVE, MN 55311

**Registered Aug. 28, 2012**

**Int. Cl.: 10**

FOR: MEDICAL CATHETERS AND MEDICAL BALLOON CATHETERS, IN CLASS 10 (U.S. CLS. 26, 39 AND 44).

**TRADEMARK**

FIRST USE 5-2-2012; IN COMMERCE 5-2-2012.

**PRINCIPAL REGISTER**

THE MARK CONSISTS OF STANDARD CHARACTERS WITHOUT CLAIM TO ANY PARTICULAR FONT, STYLE, SIZE, OR COLOR.

SN 85-212,736, FILED 1-7-2011.

MAYUR VAGHANI, EXAMINING ATTORNEY



*David J. Kybas*

Director of the United States Patent and Trademark Office

United States of America  
United States Patent and Trademark Office

LOVEWELL

**Reg. No. 4,199,291**

PINKETTE CLOTHING, INC. (CALIFORNIA CORPORATION)  
1100 S. SAN PEDRO ST., SUITE A-12  
LOS ANGELES, CA 90015

**Registered Aug. 28, 2012**

**Int. Cl.: 25**

FOR: CLOTHING, NAMELY, TOPS, BOTTOMS AND DRESSES, IN CLASS 25 (U.S. CLS. 22 AND 39).

**TRADEMARK**

FIRST USE 2-1-2012; IN COMMERCE 2-1-2012.

**PRINCIPAL REGISTER**

THE MARK CONSISTS OF STANDARD CHARACTERS WITHOUT CLAIM TO ANY PARTICULAR FONT, STYLE, SIZE, OR COLOR.

SN 85-213,029, FILED 1-7-2011.

JANICE KIM, EXAMINING ATTORNEY



*David J. Kybas*

Director of the United States Patent and Trademark Office

# United States of America

United States Patent and Trademark Office

# ECO ISLAND

**Reg. No. 4,199,292**

**Registered Aug. 28, 2012**

**Int. Cl.: 25**

**TRADEMARK**

**PRINCIPAL REGISTER**

GLOBAL TRADEMARKS, INC. (NEVADA CORPORATION)  
110 COMMERCE WAY  
STOCKERTOWN, PA 18083

FOR: COVERUPS; SWIMWEAR, IN CLASS 25 (U.S. CLS. 22 AND 39).

FIRST USE 4-25-2012; IN COMMERCE 4-25-2012.

THE MARK CONSISTS OF STANDARD CHARACTERS WITHOUT CLAIM TO ANY PARTICULAR FONT, STYLE, SIZE, OR COLOR.

SN 85-213,036, FILED 1-7-2011.

INGA ERVIN, EXAMINING ATTORNEY



*David J. Kybas*

Director of the United States Patent and Trademark Office

# United States of America

United States Patent and Trademark Office

# ECO YOUTH

**Reg. No. 4,199,293**

**Registered Aug. 28, 2012**

**Int. Cl.: 25**

**TRADEMARK**

**PRINCIPAL REGISTER**

GLOBAL TRADEMARKS, INC. (NEVADA CORPORATION)  
110 COMMERCE WAY  
STOCKERTOWN, PA 18083

FOR: COVERUPS; SWIMWEAR, IN CLASS 25 (U.S. CLS. 22 AND 39).

FIRST USE 4-25-2012; IN COMMERCE 4-25-2012.

THE MARK CONSISTS OF STANDARD CHARACTERS WITHOUT CLAIM TO ANY PARTICULAR FONT, STYLE, SIZE, OR COLOR.

NO CLAIM IS MADE TO THE EXCLUSIVE RIGHT TO USE "YOUTH", APART FROM THE MARK AS SHOWN.

SN 85-213,044, FILED 1-7-2011.

INGA ERVIN, EXAMINING ATTORNEY



*David J. Kyffers*

Director of the United States Patent and Trademark Office

# United States of America

United States Patent and Trademark Office

# ECOKINI

**Reg. No. 4,199,294**

GLOBAL TRADEMARKS, INC. (NEVADA CORPORATION)  
110 COMMERCE WAY  
STOCKERTOWN, PA 18083

**Registered Aug. 28, 2012**

**Int. Cl.: 25**

FOR: COVERUPS; SWIMWEAR, IN CLASS 25 (U.S. CLS. 22 AND 39).

**TRADEMARK**

FIRST USE 4-25-2012; IN COMMERCE 4-25-2012.

**PRINCIPAL REGISTER**

THE MARK CONSISTS OF STANDARD CHARACTERS WITHOUT CLAIM TO ANY PARTICULAR FONT, STYLE, SIZE, OR COLOR.

SN 85-213,050, FILED 1-7-2011.

INGA ERVIN, EXAMINING ATTORNEY



*David J. Kybas*

Director of the United States Patent and Trademark Office

# United States of America

United States Patent and Trademark Office

## THE ALPHA INSTITUTE

**Reg. No. 4,199,295**

**Registered Aug. 28, 2012**

**Int. Cl.: 41**

**SERVICE MARK**

**PRINCIPAL REGISTER**

THE ALPHA INSTITUTE, LLC (MASSACHUSETTS LIMITED LIABILITY COMPANY)  
TWO COPLEY PLACE, SUITE 700  
BOSTON, MA 02116

FOR: EDUCATIONAL SERVICES, NAMELY, SEMINARS, PROGRAMS, CLASSES, CONFERENCES, RETREATS, WORKSHOPS AND COACHING IN THE FIELD OF SALES TRAINING, AND DISTRIBUTION OF TRAINING MATERIAL IN CONNECTION THEREWITH; EDUCATIONAL SERVICES, NAMELY, SEMINARS, PROGRAMS, CLASSES, CONFERENCES, RETREATS, WORKSHOPS AND COACHING IN THE FIELD OF FINANCE, IN CLASS 41 (U.S. CLS. 100, 101 AND 107).

FIRST USE 1-1-2012; IN COMMERCE 1-1-2012.

THE MARK CONSISTS OF STANDARD CHARACTERS WITHOUT CLAIM TO ANY PARTICULAR FONT, STYLE, SIZE, OR COLOR.

NO CLAIM IS MADE TO THE EXCLUSIVE RIGHT TO USE "INSTITUTE", APART FROM THE MARK AS SHOWN.

SN 85-213,054, FILED 1-7-2011.

JANICE KIM, EXAMINING ATTORNEY



*David J. Kybas*

Director of the United States Patent and Trademark Office

# United States of America

United States Patent and Trademark Office

# ECO WAVE

**Reg. No. 4,199,296**

**Registered Aug. 28, 2012**

**Int. Cl.: 25**

**TRADEMARK**

**PRINCIPAL REGISTER**

GLOBAL TRADEMARKS, INC. (NEVADA CORPORATION)  
110 COMMERCE WAY  
STOCKERTOWN, PA 18083

FOR: COVERUPS; SWIMWEAR, IN CLASS 25 (U.S. CLS. 22 AND 39).

FIRST USE 4-25-2012; IN COMMERCE 4-25-2012.

THE MARK CONSISTS OF STANDARD CHARACTERS WITHOUT CLAIM TO ANY PARTICULAR FONT, STYLE, SIZE, OR COLOR.

SN 85-213,056, FILED 1-7-2011.

INGA ERVIN, EXAMINING ATTORNEY



*David J. Kyffers*

Director of the United States Patent and Trademark Office

# United States of America

United States Patent and Trademark Office

## ECO SHAPER

**Reg. No. 4,199,297**

GLOBAL TRADEMARKS, INC. (NEVADA CORPORATION)  
110 COMMERCE WAY  
STOCKERTOWN, PA 18083

**Registered Aug. 28, 2012**

**Int. Cl.: 25**

FOR: COVERUPS; SWIMWEAR, IN CLASS 25 (U.S. CLS. 22 AND 39).

**TRADEMARK**

FIRST USE 4-25-2012; IN COMMERCE 4-25-2012.

**PRINCIPAL REGISTER**

THE MARK CONSISTS OF STANDARD CHARACTERS WITHOUT CLAIM TO ANY PARTICULAR FONT, STYLE, SIZE, OR COLOR.

NO CLAIM IS MADE TO THE EXCLUSIVE RIGHT TO USE "SHAPER", APART FROM THE MARK AS SHOWN.

SN 85-213,062, FILED 1-7-2011.

INGA ERVIN, EXAMINING ATTORNEY



*David J. Kyffers*

Director of the United States Patent and Trademark Office



# United States of America

United States Patent and Trademark Office

## ECO CONTROL

**Reg. No. 4,199,298**

**Registered Aug. 28, 2012**

**Int. Cl.: 25**

**TRADEMARK**

**PRINCIPAL REGISTER**

GLOBAL TRADEMARKS, INC. (NEVADA CORPORATION)  
110 COMMERCE WAY  
STOCKERTOWN, PA 18083

FOR: COVERUPS; SWIMWEAR, IN CLASS 25 (U.S. CLS. 22 AND 39).

FIRST USE 4-25-2012; IN COMMERCE 4-25-2012.

THE MARK CONSISTS OF STANDARD CHARACTERS WITHOUT CLAIM TO ANY PARTICULAR FONT, STYLE, SIZE, OR COLOR.

SN 85-213,064, FILED 1-7-2011.

INGA ERVIN, EXAMINING ATTORNEY



*David J. Kyffers*

Director of the United States Patent and Trademark Office

# United States of America

United States Patent and Trademark Office



Terra Environmental Technologies  
A CF Industries Company

**Reg. No. 4,199,299**

**Registered Aug. 28, 2012**

**Int. Cls.: 1 and 16**

**TRADEMARK**

**PRINCIPAL REGISTER**

TERRA INDUSTRIES INC. (MARYLAND CORPORATION)  
SUITE 400  
4 PARKWAY NORTH  
DEERFIELD, IL 60015

FOR: NITROGEN AND FERTILIZERS; NITROGEN, CALCIUM PHOSPHATE AND SODIUM PHOSPHATE, ALL FOR USE IN THE FIELDS OF EXPLOSIVES, NITROGEN OXIDE ABATEMENT, PHARMACEUTICALS, ADHESIVES, AND ETHANOL FERMENTATION; UREA BASED DIESEL EXHAUST TREATMENT FLUID, IN CLASS 1 (U.S. CLS. 1, 5, 6, 10, 26 AND 46).

FIRST USE 1-22-2011; IN COMMERCE 1-22-2011.

FOR: PRINTED REPORTS CONCERNING AGRICULTURE, FARM, INDUSTRIAL AND AUTOMOTIVE APPLICATIONS, IN CLASS 16 (U.S. CLS. 2, 5, 22, 23, 29, 37, 38 AND 50).

FIRST USE 1-22-2011; IN COMMERCE 1-22-2011.

OWNER OF U.S. REG. NOS. 1,055,842, 3,117,695, AND OTHERS.

NO CLAIM IS MADE TO THE EXCLUSIVE RIGHT TO USE "ENVIRONMENTAL TECHNOLOGIES" AND "INDUSTRIES COMPANY", APART FROM THE MARK AS SHOWN.



THE MARK CONSISTS OF A SQUARE ROTATED 90 DEGREES WITH THE STYLIZED LETTERS "TET" CENTERED ON A DARKENED BACKGROUND ABOVE A DESIGN OF FOUR DESCENDING CURVED LINES WITH THREE CURVED SUBSTANTIALLY HORIZONTAL LINES IN THE LOWER RIGHT QUADRANT AND THE WORDS "TERRA ENVIRONMENTAL TECHNOLOGIES" TO THE RIGHT OF THE SQUARE AND ABOVE THE WORDS "A CF INDUSTRIES COMPANY".

SN 85-213,313, FILED 1-7-2011.

MARK SHINER, EXAMINING ATTORNEY

*David J. Kyffers*

Director of the United States Patent and Trademark Office

# United States of America

United States Patent and Trademark Office

## NIKE BETTER WORLD

**Reg. No. 4,199,300**

**Registered Aug. 28, 2012**

**Int. Cl.: 35**

**SERVICE MARK**

**PRINCIPAL REGISTER**

NIKE, INC. (OREGON CORPORATION)  
ONE BOWERMAN DRIVE, DF-4  
BEAVERTON, OR 97005

FOR: PROMOTING PUBLIC INTEREST AND AWARENESS IN THE FIELD OF SPORTS, SPORTS COMPETITIONS, PHYSICAL FITNESS AND TRAINING, AND RELATING TO HUMANITARIAN, COMMUNITY, HEALTH, AND ENVIRONMENTAL SUSTAINABILITY ISSUES; PROVIDING A WEBSITE PROMOTING PUBLIC INTEREST AND AWARENESS IN THE FIELD OF SPORTS, SPORTS COMPETITIONS, PHYSICAL FITNESS AND TRAINING, AND RELATING TO HUMANITARIAN, COMMUNITY, HEALTH, AND ENVIRONMENTAL SUSTAINABILITY ISSUES FEATURING INFORMATION ON ENVIRONMENTALLY PREFERRED MATERIALS, WASTE REDUCTION, AND OTHER MEANS OF REDUCING ENVIRONMENTAL IMPACT OF CONSUMER PRODUCTS MANUFACTURING AND DISTRIBUTION, IN CLASS 35 (U.S. CLS. 100, 101 AND 102).

FIRST USE 1-1-2011; IN COMMERCE 1-1-2011.

THE MARK CONSISTS OF STANDARD CHARACTERS WITHOUT CLAIM TO ANY PARTICULAR FONT, STYLE, SIZE, OR COLOR.

SN 85-213,316, FILED 1-7-2011.

CHARLOTTE CORWIN, EXAMINING ATTORNEY



*David J. Kybas*

Director of the United States Patent and Trademark Office

# United States of America

United States Patent and Trademark Office

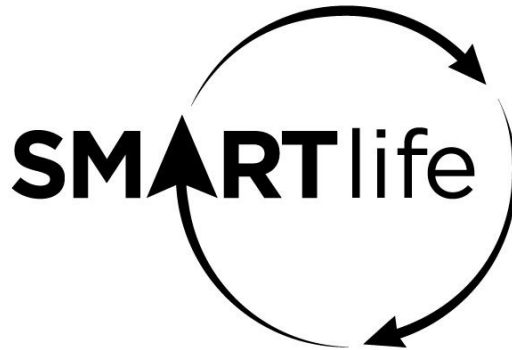

**Reg. No. 4,199,301**

**Registered Aug. 28, 2012**

**Int. Cl.: 42**

**SERVICE MARK**

**PRINCIPAL REGISTER**

SEALED AIR CORPORATION (US) (DELAWARE CORPORATION)  
200 RIVERFRONT BOULEVARD  
ELMWOOD PARK, NJ 07407

FOR: TECHNICAL CONSULTING IN THE FIELD OF PRODUCT MATERIALS AND DESIGN, NAMELY, PACKAGING AND PACKAGING SUSTAINABILITY, IN CLASS 42 (U.S. CLS. 100 AND 101).

FIRST USE 9-12-2011; IN COMMERCE 9-12-2011.

THE MARK CONSISTS OF THE STYLIZED WORDING "SMARTLIFE" WHERE THE LETTER "A" IS IN THE FORMAT OF AN UPWARD POINTING ARROWHEAD WHICH FORMS ONE SEGMENT OF THREE ARROWS FORMING A CIRCLE THAT SURROUNDS THE RIGHT SIDE PORTION OF THE WORDING.

SN 85-214,148, FILED 1-10-2011.

CHRISTINE COOPER, EXAMINING ATTORNEY



*David J. Kyffers*

Director of the United States Patent and Trademark Office

# United States of America

United States Patent and Trademark Office

## PATIENTS FOR LIFE

**Reg. No. 4,199,302**

AUDIGY GROUP, LLC (WASHINGTON LIMITED LIABILITY COMPANY)  
11201 NE 9TH ST  
VANCOUVER, WA 98684

**Registered Aug. 28, 2012**

**Int. Cl.: 35**

FOR: BUSINESS CONSULTING SERVICES IN THE FIELD OF HEALTH CARE PRACTICE MANAGEMENT, IN CLASS 35 (U.S. CLS. 100, 101 AND 102).

**SERVICE MARK**

FIRST USE 7-0-2007; IN COMMERCE 7-0-2007.

**PRINCIPAL REGISTER**

THE MARK CONSISTS OF STANDARD CHARACTERS WITHOUT CLAIM TO ANY PARTICULAR FONT, STYLE, SIZE, OR COLOR.

SN 85-214,572, FILED 1-11-2011.

ALICE BENMAMAN, EXAMINING ATTORNEY



*David J. Kybas*

Director of the United States Patent and Trademark Office

# United States of America

United States Patent and Trademark Office

## Kathy D. Woods

**Reg. No. 4,199,303**

US 3 FITS, LLC (CALIFORNIA LIMITED LIABILITY COMPANY)  
PO BOX 3856

**Registered Aug. 28, 2012**

VALLEY VILLAGE, CA 91617

**Int. Cl.: 25**

FOR: CLOTHING, NAMELY, SHIRTS, T-SHIRTS, JACKETS, COATS, FABRIC BELTS, LEATHER BELTS, CAPS, HATS, VISORS, BEANIES, FLEECE PULLOVERS, SWEATERS, JACKETS, JEANS, PANTS, TROUSERS, POLO SHIRTS, SWEAT PANTS, SWEATSHIRTS, SWEAT SUITS, TANK TOPS, SHORTS, FIGHTING SHORTS, SWIM SUITS, TRUNKS, BOARD SHORTS, BANDANAS, SHOES, SANDALS, BOOTS, FOOTWEAR, THERMAL UNDERWEAR, SOCKS, NIGHT GOWNS, PAJAMAS, WIND SHIRTS, PONCHOS, VESTS, PARKAS, BOXER SHORTS, BRIEFS, UNDERWEAR, BRAS, YOGA PANTS, BATHROBES, JERSEYS, CAPRI PANTS, CARDIGAN SWEATERS, SWEATER VESTS, BLAZERS, DRESS SHIRTS, SNAP CROTCH SHIRTS, BODY SUITS, ROMPERS, PANTIES, DRESSES, GLOVES, SKIRTS, BLOUSES, IN CLASS 25 (U.S. CLS. 22 AND 39).

**TRADEMARK**

**PRINCIPAL REGISTER**

FIRST USE 6-22-2012; IN COMMERCE 6-22-2012.

THE MARK CONSISTS OF STANDARD CHARACTERS WITHOUT CLAIM TO ANY PARTICULAR FONT, STYLE, SIZE, OR COLOR.

THE NAME "KATHY D. WOODS" IDENTIFIES A LIVING INDIVIDUAL WHOSE CONSENT IS OF RECORD.

SN 85-215,204, FILED 1-11-2011.

RAUL CORDOVA, EXAMINING ATTORNEY



*David J. Kyjars*

Director of the United States Patent and Trademark Office

# United States of America

United States Patent and Trademark Office

## THIS SHIRT HELPS

**Reg. No. 4,199,304**

THIS SHIRT HELPS, INC. (CALIFORNIA CORPORATION)  
14520 DELTA LANE #105  
HUNTINGTOM BEACH, CA 91602

**Registered Aug. 28, 2012**

**Int. Cl.: 25**

FOR: CLOTHING, NAMELY, SHIRTS, T-SHIRTS, SWEATERS, TOPS AND BLOUSES, IN CLASS 25 (U.S. CLS. 22 AND 39).

**TRADEMARK**

FIRST USE 4-19-2011; IN COMMERCE 4-19-2011.

**PRINCIPAL REGISTER**

THE MARK CONSISTS OF STANDARD CHARACTERS WITHOUT CLAIM TO ANY PARTICULAR FONT, STYLE, SIZE, OR COLOR.

NO CLAIM IS MADE TO THE EXCLUSIVE RIGHT TO USE "SHIRT", APART FROM THE MARK AS SHOWN.

SN 85-215,271, FILED 1-11-2011.

MARK SHINER, EXAMINING ATTORNEY



*David J. Kyffers*

Director of the United States Patent and Trademark Office

# United States of America

United States Patent and Trademark Office

## RATE THE UNIVERSE

**Reg. No. 4,199,305**

JUSTIN ADAMS ENTERPRISES LLC (ILLINOIS LIMITED LIABILITY COMPANY)  
1848 WEST HURON  
CHICAGO, IL 60622

**Registered Aug. 28, 2012**

**Int. Cl.: 35**

FOR: PROVIDING RATINGS VIA A GLOBAL COMPUTER NETWORK FOR HOME PRODUCTS AND SERVICES RECOMMENDED BY CONSUMERS AND MEMBERSHIP CLUB SERVICES, IN CLASS 35 (U.S. CLS. 100, 101 AND 102).

**SERVICE MARK**

FIRST USE 7-15-2011; IN COMMERCE 7-15-2011.

**PRINCIPAL REGISTER**

THE MARK CONSISTS OF STANDARD CHARACTERS WITHOUT CLAIM TO ANY PARTICULAR FONT, STYLE, SIZE, OR COLOR.

SN 85-216,336, FILED 1-12-2011.

ANTHONY RINKER, EXAMINING ATTORNEY



*David J. Kyffers*

Director of the United States Patent and Trademark Office



# United States of America

United States Patent and Trademark Office

## URBAN CANVAS

**Reg. No. 4,199,306**

MARIA CHEE DESIGN LLC. (DELAWARE LIMITED LIABILITY COMPANY)

**Registered Aug. 28, 2012**

35-59 161ST STREET  
FLUSHING, NY 11358

**Int. Cl.: 16**

FOR: TOYS AND PLAYTHINGS, NAMELY, CHILDREN'S ACTIVITY KITS TO CREATE INANIMATE OBJECTS FOR CREATION, NAMELY, DO-IT-YOURSELF PAPER AND CARDBOARD SCULPTURE KIT, IN CLASS 16 (U.S. CLS. 2, 5, 22, 23, 29, 37, 38 AND 50).

**TRADEMARK**

FIRST USE 3-22-2012; IN COMMERCE 3-22-2012.

**PRINCIPAL REGISTER**

THE MARK CONSISTS OF STANDARD CHARACTERS WITHOUT CLAIM TO ANY PARTICULAR FONT, STYLE, SIZE, OR COLOR.

NO CLAIM IS MADE TO THE EXCLUSIVE RIGHT TO USE "CANVAS", APART FROM THE MARK AS SHOWN.

SN 85-216,524, FILED 1-13-2011.

JOHN LINCOSKI, EXAMINING ATTORNEY



*David J. Kyffers*

Director of the United States Patent and Trademark Office

# United States of America

United States Patent and Trademark Office

## NO SOCKS ALLOWED

**Reg. No. 4,199,307**

**Registered Aug. 28, 2012**

**Int. Cl.: 25**

**TRADEMARK**

**PRINCIPAL REGISTER**

SR HOLDINGS, LLC (DELAWARE LIMITED LIABILITY COMPANY)  
191 SPRING STREET  
LEXINGTON, MA 02420

FOR: FOOTWEAR, IN CLASS 25 (U.S. CLS. 22 AND 39).

FIRST USE 3-0-2010; IN COMMERCE 3-0-2010.

THE MARK CONSISTS OF STANDARD CHARACTERS WITHOUT CLAIM TO ANY PARTICULAR FONT, STYLE, SIZE, OR COLOR.

SN 85-216,574, FILED 1-13-2011.

JOHN DWYER, EXAMINING ATTORNEY



*David J. Kyffers*

Director of the United States Patent and Trademark Office

# United States of America

United States Patent and Trademark Office

## OWN THE ORIGINAL

**Reg. No. 4,199,308**

**Registered Aug. 28, 2012**

**Int. Cl.: 25**

**TRADEMARK**

**PRINCIPAL REGISTER**

SR HOLDINGS, LLC (DELAWARE LIMITED LIABILITY COMPANY)  
191 SPRING STREET  
LEXINGTON, MA 02420

FOR: FOOTWEAR, IN CLASS 25 (U.S. CLS. 22 AND 39).

FIRST USE 3-1-2010; IN COMMERCE 3-1-2010.

THE MARK CONSISTS OF STANDARD CHARACTERS WITHOUT CLAIM TO ANY PARTICULAR FONT, STYLE, SIZE, OR COLOR.

SN 85-216,588, FILED 1-13-2011.

JOHN DWYER, EXAMINING ATTORNEY



*David J. Kyffers*

Director of the United States Patent and Trademark Office

# United States of America

United States Patent and Trademark Office

## ROBERT JOHNSON'S HELLHOUND ON MY ALE

**Reg. No. 4,199,309**

SONY MUSIC ENTERTAINMENT (DELAWARE PARTNERSHIP)  
550 MADISON AVENUE  
NEW YORK, NY 10022

**Registered Aug. 28, 2012**

**Int. Cl.: 32**

FOR: BEER, ALE, LAGER, STOUT AND PORTER, IN CLASS 32 (U.S. CLS. 45, 46 AND 48).

**TRADEMARK**

FIRST USE 5-8-2011; IN COMMERCE 5-8-2011.

**PRINCIPAL REGISTER**

THE MARK CONSISTS OF STANDARD CHARACTERS WITHOUT CLAIM TO ANY PARTICULAR FONT, STYLE, SIZE, OR COLOR.

NO CLAIM IS MADE TO THE EXCLUSIVE RIGHT TO USE "ALE", APART FROM THE MARK AS SHOWN.

THE NAME "ROBERT JOHNSON" DOES NOT IDENTIFY A LIVING INDIVIDUAL.

SN 85-216,638, FILED 1-13-2011.

MIDGE BUTLER, EXAMINING ATTORNEY



*David J. Kybas*

Director of the United States Patent and Trademark Office

# United States of America

United States Patent and Trademark Office



**Reg. No. 4,199,310**

ALAMO DRAFTHOUSE CINEMAS, LLC (TEXAS LIMITED LIABILITY COMPANY)  
1717 WEST SIXTH STREET, STE. 351  
AUSTIN, TX 78703

**Registered Aug. 28, 2012**

**Int. Cls.: 41 and 43**

FOR: ENTERTAINMENT SERVICES, NAMELY, CINEMA THEATER SERVICES, IN CLASS 41 (U.S. CLS. 100, 101 AND 107).

**SERVICE MARK**

FIRST USE 12-13-2010; IN COMMERCE 12-13-2010.

**PRINCIPAL REGISTER**

FOR: RESTAURANT SERVICES, IN CLASS 43 (U.S. CLS. 100 AND 101).

FIRST USE 12-13-2010; IN COMMERCE 12-13-2010.

OWNER OF U.S. REG. NOS. 2,885,284, 3,034,601, AND 3,484,037.

NO CLAIM IS MADE TO THE EXCLUSIVE RIGHT TO USE "DRAFTHOUSE CINEMA", APART FROM THE MARK AS SHOWN.

THE MARK CONSISTS OF THE WORD "ALAMO" WITH THE WORDS "DRAFTHOUSE CINEMA" BELOW IT TRANSPOSED ON A DARK, ROUNDED RECTANGULAR BACKGROUND FEATURING PROTRUSIONS ON THE TOP, BOTTOM, AND UPPER LEFT AND RIGHT SIDES OF THE RECTANGULAR BACKGROUND, WITH A LIGHTER LINE TRACING THE OUTSIDE SHAPE OF THE RECTANGULAR BACKGROUND AND TWO HORIZONTAL LINES TO THE LEFT OF THE WORD "ALAMO" AND TWO HORIZONTAL LINES TO THE RIGHT OF THE WORD "ALAMO".



SN 85-217,385, FILED 1-13-2011.

TEJBIR SINGH, EXAMINING ATTORNEY

*David J. Kybas*

Director of the United States Patent and Trademark Office

# United States of America

United States Patent and Trademark Office

# KleverSHOP

**Reg. No. 4,199,311**

KLEVER MARKETING, INC. (DELAWARE CORPORATION)

**Registered Aug. 28, 2012**

1601 ALVIRA STREET  
LOS ANGELES, CA 90035

**Int. Cl.: 35**

FOR: ADVERTISING AND COMMERCIAL INFORMATION SERVICES, VIA THE INTERNET; ADVICE AND INFORMATION ABOUT CUSTOMER SERVICES AND PRODUCT MANAGEMENT AND PRICES ON INTERNET SITES IN CONNECTION WITH PURCHASES MADE OVER THE INTERNET; DISSEMINATION OF ADVERTISING FOR OTHERS VIA AN ON-LINE COMMUNICATIONS NETWORK ON THE INTERNET; FACILITATING THE EXCHANGE OF NEEDED INFORMATION FOR FINANCIAL COMPENSATION VIA THE INTERNET INCLUDING DISCOUNT AND COUPONING OPPORTUNITIES; PROVIDING INFORMATION PERTAINING TO PROCUREMENT, BUYING, SELLING AND TENDERING INFORMATION AND OPPORTUNITIES RELATING TO GOODS AND SERVICES VIA COMPUTER, COMPUTER NETWORKS, TELEPHONE, THE INTERNET OR ELECTRONIC MAIL, IN CLASS 35 (U.S. CLS. 100, 101 AND 102).

**SERVICE MARK**

**PRINCIPAL REGISTER**

FIRST USE 4-30-2012; IN COMMERCE 4-30-2012.

THE MARK CONSISTS OF STANDARD CHARACTERS WITHOUT CLAIM TO ANY PARTICULAR FONT, STYLE, SIZE, OR COLOR.

SN 85-217,576, FILED 1-14-2011.

LINDA E. BLOHM, EXAMINING ATTORNEY



*David J. Kyros*

Director of the United States Patent and Trademark Office

# United States of America

United States Patent and Trademark Office

# KleverBANK

**Reg. No. 4,199,312**

KLEVER MARKETING, INC. (DELAWARE CORPORATION)

**Registered Aug. 28, 2012**

1601 ALVIRA STREET  
LOS ANGELES, CA 90035

**Int. Cl.: 35**

FOR: ADVERTISING AND COMMERCIAL INFORMATION SERVICES, VIA THE INTERNET; ADVICE AND INFORMATION ABOUT CUSTOMER SERVICES AND PRODUCT MANAGEMENT AND PRICES ON INTERNET SITES IN CONNECTION WITH PURCHASES MADE OVER THE INTERNET; DISSEMINATION OF ADVERTISING FOR OTHERS VIA AN ON-LINE COMMUNICATIONS NETWORK ON THE INTERNET; FACILITATING THE EXCHANGE OF NEEDED INFORMATION FOR FINANCIAL COMPENSATION VIA THE INTERNET INCLUDING DISCOUNT AND COUPONING OPPORTUNITIES; PROVIDING INFORMATION PERTAINING TO PROCUREMENT, BUYING, SELLING AND TENDERING INFORMATION AND OPPORTUNITIES RELATING TO GOODS AND SERVICES VIA COMPUTER, COMPUTER NETWORKS, TELEPHONE, THE INTERNET OR ELECTRONIC MAIL, IN CLASS 35 (U.S. CLS. 100, 101 AND 102).

**SERVICE MARK**

**PRINCIPAL REGISTER**

FIRST USE 4-30-2012; IN COMMERCE 4-30-2012.

THE MARK CONSISTS OF STANDARD CHARACTERS WITHOUT CLAIM TO ANY PARTICULAR FONT, STYLE, SIZE, OR COLOR.

SN 85-217,577, FILED 1-14-2011.

LINDA E. BLOHM, EXAMINING ATTORNEY



*David J. Kyros*

Director of the United States Patent and Trademark Office

# United States of America

United States Patent and Trademark Office

## SOMEWHAT LIMITED GOLD COLLECTION

**Reg. No. 4,199,313**

**Registered Aug. 28, 2012**

**Int. Cl.: 3**

**TRADEMARK**

**PRINCIPAL REGISTER**

THE PROCTER & GAMBLE COMPANY (OHIO CORPORATION)  
ONE PROCTER & GAMBLE PLAZA  
CINCINNATI, OH 45202

FOR: ANTIPERSPIRANTS, PERSONAL DEODORANTS, BODY WASH FOR HUMANS AND SOAPS FOR PERSONAL USE, FRAGRANT BODY SPRAYS, IN CLASS 3 (U.S. CLS. 1, 4, 6, 50, 51 AND 52).

FIRST USE 1-31-2012; IN COMMERCE 1-31-2012.

THE MARK CONSISTS OF STANDARD CHARACTERS WITHOUT CLAIM TO ANY PARTICULAR FONT, STYLE, SIZE, OR COLOR.

NO CLAIM IS MADE TO THE EXCLUSIVE RIGHT TO USE "COLLECTION", APART FROM THE MARK AS SHOWN.

SN 85-217,903, FILED 1-14-2011.

BILL DAWE, EXAMINING ATTORNEY



*David J. Kyffers*

Director of the United States Patent and Trademark Office



# United States of America

United States Patent and Trademark Office

# THERMBLOCK

**Reg. No. 4,199,314**

**Registered Aug. 28, 2012**

**Int. Cl.: 19**

**TRADEMARK**

**PRINCIPAL REGISTER**

STELLAR MATERIALS, INC (FLORIDA CORPORATION)  
SUITE 200  
7777 GLADES ROAD  
BOCA RATON, FL 33434

FOR: REFRACTORY MATERIAL PRIMARILY NOT OF METAL, NAMELY, REFRACTORY MATERIAL FOR USE IN THE MANUFACTURE OF PRECAST SHAPES; REFRACTORY PRECAST SHAPES PRIMARILY NOT OF METAL, IN CLASS 19 (U.S. CLS. 1, 12, 33 AND 50).

FIRST USE 5-21-2012; IN COMMERCE 5-21-2012.

THE MARK CONSISTS OF STANDARD CHARACTERS WITHOUT CLAIM TO ANY PARTICULAR FONT, STYLE, SIZE, OR COLOR.

SN 85-217,924, FILED 1-14-2011.

DAWN FELDMAN, EXAMINING ATTORNEY



*David J. Kybas*

Director of the United States Patent and Trademark Office

# United States of America

United States Patent and Trademark Office



**Reg. No. 4,199,315**

**Registered Aug. 28, 2012**

**Int. Cl.: 40**

**SERVICE MARK**

**PRINCIPAL REGISTER**

ONE SOURCE APPAREL (NEW HAMPSHIRE LIMITED LIABILITY COMPANY)  
235 WEST ROAD  
UNIT 11  
PORTSMOUTH, NH 03801

FOR: CONTRACT MANUFACTURING IN THE FIELD OF APPAREL, NAMELY, JACKETS, VESTS, PULLOVERS, SHIRTS, SWEATSHIRTS, SHORTS, PANTS, HEADWEAR, FOOTWEAR, IN CLASS 40 (U.S. CLS. 100, 103 AND 106).

FIRST USE 1-0-2010; IN COMMERCE 1-0-2010.

THE MARK CONSISTS OF A BLUE BACKGROUND, IN THE CENTER APPEARS A GLOBE WITH THE OCEANS IN LIGHT BLUE AND THE CONTINENTS IN DARK BLUE, INSIDE THE GLOBE APPEARS THE NUMBER "1" IN WHITE.

THE COLOR(S) LIGHT BLUE, BLUE, DARK BLUE, WHITE IS/ARE CLAIMED AS A FEATURE OF THE MARK.

SN 85-218,048, FILED 1-14-2011.

DARRYL SPRUILL, EXAMINING ATTORNEY



*David J. Kyffers*

Director of the United States Patent and Trademark Office

# United States of America

United States Patent and Trademark Office

# Bazonzoes

**Reg. No. 4,199,316**

**Registered Aug. 28, 2012**

**Int. Cl.: 35**

**SERVICE MARK**

**PRINCIPAL REGISTER**

BAZONZOES (MICHIGAN LIMITED LIABILITY COMPANY)  
1123 EAST WEST MAPLE ROAD  
SUITE 8  
WALLED LAKE, MI 48390

FOR: RETAIL STORE SERVICES FEATURING CLOTHING, IN CLASS 35 (U.S. CLS. 100, 101 AND 102).

FIRST USE 9-17-2010; IN COMMERCE 12-1-2010.

THE MARK CONSISTS OF STANDARD CHARACTERS WITHOUT CLAIM TO ANY PARTICULAR FONT, STYLE, SIZE, OR COLOR.

SN 85-218,346, FILED 1-14-2011.

GIANCARLO CASTRO, EXAMINING ATTORNEY



*David J. Kyffers*

Director of the United States Patent and Trademark Office

# United States of America

United States Patent and Trademark Office

# KEEL

**Reg. No. 4,199,317**

**Registered Aug. 28, 2012**

**Int. Cl.: 20**

**TRADEMARK**

**PRINCIPAL REGISTER**

JSJ FURNITURE CORPORATION (MICHIGAN CORPORATION)  
700 ROBBINS ROAD  
GRAND HAVEN, MI 494172603

FOR: OFFICE FURNITURE, IN CLASS 20 (U.S. CLS. 2, 13, 22, 25, 32 AND 50).

FIRST USE 6-13-2011; IN COMMERCE 6-13-2011.

THE MARK CONSISTS OF STANDARD CHARACTERS WITHOUT CLAIM TO ANY PARTICULAR FONT, STYLE, SIZE, OR COLOR.

SN 85-218,882, FILED 1-17-2011.

KRISTIN DAHLING, EXAMINING ATTORNEY



*David J. Kybas*

Director of the United States Patent and Trademark Office

# United States of America

United States Patent and Trademark Office

# FILL-AIR R5

**Reg. No. 4,199,318**

SEALED AIR CORPORATION (US) (DELAWARE CORPORATION)  
200 RIVERFRONT BOULEVARD  
ELMWOOD PARK, NJ 07407

**Registered Aug. 28, 2012**

**Int. Cl.: 17**

FOR: PLASTIC FILM PRODUCTS, NAMELY, RECYCLABLE PLASTIC MATERIALS USED IN CREATING INFLATED AIR CUSHION FOR USE IN RECYCLABLE PACKAGING , IN CLASS 17 (U.S. CLS. 1, 5, 12, 13, 35 AND 50).

**TRADEMARK**

FIRST USE 2-3-2011; IN COMMERCE 2-3-2011.

**PRINCIPAL REGISTER**

THE MARK CONSISTS OF STANDARD CHARACTERS WITHOUT CLAIM TO ANY PARTICULAR FONT, STYLE, SIZE, OR COLOR.

OWNER OF U.S. REG. NOS. 2,808,546, 2,953,524, AND 3,897,761.

SN 85-219,691, FILED 1-18-2011.

CHRISTINE COOPER, EXAMINING ATTORNEY



*David J. Kyffers*

Director of the United States Patent and Trademark Office

# United States of America

United States Patent and Trademark Office



**Reg. No. 4,199,319**

**Registered Aug. 28, 2012**

**Int. Cl.: 35**

**SERVICE MARK**

**PRINCIPAL REGISTER**

THE ELECTRIC BIKE SHOP, LLC (CALIFORNIA LIMITED LIABILITY COMPANY)  
3644 J STREET, UNIT #B  
SACRAMENTO, CA 95816

FOR: RETAIL STORE SERVICES FEATURING BICYCLE AND SCOOTER ACCESSORIES,  
IN CLASS 35 (U.S. CLS. 100, 101 AND 102).

FIRST USE 12-11-2010; IN COMMERCE 12-11-2010.

NO CLAIM IS MADE TO THE EXCLUSIVE RIGHT TO USE "THE ELECTRIC BIKE SHOP",  
APART FROM THE MARK AS SHOWN.

THE MARK CONSISTS OF THE DESIGN OF A BICYCLE ON THE UPPER PORTION OF AN  
INTERSTATE HIGHWAY CREST SYMBOL WITH ELECTRICAL CHORDS FOR WHEELS  
AND HAVING LIGHTING BOLTS ON EITHER SIDE. BELOW THE BICYCLE DESIGN IS A  
FANCIFUL GRILL DESIGN WING ELEMENT, WITHIN WHICH APPEARS THE WORDING  
"THE ELECTRIC BIKE SHOP".

SN 85-221,861, FILED 1-20-2011.

GEOFFREY FOSDICK, EXAMINING ATTORNEY



*David J. Kyffers*

Director of the United States Patent and Trademark Office

# United States of America

United States Patent and Trademark Office

# WEIDT

**Reg. No. 4,199,320**

**Registered Aug. 28, 2012**

**Int. Cl.: 42**

**SERVICE MARK**

**PRINCIPAL REGISTER**

THE WEIDT GROUP, INC. (MINNESOTA CORPORATION)  
5800 BAKER ROAD  
MINNETONKA, MN 55345

FOR: ARCHITECTURAL DESIGN; COMPUTER NETWORK DESIGN FOR OTHERS; COMPUTER SOFTWARE DESIGN FOR OTHERS; COMPUTER SOFTWARE DESIGN, COMPUTER PROGRAMMING, OR MAINTENANCE OF COMPUTER SOFTWARE; CONSULTANCY IN THE FIELD OF SOFTWARE DESIGN; CONSULTING SERVICES IN THE FIELD OF DESIGN, SELECTION, IMPLEMENTATION AND USE OF COMPUTER HARDWARE AND SOFTWARE SYSTEMS FOR OTHERS; DESIGN AND DEVELOPMENT OF INFORMATION AND DATABASES; DESIGN OF HOME PAGES, COMPUTER SOFTWARE AND WEB SITES; DESIGN, CREATION, HOSTING, MAINTENANCE OF WEBSITES FOR OTHERS; DESIGN, DEVELOPMENT AND IMPLEMENTATION OF SOFTWARE; ENGINEERING SERVICES FOR BUILDING AND PROPERTY CONDITION ASSESSMENT, FACILITY MANAGEMENT, REPAIR AND RESTORATION, BUILDING INSTRUMENTATION AND MONITORING, AND ENVIRONMENTAL CONSULTING; ENVIRONMENTAL SERVICES, NAMELY, TECHNICAL CONSULTATION IN THE FIELD OF ENVIRONMENTAL SCIENCE, ENGINEERING SERVICES, DESIGN FOR OTHERS IN THE FIELD OF ENVIRONMENTAL ENGINEERING, DESIGNING AND TESTING OF NEW ENVIRONMENTALLY FRIENDLY PRODUCTS FOR OTHERS; RESEARCH AND DEVELOPMENT AND CONSULTATION RELATED THERETO IN THE FIELD OF COMPUTER SOFTWARE AND ARCHITECTURAL DESIGN; RESEARCH ON BUILDING CONSTRUCTION OR CITY PLANNING; RESEARCH RELATING TO MECHANICAL ENGINEERING; SCIENTIFIC RESEARCH; SCIENTIFIC RESEARCH AND DEVELOPMENT; TECHNOLOGY CONSULTATION AND RESEARCH IN THE FIELD OF COMPUTER SOFTWARE AND ENERGY EFFICIENT DESIGN; TESTING OR RESEARCH ON ELECTRICITY, IN CLASS 42 (U.S. CLS. 100 AND 101).



FIRST USE 2-23-2012; IN COMMERCE 2-23-2012.

THE MARK CONSISTS OF STANDARD CHARACTERS WITHOUT CLAIM TO ANY PARTICULAR FONT, STYLE, SIZE, OR COLOR.

SEC. 2(F).

OWNER OF U.S. REG. NOS. 3,338,694, 3,434,052, AND OTHERS.

SN 85-224,324, FILED 1-24-2011.

*David J. Kyros*

Director of the United States Patent and Trademark Office

**Reg. No. 4,199,320** TINA BROWN, EXAMINING ATTORNEY



# United States of America

United States Patent and Trademark Office

# TRIG

**Reg. No. 4,199,321**

**Registered Aug. 28, 2012**

**Int. Cl.: 20**

**TRADEMARK**

**PRINCIPAL REGISTER**

TRENDWAY CORPORATION (MICHIGAN CORPORATION)  
13467 QUINCY STREET  
HOLLAND, MI 49422

FOR: OFFICE FURNITURE, IN CLASS 20 (U.S. CLS. 2, 13, 22, 25, 32 AND 50).

FIRST USE 7-12-2011; IN COMMERCE 7-12-2011.

THE MARK CONSISTS OF STANDARD CHARACTERS WITHOUT CLAIM TO ANY PARTICULAR FONT, STYLE, SIZE, OR COLOR.

SN 85-224,473, FILED 1-24-2011.

ANDREW LEASER, EXAMINING ATTORNEY



*David J. Kybas*

Director of the United States Patent and Trademark Office

# United States of America

United States Patent and Trademark Office



**Reg. No. 4,199,322**

**Registered Aug. 28, 2012**

**Int. Cls.: 9 and 25**

**TRADEMARK**

**PRINCIPAL REGISTER**

PATTISON COLE LLC (NEW JERSEY LIMITED LIABILITY COMPANY), DBA TORTOISE  
& BLONDE,  
17 GRAND AVENUE  
ENGLEWOOD, NJ 07631

FOR: EYEWEAR ACCESSORIES, NAMELY, STRAPS, NECK CORDS AND HEAD STRAPS WHICH RESTRAIN EYEWEAR FROM MOVEMENT ON A WEARER; EYEWEAR, NAMELY, SUNGLASSES, EYEGASSES AND OPHTHALMIC FRAMES AND CASES THEREFOR, IN CLASS 9 (U.S. CLS. 21, 23, 26, 36 AND 38).

FIRST USE 4-17-2011; IN COMMERCE 4-17-2011.

FOR: BASEBALL CAPS AND HATS; PANTIES, SHORTS AND BRIEFS; SHIRTS AND SHORT-SLEEVED SHIRTS; SWEATSHIRTS; T-SHIRTS, IN CLASS 25 (U.S. CLS. 22 AND 39).

FIRST USE 3-14-2012; IN COMMERCE 3-14-2012.

THE MARK CONSISTS OF AN AMPERSAND CONTAINED WITHIN A GUITAR PICK.

SN 85-225,162, FILED 1-25-2011.

DANNEAN HETZEL, EXAMINING ATTORNEY



*David J. Kybas*

Director of the United States Patent and Trademark Office

# United States of America

United States Patent and Trademark Office

# LEV10

**Reg. No. 4,199,323**

**Registered Aug. 28, 2012**

**Int. Cl.: 18**

**TRADEMARK**

**PRINCIPAL REGISTER**

FUCHS, AMANDA JILL (UNITED STATES INDIVIDUAL)  
300 NEWARK STREET, APT 1D  
HOBOKEN, NJ 07030

FOR: ALL PURPOSE SPORT BAGS; BACKPACKS, BOOK BAGS, SPORTS BAGS, BUM BAGS, WALLETS AND HANDBAGS; BAGS AND HOLDALLS FOR SPORTS CLOTHING; BAGS FOR SPORTS; FABRIC POUCHES SOLD EMPTY THAT MAY BE USED TO HOLD ITEMS SUCH AS DENTAL RETAINERS AND SPORTS MOUTH GUARDS; GENERAL PURPOSE SPORT TROLLEY BAGS; LEATHER AND IMITATION LEATHER SPORT BAGS AND GENERAL PURPOSE TROLLEY BAGS; SPORTS BAGS; SPORTS PACKS, IN CLASS 18 (U.S. CLS. 1, 2, 3, 22 AND 41).

FIRST USE 6-1-2011; IN COMMERCE 6-1-2011.

THE MARK CONSISTS OF STANDARD CHARACTERS WITHOUT CLAIM TO ANY PARTICULAR FONT, STYLE, SIZE, OR COLOR.

SN 85-225,307, FILED 1-25-2011.

KIMBERLY FRYE, EXAMINING ATTORNEY



*David J. Kybas*

Director of the United States Patent and Trademark Office

# United States of America

United States Patent and Trademark Office



**Reg. No. 4,199,324**

**Registered Aug. 28, 2012**

**Int. Cl.: 30**

SOUTHWEST BEVERAGES, LLC (ARIZONA LIMITED LIABILITY COMPANY), DBA  
SOUTHWEST BEVERAGES,  
PO BOX 37272  
SOUTHWEST BEVERAGES, LLC  
TUCSON, AZ 85740

**TRADEMARK**

**PRINCIPAL REGISTER**

FOR: BEVERAGES WITH A COFFEE BASE; COCOA; COCOA POWDER; COCOA-BASED BEVERAGES; COFFEE; COFFEE BASED BEVERAGES; COFFEE-BASED BEVERAGES; PREPARED COCOA AND COCOA-BASED BEVERAGES, IN CLASS 30 (U.S. CL. 46).

FIRST USE 8-31-2011; IN COMMERCE 12-18-2011.

NO CLAIM IS MADE TO THE EXCLUSIVE RIGHT TO USE "BEVERAGES", APART FROM THE MARK AS SHOWN.

THE COLOR(S) WHITE, BLACK, RED, BROWN, AND ORANGE IS/ARE CLAIMED AS A FEATURE OF THE MARK.

THE MARK CONSISTS OF THE STYLIZED WORDING "SOUTHWEST BEVERAGES" DEPICTED IN THE COLOR RED OUTLINED IN WHITE. THERE ARE FOUR STRIPES LOCATED IMMEDIATELY BELOW THE WORDS AND RUN THE FULL LENGTH OF THE DESIGN IMAGE FROM LEFT TO RIGHT-THE COLORS OF THESE STRIPS ARE BLACK (IMMEDIATELY BELOW THE WORDS "SOUTHWEST BEVERAGES") FOLLOWED BY A THIN BROWN STRIPE FOLLOWED BY A RED STRIPE SET FORTH IMMEDIATELY BELOW THE THIN BROWN STRIPE FOLLOWED BY A BROWN STRIPE. SIX MOUNTAIN PEAKS THE TALLEST OF WHICH IS ON THE LEFT SIDE OF THE DESIGN IMAGE AND THE SMALLEST OF WHICH IS LOCATED ON THE RIGHT SIDE OF THE DESIGN IMAGE. THE INTERIOR SECTION OF THE MOUNTAIN RIDGE IS BROWN IN COLOR OUTLINED IN BLACK ON THE TOP OF THE PEAKS. A SETTING SUN PLACED BETWEEN THE SECOND AND THIRD MOUNTAIN PEAKS OUTLINED WITH TWO BLACK LINES AT THE TOP OF THE SUN WITH THE SUN DEPICTED IN THE COLOR ORANGE. A COWBOY IMAGE CONSISTING OF A COWBOY HOLDING A SADDLE IN HIS LEFT HAND, HIS RIGHT HAND IN HIS RIGHT PANTS POCKET AND WEARING A COWBOY HAT. THE COWBOY IS DEPICTED IN THE COLOR BLACK.



*David J. Kybas*

SN 85-225,537, FILED 1-25-2011.

Director of the United States Patent and Trademark Office

**Reg. No. 4,199,324** BRIDGETT SMITH, EXAMINING ATTORNEY

# United States of America

United States Patent and Trademark Office

# CASTLEVALE

**Reg. No. 4,199,325**

COX-MARTINI 2006 REVOCABLE TRUST (CALIFORNIA TRUST)  
PO BOX 61  
ST. HELENA, CA 94574

**Registered Aug. 28, 2012**

**Int. Cl.: 33**

FOR: WINES, IN CLASS 33 (U.S. CLS. 47 AND 49).

**TRADEMARK**

FIRST USE 4-9-2012; IN COMMERCE 4-23-2012.

**PRINCIPAL REGISTER**

THE MARK CONSISTS OF STANDARD CHARACTERS WITHOUT CLAIM TO ANY PARTICULAR FONT, STYLE, SIZE, OR COLOR.

SN 85-226,524, FILED 1-26-2011.

JANICE KIM, EXAMINING ATTORNEY



*David J. Kybas*

Director of the United States Patent and Trademark Office

# United States of America

United States Patent and Trademark Office

# SLEEPWEAR

**Reg. No. 4,199,326**

**Registered Aug. 28, 2012**

**Int. Cl.: 24**

**TRADEMARK**

**PRINCIPAL REGISTER**

GUARD MASTER INC. (NEW YORK CORPORATION)  
SUITE 101  
110 BI-COUNTY BLVD.  
FARMINGDALE, NY 11735

FOR: MATTRESS PROTECTORS, PILLOW PROTECTORS AND BED SHEETS, IN CLASS 24 (U.S. CLS. 42 AND 50).

FIRST USE 12-1-2011; IN COMMERCE 12-1-2011.

THE MARK CONSISTS OF STANDARD CHARACTERS WITHOUT CLAIM TO ANY PARTICULAR FONT, STYLE, SIZE, OR COLOR.

SN 85-227,734, FILED 1-27-2011.

TEJBIR SINGH, EXAMINING ATTORNEY



*David J. Kybas*

Director of the United States Patent and Trademark Office

# United States of America

United States Patent and Trademark Office

## BECAUSE YOU LOVE THEM

**Reg. No. 4,199,327**

**Registered Aug. 28, 2012**

**Int. Cl.: 45**

**SERVICE MARK**

**PRINCIPAL REGISTER**

BECAUSE YOU LOVE THEM, LLC (OREGON LIMITED LIABILITY COMPANY)  
523 ANTELOPE WAY  
EUGENE, OR 97401

FOR: PLACEMENT SERVICES FOR A PET WHEN THE OWNER IS UNAVAILABLE TO CARE FOR THE PET DUE TO AN EMERGENCY OR UNEXPECTED ABSENCE, NAMELY, NOTIFYING DESIGNATED PET CAREGIVERS , IN CLASS 45 (U.S. CLS. 100 AND 101).

FIRST USE 11-30-2010; IN COMMERCE 3-15-2012.

THE MARK CONSISTS OF STANDARD CHARACTERS WITHOUT CLAIM TO ANY PARTICULAR FONT, STYLE, SIZE, OR COLOR.

SN 85-228,267, FILED 1-27-2011.

MARK SPARACINO, EXAMINING ATTORNEY



*David J. Kyffers*

Director of the United States Patent and Trademark Office



# United States of America

United States Patent and Trademark Office

# Fly Armor

**Reg. No. 4,199,328**

FLY ARMOR, LLC (KENTUCKY LIMITED LIABILITY COMPANY)  
15844 S. CLIFF CT  
RIVERSIDE, CA 92503

**Registered Aug. 28, 2012**

**Int. Cl.: 5**

FOR: INSECT REPELLENTS, NAMELY, REPELLENTS THAT ARE COMPRISED OF ALL-NATURAL OILS THAT ARE WEARABLE BY AN ANIMAL AND/OR HUMAN, IN CLASS 5 (U.S. CLS. 6, 18, 44, 46, 51 AND 52).

**TRADEMARK**

FIRST USE 4-3-2011; IN COMMERCE 4-3-2011.

**PRINCIPAL REGISTER**

THE MARK CONSISTS OF STANDARD CHARACTERS WITHOUT CLAIM TO ANY PARTICULAR FONT, STYLE, SIZE, OR COLOR.

NO CLAIM IS MADE TO THE EXCLUSIVE RIGHT TO USE "FLY", APART FROM THE MARK AS SHOWN.

SN 85-229,284, FILED 1-28-2011.

TRACY FLETCHER, EXAMINING ATTORNEY



*David J. Kypos*

Director of the United States Patent and Trademark Office

# United States of America

United States Patent and Trademark Office



**Reg. No. 4,199,329**

**Registered Aug. 28, 2012**

**Int. Cls.: 35 and 42**

**SERVICE MARK**

**PRINCIPAL REGISTER**

PROVO CRAFT AND NOVELTY, INC. (UTAH CORPORATION)  
10876 SOUTH RIVER FRONT PARKWAY  
SOUTH JORDAN, UT 84095

FOR: PROVIDING VIA ON-LINE COMPUTER SERVICES A MEMBERSHIP PROGRAM ENTITLING THE PARTICIPANTS TO RECEIVE CONSUMER INFORMATION, INCENTIVE REWARDS AND DISCOUNTS ALL RELATING TO CRAFTING; CUSTOMER INCENTIVE AWARD PROGRAMS FOR COMMERCIAL, PROMOTIONAL AND/OR ADVERTISING PURPOSES THROUGH ISSUANCE AND PROCESSING OF LOYALTY POINTS FOR ON-LINE PURCHASE OF COMPANY'S GOODS AND SERVICES, IN CLASS 35 (U.S. CLS. 100, 101 AND 102).

FIRST USE 5-15-2010; IN COMMERCE 5-15-2010.

FOR: PROVIDING A WEBSITE FEATURING INFORMATION REGARDING CRAFTING WHICH ALLOWS USERS TO UPLOAD AND DOWNLOAD IMAGE FILES AND VIDEOS RELATING TO CRAFTING, IN CLASS 42 (U.S. CLS. 100 AND 101).

FIRST USE 5-15-2010; IN COMMERCE 5-15-2010.

THE MARK CONSISTS OF A CIRCLE WITH TWO ANTENNAS.

SN 85-229,543, FILED 1-29-2011.

ANGELA DUONG, EXAMINING ATTORNEY



*David J. Kyffers*

Director of the United States Patent and Trademark Office

# United States of America

United States Patent and Trademark Office

## ADOPT-A-SHELTER

**Reg. No. 4,199,330**

**Registered Aug. 28, 2012**

**Int. Cl.: 35**

**SERVICE MARK**

**PRINCIPAL REGISTER**

CMR CREATIVE MARKETING RESOURCES, INC. (TEXAS CORPORATION)  
SUITE 100  
5108 CHAD DRIVE  
TYLER, TX 757033919

FOR: THE BRINGING TOGETHER, FOR THE BENEFIT OF OTHERS, OF A VARIETY OF GOODS AND SERVICES, ENABLING CUSTOMERS TO CONVENIENTLY VIEW AND PURCHASE THOSE GOODS AND SERVICES FROM AN INTERNET WEB SITE, WITH A PORTION OF THE PROCEEDS DEDICATED TO HELPING ANIMAL SHELTERS, IN CLASS 35 (U.S. CLS. 100, 101 AND 102).

FIRST USE 8-22-2011; IN COMMERCE 8-22-2011.

THE MARK CONSISTS OF STANDARD CHARACTERS WITHOUT CLAIM TO ANY PARTICULAR FONT, STYLE, SIZE, OR COLOR.

SN 85-229,620, FILED 1-30-2011.

SUSAN LESLIE DUBOIS, EXAMINING ATTORNEY



*David J. Kyffers*

Director of the United States Patent and Trademark Office

# United States of America

United States Patent and Trademark Office

# TING

**Reg. No. 4,199,331**

**Registered Aug. 28, 2012**

**Int. Cl.: 38**

**SERVICE MARK**

**PRINCIPAL REGISTER**

TUCOWS (DELAWARE) INC. (DELAWARE CORPORATION)  
1209 ORANGE ST. CORPORATION TRUST CENTER  
WILMINGTON, DE 19801

FOR: MOBILE PHONE COMMUNICATION SERVICES, EXCLUDING GPS OR OTHER  
SATELLITE-BASED SERVICES USED FOR VEHICLE TRACKING OR MONITORING , IN  
CLASS 38 (U.S. CLS. 100, 101 AND 104).

FIRST USE 6-3-2011; IN COMMERCE 10-13-2011.

THE MARK CONSISTS OF STANDARD CHARACTERS WITHOUT CLAIM TO ANY PAR-  
TICULAR FONT, STYLE, SIZE, OR COLOR.

SN 85-229,794, FILED 1-31-2011.

HEATHER THOMPSON, EXAMINING ATTORNEY



*David J. Kyffers*

Director of the United States Patent and Trademark Office

# United States of America

United States Patent and Trademark Office



## Schwarzkopf

*Professional HairCare for you.*

**Reg. No. 4,199,332**

**Registered Aug. 28, 2012**

**Int. Cl.: 3**

**TRADEMARK**

**PRINCIPAL REGISTER**

HENKEL AG & CO. KGAA (FED REP GERMANY KOMMANDITGESELLSCHAFT AUF AKTIEN (KGAA))  
67 HENKELSTRASSE  
DUESSELDORF, FED REP GERMANY 40589

FOR: HAIR CARE PREPARATIONS; HAIR STYLING PREPARATIONS, IN CLASS 3 (U.S. CLS. 1, 4, 6, 50, 51 AND 52).

FIRST USE 3-31-2012; IN COMMERCE 3-31-2012.

OWNER OF U.S. REG. NOS. 613,665, 2,422,970, AND OTHERS.

NO CLAIM IS MADE TO THE EXCLUSIVE RIGHT TO USE "PROFESSIONAL HAIRCARE", APART FROM THE MARK AS SHOWN.

THE MARK CONSISTS OF A SILHOUETTE OF A FEMALE HEAD AND THE WORDS "SCHWARZKOPF" AND "PROFESSIONAL HAIRCARE FOR YOU" BELOW.

THE ENGLISH TRANSLATION OF "SCHWARZKOPF" IN THE MARK IS "BLACK HEAD".

SN 85-229,990, FILED 1-31-2011.

DOMINIC FATHY, EXAMINING ATTORNEY



*David J. Kybas*

Director of the United States Patent and Trademark Office

# United States of America

United States Patent and Trademark Office



**Reg. No. 4,199,333**

**Registered Aug. 28, 2012**

**Int. Cl.: 36**

**SERVICE MARK**

**PRINCIPAL REGISTER**

EXREMA CO. (OHIO CORPORATION)  
2783 MARTIN RD  
#350  
DUBLIN, OH 43017

FOR: ARRANGING OF LEASES AND RENTAL AGREEMENTS FOR REAL ESTATE; CLASSIFIED REAL ESTATE LISTINGS OF APARTMENT RENTALS AND HOUSING RENTALS; LEASE OF REAL ESTATE; LEASING OF REAL ESTATE; LEASING OF REAL PROPERTY; PROVIDING A DATABASE OF INFORMATION ABOUT RESIDENTIAL REAL ESTATE LISTINGS IN DIFFERENT NEIGHBORHOODS AND COMMUNITIES; PROVIDING A DATABASE OF RESIDENTIAL REAL ESTATE LISTINGS WITHIN NEIGHBORHOODS AND COMMUNITIES SPECIFICALLY IDENTIFIED BY USERS; PROVIDING AN INTERNET WEBSITE PORTAL OFFERING INFORMATION IN THE FIELDS OF REAL ESTATE CONCERNING THE PURCHASE AND SALE OF NEW AND RESALE HOMES AND CONDOS; PROVIDING INFORMATION IN THE FIELD OF REAL ESTATE BY MEANS OF LINKING THE WEB SITE TO OTHER WEB SITES FEATURING REAL ESTATE INFORMATION; PROVIDING INFORMATION IN THE FIELD OF REAL ESTATE VIA THE INTERNET; PROVIDING REAL ESTATE LISTINGS AND REAL ESTATE INFORMATION VIA THE INTERNET; PROVIDING REAL ESTATE LISTINGS VIA THE INTERNET; REAL ESTATE LISTING; REAL ESTATE LISTING SERVICES FOR HOUSING RENTALS AND APARTMENT RENTALS; REAL ESTATE MULTIPLE LISTING SERVICES; REAL ESTATE PROCUREMENT FOR OTHERS; REAL ESTATE RENTAL SERVICES, NAMELY, RENTAL OF RESIDENTIAL HOUSING; REAL ESTATE SERVICES, NAMELY, PROVIDING ONLINE QUESTIONS TO HELP USERS DETERMINE THE BEST NEIGHBORHOODS AND COMMUNITIES SUITED TO THEIR INDIVIDUAL NEEDS AND PREFERENCES; REAL ESTATE SERVICES, NAMELY, RENTAL OF SHORT-TERM FURNISHED APARTMENTS; REAL ESTATE SERVICES, NAMELY, RENTAL OF VACATION HOMES; REAL ESTATE SERVICES, NAMELY, RENTAL OF VACATION HOMES, CONDOMINIUMS, CABINS, AND VILLAS USING PAY PER CLICK ADVERTISING ON A GLOBAL COMPUTER NETWORK; REAL ESTATE SERVICES, NAMELY, RENTAL, BROKERAGE, LEASING AND MANAGEMENT OF COMMERCIAL PROPERTY, OFFICES AND OFFICE SPACE, IN CLASS 36 (U.S. CLS. 100, 101 AND 102).



*David J. Kappas*

Director of the United States Patent and Trademark Office

FIRST USE 6-4-2012; IN COMMERCE 6-4-2012.

NO CLAIM IS MADE TO THE EXCLUSIVE RIGHT TO USE "REAL ESTATE MARKET", APART FROM THE MARK AS SHOWN.

**Reg. No. 4,199,333** THE COLOR(S) GRAY, LIME GREEN AND DARK GREEN IS/ARE CLAIMED AS A FEATURE OF THE MARK.

THE MARK CONSISTS OF THE WORD "EXREMA" IN GRAY ON ONE LINE WITH THE RIGHT SLASH OF THE LETTER "X" BEING GREEN AND BEING PART OF A DESIGN THAT IMITATES A ROOF TYPE STRUCTURE OF A HOUSE. THE ROOF STRUCTURE ALSO CONTAINS FOUR SQUARES ARRANGED IN SUCH A MANNER TO CREATE A SQUARE WITH A CROSS SHAPED WHITE SPACE IN THE MIDDLE, REPRESENTING A WINDOW TYPE STRUCTURE IN THE ROOF TYPE STRUCTURE. ON A SECOND LINE, THE WORDS "EXTENSIVE REAL ESTATE MARKET" IN DARK GREEN.

SN 85-230,249, FILED 1-31-2011.

NAAKWAMA ANKRAH, EXAMINING ATTORNEY

# United States of America

United States Patent and Trademark Office

## CHANGING LIFESTYLES. CHANGING LIVES.

**Reg. No. 4,199,334**

LIFE CARE COMPANIES LLC (IOWA LIMITED LIABILITY COMPANY)

**Registered Aug. 28, 2012**

400 LOCUST ST., STE. 820  
DES MOINES, IA 50309

**Int. Cl.: 35**

FOR: BUSINESS MANAGEMENT OF RESIDENTIAL COMMUNITIES, CONTINUING CARE COMMUNITIES, ASSISTED LIVING COMMUNITIES AND RETIREMENT COMMUNITIES; BUSINESS DEVELOPMENT OF RESIDENTIAL, CONTINUING CARE, ASSISTED LIVING COMMUNITIES AND RETIREMENT COMMUNITIES; BUSINESS MANAGEMENT AND OPERATION OF CONTINUING CARE RETIREMENT COMMUNITIES, IN CLASS 35 (U.S. CLS. 100, 101 AND 102).

**SERVICE MARK**

**PRINCIPAL REGISTER**

FIRST USE 10-0-2011; IN COMMERCE 10-0-2011.

THE MARK CONSISTS OF STANDARD CHARACTERS WITHOUT CLAIM TO ANY PARTICULAR FONT, STYLE, SIZE, OR COLOR.

SN 85-230,416, FILED 1-31-2011.

BRENDAN MCCAULEY, EXAMINING ATTORNEY



*David J. Kyros*

Director of the United States Patent and Trademark Office



# United States of America

United States Patent and Trademark Office

## MOM'S RECIPES

**Reg. No. 4,199,335**

360 PLUS MEDIA, LLC (TEXAS LIMITED LIABILITY COMPANY)  
12026 NORTH 29TH STREET  
PHOENIX, AZ 85028

**Registered Aug. 28, 2012**

**Int. Cl.: 43**

FOR: PROVIDING A WEBSITE WHERE USERS CAN POST RATINGS, REVIEWS AND RECOMMENDATIONS ON FOODS AND RECIPES FOR FOOD APPRECIATION PURPOSES; PROVIDING INFORMATION, NEWS AND COMMENTARY IN THE FIELD OF FOODS, COOKING AND RECIPES, IN CLASS 43 (U.S. CLS. 100 AND 101).

**SERVICE MARK**

**PRINCIPAL REGISTER**

FIRST USE 6-8-2012; IN COMMERCE 6-8-2012.

THE MARK CONSISTS OF STANDARD CHARACTERS WITHOUT CLAIM TO ANY PARTICULAR FONT, STYLE, SIZE, OR COLOR.

NO CLAIM IS MADE TO THE EXCLUSIVE RIGHT TO USE "RECIPES", APART FROM THE MARK AS SHOWN.

SN 85-231,303, FILED 2-1-2011.

MARC LEIPZIG, EXAMINING ATTORNEY



*David J. Kyffers*

Director of the United States Patent and Trademark Office

# United States of America

United States Patent and Trademark Office

# TMR Buster

**Reg. No. 4,199,336**

WINN, ROBERT T. (UNITED STATES INDIVIDUAL), DBA TEXAS CREEK FARMS,  
2869 FM 1002

**Registered Aug. 28, 2012**

BIG SANDY, TX 75755

**Int. Cl.: 5**

FOR: ANIMAL FEED SUPPLEMENTS, IN CLASS 5 (U.S. CLS. 6, 18, 44, 46, 51 AND 52).

**TRADEMARK**

FIRST USE 6-1-2010; IN COMMERCE 6-1-2010.

**PRINCIPAL REGISTER**

THE MARK CONSISTS OF STANDARD CHARACTERS WITHOUT CLAIM TO ANY PARTICULAR FONT, STYLE, SIZE, OR COLOR.

NO CLAIM IS MADE TO THE EXCLUSIVE RIGHT TO USE "TMR", APART FROM THE MARK AS SHOWN.

SN 85-231,953, FILED 2-2-2011.

MARY CRAWFORD, EXAMINING ATTORNEY



*David J. Kyffers*

Director of the United States Patent and Trademark Office

# United States of America

United States Patent and Trademark Office

## AUTHENTIPROOF

**Reg. No. 4,199,337**

**Registered Aug. 28, 2012**

**Int. Cl.: 9**

**TRADEMARK**

**PRINCIPAL REGISTER**

AUTHENTIDATE HOLDING CORP. (DELAWARE CORPORATION)  
300 CONNELL DRIVE, 5TH FLOOR  
BERKELEY HEIGHTS, NJ 07922

FOR: DOCUMENT AND DATA MANAGEMENT AND PROCESSING SOFTWARE FEATURING ROUTINES FOR THE AUTHENTICATION, TIME STAMPING AND VERIFICATION OF DOCUMENTS AND DATA FILES, FOR THE STORAGE, TRANSMISSION AND RETRIEVAL OF DOCUMENTS AND DATA FILES, FOR THE CONVERSION OF DOCUMENTS INTO ELECTRONIC, MAGNETIC, OPTICAL OR OTHER FORMATS, AND FOR THE CODING OF DOCUMENTS AND DATA FILES; AND DOCUMENT AND DATA MANAGEMENT AND PROCESSING SYSTEMS WHICH CONSIST PRIMARILY OF SERVERS AND SOFTWARE, IN CLASS 9 (U.S. CLS. 21, 23, 26, 36 AND 38).

FIRST USE 3-0-2011; IN COMMERCE 3-0-2011.

THE MARK CONSISTS OF STANDARD CHARACTERS WITHOUT CLAIM TO ANY PARTICULAR FONT, STYLE, SIZE, OR COLOR.

SN 85-232,157, FILED 2-2-2011.

NATALIE POLZER, EXAMINING ATTORNEY



*David J. Kybas*

Director of the United States Patent and Trademark Office

# United States of America

United States Patent and Trademark Office

## AUTHENTIPROOF

**Reg. No. 4,199,338**

**Registered Aug. 28, 2012**

**Int. Cl.: 39**

**SERVICE MARK**

**PRINCIPAL REGISTER**

AUTHENTIDATE HOLDING CORP. (DELAWARE CORPORATION)  
300 CONNELL DRIVE, 5TH FLOOR  
BERKELEY HEIGHTS, NJ 07922

FOR: ELECTRONIC STORAGE AND RETRIEVAL OF DOCUMENTS AND DATA FILES,  
AND CONSULTATION SERVICES RELATED THERETO, IN CLASS 39 (U.S. CLS. 100 AND  
105).

FIRST USE 3-0-2011; IN COMMERCE 3-0-2011.

THE MARK CONSISTS OF STANDARD CHARACTERS WITHOUT CLAIM TO ANY PAR-  
TICULAR FONT, STYLE, SIZE, OR COLOR.

SN 85-232,177, FILED 2-2-2011.

NATALIE POLZER, EXAMINING ATTORNEY



*David J. Kybas*

Director of the United States Patent and Trademark Office

# United States of America

United States Patent and Trademark Office

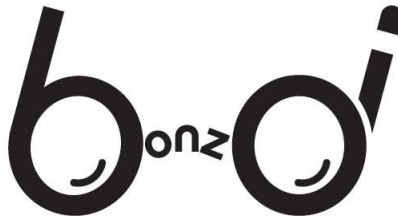

**Reg. No. 4,199,339**

**Registered Aug. 28, 2012**

**Int. Cl.: 42**

**SERVICE MARK**

**PRINCIPAL REGISTER**

WEBSISTANT, LLC (CALIFORNIA LIMITED LIABILITY COMPANY)  
233 N. BRAND BLVD.  
GLENDALE, CA 91203

FOR: FILE SHARING SERVICES, NAMELY, PROVIDING A WEBSITE FEATURING TECHNOLOGY ENABLING USERS TO UPLOAD AND DOWNLOAD ELECTRONIC FILES; PEER-TO-BROWSER PHOTO SHARING SERVICES, NAMELY, PROVIDING A WEBSITE FEATURING TECHNOLOGY ENABLING USERS TO UPLOAD, VIEW, AND DOWNLOAD DIGITAL PHOTOS; PROVIDING A WEB SITE FEATURING TECHNOLOGY THAT ENABLES INTERNET USERS TO CREATE, BOOKMARK, ANNOTATE, AND PUBLICLY SHARE DATA; PROVIDING A WEB SITE FEATURING TECHNOLOGY THAT ENABLES INTERNET USERS TO SHARE DOCUMENTS, IMAGES AND VIDEOS; PROVIDING A WEB SITE FEATURING TEMPORARY USE OF NON-DOWNLOADABLE SOFTWARE ALLOWING WEB SITE USERS TO UPLOAD ON-LINE VIDEOS FOR SHARING WITH OTHERS FOR ENTERTAINMENT PURPOSES; PROVIDING A WEB SITE THAT GIVES COMPUTER USERS THE ABILITY TO UPLOAD, EXCHANGE AND SHARE PHOTOS, VIDEOS AND VIDEO LOGS; PROVIDING A WEBSITE FEATURING TECHNOLOGY THAT ENABLES USERS TO UPLOAD, EDIT AND SHARE PHOTO SCRAPBOOKS; PROVIDING A WEBSITE THAT GIVES USERS THE ABILITY TO CREATE CUSTOMIZED WEB PAGES FEATURING USER-DEFINED INFORMATION; PROVIDING AN INTERACTIVE WEBSITE FEATURING TECHNOLOGY THAT ALLOWS USERS TO UPLOAD, DOWNLOAD, SHARE AND SELL CUSTOM AND BRANDED DIGITAL PUBLICATIONS, IN CLASS 42 (U.S. CLS. 100 AND 101).

FIRST USE 8-1-2011; IN COMMERCE 8-1-2011.

THE MARK CONSISTS OF THE LETTER "B" WITH A SMALL CURVE ON THE INSIDE OF THE LETTER STYLIZED TO RESEMBLE THE LEFT SIDE OF A PAIR OF GLASSES, WITH THE LETTERS "ONZ" CURVED SLIGHTLY TO THE RIGHT OF THE "B" IN THE MIDDLE OF THE MARK, AND TO THE RIGHT OF THE "ONZ" IS ANOTHER CIRCLE WITH AN INTERIOR CURVE AND THE STYLIZED LETTER "I" ABOVE THE CIRCLE GIVING THE IMPRESSION OF A PAIR OF EYEGLASSES.

SN 85-232,808, FILED 2-2-2011.

IRA J. GOODSaid, EXAMINING ATTORNEY



*David J. Kyros*

Director of the United States Patent and Trademark Office

# United States of America

United States Patent and Trademark Office

## RAPID RING

**Reg. No. 4,199,340**

**Registered Aug. 28, 2012**

**Int. Cl.: 6**

**TRADEMARK**

**PRINCIPAL REGISTER**

COOPER TECHNOLOGIES COMPANY (DELAWARE CORPORATION)  
600 TRAVIS, SUITE 5600  
HOUSTON, TX 77002

FOR: HARDWARE, NAMELY, METAL BRACKETS AND METAL EXTENSION BRACKETS FOR GENERAL USE; METAL CABLE WIRE; CABLE JUNCTION SLEEVES OF METAL; METAL RINGS IN THE NATURE OF MUD RINGS, NAMELY, RINGS THAT ALLOW FOR THE MOUNTING OF A JUNCTION BOX OR ELECTRICAL OUTLET, TOGGLE SWITCHES, GROUND FAULT CIRCUIT INTERRUPTERS OR OCCUPANCY SENSORS WHERE THE EDGES PROTRUDE THROUGH THE DRYWALL OR PLASTER TO THE OUTER SURFACE OF THE WALL; EXTENSION BRACKETS INTENDED TO BE USED TO MOUNT A JUNCTION BOX OR OTHER ELECTRICAL BOX BETWEEN STUDS; SELF-ADJUSTING AND ADJUSTABLE METAL RINGS INTENDED TO BE USED TO MOUNT A JUNCTION BOX OR ELECTRICAL OUTLET, TOGGLE SWITCHES, GROUND FAULT CIRCUIT INTERRUPTERS OR OCCUPANCY SENSORS AND ALLOW FOR THE SEATING OF A JUNCTION BOX OR ELECTRICAL OUTLET IN VARIOUS DRYWALL THICKNESSES; AND RING-SHAPED FITTINGS OF METAL, IN CLASS 6 (U.S. CLS. 2, 12, 13, 14, 23, 25 AND 50).

FIRST USE 6-28-2011; IN COMMERCE 6-28-2011.

THE MARK CONSISTS OF STANDARD CHARACTERS WITHOUT CLAIM TO ANY PARTICULAR FONT, STYLE, SIZE, OR COLOR.

NO CLAIM IS MADE TO THE EXCLUSIVE RIGHT TO USE "RING", APART FROM THE MARK AS SHOWN.

SN 85-233,263, FILED 2-3-2011.

NANCY CLARKE, EXAMINING ATTORNEY



*David J. Kyros*

Director of the United States Patent and Trademark Office

# United States of America

United States Patent and Trademark Office

## ECO-HYDRATION

**Reg. No. 4,199,341**

**Registered Aug. 28, 2012**

**Int. Cl.: 32**

**TRADEMARK**

**PRINCIPAL REGISTER**

HDX MIX, LLC (CALIFORNIA LIMITED LIABILITY COMPANY)  
17381 NICHOLS LANE  
SUITE L  
HUNTINGTON BEACH, CA 92647

FOR: BEVERAGES, NAMELY, SOFT DRINKS, SOFT DRINK MIXES; POWDERS, SYRUPS OR CONCENTRATES FOR MAKING SOFT DRINKS, COFFEE, TEA, FRUIT JUICES, FRUIT FLAVORED BEVERAGES, ENERGY DRINKS AND SPORTS BEVERAGES, IN CLASS 32 (U.S. CLS. 45, 46 AND 48).

FIRST USE 4-1-2011; IN COMMERCE 4-1-2011.

THE MARK CONSISTS OF STANDARD CHARACTERS WITHOUT CLAIM TO ANY PARTICULAR FONT, STYLE, SIZE, OR COLOR.

SN 85-233,330, FILED 2-3-2011.

SAMUEL E. SHARPER JR., EXAMINING ATTORNEY



*David J. Kybas*

Director of the United States Patent and Trademark Office

# United States of America

United States Patent and Trademark Office

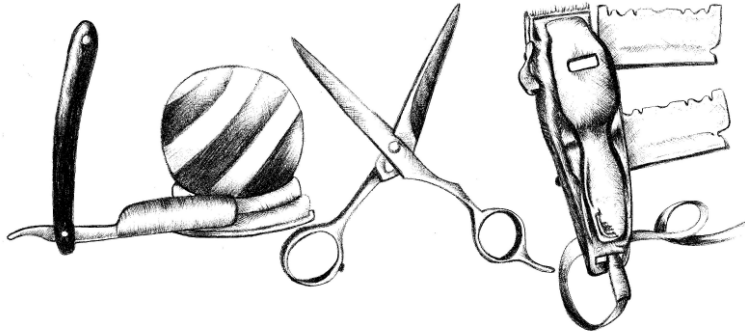

**Reg. No. 4,199,342**

**Registered Aug. 28, 2012**

**Int. Cl.: 25**

**TRADEMARK**

**PRINCIPAL REGISTER**

ECHOLS,LADON (UNITED STATES INDIVIDUAL)  
320 NW 33RD STREET  
MIAMI, FL 33127

FOR: A-SHIRTS; ATHLETIC APPAREL, NAMELY, SHIRTS, PANTS, JACKETS, FOOTWEAR, HATS AND CAPS, ATHLETIC UNIFORMS; BASEBALL CAPS AND HATS; BODY SHIRTS; BUTTON DOWN SHIRTS; CAMOUFLAGE SHIRTS; CAMP SHIRTS; CARGO PANTS; CLOTHING FOR BABIES, TODDLERS AND CHILDREN, TREATED WITH FIRE AND HEAT RETARDANTS, NAMELY, PAJAMAS, JACKETS, SHIRTS, PANTS, JUMPERS; COLLARED SHIRTS; DRESS SHIRTS; GOLF PANTS, SHIRTS AND SKIRTS; GYM PANTS; HAT BANDS; HATS; HATS FOR INFANTS, BABIES, TODDLERS AND CHILDREN; HOODED SWEAT SHIRTS; JOGGING PANTS; KNIT SHIRTS; LONG-SLEEVED SHIRTS; OPEN-NECKED SHIRTS; POLO SHIRTS; SHIRTS AND SHORT-SLEEVED SHIRTS; SHORT-SLEEVED OR LONG-SLEEVED T-SHIRTS; SPORTS CAPS AND HATS; SPORTS SHIRTS; SWEAT PANTS; SWEAT SHIRTS; T-SHIRTS; TEE SHIRTS; TURTLE NECK SHIRTS, IN CLASS 25 (U.S. CLS. 22 AND 39).

FIRST USE 1-25-2011; IN COMMERCE 1-1-2012.

THE MARK CONSISTS OF THE WORD "LOVE" WHICH CONSISTS OF A RAZOR, BARBER POLE BALL, SHEARS, A CLIPPER AND RAZOR BLADES.

SN 85-234,186, FILED 2-4-2011.

DAVID I, EXAMINING ATTORNEY



*David J. Kypos*

Director of the United States Patent and Trademark Office



# United States of America

United States Patent and Trademark Office



**Reg. No. 4,199,343**

**Registered Aug. 28, 2012**

**Int. Cl.: 9**

**TRADEMARK**

**PRINCIPAL REGISTER**

ADENUS GROUP, LLC (TENNESSEE LIMITED LIABILITY COMPANY)  
849 AVIATION PARKWAY  
SMYRNA, TN 37167

FOR: SUPERVISORY CONTROL AND DATA ACQUISITION (SCADA) COMPUTER SOFTWARE AND HARDWARE FOR USE IN THE FIELDS OF WASTEWATER PROCESSING, PURIFICATION, TREATMENT AND DISPOSAL, FOR THE PURPOSE OF MONITORING AND AUTOMATING WASTEWATER SYSTEM CONTROL PANELS, IN CLASS 9 (U.S. CLS. 21, 23, 26, 36 AND 38).

FIRST USE 12-20-2011; IN COMMERCE 12-20-2011.

NO CLAIM IS MADE TO THE EXCLUSIVE RIGHT TO USE "MONITORING SYSTEM", APART FROM THE MARK AS SHOWN.

THE MARK CONSISTS OF A STYLIZED REPRESENTATION OF A HAWK'S HEAD, ACCOMPANIED BY THE TERM "HAWK" APPEARING ABOVE A HORIZONTAL LINE, AND THE PHRASE "MONITORING SYSTEM" APPEARING BELOW THE LINE.

SN 85-236,807, FILED 2-8-2011.

RONALD DELGIZZI, EXAMINING ATTORNEY



*David J. Kyffers*

Director of the United States Patent and Trademark Office

# United States of America

United States Patent and Trademark Office



**Reg. No. 4,199,344**

**Registered Aug. 28, 2012**

**Int. Cl.: 9**

**TRADEMARK**

**PRINCIPAL REGISTER**

ADENUS GROUP, LLC (TENNESSEE LIMITED LIABILITY COMPANY)  
849 AVIATION PARKWAY  
SMYRNA, TN 37167

FOR: SUPERVISORY CONTROL AND DATA ACQUISITION (SCADA) COMPUTER SOFTWARE AND HARDWARE FOR USE IN THE FIELDS OF WASTEWATER PROCESSING, PURIFICATION, TREATMENT AND DISPOSAL, FOR THE PURPOSE OF MONITORING AND AUTOMATING WASTEWATER SYSTEM CONTROL PANELS, IN CLASS 9 (U.S. CLS. 21, 23, 26, 36 AND 38).

FIRST USE 4-17-2012; IN COMMERCE 4-17-2012.

THE MARK CONSISTS OF A STYLIZED REPRESENTATION OF A HAWK'S HEAD, ACCOMPANIED BY THE LETTERS "MS".

SN 85-236,815, FILED 2-8-2011.

RONALD DELGIZZI, EXAMINING ATTORNEY



*David J. Kyffers*

Director of the United States Patent and Trademark Office

# United States of America

United States Patent and Trademark Office



**Reg. No. 4,199,345**

**Registered Aug. 28, 2012**

**Int. Cl.: 9**

**TRADEMARK**

**PRINCIPAL REGISTER**

ADENUS GROUP, LLC (TENNESSEE LIMITED LIABILITY COMPANY)  
849 AVIATION PARKWAY  
SMYRNA, TN 37167

FOR: SUPERVISORY CONTROL AND DATA ACQUISITION (SCADA) COMPUTER SOFTWARE AND HARDWARE FOR USE IN THE FIELDS OF WASTEWATER PROCESSING, PURIFICATION, TREATMENT AND DISPOSAL, FOR THE PURPOSE OF MONITORING AND AUTOMATING WASTEWATER SYSTEM CONTROL PANELS, IN CLASS 9 (U.S. CLS. 21, 23, 26, 36 AND 38).

FIRST USE 12-20-2011; IN COMMERCE 12-20-2011.

NO CLAIM IS MADE TO THE EXCLUSIVE RIGHT TO USE "OS", APART FROM THE MARK AS SHOWN.

THE MARK CONSISTS OF A STYLIZED REPRESENTATION OF A HAWK'S HEAD, ACCOMPANIED BY THE LETTERS "OS".

SN 85-236,821, FILED 2-8-2011.

RONALD DELGIZZI, EXAMINING ATTORNEY



*David J. Kyffers*

Director of the United States Patent and Trademark Office

# United States of America

United States Patent and Trademark Office



**Reg. No. 4,199,346**

**Registered Aug. 28, 2012**

**Int. Cl.: 9**

**TRADEMARK**

**PRINCIPAL REGISTER**

ADENUS GROUP, LLC (TENNESSEE LIMITED LIABILITY COMPANY)  
849 AVIATION PARKWAY  
SMYRNA, TN 37167

FOR: SUPERVISORY CONTROL AND DATA ACQUISITION (SCADA) COMPUTER SOFTWARE AND HARDWARE FOR USE IN THE FIELDS OF WASTEWATER PROCESSING, PURIFICATION, TREATMENT AND DISPOSAL, FOR THE PURPOSE OF MONITORING AND AUTOMATING WASTEWATER SYSTEM CONTROL PANELS, IN CLASS 9 (U.S. CLS. 21, 23, 26, 36 AND 38).

FIRST USE 3-23-2012; IN COMMERCE 3-23-2012.

THE MARK CONSISTS OF A STYLIZED REPRESENTATION OF A HAWK'S HEAD.

SN 85-236,828, FILED 2-8-2011.

RONALD DELGIZZI, EXAMINING ATTORNEY



*David J. Kyffers*

Director of the United States Patent and Trademark Office

# United States of America

United States Patent and Trademark Office

## HAWK OPERATING SYSTEM

**Reg. No. 4,199,347**

**Registered Aug. 28, 2012**

**Int. Cl.: 9**

**TRADEMARK**

**PRINCIPAL REGISTER**

ADENUS GROUP, LLC (TENNESSEE LIMITED LIABILITY COMPANY)  
849 AVIATION PARKWAY  
SMYRNA, TN 37167

FOR: SUPERVISORY CONTROL AND DATA ACQUISITION (SCADA) COMPUTER SOFTWARE AND HARDWARE FOR USE IN THE FIELDS OF WASTEWATER PROCESSING, PURIFICATION, TREATMENT AND DISPOSAL, FOR THE PURPOSE OF MONITORING AND AUTOMATING WASTEWATER SYSTEM CONTROL PANELS, IN CLASS 9 (U.S. CLS. 21, 23, 26, 36 AND 38).

FIRST USE 12-20-2011; IN COMMERCE 12-20-2011.

THE MARK CONSISTS OF STANDARD CHARACTERS WITHOUT CLAIM TO ANY PARTICULAR FONT, STYLE, SIZE, OR COLOR.

NO CLAIM IS MADE TO THE EXCLUSIVE RIGHT TO USE "OPERATING SYSTEM", APART FROM THE MARK AS SHOWN.

SN 85-236,837, FILED 2-8-2011.

RONALD DELGIZZI, EXAMINING ATTORNEY



*David J. Kyfos*

Director of the United States Patent and Trademark Office

# United States of America

United States Patent and Trademark Office

## HAWK MONITORING SYSTEM

**Reg. No. 4,199,348**

**Registered Aug. 28, 2012**

**Int. Cl.: 9**

**TRADEMARK**

**PRINCIPAL REGISTER**

ADENUS GROUP, LLC (TENNESSEE LIMITED LIABILITY COMPANY)  
849 AVIATION PARKWAY  
SMYRNA, TN 37167

FOR: SUPERVISORY CONTROL AND DATA ACQUISITION (SCADA) COMPUTER SOFTWARE AND HARDWARE FOR USE IN THE FIELDS OF WASTEWATER PROCESSING, PURIFICATION, TREATMENT AND DISPOSAL, FOR THE PURPOSE OF MONITORING AND AUTOMATING WASTEWATER SYSTEM CONTROL PANELS, IN CLASS 9 (U.S. CLS. 21, 23, 26, 36 AND 38).

FIRST USE 12-20-2011; IN COMMERCE 12-20-2011.

THE MARK CONSISTS OF STANDARD CHARACTERS WITHOUT CLAIM TO ANY PARTICULAR FONT, STYLE, SIZE, OR COLOR.

NO CLAIM IS MADE TO THE EXCLUSIVE RIGHT TO USE "MONITORING SYSTEM", APART FROM THE MARK AS SHOWN.

SN 85-236,840, FILED 2-8-2011.

RONALD DELGIZZI, EXAMINING ATTORNEY



*David J. Kyffers*

Director of the United States Patent and Trademark Office

United States of America  
United States Patent and Trademark Office

HAWKOS

**Reg. No. 4,199,349**

ADENUS GROUP, LLC (TENNESSEE LIMITED LIABILITY COMPANY)  
849 AVIATION PARKWAY  
SMYRNA, TN 37167

**Registered Aug. 28, 2012**

**Int. Cl.: 9**

FOR: SUPERVISORY CONTROL AND DATA ACQUISITION (SCADA) COMPUTER SOFTWARE AND HARDWARE FOR USE IN THE FIELDS OF WASTEWATER PROCESSING, PURIFICATION, TREATMENT AND DISPOSAL, FOR THE PURPOSE OF MONITORING AND AUTOMATING WASTEWATER SYSTEM CONTROL PANELS, IN CLASS 9 (U.S. CLS. 21, 23, 26, 36 AND 38).

**TRADEMARK**

**PRINCIPAL REGISTER**

FIRST USE 12-20-2011; IN COMMERCE 12-20-2011.

THE MARK CONSISTS OF STANDARD CHARACTERS WITHOUT CLAIM TO ANY PARTICULAR FONT, STYLE, SIZE, OR COLOR.

SN 85-236,853, FILED 2-8-2011.

RONALD DELGIZZI, EXAMINING ATTORNEY



*David J. Kyffers*

Director of the United States Patent and Trademark Office

United States of America  
United States Patent and Trademark Office

HAWKMS

**Reg. No. 4,199,350**

ADENUS GROUP, LLC (TENNESSEE LIMITED LIABILITY COMPANY)  
849 AVIATION PARKWAY  
SMYRNA, TN 37167

**Registered Aug. 28, 2012**

**Int. Cl.: 9**

FOR: SUPERVISORY CONTROL AND DATA ACQUISITION (SCADA) COMPUTER SOFTWARE AND HARDWARE FOR USE IN THE FIELDS OF WASTEWATER PROCESSING, PURIFICATION, TREATMENT AND DISPOSAL, FOR THE PURPOSE OF MONITORING AND AUTOMATING WASTEWATER SYSTEM CONTROL PANELS, IN CLASS 9 (U.S. CLS. 21, 23, 26, 36 AND 38).

**TRADEMARK**

**PRINCIPAL REGISTER**

FIRST USE 3-23-2012; IN COMMERCE 3-23-2012.

THE MARK CONSISTS OF STANDARD CHARACTERS WITHOUT CLAIM TO ANY PARTICULAR FONT, STYLE, SIZE, OR COLOR.

SN 85-236,858, FILED 2-8-2011.

RONALD DELGIZZI, EXAMINING ATTORNEY



*David J. Kyffers*

Director of the United States Patent and Trademark Office



# United States of America

United States Patent and Trademark Office

# HemSavers

**Reg. No. 4,199,351**

TERRY, DELPHIA RENAEE (UNITED STATES INDIVIDUAL)  
3 JOSHUA LANE  
HENDERSON, NC 27537

**Registered Aug. 28, 2012**

**Int. Cl.: 26**

FOR: FABRIC APPLIQUES, IN CLASS 26 (U.S. CLS. 37, 39, 40, 42 AND 50).

**TRADEMARK**

FIRST USE 8-1-2010; IN COMMERCE 12-1-2010.

**PRINCIPAL REGISTER**

THE MARK CONSISTS OF STANDARD CHARACTERS WITHOUT CLAIM TO ANY PARTICULAR FONT, STYLE, SIZE, OR COLOR.

SN 85-237,460, FILED 2-9-2011.

MICHAEL ENGEL, EXAMINING ATTORNEY



*David J. Kybas*

Director of the United States Patent and Trademark Office

# United States of America

United States Patent and Trademark Office

## TIMELESS MOVIEGOING

**Reg. No. 4,199,352**

VINTAGE CINEMAS, INC. (CALIFORNIA CORPORATION)  
1822 N. VERMONT AVE.  
LOS ANGELES, CA 90027

**Registered Aug. 28, 2012**

**Int. Cls.: 35, 41, and 43**

FOR: MOTION PICTURE THEATER CONCESSION STANDS FEATURING FOOD AND BEVERAGES, IN CLASS 35 (U.S. CLS. 100, 101 AND 102).

**SERVICE MARK**

FIRST USE 6-1-2009; IN COMMERCE 6-1-2009.

**PRINCIPAL REGISTER**

FOR: MOTION PICTURE THEATER SERVICES; CONSULTING SERVICES IN THE FIELD OF EVENT PLANNING, CONCERT PLANNING AND PARTY PLANNING SERVICES; VENUE RENTAL SERVICES, NAMELY, RENTAL OF ROOMS FOR CONCERTS, IN CLASS 41 (U.S. CLS. 100, 101 AND 107).

FIRST USE 6-1-2009; IN COMMERCE 6-1-2009.

FOR: VENUE RENTAL, NAMELY, RENTAL OF ROOMS AND FACILITIES FOR SOCIAL FUNCTIONS, IN CLASS 43 (U.S. CLS. 100 AND 101).

FIRST USE 6-1-2009; IN COMMERCE 6-1-2009.

THE MARK CONSISTS OF STANDARD CHARACTERS WITHOUT CLAIM TO ANY PARTICULAR FONT, STYLE, SIZE, OR COLOR.

NO CLAIM IS MADE TO THE EXCLUSIVE RIGHT TO USE "MOVIEGOING", APART FROM THE MARK AS SHOWN.

SN 85-237,522, FILED 2-9-2011.

DAWN FELDMAN, EXAMINING ATTORNEY



*David J. Kyros*

Director of the United States Patent and Trademark Office

# United States of America

United States Patent and Trademark Office

## COMFORT GLOW

**Reg. No. 4,199,353**

WORLD MARKETING OF AMERICA, INC. (PENNSYLVANIA CORPORATION)  
P.O. BOX 192, ROUTE 22 WEST  
MILL CREEK, PA 17060

**Registered Aug. 28, 2012**

**Int. Cl.: 11**

FOR: ELECTRIC STOVES; ELECTRIC FIREPLACES; ELECTRIC FIREPLACES, NAMELY, ELECTRIC LOG INSERTS, IN CLASS 11 (U.S. CLS. 13, 21, 23, 31 AND 34).

**TRADEMARK**

FIRST USE 4-0-2011; IN COMMERCE 4-0-2011.

**PRINCIPAL REGISTER**

THE MARK CONSISTS OF STANDARD CHARACTERS WITHOUT CLAIM TO ANY PARTICULAR FONT, STYLE, SIZE, OR COLOR.

OWNER OF U.S. REG. NO. 1,188,544.

SN 85-239,386, FILED 2-10-2011.

LAURA KOVALSKY, EXAMINING ATTORNEY



*David J. Kyffers*

Director of the United States Patent and Trademark Office

# United States of America

United States Patent and Trademark Office

## Intervention4Success

**Reg. No. 4,199,354**

**Registered Aug. 28, 2012**

**Int. Cl.: 16**

**TRADEMARK**

**PRINCIPAL REGISTER**

WISEBURN SCHOOL DISTRICT (CALIFORNIA EDUCATIONAL INSTITUTION)  
13530 AVIATION BLVD  
HAWTHORNE, CA 902506498

FOR: EDUCATIONAL AND LEARNING PUBLICATIONS, NAMELY, BOOKLETS AND FLASH CARDS ON A VARIETY OF EDUCATIONAL DISCIPLINES IN PRE-SCHOOL THROUGH EIGHTH GRADE; EDUCATIONAL PUBLICATIONS, NAMELY, TRAINING MANUALS IN THE FIELD OF STUDENT STUDY TEAMS AND SPECIAL EDUCATION; EDUCATIONAL PUBLICATIONS, NAMELY, BOOKS, HAND-OUTS, WORKBOOKS, BROCHURES, BUSINESS CARDS IN THE FIELDS OF SPECIAL EDUCATION AND STUDENT STUDY TEAMS; PRINTED EDUCATIONAL MATERIALS IN THE FIELD OF SPECIAL EDUCATION AND STUDENT STUDY TEAMS; PRINTED INSTRUCTIONAL, EDUCATIONAL, AND TEACHING MATERIALS IN THE FIELD OF RESPONSE TO INTERVENTION; PRINTED MATERIAL, NAMELY, SURVEYS AND ASSESSMENTS IN THE FIELD OF EDUCATOR TRAINING AND PERFORMANCE, IN CLASS 16 (U.S. CLS. 2, 5, 22, 23, 29, 37, 38 AND 50).

FIRST USE 8-1-2011; IN COMMERCE 8-1-2011.

THE MARK CONSISTS OF STANDARD CHARACTERS WITHOUT CLAIM TO ANY PARTICULAR FONT, STYLE, SIZE, OR COLOR.

SN 85-240,251, FILED 2-11-2011.

JAMES A. RAUEN, EXAMINING ATTORNEY



*David J. Kyffers*

Director of the United States Patent and Trademark Office

# United States of America

United States Patent and Trademark Office

# RELIEFGRIP

**Reg. No. 4,199,355**

HILLERICH & BRADSBY CO. (KENTUCKY CORPORATION)  
800 WEST MAIN STREET  
LOUISVILLE, KY 40202

**Registered Aug. 28, 2012**

**Int. Cls.: 21, 25, and 28**

FOR: GLOVES FOR GARDENING AND LANDSCAPING PURPOSES, IN CLASS 21 (U.S. CLS. 2, 13, 23, 29, 30, 33, 40 AND 50).

**TRADEMARK**

FIRST USE 6-18-2012; IN COMMERCE 6-18-2012.

**PRINCIPAL REGISTER**

FOR: GLOVES, IN CLASS 25 (U.S. CLS. 22 AND 39).

FIRST USE 6-18-2012; IN COMMERCE 6-18-2012.

FOR: GOLF GLOVES, IN CLASS 28 (U.S. CLS. 22, 23, 38 AND 50).

FIRST USE 12-14-2011; IN COMMERCE 12-14-2011.

THE MARK CONSISTS OF STANDARD CHARACTERS WITHOUT CLAIM TO ANY PARTICULAR FONT, STYLE, SIZE, OR COLOR.

SN 85-240,430, FILED 2-11-2011.

CHRISTINA SOBRAL, EXAMINING ATTORNEY



*David J. Kybas*

Director of the United States Patent and Trademark Office

# United States of America

United States Patent and Trademark Office



**Reg. No. 4,199,356**

TWIN STAR INTERNATIONAL, INC. (FLORIDA CORPORATION)  
115 S. E 4TH AVENUE  
DELRAY BEACH, FL 33483

**Registered Aug. 28, 2012**

**Int. Cl.: 11**

FOR: FUEL AND ELECTRICITY OPERATED FIREPLACES AND HEATERS WHICH REQUIRE NO HOOK-UPS OR VENTING, IN CLASS 11 (U.S. CLS. 13, 21, 23, 31 AND 34).

**TRADEMARK**

FIRST USE 4-15-2012; IN COMMERCE 4-15-2012.

**PRINCIPAL REGISTER**

NO CLAIM IS MADE TO THE EXCLUSIVE RIGHT TO USE "WALL OR CORNER DUAL USE", APART FROM THE MARK AS SHOWN.

THE MARK CONSISTS OF THE WORDS "WALL OR CORNER DUAL USE", AND A SQUARE WITH ONE OF THE CORNERS CUTOFF. THE WORD "WALL" APPEARS AT THE TOP OF THE MARK, AND THE WORD "OR" UNDER THE LAST "L". THE WORD APPEARS VERTICALLY WITH THE "C" STARTING AT THE LETTER "L" OF THE WORD "WALL". THE WORDING "DUAL USE" APPEARS INSIDE OF THE SQUARE, AND BENEATH THE WORDING "WALL".

SN 85-240,809, FILED 2-12-2011.

DARRYL SPRUILL, EXAMINING ATTORNEY



*David J. Kyros*

Director of the United States Patent and Trademark Office

# United States of America

United States Patent and Trademark Office

# CHAHUA

**Reg. No. 4,199,357**

**Registered Aug. 28, 2012**

**Int. Cl.: 21**

**TRADEMARK**

**PRINCIPAL REGISTER**

FUJIAN CHAHUA HOUSEHOLD PLASTICS CO., LTD. (CHINA LIMITED COMPANY (LTD.))  
5 FUXING AVE.  
FUXING ECONOMIC DEVELOPMENT ZONE, FUZHOU  
FUJIAN, 350014, CHINA

FOR: BASINS; CONTAINERS FOR HOUSEHOLD OR KITCHEN USE; CONTAINERS FOR HOUSEHOLD OR KITCHEN USE NOT OF PRECIOUS METAL; DRINKING VESSELS; GARBAGE CANS; LUNCH BOXES; PORTABLE COLDBOXES; SOAP BOXES; THERMAL INSULATED CONTAINERS FOR FOOD OR BEVERAGES; TOILET PAPER DISPENSERS, IN CLASS 21 (U.S. CLS. 2, 13, 23, 29, 30, 33, 40 AND 50).

FIRST USE 10-10-2008; IN COMMERCE 12-5-2008.

THE MARK CONSISTS OF STANDARD CHARACTERS WITHOUT CLAIM TO ANY PARTICULAR FONT, STYLE, SIZE, OR COLOR.

OWNER OF U.S. REG. NO. 3,139,353.

THE WORDING "CHAHUA" HAS NO MEANING IN A FOREIGN LANGUAGE.

SN 85-241,143, FILED 2-14-2011.

ANDREA HACK, EXAMINING ATTORNEY



*David J. Kyffers*

Director of the United States Patent and Trademark Office

# United States of America

United States Patent and Trademark Office

## BLUEPHASE STYLE

**Reg. No. 4,199,358**

**Registered Aug. 28, 2012**

**Int. Cl.: 10**

**TRADEMARK**

**PRINCIPAL REGISTER**

IVOCAR VIVADENT, INC. (NEW YORK CORPORATION)  
175 PINEVIEW DRIVE  
AMHERST, NY 14228

FOR: DENTAL CURING LIGHTS, IN CLASS 10 (U.S. CLS. 26, 39 AND 44).

FIRST USE 1-9-2012; IN COMMERCE 2-23-2012.

THE MARK CONSISTS OF STANDARD CHARACTERS WITHOUT CLAIM TO ANY PARTICULAR FONT, STYLE, SIZE, OR COLOR.

OWNER OF U.S. REG. NO. 2,879,886.

SN 85-241,212, FILED 2-14-2011.

DEZMONA MIZELLE, EXAMINING ATTORNEY



*David J. Kyffers*

Director of the United States Patent and Trademark Office



# United States of America

United States Patent and Trademark Office

## LASH FANATIC

**Reg. No. 4,199,359**

NOXELL CORPORATION (DELAWARE CORPORATION)  
11050 YORK ROAD  
HUNT VALLEY, MD 210302098

**Registered Aug. 28, 2012**

**Int. Cl.: 3**

FOR: MASCARA, IN CLASS 3 (U.S. CLS. 1, 4, 6, 50, 51 AND 52).

**TRADEMARK**

FIRST USE 12-12-2011; IN COMMERCE 12-12-2011.

**PRINCIPAL REGISTER**

THE MARK CONSISTS OF STANDARD CHARACTERS WITHOUT CLAIM TO ANY PARTICULAR FONT, STYLE, SIZE, OR COLOR.

NO CLAIM IS MADE TO THE EXCLUSIVE RIGHT TO USE "LASH", APART FROM THE MARK AS SHOWN.

SN 85-242,311, FILED 2-15-2011.

STEVEN R. FINE, EXAMINING ATTORNEY



*David J. Kyffers*

Director of the United States Patent and Trademark Office

# United States of America

United States Patent and Trademark Office

# IN TOUCH

**Reg. No. 4,199,360**

**Registered Aug. 28, 2012**

**Int. Cl.: 35**

**SERVICE MARK**

**PRINCIPAL REGISTER**

IN TOUCH ELECTRONICS, LLC (FLORIDA LIMITED LIABILITY COMPANY)  
BLDG. #2  
13944 LYNMAR BLVD.  
TAMPA, FL 33626

FOR: DISTRIBUTORSHIPS IN THE FIELD OF ELECTRONIC DEVICES, NAMELY, CONSUMER DISPLAY SCREENS FOR VEHICLES, IN CLASS 35 (U.S. CLS. 100, 101 AND 102).

FIRST USE 3-10-2011; IN COMMERCE 3-10-2011.

THE MARK CONSISTS OF STANDARD CHARACTERS WITHOUT CLAIM TO ANY PARTICULAR FONT, STYLE, SIZE, OR COLOR.

SN 85-242,709, FILED 2-15-2011.

ESTHER A. BORSUK, EXAMINING ATTORNEY



*David J. Kybas*

Director of the United States Patent and Trademark Office

# United States of America

United States Patent and Trademark Office

## HASTY SEARCH KIT

**Reg. No. 4,199,361**

**Registered Aug. 28, 2012**

**Int. Cl.: 9**

**TRADEMARK**

**PRINCIPAL REGISTER**

CON-SPACE COMMUNICATIONS LTD. (CANADA CORPORATION)  
#280 - 13775 COMMERCE PARKWAY  
RICHMOND, BC, CANADA V6V2V4

FOR: A SEARCH AND RESCUE KIT CONSISTING OF A SPECIALIZED VIDEO SEARCH CAMERA USED TO LOCATE DISASTER OR ACCIDENT VICTIMS IN CONFINED SPACES OR COLLAPSED STRUCTURES AND AN ELECTROSTATIC FIELD OBJECT DETECTOR, IN CLASS 9 (U.S. CLS. 21, 23, 26, 36 AND 38).

FIRST USE 3-31-2011; IN COMMERCE 3-31-2011.

THE MARK CONSISTS OF STANDARD CHARACTERS WITHOUT CLAIM TO ANY PARTICULAR FONT, STYLE, SIZE, OR COLOR.

PRIORITY CLAIMED UNDER SEC. 44(D) ON CANADA APPLICATION NO. 1515329, FILED 2-15-2011, REG. NO. TMA818077, DATED 2-21-2012, EXPIRES 2-21-2027.

NO CLAIM IS MADE TO THE EXCLUSIVE RIGHT TO USE "SEARCH KIT", APART FROM THE MARK AS SHOWN.

SN 85-244,362, FILED 2-16-2011.

ALEX KEAM, EXAMINING ATTORNEY



*David J. Kybas*

Director of the United States Patent and Trademark Office

# United States of America

United States Patent and Trademark Office

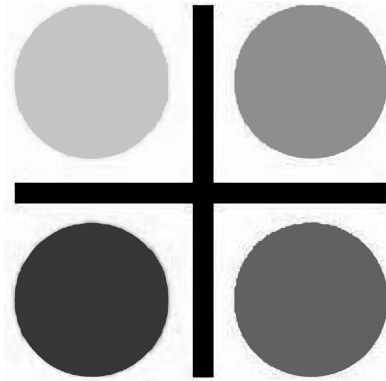

**Reg. No. 4,199,362**

**Registered Aug. 28, 2012**

**Int. Cl.: 9**

**TRADEMARK**

**PRINCIPAL REGISTER**

BITCENTRAL, INC. (CALIFORNIA CORPORATION)  
4340 VON KARMAN AVENUE, SUITE 410  
NEWPORT BEACH, CA 92660

FOR: MEDIA AND NEWS AGGREGATION, PRODUCTION MANAGEMENT AND DISTRIBUTION SYSTEMS COMPRISED OF COMPUTER HARDWARE AND SOFTWARE FOR RECEIVING, UPLOADING, MANIPULATING AND VIDEO PLAYBACK OF INFORMATION AND DATA, IN CLASS 9 (U.S. CLS. 21, 23, 26, 36 AND 38).

FIRST USE 3-31-2011; IN COMMERCE 3-31-2011.

OWNER OF U.S. REG. NOS. 2,886,961 AND 3,900,128.

THE MARK CONSISTS OF A PLUS SYMBOL AND FOUR CIRCLES LOCATED IN EACH CORNER OF THE PLUS SYMBOL.

SN 85-244,687, FILED 2-17-2011.

JASON BLAIR, EXAMINING ATTORNEY



*David J. Kybas*

Director of the United States Patent and Trademark Office

# United States of America

United States Patent and Trademark Office

## WE RESTORE, YOU RECOVER

**Reg. No. 4,199,363**

**Registered Aug. 28, 2012**

**Int. Cls.: 37 and 40**

**SERVICE MARK**

**PRINCIPAL REGISTER**

RAINBOW INTERNATIONAL CARPET DYEING & CLEANING CO. (TEXAS CORPORATION)  
1010-1020 N. UNIVERSITY PARKS DRIVE  
WACO, TX 76707

FOR: CARPET, UPHOLSTERY AND DRAPERY CLEANING, AND SPOT AND STAIN REMOVAL SERVICES, AIR-DUCT CLEANING SERVICES, DISASTER RESTORATION SERVICES, NAMELY, RESTORING BUILDING INTERIORS, CARPET AND FURNISHINGS DAMAGED BY FIRE, WATER, SMOKE AND OTHER DISASTERS; CARPET REPAIR SERVICES, COMMERCIAL AND RESIDENTIAL BUILDING CLEANING SERVICES; PROVIDING CARPET AND UPHOLSTERY DYEING, TINTING AND COLORIZING SERVICES, IN CLASS 37 (U.S. CLS. 100, 103 AND 106).

FIRST USE 11-0-2010; IN COMMERCE 11-0-2010.

FOR: CARPET, UPHOLSTERY AND DRAPERY ODOR REMOVAL SERVICES, MOLD INHIBITION SERVICES OF BUILDINGS AND THEIR CONTENTS, IN CLASS 40 (U.S. CLS. 100, 103 AND 106).

FIRST USE 11-0-2010; IN COMMERCE 11-0-2010.

THE MARK CONSISTS OF STANDARD CHARACTERS WITHOUT CLAIM TO ANY PARTICULAR FONT, STYLE, SIZE, OR COLOR.

SN 85-245,050, FILED 2-17-2011.

KAREN SEVERSON, EXAMINING ATTORNEY



*David J. Kybas*

Director of the United States Patent and Trademark Office

# United States of America

United States Patent and Trademark Office

## RACK TAKER

**Reg. No. 4,199,364**

KALMBACH FEEDS, INC. (OHIO CORPORATION)  
7148 STATE HIGHWAY 199  
UPPER SANDUSKY, OH 43351

**Registered Aug. 28, 2012**

**Int. Cls.: 5, 28, and 31**

FOR: DIETARY SUPPLEMENTS FOR DEER; FEED SUPPLEMENTS FOR DEER; MINERAL SUPPLEMENTS, IN CLASS 5 (U.S. CLS. 6, 18, 44, 46, 51 AND 52).

**TRADEMARK**

FIRST USE 7-1-2011; IN COMMERCE 7-1-2011.

**PRINCIPAL REGISTER**

FOR: DEER ATTRACTANTS, IN CLASS 28 (U.S. CLS. 22, 23, 38 AND 50).

FIRST USE 7-1-2011; IN COMMERCE 7-1-2011.

FOR: WILDLIFE SEED MIXTURES, IN CLASS 31 (U.S. CLS. 1 AND 46).

FIRST USE 7-1-2011; IN COMMERCE 7-1-2011.

THE MARK CONSISTS OF STANDARD CHARACTERS WITHOUT CLAIM TO ANY PARTICULAR FONT, STYLE, SIZE, OR COLOR.

SN 85-245,092, FILED 2-17-2011.

ANDREA BUTLER, EXAMINING ATTORNEY



*David J. Kyros*

Director of the United States Patent and Trademark Office

# United States of America

United States Patent and Trademark Office

## VACATIONOLOGY

**Reg. No. 4,199,365**

**Registered Aug. 28, 2012**

**Int. Cl.: 41**

**SERVICE MARK**

**PRINCIPAL REGISTER**

MARRIOTT VACATIONS WORLDWIDE CORPORATION (DELAWARE CORPORATION)  
6649 WESTWOOD BLVD.  
SUITE 300  
ORLANDO, FL 328216090

FOR: PROVIDING EDUCATION AND TRAINING IN THE FIELDS OF FOREIGN LANGUAGE,  
ARTS AND CRAFTS, AND TECHNOLOGY, IN CLASS 41 (U.S. CLS. 100, 101 AND 107).

FIRST USE 8-0-2010; IN COMMERCE 8-0-2010.

THE MARK CONSISTS OF STANDARD CHARACTERS WITHOUT CLAIM TO ANY PAR-  
TICULAR FONT, STYLE, SIZE, OR COLOR.

SN 85-245,094, FILED 2-17-2011.

GINA HAYES, EXAMINING ATTORNEY



*David J. Kyffers*

Director of the United States Patent and Trademark Office

# United States of America

United States Patent and Trademark Office

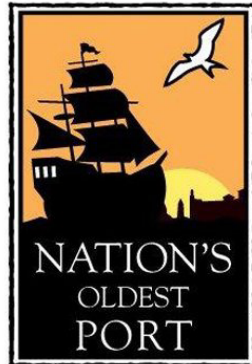

**Reg. No. 4,199,366**

**Registered Aug. 28, 2012**

**Int. Cl.: 41**

**SERVICE MARK**

**PRINCIPAL REGISTER**

THE SAINT AUGUSTINE LIGHTHOUSE AND MUSEUM, INC. (FLORIDA CORPORATION)  
81 LIGHTHOUSE AVENUE  
ST. AUGUSTINE, FL 32080

FOR: EDUCATIONAL SERVICES, NAMELY, CONDUCTING PROGRAMS IN THE FIELD OF TOURISM, TRAVEL, MARITIME, ARCHEOLOGY AND LOCAL HISTORY; MUSEUM SERVICES, IN CLASS 41 (U.S. CLS. 100, 101 AND 107).

FIRST USE 8-1-2011; IN COMMERCE 8-1-2011.

NO CLAIM IS MADE TO THE EXCLUSIVE RIGHT TO USE "NATION'S OLDEST PORT", APART FROM THE MARK AS SHOWN.

THE COLOR(S) BLACK, WHITE, ORANGE AND YELLOW IS/ARE CLAIMED AS A FEATURE OF THE MARK.

THE MARK CONSISTS OF A SILHOUETTE OF A HISTORICAL SHIP APPEARING IN BLACK AND WHITE SAILING TOWARDS A FORT APPEARING IN THE COLOR BLACK, WITH A RISING SUN APPEARING IN THE COLOR YELLOW IN THE BACKGROUND, AND TO THE RIGHT APPEARS A SILHOUETTE OF A FLYING BIRD IN WHITE OUTLINED IN BLACK, AND BELOW THE HISTORICAL SHIP APPEARS THE WORDING "NATION'S OLDEST PORT" IN WHITE AGAINST A BLACK BACKGROUND, ALL APPEARING AGAINST AN ORANGE BACKGROUND AND CONTAINED WITHIN A DOUBLE-SIDED BLACK AND WHITE RECTANGULAR CARRIER.

SN 85-245,300, FILED 2-17-2011.

APRIL HESIK, EXAMINING ATTORNEY



*David J. Kybas*

Director of the United States Patent and Trademark Office



# United States of America

United States Patent and Trademark Office

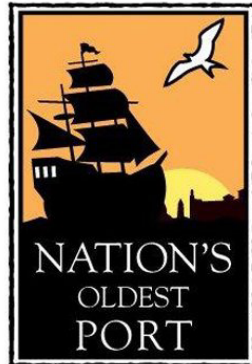

**Reg. No. 4,199,367**

**Registered Aug. 28, 2012**

**Int. Cl.: 35**

**SERVICE MARK**

**PRINCIPAL REGISTER**

THE SAINT AUGUSTINE LIGHTHOUSE AND MUSEUM, INC. (FLORIDA CORPORATION)  
81 LIGHTHOUSE AVENUE  
ST. AUGUSTINE, FL 32080

FOR: PROMOTING RECREATION AND TOURISM IN ST. AUGUSTINE, FLORIDA; MARKETING, ADVERTISING AND PROMOTING THE GOODS AND SERVICES OF OTHERS IN THE FIELDS OF TRAVEL, TOURISM, MARITIME, ARCHEOLOGY AND LOCAL HISTORY, IN CLASS 35 (U.S. CLS. 100, 101 AND 102).

FIRST USE 8-1-2011; IN COMMERCE 8-1-2011.

NO CLAIM IS MADE TO THE EXCLUSIVE RIGHT TO USE "NATION'S OLDEST PORT", APART FROM THE MARK AS SHOWN.

THE COLOR(S) BLACK, WHITE, ORANGE AND YELLOW IS/ARE CLAIMED AS A FEATURE OF THE MARK.

THE MARK CONSISTS OF A SILHOUETTE OF A HISTORICAL SHIP APPEARING IN BLACK AND WHITE SAILING TOWARDS A FORT APPEARING IN THE COLOR BLACK, WITH A RISING SUN APPEARING IN THE COLOR YELLOW IN THE BACKGROUND, AND TO THE RIGHT APPEARS A SILHOUETTE OF A FLYING BIRD IN WHITE OUTLINED IN BLACK, AND BELOW THE HISTORICAL SHIP APPEARS THE WORDING "NATION'S OLDEST PORT" IN WHITE AGAINST A BLACK BACKGROUND, ALL APPEARING AGAINST AN ORANGE BACKGROUND AND CONTAINED WITHIN A DOUBLE-SIDED BLACK AND WHITE RECTANGULAR CARRIER.

SN 85-245,351, FILED 2-17-2011.

APRIL HESIK, EXAMINING ATTORNEY



*David J. Kybas*

Director of the United States Patent and Trademark Office

# United States of America

United States Patent and Trademark Office

## B. BRILLIANT

**Reg. No. 4,199,368**

DESIGNS BY FMC, INC. (NEW YORK CORPORATION)  
1533 60TH STREET  
BROOKLYN, NY 11219

**Registered Aug. 28, 2012**

**Int. Cl.: 14**

FOR: JEWELRY, IN CLASS 14 (U.S. CLS. 2, 27, 28 AND 50).

**TRADEMARK**

FIRST USE 5-25-2011; IN COMMERCE 5-25-2011.

**PRINCIPAL REGISTER**

THE MARK CONSISTS OF STANDARD CHARACTERS WITHOUT CLAIM TO ANY PARTICULAR FONT, STYLE, SIZE, OR COLOR.

SN 85-245,727, FILED 2-18-2011.

JANICE L. MCMORROW, EXAMINING ATTORNEY



*David J. Kyffers*

Director of the United States Patent and Trademark Office

# United States of America

United States Patent and Trademark Office

# GEOSOURCE

**Reg. No. 4,199,369**

**Registered Aug. 28, 2012**

**Int. Cls.: 9, 35, and 42**

**TRADEMARK**

**SERVICE MARK**

**PRINCIPAL REGISTER**

PETROLEUM GEO-SERVICES ASA (NORWAY CORPORATION)  
STRANDVEIEN 4  
LYSAKER, NORWAY N-1366

FOR: ELECTRONIC DATABASE IN THE FIELD OF SEISMIC INFORMATION RECORDED ON COMPUTER MEDIA; COMPUTER HARDWARE AND SOFTWARE FOR PROCESSING SEISMIC DATA; SEISMIC SOURCE APPARATUS, NAMELY, AIR GUNS, PLASMA SOUND SOURCES, SEISMIC VIBRATORS, BOOMER SOURCES, AND ARRAYS OF SEISMIC SOURCES, IN CLASS 9 (U.S. CLS. 21, 23, 26, 36 AND 38).

FIRST USE 9-21-2011; IN COMMERCE 9-21-2011.

FOR: DATA PROCESSING SERVICES REGARDING SEISMIC INFORMATION, IN CLASS 35 (U.S. CLS. 100, 101 AND 102).

FIRST USE 9-21-2011; IN COMMERCE 9-21-2011.

FOR: GEOPHYSICAL EXPLORATION FOR OIL AND GAS AND OTHER MINERALS; RECORDING OF SEISMIC DATA FOR OTHERS ON OPTICAL, DIGITAL AND MAGNETIC MEDIA FOR ELECTRONIC STORAGE; ANALYSIS OF SEISMIC DATA FOR THE OIL AND GAS INDUSTRY, IN CLASS 42 (U.S. CLS. 100 AND 101).

FIRST USE 9-21-2011; IN COMMERCE 9-21-2011.

THE MARK CONSISTS OF STANDARD CHARACTERS WITHOUT CLAIM TO ANY PARTICULAR FONT, STYLE, SIZE, OR COLOR.

SN 85-246,002, FILED 2-18-2011.

PAM WILLIS, EXAMINING ATTORNEY



*David J. Kypos*

Director of the United States Patent and Trademark Office

# United States of America

United States Patent and Trademark Office

## AROMA RESORT

**Reg. No. 4,199,370**

KRACIE HOME PRODUCTS, LTD. (JAPAN JOINT STOCK COMPANY)  
20-20, KAIGAN 3-CHOME, MINATO-KU  
TOKYO, JAPAN

**Registered Aug. 28, 2012**

**Int. Cl.: 3**

FOR: COSMETICS; BODY SCRUB; BODY LOTION; BODY CREAM; BODY GEL; SOAPS;  
BODY SOAPS; HAIR SHAMPOO; HAIR RINSE; HAIR CONDITIONER; COSMETIC PREPAR-  
ATIONS FOR BATH, NAMELY, BUBBLE BATH; BATH GEL; BATH POWDER; BATH OILS;  
NON-MEDICATED BATH SALTS, IN CLASS 3 (U.S. CLS. 1, 4, 6, 50, 51 AND 52).

**TRADEMARK**

**PRINCIPAL REGISTER**

FIRST USE 10-1-2010; IN COMMERCE 4-1-2012.

THE MARK CONSISTS OF STANDARD CHARACTERS WITHOUT CLAIM TO ANY PAR-  
TICULAR FONT, STYLE, SIZE, OR COLOR.

NO CLAIM IS MADE TO THE EXCLUSIVE RIGHT TO USE "AROMA", APART FROM THE  
MARK AS SHOWN.

SN 85-248,022, FILED 2-22-2011.

SANI KHOURI, EXAMINING ATTORNEY



*David J. Kyffers*

Director of the United States Patent and Trademark Office

# United States of America

United States Patent and Trademark Office

# POPLITICAL

**Reg. No. 4,199,371**

**Registered Aug. 28, 2012**

**Int. Cl.: 41**

**SERVICE MARK**

**PRINCIPAL REGISTER**

TALL HISPANIC SHORT HISPANIC PRODUCTIONS, LLC (ILLINOIS LIMITED LIABILITY COMPANY)  
1917 W. BERTEAU AVENUE # 2  
CHICAGO, IL 60613

FOR: ENTERTAINMENT SERVICES, NAMELY, THE PROVISION OF CONTINUING SHOWS FEATURING AMERICAN CULTURE DELIVERED BY THE INTERNET, IN CLASS 41 (U.S. CLS. 100, 101 AND 107).

FIRST USE 2-9-2011; IN COMMERCE 2-9-2011.

THE MARK CONSISTS OF STANDARD CHARACTERS WITHOUT CLAIM TO ANY PARTICULAR FONT, STYLE, SIZE, OR COLOR.

SN 85-248,145, FILED 2-22-2011.

ALEX KEAM, EXAMINING ATTORNEY



*David J. Kybas*

Director of the United States Patent and Trademark Office

# United States of America

United States Patent and Trademark Office

## DANS LE BAIN

**Reg. No. 4,199,372**

**Registered Aug. 28, 2012**

**Int. Cls.: 3 and 4**

**TRADEMARK**

**PRINCIPAL REGISTER**

MEER, SCOTT (UNITED STATES INDIVIDUAL)  
11067 WEST LILAC ROAD  
VALLEY CENTER, CA 92082

FOR: CLEANING PREPARATIONS, NAMELY, SOAP, LIQUID SOAP, BAR SOAP; MOISTURIZING PREPARATIONS FOR SKIN; SHAMPOOS; HAIR CONDITIONERS, IN CLASS 3 (U.S. CLS. 1, 4, 6, 50, 51 AND 52).

FIRST USE 3-15-2011; IN COMMERCE 3-15-2011.

FOR: CANDLES; PARAFFIN WAX; SOY WAX CANDLE, IN CLASS 4 (U.S. CLS. 1, 6 AND 15).

FIRST USE 3-15-2011; IN COMMERCE 3-15-2011.

THE MARK CONSISTS OF STANDARD CHARACTERS WITHOUT CLAIM TO ANY PARTICULAR FONT, STYLE, SIZE, OR COLOR.

NO CLAIM IS MADE TO THE EXCLUSIVE RIGHT TO USE "BAIN", APART FROM THE MARK AS SHOWN.

THE ENGLISH TRANSLATION OF "DANS LE BAIN" IS "IN THE BATH."

SN 85-249,053, FILED 2-23-2011.

MICHAEL WIENER, EXAMINING ATTORNEY



*David J. Kyros*

Director of the United States Patent and Trademark Office

# United States of America

United States Patent and Trademark Office

## How They Did It

**Reg. No. 4,199,373**

JORDAN, ROBERT (UNITED STATES INDIVIDUAL)  
1450 TECHNY ROAD  
NORTHBROOK, IL 60062

**Registered Aug. 28, 2012**

**Int. Cls.: 16 and 41**

FOR: NON-FICTION BOOKS IN THE FIELD OF INSPIRATION AND PRACTICAL CAREER, ENTREPRENEURIAL, BUSINESS ADVICE; A SERIES OF WORK BOOKS IN THE FIELD OF INSPIRATION AND PRACTICAL CAREER, ENTREPRENEURIAL, BUSINESS ADVICE, IN CLASS 16 (U.S. CLS. 2, 5, 22, 23, 29, 37, 38 AND 50).

**TRADEMARK**

**SERVICE MARK**

FIRST USE 11-16-2010; IN COMMERCE 11-16-2010.

**PRINCIPAL REGISTER**

FOR: CONDUCTING WORKSHOPS AND SEMINARS IN THE FIELD OF INSPIRATION AND PRACTICAL CAREER, ENTREPRENEURIAL, BUSINESS ADVICE, IN CLASS 41 (U.S. CLS. 100, 101 AND 107).

FIRST USE 11-16-2010; IN COMMERCE 11-16-2010.

THE MARK CONSISTS OF STANDARD CHARACTERS WITHOUT CLAIM TO ANY PARTICULAR FONT, STYLE, SIZE, OR COLOR.

SN 85-249,349, FILED 2-23-2011.

LAKEISHA LEWIS, EXAMINING ATTORNEY



*David J. Kybas*

Director of the United States Patent and Trademark Office

# United States of America

United States Patent and Trademark Office



**BLEU 23**

**Reg. No. 4,199,374**

**Registered Aug. 28, 2012**

**Int. Cl.: 43**

**SERVICE MARK**

**PRINCIPAL REGISTER**

WEDDINGTON, DANIEL (UNITED STATES INDIVIDUAL)  
1554 W. FRANKLIN, SUITE A  
ELKHART, IN 46516 AND

SHERROD SR., ERROL TYRESE (UNITED STATES INDIVIDUAL)  
1554 W. FRANKLIN, SUITE A  
ELKHART, IN 46516

FOR: PROVIDING OF FOOD AND DRINK VIA A MOBILE TRUCK , IN CLASS 43 (U.S. CLS. 100 AND 101).

FIRST USE 2-25-2011; IN COMMERCE 5-25-2011.

THE MARK CONSISTS OF A STYLIZED NUMBER "23" IN LARGE TYPE IN THE COLOR BLUE TRIMMED IN WHITE AND BLACK. DIRECTLY BELOW THE NUMBER "23" IS "BLEU 23" IN THE COLOR BLACK.

THE COLOR(S) BLUE, WHITE AND BLACK IS/ARE CLAIMED AS A FEATURE OF THE MARK.

THE ENGLISH TRANSLATION OF THE WORD "BLEU" IN THE MARK IS "BLUE".

SN 85-249,527, FILED 2-23-2011.

MARK T. MULLEN, EXAMINING ATTORNEY



*David J. Kyffers*

Director of the United States Patent and Trademark Office



# United States of America

United States Patent and Trademark Office

## Keep Stomachs Calm and Carry On

**Reg. No. 4,199,375**

WELLSPRING PHARMACEUTICAL CORPORATION (DELAWARE CORPORATION)  
5911 NORTH HONORE AVENUE, SUITE 211  
SARASOTA, FL 34243

**Registered Aug. 28, 2012**

**Int. Cl.: 5**

FOR: PREPARATION CONTAINING ACID AND SUGAR FOR THE PREVENTION OF  
VOMITING, IN CLASS 5 (U.S. CLS. 6, 18, 44, 46, 51 AND 52).

**TRADEMARK**

FIRST USE 3-28-2012; IN COMMERCE 4-3-2012.

**PRINCIPAL REGISTER**

THE MARK CONSISTS OF STANDARD CHARACTERS WITHOUT CLAIM TO ANY PAR-  
TICULAR FONT, STYLE, SIZE, OR COLOR.

SN 85-250,507, FILED 2-24-2011.

BILL DAWE, EXAMINING ATTORNEY



*David J. Kyffers*

Director of the United States Patent and Trademark Office

# United States of America

United States Patent and Trademark Office



**Reg. No. 4,199,376**

DANIEL K. KIM (UNITED STATES INDIVIDUAL)  
2809 HAMPTON HWY  
YORKTOWN, VA 23693

**Registered Aug. 28, 2012**

**Int. Cl.: 35**

FOR: ASSOCIATION SERVICES, NAMELY, PROMOTING THE INTERESTS OF ASIAN AMERICAN CONSUMERS IN U.S., IN CLASS 35 (U.S. CLS. 100, 101 AND 102).

**SERVICE MARK**

FIRST USE 6-1-2011; IN COMMERCE 6-1-2011.

**PRINCIPAL REGISTER**

NO CLAIM IS MADE TO THE EXCLUSIVE RIGHT TO USE "NATIONAL ASSOCIATION OF ASIAN AMERICAN CONSUMERS", APART FROM THE MARK AS SHOWN.

THE MARK CONSISTS OF A PLAIN OVAL GLOBE WITH "NAAAC" DESIGN IN THE CENTER WITH "NATIONAL ASSOCIATION OF ASIAN AMERICAN CONSUMERS" BORDERING THE OUTSIDE.

SN 85-251,689, FILED 2-25-2011.

BARBARA BROWN, EXAMINING ATTORNEY



*David J. Kyffers*

Director of the United States Patent and Trademark Office

# United States of America

United States Patent and Trademark Office

## PHILLIE PHANATIC

**Reg. No. 4,199,377**

**Registered Aug. 28, 2012**

**Int. Cl.: 16**

**TRADEMARK**

**PRINCIPAL REGISTER**

THE PHILLIES (PENNSYLVANIA LIMITED PARTNERSHIP)  
CITIZENS BANK PARK  
ONE CITIZENS BANK WAY  
PHILADELPHIA, PA 19148

FOR: PAPER GOODS AND PRINTED MATTER, NAMELY, TRADING CARDS, POSTERS, STICKERS, DECALS, TEMPORARY TATTOOS, BUMPER STICKERS, BOOKS FEATURING BASEBALL, MEMO BOARDS, MOUNTED AND UN-MOUNTED PHOTOGRAPHS, PENS, PENCILS, ART PICTURES, AND ART PRINTS, IN CLASS 16 (U.S. CLS. 2, 5, 22, 23, 29, 37, 38 AND 50).

FIRST USE 8-0-2007; IN COMMERCE 8-0-2007.

THE MARK CONSISTS OF STANDARD CHARACTERS WITHOUT CLAIM TO ANY PARTICULAR FONT, STYLE, SIZE, OR COLOR.

OWNER OF U.S. REG. NOS. 1,604,774, 3,747,556, AND OTHERS.

SN 85-251,987, FILED 2-25-2011.

RON FAIRBANKS, EXAMINING ATTORNEY



*David J. Kyffers*

Director of the United States Patent and Trademark Office

# United States of America

United States Patent and Trademark Office

## VAULT Lifetime Income MAX

**Reg. No. 4,199,378**

**Registered Aug. 28, 2012**

**Int. Cl.: 36**

**SERVICE MARK**

**PRINCIPAL REGISTER**

AEGIS WEALTH GROUP (UTAH LIMITED LIABILITY COMPANY)  
SUITE A  
9125 MONROE STREET  
SANDY, UT 84070

FOR: FINANCIAL SERVICES, NAMELY, PROVIDING LIFETIME INCOME STRATEGY FOR INVESTORS THAT SEGMENTS INCOME BY GOALS AND TIME HORIZONS AND RECOMMENDS INVESTMENT SOLUTIONS SUCH AS SECURITIES, MUTUAL FUNDS, ANNUITIES, MANAGED ACCOUNTS AND ALTERNATIVE INVESTMENTS APPROPRIATE TO EACH SPECIFIC GOAL, IN CLASS 36 (U.S. CLS. 100, 101 AND 102).

FIRST USE 1-1-2011; IN COMMERCE 1-1-2011.

THE MARK CONSISTS OF STANDARD CHARACTERS WITHOUT CLAIM TO ANY PARTICULAR FONT, STYLE, SIZE, OR COLOR.

NO CLAIM IS MADE TO THE EXCLUSIVE RIGHT TO USE "LIFETIME INCOME", APART FROM THE MARK AS SHOWN.

SN 85-252,345, FILED 2-25-2011.

SHAUNIA CARLYLE, EXAMINING ATTORNEY



*David J. Kyros*

Director of the United States Patent and Trademark Office

# United States of America

United States Patent and Trademark Office

# PAYVMENT

**Reg. No. 4,199,379**

**Registered Aug. 28, 2012**

**Int. Cls.: 35, 36, 42, and 45**

**SERVICE MARK**

**PRINCIPAL REGISTER**

PAYVMENT, INC. (DELAWARE CORPORATION)  
250 CAMBRIDGE, SUITE 301  
PALO ALTO, CA 94306

FOR: PROVIDING INFORMATION ABOUT THE GOODS AND SERVICES OF OTHERS VIA THE INTERNET; PROMOTING THE SALE OF GOODS AND SERVICES OF OTHERS VIA THE INTERNET; PROVIDING INFORMATION ABOUT RETAILERS VIA THE INTERNET, IN CLASS 35 (U.S. CLS. 100, 101 AND 102).

FIRST USE 11-3-2009; IN COMMERCE 11-3-2009.

FOR: PROVIDING FINANCIAL INFORMATION BY ELECTRONIC MEANS, IN CLASS 36 (U.S. CLS. 100, 101 AND 102).

FIRST USE 11-3-2009; IN COMMERCE 11-3-2009.

FOR: PROVIDING TEMPORARY USE OF ON-LINE NON-DOWNLOADABLE SOFTWARE FOR USE BY ONLINE RETAIL MERCHANTS TO FACILITATE ONLINE ORDERING OF SUCH MERCHANTS' GOODS BY THEIR CUSTOMERS AND ELECTRONIC TRANSACTION PROCESSING VIA AN INTEGRATED ONLINE SHOPPING CART; DESIGNING, CREATING, MAINTAINING AND HOSTING ONLINE RETAIL AND ELECTRONIC COMMERCE WEBSITES FOR OTHERS; DEVELOPING AND HOSTING A SERVER ON A GLOBAL COMPUTER NETWORK FOR THE PURPOSE OF FACILITATING E-COMMERCE VIA SUCH A SERVER; SOFTWARE AS A SERVICE (SAAS) SERVICES FEATURING SOFTWARE FOR CREATING, MODIFYING, CONFIGURING, MANAGING, AND HOSTING ECOMMERCE WEBSITES, AND FOR CREATING, MODIFYING, CONFIGURING, MANAGING AND CONDUCTING AN ONLINE BUSINESS; ELECTRONIC COMMERCE AUTOMATION SERVICES, NAMELY, DATA AUTOMATION AND COLLECTION SERVICE USING PROPRIETARY SOFTWARE TO EVALUATE, ANALYZE AND COLLECT SERVICE DATA; COMPUTER SERVICES, NAMELY, HOSTING ONLINE WEB FACILITIES FOR OTHERS FOR ORGANIZING AND CONDUCTING ONLINE MEETINGS, AND INTERACTIVE DISCUSSIONS; COMPUTER SERVICES, NAMELY, PROVIDING CUSTOMIZED WEB PAGES FEATURING USER-DEFINED INFORMATION; COMPUTER SERVICES, NAMELY, CREATING AN ONLINE COMMUNITY FOR REGISTERED USERS TO FORM VIRTUAL COMMUNITIES, ENGAGE IN SOCIAL NETWORKING, BLOG AND PARTICIPATE IN DISCUSSIONS; PROVIDING A SEARCH ENGINE FOR GENERATING CUSTOMIZED WEB PAGES IN RESPONSE TO THE USER REQUESTED INFORMATION ABOUT THE GOODS AND SERVICES OF OTHERS;



*David J. Kyjars*

Director of the United States Patent and Trademark Office

**Reg. No. 4,199,379** HOSTING ON LINE WEB FACILITIES FOR OTHERS FOR SHARING ON-LINE CONTENT AND CONDUCTING INTERACTIVE DISCUSSIONS IN THE FIELD OF SOCIAL NETWORKING, IN CLASS 42 (U.S. CLS. 100 AND 101).

FIRST USE 11-3-2009; IN COMMERCE 11-3-2009.

FOR: INTERNET BASED SOCIAL NETWORKING SERVICES; PROVIDING ONLINE COMPUTER DATABASES AND ONLINE SEARCHABLE DATABASES IN THE FIELD OF SOCIAL NETWORKING, IN CLASS 45 (U.S. CLS. 100 AND 101).

FIRST USE 5-15-2011; IN COMMERCE 5-15-2011.

THE MARK CONSISTS OF STANDARD CHARACTERS WITHOUT CLAIM TO ANY PARTICULAR FONT, STYLE, SIZE, OR COLOR.

SN 85-252,368, FILED 2-25-2011.

SCOTT BIBB, EXAMINING ATTORNEY

# United States of America

United States Patent and Trademark Office

## GREENFOOT GLOBAL

**Reg. No. 4,199,380**

**Registered Aug. 28, 2012**

**Int. Cl.: 1**

**TRADEMARK**

**PRINCIPAL REGISTER**

GREEN FOOT GLOBAL, L.L.C. (NEVADA LIMITED LIABILITY COMPANY)  
375 STEPHANIE STREET, SUITE 1411  
HENDERSON, NV 89014

FOR: CHEMICAL ADDITIVES FOR USE WITH INTERNAL COMBUSTION ENGINE FUELS;  
CHEMICAL ADDITIVES FOR ENHANCING THE PERFORMANCE OF INTERNAL COM-  
BUSTION ENGINE FUELS; CHEMICAL ENGINE TREATMENTS AND ADDITIVES FOR  
USE WITH INTERNAL COMBUSTION ENGINE FUELS INCLUDING BUT NOT LIMITED  
TO GASOLINE AND DIESEL FUELS, IN CLASS 1 (U.S. CLS. 1, 5, 6, 10, 26 AND 46).

FIRST USE 5-31-2009; IN COMMERCE 5-31-2009.

THE MARK CONSISTS OF STANDARD CHARACTERS WITHOUT CLAIM TO ANY PAR-  
TICULAR FONT, STYLE, SIZE, OR COLOR.

OWNER OF U.S. REG. NO. 3,802,188.

NO CLAIM IS MADE TO THE EXCLUSIVE RIGHT TO USE "GLOBAL", APART FROM THE  
MARK AS SHOWN.

SN 85-252,559, FILED 2-26-2011.

TINA BROWN, EXAMINING ATTORNEY



*David J. Kyjars*

Director of the United States Patent and Trademark Office

# United States of America

United States Patent and Trademark Office

## Salty Pond Publishers

**Reg. No. 4,199,381**

LINEHAN, JESSICA A (UNITED STATES INDIVIDUAL), DBA SALTY POND PUBLISHERS,  
10 EDWARD KELLY RD.

**Registered Aug. 28, 2012**

EAST SANDWICH, MA 02537

**Int. Cl.: 16**

FOR: CHILDREN'S BOOKS; SERIES OF FICTION WORKS, NAMELY, NOVELS AND BOOKS,  
IN CLASS 16 (U.S. CLS. 2, 5, 22, 23, 29, 37, 38 AND 50).

**TRADEMARK**

FIRST USE 2-28-2011; IN COMMERCE 5-26-2011.

**PRINCIPAL REGISTER**

THE MARK CONSISTS OF STANDARD CHARACTERS WITHOUT CLAIM TO ANY PAR-  
TICULAR FONT, STYLE, SIZE, OR COLOR.

NO CLAIM IS MADE TO THE EXCLUSIVE RIGHT TO USE "PUBLISHERS", APART FROM  
THE MARK AS SHOWN.

SN 85-252,563, FILED 2-26-2011.

TINA BROWN, EXAMINING ATTORNEY



*David J. Kybas*

Director of the United States Patent and Trademark Office



# United States of America

United States Patent and Trademark Office

## THE BOX BUDDIES

**Reg. No. 4,199,382**

RENT OUR BOXES, LLC (DELAWARE LIMITED LIABILITY COMPANY)  
BOX 21463

**Registered Aug. 28, 2012**

WASHINGTON DC, DC 20009

**Int. Cl.: 39**

FOR: RENTAL OF NEW AND USED MOVING BOXES, WARDROBE BOXES, TAPE DISPENSERS AND OTHER ANCILLARY MOVING SUPPLIES TO THE GENERAL PUBLIC AND TO BUSINESSES, IN CLASS 39 (U.S. CLS. 100 AND 105).

**SERVICE MARK**

FIRST USE 11-23-2011; IN COMMERCE 11-23-2011.

**PRINCIPAL REGISTER**

THE MARK CONSISTS OF STANDARD CHARACTERS WITHOUT CLAIM TO ANY PARTICULAR FONT, STYLE, SIZE, OR COLOR.

NO CLAIM IS MADE TO THE EXCLUSIVE RIGHT TO USE "BOX", APART FROM THE MARK AS SHOWN.

SN 85-252,822, FILED 2-27-2011.

LINDA ORNDORFF, EXAMINING ATTORNEY



*David J. Kybas*

Director of the United States Patent and Trademark Office

# United States of America

United States Patent and Trademark Office



**Reg. No. 4,199,383**

**Registered Aug. 28, 2012**

**Int. Cls.: 35 and 36**

**SERVICE MARK**

**PRINCIPAL REGISTER**

CENTER FOR ORANGUTAN AND CHIMPANZEE CONSERVATION, INC. (FLORIDA  
NON-PROFIT CORPORATION)  
5843 VAN SIMMONS ROAD  
WAUCHULA, FL 33873

FOR: PROMOTING PUBLIC AWARENESS OF THE NEED FOR PROTECTION OF ANIMAL  
WELFARE, IN CLASS 35 (U.S. CLS. 100, 101 AND 102).

FIRST USE 2-1-2011; IN COMMERCE 2-1-2011.

FOR: CHARITABLE FUNDRAISING SERVICES; CHARITABLE SERVICES, NAMELY,  
ORGANIZING FUNDRAISING SERVICES AND EVENTS TO RAISE FUNDS IN THE FIELD  
OF THE PROTECTION OF WILDLIFE, IN CLASS 36 (U.S. CLS. 100, 101 AND 102).

FIRST USE 2-1-2011; IN COMMERCE 2-1-2011.

NO CLAIM IS MADE TO THE EXCLUSIVE RIGHT TO USE THE DESIGN OF THE APE AND  
THE WORDING "CENTER FOR GREAT APES", APART FROM THE MARK AS SHOWN.

THE MARK CONSISTS OF A DRAWING OF AN APE OVER THE WORDS "CENTER FOR  
GREAT" OVER THE WORD "APES" WITH A PAW PRINT DESIGN IN THE "A".

SN 85-254,296, FILED 3-1-2011.

LESLIE RICHARDS, EXAMINING ATTORNEY



*David J. Kybas*

Director of the United States Patent and Trademark Office

# United States of America

United States Patent and Trademark Office

## ABUELA SANGARITA

**Reg. No. 4,199,384**

VISION WINE & SPIRITS LLC (NEW JERSEY LIMITED LIABILITY COMPANY)  
700 PLAZA DRIVE, SECOND FLOOR  
SECAUCUS, NJ 07094

**Registered Aug. 28, 2012**

**Int. Cl.: 33**

FOR: WINES, SPIRITS AND LIQUORS, IN CLASS 33 (U.S. CLS. 47 AND 49).

FIRST USE 6-1-2012; IN COMMERCE 6-19-2012.

**TRADEMARK**

THE MARK CONSISTS OF STANDARD CHARACTERS WITHOUT CLAIM TO ANY PARTICULAR FONT, STYLE, SIZE, OR COLOR.

**PRINCIPAL REGISTER**

NO CLAIM IS MADE TO THE EXCLUSIVE RIGHT TO USE "SANGARITA", APART FROM THE MARK AS SHOWN.

THE ENGLISH TRANSLATION OF "ABUELA" IS "GRANDMOTHER".

SN 85-254,573, FILED 3-1-2011.

JAMES A. RAUEN, EXAMINING ATTORNEY



*David J. Kyffers*

Director of the United States Patent and Trademark Office

# United States of America

United States Patent and Trademark Office



**Reg. No. 4,199,385**

**Registered Aug. 28, 2012**

**Int. Cl.: 33**

**TRADEMARK**

**PRINCIPAL REGISTER**

VISION WINE & SPIRITS LLC (NEW JERSEY LIMITED LIABILITY COMPANY)  
700 PLAZA DRIVE, SECOND FLOOR  
SECAUCUS, NJ 07094

FOR: WINES, SPIRITS AND LIQUORS, IN CLASS 33 (U.S. CLS. 47 AND 49).

FIRST USE 6-1-2012; IN COMMERCE 6-19-2012.

NO CLAIM IS MADE TO THE EXCLUSIVE RIGHT TO USE "SANGARITA", APART FROM THE MARK AS SHOWN.

THE COLOR(S) ORANGE, YELLOW AND WHITE IS/ARE CLAIMED AS A FEATURE OF THE MARK.

THE MARK CONSISTS OF ABUELA IN ORANGE SCRIPT ABOVE AND TO THE LEFT OF "SANGARITA" IN YELLOW AND WHITE LETTERS OUTLINED IN ORANGE AND ORANGE SWIRL DESIGNS ABOVE AND BELOW "SANGARITA".

THE ENGLISH TRANSLATION OF "ABUELA" IS "GRANDMOTHER".

SN 85-254,620, FILED 3-1-2011.

JAMES A. RAUEN, EXAMINING ATTORNEY



*David J. Kyffers*

Director of the United States Patent and Trademark Office

# United States of America

United States Patent and Trademark Office



**Reg. No. 4,199,386**

**Registered Aug. 28, 2012**

**Int. Cl.: 25**

**TRADEMARK**

**PRINCIPAL REGISTER**

TECH SPORT GROUP PTY LIMITED (AUSTRALIA PROPRIETARY LIMITED COMPANY  
(P/L OR PTY. LTD.))  
142-144 UPPER HEIDELBERG ROAD 1ST FLOOR  
INVANHOE, VICTORIA, AUSTRALIA 3079

FOR: FOOTWEAR, IN CLASS 25 (U.S. CLS. 22 AND 39).

FIRST USE 9-30-2009; IN COMMERCE 2-2-2012.

THE MARK CONSISTS OF THE STYLIZED WORDING "DEUCE GENERATION", WITH THE WORD "GENERATION" SHOWN BELOW THE WORD "DEUCE". BELOW THE WORDING AND CONTINUING TO ABOUT THE LETTER "A" IN "GENERATION" IS A QUADRILATERAL DESIGN.

SN 85-256,667, FILED 3-3-2011.

ANGELA DUONG, EXAMINING ATTORNEY



*David J. Kybas*

Director of the United States Patent and Trademark Office

# United States of America

United States Patent and Trademark Office

# YouGiveGoods

**Reg. No. 4,199,387**

YOUGIVEGOODS, LLC (DELAWARE LIMITED LIABILITY COMPANY)

**Registered Aug. 28, 2012**

P.O. BOX 141  
MORISTOWN, NJ 07963

**Int. Cl.: 35**

FOR: OPERATING A WEBSITE TO PROMOTE PUBLIC AWARENESS OF THE NEEDS OF CHARITABLE ORGANIZATIONS FOR DONATIONS OF GOODS SUCH AS CLOTHING, FOOD, BLANKETS, ANIMAL PRODUCTS, BABY SUPPLIES AND SIMILAR ITEMS, IN CLASS 35 (U.S. CLS. 100, 101 AND 102).

**SERVICE MARK**

**PRINCIPAL REGISTER**

FIRST USE 12-31-2011; IN COMMERCE 12-31-2011.

THE MARK CONSISTS OF STANDARD CHARACTERS WITHOUT CLAIM TO ANY PARTICULAR FONT, STYLE, SIZE, OR COLOR.

SN 85-257,324, FILED 3-3-2011.

LIEF MARTIN, EXAMINING ATTORNEY



*David J. Kybas*

Director of the United States Patent and Trademark Office

# United States of America

United States Patent and Trademark Office

# YouGiveGoods

**Reg. No. 4,199,388**

**Registered Aug. 28, 2012**

**Int. Cl.: 35**

**SERVICE MARK**

**PRINCIPAL REGISTER**

YOUNGIVEGOODS, LLC (DELAWARE LIMITED LIABILITY COMPANY)  
P.O. BOX 141  
MORISTOWN, NJ 07963

FOR: OPERATING A WEBSITE WHICH PROVIDES A SERVICE WHEREBY USERS MAY PURCHASE ITEMS ONLINE FOR DELIVERY TO CHARITABLE ORGANIZATIONS, NAMELY, AN ONLINE RETAIL STORE SERVICE FEATURING CANNED FOODS, BLANKETS, BABY PRODUCTS, ANIMAL FOOD, AND CLOTHING, IN CLASS 35 (U.S. CLS. 100, 101 AND 102).

FIRST USE 12-31-2011; IN COMMERCE 12-31-2011.

THE MARK CONSISTS OF STANDARD CHARACTERS WITHOUT CLAIM TO ANY PARTICULAR FONT, STYLE, SIZE, OR COLOR.

SN 85-257,332, FILED 3-3-2011.

LIEF MARTIN, EXAMINING ATTORNEY



*David J. Kyffers*

Director of the United States Patent and Trademark Office

# United States of America

United States Patent and Trademark Office

# YGG

**Reg. No. 4,199,389**

YOUGIVEGOODS, LLC (DELAWARE LIMITED LIABILITY COMPANY)  
P.O. BOX 141  
MORISTOWN, NJ 07963

**Registered Aug. 28, 2012**

**Int. Cl.: 35**

FOR: OPERATING A WEBSITE TO PROMOTE PUBLIC AWARENESS OF THE NEEDS OF CHARITABLE ORGANIZATIONS FOR DONATIONS OF GOODS SUCH AS CLOTHING, FOOD, BLANKETS, ANIMAL PRODUCTS, BABY SUPPLIES AND SIMILAR ITEMS, IN CLASS 35 (U.S. CLS. 100, 101 AND 102).

**SERVICE MARK**

**PRINCIPAL REGISTER**

FIRST USE 12-31-2011; IN COMMERCE 12-31-2011.

THE MARK CONSISTS OF STANDARD CHARACTERS WITHOUT CLAIM TO ANY PARTICULAR FONT, STYLE, SIZE, OR COLOR.

SN 85-257,348, FILED 3-3-2011.

LIEF MARTIN, EXAMINING ATTORNEY



*David J. Kybas*

Director of the United States Patent and Trademark Office



# United States of America

United States Patent and Trademark Office

# YGG

**Reg. No. 4,199,390**

YOUNGIVEGOODS, LLC (DELAWARE LIMITED LIABILITY COMPANY)

**Registered Aug. 28, 2012**

P.O. BOX 141  
MORISTOWN, NJ 07963

**Int. Cl.: 35**

FOR: OPERATING A WEBSITE WHICH PROVIDES A SERVICE WHEREBY USERS MAY PURCHASE ITEMS ONLINE FOR DELIVERY TO CHARITABLE ORGANIZATIONS, NAMELY, AN ONLINE RETAIL STORE SERVICE FEATURING CANNED FOODS, BLANKETS, BABY PRODUCTS, ANIMAL FOOD, AND CLOTHING, IN CLASS 35 (U.S. CLS. 100, 101 AND 102).

**SERVICE MARK**

**PRINCIPAL REGISTER**

FIRST USE 12-31-2011; IN COMMERCE 12-31-2011.

THE MARK CONSISTS OF STANDARD CHARACTERS WITHOUT CLAIM TO ANY PARTICULAR FONT, STYLE, SIZE, OR COLOR.

SN 85-257,355, FILED 3-3-2011.

LIEF MARTIN, EXAMINING ATTORNEY



*David J. Kybas*

Director of the United States Patent and Trademark Office

# United States of America

United States Patent and Trademark Office



**Reg. No. 4,199,391**

**Registered Aug. 28, 2012**

**Int. Cl.: 44**

**SERVICE MARK**

**PRINCIPAL REGISTER**

INSTITUTO INTERAMERICANO DE HIPNOSIS, INC. (FLORIDA CORPORATION)  
14629 SW 104TH STREET #307  
MIAMI, FL 33186

FOR: HYPNOSIS SERVICES, IN CLASS 44 (U.S. CLS. 100 AND 101).

FIRST USE 1-17-2012; IN COMMERCE 3-13-2012.

NO CLAIM IS MADE TO THE EXCLUSIVE RIGHT TO USE "INSTITUTO INTERAMERICANO DE HIPNOSIS" AND "INTERAMERICAN INSTITUTE OF HYPNOSIS", APART FROM THE MARK AS SHOWN.

THE COLOR(S) BLUE, RED, BLACK, WHITE AND GREY IS/ARE CLAIMED AS A FEATURE OF THE MARK.

THE MARK CONSISTS OF TWO CONCENTRIC BLUE CIRCLES ENCLOSING A GRAY AND WHITE WORLD MAP WITH BLACK WORDING "INTERAMERICAN INSTITUTE OF HYPNOSIS" ON THE TOP HALF OF THE CIRCLE AND IN SPANISH "INSTITUTO INTERAMERICANO DE HIPNOSIS" IN THE HALF BOTTOM PART OF THE CIRCLE. OVER THE MAP ARE THE LETTERS "IIH" IN BLUE AND RED WITH TWO RED DOTS ON EACH SIDE OF THE CIRCLE.

THE ENGLISH TRANSLATION OF "INSTITUTO INTERAMERICANO DE HIPNOSIS" IN THE MARK IS INTERAMERICAN INSTITUTE OF HYPNOSIS.

SN 85-259,220, FILED 3-6-2011.

KYLE PEETE, EXAMINING ATTORNEY



*David J. Kyros*

Director of the United States Patent and Trademark Office

# United States of America

United States Patent and Trademark Office

# CRAFTSMART

**Reg. No. 4,199,392**

**Registered Aug. 28, 2012**

**Int. Cl.: 9**

**TRADEMARK**

**PRINCIPAL REGISTER**

CLEARFIELD, INC. (MINNESOTA CORPORATION)  
5480 NATHAN LANE, SUITE 120  
PLYMOUTH, MN 55442

FOR: PASSIVE COMPONENTS FOR BROADBAND APPLICATIONS, NAMELY, OPTICAL FIBER AND COPPER CABLE ASSEMBLIES, COMPRISING OPTICAL FIBER, COPPER CABLE, ADAPTERS, CONNECTORS, AND JUNCTION SLEEVES; OPTICAL FIBER AND COPPER CABLE TERMINATION SYSTEMS COMPRISING ADAPTERS, CONNECTORS, PATCH CABLES, PIGTAIL PLUG CONNECTORS, AND BREAK-OUT CABLES; OPTICAL FIBER AND COPPER CABLE DISTRIBUTION CABINETS, FRAMES, AND PANELS FOR PHYSICALLY DISTRIBUTING AND ROUTING OPTICAL FIBER AND COPPER CABLE, COMPRISING FIBER OPTIC CONNECTORS HOUSINGS, CABLE ADAPTERS, CABLE ROUTING CASSETTES, PATCH PANELS FOR HOUSING OPTICAL FIBER AND COPPER CABLE, OPTICAL SIGNAL SPLITTERS, AND MULTIPLEXERS; OPTICAL FIBER MANAGEMENT COMPONENTS, NAMELY, CASSETTES FOR PHYSICALLY HOLDING AND ROUTING OPTICAL FIBER MANAGEMENT COMPONENTS COMPRISING PLASTIC HOUSINGS, BEND RADIUS ELECTRICITY LIMITERS, SPLICES FOR FIBER OPTIC TRANSMISSION LINES, CONNECTORS, ADAPTERS, SPLITTERS, AND WAVELENGTH DIVISION MULTIPLIERS, IN CLASS 9 (U.S. CLS. 21, 23, 26, 36 AND 38).

FIRST USE 5-26-2011; IN COMMERCE 5-26-2011.

THE MARK CONSISTS OF STANDARD CHARACTERS WITHOUT CLAIM TO ANY PARTICULAR FONT, STYLE, SIZE, OR COLOR.

SN 85-259,526, FILED 3-7-2011.

KAPIL BHANOT, EXAMINING ATTORNEY



*David J. Kybas*

Director of the United States Patent and Trademark Office

# United States of America

United States Patent and Trademark Office

# SOLVIMO

**Reg. No. 4,199,393**

**Registered Aug. 28, 2012**

**Int. Cl.: 36**

**SERVICE MARK**

**PRINCIPAL REGISTER**

SOLVIMO (FRANCE SOCIÉTÉ PAR ACTIONS SIMPLIFIÉE (SAS))  
CENTRE D' AFFAIRES GRAND VAR -BATIMENT A  
1110 CHEMIN DES PLANTADES  
LA GARDE, FRANCE 83130

FOR: REAL ESTATE AGENCIES; APPRAISAL AND EVALUATION OF REAL ESTATE; ARRANGING OF LEASES AND RENTAL AGREEMENTS FOR REAL ESTATE; CLASSIFIED REAL ESTATE LISTINGS OF APARTMENT RENTALS AND HOUSING RENTALS; COMMERCIAL AND RESIDENTIAL REAL ESTATE AGENCY SERVICES; FINANCIAL DUE DILIGENCE SERVICES IN THE FIELD OF REAL ESTATE; LAND ACQUISITION, NAMELY, REAL ESTATE BROKERAGE; PROVIDING INFORMATION IN THE FIELD OF REAL ESTATE VIA THE INTERNET; REAL ESTATE TIME-SHARING; RENTAL, BROKERAGE, LEASING AND MANAGEMENT OF COMMERCIAL PROPERTY, OFFICES AND OFFICE SPACE; RENTAL OF APARTMENTS; RENTAL PROPERTY MANAGEMENT, IN CLASS 36 (U.S. CLS. 100, 101 AND 102).

FIRST USE 4-30-2011; IN COMMERCE 4-30-2011.

THE MARK CONSISTS OF STANDARD CHARACTERS WITHOUT CLAIM TO ANY PARTICULAR FONT, STYLE, SIZE, OR COLOR.

SN 85-260,708, FILED 3-8-2011.

JOHN SCHUYLER YARD, EXAMINING ATTORNEY



*David J. Kybas*

Director of the United States Patent and Trademark Office

United States of America  
United States Patent and Trademark Office

# TRUEGIRL

**Reg. No. 4,199,394**

PURVIS, JOANNE (UNITED KINGDOM INDIVIDUAL)  
258 AMBROISE

**Registered Aug. 28, 2012**

NEWPORT COAST, CA 92657

**Int. Cl.: 3**

FOR: COSMETIC PREPARATIONS FOR SKIN CARE; NON-MEDICATED SKIN CARE PREPARATIONS, IN CLASS 3 (U.S. CLS. 1, 4, 6, 50, 51 AND 52).

**TRADEMARK**

FIRST USE 5-1-2012; IN COMMERCE 5-1-2012.

**PRINCIPAL REGISTER**

THE MARK CONSISTS OF STANDARD CHARACTERS WITHOUT CLAIM TO ANY PARTICULAR FONT, STYLE, SIZE, OR COLOR.

SN 85-261,700, FILED 3-9-2011.

BRIAN NEVILLE, EXAMINING ATTORNEY



*David J. Kyffers*

Director of the United States Patent and Trademark Office

# United States of America

United States Patent and Trademark Office

# UTILIWRAP

**Reg. No. 4,199,395**

**Registered Aug. 28, 2012**

**Int. Cl.: 17**

**TRADEMARK**

**PRINCIPAL REGISTER**

OWENS CORNING INTELLECTUAL CAPITAL, LLC (DELAWARE LIMITED LIABILITY COMPANY)  
ONE OWENS CORNING PARKWAY  
TOLEDO, OH 43659

FOR: FIBERGLASS PACKING MATERIALS, NAMELY, PACKAGING AND DUNNAGE; FIBERGLASS THERMAL INSULATION, IN CLASS 17 (U.S. CLS. 1, 5, 12, 13, 35 AND 50).

FIRST USE 5-31-2011; IN COMMERCE 5-31-2011.

THE MARK CONSISTS OF STANDARD CHARACTERS WITHOUT CLAIM TO ANY PARTICULAR FONT, STYLE, SIZE, OR COLOR.

SN 85-262,072, FILED 3-9-2011.

Laurie Kaufman, Examining Attorney



*David J. Kyffers*

Director of the United States Patent and Trademark Office

# United States of America

United States Patent and Trademark Office

# CRSA

**Reg. No. 4,199,396**

**Registered Aug. 28, 2012**

**Int. Cls.: 35 and 36**

**SERVICE MARK**

**PRINCIPAL REGISTER**

LIFE CARE COMPANIES LLC (IOWA LIMITED LIABILITY COMPANY)  
400 LOCUST ST., STE. 820  
DES MOINES, IA 50309

FOR: BUSINESS MANAGEMENT OF RESIDENTIAL COMMUNITIES, CONTINUING CARE COMMUNITIES, ASSISTED LIVING COMMUNITIES AND RETIREMENT COMMUNITIES; BUSINESS DEVELOPMENT OF RESIDENTIAL, CONTINUING CARE, ASSISTED LIVING COMMUNITIES AND RETIREMENT COMMUNITIES; BUSINESS MANAGEMENT AND OPERATION OF CONTINUING CARE RETIREMENT COMMUNITIES, IN CLASS 35 (U.S. CLS. 100, 101 AND 102).

FIRST USE 10-0-2011; IN COMMERCE 10-0-2011.

FOR: FINANCIAL MANAGEMENT OF RESIDENTIAL COMMUNITIES, CONTINUING CARE COMMUNITIES, ASSISTED LIVING COMMUNITIES AND RETIREMENT COMMUNITIES; REAL ESTATE MANAGEMENT OF CONTINUING CARE RETIREMENT COMMUNITIES, IN CLASS 36 (U.S. CLS. 100, 101 AND 102).

FIRST USE 10-0-2011; IN COMMERCE 10-0-2011.

THE MARK CONSISTS OF STANDARD CHARACTERS WITHOUT CLAIM TO ANY PARTICULAR FONT, STYLE, SIZE, OR COLOR.

SN 85-262,327, FILED 3-9-2011.

BRENDAN MCCAULEY, EXAMINING ATTORNEY



*David J. Kybas*

Director of the United States Patent and Trademark Office

# United States of America

United States Patent and Trademark Office



**Reg. No. 4,199,397**

**Registered Aug. 28, 2012**

**Int. Cls.: 35 and 36**

**SERVICE MARK**

**PRINCIPAL REGISTER**

LIFE CARE COMPANIES LLC (IOWA LIMITED LIABILITY COMPANY)  
400 LOCUST ST., STE. 820  
DES MOINES, IA 50309

FOR: BUSINESS MANAGEMENT OF RESIDENTIAL COMMUNITIES, CONTINUING CARE COMMUNITIES, ASSISTED LIVING COMMUNITIES AND RETIREMENT COMMUNITIES; BUSINESS DEVELOPMENT OF RESIDENTIAL, CONTINUING CARE, ASSISTED LIVING COMMUNITIES AND RETIREMENT COMMUNITIES; BUSINESS MANAGEMENT AND OPERATION OF CONTINUING CARE RETIREMENT COMMUNITIES, IN CLASS 35 (U.S. CLS. 100, 101 AND 102).

FIRST USE 10-0-2011; IN COMMERCE 10-0-2011.

FOR: FINANCIAL MANAGEMENT OF RESIDENTIAL COMMUNITIES, CONTINUING CARE COMMUNITIES, ASSISTED LIVING COMMUNITIES AND RETIREMENT COMMUNITIES; REAL ESTATE MANAGEMENT OF CONTINUING CARE RETIREMENT COMMUNITIES, IN CLASS 36 (U.S. CLS. 100, 101 AND 102).

FIRST USE 10-0-2011; IN COMMERCE 10-0-2011.

THE MARK CONSISTS OF FOUR OVERLAPPING TRIANGLES OF INCREASING SIZE ABOVE A HORIZONTAL LINE, ABOVE THE LETTERING "CRSA", WITH ANOTHER HORIZONTAL LINE BELOW.

SN 85-262,341, FILED 3-9-2011.

MARK SHINER, EXAMINING ATTORNEY



*David J. Kyjars*

Director of the United States Patent and Trademark Office



# United States of America

United States Patent and Trademark Office

## SPIRAL DECK MATE

**Reg. No. 4,199,398**

**Registered Aug. 28, 2012**

**Int. Cl.: 6**

**TRADEMARK**

**PRINCIPAL REGISTER**

M. COHEN AND SONS, INC. (PENNSYLVANIA CORPORATION)  
400 REED ROAD  
BROOMALL, PA 19008

FOR: METAL STAIRCASES, IN CLASS 6 (U.S. CLS. 2, 12, 13, 14, 23, 25 AND 50).

FIRST USE 11-18-2011; IN COMMERCE 3-8-2012.

THE MARK CONSISTS OF STANDARD CHARACTERS WITHOUT CLAIM TO ANY PARTICULAR FONT, STYLE, SIZE, OR COLOR.

NO CLAIM IS MADE TO THE EXCLUSIVE RIGHT TO USE "SPIRAL" AND "DECK", APART FROM THE MARK AS SHOWN.

SN 85-262,653, FILED 3-9-2011.

DEZMONA MIZELLE, EXAMINING ATTORNEY



*David J. Kyffers*

Director of the United States Patent and Trademark Office

# United States of America

United States Patent and Trademark Office

## The Rustic Gourmet

**Reg. No. 4,199,399**

**Registered Aug. 28, 2012**

**Int. Cl.: 43**

**SERVICE MARK**

**PRINCIPAL REGISTER**

FLEURS D'ALLUMAGE, LTD. (NEW YORK CORPORATION), DBA THE RUSTIC GOURMET,  
ATTN: BONNIE KOHL  
367 COUNTY ROUTE 312  
WESTERLO, NY 121932811

FOR: CAFE-RESTAURANTS; CARRY-OUT RESTAURANTS; RESTAURANT; RESTAURANT  
SERVICES FEATURING SANDWICHES; RESTAURANTS, IN CLASS 43 (U.S. CLS. 100 AND  
101).

FIRST USE 4-10-2011; IN COMMERCE 4-25-2011.

THE MARK CONSISTS OF STANDARD CHARACTERS WITHOUT CLAIM TO ANY PAR-  
TICULAR FONT, STYLE, SIZE, OR COLOR.

NO CLAIM IS MADE TO THE EXCLUSIVE RIGHT TO USE "GOURMET", APART FROM  
THE MARK AS SHOWN.

SN 85-264,029, FILED 3-10-2011.

RAMONA ORTIGA, EXAMINING ATTORNEY



*David J. Kybas*

Director of the United States Patent and Trademark Office

# United States of America

United States Patent and Trademark Office

# GIINII

**Reg. No. 4,199,400**

**Registered Aug. 28, 2012**

**Int. Cl.: 9**

**TRADEMARK**

**PRINCIPAL REGISTER**

SILVERLINK INTERNATIONAL LIMITED (HONG KONG CORPORATION)  
18 QUEENS ROAD CENTRAL NEW TOWER 1  
21 FLOOR  
HONG KONG, HONG KONG

FOR: DIGITAL CAMERAS; DIGITAL PHOTO FRAMES FOR DISPLAYING DIGITAL PICTURES, VIDEO CLIPS AND MUSIC; SCANNERS; DIGITAL AUDIO AND VIDEO RECORDERS AND PLAYERS, IN CLASS 9 (U.S. CLS. 21, 23, 26, 36 AND 38).

FIRST USE 10-1-2007; IN COMMERCE 1-1-2008.

THE MARK CONSISTS OF STANDARD CHARACTERS WITHOUT CLAIM TO ANY PARTICULAR FONT, STYLE, SIZE, OR COLOR.

OWNER OF U.S. REG. NOS. 3,656,483 AND 3,798,180.

SN 85-264,454, FILED 3-11-2011.

MICHELE SWAIN, EXAMINING ATTORNEY



*David J. Kybas*

Director of the United States Patent and Trademark Office

# United States of America

United States Patent and Trademark Office

## OUR POINTS GO FARTHER

**Reg. No. 4,199,401**

U.S. BANK, N.A. (UNITED STATES NATIONAL BANKING ASSOCIATION)  
800 NICOLLET

**Registered Aug. 28, 2012**

MINNEAPOLIS, MN 55402

**Int. Cls.: 35 and 36**

FOR: PROMOTING THE SALE OF GOODS AND SERVICES OF OTHERS BY AWARDING PURCHASE POINTS FOR CREDIT CARD USE, IN CLASS 35 (U.S. CLS. 100, 101 AND 102).

**SERVICE MARK**

FIRST USE 3-30-2011; IN COMMERCE 3-30-2011.

**PRINCIPAL REGISTER**

FOR: CREDIT AND DEBIT CARD SERVICES, IN CLASS 36 (U.S. CLS. 100, 101 AND 102).

FIRST USE 3-30-2011; IN COMMERCE 3-30-2011.

THE MARK CONSISTS OF STANDARD CHARACTERS WITHOUT CLAIM TO ANY PARTICULAR FONT, STYLE, SIZE, OR COLOR.

NO CLAIM IS MADE TO THE EXCLUSIVE RIGHT TO USE "POINTS", APART FROM THE MARK AS SHOWN.

SN 85-264,564, FILED 3-11-2011.

KATHERINE STOIDES, EXAMINING ATTORNEY



*David J. Kybas*

Director of the United States Patent and Trademark Office

United States of America  
United States Patent and Trademark Office

# EtherCloud

**Reg. No. 4,199,402**

NEUTRAL TANDEM, INC. (DELAWARE CORPORATION)  
550 WEST ADAMS STREET, SUITE 900  
CHICAGO, IL 60661

**Registered Aug. 28, 2012**

**Int. Cl.: 38**

FOR: TELECOMMUNICATION SERVICES, NAMELY, ETHERNET BASED CONNECTIVITY SERVICES, IN CLASS 38 (U.S. CLS. 100, 101 AND 104).

**SERVICE MARK**

FIRST USE 4-4-2011; IN COMMERCE 4-4-2011.

**PRINCIPAL REGISTER**

THE MARK CONSISTS OF STANDARD CHARACTERS WITHOUT CLAIM TO ANY PARTICULAR FONT, STYLE, SIZE, OR COLOR.

SN 85-265,067, FILED 3-11-2011.

HEATHER THOMPSON, EXAMINING ATTORNEY



*David J. Kyjars*

Director of the United States Patent and Trademark Office

# United States of America

United States Patent and Trademark Office

## WHEELIN' N' DEALIN'

**Reg. No. 4,199,403**

**Registered Aug. 28, 2012**

**Int. Cl.: 9**

MIAMI TRIBE OF OKLAHOMA BUSINESS DEVELOPMENT AUTHORITY, A TRIBAL  
ENTERPRISE OF THE MIAMI TRIBE OF OKLAHOMA (UNITED STATES  
FEDERALLY-RECOGNIZED INDIAN TRIBE)  
3410 P STREET NW  
MIAMI, OK 74355

**TRADEMARK**

FOR: GAMING MACHINES, NAMELY, BINGO-RELATED GAMES AND SLOT MACHINES  
, IN CLASS 9 (U.S. CLS. 21, 23, 26, 36 AND 38).

**PRINCIPAL REGISTER**

FIRST USE 12-12-2011; IN COMMERCE 12-12-2011.

THE MARK CONSISTS OF STANDARD CHARACTERS WITHOUT CLAIM TO ANY PAR-  
TICULAR FONT, STYLE, SIZE, OR COLOR.

SN 85-265,157, FILED 3-11-2011.

KATHY DE JONGE, EXAMINING ATTORNEY



*David J. Kyffers*

Director of the United States Patent and Trademark Office

# United States of America

United States Patent and Trademark Office

# Colin's Pack

**Reg. No. 4,199,404**

**Registered Aug. 28, 2012**

**Int. Cl.: 44**

**SERVICE MARK**

**PRINCIPAL REGISTER**

WEST, COLIN TAYLOR (UNITED STATES INDIVIDUAL), DBA COLIN'S PACK,  
1164 BERKELEY ST. APT C  
SANTA MONICA, CA 90403

FOR: DOG WALKING SERVICES; DOG WALKING, IN CLASS 44 (U.S. CLS. 100 AND 101).

FIRST USE 12-1-2010; IN COMMERCE 1-1-2011.

THE MARK CONSISTS OF STANDARD CHARACTERS WITHOUT CLAIM TO ANY PARTICULAR FONT, STYLE, SIZE, OR COLOR.

SN 85-265,674, FILED 3-13-2011.

VERNA BETH RIRIE, EXAMINING ATTORNEY



*David J. Kyffers*

Director of the United States Patent and Trademark Office

# United States of America

United States Patent and Trademark Office



**Reg. No. 4,199,405**

**Registered Aug. 28, 2012**

**Int. Cl.: 33**

ONE TRUE VINE, LLC (CALIFORNIA LIMITED LIABILITY COMPANY)  
1050 ADAMS STREET  
SUITE C  
ST. HELENA, CA 94574

FOR: WINES, IN CLASS 33 (U.S. CLS. 47 AND 49).

**TRADEMARK**

FIRST USE 5-29-2012; IN COMMERCE 5-29-2012.

**PRINCIPAL REGISTER**

THE MARK CONSISTS OF A TATTOOED WOMEN SITTING BEHIND THE STEERING WHEEL OF A VEHICLE, WITH A MANUAL TRANSMISSION GEAR SHIFT WITH A SKULL SHAPE AT THE TOP OF THE GEAR SHIFT, ALL SET IN FRONT OF A BLUE AND WHITE STRIPED SKY. THE WOMEN IS WEARING BLACK AND RED BOOTS, TAN PANTS, A TAN BELT WITH A ROUND BLACK, TAN, AND GREEN BELT BUCKLE. THE WOMAN'S ARMS ARE COVERED WITH BLACK, YELLOW, RED, PINK, WHITE, TAN, GRAY, AND GREEN TATTOOS. THE WOMAN HAS WHITE SKIN AND YELLOW AND RED HAIR. THE WOMAN IS WEARING A BROWN SHIRT, AND BLUE TINTED SUNGLASSES. THE VEHICLE SEAT IS PINK AND THE STEERING WHEEL IS COLORED WHITE AND BLACK. TO THE RIGHT OF THE WOMAN THERE APPEARS A TALL MANUAL TRANSMISSION GEAR SHIFT WHICH APPEARS IN THE COLORS BLACK, GRAY AND BLUE. ON THE INSIDE DOOR PANEL OF THE VEHICLE THERE IS A FLAME DESIGN APPEARING IN THE COLORS ORANGE, BLACK, PINK, AND BLUE. ALL THE PRECEDING IS SET IN FRONT OF A BLUE AND WHITE STRIPED SKY.

THE COLOR(S) BLUE, WHITE, TAN, BROWN, PINK, ORANGE, BLACK, GREY, GREEN, YELLOW AND RED IS/ARE CLAIMED AS A FEATURE OF THE MARK.

SN 85-265,995, FILED 3-14-2011.

GEOFFREY FOSDICK, EXAMINING ATTORNEY



*David J. Kypos*

Director of the United States Patent and Trademark Office



# United States of America

United States Patent and Trademark Office

THE  
BLACK  
ABBEY  
BREWING + COMPANY

**Reg. No. 4,199,406**

**Registered Aug. 28, 2012**

**Int. Cl.: 32**

**TRADEMARK**

**PRINCIPAL REGISTER**

THE BLACK ABBEY BREWING COMPANY, LLC (TENNESSEE LIMITED LIABILITY COMPANY)  
311 SADDLEBRIDGE LN  
FRANKLIN, TN 37069

FOR: BEER, IN CLASS 32 (U.S. CLS. 45, 46 AND 48).

FIRST USE 12-14-2011; IN COMMERCE 12-14-2011.

NO CLAIM IS MADE TO THE EXCLUSIVE RIGHT TO USE "BREWING COMPANY", APART FROM THE MARK AS SHOWN.

THE MARK CONSISTS OF THE WORD "THE" IN SMALL STYLIZED LETTERS DEPICTED OVER THE LETTER "B" IN THE WORD "BLACK", ALSO IN STYLIZED LETTERING, WITH THE LETTER "A" IN THE WORD "BLACK" BEING DEPICTED AS A STAINED GLASS WINDOW; THE WORD "ABBEY" IS BELOW THE WORD "BLACK" IN STYLIZED LETTERS WITH THE WORDING "BREWING COMPANY" IN SMALLER STYLIZED LETTERS BELOW "ABBEY", WITH A CROSS DESIGN DEPICTED BETWEEN THE WORDS "BREWING" AND "COMPANY".

SN 85-266,168, FILED 3-14-2011.

KATHERINE STOIDES, EXAMINING ATTORNEY



*David J. Kybas*

Director of the United States Patent and Trademark Office

# United States of America

United States Patent and Trademark Office

## GREAT WOLF CONNECT

**Reg. No. 4,199,407**

**Registered Aug. 28, 2012**

**Int. Cls.: 41 and 42**

**SERVICE MARK**

**PRINCIPAL REGISTER**

GREAT LAKES SERVICES, LLC (DELAWARE LIMITED LIABILITY COMPANY)  
SOUTH TOWER, SUITE 6000  
525 JUNCTION ROAD  
MADISON, WI 53717

FOR: PHOTOGRAPHY SERVICES, IN CLASS 41 (U.S. CLS. 100, 101 AND 107).

FIRST USE 6-9-2011; IN COMMERCE 6-9-2011.

FOR: APPLICATION SERVICE PROVIDER (ASP), NAMELY, HOSTING COMPUTER SOFTWARE THAT ENABLES OTHERS TO IDENTIFY AND UPDATE THEIR LOCATION ONLINE USING INFORMATION DERIVED FROM RADIO FREQUENCY IDENTIFICATION (RFID) TAGS AND READERS, IN CLASS 42 (U.S. CLS. 100 AND 101).

FIRST USE 6-9-2011; IN COMMERCE 6-9-2011.

THE MARK CONSISTS OF STANDARD CHARACTERS WITHOUT CLAIM TO ANY PARTICULAR FONT, STYLE, SIZE, OR COLOR.

OWNER OF U.S. REG. NOS. 2,941,852, 3,751,580, AND OTHERS.

NO CLAIM IS MADE TO THE EXCLUSIVE RIGHT TO USE "CONNECT" AS TO CLASS 042, APART FROM THE MARK AS SHOWN.

SN 85-266,309, FILED 3-14-2011.

TAMARA FRAZIER, EXAMINING ATTORNEY



*David J. Kybas*

Director of the United States Patent and Trademark Office

# United States of America

United States Patent and Trademark Office

The logo for "Vent-All" features the word "Vent-All" in a bold, italicized, sans-serif font. To the left of the "V", there are five horizontal arrows of increasing size from top to bottom, pointing to the right. A long, thick horizontal arrow points to the right underneath the word "All".

**Reg. No. 4,199,408**

**Registered Aug. 28, 2012**

**Int. Cl.: 6**

**TRADEMARK**

**PRINCIPAL REGISTER**

INFASTECH INTELLECTUAL PROPERTIES PTE. LTD. (SINGAPORE LIMITED LIABILITY COMPANY)  
MARINA BAY FINANCIAL CENTRE TOWER 1  
SINGAPORE, SINGAPORE 018981

FOR: METAL THREADED FASTENERS; METAL FASTENERS, NAMELY, SCREW AND WASHER ASSEMBLIES IN THE NATURE OF A SCREW AND A WASHER SOLD TOGETHER AS A UNIT, IN CLASS 6 (U.S. CLS. 2, 12, 13, 14, 23, 25 AND 50).

FIRST USE 12-31-2011; IN COMMERCE 12-31-2011.

THE MARK CONSISTS OF THE WORD "VENT-ALL" AND FIVE HORIZONTAL ARROWS, WITH FOUR OF THE HORIZONTAL ARROWS TO THE LEFT OF THE "V" GRADUALLY GETTING BIGGER FROM TOP TO BOTTOM SUCH THAT THEIR LEFT EDGE FORMS A DIAGONAL LINE, AND WITH THE FIFTH ARROW STARTING FARTHEST TO THE LEFT AT THE BOTTOM AND EXTENDING ALL THE WAY ACROSS UNDERNEATH THE WORDING AND ENDING JUST AFTER THE SECOND "L".

SN 85-266,430, FILED 3-14-2011.

JENNIFER DIXON, EXAMINING ATTORNEY



*David J. Kypos*

Director of the United States Patent and Trademark Office

United States of America  
United States Patent and Trademark Office

MICHIGAN  
F.A.S.H. FEST

**Reg. No. 4,199,409**

PRESENCE II INC. (MICHIGAN CORPORATION), DBA PRESENCE II PRODUCTIONS,  
3810 MYSTIC VALLEY DRIVE  
BLOOMFIELD HILLS, MI 48302

**Registered Aug. 28, 2012**

**Int. Cl.: 35**

FOR: FASHION SHOW EXHIBITIONS FOR COMMERCIAL PURPOSES, IN CLASS 35 (U.S. CLS. 100, 101 AND 102).

**SERVICE MARK**

FIRST USE 1-30-2011; IN COMMERCE 1-30-2011.

**PRINCIPAL REGISTER**

THE MARK CONSISTS OF STANDARD CHARACTERS WITHOUT CLAIM TO ANY PARTICULAR FONT, STYLE, SIZE, OR COLOR.

NO CLAIM IS MADE TO THE EXCLUSIVE RIGHT TO USE "MICHIGAN" AND "FEST", APART FROM THE MARK AS SHOWN.

SN 85-267,016, FILED 3-15-2011.

BRENDAN MCCAULEY, EXAMINING ATTORNEY



*David J. Kybas*

Director of the United States Patent and Trademark Office

# United States of America

United States Patent and Trademark Office

# MINT FROST

**Reg. No. 4,199,410**

KRAFT FOODS GLOBAL BRANDS LLC (DELAWARE LIMITED LIABILITY COMPANY)  
THREE LAKES DRIVE  
NORTHFIELD, IL 60093

**Registered Aug. 28, 2012**

**Int. Cl.: 30**

FOR: CHEWING GUM, IN CLASS 30 (U.S. CL. 46).

**TRADEMARK**

FIRST USE 12-1-2011; IN COMMERCE 12-1-2011.

**PRINCIPAL REGISTER**

THE MARK CONSISTS OF STANDARD CHARACTERS WITHOUT CLAIM TO ANY PARTICULAR FONT, STYLE, SIZE, OR COLOR.

NO CLAIM IS MADE TO THE EXCLUSIVE RIGHT TO USE "MINT", APART FROM THE MARK AS SHOWN.

SN 85-267,103, FILED 3-15-2011.

KELLY BOULTON, EXAMINING ATTORNEY



*David J. Kyffers*

Director of the United States Patent and Trademark Office

# United States of America

United States Patent and Trademark Office

## WAVE MEDLEYS

**Reg. No. 4,199,411**

BALL HORTICULTURAL COMPANY (ILLINOIS CORPORATION)  
622 TOWN ROAD  
WEST CHICAGO, IL 60185

**Registered Aug. 28, 2012**

**Int. Cl.: 31**

FOR: LIVING PLANTS, IN CLASS 31 (U.S. CLS. 1 AND 46).

**TRADEMARK**

FIRST USE 5-1-2012; IN COMMERCE 5-1-2012.

**PRINCIPAL REGISTER**

THE MARK CONSISTS OF STANDARD CHARACTERS WITHOUT CLAIM TO ANY PARTICULAR FONT, STYLE, SIZE, OR COLOR.

SN 85-267,601, FILED 3-15-2011.

HANNO RITTNER, EXAMINING ATTORNEY



*David J. Kyffers*

Director of the United States Patent and Trademark Office

# United States of America

United States Patent and Trademark Office

# HANES ECO

**Reg. No. 4,199,412**

HBI BRANDED APPAREL LIMITED, INC (DELAWARE CORPORATION)  
1000 EAST HANES MILL ROAD  
WINSTON-SALEM, NC 27105

**Registered Aug. 28, 2012**

**Int. Cl.: 25**

FOR: T-SHIRTS, IN CLASS 25 (U.S. CLS. 22 AND 39).

**TRADEMARK**

FIRST USE 3-2-2012; IN COMMERCE 3-2-2012.

**PRINCIPAL REGISTER**

THE MARK CONSISTS OF STANDARD CHARACTERS WITHOUT CLAIM TO ANY PARTICULAR FONT, STYLE, SIZE, OR COLOR.

OWNER OF U.S. REG. NOS. 847,649, 2,247,831, AND OTHERS.

SN 85-269,236, FILED 3-17-2011.

GEORGE LORENZO, EXAMINING ATTORNEY



*David J. Kyffers*

Director of the United States Patent and Trademark Office

# United States of America

United States Patent and Trademark Office

## BUILDING POWERFUL BUSINESS TEAMS

**Reg. No. 4,199,413**

**Registered Aug. 28, 2012**

**Int. Cl.: 35**

**SERVICE MARK**

**PRINCIPAL REGISTER**

TRIXIA PARTNERS, INC. (GEORGIA CORPORATION)  
SUITE 1650  
900 CIRCLE 75 PARKWAY  
ATLANTA, GA 30339

FOR: PROVIDING CONSULTING SERVICES, NAMELY, ORGANIZATIONAL DEVELOPMENT CONSULTING, BUSINESS MANAGEMENT CONSULTING IN THE FIELD OF TEAM DEVELOPMENT, AND CONSULTATION IN BUSINESS LEADERSHIP DEVELOPMENT TO BUSINESS ORGANIZATIONS, SUCH AS CORPORATIONS, PARTNERSHIPS AND INDIVIDUALLY OWNED BUSINESSES, IN THE ASSESSMENT OF THE ORGANIZATION, TEAMS AND INDIVIDUALS WITH CONSULTATION IN HELPING BUILD A POWERFUL BUSINESS TEAM FOR THE ORGANIZATION, IN CLASS 35 (U.S. CLS. 100, 101 AND 102).

FIRST USE 12-31-1997; IN COMMERCE 12-31-1997.

THE MARK CONSISTS OF STANDARD CHARACTERS WITHOUT CLAIM TO ANY PARTICULAR FONT, STYLE, SIZE, OR COLOR.

NO CLAIM IS MADE TO THE EXCLUSIVE RIGHT TO USE "BUILDING" AND "BUSINESS TEAMS", APART FROM THE MARK AS SHOWN.

SN 85-269,406, FILED 3-17-2011.

KRISTIN CARLSON, EXAMINING ATTORNEY



*David J. Kyffers*

Director of the United States Patent and Trademark Office



# United States of America

United States Patent and Trademark Office

# ENVIRACHAR

**Reg. No. 4,199,414**

ENVIRACHAR, INC. (FLORIDA CORPORATION)  
3245 S. ATLANTIC AVE.

**Registered Aug. 28, 2012**

DAYTONA BEACH SHORES, FL 32118

**Int. Cl.: 4**

FOR: FOSSIL FUEL SUBSTITUTES, NAMELY, BIOFUELS, IN CLASS 4 (U.S. CLS. 1, 6 AND 15).

**TRADEMARK**

FIRST USE 3-28-2011; IN COMMERCE 3-28-2011.

**PRINCIPAL REGISTER**

THE MARK CONSISTS OF STANDARD CHARACTERS WITHOUT CLAIM TO ANY PARTICULAR FONT, STYLE, SIZE, OR COLOR.

SN 85-269,941, FILED 3-17-2011.

ASMAT KHAN, EXAMINING ATTORNEY



*David J. Kybas*

Director of the United States Patent and Trademark Office

# United States of America

United States Patent and Trademark Office

## THELEOMOVEMENT

**Reg. No. 4,199,415**

**Registered Aug. 28, 2012**

**Int. Cl.: 35**

**SERVICE MARK**

**PRINCIPAL REGISTER**

SUBIR AND MALINI CHOWDHURY FOUNDATION (MICHIGAN NON-PROFIT CORPORATION)  
1881 HERON RIDGE DRIVE  
BLOOMFIELD HILLS, MI 48302

FOR: PROMOTING QUALITY SELF-IMPROVEMENT PRACTICES IN PERSONAL ACTIVITIES, IN CLASS 35 (U.S. CLS. 100, 101 AND 102).

FIRST USE 4-1-2011; IN COMMERCE 4-1-2011.

THE MARK CONSISTS OF THE WORDS "THELEOMOVEMENT" AND THE WORD "LEO" IS EMPHASIZED.

SN 85-270,906, FILED 3-18-2011.

KARANENDRA S. CHHINA, EXAMINING ATTORNEY



*David J. Kyjars*

Director of the United States Patent and Trademark Office

# United States of America

United States Patent and Trademark Office

# QKR

**Reg. No. 4,199,416**

MASTERCARD INTERNATIONAL INCORPORATED (DELAWARE CORPORATION)  
2000 PURCHASE STREET  
PURCHASE, NY 10577

**Registered Aug. 28, 2012**

**Int. Cl.: 36**

FOR: PAYMENT PROCESSING SERVICES INVOLVING CREDIT, DEBIT OR PREPAID CARDS THROUGH USE OF A BAR CODE, IN CLASS 36 (U.S. CLS. 100, 101 AND 102).

**SERVICE MARK**

FIRST USE 4-27-2011; IN COMMERCE 4-27-2011.

**PRINCIPAL REGISTER**

THE MARK CONSISTS OF STANDARD CHARACTERS WITHOUT CLAIM TO ANY PARTICULAR FONT, STYLE, SIZE, OR COLOR.

SN 85-270,969, FILED 3-18-2011.

LEIGH LOWRY, EXAMINING ATTORNEY



*David J. Kybas*

Director of the United States Patent and Trademark Office

# United States of America

United States Patent and Trademark Office

## Phoenix Restoration and Renovation

**Reg. No. 4,199,417**

PHOENIX RESTORATION AND RENOVATION, INC. (MARYLAND CORPORATION)  
2310 PUTNAM ROAD

**Registered Aug. 28, 2012**

FOREST HILL, MD 21050

**Int. Cl.: 37**

FOR: CONSTRUCTION, MAINTENANCE AND RENOVATION OF PROPERTY, IN CLASS  
37 (U.S. CLS. 100, 103 AND 106).

**SERVICE MARK**

FIRST USE 2-10-2011; IN COMMERCE 3-19-2011.

**PRINCIPAL REGISTER**

THE MARK CONSISTS OF STANDARD CHARACTERS WITHOUT CLAIM TO ANY PAR-  
TICULAR FONT, STYLE, SIZE, OR COLOR.

NO CLAIM IS MADE TO THE EXCLUSIVE RIGHT TO USE "RESTORATION AND  
RENOVATION", APART FROM THE MARK AS SHOWN.

SN 85-271,061, FILED 3-18-2011.

COLLEEN KEARNEY, EXAMINING ATTORNEY



*David J. Kybas*

Director of the United States Patent and Trademark Office

# United States of America

United States Patent and Trademark Office

# GET REAL

**Reg. No. 4,199,418**

**Registered Aug. 28, 2012**

**Int. Cl.: 21**

**TRADEMARK**

**PRINCIPAL REGISTER**

TALISMAN DESIGNS, LLC (MINNESOTA LIMITED LIABILITY COMPANY)  
SUITE 105  
2112 BROADWAY STREET NE  
MINNEAPOLIS, MN 55413

FOR: BASKETS OF WICKER; BEVERAGE GLASSWARE; BEVERAGeware; BOWLS; BRUSHES FOR BASTING MEAT; BUTTER DISHES; CAKE BRUSHES; CHARMS FOR ATTACHMENT TO BEVERAGE GLASSWARE FOR IDENTIFICATION PURPOSES; CHEESE GRATERS; COASTERS NOT OF PAPER AND NOT BEING TABLE LINEN; COOKING FORKS; COOKING FUNNELS; COOKING SIEVES AND SIFTERS; COOKING SKEWERS; COOKWARE, NAMELY, POTS AND PANS; CUTTING BOARDS; DINNERWARE; DISHWASHING BRUSHES; DISPENSERS FOR PAPER TOWELS; HOLDER FOR CUTTING BOARD; HOUSEHOLD UTENSILS, NAMELY, BUTTER DISPENSERS; INSULATING SLEEVE HOLDERS FOR BEVERAGE CANS; JAPANESE STYLE PERSONAL DINING TRAYS OR STANDS (ZEN); KITCHEN UTENSIL, NAMELY, NON-METAL FLEXIBLE LID DESIGNED FOR DRAINING OR PRESSING LIQUIDS FROM A FOOD CAN; LEMON SQUEEZERS; MANUALLY ACTUATED PUMP DISPENSERS FOR ATTACHMENT TO CONTAINERS FOR USE IN DISPENSING LIQUIDS; NON-ELECTRIC JUICERS; PLASTIC STORAGE CONTAINERS FOR HOUSEHOLD OR DOMESTIC USE; PLATES; PORCELAIN MUGS; PORTABLE COOKING KITS FOR OUTDOOR USE; ROLLING PINS; TRASH CANS; TRASH CONTAINERS FOR HOUSEHOLD USE; URNS; UTENSILS FOR BARBECUES, NAMELY, FORKS, TONGS, TURNERS; WHISKS, IN CLASS 21 (U.S. CLS. 2, 13, 23, 29, 30, 33, 40 AND 50).

FIRST USE 1-31-2011; IN COMMERCE 1-31-2011.

THE MARK CONSISTS OF STANDARD CHARACTERS WITHOUT CLAIM TO ANY PARTICULAR FONT, STYLE, SIZE, OR COLOR.

SN 85-271,144, FILED 3-18-2011.

DAWN HAN, EXAMINING ATTORNEY



*David J. Kyros*

Director of the United States Patent and Trademark Office

# United States of America

United States Patent and Trademark Office

## THE ROBOT GARAGE

**Reg. No. 4,199,419**

**Registered Aug. 28, 2012**

**Int. Cl.: 41**

**SERVICE MARK**

**PRINCIPAL REGISTER**

THE ROBOT GARAGE INC. (MICHIGAN CORPORATION)  
SARAH JACOBS  
637 S. ETON ROAD  
BIRMINGHAM, MI 48025

FOR: EDUCATION SERVICES, NAMELY, PRE-KINDERGARTEN THROUGH 12TH GRADE CLASSROOM INSTRUCTION, MENTORING, CLASSES, SEMINARS AND WORKSHOPS FOR INDIVIDUALS WITH AUTISM AND OTHER DEVELOPMENTAL DISORDERS; EDUCATION SERVICES, NAMELY, PROVIDING LIVE AND ON-LINE CLASSES, CAMPS, WORKSHOPS, LECTURES, AND DEMONSTRATIONS IN THE FIELD OF ROBOT AND TOY BRICK BUILDING, ENGINEERING, AND ROBOTICS; CONDUCTING BIRTHDAY PARTIES THAT PROVIDE EDUCATIONAL ACTIVITIES IN THE FIELD OF ROBOT AND TOY BRICK BUILDING, ENGINEERING, AND ROBOTICS; EDUCATION SERVICES, NAMELY, PROVIDING MENTORING, CLASSES, SEMINARS AND WORKSHOPS IN THE FIELD OF ROBOT AND TOY BRICK BUILDING, ENGINEERING, AND ROBOTICS; EDUCATIONAL AND ENTERTAINMENT SERVICES FOR CHILDREN, NAMELY, PROVIDING INTERACTIVE PLAY AREAS, INSTRUCTIONAL CLASSES IN THE FIELD OF ROBOT AND TOY BRICK BUILDING, ENGINEERING, AND ROBOTICS AND SOCIAL GATHERINGS FOR CHILDREN; EDUCATIONAL AND ENTERTAINMENT SERVICES, NAMELY, CONDUCTING CLASSES, WORKSHOPS, CAMPS, AND EDUCATIONAL COMPETITIONS IN THE FIELD OF ROBOT AND TOY BRICK BUILDING, ENGINEERING, AND ROBOTICS AND DISTRIBUTION OF COURSE MATERIALS IN CONNECTION THEREWITH, AND EDUCATION CONSULTING RELATED THERETO; EDUCATIONAL SERVICES, NAMELY, CONDUCTING CLASSES, SEMINARS, CONFERENCES, WORKSHOPS, CAMPS AND FIELD TRIPS IN THE FIELD OF ROBOT AND TOY BRICK BUILDING, ENGINEERING, AND ROBOTICS AND DISTRIBUTION OF TRAINING MATERIAL IN CONNECTION THEREWITH; EDUCATIONAL SERVICES, NAMELY, PROVIDING ON-LINE PHOTO GALLERIES, EDUCATIONAL COMPETITIONS IN THE FIELD OF ROBOT AND TOY BRICK BUILDING, ENGINEERING, AND ROBOTICS; ENTERTAINMENT SERVICES, NAMELY, PROVIDING A WEB SITE FEATURING PHOTOGRAPHIC, VIDEO AND PROSE PRESENTATIONS FEATURING ROBOT AND TOY BUILDING, ENGINEERING AND ROBOTICS EDUCATIONAL COMPETITIONS; PROVIDING CLASSES, SEMINARS, WORKSHOPS, AND TRAINING FOR PARENTS, INSTRUCTORS, AND OTHER INDIVIDUALS IN THE FIELD OF EDUCATION FOR INDIVIDUALS WITH AUTISM AND OTHER DEVELOPMENTAL DISORDERS, IN CLASS 41 (U.S. CLS. 100, 101 AND 107).



*David J. Kappas*

Director of the United States Patent and Trademark Office

FIRST USE 5-5-2011; IN COMMERCE 5-5-2011.

**Reg. No. 4,199,419** THE MARK CONSISTS OF STANDARD CHARACTERS WITHOUT CLAIM TO ANY PARTICULAR FONT, STYLE, SIZE, OR COLOR.

NO CLAIM IS MADE TO THE EXCLUSIVE RIGHT TO USE "ROBOT", APART FROM THE MARK AS SHOWN.

SN 85-271,694, FILED 3-20-2011.

KRISTINA MORRIS, EXAMINING ATTORNEY

# United States of America

United States Patent and Trademark Office

## REPROCONNECTIONS

**Reg. No. 4,199,420**

**Registered Aug. 28, 2012**

**Int. Cl.: 35**

**SERVICE MARK**

**PRINCIPAL REGISTER**

TRI-STATE BREEDERS COOPERATIVE (WISCONSIN COOPERATIVE CORPORATION),  
DBA ACCELERATED GENETICS,  
E10890 PENNY LANE  
BARABOO, WI 539139408

FOR: DAIRY BUSINESS MANAGEMENT CONSULTING SERVICES, NAMELY, PROVIDING INFORMATION TO DAIRY PRODUCERS, RANCHERS AND LIVESTOCK MANAGERS REGARDING THE PRODUCTIVITY, MAINTENANCE, REPRODUCTION, AND HISTORY OF THEIR COWS AND/OR HERDS AND REGARDING FARM AND RANCH OPERATIONS AND EXPENSES FOR PURPOSES OF MAKING BUSINESS DECISIONS RELATED THERETO; PROVIDING DATA GATHERING, ANALYSIS AND RECORDKEEPING OF LIVESTOCK PRODUCTION DATA AND DAIRY PRODUCTION DATA FOR FARMS AND RANCHES FOR BUSINESS OR COMMERCIAL PURPOSES; PROVIDING ANALYSES OF PRODUCTIVITY, EFFICIENCY, HISTORY AND FINANCES OF AGRICULTURAL OPERATIONS TO OTHERS FOR PURPOSES OF MAKING BUSINESS DECISIONS RELATED TO THEIR AGRICULTURAL OPERATIONS, IN CLASS 35 (U.S. CLS. 100, 101 AND 102).

FIRST USE 6-13-2012; IN COMMERCE 6-13-2012.

THE MARK CONSISTS OF STANDARD CHARACTERS WITHOUT CLAIM TO ANY PARTICULAR FONT, STYLE, SIZE, OR COLOR.

OWNER OF U.S. REG. NOS. 3,804,629 AND 3,804,630.

SN 85-272,005, FILED 3-21-2011.

JEFFREY LOOK, EXAMINING ATTORNEY



*David J. Kybas*

Director of the United States Patent and Trademark Office



# United States of America

United States Patent and Trademark Office

## GLOBAL AG CONNECTIONS

**Reg. No. 4,199,421**

**Registered Aug. 28, 2012**

**Int. Cl.: 35**

**SERVICE MARK**

**PRINCIPAL REGISTER**

GLOBAL AG CONNECTIONS, INC. (WISCONSIN CORPORATION)  
E10890 PENNY LANE  
BARABOO, WI 53913

FOR: AGRICULTURAL DATA MANAGEMENT SERVICES, NAMELY, PROVIDING DATA GATHERING, ANALYSIS, AND RECORDKEEPING OF LIVESTOCK AND CROP PRODUCTION DATA FOR AGRICULTURAL PRODUCERS FOR BUSINESS OR COMMERCIAL PURPOSES; PROVIDING ANALYSES OF PRODUCTIVITY, EFFICIENCY, HISTORY, AND FINANCES OF AGRICULTURAL OPERATIONS TO OTHERS FOR PURPOSES OF MAKING BUSINESS DECISIONS RELATED TO THEIR AGRICULTURAL OPERATIONS; DAIRY BUSINESS MANAGEMENT CONSULTING SERVICES, NAMELY, PROVIDING INFORMATION TO DAIRY PRODUCERS, RANCHERS, AND LIVESTOCK MANAGERS REGARDING THE PRODUCTIVITY, MAINTENANCE, REPRODUCTION AND HISTORY OF THEIR COWS AND/OR HERDS AND REGARDING FARM AND RANCH OPERATIONS AND EXPENSES FOR PURPOSES OF MAKING BUSINESS DECISIONS RELATED THERETO, IN CLASS 35 (U.S. CLS. 100, 101 AND 102).

FIRST USE 6-13-2012; IN COMMERCE 6-13-2012.

THE MARK CONSISTS OF STANDARD CHARACTERS WITHOUT CLAIM TO ANY PARTICULAR FONT, STYLE, SIZE, OR COLOR.

NO CLAIM IS MADE TO THE EXCLUSIVE RIGHT TO USE "GLOBAL AG", APART FROM THE MARK AS SHOWN.

SN 85-272,017, FILED 3-21-2011.

JEFFREY LOOK, EXAMINING ATTORNEY



*David J. Kybas*

Director of the United States Patent and Trademark Office

# United States of America

United States Patent and Trademark Office

## MIRROR TRADER

**Reg. No. 4,199,422**

**Registered Aug. 28, 2012**

**Int. Cl.: 36**

**SERVICE MARK**

**PRINCIPAL REGISTER**

TRADENCY INC. (BR. VIRGIN ISLANDS CORPORATION)  
2ND FLOOR GENEVA PLACE  
333 WATERFRONT DRIVE  
ROAD TOWN, TORTOLA, BR. VIRGIN ISLANDS

FOR: COMMODITY TRADING FOR OTHERS; EXCHANGE MARKET SERVICES RELATING TO COMMODITY FUTURES CONTRACTS; TRADING SERVICES IN FOREIGN CURRENCY; ELECTRONIC FINANCIAL TRADING SERVICES USING FINANCIAL TOOLS; INVESTMENT FUNDS MANagements SERVICES, INCLUDING TRUST FUNDS MANAGEMENT SERVICES, FINANCIAL PLANNING; BANK SECURITIES TRADING SERVICES, IN CLASS 36 (U.S. CLS. 100, 101 AND 102).

FIRST USE 5-31-2011; IN COMMERCE 5-31-2011.

THE MARK CONSISTS OF STANDARD CHARACTERS WITHOUT CLAIM TO ANY PARTICULAR FONT, STYLE, SIZE, OR COLOR.

NO CLAIM IS MADE TO THE EXCLUSIVE RIGHT TO USE "TRADER", APART FROM THE MARK AS SHOWN.

SN 85-272,630, FILED 3-21-2011.

HEATHER BIDDULPH, EXAMINING ATTORNEY



*David J. Kyffers*

Director of the United States Patent and Trademark Office

# United States of America

United States Patent and Trademark Office



**Reg. No. 4,199,423**

**Registered Aug. 28, 2012**

**Int. Cl.: 21**

**TRADEMARK**

**PRINCIPAL REGISTER**

NEW STAR WHOLESALE INC (CALIFORNIA CORPORATION)  
2211 E 27TH STREET  
VERNON, CA 90058

FOR: COOKWARE FOR USE IN MICROWAVE OVENS; COOKWARE, NAMELY, POTS AND PANS; COOKWARE, NAMELY, ROASTING PANS; COOKWARE, NAMELY, STEAMERS, IN CLASS 21 (U.S. CLS. 2, 13, 23, 29, 30, 33, 40 AND 50).

FIRST USE 6-30-2011; IN COMMERCE 6-30-2011.

NO CLAIM IS MADE TO THE EXCLUSIVE RIGHT TO USE "DESIGN", APART FROM THE MARK AS SHOWN.

THE COLOR(S) RED, BLACK, GRAY AND WHITE IS/ARE CLAIMED AS A FEATURE OF THE MARK.

THE MARK CONSISTS OF THE STYLIZED WORD "WHÜRSCH" IN LOWER CASE LETTERS IN RED WITH BLACK AND WHITE SHADING ON THE EDGES WITH A WHITE LINE UNDERNEATH AND A LIGHT REFLECTION BELOW. THE STYLIZED WORD "EUROSWISS DESIGN" IN LOWER CASE LETTERS IN GRADIENT WHITE/GRAY LIES DIRECTLY BENEATH THE "Ü, R, S, C, & H" OF THE WORD "WHÜRSCH". THE WORD "WHÜRSCH" AND "EUROSWISS DESIGN" IS SEPARATED BY A WHITE LINE. THE WORDING IS SUPERIMPOSED OVER A RECTANGLE-LIKE CARRIER WITH A ROUNDED EDGE AT THE BOTTOM AND WITH A GRADIENT BLACK/GRAY TO WHITE TONE FROM THE MIDDLE WHICH SERVE AS ITS BACKGROUND PLATE.

THE WORDING "WHÜRSCH" HAS NO MEANING IN A FOREIGN LANGUAGE.

SN 85-273,935, FILED 3-22-2011.

TASNEEM HUSSAIN, EXAMINING ATTORNEY



*David J. Kypos*

Director of the United States Patent and Trademark Office

# United States of America

United States Patent and Trademark Office

## ICEPLORATION

**Reg. No. 4,199,424**

**Registered Aug. 28, 2012**

**Int. Cl.: 41**

SEAWORLD PARKS & ENTERTAINMENT LLC (DELAWARE LIMITED LIABILITY COMPANY)  
SUITE 400  
9205 SOUTH PARK CENTER LOOP  
ORLANDO, FL 32819

**SERVICE MARK**

FOR: ENTERTAINMENT SERVICES IN THE NATURE OF AN AMUSEMENT PARK SHOW, IN CLASS 41 (U.S. CLS. 100, 101 AND 107).

**PRINCIPAL REGISTER**

FIRST USE 2-1-2012; IN COMMERCE 2-1-2012.

THE MARK CONSISTS OF STANDARD CHARACTERS WITHOUT CLAIM TO ANY PARTICULAR FONT, STYLE, SIZE, OR COLOR.

SN 85-274,407, FILED 3-23-2011.

DAVID TAYLOR, EXAMINING ATTORNEY



*David J. Kyffers*

Director of the United States Patent and Trademark Office

# United States of America

United States Patent and Trademark Office

## MIND BODY BARRE

**Reg. No. 4,199,425**

VERNAGLIA, ANGELA (UNITED STATES INDIVIDUAL)  
242 SOUTH WORCESTER STREET, APT A  
NORTON, MA 02766

**Registered Aug. 28, 2012**

**Int. Cl.: 41**

FOR: EDUCATION AND ENTERTAINMENT SERVICES; NAMELY, PHYSICAL FITNESS CONDITIONING CLASSES, PHYSICAL FITNESS INSTRUCTION, PERSONAL TRAINING, DANCE CLASSES, AND WORKSHOPS AND SEMINARS IN THE FIELD OF SELF HELP FOR CONSUMERS, IN CLASS 41 (U.S. CLS. 100, 101 AND 107).

**SERVICE MARK**

**PRINCIPAL REGISTER**

FIRST USE 3-15-2011; IN COMMERCE 3-15-2011.

THE MARK CONSISTS OF STANDARD CHARACTERS WITHOUT CLAIM TO ANY PARTICULAR FONT, STYLE, SIZE, OR COLOR.

SN 85-274,873, FILED 3-23-2011.

CARYN GLASSER, EXAMINING ATTORNEY



*David J. Kyjars*

Director of the United States Patent and Trademark Office

# United States of America

United States Patent and Trademark Office

## ENERGYEARTH.COM SUPERSTORE

**Reg. No. 4,199,426**

ENERGY EARTH, LLC (TENNESSEE LIMITED LIABILITY COMPANY)

**Registered Aug. 28, 2012**

P. O. BOX 4303  
CHATTANOOGA, TN 37405

**Int. Cl.: 35**

FOR: RETAIL STORE SERVICES PROVIDED FROM AN ON-LINE, WEB-BASED VIRTUAL STOREFRONT FEATURING ENERGY EFFICIENT, ENVIRONMENTALLY FRIENDLY, AND RENEWABLE ENERGY-RELATED PRODUCTS AND SERVICES, IN CLASS 35 (U.S. CLS. 100, 101 AND 102).

**SERVICE MARK**

**PRINCIPAL REGISTER**

FIRST USE 5-1-2012; IN COMMERCE 5-1-2012.

THE MARK CONSISTS OF STANDARD CHARACTERS WITHOUT CLAIM TO ANY PARTICULAR FONT, STYLE, SIZE, OR COLOR.

NO CLAIM IS MADE TO THE EXCLUSIVE RIGHT TO USE "ENERGY" OR "SUPERSTORE", APART FROM THE MARK AS SHOWN.

SN 85-275,798, FILED 3-24-2011.

DAVID TAYLOR, EXAMINING ATTORNEY



*David J. Kyfos*

Director of the United States Patent and Trademark Office

# United States of America

United States Patent and Trademark Office

## Animal Allure

**Reg. No. 4,199,427**

ARTWORK TO WEAR, LLC (OHIO LIMITED LIABILITY COMPANY)  
3176 STATE RT. 5  
CORTLAND, OH 44410

**Registered Aug. 28, 2012**

**Int. Cl.: 14**

FOR: JEWELRY, IN CLASS 14 (U.S. CLS. 2, 27, 28 AND 50).

**TRADEMARK**

FIRST USE 12-15-2011; IN COMMERCE 12-15-2011.

**PRINCIPAL REGISTER**

THE MARK CONSISTS OF STANDARD CHARACTERS WITHOUT CLAIM TO ANY PARTICULAR FONT, STYLE, SIZE, OR COLOR.

NO CLAIM IS MADE TO THE EXCLUSIVE RIGHT TO USE "ANIMAL", APART FROM THE MARK AS SHOWN.

SN 85-277,163, FILED 3-25-2011.

JULIE GUTTADAURO, EXAMINING ATTORNEY



*David J. Kyffers*

Director of the United States Patent and Trademark Office

# United States of America

United States Patent and Trademark Office

## AMBIR TECHNOLOGY

**Reg. No. 4,199,428**

**Registered Aug. 28, 2012**

**Int. Cls.: 9 and 35**

**TRADEMARK**

**SERVICE MARK**

**PRINCIPAL REGISTER**

AMBIR TECHNOLOGY, INC. (ILLINOIS CORPORATION)  
918 NORTH OAK LAWN AVENUE  
ELMHURST, IL 60126

FOR: IMAGING AND SCANNING SOFTWARE, PERIPHERAL DEVICES AND ACCESSORIES FOR COMPUTERS, NAMELY, PORTABLE SCANNERS, SIGNATURE CAPTURE DEVICES, MONITOR STANDS, COMPUTER MICE, PORTABLE KEYPADS, ADAPTER CABLES, TRANSFER CABLES, PORT REPLICATORS AND USB HUBS; ACCESSORIES FOR PORTABLE SCANNERS AND SIGNATURE CAPTURE DEVICES, NAMELY, TRAVEL AND CARRYING CASES, IN CLASS 9 (U.S. CLS. 21, 23, 26, 36 AND 38).

FIRST USE 7-17-2001; IN COMMERCE 7-17-2001.

FOR: ONLINE RETAIL STORE SERVICES AND ORDERING SERVICES FEATURING IMAGING AND SCANNING SOFTWARE, PERIPHERAL DEVICES AND ACCESSORIES FOR COMPUTERS, NAMELY, PORTABLE SCANNERS, SIGNATURE CAPTURE DEVICES, MONITOR STANDS, COMPUTER MICE, PORTABLE KEYPADS, ADAPTER CABLES, TRANSFER CABLES, PORT REPLICATORS AND USB HUBS; ONLINE RETAIL STORE SERVICES AND ORDERING SERVICES FEATURING ACCESSORIES FOR PORTABLE SCANNERS AND SIGNATURE CAPTURE DEVICES, NAMELY, TRAVEL AND CARRYING CASES, IN CLASS 35 (U.S. CLS. 100, 101 AND 102).

FIRST USE 7-17-2001; IN COMMERCE 7-17-2001.

THE MARK CONSISTS OF STANDARD CHARACTERS WITHOUT CLAIM TO ANY PARTICULAR FONT, STYLE, SIZE, OR COLOR.

NO CLAIM IS MADE TO THE EXCLUSIVE RIGHT TO USE "TECHNOLOGY", APART FROM THE MARK AS SHOWN.

SN 85-277,537, FILED 3-25-2011.

ANNE MADDEN, EXAMINING ATTORNEY



*David J. Kybas*

Director of the United States Patent and Trademark Office



# United States of America

United States Patent and Trademark Office

## CLEVELAND BABY!

**Reg. No. 4,199,429**

FAYGO, BRAZIL (UNITED STATES INDIVIDUAL), AKA ABDULLA TAFEEQ,  
1627 BALMORAL WAY  
WESTLAKE, OH 44145

**Registered Aug. 28, 2012**

**Int. Cl.: 25**

FOR: COLLARED SHIRTS; POLO SHIRTS; SHIRTS; SWEAT SHIRTS; T-SHIRTS, IN CLASS  
25 (U.S. CLS. 22 AND 39).

**TRADEMARK**

FIRST USE 4-9-2011; IN COMMERCE 4-9-2011.

**PRINCIPAL REGISTER**

THE MARK CONSISTS OF STANDARD CHARACTERS WITHOUT CLAIM TO ANY PAR-  
TICULAR FONT, STYLE, SIZE, OR COLOR.

NO CLAIM IS MADE TO THE EXCLUSIVE RIGHT TO USE "CLEVELAND", APART FROM  
THE MARK AS SHOWN.

SN 85-278,192, FILED 3-28-2011.

ROBERT C. CLARK JR., EXAMINING ATTORNEY



*David J. Kyffers*

Director of the United States Patent and Trademark Office

# United States of America

United States Patent and Trademark Office

## Cast A Smile

**Reg. No. 4,199,430**

**Registered Aug. 28, 2012**

**Int. Cl.: 25**

**TRADEMARK**

**PRINCIPAL REGISTER**

SIMS, COLLEEN SEGURA (UNITED STATES INDIVIDUAL)  
15237 PENDORA LANE  
GULFPORT, MS 39503

FOR: ATHLETIC APPAREL, NAMELY, SHIRTS, PANTS, JACKETS, FOOTWEAR, HATS AND CAPS, ATHLETIC UNIFORMS; BASEBALL CAPS AND HATS; CHEF'S HATS; CLOTHING FOR BABIES, TODDLERS AND CHILDREN, TREATED WITH FIRE AND HEAT RETARDANTS, NAMELY, PAJAMAS, JACKETS, SHIRTS, PANTS, JUMPERS; HATS; HATS FOR INFANTS, BABIES, TODDLERS AND CHILDREN; MEN'S SOCKS; SHORT-SLEEVED OR LONG-SLEEVED T-SHIRTS; SOCKS; SOCKS AND STOCKINGS; T-SHIRTS; TIES; TOPS; WEARABLE GARMENTS AND CLOTHING, NAMELY, SHIRTS, IN CLASS 25 (U.S. CLS. 22 AND 39).

FIRST USE 3-16-2012; IN COMMERCE 3-16-2012.

THE MARK CONSISTS OF STANDARD CHARACTERS WITHOUT CLAIM TO ANY PARTICULAR FONT, STYLE, SIZE, OR COLOR.

SN 85-278,974, FILED 3-28-2011.

SCOTT BIBB, EXAMINING ATTORNEY



*David J. Kyffers*

Director of the United States Patent and Trademark Office

# United States of America

United States Patent and Trademark Office

BE CAREFUL IT'S YOUR MONEY

**Reg. No. 4,199,431**

FIVE PEAKS, LLC (FLORIDA LIMITED LIABILITY COMPANY)  
6400 CONGRESS AVENUE, SUITE 2250  
BOCA RATON, FL 33487

**Registered Aug. 28, 2012**

**Int. Cl.: 16**

FOR: BULLETINS CONCERNING FINANCIAL RESEARCH, IN CLASS 16 (U.S. CLS. 2, 5, 22, 23, 29, 37, 38 AND 50).

**TRADEMARK**

FIRST USE 8-11-2011; IN COMMERCE 8-11-2011.

**PRINCIPAL REGISTER**

THE MARK CONSISTS OF STANDARD CHARACTERS WITHOUT CLAIM TO ANY PARTICULAR FONT, STYLE, SIZE, OR COLOR.

SN 85-279,622, FILED 3-29-2011.

SANJEEV VOHRA, EXAMINING ATTORNEY



*David J. Kybas*

Director of the United States Patent and Trademark Office

# United States of America

United States Patent and Trademark Office



UNSELFISHWORLD.ORG

**Reg. No. 4,199,432**

**Registered Aug. 28, 2012**

**Int. Cls.: 25 and 36**

**TRADEMARK**

**SERVICE MARK**

**PRINCIPAL REGISTER**

SASSO, RICHARD (UNITED STATES INDIVIDUAL)  
1042 SEA SPRAY AVE  
DELRAY BEACH, FL 33483

FOR: CAPS; JACKETS; POLO SHIRTS; T-SHIRTS, IN CLASS 25 (U.S. CLS. 22 AND 39).

FIRST USE 11-1-2010; IN COMMERCE 2-1-2012.

FOR: CHARITABLE FUNDRAISING SERVICES, IN CLASS 36 (U.S. CLS. 100, 101 AND 102).

FIRST USE 11-1-2011; IN COMMERCE 2-1-2012.

SN 85-279,663, FILED 3-29-2011.

MARILYN IZZI, EXAMINING ATTORNEY



*David J. Kybas*

Director of the United States Patent and Trademark Office

United States of America  
United States Patent and Trademark Office

SIRIUSXM

**Reg. No. 4,199,433**

SIRIUS XM RADIO INC. (DELAWARE CORPORATION)  
1221 AVENUE OF THE AMERICAS, 36TH FLOOR  
NEW YORK, NY 10020

**Registered Aug. 28, 2012**

**Int. Cl.: 9**

FOR: ELECTRONIC HARDWARE DEVICE FOR RECEIVING BROADCAST RADIO TRANSMISSIONS AND AUDIO, VISUAL AND DATA INFORMATION, IN CLASS 9 (U.S. CLS. 21, 23, 26, 36 AND 38).

**TRADEMARK**

FIRST USE 10-0-2011; IN COMMERCE 10-0-2011.

**PRINCIPAL REGISTER**

THE MARK CONSISTS OF STANDARD CHARACTERS WITHOUT CLAIM TO ANY PARTICULAR FONT, STYLE, SIZE, OR COLOR.

OWNER OF U.S. REG. NOS. 2,547,677, 3,204,232, AND OTHERS.

SN 85-279,859, FILED 3-29-2011.

ANGELA M. MICHELI, EXAMINING ATTORNEY



*David J. Kyffers*

Director of the United States Patent and Trademark Office

# United States of America

United States Patent and Trademark Office

**(((SiriusXM)))**  
SATELLITE RADIO

**Reg. No. 4,199,434**

SIRIUS XM RADIO INC. (DELAWARE CORPORATION)  
1221 AVENUE OF THE AMERICAS, 36TH FLOOR  
NEW YORK, NY 10020

**Registered Aug. 28, 2012**

**Int. Cl.: 9**

FOR: ELECTRONIC HARDWARE DEVICE FOR RECEIVING BROADCAST RADIO TRANSMISSIONS AND AUDIO, VISUAL AND DATA INFORMATION, IN CLASS 9 (U.S. CLS. 21, 23, 26, 36 AND 38).

**TRADEMARK**

FIRST USE 10-0-2011; IN COMMERCE 10-0-2011.

**PRINCIPAL REGISTER**

OWNER OF U.S. REG. NOS. 3,071,291, 3,818,003, AND OTHERS.

NO CLAIM IS MADE TO THE EXCLUSIVE RIGHT TO USE "SATELLITE RADIO", APART FROM THE MARK AS SHOWN.

THE MARK CONSISTS OF THE WORD "SIRIUSXM" WITH THREE CURVED LINES ON EACH SIDE ABOVE THE WORDS "SATELLITE RADIO".

SN 85-279,869, FILED 3-29-2011.

ANGELA M. MICHELI, EXAMINING ATTORNEY



*David J. Kyffers*

Director of the United States Patent and Trademark Office

# United States of America

United States Patent and Trademark Office

## SALVATIERRA

**Reg. No. 4,199,435**

**Registered Aug. 28, 2012**

**Int. Cl.: 30**

**TRADEMARK**

**PRINCIPAL REGISTER**

WAGNER TORRES, JULIAN MARCELO (MEXICO INDIVIDUAL)  
CALZADA DEL VALLE #150 PONIENTE  
SAN PEDRO, GARZA GARCI  
NUEVO LEON, MEXICO

FOR: COFFEE, SUGAR, ROASTED COFFEE BEANS, AND GREEN COFFEE, IN CLASS 30  
(U.S. CL. 46).

FIRST USE 11-1-2011; IN COMMERCE 2-1-2012.

THE MARK CONSISTS OF STANDARD CHARACTERS WITHOUT CLAIM TO ANY PARTICULAR FONT, STYLE, SIZE, OR COLOR.

SN 85-280,491, FILED 3-29-2011.

ANDREW LEASER, EXAMINING ATTORNEY



*David J. Kyros*

Director of the United States Patent and Trademark Office

# United States of America

United States Patent and Trademark Office

# BeneCard<sup>BCF</sup>

*Benecard Central Fill*

**Reg. No. 4,199,436**

BENECARD CENTRAL FILL, LLC (PENNSYLVANIA LIMITED LIABILITY COMPANY)  
P.O. BOX 779

**Registered Aug. 28, 2012**

MECHANICSBURG, PA 170550779

**Int. Cl.: 35**

FOR: MAIL ORDER PHARMACY SERVICES; RETAIL PHARMACY SERVICES; RETAIL DRUG STORES; RETAIL DRUG STORE SERVICES; PHARMACEUTICAL SERVICES, NAMELY, PROCESSING ONLINE AND TELEPHONE PRESCRIPTION ORDERS IN RETAIL AND CENTRAL FILL PHARMACIES, IN CLASS 35 (U.S. CLS. 100, 101 AND 102).

**SERVICE MARK**

**PRINCIPAL REGISTER**

FIRST USE 4-0-2009; IN COMMERCE 4-0-2009.

OWNER OF U.S. REG. NOS. 1,747,906 AND 2,809,304.

THE COLOR(S) GREEN, WHITE, AND BLACK IS/ARE CLAIMED AS A FEATURE OF THE MARK.

NO CLAIM IS MADE TO THE EXCLUSIVE RIGHT TO USE "CENTRAL FILL", APART FROM THE MARK AS SHOWN.

THE MARK CONSISTS OF THE STYLIZED WORD "BENECARD" IN GREEN WITH THE VERTICAL, STYLIZED, AND BLACK LETTERS "BCF" TO THE RIGHT OF "BENECARD" AND THE STYLIZED, BLACK WORDS "BENECARD CENTRAL FILL" BELOW THE WORD "BENECARD", ALL ON A WHITE BACKGROUND.

SN 85-281,097, FILED 3-30-2011.

ANN E. SAPPENFIELD, EXAMINING ATTORNEY



*David J. Kypos*

Director of the United States Patent and Trademark Office



# United States of America

United States Patent and Trademark Office

## RENOVO BIODIESEL

**Reg. No. 4,199,437**

BUTZ, THOMPSON (UNITED STATES INDIVIDUAL)  
PO BOX 149

**Registered Aug. 28, 2012**

ADAMSTOWN, MD 21710

**Int. Cl.: 4**

FOR: BIODIESEL FUEL; ETHANOL FUELS; RENEWABLE FUELS, IN CLASS 4 (U.S. CLS. 1, 6 AND 15).

**TRADEMARK**

FIRST USE 9-12-2007; IN COMMERCE 9-12-2007.

**PRINCIPAL REGISTER**

THE MARK CONSISTS OF STANDARD CHARACTERS WITHOUT CLAIM TO ANY PARTICULAR FONT, STYLE, SIZE, OR COLOR.

NO CLAIM IS MADE TO THE EXCLUSIVE RIGHT TO USE "BIODIESEL", APART FROM THE MARK AS SHOWN.

SN 85-281,392, FILED 3-30-2011.

SCOTT BIBB, EXAMINING ATTORNEY



*David J. Kyffers*

Director of the United States Patent and Trademark Office

# United States of America

United States Patent and Trademark Office

## DRY CLEANERS GIVING HOPE

**Reg. No. 4,199,438**

CLEANER'S SUPPLY, INC. (NEW YORK CORPORATION)  
1059 POWERS ROAD  
CONKLIN, NY 13748

**Registered Aug. 28, 2012**

**Int. Cl.: 22**

FOR: GARMENT BAGS FOR STORAGE FOR USE IN THE LAUNDRY AND DRY CLEANING INDUSTRY; GARMENT COVERS IN THE NATURE OF PLASTIC BAGS FOR STORAGE USED IN THE LAUNDRY AND DRY CLEANING INDUSTRY, IN CLASS 22 (U.S. CLS. 1, 2, 7, 19, 22, 42 AND 50).

**TRADEMARK**

**PRINCIPAL REGISTER**

FIRST USE 7-1-2011; IN COMMERCE 7-1-2011.

THE MARK CONSISTS OF STANDARD CHARACTERS WITHOUT CLAIM TO ANY PARTICULAR FONT, STYLE, SIZE, OR COLOR.

NO CLAIM IS MADE TO THE EXCLUSIVE RIGHT TO USE "DRY CLEANERS", APART FROM THE MARK AS SHOWN.

SN 85-282,558, FILED 3-31-2011.

ROBIN MITTLER, EXAMINING ATTORNEY



*David J. Kybas*

Director of the United States Patent and Trademark Office

# United States of America

United States Patent and Trademark Office

## HELPING CLEAN UP BREAST CANCER

**Reg. No. 4,199,439**

CLEANER'S SUPPLY, INC. (NEW YORK CORPORATION)  
1059 POWERS ROAD  
CONKLIN, NY 13748

**Registered Aug. 28, 2012**

**Int. Cl.: 22**

FOR: GARMENT BAGS FOR STORAGE FOR USE IN THE LAUNDRY AND DRY CLEANING INDUSTRY; GARMENT COVERS IN THE NATURE OF PLASTIC BAGS FOR STORAGE USED IN THE LAUNDRY AND DRY CLEANING INDUSTRY, IN CLASS 22 (U.S. CLS. 1, 2, 7, 19, 22, 42 AND 50).

**TRADEMARK**

**PRINCIPAL REGISTER**

FIRST USE 7-1-2011; IN COMMERCE 7-1-2011.

THE MARK CONSISTS OF STANDARD CHARACTERS WITHOUT CLAIM TO ANY PARTICULAR FONT, STYLE, SIZE, OR COLOR.

SN 85-282,578, FILED 3-31-2011.

ROBIN MITTLER, EXAMINING ATTORNEY



*David J. Kyffers*

Director of the United States Patent and Trademark Office

# United States of America

United States Patent and Trademark Office

# ADVANTAGE

**Reg. No. 4,199,440**

**Registered Aug. 28, 2012**

**Int. Cls.: 9 and 42**

**TRADEMARK**

**SERVICE MARK**

**PRINCIPAL REGISTER**

FULL THROTTLE FILMS, INC. (CALIFORNIA CORPORATION)  
912 RUBERTA AVENUE  
GLENDALE, CA 91201

FOR: LED DISPLAYS, IN CLASS 9 (U.S. CLS. 21, 23, 26, 36 AND 38).

FIRST USE 2-15-2011; IN COMMERCE 2-15-2011.

FOR: LIGHTING DESIGN AND TECHNOLOGY SPECIFICATION SERVICES PERTAINING TO PERMANENT OR TEMPORARY ARCHITECTURAL, THEATRICAL, ENTERTAINMENT, COMMERCIAL AND/OR RESIDENTIAL APPLICATIONS, IN CLASS 42 (U.S. CLS. 100 AND 101).

FIRST USE 2-15-2011; IN COMMERCE 2-15-2011.

THE MARK CONSISTS OF STANDARD CHARACTERS WITHOUT CLAIM TO ANY PARTICULAR FONT, STYLE, SIZE, OR COLOR.

SN 85-283,109, FILED 3-31-2011.

DORITT L. CARROLL, EXAMINING ATTORNEY



*David J. Kypos*

Director of the United States Patent and Trademark Office

# United States of America

United States Patent and Trademark Office

## EXPLORE INTENTIONAL INVESTING WITH INVESCO

**Reg. No. 4,199,441**

**Registered Aug. 28, 2012**

**Int. Cl.: 36**

**SERVICE MARK**

**PRINCIPAL REGISTER**

INVESCO HOLDING COMPANY LIMITED (UNITED KINGDOM COMPANY)  
1555 PEACHTREE STREET NE  
ATLANTA, GA 30309

FOR: FINANCIAL AND INVESTMENT SERVICES, NAMELY, MANAGEMENT AND BROKERAGE IN THE FIELDS OF STOCKS, BONDS, OPTIONS, COMMODITIES, FUTURES AND OTHER SECURITIES, AND INVESTMENT OF FUNDS OF OTHERS; TRANSFER AGENCY SERVICES RENDERED TO THE ISSUERS OF INVESTMENT SECURITIES; INVESTMENT SERVICES, NAMELY, ASSET MANAGEMENT, IN CLASS 36 (U.S. CLS. 100, 101 AND 102).

FIRST USE 4-1-2011; IN COMMERCE 4-1-2011.

THE MARK CONSISTS OF STANDARD CHARACTERS WITHOUT CLAIM TO ANY PARTICULAR FONT, STYLE, SIZE, OR COLOR.

OWNER OF U.S. REG. NOS. 1,825,441, 3,877,427, AND OTHERS.

SN 85-283,475, FILED 4-1-2011.

LESLEY LAMOTHE, EXAMINING ATTORNEY



*David J. Kyffers*

Director of the United States Patent and Trademark Office

# United States of America

United States Patent and Trademark Office

# TAPHANDLES

**Reg. No. 4,199,442**

TAPHANDLES LLC (WASHINGTON LIMITED LIABILITY COMPANY)  
1424 4TH AVE, SUITE 201  
SEATTLE, WA 98101

**Registered Aug. 28, 2012**

**Int. Cl.: 25**

FOR: T-SHIRTS, SHIRTS, SWEATSHIRTS AND HATS, IN CLASS 25 (U.S. CLS. 22 AND 39).

FIRST USE 8-31-2010; IN COMMERCE 8-31-2010.

**TRADEMARK**

THE MARK CONSISTS OF STANDARD CHARACTERS WITHOUT CLAIM TO ANY PARTICULAR FONT, STYLE, SIZE, OR COLOR.

**PRINCIPAL REGISTER**

OWNER OF U.S. REG. NO. 3,496,570.

SN 85-284,381, FILED 4-1-2011.

DAWN FELDMAN, EXAMINING ATTORNEY



*David J. Kybas*

Director of the United States Patent and Trademark Office

# United States of America

United States Patent and Trademark Office



**Reg. No. 4,199,443**

**Registered Aug. 28, 2012**

**Int. Cl.: 25**

**TRADEMARK**

**PRINCIPAL REGISTER**

TAPHANDLES LLC (WASHINGTON LIMITED LIABILITY COMPANY)  
1424 4TH AVE, SUITE 201  
SEATTLE, WA 98101

FOR: T-SHIRTS, SHIRTS, SWEATSHIRTS AND HATS, IN CLASS 25 (U.S. CLS. 22 AND 39).

FIRST USE 8-31-2010; IN COMMERCE 8-31-2010.

OWNER OF U.S. REG. NO. 3,496,570.

THE MARK CONSISTS OF TWO CIRCLES WITH THE WORD "TAPHANDLES" ABOVE AND GARLANDS BELOW. IN THE CENTER THREE BEER SPIGOT HANDLES ARE DEPICTED.

SN 85-284,402, FILED 4-1-2011.

DAWN FELDMAN, EXAMINING ATTORNEY



*David J. Kyffers*

Director of the United States Patent and Trademark Office

# United States of America

United States Patent and Trademark Office



**Reg. No. 4,199,444**

TAPHANDLES LLC (WASHINGTON LIMITED LIABILITY COMPANY)  
1424 4TH AVE, SUITE 201  
SEATTLE, WA 98101

**Registered Aug. 28, 2012**

**Int. Cl.: 21**

FOR: BEVERAGE GLASSWARE, SERVING TRAYS, NOT OF PRECIOUS METAL, PITCHERS,  
BEER MUGS, IN CLASS 21 (U.S. CLS. 2, 13, 23, 29, 30, 33, 40 AND 50).

**TRADEMARK**

FIRST USE 11-30-2011; IN COMMERCE 11-30-2011.

**PRINCIPAL REGISTER**

OWNER OF U.S. REG. NO. 3,496,570.

THE MARK CONSISTS OF TWO CIRCLES WITH THE WORD "TAPHANDLES" ABOVE  
AND GARLANDS BELOW. IN THE CENTER THREE BEER SPIGOT HANDLES ARE DEPIC-  
TED.

SN 85-284,403, FILED 4-1-2011.

DAWN FELDMAN, EXAMINING ATTORNEY



*David J. Kyffers*

Director of the United States Patent and Trademark Office



# United States of America

United States Patent and Trademark Office



**Reg. No. 4,199,445**

TAPHANDLES LLC (WASHINGTON LIMITED LIABILITY COMPANY)  
1424 4TH AVE, SUITE 201  
SEATTLE, WA 98101

**Registered Aug. 28, 2012**

**Int. Cl.: 16**

FOR: COASTERS MADE OF PAPER, BEER LABELS MADE OF PAPER, PAPER CARTONS FOR TRANSPORTING BEER, IN CLASS 16 (U.S. CLS. 2, 5, 22, 23, 29, 37, 38 AND 50).

**TRADEMARK**

FIRST USE 8-31-2010; IN COMMERCE 8-31-2010.

**PRINCIPAL REGISTER**

OWNER OF U.S. REG. NO. 3,496,570.

THE MARK CONSISTS OF TWO CIRCLES WITH THE WORD "TAPHANDLES" ABOVE AND GARLANDS BELOW. IN THE CENTER THREE BEER SPIGOT HANDLES ARE DEPICTED.

SN 85-284,405, FILED 4-1-2011.

DAWN FELDMAN, EXAMINING ATTORNEY



*David J. Kyffers*

Director of the United States Patent and Trademark Office

# United States of America

United States Patent and Trademark Office

## The Beauty Pill

**Reg. No. 4,199,446**

THE PINK AND GREEN COMPANY (OREGON CORPORATION)  
4006 NE 15TH AVE  
PORTLAND, OR 97212

**Registered Aug. 28, 2012**

**Int. Cl.: 5**

FOR: MULTI-VITAMIN PREPARATIONS, IN CLASS 5 (U.S. CLS. 6, 18, 44, 46, 51 AND 52).

**TRADEMARK**

FIRST USE 12-31-2010; IN COMMERCE 11-1-2011.

**PRINCIPAL REGISTER**

THE MARK CONSISTS OF STANDARD CHARACTERS WITHOUT CLAIM TO ANY PARTICULAR FONT, STYLE, SIZE, OR COLOR.

NO CLAIM IS MADE TO THE EXCLUSIVE RIGHT TO USE "PILL", APART FROM THE MARK AS SHOWN.

SN 85-284,838, FILED 4-4-2011.

SHAILA SETTLES, EXAMINING ATTORNEY



*David J. Kyffers*

Director of the United States Patent and Trademark Office

# United States of America

United States Patent and Trademark Office

# V-STICK

**Reg. No. 4,199,447**

BRUCE D. HIRSCHHORN (UNITED STATES INDIVIDUAL)  
173 KINGSLAND ROAD  
BOONTON, NJ 07005

**Registered Aug. 28, 2012**

**Int. Cl.: 20**

FOR: VALVE MARKER, NAMELY, A NON-METAL STICK THAT FITS INSIDE THE HOUSING OF UTILITY SHUT-OFF VALVES AND UTILITY CONTROL VALVES IN BURIED TRANSPORT LINES, SUCH AS WATER AND GAS LINES, TO IDENTIFY THE UTILITY CONTROLLED BY THE VALVE, IN CLASS 20 (U.S. CLS. 2, 13, 22, 25, 32 AND 50).

**TRADEMARK**

**PRINCIPAL REGISTER**

FIRST USE 5-9-2012; IN COMMERCE 5-9-2012.

THE MARK CONSISTS OF STANDARD CHARACTERS WITHOUT CLAIM TO ANY PARTICULAR FONT, STYLE, SIZE, OR COLOR.

SN 85-284,932, FILED 4-4-2011.

AISHA CLARKE, EXAMINING ATTORNEY



*David J. Kyjars*

Director of the United States Patent and Trademark Office

# United States of America

United States Patent and Trademark Office

## READY PACK

**Reg. No. 4,199,448**

ARJ INFUSION SERVICES, INC. (KANSAS CORPORATION)  
10049 LAKEVIEW AVENUE  
LENEXA, KS 66219

**Registered Aug. 28, 2012**

**Int. Cl.: 10**

FOR: KITS FOR PERFORMING IN-HOME INFUSION TREATMENTS, NAMELY, PREPACKAGED COLLECTIONS OF SYRINGES, TUBING, GAUZE AND TOPICAL DISINFECTANT USED TO ADMINISTER MEDICINE INTRAVENOUSLY FOR IN-HOME INFUSION TREATMENT OF BLOOD DISORDERS, IN CLASS 10 (U.S. CLS. 26, 39 AND 44).

**TRADEMARK**

**PRINCIPAL REGISTER**

FIRST USE 3-0-2011; IN COMMERCE 3-0-2011.

THE MARK CONSISTS OF STANDARD CHARACTERS WITHOUT CLAIM TO ANY PARTICULAR FONT, STYLE, SIZE, OR COLOR.

NO CLAIM IS MADE TO THE EXCLUSIVE RIGHT TO USE "PACK", APART FROM THE MARK AS SHOWN.

SN 85-285,090, FILED 4-4-2011.

SKYE YOUNG, EXAMINING ATTORNEY



*David J. Kyros*

Director of the United States Patent and Trademark Office

# United States of America

United States Patent and Trademark Office



**Reg. No. 4,199,449**

**Registered Aug. 28, 2012**

**Int. Cl.: 2**

**TRADEMARK**

**PRINCIPAL REGISTER**

JOVIAL INC. (NEW JERSEY CORPORATION), DBA SILVER SAILS PAINTS,  
691 WICKLOW WAY  
RIVER VALE, NJ 07675

FOR: COATING COMPOSITIONS IN THE NATURE OF PAINT FOR INDUSTRIAL APPLICATIONS, IN CLASS 2 (U.S. CLS. 6, 11 AND 16).

FIRST USE 5-30-2011; IN COMMERCE 5-30-2011.

A DESIGN OF SAILS IN AN OVAL CIRCLE WITH THE SAILS IN BLUE AND SILVER WITH BLACK OUTLINES. THE WORDING "SILVER SAILS" IS DIRECTLY BELOW THE DESIGN AND IN SILVER WITH AN UNDERLINE ALSO IN SILVER.

THE COLOR(S) BLUE, SILVER, AND BLACK IS/ARE CLAIMED AS A FEATURE OF THE MARK.

SN 85-286,200, FILED 4-5-2011.

CURTIS FRENCH, EXAMINING ATTORNEY



*David J. Kybas*

Director of the United States Patent and Trademark Office

# United States of America

United States Patent and Trademark Office



**Reg. No. 4,199,450**

**Registered Aug. 28, 2012**

**Int. Cl.: 2**

**TRADEMARK**

**PRINCIPAL REGISTER**

JOVIAL INC. (NEW JERSEY CORPORATION), DBA SILVER SAILS PAINTS,  
691 WICKLOW WAY  
RIVER VALE, NJ 07675

FOR: COATING COMPOSITIONS IN THE NATURE OF PAINT CONTAINING THERMOSETTING RESINS AND THERMOPLASTIC RESINS USED TO COAT METAL PRODUCTS, FOR INDUSTRIAL APPLICATIONS, IN CLASS 2 (U.S. CLS. 6, 11 AND 16).

FIRST USE 5-30-2011; IN COMMERCE 5-30-2011.

A DESIGN OF SAILS IN AN OVAL CIRCLE WITH THE SAILS IN WHITE AND SILVER ON A BLUE OVAL WITH A SILVER BORDER. THE WORDING "YINYAN" IS DIRECTLY BELOW THE DESIGN AND IN SILVER.

THE COLOR(S) BLUE, SILVER, AND WHITE IS/ARE CLAIMED AS A FEATURE OF THE MARK.

THE ENGLISH TRANSLATION OF THE WORD "YINFAN" IN THE MARK IS "SILVER SAILS".

SN 85-286,486, FILED 4-5-2011.

CURTIS FRENCH, EXAMINING ATTORNEY



*David J. Kyros*

Director of the United States Patent and Trademark Office

# United States of America

United States Patent and Trademark Office

## We Want Tacos!

**Reg. No. 4,199,451**

**Registered Aug. 28, 2012**

**Int. Cl.: 35**

**SERVICE MARK**

**PRINCIPAL REGISTER**

DENVER TACO BELL RESTAURANT ADVERTISING ASSOCIATION INC. (COLORADO CORPORATION)  
924 WEST COLFAX AVENUE, SUITE 302  
DENVER, CO 80204

FOR: RETAIL STORE SERVICES FEATURING TACOS, IN CLASS 35 (U.S. CLS. 100, 101 AND 102).

FIRST USE 1-1-2011; IN COMMERCE 4-1-2011.

THE MARK CONSISTS OF STANDARD CHARACTERS WITHOUT CLAIM TO ANY PARTICULAR FONT, STYLE, SIZE, OR COLOR.

SN 85-287,108, FILED 4-5-2011.

JEAN IM, EXAMINING ATTORNEY



*David J. Kyffers*

Director of the United States Patent and Trademark Office

# United States of America

United States Patent and Trademark Office



**Reg. No. 4,199,452**

HAYFORD, WILLIAM (UNITED STATES INDIVIDUAL)  
157 E. MAIN ST. NORTH  
RAPID CITY, SD 57701

**Registered Aug. 28, 2012**

**Int. Cl.: 41**

FOR: PERSONAL FITNESS TRAINING SERVICES AND CONSULTANCY; PHYSICAL FITNESS STUDIO SERVICES, NAMELY, PROVIDING GROUP EXERCISE INSTRUCTION, EQUIPMENT, AND FACILITIES; PROVIDING AN INTERACTIVE WEBSITE FEATURING INFORMATION AND LINKS RELATING TO FITNESS, IN CLASS 41 (U.S. CLS. 100, 101 AND 107).

**SERVICE MARK**

**PRINCIPAL REGISTER**

FIRST USE 9-15-2011; IN COMMERCE 9-15-2011.

NO CLAIM IS MADE TO THE EXCLUSIVE RIGHT TO USE "FITNESS", APART FROM THE MARK AS SHOWN.

THE MARK CONSISTS OF AN OVAL IN SHAPE ON ITS SIDE, AND THE TEXT "HURRICANE FITNESS" IN THE MIDDLE, SURROUNDED BY SWIRLS.

SN 85-287,159, FILED 4-5-2011.

APRIL HESIK, EXAMINING ATTORNEY



*David J. Kyfos*

Director of the United States Patent and Trademark Office



# United States of America

United States Patent and Trademark Office

## Streets of Georgetown

**Reg. No. 4,199,453**

**Registered Aug. 28, 2012**

**Int. Cl.: 35**

**SERVICE MARK**

**PRINCIPAL REGISTER**

HMX POLAND SP. Z.O.O., LUXEMBOURG BRANCH (POLAND SPÓLKA Z OGRANICZONA ODPOWIEDZIALNOSCIA (SP. Z.O.O.))  
ALLEE SCHEFFER STREET NO. 1  
LUXEMBOURG, LUXEMBOURG L-2520

FOR: RETAIL STORE SERVICES FEATURING APPAREL AND ACCESSORIES, IN CLASS 35 (U.S. CLS. 100, 101 AND 102).

FIRST USE 9-23-2011; IN COMMERCE 9-23-2011.

THE MARK CONSISTS OF STANDARD CHARACTERS WITHOUT CLAIM TO ANY PARTICULAR FONT, STYLE, SIZE, OR COLOR.

SN 85-287,850, FILED 4-6-2011.

MICHAEL ENGEL, EXAMINING ATTORNEY



*David J. Kybas*

Director of the United States Patent and Trademark Office

# United States of America

United States Patent and Trademark Office

## FREEDOM TOGETHER

**Reg. No. 4,199,454**

NAP, INC. (COLORADO CORPORATION), DBA SLEEPY WRAP, INC.,  
P. O. BOX 3808  
BOULDER, CO 80307

**Registered Aug. 28, 2012**

**Int. Cl.: 18**

FOR: ALL-PURPOSE CARRYING BAGS; BABY CARRIERS WORN ON THE BODY; LUGGAGE, IN CLASS 18 (U.S. CLS. 1, 2, 3, 22 AND 41).

**TRADEMARK**

FIRST USE 10-1-2011; IN COMMERCE 10-1-2011.

**PRINCIPAL REGISTER**

THE MARK CONSISTS OF STANDARD CHARACTERS WITHOUT CLAIM TO ANY PARTICULAR FONT, STYLE, SIZE, OR COLOR.

SN 85-288,403, FILED 4-6-2011.

ALYSSA STEEL, EXAMINING ATTORNEY



*David J. Kyffers*

Director of the United States Patent and Trademark Office

# United States of America

United States Patent and Trademark Office

## Idée Fixe Clothing & Apparel

**Reg. No. 4,199,455**

**Registered Aug. 28, 2012**

**Int. Cl.: 25**

**TRADEMARK**

**PRINCIPAL REGISTER**

POLK, MICHAEL D (UNITED STATES INDIVIDUAL), DBA IDÉE FIXE CLOTHING & APPAREL,  
2880 ROCKWOOD RD  
EAST POINT, GA 30344

FOR: A-SHIRTS; ATHLETIC APPAREL, NAMELY, SHIRTS, PANTS, JACKETS, FOOTWEAR, HATS AND CAPS, ATHLETIC UNIFORMS; BASEBALL CAPS AND HATS; CLOTHING FOR BABIES, TODDLERS AND CHILDREN, TREATED WITH FIRE AND HEAT RETARDANTS, NAMELY, PAJAMAS, JACKETS, SHIRTS, PANTS, JUMPERS; HATS; HOODED SWEAT SHIRTS; JOGGING PANTS; POLO SHIRTS; SHIRTS; SHIRTS AND SHORT-SLEEVED SHIRTS; SHIRTS FOR INFANTS, BABIES, TODDLERS AND CHILDREN; T-SHIRTS, IN CLASS 25 (U.S. CLS. 22 AND 39).

FIRST USE 4-16-2012; IN COMMERCE 4-16-2012.

THE MARK CONSISTS OF STANDARD CHARACTERS WITHOUT CLAIM TO ANY PARTICULAR FONT, STYLE, SIZE, OR COLOR.

NO CLAIM IS MADE TO THE EXCLUSIVE RIGHT TO USE "CLOTHING & APPAREL", APART FROM THE MARK AS SHOWN.

SN 85-288,412, FILED 4-6-2011.

WILLIAM VERHOSEK, EXAMINING ATTORNEY



*David J. Kypos*

Director of the United States Patent and Trademark Office

# United States of America

United States Patent and Trademark Office

# I-KLING

**Reg. No. 4,199,456**

PRESSENSE (ILLINOIS LIMITED LIABILITY COMPANY)  
13655 MAIN STREET  
LEMONT, IL 60439

**Registered Aug. 28, 2012**

**Int. Cl.: 16**

FOR: PRINT SUBSTRATE, NAMELY, TRANSPARENT, OPAQUE, AND TRANSLUCENT FILMS FOR USE WITH INK JET COPIERS AND LASER PRINTERS, IN CLASS 16 (U.S. CLS. 2, 5, 22, 23, 29, 37, 38 AND 50).

**TRADEMARK**

FIRST USE 1-25-2008; IN COMMERCE 2-20-2008.

**PRINCIPAL REGISTER**

THE MARK CONSISTS OF STANDARD CHARACTERS WITHOUT CLAIM TO ANY PARTICULAR FONT, STYLE, SIZE, OR COLOR.

SN 85-289,791, FILED 4-8-2011.

SCOTT BIBB, EXAMINING ATTORNEY



*David J. Kyffers*

Director of the United States Patent and Trademark Office

# United States of America

United States Patent and Trademark Office

## LEADING WITH Y.E.S.

**Reg. No. 4,199,457**

YES2YES COMPANY (PENNSYLVANIA LIMITED LIABILITY COMPANY)  
3760 MANCHESTER ROAD

**Registered Aug. 28, 2012**

ALLENTOWN, PA 18104

**Int. Cl.: 41**

FOR: PROFESSIONAL COACHING SERVICES IN THE FIELD OF LEADERSHIP AND BUSINESS LEADERSHIP DEVELOPMENT; CONSULTING SERVICES IN THE FIELD OF LEADERSHIP TRAINING; EDUCATIONAL CONSULTING SERVICES IN THE FIELD OF LEADERSHIP DEVELOPMENT; EDUCATIONAL SERVICES, NAMELY, CONDUCTING SEMINARS, WORKSHOPS, TELECLASSES IN THE FIELD OF LEADERSHIP AND BUSINESS LEADERSHIP DEVELOPMENT, IN CLASS 41 (U.S. CLS. 100, 101 AND 107).

**SERVICE MARK**

**PRINCIPAL REGISTER**

FIRST USE 5-18-2012; IN COMMERCE 5-18-2012.

THE MARK CONSISTS OF STANDARD CHARACTERS WITHOUT CLAIM TO ANY PARTICULAR FONT, STYLE, SIZE, OR COLOR.

SN 85-290,154, FILED 4-8-2011.

DOMINICK J. SALEMI, EXAMINING ATTORNEY



*David J. Kyros*

Director of the United States Patent and Trademark Office

# United States of America

United States Patent and Trademark Office

## Y.E.S.: YOUR EXTRAORDINARY STORY

**Reg. No. 4,199,458**

YES2YES COMPANY (PENNSYLVANIA LIMITED LIABILITY COMPANY)  
3760 MANCHESTER ROAD  
ALLENTOWN, PA 18104

**Registered Aug. 28, 2012**

**Int. Cl.: 41**

FOR: PROFESSIONAL COACHING SERVICES IN THE FIELD OF LEADERSHIP AND BUSINESS LEADERSHIP DEVELOPMENT; CONSULTING SERVICES IN THE FIELD OF LEADERSHIP TRAINING; EDUCATIONAL CONSULTING SERVICES IN THE FIELD OF LEADERSHIP DEVELOPMENT; EDUCATIONAL SERVICES, NAMELY, CONDUCTING SEMINARS, WORKSHOPS, TELECLASSES IN THE FIELD OF LEADERSHIP AND BUSINESS LEADERSHIP DEVELOPMENT, IN CLASS 41 (U.S. CLS. 100, 101 AND 107).

**SERVICE MARK**

**PRINCIPAL REGISTER**

FIRST USE 5-18-2012; IN COMMERCE 5-18-2012.

THE MARK CONSISTS OF STANDARD CHARACTERS WITHOUT CLAIM TO ANY PARTICULAR FONT, STYLE, SIZE, OR COLOR.

SN 85-290,167, FILED 4-8-2011.

DOMINICK J. SALEMI, EXAMINING ATTORNEY



*David J. Kybas*

Director of the United States Patent and Trademark Office

# United States of America

United States Patent and Trademark Office



**Reg. No. 4,199,459**

**Registered Aug. 28, 2012**

**Int. Cl.: 35**

**SERVICE MARK**

**PRINCIPAL REGISTER**

SAINT GEORGE CONSULTING INC. (VIRGINIA CORPORATION)  
2603 AMANDA CT  
VIENNA, VA 22180

FOR: ACCOUNT AUDITING; ACCOUNTANCY SERVICES; ACCOUNTING CONSULTATION; ACCOUNTING FOR THIRD PARTIES; ACCOUNTING SERVICES; ACCOUNTS RECEIVABLE SERVICES; ADMINISTRATION, BILLING AND RECONCILIATION OF ACCOUNTS ON BEHALF OF OTHERS; ADMINISTRATIVE ACCOUNTING; ADVICE RELATING TO THE ORGANIZATION AND MANAGEMENT OF BUSINESS; ADVISORY SERVICES RELATING TO BUSINESS MANAGEMENT AND BUSINESS OPERATIONS; ANALYZING AND COMPILING DATA FOR MEASURING THE PERFORMANCE OF FINANCIAL MARKETS; ASSISTANCE AND ADVICE REGARDING BUSINESS ORGANIZATION AND MANAGEMENT; ASSISTANCE IN MANAGEMENT OF BUSINESS ACTIVITIES; ASSISTANCE TO INDUSTRIAL OR COMMERCIAL ENTERPRISES IN THE RUNNING OF THEIR BUSINESS; ASSISTANCE WITH BUSINESS MANAGEMENT AND PLANNING; ASSISTANCE, ADVICE AND CONSULTANCY WITH REGARD TO BUSINESS PLANNING, BUSINESS ANALYSIS, BUSINESS MANAGEMENT AND BUSINESS ORGANIZATION RELATING TO PURCHASING FUNCTIONS; ASSISTANCE, ADVISORY SERVICES AND CONSULTANCY WITH REGARD TO BUSINESS PLANNING, BUSINESS ANALYSIS, BUSINESS MANAGEMENT, AND BUSINESS ORGANIZATION; ASSISTANCE, ADVISORY SERVICES AND CONSULTANCY WITH REGARD TO BUSINESS PLANNING, BUSINESS ANALYSIS, BUSINESS MANAGEMENT, BUSINESS ORGANIZATION, MARKETING AND CUSTOMER ANALYSIS; AUDIT SUPPORT SERVICES, NAMELY, REVIEW AND ANALYSIS OF A COMPANY'S SALES, AS WELL AS THE PREPARATION, ORGANIZATION AND PRESENTATION OF THE DOCUMENTS AND DATA REQUESTED BY A GOVERNMENT BODY, AND ADVICE ON GOVERNMENT AUDIT PROCESSES, POLICIES AND STRATEGY; BUSINESS ADMINISTRATION AND MANAGEMENT; BUSINESS ADMINISTRATION AND OFFICE WORK; BUSINESS ADMINISTRATION ASSISTANCE; BUSINESS ADMINISTRATION CONSULTANCY; BUSINESS ADVICE AND ANALYSIS OF MARKETS; BUSINESS ADVICE AND COMMERCIAL INFORMATION; BUSINESS ADVICE AND INFORMATION; BUSINESS ADVICE AND INFORMATION RELATING TO LOANS, FINANCE AND CAPITAL; BUSINESS ADVICE, INQUIRIES OR INFORMATION; BUSINESS ADVISORY SERVICES, CONSULTANCY AND INFORMATION; BUSINESS ANALYSIS AND BUSINESS STRATEGIC PLANNING SERVICES IN THE TECHNOLOGY INDUSTRY; BUSINESS ASSISTANCE, ADVISORY SERVICES AND CONSULTANCY IN THE FIELDS OF BUDGETING, BOOKKEEPING, PREPARATION AND FILING OF CLAIMS, PREPARATION AND FILING OF FORMS, BILL PAYING, ORGANIZING AND PROCESSING PAPERWORK, DEVELOPMENT OF PLAN TO ACHIEVE GOALS AND



*David J. Kybas*

Director of the United States Patent and Trademark Office

**Reg. No. 4,199,459** REFERRAL SERVICES TO BEREAVEMENT COUNSELORS; BUSINESS ASSISTANCE, MANAGEMENT AND INFORMATION SERVICES; BUSINESS AUDITING; BUSINESS CONSULTATION; BUSINESS CONSULTATION IN THE FIELD OF BUSINESS LEADERSHIP DEVELOPMENT; BUSINESS CONSULTATION SERVICES; BUSINESS CONSULTATION SERVICES IN THE FIELDS OF SUPPLY CHAIN ANALYSIS, REGULATION COMPLIANCE AND COUNTERFEIT DETECTION; BUSINESS CONSULTATION SERVICES, NAMELY, BUSINESS PROCESS IMPROVEMENT AND ENTERPRISE ARCHITECTURE DESIGN; BUSINESS CONSULTING AND BUSINESS INFORMATION FOR ENTERPRISES; BUSINESS CONSULTING AND INFORMATION SERVICES; BUSINESS CONSULTING SERVICES IN THE FIELD OF INFORMATION ASSURANCE; BUSINESS CONSULTING SERVICES IN THE FIELD OF ORGANIZATIONAL CHANGE MANAGEMENT; BUSINESS CONSULTING SERVICES, NAMELY, PROVIDING ASSISTANCE IN DEVELOPMENT OF BUSINESS STRATEGIES AND CREATIVE IDEATION; BUSINESS CONSULTING, MANAGEMENT, PLANNING AND SUPERVISION; BUSINESS DATA ANALYSIS; BUSINESS DEVELOPMENT CONSULTING SERVICES; BUSINESS DEVELOPMENT SERVICES; BUSINESS DEVELOPMENT SERVICES, NAMELY, PROVIDING START-UP SUPPORT FOR BUSINESSES OF OTHERS; BUSINESS FEASIBILITY STUDIES; BUSINESS INFORMATION AND ACCOUNTING ADVISORY SERVICES; BUSINESS INFORMATION AND INQUIRIES; BUSINESS INFORMATION MANAGEMENT; BUSINESS KNOWLEDGE MANAGEMENT SERVICES; BUSINESS MANAGEMENT; BUSINESS MANAGEMENT ADVICE; BUSINESS MANAGEMENT AND CONSULTING SERVICES FOR THE HEALTH CARE INDUSTRY, NAMELY, CUSTOMER SERVICE, ACCOUNTING SERVICES, AND MARKETING SERVICES; BUSINESS MANAGEMENT CONSULTANCY AND ADVISORY SERVICES; BUSINESS MANAGEMENT CONSULTANCY AS WELL AS DEVELOPMENT OF PROCESSES FOR THE ANALYSIS AND THE IMPLEMENTATION OF STRATEGY PLANS AND MANAGEMENT PROJECTS; BUSINESS MANAGEMENT CONSULTATION AND SERVICES, NAMELY, MANAGING AND ADMINISTERING NON-CORE FUNCTIONS, NAMELY, MAILING AND SHIPPING, RECORDS MANAGEMENT, INFORMATION SERVICES, ADMINISTRATION, PAYROLL AND ACCOUNTING, AND TELEMARKETING SERVICES; BUSINESS ORGANIZATION AND MANAGEMENT CONSULTING SERVICES; BUSINESS PROCESS RE-ENGINEERING SERVICES; BUSINESS RECORDS MANAGEMENT; BUSINESS RECORDS MANAGEMENT SERVICES RELATING TO BUSINESS ENTITY FORMATION AND ASSOCIATED STATE REPORTING REQUIREMENTS; BUSINESS RISK ASSESSMENT SERVICES; BUSINESS RISK MANAGEMENT; BUSINESS RISK MANAGEMENT CONSULTATION; BUSINESS STRATEGIC PLANNING SERVICES; BUSINESS STRATEGY DEVELOPMENT SERVICES; BUSINESS SUPERVISION; BUSINESS SUPPORT SERVICES, NAMELY, BUSINESS CONSULTING TO FREELANCERS, START-UPS, EXISTING BUSINESSES AND NON-PROFIT ORGANIZATIONS; COLLECTING AND ANALYZING CLAIMS DATA FROM HEALTHCARE ORGANIZATIONS FOR BUSINESS PURPOSES; CONDUCTING FEASIBILITY STUDIES FOR BUSINESS PURPOSES; CONSULTANCY AND ADVISORY SERVICES IN THE FIELD OF BUSINESS STRATEGY; CONSULTANCY SERVICES REGARDING BUSINESS STRATEGIES; CONSULTING AND INFORMATION CONCERNING ACCOUNTING; CONSULTING SERVICES IN BUSINESS LEADERSHIP DEVELOPMENT AND BUSINESS MANAGEMENT; CONSULTING SERVICES IN BUSINESS ORGANIZATION AND MANAGEMENT; CONSULTING SERVICES, NAMELY, EXPERT ANALYSIS AND MANAGEMENT CONSULTING IN ECONOMICS AND ACCOUNTING; COST ACCOUNTING; ESTATE MANAGEMENT, NAMELY, ASSISTANCE IN THE GATHERING AND ORGANIZATION OF PERSONAL VITAL AND FINANCIAL RECORDS IN CONJUNCTION WITH INSTRUCTIONS FOR HANDLING OF SUCH DOCUMENTS BY OTHERS, INCLUDING EXECUTORS AND ATTORNEYS, UPON DEATH OR WHEN OTHERWISE NECESSARY; FINANCIAL RECORDS MANAGEMENT; FINANCIAL STATEMENT PREPARATION AND ANALYSIS FOR BUSINESSES; FORENSIC ACCOUNTING SERVICES; GOVERNMENT RELATIONS CONSULTANCY SERVICES; INCOME TAX CONSULTATION; INCOME TAX PREPARATION; MANAGEMENT AND OPERATION ASSISTANCE TO COMMERCIAL BUSINESSES; PREPARATION OF BUSINESS REPORTS; PREPARING FINANCIAL REPORTS FOR OTHERS; PROFESSIONAL BUSINESS CONSULTATION; PROFESSIONAL BUSINESS CONSULTING; PROVIDING INFORMATION AND ANALYSIS IN THE FIELDS OF ECONOMICS AND BUSINESS; PROVIDING INFORMATION AND NEWS IN THE FIELD OF BUSINESS,



**Reg. No. 4,199,459** NAMELY, INFORMATION AND NEWS ON CURRENT EVENTS AND ON ECONOMIC, LEGISLATIVE, AND REGULATORY DEVELOPMENTS AS IT RELATES TO AND CAN IMPACT BUSINESSES; PROVIDING INFORMATION IN THE FIELDS OF BUSINESS INNOVATION PROCESS, BUSINESS MANAGEMENT AND BUSINESS OPPORTUNITIES; PROVIDING ONLINE BUSINESS MANAGEMENT SERVICES INCLUDING ACCOUNTING, MARKETING, BUSINESS PROJECT MANAGEMENT, AND BUSINESS DEVELOPMENT; TAX ADVISORY SERVICES; TAX AND TAXATION PLANNING, ADVICE, INFORMATION AND CONSULTANCY SERVICES; TAX CONSULTATION; TAX PREPARATION, IN CLASS 35 (U.S. CLS. 100, 101 AND 102).

FIRST USE 4-23-2011; IN COMMERCE 4-23-2011.

NO CLAIM IS MADE TO THE EXCLUSIVE RIGHT TO USE "CONSULTING", APART FROM THE MARK AS SHOWN.

THE COLOR(S) GOLD, RED, BLACK AND WHITE IS/ARE CLAIMED AS A FEATURE OF THE MARK.

THE MARK CONSISTS OF A SHIELD AND THE WORDING "SGC SAINT GEORGE CONSULTING". THE SHIELD IS GOLD WITH BLACK SHADOWING AND CONTAINS A RED CROSS AND AN OUTER OUTLINE OF THE SHIELD IN BLACK. CENTERED ON THE INTERSECTING PORTION OF THE RED CROSS IS A GOLD AND RED DIAMOND WITH A GOLD DIAMOND IN THE MIDDLE. THE LETTERS "SGC" APPEAR ON TOP OF THE RED CROSS ON THE SHIELD AND IS GOLD WITH A LITTLE WHITE SHADOWING AND OUTLINED IN BLACK. THE TOP OF THE SHIELD HAS A GOLD CROWN WITH 3 RED DIAMONDS BORDERING WITH GOLD CENTERS. TO THE RIGHT OF THE SHIELD IS THE BLACK UNDERLINED WORDING: "SAINT GEORGE" WITH "CONSULTING" UNDERNEATH APPEARING IN THE COLOR BLACK.

SN 85-290,884, FILED 4-8-2011.

MARK T. MULLEN, EXAMINING ATTORNEY

# United States of America

United States Patent and Trademark Office

## Tax-Free Retiree

**Reg. No. 4,199,460**

MARKETING DYNAMICS, INC. (ARIZONA CORPORATION)  
7335 E. SIERRA MORENA CIRCLE  
MESA, AZ 85207

**Registered Aug. 28, 2012**

**Int. Cl.: 35**

FOR: INSURANCE MARKETING SERVICES, NAMELY, PROMOTION OF FINANCIAL AND INSURANCE SERVICES ON BEHALF OF THIRD PARTIES, IN CLASS 35 (U.S. CLS. 100, 101 AND 102).

**SERVICE MARK**

FIRST USE 5-1-2011; IN COMMERCE 5-1-2011.

**PRINCIPAL REGISTER**

THE MARK CONSISTS OF STANDARD CHARACTERS WITHOUT CLAIM TO ANY PARTICULAR FONT, STYLE, SIZE, OR COLOR.

SN 85-291,043, FILED 4-9-2011.

KAREN K. BUSH, EXAMINING ATTORNEY



*David J. Kyffers*

Director of the United States Patent and Trademark Office

# United States of America

United States Patent and Trademark Office



**Reg. No. 4,199,461**

ORANGE, DAVID (UNITED STATES INDIVIDUAL), DBA QUESTS AND SUMMITS LLC,  
2965 BRIGGS AVENUE  
BRONX, NY 10458

**Registered Aug. 28, 2012**

**Int. Cl.: 41**

FOR: BUSINESS EDUCATION AND TRAINING SERVICES, NAMELY, DEVELOPING AND FACILITATING CUSTOMIZED LEADERSHIP AND EXECUTIVE DEVELOPMENT PROGRAMS, PROVIDING EXECUTIVE COACHING SERVICES, AND PROVIDING BUSINESS EDUCATION PROGRAMS TO EMPLOYEES AND EXECUTIVES; BUSINESS EDUCATION AND TRAINING SERVICES, NAMELY, DEVELOPING, AND FACILITATING CUSTOMIZED IN-COMPANY LEADERSHIP AND EXECUTIVE DEVELOPMENT PROGRAMS, PROVIDING EXECUTIVE COACHING SERVICES, AND PROVIDING PUBLIC AND IN-COMPANY KEYNOTE PRESENTATIONS TO BUSINESS LEADERS; CHARITABLE SERVICES, NAMELY, PROVIDING VOCATIONAL EDUCATION IN THE FIELDS OF CONSTRUCTION AND FLIGHT TRAINING TO OBTAIN PILOT'S LICENSE, PROVIDING CAREER GUIDANCE, AND PROVIDING GROUP COACHING IN THE FIELD OF LEADERSHIP DEVELOPMENT TO DISADVANTAGED YOUTH; EDUCATIONAL SERVICES, NAMELY, A LEARNING AND INNOVATION CENTER FEATURING FULLY CUSTOMIZED LEADERSHIP, MOTIVATIONAL, EDUCATIONAL, AND BRAINSTORMING TRAINING; PROVIDING GROUP COACHING AND LEARNING FORUMS IN THE FIELD OF LEADERSHIP DEVELOPMENT, IN CLASS 41 (U.S. CLS. 100, 101 AND 107).

**SERVICE MARK**

**PRINCIPAL REGISTER**

FIRST USE 5-15-2012; IN COMMERCE 5-15-2012.



THE MARK CONSISTS OF FOOTPRINTS THAT ARE ARRANGED TO FORM THE LETTER "C" SO THAT THE MARK IS READ AS "CHANGE JOURNEYS"; 3 MOUNTAIN PEAKS ARE POSITIONED JUST OVER THE LETTERS "NGE" AND "JOU"; A CRESCENT MOON IS POSITIONED IMMEDIATELY TO THE RIGHT OF THE 3 MOUNTAIN PEAKS NEAR THE TOP OF THE PEAKS.

SN 85-291,513, FILED 4-11-2011.

JULIE GUTTADAURO, EXAMINING ATTORNEY

*David J. Kyffers*

Director of the United States Patent and Trademark Office

# United States of America

United States Patent and Trademark Office

# Aquatat

**Reg. No. 4,199,462**

KOLOS, EDWARD (UNITED STATES INDIVIDUAL)  
7938 SW JACK JAMES DR  
STUART, FL 34997

**Registered Aug. 28, 2012**

**Int. Cl.: 5**

FOR: MEDICINAL CREAMS FOR SKIN CARE, IN CLASS 5 (U.S. CLS. 6, 18, 44, 46, 51 AND 52).

**TRADEMARK**

FIRST USE 6-26-2011; IN COMMERCE 6-27-2011.

**PRINCIPAL REGISTER**

THE MARK CONSISTS OF STANDARD CHARACTERS WITHOUT CLAIM TO ANY PARTICULAR FONT, STYLE, SIZE, OR COLOR.

SN 85-291,558, FILED 4-11-2011.

EDWARD NELSON, EXAMINING ATTORNEY



*David J. Kybas*

Director of the United States Patent and Trademark Office

# United States of America

United States Patent and Trademark Office

# Nasalzyme

**Reg. No. 4,199,463**

KOLOS, EDWARD (UNITED STATES INDIVIDUAL)  
7938 SW JACK JAMES DR.  
STUART, FL 34997

**Registered Aug. 28, 2012**

**Int. Cl.: 3**

FOR: TOPICAL SKIN SPRAYS FOR COSMETIC PURPOSES, IN CLASS 3 (U.S. CLS. 1, 4, 6, 50, 51 AND 52).

**TRADEMARK**

FIRST USE 8-4-2010; IN COMMERCE 8-4-2010.

**PRINCIPAL REGISTER**

THE MARK CONSISTS OF STANDARD CHARACTERS WITHOUT CLAIM TO ANY PARTICULAR FONT, STYLE, SIZE, OR COLOR.

SN 85-291,673, FILED 4-11-2011.

EDWARD NELSON, EXAMINING ATTORNEY



*David J. Kyfos*

Director of the United States Patent and Trademark Office

# United States of America

United States Patent and Trademark Office

# SENTIKON

**Reg. No. 4,199,464**

WOODHOUSE, SHEILA (UNITED STATES INDIVIDUAL)  
1082 ARBOR TRACE NE  
ATLANTA, GA 30319

**Registered Aug. 28, 2012**

**Int. Cl.: 35**

FOR: BUSINESS CONSULTING SERVICES IN THE FIELDS OF HEALTHCARE, CORPORATE AND GOVERNMENT, IN CLASS 35 (U.S. CLS. 100, 101 AND 102).

**SERVICE MARK**

FIRST USE 8-1-2011; IN COMMERCE 8-1-2011.

**PRINCIPAL REGISTER**

THE MARK CONSISTS OF STANDARD CHARACTERS WITHOUT CLAIM TO ANY PARTICULAR FONT, STYLE, SIZE, OR COLOR.

SN 85-292,385, FILED 4-12-2011.

MELISSA VALLILLO, EXAMINING ATTORNEY



*David J. Kybas*

Director of the United States Patent and Trademark Office

# United States of America

United States Patent and Trademark Office

## ALOSTAR BANK OF COMMERCE

**Reg. No. 4,199,465**

ALABAMA ACQUISITION CORP. (ALABAMA CORPORATION)  
1310 DRAYCOTT PLACE  
ATLANTA, GA 30327

**Registered Aug. 28, 2012**

**Int. Cl.: 36**

FOR: BANKING SERVICES, IN CLASS 36 (U.S. CLS. 100, 101 AND 102).

**SERVICE MARK**

FIRST USE 6-1-2012; IN COMMERCE 6-1-2012.

**PRINCIPAL REGISTER**

THE MARK CONSISTS OF STANDARD CHARACTERS WITHOUT CLAIM TO ANY PARTICULAR FONT, STYLE, SIZE, OR COLOR.

NO CLAIM IS MADE TO THE EXCLUSIVE RIGHT TO USE "BANK OF COMMERCE", APART FROM THE MARK AS SHOWN.

SN 85-292,564, FILED 4-12-2011.

ELLEN B. AWRICH, EXAMINING ATTORNEY



*David J. Kyffers*

Director of the United States Patent and Trademark Office

# United States of America

United States Patent and Trademark Office

# Beachstone

**Reg. No. 4,199,466**

MEETING HOUSE DESIGNS (MAINE CORPORATION)  
192 MUSSEY ST.

**Registered Aug. 28, 2012**

SOUTH PORTLAND, ME 04106

**Int. Cl.: 19**

FOR: BUILDING MATERIALS, NAMELY, NON-METAL COUNTERTOPS FOR FURTHER  
INSTALLATION, IN CLASS 19 (U.S. CLS. 1, 12, 33 AND 50).

**TRADEMARK**

FIRST USE 1-19-2010; IN COMMERCE 12-10-2011.

**PRINCIPAL REGISTER**

THE MARK CONSISTS OF STANDARD CHARACTERS WITHOUT CLAIM TO ANY PAR-  
TICULAR FONT, STYLE, SIZE, OR COLOR.

SN 85-293,723, FILED 4-13-2011.

DARRYL SPRUILL, EXAMINING ATTORNEY



*David J. Kyffers*

Director of the United States Patent and Trademark Office



**United States of America**  
United States Patent and Trademark Office

**Superite**

**Reg. No. 4,199,467**

**Registered Aug. 28, 2012**

**Int. Cl.: 9**

**TRADEMARK**

**PRINCIPAL REGISTER**

CHICAGO ELECTRONICS, INC (ILLINOIS CORPORATION)  
B  
8812 DEE ROAD  
DES PLAINES, IL 60016

FOR: ELECTRIC PRODUCTS, NAMELY, VOLTAGE CONVERTERS, VOLTAGE ADAPTERS, VOLTAGE REGULATORS, ELECTRIC PLUGS, ELECTRIC POWER CONVERSION DEVICES, VOLTAGE TRANSFORMERS, POWER TRANSFORMERS, AC/DC ADAPTERS, IN CLASS 9 (U.S. CLS. 21, 23, 26, 36 AND 38).

FIRST USE 4-12-2011; IN COMMERCE 9-1-2011.

THE MARK CONSISTS OF THE STYLIZED TEXT "SUPERITE" WITH AN ELECTRIC PLUG AT THE BOTTOM.

SN 85-294,423, FILED 4-13-2011.

ANNE FARRELL, EXAMINING ATTORNEY



*David J. Kyffers*

Director of the United States Patent and Trademark Office

# United States of America

United States Patent and Trademark Office

## Little Green Me

**Reg. No. 4,199,468**

**Registered Aug. 28, 2012**

**Int. Cl.: 35**

**SERVICE MARK**

**PRINCIPAL REGISTER**

LITTLE GREEN ME (CALIFORNIA PARTNERSHIP)  
417 ASSOCIATED ROAD, #304  
BREA, CA 92821

FOR: RETAIL STORE AND ON-LINE RETAIL STORE SERVICES FEATURING ENVIRONMENTALLY FRIENDLY PRODUCTS, NAMELY, CANDLES, PERFUME, COLOGNE, BODY CREAMS, SKIN CARE CREAMS, AND SOAP, ROOM SPRAYS AND DIFFUSERS, WATCHES, JEWELRY, AND HANDBAGS, BLANKETS, BABY BOTTLES, BABY CREAMS, WASHES, OINTMENTS, STATIONERY, AND DISHES, IN CLASS 35 (U.S. CLS. 100, 101 AND 102).

FIRST USE 10-14-2011; IN COMMERCE 10-14-2011.

THE MARK CONSISTS OF STANDARD CHARACTERS WITHOUT CLAIM TO ANY PARTICULAR FONT, STYLE, SIZE, OR COLOR.

NO CLAIM IS MADE TO THE EXCLUSIVE RIGHT TO USE "GREEN", APART FROM THE MARK AS SHOWN.

SN 85-296,902, FILED 4-15-2011.

DAVID C. REIHNER, EXAMINING ATTORNEY



*David J. Kyffers*

Director of the United States Patent and Trademark Office

# United States of America

United States Patent and Trademark Office

# EZ-STREET

**Reg. No. 4,199,469**

THOR TECH, INC. (NEVADA CORPORATION)  
419 WEST PIKE STREET

**Registered Aug. 28, 2012**

JACKSON CENTER, OH 45334

**Int. Cl.: 12**

FOR: BUSES, IN CLASS 12 (U.S. CLS. 19, 21, 23, 31, 35 AND 44).

**TRADEMARK**

FIRST USE 0-0-2011; IN COMMERCE 0-0-2011.

**PRINCIPAL REGISTER**

THE MARK CONSISTS OF STANDARD CHARACTERS WITHOUT CLAIM TO ANY PARTICULAR FONT, STYLE, SIZE, OR COLOR.

SN 85-297,760, FILED 4-18-2011.

CHRISTINE COOPER, EXAMINING ATTORNEY



*David J. Kyffers*

Director of the United States Patent and Trademark Office

# United States of America

United States Patent and Trademark Office

# REDUCE ME

**Reg. No. 4,199,470**

TUPPERWARE PRODUCTS S.A. (SWITZERLAND CORPORATION)  
ROUTE DU JURA 37

**Registered Aug. 28, 2012**

FRIBOURG, SWITZERLAND CH-1700

**Int. Cl.: 3**

FOR: NON-MEDICATED SKIN CARE PREPARATIONS, IN CLASS 3 (U.S. CLS. 1, 4, 6, 50, 51 AND 52).

**TRADEMARK**

FIRST USE 5-31-2012; IN COMMERCE 5-31-2012.

**PRINCIPAL REGISTER**

THE MARK CONSISTS OF STANDARD CHARACTERS WITHOUT CLAIM TO ANY PARTICULAR FONT, STYLE, SIZE, OR COLOR.

SN 85-297,808, FILED 4-18-2011.

NELSON SNYDER, EXAMINING ATTORNEY



*David J. Kybas*

Director of the United States Patent and Trademark Office

# United States of America

United States Patent and Trademark Office



**Reg. No. 4,199,471**

VERONICA CAMPANELLA (UNITED STATES INDIVIDUAL)  
321 E. PEDROGOSA STREET  
SANTA BARBARA, CA 93101

**Registered Aug. 28, 2012**

**Int. Cl.: 35**

FOR: RETAIL STORE SERVICES FEATURING SWIMWEAR, IN CLASS 35 (U.S. CLS. 100, 101 AND 102).

**SERVICE MARK**

FIRST USE 6-1-2012; IN COMMERCE 6-1-2012.

**PRINCIPAL REGISTER**

THE MARK CONSISTS OF THE STYLIZED LETTERS "CALIOCA" WITH A SINGLE WAVE FORMING THE FIRST STYLIZED LETTER "C".

SN 85-298,198, FILED 4-18-2011.

PRISCILLA MILTON, EXAMINING ATTORNEY



*David J. Kybas*

Director of the United States Patent and Trademark Office

# United States of America

United States Patent and Trademark Office

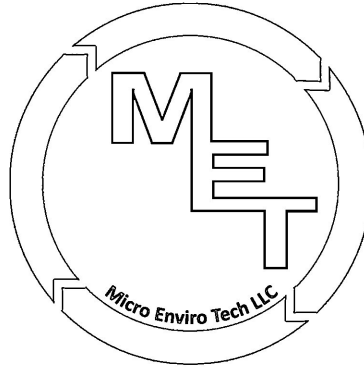

**Reg. No. 4,199,472**

MICRO ENVIRO TECH LLC (TEXAS LIMITED LIABILITY COMPANY)  
705 STEPHENS LN.  
MARION, TX 78124

**Registered Aug. 28, 2012**

**Int. Cl.: 35**

FOR: RETAIL STORE SERVICES FEATURING CLEANING PRODUCTS, IN CLASS 35 (U.S. CLS. 100, 101 AND 102).

**SERVICE MARK**

FIRST USE 6-1-2011; IN COMMERCE 6-1-2011.

**PRINCIPAL REGISTER**

NO CLAIM IS MADE TO THE EXCLUSIVE RIGHT TO USE "MICRO" AND "TECH LLC", APART FROM THE MARK AS SHOWN.

THE MARK CONSISTS OF A CIRCLE WITH ARROWS, "MET" DIAGONAL ACROSS MIDDLE, AND "MICRO ENVIRO TECH LLC" IN CURVED TEXT ACROSS BOTTOM.

SN 85-298,759, FILED 4-19-2011.

DAVID I, EXAMINING ATTORNEY



*David J. Kybas*

Director of the United States Patent and Trademark Office

# United States of America

United States Patent and Trademark Office

## Follow the Arrow

**Reg. No. 4,199,473**

**Registered Aug. 28, 2012**

**Int. Cl.: 9**

**TRADEMARK**

**PRINCIPAL REGISTER**

INTERJACENT TECHNOLOGY SYSTEMS, INC. (CALIFORNIA CORPORATION)  
747 HAINES RANCH ROAD  
CORRALITOS, CA 95076

FOR: DOWNLOADABLE COMPUTER SOFTWARE FOR USE ON MOBILE PHONES, SMART PHONES AND OTHER MOBILE DEVICES FOR INTEGRATING GEO-LOCATION DATA AND INFORMATION ABOUT PLACES OF INTEREST, IN CLASS 9 (U.S. CLS. 21, 23, 26, 36 AND 38).

FIRST USE 7-28-2011; IN COMMERCE 7-28-2011.

THE MARK CONSISTS OF STANDARD CHARACTERS WITHOUT CLAIM TO ANY PARTICULAR FONT, STYLE, SIZE, OR COLOR.

SN 85-299,836, FILED 4-20-2011.

MICHELE SWAIN, EXAMINING ATTORNEY



*David J. Kyffers*

Director of the United States Patent and Trademark Office

# United States of America

United States Patent and Trademark Office

# ZippyMeals

**Reg. No. 4,199,474**

ZIPPYZEN, LLC (VIRGINIA LIMITED LIABILITY COMPANY)  
2435 KIMBROUGH CIR  
CHARLOTTESVILLE, VA 22901

**Registered Aug. 28, 2012**

**Int. Cl.: 42**

FOR: PROVIDING A WEB SITE FEATURING TECHNOLOGY THAT ENABLES USERS TO MANAGE A MEALS ON WHEELS OPERATION, IN CLASS 42 (U.S. CLS. 100 AND 101).

**SERVICE MARK**

FIRST USE 8-1-2008; IN COMMERCE 8-1-2008.

**PRINCIPAL REGISTER**

THE MARK CONSISTS OF STANDARD CHARACTERS WITHOUT CLAIM TO ANY PARTICULAR FONT, STYLE, SIZE, OR COLOR.

SN 85-300,062, FILED 4-20-2011.

JENNIFER VASQUEZ, EXAMINING ATTORNEY



*David J. Kybas*

Director of the United States Patent and Trademark Office



# United States of America

United States Patent and Trademark Office

## TASTING ROOM 707

**Reg. No. 4,199,475**

**Registered Aug. 28, 2012**

**Int. Cl.: 41**

**SERVICE MARK**

**PRINCIPAL REGISTER**

CHATEAU DIANA LLC (CALIFORNIA LIMITED LIABILITY COMPANY)  
6195 DRY CREEK ROAD  
HEALDSBURG, CA 95448

FOR: ENTERTAINMENT, EDUCATION AND TRAINING SERVICES, ALL RELATING TO WINE, NAMELY, CONDUCTING SEMINARS AND WORKSHOPS IN THE FIELD OF WINE AND DISTRIBUTING COURSE MATERIALS IN CONNECTION THEREWITH; WINE TASTING EVENTS AND COMPETITIONS; ORGANIZATION OF WINE TASTING EVENTS AND COMPETITIONS; ENTERTAINMENT SERVICES, NAMELY, WINE TASTING; AND PROVIDING INFORMATION AND ADVICE RELATING TO WINE TASTING SERVICES, IN CLASS 41 (U.S. CLS. 100, 101 AND 107).

FIRST USE 2-1-2012; IN COMMERCE 2-1-2012.

THE MARK CONSISTS OF STANDARD CHARACTERS WITHOUT CLAIM TO ANY PARTICULAR FONT, STYLE, SIZE, OR COLOR.

OWNER OF U.S. REG. NO. 3,336,529.

NO CLAIM IS MADE TO THE EXCLUSIVE RIGHT TO USE "TASTING ROOM", APART FROM THE MARK AS SHOWN.

SN 85-300,193, FILED 4-20-2011.

MARILYN IZZI, EXAMINING ATTORNEY



*David J. Kyros*

Director of the United States Patent and Trademark Office

# United States of America

United States Patent and Trademark Office



**Reg. No. 4,199,476**

**Registered Aug. 28, 2012**

**Int. Cl.: 41**

**SERVICE MARK**

**PRINCIPAL REGISTER**

SHE ROCK SHE ROCK (MINNESOTA NON-PROFIT ORGANIZATION)  
4440 COLFAX AVENUE SOUTH  
MINNEAPOLIS, MN 55419

FOR: DAY CAMP SERVICES; RECREATIONAL CAMPS; CONDUCTING WORKSHOPS AND SEMINARS IN THE FIELD OF MUSICAL INSTRUMENT INSTRUCTION, PERFORMANCE BASED MUSICAL INSTRUCTION, MUSIC APPRECIATION, MUSIC PERFORMANCE, SONGWRITING AND ARRANGING, MUSIC HISTORY, HIP-HOP MUSIC, ROCK AND ROLL MUSIC, POPULAR MUSIC, DANCING, LIFE SKILLS DEVELOPMENT, INCREASING SELF-ESTEEM, SELF-EMPOWERMENT, MARKETING AND FORMING A MUSICAL BAND; EDUCATION SERVICES, NAMELY, PROVIDING CLASSES, SEMINARS AND WORKSHOPS IN THE FIELD OF MUSICAL INSTRUMENT INSTRUCTION, MUSIC APPRECIATION, MUSIC PERFORMANCE, SONGWRITING AND ARRANGING, MUSIC HISTORY, HIP-HOP MUSIC, ROCK AND ROLL MUSIC, POPULAR MUSIC, DANCING, LIFE SKILLS DEVELOPMENT, DEVELOPING TEAM WORK AND CONFLICT RESOLUTION, MARKETING AND FORMING A MUSICAL BAND; PROVIDING AFTER-SCHOOL, WEEKEND AND SUMMER EDUCATIONAL PROGRAMS FOR CHILDREN IN GRADES K-12; PROVIDING AFTER-SCHOOL, WEEKEND AND SUMMER EDUCATIONAL PROGRAMS FOR WOMEN IN THE FIELD OF MUSICAL INSTRUMENT INSTRUCTION, MUSIC APPRECIATION, MUSIC PERFORMANCE, PERFORMANCE BASED MUSICAL INSTRUCTION, SONGWRITING AND ARRANGING, MUSIC HISTORY, HIP-HOP MUSIC, ROCK AND ROLL MUSIC, POPULAR MUSIC, DANCING, LIFE SKILLS DEVELOPMENT, INCREASING SELF-ESTEEM, SELF-EMPOWERMENT, DEVELOPING TEAM WORK AND CONFLICT RESOLUTION, MARKETING AND FORMING A MUSICAL BAND; CONCERT BOOKING; AND ENTERTAINMENT IN THE NATURE OF LIVE MUSICAL PERFORMANCES BY MUSICIANS, SINGERS, COMPOSERS, STUDENTS, AND MUSIC PRODUCERS, IN CLASS 41 (U.S. CLS. 100, 101 AND 107).



FIRST USE 3-24-2011; IN COMMERCE 3-24-2011.

NO CLAIM IS MADE TO THE EXCLUSIVE RIGHT TO USE "GIRLS ROCK AND ROLL RETREAT", APART FROM THE MARK AS SHOWN.

*David J. Kyros*

Director of the United States Patent and Trademark Office

THE MARK CONSISTS OF THE WORDS "GIRLS ROCK N ROLL RETREAT" ABOVE A BLACK CIRCLE CONTAINING A WHITE STAR, A DEPICTION OF A SINGING GIRL'S HEAD, A HAND HOLDING A MICROPHONE, EIGHT STUDS PLACED EQUIDISTANTLY ON THE OUTER EDGE OF THE CIRCLE TO CREATE A DEPICTION THAT THE CIRCLE

**Reg. No. 4,199,476** IS A BASS DRUM, AND BLACK BOXES OUTLINED IN WHITE AND OUTLINED AGAIN IN BLACK, CONTAINING THE LETTERS "GRRR" AND A SMALL STAR BETWEEN EACH BOX.

SN 85-301,068, FILED 4-21-2011.

STEVEN R. FINE, EXAMINING ATTORNEY

# United States of America

United States Patent and Trademark Office

## YOUR LIFETIME AUTOMOTIVE ADVISOR

**Reg. No. 4,199,477**

**Registered Aug. 28, 2012**

**Int. Cls.: 9 and 35**

**TRADEMARK**

**SERVICE MARK**

**PRINCIPAL REGISTER**

AUTOBYTEL INC. (DELAWARE CORPORATION)  
18872 MACARTHUR BOULEVARD  
IRVINE, CA 92612

FOR: COMPUTER APPLICATION SOFTWARE FOR MOBILE PHONES, HANDHELD COMPUTERS, TABLETS AND OTHER INTERNET CONNECTED MOBILE DEVICES, NAMELY, SOFTWARE FOR MATCHING CONSUMERS' PURCHASE AND SERVICE REQUESTS TO RETAIL PROVIDERS VIA A GLOBAL COMPUTER NETWORK, DISSEMINATION OF ADVERTISING VIA A GLOBAL COMPUTER NETWORK, AND PROVIDING INFORMATION ABOUT AUTOMOBILES FOR SALE BY MEANS OF A GLOBAL COMPUTER NETWORK, IN CLASS 9 (U.S. CLS. 21, 23, 26, 36 AND 38).

FIRST USE 6-8-2012; IN COMMERCE 6-8-2012.

FOR: BUSINESS SERVICES IN THE NATURE OF PROVIDING ASSISTANCE TO CONSUMERS BY MATCHING CONSUMERS' PURCHASE AND SERVICE REQUESTS TO RETAIL PROVIDERS VIA A GLOBAL COMPUTER NETWORK; ADVERTISING SERVICES, NAMELY, ASSISTING IN THE SALE OF GOODS AND SERVICES OF OTHERS BY FACILITATING COMMUNICATION BETWEEN CONSUMERS AND RETAILERS THROUGH DISSEMINATION OF ADVERTISING VIA A GLOBAL COMPUTER NETWORK; MARKETING AND ADVERTISING SERVICES FOR AUTOMOBILE DEALERSHIPS; PROVIDING INFORMATION ABOUT AUTOMOBILES FOR SALE BY MEANS OF A GLOBAL COMPUTER NETWORK, IN CLASS 35 (U.S. CLS. 100, 101 AND 102).

FIRST USE 10-9-2010; IN COMMERCE 10-9-2010.

THE MARK CONSISTS OF STANDARD CHARACTERS WITHOUT CLAIM TO ANY PARTICULAR FONT, STYLE, SIZE, OR COLOR.

NO CLAIM IS MADE TO THE EXCLUSIVE RIGHT TO USE "AUTOMOTIVE" FOR CLASS 9 AND FOR "AUTOMOTIVE ADVISOR" FOR CLASS 35, APART FROM THE MARK AS SHOWN.

SN 85-302,732, FILED 4-22-2011.

HENRY S. ZAK, EXAMINING ATTORNEY



*David J. Kyffers*

Director of the United States Patent and Trademark Office

# United States of America

United States Patent and Trademark Office



**Reg. No. 4,199,478**

**Registered Aug. 28, 2012**

**Int. Cl.: 29**

**TRADEMARK**

**PRINCIPAL REGISTER**

HQM LTD. (DELAWARE CORPORATION)  
1007 ORANGE STREET  
WILMINGTON, DE 19801

FOR: PORK, IN CLASS 29 (U.S. CL. 46).

FIRST USE 1-16-2012; IN COMMERCE 1-16-2012.

OWNER OF U.S. REG. NOS. 1,250,561, 2,381,877, AND OTHERS.

THE COLOR(S) YELLOW, WHITE, BLUE, RED AND BLACK IS/ARE CLAIMED AS A FEATURE OF THE MARK.

THE MARK CONSISTS OF THE WORD "HATFIELD" WHICH APPEARS IN WHITE, OUTLINED IN RED, ON A YELLOW SUNBURST DESIGN SURROUNDING A BLUE OVAL WITH WHITE RAYS. BELOW THE SUNBURST IS A BLACK BANNER OUTLINED IN YELLOW, BEARING THE PHRASE "CHEF MASTER" IN WHITE, WITH A WHITE CHEF'S HAT.

SN 85-303,129, FILED 4-24-2011.

LAKEISHA LEWIS, EXAMINING ATTORNEY



*David J. Kyffers*

Director of the United States Patent and Trademark Office

# United States of America

United States Patent and Trademark Office



**Reg. No. 4,199,479**

**Registered Aug. 28, 2012**

**Int. Cl.: 29**

**TRADEMARK**

**PRINCIPAL REGISTER**

HQM LTD. (DELAWARE CORPORATION)  
1007 ORANGE STREET  
WILMINGTON, DE 19801

FOR: PORK, IN CLASS 29 (U.S. CL. 46).

FIRST USE 1-16-2012; IN COMMERCE 1-16-2012.

OWNER OF U.S. REG. NOS. 1,250,561, 2,381,877, AND OTHERS.

THE COLOR(S) YELLOW, WHITE, BLUE, AND RED IS/ARE CLAIMED AS A FEATURE OF THE MARK.

THE MARK CONSISTS OF THE WORD "HATFIELD" WHICH APPEARS IN WHITE, OUTLINED IN RED, ON A YELLOW SUNBURST DESIGN SURROUNDING A BLUE OVAL WITH WHITE RAYS. BELOW THE SUNBURST IS A BLUE BANNER OUTLINED IN YELLOW, BEARING THE PHRASE "CHEF SIGNATURE" IN WHITE, WITH A WHITE CHEF'S HAT.

SN 85-303,130, FILED 4-24-2011.

LAKEISHA LEWIS, EXAMINING ATTORNEY



*David J. Kybas*

Director of the United States Patent and Trademark Office

# United States of America

United States Patent and Trademark Office

## Important Life Matters

**Reg. No. 4,199,480**

NON-TRIVIAL QUEST LLC (CALIFORNIA LIMITED LIABILITY COMPANY)  
2415 SAN RAMON VALLEY BLVD., #4-415  
SAN RAMON, CA 945831651

**Registered Aug. 28, 2012**

**Int. Cl.: 28**

FOR: BOARD GAMES, IN CLASS 28 (U.S. CLS. 22, 23, 38 AND 50).

**TRADEMARK**

FIRST USE 11-14-2011; IN COMMERCE 11-14-2011.

**PRINCIPAL REGISTER**

THE MARK CONSISTS OF STANDARD CHARACTERS WITHOUT CLAIM TO ANY PARTICULAR FONT, STYLE, SIZE, OR COLOR.

SN 85-303,972, FILED 4-25-2011.

NAKIA HENRY, EXAMINING ATTORNEY



*David J. Kyffers*

Director of the United States Patent and Trademark Office

# United States of America

United States Patent and Trademark Office

## What we really need to know in life today

**Reg. No. 4,199,481**

NON-TRIVIAL QUEST LLC (CALIFORNIA LIMITED LIABILITY COMPANY)  
2415 SAN RAMON VALLEY BLVD., #4-415  
SAN RAMON, CA 945831651

**Registered Aug. 28, 2012**

**Int. Cl.: 28**

FOR: BOARD GAMES, IN CLASS 28 (U.S. CLS. 22, 23, 38 AND 50).

**TRADEMARK**

FIRST USE 11-14-2011; IN COMMERCE 11-14-2011.

**PRINCIPAL REGISTER**

THE MARK CONSISTS OF STANDARD CHARACTERS WITHOUT CLAIM TO ANY PARTICULAR FONT, STYLE, SIZE, OR COLOR.

SN 85-304,019, FILED 4-25-2011.

NAKIA HENRY, EXAMINING ATTORNEY



*David J. Kyffers*

Director of the United States Patent and Trademark Office



# United States of America

United States Patent and Trademark Office

# Humidifix

**Reg. No. 4,199,482**

**Registered Aug. 28, 2012**

**Int. Cl.: 11**

**TRADEMARK**

**PRINCIPAL REGISTER**

HUMIDIFIX INTERNATIONAL INC. (TENNESSEE CORPORATION)  
204 SNEAD DRIVE  
CROSSVILLE, TN 38558

FOR: DEHUMIDIFIERS, IN CLASS 11 (U.S. CLS. 13, 21, 23, 31 AND 34).

FIRST USE 6-7-2010; IN COMMERCE 12-8-2010.

THE MARK CONSISTS OF STANDARD CHARACTERS WITHOUT CLAIM TO ANY PARTICULAR FONT, STYLE, SIZE, OR COLOR.

SN 85-304,613, FILED 4-26-2011.

TARA PATE, EXAMINING ATTORNEY



*David J. Kybas*

Director of the United States Patent and Trademark Office

# United States of America

United States Patent and Trademark Office

# WAYBETTER

**Reg. No. 4,199,483**

WAYBETTER LTD (ISRAEL CORPORATION)  
6 YONI NETANYAHU ST  
OR YEHUDA, ISRAEL

**Registered Aug. 28, 2012**

**Int. Cl.: 9**

FOR: COMPUTER SOFTWARE AND APPLICATION SOFTWARE FOR ENABLING VEHICLE DISPATCH, TAXI DISPATCH, PUBLIC TRANSPORTATION SCHEDULING, RIDE-SHARING, RIDE ORDERING, CARPOOLING, CARGO TRANSPORT AND OPTIMIZATION OF VEHICLE FLEETS, IN CLASS 9 (U.S. CLS. 21, 23, 26, 36 AND 38).

**TRADEMARK**

**PRINCIPAL REGISTER**

FIRST USE 8-3-2011; IN COMMERCE 8-3-2011.

THE MARK CONSISTS OF STANDARD CHARACTERS WITHOUT CLAIM TO ANY PARTICULAR FONT, STYLE, SIZE, OR COLOR.

SN 85-305,567, FILED 4-27-2011.

JANICE L. MCMORROW, EXAMINING ATTORNEY



*David J. Kyros*

Director of the United States Patent and Trademark Office

# United States of America

United States Patent and Trademark Office



**Reg. No. 4,199,484**

**Registered Aug. 28, 2012**

**Int. Cl.: 7**

**TRADEMARK**

**PRINCIPAL REGISTER**

BEL - EXPORT LTDA. (BRAZIL LIMITED COMPANY (LTD.))  
RODOVIA LUIZ ROSSO, 4230 - KM 04  
CRICIUMA - SC, BRAZIL

FOR: HYDRAULIC ENGINES AND MACHINES FOR USE WITH POWER TRANSMISSIONS;  
HYDRAULIC PUMPS AS PARTS OF MACHINES AND ENGINES; PUMPS FOR INDUSTRIAL  
USE, NAMELY, HYDRAULIC PUMPS AND PISTON PUMPS, IN CLASS 7 (U.S. CLS. 13, 19,  
21, 23, 31, 34 AND 35).

FIRST USE 8-0-2011; IN COMMERCE 8-0-2011.

THE MARK CONSISTS OF A STYLIZED LETTER "H" IN OLIVE GREEN WITH A WHITE  
CENTER WHICH INCLUDES THE WORDING "HYBEL" IN BLACK AND TWO HORIZONTAL  
LINES IN BLACK ABOVE AND BELOW THE WHITE CENTER.

THE COLOR(S) OLIVE GREEN, WHITE AND BLACK IS/ARE CLAIMED AS A FEATURE  
OF THE MARK.

SN 85-305,762, FILED 4-27-2011.

KAREN K. BUSH, EXAMINING ATTORNEY



*David J. Kyffers*

Director of the United States Patent and Trademark Office

# United States of America

United States Patent and Trademark Office

## RITE WRAP NATURAL

**Reg. No. 4,199,485**

**Registered Aug. 28, 2012**

**Int. Cl.: 16**

**TRADEMARK**

**PRINCIPAL REGISTER**

DIXIE CONSUMER PRODUCTS LLC (DELAWARE LIMITED LIABILITY COMPANY)  
GA030-41N  
133 PEACHTREE STREET NE  
ATLANTA, GA 30303

FOR: FOOD WRAPPERS MADE IN PRINCIPAL PART OF NATURAL MATERIALS, IN CLASS 16 (U.S. CLS. 2, 5, 22, 23, 29, 37, 38 AND 50).

FIRST USE 11-11-2011; IN COMMERCE 4-7-2012.

THE MARK CONSISTS OF STANDARD CHARACTERS WITHOUT CLAIM TO ANY PARTICULAR FONT, STYLE, SIZE, OR COLOR.

OWNER OF U.S. REG. NOS. 1,195,713, 1,658,946, AND 2,934,054.

NO CLAIM IS MADE TO THE EXCLUSIVE RIGHT TO USE "WRAP NATURAL", APART FROM THE MARK AS SHOWN.

SN 85-305,785, FILED 4-27-2011.

NANCY CLARKE, EXAMINING ATTORNEY



*David J. Kyfos*

Director of the United States Patent and Trademark Office

# United States of America

United States Patent and Trademark Office

## DURA TOWEL

**Reg. No. 4,199,486**

**Registered Aug. 28, 2012**

**Int. Cl.: 24**

**TRADEMARK**

**PRINCIPAL REGISTER**

ALOK INTERNATIONAL INC. (TEXAS CORPORATION)  
123 OAK LAWN AVENUE  
DALLAS, TX 75207

FOR: TOWELS MADE OF TEXTILE MATERIAL, IN CLASS 24 (U.S. CLS. 42 AND 50).

FIRST USE 3-15-2012; IN COMMERCE 3-15-2012.

THE MARK CONSISTS OF STANDARD CHARACTERS WITHOUT CLAIM TO ANY PARTICULAR FONT, STYLE, SIZE, OR COLOR.

NO CLAIM IS MADE TO THE EXCLUSIVE RIGHT TO USE "TOWEL", APART FROM THE MARK AS SHOWN.

SN 85-306,203, FILED 4-27-2011.

GRETТА YAO, EXAMINING ATTORNEY



*David J. Kyffers*

Director of the United States Patent and Trademark Office

# United States of America

United States Patent and Trademark Office

## DURA SHEET

**Reg. No. 4,199,487**

ALOK INTERNATIONAL INC. (TEXAS CORPORATION)  
123 OAK LAWN AVENUE  
DALLAS, TX 75207

**Registered Aug. 28, 2012**

**Int. Cl.: 24**

FOR: TEXTILES AND FABRICS, NAMELY, BED SHEETS, AND PILLOW CASES, IN CLASS 24 (U.S. CLS. 42 AND 50).

**TRADEMARK**

FIRST USE 3-15-2012; IN COMMERCE 3-15-2012.

**PRINCIPAL REGISTER**

THE MARK CONSISTS OF STANDARD CHARACTERS WITHOUT CLAIM TO ANY PARTICULAR FONT, STYLE, SIZE, OR COLOR.

NO CLAIM IS MADE TO THE EXCLUSIVE RIGHT TO USE "SHEET", APART FROM THE MARK AS SHOWN.

SN 85-306,292, FILED 4-27-2011.

GRETTA YAO, EXAMINING ATTORNEY



*David J. Kybas*

Director of the United States Patent and Trademark Office

# United States of America

United States Patent and Trademark Office

# MUSY

**Reg. No. 4,199,488**

**Registered Aug. 28, 2012**

**Int. Cl.: 24**

**TRADEMARK**

**PRINCIPAL REGISTER**

ADEN & ANAIS, INC. (NEW YORK CORPORATION)  
SUITE 702  
55 WASHINGTON ST.  
BROOKLYN, NY 11201

FOR: BURP CLOTHS; WASH CLOTHS, IN CLASS 24 (U.S. CLS. 42 AND 50).

FIRST USE 4-27-2011; IN COMMERCE 12-31-2011.

THE MARK CONSISTS OF STANDARD CHARACTERS WITHOUT CLAIM TO ANY PARTICULAR FONT, STYLE, SIZE, OR COLOR.

SN 85-306,720, FILED 4-27-2011.

SUSAN RICHARDS, EXAMINING ATTORNEY



*David J. Kybas*

Director of the United States Patent and Trademark Office

# United States of America

United States Patent and Trademark Office

# AEGEAN

**Reg. No. 4,199,489**

**Registered Aug. 28, 2012**

**Int. Cl.: 35**

**SERVICE MARK**

**PRINCIPAL REGISTER**

PYE, DR. HAROLD T. (UNITED STATES INDIVIDUAL)  
11012 S. WESTERN AVENUE  
CHICAGO, IL 60643

FOR: INTERACTIVE RECORD-KEEPING SERVICES FOR USE IN RISK MANAGEMENT AND REGULATORY COMPLIANCE BY INSURERS AND PROFESSIONALS IN THE MEDICAL FIELD; PROVIDING AN INTERNET-BASED DATABASE OF PATIENT MEDICAL INFORMATION DESIGNED TO FACILITATE PATIENT-AUTHORIZED, HIPAA-COMPLIANT SHARING AND MAINTENANCE OF PATIENT MEDICAL INFORMATION AMONGST A PATIENT'S DOCTORS SUCH THAT THIS INFORMATION CAN BE DIRECTLY INSERTED INTO THE DOCTOR'S MEDICAL REPORTS AS A MEANS OF INCREASING MEDICAL RECORD GENERATION EFFICIENCY AND ACCURACY, IN CLASS 35 (U.S. CLS. 100, 101 AND 102).

FIRST USE 1-1-2012; IN COMMERCE 1-1-2012.

THE MARK CONSISTS OF STANDARD CHARACTERS WITHOUT CLAIM TO ANY PARTICULAR FONT, STYLE, SIZE, OR COLOR.

SN 85-307,453, FILED 4-28-2011.

RAUL CORDOVA, EXAMINING ATTORNEY



*David J. Kybas*

Director of the United States Patent and Trademark Office



# United States of America

United States Patent and Trademark Office

# Bubble Popper

**Reg. No. 4,199,490**

KEMMSIES, SUZANNE M (UNITED STATES INDIVIDUAL)  
12484 YERBA VALLEY RD  
LAKESIDE, CA 92040

**Registered Aug. 28, 2012**

**Int. Cl.: 35**

FOR: RETAIL APPAREL STORES, IN CLASS 35 (U.S. CLS. 100, 101 AND 102).

**SERVICE MARK**

FIRST USE 5-1-2012; IN COMMERCE 5-1-2012.

**PRINCIPAL REGISTER**

THE MARK CONSISTS OF STANDARD CHARACTERS WITHOUT CLAIM TO ANY PARTICULAR FONT, STYLE, SIZE, OR COLOR.

SN 85-307,766, FILED 4-28-2011.

MICHELE SWAIN, EXAMINING ATTORNEY



*David J. Kybas*

Director of the United States Patent and Trademark Office

# United States of America

United States Patent and Trademark Office

## "Hot Flash" Chile Products

**Reg. No. 4,199,491**

RIDDLE, CELIA (UNITED STATES INDIVIDUAL)

**Registered Aug. 28, 2012**

8987 E/ TANQUE VERDE #309-178  
TUCSON, AZ 85749

**Int. Cl.: 30**

FOR: READY MADE CHILE BASED SPECIALTY FOOD CONDIMENTS USED AS A THICKENER AND FOR SEASONING, NAMELY, GREEN CHILE PASTE, RED CHILE PASTE, CHIMIYO CHILE PASTE, HABENERO CHILE PASTE, GHOST CHILE PASTE, JALEPENO CHILE PASTE, CHILE CONDIMENTS IN THE NATURE OF SAUCES AND HONEY, IN CLASS 30 (U.S. CL. 46).

**TRADEMARK**

**PRINCIPAL REGISTER**

FIRST USE 10-1-2009; IN COMMERCE 4-28-2011.

THE MARK CONSISTS OF STANDARD CHARACTERS WITHOUT CLAIM TO ANY PARTICULAR FONT, STYLE, SIZE, OR COLOR.

NO CLAIM IS MADE TO THE EXCLUSIVE RIGHT TO USE "CHILE PRODUCTS", APART FROM THE MARK AS SHOWN.

SN 85-307,855, FILED 4-28-2011.

BARBARA RUTLAND, EXAMINING ATTORNEY



*David J. Kyffers*

Director of the United States Patent and Trademark Office

# United States of America

United States Patent and Trademark Office

## Lord Bless America

**Reg. No. 4,199,492**

**Registered Aug. 28, 2012**

**Int. Cl.: 25**

**TRADEMARK**

**PRINCIPAL REGISTER**

JACKSON DAVID L. (UNITED STATES INDIVIDUAL), DBA DAVID L JACKSON,  
911 SWEETGUM DRIVE  
GULFPORT, MS 39503

FOR: BODY SHIRTS, IN CLASS 25 (U.S. CLS. 22 AND 39).

FIRST USE 5-4-2012; IN COMMERCE 5-5-2012.

THE MARK CONSISTS OF STANDARD CHARACTERS WITHOUT CLAIM TO ANY PARTICULAR FONT, STYLE, SIZE, OR COLOR.

SN 85-307,943, FILED 4-29-2011.

JEFF DEFORD, EXAMINING ATTORNEY



*David J. Kyffers*

Director of the United States Patent and Trademark Office

# United States of America

United States Patent and Trademark Office

## DURA BLANKETS

**Reg. No. 4,199,493**

ALOK INTERNATIONAL INC. (TEXAS CORPORATION)  
123 OAK LAWN AVENUE  
DALLAS, TX 75207

**Registered Aug. 28, 2012**

**Int. Cl.: 24**

FOR: TEXTILES AND FABRICS, NAMELY, BED BLANKETS, COMFORTERS, DUVETS, QUILTS, AND THROWS, IN CLASS 24 (U.S. CLS. 42 AND 50).

**TRADEMARK**

FIRST USE 4-15-2012; IN COMMERCE 4-15-2012.

**PRINCIPAL REGISTER**

THE MARK CONSISTS OF STANDARD CHARACTERS WITHOUT CLAIM TO ANY PARTICULAR FONT, STYLE, SIZE, OR COLOR.

NO CLAIM IS MADE TO THE EXCLUSIVE RIGHT TO USE "BLANKETS", APART FROM THE MARK AS SHOWN.

SN 85-307,970, FILED 4-29-2011.

GRETTA YAO, EXAMINING ATTORNEY



*David J. Kybas*

Director of the United States Patent and Trademark Office

# United States of America

United States Patent and Trademark Office

# FREE FLY

**Reg. No. 4,199,494**

SUTTON, TANNER (UNITED STATES INDIVIDUAL)  
3815 TOMMY ARMOUR CIRCLE  
BILLINGS, MT 59106

**Registered Aug. 28, 2012**

**Int. Cls.: 16 and 25**

FOR: STICKERS, IN CLASS 16 (U.S. CLS. 2, 5, 22, 23, 29, 37, 38 AND 50).

FIRST USE 11-16-2011; IN COMMERCE 11-16-2011.

**TRADEMARK**

FOR: CLOTHING, NAMELY, SHIRTS, T-SHIRTS, HATS, SWEATSHIRTS, BALACLAVAS AND JACKETS, IN CLASS 25 (U.S. CLS. 22 AND 39).

**PRINCIPAL REGISTER**

FIRST USE 11-16-2011; IN COMMERCE 11-16-2011.

THE MARK CONSISTS OF STANDARD CHARACTERS WITHOUT CLAIM TO ANY PARTICULAR FONT, STYLE, SIZE, OR COLOR.

SN 85-308,039, FILED 4-29-2011.

CHRISTINA SOBRAL, EXAMINING ATTORNEY



*David J. Kybas*

Director of the United States Patent and Trademark Office

# United States of America

United States Patent and Trademark Office

# GenTEST

**Reg. No. 4,199,495**

**Registered Aug. 28, 2012**

**Int. Cl.: 42**

**SERVICE MARK**

**PRINCIPAL REGISTER**

SEPRO CORPORATION (INDIANA CORPORATION)  
SUITE 600  
11550 N. MERIDIAN STREET  
CARMEL, IN 46032

FOR: ANALYTICAL LABORATORY TESTING USING DNA SEQUENCING OF PLANT GENETICS FOR PRODUCT EFFICACY AND QUALITY CONTROL PURPOSES, IN CLASS 42 (U.S. CLS. 100 AND 101).

FIRST USE 2-1-2012; IN COMMERCE 2-1-2012.

THE MARK CONSISTS OF STANDARD CHARACTERS WITHOUT CLAIM TO ANY PARTICULAR FONT, STYLE, SIZE, OR COLOR.

SN 85-308,040, FILED 4-29-2011.

GISELLE AGOSTO, EXAMINING ATTORNEY



*David J. Kybas*

Director of the United States Patent and Trademark Office

# United States of America

United States Patent and Trademark Office

## DO SOMETHING GREEN

**Reg. No. 4,199,496**

LEADERSHIP LOUISVILLE FOUNDATION, INCORPORATED (KENTUCKY CORPORATION)  
732 WEST MAIN STREET  
LOUISVILLE, KY 40202

**Registered Aug. 28, 2012**

**Int. Cl.: 35**

FOR: PROMOTING PUBLIC AWARENESS OF ENVIRONMENTAL ISSUES AND INITIATIVES; PROMOTING PUBLIC AWARENESS OF ENVIRONMENTAL MATTERS, IN CLASS 35 (U.S. CLS. 100, 101 AND 102).

**SERVICE MARK**

FIRST USE 0-0-2010; IN COMMERCE 0-0-2010.

**PRINCIPAL REGISTER**

THE MARK CONSISTS OF STANDARD CHARACTERS WITHOUT CLAIM TO ANY PARTICULAR FONT, STYLE, SIZE, OR COLOR.

SN 85-308,169, FILED 4-29-2011.

AMY KERTGATE, EXAMINING ATTORNEY



*David J. Kybas*

Director of the United States Patent and Trademark Office

# United States of America

United States Patent and Trademark Office



**Reg. No. 4,199,497**

**Registered Aug. 28, 2012**

**Int. Cl.: 9**

**TRADEMARK**

**PRINCIPAL REGISTER**

HUDSON INSURANCE COMPANY (DELAWARE CORPORATION)  
300 FIRST STAMFORD PLACE  
STAMFORD, CT 06902

FOR: COMPUTER SOFTWARE AND DOWNLOADABLE COMPUTER SOFTWARE, ALL IN THE FIELD OF CROP INSURANCE, FOR PROVIDING DISCONNECTED INSURANCE RATE QUOTING, PROVIDING WEB-BASED ACCESS TO APPLICATIONS AND SERVICES THROUGH A WEB-OPERATING SYSTEM OR PORTAL INTERFACE, CREATING VARIOUS FORMS AND REPORTS, AND CREATING COMPUTER-GENERATED MAPS, IN CLASS 9 (U.S. CLS. 21, 23, 26, 36 AND 38).

FIRST USE 5-3-2011; IN COMMERCE 5-3-2011.

THE MARK CONSISTS OF THE STYLIZED WORDING "EHARVEST"; THE LEFT SIDE OF THE LETTER "H" CONSISTS OF THREE EARS OF WHEAT WHICH CURVE TO THE LEFT OVER AND ABOVE THE INITIAL LETTER "E".

SN 85-308,268, FILED 4-29-2011.

ESTHER A. BORSUK, EXAMINING ATTORNEY



*David J. Kyjars*

Director of the United States Patent and Trademark Office



# United States of America

## United States Patent and Trademark Office

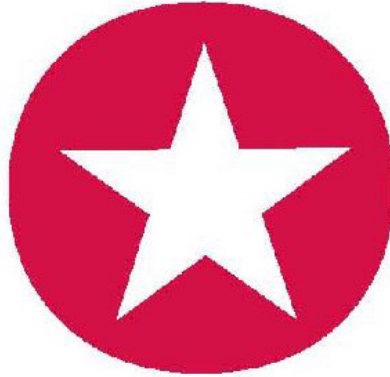

**Reg. No. 4,199,498**

**Registered Aug. 28, 2012**

**Int. Cls.: 9, 35, and 36**

**TRADEMARK**

**SERVICE MARK**

**PRINCIPAL REGISTER**

THE PROUD AMERICANS INC. (TEXAS CORPORATION)  
P.O. BOX 18256  
SUGAR LAND, TX 77496

FOR: DOWNLOADABLE ELECTRONIC PUBLICATIONS IN THE NATURE OF BOOKS, NEWSLETTERS, BULLETINS, BROCHURES, PAMPHLETS, AND MAGAZINES FOR ELDERLY AND RETIRED INDIVIDUALS IN THE FIELDS OF VISION CARE, HEARING CARE, TRAVEL, FINANCIAL PLANNING, INSURANCE, ANNUITIES, LONG TERM CARE, MEDICARE SUPPLEMENTAL INSURANCE, DISABILITY INSURANCE, RETIREMENT, LIFESTYLES OF ELDERLY AND RETIRED INDIVIDUALS, HEALTH, AGING, CONSUMER ISSUES, ECONOMIC SECURITY, AND EXERCISE AND FITNESS, IN CLASS 9 (U.S. CLS. 21, 23, 26, 36 AND 38).

FIRST USE 1-25-2011; IN COMMERCE 1-25-2011.

FOR: ASSOCIATION SERVICES, NAMELY, PROMOTING THE INTERESTS OF ELDERLY AND RETIRED INDIVIDUALS; PROMOTING PUBLIC AWARENESS AND ADVOCACY IN THE FIELDS OF VISION CARE, HEARING CARE, TRAVEL, FINANCIAL PLANNING, INSURANCE, ANNUITIES, LONG TERM CARE, MEDICARE SUPPLEMENTAL INSURANCE, DISABILITY INSURANCE, RETIREMENT, ELDERLY OR RETIRED LIFESTYLES, HEALTH, AGING, CONSUMER ISSUES, ECONOMIC SECURITY, AND EXERCISE AND FITNESS; ADMINISTRATION OF A DISCOUNT PROGRAM FOR ENABLING PARTICIPANTS TO OBTAIN DISCOUNTS ON GOODS AND SERVICES OF OTHERS THROUGH USE OF A DISCOUNT MEMBERSHIP CARD; COOPERATIVE ADVERTISING AND MARKETING; ORGANIZATION OF EXHIBITIONS AND EVENTS CONCERNING RETIREMENT PREPARATION FOR COMMERCIAL OR ADVERTISING PURPOSES; PUBLIC POLICY RESEARCH SERVICES; PROMOTING PUBLIC AWARENESS OF THE NEED FOR SOLUTIONS AND POLICIES IN THE FIELDS OF HEALTH, MEDICAL SERVICES, INSURANCE, RETIREMENT, ELDERLY OR RETIRED LIFESTYLES, FINANCE, AGING, CONSUMER ISSUES, AND ECONOMIC SECURITY, IN CLASS 35 (U.S. CLS. 100, 101 AND 102).

FIRST USE 1-25-2011; IN COMMERCE 1-25-2011.

FOR: FINANCIAL AND INVESTMENT SERVICES, NAMELY, PROVIDING FINANCIAL INFORMATION, ADVICE AND CONSULTATION IN THE FIELDS OF INSURANCE, ANNUITIES, LONG TERM CARE INSURANCE, MEDICARE SUPPLEMENTAL INSURANCE, MONEY MANAGEMENT, AND INVESTMENT; FINANCIAL CONSULTING IN THE NATURE



*David J. Kybas*

Director of the United States Patent and Trademark Office

**Reg. No. 4,199,498** OF FINANCIAL MANAGEMENT MONEY FOR OTHERS AND INVESTMENT ADVISORY SERVICES; FINANCIAL ASSET MANAGEMENT; INVESTMENT MANAGEMENT AND FINANCIAL ASSET MANAGEMENT SERVICES; FINANCIAL INVESTMENT OF FUNDS OF FOR OTHERS; FINANCIAL ADMINISTRATION OF INVESTMENT ASSETS FOR OTHERS; FINANCIAL ADMINISTRATION OF LIFE INSURANCE, LONG TERM CARE INSURANCE, AND DISABILITY INSURANCE; PROVIDING REBATES AT PARTICIPATING ESTABLISHMENTS OF OTHERS THROUGH THE USE OF MEMBERSHIP CARDS AND MEMBERSHIP PROGRAMS; PROVIDING FINANCIAL ADMINISTRATION SERVICES IN THE FIELD OF LIFE INSURANCE, ANNUITIES AND RETIREMENT PLANS, IN CLASS 36 (U.S. CLS. 100, 101 AND 102).

FIRST USE 1-25-2011; IN COMMERCE 1-25-2011.

THE MARK CONSISTS OF A WHITE FIVE-POINTED STAR SUPERIMPOSED OVER THE CENTER OF A SOLID RED CIRCLE.

THE COLOR(S) RED AND WHITE IS/ARE CLAIMED AS A FEATURE OF THE MARK.

SN 85-308,303, FILED 4-29-2011.

MICHAEL TANNER, EXAMINING ATTORNEY

# United States of America

United States Patent and Trademark Office



**Reg. No. 4,199,499**

AMERICAN AUTOMOBILE ASSOCIATION, INC. (CONNECTICUT CORPORATION)  
1000 AAA DRIVE  
HEATHROW, FL 32746

**Registered Aug. 28, 2012**

**Int. Cls.: 39, 41, and 45**

FOR: PROVIDING AUTOMOBILE ASSISTANCE SERVICES, NAMELY, VEHICLE ROUTING BY COMPUTER ON DATA NETWORKS AND CUSTOMIZED DRIVING DIRECTIONS THROUGH COMPONENTS INTEGRATED INTO A MOTOR VEHICLE, NAMELY, TRANSMITTERS, RECEIVERS, MICROPROCESSORS, SOFTWARE, AND ELECTRICAL CIRCUITRY ALL INTERACTING WITH GLOBAL POSITIONING SYSTEM SATELLITE TECHNOLOGY AND THROUGH PORTABLE HAND-HELD TWO-WAY COMMUNICATIONS DEVICES HAVING A GEO-LOCATION CAPABILITY; TRAVEL INFORMATION SERVICES, NAMELY, PROVIDING MOTOR VEHICLE OWNERS AND OPERATORS WITH INFORMATION IDENTIFYING THE GEOGRAPHIC LOCATION OF THEIR VEHICLES THROUGH THE USE OF TWO-WAY WIRELESS COMMUNICATIONS SYSTEMS, GLOBAL POSITIONING SATELLITE SYSTEMS, AND COMPUTER INTEGRATION SYSTEMS; PROVIDING TRAVEL PLANNING AND TRAVEL ROUTING SERVICES; PROVIDING TRAFFIC INFORMATION VIA TRANSMITTERS, RECEIVERS, MICROPROCESSORS, SOFTWARE, CELLULAR PHONES, AND ELECTRICAL ARCHITECTURE ALL INTERACTING WITH GLOBAL POSITIONING SYSTEM SATELLITE TECHNOLOGY AND A CUSTOMER SERVICE CENTER, AND THROUGH PORTABLE, HAND-HELD COMMUNICATIONS DEVICES HAVING A GEO-LOCATION CAPABILITY, IN CLASS 39 (U.S. CLS. 100 AND 105).

**SERVICE MARK**

**PRINCIPAL REGISTER**



FIRST USE 5-23-2012; IN COMMERCE 5-23-2012.

FOR: PROVIDING AUTOMOBILE ASSISTANCE SERVICES, NAMELY, PROVIDING POINTS-OF-INTEREST INFORMATION IN THE NATURE OF HISTORICAL SITES, CURRENT EVENTS, SPORTS EVENTS AND RECREATION AND LEISURE FACILITIES THROUGH COMPONENTS INTEGRATED INTO A MOTOR VEHICLE, NAMELY, TRANSMITTERS, RECEIVERS, MICROPROCESSORS, SOFTWARE, CELLULAR PHONES, AND ELECTRICAL CIRCUITRY ALL INTERACTING WITH GLOBAL POSITIONING SYSTEM SATELLITE TECHNOLOGY, AND THROUGH PORTABLE, HAND-HELD COMMUNICATIONS DEVICES HAVING A GEO-LOCATION CAPABILITY, IN CLASS 41 (U.S. CLS. 100, 101 AND 107).

*David J. Kyros*

FIRST USE 5-23-2012; IN COMMERCE 5-23-2012.

FOR: PROVIDING AUTOMOBILE SECURITY SERVICES, NAMELY, PROVIDING PHYSICAL ACCESS TO INTERIORS OF VEHICLES VIA A REMOTE CALL-IN LOCKING DEVICE,

**Reg. No. 4,199,499** STOLEN VEHICLE TRACKING, LOCATING AND MONITORING SERVICES FOR RECOVERING MOTOR VEHICLES, NOTIFYING MOTOR VEHICLE OWNERS OF THEFT OF THEIR VEHICLE VIA TWO-WAY WIRELESS COMMUNICATION SYSTEMS, GLOBAL POSITIONING SATELLITE SYSTEMS, AND COMPUTER INTEGRATION SYSTEMS, MONITORING VEHICLES FOR SECURITY PURPOSES FOR DEPLOYMENT OF AIRBAGS, AND TO ASCERTAIN GEOGRAPHIC LOCATIONS OF VEHICLES VIA TWO-WAY WIRELESS COMMUNICATION SYSTEMS, GLOBAL POSITIONING SATELLITE SYSTEMS, AND COMPUTER INTEGRATION SYSTEMS, IN CLASS 45 (U.S. CLS. 100 AND 101).

FIRST USE 5-23-2012; IN COMMERCE 5-23-2012.

OWNER OF U.S. REG. NOS. 2,622,099 AND 3,084,767.

THE MARK CONSISTS OF THE WORD "RESPONSE" WITH A STYLIZED STROBE LIGHT ABOVE AND BELOW THE LETTER "N".

SN 85-308,438, FILED 4-29-2011.

CHRISTOPHER BUONGIORNO, EXAMINING ATTORNEY

# United States of America

United States Patent and Trademark Office

# BALL UP

**Reg. No. 4,199,500**

**Registered Aug. 28, 2012**

**Int. Cl.: 9**

**TRADEMARK**

**PRINCIPAL REGISTER**

BALL UP, LLC (TEXAS LIMITED LIABILITY COMPANY)  
3301 AVONDALE AVE.  
FORT WORTH, TX 76109

FOR: PRE-RECORDED ELECTRONIC MEDIA IN THE NATURE OF AUDIO, VIDEO, AND COMPUTER-READABLE DISCS AND DOWNLOADABLE FILES FEATURING BASKETBALL; LASER DISCS FEATURING BASKETBALL; PRE-RECORDED AUDIO AND VIDEO CASSETTES FEATURING BASKETBALL; PRE-RECORDED AUDIO TAPES AND VIDEO TAPES FEATURING BASKETBALL; PRE-RECORDED COMPACT DISCS FEATURING BASKETBALL; PRE-RECORDED ELECTRONIC MEDIA IN THE NATURE OF COMPUTER-READABLE DISCS FEATURING BASKETBALL; COMPUTER PROGRAMS FEATURING GAMES AND INSTRUCTION IN THE FIELD OF BASKETBALL; COMPUTER SOFTWARE FEATURING GAMES AND INSTRUCTION IN THE FIELD OF BASKETBALL; COMPUTER ACCESSORIES, NAMELY, COMPUTER PERIPHERALS IN THE FIELD OF BASKETBALL, IN CLASS 9 (U.S. CLS. 21, 23, 26, 36 AND 38).

FIRST USE 5-0-2011; IN COMMERCE 5-0-2011.

THE MARK CONSISTS OF STANDARD CHARACTERS WITHOUT CLAIM TO ANY PARTICULAR FONT, STYLE, SIZE, OR COLOR.

OWNER OF U.S. REG. NO. 3,409,186.

SN 85-308,454, FILED 4-29-2011.

JAY BESCH, EXAMINING ATTORNEY



*David J. Kypos*

Director of the United States Patent and Trademark Office

# United States of America

United States Patent and Trademark Office

# BALL UP

**Reg. No. 4,199,501**

**Registered Aug. 28, 2012**

**Int. Cl.: 16**

**TRADEMARK**

**PRINCIPAL REGISTER**

BALL UP, LLC (TEXAS LIMITED LIABILITY COMPANY)  
3301 AVONDALE AVE.  
FORT WORTH, TX 76109

FOR: PUBLICATIONS AND PRINTED MATTER, NAMELY, TRADING CARDS, DANCE TEAM TRADING CARDS, MASCOT TRADING CARDS, ENTERTAINMENT TRADING CARDS, POST CARDS, PAPER PLACE MATS, MEMO PADS, BOOK COVERS, WRAPPING PAPER AND POSTERS IN THE FIELD OF BASKETBALL; STICKERS, NAMELY, STICKERS, DECALS, COMMEMORATIVE STAMPS AND BUMPER STICKERS IN THE FIELD OF BASKETBALL; COLLECTIBLE CARDBOARD TRADING CARD DISCS IN THE FIELD OF BASKETBALL; BALL POINT PENS AND PENCILS IN THE FIELD OF BASKETBALL; NOTEBOOKS, NAMELY, THREE-RING BINDERS, WIRE-BOUND NOTEBOOKS, AND PORTFOLIO NOTEBOOKS IN THE FIELD OF BASKETBALL; PHOTOGRAPHS, NAMELY, UNMOUNTED AND MOUNTED PHOTOGRAPHS IN THE FIELD OF BASKETBALL; BOOKS, NAMELY, CHILDREN'S ACTIVITY BOOKS, STATISTICAL BOOKS, CALENDARS, COMMEMORATIVE GAME EVENT PROGRAMS, GUIDE BOOKS AND REFERENCE BOOKS IN THE FIELD OF BASKETBALL; MAGAZINES IN THE FIELD OF BASKETBALL; STATIONERY, NAMELY, STATIONERY FOLDERS, NOTECARDS, PAPER PENNANTS, STATIONERY-TYPE PORTFOLIOS AND PAPER STATISTICAL SHEETS IN THE FIELD OF BASKETBALL; NEWSLETTERS AND PAMPHLETS IN THE FIELD OF BASKETBALL FOR THE DISTRIBUTION TO THE TELEVISION AND RADIO MEDIA, IN CLASS 16 (U.S. CLS. 2, 5, 22, 23, 29, 37, 38 AND 50).

FIRST USE 4-0-2011; IN COMMERCE 4-0-2011.

THE MARK CONSISTS OF STANDARD CHARACTERS WITHOUT CLAIM TO ANY PARTICULAR FONT, STYLE, SIZE, OR COLOR.

OWNER OF U.S. REG. NO. 3,409,186.

SN 85-308,522, FILED 4-29-2011.

JAY BESCH, EXAMINING ATTORNEY



*David J. Kyros*

Director of the United States Patent and Trademark Office

# United States of America

United States Patent and Trademark Office



ČESKÁ ZBROJOVKA  
SINCE 1936

**Reg. No. 4,199,502**

ČESKÁ ZBROJOVKA A.S. (CZECH REPUBLIC CORPORATION)  
SVAT. CECHA 1283

**Registered Aug. 28, 2012**

UHERSKÝ BROD, CZECH REPUBLIC 68827

**Int. Cls.: 8, 13, 16, and 25**

FOR: BAYONETS; KNIVES, NAMELY, HUNTING, FOLDING, ASSAULT AND COMBAT KNIVES, IN CLASS 8 (U.S. CLS. 23, 28 AND 44).

FIRST USE 1-1-2010; IN COMMERCE 1-1-2010.

**TRADEMARK**

FOR: FIREARMS; FIREARM ATTACHMENTS, NAMELY, MOUNTS FOR ATTACHING ACCESSORIES TO A FIREARM; CLEANING IMPLEMENTS FOR FIREARMS, NAMELY, CLEANING BRUSHES FOR FIREARMS AND CLEANING RODS FOR FIREARMS; WEAPON CASES FOR FIREARMS; MAGAZINES FOR FIREARMS; GRIPS FOR SMALL ARMS; DUMMY ROUNDS OF PLASTIC FOR FIREARMS; SLING STRAPS FOR FIREARMS; FIREARM SIGHTS, IN CLASS 13 (U.S. CLS. 2 AND 9).

**PRINCIPAL REGISTER**

FIRST USE 1-1-2010; IN COMMERCE 1-1-2010.

FOR: CATALOGUES IN THE FIELD OF FIREARMS AND FIREARM ACCESSORIES; WRAPPING PAPER; BOOKLETS IN THE FIELD OF FIREARMS AND FIREARM ACCESSORIES; NOTE PAPER; PAPER FORMS, NAMELY, BUSINESS FORMS, BOOKKEEPING FORMS, ACCOUNTING FORMS, ORDER FORMS; PHOTOGRAPHS; CALENDARS; DIARIES; BOOKS IN THE FIELD OF FIREARMS AND FIREARM ACCESSORIES; BOXES OF CARDBOARD OR PAPER; PROPELLING PENCILS IN THE NATURE OF MECHANICAL PENCILS; ENVELOPES; WRAPS, NAMELY, PLASTIC WRAPS, PAPER GIFT WRAPS, AND PAPER CARTONS FOR DELIVERING GOODS; STATIONERY; PRINTED PERIODICALS IN THE FIELD OF FIREARMS AND FIREARM ACCESSORIES; POSTERS; PADS, NAMELY, DRAWING PADS, DESK PADS; LEAFLETS ABOUT FIREARMS AND FIREARM ACCESSORIES; PAPER PUBLICATIONS, NAMELY, BROCHURES, BOOKLETS, AND TEACHING MATERIALS IN THE FIELD OF FIREARMS AND FIREARM ACCESSORIES; ALMANACS; NOTEPADS, IN CLASS 16 (U.S. CLS. 2, 5, 22, 23, 29, 37, 38 AND 50).

FIRST USE 1-1-2010; IN COMMERCE 1-1-2010.

FOR: CLOTHING, NAMELY, T-SHIRTS, SHIRTS, SWEATSHIRTS, JACKETS, SWEATERS, VESTS, PANTS; FOOTWEAR; BASEBALL CAPS, IN CLASS 25 (U.S. CLS. 22 AND 39).



*David J. Kyros*

Director of the United States Patent and Trademark Office

**Reg. No. 4,199,502** FIRST USE 1-1-2010; IN COMMERCE 1-1-2010.

OWNER OF U.S. REG. NOS. 2,863,481 AND 2,985,819.

NO CLAIM IS MADE TO THE EXCLUSIVE RIGHT TO USE "CESKÁ ZBROJOVKA SINCE 1936", APART FROM THE MARK AS SHOWN.

THE MARK CONSISTS OF A CIRCLE WITH A GUN DESIGN INSIDE DISPLAYED NEXT TO THE WORDS "CESKÁ ZBROJOVKA SINCE 1936".

SN 85-308,783, FILED 4-29-2011.

MARCIE MILONE, EXAMINING ATTORNEY



United States of America  
United States Patent and Trademark Office

**DR.V.**

**F E E L G O O D**

**Reg. No. 4,199,503**

V O ENTERPRISES LLC (CALIFORNIA LIMITED LIABILITY COMPANY)

**Registered Aug. 28, 2012**

3334 E. COAST HIGHWAY, STE. 139  
CORONA DEL MAR, CA 92625

**Int. Cl.: 32**

FOR: NON-ALCOHOLIC ENERGY BEVERAGES; NON-ALCOHOLIC SODA WATER ENERGY BEVERAGES INTENDED FOR MIXING WITH ALCOHOLIC BEVERAGES, IN CLASS 32 (U.S. CLS. 45, 46 AND 48).

**TRADEMARK**

FIRST USE 2-24-2011; IN COMMERCE 12-9-2011.

**PRINCIPAL REGISTER**

THE MARK CONSISTS OF THE WORDS "DR. V" IN BOLD FONT AND CAPITAL LETTERING, WHERE BELOW THE "V" ARE TWO DOTS ON BOTH ENDS OF AN OPEN SEMI-CIRCLE SHAPE, THE WORDS "FEEL GOOD" BELOW.

SN 85-308,834, FILED 4-29-2011.

EMILY CARLSEN, EXAMINING ATTORNEY



*David J. Kyffers*

Director of the United States Patent and Trademark Office

# United States of America

United States Patent and Trademark Office

# PCH

**Reg. No. 4,199,504**

GENESIS IP, LLC (DELAWARE LIMITED LIABILITY COMPANY)  
101 EAST STATE STREET  
KENNETT SQUARE, DE 19348

**Registered Aug. 28, 2012**

**Int. Cl.: 44**

FOR: PHYSICAL REHABILITATION SERVICES, NAMELY, METRICS USED TO MEASURE THERAPIST EFFICIENCY, IN CLASS 44 (U.S. CLS. 100 AND 101).

**SERVICE MARK**

FIRST USE 3-1-2012; IN COMMERCE 3-1-2012.

**PRINCIPAL REGISTER**

THE MARK CONSISTS OF STANDARD CHARACTERS WITHOUT CLAIM TO ANY PARTICULAR FONT, STYLE, SIZE, OR COLOR.

SN 85-309,801, FILED 5-2-2011.

KAPIL BHANOT, EXAMINING ATTORNEY



*David J. Kybas*

Director of the United States Patent and Trademark Office

# United States of America

United States Patent and Trademark Office



**Reg. No. 4,199,505**

**Registered Aug. 28, 2012**

**Int. Cls.: 25 and 43**

**TRADEMARK**

**SERVICE MARK**

**PRINCIPAL REGISTER**

GULL INDUSTRIES, INC. (WASHINGTON CORPORATION)  
3404 FOURTH AVENUE SOUTH  
SEATTLE, WA 98134

FOR: CLOTHING, NAMELY, T-SHIRTS, SWEATSHIRTS, SHIRTS, AND CAPS, IN CLASS 25 (U.S. CLS. 22 AND 39).

FIRST USE 6-28-2011; IN COMMERCE 6-28-2011.

FOR: RESORT LODGING SERVICES; TRAVEL AGENCY SERVICES, NAMELY, MAKING RESERVATIONS AND BOOKING FOR TEMPORARY LODGING; RESTAURANT SERVICES, IN CLASS 43 (U.S. CLS. 100 AND 101).

FIRST USE 3-21-2011; IN COMMERCE 3-21-2011.

NO CLAIM IS MADE TO THE EXCLUSIVE RIGHT TO USE "RESORT COPALIS BEACH WASHINGTON", APART FROM THE MARK AS SHOWN.

THE MARK CONSISTS OF THE WORDING "IRON SPRINGS RESORT" ABOVE AN UPSIDE-DOWN CANOE, AND THE WORDS "COPALIS BEACH WASHINGTON" BENEATH THE CANOE, ALL INSIDE A HORIZONTAL OVAL. THE OVAL IS INSIDE A HORIZONTAL RECTANGLE WITH ROUNDED AND EXTENDED SIDES.

SN 85-310,053, FILED 5-2-2011.

ROSELLE HERRERA, EXAMINING ATTORNEY



*David J. Kybas*

Director of the United States Patent and Trademark Office

# United States of America

United States Patent and Trademark Office

## THE FIRST NAME IN MAKEUP EDUCATION

**Reg. No. 4,199,506**

**Registered Aug. 28, 2012**

**Int. Cl.: 41**

**SERVICE MARK**

**PRINCIPAL REGISTER**

EEG, INC. (DELAWARE CORPORATION)  
396 POTTSVILLE-ST. CLAIR HIGHWAY  
POTTSVILLE, PA 17901

FOR: EDUCATION SERVICES IN THE NATURE OF COSMETOLOGY SCHOOLS; EDUCATIONAL SERVICES, NAMELY, CONDUCTING CLASSES, SEMINARS, CONFERENCES, LECTURES AND WORKSHOPS IN THE FIELD OF COSMETOLOGY, AND DISTRIBUTION OF COURSE MATERIALS IN CONNECTION THEREWITH, IN CLASS 41 (U.S. CLS. 100, 101 AND 107).

FIRST USE 4-4-2011; IN COMMERCE 9-12-2011.

THE MARK CONSISTS OF STANDARD CHARACTERS WITHOUT CLAIM TO ANY PARTICULAR FONT, STYLE, SIZE, OR COLOR.

NO CLAIM IS MADE TO THE EXCLUSIVE RIGHT TO USE "MAKEUP EDUCATION", APART FROM THE MARK AS SHOWN.

SN 85-310,261, FILED 5-2-2011.

KATHERINE STOIDES, EXAMINING ATTORNEY



*David J. Kybas*

Director of the United States Patent and Trademark Office

# United States of America

United States Patent and Trademark Office



**Reg. No. 4,199,507**

MEAL4MEAL, INC. (MASSACHUSETTS CORPORATION)  
280 LINCOLN STREET  
ALLSTON, MA 02134

**Registered Aug. 28, 2012**

**Int. Cl.: 35**

FOR: ADMINISTRATION OF A PROGRAM FOR ENABLING PARTICIPANTS TO OBTAIN DISCOUNTS ON THE COST OF SERVICES OR RECEIVE IMPROVED SERVICES; ADVERTISING AND MARKETING SERVICES, NAMELY, PROMOTING THE GOODS AND SERVICES OF OTHERS; ADVERTISING AND PROMOTIONAL SERVICES; PROMOTING THE GOODS AND SERVICES OF OTHERS BY PROVIDING A WEBSITE FEATURING DISCOUNT VOUCHERS, REBATES, PRICE-COMPARISON INFORMATION, PRODUCT REVIEWS, LINKS TO THE RETAIL WEBSITES OF OTHERS, AND DISCOUNT INFORMATION; PROVIDING A WEBSITE WHERE USERS CAN POST RATINGS, REVIEWS AND RECOMMENDATIONS ON RESTAURANTS, FOOD AND WINE FOR COMMERCIAL PURPOSES, IN CLASS 35 (U.S. CLS. 100, 101 AND 102).

**SERVICE MARK**

**PRINCIPAL REGISTER**

FIRST USE 5-11-2011; IN COMMERCE 5-11-2011.

THE MARK CONSISTS OF THE WORD "MEAL" IN ORANGE, WITH A REPRESENTATION OF A PERSON IN ORANGE HOLDING AN ORANGE FORK, CONNECTED TO A PORTION OF AN ORANGE CIRCLE, WITH A REPRESENTATION OF A PERSON IN GREEN ON THE RIGHT, HOLDING A GREEN SPOON, CONNECTED TO A PORTION OF A GREEN CIRCLE, WHEREIN THE ORANGE AND GREEN PORTIONS OF THE CIRCLE LEAVE A WHITE NUMERAL "4" BLANK WITHIN THE COMBINED CIRCLE, WITH THE TERM "MEAL" THERE BENEATH IN GREEN.

THE COLOR(S) ORANGE, GREEN AND WHITE IS/ARE CLAIMED AS A FEATURE OF THE MARK.

SN 85-310,442, FILED 5-3-2011.

YAT SYE, LEE, EXAMINING ATTORNEY



*David J. Kyffers*

Director of the United States Patent and Trademark Office

**United States of America**  
United States Patent and Trademark Office

# TENDUIT

**Reg. No. 4,199,508**

SOFTKVM LLC (WYOMING LIMITED LIABILITY COMPANY)  
1512 PALISADES POINTE LANE  
AUSTIN, TX 78738

**Registered Aug. 28, 2012**

**Int. Cl.: 9**

FOR: COMPUTER PROGRAMS AND RECORDED COMPUTER SOFTWARE FOR THE REMOTE ACCESS AND MANAGEMENT OF INFORMATION, COMMUNICATIONS, STORAGE, NETWORKING, POWER CONTROL, ENVIRONMENTAL MONITORING, PROCESS INFRASTRUCTURE, AND SECURITY FOR DATACENTERS AND OTHER INFORMATION TECHNOLOGY (IT) ASSETS, IN CLASS 9 (U.S. CLS. 21, 23, 26, 36 AND 38).

**TRADEMARK**

**PRINCIPAL REGISTER**

FIRST USE 2-8-2012; IN COMMERCE 2-8-2012.

THE MARK CONSISTS OF STANDARD CHARACTERS WITHOUT CLAIM TO ANY PARTICULAR FONT, STYLE, SIZE, OR COLOR.

SN 85-310,495, FILED 5-3-2011.

KIMBERLY FRYE, EXAMINING ATTORNEY



*David J. Kyros*

Director of the United States Patent and Trademark Office

# United States of America

United States Patent and Trademark Office

## TIRES BUILT FOR LIFE'S ROAD TRIPS.

**Reg. No. 4,199,509**

COOPER TIRE & RUBBER COMPANY (DELAWARE CORPORATION)  
701 LIMA AVENUE  
FINDLAY, OH 45840

**Registered Aug. 28, 2012**

**Int. Cl.: 35**

FOR: RETAIL STORE SERVICES IN THE FIELD OF AUTOMOTIVE, SUV, TRUCK, TRACTOR AND TRAILER TIRES, IN CLASS 35 (U.S. CLS. 100, 101 AND 102).

**SERVICE MARK**

FIRST USE 6-1-2011; IN COMMERCE 6-1-2011.

**PRINCIPAL REGISTER**

THE MARK CONSISTS OF STANDARD CHARACTERS WITHOUT CLAIM TO ANY PARTICULAR FONT, STYLE, SIZE, OR COLOR.

SN 85-310,560, FILED 5-3-2011.

JASON TURNER, EXAMINING ATTORNEY



*David J. Kybas*

Director of the United States Patent and Trademark Office

# United States of America

United States Patent and Trademark Office

# AZYRKK

**Reg. No. 4,199,510**

LIBERATORE, RAYMOND A. (UNITED STATES INDIVIDUAL)  
12143 PUNKIN HOLLOW ROAD  
BENTONVILLE, AR 72712 AND

**Registered Aug. 28, 2012**

**Int. Cl.: 25**

LIBERATORE, CAMERON (UNITED STATES INDIVIDUAL)  
12143 PUNKIN HOLLOW ROAD  
BENTONVILLE, AR 72712

**TRADEMARK**

**PRINCIPAL REGISTER**

FOR: BELTS; HATS; JACKETS; PANTS; SHIRTS; SHORTS; T-SHIRTS , IN CLASS 25 (U.S. CLS. 22 AND 39).

FIRST USE 2-17-2012; IN COMMERCE 2-17-2012.

THE MARK CONSISTS OF STANDARD CHARACTERS WITHOUT CLAIM TO ANY PARTICULAR FONT, STYLE, SIZE, OR COLOR.

SN 85-310,858, FILED 5-3-2011.

CAROLYN CATALDO, EXAMINING ATTORNEY



*David J. Kyffers*

Director of the United States Patent and Trademark Office



# United States of America

United States Patent and Trademark Office

## COMSOL DESKTOP

**Reg. No. 4,199,511**

**Registered Aug. 28, 2012**

**Int. Cl.: 9**

**TRADEMARK**

**PRINCIPAL REGISTER**

COMSOL AB (SWEDEN CORPORATION)  
SE-111 40 TEGNÉRGATAN 23  
STOCKHOLM, SWEDEN

FOR: COMPUTER SOFTWARE FOR PERFORMING TECHNICAL MATHEMATICAL CALCULATIONS IN THE FIELDS OF MATHEMATICS, ENGINEERING, AND SCIENCE, AND MANUALS AND INSTRUCTION HANDBOOKS SOLD TOGETHER AS A UNIT; COMPUTER SOFTWARE TO MODEL, SIMULATE, OPTIMIZE, CONTROL, TEST, AND ANALYZE PHYSICS-BASED SYSTEMS IN THE FIELDS OF COMPUTER-AIDED ENGINEERING AND DESIGN; COMPUTER SOFTWARE TO MODEL, SIMULATE, OPTIMIZE, CONTROL, TEST, AND ANALYZE PHYSICS-BASED SYSTEMS IN THE FIELDS OF VIRTUAL PROTOTYPING AND EXPERIMENTS; COMPUTER SOFTWARE TO MODEL, SIMULATE, OPTIMIZE, CONTROL, TEST, AND ANALYZE PHYSICS-BASED SYSTEMS IN THE FIELDS OF MULTIPHYSICS MODELING, SIMULATION, AND OPTIMIZATION; COMPUTER SOFTWARE TO MODEL, SIMULATE, OPTIMIZE, CONTROL, TEST, AND ANALYZE PHYSICS-BASED SYSTEMS IN THE FIELDS OF REACTION ENGINEERING MODELING, SIMULATION, AND OPTIMIZATION, IN CLASS 9 (U.S. CLS. 21, 23, 26, 36 AND 38).

FIRST USE 9-0-2009; IN COMMERCE 6-0-2010.

THE MARK CONSISTS OF STANDARD CHARACTERS WITHOUT CLAIM TO ANY PARTICULAR FONT, STYLE, SIZE, OR COLOR.

OWNER OF U.S. REG. NOS. 3,058,621, 3,380,556, AND OTHERS.

NO CLAIM IS MADE TO THE EXCLUSIVE RIGHT TO USE "DESKTOP" , APART FROM THE MARK AS SHOWN.

SN 85-311,114, FILED 5-3-2011.

CURTIS FRENCH, EXAMINING ATTORNEY



*David J. Kyjars*

Director of the United States Patent and Trademark Office

# United States of America

United States Patent and Trademark Office

## START THE FUN!

**Reg. No. 4,199,512**

DEL MONTE CORPORATION (DELAWARE CORPORATION)  
P.O. BOX 193575

**Registered Aug. 28, 2012**

SAN FRANCISCO, CA 941193575

**Int. Cl.: 31**

FOR: PET FOOD, IN CLASS 31 (U.S. CLS. 1 AND 46).

**TRADEMARK**

FIRST USE 9-26-2011; IN COMMERCE 9-26-2011.

**PRINCIPAL REGISTER**

THE MARK CONSISTS OF STANDARD CHARACTERS WITHOUT CLAIM TO ANY PARTICULAR FONT, STYLE, SIZE, OR COLOR.

SN 85-311,166, FILED 5-3-2011.

DAVID COLLIER, EXAMINING ATTORNEY



*David J. Kyffers*

Director of the United States Patent and Trademark Office

# United States of America

United States Patent and Trademark Office

# LAMPEIN

**Reg. No. 4,199,513**

OEM SERVICES, LLC (MISSOURI LIMITED LIABILITY COMPANY)  
1523 CORRINGTON AVE.  
KANSAS CITY, MO 64126

**Registered Aug. 28, 2012**

**Int. Cls.: 9 and 11**

FOR: ELECTRONIC LED SIGNS; LED CIRCUIT BOARDS; LIGHT EMITTING DIODE (LED) DISPLAYS; LIGHT EMITTING DIODE (LED) DEVICES FOR REPLACEMENT OF STANDARD TUNGSTEN-FILAMENT AND FLUORESCENT LIGHTING, IN CLASS 9 (U.S. CLS. 21, 23, 26, 36 AND 38).

**TRADEMARK**

**PRINCIPAL REGISTER**

FIRST USE 11-16-2011; IN COMMERCE 11-16-2011.

FOR: LED (LIGHT EMITTING DIODES) LIGHTING FIXTURES FOR USE IN DISPLAY, COMMERCIAL, INDUSTRIAL, AND RESIDENTIAL APPLICATIONS; LED (LIGHT EMITTING DIODE) LIGHTING FIXTURES; LED LIGHT BULBS; LED LIGHTING SYSTEMS, NAMELY, LED MODULES, POWER SUPPLIES, AND WIRING, IN CLASS 11 (U.S. CLS. 13, 21, 23, 31 AND 34).

FIRST USE 11-16-2011; IN COMMERCE 11-16-2011.

THE MARK CONSISTS OF STANDARD CHARACTERS WITHOUT CLAIM TO ANY PARTICULAR FONT, STYLE, SIZE, OR COLOR.

SN 85-311,491, FILED 5-3-2011.

PAUL E. FAHRENKOPF, EXAMINING ATTORNEY



*David J. Kybas*

Director of the United States Patent and Trademark Office

# United States of America

United States Patent and Trademark Office

## ROCKY SOCKY MAGNET MAN

**Reg. No. 4,199,514**

INGLE, ANTHONY (UNITED STATES INDIVIDUAL)  
108 CAPE COD DRIVE  
CARY, NC 27511

**Registered Aug. 28, 2012**

**Int. Cl.: 28**

FOR: BOARD GAMES; EQUIPMENT SOLD AS A UNIT FOR PLAYING BOARD GAMES,  
IN CLASS 28 (U.S. CLS. 22, 23, 38 AND 50).

**TRADEMARK**

FIRST USE 3-5-2011; IN COMMERCE 4-1-2012.

**PRINCIPAL REGISTER**

THE MARK CONSISTS OF STANDARD CHARACTERS WITHOUT CLAIM TO ANY PAR-  
TICULAR FONT, STYLE, SIZE, OR COLOR.

SN 85-311,668, FILED 5-4-2011.

KHANH LE, EXAMINING ATTORNEY



*David J. Kyffers*

Director of the United States Patent and Trademark Office

# United States of America

United States Patent and Trademark Office



**Reg. No. 4,199,515**

**Registered Aug. 28, 2012**

**Int. Cls.: 9 and 38**

**TRADEMARK**

**SERVICE MARK**

**PRINCIPAL REGISTER**

PROVIDENT LABEL GROUP, LLC (DELAWARE LIMITED LIABILITY COMPANY)  
550 MADISON AVENUE  
NEW YORK, NY 10022

FOR: MUSICAL SOUND RECORDINGS; DOWNLOADABLE MUSICAL SOUND RECORDINGS FEATURING MUSIC AND MUSICAL BASED ENTERTAINMENT; DOWNLOADABLE GRAPHICS AND MUSIC VIA A GLOBAL COMPUTER NETWORK AND WIRELESS DEVICES, IN CLASS 9 (U.S. CLS. 21, 23, 26, 36 AND 38).

FIRST USE 9-6-2011; IN COMMERCE 9-6-2011.

FOR: STREAMING OF AUDIO MATERIAL, NAMELY, MUSICAL RECORDINGS, ON THE INTERNET, IN CLASS 38 (U.S. CLS. 100, 101 AND 104).

FIRST USE 11-1-2011; IN COMMERCE 11-1-2011.

OWNER OF U.S. REG. NOS. 3,012,993 AND 3,012,995.

NO CLAIM IS MADE TO THE EXCLUSIVE RIGHT TO USE "SOUNDTRACKS", APART FROM THE MARK AS SHOWN.

THE MARK CONSISTS OF THE LOWERCASE RENDERINGS OF THE LETTERS "PH" WITHIN A CIRCLE, AND AN UPWARD POINTING ARROW ENCLOSED IN A CONTRASTING CIRCLE WITHIN THE ARC OF THE "H". THE WORD ELEMENT "SOUNDTRACKS" CROSSES VERTICALLY BELOW.

SN 85-311,746, FILED 5-4-2011.

JORDAN BAKER, EXAMINING ATTORNEY



*David J. Kybas*

Director of the United States Patent and Trademark Office

# United States of America

United States Patent and Trademark Office



## PRAISEHYMN SOUNDTRACKS

**Reg. No. 4,199,516**

**Registered Aug. 28, 2012**

**Int. Cl.: 9**

**TRADEMARK**

**PRINCIPAL REGISTER**

PROVIDENT LABEL GROUP, LLC (DELAWARE LIMITED LIABILITY COMPANY)  
550 MADISON AVENUE  
NEW YORK, NY 10022

FOR: MUSICAL SOUND RECORDINGS; DOWNLOADABLE MUSICAL SOUND RECORDINGS FEATURING MUSIC AND MUSICAL BASED ENTERTAINMENT; DOWNLOADABLE GRAPHICS AND MUSIC VIA A GLOBAL COMPUTER NETWORK AND WIRELESS DEVICES, IN CLASS 9 (U.S. CLS. 21, 23, 26, 36 AND 38).

FIRST USE 9-6-2011; IN COMMERCE 9-6-2011.

OWNER OF U.S. REG. NOS. 3,012,993 AND 3,012,995.

NO CLAIM IS MADE TO THE EXCLUSIVE RIGHT TO USE "PRAISE HYMN" AND "SOUNDTRACKS", APART FROM THE MARK AS SHOWN.

THE MARK CONSISTS OF A SOLID OUTLINED CIRCLE ENCLOSING THE LITERAL ELEMENTS "PH", WHEREIN AN UPWARD POINTING ARROW IS ENCLOSED IN A CONTRASTING, SMALLER CIRCLE BELOW THE ARC IN THE "H". BELOW THE CIRCLE ARE THE WORD ELEMENTS "PRAISEHYMN". BELOW THESE ELEMENTS IS THE WORD "SOUNDTRACKS".

SN 85-311,766, FILED 5-4-2011.

JORDAN BAKER, EXAMINING ATTORNEY



*David J. Kybas*

Director of the United States Patent and Trademark Office

# United States of America

United States Patent and Trademark Office



## PRAISEHYMN

### SOUNDTRACKS

HI • MEDIUM • LOW

**Reg. No. 4,199,517**

**Registered Aug. 28, 2012**

**Int. Cls.: 9 and 38**

**TRADEMARK**

**SERVICE MARK**

**PRINCIPAL REGISTER**

PROVIDENT LABEL GROUP, LLC (DELAWARE LIMITED LIABILITY COMPANY)  
550 MADISON AVENUE  
NEW YORK, NY 10022

FOR: MUSICAL SOUND RECORDINGS; DOWNLOADABLE MUSICAL SOUND RECORDINGS FEATURING MUSIC AND MUSICAL BASED ENTERTAINMENT; DOWNLOADABLE GRAPHICS AND MUSIC VIA A GLOBAL COMPUTER NETWORK AND WIRELESS DEVICES, IN CLASS 9 (U.S. CLS. 21, 23, 26, 36 AND 38).

FIRST USE 9-6-2011; IN COMMERCE 9-6-2011.

FOR: STREAMING OF AUDIO MATERIAL, NAMELY, MUSICAL RECORDINGS, ON THE INTERNET, IN CLASS 38 (U.S. CLS. 100, 101 AND 104).

FIRST USE 11-1-2011; IN COMMERCE 11-1-2011.

OWNER OF U.S. REG. NOS. 2,923,344, 3,012,995, AND OTHERS.

NO CLAIM IS MADE TO THE EXCLUSIVE RIGHT TO USE "SOUNDTRACKS" AND "PRAISE HYMN", APART FROM THE MARK AS SHOWN.

THE MARK CONSISTS OF A SOLID OUTLINED CIRCLE ENCLOSING THE LITERAL ELEMENTS "PH", WHEREIN AN UPWARD POINTING ARROW IS ENCLOSED IN A CONTRASTING, SMALLER CIRCLE BELOW THE ARC IN THE "H". BELOW THE CIRCLE ARE THE WORD ELEMENTS "PRAISEHYMN". BELOW THESE ELEMENTS IS "SOUNDTRACKS". TO THE RIGHT OF "SOUNDTRACKS" IS THE WORDING "HI MEDIUM LOW" APPEARING WITHIN A RECTANGLE DESIGN. A SMALL DOT APPEARS BETWEEN "HI" AND "MEDIUM", AND BETWEEN "MEDIUM" AND "LOW".

SN 85-311,797, FILED 5-4-2011.

JORDAN BAKER, EXAMINING ATTORNEY



*David J. Kyffers*

Director of the United States Patent and Trademark Office

# United States of America

United States Patent and Trademark Office

## THE PROUD AMERICANS

*Solid Benefits. Traditional Values.*



**Reg. No. 4,199,518**

**Registered Aug. 28, 2012**

**Int. Cls.: 9, 35, and 36**

**TRADEMARK**

**SERVICE MARK**

**PRINCIPAL REGISTER**

THE PROUD AMERICANS INC. (TEXAS CORPORATION)  
P.O. BOX 18256  
SUGAR LAND, TX 77496

FOR: DOWNLOADABLE ELECTRONIC PUBLICATIONS IN THE NATURE OF BOOKS, NEWSLETTERS, BULLETINS, BROCHURES, PAMPHLETS, AND MAGAZINES FOR ELDERLY AND RETIRED INDIVIDUALS IN THE FIELDS OF VISION CARE, HEARING CARE, TRAVEL, FINANCIAL PLANNING, INSURANCE, ANNUITIES, LONG TERM CARE, MEDICARE SUPPLEMENTAL INSURANCE, DISABILITY INSURANCE, RETIREMENT, LIFESTYLES OF ELDERLY AND RETIRED INDIVIDUALS, HEALTH, AGING, CONSUMER ISSUES, ECONOMIC SECURITY, AND EXERCISE AND FITNESS, IN CLASS 9 (U.S. CLS. 21, 23, 26, 36 AND 38).

FIRST USE 1-25-2011; IN COMMERCE 1-25-2011.

FOR: ASSOCIATION SERVICES, NAMELY, PROMOTING THE INTERESTS OF ELDERLY AND RETIRED INDIVIDUALS; PROMOTING PUBLIC AWARENESS AND ADVOCACY IN THE FIELDS OF VISION CARE, HEARING CARE, TRAVEL, FINANCIAL PLANNING, INSURANCE, ANNUITIES, LONG TERM CARE, MEDICARE SUPPLEMENTAL INSURANCE, DISABILITY INSURANCE, RETIREMENT, ELDERLY OR RETIRED LIFESTYLES, HEALTH, AGING, CONSUMER ISSUES, ECONOMIC SECURITY, AND EXERCISE AND FITNESS; ADMINISTRATION OF A DISCOUNT PROGRAM FOR ENABLING PARTICIPANTS TO OBTAIN DISCOUNTS ON GOODS AND SERVICES OF OTHERS THROUGH USE OF A DISCOUNT MEMBERSHIP CARD; COOPERATIVE ADVERTISING AND MARKETING; ORGANIZATION OF EXHIBITIONS AND EVENTS CONCERNING RETIREMENT PREPARATION FOR COMMERCIAL OR ADVERTISING PURPOSES; PUBLIC POLICY RESEARCH SERVICES; PROMOTING PUBLIC AWARENESS OF THE NEED FOR SOLUTIONS AND POLICIES IN THE FIELDS OF HEALTH, MEDICAL SERVICES, INSURANCE, RETIREMENT, ELDERLY OR RETIRED LIFESTYLES, FINANCE, AGING, CONSUMER ISSUES, AND ECONOMIC SECURITY, IN CLASS 35 (U.S. CLS. 100, 101 AND 102).

FIRST USE 1-25-2011; IN COMMERCE 1-25-2011.

FOR: FINANCIAL AND INVESTMENT SERVICES, NAMELY, PROVIDING FINANCIAL INFORMATION, ADVICE AND CONSULTATION IN THE FIELDS OF INSURANCE, ANNUITIES, LONG TERM CARE INSURANCE, MEDICARE SUPPLEMENTAL INSURANCE, MONEY MANAGEMENT, AND INVESTMENT; FINANCIAL CONSULTING IN THE NATURE



*David J. Kyjars*

Director of the United States Patent and Trademark Office



**Reg. No. 4,199,518** OF FINANCIAL MANAGEMENT MONEY FOR OTHERS AND INVESTMENT ADVISORY SERVICES; FINANCIAL ASSET MANAGEMENT; INVESTMENT MANAGEMENT AND FINANCIAL ASSET MANAGEMENT SERVICES; FINANCIAL INVESTMENT OF FUNDS OF FOR OTHERS; FINANCIAL ADMINISTRATION OF INVESTMENT ASSETS FOR OTHERS; FINANCIAL ADMINISTRATION OF LIFE INSURANCE, LONG TERM CARE INSURANCE, AND DISABILITY INSURANCE; PROVIDING REBATES AT PARTICIPATING ESTABLISHMENTS OF OTHERS THROUGH THE USE OF MEMBERSHIP CARDS AND MEMBERSHIP PROGRAMS; PROVIDING FINANCIAL ADMINISTRATION SERVICES IN THE FIELD OF LIFE INSURANCE, ANNUITIES AND RETIREMENT PLANS, IN CLASS 36 (U.S. CLS. 100, 101 AND 102).

FIRST USE 1-25-2011; IN COMMERCE 1-25-2011.

NO CLAIM IS MADE TO THE EXCLUSIVE RIGHT TO USE "AMERICANS", APART FROM THE MARK AS SHOWN.

THE MARK CONSISTS OF THE STYLIZED WORDING "THE PROUD AMERICANS SOLID BENEFITS. TRADITIONAL VALUES." APPEARING ABOVE THE PICTORIAL REPRESENTATION OF THE FOUR PRESIDENTS IN BUST ON MOUNT RUSHMORE. THE WORDING "THE PROUD" APPEARS ABOVE THE WORDING "AMERICANS" WHICH APPEARS ABOVE THE WORDING "SOLID BENEFITS. TRADITIONAL VALUES." THE LETTER "O" IN THE WORD "PROUD" APPEARS AS A FIVE-POINTED STAR SUPERIMPOSED OVER THE CENTER OF A SOLID CIRCLE.

SN 85-311,848, FILED 5-4-2011.

MICHAEL TANNER, EXAMINING ATTORNEY

# United States of America

United States Patent and Trademark Office

## SPARK THE ENGAGEMENT

**Reg. No. 4,199,519**

VOICES HEARD MEDIA, INC. (TENNESSEE CORPORATION)  
121 N. CONCORD STREET  
KNOXVILLE, TN 37919

**Registered Aug. 28, 2012**

**Int. Cl.: 9**

FOR: SOFTWARE FOR CREATING, MANAGING, EDITING, MODERATING AND DISTRIBUTING INTERACTIVE ONLINE EVENTS, INCLUDING QUESTION AND ANSWER SESSIONS, POLLS, CONTESTS, CHATS AND OTHER SIMILAR INTERACTIVE ONLINE EVENTS, IN CLASS 9 (U.S. CLS. 21, 23, 26, 36 AND 38).

**TRADEMARK**

**PRINCIPAL REGISTER**

FIRST USE 4-26-2011; IN COMMERCE 4-26-2011.

THE MARK CONSISTS OF STANDARD CHARACTERS WITHOUT CLAIM TO ANY PARTICULAR FONT, STYLE, SIZE, OR COLOR.

SN 85-311,885, FILED S.R. 5-4-2011; AM. P.R. 10-17-2011.

LINDSEY RUBIN, EXAMINING ATTORNEY



*David J. Kyffers*

Director of the United States Patent and Trademark Office

# United States of America

United States Patent and Trademark Office

# VELVET

**Reg. No. 4,199,520**

**Registered Aug. 28, 2012**

**Int. Cl.: 31**

**TRADEMARK**

**PRINCIPAL REGISTER**

KINGSBURG APPLE PACKERS, INC. (CALIFORNIA CORPORATION)  
P.O. BOX 456 10363 EAST DAVIS AVE.  
KINGSBURG, CA 93631

FOR: FRESH APRICOTS, IN CLASS 31 (U.S. CLS. 1 AND 46).

FIRST USE 5-9-2012; IN COMMERCE 5-9-2012.

THE MARK CONSISTS OF STANDARD CHARACTERS WITHOUT CLAIM TO ANY PARTICULAR FONT, STYLE, SIZE, OR COLOR.

SN 85-312,012, FILED 5-4-2011.

ALICE BENMAMAN, EXAMINING ATTORNEY



*David J. Kybas*

Director of the United States Patent and Trademark Office

# United States of America

United States Patent and Trademark Office

# C2G

**Reg. No. 4,199,521**

LASTAR, INC. (OHIO CORPORATION)  
3555 KETTERING BOULEVARD  
DAYTON, OH 45439

**Registered Aug. 28, 2012**

**Int. Cl.: 9**

FOR: CABLES, CABLE CONNECTORS AND RELATED GOODS, NAMELY, COMPUTER CABLES, PATCH CORDS, FIBER OPTIC CABLES, POWER CABLES, AUDIO CABLES, VIDEO CABLES, AUDIO/VIDEO CABLES; CABLE COUPLERS; ELECTRICAL CONNECTORS; TELEPHONE CORDS; POWER CORDS; BULK CABLE ELECTRICAL WIRE; SIGNAL SPLITTERS FOR ELECTRONIC APPARATUS, COMPUTER NETWORK ADAPTORS, SWITCHES, AND HUBS; CABLING SYSTEMS FOR USE IN COMPUTER, AUDIO, VIDEO, NETWORKING AND TELECOMMUNICATIONS APPLICATIONS, COMPRISED OF ELECTRICAL AND ELECTRONIC CABLES, CABLE CONNECTORS, WALL PLATES, CABLE LEADS, CABLE COUPLERS AND BULK ELECTRICAL WIRE, AND REPLACEMENT PARTS THEREFOR; CABLE MANAGEMENT PANELS AND RACKS; AND PARTS OF THE FOREGOING, IN CLASS 9 (U.S. CLS. 21, 23, 26, 36 AND 38).

**TRADEMARK**

**PRINCIPAL REGISTER**

FIRST USE 4-10-2011; IN COMMERCE 4-10-2011.

THE MARK CONSISTS OF STANDARD CHARACTERS WITHOUT CLAIM TO ANY PARTICULAR FONT, STYLE, SIZE, OR COLOR.

OWNER OF U.S. REG. NO. 3,547,301.

SN 85-312,068, FILED 5-4-2011.

KELLY TRUSILO, EXAMINING ATTORNEY



*David J. Kybas*

Director of the United States Patent and Trademark Office

# United States of America

United States Patent and Trademark Office

## HIDDEN ADVANTAGE

**Reg. No. 4,199,522**

**Registered Aug. 28, 2012**

**Int. Cl.: 25**

**TRADEMARK**

**PRINCIPAL REGISTER**

MAIDENFORM, INC. (NEW YORK CORPORATION)  
THIRD FLOOR - LEGAL DEPT.  
485 ROUTE 1 SOUTH, BUILDING F  
ISELIN, NJ 08830

FOR: FOUNDATION GARMENTS; WOMEN'S UNDERGARMENTS; LINGERIE; WOMEN'S INTIMATE APPAREL, NAMELY, UNDERWEAR, BRIEFS, SHAPEWEAR, NAMELY, CONTROL BRIEFS, BOY SHORTS, THIGH-SLIMMERS, PANTLINERS, BODY BRIEFERS, WAISTNIPPERS, SLIPS, UNITARDS, BODY SUITS AND BODY SHAPERS, IN CLASS 25 (U.S. CLS. 22 AND 39).

FIRST USE 2-0-2011; IN COMMERCE 2-0-2012.

THE MARK CONSISTS OF STANDARD CHARACTERS WITHOUT CLAIM TO ANY PARTICULAR FONT, STYLE, SIZE, OR COLOR.

SN 85-312,130, FILED 5-4-2011.

INGRID C. EULIN, EXAMINING ATTORNEY



*David J. Kyros*

Director of the United States Patent and Trademark Office

# United States of America

United States Patent and Trademark Office

## THE STANDARD BEER GARDEN

**Reg. No. 4,199,523**

**Registered Aug. 28, 2012**

**Int. Cl.: 43**

**SERVICE MARK**

**PRINCIPAL REGISTER**

HOTELSAB LLC (DELAWARE LIMITED LIABILITY COMPANY)  
23 EAST 4TH STREET  
5TH FLOOR  
NEW YORK, NY 10003

FOR: RESTAURANT AND BAR SERVICES, IN CLASS 43 (U.S. CLS. 100 AND 101).

FIRST USE 6-7-2012; IN COMMERCE 6-7-2012.

THE MARK CONSISTS OF STANDARD CHARACTERS WITHOUT CLAIM TO ANY PARTICULAR FONT, STYLE, SIZE, OR COLOR.

OWNER OF U.S. REG. NOS. 3,736,628 AND 3,830,438.

NO CLAIM IS MADE TO THE EXCLUSIVE RIGHT TO USE "BEER GARDEN", APART FROM THE MARK AS SHOWN.

SN 85-312,207, FILED 5-4-2011.

TASNEEM HUSSAIN, EXAMINING ATTORNEY



*David J. Kyros*

Director of the United States Patent and Trademark Office

# United States of America

United States Patent and Trademark Office

## SPEED OF THE WEB

**Reg. No. 4,199,524**

DYNATRACE SOFTWARE GMBH (AUSTRIA CORPORATION)  
FREISTAEDTER STRASSE 313  
LINZ, AUSTRIA A-4040

**Registered Aug. 28, 2012**

**Int. Cl.: 42**

FOR: PROVIDING AN INTERACTIVE WEBSITE FEATURING TECHNOLOGY THAT ALLOWS USERS TO MEASURE AND ANALYZE THE PERFORMANCE OF WEBSITES AND COMPARE AGAINST INDUSTRY PERFORMANCE INDICES, IN CLASS 42 (U.S. CLS. 100 AND 101).

**SERVICE MARK**

**PRINCIPAL REGISTER**

FIRST USE 8-31-2010; IN COMMERCE 5-25-2011.

THE MARK CONSISTS OF STANDARD CHARACTERS WITHOUT CLAIM TO ANY PARTICULAR FONT, STYLE, SIZE, OR COLOR.

SN 85-312,265, FILED 5-4-2011.

INGA ERVIN, EXAMINING ATTORNEY



*David J. Kyffers*

Director of the United States Patent and Trademark Office

# United States of America

United States Patent and Trademark Office

# NO DIG

**Reg. No. 4,199,525**

**Registered Aug. 28, 2012**

**Int. Cl.: 6**

**TRADEMARK**

**PRINCIPAL REGISTER**

ORIGIN POINT BRANDS, LLC (DELAWARE LIMITED LIABILITY COMPANY)  
2453 KING STREET EXTENSION  
CHARLESTON, SC 29045

FOR: METAL FENCE POSTS; METAL FENCING PANELS; METAL GATES AND FENCING;  
METAL WIRE FENCING; WIRE FENCES; METAL POSTS, IN CLASS 6 (U.S. CLS. 2, 12, 13,  
14, 23, 25 AND 50).

FIRST USE 4-1-2012; IN COMMERCE 4-1-2012.

THE MARK CONSISTS OF STANDARD CHARACTERS WITHOUT CLAIM TO ANY PAR-  
TICULAR FONT, STYLE, SIZE, OR COLOR.

SN 85-312,276, FILED 5-4-2011.

GISELLE AGOSTO, EXAMINING ATTORNEY



*David J. Kyffers*

Director of the United States Patent and Trademark Office



# United States of America

United States Patent and Trademark Office

# NA PALM

**Reg. No. 4,199,526**

PALM, CRAIG S. (UNITED STATES INDIVIDUAL)  
1420 W. ERIE STEET #1F  
CHICAGO, IL 60642

**Registered Aug. 28, 2012**

**Int. Cls.: 9, 25, and 41**

FOR: PRE-RECORDED COMPACT DISCS, FEATURING MUSIC, MUSICAL PERFORMANCES; DOWNLOADABLE MUSICAL SOUND RECORDINGS FEATURING PERFORMANCES OF MUSICAL WORKS, IN CLASS 9 (U.S. CLS. 21, 23, 26, 36 AND 38).

**TRADEMARK**

FIRST USE 10-1-2009; IN COMMERCE 2-1-2010.

**SERVICE MARK**

FOR: APPARELS, NAMELY, T-SHIRTS, TANK TOPS AND BALL CAPS, IN CLASS 25 (U.S. CLS. 22 AND 39).

**PRINCIPAL REGISTER**

FIRST USE 1-1-2011; IN COMMERCE 1-1-2011.

FOR: ENTERTAINMENT SERVICES IN THE NATURE OF LIVE MUSICAL PERFORMANCES, IN CLASS 41 (U.S. CLS. 100, 101 AND 107).

FIRST USE 10-1-2009; IN COMMERCE 2-1-2010.

THE MARK CONSISTS OF STANDARD CHARACTERS WITHOUT CLAIM TO ANY PARTICULAR FONT, STYLE, SIZE, OR COLOR.

THE NAME(S), PORTRAIT(S), AND/OR SIGNATURE(S) SHOWN IN THE MARK IDENTIFIES CRAIG S. "PALM", WHOSE CONSENT(S) TO REGISTER IS MADE OF RECORD.

SN 85-312,282, FILED 5-4-2011.

GISELLE AGOSTO, EXAMINING ATTORNEY



*David J. Kyffers*

Director of the United States Patent and Trademark Office

# United States of America

United States Patent and Trademark Office

BLUESMITHS



**Reg. No. 4,199,527**

SMALLEY, JOHN (UNITED KINGDOM INDIVIDUAL)  
300 INU PLACE  
KULA, HI 96790

**Registered Aug. 28, 2012**

**Int. Cl.: 25**

FOR: BOARD SHORTS; HEADWEAR; JACKETS; PANTS; SHIRTS; SHORTS; SURF WEAR;  
SWEAT SHIRTS, IN CLASS 25 (U.S. CLS. 22 AND 39).

**TRADEMARK**

FIRST USE 5-4-2011; IN COMMERCE 5-5-2012.

**PRINCIPAL REGISTER**

THE MARK CONSISTS OF A SHIELD WITH A TILTED CROSS IN THE MIDDLE AND A  
"B" ABOVE THE CROSS. ABOVE THE SHIELD IS THE WORDING "BLUESMITHS" IN SAN  
SERIF LETTERING AND SLIGHTLY ARCED.

SN 85-312,405, FILED 5-4-2011.

LINDA ESTRADA, EXAMINING ATTORNEY



*David J. Kybas*

Director of the United States Patent and Trademark Office

# United States of America

United States Patent and Trademark Office

BLUESMITHS



**Reg. No. 4,199,528**

SMALLEY, JOHN (UNITED KINGDOM INDIVIDUAL)  
300 INU PLACE  
KULA, HI 96790

**Registered Aug. 28, 2012**

**Int. Cl.: 18**

FOR: BACKPACKS; BUM BAGS; LUGGAGE; ROLL BAGS; TRAVEL BAGS, IN CLASS 18 (U.S. CLS. 1, 2, 3, 22 AND 41).

**TRADEMARK**

FIRST USE 5-4-2011; IN COMMERCE 5-5-2012.

**PRINCIPAL REGISTER**

THE MARK CONSISTS OF A SHIELD WITH A TILTED CROSS IN THE MIDDLE AND A "B" ABOVE THE CROSS. ABOVE THE SHIELD IS THE WORDING "BLUESMITHS" IN SAN SERIF LETTERING AND SLIGHTLY ARCHED.

SN 85-312,464, FILED 5-4-2011.

LINDA ESTRADA, EXAMINING ATTORNEY



*David J. Kyros*

Director of the United States Patent and Trademark Office

# United States of America

United States Patent and Trademark Office

## THAT'S AMORE

**Reg. No. 4,199,529**

LOVO, FRANCESCA (ITALY INDIVIDUAL)  
10 DELL GLEN AVE BLDG # 6  
LODI, NJ 07644

**Registered Aug. 28, 2012**

**Int. Cl.: 30**

FOR: PASTA, BEANS, PASTA SAUCES, PESTO, PASTAS, BALSALMIC VINEGAR, CANNED TOMATOES, OLIVE OIL, ANTOPASTO, IN CLASS 30 (U.S. CL. 46).

**TRADEMARK**

FIRST USE 5-15-2012; IN COMMERCE 5-15-2012.

**PRINCIPAL REGISTER**

THE MARK CONSISTS OF STANDARD CHARACTERS WITHOUT CLAIM TO ANY PARTICULAR FONT, STYLE, SIZE, OR COLOR.

THE ENGLISH TRANSLATION OF "AMORE" IN THE MARK IS "LOVE".

SN 85-312,540, FILED 5-4-2011.

LINDA ESTRADA, EXAMINING ATTORNEY



*David J. Kybas*

Director of the United States Patent and Trademark Office

# United States of America

United States Patent and Trademark Office

## KANGA GUARD

**Reg. No. 4,199,530**

KERSHENSTEIN, TIMOTHY (UNITED STATES INDIVIDUAL)  
24802 PACK SADDLE TRAIL  
SAN ANTONIO, TX 78255

**Registered Aug. 28, 2012**

**Int. Cl.: 9**

FOR: CELL PHONE CASES, IN CLASS 9 (U.S. CLS. 21, 23, 26, 36 AND 38).

**TRADEMARK**

FIRST USE 6-3-2010; IN COMMERCE 8-9-2010.

**PRINCIPAL REGISTER**

THE MARK CONSISTS OF STANDARD CHARACTERS WITHOUT CLAIM TO ANY PARTICULAR FONT, STYLE, SIZE, OR COLOR.

SN 85-312,690, FILED 5-4-2011.

DAWN FELDMAN, EXAMINING ATTORNEY



*David J. Kyffers*

Director of the United States Patent and Trademark Office

# United States of America

United States Patent and Trademark Office

# EcoMachine

**Reg. No. 4,199,531**

**Registered Aug. 28, 2012**

**Int. Cl.: 7**

**TRADEMARK**

**PRINCIPAL REGISTER**

ECOPATH CONTRACTING LLC (ARIZONA LIMITED LIABILITY COMPANY)  
C/O STRATCO, INC.  
14821 N. 73RD ST.  
SCOTTSDALE, AZ 85260

FOR: MIXING MACHINES USED TO BLEND LIQUID ASPHALT CEMENT WITH RECYCLED TIRE RUBBER, IN CLASS 7 (U.S. CLS. 13, 19, 21, 23, 31, 34 AND 35).

FIRST USE 6-13-2012; IN COMMERCE 6-13-2012.

THE MARK CONSISTS OF STANDARD CHARACTERS WITHOUT CLAIM TO ANY PARTICULAR FONT, STYLE, SIZE, OR COLOR.

SN 85-312,718, FILED 5-4-2011.

KEVIN CORWIN, EXAMINING ATTORNEY



*David J. Kyffers*

Director of the United States Patent and Trademark Office

# United States of America

United States Patent and Trademark Office

# TRUFLAME

**Reg. No. 4,199,532**

**Registered Aug. 28, 2012**

**Int. Cl.: 11**

**TRADEMARK**

**PRINCIPAL REGISTER**

SMART CANDLE, LLC (MINNESOTA LIMITED LIABILITY COMPANY)  
SUITE 100  
1701 WEST 94TH STREET  
BLOOMINGTON, MN 55431

FOR: ELECTRONIC CONTROLLED LIGHT THAT SIMULATES THE FLAME OF A WAX CANDLE, IN CLASS 11 (U.S. CLS. 13, 21, 23, 31 AND 34).

FIRST USE 4-1-2011; IN COMMERCE 8-19-2011.

THE MARK CONSISTS OF STANDARD CHARACTERS WITHOUT CLAIM TO ANY PARTICULAR FONT, STYLE, SIZE, OR COLOR.

SN 85-312,930, FILED 5-5-2011.

JESSICA FATHY, EXAMINING ATTORNEY



*David J. Kyffers*

Director of the United States Patent and Trademark Office

# United States of America

United States Patent and Trademark Office

## PMI AGILE CERTIFIED PRACTITIONER (PMI-ACP)

**Reg. No. 4,199,533**

**Registered Aug. 28, 2012**

**Int. Cl.: 35**

**SERVICE MARK**

**PRINCIPAL REGISTER**

PROJECT MANAGEMENT INSTITUTE, INC. (PENNSYLVANIA CORPORATION), AKA  
PMI,  
14 CAMPUS BOULEVARD  
NEWTOWN SQUARE, PA 19073

FOR: TESTING TO DETERMINE PROFESSIONAL COMPETENCY, NAMELY, TESTING AND EVALUATING OF PROFESSIONALS WORKING IN THE FIELD OF PROJECT MANAGEMENT TO DETERMINE THEIR LEVEL OF PROFESSIONAL EXPERIENCE AND COMPETENCY IN THE SPECIALIZED FIELD OF AGILE PROJECT MANAGEMENT; BUSINESS SERVICES FOR OTHERS, NAMELY, CREDENTIALING OF PROJECT MANAGEMENT PROFESSIONALS; AND BUSINESS SERVICES FOR OTHERS, NAMELY, VERIFYING AND MONITORING THE BUSINESS, PROFESSIONAL AND EDUCATIONAL CREDENTIALS OF PROJECT MANAGERS WITHIN THE AREA OF BUSINESS PROJECT MANAGEMENT FOR BUSINESS PURPOSES, IN CLASS 35 (U.S. CLS. 100, 101 AND 102).

FIRST USE 5-23-2011; IN COMMERCE 5-23-2011.

THE MARK CONSISTS OF STANDARD CHARACTERS WITHOUT CLAIM TO ANY PARTICULAR FONT, STYLE, SIZE, OR COLOR.

OWNER OF U.S. REG. NOS. 3,588,673, 3,819,320, AND OTHERS.

NO CLAIM IS MADE TO THE EXCLUSIVE RIGHT TO USE "AGILE CERTIFIED PRACTITIONER", APART FROM THE MARK AS SHOWN.

SN 85-313,092, FILED 5-5-2011.

JORDAN BAKER, EXAMINING ATTORNEY



*David J. Kyjars*

Director of the United States Patent and Trademark Office



# United States of America

United States Patent and Trademark Office

# PMI-ACP

**Reg. No. 4,199,534**

**Registered Aug. 28, 2012**

**Int. Cl.: 35**

**SERVICE MARK**

**PRINCIPAL REGISTER**

PROJECT MANAGEMENT INSTITUTE, INC. (PENNSYLVANIA CORPORATION), AKA  
PMI,  
14 CAMPUS BOULEVARD  
NEWTOWN SQUARE, PA 19073

FOR: TESTING TO DETERMINE PROFESSIONAL COMPETENCY, NAMELY, TESTING AND EVALUATING OF PROFESSIONALS WORKING IN THE FIELD OF PROJECT MANAGEMENT TO DETERMINE THEIR LEVEL OF PROFESSIONAL EXPERIENCE AND COMPETENCY IN THE SPECIALIZED FIELD OF AGILE PROJECT MANAGEMENT; BUSINESS SERVICES FOR OTHERS, NAMELY, CREDENTIALING OF PROJECT MANAGEMENT PROFESSIONALS; AND BUSINESS SERVICES FOR OTHERS, NAMELY, VERIFYING AND MONITORING THE BUSINESS, PROFESSIONAL AND EDUCATIONAL CREDENTIALS OF PROJECT MANAGERS WITHIN THE AREA OF BUSINESS PROJECT MANAGEMENT FOR BUSINESS PURPOSES, IN CLASS 35 (U.S. CLS. 100, 101 AND 102).

FIRST USE 5-23-2011; IN COMMERCE 5-23-2011.

THE MARK CONSISTS OF STANDARD CHARACTERS WITHOUT CLAIM TO ANY PARTICULAR FONT, STYLE, SIZE, OR COLOR.

OWNER OF U.S. REG. NOS. 3,588,673, 3,819,320, AND OTHERS.

SN 85-313,107, FILED 5-5-2011.

JORDAN BAKER, EXAMINING ATTORNEY



*David J. Kyros*

Director of the United States Patent and Trademark Office

# United States of America

United States Patent and Trademark Office

## KROOKED HORN

**Reg. No. 4,199,535**

MEDEIROS, MICHAEL T. (UNITED STATES INDIVIDUAL)  
2034 FREMONT STREET  
SONOMA, CA 95476

**Registered Aug. 28, 2012**

**Int. Cl.: 33**

FOR: ALCOHOLIC BEVERAGES EXCEPT BEERS, IN CLASS 33 (U.S. CLS. 47 AND 49).

**TRADEMARK**

FIRST USE 5-10-2012; IN COMMERCE 5-10-2012.

**PRINCIPAL REGISTER**

THE MARK CONSISTS OF STANDARD CHARACTERS WITHOUT CLAIM TO ANY PARTICULAR FONT, STYLE, SIZE, OR COLOR.

SN 85-313,164, FILED 5-5-2011.

JEFF DEFORD, EXAMINING ATTORNEY



*David J. Kyffers*

Director of the United States Patent and Trademark Office

# United States of America

United States Patent and Trademark Office



**Reg. No. 4,199,536**

**Registered Aug. 28, 2012**

**Int. Cl.: 9**

**TRADEMARK**

**PRINCIPAL REGISTER**

HATCH, INC. (NORTH CAROLINA CORPORATION)  
301 N. MAIN STREET, SUITE 101  
WINSTON-SALEM, NC 27101

FOR: EDUCATIONAL SYSTEM COMPRISED OF A MULTI-TOUCH INTERACTIVE TABLE, INTEGRATED AUDIO AND IMAGING SYSTEMS COMPRISED OF AN AUDIO MIXER, MICROPHONE, AND WEBCAM, COMPUTER SOFTWARE, AND TEACHING MANUALS ALL SOLD TOGETHER AS A UNIT OR AS A KIT CONTAINING A RETROFIT HARDWARE BEZEL INCORPORATING THE AUDIO AND IMAGING SYSTEM WITH COMPUTER SOFTWARE, DESIGNED TO ENCOURAGE PRESCHOOL AND ELEMENTARY AGE CHILDREN TO DEVELOP SOCIAL/EMOTIONAL SKILLS USING THE BACKDROP OF COGNITION AND TO ALLOW TEACHERS TO USE REAL DATA TO TRACK EACH CHILD'S DEVELOPMENT PROGRESS, IN CLASS 9 (U.S. CLS. 21, 23, 26, 36 AND 38).

FIRST USE 12-30-2011; IN COMMERCE 12-30-2011.

THE MARK CONSISTS OF A GRAPHIC ELEMENT THAT RESEMBLES TWO TALKING BUBBLES/THOUGHT BUBBLES/CHAT ICONS WITH SMILING FACES.

SN 85-313,317, FILED 5-5-2011.

STEVEN R. FINE, EXAMINING ATTORNEY



*David J. Kyffers*

Director of the United States Patent and Trademark Office

# United States of America

United States Patent and Trademark Office

# ECOVINYL

**Reg. No. 4,199,537**

**Registered Aug. 28, 2012**

**Int. Cl.: 9**

**TRADEMARK**

**PRINCIPAL REGISTER**

USFI, INC. (TEXAS CORPORATION)  
SUITE 100  
12100 FORD ROAD  
DALLAS, TX 75234

FOR: MAGNETIC CODED CARDS, NAMELY, KEY CARDS, ID CARDS, DOOR HANGERS,  
AND SLEEVES, IN CLASS 9 (U.S. CLS. 21, 23, 26, 36 AND 38).

FIRST USE 6-0-2011; IN COMMERCE 6-0-2011.

THE MARK CONSISTS OF STANDARD CHARACTERS WITHOUT CLAIM TO ANY PAR-  
TICULAR FONT, STYLE, SIZE, OR COLOR.

SN 85-313,727, FILED 5-5-2011.

MATTHEW KLINE, EXAMINING ATTORNEY



*David J. Kyffers*

Director of the United States Patent and Trademark Office

United States of America  
United States Patent and Trademark Office

# ECORFID

**Reg. No. 4,199,538**

**Registered Aug. 28, 2012**

**Int. Cl.: 9**

**TRADEMARK**

**PRINCIPAL REGISTER**

USFI, INC. (TEXAS CORPORATION)  
SUITE 100  
12100 FORD ROAD  
DALLAS, TX 75234

FOR: RADIO FREQUENCY IDENTIFICATION (RFID) SENSORS, IN CLASS 9 (U.S. CLS. 21, 23, 26, 36 AND 38).

FIRST USE 6-0-2011; IN COMMERCE 6-0-2011.

THE MARK CONSISTS OF STANDARD CHARACTERS WITHOUT CLAIM TO ANY PARTICULAR FONT, STYLE, SIZE, OR COLOR.

SN 85-313,737, FILED 5-5-2011.

MATTHEW KLINE, EXAMINING ATTORNEY



*David J. Kybas*

Director of the United States Patent and Trademark Office

# United States of America

United States Patent and Trademark Office

## MELODIE AND THE COOL CATZ

**Reg. No. 4,199,539**

**Registered Aug. 28, 2012**

**Int. Cl.: 9**

**TRADEMARK**

**PRINCIPAL REGISTER**

BLUBERI JEUX ET TECHNOLOGIES INC. (CANADA CORPORATION), AKA BLUBERI  
GAMING TECHNOLOGIES INC.,  
2120 LETENDRE STREET  
DRUMMONDVILLE, QUEBEC, CANADA J2C7E9

FOR: SOFTWARE FOR GAMING MACHINES; GAMING MACHINES WITH VIDEO OUTPUT,  
IN CLASS 9 (U.S. CLS. 21, 23, 26, 36 AND 38).

FIRST USE 1-9-2012; IN COMMERCE 1-9-2012.

THE MARK CONSISTS OF STANDARD CHARACTERS WITHOUT CLAIM TO ANY PAR-  
TICULAR FONT, STYLE, SIZE, OR COLOR.

THE NAME(S), PORTRAIT(S), AND/OR SIGNATURE(S) SHOWN IN THE MARK DOES NOT  
IDENTIFY A PARTICULAR LIVING INDIVIDUAL.

SN 85-313,772, FILED 5-5-2011.

JAMES A. RAUEN, EXAMINING ATTORNEY



*David J. Kyfos*

Director of the United States Patent and Trademark Office

# United States of America

United States Patent and Trademark Office

## THE WAY OF THE FUTURE

**Reg. No. 4,199,540**

REAL TIME SOFTWARE, INC. (CALIFORNIA CORPORATION)  
15121 GRAHAM STREET  
HUNTINGTON BEACH, CA 92649

**Registered Aug. 28, 2012**

**Int. Cl.: 9**

FOR: COMPUTER SOFTWARE, NAMELY, A TABLET COMPUTER APPLICATION ALLOWING SALES AND FIELD SERVICE REPRESENTATIVES TO CREATE AND UPDATE ON SITE AND IN REAL TIME AN ESTIMATE OR SALES CONTRACT FOR A CONSTRUCTION PROJECT, IN CLASS 9 (U.S. CLS. 21, 23, 26, 36 AND 38).

**TRADEMARK**

**PRINCIPAL REGISTER**

FIRST USE 5-31-2011; IN COMMERCE 2-14-2012.

THE MARK CONSISTS OF STANDARD CHARACTERS WITHOUT CLAIM TO ANY PARTICULAR FONT, STYLE, SIZE, OR COLOR.

SN 85-313,794, FILED 5-5-2011.

CHERYL CLAYTON, EXAMINING ATTORNEY



*David J. Kyros*

Director of the United States Patent and Trademark Office

# United States of America

United States Patent and Trademark Office

## Nurse's Helper

**Reg. No. 4,199,541**

**Registered Aug. 28, 2012**

**Int. Cl.: 12**

**TRADEMARK**

**PRINCIPAL REGISTER**

MELONE, PAUL (UNITED STATES INDIVIDUAL)  
431 EDISON STREET  
STRUTHERS, OH 44471 AND

MELONE, TAMMY (UNITED STATES INDIVIDUAL)  
431 EDISON STREET  
STRUTHERS, OH 44471

FOR: WHEELCHAIRS, IN CLASS 12 (U.S. CLS. 19, 21, 23, 31, 35 AND 44).

FIRST USE 3-1-2012; IN COMMERCE 3-1-2012.

THE MARK CONSISTS OF STANDARD CHARACTERS WITHOUT CLAIM TO ANY PARTICULAR FONT, STYLE, SIZE, OR COLOR.

SN 85-314,122, FILED 5-6-2011.

TRACY WHITTAKER-BROWN, EXAMINING ATTORNEY



*David J. Kybas*

Director of the United States Patent and Trademark Office



# United States of America

United States Patent and Trademark Office

## Top of the Notch

**Reg. No. 4,199,542**

WILLIE J. TABOR (UNITED STATES INDIVIDUAL)  
192 LONGSIGHT LANE #202  
ROCK HILL, SC 29730

**Registered Aug. 28, 2012**

**Int. Cl.: 33**

FOR: ALCOHOLIC EGG NOG, IN CLASS 33 (U.S. CLS. 47 AND 49).

**TRADEMARK**

FIRST USE 10-27-2011; IN COMMERCE 12-12-2011.

**PRINCIPAL REGISTER**

THE MARK CONSISTS OF STANDARD CHARACTERS WITHOUT CLAIM TO ANY PARTICULAR FONT, STYLE, SIZE, OR COLOR.

SN 85-314,211, FILED 5-6-2011.

ANDREA BUTLER, EXAMINING ATTORNEY



*David J. Kyffers*

Director of the United States Patent and Trademark Office

# United States of America

United States Patent and Trademark Office

# seven

**Reg. No. 4,199,543**

JUSTIN HOFFMAN (UNITED STATES INDIVIDUAL)  
4860 WARD ROAD  
WHEAT RIDGE, CO 80033

**Registered Aug. 28, 2012**

**Int. Cl.: 34**

FOR: ELECTRONIC CIGARETTES; ELECTRONIC CIGARETTES FOR USE AS AN ALTERNATIVE TO TRADITIONAL CIGARETTES, IN CLASS 34 (U.S. CLS. 2, 8, 9 AND 17).

**TRADEMARK**

FIRST USE 3-20-2012; IN COMMERCE 5-1-2012.

**PRINCIPAL REGISTER**

THE MARK CONSISTS OF STANDARD CHARACTERS WITHOUT CLAIM TO ANY PARTICULAR FONT, STYLE, SIZE, OR COLOR.

SN 85-314,235, FILED 5-6-2011.

MARLENE BELL, EXAMINING ATTORNEY



*David J. Kybas*

Director of the United States Patent and Trademark Office

# United States of America

United States Patent and Trademark Office

## FETCH THE DAY

**Reg. No. 4,199,544**

**Registered Aug. 28, 2012**

**Int. Cls.: 9 and 25**

**TRADEMARK**

**PRINCIPAL REGISTER**

GIORDANO, ANNE (UNITED STATES INDIVIDUAL)  
406 GREEN VILLAGE ROAD  
GREEN VILLAGE, NJ 07935

FOR: CAR MAGNET, IN CLASS 9 (U.S. CLS. 21, 23, 26, 36 AND 38).

FIRST USE 4-29-2012; IN COMMERCE 4-29-2012.

FOR: APPAREL, NAMELY, TEE SHIRT, BALL CAPS, WOOL CAPS, SOCKS, HOODED SWEATSHIRTS, SLEEPWEAR, SLIPPERS, FLIP FLOPS, IN CLASS 25 (U.S. CLS. 22 AND 39).

FIRST USE 4-29-2012; IN COMMERCE 4-29-2012.

THE MARK CONSISTS OF STANDARD CHARACTERS WITHOUT CLAIM TO ANY PARTICULAR FONT, STYLE, SIZE, OR COLOR.

SN 85-314,755, FILED 5-6-2011.

SUSAN BILLHEIMER, EXAMINING ATTORNEY



*David J. Kybas*

Director of the United States Patent and Trademark Office

# United States of America

United States Patent and Trademark Office

# vsnap

**Reg. No. 4,199,545**

**Registered Aug. 28, 2012**

**Int. Cl.: 42**

**SERVICE MARK**

**PRINCIPAL REGISTER**

JOYCE, JAMES (UNITED STATES INDIVIDUAL)  
96 GRANT STREET  
NEEDHAM, MA 02492

FOR: PROVIDING A WEBSITE FEATURING TECHNOLOGY THAT ENABLES USERS TO UPLOAD AND SHARE USER-GENERATED VIDEOS ON A WIDE VARIETY OF TOPICS AND SUBJECTS, IN CLASS 42 (U.S. CLS. 100 AND 101).

FIRST USE 4-8-2011; IN COMMERCE 8-13-2011.

THE MARK CONSISTS OF STANDARD CHARACTERS WITHOUT CLAIM TO ANY PARTICULAR FONT, STYLE, SIZE, OR COLOR.

SN 85-314,820, FILED 5-6-2011.

NAAKWAMA ANKRAH, EXAMINING ATTORNEY



*David J. Kyffers*

Director of the United States Patent and Trademark Office

# United States of America

United States Patent and Trademark Office

# HOODIE

**Reg. No. 4,199,546**

**Registered Aug. 28, 2012**

**Int. Cl.: 18**

**TRADEMARK**

**PRINCIPAL REGISTER**

INFANTINO, LLC (CALIFORNIA LIMITED LIABILITY COMPANY)  
SUITE 200  
4920 CARROLL CANYON RD.  
SAN DIEGO, CA 92656

FOR: FITTED COVER FOR AN INFANT CARRIER WORN ON THE BODY, IN CLASS 18  
(U.S. CLS. 1, 2, 3, 22 AND 41).

FIRST USE 10-10-2011; IN COMMERCE 10-10-2011.

THE MARK CONSISTS OF STANDARD CHARACTERS WITHOUT CLAIM TO ANY PARTICULAR FONT, STYLE, SIZE, OR COLOR.

SN 85-314,924, FILED 5-6-2011.

CHRISTINA SOBRAL, EXAMINING ATTORNEY



*David J. Kybas*

Director of the United States Patent and Trademark Office

# United States of America

United States Patent and Trademark Office

# Eventhea

**Reg. No. 4,199,547**

BAREKET, DANIEL J (UNITED STATES INDIVIDUAL)  
PO BOX 1364

**Registered Aug. 28, 2012**

HALLANDALE, FL 33008

**Int. Cl.: 42**

FOR: HOSTING ON-LINE WEB FACILITIES FOR OTHERS FOR SHARING ON-LINE CONTENT RELATING TO ENTERTAINMENT EVENTS, IN CLASS 42 (U.S. CLS. 100 AND 101).

**SERVICE MARK**

FIRST USE 4-1-2012; IN COMMERCE 4-1-2012.

**PRINCIPAL REGISTER**

THE MARK CONSISTS OF STANDARD CHARACTERS WITHOUT CLAIM TO ANY PARTICULAR FONT, STYLE, SIZE, OR COLOR.

SN 85-314,990, FILED 5-6-2011.

SHAILA SETTLES, EXAMINING ATTORNEY



*David J. Kyffers*

Director of the United States Patent and Trademark Office

# United States of America

United States Patent and Trademark Office

## PRIVATE STOCK

**Reg. No. 4,199,548**

**Registered Aug. 28, 2012**

**Int. Cls.: 9, 14, 18, and 25**

**TRADEMARK**

**PRINCIPAL REGISTER**

KOON, JONATHAN (UNITED STATES INDIVIDUAL)  
245-24 ALAMEDA AVENUE  
DOUGLSTON, NY 11362

FOR: BACKPACKS ESPECIALLY ADAPTED FOR HOLDING LAPTOPS AND NOTEBOOK COMPUTERS; CARRYING CASES FOR CELL PHONES; CARRYING CASES FOR MOBILE COMPUTERS; COMPUTER CARRYING CASES; EYE GLASSES; EYEGLASSES; EYEWEAR; EYEWEAR, NAMELY, SUNGLASSES, EYEGLASSES AND OPHTHALMIC FRAMES AND CASES THEREFOR; LAPTOP CARRYING CASES; NOTEBOOK COMPUTER CARRYING CASES; PROTECTIVE COVERS AND CASES FOR CELL PHONES, LAPTOPS AND PORTABLE MEDIA PLAYERS; SUNGLASSES AND SPECTACLES, IN CLASS 9 (U.S. CLS. 21, 23, 26, 36 AND 38).

FIRST USE 3-1-2012; IN COMMERCE 3-1-2012.

FOR: BRACELETS; DRESS WATCHES; EARRINGS; JEWELLERY; JEWELLERY AND WATCHES; JEWELRY WATCHES; NECKLACES; RINGS, IN CLASS 14 (U.S. CLS. 2, 27, 28 AND 50).

FIRST USE 9-22-2011; IN COMMERCE 9-22-2011.

FOR: BACKPACKS; BELT BAGS AND HIP BAGS; DUFFEL BAGS; HANDBAGS; LUGGAGE; PURSES AND WALLETS; TRAVEL CASES, IN CLASS 18 (U.S. CLS. 1, 2, 3, 22 AND 41).

FIRST USE 9-19-2011; IN COMMERCE 9-19-2011.

FOR: BLOUSES; BRIEFS; CAPS; COATS; DENIM JACKETS; HATS; JACKETS; JEANS; PANTS; SCARVES; SHIRTS; SHORT TROUSERS; SHORTS; SKIRTS AND DRESSES; SOCKS; SWEAT PANTS; SWEAT SHIRTS; SWEATERS; T-SHIRTS; UNDERWEAR; VESTS, IN CLASS 25 (U.S. CLS. 22 AND 39).

FIRST USE 9-15-2011; IN COMMERCE 9-15-2011.

THE MARK CONSISTS OF THE WORDS "PRIVATE STOCK" IN A STYLIZED SCRIPT THAT INCLUDES THE LETTER "V" AND THE LETTER "A" IN THE WORD "PRIVATE" SHARING A COMMON LINE; INCLUDES A PORTION OF THE RIGHT SIDE OF THE LETTER "O" CONNECTING WITH A PORTION OF THE LEFT SIDE OF THE LETTER "C" IN THE WORD



*David J. Kyffers*

Director of the United States Patent and Trademark Office

**Reg. No. 4,199,548** "STOCK" AND INCLUDES A PORTION OF THE LETTER "C" BEING CONTINUED TO FORM THE CENTER PORTION OF THE LETTER "K" IN THE WORD "STOCK".

SN 85-315,085, FILED 5-7-2011.

YAT SYE, LEE, EXAMINING ATTORNEY



# United States of America

United States Patent and Trademark Office

## SAFE & SOUND

**Reg. No. 4,199,549**

**Registered Aug. 28, 2012**

**Int. Cl.: 9**

**TRADEMARK**

**PRINCIPAL REGISTER**

VTECH COMMUNICATIONS, INC. (OREGON CORPORATION)  
SUITE 120  
9590 S.W. GEMINI DRIVE  
BEAVERTON, OR 97008

FOR: BABY MONITORS, IN CLASS 9 (U.S. CLS. 21, 23, 26, 36 AND 38).

FIRST USE 4-1-2012; IN COMMERCE 4-1-2012.

THE MARK CONSISTS OF STANDARD CHARACTERS WITHOUT CLAIM TO ANY PARTICULAR FONT, STYLE, SIZE, OR COLOR.

SN 85-315,291, FILED 5-9-2011.

CAROLINE WOOD, EXAMINING ATTORNEY



*David J. Kyffers*

Director of the United States Patent and Trademark Office

# United States of America

United States Patent and Trademark Office

# VISION

**Reg. No. 4,199,550**

FARNAM COMPANIES, INC. (ARIZONA CORPORATION)  
301 WEST OSBORN ROAD  
PHOENIX, AZ 85013

**Registered Aug. 28, 2012**

**Int. Cl.: 5**

FOR: DIETARY AND NUTRITIONAL SUPPLEMENTS FOR COMPANION ANIMALS, IN CLASS 5 (U.S. CLS. 6, 18, 44, 46, 51 AND 52).

**TRADEMARK**

FIRST USE 1-10-2012; IN COMMERCE 1-10-2012.

**PRINCIPAL REGISTER**

THE MARK CONSISTS OF STANDARD CHARACTERS WITHOUT CLAIM TO ANY PARTICULAR FONT, STYLE, SIZE, OR COLOR.

SN 85-315,576, FILED 5-9-2011.

STEVEN R. FINE, EXAMINING ATTORNEY



*David J. Kybas*

Director of the United States Patent and Trademark Office

# United States of America

United States Patent and Trademark Office



**Reg. No. 4,199,551**

**Registered Aug. 28, 2012**

**Int. Cls.: 16 and 41**

**TRADEMARK**

**SERVICE MARK**

**PRINCIPAL REGISTER**

NATIONAL NETWORK OF DIGITAL SCHOOLS MANAGEMENT FOUNDATION  
(PENNSYLVANIA NON-PROFIT CORPORATION)  
1000 THIRD STREET  
BEAVER, PA 15009

FOR: EDUCATIONAL PUBLICATIONS, NAMELY, WORKBOOKS, TEXT BOOKS, ACTIVITY BOOKS, AND A SERIES OF FICTION BOOKS FOR USE IN ELEMENTARY SCHOOL CURRICULUM, IN CLASS 16 (U.S. CLS. 2, 5, 22, 23, 29, 37, 38 AND 50).

FIRST USE 8-1-2011; IN COMMERCE 8-1-2011.

FOR: EDUCATIONAL SERVICES, NAMELY, PROVIDING ONLINE COURSES OF INSTRUCTION AT THE ELEMENTARY SCHOOL LEVEL AND DISTRIBUTION OF COURSE MATERIAL IN CONNECTION THEREWITH, IN CLASS 41 (U.S. CLS. 100, 101 AND 107).

FIRST USE 8-1-2011; IN COMMERCE 8-1-2011.

OWNER OF U.S. REG. NO. 3,632,626.

THE MARK CONSISTS OF AN IONIC COLUMN WITH THE WORD "LITTLE" TO THE RIGHT IN LOWER CASE LETTERS THEN THE WORD "LINCOLN" UNDERNEATH IT IN CAPITAL LETTERS.

SN 85-315,725, FILED 5-9-2011.

KIMBERLY PERRY, EXAMINING ATTORNEY



*David J. Kybas*

Director of the United States Patent and Trademark Office

# United States of America

United States Patent and Trademark Office



**Reg. No. 4,199,552**

**Registered Aug. 28, 2012**

**Int. Cls.: 16 and 41**

**TRADEMARK**

**SERVICE MARK**

**PRINCIPAL REGISTER**

NATIONAL NETWORK OF DIGITAL SCHOOLS MANAGEMENT FOUNDATION  
(PENNSYLVANIA NON-PROFIT CORPORATION)  
1000 THIRD STREET  
BEAVER, PA 15009

FOR: EDUCATIONAL PUBLICATIONS, NAMELY, WORKBOOKS, TEXT BOOKS, ACTIVITY BOOKS, AND A SERIES OF FICTION BOOKS FOR USE IN ELEMENTARY SCHOOL CURRICULUM, IN CLASS 16 (U.S. CLS. 2, 5, 22, 23, 29, 37, 38 AND 50).

FIRST USE 8-1-2011; IN COMMERCE 8-1-2011.

FOR: EDUCATIONAL SERVICES, NAMELY, PROVIDING ONLINE COURSES OF INSTRUCTION AT THE ELEMENTARY SCHOOL LEVEL AND DISTRIBUTION OF COURSE MATERIAL IN CONNECTION THEREWITH, IN CLASS 41 (U.S. CLS. 100, 101 AND 107).

FIRST USE 8-1-2011; IN COMMERCE 8-1-2011.

OWNER OF U.S. REG. NO. 3,632,626.

THE MARK CONSISTS OF AN IONIC COLUMN.

SN 85-315,726, FILED 5-9-2011.

KIMBERLY PERRY, EXAMINING ATTORNEY



*David J. Kyffers*

Director of the United States Patent and Trademark Office

# United States of America

United States Patent and Trademark Office

# INK N BURN

**Reg. No. 4,199,553**

**Registered Aug. 28, 2012**

**Int. Cl.: 25**

**TRADEMARK**

**PRINCIPAL REGISTER**

INK N BURN, INC. (CALIFORNIA CORPORATION)  
SUITE A  
210 MCCORMICK AVENUE  
COSTA MESA, CA 92626

FOR: PERFORMANCE APPAREL FOR ATHLETICS, NAMELY, SHIRTS, TANK TOPS, V-NECK SHIRTS, BRAS, BOARD SHORTS, WOMEN'S SHORTS, HATS, SLEEVES, SOCKS, SHORTS, COATS AND BANDANAS FOR ADULTS AND CHILDREN, IN CLASS 25 (U.S. CLS. 22 AND 39).

FIRST USE 7-14-2008; IN COMMERCE 7-14-2008.

THE MARK CONSISTS OF STANDARD CHARACTERS WITHOUT CLAIM TO ANY PARTICULAR FONT, STYLE, SIZE, OR COLOR.

SN 85-315,937, FILED 5-9-2011.

RONALD AIKENS, EXAMINING ATTORNEY



*David J. Kyffers*

Director of the United States Patent and Trademark Office

# United States of America

United States Patent and Trademark Office

## ALCO-WATER

**Reg. No. 4,199,554**

**Registered Aug. 28, 2012**

**Int. Cl.: 32**

**TRADEMARK**

**PRINCIPAL REGISTER**

MCKENZIE RIVER CORPORATION (CALIFORNIA CORPORATION)  
1160 BATTERY STREET, SUITE 30  
SAN FRANCISCO, CA 94111

FOR: ALE; BEER, IN CLASS 32 (U.S. CLS. 45, 46 AND 48).

FIRST USE 4-20-2012; IN COMMERCE 4-20-2012.

THE MARK CONSISTS OF STANDARD CHARACTERS WITHOUT CLAIM TO ANY PARTICULAR FONT, STYLE, SIZE, OR COLOR.

SN 85-316,442, FILED 5-10-2011.

VERNA BETH RIRIE, EXAMINING ATTORNEY



*David J. Kyffers*

Director of the United States Patent and Trademark Office

# United States of America

United States Patent and Trademark Office

# MAKE ME

**Reg. No. 4,199,555**

MAKE ME DRINKS LIMITED (UNITED KINGDOM PRIVATE LIMITED COMPANY)  
553 HIGH ROAD

**Registered Aug. 28, 2012**

WEMBLEY, UNITED KINGDOM HA02DW

**Int. Cl.: 5**

FOR: MINERAL, VITAMIN, AND NUTRITIONALLY ENHANCED BEVERAGES AND DRINKS; NUTRITIONAL SUPPLEMENTS IN THE FORM OF TABLETS AND POWDERS , IN CLASS 5 (U.S. CLS. 6, 18, 44, 46, 51 AND 52).

**TRADEMARK**

FIRST USE 5-8-2012; IN COMMERCE 5-8-2012.

**PRINCIPAL REGISTER**

THE MARK CONSISTS OF STANDARD CHARACTERS WITHOUT CLAIM TO ANY PARTICULAR FONT, STYLE, SIZE, OR COLOR.

SN 85-316,651, FILED 5-10-2011.

MATTHEW KLINE, EXAMINING ATTORNEY



*David J. Kyffers*

Director of the United States Patent and Trademark Office

# United States of America

United States Patent and Trademark Office

# SOLIMUD

**Reg. No. 4,199,556**

NEO SOLUTIONS, INC. (PENNSYLVANIA CORPORATION)  
1340 BRIGHTON ROAD  
BEAVER, PA 150099238

**Registered Aug. 28, 2012**

**Int. Cl.: 1**

FOR: ABSORBENT MATERIAL, NAMELY, A COPOLYMER, FOR ABSORBING LIQUID INDUSTRIAL WASTE, IN CLASS 1 (U.S. CLS. 1, 5, 6, 10, 26 AND 46).

**TRADEMARK**

FIRST USE 5-5-2012; IN COMMERCE 5-10-2012.

**PRINCIPAL REGISTER**

THE MARK CONSISTS OF STANDARD CHARACTERS WITHOUT CLAIM TO ANY PARTICULAR FONT, STYLE, SIZE, OR COLOR.

SN 85-317,086, FILED 5-10-2011.

WARREN L. OLANDRIA, EXAMINING ATTORNEY



*David J. Kybas*

Director of the United States Patent and Trademark Office



# United States of America

United States Patent and Trademark Office

## NATIONAL ARTS TREASURE INITIATIVE

**Reg. No. 4,199,557**

**Registered Aug. 28, 2012**

**Int. Cls.: 36 and 41**

**SERVICE MARK**

**PRINCIPAL REGISTER**

NATIONAL ARTS TREASURE INITIATIVE (VIRGINIA NON-PROFIT CORPORATION)  
3815 52ND STREET, NW  
WASHINGTON, DC 20016

FOR: CHARITABLE FUNDRAISING, IN CLASS 36 (U.S. CLS. 100, 101 AND 102).

FIRST USE 4-30-2011; IN COMMERCE 4-30-2011.

FOR: FILM AND VIDEO PRODUCTION, IN CLASS 41 (U.S. CLS. 100, 101 AND 107).

FIRST USE 4-30-2011; IN COMMERCE 4-30-2011.

THE MARK CONSISTS OF STANDARD CHARACTERS WITHOUT CLAIM TO ANY PARTICULAR FONT, STYLE, SIZE, OR COLOR.

NO CLAIM IS MADE TO THE EXCLUSIVE RIGHT TO USE "NATIONAL ARTS" AND "INITIATIVE", APART FROM THE MARK AS SHOWN.

SN 85-317,597, FILED 5-10-2011.

MARCIE MILONE, EXAMINING ATTORNEY



*David J. Kybas*

Director of the United States Patent and Trademark Office

# United States of America

United States Patent and Trademark Office

## SUNLESS HOURS

**Reg. No. 4,199,558**

SULLIVAN, SEAN MICHAEL (UNITED STATES INDIVIDUAL)  
1192 MITCHELL #38  
TUSTIN, CA 92780

**Registered Aug. 28, 2012**

**Int. Cl.: 25**

FOR: JACKETS; SHIRTS; SWEATSHIRTS, IN CLASS 25 (U.S. CLS. 22 AND 39).

**TRADEMARK**

FIRST USE 8-0-2011; IN COMMERCE 8-0-2011.

**PRINCIPAL REGISTER**

THE MARK CONSISTS OF STANDARD CHARACTERS WITHOUT CLAIM TO ANY PARTICULAR FONT, STYLE, SIZE, OR COLOR.

SN 85-317,697, FILED 5-11-2011.

NELSON SNYDER, EXAMINING ATTORNEY



*David J. Kybas*

Director of the United States Patent and Trademark Office

# United States of America

United States Patent and Trademark Office



**Reg. No. 4,199,559**

SUN HUA TECHNOLOGY CO., LTD (TAIWAN CORPORATION)  
5F, NO 13, HO PING RD  
LU-CHOU CITY, TAIPEI, TAIWAN

**Registered Aug. 28, 2012**

**Int. Cl.: 9**

FOR: CARRYING CASES FOR ELECTRONIC EQUIPMENT, NAMELY, PHOTOGRAPHIC, OPTICAL, NETBOOK COMPUTER, LAPTOP COMPUTERS, MOBILE PHONES, MOBILE GAMING, MOBILE VIDEO, TABLET COMPUTERS, GPS, MUSIC PLAYERS, IN CLASS 9 (U.S. CLS. 21, 23, 26, 36 AND 38).

**TRADEMARK**

**PRINCIPAL REGISTER**

FIRST USE 12-15-2011; IN COMMERCE 3-1-2012.

THE MARK CONSISTS OF A BROWN SHIELD. THERE IS A TAN BORDER INSIDE THE SHIELD. THERE IS A WHITE RIBBON BANNER ON TOP PORTION OF THE BROWN SHIELD. INSIDE THE WHITE BANNER IS BROWN LETTERING "PROFASHION". UNDER THE WHITE BANNER IS RING OF BEIGE STARS. INSIDE THE RING OF BEIGE STARS IS A WHITE RING. INSIDE THE WHITE RING IS A WHITE CAPITAL "PF". ON EACH SIDE OF "PF" IS A TAUPE CIRCLE. ABOVE AND BELOW THE WHITE "PF" IS A HORIZONTAL TAN LINE AND 7 TAUPE VERTICAL COLUMNS.

THE COLOR(S) BROWN, TAN, TAUPE, BEIGE, AND WHITE IS/ARE CLAIMED AS A FEATURE OF THE MARK.

SN 85-317,827, FILED 5-11-2011.

ELI HELLMAN, EXAMINING ATTORNEY



*David J. Kybas*

Director of the United States Patent and Trademark Office

# United States of America

United States Patent and Trademark Office

## POWERED BY COUNTRY

**Reg. No. 4,199,560**

ENTERCOM COMMUNICATIONS CORP. (PENNSYLVANIA CORPORATION)

**Registered Aug. 28, 2012**

401 CITY AVENUE, SUITE 809  
BALA CYNWYD, PA 19072

**Int. Cl.: 41**

FOR: ENTERTAINMENT SERVICES, NAMELY, PRODUCTION OF RADIO PROGRAMS, RADIO PROGRAMMING; RADIO ENTERTAINMENT SERVICES, NAMELY, ONGOING RADIO PROGRAMS IN THE FIELDS OF ENTERTAINMENT AND MUSIC, IN CLASS 41 (U.S. CLS. 100, 101 AND 107).

**SERVICE MARK**

**PRINCIPAL REGISTER**

FIRST USE 6-5-2011; IN COMMERCE 6-5-2011.

THE MARK CONSISTS OF STANDARD CHARACTERS WITHOUT CLAIM TO ANY PARTICULAR FONT, STYLE, SIZE, OR COLOR.

NO CLAIM IS MADE TO THE EXCLUSIVE RIGHT TO USE "COUNTRY", APART FROM THE MARK AS SHOWN.

SN 85-317,836, FILED 5-11-2011.

Laurie Mayes, Examining Attorney



*David J. Kyros*

Director of the United States Patent and Trademark Office

# United States of America

United States Patent and Trademark Office

# one one seven

**Reg. No. 4,199,561**

HUDSON VALLEY (NEW YORK), LTD (NEW YORK CORPORATION)  
463 SEVENTH AVE. SUITE 701  
NEW YORK, NY 10018

**Registered Aug. 28, 2012**

**Int. Cl.: 25**

FOR: COATS; DRESSES; GLOVES; HATS; JEANS; KNIT TOPS; PANTS; SHIRTS; SHOES;  
SHORTS; SNEAKERS; SWEATERS; T-SHIRTS; TIGHTS; UNDERGARMENTS, IN CLASS  
25 (U.S. CLS. 22 AND 39).

**TRADEMARK**

FIRST USE 1-6-2012; IN COMMERCE 1-6-2012.

**PRINCIPAL REGISTER**

THE MARK CONSISTS OF STANDARD CHARACTERS WITHOUT CLAIM TO ANY PAR-  
TICULAR FONT, STYLE, SIZE, OR COLOR.

SN 85-318,006, FILED 5-11-2011.

SKYE YOUNG, EXAMINING ATTORNEY



*David J. Kybas*

Director of the United States Patent and Trademark Office

# United States of America

United States Patent and Trademark Office

## SELL MORE BEER

**Reg. No. 4,199,562**

TAPHANDLES LLC (WASHINGTON LIMITED LIABILITY COMPANY)  
1424 4TH AVE., STE. 201  
SEATTLE, WA 98101

**Registered Aug. 28, 2012**

**Int. Cl.: 20**

FOR: DISPLAY STANDS, NON-METAL HANDLES FOR TAPS FOR KEGS, IN CLASS 20  
(U.S. CLS. 2, 13, 22, 25, 32 AND 50).

**TRADEMARK**

FIRST USE 1-31-2011; IN COMMERCE 1-31-2011.

**PRINCIPAL REGISTER**

THE MARK CONSISTS OF STANDARD CHARACTERS WITHOUT CLAIM TO ANY PARTICULAR FONT, STYLE, SIZE, OR COLOR.

SN 85-318,106, FILED 5-11-2011.

DAWN FELDMAN, EXAMINING ATTORNEY



*David J. Kybas*

Director of the United States Patent and Trademark Office

# United States of America

United States Patent and Trademark Office

# FitPAWS

**Reg. No. 4,199,563**

BALL DYNAMICS INTERNATIONAL, LLC (COLORADO LIMITED LIABILITY COMPANY)  
14215 MEAD ST.

**Registered Aug. 28, 2012**

LONGMONT, CO 80504

**Int. Cl.: 16**

FOR: PRINTED INSTRUCTIONAL, EDUCATIONAL AND TEACHING MATERIALS IN THE  
FIELDS OF PHYSICAL THERAPY, REHABILITATION, EXERCISE, CONDITIONING AND  
TRAINING FOR ANIMALS, IN CLASS 16 (U.S. CLS. 2, 5, 22, 23, 29, 37, 38 AND 50).

**TRADEMARK**

FIRST USE 4-26-2012; IN COMMERCE 4-26-2012.

**PRINCIPAL REGISTER**

THE MARK CONSISTS OF STANDARD CHARACTERS WITHOUT CLAIM TO ANY PAR-  
TICULAR FONT, STYLE, SIZE, OR COLOR.

OWNER OF U.S. REG. NO. 3,797,098.

SN 85-318,394, FILED 5-11-2011.

AISHA CLARKE, EXAMINING ATTORNEY



*David J. Kyffers*

Director of the United States Patent and Trademark Office

# United States of America

United States Patent and Trademark Office

# FitPAWS

**Reg. No. 4,199,564**

**Registered Aug. 28, 2012**

**Int. Cl.: 41**

**SERVICE MARK**

**PRINCIPAL REGISTER**

BALL DYNAMICS INTERNATIONAL, LLC (COLORADO LIMITED LIABILITY COMPANY)  
14215 MEAD ST.  
LONGMONT, CO 80504

FOR: EDUCATIONAL SERVICES, NAMELY, CONDUCTING LIVE CLASSES, SEMINARS, CONFERENCES AND WORKSHOPS IN THE FIELDS OF PHYSICAL THERAPY, REHABILITATION, EXERCISE, CONDITIONING AND TRAINING FOR ANIMALS AND DISTRIBUTION OF PRINTED MATERIALS IN CONNECTION THEREWITH IN HARD COPY OR ELECTRONIC FORMAT ON THE SAME TOPICS, IN CLASS 41 (U.S. CLS. 100, 101 AND 107).

FIRST USE 4-26-2012; IN COMMERCE 4-26-2012.

THE MARK CONSISTS OF STANDARD CHARACTERS WITHOUT CLAIM TO ANY PARTICULAR FONT, STYLE, SIZE, OR COLOR.

OWNER OF U.S. REG. NO. 3,797,098.

SN 85-318,425, FILED 5-11-2011.

AISHA CLARKE, EXAMINING ATTORNEY



*David J. Kyffers*

Director of the United States Patent and Trademark Office



# United States of America

United States Patent and Trademark Office

## SmartGirls' Way

**Reg. No. 4,199,565**

SMARTGIRLS' WAY (UTAH LIMITED LIABILITY COMPANY)  
3440 E SPRUCE STREET  
SEATTLE, WA 98122

**Registered Aug. 28, 2012**

**Int. Cl.: 41**

FOR: ARRANGING AND CONDUCTING BUSINESS SEMINARS IN THE FIELD OF ENTREPRENEURISM, IN CLASS 41 (U.S. CLS. 100, 101 AND 107).

**SERVICE MARK**

FIRST USE 10-24-2011; IN COMMERCE 10-24-2011.

**PRINCIPAL REGISTER**

THE MARK CONSISTS OF STANDARD CHARACTERS WITHOUT CLAIM TO ANY PARTICULAR FONT, STYLE, SIZE, OR COLOR.

SN 85-318,686, FILED 5-11-2011.

JAY BESCH, EXAMINING ATTORNEY



*David J. Kyffers*

Director of the United States Patent and Trademark Office

# United States of America

United States Patent and Trademark Office

W<sup>o</sup>W  
HANGER

**Reg. No. 4,199,566**

**Registered Aug. 28, 2012**

**Int. Cl.: 20**

**TRADEMARK**

**PRINCIPAL REGISTER**

T&P CO., LTD. (REPUBLIC OF KOREA LIMITED CORPORATION)  
283-7 TAERI, KOCHONEUP, KIMPOSHI  
KYUNGKIDO, REPUBLIC OF KOREA 415-817

FOR: HANGERS FOR CLOTHES, IN CLASS 20 (U.S. CLS. 2, 13, 22, 25, 32 AND 50).

FIRST USE 7-30-2011; IN COMMERCE 5-25-2012.

NO CLAIM IS MADE TO THE EXCLUSIVE RIGHT TO USE "HANGER", APART FROM THE MARK AS SHOWN.

THE MARK CONSISTS OF THE STYLIZED WORDS "WOW HANGER" AND A STYLIZED FIGURE OF A HOOK. THE STYLIZED FIGURE IS PLACED ON THE TOP OF THE LETTER "O" AND BEAMS OF LIGHT ARE COMING OUT FROM THE HOOK. THE STYLIZED WORD "WOW" IS POSITIONED ABOVE THE STYLIZED WORD "HANGER".

SN 85-318,798, FILED 5-12-2011.

BILL DAWE, EXAMINING ATTORNEY



*David J. Kyffers*

Director of the United States Patent and Trademark Office

# United States of America

United States Patent and Trademark Office

# Lleno

**Reg. No. 4,199,567**

**Registered Aug. 28, 2012**

**Int. Cl.: 21**

**TRADEMARK**

**PRINCIPAL REGISTER**

LU, YI-TZU (TAIWAN INDIVIDUAL)  
NO. 27, ZHONGXIAO 2ND RD., LINGYA DIST.  
KAOHSIUNG CITY, TAIWAN

FOR: CUPS; COOKING POT SETS; PLATES; DISHES; JUGS; REUSABLE PLASTIC WATER BOTTLES SOLD EMPTY; DECANTERS; WINE GLASSES; WINE JUGS; HOUSEHOLD CONTAINERS FOR FOODS; SALT AND PEPPER SHAKERS; SUGAR CANS; GLASS JARS; COASTERS NOT OF PAPER AND NOT BEING TABLE LINEN; CANDLESTICKS, IN CLASS 21 (U.S. CLS. 2, 13, 23, 29, 30, 33, 40 AND 50).

FIRST USE 3-31-2012; IN COMMERCE 5-14-2012.

THE MARK CONSISTS OF THE STYLIZED WORD "LLENO".

THE ENGLISH TRANSLATION OF "LLENO" IN THE MARK IS "FULL".

SN 85-319,282, FILED 5-12-2011.

TRACY WHITTAKER-BROWN, EXAMINING ATTORNEY



*David J. Kyffers*

Director of the United States Patent and Trademark Office

# United States of America

United States Patent and Trademark Office

## SPORTS CULTURE

**Reg. No. 4,199,568**

**Registered Aug. 28, 2012**

**Int. Cl.: 41**

**SERVICE MARK**

**PRINCIPAL REGISTER**

SPORTS CULTURE, INC. (TEXAS CORPORATION)  
SUITE 200  
1330 LAKE ROBINS  
THE WOODLANDS, TX 77380

FOR: EDUCATIONAL SERVICES, NAMELY, CONDUCTING SEMINARS AND COURSES IN THE FIELDS OF SOCCER, BASEBALL, BASKETBALL, TENNIS AND GOLF AND DISTRIBUTING COURSE MATERIALS IN CONNECTION THEREWITH; PERSONAL TRAINING SERVICES, NAMELY, STRENGTH AND CONDITIONING FOR SOCCER, BASEBALL, BASKETBALL, TENNIS AND GOLF; SOCCER, BASEBALL, BASKETBALL, TENNIS AND GOLF INSTRUCTION; SOCCER, BASEBALL, BASKETBALL, TENNIS AND GOLF CAMPS; ENTERTAINMENT IN THE NATURE OF SOCCER, BASEBALL, BASKETBALL, TENNIS AND GOLF TOURNAMENTS AND CLINICS; PROVIDING INFORMATION IN THE FIELD OF SOCCER, BASEBALL, BASKETBALL, TENNIS AND GOLF, NAMELY, RULES, SKILLS, TECHNIQUES, PRINCIPLES AND NEWS BY MEANS OF THE INTERNET AND WIRELESS COMMUNICATION DEVICES FOR VOICE, DATA, AND/OR IMAGE TRANSMISSION INCLUDING CELLULAR TELEPHONES, MOBILE TELEPHONES, AND PERSONAL DIGITAL ASSISTANTS (PDAS); EDUCATIONAL SERVICES, NAMELY, PROVIDING ONE-ON-ONE MENTORING IN THE FIELD OF SOCCER, BASEBALL, BASKETBALL, TENNIS AND GOLF VIA THE INTERNET; PROVIDING AN ON-LINE NEWSLETTER IN THE FIELD OF SOCCER, BASEBALL, BASKETBALL, TENNIS AND GOLF, IN CLASS 41 (U.S. CLS. 100, 101 AND 107).

FIRST USE 8-0-2011; IN COMMERCE 8-0-2011.

THE MARK CONSISTS OF STANDARD CHARACTERS WITHOUT CLAIM TO ANY PARTICULAR FONT, STYLE, SIZE, OR COLOR.

NO CLAIM IS MADE TO THE EXCLUSIVE RIGHT TO USE "SPORTS", APART FROM THE MARK AS SHOWN.

SN 85-319,400, FILED 5-12-2011.

SUSAN STIGLITZ, EXAMINING ATTORNEY



*David J. Kyros*

Director of the United States Patent and Trademark Office

# United States of America

United States Patent and Trademark Office

## Thumbprint Lock

**Reg. No. 4,199,569**

**Registered Aug. 28, 2012**

**Int. Cl.: 45**

**SERVICE MARK**

**PRINCIPAL REGISTER**

TAX RITE, INC. (ILLINOIS CORPORATION)  
2340 S. ARLINGTON HEIGHTS RD., SUITE 310  
ARLINGTON HEIGHTS, IL 60005

FOR: CONSULTATION IN THE FIELD OF DATA THEFT AND IDENTITY THEFT; FINANCIAL IDENTITY MONITORING SERVICE; FRAUD AND IDENTITY THEFT PROTECTION SERVICES; MONITORING OF CREDIT REPORTS, THE INTERNET, AND PUBLIC RECORDS TO FACILITATE THE DETECTION AND PREVENTION OF IDENTITY THEFT AND FRAUD, IN CLASS 45 (U.S. CLS. 100 AND 101).

FIRST USE 12-1-2011; IN COMMERCE 12-1-2011.

THE MARK CONSISTS OF STANDARD CHARACTERS WITHOUT CLAIM TO ANY PARTICULAR FONT, STYLE, SIZE, OR COLOR.

SN 85-319,442, FILED 5-12-2011.

JACQUELINE A. LAVINE, EXAMINING ATTORNEY



*David J. Kybas*

Director of the United States Patent and Trademark Office

# United States of America

United States Patent and Trademark Office



**Reg. No. 4,199,570**

DI FAZIO CIGARS CORP. (FLORIDA CORPORATION)  
18365 NE 30 CT  
AVENTURA, FL 33160

**Registered Aug. 28, 2012**

**Int. Cl.: 34**

FOR: CIGARS, IN CLASS 34 (U.S. CLS. 2, 8, 9 AND 17).

**TRADEMARK**

FIRST USE 6-1-2011; IN COMMERCE 6-1-2011.

**PRINCIPAL REGISTER**

OWNER OF U.S. REG. NOS. 3,581,957 AND 3,617,414.

NO CLAIM IS MADE TO THE EXCLUSIVE RIGHT TO USE "CIGARS", APART FROM THE MARK AS SHOWN.

THE NAME(S), PORTRAIT(S), AND/OR SIGNATURE(S) SHOWN IN THE MARK IDENTIFIES CARMELO DI FAZIO, WHOSE CONSENT(S) TO REGISTER IS MADE OF RECORD.

THE MARK CONSISTS OF A LETTER "B" WITHIN A DEPICTION OF A CREST THE WORDS "BARROCO BY DI FAZIO CIGARS" TO THE RIGHT.

THE ENGLISH TRANSLATION OF "BARROCO" IN THE MARK IS "BAROQUE".

SN 85-320,224, FILED 5-13-2011.

ZACHARY BELLO, EXAMINING ATTORNEY



*David J. Kybas*

Director of the United States Patent and Trademark Office

# United States of America

United States Patent and Trademark Office

## MAKES TAP WATER TASTE GREAT ANYWHERE

**Reg. No. 4,199,571**

**Registered Aug. 28, 2012**

**Int. Cls.: 11 and 21**

**TRADEMARK**

**PRINCIPAL REGISTER**

BRITA, LP (CANADA LIMITED PARTNERSHIP)  
PLACE PURY 13, RUE DE MOLE 2-4  
NEUCHATEL, SWITZERLAND

FOR: WATER FILTERS, IN CLASS 11 (U.S. CLS. 13, 21, 23, 31 AND 34).

FIRST USE 7-31-2011; IN COMMERCE 7-31-2011.

FOR: PLASTIC WATER BOTTLES SOLD EMPTY, IN CLASS 21 (U.S. CLS. 2, 13, 23, 29, 30,  
33, 40 AND 50).

FIRST USE 7-31-2011; IN COMMERCE 7-31-2011.

THE MARK CONSISTS OF STANDARD CHARACTERS WITHOUT CLAIM TO ANY PAR-  
TICULAR FONT, STYLE, SIZE, OR COLOR.

SEC. 2(F).

OWNER OF U.S. REG. NOS. 2,600,835 AND 3,772,070.

SN 85-320,714, FILED 5-13-2011.

WENDY GOODMAN, EXAMINING ATTORNEY



*David J. Kybas*

Director of the United States Patent and Trademark Office

# United States of America

United States Patent and Trademark Office

## Reality Draft

**Reg. No. 4,199,572**

REALITY DRAFT INC (DELAWARE CORPORATION)  
8733 SIEGEN LN #309  
BATON ROUGE, LA 70810

**Registered Aug. 28, 2012**

**Int. Cl.: 41**

FOR: ENTERTAINMENT SERVICES, NAMELY, PROVIDING AN ON-LINE COMPUTER GAME; ENTERTAINMENT SERVICES, NAMELY, PROVIDING ON-LINE COMPUTER GAMES, IN CLASS 41 (U.S. CLS. 100, 101 AND 107).

**SERVICE MARK**

FIRST USE 7-31-2011; IN COMMERCE 7-31-2011.

**PRINCIPAL REGISTER**

THE MARK CONSISTS OF STANDARD CHARACTERS WITHOUT CLAIM TO ANY PARTICULAR FONT, STYLE, SIZE, OR COLOR.

SN 85-321,020, FILED 5-13-2011.

JOHN DWYER, EXAMINING ATTORNEY



*David J. Kybas*

Director of the United States Patent and Trademark Office



**United States of America**  
United States Patent and Trademark Office

# ZIPZONE

**Reg. No. 4,199,573**

ZIPZONE, LLC (OHIO LIMITED LIABILITY COMPANY)  
PO BOX 341611  
COLUMBUS, OH 43234

**Registered Aug. 28, 2012**

**Int. Cl.: 41**

FOR: ARRANGING AND CONDUCTING CANOPY TOURS AND ZIP LINE EVENTS FOR ENTERTAINMENT PURPOSES, IN CLASS 41 (U.S. CLS. 100, 101 AND 107).

**SERVICE MARK**

FIRST USE 2-15-2012; IN COMMERCE 5-6-2012.

**PRINCIPAL REGISTER**

THE MARK CONSISTS OF STANDARD CHARACTERS WITHOUT CLAIM TO ANY PARTICULAR FONT, STYLE, SIZE, OR COLOR.

SN 85-321,244, FILED 5-15-2011.

LINDA ORNDORFF, EXAMINING ATTORNEY



*David J. Kybas*

Director of the United States Patent and Trademark Office

# United States of America

United States Patent and Trademark Office

# Paytime

**Reg. No. 4,199,574**

PAYDATA, INC. (OHIO CORPORATION), AKA PAYTIME,  
31105 BAINBRIDGE ROAD  
SOLON, OH 44139

**Registered Aug. 28, 2012**

**Int. Cl.: 35**

FOR: PAYROLL PREPARATION, ADMINISTRATION AND MANAGEMENT SERVICES, IN  
CLASS 35 (U.S. CLS. 100, 101 AND 102).

**SERVICE MARK**

FIRST USE 9-1-2011; IN COMMERCE 9-1-2011.

**PRINCIPAL REGISTER**

THE MARK CONSISTS OF THE LITERAL ELEMENT IN A STYLIZED TYPE FONT WITH  
A PATTERN OF SPHERES BRIDGING THE LETTERS "Y" AND "I".

SN 85-321,261, FILED 5-15-2011.

KIMBERLY PERRY, EXAMINING ATTORNEY



*David J. Kybas*

Director of the United States Patent and Trademark Office

# United States of America

United States Patent and Trademark Office

# ELLISMANIA

**Reg. No. 4,199,575**

JASON ELLIS, INC. (CALIFORNIA CORPORATION)  
105 W ALAMEDA AVE, SUITE 230  
BURBANK, CA 91502

**Registered Aug. 28, 2012**

**Int. Cl.: 41**

FOR: ENTERTAINMENT IN THE NATURE OF BOXING CONTESTS; PRODUCTION OF DVDS FEATURING BOXING CONTESTS, ENTERTAINMENT, CULTURAL AND SPORTING EVENTS; PROVIDING AN INTERNET WEBSITE PORTAL IN THE FIELD OF ENTERTAINMENT, CULTURAL AND SPORTING EVENTS, IN CLASS 41 (U.S. CLS. 100, 101 AND 107).

**SERVICE MARK**

**PRINCIPAL REGISTER**

FIRST USE 11-1-2011; IN COMMERCE 11-1-2011.

THE MARK CONSISTS OF STANDARD CHARACTERS WITHOUT CLAIM TO ANY PARTICULAR FONT, STYLE, SIZE, OR COLOR.

SN 85-321,397, FILED 5-16-2011.

JAY FLOWERS, EXAMINING ATTORNEY



*David J. Kyffers*

Director of the United States Patent and Trademark Office

# United States of America

United States Patent and Trademark Office

## COW TIP-FOOLERY

**Reg. No. 4,199,576**

CAT AMUCK STUDIOS INC. (CANADA CORPORATION)  
1521 DUNDAS STREET EAST

**Registered Aug. 28, 2012**

TORONTO, ONTARIO, CANADA M4L1K6

**Int. Cl.: 9**

FOR: COMPUTER GAME SOFTWARE; COMPUTER GAME SOFTWARE DOWNLOADABLE FROM A GLOBAL COMPUTER NETWORK; INTERACTIVE GAME SOFTWARE, IN CLASS 9 (U.S. CLS. 21, 23, 26, 36 AND 38).

**TRADEMARK**

FIRST USE 5-29-2012; IN COMMERCE 5-29-2012.

**PRINCIPAL REGISTER**

THE MARK CONSISTS OF STANDARD CHARACTERS WITHOUT CLAIM TO ANY PARTICULAR FONT, STYLE, SIZE, OR COLOR.

SN 85-321,404, FILED 5-16-2011.

YAT SYE, LEE, EXAMINING ATTORNEY



*David J. Kyffers*

Director of the United States Patent and Trademark Office

# United States of America

United States Patent and Trademark Office

# MEDDIFF

**Reg. No. 4,199,577**

**Registered Aug. 28, 2012**

**Int. Cl.: 42**

**SERVICE MARK**

**PRINCIPAL REGISTER**

MEDSPHERE TECHNOLOGIES PVT. LTD. (INDIA CORPORATION)  
81-84, LADY RATAN TATA MEDICAL RESEARCH  
CENTRE BLD, 8TH FLOOR, M.K. MARG  
MUMBAI, INDIA 400021

FOR: PRODUCT INSTALLATION, MAINTENANCE, DESIGNING AND CONSULTANCY  
OF COMPUTER SOFTWARE FOR MEDICAL HEALTH CARE, IN CLASS 42 (U.S. CLS. 100  
AND 101).

FIRST USE 6-30-2007; IN COMMERCE 6-30-2007.

THE MARK CONSISTS OF STANDARD CHARACTERS WITHOUT CLAIM TO ANY PAR-  
TICULAR FONT, STYLE, SIZE, OR COLOR.

SN 85-321,470, FILED 5-16-2011.

Laurie Kaufman, Examining Attorney



*David J. Kybas*

Director of the United States Patent and Trademark Office

# United States of America

United States Patent and Trademark Office

# V-Close

**Reg. No. 4,199,578**

UNITED LENDER SERVICES CORP. (PENNSYLVANIA CORPORATION)  
2000 CLIFF MINE ROAD, SUITE 610  
PITTSBURGH, PA 15275

**Registered Aug. 28, 2012**

**Int. Cl.: 45**

FOR: REAL ESTATE CLOSING SERVICES; REAL ESTATE SETTLEMENT SERVICES, IN CLASS 45 (U.S. CLS. 100 AND 101).

**SERVICE MARK**

FIRST USE 9-1-2011; IN COMMERCE 9-1-2011.

**PRINCIPAL REGISTER**

THE MARK CONSISTS OF STANDARD CHARACTERS WITHOUT CLAIM TO ANY PARTICULAR FONT, STYLE, SIZE, OR COLOR.

SN 85-321,478, FILED 5-16-2011.

STEPHANIE ALI, EXAMINING ATTORNEY



*David J. Kybas*

Director of the United States Patent and Trademark Office

# United States of America

United States Patent and Trademark Office

## PROMPTINGS

**Reg. No. 4,199,579**

EAGLE ONE PUBLISHING, LLC (UTAH LIMITED LIABILITY COMPANY)  
1825 RESEARCH WAY, SUITE A  
SALT LAKE CITY, UT 84119

**Registered Aug. 28, 2012**

**Int. Cl.: 41**

FOR: CONDUCTING WORKSHOPS AND SEMINARS IN SELF IMPROVEMENT AND SELF HELP; EDUCATIONAL AND ENTERTAINMENT SERVICES, NAMELY, PROVIDING MOTIVATIONAL AND EDUCATIONAL SPEAKERS IN THE FIELD OF SELF- AND PERSONAL IMPROVEMENT; EDUCATIONAL SERVICES, NAMELY, PROVIDING CONFERENCES AND PRINTED MATERIALS IN THE FIELDS OF SELF-HELP, IN CLASS 41 (U.S. CLS. 100, 101 AND 107).

**SERVICE MARK**

**PRINCIPAL REGISTER**

FIRST USE 5-1-2003; IN COMMERCE 5-1-2003.

THE MARK CONSISTS OF STANDARD CHARACTERS WITHOUT CLAIM TO ANY PARTICULAR FONT, STYLE, SIZE, OR COLOR.

SN 85-321,609, FILED 5-16-2011.

INGA ERVIN, EXAMINING ATTORNEY



*David J. Kyffers*

Director of the United States Patent and Trademark Office

# United States of America

United States Patent and Trademark Office

## GREEN FUSION

**Reg. No. 4,199,580**

GREEN FOODS CORPORATION (CALIFORNIA CORPORATION)  
2220 CAMINO DEL SOL  
OXNARD, CA 93030

**Registered Aug. 28, 2012**

**Int. Cl.: 5**

FOR: DIETARY SUPPLEMENTS; NUTRITIONAL SUPPLEMENTS, IN CLASS 5 (U.S. CLS. 6, 18, 44, 46, 51 AND 52).

**TRADEMARK**

FIRST USE 1-15-2012; IN COMMERCE 1-15-2012.

**PRINCIPAL REGISTER**

THE MARK CONSISTS OF STANDARD CHARACTERS WITHOUT CLAIM TO ANY PARTICULAR FONT, STYLE, SIZE, OR COLOR.

SN 85-321,622, FILED 5-16-2011.

JAMES LOVELACE, EXAMINING ATTORNEY



*David J. Kybas*

Director of the United States Patent and Trademark Office



# United States of America

United States Patent and Trademark Office

# XOVITA

**Reg. No. 4,199,581**

**Registered Aug. 28, 2012**

**Int. Cls.: 5, 30, and 32**

**TRADEMARK**

**PRINCIPAL REGISTER**

MXI CORP. (NEVADA CORPORATION)  
795 TRADEMARK DRIVE  
RENO, NV 89521

FOR: NUTRITIONAL DRINK MIX FOR USE AS A MEAL REPLACEMENT; NUTRITIONAL FOOD BARS FOR USE AS A MEAL REPLACEMENT, IN CLASS 5 (U.S. CLS. 6, 18, 44, 46, 51 AND 52).

FIRST USE 5-31-2012; IN COMMERCE 5-31-2012.

FOR: CANDY; CHOCOLATE BARS; CHOCOLATE-BASED READY-TO-EAT FOOD BARS; CHOCOLATES AND CHOCOLATE BASED READY TO EAT CANDIES AND SNACKS; CHOCOLATES CONTAINING NUTRIENTS; COCOA MIXES; COCOA-BASED BEVERAGES; COOKIES; FILLED CHOCOLATE; SNACK FOODS, NAMELY, CHOCOLATE-BASED SNACK FOODS, IN CLASS 30 (U.S. CL. 46).

FIRST USE 1-9-2012; IN COMMERCE 1-9-2012.

FOR: ENERGY DRINKS, IN CLASS 32 (U.S. CLS. 45, 46 AND 48).

FIRST USE 6-6-2012; IN COMMERCE 6-6-2012.

THE MARK CONSISTS OF STANDARD CHARACTERS WITHOUT CLAIM TO ANY PARTICULAR FONT, STYLE, SIZE, OR COLOR.

SN 85-321,788, FILED 5-16-2011.

MARK SHINER, EXAMINING ATTORNEY



*David J. Kybas*

Director of the United States Patent and Trademark Office

# United States of America

United States Patent and Trademark Office

## ARTICLES OF SOCIETY

**Reg. No. 4,199,582**

KSK PRIVATE LABEL HOLDINGS, INC. (CALIFORNIA CORPORATION)  
15301 VENTURA BOULEVARD, BUILDING B #340  
SHERMAN OAKS, CA 91403

**Registered Aug. 28, 2012**

**Int. Cl.: 25**

FOR: BELTS; BLOUSES; CAPS; COATS; DRESSES; FOOTWEAR; JACKETS; JEANS; KNIT  
TOPS; LEGGINGS; LOUNGEWEAR; PAJAMAS; PANTS; SCARVES; SHIRTS; SLACKS;  
SOCKS; SWEATERS; T-SHIRTS; UNDERGARMENTS, IN CLASS 25 (U.S. CLS. 22 AND 39).

**TRADEMARK**

FIRST USE 5-7-2012; IN COMMERCE 5-7-2012.

**PRINCIPAL REGISTER**

THE MARK CONSISTS OF STANDARD CHARACTERS WITHOUT CLAIM TO ANY PAR-  
TICULAR FONT, STYLE, SIZE, OR COLOR.

SN 85-321,820, FILED 5-16-2011.

TARA PATE, EXAMINING ATTORNEY



*David J. Kyffers*

Director of the United States Patent and Trademark Office

# United States of America

United States Patent and Trademark Office



**Reg. No. 4,199,583**

**Registered Aug. 28, 2012**

**Int. Cl.: 33**

**TRADEMARK**

**PRINCIPAL REGISTER**

SKYY SPIRITS, LLC (DELAWARE LIMITED LIABILITY COMPANY), DBA CAMPARI AMERICA,  
ONE BEACH STREET, SUITE 300  
SAN FRANCISCO, CA 94133

FOR: DISTILLED SPIRITS, IN CLASS 33 (U.S. CLS. 47 AND 49).

FIRST USE 3-12-2012; IN COMMERCE 3-12-2012.

NO CLAIM IS MADE TO THE EXCLUSIVE RIGHT TO USE "RYE", "81 PROOF" AND "KENTUCKY", APART FROM THE MARK AS SHOWN.

THE COLOR(S) GREEN AND GOLD IS/ARE CLAIMED AS A FEATURE OF THE MARK.

THE MARK CONSISTS OF THE WORD "RYE" IN GREEN WITH A GOLD OUTLINE SHADOWING THE WORD "RYE", BENEATH THE WORD "RYE" IS THE NUMBER "81" AND THE WORD "PROOF" IN GOLD, WITH A SHORT GOLD LINE PRECEDING THE "81", AND A SHORT GOLD LINE SUCCEEDING THE LETTER "F" OF THE WORD "PROOF", UNDERNEATH THE NUMBER "81" AND THE WORD "PROOF" IS A GREEN RECTANGLE WITH A GOLD BORDER, WITHIN THE GREEN RECTANGLE ARE THE WORDS "REAL KENTUCKY" IN GOLD.

SN 85-322,002, FILED 5-16-2011.

ANDREW RHIM, EXAMINING ATTORNEY



*David J. Kyros*

Director of the United States Patent and Trademark Office

# United States of America

United States Patent and Trademark Office

## LAST DIET EVER

**Reg. No. 4,199,584**

LAST DIET EVER, LLC (OHIO LIMITED LIABILITY COMPANY)  
1325 HULL ROAD  
SANDUSKY, OH 44870

**Registered Aug. 28, 2012**

**Int. Cls.: 35 and 44**

FOR: FRANCHISE SERVICES, NAMELY, OFFERING BUSINESS MANAGEMENT ASSISTANCE IN THE ESTABLISHMENT AND OPERATION OF WEIGHT LOSS AND MANAGEMENT CENTERS, IN CLASS 35 (U.S. CLS. 100, 101 AND 102).

**SERVICE MARK**

FIRST USE 12-1-2011; IN COMMERCE 12-1-2011.

**PRINCIPAL REGISTER**

FOR: WEIGHT MANAGEMENT SERVICES, NAMELY, PROVIDING WEIGHT LOSS AND WEIGHT MANAGEMENT PROGRAMS, IN CLASS 44 (U.S. CLS. 100 AND 101).

FIRST USE 1-1-2010; IN COMMERCE 1-1-2010.

THE MARK CONSISTS OF STANDARD CHARACTERS WITHOUT CLAIM TO ANY PARTICULAR FONT, STYLE, SIZE, OR COLOR.

NO CLAIM IS MADE TO THE EXCLUSIVE RIGHT TO USE "DIET", APART FROM THE MARK AS SHOWN.

SN 85-322,071, FILED 5-16-2011.

BILL DAWE, EXAMINING ATTORNEY



*David J. Kypos*

Director of the United States Patent and Trademark Office

# United States of America

United States Patent and Trademark Office



**Reg. No. 4,199,585**

LAST DIET EVER, LLC (OHIO LIMITED LIABILITY COMPANY)  
1325 HULL ROAD  
SANDUSKY, OH 44870

**Registered Aug. 28, 2012**

**Int. Cls.: 35 and 44**

FOR: FRANCHISE SERVICES, NAMELY, OFFERING BUSINESS MANAGEMENT ASSISTANCE IN THE ESTABLISHMENT AND OPERATION OF WEIGHT LOSS AND MANAGEMENT CENTERS, IN CLASS 35 (U.S. CLS. 100, 101 AND 102).

**SERVICE MARK**

FIRST USE 12-1-2011; IN COMMERCE 12-1-2011.

**PRINCIPAL REGISTER**

FOR: WEIGHT MANAGEMENT SERVICES, NAMELY, PROVIDING WEIGHT LOSS AND WEIGHT MANAGEMENT PROGRAMS, IN CLASS 44 (U.S. CLS. 100 AND 101).

FIRST USE 1-1-2010; IN COMMERCE 1-1-2010.

NO CLAIM IS MADE TO THE EXCLUSIVE RIGHT TO USE "DIET", APART FROM THE MARK AS SHOWN.

THE MARK CONSISTS OF THE STYLIZED WORDING "LAST DIET EVER" WHICH IS CONTAINED IN TWO RECTANGLES WITH THE WORDING APPEARING IN THE UPPER RECTANGLE AND AN ANIMATED HUMAN FIGURE WITH ITS ARMS AND LEGS OUTSTRETCHED APPEARING TO THE RIGHT OF THE WORDING AND SUPERIMPOSED ONTO THE RECTANGLES.

SN 85-322,086, FILED 5-16-2011.

BILL DAWE, EXAMINING ATTORNEY



*David J. Kybas*

Director of the United States Patent and Trademark Office

# United States of America

United States Patent and Trademark Office

# PROLOGIX

**Reg. No. 4,199,586**

PROLOGIX INC. (NEW JERSEY CORPORATION)  
630 INDUSTRIAL ROAD  
CARLSTADT, NJ 07072

**Registered Aug. 28, 2012**

**Int. Cl.: 35**

FOR: FUEL INVENTORY AND MONITORING SERVICES FOR GAS STATIONS AND OTHER HIGH VOLUME FUEL USERS, IN CLASS 35 (U.S. CLS. 100, 101 AND 102).

**SERVICE MARK**

FIRST USE 6-0-2011; IN COMMERCE 6-0-2011.

**PRINCIPAL REGISTER**

THE MARK CONSISTS OF STANDARD CHARACTERS WITHOUT CLAIM TO ANY PARTICULAR FONT, STYLE, SIZE, OR COLOR.

SN 85-322,570, FILED 5-17-2011.

CHRIS WELLS, EXAMINING ATTORNEY



*David J. Kybas*

Director of the United States Patent and Trademark Office

# United States of America

United States Patent and Trademark Office



The Yellow Crane, Inc.

**Reg. No. 4,199,587**

**Registered Aug. 28, 2012**

**Int. Cl.: 41**

**SERVICE MARK**

**PRINCIPAL REGISTER**

THE YELLOW CRANE, INC. (ALABAMA CORPORATION)  
3901 NAZHA LN.  
BIRMINGHAM, AL 35243

FOR: EDUCATION SERVICES, NAMELY, PROVIDING CLASSES, SEMINARS, AND WORKSHOPS IN THE FIELDS OF BUSINESS, FINANCE, BUSINESS ADMINISTRATION, COMPARATIVE LAW, INTERNATIONAL LAW, POLITICAL ECONOMY, POLITICAL SCIENCE, INTERNATIONAL RELATIONS, WORLD POLITICS, PUBLIC AFFAIRS, PUBLIC ADMINISTRATION, GOVERNMENT, AND INTERNATIONAL TRADE AND DISTRIBUTION OF INSTRUCTIONAL AND SUPPLEMENTAL MATERIALS IN CONNECTION THEREWITH, IN CLASS 41 (U.S. CLS. 100, 101 AND 107).

FIRST USE 6-1-2012; IN COMMERCE 6-1-2012.

NO CLAIM IS MADE TO THE EXCLUSIVE RIGHT TO USE "INC.", APART FROM THE MARK AS SHOWN.

THE MARK CONSISTS OF A DESIGN OF A CRANE WITH OPEN WINGS OVER THE STYLIZED TEXT "THE YELLOW CRANE, INC.".

SN 85-322,669, FILED 5-17-2011.

SHAUNIA CARLYLE, EXAMINING ATTORNEY



*David J. Kyffers*

Director of the United States Patent and Trademark Office

# United States of America

United States Patent and Trademark Office

## LIFE'S PERFECT BLEND

**Reg. No. 4,199,588**

**Registered Aug. 28, 2012**

**Int. Cls.: 5, 30, and 32**

**TRADEMARK**

**PRINCIPAL REGISTER**

MXI CORP. (NEVADA CORPORATION)  
795 TRADEMARK DRIVE  
RENO, NV 89521

FOR: NUTRITIONAL DRINK MIX FOR USE AS A MEAL REPLACEMENT; NUTRITIONAL FOOD BARS FOR USE AS A MEAL REPLACEMENT, IN CLASS 5 (U.S. CLS. 6, 18, 44, 46, 51 AND 52).

FIRST USE 5-31-2012; IN COMMERCE 5-31-2012.

FOR: CANDY; CHOCOLATE BARS; CHOCOLATE-BASED READY-TO-EAT FOOD BARS; CHOCOLATES AND CHOCOLATE BASED READY TO EAT CANDIES AND SNACKS; CHOCOLATES CONTAINING NUTRIENTS; COCOA MIXES; COCOA-BASED BEVERAGES; COOKIES; FILLED CHOCOLATE; SNACK FOODS, NAMELY, CHOCOLATE-BASED SNACK FOODS, IN CLASS 30 (U.S. CL. 46).

FIRST USE 1-9-2012; IN COMMERCE 1-9-2012.

FOR: ENERGY DRINKS, IN CLASS 32 (U.S. CLS. 45, 46 AND 48).

FIRST USE 6-6-2012; IN COMMERCE 6-6-2012.

THE MARK CONSISTS OF STANDARD CHARACTERS WITHOUT CLAIM TO ANY PARTICULAR FONT, STYLE, SIZE, OR COLOR.

SN 85-322,677, FILED 5-17-2011.

MARK SHINER, EXAMINING ATTORNEY



*David J. Kybas*

Director of the United States Patent and Trademark Office



# United States of America

United States Patent and Trademark Office

**INDEPENDENT BY CHOICE.  
INNOVATIVE BY DESIGN.**

**Reg. No. 4,199,589**

CHESAPEAKE HOSPITAL AUTHORITY (VIRGINIA VIRGINIA POLITICAL SUBDIVISION)  
736 BATTLEFIELD BOULEVARD, NORTH  
CHESAPEAKE, VA 23320

**Registered Aug. 28, 2012**

**Int. Cls.: 42, 43, and 44**

FOR: MEDICAL LABORATORY SERVICES, IN CLASS 42 (U.S. CLS. 100 AND 101).

**SERVICE MARK**

FIRST USE 4-0-2011; IN COMMERCE 4-0-2011.

**PRINCIPAL REGISTER**

FOR: DAY CARE CENTERS; PROVIDING ELDER CARE, IN CLASS 43 (U.S. CLS. 100 AND 101).

FIRST USE 4-0-2011; IN COMMERCE 4-0-2011.

FOR: HEALTH CARE AND MEDICAL SERVICES; HOSPITAL SERVICES; EMERGENCY HEALTH CARE SERVICES; NURSING HOME SERVICES; HOME HEALTH CARE AND HOME COMPANION SERVICES; MEDICAL CLINIC DAY CARE SERVICES FOR SICK CHILDREN; PHYSICAL THERAPY SERVICES; CT SCAN AND DIAGNOSTIC IMAGERY SERVICES; OUTPATIENT AND AMBULATORY DIAGNOSTIC, SURGICAL AND IV THERAPY SERVICES, IN CLASS 44 (U.S. CLS. 100 AND 101).

FIRST USE 4-0-2011; IN COMMERCE 4-0-2011.

THE MARK CONSISTS OF STANDARD CHARACTERS WITHOUT CLAIM TO ANY PARTICULAR FONT, STYLE, SIZE, OR COLOR.

SN 85-322,918, FILED 5-17-2011.

CHERYL CLAYTON, EXAMINING ATTORNEY



*David J. Kyffers*

Director of the United States Patent and Trademark Office

# United States of America

United States Patent and Trademark Office

# Star Legends

**Reg. No. 4,199,590**

**Registered Aug. 28, 2012**

**Int. Cl.: 9**

**TRADEMARK**

**PRINCIPAL REGISTER**

SPACETIME STUDIOS, INC. (DELAWARE CORPORATION)  
8303 NORTH MOPAC EXPRESSWAY  
SUITE C140  
AUSTIN, TX 78759

FOR: COMPUTER GAME PROGRAMS; COMPUTER GAME SOFTWARE; COMPUTER GAME SOFTWARE DOWNLOADABLE FROM A GLOBAL COMPUTER NETWORK; COMPUTER GAME SOFTWARE FOR USE ON MOBILE AND CELLULAR PHONES; COMPUTER PROGRAMS FOR VIDEO AND COMPUTER GAMES; DOWNLOADABLE COMPUTER GAME PROGRAMS; DOWNLOADABLE COMPUTER GAME SOFTWARE VIA A GLOBAL COMPUTER NETWORK AND WIRELESS DEVICES; DOWNLOADABLE ELECTRONIC GAME PROGRAMS; ELECTRONIC GAME SOFTWARE FOR CELLULAR TELEPHONES; ELECTRONIC GAME SOFTWARE FOR HANDHELD ELECTRONIC DEVICES; ELECTRONIC GAME SOFTWARE FOR WIRELESS DEVICES; INTERACTIVE GAME PROGRAMS; INTERACTIVE GAME SOFTWARE; VIDEO AND COMPUTER GAME PROGRAMS, IN CLASS 9 (U.S. CLS. 21, 23, 26, 36 AND 38).

FIRST USE 8-15-2011; IN COMMERCE 8-15-2011.

THE MARK CONSISTS OF STANDARD CHARACTERS WITHOUT CLAIM TO ANY PARTICULAR FONT, STYLE, SIZE, OR COLOR.

SN 85-322,955, FILED 5-17-2011.

ANNE MADDEN, EXAMINING ATTORNEY



*David J. Kybas*

Director of the United States Patent and Trademark Office

# United States of America

United States Patent and Trademark Office

# Dark Legends

**Reg. No. 4,199,591**

**Registered Aug. 28, 2012**

**Int. Cl.: 9**

**TRADEMARK**

**PRINCIPAL REGISTER**

SPACETIME STUDIOS, INC. (DELAWARE CORPORATION)  
8303 NORTH MOPAC EXPRESSWAY  
SUITE C140  
AUSTIN, TX 78759

FOR: COMPUTER GAME PROGRAMS; COMPUTER GAME SOFTWARE; COMPUTER GAME SOFTWARE DOWNLOADABLE FROM A GLOBAL COMPUTER NETWORK; COMPUTER GAME SOFTWARE FOR USE ON MOBILE AND CELLULAR PHONES; COMPUTER PROGRAMS FOR VIDEO AND COMPUTER GAMES; DOWNLOADABLE COMPUTER GAME PROGRAMS; DOWNLOADABLE COMPUTER GAME SOFTWARE VIA A GLOBAL COMPUTER NETWORK AND WIRELESS DEVICES; DOWNLOADABLE ELECTRONIC GAME PROGRAMS; ELECTRONIC GAME SOFTWARE FOR CELLULAR TELEPHONES; ELECTRONIC GAME SOFTWARE FOR HANDHELD ELECTRONIC DEVICES; ELECTRONIC GAME SOFTWARE FOR WIRELESS DEVICES; INTERACTIVE GAME PROGRAMS; INTERACTIVE GAME SOFTWARE; VIDEO AND COMPUTER GAME PROGRAMS, IN CLASS 9 (U.S. CLS. 21, 23, 26, 36 AND 38).

FIRST USE 4-15-2012; IN COMMERCE 4-15-2012.

THE MARK CONSISTS OF STANDARD CHARACTERS WITHOUT CLAIM TO ANY PARTICULAR FONT, STYLE, SIZE, OR COLOR.

SN 85-322,957, FILED 5-17-2011.

ANNE MADDEN, EXAMINING ATTORNEY



*David J. Kybas*

Director of the United States Patent and Trademark Office

# United States of America

United States Patent and Trademark Office

# SKIN MY

**Reg. No. 4,199,592**

**Registered Aug. 28, 2012**

**Int. Cl.: 16**

**TRADEMARK**

**PRINCIPAL REGISTER**

NUTIS PRESS, INC. (OHIO CORPORATION)  
3540 E. FULTON STREET  
COLUMBUS, OH 43227

FOR: POSTERS, IN CLASS 16 (U.S. CLS. 2, 5, 22, 23, 29, 37, 38 AND 50).

FIRST USE 10-24-2011; IN COMMERCE 3-12-2012.

THE MARK CONSISTS OF STANDARD CHARACTERS WITHOUT CLAIM TO ANY PARTICULAR FONT, STYLE, SIZE, OR COLOR.

SN 85-323,049, FILED 5-17-2011.

MATTHEW EINSTEIN, EXAMINING ATTORNEY



*David J. Kybas*

Director of the United States Patent and Trademark Office

# United States of America

United States Patent and Trademark Office

## QDILIGENCE

**Reg. No. 4,199,593**

**Registered Aug. 28, 2012**

**Int. Cls.: 35 and 42**

**SERVICE MARK**

**PRINCIPAL REGISTER**

QDILIGENCE, L.L.C. (ILLINOIS LIMITED LIABILITY COMPANY)  
508 E. EUCLID AVENUE  
ARLINGTON HEIGHTS, IL 60004

FOR: DATA PROCESSING SERVICES, NAMELY, DATA INPUT IN CONNECTION WITH THE CREATION, MODIFICATION, UPDATING, COLLECTION, MAINTENANCE, ANALYSIS, REPORTING AND TRANSFER OF ON-LINE SINGLE- AND MULTI-PAGE LEGAL AND CORPORATE COMPLIANCE QUESTIONNAIRES UTILIZING A WEBSITE AND PROPRIETARY NON-DOWNLOADABLE ON-LINE SOFTWARE, IN CLASS 35 (U.S. CLS. 100, 101 AND 102).

FIRST USE 7-1-2010; IN COMMERCE 6-15-2011.

FOR: APPLICATION SERVICE PROVIDER SERVICES, NAMELY, CREATING, DESIGNING, MAINTAINING AND HOSTING NON-DOWNLOADABLE COMPUTER APPLICATION SOFTWARE AND DATABASES ON A COMPUTER SERVER FOR OTHERS FOR CONFIGURING AND IMPLEMENTING LEGAL AND CORPORATE COMPLIANCE PROCESS QUESTIONNAIRES VIA COMPUTER AND COMMUNICATION NETWORKS; APPLICATION SERVICE PROVIDER SERVICES, NAMELY, HOSTING NON-DOWNLOADABLE COMPUTER APPLICATION SOFTWARE AND DATABASES ON A COMPUTER SERVER FOR OTHERS FOR THE ADMINISTRATION, DISTRIBUTION, COLLECTION, REPORTING, ANALYSIS AND PRESENTATION OF RESPONDENTS' FEEDBACK AND OTHER INFORMATION GATHERED VIA COMPUTER AND COMMUNICATION NETWORKS; HOSTING NON-DOWNLOADABLE WEB-BASED LEGAL AND CORPORATE COMPLIANCE PROCESS QUESTIONNAIRES FOR OTHERS, IN CLASS 42 (U.S. CLS. 100 AND 101).

FIRST USE 7-1-2010; IN COMMERCE 6-15-2011.

THE MARK CONSISTS OF STANDARD CHARACTERS WITHOUT CLAIM TO ANY PARTICULAR FONT, STYLE, SIZE, OR COLOR.

SN 85-323,404, FILED 5-17-2011.

ALYSSA STEEL, EXAMINING ATTORNEY



*David J. Kyffers*

Director of the United States Patent and Trademark Office

# United States of America

United States Patent and Trademark Office

# VIMVIDA

**Reg. No. 4,199,594**

VIM VIDA CORPORATION (CALIFORNIA CORPORATION)  
2159 AVENIDA DE LA PLAYA  
LA JOLLA, CA 92037

**Registered Aug. 28, 2012**

**Int. Cl.: 5**

FOR: VITAMIN FOOD PRODUCTS, NAMELY, VITAMINS CONTAINING MINT, IN CLASS 5 (U.S. CLS. 6, 18, 44, 46, 51 AND 52).

**TRADEMARK**

FIRST USE 6-0-2011; IN COMMERCE 6-0-2011.

**PRINCIPAL REGISTER**

THE MARK CONSISTS OF STANDARD CHARACTERS WITHOUT CLAIM TO ANY PARTICULAR FONT, STYLE, SIZE, OR COLOR.

THE WORDING "VIMVIDA" HAS NO MEANING IN A FOREIGN LANGUAGE.

SN 85-323,448, FILED 5-17-2011.

BRIAN PINO, EXAMINING ATTORNEY



*David J. Kyffers*

Director of the United States Patent and Trademark Office

# United States of America

United States Patent and Trademark Office

## Trailer Park Optimizer

**Reg. No. 4,199,595**

**Registered Aug. 28, 2012**

**Int. Cl.: 41**

**SERVICE MARK**

**PRINCIPAL REGISTER**

TRAILER PARK, INC. (CALIFORNIA CORPORATION)  
12TH FLOOR  
6922 HOLLYWOOD BLVD.  
HOLLYWOOD, CA 90028

FOR: PUBLISHING OF THE ELECTRONIC PUBLICATIONS AND GRAPHICS OF OTHERS FOR USE ON MOBILE PHONES, TABLETS AND E-READERS, IN CLASS 41 (U.S. CLS. 100, 101 AND 107).

FIRST USE 4-15-2012; IN COMMERCE 4-15-2012.

THE MARK CONSISTS OF STANDARD CHARACTERS WITHOUT CLAIM TO ANY PARTICULAR FONT, STYLE, SIZE, OR COLOR.

NO CLAIM IS MADE TO THE EXCLUSIVE RIGHT TO USE "OPTIMIZER", APART FROM THE MARK AS SHOWN.

SN 85-323,880, FILED 5-18-2011.

KELLEY WELLS, EXAMINING ATTORNEY



*David J. Kyffers*

Director of the United States Patent and Trademark Office

# United States of America

United States Patent and Trademark Office

# TPO

**Reg. No. 4,199,596**

**Registered Aug. 28, 2012**

**Int. Cl.: 41**

**SERVICE MARK**

**PRINCIPAL REGISTER**

TRAILER PARK, INC. (CALIFORNIA CORPORATION)  
12TH FLOOR  
6922 HOLLYWOOD BLVD  
HOLLYWOOD, CA 90028

FOR: PUBLISHING OF THE ELECTRONIC PUBLICATIONS AND GRAPHICS OF OTHERS FOR USE ON MOBILE PHONES, TABLETS AND E-READERS, IN CLASS 41 (U.S. CLS. 100, 101 AND 107).

FIRST USE 4-15-2012; IN COMMERCE 4-15-2012.

THE MARK CONSISTS OF STANDARD CHARACTERS WITHOUT CLAIM TO ANY PARTICULAR FONT, STYLE, SIZE, OR COLOR.

SN 85-324,077, FILED 5-18-2011.

KELLEY WELLS, EXAMINING ATTORNEY



*David J. Kybas*

Director of the United States Patent and Trademark Office



**United States of America**  
United States Patent and Trademark Office

**RALEIGH**

**Reg. No. 4,199,597**

RALEIGH WORKSHOP, INC. (NORTH CAROLINA CORPORATION)  
301 WEST MARTIN STREET, SUITE 100  
RALEIGH, NC 27601

**Registered Aug. 28, 2012**

**Int. Cl.: 25**

FOR: SHIRTS, SWEATERS, JACKETS, BELTS, DRESSES, NECKTIES, SPORT COATS,  
SHOES, HATS, IN CLASS 25 (U.S. CLS. 22 AND 39).

**TRADEMARK**

FIRST USE 6-13-2012; IN COMMERCE 6-13-2012.

**PRINCIPAL REGISTER**

THE MARK CONSISTS OF STANDARD CHARACTERS WITHOUT CLAIM TO ANY PAR-  
TICULAR FONT, STYLE, SIZE, OR COLOR.

SEC. 2(F).

OWNER OF U.S. REG. NO. 3,972,322.

SN 85-324,599, FILED 5-19-2011.

KATHLEEN M. VANSTON, EXAMINING ATTORNEY



*David J. Kybas*

Director of the United States Patent and Trademark Office

# United States of America

United States Patent and Trademark Office

# ROBOFUSION

**Reg. No. 4,199,598**

**Registered Aug. 28, 2012**

**Int. Cls.: 7 and 30**

**TRADEMARK**

**PRINCIPAL REGISTER**

ROBOFUSION, INC. (DELAWARE CORPORATION)  
6225 RUDDER LANE  
AWENDAW, SC 294296023

FOR: ROBOTIC MACHINES FOR CREATING TREATS FROM FROZEN CONFECTIONERIES,  
IN CLASS 7 (U.S. CLS. 13, 19, 21, 23, 31, 34 AND 35).

FIRST USE 5-15-2011; IN COMMERCE 5-15-2011.

FOR: ICE CREAM AND FROZEN CONFECTIONERIES, IN CLASS 30 (U.S. CL. 46).

FIRST USE 5-15-2011; IN COMMERCE 5-15-2011.

THE MARK CONSISTS OF STANDARD CHARACTERS WITHOUT CLAIM TO ANY PARTICULAR FONT, STYLE, SIZE, OR COLOR.

SN 85-324,851, FILED 5-19-2011.

MELISSA VALLILLO, EXAMINING ATTORNEY



*David J. Kybas*

Director of the United States Patent and Trademark Office

# United States of America

United States Patent and Trademark Office

## ROBOFUSION ICE CREAM

**Reg. No. 4,199,599**

ROBOFUSION, INC. (DELAWARE CORPORATION)  
6225 RUDDER LANE  
AWENDAW, SC 294296023

**Registered Aug. 28, 2012**

**Int. Cls.: 7 and 30**

FOR: ROBOTIC MACHINES FOR CREATING TREATS FROM FROZEN CONFECTIONERIES,  
IN CLASS 7 (U.S. CLS. 13, 19, 21, 23, 31, 34 AND 35).

**TRADEMARK**

FIRST USE 5-15-2011; IN COMMERCE 5-15-2011.

**PRINCIPAL REGISTER**

FOR: ICE CREAM AND FROZEN CONFECTIONERIES, IN CLASS 30 (U.S. CL. 46).

FIRST USE 5-15-2011; IN COMMERCE 5-15-2011.

THE MARK CONSISTS OF STANDARD CHARACTERS WITHOUT CLAIM TO ANY PARTICULAR FONT, STYLE, SIZE, OR COLOR.

NO CLAIM IS MADE TO THE EXCLUSIVE RIGHT TO USE "ICE CREAM", APART FROM THE MARK AS SHOWN.

SN 85-324,917, FILED 5-19-2011.

MELISSA VALLILLO, EXAMINING ATTORNEY



*David J. Kybas*

Director of the United States Patent and Trademark Office

# United States of America

United States Patent and Trademark Office

# CYFLOC

**Reg. No. 4,199,600**

**Registered Aug. 28, 2012**

**Int. Cl.: 1**

**TRADEMARK**

**PRINCIPAL REGISTER**

CYTEC INDUSTRIES INC. (DELAWARE CORPORATION)  
5 GARRET MOUNTAIN PLAZA  
WOODLAND PARK, NJ 07424

FOR: COAGULANT AND FLOCCULANT FOR USE IN THE ALUMINA AND MINERAL PROCESSING INDUSTRIES, IN CLASS 1 (U.S. CLS. 1, 5, 6, 10, 26 AND 46).

FIRST USE 8-1-2011; IN COMMERCE 8-1-2011.

THE MARK CONSISTS OF STANDARD CHARACTERS WITHOUT CLAIM TO ANY PARTICULAR FONT, STYLE, SIZE, OR COLOR.

SN 85-324,926, FILED 5-19-2011.

WARREN L. OLANDRIA, EXAMINING ATTORNEY



*David J. Kybas*

Director of the United States Patent and Trademark Office

# United States of America

United States Patent and Trademark Office

# Whitewood

**Reg. No. 4,199,601**

WHITE, BRANTLEY E. (UNITED STATES INDIVIDUAL)  
1400 WEST NORTHWOOD  
GREENSBORO, NC 27408

**Registered Aug. 28, 2012**

**Int. Cl.: 37**

FOR: BUILDING CONSTRUCTION, IN CLASS 37 (U.S. CLS. 100, 103 AND 106).

**SERVICE MARK**

FIRST USE 6-1-2010; IN COMMERCE 8-15-2011.

**PRINCIPAL REGISTER**

THE MARK CONSISTS OF STANDARD CHARACTERS WITHOUT CLAIM TO ANY PARTICULAR FONT, STYLE, SIZE, OR COLOR.

SN 85-324,928, FILED 5-19-2011.

JEFF DEFORD, EXAMINING ATTORNEY



*David J. Kyffers*

Director of the United States Patent and Trademark Office

# United States of America

United States Patent and Trademark Office

# WEBPLACE

**Reg. No. 4,199,602**

NO BRAKES PRODUCTIONS, INC. (CALIFORNIA CORPORATION)  
4250 WILSHIRE BOULEVARD  
LOS ANGELES, CA 90010

**Registered Aug. 28, 2012**

**Int. Cl.: 42**

FOR: DESIGN AND CREATING WEB SITES FOR OTHERS, IN CLASS 42 (U.S. CLS. 100 AND 101).

**SERVICE MARK**

FIRST USE 3-1-2010; IN COMMERCE 3-1-2010.

**PRINCIPAL REGISTER**

THE MARK CONSISTS OF STANDARD CHARACTERS WITHOUT CLAIM TO ANY PARTICULAR FONT, STYLE, SIZE, OR COLOR.

SN 85-325,025, FILED 5-19-2011.

CAROLYN CATALDO, EXAMINING ATTORNEY



*David J. Kybas*

Director of the United States Patent and Trademark Office

# United States of America

United States Patent and Trademark Office

# APIARY

**Reg. No. 4,199,603**

RETREAT CORPORATION (CALIFORNIA CORPORATION)  
6520 MOORE DRIVE

**Registered Aug. 28, 2012**

LOS ANGELES, CA 90048

**Int. Cl.: 45**

FOR: ONLINE SOCIAL NETWORKING SERVICES, IN CLASS 45 (U.S. CLS. 100 AND 101).

**SERVICE MARK**

FIRST USE 4-1-2011; IN COMMERCE 11-15-2011.

**PRINCIPAL REGISTER**

THE MARK CONSISTS OF STANDARD CHARACTERS WITHOUT CLAIM TO ANY PARTICULAR FONT, STYLE, SIZE, OR COLOR.

SN 85-325,230, FILED 5-19-2011.

DAVID H. STINE, EXAMINING ATTORNEY



*David J. Kybas*

Director of the United States Patent and Trademark Office

# United States of America

United States Patent and Trademark Office

## MYCITYANTIQUING

**Reg. No. 4,199,604**

GPSMYCITY.COM, INC. (NEVADA CORPORATION)

**Registered Aug. 28, 2012**

2780 SOUTH JONES BLVD., #3365  
LAS VEGAS, NV 89146

**Int. Cl.: 9**

FOR: DOWNLOADABLE SOFTWARE FEATURING DIRECTIONS, MAPS, PICTURES, AND INFORMATION DESCRIBING ANTIQUE FAIRS, ANTIQUE OPEN-AIR MARKETS, ANTIQUE SHOPS, ANTIQUE MALLS, ANTIQUE SHOPPING DISTRICTS, ANTIQUE AUCTION HOUSES, AND CONSIGNMENT STORES, ALL PLAYABLE ON ELECTRONIC DEVICES, NAMELY, SMARTPHONES, PORTABLE MEDIA PLAYERS, USB HUBS, HANDHELD COMPUTERS, GLOBAL POSITIONING SYSTEMS, AND GLOBAL POSITIONING SYSTEM DEVICES; COMPUTER APPLICATION SOFTWARE FOR MOBILE PHONES, NAMELY, SOFTWARE FOR USE IN DATA PROCESSING AND GRAPHIC DISPLAY; DOWNLOADABLE SOFTWARE IN THE NATURE OF A MOBILE APPLICATION FOR USE IN DATA PROCESSING AND GRAPHIC DISPLAY; DOWNLOADABLE SOFTWARE FOR USE IN DATA PROCESSING AND GRAPHIC DISPLAY, IN CLASS 9 (U.S. CLS. 21, 23, 26, 36 AND 38).

**TRADEMARK**

**PRINCIPAL REGISTER**

FIRST USE 5-10-2012; IN COMMERCE 5-10-2012.

THE MARK CONSISTS OF STANDARD CHARACTERS WITHOUT CLAIM TO ANY PARTICULAR FONT, STYLE, SIZE, OR COLOR.

SN 85-325,392, FILED 5-19-2011.

KATHRYN COWARD, EXAMINING ATTORNEY



*David J. Kyros*

Director of the United States Patent and Trademark Office



# United States of America

United States Patent and Trademark Office

# ZEAL

**Reg. No. 4,199,605**

THE HONEST KITCHEN, INC. (CALIFORNIA CORPORATION)  
145 14TH STREET  
SAN DIEGO, CA 92101

**Registered Aug. 28, 2012**

**Int. Cl.: 31**

FOR: DOG FOOD, IN CLASS 31 (U.S. CLS. 1 AND 46).

**TRADEMARK**

FIRST USE 9-28-2010; IN COMMERCE 9-28-2010.

**PRINCIPAL REGISTER**

THE MARK CONSISTS OF STANDARD CHARACTERS WITHOUT CLAIM TO ANY PARTICULAR FONT, STYLE, SIZE, OR COLOR.

SN 85-325,527, FILED 5-20-2011.

MIDGE BUTLER, EXAMINING ATTORNEY



*David J. Kybas*

Director of the United States Patent and Trademark Office

# United States of America

United States Patent and Trademark Office

# WISHES

**Reg. No. 4,199,606**

**Registered Aug. 28, 2012**

**Int. Cl.: 31**

**TRADEMARK**

**PRINCIPAL REGISTER**

THE HONEST KITCHEN, INC. (CALIFORNIA CORPORATION)  
145 14TH STREET  
SAN DIEGO, CA 92101

FOR: CAT TREATS; DOG TREATS, IN CLASS 31 (U.S. CLS. 1 AND 46).

FIRST USE 4-9-2010; IN COMMERCE 4-9-2010.

THE MARK CONSISTS OF STANDARD CHARACTERS WITHOUT CLAIM TO ANY PARTICULAR FONT, STYLE, SIZE, OR COLOR.

SN 85-325,530, FILED 5-20-2011.

MIDGE BUTLER, EXAMINING ATTORNEY



*David J. Kybas*

Director of the United States Patent and Trademark Office

# United States of America

United States Patent and Trademark Office

# GRACE

**Reg. No. 4,199,607**

**Registered Aug. 28, 2012**

**Int. Cl.: 31**

**TRADEMARK**

**PRINCIPAL REGISTER**

THE HONEST KITCHEN, INC. (CALIFORNIA CORPORATION)  
145 14TH STREET  
SAN DIEGO, CA 92101

FOR: CAT FOOD, IN CLASS 31 (U.S. CLS. 1 AND 46).

FIRST USE 8-31-2011; IN COMMERCE 8-31-2011.

THE MARK CONSISTS OF STANDARD CHARACTERS WITHOUT CLAIM TO ANY PARTICULAR FONT, STYLE, SIZE, OR COLOR.

SN 85-325,534, FILED 5-20-2011.

MIDGE BUTLER, EXAMINING ATTORNEY



*David J. Kybas*

Director of the United States Patent and Trademark Office

# United States of America

United States Patent and Trademark Office

## PAWLANTHROPY

**Reg. No. 4,199,608**

**Registered Aug. 28, 2012**

**Int. Cl.: 36**

**SERVICE MARK**

**PRINCIPAL REGISTER**

THE HONEST KITCHEN, INC. (CALIFORNIA CORPORATION)  
145 14TH STREET  
SAN DIEGO, CA 92101

FOR: CHARITABLE FUNDRAISING SERVICES BY MEANS OF SELLING GOODS TO RAISE FUNDS FOR ANIMAL-WELFARE, HUMANITARIAN AND ENVIRONMENTAL CHARITABLE CAUSES; CHARITABLE FUNDRAISING SERVICES BY MEANS OF SELLING AND DONATING PET FOODS AND TREATS TO RAISE FUNDS FOR ANIMAL-WELFARE, HUMANITARIAN AND ENVIRONMENTAL CHARITABLE CAUSES; CHARITABLE FUNDRAISING TO SUPPORT ANIMAL-WELFARE, HUMANITARIAN AND ENVIRONMENTAL CHARITABLE CAUSES, IN CLASS 36 (U.S. CLS. 100, 101 AND 102).

FIRST USE 3-7-2007; IN COMMERCE 3-7-2007.

THE MARK CONSISTS OF STANDARD CHARACTERS WITHOUT CLAIM TO ANY PARTICULAR FONT, STYLE, SIZE, OR COLOR.

SN 85-325,538, FILED 5-20-2011.

MIDGE BUTLER, EXAMINING ATTORNEY



*David J. Kyros*

Director of the United States Patent and Trademark Office

# United States of America

United States Patent and Trademark Office

## SPIRIT GARDENS

**Reg. No. 4,199,609**

ESTATE COFFEE IMPORTS, LLC (GEORGIA LIMITED LIABILITY COMPANY)  
4535 S. BERKELEY LAKE ROAD  
NORCROSS, GA 30071

**Registered Aug. 28, 2012**

**Int. Cl.: 30**

FOR: COFFEE, COFFEE BEANS AND GROUND COFFEE, IN CLASS 30 (U.S. CL. 46).

**TRADEMARK**

FIRST USE 7-15-2011; IN COMMERCE 7-15-2011.

**PRINCIPAL REGISTER**

THE MARK CONSISTS OF STANDARD CHARACTERS WITHOUT CLAIM TO ANY PARTICULAR FONT, STYLE, SIZE, OR COLOR.

SN 85-325,603, FILED 5-20-2011.

ELI HELLMAN, EXAMINING ATTORNEY



*David J. Kyffers*

Director of the United States Patent and Trademark Office

# United States of America

United States Patent and Trademark Office



**Reg. No. 4,199,610**

MAINSTREET CREDIT UNION (KANSAS CREDIT UNION)  
13001 W. 95TH STREET  
LENEXA, KS 66215

**Registered Aug. 28, 2012**

**Int. Cl.: 36**

FOR: BANKING AND FINANCING SERVICES, IN CLASS 36 (U.S. CLS. 100, 101 AND 102).

**SERVICE MARK**

FIRST USE 11-10-2009; IN COMMERCE 1-28-2010.

**PRINCIPAL REGISTER**

OWNER OF U.S. REG. NO. 3,929,425.

NO CLAIM IS MADE TO THE EXCLUSIVE RIGHT TO USE "CREDIT UNION", APART FROM THE MARK AS SHOWN.

THE MARK CONSISTS OF A STYLIZED LETTER "M" CENTERED ABOVE THE WORDS "MAINSTREET CREDIT UNION".

SN 85-325,708, FILED 5-20-2011.

RICHARD WHITE, EXAMINING ATTORNEY



*David J. Kyffers*

Director of the United States Patent and Trademark Office

# United States of America

United States Patent and Trademark Office

# REPRIS

**Reg. No. 4,199,611**

RIGHT BANKE LLC (CALIFORNIA LIMITED LIABILITY COMPANY)  
12890 MAPLE GLEN RD.  
GLEN ELLEN, CA 95442

**Registered Aug. 28, 2012**

**Int. Cl.: 33**

FOR: WINE, IN CLASS 33 (U.S. CLS. 47 AND 49).

**TRADEMARK**

FIRST USE 5-1-2012; IN COMMERCE 5-1-2012.

**PRINCIPAL REGISTER**

THE MARK CONSISTS OF STANDARD CHARACTERS WITHOUT CLAIM TO ANY PARTICULAR FONT, STYLE, SIZE, OR COLOR.

THE ENGLISH TRANSLATION OF "REPRIS" IS REPRISE.

SN 85-325,821, FILED 5-20-2011.

MAUREEN DALL, EXAMINING ATTORNEY



*David J. Kyffers*

Director of the United States Patent and Trademark Office

# United States of America

United States Patent and Trademark Office

# TOKDOK

**Reg. No. 4,199,612**

YU, MICHAEL (UNITED STATES INDIVIDUAL)  
9 CALLE VIENTO

**Registered Aug. 28, 2012**

RANCHO PALOS VERDES, CA 90275

**Int. Cl.: 35**

FOR: ON-LINE RETAIL STORE SERVICES FEATURING STUFFED ANIMALS, STUFFED DOLLS, AND PLUSH TOYS, IN CLASS 35 (U.S. CLS. 100, 101 AND 102).

**SERVICE MARK**

FIRST USE 11-4-2011; IN COMMERCE 11-4-2011.

**PRINCIPAL REGISTER**

THE MARK CONSISTS OF STANDARD CHARACTERS WITHOUT CLAIM TO ANY PARTICULAR FONT, STYLE, SIZE, OR COLOR.

SN 85-325,997, FILED 5-20-2011.

THEODORE MCBRIDE, EXAMINING ATTORNEY



*David J. Kybas*

Director of the United States Patent and Trademark Office



# United States of America

United States Patent and Trademark Office

# RELACS

**Reg. No. 4,199,613**

**Registered Aug. 28, 2012**

**Int. Cl.: 44**

**SERVICE MARK**

**PRINCIPAL REGISTER**

MATT JENSEN MARKETING, LLC (SOUTH DAKOTA LIMITED LIABILITY COMPANY)  
SUITE 105-306  
2601 S. MINNESOTA AVENUE  
SIOUX FALLS, SD 571105710

FOR: MEDICAL AND SURGICAL EYE CARE SERVICES, NAMELY, LASER VISION SURGICAL SERVICES, IN CLASS 44 (U.S. CLS. 100 AND 101).

FIRST USE 6-1-2011; IN COMMERCE 6-1-2011.

THE MARK CONSISTS OF STANDARD CHARACTERS WITHOUT CLAIM TO ANY PARTICULAR FONT, STYLE, SIZE, OR COLOR.

SN 85-326,190, FILED 5-20-2011.

AMY C. KEAN, EXAMINING ATTORNEY



*David J. Kappas*

Director of the United States Patent and Trademark Office

# United States of America

United States Patent and Trademark Office

## SPIN 4 WORDS!

**Reg. No. 4,199,614**

FAMLEEFUN GAMES, LLC (OREGON LIMITED LIABILITY COMPANY)  
21235 TUMALO RD.  
BEND, OR 97701

**Registered Aug. 28, 2012**

**Int. Cl.: 28**

FOR: BOARD GAMES, IN CLASS 28 (U.S. CLS. 22, 23, 38 AND 50).

**TRADEMARK**

FIRST USE 7-30-2011; IN COMMERCE 7-30-2011.

**PRINCIPAL REGISTER**

THE MARK CONSISTS OF STANDARD CHARACTERS WITHOUT CLAIM TO ANY PARTICULAR FONT, STYLE, SIZE, OR COLOR.

SN 85-326,219, FILED 5-20-2011.

MARK SPARACINO, EXAMINING ATTORNEY



*David J. Kyffers*

Director of the United States Patent and Trademark Office

# United States of America

United States Patent and Trademark Office

# LAFEADA

**Reg. No. 4,199,615**

**Registered Aug. 28, 2012**

**Int. Cl.: 9**

**TRADEMARK**

**PRINCIPAL REGISTER**

E-CMOS CORPORATION (TAIWAN CORPORATION)  
NO.1, YANXIN 2ND RD., HSINCHU SCIENCE PARK  
HSINCHU CITY, TAIWAN

FOR: CARRYING CASES FOR MOBILE COMPUTERS; CASES FOR TELEPHONES; CELL PHONE COVERS; COMPONENTS FOR GAMING MACHINES, NAMELY, CONTROLLERS, DISPLAYS, BUTTON PANELS, BOLSTERS, ELECTRICAL WIRING, AND COMPUTER HARDWARE AND SOFTWARE ASSOCIATED THEREWITH; COMPUTER BAGS; COMPUTER CARRYING CASES; COMPUTER CURSOR CONTROL DEVICES, NAMELY, LIGHT PENS; DUST COVERS FOR COMPUTERS; ELECTRIC LUMINESCENT DISPLAY PANELS; ELECTRONIC APPARATUS, NAMELY, ELECTRONIC DISPLAY BOARDS, PLASMA DISPLAY BOARDS, ELECTRONIC DISPLAY SCREENS; ELECTRONIC BOOK READER; ELECTRONIC LCD DISPLAY UNIT WITH MULTI-NETWORKING (TCP/IP) CAPABILITIES; ELECTRONIC PENS; FITTED PLASTIC FILMS KNOWN AS SKINS FOR COVERING AND PROTECTING ELECTRONIC APPARATUS, NAMELY, PERSONAL DIGITAL ASSISTANTS; FITTED PLASTIC FILMS KNOWN AS SKINS FOR COVERING AND PROVIDING A SCRATCH PROOF BARRIER OR PROTECTION FOR ELECTRONIC DEVICES, NAMELY, MP3 PLAYERS, MOBILE TELEPHONES, SMART TELEPHONES, DIGITAL CAMERAS, GLOBAL POSITIONING SYSTEMS AND PERSONAL DIGITAL ASSISTANTS; FLAT PANEL DISPLAY SCREENS; HANDHELD COMPUTERS; HEADPHONES; INPUT DEVICES FOR COMPUTERS; LIGHT EMITTING DIODE (LED) DISPLAYS; LIQUID CRYSTAL DISPLAYS; MESSENGER BAGS ESPECIALLY ADAPTED FOR HOLDING LAPTOPS; NOTEBOOK AND LAPTOP COMPUTERS; NOTEBOOK COMPUTER CARRYING CASES; OVERLAYS SPECIALLY ADAPTED FOR TOUCHSCREEN DISPLAYS; PERSONAL DIGITAL ASSISTANTS (PDA); POCKET COMPUTERS FOR NOTE-TAKING; PROTECTIVE CARRYING CASES SPECIALLY ADAPTED FOR PERSONAL DIGITAL ASSISTANTS (PDA); ROLLING CASES ESPECIALLY ADAPTED FOR HOLDING LAPTOPS AND NOTEBOOK COMPUTERS; SPECIALTY HOLSTER FOR CARRYING PERSONAL DIGITAL ASSISTANTS; VINYL COVERS SPECIALLY ADAPTED FOR CELL PHONES, MP3 PLAYERS, LAPTOPS, COMPUTERS, PORTABLE SATELLITE RADIOS, PERSONAL DIGITAL ASSISTANTS, REMOTE CONTROLS, AND TELEVISION SATELLITE RECORDERS, IN CLASS 9 (U.S. CLS. 21, 23, 26, 36 AND 38).



*David J. Kappas*

Director of the United States Patent and Trademark Office

FIRST USE 9-14-2011; IN COMMERCE 1-13-2012.

THE MARK CONSISTS OF STANDARD CHARACTERS WITHOUT CLAIM TO ANY PARTICULAR FONT, STYLE, SIZE, OR COLOR.

**Reg. No. 4,199,615** SN 85-326,378, FILED 5-20-2011.

SHANNON TWOHIG, EXAMINING ATTORNEY

# United States of America

United States Patent and Trademark Office



**Reg. No. 4,199,616**

**Registered Aug. 28, 2012**

**Int. Cl.: 36**

**SERVICE MARK**

**PRINCIPAL REGISTER**

STORE CAPITAL ADVISORS, LLC (ARIZONA LIMITED LIABILITY COMPANY)  
6324 NORTH 48TH PLACE  
PARADISE VALLEY, AZ 85253

FOR: FINANCIAL SERVICES, NAMELY, REAL ESTATE ASSET MANAGEMENT, REAL ESTATE INVESTMENT, AND MORTGAGE LENDING, IN CLASS 36 (U.S. CLS. 100, 101 AND 102).

FIRST USE 5-18-2011; IN COMMERCE 6-9-2011.

NO CLAIM IS MADE TO THE EXCLUSIVE RIGHT TO USE "CAPITAL", APART FROM THE MARK AS SHOWN.

THE COLOR(S) GOLD, WHITE, AND DARK BLUE IS/ARE CLAIMED AS A FEATURE OF THE MARK.

THE MARK CONSISTS OF THE WORD "STORE" IN DARK BLUE UPPER CASE LETTERS, WITH EACH LETTER OF THE WORD "STORE" SEPARATED BY DARK BLUE VERTICAL LINES OF THE SAME CHARACTER HEIGHT. THE WORD "CAPITAL" IS IN GOLD LOWER CASE LETTERS AND IS RIGHT-ALIGNED BENEATH THE WORD "STORE". A STYLIZED BOX IS PLACED DIRECTLY TO THE RIGHT OF THE WORDS "STORE" AND "CAPITAL", AND IS THE SAME HEIGHT AS THE COMBINED TWO LINES OF TEXT. THE STYLIZED BOX CONSISTS OF A GOLD, LEFT-POINTED APEX WHICH IS SHADOWED ON THE UPPER ANGLE, AND A DARK BLUE, RIGHT-POINTED APEX WHICH IS SHADOWED ON THE LOWER ANGLE. THE GOLD AND BLUE APEXES ARE SEPARATED BY WHITE SPACE.

SN 85-326,543, FILED 5-20-2011.

MEGHAN REINHART, EXAMINING ATTORNEY



*David J. Kyros*

Director of the United States Patent and Trademark Office

# United States of America

United States Patent and Trademark Office

## Go Further with WGU Indiana

**Reg. No. 4,199,617**

WESTERN GOVERNORS UNIVERSITY (UTAH CORPORATION)

**Registered Aug. 28, 2012**

4001 SOUTH 700 EAST, SUITE 700  
SALT LAKE CITY, UT 84107

**Int. Cl.: 41**

FOR: CAREER COUNSELING; EDUCATION SERVICES, NAMELY, PROVIDING ON-LINE CLASSES, SEMINARS, MODULES AND WORKSHOPS IN THE FIELD OF EDUCATION, BUSINESS, INFORMATION TECHNOLOGY, NURSING, HEALTH AND HEALTH CARE; EDUCATIONAL COUNSELING SERVICES TO ASSIST STUDENTS IN PLANNING AND PREPARING FOR FURTHER EDUCATION; EDUCATIONAL TESTING, IN CLASS 41 (U.S. CLS. 100, 101 AND 107).

**SERVICE MARK**

**PRINCIPAL REGISTER**

FIRST USE 1-31-2011; IN COMMERCE 1-31-2011.

THE MARK CONSISTS OF STANDARD CHARACTERS WITHOUT CLAIM TO ANY PARTICULAR FONT, STYLE, SIZE, OR COLOR.

OWNER OF U.S. REG. NO. 2,374,880.

NO CLAIM IS MADE TO THE EXCLUSIVE RIGHT TO USE "INDIANA", APART FROM THE MARK AS SHOWN.

SN 85-326,665, FILED 5-21-2011.

SKYE YOUNG, EXAMINING ATTORNEY



*David J. Kybas*

Director of the United States Patent and Trademark Office

# United States of America

United States Patent and Trademark Office



**Reg. No. 4,199,618**

**Registered Aug. 28, 2012**

**Int. Cl.: 5**

**TRADEMARK**

**PRINCIPAL REGISTER**

KL&M ENTERPRISES INC (CALIFORNIA CORPORATION)  
5052 NIGHTHAWK WAY  
OCEANSIDE, CA 92056

FOR: VITAMIN, MINERAL, DIETARY AND NUTRITIONAL SUPPLEMENTS, NAMELY, ANTIOXIDANT SUPPLEMENTS, HERBAL SUPPLEMENTS FOR BOOSTING ENERGY AND NUTRITIONAL SUPPLEMENTS FOR BOOSTING ENERGY, IN CLASS 5 (U.S. CLS. 6, 18, 44, 46, 51 AND 52).

FIRST USE 8-25-2011; IN COMMERCE 8-25-2011.

THE MARK CONSISTS OF A ROUND CLOCK WITH A THIN RED LINE AROUND THE OUTER EDGE THEN MOVING INWARD FROM THE EDGE THERE IS A SMALL GAP BETWEEN THE OUTER EDGE AND THE INNER FACE OF THE CLOCK WITH ANOTHER THIN RED CIRCLE. AND THAT GAP BETWEEN THE TWO RED CIRCLES IS A CHROME RING. THE INNER FACE OF THE CLOCK SURFACE IS BLACK IN COLOR AND HAS A RED SUNBURST OF COLOR OFF TO THE RIGHT SIDE OF THE CLOCK SURFACE. THE "8HR DAY" IS BEING USED FOR THE HANDS ON THE CLOCK "8 HR" IS THE SMALL HAND ON THE CLOCK POINTING TO THE LOCATION OF THE "8" ON THE CLOCK. "DAY" IS THE BIG HAND AND IT IS POINTING TO THE LOCATION OF THE 12 ON THE CLOCK. THE CLOCK HANDS ARE RED IN COLOR.

THE COLOR(S) RED, BLACK, AND CHROME IS/ARE CLAIMED AS A FEATURE OF THE MARK.

SN 85-326,691, FILED 5-21-2011.

PAUL E. FAHRENKOPF, EXAMINING ATTORNEY



*David J. Kyros*

Director of the United States Patent and Trademark Office

United States of America  
United States Patent and Trademark Office

# ESECURE

**Reg. No. 4,199,619**

**Registered Aug. 28, 2012**

**Int. Cl.: 45**

**SERVICE MARK**

**PRINCIPAL REGISTER**

ADAPTIVE PAYMENTS, INC. (FLORIDA CORPORATION)  
945 E LAS OLAS BLVD #201  
FORT LAUDERDALE, FL 33301

FOR: PROVIDING AUTHENTICATION OF PERSONAL IDENTIFICATION AND ACCOUNT INFORMATION IN CONNECTION WITH FINANCIAL TRANSACTIONS; PROVIDING AUTHENTICATION OF PERSONAL IDENTIFICATION AND ACCOUNT INFORMATION IN CONNECTION WITH PAYMENTS FOR GOODS OR SERVICES; PROVIDING USER AUTHENTICATION SERVICES IN CREDIT AND DEBIT CARD TRANSACTIONS, IN CLASS 45 (U.S. CLS. 100 AND 101).

FIRST USE 6-21-2012; IN COMMERCE 6-21-2012.

THE MARK CONSISTS OF STANDARD CHARACTERS WITHOUT CLAIM TO ANY PARTICULAR FONT, STYLE, SIZE, OR COLOR.

SN 85-327,201, FILED 5-23-2011.

LESLIE RICHARDS, EXAMINING ATTORNEY



*David J. Kyffers*

Director of the United States Patent and Trademark Office



# United States of America

United States Patent and Trademark Office



**Reg. No. 4,199,620**

**Registered Aug. 28, 2012**

**Int. Cl.: 21**

**TRADEMARK**

**PRINCIPAL REGISTER**

JOHNSON & JOHNSON (NEW JERSEY CORPORATION)  
ONE JOHNSON & JOHNSON PLAZA  
NEW BRUNSWICK, NJ 089337001

FOR: DENTAL FLOSS, IN CLASS 21 (U.S. CLS. 2, 13, 23, 29, 30, 33, 40 AND 50).

FIRST USE 12-15-2011; IN COMMERCE 12-15-2011.

SN 85-327,479, FILED 5-23-2011.

MARK SPARACINO, EXAMINING ATTORNEY



*David J. Kyffers*

Director of the United States Patent and Trademark Office

# United States of America

United States Patent and Trademark Office



**Reg. No. 4,199,621**

**Registered Aug. 28, 2012**

**Int. Cl.: 21**

**TRADEMARK**

**PRINCIPAL REGISTER**

JOHNSON & JOHNSON (NEW JERSEY CORPORATION)  
ONE JOHNSON & JOHNSON PLAZA  
NEW BRUNSWICK, NJ 089337001

FOR: DENTAL FLOSS, IN CLASS 21 (U.S. CLS. 2, 13, 23, 29, 30, 33, 40 AND 50).

FIRST USE 12-15-2011; IN COMMERCE 12-15-2011.

THE MARK CONSISTS OF IMAGE OF TWO TEETH WITH A BRUSH IN BETWEEN ALL  
INSIDE A CIRCLE.

SN 85-327,481, FILED 5-23-2011.

MARK SPARACINO, EXAMINING ATTORNEY



*David J. Kyffers*

Director of the United States Patent and Trademark Office

# United States of America

United States Patent and Trademark Office

## EVERYBODY DANCE

**Reg. No. 4,199,622**

**Registered Aug. 28, 2012**

**Int. Cl.: 9**

**TRADEMARK**

**PRINCIPAL REGISTER**

SONY COMPUTER ENTERTAINMENT AMERICA LLC (DELAWARE LIMITED LIABILITY COMPANY)  
919 E. HILLSDALE BLVD  
FOSTER CITY, CA 94404

FOR: COMPUTER GAME SOFTWARE AND VIDEO GAME SOFTWARE, IN CLASS 9 (U.S. CLS. 21, 23, 26, 36 AND 38).

FIRST USE 10-18-2011; IN COMMERCE 10-18-2011.

THE MARK CONSISTS OF STANDARD CHARACTERS WITHOUT CLAIM TO ANY PARTICULAR FONT, STYLE, SIZE, OR COLOR.

NO CLAIM IS MADE TO THE EXCLUSIVE RIGHT TO USE "DANCE", APART FROM THE MARK AS SHOWN.

SN 85-327,882, FILED 5-23-2011.

NELSON SNYDER, EXAMINING ATTORNEY



*David J. Kyros*

Director of the United States Patent and Trademark Office

# United States of America

United States Patent and Trademark Office

## SUPPORTING YOUR INVESTMENTS

**Reg. No. 4,199,623**

**Registered Aug. 28, 2012**

**Int. Cl.: 6**

**TRADEMARK**

**PRINCIPAL REGISTER**

SOLAR LIBERTY ENERGY SYSTEMS, INC. (NEW YORK CORPORATION), DBA  
DYNORAXX,  
6500 SHERIDAN DRIVE SUITE 120  
BUFFALO, NY 14221

FOR: METAL MOUNTING SYSTEMS COMPRISING FASTENERS, RACKS, RAILS, BALAST  
TRAYS, BALASTS, FASTENING PLATES, VERTICAL SUPPORTS FOR SOLAR ENERGY  
EQUIPMENT, IN CLASS 6 (U.S. CLS. 2, 12, 13, 14, 23, 25 AND 50).

FIRST USE 3-15-2011; IN COMMERCE 3-15-2011.

THE MARK CONSISTS OF STANDARD CHARACTERS WITHOUT CLAIM TO ANY PAR-  
TICULAR FONT, STYLE, SIZE, OR COLOR.

SN 85-328,042, FILED 5-23-2011.

KELLY BOULTON, EXAMINING ATTORNEY



*David J. Kybas*

Director of the United States Patent and Trademark Office

# United States of America

United States Patent and Trademark Office

# ITCH SHIELD

**Reg. No. 4,199,624**

JOHNSON & JOHNSON (NEW JERSEY CORPORATION)  
ONE JOHNSON & JOHNSON PLAZA  
NEW BRUNSWICK, NJ 089337001

**Registered Aug. 28, 2012**

**Int. Cl.: 5**

FOR: TOPICAL ANTI-ITCH PREPARATIONS, IN CLASS 5 (U.S. CLS. 6, 18, 44, 46, 51 AND 52).

**TRADEMARK**

FIRST USE 12-0-2009; IN COMMERCE 12-0-2009.

**PRINCIPAL REGISTER**

THE MARK CONSISTS OF STANDARD CHARACTERS WITHOUT CLAIM TO ANY PARTICULAR FONT, STYLE, SIZE, OR COLOR.

NO CLAIM IS MADE TO THE EXCLUSIVE RIGHT TO USE "ITCH", APART FROM THE MARK AS SHOWN.

SN 85-328,775, FILED 5-24-2011.

MARK SPARACINO, EXAMINING ATTORNEY



*David J. Kyffers*

Director of the United States Patent and Trademark Office

# United States of America

United States Patent and Trademark Office

# BE A JOKE!

**Reg. No. 4,199,625**

**Registered Aug. 28, 2012**

**Int. Cl.: 25**

**TRADEMARK**

**PRINCIPAL REGISTER**

BE A JOKE! INDUSTRIES, INC. (MICHIGAN CORPORATION)  
10603 ROYSTON ROAD  
GRAND LEDGE, MI 48837

FOR: CASUAL CLOTHING, NAMELY, T-SHIRTS, POLO SHIRTS, RUGBY SHIRTS, SWEAT PANTS, DENIM AND NON-DENIM PANTS; CASUAL FOOTWEAR, SANDALS AND BOAT SHOES, IN CLASS 25 (U.S. CLS. 22 AND 39).

FIRST USE 1-1-2012; IN COMMERCE 1-1-2012.

THE MARK CONSISTS OF STANDARD CHARACTERS WITHOUT CLAIM TO ANY PARTICULAR FONT, STYLE, SIZE, OR COLOR.

SN 85-328,829, FILED 5-24-2011.

KEVIN CORWIN, EXAMINING ATTORNEY



*David J. Kyffers*

Director of the United States Patent and Trademark Office

# United States of America

United States Patent and Trademark Office

## SN-ALLOWEEN

**Reg. No. 4,199,626**

DEL MONTE CORPORATION (DELAWARE CORPORATION)  
P.O. BOX 193575

**Registered Aug. 28, 2012**

SAN FRANCISCO, CA 941193575

**Int. Cl.: 31**

FOR: PET FOOD, IN CLASS 31 (U.S. CLS. 1 AND 46).

**TRADEMARK**

FIRST USE 9-26-2011; IN COMMERCE 9-26-2011.

**PRINCIPAL REGISTER**

THE MARK CONSISTS OF STANDARD CHARACTERS WITHOUT CLAIM TO ANY PARTICULAR FONT, STYLE, SIZE, OR COLOR.

SN 85-329,255, FILED 5-24-2011.

DAVID COLLIER, EXAMINING ATTORNEY



*David J. Kyffers*

Director of the United States Patent and Trademark Office

# United States of America

United States Patent and Trademark Office

# SURETAX

**Reg. No. 4,199,627**

**Registered Aug. 28, 2012**

**Int. Cl.: 35**

**SERVICE MARK**

**PRINCIPAL REGISTER**

FAR POINT CONSULTING, LLC (GEORGIA LIMITED LIABILITY COMPANY), DBA FAR POINT SYSTEMS,  
SUITE 1204  
CUMMING, GA 30041

FOR: ONLINE SALES AND TRANSACTION TAX DETERMINATION AND CALCULATION SERVICES, IN CLASS 35 (U.S. CLS. 100, 101 AND 102).

FIRST USE 1-7-2012; IN COMMERCE 1-7-2012.

THE MARK CONSISTS OF STANDARD CHARACTERS WITHOUT CLAIM TO ANY PARTICULAR FONT, STYLE, SIZE, OR COLOR.

SN 85-329,367, FILED 5-24-2011.

TOBY BULLOFF, EXAMINING ATTORNEY



*David J. Kyffers*

Director of the United States Patent and Trademark Office



# United States of America

United States Patent and Trademark Office

# Privalytics

**Reg. No. 4,199,628**

SKYBOARD, LLC (LOUISIANA LIMITED LIABILITY COMPANY)  
3812 BISSONET DRIVE  
METAIRIE, LA 70003

**Registered Aug. 28, 2012**

**Int. Cl.: 42**

FOR: PROVIDING A WEBSITE FEATURING NON-DOWNLOADABLE SOFTWARE FOR MEASURING, COLLECTING, ANALYZING AND REPORTING ON INTERNET DATA FOR PURPOSES OF DISPLAYING, UNDERSTANDING AND IMPROVING ONLINE USERS' PRIVACY AND SECURITY; PROVIDING A WEBSITE FEATURING ON-LINE NON-DOWNLOADABLE SOFTWARE THAT ENABLES USERS TO MEASURE, COLLECT, ANALYZE AND REPORT ON INTERNET DATA FOR PURPOSES OF DISPLAYING, UNDERSTANDING AND IMPROVING ONLINE USERS' PRIVACY AND SECURITY, IN CLASS 42 (U.S. CLS. 100 AND 101).

**SERVICE MARK**

**PRINCIPAL REGISTER**

FIRST USE 5-19-2011; IN COMMERCE 5-9-2012.

THE MARK CONSISTS OF STANDARD CHARACTERS WITHOUT CLAIM TO ANY PARTICULAR FONT, STYLE, SIZE, OR COLOR.

SN 85-329,773, FILED 5-25-2011.

SEAN CROWLEY, EXAMINING ATTORNEY



*David J. Kyros*

Director of the United States Patent and Trademark Office

# United States of America

United States Patent and Trademark Office

## New Resolution

**Reg. No. 4,199,629**

DASILVA, LUIS (UNITED STATES INDIVIDUAL)  
936 SANFORD AVENUE  
IRVINGTON, NJ 07111

**Registered Aug. 28, 2012**

**Int. Cl.: 16**

FOR: DISPOSABLE DIAPERS, IN CLASS 16 (U.S. CLS. 2, 5, 22, 23, 29, 37, 38 AND 50).

**TRADEMARK**

FIRST USE 3-15-2012; IN COMMERCE 3-15-2012.

**PRINCIPAL REGISTER**

THE MARK CONSISTS OF STANDARD CHARACTERS WITHOUT CLAIM TO ANY PARTICULAR FONT, STYLE, SIZE, OR COLOR.

SN 85-329,778, FILED 5-25-2011.

ALICE BENMAMAN, EXAMINING ATTORNEY



*David J. Kyffers*

Director of the United States Patent and Trademark Office

# United States of America

United States Patent and Trademark Office

# INVIGORATE

**Reg. No. 4,199,630**

**Registered Aug. 28, 2012**

**Int. Cl.: 1**

**TRADEMARK**

**PRINCIPAL REGISTER**

AGRINOS, INC. (DELAWARE CORPORATION)  
820 SOUTH MACARTHUR BLVD. SUITE 150-357  
COPPELL, TX 75019

FOR: MICROBIAL SOIL ENHANCERS, IN CLASS 1 (U.S. CLS. 1, 5, 6, 10, 26 AND 46).

FIRST USE 5-1-2012; IN COMMERCE 5-1-2012.

THE MARK CONSISTS OF STANDARD CHARACTERS WITHOUT CLAIM TO ANY PARTICULAR FONT, STYLE, SIZE, OR COLOR.

SN 85-329,801, FILED 5-25-2011.

INGA ERVIN, EXAMINING ATTORNEY



*David J. Kyffers*

Director of the United States Patent and Trademark Office

# United States of America

United States Patent and Trademark Office

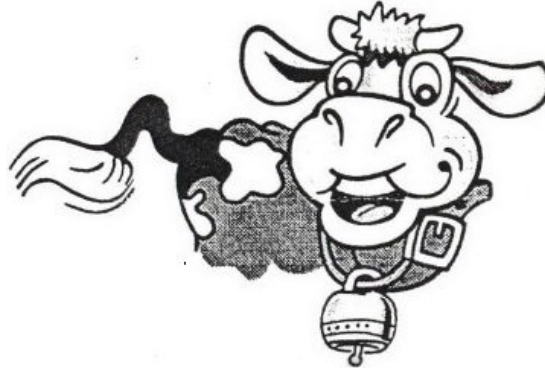

**Reg. No. 4,199,631**

**Registered Aug. 28, 2012**

**Int. Cl.: 30**

**TRADEMARK**

**PRINCIPAL REGISTER**

KRAFT FOODS SCHWEIZ HOLDING GMBH (SWITZERLAND LIMITED LIABILITY COMPANY)  
CHOLLERSTRASSE 4  
6301 ZUG, SWITZERLAND

FOR: CHOCOLATE, IN CLASS 30 (U.S. CL. 46).

FIRST USE 2-1-2012; IN COMMERCE 2-1-2012.

THE MARK CONSISTS OF A STYLIZED SMILING COW WITH A BELL HUNG AROUND ITS NECK ON A COLLAR. THE FIGURE INCLUDES ONLY THE HEAD, BODY AND TAIL AND DOES NOT INCLUDE THE LEGS OF THE COW.

SN 85-329,843, FILED 5-25-2011.

CIMMERIAN COLEMAN, EXAMINING ATTORNEY



*David J. Kybas*

Director of the United States Patent and Trademark Office

# United States of America

United States Patent and Trademark Office

# DELTAMAXX

**Reg. No. 4,199,632**

JOHNSON & JOHNSON (NEW JERSEY CORPORATION)  
ONE JOHNSON & JOHNSON PLAZA  
NEW BRUNSWICK, NJ 089337001

**Registered Aug. 28, 2012**

**Int. Cl.: 10**

FOR: MEDICAL DEVICES, NAMELY, NEUROVASCULAR COILS, IN CLASS 10 (U.S. CLS. 26, 39 AND 44).

**TRADEMARK**

FIRST USE 4-24-2012; IN COMMERCE 4-24-2012.

**PRINCIPAL REGISTER**

THE MARK CONSISTS OF STANDARD CHARACTERS WITHOUT CLAIM TO ANY PARTICULAR FONT, STYLE, SIZE, OR COLOR.

SN 85-330,069, FILED 5-25-2011.

MARK SPARACINO, EXAMINING ATTORNEY



*David J. Kyffers*

Director of the United States Patent and Trademark Office

# United States of America

United States Patent and Trademark Office

## SHOOTWEAR

**Reg. No. 4,199,633**

**Registered Aug. 28, 2012**

**Int. Cl.: 25**

**TRADEMARK**

**PRINCIPAL REGISTER**

RED.COM, INC. (WASHINGTON CORPORATION)  
34 PARKER  
IRVINE, CA 92618

FOR: CLOTHING, NAMELY, SHIRTS, T-SHIRTS, BLOUSES, SPORTS SHIRTS, KNIT SHIRTS, JERSEYS, BEACH-WEAR, SWIMWEAR, SWIM TRUNKS, SHORTS, UNDERWEAR, SHORTS, PANTS, JEANS, SWEATPANTS, RACING PANTS, SKI AND SNOWBOARD PANTS AND JACKETS, VESTS, JACKETS, WETSUITS, SWEATERS, PULLOVERS, COATS, BELTS, TIES, SOCKS, SLEEPWEAR, MEN'S SUITS, HEADWEAR, NAMELY, HATS, CAPS, VISORS, AND FOOTWEAR, NAMELY, WETSUIT BOOTIES, SHOES, SANDALS, ATHLETIC FOOTWEAR, ALL PURPOSE SPORTS FOOTWEAR, THONGS AND BOOTS, IN CLASS 25 (U.S. CLS. 22 AND 39).

FIRST USE 8-30-2011; IN COMMERCE 8-30-2011.

THE MARK CONSISTS OF STANDARD CHARACTERS WITHOUT CLAIM TO ANY PARTICULAR FONT, STYLE, SIZE, OR COLOR.

SN 85-330,338, FILED 5-25-2011.

SUNG IN, EXAMINING ATTORNEY



*David J. Kyfos*

Director of the United States Patent and Trademark Office

# United States of America

United States Patent and Trademark Office

## SNOWMASSTODON

**Reg. No. 4,199,634**

**Registered Aug. 28, 2012**

**Int. Cl.: 18**

**TRADEMARK**

**PRINCIPAL REGISTER**

JOHN R. (JACK) RAFFERTY (UNITED STATES INDIVIDUAL), DBA  
SNOWMASSTODON.COM,  
105 VILLAGE SQ.  
P.O. BOX 5939  
SNOWMASS VILLAGE, CO 81615

FOR: TOTE BAGS, IN CLASS 18 (U.S. CLS. 1, 2, 3, 22 AND 41).

FIRST USE 11-11-2011; IN COMMERCE 1-15-2012.

THE MARK CONSISTS OF STANDARD CHARACTERS WITHOUT CLAIM TO ANY PARTICULAR FONT, STYLE, SIZE, OR COLOR.

SN 85-330,365, FILED 5-25-2011.

JACQUELINE A. LAVINE, EXAMINING ATTORNEY



*David J. Kyffers*

Director of the United States Patent and Trademark Office

# United States of America

United States Patent and Trademark Office

## SNOWMASSTODON

**Reg. No. 4,199,635**

**Registered Aug. 28, 2012**

**Int. Cl.: 21**

**TRADEMARK**

**PRINCIPAL REGISTER**

JOHN R. (JACK) RAFFERTY (UNITED STATES INDIVIDUAL), DBA  
SNOWMASSTODON.COM,  
105 VILLAGE SQ.  
P.O. BOX 5939  
SNOWMASS VILLAGE, CO 81615

FOR: CUPS AND MUGS, IN CLASS 21 (U.S. CLS. 2, 13, 23, 29, 30, 33, 40 AND 50).

FIRST USE 12-22-2010; IN COMMERCE 12-22-2010.

THE MARK CONSISTS OF STANDARD CHARACTERS WITHOUT CLAIM TO ANY PARTICULAR FONT, STYLE, SIZE, OR COLOR.

SN 85-330,374, FILED 5-25-2011.

JACQUELINE A. LAVINE, EXAMINING ATTORNEY



*David J. Kyffers*

Director of the United States Patent and Trademark Office



# United States of America

United States Patent and Trademark Office

*Gogo Heel*

**Reg. No. 4,199,636**

GOGO HEEL, LLC (CALIFORNIA LIMITED LIABILITY COMPANY)  
1106 SECOND STREET, #203  
ENCINITAS, CA 92024

**Registered Aug. 28, 2012**

**Int. Cl.: 25**

FOR: HEEL PIECES FOR SHOES; SHOE COVERS FOR USE WHEN WEARING SHOES;  
SHOE DOWELS, IN CLASS 25 (U.S. CLS. 22 AND 39).

**TRADEMARK**

FIRST USE 4-24-2012; IN COMMERCE 5-12-2012.

**PRINCIPAL REGISTER**

THE MARK CONSISTS OF THE STYLIZED WORDING "GOGO HEEL" TO THE RIGHT OF  
A SKETCH OF A HIGH HEEL WITH A SQUIGGLE MARK ON THE HEEL TIP.

SN 85-331,137, FILED 5-26-2011.

KAREN K. BUSH, EXAMINING ATTORNEY



*David J. Kybas*

Director of the United States Patent and Trademark Office

# United States of America

United States Patent and Trademark Office

# DELTA MAX

**Reg. No. 4,199,637**

**Registered Aug. 28, 2012**

**Int. Cl.: 5**

**TRADEMARK**

**PRINCIPAL REGISTER**

P.F. HARRIS MANUFACTURING COMPANY, LLC (GEORGIA LIMITED LIABILITY COMPANY)  
3575 TROTTER DR. BLDG A  
ALPHARETTA, GA 30009

FOR: HERBICIDES, INSECTICIDES, PESTICIDES AND FUNGICIDES FOR HOME, GARDEN AND LAWN USE AND FOR PROFESSIONAL USE, IN CLASS 5 (U.S. CLS. 6, 18, 44, 46, 51 AND 52).

FIRST USE 2-2-2012; IN COMMERCE 5-13-2012.

THE MARK CONSISTS OF STANDARD CHARACTERS WITHOUT CLAIM TO ANY PARTICULAR FONT, STYLE, SIZE, OR COLOR.

SN 85-331,499, FILED 5-26-2011.

CHRISTINA SOBRAL, EXAMINING ATTORNEY



*David J. Kyjars*

Director of the United States Patent and Trademark Office

# United States of America

United States Patent and Trademark Office

# EVERSMILE

**Reg. No. 4,199,638**

DOSA MANAGEMENT SERVICES, LLC (TEXAS LIMITED LIABILITY COMPANY)  
8501 WADE BLVD., SUITE 250  
FRISCO, TX 75034

**Registered Aug. 28, 2012**

**Int. Cl.: 44**

FOR: DENTAL SERVICES, NAMELY, ORAL SURGERY AND COSMETIC PROCEDURES,  
IN CLASS 44 (U.S. CLS. 100 AND 101).

**SERVICE MARK**

FIRST USE 8-31-2011; IN COMMERCE 8-31-2011.

**PRINCIPAL REGISTER**

THE MARK CONSISTS OF STANDARD CHARACTERS WITHOUT CLAIM TO ANY PAR-  
TICULAR FONT, STYLE, SIZE, OR COLOR.

SN 85-331,570, FILED 5-26-2011.

B. PARADEWELAI, EXAMINING ATTORNEY



*David J. Kyffers*

Director of the United States Patent and Trademark Office

# United States of America

United States Patent and Trademark Office

# NFR

**Reg. No. 4,199,639**

BUNCH AND ASSOCIATES, LLC (DELAWARE LIMITED LIABILITY COMPANY)  
3500 REYNOLDS ROAD  
LAKELAND, FL 33803

**Registered Aug. 28, 2012**

**Int. Cls.: 35 and 36**

FOR: WORKERS' COMPENSATION CLAIMS MANAGEMENT SERVICES, NAMELY, ELECTRONIC DATA COLLECTION AND DATA ENTERING IN THE FIELD OF WORKERS' COMPENSATION; AND COLLECTING AND ANALYZING WORKERS' COMPENSATION CLAIMS DATA FOR BUSINESS PURPOSES, IN CLASS 35 (U.S. CLS. 100, 101 AND 102).

**SERVICE MARK**

**PRINCIPAL REGISTER**

FIRST USE 2-0-2009; IN COMMERCE 2-0-2009.

FOR: CLAIMS ADMINISTRATION IN THE FIELD OF WORKERS' COMPENSATION; CONSULTATION AND CLAIMS PROCESSING IN THE FIELD OF WORKERS' COMPENSATION INSURANCE, IN CLASS 36 (U.S. CLS. 100, 101 AND 102).

FIRST USE 2-0-2009; IN COMMERCE 2-0-2009.

THE MARK CONSISTS OF STANDARD CHARACTERS WITHOUT CLAIM TO ANY PARTICULAR FONT, STYLE, SIZE, OR COLOR.

SN 85-331,630, FILED 5-26-2011.

ALEXANDER L. POWERS, EXAMINING ATTORNEY



*David J. Kybas*

Director of the United States Patent and Trademark Office

# United States of America

United States Patent and Trademark Office

# NFR

**Reg. No. 4,199,640**

BUNCH AND ASSOCIATES, LLC (DELAWARE LIMITED LIABILITY COMPANY)  
3500 REYNOLDS ROAD  
LAKELAND, FL 33803

**Registered Aug. 28, 2012**

**Int. Cl.: 9**

FOR: COMPUTER SOFTWARE AND APPLICATIONS FOR PROCESSING, ANALYZING AND MANAGING WORKERS' COMPENSATION CLAIMS, IN CLASS 9 (U.S. CLS. 21, 23, 26, 36 AND 38).

**TRADEMARK**

FIRST USE 2-0-2009; IN COMMERCE 2-0-2009.

**PRINCIPAL REGISTER**

THE MARK CONSISTS OF STANDARD CHARACTERS WITHOUT CLAIM TO ANY PARTICULAR FONT, STYLE, SIZE, OR COLOR.

SN 85-331,635, FILED 5-26-2011.

ALEXANDER L. POWERS, EXAMINING ATTORNEY



*David J. Kyffers*

Director of the United States Patent and Trademark Office

# United States of America

United States Patent and Trademark Office

# CIA

**Reg. No. 4,199,641**

BUNCH AND ASSOCIATES, LLC (DELAWARE LIMITED LIABILITY COMPANY)  
3500 REYNOLDS ROAD  
LAKELAND, FL 33803

**Registered Aug. 28, 2012**

**Int. Cls.: 35 and 36**

FOR: WORKERS' COMPENSATION CLAIMS MANAGEMENT SERVICES, NAMELY, ELECTRONIC DATA COLLECTION AND DATA ENTERING IN THE FIELD OF WORKERS' COMPENSATION; AND COLLECTING AND ANALYZING WORKERS' COMPENSATION CLAIMS DATA FOR BUSINESS PURPOSES, IN CLASS 35 (U.S. CLS. 100, 101 AND 102).

**SERVICE MARK**

**PRINCIPAL REGISTER**

FIRST USE 3-0-2011; IN COMMERCE 3-0-2011.

FOR: CLAIMS ADMINISTRATION IN THE FIELD OF WORKERS' COMPENSATION; CONSULTATION AND CLAIMS PROCESSING IN THE FIELD OF WORKERS' COMPENSATION INSURANCE, IN CLASS 36 (U.S. CLS. 100, 101 AND 102).

FIRST USE 3-0-2011; IN COMMERCE 3-0-2011.

THE MARK CONSISTS OF STANDARD CHARACTERS WITHOUT CLAIM TO ANY PARTICULAR FONT, STYLE, SIZE, OR COLOR.

SN 85-331,640, FILED 5-26-2011.

ALEXANDER L. POWERS, EXAMINING ATTORNEY



*David J. Kybas*

Director of the United States Patent and Trademark Office

# United States of America

United States Patent and Trademark Office



**Reg. No. 4,199,642**

**Registered Aug. 28, 2012**

**Int. Cl.: 41**

**SERVICE MARK**

**PRINCIPAL REGISTER**

AMAZON TECHNOLOGIES, INC. (NEVADA CORPORATION)  
PO BOX 8102  
ATTN: TRADEMARKS  
RENO, NV 89507

FOR: PROVIDING RECOGNITION AND INCENTIVES BY THE WAY OF AWARDS AND CONTESTS TO DEMONSTRATE EXCELLENCE IN THE FIELD OF FICTION BOOK AND NOVEL WRITING; PROVIDING INFORMATION RELATED TO PUBLISHING OF BOOKS AND OTHER PRINTED MATTER VIA THE INTERNET; PROVIDING INFORMATION RELATED TO THE SELF-PUBLICATION OF BOOKS AND OTHER PRINTED MATTER VIA THE INTERNET; PROVIDING A WEBSITE FOR ENTERTAINMENT PURPOSES WHERE USERS CAN VIEW VIDEOS FEATURING PAST WINNERS OF BOOK AND NOVEL WRITING CONTESTS, IN CLASS 41 (U.S. CLS. 100, 101 AND 107).

FIRST USE 1-16-2008; IN COMMERCE 1-16-2008.

NO CLAIM IS MADE TO THE EXCLUSIVE RIGHT TO USE "NOVEL AWARD" , APART FROM THE MARK AS SHOWN.

THE MARK CONSISTS OF A CIRCLE IN THE SHAPE OF A SEAL, WITH THE OUTLINE OF A BOOK IN THE CENTER AND THE WORDS "AMAZON BREAKTHROUGH NOVEL AWARD" IN A CIRCLE AROUND THE BOOK.

SN 85-331,671, FILED 5-26-2011.

ANGELA M. MICHELI, EXAMINING ATTORNEY



*David J. Kyffers*

Director of the United States Patent and Trademark Office

# United States of America

United States Patent and Trademark Office

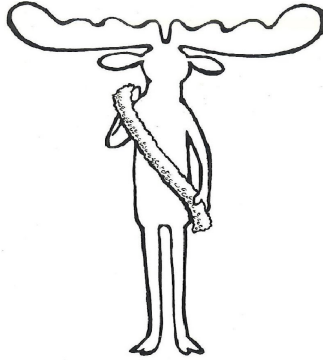

**Reg. No. 4,199,643**

MICHELLE O'DONNELL (UNITED STATES INDIVIDUAL)  
32 WOODMAN ROAD  
DURHAM, NH 03824

**Registered Aug. 28, 2012**

**Int. Cl.: 24**

FOR: BATH TOWELS; BEACH TOWELS; CHILDREN'S TOWELS; HOUSEHOLD LINEN, INCLUDING FACE TOWELS; LARGE BATH TOWELS; TOWEL SETS; WASHCLOTHS; TOWELS DESIGNED TO WASH AND DRY THE USERS BACK, IN CLASS 24 (U.S. CLS. 42 AND 50).

**TRADEMARK**

**PRINCIPAL REGISTER**

FIRST USE 5-27-2011; IN COMMERCE 5-27-2011.

THE MARK CONSISTS OF MOOSE STANDING ON TWO LEGS; TOWEL DRAPED OVER STANDING MOOSE'S SHOULDER.

SN 85-332,090, FILED 5-27-2011.

LINDA ESTRADA, EXAMINING ATTORNEY



*David J. Kyffers*

Director of the United States Patent and Trademark Office



# United States of America

United States Patent and Trademark Office

## COMBAT CLAW

**Reg. No. 4,199,644**

**Registered Aug. 28, 2012**

**Int. Cl.: 28**

**TRADEMARK**

**PRINCIPAL REGISTER**

MATTEL, INC. (DELAWARE CORPORATION)  
M1-1518  
333 CONTINENTAL BOULEVARD  
EL SEGUNDO, CA 90245

FOR: TOY ACTION FIGURES AND ACCESSORIES THEREFOR, IN CLASS 28 (U.S. CLS. 22, 23, 38 AND 50).

FIRST USE 5-21-2012; IN COMMERCE 5-21-2012.

THE MARK CONSISTS OF STANDARD CHARACTERS WITHOUT CLAIM TO ANY PARTICULAR FONT, STYLE, SIZE, OR COLOR.

SN 85-332,213, FILED 5-27-2011.

WENDY GOODMAN, EXAMINING ATTORNEY



*David J. Kyffers*

Director of the United States Patent and Trademark Office

# United States of America

United States Patent and Trademark Office

## RACE RALLY WATER PARK

**Reg. No. 4,199,645**

**Registered Aug. 28, 2012**

**Int. Cl.: 28**

**TRADEMARK**

**PRINCIPAL REGISTER**

MATTEL, INC. (DELAWARE CORPORATION)  
M1-1518  
333 CONTINENTAL BOULEVARD  
EL SEGUNDO, CA 90245

FOR: TOY VEHICLE TRACK SETS AND ACCESSORIES THEREFOR, IN CLASS 28 (U.S. CLS. 22, 23, 38 AND 50).

FIRST USE 10-25-2011; IN COMMERCE 10-25-2011.

THE MARK CONSISTS OF STANDARD CHARACTERS WITHOUT CLAIM TO ANY PARTICULAR FONT, STYLE, SIZE, OR COLOR.

NO CLAIM IS MADE TO THE EXCLUSIVE RIGHT TO USE "WATER PARK", APART FROM THE MARK AS SHOWN.

SN 85-332,230, FILED 5-27-2011.

LESLIE RICHARDS, EXAMINING ATTORNEY



*David J. Kyffers*

Director of the United States Patent and Trademark Office

# United States of America

United States Patent and Trademark Office

## WEEKEND MACHINES

**Reg. No. 4,199,646**

**Registered Aug. 28, 2012**

**Int. Cl.: 28**

**TRADEMARK**

**PRINCIPAL REGISTER**

MATTEL, INC. (DELAWARE CORPORATION)  
M1-1518  
333 CONTINENTAL BOULEVARD  
EL SEGUNDO, CA 90245

FOR: TOY VEHICLES AND ACCESSORIES THEREFOR, IN CLASS 28 (U.S. CLS. 22, 23, 38 AND 50).

FIRST USE 11-21-2011; IN COMMERCE 11-21-2011.

THE MARK CONSISTS OF STANDARD CHARACTERS WITHOUT CLAIM TO ANY PARTICULAR FONT, STYLE, SIZE, OR COLOR.

NO CLAIM IS MADE TO THE EXCLUSIVE RIGHT TO USE "MACHINES", APART FROM THE MARK AS SHOWN.

SN 85-332,251, FILED 5-27-2011.

LESLIE RICHARDS, EXAMINING ATTORNEY



*David J. Kyros*

Director of the United States Patent and Trademark Office

# United States of America

United States Patent and Trademark Office

# VERSAPONIC

**Reg. No. 4,199,647**

**Registered Aug. 28, 2012**

**Int. Cl.: 21**

**TRADEMARK**

**PRINCIPAL REGISTER**

VERSA HOLDINGS, LLC (MISSOURI LIMITED LIABILITY COMPANY)  
879 S KINGSHIGHWAY STREET  
CAPE GIRARDEAU, MO 63703

FOR: PLANTER SYSTEM CONSISTING OF A RESERVOIR, A LOWER GROWTH CHAMBER, AN UPPER GROWTH CHAMBER, AND A DOME, ALONG WITH A SPRAY/WATERING ASSEMBLY, ALL OF WHICH IS USED FOR INDOOR AND OUTDOOR GARDENING, HORTICULTURE, AEROPONICS, AQUAPONICS, FOGPONICS, OR HYDROPONICS INDUSTRIES, IN CLASS 21 (U.S. CLS. 2, 13, 23, 29, 30, 33, 40 AND 50).

FIRST USE 10-0-2011; IN COMMERCE 10-0-2011.

THE MARK CONSISTS OF STANDARD CHARACTERS WITHOUT CLAIM TO ANY PARTICULAR FONT, STYLE, SIZE, OR COLOR.

SN 85-332,388, FILED 5-27-2011.

ANDREA HACK, EXAMINING ATTORNEY



*David J. Kybas*

Director of the United States Patent and Trademark Office

# United States of America

United States Patent and Trademark Office

## California Rancher

**Reg. No. 4,199,648**

CALIFORNIA RANCHER, LLC (CALIFORNIA LIMITED LIABILITY COMPANY)  
622 W. FRANKLIN AVE  
EL SEGUNDO, CA 90245

**Registered Aug. 28, 2012**

**Int. Cl.: 30**

FOR: BARBECUE DRY RUB; BARBEQUE SAUCE, IN CLASS 30 (U.S. CL. 46).

**TRADEMARK**

FIRST USE 6-15-2012; IN COMMERCE 6-15-2012.

**PRINCIPAL REGISTER**

THE MARK CONSISTS OF STANDARD CHARACTERS WITHOUT CLAIM TO ANY PARTICULAR FONT, STYLE, SIZE, OR COLOR.

NO CLAIM IS MADE TO THE EXCLUSIVE RIGHT TO USE "CALIFORNIA", APART FROM THE MARK AS SHOWN.

SN 85-332,532, FILED 5-27-2011.

MICHAEL ENGEL, EXAMINING ATTORNEY



*David J. Kyros*

Director of the United States Patent and Trademark Office

# United States of America

United States Patent and Trademark Office



## DUNSTAN CHESTNUT

**Reg. No. 4,199,649**

CHESTNUT HILL TREE FARM, LLC (FLORIDA LIMITED LIABILITY COMPANY)  
15105 N.W. 94TH AVENUE  
ALACHUA, FL 32615

**Registered Aug. 28, 2012**

**Int. Cl.: 31**

FOR: LIVE TREES; LIVING TREES, NAMELY, CHESTNUT TREES, IN CLASS 31 (U.S. CLS. 1 AND 46).

**TRADEMARK**

FIRST USE 4-17-2012; IN COMMERCE 4-17-2012.

**PRINCIPAL REGISTER**

NO CLAIM IS MADE TO THE EXCLUSIVE RIGHT TO USE "DUNSTAN CHESTNUT", APART FROM THE MARK AS SHOWN.

THE COLOR(S) BROWN, TAN, GREEN AND WHITE IS/ARE CLAIMED AS A FEATURE OF THE MARK.

THE MARK CONSISTS OF THE WORDS "DUNSTAN CHESTNUT" IN ALL CAPITAL, BOLD TIMES NEW ROMAN BROWN FONT, TO THE RIGHT SIDE OF A DESIGN OF THREE BROWN AND TAN CHESTNUTS, OUTLINED IN WHITE, INSIDE A GREEN BURR.

SN 85-332,564, FILED 5-27-2011.

SIMON TENG, EXAMINING ATTORNEY



*David J. Kybas*

Director of the United States Patent and Trademark Office

# United States of America

United States Patent and Trademark Office

# alphagraphics

**Reg. No. 4,199,650**

ALPHAGRAPHICS, INC. (DELAWARE CORPORATION)

**Registered Aug. 28, 2012**

215 SOUTH STATE STREET, SUITE 320  
SALT LAKE CITY, UT 84111

**Int. Cls.: 35, 38, 40, and  
42**

FOR: WORD-PROCESSING AND TYPING SERVICES; PHOTOCOPYING AND REPRODUCING AND COMPILING DOCUMENTS FOR OTHERS; PREPARING PUBLICITY DOCUMENTS FOR OTHERS; DOCUMENT REPRODUCTION SERVICES; DIRECT MAILING SERVICES, NAMELY, THE PREPARATION OF MAILING LISTS, ADDRESSING OF PACKAGES, ENVELOPES AND CARDS FOR MAILING, AND ARRANGING FOR MAILING WITH POST OFFICE OR OTHER CARRIERS; BUSINESS AND NOT-FOR-PROFIT ORGANIZATIONS BULK MAILING SERVICES, NAMELY, PREPARING AND ASSEMBLING DOCUMENT PACKAGES FOR MAILING; COPYING DOCUMENTS FOR CORPORATE AND BUSINESS CLIENTS; COMPUTERIZED ON-LINE ORDERING SERVICES FEATURING STATIONERY, BUSINESS FORMS AND BUSINESS CARDS; MANAGEMENT AND OPERATION ASSISTANCE TO COMMERCIAL BUSINESSES, NAMELY, MANAGEMENT OF COPYING AND PRINTING OPERATIONS FOR CORPORATE AND BUSINESS CLIENTS; RETAIL STORE SERVICES FEATURING PAPER, NAMELY, WRITING, TYPING, PRINTING, DRAWING, PHOTOCOPYING, BOND, LASER, LETTERHEAD AND COLOR PAPER, STATIONERY, ENVELOPES, BUSINESS CARDS, POSTCARDS, CALENDARS, ANNOUNCEMENT CARDS, INVITATIONS, WRITING AND DRAFTING INSTRUMENTS, NAMELY, PENS, PENCILS, MARKERS AND HIGHLIGHTING MARKERS, OFFICE REQUISITES, NAMELY, BINDER CLIPS, BOOKMARKS, BUBBLE MAILERS, CORRECTION FLUID, GLUE STICKS, NOTEPADS, ORDER PADS, PLASTIC BAGS, PAPER CLIPS, SELF-ADHESIVE PADS, RUBBER BANDS, DRAWING RULERS AND ADHESIVE TAPE FOR HOUSEHOLD AND OFFICE USE, PRINTERS TYPE AND PRINTING BLOCKS, AND PHOTOGRAPHIC REPRODUCTIONS; BUSINESS MANAGEMENT ASSISTANCE AND CONSULTATION IN THE ESTABLISHMENT, OPERATION AND MANAGEMENT OF RETAIL PRINT SHOPS; PROVIDING CONSULTING SERVICES VIA TELEPHONE, DIGITAL COMMUNICATIONS AND OVER THE INTERNET TO OTHERS IN THE AREA OF EMPLOYEE AND MANAGEMENT RETENTION; MANAGEMENT AND BUSINESS CONSULTING SERVICES IN THE FIELD OF TRAINING AND RECRUITMENT; PROVIDING ASSISTANCE TO OTHERS IN THE AREA OF INTEGRATING AND IMPROVING THE MARKETING OF THEIR GOODS AND SERVICES AND IMPROVING THE DELIVERY OF THEIR SERVICES, IN CLASS 35 (U.S. CLS. 100, 101 AND 102).

**SERVICE MARK**

**PRINCIPAL REGISTER**



*David J. Kyjars*

FIRST USE 8-12-2011; IN COMMERCE 8-12-2011.

**Reg. No. 4,199,650** FOR: COMMUNICATION SERVICES, NAMELY, ELECTRONIC TRANSMISSION OF DATA AND DOCUMENTS VIA COMPUTER TERMINALS; FACSIMILE TRANSMISSION SERVICES; DIGITAL TRANSMISSION OF DOCUMENTS AND INFORMATION, IN CLASS 38 (U.S. CLS. 100, 101 AND 104).

FIRST USE 8-12-2011; IN COMMERCE 8-12-2011.

FOR: TREATMENT OF MATERIALS, NAMELY, THE LAMINATING AND COLLATING OF DOCUMENTS, PHOTOGRAPHS, SIGNS, BANNERS, AND CERTIFICATES; ASSEMBLING OF DOCUMENTS; PHOTOGRAPHIC REPRODUCTION SERVICES; DOCUMENT BINDING; SCANNING, DIGITIZING, ALTERATION AND/OR RETOUCHING OF PHOTOGRAPHIC IMAGES, ARTWORK, PAINTINGS AND MEMENTOS; HARD AND SOFT COVER BOOK BINDING SERVICES; MEDIA DUPLICATION OF DATA AND DIGITAL INFORMATION; PRINTING SERVICES; DESIGN PRINTING FOR OTHERS; LITHOGRAPHIC PRINTING; RAPID PRINTING; MECHANICAL AND LASER TYPESETTING; DISK TO LASER TYPESETTING; DESKTOP AND DIGITAL PUBLISHING SERVICES; PHOTOGRAPHIC PRINTING; CONVERSION OF DATA OR PRINTED DOCUMENTS FROM PHYSICAL TO ELECTRONIC MEDIA, IN CLASS 40 (U.S. CLS. 100, 103 AND 106).

FIRST USE 8-12-2011; IN COMMERCE 8-12-2011.

FOR: GRAPHICS ART DESIGN; COMPUTER-AIDED GRAPHIC DESIGN; LEASING OF COMPUTERS AND COMPUTER FACILITIES; GRAPHIC ARTS SERVICES, NAMELY, DESIGN AND LAYOUT ASSISTANCE, CREATING WEB SITES FOR OTHERS AND CREATING GRAPHICS AND ILLUSTRATIONS FOR OTHERS, IN CLASS 42 (U.S. CLS. 100 AND 101).

FIRST USE 8-12-2011; IN COMMERCE 8-12-2011.

OWNER OF U.S. REG. NOS. 1,132,841, 3,437,778, AND OTHERS.

THE COLOR(S) RED, WHITE AND GREY IS/ARE CLAIMED AS A FEATURE OF THE MARK.

THE MARK CONSISTS OF THE WORD "ALPHAGRAPHS" IN STYLIZED LETTERING. THE "ALPHA" PORTION OF THE MARK IS IN RED STYLIZED LETTERING. THE "GRAPHICS" PORTION OF THE MARK IS IN GREY STYLIZED LETTERING. THERE IS A WHITE CIRCLE WITH GREY EDGES AROUND THE STYLIZED LETTERS "AG" IN "ALPHAGRAPHS".

SN 85-332,879, FILED 5-27-2011.

HOWARD SMIGA, EXAMINING ATTORNEY



# United States of America

United States Patent and Trademark Office



**Reg. No. 4,199,651**

**Registered Aug. 28, 2012**

**Int. Cls.: 35, 38, 40, and 42**

**SERVICE MARK**

**PRINCIPAL REGISTER**

ALPHAGRAPHS, INC. (DELAWARE CORPORATION)  
215 SOUTH STATE STREET, SUITE 320  
SALT LAKE CITY, UT 84111

FOR: WORD-PROCESSING AND TYPING SERVICES; PHOTOCOPYING AND REPRODUCING AND COMPILING DOCUMENTS FOR OTHERS; PREPARING PUBLICITY DOCUMENTS FOR OTHERS; DOCUMENT REPRODUCTION SERVICES; DIRECT MAILING SERVICES, NAMELY, THE PREPARATION OF MAILING LISTS, ADDRESSING OF PACKAGES, ENVELOPES AND CARDS FOR MAILING, AND ARRANGING FOR MAILING WITH POST OFFICE OR OTHER CARRIERS; BUSINESS AND NOT-FOR-PROFIT ORGANIZATIONS BULK MAILING SERVICES, NAMELY, PREPARING AND ASSEMBLING DOCUMENT PACKAGES FOR MAILING; COPYING DOCUMENTS FOR CORPORATE AND BUSINESS CLIENTS; COMPUTERIZED ON-LINE ORDERING SERVICES FEATURING STATIONERY, BUSINESS FORMS AND BUSINESS CARDS; MANAGEMENT AND OPERATION ASSISTANCE TO COMMERCIAL BUSINESSES, NAMELY, MANAGEMENT OF COPYING AND PRINTING OPERATIONS FOR CORPORATE AND BUSINESS CLIENTS; RETAIL STORE SERVICES FEATURING PAPER, NAMELY, WRITING, TYPING, PRINTING, DRAWING, PHOTOCOPYING, BOND, LASER, LETTERHEAD AND COLOR PAPER, STATIONERY, ENVELOPES, BUSINESS CARDS, POSTCARDS, CALENDARS, ANNOUNCEMENT CARDS, INVITATIONS, WRITING AND DRAFTING INSTRUMENTS, NAMELY, PENS, PENCILS, MARKERS AND HIGHLIGHTING MARKERS, OFFICE REQUISITES, NAMELY, BINDER CLIPS, BOOKMARKS, BUBBLE MAILERS, CORRECTION FLUID, GLUE STICKS, NOTEPADS, ORDER PADS, PLASTIC BAGS, PAPER CLIPS, SELF-ADHESIVE PADS, RUBBER BANDS, DRAWING RULERS AND ADHESIVE TAPE FOR HOUSEHOLD AND OFFICE USE, PRINTERS TYPE AND PRINTING BLOCKS, AND PHOTOGRAPHIC REPRODUCTIONS; BUSINESS MANAGEMENT ASSISTANCE AND CONSULTATION IN THE ESTABLISHMENT, OPERATION AND MANAGEMENT OF RETAIL PRINT SHOPS; PROVIDING CONSULTING SERVICES VIA TELEPHONE, DIGITAL COMMUNICATIONS AND OVER THE INTERNET TO OTHERS IN THE AREA OF EMPLOYEE AND MANAGEMENT RETENTION; MANAGEMENT AND BUSINESS CONSULTING SERVICES IN THE FIELD OF TRAINING AND RECRUITMENT; PROVIDING ASSISTANCE TO OTHERS IN THE AREA OF INTEGRATING AND IMPROVING THE MARKETING OF THEIR GOODS AND SERVICES AND IMPROVING THE DELIVERY OF THEIR SERVICES, IN CLASS 35 (U.S. CLS. 100, 101 AND 102).



*David J. Kappas*

FIRST USE 8-12-2011; IN COMMERCE 8-12-2011.

**Reg. No. 4,199,651** FOR: COMMUNICATION SERVICES, NAMELY, ELECTRONIC TRANSMISSION OF DATA AND DOCUMENTS VIA COMPUTER TERMINALS; FACSIMILE TRANSMISSION SERVICES; DIGITAL TRANSMISSION OF DOCUMENTS AND INFORMATION, IN CLASS 38 (U.S. CLS. 100, 101 AND 104).

FIRST USE 8-12-2011; IN COMMERCE 8-12-2011.

FOR: TREATMENT OF MATERIALS, NAMELY, THE LAMINATING AND COLLATING OF DOCUMENTS, PHOTOGRAPHS, SIGNS, BANNERS, AND CERTIFICATES; ASSEMBLING OF DOCUMENTS; PHOTOGRAPHIC REPRODUCTION SERVICES; DOCUMENT BINDING; SCANNING, DIGITIZING, ALTERATION AND/OR RETOUCHING OF PHOTOGRAPHIC IMAGES, ARTWORK, PAINTINGS AND MEMENTOS; HARD AND SOFT COVER BOOK BINDING SERVICES; MEDIA DUPLICATION OF DATA AND DIGITAL INFORMATION; PRINTING SERVICES; DESIGN PRINTING FOR OTHERS; LITHOGRAPHIC PRINTING; RAPID PRINTING; PHOTOGRAPHIC PRINTING; CONVERSION OF DATA OR PRINTED DOCUMENTS FROM PHYSICAL TO ELECTRONIC MEDIA, IN CLASS 40 (U.S. CLS. 100, 103 AND 106).

FIRST USE 8-12-2011; IN COMMERCE 8-12-2011.

FOR: GRAPHICS ART DESIGN; COMPUTER-AIDED GRAPHIC DESIGN; LEASING OF COMPUTERS AND COMPUTER FACILITIES; GRAPHIC ARTS SERVICES, NAMELY, DESIGN AND LAYOUT ASSISTANCE, CREATING WEB SITES FOR OTHERS AND CREATING GRAPHICS AND ILLUSTRATIONS FOR OTHERS, IN CLASS 42 (U.S. CLS. 100 AND 101).

FIRST USE 8-12-2011; IN COMMERCE 8-12-2011.

OWNER OF U.S. REG. NOS. 1,132,841, 3,568,288, AND OTHERS.

THE COLOR(S) RED, WHITE AND GREY IS/ARE CLAIMED AS A FEATURE OF THE MARK.

THE MARK CONSISTS OF THE STYLIZED LETTERS "AG" WITH THE STYLIZED LETTER "A" IN RED AND THE STYLIZED LETTER "G" IN GREY INSIDE A WHITE CIRCLE WITH A GREY EDGE.

SN 85-332,899, FILED 5-27-2011.

HOWARD SMIGA, EXAMINING ATTORNEY

# United States of America

United States Patent and Trademark Office

## INCREASE YOUR REACH

**Reg. No. 4,199,652**

**Registered Aug. 28, 2012**

**Int. Cls.: 35, 38, 40, and 42**

**SERVICE MARK**

**PRINCIPAL REGISTER**

ALPHAGRAPHS, INC. (DELAWARE CORPORATION)  
215 SOUTH STATE STREET, SUITE 320  
SALT LAKE CITY, UT 84111

FOR: WORD-PROCESSING AND TYPING SERVICES; PHOTOCOPYING AND REPRODUCING AND COMPILING DOCUMENTS FOR OTHERS; PREPARING PUBLICITY DOCUMENTS FOR OTHERS; DOCUMENT REPRODUCTION SERVICES; DIRECT MAILING SERVICES, NAMELY, THE PREPARATION OF MAILING LISTS, ADDRESSING OF PACKAGES, ENVELOPES AND CARDS FOR MAILING, AND ARRANGING FOR MAILING WITH POST OFFICE OR OTHER CARRIERS; BUSINESS AND NOT-FOR-PROFIT ORGANIZATIONS BULK MAILING SERVICES, NAMELY, PREPARING AND ASSEMBLING DOCUMENT PACKAGES FOR MAILING; COPYING DOCUMENTS FOR CORPORATE AND BUSINESS CLIENTS; COMPUTERIZED ON-LINE ORDERING SERVICES FEATURING STATIONERY, BUSINESS FORMS AND BUSINESS CARDS; MANAGEMENT AND OPERATION ASSISTANCE TO COMMERCIAL BUSINESSES, NAMELY, MANAGEMENT OF COPYING AND PRINTING OPERATIONS FOR CORPORATE AND BUSINESS CLIENTS; RETAIL STORE SERVICES FEATURING PAPER, NAMELY, WRITING, TYPING, PRINTING, DRAWING, PHOTOCOPYING, BOND, LASER, LETTERHEAD AND COLOR PAPER, STATIONERY, ENVELOPES, BUSINESS CARDS, POSTCARDS, CALENDARS, ANNOUNCEMENT CARDS, INVITATIONS, WRITING AND DRAFTING INSTRUMENTS, NAMELY, PENS, PENCILS, MARKERS AND HIGHLIGHTING MARKERS, OFFICE REQUISITES, NAMELY, BINDER CLIPS, BOOKMARKS, BUBBLE MAILERS, CORRECTION FLUID, GLUE STICKS, NOTEPADS, ORDER PADS, PLASTIC BAGS, PAPER CLIPS, SELF-ADHESIVE PADS, RUBBER BANDS, DRAWING RULERS AND ADHESIVE TAPE FOR HOUSEHOLD AND OFFICE USE, PRINTERS TYPE AND PRINTING BLOCKS, AND PHOTOGRAPHIC REPRODUCTIONS; BUSINESS MANAGEMENT ASSISTANCE AND CONSULTATION IN THE ESTABLISHMENT, OPERATION AND MANAGEMENT OF RETAIL PRINT SHOPS; PROVIDING CONSULTING SERVICES VIA TELEPHONE, DIGITAL COMMUNICATIONS AND OVER THE INTERNET TO OTHERS IN THE AREA OF EMPLOYEE AND MANAGEMENT RETENTION; MANAGEMENT AND BUSINESS CONSULTING SERVICES IN THE FIELD OF TRAINING AND RECRUITMENT; PROVIDING ASSISTANCE TO OTHERS IN THE AREA OF INTEGRATING AND IMPROVING THE MARKETING OF THEIR GOODS AND SERVICES AND IMPROVING THE DELIVERY OF THEIR SERVICES, IN CLASS 35 (U.S. CLS. 100, 101 AND 102).



*David J. Kyros*

FIRST USE 8-12-2011; IN COMMERCE 8-12-2011.

**Reg. No. 4,199,652** FOR: COMMUNICATION SERVICES, NAMELY, ELECTRONIC TRANSMISSION OF DATA AND DOCUMENTS VIA COMPUTER TERMINALS; FACSIMILE TRANSMISSION SERVICES; DIGITAL TRANSMISSION OF DOCUMENTS AND INFORMATION, IN CLASS 38 (U.S. CLS. 100, 101 AND 104).

FIRST USE 8-12-2011; IN COMMERCE 8-12-2011.

FOR: TREATMENT OF MATERIALS, NAMELY, THE LAMINATING AND COLLATING OF DOCUMENTS, PHOTOGRAPHS, SIGNS, BANNERS, AND CERTIFICATES; ASSEMBLING OF DOCUMENTS; PHOTOGRAPHIC REPRODUCTION SERVICES; DOCUMENT BINDING; SCANNING, DIGITIZING, ALTERATION AND/OR RETOUCHING OF PHOTOGRAPHIC IMAGES, ARTWORK, PAINTINGS AND MEMENTOS; HARD AND SOFT COVER BOOK BINDING SERVICES; MEDIA DUPLICATION OF DATA AND DIGITAL INFORMATION; PRINTING SERVICES; DESIGN PRINTING FOR OTHERS; LITHOGRAPHIC PRINTING; RAPID PRINTING; MECHANICAL AND LASER TYPESETTING; DISK TO LASER TYPESETTING; DESKTOP AND DIGITAL PUBLISHING SERVICES; PHOTOGRAPHIC PRINTING; CONVERSION OF DATA OR PRINTED DOCUMENTS FROM PHYSICAL TO ELECTRONIC MEDIA, IN CLASS 40 (U.S. CLS. 100, 103 AND 106).

FIRST USE 8-12-2011; IN COMMERCE 8-12-2011.

FOR: GRAPHICS ART DESIGN; COMPUTER-AIDED GRAPHIC DESIGN; LEASING OF COMPUTERS AND COMPUTER FACILITIES; GRAPHIC ARTS SERVICES, NAMELY, DESIGN AND LAYOUT ASSISTANCE, CREATING WEB SITES FOR OTHERS AND CREATING GRAPHICS AND ILLUSTRATIONS FOR OTHERS, IN CLASS 42 (U.S. CLS. 100 AND 101).

FIRST USE 8-12-2011; IN COMMERCE 8-12-2011.

THE MARK CONSISTS OF STANDARD CHARACTERS WITHOUT CLAIM TO ANY PARTICULAR FONT, STYLE, SIZE, OR COLOR.

SN 85-332,906, FILED 5-27-2011.

HOWARD SMIGA, EXAMINING ATTORNEY

**United States of America**  
United States Patent and Trademark Office

# PLINOSA

**Reg. No. 4,199,653**

RESEARCH AND DIAGNOSTIC ANTIBODIES (CALIFORNIA CORPORATION)  
601 UNIVERSITY AVE. STE 278  
SACRAMENTO, CA 95825

**Registered Aug. 28, 2012**

**Int. Cl.: 5**

FOR: DIAGNOSTIC PREPARATIONS FOR MEDICAL OR VETERINARY PURPOSES, IN CLASS 5 (U.S. CLS. 6, 18, 44, 46, 51 AND 52).

**TRADEMARK**

FIRST USE 1-23-2012; IN COMMERCE 1-23-2012.

**PRINCIPAL REGISTER**

THE MARK CONSISTS OF STANDARD CHARACTERS WITHOUT CLAIM TO ANY PARTICULAR FONT, STYLE, SIZE, OR COLOR.

SN 85-332,910, FILED 5-27-2011.

REBECCA EISINGER, EXAMINING ATTORNEY



*David J. Kybas*

Director of the United States Patent and Trademark Office

# United States of America

United States Patent and Trademark Office

# Vinotype

**Reg. No. 4,199,654**

HANNICO LLC (CALIFORNIA LIMITED LIABILITY COMPANY)  
159 SILVERADO SPRINGS DRIVE  
NAPA, CA 94558

**Registered Aug. 28, 2012**

**Int. Cl.: 35**

FOR: PROVIDING A WEB-BASED SYSTEM AND ONLINE PORTALS IN THE FIELD OF CONSUMER-TO-BUSINESS COMMERCE FOR CONSUMERS TO ENTER, MANAGE AND MODIFY THEIR CONSUMER PREFERENCE INFORMATION FOR USE BY MERCHANTS TO CREATE AND MANAGE OFFERS FOR DELIVERY TO CONSUMERS; PROVIDING A WEBSITE WHERE USERS CAN POST RATINGS, REVIEWS AND RECOMMENDATIONS ON RESTAURANTS, FOOD AND WINE FOR COMMERCIAL PURPOSES, IN CLASS 35 (U.S. CLS. 100, 101 AND 102).

**SERVICE MARK**

**PRINCIPAL REGISTER**

FIRST USE 10-1-2011; IN COMMERCE 10-1-2011.

THE MARK CONSISTS OF STANDARD CHARACTERS WITHOUT CLAIM TO ANY PARTICULAR FONT, STYLE, SIZE, OR COLOR.

SN 85-333,338, FILED 5-30-2011.

ANDREA HACK, EXAMINING ATTORNEY



*David J. Kyjars*

Director of the United States Patent and Trademark Office

# United States of America

United States Patent and Trademark Office

## TEKNIK STUDIOS

**Reg. No. 4,199,655**

TEKNIK STUDIOS, LLC (TENNESSEE LIMITED LIABILITY COMPANY)  
7885 HYMAN DR.

**Registered Aug. 28, 2012**

BARTLETT, TN 38133

**Int. Cl.: 42**

FOR: WEBSITE DESIGN AND DEVELOPMENT FOR OTHERS; CUSTOM DESIGN AND DEVELOPMENT OF COMPUTER SOFTWARE, IN CLASS 42 (U.S. CLS. 100 AND 101).

**SERVICE MARK**

FIRST USE 9-25-2010; IN COMMERCE 9-15-2010.

**PRINCIPAL REGISTER**

THE MARK CONSISTS OF STANDARD CHARACTERS WITHOUT CLAIM TO ANY PARTICULAR FONT, STYLE, SIZE, OR COLOR.

NO CLAIM IS MADE TO THE EXCLUSIVE RIGHT TO USE "STUDIOS", APART FROM THE MARK AS SHOWN.

THE ENGLISH TRANSLATION OF "TEKNIK" IN THE MARK IS TECHNICAL.

SN 85-333,404, FILED 5-30-2011.

ANDREW LEASER, EXAMINING ATTORNEY



*David J. Kyros*

Director of the United States Patent and Trademark Office

# United States of America

United States Patent and Trademark Office

## SURE THING KNOCKOUTS

**Reg. No. 4,199,656**

HROMADA, STEPHEN (UNITED STATES INDIVIDUAL)  
20 CIRCLE DRIVE

**Registered Aug. 28, 2012**

WHEATLEY HEIGHTS, NY 11798

**Int. Cl.: 25**

FOR: SHIRTS; T-SHIRTS, IN CLASS 25 (U.S. CLS. 22 AND 39).

**TRADEMARK**

FIRST USE 4-0-2012; IN COMMERCE 4-0-2012.

**PRINCIPAL REGISTER**

THE MARK CONSISTS OF STANDARD CHARACTERS WITHOUT CLAIM TO ANY PARTICULAR FONT, STYLE, SIZE, OR COLOR.

SN 85-333,582, FILED 5-31-2011.

LINDA ORNDORFF, EXAMINING ATTORNEY



*David J. Kybas*

Director of the United States Patent and Trademark Office



# United States of America

United States Patent and Trademark Office

# AVENTURO

**Reg. No. 4,199,657**

**Registered Aug. 28, 2012**

**Int. Cl.: 34**

**TRADEMARK**

**PRINCIPAL REGISTER**

CHEYENNE INTERNATIONAL, LLC (NORTH CAROLINA LIMITED LIABILITY COMPANY)  
701 S. BATTLEGROUND AVENUE  
GROVER, NC 28073

FOR: CIGARS, IN CLASS 34 (U.S. CLS. 2, 8, 9 AND 17).

FIRST USE 5-18-2012; IN COMMERCE 5-18-2012.

THE MARK CONSISTS OF STANDARD CHARACTERS WITHOUT CLAIM TO ANY PARTICULAR FONT, STYLE, SIZE, OR COLOR.

THE ENGLISH TRANSLATION OF "AVENTURO" IN THE MARK IS "TO DARE OR TO TAKE A RISK".

SN 85-333,860, FILED 5-31-2011.

JOHN DWYER, EXAMINING ATTORNEY



*David J. Kyffers*

Director of the United States Patent and Trademark Office

# United States of America

United States Patent and Trademark Office

## DELI CARVERS

**Reg. No. 4,199,658**

SARA LEE FOODS, LLC (DELAWARE LIMITED LIABILITY COMPANY)  
3500 LACEY ROAD  
DOWNERS GROVE, IL 60515

**Registered Aug. 28, 2012**

**Int. Cl.: 29**

FOR: PROCESSED MEAT, NAMELY, PORK, POULTRY, IN CLASS 29 (U.S. CL. 46).

FIRST USE 10-1-2011; IN COMMERCE 10-1-2011.

**TRADEMARK**

THE MARK CONSISTS OF STANDARD CHARACTERS WITHOUT CLAIM TO ANY PARTICULAR FONT, STYLE, SIZE, OR COLOR.

**PRINCIPAL REGISTER**

NO CLAIM IS MADE TO THE EXCLUSIVE RIGHT TO USE "DELI", APART FROM THE MARK AS SHOWN.

SN 85-333,871, FILED 5-31-2011.

ELLEN PERKINS, EXAMINING ATTORNEY



*David J. Kyffers*

Director of the United States Patent and Trademark Office

# United States of America

United States Patent and Trademark Office

## HOBBS CREEK

**Reg. No. 4,199,659**

**Registered Aug. 28, 2012**

**Int. Cl.: 22**

**TRADEMARK**

**PRINCIPAL REGISTER**

BASS PRO INTELLECTUAL PROPERTY, L.L.C. (MISSOURI LIMITED LIABILITY COMPANY)  
2500 E. KEARNEY STREET  
SPRINGFIELD, MO 65898

FOR: FISHING NETS, IN CLASS 22 (U.S. CLS. 1, 2, 7, 19, 22, 42 AND 50).

FIRST USE 1-0-1982; IN COMMERCE 1-0-1982.

THE MARK CONSISTS OF STANDARD CHARACTERS WITHOUT CLAIM TO ANY PARTICULAR FONT, STYLE, SIZE, OR COLOR.

SN 85-334,551, FILED 5-31-2011.

ELLEN BURNS, EXAMINING ATTORNEY



*David J. Kybas*

Director of the United States Patent and Trademark Office

# United States of America

United States Patent and Trademark Office

## CLOUD AUTHORITY

**Reg. No. 4,199,660**

NEWTEK BUSINESS SERVICES, INC. (NEW YORK CORPORATION)  
1440 BROADWAY

**Registered Aug. 28, 2012**

NEW YORK, NY 10018

**Int. Cl.: 42**

FOR: COMPUTER SERVICES, NAMELY, CLOUD HOSTING PROVIDER SERVICES; COMPUTER SERVICES, NAMELY, CLOUD HOSTING PROVIDER SERVICES FOR DATA AND APPLICATIONS; TECHNICAL SUPPORT SERVICES, NAMELY, REMOTE SERVICES FOR MONITORING, ADMINISTRATION AND MANAGEMENT OF CLOUD COMPUTING IT AND APPLICATIONS, IN CLASS 42 (U.S. CLS. 100 AND 101).

**SERVICE MARK**

**PRINCIPAL REGISTER**

FIRST USE 11-10-2011; IN COMMERCE 11-10-2011.

THE MARK CONSISTS OF STANDARD CHARACTERS WITHOUT CLAIM TO ANY PARTICULAR FONT, STYLE, SIZE, OR COLOR.

OWNER OF U.S. REG. NO. 3,955,632.

NO CLAIM IS MADE TO THE EXCLUSIVE RIGHT TO USE "CLOUD", APART FROM THE MARK AS SHOWN.

SN 85-335,142, FILED 6-1-2011.

WILLIAM ROSSMAN, EXAMINING ATTORNEY



*David J. Kybas*

Director of the United States Patent and Trademark Office

**United States of America**  
United States Patent and Trademark Office

**PAWPAD**

**Reg. No. 4,199,661**

BUILD-A-BEAR RETAIL MANAGEMENT, INC. (DELAWARE CORPORATION)  
1954 INNERBELT BUSINESS CENTER DRIVE  
ST. LOUIS, MO 631145760

**Registered Aug. 28, 2012**

**Int. Cl.: 28**

FOR: TOY ACCESSORIES FOR STUFFED AND PLUSH TOYS, NAMELY, A TOY RESEMBLING A TABLET COMPUTER, BUT HAVING NO COMPUTER FUNCTIONALITY , IN CLASS 28 (U.S. CLS. 22, 23, 38 AND 50).

**TRADEMARK**

FIRST USE 11-18-2011; IN COMMERCE 11-18-2011.

**PRINCIPAL REGISTER**

THE MARK CONSISTS OF STANDARD CHARACTERS WITHOUT CLAIM TO ANY PARTICULAR FONT, STYLE, SIZE, OR COLOR.

SN 85-335,507, FILED 6-1-2011.

RONALD MCMORROW, EXAMINING ATTORNEY



*David J. Kyros*

Director of the United States Patent and Trademark Office

# United States of America

United States Patent and Trademark Office

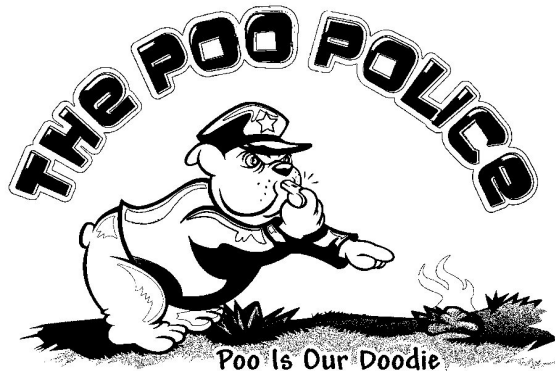

**Reg. No. 4,199,662**

**Registered Aug. 28, 2012**

**Int. Cl.: 37**

**SERVICE MARK**

**PRINCIPAL REGISTER**

PARSEL, BRANDON (UNITED STATES INDIVIDUAL)  
1475 N ROSE ST  
BURBANK, CA 91505 AND

GERBEL LUCAS, MELISSA (UNITED STATES INDIVIDUAL)  
1475 N ROSE ST  
BURBANK, CA 91505

FOR: ECO-FRIENDLY PET WASTE REMOVAL SERVICES, IN CLASS 37 (U.S. CLS. 100, 103 AND 106).

FIRST USE 4-30-2012; IN COMMERCE 4-30-2012.

THE STIPPLING IS FOR SHADING PURPOSES ONLY.

THE MARK CONSISTS OF AN ENGLISH BULLDOG IN A POLICE UNIFORM, POINTING AT A PILE OF POOP, THE TEXT "THE POO POLICE" ARCHED ABOVE, AND "POO IS OUR DOODIE" BELOW THE DESIGN.

SN 85-335,682, FILED 6-1-2011.

PAUL MORENO, EXAMINING ATTORNEY



*David J. Kyfos*

Director of the United States Patent and Trademark Office

# United States of America

United States Patent and Trademark Office

## OH MY GOFF

**Reg. No. 4,199,663**

GOFF, ANGELA (UNITED STATES INDIVIDUAL)  
722 GENTLE BREEZE CT  
HERNDON, VA 20170

**Registered Aug. 28, 2012**

**Int. Cl.: 41**

FOR: ON-LINE JOURNALS, NAMELY, BLOGS FEATURING GENERAL INTEREST STORIES FOR ENTERTAINMENT PURPOSES; NEWS REPORTERS SERVICES; NEWS REPORTER SERVICES IN THE NATURE OF NEWS ANALYSIS AND NEWS COMMENTARY, IN CLASS 41 (U.S. CLS. 100, 101 AND 107).

**SERVICE MARK**

**PRINCIPAL REGISTER**

FIRST USE 1-28-2008; IN COMMERCE 1-28-2008.

THE MARK CONSISTS OF STANDARD CHARACTERS WITHOUT CLAIM TO ANY PARTICULAR FONT, STYLE, SIZE, OR COLOR.

SN 85-336,297, FILED 6-2-2011.

FRED CARL, EXAMINING ATTORNEY



*David J. Kyffers*

Director of the United States Patent and Trademark Office

# United States of America

United States Patent and Trademark Office



ITALIAN SUPERIOR BAKERY

**Reg. No. 4,199,664**

**Registered Aug. 28, 2012**

**Int. Cl.: 30**

**TRADEMARK**

**PRINCIPAL REGISTER**

SOCCOBROS (ILLINOIS CORPORATION), DBA ITALIAN SUPERIOR BAKERY,  
933 S WESTERN AVENUE  
CHICAGO, IL 60612

FOR: BREAD AND PASTRY; BUNS; PIZZA, IN CLASS 30 (U.S. CL. 46).

FIRST USE 2-25-2012; IN COMMERCE 2-28-2012.

OWNER OF U.S. REG. NO. 3,904,170.

NO CLAIM IS MADE TO THE EXCLUSIVE RIGHT TO USE "ITALIAN SUPERIOR BAKERY",  
APART FROM THE MARK AS SHOWN.

THE MARK CONSISTS OF A STYLIZED HUMAN IN CARICATURE FORM, WEARING AN  
APRON AND CARRYING BAKED GOODS WITH THE WORDING "ITALIAN SUPERIOR  
BAKERY" SUPERIMPOSED ON THE DESIGN.

SN 85-336,323, FILED 6-2-2011.

CHRISTINE COOPER, EXAMINING ATTORNEY



*David J. Kyros*

Director of the United States Patent and Trademark Office



**United States of America**  
United States Patent and Trademark Office

**SPLUNK**

**Reg. No. 4,199,665**

SPLUNK INC. (DELAWARE CORPORATION)  
250 BRANNAN STREET, 2ND FLOOR  
SAN FRANCISCO, CA 94107

**Registered Aug. 28, 2012**

**Int. Cl.: 41**

FOR: EDUCATIONAL SERVICES, NAMELY, PROVIDING TRAINING, TUTORIALS, CLASSES AND SEMINARS IN THE FIELD OF COMPUTERS, COMPUTER SOFTWARE AND COMPUTER NETWORKS AND THE DEVELOPMENT AND OPERATION OF CLOUD COMPUTING NETWORKS, IN CLASS 41 (U.S. CLS. 100, 101 AND 107).

**SERVICE MARK**

**PRINCIPAL REGISTER**

FIRST USE 7-31-2006; IN COMMERCE 7-31-2006.

THE MARK CONSISTS OF STANDARD CHARACTERS WITHOUT CLAIM TO ANY PARTICULAR FONT, STYLE, SIZE, OR COLOR.

OWNER OF U.S. REG. NO. 3,269,249.

SN 85-336,540, FILED 6-2-2011.

THEODORE MCBRIDE, EXAMINING ATTORNEY



*David J. Kyffers*

Director of the United States Patent and Trademark Office

# United States of America

United States Patent and Trademark Office

# Wus'band

**Reg. No. 4,199,666**

SHAYNE COTNER (UNITED STATES INDIVIDUAL)  
2001 SOUTH VENTURA AVE  
SPRINGFIELD, MO 65804

**Registered Aug. 28, 2012**

**Int. Cl.: 25**

FOR: ATHLETIC APPAREL, NAMELY, SHIRTS, PANTS, JACKETS, FOOTWEAR, HATS AND CAPS, ATHLETIC UNIFORMS; BASEBALL CAPS; BASEBALL CAPS AND HATS; BATHING CAPS; BLOUSES; BODY SHIRTS; BUTTON DOWN SHIRTS; CAP VISORS; CAPS; CAPS WITH VISORS; CHEF'S HATS; COLLARED SHIRTS; DRESS SHIRTS; FUR HATS; GOLF CAPS; GOLF PANTS, SHIRTS AND SKIRTS; GOLF SHIRTS; HAT BANDS; HATS; HEADGEAR, NAMELY, WOMEN'S HATS, CAPS AND HEADBANDS; HOODED SWEAT SHIRTS; KNIT SHIRTS; KNITTED CAPS; LEATHER HATS; LEATHER SHIRTS; LONG-SLEEVED SHIRTS; NIGHT SHIRTS; OPEN-NECKED SHIRTS; OVER SHIRTS; PARTY HATS; POLO KNIT TOPS; POLO SHIRTS; RAIN HATS; SHIRT INSERTS, NAMELY, DICKIES; SHIRT YOKES; SHIRTS AND SLIPS; SHORT-SLEEVED OR LONG-SLEEVED T-SHIRTS; SHORT-SLEEVED SHIRTS; SHOWER CAPS; SLEEP SHIRTS; SMALL HATS; SPORT SHIRTS; SPORTS CAPS AND HATS; SPORTS SHIRTS; SPORTS SHIRTS WITH SHORT SLEEVES; SUN PROTECTIVE CLOTHING, NAMELY, SWIMSUIT COVER, T-SHIRT; SWEAT SHIRTS; SWIM CAPS; SWIMMING CAPS; SWIMMING CAPS; T-SHIRTS; T-SHIRTS FOR WOMEN LONG SLEEVE, SHORT SLEEVE; TEE SHIRTS; TURTLE NECK SHIRTS; WEARABLE GARMENTS AND CLOTHING, NAMELY, SHIRTS, SHIRTS; WIND SHIRTS; WOMEN'S CLOTHING, NAMELY, SHIRTS, DRESSES, SKIRTS, BLOUSES; WOMEN'S HATS AND HOODS; WOOLLY HATS; YOGA SHIRTS, IN CLASS 25 (U.S. CLS. 22 AND 39).

**TRADEMARK**

**PRINCIPAL REGISTER**



FIRST USE 6-5-2012; IN COMMERCE 6-5-2012.

THE MARK CONSISTS OF STANDARD CHARACTERS WITHOUT CLAIM TO ANY PARTICULAR FONT, STYLE, SIZE, OR COLOR.

SN 85-336,986, FILED 6-2-2011.

CAROLINE WOOD, EXAMINING ATTORNEY

*David J. Kypos*

Director of the United States Patent and Trademark Office

# United States of America

United States Patent and Trademark Office



**Reg. No. 4,199,667**

**Registered Aug. 28, 2012**

**Int. Cl.: 9**

**TRADEMARK**

**PRINCIPAL REGISTER**

SHENZHEN NETCOM ELECTRONICS CO., LTD. (CHINA CORPORATION)  
8F, BLOCK 1, FINANCE BASE  
8# KEFA ROAD, NANSHAN DISTRICT  
SHENZHEN, CHINA

FOR: COMPUTER MEMORIES; COMPUTER PERIPHERAL DEVICES; RECORDED COMPUTER SOFTWARE FOR PROGRAMING PAYMENT CARDS FOR USE IN THE FIELD OF FINANCIAL PAYMENT; ENCODED SMART CARDS CONTAINING PROGRAMMING FOR USE AS PAYMENT CARDS FOR FINANCIAL PURPOSE; CASH REGISTERS; AMUSEMENT APPARATUS ADAPTED FOR USE WITH AN EXTERNAL DISPLAY SCREEN OR MONITOR; INTEGRATED CIRCUITS, IN CLASS 9 (U.S. CLS. 21, 23, 26, 36 AND 38).

FIRST USE 10-29-2010; IN COMMERCE 6-15-2012.

THE MARK CONSISTS OF A COINED WORD "LONGSYS" IN STYLIZED LETTERS, ESPECIALLY FOR THE FIRST LETTER "L" AND THE LAST LETTER "S", THUS ENTIRELY LOOKS LIKE A DRAGON BOAT.

SN 85-337,039, FILED 6-3-2011.

BRENDAN MCCAULEY, EXAMINING ATTORNEY



*David J. Kybas*

Director of the United States Patent and Trademark Office

# United States of America

United States Patent and Trademark Office

# VIRAVUE

**Reg. No. 4,199,668**

**Registered Aug. 28, 2012**

**Int. Cl.: 10**

**TRADEMARK**

**PRINCIPAL REGISTER**

JOYCE, SHAWN (UNITED STATES INDIVIDUAL)  
781 THIRD STREET  
ENCINITAS, CA 92024

FOR: MEDICAL DIAGNOSTIC APPARATUS FOR PERFORMING POLYMERASE CHAIN REACTION (PCR) TESTS FOR INFECTIOUS DISEASES, IN CLASS 10 (U.S. CLS. 26, 39 AND 44).

FIRST USE 11-4-2010; IN COMMERCE 11-4-2010.

THE MARK CONSISTS OF STANDARD CHARACTERS WITHOUT CLAIM TO ANY PARTICULAR FONT, STYLE, SIZE, OR COLOR.

SN 85-337,063, FILED 6-3-2011.

WENDY JUN, EXAMINING ATTORNEY



*David J. Kyffers*

Director of the United States Patent and Trademark Office

# United States of America

United States Patent and Trademark Office

# XCHEKPLUS

**Reg. No. 4,199,669**

**Registered Aug. 28, 2012**

**Int. Cl.: 9**

**TRADEMARK**

**PRINCIPAL REGISTER**

IDEXX LABORATORIES, INC. (DELAWARE CORPORATION)  
ONE IDEXX DRIVE  
WESTBROOK, ME 04092

FOR: SOFTWARE FOR CALCULATING RESULTS OF LIVESTOCK AND POULTRY DIAGNOSTIC TESTS, IN CLASS 9 (U.S. CLS. 21, 23, 26, 36 AND 38).

FIRST USE 5-31-2012; IN COMMERCE 5-31-2012.

THE MARK CONSISTS OF STANDARD CHARACTERS WITHOUT CLAIM TO ANY PARTICULAR FONT, STYLE, SIZE, OR COLOR.

OWNER OF U.S. REG. NO. 2,816,685.

SN 85-337,116, FILED 6-3-2011.

CYNTHIA TRIPI, EXAMINING ATTORNEY



*David J. Kyffers*

Director of the United States Patent and Trademark Office

# United States of America

United States Patent and Trademark Office



**Reg. No. 4,199,670**

**Registered Aug. 28, 2012**

**Int. Cl.: 3**

**TRADEMARK**

**PRINCIPAL REGISTER**

GOSMILE, INC. (DELAWARE CORPORATION)  
715 HEARST AVENUE, SUITE 300  
BERKELEY, CA 94710

FOR: TOOTH WHITENING PREPARATIONS; KITS COMPRISED PRIMARILY OF TOOTH WHITENING PREPARATIONS, IN CLASS 3 (U.S. CLS. 1, 4, 6, 50, 51 AND 52).

FIRST USE 9-0-2011; IN COMMERCE 9-0-2011.

THE MARK CONSISTS OF THE DESIGN OF A CLOCK.

SN 85-337,174, FILED 6-3-2011.

KATHERINE CHANG, EXAMINING ATTORNEY



*David J. Kybas*

Director of the United States Patent and Trademark Office

# United States of America

United States Patent and Trademark Office

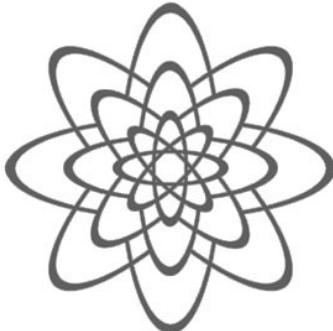

**WALLFLOWER**

**Reg. No. 4,199,671**

**Registered Aug. 28, 2012**

**Int. Cls.: 9 and 41**

**TRADEMARK**

**SERVICE MARK**

**PRINCIPAL REGISTER**

COLUMBIA UNIVERSITY PRESS (NEW YORK NON-PROFIT CORPORATION)  
61 WEST 62ND STREET  
NEW YORK, NY 10023

FOR: DOWNLOADABLE ELECTRONIC PUBLICATIONS IN THE NATURE OF SCHOLARLY AND REFERENCE BOOKS CONTAINING GENERAL INFORMATION ON FILM, TV, VIDEO, DIRECTORS, PERFORMERS, CAMERA TECHNIQUES AND POPULAR CULTURE; BOOKS, PAMPHLETS ALL BEING OF A TRADE, SCHOLARLY AND PROFESSIONAL NATURE; DOWNLOADABLE ELECTRONIC PUBLICATIONS IN THE NATURE OF BOOKS AND PAMPHLETS, ALL BEING OF A TRADE, SCHOLARLY AND PROFESSIONAL NATURE IN THE FIELD OF FILM, TV, VIDEO, RADIO, DIRECTORS, PERFORMERS, CINEMATOGRAPHY, SOUND TECHNIQUE, AND POPULAR CULTURE, IN CLASS 9 (U.S. CLS. 21, 23, 26, 36 AND 38).

FIRST USE 12-31-2011; IN COMMERCE 12-31-2011.

FOR: ONLINE ELECTRONIC PUBLISHING SERVICES, NAMELY, PROVIDING A WEBSITE FEATURING NON-DOWNLOADABLE PUBLICATIONS IN THE NATURE OF IN THE NATURE OF SCHOLARLY AND REFERENCE BOOKS CONTAINING GENERAL INFORMATION ON FILM, TV, VIDEO, DIRECTORS, PERFORMERS, CAMERA TECHNIQUES AND POPULAR CULTURE; PROVIDING A WEBSITE FEATURING NON-DOWNLOADABLE PUBLICATIONS IN THE NATURE OF BOOKS, PAMPHLETS, ALL BEING OF A TRADE, SCHOLARLY AND PROFESSIONAL NATURE IN THE FIELD OF FILM, TV, VIDEO, RADIO, DIRECTORS, PERFORMERS, CINEMATOGRAPHY, SOUND TECHNIQUE, AND POPULAR CULTURE, IN CLASS 41 (U.S. CLS. 100, 101 AND 107).

FIRST USE 12-31-2011; IN COMMERCE 3-6-2012.

THE MARK CONSISTS OF A FLOWER DESIGN AND THE WORD "WALLFLOWER" BELOW THE DESIGN.

SN 85-337,265, FILED 6-3-2011.

THEODORE MCBRIDE, EXAMINING ATTORNEY



*David J. Kyffers*

Director of the United States Patent and Trademark Office

# United States of America

United States Patent and Trademark Office

## Blissful Baby

**Reg. No. 4,199,672**

**Registered Aug. 28, 2012**

**Int. Cl.: 45**

CAVAZOS, NANCY (TEXAS LIMITED LIABILITY COMPANY), AKA BLISSFUL BABY CONSULTANTS, LLC,  
BLISSFUL BABY  
4811 S JACKSON RD  
EDINBURG, TX 78539

**SERVICE MARK**

**PRINCIPAL REGISTER**

FOR: PERSONAL CONCIERGE SERVICES FOR OTHERS COMPRISING MAKING REQUESTED PERSONAL ARRANGEMENTS AND RESERVATIONS, RUNNING ERRANDS AND PROVIDING CUSTOMER SPECIFIC INFORMATION TO MEET INDIVIDUAL NEEDS, ALL RENDERED IN BUSINESS ESTABLISHMENTS, OFFICE BUILDINGS, HOTELS, RESIDENTIAL COMPLEXES AND HOMES, IN CLASS 45 (U.S. CLS. 100 AND 101).

FIRST USE 6-13-2011; IN COMMERCE 6-13-2011.

THE MARK CONSISTS OF STANDARD CHARACTERS WITHOUT CLAIM TO ANY PARTICULAR FONT, STYLE, SIZE, OR COLOR.

NO CLAIM IS MADE TO THE EXCLUSIVE RIGHT TO USE "BABY", APART FROM THE MARK AS SHOWN.

SN 85-337,341, FILED 6-3-2011.

ANNE E. GUSTASON, EXAMINING ATTORNEY



*David J. Kyfos*

Director of the United States Patent and Trademark Office



# United States of America

United States Patent and Trademark Office

# ENDDDD

**Reg. No. 4,199,673**

**Registered Aug. 28, 2012**

**Int. Cls.: 35 and 41**

**SERVICE MARK**

**PRINCIPAL REGISTER**

CASEY FELDMAN MEMORIAL FOUNDATION (PENNSYLVANIA NON-PROFIT CORPORATION)  
C/O JOEL FELDMAN  
1710 SPRUCE STREET  
PHILADELPHIA, PA 19103

FOR: PROMOTING PUBLIC AWARENESS VIA PROGRAMS IN THE FIELDS OF DRIVING SAFETY, DRIVER EDUCATION, PUBLIC SAFETY AND HIGHWAY SAFETY, IN CLASS 35 (U.S. CLS. 100, 101 AND 102).

FIRST USE 3-11-2011; IN COMMERCE 3-11-2011.

FOR: PROVIDING A WEBSITE FEATURING INFORMATION AND CONTENT IN THE FIELD OF DRIVER EDUCATION; EDUCATIONAL SERVICES, NAMELY, PROVIDING LIVE AND ON-LINE CLASSES, SEMINARS, WORKSHOPS, AND CONFERENCES IN THE FIELDS OF DRIVING, DRIVER EDUCATION, PUBLIC SAFETY AND HIGHWAY SAFETY, IN CLASS 41 (U.S. CLS. 100, 101 AND 107).

FIRST USE 3-11-2011; IN COMMERCE 3-11-2011.

THE MARK CONSISTS OF STANDARD CHARACTERS WITHOUT CLAIM TO ANY PARTICULAR FONT, STYLE, SIZE, OR COLOR.

SN 85-337,358, FILED 6-3-2011.

WILLIAM BRECKENFELD, EXAMINING ATTORNEY



*David J. Kypos*

Director of the United States Patent and Trademark Office

# United States of America

United States Patent and Trademark Office

# CCA

**Reg. No. 4,199,674**

**Registered Aug. 28, 2012**

**CERTIFICATION MARK**

**SERVICES**

**PRINCIPAL REGISTER**

BOARD FOR CERTIFICATION IN CLINICAL ANAPLASTOLOGY (SOUTH CAROLINA  
NON-PROFIT CORPORATION)

P. O. BOX 474  
S. BELOIT, IL 610800474

FOR: CLINICAL ANAPLASTOLOGY, NAMELY, PREPARATION AND FITTING OF PROS-  
THETIC DEVICES, IN CLASS B (U.S. CL. B).

FIRST USE 1-0-2002; IN COMMERCE 1-0-2002.

THE MARK CONSISTS OF STANDARD CHARACTERS WITHOUT CLAIM TO ANY PAR-  
TICULAR FONT, STYLE, SIZE, OR COLOR.

THE CERTIFICATION MARK, AS USED BY PERSONS AUTHORIZED BY CERTIFIER, ARE  
TO INDICATE THAT THE CLINICAL ANAPLASTOLOGY SERVICES PERFORMED OR TO  
BE PERFORMED HAVE BEEN OR WILL BE PERFORMED BY A PERSON THAT HAS BEEN  
CERTIFIED AND HAS ACHIEVED CERTAIN KNOWLEDGE, SKILLS AND ABILITIES IN  
THE FIELD OF CLINICAL ANAPLASTOLOGY.

SN 85-337,552, FILED 6-3-2011.

KATHLEEN LORENZO, EXAMINING ATTORNEY



*David J. Kyjars*

Director of the United States Patent and Trademark Office

# United States of America

United States Patent and Trademark Office

# DAISOLBOND

**Reg. No. 4,199,675**

**Registered Aug. 28, 2012**

**Int. Cl.: 1**

**TRADEMARK**

**PRINCIPAL REGISTER**

DAINICHISEIKA COLOR & CHEMICALS MFG. CO., LTD. (JAPAN CORPORATION)  
7-6, NIHONBASHI-BAKUROCHO 1-CHOME  
CHUO-KU, TOKYO, JAPAN 103-8383

FOR: ADHESIVES FOR INDUSTRIAL PURPOSES; ADHESIVES FOR PAPERHANGING; ADHESIVES FOR WALL TILES; ADHESIVES FOR LAMINATING PLASTIC FILMS; ADHESIVES FOR USE IN MANUFACTURING TEXTILES; ADHESIVES FOR USE IN THE MANUFACTURE OF CORRUGATED PAPER; ADHESIVES PREPARATIONS FOR USE IN MANUFACTURING SURGICAL BANDAGES; ADHESIVES FOR LAMINATING METAL SHEETS; INDUSTRIAL CHEMICALS; CHEMICAL PREPARATIONS FOR SCIENTIFIC PURPOSES OTHER THAN FOR MEDICAL OR VETERINARY USE, IN CLASS 1 (U.S. CLS. 1, 5, 6, 10, 26 AND 46).

FIRST USE 4-16-2012; IN COMMERCE 4-16-2012.

THE MARK CONSISTS OF STANDARD CHARACTERS WITHOUT CLAIM TO ANY PARTICULAR FONT, STYLE, SIZE, OR COLOR.

SN 85-337,562, FILED 6-3-2011.

APRIL ROACH, EXAMINING ATTORNEY



*David J. Kyffers*

Director of the United States Patent and Trademark Office

# United States of America

United States Patent and Trademark Office



**Reg. No. 4,199,676**

THE DENIM DOG (NEW JERSEY PARTNERSHIP)  
133 BROAD STREET  
ELMER, NJ 08318

**Registered Aug. 28, 2012**

**Int. Cl.: 18**

FOR: DOG LEASHES AND COLLARS, ALL COMPOSED OF HIGHLY FASHIONABLE AND UPCYCLED DENIM FABRICS, IN CLASS 18 (U.S. CLS. 1, 2, 3, 22 AND 41).

**TRADEMARK**

FIRST USE 8-10-2010; IN COMMERCE 10-3-2010.

**PRINCIPAL REGISTER**

NO CLAIM IS MADE TO THE EXCLUSIVE RIGHT TO USE "DENIM DOG SUPPLY", APART FROM THE MARK AS SHOWN.

THE MARK CONSISTS OF STYLIZED LETTERING OF "THE DENIM DOG SUPPLY" IN AN OUTER CIRCLE AND THE NUMBERS "09" IN AN INNER CIRCLE.

SN 85-337,575, FILED 6-3-2011.

ELLEN B. AWRICH, EXAMINING ATTORNEY



*David J. Kybas*

Director of the United States Patent and Trademark Office

United States of America  
United States Patent and Trademark Office

# VocalizeU

**Reg. No. 4,199,677**

**Registered Aug. 28, 2012**

**Int. Cl.: 9**

**TRADEMARK**

**PRINCIPAL REGISTER**

DS VOCOLOGY LLC. (CALIFORNIA LIMITED LIABILITY COMPANY)  
8210 W. SUNSET BLVD. LA, CA 90046  
8210 W. SUNSET BLVD.  
LOS ANGELES, CA 90046

FOR: COMPUTER APPLICATION SOFTWARE FOR MUSIC EDUCATION, NAMELY, SOFTWARE FOR MOBILE DEVICES, TABLETS, COMPUTERS AND SMART PHONES, IN CLASS 9 (U.S. CLS. 21, 23, 26, 36 AND 38).

FIRST USE 1-1-2011; IN COMMERCE 5-10-2011.

THE MARK CONSISTS OF STANDARD CHARACTERS WITHOUT CLAIM TO ANY PARTICULAR FONT, STYLE, SIZE, OR COLOR.

SN 85-337,767, FILED 6-3-2011.

ALLISON HOLTZ, EXAMINING ATTORNEY



*David J. Kybas*

Director of the United States Patent and Trademark Office

# United States of America

United States Patent and Trademark Office

# TwistGist

**Reg. No. 4,199,678**

**Registered Aug. 28, 2012**

**Int. Cl.: 9**

**TRADEMARK**

**PRINCIPAL REGISTER**

EAGLE ZAP TECHNOLOGIES, INC. (FLORIDA CORPORATION)  
197 SW DALTON CI  
PORT SAINT LUCIE, FL 34953

FOR: COMPUTER GAME PROGRAMS; COMPUTER GAME SOFTWARE; COMPUTER GAME SOFTWARE DOWNLOADABLE FROM A GLOBAL COMPUTER NETWORK; COMPUTER GAME SOFTWARE FOCUSING ON ACHIEVING A SET OF GOALS, POSITIONS, OWNERSHIP, AND CREDENTIALS, AND PROFESSIONAL AND SOCIAL STATUS, AND GOOD FORTUNE NECESSARY TO SUCCEED PROFESSIONALLY AND PERSONALLY, AND NOT REFERRING EITHER TO A GROUP OF SOFTWARE FOR USE IN COMMERCE OR TO A GROUP OF OFFICES; COMPUTER GAME SOFTWARE FOR GAMING MACHINES INCLUDING SLOT MACHINES OR VIDEO LOTTERY TERMINALS; COMPUTER GAME SOFTWARE FOR PERSONAL COMPUTERS AND HOME VIDEO GAME CONSOLES; COMPUTER GAME SOFTWARE FOR USE ON MOBILE AND CELLULAR PHONES; COMPUTER GAME SOFTWARE FOR USE WITH PERSONAL COMPUTERS, HOME VIDEO GAME CONSOLES USED WITH TELEVISIONS AND ARCADE-BASED VIDEO GAME CONSOLES; COMPUTER SOFTWARE, NAMELY, GAME ENGINE SOFTWARE FOR VIDEO GAME DEVELOPMENT AND OPERATION; ELECTRONIC GAME PROGRAMS; ELECTRONIC GAME SOFTWARE; ELECTRONIC GAME SOFTWARE FOR CELLULAR TELEPHONES; ELECTRONIC GAME SOFTWARE FOR HANDHELD ELECTRONIC DEVICES; ELECTRONIC GAME SOFTWARE FOR WIRELESS DEVICES; ELECTRONIC GAMING MACHINES, NAMELY, DEVICES WHICH ACCEPT A WAGER; ELECTRONIC INTERACTIVE BOARD GAMES FOR USE WITH EXTERNAL MONITOR; INTERACTIVE GAME PROGRAMS; INTERACTIVE GAME SOFTWARE; INTERACTIVE MULTIMEDIA COMPUTER GAME PROGRAM; INTERACTIVE VIDEO GAME PROGRAMS; INTERACTIVE VIDEO GAMES OF VIRTUAL REALITY COMPRISED OF COMPUTER HARDWARE FOR USE WITH AN EXTERNAL MONITOR AND SOFTWARE; VIRTUAL REALITY GAME SOFTWARE, IN CLASS 9 (U.S. CLS. 21, 23, 26, 36 AND 38).



FIRST USE 6-4-2011; IN COMMERCE 6-4-2011.

THE MARK CONSISTS OF STANDARD CHARACTERS WITHOUT CLAIM TO ANY PARTICULAR FONT, STYLE, SIZE, OR COLOR.

*David J. Kyros*

SN 85-338,085, FILED 6-4-2011.

LINDSEY RUBIN, EXAMINING ATTORNEY

# United States of America

United States Patent and Trademark Office

## DIZZY DANCERS

**Reg. No. 4,199,679**

HASBRO, INC. (RHODE ISLAND CORPORATION)  
1027 NEWPORT AVENUE  
PAWTUCKET, RI 02862

**Registered Aug. 28, 2012**

**Int. Cl.: 28**

FOR: TOY ANIMAL FIGURES AND TOY PLAYSETS FOR USE THEREWITH, IN CLASS 28  
(U.S. CLS. 22, 23, 38 AND 50).

**TRADEMARK**

FIRST USE 10-17-2011; IN COMMERCE 10-17-2011.

**PRINCIPAL REGISTER**

THE MARK CONSISTS OF STANDARD CHARACTERS WITHOUT CLAIM TO ANY PARTICULAR FONT, STYLE, SIZE, OR COLOR.

SN 85-338,432, FILED 6-6-2011.

NAKIA HENRY, EXAMINING ATTORNEY



*David J. Kyffers*

Director of the United States Patent and Trademark Office

# United States of America

United States Patent and Trademark Office

## MCGRAW-HILL BUZZ

**Reg. No. 4,199,680**

THE MCGRAW-HILL COMPANIES, INC. (NEW YORK CORPORATION)  
1221 AVENUE OF THE AMERICAS  
NEW YORK, NY 10020

**Registered Aug. 28, 2012**

**Int. Cls.: 35 and 45**

FOR: ON-LINE BUSINESS NETWORKING SERVICES, IN CLASS 35 (U.S. CLS. 100, 101 AND 102).

**SERVICE MARK**

FIRST USE 8-15-2011; IN COMMERCE 8-15-2011.

**PRINCIPAL REGISTER**

FOR: ON-LINE SOCIAL NETWORKING SERVICES, IN CLASS 45 (U.S. CLS. 100 AND 101).

FIRST USE 8-15-2011; IN COMMERCE 8-15-2011.

THE MARK CONSISTS OF STANDARD CHARACTERS WITHOUT CLAIM TO ANY PARTICULAR FONT, STYLE, SIZE, OR COLOR.

OWNER OF U.S. REG. NOS. 1,350,345, 3,988,680, AND OTHERS.

NO CLAIM IS MADE TO THE EXCLUSIVE RIGHT TO USE "BUZZ", APART FROM THE MARK AS SHOWN.

SN 85-338,679, FILED 6-6-2011.

SHARON MEIER, EXAMINING ATTORNEY



*David J. Kyjars*

Director of the United States Patent and Trademark Office



# United States of America

United States Patent and Trademark Office

## FREASY FUNNEL

**Reg. No. 4,199,681**

FREASY FUNNEL, LLC (MISSOURI CORPORATION)  
501 N. LINDBERGH BLVD., STE 107  
ST. LOUIS, MO 63141

**Registered Aug. 28, 2012**

**Int. Cl.: 21**

FOR: FUNNEL FOR USE WITH MACHINES THAT MAKE AND DISPENSE FROZEN AND SEMI-FROZEN CONFECTIONS AND BEVERAGES, IN CLASS 21 (U.S. CLS. 2, 13, 23, 29, 30, 33, 40 AND 50).

**TRADEMARK**

FIRST USE 4-17-2012; IN COMMERCE 4-17-2012.

**PRINCIPAL REGISTER**

THE MARK CONSISTS OF STANDARD CHARACTERS WITHOUT CLAIM TO ANY PARTICULAR FONT, STYLE, SIZE, OR COLOR.

NO CLAIM IS MADE TO THE EXCLUSIVE RIGHT TO USE "FUNNEL", APART FROM THE MARK AS SHOWN.

SN 85-338,704, FILED 6-6-2011.

BARNEY CHARLON, EXAMINING ATTORNEY



*David J. Kyros*

Director of the United States Patent and Trademark Office

# United States of America

United States Patent and Trademark Office

## PERMANENT GLUE RUNNER

**Reg. No. 4,199,682**

**Registered Aug. 28, 2012**

**Int. Cl.: 16**

**TRADEMARK**

**PRINCIPAL REGISTER**

ADHESIVE TECHNOLOGIES, INC. (NEW HAMPSHIRE CORPORATION)  
3 MERRILL INDUSTRIAL DRIVE  
HAMPTON, NH 03842

FOR: ADHESIVE GLUE DISPENSER FOR HOUSEHOLD, STATIONERY, SCRAPBOOKING,  
GENERAL CRAFT AND OFFICE USE, IN CLASS 16 (U.S. CLS. 2, 5, 22, 23, 29, 37, 38 AND  
50).

FIRST USE 0-0-2004; IN COMMERCE 0-0-2004.

THE MARK CONSISTS OF STANDARD CHARACTERS WITHOUT CLAIM TO ANY PAR-  
TICULAR FONT, STYLE, SIZE, OR COLOR.

OWNER OF U.S. REG. NO. 3,112,115.

NO CLAIM IS MADE TO THE EXCLUSIVE RIGHT TO USE "PERMANENT GLUE", APART  
FROM THE MARK AS SHOWN.

SN 85-338,727, FILED 6-6-2011.

KAPIL BHANOT, EXAMINING ATTORNEY



*David J. Kyffers*

Director of the United States Patent and Trademark Office

# United States of America

United States Patent and Trademark Office

# POKÉDEX

**Reg. No. 4,199,683**

**Registered Aug. 28, 2012**

**Int. Cl.: 9**

**TRADEMARK**

**PRINCIPAL REGISTER**

NINTENDO OF AMERICA INC. (WASHINGTON CORPORATION)  
4600 150TH AVENUE NE  
REDMOND, WA 98052

FOR: CARTRIDGES, MEMORY CARDS AND OTHER STORAGE MEDIA, NAMELY, FLASH MEMORY, FEATURING ENTERTAINMENT, EDUCATIONAL AND INFORMATIONAL CONTENT, NAMELY, VIDEO GAMES; COMPUTER SOFTWARE FOR VIEWING GRAPHIC IMAGES AND RELATED TEXT; COMPUTER GAME SOFTWARE FEATURING ANIMATED CHARACTERS, VIDEO GAME CHARACTERS AND TEXT RELATED TO VIDEO GAMES AND CONTENT THEREIN; COMPUTER DATABASE SOFTWARE FEATURING ANIMATED CHARACTERS, VIDEO GAME CHARACTERS AND TEXT RELATED TO VIDEO GAMES AND CONTENT THEREIN; COMPUTER SOFTWARE FOR USE IN VIEWING AND MANAGING ELECTRONIC DICTIONARIES AND ENCYCLOPEDIAS; DOWNLOADABLE MULTIMEDIA FILES, NAMELY, VIDEO GAMES; DOWNLOADABLE ELECTRONIC GAME PROGRAMS; DOWNLOADABLE ELECTRONIC GAME SOFTWARE; DOWNLOADABLE ELECTRONIC PUBLICATIONS, NAMELY, BOOKS IN THE FIELD OF ANIMATED AND VIDEO GAME CHARACTERS; DOWNLOADABLE ELECTRONIC DICTIONARIES AND ENCYCLOPEDIAS; HAND-HELD ELECTRONIC DICTIONARIES AND ENCYCLOPEDIAS; ELECTRONIC GAME PROGRAMS; ELECTRONIC GAME SOFTWARE; VIDEO GAME CARTRIDGES; VIDEO GAME MEMORY CARDS; VIDEO GAME PROGRAMS; VIDEO GAME SOFTWARE, IN CLASS 9 (U.S. CLS. 21, 23, 26, 36 AND 38).

FIRST USE 9-28-1998; IN COMMERCE 9-28-1998.

THE MARK CONSISTS OF STANDARD CHARACTERS WITHOUT CLAIM TO ANY PARTICULAR FONT, STYLE, SIZE, OR COLOR.

SN 85-338,728, FILED 6-6-2011.

B. PARADEWELAI, EXAMINING ATTORNEY



*David J. Kypos*

Director of the United States Patent and Trademark Office

# United States of America

United States Patent and Trademark Office

# POKÉDEX

**Reg. No. 4,199,684**

**Registered Aug. 28, 2012**

**Int. Cl.: 41**

**SERVICE MARK**

**PRINCIPAL REGISTER**

NINTENDO OF AMERICA INC. (WASHINGTON CORPORATION)  
4600 150TH AVENUE NE  
REDMOND, WA 98052

FOR: ENTERTAINMENT SERVICES, NAMELY, PROVIDING AN ON-LINE NON-DOWNLOADABLE INTERACTIVE ENCYCLOPEDIA OF ANIMATED AND VIDEO GAME CHARACTERS; ENTERTAINMENT SERVICES, NAMELY, PROVIDING ELECTRONIC IMAGES AND TEXT FEATURING ANIMATED AND VIDEO GAME CHARACTERS ON-LINE; ENTERTAINMENT IN THE NATURE OF PROVIDING AN INFORMATIONAL AND ENTERTAINMENT WEBSITE IN THE FIELD OF ANIMATED AND VIDEO GAME CHARACTERS; ENTERTAINMENT INFORMATION PROVIDED ON-LINE FROM A COMPUTER DATABASE OR THE INTERNET; ON-LINE INTERACTIVE ENCYCLOPEDIA IN THE FIELD OF ANIMATED AND VIDEO GAME CHARACTERS; ENTERTAINMENT SERVICES, NAMELY, PROVIDING AN ONLINE DATABASE FEATURING INFORMATION ABOUT ANIMATED AND VIDEO GAME CHARACTERS; ENTERTAINMENT SERVICES, NAMELY, PROVIDING A WEB SITE FEATURING IMAGES, VIDEOS AND SOUND IN THE FIELDS OF VIDEO GAMES, COMPUTER GAMES, ANIMATED AND VIDEO GAME CHARACTERS VIA WIRELESS COMMUNICATION AND THE INTERNET; NON-DOWNLOADABLE ELECTRONIC PUBLICATIONS IN THE NATURE OF NEWSLETTERS IN THE FIELDS OF VIDEO GAMES, COMPUTER GAMES AND ANIMATED AND VIDEO GAME CHARACTERS VIA WIRELESS COMMUNICATION AND THE INTERNET; PROVIDING A WEBSITE FEATURING INFORMATION IN THE FIELDS OF VIDEO GAMES, COMPUTER GAMES AND ANIMATED AND VIDEO GAME CHARACTERS VIA WIRELESS COMMUNICATION AND THE INTERNET, IN CLASS 41 (U.S. CLS. 100, 101 AND 107).



FIRST USE 0-0-2000; IN COMMERCE 0-0-2000.

THE MARK CONSISTS OF STANDARD CHARACTERS WITHOUT CLAIM TO ANY PARTICULAR FONT, STYLE, SIZE, OR COLOR.

SN 85-338,733, FILED 6-6-2011.

B. PARADEWELAI, EXAMINING ATTORNEY

*David J. Kyffers*

Director of the United States Patent and Trademark Office

# United States of America

United States Patent and Trademark Office

# Wind 'n Curl

**Reg. No. 4,199,685**

CONAIR CORPORATION (DELAWARE CORPORATION)  
ONE CUMMINGS POINT ROAD  
STAMFORD, CT 06902

**Registered Aug. 28, 2012**

**Int. Cl.: 9**

FOR: ELECTRIC HAND-HELD HAIR STYLING IRONS, IN CLASS 9 (U.S. CLS. 21, 23, 26, 36 AND 38).

**TRADEMARK**

FIRST USE 8-2-2011; IN COMMERCE 8-2-2011.

**PRINCIPAL REGISTER**

THE MARK CONSISTS OF STANDARD CHARACTERS WITHOUT CLAIM TO ANY PARTICULAR FONT, STYLE, SIZE, OR COLOR.

SN 85-338,792, FILED 6-6-2011.

JENNIFER MARTIN, EXAMINING ATTORNEY



*David J. Kybas*

Director of the United States Patent and Trademark Office

# United States of America

United States Patent and Trademark Office

# RUFFLED

**Reg. No. 4,199,686**

**Registered Aug. 28, 2012**

**Int. Cl.: 9**

**TRADEMARK**

**PRINCIPAL REGISTER**

PIXELLOOP, LLC (TEXAS LIMITED LIABILITY COMPANY)  
5039 BECKWITH BLVD.  
SAN ANTONIO, TX 78249

FOR: COMPUTER GAME PROGRAMMES; COMPUTER GAME PROGRAMMES DOWNLOADABLE VIA THE INTERNET; COMPUTER GAME PROGRAMS; COMPUTER GAME SOFTWARE; COMPUTER GAME SOFTWARE DOWNLOADABLE FROM A GLOBAL COMPUTER NETWORK; COMPUTER GAME SOFTWARE FOR PERSONAL COMPUTERS AND HOME VIDEO GAME CONSOLES; COMPUTER GAME SOFTWARE FOR USE ON MOBILE AND CELLULAR PHONES; COMPUTER GAME SOFTWARE FOR USE WITH PERSONAL COMPUTERS, HOME VIDEO GAME CONSOLES USED WITH TELEVISIONS AND ARCADE-BASED VIDEO GAME CONSOLES; DOWNLOADABLE COMPUTER GAME PROGRAMS; DOWNLOADABLE COMPUTER GAME SOFTWARE VIA A GLOBAL COMPUTER NETWORK AND WIRELESS DEVICES; VIDEO AND COMPUTER GAME PROGRAMS, IN CLASS 9 (U.S. CLS. 21, 23, 26, 36 AND 38).

FIRST USE 6-18-2011; IN COMMERCE 6-18-2011.

THE MARK CONSISTS OF STANDARD CHARACTERS WITHOUT CLAIM TO ANY PARTICULAR FONT, STYLE, SIZE, OR COLOR.

SN 85-339,197, FILED 6-6-2011.

CHRISTINA SOBRAL, EXAMINING ATTORNEY



*David J. Kybas*

Director of the United States Patent and Trademark Office

# United States of America

United States Patent and Trademark Office



**Reg. No. 4,199,687**

**Registered Aug. 28, 2012**

**Int. Cl.: 41**

**SERVICE MARK**

**PRINCIPAL REGISTER**

CORPORACIÓN FRANCISCO EL HOMBRE CORP (FLORIDA CORPORATION)  
SUITE 2  
5951 NW 173 DR.  
MIAMI, FL 33015

FOR: PUBLICATION OF MAGAZINES, JOURNALS, NEWSPAPER, BROCHURES AND PRINTED MATTER; ENTERTAINMENT MEDIA PRODUCTION SERVICES FOR TELEVISION AND INTERNET; ENTERTAINMENT SERVICES IN THE NATURE OF PRESENTING LIVE MUSICAL PERFORMANCES; ORGANIZING COMMUNITY FESTIVALS FEATURING CULTURAL EVENTS; PUBLICATION AND EDITING OF PRINTED MATTERS, IN CLASS 41 (U.S. CLS. 100, 101 AND 107).

FIRST USE 5-30-2011; IN COMMERCE 6-30-2011.

NO CLAIM IS MADE TO THE EXCLUSIVE RIGHT TO USE "FESTIVAL", APART FROM THE MARK AS SHOWN.

THE COLOR(S) ORANGE, YELLOW, WHITE AND BLACK IS/ARE CLAIMED AS A FEATURE OF THE MARK.

THE MARK CONSISTS OF WORDING "FESTIVAL FRANCISCO EL HOMBRE" IN THE CENTER OF A BLACK BACKGROUND WITH AN ACCORDION SHAPE. THE LETTERS "FRANCISCO" AND "HOMBRE" APPEAR IN WHITE COLOR, THE WORDS "FESTIVAL", AND "EL" APPEAR IN ORANGE COLOR, A HAT IS DEPICTED WITH YELLOW AND WHITE STRIPES IN THE UPPER RIGHT CORNER OF THE LOGO, EACH SIDE OF THE LOGO IS AN END OF A YELLOW ACCORDION SHAPE, THE WORD "FESTIVAL" IS ALSO LOCATED ON THE TOP LEFT OF THE LOGO, THERE IS A YELLOW LINE LOCATED BELOW THE WORD "EL HOMBRE" EXTENDING FROM BELOW THE LETTER "E" ENDING IN A YELLOW SWIRL BELOW THE LETTERS "ER", ANOTHER YELLOW LINE IS PRESENT ON THE TOP OF THE LOGO EXTENDING FROM THE LEFT SIDE OF THE HAT AND ENDING IN A YELLOW SWIRL ABOVE THE LETTER "T" IN "FESTIVAL".

THE ENGLISH TRANSLATION OF "EL HOMBRE" IN THE MARK IS "THE MAN".

SN 85-339,249, FILED 6-6-2011.

LAURIE MAYES, EXAMINING ATTORNEY



*David J. Kyros*

Director of the United States Patent and Trademark Office

# United States of America

United States Patent and Trademark Office

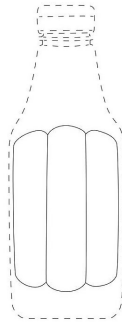

**Reg. No. 4,199,688**

**Registered Aug. 28, 2012**

**Int. Cl.: 30**

**TRADEMARK**

**PRINCIPAL REGISTER**

H. J. HEINZ COMPANY (PENNSYLVANIA CORPORATION)  
P.O. BOX 57  
PITTSBURGH, PA 15230

FOR: KETCHUP, SAUCES, IN CLASS 30 (U.S. CL. 46).

FIRST USE 6-1-2012; IN COMMERCE 6-1-2012.

OWNER OF U.S. REG. NOS. 2,233,574, 3,939,679, AND OTHERS.

SEC. 2(F) AS TO "THE PANELS ELEMENT OF THE MARK".

THE MARK CONSISTS OF THE CONFIGURATION OF THE PACKAGING FOR THE GOODS AS DEPICTED IN THE DRAWING WHICH SHOWS A CLEAR BOTTLE WITH A LID, THE LOWER PORTION OF WHICH CONTAINS SIX OBLONG PANELS WHICH ARE ROUND ON THE TOP AND BOTTOM. THE LID AND OUTLINE OF THE BOTTLE APPEAR IN DOTTED LINES TO SHOW THAT THEY ARE NOT CLAIMED AS A FEATURE OF THE MARK AND ONLY SERVE TO SHOW POSITIONING OF THE FEATURES OF THE MARK ON THE BOTTLE.

SN 85-339,587, FILED 6-7-2011.

SHAUNIA CARLYLE, EXAMINING ATTORNEY



*David J. Kybas*

Director of the United States Patent and Trademark Office



# United States of America

United States Patent and Trademark Office

## ANIMAL BAKERY

**Reg. No. 4,199,689**

CYBERAGENT AMERICA, INC. (CALIFORNIA CORPORATION)  
221 MAIN ST. SUITE 240  
SAN FRANCISCO, CA 94105

**Registered Aug. 28, 2012**

**Int. Cl.: 9**

FOR: COMPUTER GAME SOFTWARE, MOBILE APPLICATION GAME SOFTWARE, IN CLASS 9 (U.S. CLS. 21, 23, 26, 36 AND 38).

**TRADEMARK**

FIRST USE 6-7-2011; IN COMMERCE 10-24-2011.

**PRINCIPAL REGISTER**

THE MARK CONSISTS OF STANDARD CHARACTERS WITHOUT CLAIM TO ANY PARTICULAR FONT, STYLE, SIZE, OR COLOR.

SN 85-339,794, FILED 6-7-2011.

TRACY FLETCHER, EXAMINING ATTORNEY



*David J. Kybas*

Director of the United States Patent and Trademark Office

# United States of America

United States Patent and Trademark Office

# NINJAFARM

**Reg. No. 4,199,690**

CYBERAGENT AMERICA, INC. (CALIFORNIA CORPORATION)

**Registered Aug. 28, 2012**

221 MAIN ST. SUITE 240  
SAN FRANCISCO, CA 94105

**Int. Cl.: 9**

FOR: COMPUTER GAME SOFTWARE, MOBILE APPLICATION GAME SOFTWARE, IN CLASS 9 (U.S. CLS. 21, 23, 26, 36 AND 38).

**TRADEMARK**

FIRST USE 6-7-2011; IN COMMERCE 1-17-2012.

**PRINCIPAL REGISTER**

THE MARK CONSISTS OF STANDARD CHARACTERS WITHOUT CLAIM TO ANY PARTICULAR FONT, STYLE, SIZE, OR COLOR.

SN 85-339,830, FILED 6-7-2011.

TRACY FLETCHER, EXAMINING ATTORNEY



*David J. Kybas*

Director of the United States Patent and Trademark Office

# United States of America

United States Patent and Trademark Office

## YARD SALE

**Reg. No. 4,199,691**

UINTA BREWING COMPANY (UTAH CORPORATION)  
1722 S. FREMONT DR.

**Registered Aug. 28, 2012**

SALT LAKE CITY, UT 84104

**Int. Cl.: 32**

FOR: BEER, IN CLASS 32 (U.S. CLS. 45, 46 AND 48).

**TRADEMARK**

FIRST USE 5-29-2011; IN COMMERCE 12-28-2011.

**PRINCIPAL REGISTER**

THE MARK CONSISTS OF STANDARD CHARACTERS WITHOUT CLAIM TO ANY PARTICULAR FONT, STYLE, SIZE, OR COLOR.

SN 85-340,010, FILED 6-7-2011.

GRETCHEN ULRICH, EXAMINING ATTORNEY



*David J. Kyffers*

Director of the United States Patent and Trademark Office

# United States of America

United States Patent and Trademark Office

## BIRTHDAY SUIT

**Reg. No. 4,199,692**

UINTA BREWING COMPANY (UTAH CORPORATION)  
1722 S. FREMONT DR.

**Registered Aug. 28, 2012**

SALT LAKE CITY, UT 84104

**Int. Cl.: 32**

FOR: BEER, IN CLASS 32 (U.S. CLS. 45, 46 AND 48).

**TRADEMARK**

FIRST USE 3-10-2011; IN COMMERCE 3-1-2012.

**PRINCIPAL REGISTER**

THE MARK CONSISTS OF STANDARD CHARACTERS WITHOUT CLAIM TO ANY PARTICULAR FONT, STYLE, SIZE, OR COLOR.

SN 85-340,151, FILED 6-7-2011.

GRETCHEN ULRICH, EXAMINING ATTORNEY



*David J. Kyffers*

Director of the United States Patent and Trademark Office

# United States of America

United States Patent and Trademark Office

## SPO KNOWS

**Reg. No. 4,199,693**

PEREZ, GUSTAVO A. (UNITED STATES INDIVIDUAL)  
11174 SW 112 TERRACE  
MIAMI, FL 33176

**Registered Aug. 28, 2012**

**Int. Cl.: 25**

FOR: SHIRTS, TEE SHIRTS, SPORTS SHIRTS; SPORTS SHIRTS WITH SHORT SLEEVES;  
POLO SHIRTS, IN CLASS 25 (U.S. CLS. 22 AND 39).

**TRADEMARK**

FIRST USE 2-1-2012; IN COMMERCE 2-1-2012.

**PRINCIPAL REGISTER**

THE MARK CONSISTS OF STANDARD CHARACTERS WITHOUT CLAIM TO ANY PARTICULAR FONT, STYLE, SIZE, OR COLOR.

SN 85-340,173, FILED 6-7-2011.

CHARLES L. JENKINS, EXAMINING ATTORNEY



*David J. Kybas*

Director of the United States Patent and Trademark Office

# United States of America

United States Patent and Trademark Office

## EARLY BIRD ALERT

**Reg. No. 4,199,694**

**Registered Aug. 28, 2012**

**Int. Cl.: 38**

**SERVICE MARK**

**PRINCIPAL REGISTER**

EARLY BIRD ALERT, INC. (TEXAS CORPORATION)  
SUITE 106  
70 MITCHELL BOULEVARD  
SAN RAFAEL, CA 94903

FOR: TELECOMMUNICATION SERVICES, NAMELY, ELECTRONIC AND DIGITAL TRANSMISSION OF VOICE, DATA, SIGNALS AND MESSAGES FOR PROVIDING COMMUNICATION BETWEEN USERS OF THE SERVICE AND HEALTHCARE PROVIDERS, IN CLASS 38 (U.S. CLS. 100, 101 AND 104).

FIRST USE 7-1-2011; IN COMMERCE 7-1-2011.

THE MARK CONSISTS OF STANDARD CHARACTERS WITHOUT CLAIM TO ANY PARTICULAR FONT, STYLE, SIZE, OR COLOR.

NO CLAIM IS MADE TO THE EXCLUSIVE RIGHT TO USE "ALERT", APART FROM THE MARK AS SHOWN.

SN 85-340,270, FILED 6-7-2011.

HEATHER THOMPSON, EXAMINING ATTORNEY



*David J. Kyffers*

Director of the United States Patent and Trademark Office

# United States of America

United States Patent and Trademark Office

## DOTNETNUKE WORLD

**Reg. No. 4,199,695**

DOTNETNUKE CORP. (DELAWARE CORPORATION)

**Registered Aug. 28, 2012**

155 BOVET ROAD, SUITE 201  
SAN MATEO, CA 94402

**Int. Cl.: 41**

FOR: EDUCATIONAL SERVICES, NAMELY, CONDUCTING CONFERENCES IN THE FIELD OF WEB SITE DESIGN AND HOSTING, COMPUTER PROGRAMMING, SOFTWARE DESIGN AND DEVELOPMENT, COMPUTER SYSTEMS AND COMPUTER SOFTWARE, IN CLASS 41 (U.S. CLS. 100, 101 AND 107).

**SERVICE MARK**

**PRINCIPAL REGISTER**

FIRST USE 11-0-2011; IN COMMERCE 11-0-2011.

THE MARK CONSISTS OF STANDARD CHARACTERS WITHOUT CLAIM TO ANY PARTICULAR FONT, STYLE, SIZE, OR COLOR.

OWNER OF U.S. REG. NOS. 3,206,060 AND 3,579,091.

SN 85-340,293, FILED 6-7-2011.

STEPHANIE ALI, EXAMINING ATTORNEY



*David J. Kyffers*

Director of the United States Patent and Trademark Office

# United States of America

United States Patent and Trademark Office

 earlybird alert

**Reg. No. 4,199,696**

**Registered Aug. 28, 2012**

**Int. Cl.: 38**

**SERVICE MARK**

**PRINCIPAL REGISTER**

EARLY BIRD ALERT, INC. (TEXAS CORPORATION)  
SUITE 106  
70 MITCHELL BOULEVARD  
SAN RAFAEL, CA 94903

FOR: TELECOMMUNICATION SERVICES, NAMELY, ELECTRONIC AND DIGITAL TRANSMISSION OF VOICE, DATA, SIGNALS AND MESSAGES FOR PROVIDING COMMUNICATION BETWEEN USERS OF THE SERVICE AND HEALTHCARE PROVIDERS, IN CLASS 38 (U.S. CLS. 100, 101 AND 104).

FIRST USE 7-1-2011; IN COMMERCE 7-1-2011.

NO CLAIM IS MADE TO THE EXCLUSIVE RIGHT TO USE "ALERT", APART FROM THE MARK AS SHOWN.

THE MARK CONSISTS OF THE PHRASE "EARLY BIRD ALERT" IN STYLIZED LETTERING TO THE RIGHT OF A STYLIZED BIRD HEAD LOGO.

SN 85-340,312, FILED 6-7-2011.

HEATHER THOMPSON, EXAMINING ATTORNEY



*David J. Kybas*

Director of the United States Patent and Trademark Office



# United States of America

United States Patent and Trademark Office



**Reg. No. 4,199,697**

**Registered Aug. 28, 2012**

**Int. Cls.: 35 and 41**

**SERVICE MARK**

**PRINCIPAL REGISTER**

CASEY FELDMAN MEMORIAL FOUNDATION (PENNSYLVANIA NON-PROFIT CORPORATION)  
C/O JOEL FELDMAN  
1710 SPRUCE STREET  
PHILADELPHIA, PA 19103

FOR: PROMOTING PUBLIC AWARENESS VIA PROGRAMS IN THE FIELDS OF DRIVING SAFETY, DRIVER EDUCATION, PUBLIC SAFETY AND HIGHWAY SAFETY, IN CLASS 35 (U.S. CLS. 100, 101 AND 102).

FIRST USE 3-11-2011; IN COMMERCE 3-11-2011.

FOR: PROVIDING A WEBSITE FEATURING INFORMATION AND CONTENT IN THE FIELD OF DRIVER EDUCATION; EDUCATIONAL SERVICES, NAMELY, PROVIDING LIVE AND ON-LINE CLASSES, SEMINARS, WORKSHOPS, AND CONFERENCES IN THE FIELDS OF DRIVING, DRIVER EDUCATION, PUBLIC SAFETY AND HIGHWAY SAFETY, IN CLASS 41 (U.S. CLS. 100, 101 AND 107).

FIRST USE 3-11-2011; IN COMMERCE 3-11-2011.

THE MARK CONSISTS OF THE IMAGE OF TWO HANDS HOLDING A CIRCULAR OBJECT WITH THE CIRCULAR OBJECT SURROUNDING THE IMAGE OF A ROADWAY.

SN 85-340,448, FILED 6-7-2011.

WILLIAM BRECKENFELD, EXAMINING ATTORNEY



*David J. Kybas*

Director of the United States Patent and Trademark Office

# United States of America

United States Patent and Trademark Office

# SecureNet-RT

**Reg. No. 4,199,698**

**Registered Aug. 28, 2012**

**Int. Cl.: 9**

**TRADEMARK**

**PRINCIPAL REGISTER**

CUSTOMIZED ENERGY SOLUTIONS, LTD. (PENNSYLVANIA CORPORATION)  
SUITE 2200  
1528 WALNUT STREET  
PHILADELPHIA, PA 19102

FOR: COMMUNICATIONS COMPUTERS; COMPUTER OPERATING PROGRAMS AND  
COMPUTER OPERATING SYSTEMS, IN CLASS 9 (U.S. CLS. 21, 23, 26, 36 AND 38).

FIRST USE 12-1-2010; IN COMMERCE 3-1-2011.

THE MARK CONSISTS OF STANDARD CHARACTERS WITHOUT CLAIM TO ANY PAR-  
TICULAR FONT, STYLE, SIZE, OR COLOR.

SN 85-340,727, FILED 6-8-2011.

LEIGH CAROLINE CASE, EXAMINING ATTORNEY



*David J. Kybas*

Director of the United States Patent and Trademark Office

# United States of America

United States Patent and Trademark Office

# pour-tech

**Reg. No. 4,199,699**

**Registered Aug. 28, 2012**

**Int. Cls.: 9, 37, and 42**

VIKING TECHNOLOGIES INC (MICHIGAN CORPORATION), DBA VIKING TECHNOLOGIES,  
25169 DEQUINDRE  
MADISON HEIGHTS, MI 48071

FOR: LASER MEASURING SYSTEMS, IN CLASS 9 (U.S. CLS. 21, 23, 26, 36 AND 38).

**TRADEMARK**

FIRST USE 1-20-2012; IN COMMERCE 1-20-2012.

**SERVICE MARK**

FOR: INSTALLATION OF FOUNDRY PRODUCTS, IN CLASS 37 (U.S. CLS. 100, 103 AND 106).

**PRINCIPAL REGISTER**

FIRST USE 1-20-2012; IN COMMERCE 1-20-2012.

FOR: COMPUTER SOFTWARE DESIGN, COMPUTER PROGRAMMING, OR MAINTENANCE OF COMPUTER SOFTWARE, IN CLASS 42 (U.S. CLS. 100 AND 101).

FIRST USE 1-20-2012; IN COMMERCE 1-20-2012.

THE MARK CONSISTS OF STANDARD CHARACTERS WITHOUT CLAIM TO ANY PARTICULAR FONT, STYLE, SIZE, OR COLOR.

SN 85-341,067, FILED 6-8-2011.

THEODORE MCBRIDE, EXAMINING ATTORNEY



*David J. Kybas*

Director of the United States Patent and Trademark Office

# United States of America

United States Patent and Trademark Office

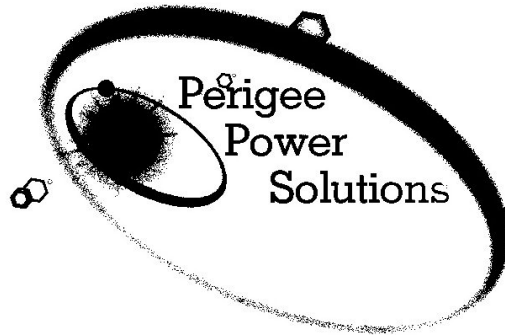

**Reg. No. 4,199,700**

PERIGEE POWER SOLUTIONS LLC (MARYLAND LIMITED LIABILITY COMPANY)  
4622 WAR PATH DR.  
HAMPSTEAD, MD 21074

**Registered Aug. 28, 2012**

**Int. Cl.: 7**

FOR: PORTABLE ELECTRIC POWER GENERATORS, IN CLASS 7 (U.S. CLS. 13, 19, 21, 23, 31, 34 AND 35).

**TRADEMARK**

FIRST USE 9-30-2010; IN COMMERCE 1-1-2011.

**PRINCIPAL REGISTER**

NO CLAIM IS MADE TO THE EXCLUSIVE RIGHT TO USE "POWER SOLUTIONS", APART FROM THE MARK AS SHOWN.

THE STIPPLING IS FOR SHADING PURPOSES ONLY.

THE MARK CONSISTS OF THE WORDING "PERIGEE POWER SOLUTIONS" NEXT TO A STYLIZED PLANET AND SUN WITH RINGS AROUND IT, ALL INSIDE OF A CIRCULAR BAND. THE GEOMETRICAL SHAPES OUTSIDE OF THE BAND, ABOVE THE RING AND ABOVE THE LETTER "E" IN "PERIGEE" ARE ALL STYLIZED LENS FLARES THAT ARE TYPICAL OF LOOKING AT A BRIGHT LIGHT SOURCE.

SN 85-341,177, FILED 6-8-2011.

WENDY GOODMAN, EXAMINING ATTORNEY



*David J. Kyjars*

Director of the United States Patent and Trademark Office

# United States of America

United States Patent and Trademark Office

## ZOMBIE SPEAK

**Reg. No. 4,199,701**

**Registered Aug. 28, 2012**

**Int. Cl.: 9**

**TRADEMARK**

**PRINCIPAL REGISTER**

MATTEL, INC. (DELAWARE CORPORATION)  
M1-1518  
333 CONTINENTAL BOULEVARD  
EL SEGUNDO, CA 90254

FOR: GAME APPLICATION SOFTWARE FOR MOBILE DEVICES AND TABLETS, IN CLASS 9 (U.S. CLS. 21, 23, 26, 36 AND 38).

FIRST USE 2-15-2012; IN COMMERCE 2-15-2012.

THE MARK CONSISTS OF STANDARD CHARACTERS WITHOUT CLAIM TO ANY PARTICULAR FONT, STYLE, SIZE, OR COLOR.

SN 85-341,409, FILED 6-8-2011.

LESLIE RICHARDS, EXAMINING ATTORNEY



*David J. Kybas*

Director of the United States Patent and Trademark Office

# United States of America

United States Patent and Trademark Office



**Reg. No. 4,199,702**

**Registered Aug. 28, 2012**

**Int. Cl.: 43**

**SERVICE MARK**

**PRINCIPAL REGISTER**

VIVA TACO, LLC (TEXAS LIMITED LIABILITY COMPANY)  
105 YMCA DRIVE  
WAXAHACHIE, TX 75251

FOR: RESTAURANT SERVICES, IN CLASS 43 (U.S. CLS. 100 AND 101).

FIRST USE 4-0-2012; IN COMMERCE 4-0-2012.

THE MARK CONSISTS OF A DESIGN ELEMENT REPRESENTING A SMILEY FACE THAT CONSISTS OF A SOLID CIRCLE BACKGROUND WITH THE WORDS "GO LOCO" IN STYLIZED FONT PLACED IN THE TOP HALF OF THE CIRCLE AND A SMILING MOUTH WITH A TONGUE EXTENDED UPWARD PLACED IN THE BOTTOM HALF OF THE CIRCLE.

SN 85-341,465, FILED 6-8-2011.

INGRID C. EULIN, EXAMINING ATTORNEY



*David J. Kyffers*

Director of the United States Patent and Trademark Office

# United States of America

United States Patent and Trademark Office



**Reg. No. 4,199,703**

BIG IDEA HOLDINGS, LLC (DELAWARE LIMITED LIABILITY COMPANY)  
900 WORK STREET  
SALINAS, CA 93901

**Registered Aug. 28, 2012**

**Int. Cl.: 31**

FOR: FRESH VEGETABLES, IN CLASS 31 (U.S. CLS. 1 AND 46).

**TRADEMARK**

FIRST USE 6-30-2011; IN COMMERCE 6-30-2011.

**PRINCIPAL REGISTER**

NO CLAIM IS MADE TO THE EXCLUSIVE RIGHT TO USE "GREENS", APART FROM THE MARK AS SHOWN.

THE COLOR(S) RED, GREEN AND ORANGE IS/ARE CLAIMED AS A FEATURE OF THE MARK.

THE MARK CONSISTS OF THE WORDING "GREAT GREENS!" IN STYLIZED LETTERING. THE WORD "GREAT" APPEARS IN RED. THE WORDING "GREENS!" APPEARS IN GREEN. THE WORD "GREAT" APPEARS INSIDE OF AN ORANGE COMIC BLAST DESIGN FORMED BY A RECTANGULAR SHAPE HAVING JAGGED EDGES.

SN 85-341,933, FILED 6-9-2011.

KRISTINA MORRIS, EXAMINING ATTORNEY



*David J. Kyffers*

Director of the United States Patent and Trademark Office

# United States of America

United States Patent and Trademark Office

## K & M'S BLUE MOON PIZZA

**Reg. No. 4,199,704**

EXPANSION MANAGEMENT GROUP, LLC (DELAWARE LIMITED LIABILITY COMPANY)  
SUITE 284  
4514 CHAMBLEE DUNWOODY ROAD  
ATLANTA, GA 30338

**Registered Aug. 28, 2012**

**Int. Cl.: 43**

FOR: RESTAURANT AND BAR SERVICES, IN CLASS 43 (U.S. CLS. 100 AND 101).

**SERVICE MARK**

FIRST USE 6-22-2012; IN COMMERCE 6-22-2012.

**PRINCIPAL REGISTER**

THE MARK CONSISTS OF STANDARD CHARACTERS WITHOUT CLAIM TO ANY PARTICULAR FONT, STYLE, SIZE, OR COLOR.

NO CLAIM IS MADE TO THE EXCLUSIVE RIGHT TO USE "PIZZA", APART FROM THE MARK AS SHOWN.

SN 85-342,131, FILED 6-9-2011.

KELLY TRUSILO, EXAMINING ATTORNEY



*David J. Kybas*

Director of the United States Patent and Trademark Office



# United States of America

United States Patent and Trademark Office



**Reg. No. 4,199,705**

CSXT INTELLECTUAL PROPERTIES CORPORATION (DELAWARE CORPORATION)  
500 WATER STREET, J150  
JACKSONVILLE, FL 32202

**Registered Aug. 28, 2012**

**Int. Cl.: 35**

FOR: BUSINESS CONSULTING SERVICES IN THE FIELD OF INDUSTRIAL SITE SELECTION, IN CLASS 35 (U.S. CLS. 100, 101 AND 102).

**SERVICE MARK**

FIRST USE 12-30-2011; IN COMMERCE 12-30-2011.

**PRINCIPAL REGISTER**

OWNER OF U.S. REG. NOS. 2,475,447, 2,543,728, AND 3,712,055.

NO CLAIM IS MADE TO THE EXCLUSIVE RIGHT TO USE "SELECT SITE", APART FROM THE MARK AS SHOWN.

THE MARK CONSISTS OF THE WORD "CSX" WITH A RAILROAD TRACK TO THE RIGHT OF THE WORD THEN THE WORDS "SELECT SITE" UNDERNEATH.

SN 85-342,773, FILED 6-9-2011.

EMILY CARLSEN, EXAMINING ATTORNEY



*David J. Kybas*

Director of the United States Patent and Trademark Office

**United States of America**  
United States Patent and Trademark Office

# AquaPLEX

**Reg. No. 4,199,706**

PVI INDUSTRIES, LLC (TEXAS LIMITED LIABILITY COMPANY)  
P.O. BOX 7124

**Registered Aug. 28, 2012**

FORT WORTH, TX 761110124

**Int. Cl.: 11**

FOR: WATER HEATERS, BOILERS AND HOT WATER TANKS, IN CLASS 11 (U.S. CLS. 13, 21, 23, 31 AND 34).

**TRADEMARK**

FIRST USE 5-26-2011; IN COMMERCE 5-26-2011.

**PRINCIPAL REGISTER**

THE MARK CONSISTS OF STANDARD CHARACTERS WITHOUT CLAIM TO ANY PARTICULAR FONT, STYLE, SIZE, OR COLOR.

SN 85-343,159, FILED 6-10-2011.

ZACHARY BELLO, EXAMINING ATTORNEY



*David J. Kyffers*

Director of the United States Patent and Trademark Office

# United States of America

United States Patent and Trademark Office



**Reg. No. 4,199,707**

BIG IDEA HOLDINGS, LLC (DELAWARE LIMITED LIABILITY COMPANY)  
900 WORK STREET  
SALINAS, CA 93901

**Registered Aug. 28, 2012**

**Int. Cl.: 29**

FOR: PACKAGED PROCESSED FRESH VEGETABLES, IN CLASS 29 (U.S. CL. 46).

**TRADEMARK**

FIRST USE 6-30-2011; IN COMMERCE 6-30-2011.

**PRINCIPAL REGISTER**

NO CLAIM IS MADE TO THE EXCLUSIVE RIGHT TO USE "GREENS", APART FROM THE MARK AS SHOWN.

THE COLOR(S) RED, GREEN AND ORANGE IS/ARE CLAIMED AS A FEATURE OF THE MARK.

THE MARK CONSISTS OF THE WORDING "GREAT GREENS!" IN STYLIZED LETTERING. THE WORD "GREAT" APPEARS IN RED. THE WORDING "GREENS!" APPEARS IN GREEN. THE WORD "GREAT" APPEARS INSIDE OF AN ORANGE COMIC BLAST DESIGN FORMED BY A RECTANGULAR SHAPE HAVING JAGGED EDGES.

SN 85-343,564, FILED 6-10-2011.

KRISTINA MORRIS, EXAMINING ATTORNEY



*David J. Kyffers*

Director of the United States Patent and Trademark Office

# United States of America

United States Patent and Trademark Office

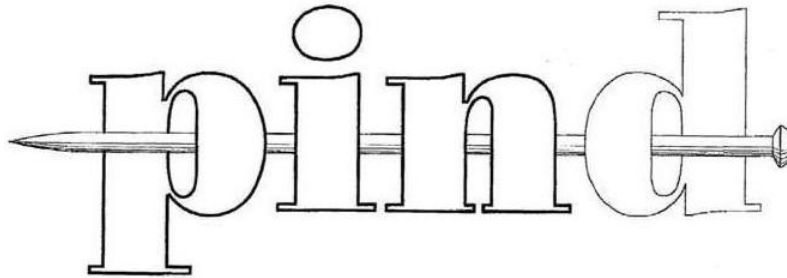

**Reg. No. 4,199,708**

ROBERTO GARCIA (UNITED STATES INDIVIDUAL)  
268 WINDSOR WAY  
VALLEJO, CA 94591

**Registered Aug. 28, 2012**

**Int. Cl.: 20**

FOR: QUILTING FRAME, IN CLASS 20 (U.S. CLS. 2, 13, 22, 25, 32 AND 50).

**TRADEMARK**

FIRST USE 3-17-2012; IN COMMERCE 3-17-2012.

**PRINCIPAL REGISTER**

THE MARK CONSISTS OF THE TERM "PIND"; RUNNING HORIZONTALLY THROUGH THE CENTER OF THE TERM "PIND" IS A DESIGN OF A PIN.

SN 85-343,707, FILED 6-10-2011.

DAVID HOFFMAN, EXAMINING ATTORNEY



*David J. Kyffers*

Director of the United States Patent and Trademark Office

# United States of America

United States Patent and Trademark Office

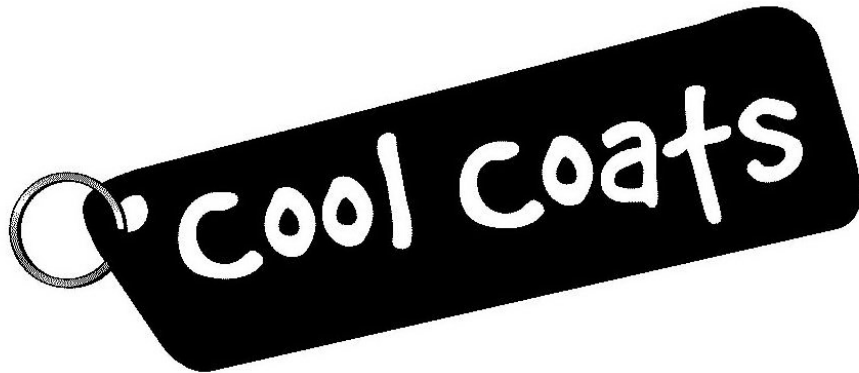

**Reg. No. 4,199,709**

**Registered Aug. 28, 2012**

**Int. Cl.: 18**

**TRADEMARK**

**PRINCIPAL REGISTER**

WILSON, VALERIE (CANADA INDIVIDUAL)  
2920 MAJOR MACKENZIE DRIVE EAST, #7005  
MARKHAM ON, CANADA L6C0G0

FOR: DOG COATS, IN CLASS 18 (U.S. CLS. 1, 2, 3, 22 AND 41).

FIRST USE 6-12-2011; IN COMMERCE 6-12-2011.

NO CLAIM IS MADE TO THE EXCLUSIVE RIGHT TO USE "COATS", APART FROM THE MARK AS SHOWN.

THE MARK CONSISTS OF THE STYLIZED WORDS "COOL COATS" IN THE CENTER OF A RECTANGULAR DOG TAG.

SN 85-344,005, FILED 6-12-2011.

JULIE GUTTADAURO, EXAMINING ATTORNEY



*David J. Kyffers*

Director of the United States Patent and Trademark Office

# United States of America

United States Patent and Trademark Office

## ROCK + RECOVERY

**Reg. No. 4,199,710**

**Registered Aug. 28, 2012**

**Int. Cl.: 41**

**SERVICE MARK**

**PRINCIPAL REGISTER**

AKRON BOARD OF EDUCATION (OHIO STATE AGENCY)  
ADMINISTRATION BUILDING  
70 NORTH BROADWAY  
AKRON, OH 44308

FOR: EDUCATIONAL AND ENTERTAINMENT SERVICES, NAMELY, PROVIDING AN ONGOING RADIO PROGRAM FEATURING MUSIC AND TOPICS RELATED TO RECOVERY FROM ADDICTION AND SUBSTANCE ABUSE, DELIVERED VIA RADIO AND THE INTERNET, IN CLASS 41 (U.S. CLS. 100, 101 AND 107).

FIRST USE 9-15-2011; IN COMMERCE 9-15-2011.

THE MARK CONSISTS OF STANDARD CHARACTERS WITHOUT CLAIM TO ANY PARTICULAR FONT, STYLE, SIZE, OR COLOR.

NO CLAIM IS MADE TO THE EXCLUSIVE RIGHT TO USE "RECOVERY", APART FROM THE MARK AS SHOWN.

SN 85-344,122, FILED 6-12-2011.

DOMINICK J. SALEMI, EXAMINING ATTORNEY



*David J. Kyffers*

Director of the United States Patent and Trademark Office

# United States of America

United States Patent and Trademark Office



**Reg. No. 4,199,711**

**Registered Aug. 28, 2012**

**Int. Cl.: 41**

**SERVICE MARK**

**PRINCIPAL REGISTER**

AKRON BOARD OF EDUCATION (OHIO STATE AGENCY)  
ADMINISTRATION BUILDING  
70 NORTH BROADWAY  
AKRON, OH 44308

FOR: EDUCATIONAL AND ENTERTAINMENT SERVICES, NAMELY, PROVIDING AN ONGOING RADIO PROGRAM FEATURING MUSIC AND TOPICS RELATED TO RECOVERY FROM ADDICTION AND SUBSTANCE ABUSE, DELIVERED VIA RADIO AND THE INTERNET, IN CLASS 41 (U.S. CLS. 100, 101 AND 107).

FIRST USE 9-15-2011; IN COMMERCE 9-15-2011.

NO CLAIM IS MADE TO THE EXCLUSIVE RIGHT TO USE "RECOVERY", ".COM", AND "EST. 2011", APART FROM THE MARK AS SHOWN.

THE MARK CONSISTS OF THE WORD "ROCK" IN CAPITALIZED BLOCK TEXT, FOLLOWED BY A GUITAR PICK SHAPE WITH A "+" ON IT, FOLLOWED BY THE MUCH SMALLER TEXT "EST.2011"; BELOW ALL OF THE FOREGOING IS THE WORD "RECOVERY" IN CAPITALIZED BLOCK LETTERS, AND BELOW THE "RY" IN "RECOVERY" IS THE MUCH SMALLER TEXT ".COM"; ALL OF THE FOREGOING TEXT AND DESIGNS HAVE A DISTRESSED EFFECT THAT MAKES THEM APPEAR WORN.

SN 85-344,136, FILED 6-12-2011.

DOMINICK J. SALEMI, EXAMINING ATTORNEY



*David J. Kyros*

Director of the United States Patent and Trademark Office

# United States of America

United States Patent and Trademark Office



**Reg. No. 4,199,712**

ENGLANDER SLEEP PRODUCTS, L.L.C. (DELAWARE LIMITED LIABILITY COMPANY)  
8300 INDUSTRIAL DRIVE  
OLIVE BRANCH, MS 38654

**Registered Aug. 28, 2012**

**Int. Cl.: 20**

FOR: MATTRESSES, FOUNDATIONS AND PILLOWS, IN CLASS 20 (U.S. CLS. 2, 13, 22, 25, 32 AND 50).

**TRADEMARK**

FIRST USE 6-29-2011; IN COMMERCE 6-29-2011.

**PRINCIPAL REGISTER**

THE MARK CONSISTS OF THE CAPITAL LETTER "E" IN BLUE SURROUNDED BY A SILVER CIRCLE, WITH THE LETTERS "GEL" IN BLACK TO THE RIGHT OF THE "E".

THE COLOR(S) BLUE, SILVER AND BLACK IS/ARE CLAIMED AS A FEATURE OF THE MARK.

SN 85-344,249, FILED 6-13-2011.

ANN E. SAPPENFIELD, EXAMINING ATTORNEY



*David J. Kybas*

Director of the United States Patent and Trademark Office



# United States of America

United States Patent and Trademark Office

## COOLBLUE SLEEP TECHNOLOGY

**Reg. No. 4,199,713**

ENGLANDER SLEEP PRODUCTS, L.L.C. (DELAWARE LIMITED LIABILITY COMPANY)  
8300 INDUSTRIAL DRIVE  
OLIVE BRANCH, MS 38654

**Registered Aug. 28, 2012**

**Int. Cl.: 20**

FOR: MATTRESSES, FOUNDATIONS AND PILLOWS, IN CLASS 20 (U.S. CLS. 2, 13, 22, 25, 32 AND 50).

**TRADEMARK**

FIRST USE 6-29-2011; IN COMMERCE 6-29-2011.

**PRINCIPAL REGISTER**

THE MARK CONSISTS OF STANDARD CHARACTERS WITHOUT CLAIM TO ANY PARTICULAR FONT, STYLE, SIZE, OR COLOR.

NO CLAIM IS MADE TO THE EXCLUSIVE RIGHT TO USE "SLEEP TECHNOLOGY", APART FROM THE MARK AS SHOWN.

SN 85-344,272, FILED 6-13-2011.

ANN E. SAPPENFIELD, EXAMINING ATTORNEY



*David J. Kyffers*

Director of the United States Patent and Trademark Office

# United States of America

United States Patent and Trademark Office



**Reg. No. 4,199,714**

**Registered Aug. 28, 2012**

**Int. Cls.: 30 and 31**

**TRADEMARK**

**PRINCIPAL REGISTER**

MARQUIS ENERGY LLC (ILLINOIS LIMITED LIABILITY COMPANY)  
11953 PRAIRIE INDUSTRIAL PKWY  
HENNEPIN, IL 61327

FOR: PROCESSED GRAINS, IN CLASS 30 (U.S. CL. 46).

FIRST USE 3-31-2011; IN COMMERCE 3-31-2011.

FOR: ANIMAL FEED; UNPROCESSED GRAIN, IN CLASS 31 (U.S. CLS. 1 AND 46).

FIRST USE 3-31-2011; IN COMMERCE 3-31-2011.

NO CLAIM IS MADE TO THE EXCLUSIVE RIGHT TO USE "PREMIUM PROTEIN FEED",  
APART FROM THE MARK AS SHOWN.

THE MARK CONSISTS OF A CIRCULAR BAND WITH THE BOTTOM PORTION OF AN  
INTERIOR SECTION INSIDE THE CIRCULAR BAND HAVING A STYLIZED DEPICTION  
OF FARM LAND. THE UPPER PORTION OF THE INTERIOR SECTION BEING A DEPICTION  
OF THE SKY WITH RADIALLY SPACED STYLIZED RAYS OF SUNLIGHT PROJECTING  
FROM THE CENTER OUTWARD. THE WORDS "MARQUIS GOLD 60 PREMIUM PROTEIN  
FEED" WRITTEN IN STYLIZED FORM INSIDE THE CIRCULAR BAND.

SN 85-345,493, FILED 6-14-2011.

AISHA CLARKE, EXAMINING ATTORNEY



*David J. Kybas*

Director of the United States Patent and Trademark Office

# United States of America

United States Patent and Trademark Office

## AMERICA EATS TAVERN

**Reg. No. 4,199,715**

**Registered Aug. 28, 2012**

**Int. Cl.: 43**

**SERVICE MARK**

**PRINCIPAL REGISTER**

THINKFOODGROUP, LLC (DELAWARE LIMITED LIABILITY COMPANY)  
SUITE 1131 425 8TH STREET, NW  
WASHINGTON, DC 20004

FOR: RESTAURANT SERVICES, IN CLASS 43 (U.S. CLS. 100 AND 101).

FIRST USE 7-1-2011; IN COMMERCE 7-1-2011.

THE MARK CONSISTS OF STANDARD CHARACTERS WITHOUT CLAIM TO ANY PARTICULAR FONT, STYLE, SIZE, OR COLOR.

NO CLAIM IS MADE TO THE EXCLUSIVE RIGHT TO USE "AMERICA" AND "TAVERN", APART FROM THE MARK AS SHOWN.

SN 85-345,539, FILED 6-14-2011.

PAM WILLIS, EXAMINING ATTORNEY



*David J. Kyffers*

Director of the United States Patent and Trademark Office

# United States of America

United States Patent and Trademark Office

## ECO-CHIC CABERNET SAUVIGNON

**Reg. No. 4,199,716**

RAVERTY, KENT (UNITED STATES INDIVIDUAL)  
100 EAST TADDEI ROAD  
ACAMPO, CA 95220 AND

**Registered Aug. 28, 2012**

**Int. Cl.: 33**

RAVERTY, TAMARA (UNITED STATES INDIVIDUAL)  
100 EAST TADDEI ROAD  
ACAMPO, CA 95220

**TRADEMARK**

**PRINCIPAL REGISTER**

FOR: WINE MADE WITH CABERNET GRAPES, IN CLASS 33 (U.S. CLS. 47 AND 49).

FIRST USE 6-1-2012; IN COMMERCE 6-1-2012.

THE MARK CONSISTS OF STANDARD CHARACTERS WITHOUT CLAIM TO ANY PARTICULAR FONT, STYLE, SIZE, OR COLOR.

NO CLAIM IS MADE TO THE EXCLUSIVE RIGHT TO USE "CABERNET SAUVIGNON", APART FROM THE MARK AS SHOWN.

SN 85-345,556, FILED 6-14-2011.

VERNA BETH RIRIE, EXAMINING ATTORNEY



*David J. Kyffers*

Director of the United States Patent and Trademark Office

# United States of America

United States Patent and Trademark Office

## LOKKI Video Stabilizer

**Reg. No. 4,199,717**

AHLBLAD, STEFAN A (UNITED STATES INDIVIDUAL)  
30 HASTINGS ROAD  
BELMONT, MA 02478

**Registered Aug. 28, 2012**

**Int. Cl.: 9**

FOR: CAMERA HANDLES; CAMERA MOUNTS AND SUPPORTS; CAMERA STABILITY ACCESSORY, NAMELY, A SUPPORT ARM, VEST AND SLED FOR FILM AND VIDEO CAMERAS TO ABSORB SHAKING MOVES WHILE SHOOTING, IN CLASS 9 (U.S. CLS. 21, 23, 26, 36 AND 38).

**TRADEMARK**

**PRINCIPAL REGISTER**

FIRST USE 3-14-2012; IN COMMERCE 3-14-2012.

THE MARK CONSISTS OF STANDARD CHARACTERS WITHOUT CLAIM TO ANY PARTICULAR FONT, STYLE, SIZE, OR COLOR.

NO CLAIM IS MADE TO THE EXCLUSIVE RIGHT TO USE "VIDEO STABILIZER", APART FROM THE MARK AS SHOWN.

SN 85-345,860, FILED 6-14-2011.

JAY FLOWERS, EXAMINING ATTORNEY



*David J. Kyffers*

Director of the United States Patent and Trademark Office

# United States of America

United States Patent and Trademark Office

## SHAPE YOUR RETIREMENT.

**Reg. No. 4,199,718**

**Registered Aug. 28, 2012**

**Int. Cl.: 36**

**SERVICE MARK**

**PRINCIPAL REGISTER**

T. ROWE PRICE GROUP, INC. (MARYLAND CORPORATION)  
100 EAST PRATT STREET  
BALTIMORE, MD 21202

FOR: FINANCIAL ADMINISTRATION OF RETIREMENT PLANS FOR RETIREMENT PLAN PROVIDERS AND RETIREMENT PLAN PARTICIPANTS, IN CLASS 36 (U.S. CLS. 100, 101 AND 102).

FIRST USE 9-0-2011; IN COMMERCE 9-0-2011.

THE MARK CONSISTS OF STANDARD CHARACTERS WITHOUT CLAIM TO ANY PARTICULAR FONT, STYLE, SIZE, OR COLOR.

NO CLAIM IS MADE TO THE EXCLUSIVE RIGHT TO USE "RETIREMENT", APART FROM THE MARK AS SHOWN.

SN 85-346,041, FILED 6-14-2011.

GEOFFREY FOSDICK, EXAMINING ATTORNEY



*David J. Kyros*

Director of the United States Patent and Trademark Office

# United States of America

United States Patent and Trademark Office

## NUTRAGUARD

**Reg. No. 4,199,719**

**Registered Aug. 28, 2012**

**Int. Cl.: 5**

**TRADEMARK**

**PRINCIPAL REGISTER**

PBM PRODUCTS, LLC (DELAWARE LIMITED LIABILITY COMPANY)  
204 NORTH MAIN STREET  
GORDONSVILLE, VA 22942

FOR: INFANT FORMULA, IN CLASS 5 (U.S. CLS. 6, 18, 44, 46, 51 AND 52).

FIRST USE 3-0-2012; IN COMMERCE 3-0-2012.

THE MARK CONSISTS OF STANDARD CHARACTERS WITHOUT CLAIM TO ANY PARTICULAR FONT, STYLE, SIZE, OR COLOR.

SN 85-346,054, FILED 6-14-2011.

SHAILA SETTLES, EXAMINING ATTORNEY



*David J. Kyffers*

Director of the United States Patent and Trademark Office

# United States of America

United States Patent and Trademark Office



**Reg. No. 4,199,720**

**Registered Aug. 28, 2012**

**Int. Cl.: 9**

**TRADEMARK**

**PRINCIPAL REGISTER**

SNAPPAFRAS CORP (DELAWARE CORPORATION)  
26 CART PATH RD  
WESTON, MA 02493

FOR: COMPUTER APPLICATION SOFTWARE FOR MOBILE PHONES, HANDHELD COMPUTERS, NAMELY, SOFTWARE FOR BLOCKING SELECTIVE COMMUNICATION TO THE DEVICE DEPENDING ON THE LOCATION, PROVIDING INFORMATION ON LAWS DEPENDING ON THE LOCATION, BUSINESS RATING DEPENDING ON THE LOCATION, RISK ALERTS OF ANY KIND DEPENDING ON THE LOCATION, IN CLASS 9 (U.S. CLS. 21, 23, 26, 36 AND 38).

FIRST USE 4-27-2012; IN COMMERCE 4-27-2012.

NO CLAIM IS MADE TO THE EXCLUSIVE RIGHT TO USE "APPS", APART FROM THE MARK AS SHOWN.

THE MARK CONSISTS OF THE STYLIZED WORDS "HERE" AND "APPS" WITH AN EXCLAMATION POINT IN BETWEEN THE WORDS. THE EXCLAMATION POINT IS INSIDE A DOWN-POINTING ARROW WITH DISC BENEATH THE ARROW POINT. THE ARROW APPEARS BEHIND THE TEXT.

SN 85-346,946, FILED 6-15-2011.

ARETHA SOMERVILLE, EXAMINING ATTORNEY



*David J. Kybas*

Director of the United States Patent and Trademark Office



# United States of America

United States Patent and Trademark Office

# AudioName

**Reg. No. 4,199,721**

AUDIONAME, INC. (OREGON CORPORATION)  
13098 NW HARTFORD STREET  
PORTLAND, OR 97229

**Registered Aug. 28, 2012**

**Int. Cls.: 38 and 39**

FOR: PLAYBACK SERVICES, NAMELY, TRANSMISSION OF RECORDED SOUND CLIPS VIA A GLOBAL COMPUTER NETWORK OR THE INTERNET FOR AUDIO ANNOTATION OF ELECTRONIC MAIL, AND ONLINE AND MOBILE CONTENT, IN CLASS 38 (U.S. CLS. 100, 101 AND 104).

**SERVICE MARK**

**PRINCIPAL REGISTER**

FIRST USE 6-23-2011; IN COMMERCE 5-29-2012.

FOR: PROVIDING AUDIO RECORDINGS, NAMELY, ELECTRONIC STORAGE OF DIGITAL RECORDED SOUND CLIPS TO BE USED FOR AUDIO ANNOTATION OF ELECTRONIC MAIL AND ONLINE AND MOBILE CONTENT, IN CLASS 39 (U.S. CLS. 100 AND 105).

FIRST USE 6-23-2011; IN COMMERCE 4-16-2012.

THE MARK CONSISTS OF STANDARD CHARACTERS WITHOUT CLAIM TO ANY PARTICULAR FONT, STYLE, SIZE, OR COLOR.

SN 85-347,402, FILED 6-15-2011.

ANDREA K. NADELMAN, EXAMINING ATTORNEY



*David J. Kyros*

Director of the United States Patent and Trademark Office

# United States of America

United States Patent and Trademark Office

www.skinpros.com



**Reg. No. 4,199,722**

CRUZ, ANTONIO (UNITED STATES INDIVIDUAL)  
17 OLNEY AVE #2  
LINCOLN, RI 02865

**Registered Aug. 28, 2012**

**Int. Cl.: 44**

FOR: DERMATOLOGY SERVICES, IN CLASS 44 (U.S. CLS. 100 AND 101).

**SERVICE MARK**

FIRST USE 3-5-2012; IN COMMERCE 3-15-2012.

**PRINCIPAL REGISTER**

NO CLAIM IS MADE TO THE EXCLUSIVE RIGHT TO USE "SKIN" , APART FROM THE MARK AS SHOWN.

THE COLOR(S) BROWN, YELLOW, WHITE IS/ARE CLAIMED AS A FEATURE OF THE MARK.

THE MARK CONSISTS OF THE LITERAL ELEMENTS "WWW.SKINPROS.COM", SKIN PROS, "YOUR SKIN. OUR EXPERTISE" IN BROWN COLOR EXCEPT THE WORD SKIN WHICH IS IN WHITE COLOR WHEREIN THE LETTERS OF THE WORD "SKIN" ARE WRITTEN IN FOUR DIFFERENT SQUARES LIKE "K" IS IN YELLOW SQUARE AND "S", "I" AND "N" ARE IN SQUARES WITH DIFFERENT SHADES OF BROWN COLOR AND THE WORD "PROS" IS WRITTEN BELOW THE WORD "SKIN" IN THE RIGHT CORNER. THE WORDS "YOUR SKIN OUR EXPERTISE" ARE PLACED BESIDE THE WORDS "SKIN PROS" WITH FULL STOP AFTER "SKIN" AND "EXPERTISE". THE WEBSITE "WWW.SKIN-PROS.COM" IS PLACED ABOVE THE WORD "SKIN PROS" AS SHOWN IN THE MARK.

SN 85-347,542, FILED 6-16-2011.

ANN E. SAPPENFIELD, EXAMINING ATTORNEY



*David J. Kyros*

Director of the United States Patent and Trademark Office

# United States of America

United States Patent and Trademark Office

# INVITELY

**Reg. No. 4,199,723**

**Registered Aug. 28, 2012**

**Int. Cl.: 42**

**SERVICE MARK**

**PRINCIPAL REGISTER**

INVITELY INC. (CANADA CORPORATION)  
577 EDGELEY BLVD., SUITE 11  
CONCORD, CANADA L4K4B2

FOR: SOFTWARE AS A SERVICE (SAAS) SERVICES FEATURING SOFTWARE IN THE FIELDS OF PROJECT COLLABORATION, PROJECT MANAGEMENT, DOCUMENT COLLABORATION, DOCUMENT MANAGEMENT AND BID MANAGEMENT, IN CLASS 42 (U.S. CLS. 100 AND 101).

FIRST USE 9-5-2011; IN COMMERCE 9-5-2011.

THE MARK CONSISTS OF STANDARD CHARACTERS WITHOUT CLAIM TO ANY PARTICULAR FONT, STYLE, SIZE, OR COLOR.

SN 85-347,678, FILED 6-16-2011.

ANNE FARRELL, EXAMINING ATTORNEY



*David J. Kybas*

Director of the United States Patent and Trademark Office

# United States of America

United States Patent and Trademark Office

## BLUEBERRY MAINE-IA

**Reg. No. 4,199,724**

LB BRANDS, LLC (MAINE LIMITED LIABILITY COMPANY)  
PO BOX 239  
PORT CLYDE, ME 04855

**Registered Aug. 28, 2012**

**Int. Cl.: 30**

FOR: ICE CREAM, IN CLASS 30 (U.S. CL. 46).

**TRADEMARK**

FIRST USE 7-31-2011; IN COMMERCE 7-31-2011.

**PRINCIPAL REGISTER**

THE MARK CONSISTS OF STANDARD CHARACTERS WITHOUT CLAIM TO ANY PARTICULAR FONT, STYLE, SIZE, OR COLOR.

NO CLAIM IS MADE TO THE EXCLUSIVE RIGHT TO USE "BLUEBERRY", APART FROM THE MARK AS SHOWN.

SN 85-348,707, FILED 6-17-2011.

THOMAS MANOR, EXAMINING ATTORNEY



*David J. Kyfos*

Director of the United States Patent and Trademark Office

# United States of America

United States Patent and Trademark Office

# VI FUEL

**Reg. No. 4,199,725**

VI ENDURANCE, LLC (COLORADO LIMITED LIABILITY COMPANY)  
453 E WONDER VIEW AVE #112  
ESTES PARK, CO 80517

**Registered Aug. 28, 2012**

**Int. Cl.: 5**

FOR: NUTRITIONAL SUPPLEMENTS; ORALLY INGESTED GEL FOR BOOSTING ENERGY,  
IN CLASS 5 (U.S. CLS. 6, 18, 44, 46, 51 AND 52).

**TRADEMARK**

FIRST USE 2-1-2012; IN COMMERCE 2-1-2012.

**PRINCIPAL REGISTER**

THE MARK CONSISTS OF STANDARD CHARACTERS WITHOUT CLAIM TO ANY PARTICULAR FONT, STYLE, SIZE, OR COLOR.

THE WORDING "VI" HAS NO MEANING IN A FOREIGN LANGUAGE.

SN 85-348,878, FILED 6-17-2011.

SHANNON TWOHIG, EXAMINING ATTORNEY



*David J. Kybas*

Director of the United States Patent and Trademark Office

# United States of America

United States Patent and Trademark Office

## VI ENDURANCE

**Reg. No. 4,199,726**

VI ENDURANCE, LLC (COLORADO LIMITED LIABILITY COMPANY)  
453 E WONDER VIEW AVE #112  
ESTES PARK, CO 80517

**Registered Aug. 28, 2012**

**Int. Cl.: 5**

FOR: NUTRITIONAL SUPPLEMENTS, IN CLASS 5 (U.S. CLS. 6, 18, 44, 46, 51 AND 52).

**TRADEMARK**

FIRST USE 2-1-2012; IN COMMERCE 2-1-2012.

**PRINCIPAL REGISTER**

THE MARK CONSISTS OF STANDARD CHARACTERS WITHOUT CLAIM TO ANY PARTICULAR FONT, STYLE, SIZE, OR COLOR.

NO CLAIM IS MADE TO THE EXCLUSIVE RIGHT TO USE "ENDURANCE", APART FROM THE MARK AS SHOWN.

THE WORDING "VI" HAS NO MEANING IN A FOREIGN LANGUAGE.

SN 85-348,914, FILED 6-17-2011.

SHANNON TWOHIG, EXAMINING ATTORNEY



*David J. Kyros*

Director of the United States Patent and Trademark Office

# United States of America

United States Patent and Trademark Office



**Reg. No. 4,199,727**

**Registered Aug. 28, 2012**

**Int. Cl.: 38**

SOKOOS INTERNATIONAL INFORMATION CO., LTD (TAIWAN LIMITED LIABILITY COMPANY)  
4TH FLOOR, NO. 60, SEC. 1  
XINSHENG S. ROAD  
TAIPEI, TAIWAN

**SERVICE MARK**

**PRINCIPAL REGISTER**

FOR: PROVIDING ACCESS TO COMPUTER DATABASES IN THE FIELDS OF SOCIAL NETWORKING, SOCIAL INTRODUCTION AND DATING; PEER-TO-PEER PHOTO SHARING SERVICES, NAMELY, ELECTRONIC TRANSMISSION OF DIGITAL PHOTO FILES AMONG INTERNET USERS; PROVIDING ACCESS TO COMPUTER, ELECTRONIC AND ONLINE DATABASES; TELECOMMUNICATIONS SERVICES, NAMELY, ELECTRONIC TRANSMISSION OF DATA, MESSAGES AND INFORMATION; PROVIDING ONLINE FORUMS FOR COMMUNICATION ON TOPICS OF GENERAL INTEREST; PROVIDING ONLINE COMMUNICATIONS LINKS WHICH TRANSFER WEB SITE USERS TO OTHER LOCAL AND GLOBAL WEB PAGES; PROVIDING ACCESS TO WEB SITES FOR OTHERS HOSTED ON COMPUTER SERVERS ACCESSIBLE VIA A GLOBAL COMPUTER NETWORK; PROVIDING ACCESS TO THIRD PARTY WEB SITES BY ENABLING USERS TO LOG IN THROUGH A UNIVERSAL USERNAME AND PASSWORD VIA A GLOBAL COMPUTER NETWORK AND OTHER COMMUNICATION NETWORKS; PROVIDING ONLINE CHAT ROOMS AND ELECTRONIC BULLETIN BOARDS FOR TRANSMISSION OF MESSAGES AMONG USERS IN THE FIELD OF GENERAL INTEREST; AUDIO, TEXT AND VIDEO BROADCASTING SERVICES OVER COMPUTER OR OTHER COMMUNICATION NETWORKS, NAMELY, UPLOADING, POSTING, DISPLAYING, TAGGING, AND ELECTRONICALLY TRANSMITTING DATA, INFORMATION, AUDIO AND VIDEO IMAGES; DELIVERY OF DIGITAL MUSIC BY ELECTRONIC TRANSMISSION, IN CLASS 38 (U.S. CLS. 100, 101 AND 104).



FIRST USE 10-3-2011; IN COMMERCE 5-1-2012.

THE MARK CONSISTS OF A LARGE CIRCLE THAT IS FLANKED BY A SMALLER CIRCLE BOTH ON ITS LEFT AND RIGHT SIDE. AN "S" APPEARS TO THE LEFT OF THE OUTER LEFT CIRCLE. AN ADDITIONAL "S" APPEARS TO THE RIGHT OF THE OUTER RIGHT CIRCLE. A LETTER "K" IS SUPERIMPOSED OVER THE CENTER "O". THESE LETTERS ARE ALL PRESENTED IN STYLIZED FONT AND FORM THE TERM "SOKOOS".

*David J. Kyros*

SN 85-349,123, FILED 6-17-2011.

GRETCHEN ULRICH, EXAMINING ATTORNEY

# United States of America

United States Patent and Trademark Office



**Reg. No. 4,199,728**

**Registered Aug. 28, 2012**

**Int. Cl.: 42**

SOKOOS INTERNATIONAL INFORMATION CO., LTD (TAIWAN LIMITED LIABILITY COMPANY)  
4TH FLOOR, NO. 60, SEC. 1  
XINSHENG S. ROAD  
TAIPEI, TAIWAN

**SERVICE MARK**

**PRINCIPAL REGISTER**

FOR: COMPUTER SERVICES, NAMELY, CREATING ON-LINE VIRTUAL COMMUNITIES FOR REGISTERED USERS TO ORGANIZE GROUPS AND EVENTS, PARTICIPATE IN DISCUSSIONS, AND ENGAGE IN SOCIAL, BUSINESS AND COMMUNITY NETWORKING; COMPUTER SERVICES, NAMELY, HOSTING ELECTRONIC FACILITIES FOR OTHERS FOR ORGANIZING AND CONDUCTING MEETINGS, EVENTS AND INTERACTIVE DISCUSSIONS VIA COMMUNICATION NETWORKS; APPLICATION SERVICE PROVIDER (ASP) SERVICES, NAMELY, HOSTING COMPUTER SOFTWARE APPLICATIONS OF OTHERS; APPLICATION SERVICE PROVIDER (ASP) FEATURING SOFTWARE TO ENABLE OR FACILITATE THE UPLOADING, DOWNLOADING, STREAMING, POSTING, DISPLAYING, BLOGGING, LINKING, SHARING OR OTHERWISE PROVIDING ELECTRONIC MEDIA OR INFORMATION OVER COMMUNICATION NETWORKS; PROVIDING AN ONLINE NETWORK SERVICE THAT ENABLES USERS TO TRANSFER PERSONAL IDENTITY DATA TO AND SHARE PERSONAL IDENTITY DATA WITH AND AMONG MULTIPLE WEBSITES; PROVIDING A WEB SITE FEATURING TECHNOLOGY THAT ENABLES ONLINE USERS TO CREATE PERSONAL PROFILES FEATURING SOCIAL NETWORKING INFORMATION AND TO TRANSFER AND SHARE SUCH INFORMATION AMONG MULTIPLE WEBSITES; COMPUTER SERVICES, NAMELY, CREATING INDEXES OF INFORMATION, SITES AND OTHER RESOURCES AVAILABLE ON COMPUTER NETWORKS; PROVIDING TEMPORARY USE OF NON-DOWNLOADABLE SOFTWARE APPLICATIONS FOR SOCIAL NETWORKING, CREATING A VIRTUAL COMMUNITY, AND TRANSMISSION OF AUDIO, VIDEO, PHOTOGRAPHIC IMAGES, TEXT, GRAPHICS AND DATA; COMPUTER SERVICES IN THE NATURE OF CUSTOMIZED WEB PAGES FEATURING USER-DEFINED OR SPECIFIED INFORMATION, PERSONAL PROFILES, AUDIO, VIDEO, PHOTOGRAPHIC IMAGES, TEXT, GRAPHICS AND DATA; PEER-TO-BROWSER PHOTO SHARING SERVICES, NAMELY, PROVIDING A WEBSITE FEATURING TECHNOLOGY ENABLING USERS TO UPLOAD, VIEW, AND DOWNLOAD DIGITAL PHOTOS; PROVIDING A WEB SITE FEATURING TECHNOLOGY THAT ENABLES USERS TO UPLOAD AND SHARE VIDEO, PHOTOS, TEXT, GRAPHICS AND DATA; CREATING AND MAINTAINING BLOGS FOR OTHERS; PROVIDING A WEB HOSTING PLATFORM FOR USE OF NON-DOWNLOADABLE SOFTWARE IN CONNECTION WITH INTERACTIVE, MULTIPLAYER AND SINGLE PLAYER GAMES FOR THIRD PARTIES, IN CLASS 42 (U.S. CLS. 100 AND 101).



*David J. Kybas*

Director of the United States Patent and Trademark Office



**Reg. No. 4,199,728** FIRST USE 10-3-2011; IN COMMERCE 5-1-2012.

THE MARK CONSISTS OF A LARGE CIRCLE THAT IS FLANKED BY A SMALLER CIRCLE BOTH ON ITS LEFT AND RIGHT SIDE. AN "S" APPEARS TO THE LEFT OF THE OUTER LEFT CIRCLE. AN ADDITIONAL "S" APPEARS TO THE RIGHT OF THE OUTER RIGHT CIRCLE. A LETTER "K" IS SUPERIMPOSED OVER THE CENTER "O". THESE LETTERS ARE ALL PRESENTED IN STYLIZED FONT AND FORM THE TERM "SOKOOS".

SN 85-349,142, FILED 6-17-2011.

GRETCHEN ULRICH, EXAMINING ATTORNEY

# United States of America

United States Patent and Trademark Office

## KERMAPARTNERS

**Reg. No. 4,199,729**

**Registered Aug. 28, 2012**

**Int. Cls.: 16, 35, 36, and  
41**

KERMAPARTNERS (GLOBAL) LIMITED (UNITED KINGDOM LIMITED LIABILITY COMPANY)

37 CHAMBERLAIN STREET  
ST. LAWRENCE LODGE

WELLS, SOMERSET, UNITED KINGDOM BA52PQ

FOR: PRINTED MATERIALS, NAMELY, PAMPHLETS, BOOKS, NEWSLETTERS, BROCHURES, MAGAZINES, REPORTS, JOURNALS, MANUALS, AND GUIDES IN THE FIELD OF BUSINESS MANAGEMENT, OR BUSINESS MANAGEMENT CONSULTING, IN CLASS 16 (U.S. CLS. 2, 5, 22, 23, 29, 37, 38 AND 50).

**TRADEMARK**

**SERVICE MARK**

**PRINCIPAL REGISTER**

FIRST USE 12-12-2006; IN COMMERCE 12-12-2006.

FOR: BUSINESS MANAGEMENT CONSULTING; BUSINESS CONSULTING SERVICES IN THE FIELD OF EXECUTIVE AND LEADERSHIP DEVELOPMENT, BUSINESS OPERATIONS, MARKETING INITIATIVES, AND FISCAL STRATEGIES; BUSINESS PROCESS MANAGEMENT AND CONSULTING; BUSINESS MARKETING CONSULTING SERVICES; BUSINESS DATA ANALYSIS; BUSINESS APPRAISALS; CONDUCTING BUSINESS AND MARKET RESEARCH SURVEYS; BUSINESS MANAGEMENT PLANNING; BUSINESS MERGER CONSULTATION; BUSINESS SUPERVISION; COMMERCIAL AND INDUSTRIAL MANAGEMENT ASSISTANCE; ECONOMIC FORECASTING AND ANALYSIS; PERSONNEL MANAGEMENT CONSULTATION; PREPARING BUSINESS REPORTS, IN CLASS 35 (U.S. CLS. 100, 101 AND 102).

FIRST USE 12-12-2006; IN COMMERCE 12-12-2006.

FOR: FINANCIAL ANALYSIS AND CONSULTATION IN THE NATURE OF ASSISTING PROFESSIONAL SERVICE COMPANIES WITH FINANCIAL AND STRATEGIC INITIATIVES, NAMELY, FINANCIAL RESTRUCTURING, EXECUTIVE COMPENSATION, FISCAL VALUATION, MERGERS, ACQUISITIONS, ALLIANCES AND JOINT VENTURES, TAKEOVER DEFENSE, FINANCIAL ENGINEERING, ASSET OPTIONS, HEDGING AND RISK MANAGEMENT, IN CLASS 36 (U.S. CLS. 100, 101 AND 102).

FIRST USE 12-12-2006; IN COMMERCE 12-12-2006.



*David J. Kyjars*

Director of the United States Patent and Trademark Office

**Reg. No. 4,199,729** FOR: EDUCATIONAL SERVICES, NAMELY, CONDUCTING COURSES, SEMINARS, WORKSHOPS, AND CLASSES IN THE FIELDS OF BUSINESS MANAGEMENT, AND BUSINESS OPERATIONS AND DISTRIBUTING COURSE MATERIALS IN CONNECTION THEREWITH; DEVELOPING EDUCATIONAL MATERIALS FOR OTHERS IN THE FIELDS OF BUSINESS MANAGEMENT AND BUSINESS OPERATIONS, IN CLASS 41 (U.S. CLS. 100, 101 AND 107).

FIRST USE 12-12-2006; IN COMMERCE 9-21-2011.

THE MARK CONSISTS OF STANDARD CHARACTERS WITHOUT CLAIM TO ANY PARTICULAR FONT, STYLE, SIZE, OR COLOR.

SN 85-349,266, FILED 6-17-2011.

JAY FLOWERS, EXAMINING ATTORNEY

# United States of America

United States Patent and Trademark Office

# Inception

**Reg. No. 4,199,730**

JSR CIGAR DISTRIBUTORS, LLC (TEXAS LIMITED LIABILITY COMPANY)  
2803 BUSINESS CENTER DR STE 137  
PEARLAND, TX 77584

**Registered Aug. 28, 2012**

**Int. Cl.: 34**

FOR: TOBACCO; TOBACCO, CIGARS AND CIGARETTES, IN CLASS 34 (U.S. CLS. 2, 8, 9 AND 17).

**TRADEMARK**

FIRST USE 5-4-2012; IN COMMERCE 5-4-2012.

**PRINCIPAL REGISTER**

THE MARK CONSISTS OF STANDARD CHARACTERS WITHOUT CLAIM TO ANY PARTICULAR FONT, STYLE, SIZE, OR COLOR.

SN 85-349,461, FILED 6-17-2011.

THEODORE MCBRIDE, EXAMINING ATTORNEY



*David J. Kybas*

Director of the United States Patent and Trademark Office

# United States of America

United States Patent and Trademark Office

## GRIP THAT NEVER SLIPS

**Reg. No. 4,199,731**

BIG TIME HOLDINGS, INC (GEORGIA CORPORATION)  
2 WILBANKS ROAD  
ROME, GA 30161

**Registered Aug. 28, 2012**

**Int. Cls.: 9, 21, and 25**

FOR: PROTECTIVE WORK GLOVES FOR INDUSTRIAL USE, IN CLASS 9 (U.S. CLS. 21, 23, 26, 36 AND 38).

**TRADEMARK**

FIRST USE 3-0-2011; IN COMMERCE 3-0-2011.

**PRINCIPAL REGISTER**

FOR: DISPOSABLE LATEX GLOVES FOR GENERAL USE; HOUSEHOLD GLOVES FOR GENERAL USE; GARDENING GLOVES, IN CLASS 21 (U.S. CLS. 2, 13, 23, 29, 30, 33, 40 AND 50).

FIRST USE 3-0-2011; IN COMMERCE 3-0-2011.

FOR: GLOVES, IN CLASS 25 (U.S. CLS. 22 AND 39).

FIRST USE 3-0-2011; IN COMMERCE 3-0-2011.

THE MARK CONSISTS OF STANDARD CHARACTERS WITHOUT CLAIM TO ANY PARTICULAR FONT, STYLE, SIZE, OR COLOR.

SN 85-349,648, FILED 6-17-2011.

STEPHANIE ALI, EXAMINING ATTORNEY



*David J. Kybas*

Director of the United States Patent and Trademark Office

# United States of America

United States Patent and Trademark Office

# snirkles

**Reg. No. 4,199,732**

**Registered Aug. 28, 2012**

**Int. Cl.: 30**

**TRADEMARK**

**PRINCIPAL REGISTER**

OSMANIUM, LLC (WISCONSIN LIMITED LIABILITY COMPANY)  
P.O. BOX 511485  
MILWAUKEE, WI 53203

FOR: CANDY, IN CLASS 30 (U.S. CL. 46).

FIRST USE 5-14-2012; IN COMMERCE 5-14-2012.

THE MARK CONSISTS OF STANDARD CHARACTERS WITHOUT CLAIM TO ANY PARTICULAR FONT, STYLE, SIZE, OR COLOR.

SN 85-349,779, FILED 6-17-2011.

JOHN SCHUYLER YARD, EXAMINING ATTORNEY



*David J. Kyros*

Director of the United States Patent and Trademark Office

# United States of America

United States Patent and Trademark Office

# NETGRAPPLER

**Reg. No. 4,199,733**

NEWMAN, KENNETH (UNITED STATES INDIVIDUAL)  
2 GOLD STREET, APT. 3506  
NEW YORK, NY 10038

**Registered Aug. 28, 2012**

**Int. Cl.: 9**

FOR: COMPUTER HARDWARE AND SOFTWARE FOR SETTING UP AND CONFIGURING LOCAL AREA NETWORKS; COMPUTER HARDWARE AND SOFTWARE FOR SETTING UP AND CONFIGURING WIDE AREA NETWORKS; COMPUTER NETWORK INTERFACE DEVICES; COMPUTER NETWORK SERVER; COMPUTER NETWORKING HARDWARE; COMPUTER PROGRAMS FOR CONNECTING REMOTELY TO COMPUTERS OR COMPUTER NETWORKS; COMPUTER PROGRAMS FOR SEARCHING REMOTELY FOR CONTENT ON COMPUTERS AND COMPUTER NETWORKS; COMPUTER PROGRAMS FOR SEARCHING THE CONTENTS OF COMPUTERS AND COMPUTER NETWORKS BY REMOTE CONTROL; COMPUTER SOFTWARE AND HARDWARE FOR USE IN NETWORK MANAGEMENT; COMPUTER SOFTWARE FOR ADMINISTRATION OF COMPUTER LOCAL AREA NETWORKS; COMPUTER SOFTWARE FOR ADMINISTRATION OF COMPUTER NETWORKS; COMPUTERS FOR NETWORK MANAGEMENT; ELECTRONIC TEST AND MEASUREMENT DEVICES FOR USE IN THE FIELDS OF NETWORKS AND TELECOMMUNICATIONS, NAMELY, INSTRUMENTATION USED TO TEST AND CERTIFY NEW AND EXISTING DATA AND VOICE COMMUNICATION CABLE AND COAXIAL CABLE; LAN (LOCAL AREA NETWORK) HARDWARE; LAN (LOCAL AREA NETWORK) OPERATING SOFTWARE; NETWORK ACCESS SERVER HARDWARE; NETWORK ACCESS SERVER OPERATING SOFTWARE; NETWORK SERVERS; WAN (WIDE AREA NETWORK) HARDWARE; WAN (WIDE AREA NETWORK) OPERATING SOFTWARE, IN CLASS 9 (U.S. CLS. 21, 23, 26, 36 AND 38).

**TRADEMARK**

**PRINCIPAL REGISTER**



FIRST USE 7-1-2011; IN COMMERCE 10-1-2011.

THE MARK CONSISTS OF STANDARD CHARACTERS WITHOUT CLAIM TO ANY PARTICULAR FONT, STYLE, SIZE, OR COLOR.

SN 85-349,885, FILED 6-18-2011.

DANNEAN HETZEL, EXAMINING ATTORNEY

*David J. Kyffers*

Director of the United States Patent and Trademark Office

# United States of America

United States Patent and Trademark Office



**Reg. No. 4,199,734**

**Registered Aug. 28, 2012**

**Int. Cl.: 5**

**TRADEMARK**

**PRINCIPAL REGISTER**

HEADGRIN PRODUCTS (ILLINOIS LIMITED LIABILITY COMPANY)  
604 N. SECOND STREET  
LIBERTYVILLE, IL 60048

FOR: PHARMACEUTICAL PREPARATIONS, NAMELY, NEOPRENE BANDS THAT WRAPS AROUND THE HEAD TO REDUCE FEVERS AND MIGRAINES, IN CLASS 5 (U.S. CLS. 6, 18, 44, 46, 51 AND 52).

FIRST USE 5-2-2012; IN COMMERCE 5-2-2012.

NO CLAIM IS MADE TO THE EXCLUSIVE RIGHT TO USE "HEAD", APART FROM THE MARK AS SHOWN.

THE COLOR(S) GREEN, PURPLE, BLUE AND ORANGE IS/ARE CLAIMED AS A FEATURE OF THE MARK.

THE MARK CONSISTS OF THE WORD "HEADGRIN" WITH "HEAD" ON THE LEFT OF A STYLIZED SMILEY FACE IMAGE, WITH THE LETTER "H" APPEARING IN THE COLOR GREEN, THE LETTER "E" APPEARING IN THE COLOR PURPLE, THE LETTER "A" APPEARING IN THE COLOR BLUE AND THE LETTER "D" APPEARING IN THE COLOR YELLOW, AND "GRIN" ON THE RIGHT OF THE STYLIZED SMILEY FACE IMAGE WITH THE LETTER "G" APPEARING IN THE COLOR YELLOW, THE LETTER "R" APPEARING IN THE COLOR BLUE, THE LETTER "I" APPEARING IN THE COLOR PURPLE AND THE LETTER "N" APPEARING IN THE COLOR GREEN.

SN 85-350,067, FILED 6-20-2011.

RONALD AIKENS, EXAMINING ATTORNEY



*David J. Kybas*

Director of the United States Patent and Trademark Office



# United States of America

United States Patent and Trademark Office

## COMPLIANT DEALER

**Reg. No. 4,199,735**

WORLD CLASS DEALER SERVICES INCORPORATED (PENNSYLVANIA CORPORATION)  
328 W. BROAD STREET  
QUAKERTOWN, PA 18951

**Registered Aug. 28, 2012**

**Int. Cls.: 41 and 42**

FOR: EDUCATION SERVICES, NAMELY, PROVIDING ONLINE SEMINARS IN THE FIELD OF REGULATORY COMPLIANCE FOR VEHICLE DEALERSHIPS; PROVIDING ONLINE, NON-DOWNLOADABLE RESOURCE GUIDES FOR VEHICLE DEALERS IN THE FIELD OF REGULATORY COMPLIANCE, IN CLASS 41 (U.S. CLS. 100, 101 AND 107).

**SERVICE MARK**

**PRINCIPAL REGISTER**

FIRST USE 3-29-2010; IN COMMERCE 3-29-2010.

FOR: COMPUTER SERVICES, NAMELY, PROVIDING AN INTERACTIVE WEB SITE FEATURING TECHNOLOGY THAT ALLOWS USERS TO AUDIT AND REPORT ON BUSINESS AND REGULATORY RISKS RELEVANT TO VEHICLE DEALERSHIPS, IN CLASS 42 (U.S. CLS. 100 AND 101).

FIRST USE 3-29-2010; IN COMMERCE 3-29-2010.

THE MARK CONSISTS OF STANDARD CHARACTERS WITHOUT CLAIM TO ANY PARTICULAR FONT, STYLE, SIZE, OR COLOR.

NO CLAIM IS MADE TO THE EXCLUSIVE RIGHT TO USE "DEALER", APART FROM THE MARK AS SHOWN.

SN 85-350,071, FILED 6-20-2011.

KIMBERLY FRYE, EXAMINING ATTORNEY



*David J. Kyffers*

Director of the United States Patent and Trademark Office

United States of America  
United States Patent and Trademark Office

# ONEZIEME

**Reg. No. 4,199,736**

MOUTON, ONEZIEME (UNITED STATES INDIVIDUAL)  
205 STEPHANIE ST.

**Registered Aug. 28, 2012**

LAFAYETTE, LA 70503

**Int. Cl.: 18**

FOR: HANDBAGS; WALLETS; PURSES; LEATHER FOR FURNITURE; LUGGAGE, IN CLASS  
18 (U.S. CLS. 1, 2, 3, 22 AND 41).

**TRADEMARK**

FIRST USE 8-15-2010; IN COMMERCE 8-15-2011.

**PRINCIPAL REGISTER**

THE MARK CONSISTS OF STANDARD CHARACTERS WITHOUT CLAIM TO ANY PAR-  
TICULAR FONT, STYLE, SIZE, OR COLOR.

SN 85-350,456, FILED 6-20-2011.

ADA HAN, EXAMINING ATTORNEY



*David J. Kybas*

Director of the United States Patent and Trademark Office

# United States of America

United States Patent and Trademark Office

## THE HANGING JUDGE

**Reg. No. 4,199,737**

**Registered Aug. 28, 2012**

**Int. Cl.: 6**

**TRADEMARK**

**PRINCIPAL REGISTER**

FOXWORTHY, JEFF (UNITED STATES INDIVIDUAL)  
C/O FOX LAW GROUP  
14724 VENTURA BLVD., PENTHOUSE  
SHERMAN OAKS, CA 914033513

FOR: METAL GAMBRELS, CLAMPS AND HANGERS FOR HANGING DEAD ANIMALS,  
IN CLASS 6 (U.S. CLS. 2, 12, 13, 14, 23, 25 AND 50).

FIRST USE 1-9-2012; IN COMMERCE 1-9-2012.

THE MARK CONSISTS OF STANDARD CHARACTERS WITHOUT CLAIM TO ANY PAR-  
TICULAR FONT, STYLE, SIZE, OR COLOR.

SN 85-350,804, FILED 6-20-2011.

BRENDAN REGAN, EXAMINING ATTORNEY



*David J. Kybas*

Director of the United States Patent and Trademark Office

# United States of America

United States Patent and Trademark Office

## THE HANGING JUDGE

**Reg. No. 4,199,738**

**Registered Aug. 28, 2012**

**Int. Cl.: 7**

**TRADEMARK**

**PRINCIPAL REGISTER**

FOXWORTHY, JEFF (UNITED STATES INDIVIDUAL)  
C/O FOX LAW GROUP  
14724 VENTURA BLVD., PENTHOUSE  
SHERMAN OAKS, CA 914033513

FOR: WINCH AND CLAMP COMBINATIONS USED FOR ANIMAL PROCESSING, IN CLASS 7 (U.S. CLS. 13, 19, 21, 23, 31, 34 AND 35).

FIRST USE 1-9-2012; IN COMMERCE 1-9-2012.

THE MARK CONSISTS OF STANDARD CHARACTERS WITHOUT CLAIM TO ANY PARTICULAR FONT, STYLE, SIZE, OR COLOR.

SN 85-350,845, FILED 6-20-2011.

BRENDAN REGAN, EXAMINING ATTORNEY



*David J. Kyffers*

Director of the United States Patent and Trademark Office

# United States of America

United States Patent and Trademark Office

## THE HANGING JUDGE

**Reg. No. 4,199,739**

**Registered Aug. 28, 2012**

**Int. Cl.: 9**

**TRADEMARK**

**PRINCIPAL REGISTER**

FOXWORTHY, JEFF (UNITED STATES INDIVIDUAL)  
C/O FOX LAW GROUP  
14724 VENTURA BLVD., PENTHOUSE  
SHERMAN OAKS, CA 914033513

FOR: WEIGHING SCALES, IN CLASS 9 (U.S. CLS. 21, 23, 26, 36 AND 38).

FIRST USE 1-9-2012; IN COMMERCE 1-9-2012.

THE MARK CONSISTS OF STANDARD CHARACTERS WITHOUT CLAIM TO ANY PARTICULAR FONT, STYLE, SIZE, OR COLOR.

SN 85-350,867, FILED 6-20-2011.

BRENDAN REGAN, EXAMINING ATTORNEY



*David J. Kybas*

Director of the United States Patent and Trademark Office

# United States of America

United States Patent and Trademark Office

tease

**Reg. No. 4,199,740**

CLS VENTURES, LLC (CALIFORNIA LIMITED LIABILITY COMPANY)  
311 FOURTH AVENUE, SUITE 512  
SAN DIEGO, CA 92101

**Registered Aug. 28, 2012**

**Int. Cls.: 25 and 35**

FOR: T-SHIRTS FOR WOMEN, IN CLASS 25 (U.S. CLS. 22 AND 39).

**TRADEMARK**

FIRST USE 12-2-2011; IN COMMERCE 12-2-2011.

**SERVICE MARK**

FOR: RETAIL STORE AND ON-LINE RETAIL STORE SERVICES FEATURING WOMEN'S CLOTHING, ACCESSORIES AND JEWELRY, IN CLASS 35 (U.S. CLS. 100, 101 AND 102).

**PRINCIPAL REGISTER**

FIRST USE 12-2-2011; IN COMMERCE 12-2-2011.

THE MARK CONSISTS OF THE WORD "TEASE" IN LOWER-CASE LETTERS WITH THE UPPER PORTION OF THE SECOND "E" ANGLED SLIGHTLY UP AND TO THE RIGHT AND A PAIR OF LIPS ANGLED SLIGHTLY UP AND TO THE RIGHT OVERLAPPING THE UPPER RIGHT PORTION OF THE SECOND "E".

SN 85-351,080, FILED 6-20-2011.

RUDY R. SINGLETON, EXAMINING ATTORNEY



*David J. Kyffers*

Director of the United States Patent and Trademark Office

# United States of America

United States Patent and Trademark Office

# teaseboutique.com

**Reg. No. 4,199,741**

CLS VENTURES, LLC (CALIFORNIA LIMITED LIABILITY COMPANY)  
311 FOURTH AVENUE, SUITE 512  
SAN DIEGO, CA 92101

**Registered Aug. 28, 2012**

**Int. Cl.: 35**

FOR: ON-LINE RETAIL STORE SERVICES FEATURING WOMEN'S CLOTHING, ACCESSORIES AND JEWELRY, IN CLASS 35 (U.S. CLS. 100, 101 AND 102).

**SERVICE MARK**

FIRST USE 12-2-2011; IN COMMERCE 12-2-2011.

**PRINCIPAL REGISTER**

THE MARK CONSISTS OF STANDARD CHARACTERS WITHOUT CLAIM TO ANY PARTICULAR FONT, STYLE, SIZE, OR COLOR.

SN 85-351,115, FILED 6-20-2011.

RUDY R. SINGLETON, EXAMINING ATTORNEY



*David J. Kybas*

Director of the United States Patent and Trademark Office

# United States of America

United States Patent and Trademark Office

# dada land

**Reg. No. 4,199,742**

**Registered Aug. 28, 2012**

**Int. Cls.: 18 and 25**

**TRADEMARK**

**PRINCIPAL REGISTER**

DADA CORPORATION (REPUBLIC OF KOREA CORPORATION)  
#790-4 YEOKSAM-DONG  
KANGNAM-KU  
SEOUL, REPUBLIC OF KOREA 135-080

FOR: BACKPACKS; BELT BAGS; BRIEFCASES; BUMBAGS; DAYPACKS; DIAPER BAGS;  
HANDBAGS; HIPSACKS; SCHOOL BAGS; SHOULDER BAGS; SUITCASES; TOTE BAGS;  
WALLETS, IN CLASS 18 (U.S. CLS. 1, 2, 3, 22 AND 41).

FIRST USE 5-21-2012; IN COMMERCE 5-21-2012.

FOR: BASEBALL CAPS; CAPS; GOLF CAPS; HATS; HEADBANDS; HEADWEAR; KNIT  
SHIRTS; KNITTED CAPS; PANTS; POLO SHIRTS; SHIRTS; SHORTS; SUN VISORS;  
SWEATERS; T-SHIRTS; VISORS, IN CLASS 25 (U.S. CLS. 22 AND 39).

FIRST USE 5-21-2012; IN COMMERCE 5-21-2012.

THE MARK CONSISTS OF STANDARD CHARACTERS WITHOUT CLAIM TO ANY PAR-  
TICULAR FONT, STYLE, SIZE, OR COLOR.

SN 85-351,223, FILED 6-21-2011.

JOSETTE BEVERLY, EXAMINING ATTORNEY



*David J. Kyjars*

Director of the United States Patent and Trademark Office



# United States of America

United States Patent and Trademark Office

Tea  
Kravings

**Reg. No. 4,199,743**

HYSON TEAS (PRIVATE) LIMITED (SRI LANKA PRIVATE LIMITED COMPANY)  
NO. 190/1, SIRI SUMANA MAWATHA  
KELANIMULLA, ANGODA, SRI LANKA

**Registered Aug. 28, 2012**

**Int. Cl.: 30**

FOR: TEA; TEA-BASED BEVERAGES; HERBAL TEA FOR FOOD PURPOSES; GREEN TEA;  
BLACK TEA; FLAVORINGS OF TEA, IN CLASS 30 (U.S. CL. 46).

**TRADEMARK**

FIRST USE 4-21-2012; IN COMMERCE 4-21-2012.

**PRINCIPAL REGISTER**

NO CLAIM IS MADE TO THE EXCLUSIVE RIGHT TO USE "TEA", APART FROM THE  
MARK AS SHOWN.

THE MARK CONSISTS OF THE TERM "TEA" IN STYLIZED LETTERING WITH AN AB-  
STRACT DRAWING OF A TEA PLANT DIRECTLY TO THE RIGHT OF THE TERM. THE  
TERM "KRAVINGS" APPEARS IN STYLIZED LETTERING DIRECTLY BENEATH THE  
TERM "TEA" AND HAS THE LETTERS "AVIN" UNDERLINED.

SN 85-351,466, FILED 6-21-2011.

PAM WILLIS, EXAMINING ATTORNEY



*David J. Kyros*

Director of the United States Patent and Trademark Office

# United States of America

United States Patent and Trademark Office

## VEGETAMIDE

**Reg. No. 4,199,744**

SEIWA SUPPLY CO., LTD. (JAPAN CORPORATION)

**Registered Aug. 28, 2012**

1-2-14, NUNOICHI-CHO, HIGASHIOSAKA  
OSAKA, JAPAN

**Int. Cl.: 1**

FOR: ION COMPLEX OF HYDROLYZED PROTEIN AND FATTY ACID AMIDOAMINE FOR USE IN MANUFACTURING COSMETICS AND HAIR CARE PRODUCTS; ION COMPLEX OF HYDROLYZED PROTEIN AND FATTY ACID AMIDOETHYL DIETHYLAMMONIUM FOR USE IN MANUFACTURING COSMETICS AND HAIR CARE PRODUCTS; CETOSTEARYL AMIDOETHYL DIETHYLAMMONIUM HYDROLYZED PROTEIN FOR USE IN MANUFACTURING COSMETICS AND HAIR CARE PRODUCTS, IN CLASS 1 (U.S. CLS. 1, 5, 6, 10, 26 AND 46).

**TRADEMARK**

**PRINCIPAL REGISTER**

FIRST USE 4-28-2011; IN COMMERCE 4-28-2011.

THE MARK CONSISTS OF STANDARD CHARACTERS WITHOUT CLAIM TO ANY PARTICULAR FONT, STYLE, SIZE, OR COLOR.

SN 85-351,590, FILED 6-21-2011.

ELIZABETH KAJUBI, EXAMINING ATTORNEY



*David J. Kyros*

Director of the United States Patent and Trademark Office

# United States of America

United States Patent and Trademark Office

# tease

**Reg. No. 4,199,745**

CLS VENTURES, LLC (CALIFORNIA LIMITED LIABILITY COMPANY)  
311 FOURTH AVENUE, SUITE 512  
SAN DIEGO, CA 92101

**Registered Aug. 28, 2012**

**Int. Cl.: 35**

FOR: RETAIL STORE AND ON-LINE RETAIL STORE SERVICES FEATURING WOMEN'S CLOTHING, ACCESSORIES AND JEWELRY, IN CLASS 35 (U.S. CLS. 100, 101 AND 102).

**SERVICE MARK**

FIRST USE 12-2-2011; IN COMMERCE 12-2-2011.

**PRINCIPAL REGISTER**

THE MARK CONSISTS OF STANDARD CHARACTERS WITHOUT CLAIM TO ANY PARTICULAR FONT, STYLE, SIZE, OR COLOR.

SN 85-351,777, FILED 6-21-2011.

RUDY R. SINGLETON, EXAMINING ATTORNEY



*David J. Kybas*

Director of the United States Patent and Trademark Office

# United States of America

United States Patent and Trademark Office

# SUPRENZA

**Reg. No. 4,199,746** CITIUS PHARMACEUTICALS, LLC (MASSACHUSETTS LIMITED LIABILITY COMPANY)  
**Registered Aug. 28, 2012** 63 GREAT ROAD  
MAYNARD, MA 01754

**Int. Cl.: 5** FOR: PHARMACEUTICALS FOR WEIGHT LOSS, IN CLASS 5 (U.S. CLS. 6, 18, 44, 46, 51 AND 52).

**TRADEMARK** FIRST USE 4-0-2012; IN COMMERCE 4-0-2012.

**PRINCIPAL REGISTER** THE MARK CONSISTS OF STANDARD CHARACTERS WITHOUT CLAIM TO ANY PARTICULAR FONT, STYLE, SIZE, OR COLOR.

SN 85-352,813, FILED 6-22-2011.

ELI HELLMAN, EXAMINING ATTORNEY



*David J. Kybas*

Director of the United States Patent and Trademark Office

# United States of America

United States Patent and Trademark Office

# QUANTUM 4

**Reg. No. 4,199,747**

**Registered Aug. 28, 2012**

**Int. Cl.: 8**

**TRADEMARK**

**PRINCIPAL REGISTER**

EVEREADY BATTERY COMPANY, INC. (DELAWARE CORPORATION)  
SWS LEGAL TRADEMARKS  
533 MARYVILLE UNIVERSITY DRIVE  
ST. LOUIS, MO 63141

FOR: RAZORS AND RAZOR BLADES, IN CLASS 8 (U.S. CLS. 23, 28 AND 44).

FIRST USE 5-1-2012; IN COMMERCE 5-1-2012.

THE MARK CONSISTS OF STANDARD CHARACTERS WITHOUT CLAIM TO ANY PARTICULAR FONT, STYLE, SIZE, OR COLOR.

OWNER OF U.S. REG. NOS. 2,813,551, 3,123,031, AND OTHERS.

NO CLAIM IS MADE TO THE EXCLUSIVE RIGHT TO USE "4", APART FROM THE MARK AS SHOWN.

SN 85-352,871, FILED 6-22-2011.

EMILY CARLSEN, EXAMINING ATTORNEY



*David J. Kybas*

Director of the United States Patent and Trademark Office

# United States of America

United States Patent and Trademark Office

## INDIGO SCHUY

**Reg. No. 4,199,748**

INDIGO SCHUY, LLC (PENNSYLVANIA LIMITED LIABILITY COMPANY)  
8432 GERMANTOWN AVENUE  
CHESTNUT HILL, PA 19118

**Registered Aug. 28, 2012**

**Int. Cl.: 35**

FOR: RETAIL STORE AND ON-LINE RETAIL STORE SERVICES FEATURING CLOTHING, FOOTWEAR, HEADWEAR, APPAREL, ACTIVE APPAREL, SPORTS APPAREL, FASHION ACCESSORIES, JEWELRY, WATCHES, EYEWEAR, IN CLASS 35 (U.S. CLS. 100, 101 AND 102).

**SERVICE MARK**

**PRINCIPAL REGISTER**

FIRST USE 12-8-2011; IN COMMERCE 1-8-2012.

THE MARK CONSISTS OF STANDARD CHARACTERS WITHOUT CLAIM TO ANY PARTICULAR FONT, STYLE, SIZE, OR COLOR.

THE WORDING "INDIGO SCHUY" HAS NO MEANING IN A FOREIGN LANGUAGE.

SN 85-352,928, FILED 6-22-2011.

GENE MACIOL, EXAMINING ATTORNEY



*David J. Kyffers*

Director of the United States Patent and Trademark Office

# United States of America

United States Patent and Trademark Office

## INNOVATION FUND AMERICA

**Reg. No. 4,199,749**

**Registered Aug. 28, 2012**

**Int. Cls.: 35 and 36**

**SERVICE MARK**

**PRINCIPAL REGISTER**

LORAIN COUNTY COMMUNITY COLLEGE FOUNDATION (OHIO NON-PROFIT CORPORATION)  
1005 NORTH ABBE ROAD  
ELYRIA, OH 44035

FOR: ASSISTANCE AND ADVICE REGARDING BUSINESS ORGANIZATION AND MANAGEMENT; BUSINESS ADVICE AND INFORMATION; BUSINESS CONSULTATION; BUSINESS DEVELOPMENT SERVICES, NAMELY, PROVIDING START-UP SUPPORT FOR BUSINESSES OF OTHERS; OPERATIONAL BUSINESS ASSISTANCE TO ENTERPRISES, IN CLASS 35 (U.S. CLS. 100, 101 AND 102).

FIRST USE 6-7-2012; IN COMMERCE 6-7-2012.

FOR: CHARITABLE FOUNDATION SERVICES, NAMELY, PROVIDING FUNDRAISING ACTIVITIES, FUNDING, SCHOLARSHIPS AND/OR FINANCIAL ASSISTANCE FOR START-UP COMPANIES; CHARITABLE FUNDRAISING, IN CLASS 36 (U.S. CLS. 100, 101 AND 102).

FIRST USE 6-7-2012; IN COMMERCE 6-7-2012.

THE MARK CONSISTS OF STANDARD CHARACTERS WITHOUT CLAIM TO ANY PARTICULAR FONT, STYLE, SIZE, OR COLOR.

NO CLAIM IS MADE TO THE EXCLUSIVE RIGHT TO USE "FUND AMERICA", APART FROM THE MARK AS SHOWN.

SN 85-353,020, FILED 6-22-2011.

KAREN K. BUSH, EXAMINING ATTORNEY



*David J. Kyjars*

Director of the United States Patent and Trademark Office

# United States of America

United States Patent and Trademark Office



**Reg. No. 4,199,750**

**Registered Aug. 28, 2012**

**Int. Cl.: 25**

**TRADEMARK**

**PRINCIPAL REGISTER**

NASHVILLE HOCKEY CLUB LIMITED PARTNERSHIP (WISCONSIN LIMITED PARTNERSHIP)  
501 BROADWAY  
NASHVILLE, TN 37203

FOR: CLOTHING, NAMELY, BANDANNAS, BOXER SHORTS, CAPS, COATS, GLOVES, HATS, HEADBANDS, JACKETS, JERSEYS, NIGHTSHIRTS, PAJAMAS, PANTS, ROBES, SCARVES, SHIRTS, SHORTS, SOCKS, SWEATERS, SWEATPANTS, SWEATSHIRTS, T-SHIRTS, TOQUES, VESTS, WARM-UP SUITS AND WRISTBANDS, IN CLASS 25 (U.S. CLS. 22 AND 39).

FIRST USE 6-22-2011; IN COMMERCE 6-22-2011.

THE MARK CONSISTS OF THE LETTERS "NP" IN THE LOWER PART OF AN OBLONG DESIGN AND 3 STARS IN AN INNER CIRCLE WITHIN THE ENTIRE DESIGN.

SN 85-353,217, FILED 6-22-2011.

JORDAN BAKER, EXAMINING ATTORNEY



*David J. Kybas*

Director of the United States Patent and Trademark Office



# United States of America

United States Patent and Trademark Office



**Reg. No. 4,199,751**

**Registered Aug. 28, 2012**

**Int. Cl.: 41**

**SERVICE MARK**

**PRINCIPAL REGISTER**

NASHVILLE HOCKEY CLUB LIMITED PARTNERSHIP (WISCONSIN LIMITED PARTNERSHIP)  
501 BROADWAY  
NASHVILLE, TN 37203

FOR: ENTERTAINMENT SERVICES, NAMELY, PROFESSIONAL ICE HOCKEY EXHIBITIONS, IN CLASS 41 (U.S. CLS. 100, 101 AND 107).

FIRST USE 6-22-2011; IN COMMERCE 6-22-2011.

THE MARK CONSISTS OF THE LETTERS "NP" IN THE LOWER PART OF AN OBLONG DESIGN AND 3 STARS IN AN INNER CIRCLE WITHIN THE ENTIRE DESIGN.

SN 85-353,228, FILED 6-22-2011.

JORDAN BAKER, EXAMINING ATTORNEY



*David J. Kybas*

Director of the United States Patent and Trademark Office

# United States of America

United States Patent and Trademark Office



**Reg. No. 4,199,752**

**Registered Aug. 28, 2012**

**Int. Cl.: 41**

**SERVICE MARK**

**PRINCIPAL REGISTER**

NASHVILLE HOCKEY CLUB LIMITED PARTNERSHIP (WISCONSIN LIMITED PARTNERSHIP)  
501 BROADWAY  
NASHVILLE, TN 37203

FOR: ENTERTAINMENT SERVICES, NAMELY, PROFESSIONAL ICE HOCKEY EXHIBITIONS, IN CLASS 41 (U.S. CLS. 100, 101 AND 107).

FIRST USE 6-22-2011; IN COMMERCE 6-22-2011.

OWNER OF U.S. REG. NOS. 2,251,939, 2,730,071, AND OTHERS.

THE MARK CONSISTS OF THE SIDE PROFILE OF A FANGED ANIMAL HEAD.

SN 85-353,238, FILED 6-22-2011.

JORDAN BAKER, EXAMINING ATTORNEY



*David J. Kyffers*

Director of the United States Patent and Trademark Office

# United States of America

United States Patent and Trademark Office



**Reg. No. 4,199,753**

**Registered Aug. 28, 2012**

**Int. Cl.: 25**

**TRADEMARK**

**PRINCIPAL REGISTER**

NASHVILLE HOCKEY CLUB LIMITED PARTNERSHIP (WISCONSIN LIMITED PARTNERSHIP)  
501 BROADWAY  
NASHVILLE, TN 37203

FOR: CLOTHING, NAMELY, BANDANNAS, BEACH COVER-UPS, BELTS, BODY SUITS, BOXER SHORTS, CAPS, CLOTH BIBS, COATS, DRESSES, FOOTWEAR, EAR MUFFS, GLOVES, HATS, HEADBANDS, HOSIERY, HOUSECOATS, JACKETS, JERSEYS, LEGGINGS, LEOTARDS, MITTENS, NIGHTSHIRTS, PAJAMAS, PANTS, RAIN COATS, RAIN WEAR, ROBES, SCARVES, SHIRTS, SHORTS, SKIRTS, SOCKS, SUITS, SUN VISORS, SUSPENDERS, SWEATERS, SWEATPANTS, SWEATSHIRTS, SWIMSUITS, SWIM TRUNKS, T-SHIRTS, TIES, TOQUES, UNDERWEAR, VESTS, WARM-UP SUITS AND WRISTBANDS, IN CLASS 25 (U.S. CLS. 22 AND 39).

FIRST USE 6-22-2011; IN COMMERCE 6-22-2011.

OWNER OF U.S. REG. NOS. 2,347,506, 2,919,288, AND OTHERS.

THE MARK CONSISTS OF THE SIDE PROFILE OF A FANGED ANIMAL HEAD.

SN 85-353,255, FILED 6-22-2011.

JORDAN BAKER, EXAMINING ATTORNEY



*David J. Kybas*

Director of the United States Patent and Trademark Office

# United States of America

United States Patent and Trademark Office

## Wizard of Laws

**Reg. No. 4,199,754**

**Registered Aug. 28, 2012**

**Int. Cl.: 45**

**SERVICE MARK**

**PRINCIPAL REGISTER**

RAY R. COULTER, A PROFESSIONAL CORPORATION (CALIFORNIA CORPORATION)  
777 E. TAHQUITZ CANYON WAY, SUITE 312  
PALM SPRINGS, CA 92262

FOR: LEGAL SERVICES, IN CLASS 45 (U.S. CLS. 100 AND 101).

FIRST USE 5-6-2012; IN COMMERCE 5-6-2012.

THE MARK CONSISTS OF STANDARD CHARACTERS WITHOUT CLAIM TO ANY PARTICULAR FONT, STYLE, SIZE, OR COLOR.

NO CLAIM IS MADE TO THE EXCLUSIVE RIGHT TO USE "LAWS", APART FROM THE MARK AS SHOWN.

SN 85-353,366, FILED 6-22-2011.

AMY KELLY, EXAMINING ATTORNEY



*David J. Kyros*

Director of the United States Patent and Trademark Office

# United States of America

United States Patent and Trademark Office

## SETTLEMENTARY

**Reg. No. 4,199,755**

DISPUTE RESOLUTION CONSULTANTS, INC. (OKLAHOMA CORPORATION)  
1602 S. MAIN STREET  
TULSA, OK 74119

**Registered Aug. 28, 2012**

**Int. Cl.: 45**

FOR: MEDIATION SERVICES, NAMELY, PERSUASIVE SETTLEMENT PRESENTATIONS IN DOCUMENTARY FORM ACCESSIBLE VIA THE INTERNET IN A CONTROLLED ENVIRONMENT OR PRESENTED TO AN OPPOSING PARTY TO A DISPUTE, IN CLASS 45 (U.S. CLS. 100 AND 101).

**SERVICE MARK**

**PRINCIPAL REGISTER**

FIRST USE 5-14-2012; IN COMMERCE 5-14-2012.

THE MARK CONSISTS OF STANDARD CHARACTERS WITHOUT CLAIM TO ANY PARTICULAR FONT, STYLE, SIZE, OR COLOR.

SN 85-353,396, FILED 6-22-2011.

JACQUELINE A. LAVINE, EXAMINING ATTORNEY



*David J. Kyffers*

Director of the United States Patent and Trademark Office

**United States of America**  
United States Patent and Trademark Office

**MINISTAZ**

**Reg. No. 4,199,756**

MINISTAZ, LLC. (PENNSYLVANIA LIMITED LIABILITY COMPANY)  
51 ENGLISH WAY  
GOULDSBORO, PA 18424

**Registered Aug. 28, 2012**

**Int. Cl.: 9**

FOR: EAR BUDS; EARPHONES, IN CLASS 9 (U.S. CLS. 21, 23, 26, 36 AND 38).

**TRADEMARK**

FIRST USE 6-23-2011; IN COMMERCE 6-23-2011.

**PRINCIPAL REGISTER**

THE MARK CONSISTS OF STANDARD CHARACTERS WITHOUT CLAIM TO ANY PARTICULAR FONT, STYLE, SIZE, OR COLOR.

SN 85-353,544, FILED 6-22-2011.

KIMBERLY PERRY, EXAMINING ATTORNEY



*David J. Kyffers*

Director of the United States Patent and Trademark Office

# United States of America

United States Patent and Trademark Office

## BACTI BARRIER

**Reg. No. 4,199,757**

BRADFORD, DOUG (UNITED STATES INDIVIDUAL)  
569 Highbank Road  
Severna Park, MD 21146 AND

**Registered Aug. 28, 2012**

**Int. Cl.: 5**

WESTERVELT, DREW (UNITED STATES INDIVIDUAL)  
810 GRUNDY STREET  
BALTIMORE, MD 21224

**TRADEMARK**

**PRINCIPAL REGISTER**

FOR: ECO-FRIENDLY ANTIMICROBIAL PREPARATIONS IN THE NATURE OF COATINGS, SPRAYS, AND LAUNDRY DETERGENT ADDITIVES FOR USE IN PREVENTING ODORS IN ATHLETIC GEAR AND APPAREL, IN CLASS 5 (U.S. CLS. 6, 18, 44, 46, 51 AND 52).

FIRST USE 5-21-2012; IN COMMERCE 5-21-2012.

THE MARK CONSISTS OF STANDARD CHARACTERS WITHOUT CLAIM TO ANY PARTICULAR FONT, STYLE, SIZE, OR COLOR.

SN 85-353,768, FILED 6-23-2011.

LINDSEY RUBIN, EXAMINING ATTORNEY



*David J. Kybas*

Director of the United States Patent and Trademark Office

United States of America  
United States Patent and Trademark Office

KARISMA

**Reg. No. 4,199,758**

ROYAL CHAIN, INC. (NEW YORK CORPORATION)  
2 WEST 46TH STREET  
NEW YORK, NY 10036

**Registered Aug. 28, 2012**

**Int. Cl.: 14**

FOR: JEWELRY, NAMELY, RINGS, BROOCHES, EARRINGS, NECKLACES, PINS, CHAINS,  
PENDANTS, BRACELETS, CHARMS, IN CLASS 14 (U.S. CLS. 2, 27, 28 AND 50).

**TRADEMARK**

FIRST USE 10-11-2011; IN COMMERCE 10-11-2011.

**PRINCIPAL REGISTER**

THE MARK CONSISTS OF STANDARD CHARACTERS WITHOUT CLAIM TO ANY PAR-  
TICULAR FONT, STYLE, SIZE, OR COLOR.

SN 85-353,839, FILED 6-23-2011.

KEVON CHISOLM, EXAMINING ATTORNEY



*David J. Kybas*

Director of the United States Patent and Trademark Office



# United States of America

United States Patent and Trademark Office



**Reg. No. 4,199,759**

**Registered Aug. 28, 2012**

**Int. Cl.: 30**

**TRADEMARK**

**PRINCIPAL REGISTER**

KRAFT FOODS GLOBAL BRANDS LLC (DELAWARE LIMITED LIABILITY COMPANY)  
THREE LAKES DRIVE  
NORTHFIELD, IL 60093

FOR: COFFEE, IN CLASS 30 (U.S. CL. 46).

FIRST USE 7-18-2011; IN COMMERCE 7-18-2011.

OWNER OF U.S. REG. NOS. 599,153, 3,929,128, AND OTHERS.

THE MARK CONSISTS OF THE MARK "MAXWELL HOUSE GOOD TO THE LAST" WITH A TILTED CUP. THE DROP COMING OUT OF THE TILTED CUP DENOTES THE WORD DROP. ALL THE AFORESAID APPEAR IN A SHADED RECTANGLE WHICH IS ROUNDED AT THE TOP AND BOTTOM.

SN 85-354,371, FILED 6-23-2011.

EVELYN BRADLEY, EXAMINING ATTORNEY



*David J. Kybas*

Director of the United States Patent and Trademark Office

# United States of America

United States Patent and Trademark Office

# SAMMY'S

**Reg. No. 4,199,760**

**Registered Aug. 28, 2012**

**Int. Cls.: 29 and 30**

**TRADEMARK**

**PRINCIPAL REGISTER**

WEBB CANDY, INC. (MINNESOTA CORPORATION)  
15197 BOULDER AVENUE  
ROSEMOUNT, MN 55068

FOR: CANDIED NUTS; PROCESSED SUNFLOWER SEEDS, IN CLASS 29 (U.S. CL. 46).

FIRST USE 11-1-2011; IN COMMERCE 11-1-2011.

FOR: CANDIES; CHOCOLATE CANDIES; CHOCOLATE COVERED NUTS; CHOCOLATES AND CHOCOLATE BASED READY TO EAT CANDIES AND SNACKS; CONFECTIONERIES, NAMELY, SNACK FOODS, NAMELY, CHOCOLATE; SNACK FOODS, NAMELY, CHOCOLATE-BASED SNACK FOODS, IN CLASS 30 (U.S. CL. 46).

FIRST USE 11-1-2011; IN COMMERCE 11-1-2011.

THE MARK CONSISTS OF STANDARD CHARACTERS WITHOUT CLAIM TO ANY PARTICULAR FONT, STYLE, SIZE, OR COLOR.

SN 85-354,775, FILED 6-23-2011.

REBECCA EISINGER, EXAMINING ATTORNEY



*David J. Kybas*

Director of the United States Patent and Trademark Office

# United States of America

United States Patent and Trademark Office

# Viaprestige

**Reg. No. 4,199,761**

POITELON, PIERRE PHILIPPE (FRANCE INDIVIDUAL)  
LA RÉCUQUELLE

**Registered Aug. 28, 2012**

LABRUGUIÈRE, FRANCE 81290

**Int. Cls.: 35, 36, and 39**

FOR: PROVIDING A SEARCHABLE ON-LINE ADVERTISING WEBSITE AND GUIDE FEATURING THE GOODS AND SERVICES OF OTHER VENDORS VIA THE INTERNET , IN CLASS 35 (U.S. CLS. 100, 101 AND 102).

**SERVICE MARK**

FIRST USE 1-1-2012; IN COMMERCE 1-1-2012.

**PRINCIPAL REGISTER**

FOR: PROVIDING REAL ESTATE LISTINGS AND REAL ESTATE INFORMATION VIA THE INTERNET; REAL ESTATE APPRAISAL; REAL ESTATE BROKERAGE; REAL ESTATE CONSULTANCY, IN CLASS 36 (U.S. CLS. 100, 101 AND 102).

FIRST USE 1-1-2012; IN COMMERCE 1-1-2012.

FOR: TRAVEL AGENCY SERVICES, NAMELY, MAKING RESERVATIONS AND BOOKINGS FOR TRANSPORTATION; TRAVEL BOOKING AGENCIES; TRAVEL INFORMATION SERVICES , IN CLASS 39 (U.S. CLS. 100 AND 105).

FIRST USE 1-1-2012; IN COMMERCE 1-1-2012.

THE MARK CONSISTS OF STANDARD CHARACTERS WITHOUT CLAIM TO ANY PARTICULAR FONT, STYLE, SIZE, OR COLOR.

PRIORITY CLAIMED UNDER SEC. 44(D) ON ERPN CMNTY TM OFC APPLICATION NO. 3797476, FILED 1-13-2011.

THE WORDING "VIAPRESTIGE" HAS NO MEANING IN A FOREIGN LANGUAGE.

SN 85-354,926, FILED 6-24-2011.

ANDREW LEASER, EXAMINING ATTORNEY



*David J. Kyffers*

Director of the United States Patent and Trademark Office

# United States of America

United States Patent and Trademark Office

## EXPRESS PRICING

**Reg. No. 4,199,762**

PENSKE AUTOMOTIVE GROUP, INC. (DELAWARE CORPORATION)  
2555 TELEGRAPH RD.

**Registered Aug. 28, 2012**

BLOOMFIELD HILLS, MI 48302

**Int. Cl.: 35**

FOR: AUTOMOBILE DEALERSHIPS; PROVIDING CONSUMER PRODUCT INFORMATION ABOUT VEHICLES FOR SALE BY MEANS OF A GLOBAL COMMUNICATIONS NETWORK, NAMELY, PROVIDING INFORMATION ABOUT VEHICLE SPECIFICATIONS, SELECTION, AVAILABILITY, PRICING, AND PHOTOGRAPHS OF VEHICLES, IN CLASS 35 (U.S. CLS. 100, 101 AND 102).

**SERVICE MARK**

**PRINCIPAL REGISTER**

FIRST USE 7-6-2011; IN COMMERCE 7-6-2011.

THE MARK CONSISTS OF STANDARD CHARACTERS WITHOUT CLAIM TO ANY PARTICULAR FONT, STYLE, SIZE, OR COLOR.

NO CLAIM IS MADE TO THE EXCLUSIVE RIGHT TO USE "PRICING", APART FROM THE MARK AS SHOWN.

SN 85-355,102, FILED 6-24-2011.

EMILY CARLSEN, EXAMINING ATTORNEY



*David J. Kyros*

Director of the United States Patent and Trademark Office

# United States of America

United States Patent and Trademark Office

GLOBAL VIEW CAPITAL



**Reg. No. 4,199,763**

**Registered Aug. 28, 2012**

**Int. Cl.: 36**

**SERVICE MARK**

**PRINCIPAL REGISTER**

GLOBAL VIEW CAPITAL HOLDINGS (WISCONSIN CORPORATION)  
SUITE 350  
N14 W23833 STONE RIDGE DR  
WAUKESHA, WI 53188

FOR: FINANCIAL ADVICE AND CONSULTANCY SERVICES; FINANCIAL ADVISORY AND CONSULTANCY SERVICES; FINANCIAL ADVISORY AND CONSULTANCY SERVICES, NAMELY, THE CREATION OF PERSONALIZED STRATEGIES TO ACHIEVE FINANCIAL INDEPENDENCE; FINANCIAL AND INVESTMENT SERVICES, NAMELY, MANAGEMENT AND BROKERAGE IN THE FIELDS OF STOCKS, BONDS, OPTIONS, COMMODITIES, FUTURES AND OTHER SECURITIES, AND THE INVESTMENT OF FUNDS OF OTHERS; FINANCIAL SERVICES, NAMELY, A TOTAL PORTFOLIO OFFERING FOR HIGH NET WORTH CLIENTS CONSISTING OF BOTH SEPARATE ACCOUNTS AND MUTUAL FUNDS FOR EQUITY AND FIXED INCOME INVESTMENTS; FINANCIAL SERVICES, NAMELY, INVESTMENT ADVICE, INVESTMENT MANAGEMENT, INVESTMENT CONSULTATION AND INVESTMENT OF FUNDS FOR OTHERS, INCLUDING PRIVATE AND PUBLIC EQUITY AND DEBT INVESTMENT SERVICES; FINANCIAL SERVICES, NAMELY, PROVIDING AN INVESTMENT OPTION AVAILABLE FOR VARIABLE ANNUITY AND VARIABLE LIFE INSURANCE PRODUCTS; FINANCIAL SERVICES, NAMELY, WEALTH MANAGEMENT SERVICES; INSURANCE AND FINANCIAL INFORMATION AND CONSULTANCY SERVICES; STRATEGIC CORPORATE FINANCIAL ADVISORY SERVICES; STRATEGIC FINANCIAL ADVISORY SERVICES, IN CLASS 36 (U.S. CLS. 100, 101 AND 102).

FIRST USE 6-1-2011; IN COMMERCE 6-1-2011.

NO CLAIM IS MADE TO THE EXCLUSIVE RIGHT TO USE "GLOBAL" AND "CAPITAL", APART FROM THE MARK AS SHOWN.

THE MARK CONSISTS OF THE STYLIZED TEXT "GLOBAL VIEW CAPITAL" WITH A REPRESENTATION OF THE HUMAN EYE WHERE THERE IS A STYLIZED "LIDDED" ARCH OVER A IRIS WHERE THE IRIS IS ACTUALLY A GLOBE WITH THE CONTINENTS OF NORTH AND SOUTH AMERICA.



*David J. Kyffers*

SN 85-355,136, FILED 6-24-2011.

ELLEN PERKINS, EXAMINING ATTORNEY

# United States of America

United States Patent and Trademark Office



**Reg. No. 4,199,764**

**Registered Aug. 28, 2012**

**Int. Cl.: 30**

**TRADEMARK**

**PRINCIPAL REGISTER**

AHOLD LICENSING SARL (SWITZERLAND LIMITED LIABILITY COMPANY)  
2 RUE JEAN-PETITOT  
GENEVA, SWITZERLAND 1204

FOR: BREAKFAST CEREALS, IN CLASS 30 (U.S. CL. 46).

FIRST USE 5-30-2012; IN COMMERCE 5-30-2012.

THE MARK CONSISTS OF A PURPLE DINOSAUR HOLDS A LIGHT GRAY SPOON.

THE COLOR(S) PURPLE AND GRAY IS/ARE CLAIMED AS A FEATURE OF THE MARK.

SN 85-355,251, FILED 6-24-2011.

GEORGE LORENZO, EXAMINING ATTORNEY



*David J. Kybas*

Director of the United States Patent and Trademark Office

# United States of America

United States Patent and Trademark Office

## CYBER PLANET

**Reg. No. 4,199,765**

WARREN GIBSON, DAVID (UNITED STATES INDIVIDUAL)  
1002 VERRET LANE  
HOUSTON, TX 77090

**Registered Aug. 28, 2012**

**Int. Cl.: 25**

FOR: CLOTHING, NAMELY, PANTS, SHORTS, T-SHIRTS, UNDERWEAR, SWEATSHIRTS, JACKETS, HATS, TANK-TOPS, TOPS, BOTTOMS, SOCKS, DRESSES, SWIMWEAR, IN CLASS 25 (U.S. CLS. 22 AND 39).

**TRADEMARK**

FIRST USE 3-22-2012; IN COMMERCE 3-22-2012.

**PRINCIPAL REGISTER**

THE MARK CONSISTS OF STANDARD CHARACTERS WITHOUT CLAIM TO ANY PARTICULAR FONT, STYLE, SIZE, OR COLOR.

SN 85-355,506, FILED 6-24-2011.

DORITT L. CARROLL, EXAMINING ATTORNEY



*David J. Kyros*

Director of the United States Patent and Trademark Office

# United States of America

United States Patent and Trademark Office

# FLATCALL

**Reg. No. 4,199,766**

**Registered Aug. 28, 2012**

**Int. Cl.: 25**

**TRADEMARK**

**PRINCIPAL REGISTER**

FLATCALL LLC (NEW JERSEY LIMITED LIABILITY COMPANY)  
PO BOX 867  
DENVER, NJ 07834

FOR: POKER-THEMED APPAREL, NAMELY, T-SHIRTS, HOODED SWEATSHIRTS, SWEATSHIRTS, POLO SHIRTS, SHIRTS, BASEBALL HATS, KNITTED HATS, AND JACKETS, IN CLASS 25 (U.S. CLS. 22 AND 39).

FIRST USE 12-5-2011; IN COMMERCE 1-25-2012.

THE MARK CONSISTS OF STANDARD CHARACTERS WITHOUT CLAIM TO ANY PARTICULAR FONT, STYLE, SIZE, OR COLOR.

SN 85-355,696, FILED 6-24-2011.

MICHAEL TANNER, EXAMINING ATTORNEY



*David J. Kyffers*

Director of the United States Patent and Trademark Office



# United States of America

United States Patent and Trademark Office



**Reg. No. 4,199,767**

WALGREEN CO. (ILLINOIS CORPORATION)  
200 WILMOT ROAD  
DEERFIELD, IL 60015

**Registered Aug. 28, 2012**

**Int. Cl.: 45**

FOR: SECURITY SERVICES, NAMELY, PROVIDING SECURITY ASSESSMENTS OF PHYSICAL LOCATIONS, INFORMATION SYSTEMS, AND WORKING ENVIRONMENTS, INCLUDING SECURITY IN RETAIL AND DISTRIBUTION CENTER ENVIRONMENTS IN THE NATURE OF SECURITY CONSULTANCY, IN CLASS 45 (U.S. CLS. 100 AND 101).

**SERVICE MARK**

**PRINCIPAL REGISTER**

FIRST USE 4-15-2011; IN COMMERCE 4-15-2011.

NO CLAIM IS MADE TO THE EXCLUSIVE RIGHT TO USE "ASSET PROTECTION", APART FROM THE MARK AS SHOWN.

THE MARK CONSISTS OF A STYLIZED "W" ENCOMPASSED WITHIN A CIRCLE THAT IS POSITIONED WITHIN A GRID SPHERE DESIGN WHICH IS ENCOMPASSED WITHIN A SHADED AND BORDERED CIRCLE CONTAINING THE WORDS "ASSET PROTECTION" POSITIONED AT THE TOP LEFT SIDE OF THE SHADED AND BORDERED CIRCLE, AND THE WORDS "BUSINESS CONTINUITY" POSITIONED AT THE TOP RIGHT SIDE OF THE SHADED AND BORDERED CIRCLE AND THE WORDS "WELL PREPARED" POSITIONED AT THE BOTTOM CENTER OF THE SHADED AND BORDERED CIRCLE, EACH SET OF WORDS SEPARATED BY A PERIOD.



SN 85-355,939, FILED 6-24-2011.

THOMAS MANOR, EXAMINING ATTORNEY

*David J. Kypos*

Director of the United States Patent and Trademark Office

# United States of America

United States Patent and Trademark Office

## HEN'S TEETH

**Reg. No. 4,199,768**

**Registered Aug. 28, 2012**

**Int. Cl.: 35**

**SERVICE MARK**

**PRINCIPAL REGISTER**

HEN'S TEETH, LLC (MINNESOTA LIMITED LIABILITY COMPANY)  
SUITE 909  
12 SOUTH 6TH STREET  
MINNEAPOLIS, MN 55402

FOR: ADVERTISING AND MARKETING SERVICES, IN CLASS 35 (U.S. CLS. 100, 101 AND 102).

FIRST USE 5-15-2012; IN COMMERCE 5-15-2012.

THE MARK CONSISTS OF STANDARD CHARACTERS WITHOUT CLAIM TO ANY PARTICULAR FONT, STYLE, SIZE, OR COLOR.

SN 85-355,944, FILED 6-24-2011.

STEPHANIE ALI, EXAMINING ATTORNEY



*David J. Kyffers*

Director of the United States Patent and Trademark Office

# United States of America

United States Patent and Trademark Office

LET US ACCESSORIZE YOUR  
LIFE!

**Reg. No. 4,199,769**

DCWV ACQUISITION CORPORATION (DELAWARE CORPORATION)  
2250 NORTH UNIVERSITY PARKWAY  
PROVO, UT 84604

**Registered Aug. 28, 2012**

**Int. Cl.: 16**

FOR: NOTEBOOKS; BLANK JOURNALS; NOTE PADS; PAPER; MEMO PADS; BINDER CLIPS; AND DRY ERASE CALENDARS, IN CLASS 16 (U.S. CLS. 2, 5, 22, 23, 29, 37, 38 AND 50).

**TRADEMARK**

FIRST USE 6-6-2012; IN COMMERCE 6-6-2012.

**PRINCIPAL REGISTER**

THE MARK CONSISTS OF STANDARD CHARACTERS WITHOUT CLAIM TO ANY PARTICULAR FONT, STYLE, SIZE, OR COLOR.

SN 85-356,881, FILED 6-27-2011.

MARK SHINER, EXAMINING ATTORNEY



*David J. Kyffers*

Director of the United States Patent and Trademark Office

# United States of America

United States Patent and Trademark Office



**Reg. No. 4,199,770**

WARREN, RICHARD D. (UNITED STATES INDIVIDUAL)  
29881 SANTA MARGARITA PARKWAY, SUITE 100  
RANCHO SANTA MARGARITA, CA 92688

**Registered Aug. 28, 2012**

**Int. Cl.: 16**

FOR: SERIES OF BOOKS IN THE FIELD OF RELIGION; BOOKS, STUDY GUIDES, WORK-BOOKS, HANDOUTS, AND PRINTED EDUCATIONAL MATERIALS IN THE FIELD OF RELIGION; BOOKMARKS, IN CLASS 16 (U.S. CLS. 2, 5, 22, 23, 29, 37, 38 AND 50).

**TRADEMARK**

FIRST USE 8-1-2011; IN COMMERCE 8-1-2011.

**PRINCIPAL REGISTER**

THE MARK CONSISTS OF THE NUMBER "40" ABOVE THE WORD "DAYS" WITH A HORIZONTAL LINE SEGMENT BETWEEN "40" AND "DAYS", A DESIGN IN THE LETTER "D" OF "DAYS" WHICH RESEMBLES A BOOK HAVING A BOOKMARK EXTENDING FROM ITS PAGES, AND THE WORDS "IN THE WORD" IN A RECTANGULAR DESIGN BELOW "DAYS".

SN 85-356,892, FILED 6-27-2011.

KARANENDRA S. CHHINA, EXAMINING ATTORNEY



*David J. Kybas*

Director of the United States Patent and Trademark Office

# United States of America

United States Patent and Trademark Office

## HERSHEY'S SAVES THE DAY

**Reg. No. 4,199,771**

**Registered Aug. 28, 2012**

**Int. Cl.: 30**

**TRADEMARK**

**PRINCIPAL REGISTER**

HERSHEY CHOCOLATE & CONFECTIONERY CORPORATION (DELAWARE CORPORATION)  
SUITE 204  
4860 ROBB STREET  
WHEAT RIDGE, CO 80033

FOR: CANDY; CHOCOLATE, IN CLASS 30 (U.S. CL. 46).

FIRST USE 4-15-2012; IN COMMERCE 4-15-2012.

THE MARK CONSISTS OF STANDARD CHARACTERS WITHOUT CLAIM TO ANY PARTICULAR FONT, STYLE, SIZE, OR COLOR.

OWNER OF U.S. REG. NOS. 54,041, 863,592, AND 1,367,943.

SN 85-356,960, FILED 6-27-2011.

CHRISTOPHER SIDOTI, EXAMINING ATTORNEY



*David J. Kyffers*

Director of the United States Patent and Trademark Office

# United States of America

United States Patent and Trademark Office

# Darensberries

**Reg. No. 4,199,772**

DARENSBERRIES, LLC (CALIFORNIA LIMITED LIABILITY COMPANY)  
2515 PROFESSIONAL PARKWAY  
SANTA MARIA, CA 93455

**Registered Aug. 28, 2012**

**Int. Cl.: 31**

FOR: FRESH FRUIT AND VEGETABLES, IN CLASS 31 (U.S. CLS. 1 AND 46).

**TRADEMARK**

FIRST USE 5-19-2012; IN COMMERCE 5-19-2012.

**PRINCIPAL REGISTER**

THE MARK CONSISTS OF STANDARD CHARACTERS WITHOUT CLAIM TO ANY PARTICULAR FONT, STYLE, SIZE, OR COLOR.

SN 85-356,994, FILED 6-27-2011.

DAVID COLLIER, EXAMINING ATTORNEY



*David J. Kyffers*

Director of the United States Patent and Trademark Office

# United States of America

United States Patent and Trademark Office

# CYBERBIKE

**Reg. No. 4,199,773**

**Registered Aug. 28, 2012**

**Int. Cls.: 9 and 28**

**TRADEMARK**

**PRINCIPAL REGISTER**

DELTAREFERENCE, BESLOTEN VENNOOTSCHAP MET BEPERKTE  
AANSPRAKELIJKHEID (BELGIUM BESLOTEN VENNOOTSCHAP MET BEPERKTE  
AANSPRAKELIJKHEID (BVBA))  
PUINSTRAAT 26  
GENT, BELGIUM 9000

FOR: PRERECORDED MAGNETIC DATA CARRIERS FEATURING COMPUTER GAME PROGRAMS, COMPUTER GAME CARTRIDGES, COMPUTER GAME CASSETTES, COMPUTER GAME CONSOLES FOR USE WITH AN EXTERNAL DISPLAY SCREEN OR MONITOR; COMPUTER GAME DISCS; COMPUTER GAME JOYSTICKS; COMPUTER GAME SOFTWARE; GAME CONTROLLERS FOR COMPUTER GAMES, IN CLASS 9 (U.S. CLS. 21, 23, 26, 36 AND 38).

FIRST USE 9-6-2006; IN COMMERCE 6-29-2011.

FOR: EXERCISE MACHINES INCORPORATING ELECTRONIC AND VIDEO GAME CONTROLLERS; ELECTRONIC SPORTS TRAINING SIMULATORS; EXERCISE EQUIPMENT, NAMELY, STATIONARY CYCLES, IN CLASS 28 (U.S. CLS. 22, 23, 38 AND 50).

FIRST USE 9-6-2006; IN COMMERCE 6-29-2011.

THE MARK CONSISTS OF STANDARD CHARACTERS WITHOUT CLAIM TO ANY PARTICULAR FONT, STYLE, SIZE, OR COLOR.

OWNER OF U.S. REG. NO. 3,713,855.

SN 85-357,058, FILED 6-27-2011.

HENRY S. ZAK, EXAMINING ATTORNEY



*David J. Kyfos*

Director of the United States Patent and Trademark Office

# United States of America

United States Patent and Trademark Office

# RA

**Reg. No. 4,199,774**

**Registered Aug. 28, 2012**

**Int. Cl.: 33**

**TRADEMARK**

**PRINCIPAL REGISTER**

RA SUSHI HOLDING CORP. (DELAWARE CORPORATION)  
6263 N. SCOTTSDALE ROAD  
SUITE 285  
SCOTTSDALE, AZ 85250

FOR: ALCOHOLIC MIXED BEVERAGES EXCEPT BEERS, IN CLASS 33 (U.S. CLS. 47 AND 49).

FIRST USE 11-0-2004; IN COMMERCE 11-0-2004.

THE MARK CONSISTS OF STANDARD CHARACTERS WITHOUT CLAIM TO ANY PARTICULAR FONT, STYLE, SIZE, OR COLOR.

OWNER OF U.S. REG. NOS. 2,209,246, 3,087,775, AND 3,087,776.

SN 85-357,575, FILED 6-27-2011.

GIANCARLO CASTRO, EXAMINING ATTORNEY



*David J. Kyffers*

Director of the United States Patent and Trademark Office



# United States of America

United States Patent and Trademark Office

# PENNYPOP

**Reg. No. 4,199,775**

MIR PARTNERS INC. (DELAWARE CORPORATION)  
UNIT S1209 355 1ST ST  
SAN FRANCISCO, CA 94105

**Registered Aug. 28, 2012**

**Int. Cl.: 9**

FOR: DOWNLOADABLE COMPUTER GAME SOFTWARE AND ENTERTAINMENT SOFTWARE IN THE NATURE OF SOCIAL COMPUTER GAMES WHICH ALLOW INTERACTIVE GAME PLAY, SHARING OF INFORMATION AND DATA AND COMMUNICATION AMONGST AN ONLINE COMMUNITY, FOR USE ON WIRELESS DEVICES AND COMPUTERS, IN CLASS 9 (U.S. CLS. 21, 23, 26, 36 AND 38).

**TRADEMARK**

**PRINCIPAL REGISTER**

FIRST USE 5-9-2012; IN COMMERCE 5-9-2012.

THE MARK CONSISTS OF STANDARD CHARACTERS WITHOUT CLAIM TO ANY PARTICULAR FONT, STYLE, SIZE, OR COLOR.

SN 85-357,674, FILED 6-28-2011.

RAMONA ORTIGA, EXAMINING ATTORNEY



*David J. Kyffers*

Director of the United States Patent and Trademark Office

# United States of America

United States Patent and Trademark Office

## PHONE BUDDY

**Reg. No. 4,199,776**

DIGITAT CONCEPTS LLC. (FLORIDA LIMITED LIABILITY COMPANY)  
POB 212034

**Registered Aug. 28, 2012**

WEST PALM BEACH, FL 33421

**Int. Cl.: 9**

FOR: STANDS FOR HANDHELD DIGITAL ELECTRONIC DEVICES, IN CLASS 9 (U.S. CLS. 21, 23, 26, 36 AND 38).

**TRADEMARK**

FIRST USE 6-18-2011; IN COMMERCE 7-19-2011.

**PRINCIPAL REGISTER**

THE MARK CONSISTS OF STANDARD CHARACTERS WITHOUT CLAIM TO ANY PARTICULAR FONT, STYLE, SIZE, OR COLOR.

NO CLAIM IS MADE TO THE EXCLUSIVE RIGHT TO USE "PHONE", APART FROM THE MARK AS SHOWN.

SN 85-358,483, FILED 6-28-2011.

ALAIN LAPTER, EXAMINING ATTORNEY



*David J. Kyffers*

Director of the United States Patent and Trademark Office

# United States of America

United States Patent and Trademark Office

## FEATHERWEIGHT

**Reg. No. 4,199,777**

V2 WINE GROUP, LLC (CALIFORNIA LIMITED LIABILITY COMPANY)  
567 FIRST STREET EAST  
SONOMA, CA 95476

**Registered Aug. 28, 2012**

**Int. Cl.: 33**

FOR: WINES, IN CLASS 33 (U.S. CLS. 47 AND 49).

**TRADEMARK**

FIRST USE 4-30-2012; IN COMMERCE 5-7-2012.

**PRINCIPAL REGISTER**

THE MARK CONSISTS OF STANDARD CHARACTERS WITHOUT CLAIM TO ANY PARTICULAR FONT, STYLE, SIZE, OR COLOR.

SN 85-358,704, FILED 6-28-2011.

JENNIFER VASQUEZ, EXAMINING ATTORNEY



*David J. Kybas*

Director of the United States Patent and Trademark Office

# United States of America

United States Patent and Trademark Office

# MIECHLEN

**Reg. No. 4,199,778**

**Registered Aug. 28, 2012**

**Int. Cl.: 20**

**TRADEMARK**

**PRINCIPAL REGISTER**

LIAO SHUNNAN (CHINA INDIVIDUAL)  
NO.12, HUIYUAN 1ST STREET, HUIYUAN ROAD  
JIBEI, LONGJIANG TOWN, SHUNDE DISTRICT  
FOSHAN, GUANGDONG, CHINA

FOR: BEDS; FURNITURE; FURNITURE OF METAL; MATTRESSES; OFFICE FURNITURE;  
SCREENS; SEATS; SOFAS; TEA TABLES; WOODEN DISPLAY STANDS, IN CLASS 20 (U.S.  
CLS. 2, 13, 22, 25, 32 AND 50).

FIRST USE 1-20-2009; IN COMMERCE 1-9-2010.

THE MARK CONSISTS OF THE STYLIZED WORD "MIECHLEN".

THE WORDING "MIECHLEN" HAS NO MEANING IN A FOREIGN LANGUAGE.

SN 85-358,908, FILED 6-28-2011.

FRED CARL, EXAMINING ATTORNEY



*David J. Kybas*

Director of the United States Patent and Trademark Office

# United States of America

United States Patent and Trademark Office



**Reg. No. 4,199,779**

**Registered Aug. 28, 2012**

**Int. Cl.: 11**

**TRADEMARK**

**PRINCIPAL REGISTER**

STANDARD SALES, INC. (CALIFORNIA CORPORATION)  
2801 EAST 12TH STEET  
LOS ANGELES, CA 90023

FOR: FLASHLIGHTS, TENT LIGHTS, ELECTRIC LANTERNS, PORTABLE PROPANE HEATERS, PORTABLE TOILETS, BARBEQUE GRILLS, ELECTRIC GRILLS, AND PORTABLE PROPANE AND BUTANE FIRED GRILLS, IN CLASS 11 (U.S. CLS. 13, 21, 23, 31 AND 34).

FIRST USE 4-23-2012; IN COMMERCE 4-23-2012.

OWNER OF U.S. REG. NO. 3,659,321.

NO CLAIM IS MADE TO THE EXCLUSIVE RIGHT TO USE "SINCE 1949", APART FROM THE MARK AS SHOWN.

THE MARK CONSISTS OF THE WORDING "STANSport" WITH A BACKGROUND OF MOUNTAINS AND A WINDING RIVER, BELOW WHICH THE WORDS "SINCE 1949" ARE DISPLAYED INSIDE AN OVAL.

SN 85-358,917, FILED 6-29-2011.

ELIZABETH KAJUBI, EXAMINING ATTORNEY



*David J. Kypos*

Director of the United States Patent and Trademark Office

# United States of America

United States Patent and Trademark Office



**Reg. No. 4,199,780**

**Registered Aug. 28, 2012**

**Int. Cl.: 20**

**TRADEMARK**

**PRINCIPAL REGISTER**

STANDARD SALES, INC. (CALIFORNIA CORPORATION)  
2801 EAST 12TH STREET  
LOS ANGELES, CA 90023

FOR: COLLAPSIBLE CHAIRS FOR CAMPING, STOOLS, COTS, AIR BEDS FOR USE WHEN CAMPING, SLEEPING BAGS, AIR MATTRESS FOR USE WHEN CAMPING, IN CLASS 20 (U.S. CLS. 2, 13, 22, 25, 32 AND 50).

FIRST USE 12-12-2011; IN COMMERCE 12-12-2011.

OWNER OF U.S. REG. NO. 3,659,321.

NO CLAIM IS MADE TO THE EXCLUSIVE RIGHT TO USE "SINCE 1949", APART FROM THE MARK AS SHOWN.

THE MARK CONSISTS OF THE WORDING "STANSPORT" WITH A BACKGROUND OF MOUNTAINS AND A WINDING RIVER, BELOW WHICH THE WORDS "SINCE 1949" ARE DISPLAYED INSIDE AN OVAL.

SN 85-358,923, FILED 6-29-2011.

ELIZABETH KAJUBI, EXAMINING ATTORNEY



*David J. Kyros*

Director of the United States Patent and Trademark Office

# United States of America

United States Patent and Trademark Office



**Reg. No. 4,199,781**

**Registered Aug. 28, 2012**

**Int. Cl.: 21**

**TRADEMARK**

**PRINCIPAL REGISTER**

STANDARD SALES, INC. (CALIFORNIA CORPORATION)  
2801 EAST 12TH STREET  
LOS ANGELES, CA 90023

FOR: COOKWARE AND DINNERWARE, NAMELY, POTS, FRYING PANS, PLATES, NON-ELECTRIC COFFEE POTS NOT OF PRECIOUS METAL, COFFEE MUGS, CUPS, PLASTIC WATER BOTTLES SOLD EMPTY, CANTEENS, AND BOWLS; MESS KITS CONSISTING OF FRYING PAN, POT, LID AND HANDLE FOR USE WITH PANS AND POTS, PLATES, CUPS, AND COOKING UTENSILS, NAMELY, KNIVES, FORKS, AND SPOONS, IN CLASS 21 (U.S. CLS. 2, 13, 23, 29, 30, 33, 40 AND 50).

FIRST USE 2-1-2012; IN COMMERCE 2-1-2012.

OWNER OF U.S. REG. NO. 3,659,321.

NO CLAIM IS MADE TO THE EXCLUSIVE RIGHT TO USE "SINCE 1949", APART FROM THE MARK AS SHOWN.

THE MARK CONSISTS OF THE WORDING "STANSPOORT" WITH A BACKGROUND OF MOUNTAINS AND A WINDING RIVER, BELOW WHICH THE WORDS "SINCE 1949" ARE DISPLAYED INSIDE AN OVAL.

SN 85-358,926, FILED 6-29-2011.

KATHLEEN M. VANSTON, EXAMINING ATTORNEY



*David J. Kyffers*

Director of the United States Patent and Trademark Office

# United States of America

United States Patent and Trademark Office



**Reg. No. 4,199,782**

STANDARD SALES, INC. (CALIFORNIA CORPORATION)  
2801 EAST 12TH STREET  
LOS ANGELES, CA 90023

**Registered Aug. 28, 2012**

**Int. Cl.: 22**

FOR: TENTS, TARPS, CANVAS CANOPIES, TENTS IN THE NATURE OF PAVILIONS AND SUN SHELTERS, AND HAMMOCKS, IN CLASS 22 (U.S. CLS. 1, 2, 7, 19, 22, 42 AND 50).

**TRADEMARK**

FIRST USE 12-23-2011; IN COMMERCE 12-23-2011.

**PRINCIPAL REGISTER**

OWNER OF U.S. REG. NO. 3,659,321.

NO CLAIM IS MADE TO THE EXCLUSIVE RIGHT TO USE "SINCE 1949", APART FROM THE MARK AS SHOWN.

THE MARK CONSISTS OF THE WORDING "STANSPORT" WITH A BACKGROUND OF MOUNTAINS AND A WINDING RIVER, BELOW WHICH THE WORDS "SINCE 1949" ARE DISPLAYED INSIDE AN OVAL.

SN 85-358,928, FILED 6-29-2011.

KATHLEEN M. VANSTON, EXAMINING ATTORNEY



*David J. Kyros*

Director of the United States Patent and Trademark Office



# United States of America

United States Patent and Trademark Office

# FARAA

**Reg. No. 4,199,783**

BECHTOLD, CLIFFORD (UNITED STATES INDIVIDUAL)  
5818 BACK COURT  
AUSTIN, TX 78731

**Registered Aug. 28, 2012**

**Int. Cls.: 35, 41, and 45**

FOR: PROMOTING THE GOODS AND SERVICES OF OTHERS BY PROVIDING A COMMUNITY-DRIVEN WEB SITE FEATURING USER-SUBMITTED CONTENT IN THE NATURE OF COUPONS, REBATES, PRICE-COMPARISON INFORMATION, PRODUCT REVIEWS, LINKS TO THE RETAIL WEB SITES OF OTHERS, AND DISCOUNT INFORMATION, IN CLASS 35 (U.S. CLS. 100, 101 AND 102).

**SERVICE MARK**

**PRINCIPAL REGISTER**

FIRST USE 2-17-2012; IN COMMERCE 2-17-2012.

FOR: ON-LINE JOURNALS, NAMELY, BLOGS FEATURING ISSUES RELEVANT TO THOSE OVER THE AGE OF FORTY, IN CLASS 41 (U.S. CLS. 100, 101 AND 107).

FIRST USE 2-17-2012; IN COMMERCE 2-17-2012.

FOR: ON-LINE SOCIAL NETWORKING SERVICES, IN CLASS 45 (U.S. CLS. 100 AND 101).

FIRST USE 2-17-2012; IN COMMERCE 2-17-2012.

THE MARK CONSISTS OF STANDARD CHARACTERS WITHOUT CLAIM TO ANY PARTICULAR FONT, STYLE, SIZE, OR COLOR.

SN 85-359,209, FILED 6-29-2011.

ESTHER BELENKER, EXAMINING ATTORNEY



*David J. Kyros*

Director of the United States Patent and Trademark Office

# United States of America

United States Patent and Trademark Office

## The Hunters Hammock

**Reg. No. 4,199,784**

FUNCTIONAL SOLUTIONS LLC (SOUTH CAROLINA LIMITED LIABILITY COMPANY)  
1241 TYLER DR.  
HEMINGWAY, SC 29554

**Registered Aug. 28, 2012**

**Int. Cl.: 20**

FOR: TREESTAND SEAT FOR HUNTING, IN CLASS 20 (U.S. CLS. 2, 13, 22, 25, 32 AND 50).

FIRST USE 10-17-2011; IN COMMERCE 10-17-2011.

**TRADEMARK**

THE MARK CONSISTS OF STANDARD CHARACTERS WITHOUT CLAIM TO ANY PARTICULAR FONT, STYLE, SIZE, OR COLOR.

**PRINCIPAL REGISTER**

NO CLAIM IS MADE TO THE EXCLUSIVE RIGHT TO USE "HUNTERS", APART FROM THE MARK AS SHOWN.

SN 85-360,281, FILED 6-30-2011.

TOBY BULLOFF, EXAMINING ATTORNEY



*David J. Kyffers*

Director of the United States Patent and Trademark Office

# United States of America

United States Patent and Trademark Office

## DIZZY DANCERS

**Reg. No. 4,199,785**

HASBRO, INC. (RHODE ISLAND CORPORATION)  
1027 NEWPORT AVENUE  
PAWTUCKET, RI 02862

**Registered Aug. 28, 2012**

**Int. Cl.: 28**

FOR: TOY SPINNING TOPS, IN CLASS 28 (U.S. CLS. 22, 23, 38 AND 50).

**TRADEMARK**

FIRST USE 10-17-2011; IN COMMERCE 10-17-2011.

**PRINCIPAL REGISTER**

THE MARK CONSISTS OF STANDARD CHARACTERS WITHOUT CLAIM TO ANY PARTICULAR FONT, STYLE, SIZE, OR COLOR.

SN 85-360,409, FILED 6-30-2011.

NAKIA HENRY, EXAMINING ATTORNEY



*David J. Kyffers*

Director of the United States Patent and Trademark Office

# United States of America

United States Patent and Trademark Office



**Reg. No. 4,199,786**

**Registered Aug. 28, 2012**

**Int. Cl.: 28**

**TRADEMARK**

**PRINCIPAL REGISTER**

HASBRO, INC. (RHODE ISLAND CORPORATION)  
1027 NEWPORT AVENUE  
PAWTUCKET, RI 02862

FOR: TOY SPINNING TOPS, IN CLASS 28 (U.S. CLS. 22, 23, 38 AND 50).

FIRST USE 10-17-2011; IN COMMERCE 10-17-2011.

OWNER OF U.S. REG. NO. 2,858,431.

THE MARK CONSISTS OF THE WORD "FURREAL" WITHIN AN OVAL, THE WORD "FRIENDS" WITHIN A HEART AND HAVING A PAWPRINT ABOVE THE "I", AND THE WORDS "DIZZY DANCERS", ALL ENCLOSED WITHIN A SHIELD-SHAPED OUTLINE WITH A CROWN SHAPE ALONG THE TOP EDGE AND CURVED SWIRLS ON EITHER SIDE.

SN 85-360,413, FILED 6-30-2011.

NAKIA HENRY, EXAMINING ATTORNEY



*David J. Kyffers*

Director of the United States Patent and Trademark Office

# United States of America

United States Patent and Trademark Office

*my*  
**EZ**  
*Nutrition*

**Reg. No. 4,199,787**

**Registered Aug. 28, 2012**

**Int. Cl.: 44**

**SERVICE MARK**

**PRINCIPAL REGISTER**

MY EZ NUTRITION, INC. (VIRGINIA CORPORATION)  
SUITE 100  
21515 RIDGETOP CIRCLE  
STERLING, VA 20166

FOR: WEIGHT REDUCTION, DIET PLANNING AND SUPERVISION SERVICES; NUTRITION COUNSELING SERVICES; PROVIDING WEIGHT LOSS AND/OR WEIGHT MAINTENANCE PROGRAM SERVICES, IN CLASS 44 (U.S. CLS. 100 AND 101).

FIRST USE 6-1-2012; IN COMMERCE 6-1-2012.

NO CLAIM IS MADE TO THE EXCLUSIVE RIGHT TO USE "NUTRITION", APART FROM THE MARK AS SHOWN.

THE COLOR(S) BLACK AND BLUE IS/ARE CLAIMED AS A FEATURE OF THE MARK.

THE MARK CONSISTS OF THE WORDING "MY" IN STYLIZED, BLACK LETTERING TO THE UPPER LEFT OF "EZ" IN STYLIZED, BLUE LETTERING, WHICH IS TO THE UPPER LEFT OF "NUTRITION" IN STYLIZED, BLACK LETTERING.

SN 85-360,441, FILED 6-30-2011.

KATHERINE CHANG, EXAMINING ATTORNEY



*David J. Kyros*

Director of the United States Patent and Trademark Office

# United States of America

United States Patent and Trademark Office

## MY EZ NUTRITION

**Reg. No. 4,199,788**

**Registered Aug. 28, 2012**

**Int. Cl.: 44**

**SERVICE MARK**

**PRINCIPAL REGISTER**

MY EZ NUTRITION, INC. (VIRGINIA CORPORATION)  
SUITE 100  
21515 RIDGETOP CIRCLE  
STERLING, VA 20166

FOR: WEIGHT REDUCTION, DIET PLANNING AND SUPERVISION SERVICES; NUTRITION COUNSELING SERVICES; PROVIDING WEIGHT LOSS AND/OR WEIGHT MAINTENANCE PROGRAM SERVICES, IN CLASS 44 (U.S. CLS. 100 AND 101).

FIRST USE 6-1-2012; IN COMMERCE 6-1-2012.

THE MARK CONSISTS OF STANDARD CHARACTERS WITHOUT CLAIM TO ANY PARTICULAR FONT, STYLE, SIZE, OR COLOR.

NO CLAIM IS MADE TO THE EXCLUSIVE RIGHT TO USE "NUTRITION", APART FROM THE MARK AS SHOWN.

SN 85-360,442, FILED 6-30-2011.

KATHERINE CHANG, EXAMINING ATTORNEY



*David J. Kyros*

Director of the United States Patent and Trademark Office

# United States of America

United States Patent and Trademark Office

## AVERAGE JOE

**Reg. No. 4,199,789**

AVERAGE JOE ARTISAN BREAD LLC (INDIANA LIMITED LIABILITY COMPANY)  
9935 RED PINE COURT  
FORT WAYNE, IN 46804

**Registered Aug. 28, 2012**

**Int. Cl.: 30**

FOR: KITS FOR MAKING BREAD COMPRISING BREAD MIXES AND BAKING PAN, IN CLASS 30 (U.S. CL. 46).

**TRADEMARK**

FIRST USE 7-31-2011; IN COMMERCE 7-31-2011.

**PRINCIPAL REGISTER**

THE MARK CONSISTS OF STANDARD CHARACTERS WITHOUT CLAIM TO ANY PARTICULAR FONT, STYLE, SIZE, OR COLOR.

SN 85-361,608, FILED 7-1-2011.

TINA MAI, EXAMINING ATTORNEY



*David J. Kyffers*

Director of the United States Patent and Trademark Office

# United States of America

United States Patent and Trademark Office



**Reg. No. 4,199,790**

WORLD SPORT CHICAGO (ILLINOIS NON-PROFIT CORPORATION)  
200 E. RANDOLPH ST., 20TH FLOOR  
CHICAGO, IL 60601

**Registered Aug. 28, 2012**

**Int. Cls.: 25, 35, and 41**

FOR: CLOTHING AND ATHLETIC APPAREL, NAMELY, T-SHIRTS, SHIRTS, IN CLASS 25 (U.S. CLS. 22 AND 39).

**TRADEMARK**

FIRST USE 8-23-2011; IN COMMERCE 8-23-2011.

**SERVICE MARK**

FOR: PROMOTION OF SPORTS EVENTS, ATHLETIC CONTESTS, ATHLETIC GAMES AND ATHLETIC ACTIVITIES, IN CLASS 35 (U.S. CLS. 100, 101 AND 102).

**PRINCIPAL REGISTER**

FIRST USE 5-15-2011; IN COMMERCE 5-15-2011.

FOR: ARRANGING, ORGANIZING, OPERATING AND CONDUCTING ATHLETIC COMPETITIONS AND SPORTING EVENTS; ATHLETIC TRAINING SERVICES; ENCOURAGING AMATEUR SPORTS AND PHYSICAL EDUCATION BY ORGANIZING, SANCTIONING, CONDUCTING, AND REGULATING AMATEUR ATHLETIC PROGRAMS AND ACTIVITIES, IN CLASS 41 (U.S. CLS. 100, 101 AND 107).

FIRST USE 5-15-2011; IN COMMERCE 5-15-2011.

THE MARK CONSISTS OF THE STYLIZED LETTERS "V" AND "G" INSIDE OF A CIRCLE, WITH THE "V" ATTACHED TO THE LETTER "G" AND WITH THE BODY OF THE "V" FORMING THE BASE OF AN ABSTRACT REPRESENTATION OF A TORCH.

SN 85-361,808, FILED 7-1-2011.

EDWARD NELSON, EXAMINING ATTORNEY



*David J. Kybas*

Director of the United States Patent and Trademark Office



# United States of America

United States Patent and Trademark Office

## VARMAGEDDON

**Reg. No. 4,199,791**

NOSLER, INC. (OREGON CORPORATION)  
107 SW COLUMBIA STREET  
BEND, OR 97702

**Registered Aug. 28, 2012**

**Int. Cl.: 13**

FOR: AMMUNITION; BULLETS, IN CLASS 13 (U.S. CLS. 2 AND 9).

**TRADEMARK**

FIRST USE 10-13-2011; IN COMMERCE 10-13-2011.

**PRINCIPAL REGISTER**

THE MARK CONSISTS OF STANDARD CHARACTERS WITHOUT CLAIM TO ANY PARTICULAR FONT, STYLE, SIZE, OR COLOR.

SN 85-362,234, FILED 7-1-2011.

JUDITH HELFMAN, EXAMINING ATTORNEY



*David J. Kyffers*

Director of the United States Patent and Trademark Office

# United States of America

United States Patent and Trademark Office

# Extra Credit

**Reg. No. 4,199,792**

**Registered Aug. 28, 2012**

**Int. Cl.: 36**

**SERVICE MARK**

**PRINCIPAL REGISTER**

EXTRA CREDIT INC. (MISSISSIPPI CORPORATION)  
6375 NELLWOOD DR.  
OLIVE BRANCH, MS 386548268

FOR: FINANCIAL INTERMEDIARY SERVICES, NAMELY, ARRANGING CREDIT CARD PROCESSING FOR MERCHANTS ON BEHALF OF SCHOOLS OR CHARITABLE ORGANIZATIONS, WHEREBY A FEE FOR EACH CREDIT CARD TRANSACTION IS DONATED TO THE SCHOOL OR CHARITABLE ORGANIZATION IN RETURN FOR RECOGNITION OF THE MERCHANT BY THE SCHOOL OR CHARITABLE ORGANIZATION, IN CLASS 36 (U.S. CLS. 100, 101 AND 102).

FIRST USE 6-1-2012; IN COMMERCE 6-1-2012.

THE MARK CONSISTS OF THE WORD "EXTRA" ABOVE AND TO THE RIGHT OF THE WORD "CREDIT"; THE LETTER "C" OF THE WORD "CREDIT" IS FORMED FROM A STYLIZED APPLE.

SN 85-362,320, FILED 7-1-2011.

ANDREW LEASER, EXAMINING ATTORNEY



*David J. Kyffers*

Director of the United States Patent and Trademark Office

# United States of America

United States Patent and Trademark Office

# HardCrush

**Reg. No. 4,199,793**

LEIGH WELSH (UNITED STATES INDIVIDUAL)  
370 GUNSTON HALL CIR  
MILTON, GA 30004

**Registered Aug. 28, 2012**

**Int. Cls.: 9 and 41**

FOR: AUDIO AND VIDEO RECORDINGS FEATURING MUSIC AND ARTISTIC PERFORMANCES, IN CLASS 9 (U.S. CLS. 21, 23, 26, 36 AND 38).

**TRADEMARK**

FIRST USE 3-1-2008; IN COMMERCE 3-1-2008.

**SERVICE MARK**

FOR: ENTERTAINMENT SERVICES IN THE NATURE OF LIVE MUSICAL PERFORMANCES, IN CLASS 41 (U.S. CLS. 100, 101 AND 107).

**PRINCIPAL REGISTER**

FIRST USE 3-1-2008; IN COMMERCE 6-25-2009.

THE MARK CONSISTS OF STANDARD CHARACTERS WITHOUT CLAIM TO ANY PARTICULAR FONT, STYLE, SIZE, OR COLOR.

SN 85-362,641, FILED 7-4-2011.

RAMONA ORTIGA, EXAMINING ATTORNEY



*David J. Kyros*

Director of the United States Patent and Trademark Office

# United States of America

United States Patent and Trademark Office

# Lux Nation

**Reg. No. 4,199,794**

SHARON YOUNG INC (TEXAS CORPORATION)  
10367 BROCKWOOD RD  
DALLAS, TX 75238

**Registered Aug. 28, 2012**

**Int. Cl.: 25**

FOR: CLOTHING, NAMELY, JEANS, SHIRTS, JACKETS, BLOUSES, SLACKS, PANTS, SHORTS, SWEATERS, SWIMWEAR, SKIRTS, SKORTS, SUITS, TANK TOPS, T-SHIRTS, VESTS, HALTERS, DRESSES, IN CLASS 25 (U.S. CLS. 22 AND 39).

**TRADEMARK**

FIRST USE 7-5-2011; IN COMMERCE 7-5-2011.

**PRINCIPAL REGISTER**

THE MARK CONSISTS OF STANDARD CHARACTERS WITHOUT CLAIM TO ANY PARTICULAR FONT, STYLE, SIZE, OR COLOR.

NO CLAIM IS MADE TO THE EXCLUSIVE RIGHT TO USE "LUX", APART FROM THE MARK AS SHOWN.

SN 85-362,963, FILED 7-5-2011.

JESSICA A. POWERS, EXAMINING ATTORNEY



*David J. Kyros*

Director of the United States Patent and Trademark Office

# United States of America

United States Patent and Trademark Office

# Steute Xtreme

**Reg. No. 4,199,795**

**Registered Aug. 28, 2012**

**Int. Cls.: 9, 40, and 42**

**TRADEMARK**

**SERVICE MARK**

**PRINCIPAL REGISTER**

STEUTE SCHALTGERATE GMBH & CO. KG (FED REP GERMANY GESELLSCHAFT MIT  
BESCHRÄNKTER HAFTUNG (GMBH))  
BRÜCKENSTRASSE 91  
LÖHNE, FED REP GERMANY 32584

FOR: SWITCHGEARS, ELECTRIC SWITCHES; ELECTRONIC MOTION SENSITIVE  
SWITCHES; ELECTRONIC TOUCH SENSITIVE SWITCHES, POWER SWITCHES, AND  
HAND AND FOOT OPERATED ELECTRIC SWITCHES FOR MACHINES, IN CLASS 9 (U.S.  
CLS. 21, 23, 26, 36 AND 38).

FIRST USE 5-24-2012; IN COMMERCE 5-24-2012.

FOR: CUSTOM MANUFACTURE OF SWITCHES AND CONTROLS IN THE FIELD OF IN-  
DUSTRIAL PROCESSING MACHINES, IN CLASS 40 (U.S. CLS. 100, 103 AND 106).

FIRST USE 5-24-2012; IN COMMERCE 5-24-2012.

FOR: CUSTOM DESIGN OF SWITCHES AND CONTROLS IN THE FIELD OF INDUSTRIAL  
PROCESSING MACHINES, IN CLASS 42 (U.S. CLS. 100 AND 101).

FIRST USE 5-24-2012; IN COMMERCE 5-24-2012.

THE MARK CONSISTS OF STANDARD CHARACTERS WITHOUT CLAIM TO ANY PAR-  
TICULAR FONT, STYLE, SIZE, OR COLOR.

OWNER OF U.S. REG. NOS. 2,580,921, 2,604,434, AND 3,617,928.

SN 85-363,144, FILED 7-5-2011.

MARK SHINER, EXAMINING ATTORNEY



*David J. Kypos*

Director of the United States Patent and Trademark Office

# United States of America

United States Patent and Trademark Office

## The Make or Break Minute

**Reg. No. 4,199,796**

**Registered Aug. 28, 2012**

**Int. Cl.: 41**

**SERVICE MARK**

**PRINCIPAL REGISTER**

MAKE OR BREAK COMMUNICATIONS, LLC (FLORIDA LIMITED LIABILITY COMPANY)  
UNIT 510  
1345 N HWY A1A  
INDIALANTIC, FL 32903

FOR: EDUCATIONAL SERVICES, NAMELY, CONDUCTING LIVE TRAINING CLASSES, SEMINARS, WORKSHOPS AND WEBINARS AND SPEAKING PROGRAMS AND WEB-BASED AND VIDEO TRAINING PROGRAMS IN THE FIELD OF EXECUTIVE PUBLIC RELATIONS, COACHING AND DEVELOPMENT AND PUBLICATION AND DISTRIBUTION OF BOOKS AND TRAINING MATERIALS IN DIGITAL, ELECTRONIC AND HARD COPY FORMATS IN CONNECTION THEREWITH, IN CLASS 41 (U.S. CLS. 100, 101 AND 107).

FIRST USE 12-1-2010; IN COMMERCE 10-3-2011.

THE MARK CONSISTS OF STANDARD CHARACTERS WITHOUT CLAIM TO ANY PARTICULAR FONT, STYLE, SIZE, OR COLOR.

SN 85-363,254, FILED 7-5-2011.

DAVID COLLIER, EXAMINING ATTORNEY



*David J. Kyros*

Director of the United States Patent and Trademark Office

# United States of America

United States Patent and Trademark Office

patriotpqt

**Reg. No. 4,199,797**

SAVANH, BOBBY (UNITED STATES INDIVIDUAL)  
8830 NE SANDY BLVD., UNIT C  
PORTLAND, OR 97220

**Registered Aug. 28, 2012**

**Int. Cl.: 22**

FOR: PLANT WRAP COMPRISED OF CANVAS FABRIC TO ALLOW FOR MORE AIR CIRCULATION FOR THE ROOTS, FOR USE IN THE INDOOR GARDEN INDUSTRY, IN CLASS 22 (U.S. CLS. 1, 2, 7, 19, 22, 42 AND 50).

**TRADEMARK**

FIRST USE 6-1-2009; IN COMMERCE 6-1-2009.

**PRINCIPAL REGISTER**

THE MARK CONSISTS OF THE WORD "PATRIOTPOT" WITH THE "O" IN "POT" EXTENDING DOWNWARD INTO A DESIGN RESEMBLING A STYLIZED STEM WITH TWO LEAVES. EXTENDING OUTWARD FROM THE TOP LEFT PORTION OF THE "P" IN "PATRIOT" IS A SINGLE STYLIZED LEAF DESIGN.

SN 85-363,366, FILED 7-5-2011.

PAULA MAHONEY, EXAMINING ATTORNEY



*David J. Kyffers*

Director of the United States Patent and Trademark Office

# United States of America

United States Patent and Trademark Office

# Artanky

**Reg. No. 4,199,798**

**Registered Aug. 28, 2012**

**Int. Cl.: 25**

**TRADEMARK**

**PRINCIPAL REGISTER**

ARTANKY CLOTHING (US) CO., LTD. (DELAWARE CORPORATION)  
SUITE 806  
1220 N. MARKET STREET  
WILMINGTON, DE 19801

FOR: COATS; DOWN JACKETS; FOOTWEAR; HEADWEAR; JACKETS; SINGLET;  
SWIMSUITS; TEE SHIRTS; TROUSERS; UNDERWEAR, IN CLASS 25 (U.S. CLS. 22 AND  
39).

FIRST USE 4-10-2010; IN COMMERCE 4-30-2010.

THE WORDING "ARTANKY" HAS NO MEANING IN A FOREIGN LANGUAGE.

SN 85-363,739, FILED 7-6-2011.

SIMON TENG, EXAMINING ATTORNEY



*David J. Kyros*

Director of the United States Patent and Trademark Office



# United States of America

United States Patent and Trademark Office

## COUTURE GEL NAILS

**Reg. No. 4,199,799**

JENKINS, LAURA (UNITED STATES INDIVIDUAL)

**Registered Aug. 28, 2012**

STE. 16-222  
4460 REDWOOD HWY.  
SAN RAFAEL, CA 94903

**Int. Cl.: 3**

FOR: UV SOAK OFF GEL NAIL POLISH; NAIL POLISH, IN CLASS 3 (U.S. CLS. 1, 4, 6, 50, 51 AND 52).

**TRADEMARK**

FIRST USE 6-1-2011; IN COMMERCE 10-3-2011.

**PRINCIPAL REGISTER**

THE MARK CONSISTS OF STANDARD CHARACTERS WITHOUT CLAIM TO ANY PARTICULAR FONT, STYLE, SIZE, OR COLOR.

NO CLAIM IS MADE TO THE EXCLUSIVE RIGHT TO USE "GEL NAILS", APART FROM THE MARK AS SHOWN.

SN 85-363,760, FILED 7-6-2011.

EMILY CARLSEN, EXAMINING ATTORNEY



*David J. Kyjars*

Director of the United States Patent and Trademark Office

# United States of America

United States Patent and Trademark Office

## THE ENTOURAGE

**Reg. No. 4,199,800**

**Registered Aug. 28, 2012**

**Int. Cl.: 28**

**TRADEMARK**

**PRINCIPAL REGISTER**

WILDGAME INNOVATIONS, LLC (LOUISIANA LIMITED LIABILITY COMPANY)  
101 CASON ROAD, 1ST FLOOR  
BROUSSARD, LA 70518

FOR: HUNTING GAME CALLS, IN CLASS 28 (U.S. CLS. 22, 23, 38 AND 50).

FIRST USE 12-16-2011; IN COMMERCE 12-16-2011.

THE MARK CONSISTS OF STANDARD CHARACTERS WITHOUT CLAIM TO ANY PARTICULAR FONT, STYLE, SIZE, OR COLOR.

SN 85-363,830, FILED 7-6-2011.

BRIAN CALLAGHAN, EXAMINING ATTORNEY



*David J. Kyffers*

Director of the United States Patent and Trademark Office

# United States of America

United States Patent and Trademark Office

## FOREVER GRATEFUL

**Reg. No. 4,199,801**

VAUGHAN, KENNY (UNITED STATES INDIVIDUAL)  
1555 SOUTH MAJOR DRIVE  
BEAUMONT, TX 77707

**Registered Aug. 28, 2012**

**Int. Cl.: 14**

FOR: JEWELRY; NON-MONETARY COINS, IN CLASS 14 (U.S. CLS. 2, 27, 28 AND 50).

**TRADEMARK**

FIRST USE 10-0-2011; IN COMMERCE 10-0-2011.

**PRINCIPAL REGISTER**

THE MARK CONSISTS OF STANDARD CHARACTERS WITHOUT CLAIM TO ANY PARTICULAR FONT, STYLE, SIZE, OR COLOR.

SN 85-364,607, FILED 7-6-2011.

JANICE L. MCMORROW, EXAMINING ATTORNEY



*David J. Kyffers*

Director of the United States Patent and Trademark Office

# United States of America

United States Patent and Trademark Office



**Reg. No. 4,199,802**

FUENTEZ, ANTHONY (UNITED STATES INDIVIDUAL)  
3467 VILLA KNOLLS SOUTH DR.  
LAS VEGAS, NV 89120

**Registered Aug. 28, 2012**

**Int. Cl.: 25**

FOR: T-SHIRTS, IN CLASS 25 (U.S. CLS. 22 AND 39).

**TRADEMARK**

FIRST USE 10-1-2011; IN COMMERCE 10-1-2011.

**PRINCIPAL REGISTER**

NO CLAIM IS MADE TO THE EXCLUSIVE RIGHT TO USE "SURF SHOP" , APART FROM THE MARK AS SHOWN.

THE MARK CONSISTS OF A CRESTING OCEAN WAVE FORMED BY NINE ROWS OF THE REPEATING BINARY NUMBERS "0" AND "1", WITH THE WORDS "DIGITAL WAVE SURF SHOP" APPEARING AT THE BOTTOM OF THE WAVE.

SN 85-364,617, FILED 7-6-2011.

COURTNEY ALVAREZ, EXAMINING ATTORNEY



*David J. Kybas*

Director of the United States Patent and Trademark Office

# United States of America

United States Patent and Trademark Office



**Reg. No. 4,199,803**

**Registered Aug. 28, 2012**

**Int. Cl.: 20**

**TRADEMARK**

**PRINCIPAL REGISTER**

STANDARD SALES, INC. (CALIFORNIA CORPORATION)  
2801 EAST 12TH STREET  
LOS ANGELES, CA 90023

FOR: COLLAPSIBLE CHAIRS FOR CAMPING, STOOLS, COTS, AIR BEDS FOR USE WHEN CAMPING, SLEEPING BAGS, AIR MATTRESS FOR USE WHEN CAMPING, IN CLASS 20 (U.S. CLS. 2, 13, 22, 25, 32 AND 50).

FIRST USE 12-22-2011; IN COMMERCE 12-22-2011.

OWNER OF U.S. REG. NO. 3,659,321.

THE COLOR(S) BEIGE, GREEN AND BLUE IS/ARE CLAIMED AS A FEATURE OF THE MARK.

NO CLAIM IS MADE TO THE EXCLUSIVE RIGHT TO USE "SINCE 1949", APART FROM THE MARK AS SHOWN.

THE MARK CONSISTS OF THE WORDS "STANSPORT" AND "SINCE 1949" IN BEIGE WITH GREEN AND BEIGE MOUNTAINS AND A WINDING RIVER IN BLUE, BELOW WHICH THE WORDS "SINCE 1949" ARE DISPLAYED INSIDE A GREEN OVAL. THE ENTIRE MARK AND THE OVAL ARE OUTLINED IN BEIGE.

SN 85-364,826, FILED 7-7-2011.

KATHLEEN M. VANSTON, EXAMINING ATTORNEY



*David J. Kybas*

Director of the United States Patent and Trademark Office

# United States of America

United States Patent and Trademark Office



**Reg. No. 4,199,804**

**Registered Aug. 28, 2012**

**Int. Cl.: 21**

**TRADEMARK**

**PRINCIPAL REGISTER**

STANDARD SALES, INC. (CALIFORNIA CORPORATION)  
2801 EAST 12TH STREET  
LOS ANGELES, CA 90023

FOR: COOKWARE AND DINNERWARE, NAMELY, POTS, FRYING PANS, PLATES, NON-ELECTRIC COFFEE POTS NOT OF PRECIOUS METAL, COFFEE MUGS, CUPS, PLASTIC WATER BOTTLES SOLD EMPTY, CANTEENS, AND BOWLS; MESS KITS CONSISTING OF FRYING PAN, POT, LID AND HANDLE FOR USE WITH PANS AND POTS, PLATES, CUPS, AND COOKING UTENSILS, NAMELY, KNIVES, FORKS, AND SPOONS, IN CLASS 21 (U.S. CLS. 2, 13, 23, 29, 30, 33, 40 AND 50).

FIRST USE 2-1-2012; IN COMMERCE 2-1-2012.

OWNER OF U.S. REG. NO. 3,659,321.

THE COLOR(S) BEIGE, GREEN AND BLUE IS/ARE CLAIMED AS A FEATURE OF THE MARK.

NO CLAIM IS MADE TO THE EXCLUSIVE RIGHT TO USE "SINCE 1949", APART FROM THE MARK AS SHOWN.

THE MARK CONSISTS OF THE WORDS "STANSPORT" AND "SINCE 1949" IN BEIGE WITH GREEN AND BEIGE MOUNTAINS AND A WINDING RIVER IN BLUE, BELOW WHICH THE WORDS "SINCE 1949" ARE DISPLAYED INSIDE A GREEN OVAL. THE ENTIRE MARK AND THE OVAL ARE OUTLINED IN BEIGE.

SN 85-364,828, FILED 7-7-2011.

KATHLEEN M. VANSTON, EXAMINING ATTORNEY



*David J. Kybas*

Director of the United States Patent and Trademark Office

# United States of America

United States Patent and Trademark Office



**Reg. No. 4,199,805**

STANDARD SALES, INC. (CALIFORNIA CORPORATION)  
2801 EAST 12TH STREET  
LOS ANGELES, CA 90023

**Registered Aug. 28, 2012**

**Int. Cl.: 22**

FOR: TENTS, TARPS, CANVAS CANOPIES, TENTS IN THE NATURE OF PAVILIONS AND SUN SHELTERS, AND HAMMOCKS, IN CLASS 22 (U.S. CLS. 1, 2, 7, 19, 22, 42 AND 50).

**TRADEMARK**

FIRST USE 12-23-2011; IN COMMERCE 12-23-2011.

**PRINCIPAL REGISTER**

OWNER OF U.S. REG. NO. 3,659,321.

THE COLOR(S) BEIGE, GREEN AND BLUE IS/ARE CLAIMED AS A FEATURE OF THE MARK.

NO CLAIM IS MADE TO THE EXCLUSIVE RIGHT TO USE "SINCE 1949", APART FROM THE MARK AS SHOWN.

THE MARK CONSISTS OF THE WORDS "STANSPORT" AND "SINCE 1949" IN BEIGE WITH GREEN AND BEIGE MOUNTAINS AND A WINDING RIVER IN BLUE, BELOW WHICH THE WORDS "SINCE 1949" ARE DISPLAYED INSIDE A GREEN OVAL. THE ENTIRE MARK AND THE OVAL ARE OUTLINED IN BEIGE.

SN 85-364,829, FILED 7-7-2011.

ELIZABETH KAJUBI, EXAMINING ATTORNEY



*David J. Kybas*

Director of the United States Patent and Trademark Office

# United States of America

United States Patent and Trademark Office

## VETERAN EMPIRE

**Reg. No. 4,199,806**

QUITEVIS, ALFRED PHILIP (UNITED STATES INDIVIDUAL)  
3328 CHATHAM RD.  
WAUKEGAN, IL 60087

**Registered Aug. 28, 2012**

**Int. Cls.: 18 and 25**

FOR: BACKPACK, TRAVEL BAG, DUFFLE BAG, SCHOOL BAG, BAG FOR SPORTS, IN CLASS 18 (U.S. CLS. 1, 2, 3, 22 AND 41).

**TRADEMARK**

FIRST USE 7-1-2011; IN COMMERCE 4-1-2012.

**PRINCIPAL REGISTER**

FOR: CLOTHING, NAMELY, PANTS, SOCKS, BELTS, BLAZERS, BLOUSES, COATS, DRESSES, FOOTWEAR, HALTER TOPS, HATS, JACKETS, JEANS, JERSEYS, JUMPERS, JUMPSUITS, OVERALLS, PULLOVERS, SHIRTS, SHORTS, SKIRTS, SLACKS, SPORT COATS, SWEATSHIRTS, T-SHIRTS AND TANK TOPS, IN CLASS 25 (U.S. CLS. 22 AND 39).

FIRST USE 7-1-2011; IN COMMERCE 4-1-2012.

THE MARK CONSISTS OF STANDARD CHARACTERS WITHOUT CLAIM TO ANY PARTICULAR FONT, STYLE, SIZE, OR COLOR.

SN 85-364,831, FILED 7-7-2011.

SALLY SHIH, EXAMINING ATTORNEY



*David J. Kypos*

Director of the United States Patent and Trademark Office



# United States of America

United States Patent and Trademark Office

# AVALYA

**Reg. No. 4,199,807**

AMERICAN WATER CHEMICALS, INC. (DELAWARE CORPORATION)  
1802 CORPORATE CENTER LANE  
PLANT CITY, FL 33563

**Registered Aug. 28, 2012**

**Int. Cl.: 1**

FOR: WATER TREATMENT CHEMICALS, NAMELY, ANTI-SCALANTS, ANTI-FOULANTS, BIOCIDES, CLEANSERS, COAGULANTS, FLOCCULANTS AND CORROSION INHIBITORS, IN CLASS 1 (U.S. CLS. 1, 5, 6, 10, 26 AND 46).

**TRADEMARK**

FIRST USE 10-11-2011; IN COMMERCE 10-11-2011.

**PRINCIPAL REGISTER**

THE MARK CONSISTS OF STANDARD CHARACTERS WITHOUT CLAIM TO ANY PARTICULAR FONT, STYLE, SIZE, OR COLOR.

THE WORDING "AVALYA" HAS NO MEANING IN A FOREIGN LANGUAGE.

SN 85-365,000, FILED 7-7-2011.

TINA BROWN, EXAMINING ATTORNEY



*David J. Kybas*

Director of the United States Patent and Trademark Office

# United States of America

United States Patent and Trademark Office



**Reg. No. 4,199,808**

**Registered Aug. 28, 2012**

**Int. Cl.: 7**

**TRADEMARK**

**PRINCIPAL REGISTER**

HUSKIE TOOLS, INC. (ILLINOIS CORPORATION)  
198 N. BRANDON DRIVE  
GLENDALE HEIGHTS, IL 60139

FOR: POWER TOOLS, NAMELY, HYDRAULIC COMPRESSION TOOLS, HYDRAULIC CUTTING TOOLS, BATTERY OPERATED COMPRESSION TOOLS AND BATTERY OPERATED CUTTING TOOLS; AND HYDRAULIC PUMPS, IN CLASS 7 (U.S. CLS. 13, 19, 21, 23, 31, 34 AND 35).

FIRST USE 6-19-2012; IN COMMERCE 6-19-2012.

OWNER OF U.S. REG. NOS. 2,018,990 AND 2,018,991.

THE COLOR(S) BLUE, ORANGE, GRAY AND WHITE IS/ARE CLAIMED AS A FEATURE OF THE MARK.

NO CLAIM IS MADE TO THE EXCLUSIVE RIGHT TO USE "TOOLS", APART FROM THE MARK AS SHOWN.

THE MARK CONSISTS OF AN ORANGE BLOCK "H" BEHIND A SILHOUETTE OF A BLUE MAN WEARING GLOVES AND OUTLINED IN WHITE AND HAVING A HARDHAT THAT IS WHITE WITH A BLUE OUTLINE, THE ELBOWS AND FINGERTIPS BEING WHITE, THE ARMS HOLDING AN ORANGE AND LIGHT BLUE GLOBE WITH A WHITE FLASH BETWEEN THE TWO HANDS AND A LIGHTNING BOLT EXTENDING TO THE SIDE FROM EACH GLOVE, THE BOLT BEING WHITE WITH A BLUE OUTLINE AND THE WORD "HUSKIE" IN BLUE TO THE RIGHT OF THE LETTER "H" AND THE WORD "TOOLS" IN GRAY BELOW THE WORD "HUSKIE".

SN 85-365,030, FILED 7-7-2011.

WARREN L. OLANDRIA, EXAMINING ATTORNEY



*David J. Kyffers*

Director of the United States Patent and Trademark Office

# United States of America

United States Patent and Trademark Office

## LAS LINKS ONLINE

**Reg. No. 4,199,809**

THE MCGRAW-HILL COMPANIES, INC. (NEW YORK CORPORATION)  
1221 AVENUE OF THE AMERICAS  
NEW YORK, NY 10020

**Registered Aug. 28, 2012**

**Int. Cl.: 41**

FOR: PROVIDING A WEB SITE CONTAINING NON-DOWNLOADABLE STUDENT ASSESSMENT TESTS AND TEACHER TRAINING INFORMATION; TEACHER TRAINING SERVICES IN THE FIELD OF ADMINISTERING TESTS; TEST SCORING SERVICES, IN CLASS 41 (U.S. CLS. 100, 101 AND 107).

**SERVICE MARK**

**PRINCIPAL REGISTER**

FIRST USE 8-23-2011; IN COMMERCE 8-23-2011.

THE MARK CONSISTS OF STANDARD CHARACTERS WITHOUT CLAIM TO ANY PARTICULAR FONT, STYLE, SIZE, OR COLOR.

OWNER OF U.S. REG. NOS. 1,596,392, 3,648,905, AND OTHERS.

NO CLAIM IS MADE TO THE EXCLUSIVE RIGHT TO USE "ONLINE", APART FROM THE MARK AS SHOWN.

SN 85-365,611, FILED 7-7-2011.

SHARON MEIER, EXAMINING ATTORNEY



*David J. Kybas*

Director of the United States Patent and Trademark Office

# United States of America

United States Patent and Trademark Office

## SKULL SHORES

**Reg. No. 4,199,810**

**Registered Aug. 28, 2012**

**Int. Cl.: 28**

**TRADEMARK**

**PRINCIPAL REGISTER**

MATTEL, INC. (DELAWARE CORPORATION)  
M1-1518  
333 CONTINENTAL BOULEVARD  
EL SEGUNDO, CA 90245

FOR: DOLLS, DOLL CLOTHING AND DOLL ACCESSORIES, IN CLASS 28 (U.S. CLS. 22, 23, 38 AND 50).

FIRST USE 5-10-2012; IN COMMERCE 5-10-2012.

THE MARK CONSISTS OF STANDARD CHARACTERS WITHOUT CLAIM TO ANY PARTICULAR FONT, STYLE, SIZE, OR COLOR.

SN 85-365,617, FILED 7-7-2011.

JESSICA FATHY, EXAMINING ATTORNEY



*David J. Kyros*

Director of the United States Patent and Trademark Office

# United States of America

United States Patent and Trademark Office

## SPLASH TRACK

**Reg. No. 4,199,811**

**Registered Aug. 28, 2012**

**Int. Cl.: 28**

**TRADEMARK**

**PRINCIPAL REGISTER**

MATTEL, INC. (DELAWARE CORPORATION)  
M1-1518  
333 CONTINENTAL BOULEVARD  
EL SEGUNDO, CA 90245

FOR: TOY VEHICLE TRACK SETS AND ACCESSORIES THEREFOR; TOY VEHICLES AND ACCESSORIES THEREFOR, IN CLASS 28 (U.S. CLS. 22, 23, 38 AND 50).

FIRST USE 9-22-2011; IN COMMERCE 9-22-2011.

THE MARK CONSISTS OF STANDARD CHARACTERS WITHOUT CLAIM TO ANY PARTICULAR FONT, STYLE, SIZE, OR COLOR.

NO CLAIM IS MADE TO THE EXCLUSIVE RIGHT TO USE "TRACK", APART FROM THE MARK AS SHOWN.

SN 85-365,658, FILED 7-7-2011.

WENDY GOODMAN, EXAMINING ATTORNEY



*David J. Kybas*

Director of the United States Patent and Trademark Office

# United States of America

United States Patent and Trademark Office

## MAJORITY WHIPS

**Reg. No. 4,199,812**

DC ROLLERGIRLS (D.C. NON-PROFIT CORPORATION)

**Registered Aug. 28, 2012**

P.O. BOX 75033  
WASHINGTON, DC 20013

**Int. Cls.: 16, 25, and 41**

FOR: PRINTED INFORMATIONAL CARDS IN THE FIELD OF ROLLER DERBY; PRINTED EVENT PROGRAMS; POSTERS; STICKERS, IN CLASS 16 (U.S. CLS. 2, 5, 22, 23, 29, 37, 38 AND 50).

**TRADEMARK**

FIRST USE 11-5-2011; IN COMMERCE 2-25-2012.

**SERVICE MARK**

FOR: CLOTHING, NAMELY, T-SHIRTS AND TANK TOPS, IN CLASS 25 (U.S. CLS. 22 AND 39).

**PRINCIPAL REGISTER**

FIRST USE 11-5-2011; IN COMMERCE 2-25-2012.

FOR: ORGANIZING ENTERTAINMENT EXHIBITIONS INVOLVING ONE OR MORE ROLLER SKATERS, IN CLASS 41 (U.S. CLS. 100, 101 AND 107).

FIRST USE 11-5-2011; IN COMMERCE 2-25-2012.

THE MARK CONSISTS OF STANDARD CHARACTERS WITHOUT CLAIM TO ANY PARTICULAR FONT, STYLE, SIZE, OR COLOR.

SN 85-366,367, FILED 7-8-2011.

TIMOTHY FINNEGAN, EXAMINING ATTORNEY



*David J. Kybas*

Director of the United States Patent and Trademark Office

# United States of America

United States Patent and Trademark Office

## ORANGE CRUSHER

**Reg. No. 4,199,813**

REAGENT CHEMICAL & RESEARCH, INC. (DELAWARE CORPORATION)  
115 RT. 202 / 31 SOUTH  
RINGOES, NJ 08551

**Registered Aug. 28, 2012**

**Int. Cl.: 28**

FOR: THREE DIMENSIONAL LAUNCHABLE DISKS FOR TRAP AND SKEET SHOOTING,  
IN CLASS 28 (U.S. CLS. 22, 23, 38 AND 50).

**TRADEMARK**

FIRST USE 10-31-2011; IN COMMERCE 10-31-2011.

**PRINCIPAL REGISTER**

THE MARK CONSISTS OF STANDARD CHARACTERS WITHOUT CLAIM TO ANY PAR-  
TICULAR FONT, STYLE, SIZE, OR COLOR.

SN 85-366,665, FILED 7-8-2011.

MARK RADEMACHER, EXAMINING ATTORNEY



*David J. Kyfos*

Director of the United States Patent and Trademark Office

# United States of America

United States Patent and Trademark Office

# DEXX

**Reg. No. 4,199,814**

**Registered Aug. 28, 2012**

**Int. Cl.: 1**

**TRADEMARK**

**PRINCIPAL REGISTER**

DUNE COMPANY OF YUMA, L.L.C. (ARIZONA LIMITED LIABILITY COMPANY)  
PO BOX 5569, 370 S MAIN STREET  
370 S MAIN STREET  
YUMA, AZ 853665569

FOR: SOIL CONDITIONING PREPARATIONS, IN CLASS 1 (U.S. CLS. 1, 5, 6, 10, 26 AND 46).

FIRST USE 11-21-2011; IN COMMERCE 11-21-2011.

THE MARK CONSISTS OF STANDARD CHARACTERS WITHOUT CLAIM TO ANY PARTICULAR FONT, STYLE, SIZE, OR COLOR.

SN 85-366,692, FILED 7-8-2011.

THEODORE MCBRIDE, EXAMINING ATTORNEY



*David J. Kybas*

Director of the United States Patent and Trademark Office



# United States of America

United States Patent and Trademark Office

# HEXAPHOS

**Reg. No. 4,199,815**

ICL PERFORMANCE PRODUCTS LP (DELAWARE LIMITED PARTNERSHIP)  
622 EMERSON ROAD, SUITE 500  
ST. LOUIS, MO 631411160

**Registered Aug. 28, 2012**

**Int. Cl.: 1**

FOR: CHEMICAL ADDITIVES FOR USE IN THE MANUFACTURE OF FOOD, BEVERAGES  
AND DENTIFRICES, IN CLASS 1 (U.S. CLS. 1, 5, 6, 10, 26 AND 46).

**TRADEMARK**

FIRST USE 1-1-2000; IN COMMERCE 1-1-2000.

**PRINCIPAL REGISTER**

THE MARK CONSISTS OF STANDARD CHARACTERS WITHOUT CLAIM TO ANY PAR-  
TICULAR FONT, STYLE, SIZE, OR COLOR.

OWNER OF U.S. REG. NO. 608,530.

SN 85-366,837, FILED 7-8-2011.

CHARLOTTE CORWIN, EXAMINING ATTORNEY



*David J. Kyffers*

Director of the United States Patent and Trademark Office

# United States of America

United States Patent and Trademark Office

## MIGHTY PACS

**Reg. No. 4,199,816**

**Registered Aug. 28, 2012**

**Int. Cl.: 3**

**TRADEMARK**

**PRINCIPAL REGISTER**

THE SUN PRODUCTS CORPORATION (DELAWARE CORPORATION)  
60 DANBURY ROAD  
WILTON, CT 06897

FOR: LAUNDRY DETERGENT, IN CLASS 3 (U.S. CLS. 1, 4, 6, 50, 51 AND 52).

FIRST USE 1-15-2012; IN COMMERCE 1-15-2012.

THE MARK CONSISTS OF STANDARD CHARACTERS WITHOUT CLAIM TO ANY PARTICULAR FONT, STYLE, SIZE, OR COLOR.

OWNER OF U.S. REG. NO. 3,113,168.

NO CLAIM IS MADE TO THE EXCLUSIVE RIGHT TO USE "PACKS", APART FROM THE MARK AS SHOWN.

SN 85-366,879, FILED 7-8-2011.

NICHOLAS COLEMAN, EXAMINING ATTORNEY



*David J. Kyffers*

Director of the United States Patent and Trademark Office

# United States of America

United States Patent and Trademark Office

## Drop Dead Beautiful

**Reg. No. 4,199,817**

**Registered Aug. 28, 2012**

**Int. Cl.: 3**

**TRADEMARK**

**PRINCIPAL REGISTER**

DROP DEAD BEAUTIFUL (TEXAS LIMITED LIABILITY COMPANY)  
700  
15770 N. DALLAS PKWY  
DALLAS, TX 75248

FOR: INDOOR TANNING PRODUCTS, NAMELY, NON-MEDICATED SKIN TAN DARKENING LOTIONS AND MOISTURIZERS, IN CLASS 3 (U.S. CLS. 1, 4, 6, 50, 51 AND 52).

FIRST USE 10-14-2011; IN COMMERCE 11-8-2011.

THE MARK CONSISTS OF STANDARD CHARACTERS WITHOUT CLAIM TO ANY PARTICULAR FONT, STYLE, SIZE, OR COLOR.

SN 85-366,963, FILED 7-8-2011.

RENEE MCCRAY, EXAMINING ATTORNEY



*David J. Kyffers*

Director of the United States Patent and Trademark Office

# United States of America

United States Patent and Trademark Office

# 23ANDME

**Reg. No. 4,199,818**

**Registered Aug. 28, 2012**

**Int. Cl.: 9**

**TRADEMARK**

**PRINCIPAL REGISTER**

23ANDME, INC. (DELAWARE CORPORATION)  
1390 SHOREBIRD WAY  
MOUNTAIN VIEW, CA 94043

FOR: COMPUTER SOFTWARE FOR RECORDING, ANALYSIS, STORAGE, MANIPULATION AND ORGANIZATION OF GENETIC AND MOLECULAR DATA; COMPUTER SOFTWARE FOR PROVIDING ACCESS TO MULTIPLE DATABASES THAT CONTAIN AGGREGATED RESULTS OF MOLECULAR BIOLOGY TESTING AND GENOTYPING; DOWNLOADABLE SOFTWARE IN THE NATURE OF A MOBILE APPLICATION FOR RECORDING, ANALYSIS, STORAGE, MANIPULATION AND ORGANIZATION OF GENETIC AND MOLECULAR DATA; DOWNLOADABLE SOFTWARE IN THE NATURE OF A MOBILE APPLICATION FOR PROVIDING ACCESS TO MULTIPLE DATABASES THAT CONTAIN AGGREGATED RESULTS OF MOLECULAR BIOLOGY TESTING AND GENOTYPING, IN CLASS 9 (U.S. CLS. 21, 23, 26, 36 AND 38).

FIRST USE 5-19-2012; IN COMMERCE 5-19-2012.

THE MARK CONSISTS OF STANDARD CHARACTERS WITHOUT CLAIM TO ANY PARTICULAR FONT, STYLE, SIZE, OR COLOR.

OWNER OF U.S. REG. NOS. 3,577,147, 4,022,980, AND OTHERS.

SN 85-367,050, FILED 7-8-2011.

WANDA KAY PRICE, EXAMINING ATTORNEY



*David J. Kyros*

Director of the United States Patent and Trademark Office

# United States of America

United States Patent and Trademark Office

## NO REGRETS ONLY RESULTS

**Reg. No. 4,199,819**

**Registered Aug. 28, 2012**

**Int. Cls.: 36 and 41**

**SERVICE MARK**

**PRINCIPAL REGISTER**

NO REGRETS ONLY RESULTS, LLC (KENTUCKY LIMITED LIABILITY COMPANY)  
3070 LAKECREST CIRCLE, SUITE 400-260  
LEXINGTON, KY 40513

FOR: REAL ESTATE INVESTMENT SERVICES; PROVIDING INFORMATION IN THE FIELD OF REAL ESTATE INVESTMENT; PROVIDING A WEBSITE FEATURING INFORMATION AND VIDEOS IN THE FIELD OF REAL ESTATE INVESTMENT; CONSULTATION IN THE FIELD OF REAL ESTATE INVESTMENT, IN CLASS 36 (U.S. CLS. 100, 101 AND 102).

FIRST USE 5-20-2011; IN COMMERCE 5-20-2011.

FOR: EDUCATIONAL, HOME STUDY AND TRAINING SERVICES, NAMELY, CONDUCTING SEMINARS, LECTURES, CONFERENCES, AND WORKSHOPS IN THE FIELD OF REAL ESTATE INVESTMENT AND ENTREPRENEURSHIP, AND PRINTED AND INSTRUCTIONAL MATERIALS IN CONNECTION THEREWITH; PROVIDING EDUCATION, NAMELY, CLASSES AND WORKSHOPS, RENDERED ONLINE THROUGH VIDEOS IN THE FIELD OF REAL ESTATE INVESTMENT, IN CLASS 41 (U.S. CLS. 100, 101 AND 107).

FIRST USE 5-20-2011; IN COMMERCE 5-20-2011.

THE MARK CONSISTS OF STANDARD CHARACTERS WITHOUT CLAIM TO ANY PARTICULAR FONT, STYLE, SIZE, OR COLOR.

SN 85-368,106, FILED 7-11-2011.

NAAKWAMA ANKRAH, EXAMINING ATTORNEY



*David J. Kyffers*

Director of the United States Patent and Trademark Office

# United States of America

United States Patent and Trademark Office



**Reg. No. 4,199,820**

**Registered Aug. 28, 2012**

**Int. Cl.: 41**

**SERVICE MARK**

**PRINCIPAL REGISTER**

THE MCGRAW-HILL COMPANIES, INC. (NEW YORK CORPORATION)  
1221 AVENUE OF THE AMERICAS  
NEW YORK, NY 10020

FOR: PROVIDING A WEB SITE CONTAINING NON-DOWNLOADABLE STUDENT ASSESSMENT TESTS AND TEACHER TRAINING INFORMATION; TEACHER TRAINING SERVICES IN THE FIELD OF ADMINISTERING TESTS; TEST SCORING SERVICES, IN CLASS 41 (U.S. CLS. 100, 101 AND 107).

FIRST USE 8-23-2011; IN COMMERCE 8-23-2011.

OWNER OF U.S. REG. NOS. 1,596,392, 3,648,905, AND OTHERS.

NO CLAIM IS MADE TO THE EXCLUSIVE RIGHT TO USE "ONLINE", APART FROM THE MARK AS SHOWN.

THE MARK CONSISTS OF THE TERM "LAS" SHOWN IN UPPERCASE LETTERS AND THE TERM "LINKS" SHOWN WITH THE FIRST LETTER IN UPPERCASE LETTERS AND THE REMAINING LETTERS IN LOWERCASE LETTERS, ALL CONTAINED WITHIN A CIRCLE MADE OF OVERLAPPING CURVED LINES ABOVE THE TERM "ONLINE" SHOWN IN LOWERCASE LETTERS.

SN 85-368,445, FILED 7-11-2011.

SHARON MEIER, EXAMINING ATTORNEY



*David J. Kyjars*

Director of the United States Patent and Trademark Office

# United States of America

United States Patent and Trademark Office

## Fulfillment Factor Formula

**Reg. No. 4,199,821**

ZOLFO, JULIE (UNITED STATES INDIVIDUAL)

**Registered Aug. 28, 2012**

P.O. BOX 66233  
ST. PETERSBURG, FL 33736

**Int. Cl.: 41**

FOR: ENTERTAINMENT AND EDUCATIONAL SERVICES, NAMELY, THE PRESENTATION OF SEMINARS, LECTURES, WORKSHOPS, AND PANEL DISCUSSIONS IN PROFESSIONAL AND PERSONAL DEVELOPMENT, IN CLASS 41 (U.S. CLS. 100, 101 AND 107).

**SERVICE MARK**

FIRST USE 10-24-2010; IN COMMERCE 12-10-2010.

**PRINCIPAL REGISTER**

THE MARK CONSISTS OF STANDARD CHARACTERS WITHOUT CLAIM TO ANY PARTICULAR FONT, STYLE, SIZE, OR COLOR.

NO CLAIM IS MADE TO THE EXCLUSIVE RIGHT TO USE "FULFILLMENT" AND "FORMULA", APART FROM THE MARK AS SHOWN.

SN 85-370,064, FILED 7-13-2011.

RICHARD WHITE, EXAMINING ATTORNEY



*David J. Kyfos*

Director of the United States Patent and Trademark Office

# United States of America

United States Patent and Trademark Office

# IMPULSE

**Reg. No. 4,199,822**

CELESTRON ACQUISITION LLC (DELAWARE LIMITED LIABILITY COMPANY)  
2835 COLUMBIA STREET  
TORRANCE, CA 90503

**Registered Aug. 28, 2012**

**Int. Cl.: 9**

FOR: BINOCULARS, IN CLASS 9 (U.S. CLS. 21, 23, 26, 36 AND 38).

**TRADEMARK**

FIRST USE 3-31-2012; IN COMMERCE 3-31-2012.

**PRINCIPAL REGISTER**

THE MARK CONSISTS OF STANDARD CHARACTERS WITHOUT CLAIM TO ANY PARTICULAR FONT, STYLE, SIZE, OR COLOR.

SN 85-370,726, FILED 7-13-2011.

KEVIN CORWIN, EXAMINING ATTORNEY



*David J. Kybas*

Director of the United States Patent and Trademark Office



# United States of America

United States Patent and Trademark Office

# AMOEBA

**Reg. No. 4,199,823**

CELESTRON ACQUISITION LLC (DELAWARE LIMITED LIABILITY COMPANY)  
2835 COLUMBIA STREET  
TORRANCE, CA 90503

**Registered Aug. 28, 2012**

**Int. Cl.: 9**

FOR: MICROSCOPES, IN CLASS 9 (U.S. CLS. 21, 23, 26, 36 AND 38).

**TRADEMARK**

FIRST USE 3-31-2012; IN COMMERCE 3-31-2012.

**PRINCIPAL REGISTER**

THE MARK CONSISTS OF STANDARD CHARACTERS WITHOUT CLAIM TO ANY PARTICULAR FONT, STYLE, SIZE, OR COLOR.

SN 85-370,733, FILED 7-13-2011.

KEVIN CORWIN, EXAMINING ATTORNEY



*David J. Kybas*

Director of the United States Patent and Trademark Office

# United States of America

United States Patent and Trademark Office

# WINDGUIDE

**Reg. No. 4,199,824**

CELESTRON ACQUISITION LLC (DELAWARE LIMITED LIABILITY COMPANY)  
2835 COLUMBIA STREET  
TORRANCE, CA 90503

**Registered Aug. 28, 2012**

**Int. Cl.: 9**

FOR: ANEMOMETERS, IN CLASS 9 (U.S. CLS. 21, 23, 26, 36 AND 38).

**TRADEMARK**

FIRST USE 3-31-2012; IN COMMERCE 3-31-2012.

**PRINCIPAL REGISTER**

THE MARK CONSISTS OF STANDARD CHARACTERS WITHOUT CLAIM TO ANY PARTICULAR FONT, STYLE, SIZE, OR COLOR.

SN 85-370,736, FILED 7-13-2011.

KEVIN CORWIN, EXAMINING ATTORNEY



*David J. Kyffers*

Director of the United States Patent and Trademark Office

# United States of America

United States Patent and Trademark Office

## Sky Dreams travel blanket. Your ticket to First Class comfort.

**Reg. No. 4,199,825**

SKY DREAMS LLC (HAWAII LIMITED LIABILITY COMPANY)  
95-1018 PUUKOA STREET  
MILILANI, HI 96789

**Registered Aug. 28, 2012**

**Int. Cl.: 18**

FOR: TRAVEL BAGS, IN CLASS 18 (U.S. CLS. 1, 2, 3, 22 AND 41).

**TRADEMARK**

FIRST USE 6-30-2011; IN COMMERCE 6-30-2011.

**PRINCIPAL REGISTER**

THE MARK CONSISTS OF STANDARD CHARACTERS WITHOUT CLAIM TO ANY PARTICULAR FONT, STYLE, SIZE, OR COLOR.

NO CLAIM IS MADE TO THE EXCLUSIVE RIGHT TO USE "TRAVEL BLANKET", APART FROM THE MARK AS SHOWN.

SN 85-370,964, FILED S.R. 7-14-2011; AM. P.R. 2-7-2012.

RICHARD WHITE, EXAMINING ATTORNEY



*David J. Kyffers*

Director of the United States Patent and Trademark Office

# United States of America

United States Patent and Trademark Office

# IROVIT

**Reg. No. 4,199,826**

**Registered Aug. 28, 2012**

**Int. Cl.: 5**

**TRADEMARK**

**PRINCIPAL REGISTER**

VITANE PHARMACEUTICALS, INC. (CALIFORNIA CORPORATION)  
STE 150  
17701 COWAN  
IRVINE, CA 92614

FOR: DIETARY SUPPLEMENTS, IN CLASS 5 (U.S. CLS. 6, 18, 44, 46, 51 AND 52).

FIRST USE 3-12-2012; IN COMMERCE 3-12-2012.

THE MARK CONSISTS OF STANDARD CHARACTERS WITHOUT CLAIM TO ANY PARTICULAR FONT, STYLE, SIZE, OR COLOR.

THE WORDING "IROVIT" HAS NO MEANING IN A FOREIGN LANGUAGE.

SN 85-371,118, FILED 7-14-2011.

MARILYN IZZI, EXAMINING ATTORNEY



*David J. Kybas*

Director of the United States Patent and Trademark Office

# United States of America

United States Patent and Trademark Office

# LUNA

**Reg. No. 4,199,827**

**Registered Aug. 28, 2012**

**Int. Cl.: 31**

**TRADEMARK**

**PRINCIPAL REGISTER**

PURE HOT HOUSE FOODS INC. (CANADA CORPORATION)  
P.O. BOX 607  
459 HIGHWAY 77  
LEAMINGTON, ONTARIO, CANADA N8H3X4

FOR: FRESH FRUITS AND VEGETABLES, IN CLASS 31 (U.S. CLS. 1 AND 46).

FIRST USE 1-0-2012; IN COMMERCE 1-0-2012.

THE MARK CONSISTS OF STANDARD CHARACTERS WITHOUT CLAIM TO ANY PARTICULAR FONT, STYLE, SIZE, OR COLOR.

SN 85-371,358, FILED 7-14-2011.

DAVID MURRAY, EXAMINING ATTORNEY



*David J. Kybas*

Director of the United States Patent and Trademark Office

# United States of America

United States Patent and Trademark Office

# EXTENDRA

**Reg. No. 4,199,828**

**Registered Aug. 28, 2012**

**Int. Cl.: 1**

**TRADEMARK**

**PRINCIPAL REGISTER**

DULCETTE TECHNOLOGIES LLC (NEW YORK LIMITED LIABILITY COMPANY)  
2 HICKS STREET  
LINDENHURST, NY 11757

FOR: FOOD PRESERVING CHEMICALS, IN CLASS 1 (U.S. CLS. 1, 5, 6, 10, 26 AND 46).

FIRST USE 11-1-2011; IN COMMERCE 11-1-2011.

THE MARK CONSISTS OF STANDARD CHARACTERS WITHOUT CLAIM TO ANY PARTICULAR FONT, STYLE, SIZE, OR COLOR.

SN 85-371,591, FILED 7-14-2011.

SUSAN STIGLITZ, EXAMINING ATTORNEY



*David J. Kybas*

Director of the United States Patent and Trademark Office

# United States of America

United States Patent and Trademark Office

# REST EASY

**Reg. No. 4,199,829**

**Registered Aug. 28, 2012**

**Int. Cl.: 8**

**TRADEMARK**

**PRINCIPAL REGISTER**

NUK USA LLC (DELAWARE LIMITED LIABILITY COMPANY)  
CORPORATION TRUST CO., CORP. TRUST CTR.  
1209 ORANGE STREET  
WILMINGTON, DE 19801

FOR: CUTLERY, NAMELY, FORKS, SPOONS, KNIVES, IN CLASS 8 (U.S. CLS. 23, 28 AND 44).

FIRST USE 12-15-2011; IN COMMERCE 12-15-2011.

THE MARK CONSISTS OF STANDARD CHARACTERS WITHOUT CLAIM TO ANY PARTICULAR FONT, STYLE, SIZE, OR COLOR.

SN 85-371,847, FILED 7-14-2011.

BRIAN CALLAGHAN, EXAMINING ATTORNEY



*David J. Kyffers*

Director of the United States Patent and Trademark Office

# United States of America

United States Patent and Trademark Office

# POLICE

**Reg. No. 4,199,830**

PROGRESSIVE BRANDS INC. (TEXAS CORPORATION)  
14610 ARCHER DRIVE  
LAREDO, TX 78045

**Registered Aug. 28, 2012**

**Int. Cl.: 34**

FOR: TOBACCO PRODUCTS, NAMELY, CIGARETTES, IN CLASS 34 (U.S. CLS. 2, 8, 9 AND 17).

**TRADEMARK**

FIRST USE 2-17-2012; IN COMMERCE 2-17-2012.

**PRINCIPAL REGISTER**

THE MARK CONSISTS OF STANDARD CHARACTERS WITHOUT CLAIM TO ANY PARTICULAR FONT, STYLE, SIZE, OR COLOR.

SN 85-372,163, FILED 7-15-2011.

KIMBERLY PERRY, EXAMINING ATTORNEY



*David J. Kyffers*

Director of the United States Patent and Trademark Office



# United States of America

United States Patent and Trademark Office

## LIFEMINDER PLUS

**Reg. No. 4,199,831**

REALITY MARKETING, L.L.C. (ARIZONA LIMITED LIABILITY COMPANY)  
4844 E. ONYX AVENUE

**Registered Aug. 28, 2012**

PARADISE VALLEY, AZ 852531032

**Int. Cl.: 35**

FOR: BUSINESS MANAGEMENT CONSULTATION IN THE FIELD OF MEDICAL, LEGAL AND FINANCIAL INFORMATION FOR INDIVIDUALS AND BUSINESSES; COLLECTION AND COMPILATION OF INFORMATION INTO COMPUTER DATABASES IN THE FIELD OF MEDICAL, LEGAL AND FINANCIAL INFORMATION FOR INDIVIDUALS AND BUSINESSES, IN CLASS 35 (U.S. CLS. 100, 101 AND 102).

**SERVICE MARK**

**PRINCIPAL REGISTER**

FIRST USE 7-15-2011; IN COMMERCE 7-15-2011.

THE MARK CONSISTS OF STANDARD CHARACTERS WITHOUT CLAIM TO ANY PARTICULAR FONT, STYLE, SIZE, OR COLOR.

SN 85-372,295, FILED 7-15-2011.

MAYUR VAGHANI, EXAMINING ATTORNEY



*David J. Kyros*

Director of the United States Patent and Trademark Office

# United States of America

United States Patent and Trademark Office

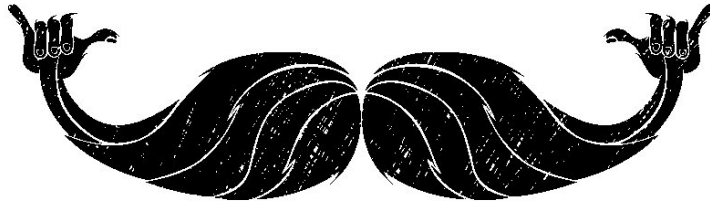

**Reg. No. 4,199,832**

**Registered Aug. 28, 2012**

**Int. Cl.: 25**

**TRADEMARK**

**PRINCIPAL REGISTER**

SMITH, MARCOS (UNITED STATES INDIVIDUAL)  
1311 SE 12TH TERRACE  
DEERFIELD BEACH, FL 33441

FOR: T-SHIRTS, IN CLASS 25 (U.S. CLS. 22 AND 39).

FIRST USE 11-1-2011; IN COMMERCE 11-30-2011.

THE MARK CONSISTS OF A MUSTACHE WITH HANDS AT THE TIPS THAT FORM THE SHAPE OF A HAWAIIAN HAND SIGNAL CALLED "THE SHAKA". CURVED LINES EMERGE FROM THE CENTER OF THE MUSTACHE AND STRETCH OUT TO THE SIDES.

SN 85-372,550, FILED 7-15-2011.

JASON TURNER, EXAMINING ATTORNEY



*David J. Kybas*

Director of the United States Patent and Trademark Office

# United States of America

United States Patent and Trademark Office

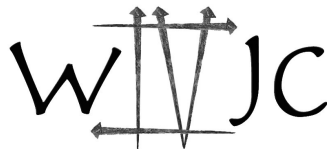

**Reg. No. 4,199,833**

**Registered Aug. 28, 2012**

**Int. Cl.: 25**

**TRADEMARK**

**PRINCIPAL REGISTER**

LIVINGSTON, TERESA A. (UNITED STATES INDIVIDUAL)  
P.O. BOX 6076  
GARDEN GROVE, CA 928466076 AND

LIVINGSTON, ASHLEY M. (UNITED STATES INDIVIDUAL)  
P.O. BOX 6076  
GARDEN GROVE, CA 928466076

FOR: WEARING APPAREL, NAMELY, MEN'S AND WOMEN'S T-SHIRTS, CAPS, SWEAT SHIRTS, HOODED PULLOVERS, HOODED SWEATSHIRTS, AND SWEAT JACKETS, IN CLASS 25 (U.S. CLS. 22 AND 39).

FIRST USE 5-4-2012; IN COMMERCE 5-4-2012.

THE MARK CONSISTS OF THE CAPITALIZED LETTERS "W" "J" "C" WITH THE "W" SEPARATED FROM THE "J" AND "C" BY THE ROMAN NUMERAL "IV" GRAPHICALLY DEPICTED USING HAND-FORMED NAILS.

SN 85-372,554, FILED 7-15-2011.

DAVID MURRAY, EXAMINING ATTORNEY



*David J. Kyffers*

Director of the United States Patent and Trademark Office

# United States of America

United States Patent and Trademark Office

# IGOR

**Reg. No. 4,199,834**

**Registered Aug. 28, 2012**

**Int. Cl.: 9**

**TRADEMARK**

**PRINCIPAL REGISTER**

CTC, INC (NEVADA CORPORATION), DBA CAMPBELL TECHNOLOGY CORPORATION,  
SUITE 500  
6100 SOUTHWEST BOULEVARD  
FORT WORTH, TX 76109

FOR: A RECORDING DEVICE CONTAINED IN A BOX AND INSTALLED AT INTERSECTIONS OF RAILROAD CROSSINGS AND HIGHWAYS OR ROADWAYS WHICH PROVIDES CONTINUOUS SIMULTANEOUS RECORDING OF THE OPERATION OF BOTH RAILROAD WAYSIDE SIGNAL STATUS AND OPERATION OF THE HIGHWAY TRAFFIC SIGNAL SYSTEMS SOLD AND MARKETED TO GOVERNMENT AND TRANSPORTATION ENTITIES, IN CLASS 9 (U.S. CLS. 21, 23, 26, 36 AND 38).

FIRST USE 5-22-2012; IN COMMERCE 5-22-2012.

THE MARK CONSISTS OF STANDARD CHARACTERS WITHOUT CLAIM TO ANY PARTICULAR FONT, STYLE, SIZE, OR COLOR.

SN 85-372,916, FILED 7-15-2011.

DANIEL CAPSHAW, EXAMINING ATTORNEY



*David J. Kypos*

Director of the United States Patent and Trademark Office

# United States of America

United States Patent and Trademark Office

## Rebecca Brand

**Reg. No. 4,199,835**

BRAND, REBECCA (UNITED STATES INDIVIDUAL)  
1125 VERONICA SPRINGS RD.  
SANTA BARBARA, CA 93105

**Registered Aug. 28, 2012**

**Int. Cl.: 28**

FOR: HOBBY CRAFT KIT COMPRISING OF PAINTS, BRUSHES, MEDIUMS, DVD'S, CANVASES, CHARCOAL, VARNISHES, EASELS, CONTAINERS, APRONS, GLASSES, DROP CLOTHES, PHOTOS, MODELS, AND PALLETES, IN CLASS 28 (U.S. CLS. 22, 23, 38 AND 50).

**TRADEMARK**

**PRINCIPAL REGISTER**

FIRST USE 12-12-2011; IN COMMERCE 12-12-2011.

THE MARK CONSISTS OF STANDARD CHARACTERS WITHOUT CLAIM TO ANY PARTICULAR FONT, STYLE, SIZE, OR COLOR.

THE NAME "REBECCA BRAND" IDENTIFIES A LIVING INDIVIDUAL WHOSE CONSENT IS OF RECORD.

SN 85-373,778, FILED 7-18-2011.

DOMINICK J. SALEMI, EXAMINING ATTORNEY



*David J. Kyfos*

Director of the United States Patent and Trademark Office

# United States of America

United States Patent and Trademark Office

## Red Red Vine

**Reg. No. 4,199,836**

DEL MONTE INTERNATIONAL GMBH (SWITZERLAND LIMITED LIABILITY COMPANY)  
74 BOULEVARD D'ITALIE  
MONTE CARLO, MONACO 98000

**Registered Aug. 28, 2012**

**Int. Cl.: 31**

FOR: FRESH FRUITS; FRESH VEGETABLES, IN CLASS 31 (U.S. CLS. 1 AND 46).

**TRADEMARK**

FIRST USE 3-30-2012; IN COMMERCE 3-30-2012.

**PRINCIPAL REGISTER**

THE MARK CONSISTS OF STANDARD CHARACTERS WITHOUT CLAIM TO ANY PARTICULAR FONT, STYLE, SIZE, OR COLOR.

SN 85-373,807, FILED 7-18-2011.

FRANK LATTUCA, EXAMINING ATTORNEY



*David J. Kyffers*

Director of the United States Patent and Trademark Office

# United States of America

United States Patent and Trademark Office

# Vigorousos

**Reg. No. 4,199,837**

DEL MONTE INTERNATIONAL GMBH (SWITZERLAND LIMITED LIABILITY COMPANY)  
74 BOULEVARD D'ITALIE  
MONTE CARLO, MONACO 98000

**Registered Aug. 28, 2012**

**Int. Cl.: 31**

FOR: FRESH FRUITS; FRESH VEGETABLES, IN CLASS 31 (U.S. CLS. 1 AND 46).

**TRADEMARK**

FIRST USE 3-30-2012; IN COMMERCE 3-30-2012.

**PRINCIPAL REGISTER**

THE MARK CONSISTS OF STANDARD CHARACTERS WITHOUT CLAIM TO ANY PARTICULAR FONT, STYLE, SIZE, OR COLOR.

THE ENGLISH TRANSLATION OF "VIGOROSOS" IN THE MARK IS "VIGOROUS".

SN 85-373,835, FILED 7-18-2011.

FRANK LATTUCA, EXAMINING ATTORNEY



*David J. Kyffers*

Director of the United States Patent and Trademark Office

# United States of America

United States Patent and Trademark Office

# Castanets

**Reg. No. 4,199,838**

**Registered Aug. 28, 2012**

**Int. Cl.: 31**

**TRADEMARK**

**PRINCIPAL REGISTER**

DEL MONTE INTERNATIONAL GMBH (SWITZERLAND LIMITED LIABILITY COMPANY)  
74 BOULEVARD D'ITALIE  
MONTE CARLO, MONACO 98000

FOR: FRESH FRUITS; FRESH VEGETABLES, IN CLASS 31 (U.S. CLS. 1 AND 46).

FIRST USE 3-30-2012; IN COMMERCE 3-30-2012.

THE MARK CONSISTS OF STANDARD CHARACTERS WITHOUT CLAIM TO ANY PARTICULAR FONT, STYLE, SIZE, OR COLOR.

SN 85-373,851, FILED 7-18-2011.

FRANK LATTUCA, EXAMINING ATTORNEY



*David J. Kyffers*

Director of the United States Patent and Trademark Office



# United States of America

United States Patent and Trademark Office

# Romeos

**Reg. No. 4,199,839**

**Registered Aug. 28, 2012**

**Int. Cl.: 31**

**TRADEMARK**

**PRINCIPAL REGISTER**

DEL MONTE INTERNATIONAL GMBH (SWITZERLAND LIMITED LIABILITY COMPANY)  
74 BOULEVARD D'ITALIE  
MONTE CARLO, MONACO 98000

FOR: FRESH FRUITS; FRESH VEGETABLES, IN CLASS 31 (U.S. CLS. 1 AND 46).

FIRST USE 3-30-2012; IN COMMERCE 3-30-2012.

THE MARK CONSISTS OF STANDARD CHARACTERS WITHOUT CLAIM TO ANY PARTICULAR FONT, STYLE, SIZE, OR COLOR.

SN 85-373,863, FILED 7-18-2011.

FRANK LATTUCA, EXAMINING ATTORNEY



*David J. Kybas*

Director of the United States Patent and Trademark Office

# United States of America

United States Patent and Trademark Office

# Marionettes

**Reg. No. 4,199,840**

DEL MONTE INTERNATIONAL GMBH (SWITZERLAND LIMITED LIABILITY COMPANY)  
74 BOULEVARD D'ITALIE  
MONTE CARLO, MONACO 98000

**Registered Aug. 28, 2012**

**Int. Cl.: 31**

FOR: FRESH FRUITS; FRESH VEGETABLES, IN CLASS 31 (U.S. CLS. 1 AND 46).

**TRADEMARK**

FIRST USE 3-30-2012; IN COMMERCE 3-30-2012.

**PRINCIPAL REGISTER**

THE MARK CONSISTS OF STANDARD CHARACTERS WITHOUT CLAIM TO ANY PARTICULAR FONT, STYLE, SIZE, OR COLOR.

SN 85-373,888, FILED 7-18-2011.

FRANK LATTUCA, EXAMINING ATTORNEY



*David J. Kyffers*

Director of the United States Patent and Trademark Office

# United States of America

United States Patent and Trademark Office

# Bon Bon

**Reg. No. 4,199,841**

**Registered Aug. 28, 2012**

**Int. Cl.: 31**

**TRADEMARK**

**PRINCIPAL REGISTER**

DEL MONTE INTERNATIONAL GMBH (SWITZERLAND LIMITED LIABILITY COMPANY)  
74 BOULEVARD D'ITALIE  
MONTE CARLO, MONACO 98000

FOR: FRESH FRUITS; FRESH VEGETABLES, IN CLASS 31 (U.S. CLS. 1 AND 46).

FIRST USE 3-30-2012; IN COMMERCE 3-30-2012.

THE MARK CONSISTS OF STANDARD CHARACTERS WITHOUT CLAIM TO ANY PARTICULAR FONT, STYLE, SIZE, OR COLOR.

SN 85-373,924, FILED 7-18-2011.

FRANK LATTUCA, EXAMINING ATTORNEY



*David J. Kyffers*

Director of the United States Patent and Trademark Office

# United States of America

United States Patent and Trademark Office

# PUREDRIFT

**Reg. No. 4,199,842**

BROOKS SPORTS, INC. (WASHINGTON CORPORATION)  
19910 NORTH CREEK PARKWAY, SUITE 200  
BOTHELL, WA 98011

**Registered Aug. 28, 2012**

**Int. Cl.: 25**

FOR: ATHLETIC FOOTWEAR, IN CLASS 25 (U.S. CLS. 22 AND 39).

**TRADEMARK**

FIRST USE 2-10-2012; IN COMMERCE 2-10-2012.

**PRINCIPAL REGISTER**

THE MARK CONSISTS OF STANDARD CHARACTERS WITHOUT CLAIM TO ANY PARTICULAR FONT, STYLE, SIZE, OR COLOR.

SN 85-374,005, FILED 7-18-2011.

TRACY WHITTAKER-BROWN, EXAMINING ATTORNEY



*David J. Kybas*

Director of the United States Patent and Trademark Office

# United States of America

United States Patent and Trademark Office

# JELLY GEMS

**Reg. No. 4,199,843**

PIPEDREAM PRODUCTS, INC. (CALIFORNIA CORPORATION)  
21350 LASSEN ST.  
CHATSWORTH, CA 91311

**Registered Aug. 28, 2012**

**Int. Cl.: 10**

FOR: ADULT SEXUAL STIMULATION AIDS, NAMELY, VIBRATORS, IN CLASS 10 (U.S. CLS. 26, 39 AND 44).

**TRADEMARK**

FIRST USE 8-30-2011; IN COMMERCE 8-30-2011.

**PRINCIPAL REGISTER**

THE MARK CONSISTS OF STANDARD CHARACTERS WITHOUT CLAIM TO ANY PARTICULAR FONT, STYLE, SIZE, OR COLOR.

NO CLAIM IS MADE TO THE EXCLUSIVE RIGHT TO USE "JELLY", APART FROM THE MARK AS SHOWN.

SN 85-374,277, FILED 7-18-2011.

MEGHAN REINHART, EXAMINING ATTORNEY



*David J. Kybas*

Director of the United States Patent and Trademark Office

# United States of America

United States Patent and Trademark Office

# PNR

**Reg. No. 4,199,844**

**Registered Aug. 28, 2012**

**Int. Cl.: 5**

**TRADEMARK**

**PRINCIPAL REGISTER**

VITASPORT, INC. (CALIFORNIA CORPORATION)  
3450 E. PHILADELPHIA STREET  
ONTARIO, CA 91761

FOR: DIETARY FOOD SUPPLEMENTS; DIETARY SUPPLEMENTS; NUTRITIONAL SUPPLEMENTS, VITAMINS, DIETARY SUPPLEMENTS AND NUTRITIONAL SUPPLEMENTS FOR ENDURANCE SPORTS, AND DIETARY SUPPLEMENTS USED FOR WEIGHT LOSS, IN CLASS 5 (U.S. CLS. 6, 18, 44, 46, 51 AND 52).

FIRST USE 7-0-2011; IN COMMERCE 7-0-2011.

THE MARK CONSISTS OF STANDARD CHARACTERS WITHOUT CLAIM TO ANY PARTICULAR FONT, STYLE, SIZE, OR COLOR.

SN 85-375,021, FILED 7-19-2011.

ODESSA BIBBINS, EXAMINING ATTORNEY



*David J. Kybas*

Director of the United States Patent and Trademark Office

# United States of America

United States Patent and Trademark Office

# SUNANDA

**Reg. No. 4,199,845**

SUPHACHATWONG INNOVATION CO., LTD. (THAILAND LIMITED COMPANY)  
29/ 11 MOO 11, 20110

**Registered Aug. 28, 2012**

BANGPHRA, CHONBURI, THAILAND

**Int. Cl.: 31**

FOR: NATURAL PLANTS AND FLOWERS, IN CLASS 31 (U.S. CLS. 1 AND 46).

**TRADEMARK**

FIRST USE 1-1-2012; IN COMMERCE 1-1-2012.

**PRINCIPAL REGISTER**

THE MARK CONSISTS OF STANDARD CHARACTERS WITHOUT CLAIM TO ANY PARTICULAR FONT, STYLE, SIZE, OR COLOR.

THE WORDING "SUNANDA" HAS NO MEANING IN A FOREIGN LANGUAGE.

SN 85-375,711, FILED 7-20-2011.

KIM MONINGHOFF, EXAMINING ATTORNEY



*David J. Kyffers*

Director of the United States Patent and Trademark Office

# United States of America

United States Patent and Trademark Office



**Reg. No. 4,199,846**

**Registered Aug. 28, 2012**

**Int. Cls.: 9 and 28**

**TRADEMARK**

**PRINCIPAL REGISTER**

LOGICAL CHOICE TECHNOLOGIES, INC. (GEORGIA CORPORATION)  
1045 PROGRESS CIRCLE  
LAWRENCEVILLE, GA 30043

FOR: EDUCATIONAL SOFTWARE FEATURING INTERACTIVE AUGMENTED REALITY PLATFORMS TO PROVIDE INSTRUCTION IN READING, IN CLASS 9 (U.S. CLS. 21, 23, 26, 36 AND 38).

FIRST USE 1-1-2012; IN COMMERCE 1-1-2012.

FOR: ELECTRONIC GAMES FOR THE TEACHING OF CHILDREN, IN CLASS 28 (U.S. CLS. 22, 23, 38 AND 50).

FIRST USE 1-1-2012; IN COMMERCE 1-1-2012.

NO CLAIM IS MADE TO THE EXCLUSIVE RIGHT TO USE "SERIES" AND "LEARNING", APART FROM THE MARK AS SHOWN.

THE MARK CONSISTS OF AN ARC, BOUNDED BY A HORIZONTAL LINE, THE ARC BEING DARKER THAN THE STRAIGHT LINE AND WIDER ON THE LEFT THAN ON THE RIGHT, THE ARC STARTING AT THE LEFT END OF THE HORIZONTAL LINE, TAPERING AS IT MOVES UP FROM THE HORIZONTAL LINE AND TO THE RIGHT, REACHING A MAXIMUM TAPER AFTER EXTENDING APPROXIMATELY 135 DEGREES, THEN EXPANDING AGAIN TO REACH THE RIGHT END OF THE HORIZONTAL LINE, WITH THE WORDS "LOGICAL CHOICE" ON THE LEFT SIDE OF THE ARC, FURTHER WITH A CIRCLE IN THE ARC AND THE WORD "ALIVE" BEGINNING IN THE CIRCLE AND EXTENDING TO THE RIGHT OUTSIDE AND AWAY FROM THE CIRCLE, WITH THE WORD "SERIES" BENEATH THE WORD "ALIVE", FURTHER WITH THE WORDS "AUGMENTED REALITY FOR LEARNING" BENEATH THE HORIZONTAL LINE, WITH THE "A" IN "AUGMENTED" AND THE "R" IN "REALITY" UNDERLINED.

SN 85-375,890, FILED 7-20-2011.

INGA ERVIN, EXAMINING ATTORNEY



*David J. Kappas*

Director of the United States Patent and Trademark Office



# United States of America

United States Patent and Trademark Office

# ROLLAWRAP

**Reg. No. 4,199,847**

D.M. MERCHANDISING, INC. (ILLINOIS CORPORATION)  
835 N. CHURCH COURT  
ELMHURST, IL 60126

**Registered Aug. 28, 2012**

**Int. Cl.: 25**

FOR: CLOTHING, NAMELY, WRAP-AROUNDS, IN CLASS 25 (U.S. CLS. 22 AND 39).

**TRADEMARK**

FIRST USE 5-4-2012; IN COMMERCE 5-4-2012.

**PRINCIPAL REGISTER**

THE MARK CONSISTS OF STANDARD CHARACTERS WITHOUT CLAIM TO ANY PARTICULAR FONT, STYLE, SIZE, OR COLOR.

SN 85-376,264, FILED 7-20-2011.

RAUL CORDOVA, EXAMINING ATTORNEY



*David J. Kyffers*

Director of the United States Patent and Trademark Office

# United States of America

United States Patent and Trademark Office

# SARITA

**Reg. No. 4,199,848**

**Registered Aug. 28, 2012**

**Int. Cl.: 30**

**TRADEMARK**

**PRINCIPAL REGISTER**

SARITA MARKETING, LLC (TEXAS LIMITED LIABILITY COMPANY)  
12010 TAYLOR ROAD  
HOUSTON, TX 77041

FOR: ENRICHED RICE; HUSKED RICE; RICE; RICE FLOUR, IN CLASS 30 (U.S. CL. 46).

FIRST USE 4-19-2012; IN COMMERCE 4-19-2012.

THE MARK CONSISTS OF STANDARD CHARACTERS WITHOUT CLAIM TO ANY PARTICULAR FONT, STYLE, SIZE, OR COLOR.

SN 85-376,984, FILED 7-21-2011.

ALLISON SCHRODY, EXAMINING ATTORNEY



*David J. Kybas*

Director of the United States Patent and Trademark Office

# United States of America

United States Patent and Trademark Office

## STRIKEFORCE: MORITURI

**Reg. No. 4,199,849**

MARVEL CHARACTERS, INC. (DELAWARE CORPORATION)  
1600 ROSECRANS AVENUE  
MANHATTAN BEACH, CA 90266

**Registered Aug. 28, 2012**

**Int. Cl.: 16**

FOR: COMIC BOOKS; PRINTED PERIODICALS IN THE FIELD OF COMIC BOOK STORIES AND ARTWORK, IN CLASS 16 (U.S. CLS. 2, 5, 22, 23, 29, 37, 38 AND 50).

**TRADEMARK**

FIRST USE 1-4-2012; IN COMMERCE 1-4-2012.

**PRINCIPAL REGISTER**

THE MARK CONSISTS OF STANDARD CHARACTERS WITHOUT CLAIM TO ANY PARTICULAR FONT, STYLE, SIZE, OR COLOR.

SN 85-377,485, FILED 7-21-2011.

JOHN GARTNER, EXAMINING ATTORNEY



*David J. Kybas*

Director of the United States Patent and Trademark Office

# United States of America

United States Patent and Trademark Office

# DARK SEAS

**Reg. No. 4,199,850**

**Registered Aug. 28, 2012**

**Int. Cl.: 25**

**TRADEMARK**

**PRINCIPAL REGISTER**

LOSER MACHINE, LLC (CALIFORNIA LIMITED LIABILITY COMPANY)  
17462 VON KARMAN AVENUE  
IRVINE, CA 92614

FOR: CLOTHING, NAMELY, T-SHIRTS, SHIRTS, WOVEN AND KNIT SHIRTS, TOPS, JACKETS, SWEATSHIRTS, SWEATERS, DENIM, NAMELY, JEANS, PANTS, BOARD-SHORTS, SHORTS, HATS, BELTS, HEADWEAR, UNDERWEAR, SOCKS, GLOVES, FOOTWEAR, WORK SHOES AND BOOTS, MOTORCYCLE SHOES AND BOOTS, AUTOMOBILE SHOES AND BOOTS, IN CLASS 25 (U.S. CLS. 22 AND 39).

FIRST USE 3-0-2009; IN COMMERCE 3-0-2009.

THE MARK CONSISTS OF STANDARD CHARACTERS WITHOUT CLAIM TO ANY PARTICULAR FONT, STYLE, SIZE, OR COLOR.

SN 85-377,882, FILED 7-21-2011.

BARBARA GAYNOR, EXAMINING ATTORNEY



*David J. Kyffers*

Director of the United States Patent and Trademark Office

**United States of America**  
United States Patent and Trademark Office

# FAT BAR

**Reg. No. 4,199,851**

FB VEGAS, LLC (NEVADA LIMITED LIABILITY COMPANY)  
11151 MISSOURI AVENUE  
LOS ANGELES, CA 90025

**Registered Aug. 28, 2012**

**Int. Cl.: 43**

FOR: RESTAURANT AND BAR SERVICES, INCLUDING RESTAURANT CARRYOUT SERVICES, IN CLASS 43 (U.S. CLS. 100 AND 101).

**SERVICE MARK**

FIRST USE 5-1-2011; IN COMMERCE 12-29-2011.

**PRINCIPAL REGISTER**

THE MARK CONSISTS OF STANDARD CHARACTERS WITHOUT CLAIM TO ANY PARTICULAR FONT, STYLE, SIZE, OR COLOR.

NO CLAIM IS MADE TO THE EXCLUSIVE RIGHT TO USE "BAR", APART FROM THE MARK AS SHOWN.

SN 85-377,899, FILED 7-21-2011.

ALICE BENMAMAN, EXAMINING ATTORNEY



*David J. Kyffers*

Director of the United States Patent and Trademark Office

# United States of America

United States Patent and Trademark Office

# AMWAY

**Reg. No. 4,199,852**

**Registered Aug. 28, 2012**

**Int. Cl.: 5**

**TRADEMARK**

**PRINCIPAL REGISTER**

ALTICOR INC. (MICHIGAN CORPORATION)  
7575 FULTON STREET EAST  
ADA, MI 49355

FOR: PROTEIN SUPPLEMENTS IN POWDER FORM; VITAMIN AND MINERAL SUPPLEMENTS FOR ANIMALS; NUTRITIONALLY FORTIFIED SNACK FOODS, NAMELY, PROCESSED FRUIT AND/OR NUT-BASED SNACK BARS FORTIFIED WITH VITAMINS AND/OR MINERALS FOR USE AS DIETARY OR NUTRITIONAL SUPPLEMENTS; MEAL REPLACEMENT BARS, DRINKS, DRINK MIXES, AND SNACKS; POWDERED NUTRITIONAL SUPPLEMENT DRINK MIX AND CONCENTRATE; NUTRITIONALLY FORTIFIED BEVERAGES, FIBER POWDER FOR USE AS A NUTRITIONAL SUPPLEMENT; DISINFECTANT TOILET BOWL CLEANER; ANTI-DANDRUFF HAIR SHAMPOOS, ALL-PURPOSE DISINFECTANTS, ANTI-BACTERIAL HAND WASH, IN CLASS 5 (U.S. CLS. 6, 18, 44, 46, 51 AND 52).

FIRST USE 4-1-2011; IN COMMERCE 4-1-2011.

THE MARK CONSISTS OF STANDARD CHARACTERS WITHOUT CLAIM TO ANY PARTICULAR FONT, STYLE, SIZE, OR COLOR.

OWNER OF U.S. REG. NOS. 707,656, 727,367, AND OTHERS.

SN 85-378,766, FILED 7-22-2011.

SUSAN BILLHEIMER, EXAMINING ATTORNEY



*David J. Kyros*

Director of the United States Patent and Trademark Office

# United States of America

United States Patent and Trademark Office

# Monster Eater

**Reg. No. 4,199,853**

**Registered Aug. 28, 2012**

**Int. Cls.: 16 and 28**

**TRADEMARK**

**PRINCIPAL REGISTER**

DANDY INNOVATIONS, LLC (NEW JERSEY LIMITED LIABILITY COMPANY)  
249 STONEHURST BOULEVARD  
FREEHOLD, NJ 07728

FOR: CHILDREN'S BOOKS, IN CLASS 16 (U.S. CLS. 2, 5, 22, 23, 29, 37, 38 AND 50).

FIRST USE 12-10-2010; IN COMMERCE 5-20-2011.

FOR: STUFFED AND PLUSH TOYS, IN CLASS 28 (U.S. CLS. 22, 23, 38 AND 50).

FIRST USE 12-10-2010; IN COMMERCE 5-20-2011.

THE MARK CONSISTS OF STANDARD CHARACTERS WITHOUT CLAIM TO ANY PARTICULAR FONT, STYLE, SIZE, OR COLOR.

SN 85-379,447, FILED 7-24-2011.

KAPIL BHANOT, EXAMINING ATTORNEY



*David J. Kybas*

Director of the United States Patent and Trademark Office

# United States of America

United States Patent and Trademark Office

## FRUIT'S BEST FRIEND

**Reg. No. 4,199,854**

**Registered Aug. 28, 2012**

**Int. Cl.: 30**

**TRADEMARK**

**PRINCIPAL REGISTER**

T. MARZETTI COMPANY (OHIO CORPORATION)  
1105 SCHROCK ROAD COLUMBUS  
COLUMBUS, OH 43229

FOR: CARAMEL DIPS, IN CLASS 30 (U.S. CL. 46).

FIRST USE 8-1-2011; IN COMMERCE 8-1-2011.

THE MARK CONSISTS OF STANDARD CHARACTERS WITHOUT CLAIM TO ANY PARTICULAR FONT, STYLE, SIZE, OR COLOR.

SN 85-379,565, FILED 7-25-2011.

SANDRA BUJA, EXAMINING ATTORNEY



*David J. Kybas*

Director of the United States Patent and Trademark Office



# United States of America

United States Patent and Trademark Office

# BREATHE

**Reg. No. 4,199,855**

**Registered Aug. 28, 2012**

**Int. Cls.: 35 and 41**

**SERVICE MARK**

**PRINCIPAL REGISTER**

BREATHE YOGA & JUICE BAR, INC. (NEW YORK CORPORATION)  
19 SOUTH MAIN STREET  
PITTSFORD, NY 14534

FOR: FRANCHISING, NAMELY, OFFERING BUSINESS MANAGEMENT ASSISTANCE IN THE ESTABLISHMENT AND/OR OPERATION OF BUSINESSES PROVIDING YOGA INSTRUCTION, JUICE BARS, ACUPUNCTURE, SPA SERVICES, DIET AND NUTRITION COUNSELING AND CLASSES, IN CLASS 35 (U.S. CLS. 100, 101 AND 102).

FIRST USE 9-20-2011; IN COMMERCE 9-20-2011.

FOR: YOGA INSTRUCTION, IN CLASS 41 (U.S. CLS. 100, 101 AND 107).

FIRST USE 4-1-2009; IN COMMERCE 4-1-2009.

THE MARK CONSISTS OF STANDARD CHARACTERS WITHOUT CLAIM TO ANY PARTICULAR FONT, STYLE, SIZE, OR COLOR.

OWNER OF U.S. REG. NO. 3,066,301.

SN 85-379,642, FILED 7-25-2011.

CHRIS WELLS, EXAMINING ATTORNEY



*David J. Kypos*

Director of the United States Patent and Trademark Office

United States of America  
United States Patent and Trademark Office

# HOVERPRO

**Reg. No. 4,199,856**

THE TORO COMPANY (DELAWARE CORPORATION)  
8111 LYNDAL AVENUE SOUTH  
BLOOMINGTON, MN 55420

**Registered Aug. 28, 2012**

**Int. Cl.: 7**

FOR: OUTDOOR POWER EQUIPMENT, NAMELY, LAWN MOWERS, IN CLASS 7 (U.S. CLS. 13, 19, 21, 23, 31, 34 AND 35).

**TRADEMARK**

FIRST USE 12-0-2011; IN COMMERCE 12-0-2011.

**PRINCIPAL REGISTER**

THE MARK CONSISTS OF STANDARD CHARACTERS WITHOUT CLAIM TO ANY PARTICULAR FONT, STYLE, SIZE, OR COLOR.

SN 85-380,129, FILED 7-25-2011.

ANTHONY RINKER, EXAMINING ATTORNEY



*David J. Kybas*

Director of the United States Patent and Trademark Office

# United States of America

United States Patent and Trademark Office

## TAKE COMFORT IN OUR CARE

**Reg. No. 4,199,857**

TUTERA INVESTMENTS, L.L.C. (MISSOURI LIMITED LIABILITY COMPANY)  
7611 STATE LINE RD., SUITE 303  
KANSAS CITY, MO 64114

**Registered Aug. 28, 2012**

**Int. Cl.: 44**

FOR: HOME HEALTH CARE SERVICES AND HOSPICE CARE SERVICES, IN CLASS 44  
(U.S. CLS. 100 AND 101).

**SERVICE MARK**

FIRST USE 1-11-2012; IN COMMERCE 1-11-2012.

**PRINCIPAL REGISTER**

THE MARK CONSISTS OF STANDARD CHARACTERS WITHOUT CLAIM TO ANY PARTICULAR FONT, STYLE, SIZE, OR COLOR.

SN 85-380,377, FILED 7-25-2011.

MICHELE SWAIN, EXAMINING ATTORNEY



*David J. Kybas*

Director of the United States Patent and Trademark Office

# United States of America

United States Patent and Trademark Office



**Reg. No. 4,199,858**

LOSER MACHINE, LLC (CALIFORNIA LIMITED LIABILITY COMPANY)  
17462 VON KARMAN AVENUE  
IRVINE, CA 92614

**Registered Aug. 28, 2012**

**Int. Cls.: 18, 25, and 28**

FOR: LEATHER BAGS, BACKPACKS, LUGGAGE, WALLETS, LEATHER KEY CHAINS,  
IN CLASS 18 (U.S. CLS. 1, 2, 3, 22 AND 41).

**TRADEMARK**

FIRST USE 3-0-2009; IN COMMERCE 3-0-2009.

**PRINCIPAL REGISTER**

FOR: CLOTHING, NAMELY, T-SHIRTS, SHIRTS, WOVEN AND KNIT SHIRTS, TOPS,  
JACKETS, SWEATSHIRTS, SWEATERS, DENIM, NAMELY, JEANS, PANTS, BOARD-  
SHORTS, SHORTS, HATS, BELTS, HEADWEAR, UNDERWEAR, SOCKS, GLOVES, FOOT-  
WEAR, WORK SHOES AND BOOTS, MOTORCYCLE SHOES AND BOOTS, AUTOMOBILE  
SHOES AND BOOTS, IN CLASS 25 (U.S. CLS. 22 AND 39).

FIRST USE 3-0-2009; IN COMMERCE 3-0-2009.

FOR: SKATEBOARDS, IN CLASS 28 (U.S. CLS. 22, 23, 38 AND 50).

FIRST USE 3-0-2009; IN COMMERCE 3-0-2009.

OWNER OF U.S. REG. NO. 3,900,103.

THE MARK CONSISTS OF THE DESIGN OF A HAND WITH THE MIDDLE FINGER AND  
FOREFINGER CROSSED AND A SCAR ON THE WRIST.

SN 85-380,447, FILED 7-25-2011.

BARBARA GAYNOR, EXAMINING ATTORNEY



*David J. Kybas*

Director of the United States Patent and Trademark Office

# United States of America

United States Patent and Trademark Office

# LEXITY

**Reg. No. 4,199,859**

**Registered Aug. 28, 2012**

**Int. Cl.: 35**

**SERVICE MARK**

**PRINCIPAL REGISTER**

LEXITY, INC. (DELAWARE CORPORATION)  
280 HOPE STREET  
MOUNTAIN VIEW, CA 94041

FOR: DISSEMINATION OF ADVERTISING FOR OTHERS VIA ELECTRONIC COMMUNICATIONS NETWORKS; ADVERTISING SERVICES, NAMELY, MANAGEMENT OF ONLINE ADVERTISING FOR OTHERS, IN CLASS 35 (U.S. CLS. 100, 101 AND 102).

FIRST USE 9-28-2011; IN COMMERCE 9-28-2011.

THE MARK CONSISTS OF STANDARD CHARACTERS WITHOUT CLAIM TO ANY PARTICULAR FONT, STYLE, SIZE, OR COLOR.

SN 85-380,503, FILED 7-25-2011.

JULIE GUTTADAURO, EXAMINING ATTORNEY



*David J. Kybas*

Director of the United States Patent and Trademark Office

# United States of America

United States Patent and Trademark Office

## MICRO MAID

**Reg. No. 4,199,860**

SAFE TV SHOP, LLC (NORTH CAROLINA LIMITED LIABILITY COMPANY)  
520 ELLIOT STREET  
CHARLOTTE, NC 28202

**Registered Aug. 28, 2012**

**Int. Cl.: 7**

FOR: FREE-STANDING STEAM CLEANING DEVICE FOR MICROWAVES, IN CLASS 7  
(U.S. CLS. 13, 19, 21, 23, 31, 34 AND 35).

**TRADEMARK**

FIRST USE 2-28-2012; IN COMMERCE 2-28-2012.

**PRINCIPAL REGISTER**

THE MARK CONSISTS OF STANDARD CHARACTERS WITHOUT CLAIM TO ANY PARTICULAR FONT, STYLE, SIZE, OR COLOR.

SN 85-380,922, FILED 7-26-2011.

MICHELLE DUBOIS, EXAMINING ATTORNEY



*David J. Kyffers*

Director of the United States Patent and Trademark Office

# United States of America

United States Patent and Trademark Office

# ERT

**Reg. No. 4,199,861**

**Registered Aug. 28, 2012**

**Int. Cl.: 12**

**TRADEMARK**

**PRINCIPAL REGISTER**

CARLISLE INTANGIBLE COMPANY (DELAWARE CORPORATION)  
SUITE 201  
250 SOUTH CLINTON STREET  
SYRACUSE, NY 13202

FOR: ATV TIRES, IN CLASS 12 (U.S. CLS. 19, 21, 23, 31, 35 AND 44).

FIRST USE 10-0-2011; IN COMMERCE 10-0-2011.

THE MARK CONSISTS OF STANDARD CHARACTERS WITHOUT CLAIM TO ANY PARTICULAR FONT, STYLE, SIZE, OR COLOR.

SN 85-380,934, FILED 7-26-2011.

FLORENTINA BLANDU, EXAMINING ATTORNEY



*David J. Kybas*

Director of the United States Patent and Trademark Office

# United States of America

United States Patent and Trademark Office

## MONTGOMERY NEW START

**Reg. No. 4,199,862**

**Registered Aug. 28, 2012**

**Int. Cl.: 36**

**SERVICE MARK**

**PRINCIPAL REGISTER**

MONTGOMERY BANK, NATIONAL ASSOCIATION (MISSOURI NATIONAL BANKING ASSOCIATION)  
ONE FIRST NATIONAL PLAZA  
SIKESTON, MO 63801

FOR: BANKING SERVICES, IN CLASS 36 (U.S. CLS. 100, 101 AND 102).

FIRST USE 8-0-2011; IN COMMERCE 8-0-2011.

THE MARK CONSISTS OF STANDARD CHARACTERS WITHOUT CLAIM TO ANY PARTICULAR FONT, STYLE, SIZE, OR COLOR.

OWNER OF U.S. REG. NOS. 2,454,389, 2,860,611, AND 3,200,643.

SN 85-381,599, FILED 7-26-2011.

JANICE L. MCMORROW, EXAMINING ATTORNEY



*David J. Kybas*

Director of the United States Patent and Trademark Office



# United States of America

United States Patent and Trademark Office

# AVATHERAPY

**Reg. No. 4,199,863**

**Registered Aug. 28, 2012**

**Int. Cl.: 44**

**SERVICE MARK**

**PRINCIPAL REGISTER**

TECH 4 PROFIT (CALIFORNIA LIMITED LIABILITY COMPANY)  
103 TALLSTAR DR  
103 TALLSTAR DRIVE  
LAKEWAY, TX 78734

FOR: COGNITIVE THERAPY SERVICES; LISTENING THERAPY SERVICES; MENTAL HEALTH THERAPY SERVICES; MUSIC THERAPY FOR PHYSICAL, PSYCHOLOGICAL AND COGNITIVE PURPOSES; MUSIC THERAPY FOR SOCIAL ASSIMILATION PURPOSES; OCCUPATIONAL THERAPY SERVICES; PROVIDING AN ON-LINE, PATIENT-INITIATED, PATIENT-AUTHORIZED, FEE-FOR-SERVICE, MEDICAL PROFILE AND MEDICAL RECORD ANALYSIS SERVICE DESIGNED TO PROVIDE PATIENTS WITH CUSTOM TAILORED INFORMATION ABOUT THE RANGE OF POSSIBLE DIAGNOSES AND THERAPIES ASSOCIATED WITH A DEFINED SET OF SYMPTOMS; STRESS REDUCTION THERAPY, IN CLASS 44 (U.S. CLS. 100 AND 101).

FIRST USE 10-24-2011; IN COMMERCE 10-24-2011.

THE MARK CONSISTS OF STANDARD CHARACTERS WITHOUT CLAIM TO ANY PARTICULAR FONT, STYLE, SIZE, OR COLOR.

SN 85-381,746, FILED 7-26-2011.

DOUGLAS LEE, EXAMINING ATTORNEY



*David J. Kyros*

Director of the United States Patent and Trademark Office

# United States of America

United States Patent and Trademark Office



**Reg. No. 4,199,864**

**Registered Aug. 28, 2012**

**Int. Cl.: 43**

**SERVICE MARK**

**PRINCIPAL REGISTER**

TIMBERLAND TRADING, INC. (PANAMA CORPORATION)  
6263 NORTH SCOTTSDALE ROAD  
C/O WEISS BROWN, PLLC, SUITE 143  
SCOTTSDALE, AZ 85250 AND

MADEIRA SERVICES (BR. VIRGIN ISLANDS LIMITED LIABILITY COMPANY)  
6263 NORTH SCOTTSDALE ROAD  
C/O WEISS BROWN PLLC, SUITE 143  
SCOTTSDALE, AZ 85250

FOR: FAST-FOOD RESTAURANTS; RESTAURANT SERVICES, IN CLASS 43 (U.S. CLS. 100 AND 101).

FIRST USE 5-28-2012; IN COMMERCE 5-28-2012.

NO CLAIM IS MADE TO THE EXCLUSIVE RIGHT TO USE "HAMBURGERS" AND "THE ORIGINAL RECIPE", APART FROM THE MARK AS SHOWN.

THE COLOR(S) YELLOW, BROWN, ORANGE, AND WHITE IS/ARE CLAIMED AS A FEATURE OF THE MARK.

THE MARK CONSISTS OF A DECORATIVE BROWN FENCE, WITH A LARGE YELLOW HAMBURGER BUN SHAPED CIRCLE IN THE MIDDLE OF THE FENCE. THE TEXT "HAMBURGERS" IS AT THE TOP OF THE CIRCLE IN WHITE LETTERING AND THE TEXT "THE ORIGINAL RECIPE" IS AT THE BOTTOM OF THE CIRCLE IN WHITE LETTERING. THERE IS A BROWN RECTANGLE WITH ROUNDED EDGES THAT GOES THROUGH THE MIDDLE OF THE YELLOW CIRCLE, EXTENDING PAST THE EDGES OF THE FENCE. THE BROWN RECTANGLE HAS ORANGE TEXT THAT READS "EL CORRAL" IN THE MIDDLE WITH WHITE BORDERS.

THE ENGLISH TRANSLATION OF "EL CORRAL" IS "THE CORRAL".

SN 85-382,419, FILED 7-27-2011.

ALICE BENMAMAN, EXAMINING ATTORNEY



*David J. Kyros*

Director of the United States Patent and Trademark Office

# United States of America

United States Patent and Trademark Office



# VAMPLIERS

**Reg. No. 4,199,865**

HASHI LINK CORP. (CALIFORNIA CORPORATION)

**Registered Aug. 28, 2012**

459 WALD STREET  
IRVINE, CA 92618

**Int. Cl.: 8**

**TRADEMARK**

**PRINCIPAL REGISTER**

FOR: HAND TOOL FOR REMOVING HEARING AID BATTERIES; HAND TOOLS FOR REPAIR AND MAINTENANCE OF BICYCLES; HAND TOOLS, NAMELY, AWLS; HAND TOOLS, NAMELY, BAR CUTTERS; HAND TOOLS, NAMELY, BOLT CUTTERS; HAND TOOLS, NAMELY, CLAMPS; HAND TOOLS, NAMELY, CRIMP WRENCH SETS; HAND TOOLS, NAMELY, CRIMP WRENCHES; HAND TOOLS, NAMELY, CRIMPING IRONS; HAND TOOLS, NAMELY, CUTTER BARS; HAND TOOLS, NAMELY, ENGRAVERS; HAND TOOLS, NAMELY, HAND SEAMERS; HAND TOOLS, NAMELY, PINCERS; HAND TOOLS, NAMELY, PLIERS SETS; HAND TOOLS, NAMELY, PULLERS AND SPLITTERS; HAND TOOLS, NAMELY, RATCHET WRENCHES; HAND TOOLS, NAMELY, RIVETERS; HAND TOOLS, NAMELY, SCREW EXTRACTORS; HAND TOOLS, NAMELY, SCREWDRIVERS; HAND TOOLS, NAMELY, TOOLS FOR PLACING A ROPE OR OTHER FLEXIBLE MEMBER THROUGH AN EYE OR AROUND A TARGET OBJECT; HAND TOOLS, NAMELY, TORQUE MULTIPLIERS; HAND TOOLS, NAMELY, VICES; HAND TOOLS, NAMELY, WIRE CUTTERS; HAND TOOLS, NAMELY, WIRE NIPPERS; HAND TOOLS, NAMELY, WIRE STRIPPERS; HAND TOOLS, NAMELY, WRECKING BARS, STRIPPING BARS, SMALL BARS AND NAIL PULLERS, SAN ANGELO BARS, TAMPER BARS, WEDGE POINT BARS, PITCH POINT BARS; HAND TOOLS, NAMELY, WRENCHES; HAND TOOLS, NAMELY, PLIERS AND CHANNEL LOCKS; HAND-OPERATED AUTOMOTIVE REPAIR TOOLS, NAMELY, MAGNETIC PICK-UP TOOLS; HAND-OPERATED DISARMING TOOLS FOR IMPROVISED EXPLOSIVE DEVICES (IED); HAND-OPERATED RIVETING TOOLS; HAND-OPERATED SHARPENING TOOLS AND INSTRUMENTS; HAND-OPERATED TOOLS, NAMELY, CHISELS; HAND-TOOLS, NAMELY, WIRE CRIMPERS; MANUALLY OPERATED HAND TOOLS, NAMELY, PLIERS AND CHANNEL LOCKS; MANUALLY OPERATED SHOP TOOLS FOR WORK ON MOTORCYCLES, NAMELY, CHAIN BREAKER TOOL, CHAIN RIVETING TOOL, CHAIN PRESS TOOL, CHAIN ALIGNMENT TOOL, CARBURETOR TUNING TOOL, CARBURETOR TUNING GAUGE SET, TIRE IRONS, TAPPET ADJUSTMENT TOOLS, VALVE SHIM TOOLS, TAPPET FEELER GAUGE, CARBURETOR JET WRENCHES, CLUTCH HOLDING TOOL, PISTON PIN REMOVING TOOL, SPRING REMOVING TOOL, TIMING COVER WRENCH, OIL FILTER WRENCH, SHOCK ABSORBER WRENCH, AXLE WRENCH, FLY WHEEL PULLER TOOL, CLUTCH PULLER TOOL AND MAGNETO FLYWHEEL PULLER TOOL; MULTIFUNCTION HAND TOOLS COMPRISED OF PLIERS, WRENCHES, CHANNEL LOCKS, WIRE CUTTERS, WIRE CRIMPERS; HAND-OPERATED CUTTING TOOLS, NAMELY, SAFETY CUTTERS, IN CLASS 8 (U.S. CLS. 23, 28 AND 44).



*David J. Kappas*

Director of the United States Patent and Trademark Office

**Reg. No. 4,199,865** FIRST USE 5-1-2012; IN COMMERCE 5-1-2012.

THE MARK CONSISTS OF THE WORD "VAMPLIERS" WRITTEN IN RED BLOCK LETTERS. THE TOP PORTION OF A GRAY SCREW IS POSITIONED ABOVE THE "V" IN THE WORD "VAMPLIERS" WHEREIN THE BODY PORTION OF THE GRAY SCREW SITS IN THE GROOVE OF THE "V". THERE IS A SMALL SLIT IN THE TOP OF THE GRAY SCREW. THE TOP OF THE GRAY SCREW IS SURROUNDED BY A BLACK VAMPIRE BAT-LIKE CREATURE HAVING WINGS AND TWO ADDITIONAL APPENDAGES (LEGS) THAT RESEMBLE PLIERS GRABBING ONTO THE TOP OF THE GRAY SCREW. THE APPENDAGES HAVE GROOVES CARVED THEREIN, SHOWING THAT THEY GRAB THE GRAY SCREW. THE BAT-LIKE CREATURE IS BLACK AND OUTLINED IN RED. FURTHER, THERE IS A YELLOW-ORANGE CIRCLE POSITIONED BEHIND THE BAT-LIKE CREATURE, THAT SPILLS INTO THE GROOVE OF THE RED BLOCK "V" OF "VAMPLIERS". IN ADDITION, THE YELLOW-ORANGE BACKDROP ALSO FORMS AN OUTLINE FOR THE TOP PORTION OF THE "V" AND THE INNER PORTIONS OF THE GROOVE OF THE "V". FINALLY, THERE IS A MAROON DROP AT THE BOTTOM OF THE RED "V" OF "VAMPLIERS", THAT RESEMBLES A DROP OF BLOOD.

THE COLOR(S) YELLOW-ORANGE, BLACK, GRAY, MAROON AND RED IS/ARE CLAIMED AS A FEATURE OF THE MARK.

SN 85-382,978, FILED 7-27-2011.

ANGELA M. MICHELI, EXAMINING ATTORNEY

# United States of America

United States Patent and Trademark Office



**Reg. No. 4,199,866**

VALLEY FINE FOODS COMPANY, INC. (CALIFORNIA CORPORATION)  
3909 PARK ROAD  
BENICIA, CA 94510

**Registered Aug. 28, 2012**

**Int. Cl.: 30**

FOR: PREPARED ENTREES CONSISTING PRIMARILY OF PASTA; PREPARED ENTREES CONSISTING PRIMARILY OF PASTA WITH MEAT, POULTRY, SEAFOOD, VEGETABLES OR CHEESE; PASTA; PASTA SAUCES, MEAT SAUCES; READY-MADE SAUCES; SPICES; SPICE BLENDS; SPICE AND CHEESE BLENDS, IN CLASS 30 (U.S. CL. 46).

**TRADEMARK**

**PRINCIPAL REGISTER**

FIRST USE 8-31-1992; IN COMMERCE 8-31-1992.

NO CLAIM IS MADE TO THE EXCLUSIVE RIGHT TO USE "PASTA", APART FROM THE MARK AS SHOWN.

THE MARK CONSISTS OF THE WORDS "PASTA PRIMA" INSIDE A STYLIZED RECTANGLE WITH THE IMAGE OF A LEAF.

THE ENGLISH TRANSLATION OF "PRIMA" IN THE MARK IS "FIRST".

SN 85-383,006, FILED 7-28-2011.

JACLYN KIDWELL WALKER, EXAMINING ATTORNEY



*David J. Kyros*

Director of the United States Patent and Trademark Office

# United States of America

United States Patent and Trademark Office

## EVENT MESSENGER

**Reg. No. 4,199,867**

**Registered Aug. 28, 2012**

**Int. Cl.: 9**

**TRADEMARK**

**PRINCIPAL REGISTER**

DAYMEN CANADA ACQUISITION ULC (CANADA UNLIMITED LIABILITY CORPORATION)  
2800 PARK PLACE  
666 BURRARD STREET  
VANCOUVER, BC, CANADA V6C2Z7

FOR: SHOULDER BAGS AND MESSENGER BAGS DESIGNED FOR CARRYING CAMERAS, PHOTOGRAPHIC EQUIPMENT AND ACCESSORIES, AUDIO, VISUAL AND ELECTRONIC EQUIPMENT, CELLULAR TELEPHONES, COMPUTER NOTEBOOKS, COMPUTER EQUIPMENT AND COMPUTER PERIPHERALS, IN CLASS 9 (U.S. CLS. 21, 23, 26, 36 AND 38).

FIRST USE 3-21-2012; IN COMMERCE 3-21-2012.

THE MARK CONSISTS OF STANDARD CHARACTERS WITHOUT CLAIM TO ANY PARTICULAR FONT, STYLE, SIZE, OR COLOR.

OWNER OF U.S. REG. NO. 3,726,599.

NO CLAIM IS MADE TO THE EXCLUSIVE RIGHT TO USE "MESSENGER", APART FROM THE MARK AS SHOWN.

SN 85-383,456, FILED 7-28-2011.

DARRYL SPRUILL, EXAMINING ATTORNEY



*David J. Kyffers*

Director of the United States Patent and Trademark Office

**United States of America**  
United States Patent and Trademark Office

# PROSFLEX

**Reg. No. 4,199,868**

ORGANIC FARMS VITAMINS CORP (FLORIDA CORPORATION)  
52 RILEY ROAD  
CELEBRATION, FL 34747

**Registered Aug. 28, 2012**

**Int. Cl.: 5**

FOR: DIETARY SUPPLEMENTS, IN CLASS 5 (U.S. CLS. 6, 18, 44, 46, 51 AND 52).

**TRADEMARK**

FIRST USE 7-29-2011; IN COMMERCE 7-29-2011.

**PRINCIPAL REGISTER**

THE MARK CONSISTS OF STANDARD CHARACTERS WITHOUT CLAIM TO ANY PARTICULAR FONT, STYLE, SIZE, OR COLOR.

SN 85-383,746, FILED 7-28-2011.

CHERYL CLAYTON, EXAMINING ATTORNEY



*David J. Kybas*

Director of the United States Patent and Trademark Office

# United States of America

United States Patent and Trademark Office

# KIDSME

**Reg. No. 4,199,869**

**Registered Aug. 28, 2012**

**Int. Cls.: 10 and 21**

**TRADEMARK**

**PRINCIPAL REGISTER**

FU HONG INDUSTRIES LIMITED (HONG KONG LIMITED COMPANY (LTD.))  
FLAT B, 9F, GEE LUEN CHANG IND. BLDG.  
NO. 11, YUK YAT STREET, TOKWAWAN  
KOWLOON, HONG KONG

FOR: BABY BOTTLES; CUPS ADAPTED FOR FEEDING BABIES AND CHILDREN; FEEDING BOTTLES; PACIFIERS FOR BABIES; TEETHING RINGS; TEETHING RINGS INCORPORATING BABY RATTLES, IN CLASS 10 (U.S. CLS. 26, 39 AND 44).

FIRST USE 6-0-2010; IN COMMERCE 11-15-2011.

FOR: DRINKING CUPS FOR BABIES AND CHILDREN AND PARTS AND FITTINGS THEREFOR, NAMELY, CUPS FOR BABIES AND CHILDREN SOLD AS A UNIT WITH VALVES AND LIDS; DRINKING CUPS FOR INFANTS AND PARTS AND FITTINGS THEREFOR, NAMELY, VALVES AND LIDS SOLD AS A UNIT; HAND-OPERATED FOOD GRINDERS; TRAINING CUPS FOR BABIES AND CHILDREN, IN CLASS 21 (U.S. CLS. 2, 13, 23, 29, 30, 33, 40 AND 50).

FIRST USE 6-0-2010; IN COMMERCE 11-15-2011.

THE MARK CONSISTS OF STANDARD CHARACTERS WITHOUT CLAIM TO ANY PARTICULAR FONT, STYLE, SIZE, OR COLOR.

SN 85-383,840, FILED 7-28-2011.

KRISTIN DAHLING, EXAMINING ATTORNEY



*David J. Kyros*

Director of the United States Patent and Trademark Office



# United States of America

United States Patent and Trademark Office

## KEEP PORTLAND GEARED

**Reg. No. 4,199,870**

T LINE DESIGN INC. (OREGON CORPORATION)  
158 SW 1ST AVE.  
CANBY, OR 97013

**Registered Aug. 28, 2012**

**Int. Cl.: 25**

FOR: HATS; T-SHIRTS, IN CLASS 25 (U.S. CLS. 22 AND 39).

**TRADEMARK**

FIRST USE 4-24-2012; IN COMMERCE 4-24-2012.

**PRINCIPAL REGISTER**

THE MARK CONSISTS OF STANDARD CHARACTERS WITHOUT CLAIM TO ANY PARTICULAR FONT, STYLE, SIZE, OR COLOR.

SN 85-383,991, FILED 7-28-2011.

JORDAN BAKER, EXAMINING ATTORNEY



*David J. Kyffers*

Director of the United States Patent and Trademark Office

# United States of America

United States Patent and Trademark Office

## PADDLESAVER

**Reg. No. 4,199,871**

JOHN SMALLEY (UNITED KINGDOM INDIVIDUAL)  
300 INU PLACE  
KULA, HI 96790

**Registered Aug. 28, 2012**

**Int. Cl.: 22**

FOR: LANYARDS FOR HOLDING PADDLES, IN CLASS 22 (U.S. CLS. 1, 2, 7, 19, 22, 42 AND 50).

**TRADEMARK**

FIRST USE 7-28-2011; IN COMMERCE 5-5-2012.

**PRINCIPAL REGISTER**

THE MARK CONSISTS OF STANDARD CHARACTERS WITHOUT CLAIM TO ANY PARTICULAR FONT, STYLE, SIZE, OR COLOR.

SN 85-384,042, FILED 7-28-2011.

FLORENTINA BLANDU, EXAMINING ATTORNEY



*David J. Kyffers*

Director of the United States Patent and Trademark Office

# United States of America

United States Patent and Trademark Office

## PADDLESAVER

**Reg. No. 4,199,872**

JOHN SMALLEY (UNITED KINGDOM INDIVIDUAL)  
300 INU PLACE  
KULA, HI 96790

**Registered Aug. 28, 2012**

**Int. Cl.: 25**

FOR: BOARD SHORTS; RASH GUARDS; WETSUITS, IN CLASS 25 (U.S. CLS. 22 AND 39).

**TRADEMARK**

FIRST USE 7-28-2011; IN COMMERCE 5-5-2012.

**PRINCIPAL REGISTER**

THE MARK CONSISTS OF STANDARD CHARACTERS WITHOUT CLAIM TO ANY PARTICULAR FONT, STYLE, SIZE, OR COLOR.

SN 85-384,057, FILED 7-28-2011.

FLORENTINA BLANDU, EXAMINING ATTORNEY



*David J. Kybas*

Director of the United States Patent and Trademark Office

# United States of America

United States Patent and Trademark Office



**Reg. No. 4,199,873**

3ST INDUSTRY CO., LTD. (TAIWAN CORPORATION)  
2F.,NO.8,ALY.4,LN. 287,SEC.1,NANGANG RD.  
NANGANG DIST., TAIPEI, TAIWAN

**Registered Aug. 28, 2012**

**Int. Cl.: 7**

FOR: AIR-OPERATED POWER TOOLS, NAMELY, IMPACT WRENCHES, RATCHET WRENCHES, DRILLS, GRINDERS, ORBITAL SANDERS; AIR POWERED TOOLS, NAMELY, DRILLS, SCREWDRIVERS, RIVET HAMMERS, SAWS, IN CLASS 7 (U.S. CLS. 13, 19, 21, 23, 31, 34 AND 35).

**TRADEMARK**

**PRINCIPAL REGISTER**

FIRST USE 1-18-2008; IN COMMERCE 1-18-2008.

NO CLAIM IS MADE TO THE EXCLUSIVE RIGHT TO USE "CAR TOOL", APART FROM THE MARK AS SHOWN.

THE MARK CONSISTS OF THE TERM "CAR" ABOVE THE TERM "TOOL", WITH THE "C" EXTENDING BELOW THE TERM "CAR" TO FORM A HORIZONTAL BAR BETWEEN THE TERMS "CAR" AND "TOOL". ALL OF THE AFOREMENTIONED APPEARS WITHIN TWO CONCENTRIC CIRCLES THAT ARE SHADED TO GIVE A DOME-LIKE APPEARANCE.

SN 85-384,209, FILED 7-29-2011.

KAREN SEVERSON, EXAMINING ATTORNEY



*David J. Kybas*

Director of the United States Patent and Trademark Office

# United States of America

United States Patent and Trademark Office



**Reg. No. 4,199,874**

**Registered Aug. 28, 2012**

**Int. Cl.: 35**

**SERVICE MARK**

**PRINCIPAL REGISTER**

MADISON L DESIGNS INC. (NEW YORK CORPORATION)  
71 WEST 47TH STREET SUITE 1003  
NEW YORK, NY 10036

FOR: RETAIL JEWELRY STORES, IN CLASS 35 (U.S. CLS. 100, 101 AND 102).

FIRST USE 4-1-2012; IN COMMERCE 4-1-2012.

NO CLAIM IS MADE TO THE EXCLUSIVE RIGHT TO USE "DESIGNS", APART FROM THE MARK AS SHOWN.

THE COLOR(S) BLACK AND GREEN IS/ARE CLAIMED AS A FEATURE OF THE MARK.

THE NAME(S), PORTRAIT(S), AND/OR SIGNATURE(S) SHOWN IN THE MARK IDENTIFIES "LEORA AMINOFF", WHOSE CONSENT(S) TO REGISTER IS MADE OF RECORD.

THE MARK CONSISTS OF STYLIZED WORDS "MADISON L DESIGNS BY LEORA AMINOFF", STYLIZED LETTER "L" BEING IN GREEN COLOR, AND THE REST OF THE TEXT BEING IN BLACK.

SN 85-384,304, FILED 7-29-2011.

DAVID H. STINE, EXAMINING ATTORNEY



*David J. Kybas*

Director of the United States Patent and Trademark Office

# United States of America

United States Patent and Trademark Office

## PEARL SALON

**Reg. No. 4,199,875**

USP LLC (CALIFORNIA LIMITED LIABILITY COMPANY)  
1818 ORD WAY  
OCEANSIDE, CA 92056

**Registered Aug. 28, 2012**

**Int. Cls.: 35 and 44**

FOR: PROVIDING ON-LINE INFORMATION IN THE FIELD OF EMPLOYMENT OPPORTUNITIES IN THE FIELD OF COSMETOLOGY; FRANCHISING, NAMELY, OFFERING BUSINESS MANAGEMENT ASSISTANCE IN THE ESTABLISHMENT AND OPERATION OF HAIR CARE AND HAIR CUTTING SHOPS, BEAUTY, COSMETIC, SPA AND LIFE STYLE SALONS; RETAIL AND ONLINE STORE SERVICES FEATURING CLOTHING, HAIR CARE PRODUCTS, AND BEAUTY PRODUCTS, IN CLASS 35 (U.S. CLS. 100, 101 AND 102).

**SERVICE MARK**

**PRINCIPAL REGISTER**

FIRST USE 7-1-2011; IN COMMERCE 7-1-2011.

FOR: HAIR CARE CENTER SERVICES, NAMELY, HAIR CUTTING, SHAMPOOING, COLORING, CONDITIONING AND STRAIGHTENING; HAIR STYLING, HAIR COLORING, AND MAKE-UP APPLICATION; COSMETICIAN AND ESTHETICIAN SERVICES; HAIRDRESSING SERVICES; BEAUTY SALONS, IN CLASS 44 (U.S. CLS. 100 AND 101).

FIRST USE 7-1-2011; IN COMMERCE 7-1-2011.

THE MARK CONSISTS OF STANDARD CHARACTERS WITHOUT CLAIM TO ANY PARTICULAR FONT, STYLE, SIZE, OR COLOR.

NO CLAIM IS MADE TO THE EXCLUSIVE RIGHT TO USE "SALON", APART FROM THE MARK AS SHOWN.

SN 85-384,557, FILED 7-29-2011.

KEVON CHISOLM, EXAMINING ATTORNEY



*David J. Kypos*

Director of the United States Patent and Trademark Office

# United States of America

United States Patent and Trademark Office

## YOUR INSTANT GARAGE

**Reg. No. 4,199,876**

NICKERSON INVESTMENTS L.L.C. (WASHINGTON LIMITED LIABILITY COMPANY)  
1300 W. NICKERSON STREET  
SEATTLE, WA 98119

**Registered Aug. 28, 2012**

**Int. Cl.: 39**

FOR: STORAGE SERVICES, NAMELY, PROVIDING SELF-SERVICE STORAGE FACILITIES FOR STORAGE OF GOODS BY OTHERS; STORAGE SERVICES FOR VEHICLES AND BOATS, IN CLASS 39 (U.S. CLS. 100 AND 105).

**SERVICE MARK**

FIRST USE 7-22-2011; IN COMMERCE 7-22-2011.

**PRINCIPAL REGISTER**

THE MARK CONSISTS OF STANDARD CHARACTERS WITHOUT CLAIM TO ANY PARTICULAR FONT, STYLE, SIZE, OR COLOR.

NO CLAIM IS MADE TO THE EXCLUSIVE RIGHT TO USE "GARAGE", APART FROM THE MARK AS SHOWN.

SN 85-384,645, FILED 7-29-2011.

KAREN SEVERSON, EXAMINING ATTORNEY



*David J. Kybas*

Director of the United States Patent and Trademark Office

# United States of America

United States Patent and Trademark Office

## Neva Meetings

**Reg. No. 4,199,877**

NEVA MEETINGS, LLC (COLORADO LIMITED LIABILITY COMPANY)  
3189 GENEVA CT.  
DENVER, CO 80238

**Registered Aug. 28, 2012**

**Int. Cl.: 35**

FOR: SPECIAL EVENT PLANNING FOR BUSINESS PURPOSES, IN CLASS 35 (U.S. CLS. 100, 101 AND 102).

**SERVICE MARK**

FIRST USE 8-6-2011; IN COMMERCE 12-8-2011.

**PRINCIPAL REGISTER**

THE MARK CONSISTS OF STANDARD CHARACTERS WITHOUT CLAIM TO ANY PARTICULAR FONT, STYLE, SIZE, OR COLOR.

NO CLAIM IS MADE TO THE EXCLUSIVE RIGHT TO USE "MEETINGS", APART FROM THE MARK AS SHOWN.

SN 85-385,067, FILED 7-29-2011.

ARETHA SOMERVILLE, EXAMINING ATTORNEY



*David J. Kyffers*

Director of the United States Patent and Trademark Office



# United States of America

United States Patent and Trademark Office

# DR. EVIL

**Reg. No. 4,199,878**

CAPTAIN ACTION ENTERPRISES, LLC (NEW JERSEY LIMITED LIABILITY COMPANY)  
656 WYNDEMERE AVE  
RIDGEWOOD, NJ 07450

**Registered Aug. 28, 2012**

**Int. Cl.: 28**

FOR: ACTION FIGURES AND ACCESSORIES THEREFOR, IN CLASS 28 (U.S. CLS. 22, 23, 38 AND 50).

**TRADEMARK**

FIRST USE 8-1-2011; IN COMMERCE 4-15-2012.

**PRINCIPAL REGISTER**

THE MARK CONSISTS OF STYLIZED LETTERS SPELLING "DR. EVIL".

SN 85-385,157, FILED 7-29-2011.

DOUGLAS LEE, EXAMINING ATTORNEY



*David J. Kyffers*

Director of the United States Patent and Trademark Office

# United States of America

United States Patent and Trademark Office

# DigiPOP

**Reg. No. 4,199,879**

**Registered Aug. 28, 2012**

**Int. Cl.: 16**

**TRADEMARK**

**PRINCIPAL REGISTER**

RELYCO SALES, INC. (NEW HAMPSHIRE CORPORATION)  
121 BROADWAY  
DOVER, NH 03820

FOR: BOXES, CARTONS AND CONTAINERS OF PAPERBOARD OR CARDBOARD FOR COMMERCIAL OR INDUSTRIAL PACKAGING; CARDBOARD PACKAGING; CARDBOARD PACKAGING BOXES IN COLLAPSIBLE FORM, IN CLASS 16 (U.S. CLS. 2, 5, 22, 23, 29, 37, 38 AND 50).

FIRST USE 9-30-2011; IN COMMERCE 9-30-2011.

THE MARK CONSISTS OF STANDARD CHARACTERS WITHOUT CLAIM TO ANY PARTICULAR FONT, STYLE, SIZE, OR COLOR.

SN 85-385,183, FILED 7-29-2011.

LYDIA BELZER, EXAMINING ATTORNEY



*David J. Kyffers*

Director of the United States Patent and Trademark Office

**United States of America**  
United States Patent and Trademark Office

# CrowdSpot

**Reg. No. 4,199,880**

VAN DER ZEE, CORNELIS WYBREN (NETHERLANDS INDIVIDUAL)  
SPANJAARDSLAAN 127

**Registered Aug. 28, 2012**

LEEWARDEN, NETHERLANDS

**Int. Cl.: 9**

FOR: COMPUTER APPLICATION SOFTWARE FOR SMARTPHONES, NAMELY, SOFTWARE FOR USE IN PROVIDING GEOGRAPHIC LOCATION BASED INFORMATION SERVICES, IN CLASS 9 (U.S. CLS. 21, 23, 26, 36 AND 38).

**TRADEMARK**

FIRST USE 6-6-2012; IN COMMERCE 6-6-2012.

**PRINCIPAL REGISTER**

THE MARK CONSISTS OF STANDARD CHARACTERS WITHOUT CLAIM TO ANY PARTICULAR FONT, STYLE, SIZE, OR COLOR.

SN 85-385,350, FILED 7-30-2011.

JAY BESCH, EXAMINING ATTORNEY



*David J. Kyffers*

Director of the United States Patent and Trademark Office

# United States of America

United States Patent and Trademark Office

# TOWNSEN

**Reg. No. 4,199,881**

**Registered Aug. 28, 2012**

**Int. Cl.: 25**

**TRADEMARK**

**PRINCIPAL REGISTER**

HOWARD HIGHMAN (UNITED STATES INDIVIDUAL)  
SUITE 911  
234 WEST 39TH STREET  
NEW YORK, NY 10018

FOR: MEN'S AND WOMEN'S JACKETS, COATS, TROUSERS, VESTS; PANTS; WOMEN'S CLOTHING, NAMELY, SHIRTS, DRESSES, SKIRTS, BLOUSES, IN CLASS 25 (U.S. CLS. 22 AND 39).

FIRST USE 3-7-2012; IN COMMERCE 3-7-2012.

THE MARK CONSISTS OF STANDARD CHARACTERS WITHOUT CLAIM TO ANY PARTICULAR FONT, STYLE, SIZE, OR COLOR.

SN 85-385,928, FILED 8-1-2011.

COURTNEY ALVAREZ, EXAMINING ATTORNEY



*David J. Kyffers*

Director of the United States Patent and Trademark Office

# United States of America

United States Patent and Trademark Office

# MICRO360

**Reg. No. 4,199,882**

CELESTRON ACQUISITION LLC (DELAWARE LIMITED LIABILITY COMPANY)  
2835 COLUMBIA STREET  
TORRANCE, CA 90503

**Registered Aug. 28, 2012**

**Int. Cl.: 9**

FOR: MICROSCOPES, IN CLASS 9 (U.S. CLS. 21, 23, 26, 36 AND 38).

**TRADEMARK**

FIRST USE 3-31-2012; IN COMMERCE 3-31-2012.

**PRINCIPAL REGISTER**

THE MARK CONSISTS OF STANDARD CHARACTERS WITHOUT CLAIM TO ANY PARTICULAR FONT, STYLE, SIZE, OR COLOR.

SN 85-385,938, FILED 8-1-2011.

KEVIN CORWIN, EXAMINING ATTORNEY



*David J. Kyffers*

Director of the United States Patent and Trademark Office

# United States of America

United States Patent and Trademark Office

## Soothe 'n Groove Mobile

**Reg. No. 4,199,883**

**Registered Aug. 28, 2012**

**Int. Cl.: 28**

**TRADEMARK**

**PRINCIPAL REGISTER**

TINY LOVE LTD. (ISRAEL CORPORATION)  
TOP DAN BUILDING, FLOOR D  
72 PINCHAS ROSEN STREET  
TEL AVIV, ISRAEL 69512

FOR: TOYS, GAMES, AND PLAYTHINGS, FOR BABIES, INFANTS AND CHILDREN,  
NAMELY, MOBILES, IN CLASS 28 (U.S. CLS. 22, 23, 38 AND 50).

FIRST USE 1-0-2012; IN COMMERCE 1-0-2012.

THE MARK CONSISTS OF STANDARD CHARACTERS WITHOUT CLAIM TO ANY PAR-  
TICULAR FONT, STYLE, SIZE, OR COLOR.

NO CLAIM IS MADE TO THE EXCLUSIVE RIGHT TO USE "MOBILE", APART FROM THE  
MARK AS SHOWN.

SN 85-386,683, FILED 8-2-2011.

KELLEY WELLS, EXAMINING ATTORNEY



*David J. Kyros*

Director of the United States Patent and Trademark Office

# United States of America

United States Patent and Trademark Office

# EXCITE

**Reg. No. 4,199,884**

**Registered Aug. 28, 2012**

**Int. Cl.: 9**

**TRADEMARK**

**PRINCIPAL REGISTER**

TOSHIBA AMERICA INFORMATION SYSTEMS, INC. (CALIFORNIA CORPORATION)  
9740 IRVINE BOULEVARD  
IRVINE, CA 92618

FOR: TABLET COMPUTERS, IN CLASS 9 (U.S. CLS. 21, 23, 26, 36 AND 38).

FIRST USE 2-25-2012; IN COMMERCE 2-25-2012.

THE MARK CONSISTS OF STANDARD CHARACTERS WITHOUT CLAIM TO ANY PARTICULAR FONT, STYLE, SIZE, OR COLOR.

SN 85-386,996, FILED 8-2-2011.

EDWARD NELSON, EXAMINING ATTORNEY



*David J. Kyffers*

Director of the United States Patent and Trademark Office

# United States of America

United States Patent and Trademark Office

## FOLDED WORDS

**Reg. No. 4,199,885**

**Registered Aug. 28, 2012**

**Int. Cls.: 16 and 35**

**TRADEMARK**

**SERVICE MARK**

**PRINCIPAL REGISTER**

WALGREEN CO. (ILLINOIS CORPORATION)  
200 WILMOT ROAD  
DEERFIELD, IL 60015

FOR: PAPER STATIONERY; GREETING CARDS, IN CLASS 16 (U.S. CLS. 2, 5, 22, 23, 29, 37, 38 AND 50).

FIRST USE 1-30-2012; IN COMMERCE 1-30-2012.

FOR: ONLINE RETAIL STORE SERVICES FEATURING GREETING CARDS AND STATIONERY, IN CLASS 35 (U.S. CLS. 100, 101 AND 102).

FIRST USE 1-30-2012; IN COMMERCE 1-30-2012.

THE MARK CONSISTS OF STANDARD CHARACTERS WITHOUT CLAIM TO ANY PARTICULAR FONT, STYLE, SIZE, OR COLOR.

SN 85-387,318, FILED 8-2-2011.

GIANCARLO CASTRO, EXAMINING ATTORNEY



*David J. Kybas*

Director of the United States Patent and Trademark Office



# United States of America

United States Patent and Trademark Office

# POLLENAID

**Reg. No. 4,199,886**

FIRMYIELD POLLEN, LLC (WASHINGTON LIMITED LIABILITY COMPANY)  
501 DEERINGHOFF RD.  
MOXEE, WA 98936

**Registered Aug. 28, 2012**

**Int. Cl.: 1**

FOR: CHEMICALS FOR USE IN AGRICULTURE, HORTICULTURE AND FORESTRY EXCEPT FUNGICIDES, HERBICIDES, INSECTICIDES AND PARASITICIDES, IN CLASS 1 (U.S. CLS. 1, 5, 6, 10, 26 AND 46).

**TRADEMARK**

FIRST USE 4-1-2008; IN COMMERCE 4-1-2008.

**PRINCIPAL REGISTER**

THE MARK CONSISTS OF STANDARD CHARACTERS WITHOUT CLAIM TO ANY PARTICULAR FONT, STYLE, SIZE, OR COLOR.

SN 85-387,641, FILED 8-2-2011.

ROBERT STRUCK, EXAMINING ATTORNEY



*David J. Kyfos*

Director of the United States Patent and Trademark Office

# United States of America

United States Patent and Trademark Office

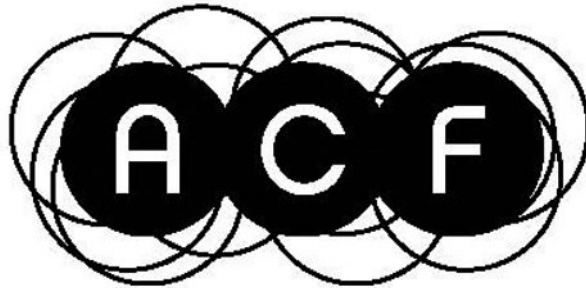

**Reg. No. 4,199,887**

**Registered Aug. 28, 2012**

**Int. Cl.: 41**

**SERVICE MARK**

**PRINCIPAL REGISTER**

AMERICAN COMPOSERS FORUM (MINNESOTA NON-PROFIT CORPORATION)  
SUITE E145  
332 MINNESOTA STREET  
ST. PAUL, MN 55101

FOR: EDUCATIONAL SERVICES, NAMELY, CONDUCTING WORKSHOPS, CLASSES, AND SEMINARS FOR COMPOSERS AND AUDIENCES IN THE FIELDS OF CREATING, PLAYING, AND ENJOYING MUSIC; ENTERTAINMENT PROGRAMS, NAMELY, ARRANGING, ORGANIZING, AND CONDUCTING LIVE MUSICAL PERFORMANCES AND CONCERTS; PRODUCTION OF SOUND RECORDINGS; PROVIDING A WEBSITE FEATURING INFORMATION ABOUT MUSICIANS, COMPOSERS, AND MUSIC; PROVIDING INFORMATION RELATING TO MUSICIANS, COMPOSERS, AND MUSIC; PROVIDING NEWSLETTERS IN THE FIELD OF MUSIC VIA E-MAIL; PROVIDING ON-LINE NEWSLETTERS IN THE FIELD OF MUSIC, IN CLASS 41 (U.S. CLS. 100, 101 AND 107).

FIRST USE 9-26-2011; IN COMMERCE 9-26-2011.

THE MARK CONSISTS OF THE STYLIZED LETTERS "ACF" APPEARING IN THE CENTER OF THREE SHADED AND CONNECTED CIRCLES WITH SEVERAL NON-SHADED AND INTERCONNECTED CIRCLES BEHIND THE SHADED CIRCLES.

SN 85-387,837, FILED 8-3-2011.

CHARLES L. JENKINS, EXAMINING ATTORNEY



*David J. Kyffers*

Director of the United States Patent and Trademark Office

# United States of America

United States Patent and Trademark Office

# MEZZ

**Reg. No. 4,199,888**

**Registered Aug. 28, 2012**

**Int. Cls.: 9 and 38**

**TRADEMARK**

**SERVICE MARK**

**PRINCIPAL REGISTER**

MEZZ, INC. (DELAWARE CORPORATION)  
SUITE 560  
20863 STEVENS CREEK BOULEVARD  
CUPERTINO, CA 95014

FOR: COMPUTER APPLICATION SOFTWARE FOR MOBILE PHONES, NAMELY, SOFTWARE FOR USE IN COMMUNICATION, MESSAGING, ELECTRONIC MAIL AND DIGITAL COMMUNICATION; COMPUTER APPLICATION SOFTWARE FOR MOBILE PHONES, MOBILE DEVICES, ELECTRONIC TABLETS, AND COMPUTERS, NAMELY, SOFTWARE FOR USE IN COMMUNICATION, MESSAGING, ELECTRONIC MAIL AND DIGITAL COMMUNICATION; COMPUTER SOFTWARE FOR ACCESSING INFORMATION DIRECTORIES THAT MAY BE DOWNLOADED FROM THE GLOBAL COMPUTER NETWORK; COMPUTER SOFTWARE FOR WIRELESS CONTENT DELIVERY; COMPUTER SOFTWARE FOR SHARING CONTENT AND INFORMATION ABOUT PEOPLE, PLACES, THINGS, BUSINESSES, ORGANIZATIONS, PRODUCTS, EVENTS, WEBSITES, PHOTOS, VIDEOS, AND DIGITAL CONTENT; DOWNLOADABLE COMPUTER SOFTWARE FOR SHARING CONTENT AND INFORMATION ABOUT PEOPLE, PLACES, THINGS, BUSINESSES, ORGANIZATIONS, PRODUCTS, EVENTS, WEBSITES, PHOTOS, VIDEOS, AND DIGITAL CONTENT, IN CLASS 9 (U.S. CLS. 21, 23, 26, 36 AND 38).

FIRST USE 10-31-2011; IN COMMERCE 10-31-2011.

FOR: ELECTRONIC MAIL AND MESSAGING SERVICES; ELECTRONIC MESSAGING; TEXT AND NUMERIC WIRELESS DIGITAL MESSAGING SERVICES; WEB MESSAGING; WIRELESS DIGITAL MESSAGING SERVICES, IN CLASS 38 (U.S. CLS. 100, 101 AND 104).

FIRST USE 10-31-2011; IN COMMERCE 10-31-2011.

THE MARK CONSISTS OF STANDARD CHARACTERS WITHOUT CLAIM TO ANY PARTICULAR FONT, STYLE, SIZE, OR COLOR.

SN 85-388,842, FILED 8-3-2011.

NAAKWAMA ANKRAH, EXAMINING ATTORNEY



*David J. Kypos*

Director of the United States Patent and Trademark Office

# United States of America

United States Patent and Trademark Office

# SKIPIT

**Reg. No. 4,199,889**

SPOTXCHANGE, INC. (DELAWARE CORPORATION)  
11030 CIRCLEPOINT ROAD, SUITE 350  
DENVER, CO 80020

**Registered Aug. 28, 2012**

**Int. Cl.: 35**

FOR: ADVERTISING SERVICES, NAMELY, PROMOTING AND MARKETING THE GOODS AND SERVICES OF OTHERS THROUGH ALL PUBLIC COMMUNICATION MEANS; ADVERTISING, MARKETING AND PROMOTION SERVICES; INTERNET ADVERTISING SERVICES, IN CLASS 35 (U.S. CLS. 100, 101 AND 102).

**SERVICE MARK**

**PRINCIPAL REGISTER**

FIRST USE 3-31-2012; IN COMMERCE 3-31-2012.

THE MARK CONSISTS OF STANDARD CHARACTERS WITHOUT CLAIM TO ANY PARTICULAR FONT, STYLE, SIZE, OR COLOR.

SN 85-389,023, FILED 8-3-2011.

JOHN WILKE, EXAMINING ATTORNEY



*David J. Kyffers*

Director of the United States Patent and Trademark Office

# United States of America

United States Patent and Trademark Office

# CISNAP

**Reg. No. 4,199,890**

**Registered Aug. 28, 2012**

**Int. Cl.: 10**

**TRADEMARK**

**PRINCIPAL REGISTER**

SPIRACUR INC. (DELAWARE CORPORATION)  
1180 BORDEAUX DRIVE  
SUNNYVALE, CA 94089

FOR: MEDICAL DEVICES, NAMELY, WOUND TREATMENT APPARATUS AND INSTRUMENTS AND SURGICAL AND POST-SURGICAL INCISION CARE APPARATUS AND INSTRUMENTS; WOUND AND SURGICAL INCISION CARE AND THERAPY SYSTEMS COMPRISED PRIMARILY OF WOUND AND INCISION CARE TREATMENT APPARATUS, WOUND DRESSINGS, VALVES, TUBES, STRAPS, FLUID REMOVAL CONDUITS, PRESSURE DELIVERY CONDUITS, INCISION APPROXIMATION SUPPORTS AND INCISION TENSION RELIEF SUPPORTS; ACCESSORY FOR WOUND TREATMENT APPARATUS, NAMELY, STRAP AND CLIP USED TO SECURE APPARATUS TO PATIENT, IN CLASS 10 (U.S. CLS. 26, 39 AND 44).

FIRST USE 10-19-2011; IN COMMERCE 2-24-2012.

THE MARK CONSISTS OF STANDARD CHARACTERS WITHOUT CLAIM TO ANY PARTICULAR FONT, STYLE, SIZE, OR COLOR.

SN 85-389,024, FILED 8-3-2011.

JOHN WILKE, EXAMINING ATTORNEY



*David J. Kypos*

Director of the United States Patent and Trademark Office

# United States of America

United States Patent and Trademark Office

# SWANK

**Reg. No. 4,199,891**

STUDIO KELLESE, LLC (TEXAS LIMITED LIABILITY COMPANY)  
1558 OAK WAY

**Registered Aug. 28, 2012**

SARASOTA, FL 34232

**Int. Cl.: 9**

FOR: VIDEO RECORDINGS FEATURING DANCE AND FITNESS INSTRUCTION; PRE-RECORDED DIGITAL MEDIA FEATURING DANCE INSTRUCTION; VIDEO RECORDINGS FEATURING DANCE INSTRUCTION; DOWNLOADABLE VIDEO RECORDINGS FEATURING DANCE INSTRUCTION; DIGITAL MEDIA, NAMELY, PRE-RECORDED VIDEO CASSETTES, DIGITAL VIDEO DISCS, DIGITAL VERSATILE DISCS, DOWNLOADABLE AUDIO AND VIDEO RECORDINGS, DVDS, AND HIGH DEFINITION DIGITAL DISKS FEATURING PHYSICAL FITNESS AND DANCE EXERCISE INSTRUCTION; PRE-RECORDED DVDS FEATURING DANCE INSTRUCTION, IN CLASS 9 (U.S. CLS. 21, 23, 26, 36 AND 38).

**TRADEMARK**

**PRINCIPAL REGISTER**

FIRST USE 4-0-2012; IN COMMERCE 4-0-2012.

THE MARK CONSISTS OF STANDARD CHARACTERS WITHOUT CLAIM TO ANY PARTICULAR FONT, STYLE, SIZE, OR COLOR.

SN 85-389,033, FILED 8-3-2011.

SALLY SHIH, EXAMINING ATTORNEY



*David J. Kypos*

Director of the United States Patent and Trademark Office

# United States of America

United States Patent and Trademark Office



**Reg. No. 4,199,892**

RUKA, JACKIE (UNITED STATES INDIVIDUAL)  
1482 EAST VALLEY ROAD, #140  
MONTECITO, CA 93108

**Registered Aug. 28, 2012**

**Int. Cl.: 45**

FOR: PROVIDING INFORMATION IN THE FIELD OF PERSONAL DEVELOPMENT,  
NAMELY, PERSONAL IMPROVEMENT, IN CLASS 45 (U.S. CLS. 100 AND 101).

**SERVICE MARK**

FIRST USE 10-1-2011; IN COMMERCE 3-1-2012.

**PRINCIPAL REGISTER**

THE MARK CONSISTS OF THE STYLIZED WORD "GET HAPPY ZONE". AN IMAGE OF  
A HUMAN FIGURE SITTING WITH ARMS OPEN AND EXTENDED OUT WITH HEARTS  
FLOATING ABOVE.

SN 85-389,706, FILED 8-4-2011.

DANIEL CAPSHAW, EXAMINING ATTORNEY



*David J. Kyros*

Director of the United States Patent and Trademark Office

# United States of America

United States Patent and Trademark Office

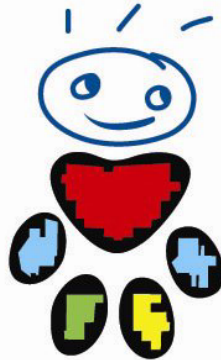

**Reg. No. 4,199,893**

**Registered Aug. 28, 2012**

**Int. Cls.: 25 and 41**

**TRADEMARK**

**SERVICE MARK**

**PRINCIPAL REGISTER**

CENTRE DE TERÀPIES ASSISTIDES AMB CANS S.L. (SPAIN SOCIEDAD DE RESPONSABILIDAD LIMITADA (SL))  
TRAVESSERA DE DALT 100  
BARCELONA, SPAIN 08024

FOR: BATHING SUITS; BATHING TRUNKS; BEACH COVERUPS; BEACH FOOTWEAR; CAPS; JERSEYS; NECKTIES; PANTS; SANDALS; SCARVES; SHIRTS; SHOES; SINGLET; SKIRTS; SWIMMING TRUNKS; T-SHIRTS, IN CLASS 25 (U.S. CLS. 22 AND 39).

FIRST USE 1-1-2012; IN COMMERCE 1-1-2012.

FOR: ANIMAL TRAINING; CONDUCTING WORKSHOPS AND SEMINARS IN ANIMAL TRAINING AND THERAPY ASSISTED WITH ANIMALS; CONTINUING EDUCATION SERVICES, NAMELY, PROVIDING LIVE AND ON-LINE CONTINUING PROFESSIONAL EDUCATION SEMINARS IN THE LEGAL, MEDICAL, ACCOUNTING, AND REAL ESTATE FIELDS; EDUCATION IN THE FIELD OF ANIMAL TRAINING AND THERAPY ASSISTED WITH ANIMALS RENDERED THROUGH CORRESPONDENCE COURSES; EDUCATIONAL AND ENTERTAINMENT SERVICES, NAMELY, CONDUCTING SEMINARS AND WORKSHOPS IN THE FIELD OF ANIMAL TRAINING AND THERAPY ASSISTED WITH ANIMALS AND DISTRIBUTION OF COURSE MATERIALS IN CONNECTION THEREWITH, AND EDUCATION CONSULTING RELATED THERETO; INFORMATION RELATING TO ENTERTAINMENT AND EDUCATION, PROVIDED ON-LINE FROM A COMPUTER DATABASE OR THE INTERNET; PROVIDING INFORMATION AND ADVICE IN THE FIELD OF PET TRAINING; PROVIDING INFORMATION IN THE FIELDS OF ANIMALS AND PETS IN THE FIELD OF ANIMAL TRAINING AND ANIMAL EXHIBITIONS FOR EDUCATIONAL OR ENTERTAINMENT PURPOSES; PUBLICATION OF TEXTS, BOOKS, MAGAZINES AND OTHER PRINTED MATTER; TEACHING IN THE FIELD OF ANIMAL TRAINING AND THERAPY ASSISTED WITH ANIMALS; WRITING OF TEXTS, IN CLASS 41 (U.S. CLS. 100, 101 AND 107).

FIRST USE 1-1-2012; IN COMMERCE 1-1-2012.

THE MARK CONSISTS OF A STYLISTIC FIGURE OF A PERSON, COMPOSED OF A BLUE FACE, MOUTH, HAIR, AND EYES; ABOVE A BLACK HEART SHAPED BODY WITH A RED INSET; ABOVE 4 BLACK OVALS REPRESENTING ARMS AND LEGS WITH THE ARMS CONTAINING CYAN INSETS, THE LEFT LEG CONTAINING A GREEN INSET, AND THE RIGHT LEG CONTAINING A YELLOW INSET.



*David J. Kybas*

Director of the United States Patent and Trademark Office



**Reg. No. 4,199,893** THE COLOR(S) BLUE, RED, CYAN, GREEN, YELLOW, AND BLACK IS/ARE CLAIMED  
AS A FEATURE OF THE MARK.

SN 85-390,275, FILED 8-5-2011.

TRACY FLETCHER, EXAMINING ATTORNEY

# United States of America

United States Patent and Trademark Office

## DESTINATION DASHBOARD

**Reg. No. 4,199,894**

**Registered Aug. 28, 2012**

**Int. Cls.: 35, 41, 44, and  
45**

**SERVICE MARK**

**PRINCIPAL REGISTER**

HIGHWAY TO HEALTH, INC. (DELAWARE CORPORATION)  
ONE RADNOR CORPORATE CENTER, SUITE 100  
100 MATSON FORD ROAD  
RADNOR, PA 19087

FOR: PROVIDING A SEARCHABLE DATABASE FOR INFORMATION RELATED TO MEDICAL PROVIDERS IN THE NATURE OF DOCTOR REFERRALS, RATINGS, REVIEWS AND RECOMMENDATIONS OF MEDICAL FACILITIES FOR COMMERCIAL PURPOSES, AND RETAIL PHARMACY SERVICES, AVAILABLE BY THE INTERNET, IN CLASS 35 (U.S. CLS. 100, 101 AND 102).

FIRST USE 11-8-2011; IN COMMERCE 11-8-2011.

FOR: PROVIDING A SEARCHABLE LANGUAGE TRANSLATION DATABASE CONTAINING INFORMATION RELATED TO MEDICAL CONDITIONS IN PARTICULAR GEOGRAPHIC AREAS, KEY MEDICAL TERMS AND PHRASES, AND MEDICATION NAMES, AVAILABLE BY THE INTERNET, IN CLASS 41 (U.S. CLS. 100, 101 AND 107).

FIRST USE 11-8-2011; IN COMMERCE 11-8-2011.

FOR: PROVIDING A SEARCHABLE DATABASE FOR INFORMATION RELATED TO MEDICAL FACILITIES IN THE NATURE OF HOSPITALS, AND THE DISPENSATION OF PHARMACEUTICALS, AVAILABLE BY THE INTERNET; PROVIDING A SEARCHABLE DATABASE FOR MEDICAL INFORMATION RELATED TO MEDICAL CONDITIONS AND VACCINATION REQUIREMENTS, IN PARTICULAR GEOGRAPHIC AREAS AND MEDICATION NAMES, AVAILABLE BY THE INTERNET, IN CLASS 44 (U.S. CLS. 100 AND 101).

FIRST USE 11-8-2011; IN COMMERCE 11-8-2011.

FOR: PROVIDING A SEARCHABLE DATABASE CONTAINING SECURITY INFORMATION RELATED TO SOCIO-POLITICAL AND ECONOMIC CONDITIONS, EMERGENCY CONTACT INFORMATION, HEALTH RISKS, AND HEALTH AND SAFETY NEWS ALERTS, ALL IN PARTICULAR GEOGRAPHIC AREAS, AND ALL AVAILABLE BY THE INTERNET, IN CLASS 45 (U.S. CLS. 100 AND 101).

FIRST USE 11-8-2011; IN COMMERCE 11-8-2011.



*David J. Kyjars*

Director of the United States Patent and Trademark Office

**Reg. No. 4,199,894** THE MARK CONSISTS OF STANDARD CHARACTERS WITHOUT CLAIM TO ANY PARTICULAR FONT, STYLE, SIZE, OR COLOR.

NO CLAIM IS MADE TO THE EXCLUSIVE RIGHT TO USE "DASHBOARD", APART FROM THE MARK AS SHOWN.

SN 85-390,981, FILED 8-5-2011.

TRACY FLETCHER, EXAMINING ATTORNEY

# United States of America

United States Patent and Trademark Office

## Judge & Draw

**Reg. No. 4,199,895**

KEVIN ROSS HARPER (UNITED STATES INDIVIDUAL)  
4640 W. DOUGLAS AVE. APT. 206  
VISALIA, CA 93291 AND

**Registered Aug. 28, 2012**

**Int. Cl.: 28**

BRANDON DANIEL SHERRILL (UNITED STATES INDIVIDUAL)  
3310 W. CYPRESS  
VISALIA, CA 93277

**TRADEMARK**

FOR: CARD GAME, IN CLASS 28 (U.S. CLS. 22, 23, 38 AND 50).

**PRINCIPAL REGISTER**

FIRST USE 3-1-2010; IN COMMERCE 5-6-2012.

THE MARK CONSISTS OF STANDARD CHARACTERS WITHOUT CLAIM TO ANY PARTICULAR FONT, STYLE, SIZE, OR COLOR.

SN 85-391,563, FILED 8-7-2011.

DOMINICK J. SALEMI, EXAMINING ATTORNEY



*David J. Kyros*

Director of the United States Patent and Trademark Office

# United States of America

United States Patent and Trademark Office

## BRIGHTCROWD

**Reg. No. 4,199,896**

BRIGHTCROWD, INC. (COLORADO CORPORATION)  
625 CLAYTON ST.  
DENVER, CO 80206

**Registered Aug. 28, 2012**

**Int. Cl.: 35**

FOR: OPERATING ON-LINE MARKETPLACES FOR SELLERS OF GOODS AND/OR SERVICES, IN CLASS 35 (U.S. CLS. 100, 101 AND 102).

**SERVICE MARK**

FIRST USE 1-1-2012; IN COMMERCE 5-1-2012.

**PRINCIPAL REGISTER**

THE MARK CONSISTS OF STANDARD CHARACTERS WITHOUT CLAIM TO ANY PARTICULAR FONT, STYLE, SIZE, OR COLOR.

SN 85-391,698, FILED 8-7-2011.

WILLIAM BRECKENFELD, EXAMINING ATTORNEY



*David J. Kybas*

Director of the United States Patent and Trademark Office

# United States of America

United States Patent and Trademark Office

## QUADRA ASSURA

**Reg. No. 4,199,897**

**Registered Aug. 28, 2012**

**Int. Cl.: 10**

**TRADEMARK**

**PRINCIPAL REGISTER**

PACESETTER, INC. (DELAWARE CORPORATION), DBA ST. JUDE MEDICAL CARDIAC RHYTHM MANAGEMENT DIVISION,  
15900 VALLEY VIEW COURT  
SYLMAR, CA 913929221

FOR: IMPLANTABLE CARDIOVERTER DEFIBRILLATORS AND IMPLANTABLE CARDIAC PULSE GENERATORS, IN CLASS 10 (U.S. CLS. 26, 39 AND 44).

FIRST USE 3-16-2012; IN COMMERCE 3-16-2012.

THE MARK CONSISTS OF STANDARD CHARACTERS WITHOUT CLAIM TO ANY PARTICULAR FONT, STYLE, SIZE, OR COLOR.

OWNER OF U.S. REG. NOS. 3,874,233 AND 3,967,712.

SN 85-392,016, FILED 8-8-2011.

TINA MAI, EXAMINING ATTORNEY



*David J. Kyfos*

Director of the United States Patent and Trademark Office

# United States of America

United States Patent and Trademark Office

## FORTIFY ASSURA

**Reg. No. 4,199,898**

**Registered Aug. 28, 2012**

**Int. Cl.: 10**

**TRADEMARK**

**PRINCIPAL REGISTER**

PACESETTER, INC. (DELAWARE CORPORATION), DBA ST. JUDE MEDICAL CARDIAC RHYTHM MANAGEMENT DIVISION,  
15900 VALLEY VIEW COURT  
SYLMAR, CA 913929221

FOR: IMPLANTABLE CARDIOVERTER DEFIBRILLATORS AND IMPLANTABLE CARDIAC PULSE GENERATORS, IN CLASS 10 (U.S. CLS. 26, 39 AND 44).

FIRST USE 4-19-2012; IN COMMERCE 4-19-2012.

THE MARK CONSISTS OF STANDARD CHARACTERS WITHOUT CLAIM TO ANY PARTICULAR FONT, STYLE, SIZE, OR COLOR.

OWNER OF U.S. REG. NO. 3,815,722.

SN 85-392,023, FILED 8-8-2011.

TINA MAI, EXAMINING ATTORNEY



*David J. Kyffers*

Director of the United States Patent and Trademark Office

# United States of America

United States Patent and Trademark Office

## UNIFY ASSURA

**Reg. No. 4,199,899**

**Registered Aug. 28, 2012**

**Int. Cl.: 10**

**TRADEMARK**

**PRINCIPAL REGISTER**

PACESETTER, INC. (DELAWARE CORPORATION), DBA ST. JUDE MEDICAL CARDIAC RHYTHM MANAGEMENT DIVISION,  
15900 VALLEY VIEW COURT  
SYLMAR, CA 913929221

FOR: IMPLANTABLE CARDIOVERTER DEFIBRILLATORS AND IMPLANTABLE CARDIAC PULSE GENERATORS, IN CLASS 10 (U.S. CLS. 26, 39 AND 44).

FIRST USE 3-15-2012; IN COMMERCE 3-15-2012.

THE MARK CONSISTS OF STANDARD CHARACTERS WITHOUT CLAIM TO ANY PARTICULAR FONT, STYLE, SIZE, OR COLOR.

OWNER OF U.S. REG. NOS. 3,815,723 AND 3,967,712.

SN 85-392,032, FILED 8-8-2011.

TINA MAI, EXAMINING ATTORNEY



*David J. Kyffers*

Director of the United States Patent and Trademark Office



# United States of America

United States Patent and Trademark Office

## PHYLIA DE M

**Reg. No. 4,199,900**

**Registered Aug. 28, 2012**

**Int. Cl.: 3**

**TRADEMARK**

**PRINCIPAL REGISTER**

PHYLIA DE M., LLC (CALIFORNIA LIMITED LIABILITY COMPANY)  
C/O BUCHALTER NEMER, APC  
1000 WILSHIRE BLVD., SUITE 1500  
LOS ANGELES, CA 90017

FOR: CONDITIONERS; HAIR CARE PREPARATIONS; NON-MEDICATED SKIN CARE PREPARATIONS; SHAMPOOS, IN CLASS 3 (U.S. CLS. 1, 4, 6, 50, 51 AND 52).

FIRST USE 1-0-2012; IN COMMERCE 1-0-2012.

THE MARK CONSISTS OF STANDARD CHARACTERS WITHOUT CLAIM TO ANY PARTICULAR FONT, STYLE, SIZE, OR COLOR.

SN 85-392,089, FILED 8-8-2011.

ANNE FARRELL, EXAMINING ATTORNEY



*David J. Kyffers*

Director of the United States Patent and Trademark Office

# United States of America

United States Patent and Trademark Office

# 4WEB

**Reg. No. 4,199,901**

**Registered Aug. 28, 2012**

**Int. Cl.: 10**

**TRADEMARK**

**PRINCIPAL REGISTER**

4-WEB, INC. (TEXAS CORPORATION)  
SUITE 219  
6170 RESEARCH ROAD  
FRISCO, TX 75033

FOR: MEDICAL DEVICES, NAMELY, DELIVERY TOOLS AND IMPLANTS COMPRISING ARTIFICIAL MATERIAL FOR USE IN ORTHOPEDIC SURGERY; DELIVERY TOOLS AND IMPLANTS COMPRISING ARTIFICIAL MATERIAL FOR USE IN SPINAL SURGERY, IN CLASS 10 (U.S. CLS. 26, 39 AND 44).

FIRST USE 1-17-2012; IN COMMERCE 1-17-2012.

THE MARK CONSISTS OF STANDARD CHARACTERS WITHOUT CLAIM TO ANY PARTICULAR FONT, STYLE, SIZE, OR COLOR.

SN 85-392,276, FILED 8-8-2011.

REBECCA GILBERT, EXAMINING ATTORNEY



*David J. Kyffers*

Director of the United States Patent and Trademark Office

# United States of America

United States Patent and Trademark Office

## READYFORZERO

**Reg. No. 4,199,902**

**Registered Aug. 28, 2012**

**Int. Cl.: 42**

**SERVICE MARK**

**PRINCIPAL REGISTER**

READYFORZERO INC. (DELAWARE CORPORATION)  
71 STEVENSON STREET #800  
SAN FRANCISCO, CA 94105

FOR: PROVIDING A WEBSITE FEATURING NON-DOWNLOADABLE SOFTWARE FOR ASSISTING INDIVIDUALS IN MANAGING AND REDUCING DEBT, THAT PROVIDES PERSONALIZED FINANCIAL RECOMMENDATIONS FOR MANAGING AND REDUCING DEBT AND ASSESSING CREDITWORTHINESS BASED ON THE USER'S CREDIT REPORTING DATA, ACCOUNT BALANCES, TRANSACTION HISTORY, PAYMENT BEHAVIOR AND OTHER FINANCIAL DATA; PROVIDING A WEBSITE FEATURING TECHNOLOGY THAT ENABLES USERS TO OBTAIN AUTOMATED, PERSONALIZED FINANCIAL RECOMMENDATIONS FOR MANAGING AND REDUCING DEBT AND FOR ASSESSING THEIR CREDITWORTHINESS, IN CLASS 42 (U.S. CLS. 100 AND 101).

FIRST USE 2-2-2011; IN COMMERCE 2-2-2011.

THE MARK CONSISTS OF STANDARD CHARACTERS WITHOUT CLAIM TO ANY PARTICULAR FONT, STYLE, SIZE, OR COLOR.

SN 85-392,581, FILED 8-8-2011.

JAMES GRIFFIN, EXAMINING ATTORNEY



*David J. Kybas*

Director of the United States Patent and Trademark Office

# United States of America

United States Patent and Trademark Office

## BAD ASS SPORTS

**Reg. No. 4,199,903**

LA ROCHE, DENIS ALFRED (UNITED STATES INDIVIDUAL)

**Registered Aug. 28, 2012**

P.O. BOX 3708  
TUSTIN, CA 92781

**Int. Cl.: 25**

FOR: HEADBANDS FOR CLOTHING; HOODS; SPORT SHIRTS; SPORTS CAPS AND HATS; SPORTS JACKETS; SPORTS PANTS; SPORTS SHIRTS; SPORTS SHIRTS WITH SHORT SLEEVES; TOPS, IN CLASS 25 (U.S. CLS. 22 AND 39).

**TRADEMARK**

FIRST USE 2-14-2012; IN COMMERCE 6-18-2012.

**PRINCIPAL REGISTER**

THE MARK CONSISTS OF STANDARD CHARACTERS WITHOUT CLAIM TO ANY PARTICULAR FONT, STYLE, SIZE, OR COLOR.

NO CLAIM IS MADE TO THE EXCLUSIVE RIGHT TO USE "SPORTS", APART FROM THE MARK AS SHOWN.

SN 85-392,612, FILED 8-8-2011.

MIDGE BUTLER, EXAMINING ATTORNEY



*David J. Kyffers*

Director of the United States Patent and Trademark Office

# United States of America

United States Patent and Trademark Office



**Reg. No. 4,199,904**

UBERMORIALS, INC. (MICHIGAN CORPORATION)  
8187 SILVERTON DRIVE  
WHITMORE LAKE, MI 48189

**Registered Aug. 28, 2012**

**Int. Cl.: 11**

FOR: ELECTRIC LIGHTING FIXTURES; ELECTRIC LIGHTING FIXTURES, NAMELY, SCONCES; LAMPS FOR OUTDOOR USE; LANDSCAPE LIGHTING INSTALLATIONS; LED (LIGHT EMITTING DIODE) LIGHTING FIXTURES; LED (LIGHT EMITTING DIODES) LIGHTING FIXTURES FOR USE IN DISPLAY, COMMERCIAL, INDUSTRIAL, RESIDENTIAL, AND ARCHITECTURAL ACCENT LIGHTING APPLICATIONS; LED LANDSCAPE LIGHTS; LED LIGHT ASSEMBLIES FOR STREET LIGHTS, SIGNS, COMMERCIAL LIGHTING, AUTOMOBILES, BUILDINGS, AND OTHER ARCHITECTURAL USES; LED LIGHTING FIXTURES FOR INDOOR AND OUTDOOR LIGHTING APPLICATIONS; LED LIGHTING SYSTEMS, NAMELY, LED MODULES, POWER SUPPLIES, AND WIRING; LED LUMINAIRES; LIGHTING APPARATUS, NAMELY, LIGHTING INSTALLATIONS; LIGHTING FIXTURES; LUMINARIES; OUTDOOR LIGHTING, NAMELY, PAVER LIGHTS; SCONCE LIGHTING FIXTURES; SOLAR LIGHT FIXTURES, NAMELY, INDOOR AND OUTDOOR SOLAR POWERED LIGHTING UNITS AND FIXTURES; SOLAR-POWERED ALL-WEATHER LIGHTS, IN CLASS 11 (U.S. CLS. 13, 21, 23, 31 AND 34).

**TRADEMARK**

**PRINCIPAL REGISTER**

FIRST USE 3-1-2012; IN COMMERCE 3-1-2012.

THE MARK CONSISTS OF A DRAWING OF A HEAD OF A LION.

SN 85-392,917, FILED 8-9-2011.

SUNG IN, EXAMINING ATTORNEY



*David J. Kybas*

Director of the United States Patent and Trademark Office

**United States of America**  
United States Patent and Trademark Office

# ANESOFT

**Reg. No. 4,199,905**

AMERICAN & EFIRD ENTERPRISES, INC. (NORTH CAROLINA CORPORATION)  
22 AMERICAN STREET  
MOUNT HOLLY, NC 28120

**Registered Aug. 28, 2012**

**Int. Cl.: 23**

FOR: THREAD AND YARN, IN CLASS 23 (U.S. CL. 43).

**TRADEMARK**

FIRST USE 3-28-2012; IN COMMERCE 3-28-2012.

**PRINCIPAL REGISTER**

THE MARK CONSISTS OF STANDARD CHARACTERS WITHOUT CLAIM TO ANY PARTICULAR FONT, STYLE, SIZE, OR COLOR.

SN 85-393,003, FILED 8-9-2011.

ALICE BENMAMAN, EXAMINING ATTORNEY



*David J. Kyffers*

Director of the United States Patent and Trademark Office

# United States of America

United States Patent and Trademark Office



**Reg. No. 4,199,906**

MARVEL CHARACTERS, INC. (DELAWARE CORPORATION)  
1600 ROSECRANS AVENUE  
MANHATTAN BEACH, CA 90266

**Registered Aug. 28, 2012**

**Int. Cl.: 16**

FOR: COMIC BOOKS; PRINTED PERIODICALS IN THE FIELD OF COMIC BOOK STORIES AND ARTWORK, IN CLASS 16 (U.S. CLS. 2, 5, 22, 23, 29, 37, 38 AND 50).

**TRADEMARK**

FIRST USE 1-4-2012; IN COMMERCE 1-4-2012.

**PRINCIPAL REGISTER**

THE MARK CONSISTS OF THE WORDS "'WE WHO ARE ABOUT TO DIE' STRIKEFORCE: MORITURI" IN STYLIZED FONTS.

SN 85-393,389, FILED 8-9-2011.

JOHN GARTNER, EXAMINING ATTORNEY



*David J. Kappas*

Director of the United States Patent and Trademark Office

# United States of America

United States Patent and Trademark Office

designergreetings

**Reg. No. 4,199,907**

DESIGNER GREETINGS, INC. (NEW YORK CORPORATION)  
11 EXECUTIVE AVENUE  
EDISON, NJ 08817

**Registered Aug. 28, 2012**

**Int. Cl.: 16**

FOR: GREETING CARDS, STATIONERY, NAMELY, PAPER GIFT CARDS, NOTE CARDS, CHRISTMAS CARDS, CORRESPONDENCE CARDS, HOLIDAY CARDS, INVITATION CARDS, AND MOTIVATIONAL CARDS, WRAPPING PAPER AND GIFT ITEMS, NAMELY, GIFT BAGS, GIFT BOXES, PAPER GIFT TAGS AND WRAPPING RIBBONS, IN CLASS 16 (U.S. CLS. 2, 5, 22, 23, 29, 37, 38 AND 50).

**TRADEMARK**

**PRINCIPAL REGISTER**

FIRST USE 5-21-2012; IN COMMERCE 5-21-2012.

OWNER OF U.S. REG. NO. 3,306,080.

THE COLOR(S) BROWN AND GREEN IS/ARE CLAIMED AS A FEATURE OF THE MARK.

THE MARK CONSISTS OF ONE WORD CONSISTING OF THE WORD "DESIGNER" IN BROWN FOLLOWED BY THE WORD "GREETINGS" IN GREEN.

SN 85-394,278, FILED 8-10-2011.

CHERYL CLAYTON, EXAMINING ATTORNEY



*David J. Kyffers*

Director of the United States Patent and Trademark Office



# United States of America

United States Patent and Trademark Office

## Momma Pearl's Original Sweet Potato Pie

**Reg. No. 4,199,908**

BOLDEN JAMES L. JR. (UNITED STATES INDIVIDUAL)  
4128 SE RIDGEVIEW TERR.  
TOPEKA, KS 66605 AND

**Registered Aug. 28, 2012**

**Int. Cl.: 30**

BOLDEN MARGARET PEARL (UNITED STATES INDIVIDUAL)  
830 SE 37TH ST.  
TOPEKA, KS 66605

**TRADEMARK**

FOR: BAKERY PRODUCTS, IN CLASS 30 (U.S. CL. 46).

**PRINCIPAL REGISTER**

FIRST USE 7-1-1993; IN COMMERCE 7-1-1993.

THE MARK CONSISTS OF STANDARD CHARACTERS WITHOUT CLAIM TO ANY PARTICULAR FONT, STYLE, SIZE, OR COLOR.

NO CLAIM IS MADE TO THE EXCLUSIVE RIGHT TO USE "ORIGINAL SWEET POTATO PIE", APART FROM THE MARK AS SHOWN.

THE NAME "MOMMA PEARL" IDENTIFIES THE PSEUDONYM OF MARGARET PEARL BOLDEN, A LIVING INDIVIDUAL WHOSE CONSENT IS OF RECORD.

SN 85-394,281, FILED 8-10-2011.

ROBERT STRUCK, EXAMINING ATTORNEY



*David J. Kyffers*

Director of the United States Patent and Trademark Office

**United States of America**  
**United States Patent and Trademark Office**

**AMWAY**

**Reg. No. 4,199,909**

ALTICOR INC. (MICHIGAN CORPORATION)  
7575 FULTON STREET EAST, 78-2M  
ADA, MI 49355

**Registered Aug. 28, 2012**

**Int. Cls.: 18 and 31**

FOR: TOTE BAGS, IN CLASS 18 (U.S. CLS. 1, 2, 3, 22 AND 41).

**TRADEMARK**

FIRST USE 10-17-2011; IN COMMERCE 10-17-2011.

**PRINCIPAL REGISTER**

FOR: DOG TREATS, PET FOOD, IN CLASS 31 (U.S. CLS. 1 AND 46).

FIRST USE 6-12-2012; IN COMMERCE 6-12-2012.

THE MARK CONSISTS OF STANDARD CHARACTERS WITHOUT CLAIM TO ANY PARTICULAR FONT, STYLE, SIZE, OR COLOR.

OWNER OF U.S. REG. NOS. 707,656, 727,367, AND OTHERS.

SN 85-394,307, FILED 8-10-2011.

SUSAN BILLHEIMER, EXAMINING ATTORNEY



*David J. Kybas*

Director of the United States Patent and Trademark Office

# United States of America

United States Patent and Trademark Office



**WINETABLE**.COM  
YOUR SEAT IS WAITING

**Reg. No. 4,199,910**

WINE TABLE, LLC (DELAWARE LIMITED LIABILITY COMPANY)

**Registered Aug. 28, 2012**

P.O. BOX 147  
MOUND, MN 55364

**Int. Cls.: 43 and 45**

FOR: PROVIDING A WEBSITE WHERE GENERAL USERS AND SOMMELIERS CAN POST RATINGS, REVIEWS AND RECOMMENDATIONS ON WINES FOR WINE APPRECIATION PURPOSES, IN CLASS 43 (U.S. CLS. 100 AND 101).

**SERVICE MARK**

FIRST USE 7-18-2011; IN COMMERCE 7-18-2011.

**PRINCIPAL REGISTER**

FOR: ONLINE SOCIAL NETWORKING SERVICES, IN CLASS 45 (U.S. CLS. 100 AND 101).

FIRST USE 7-18-2011; IN COMMERCE 7-18-2011.

NO CLAIM IS MADE TO THE EXCLUSIVE RIGHT TO USE ".COM", APART FROM THE MARK AS SHOWN.

THE MARK CONSISTS OF TWO RECTANGULAR BOXES ON THE LEFT WITH ONE OVERLAPPING THE OTHER WITH A "W" IN THE CENTER OF THE TWO RECTANGLES AS WELL AS A "T" IN THE FORM OF A CORK SCREW JUST BELOW THE "W". TO THE RIGHT OF THE TWO RECTANGULAR BOXES ARE THE WORDS "WINETABLE.COM YOUR SEAT IS WAITING."

SN 85-395,160, FILED 8-11-2011.

WILLIAM BRECKENFELD, EXAMINING ATTORNEY



*David J. Kybas*

Director of the United States Patent and Trademark Office

# United States of America

United States Patent and Trademark Office

# SnipSnap

**Reg. No. 4,199,911**

**Registered Aug. 28, 2012**

**Int. Cl.: 35**

**SERVICE MARK**

**PRINCIPAL REGISTER**

SNIPSNAP APP LIMITED LIABILITY COMPANY (NEW JERSEY LIMITED LIABILITY COMPANY)  
549 REDWOOD AVE.  
HADDONFIELD, NJ 08033

FOR: AD SERVING, NAMELY, PLACING ADVERTISEMENTS ON WEBSITES FOR OTHERS USING SPECIALIZED COMPUTER SOFTWARE; ADVERTISEMENT VIA MOBILE PHONE NETWORKS; ADVERTISING AND DIRECTORY SERVICES, NAMELY, PROMOTING THE SERVICES OF OTHERS BY PROVIDING A WEB PAGE FEATURING LINKS TO THE WEBSITES OF OTHERS; ADVERTISING, PROMOTION, AND MARKETING SERVICES IN THE NATURE OF COUPONS FOR MOBILE PHONE; ON-LINE PROMOTION OF COMPUTER NETWORKS AND WEBSITES; ON-LINE RETAIL STORE SERVICES FEATURING PHYSICAL AND VIRTUAL MERCHANDISE FOR USE BY MEMBERS OF AN ONLINE COMMUNITY IN CONNECTION WITH A DESIGNATED WEBSITE FEATURING FICTIONAL CHARACTERS; ONLINE MEDIA MONITORING SERVICES USING COMPUTER SOFTWARE TO AUTOMATICALLY MONITOR INTERNET WEBSITES AND ONLINE PUBLICATIONS FOR CUSTOMER-SPECIFIED TOPICS AND TO CAPTURE RELEVANT CONTENT ON THOSE TOPICS, AND PROVIDING DOCUMENTATION AND ANALYSIS OF THAT ONLINE CONTENT TO OTHERS FOR BUSINESS PURPOSES; PROMOTING THE GOODS AND SERVICES OF OTHERS BY PROVIDING A WEBSITE FEATURING COUPONS, REBATES, PRICE-COMPARISON INFORMATION, PRODUCT REVIEWS, LINKS TO THE RETAIL WEBSITES OF OTHERS, AND DISCOUNT INFORMATION; PROMOTING THE GOODS AND SERVICES OF OTHERS BY PROVIDING A WEBSITE FEATURING COUPONS; PROMOTING THE GOODS AND SERVICES OF OTHERS BY PROVIDING AN INTERACTIVE WEBSITE WHERE USERS CAN INCREASE THE CURRENT VALUE OF AN ONLINE DISCOUNT BEING OFFERED BY PURCHASING THE GOODS AND SERVICES ASSOCIATED WITH THAT DISCOUNT IN THE FORM OF AN ONLINE COUPON, VOUCHER OR GIFT CARD; PROMOTING THE GOODS AND SERVICES OF OTHERS BY COUPONS; PROMOTING THE GRAPHIC ARTS DESIGN SERVICES OF OTHERS BY MEANS OF A WEBSITE FEATURING GRAPHIC ARTWORK SUBMITTED BY GRAPHIC ART DESIGNERS; PROMOTING, ADVERTISING AND MARKETING OF THE BRANDS, PRODUCTS, SERVICES AND ONLINE WEBSITES OF INDIVIDUALS, BUSINESSES AND NONPROFIT ORGANIZATIONS; PROMOTIONAL SERVICES, NAMELY, PROVIDING A WEBSITE AT WHICH ARTISTS CAN SHOWCASE THEIR TALENTS VIA AN ONLINE PORTFOLIO; PROVIDING A SEARCHABLE ON-LINE ADVERTISING WEBSITE AND GUIDE FEATURING THE GOODS AND SERVICES OF OTHER VENDORS VIA THE INTERNET; PROVIDING A SEARCHABLE ONLINE ADVERTISING WEBSITE AND INFORMATIONAL GUIDE FEATURING THE GOODS AND



*David J. Kybas*

Director of the United States Patent and Trademark Office

**Reg. No. 4,199,911** SERVICES OF OTHER VENDORS VIA THE INTERNET IN THE FIELD OF COUPONS; PROVIDING A SEARCHABLE WEBSITE FEATURING THE GOODS AND SERVICES OF OTHER VENDORS, IN CLASS 35 (U.S. CLS. 100, 101 AND 102).

FIRST USE 8-11-2011; IN COMMERCE 4-24-2012.

THE MARK CONSISTS OF STANDARD CHARACTERS WITHOUT CLAIM TO ANY PARTICULAR FONT, STYLE, SIZE, OR COLOR.

SN 85-395,778, FILED 8-11-2011.

ZACHARY BELLO, EXAMINING ATTORNEY

# United States of America

United States Patent and Trademark Office

# SMARTSHOT

**Reg. No. 4,199,912**

T-MOBILE USA, INC. (DELAWARE CORPORATION)  
12920 S.E. 38TH STREET  
BELLEVUE, WA 98006

**Registered Aug. 28, 2012**

**Int. Cl.: 9**

FOR: FEATURE OF WIRELESS TELECOMMUNICATIONS DEVICES, NAMELY, MOBILE TELEPHONES AND SMARTPHONES, IN THE NATURE OF SOFTWARE THAT ENABLES THE MANIPULATING AND EDITING OF TWO OR MORE DIGITAL IMAGES TO GENERATE A COMPOSITE DIGITAL IMAGE, IN CLASS 9 (U.S. CLS. 21, 23, 26, 36 AND 38).

**TRADEMARK**

**PRINCIPAL REGISTER**

FIRST USE 10-12-2011; IN COMMERCE 10-12-2011.

THE MARK CONSISTS OF STANDARD CHARACTERS WITHOUT CLAIM TO ANY PARTICULAR FONT, STYLE, SIZE, OR COLOR.

SN 85-396,511, FILED 8-12-2011.

ALAIN LAPTER, EXAMINING ATTORNEY



*David J. Kyffers*

Director of the United States Patent and Trademark Office

# United States of America

United States Patent and Trademark Office

# READYSCRIPT

**Reg. No. 4,199,913**

SIGMA-ALDRICH CO. LLC (DELAWARE LIMITED LIABILITY COMPANY)  
3050 SPRUCE STREET  
ST. LOUIS, MO 63103

**Registered Aug. 28, 2012**

**Int. Cl.: 1**

FOR: CDNA SYNTHESIS KITS FOR LABORATORY OR RESEARCH USE, IN CLASS 1 (U.S. CLS. 1, 5, 6, 10, 26 AND 46).

**TRADEMARK**

FIRST USE 3-31-2012; IN COMMERCE 3-31-2012.

**PRINCIPAL REGISTER**

THE MARK CONSISTS OF STANDARD CHARACTERS WITHOUT CLAIM TO ANY PARTICULAR FONT, STYLE, SIZE, OR COLOR.

SN 85-398,287, FILED 8-15-2011.

MARLENE BELL, EXAMINING ATTORNEY



*David J. Kybas*

Director of the United States Patent and Trademark Office

# United States of America

United States Patent and Trademark Office

# CERTIS

**Reg. No. 4,199,914**

**Registered Aug. 28, 2012**

**Int. Cl.: 20**

**TRADEMARK**

**PRINCIPAL REGISTER**

TEGRANT DIVERSIFIED BRANDS, INC. (PENNSYLVANIA CORPORATION)  
SUITE 450  
3930 NORTH VENTURE DRIVE  
ARLINGTON HEIGHTS, IL 60004

FOR: NONMETAL MEDICAL CONTAINERS FOR STORAGE, TRANSPORTATION AND MAINTENANCE OF STANDARD TEMPERATURE DURING TRANSPORT FOR MEDICATIONS, TRANSPLANT ORGANS, BLOOD AND OTHER MEDICAL OR BIOLOGICAL ITEMS, IN CLASS 20 (U.S. CLS. 2, 13, 22, 25, 32 AND 50).

FIRST USE 5-30-2012; IN COMMERCE 5-30-2012.

THE MARK CONSISTS OF STANDARD CHARACTERS WITHOUT CLAIM TO ANY PARTICULAR FONT, STYLE, SIZE, OR COLOR.

SN 85-398,903, FILED 8-16-2011.

ANDREA K. NADELMAN, EXAMINING ATTORNEY



*David J. Kyffers*

Director of the United States Patent and Trademark Office



# United States of America

United States Patent and Trademark Office

## WHEN CHICKEN WAS CHICKEN

**Reg. No. 4,199,915**

OZARK MOUNTAIN POULTRY, INC. (ARKANSAS CORPORATION)  
750 W. EASY STREET  
ROGERS, AR 72756

**Registered Aug. 28, 2012**

**Int. Cl.: 29**

FOR: POULTRY, IN CLASS 29 (U.S. CL. 46).

**TRADEMARK**

FIRST USE 3-30-2012; IN COMMERCE 3-30-2012.

**PRINCIPAL REGISTER**

THE MARK CONSISTS OF STANDARD CHARACTERS WITHOUT CLAIM TO ANY PARTICULAR FONT, STYLE, SIZE, OR COLOR.

SN 85-399,423, FILED 8-16-2011.

MARY ROSSMAN, EXAMINING ATTORNEY



*David J. Kyffers*

Director of the United States Patent and Trademark Office

# United States of America

United States Patent and Trademark Office



**Reg. No. 4,199,916**

PIT BULL USA LLC (FLORIDA LIMITED LIABILITY COMPANY)  
3665 BONITA BEACH RD. SUITE 1-3  
BONITA SPRINGS, FL 34134

**Registered Aug. 28, 2012**

**Int. Cls.: 14, 16, 18, and 24**

FOR: BODY JEWELRY; JEWELRY, IN CLASS 14 (U.S. CLS. 2, 27, 28 AND 50).

FIRST USE 1-1-2012; IN COMMERCE 1-1-2012.

**TRADEMARK**

FOR: ADDRESS PLATES; BUMPER STICKERS; DECORATIVE STICKERS FOR HELMETS; MAGNETIC BUMPER STICKERS; STICKERS; STICKERS AND TRANSFERS, IN CLASS 16 (U.S. CLS. 2, 5, 22, 23, 29, 37, 38 AND 50).

**PRINCIPAL REGISTER**

FIRST USE 1-1-2012; IN COMMERCE 1-1-2012.

FOR: COLLARS FOR PETS; DOG APPAREL; DOG COLLARS; DOG COLLARS AND LEADS; DOG LEASHES; FASHION HANDBAGS; HANDBAGS; HANDBAGS FOR LADIES; HANDBAGS FOR MEN; HANDBAGS, PURSES AND WALLETS; NECKWEAR FOR DOGS; PET COLLAR ACCESSORIES, NAMELY, BELLS, SILENCERS, SAFETY LIGHTS AND BLINKERS, PENDANTS AND CHARMS; PET COLLAR ACCESSORIES, NAMELY, BOWS AND CHARMS; PET COLLAR ACCESSORIES, NAMELY, CHARMS; PET TAGS SPECIALLY ADAPTED FOR ATTACHING TO PET LEASHES OR COLLARS, IN CLASS 18 (U.S. CLS. 1, 2, 3, 22 AND 41).

FIRST USE 1-1-2012; IN COMMERCE 1-1-2012.

FOR: BATH TOWELS; BEACH TOWELS; LARGE BATH TOWELS, IN CLASS 24 (U.S. CLS. 42 AND 50).

FIRST USE 1-1-2012; IN COMMERCE 1-1-2012.

NO CLAIM IS MADE TO THE EXCLUSIVE RIGHT TO USE "PIT BULL" AS TO INTERNATIONAL CLASS 018, AND "USA", APART FROM THE MARK AS SHOWN.



*David J. Kyros*

Director of the United States Patent and Trademark Office

THE MARK CONSISTS OF THREE WORDS AND AN IMAGE. THE THREE WORDS ARE: "PIT BULL USA" AND ARE WRITTEN IN THE FONT AMERICANTEXTBT. THE WORDS "PIT" AND "BULL" ARE STARTING WITH A CAPITAL LETTER AND THE WORD "USA" IS ALL WRITTEN IN CAPITAL LETTERS. THE IMAGE SHOWS THE FACE OF A PIT BULL.

**Reg. No. 4,199,916** THE IMAGE IS PLACED BETWEEN THE WORDS "PIT" AND "BULL" AND THE WORD "USA" UNDERNEATH THE IMAGE OF THE PIT BULL FACE

SN 85-399,793, FILED 8-17-2011.

KATHERINE M. DUBRAY, EXAMINING ATTORNEY

# United States of America

United States Patent and Trademark Office



**Reg. No. 4,199,917**

**Registered Aug. 28, 2012**

**Int. Cl.: 39**

**SERVICE MARK**

**PRINCIPAL REGISTER**

WORLD TRAVEL HOLDINGS, INC. (DELAWARE CORPORATION)  
BUILDING C  
100 FORDHAM ROAD  
WILMINGTON, MA 01887

FOR: TRAVEL AGENCY SERVICES, NAMELY, MAKING RESERVATIONS AND BOOKINGS FOR VACATION TRANSPORTATION FOR VACATIONERS; ORGANIZATION OF VACATION TRAVEL; TRAVEL, EXCURSION AND CRUISE ARRANGEMENTS, IN CLASS 39 (U.S. CLS. 100 AND 105).

FIRST USE 10-10-2011; IN COMMERCE 10-10-2011.

OWNER OF U.S. REG. NO. 1,799,689.

THE MARK CONSISTS OF THE WORD "CRUISEONE" OVER TWO WAVES.

SN 85-399,994, FILED 8-17-2011.

ANN E. SAPPENFIELD, EXAMINING ATTORNEY



*David J. Kybas*

Director of the United States Patent and Trademark Office

# United States of America

United States Patent and Trademark Office



**Reg. No. 4,199,918**

**Registered Aug. 28, 2012**

**Int. Cl.: 39**

**SERVICE MARK**

**PRINCIPAL REGISTER**

WORLD TRAVEL HOLDINGS, INC. (DELAWARE CORPORATION)  
BUILDING C  
100 FORDHAM ROAD  
WILMINGTON, MA 01887

FOR: TRAVEL AGENCY SERVICES, NAMELY, MAKING RESERVATIONS AND BOOKINGS FOR VACATION TRANSPORTATION FOR VACATIONERS; ORGANIZATION OF VACATION TRAVEL; TRAVEL, EXCURSION AND CRUISE ARRANGEMENTS, IN CLASS 39 (U.S. CLS. 100 AND 105).

FIRST USE 10-10-2011; IN COMMERCE 10-10-2011.

OWNER OF U.S. REG. NOS. 3,173,311 AND 3,179,531.

NO CLAIM IS MADE TO THE EXCLUSIVE RIGHT TO USE "CRUISES INC. YOUR VACATION SPECIALISTS", APART FROM THE MARK AS SHOWN.

THE MARK CONSISTS OF THE BOW OF A CRUISE SHIP ON WAVES AND THE WORDS "CRUISES INC. YOUR VACATION SPECIALISTS".

SN 85-400,151, FILED 8-17-2011.

ANN E. SAPPENFIELD, EXAMINING ATTORNEY



*David J. Kyffers*

Director of the United States Patent and Trademark Office

# United States of America

United States Patent and Trademark Office

## IZOTOPE IRIS

**Reg. No. 4,199,919**

**Registered Aug. 28, 2012**

**Int. Cl.: 9**

**TRADEMARK**

**PRINCIPAL REGISTER**

IZOTOPE INC. (MASSACHUSETTS CORPORATION)  
SUITE 400  
700 TECHNOLOGY SQUARE  
CAMBRIDGE, MA 02139

FOR: COMPUTER SOFTWARE FOR CREATING, SYNTHESIZING, EDITING, MIXING AND MODIFYING SOUNDS, AUDIO AND MUSIC, IN CLASS 9 (U.S. CLS. 21, 23, 26, 36 AND 38).

FIRST USE 4-17-2012; IN COMMERCE 4-17-2012.

THE MARK CONSISTS OF STANDARD CHARACTERS WITHOUT CLAIM TO ANY PARTICULAR FONT, STYLE, SIZE, OR COLOR.

OWNER OF U.S. REG. NO. 3,381,488.

SN 85-400,219, FILED 8-17-2011.

AMY C. KEAN, EXAMINING ATTORNEY



*David J. Kappas*

Director of the United States Patent and Trademark Office

# United States of America

United States Patent and Trademark Office

POWER of  
PARENTS

madd

**Reg. No. 4,199,920**

**Registered Aug. 28, 2012**

**Int. Cl.: 35**

**SERVICE MARK**

**PRINCIPAL REGISTER**

MOTHERS AGAINST DRUNK DRIVING (D.C. NON-PROFIT CORPORATION)  
SUITE 700  
511 E. JOHN CARPENTER FREEWAY  
IRVING, TX 75062

FOR: ASSOCIATION SERVICES, NAMELY, PROMOTING THE INTERESTS OF PARENTS AND OTHER INDIVIDUALS OPPOSED TO DRUNK DRIVING AND UNDERAGE DRINKING, IN CLASS 35 (U.S. CLS. 100, 101 AND 102).

FIRST USE 4-12-2011; IN COMMERCE 4-12-2011.

OWNER OF U.S. REG. NOS. 1,250,706, 4,012,965, AND OTHERS.

NO CLAIM IS MADE TO THE EXCLUSIVE RIGHT TO USE "PARENTS", APART FROM THE MARK AS SHOWN.

THE MARK CONSISTS OF THE TERM "MADD" IN LOWERCASE LETTERS IN PROXIMITY WITH A SPEECH BALLOON WITH THE TERMS "POWER OF PARENTS" SET FORTH THEREIN.

SN 85-400,305, FILED 8-17-2011.

LUCY ARANT, EXAMINING ATTORNEY



*David J. Kyffers*

Director of the United States Patent and Trademark Office

# United States of America

United States Patent and Trademark Office

POWER of  
PARENTS

madd

**Reg. No. 4,199,921**

**Registered Aug. 28, 2012**

**Int. Cl.: 36**

**SERVICE MARK**

**PRINCIPAL REGISTER**

MOTHERS AGAINST DRUNK DRIVING (D.C. NON-PROFIT CORPORATION)  
SUITE 700  
511 E. JOHN CARPENTER FREEWAY  
IRVING, TX 75062

FOR: CHARITABLE FUND RAISING SERVICES, NAMELY, CONDUCTING AND PROMOTING EVENTS TO RAISE MONEY FOR ACTIVITIES DESIGNED TO PROMOTE THE INTERESTS OF PERSONS OPPOSED TO DRUNK DRIVING AND TO SUPPORT VICTIMS OF DRUNK DRIVING, IN CLASS 36 (U.S. CLS. 100, 101 AND 102).

FIRST USE 4-12-2011; IN COMMERCE 4-12-2011.

OWNER OF U.S. REG. NOS. 1,250,706, 4,012,965, AND OTHERS.

NO CLAIM IS MADE TO THE EXCLUSIVE RIGHT TO USE "PARENTS", APART FROM THE MARK AS SHOWN.

THE MARK CONSISTS OF THE TERM "MADD" IN LOWERCASE LETTERS IN PROXIMITY WITH A SPEECH BALLOON WITH THE WORDS "POWER OF PARENTS" SET FORTH THEREIN.

SN 85-400,327, FILED 8-17-2011.

LUCY ARANT, EXAMINING ATTORNEY



*David J. Kybas*

Director of the United States Patent and Trademark Office



# United States of America

United States Patent and Trademark Office

POWER of  
PARENTS

madd

**Reg. No. 4,199,922**

**Registered Aug. 28, 2012**

**Int. Cl.: 41**

**SERVICE MARK**

**PRINCIPAL REGISTER**

MOTHERS AGAINST DRUNK DRIVING (D.C. NON-PROFIT CORPORATION)  
SUITE 700  
511 E. JOHN CARPENTER FREEWAY  
IRVING, TX 75062

FOR: EDUCATION SERVICES, NAMELY, ARRANGING CONFERENCES, SEMINARS, TRAINING COURSES, WORKSHOPS AND PROGRAMS IN THE FIELDS OF PREVENTING UNDERAGE DRINKING, IMPAIRED DRIVING, AND DRUG AND ALCOHOL ABUSE, IN CLASS 41 (U.S. CLS. 100, 101 AND 107).

FIRST USE 4-12-2011; IN COMMERCE 4-12-2011.

OWNER OF U.S. REG. NOS. 1,250,706, 4,012,965, AND OTHERS.

NO CLAIM IS MADE TO THE EXCLUSIVE RIGHT TO USE "PARENTS", APART FROM THE MARK AS SHOWN.

THE MARK CONSISTS OF THE TERM "MADD" IN LOWERCASE LETTERS IN PROXIMITY WITH A SPEECH BALLOON WITH THE WORDS "POWER OF PARENTS" SET FORTH THEREIN.

SN 85-400,350, FILED 8-17-2011.

LUCY ARANT, EXAMINING ATTORNEY



*David J. Kyffers*

Director of the United States Patent and Trademark Office

# United States of America

United States Patent and Trademark Office

## READ FOR THE HEART

**Reg. No. 4,199,923**

PENGUIN GROUP (USA) INC. (DELAWARE CORPORATION)  
375 HUDSON STREET  
NEW YORK, NY 10014

**Registered Aug. 28, 2012**

**Int. Cls.: 16 and 35**

FOR: FICTION BOOKS, IN CLASS 16 (U.S. CLS. 2, 5, 22, 23, 29, 37, 38 AND 50).

**TRADEMARK**

FIRST USE 1-1-2012; IN COMMERCE 1-1-2012.

**SERVICE MARK**

FOR: PROMOTING AWARENESS OF HEART DISEASE AND HEART HEALTH ADVOCACY AND RESEARCH ORGANIZATIONS, AND HOW TO SUPPORT SUCH ORGANIZATIONS, IN CLASS 35 (U.S. CLS. 100, 101 AND 102).

**PRINCIPAL REGISTER**

FIRST USE 1-1-2012; IN COMMERCE 1-1-2012.

THE MARK CONSISTS OF STANDARD CHARACTERS WITHOUT CLAIM TO ANY PARTICULAR FONT, STYLE, SIZE, OR COLOR.

SN 85-400,432, FILED 8-17-2011.

JOHN GARTNER, EXAMINING ATTORNEY



*David J. Kybas*

Director of the United States Patent and Trademark Office

United States of America  
United States Patent and Trademark Office

# FLEXEES

**Reg. No. 4,199,924**

HANDI-CRAFT COMPANY (MISSOURI CORPORATION)  
4433 FYLER AVENUE  
ST. LOUIS, MO 63116

**Registered Aug. 28, 2012**

**Int. Cl.: 10**

FOR: TEETHERS FOR INFANTS, IN CLASS 10 (U.S. CLS. 26, 39 AND 44).

**TRADEMARK**

FIRST USE 1-30-2012; IN COMMERCE 1-30-2012.

**PRINCIPAL REGISTER**

THE MARK CONSISTS OF STANDARD CHARACTERS WITHOUT CLAIM TO ANY PARTICULAR FONT, STYLE, SIZE, OR COLOR.

SN 85-400,892, FILED 8-18-2011.

WANDA KAY PRICE, EXAMINING ATTORNEY



*David J. Kybas*

Director of the United States Patent and Trademark Office

# United States of America

United States Patent and Trademark Office

# COOLEES

**Reg. No. 4,199,925**

HANDI-CRAFT COMPANY (MISSOURI CORPORATION)  
4433 FYLER AVENUE  
ST. LOUIS, MO 63116

**Registered Aug. 28, 2012**

**Int. Cl.: 10**

FOR: TEETHERS FOR INFANTS, IN CLASS 10 (U.S. CLS. 26, 39 AND 44).

**TRADEMARK**

FIRST USE 1-30-2012; IN COMMERCE 1-30-2012.

**PRINCIPAL REGISTER**

THE MARK CONSISTS OF STANDARD CHARACTERS WITHOUT CLAIM TO ANY PARTICULAR FONT, STYLE, SIZE, OR COLOR.

SN 85-400,893, FILED 8-18-2011.

WANDA KAY PRICE, EXAMINING ATTORNEY



*David J. Kybas*

Director of the United States Patent and Trademark Office

# United States of America

United States Patent and Trademark Office

## TRACEMARK

**Reg. No. 4,199,926**

IRDETO B.V. (NETHERLANDS COMPANY)  
TAURUS AVENUE 105  
2132 LS HOOFDORP, NETHERLANDS

**Registered Aug. 28, 2012**

**Int. Cls.: 35 and 42**

FOR: PROVIDING ELECTRONIC TRACKING OF INTELLECTUAL AND INDUSTRIAL PROPERTY ASSETS TO OTHERS, IN CLASS 35 (U.S. CLS. 100, 101 AND 102).

**SERVICE MARK**

FIRST USE 8-18-2011; IN COMMERCE 8-18-2011.

**PRINCIPAL REGISTER**

FOR: TECHNICAL SERVICES PROVIDED TO RESELLERS AND PUBLISHERS OF DIGITAL CONTENT, NAMELY, APPLICATION SERVICE PROVIDER FEATURING SOFTWARE THAT ENABLES PUBLISHERS TO TAG DIGITAL CONTENT TO TRACK UNAUTHORIZED COPYING AND DISTRIBUTION; DESIGN AND IMPLEMENTATION OF SOFTWARE AND TECHNOLOGY SOLUTIONS FOR THE PURPOSE OF AUTHENTICATION AND TRACKING OF DIGITAL CONTENT TO PROTECT AGAINST COUNTERFEITING, TAMPERING, AND DIVERSION, IN CLASS 42 (U.S. CLS. 100 AND 101).

FIRST USE 8-18-2011; IN COMMERCE 8-18-2011.

THE MARK CONSISTS OF STANDARD CHARACTERS WITHOUT CLAIM TO ANY PARTICULAR FONT, STYLE, SIZE, OR COLOR.

SN 85-400,930, FILED 8-18-2011.

SANI KHOURI, EXAMINING ATTORNEY



*David J. Kybas*

Director of the United States Patent and Trademark Office

# United States of America

United States Patent and Trademark Office

# ORTHEES

**Reg. No. 4,199,927**

HANDI-CRAFT COMPANY (MISSOURI CORPORATION)  
4433 FYLER AVENUE  
ST. LOUIS, MO 63116

**Registered Aug. 28, 2012**

**Int. Cl.: 10**

FOR: TEETHERS FOR INFANTS, IN CLASS 10 (U.S. CLS. 26, 39 AND 44).

**TRADEMARK**

FIRST USE 1-30-2012; IN COMMERCE 1-30-2012.

**PRINCIPAL REGISTER**

THE MARK CONSISTS OF STANDARD CHARACTERS WITHOUT CLAIM TO ANY PARTICULAR FONT, STYLE, SIZE, OR COLOR.

SN 85-401,063, FILED 8-18-2011.

WANDA KAY PRICE, EXAMINING ATTORNEY



*David J. Kybas*

Director of the United States Patent and Trademark Office

# United States of America

United States Patent and Trademark Office



**Reg. No. 4,199,928**

GOODWORDS, LLC (COLORADO LIMITED LIABILITY COMPANY)  
4240 BREAKWATER COURT  
FORT COLLINS, CO 80525

**Registered Aug. 28, 2012**

**Int. Cl.: 9**

FOR: DOWNLOADABLE ELECTRONIC PUBLICATIONS IN THE NATURE OF GUIDES IN THE FIELD OF TRADE SHOWS, IN CLASS 9 (U.S. CLS. 21, 23, 26, 36 AND 38).

**TRADEMARK**

FIRST USE 5-1-2011; IN COMMERCE 5-1-2011.

**PRINCIPAL REGISTER**

THE MARK CONSISTS OF THE STYLIZED WORDS "NOW WHAT?" CONTAINED WITHIN A COMMENT BOX.

SN 85-401,746, FILED 8-18-2011.

SALLY SHIH, EXAMINING ATTORNEY



*David J. Kyffers*

Director of the United States Patent and Trademark Office

# United States of America

United States Patent and Trademark Office

# Age Ready

**Reg. No. 4,199,929**

**Registered Aug. 28, 2012**

**Int. Cl.: 35**

**SERVICE MARK**

**PRINCIPAL REGISTER**

BOOMER PROJECT, LLC, THE (VIRGINIA LIMITED LIABILITY COMPANY)  
2601 FLOYD AVENUE  
RICHMOND, VA 23220

FOR: DEMOGRAPHIC CONSULTATION AND STUDIES. PROVIDING INFORMATION VIA A WEBSITE FEATURING INFORMATION IN THE FIELD OF DEMOGRAPHICS, IN CLASS 35 (U.S. CLS. 100, 101 AND 102).

FIRST USE 10-31-2011; IN COMMERCE 10-31-2011.

THE MARK CONSISTS OF STANDARD CHARACTERS WITHOUT CLAIM TO ANY PARTICULAR FONT, STYLE, SIZE, OR COLOR.

NO CLAIM IS MADE TO THE EXCLUSIVE RIGHT TO USE "AGE", APART FROM THE MARK AS SHOWN.

SN 85-402,611, FILED 8-19-2011.

JILL PRATER, EXAMINING ATTORNEY



*David J. Kybas*

Director of the United States Patent and Trademark Office



# United States of America

United States Patent and Trademark Office

# Due North

**Reg. No. 4,199,930**

**Registered Aug. 28, 2012**

**Int. Cl.: 33**

**TRADEMARK**

**PRINCIPAL REGISTER**

VAN BRUNT STILLHOUSE LLC (NEW YORK LIMITED LIABILITY COMPANY), DBA VAN BRUNT STILLHOUSE,  
6 BAY STREET 1ST FLOOR  
BROOKLYN, NY 11231

FOR: LIQUOR; LIQUOR AND LIQUEUR BEVERAGES, NAMELY, RUM, IN CLASS 33 (U.S. CLS. 47 AND 49).

FIRST USE 4-28-2012; IN COMMERCE 4-28-2012.

THE MARK CONSISTS OF STANDARD CHARACTERS WITHOUT CLAIM TO ANY PARTICULAR FONT, STYLE, SIZE, OR COLOR.

SN 85-403,001, FILED 8-20-2011.

JULIE GUTTADAURO, EXAMINING ATTORNEY



*David J. Kyffers*

Director of the United States Patent and Trademark Office

# United States of America

United States Patent and Trademark Office

## Text It Forward

**Reg. No. 4,199,931**

TAYLOR BARTON FOUNDATION (NEVADA NON-PROFIT CORPORATION)  
7816 PURPLE MOUNTAIN AVENUE  
LAS VEGAS, NV 89131

**Registered Aug. 28, 2012**

**Int. Cl.: 35**

FOR: PROMOTING PUBLIC AWARENESS OF THE NEED FOR ENDING BULLYING IN THE UNITED STATES, IN CLASS 35 (U.S. CLS. 100, 101 AND 102).

**SERVICE MARK**

FIRST USE 11-1-2010; IN COMMERCE 11-1-2011.

**PRINCIPAL REGISTER**

THE MARK CONSISTS OF STANDARD CHARACTERS WITHOUT CLAIM TO ANY PARTICULAR FONT, STYLE, SIZE, OR COLOR.

SN 85-405,092, FILED 8-23-2011.

AMY KELLY, EXAMINING ATTORNEY



*David J. Kybas*

Director of the United States Patent and Trademark Office

# United States of America

United States Patent and Trademark Office



**Reg. No. 4,199,932**

AIRBRUSH ACTION, INC. (NEW JERSEY CORPORATION)  
3209 ATLANTIC AVENUE, P.O. BOX 438  
ALLENWOOD, NJ 08720

**Registered Aug. 28, 2012**

**Int. Cl.: 25**

FOR: ATHLETIC SHOES; CAPS; COATS; GLOVES; HATS; JACKETS; PANTS; SCARVES;  
SHIRTS; SHOES; SOCKS, IN CLASS 25 (U.S. CLS. 22 AND 39).

**TRADEMARK**

FIRST USE 1-20-2012; IN COMMERCE 1-20-2012.

**PRINCIPAL REGISTER**

NO CLAIM IS MADE TO THE EXCLUSIVE RIGHT TO USE "AIRBRUSH", APART FROM  
THE MARK AS SHOWN.

THE COLOR(S) RED, BLACK AND SILVER IS/ARE CLAIMED AS A FEATURE OF THE  
MARK.

THE MARK CONSISTS OF "AIRBRUSH MAFIA" STYLIZED IN RED OVER A BLACK  
SHIELD. THE SHIELD CONTAINS BLACK AND RED SCROLLWORK ABOVE AND BE-  
NEATH THE WORDING. BEHIND THE LEFT AND RIGHT HAND SIDES OF THE SHIELD  
ARE IMAGES OF AIRBRUSHES IN SILVER. THE TOP OF THE SHIELD CONTAINS FIVE  
HUMAN SKULLS IN BLACK AND SILVER. BEHIND THE TOP OF THE SHIELD AND  
FRAMING THE SKULLS ARE SEVERAL CURVED LINES IN DARK SILVER.

SN 85-406,252, FILED 8-24-2011.

MICHELLE DUBOIS, EXAMINING ATTORNEY



*David J. Kybas*

Director of the United States Patent and Trademark Office

# United States of America

United States Patent and Trademark Office

**Learn How to**  
**AIRBRUSH**

**Reg. No. 4,199,933**

AIRBRUSH ACTION, INC. (NEW JERSEY CORPORATION)  
3209 ATLANTIC AVENUE, P.O. BOX 438  
ALLENWOOD, NJ 08720

**Registered Aug. 28, 2012**

**Int. Cl.: 41**

FOR: EDUCATIONAL SERVICES, NAMELY, CONDUCTING WORKSHOPS, SEMINARS, CLASSES, COURSES IN THE FIELD OF GRAPHIC ARTS AND DISTRIBUTING COURSE MATERIAL IN CONNECTION WITH SERVICES, IN CLASS 41 (U.S. CLS. 100, 101 AND 107).

**SERVICE MARK**

**PRINCIPAL REGISTER**

FIRST USE 1-20-2012; IN COMMERCE 1-20-2012.

NO CLAIM IS MADE TO THE EXCLUSIVE RIGHT TO USE "LEARN HOW TO AIRBRUSH", APART FROM THE MARK AS SHOWN.

THE COLOR(S) RED, WHITE, AND BLACK IS/ARE CLAIMED AS A FEATURE OF THE MARK.

THE MARK CONSISTS OF "LEARN HOW TO AIRBRUSH". THE WORDS "LEARN HOW TO" ARE IN BLACK AND OUTLINED IN RED. THE WORD "AIRBRUSH" IS WHITE AND OUTLINED IN BLACK AND RED. AN IMAGE OF AN AIRBRUSH IN BLACK APPEARS IN THE LETTER "A" IN "AIRBRUSH".

SN 85-406,298, FILED 8-24-2011.

MICHELLE DUBOIS, EXAMINING ATTORNEY



*David J. Kybas*

Director of the United States Patent and Trademark Office

# United States of America

United States Patent and Trademark Office

LOG ON. SHOW UP. BE SEEN.

**Reg. No. 4,199,934**

**Registered Aug. 28, 2012**

**Int. Cl.: 44**

**SERVICE MARK**

**PRINCIPAL REGISTER**

SETON HEALTHCARE (TEXAS NON-PROFIT CORPORATION), DBA SETON HEALTHCARE FAMILY,  
1345 PHILOMENA STREET, SUITE 402  
AUSTIN, TX 78723

FOR: HOSPITAL AND IN-PERSON MEDICAL SERVICES, IN CLASS 44 (U.S. CLS. 100 AND 101).

FIRST USE 3-4-2011; IN COMMERCE 3-4-2011.

THE MARK CONSISTS OF STANDARD CHARACTERS WITHOUT CLAIM TO ANY PARTICULAR FONT, STYLE, SIZE, OR COLOR.

SN 85-406,483, FILED 8-24-2011.

GEOFFREY FOSDICK, EXAMINING ATTORNEY



*David J. Kybas*

Director of the United States Patent and Trademark Office

# United States of America

United States Patent and Trademark Office

## Instruct Your Body

**Reg. No. 4,199,935**

MICRONUTRIENT LLC (DELAWARE LIMITED LIABILITY COMPANY)  
PO BOX 318  
LINCOLNSHIRE, IL 60069

**Registered Aug. 28, 2012**

**Int. Cl.: 5**

FOR: DIETARY AND NUTRITIONAL SUPPLEMENTS, IN CLASS 5 (U.S. CLS. 6, 18, 44, 46, 51 AND 52).

**TRADEMARK**

FIRST USE 9-15-2011; IN COMMERCE 5-1-2012.

**PRINCIPAL REGISTER**

THE MARK CONSISTS OF STANDARD CHARACTERS WITHOUT CLAIM TO ANY PARTICULAR FONT, STYLE, SIZE, OR COLOR.

SN 85-407,353, FILED 8-25-2011.

GRETTA YAO, EXAMINING ATTORNEY



*David J. Kybas*

Director of the United States Patent and Trademark Office

# United States of America

United States Patent and Trademark Office



**Reg. No. 4,199,936**

**Registered Aug. 28, 2012**

**Int. Cl.: 14**

**TRADEMARK**

**PRINCIPAL REGISTER**

SOLAR TIME LIMITED (HONG KONG LIMITED LIABILITY COMPANY)  
15/F, KOWLOON CENTRE  
29-39 ASHLEY ROAD, TSIM SHA TSUI  
KOWLOON, HONG KONG

FOR: CLOCKS; HOROLOGICAL AND CHRONOMETRIC INSTRUMENTS AND PARTS THEREOF; WATCH BANDS; WATCH CASES; WATCH CHAINS; WATCH STRAPS; WATCHES, IN CLASS 14 (U.S. CLS. 2, 27, 28 AND 50).

FIRST USE 6-27-2011; IN COMMERCE 1-15-2012.

NO CLAIM IS MADE TO THE EXCLUSIVE RIGHT TO USE "TECH", APART FROM THE MARK AS SHOWN.

THE MARK CONSISTS OF THREE STYLIZED LETTERS "ECH" WITH ONE HORIZONTAL BAND AND ONE VERTICAL BAND AT THE UPPER LEFT CORNER OF THE LETTER "E", THE WORDS "PLUS TECH" AT THE BOTTOM.

SN 85-407,897, FILED 8-25-2011.

KATHLEEN M. VANSTON, EXAMINING ATTORNEY



*David J. Kybas*

Director of the United States Patent and Trademark Office

# United States of America

United States Patent and Trademark Office

## Holistic Heroes

**Reg. No. 4,199,937**

**Registered Aug. 28, 2012**

**Int. Cl.: 44**

**SERVICE MARK**

**PRINCIPAL REGISTER**

KRISTI LEE UBER (TEXAS SOLE PROPRIETORSHIP), DBA HOLISTIC HEROES,  
317 LEXINGTON AVE. #115  
SAN ANTONIO, TX 78215

FOR: HOLISTIC HEALTH SERVICES; NUTRITION COUNSELING; PROVIDING A INTER-  
ACTIVE HOLISTIC WEB SITE FEATURING HEALTH INFORMATION AND PATIENT INITI-  
TIATED, PATIENT AUTHORIZED, FEE-FOR-SERVICE, HOLISTIC APPROACH DISTANCE  
HEALING SESSIONS BASED ON THE PATIENT'S SPECIFIC SET OF SYMPTOMS, MEDICAL  
PROFILE AND MEDICAL RECORD ANALYSIS AND PATIENT BENEFIT INFORMATION  
CONCERNING ORGANIC AND HOLISTIC PRODUCTS AND SERVICES, IN CLASS 44 (U.S.  
CLS. 100 AND 101).

FIRST USE 6-9-2011; IN COMMERCE 6-9-2011.

THE MARK CONSISTS OF STANDARD CHARACTERS WITHOUT CLAIM TO ANY PAR-  
TICULAR FONT, STYLE, SIZE, OR COLOR.

NO CLAIM IS MADE TO THE EXCLUSIVE RIGHT TO USE "HOLISTIC", APART FROM  
THE MARK AS SHOWN.

SN 85-407,914, FILED 8-26-2011.

MICHAEL WEBSTER, EXAMINING ATTORNEY



*David J. Kybas*

Director of the United States Patent and Trademark Office



# United States of America

United States Patent and Trademark Office

# HUG FIT

**Reg. No. 4,199,938**

NC TEXTILES, INC. (NORTH CAROLINA CORPORATION)  
10612 CLEMSON BLVD., SUITE 2B  
SENECA, SC 29678

**Registered Aug. 28, 2012**

**Int. Cl.: 24**

FOR: BED BLANKETS; BED SHEETS; COMFORTERS; DUVET COVERS; DUVETS, IN CLASS 24 (U.S. CLS. 42 AND 50).

**TRADEMARK**

FIRST USE 12-0-2011; IN COMMERCE 12-0-2011.

**PRINCIPAL REGISTER**

THE MARK CONSISTS OF STANDARD CHARACTERS WITHOUT CLAIM TO ANY PARTICULAR FONT, STYLE, SIZE, OR COLOR.

SN 85-407,966, FILED 8-26-2011.

ALICE BENMAMAN, EXAMINING ATTORNEY



*David J. Kyros*

Director of the United States Patent and Trademark Office

# United States of America

United States Patent and Trademark Office



**Reg. No. 4,199,939**

WHAT'S HOT, LLC (TENNESSEE LIMITED LIABILITY COMPANY)  
1306 BENBROOKE LANE, N.W.  
ACWORTH, GA 30101

**Registered Aug. 28, 2012**

**Int. Cl.: 35**

FOR: ADVERTISING AND PUBLICITY SERVICES, NAMELY, PROMOTING THE GOODS, SERVICES, BRAND IDENTITY AND COMMERCIAL INFORMATION AND NEWS OF THIRD PARTIES BASED ON GEOGRAPHIC AREA VIA THE INTERNET, IN CLASS 35 (U.S. CLS. 100, 101 AND 102).

**SERVICE MARK**

**PRINCIPAL REGISTER**

FIRST USE 3-5-2011; IN COMMERCE 3-5-2011.

THE MARK CONSISTS OF AN IMAGE REPRESENTING THE SUN INCLUDING A PAIR OF SUNGLASSES THEREON WITH THE PHRASE "WHAT'S HOT!" ON THE SUNGLASSES, AND THE TERM "WHATSHOTSITES.COM" IN STYLIZED FORM TO THE RIGHT OF THE IMAGE REPRESENTING THE SUN.

SN 85-408,576, FILED 8-26-2011.

GIANCARLO CASTRO, EXAMINING ATTORNEY



*David J. Kyros*

Director of the United States Patent and Trademark Office

# United States of America

United States Patent and Trademark Office

## RASPBERRY BERET

**Reg. No. 4,199,940**

**Registered Aug. 28, 2012**

**Int. Cl.: 32**

**TRADEMARK**

**PRINCIPAL REGISTER**

SNEAKY PETE'S BEVERAGE, LLC (NEW JERSEY LIMITED LIABILITY COMPANY)  
576 VALLEY ROAD  
#161  
WAYNE, NJ 07470

FOR: FRUIT-FLAVORED BEVERAGES; NON-ALCOHOLIC BEVERAGES CONTAINING  
FRUIT JUICES; SMOOTHIES CONTAINING GRAINS AND OATS, IN CLASS 32 (U.S. CLS.  
45, 46 AND 48).

FIRST USE 12-15-2011; IN COMMERCE 12-15-2011.

THE MARK CONSISTS OF STANDARD CHARACTERS WITHOUT CLAIM TO ANY PAR-  
TICULAR FONT, STYLE, SIZE, OR COLOR.

NO CLAIM IS MADE TO THE EXCLUSIVE RIGHT TO USE "RASPBERRY", APART FROM  
THE MARK AS SHOWN.

SN 85-409,112, FILED 8-28-2011.

CURTIS FRENCH, EXAMINING ATTORNEY



*David J. Kybas*

Director of the United States Patent and Trademark Office

# United States of America

United States Patent and Trademark Office

# SHERIFF

**Reg. No. 4,199,941**

GDP GROUP INC. (CALIFORNIA CORPORATION)  
7050 FAIRPLAY RD.  
SOMERSET, CA 95684

**Registered Aug. 28, 2012**

**Int. Cl.: 33**

FOR: WINE, IN CLASS 33 (U.S. CLS. 47 AND 49).

**TRADEMARK**

FIRST USE 5-4-2012; IN COMMERCE 5-14-2012.

**PRINCIPAL REGISTER**

THE MARK CONSISTS OF STANDARD CHARACTERS WITHOUT CLAIM TO ANY PARTICULAR FONT, STYLE, SIZE, OR COLOR.

SN 85-409,218, FILED 8-29-2011.

RUDY R. SINGLETON, EXAMINING ATTORNEY



*David J. Kybas*

Director of the United States Patent and Trademark Office

# United States of America

United States Patent and Trademark Office

## Comfort In A Cup

**Reg. No. 4,199,942**

**Registered Aug. 28, 2012**

**Int. Cl.: 30**

**TRADEMARK**

**PRINCIPAL REGISTER**

SOUTHWEST BEVERAGES, LLC (ARIZONA LIMITED LIABILITY COMPANY), DBA  
SOUTHWEST BEVERAGES,  
PO BOX 37272  
SOUTHWEST BEVERAGES, LLC  
TUCSON, AZ 85740

FOR: COCOA; COCOA; COCOA BEVERAGES WITH MILK; COCOA EXTRACTS FOR HUMAN CONSUMPTION; COCOA MIXES; COCOA POWDER; COCOA-BASED BEVERAGES; COCOA-BASED CONDIMENTS AND SEASONINGS FOR FOOD AND DRINK; PREPARED COCOA AND COCOA-BASED BEVERAGES, IN CLASS 30 (U.S. CL. 46).

FIRST USE 8-8-2011; IN COMMERCE 8-8-2011.

THE MARK CONSISTS OF STANDARD CHARACTERS WITHOUT CLAIM TO ANY PARTICULAR FONT, STYLE, SIZE, OR COLOR.

SN 85-409,254, FILED 8-29-2011.

ANDREA HACK, EXAMINING ATTORNEY



*David J. Kyffers*

Director of the United States Patent and Trademark Office

# United States of America

United States Patent and Trademark Office

## LIVE WITH PASSION

**Reg. No. 4,199,943**

**Registered Aug. 28, 2012**

**Int. Cls.: 9 and 41**

**TRADEMARK**

**SERVICE MARK**

**PRINCIPAL REGISTER**

ROBBINS RESEARCH INTERNATIONAL, INC. (NEVADA CORPORATION)  
930 S. ANDREASEN DRIVE, SUITE H  
ESCONDIDO, CA 92029

FOR: AUDIO AND VIDEO RECORDINGS IN THE FIELD OF PERSONAL IMPROVEMENT,  
IN CLASS 9 (U.S. CLS. 21, 23, 26, 36 AND 38).

FIRST USE 0-0-1998; IN COMMERCE 0-0-1998.

FOR: EDUCATIONAL SERVICES, NAMELY, CONDUCTING CLASSES AND SEMINARS  
IN THE FIELD OF PERSONAL IMPROVEMENT, IN CLASS 41 (U.S. CLS. 100, 101 AND 107).

FIRST USE 0-0-1998; IN COMMERCE 0-0-1998.

THE MARK CONSISTS OF STANDARD CHARACTERS WITHOUT CLAIM TO ANY PAR-  
TICULAR FONT, STYLE, SIZE, OR COLOR.

SN 85-409,436, FILED 8-29-2011.

DAVID MURRAY, EXAMINING ATTORNEY



*David J. Kyros*

Director of the United States Patent and Trademark Office

# United States of America

United States Patent and Trademark Office



**Reg. No. 4,199,944**

**Registered Aug. 28, 2012**

**Int. Cl.: 9**

**TRADEMARK**

**PRINCIPAL REGISTER**

SHONIK IDEAS LLC (MINNESOTA LIMITED LIABILITY COMPANY)  
3432 DENMARK AVENUE #160  
EAGAN, MN 55123

FOR: DOWNLOADABLE SOFTWARE IN THE NATURE OF A MOBILE APPLICATION FOR DISSEMINATION OF INFORMATION AND CONTENT REGARDING DERMATOLOGY AND SKIN CARE PROTECTION AND THE ABILITY OF THE USER TO TRACK SKIN CHANGES, IN CLASS 9 (U.S. CLS. 21, 23, 26, 36 AND 38).

FIRST USE 4-25-2012; IN COMMERCE 4-25-2012.

NO CLAIM IS MADE TO THE EXCLUSIVE RIGHT TO USE "NEVUS", APART FROM THE MARK AS SHOWN.

THE COLOR(S) TEAL, YELLOW, PURPLE, BLUE, GREY, AND PINK IS/ARE CLAIMED AS A FEATURE OF THE MARK.

THE MARK CONSISTS OF THE WORD "NEVUS" IN TEAL IN LOWERCASE STYLIZED LETTERING SURROUNDED BY VARYING BANDS OF CIRCLES IN THE COLORS YELLOW, PURPLE, BLUE, GREY, TEAL AND PINK.

SN 85-409,652, FILED 8-29-2011.

JANICE L. MCMORROW, EXAMINING ATTORNEY



*David J. Kyffers*

Director of the United States Patent and Trademark Office

# United States of America

United States Patent and Trademark Office

# froth PLUS

**Reg. No. 4,199,945**

JURA-CAPRESSO, INC. (NEW JERSEY CORPORATION)  
81 RUCKMAN ROAD  
CLOSTER, NJ 07624

**Registered Aug. 28, 2012**

**Int. Cl.: 7**

FOR: ELECTRIC MILK FROTHERS, IN CLASS 7 (U.S. CLS. 13, 19, 21, 23, 31, 34 AND 35).

FIRST USE 8-30-2011; IN COMMERCE 8-30-2011.

**TRADEMARK**

THE MARK CONSISTS OF STANDARD CHARACTERS WITHOUT CLAIM TO ANY PARTICULAR FONT, STYLE, SIZE, OR COLOR.

**PRINCIPAL REGISTER**

OWNER OF U.S. REG. NO. 3,955,790.

NO CLAIM IS MADE TO THE EXCLUSIVE RIGHT TO USE "FROTH", APART FROM THE MARK AS SHOWN.

SN 85-410,351, FILED 8-30-2011.

JEFFERY COWARD, EXAMINING ATTORNEY



*David J. Kybas*

Director of the United States Patent and Trademark Office



# United States of America

United States Patent and Trademark Office

# Suite HOPE

**Reg. No. 4,199,946**

JEANNA DOYLE (UNITED STATES INDIVIDUAL)

**Registered Aug. 28, 2012**

#2025  
5300 KELLER SPRINGS RD  
DALLAS, TX 75248

**Int. Cl.: 41**

FOR: PROVIDING EDUCATIONAL SERVICES TO HELP ONCOLOGY PATIENTS ESTHETICALLY, NAMELY, CONDUCTING SEMINARS, CLASSES, AND WORKSHOPS IN THE FIELD OF COSMETOLOGY, IN CLASS 41 (U.S. CLS. 100, 101 AND 107).

**SERVICE MARK**

**PRINCIPAL REGISTER**

FIRST USE 8-15-2011; IN COMMERCE 6-7-2012.

THE MARK CONSISTS OF STANDARD CHARACTERS WITHOUT CLAIM TO ANY PARTICULAR FONT, STYLE, SIZE, OR COLOR.

SN 85-410,948, FILED 8-30-2011.

SHARON MEIER, EXAMINING ATTORNEY



*David J. Kybas*

Director of the United States Patent and Trademark Office

# United States of America

United States Patent and Trademark Office

## APPLES AWAY

**Reg. No. 4,199,947**

**Registered Aug. 28, 2012**

**Int. Cl.: 32**

**TRADEMARK**

**PRINCIPAL REGISTER**

SNEAKY PETE'S BEVERAGE, LLC (NEW JERSEY LIMITED LIABILITY COMPANY)  
#161  
576 VALLEY ROAD  
WAYNE, NJ 07470

FOR: FRUIT-FLAVORED BEVERAGES; NON-ALCOHOLIC BEVERAGES CONTAINING  
FRUIT JUICES; SMOOTHIES CONTAINING GRAINS AND OATS, IN CLASS 32 (U.S. CLS.  
45, 46 AND 48).

FIRST USE 12-15-2011; IN COMMERCE 12-15-2011.

THE MARK CONSISTS OF STANDARD CHARACTERS WITHOUT CLAIM TO ANY PAR-  
TICULAR FONT, STYLE, SIZE, OR COLOR.

NO CLAIM IS MADE TO THE EXCLUSIVE RIGHT TO USE "APPLES", APART FROM THE  
MARK AS SHOWN.

SN 85-411,084, FILED 8-30-2011.

CURTIS FRENCH, EXAMINING ATTORNEY



*David J. Kybas*

Director of the United States Patent and Trademark Office

# United States of America

United States Patent and Trademark Office

# WING-IT

**Reg. No. 4,199,948**

**Registered Aug. 28, 2012**

**Int. Cl.: 28**

**TRADEMARK**

**PRINCIPAL REGISTER**

INNOVATIVE DESIGN & SOURCING, LLC (CONNECTICUT LIMITED LIABILITY COMPANY)  
175 CARMEN ROAD  
MILFORD, CT 06460

FOR: DOG TOYS, IN CLASS 28 (U.S. CLS. 22, 23, 38 AND 50).

FIRST USE 12-1-2011; IN COMMERCE 12-1-2011.

THE MARK CONSISTS OF STANDARD CHARACTERS WITHOUT CLAIM TO ANY PARTICULAR FONT, STYLE, SIZE, OR COLOR.

SN 85-411,536, FILED 8-31-2011.

GRETTA YAO, EXAMINING ATTORNEY



*David J. Kybas*

Director of the United States Patent and Trademark Office

# United States of America

United States Patent and Trademark Office

# kritterkooks

**Reg. No. 4,199,949**

GROZNIK, LEE (UNITED STATES INDIVIDUAL)  
101 HAMTOM RD  
EIGHTY FOUR, PA 15330

**Registered Aug. 28, 2012**

**Int. Cls.: 16 and 25**

FOR: BUMPER STICKERS, IN CLASS 16 (U.S. CLS. 2, 5, 22, 23, 29, 37, 38 AND 50).

**TRADEMARK**

FIRST USE 12-5-2011; IN COMMERCE 1-13-2012.

**PRINCIPAL REGISTER**

FOR: T-SHIRTS , IN CLASS 25 (U.S. CLS. 22 AND 39).

FIRST USE 12-5-2011; IN COMMERCE 1-13-2012.

THE MARK CONSISTS OF STANDARD CHARACTERS WITHOUT CLAIM TO ANY PARTICULAR FONT, STYLE, SIZE, OR COLOR.

SN 85-411,575, FILED 8-31-2011.

JILL PRATER, EXAMINING ATTORNEY



*David J. Kybas*

Director of the United States Patent and Trademark Office

United States of America  
United States Patent and Trademark Office

**Myiak**

**Reg. No. 4,199,950**

**Registered Aug. 28, 2012**

**Int. Cl.: 2**

**TRADEMARK**

**PRINCIPAL REGISTER**

NINESTAR MANAGEMENT CO., LTD. (CHINA LIMITED COMPANY (LTD.))  
7TH 03BLDG, NO.63 MINGZHUBEI ROAD  
QIANSHAN, ZHUHAI CITY  
GUANGDONG, 519075, CHINA

FOR: COATING COMPOSITION IN THE NATURE OF PAINT FOR INDUSTRIAL APPLICATIONS; COPYING INKS; FILLED INK CARTRIDGES; PIGMENTS; PRINTERS' PASTES; PRINTING COMPOSITIONS; PRINTING INK; SYNTHETIC DYES; TONER CARTRIDGES; TONERS, IN CLASS 2 (U.S. CLS. 6, 11 AND 16).

FIRST USE 5-18-2008; IN COMMERCE 3-3-2010.

THE MARK CONSISTS OF THE STYLIZED LETTERS "MYIK", AND A BAND FORMING AN ANGLE BETWEEN THE LETTER "I" AND "K".

THE WORDING "MYIK" HAS NO MEANING IN A FOREIGN LANGUAGE.

SN 85-413,681, FILED 9-2-2011.

CHRIS WELLS, EXAMINING ATTORNEY



*David J. Kypos*

Director of the United States Patent and Trademark Office

# United States of America

United States Patent and Trademark Office

# FABU

**Reg. No. 4,199,951**

**Registered Aug. 28, 2012**

**Int. Cl.: 41**

**SERVICE MARK**

**PRINCIPAL REGISTER**

MORRISSEY, JANEL (UNITED STATES INDIVIDUAL)  
32 STEVENS TRAIL  
HOPATCONG, NJ 07843

FOR: CONDUCTING DANCE FITNESS CLASSES; CONDUCTING FITNESS CLASSES;  
CONSULTING SERVICES IN THE FIELDS OF FITNESS AND EXERCISE; DANCE INSTRU-  
CTION, IN CLASS 41 (U.S. CLS. 100, 101 AND 107).

FIRST USE 1-1-2012; IN COMMERCE 1-1-2012.

THE MARK CONSISTS OF STANDARD CHARACTERS WITHOUT CLAIM TO ANY PAR-  
TICULAR FONT, STYLE, SIZE, OR COLOR.

SN 85-414,240, FILED 9-2-2011.

MICHAEL LITZAU, EXAMINING ATTORNEY



*David J. Kyffers*

Director of the United States Patent and Trademark Office

# United States of America

United States Patent and Trademark Office

# EagleEye

**Reg. No. 4,199,952**

**Registered Aug. 28, 2012**

**Int. Cl.: 9**

**TRADEMARK**

**PRINCIPAL REGISTER**

TCI INTERNATIONAL, INC. (DELAWARE CORPORATION)  
3541 GATEWAY BLVD.  
FREMONT, CA 94538

FOR: RADIO FREQUENCY COMMUNICATION SEARCH AND PRECISE GEOLOCATION SYSTEM FOR AIRBORNE AND GROUND APPLICATIONS, COMPRISED OF A TIME DIFFERENCE OF ARRIVAL SENSOR WORKING IN CONJUNCTION WITH A DIRECTION FINDING SEARCH SYSTEM, THAT PROVIDE RESULTS TO PINPOINT TARGET EMITTERS IN A REDUCED TIMEFRAME, FOR USE IN MILITARY AND CIVILIAN COMMERCIAL APPLICATIONS, IN CLASS 9 (U.S. CLS. 21, 23, 26, 36 AND 38).

FIRST USE 7-0-2011; IN COMMERCE 7-0-2011.

THE MARK CONSISTS OF STANDARD CHARACTERS WITHOUT CLAIM TO ANY PARTICULAR FONT, STYLE, SIZE, OR COLOR.

SN 85-414,647, FILED 9-2-2011.

LINDA ORNDORFF, EXAMINING ATTORNEY



*David J. Kyros*

Director of the United States Patent and Trademark Office

# United States of America

United States Patent and Trademark Office

## ECLECTICA SKIN CARE BY ALANA CAPPELLI

**Reg. No. 4,199,953**

ECLECTICA SKIN CARE LLC (VIRGINIA LIMITED LIABILITY COMPANY)

**Registered Aug. 28, 2012**

9 - J CATOCTIN CIRCLE SW  
LEESBURG, VA 20175

**Int. Cl.: 3**

FOR: SKIN CLEANSERS; SKIN MOISTURIZERS; MAKE-UP, IN CLASS 3 (U.S. CLS. 1, 4, 6, 50, 51 AND 52).

**TRADEMARK**

FIRST USE 11-28-2011; IN COMMERCE 11-28-2011.

**PRINCIPAL REGISTER**

THE MARK CONSISTS OF STANDARD CHARACTERS WITHOUT CLAIM TO ANY PARTICULAR FONT, STYLE, SIZE, OR COLOR.

NO CLAIM IS MADE TO THE EXCLUSIVE RIGHT TO USE "SKIN CARE", APART FROM THE MARK AS SHOWN.

THE NAME(S), PORTRAIT(S), AND/OR SIGNATURE(S) SHOWN IN THE MARK IDENTIFIES "ALANA CAPPELLI", WHOSE CONSENT(S) TO REGISTER IS MADE OF RECORD.

THE WORD(S) "ECLECTICA" HAS NO MEANING IN A FOREIGN LANGUAGE.

SN 85-416,201, FILED 9-7-2011.

KATHERINE STOIDES, EXAMINING ATTORNEY



*David J. Kybas*

Director of the United States Patent and Trademark Office



# United States of America

United States Patent and Trademark Office

## Life Deserves Grins

**Reg. No. 4,199,954**

GRINS ENTERPRISES LLC (NORTH CAROLINA LIMITED LIABILITY COMPANY)  
235 N CHERRY STREET, SUITE 200  
WINSTON-SALEM, NC 27101

**Registered Aug. 28, 2012**

**Int. Cl.: 5**

FOR: VITAMIN FORTIFIED BEVERAGES, IN CLASS 5 (U.S. CLS. 6, 18, 44, 46, 51 AND 52).

**TRADEMARK**

FIRST USE 11-2-2011; IN COMMERCE 11-4-2011.

**PRINCIPAL REGISTER**

THE MARK CONSISTS OF STANDARD CHARACTERS WITHOUT CLAIM TO ANY PARTICULAR FONT, STYLE, SIZE, OR COLOR.

SN 85-416,419, FILED 9-7-2011.

JUDITH HELFMAN, EXAMINING ATTORNEY



*David J. Kyffers*

Director of the United States Patent and Trademark Office

# United States of America

United States Patent and Trademark Office

## PASSION FOR JUICE

**Reg. No. 4,199,955**

**Registered Aug. 28, 2012**

**Int. Cl.: 43**

**SERVICE MARK**

**PRINCIPAL REGISTER**

BALBOA BRANDS, INC. (DELAWARE CORPORATION)  
SUITE J  
17915 SKY PARK CIRCLE  
IRVINE, CA 92614

FOR: RESTAURANT SERVICES FEATURING FRUIT AND VEGETABLE JUICES AND JUICE SMOOTHIES, IN CLASS 43 (U.S. CLS. 100 AND 101).

FIRST USE 9-7-2011; IN COMMERCE 9-7-2011.

THE MARK CONSISTS OF STANDARD CHARACTERS WITHOUT CLAIM TO ANY PARTICULAR FONT, STYLE, SIZE, OR COLOR.

NO CLAIM IS MADE TO THE EXCLUSIVE RIGHT TO USE "JUICE", APART FROM THE MARK AS SHOWN.

SN 85-416,572, FILED 9-7-2011.

REGINA DRUMMOND, EXAMINING ATTORNEY



*David J. Kyros*

Director of the United States Patent and Trademark Office

# United States of America

United States Patent and Trademark Office

## JETT.CONNECT

**Reg. No. 4,199,956**

TWO TECHNOLOGIES, INC. (PENNSYLVANIA CORPORATION)  
419 SARGON WAY  
HORSHAM, PA 19044

**Registered Aug. 28, 2012**

**Int. Cl.: 9**

FOR: COMPUTER HARDWARE AND SOFTWARE, NAMELY, A HAND-HELD OPERATOR INTERFACE WITH BUILT-IN CAMERA; COMPUTER HARDWARE AND SOFTWARE, NAMELY, A HAND-HELD DATA PROCESSOR WITH BUILT-IN CAMERA, IN CLASS 9 (U.S. CLS. 21, 23, 26, 36 AND 38).

**TRADEMARK**

**PRINCIPAL REGISTER**

FIRST USE 10-3-2003; IN COMMERCE 10-3-2003.

THE MARK CONSISTS OF STANDARD CHARACTERS WITHOUT CLAIM TO ANY PARTICULAR FONT, STYLE, SIZE, OR COLOR.

OWNER OF U.S. REG. NOS. 2,850,456, 3,823,243, AND OTHERS.

SN 85-416,660, FILED 9-7-2011.

DAVID ELTON, EXAMINING ATTORNEY



*David J. Kyffers*

Director of the United States Patent and Trademark Office

# United States of America

United States Patent and Trademark Office

## Mojo's Full Service Car Wash & Detail Center

**Reg. No. 4,199,957**

**Registered Aug. 28, 2012**

**Int. Cl.: 37**

**SERVICE MARK**

**PRINCIPAL REGISTER**

MOJO ENTERPRISES I, INC. (NEBRASKA CORPORATION), DBA MOJO'S FULL SERVICE  
CAR WASH & DETAIL CENTER,  
9885 DEVONSHIRE DRIVE  
OMAHA, NE 68114

FOR: AUTOMOBILE CLEANING AND CAR WASHING; AUTOMOBILE WASHING; CAR  
CLEANING; CAR WASHING, IN CLASS 37 (U.S. CLS. 100, 103 AND 106).

FIRST USE 2-29-2012; IN COMMERCE 2-29-2012.

THE MARK CONSISTS OF STANDARD CHARACTERS WITHOUT CLAIM TO ANY PAR-  
TICULAR FONT, STYLE, SIZE, OR COLOR.

NO CLAIM IS MADE TO THE EXCLUSIVE RIGHT TO USE "FULL SERVICE CAR WASH  
& DETAIL CENTER", APART FROM THE MARK AS SHOWN.

SN 85-416,704, FILED 9-7-2011.

WENDY GOODMAN, EXAMINING ATTORNEY



*David J. Kybas*

Director of the United States Patent and Trademark Office

# United States of America

United States Patent and Trademark Office

ENERGIZE. MAXIMIZE.  
SUSTAIN.

**Reg. No. 4,199,958**

BONISA, JEFF (UNITED STATES INDIVIDUAL)  
260 CALLE CUERVO  
SAN CLEMENTE, CA 92672

**Registered Aug. 28, 2012**

**Int. Cl.: 5**

FOR: ORALLY INGESTED GELS FOR BOOSTING ENERGY, IN CLASS 5 (U.S. CLS. 6, 18, 44, 46, 51 AND 52).

**TRADEMARK**

FIRST USE 4-8-2012; IN COMMERCE 5-6-2012.

**PRINCIPAL REGISTER**

THE MARK CONSISTS OF STANDARD CHARACTERS WITHOUT CLAIM TO ANY PARTICULAR FONT, STYLE, SIZE, OR COLOR.

SN 85-416,937, FILED 9-7-2011.

HEATHER THOMPSON, EXAMINING ATTORNEY



*David J. Kybas*

Director of the United States Patent and Trademark Office

# United States of America

United States Patent and Trademark Office

# TAKE & GO

**Reg. No. 4,199,959**

AMHIL ENTERPRISES (CANADA CORPORATION)  
400 TRADERS BLVD. EAST  
MISSISSAUGA, ONTARIO, CANADA L4Z1W7

**Registered Aug. 28, 2012**

**Int. Cl.: 20**

FOR: PLASTIC STORAGE CONTAINERS FOR THE STORAGE OF FOOD FOR THE FOOD INDUSTRY, IN CLASS 20 (U.S. CLS. 2, 13, 22, 25, 32 AND 50).

**TRADEMARK**

FIRST USE 5-31-2012; IN COMMERCE 5-31-2012.

**PRINCIPAL REGISTER**

THE MARK CONSISTS OF STANDARD CHARACTERS WITHOUT CLAIM TO ANY PARTICULAR FONT, STYLE, SIZE, OR COLOR.

SN 85-417,974, FILED 9-8-2011.

JOHN SCHUYLER YARD, EXAMINING ATTORNEY



*David J. Kyffers*

Director of the United States Patent and Trademark Office

# United States of America

United States Patent and Trademark Office

## WIDEOPENGARAGE.COM

**Reg. No. 4,199,960**

RACEWAY MEDIA, LLC (MASSACHUSETTS LIMITED LIABILITY COMPANY)  
106 MAIN STREET  
NORTH ADAMS, MA 01247

**Registered Aug. 28, 2012**

**Int. Cl.: 45**

FOR: INTERNET-BASED SOCIAL NETWORKING SERVICES, IN CLASS 45 (U.S. CLS. 100 AND 101).

**SERVICE MARK**

FIRST USE 11-30-2011; IN COMMERCE 11-30-2011.

**PRINCIPAL REGISTER**

THE MARK CONSISTS OF STANDARD CHARACTERS WITHOUT CLAIM TO ANY PARTICULAR FONT, STYLE, SIZE, OR COLOR.

SN 85-418,023, FILED 9-8-2011.

ALEXANDER L. POWERS, EXAMINING ATTORNEY



*David J. Kyffers*

Director of the United States Patent and Trademark Office

# United States of America

United States Patent and Trademark Office



## Physician Prosperity Program

**Reg. No. 4,199,961**

**Registered Aug. 28, 2012**

**Int. Cl.: 35**

**SERVICE MARK**

**PRINCIPAL REGISTER**

PHYSICIAN PROSPERITY PLACE, LLC (PENNSYLVANIA LIMITED LIABILITY COMPANY)  
60 N. UNION STREET  
MIDDLETOWN, PA 17057

FOR: PROVIDING ADVICE AND CONSULTATION TO PHYSICIANS IN THE FIELD OF EMPLOYMENT AGREEMENTS, PROVIDING EMPLOYMENT INFORMATION TO PHYSICIANS, PROVIDING REVIEW OF PHYSICIAN EMPLOYMENT AGREEMENTS, AND NEGOTIATING EMPLOYMENT AGREEMENTS ON BEHALF OF PHYSICIANS, IN CLASS 35 (U.S. CLS. 100, 101 AND 102).

FIRST USE 10-0-2011; IN COMMERCE 10-0-2011.

NO CLAIM IS MADE TO THE EXCLUSIVE RIGHT TO USE "PHYSICIAN PROSPERITY PROGRAM", APART FROM THE MARK AS SHOWN.

THE MARK CONSISTS OF A HIGHLY STYLIZED CADUCEUS DESIGN WITH THE WORDS "PHYSICIAN PROSPERITY PROGRAM" CENTERED BENEATH THE DESIGN.

SN 85-418,169, FILED 9-8-2011.

JOHN WILKE, EXAMINING ATTORNEY



*David J. Kyffers*

Director of the United States Patent and Trademark Office



# United States of America

United States Patent and Trademark Office

# JOYLIFT

**Reg. No. 4,199,962**

AYUSH HERBS INC. (WASHINGTON CORPORATION)  
2239 152ND AVE NE  
REDMOND, WA 98052

**Registered Aug. 28, 2012**

**Int. Cl.: 5**

FOR: DIETARY SUPPLEMENTS, IN CLASS 5 (U.S. CLS. 6, 18, 44, 46, 51 AND 52).

**TRADEMARK**

FIRST USE 5-20-2012; IN COMMERCE 5-20-2012.

**PRINCIPAL REGISTER**

THE MARK CONSISTS OF STANDARD CHARACTERS WITHOUT CLAIM TO ANY PARTICULAR FONT, STYLE, SIZE, OR COLOR.

SN 85-418,318, FILED 9-9-2011.

SUNG IN, EXAMINING ATTORNEY



*David J. Kyffers*

Director of the United States Patent and Trademark Office

# United States of America

United States Patent and Trademark Office

## HANES SIGNATURE

**Reg. No. 4,199,963**

**Registered Aug. 28, 2012**

**Int. Cl.: 25**

**TRADEMARK**

**PRINCIPAL REGISTER**

HBI BRANDED APPAREL LIMITED, INC. (DELAWARE CORPORATION)  
1000 EAST HANES MILL ROAD  
WINSTON-SALEM, NC 27105

FOR: SCARVES, IN CLASS 25 (U.S. CLS. 22 AND 39).

FIRST USE 10-17-2011; IN COMMERCE 10-17-2011.

THE MARK CONSISTS OF STANDARD CHARACTERS WITHOUT CLAIM TO ANY PARTICULAR FONT, STYLE, SIZE, OR COLOR.

OWNER OF U.S. REG. NOS. 847,649, 2,247,831, AND OTHERS.

SN 85-418,435, FILED 9-9-2011.

DAVID COLLIER, EXAMINING ATTORNEY



*David J. Kyffers*

Director of the United States Patent and Trademark Office

# United States of America

United States Patent and Trademark Office

## HONEYLICIOUS

**Reg. No. 4,199,964**

**Registered Aug. 28, 2012**

**Int. Cl.: 3**

**TRADEMARK**

**PRINCIPAL REGISTER**

BATH & BODY WORKS BRAND MANAGEMENT, INC. (DELAWARE CORPORATION)  
SEVEN LIMITED PARKWAY  
REYNOLDSBURG, OH 43068

FOR: LIP BALM; LIP CREAM; LIP GLOSS; LIP GLOSS PALATTE; LIP POLISHER; MAKE-  
UP KITS COMPRISED OF LIP BALMS, LIP CREAMS, AND LIP GLOSSES , IN CLASS 3  
(U.S. CLS. 1, 4, 6, 50, 51 AND 52).

FIRST USE 2-8-2012; IN COMMERCE 2-8-2012.

THE MARK CONSISTS OF STANDARD CHARACTERS WITHOUT CLAIM TO ANY PAR-  
TICULAR FONT, STYLE, SIZE, OR COLOR.

SN 85-418,514, FILED 9-9-2011.

ANDREA BUTLER, EXAMINING ATTORNEY



*David J. Kyffers*

Director of the United States Patent and Trademark Office

United States of America  
United States Patent and Trademark Office

# HypnoBliss

**Reg. No. 4,199,965**

BISCHOFF, BRENDA Q. (UNITED STATES INDIVIDUAL)  
1637 N. 20TH AVENUE  
PENSACOLA, FL 32503

**Registered Aug. 28, 2012**

**Int. Cl.: 44**

FOR: HYPNOSIS SERVICES, IN CLASS 44 (U.S. CLS. 100 AND 101).

**SERVICE MARK**

FIRST USE 9-1-2011; IN COMMERCE 9-1-2011.

**PRINCIPAL REGISTER**

THE MARK CONSISTS OF STANDARD CHARACTERS WITHOUT CLAIM TO ANY PARTICULAR FONT, STYLE, SIZE, OR COLOR.

SN 85-418,668, FILED 9-9-2011.

SANJEEV VOHRA, EXAMINING ATTORNEY



*David J. Kybas*

Director of the United States Patent and Trademark Office

# United States of America

United States Patent and Trademark Office

## FAST FLIGHT & AIRCRAFT SERVICES TRACKING

**Reg. No. 4,199,966**

**Registered Aug. 28, 2012**

**Int. Cl.: 9**

FLIGHT AND AIRCRAFT SERVICES TRACKING, LLC (UNITED STATES LIMITED  
LIABILITY COMPANY)  
1725 I ST. NW #300  
C/O THE LEE GROUP  
WASHINGTON, DC 20006

**TRADEMARK**

**PRINCIPAL REGISTER**

FOR: COMPUTER SOFTWARE FOR CONTROLLING AND TRACKING THE COMPONENTS,  
MAINTENANCE, COST SUPPLIERS, AND HOURS FLOWN OF GENERAL AVIATION  
AIRCRAFT, IN CLASS 9 (U.S. CLS. 21, 23, 26, 36 AND 38).

FIRST USE 3-27-2012; IN COMMERCE 3-27-2012.

THE MARK CONSISTS OF STANDARD CHARACTERS WITHOUT CLAIM TO ANY PAR-  
TICULAR FONT, STYLE, SIZE, OR COLOR.

NO CLAIM IS MADE TO THE EXCLUSIVE RIGHT TO USE "FLIGHT & AIRCRAFT SER-  
VICES TRACKING", APART FROM THE MARK AS SHOWN.

SN 85-418,795, FILED 9-9-2011.

DAWN FELDMAN, EXAMINING ATTORNEY



*David J. Kyffers*

Director of the United States Patent and Trademark Office

# United States of America

United States Patent and Trademark Office

# EventHub

**Reg. No. 4,199,967**

VALIDAR INC (WASHINGTON CORPORATION)  
800 MAYNARD AVE SOUTH SUITE 401  
SEATTLE, WA 98134

**Registered Aug. 28, 2012**

**Int. Cl.: 42**

FOR: COMPUTER SERVICES, NAMELY, HOSTING AN INTERACTIVE WEB SITE THAT ALLOWS EVENT MARKETERS TO CONNECT TO THEIR ATTENDEES PRIOR, DURING AND AFTER AN EVENT BY ENABLING FEATURES OF REGISTRATION, SURVEY FEEDBACK, SCHEDULES, EXCHANGE OF CONTACT INFORMATION BETWEEN ATTENDEES, IN CLASS 42 (U.S. CLS. 100 AND 101).

**SERVICE MARK**

**PRINCIPAL REGISTER**

FIRST USE 3-1-2012; IN COMMERCE 3-1-2012.

THE MARK CONSISTS OF STANDARD CHARACTERS WITHOUT CLAIM TO ANY PARTICULAR FONT, STYLE, SIZE, OR COLOR.

SN 85-418,954, FILED 9-9-2011.

DAVID TAYLOR, EXAMINING ATTORNEY



*David J. Kyffers*

Director of the United States Patent and Trademark Office

# United States of America

United States Patent and Trademark Office

# BIG DADDY

**Reg. No. 4,199,968**

**Registered Aug. 28, 2012**

**Int. Cl.: 6**

**TRADEMARK**

**PRINCIPAL REGISTER**

GRANITE SECURITY PRODUCTS, INC. (TEXAS CORPORATION)  
SUITE 510  
1431 GREENWAY DRIVE  
IRVING, TX 75038

FOR: METAL SAFES, IN CLASS 6 (U.S. CLS. 2, 12, 13, 14, 23, 25 AND 50).

FIRST USE 3-21-2012; IN COMMERCE 3-21-2012.

THE MARK CONSISTS OF STANDARD CHARACTERS WITHOUT CLAIM TO ANY PARTICULAR FONT, STYLE, SIZE, OR COLOR.

SN 85-419,149, FILED 9-9-2011.

MICHELLE DUBOIS, EXAMINING ATTORNEY



*David J. Kybas*

Director of the United States Patent and Trademark Office

# United States of America

United States Patent and Trademark Office

## Super Roots Hydroponics

**Reg. No. 4,199,969**

**Registered Aug. 28, 2012**

**Int. Cl.: 35**

**SERVICE MARK**

**PRINCIPAL REGISTER**

AQUADOT ENTERPRISES, INC. (NEVADA CORPORATION), DBA SUPER ROOTS  
HYDROPONICS,  
1330 N. HULBERT AVE. #105  
FRESNO, CA 93728

FOR: ON-LINE WHOLESALE AND RETAIL STORE SERVICES FEATURING HYDROPONIC  
AND GARDEN SUPPLIES; RETAIL LAWN, GARDEN AND NURSERY STORES , IN CLASS  
35 (U.S. CLS. 100, 101 AND 102).

FIRST USE 9-12-2011; IN COMMERCE 9-12-2011.

THE MARK CONSISTS OF STANDARD CHARACTERS WITHOUT CLAIM TO ANY PAR-  
TICULAR FONT, STYLE, SIZE, OR COLOR.

NO CLAIM IS MADE TO THE EXCLUSIVE RIGHT TO USE "HYDROPONICS", APART  
FROM THE MARK AS SHOWN.

SN 85-420,784, FILED 9-12-2011.

ANGELA M. MICHELI, EXAMINING ATTORNEY



*David J. Kybas*

Director of the United States Patent and Trademark Office



# United States of America

United States Patent and Trademark Office

# FORCITE

**Reg. No. 4,199,970**

**Registered Aug. 28, 2012**

**Int. Cl.: 9**

**TRADEMARK**

**PRINCIPAL REGISTER**

TWO TECHNOLOGIES, INC. (PENNSYLVANIA CORPORATION)  
419 SARGON WAY  
HORSHAM, PA 19044

FOR: COMPUTER SOFTWARE FOR USE IN A HAND-HELD OPERATOR INTERFACE WITH BUILT-IN CAMERA FOR THE ISSUANCE OF TRAFFIC AND NON TRAFFIC CITATIONS FOR LAW ENFORCEMENT, PARKING AGENCIES, UNIVERSITIES AND MUNICIPALITIES; COMPUTER SOFTWARE FOR USE IN A HAND-HELD DATA PROCESSOR WITH BUILT-IN CAMERA FOR THE ISSUANCE OF TRAFFIC AND NON TRAFFIC CITATIONS FOR LAW ENFORCEMENT, PARKING AGENCIES, UNIVERSITIES AND MUNICIPALITIES, IN CLASS 9 (U.S. CLS. 21, 23, 26, 36 AND 38).

FIRST USE 11-21-2011; IN COMMERCE 11-21-2011.

THE MARK CONSISTS OF STANDARD CHARACTERS WITHOUT CLAIM TO ANY PARTICULAR FONT, STYLE, SIZE, OR COLOR.

SN 85-421,109, FILED 9-13-2011.

DAVID ELTON, EXAMINING ATTORNEY



*David J. Kyros*

Director of the United States Patent and Trademark Office

# United States of America

United States Patent and Trademark Office

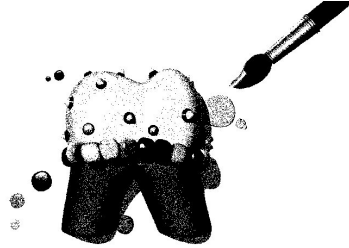

art that bites

**Reg. No. 4,199,971**

KAWASS, DESIREE (UNITED STATES INDIVIDUAL)  
5881 SW 51ST TERRACE  
MIAMI, FL 33155

**Registered Aug. 28, 2012**

**Int. Cl.: 10**

FOR: ARTIFICIAL TEETH, IN CLASS 10 (U.S. CLS. 26, 39 AND 44).

**TRADEMARK**

FIRST USE 9-1-2011; IN COMMERCE 9-1-2011.

**PRINCIPAL REGISTER**

THE STIPPLING IS FOR SHADING PURPOSES ONLY.

THE MARK CONSISTS OF THE DESIGN OF A MOLAR WITH SPHERICAL OBJECTS AROUND IT AND A PAINTBRUSH ALL ABOVE THE STYLIZED WORDS "ART THAT BITES".

SN 85-421,305, FILED 9-13-2011.

AHSEN KHAN, EXAMINING ATTORNEY



*David J. Kybas*

Director of the United States Patent and Trademark Office

# United States of America

United States Patent and Trademark Office

## WEST COAST RHINOS

**Reg. No. 4,199,972**

**Registered Aug. 28, 2012**

**Int. Cl.: 25**

**TRADEMARK**

**PRINCIPAL REGISTER**

STARFISH HOLDINGS, LLC (WASHINGTON LIMITED LIABILITY COMPANY)  
1646 WIND DANCER PLACE  
P.O. BOX 1585  
COUPEVILLE, WA 98239

FOR: CLOTHING, NAMELY, SHORT SLEEVE T-SHIRTS, LONG SLEEVE T-SHIRTS,  
HOODED SWEATSHIRTS, AND BEANIES, IN CLASS 25 (U.S. CLS. 22 AND 39).

FIRST USE 1-10-2012; IN COMMERCE 1-10-2012.

THE MARK CONSISTS OF STANDARD CHARACTERS WITHOUT CLAIM TO ANY PAR-  
TICULAR FONT, STYLE, SIZE, OR COLOR.

SN 85-421,862, FILED 9-13-2011.

AHSEN KHAN, EXAMINING ATTORNEY



*David J. Kybas*

Director of the United States Patent and Trademark Office

# United States of America

United States Patent and Trademark Office

## diamondblades4us

**Reg. No. 4,199,973**

FRITCHEN, RYAN (UNITED STATES INDIVIDUAL), DBA DIAMONDBLADES4US,  
2150 SW 10TH STREET  
DEERFIELD BEACH, FL 33442

**Registered Aug. 28, 2012**

**Int. Cl.: 7**

FOR: DIAMOND BLADES FOR POWER SAWS, IN CLASS 7 (U.S. CLS. 13, 19, 21, 23, 31, 34  
AND 35).

**TRADEMARK**

FIRST USE 11-1-2011; IN COMMERCE 11-1-2011.

**PRINCIPAL REGISTER**

THE MARK CONSISTS OF STANDARD CHARACTERS WITHOUT CLAIM TO ANY PAR-  
TICULAR FONT, STYLE, SIZE, OR COLOR.

SN 85-421,883, FILED 9-13-2011.

LESLEY LAMOTHE, EXAMINING ATTORNEY



*David J. Kyffers*

Director of the United States Patent and Trademark Office

# United States of America

United States Patent and Trademark Office

## SLIPPITY DIPPITY

**Reg. No. 4,199,974**

**Registered Aug. 28, 2012**

**Int. Cl.: 41**

**SERVICE MARK**

**PRINCIPAL REGISTER**

SEAWORLD PARKS & ENTERTAINMENT LLC (DELAWARE LIMITED LIABILITY COMPANY)  
SUITE 400  
9205 SOUTH PARK CENTER LOOP  
ORLANDO, FL 32819

FOR: ENTERTAINMENT SERVICES IN THE NATURE OF AN AMUSEMENT PARK ATTRACTION, IN CLASS 41 (U.S. CLS. 100, 101 AND 107).

FIRST USE 5-19-2012; IN COMMERCE 5-19-2012.

THE MARK CONSISTS OF STANDARD CHARACTERS WITHOUT CLAIM TO ANY PARTICULAR FONT, STYLE, SIZE, OR COLOR.

OWNER OF U.S. REG. NO. 3,489,821.

SN 85-421,999, FILED 9-14-2011.

WILLIAM ROSSMAN, EXAMINING ATTORNEY



*David J. Kyfos*

Director of the United States Patent and Trademark Office

# United States of America

United States Patent and Trademark Office

## AGRICULTURE WORKS HERE

**Reg. No. 4,199,975**

**Registered Aug. 28, 2012**

**Int. Cl.: 36**

**SERVICE MARK**

**PRINCIPAL REGISTER**

FARM CREDIT SERVICES OF AMERICA, ACA (UNITED STATES FEDERALLY CHARTERED CORPORATION)  
5015 SOUTH 118TH STREET  
OMAHA, NE 68137

FOR: INSURANCE SERVICES, NAMELY, WRITING MULTI-PERIL CROP INSURANCE AND CROP HAIL INSURANCE; REAL ESTATE APPRAISAL; FINANCING SERVICES; LOAN FINANCING; LEASE FINANCING SERVICES; AND, LEASE-PURCHASE FINANCING SERVICES; LOAN-PURCHASE FINANCING SERVICES, IN CLASS 36 (U.S. CLS. 100, 101 AND 102).

FIRST USE 1-2-2012; IN COMMERCE 1-2-2012.

THE MARK CONSISTS OF STANDARD CHARACTERS WITHOUT CLAIM TO ANY PARTICULAR FONT, STYLE, SIZE, OR COLOR.

SN 85-422,394, FILED 9-14-2011.

MARIA-VICTORIA SUAREZ, EXAMINING ATTORNEY



*David J. Kybas*

Director of the United States Patent and Trademark Office

# United States of America

United States Patent and Trademark Office

## INTEGRITYWISE CONSULTING

**Reg. No. 4,199,976**

**Registered Aug. 28, 2012**

**Int. Cl.: 35**

**SERVICE MARK**

**PRINCIPAL REGISTER**

INTEGRITYWISE CONSULTING, LLC (NEW JERSEY LIMITED LIABILITY COMPANY)  
5 LEWIS DRIVE  
MAPLEWOOD, NJ 07040

FOR: BUSINESS CONSULTATION IN THE FIELD OF BUSINESS STRATEGY, OPERATIONS AND CHANGE MANAGEMENT; BUSINESS CONSULTATION SERVICES , IN CLASS 35 (U.S. CLS. 100, 101 AND 102).

FIRST USE 0-0-2011; IN COMMERCE 0-0-2011.

THE MARK CONSISTS OF STANDARD CHARACTERS WITHOUT CLAIM TO ANY PARTICULAR FONT, STYLE, SIZE, OR COLOR.

NO CLAIM IS MADE TO THE EXCLUSIVE RIGHT TO USE "CONSULTING", APART FROM THE MARK AS SHOWN.

SN 85-422,907, FILED 9-14-2011.

JOHN DALIER, EXAMINING ATTORNEY



*David J. Kyffers*

Director of the United States Patent and Trademark Office

# United States of America

United States Patent and Trademark Office

# InforMeGene

**Reg. No. 4,199,977**

SCOTLAND, REBECCA (UNITED STATES INDIVIDUAL)  
4613 MESA PLACE  
HAMILTON, OH 45011

**Registered Aug. 28, 2012**

**Int. Cl.: 42**

FOR: GENETIC TESTING FOR SCIENTIFIC RESEARCH PURPOSES, IN CLASS 42 (U.S. CLS. 100 AND 101).

**SERVICE MARK**

FIRST USE 11-1-2011; IN COMMERCE 5-1-2012.

**PRINCIPAL REGISTER**

THE MARK CONSISTS OF STANDARD CHARACTERS WITHOUT CLAIM TO ANY PARTICULAR FONT, STYLE, SIZE, OR COLOR.

SN 85-423,283, FILED 9-15-2011.

JORDAN BAKER, EXAMINING ATTORNEY



*David J. Kybas*

Director of the United States Patent and Trademark Office



# United States of America

United States Patent and Trademark Office

## TURN YOUR ONE WAY COMMUNICATION INTO A TWO WAY CONVERSATION

**Reg. No. 4,199,978**

E-MILES, INC. (DELAWARE CORPORATION)  
5800 TENNYSON PARKWAY, SUITE 600  
PLANO, TX 75024

**Registered Aug. 28, 2012**

**Int. Cl.: 35**

FOR: ONLINE ADVERTISING SERVICES FOR OTHERS; BUSINESS AND TECHNICAL CONSULTING SERVICES IN THE FIELD OF ADVERTISING SERVICES AND CUSTOMER RELATIONSHIP MANAGEMENT (CRM) PROGRAMS; PROMOTING THE GOODS AND SERVICES OF OTHERS THROUGH INCENTIVE PROGRAMS, IN CLASS 35 (U.S. CLS. 100, 101 AND 102).

**SERVICE MARK**

**PRINCIPAL REGISTER**

FIRST USE 5-22-2012; IN COMMERCE 5-22-2012.

THE MARK CONSISTS OF STANDARD CHARACTERS WITHOUT CLAIM TO ANY PARTICULAR FONT, STYLE, SIZE, OR COLOR.

SN 85-423,613, FILED 9-15-2011.

TASHIA BUNCH, EXAMINING ATTORNEY



*David J. Kyros*

Director of the United States Patent and Trademark Office

# United States of America

United States Patent and Trademark Office

# GAME BABE

**Reg. No. 4,199,979**

BENHAM, BRENT (UNITED STATES INDIVIDUAL)  
1113 HIGH STREET, SUITE 4  
AUBURN, CA 95603

**Registered Aug. 28, 2012**

**Int. Cl.: 25**

FOR: SPORT SHIRTS; SPORTS CAPS AND HATS; SPORTS JACKETS; T-SHIRTS, IN CLASS 25 (U.S. CLS. 22 AND 39).

**TRADEMARK**

FIRST USE 3-8-2012; IN COMMERCE 3-8-2012.

**PRINCIPAL REGISTER**

THE MARK CONSISTS OF STANDARD CHARACTERS WITHOUT CLAIM TO ANY PARTICULAR FONT, STYLE, SIZE, OR COLOR.

SN 85-423,992, FILED 9-15-2011.

DOMINICK J. SALEMI, EXAMINING ATTORNEY



*David J. Kyffers*

Director of the United States Patent and Trademark Office

# United States of America

United States Patent and Trademark Office

## VERSATOUCH

**Reg. No. 4,199,980**

**Registered Aug. 28, 2012**

**Int. Cl.: 9**

**TRADEMARK**

**PRINCIPAL REGISTER**

ANSELL LIMITED (AUSTRALIA CORPORATION)  
VICTORIA GARDENS  
678 VICTORIA STREET  
RICHMOND, AUSTRALIA 3121

FOR: CLOTHING FOR PROTECTION AGAINST ACCIDENTS; GLOVES FOR PROTECTION AGAINST ACCIDENTS; PROTECTIVE GLOVES FOR INDUSTRIAL USE, IN CLASS 9 (U.S. CLS. 21, 23, 26, 36 AND 38).

FIRST USE 4-20-2012; IN COMMERCE 4-20-2012.

THE MARK CONSISTS OF STANDARD CHARACTERS WITHOUT CLAIM TO ANY PARTICULAR FONT, STYLE, SIZE, OR COLOR.

SN 85-424,544, FILED 9-16-2011.

ANDREA HACK, EXAMINING ATTORNEY



*David J. Kybas*

Director of the United States Patent and Trademark Office

# United States of America

United States Patent and Trademark Office

## LA VERDAD DE MI VIDA

**Reg. No. 4,199,981**

AZTECA INTERNATIONAL CORPORATION (DELAWARE CORPORATION)  
1139 GRAND CENTRAL AVENUE  
GLENDALE, CA 91201

**Registered Aug. 28, 2012**

**Int. Cl.: 41**

FOR: ONGOING TELEVISION PROGRAM IN THE FIELD OF DRAMA, IN CLASS 41 (U.S. CLS. 100, 101 AND 107).

**SERVICE MARK**

FIRST USE 2-1-2012; IN COMMERCE 2-1-2012.

**PRINCIPAL REGISTER**

THE MARK CONSISTS OF STANDARD CHARACTERS WITHOUT CLAIM TO ANY PARTICULAR FONT, STYLE, SIZE, OR COLOR.

THE ENGLISH TRANSLATION OF "LA VERDAD DE MI VIDA" IN THE MARK IS "THE TRUTH OF MY LIFE".

SN 85-424,614, FILED 9-16-2011.

ROSELLE HERRERA, EXAMINING ATTORNEY



*David J. Kyffers*

Director of the United States Patent and Trademark Office

# United States of America

United States Patent and Trademark Office

## SENSATIONS LOVING FEELINGS

**Reg. No. 4,199,982**

TUPPERWARE PRODUCTS S.A. (SWITZERLAND CORPORATION)  
ROUTE DU JURA 37

**Registered Aug. 28, 2012**

FRIBOURG, SWITZERLAND CH-1700

**Int. Cl.: 3**

FOR: PERFUMERY; NON-MEDICATED SKIN CARE PREPARATIONS; AND NON-MEDICATED HAIR CARE PREPARATIONS, IN CLASS 3 (U.S. CLS. 1, 4, 6, 50, 51 AND 52).

**TRADEMARK**

FIRST USE 5-31-2012; IN COMMERCE 5-31-2012.

**PRINCIPAL REGISTER**

THE MARK CONSISTS OF STANDARD CHARACTERS WITHOUT CLAIM TO ANY PARTICULAR FONT, STYLE, SIZE, OR COLOR.

SN 85-424,798, FILED 9-16-2011.

ANDREW RHIM, EXAMINING ATTORNEY



*David J. Kybas*

Director of the United States Patent and Trademark Office

# United States of America

United States Patent and Trademark Office

# EZ AIR

**Reg. No. 4,199,983**

WHELDOK, LLC (OKLAHOMA LIMITED LIABILITY COMPANY)  
P.O. BOX 1927  
STILLWATER, OK 74076

**Registered Aug. 28, 2012**

**Int. Cl.: 12**

FOR: EXTENSION KITS FOR INFLATION VALVES OF MOTORCYCLE SHOCK ABSORBERS,  
IN CLASS 12 (U.S. CLS. 19, 21, 23, 31, 35 AND 44).

**TRADEMARK**

FIRST USE 12-21-2011; IN COMMERCE 12-21-2011.

**PRINCIPAL REGISTER**

THE MARK CONSISTS OF STANDARD CHARACTERS WITHOUT CLAIM TO ANY PARTICULAR FONT, STYLE, SIZE, OR COLOR.

SN 85-424,808, FILED 9-16-2011.

BRETT J. GOLDEN, EXAMINING ATTORNEY



*David J. Kybas*

Director of the United States Patent and Trademark Office

# United States of America

United States Patent and Trademark Office

# Stowbee

**Reg. No. 4,199,984**

HABAKKUK HOLDINGS, LLC (INDIANA LIMITED LIABILITY COMPANY)  
233 E. 175TH STREET  
WESTFIELD, IN 46074

**Registered Aug. 28, 2012**

**Int. Cl.: 21**

FOR: TOILET PAPER HOLDERS, PAPER TOWEL HOLDERS AND FACIAL TISSUE HOLDERS, IN CLASS 21 (U.S. CLS. 2, 13, 23, 29, 30, 33, 40 AND 50).

**TRADEMARK**

FIRST USE 10-15-2011; IN COMMERCE 10-15-2011.

**PRINCIPAL REGISTER**

THE MARK CONSISTS OF STANDARD CHARACTERS WITHOUT CLAIM TO ANY PARTICULAR FONT, STYLE, SIZE, OR COLOR.

SN 85-425,689, FILED 9-19-2011.

WILLIAM JACKSON, EXAMINING ATTORNEY



*David J. Kyffers*

Director of the United States Patent and Trademark Office

# United States of America

United States Patent and Trademark Office

## WORD'S OUT

**Reg. No. 4,199,985**

**Registered Aug. 28, 2012**

**Int. Cl.: 28**

**TRADEMARK**

**PRINCIPAL REGISTER**

JAX LTD., INC. (MINNESOTA CORPORATION)  
141 CHESHIRE LANE N.  
SUITE 100  
PLYMOUTH, MN 55441

FOR: GAMES, NAMELY, A CARD AND BOARD GAME, IN CLASS 28 (U.S. CLS. 22, 23, 38 AND 50).

FIRST USE 5-23-2012; IN COMMERCE 5-23-2012.

THE MARK CONSISTS OF STANDARD CHARACTERS WITHOUT CLAIM TO ANY PARTICULAR FONT, STYLE, SIZE, OR COLOR.

SN 85-425,802, FILED 9-19-2011.

JORDAN BAKER, EXAMINING ATTORNEY



*David J. Kyffers*

Director of the United States Patent and Trademark Office



# United States of America

United States Patent and Trademark Office

## SPORTSFLUFFIES

**Reg. No. 4,199,986**

ADKINS, JILL (UNITED STATES INDIVIDUAL)  
5132 COCHRAN DRIVE  
NASHVILLE, TN 37220

**Registered Aug. 28, 2012**

**Int. Cl.: 25**

FOR: BOOT ACCESSORIES, NAMELY, FITTED DECORATIVE COVERS FOR BOOTS; LEG WARMERS, IN CLASS 25 (U.S. CLS. 22 AND 39).

**TRADEMARK**

FIRST USE 9-25-2011; IN COMMERCE 9-25-2011.

**PRINCIPAL REGISTER**

THE MARK CONSISTS OF STANDARD CHARACTERS WITHOUT CLAIM TO ANY PARTICULAR FONT, STYLE, SIZE, OR COLOR.

SN 85-426,485, FILED 9-19-2011.

TARAH HARDY, EXAMINING ATTORNEY



*David J. Kybas*

Director of the United States Patent and Trademark Office

# United States of America

United States Patent and Trademark Office

## Sonny the Seal

**Reg. No. 4,199,987**

GOLAD, ADAR (NETHERLANDS INDIVIDUAL)  
SCHERENENKWEG 16

**Registered Aug. 28, 2012**

HATTEM, NETHERLANDS 8051KH

**Int. Cl.: 28**

FOR: ACTION SKILL GAMES; ACTION TARGET GAMES; EQUIPMENT SOLD AS A UNIT FOR PLAYING ACTION TYPE TARGET GAMES; RING GAMES, IN CLASS 28 (U.S. CLS. 22, 23, 38 AND 50).

**TRADEMARK**

FIRST USE 10-4-2011; IN COMMERCE 11-12-2011.

**PRINCIPAL REGISTER**

THE MARK CONSISTS OF STANDARD CHARACTERS WITHOUT CLAIM TO ANY PARTICULAR FONT, STYLE, SIZE, OR COLOR.

SN 85-426,616, FILED 9-20-2011.

ELI HELLMAN, EXAMINING ATTORNEY



*David J. Kybas*

Director of the United States Patent and Trademark Office

# United States of America

United States Patent and Trademark Office

## SAMBULANCE

**Reg. No. 4,199,988**

SAHARA SAM'S OASIS, LLC (NEW JERSEY LIMITED LIABILITY COMPANY)  
535 N. ROUTE 73

**Registered Aug. 28, 2012**

WEST BERLIN, NJ 08091

**Int. Cl.: 41**

FOR: EDUCATIONAL SERVICES, NAMELY, PROVIDING CLASSES, SEMINARS, WORKSHOPS AND TRAINING IN THE FIELDS OF CPR AND FIRST AID; EDUCATIONAL SERVICES, NAMELY, PROVIDING CLASSES, SEMINARS, WORKSHOPS AND TRAINING IN THE FIELDS OF POOL OPERATION, CARE AND WATER TREATMENT, IN CLASS 41 (U.S. CLS. 100, 101 AND 107).

**SERVICE MARK**

**PRINCIPAL REGISTER**

FIRST USE 1-0-2012; IN COMMERCE 1-0-2012.

THE MARK CONSISTS OF STANDARD CHARACTERS WITHOUT CLAIM TO ANY PARTICULAR FONT, STYLE, SIZE, OR COLOR.

SN 85-426,726, FILED 9-20-2011.

TINA MAI, EXAMINING ATTORNEY



*David J. Kypos*

Director of the United States Patent and Trademark Office

# United States of America

United States Patent and Trademark Office

# KIDIPLAY

**Reg. No. 4,199,989**

INGENGO LLC (NEW YORK LIMITED LIABILITY COMPANY)  
PO BOX 771

**Registered Aug. 28, 2012**

WURTSBORO, NY 12790

**Int. Cl.: 9**

FOR: COMPUTER APPLICATION SOFTWARE FOR MOBILE PHONES, TABLETS, PORTABLE, HANDHELD, DIGITAL AND TOUCHSCREEN DEVICES, NAMELY, SOFTWARE FOR USE IN THE FIELD OF CHILDREN'S EDUCATION AND ENTERTAINMENT, IN CLASS 9 (U.S. CLS. 21, 23, 26, 36 AND 38).

**TRADEMARK**

**PRINCIPAL REGISTER**

FIRST USE 12-15-2011; IN COMMERCE 12-15-2011.

THE MARK CONSISTS OF STANDARD CHARACTERS WITHOUT CLAIM TO ANY PARTICULAR FONT, STYLE, SIZE, OR COLOR.

SN 85-427,012, FILED 9-20-2011.

VERNA BETH RIRIE, EXAMINING ATTORNEY



*David J. Kyffers*

Director of the United States Patent and Trademark Office

# United States of America

United States Patent and Trademark Office

# KIDILEARN

**Reg. No. 4,199,990**

INGENGO LLC (NEW YORK LIMITED LIABILITY COMPANY)  
PO BOX 771

**Registered Aug. 28, 2012**

WURTSBORO, NY 12790

**Int. Cl.: 9**

FOR: COMPUTER APPLICATION SOFTWARE FOR MOBILE PHONES, TABLETS, PORTABLE, HANDHELD, DIGITAL AND TOUCHSCREEN DEVICES, NAMELY, SOFTWARE FOR USE IN THE FIELD OF CHILDREN'S EDUCATION AND ENTERTAINMENT, IN CLASS 9 (U.S. CLS. 21, 23, 26, 36 AND 38).

**TRADEMARK**

**PRINCIPAL REGISTER**

FIRST USE 12-18-2011; IN COMMERCE 12-18-2011.

THE MARK CONSISTS OF STANDARD CHARACTERS WITHOUT CLAIM TO ANY PARTICULAR FONT, STYLE, SIZE, OR COLOR.

SN 85-427,031, FILED 9-20-2011.

VERNA BETH RIRIE, EXAMINING ATTORNEY



*David J. Kyffers*

Director of the United States Patent and Trademark Office

# United States of America

United States Patent and Trademark Office

## MALIBU WAVES

**Reg. No. 4,199,991**

BATH & BODY WORKS BRAND MANAGEMENT, INC. (DELAWARE CORPORATION)  
SEVEN LIMITED PARKWAY  
REYNOLDSBURG, OH 43068

**Registered Aug. 28, 2012**

**Int. Cl.: 3**

FOR: PERSONAL CARE PRODUCTS, NAMELY, HAIR CARE CREAMS, HAIR CONDITIONERS, HAIR GELS, HAIR POMADES, HAIR SHAMPOO, HAIR STYLING MISTS, IN CLASS 3 (U.S. CLS. 1, 4, 6, 50, 51 AND 52).

**TRADEMARK**

FIRST USE 3-5-2012; IN COMMERCE 3-5-2012.

**PRINCIPAL REGISTER**

THE MARK CONSISTS OF STANDARD CHARACTERS WITHOUT CLAIM TO ANY PARTICULAR FONT, STYLE, SIZE, OR COLOR.

SN 85-427,150, FILED 9-20-2011.

ANDREA BUTLER, EXAMINING ATTORNEY



*David J. Kyffers*

Director of the United States Patent and Trademark Office

# United States of America

United States Patent and Trademark Office



## neverthirst

**Reg. No. 4,199,992**

**Registered Aug. 28, 2012**

**Int. Cl.: 32**

**TRADEMARK**

**PRINCIPAL REGISTER**

NEVER THIRST, INC. (ARKANSAS NON-PROFIT CORPORATION)  
PO BOX 464  
SPARKMAN, AR 71763

FOR: DRINKING WATER, IN CLASS 32 (U.S. CLS. 45, 46 AND 48).

FIRST USE 6-23-2011; IN COMMERCE 6-23-2011.

THE MARK CONSISTS OF A SHADOWED DROPLET CENTERED ABOVE THE WORD "NEVER THIRST".

SN 85-427,157, FILED 9-20-2011.

MICHAEL WEBSTER, EXAMINING ATTORNEY



*David J. Kybas*

Director of the United States Patent and Trademark Office

# United States of America

United States Patent and Trademark Office

# LIBERTY

**Reg. No. 4,199,993**

UNISOURCE WORLDWIDE, INC. (DELAWARE CORPORATION)  
6600 GOVERNORS LAKE PARKWAY  
NORCROSS, GA 30071

**Registered Aug. 28, 2012**

**Int. Cl.: 17**

FOR: PLASTIC FLEXIBLE PACKAGING FILM SOLD IN BULK TO INDUSTRIAL AND COMMERCIAL MANUFACTURERS, IN CLASS 17 (U.S. CLS. 1, 5, 12, 13, 35 AND 50).

**TRADEMARK**

FIRST USE 11-29-2011; IN COMMERCE 11-29-2011.

**PRINCIPAL REGISTER**

THE MARK CONSISTS OF STANDARD CHARACTERS WITHOUT CLAIM TO ANY PARTICULAR FONT, STYLE, SIZE, OR COLOR.

SN 85-428,598, FILED 9-21-2011.

JAMES GRIFFIN, EXAMINING ATTORNEY



*David J. Kyffers*

Director of the United States Patent and Trademark Office



# United States of America

United States Patent and Trademark Office

# WINGMAN

**Reg. No. 4,199,994**

**Registered Aug. 28, 2012**

**Int. Cl.: 9**

**TRADEMARK**

**PRINCIPAL REGISTER**

LIMA WINGMAN LLC (PENNSYLVANIA LIMITED LIABILITY COMPANY)  
5624 BARTLETT ST.  
PITTSBURGH, PA 15217

FOR: COMPUTER APPLICATION SOFTWARE FOR MOBILE PHONES, NAMELY, SOFTWARE FOR PAYMENT PROCESSING AND PURCHASING OF GOODS OR SERVICES, IN CLASS 9 (U.S. CLS. 21, 23, 26, 36 AND 38).

FIRST USE 4-1-2012; IN COMMERCE 5-1-2012.

THE MARK CONSISTS OF STANDARD CHARACTERS WITHOUT CLAIM TO ANY PARTICULAR FONT, STYLE, SIZE, OR COLOR.

SN 85-428,852, FILED 9-22-2011.

BRENDAN REGAN, EXAMINING ATTORNEY



*David J. Kyffers*

Director of the United States Patent and Trademark Office

# United States of America

United States Patent and Trademark Office

## BELLE AND CLIVE

**Reg. No. 4,199,995**

BLUEFLY, INC. (DELAWARE CORPORATION)  
42 WEST 39TH STREET, 9TH FLOOR  
NEW YORK, NY 10018

**Registered Aug. 28, 2012**

**Int. Cl.: 35**

FOR: ON-LINE RETAIL STORE SERVICES FEATURING APPAREL, ACCESSORIES, AND HOME FURNISHINGS, IN CLASS 35 (U.S. CLS. 100, 101 AND 102).

**SERVICE MARK**

FIRST USE 12-13-2011; IN COMMERCE 12-13-2011.

**PRINCIPAL REGISTER**

THE MARK CONSISTS OF STANDARD CHARACTERS WITHOUT CLAIM TO ANY PARTICULAR FONT, STYLE, SIZE, OR COLOR.

SN 85-429,665, FILED 9-22-2011.

TASHIA BUNCH, EXAMINING ATTORNEY



*David J. Kybas*

Director of the United States Patent and Trademark Office

# United States of America

United States Patent and Trademark Office



**Reg. No. 4,199,996**

ROWZEE, ROBERT (UNITED STATES INDIVIDUAL)  
14580 HIGH STREET  
THORNTON, CO 80602

**Registered Aug. 28, 2012**

**Int. Cl.: 9**

FOR: EYEWEAR, IN CLASS 9 (U.S. CLS. 21, 23, 26, 36 AND 38).

**TRADEMARK**

FIRST USE 4-5-2011; IN COMMERCE 4-5-2011.

**PRINCIPAL REGISTER**

THE MARK CONSISTS OF A RECTANGLE CONTAINING A STYLIZED LETTER "S" FORMED FROM TWO LIGHTNING BOLTS WHICH APPEARS TO THE LEFT OF THE STYLIZED TERM "SKELETON".

SN 85-429,825, FILED 9-22-2011.

NELSON SNYDER, EXAMINING ATTORNEY



*David J. Kybas*

Director of the United States Patent and Trademark Office

# United States of America

United States Patent and Trademark Office

# KIDISMART

**Reg. No. 4,199,997**

INGENGO LLC (NEW YORK LIMITED LIABILITY COMPANY)  
PO BOX 771

**Registered Aug. 28, 2012**

WURTSBORO, NY 12790

**Int. Cl.: 41**

FOR: PROVIDING A WEBSITE FEATURING BLOGS AND NON-DOWNLOADABLE PUBLICATIONS IN THE NATURE OF ARTICLES AND REVIEWS IN THE FIELD(S) OF ELECTRONIC GAME PROGRAMS AND PRODUCTS, FAMILY, PARENTING, LIFESTYLE, CHILDREN'S EDUCATION AND ENTERTAINMENT; PROVIDING A WEBSITE FEATURING INFORMATION IN THE FIELDS OF EDUCATION AND ENTERTAINMENT FOR CHILDREN; PROVIDING INFORMATION IN THE FIELD OF CHILDREN'S EDUCATION; PROVISION OF INFORMATION RELATING TO CHILDREN'S ENTERTAINMENT, IN CLASS 41 (U.S. CLS. 100, 101 AND 107).

**SERVICE MARK**

**PRINCIPAL REGISTER**

FIRST USE 12-15-2011; IN COMMERCE 12-15-2011.

THE MARK CONSISTS OF STANDARD CHARACTERS WITHOUT CLAIM TO ANY PARTICULAR FONT, STYLE, SIZE, OR COLOR.

SN 85-430,017, FILED 9-23-2011.

VERNA BETH RIRIE, EXAMINING ATTORNEY



*David J. Kyffers*

Director of the United States Patent and Trademark Office

# United States of America

United States Patent and Trademark Office

# Kitchen Thyme

**Reg. No. 4,199,998**

**Registered Aug. 28, 2012**

**Int. Cl.: 43**

**SERVICE MARK**

**PRINCIPAL REGISTER**

KITCHEN THYME, LLC (VIRGINIA LIMITED LIABILITY COMPANY), DBA KITCHEN THYME,  
7801-25 WEST BROAD STREET  
RICHMOND, VA 23294

FOR: PROVIDING TEMPORARY KITCHEN FACILITIES, IN CLASS 43 (U.S. CLS. 100 AND 101).

FIRST USE 10-1-2011; IN COMMERCE 10-1-2011.

NO CLAIM IS MADE TO THE EXCLUSIVE RIGHT TO USE "KITCHEN", APART FROM THE MARK AS SHOWN.

THE MARK CONSISTS OF THE WORD "KITCHEN" ARRANGED OVER THE WORD "THYME" DISPLAYED IN A STYLIZED FONT.

SN 85-431,850, FILED 9-26-2011.

JOHN GARTNER, EXAMINING ATTORNEY



*David J. Kybas*

Director of the United States Patent and Trademark Office

# United States of America

United States Patent and Trademark Office

# SWAGEFORM

**Reg. No. 4,199,999**

SEMS AND SPECIALS, INC. (ILLINOIS CORPORATION)  
6483 FALCON ROAD  
ROCKFORD, IL 61109

**Registered Aug. 28, 2012**

**Int. Cl.: 6**

FOR: METAL SELF-TAPPING SCREWS, IN CLASS 6 (U.S. CLS. 2, 12, 13, 14, 23, 25 AND 50).

**TRADEMARK**

FIRST USE 1-0-2002; IN COMMERCE 1-0-2002.

**PRINCIPAL REGISTER**

THE MARK CONSISTS OF STANDARD CHARACTERS WITHOUT CLAIM TO ANY PARTICULAR FONT, STYLE, SIZE, OR COLOR.

SN 85-432,017, FILED 9-26-2011.

KATHLEEN KOLACZ, EXAMINING ATTORNEY



*David J. Kybas*

Director of the United States Patent and Trademark Office

# United States of America

United States Patent and Trademark Office

# Tru) Hearing

**Reg. No. 4,200,000**

**Registered Aug. 28, 2012**

**Int. Cls.: 10 and 44**

**TRADEMARK**

**SERVICE MARK**

**PRINCIPAL REGISTER**

TRUHEARING, INC. (UTAH CORPORATION)  
9071 SOUTH 1300 WEST  
WEST JORDON, UT 84088

FOR: HEARING AIDS, IN CLASS 10 (U.S. CLS. 26, 39 AND 44).

FIRST USE 11-13-2011; IN COMMERCE 11-13-2011.

FOR: HEARING AID SERVICES , IN CLASS 44 (U.S. CLS. 100 AND 101).

FIRST USE 11-13-2011; IN COMMERCE 11-13-2011.

OWNER OF U.S. REG. NOS. 2,961,127 AND 2,973,590.

NO CLAIM IS MADE TO THE EXCLUSIVE RIGHT TO USE "HEARING", APART FROM THE MARK AS SHOWN.

THE MARK CONSISTS OF THE WORD "TRU" WITH A THREE PARENTHESIS MARK LIKE DESIGN THAT IS TOGETHER AT THE BOTTOM AND FANS OUT AT THE TOP WITH THE WORD "HEARING" AFTER.

SN 85-432,928, FILED 9-27-2011.

MARK SHINER, EXAMINING ATTORNEY



*David J. Kybas*

Director of the United States Patent and Trademark Office

# United States of America

United States Patent and Trademark Office

# ENDURANCE

**Reg. No. 4,200,001**

UNIVERSAL COOPERATIVES, INC. (MINNESOTA CORPORATION)  
1300 CORPORATE CENTER CURVE  
EAGAN, MN 55121

**Registered Aug. 28, 2012**

**Int. Cl.: 22**

FOR: TWINE, BALING TWINE, TYING TWINE, BALER AND BINDER TWINE, AND BUNDLING TWINE, IN CLASS 22 (U.S. CLS. 1, 2, 7, 19, 22, 42 AND 50).

**TRADEMARK**

FIRST USE 12-7-2011; IN COMMERCE 12-7-2011.

**PRINCIPAL REGISTER**

THE MARK CONSISTS OF STANDARD CHARACTERS WITHOUT CLAIM TO ANY PARTICULAR FONT, STYLE, SIZE, OR COLOR.

SN 85-433,332, FILED 9-27-2011.

JULIE GUTTADAURO, EXAMINING ATTORNEY



*David J. Kyffers*

Director of the United States Patent and Trademark Office



# United States of America

United States Patent and Trademark Office

# PLAYTECH

**Reg. No. 4,200,002**

**Registered Aug. 28, 2012**

**Int. Cl.: 28**

**TRADEMARK**

**PRINCIPAL REGISTER**

CREATIVE IMPACT INC. (BR.VIRGIN ISLANDS CORPORATION)  
P.O. BOX 957, OFFSHORE INCORPORATIONS  
CENTRE, ROAD TOWN  
TORTOLA, BR.VIRGIN ISLANDS 957

FOR: TOYS, GAMES AND PLAYTHINGS, NAMELY, ELECTRIC ACTION TOYS, BATTERY OPERATED ACTION TOYS, R/C CREATURES, R/C AQUATIC TOYS, R/C VEHICLES AND CRAFT, TOY R/C FIGURES, IN CLASS 28 (U.S. CLS. 22, 23, 38 AND 50).

FIRST USE 9-20-2011; IN COMMERCE 1-5-2012.

THE MARK CONSISTS OF STANDARD CHARACTERS WITHOUT CLAIM TO ANY PARTICULAR FONT, STYLE, SIZE, OR COLOR.

SN 85-433,650, FILED 9-28-2011.

ELLEN B. AWRICH, EXAMINING ATTORNEY



*David J. Kyffers*

Director of the United States Patent and Trademark Office

# United States of America

## United States Patent and Trademark Office



### CONSTRUCTIVE CHAOS

**Reg. No. 4,200,003**

**Registered Aug. 28, 2012**

**Int. Cl.: 41**

**SERVICE MARK**

**PRINCIPAL REGISTER**

CONSTRUCTIVE CHAOS, LLC (ILLINOIS LIMITED LIABILITY COMPANY)  
349 ASHLAND AVENUE  
RIVER FOREST, IL 60305

FOR: EDUCATIONAL SERVICES, NAMELY, CONDUCTING CLASSES IN THE FIELD OF VISUAL AND CULINARY ARTS AND DISTRIBUTION OF EDUCATIONAL MATERIALS IN CONNECTION THEREWITH; ENTERTAINMENT SERVICES, NAMELY, CONDUCTING PARTIES, IN CLASS 41 (U.S. CLS. 100, 101 AND 107).

FIRST USE 1-1-2012; IN COMMERCE 3-1-2012.

NO CLAIM IS MADE TO THE EXCLUSIVE RIGHT TO USE "CULINARY" AND "ARTISTIC", APART FROM THE MARK AS SHOWN.

THE COLOR(S) GREEN, BROWN AND WHITE IS/ARE CLAIMED AS A FEATURE OF THE MARK.

THE MARK CONSISTS OF LITERAL ELEMENTS "A CULINARY AND ARTISTIC EXPERIENCE" APPEARING ABOVE A CIRCLE CONTAINING TWO "C'S", A PAINT BRUSH AND A WHISK. THE TWO "C'S" MIRROR EACH OTHER, THE PAINT BRUSH AND WHISK ARE CROSSED. LITERAL ELEMENTS "CONSTRUCTIVE CHAOS" APPEAR BELOW THE CIRCLE. ALL LITERAL ELEMENTS ARE IN BROWN, CIRCLE HAS A GREEN CENTER WITH A BROWN AND WHITE BORDER, AND THE PAINT BRUSH AND WHISK ARE IN BROWN AND WHITE.

SN 85-434,018, FILED 9-28-2011.

TEJBIR SINGH, EXAMINING ATTORNEY



*David J. Kypos*

Director of the United States Patent and Trademark Office

# United States of America

United States Patent and Trademark Office

## FLYING BUTTRESS

**Reg. No. 4,200,004**

OH WELL DESIGNS LLC (CALIFORNIA LIMITED LIABILITY COMPANY)

**Registered Aug. 28, 2012**

531 MAIN STREET, #601  
EL SEGUNDO, CA 90245

**Int. Cls.: 9, 18, and 21**

FOR: CARRYING CASES FOR ELECTRONIC EQUIPMENT, NAMELY, TABLETS, IN CLASS 9 (U.S. CLS. 21, 23, 26, 36 AND 38).

**TRADEMARK**

FIRST USE 5-28-2012; IN COMMERCE 5-28-2012.

**PRINCIPAL REGISTER**

FOR: HANDBAGS; INTERCHANGEABLE DECORATIVE COVERS FOR ACCESSORIZATION PURPOSES THAT ARE SPECIALLY ADAPTED TO HANDBAGS, IN CLASS 18 (U.S. CLS. 1, 2, 3, 22 AND 41).

FIRST USE 5-28-2012; IN COMMERCE 5-28-2012.

FOR: LUNCH BOXES, IN CLASS 21 (U.S. CLS. 2, 13, 23, 29, 30, 33, 40 AND 50).

FIRST USE 5-28-2012; IN COMMERCE 5-28-2012.

THE MARK CONSISTS OF STANDARD CHARACTERS WITHOUT CLAIM TO ANY PARTICULAR FONT, STYLE, SIZE, OR COLOR.

SN 85-434,080, FILED 9-28-2011.

BRENDAN REGAN, EXAMINING ATTORNEY



*David J. Kybas*

Director of the United States Patent and Trademark Office

# United States of America

United States Patent and Trademark Office



**Reg. No. 4,200,005**

**Registered Aug. 28, 2012**

**Int. Cls.: 9, 18, and 21**

**TRADEMARK**

**PRINCIPAL REGISTER**

OH WELL DESIGNS LLC (CALIFORNIA LIMITED LIABILITY COMPANY)  
531 MAIN STREET, #601  
EL SEGUNDO, CA 90245

FOR: CARRYING CASES FOR ELECTRONIC EQUIPMENT, NAMELY, TABLETS, IN CLASS 9 (U.S. CLS. 21, 23, 26, 36 AND 38).

FIRST USE 5-28-2012; IN COMMERCE 5-28-2012.

FOR: HANDBAGS; INTERCHANGEABLE DECORATIVE COVERS FOR ACCESSORIZATION PURPOSES THAT ARE SPECIALLY ADAPTED TO HANDBAGS, IN CLASS 18 (U.S. CLS. 1, 2, 3, 22 AND 41).

FIRST USE 5-28-2012; IN COMMERCE 5-28-2012.

FOR: LUNCH BOXES, IN CLASS 21 (U.S. CLS. 2, 13, 23, 29, 30, 33, 40 AND 50).

FIRST USE 5-28-2012; IN COMMERCE 5-28-2012.

THE MARK CONSISTS OF A STYLIZED REPRESENTATION OF A BUTTERFLY.

SN 85-434,091, FILED 9-28-2011.

BRENDAN REGAN, EXAMINING ATTORNEY



*David J. Kybas*

Director of the United States Patent and Trademark Office

United States of America  
United States Patent and Trademark Office

yuvia

**Reg. No. 4,200,006**

FISCHLER, ERIC (UNITED STATES INDIVIDUAL)  
98 CAZNEAU AVE  
SAUSALITO, CA 94965 AND

**Registered Aug. 28, 2012**

**Int. Cl.: 5**

BAHA, WALID (UNITED STATES INDIVIDUAL)  
6026 CALVERT CIRCLE  
SAN RAMON, CA 94582

**TRADEMARK**

**PRINCIPAL REGISTER**

FOR: DIETARY SUPPLEMENTAL DRINKS IN THE NATURE OF VITAMIN AND MINERAL BEVERAGES , IN CLASS 5 (U.S. CLS. 6, 18, 44, 46, 51 AND 52).

FIRST USE 4-1-2012; IN COMMERCE 5-1-2012.

THE MARK CONSISTS OF THE WORD "YUVIA" IN BLACK WITH A GREEN LEAF OVER THE "I".

THE COLOR(S) BLACK AND GREEN IS/ARE CLAIMED AS A FEATURE OF THE MARK.

SN 85-434,121, FILED 9-28-2011.

SAMUEL E. SHARPER JR., EXAMINING ATTORNEY



*David J. Kyros*

Director of the United States Patent and Trademark Office

# United States of America

United States Patent and Trademark Office

## EDGE OF GLORY

**Reg. No. 4,200,007**

TELEBRANDS CORP. (NEW JERSEY CORPORATION)  
79 TWO BRIDGES ROAD  
FAIRFIELD, NJ 07004

**Registered Aug. 28, 2012**

**Int. Cl.: 8**

FOR: KNIFE SHARPENER, IN CLASS 8 (U.S. CLS. 23, 28 AND 44).

**TRADEMARK**

FIRST USE 11-14-2011; IN COMMERCE 11-14-2011.

**PRINCIPAL REGISTER**

THE MARK CONSISTS OF STANDARD CHARACTERS WITHOUT CLAIM TO ANY PARTICULAR FONT, STYLE, SIZE, OR COLOR.

SN 85-434,122, FILED 9-28-2011.

SAMUEL E. SHARPER JR., EXAMINING ATTORNEY



*David J. Kyffers*

Director of the United States Patent and Trademark Office

United States of America  
United States Patent and Trademark Office

**MEGA**  
**SHOES**

**Reg. No. 4,200,008**

MEGA SHOES, INC. (FLORIDA CORPORATION)  
2090 N. MIAMI AVE.  
MIAMI, FL 33127

**Registered Aug. 28, 2012**

**Int. Cl.: 35**

FOR: WHOLESALE AND RETAIL DISTRIBUTORSHIP SERVICES IN THE FIELD OF FOOTWEAR, IN CLASS 35 (U.S. CLS. 100, 101 AND 102).

**SERVICE MARK**

FIRST USE 8-1-2011; IN COMMERCE 1-1-2012.

**PRINCIPAL REGISTER**

OWNER OF U.S. REG. NO. 3,748,641.

NO CLAIM IS MADE TO THE EXCLUSIVE RIGHT TO USE "SHOES", APART FROM THE MARK AS SHOWN.

THE MARK CONSISTS OF THE WORD "MEGA" IN STYLIZED WRITING POSITIONED ABOVE THE WORD "SHOES".

SN 85-434,165, FILED 9-28-2011.

DOMINIC J. FERRAIUOLO, EXAMINING ATTORNEY



*David J. Kyffers*

Director of the United States Patent and Trademark Office

# United States of America

United States Patent and Trademark Office

## THE ULTIMATE MATCH-UP

**Reg. No. 4,200,009**

PEPSICO, INC. (NORTH CAROLINA CORPORATION)  
700 ANDERSON HILL ROAD  
PURCHASE, NY 10577

**Registered Aug. 28, 2012**

**Int. Cl.: 32**

FOR: SOFT DRINKS, IN CLASS 32 (U.S. CLS. 45, 46 AND 48).

**TRADEMARK**

FIRST USE 1-2-2012; IN COMMERCE 1-2-2012.

**PRINCIPAL REGISTER**

THE MARK CONSISTS OF STANDARD CHARACTERS WITHOUT CLAIM TO ANY PARTICULAR FONT, STYLE, SIZE, OR COLOR.

SN 85-434,668, FILED 9-28-2011.

MARK SPARACINO, EXAMINING ATTORNEY



*David J. Kyffers*

Director of the United States Patent and Trademark Office



# United States of America

United States Patent and Trademark Office

## For Guys Only

**Reg. No. 4,200,010**

THREE ANGELS BROADCASTING NETWORK, INC. (ILLINOIS CORPORATION)  
P.O. BOX 220

**Registered Aug. 28, 2012**

WEST FRANKFORT, IL 62896

**Int. Cl.: 41**

FOR: EDUCATIONAL AND ENTERTAINMENT SERVICES, NAMELY, A CONTINUING PROGRAM ABOUT CHRISTIANITY, NAMELY, CHRISTIAN TALK SHOW ABOUT MALE CHALLENGES ACCESSIBLE BY RADIO, TELEVISION, SATELLITE, AUDIO, VIDEO AND COMPUTER NETWORKS, IN CLASS 41 (U.S. CLS. 100, 101 AND 107).

**SERVICE MARK**

**PRINCIPAL REGISTER**

FIRST USE 4-0-2012; IN COMMERCE 4-0-2012.

THE MARK CONSISTS OF STANDARD CHARACTERS WITHOUT CLAIM TO ANY PARTICULAR FONT, STYLE, SIZE, OR COLOR.

NO CLAIM IS MADE TO THE EXCLUSIVE RIGHT TO USE "GUYS", APART FROM THE MARK AS SHOWN.

SN 85-434,749, FILED 9-28-2011.

LINDA MICKLEBURGH, EXAMINING ATTORNEY



*David J. Kyjars*

Director of the United States Patent and Trademark Office

# United States of America

United States Patent and Trademark Office

## Do Good Kids Kids Doing Good

**Reg. No. 4,200,011**

ORIENTE, LISA (CANADA INDIVIDUAL)  
240 MARY STREET

**Registered Aug. 28, 2012**

PORT PERRY, CANADA

**Int. Cl.: 35**

FOR: CHARITABLE SERVICES, NAMELY, ORGANIZING YOUTH GROUPS TO UNDERTAKE PROJECTS TO BENEFIT THE NEEDY AND THE COMMUNITY TO ENCOURAGE LEADERSHIP, CHARACTER, COMPASSION, AND GOOD CITIZENSHIP, IN CLASS 35 (U.S. CLS. 100, 101 AND 102).

**SERVICE MARK**

**PRINCIPAL REGISTER**

FIRST USE 2-1-2012; IN COMMERCE 3-3-2012.

THE MARK CONSISTS OF STANDARD CHARACTERS WITHOUT CLAIM TO ANY PARTICULAR FONT, STYLE, SIZE, OR COLOR.

SN 85-435,004, FILED 9-29-2011.

KAREN K. BUSH, EXAMINING ATTORNEY



*David J. Kyffers*

Director of the United States Patent and Trademark Office

# United States of America

United States Patent and Trademark Office

# SmartPulse

**Reg. No. 4,200,012**

**Registered Aug. 28, 2012**

**Int. Cl.: 9**

**TRADEMARK**

**PRINCIPAL REGISTER**

DIALOG SEMICONDUCTOR GMBH (FED REP GERMANY CORPORATION)  
NEUE STRASSE 95  
KIRCHHEIM/TECK-NABERN, FED REP GERMANY D-73230

FOR: INTEGRATED CIRCUITS; INTEGRATED CIRCUIT MODULES; INTEGRATED CIRCUITS, INTEGRATED CIRCUIT CHIPS AND INTEGRATED CIRCUIT MODULES FOR WIRELESS NETWORKS, WIRELESS SENSOR NETWORKS, HOME AUTOMATION, HOME SECURITY, HOME CARE AND SMART METERING; ELECTRONIC INTEGRATED CIRCUITS; SOFTWARE FOR CONTROLLING AND OPERATING WIRELESS SENSOR NETWORKS, AND FOR CONTROLLING AND OPERATING DEVICES THAT ARE PART OF THE WIRELESS SENSOR NETWORKS; DEVELOPMENT TOOLS, COMPRISING ELECTRONIC CIRCUIT BOARDS, ELECTRONIC CABLES, SOFTWARE AND DOCUMENTATION, FOR ASSISTING PRODUCT DEVELOPERS TO DESIGN NEW PRODUCTS, FOR WIRELESS SENSOR NETWORKS; REFERENCE DESIGNS, COMPRISING ELECTRONIC CIRCUIT BOARDS, ELECTRONIC CABLES, AND SOFTWARE FOR ASSISTING PRODUCT DEVELOPERS TO DESIGN NEW PRODUCTS, FOR WIRELESS SENSOR NETWORKS, IN CLASS 9 (U.S. CLS. 21, 23, 26, 36 AND 38).

FIRST USE 7-31-2011; IN COMMERCE 7-31-2011.

THE MARK CONSISTS OF STANDARD CHARACTERS WITHOUT CLAIM TO ANY PARTICULAR FONT, STYLE, SIZE, OR COLOR.

PRIORITY CLAIMED UNDER SEC. 44(D) ON ERPN CMNTY TM OFC APPLICATION NO. 010183879, FILED 8-8-2011.

SN 85-435,173, FILED 9-29-2011.

DAWN FELDMAN, EXAMINING ATTORNEY



*David J. Kyros*

Director of the United States Patent and Trademark Office

# United States of America

United States Patent and Trademark Office

## ARCTIC BLUE

**Reg. No. 4,200,013**

JAY-Y ENTERPRISE CO., INC. (CALIFORNIA CORPORATION)  
632 NEW YORK DRIVE  
POMONA, CA 91768

**Registered Aug. 28, 2012**

**Int. Cl.: 9**

FOR: SUNGLASSES, IN CLASS 9 (U.S. CLS. 21, 23, 26, 36 AND 38).

**TRADEMARK**

FIRST USE 2-2-2012; IN COMMERCE 2-2-2012.

**PRINCIPAL REGISTER**

THE MARK CONSISTS OF STANDARD CHARACTERS WITHOUT CLAIM TO ANY PARTICULAR FONT, STYLE, SIZE, OR COLOR.

SN 85-436,169, FILED 9-30-2011.

JOHN GARTNER, EXAMINING ATTORNEY



*David J. Kyffers*

Director of the United States Patent and Trademark Office

# United States of America

United States Patent and Trademark Office

# COCOFRÜT

**Reg. No. 4,200,014**

COCOFRUT, LLC (DELAWARE LIMITED LIABILITY COMPANY)  
815 SUMMIT ROAD  
NARBETH, PA 19072

**Registered Aug. 28, 2012**

**Int. Cls.: 30 and 43**

FOR: CHOCOLATE FONDUE; CHOCOLATE-COVERED FOOD PRODUCTS, NAMELY, FRUIT, WAFFLES, PRETZELS, MARSHMALLOWS AND POTATO CHIPS; CARAMEL-COVERED FOOD PRODUCTS, NAMELY, FRUIT, WAFFLES, PRETZELS, MARSHMALLOWS AND POTATO CHIPS, IN CLASS 30 (U.S. CL. 46).

**TRADEMARK**

**SERVICE MARK**

FIRST USE 9-15-2011; IN COMMERCE 6-1-2012.

**PRINCIPAL REGISTER**

FOR: RESTAURANT SERVICES, IN CLASS 43 (U.S. CLS. 100 AND 101).

FIRST USE 9-15-2011; IN COMMERCE 6-1-2012.

THE MARK CONSISTS OF STANDARD CHARACTERS WITHOUT CLAIM TO ANY PARTICULAR FONT, STYLE, SIZE, OR COLOR.

SN 85-436,284, FILED 9-30-2011.

JENNIFER VASQUEZ, EXAMINING ATTORNEY



*David J. Kypos*

Director of the United States Patent and Trademark Office

# United States of America

United States Patent and Trademark Office

## ZOMBIWOOD

**Reg. No. 4,200,015**

**Registered Aug. 28, 2012**

**Int. Cl.: 9**

**TRADEMARK**

**PRINCIPAL REGISTER**

GAMELOFT, S.A. (FRANCE CORPORATION)  
14, RUE AUBER  
PARIS, FRANCE 75009

FOR: COMPUTER SOFTWARE FOR ELECTRONIC GAMES AND ENTERTAINMENT, NAMELY, COMPUTER GAME SOFTWARE USED AND PLAYED ON MOBILE AND CELLULAR TELEPHONES, HANDHELD COMPUTERS, HANDHELD CONSOLES, HOME CONSOLES, PERSONAL COMPUTERS AND PERSONAL DIGITAL ASSISTANTS; DOWNLOADABLE ELECTRONIC GAME PROGRAMS; DOWNLOADABLE VOICE RINGERS FOR MOBILE TELECOMMUNICATIONS DEVICES; COMPUTER SOFTWARE FOR WALL PAPERS, NAMELY, STILL IMAGES FOR USE IN BACKGROUNDS ON MOBILE PHONE SCREENS; COMPUTER SCREEN SAVER SOFTWARE; COMPUTER SOFTWARE FOR PROCESSING ANIMATED IMAGES FOR USE ON MOBILE PHONE SCREENS; AND COMPUTER PROGRAMS FOR DOWNLOADING IMAGES TO MOBILE TELECOMMUNICATION DEVICES, NAMELY, MOBILE AND CELLULAR TELEPHONES, HANDHELD COMPUTERS, HANDHELD CONSOLES, HOME CONSOLES, PERSONAL COMPUTERS AND PERSONAL DIGITAL ASSISTANTS VIA THE GLOBAL COMPUTER NETWORK AND WIRELESS DEVICES; AND COMPUTER SOFTWARE FOR USE IN THE DESIGN, DEVELOPMENT AND EXECUTION OF WIRELESS COMPUTER GAMES, IN CLASS 9 (U.S. CLS. 21, 23, 26, 36 AND 38).

FIRST USE 3-7-2012; IN COMMERCE 3-7-2012.

THE MARK CONSISTS OF STANDARD CHARACTERS WITHOUT CLAIM TO ANY PARTICULAR FONT, STYLE, SIZE, OR COLOR.

SN 85-436,319, FILED 9-30-2011.

RICHARD WHITE, EXAMINING ATTORNEY



*David J. Kypos*

Director of the United States Patent and Trademark Office

# United States of America

United States Patent and Trademark Office

## BRICK HARBOR

**Reg. No. 4,200,016**

KARMALoop, INC. (DELAWARE CORPORATION)  
334 BOYLSTON STREET, 5TH FLOOR  
BOSTON, MA 02116

**Registered Aug. 28, 2012**

**Int. Cl.: 35**

FOR: ON-LINE RETAIL STORE SERVICES FEATURING APPAREL, FOOTWEAR, WATCHES, WALLETS, HATS, MESSENGER BAGS, TOTE BAGS, BACKPACKS, ALL-PURPOSES CARRYING BAGS, UNDERWEAR, BELTS, TOYS, HEADPHONES, SKATEBOARDS, SKATEBOARD ACCESSORIES, JEWELRY, SUNGLASSES, AND ACCESSORIES, IN CLASS 35 (U.S. CLS. 100, 101 AND 102).

**SERVICE MARK**

**PRINCIPAL REGISTER**

FIRST USE 4-4-2012; IN COMMERCE 4-4-2012.

THE MARK CONSISTS OF STANDARD CHARACTERS WITHOUT CLAIM TO ANY PARTICULAR FONT, STYLE, SIZE, OR COLOR.

SN 85-437,381, FILED 10-3-2011.

LINDA ORNDORFF, EXAMINING ATTORNEY



*David J. Kyffers*

Director of the United States Patent and Trademark Office

# United States of America

United States Patent and Trademark Office

# blu pepper

**Reg. No. 4,200,017**

EDGE CLOTHING, INC. (CALIFORNIA CORPORATION)  
1801 EAST 50TH STREET  
VERNON, CA 90058

**Registered Aug. 28, 2012**

**Int. Cls.: 25 and 35**

FOR: BLOUSES; BOTTOMS; CARDIGANS; COATS; DRESSES; PANTS; SCARVES; SHIRTS; SKIRTS; SWEATERS; SWIMWEAR; T-SHIRTS; TOPS; VESTS, IN CLASS 25 (U.S. CLS. 22 AND 39).

**TRADEMARK**

FIRST USE 1-1-2012; IN COMMERCE 1-1-2012.

**SERVICE MARK**

**PRINCIPAL REGISTER**

FOR: ON-LINE WHOLESALE AND RETAIL STORE SERVICES FEATURING CLOTHING, HANDBAG, AND CLOTHING ACCESSORIES ITEMS; WHOLESALE AND RETAIL STORE SERVICES AND ON-LINE RETAIL AND WHOLESALE STORE SERVICES FEATURING CLOTHING, HANDBAG, AND CLOTHING ACCESSORIES ITEMS, IN CLASS 35 (U.S. CLS. 100, 101 AND 102).

FIRST USE 1-1-2012; IN COMMERCE 1-1-2012.

THE MARK CONSISTS OF STANDARD CHARACTERS WITHOUT CLAIM TO ANY PARTICULAR FONT, STYLE, SIZE, OR COLOR.

SN 85-437,783, FILED 10-3-2011.

ANTHONY RINKER, EXAMINING ATTORNEY



*David J. Kybas*

Director of the United States Patent and Trademark Office



# United States of America

United States Patent and Trademark Office



**Reg. No. 4,200,018**

**Registered Aug. 28, 2012**

**Int. Cl.: 9**

**TRADEMARK**

**PRINCIPAL REGISTER**

RHI ENTERTAINMENT, LLC (DELAWARE LIMITED LIABILITY COMPANY)  
423 WEST 55TH STREET, 12TH FLOOR  
NEW YORK, NY 10019

FOR: PRE-RECORDED COMPACT DISCS, CDS AND DVDS FEATURING MOTION PICTURE FILMS, MINISERIES, TELEVISION SHOWS, MUSIC, MUSIC PERFORMANCES AND MUSIC VIDEOS, IN CLASS 9 (U.S. CLS. 21, 23, 26, 36 AND 38).

FIRST USE 9-20-2011; IN COMMERCE 9-20-2011.

OWNER OF U.S. REG. NOS. 3,843,184, 3,851,742, AND OTHERS.

NO CLAIM IS MADE TO THE EXCLUSIVE RIGHT TO USE "ENTERTAINMENT", APART FROM THE MARK AS SHOWN.

THE MARK CONSISTS OF THE LETTERS "RHI" IN STYLIZED LETTERING LOCATED WITHIN A SHADED RECTANGLE, BELOW WHICH IS THE WORD "ENTERTAINMENT" IN STYLIZED LETTERING.

SN 85-437,932, FILED 10-3-2011.

LANA PHAM, EXAMINING ATTORNEY



*David J. Kyjars*

Director of the United States Patent and Trademark Office

# United States of America

United States Patent and Trademark Office



**Reg. No. 4,200,019**

**Registered Aug. 28, 2012**

**Int. Cl.: 41**

**SERVICE MARK**

**PRINCIPAL REGISTER**

RHI ENTERTAINMENT, LLC (DELAWARE LIMITED LIABILITY COMPANY)  
423 WEST 55TH STREET, 12TH FLOOR  
NEW YORK, NY 10019

FOR: ENTERTAINMENT SERVICES, NAMELY, PRODUCTION AND DISTRIBUTION OF MOTION PICTURE FILMS, MINISERIES, TELEVISION SHOWS, MUSIC PERFORMANCE TELEVISION SHOWS AND MUSIC VIDEOS; MOTION PICTURE SONG PRODUCTION; PRODUCTION OF MUSIC PERFORMANCES AND LIVE MUSIC PERFORMANCE SHOWS, IN CLASS 41 (U.S. CLS. 100, 101 AND 107).

FIRST USE 9-20-2011; IN COMMERCE 9-20-2011.

OWNER OF U.S. REG. NOS. 3,843,184, 3,851,742, AND OTHERS.

NO CLAIM IS MADE TO THE EXCLUSIVE RIGHT TO USE "ENTERTAINMENT", APART FROM THE MARK AS SHOWN.

THE MARK CONSISTS OF THE LETTERS "RHI" IN STYLIZED LETTERING LOCATED WITHIN A SHADED RECTANGLE, BELOW WHICH IS THE WORD "ENTERTAINMENT" IN STYLIZED LETTERING.

SN 85-437,935, FILED 10-3-2011.

LANA PHAM, EXAMINING ATTORNEY



*David J. Kybas*

Director of the United States Patent and Trademark Office

# United States of America

United States Patent and Trademark Office

## WOLFS LAIR

**Reg. No. 4,200,020**

MH50 LLC (CALIFORNIA LIMITED LIABILITY COMPANY)  
341 N. CANON DRIVE  
BEVERLY HILLS, CA 90210

**Registered Aug. 28, 2012**

**Int. Cl.: 43**

FOR: RESTAURANT AND BAR SERVICES, IN CLASS 43 (U.S. CLS. 100 AND 101).

**SERVICE MARK**

FIRST USE 3-1-2012; IN COMMERCE 3-1-2012.

**PRINCIPAL REGISTER**

THE MARK CONSISTS OF STANDARD CHARACTERS WITHOUT CLAIM TO ANY PARTICULAR FONT, STYLE, SIZE, OR COLOR.

SN 85-438,565, FILED 10-4-2011.

LAKEISHA LEWIS, EXAMINING ATTORNEY



*David J. Kyffers*

Director of the United States Patent and Trademark Office

# United States of America

United States Patent and Trademark Office

# LANA

**Reg. No. 4,200,021**

COOLTOUCH INCORPORATED (CALIFORNIA CORPORATION)  
9085 FOOTHILLS BLVD.  
ROSEVILLE, CA 95747

**Registered Aug. 28, 2012**

**Int. Cl.: 44**

FOR: PODIATRY SERVICES; PROVIDING LASER THERAPY FOR TREATING MEDICAL CONDITIONS, IN CLASS 44 (U.S. CLS. 100 AND 101).

**SERVICE MARK**

FIRST USE 11-30-2011; IN COMMERCE 11-30-2011.

**PRINCIPAL REGISTER**

THE MARK CONSISTS OF STANDARD CHARACTERS WITHOUT CLAIM TO ANY PARTICULAR FONT, STYLE, SIZE, OR COLOR.

SN 85-438,828, FILED 10-4-2011.

SHAILA SETTLES, EXAMINING ATTORNEY



*David J. Kyffers*

Director of the United States Patent and Trademark Office

**United States of America**  
United States Patent and Trademark Office

**LINEUM**

**Reg. No. 4,200,022**

EBI, LLC (INDIANA LIMITED LIABILITY COMPANY)  
100 INTERPACE PARKWAY  
PARSIPPANY, NJ 07054

**Registered Aug. 28, 2012**

**Int. Cl.: 10**

FOR: ORTHOPEDIC APPARATUS, IMPLANTS, AND INSTRUMENTS FOR SURGICAL REPAIR AND/OR FUSION OF THE SPINE, IN CLASS 10 (U.S. CLS. 26, 39 AND 44).

**TRADEMARK**

FIRST USE 6-8-2012; IN COMMERCE 6-8-2012.

**PRINCIPAL REGISTER**

THE MARK CONSISTS OF STANDARD CHARACTERS WITHOUT CLAIM TO ANY PARTICULAR FONT, STYLE, SIZE, OR COLOR.

SN 85-438,951, FILED 10-4-2011.

KAREN BRACEY, EXAMINING ATTORNEY



*David J. Kybas*

Director of the United States Patent and Trademark Office

# United States of America

United States Patent and Trademark Office

## Eating Well Living Well

**Reg. No. 4,200,023**

WATSON, LAREN R (UNITED STATES INDIVIDUAL), DBA EATING WELL LIVING WELL,  
16247 21ST AVE SW  
BURIEN, WA 98166

**Registered Aug. 28, 2012**

**Int. Cl.: 44**

FOR: COUNSELING SERVICES IN THE FIELDS OF HEALTH, NUTRITION AND LIFESTYLE  
WELLNESS, IN CLASS 44 (U.S. CLS. 100 AND 101).

**SERVICE MARK**

FIRST USE 11-15-2011; IN COMMERCE 11-15-2011.

**PRINCIPAL REGISTER**

THE MARK CONSISTS OF STANDARD CHARACTERS WITHOUT CLAIM TO ANY PAR-  
TICULAR FONT, STYLE, SIZE, OR COLOR.

SN 85-439,084, FILED 10-4-2011.

JEFFREY LOOK, EXAMINING ATTORNEY



*David J. Kyros*

Director of the United States Patent and Trademark Office

# United States of America

United States Patent and Trademark Office

## OFFICE ZILLA

**Reg. No. 4,200,024**

ZILLA HOLDINGS, LLC (DELAWARE LIMITED LIABILITY COMPANY)  
2885 HILTON CIRCLE  
KENNESAW, GA 30152

**Registered Aug. 28, 2012**

**Int. Cl.: 35**

FOR: RETAIL STORE AND ON-LINE RETAIL STORE SERVICES FEATURING OFFICE AND SCHOOL SUPPLIES, OFFICE EQUIPMENT, INCLUDING COMPUTER HARDWARE, COPIERS, TELEPHONES, AND OFFICE FURNITURE, IN CLASS 35 (U.S. CLS. 100, 101 AND 102).

**SERVICE MARK**

**PRINCIPAL REGISTER**

FIRST USE 4-1-2012; IN COMMERCE 4-1-2012.

THE MARK CONSISTS OF STANDARD CHARACTERS WITHOUT CLAIM TO ANY PARTICULAR FONT, STYLE, SIZE, OR COLOR.

NO CLAIM IS MADE TO THE EXCLUSIVE RIGHT TO USE "OFFICE", APART FROM THE MARK AS SHOWN.

SN 85-439,111, FILED 10-4-2011.

JUDITH HELFMAN, EXAMINING ATTORNEY



*David J. Kyros*

Director of the United States Patent and Trademark Office

# United States of America

United States Patent and Trademark Office

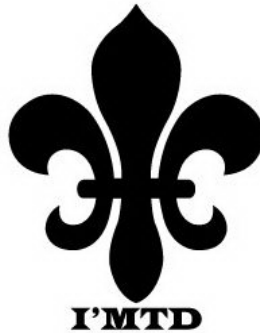

**Reg. No. 4,200,025**

**Registered Aug. 28, 2012**

**Int. Cl.: 25**

**TRADEMARK**

**PRINCIPAL REGISTER**

YOO, SANG DAI (REPUBLIC OF KOREA INDIVIDUAL)  
VARSOVIA NO.53 PICO 4 OFI 402 COL JUAREZ  
LONDRES DEL CUAUHEMOC, MEXICO 06600 AND

WANG, MENG BI (CHINA INDIVIDUAL)  
VARSOVIA NO.53 PICO 4 OFI 402 COL JUAREZ  
LONDRES DEL CUAUHEMOC, MEXICO 06600

FOR: SHORTS, SKIRTS, DRESSES, BLOUSES, JUMPER SUITS, JACKET, WARM-UPS, SWEAT SHIRTS, SWEAT PANTS, SWEATERS, UNDERWEAR, T-SHIRTS, SUITS, TANK-TOPS, SOCKS, HATS, CAPS, BELTS, KNITTED HATS, GLOVES, SNEAKERS, RUNNING SHOES, SPORT SHOES, BOOTS, SANDALS, IN CLASS 25 (U.S. CLS. 22 AND 39).

FIRST USE 10-15-2011; IN COMMERCE 3-31-2012.

OWNER OF U.S. REG. NO. 3,149,836.

SN 85-439,269, FILED 10-4-2011.

ANDREA BUTLER, EXAMINING ATTORNEY



*David J. Kybas*

Director of the United States Patent and Trademark Office



# United States of America

United States Patent and Trademark Office

## LOVE ALCHEMY

**Reg. No. 4,200,026**

LOVE ALCHEMY, LLC (FLORIDA LIMITED LIABILITY COMPANY)  
87 N. ROSCOE BLVD.

**Registered Aug. 28, 2012**

PONTE VEDRA BEACH, FL 32082

**Int. Cl.: 3**

FOR: LOTIONS FOR FACE AND BODY CARE, IN CLASS 3 (U.S. CLS. 1, 4, 6, 50, 51 AND 52).

**TRADEMARK**

FIRST USE 5-3-2012; IN COMMERCE 5-23-2012.

**PRINCIPAL REGISTER**

THE MARK CONSISTS OF STANDARD CHARACTERS WITHOUT CLAIM TO ANY PARTICULAR FONT, STYLE, SIZE, OR COLOR.

SN 85-439,619, FILED 10-5-2011.

KRISTIN DAHLING, EXAMINING ATTORNEY



*David J. Kyffers*

Director of the United States Patent and Trademark Office

# United States of America

United States Patent and Trademark Office

## AMAZINGALLERGIST

**Reg. No. 4,200,027**

**Registered Aug. 28, 2012**

**Int. Cls.: 41 and 44**

**SERVICE MARK**

**PRINCIPAL REGISTER**

ATUL N. SHAH, MD, PC (NEW YORK CORPORATION)  
2 CORACI BLVD SUITES 13 AND 14  
SHIRLEY, NY 11967

FOR: EDUCATIONAL SERVICES, NAMELY, CONDUCTING LECTURES, WORKSHOPS, SEMINARS AND CLASSES IN THE FIELD OF DIAGNOSING, TREATING AND MANAGING ASTHMA AND ALLERGIES FOR INDIVIDUALS, PATIENTS AND DOCTORS AND DISTRIBUTING COURSE MATERIALS IN CONNECTION THEREWITH; PROFESSIONAL COACHING SERVICES IN THE FIELD OF ASTHMA AND ALLERGY, IN CLASS 41 (U.S. CLS. 100, 101 AND 107).

FIRST USE 5-24-2012; IN COMMERCE 5-24-2012.

FOR: INTERNET-BASED MEDICAL DIAGNOSIS AND COUNSELING PERTAINING TO ALLERGIES AND ASTHMA, NAMELY, INFORMATION REGARDING TREATMENT OF ALLERGY AND ASTHMA DISEASES AND CONDITIONS AND POSSIBLE TREATMENTS AND LIKELY OUTCOMES; ALLERGY AND ASTHMA MEDICAL SCREENING SERVICES; ADVICE RELATING TO ALLERGIES; MEDICAL COUNSELING FOR INDIVIDUALS WITH ASTHMA OR ALLERGIES, IN CLASS 44 (U.S. CLS. 100 AND 101).

FIRST USE 3-0-2012; IN COMMERCE 3-0-2012.

THE MARK CONSISTS OF STANDARD CHARACTERS WITHOUT CLAIM TO ANY PARTICULAR FONT, STYLE, SIZE, OR COLOR.

SN 85-439,837, FILED 10-5-2011.

APRIL HESIK, EXAMINING ATTORNEY



*David J. Kyros*

Director of the United States Patent and Trademark Office

# United States of America

United States Patent and Trademark Office

# POLARSPEX

**Reg. No. 4,200,028**

JAY-Y ENTERPRISE CO., INC. (CALIFORNIA CORPORATION)  
632 NEW YORK DRIVE  
POMONA, CA 91768

**Registered Aug. 28, 2012**

**Int. Cl.: 9**

FOR: SUNGLASSES, IN CLASS 9 (U.S. CLS. 21, 23, 26, 36 AND 38).

**TRADEMARK**

FIRST USE 1-25-2012; IN COMMERCE 1-25-2012.

**PRINCIPAL REGISTER**

THE MARK CONSISTS OF STANDARD CHARACTERS WITHOUT CLAIM TO ANY PARTICULAR FONT, STYLE, SIZE, OR COLOR.

SN 85-439,866, FILED 10-5-2011.

JOHN GARTNER, EXAMINING ATTORNEY



*David J. Kyffers*

Director of the United States Patent and Trademark Office

# United States of America

United States Patent and Trademark Office

# WhAtIf

**Reg. No. 4,200,029**

**Registered Aug. 28, 2012**

**Int. Cl.: 16**

**TRADEMARK**

**PRINCIPAL REGISTER**

CROOK, KEVIN (UNITED STATES INDIVIDUAL)  
2999 ROCHESTER CIRCLE  
CORONA, CA 92879

FOR: NOVELTY BROCHURES THAT FEATURES LIVING ACCOMMODATIONS, NAMELY, VILLAS, CONDOS, AND APARTMENTS LOCATED IN HELL, IN CLASS 16 (U.S. CLS. 2, 5, 22, 23, 29, 37, 38 AND 50).

FIRST USE 5-18-2012; IN COMMERCE 5-18-2012.

THE MARK CONSISTS OF STANDARD CHARACTERS WITHOUT CLAIM TO ANY PARTICULAR FONT, STYLE, SIZE, OR COLOR.

SN 85-439,888, FILED 10-5-2011.

KEVIN DINALLO, EXAMINING ATTORNEY



*David J. Kyffers*

Director of the United States Patent and Trademark Office

# United States of America

United States Patent and Trademark Office

## DOCUSIGN INK

**Reg. No. 4,200,030**

**Registered Aug. 28, 2012**

**Int. Cls.: 38, 42, and 45**

**SERVICE MARK**

**PRINCIPAL REGISTER**

DOCUSIGN, INC. (WASHINGTON CORPORATION)  
SUITE 2000  
1301 SECOND AVENUE  
SEATTLE, WA 98101

FOR: DELIVERY OF MESSAGES BY ELECTRONIC TRANSMISSION; ON-LINE DOCUMENT DELIVERY VIA A GLOBAL COMPUTER NETWORK, IN CLASS 38 (U.S. CLS. 100, 101 AND 104).

FIRST USE 10-30-2011; IN COMMERCE 10-30-2011.

FOR: PROVIDING A WEBSITE FEATURING NON-DOWNLOADABLE SOFTWARE FOR USE WITH ELECTRONIC DATA VERIFICATION AND SECURE DIGITAL TRANSACTIONS VIA GLOBAL INFORMATION NETWORKS; PROVIDING A WEBSITE FEATURING TECHNOLOGY THAT ENABLES USERS TO UPLOAD, ELECTRONICALLY AUTHENTICATE, STORE AND SECURELY DISTRIBUTE A DOCUMENT OR FILE VIA GLOBAL INFORMATION NETWORKS, IN CLASS 42 (U.S. CLS. 100 AND 101).

FIRST USE 10-30-2011; IN COMMERCE 10-30-2011.

FOR: PROVIDING USER AUTHENTICATION SERVICES IN E-COMMERCE TRANSACTIONS, IN CLASS 45 (U.S. CLS. 100 AND 101).

FIRST USE 10-30-2011; IN COMMERCE 10-30-2011.

THE MARK CONSISTS OF STANDARD CHARACTERS WITHOUT CLAIM TO ANY PARTICULAR FONT, STYLE, SIZE, OR COLOR.

OWNER OF U.S. REG. NOS. 2,845,169, 2,939,871, AND 4,049,334.

SN 85-440,115, FILED 10-5-2011.

JAY FLOWERS, EXAMINING ATTORNEY



*David J. Kyffers*

Director of the United States Patent and Trademark Office

# United States of America

United States Patent and Trademark Office

# RED WITCH

**Reg. No. 4,200,031**

**Registered Aug. 28, 2012**

**Int. Cl.: 34**

**TRADEMARK**

**PRINCIPAL REGISTER**

K. HANSOTIA & CO., INC. (FLORIDA CORPORATION)  
BAY #5  
3705 N.W. 115 AVENUE  
MIAMI, FL 33178

FOR: CIGARS, IN CLASS 34 (U.S. CLS. 2, 8, 9 AND 17).

FIRST USE 1-15-2012; IN COMMERCE 1-15-2012.

THE MARK CONSISTS OF STANDARD CHARACTERS WITHOUT CLAIM TO ANY PARTICULAR FONT, STYLE, SIZE, OR COLOR.

OWNER OF U.S. REG. NOS. 3,690,023 AND 3,978,673.

SN 85-440,399, FILED 10-6-2011.

DOMINICK J. SALEMI, EXAMINING ATTORNEY



*David J. Kybas*

Director of the United States Patent and Trademark Office

# United States of America

United States Patent and Trademark Office

# SHIVA

**Reg. No. 4,200,032**

**Registered Aug. 28, 2012**

**Int. Cl.: 34**

**TRADEMARK**

**PRINCIPAL REGISTER**

K. HANSOTIA & CO., INC. (FLORIDA CORPORATION)  
BAY #5  
3705 N.W. 115 AVENUE  
MIAMI, FL 33178

FOR: CIGARS, IN CLASS 34 (U.S. CLS. 2, 8, 9 AND 17).

FIRST USE 1-15-2012; IN COMMERCE 1-15-2012.

THE MARK CONSISTS OF STANDARD CHARACTERS WITHOUT CLAIM TO ANY PARTICULAR FONT, STYLE, SIZE, OR COLOR.

SN 85-440,401, FILED 10-6-2011.

DOMINICK J. SALEMI, EXAMINING ATTORNEY



*David J. Kybas*

Director of the United States Patent and Trademark Office

# United States of America

United States Patent and Trademark Office

## DEFY THE COMMON

**Reg. No. 4,200,033**

**Registered Aug. 28, 2012**

**Int. Cl.: 36**

**SERVICE MARK**

**PRINCIPAL REGISTER**

WEALTHCARE CAPITAL MANAGEMENT IP, LLC (DELAWARE LIMITED LIABILITY COMPANY)  
600 EAST MAIN STREET, SUITE 1240  
RICHMOND, VA 23219

FOR: FINANCIAL PLANNING, FINANCIAL ANALYSIS, AND FINANCIAL ADVISING SERVICES, IN CLASS 36 (U.S. CLS. 100, 101 AND 102).

FIRST USE 11-30-2011; IN COMMERCE 11-30-2011.

THE MARK CONSISTS OF STANDARD CHARACTERS WITHOUT CLAIM TO ANY PARTICULAR FONT, STYLE, SIZE, OR COLOR.

SN 85-440,698, FILED 10-6-2011.

MICHELLE DUBOIS, EXAMINING ATTORNEY



*David J. Kyffers*

Director of the United States Patent and Trademark Office



# United States of America

United States Patent and Trademark Office

DREAM CAPSULE

**Reg. No. 4,200,034**

**Registered Aug. 28, 2012**

**Int. Cls.: 20 and 35**

**TRADEMARK**

**SERVICE MARK**

**PRINCIPAL REGISTER**

FLY AND DREAM INTERNATIONAL, INC. (ILLINOIS CORPORATION)  
229 REGENCY DRIVE  
BARTLETT, IL 60103

FOR: WOODEN CHEST MADE OF DIFFERENT TYPES OF WOOD SUCH AS CHESTNUT, CHERRY WOOD OR RUBBER WOOD WITH A KEY HOLE PROTECTOR FOR CONCEALING A KEY OPERATED LOCKING MECHANISM AND A HANDBOOK MADE OF PAPER AND CONTAINING INSPIRATIONAL MESSAGES, IN CLASS 20 (U.S. CLS. 2, 13, 22, 25, 32 AND 50).

FIRST USE 7-1-2011; IN COMMERCE 7-1-2011.

FOR: COMPUTERIZED ON-LINE ORDERING SERVICES IN THE FIELD OF WOOD CHESTS WITH A KEY HOLE PROTECTOR FOR CONCEALING THE KEY OPERATED LOCKING MECHANISM AND A HANDBOOK MADE OF PAPER, IN CLASS 35 (U.S. CLS. 100, 101 AND 102).

FIRST USE 7-1-2011; IN COMMERCE 7-1-2011.

THE MARK CONSISTS OF TWO WORDS, THE FIRST WORD: "DREAM" ALL IN STANDARD CAPITAL LETTERS AND THE SECOND WORD: "CAPSULE" WITH A STYLIZED INITIAL CAPITAL LETTER FOR "C" AND STANDARD CAPITAL LETTERS FOR "APSULE".

SN 85-442,114, FILED 10-7-2011.

BILL DAWE, EXAMINING ATTORNEY



*David J. Kyffers*

Director of the United States Patent and Trademark Office

# United States of America

United States Patent and Trademark Office

# POWHOW

**Reg. No. 4,200,035**

**Registered Aug. 28, 2012**

**Int. Cls.: 38 and 41**

**SERVICE MARK**

**PRINCIPAL REGISTER**

POWHOW, INC. (DELAWARE CORPORATION)  
535 FIFTH AVENUE, 4TH FLOOR  
NEW YORK, NY 10017

FOR: EDUCATIONAL SERVICES, NAMELY, PROVIDING REMOTE INTERNET ACCESS FOR EDUCATORS AND INSTRUCTORS TO TEACH, PROVIDE, OR LEAD EDUCATIONAL CLASSES, COURSES, SEMINARS, AND WORKSHOPS; EDUCATIONAL SERVICES, NAMELY, PROVIDING REMOTE INTERNET ACCESS FOR STUDENTS TO ATTEND EDUCATIONAL CLASSES, COURSES, SEMINARS, AND WORKSHOPS; PROVIDING ACCESS TO AN ON-LINE EDUCATIONAL PLATFORM FOR EDUCATORS, INSTRUCTORS, AND STUDENTS CAN PARTICIPATE IN DISCUSSIONS AND EXCHANGE FEEDBACK RELATED TO EDUCATIONAL CLASSES, COURSES, SEMINARS, AND WORKSHOPS, IN CLASS 38 (U.S. CLS. 100, 101 AND 104).

FIRST USE 8-18-2011; IN COMMERCE 8-18-2011.

FOR: EDUCATIONAL SERVICES, NAMELY, PROVIDING A WEBSITE FOR EDUCATORS AND INSTRUCTORS TO OFFER EDUCATIONAL CLASSES, COURSES, SEMINARS, AND WORKSHOPS; EDUCATIONAL SERVICES, NAMELY, PROVIDING A WEBSITE WHERE EDUCATORS AND INSTRUCTORS CAN CREATE PERSONAL PROFILE PAGES TO DESCRIBE THEIR BACKGROUNDS AND OFFER EDUCATIONAL CLASSES, COURSES, SEMINARS, AND WORKSHOPS; EDUCATIONAL SERVICES, NAMELY, PROVIDING A WEBSITE WHERE STUDENTS CAN RESEARCH, REVIEW, AND LOCATE EDUCATIONAL CLASSES, COURSES, SEMINARS, AND WORKSHOPS, IN CLASS 41 (U.S. CLS. 100, 101 AND 107).

FIRST USE 8-18-2011; IN COMMERCE 8-18-2011.

THE MARK CONSISTS OF STANDARD CHARACTERS WITHOUT CLAIM TO ANY PARTICULAR FONT, STYLE, SIZE, OR COLOR.

SN 85-442,455, FILED 10-7-2011.

DOMINIC J. FERRAIUOLO, EXAMINING ATTORNEY



*David J. Kyros*

Director of the United States Patent and Trademark Office

# United States of America

United States Patent and Trademark Office

# PROESS

**Reg. No. 4,200,036**

PROESS FOOD, LLC (PENNSYLVANIA LIMITED LIABILITY COMPANY)  
182 LANCASTER AVENUE  
MALVERN, PA 19355

**Registered Aug. 28, 2012**

**Int. Cl.: 29**

FOR: PROTEIN FOR USE AS A FOOD ADDITIVE; PROTEIN POWDERS FOR HUMAN CONSUMPTION FOR USE AS A FOOD ADDITIVE, IN CLASS 29 (U.S. CL. 46).

**TRADEMARK**

FIRST USE 9-1-2011; IN COMMERCE 1-10-2012.

**PRINCIPAL REGISTER**

THE MARK CONSISTS OF STANDARD CHARACTERS WITHOUT CLAIM TO ANY PARTICULAR FONT, STYLE, SIZE, OR COLOR.

SN 85-442,461, FILED 10-7-2011.

DOMINIC J. FERRAIUOLO, EXAMINING ATTORNEY



*David J. Kyffers*

Director of the United States Patent and Trademark Office

**United States of America**  
United States Patent and Trademark Office

**DIATRIX**

**Reg. No. 4,200,037**

INFINITI CREATIONS, LLC (UTAH LIMITED LIABILITY COMPANY)  
80 NORTH 850 EAST, SUITE A  
LEHI, UT 84043

**Registered Aug. 28, 2012**

**Int. Cl.: 5**

FOR: DIETARY AND NUTRITIONAL SUPPLEMENTS, IN CLASS 5 (U.S. CLS. 6, 18, 44, 46, 51 AND 52).

**TRADEMARK**

FIRST USE 11-9-2011; IN COMMERCE 11-9-2011.

**PRINCIPAL REGISTER**

THE MARK CONSISTS OF STANDARD CHARACTERS WITHOUT CLAIM TO ANY PARTICULAR FONT, STYLE, SIZE, OR COLOR.

SN 85-442,477, FILED 10-7-2011.

DOMINIC J. FERRAIUOLO, EXAMINING ATTORNEY



*David J. Kyffers*

Director of the United States Patent and Trademark Office

# United States of America

United States Patent and Trademark Office

# Tacera

**Reg. No. 4,200,038**

**Registered Aug. 28, 2012**

**Int. Cl.: 25**

**TRADEMARK**

**PRINCIPAL REGISTER**

XIE, WANXIANG (CHINA INDIVIDUAL)  
#1017  
1407 BROADWAY  
NEW YORK, NY 10018

FOR: CAPRIS; COATS; DRESSES; JACKETS; LEGGINGS; PANTS; ROMPERS; SKIRTS;  
SWEATERS; TOPS; VESTS, IN CLASS 25 (U.S. CLS. 22 AND 39).

FIRST USE 3-1-2012; IN COMMERCE 4-30-2012.

THE MARK CONSISTS OF STANDARD CHARACTERS WITHOUT CLAIM TO ANY PAR-  
TICULAR FONT, STYLE, SIZE, OR COLOR.

SN 85-443,271, FILED 10-10-2011.

TIMOTHY FINNEGAN, EXAMINING ATTORNEY



*David J. Kyffers*

Director of the United States Patent and Trademark Office

# United States of America

United States Patent and Trademark Office

# THE HABITUDE

**Reg. No. 4,200,039**

IT'S A NEED, INC. (CALIFORNIA CORPORATION)  
19 MOTT DRIVE  
ALAMO, CA 94507

**Registered Aug. 28, 2012**

**Int. Cl.: 14**

FOR: BRACELETS, IN CLASS 14 (U.S. CLS. 2, 27, 28 AND 50).

**TRADEMARK**

FIRST USE 3-1-2012; IN COMMERCE 5-17-2012.

**PRINCIPAL REGISTER**

THE MARK CONSISTS OF THE STYLIZED WORDS "THEHABITUDE". AN IMAGE OF A HALO APPEARS OVER THE LETTER "A".

SN 85-443,750, FILED 10-10-2011.

JASON BLAIR, EXAMINING ATTORNEY



*David J. Kyros*

Director of the United States Patent and Trademark Office

# United States of America

United States Patent and Trademark Office

# Stemáge

**Reg. No. 4,200,040**

EDISON NATION, LLC (NORTH CAROLINA LIMITED LIABILITY COMPANY)  
520 ELLIOT STREET  
CHARLOTTE, NC 28202

**Registered Aug. 28, 2012**

**Int. Cl.: 3**

FOR: AGE SPOT REDUCING CREAMS; ANTI-AGING CREAM; ANTI-WRINKLE CREAM;  
CLEANSING CREAMS; COSMETIC CREAMS FOR SKIN CARE; EYE CREAM; FACE  
CREAMS; FACIAL CLEANSERS; FACIAL CREAM; FACIAL SCRUBS; FACIAL WASHES;  
SKIN CREAM, IN CLASS 3 (U.S. CLS. 1, 4, 6, 50, 51 AND 52).

**TRADEMARK**

**PRINCIPAL REGISTER**

FIRST USE 6-4-2012; IN COMMERCE 6-4-2012.

THE MARK CONSISTS OF STANDARD CHARACTERS WITHOUT CLAIM TO ANY PAR-  
TICULAR FONT, STYLE, SIZE, OR COLOR.

SN 85-444,225, FILED 10-11-2011.

GEORGE LORENZO, EXAMINING ATTORNEY



*David J. Kyffers*

Director of the United States Patent and Trademark Office

# United States of America

United States Patent and Trademark Office

*Be...*

**Reg. No. 4,200,041**

BE3T, LLC (FLORIDA LIMITED LIABILITY COMPANY)  
4912 W. SAN RAFAEL STREET  
TAMPA, FL 33629

**Registered Aug. 28, 2012**

**Int. Cl.: 25**

FOR: T-SHIRTS AND BASEBALL CAPS, IN CLASS 25 (U.S. CLS. 22 AND 39).

**TRADEMARK**

FIRST USE 12-10-2011; IN COMMERCE 12-10-2011.

**PRINCIPAL REGISTER**

THE MARK CONSISTS OF THE WORD "BE" FOLLOWED BY THREE PERIODS, WHERE THE LETTER "B" IS IN THE SHAPE OF A HEART SET AT ABOUT A 45 DEGREE ANGLE.

SN 85-444,395, FILED 10-11-2011.

JOHN E. MICHOS, EXAMINING ATTORNEY



*David J. Kyffers*

Director of the United States Patent and Trademark Office



# United States of America

United States Patent and Trademark Office

## HELMET HUGGERS

**Reg. No. 4,200,042**

HELMET HUGGERS LLC (NEW JERSEY LIMITED LIABILITY COMPANY)  
299 HIGHLAND AVENUE  
RIDGEWOOD, NJ 07450

**Registered Aug. 28, 2012**

**Int. Cl.: 9**

FOR: DECORATIVE REMOVABLE COVERS FOR RIGID SPORTS HELMETS, NAMELY, SKI HELMETS, SNOWBOARD HELMETS, SKATEBOARDS HELMETS AND BICYCLE HELMETS, IN CLASS 9 (U.S. CLS. 21, 23, 26, 36 AND 38).

**TRADEMARK**

FIRST USE 12-3-2011; IN COMMERCE 12-3-2011.

**PRINCIPAL REGISTER**

THE MARK CONSISTS OF STANDARD CHARACTERS WITHOUT CLAIM TO ANY PARTICULAR FONT, STYLE, SIZE, OR COLOR.

NO CLAIM IS MADE TO THE EXCLUSIVE RIGHT TO USE "HELMET", APART FROM THE MARK AS SHOWN.

SN 85-444,609, FILED 10-11-2011.

ZACHARY BELLO, EXAMINING ATTORNEY



*David J. Kyffers*

Director of the United States Patent and Trademark Office

# United States of America

United States Patent and Trademark Office

Buy it once, Enjoy it for  
life

**Reg. No. 4,200,043**

DROLL YANKEES, INC. (CONNECTICUT CORPORATION)  
55 LATHROP ROAD EXT.  
PLAINFIELD, CT 06374

**Registered Aug. 28, 2012**

**Int. Cl.: 21**

FOR: BIRD FEEDERS, IN CLASS 21 (U.S. CLS. 2, 13, 23, 29, 30, 33, 40 AND 50).

**TRADEMARK**

FIRST USE 1-6-2012; IN COMMERCE 1-6-2012.

**PRINCIPAL REGISTER**

THE MARK CONSISTS OF STANDARD CHARACTERS WITHOUT CLAIM TO ANY PARTICULAR FONT, STYLE, SIZE, OR COLOR.

SN 85-444,954, FILED 10-11-2011.

MICHELE SWAIN, EXAMINING ATTORNEY



*David J. Kyffers*

Director of the United States Patent and Trademark Office

# United States of America

United States Patent and Trademark Office



**Reg. No. 4,200,044**

BEN YITZHAK, ELISHA (UNITED STATES INDIVIDUAL)  
3900 W. BROWN DEER ROAD, SUITE A-134  
MILWAUKEE, WI 53209

**Registered Aug. 28, 2012**

**Int. Cl.: 35**

FOR: ADVERTISING AND PROMOTING THE GOODS AND SERVICES OF A GROUP OF VISUAL ARTISTS, IN CLASS 35 (U.S. CLS. 100, 101 AND 102).

**SERVICE MARK**

FIRST USE 10-1-2011; IN COMMERCE 10-1-2011.

**PRINCIPAL REGISTER**

NO CLAIM IS MADE TO THE EXCLUSIVE RIGHT TO USE "INTERNATIONAL BIENNALE ARTISTS", APART FROM THE MARK AS SHOWN.

THE COLOR(S) WHITE, YELLOW, ORANGE, RED, BLUE, GREEN AND PINK IS/ARE CLAIMED AS A FEATURE OF THE MARK.

THE MARK CONSISTS OF THE WORDS "INTERNATIONAL BIENNALE ARTISTS" APPEARING ON AN ARTIST'S PALETTE, WITH THE WORDS IN WHITE AND THE PALETTE IN YELLOW, ORANGE, RED, BLUE, GREEN, AND PINK.

THE ENGLISH TRANSLATION OF THE WORD "BIENNALE" IN THE MARK IS "BIENNIAL".

SN 85-445,113, FILED 10-12-2011.

ANDREA K. NADELMAN, EXAMINING ATTORNEY



*David J. Kybas*

Director of the United States Patent and Trademark Office

# United States of America

United States Patent and Trademark Office

# QCBD

**Reg. No. 4,200,045**

**Registered Aug. 28, 2012**

**Int. Cl.: 9**

**TRADEMARK**

**PRINCIPAL REGISTER**

KERN, CARL (UNITED STATES INDIVIDUAL)  
19 GINGHAM ST., SUITE 100  
TRABUCO CANYON, CA 92679

FOR: COMPUTER SOFTWARE, NAMELY, A CLIENT-SERVER SOFTWARE APPLICATION FOR MANAGING QUALITY DATA INCLUDING MODULES FOR HANDLING COMPLAINTS, CORRECTIVE AND PREVENTIVE ACTIONS, CALIBRATION, DOCUMENT CONTROL, NON-CONFORMING MATERIAL CONTROL, SUPPLIER MANAGEMENT, PROCESS DEVIATIONS AND EMPLOYEE TRAINING RECORDS MANAGEMENT, IN CLASS 9 (U.S. CLS. 21, 23, 26, 36 AND 38).

FIRST USE 4-5-2003; IN COMMERCE 7-23-2004.

THE MARK CONSISTS OF STANDARD CHARACTERS WITHOUT CLAIM TO ANY PARTICULAR FONT, STYLE, SIZE, OR COLOR.

SN 85-445,898, FILED 10-12-2011.

TOBY BULLOFF, EXAMINING ATTORNEY



*David J. Kyffers*

Director of the United States Patent and Trademark Office

# United States of America

United States Patent and Trademark Office

# AYEASTA

**Reg. No. 4,200,046**

GNP, INC. (NEBRASKA CORPORATION)  
5201 NORTH 196TH STREET  
ELKHORN, NE 68022

**Registered Aug. 28, 2012**

**Int. Cl.: 5**

FOR: DIETARY AND NUTRITIONAL SUPPLEMENTS; DIETARY AND NUTRITIONAL SUPPLEMENTS CAUSING AN ANTIOXIDANT AND/OR PROBIOTIC EFFECT; DIETARY AND NUTRITIONAL SUPPLEMENTS HAVING AN ANTIOXIDANT AND/OR A YEAST, IN CLASS 5 (U.S. CLS. 6, 18, 44, 46, 51 AND 52).

**TRADEMARK**

**PRINCIPAL REGISTER**

FIRST USE 3-9-2012; IN COMMERCE 3-29-2012.

THE MARK CONSISTS OF STANDARD CHARACTERS WITHOUT CLAIM TO ANY PARTICULAR FONT, STYLE, SIZE, OR COLOR.

SN 85-446,317, FILED 10-13-2011.

JAMES GRIFFIN, EXAMINING ATTORNEY



*David J. Kybas*

Director of the United States Patent and Trademark Office

# United States of America

United States Patent and Trademark Office

## PRINTEMS.COM

**Reg. No. 4,200,047**

R.H. ROSENFELD CO. (MAINE CORPORATION)

**Registered Aug. 28, 2012**

2066 MAIN STREET  
SANFORD, ME 04073

**Int. Cl.: 40**

FOR: CUSTOM IMPRINTING OF PAPER OR MERCHANDISE; DESIGN PRINTING FOR OTHERS; DIGITAL ON-DEMAND PRINTING SERVICES OF BOOKS AND OTHER DOCUMENTS; DIGITAL PRINTING; PRINTING SERVICES, IN CLASS 40 (U.S. CLS. 100, 103 AND 106).

**SERVICE MARK**

**PRINCIPAL REGISTER**

FIRST USE 1-13-2012; IN COMMERCE 1-13-2012.

THE MARK CONSISTS OF STANDARD CHARACTERS WITHOUT CLAIM TO ANY PARTICULAR FONT, STYLE, SIZE, OR COLOR.

SN 85-446,891, FILED 10-13-2011.

YAT SYE, LEE, EXAMINING ATTORNEY



*David J. Kyffers*

Director of the United States Patent and Trademark Office

# United States of America

United States Patent and Trademark Office

## MINE SMARTER

**Reg. No. 4,200,048**

**Registered Aug. 28, 2012**

**Int. Cl.: 9**

**TRADEMARK**

**PRINCIPAL REGISTER**

MODULAR MINING SYSTEMS, INC. (ARIZONA CORPORATION)  
3289 E. HEMISPHERE LOOP  
TUCSON, AZ 85706

FOR: KNOWLEDGE-BASED SOLUTIONS, CONSISTING OF SOFTWARE AND COMPUTER HARDWARE, FOR MANAGING MINING FLEETS AND OPTIMIZING PRODUCTIVITY, IN CLASS 9 (U.S. CLS. 21, 23, 26, 36 AND 38).

FIRST USE 11-30-2011; IN COMMERCE 11-30-2011.

THE MARK CONSISTS OF STANDARD CHARACTERS WITHOUT CLAIM TO ANY PARTICULAR FONT, STYLE, SIZE, OR COLOR.

OWNER OF U.S. REG. NO. 3,987,229.

NO CLAIM IS MADE TO THE EXCLUSIVE RIGHT TO USE "MINE", APART FROM THE MARK AS SHOWN.

SN 85-447,180, FILED 10-13-2011.

FONG HSU, EXAMINING ATTORNEY



*David J. Kyffers*

Director of the United States Patent and Trademark Office

# United States of America

United States Patent and Trademark Office

## BATTLE STAR

**Reg. No. 4,200,049**

ALBAUGH, INC. (IOWA CORPORATION)  
1525 NE 36TH STREET  
ANKENY, IA 50021

**Registered Aug. 28, 2012**

**Int. Cl.: 5**

FOR: PESTICIDES, IN CLASS 5 (U.S. CLS. 6, 18, 44, 46, 51 AND 52).

**TRADEMARK**

FIRST USE 4-30-2012; IN COMMERCE 4-30-2012.

**PRINCIPAL REGISTER**

THE MARK CONSISTS OF STANDARD CHARACTERS WITHOUT CLAIM TO ANY PARTICULAR FONT, STYLE, SIZE, OR COLOR.

SN 85-448,603, FILED 10-17-2011.

GEORGE LORENZO, EXAMINING ATTORNEY



*David J. Kyffers*

Director of the United States Patent and Trademark Office



# United States of America

United States Patent and Trademark Office



**Reg. No. 4,200,050**

**Registered Aug. 28, 2012**

**Int. Cl.: 41**

**SERVICE MARK**

**PRINCIPAL REGISTER**

LAURIA, FRANKE NIKLAS (UNITED STATES INDIVIDUAL)  
4429 NORTH AVENUE  
SAN DIEGO, CA 92116

FOR: EDUCATION SERVICES, NAMELY, PROVIDING LIVE AND ON-LINE CLASSES, SEMINARS, WORKSHOPS AND VIDEOS IN THE FIELD OF PHILOSOPHY, LOGIC AND CRITICAL THINKING, IN CLASS 41 (U.S. CLS. 100, 101 AND 107).

FIRST USE 11-25-2011; IN COMMERCE 11-25-2011.

THE STIPLING IS FOR SHADING PURPOSES ONLY.

THE MARK CONSISTS OF A CIRCLE CONTAINING A PAIR OF VERTICALLY-REFLECTED QUESTION MARKS JOINED AT THEIR PERIOD-BASE. JUST ABOVE AND BEHIND THESE MARKS IS A STARBURST RISING. BELOW THESE MARKS ARE TWO HORIZONTALLY-REFLECTED PENROSE TRIANGLES. THE PENROSE TRIANGLES MAKE THE CENTER OF A LAUREL WREATH WHICH CIRCLES EITHER SIDE OF THE QUESTION MARKS. THE WREATH STOPS JUST AFTER THE TOP OF THE QUESTION MARKS BUT BEFORE THE RAYS OF THE STARBURST.

SN 85-448,889, FILED 10-17-2011.

ALAIN LAPTER, EXAMINING ATTORNEY



*David J. Kybas*

Director of the United States Patent and Trademark Office

# United States of America

United States Patent and Trademark Office

## TERRA-LOCK

**Reg. No. 4,200,051**

**Registered Aug. 28, 2012**

**Int. Cl.: 6**

**TRADEMARK**

**PRINCIPAL REGISTER**

GRIPPLE LIMITED (GREAT BRITAIN CORPORATION)  
THE OLD WEST GUN WORKS  
SAVILE STREET EAST  
SHEFFIELD, GREAT BRITAIN S47UQ

FOR: ANCHORS, IN CLASS 6 (U.S. CLS. 2, 12, 13, 14, 23, 25 AND 50).

FIRST USE 12-22-2011; IN COMMERCE 12-22-2011.

THE MARK CONSISTS OF STANDARD CHARACTERS WITHOUT CLAIM TO ANY PARTICULAR FONT, STYLE, SIZE, OR COLOR.

SN 85-449,054, FILED 10-17-2011.

SUNG IN, EXAMINING ATTORNEY



*David J. Kyfos*

Director of the United States Patent and Trademark Office

# United States of America

United States Patent and Trademark Office



**Reg. No. 4,200,052**

DUY, WALTER (UNITED STATES INDIVIDUAL)  
1140 JOHNSTON DR.  
AURORA, IL 60506

**Registered Aug. 28, 2012**

**Int. Cl.: 16**

FOR: COLORING BOOKS; FLASH CARDS; TRADING CARDS; WORKBOOKS DIRECTED TO CHILDREN IN THE FIELDS OF MATH, SCIENCE, HISTORY, ENGLISH, SOCIAL STUDIES AND LANGUAGE, IN CLASS 16 (U.S. CLS. 2, 5, 22, 23, 29, 37, 38 AND 50).

**TRADEMARK**

FIRST USE 5-1-2012; IN COMMERCE 5-1-2012.

**PRINCIPAL REGISTER**

THE NAME(S), PORTRAIT(S), AND/OR SIGNATURE(S) SHOWN IN THE MARK DOES NOT IDENTIFY A PARTICULAR LIVING INDIVIDUAL.

THE MARK CONSISTS OF CIRCLE WITH "COOL CARL" WITHIN THE CIRCLE IN STYLIZED FONT; WITHIN THE CIRCLE IS AN IMAGE OF A PUPPET BOY.

SN 85-449,083, FILED 10-17-2011.

ALEX KEAM, EXAMINING ATTORNEY



*David J. Kybas*

Director of the United States Patent and Trademark Office

# United States of America

United States Patent and Trademark Office

## KISS MY FACE SHIMMER

**Reg. No. 4,200,053**

KISS MY FACE, LLC (DELAWARE LIMITED LIABILITY COMPANY)  
11766 WILSHIRE BOULEVARD SUITE 850  
LOS ANGELES, CA 900256567

**Registered Aug. 28, 2012**

**Int. Cl.: 3**

FOR: NON-MEDICATED TINTED LIP BALMS, IN CLASS 3 (U.S. CLS. 1, 4, 6, 50, 51 AND 52).

**TRADEMARK**

FIRST USE 3-20-2012; IN COMMERCE 3-20-2012.

**PRINCIPAL REGISTER**

THE MARK CONSISTS OF STANDARD CHARACTERS WITHOUT CLAIM TO ANY PARTICULAR FONT, STYLE, SIZE, OR COLOR.

OWNER OF U.S. REG. NOS. 1,513,297, 2,301,324, AND OTHERS.

NO CLAIM IS MADE TO THE EXCLUSIVE RIGHT TO USE "SHIMMER", APART FROM THE MARK AS SHOWN.

SN 85-449,891, FILED 10-18-2011.

JEFFREY LOOK, EXAMINING ATTORNEY



*David J. Kybas*

Director of the United States Patent and Trademark Office

# United States of America

United States Patent and Trademark Office

## THE SIGN OF A BETTER DELI

**Reg. No. 4,200,054**

FRANK BRUNCKHORST CO., L.L.C. (NEW YORK LIMITED LIABILITY COMPANY)  
24 ROCK STREET  
BROOKLYN, NY 11206

**Registered Aug. 28, 2012**

**Int. Cls.: 29 and 30**

FOR: CHEESE; PROCESSED MEAT, IN CLASS 29 (U.S. CL. 46).

**TRADEMARK**

FIRST USE 9-30-2011; IN COMMERCE 9-30-2011.

**PRINCIPAL REGISTER**

FOR: CONDIMENTS, IN CLASS 30 (U.S. CL. 46).

FIRST USE 9-30-2011; IN COMMERCE 9-30-2011.

THE MARK CONSISTS OF STANDARD CHARACTERS WITHOUT CLAIM TO ANY PARTICULAR FONT, STYLE, SIZE, OR COLOR.

SN 85-450,747, FILED 10-19-2011.

ALLISON HOLTZ, EXAMINING ATTORNEY



*David J. Kybas*

Director of the United States Patent and Trademark Office

# United States of America

United States Patent and Trademark Office

## PEAK Plasmablade

**Reg. No. 4,200,055**

MEDTRONIC ADVANCED ENERGY LLC (DELAWARE LIMITED LIABILITY COMPANY)  
180 INTERNATIONAL DRIVE  
PORTSMOUTH, NH 03801

**Registered Aug. 28, 2012**

**Int. Cl.: 10**

FOR: MEDICAL, DENTAL AND VETERINARY APPARATUS, NAMELY, ELECTRODES FOR THE PERFORMANCE OF ELECTROSURGICAL OR ELECTROCAUTERY PROCEDURES FOR TISSUE CUTTING, TISSUE RESECTIONING, HEMOSTASIS, AND COAGULATION OF BLOOD VESSELS, IN CLASS 10 (U.S. CLS. 26, 39 AND 44).

**TRADEMARK**

**PRINCIPAL REGISTER**

FIRST USE 12-31-2011; IN COMMERCE 12-31-2011.

THE MARK CONSISTS OF STANDARD CHARACTERS WITHOUT CLAIM TO ANY PARTICULAR FONT, STYLE, SIZE, OR COLOR.

OWNER OF U.S. REG. NO. 3,686,730.

NO CLAIM IS MADE TO THE EXCLUSIVE RIGHT TO USE "PLASMABLADE", APART FROM THE MARK AS SHOWN.

SN 85-451,188, FILED 10-19-2011.

ANNE E. GUSTASON, EXAMINING ATTORNEY



*David J. Kyros*

Director of the United States Patent and Trademark Office

# United States of America

United States Patent and Trademark Office

# BIZWIG

**Reg. No. 4,200,056**

CONTAKS CORPORATION (NORTH CAROLINA CORPORATION), DBA CONTAKS.COM,  
5995 CHAPEL HILL RD STE 109  
RALEIGH, NC 27607

**Registered Aug. 28, 2012**

**Int. Cls.: 35 and 41**

FOR: ON-LINE BUSINESS NETWORKING SERVICES, IN CLASS 35 (U.S. CLS. 100, 101 AND 102).

**SERVICE MARK**

FIRST USE 5-20-2012; IN COMMERCE 5-20-2012.

**PRINCIPAL REGISTER**

FOR: ENTERTAINMENT SERVICES, NAMELY, PROVIDING ON-LINE COMPUTER GAMES, IN CLASS 41 (U.S. CLS. 100, 101 AND 107).

FIRST USE 5-20-2012; IN COMMERCE 5-20-2012.

THE MARK CONSISTS OF STANDARD CHARACTERS WITHOUT CLAIM TO ANY PARTICULAR FONT, STYLE, SIZE, OR COLOR.

SN 85-451,210, FILED 10-19-2011.

LINDA ORNDORFF, EXAMINING ATTORNEY



*David J. Kyffers*

Director of the United States Patent and Trademark Office

# United States of America

United States Patent and Trademark Office

## TWANG A RITA

**Reg. No. 4,200,057**

TWANG PARTNERS, LTD. (TEXAS LIMITED PARTNERSHIP)  
6255 W.T. MONTGOMERY ROAD  
SAN ANTONIO, TX 78252

**Registered Aug. 28, 2012**

**Int. Cl.: 30**

FOR: SALT; SALT-BASED SPICES; SALT BLENDS; FLAVORED SALT, IN CLASS 30 (U.S. CL. 46).

**TRADEMARK**

FIRST USE 3-29-2012; IN COMMERCE 3-29-2012.

**PRINCIPAL REGISTER**

THE MARK CONSISTS OF STANDARD CHARACTERS WITHOUT CLAIM TO ANY PARTICULAR FONT, STYLE, SIZE, OR COLOR.

OWNER OF U.S. REG. NOS. 3,649,242 AND 3,918,401.

SN 85-451,235, FILED 10-19-2011.

LOURDES AYALA, EXAMINING ATTORNEY



*David J. Kybas*

Director of the United States Patent and Trademark Office



# United States of America

United States Patent and Trademark Office

## PROBIOTIC MACHINE

**Reg. No. 4,200,058**

NAKED JUICE CO. OF GLENDORA, INC. (CALIFORNIA CORPORATION)  
1333 S. MAYFLOWER AVE.  
MONROVIA, CA 91016

**Registered Aug. 28, 2012**

**Int. Cl.: 32**

FOR: FRUIT AND VEGETABLE JUICES, FRUIT JUICE DRINKS AND FRUIT FLAVORED WATERS; ALL OF THE AFOREMENTIONED GOODS MADE IN SIGNIFICANT PART WITH PROBIOTICS, IN CLASS 32 (U.S. CLS. 45, 46 AND 48).

**TRADEMARK**

FIRST USE 1-31-2012; IN COMMERCE 1-31-2012.

**PRINCIPAL REGISTER**

THE MARK CONSISTS OF STANDARD CHARACTERS WITHOUT CLAIM TO ANY PARTICULAR FONT, STYLE, SIZE, OR COLOR.

OWNER OF U.S. REG. NOS. 2,066,700, 3,355,039, AND OTHERS.

NO CLAIM IS MADE TO THE EXCLUSIVE RIGHT TO USE "PROBIOTIC", APART FROM THE MARK AS SHOWN.

SN 85-451,925, FILED 10-20-2011.

CHARLOTTE CORWIN, EXAMINING ATTORNEY



*David J. Kyros*

Director of the United States Patent and Trademark Office

# United States of America

United States Patent and Trademark Office

## AMERICAN WEST

**Reg. No. 4,200,059**

**Registered Aug. 28, 2012**

**Int. Cl.: 14**

**TRADEMARK**

**PRINCIPAL REGISTER**

RELIOS, INC. (NEW MEXICO CORPORATION)  
6815 ACADEMY PARKWAY WEST NE  
ALBUQUERQUE, NM 87109

FOR: JEWELRY, IN CLASS 14 (U.S. CLS. 2, 27, 28 AND 50).

FIRST USE 3-13-2012; IN COMMERCE 4-29-2012.

THE MARK CONSISTS OF STANDARD CHARACTERS WITHOUT CLAIM TO ANY PARTICULAR FONT, STYLE, SIZE, OR COLOR.

SN 85-452,363, FILED 10-20-2011.

TASNEEM HUSSAIN, EXAMINING ATTORNEY



*David J. Kyffers*

Director of the United States Patent and Trademark Office

# United States of America

United States Patent and Trademark Office



**Reg. No. 4,200,060**

**Registered Aug. 28, 2012**

**Int. Cls.: 9 and 42**

**TRADEMARK**

**SERVICE MARK**

**PRINCIPAL REGISTER**

J. E. DUNN CONSTRUCTION COMPANY (MISSOURI CORPORATION)  
1001 LOCUST  
KANSAS CITY, MO 64106

FOR: COMPUTER SOFTWARE FOR DOCUMENTING THE BUILDING PROCESS AND FACILITIES MANAGEMENT, NAMELY, SOFTWARE TO MANAGE A FACILITY'S CONTENTS, EQUIPMENT, FURNITURE, AND INFRASTRUCTURE; COMPUTER APPLICATION SOFTWARE FOR MOBILE PHONES, PORTABLE MEDIA PLAYERS, AND HANDHELD COMPUTERS, NAMELY, SOFTWARE FOR DOCUMENTING THE BUILDING PROCESS AND TO MANAGE A FACILITY'S CONTENTS, EQUIPMENT, FURNITURE, AND INFRASTRUCTURE, IN CLASS 9 (U.S. CLS. 21, 23, 26, 36 AND 38).

FIRST USE 9-0-2011; IN COMMERCE 11-0-2011.

FOR: PROVIDING ON-LINE, NON-DOWNLOADABLE, INTERNET-BASED FACILITIES MANAGEMENT SOFTWARE FOR DOCUMENTING THE BUILDING PROCESS AND TO MANAGE A FACILITY'S CONTENTS, EQUIPMENT, FURNITURE, AND INFRASTRUCTURE, IN CLASS 42 (U.S. CLS. 100 AND 101).

FIRST USE 9-0-2011; IN COMMERCE 11-0-2011.

NO CLAIM IS MADE TO THE EXCLUSIVE RIGHT TO USE THE DESIGN OF THE QUICK RESPONSE CODE, APART FROM THE MARK AS SHOWN.

THE MARK CONSISTS OF THE WORDING "SITE 10.01" IN A STYLIZED FORMAT. "SITE" IS ABOVE "10.01". A SQUARE WHICH IS PART OF A QUICK RESPONSE DESIGN CODE REPLACES THE DOT IN THE "I" AND A DESIGN OF A QUICK RESPONSE CODE IS IN THE UPPER LEFT HAND CORNER OF THE MARK. AN INVISIBLE HORIZONTAL LINE BISECTS THE MIDDLE OF "10.01".

SN 85-452,529, FILED 10-20-2011.

COLLEEN KEARNEY, EXAMINING ATTORNEY



*David J. Kyros*

Director of the United States Patent and Trademark Office

# United States of America

United States Patent and Trademark Office



**Reg. No. 4,200,061**

**Registered Aug. 28, 2012**

**Int. Cl.: 16**

**TRADEMARK**

**PRINCIPAL REGISTER**

FIBERMARK NORTH AMERICA, INC. (DELAWARE CORPORATION)  
161 WELLINGTON ROAD  
BRATTLEBORO, VT 05302

FOR: RECYCLABLE PAPERBOARD USED IN THE PACKAGING, PUBLISHING, GRAPHIC DESIGN, OFFICE PRODUCT AND TECHNICAL/INDUSTRIAL INDUSTRIES, IN CLASS 16 (U.S. CLS. 2, 5, 22, 23, 29, 37, 38 AND 50).

FIRST USE 7-27-2011; IN COMMERCE 7-27-2011.

NO CLAIM IS MADE TO THE EXCLUSIVE RIGHT TO USE "GREEN", APART FROM THE MARK AS SHOWN.

THE MARK CONSISTS OF THE WORDS "GREEN STEAM" WITH A STYLIZED BURST OF STEAM RISING BETWEEN THE WORDS "GREEN" AND "STEAM".

SN 85-452,816, FILED 10-21-2011.

JOHN WILKE, EXAMINING ATTORNEY



*David J. Kybas*

Director of the United States Patent and Trademark Office

# United States of America

United States Patent and Trademark Office

## UPTOWN ALLEY

**Reg. No. 4,200,062**

**Registered Aug. 28, 2012**

**Int. Cl.: 41**

**SERVICE MARK**

**PRINCIPAL REGISTER**

UPTOWN ALLEY I, LLC (VIRGINIA LIMITED LIABILITY COMPANY)  
P.O. BOX 1750  
CHESTERFIELD, VA 238321750

FOR: PROVIDING BOWLING ALLEYS, IN CLASS 41 (U.S. CLS. 100, 101 AND 107).

FIRST USE 5-4-2012; IN COMMERCE 5-4-2012.

THE MARK CONSISTS OF STANDARD CHARACTERS WITHOUT CLAIM TO ANY PARTICULAR FONT, STYLE, SIZE, OR COLOR.

NO CLAIM IS MADE TO THE EXCLUSIVE RIGHT TO USE "ALLEY", APART FROM THE MARK AS SHOWN.

SN 85-453,160, FILED 10-21-2011.

AISHA SALEM, EXAMINING ATTORNEY



*David J. Kyffers*

Director of the United States Patent and Trademark Office

# United States of America

United States Patent and Trademark Office

## THE BRIDAL CIRCLE

**Reg. No. 4,200,063**

**Registered Aug. 28, 2012**

**Int. Cl.: 41**

**SERVICE MARK**

**PRINCIPAL REGISTER**

THE BRIDAL CIRCLE, INC. (TEXAS CORPORATION)  
1664 SANDSTONE DRIVE  
FRISCO, TX 75034

FOR: EDUCATIONAL SERVICES, NAMELY, PROVIDING ONLINE INSTRUCTION IN THE FIELD OF WEDDING PLANNING VIA AN ONLINE WEBSITE; ENTERTAINMENT SERVICES, NAMELY, PROVIDING A WEB SITE FEATURING PHOTOGRAPHIC, AUDIO, VIDEO AND PROSE PRESENTATIONS FEATURING WEDDINGS AND PARTIES; PROVIDING A WEBSITE FEATURING BLOGS AND NON-DOWNLOADABLE PUBLICATIONS IN THE NATURE OF ARTICLES AND BROCHURES IN THE FIELD OF WEDDING PLANNING; PROVIDING INFORMATION IN THE FIELD OF WEDDING PARTY PLANNING; PROVIDING INFORMATION REGARDING WEDDING PLANNING FOR WEDDING PARTIES, IN CLASS 41 (U.S. CLS. 100, 101 AND 107).

FIRST USE 9-6-2011; IN COMMERCE 11-1-2011.

THE MARK CONSISTS OF STANDARD CHARACTERS WITHOUT CLAIM TO ANY PARTICULAR FONT, STYLE, SIZE, OR COLOR.

NO CLAIM IS MADE TO THE EXCLUSIVE RIGHT TO USE "BRIDAL", APART FROM THE MARK AS SHOWN.

SN 85-454,869, FILED 10-24-2011.

TINA BROWN, EXAMINING ATTORNEY



*David J. Kyjars*

Director of the United States Patent and Trademark Office

# United States of America

United States Patent and Trademark Office

# MAVENSAY

**Reg. No. 4,200,064**

**Registered Aug. 28, 2012**

**Int. Cl.: 35**

**SERVICE MARK**

**PRINCIPAL REGISTER**

MAVENSAY INC. (CANADA CORPORATION)  
150 FERRAND DRIVE, SUITE 802  
TORONTO, ONTARIO, CANADA M3C3E5

FOR: ADVERTISING AND MARKETING SERVICES PROVIDED BY MEANS OF INDIRECT METHODS OF MARKETING COMMUNICATIONS, NAMELY, SOCIAL MEDIA, SEARCH ENGINE MARKETING, INQUIRY MARKETING, INTERNET MARKETING, MOBILE MARKETING, BLOGGING AND OTHER FORMS OF PASSIVE, SHARABLE OR VIRAL COMMUNICATIONS CHANNELS, IN CLASS 35 (U.S. CLS. 100, 101 AND 102).

FIRST USE 1-9-2012; IN COMMERCE 3-25-2012.

THE MARK CONSISTS OF STANDARD CHARACTERS WITHOUT CLAIM TO ANY PARTICULAR FONT, STYLE, SIZE, OR COLOR.

SN 85-454,908, FILED 10-24-2011.

JACLYN KIDWELL WALKER, EXAMINING ATTORNEY



*David J. Kyffers*

Director of the United States Patent and Trademark Office

# United States of America

United States Patent and Trademark Office

# PRONTONI

**Reg. No. 4,200,065**

**Registered Aug. 28, 2012**

**Int. Cl.: 30**

**TRADEMARK**

**PRINCIPAL REGISTER**

VENROD TRADING COMPANY INC. (PUERTO RICO CORPORATION)  
STREET 4, BLDG. B MERCADO CENTRAL  
SAN JUAN, PUERTO RICO 00922

FOR: ALIMENTARY PASTE (PASTAS AND NOODLES); COMBINATION MEALS CONSISTING PRIMARILY OF PASTA OR RICE-BASED ENTREES AND SOUP OR SALAD FOR CONSUMPTION ON OR OFF THE PREMISES; DRIED PASTA; FRESH PASTA; MACARONI; MACARONI; MACARONI AND CHEESE; MACARONI SALAD; PACKAGED MEAL KITS CONSISTING PRIMARILY OF PASTA OR RICE; PACKAGED MEAL MIXES CONSISTING PRIMARILY OF PASTA OR RICE; PASTA; PASTA AND NOODLES; PASTA FOR SOUPS; PREPARED PASTA; RAVIOLI; RAVIOLI; SPAGHETTI; SPAGHETTI AND MEATBALLS; SPAGHETTI SAUCE, IN CLASS 30 (U.S. CL. 46).

FIRST USE 1-1-1999; IN COMMERCE 1-1-1999.

THE MARK CONSISTS OF STANDARD CHARACTERS WITHOUT CLAIM TO ANY PARTICULAR FONT, STYLE, SIZE, OR COLOR.

SN 85-455,026, FILED 10-24-2011.

SUNG IN, EXAMINING ATTORNEY



*David J. Kyffers*

Director of the United States Patent and Trademark Office



# United States of America

United States Patent and Trademark Office

# Vindetti

**Reg. No. 4,200,066**

NAZER, TAHMER (UNITED STATES INDIVIDUAL)  
1500 CHESAPEAKE COURT  
MELBOURNE, FL 32940

**Registered Aug. 28, 2012**

**Int. Cl.: 41**

FOR: ENTERTAINMENT SERVICES IN THE NATURE OF LIVE MUSICAL PERFORMANCES;  
ENTERTAINMENT SERVICES, NAMELY, LIVE, TELEVISED AND MOVIE APPEARANCES  
BY A PROFESSIONAL ENTERTAINER; MUSIC PRODUCTION SERVICES, IN CLASS 41  
(U.S. CLS. 100, 101 AND 107).

**SERVICE MARK**

**PRINCIPAL REGISTER**

FIRST USE 8-6-2008; IN COMMERCE 3-23-2012.

THE MARK CONSISTS OF STANDARD CHARACTERS WITHOUT CLAIM TO ANY PARTICULAR FONT, STYLE, SIZE, OR COLOR.

SN 85-455,231, FILED 10-25-2011.

NICHOLAS ALTREE, EXAMINING ATTORNEY



*David J. Kybas*

Director of the United States Patent and Trademark Office

# United States of America

United States Patent and Trademark Office

# BESITOS

**Reg. No. 4,200,067**

IDT TELECOM, INC. (DELAWARE CORPORATION)  
550 BROAD STREET  
NEWARK, NJ 07102

**Registered Aug. 28, 2012**

**Int. Cls.: 16, 36, and 38**

FOR: PREPAID TELEPHONE CALLING CARDS, NOT MAGNETICALLY ENCODED, IN CLASS 16 (U.S. CLS. 2, 5, 22, 23, 29, 37, 38 AND 50).

**TRADEMARK**

FIRST USE 2-27-2012; IN COMMERCE 2-27-2012.

**SERVICE MARK**

FOR: PREPAID TELEPHONE CALLING CARD AND TELEPHONE DEBIT CARD SERVICES, IN CLASS 36 (U.S. CLS. 100, 101 AND 102).

**PRINCIPAL REGISTER**

FIRST USE 2-27-2012; IN COMMERCE 2-27-2012.

FOR: TELEPHONE TELECOMMUNICATIONS SERVICES PROVIDED VIA PREPAID TELEPHONE CALLING CARDS, IN CLASS 38 (U.S. CLS. 100, 101 AND 104).

FIRST USE 2-27-2012; IN COMMERCE 2-27-2012.

THE MARK CONSISTS OF STANDARD CHARACTERS WITHOUT CLAIM TO ANY PARTICULAR FONT, STYLE, SIZE, OR COLOR.

THE ENGLISH TRANSLATION OF "BESITOS" IN THE MARK IS "KISSES".

SN 85-455,324, FILED 10-25-2011.

LEIGH CAROLINE CASE, EXAMINING ATTORNEY



*David J. Kybas*

Director of the United States Patent and Trademark Office

# United States of America

United States Patent and Trademark Office

## KELLY GREEN HEALTHY CLEAN

**Reg. No. 4,200,068**

KELLY GREEN ALL-NATURAL CLEAN LLC (ILLINOIS LIMITED LIABILITY COMPANY)  
1811 WEST ADDISON 1W  
CHICAGO, IL 60613

**Registered Aug. 28, 2012**

**Int. Cl.: 37**

FOR: CARPET AND RUG CLEANING; CARPET CLEANING; CLEANING OF BUILDINGS;  
CLEANING OF COMMERCIAL PREMISES; CLEANING OF RESIDENTIAL HOUSES; ; MAID  
SERVICES; REAL ESTATE PROPERTY CLEANING, REPAIR AND MAINTENANCE SER-  
VICES; RUG CLEANING, IN CLASS 37 (U.S. CLS. 100, 103 AND 106).

**SERVICE MARK**

**PRINCIPAL REGISTER**

FIRST USE 6-1-2012; IN COMMERCE 6-1-2012.

THE MARK CONSISTS OF STANDARD CHARACTERS WITHOUT CLAIM TO ANY PAR-  
TICULAR FONT, STYLE, SIZE, OR COLOR.

NO CLAIM IS MADE TO THE EXCLUSIVE RIGHT TO USE "CLEAN", APART FROM THE  
MARK AS SHOWN.

THE NAME(S), PORTRAIT(S), AND/OR SIGNATURE(S) SHOWN IN THE MARK IDENTIFIES  
"KELLY GREEN", WHOSE CONSENT(S) TO REGISTER IS MADE OF RECORD.

SN 85-456,225, FILED 10-26-2011.

JOHN GARTNER, EXAMINING ATTORNEY



*David J. Kybas*

Director of the United States Patent and Trademark Office

# United States of America

United States Patent and Trademark Office

# WAFFLERS

**Reg. No. 4,200,069**

**Registered Aug. 28, 2012**

**Int. Cl.: 30**

**TRADEMARK**

**PRINCIPAL REGISTER**

KELLOGG NORTH AMERICA COMPANY (DELAWARE CORPORATION)  
ONE KELLOGG SQUARE, PO BOX 3599  
BATTLE CREEK, MI 490163599

FOR: WAFFLES, IN CLASS 30 (U.S. CL. 46).

FIRST USE 1-1-2012; IN COMMERCE 1-1-2012.

THE MARK CONSISTS OF STANDARD CHARACTERS WITHOUT CLAIM TO ANY PARTICULAR FONT, STYLE, SIZE, OR COLOR.

SN 85-457,018, FILED 10-26-2011.

MELISSA VALLILLO, EXAMINING ATTORNEY



*David J. Kybas*

Director of the United States Patent and Trademark Office

# United States of America

United States Patent and Trademark Office



**Reg. No. 4,200,070**

**Registered Aug. 28, 2012**

**Int. Cl.: 42**

**SERVICE MARK**

**PRINCIPAL REGISTER**

VOTER'S FRIEND LLC (DELAWARE LIMITED LIABILITY COMPANY)  
108 E 4TH STREET, #13  
NEW YORK, NY 10003

FOR: PROVIDING A WEBSITE FEATURING TECHNOLOGY THAT ENABLES USERS TO OBTAIN INFORMATION ON ELECTED OFFICIALS AND POLITICAL CANDIDATES, IN CLASS 42 (U.S. CLS. 100 AND 101).

FIRST USE 12-1-2011; IN COMMERCE 5-1-2012.

NO CLAIM IS MADE TO THE EXCLUSIVE RIGHT TO USE "VOTER'S", APART FROM THE MARK AS SHOWN.

THE COLOR(S) RED, WHITE, BLUE, LIGHT BLUE, BLUE/BLACK, OFF-WHITE AND BLACK IS/ARE CLAIMED AS A FEATURE OF THE MARK.

THE MARK CONSISTS OF A BLUE/BLACK EAGLE HEAD AND WING SILHOUETTE WITH LIGHT BLUE WING SILHOUETTE BEHIND ON A LIGHT BLUE BACKGROUND WITH 3 OFF-WHITE STARS, TWO TO THE SIDE, ONE ABOVE, ALL PARTIALLY SHOWN, ABOVE A WHITE STRIPE CONTAINING THE WORDS "VOTER'S" IN RED AND "FRIEND" IN BLUE, "FRIEND" FRAMED BY BLUE STARS, ABOVE A STRIP OF ALTERNATING VERTICAL RED AND WHITE STRIPES.

SN 85-457,294, FILED 10-26-2011.

NAAKWAMA ANKRAH, EXAMINING ATTORNEY



*David J. Kybas*

Director of the United States Patent and Trademark Office

# United States of America

United States Patent and Trademark Office

# Worry

**Reg. No. 4,200,071**

**Registered Aug. 28, 2012**

**Int. Cl.: 32**

**TRADEMARK**

**PRINCIPAL REGISTER**

HERETIC BREWING COMPANY (CALIFORNIA CORPORATION)  
STE. 106, #301  
9630 BRUCEVILLE RD.  
ELK GROVE, CA 95757

FOR: BEER, IN CLASS 32 (U.S. CLS. 45, 46 AND 48).

FIRST USE 5-21-2012; IN COMMERCE 5-23-2012.

THE MARK CONSISTS OF STANDARD CHARACTERS WITHOUT CLAIM TO ANY PARTICULAR FONT, STYLE, SIZE, OR COLOR.

SN 85-457,665, FILED 10-27-2011.

JAMES LOVELACE, EXAMINING ATTORNEY



*David J. Kybas*

Director of the United States Patent and Trademark Office

# United States of America

United States Patent and Trademark Office

## LAWYERS V. BREAST CANCER

**Reg. No. 4,200,072**

**Registered Aug. 28, 2012**

**Int. Cl.: 36**

**SERVICE MARK**

**PRINCIPAL REGISTER**

FREEMAN, YALE T. (UNITED STATES INDIVIDUAL)  
SUITE 101  
7400 TAMIAMI TRAIL N.  
NAPLES, FL 34108

FOR: CHARITABLE FUNDRAISING SERVICES, IN CLASS 36 (U.S. CLS. 100, 101 AND 102).

FIRST USE 10-22-2011; IN COMMERCE 10-22-2011.

THE MARK CONSISTS OF STANDARD CHARACTERS WITHOUT CLAIM TO ANY PARTICULAR FONT, STYLE, SIZE, OR COLOR.

NO CLAIM IS MADE TO THE EXCLUSIVE RIGHT TO USE "BREAST CANCER", APART FROM THE MARK AS SHOWN.

SN 85-457,960, FILED 10-27-2011.

DEZMONA MIZELLE, EXAMINING ATTORNEY



*David J. Kybas*

Director of the United States Patent and Trademark Office

# United States of America

United States Patent and Trademark Office

# InteriorArts

**Reg. No. 4,200,073**

THE OCTOBER COMPANY, INC. (MASSACHUSETTS CORPORATION)

**Registered Aug. 28, 2012**

51 FERRY STREET  
EASTHAMPTON, MA 01027

**Int. Cl.: 17**

FOR: NON-METALLIC LAMINATE SHEETS AND PANELS FOR USE ON COUNTERTOPS, TABLETOPS, CABINETS, ARCHITECTURAL MILLWORK, FURNITURE, WALLS AND SHELVING , IN CLASS 17 (U.S. CLS. 1, 5, 12, 13, 35 AND 50).

**TRADEMARK**

FIRST USE 4-30-2012; IN COMMERCE 4-30-2012.

**PRINCIPAL REGISTER**

THE MARK CONSISTS OF STANDARD CHARACTERS WITHOUT CLAIM TO ANY PARTICULAR FONT, STYLE, SIZE, OR COLOR.

SN 85-458,764, FILED 10-28-2011.

BRIDGETT SMITH, EXAMINING ATTORNEY



*David J. Kyffers*

Director of the United States Patent and Trademark Office



# United States of America

United States Patent and Trademark Office

## BERNARD JOHNSON

**Reg. No. 4,200,074**

YOUNG, GREGG WHEELER (UNITED STATES INDIVIDUAL)  
6101 CHICTORA COVE  
AUSTIN, TX 78759

**Registered Aug. 28, 2012**

**Int. Cl.: 37**

**SERVICE MARK**

**PRINCIPAL REGISTER**

FOR: BUILDING CAULKING SERVICES; BUILDING CONSTRUCTION SERVICES; BUILDING SEALING AND CAULKING SERVICES; CONSTRUCTION GRADING SERVICES; CONSTRUCTION PROJECT MANAGEMENT SERVICES; CONSTRUCTION PROJECT MANAGEMENT SERVICES IN THE FIELD OF CONSTRUCTION OF RENEWABLE ENERGY AND ENERGY GENERATION EQUIPMENT SUPPORT STRUCTURES AND ANCILLARY STRUCTURES FOR SUPPORTING METEOROLOGICAL DATA GATHERING EQUIPMENT; CONSULTATION SERVICES IN THE FIELD OF CONSTRUCTION OF ENVIRONMENTALLY-CONSCIOUS BUILDINGS; CONSULTING SERVICES IN THE FIELD OF CONSTRUCTION OF WIND ENERGY FACILITIES; DAMP PROOFING SERVICES; ELECTRICAL CONTRACTOR SERVICES; GENERAL BUILDING CONTRACTOR SERVICES; GENERAL CONTRACTING SERVICES IN THE FIELD OF FLOORING; GENERAL CONTRACTOR SERVICES, NAMELY, PLUMBING, HEATING AND AIR CONDITIONING, CARPENTRY, DRYWALL, PAINTING, ELECTRICAL, BUILDING AND FRAMING CONTRACTOR SERVICES; EATING CONTRACTOR SERVICES; HOME ENERGY ASSESSMENT SERVICES FOR THE PURPOSE OF DETERMINING HOME IMPROVEMENTS NEEDED TO IMPROVE ENERGY USE AND EFFICIENCY; HVAC CONTRACTOR SERVICES; INSPECTION SERVICES IN THE COURSE OF CONSTRUCTION OF DAMS, BRIDGES, NEW COMMERCIAL AND RESIDENTIAL BUILDINGS; MECHANIC SERVICES; MECHANICAL CONTRACTOR SERVICES; PLUMBING CONTRACTOR SERVICES; PLUMBING SERVICES; TECHNICAL SUPPORT SERVICES, NAMELY, TROUBLESHOOTING IN THE NATURE OF THE REPAIR OF COMPUTER HARDWARE, IN CLASS 37 (U.S. CLS. 100, 103 AND 106).



FIRST USE 6-1-1972; IN COMMERCE 11-15-2011.

THE NAME(S), PORTRAIT(S), AND/OR SIGNATURE(S) SHOWN IN THE MARK DOES NOT IDENTIFY A PARTICULAR LIVING INDIVIDUAL.

THE COLOR(S) BLUE IS/ARE CLAIMED AS A FEATURE OF THE MARK.

THE MARK CONSISTS OF THE WORDS "BERNARD JOHNSON" IN BLOCK LETTERS IN BLUE.

*David J. Kyffers*

Director of the United States Patent and Trademark Office

SN 85-460,458, FILED 10-31-2011.

**Reg. No. 4,200,074** ANDREA BUTLER, EXAMINING ATTORNEY

# United States of America

United States Patent and Trademark Office



**Reg. No. 4,200,075**

**Registered Aug. 28, 2012**

**Int. Cl.: 35**

**SERVICE MARK**

**PRINCIPAL REGISTER**

BHUSHAN, NEERAJ (UNITED STATES INDIVIDUAL)  
SUITE 410  
1850 TOWN CENTER PARKWAY  
RESTON, VA 20190

FOR: HEALTHCARE MANAGEMENT SERVICE ORGANIZATION (MSO) SERVICES, NAMELY, PROVIDING PRACTICE ORGANIZATION, MANAGEMENT AND ADMINISTRATIVE SUPPORT SERVICES TO INDIVIDUAL PHYSICIANS OR SMALL GROUP PRACTICES, IN CLASS 35 (U.S. CLS. 100, 101 AND 102).

FIRST USE 2-29-2012; IN COMMERCE 2-29-2012.

NO CLAIM IS MADE TO THE EXCLUSIVE RIGHT TO USE "HEALTH SYSTEMS", APART FROM THE MARK AS SHOWN.

THE COLOR(S) BLUE, GREEN IS/ARE CLAIMED AS A FEATURE OF THE MARK.

THE MARK CONSISTS OF THE LITERAL ELEMENTS "BENCHMARK HEALTH SYSTEMS" WRITTEN IN STYLIZED FORM IN BLUE COLOR WHEREIN THE WORDS STARTING FROM "BENCHMARK" UP TO "SYSTEMS" ARE PLACED AS AN ARC ABOVE AN IMAGE OF A GREEN COLORED ROOF SUPPORTED BY BLUE COLORED FOUR PILLARS AND UNDER THE SAID IMAGE A GREEN COLORED BASE LINE IS PLACED AT THE BOTTOM OF THE MARK AS SHOWN IN THE MARK.

SN 85-461,052, FILED 11-1-2011.

SETH A. RAPPAPORT, EXAMINING ATTORNEY



*David J. Kyros*

Director of the United States Patent and Trademark Office

# United States of America

United States Patent and Trademark Office

# Anyray

**Reg. No. 4,200,076**

**Registered Aug. 28, 2012**

**Int. Cl.: 11**

**TRADEMARK**

**PRINCIPAL REGISTER**

MITSKEVICH, YULYANA (BELARUS INDIVIDUAL)  
9655 CLARK ST  
PHILADELPHIA, PA 19115

FOR: ELECTRIC LIGHT BULBS; LED (LIGHT EMITTING DIODE) LIGHTING FIXTURES; LIGHT BULBS; LAMP BULBS; LED LIGHT BULBS; ELECTRIC LIGHTS FOR CHRISTMAS TREES; CULTIVATION LAMPS AND PARTS THEREOF, NAMELY, HIGH PRESSURE SODIUM (HPS), METAL HALIDE, PLASMA, AND LIGHT EMITTING DIODE (LED); UV HALOGEN METAL VAPOUR LAMPS; HALOGEN LIGHT BULBS; ULTRAVIOLET LAMPS NOT FOR MEDICAL PURPOSES, IN CLASS 11 (U.S. CLS. 13, 21, 23, 31 AND 34).

FIRST USE 10-1-2011; IN COMMERCE 11-1-2011.

THE MARK CONSISTS OF STANDARD CHARACTERS WITHOUT CLAIM TO ANY PARTICULAR FONT, STYLE, SIZE, OR COLOR.

SN 85-461,158, FILED 11-1-2011.

RONALD MCMORROW, EXAMINING ATTORNEY



*David J. Kyros*

Director of the United States Patent and Trademark Office

# United States of America

United States Patent and Trademark Office

## Perrin Naturals

**Reg. No. 4,200,077**

PERRIN'S PRODUCTS (TENNESSEE LIMITED LIABILITY COMPANY)  
2985 SAND MOUNTAIN RD  
ENVILLE, TN 38332

**Registered Aug. 28, 2012**

**Int. Cls.: 3 and 5**

FOR: COSMETIC CREAMS; COSMETIC OILS; GENERAL PURPOSE MENTHOLATED OINTMENT NOT FOR MEDICAL USE; NON-MEDICATED HERBAL BODY CARE PRODUCTS, NAMELY, BODY OILS, SALVES, AND LIP BALMS; SOAPS FOR PERSONAL USE, IN CLASS 3 (U.S. CLS. 1, 4, 6, 50, 51 AND 52).

**TRADEMARK**

**PRINCIPAL REGISTER**

FIRST USE 4-1-2011; IN COMMERCE 4-1-2011.

FOR: VITAMIN SUPPLEMENTS, IN CLASS 5 (U.S. CLS. 6, 18, 44, 46, 51 AND 52).

FIRST USE 3-20-2012; IN COMMERCE 3-20-2012.

THE MARK CONSISTS OF STANDARD CHARACTERS WITHOUT CLAIM TO ANY PARTICULAR FONT, STYLE, SIZE, OR COLOR.

NO CLAIM IS MADE TO THE EXCLUSIVE RIGHT TO USE "NATURALS", APART FROM THE MARK AS SHOWN.

SN 85-461,597, FILED 11-1-2011.

WILLIAM VERHOSEK, EXAMINING ATTORNEY



*David J. Kyros*

Director of the United States Patent and Trademark Office

# United States of America

United States Patent and Trademark Office

# PROTECTPAK

**Reg. No. 4,200,078**

AMERICAN INTERNATIONAL GROUP, INC (NEW JERSEY CORPORATION)  
180 MAIDEN LANE  
NEW YORK, NY 10038

**Registered Aug. 28, 2012**

**Int. Cl.: 36**

FOR: INSURANCE UNDERWRITING IN THE FIELD OF LIFE, ACCIDENT AND HEALTH, SHORT TERM DISABILITY, ACCIDENTAL DEATH, CRITICAL ILLNESS AND VISION INSURANCE, IN CLASS 36 (U.S. CLS. 100, 101 AND 102).

**SERVICE MARK**

FIRST USE 1-0-2012; IN COMMERCE 1-0-2012.

**PRINCIPAL REGISTER**

THE MARK CONSISTS OF STANDARD CHARACTERS WITHOUT CLAIM TO ANY PARTICULAR FONT, STYLE, SIZE, OR COLOR.

SN 85-462,197, FILED 11-2-2011.

ALLISON HOLTZ, EXAMINING ATTORNEY



*David J. Kyros*

Director of the United States Patent and Trademark Office

# United States of America

United States Patent and Trademark Office

## VASTREE REAL ESTATE

**Reg. No. 4,200,079**

ZHANG, JEANNETTE (UNITED STATES INDIVIDUAL)  
362 LONGFORD PL.  
MONROVIA, CA 91016

**Registered Aug. 28, 2012**

**Int. Cl.: 35**

FOR: REAL ESTATE BROKERAGE SERVICES, IN CLASS 35 (U.S. CLS. 100, 101 AND 102).

**SERVICE MARK**

FIRST USE 8-22-2011; IN COMMERCE 8-22-2011.

**PRINCIPAL REGISTER**

THE MARK CONSISTS OF STANDARD CHARACTERS WITHOUT CLAIM TO ANY PARTICULAR FONT, STYLE, SIZE, OR COLOR.

NO CLAIM IS MADE TO THE EXCLUSIVE RIGHT TO USE "REAL ESTATE", APART FROM THE MARK AS SHOWN.

SN 85-462,701, FILED 11-2-2011.

WENDY JUN, EXAMINING ATTORNEY



*David J. Kybas*

Director of the United States Patent and Trademark Office

# United States of America

United States Patent and Trademark Office

## TAKE THE COST OUT OF HEALTHY LIVING

**Reg. No. 4,200,080**

**Registered Aug. 28, 2012**

**Int. Cl.: 35**

**SERVICE MARK**

**PRINCIPAL REGISTER**

VITACOST.COM, INC. (DELAWARE CORPORATION)  
SUITE 500  
5400 BROKEN SOUND BLVD N.W.  
BOCA RATON, FL 33487

FOR: MAIL ORDER CATALOG SERVICES FEATURING DIETARY AND NUTRITIONAL SUPPLEMENTS; ON-LINE RETAIL STORE SERVICES FEATURING DIETARY AND NUTRITIONAL SUPPLEMENTS, IN CLASS 35 (U.S. CLS. 100, 101 AND 102).

FIRST USE 2-15-2012; IN COMMERCE 2-15-2012.

THE MARK CONSISTS OF STANDARD CHARACTERS WITHOUT CLAIM TO ANY PARTICULAR FONT, STYLE, SIZE, OR COLOR.

SN 85-462,886, FILED 11-2-2011.

JOHN DWYER, EXAMINING ATTORNEY



*David J. Kyros*

Director of the United States Patent and Trademark Office



# United States of America

United States Patent and Trademark Office



**Reg. No. 4,200,081**

ZHANG, JEANNETTE (UNITED STATES INDIVIDUAL)  
362 LONGFORD PL.  
MONROVIA, CA 91016

**Registered Aug. 28, 2012**

**Int. Cl.: 36**

FOR: REAL ESTATE BROKERAGE SERVICES, IN CLASS 36 (U.S. CLS. 100, 101 AND 102).

**SERVICE MARK**

FIRST USE 8-22-2011; IN COMMERCE 8-22-2011.

**PRINCIPAL REGISTER**

THE STIPPLING IS FOR SHADING PURPOSES ONLY.

THE MARK CONSISTS OF THE STYLIZED TEXT "VASTREE" WITH A STYLIZED TREE TO THE RIGHT.

SN 85-462,933, FILED 11-2-2011.

WENDY JUN, EXAMINING ATTORNEY



*David J. Kybas*

Director of the United States Patent and Trademark Office

# United States of America

United States Patent and Trademark Office

## Smackers Smack Me

**Reg. No. 4,200,082**

SMACKERS BBQ, LLC (TENNESSEE LIMITED LIABILITY COMPANY)  
10080 E. COUNTRY WAY DRIVE  
CORDOVA, TN 38018

**Registered Aug. 28, 2012**

**Int. Cl.: 30**

FOR: SAUCES FOR USE IN COOKING OR FLAVORING MEATS, POULTRY, SEAFOOD AND VEGETABLES, IN CLASS 30 (U.S. CL. 46).

**TRADEMARK**

FIRST USE 11-15-2011; IN COMMERCE 11-15-2011.

**PRINCIPAL REGISTER**

THE MARK CONSISTS OF STANDARD CHARACTERS WITHOUT CLAIM TO ANY PARTICULAR FONT, STYLE, SIZE, OR COLOR.

OWNER OF U.S. REG. NO. 3,147,930.

SN 85-463,911, FILED 11-3-2011.

TASHIA BUNCH, EXAMINING ATTORNEY



*David J. Kyffers*

Director of the United States Patent and Trademark Office

# United States of America

United States Patent and Trademark Office

# Targesphere

**Reg. No. 4,200,083**

**Registered Aug. 28, 2012**

**Int. Cl.: 5**

**TRADEMARK**

**PRINCIPAL REGISTER**

TARGESON, INC (DELAWARE CORPORATION)  
MS 02/444-445  
3550 GENERAL ATOMICS CT.  
SAN DIEGO, CA 92121

FOR: DRUG DELIVERY AGENTS CONSISTING OF COMPOUNDS THAT FACILITATE DELIVERY OF A WIDE RANGE OF PHARMACEUTICALS, IN CLASS 5 (U.S. CLS. 6, 18, 44, 46, 51 AND 52).

FIRST USE 10-31-2011; IN COMMERCE 1-12-2012.

THE MARK CONSISTS OF STANDARD CHARACTERS WITHOUT CLAIM TO ANY PARTICULAR FONT, STYLE, SIZE, OR COLOR.

SN 85-464,071, FILED 11-3-2011.

JENNY PARK, EXAMINING ATTORNEY



*David J. Kyjars*

Director of the United States Patent and Trademark Office

# United States of America

United States Patent and Trademark Office

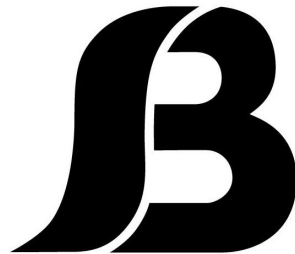

**Reg. No. 4,200,084**

**Registered Aug. 28, 2012**

**Int. Cl.: 25**

**TRADEMARK**

**PRINCIPAL REGISTER**

MCKOY, HOWARD (UNITED STATES INDIVIDUAL)  
3118 ARIZONA ST.  
OAKLAND, CA 94602

FOR: ATHLETIC APPAREL, NAMELY, SHIRTS, PANTS, JACKETS, FOOTWEAR, HATS AND CAPS, ATHLETIC UNIFORMS; BODY SHIRTS; GOLF SHIRTS; HOODED SWEAT SHIRTS; POLO SHIRTS; RUGBY SHIRTS; SPORTS SHIRTS; SPORTS SHIRTS WITH SHORT SLEEVES; SWEAT SHIRTS; TEE SHIRTS; YOGA SHIRTS, IN CLASS 25 (U.S. CLS. 22 AND 39).

FIRST USE 4-1-2012; IN COMMERCE 6-1-2012.

THE MARK CONSISTS OF THE LETTER "S". THE LETTER "B".

SN 85-465,400, FILED 11-5-2011.

WILLIAM BRECKENFELD, EXAMINING ATTORNEY



*David J. Kybas*

Director of the United States Patent and Trademark Office

# United States of America

United States Patent and Trademark Office

# FORMAT

**Reg. No. 4,200,085**

BECKER DESIGNED, INC. (D.C. CORPORATION)  
14954 BOGLE DRIVE  
CHANTILLY, VA 20151

**Registered Aug. 28, 2012**

**Int. Cl.: 20**

FOR: FURNITURE, IN CLASS 20 (U.S. CLS. 2, 13, 22, 25, 32 AND 50).

**TRADEMARK**

FIRST USE 4-3-2012; IN COMMERCE 4-3-2012.

**PRINCIPAL REGISTER**

THE MARK CONSISTS OF STANDARD CHARACTERS WITHOUT CLAIM TO ANY PARTICULAR FONT, STYLE, SIZE, OR COLOR.

SN 85-466,857, FILED 11-8-2011.

TRACY FLETCHER, EXAMINING ATTORNEY



*David J. Kyffers*

Director of the United States Patent and Trademark Office

# United States of America

United States Patent and Trademark Office

# SNACKDOM

**Reg. No. 4,200,086**

HEALTHY FUNDRAISING SOLUTIONS, LLC (WISCONSIN LIMITED LIABILITY COMPANY)  
101 S. MILITARY AVE. PMB # 208  
GREEN BAY, WI 54303

**Registered Aug. 28, 2012**

**Int. Cls.: 30 and 36**

FOR: SNACK PACKAGES FOR FUNDRAISING, NAMELY, PACKAGES OF GRAIN-BASED SNACK FOODS, CEREAL-BASED SNACK FOODS, WHEAT-BASED SNACK FOODS, AND RICE-BASED SNACK FOODS, IN CLASS 30 (U.S. CL. 46).

**TRADEMARK**

FIRST USE 12-2-2011; IN COMMERCE 12-2-2011.

**SERVICE MARK**

FOR: CHARITABLE FUNDRAISING SERVICES BY MEANS OF SELLING GOODS TO RAISE FUNDS, IN CLASS 36 (U.S. CLS. 100, 101 AND 102).

**PRINCIPAL REGISTER**

FIRST USE 11-7-2011; IN COMMERCE 11-7-2011.

THE MARK CONSISTS OF STANDARD CHARACTERS WITHOUT CLAIM TO ANY PARTICULAR FONT, STYLE, SIZE, OR COLOR.

SN 85-467,294, FILED 11-8-2011.

BRENDAN MCCAULEY, EXAMINING ATTORNEY



*David J. Kypos*

Director of the United States Patent and Trademark Office

# United States of America

United States Patent and Trademark Office

# RideConnect

**Reg. No. 4,200,087**

**Registered Aug. 28, 2012**

**Int. Cl.: 9**

**TRADEMARK**

**PRINCIPAL REGISTER**

SKRISHNAN MEDIA ENTERPRISES INC. (TEXAS CORPORATION)  
APT. 130-352  
2633 MCKINNEY AVE  
DALLAS, TX 75204

FOR: COMPUTER APPLICATION SOFTWARE FOR MOBILE PHONES, NAMELY, TRANSPORTATION SOFTWARE THAT CONNECTS RIDERS WITH DRIVERS, IN CLASS 9 (U.S. CLS. 21, 23, 26, 36 AND 38).

FIRST USE 12-10-2011; IN COMMERCE 6-19-2012.

THE MARK CONSISTS OF STANDARD CHARACTERS WITHOUT CLAIM TO ANY PARTICULAR FONT, STYLE, SIZE, OR COLOR.

SN 85-467,617, FILED 11-8-2011.

ANGELA M. MICHELI, EXAMINING ATTORNEY



*David J. Kyros*

Director of the United States Patent and Trademark Office

# United States of America

United States Patent and Trademark Office

# THORBAR 50

**Reg. No. 4,200,088**

**Registered Aug. 28, 2012**

**Int. Cl.: 6**

**TRADEMARK**

**PRINCIPAL REGISTER**

NELSEN STEEL AND WIRE L.P. (ILLINOIS LIMITED PARTNERSHIP), AKA NELSEN STEEL COMPANY,  
9400 W. BELMONT AVE.  
FRANKLIN PARK, IL 60131

FOR: METAL BARS FOR TESTING LOW TEMPERATURES AND NOTCH TOUGHNESS CHARACTERISTICS, IN CLASS 6 (U.S. CLS. 2, 12, 13, 14, 23, 25 AND 50).

FIRST USE 11-28-2011; IN COMMERCE 11-28-2011.

THE MARK CONSISTS OF STANDARD CHARACTERS WITHOUT CLAIM TO ANY PARTICULAR FONT, STYLE, SIZE, OR COLOR.

SN 85-468,404, FILED 11-9-2011.

JAY FLOWERS, EXAMINING ATTORNEY



*David J. Kyffers*

Director of the United States Patent and Trademark Office



United States of America  
United States Patent and Trademark Office

# BUSCADO

**Reg. No. 4,200,089**

**Registered Aug. 28, 2012**

**Int. Cl.: 33**

**TRADEMARK**

**PRINCIPAL REGISTER**

QUINTESSENTIAL, LLC (CALIFORNIA LIMITED LIABILITY COMPANY)  
1310 SECOND STREET  
NAPA, CA 94559

FOR: WINES, IN CLASS 33 (U.S. CLS. 47 AND 49).

FIRST USE 9-8-2011; IN COMMERCE 9-8-2011.

THE MARK CONSISTS OF STANDARD CHARACTERS WITHOUT CLAIM TO ANY PARTICULAR FONT, STYLE, SIZE, OR COLOR.

THE ENGLISH TRANSLATION OF "BUSCADO" IN THE MARK IS "WANTED".

SN 85-468,558, FILED 11-9-2011.

TRACY FLETCHER, EXAMINING ATTORNEY



*David J. Kyffers*

Director of the United States Patent and Trademark Office

# United States of America

United States Patent and Trademark Office

## REDFLEX STUDENT GUARDIAN

**Reg. No. 4,200,090**

REDFLEX TRAFFIC SYSTEMS, INC. (DELAWARE CORPORATION)

**Registered Aug. 28, 2012**

23751 N. 23RD AVENUE, SUITE 150  
PHOENIX, AZ 85085

**Int. Cl.: 9**

FOR: COMPUTER HARDWARE AND SOFTWARE FOR TRAFFIC MONITORING, TRAFFIC INFORMATION PROCESSING, TRAFFIC CITATION MANAGEMENT; COMPUTER HARDWARE AND SOFTWARE FOR ANALYZING, MONITORING, EVALUATING, AND REPORTING SURROUNDING TRAFFIC TO ENSURE THE SAFETY OF VEHICLE PASSENGERS AND PEDESTRIANS, IN CLASS 9 (U.S. CLS. 21, 23, 26, 36 AND 38).

**TRADEMARK**

**PRINCIPAL REGISTER**

FIRST USE 4-30-2012; IN COMMERCE 4-30-2012.

THE MARK CONSISTS OF STANDARD CHARACTERS WITHOUT CLAIM TO ANY PARTICULAR FONT, STYLE, SIZE, OR COLOR.

OWNER OF U.S. REG. NOS. 3,807,435, 3,857,162, AND OTHERS.

NO CLAIM IS MADE TO THE EXCLUSIVE RIGHT TO USE "STUDENT", APART FROM THE MARK AS SHOWN.

SN 85-468,811, FILED 11-9-2011.

RONALD MCMORROW, EXAMINING ATTORNEY



*David J. Kybas*

Director of the United States Patent and Trademark Office

# United States of America

United States Patent and Trademark Office

## The Online Creative Archive

**Reg. No. 4,200,091**

**Registered Aug. 28, 2012**

**Int. Cl.: 41**

**SERVICE MARK**

**PRINCIPAL REGISTER**

DECLARATION ARCHIVE, LLC (NEW YORK LIMITED LIABILITY COMPANY)  
APT 31  
190 SOUTH 8TH STREET  
BROOKLYN, NY 11211

FOR: PROVIDING AN ON-LINE PUBLICATION IN THE NATURE OF AN INTERACTIVE ENCYCLOPEDIA IN THE FIELD OF A WIDE VARIETY OF GENERAL ENCYCLOPEDIA KNOWLEDGE , IN CLASS 41 (U.S. CLS. 100, 101 AND 107).

FIRST USE 12-1-2009; IN COMMERCE 6-5-2012.

THE MARK CONSISTS OF STANDARD CHARACTERS WITHOUT CLAIM TO ANY PARTICULAR FONT, STYLE, SIZE, OR COLOR.

NO CLAIM IS MADE TO THE EXCLUSIVE RIGHT TO USE "ONLINE" AND "ARCHIVE", APART FROM THE MARK AS SHOWN.

SN 85-469,068, FILED 11-10-2011.

MARK T. MULLEN, EXAMINING ATTORNEY



*David J. Kyffers*

Director of the United States Patent and Trademark Office

# United States of America

United States Patent and Trademark Office



**Reg. No. 4,200,092**

**Registered Aug. 28, 2012**

**Int. Cl.: 29**

**TRADEMARK**

**PRINCIPAL REGISTER**

SF INVESTMENTS, INC. (DELAWARE CORPORATION)  
BAYNARD BLDG., STE. 103  
3411 SILVERSIDE ROAD  
WILMINGTON, DE 19810

FOR: MEAT; PORK, IN CLASS 29 (U.S. CL. 46).

FIRST USE 11-30-2011; IN COMMERCE 11-30-2011.

THE MARK CONSISTS OF THREE CONCENTRIC CIRCLES; THE SECOND CIRCLE IS BORDERED BY A THICKER LINE AND COMPRISED OF THE WORDS "VERTICAL INTEGRATION CONSISTENT QUALITY SUPPLY", WITH SOLID STARS BEFORE AND AFTER THE WORDS "VERTICAL INTEGRATION" AND BULLETS BETWEEN THE WORDS "CONSISTENT QUALITY SUPPLY"; THE INNER CIRCLE IS COMPRISED OF A SOLID IMAGE OF A PIG.

SN 85-470,251, FILED 11-11-2011.

REBECCA EISINGER, EXAMINING ATTORNEY



*David J. Kyffers*

Director of the United States Patent and Trademark Office

# United States of America

United States Patent and Trademark Office

# FERTILINK

**Reg. No. 4,200,093**

HELENA HOLDING COMPANY (DELAWARE CORPORATION)  
300 DELAWARE AVENUE, 9TH FLOOR - DE 5403  
WILMINGTON, DE 19801

**Registered Aug. 28, 2012**

**Int. Cl.: 1**

FOR: FERTILIZER, SOIL AMENDMENT FOR USE IN AGRICULTURE INDUSTRY, IN CLASS 1 (U.S. CLS. 1, 5, 6, 10, 26 AND 46).

**TRADEMARK**

FIRST USE 4-13-2012; IN COMMERCE 4-13-2012.

**PRINCIPAL REGISTER**

THE MARK CONSISTS OF STANDARD CHARACTERS WITHOUT CLAIM TO ANY PARTICULAR FONT, STYLE, SIZE, OR COLOR.

SN 85-470,328, FILED 11-11-2011.

SEAN CROWLEY, EXAMINING ATTORNEY



*David J. Kybas*

Director of the United States Patent and Trademark Office

# United States of America

United States Patent and Trademark Office

## FiberTag

**Reg. No. 4,200,094**

**Registered Aug. 28, 2012**

**Int. Cl.: 16**

**TRADEMARK**

**PRINCIPAL REGISTER**

FIBERMARK NORTH AMERICA, INC. (DELAWARE CORPORATION)  
161 WELLINGTON ROAD  
BRATTLEBORO, MD 05302

FOR: LATEX SATURATED PAPER, IN CLASS 16 (U.S. CLS. 2, 5, 22, 23, 29, 37, 38 AND 50).

FIRST USE 1-13-2012; IN COMMERCE 1-13-2012.

THE MARK CONSISTS OF STANDARD CHARACTERS WITHOUT CLAIM TO ANY PARTICULAR FONT, STYLE, SIZE, OR COLOR.

SN 85-471,389, FILED 11-14-2011.

JOHN WILKE, EXAMINING ATTORNEY



*David J. Kyjars*

Director of the United States Patent and Trademark Office

# United States of America

United States Patent and Trademark Office

## ROMANCE BROKERS

**Reg. No. 4,200,095**

ROMANCE BROKERS, INC. (NEW YORK CORPORATION)  
47 CORBIN PLACE  
BROOKLYN, NY 11235

**Registered Aug. 28, 2012**

**Int. Cl.: 45**

FOR: SOCIAL MEDIA BASED DATING SERVICES; SOCIAL INTRODUCTION AND NETWORKING SERVICES; CONSULTATION IN THE FIELD OF DATING, ETIQUETTE AND PERSONAL IMAGE DEVELOPMENT, IN CLASS 45 (U.S. CLS. 100 AND 101).

**SERVICE MARK**

FIRST USE 1-1-2012; IN COMMERCE 3-1-2012.

**PRINCIPAL REGISTER**

THE MARK CONSISTS OF STANDARD CHARACTERS WITHOUT CLAIM TO ANY PARTICULAR FONT, STYLE, SIZE, OR COLOR.

SN 85-472,744, FILED 11-15-2011.

ANDREW LEASER, EXAMINING ATTORNEY



*David J. Kyffers*

Director of the United States Patent and Trademark Office

# United States of America

United States Patent and Trademark Office

## Betty Black Lager

**Reg. No. 4,200,096**

EMERALD CITY BEER COMPANY, LLC (WASHINGTON LIMITED LIABILITY COMPANY)  
3100 AIRPORT WAY SOUTH, SUITE 8100  
SEATTLE, WA 98134

**Registered Aug. 28, 2012**

**Int. Cl.: 32**

FOR: BEER, IN CLASS 32 (U.S. CLS. 45, 46 AND 48).

**TRADEMARK**

FIRST USE 1-1-2012; IN COMMERCE 1-1-2012.

**PRINCIPAL REGISTER**

THE MARK CONSISTS OF STANDARD CHARACTERS WITHOUT CLAIM TO ANY PARTICULAR FONT, STYLE, SIZE, OR COLOR.

NO CLAIM IS MADE TO THE EXCLUSIVE RIGHT TO USE "BLACK LAGER", APART FROM THE MARK AS SHOWN.

SN 85-473,234, FILED 11-15-2011.

AMY KELLY, EXAMINING ATTORNEY



*David J. Kyffers*

Director of the United States Patent and Trademark Office



# United States of America

United States Patent and Trademark Office

# JCR Vineyard

**Reg. No. 4,200,097**

**Registered Aug. 28, 2012**

**Int. Cl.: 33**

**TRADEMARK**

**PRINCIPAL REGISTER**

JALAMA CANON RANCH, LLC (CALIFORNIA LIMITED LIABILITY COMPANY)  
SUITE 11  
1224 COAST VILLAGE CIRCLE  
SANTA BARBARA, CA 93108

FOR: RED WINE; RED WINES; WHITE WINE; WINE; WINES, IN CLASS 33 (U.S. CLS. 47 AND 49).

FIRST USE 4-13-2011; IN COMMERCE 6-14-2012.

THE MARK CONSISTS OF STANDARD CHARACTERS WITHOUT CLAIM TO ANY PARTICULAR FONT, STYLE, SIZE, OR COLOR.

NO CLAIM IS MADE TO THE EXCLUSIVE RIGHT TO USE "VINEYARD", APART FROM THE MARK AS SHOWN.

SN 85-475,722, FILED 11-17-2011.

DAVID MURRAY, EXAMINING ATTORNEY



*David J. Kyfos*

Director of the United States Patent and Trademark Office

# United States of America

United States Patent and Trademark Office

# ACCOTERIC

**Reg. No. 4,200,098**

**Registered Aug. 28, 2012**

**Int. Cl.: 1**

**TRADEMARK**

**PRINCIPAL REGISTER**

ABITEC CORPORATION (DELAWARE CORPORATION)  
501 WEST FIRST AVE  
COLUMBUS, OH 43215

FOR: CHEMICALS FOR USE IN THE MANUFACTURE OF GOODS IN THE NATURE OF AMPHOTERIC, QUATERNARY AMMONIUM CATIONIC, AND BLENDS THEREOF, WHICH CAN ACT AS CATIONS OR ANIONS DEPENDING ON THE PH, OR AS BOTH CATION AND ANION, FOR USE IN A WIDE VARIETY OF GOODS INCLUDING HOUSEHOLD, INDUSTRIAL, AND INSTITUTIONAL APPLICATIONS, PERSONAL CARE, AND OILFIELD EXPLORATION, IN CLASS 1 (U.S. CLS. 1, 5, 6, 10, 26 AND 46).

FIRST USE 10-27-2011; IN COMMERCE 10-27-2011.

THE MARK CONSISTS OF STANDARD CHARACTERS WITHOUT CLAIM TO ANY PARTICULAR FONT, STYLE, SIZE, OR COLOR.

SN 85-479,783, FILED 11-23-2011.

REBECCA GILBERT, EXAMINING ATTORNEY



*David J. Kyffers*

Director of the United States Patent and Trademark Office

# United States of America

United States Patent and Trademark Office

# EverBank Infinity

**Reg. No. 4,200,099**

**Registered Aug. 28, 2012**

**Int. Cl.: 36**

**SERVICE MARK**

**PRINCIPAL REGISTER**

EVERBANK (UNITED STATES FEDERAL SAVINGS ASSOCIATION)  
KAREN KOSTER BURR  
501 RIVERSIDE AVENUE - 5TH FLOOR  
JACKSONVILLE, FL 32202

FOR: BANKING AND FINANCING SERVICES; BANKING CONSULTATION; ON-LINE BANKING SERVICES, IN CLASS 36 (U.S. CLS. 100, 101 AND 102).

FIRST USE 2-27-2012, THE MARK WAS FIRST USED ANYWHERE IN A DIFFERENT FORM OTHER THAN THAT SOUGHT TO BE REGISTERED AT LEAST AS EARLY AS 04/01/2004.; IN COMMERCE 2-27-2012, THE MARK WAS FIRST USED IN COMMERCE IN A DIFFERENT FORM OTHER THAN THAT SOUGHT TO BE REGISTERED AT LEAST AS EARLY AS 04/01/2004..

OWNER OF U.S. REG. NOS. 2,568,122, 3,845,024, AND OTHERS.

THE MARK CONSISTS OF WORDS "EVERBANK INFINITY" WITH THE DESIGN ELEMENT IN THE "Y" IN THE WORD "INFINITY" DISPLAYING THE SYMBOL FOR INFINITY.

SN 85-479,968, FILED 11-23-2011.

TINA MAI, EXAMINING ATTORNEY



*David J. Kyffers*

Director of the United States Patent and Trademark Office

# United States of America

United States Patent and Trademark Office

## AE LEGEND

**Reg. No. 4,200,100**

RETAIL ROYALTY COMPANY (NEVADA CORPORATION)  
101 CONVENTION CENTER DRIVE  
LAS VEGAS, NV 89109

**Registered Aug. 28, 2012**

**Int. Cl.: 25**

FOR: SHIRTS, IN CLASS 25 (U.S. CLS. 22 AND 39).

**TRADEMARK**

FIRST USE 2-0-2012; IN COMMERCE 2-0-2012.

**PRINCIPAL REGISTER**

THE MARK CONSISTS OF STANDARD CHARACTERS WITHOUT CLAIM TO ANY PARTICULAR FONT, STYLE, SIZE, OR COLOR.

OWNER OF U.S. REG. NOS. 2,216,789, 2,574,009, AND OTHERS.

SN 85-482,241, FILED 11-29-2011.

DAWN FELDMAN, EXAMINING ATTORNEY



*David J. Kyffers*

Director of the United States Patent and Trademark Office

# United States of America

United States Patent and Trademark Office

# JOYLICIOUS

**Reg. No. 4,200,101**

**Registered Aug. 28, 2012**

**Int. Cl.: 30**

**TRADEMARK**

**PRINCIPAL REGISTER**

KELLOGG NORTH AMERICA COMPANY (DELAWARE CORPORATION)  
ONE KELLOGG SQUARE  
PO BOX 3599  
BATTLE CREEK, MI 490163499

FOR: TOASTER PASTRIES, IN CLASS 30 (U.S. CL. 46).

FIRST USE 1-0-2012; IN COMMERCE 1-0-2012.

THE MARK CONSISTS OF STANDARD CHARACTERS WITHOUT CLAIM TO ANY PARTICULAR FONT, STYLE, SIZE, OR COLOR.

SN 85-485,568, FILED 12-2-2011.

MELISSA VALLILLO, EXAMINING ATTORNEY



*David J. Kybas*

Director of the United States Patent and Trademark Office

# United States of America

United States Patent and Trademark Office

## SHIPPING WARS

**Reg. No. 4,200,102**

A&E TELEVISION NETWORKS, LLC (DELAWARE LIMITED LIABILITY COMPANY)  
235 EAST 45TH STREET  
NEW YORK, NY 10017

**Registered Aug. 28, 2012**

**Int. Cls.: 9 and 41**

FOR: MULTIMEDIA GOODS, NAMELY, PRERECORDED DIGITAL VIDEO DISCS AND DVDS FEATURING SUBJECTS OF GENERAL HUMAN INTEREST; DIGITAL MEDIA, NAMELY, DOWNLOADABLE AUDIO AND VIDEO FILES FEATURING SUBJECTS OF GENERAL HUMAN INTEREST; DOWNLOADABLE WEBCASTS FEATURING SUBJECTS OF GENERAL HUMAN INTEREST; DOWNLOADABLE GRAPHICS FOR WIRELESS DEVICES; DOWNLOADABLE ON-LINE DISCUSSION BOARDS AND WEBCASTS FEATURING SUBJECTS OF GENERAL HUMAN INTEREST, IN CLASS 9 (U.S. CLS. 21, 23, 26, 36 AND 38).

**TRADEMARK**

**SERVICE MARK**

**PRINCIPAL REGISTER**

FIRST USE 1-10-2012; IN COMMERCE 1-10-2012.

FOR: ENTERTAINMENT SERVICES, NAMELY, A MULTIMEDIA PROGRAM SERIES FEATURING SUBJECTS OF GENERAL HUMAN INTEREST DISTRIBUTED VIA VARIOUS PLATFORMS ACROSS MULTIPLE FORMS OF TRANSMISSION MEDIA; ENTERTAINMENT SERVICES, NAMELY, AN ONGOING TELEVISION SERIES FEATURING SUBJECTS OF GENERAL HUMAN INTEREST; PROVIDING A WEBSITE FEATURING GENERAL HUMAN INTEREST FOR ENTERTAINMENT PURPOSES ONLY, IN CLASS 41 (U.S. CLS. 100, 101 AND 107).

FIRST USE 1-10-2012; IN COMMERCE 1-10-2012.

THE MARK CONSISTS OF STANDARD CHARACTERS WITHOUT CLAIM TO ANY PARTICULAR FONT, STYLE, SIZE, OR COLOR.

SN 85-491,250, FILED 12-9-2011.

GINA HAYES, EXAMINING ATTORNEY



*David J. Kyros*

Director of the United States Patent and Trademark Office

# United States of America

United States Patent and Trademark Office

## DISTINCTIVE

**Reg. No. 4,200,103**

TUPPERWARE PRODUCTS S.A. (SWITZERLAND CORPORATION)  
ROUTE DU JURA 37

**Registered Aug. 28, 2012**

FRIBOURG, SWITZERLAND CH-1700

**Int. Cl.: 3**

FOR: PERFUMERY, IN CLASS 3 (U.S. CLS. 1, 4, 6, 50, 51 AND 52).

**TRADEMARK**

FIRST USE 5-3-2012; IN COMMERCE 5-3-2012.

**PRINCIPAL REGISTER**

THE MARK CONSISTS OF STANDARD CHARACTERS WITHOUT CLAIM TO ANY PARTICULAR FONT, STYLE, SIZE, OR COLOR.

SN 85-491,255, FILED 12-9-2011.

HOWARD SMIGA, EXAMINING ATTORNEY



*David J. Kybas*

Director of the United States Patent and Trademark Office

# United States of America

United States Patent and Trademark Office



**Reg. No. 4,200,104**

TAKEDA PHARMACEUTICAL COMPANY LIMITED (JAPAN CORPORATION)  
1-1, DOSHOMACHI 4-CHOME, CHUO-KU  
OSAKA, JAPAN

**Registered Aug. 28, 2012**

**Int. Cl.: 5**

FOR: PHARMACEUTICAL PREPARATIONS FOR THE TREATMENT AND PREVENTION  
OF CARDIOVASCULAR DISEASES, IN CLASS 5 (U.S. CLS. 6, 18, 44, 46, 51 AND 52).

**TRADEMARK**

FIRST USE 2-7-2012; IN COMMERCE 2-7-2012.

**PRINCIPAL REGISTER**

OWNER OF U.S. REG. NO. 3,807,333.

THE COLOR(S) GRAY, GREEN IS/ARE CLAIMED AS A FEATURE OF THE MARK.

THE MARK CONSISTS OF THE WORD "EDARBYCLOR" IN STYLIZED GRAY LETTERING  
APPEARING BENEATH A CIRCLE OF GREEN TRIANGLES OF DIFFERENT SIZES, IN-  
CREASING IN SIZE IN A CLOCKWISE DIRECTION.

THE WORDING EDARBYCLOR HAS NO MEANING IN A FOREIGN LANGUAGE.

SN 85-498,541, FILED 12-19-2011.

JANICE KIM, EXAMINING ATTORNEY



*David J. Kybas*

Director of the United States Patent and Trademark Office



# United States of America

United States Patent and Trademark Office

## CINEMA SYNC

**Reg. No. 4,200,105**

**Registered Aug. 28, 2012**

**Int. Cl.: 9**

**TRADEMARK**

**PRINCIPAL REGISTER**

NATIONAL CINEMEDIA, LLC (DELAWARE LIMITED LIABILITY COMPANY)  
9110 EAST NICHOLS AVENUE, SUITE 200  
CENTENNIAL, CO 80112

FOR: DOWNLOADABLE SOFTWARE APPLICATION FOR MOBILE AND TABLET DEVICES AND ELECTRONIC COMMUNICATION NETWORKS THAT ENABLES USERS TO OBTAIN AND SHARE INFORMATION ABOUT MOTION PICTURES AND PROVIDES INTERACTIVE ENHANCEMENTS TO MOTION PICTURE VIEWING, IN CLASS 9 (U.S. CLS. 21, 23, 26, 36 AND 38).

FIRST USE 2-11-2012; IN COMMERCE 2-11-2012.

THE MARK CONSISTS OF STANDARD CHARACTERS WITHOUT CLAIM TO ANY PARTICULAR FONT, STYLE, SIZE, OR COLOR.

NO CLAIM IS MADE TO THE EXCLUSIVE RIGHT TO USE "CINEMA", APART FROM THE MARK AS SHOWN.

SN 85-499,045, FILED 12-19-2011.

WILLIAM VERHOSEK, EXAMINING ATTORNEY



*David J. Kyros*

Director of the United States Patent and Trademark Office

# United States of America

United States Patent and Trademark Office



**Reg. No. 4,200,106**

**Registered Aug. 28, 2012**

**Int. Cl.: 32**

**TRADEMARK**

**PRINCIPAL REGISTER**

MILNE, INC. (OREGON CORPORATION)  
5224 NE CLEVELAND  
PORTLAND, OR 97211

FOR: BEER, CRAFT BEER AND ALES, IN CLASS 32 (U.S. CLS. 45, 46 AND 48).

FIRST USE 12-20-2011; IN COMMERCE 12-20-2011.

THE MARK CONSISTS OF A STYLIZED DESIGN OF AN ANTLERED DEER IN A JUMPING STANCE.

SN 85-499,306, FILED 12-19-2011.

ANTHONY RINKER, EXAMINING ATTORNEY



*David J. Kybas*

Director of the United States Patent and Trademark Office

# United States of America

United States Patent and Trademark Office

## SIMONIZ HOT WAX

**Reg. No. 4,200,107**

**Registered Aug. 28, 2012**

**Int. Cls.: 3 and 37**

**TRADEMARK**

**SERVICE MARK**

**PRINCIPAL REGISTER**

SIMONIZ USA, INC. (CONNECTICUT CORPORATION)  
201 BOSTON TURNPIKE  
BOLTON, CT 06043

FOR: SPRAY ON AUTOMOTIVE WAX AND POLISH, IN CLASS 3 (U.S. CLS. 1, 4, 6, 50, 51 AND 52).

FIRST USE 5-18-2012; IN COMMERCE 5-18-2012.

FOR: PROVIDING A WAX AND POLISH TREATMENT AS A VEHICLE PASSES THROUGH AN AUTOMATIC CARWASH, IN CLASS 37 (U.S. CLS. 100, 103 AND 106).

FIRST USE 5-18-2012; IN COMMERCE 5-18-2012.

THE MARK CONSISTS OF STANDARD CHARACTERS WITHOUT CLAIM TO ANY PARTICULAR FONT, STYLE, SIZE, OR COLOR.

OWNER OF U.S. REG. NOS. 3,100,664, 3,392,950, AND OTHERS.

NO CLAIM IS MADE TO THE EXCLUSIVE RIGHT TO USE "HOT WAX", APART FROM THE MARK AS SHOWN.

SN 85-499,738, FILED 12-20-2011.

ALAIN LAPTEY, EXAMINING ATTORNEY



*David J. Kyffers*

Director of the United States Patent and Trademark Office

# United States of America

United States Patent and Trademark Office

## SIMONIZ HOT WAX AND SHINE

**Reg. No. 4,200,108**

**Registered Aug. 28, 2012**

**Int. Cls.: 3 and 37**

**TRADEMARK**

**SERVICE MARK**

**PRINCIPAL REGISTER**

SIMONIZ USA, INC. (CONNECTICUT CORPORATION)  
201 BOSTON TURNPIKE  
BOLTON, CT 06043

FOR: SPRAY ON AUTOMOTIVE WAX AND POLISH, IN CLASS 3 (U.S. CLS. 1, 4, 6, 50, 51 AND 52).

FIRST USE 2-3-2012; IN COMMERCE 2-3-2012.

FOR: PROVIDING A WAX AND POLISH TREATMENT AS A VEHICLE PASSES THROUGH AN AUTOMATIC CARWASH, IN CLASS 37 (U.S. CLS. 100, 103 AND 106).

FIRST USE 2-3-2012; IN COMMERCE 2-3-2012.

THE MARK CONSISTS OF STANDARD CHARACTERS WITHOUT CLAIM TO ANY PARTICULAR FONT, STYLE, SIZE, OR COLOR.

OWNER OF U.S. REG. NOS. 3,100,664, 3,392,950, AND OTHERS.

NO CLAIM IS MADE TO THE EXCLUSIVE RIGHT TO USE "HOT WAX AND SHINE", APART FROM THE MARK AS SHOWN.

SN 85-499,762, FILED 12-20-2011.

ALAIN LAPTER, EXAMINING ATTORNEY



*David J. Kyffers*

Director of the United States Patent and Trademark Office

# United States of America

United States Patent and Trademark Office

## SIMONIZ HOT WAX & SHINE

**Reg. No. 4,200,109**

**Registered Aug. 28, 2012**

**Int. Cls.: 3 and 37**

**TRADEMARK**

**SERVICE MARK**

**PRINCIPAL REGISTER**

SIMONIZ USA, INC. (CONNECTICUT CORPORATION)  
201 BOSTON TURNPIKE  
BOLTON, CT 06043

FOR: SPRAY ON AUTOMOTIVE WAX AND POLISH, IN CLASS 3 (U.S. CLS. 1, 4, 6, 50, 51 AND 52).

FIRST USE 2-10-2012; IN COMMERCE 2-10-2012.

FOR: PROVIDING A WAX AND POLISH TREATMENT AS A VEHICLE PASSES THROUGH AN AUTOMATIC CARWASH, IN CLASS 37 (U.S. CLS. 100, 103 AND 106).

FIRST USE 2-10-2012; IN COMMERCE 2-10-2012.

THE MARK CONSISTS OF STANDARD CHARACTERS WITHOUT CLAIM TO ANY PARTICULAR FONT, STYLE, SIZE, OR COLOR.

OWNER OF U.S. REG. NOS. 3,100,664, 3,392,950, AND OTHERS.

NO CLAIM IS MADE TO THE EXCLUSIVE RIGHT TO USE "HOT WAX & SHINE", APART FROM THE MARK AS SHOWN.

SN 85-499,771, FILED 12-20-2011.

ALAIN LAPTEY, EXAMINING ATTORNEY



*David J. Kyffers*

Director of the United States Patent and Trademark Office

# United States of America

United States Patent and Trademark Office

**PediaSure**  
**SIDEKICKS** Clear

**Reg. No. 4,200,110**

ABBOTT LABORATORIES (ILLINOIS CORPORATION)  
100 ABBOTT PARK ROAD  
ABBOTT PARK, IL 60064

**Registered Aug. 28, 2012**

**Int. Cls.: 5 and 32**

FOR: LIQUID NUTRITIVE SUPPLEMENTS FOR HUMAN USE; NUTRITIONALLY FORTIFIED BEVERAGES AND POWDERS FOR MEAL REPLACEMENT, IN CLASS 5 (U.S. CLS. 6, 18, 44, 46, 51 AND 52).

**TRADEMARK**

FIRST USE 3-19-2012; IN COMMERCE 3-19-2012.

**PRINCIPAL REGISTER**

FOR: FRUIT DRINKS AND JUICES, IN CLASS 32 (U.S. CLS. 45, 46 AND 48).

FIRST USE 3-19-2012; IN COMMERCE 3-19-2012.

OWNER OF U.S. REG. NOS. 1,475,612, 3,858,192, AND 3,862,056.

NO CLAIM IS MADE TO THE EXCLUSIVE RIGHT TO USE "CLEAR", APART FROM THE MARK AS SHOWN.

THE MARK CONSISTS OF THE STYLIZED WORD "PEDIASURE SIDEKICKS CLEAR".

SN 85-501,251, FILED 12-21-2011.

TEJBIR SINGH, EXAMINING ATTORNEY



*David J. Kybas*

Director of the United States Patent and Trademark Office

# United States of America

United States Patent and Trademark Office

## THE WARM BLOODED SHARK

**Reg. No. 4,200,111**

FOR YOUR EASE ONLY, INC. (ILLINOIS CORPORATION)  
1301 NORTH DEARBORN PARKWAY  
CHICAGO, IL 60610

**Registered Aug. 28, 2012**

**Int. Cls.: 16, 35, and 41**

FOR: PUBLICATIONS, NAMELY, NEWSLETTERS IN THE FIELD OF INVENTORS, ENTREPRENEURS AND PRODUCT DEVELOPMENT, IN CLASS 16 (U.S. CLS. 2, 5, 22, 23, 29, 37, 38 AND 50).

**TRADEMARK**

FIRST USE 2-29-2012; IN COMMERCE 6-22-2012.

**SERVICE MARK**

FOR: PROVIDING A WEBSITE FEATURING BUSINESS INFORMATION ABOUT INVENTORS, ENTREPRENEURS AND PRODUCT DEVELOPMENT, IN CLASS 35 (U.S. CLS. 100, 101 AND 102).

**PRINCIPAL REGISTER**

FIRST USE 2-29-2012; IN COMMERCE 6-22-2012.

FOR: ENTERTAINMENT SERVICES, NAMELY, PERSONAL APPEARANCES BY A TELEVISION AND BUSINESS PERSONALITY, IN CLASS 41 (U.S. CLS. 100, 101 AND 107).

FIRST USE 2-29-2012; IN COMMERCE 6-22-2012.

THE MARK CONSISTS OF STANDARD CHARACTERS WITHOUT CLAIM TO ANY PARTICULAR FONT, STYLE, SIZE, OR COLOR.

SN 85-510,260, FILED 1-6-2012.

JIM RINGLE, EXAMINING ATTORNEY



*David J. Kyros*

Director of the United States Patent and Trademark Office

# United States of America

United States Patent and Trademark Office

# PAPER

**Reg. No. 4,200,112**

PAPER DENIM AND CLOTH, LLC (DELAWARE LIMITED LIABILITY COMPANY)  
530 7TH AVENUE  
NEW YORK, NY 10018

**Registered Aug. 28, 2012**

**Int. Cl.: 25**

FOR: JEANS, SWEATERS, JACKETS, COATS, SHIRTS, T-SHIRTS, SKIRTS, VESTS, AND TANK TOPS, IN CLASS 25 (U.S. CLS. 22 AND 39).

**TRADEMARK**

FIRST USE 6-1-2012; IN COMMERCE 6-1-2012.

**PRINCIPAL REGISTER**

THE MARK CONSISTS OF STANDARD CHARACTERS WITHOUT CLAIM TO ANY PARTICULAR FONT, STYLE, SIZE, OR COLOR.

OWNER OF U.S. REG. NO. 2,553,907.

SN 85-538,643, FILED 2-9-2012.

JANICE L. MCMORROW, EXAMINING ATTORNEY



*David J. Kybas*

Director of the United States Patent and Trademark Office



# United States of America

United States Patent and Trademark Office

## WINE SISTERHOOD

**Reg. No. 4,200,113**

CANOPY MANAGEMENT, LLC (CALIFORNIA LIMITED LIABILITY COMPANY)  
1403 JEFFERSON STREET  
NAPA, CA 94559

**Registered Aug. 28, 2012**

**Int. Cls.: 35 and 42**

FOR: ONLINE RETAIL STORE SERVICES FEATURING WINE, CLOTHING, POSTERS, APRONS AND TOTE BAGS; MARKETING SERVICES; CONDUCTING BUSINESS AND MARKET RESEARCH SURVEYS; BUSINESS NETWORKING, IN CLASS 35 (U.S. CLS. 100, 101 AND 102).

**SERVICE MARK**

**PRINCIPAL REGISTER**

FIRST USE 9-1-2009; IN COMMERCE 9-1-2009.

FOR: COMPUTER SERVICES, NAMELY, CREATING AN ON-LINE COMMUNITY FOR REGISTERED USERS TO PARTICIPATE IN DISCUSSIONS, GET FEEDBACK FROM THEIR PEERS, FORM VIRTUAL COMMUNITIES, AND ENGAGE IN SOCIAL NETWORKING, IN CLASS 42 (U.S. CLS. 100 AND 101).

FIRST USE 9-1-2009; IN COMMERCE 9-1-2009.

THE MARK CONSISTS OF STANDARD CHARACTERS WITHOUT CLAIM TO ANY PARTICULAR FONT, STYLE, SIZE, OR COLOR.

NO CLAIM IS MADE TO THE EXCLUSIVE RIGHT TO USE "WINE", APART FROM THE MARK AS SHOWN.

SN 85-975,563, FILED 5-4-2010.

BARBARA BROWN, EXAMINING ATTORNEY



*David J. Kyjars*

Director of the United States Patent and Trademark Office

# United States of America

United States Patent and Trademark Office

# PHOENIX

**Reg. No. 4,200,114**

ATHEROMED, INC. (DELAWARE CORPORATION)

**Registered Aug. 28, 2012**

1455 ADAMS DRIVE NO. 1120  
MENLO PARK, CA 94025

**Int. Cl.: 10**

FOR: MEDICAL DEVICES AND INSTRUMENTS, NAMELY, MEDICAL DEVICES AND INSTRUMENTS FOR ENDOVASCULAR PROCEDURES, KITS COMPRISING MEDICAL DEVICES AND INSTRUMENTS FOR ENDOVASCULAR PROCEDURES AND INSTRUCTIONS SOLD THEREWITH, AND PARTS AND FITTINGS FOR ALL OF THE FOREGOING MEDICAL DEVICES AND INSTRUMENTS, IN CLASS 10 (U.S. CLS. 26, 39 AND 44).

**TRADEMARK**

**PRINCIPAL REGISTER**

FIRST USE 2-8-2007; IN COMMERCE 2-8-2007.

THE MARK CONSISTS OF STANDARD CHARACTERS WITHOUT CLAIM TO ANY PARTICULAR FONT, STYLE, SIZE, OR COLOR.

SN 85-975,939, FILED 10-11-2010.

ROBIN CHOSID, EXAMINING ATTORNEY



*David J. Kyffers*

Director of the United States Patent and Trademark Office

# United States of America

United States Patent and Trademark Office

# gabacus

**Reg. No. 4,200,115**

**Registered Aug. 28, 2012**

**Int. Cl.: 42**

**SERVICE MARK**

**PRINCIPAL REGISTER**

EMCIEN CORPORATION (GEORGIA CORPORATION)  
75 5TH STREET NW, SUITE 318  
ATLANTA, GA 30308

FOR: PROVIDING TEMPORARY USE OF NON-DOWNLOADABLE COMPUTER SOFTWARE FOR PROVIDING AN ON-LINE DATABASE IN THE FIELD OF TRANSACTION PROCESSING TO UPLOAD TRANSACTIONAL DATA, PROVIDE STATISTICAL ANALYSIS, AND PRODUCE NOTIFICATIONS AND REPORTS; PROVIDING TEMPORARY USE OF NON-DOWNLOADABLE COMPUTER SOFTWARE FOR THE COLLECTION, EDITING, ORGANIZING, MODIFYING, BOOK MARKING, TRANSMISSION, STORAGE AND SHARING OF DATA AND INFORMATION; PROVIDING TEMPORARY USE OF NON-DOWNLOADABLE COMPUTER SOFTWARE THAT PROVIDES REAL-TIME, INTEGRATED BUSINESS MANAGEMENT INTELLIGENCE BY COMBINING INFORMATION FROM VARIOUS DATABASES AND PRESENTING IT IN AN EASY TO- UNDERSTAND USER INTERFACE; PROVIDING TEMPORARY USE OF NON-DOWNLOADABLE COMPUTER SOFTWARE THAT PROVIDES WEB-BASED ACCESS TO APPLICATIONS AND SERVICES THROUGH A WEB OPERATING SYSTEM OR PORTAL INTERFACE, IN CLASS 42 (U.S. CLS. 100 AND 101).

FIRST USE 1-13-2011; IN COMMERCE 1-13-2011.

THE MARK CONSISTS OF STANDARD CHARACTERS WITHOUT CLAIM TO ANY PARTICULAR FONT, STYLE, SIZE, OR COLOR.

SN 85-976,130, FILED 1-13-2011.

JOHN GARTNER, EXAMINING ATTORNEY



*David J. Kyffers*

Director of the United States Patent and Trademark Office

# United States of America

United States Patent and Trademark Office

## MERRY CHERRY

**Reg. No. 4,200,116**

SEATTLE GOURMET FOODS, INC. (WASHINGTON CORPORATION)  
19016 72ND AVE. S.  
KENT, WA 98032

**Registered Aug. 28, 2012**

**Int. Cl.: 30**

FOR: COFFEE-BASED BEVERAGES, HOT CHOCOLATE, CHOCOLATES AND PASTRIES,  
IN CLASS 30 (U.S. CL. 46).

**TRADEMARK**

FIRST USE 11-1-2010; IN COMMERCE 11-1-2010.

**PRINCIPAL REGISTER**

THE MARK CONSISTS OF STANDARD CHARACTERS WITHOUT CLAIM TO ANY PAR-  
TICULAR FONT, STYLE, SIZE, OR COLOR.

NO CLAIM IS MADE TO THE EXCLUSIVE RIGHT TO USE "CHERRY", APART FROM THE  
MARK AS SHOWN.

SN 85-976,143, FILED 4-27-2011.

JIM RINGLE, EXAMINING ATTORNEY



*David J. Kybas*

Director of the United States Patent and Trademark Office

# United States of America

United States Patent and Trademark Office

**girl scouts** 

**Reg. No. 4,200,117**

**Registered Aug. 28, 2012**

**Int. Cl.: 16**

**TRADEMARK**

**PRINCIPAL REGISTER**

GIRL SCOUTS OF THE UNITED STATES OF AMERICA (D.C. CONGRESSIONALLY  
CHARTERED NON-PROFIT CORPORATION)  
420 FIFTH AVENUE  
NEW YORK, NY 100182798

FOR: STATIONERY, NAMELY, PENS AND PENCILS, IN CLASS 16 (U.S. CLS. 2, 5, 22, 23,  
29, 37, 38 AND 50).

FIRST USE 6-0-2010; IN COMMERCE 6-0-2010.

OWNER OF U.S. REG. NOS. 1,142,655, 1,318,643, AND OTHERS.

THE MARK CONSISTS OF THE WORDS "GIRL SCOUTS" IN LOWERCASE LETTERS WITH  
THE DESIGN OF A CLOVER WITH THREE ALTERNATING PROFILES OF A WOMAN'S  
FACE WITHIN THE BORDERS OF THE CLOVER, TO THE IMMEDIATE RIGHT, SLIGHTLY  
ABOVE THE WORD "SCOUTS".

SN 85-976,424, FILED 9-21-2010.

MARK PILARO, EXAMINING ATTORNEY



*David J. Kybas*

Director of the United States Patent and Trademark Office

# United States of America

United States Patent and Trademark Office



**Reg. No. 4,200,118**

**Registered Aug. 28, 2012**

**Int. Cls.: 9, 39, 42, and 43**

**TRADEMARK**

**SERVICE MARK**

**PRINCIPAL REGISTER**

HOTEL TONIGHT, INC. (DELAWARE CORPORATION)  
217 SOUTH B. STREET  
SAN MATEO, CA 94401

FOR: COMPUTER APPLICATION SOFTWARE FOR MOBILE PHONES, NAMELY, SOFTWARE THAT ALLOWS USERS TO FIND, RESEARCH, ANALYZE, COMPARE AND BOOK SPECIAL OFFERS AND PROMOTIONS IN THE FIELDS OF CONSUMER GOODS AND SERVICES, NAMELY, TRAVEL AND LODGING, IN CLASS 9 (U.S. CLS. 21, 23, 26, 36 AND 38).

FIRST USE 12-15-2010; IN COMMERCE 12-15-2010.

FOR: PROVIDING AN INTERACTIVE WEBSITE FEATURING INFORMATION ON TRAVEL, IN CLASS 39 (U.S. CLS. 100 AND 105).

FIRST USE 12-15-2010; IN COMMERCE 12-15-2010.

FOR: PROVIDING TEMPORARY USE OF A WEB-BASED SOFTWARE APPLICATION THAT ALLOWS USERS TO FIND, RESEARCH, ANALYZE, TRACK, MANAGE, COMPARE AND BOOK SPECIAL OFFERS AND PROMOTIONS IN THE FIELDS OF CONSUMER GOODS AND SERVICES, NAMELY, TRAVEL AND LODGING, IN CLASS 42 (U.S. CLS. 100 AND 101).

FIRST USE 12-15-2010; IN COMMERCE 12-15-2010.

FOR: PROVIDING AN INTERACTIVE WEBSITE FEATURING TRAVEL AGENCY SERVICES, NAMELY, MAKING RESERVATIONS AND BOOKINGS FOR TEMPORARY LODGINGS, IN CLASS 43 (U.S. CLS. 100 AND 101).

FIRST USE 12-15-2010; IN COMMERCE 12-15-2010.

NO CLAIM IS MADE TO THE EXCLUSIVE RIGHT TO USE "HOTEL" , APART FROM THE MARK AS SHOWN.

THE MARK CONSISTS OF A STYLIZED DRAWING OF THE LETTER "H" SHAPED AS THE SIDE VIEW OF A BED WITH THE STYLIZED WORDS "HOTEL TONIGHT" ABOVE.



*David J. Kybas*

Director of the United States Patent and Trademark Office

**Reg. No. 4,200,118** SN 85-976,438, FILED 11-23-2010.

AMEEN IMAM, EXAMINING ATTORNEY

# United States of America

United States Patent and Trademark Office

## HOTEL TONIGHT

**Reg. No. 4,200,119**

**Registered Aug. 28, 2012**

**Int. Cls.: 9, 39, 42, and 43**

**TRADEMARK**

**SERVICE MARK**

**PRINCIPAL REGISTER**

HOTEL TONIGHT, INC. (DELAWARE CORPORATION)  
217 SOUTH B. STREET  
SAN MATEO, CA 94401

FOR: COMPUTER APPLICATION SOFTWARE FOR MOBILE PHONES, NAMELY, SOFTWARE THAT ALLOWS USERS TO FIND, RESEARCH, ANALYZE, COMPARE AND BOOK SPECIAL OFFERS AND PROMOTIONS IN THE FIELDS OF CONSUMER GOODS AND SERVICES, NAMELY, TRAVEL AND LODGING, IN CLASS 9 (U.S. CLS. 21, 23, 26, 36 AND 38).

FIRST USE 12-15-2010; IN COMMERCE 12-15-2010.

FOR: PROVIDING AN INTERACTIVE WEBSITE FEATURING INFORMATION ON TRAVEL, IN CLASS 39 (U.S. CLS. 100 AND 105).

FIRST USE 12-15-2010; IN COMMERCE 12-15-2010.

FOR: PROVIDING TEMPORARY USE OF A WEB-BASED SOFTWARE APPLICATION THAT ALLOWS USERS TO FIND, RESEARCH, ANALYZE, TRACK, MANAGE, COMPARE AND BOOK SPECIAL OFFERS AND PROMOTIONS IN THE FIELDS OF CONSUMER GOODS AND SERVICES, NAMELY, TRAVEL AND LODGING, IN CLASS 42 (U.S. CLS. 100 AND 101).

FIRST USE 12-15-2010; IN COMMERCE 12-15-2010.

FOR: PROVIDING AN INTERACTIVE WEBSITE FEATURING TRAVEL AGENCY SERVICES, NAMELY, MAKING RESERVATIONS AND BOOKINGS FOR TEMPORARY LODGINGS, IN CLASS 43 (U.S. CLS. 100 AND 101).

FIRST USE 12-15-2010; IN COMMERCE 12-15-2010.

THE MARK CONSISTS OF STANDARD CHARACTERS WITHOUT CLAIM TO ANY PARTICULAR FONT, STYLE, SIZE, OR COLOR.

NO CLAIM IS MADE TO THE EXCLUSIVE RIGHT TO USE "HOTEL", APART FROM THE MARK AS SHOWN.



*David J. Kybas*

Director of the United States Patent and Trademark Office



**Reg. No. 4,200,119** SN 85-976,439, FILED 11-23-2010.

AMEEN IMAM, EXAMINING ATTORNEY

# United States of America

United States Patent and Trademark Office



**Reg. No. 4,200,120**

**Registered Aug. 28, 2012**

**Int. Cls.: 9, 39, 42, and 43**

**TRADEMARK**

**SERVICE MARK**

**PRINCIPAL REGISTER**

HOTEL TONIGHT, INC. (DELAWARE CORPORATION)  
217 SOUTH B. STREET  
SAN MATEO, CA 94401

FOR: COMPUTER APPLICATION SOFTWARE FOR MOBILE PHONES, NAMELY, SOFTWARE THAT ALLOWS USERS TO FIND, RESEARCH, ANALYZE, COMPARE AND BOOK SPECIAL OFFERS AND PROMOTIONS IN THE FIELDS OF CONSUMER GOODS AND SERVICES, NAMELY, TRAVEL AND LODGING, IN CLASS 9 (U.S. CLS. 21, 23, 26, 36 AND 38).

FIRST USE 12-15-2010; IN COMMERCE 12-15-2010.

FOR: PROVIDING AN INTERACTIVE WEBSITE FEATURING INFORMATION ON TRAVEL, IN CLASS 39 (U.S. CLS. 100 AND 105).

FIRST USE 12-15-2010; IN COMMERCE 12-15-2010.

FOR: PROVIDING TEMPORARY USE OF A WEB-BASED SOFTWARE APPLICATION THAT ALLOWS USERS TO FIND, RESEARCH, ANALYZE, TRACK, MANAGE, COMPARE AND BOOK SPECIAL OFFERS AND PROMOTIONS IN THE FIELDS OF CONSUMER GOODS AND SERVICES, NAMELY, TRAVEL AND LODGING, IN CLASS 42 (U.S. CLS. 100 AND 101).

FIRST USE 12-15-2010; IN COMMERCE 12-15-2010.

FOR: PROVIDING AN INTERACTIVE WEBSITE FEATURING TRAVEL AGENCY SERVICES, NAMELY, MAKING RESERVATIONS AND BOOKINGS FOR TEMPORARY LODGINGS, IN CLASS 43 (U.S. CLS. 100 AND 101).

FIRST USE 12-15-2010; IN COMMERCE 12-15-2010.

THE MARK CONSISTS OF A STYLIZED DRAWING OF THE LETTER "H" SHAPED AS THE SIDE VIEW OF A BED.

SN 85-976,460, FILED 11-23-2010.

AMEEN IMAM, EXAMINING ATTORNEY



*David J. Kyros*

Director of the United States Patent and Trademark Office

# United States of America

United States Patent and Trademark Office



**Reg. No. 4,200,121**

NAS GLOBAL TRADE LTD. (US VIRGIN ISLANDS CORPORATION), DBA GOLDEN HANDS,  
3516 TRIPOLI CT. S.E.  
GRAND RAPIDS, MI 49546

**Registered Aug. 28, 2012**

**Int. Cl.: 18**

FOR: HANDBAGS, PURSES AND WALLETS, IN CLASS 18 (U.S. CLS. 1, 2, 3, 22 AND 41).

**TRADEMARK**

FIRST USE 7-6-2011; IN COMMERCE 7-6-2011.

**PRINCIPAL REGISTER**

THE MARK CONSISTS OF A BLACK RECTANGLE WITH HORIZONTAL BLACK AND YELLOW-GOLD PANELS. THE UPPER PANEL BEARS THE WORD "GOLDEN" IN YELLOW-GOLD COLOR AND THE LOWER PANEL BEARS THE WORD "HANDS" IN BLACK COLOR.

THE COLOR(S) BLACK AND YELLOW-GOLD IS/ARE CLAIMED AS A FEATURE OF THE MARK.

SN 85-976,774, FILED 12-11-2010.

DAWN FELDMAN, EXAMINING ATTORNEY



*David J. Kybas*

Director of the United States Patent and Trademark Office

# United States of America

United States Patent and Trademark Office

## JAWBONE ERA

**Reg. No. 4,200,122**

**Registered Aug. 28, 2012**

**Int. Cls.: 9 and 42**

**TRADEMARK**

**SERVICE MARK**

**PRINCIPAL REGISTER**

ALIPHCOM (CALIFORNIA CORPORATION)  
99 RHODE ISLAND  
3RD FLOOR  
SAN FRANCISCO, CA 94105

FOR: COMMUNICATION DEVICES, NAMELY, EAR PHONES, CELLULAR PHONE HEADSETS, TRANSMITTERS OF ELECTRONIC SIGNALS, TELECOMMUNICATIONS TRANSMITTERS, AUDIO TRANSMITTERS, VIDEO TRANSMITTERS, TELECOMMUNICATIONS RECEIVERS, AUDIO-VIDEO RECEIVERS, TELEPHONE RECEIVERS, NAMELY, AUDIO RECEIVERS, AND VIDEO RECEIVERS; WEARABLE AUDIO DISPLAY, NAMELY, EAR PHONES AND CELLULAR PHONE HEADSETS CONTAINING AN AUDIO DISPLAY; CARRYING CASES FOR TELEPHONE ACCESSORIES; STEREO HEADSETS FOR MOBILE PHONES AND CELLULAR PHONES; HEADSETS FOR USE WITH COMPUTERS; OPERATING SOFTWARE FOR THE CONTROL, MANAGEMENT, CONFIGURATION AND PERSONALIZATION OF FEATURES AND FUNCTIONS OF HEADSETS; USB CABLES; BATTERY CHARGERS FOR HEADSETS USED WITH CELLULAR PHONES, TELEPHONES, AND COMPUTERS; ON-LINE DOWNLOADABLE COMPUTER SOFTWARE FOR RECORDING, ORGANIZING, TRANSMITTING, RECEIVING, MANIPULATING, REVIEWING AND TRANSCRIBING TEXT, DATA, AUDIO AND VIDEO CONTENT FOR USE WITH COMMUNICATIONS EQUIPMENT, DEVICES AND ACCESSORIES, IN CLASS 9 (U.S. CLS. 21, 23, 26, 36 AND 38).

FIRST USE 11-10-2010; IN COMMERCE 1-20-2011.



FOR: SOFTWARE AS A SERVICE SERVICES FOR MANAGING THE DELIVERY OF CONTENT AND SERVICES TO EQUIPMENT, DEVICES AND ACCESSORIES FOR RECORDING, ORGANIZING, TRANSMITTING, RECEIVING, MANIPULATING, REVIEWING AND TRANSCRIBING TEXT, DATA, AUDIO, AND VIDEO CONTENT; COMPUTER SERVICES, NAMELY, REMOTE MANAGEMENT OF COMPUTER APPLICATIONS FOR OTHERS IN CONNECTION WITH EQUIPMENT, DEVICES AND ACCESSORIES FOR RECORDING, ORGANIZING, TRANSMITTING, RECEIVING, MANIPULATING, REVIEWING AND TRANSCRIBING TEXT, DATA, AUDIO, AND VIDEO CONTENT, IN CLASS 42 (U.S. CLS. 100 AND 101).

FIRST USE 11-10-2010; IN COMMERCE 1-20-2011.

*David J. Kyjars*

Director of the United States Patent and Trademark Office

**Reg. No. 4,200,122** THE MARK CONSISTS OF STANDARD CHARACTERS WITHOUT CLAIM TO ANY PARTICULAR FONT, STYLE, SIZE, OR COLOR.

OWNER OF U.S. REG. NO. 3,046,856.

SN 85-976,837, FILED 12-2-2010.

CHRISTINE COOPER, EXAMINING ATTORNEY

# United States of America

United States Patent and Trademark Office

## THE CHOO CHOO BOB SHOW

**Reg. No. 4,200,123**

**Registered Aug. 28, 2012**

**Int. Cls.: 9 and 41**

**TRADEMARK**

**SERVICE MARK**

**PRINCIPAL REGISTER**

BIRDHOUSE HOLDINGS, LLC (MINNESOTA LIMITED LIABILITY COMPANY)  
2050 MARSHALL AVENUE  
ST. PAUL, MN 55104

FOR: PRE-RECORDED MUSIC RECORDINGS; PRE-RECORDED ENTERTAINMENT RECORDINGS FEATURING CHILDREN'S PROGRAMMING; MUSIC, AND ARTISTIC PERFORMANCES, IN CLASS 9 (U.S. CLS. 21, 23, 26, 36 AND 38).

FIRST USE 12-31-2009; IN COMMERCE 12-31-2009.

FOR: TELEVISION SHOW AND MUSIC PRODUCTION, IN CLASS 41 (U.S. CLS. 100, 101 AND 107).

FIRST USE 12-31-2009; IN COMMERCE 12-31-2009.

THE MARK CONSISTS OF STANDARD CHARACTERS WITHOUT CLAIM TO ANY PARTICULAR FONT, STYLE, SIZE, OR COLOR.

NO CLAIM IS MADE TO THE EXCLUSIVE RIGHT TO USE "SHOW", APART FROM THE MARK AS SHOWN.

THE NAME "CHOO CHOO BOB" IDENTIFIES A LIVING INDIVIDUAL WHOSE CONSENT IS OF RECORD.

SN 85-976,851, FILED 1-24-2011.

ANN E. SAPPENFIELD, EXAMINING ATTORNEY



*David J. Kyros*

Director of the United States Patent and Trademark Office

# United States of America

United States Patent and Trademark Office

## MISS PERLE

**Reg. No. 4,200,124**

**Registered Aug. 28, 2012**

**Int. Cls.: 14 and 18**

**TRADEMARK**

**PRINCIPAL REGISTER**

ROBERT WAN LUXURY LIMITED (HONG KONG LIMITED LIABILITY COMPANY)  
26 HARBOUR ROAD  
ROOM 2410 CHINA RESOURCES BUILDING  
WANCHAI, HONG KONG

FOR: YELLOW AMBER JEWELRY, PEARLS, WRIST WATCHES, CHARMS, TRINKETS AS JEWELRY, NAMELY, RINGS AND CHARMS, BROOCHES, JEWELRY CHAINS, CHRONOGRAPHS AS WATCHES, NECKLACES, DIAMONDS, JEWELRY, MEDALLIONS, WATCHES, ORNAMENTS OF PRECIOUS METAL IN THE NATURE OF JEWELRY, RINGS, EARRINGS, PINS BEING JEWELRY, KEY RINGS OF PRECIOUS METAL, CLOISONNE JEWELRY, IN CLASS 14 (U.S. CLS. 2, 27, 28 AND 50).

FIRST USE 4-0-2011; IN COMMERCE 3-1-2012.

FOR: POCKET WALLETS, HANDBAGS, TRAVELLING BAGS, LEATHER BAGS, BRIEFCASES, TRAVEL BAGGAGE, LEATHER BOXES, TRUNKS, GARMENT BAGS FOR TRAVEL, KEY CASES, LEATHER SHOPPING BAGS, SUITCASES, IN CLASS 18 (U.S. CLS. 1, 2, 3, 22 AND 41).

FIRST USE 4-0-2011; IN COMMERCE 3-1-2012.

THE MARK CONSISTS OF STANDARD CHARACTERS WITHOUT CLAIM TO ANY PARTICULAR FONT, STYLE, SIZE, OR COLOR.

NO CLAIM IS MADE TO THE EXCLUSIVE RIGHT TO USE "PERLE", APART FROM THE MARK AS SHOWN.

THE ENGLISH TRANSLATION OF "PERLE" IN THE MARK IS "PEARL".

SN 85-976,853, FILED 2-10-2011.

MICHELE SWAIN, EXAMINING ATTORNEY



*David J. Kyffers*

Director of the United States Patent and Trademark Office

# United States of America

United States Patent and Trademark Office

# HICKIES

**Reg. No. 4,200,125**

**Registered Aug. 28, 2012**

**Int. Cl.: 26**

**TRADEMARK**

**PRINCIPAL REGISTER**

HICKIES, INC. (DELAWARE CORPORATION)  
3411 SILVERSIDE ROAD  
RODNEY BUILDING #104  
WILMINGTON, DE 19810

FOR: SHOE LACES, IN CLASS 26 (U.S. CLS. 37, 39, 40, 42 AND 50).

FIRST USE 6-0-2010; IN COMMERCE 4-30-2012.

THE MARK CONSISTS OF STANDARD CHARACTERS WITHOUT CLAIM TO ANY PARTICULAR FONT, STYLE, SIZE, OR COLOR.

SN 85-976,869, FILED 6-7-2010.

JOHN KELLY, EXAMINING ATTORNEY



*David J. Kybas*

Director of the United States Patent and Trademark Office



# United States of America

United States Patent and Trademark Office

## FEEDING HEALTH

**Reg. No. 4,200,126**

GITA PATEL (UNITED STATES INDIVIDUAL)  
7 PARTRIDGE ROAD  
ETNA, NH 03750

**Registered Aug. 28, 2012**

**Int. Cl.: 16**

FOR: COOK BOOKS, IN CLASS 16 (U.S. CLS. 2, 5, 22, 23, 29, 37, 38 AND 50).

**TRADEMARK**

FIRST USE 7-22-2011; IN COMMERCE 7-22-2011.

**PRINCIPAL REGISTER**

THE MARK CONSISTS OF STANDARD CHARACTERS WITHOUT CLAIM TO ANY PARTICULAR FONT, STYLE, SIZE, OR COLOR.

NO CLAIM IS MADE TO THE EXCLUSIVE RIGHT TO USE "HEALTH", APART FROM THE MARK AS SHOWN.

SN 85-976,871, FILED 5-9-2011.

SUSAN LESLIE DUBOIS, EXAMINING ATTORNEY



*David J. Kyffers*

Director of the United States Patent and Trademark Office

# United States of America

United States Patent and Trademark Office

## ROYAL POOCH

**Reg. No. 4,200,127**

ROYAL ANIMALS LTD. (NEW YORK CORPORATION)  
400 EAST 57TH STREET, SUITE PHA  
NEW YORK, NY 10022

**Registered Aug. 28, 2012**

**Int. Cls.: 18, 20, and 28**

FOR: CLOTHING FOR DOMESTIC PETS; GARMENTS FOR PETS; PET CLOTHING; PET PRODUCTS, NAMELY, PET RESTRAINING DEVICES CONSISTING OF LEASHES, COLLARS, HARNESSSES, RESTRAINING STRAPS, AND LEASHES WITH LOCKING DEVICES, IN CLASS 18 (U.S. CLS. 1, 2, 3, 22 AND 41).

**TRADEMARK**

**PRINCIPAL REGISTER**

FIRST USE 6-1-2011; IN COMMERCE 6-1-2011.

FOR: BEDS FOR HOUSEHOLD PETS; PET CUSHIONS; PORTABLE BEDS FOR PETS, IN CLASS 20 (U.S. CLS. 2, 13, 22, 25, 32 AND 50).

FIRST USE 6-1-2011; IN COMMERCE 6-1-2011.

FOR: PET TOYS; TOYS FOR DOMESTIC PETS, IN CLASS 28 (U.S. CLS. 22, 23, 38 AND 50).

FIRST USE 6-1-2011; IN COMMERCE 6-1-2011.

THE MARK CONSISTS OF STANDARD CHARACTERS WITHOUT CLAIM TO ANY PARTICULAR FONT, STYLE, SIZE, OR COLOR.

OWNER OF U.S. REG. NO. 3,997,075.

NO CLAIM IS MADE TO THE EXCLUSIVE RIGHT TO USE "POOCH", APART FROM THE MARK AS SHOWN.

SN 85-976,874, FILED 5-10-2011.

RICHARD WHITE, EXAMINING ATTORNEY



*David J. Kyros*

Director of the United States Patent and Trademark Office

# United States of America

United States Patent and Trademark Office

# COTTONOVA

**Reg. No. 4,200,128**

**Registered Aug. 28, 2012**

**Int. Cl.: 24**

**TRADEMARK**

**PRINCIPAL REGISTER**

ALOK INTERNATIONAL INC. (TEXAS CORPORATION)  
123 OAK AVENUE  
DALLAS, TX 75207

FOR: BEDDING, NAMELY, CRIB BUMPERS, CRIB CANOPIES, PILLOW SHAMS, PILLOW COVERS, CHILDREN'S BLANKETS, CASHMERE BLANKETS, BED THROWS; BED BLANKETS; PET BLANKETS; BED SHEETS; BED SKIRTS; BEDSPREADS; COMFORTERS; COVERLETS; QUILTS; THROWS; DUVETS; PILLOW CASES; MATTRESS COVERS; MATTRESS PADS; BATH LINENS; TOWELS; WASH CLOTHS; SHOWER CURTAINS; TEXTILE TOILET TANK COVERS; TABLE AND KITCHEN LINENS; FABRIC TABLE RUNNERS; TEXTILE NAPKINS; TEXTILE PLACE MATS; CLOTH COASTERS; DISH CLOTHS; POT HOLDERS; KITCHEN TOWELS; FABRIC WINDOW COVERINGS AND WINDOW TREATMENTS, NAMELY, CURTAINS, DRAPERIES, SHEERS, SWAGS, AND VALANCES; AND CUSHION COVERS, ALL MADE IN WHOLE OR IN SUBSTANTIAL PART OF COTTON, IN CLASS 24 (U.S. CLS. 42 AND 50).

FIRST USE 8-1-2009; IN COMMERCE 8-1-2009.

THE MARK CONSISTS OF STANDARD CHARACTERS WITHOUT CLAIM TO ANY PARTICULAR FONT, STYLE, SIZE, OR COLOR.

SN 85-976,898, FILED 8-17-2010.

MARY CRAWFORD, EXAMINING ATTORNEY



*David J. Kybas*

Director of the United States Patent and Trademark Office

# United States of America

United States Patent and Trademark Office

BE YOURSELF. BE UNIQUE. BE  
A MONSTER

**Reg. No. 4,200,129**

**Registered Aug. 28, 2012**

**Int. Cl.: 28**

**TRADEMARK**

**PRINCIPAL REGISTER**

MATTEL, INC. (DELAWARE CORPORATION)  
M1-1518  
333 CONTINENTAL BOULEVARD  
EL SEGUNDO, CA 90245

FOR: DOLLS, DOLL CLOTHING AND DOLL ACCESSORIES, IN CLASS 28 (U.S. CLS. 22, 23, 38 AND 50).

FIRST USE 11-21-2011; IN COMMERCE 11-21-2011.

THE MARK CONSISTS OF STANDARD CHARACTERS WITHOUT CLAIM TO ANY PARTICULAR FONT, STYLE, SIZE, OR COLOR.

SN 85-976,967, FILED 8-23-2011.

WENDY GOODMAN, EXAMINING ATTORNEY



*David J. Kyffers*

Director of the United States Patent and Trademark Office

# United States of America

United States Patent and Trademark Office

# REACHCAST

**Reg. No. 4,200,130**

**Registered Aug. 28, 2012**

**Int. Cls.: 35, 38, 41, and  
42**

**SERVICE MARK**

**PRINCIPAL REGISTER**

REACHLOCAL, INC. (DELAWARE CORPORATION)  
SUITE 1600  
21700 OXNARD STREET  
WOODLAND HILLS, CA 91367

FOR: ONLINE MEDIA MONITORING SERVICES FOR BUSINESSES USING COMPUTER SOFTWARE TO AUTOMATICALLY MONITOR INTERNET WEBSITES AND ONLINE PUBLICATIONS FOR REFERENCES TO BUSINESSES AND TO CAPTURE RELEVANT CONTENT ABOUT THOSE BUSINESSES, AND PROVIDING DOCUMENTATION AND ANALYSIS OF THAT ONLINE CONTENT TO OTHERS FOR BUSINESS PURPOSES; BRAND CONCEPT AND BRAND DEVELOPMENT SERVICES FOR CORPORATE AND INDIVIDUAL CLIENTS, ALL FOR BUSINESS ACTIVITIES CONDUCTED OVER THE INTERNET; BRAND POSITIONING SERVICES RELATING TO A BUSINESS' PRESENCE AND REPUTATION ON THE INTERNET; CONSULTING SERVICES IN THE FIELD OF BRAND IMAGERY RELATING TO A BUSINESS' PRESENCE AND REPUTATION ON THE INTERNET; CUSTOMER RELATIONSHIP MANAGEMENT SERVICES; CUSTOMER SERVICE MANAGEMENT FOR OTHERS, IN CLASS 35 (U.S. CLS. 100, 101 AND 102).

FIRST USE 7-13-2010; IN COMMERCE 7-13-2010.

FOR: ELECTRONIC TRANSMISSION OF DATA, TEXT, GRAPHICS, IMAGES, AUDIO FILES, AND VIDEOS VIA A GLOBAL COMPUTER NETWORK, IN CLASS 38 (U.S. CLS. 100, 101 AND 104).

FIRST USE 7-13-2010; IN COMMERCE 7-13-2010.

FOR: ELECTRONIC PUBLISHING SERVICES, NAMELY, PUBLICATION OF TEXT AND GRAPHIC WORKS OF BUSINESSES ONLINE FEATURING PRODUCT, SERVICES, SALES AND MARKETING INFORMATION ACROSS MULTIPLE ONLINE PLATFORMS, INCLUDING SEARCH ENGINES, WEBSITES, DIRECTORIES, SOCIAL NETWORKS, AND CONTENT NETWORKS, IN CLASS 41 (U.S. CLS. 100, 101 AND 107).

FIRST USE 7-13-2010; IN COMMERCE 7-13-2010.

FOR: COMPUTER SERVICES, NAMELY, CREATING, MAINTAINING AND HOSTING THE WEBSITES OF OTHERS ON A COMPUTER SERVER FOR A GLOBAL COMPUTER NETWORK; PROVIDING SEARCH ENGINE SERVICES FOR OBTAINING DATA VIA GLOBAL



*David J. Kyffers*

Director of the United States Patent and Trademark Office

**Reg. No. 4,200,130** COMPUTER NETWORK; CROSS-PLATFORM CONVERSION OF DIGITAL DATA INTO OTHER FORMS OF DIGITAL DATA; PROVIDING A WEB-BASED SERVICE FEATURING TECHNOLOGY THAT ENABLE USERS TO MANAGE THE PRODUCTION AND PUBLICATION OF TEXT, GRAPHICS, IMAGES, AUDIO FILES, VIDEOS, AND RELATED DIGITAL CONTENT FOR USE BY THE GENERAL PUBLIC; APPLICATION SERVICE PROVIDER (ASP), NAMELY, PROVIDING BUSINESSES WITH AN ON-LINE PORTAL AND WEB-BASED SYSTEM USED BY CUSTOMERS TO CREATE, MANAGE, MAINTAIN, UPDATE, AND CONTROL THEIR WEBSITES AND THEIR PRESENCE ON THE INTERNET; PLATFORM AS A SERVICE (PAAS) FEATURING COMPUTER SOFTWARE PLATFORM USED TO DISTRIBUTE CONTENT ON THE INTERNET AND MONITOR THE INTERNET FOR USE OF BRAND NAMES BY OTHERS IN ORDER TO OPTIMIZE THE PRESENCE OF A BUSINESS BRAND IN SEARCH ENGINES, WEBSITES, DIRECTORIES, SOCIAL NETWORKS, AND CONTENT NETWORKS, IN CLASS 42 (U.S. CLS. 100 AND 101).

FIRST USE 7-13-2010; IN COMMERCE 7-13-2010.

THE MARK CONSISTS OF STANDARD CHARACTERS WITHOUT CLAIM TO ANY PARTICULAR FONT, STYLE, SIZE, OR COLOR.

SN 85-976,968, FILED 5-28-2010.

RENEE SERVANCE, EXAMINING ATTORNEY

# United States of America

United States Patent and Trademark Office

## DRUG POLICY ACTION

**Reg. No. 4,200,131**

DRUG POLICY ALLIANCE (D.C. CORPORATION)

**Registered Aug. 28, 2012**

70 WEST 36TH STREET  
NEW YORK, NY 10018

**Int. Cl.: 36**

FOR: FUNDRAISING IN THE FIELD OF POLITICS AS RELATED TO POLICY TOWARDS CONTROLLED AND NON-CONTROLLED SUBSTANCES, IN CLASS 36 (U.S. CLS. 100, 101 AND 102).

**SERVICE MARK**

FIRST USE 6-5-2012; IN COMMERCE 6-5-2012.

**PRINCIPAL REGISTER**

THE MARK CONSISTS OF STANDARD CHARACTERS WITHOUT CLAIM TO ANY PARTICULAR FONT, STYLE, SIZE, OR COLOR.

NO CLAIM IS MADE TO THE EXCLUSIVE RIGHT TO USE "DRUG POLICY", APART FROM THE MARK AS SHOWN.

SN 85-976,969, FILED 10-6-2010.

NANCY CLARKE, EXAMINING ATTORNEY



*David J. Kyros*

Director of the United States Patent and Trademark Office

# United States of America

United States Patent and Trademark Office



**Reg. No. 4,200,132**

**Registered Aug. 28, 2012**

**Int. Cls.: 9 and 41**

**TRADEMARK**

**SERVICE MARK**

**PRINCIPAL REGISTER**

BIRDHOUSE HOLDINGS, LLC (MINNESOTA LIMITED LIABILITY COMPANY)  
2050 MARSHALL AVENUE  
ST. PAUL, MN 55104

FOR: PRE-RECORDED MUSIC RECORDINGS; PRE-RECORDED ENTERTAINMENT RECORDINGS FEATURING CHILDREN'S PROGRAMMING; MUSIC, AND ARTISTIC PERFORMANCES, IN CLASS 9 (U.S. CLS. 21, 23, 26, 36 AND 38).

FIRST USE 12-31-2009; IN COMMERCE 12-31-2009.

FOR: TELEVISION SHOW AND MUSIC PRODUCTION, IN CLASS 41 (U.S. CLS. 100, 101 AND 107).

FIRST USE 12-31-2009; IN COMMERCE 12-31-2009.

NO CLAIM IS MADE TO THE EXCLUSIVE RIGHT TO USE "SHOW", APART FROM THE MARK AS SHOWN.

THE NAME(S), PORTRAIT(S), AND/OR SIGNATURE(S) SHOWN IN THE MARK IDENTIFIES "CHOO CHOO BOB", WHOSE CONSENT(S) TO REGISTER IS MADE OF RECORD.

THE MARK CONSISTS OF AN IMAGE OF A TRAIN WITHIN A SEMI-CIRCLE CONTAINING THE TERMS "THE CHOO CHOO BOB SHOW" WITH STARS ON EITHER END. THE FRONT OF THE TRAIN INCLUDES THE NUMBERS "2005".

SN 85-977,000, FILED 1-24-2011.

ANN E. SAPPENFIELD, EXAMINING ATTORNEY



*David J. Kybas*

Director of the United States Patent and Trademark Office



# United States of America

United States Patent and Trademark Office

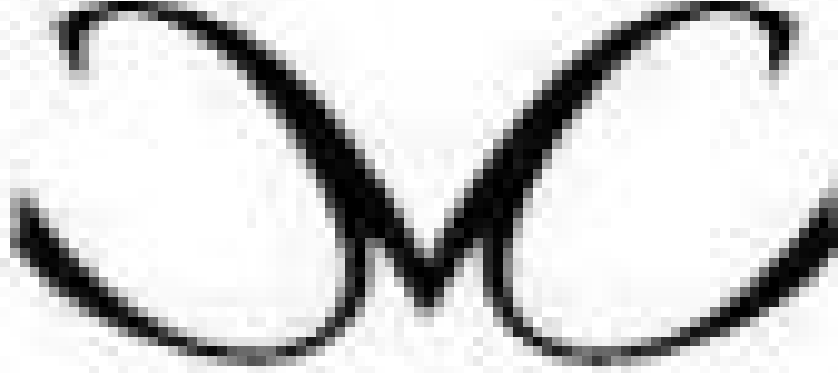

**Reg. No. 4,200,133**

**Registered Aug. 28, 2012**

**Int. Cl.: 18**

**TRADEMARK**

**PRINCIPAL REGISTER**

MONIKA CHIANG, LLC (DELAWARE LIMITED LIABILITY COMPANY)  
1115 BROADWAY  
5TH FLOOR  
NEW YORK, NY 10010

FOR: LEATHER GOODS, NAMELY, LEATHER HANDBAGS; MESSENGER BAGS; PURSES;  
WALLETS; HAND BAGS; TOTE BAGS, IN CLASS 18 (U.S. CLS. 1, 2, 3, 22 AND 41).

FIRST USE 10-10-2011; IN COMMERCE 10-10-2011.

THE MARK CONSISTS OF A STYLIZED LETTER "M".

SN 85-977,014, FILED 5-20-2011.

KAREN BRACEY, EXAMINING ATTORNEY



*David J. Kybas*

Director of the United States Patent and Trademark Office

# United States of America

United States Patent and Trademark Office

## ESSENTIAL EVERYDAY

**Reg. No. 4,200,134**

**Registered Aug. 28, 2012**

**Int. Cls.: 3, 4, 5, 16, 21,  
29, 30, and 32**

SUPERVALU INC. (DELAWARE CORPORATION)  
7075 FLYING CLOUD DRIVE  
EDEN PRAIRIE, MN 55344

FOR: HOUSEHOLD DETERGENTS, LAUNDRY BLEACH, FABRIC SOFTENERS AND STAIN REMOVERS, IN CLASS 3 (U.S. CLS. 1, 4, 6, 50, 51 AND 52).

FIRST USE 1-2-2012; IN COMMERCE 1-2-2012.

**TRADEMARK**

FOR: CHARCOAL LIGHTER FLUID; CHARCOAL BRIQUETTES; INSTANT LIGHT CHARCOAL AND MESQUITE BRIQUETTES, IN CLASS 4 (U.S. CLS. 1, 6 AND 15).

**PRINCIPAL REGISTER**

FIRST USE 12-3-2011; IN COMMERCE 12-3-2011.

FOR: HOUSEHOLD PRODUCTS, NAMELY, DISINFECTANT BATHROOM CLEANERS, IN CLASS 5 (U.S. CLS. 6, 18, 44, 46, 51 AND 52).

FIRST USE 5-13-2012; IN COMMERCE 5-13-2012.

FOR: PAPER COFFEE FILTERS, IN CLASS 16 (U.S. CLS. 2, 5, 22, 23, 29, 37, 38 AND 50).

FIRST USE 1-2-2012; IN COMMERCE 1-2-2012.

FOR: HOUSEHOLD PRODUCTS, NAMELY, SCOURING PADS AND SPONGES FOR HOUSEHOLD PURPOSES, IN CLASS 21 (U.S. CLS. 2, 13, 23, 29, 30, 33, 40 AND 50).

FIRST USE 4-26-2012; IN COMMERCE 4-26-2012.

FOR: MEAT, FISH, SEAFOOD, POULTRY, CHEESES, SOUPS, CANNED VEGETABLES, CANNED FRUITS, NON-DIARY COFFEE CREAMER, PROCESSED OLIVES, WHIPPED TOPPING, CANNED TUNA FISH, PROCESSED NUTS, DRIED BEANS, BAKED BEANS, OLIVE OIL, CANNED TOMATOES, CANNED BLACK BEANS, BEEF JERKY, CHEESE SPREADS, PROCESSED FRUIT, PROCESSED VEGETABLES, FROZEN POTATOES, FROZEN VEGETABLES, FROZEN FRUITS AND CREAM CHEESE; FROZEN TOPPING, NAMELY, STRAWBERRY TOPPING, IN CLASS 29 (U.S. CL. 46).

FIRST USE 12-24-2011; IN COMMERCE 12-24-2011.

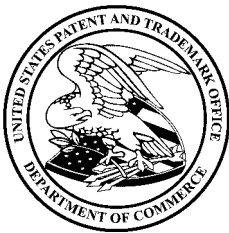

*David J. Kyros*

Director of the United States Patent and Trademark Office

**Reg. No. 4,200,134** FOR: BREAD, CROUTONS, CRACKERS, SALAD DRESSING, BREAKFAST CEREAL, MAYONNAISE, KETCHUP, MUSTARD, OATMEAL, SEASONINGS, RICE, SUGAR, PASTA, PASTA SAUCE, SAUCES, PANCAKE SYRUP, TEA, HORSERADISH, BARBECUE SAUCE, WAFFLES, BAKERY GOODS, SALSA, GRAVY, UNPOPPED POPCORN, COCOA, TOMATO SAUCE, PUDDING, SPAGHETTI SAUCE, STEW BASE SAUCE FOR MEAT, GROUND COFFEE, BREAD CRUMBS, READY-TO-EAT CEREAL DERIVED FOOD BARS, MACARONI AND CHEESE, RICE CAKES, GRANOLA-BASED SNACK BARS, SOY SAUCE, PIE SHELLS, GRITS, HOMINY, PRETZELS, GRANOLA, FROZEN PIZZA, NOODLES AND MARINADES, IN CLASS 30 (U.S. CL. 46).

FIRST USE 6-15-2011; IN COMMERCE 6-15-2011.

FOR: BEVERAGES, NAMELY, SOFT DRINKS AND SMOOTHIES , IN CLASS 32 (U.S. CLS. 45, 46 AND 48).

FIRST USE 9-16-2011; IN COMMERCE 9-16-2011.

THE MARK CONSISTS OF STANDARD CHARACTERS WITHOUT CLAIM TO ANY PARTICULAR FONT, STYLE, SIZE, OR COLOR.

SN 85-977,016, FILED 10-29-2010.

TASNEEM HUSSAIN, EXAMINING ATTORNEY

# United States of America

United States Patent and Trademark Office

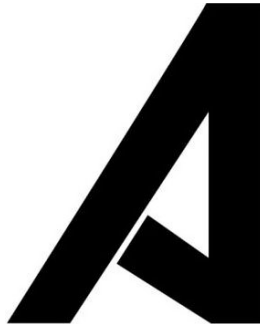

**Reg. No. 4,200,135**

**Registered Aug. 28, 2012**

**Int. Cls.: 38 and 41**

**SERVICE MARK**

**PRINCIPAL REGISTER**

DIRECTV, LLC (CALIFORNIA LIMITED LIABILITY COMPANY)  
2230 EAST IMPERIAL HWY  
EL SEGUNDO, CA 90245

FOR: SATELLITE TELEVISION BROADCASTING; SATELLITE TRANSMISSION SERVICES; BROADCASTING PROGRAMS VIA A GLOBAL COMPUTER NETWORK; VIDEO-ON-DEMAND TRANSMISSION SERVICES; TRANSMISSION OF PAY-PER-VIEW TELEVISION AND OTHER AUDIO, VIDEO, AND AUDIOVISUAL MATERIAL; STREAMING OF AUDIO AND VIDEO MATERIAL ON THE INTERNET, AND GLOBAL AND LOCAL COMPUTER NETWORKS, WIRELESS NETWORKS AND ELECTRONIC COMMUNICATION NETWORKS; ELECTRONIC TRANSMISSION OF DATA VIA GLOBAL COMPUTER NETWORKS, WIRELESS NETWORKS AND ELECTRONIC COMMUNICATION NETWORKS, IN CLASS 38 (U.S. CLS. 100, 101 AND 104).

FIRST USE 6-30-2011; IN COMMERCE 6-30-2011.

FOR: DISTRIBUTION OF TELEVISION PROGRAMS FOR OTHERS; TELEVISION PROGRAMMING; PROGRAMMING ON A GLOBAL COMPUTER NETWORK OF TELEVISION PROGRAMMING; PAY-PER-VIEW TELEVISION PROGRAMMING; VIDEO-ON-DEMAND TELEVISION PROGRAMMING; PROVIDING ON-LINE INTERACTIVE COMPUTER DATABASES FEATURING TELEVISION PROGRAMMING LISTS, SCHEDULES AND RELATED INFORMATION; PROVIDING ON-LINE INTERACTIVE COMPUTER DATABASES FEATURING INFORMATION ABOUT TELEVISION SHOWS, MOVIES, AND OTHER DIGITAL IMAGES, AUDIO, VIDEO AND MULTIMEDIA CONTENT, ALL IN THE FIELD OF ENTERTAINMENT; PROVIDING A WEBSITE FEATURING INFORMATION ABOUT TELEVISION PROGRAMMING, IN CLASS 41 (U.S. CLS. 100, 101 AND 107).

FIRST USE 6-30-2011; IN COMMERCE 6-30-2011.

THE MARK CONSISTS OF A STYLIZED LETTER "A".

SN 85-977,035, FILED 4-29-2011.

THOMAS MANOR, EXAMINING ATTORNEY



*David J. Kyffers*

Director of the United States Patent and Trademark Office

# United States of America

United States Patent and Trademark Office

# STARDOLL

**Reg. No. 4,200,136**

**Registered Aug. 28, 2012**

**Int. Cls.: 3 and 25**

**TRADEMARK**

**PRINCIPAL REGISTER**

STARDOLL AB (SWEDEN CORPORATION)  
HUDIKSVALLSGATAN 8  
STOCKHOLM, SWEDEN 11330

FOR: COSMETICS, BODY GELS FOR MASSAGE USE, BODY LOTIONS, BODY GLITTER, CLEANSING MILK FOR TOILET PURPOSES, COSMETIC CREAMS, COSMETIC LOTIONS, DEPILATORY PREPARATIONS EAU DE COLOGNE, EYEBROW COSMETICS, EYEBROW PENCILS, ARTIFICIAL EYELASHES, EYE SHADOWS, EYE LINERS, FALSE NAILS, NAIL GLOSS, HAIR DYES, HAIR GELS, HAIR LOTIONS, HAIR SPRAY, GLITTER HAIR SPRAY, HAIR WAVING PREPARATIONS, LIPSTICKS, LIP BALM, MAKEUP POWDER, MAKEUP REMOVING PREPARATIONS, MASCARA, NAIL POLISH, NAIL VARNISH, PERFUMES, SHAMPOOS, SHOWER GELS, COSMETIC PREPARATIONS FOR SKIN CARE, SOAP, SUNSCREEN PREPARATIONS, TISSUES IMPREGNATED WITH COSMETIC LOTIONS, IN CLASS 3 (U.S. CLS. 1, 4, 6, 50, 51 AND 52).

FIRST USE 7-11-2011; IN COMMERCE 7-11-2011.

FOR: CLOTHING FOR TEENAGERS AND WOMEN, NAMELY, COATS, BATH ROBES, BEACH CLOTHES ALSO KNOWN AS BEACHWEAR, SWIMWEAR, BRASSIERES, BOTTOMS, DRESSES, DENIMS, JACKETS, JERSEYS, JUMPERS, GIRDLES, OVERALLS, PAJAMAS, PARKAS, PETTICOATS, SCARVES, SHIRTS, SOCKS, STOCKINGS, T-SHIRTS, TIGHTS, TROUSERS, UNDERCLOTHING ALSO KNOWN AS UNDERWEAR; FOOTWEAR, IN CLASS 25 (U.S. CLS. 22 AND 39).

FIRST USE 7-11-2011; IN COMMERCE 7-11-2011.

THE MARK CONSISTS OF STANDARD CHARACTERS WITHOUT CLAIM TO ANY PARTICULAR FONT, STYLE, SIZE, OR COLOR.

OWNER OF U.S. REG. NO. 3,410,951.

SN 85-977,036, FILED 1-18-2011.

RONALD AIKENS, EXAMINING ATTORNEY



*David J. Kyffers*

Director of the United States Patent and Trademark Office

# United States of America

United States Patent and Trademark Office

## MEMORELLE

**Reg. No. 4,200,137**

INVISTA NORTH AMERICA S.A R.L. (LUXEMBOURG CORPORATION)  
4123 E. 37TH STREET N., LEGAL DEPARTMENT  
WICHITA, KS 67220

**Registered Aug. 28, 2012**

**Int. Cl.: 20**

FOR: PILLOWS CONTAINING SYNTHETIC FIBERS, IN CLASS 20 (U.S. CLS. 2, 13, 22, 25, 32 AND 50).

**TRADEMARK**

FIRST USE 5-25-2012; IN COMMERCE 5-25-2012.

**PRINCIPAL REGISTER**

THE MARK CONSISTS OF STANDARD CHARACTERS WITHOUT CLAIM TO ANY PARTICULAR FONT, STYLE, SIZE, OR COLOR.

SN 85-977,052, FILED 7-22-2011.

NAAKWAMA ANKRAH, EXAMINING ATTORNEY



*David J. Kyffers*

Director of the United States Patent and Trademark Office

# United States of America

United States Patent and Trademark Office

# ChocRocs

**Reg. No. 4,200,138**

**Registered Aug. 28, 2012**

**Int. Cls.: 16, 25, and 28**

**TRADEMARK**

**PRINCIPAL REGISTER**

SMISEK, WAYNE (UNITED STATES INDIVIDUAL)  
P.O. BOX 1389  
20 WEST COSTILLA  
COLORADO SPRINGS, CO 80901

FOR: PUBLICATIONS AND PRINTED MATERIALS, NAMELY, CHILDREN'S BOOKS, ACTIVITY BOOKS, PICTURE BOOKS, PRINTED LESSON BOOKS IN THE FIELD OF EDUCATION AND CHARACTER DEVELOPMENT, COLORING BOOKS, POSTERS FOR CHILDREN, CARTOON PRINTS, CARTOON STRIPS, IN CLASS 16 (U.S. CLS. 2, 5, 22, 23, 29, 37, 38 AND 50).

FIRST USE 6-28-2012; IN COMMERCE 6-28-2012.

FOR: CHILDREN'S AND BABY CLOTHING, NAMELY, SHIRTS, PANTS, SHORTS, ROMPERS, PAJAMAS, CLOTH BIBS, SOCKS, UNDERWEAR, JACKETS; SPORTSWEAR, NAMELY, T-SHIRTS, SWEATSHIRTS, SHIRTS, HATS, SOCKS, CAPS, PANTS, SHORTS, SHOES, BOOTS, IN CLASS 25 (U.S. CLS. 22 AND 39).

FIRST USE 6-28-2012; IN COMMERCE 6-28-2012.

FOR: TOYS, NAMELY, BATH TOYS, PLASTIC ACTION FIGURES, STUFFED DOLLS AND ANIMALS, FANTASY CHARACTER TOYS, BOARD GAMES, PUZZLES, IN CLASS 28 (U.S. CLS. 22, 23, 38 AND 50).

FIRST USE 6-28-2012; IN COMMERCE 6-28-2012.

THE MARK CONSISTS OF STANDARD CHARACTERS WITHOUT CLAIM TO ANY PARTICULAR FONT, STYLE, SIZE, OR COLOR.

SN 85-977,065, FILED 10-8-2010.

KAREN K. BUSH, EXAMINING ATTORNEY



*David J. Kyros*

Director of the United States Patent and Trademark Office

# United States of America

United States Patent and Trademark Office

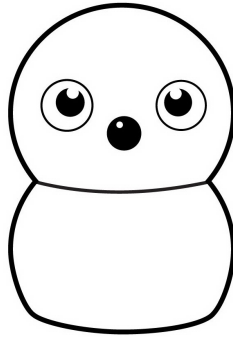

**Reg. No. 4,200,139**

**Registered Aug. 28, 2012**

**Int. Cls.: 9 and 28**

**TRADEMARK**

**PRINCIPAL REGISTER**

BEATBOTS LLC (DELAWARE LIMITED LIABILITY COMPANY)  
154 MISSISSIPPI ST  
SAN FRANCISCO, CA 941072524

FOR: LABORATORY ROBOTS; ROBOTS FOR PERSONAL OR HOBBY USE, IN CLASS 9  
(U.S. CLS. 21, 23, 26, 36 AND 38).

FIRST USE 1-21-2009; IN COMMERCE 1-21-2009.

FOR: BATTERY OPERATED ACTION TOYS; ELECTRONIC ACTION TOYS; TOY FIGURES,  
IN CLASS 28 (U.S. CLS. 22, 23, 38 AND 50).

FIRST USE 10-0-2011; IN COMMERCE 10-0-2011.

THE MARK CONSISTS OF A CHARACTER FORMED BY A CIRCULAR SHAPE ON TOP  
OF ANOTHER CIRCULAR SHAPE WITH TWO CIRCULAR EYES AND A CIRCULAR NOSE  
ON THE TOP CIRCLE.

SN 85-977,074, FILED 5-24-2010.

TINA BROWN, EXAMINING ATTORNEY



*David J. Kybas*

Director of the United States Patent and Trademark Office



# United States of America

United States Patent and Trademark Office

# MOMOFUKU

**Reg. No. 4,200,140**

**Registered Aug. 28, 2012**

**Int. Cl.: 30**

**TRADEMARK**

**PRINCIPAL REGISTER**

DAVID CHANG, LLC (NEW YORK LIMITED LIABILITY COMPANY)  
SUITE 1211  
853 BROADWAY  
NEW YORK, NY 10003

FOR: BARBECUE SAUCE; CAKE MIXES; CHILI SAUCE; COOKIE MIXES; DIPPING SAUCES; HOT SAUCE; ICE CREAM MIXES; ICE CREAM POWDER; MIXES FOR BAKERY GOODS; NOODLES; NOODLES AND SAUCE MIXES COMBINED IN UNITARY PACKAGES; NOODLES AND SEASONING MIXES COMBINED IN UNITARY PACKAGES; NOODLES, SAUCE, AND TOPPING COMBINED IN UNITARY PACKAGES; READY-MADE SAUCES; SOY SAUCE; TERIYAKI SAUCE, IN CLASS 30 (U.S. CL. 46).

FIRST USE 5-16-2011; IN COMMERCE 5-16-2011.

THE MARK CONSISTS OF STANDARD CHARACTERS WITHOUT CLAIM TO ANY PARTICULAR FONT, STYLE, SIZE, OR COLOR.

OWNER OF U.S. REG. NOS. 3,241,296, 3,364,565, AND 3,768,197.

THE ENGLISH TRANSLATION OF "MOMOFUKU" IN THE MARK IS "LUCKY PEACH".

SN 85-977,078, FILED 12-2-2010.

MATTHEW PAPPAS, EXAMINING ATTORNEY



*David J. Kyppas*

Director of the United States Patent and Trademark Office

# United States of America

United States Patent and Trademark Office

## PUREANTI-REFLECT

**Reg. No. 4,200,141**

**Registered Aug. 28, 2012**

**Int. Cl.: 9**

**TRADEMARK**

**PRINCIPAL REGISTER**

SWITCHEASY LIMITED (HONG KONG LIMITED LIABILITY COMPANY)  
RM. 314, SING WIN FACTORY BLDG.  
15-17 SHING YIP STREET, KWUN TONG  
KOWLOON, HONG KONG

FOR: PLASTIC FILMS AND MEMBRANES ADAPTED FOR COVERING AND PROTECTING THE SURFACES OF ELECTRONIC DEVICES, NAMELY, HANDHELD PERSONAL ELECTRONIC DEVICES, NAMELY, DIGITAL MEDIA PLAYER DEVICES, PERSONAL DIGITAL ASSISTANT, HANDHELD WIRELESS DEVICES, MOBILE TELEPHONES, HANDHELD DIGITAL AUDIO AND/OR VIDEO CAPTURE DEVICES, OR DEVICES HAVING A COMBINATION OF ONE OF MORE FUNCTIONALITIES OF THE FOREGOING; FITTED PLASTIC FILMS AND MEMBRANES ADAPTED FOR COVERING AND PROTECTING THE SURFACES OF ELECTRONIC DEVICES, NAMELY, HANDHELD PERSONAL ELECTRONIC DEVICES, NAMELY, DIGITAL MEDIA PLAYER DEVICES, PERSONAL DIGITAL ASSISTANT, HANDHELD WIRELESS DEVICES, MOBILE TELEPHONES, HANDHELD DIGITAL AUDIO AND/OR VIDEO CAPTURE DEVICES, OR DEVICES HAVING A COMBINATION OF ONE OF MORE FUNCTIONALITIES OF THE FOREGOING; FITTED PLASTIC FILMS AND MEMBRANES ADAPTED FOR COVERING AND PROTECTING THE DISPLAY SCREENS OF ELECTRONIC DEVICES, NAMELY, HANDHELD PERSONAL ELECTRONIC DEVICES, NAMELY, DIGITAL MEDIA PLAYER DEVICES, PERSONAL DIGITAL ASSISTANT, HANDHELD WIRELESS DEVICES, MOBILE TELEPHONES, HANDHELD DIGITAL AUDIO AND/OR VIDEO CAPTURE DEVICES, OR DEVICES HAVING A COMBINATION OF ONE OF MORE FUNCTIONALITIES OF THE FOREGOING; PLASTIC FILMS AND MEMBRANES ADAPTED FOR COVERING AND PROVIDING A SCRATCH PROOF BARRIER OR PROTECTION FOR ELECTRONIC DEVICES, NAMELY, HANDHELD PERSONAL ELECTRONIC DEVICES, NAMELY, DIGITAL MEDIA PLAYER DEVICES, PERSONAL DIGITAL ASSISTANT, HANDHELD WIRELESS DEVICES, MOBILE TELEPHONES, HANDHELD DIGITAL AUDIO AND/OR VIDEO CAPTURE DEVICES, OR DEVICES HAVING A COMBINATION OF ONE OF MORE FUNCTIONALITIES OF THE FOREGOING, IN CLASS 9 (U.S. CLS. 21, 23, 26, 36 AND 38).



FIRST USE 8-4-2008; IN COMMERCE 8-4-2008.

*David J. Kyros*

THE MARK CONSISTS OF STANDARD CHARACTERS WITHOUT CLAIM TO ANY PARTICULAR FONT, STYLE, SIZE, OR COLOR.

SN 85-977,083, FILED 5-25-2011.

**Reg. No. 4,200,141** ALEXANDER L. POWERS, EXAMINING ATTORNEY

# United States of America

United States Patent and Trademark Office

## PUREPRIVACY

**Reg. No. 4,200,142**

**Registered Aug. 28, 2012**

**Int. Cl.: 9**

**TRADEMARK**

**PRINCIPAL REGISTER**

SWITCHEASY LIMITED (HONG KONG LIMITED LIABILITY COMPANY)  
RM. 314, SING WIN FACTORY BLDG.  
15-17 SHING YIP STREET, KWUN TONG  
KOWLOON, HONG KONG

FOR: PLASTIC FILMS AND MEMBRANES ADAPTED FOR COVERING AND PROTECTING THE SURFACES OF ELECTRONIC DEVICES, NAMELY, HANDHELD PERSONAL ELECTRONIC DEVICES, NAMELY, DIGITAL MEDIA PLAYER DEVICES, PERSONAL DIGITAL ASSISTANT, HANDHELD WIRELESS DEVICES, MOBILE TELEPHONES, HANDHELD DIGITAL AUDIO AND/OR VIDEO CAPTURE DEVICES, OR DEVICES HAVING A COMBINATION OF ONE OF MORE FUNCTIONALITIES OF THE FOREGOING; FITTED PLASTIC FILMS AND MEMBRANES ADAPTED FOR COVERING AND PROTECTING THE SURFACES OF ELECTRONIC DEVICES, NAMELY, HANDHELD PERSONAL ELECTRONIC DEVICES, NAMELY, DIGITAL MEDIA PLAYER DEVICES, PERSONAL DIGITAL ASSISTANT, HANDHELD WIRELESS DEVICES, MOBILE TELEPHONES, HANDHELD DIGITAL AUDIO AND/OR VIDEO CAPTURE DEVICES, OR DEVICES HAVING A COMBINATION OF ONE OF MORE FUNCTIONALITIES OF THE FOREGOING; FITTED PLASTIC FILMS AND MEMBRANES ADAPTED FOR COVERING AND PROTECTING THE DISPLAY SCREENS OF ELECTRONIC DEVICES, NAMELY, HANDHELD PERSONAL ELECTRONIC DEVICES, NAMELY, DIGITAL MEDIA PLAYER DEVICES, PERSONAL DIGITAL ASSISTANT, HANDHELD WIRELESS DEVICES, MOBILE TELEPHONES, HANDHELD DIGITAL AUDIO AND/OR VIDEO CAPTURE DEVICES, OR DEVICES HAVING A COMBINATION OF ONE OF MORE FUNCTIONALITIES OF THE FOREGOING; PLASTIC FILMS AND MEMBRANES ADAPTED FOR COVERING AND PROVIDING A SCRATCH PROOF BARRIER OR PROTECTION FOR ELECTRONIC DEVICES, NAMELY, HANDHELD PERSONAL ELECTRONIC DEVICES, NAMELY, DIGITAL MEDIA PLAYER DEVICES, PERSONAL DIGITAL ASSISTANT, HANDHELD WIRELESS DEVICES, MOBILE TELEPHONES, HANDHELD DIGITAL AUDIO AND/OR VIDEO CAPTURE DEVICES, OR DEVICES HAVING A COMBINATION OF ONE OF MORE FUNCTIONALITIES OF THE FOREGOING, IN CLASS 9 (U.S. CLS. 21, 23, 26, 36 AND 38).



FIRST USE 5-26-2010; IN COMMERCE 5-26-2010.

*David J. Kyros*

THE MARK CONSISTS OF STANDARD CHARACTERS WITHOUT CLAIM TO ANY PARTICULAR FONT, STYLE, SIZE, OR COLOR.

SN 85-977,084, FILED 5-25-2011.

**Reg. No. 4,200,142** ALEXANDER L. POWERS, EXAMINING ATTORNEY

# United States of America

United States Patent and Trademark Office



**Reg. No. 4,200,143**

**Registered Aug. 28, 2012**

**Int. Cl.: 25**

**TRADEMARK**

**PRINCIPAL REGISTER**

MONIKA CHIANG, LLC (DELAWARE LIMITED LIABILITY COMPANY)  
5TH FLOOR  
1115 BROADWAY  
NEW YORK, NY 10010

FOR: CLOTHING, NAMELY, SHIRTS, PANTS, SWEATERS, JACKETS, COATS, SHOES, BOOTS, SANDALS, SNEAKERS, SKIRTS, DRESSES, BLOUSES, AND BELTS, SCARVES, IN CLASS 25 (U.S. CLS. 22 AND 39).

FIRST USE 10-10-2011; IN COMMERCE 10-10-2011.

THE MARK CONSISTS OF A STYLIZED LETTER "M".

SN 85-977,102, FILED 5-20-2011.

KAREN BRACEY, EXAMINING ATTORNEY



*David J. Kybas*

Director of the United States Patent and Trademark Office

# United States of America

United States Patent and Trademark Office



**Reg. No. 4,200,144**

**Registered Aug. 28, 2012**

**Int. Cls.: 11 and 24**

**TRADEMARK**

**PRINCIPAL REGISTER**

ALOK INTERNATIONAL INC. (TEXAS CORPORATION)  
123 OAK AVENUE  
DALLAS, TX 75207

FOR: LAMPS; LANTERNS; LIGHTING FIXTURES, IN CLASS 11 (U.S. CLS. 13, 21, 23, 31 AND 34).

FIRST USE 2-1-2012; IN COMMERCE 2-1-2012.

FOR: BEDDING, NAMELY, CRIB BUMPERS, CRIB CANOPIES, PILLOW SHAMS, PILLOW COVERS, CHILDREN'S BLANKETS, CASHMERE BLANKETS, BED THROWS; BED BLANKETS; PET BLANKETS; BED SHEETS; BEDSKIRTS; BEDSPREADS; COMFORTERS; COVERLETS; QUILTS; THROWS; DUVETS; PILLOW CASES; MATTRESS COVERS; MATTRESS PADS; BATH LINENS; TOWELS; WASH CLOTHS; SHOWER CURTAINS; FABRIC TOILET TANK COVERS; TABLE AND KITCHEN LINENS; FABRIC TABLE RUNNERS; TEXTILE NAPKINS; TEXTILE PLACE MATS; CLOTH COASTERS; DISH CLOTHS; POT HOLDERS; KITCHEN TOWELS; WINDOW COVERINGS AND WINDOW TREATMENTS, NAMELY, CURTAINS, DRAPERIES, SHEERS, SWAGS, POUFS, FABRIC VALANCES; CUSHION COVERS, IN CLASS 24 (U.S. CLS. 42 AND 50).

FIRST USE 2-1-2012; IN COMMERCE 2-1-2012.

NO CLAIM IS MADE TO THE EXCLUSIVE RIGHT TO USE "HOME" FOR THE GOODS IN CLASSES 11, 18, 20, 21, 24 AND 27, APART FROM THE MARK AS SHOWN.

SN 85-977,104, FILED 8-17-2010.

MARY CRAWFORD, EXAMINING ATTORNEY



*David J. Kybas*

Director of the United States Patent and Trademark Office

# United States of America

United States Patent and Trademark Office

# ECOLIBRIUM

**Reg. No. 4,200,145**

JOHNSONITE INC. (OHIO CORPORATION)

**Registered Aug. 28, 2012**

16910 MUNN ROAD  
CHAGRIN FALLS, OH 44023

**Int. Cl.: 19**

FOR: NON-METAL COVE BASE; NON-METAL WALL BASE; NON-METAL DECORATIVE AND DECORATIVE TRIM FOR USE IN BUILDING CONSTRUCTION, IN CLASS 19 (U.S. CLS. 1, 12, 33 AND 50).

**TRADEMARK**

FIRST USE 4-11-2012; IN COMMERCE 4-11-2012.

**PRINCIPAL REGISTER**

THE MARK CONSISTS OF STANDARD CHARACTERS WITHOUT CLAIM TO ANY PARTICULAR FONT, STYLE, SIZE, OR COLOR.

SN 85-977,115, FILED 5-28-2010.

MARIA-VICTORIA SUAREZ, EXAMINING ATTORNEY



*David J. Kyffers*

Director of the United States Patent and Trademark Office



# United States of America

United States Patent and Trademark Office

# Fear No Evil

**Reg. No. 4,200,146**

CHRIS BRACKETT OUTDOORS, LTD. (ILLINOIS CORPORATION)  
8706 S. POWELL RD.

**Registered Aug. 28, 2012**

BARTONVILLE, IL 61607

**Int. Cls.: 25 and 41**

FOR: T-SHIRTS, SHIRTS, SWEATSHIRTS, JACKETS, HATS, CAPS, AND BANDANAS, IN CLASS 25 (U.S. CLS. 22 AND 39).

**TRADEMARK**

FIRST USE 2-4-2011; IN COMMERCE 2-4-2011.

**SERVICE MARK**

FOR: ENTERTAINMENT SERVICES, NAMELY, AN ON-GOING SERIES ABOUT HUNTING PROVIDED THROUGH TELEVISION, RADIO, AND WEBCASTS, IN CLASS 41 (U.S. CLS. 100, 101 AND 107).

**PRINCIPAL REGISTER**

FIRST USE 3-30-2011; IN COMMERCE 3-30-2011.

THE MARK CONSISTS OF STANDARD CHARACTERS WITHOUT CLAIM TO ANY PARTICULAR FONT, STYLE, SIZE, OR COLOR.

SN 85-977,132, FILED 9-16-2010.

CHRISTINE COOPER, EXAMINING ATTORNEY



*David J. Kybas*

Director of the United States Patent and Trademark Office

# United States of America

United States Patent and Trademark Office

# ONSAAGE

**Reg. No. 4,200,147**

WYETH LLC (DELAWARE LIMITED LIABILITY COMPANY)  
FIVE GIRALDA FARMS  
MADISON, NJ 07940

**Registered Aug. 28, 2012**

**Int. Cl.: 5**

FOR: PHARMACEUTICAL PREPARATIONS FOR THE TREATMENT OF CENTRAL NERVOUS SYSTEM, NEUROLOGICAL DISEASES AND DISORDERS, IN CLASS 5 (U.S. CLS. 6, 18, 44, 46, 51 AND 52).

**TRADEMARK**

FIRST USE 1-25-2012; IN COMMERCE 1-25-2012.

**PRINCIPAL REGISTER**

THE MARK CONSISTS OF STANDARD CHARACTERS WITHOUT CLAIM TO ANY PARTICULAR FONT, STYLE, SIZE, OR COLOR.

SN 85-977,139, FILED 10-1-2010.

IRA J. GOODSaid, EXAMINING ATTORNEY



*David J. Kyffers*

Director of the United States Patent and Trademark Office

# United States of America

United States Patent and Trademark Office

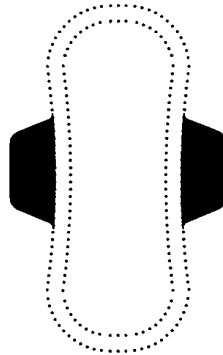

**Reg. No. 4,200,148**

RUBIO, ILSE (UNITED STATES INDIVIDUAL)

**Registered Aug. 28, 2012**

P. O. BOX 93064  
LOS ANGELES, CA 90093

**Int. Cl.: 5**

FOR: FEMININE HYGIENE PRODUCTS, NAMELY, FEMININE HYGIENE PADS, PANTY LINERS, SANITARY NAPKINS, VARIOUS TYPES OF ABSORBENT PADS, NAMELY, SANITARY PADS, IN CLASS 5 (U.S. CLS. 6, 18, 44, 46, 51 AND 52).

**TRADEMARK**

FIRST USE 12-30-2011; IN COMMERCE 12-30-2011.

**SUPPLEMENTAL REGISTER**

THE MARK CONSISTS OF THE COLOR BLACK AS IT IS APPLIED TO THE FLAPS OF A FEMININE HYGIENE PRODUCT. THE MATTER SHOWN IN BROKEN LINES SHOWS POSITIONING OF THE MARK ON THE GOODS AND THE CONFIGURATION OF THE GOODS IS NOT CLAIMED AS A FEATURE OF THE MARK.

THE COLOR(S) BLACK IS/ARE CLAIMED AS A FEATURE OF THE MARK.

SER. NO. 76-699,873, FILED P.R. 10-15-2009; AM. S.R. 6-25-2012.

STACY WAHLBERG, EXAMINING ATTORNEY



*David J. Kybas*

Director of the United States Patent and Trademark Office

# United States of America

United States Patent and Trademark Office

## THE MEDIATION COLLECTION PROFESSIONALS

**Reg. No. 4,200,149**

COMMUNICATIONS CREDIT & RECOVERY CORP. (NEW YORK CORPORATION)  
200 GARDEN CITY PLAZA, SUITE 200  
GARDEN CITY, NY 11530

**Registered Aug. 28, 2012**

**Int. Cl.: 36**

FOR: COLLECTION AGENCIES, IN CLASS 36 (U.S. CLS. 100, 101 AND 102).

**SERVICE MARK**

FIRST USE 12-27-1987; IN COMMERCE 12-27-1987.

**SUPPLEMENTAL REGISTER**

THE MARK CONSISTS OF STANDARD CHARACTERS WITHOUT CLAIM TO ANY PARTICULAR FONT, STYLE, SIZE, OR COLOR.

NO CLAIM IS MADE TO THE EXCLUSIVE RIGHT TO USE "MEDIATION COLLECTION", APART FROM THE MARK AS SHOWN.

SER. NO. 76-708,854, FILED P.R. 8-26-2011; AM. S.R. 7-16-2012.

MARK SPARACINO, EXAMINING ATTORNEY



*David J. Kyffers*

Director of the United States Patent and Trademark Office

# United States of America

United States Patent and Trademark Office

## AMERICAN LIMESTONE COLLECTION

**Reg. No. 4,200,150**

TRAVERTINOS LAGUNA, S.A. DE C.V. (MEXICO CORPORATION)  
ZARAGOZA #515 NORTE COL. CENTRO LERDO  
DURANGO, MEXICO 35150

**Registered Aug. 28, 2012**

**Int. Cl.: 19**

FOR: FLOOR COVERINGS, NAMELY, NON METAL TILES THAT MAY BE APPLIED TO FLOORS MADE OF NONMETALLIC MATERIAL, NAMELY, MARBLE, TRAVERTINE, GRANITE AND NATURAL STONES; WALL COVERINGS, NAMELY, NON-METAL TILES THAT MAY BE APPLIED TO WALLS MADE OF NONMETALLIC MATERIAL, NAMELY, MARBLE, TRAVERTINE, GRANITE, AND NATURAL STONES, IN CLASS 19 (U.S. CLS. 1, 12, 33 AND 50).

**TRADEMARK**

**SUPPLEMENTAL REGISTER**

FIRST USE 2-15-2012; IN COMMERCE 2-15-2012.

THE MARK CONSISTS OF STANDARD CHARACTERS WITHOUT CLAIM TO ANY PARTICULAR FONT, STYLE, SIZE, OR COLOR.

NO CLAIM IS MADE TO THE EXCLUSIVE RIGHT TO USE "LIMESTONE COLLECTION", APART FROM THE MARK AS SHOWN.

SER. NO. 76-709,893, FILED 12-5-2011.

JAMES STEIN, EXAMINING ATTORNEY



*David J. Kyffers*

Director of the United States Patent and Trademark Office

# United States of America

United States Patent and Trademark Office

## DURABLE PORTFOLIO CONSTRUCTION

**Reg. No. 4,200,151**

NGAM DISTRIBUTION, L.P. (DELAWARE LIMITED PARTNERSHIP)  
399 BOYLSTON STREET  
BOSTON, MA 02116

**Registered Aug. 28, 2012**

**Int. Cl.: 36**

FOR: INVESTMENT MANAGEMENT AND ADVISORY SERVICES, IN CLASS 36 (U.S. CLS. 100, 101 AND 102).

**SERVICE MARK**

FIRST USE 0-0-2011; IN COMMERCE 0-0-2011.

**SUPPLEMENTAL REGISTER**

THE MARK CONSISTS OF STANDARD CHARACTERS WITHOUT CLAIM TO ANY PARTICULAR FONT, STYLE, SIZE, OR COLOR.

SER. NO. 76-710,614, FILED P.R. 2-9-2012; AM. S.R. 6-29-2012.

JENNIFER VASQUEZ, EXAMINING ATTORNEY



*David J. Kyffers*

Director of the United States Patent and Trademark Office

# United States of America

United States Patent and Trademark Office

## TIMESHARE MARKETPLACE

**Reg. No. 4,200,152**

**Registered Aug. 28, 2012**

**Int. Cl.: 35**

**SERVICE MARK**

**SUPPLEMENTAL REGISTER**

MARKETING SPACE LLC (FLORIDA LIMITED LIABILITY COMPANY)  
2007 EAST ROBINSON STREET  
ORLANDO, FL 32803

FOR: COOPERATIVE ADVERTISING SERVICES, NAMELY, POOLING THIRD PARTY ADVERTISING RESOURCES TO MAXIMIZE EXPOSURE TO WEBSITE, IN CLASS 35 (U.S. CLS. 100, 101 AND 102).

FIRST USE 3-0-2010; IN COMMERCE 1-1-2012.

THE MARK CONSISTS OF STANDARD CHARACTERS WITHOUT CLAIM TO ANY PARTICULAR FONT, STYLE, SIZE, OR COLOR.

NO CLAIM IS MADE TO THE EXCLUSIVE RIGHT TO USE "TIMESHARE", APART FROM THE MARK AS SHOWN.

SER. NO. 76-710,677, FILED P.R. 2-22-2012; AM. S.R. 6-13-2012.

SUSAN BILLHEIMER, EXAMINING ATTORNEY



*David J. Kyffers*

Director of the United States Patent and Trademark Office

# United States of America

United States Patent and Trademark Office

“ENERGY EFFICIENT, ENVIRONMENTALLY RESPONSIBLE”

**Reg. No. 4,200,153**

GREEN HOMEBUILDERS, LLC (TEXAS LIMITED LIABILITY COMPANY)  
3 LEGACY PARK

**Registered Aug. 28, 2012**

SAN ANTONIO, TX 782571307

**Int. Cl.: 37**

FOR: CONSTRUCTION OF RESIDENTIAL HOMES, IN CLASS 37 (U.S. CLS. 100, 103 AND 106).

**SERVICE MARK**

FIRST USE 10-0-2008; IN COMMERCE 10-0-2008.

**SUPPLEMENTAL REGISTER**

THE MARK CONSISTS OF STANDARD CHARACTERS WITHOUT CLAIM TO ANY PARTICULAR FONT, STYLE, SIZE, OR COLOR.

SER. NO. 76-710,907, FILED P.R. 3-14-2012; AM. S.R. 7-5-2012.

MICHAEL SOUDERS, EXAMINING ATTORNEY



*David J. Kyffers*

Director of the United States Patent and Trademark Office



# United States of America

United States Patent and Trademark Office

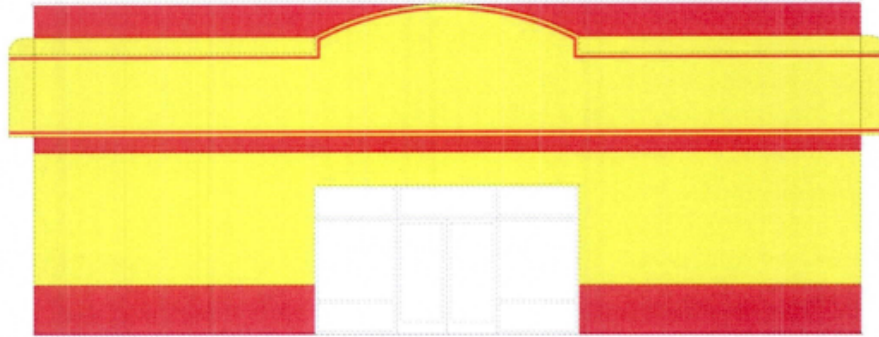

**Reg. No. 4,200,154**

**Registered Aug. 28, 2012**

**Int. Cl.: 36**

**SERVICE MARK**

**SUPPLEMENTAL REGISTER**

ARMCO INSURANCE AGENCY, INC. (TEXAS CORPORATION)  
3030 N STEMMONS FREEWAY  
DALLAS, TX 75247 AND

INSUREMAX INSURANCE AGENCY, INC. (TEXAS CORPORATION)  
3030 N STEMMONS FREEWAY  
DALLAS, TX 75247 AND

WELSON HOLDINGS, INC. (TEXAS CORPORATION)  
DALLAS, TX 75247

FOR: INSURANCE AGENCY SERVICES IN THE FIELD OF COMMERCIAL, HOME AND AUTO INSURANCE, IN CLASS 36 (U.S. CLS. 100, 101 AND 102).

FIRST USE 4-15-2001; IN COMMERCE 4-15-2001.

THE MARK CONSISTS OF THE COLOR COMBINATION OF RED AND YELLOW APPLIED TO THE EXTERIOR SURFACE OF APPLICANTS' RETAIL BUILDING WHEREIN THE COLORS APPEAR FROM THE TOP TO THE BOTTOM OF THE BUILDING IN HORIZONTAL BANDS OF RED, YELLOW, INCLUDING TWO RED PIN STRIPES, RED, YELLOW AND THEN RED. BROKEN-LINE OUTLINING IS USED TO SHOW THE POSITION OR PLACEMENT OF THE MARK ON THE BUILDING. THE OUTLINE AND THE SHAPE OF THE BUILDING ARE NOT CLAIMED AS PART OF THE MARK.

THE COLOR(S) RED AND YELLOW IS/ARE CLAIMED AS A FEATURE OF THE MARK.

SER. NO. 76-710,997, FILED P.R. 3-23-2012; AM. S.R. 6-15-2012.

MARK RADEMACHER, EXAMINING ATTORNEY



*David J. Kybas*

Director of the United States Patent and Trademark Office

# United States of America

United States Patent and Trademark Office



**Blondes and Girls**

**Reg. No. 4,200,155**

LEE, THOMAS MICHAEL (UNITED STATES INDIVIDUAL)  
25422 TRABUCO ROAD  
LAKE FOREST, CA 92630

**Registered Aug. 28, 2012**

**Int. Cl.: 25**

FOR: CLOTHING, NAMELY, SHIRTS, T-SHIRTS, TANK TOPS, VESTS, JERSEYS, FLEECE TOPS AND BOOTS, BLOUSES, SWEATERS, SWEATSHIRTS, CARDIGANS, WIND RESISTANT JACKETS, JACKETS, COATS, SUITS, SKIRTS, SKORTS, DRESSES, JUMPERS, SHORTS, SLACKS, KHAKIS, JEANS, OVERALLS, BELTS, UNDERWEAR, WOMEN'S LINGERIE, SLEEPWEAR, SOCKS, GLOVES AND MITTENS, HEADWEAR, AND FOOTWEAR; SNOWBOARD APPAREL, NAMELY, SNOW PANTS, SNOW SUITS, SNOWBOARD JACKETS, SNOWBOARD BOOTS, AND SNOWBOARD GLOVES AND MITTENS; SURFWEAR, NAMELY, RASHGUARDS AND WETSUITS; SWIMWEAR, NAMELY, SWIM TRUNKS AND SWIMSUITS; SKIWEAR, NAMELY, SKI BIBS, SKI BOOT BAGS, SKI BOOTS, SKI GLOVES, SKI MASKS, SKI PANTS, AND SKI SUITS, IN CLASS 25 (U.S. CLS. 22 AND 39).

**TRADEMARK**

**SUPPLEMENTAL REGISTER**

FIRST USE 1-1-2010; IN COMMERCE 1-1-2010.

THE MARK CONSISTS OF THE LETTERS "BG" AND THE WORDS "BLONDES AND GIRLS".

SER. NO. 77-102,164, FILED P.R. 2-8-2007; AM. S.R. 7-23-2012.

KAREN K. BUSH, EXAMINING ATTORNEY



*David J. Kybas*

Director of the United States Patent and Trademark Office

# United States of America

United States Patent and Trademark Office

## AFRICVILLE SEA-SIDES

**Reg. No. 4,200,156**

**Registered Aug. 28, 2012**

**Int. Cl.: 25**

**TRADEMARK**

**SUPPLEMENTAL REGISTER**

STRYKER-INDIGO PUBLISHING COMPANY, INC. (NEW YORK CORPORATION), DBA  
STRYKER-INDIGO NEW YORK,  
37 ROLLING LANE  
LEVITTOWN, NY 11756

FOR: SPORTS JERSEYS, IN CLASS 25 (U.S. CLS. 22 AND 39).

FIRST USE 9-30-2004; IN COMMERCE 10-11-2004.

THE MARK CONSISTS OF STANDARD CHARACTERS WITHOUT CLAIM TO ANY PARTICULAR FONT, STYLE, SIZE, OR COLOR.

SER. NO. 77-416,236, FILED P.R. 3-7-2008; AM. S.R. 7-6-2012.

JOHN LINCOSKI, EXAMINING ATTORNEY



*David J. Kybas*

Director of the United States Patent and Trademark Office

# United States of America

United States Patent and Trademark Office

## Charlottetown West End Rangers

**Reg. No. 4,200,157**

**Registered Aug. 28, 2012**

**Int. Cl.: 25**

**TRADEMARK**

**SUPPLEMENTAL REGISTER**

STRYKER-INDIGO PUBLISHING COMPANY, INC. (NEW YORK CORPORATION), DBA  
STRYKER-INDIGO NEW YORK,  
37 ROLLING LANE  
LEVITTOWN, NY 11756

FOR: SPORTS JERSEYS, IN CLASS 25 (U.S. CLS. 22 AND 39).

FIRST USE 9-30-2004; IN COMMERCE 10-11-2004.

THE MARK CONSISTS OF STANDARD CHARACTERS WITHOUT CLAIM TO ANY PARTICULAR FONT, STYLE, SIZE, OR COLOR.

NO CLAIM IS MADE TO THE EXCLUSIVE RIGHT TO USE "CHARLOTTETOWN", APART FROM THE MARK AS SHOWN.

SER. NO. 77-416,299, FILED P.R. 3-7-2008; AM. S.R. 7-6-2012.

JOHN LINCOSKI, EXAMINING ATTORNEY



*David J. Kyffers*

Director of the United States Patent and Trademark Office

# United States of America

United States Patent and Trademark Office

## OSTEOFACET WEDGE

**Reg. No. 4,200,158**

**Registered Aug. 28, 2012**

**Int. Cl.: 5**

**TRADEMARK**

**SUPPLEMENTAL REGISTER**

FACET FUSION TECHNOLOGIES, LLC (DELAWARE LIMITED LIABILITY COMPANY)  
CITY VIEW BUILDING, SUITE 365  
10999 IH-10 WEST  
SAN ANTONIO, TX 78230

FOR: SPINAL IMPLANTS, NAMELY, IMPLANTS TO FUSE JOINTS COMPOSED OF HUMAN ALLOGRAFT BONE TISSUE, IN CLASS 5 (U.S. CLS. 6, 18, 44, 46, 51 AND 52).

FIRST USE 4-30-2009; IN COMMERCE 9-16-2009.

THE MARK CONSISTS OF STANDARD CHARACTERS WITHOUT CLAIM TO ANY PARTICULAR FONT, STYLE, SIZE, OR COLOR.

NO CLAIM IS MADE TO THE EXCLUSIVE RIGHT TO USE "WEDGE", APART FROM THE MARK AS SHOWN.

SER. NO. 77-836,852, FILED P.R. 9-29-2009; AM. S.R. 5-14-2012.

SUSAN STIGLITZ, EXAMINING ATTORNEY



*David J. Kybas*

Director of the United States Patent and Trademark Office

# United States of America

United States Patent and Trademark Office

## HAPA IS PRAPA

**Reg. No. 4,200,159**

BRANDON HOLSTEIN (UNITED STATES INDIVIDUAL)  
5833 GAVIOTA AVE.

**Registered Aug. 28, 2012**

LONG BEACH, CA 90805

**Int. Cl.: 25**

FOR: SHORT-SLEEVED OR LONG-SLEEVED T-SHIRTS; T-SHIRTS, IN CLASS 25 (U.S. CLS. 22 AND 39).

**TRADEMARK**

FIRST USE 3-15-2010; IN COMMERCE 7-28-2010.

**SUPPLEMENTAL REGISTER**

THE MARK CONSISTS OF STANDARD CHARACTERS WITHOUT CLAIM TO ANY PARTICULAR FONT, STYLE, SIZE, OR COLOR.

SER. NO. 77-958,286, FILED P.R. 3-12-2010; AM. S.R. 6-12-2012.

PAUL E. FAHRENKOPF, EXAMINING ATTORNEY



*David J. Kybas*

Director of the United States Patent and Trademark Office

# United States of America

United States Patent and Trademark Office

## 건강저널

**Reg. No. 4,200,160**

KOREAN HEALTH JOURNAL, INC. (CALIFORNIA CORPORATION)

**Registered Aug. 28, 2012**

3680 WILSHIRE BLVD., #107  
LOS ANGELES, CA 90010

**Int. Cl.: 16**

FOR: PERIODICALS IN THE FIELD OF HEALTH AND FITNESS, IN CLASS 16 (U.S. CLS. 2, 5, 22, 23, 29, 37, 38 AND 50).

**TRADEMARK**

FIRST USE 11-30-2002; IN COMMERCE 11-30-2002.

**SUPPLEMENTAL REGISTER**

OWNER OF U.S. REG. NO. 2,830,973.

NO CLAIM IS MADE TO THE EXCLUSIVE RIGHT TO USE "JOURNAL", APART FROM THE MARK AS SHOWN.

THE MARK CONSISTS OF FOUR KOREAN CHARACTERS, WHOSE TRANSLITERATION IS "GUN KANG JOURNAL" AND WHICH DIRECT TRANSLATION IS "HEALTH JOURNAL".

SER. NO. 85-006,397, FILED 4-5-2010.

KATINA MISTER, EXAMINING ATTORNEY



*David J. Kybas*

Director of the United States Patent and Trademark Office

# United States of America

United States Patent and Trademark Office

## SMART SIGNAGE

**Reg. No. 4,200,161**

RETAIL COMMUNICATIONS GP, INC. (TEXAS CORPORATION), DBA RETAILCOMM,  
15303 DALLAS PARKWAY #150  
ADDISON, TX 75001

**Registered Aug. 28, 2012**

**Int. Cl.: 35**

FOR: MARKETING, ADVERTISING, PROMOTION AND PUBLIC RELATIONS SERVICES,  
IN CLASS 35 (U.S. CLS. 100, 101 AND 102).

**SERVICE MARK**

FIRST USE 6-18-2012; IN COMMERCE 6-18-2012.

**SUPPLEMENTAL REGISTER**

THE MARK CONSISTS OF STANDARD CHARACTERS WITHOUT CLAIM TO ANY PARTICULAR FONT, STYLE, SIZE, OR COLOR.

SER. NO. 85-048,550, FILED P.R. 5-26-2010; AM. S.R. 6-18-2012.

MICHELLE DUBOIS, EXAMINING ATTORNEY



*David J. Kyffers*

Director of the United States Patent and Trademark Office



# United States of America

United States Patent and Trademark Office

# MedReview

**Reg. No. 4,200,162**

ALLMED HEALTHCARE MANAGEMENT, INC. (OREGON CORPORATION)  
621 SW ALDER ST, STE 740  
PORTLAND, OR 97205

**Registered Aug. 28, 2012**

**Int. Cl.: 36**

FOR: MEDICAL INSURANCE CLAIMS CASE REVIEW SERVICES FOR HEALTHCARE PURCHASERS AND PAYORS AND PROVIDERS AND MEDICARE BENEFICIARIES , IN CLASS 36 (U.S. CLS. 100, 101 AND 102).

**SERVICE MARK**

FIRST USE 5-1-2010; IN COMMERCE 5-1-2010.

**SUPPLEMENTAL REGISTER**

THE MARK CONSISTS OF STANDARD CHARACTERS WITHOUT CLAIM TO ANY PARTICULAR FONT, STYLE, SIZE, OR COLOR.

SER. NO. 85-048,670, FILED P.R. 5-26-2010; AM. S.R. 7-3-2012.

MICHAEL SOUDERS, EXAMINING ATTORNEY



*David J. Kyffers*

Director of the United States Patent and Trademark Office

# United States of America

United States Patent and Trademark Office

# iDesktop

**Reg. No. 4,200,163**

**Registered Aug. 28, 2012**

**Int. Cl.: 9**

**TRADEMARK**

**SUPPLEMENTAL REGISTER**

INTELLECTUS HOLDINGS (FLORIDA LIMITED LIABILITY COMPANY)  
300 BUCKSLEY LANE #305  
DANIEL ISLAND, SC 29492

FOR: COMPUTER HARDWARE AND COMPUTER SOFTWARE PROGRAMS FOR THE INTEGRATION OF TEXT, AUDIO, GRAPHICS, STILL IMAGES AND MOVING PICTURES INTO AN INTERACTIVE DELIVERY FOR MULTIMEDIA APPLICATIONS; COMPUTER PROGRAMS AND COMPUTER SOFTWARE FOR ELECTRONICALLY TRADING SECURITIES; COMPUTER SOFTWARE FOR APPLICATION AND DATABASE INTEGRATION; COMPUTER SOFTWARE FOR CREATING SEARCHABLE DATABASES OF INFORMATION AND DATA; COMPUTER SOFTWARE FOR ORGANIZING AND VIEWING DIGITAL IMAGES AND PHOTOGRAPHS; COMPUTER SOFTWARE FOR THE FIELD OF WAREHOUSING AND DISTRIBUTION, TO MANAGE TRANSACTIONAL DATA, PROVIDE STATISTICAL ANALYSIS, AND PRODUCE NOTIFICATIONS AND REPORTS; COMPUTER SOFTWARE FOR THE MANAGEMENT OF COMMERCIAL PRINTING COMPANIES IN THE FIELD OF COST ESTIMATING, PRODUCTION PLANNING, SCHEDULING PRODUCTION, BINDING, SHIPPING AND ANALYSIS OF THE PRINTING JOB; COMPUTER SOFTWARE FOR USE IN CUSTOMER RELATIONSHIP MANAGEMENT (CRM); COMPUTER SOFTWARE FOR WIRELESS CONTENT DELIVERY; COMPUTER SOFTWARE THAT PROVIDES WEB-BASED ACCESS TO APPLICATIONS AND SERVICES THROUGH A WEB OPERATING SYSTEM OR PORTAL INTERFACE; COMPUTER SOFTWARE TO AUTOMATE DATA WAREHOUSING , IN CLASS 9 (U.S. CLS. 21, 23, 26, 36 AND 38).

FIRST USE 9-10-2009; IN COMMERCE 1-15-2010.

THE MARK CONSISTS OF STANDARD CHARACTERS WITHOUT CLAIM TO ANY PARTICULAR FONT, STYLE, SIZE, OR COLOR.

SER. NO. 85-081,940, FILED P.R. 7-10-2010; AM. S.R. 5-14-2012.

EUGENIA MARTIN, EXAMINING ATTORNEY



*David J. Kyffers*

Director of the United States Patent and Trademark Office

# United States of America

United States Patent and Trademark Office

## Equine Assisted Healing

**Reg. No. 4,200,164**

STAND INBALANCE, LLC (CALIFORNIA LIMITED LIABILITY COMPANY)  
3231 OCEAN PARK BLVD., STE. 205  
SANTA MONICA, CA 904053232

**Registered Aug. 28, 2012**

**Int. Cl.: 44**

FOR: PSYCHOTHERAPY AND MENTAL HEALTH SERVICES, NAMELY, USING HORSES TO HELP INDIVIDUALS, COUPLES, FAMILIES AND GROUPS, BATTERED WOMEN, GAY AND LESBIAN YOUTH AND OTHER TRAUMA VICTIMS GROW AND HEAL, IN CLASS 44 (U.S. CLS. 100 AND 101).

**SERVICE MARK**

**SUPPLEMENTAL REGISTER** FIRST USE 4-3-2010; IN COMMERCE 4-11-2010.

THE MARK CONSISTS OF STANDARD CHARACTERS WITHOUT CLAIM TO ANY PARTICULAR FONT, STYLE, SIZE, OR COLOR.

SER. NO. 85-108,237, FILED P.R. 8-16-2010; AM. S.R. 12-6-2011.

KELLEY WELLS, EXAMINING ATTORNEY



*David J. Kyffers*

Director of the United States Patent and Trademark Office

# United States of America

United States Patent and Trademark Office

## COLLECTION PERFORMANCE ADVISOR

**Reg. No. 4,200,165**

SEARCH AMERICA, INC. (MINNESOTA CORPORATION)  
6450 WEDGWOOD ROAD  
MAPLE GROVE, MN 55311

**Registered Aug. 28, 2012**

**Int. Cl.: 36**

FOR: PROVIDING FINANCIAL INFORMATION TO HEALTHCARE ORGANIZATIONS AND CREDIT GRANTORS REGARDING A PERSON'S ABILITY TO MAKE PAYMENTS ON FINANCIAL OBLIGATIONS BASED UPON A CREDIT SCORING SERVICE VIA A GLOBAL COMPUTER NETWORK, IN CLASS 36 (U.S. CLS. 100, 101 AND 102).

**SERVICE MARK**

**SUPPLEMENTAL REGISTER** FIRST USE 6-14-2010; IN COMMERCE 6-14-2010.

THE MARK CONSISTS OF STANDARD CHARACTERS WITHOUT CLAIM TO ANY PARTICULAR FONT, STYLE, SIZE, OR COLOR.

SER. NO. 85-127,346, FILED P.R. 9-10-2010; AM. S.R. 12-22-2011.

ROBERT C. CLARK JR., EXAMINING ATTORNEY



*David J. Kybas*

Director of the United States Patent and Trademark Office

# United States of America

United States Patent and Trademark Office

## NAME YOUR PRICE

**Reg. No. 4,200,166**

FAMOUS SMOKE SHOP-PA, INC. (PENNSYLVANIA CORPORATION)  
90 MORT DRIVE  
EASTON, PA 18040

**Registered Aug. 28, 2012**

**Int. Cl.: 35**

FOR: ONLINE RETAIL STORE SERVICES FEATURING TOBACCO PRODUCTS AND SMOKERS' ARTICLES, IN CLASS 35 (U.S. CLS. 100, 101 AND 102).

**SERVICE MARK**

FIRST USE 10-22-2010; IN COMMERCE 10-22-2010.

**SUPPLEMENTAL REGISTER**

THE MARK CONSISTS OF STANDARD CHARACTERS WITHOUT CLAIM TO ANY PARTICULAR FONT, STYLE, SIZE, OR COLOR.

SER. NO. 85-155,709, FILED P.R. 10-19-2010; AM. S.R. 6-12-2012.

DOMINIC J. FERRAIUOLO, EXAMINING ATTORNEY



*David J. Kyros*

Director of the United States Patent and Trademark Office

United States of America  
United States Patent and Trademark Office

wasabi

**Reg. No. 4,200,167**

WASABI SUSHI CO. (DELAWARE CORPORATION)  
908 17TH ST NW  
WASHINGTON, DC 20006

**Registered Aug. 28, 2012**

**Int. Cl.: 43**

FOR: RESTAURANT AND BAR SERVICES, IN CLASS 43 (U.S. CLS. 100 AND 101).

**SERVICE MARK**

FIRST USE 7-1-2006; IN COMMERCE 7-1-2006.

**SUPPLEMENTAL REGISTER**

NO CLAIM IS MADE TO THE EXCLUSIVE RIGHT TO USE "WASABI", APART FROM THE MARK AS SHOWN.

THE MARK CONSISTS OF THE WORD "WASABI" IN A STYLIZED FONT.

SER. NO. 85-156,435, FILED P.R. 10-19-2010; AM. S.R. 6-6-2012.

B. PARADEWELAI, EXAMINING ATTORNEY



*David J. Kyffers*

Director of the United States Patent and Trademark Office

**United States of America**  
United States Patent and Trademark Office

**ALAFIA**

**Reg. No. 4,200,168**

DRISCOLL STRAWBERRY ASSOCIATES, INC. (CALIFORNIA CORPORATION)  
345 WESTRIDGE DRIVE  
WATSONVILLE, CA 95077

**Registered Aug. 28, 2012**

**Int. Cl.: 31**

FOR: LIVING FRUIT PLANTS, NAMELY, BERRY PLANTS, IN CLASS 31 (U.S. CLS. 1 AND 46).

**TRADEMARK**

FIRST USE 10-6-2008; IN COMMERCE 10-6-2008.

**SUPPLEMENTAL REGISTER**

THE MARK CONSISTS OF STANDARD CHARACTERS WITHOUT CLAIM TO ANY PARTICULAR FONT, STYLE, SIZE, OR COLOR.

SER. NO. 85-169,121, FILED P.R. 11-4-2010; AM. S.R. 6-27-2012.

SARA BENJAMIN, EXAMINING ATTORNEY



*David J. Kyros*

Director of the United States Patent and Trademark Office

# United States of America

United States Patent and Trademark Office

# WebChannel

**Reg. No. 4,200,169**

**Registered Aug. 28, 2012**

**Int. Cl.: 42**

**SERVICE MARK**

**SUPPLEMENTAL REGISTER**

APPLE PARTNERS, LP (OKLAHOMA LIMITED PARTNERSHIP)  
7152 NW 112TH STREET  
OKLAHOMA CITY, OK 73162

FOR: ENTERTAINMENT, SERVICES, NAMELY, PROVIDING A WEBSITE THAT USES CHANNEL NUMBERS FOR NAVIGATION THAT GIVES COMPUTER USERS THE ABILITY TO UPLOAD AND SHARE USER GENERATED VIDEOS, MOVIES, PICTURES, IMAGES, TEXT, PHOTOS, AUDIO CLIPS, VIDEO CLIPS VIA THE INTERNET AND OTHER COMMUNICATIONS NETWORKS ON A WIDE VARIETY OF TOPICS AND SUBJECTS, IN CLASS 42 (U.S. CLS. 100 AND 101).

FIRST USE 8-25-2006; IN COMMERCE 8-25-2006.

THE MARK CONSISTS OF STANDARD CHARACTERS WITHOUT CLAIM TO ANY PARTICULAR FONT, STYLE, SIZE, OR COLOR.

SER. NO. 85-170,164, FILED P.R. 11-5-2010; AM. S.R. 3-7-2011.

DAVID I, EXAMINING ATTORNEY



*David J. Kyfos*

Director of the United States Patent and Trademark Office



# United States of America

United States Patent and Trademark Office

## HYPNOLINGUISTICS

**Reg. No. 4,200,170**

DERRICK SWEET (CANADA INDIVIDUAL)

**Registered Aug. 28, 2012**

212 MARTIN'S ROAD, RR 3  
FENELON FALLS, ONTARIO, CANADA K0M1N0

**Int. Cl.: 41**

FOR: EDUCATIONAL SERVICES, NAMELY, PROVIDING ON-LINE AND LIVE EVENTS, NAMELY, COURSES, CONFERENCE SPEECHES, WORKSHOPS AND SEMINARS IN THE FIELD OF THE COMPREHENSION AND DEVELOPMENT OF ORAL COMMUNICATION, COMMUNICATION SKILLS, PERSONAL DEVELOPMENT AND WELL-BEING, IN CLASS 41 (U.S. CLS. 100, 101 AND 107).

**SERVICE MARK**

**SUPPLEMENTAL REGISTER**

THE MARK CONSISTS OF STANDARD CHARACTERS WITHOUT CLAIM TO ANY PARTICULAR FONT, STYLE, SIZE, OR COLOR.

PRIORITY CLAIMED UNDER SEC. 44(D) ON CANADA APPLICATION NO. 1,490,639, FILED 7-30-2010, REG. NO. TMA823,711, DATED 5-9-2012, EXPIRES 5-9-2027.

SER. NO. 85-173,760, FILED P.R. 11-10-2010; AM. S.R. 7-12-2012.

BRIDGETT SMITH, EXAMINING ATTORNEY



*David J. Kybas*

Director of the United States Patent and Trademark Office

# United States of America

United States Patent and Trademark Office

## PREMIER SOFT COLLECTION

**Reg. No. 4,200,171**

**Registered Aug. 28, 2012**

**Int. Cl.: 27**

MOHAWK CARPET DISTRIBUTION, INC. (DELAWARE CORPORATION)  
P.O. BOX 800  
MISTY YOUNG - LEGAL DEPT  
CHATSWORTH, GA 30705

FOR: CARPETS, IN CLASS 27 (U.S. CLS. 19, 20, 37, 42 AND 50).

**TRADEMARK**

FIRST USE 10-11-2011; IN COMMERCE 10-11-2011.

**SUPPLEMENTAL REGISTER**

THE MARK CONSISTS OF STANDARD CHARACTERS WITHOUT CLAIM TO ANY PARTICULAR FONT, STYLE, SIZE, OR COLOR.

NO CLAIM IS MADE TO THE EXCLUSIVE RIGHT TO USE "COLLECTION", APART FROM THE MARK AS SHOWN.

SER. NO. 85-179,063, FILED P.R. 11-17-2010; AM. S.R. 7-9-2012.

ANGELA DUONG, EXAMINING ATTORNEY



*David J. Kyjars*

Director of the United States Patent and Trademark Office

# United States of America

United States Patent and Trademark Office

# X CON OHANA

**Reg. No. 4,200,172**

HARBIN, EARL (UNITED STATES INDIVIDUAL)  
P. O. BOX 1153  
MOUNTAIN VIEW, HI 96771

**Registered Aug. 28, 2012**

**Int. Cl.: 25**

FOR: HEADWEAR; PULLOVERS; SHIRTS; SHORTS; SWIMWEAR; T-SHIRTS; TANK TOPS,  
IN CLASS 25 (U.S. CLS. 22 AND 39).

**TRADEMARK**

FIRST USE 11-1-2011; IN COMMERCE 11-1-2011.

**SUPPLEMENTAL REGISTER**

THE MARK CONSISTS OF STANDARD CHARACTERS WITHOUT CLAIM TO ANY PARTICULAR FONT, STYLE, SIZE, OR COLOR.

THE ENGLISH TRANSLATION OF "OHANA" IN THE MARK IS "FAMILY".

SER. NO. 85-182,213, FILED P.R. 11-22-2010; AM. S.R. 7-11-2012.

PAULA MAHONEY, EXAMINING ATTORNEY



*David J. Kyffers*

Director of the United States Patent and Trademark Office

# United States of America

United States Patent and Trademark Office

## Cyber Rumors

**Reg. No. 4,200,173**

**Registered Aug. 28, 2012**

**Int. Cl.: 41**

**SERVICE MARK**

**SUPPLEMENTAL REGISTER**

TSG THE SIERRA GROUP, INC. (TEXAS CORPORATION)  
CYBER RUMORS  
PO BOX 180791  
ARLINGTON, TX 76096

FOR: ENTERTAINMENT SERVICES, NAMELY, PROVIDING A WEB SITE FEATURING PHOTOGRAPHIC, AUDIO, VIDEO AND PROSE PRESENTATIONS FEATURING NEWS INFORMATION FOR VALIDATION OF INTERNET RUMORS AND MISINFORMATION, IN CLASS 41 (U.S. CLS. 100, 101 AND 107).

FIRST USE 0-0-2012; IN COMMERCE 0-0-2012.

THE MARK CONSISTS OF STANDARD CHARACTERS WITHOUT CLAIM TO ANY PARTICULAR FONT, STYLE, SIZE, OR COLOR.

SER. NO. 85-192,734, FILED P.R. 12-7-2010; AM. S.R. 6-5-2012.

SUSAN STIGLITZ, EXAMINING ATTORNEY



*David J. Kyffers*

Director of the United States Patent and Trademark Office

# United States of America

United States Patent and Trademark Office

## ADDICTION CURE

**Reg. No. 4,200,174**

GRASSHOPPER HOUSE, LLC (CALIFORNIA LIMITED LIABILITY COMPANY)  
6428 MEADOWS COURT  
MALIBU, CA 90265

**Registered Aug. 28, 2012**

**Int. Cls.: 41, 44, and 45**

FOR: TRAINING SERVICES, NAMELY, TRAINING OF PARENTS, SPOUSES, CHILDREN, RELATIVES, AND FRIENDS OF PERSONS SUFFERING FROM ADDICTION ON HOW TO ASSIST THE PERSON IN OVERCOMING ADDICTION; PHYSICAL FITNESS TRAINING OF INDIVIDUALS AND GROUPS, IN CLASS 41 (U.S. CLS. 100, 101 AND 107).

**SERVICE MARK**

**SUPPLEMENTAL REGISTER** FIRST USE 10-31-2001; IN COMMERCE 10-31-2001.

FOR: ADDICTION TREATMENT AND REHABILITATION SERVICES FOR PERSONS SUFFERING FROM SUBSTANCE ABUSE AND DEPENDENCIES, INCLUDING FROM DRUGS AND ALCOHOL; PSYCHOLOGICAL COUNSELING FOR PERSONS SUFFERING FROM SUBSTANCE ABUSE AND DEPENDENCIES, INCLUDING FROM DRUGS AND ALCOHOL; COUNSELING SERVICES IN THE FIELD OF MENTAL HEALTH; ADDICTION TREATMENT, COUNSELING, AND REHABILITATION SERVICES FOR PERSONS SUFFERING FROM SUBSTANCE ABUSE AND DEPENDENCIES, INCLUDING FROM DRUGS AND ALCOHOL; COUNSELING RELATED TO MENTAL, PHYSICAL REHABILITATE AND THERAPY, AND BODY AND SPIRIT HEALTH AND WELL-BEING; PROVIDING MENTAL REHABILITATION FACILITIES; PROVIDING PHYSICAL REHABILITATION FACILITIES, IN CLASS 44 (U.S. CLS. 100 AND 101).

FIRST USE 10-31-2001; IN COMMERCE 10-31-2001.

FOR: SPIRITUAL COUNSELING, IN CLASS 45 (U.S. CLS. 100 AND 101).

FIRST USE 1-31-2002; IN COMMERCE 1-31-2002.

THE MARK CONSISTS OF STANDARD CHARACTERS WITHOUT CLAIM TO ANY PARTICULAR FONT, STYLE, SIZE, OR COLOR.

NO CLAIM IS MADE TO THE EXCLUSIVE RIGHT TO USE "ADDICTION", APART FROM THE MARK AS SHOWN.

SER. NO. 85-195,371, FILED P.R. 12-10-2010; AM. S.R. 9-16-2011.



*David J. Kybas*

Director of the United States Patent and Trademark Office

**Reg. No. 4,200,174** GINA FINK, EXAMINING ATTORNEY

# United States of America

United States Patent and Trademark Office

## Doorman Chronicles

**Reg. No. 4,200,175**

RAPHAEL A DENT (UNITED STATES INDIVIDUAL)  
6910 WOODRIDGE ROW DRIVE  
HOUSTON, TX 77087

**Registered Aug. 28, 2012**

**Int. Cl.: 41**

FOR: ENTERTAINMENT SERVICES IN THE NATURE OF CREATION, DEVELOPMENT, AND PRODUCTION OF TELEVISION PROGRAMMING; ENTERTAINMENT SERVICES IN THE NATURE OF DEVELOPMENT, CREATION, PRODUCTION AND POST-PRODUCTION SERVICES OF MULTIMEDIA ENTERTAINMENT CONTENT, IN CLASS 41 (U.S. CLS. 100, 101 AND 107).

**SERVICE MARK**

**SUPPLEMENTAL REGISTER**

FIRST USE 4-28-2010; IN COMMERCE 4-28-2010.

THE MARK CONSISTS OF STANDARD CHARACTERS WITHOUT CLAIM TO ANY PARTICULAR FONT, STYLE, SIZE, OR COLOR.

SER. NO. 85-200,184, FILED 12-17-2010.

PAULA MAHONEY, EXAMINING ATTORNEY



*David J. Kyffers*

Director of the United States Patent and Trademark Office

# United States of America

United States Patent and Trademark Office

## A TOTAL CONCEALMENT SOLUTION

**Reg. No. 4,200,176**

DIGITAL CONCEALMENT SYSTEMS, LLC (GEORGIA LIMITED LIABILITY COMPANY)  
618 - 10TH PLACE

**Registered Aug. 28, 2012**

PHENIX CITY, AL 36867

**Int. Cl.: 45**

FOR: LICENSING OF INTELLECTUAL PROPERTY IN THE FIELD OF CAMOUFLAGE PATTERNS FOR DECORATING GOODS USED IN CONNECTION WITH HUNTING, FISHING, AND OTHER OUTDOOR SPORTS AND ACTIVITIES, IN CLASS 45 (U.S. CLS. 100 AND 101).

**SERVICE MARK**

**SUPPLEMENTAL REGISTER** FIRST USE 9-30-2009; IN COMMERCE 9-30-2009.

THE MARK CONSISTS OF STANDARD CHARACTERS WITHOUT CLAIM TO ANY PARTICULAR FONT, STYLE, SIZE, OR COLOR.

SER. NO. 85-213,579, FILED P.R. 1-9-2011; AM. S.R. 10-6-2011.

RUDY R. SINGLETON, EXAMINING ATTORNEY



*David J. Kyfos*

Director of the United States Patent and Trademark Office



# United States of America

United States Patent and Trademark Office

# Womp

**Reg. No. 4,200,177**

JOSHUA MAX KENT (UNITED STATES INDIVIDUAL)  
4851 OLD ORCHARD TRAIL  
ORCHARD LAKE, MI 48324

**Registered Aug. 28, 2012**

**Int. Cl.: 25**

FOR: SHORT-SLEEVED OR LONG-SLEEVED T-SHIRTS, IN CLASS 25 (U.S. CLS. 22 AND 39).

**TRADEMARK**

FIRST USE 7-20-2011; IN COMMERCE 9-17-2011.

**SUPPLEMENTAL REGISTER**

THE MARK CONSISTS OF STANDARD CHARACTERS WITHOUT CLAIM TO ANY PARTICULAR FONT, STYLE, SIZE, OR COLOR.

SER. NO. 85-213,742, FILED P.R. 1-10-2011; AM. S.R. 7-18-2012.

HELENE LIWINSKI, EXAMINING ATTORNEY



*David J. Kybas*

Director of the United States Patent and Trademark Office

# United States of America

United States Patent and Trademark Office

## FIGURE FIXING FASHION

**Reg. No. 4,200,178**

BJ GLOBAL DIRECT, INC. (CALIFORNIA CORPORATION)  
8645 RESEARCH DR.  
IRVINE, CA 92618

**Registered Aug. 28, 2012**

**Int. Cl.: 25**

FOR: CLOTHING, NAMELY, SHAPEWARE, NAMELY, GIRDLES, UNDERWEAR, SLIPS AND BRASSIERES; JEANS; PANTS; CARDIGANS; SWEATERS; BLOUSES; SHIRTS; SWIMWEAR, IN CLASS 25 (U.S. CLS. 22 AND 39).

**TRADEMARK**

FIRST USE 10-8-2010; IN COMMERCE 10-8-2010.

**SUPPLEMENTAL REGISTER**

THE MARK CONSISTS OF STANDARD CHARACTERS WITHOUT CLAIM TO ANY PARTICULAR FONT, STYLE, SIZE, OR COLOR.

NO CLAIM IS MADE TO THE EXCLUSIVE RIGHT TO USE "FASHION", APART FROM THE MARK AS SHOWN.

SER. NO. 85-216,427, FILED P.R. 1-12-2011; AM. S.R. 7-3-2012.

DAWN FELDMAN, EXAMINING ATTORNEY



*David J. Kyffers*

Director of the United States Patent and Trademark Office

# United States of America

United States Patent and Trademark Office



**Reg. No. 4,200,179**

COREY C. JOHNSON, SR. (UNITED STATES INDIVIDUAL)  
16 ACORN CIRCLE SUITE #101  
TOWSON, MD 21286

**Registered Aug. 28, 2012**

**Int. Cl.: 25**

FOR: ATHLETIC APPAREL, NAMELY, SHIRTS, PANTS, JACKETS, FOOTWEAR, HATS AND CAPS, ATHLETIC UNIFORMS, IN CLASS 25 (U.S. CLS. 22 AND 39).

**TRADEMARK**

FIRST USE 1-1-2011; IN COMMERCE 1-1-2011.

**SUPPLEMENTAL REGISTER**

THE MARK CONSISTS OF THE TERM "BOSSHII" AND HUMAN EYE DESIGN; THE LETTERS ARE IN HOT PINK AND OUTLINED IN BLUE; THE HUMAN EYE DESIGN APPEARS ABOVE THE LETTERS "II" AND ARE BLACK WITH BLACK EYEBROWS; THE PUPILS OF THE EYES ARE BLACK, THE IRIS OF THE EYES ARE GRAY AND WHITE REFLECTIONS APPEAR IN THE IRIS OF BOTH EYES.

THE COLOR(S) HOT PINK, BLUE, BLACK, GRAY AND WHITE IS/ARE CLAIMED AS A FEATURE OF THE MARK.

THE WORDING "BOOSHII" HAS NO MEANING IN A FOREIGN LANGUAGE.

SER. NO. 85-232,103, FILED P.R. 2-2-2011; AM. S.R. 7-17-2012.

BILL DAWE, EXAMINING ATTORNEY



*David J. Kyffers*

Director of the United States Patent and Trademark Office

# United States of America

United States Patent and Trademark Office

## VINTAGE CINEMAS

**Reg. No. 4,200,180**

VINTAGE CINEMAS, INC. (CALIFORNIA CORPORATION)  
1822 N. VERMONT AVE.

**Registered Aug. 28, 2012**

LOS ANGELES, CA 90027

**Int. Cls.: 35, 41, and 43**

FOR: MOTION PICTURE THEATER CONCESSION STANDS FEATURING FOOD AND BEVERAGES, IN CLASS 35 (U.S. CLS. 100, 101 AND 102).

**SERVICE MARK**

FIRST USE 6-1-2009; IN COMMERCE 6-1-2009.

**SUPPLEMENTAL REGISTER**

FOR: MOTION PICTURE THEATER SERVICES; CONSULTING SERVICES IN THE FIELD OF EVENT PLANNING, CONCERT PLANNING AND PARTY PLANNING SERVICES; VENUE RENTAL SERVICES, NAMELY, RENTAL OF ROOMS FOR CONCERTS, IN CLASS 41 (U.S. CLS. 100, 101 AND 107).

FIRST USE 6-1-2009; IN COMMERCE 6-1-2009.

FOR: VENUE RENTAL, NAMELY, RENTAL OF ROOMS AND FACILITIES FOR SOCIAL FUNCTIONS, IN CLASS 43 (U.S. CLS. 100 AND 101).

FIRST USE 6-1-2009; IN COMMERCE 6-1-2009.

THE MARK CONSISTS OF STANDARD CHARACTERS WITHOUT CLAIM TO ANY PARTICULAR FONT, STYLE, SIZE, OR COLOR.

NO CLAIM IS MADE TO THE EXCLUSIVE RIGHT TO USE "CINEMAS", APART FROM THE MARK AS SHOWN.

SER. NO. 85-236,442, FILED P.R. 2-8-2011; AM. S.R. 2-15-2012.

DAWN FELDMAN, EXAMINING ATTORNEY



*David J. Kyros*

Director of the United States Patent and Trademark Office

# United States of America

United States Patent and Trademark Office

## TABLET TEXTBOOK

**Reg. No. 4,200,181**

KNO, INC. (DELAWARE CORPORATION)  
5155 OLD IRONSIDES DRIVE  
SANTA CLARA, CA 95054

**Registered Aug. 28, 2012**

**Int. Cl.: 9**

FOR: SOFTWARE FOR DELIVERY, DISPLAY, STORAGE AND MANIPULATION OF DATA, TEXT, IMAGES, AUDIO, AND VIDEO, IN CLASS 9 (U.S. CLS. 21, 23, 26, 36 AND 38).

**TRADEMARK**

FIRST USE 3-8-2012; IN COMMERCE 3-8-2012.

**SUPPLEMENTAL REGISTER**

THE MARK CONSISTS OF STANDARD CHARACTERS WITHOUT CLAIM TO ANY PARTICULAR FONT, STYLE, SIZE, OR COLOR.

NO CLAIM IS MADE TO THE EXCLUSIVE RIGHT TO USE "TEXTBOOK", APART FROM THE MARK AS SHOWN.

SER. NO. 85-237,252, FILED P.R. 2-8-2011; AM. S.R. 7-17-2012.

KIMBERLY PERRY, EXAMINING ATTORNEY



*David J. Kyffers*

Director of the United States Patent and Trademark Office

# United States of America

United States Patent and Trademark Office

## SHOP MIDWEST

**Reg. No. 4,200,182**

MIDWEST FASHION WEEK LLC (INDIANA LIMITED LIABILITY COMPANY)  
6057 LAKESIDE MANOR AVENUE  
INDIANAPOLIS, IN 46254

**Registered Aug. 28, 2012**

**Int. Cl.: 41**

FOR: ENTERTAINMENT IN THE NATURE OF FASHION SHOWS, IN CLASS 41 (U.S. CLS. 100, 101 AND 107).

**SERVICE MARK**

FIRST USE 3-12-2011; IN COMMERCE 3-12-2011.

**SUPPLEMENTAL REGISTER**

THE MARK CONSISTS OF STANDARD CHARACTERS WITHOUT CLAIM TO ANY PARTICULAR FONT, STYLE, SIZE, OR COLOR.

NO CLAIM IS MADE TO THE EXCLUSIVE RIGHT TO USE "SHOP", APART FROM THE MARK AS SHOWN.

SER. NO. 85-242,873, FILED P.R. 2-15-2011; AM. S.R. 7-9-2012.

CHARLES L. JENKINS, EXAMINING ATTORNEY



*David J. Kyffers*

Director of the United States Patent and Trademark Office

# United States of America

United States Patent and Trademark Office

## BOSTON TEA PARTY

**Reg. No. 4,200,183**

**Registered Aug. 28, 2012**

**Int. Cl.: 41**

**SERVICE MARK**

**SUPPLEMENTAL REGISTER**

BOSTON TEA PARTY SHIP, INC. (MASSACHUSETTS CORPORATION)  
201 FRONT STREET  
KEY WEST, FL 33040

FOR: MUSEUM SERVICES, NAMELY, SHIP MUSEUMS FEATURING HISTORICAL DISPLAYS THAT OFFER ACTIVE PARTICIPATION IN EVENTS AND ATTRACTIONS; GUIDED TOURS OF MUSEUMS; ENTERTAINMENT SERVICES, NAMELY, PROVIDING A WEB SITE FEATURING PHOTOGRAPHIC, AUDIO, VIDEO AND PROSE PRESENTATIONS FEATURING HISTORICAL EVENTS, HISTORICAL FEATURES, AND HISTORICAL CHARACTERS, IN CLASS 41 (U.S. CLS. 100, 101 AND 107).

FIRST USE 0-0-1973; IN COMMERCE 6-26-2012.

THE MARK CONSISTS OF STANDARD CHARACTERS WITHOUT CLAIM TO ANY PARTICULAR FONT, STYLE, SIZE, OR COLOR.

SER. NO. 85-248,623, FILED P.R. 2-22-2011; AM. S.R. 7-3-2012.

DAVID ELTON, EXAMINING ATTORNEY



*David J. Kyffers*

Director of the United States Patent and Trademark Office

# United States of America

## United States Patent and Trademark Office

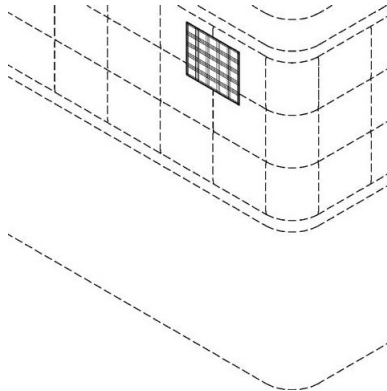

**Reg. No. 4,200,184**

**Registered Aug. 28, 2012**

**Int. Cl.: 20**

**TRADEMARK**

**SUPPLEMENTAL REGISTER**

E. S. KLUFT & COMPANY, LLC (CALIFORNIA LIMITED LIABILITY COMPANY)  
11096 JERSEY BOULEVARD, SUITE 101  
RANCHO CUCAMONGA, CA 91730

FOR: MATTRESSES, IN CLASS 20 (U.S. CLS. 2, 13, 22, 25, 32 AND 50).

FIRST USE 1-24-2011; IN COMMERCE 1-24-2011.

THE MARK CONSISTS OF A RECTANGULAR PLAID DESIGN LOCATED NEAR ONE CORNER OF THE FOOT OF A MATTRESS. THE MATTER SHOWN IN DOTTED LINES IS NOT PART OF THE MARK BUT MERELY SERVES TO SHOW THE PLACEMENT OF THE MARK ON THE GOODS.

SER. NO. 85-250,019, FILED P.R. 2-23-2011; AM. S.R. 6-18-2012.

KIMBERLY FRYE, EXAMINING ATTORNEY



*David J. Kyffers*

Director of the United States Patent and Trademark Office



# United States of America

United States Patent and Trademark Office

## HEALTHCARE SUPPLY CLOUD

**Reg. No. 4,200,185**

GLOBAL HEALTHCARE EXCHANGE, LLC (DELAWARE LIMITED LIABILITY COMPANY)  
1315 W. CENTURY DRIVE

**Registered Aug. 28, 2012**

LOUISVILLE, CO 80027

**Int. Cls.: 35 and 42**

FOR: ON-LINE ORDERING SERVICES FOR ORDERING MEDICAL EQUIPMENT AND DEVICES, PHARMACEUTICAL AND MEDICAL PRODUCTS AND OTHER SERVICES USED IN HOSPITALS AND BY HEALTHCARE PROVIDERS, IN CLASS 35 (U.S. CLS. 100, 101 AND 102).

**SERVICE MARK**

**SUPPLEMENTAL REGISTER** FIRST USE 4-18-2011; IN COMMERCE 4-18-2011.

FOR: PROVIDING TEMPORARY USE OF NON-DOWNLOADABLE NETWORK SOFTWARE FOR PROVIDING HEALTHCARE INFORMATION, HEALTHCARE TRANSACTIONS BEING PROCUREMENT, PURCHASING, ACKNOWLEDGEMENT, INVOICE AND PAYMENT INFORMATION; PROVIDING TEMPORARY USE OF NON-DOWNLOADABLE NETWORK SOFTWARE FOR HEALTHCARE TRADING IN THE FIELD OF MEDICAL PRODUCTS AND DEVICES USED IN DELIVERING HEALTHCARE SERVICES; PROVIDING TEMPORARY USE OF NON-DOWNLOADABLE NETWORK SOFTWARE FOR HEALTHCARE MANAGEMENT, AND HEALTHCARE ANALYSIS IN THE FIELDS OF PROCUREMENT, ORDERING, PRICING AND CONTRACT, SHIPPING, PAYMENT AND USAGE DATA; APPLICATION SERVICE PROVIDER (ASP) FEATURING SOFTWARE USED FOR INVENTORY AUTOMATION, HEALTHCARE DATA COLLECTION IN THE NATURE OF PROCUREMENT, ORDERING, PRICING AND CONTRACT, SHIPPING, PAYMENT AND USAGE DATA; APPLICATION SERVICE PROVIDER (ASP) FEATURING SOFTWARE USED FOR HEALTHCARE DATA MANAGEMENT, REPORTING AND PERFORMING BUSINESS ANALYTICS OF THE HEALTHCARE INDUSTRY, AND FOR ENABLING USERS TO CONNECT TO AND USE AN ELECTRONIC EXCHANGE FOR PROCUREMENT, ORDERING, PRICING AND CONTRACT, SHIPPING, PAYMENT AND USAGE TRANSACTIONS IN THE FIELD OF HEALTHCARE PRODUCTS AND SERVICES BETWEEN HEALTHCARE PROVIDERS, SUPPLIERS AND DISTRIBUTORS OF MEDICAL AND HEALTHCARE PRODUCTS AND SERVICES; APPLICATION SERVICE PROVIDER (ASP) FEATURING SOFTWARE FOR PROVIDING AN ON-LINE FORUM FOR THE EXCHANGE OF INFORMATION IN THE FIELD OF MEDICAL AND PHARMACEUTICAL HEALTHCARE SERVICES AND MEDICAL EQUIPMENT AND SUPPLIES IN THE HEALTHCARE INDUSTRY; APPLICATION SERVICE PROVIDER (ASP) FEATURING SOFTWARE PROVIDING OPERATIONAL SUPPORT AND MATERIALS MANAGEMENT SYSTEMS IN THE FIELD OF HEALTHCARE HOSPITAL MANAGEMENT, NAMELY, PROVIDING SOFTWARE USED FOR ON-LINE PROCUREMENT, COMPARATIVE



*David J. Kyffers*

Director of the United States Patent and Trademark Office

**Reg. No. 4,200,185** PRICING ANALYSIS, INVENTORY CONTROL, AND MATCHING OF PROVIDERS AND CONSUMERS OF MEDICAL EQUIPMENT AND DEVICES, PHARMACEUTICAL AND MEDICAL PRODUCTS AND OTHER GOODS AND SERVICES USED IN HOSPITALS AND BY HEALTHCARE PROVIDERS, AS WELL AS PROVIDING INFORMATION ABOUT MEDICAL EQUIPMENT AND DEVICES, PHARMACEUTICAL AND MEDICAL PRODUCTS, AND OTHER GOODS AND SERVICES USED IN HOSPITALS AND BY HEALTHCARE PROVIDERS, APPLICATION SERVICE PROVIDER (ASP) FEATURING DATABASE MANAGEMENT SOFTWARE USED IN PROVIDING DETAILS OF MEDICAL EQUIPMENT AND DEVICES, PHARMACEUTICAL AND MEDICAL PRODUCTS, IN CLASS 42 (U.S. CLS. 100 AND 101).

FIRST USE 4-18-2011; IN COMMERCE 4-18-2011.

THE MARK CONSISTS OF STANDARD CHARACTERS WITHOUT CLAIM TO ANY PARTICULAR FONT, STYLE, SIZE, OR COLOR.

NO CLAIM IS MADE TO THE EXCLUSIVE RIGHT TO USE "HEALTHCARE SUPPLY" IN CLASS 35 AND "CLOUD" IN CLASS 42, APART FROM THE MARK AS SHOWN.

SER. NO. 85-251,447, FILED P.R. 2-25-2011; AM. S.R. 12-1-2011.

LINDA POWELL, EXAMINING ATTORNEY

# United States of America

United States Patent and Trademark Office

## "Stand-By" Cycle

**Reg. No. 4,200,186**

JOHN BAKER SALES, LLC (MICHIGAN LIMITED LIABILITY COMPANY)

**Registered Aug. 28, 2012**

P.O. BOX 2096  
RIVERVIEW, MI 48193

**Int. Cl.: 9**

FOR: ELECTRICAL CONTROLLING DEVICES, NAMELY, AUTOMATIC CONTROLS FOR ENERGY CONSERVATION FOR USE WITH PAINT SPRAY BOOTHS, IN CLASS 9 (U.S. CLS. 21, 23, 26, 36 AND 38).

**TRADEMARK**

FIRST USE 3-23-2010; IN COMMERCE 3-23-2010.

**SUPPLEMENTAL REGISTER**

THE MARK CONSISTS OF STANDARD CHARACTERS WITHOUT CLAIM TO ANY PARTICULAR FONT, STYLE, SIZE, OR COLOR.

SER. NO. 85-254,782, FILED P.R. 3-1-2011; AM. S.R. 7-16-2012.

TINA BROWN, EXAMINING ATTORNEY



*David J. Kyffers*

Director of the United States Patent and Trademark Office

United States of America  
United States Patent and Trademark Office

ISMOK

**Reg. No. 4,200,187**

**Registered Aug. 28, 2012**

**Int. Cl.: 34**

ISMOKE LLC (NEW YORK LIMITED LIABILITY COMPANY)  
C/O KAPLAN MASSAMILLO ATTN T CARULLI  
70 EAST 55TH STREET, 25TH FLOOR  
NEW YORK, NY 10022

FOR: ELECTRONIC CIGARETTES, IN CLASS 34 (U.S. CLS. 2, 8, 9 AND 17).

**TRADEMARK**

FIRST USE 11-30-2011; IN COMMERCE 11-30-2011.

**SUPPLEMENTAL REGISTER**

THE MARK CONSISTS OF STANDARD CHARACTERS WITHOUT CLAIM TO ANY PARTICULAR FONT, STYLE, SIZE, OR COLOR.

SER. NO. 85-255,309, FILED P.R. 3-2-2011; AM. S.R. 6-27-2012.

ZACHARY BELLO, EXAMINING ATTORNEY



*David J. Kybas*

Director of the United States Patent and Trademark Office

# United States of America

United States Patent and Trademark Office

## LIGHT BLOCKZ

**Reg. No. 4,200,188**

AMERICAN ILLUMINATION, INC. (NEVADA CORPORATION)  
8018 E. SANTA ANA CANYON ROAD, SUITE 100  
ANAHEIM HILLS, CA 92808

**Registered Aug. 28, 2012**

**Int. Cl.: 11**

FOR: SOLID STATE LIGHTING MODULES USING LIGHT EMITTING DIODES, NAMELY, LED LIGHT ENGINES, AND ATTACHMENTS AND ACCESSORIES THERETO, NAMELY, LENSES, LENS CAPS AND REFLECTORS, IN CLASS 11 (U.S. CLS. 13, 21, 23, 31 AND 34).

**TRADEMARK**

FIRST USE 1-31-2009; IN COMMERCE 4-30-2009.

**SUPPLEMENTAL REGISTER**

THE MARK CONSISTS OF STANDARD CHARACTERS WITHOUT CLAIM TO ANY PARTICULAR FONT, STYLE, SIZE, OR COLOR.

NO CLAIM IS MADE TO THE EXCLUSIVE RIGHT TO USE "LIGHT", APART FROM THE MARK AS SHOWN.

SER. NO. 85-256,233, FILED P.R. 3-2-2011; AM. S.R. 7-5-2012.

ALLISON SCHRODY, EXAMINING ATTORNEY



*David J. Kyjars*

Director of the United States Patent and Trademark Office

# United States of America

United States Patent and Trademark Office

## MARQUETTE BACKCOUNTRY

**Reg. No. 4,200,189**

SNAPPERHEAD INVENTIONS LLC (MICHIGAN LIMITED LIABILITY COMPANY)  
420 EAST PROSPECT STREET  
MARQUETTE, MI 49855

**Registered Aug. 28, 2012**

**Int. Cl.: 28**

FOR: SPORTING GOODS FOR OUTDOOR ACTIVITIES, NAMELY, SKIS, SKI POLES, AND NORDIC WALKING POLES, IN CLASS 28 (U.S. CLS. 22, 23, 38 AND 50).

**TRADEMARK**

FIRST USE 11-16-2010; IN COMMERCE 11-16-2010.

**SUPPLEMENTAL REGISTER**

THE MARK CONSISTS OF STANDARD CHARACTERS WITHOUT CLAIM TO ANY PARTICULAR FONT, STYLE, SIZE, OR COLOR.

SER. NO. 85-261,976, FILED P.R. 3-9-2011; AM. S.R. 7-3-2012.

CHRISTINA SOBRAL, EXAMINING ATTORNEY



*David J. Kybas*

Director of the United States Patent and Trademark Office

# United States of America

United States Patent and Trademark Office

## SWEET-DELICIOUS

**Reg. No. 4,200,190**

**Registered Aug. 28, 2012**

**Int. Cls.: 29, 30, and 32**

**TRADEMARK**

**SUPPLEMENTAL REGISTER**

BIOVITTORIA LIMITED (NEW ZEALAND LIMITED LIABILITY COMPANY)  
WAIKATO INNOVATION PARK  
RUAKURA ROAD, P.O. BOX 9466  
HAMILTON, NEW ZEALAND

FOR: FRUIT EXTRACT, NAMELY, NON-ALCOHOLIC FRUIT EXTRACTS USED AS INGREDIENTS AND ADDITIVES IN FOOD, IN CLASS 29 (U.S. CL. 46).

FIRST USE 6-28-2012; IN COMMERCE 6-28-2012.

FOR: NATURAL SWEETENER; FRUIT EXTRACT, NAMELY, FRUIT EXTRACTS USED AS FOOD FLAVORINGS, IN CLASS 30 (U.S. CL. 46).

FIRST USE 6-28-2012; IN COMMERCE 6-28-2012.

FOR: FRUIT JUICE; FRUIT EXTRACT, NAMELY, NON-ALCOHOLIC FRUIT EXTRACTS USED FOR PREPARATION OF BEVERAGES, IN CLASS 32 (U.S. CLS. 45, 46 AND 48).

FIRST USE 6-28-2012; IN COMMERCE 6-28-2012.

THE MARK CONSISTS OF STANDARD CHARACTERS WITHOUT CLAIM TO ANY PARTICULAR FONT, STYLE, SIZE, OR COLOR.

SER. NO. 85-261,982, FILED P.R. 3-9-2011; AM. S.R. 6-29-2012.

APRIL ROACH, EXAMINING ATTORNEY



*David J. Kyros*

Director of the United States Patent and Trademark Office

# United States of America

## United States Patent and Trademark Office

*Prost!* <sup>CHEERS!</sup> *Salud!* *Gan Bei!* *Skål!* *Prost!* <sup>SALUD!</sup> *Cin Cin!* *L'chaim!* <sup>A VOTRE SANTE!</sup> *Cheers!* *Banzai!* *Lchaim!*  
<sup>GAN BEI!</sup> *A Votre Sante!* <sup>TSJOCH!</sup> *Kippis!* *Jamas!* <sup>SKÅL!</sup> *Banzai!* *Salud!* *Jamas!* <sup>CIN CIN!</sup> *Zum Wohl!*  
*Kippis!* <sup>SKÅL!</sup> *Cin Cin!* <sup>BANZAI!</sup> <sup>SKÅL!</sup> *Zum Wohl!* <sup>LCHAIM!</sup> <sup>KIPPIS!</sup> *Cheers!* <sup>GAN BEI!</sup> <sup>PROST!</sup> <sup>TSJOCH!</sup> *Skål!* <sup>JAMAS!</sup>

**Reg. No. 4,200,191**

LUND FOOD HOLDINGS, INC. (MINNESOTA CORPORATION)  
4100 WEST 50TH STREET, SUITE 2100  
EDINA, MN 55424

**Registered Aug. 28, 2012**

**Int. Cl.: 35**

FOR: RETAIL STORE SERVICES FEATURING WINE AND BEER, IN CLASS 35 (U.S. CLS. 100, 101 AND 102).

**SERVICE MARK**

FIRST USE 9-0-2010; IN COMMERCE 9-0-2010.

**SUPPLEMENTAL REGISTER**

THE MARK CONSISTS OF THE WORDING "PROST! CHEERS! SALUD! GAN BEI! SKÅL! PROST! SALUD! CIN CIN! LCHAIM! A VOTRE SANTE! CHEERS! BANZAI! LCHAIM!" ON TOP OF THE WORDS "GAN BEI! TSJOCH! A VOTRE SANTE! KIPPIS! JAMAS! TSJOCH! A VOTRE SANTE! SKÅL! BANZAI! SALUD! JAMAS! ZUM WOHL! CIN CIN!" ON TOP OF THE WORDS "KIPPIS! SKÅL! CIN CIN! BANZAI! SKÅL! ZUM WOHL! LCHAIM! KIPPIS! CHEERS! GAN BEI! PROST! TSJOCH! SKÅL! JAMAS!".

THE ENGLISH TRANSLATION OF "PROST!," "SALUD!," "GAN BEI!," "SKÅL!," "CIN CIN!," "L'CHAIM!," "A VOTRE SANTE!," "BANZAI!," "TSJOCH!," "KIPPIS!," "JAMAS!," "ZUM WOHL!" IN THE MARK IS "CHEERS".

SER. NO. 85-262,318, FILED P.R. 3-9-2011; AM. S.R. 6-28-2012.

ALICE BENMAMAN, EXAMINING ATTORNEY



*David J. Kippis*

Director of the United States Patent and Trademark Office



# United States of America

United States Patent and Trademark Office

# PUNK PET

**Reg. No. 4,200,192**

JUSTIN M. BREVOORT (UNITED STATES INDIVIDUAL)  
328 PALM DRIVE  
HERMOSA BEACH, CA 90254

**Registered Aug. 28, 2012**

**Int. Cl.: 18**

FOR: DOG COLLARS; DOG COLLARS AND LEADS; PET ACCESSORIES, NAMELY, CANVAS, VINYL AND LEATHER POUCHES FOR HOLDING DISPOSABLE BAGS TO PLACE PET WASTE IN; PET ACCESSORIES, NAMELY, SPECIALLY DESIGNED CANVAS, VINYL OR LEATHER BAGS ATTACHED TO ANIMAL LEASHES FOR HOLDING SMALL ITEMS SUCH AS KEYS, CREDIT CARDS, MONEY OR DISPOSABLE BAGS FOR DISPOSING OF PET WASTE; PET CLOTHING; PET COLLAR ACCESSORIES, NAMELY, BELLS, SILENCERS, SAFETY LIGHTS AND BLINKERS, PENDANTS AND CHARMS; PET COLLAR ACCESSORIES, NAMELY, BOWS AND CHARMS; PET COLLAR ACCESSORIES, NAMELY, CHARMS; PET PRODUCTS IN THE NATURE OF A RESTRAINING DEVICE, NAMELY, TIE-OUT STAKES AND TIE-OUT CHAINS; PET PRODUCTS, NAMELY, PET RESTRAINING DEVICES CONSISTING OF LEASHES, COLLARS, HARNESES, RESTRAINING STRAPS, AND LEASHES WITH LOCKING DEVICES; PET TAGS SPECIALLY ADAPTED FOR ATTACHING TO PET LEASHES OR COLLARS, IN CLASS 18 (U.S. CLS. 1, 2, 3, 22 AND 41).

**TRADEMARK**

**SUPPLEMENTAL REGISTER**

FIRST USE 7-1-2012; IN COMMERCE 7-1-2012.

THE MARK CONSISTS OF STANDARD CHARACTERS WITHOUT CLAIM TO ANY PARTICULAR FONT, STYLE, SIZE, OR COLOR.

NO CLAIM IS MADE TO THE EXCLUSIVE RIGHT TO USE "PET", APART FROM THE MARK AS SHOWN.

SER. NO. 85-266,799, FILED P.R. 3-14-2011; AM. S.R. 7-9-2012.

LOURDES AYALA, EXAMINING ATTORNEY



*David J. Kybas*

Director of the United States Patent and Trademark Office

# United States of America

United States Patent and Trademark Office

## DIFUSION TECHNOLOGIES, INC.

**Reg. No. 4,200,193**

**Registered Aug. 28, 2012**

**Int. Cl.: 10**

**TRADEMARK**

**SUPPLEMENTAL REGISTER**

DIFUSION, INC. (DELAWARE CORPORATION)  
SUITE 500  
701 BRAZOS STREET  
AUSTIN, TX 78701

FOR: ORTHOPAEDIC IMPLANTS COMPOSED OF NON-LIVING MATERIAL, IN CLASS 10  
(U.S. CLS. 26, 39 AND 44).

FIRST USE 9-13-2011; IN COMMERCE 9-13-2011.

THE MARK CONSISTS OF STANDARD CHARACTERS WITHOUT CLAIM TO ANY PARTICULAR FONT, STYLE, SIZE, OR COLOR.

SER. NO. 85-274,537, FILED P.R. 3-23-2011; AM. S.R. 6-28-2012.

DORITT L. CARROLL, EXAMINING ATTORNEY



*David J. Kybas*

Director of the United States Patent and Trademark Office

# United States of America

United States Patent and Trademark Office



**Reg. No. 4,200,194**

**Registered Aug. 28, 2012**

**Int. Cl.: 10**

**TRADEMARK**

**SUPPLEMENTAL REGISTER**

DIFUSION, INC. (DELAWARE CORPORATION)  
SUITE 500  
701 BRAZOS STREET  
AUSTIN, TX 78701

FOR: ORTHOPAEDIC IMPLANTS COMPOSED OF NON-LIVING MATERIAL, IN CLASS 10  
(U.S. CLS. 26, 39 AND 44).

FIRST USE 9-13-2011; IN COMMERCE 9-13-2011.

NO CLAIM IS MADE TO THE EXCLUSIVE RIGHT TO USE "DIFFUSION TECHNOLOGIES  
INC.", APART FROM THE MARK AS SHOWN.

THE MARK CONSISTS OF THE WORD "DIFUSION" IN ALL CAPITAL LETTERS WITH  
"TECHNOLOGIES, INC." BELOW IT, WITH A CIRCULAR SHAPED DESIGN CONTAINING  
THREE SPHERES THAT INTERSECTS THE LETTER "N" OF "DIFUSION".

SER. NO. 85-274,562, FILED P.R. 3-23-2011; AM. S.R. 6-28-2012.

DORITT L. CARROLL, EXAMINING ATTORNEY



*David J. Kybas*

Director of the United States Patent and Trademark Office

# United States of America

United States Patent and Trademark Office

## METACARRIER

**Reg. No. 4,200,195**

**Registered Aug. 28, 2012**

**Int. Cl.: 9**

**TRADEMARK**

**SUPPLEMENTAL REGISTER**

COMTECH EF DATA CORP. (DELAWARE CORPORATION)  
2114 W. 7TH ST.  
TEMPE, AZ 85281

FOR: COMPUTER SOFTWARE AND HARDWARE FOR TRANSMITTING SPREAD CARRIER SIGNALS IN A FORM THAT DESCRIBES ANOTHER CARRIER WITH WHICH THE SIGNAL IS ASSOCIATED, FOR USE WITH POINT-TO-POINT COMMUNICATION SYSTEMS AS WELL AS POINT-TO-MULTIPOINT COMMUNICATION SYSTEMS, IN CLASS 9 (U.S. CLS. 21, 23, 26, 36 AND 38).

FIRST USE 2-15-2012; IN COMMERCE 2-15-2012.

THE MARK CONSISTS OF STANDARD CHARACTERS WITHOUT CLAIM TO ANY PARTICULAR FONT, STYLE, SIZE, OR COLOR.

SER. NO. 85-276,148, FILED P.R. 3-24-2011; AM. S.R. 6-20-2012.

JOHN WILKE, EXAMINING ATTORNEY



*David J. Kyfos*

Director of the United States Patent and Trademark Office

# United States of America

United States Patent and Trademark Office

## OBSTACLE DETECT

**Reg. No. 4,200,196**

HILL-ROM SERVICES, INC. (INDIANA CORPORATION)  
1069 STATE ROUTE 46 EAST  
BATESVILLE, IN 47006

**Registered Aug. 28, 2012**

**Int. Cl.: 10**

FOR: MEDICAL BED COMPONENT, NAMELY, AN AUTOMATED OBSTRUCTION AVOIDANCE SYSTEM CONSISTING OF PROXIMITY SENSORS AND MOTORIZED MECHANISM TO ASSIST IN BED REPOSITIONING AND ADJUSTMENT, IN CLASS 10 (U.S. CLS. 26, 39 AND 44).

**TRADEMARK**

**SUPPLEMENTAL REGISTER** FIRST USE 0-0-2011; IN COMMERCE 0-0-2011.

THE MARK CONSISTS OF STANDARD CHARACTERS WITHOUT CLAIM TO ANY PARTICULAR FONT, STYLE, SIZE, OR COLOR.

SER. NO. 85-287,856, FILED P.R. 4-6-2011; AM. S.R. 6-20-2012.

KRISTINA MORRIS, EXAMINING ATTORNEY



*David J. Kybas*

Director of the United States Patent and Trademark Office

# United States of America

United States Patent and Trademark Office



**Reg. No. 4,200,197**

**Registered Aug. 28, 2012**

**Int. Cl.: 45**

**SERVICE MARK**

**SUPPLEMENTAL REGISTER**

CROSS-STAR MINISTRIES, INC. (NEW MEXICO CORPORATION)  
7200 MONTGOMERY NE #238  
ALBUQUERQUE, NM 87109

FOR: MINISTERIAL SERVICES, IN CLASS 45 (U.S. CLS. 100 AND 101).

FIRST USE 5-6-2008; IN COMMERCE 9-11-2008.

THE MARK CONSISTS OF A GOLDEN-YELLOW CHRISTIAN CROSS IN FRONT OF THE BLUE STAR OF DAVID; AND THE BACKGROUND OF THE MARK IS TRANSPARENT.

THE COLOR(S) BLUE AND GOLDEN-YELLOW IS/ARE CLAIMED AS A FEATURE OF THE MARK.

SER. NO. 85-292,426, FILED P.R. 4-12-2011; AM. S.R. 6-8-2012.

BILL DAWE, EXAMINING ATTORNEY



*David J. Kyffers*

Director of the United States Patent and Trademark Office

# United States of America

United States Patent and Trademark Office

## THIN & CRISPY

**Reg. No. 4,200,198**

SHEARER'S FOODS, INC. (OHIO CORPORATION)  
692 WABASH AVENUE  
NORTH BREWSTER, OH 44613

**Registered Aug. 28, 2012**

**Int. Cl.: 29**

FOR: CORN-BASED AND POTATO-BASED SNACK FOODS; POTATO CHIPS, IN CLASS 29 (U.S. CL. 46).

**TRADEMARK**

FIRST USE 11-30-1999; IN COMMERCE 11-30-1999.

**SUPPLEMENTAL REGISTER**

THE MARK CONSISTS OF STANDARD CHARACTERS WITHOUT CLAIM TO ANY PARTICULAR FONT, STYLE, SIZE, OR COLOR.

OWNER OF U.S. REG. NO. 2,501,593.

SER. NO. 85-296,050, FILED P.R. 4-15-2011; AM. S.R. 7-8-2012.

DORITT L. CARROLL, EXAMINING ATTORNEY



*David J. Kybas*

Director of the United States Patent and Trademark Office

# United States of America

United States Patent and Trademark Office

## Energy Efficient Group

**Reg. No. 4,200,199**

BRILLIANT PRODUCTS, LLC (MONTANA LIMITED LIABILITY COMPANY)  
200 REGAL STREET  
BILLINGS, MT 59101

**Registered Aug. 28, 2012**

**Int. Cls.: 9, 11, and 35**

FOR: ELECTRONIC LED SIGNS; FIBER OPTIC LIGHT AND IMAGE CONDUITS; LED AND HID LIGHT CONTROLS; LED CIRCUIT BOARDS; LIGHT EMITTING DIODE (LED) DISPLAYS; LIGHT EMITTING DIODES (LEDS), IN CLASS 9 (U.S. CLS. 21, 23, 26, 36 AND 38).

**TRADEMARK**

FIRST USE 9-18-2008; IN COMMERCE 9-18-2008.

**SERVICE MARK**

**SUPPLEMENTAL REGISTER**

FOR: FIBER OPTIC LIGHTING FIXTURES USED IN CONJUNCTION WITH ELECTRICAL ILLUMINATORS; LED (LIGHT EMITTING DIODE) LIGHTING FIXTURES; LED (LIGHT EMITTING DIODES) LIGHTING FIXTURES FOR USE IN DISPLAY, COMMERCIAL, INDUSTRIAL, RESIDENTIAL, AND ARCHITECTURAL ACCENT LIGHTING APPLICATIONS; LED AND HID LIGHT FIXTURES; LED LIGHT BULBS; LED LIGHTING FIXTURES FOR INDOOR AND OUTDOOR LIGHTING APPLICATIONS; LED LIGHTING SYSTEMS, NAMELY, LED MODULES, POWER SUPPLIES, AND WIRING; LED LIGHTS FOR STRINGS, FLOWERS, BRANCHES AND OTHER ORNAMENTAL DECORATIONS; LED LUMINAIRES; TOOLS, COMPONENTS AND SUPPLIES FOR USE IN MAKING SIGNS, NAMELY, FLUORESCENT, HID, LED AND INCANDESCENT BULBS, LAMPS AND FIXTURES, IN CLASS 11 (U.S. CLS. 13, 21, 23, 31 AND 34).

FIRST USE 8-19-2008; IN COMMERCE 8-19-2008.

FOR: RETAIL STORE AND ON-LINE RETAIL STORE SERVICES FEATURING LIGHTING AND LIGHTING PRODUCTS, IN CLASS 35 (U.S. CLS. 100, 101 AND 102).

FIRST USE 8-19-2008; IN COMMERCE 8-19-2008.

THE MARK CONSISTS OF STANDARD CHARACTERS WITHOUT CLAIM TO ANY PARTICULAR FONT, STYLE, SIZE, OR COLOR.

NO CLAIM IS MADE TO THE EXCLUSIVE RIGHT TO USE "GROUP", APART FROM THE MARK AS SHOWN.

SER. NO. 85-296,125, FILED P.R. 4-15-2011; AM. S.R. 1-4-2012.



*David J. Kyffers*

Director of the United States Patent and Trademark Office



**Reg. No. 4,200,199** JOHN WILKE, EXAMINING ATTORNEY

# United States of America

United States Patent and Trademark Office

# DRY MIC

**Reg. No. 4,200,200**

VERTO MEDICAL SOLUTIONS, LLC (DELAWARE CORPORATION), DBA YURBUDS,  
4041 FOREST PARK AVENUE  
ST. LOUIS, MO 63108

**Registered Aug. 28, 2012**

**Int. Cl.: 9**

FOR: EARBUDS; HEADPHONES INCORPORATING A MICROPHONE, IN CLASS 9 (U.S. CLS. 21, 23, 26, 36 AND 38).

**TRADEMARK**

FIRST USE 8-31-2011; IN COMMERCE 8-31-2011.

**SUPPLEMENTAL REGISTER**

THE MARK CONSISTS OF STANDARD CHARACTERS WITHOUT CLAIM TO ANY PARTICULAR FONT, STYLE, SIZE, OR COLOR.

SER. NO. 85-297,829, FILED P.R. 4-18-2011; AM. S.R. 7-5-2012.

DAVID C. REIHNER, EXAMINING ATTORNEY



*David J. Kyfos*

Director of the United States Patent and Trademark Office

# United States of America

United States Patent and Trademark Office

## FAVOR EIGHT

**Reg. No. 4,200,201**

SMITH, ANTHONY (UNITED STATES INDIVIDUAL)  
12325 S HOMORE

**Registered Aug. 28, 2012**

CALUMET PARK, IL 60827

**Int. Cl.: 25**

FOR: HATS; HEADWEAR; SHIRTS; T-SHIRTS; TOPS; WRISTBANDS, IN CLASS 25 (U.S. CLS. 22 AND 39).

**TRADEMARK**

FIRST USE 3-25-2011; IN COMMERCE 3-1-2012.

**SUPPLEMENTAL REGISTER**

THE MARK CONSISTS OF STANDARD CHARACTERS WITHOUT CLAIM TO ANY PARTICULAR FONT, STYLE, SIZE, OR COLOR.

SER. NO. 85-300,560, FILED P.R. 4-20-2011; AM. S.R. 6-18-2012.

EMILY CARLSEN, EXAMINING ATTORNEY



*David J. Kybas*

Director of the United States Patent and Trademark Office

# United States of America

United States Patent and Trademark Office

## AMERICANS FOR SENIORS

**Reg. No. 4,200,202**

AMERICAN FOR FINANCIAL SECURITY, INC. (D.C. NOT-FOR-PROFIT CORPORATION)  
130 E. JOHN CARPENTER FREEWAY  
IRVING, TX 75062

**Registered Aug. 28, 2012**

**Int. Cl.: 35**

FOR: ASSOCIATION SERVICES, NAMELY, ADMINISTRATION OF A DISCOUNT PROGRAM FOR ENABLING ASSOCIATION MEMBERS TO OBTAIN DISCOUNTS ON GOODS AND SERVICES, IN CLASS 35 (U.S. CLS. 100, 101 AND 102).

**SERVICE MARK**

FIRST USE 9-1-2011; IN COMMERCE 9-1-2011.

**SUPPLEMENTAL REGISTER**

THE MARK CONSISTS OF STANDARD CHARACTERS WITHOUT CLAIM TO ANY PARTICULAR FONT, STYLE, SIZE, OR COLOR.

OWNER OF U.S. REG. NO. 3,161,438.

SER. NO. 85-303,399, FILED P.R. 4-25-2011; AM. S.R. 7-10-2012.

NAAKWAMA ANKRAH, EXAMINING ATTORNEY



*David J. Kyffers*

Director of the United States Patent and Trademark Office

# United States of America

United States Patent and Trademark Office

## BEST FRESH SIDES

**Reg. No. 4,200,203**

KAHALA FRANCHISING, L.L.C. (ARIZONA LIMITED LIABILITY COMPANY)  
9311 E. VIA DE VENTURA  
SCOTTSDALE, AZ 85258

**Registered Aug. 28, 2012**

**Int. Cl.: 43**

FOR: RESTAURANT SERVICES, IN CLASS 43 (U.S. CLS. 100 AND 101).

**SERVICE MARK**

FIRST USE 6-24-2011; IN COMMERCE 8-13-2011.

**SUPPLEMENTAL REGISTER**

THE MARK CONSISTS OF STANDARD CHARACTERS WITHOUT CLAIM TO ANY PARTICULAR FONT, STYLE, SIZE, OR COLOR.

NO CLAIM IS MADE TO THE EXCLUSIVE RIGHT TO USE "FRESH SIDES", APART FROM THE MARK AS SHOWN.

SER. NO. 85-312,074, FILED P.R. 5-4-2011; AM. S.R. 12-8-2011.

SAIMA MAKHDOOM, EXAMINING ATTORNEY



*David J. Kyffers*

Director of the United States Patent and Trademark Office

# United States of America

United States Patent and Trademark Office

## LIGHTER PIES

**Reg. No. 4,200,204**

KAHALA FRANCHISING, L.L.C. (ARIZONA LIMITED LIABILITY COMPANY)  
9311 E. VIA DE VENTURA  
SCOTTSDALE, AZ 85258

**Registered Aug. 28, 2012**

**Int. Cl.: 43**

FOR: RESTAURANT SERVICES, IN CLASS 43 (U.S. CLS. 100 AND 101).

**SERVICE MARK**

FIRST USE 6-24-2011; IN COMMERCE 8-13-2011.

**SUPPLEMENTAL REGISTER**

THE MARK CONSISTS OF STANDARD CHARACTERS WITHOUT CLAIM TO ANY PARTICULAR FONT, STYLE, SIZE, OR COLOR.

NO CLAIM IS MADE TO THE EXCLUSIVE RIGHT TO USE "PIES", APART FROM THE MARK AS SHOWN.

SER. NO. 85-312,097, FILED P.R. 5-4-2011; AM. S.R. 6-27-2012.

SAIMA MAKHDOOM, EXAMINING ATTORNEY



*David J. Kyros*

Director of the United States Patent and Trademark Office

# United States of America

United States Patent and Trademark Office

# DISCOUNTS.COM

**Reg. No. 4,200,205**

FIRST AMERICAN FINANCIAL CORPORATION (DELAWARE CORPORATION)  
1 FIRST AMERICAN WAY  
SANTA ANA, CA 92707

**Registered Aug. 28, 2012**

**Int. Cl.: 35**

FOR: PROMOTING THE GOODS AND SERVICES OF OTHERS BY PROVIDING A WEB SITE FEATURING A CUSTOMIZED DISCOUNT PROGRAM AND LINKS TO THE WEB SITES OF OTHERS WHO PARTICIPATE IN THE DISCOUNT PROGRAM, IN CLASS 35 (U.S. CLS. 100, 101 AND 102).

**SERVICE MARK**

**SUPPLEMENTAL REGISTER** FIRST USE 12-5-2011; IN COMMERCE 12-5-2011.

THE MARK CONSISTS OF STANDARD CHARACTERS WITHOUT CLAIM TO ANY PARTICULAR FONT, STYLE, SIZE, OR COLOR.

NO CLAIM IS MADE TO THE EXCLUSIVE RIGHT TO USE "DISCOUNTS.COM", APART FROM THE MARK AS SHOWN.

SER. NO. 85-314,819, FILED P.R. 5-6-2011; AM. S.R. 2-24-2012.

WANDA KAY PRICE, EXAMINING ATTORNEY



*David J. Kybas*

Director of the United States Patent and Trademark Office

# United States of America

United States Patent and Trademark Office

CRAFTED BY AMERICAN HANDS

**Reg. No. 4,200,206**

**Registered Aug. 28, 2012**

**Int. Cl.: 35**

**SERVICE MARK**

**SUPPLEMENTAL REGISTER**

RIEGELMAN ENTERPRISES, LLC (WISCONSIN LIMITED LIABILITY COMPANY)  
#665  
132 N. JEFFERSON STREET  
MILWAUKEE, WI 53202

FOR: PROVIDING A WEBSITE FEATURING AN ONLINE MARKETPLACE FOR EXCHANGING GOODS AND SERVICES WITH OTHER USERS, IN CLASS 35 (U.S. CLS. 100, 101 AND 102).

FIRST USE 6-0-2012; IN COMMERCE 6-0-2012.

THE MARK CONSISTS OF STANDARD CHARACTERS WITHOUT CLAIM TO ANY PARTICULAR FONT, STYLE, SIZE, OR COLOR.

SER. NO. 85-316,126, FILED P.R. 5-9-2011; AM. S.R. 7-3-2012.

JAMES STEIN, EXAMINING ATTORNEY



*David J. Kybas*

Director of the United States Patent and Trademark Office



# United States of America

United States Patent and Trademark Office

## Academic Aftercare

**Reg. No. 4,200,207**

**Registered Aug. 28, 2012**

**Int. Cl.: 41**

**SERVICE MARK**

**SUPPLEMENTAL REGISTER**

ACADEMIC AFTERCARE (FLORIDA LIMITED LIABILITY COMPANY)  
SUITE C  
620 S. MACDILL AVENUE  
TAMPA, FL 33609

FOR: CONDUCTING AFTER SCHOOL TUTORING PROGRAMS, IN CLASS 41 (U.S. CLS. 100, 101 AND 107).

FIRST USE 9-2-2009; IN COMMERCE 9-2-2009.

THE MARK CONSISTS OF STANDARD CHARACTERS WITHOUT CLAIM TO ANY PARTICULAR FONT, STYLE, SIZE, OR COLOR.

SER. NO. 85-317,964, FILED P.R. 5-11-2011; AM. S.R. 6-28-2012.

KELLY BOULTON, EXAMINING ATTORNEY



*David J. Kyffers*

Director of the United States Patent and Trademark Office

# United States of America

United States Patent and Trademark Office

## Lace Anchors

**Reg. No. 4,200,208**

HARRIS, CHARLES, DAVID (UNITED STATES INDIVIDUAL)  
2002 HIGHLAND DR.  
ANACORTES, WA 98221

**Registered Aug. 28, 2012**

**Int. Cl.: 26**

FOR: SHOELACE RESTRAINING DEVICE IN THE NATURE OF A PIECE OF PLASTIC CONTAINING HOLES AND A SLOT THAT IS AFFIXED TO SHOELACES AND PREVENTS THEM FROM PULLING THROUGH EYELETS IN SHOES, IN CLASS 26 (U.S. CLS. 37, 39, 40, 42 AND 50).

**TRADEMARK**

**SUPPLEMENTAL REGISTER** FIRST USE 5-20-2011; IN COMMERCE 2-1-2012.

THE MARK CONSISTS OF STANDARD CHARACTERS WITHOUT CLAIM TO ANY PARTICULAR FONT, STYLE, SIZE, OR COLOR.

NO CLAIM IS MADE TO THE EXCLUSIVE RIGHT TO USE "LACE", APART FROM THE MARK AS SHOWN.

SER. NO. 85-326,022, FILED P.R. 5-20-2011; AM. S.R. 7-5-2012.

KAREN BRACEY, EXAMINING ATTORNEY



*David J. Kyjars*

Director of the United States Patent and Trademark Office

# United States of America

United States Patent and Trademark Office

## HAIR STICKERS

**Reg. No. 4,200,209**

MOSAIC INTERNATIONAL, LLC (CALIFORNIA LIMITED LIABILITY COMPANY)  
P.O. BOX 2638  
SAN RAMON, CA 94583

**Registered Aug. 28, 2012**

**Int. Cl.: 26**

FOR: HAIR ORNAMENTS, IN CLASS 26 (U.S. CLS. 37, 39, 40, 42 AND 50).

**TRADEMARK**

FIRST USE 1-15-2011; IN COMMERCE 1-15-2011.

**SUPPLEMENTAL REGISTER**

THE MARK CONSISTS OF STANDARD CHARACTERS WITHOUT CLAIM TO ANY PARTICULAR FONT, STYLE, SIZE, OR COLOR.

OWNER OF U.S. REG. NO. 3,946,496.

NO CLAIM IS MADE TO THE EXCLUSIVE RIGHT TO USE "HAIR", APART FROM THE MARK AS SHOWN.

SER. NO. 85-327,645, FILED P.R. 5-23-2011; AM. S.R. 6-25-2012.

BILL DAWE, EXAMINING ATTORNEY



*David J. Kyffers*

Director of the United States Patent and Trademark Office

United States of America  
United States Patent and Trademark Office

HENNEY

**Reg. No. 4,200,210**

MICHAEL E. KASABA (UNITED STATES INDIVIDUAL)  
3311 VAN ALLEN PLACE  
TOPANGA, CA 90290

**Registered Aug. 28, 2012**

**Int. Cl.: 12**

FOR: AUTOMOBILES AND STRUCTURAL PARTS THEREFOR, IN CLASS 12 (U.S. CLS. 19, 21, 23, 31, 35 AND 44).

**TRADEMARK**

FIRST USE 5-10-2011; IN COMMERCE 5-10-2011.

**SUPPLEMENTAL REGISTER**

THE MARK CONSISTS OF STANDARD CHARACTERS WITHOUT CLAIM TO ANY PARTICULAR FONT, STYLE, SIZE, OR COLOR.

SER. NO. 85-329,355, FILED P.R. 5-24-2011; AM. S.R. 6-18-2012.

JASON BLAIR, EXAMINING ATTORNEY



*David J. Kybas*

Director of the United States Patent and Trademark Office

# United States of America

United States Patent and Trademark Office

## Social Giveaway

**Reg. No. 4,200,211**

**Registered Aug. 28, 2012**

**Int. Cl.: 35**

**SERVICE MARK**

**SUPPLEMENTAL REGISTER**

SOCIAL GIVEAWAY (NEVADA LIMITED LIABILITY COMPANY)  
SUITE 102-540  
8550 WEST DESERT INN  
LAS VEGAS, NV 89117

FOR: PROMOTING, ADVERTISING AND MARKETING OF THE ON-LINE WEB SITES OF OTHERS, IN CLASS 35 (U.S. CLS. 100, 101 AND 102).

FIRST USE 9-9-2009; IN COMMERCE 10-1-2009.

THE MARK CONSISTS OF STANDARD CHARACTERS WITHOUT CLAIM TO ANY PARTICULAR FONT, STYLE, SIZE, OR COLOR.

SER. NO. 85-334,313, FILED P.R. 5-31-2011; AM. S.R. 5-22-2012.

DEZMONA MIZELLE, EXAMINING ATTORNEY



*David J. Kyffers*

Director of the United States Patent and Trademark Office

# United States of America

United States Patent and Trademark Office

## BENCH JEWELER

**Reg. No. 4,200,212**

STULLER, INC. (LOUISIANA CORPORATION)  
302 RUE LOUIS XIV  
LAFAYETTE, LA 70508

**Registered Aug. 28, 2012**

**Int. Cls.: 35, 38, 40, and 45**

FOR: PROVIDING A WEBSITE FEATURING INFORMATION DIRECTED TO PROFESSIONAL JEWELERS ABOUT JEWELRY SALES AND SALES METHODS, IN CLASS 35 (U.S. CLS. 100, 101 AND 102).

**SERVICE MARK**

FIRST USE 3-28-2011; IN COMMERCE 3-28-2011.

**SUPPLEMENTAL REGISTER**

FOR: PROVIDING AN ON-LINE FORUM FOR DISCUSSION OF JEWELRY, JEWELERS, JEWELRY MAKING, JEWELER'S TOOLS AND SKILLS, AND JEWELRY SALES, IN CLASS 38 (U.S. CLS. 100, 101 AND 104).

FIRST USE 3-28-2011; IN COMMERCE 3-28-2011.

FOR: PROVIDING A WEBSITE FEATURING INFORMATION DIRECTED TO PROFESSIONAL JEWELERS IN THE FIELD OF JEWELRY MAKING AND JEWELRY MAKING TOOLS, IN CLASS 40 (U.S. CLS. 100, 103 AND 106).

FIRST USE 3-28-2011; IN COMMERCE 3-28-2011.

FOR: PROVIDING A WEBSITE FEATURING FASHION INFORMATION DIRECTED TO PROFESSIONAL JEWELERS IN THE FIELD OF JEWELRY, IN CLASS 45 (U.S. CLS. 100 AND 101).

FIRST USE 3-28-2011; IN COMMERCE 3-28-2011.

THE MARK CONSISTS OF STANDARD CHARACTERS WITHOUT CLAIM TO ANY PARTICULAR FONT, STYLE, SIZE, OR COLOR.

SER. NO. 85-336,585, FILED P.R. 6-2-2011; AM. S.R. 6-13-2012.

KATHERINE E. HALMEN, EXAMINING ATTORNEY



*David J. Kyffers*

Director of the United States Patent and Trademark Office

# United States of America

United States Patent and Trademark Office

## High School Illustrated

**Reg. No. 4,200,213**

HIGH SCHOOL MEDIA (DELAWARE LIMITED LIABILITY COMPANY)

**Registered Aug. 28, 2012**

8245 E. BROOKDALE LANE  
ANAHEIM, CA 92807

**Int. Cl.: 16**

FOR: MAGAZINES IN THE FIELD OF HIGH SCHOOL SPORTS, HIGH SCHOOL CLUBS, NUTRITION, AND HIGH SCHOOL ATHLETE LIFESTYLE, IN CLASS 16 (U.S. CLS. 2, 5, 22, 23, 29, 37, 38 AND 50).

**TRADEMARK**

FIRST USE 10-1-2010; IN COMMERCE 10-1-2010.

**SUPPLEMENTAL REGISTER**

THE MARK CONSISTS OF STANDARD CHARACTERS WITHOUT CLAIM TO ANY PARTICULAR FONT, STYLE, SIZE, OR COLOR.

NO CLAIM IS MADE TO THE EXCLUSIVE RIGHT TO USE "ILLUSTRATED", APART FROM THE MARK AS SHOWN.

SER. NO. 85-341,965, FILED P.R. 6-9-2011; AM. S.R. 7-5-2012.

JANICE KIM, EXAMINING ATTORNEY



*David J. Kyffers*

Director of the United States Patent and Trademark Office

# United States of America

United States Patent and Trademark Office

## superfine bakery

**Reg. No. 4,200,214**

**Registered Aug. 28, 2012**

**Int. Cl.: 30**

BOUDEWIJN, ANDREA C. (CALIFORNIA LIMITED LIABILITY COMPANY), DBA  
SUPERFINE BAKERY,  
#20  
11138 AQUA VISTA ST.  
STUDIO CITY, CA 91602

**TRADEMARK**

**SUPPLEMENTAL REGISTER**

FOR: BAKERY DESSERTS, IN CLASS 30 (U.S. CL. 46).

FIRST USE 7-1-2009; IN COMMERCE 7-1-2009.

THE MARK CONSISTS OF STANDARD CHARACTERS WITHOUT CLAIM TO ANY PARTICULAR FONT, STYLE, SIZE, OR COLOR.

NO CLAIM IS MADE TO THE EXCLUSIVE RIGHT TO USE "BAKERY", APART FROM THE MARK AS SHOWN.

SER. NO. 85-345,174, FILED P.R. 6-14-2011; AM. S.R. 6-15-2012.

NAKIA HENRY, EXAMINING ATTORNEY



*David J. Kyffers*

Director of the United States Patent and Trademark Office



# United States of America

United States Patent and Trademark Office

## INLAND LOGISTICS MANAGEMENT

**Reg. No. 4,200,215**

**Registered Aug. 28, 2012**

**Int. Cls.: 35 and 39**

**SERVICE MARK**

**SUPPLEMENTAL REGISTER**

SCHNEIDER NATIONAL, INC. (WISCONSIN CORPORATION)  
3101 SOUTH PACKERLAND DRIVE  
GREEN BAY, WI 54306

FOR: CONSULTATION SERVICES IN THE FIELDS OF LOGISTICS MANAGEMENT AND TRANSPORTATION LOGISTICS SERVICES, NAMELY, MANAGING AND SYNCHRONIZING SHIPMENTS OF GOODS FOR MULTIPLE DOMESTIC AND INTERNATIONAL SUPPLY CHAIN TRADING ENTITIES, NAMELY, STEAMSHIP LINES, TERMINALS, CUSTOM BROKERS, RAILROADS, DRAY CARRIERS AND DISTRIBUTION CENTERS, IN CLASS 35 (U.S. CLS. 100, 101 AND 102).

FIRST USE 3-30-2009; IN COMMERCE 3-30-2009.

FOR: FREIGHT TRANSPORTATION LOGISTICS AND LOGISTICS MANAGEMENT SERVICES FOR OTHERS, NAMELY, TRACKING THE LOCATION OF FREIGHT AND SYNCHRONIZING THE DELIVERY OF FREIGHT FROM MULTIPLE DOMESTIC AND INTERNATIONAL SUPPLY CHAIN TRADING ENTITIES, NAMELY, STEAMSHIP LINES, TERMINALS, CUSTOM BROKERS, RAILROADS, DRAY CARRIERS AND DISTRIBUTION CENTERS WITH RETAILERS, IN CLASS 39 (U.S. CLS. 100 AND 105).

FIRST USE 3-30-2009; IN COMMERCE 3-30-2009.

THE MARK CONSISTS OF STANDARD CHARACTERS WITHOUT CLAIM TO ANY PARTICULAR FONT, STYLE, SIZE, OR COLOR.

NO CLAIM IS MADE TO THE EXCLUSIVE RIGHT TO USE "LOGISTICS MANAGEMENT", APART FROM THE MARK AS SHOWN.

SER. NO. 85-345,947, FILED P.R. 6-14-2011; AM. S.R. 3-13-2012.

BILL DAWE, EXAMINING ATTORNEY



*David J. Kypos*

Director of the United States Patent and Trademark Office

# United States of America

United States Patent and Trademark Office

## Professionals Realty Group

**Reg. No. 4,200,216**

**Registered Aug. 28, 2012**

**Int. Cls.: 35 and 36**

**SERVICE MARK**

**SUPPLEMENTAL REGISTER**

PROFESSIONALS GLOBAL LIMITED (AUSTRALIA CORPORATION)  
C/O WEISS BROWN, PLLC, SUITE 143  
6263 NORTH SCOTTSDALE ROAD  
SCOTTSDALE, AZ 85250

FOR: ORGANIZATION OF HOUSING AND REAL ESTATE DISPLAYS AND EXHIBITIONS FOR PROMOTION OR ADVERTISING PURPOSES; REAL ESTATE AUCTIONEERING; ADVERTISING, MARKETING, MARKETING RESEARCH, MARKETING STUDIES, PUBLICITY, PUBLIC RELATIONS AND PROMOTIONAL SERVICES RELATING TO REAL ESTATE AND BUSINESSES AND PROPERTY; PROMOTING THE REAL ESTATE OF OTHERS, NAMELY, RESIDENTIAL PROPERTIES, COMMERCIAL PROPERTIES, RESIDENCES, HOUSES, FLATS, APARTMENTS, TOWN HOUSES, HOLIDAY PROPERTIES, LAND, FARMS, OFFICES, OFFICE SPACE, CAR PARKS, STORAGE SPACES, FACTORIES, WAREHOUSES, PROPERTIES FOR SALE, LEASE OR RENT BY PREPARING, PLACING AND DISSEMINATING ADVERTISING VIA ON-LINE AND PRINTED FORMATS; DISSEMINATION OF ADVERTISING MATERIAL; RENTAL OF ADVERTISING SPACE; COMPILATION OF ADVERTISEMENTS; ON-LINE ADVERTISING ON A COMPUTER NETWORK; ADVERTISING SERVICES PROMOTING THE GOODS AND SERVICES OF OTHERS; ADVERTISING AND MARKETING THE PROPERTY DEVELOPMENTS OF OTHERS; ORGANIZING OF HOUSING AND REAL ESTATE DISPLAYS, VIEWINGS AND EXHIBITIONS FOR PROMOTION OR ADVERTISING PURPOSES; BUSINESS MANAGEMENT SERVICES, NAMELY, BUSINESS MANAGEMENT OF REAL ESTATE FOR INVESTORS AND OTHERS; FRANCHISING AND FRANCHISOR SERVICES, NAMELY, PROVIDING BUSINESS ADVICE AND ASSISTANCE IN THE ESTABLISHMENT, OPERATION AND MANAGEMENT OF REAL ESTATE BUSINESSES; BUSINESS ADVICE, ASSISTANCE AND DEVELOPMENT; BUSINESS ADMINISTRATION SERVICES; BUSINESS CONSULTANCY AND ADVISORY SERVICES, NAMELY, CONSULTANCY SERVICES RELATING TO MANAGEMENT OF A REAL ESTATE BUSINESS, THE SUPPLY OF QUALITY MANAGEMENT SYSTEMS, BUSINESS RISK MANAGEMENT CONSULTANCY, BUSINESS EFFICIENCY CONSULTANCY, PROCUREMENT SERVICES FOR OTHERS, PERTAINING TO THE PURCHASING OF GOODS AND SERVICES AND PROCUREMENT OF CONTRACTS ON BEHALF OF FRANCHISEES, LANDLORDS OR TENANTS, IN THE FIELDS OF GROUP PURCHASING, SELECTION AND PROCUREMENT OF GOODS AND SERVICES BASED ON ENERGY EFFICIENCY, WATER EFFICIENCY, CARBON OFFSETTING, WASTE REDUCTION AND OTHER SUSTAINABILITY AND ENVIRONMENTAL CONSIDERATIONS AND CRITERIA; PROCUREMENT OF ENERGY, WATER, WASTE MANAGEMENT AND CLEANING SERVICES AND PRODUCTS FOR OTHERS; EFFICIENCY EXPERTS; BUSINESS EFFICIENCY ADVISORY SERVICES,



*David J. Kybas*

Director of the United States Patent and Trademark Office

**Reg. No. 4,200,216** NAMELY, EFFICIENCY AND PROCESS AUDITING; ENERGY, WATER, RESOURCE USE MANAGEMENT FOR RESIDENTIAL AND COMMERCIAL BUILDINGS, COMPLEXES AND OTHER PROPERTIES; ORGANIZATION OF EXHIBITIONS AND TRADE FAIRS FOR COMMERCIAL OR ADVERTISING PURPOSES; DIRECTORY INFORMATION SERVICES, INCLUDING PROVISION OF ONLINE DIRECTORIES IN THE FIELDS OF REAL ESTATE AND PROPERTY MANAGEMENT; PROVISION OF ON-LINE BUSINESS LISTINGS AND CLASSIFIED ADS FOR THE GOODS/SERVICES OF OTHERS; COLLECTION, PREPARATION, COMPILATION, STORAGE, PROCESSING, RETRIEVAL AND PROVISION OF BUSINESS INFORMATION AND BUSINESS LISTINGS, INCLUDING COMPILATION OF BUSINESS LISTINGS FOR PUBLISHING ON THE INTERNET; PROVISION OF ADVERTISING SPACE ON A WEBSITE RELATING TO PROPERTY, ELECTRONIC PUBLICATIONS RELATING TO PROPERTY, DOWNLOADABLE PUBLICATIONS RELATING TO PROPERTY OR PRINTED PUBLICATIONS RELATING TO PROPERTY; RENTAL OF ADVERTISING SPACE ON THE INTERNET; COMPILATION OF INFORMATION INTO COMPUTER DATABASES; PROVISION OF COMPUTER ASSISTED BUSINESS INFORMATION; COMPUTERIZED DATABASE MANAGEMENT; SYSTEMIZATION OF INFORMATION INTO COMPUTER DATABASES; CONDUCT OF BUSINESS STUDIES AND PREPARATION OF BUSINESS REPORTS; ECONOMIC FORECASTING AND ANALYSIS FOR BUSINESS PURPOSES; MARKET ANALYSIS, RESEARCH AND MONITORING SERVICES FOR BUSINESS PURPOSES; BUSINESS ADVISORY SERVICES; BUSINESS PLANNING AND ANALYSIS SERVICES; BUSINESS MANAGEMENT AND BUSINESS ADMINISTRATION SERVICES; BUSINESS SURVEYS, APPRAISALS AND RESEARCH; BUSINESS REFERRALS SERVICES; BUSINESS NETWORKING SERVICES; FRANCHISING CONSULTANCY AND BUSINESS SUPPORT SERVICES; FRANCHISING SERVICES, NAMELY, GROUP PURCHASING AND GROUP ADVERTISING; PROVIDING STATISTICAL INFORMATION RELATING TO REAL ESTATE FOR BUSINESS OR COMMERCIAL PURPOSES; RETAIL STORE SERVICES AND WHOLESALE DISTRIBUTORSHIP SERVICES IN THE FIELD OF PRODUCTS AND SYSTEMS TO MONITOR AND IMPROVE ENERGY AND RESOURCE EFFICIENCY AND REDUCE WASTE AND EMISSIONS; BUSINESS APPRAISALS; ENERGY USE AND ENVIRONMENTAL IMPACT MANAGEMENT SERVICES FOR THE REAL PROPERTY HOLDINGS OF OTHERS, COMPRISING A REVIEW OF ENERGY USE PERFORMANCE AND ENERGY EFFICIENCY IMPROVEMENTS OF PROPERTIES, SETTING ENVIRONMENTAL GOALS FOR PROPERTIES, MONITORING PROGRESS TOWARDS THOSE GOALS, RECOMMENDING IMPROVEMENTS IN THE PERFORMANCE OF SYSTEMS WITHIN PROPERTIES, PROVIDING GUIDELINES AND PLANS TO TENANTS, SUPPLIERS, MANAGERS AND OWNERS, PROVIDING DATA ON EFFICIENCIES AND INEFFICIENCIES AND USE OF ENERGY, WATER AND OTHER RESOURCES AND CREATION OF WASTE TO TENANTS, SUPPLIERS, MANAGERS AND OWNERS; BUSINESS SERVICES RELATING TO THE ACQUISITION/DISPOSAL OF BUSINESSES NOT INVOLVING REAL ESTATE, IN CLASS 35 (U.S. CLS. 100, 101 AND 102).

FIRST USE 4-16-2012; IN COMMERCE 4-16-2012.

FOR: REAL ESTATE AGENCY SERVICES AND REAL ESTATE BROKERAGE SERVICES; LEASING AND RENTAL OF REAL ESTATE, HOUSES, APARTMENTS, FARMS, OFFICE SPACE, SHOPPING PREMISES, AND INDUSTRIAL PREMISES; FINANCIAL APPRAISALS, EVALUATIONS AND ESTIMATES FOR FINANCIAL OR INSURANCE PURPOSES, IN THE FIELDS OF REAL ESTATE, PROPERTY AND LAND; REAL ESTATE MANAGEMENT; REAL ESTATE SELECTION AND/OR ACQUISITION FOR OTHERS; REAL ESTATE INVESTMENT SERVICES; REAL ESTATE INVESTMENT MANAGEMENT SERVICES; REAL ESTATE MANAGEMENT SERVICES INCLUDING COLLECTION OF RENT AND USAGE FEES; BROKERAGE OF CARBON DIOXIDE AND OTHER GREENHOUSE GAS EMISSION CREDITS, ALLOWANCES OR OFFSETS ON BEHALF OF PROPERTY OWNERS OR USERS; PROPERTY MANAGEMENT SERVICES; INSURANCE RISK MANAGEMENT, ENVIRONMENTAL INSURANCE RISK MANAGEMENT; INSURANCE BROKERAGE SERVICES IN THE FIELD OF ENVIRONMENTAL INSURANCE SERVICES; MANAGING THE FINANCIAL RISK RESULTING FROM EXPOSURE TO ENVIRONMENTAL LIABILITIES, SPECIFICALLY IN RELATION TO THE SALE, PURCHASE AND MANAGEMENT OF REAL ESTATE; REAL

**Reg. No. 4,200,216** ESTATE BROKERAGE SERVICES IN THE FIELD OF ACQUISITION AND DISPOSAL OF COMMERCIAL, INDUSTRIAL AND DOMESTIC PROPERTIES; MORTGAGE BROKERAGE AND REAL PROPERTY INSURANCE BROKERAGE; PROVIDING INFORMATION, CONSULTATION SERVICES AND ADVISORY SERVICES, ALL REGARDING REAL ESTATE, CREDIT, LOANS, MORTGAGES AND/OR REAL PROPERTY INSURANCE; FINANCIAL SPONSORSHIP SERVICES, NAMELY, FINANCIAL SPONSORSHIP OF EDUCATIONAL, ENTERTAINMENT, SPORTING AND CULTURAL ACTIVITIES; REAL ESTATE BROKERAGE LISTING SERVICES; AND PROVIDING INFORMATION IN ANY FORMAT IN THE FIELDS OF REAL ESTATE, IN CLASS 36 (U.S. CLS. 100, 101 AND 102).

FIRST USE 4-16-2012; IN COMMERCE 4-16-2012.

THE MARK CONSISTS OF STANDARD CHARACTERS WITHOUT CLAIM TO ANY PARTICULAR FONT, STYLE, SIZE, OR COLOR.

PRIORITY CLAIMED UNDER SEC. 44(D) ON AUSTRALIA APPLICATION NO. 14909504, FILED 6-16-2011.

NO CLAIM IS MADE TO THE EXCLUSIVE RIGHT TO USE "REALTY GROUP", APART FROM THE MARK AS SHOWN.

SER. NO. 85-349,742, FILED P.R. 6-17-2011; AM. S.R. 6-29-2012.

JENNIFER MARTIN, EXAMINING ATTORNEY

# United States of America

United States Patent and Trademark Office

## The East Coast Drum School

**Reg. No. 4,200,217**

TIBALDI, CHRIS (UNITED STATES INDIVIDUAL)  
63 JENKINS STREET  
MERRICK, NY 11566

**Registered Aug. 28, 2012**

**Int. Cl.: 41**

FOR: TRAINING SERVICES IN THE FIELD OF MUSICAL INSTRUMENTS, IN CLASS 41  
(U.S. CLS. 100, 101 AND 107).

**SERVICE MARK**

FIRST USE 8-1-2011; IN COMMERCE 1-15-2012.

**SUPPLEMENTAL REGISTER**

THE MARK CONSISTS OF STANDARD CHARACTERS WITHOUT CLAIM TO ANY PARTICULAR FONT, STYLE, SIZE, OR COLOR.

NO CLAIM IS MADE TO THE EXCLUSIVE RIGHT TO USE "DRUM SCHOOL", APART FROM THE MARK AS SHOWN.

SER. NO. 85-351,439, FILED P.R. 6-21-2011; AM. S.R. 6-29-2012.

AISHA CLARKE, EXAMINING ATTORNEY



*David J. Kyffers*

Director of the United States Patent and Trademark Office

# United States of America

United States Patent and Trademark Office

## FESTIVAL DELLA CANZONE ITALIANA DI NEW YORK

**Reg. No. 4,200,218**

ASSOCIAZIONE CULTURALE ITALIANA DI NEW YORK (NEW YORK CORPORATION)  
66-31 FRESH POND RD  
RIDGEWOOD, NY 11385

**Registered Aug. 28, 2012**

**Int. Cl.: 41**

FOR: ENTERTAINMENT SERVICES, NAMELY, AN ON-GOING SERIES FEATURING TALENT, SONG AND MUSICAL COMPETITIONS PROVIDED THROUGH CABLE TELEVISION, SATELLITE TELEVISION, GLOBAL COMPUTER NETWORK, FESTIVALS AND THEATRE PRODUCTIONS, IN CLASS 41 (U.S. CLS. 100, 101 AND 107).

**SERVICE MARK**

**SUPPLEMENTAL REGISTER** FIRST USE 9-1-2008; IN COMMERCE 9-1-2008.

THE MARK CONSISTS OF STANDARD CHARACTERS WITHOUT CLAIM TO ANY PARTICULAR FONT, STYLE, SIZE, OR COLOR.

NO CLAIM IS MADE TO THE EXCLUSIVE RIGHT TO USE "FESTIVAL", APART FROM THE MARK AS SHOWN.

THE ENGLISH TRANSLATION OF "FESTIVAL DELLA CANZONE ITALIANA DI NEW YORK" IN THE MARK IS "ITALIAN SONG FESTIVAL OF NEW YORK".

SER. NO. 85-365,354, FILED P.R. 7-7-2011; AM. S.R. 6-18-2012.

MARC LEIPZIG, EXAMINING ATTORNEY



*David J. Kybas*

Director of the United States Patent and Trademark Office

# United States of America

United States Patent and Trademark Office

# VELO

**Reg. No. 4,200,219**

COMPETITOR GROUP, INC. (DELAWARE CORPORATION)

**Registered Aug. 28, 2012**

9477 WAPLES STREET, SUITE 150  
SAN DIEGO, CA 92121

**Int. Cl.: 9**

FOR: DOWNLOADABLE ELECTRONIC PUBLICATIONS IN THE NATURE OF MAGAZINES  
FEATURING NEWS AND INFORMATION IN THE FIELD OF SPORTS, IN CLASS 9 (U.S.  
CLS. 21, 23, 26, 36 AND 38).

**TRADEMARK**

FIRST USE 7-19-2011; IN COMMERCE 7-19-2011.

**SUPPLEMENTAL REGISTER**

THE MARK CONSISTS OF STANDARD CHARACTERS WITHOUT CLAIM TO ANY PAR-  
TICULAR FONT, STYLE, SIZE, OR COLOR.

SER. NO. 85-370,453, FILED P.R. 7-13-2011; AM. S.R. 6-14-2012.

NAAKWAMA ANKRAH, EXAMINING ATTORNEY



*David J. Kyffers*

Director of the United States Patent and Trademark Office

# United States of America

United States Patent and Trademark Office

# VELO

**Reg. No. 4,200,220**

COMPETITOR GROUP, INC. (DELAWARE CORPORATION)  
9477 WAPLES STREET, SUITE 150  
SAN DIEGO, CA 92121

**Registered Aug. 28, 2012**

**Int. Cl.: 16**

FOR: MAGAZINES IN THE FIELD OF SPORTS, IN CLASS 16 (U.S. CLS. 2, 5, 22, 23, 29, 37, 38 AND 50).

**TRADEMARK**

FIRST USE 7-19-2011; IN COMMERCE 7-19-2011.

**SUPPLEMENTAL REGISTER**

THE MARK CONSISTS OF STANDARD CHARACTERS WITHOUT CLAIM TO ANY PARTICULAR FONT, STYLE, SIZE, OR COLOR.

SER. NO. 85-370,464, FILED P.R. 7-13-2011; AM. S.R. 6-14-2012.

NAAKWAMA ANKRAH, EXAMINING ATTORNEY



*David J. Kyfos*

Director of the United States Patent and Trademark Office



# United States of America

United States Patent and Trademark Office

# ARCH-SPAN

**Reg. No. 4,200,221**

**Registered Aug. 28, 2012**

**Int. Cl.: 7**

**TRADEMARK**

**SUPPLEMENTAL REGISTER**

M.I.C. INDUSTRIES, INC. (DELAWARE CORPORATION)  
ONE FOUNTAIN SQUARE, 11911 FREEDOM DRIVE  
RESTON, VA 20190

FOR: MOBILE METAL FORMING MACHINES FOR USE IN BUILDING CONSTRUCTION,  
IN CLASS 7 (U.S. CLS. 13, 19, 21, 23, 31, 34 AND 35).

FIRST USE 6-16-2012; IN COMMERCE 6-16-2012.

THE MARK CONSISTS OF STANDARD CHARACTERS WITHOUT CLAIM TO ANY PARTICULAR FONT, STYLE, SIZE, OR COLOR.

OWNER OF U.S. REG. NOS. 1,047,138, 1,715,067, AND 1,774,950.

SER. NO. 85-371,196, FILED P.R. 7-14-2011; AM. S.R. 7-3-2012.

MARK SPARACINO, EXAMINING ATTORNEY



*David J. Kyffers*

Director of the United States Patent and Trademark Office

# United States of America

United States Patent and Trademark Office

## SOUTH BEACH CANDLE CO.

**Reg. No. 4,200,222**

SOUTH BEACH CANDLE COMPANY, INC. (FLORIDA CORPORATION)  
2260 WEST 80 STREET, BAY-4  
HIALEAH, FL 33016

**Registered Aug. 28, 2012**

**Int. Cl.: 4**

FOR: CANDLES, SCENTED WAX, IN CLASS 4 (U.S. CLS. 1, 6 AND 15).

FIRST USE 3-31-2011; IN COMMERCE 3-31-2011.

**TRADEMARK**

THE MARK CONSISTS OF STANDARD CHARACTERS WITHOUT CLAIM TO ANY PARTICULAR FONT, STYLE, SIZE, OR COLOR.

**SUPPLEMENTAL REGISTER**

NO CLAIM IS MADE TO THE EXCLUSIVE RIGHT TO USE "CANDLE CO.", APART FROM THE MARK AS SHOWN.

SER. NO. 85-376,142, FILED P.R. 7-20-2011; AM. S.R. 5-15-2012.

JOHN DWYER, EXAMINING ATTORNEY



*David J. Kyffers*

Director of the United States Patent and Trademark Office

# United States of America

United States Patent and Trademark Office

## MILLER BROTHERS

**Reg. No. 4,200,223**

FROST CUTLERY COMPANY LLC (TENNESSEE LIMITED LIABILITY COMPANY)  
6861 MOUNTAIN VIEW ROAD  
OOLTEWAH, TN 37363

**Registered Aug. 28, 2012**

**Int. Cl.: 8**

FOR: CUTLERY, NAMELY, POCKET KNIVES, BOOT KNIVES, HUNTING KNIVES AND COLLECTOR'S KNIVES, IN CLASS 8 (U.S. CLS. 23, 28 AND 44).

**TRADEMARK**

FIRST USE 4-19-2012; IN COMMERCE 4-19-2012.

**SUPPLEMENTAL REGISTER**

THE MARK CONSISTS OF STANDARD CHARACTERS WITHOUT CLAIM TO ANY PARTICULAR FONT, STYLE, SIZE, OR COLOR.

SER. NO. 85-378,499, FILED P.R. 7-22-2011; AM. S.R. 6-20-2012.

SETH A. RAPPAPORT, EXAMINING ATTORNEY



*David J. Kyffers*

Director of the United States Patent and Trademark Office

# United States of America

United States Patent and Trademark Office

## **-Level-Ice-**

**Reg. No. 4,200,224**

LATEC INSTRUMENTS INC. (CANADA CORPORATION)  
240 THAMES ROAD WEST  
EXETER, ONTARIO, CANADA N0M1S3

**Registered Aug. 28, 2012**

**Int. Cl.: 7**

FOR: LASER MEASURING INSTRUMENTS AND CONTROL APPARATUSES FOR MAINTAINING THE SURFACE OF AN ICE RINK, NAMELY, LASER TRANSMITTERS, LASER RECEIVERS AND CONTROLLERS TO BE USED WITH ICE RESURFACING MACHINES, IN CLASS 7 (U.S. CLS. 13, 19, 21, 23, 31, 34 AND 35).

**TRADEMARK**

**SUPPLEMENTAL REGISTER** FIRST USE 12-31-2011; IN COMMERCE 12-31-2011.

THE MARK CONSISTS OF THE WORDING "LEVEL ICE" IN STYLIZED FORM WITH A CENTRALLY LOCATED LINE POSITIONED BEFORE, BETWEEN AND AFTER THE WORDING.

SER. NO. 85-384,731, FILED P.R. 7-29-2011; AM. S.R. 5-21-2012.

APRIL ROACH, EXAMINING ATTORNEY



*David J. Kyfos*

Director of the United States Patent and Trademark Office

# United States of America

United States Patent and Trademark Office

## E-PLANCHECK

**Reg. No. 4,200,225**

E-PLAN, INC. (CALIFORNIA CORPORATION)

**Registered Aug. 28, 2012**

20 MORGAN, SUITE 100  
IRVINE, CA 92618

**Int. Cl.: 9**

FOR: COMPUTER SOFTWARE FOR PROJECT MANAGEMENT, COLLABORATION, COMMUNICATION, COORDINATION, NOTIFICATION, AND SYNCHRONIZATION IN THE FIELD OF CONSTRUCTION DRAWINGS AND PROJECT MANAGEMENT; COMPUTER SOFTWARE IN THE FIELD OF CONSTRUCTION AND PROJECT MANAGEMENT, NAMELY, SOFTWARE TO MANAGE CONSTRUCTION DRAWINGS; COMPUTER SOFTWARE IN THE FIELD OF CONSTRUCTION COLLABORATION AND PERMIT MANAGEMENT; COMPUTER SOFTWARE FOR MANAGING BUILDING DESIGNS OR MARKUPS AND SUBMITTING COMMENTS IN AN ELECTRONIC FORMAT, IN CLASS 9 (U.S. CLS. 21, 23, 26, 36 AND 38).

**TRADEMARK**

**SUPPLEMENTAL REGISTER**

FIRST USE 1-0-2010; IN COMMERCE 1-0-2010.

THE MARK CONSISTS OF STANDARD CHARACTERS WITHOUT CLAIM TO ANY PARTICULAR FONT, STYLE, SIZE, OR COLOR.

OWNER OF U.S. REG. NOS. 3,240,910 AND 3,240,911.

SER. NO. 85-385,178, FILED P.R. 7-29-2011; AM. S.R. 5-21-2012.

LAKEISHA LEWIS, EXAMINING ATTORNEY



*David J. Kyros*

Director of the United States Patent and Trademark Office

# United States of America

United States Patent and Trademark Office

# eLeads

**Reg. No. 4,200,226**

**Registered Aug. 28, 2012**

**Int. Cl.: 42**

**SERVICE MARK**

**SUPPLEMENTAL REGISTER**

CENTRAL DYNAMICS CORP. (DELAWARE CORPORATION), AKA CENDYN,  
SUITE 419  
1515 N FEDERAL HIGHWAY  
BOCA RATON, FL 33432

FOR: PROVIDING TEMPORARY USE OF ON-LINE NON-DOWNLOADABLE SOFTWARE FOR WEBSITE DESIGN SERVICES, FEATURING SOFTWARE THAT CREATES A MARKETING TOOL FOR THE HOSPITALITY INDUSTRY AROUND THE WORLD - WHEREBY THEY CAN SUBMIT THEIR MESSAGE IN FRONT OF THE RIGHT AUDIENCE, AT THE RIGHT TIME, WITH THE RIGHT OFFER, TO FULFILL THEIR ONLINE LEAD GENERATION OBJECTIVES, IN CLASS 42 (U.S. CLS. 100 AND 101).

FIRST USE 9-28-2001; IN COMMERCE 9-28-2001.

THE MARK CONSISTS OF STANDARD CHARACTERS WITHOUT CLAIM TO ANY PARTICULAR FONT, STYLE, SIZE, OR COLOR.

SER. NO. 85-385,464, FILED P.R. 7-30-2011; AM. S.R. 12-2-2011.

WILLIAM BRECKENFELD, EXAMINING ATTORNEY



*David J. Kyfos*

Director of the United States Patent and Trademark Office

# United States of America

United States Patent and Trademark Office

## CANYON LAKE HELICOPTERS, LLC

**Reg. No. 4,200,227**

CANYON LAKE HELICOPTERS (TEXAS LIMITED LIABILITY COMPANY)  
19141 STONE OAK PKWY 104 151  
SAN ANTONIO, TX 78258

**Registered Aug. 28, 2012**

**Int. Cl.: 41**

FOR: ENTERTAINMENT SERVICES, NAMELY, HELICOPTER RIDES, IN CLASS 41 (U.S. CLS. 100, 101 AND 107).

**SERVICE MARK**

FIRST USE 8-2-2011; IN COMMERCE 6-2-2012.

**SUPPLEMENTAL REGISTER**

THE MARK CONSISTS OF STANDARD CHARACTERS WITHOUT CLAIM TO ANY PARTICULAR FONT, STYLE, SIZE, OR COLOR.

SER. NO. 85-387,618, FILED P.R. 8-2-2011; AM. S.R. 6-14-2012.

SALLY SHIH, EXAMINING ATTORNEY



*David J. Kybas*

Director of the United States Patent and Trademark Office

# United States of America

United States Patent and Trademark Office

## UNIVERSAL TENNIS RATING

**Reg. No. 4,200,228**

UNIVERSAL TENNIS, LLC (VIRGINIA LIMITED LIABILITY COMPANY)  
116 W. BELVEDERE RD  
NORFOLK, VA 23505

**Registered Aug. 28, 2012**

**Int. Cl.: 41**

FOR: COMPUTERIZED TENNIS RATING SERVICES OF AMATEUR AND PROFESSIONAL TENNIS PLAYERS AND PREPARATION OF COMPUTER GENERATED TENNIS RATING REPORTS FOR OTHERS , IN CLASS 41 (U.S. CLS. 100, 101 AND 107).

**SERVICE MARK**

FIRST USE 11-2-2005; IN COMMERCE 11-2-2005.

**SUPPLEMENTAL REGISTER**

THE MARK CONSISTS OF STANDARD CHARACTERS WITHOUT CLAIM TO ANY PARTICULAR FONT, STYLE, SIZE, OR COLOR.

NO CLAIM IS MADE TO THE EXCLUSIVE RIGHT TO USE "RATING", APART FROM THE MARK AS SHOWN.

SER. NO. 85-387,639, FILED 8-2-2011.

ALAIN LAPTER, EXAMINING ATTORNEY



*David J. Kyffers*

Director of the United States Patent and Trademark Office



# United States of America

United States Patent and Trademark Office

## SINGLE ANTE

**Reg. No. 4,200,229**

SHOLES, GREGORY (UNITED STATES INDIVIDUAL)  
7 ARAPAHOE DRIVE, #10  
VERNON, NJ 074625540

**Registered Aug. 28, 2012**

**Int. Cl.: 41**

FOR: LEASING OF CASINO GAMES, IN CLASS 41 (U.S. CLS. 100, 101 AND 107).

**SERVICE MARK**

FIRST USE 9-17-2010; IN COMMERCE 9-17-2010.

**SUPPLEMENTAL REGISTER**

THE MARK CONSISTS OF STANDARD CHARACTERS WITHOUT CLAIM TO ANY PARTICULAR FONT, STYLE, SIZE, OR COLOR.

SER. NO. 85-388,526, FILED P.R. 8-3-2011; AM. S.R. 7-5-2012.

JIM RINGLE, EXAMINING ATTORNEY



*David J. Kyffers*

Director of the United States Patent and Trademark Office

# United States of America

United States Patent and Trademark Office

# SINGLE BET

**Reg. No. 4,200,230**

SHOLES, GREGORY (UNITED STATES INDIVIDUAL)  
7 ARAPAHOE DRIVE, #10  
VERNON, NJ 074625540

**Registered Aug. 28, 2012**

**Int. Cl.: 41**

FOR: LEASING OF CASINO GAMES, IN CLASS 41 (U.S. CLS. 100, 101 AND 107).

**SERVICE MARK**

FIRST USE 9-17-2010; IN COMMERCE 9-17-2010.

**SUPPLEMENTAL REGISTER**

THE MARK CONSISTS OF STANDARD CHARACTERS WITHOUT CLAIM TO ANY PARTICULAR FONT, STYLE, SIZE, OR COLOR.

SER. NO. 85-388,596, FILED P.R. 8-3-2011; AM. S.R. 7-5-2012.

JIM RINGLE, EXAMINING ATTORNEY



*David J. Kyffers*

Director of the United States Patent and Trademark Office

# United States of America

United States Patent and Trademark Office

## THE COOL SACK

**Reg. No. 4,200,231**

FARHAN KHAN (UNITED STATES INDIVIDUAL), DBA ARTISTIC CREATIONS,  
5300 MCINTOSH POINT  
SANFORD, FL 32773

**Registered Aug. 28, 2012**

**Int. Cl.: 21**

FOR: PORTABLE COOLERS, IN CLASS 21 (U.S. CLS. 2, 13, 23, 29, 30, 33, 40 AND 50).

FIRST USE 10-15-2009; IN COMMERCE 10-15-2009.

**TRADEMARK**

THE MARK CONSISTS OF STANDARD CHARACTERS WITHOUT CLAIM TO ANY PARTICULAR FONT, STYLE, SIZE, OR COLOR.

**SUPPLEMENTAL REGISTER**

NO CLAIM IS MADE TO THE EXCLUSIVE RIGHT TO USE "SACK", APART FROM THE MARK AS SHOWN.

SER. NO. 85-389,661, FILED P.R. 8-4-2011; AM. S.R. 12-6-2011.

ANDREA K. NADELMAN, EXAMINING ATTORNEY



*David J. Kybas*

Director of the United States Patent and Trademark Office

# United States of America

United States Patent and Trademark Office

**BOLAVEN**  
— C A F É S —

**Reg. No. 4,200,232**

**Registered Aug. 28, 2012**

**Int. Cl.: 43**

BOLAVEN FARMS LIMITED (HONG KONG LIMITED LIABILITY COMPANY), DBA  
BOLAVEN FARMS,  
42/F  
333 LOCKHART ROAD, WANCHAI  
HONG KONG, HONG KONG

**SERVICE MARK**

FOR: CAFE AND RESTAURANT SERVICES; CAFE-RESTAURANTS; CAFES; COFFEE BARS; COFFEE SHOPS; RESTAURANT AND CAFE SERVICES, IN CLASS 43 (U.S. CLS. 100 AND 101).

**SUPPLEMENTAL REGISTER**

PRIORITY CLAIMED UNDER SEC. 44(D) ON HONG KONG APPLICATION NO. 301883061, FILED 4-8-2011, REG. NO. 301883061, DATED 9-22-2011, EXPIRES 4-8-2021.

THE COLOR(S) BLACK IS/ARE CLAIMED AS A FEATURE OF THE MARK.

NO CLAIM IS MADE TO THE EXCLUSIVE RIGHT TO USE "CAFÉS", APART FROM THE MARK AS SHOWN.

THE MARK CONSISTS OF THE LETTERS "B O L A V E N" IN THE FIRST LINE. THE COLOR BLACK IS USED IN THE LETTERS "B O L A V E N". THE FIRST LETTER IS A CAPITAL "B" FOLLOWED BY SMALLER LETTERS OF "O L A V E N". THE SECOND LINE OF THE MARK STARTS WITH A BLACK COLORED EM LINE ABOUT 3 CENTIMETERS LONG, FOLLOWED BY THE LETTERS "C A F E S" WHICH ARE ALL CAPITALS BUT WITH A REDUCED FONT SIZE. THE LETTER "E" IN "C A F E S" IS HYPHENATED FOR ITS FRENCH PRONUNCIATION. THE COLOR BLACK IS USED FOR THE LETTERS "C A F E S". THE WORD "C A F E S" IS FOLLOWED BY ANOTHER BLACK COLORED EM LINE ONCE AGAIN ABOUT 3 CENTIMETERS LONG.

SER. NO. 85-391,748, FILED P.R. 8-8-2011; AM. S.R. 7-18-2012.

EMILY CHUO, EXAMINING ATTORNEY



*David J. Kybas*

Director of the United States Patent and Trademark Office

# United States of America

United States Patent and Trademark Office

# Mass XL

**Reg. No. 4,200,233**

MOLLOY, OREN DON (UNITED STATES INDIVIDUAL), DBA PLASKA INDUSTRIES,  
14041 COUNTY RD C  
MEMPHIS, TX 79245

**Registered Aug. 28, 2012**

**Int. Cl.: 5**

FOR: ANIMAL FEED SUPPLEMENTS, IN CLASS 5 (U.S. CLS. 6, 18, 44, 46, 51 AND 52).

**TRADEMARK**

FIRST USE 10-1-2011; IN COMMERCE 1-12-2012.

**SUPPLEMENTAL REGISTER**

THE MARK CONSISTS OF STANDARD CHARACTERS WITHOUT CLAIM TO ANY PARTICULAR FONT, STYLE, SIZE, OR COLOR.

SER. NO. 85-392,733, FILED P.R. 8-8-2011; AM. S.R. 2-28-2012.

EDWARD FENNESSY, EXAMINING ATTORNEY



*David J. Kyffers*

Director of the United States Patent and Trademark Office

# United States of America

United States Patent and Trademark Office

## The Lyric Coach

**Reg. No. 4,200,234**

U-SING (CALIFORNIA LIMITED LIABILITY COMPANY)  
1542 WOODBURY

**Registered Aug. 28, 2012**

PASADENA, CA 91104

**Int. Cl.: 9**

FOR: COMPUTER APPLICATION SOFTWARE FOR MOBILE PHONES, PORTABLE MEDIA PLAYERS, HANDHELD COMPUTERS AND DESKTOP COMPUTERS, NAMELY, SOFTWARE FOR PROVIDING PRECEDENT ORAL LYRIC PROMPTING, IN CLASS 9 (U.S. CLS. 21, 23, 26, 36 AND 38).

**TRADEMARK**

**SUPPLEMENTAL REGISTER** FIRST USE 12-1-2011; IN COMMERCE 12-1-2011.

THE MARK CONSISTS OF STANDARD CHARACTERS WITHOUT CLAIM TO ANY PARTICULAR FONT, STYLE, SIZE, OR COLOR.

SER. NO. 85-394,164, FILED P.R. 8-10-2011; AM. S.R. 6-5-2012.

ANNE E. GUSTASON, EXAMINING ATTORNEY



*David J. Kybas*

Director of the United States Patent and Trademark Office

# United States of America

United States Patent and Trademark Office

## MÉXICO SUENA

**Reg. No. 4,200,235**

**Registered Aug. 28, 2012**

**Int. Cls.: 9 and 41**

**TRADEMARK**

**SERVICE MARK**

**SUPPLEMENTAL REGISTER**

TELEVISA, S.A. DE C.V. (MEXICO CORPORATION)  
EDIFICIO A PISO 4, COLONIA ZEDEC  
AVENIDA VASCO DE QUIROGA 2000  
SANTA FE, MEXICO 01210

FOR: PRE-RECORDED DIGITAL AND ELECTRONIC MEDIA, NAMELY, CDS AND DVDS FEATURING CONCERTS AND MUSICAL EVENTS, IN CLASS 9 (U.S. CLS. 21, 23, 26, 36 AND 38).

FOR: ARRANGING AND CONDUCTING CONCERTS FEATURING POP SINGERS, MULTIPLE MUSICAL GROUPS AND BANDS; ARRANGING AND CONDUCTING FESTIVALS FEATURING POP SINGERS, MUSICAL GROUPS, ROCK MUSIC; PROVIDING A WEB SITE ON GLOBAL COMPUTER NETWORKS FEATURING INFORMATION ON MUSIC, MUSICAL PERFORMANCES AND MUSICAL PERFORMERS; PRODUCING AND ARRANGING CONCERTS AND MUSICAL EVENTS; PROVIDING INFORMATION IN THE FIELD OF ENTERTAINMENT AND MUSIC BY MEANS OF A GLOBAL COMPUTER NETWORK AND PRINTED MATERIALS; ENTERTAINMENT SERVICES, NAMELY, PROVIDING A WEB SITE FEATURING MUSICAL PERFORMANCES, MUSIC VIDEOS, PHOTOGRAPHS, AND OTHER MULTIMEDIA MATERIALS FEATURING MUSIC; AND ENTERTAINMENT SERVICES, NAMELY, CONCERTS AND MUSICAL EVENTS DISTRIBUTED VIA VARIOUS PLATFORMS ACROSS MULTIPLE FORMS OF TRANSMISSION MEDIA, NAMELY, TELEVISION BROADCASTS, TELECOMMUNICATIONS, SATELLITE, CABLE, FIBER-OPTIC CABLE AND THE INTERNET, IN CLASS 41 (U.S. CLS. 100, 101 AND 107).



THE MARK CONSISTS OF STANDARD CHARACTERS WITHOUT CLAIM TO ANY PARTICULAR FONT, STYLE, SIZE, OR COLOR.

OWNER OF MEXICO REG. NO. 1188571, DATED 11-9-2010, EXPIRES 11-9-2020.

OWNER OF MEXICO REG. NO. 1239527, DATED 9-23-2011, EXPIRES 9-23-2021.

THE ENGLISH TRANSLATION OF "MÉXICO SUENA" IN THE MARK IS "MEXICO SOUNDS".

SER. NO. 85-399,248, FILED P.R. 8-16-2011; AM. S.R. 5-31-2012.

KATHLEEN LORENZO, EXAMINING ATTORNEY

*David J. Kyffers*

Director of the United States Patent and Trademark Office

# United States of America

United States Patent and Trademark Office

# dvAd

**Reg. No. 4,200,236**

DYNAMIC VIDEO, LLC (DELAWARE LIMITED LIABILITY COMPANY)  
71 WEST 23RD STREET, 17TH FLOOR  
NEW YORK, NY 10010

**Registered Aug. 28, 2012**

**Int. Cl.: 35**

FOR: ADVERTISING SERVICES, NAMELY, PREPARING ADVERTISEMENTS FOR OTHERS FOR PROMOTING AND MARKETING THE GOODS AND SERVICES OF OTHERS THROUGH ALL PUBLIC COMMUNICATION MEANS, IN CLASS 35 (U.S. CLS. 100, 101 AND 102).

**SERVICE MARK**

FIRST USE 11-1-2010; IN COMMERCE 11-1-2010.

**SUPPLEMENTAL REGISTER**

THE MARK CONSISTS OF STANDARD CHARACTERS WITHOUT CLAIM TO ANY PARTICULAR FONT, STYLE, SIZE, OR COLOR.

SER. NO. 85-399,508, FILED P.R. 8-16-2011; AM. S.R. 6-29-2012.

CHRISIE B. KING, EXAMINING ATTORNEY



*David J. Kyffers*

Director of the United States Patent and Trademark Office



United States of America  
United States Patent and Trademark Office

# DimpleClip

**Reg. No. 4,200,237**

**Registered Aug. 28, 2012**

**Int. Cl.: 14**

**TRADEMARK**

**SUPPLEMENTAL REGISTER**

ANTHONY M MITCHELL (NEVADA CORPORATION), DBA MITCHELL & MITCHELL  
INTERNATIONAL LLC,  
35 EAST HORIZON RIDGE PARKWAY 110-229  
HENDERSON, NV 89002

FOR: TIE CLIPS, IN CLASS 14 (U.S. CLS. 2, 27, 28 AND 50).

FIRST USE 8-20-2010; IN COMMERCE 8-20-2010.

THE MARK CONSISTS OF STANDARD CHARACTERS WITHOUT CLAIM TO ANY PARTICULAR FONT, STYLE, SIZE, OR COLOR.

SER. NO. 85-400,819, FILED P.R. 8-18-2011; AM. S.R. 6-14-2012.

GRETТА YAO, EXAMINING ATTORNEY



*David J. Kybas*

Director of the United States Patent and Trademark Office

# United States of America

United States Patent and Trademark Office

## GRIP GUIDES

**Reg. No. 4,200,238**

**Registered Aug. 28, 2012**

**Int. Cl.: 28**

**TRADEMARK**

**SUPPLEMENTAL REGISTER**

B 10 LLC (ILLINOIS LIMITED LIABILITY COMPANY)  
SUITE 317  
736 N. WESTERN AVENUE  
LAKE FOREST, IL 60045

FOR: GOLF TRAINING AIDS, NAMELY, A DEVICE THAT INDICATES WHERE YOUR HANDS SHOULD BE PLACED ON A GOLF GRIP, IN CLASS 28 (U.S. CLS. 22, 23, 38 AND 50).

FIRST USE 1-0-2012; IN COMMERCE 2-0-2012.

THE MARK CONSISTS OF STANDARD CHARACTERS WITHOUT CLAIM TO ANY PARTICULAR FONT, STYLE, SIZE, OR COLOR.

SER. NO. 85-404,630, FILED P.R. 8-23-2011; AM. S.R. 6-15-2012.

GIANCARLO CASTRO, EXAMINING ATTORNEY



*David J. Kyffers*

Director of the United States Patent and Trademark Office

# United States of America

United States Patent and Trademark Office

# HAWTHORNE

**Reg. No. 4,200,239**

LEUPOLD & STEVENS, INC. (OREGON CORPORATION)  
P.O. BOX 688

**Registered Aug. 28, 2012**

BEAVERTON, OR 97075

**Int. Cl.: 9**

FOR: BINOCULARS, IN CLASS 9 (U.S. CLS. 21, 23, 26, 36 AND 38).

**TRADEMARK**

FIRST USE 1-2-2012; IN COMMERCE 1-2-2012.

**SUPPLEMENTAL REGISTER**

THE MARK CONSISTS OF STANDARD CHARACTERS WITHOUT CLAIM TO ANY PARTICULAR FONT, STYLE, SIZE, OR COLOR.

SER. NO. 85-404,927, FILED P.R. 8-23-2011; AM. S.R. 6-13-2012.

CURTIS FRENCH, EXAMINING ATTORNEY



*David J. Kyffers*

Director of the United States Patent and Trademark Office

# United States of America

United States Patent and Trademark Office

## Base Guide

**Reg. No. 4,200,240**

VICTORY MEDIA, INC. (PENNSYLVANIA CORPORATION)  
429 MILL STREET  
CORAOPOLIS, PA 15108

**Registered Aug. 28, 2012**

**Int. Cl.: 35**

FOR: PROVIDING A WEBSITE FEATURING AN ONLINE COMMERCIAL INFORMATION DIRECTORY ON THE INTERNET FEATURING INFORMATION ASSOCIATED WITH U.S. MILITARY BASES AND MERCHANTS LOCAL TO THOSE BASES, TO PROMOTE THE EXCHANGE OF IDEAS AND SHARING RESOURCES, DIRECTED TOWARDS AN ONLINE COMMUNITY OF MILITARY SPOUSES; PROVIDING A WEBSITE FEATURING A SEARCHABLE ONLINE ADVERTISING GUIDE FEATURING THE GOODS AND SERVICES OF ONLINE VENDORS ASSOCIATED WITH U.S. MILITARY BASE MERCHANTS, TO PROMOTE THE EXCHANGE OF IDEAS AND SHARING RESOURCES, DIRECTED TOWARDS AN ONLINE COMMUNITY OF MILITARY SPOUSES, IN CLASS 35 (U.S. CLS. 100, 101 AND 102).

**SERVICE MARK**

**SUPPLEMENTAL REGISTER**

FIRST USE 8-5-2011; IN COMMERCE 8-17-2011.

THE MARK CONSISTS OF STANDARD CHARACTERS WITHOUT CLAIM TO ANY PARTICULAR FONT, STYLE, SIZE, OR COLOR.

NO CLAIM IS MADE TO THE EXCLUSIVE RIGHT TO USE "GUIDE", APART FROM THE MARK AS SHOWN.

SER. NO. 85-406,982, FILED P.R. 8-25-2011; AM. S.R. 6-11-2012.

LINDA M. KING, EXAMINING ATTORNEY



*David J. Kypos*

Director of the United States Patent and Trademark Office

# United States of America

United States Patent and Trademark Office

# SuperFood

**Reg. No. 4,200,241**

**Registered Aug. 28, 2012**

**Int. Cl.: 1**

**TRADEMARK**

**SUPPLEMENTAL REGISTER**

SOIL HEALTH SOLUTIONS LLC (COLORADO LIMITED LIABILITY COMPANY), DBA  
ORGANIC BOUNTEA,  
948 NORTH STREET #5  
BOULDER, CO 80304

FOR: FERTILISER FOR SOIL AND POTTING SOIL; FERTILISERS FOR SOIL AND POTTING SOIL; FOOD SUPPLEMENTS FOR AGRICULTURAL PRODUCTS AND OTHER PLANTS; HORTICULTURAL PRODUCTS, NAMELY, SOIL AMENDMENTS THAT ARE INCORPORATED INTO OR ONTO A TURF, LAWN OR SOIL PROFILE FOR CREATING A HEALTH MEDIUM FOR INCREASED ROOT GROWTH AND/OR A SMOOTHER TURF OR LAWN SURFACE CUT OR APPEARANCE; ORGANIC SOIL ENHANCEMENT POWDERS AND PREPARATIONS; PLANT FOOD; PLANT GROWTH NUTRIENTS; PLANT NUTRITION PREPARATIONS; PREPARATIONS FOR FORTIFYING PLANTS; SOIL AMENDMENTS; SOIL IMPROVING AGENTS; SOIL IMPROVING PREPARATIONS; SUBSTANCES FOR REGULATING PLANT GROWTH , IN CLASS 1 (U.S. CLS. 1, 5, 6, 10, 26 AND 46).

FIRST USE 11-30-2009; IN COMMERCE 3-31-2011.

THE MARK CONSISTS OF STANDARD CHARACTERS WITHOUT CLAIM TO ANY PARTICULAR FONT, STYLE, SIZE, OR COLOR.

SER. NO. 85-408,235, FILED P.R. 8-26-2011; AM. S.R. 6-27-2012.

WILLIAM ROSSMAN, EXAMINING ATTORNEY



*David J. Kyros*

Director of the United States Patent and Trademark Office

# United States of America

United States Patent and Trademark Office

## DERMATOLOGIST ON CALL

**Reg. No. 4,200,242**

IAGNOSIS, INC. (PENNSYLVANIA CORPORATION)  
222 E. MCMURRAY ROAD  
MCMURRAY, PA 15317

**Registered Aug. 28, 2012**

**Int. Cl.: 44**

FOR: MEDICAL SERVICES RENDERED ON THE WORLD-WIDE WEB ALLOWING INTERACTION BETWEEN PROSPECTIVE AND EXISTING PATIENTS AND A DERMATOLOGIST CONCERNING HAIR, SKIN AND NAIL CONDITIONS , IN CLASS 44 (U.S. CLS. 100 AND 101).

**SERVICE MARK**

**SUPPLEMENTAL REGISTER** FIRST USE 8-30-2011; IN COMMERCE 8-30-2011.

THE MARK CONSISTS OF STANDARD CHARACTERS WITHOUT CLAIM TO ANY PARTICULAR FONT, STYLE, SIZE, OR COLOR.

NO CLAIM IS MADE TO THE EXCLUSIVE RIGHT TO USE "DERMATOLOGIST", APART FROM THE MARK AS SHOWN.

SER. NO. 85-408,464, FILED P.R. 8-26-2011; AM. S.R. 6-26-2012.

NICHOLAS ALTREE, EXAMINING ATTORNEY



*David J. Kyffers*

Director of the United States Patent and Trademark Office

# United States of America

United States Patent and Trademark Office

## MCLE OnlineLibrary

**Reg. No. 4,200,243**

**Registered Aug. 28, 2012**

**Int. Cl.: 9**

MASSACHUSETTS CONTINUING LEGAL EDUCATION, INC. (MASSACHUSETTS CORPORATION), AKA MCLE | NEW ENGLAND,  
WWW.MCLE.ORG  
10 WINTER PLACE  
BOSTON, MA 02108

**TRADEMARK**

**SUPPLEMENTAL REGISTER**

FOR: DOWNLOADABLE ELECTRONIC PUBLICATIONS IN THE NATURE OF HANDBOOKS, ARTICLES AND CHECKLISTS IN THE FIELD OF CONTINUING LEGAL EDUCATION AND THE PRACTICAL APPLICATION OF THE LAW; DOWNLOADABLE MP3 FILES, MP3 RECORDINGS, ON-LINE DISCUSSION BOARDS, WEBCASTS, WEBINARS AND PODCASTS FEATURING MUSIC, AUDIO BOOKS IN THE FIELD OF CONTINUING LEGAL EDUCATION AND THE PRACTICAL APPLICATION OF THE LAW, AND NEWS BROADCASTS, IN CLASS 9 (U.S. CLS. 21, 23, 26, 36 AND 38).

FIRST USE 2-1-2005; IN COMMERCE 2-1-2005.

THE MARK CONSISTS OF STANDARD CHARACTERS WITHOUT CLAIM TO ANY PARTICULAR FONT, STYLE, SIZE, OR COLOR.

OWNER OF U.S. REG. NOS. 2,519,785, 3,861,695, AND OTHERS.

NO CLAIM IS MADE TO THE EXCLUSIVE RIGHT TO USE "MCLE", APART FROM THE MARK AS SHOWN.

SER. NO. 85-409,655, FILED P.R. 8-29-2011; AM. S.R. 6-28-2012.

JAMES LOVELACE, EXAMINING ATTORNEY



*David J. Kybas*

Director of the United States Patent and Trademark Office

# United States of America

United States Patent and Trademark Office

## MCLE OnDemand

**Reg. No. 4,200,244**

**Registered Aug. 28, 2012**

**Int. Cl.: 41**

**SERVICE MARK**

**SUPPLEMENTAL REGISTER**

MASSACHUSETTS CONTINUING LEGAL EDUCATION, INC. (MASSACHUSETTS CORPORATION), AKA MCLE | NEW ENGLAND,  
10 WINTER PLACE  
BOSTON, MA 02108

FOR: EDUCATIONAL SERVICES, NAMELY, CONDUCTING ONLINE REAL TIME AND ARCHIVED CONTINUING LEGAL EDUCATION TRAININGS IN THE FIELDS OF THE PRACTICAL APPLICATION OF THE LAW AND DISTRIBUTION OF TRAINING MATERIALS IN CONNECTION THEREWITH, IN CLASS 41 (U.S. CLS. 100, 101 AND 107).

FIRST USE 2-1-2005; IN COMMERCE 2-1-2005.

THE MARK CONSISTS OF STANDARD CHARACTERS WITHOUT CLAIM TO ANY PARTICULAR FONT, STYLE, SIZE, OR COLOR.

OWNER OF U.S. REG. NOS. 2,519,785, 3,861,695, AND OTHERS.

NO CLAIM IS MADE TO THE EXCLUSIVE RIGHT TO USE "MCLE", APART FROM THE MARK AS SHOWN.

SER. NO. 85-409,733, FILED P.R. 8-29-2011; AM. S.R. 6-28-2012.

JAMES LOVELACE, EXAMINING ATTORNEY



*David J. Kyffers*

Director of the United States Patent and Trademark Office



# United States of America

United States Patent and Trademark Office

# Store Coach

**Reg. No. 4,200,245**

STORE COACH, INC. (IDAHO CORPORATION)

**Registered Aug. 28, 2012**

4016 JOURNEY CIRCLE  
AMMON, ID 83406

**Int. Cl.: 42**

FOR: PROVIDING A WEBSITE FEATURING TECHNOLOGY THAT ENABLES USERS TO VIEW AND SHARE INSTRUCTIONAL VIDEOS, WRITTEN TUTORIALS AND STEP-BY-STEP GUIDES FOR BUILDING, MARKETING AND OPERATING AN ECOMMERCE WEBSITE; PROVIDING TEMPORARY USE OF NON-DOWNLOADABLE SOFTWARE FOR BUILDING, MARKETING AND OPERATING AN ECOMMERCE WEBSITE, IN CLASS 42 (U.S. CLS. 100 AND 101).

**SERVICE MARK**

**SUPPLEMENTAL REGISTER**

FIRST USE 3-12-2010; IN COMMERCE 5-23-2011.

THE MARK CONSISTS OF STANDARD CHARACTERS WITHOUT CLAIM TO ANY PARTICULAR FONT, STYLE, SIZE, OR COLOR.

SER. NO. 85-411,205, FILED P.R. 8-30-2011; AM. S.R. 6-8-2012.

CURTIS FRENCH, EXAMINING ATTORNEY



*David J. Kybas*

Director of the United States Patent and Trademark Office

# United States of America

United States Patent and Trademark Office

## STRONGER BATTERY

**Reg. No. 4,200,246**

888 CONGLOMERATE CA, LLC (CALIFORNIA LIMITED LIABILITY COMPANY)  
17870 NEWHOPE ST #104-282  
FOUNTAIN VALLEY, CA 92708

**Registered Aug. 28, 2012**

**Int. Cl.: 9**

FOR: BATTERIES; BATTERY PACKS; BATTERY PACKS FOR LAPTOPS, IN CLASS 9 (U.S. CLS. 21, 23, 26, 36 AND 38).

**TRADEMARK**

FIRST USE 9-1-2011; IN COMMERCE 1-9-2012.

**SUPPLEMENTAL REGISTER**

THE MARK CONSISTS OF STANDARD CHARACTERS WITHOUT CLAIM TO ANY PARTICULAR FONT, STYLE, SIZE, OR COLOR.

NO CLAIM IS MADE TO THE EXCLUSIVE RIGHT TO USE "BATTERY", APART FROM THE MARK AS SHOWN.

SER. NO. 85-413,020, FILED P.R. 9-1-2011; AM. S.R. 6-21-2012.

JOHN SCHUYLER YARD, EXAMINING ATTORNEY



*David J. Kybas*

Director of the United States Patent and Trademark Office

# United States of America

United States Patent and Trademark Office

## JERSEY SHORE POPS

**Reg. No. 4,200,247** JERSEY SHORE POPS A NJ NONPROFIT CORPORATION (NEW JERSEY CORPORATION)  
**Registered Aug. 28, 2012** 88 ROUTE 610  
PETERSBURG, NJ 08270

**Int. Cl.: 41** FOR: ENTERTAINMENT SERVICES IN THE NATURE OF LIVE MUSICAL PERFORMANCES,  
IN CLASS 41 (U.S. CLS. 100, 101 AND 107).

**SERVICE MARK** FIRST USE 10-17-2009; IN COMMERCE 10-17-2009.

**SUPPLEMENTAL REGISTER** THE MARK CONSISTS OF STANDARD CHARACTERS WITHOUT CLAIM TO ANY PAR-  
TICULAR FONT, STYLE, SIZE, OR COLOR.

NO CLAIM IS MADE TO THE EXCLUSIVE RIGHT TO USE "POPS", APART FROM THE  
MARK AS SHOWN.

SER. NO. 85-413,283, FILED P.R. 9-1-2011; AM. S.R. 6-26-2012.

RONALD DELGIZZI, EXAMINING ATTORNEY



*David J. Kybas*

Director of the United States Patent and Trademark Office

# United States of America

United States Patent and Trademark Office

## SMS REWARDS

**Reg. No. 4,200,248**

REWARDPAL INC. (DELAWARE CORPORATION)  
43422 WEST OAK DR., #145  
NOVI, MI 48377

**Registered Aug. 28, 2012**

**Int. Cls.: 35 and 36**

FOR: ADMINISTRATION OF A CONSUMER LOYALTY PROGRAM TO PROMOTE RESTAURANT SERVICES AND RETAIL SERVICES OF OTHERS; INCENTIVE AWARD PROGRAMS TO PROMOTE THE SALE OF PRODUCTS AND SERVICES OF OTHERS; PROVIDING INCENTIVE AWARD PROGRAMS FOR CUSTOMERS THROUGH THE ISSUANCE AND PROCESSING OF LOYALTY COUPONS FOR FREQUENT USE OF PARTICIPATING BUSINESSES, IN CLASS 35 (U.S. CLS. 100, 101 AND 102).

**SERVICE MARK**

**SUPPLEMENTAL REGISTER**

FIRST USE 10-1-2011; IN COMMERCE 10-1-2011.

FOR: FINANCIAL TRANSACTION SERVICES, NAMELY, PROVIDING SECURE COMMERCIAL TRANSACTIONS AND PAYMENT OPTIONS USING A MOBILE DEVICE AT A POINT OF SALE; LOYALTY COUPON PAYMENT PROCESSING SERVICES; LOYALTY PROGRAM PAYMENT PROCESSING SERVICES, IN CLASS 36 (U.S. CLS. 100, 101 AND 102).

FIRST USE 10-1-2011; IN COMMERCE 10-1-2011.

THE MARK CONSISTS OF STANDARD CHARACTERS WITHOUT CLAIM TO ANY PARTICULAR FONT, STYLE, SIZE, OR COLOR.

SER. NO. 85-413,369, FILED P.R. 9-1-2011; AM. S.R. 7-6-2012.

DOUGLAS LEE, EXAMINING ATTORNEY



*David J. Kypos*

Director of the United States Patent and Trademark Office

# United States of America

United States Patent and Trademark Office

## INTERLOCKING CROCHET

**Reg. No. 4,200,249**

GALIK, TANIS (UNITED STATES INDIVIDUAL)  
908 LAURA LANE  
TEHACHAPI, CA 93561

**Registered Aug. 28, 2012**

**Int. Cl.: 41**

FOR: ON-LINE JOURNALS, NAMELY, BLOGS FEATURING CROCHET, IN CLASS 41 (U.S. CLS. 100, 101 AND 107).

**SERVICE MARK**

FIRST USE 11-1-2010; IN COMMERCE 11-1-2010.

**SUPPLEMENTAL REGISTER**

THE MARK CONSISTS OF STANDARD CHARACTERS WITHOUT CLAIM TO ANY PARTICULAR FONT, STYLE, SIZE, OR COLOR.

NO CLAIM IS MADE TO THE EXCLUSIVE RIGHT TO USE "CROCHET", APART FROM THE MARK AS SHOWN.

SER. NO. 85-413,459, FILED P.R. 9-1-2011; AM. S.R. 6-30-2012.

KATHLEEN KOLACZ, EXAMINING ATTORNEY



*David J. Kyffers*

Director of the United States Patent and Trademark Office

# United States of America

United States Patent and Trademark Office

## MERCHANT NATIONAL

**Reg. No. 4,200,250**

MERCHANT NATIONAL, LLC (DELAWARE LIMITED LIABILITY COMPANY)

**Registered Aug. 28, 2012**

545 8TH AVE STE 401  
NEW YORK, NY 10018

**Int. Cl.: 36**

FOR: MERCHANT SERVICES, NAMELY, PAYMENT TRANSACTION PROCESSING SERVICES; PAYMENT PROCESSING SERVICES, NAMELY, CREDIT CARD AND DEBIT CARD TRANSACTION PROCESSING SERVICES; CREDIT CARD PAYMENT PROCESSING SERVICES; PROVIDING ELECTRONIC PROCESSING OF ELECTRONIC FUNDS TRANSFER, ACH, CREDIT CARD, DEBIT CARD, ELECTRONIC CHECK AND ELECTRONIC PAYMENTS, IN CLASS 36 (U.S. CLS. 100, 101 AND 102).

**SERVICE MARK**

**SUPPLEMENTAL REGISTER**

FIRST USE 8-1-2010; IN COMMERCE 10-1-2010.

THE MARK CONSISTS OF STANDARD CHARACTERS WITHOUT CLAIM TO ANY PARTICULAR FONT, STYLE, SIZE, OR COLOR.

SER. NO. 85-413,532, FILED P.R. 9-1-2011; AM. S.R. 6-19-2012.

KATHERINE CHANG, EXAMINING ATTORNEY



*David J. Kyros*

Director of the United States Patent and Trademark Office

# United States of America

United States Patent and Trademark Office

## RAPID RESPONSE TEAM

**Reg. No. 4,200,251**

**Registered Aug. 28, 2012**

**Int. Cls.: 41 and 45**

**SERVICE MARK**

**SUPPLEMENTAL REGISTER**

BILLY GRAHAM EVANGELISTIC ASSOCIATION (MINNESOTA CORPORATION)  
1 BILLY GRAHAM PARKWAY  
CHARLOTTE, NC 28201

FOR: RELIGIOUS EDUCATIONAL SERVICES, NAMELY, CONDUCTING SEMINARS, CONFERENCES, WORKSHOPS, AND INSTRUCTION TO TEACH RELIGIOUS DOCTRINE AND GOSPEL AND DISTRIBUTING COURSE MATERIALS IN CONNECTION THEREWITH; RELIGIOUS TRAINING SERVICES TO TEACH RELIGIOUS DOCTRINE AND GOSPEL; EDUCATIONAL TRAINING SERVICES TO TRAIN CHAPLAINS IN THE FIELDS OF CRISIS MANAGEMENT AND HOW TO MINISTER TO THE EMOTIONAL AND SPIRITUAL NEEDS OF PEOPLE IN CRISIS, IN CLASS 41 (U.S. CLS. 100, 101 AND 107).

FIRST USE 9-30-2001; IN COMMERCE 9-30-2001.

FOR: EVANGELISTIC MINISTERIAL SERVICES; MINISTERING AND PROVIDING RELIGIOUS SPIRITUAL CARE TO INDIVIDUALS IN CRISIS, IN CLASS 45 (U.S. CLS. 100 AND 101).

FIRST USE 9-30-2001; IN COMMERCE 9-30-2001.

THE MARK CONSISTS OF STANDARD CHARACTERS WITHOUT CLAIM TO ANY PARTICULAR FONT, STYLE, SIZE, OR COLOR.

SER. NO. 85-414,393, FILED P.R. 9-2-2011; AM. S.R. 6-20-2012.

TRICIA SONNEBORN, EXAMINING ATTORNEY



*David J. Kyros*

Director of the United States Patent and Trademark Office

# United States of America

United States Patent and Trademark Office

## SILICA FIBER FREE

**Reg. No. 4,200,252**

CANA, LLC (COLORADO LIMITED LIABILITY COMPANY)  
314 PETERSON

**Registered Aug. 28, 2012**

ST. FORT COLLINS, CO 80524

**Int. Cl.: 5**

FOR: DIETARY SUPPLEMENTS, IN CLASS 5 (U.S. CLS. 6, 18, 44, 46, 51 AND 52).

**TRADEMARK**

FIRST USE 3-16-2010; IN COMMERCE 4-12-2010.

**SUPPLEMENTAL REGISTER**

THE MARK CONSISTS OF STANDARD CHARACTERS WITHOUT CLAIM TO ANY PARTICULAR FONT, STYLE, SIZE, OR COLOR.

SER. NO. 85-414,744, FILED P.R. 9-3-2011; AM. S.R. 6-27-2012.

DANNEAN HETZEL, EXAMINING ATTORNEY



*David J. Kyffers*

Director of the United States Patent and Trademark Office



# United States of America

United States Patent and Trademark Office

## MMA World News

**Reg. No. 4,200,253**

FERNANDEZ-BUSSY, MARCOS (UNITED STATES INDIVIDUAL)  
1608 16TH AVE.

**Registered Aug. 28, 2012**

SAN FRANCISCO, CA 94122

**Int. Cl.: 41**

FOR: ENTERTAINMENT SERVICES, NAMELY, PROVIDING A WEB SITE FEATURING PHOTOGRAPHIC, VIDEO, AND PROSE PRESENTATIONS ABOUT SPORTS, IN CLASS 41 (U.S. CLS. 100, 101 AND 107).

**SERVICE MARK**

FIRST USE 6-0-2011; IN COMMERCE 6-0-2011.

**SUPPLEMENTAL REGISTER**

THE MARK CONSISTS OF STANDARD CHARACTERS WITHOUT CLAIM TO ANY PARTICULAR FONT, STYLE, SIZE, OR COLOR.

NO CLAIM IS MADE TO THE EXCLUSIVE RIGHT TO USE "NEWS", APART FROM THE MARK AS SHOWN.

SER. NO. 85-415,304, FILED P.R. 9-6-2011; AM. S.R. 6-28-2012.

CHRISTOPHER SIDOTI, EXAMINING ATTORNEY



*David J. Kybas*

Director of the United States Patent and Trademark Office

# United States of America

United States Patent and Trademark Office

## Advanced Skills Management

**Reg. No. 4,200,254**

PALADIN DATA SYSTEMS CORPORATION (WASHINGTON CORPORATION)  
19362 POWDER HILL PLACE NE  
POULSBO, WA 98370

**Registered Aug. 28, 2012**

**Int. Cl.: 42**

FOR: SOFTWARE AS A SERVICE (SAAS) FOR THE ADMINISTRATION AND IMPROVEMENT OF TALENT DEVELOPMENT OF PERSONNEL BY ORGANIZATIONS, IN CLASS 42 (U.S. CLS. 100 AND 101).

**SERVICE MARK**

FIRST USE 1-1-2008; IN COMMERCE 1-1-2008.

**SUPPLEMENTAL REGISTER**

THE MARK CONSISTS OF STANDARD CHARACTERS WITHOUT CLAIM TO ANY PARTICULAR FONT, STYLE, SIZE, OR COLOR.

SER. NO. 85-415,494, FILED P.R. 9-6-2011; AM. S.R. 6-27-2012.

RENEE MCCRAY, EXAMINING ATTORNEY



*David J. Kyros*

Director of the United States Patent and Trademark Office

# United States of America

## United States Patent and Trademark Office



**Reg. No. 4,200,255**

**Registered Aug. 28, 2012**

**Int. Cl.: 9**

**TRADEMARK**

**SUPPLEMENTAL REGISTER**

MARCUM TECHNOLOGIES, INC. (MINNESOTA CORPORATION)  
C/O FREDRIKSON & BYRON, P.A.  
200 SOUTH SIXTH STREET, SUITE 4000  
MINNEAPOLIS, MN 55402

FOR: MARINE ELECTRONIC FISH FINDERS AND UNDERWATER FISH VIEWERS, IN CLASS 9 (U.S. CLS. 21, 23, 26, 36 AND 38).

FIRST USE 10-11-2005; IN COMMERCE 10-11-2005.

THE MARK CONSISTS OF THE COLOR RED AS APPLIED TO THE PADDED SOFT PACK SURROUNDING THE GOODS. THE MATTER SHOWN IN BROKEN LINES ON THE DRAWING SERVES TO SHOW PLACEMENT OF THE MARK AND IS NOT PART OF THE MARK.

THE COLOR(S) RED IS/ARE CLAIMED AS A FEATURE OF THE MARK.

SER. NO. 85-417,109, FILED 9-7-2011.

WILLIAM VERHOSEK, EXAMINING ATTORNEY



*David J. Kyfos*

Director of the United States Patent and Trademark Office

# United States of America

United States Patent and Trademark Office

## twist and seal

**Reg. No. 4,200,256**

DISTINCTIVE ENTERPRISE GROUP, LTD. (ILLINOIS CORPORATION)  
18304 DISTINCTIVE DRIVE  
ORLAND PARK, IL 60467

**Registered Aug. 28, 2012**

**Int. Cl.: 9**

FOR: EXTENSION CORD CONNECTION COVERS, IN CLASS 9 (U.S. CLS. 21, 23, 26, 36 AND 38).

**TRADEMARK**

FIRST USE 11-20-2011; IN COMMERCE 11-20-2011.

**SUPPLEMENTAL REGISTER**

THE MARK CONSISTS OF STANDARD CHARACTERS WITHOUT CLAIM TO ANY PARTICULAR FONT, STYLE, SIZE, OR COLOR.

SER. NO. 85-418,769, FILED P.R. 9-9-2011; AM. S.R. 6-29-2012.

MARCIE MILONE, EXAMINING ATTORNEY



*David J. Kyffers*

Director of the United States Patent and Trademark Office

# United States of America

United States Patent and Trademark Office

# goldmart

**Reg. No. 4,200,257**

LEGACY PRECIOUS METALS INC. (NEVADA CORPORATION)  
620 NEWPORT CENTER DRIVE  
NEWPORT BEACH, CA 92660

**Registered Aug. 28, 2012**

**Int. Cl.: 36**

FOR: PROVIDING MONETARY EXCHANGE SERVICES, NAMELY, BUYING, SELLING, AND EXCHANGING GOLD AND SILVER OF OTHERS FOR CASH, IN CLASS 36 (U.S. CLS. 100, 101 AND 102).

**SERVICE MARK**

FIRST USE 2-19-2010; IN COMMERCE 1-3-2011.

**SUPPLEMENTAL REGISTER**

THE MARK CONSISTS OF STANDARD CHARACTERS WITHOUT CLAIM TO ANY PARTICULAR FONT, STYLE, SIZE, OR COLOR.

SER. NO. 85-419,611, FILED P.R. 9-10-2011; AM. S.R. 6-28-2012.

AMY C. KEAN, EXAMINING ATTORNEY



*David J. Kappas*

Director of the United States Patent and Trademark Office

**United States of America**  
United States Patent and Trademark Office

# BIRTHPOP

**Reg. No. 4,200,258**

**Registered Aug. 28, 2012**

**Int. Cl.: 14**

JEWELPOP INC (CANADA CORPORATION), DBA KAMELEON JEWELRY,  
SUITE 100  
63 TACOMA DRIVE  
DARTMOUTH NS, CANADA B2W6E2

FOR: JEWELRY, IN CLASS 14 (U.S. CLS. 2, 27, 28 AND 50).

**TRADEMARK**

FIRST USE 1-1-2009; IN COMMERCE 1-1-2009.

**SUPPLEMENTAL REGISTER**

THE MARK CONSISTS OF STANDARD CHARACTERS WITHOUT CLAIM TO ANY PARTICULAR FONT, STYLE, SIZE, OR COLOR.

SER. NO. 85-419,844, FILED P.R. 9-12-2011; AM. S.R. 6-11-2012.

ESTHER A. BORSUK, EXAMINING ATTORNEY



*David J. Kybas*

Director of the United States Patent and Trademark Office

# United States of America

United States Patent and Trademark Office

# SUPERFRUITZ

**Reg. No. 4,200,259**

PHILLY'S FAMOUS WATER ICE, INC. (FLORIDA CORPORATION)  
1102 NORTH 28TH STREET  
TAMPA, FL 33605

**Registered Aug. 28, 2012**

**Int. Cl.: 30**

FOR: FROZEN CONFECTIONS, IN CLASS 30 (U.S. CL. 46).

**TRADEMARK**

FIRST USE 8-24-2011; IN COMMERCE 8-24-2011.

**SUPPLEMENTAL REGISTER**

THE MARK CONSISTS OF STANDARD CHARACTERS WITHOUT CLAIM TO ANY PARTICULAR FONT, STYLE, SIZE, OR COLOR.

SER. NO. 85-421,596, FILED P.R. 9-13-2011; AM. S.R. 7-23-2012.

JAMES A. RAUEN, EXAMINING ATTORNEY



*David J. Kyfos*

Director of the United States Patent and Trademark Office

# United States of America

United States Patent and Trademark Office

## POKER RUNS AMERICA

**Reg. No. 4,200,260**

POKER RUNS OF AMERICA, INC. (MICHIGAN CORPORATION)  
14100 OAKLAND AVENUE  
HIGHLAND PARK, MI 48203

**Registered Aug. 28, 2012**

**Int. Cls.: 16, 25, and 41**

FOR: MAGAZINES DEALING WITH BOATING, IN CLASS 16 (U.S. CLS. 2, 5, 22, 23, 29, 37, 38 AND 50).

**TRADEMARK**

FIRST USE 11-0-1997; IN COMMERCE 11-0-1997.

**SERVICE MARK**

FOR: CLOTHING, NAMELY, SWEATSHIRTS, T-SHIRTS, HATS AND JACKETS, IN CLASS 25 (U.S. CLS. 22 AND 39).

**SUPPLEMENTAL REGISTER**

FIRST USE 11-0-1997; IN COMMERCE 11-0-1997.

FOR: ORGANIZATION OF BOATING CONTESTS, IN CLASS 41 (U.S. CLS. 100, 101 AND 107).

FIRST USE 6-0-2000; IN COMMERCE 6-0-2000.

THE MARK CONSISTS OF STANDARD CHARACTERS WITHOUT CLAIM TO ANY PARTICULAR FONT, STYLE, SIZE, OR COLOR.

OWNER OF U.S. REG. NOS. 2,681,998 AND 2,682,184.

SER. NO. 85-422,173, FILED P.R. 9-14-2011; AM. S.R. 6-29-2012.

TRACY CROSS, EXAMINING ATTORNEY

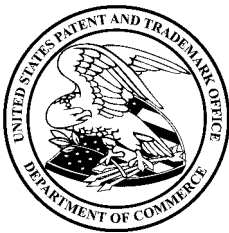

*David J. Kyros*

Director of the United States Patent and Trademark Office



# United States of America

United States Patent and Trademark Office

## Motor City Revue

**Reg. No. 4,200,261**

**Registered Aug. 28, 2012**

**Int. Cls.: 9 and 41**

HOLMES, LAYONNE PAULETTE (NEW JERSEY SOLE PROPRIETORSHIP), DBA MOTOR CITY REVUE,  
802 CLIFFWOOD AVE.  
KEYPORT, NJ 07735

FOR: MUSICAL SOUND RECORDINGS, IN CLASS 9 (U.S. CLS. 21, 23, 26, 36 AND 38).

**TRADEMARK**

FIRST USE 2-1-2012; IN COMMERCE 2-1-2012.

**SERVICE MARK**

FOR: LIVE PERFORMANCES BY A MUSICAL GROUP, IN CLASS 41 (U.S. CLS. 100, 101 AND 107).

**SUPPLEMENTAL REGISTER**

FIRST USE 11-5-2010; IN COMMERCE 11-5-2010.

THE MARK CONSISTS OF STANDARD CHARACTERS WITHOUT CLAIM TO ANY PARTICULAR FONT, STYLE, SIZE, OR COLOR.

SER. NO. 85-422,417, FILED P.R. 9-14-2011; AM. S.R. 7-9-2012.

KRISTINA MORRIS, EXAMINING ATTORNEY



*David J. Kybas*

Director of the United States Patent and Trademark Office

# United States of America

United States Patent and Trademark Office



**Reg. No. 4,200,262**

FABULOUS AMERICAN BEVERAGES LTD. (NEW YORK CORPORATION)  
50 WOODS ROAD  
PALISADES, NY 10964

**Registered Aug. 28, 2012**

**Int. Cl.: 33**

FOR: WHISKEY, IN CLASS 33 (U.S. CLS. 47 AND 49).

**TRADEMARK**

FIRST USE 9-14-2011; IN COMMERCE 9-14-2011.

**SUPPLEMENTAL REGISTER**

OWNER OF U.S. REG. NO. 4,060,560.

THE MARK CONSISTS OF THE WORD "KANSAS" IN STYLIZED LETTERING, ABOVE WHICH ARE TWO CURVED LINES OF UNEQUAL LENGTH.

SER. NO. 85-423,533, FILED P.R. 9-15-2011; AM. S.R. 6-28-2012.

JIM RINGLE, EXAMINING ATTORNEY



*David J. Kyffers*

Director of the United States Patent and Trademark Office

# United States of America

United States Patent and Trademark Office

## CREATIVE LEADERSHIP AWARD

**Reg. No. 4,200,263**

**Registered Aug. 28, 2012**

**Int. Cl.: 41**

**SERVICE MARK**

**SUPPLEMENTAL REGISTER**

REED ELSEVIER PROPERTIES INC. (DELAWARE CORPORATION)  
SUITE 501  
1105 NORTH MARKET STREET  
WILMINGTON, DE 19801

FOR: PROVIDING RECOGNITION AND INCENTIVES BY WAY OF EVENTS IN THE NATURE OF CELEBRATIONS AND AWARDS TO HIGH-LEVEL EXECUTIVES WHO HAVE DEDICATED TIME AND MADE A SIGNIFICANT EFFORT TO MENTOR YOUNG EXECUTIVES AND CREATIVE TALENT IN THE ENTERTAINMENT INDUSTRY, IN CLASS 41 (U.S. CLS. 100, 101 AND 107).

FIRST USE 10-11-2011; IN COMMERCE 10-11-2011.

THE MARK CONSISTS OF STANDARD CHARACTERS WITHOUT CLAIM TO ANY PARTICULAR FONT, STYLE, SIZE, OR COLOR.

NO CLAIM IS MADE TO THE EXCLUSIVE RIGHT TO USE "AWARD", APART FROM THE MARK AS SHOWN.

SER. NO. 85-423,581, FILED P.R. 9-15-2011; AM. S.R. 6-14-2012.

MATTHEW KLINE, EXAMINING ATTORNEY



*David J. Kypas*

Director of the United States Patent and Trademark Office

# United States of America

United States Patent and Trademark Office

## NATURAL PRACTITIONER

**Reg. No. 4,200,264**

VITAMIN RETAILER MAGAZINE, INC. (NEW JERSEY CORPORATION)  
431 CRANBURY RD., STE. C  
EAST BRUNSWICK, NJ 08816

**Registered Aug. 28, 2012**

**Int. Cl.: 16**

FOR: MAGAZINES FEATURING BUSINESS, HEALTH, NEW PRODUCT, AND RELATED INFORMATION FOR NATURAL AND ALTERNATIVE HEALTHCARE PROFESSIONALS AND PRACTITIONERS; MAGAZINES IN THE FIELD OF THE CHIROPRACTIC, ACUPUNCTURE, NATURAL MEDICINE, NUTRITION, AND ALTERNATIVE/HOLISTIC HEALTHCARE INDUSTRY, IN CLASS 16 (U.S. CLS. 2, 5, 22, 23, 29, 37, 38 AND 50).

**TRADEMARK**

**SUPPLEMENTAL REGISTER**

FIRST USE 1-0-2012; IN COMMERCE 1-0-2012.

THE MARK CONSISTS OF STANDARD CHARACTERS WITHOUT CLAIM TO ANY PARTICULAR FONT, STYLE, SIZE, OR COLOR.

SER. NO. 85-424,059, FILED P.R. 9-15-2011; AM. S.R. 6-29-2012.

MARIA-VICTORIA SUAREZ, EXAMINING ATTORNEY



*David J. Kybas*

Director of the United States Patent and Trademark Office

**United States of America**  
United States Patent and Trademark Office

**WALLER**

**Reg. No. 4,200,265**

**Registered Aug. 28, 2012**

**Int. Cl.: 45**

WALLER LANSDEN DORTCH & DAVIS, LLP (DELAWARE LIMITED LIABILITY  
PARTNERSHIP)  
SUITE 2700  
511 UNION STREET  
NASHVILLE, TN 37219

**SERVICE MARK**

FOR: LEGAL SERVICES, IN CLASS 45 (U.S. CLS. 100 AND 101).

**SUPPLEMENTAL REGISTER**

FIRST USE 5-18-2012; IN COMMERCE 5-18-2012.

THE MARK CONSISTS OF STANDARD CHARACTERS WITHOUT CLAIM TO ANY PARTICULAR FONT, STYLE, SIZE, OR COLOR.

OWNER OF U.S. REG. NOS. 3,157,926 AND 3,157,927.

SER. NO. 85-425,013, FILED P.R. 9-16-2011; AM. S.R. 6-18-2012.

MATTHEW KLINE, EXAMINING ATTORNEY



*David J. Kyros*

Director of the United States Patent and Trademark Office

United States of America  
United States Patent and Trademark Office

trutankless

**Reg. No. 4,200,266**

BOLLENTE COMPANIES, INC. (NEVADA CORPORATION)  
8501 NORTH SCOTTSDALE ROAD, SUITE 165  
SCOTTSDALE, AZ 85253

**Registered Aug. 28, 2012**

**Int. Cl.: 11**

FOR: TANKLESS WATER HEATERS, IN CLASS 11 (U.S. CLS. 13, 21, 23, 31 AND 34).

**TRADEMARK**

FIRST USE 10-23-2009; IN COMMERCE 10-23-2009.

**SUPPLEMENTAL REGISTER**

THE MARK CONSISTS OF THE WORD "TRUTANKLESS".

SER. NO. 85-425,091, FILED P.R. 9-16-2011; AM. S.R. 7-6-2012.

AMY ALFIERI, EXAMINING ATTORNEY



*David J. Kyffers*

Director of the United States Patent and Trademark Office

# United States of America

United States Patent and Trademark Office

# VISION BAR

**Reg. No. 4,200,267**

**Registered Aug. 28, 2012**

**Int. Cl.: 5**

**TRADEMARK**

**SUPPLEMENTAL REGISTER**

DERMAMED SOLUTIONS, LLC (PENNSYLVANIA LIMITED LIABILITY COMPANY),  
FORMERLY DERMAMED USA, INC.,  
394 PARKMOUNT ROAD  
LENNI, PA 19052

FOR: NUTRITIONAL SUPPLEMENTS, NUTRITION BARS IN THE NATURE OF NUTRITIONAL ENERGY BARS FOR USE AS A MEAL SUBSTITUTE AND NUTRITIONAL SUPPLEMENTS FORMED AND PACKAGED AS BARS, IN CLASS 5 (U.S. CLS. 6, 18, 44, 46, 51 AND 52).

FIRST USE 10-25-2011; IN COMMERCE 10-25-2011.

THE MARK CONSISTS OF STANDARD CHARACTERS WITHOUT CLAIM TO ANY PARTICULAR FONT, STYLE, SIZE, OR COLOR.

NO CLAIM IS MADE TO THE EXCLUSIVE RIGHT TO USE "BAR", APART FROM THE MARK AS SHOWN.

SER. NO. 85-425,600, FILED P.R. 9-19-2011; AM. S.R. 6-29-2012.

ANDREA K. NADELMAN, EXAMINING ATTORNEY



*David J. Kybas*

Director of the United States Patent and Trademark Office

# United States of America

United States Patent and Trademark Office

## RENT 2 OWN HQ

**Reg. No. 4,200,268**

AUTOMOTIVE PROMOTION CONSULTANTS INC. (TEXAS CORPORATION), DBA RENT  
2 OWN HQ,  
7007 HWY, 90 W  
SAN ANTONIO, TX 78227

**Registered Aug. 28, 2012**

**Int. Cl.: 35**

FOR: RETAIL STORE SERVICES IN THE FIELD OF AUTOMOBILES THAT CAN BE PUR-  
CHASED UNDER A RENT-TO-OWN CONTRACT, IN CLASS 35 (U.S. CLS. 100, 101 AND  
102).

**SERVICE MARK**

**SUPPLEMENTAL REGISTER** FIRST USE 7-28-2011; IN COMMERCE 7-28-2011.

THE MARK CONSISTS OF STANDARD CHARACTERS WITHOUT CLAIM TO ANY PAR-  
TICULAR FONT, STYLE, SIZE, OR COLOR.

NO CLAIM IS MADE TO THE EXCLUSIVE RIGHT TO USE "RENT TO OWN", APART FROM  
THE MARK AS SHOWN.

SER. NO. 85-426,303, FILED P.R. 9-19-2011; AM. S.R. 7-6-2012.

SIMON TENG, EXAMINING ATTORNEY



*David J. Kybas*

Director of the United States Patent and Trademark Office



# United States of America

United States Patent and Trademark Office

## ROLLOVER REWARDS

**Reg. No. 4,200,269**

NP IP HOLDINGS LLC (NEVADA LIMITED LIABILITY COMPANY)  
1505 SOUTH PAVILION CENTER DRIVE  
LAS VEGAS, NV 89135

**Registered Aug. 28, 2012**

**Int. Cl.: 35**

FOR: CUSTOMER LOYALTY SERVICES, NAMELY, INCENTIVE PROGRAMS TO PROMOTE FREQUENT CUSTOMER PATRONAGE THROUGH REWARDS GIVEN TO CASINO PLAYERS, IN CLASS 35 (U.S. CLS. 100, 101 AND 102).

**SERVICE MARK**

FIRST USE 9-9-2011; IN COMMERCE 9-9-2011.

**SUPPLEMENTAL REGISTER**

THE MARK CONSISTS OF STANDARD CHARACTERS WITHOUT CLAIM TO ANY PARTICULAR FONT, STYLE, SIZE, OR COLOR.

NO CLAIM IS MADE TO THE EXCLUSIVE RIGHT TO USE "REWARDS", APART FROM THE MARK AS SHOWN.

SER. NO. 85-427,657, FILED P.R. 9-20-2011; AM. S.R. 6-1-2012.

EDWARD FENNESSY, EXAMINING ATTORNEY



*David J. Kyffers*

Director of the United States Patent and Trademark Office

# United States of America

United States Patent and Trademark Office

# FLASHSEALR

**Reg. No. 4,200,270**

**Registered Aug. 28, 2012**

**Int. Cl.: 17**

**TRADEMARK**

**SUPPLEMENTAL REGISTER**

OWENS CORNING INTELLECTUAL CAPITAL, LLC (DELAWARE LIMITED LIABILITY COMPANY)  
ONE OWENS CORNING PARKWAY  
TOLEDO, OH 43659

FOR: ADHESIVE TAPE USED IN BUILDING AND CONSTRUCTION, IN CLASS 17 (U.S. CLS. 1, 5, 12, 13, 35 AND 50).

FIRST USE 5-23-2012; IN COMMERCE 5-23-2012.

THE MARK CONSISTS OF STANDARD CHARACTERS WITHOUT CLAIM TO ANY PARTICULAR FONT, STYLE, SIZE, OR COLOR.

SER. NO. 85-428,313, FILED P.R. 9-21-2011; AM. S.R. 6-11-2012.

JOHN DWYER, EXAMINING ATTORNEY



*David J. Kyffers*

Director of the United States Patent and Trademark Office

# United States of America

United States Patent and Trademark Office

## Grandparents Insurance Plans

**Reg. No. 4,200,271**

**Registered Aug. 28, 2012**

**Int. Cl.: 36**

**SERVICE MARK**

**SUPPLEMENTAL REGISTER**

GRANDPARENTS INSURANCE PLANS LLC (FLORIDA LIMITED LIABILITY COMPANY),  
DBA GRANDPARENTS INSURANCE PLAN,  
6663 CASA GRANDE WAY  
DELRAY BEACH, FL 33446

FOR: INSURANCE AGENCY AND BROKERAGE, IN CLASS 36 (U.S. CLS. 100, 101 AND 102).

FIRST USE 9-27-2011; IN COMMERCE 9-27-2011.

THE MARK CONSISTS OF STANDARD CHARACTERS WITHOUT CLAIM TO ANY PARTICULAR FONT, STYLE, SIZE, OR COLOR.

NO CLAIM IS MADE TO THE EXCLUSIVE RIGHT TO USE "INSURANCE PLANS", APART FROM THE MARK AS SHOWN.

SER. NO. 85-428,360, FILED P.R. 9-21-2011; AM. S.R. 7-12-2012.

DAWN FELDMAN, EXAMINING ATTORNEY



*David J. Kyffers*

Director of the United States Patent and Trademark Office

# United States of America

United States Patent and Trademark Office

## AMCHLOR DRY

**Reg. No. 4,200,272**

EVANS ENTERPRISES, LLC (KANSAS LIMITED LIABILITY COMPANY)  
20125 WEST 105TH STREET  
OLATHE, KS 66061

**Registered Aug. 28, 2012**

**Int. Cl.: 1**

FOR: FERTILIZER FOR AGRICULTURAL USE, IN CLASS 1 (U.S. CLS. 1, 5, 6, 10, 26 AND 46).

**TRADEMARK**

FIRST USE 1-3-2008; IN COMMERCE 1-18-2008.

**SUPPLEMENTAL REGISTER**

THE MARK CONSISTS OF STANDARD CHARACTERS WITHOUT CLAIM TO ANY PARTICULAR FONT, STYLE, SIZE, OR COLOR.

OWNER OF U.S. REG. NO. 3,666,350.

SER. NO. 85-429,487, FILED P.R. 9-22-2011; AM. S.R. 7-2-2012.

TASNEEM HUSSAIN, EXAMINING ATTORNEY



*David J. Kyffers*

Director of the United States Patent and Trademark Office

# United States of America

United States Patent and Trademark Office

# 1715

**Reg. No. 4,200,273**

MARTELL & CO. (FRANCE SOCIÉTÉ ANONYME (SA))  
PLACE EDOUARD MARTELL  
COGNAC, FRANCE 16100

**Registered Aug. 28, 2012**

**Int. Cl.: 33**

FOR: COGNAC, IN CLASS 33 (U.S. CLS. 47 AND 49).

FIRST USE 7-1-2004; IN COMMERCE 7-1-2004.

**TRADEMARK**

THE MARK CONSISTS OF STANDARD CHARACTERS WITHOUT CLAIM TO ANY PARTICULAR FONT, STYLE, SIZE, OR COLOR.

**SUPPLEMENTAL REGISTER**

PRIORITY CLAIMED UNDER SEC. 44(D) ON ERPN CMNTY TM OFC APPLICATION NO. 009834491, FILED 3-23-2011.

OWNER OF U.S. REG. NOS. 1,672,733, 3,692,707, AND OTHERS.

SER. NO. 85-429,551, FILED P.R. 9-22-2011; AM. S.R. 6-21-2012.

ELLEN BURNS, EXAMINING ATTORNEY



*David J. Kyffers*

Director of the United States Patent and Trademark Office

# United States of America

United States Patent and Trademark Office

## 1-800-HOARDERS.COM

**Reg. No. 4,200,274**

STERI-CLEAN, INC. (CALIFORNIA CORPORATION)

**Registered Aug. 28, 2012**

9785 CRESCENT CENTER DRIVE, #302  
RANCHO CUCAMONGA, CA 91730

**Int. Cl.: 37**

FOR: HOARDER CLEAN-UP SERVICES; CLEANING SERVICES, NAMELY, CLEANING OF RESIDENTIAL AND COMMERCIAL PREMISES, IN CLASS 37 (U.S. CLS. 100, 103 AND 106).

**SERVICE MARK**

FIRST USE 9-21-2011; IN COMMERCE 9-21-2011.

**SUPPLEMENTAL REGISTER**

THE MARK CONSISTS OF STANDARD CHARACTERS WITHOUT CLAIM TO ANY PARTICULAR FONT, STYLE, SIZE, OR COLOR.

SER. NO. 85-429,721, FILED P.R. 9-22-2011; AM. S.R. 7-2-2012.

KATHY DE JONGE, EXAMINING ATTORNEY



*David J. Kyffers*

Director of the United States Patent and Trademark Office

# United States of America

United States Patent and Trademark Office

## CHESAPEAKE BAY TRIPPER

**Reg. No. 4,200,275**

BAYSIDE PARTNERS, LLC (MARYLAND LIMITED LIABILITY COMPANY)  
P.O. BOX 295

**Registered Aug. 28, 2012**

NORTH BEACH, MD 20714

**Int. Cl.: 16**

FOR: MAGAZINES IN THE FIELD OF TOURIST INFORMATION, DAY TRIPS, AND VACATIONS, IN CLASS 16 (U.S. CLS. 2, 5, 22, 23, 29, 37, 38 AND 50).

**TRADEMARK**

FIRST USE 4-19-2011; IN COMMERCE 5-0-2011.

**SUPPLEMENTAL REGISTER**

THE MARK CONSISTS OF STANDARD CHARACTERS WITHOUT CLAIM TO ANY PARTICULAR FONT, STYLE, SIZE, OR COLOR.

SER. NO. 85-429,975, FILED P.R. 9-22-2011; AM. S.R. 7-10-2012.

KIMBERLY PERRY, EXAMINING ATTORNEY



*David J. Kyffers*

Director of the United States Patent and Trademark Office

# United States of America

United States Patent and Trademark Office

## Affordable IVF Abroad

**Reg. No. 4,200,276**

AFFORDABLE IVF ABROAD, LLC (GEORGIA LIMITED LIABILITY COMPANY)  
931 E. LAKE DR.

**Registered Aug. 28, 2012**

DECATUR, GA 30030

**Int. Cl.: 39**

FOR: MEDICAL TOURISM SERVICES, NAMELY, MAKING TRANSPORTATION RESERVATIONS AND BOOKINGS FOR TRAVEL TO ANOTHER COUNTRY IN ORDER TO OBTAIN HEALTH CARE RELATING TO IN VITRO FERTILIZATION, IN CLASS 39 (U.S. CLS. 100 AND 105).

**SERVICE MARK**

**SUPPLEMENTAL REGISTER** FIRST USE 10-21-2010; IN COMMERCE 12-20-2010.

THE MARK CONSISTS OF STANDARD CHARACTERS WITHOUT CLAIM TO ANY PARTICULAR FONT, STYLE, SIZE, OR COLOR.

SER. NO. 85-434,361, FILED P.R. 9-28-2011; AM. S.R. 6-25-2012.

JAY BESCH, EXAMINING ATTORNEY



*David J. Kyffers*

Director of the United States Patent and Trademark Office



# United States of America

United States Patent and Trademark Office

## FANTASY POLITICS

**Reg. No. 4,200,277**

**Registered Aug. 28, 2012**

**Int. Cls.: 35 and 41**

**SERVICE MARK**

**SUPPLEMENTAL REGISTER**

CAMPAIGNS, LLC (DELAWARE LIMITED LIABILITY COMPANY)  
3150 PORTER DRIVE  
PALO ALTO, CA 94304

FOR: PROVIDING AN INTERNET WEBSITE FEATURING NEWS AND INFORMATION IN THE FIELD OF NATIONAL AND INTERNATIONAL POLITICS; PROVIDING AN ON-LINE SEARCHABLE DATABASE FOR POLITICAL CAMPAIGNS AT WHICH USERS CAN COLLECT AND ANALYZE POLITICAL INFORMATION ELECTRONICALLY, IN CLASS 35 (U.S. CLS. 100, 101 AND 102).

FIRST USE 3-8-2012; IN COMMERCE 3-8-2012.

FOR: ENTERTAINMENT SERVICES IN THE NATURE OF A COMEDY SHOW FEATURING FANTASY POLITICAL CAMPAIGNS; ENTERTAINMENT SERVICES IN THE NATURE OF AN ON-LINE FANTASY LEAGUE BASED UPON POLITICAL VOTES AND ELECTIONS; PROVIDING A WEB-BASED SYSTEM AND ON-LINE PORTAL FOR USERS TO PARTICIPATE IN ON-LINE GAMING, OPERATION AND COORDINATION OF GAME TOURNAMENTS, LEAGUES AND TOURS, ALL RELATED TO POLITICS AND POLITICAL CAMPAIGNS, IN CLASS 41 (U.S. CLS. 100, 101 AND 107).

FIRST USE 3-8-2012; IN COMMERCE 3-8-2012.

THE MARK CONSISTS OF STANDARD CHARACTERS WITHOUT CLAIM TO ANY PARTICULAR FONT, STYLE, SIZE, OR COLOR.

SER. NO. 85-435,767, FILED P.R. 9-29-2011; AM. S.R. 5-9-2012.

DAVID MURRAY, EXAMINING ATTORNEY



*David J. Kypos*

Director of the United States Patent and Trademark Office

# United States of America

United States Patent and Trademark Office

## Native Hawaiian Organization

**Reg. No. 4,200,278**

ROYAL HAWAIIAN FOUNDATION (HAWAII CORPORATION)

**Registered Aug. 28, 2012**

P.O. BOX 29636  
HONOLULU, HI 96820

**Int. Cl.: 35**

FOR: DEVELOPING AND COORDINATING VOLUNTEER PROJECTS FOR CHARITABLE ORGANIZATIONS, IN CLASS 35 (U.S. CLS. 100, 101 AND 102).

**SERVICE MARK**

FIRST USE 1-2-2004; IN COMMERCE 1-2-2004.

**SUPPLEMENTAL REGISTER**

THE MARK CONSISTS OF STANDARD CHARACTERS WITHOUT CLAIM TO ANY PARTICULAR FONT, STYLE, SIZE, OR COLOR.

NO CLAIM IS MADE TO THE EXCLUSIVE RIGHT TO USE "ORGANIZATION", APART FROM THE MARK AS SHOWN.

SER. NO. 85-436,913, FILED P.R. 9-30-2011; AM. S.R. 7-6-2012.

DORITT L. CARROLL, EXAMINING ATTORNEY



*David J. Kyros*

Director of the United States Patent and Trademark Office

# United States of America

United States Patent and Trademark Office

## Women's Bancorp

**Reg. No. 4,200,279**

**Registered Aug. 28, 2012**

**Int. Cl.: 36**

**SERVICE MARK**

**SUPPLEMENTAL REGISTER**

G J ORIGINATORS LLC (KENTUCKY LIMITED LIABILITY COMPANY)  
SUITE 902  
1150 K STREET NW  
WASHINGTON, DC 200056809

FOR: BANKING SERVICES; FINANCIAL CONSULTING SERVICES, NAMELY, EXPERT ANALYSIS IN FINANCE, IN CLASS 36 (U.S. CLS. 100, 101 AND 102).

FIRST USE 1-30-2012; IN COMMERCE 1-30-2012.

THE MARK CONSISTS OF STANDARD CHARACTERS WITHOUT CLAIM TO ANY PARTICULAR FONT, STYLE, SIZE, OR COLOR.

SER. NO. 85-438,540, FILED P.R. 10-4-2011; AM. S.R. 7-3-2012.

KATHY DE JONGE, EXAMINING ATTORNEY



*David J. Kyffers*

Director of the United States Patent and Trademark Office

# United States of America

United States Patent and Trademark Office

# RAPID MELT

**Reg. No. 4,200,280**

**Registered Aug. 28, 2012**

**Int. Cl.: 1**

**TRADEMARK**

**SUPPLEMENTAL REGISTER**

EC GROW, INC. (WISCONSIN CORPORATION)  
P.O. BOX 837  
4970 KANE ROAD  
EAU CLAIRE, WI 54702

FOR: CHEMICAL COMPOUNDS FOR USE IN MELTING ICE AND SNOW, IN CLASS 1 (U.S. CLS. 1, 5, 6, 10, 26 AND 46).

FIRST USE 5-31-2011; IN COMMERCE 5-31-2011.

THE MARK CONSISTS OF STANDARD CHARACTERS WITHOUT CLAIM TO ANY PARTICULAR FONT, STYLE, SIZE, OR COLOR.

SER. NO. 85-438,758, FILED P.R. 10-4-2011; AM. S.R. 7-2-2012.

MARK SPARACINO, EXAMINING ATTORNEY



*David J. Kyffers*

Director of the United States Patent and Trademark Office

# United States of America

United States Patent and Trademark Office

## Cape Fear Brewing Co

**Reg. No. 4,200,281**

**Registered Aug. 28, 2012**

**Int. Cl.: 32**

**TRADEMARK**

**SUPPLEMENTAL REGISTER**

CAPE FEAR FESTIVALS, LLC (NORTH CAROLINA LIMITED LIABILITY COMPANY)  
ATTN:JOHN HORTON  
21B MARKET STREET  
WILMINGTON, NC 28401

FOR: BEER, ALE, LAGER, STOUT, PORTER AND CIDER, IN CLASS 32 (U.S. CLS. 45, 46 AND 48).

FIRST USE 3-3-2012; IN COMMERCE 5-3-2012.

THE MARK CONSISTS OF STANDARD CHARACTERS WITHOUT CLAIM TO ANY PARTICULAR FONT, STYLE, SIZE, OR COLOR.

NO CLAIM IS MADE TO THE EXCLUSIVE RIGHT TO USE "BREWING CO", APART FROM THE MARK AS SHOWN.

SER. NO. 85-439,367, FILED P.R. 10-5-2011; AM. S.R. 6-28-2012.

BARBARA A. GOLD, EXAMINING ATTORNEY



*David J. Kyffers*

Director of the United States Patent and Trademark Office

# United States of America

United States Patent and Trademark Office

## Boston Burger Company

**Reg. No. 4,200,282**

SILLARI, CHARLES J., JR. (UNITED STATES INDIVIDUAL)  
510 MEDFORD STREET  
SOMERVILLE, MA 02145

**Registered Aug. 28, 2012**

**Int. Cl.: 43**

FOR: RESTAURANT SERVICES, NAMELY, PROVIDING OF FOOD AND BEVERAGES FOR CONSUMPTION ON AND OFF THE PREMISES, IN CLASS 43 (U.S. CLS. 100 AND 101).

**SERVICE MARK**

FIRST USE 1-1-2009; IN COMMERCE 1-1-2009.

**SUPPLEMENTAL REGISTER**

THE MARK CONSISTS OF STANDARD CHARACTERS WITHOUT CLAIM TO ANY PARTICULAR FONT, STYLE, SIZE, OR COLOR.

OWNER OF U.S. REG. NO. 4,015,336.

NO CLAIM IS MADE TO THE EXCLUSIVE RIGHT TO USE "BURGER COMPANY", APART FROM THE MARK AS SHOWN.

SER. NO. 85-441,209, FILED P.R. 10-6-2011; AM. S.R. 7-17-2012.

TINA BROWN, EXAMINING ATTORNEY



*David J. Kyffers*

Director of the United States Patent and Trademark Office

# United States of America

United States Patent and Trademark Office

## AFFILIATES RISK MANAGEMENT SERVICES, INC.

**Reg. No. 4,200,283**

**Registered Aug. 28, 2012**

**Int. Cl.: 35**

AFFILIATES RISK MANAGEMENT SERVICES, INC. (NEW YORK NON-PROFIT CORPORATION)

10TH FLOOR  
434 WEST 33RD STREET  
NEW YORK, NY 10001

**SERVICE MARK**

FOR: BUSINESS RISK MANAGEMENT SERVICES, IN CLASS 35 (U.S. CLS. 100, 101 AND 102).

**SUPPLEMENTAL REGISTER** FIRST USE 7-7-2001; IN COMMERCE 7-7-2001.

THE MARK CONSISTS OF STANDARD CHARACTERS WITHOUT CLAIM TO ANY PARTICULAR FONT, STYLE, SIZE, OR COLOR.

NO CLAIM IS MADE TO THE EXCLUSIVE RIGHT TO USE "RISK MANAGEMENT SERVICES INC.", APART FROM THE MARK AS SHOWN.

SER. NO. 85-441,678, FILED P.R. 10-7-2011; AM. S.R. 6-28-2012.

DAVID COLLIER, EXAMINING ATTORNEY



*David J. Kyffers*

Director of the United States Patent and Trademark Office

# United States of America

United States Patent and Trademark Office

## CENTER FOR AFFILIATED LEARNING

**Reg. No. 4,200,284**

**Registered Aug. 28, 2012**

**Int. Cl.: 41**

AFFILIATES RISK MANAGEMENT SERVICES, INC. (NEW YORK NON-PROFIT CORPORATION)

10TH FLOOR  
434 WEST 33RD STREET  
NEW YORK, NY 10001

**SERVICE MARK**

**SUPPLEMENTAL REGISTER**

FOR: EDUCATION SERVICES, NAMELY, PROVIDING LIVE AND ON-LINE CLASSES, SEMINARS, WEBINARS, WORKSHOPS AND TRAINING IN THE FIELDS OF HEALTHCARE, BUSINESS OPERATIONS, HUMAN RESOURCES, AND SOCIAL ISSUES, AND THE DISTRIBUTION OF RELATED WRITTEN AND AUDIO/VISUAL COURSE MATERIALS IN CONNECTION THEREWITH, IN CLASS 41 (U.S. CLS. 100, 101 AND 107).

FIRST USE 3-0-2008; IN COMMERCE 3-0-2008.

THE MARK CONSISTS OF STANDARD CHARACTERS WITHOUT CLAIM TO ANY PARTICULAR FONT, STYLE, SIZE, OR COLOR.

NO CLAIM IS MADE TO THE EXCLUSIVE RIGHT TO USE "CENTER", APART FROM THE MARK AS SHOWN.

SER. NO. 85-441,742, FILED P.R. 10-7-2011; AM. S.R. 6-28-2012.

DAVID COLLIER, EXAMINING ATTORNEY



*David J. Kyros*

Director of the United States Patent and Trademark Office



# United States of America

United States Patent and Trademark Office

## CLOUD WORKFORCE SOLUTIONS

**Reg. No. 4,200,285**

**Registered Aug. 28, 2012**

**Int. Cl.: 35**

**SERVICE MARK**

**SUPPLEMENTAL REGISTER**

SKILLSTORM COMMERCIAL SERVICES LLC (FLORIDA LIMITED LIABILITY COMPANY)  
SUITE 280  
1000 CORPORATE DRIVE  
FT. LAUDERDALE, FL 33334

FOR: EMPLOYMENT STAFFING IN THE FIELD OF INFORMATION TECHNOLOGY, IN CLASS 35 (U.S. CLS. 100, 101 AND 102).

FIRST USE 8-1-2011; IN COMMERCE 8-1-2011.

THE MARK CONSISTS OF STANDARD CHARACTERS WITHOUT CLAIM TO ANY PARTICULAR FONT, STYLE, SIZE, OR COLOR.

NO CLAIM IS MADE TO THE EXCLUSIVE RIGHT TO USE "SOLUTIONS", APART FROM THE MARK AS SHOWN.

SER. NO. 85-441,805, FILED P.R. 10-7-2011; AM. S.R. 6-14-2012.

CHARISMA HAMPTON, EXAMINING ATTORNEY



*David J. Kyffers*

Director of the United States Patent and Trademark Office

# United States of America

## United States Patent and Trademark Office

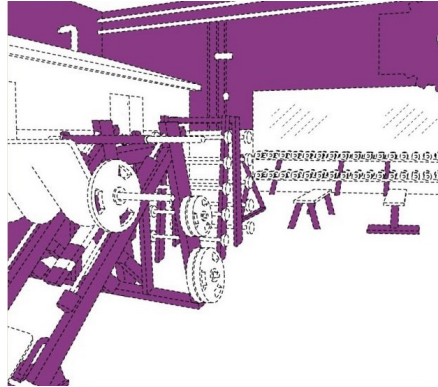

**Reg. No. 4,200,286**

**Registered Aug. 28, 2012**

**Int. Cl.: 41**

**SERVICE MARK**

**SUPPLEMENTAL REGISTER**

PFIP, LLC (NEW HAMPSHIRE LIMITED LIABILITY COMPANY)  
26 FOX RUN ROAD  
NEWINGTON, NH 03801

FOR: PHYSICAL FITNESS INSTRUCTION AND TRAINING; HEALTH CLUB SERVICES, NAMELY, PROVIDING INSTRUCTION AND EQUIPMENT IN THE FIELD OF PHYSICAL EXERCISE, IN CLASS 41 (U.S. CLS. 100, 101 AND 107).

FIRST USE 1-0-1998; IN COMMERCE 1-0-1998.

OWNER OF U.S. REG. NOS. 3,385,516, 3,936,371, AND OTHERS.

THE COLOR(S) PURPLE IS/ARE CLAIMED AS A FEATURE OF THE MARK.

THE MARK CONSISTS OF THE COLOR PURPLE AS APPLIED TO A PORTION OF THE SURFACE OF INTERIOR WALLS, FITNESS EQUIPMENT, WEIGHT RACKS, AND INTERIOR SIGNAGE WHICH ARE SHOWN IN THE DRAWING AS THEY APPEAR IN THE INTERIOR OF A FITNESS CENTER. THE MATTER SHOWN IN THE THREE-DIMENSIONAL DRAWING BY DOTTED LINES IS NOT A FEATURE OF THE MARK AND NO CLAIM IS MADE TO IT; IT SERVES ONLY TO SHOW THE POSITION OF THE MARK.

SER. NO. 85-441,980, FILED P.R. 10-7-2011; AM. S.R. 6-11-2012.

LINDA ESTRADA, EXAMINING ATTORNEY



*David J. Kyjars*

Director of the United States Patent and Trademark Office

# United States of America

United States Patent and Trademark Office

## HOUSE OF WOK

**Reg. No. 4,200,287**

**Registered Aug. 28, 2012**

**Int. Cl.: 43**

KOYFMAN, MARK (UNITED STATES INDIVIDUAL)  
APT. 604  
10275 COLLINS AVE  
BAL HARBOUR, FL 33154

FOR: RESTAURANT SERVICES, IN CLASS 43 (U.S. CLS. 100 AND 101).

**SERVICE MARK**

FIRST USE 10-10-2011; IN COMMERCE 10-10-2011.

**SUPPLEMENTAL REGISTER**

THE MARK CONSISTS OF STANDARD CHARACTERS WITHOUT CLAIM TO ANY PARTICULAR FONT, STYLE, SIZE, OR COLOR.

NO CLAIM IS MADE TO THE EXCLUSIVE RIGHT TO USE "HOUSE", APART FROM THE MARK AS SHOWN.

SER. NO. 85-445,483, FILED P.R. 10-12-2011; AM. S.R. 6-28-2012.

LINDA M. KING, EXAMINING ATTORNEY



*David J. Kyffers*

Director of the United States Patent and Trademark Office

# United States of America

United States Patent and Trademark Office

## Real Estate Transition Specialists

**Reg. No. 4,200,288**

GROSSMAN DREAM HOMES, INC. (COLORADO CORPORATION)  
6205 S. MACON WAY  
ENGLEWOOD, CO 80111

**Registered Aug. 28, 2012**

**Int. Cl.: 36**

FOR: RESIDENTIAL REAL ESTATE AGENCY SERVICES, IN CLASS 36 (U.S. CLS. 100, 101 AND 102).

**SERVICE MARK**

FIRST USE 4-1-2008; IN COMMERCE 4-1-2008.

**SUPPLEMENTAL REGISTER**

THE MARK CONSISTS OF STANDARD CHARACTERS WITHOUT CLAIM TO ANY PARTICULAR FONT, STYLE, SIZE, OR COLOR.

NO CLAIM IS MADE TO THE EXCLUSIVE RIGHT TO USE "REAL ESTATE", APART FROM THE MARK AS SHOWN.

SER. NO. 85-446,269, FILED P.R. 10-13-2011; AM. S.R. 6-21-2012.

CIMMERIAN COLEMAN, EXAMINING ATTORNEY



*David J. Kyffers*

Director of the United States Patent and Trademark Office

# United States of America

United States Patent and Trademark Office

# iParis

**Reg. No. 4,200,289**

CWEB, INC (NEVADA CORPORATION)

**Registered Aug. 28, 2012**

10624 S.EASTERN AVE A-798  
HENDERSON, CA 89052

**Int. Cl.: 45**

**SERVICE MARK**

**SUPPLEMENTAL REGISTER**

FOR: PARIS FASHION INFORMATION; ONLINE SOCIAL NETWORKING SERVICES PROVIDED THROUGH A FASHION COMMUNITY WEBSITE REGARDING PARIS FASHION; PERSONAL STYLIST SERVICES, NAMELY, EVALUATING THE PHYSICAL ATTRIBUTES, LIFESTYLE, AND FASHION STYLES OF OTHERS AND RECOMMENDING CLOTHING AND FASHION ACCESSORIES RELATED TO PARIS FASHION TO ACHIEVE THE PERSONAL IMAGE DESIRED BY THE CLIENT; PROVIDING PARIS FASHION INFORMATION; PROVIDING FASHION INFORMATION REGARDING PARIS FASHION IN THE FIELD OF DURABILITY, FIT AND STYLE OF LINGERIE PRODUCTS VIA THE INTERNET; PROVIDING INFORMATION ABOUT FASHION REGARDING PARIS FASHION; PROVIDING INFORMATION IN THE FIELD OF PARIS FASHION TRENDS; PROVIDING ONLINE FASHION QUESTIONS REGARDING PARIS FASHION TO HELP USERS DETERMINE THE STYLE OF CLOTHING BEST SUITED TO THEIR INDIVIDUAL NEEDS AND PREFERENCES; PROVISION OF A WEB SITE FEATURING INFORMATION ON PARIS FASHION, IN CLASS 45 (U.S. CLS. 100 AND 101).

FIRST USE 12-26-2009; IN COMMERCE 12-26-2009.

THE MARK CONSISTS OF STANDARD CHARACTERS WITHOUT CLAIM TO ANY PARTICULAR FONT, STYLE, SIZE, OR COLOR.

OWNER OF U.S. REG. NO. 3,919,504.

SER. NO. 85-446,833, FILED P.R. 10-13-2011; AM. S.R. 1-6-2011.

MAYUR VAGHANI, EXAMINING ATTORNEY



*David J. Kybas*

Director of the United States Patent and Trademark Office

# United States of America

United States Patent and Trademark Office

## THE REKEY SPECIAL

**Reg. No. 4,200,290**

JENNINGS, KENNETH L. (UNITED STATES INDIVIDUAL), DBA MR. REKEY,  
1421 WELLS BRANCH PARKWAY #104  
PFLUGERVILLE, TX 78660

**Registered Aug. 28, 2012**

**Int. Cl.: 37**

FOR: SERVICES PROVIDED BY LOCKSMITH, NAMELY, CHANGING, INSTALLATION,  
REPLACEMENT AND REPAIR OF LOCKS, IN CLASS 37 (U.S. CLS. 100, 103 AND 106).

**SERVICE MARK**

FIRST USE 0-0-2004; IN COMMERCE 0-0-2004.

**SUPPLEMENTAL REGISTER**

THE MARK CONSISTS OF STANDARD CHARACTERS WITHOUT CLAIM TO ANY PAR-  
TICULAR FONT, STYLE, SIZE, OR COLOR.

OWNER OF U.S. REG. NOS. 3,746,179 AND 3,859,310.

NO CLAIM IS MADE TO THE EXCLUSIVE RIGHT TO USE "REKEY", APART FROM THE  
MARK AS SHOWN.

SER. NO. 85-449,027, FILED 10-17-2011.

FRANK LATTUCA, EXAMINING ATTORNEY



*David J. Kyffers*

Director of the United States Patent and Trademark Office

# United States of America

United States Patent and Trademark Office

## CLASSIC COFFERS

**Reg. No. 4,200,291**

CLASSIC COFFERS, LLC (ILLINOIS LIMITED LIABILITY COMPANY)  
16092 LANGEMAN LN.  
BRIGHTON, IL 62012

**Registered Aug. 28, 2012**

**Int. Cl.: 19**

FOR: HARDWOOD FLOORING, IN CLASS 19 (U.S. CLS. 1, 12, 33 AND 50).

FIRST USE 2-25-2008; IN COMMERCE 2-25-2008.

**TRADEMARK**

THE MARK CONSISTS OF STANDARD CHARACTERS WITHOUT CLAIM TO ANY PARTICULAR FONT, STYLE, SIZE, OR COLOR.

**SUPPLEMENTAL REGISTER**

SER. NO. 85-449,224, FILED P.R. 10-17-2011; AM. S.R. 7-16-2012.

ROBERT C. CLARK JR., EXAMINING ATTORNEY



*David J. Kybas*

Director of the United States Patent and Trademark Office

# United States of America

United States Patent and Trademark Office

if it is to be  
it is up to me

**Reg. No. 4,200,292**

JENKINS, SHAWN Q., SR. (UNITED STATES INDIVIDUAL)  
9606 EVERGREEN STREET  
SILVER SPRING, MD 20901

**Registered Aug. 28, 2012**

**Int. Cl.: 25**

FOR: ATHLETIC APPAREL, NAMELY, SHIRTS, PANTS, JACKETS, FOOTWEAR, HATS AND CAPS, ATHLETIC UNIFORMS; BATHING SUITS; BODY SHIRTS; BOTTOMS; CYCLISTS' JERSEYS; FLEECE PULLOVERS; FLEECE VESTS; GOLF PANTS, SHIRTS AND SKIRTS; GOLF SHIRTS; HEADBANDS; HOODED SWEAT SHIRTS; JERSEYS; JOGGING SUITS; KNIT SHIRTS; LONG-SLEEVED SHIRTS; MOISTURE-WICKING SPORTS SHIRTS; PARKAS; POLO SHIRTS; PONCHOS; RAINCOATS; RUGBY SHIRTS; SHIRTS; SHIRTS AND SHORT-SLEEVED SHIRTS; SHORT-SLEEVED OR LONG-SLEEVED T-SHIRTS; SLEEVELESS JERSEYS; SOCKS; SPORT SHIRTS; SPORTS JERSEYS; SPORTS SHIRTS; SPORTS SHIRTS WITH SHORT SLEEVES; SWEAT SHIRTS; T-SHIRTS; TEE SHIRTS; TRIATHLON CLOTHING, NAMELY, TRIATHLON TIGHTS, TRIATHLON SHORTS, TRIATHLON SINGLET, TRIATHLON SHIRTS, TRIATHLON SUITS; TURTLE NECK SHIRTS; WARM UP SUITS; WIND SHIRTS; WRISTBANDS; YOGA SHIRTS, IN CLASS 25 (U.S. CLS. 22 AND 39).

**TRADEMARK**

**SUPPLEMENTAL REGISTER**

FIRST USE 10-17-2011; IN COMMERCE 10-17-2011.

THE MARK CONSISTS OF STANDARD CHARACTERS WITHOUT CLAIM TO ANY PARTICULAR FONT, STYLE, SIZE, OR COLOR.

SER. NO. 85-450,538, FILED P.R. 10-19-2011; AM. S.R. 6-25-2012.

DORITT L. CARROLL, EXAMINING ATTORNEY



*David J. Kyros*

Director of the United States Patent and Trademark Office



# United States of America

United States Patent and Trademark Office

## Annapolis Lifestyle

**Reg. No. 4,200,293**

SCHWAB, TIMOTHY J. (UNITED STATES INDIVIDUAL)  
PO BOX 2314  
EASTON, MD 21601

**Registered Aug. 28, 2012**

**Int. Cl.: 16**

FOR: GENERAL FEATURE MAGAZINES, IN CLASS 16 (U.S. CLS. 2, 5, 22, 23, 29, 37, 38 AND 50).

**TRADEMARK**

FIRST USE 10-17-2011; IN COMMERCE 10-17-2011.

**SUPPLEMENTAL REGISTER**

THE MARK CONSISTS OF STANDARD CHARACTERS WITHOUT CLAIM TO ANY PARTICULAR FONT, STYLE, SIZE, OR COLOR.

SER. NO. 85-455,315, FILED P.R. 10-25-2011; AM. S.R. 6-29-2012.

CIMMERIAN COLEMAN, EXAMINING ATTORNEY



*David J. Kybas*

Director of the United States Patent and Trademark Office

# United States of America

United States Patent and Trademark Office

## ADVANCED ENERGY B2B CONFERENCE & EXPO

**Reg. No. 4,200,294**

NORTHEAST OHIO TECHNOLOGY COALITION (OHIO CORPORATION), DBA NORTECH,  
SUITE 1000, 737 BOLIVAR ROAD  
CLEVELAND, OH 44115

**Registered Aug. 28, 2012**

**Int. Cl.: 35**

FOR: ORGANIZING AND CONDUCTING MEETINGS, TRADE SHOWS, CONFERENCES,  
EXPOSITIONS, AND INDUSTRY NETWORKING EVENTS IN THE FIELD OF ENERGY FOR  
ECONOMIC DEVELOPMENT PURPOSES, IN CLASS 35 (U.S. CLS. 100, 101 AND 102).

**SERVICE MARK**

FIRST USE 9-14-2011; IN COMMERCE 9-14-2011.

**SUPPLEMENTAL REGISTER**

THE MARK CONSISTS OF STANDARD CHARACTERS WITHOUT CLAIM TO ANY PAR-  
TICULAR FONT, STYLE, SIZE, OR COLOR.

NO CLAIM IS MADE TO THE EXCLUSIVE RIGHT TO USE "CONFERENCE & EXPO",  
APART FROM THE MARK AS SHOWN.

SER. NO. 85-456,728, FILED P.R. 10-26-2011; AM. S.R. 6-19-2012.

ELLEN B. AWRICH, EXAMINING ATTORNEY



*David J. Kyros*

Director of the United States Patent and Trademark Office

# United States of America

United States Patent and Trademark Office

## Single N Dating

**Reg. No. 4,200,295**

BARBERENA, CARLOS J (UNITED STATES INDIVIDUAL)  
1510 SW 118TH AVE  
MIAMI, FL 33184

**Registered Aug. 28, 2012**

**Int. Cl.: 45**

FOR: ON-LINE SOCIAL NETWORKING SERVICES, IN CLASS 45 (U.S. CLS. 100 AND 101).

**SERVICE MARK**

FIRST USE 4-6-2010; IN COMMERCE 4-6-2010.

**SUPPLEMENTAL REGISTER**

THE MARK CONSISTS OF STANDARD CHARACTERS WITHOUT CLAIM TO ANY PARTICULAR FONT, STYLE, SIZE, OR COLOR.

SER. NO. 85-457,401, FILED P.R. 10-27-2011; AM. S.R. 6-29-2012.

RUSS HERMAN, EXAMINING ATTORNEY



*David J. Kyffers*

Director of the United States Patent and Trademark Office

# United States of America

United States Patent and Trademark Office

## SCALED AGILE PARTNERS

**Reg. No. 4,200,296**

LEFFINGWELL, LLC (COLORADO LIMITED LIABILITY COMPANY)  
1899 CONTINENTAL VIEW DRIVE  
LOUISVILLE, CO 80027

**Registered Aug. 28, 2012**

**Int. Cl.: 42**

FOR: CONSULTING SERVICES IN THE FIELD OF THE DESIGN OF COMPUTER SOFTWARE DEVELOPMENT, IN CLASS 42 (U.S. CLS. 100 AND 101).

**SERVICE MARK**

FIRST USE 10-18-2011; IN COMMERCE 12-2-2011.

**SUPPLEMENTAL REGISTER**

THE MARK CONSISTS OF STANDARD CHARACTERS WITHOUT CLAIM TO ANY PARTICULAR FONT, STYLE, SIZE, OR COLOR.

NO CLAIM IS MADE TO THE EXCLUSIVE RIGHT TO USE "PARTNERS", APART FROM THE MARK AS SHOWN.

SER. NO. 85-458,399, FILED P.R. 10-27-2011; AM. S.R. 7-9-2012.

TRACY FLETCHER, EXAMINING ATTORNEY



*David J. Kybas*

Director of the United States Patent and Trademark Office

# United States of America

United States Patent and Trademark Office

## ACCREDITATION COUNCIL FOR EDUCATION IN NUTRITION AND DIETETICS

**Reg. No. 4,200,297**

**Registered Aug. 28, 2012**

**Int. Cl.: 42**

**SERVICE MARK**

**SUPPLEMENTAL REGISTER**

ACADEMY OF NUTRITION AND DIETETICS (ILLINOIS CORPORATION)  
120 SOUTH RIVERSIDE PLAZA  
SUITE 2000  
CHICAGO, IL 60606

FOR: ACCREDITATION SERVICES, NAMELY, ESTABLISHING AND ENFORCING ELIGIBILITY REQUIREMENTS AND ACCREDITATION STANDARDS THAT ENSURE THE QUALITY AND CONTINUED IMPROVEMENT OF NUTRITION AND DIETETICS EDUCATION PROGRAMS FOR THE PURPOSE OF ACCREDITATION; ACCREDITATION SERVICES, NAMELY, DEVELOPING AND ADMINISTERING EDUCATIONAL STANDARDS AND PROCEDURES FOR CERTIFYING PROFESSIONALS IN THE FIELDS OF NUTRITION AND DIETETICS, IN CLASS 42 (U.S. CLS. 100 AND 101).

FIRST USE 1-1-2012; IN COMMERCE 1-1-2012.

THE MARK CONSISTS OF STANDARD CHARACTERS WITHOUT CLAIM TO ANY PARTICULAR FONT, STYLE, SIZE, OR COLOR.

SER. NO. 85-465,679, FILED P.R. 11-7-2011; AM. S.R. 6-25-2012.

KYLE PEETE, EXAMINING ATTORNEY



*David J. Kypos*

Director of the United States Patent and Trademark Office

# United States of America

United States Patent and Trademark Office

## CANLESS AIR SYSTEM

**Reg. No. 4,200,298**

JWS ENTERPRISES, LLC. (ARIZONA LIMITED LIABILITY COMPANY)  
6543 E. HUMMINGBIRD LANE  
PHOENIX, AZ 85243

**Registered Aug. 28, 2012**

**Int. Cl.: 7**

FOR: POWER OPERATED BLOWERS, IN CLASS 7 (U.S. CLS. 13, 19, 21, 23, 31, 34 AND 35).

**TRADEMARK**

FIRST USE 7-1-2011; IN COMMERCE 3-25-2012.

**SUPPLEMENTAL REGISTER**

THE MARK CONSISTS OF STANDARD CHARACTERS WITHOUT CLAIM TO ANY PARTICULAR FONT, STYLE, SIZE, OR COLOR.

SER. NO. 85-466,171, FILED P.R. 11-7-2011; AM. S.R. 7-23-2012.

CHRISTOPHER LAW, EXAMINING ATTORNEY



*David J. Kyfos*

Director of the United States Patent and Trademark Office

# United States of America

United States Patent and Trademark Office

## COSMETIC CAMPUS

**Reg. No. 4,200,299**

PFEIFFER CONSULTING GMBH (FED REP GERMANY CORPORATION)  
IM BRÜNNLISLEHEN 18

**Registered Aug. 28, 2012**

PFORZHEIM, FED REP GERMANY 71580

**Int. Cls.: 16, 41, 42, and 44**

FOR: BROCHURES, BOOKS, JOURNALS, INSTRUCTIONAL AND TEACHING MATERIAL EXCEPT APPARATUSES, MAGAZINES IN THE NATURE OF JOURNALS, PERIODICALS, ALL IN THE FIELDS OF COSMETICS, LAW AND REGULATION RELATED TO THE COSMETICS INDUSTRY, PRODUCT DEVELOPMENT IN THE COSMETICS INDUSTRY, MANUFACTURING OF COSMETICS PRODUCTS, INDUSTRIAL HYGIENE, INGREDIENTS USED WITHIN COSMETICS PRODUCTS, IN CLASS 16 (U.S. CLS. 2, 5, 22, 23, 29, 37, 38 AND 50).

**TRADEMARK**

**SERVICE MARK**

**SUPPLEMENTAL REGISTER**

FOR: EDUCATION, NAMELY, PROVIDING SEMINARS AND WORKSHOPS IN THE FIELD OF COSMETICS, LAW AND REGULATION RELATED TO THE COSMETICS INDUSTRY, PRODUCT DEVELOPMENT IN THE COSMETICS INDUSTRY, MANUFACTURING OF COSMETICS PRODUCTS, INDUSTRIAL HYGIENE, INGREDIENTS USED WITHIN COSMETICS PRODUCTS, IN CLASS 41 (U.S. CLS. 100, 101 AND 107).

FOR: SCIENTIFIC AND TECHNOLOGICAL SERVICES AND RESEARCH AND DESIGN RELATING THERETO, NAMELY, DEVELOPMENT AND DESIGN OF COSMETICS, COSMETICS MANUFACTURING PROCESSES, COSMETIC TESTING PROCESSES; INDUSTRIAL ANALYSIS AND RESEARCH SERVICES, NAMELY, CHEMICAL ANALYSIS OF COSMETIC PRODUCTS, INDUSTRIAL ANALYSIS OF COSMETIC MANUFACTURING PROCESSES, IN CLASS 42 (U.S. CLS. 100 AND 101).

FOR: MEDICAL SERVICES; VETERINARY SERVICES; HEALTH AND BEAUTY CARE SERVICES, NAMELY, BEAUTY SPA SERVICES IN THE NATURE OF COSMETIC BODY CARE, HYGIENIC AND BEAUTY CARE, BEAUTY SALONS, IN CLASS 44 (U.S. CLS. 100 AND 101).



THE MARK CONSISTS OF STANDARD CHARACTERS WITHOUT CLAIM TO ANY PARTICULAR FONT, STYLE, SIZE, OR COLOR.

OWNER OF ERPN CMNTY TM OFC REG. NO. 009465543, DATED 7-15-2011, EXPIRES 7-15-2021.

SER. NO. 85-467,647, FILED P.R. 11-8-2011; AM. S.R. 6-27-2012.

*David J. Kyros*

Director of the United States Patent and Trademark Office

**Reg. No. 4,200,299** MARK SHINER, EXAMINING ATTORNEY



# United States of America

United States Patent and Trademark Office

## GRIP 'N MELT

**Reg. No. 4,200,300**

**Registered Aug. 28, 2012**

**Int. Cl.: 1**

**TRADEMARK**

**SUPPLEMENTAL REGISTER**

OMG MIDWEST, INC. (DELAWARE CORPORATION)  
C/O OLDCASTLE LAW GROUP  
900 ASHWOOD PARKWAY  
ATLANTA, GA 30338

FOR: BLEND OF CRUSHED QUARTZITE ROCK AND SODIUM CHLORIDE (SALT) USED FOR DEICING DEICING SURFACES, IN CLASS 1 (U.S. CLS. 1, 5, 6, 10, 26 AND 46).

FIRST USE 11-3-2011; IN COMMERCE 11-3-2011.

THE MARK CONSISTS OF STANDARD CHARACTERS WITHOUT CLAIM TO ANY PARTICULAR FONT, STYLE, SIZE, OR COLOR.

NO CLAIM IS MADE TO THE EXCLUSIVE RIGHT TO USE "MELT", APART FROM THE MARK AS SHOWN.

SER. NO. 85-469,639, FILED P.R. 11-10-2011; AM. S.R. 6-29-2012.

ANDREA HACK, EXAMINING ATTORNEY



*David J. Kyffers*

Director of the United States Patent and Trademark Office

# United States of America

United States Patent and Trademark Office

## Scripture Stickies

**Reg. No. 4,200,301**

JULIE ALVAREZ (UNITED STATES INDIVIDUAL), DBA SCRIPTURE STICKIES,  
405 EL CAMINO REAL #434  
MENLO PARK, CA 94025

**Registered Aug. 28, 2012**

**Int. Cl.: 16**

FOR: ADHESIVE NOTE PAPER, IN CLASS 16 (U.S. CLS. 2, 5, 22, 23, 29, 37, 38 AND 50).

FIRST USE 11-1-2007; IN COMMERCE 11-8-2008.

**TRADEMARK**

THE MARK CONSISTS OF STANDARD CHARACTERS WITHOUT CLAIM TO ANY PARTICULAR FONT, STYLE, SIZE, OR COLOR.

**SUPPLEMENTAL REGISTER**

NO CLAIM IS MADE TO THE EXCLUSIVE RIGHT TO USE "STICKIES", APART FROM THE MARK AS SHOWN.

SER. NO. 85-471,314, FILED P.R. 11-13-2011; AM. S.R. 7-12-2012.

ZACHARY BELLO, EXAMINING ATTORNEY



*David J. Kyffers*

Director of the United States Patent and Trademark Office

# United States of America

United States Patent and Trademark Office

## Fall Challenge

**Reg. No. 4,200,302**

**Registered Aug. 28, 2012**

**Int. Cl.: 35**

ILLINOIS TECHNOLOGY ASSOCIATION (ILLINOIS CORPORATION), DBA ILLINOIS  
TECHNOLOGY ASSOCIATION,  
15TH FLOOR  
200 S WACKER DRIVE  
CHICAGO, IL 60606

**SERVICE MARK**

**SUPPLEMENTAL REGISTER**

FOR: ENGAGING STUDENTS IN COMPETITION TO DISTINGUISH TOP TALENT, AND PROVIDING NETWORKING OPPORTUNITIES FOR STUDENTS SEEKING INTERNSHIPS AND EMPLOYMENT WITH EMPLOYERS SEEKING ENTRY LEVEL TALENT, NAMELY, PROVIDING NETWORKING OPPORTUNITIES FOR INDIVIDUALS SEEKING EMPLOYMENT, IN CLASS 35 (U.S. CLS. 100, 101 AND 102).

FIRST USE 9-13-2010; IN COMMERCE 9-13-2010.

THE MARK CONSISTS OF STANDARD CHARACTERS WITHOUT CLAIM TO ANY PARTICULAR FONT, STYLE, SIZE, OR COLOR.

SER. NO. 85-479,993, FILED P.R. 11-23-2011; AM. S.R. 5-23-2012.

SANI KHOURI, EXAMINING ATTORNEY



*David J. Kybas*

Director of the United States Patent and Trademark Office

# United States of America

United States Patent and Trademark Office

## AMERICAN TUBE AND PIPE

**Reg. No. 4,200,303**

AMERICAN FENCE COMPANY OF ARIZONA, INC. (ARIZONA CORPORATION)  
2502 N. 27TH AVE.

**Registered Aug. 28, 2012**

PHOENIX, AZ 85009

**Int. Cl.: 6**

FOR: METAL PIPES; METAL TUBES, IN CLASS 6 (U.S. CLS. 2, 12, 13, 14, 23, 25 AND 50).

FIRST USE 5-1-2012; IN COMMERCE 5-1-2012.

**TRADEMARK**

THE MARK CONSISTS OF STANDARD CHARACTERS WITHOUT CLAIM TO ANY PARTICULAR FONT, STYLE, SIZE, OR COLOR.

**SUPPLEMENTAL REGISTER**

NO CLAIM IS MADE TO THE EXCLUSIVE RIGHT TO USE "TUBE AND PIPE", APART FROM THE MARK AS SHOWN.

SER. NO. 85-480,148, FILED P.R. 11-23-2011; AM. S.R. 6-27-2012.

AMY HELLA, EXAMINING ATTORNEY



*David J. Kyffers*

Director of the United States Patent and Trademark Office

# United States of America

United States Patent and Trademark Office

# CLINICAL

**Reg. No. 4,200,304**

IMPERIAL PAINTS, LLC (SOUTH CAROLINA LIMITED LIABILITY COMPANY)  
POST OFFICE BOX 6404  
SPARTANBURG, SC 29304

**Registered Aug. 28, 2012**

**Int. Cl.: 2**

FOR: PAINTS, IN CLASS 2 (U.S. CLS. 6, 11 AND 16).

**TRADEMARK**

FIRST USE 3-5-2012; IN COMMERCE 3-5-2012.

**SUPPLEMENTAL REGISTER**

THE MARK CONSISTS OF STANDARD CHARACTERS WITHOUT CLAIM TO ANY PARTICULAR FONT, STYLE, SIZE, OR COLOR.

SER. NO. 85-482,267, FILED P.R. 11-29-2011; AM. S.R. 6-1-2012.

DAWN HAN, EXAMINING ATTORNEY



*David J. Kyffers*

Director of the United States Patent and Trademark Office

# United States of America

United States Patent and Trademark Office

## BICYCLE FRIENDLY PROFESSIONAL

**Reg. No. 4,200,305**

BE BIKE FRIENDLY, INC. (GEORGIA CORPORATION)  
11140 WEST ROAD  
ROSWELL, GA 30075

**Registered Aug. 28, 2012**

**Int. Cl.: 41**

FOR: EDUCATIONAL SERVICES, NAMELY, CONDUCTING TRAINING CLASSES AND COURSES IN THE FIELD OF BICYCLE INFRASTRUCTURE; CONSULTING REGARDING EDUCATIONAL COURSES AND TRAINING IN THE FIELD OF BICYCLE INFRASTRUCTURE, AWARENESS AND PROGRAMS, IN CLASS 41 (U.S. CLS. 100, 101 AND 107).

**SERVICE MARK**

**SUPPLEMENTAL REGISTER** FIRST USE 12-20-2010; IN COMMERCE 2-24-2011.

THE MARK CONSISTS OF STANDARD CHARACTERS WITHOUT CLAIM TO ANY PARTICULAR FONT, STYLE, SIZE, OR COLOR.

SER. NO. 85-482,600, FILED P.R. 11-29-2011; AM. S.R. 7-2-2012.

SUE LAWRENCE, EXAMINING ATTORNEY



*David J. Kyffers*

Director of the United States Patent and Trademark Office

**United States of America**  
United States Patent and Trademark Office

# Prime Dip

**Reg. No. 4,200,306**

PRIME DIP LLC (CALIFORNIA LIMITED LIABILITY COMPANY)  
528 LARKIN ST  
SAN FRANCISCO, CA 94109

**Registered Aug. 28, 2012**

**Int. Cl.: 43**

FOR: FAST-FOOD RESTAURANT SERVICES, IN CLASS 43 (U.S. CLS. 100 AND 101).

**SERVICE MARK**

FIRST USE 10-1-2011; IN COMMERCE 10-1-2011.

**SUPPLEMENTAL REGISTER**

THE MARK CONSISTS OF STANDARD CHARACTERS WITHOUT CLAIM TO ANY PARTICULAR FONT, STYLE, SIZE, OR COLOR.

SER. NO. 85-491,311, FILED P.R. 12-9-2011; AM. S.R. 7-2-2012.

WILLIAM JACKSON, EXAMINING ATTORNEY



*David J. Kyffers*

Director of the United States Patent and Trademark Office

# United States of America

United States Patent and Trademark Office

## BIKE BUMPER

**Reg. No. 4,200,307**

EDWARD M. FILES (UNITED STATES INDIVIDUAL)  
275 NW VICTORIA DRIVE

**Registered Aug. 28, 2012**

LEE'S SUMMIT, MO 64086

**Int. Cl.: 12**

FOR: FITTED COVERS FOR MOTORCYCLE FAIRINGS, IN CLASS 12 (U.S. CLS. 19, 21, 23, 31, 35 AND 44).

**TRADEMARK**

FIRST USE 12-1-2011; IN COMMERCE 12-1-2011.

**SUPPLEMENTAL REGISTER**

THE MARK CONSISTS OF STANDARD CHARACTERS WITHOUT CLAIM TO ANY PARTICULAR FONT, STYLE, SIZE, OR COLOR.

SER. NO. 85-491,781, FILED P.R. 12-9-2011; AM. S.R. 6-12-2012.

CORY BOONE, EXAMINING ATTORNEY



*David J. Kyffers*

Director of the United States Patent and Trademark Office



# United States of America

United States Patent and Trademark Office

# CORDLATCH

**Reg. No. 4,200,308**

R C DESIGN & ENGINEERING, INC. (KANSAS CORPORATION)  
15610 HONEY CREEK ROAD  
BONNER SPRINGS, KS 66012

**Registered Aug. 28, 2012**

**Int. Cl.: 20**

FOR: NON-METAL LATCH FOR JOINING EXTENSION CORDS AND/OR POWER TOOLS,  
IN CLASS 20 (U.S. CLS. 2, 13, 22, 25, 32 AND 50).

**TRADEMARK**

FIRST USE 6-22-2009; IN COMMERCE 6-22-2009.

**SUPPLEMENTAL REGISTER**

THE MARK CONSISTS OF STANDARD CHARACTERS WITHOUT CLAIM TO ANY PARTICULAR FONT, STYLE, SIZE, OR COLOR.

SER. NO. 85-491,846, FILED P.R. 12-9-2011; AM. S.R. 7-20-2012.

IRA J. GOODSaid, EXAMINING ATTORNEY



*David J. Kyfos*

Director of the United States Patent and Trademark Office

# United States of America

United States Patent and Trademark Office

## THE ONLY CONTINUOUS ONLINE OIL & GAS PROPERTY MARKETPLACE SPECIALIZING IN AUCTION AND NEGOTIATED SALES 24/7/365

**Reg. No. 4,200,309**

ENERGYNET.COM, INC. (TEXAS CORPORATION)  
7201 I-40 WEST, SUITE 319  
AMARILLO, TX 79106

**Registered Aug. 28, 2012**

**Int. Cl.: 35**

FOR: CONTINUOUS ONLINE OIL AND GAS AUCTION SERVICES TO QUALIFIED BUYERS AND SELLERS VIA THE INTERNET AND DIRECT NEGOTIATED SALES, IN CLASS 35 (U.S. CLS. 100, 101 AND 102).

**SERVICE MARK**

FIRST USE 11-6-2010; IN COMMERCE 11-6-2010.

**SUPPLEMENTAL REGISTER**

THE MARK CONSISTS OF STANDARD CHARACTERS WITHOUT CLAIM TO ANY PARTICULAR FONT, STYLE, SIZE, OR COLOR.

NO CLAIM IS MADE TO THE EXCLUSIVE RIGHT TO USE "ONLINE OIL & GAS PROPERTY MARKETPLACE" AND "AUCTION AND NEGOTIATED SALES", APART FROM THE MARK AS SHOWN.

SER. NO. 85-499,060, FILED P.R. 12-19-2011; AM. S.R. 7-9-2012.

LINDA MICKLEBURGH, EXAMINING ATTORNEY



*David J. Kybas*

Director of the United States Patent and Trademark Office

# United States of America

United States Patent and Trademark Office

## KNOWN CREWMEMBER

**Reg. No. 4,200,310**

**Registered Aug. 28, 2012**

**Int. Cls.: 42 and 45**

**SERVICE MARK**

**SUPPLEMENTAL REGISTER**

AIR LINE PILOTS ASSOCIATION, INT'L (STATELESS UNICORPORATED LABOR ORGANIZATION)  
535 HERNDON PARKWAY  
HERNDON, VA 22070 AND

AIR TRANSPORT ASSOCIATION OF AMERICA, INC. (D.C. NON-PROFIT CORPORATION)  
1301 PENNSYLVANIA AVE., N.W., SUITE 1100  
WASHINGTON, DC 20004

FOR: PROVIDING TEMPORARY USE OF NON-DOWNLOADABLE SOFTWARE TO CONFIRM IDENTITY AND CURRENT EMPLOYMENT STATUS OF IN-FLIGHT PERSONNEL, IN CLASS 42 (U.S. CLS. 100 AND 101).

FIRST USE 8-9-2011; IN COMMERCE 8-9-2011.

FOR: IDENTIFICATION VERIFICATION SERVICES, NAMELY, PROVIDING AUTHENTICATION OF PERSONAL IDENTIFICATION INFORMATION FOR IN-FLIGHT PERSONNEL, IN CLASS 45 (U.S. CLS. 100 AND 101).

FIRST USE 8-9-2011; IN COMMERCE 8-9-2011.

THE MARK CONSISTS OF STANDARD CHARACTERS WITHOUT CLAIM TO ANY PARTICULAR FONT, STYLE, SIZE, OR COLOR.

NO CLAIM IS MADE TO THE EXCLUSIVE RIGHT TO USE "CREWMEMBER", APART FROM THE MARK AS SHOWN.

SER. NO. 85-500,160, FILED P.R. 12-20-2011; AM. S.R. 6-11-2012.

DOMINIC J. FERRAIUOLO, EXAMINING ATTORNEY



*David J. Kybas*

Director of the United States Patent and Trademark Office

# United States of America

United States Patent and Trademark Office

## CREDIT COUNSELLING SOCIETY

**Reg. No. 4,200,311**

CREDIT COUNSELLING SOCIETY OF BRITISH COLUMBIA (CANADA A SOCIETY)  
SUITE 330 - 435 COLUMBIA STREET  
NEW WESTMINSTER, BC, CANADA V3L5N8

**Registered Aug. 28, 2012**

**Int. Cls.: 36 and 41**

FOR: DEBT COUNSELING SERVICES AND FINANCIAL COUNSELING SERVICES, NAMELY, HELPING OTHERS BUILD A BETTER WORKING RELATIONSHIP WITH THEIR MONEY; PROVIDING INFORMATION IN THE FIELD OF DEBT AND FINANCIAL COUNSELING, IN CLASS 36 (U.S. CLS. 100, 101 AND 102).

**SERVICE MARK**

**SUPPLEMENTAL REGISTER** FIRST USE 12-31-2011; IN COMMERCE 12-31-2011.

FOR: CONSUMER EDUCATION SERVICES, NAMELY, WORKSHOPS, SEMINARS, CLASSES AND WEBINARS IN THE AREAS OF MANAGING DEBT, ESTABLISHING, MANAGING AND REBUILDING CREDIT, PERSONAL BUDGET AND EXPENSE MANAGEMENT, FINANCIAL MANAGEMENT, FINANCIAL PLANNING, DEBT MANAGEMENT AND SETTLEMENT PROGRAMS, INSOLVENCY COUNSELING, MONEY MANAGEMENT, AND PERSONAL BUDGETING, SAVINGS AND EXPENSE GUIDANCE, IN CLASS 41 (U.S. CLS. 100, 101 AND 107).

FIRST USE 12-31-2011; IN COMMERCE 12-31-2011.

THE MARK CONSISTS OF STANDARD CHARACTERS WITHOUT CLAIM TO ANY PARTICULAR FONT, STYLE, SIZE, OR COLOR.

SER. NO. 85-500,223, FILED P.R. 12-20-2011; AM. S.R. 7-20-2012.

GINA HAYES, EXAMINING ATTORNEY



*David J. Kybas*

Director of the United States Patent and Trademark Office

# United States of America

United States Patent and Trademark Office

## SUPER HYDRATING WATER

**Reg. No. 4,200,312**

ESSENTIA WATER, INC. (WASHINGTON CORPORATION)  
22833 BOTHELL EVERETT HIGHWAY, SUITE 220  
BOTHELL, WA 98021

**Registered Aug. 28, 2012**

**Int. Cl.: 32**

FOR: BOTTLED WATER, IN CLASS 32 (U.S. CLS. 45, 46 AND 48).

**TRADEMARK**

FIRST USE 5-24-2012; IN COMMERCE 5-24-2012.

**SUPPLEMENTAL REGISTER**

THE MARK CONSISTS OF STANDARD CHARACTERS WITHOUT CLAIM TO ANY PARTICULAR FONT, STYLE, SIZE, OR COLOR.

NO CLAIM IS MADE TO THE EXCLUSIVE RIGHT TO USE "HYDRATING WATER", APART FROM THE MARK AS SHOWN.

SER. NO. 85-502,018, FILED P.R. 12-22-2011; AM. S.R. 5-29-2012.

CHRISTOPHER LAW, EXAMINING ATTORNEY



*David J. Kyffers*

Director of the United States Patent and Trademark Office

# United States of America

United States Patent and Trademark Office

# MAGICPLACE

**Reg. No. 4,200,313**

**Registered Aug. 28, 2012**

**Int. Cl.: 41**

**SERVICE MARK**

**SUPPLEMENTAL REGISTER**

MPOA LLC (NEVADA LIMITED LIABILITY COMPANY)  
C/O KAPLAN MASSAMILLO ATTN: T CARULLI  
70 EAST 55TH STREET 25TH FLOOR  
NEW YORK, NY 10022

FOR: ENTERTAINMENT SERVICES, NAMELY, PROVIDING AN INTERACTIVE WEBSITE  
FEATURING INFORMATION IN THE FIELD OF ILLUSION AND MAGIC, IN CLASS 41  
(U.S. CLS. 100, 101 AND 107).

FIRST USE 8-15-2011; IN COMMERCE 8-15-2011.

THE MARK CONSISTS OF STANDARD CHARACTERS WITHOUT CLAIM TO ANY PAR-  
TICULAR FONT, STYLE, SIZE, OR COLOR.

SER. NO. 85-504,092, FILED P.R. 12-27-2011; AM. S.R. 6-25-2012.

JAY BESCH, EXAMINING ATTORNEY



*David J. Kyffers*

Director of the United States Patent and Trademark Office

# United States of America

United States Patent and Trademark Office

## Military Wives Saving

**Reg. No. 4,200,314**

DUDAS, MICHELLE A (UNITED STATES INDIVIDUAL)  
5225 PRINGLE WAY

**Registered Aug. 28, 2012**

HOPE MILLS, NC 28348

**Int. Cl.: 35**

FOR: PROMOTING AND MARKETING THE GOODS AND SERVICES OF OTHERS BY DISTRIBUTING ADVERTISING MATERIAL, COUPONS AND DISCOUNT OFFERS VIA TEXT MESSAGES; PROMOTING THE GOODS AND SERVICES OF OTHERS BY PROVIDING A WEBSITE FEATURING COUPONS, REBATES, PRICE-COMPARISON INFORMATION, PRODUCT REVIEWS, LINKS TO THE RETAIL WEBSITES OF OTHERS, AND DISCOUNT INFORMATION; PROMOTING THE GOODS AND SERVICES OF OTHERS BY PROVIDING A COMMUNITY-DRIVEN WEBSITE AND PROVIDING HYPERLINKS TO OTHER WEBSITES THAT DISTRIBUTE COUPONS; PROMOTING THE GOODS OF OTHERS, NAMELY, PROVIDING COUPONS, REBATES AND VOUCHERS FOR THE GOODS OF OTHERS; PROMOTING THE GOODS OF OTHERS, NAMELY, PROVIDING INFORMATION REGARDING DISCOUNTS, COUPONS, REBATES, VOUCHERS AND SPECIAL OFFERS FOR THE GOODS OF OTHERS, IN CLASS 35 (U.S. CLS. 100, 101 AND 102).

**SERVICE MARK**

**SUPPLEMENTAL REGISTER**

FIRST USE 7-7-2010; IN COMMERCE 7-7-2010.

THE MARK CONSISTS OF STANDARD CHARACTERS WITHOUT CLAIM TO ANY PARTICULAR FONT, STYLE, SIZE, OR COLOR.

SER. NO. 85-507,290, FILED P.R. 1-2-2012; AM. S.R. 7-9-2012.

JULIE WATSON, EXAMINING ATTORNEY



*David J. Kyffers*

Director of the United States Patent and Trademark Office

# United States of America

United States Patent and Trademark Office

## College Radio Defense Fund

**Reg. No. 4,200,315**

**Registered Aug. 28, 2012**

**Int. Cl.: 36**

**SERVICE MARK**

**SUPPLEMENTAL REGISTER**

ROBERT MARK QUICKE (UNITED STATES INDIVIDUAL), DBA COLLEGE RADIO DAY, LLC,  
30 FAIRLAWN DRIVE  
HEWITT, NJ 07421

FOR: CHARITABLE FUNDRAISING TO SUPPORT COLLEGE AND HIGH SCHOOL RADIO STATIONS IN NORTH AMERICA, IN CLASS 36 (U.S. CLS. 100, 101 AND 102).

FIRST USE 1-1-2012; IN COMMERCE 1-1-2012.

THE MARK CONSISTS OF STANDARD CHARACTERS WITHOUT CLAIM TO ANY PARTICULAR FONT, STYLE, SIZE, OR COLOR.

NO CLAIM IS MADE TO THE EXCLUSIVE RIGHT TO USE "DEFENSE FUND", APART FROM THE MARK AS SHOWN.

SER. NO. 85-508,110, FILED P.R. 1-3-2012; AM. S.R. 6-29-2012.

DANIEL CAPSHAW, EXAMINING ATTORNEY



*David J. Kyffers*

Director of the United States Patent and Trademark Office



# United States of America

United States Patent and Trademark Office

## The Honorifics

**Reg. No. 4,200,316**

**Registered Aug. 28, 2012**

**Int. Cl.: 9**

**TRADEMARK**

**SUPPLEMENTAL REGISTER**

THE HONORIFICS, LLC (NEVADA LIMITED LIABILITY COMPANY)  
#245  
867 N. LAMB BLVD.  
LAS VEGAS, NV 89110

FOR: AUDIO AND VIDEO RECORDINGS FEATURING MUSIC AND ARTISTIC PERFORMANCES; DOWNLOADABLE MUSICAL SOUND RECORDINGS, IN CLASS 9 (U.S. CLS. 21, 23, 26, 36 AND 38).

FIRST USE 7-23-2010; IN COMMERCE 7-23-2010.

THE MARK CONSISTS OF STANDARD CHARACTERS WITHOUT CLAIM TO ANY PARTICULAR FONT, STYLE, SIZE, OR COLOR.

SER. NO. 85-511,883, FILED P.R. 1-9-2012; AM. S.R. 6-25-2012.

LINDA POWELL, EXAMINING ATTORNEY



*David J. Kyffers*

Director of the United States Patent and Trademark Office

# United States of America

United States Patent and Trademark Office

## COST-EFFICIENT PARALEGAL SERVICES, INC.

**Reg. No. 4,200,317**

COST-EFFICIENT PARALEGAL SERVICES, INC. (FLORIDA CORPORATION)

**Registered Aug. 28, 2012**

P.O. BOX 770754  
CORAL SPRINGS, FL 33077

**Int. Cl.: 45**

FOR: PROVIDING ASSISTANCE IN THE PROSECUTION OF PATENT AND TRADEMARK APPLICATIONS; PREPARATION OF BANKRUPTCY AND IMMIGRATION LEGAL DOCUMENTS FOR ATTORNEYS AND CLIENTS, LEGAL RESEARCH, DOCKETING, AND NOTARY SERVICES, IN CLASS 45 (U.S. CLS. 100 AND 101).

**SERVICE MARK**

**SUPPLEMENTAL REGISTER** FIRST USE 1-6-2012; IN COMMERCE 1-6-2012.

THE MARK CONSISTS OF STANDARD CHARACTERS WITHOUT CLAIM TO ANY PARTICULAR FONT, STYLE, SIZE, OR COLOR.

NO CLAIM IS MADE TO THE EXCLUSIVE RIGHT TO USE "PARALEGAL SERVICES, INC.", APART FROM THE MARK AS SHOWN.

SER. NO. 85-513,509, FILED P.R. 1-11-2012; AM. S.R. 7-9-2012.

CHRISTINA SOBRAL, EXAMINING ATTORNEY



*David J. Kybas*

Director of the United States Patent and Trademark Office

# United States of America

United States Patent and Trademark Office

## Katerpillar Killer

**Reg. No. 4,200,318**

ASAP PRODUCTS LLC (TEXAS LIMITED LIABILITY COMPANY)  
13005 MULDOON DR  
AUSTIN, TX 78729

**Registered Aug. 28, 2012**

**Int. Cl.: 5**

FOR: BIOCIDES, GERMICIDES, BACTERICIDES, VIRUCIDES, FUNGICIDES, INSECTICIDES, PESTICIDES AND HERBICIDES, IN CLASS 5 (U.S. CLS. 6, 18, 44, 46, 51 AND 52).

**TRADEMARK**

FIRST USE 6-25-2012; IN COMMERCE 6-26-2012.

**SUPPLEMENTAL REGISTER**

THE MARK CONSISTS OF STANDARD CHARACTERS WITHOUT CLAIM TO ANY PARTICULAR FONT, STYLE, SIZE, OR COLOR.

SER. NO. 85-514,772, FILED P.R. 1-12-2012; AM. S.R. 6-28-2012.

KATHLEEN LORENZO, EXAMINING ATTORNEY



*David J. Kybas*

Director of the United States Patent and Trademark Office

# United States of America

United States Patent and Trademark Office

## NATIONAL SUP DAY

**Reg. No. 4,200,319**

RAJ MANUFACTURING LLC (DELAWARE LIMITED LIABILITY COMPANY)  
2692 DOW AVENUE  
TUSTIN, CA 92780

**Registered Aug. 28, 2012**

**Int. Cl.: 35**

FOR: PROMOTING THE PUBLIC AWARENESS OF THE ENJOYMENT AND BENEFITS OF  
STAND UP PADDLEBOARDING, IN CLASS 35 (U.S. CLS. 100, 101 AND 102).

**SERVICE MARK**

FIRST USE 6-10-2012; IN COMMERCE 6-10-2012.

**SUPPLEMENTAL REGISTER**

THE MARK CONSISTS OF STANDARD CHARACTERS WITHOUT CLAIM TO ANY PAR-  
TICULAR FONT, STYLE, SIZE, OR COLOR.

SER. NO. 85-516,219, FILED P.R. 1-13-2012; AM. S.R. 6-29-2012.

ANDREW LEASER, EXAMINING ATTORNEY



*David J. Kyros*

Director of the United States Patent and Trademark Office

# United States of America

United States Patent and Trademark Office

## Critter Yard Cards

**Reg. No. 4,200,320**

CRITTER YARD CARDS, LLC (CONNECTICUT LIMITED LIABILITY COMPANY)  
2 DEMPSY RD.

**Registered Aug. 28, 2012**

ANSONIA, CT 06401

**Int. Cl.: 45**

FOR: RENTAL OF SIGNS FOR PERSONAL MESSAGES, IN CLASS 45 (U.S. CLS. 100 AND 101).

**SERVICE MARK**

FIRST USE 2-20-2001; IN COMMERCE 2-20-2001.

**SUPPLEMENTAL REGISTER**

THE MARK CONSISTS OF STANDARD CHARACTERS WITHOUT CLAIM TO ANY PARTICULAR FONT, STYLE, SIZE, OR COLOR.

SER. NO. 85-519,932, FILED P.R. 1-19-2012; AM. S.R. 6-11-2012.

SHAILA SETTLES, EXAMINING ATTORNEY



*David J. Kyffers*

Director of the United States Patent and Trademark Office

# United States of America

United States Patent and Trademark Office

# LIGHTART

**Reg. No. 4,200,321**

3FORM INC. (UTAH CORPORATION)  
2300 SOUTH 2300 WEST  
SALT LAKE CITY, UT 84119

**Registered Aug. 28, 2012**

**Int. Cl.: 42**

FOR: DESIGN OF CUSTOM LIGHT FIXTURES FOR OTHERS, IN CLASS 42 (U.S. CLS. 100 AND 101).

**SERVICE MARK**

FIRST USE 12-31-2008; IN COMMERCE 12-31-2008.

**SUPPLEMENTAL REGISTER**

THE MARK CONSISTS OF STANDARD CHARACTERS WITHOUT CLAIM TO ANY PARTICULAR FONT, STYLE, SIZE, OR COLOR.

SER. NO. 85-521,309, FILED P.R. 1-20-2012; AM. S.R. 6-20-2012.

KRISTINA MORRIS, EXAMINING ATTORNEY



*David J. Kyffers*

Director of the United States Patent and Trademark Office

# United States of America

United States Patent and Trademark Office

## THE TEN KEY ELEMENTS OF FRANCHISING

**Reg. No. 4,200,322**

BASCH, RICHARD (UNITED STATES INDIVIDUAL)  
2250 HASSELL RD, APT 311  
HOFFMAN ESTATES, IL 60169

**Registered Aug. 28, 2012**

**Int. Cl.: 35**

FOR: INTERNET CONTENT IN THE FIELD OF FRANCHISES, NAMELY, PROVIDING A WEB SITE FEATURING INFORMATION ABOUT RUNNING ESTABLISHMENTS AS FRANCHISE , IN CLASS 35 (U.S. CLS. 100, 101 AND 102).

**SERVICE MARK**

FIRST USE 5-18-2012; IN COMMERCE 6-1-2012.

**SUPPLEMENTAL REGISTER**

THE MARK CONSISTS OF STANDARD CHARACTERS WITHOUT CLAIM TO ANY PARTICULAR FONT, STYLE, SIZE, OR COLOR.

NO CLAIM IS MADE TO THE EXCLUSIVE RIGHT TO USE "FRANCHISING", APART FROM THE MARK AS SHOWN.

SER. NO. 85-522,871, FILED P.R. 1-23-2012; AM. S.R. 6-23-2012.

SAMUEL E. SHARPER JR., EXAMINING ATTORNEY



*David J. Kyffers*

Director of the United States Patent and Trademark Office

# United States of America

United States Patent and Trademark Office

## Race For The Rescues

**Reg. No. 4,200,323**

THE RESCUE TRAIN (CALIFORNIA NON-PROFIT ORGANIZATION)  
10734 VALLEY SPRING LANE  
TOLUCA LAKE, CA 91602

**Registered Aug. 28, 2012**

**Int. Cls.: 36 and 41**

FOR: CHARITABLE FUNDRAISING; CHARITABLE FUNDRAISING SERVICES BY MEANS OF ORGANIZING AND CONDUCTING SPECIAL EVENTS; CHARITABLE FUNDRAISING SERVICES BY MEANS OF RUNNING AND WALKING EVENTS; CHARITABLE FUNDRAISING SERVICES BY MEANS OF SELLING T-SHIRTS, HATS, GIFT ITEMS AND ACCESSORIES TO RAISE FUNDS FOR A NON-PROFIT ANIMAL RESCUE; CHARITABLE SERVICES, NAMELY, ORGANIZING FUNDRAISING SERVICES AND EVENTS TO RAISE FUNDS IN THE FIELDS OF ANIMAL WELFARE, ANIMAL RESCUE, ADOPTION OF HOMELESS ANIMALS, SHELTER OF HOMELESS ANIMALS, AND SPAY AND NEUTER OF ANIMALS; FINANCIAL SPONSORSHIP OF AN ANNUAL CHARITABLE RACE EVENT, IN CLASS 36 (U.S. CLS. 100, 101 AND 102).

**SERVICE MARK**

**SUPPLEMENTAL REGISTER**

FIRST USE 10-23-2005; IN COMMERCE 10-23-2005.

FOR: ATHLETIC AND SPORTS EVENT SERVICES, NAMELY, ARRANGING, ORGANIZING, OPERATING AND CONDUCTING MARATHON RACES; ORGANIZING AND CONDUCTING A RUNNING EVENT THE PROCEEDS OF WHICH ARE DONATED TO CHARITY; ORGANIZING COMMUNITY FESTIVALS FEATURING A VARIETY OF ACTIVITIES, NAMELY, SPORTING EVENTS, ART EXHIBITIONS, FLEA MARKETS, ETHNIC DANCES AND THE LIKE; ORGANIZING COMMUNITY SPORTING AND CULTURAL EVENTS; ORGANIZING SPORTING EVENTS, NAMELY, TIMED 5K AND 10K WALK/RUN EVENTS; ORGANIZING, ARRANGING, AND CONDUCTING WALKING, RUNNING, ANIMAL ADOPTION, ANIMAL WELFARE AND SPAY AND NEUTER EVENTS, IN CLASS 41 (U.S. CLS. 100, 101 AND 107).

FIRST USE 10-23-2005; IN COMMERCE 10-23-2005.

THE MARK CONSISTS OF STANDARD CHARACTERS WITHOUT CLAIM TO ANY PARTICULAR FONT, STYLE, SIZE, OR COLOR.

NO CLAIM IS MADE TO THE EXCLUSIVE RIGHT TO USE "RACE", APART FROM THE MARK AS SHOWN.

SER. NO. 85-524,394, FILED P.R. 1-24-2012; AM. S.R. 6-26-2012.



*David J. Kyffers*

Director of the United States Patent and Trademark Office



**Reg. No. 4,200,323** DOMINIC J. FERRAIUOLO, EXAMINING ATTORNEY

# United States of America

United States Patent and Trademark Office

# desi roti

**Reg. No. 4,200,324**

SRINIVAS GANADINNI (INDIA INDIVIDUAL)  
40 TEA BERRY DRIVE  
EDISON, NJ 08820

**Registered Aug. 28, 2012**

**Int. Cl.: 30**

FOR: BREAD; BREAD ROLLS; FLAT BREAD; PITA BREAD; RICE; WHOLEMEAL BREAD,  
IN CLASS 30 (U.S. CL. 46).

**TRADEMARK**

FIRST USE 1-25-2012; IN COMMERCE 5-5-2012.

**SUPPLEMENTAL REGISTER**

THE MARK CONSISTS OF STANDARD CHARACTERS WITHOUT CLAIM TO ANY PARTICULAR FONT, STYLE, SIZE, OR COLOR.

NO CLAIM IS MADE TO THE EXCLUSIVE RIGHT TO USE "ROTI", APART FROM THE MARK AS SHOWN.

THE ENGLISH TRANSLATION OF "DESI" IN THE MARK IS "AUTHENTIC".

SER. NO. 85-524,781, FILED P.R. 1-25-2012; AM. S.R. 7-11-2012.

AMY KERTGATE, EXAMINING ATTORNEY



*David J. Kybas*

Director of the United States Patent and Trademark Office

# United States of America

United States Patent and Trademark Office

## Adoption Links

**Reg. No. 4,200,325**

**Registered Aug. 28, 2012**

**Int. Cl.: 45**

LUTHERAN FAMILY SERVICES OF NEBRASKA, INC. (NEBRASKA CORPORATION),  
AKA LFS,  
SUITE 230  
124 SOUTH 24 STREET  
OMAHA, NE 68102

**SERVICE MARK**

FOR: ADOPTION AGENCIES; ADOPTION COUNSELING; ADOPTION PLACEMENT;  
PROVIDING INFORMATION ABOUT ADOPTING CHILDREN, IN CLASS 45 (U.S. CLS. 100  
AND 101).

**SUPPLEMENTAL REGISTER**

FIRST USE 1-1-1994; IN COMMERCE 1-1-1994.

THE MARK CONSISTS OF STANDARD CHARACTERS WITHOUT CLAIM TO ANY PAR-  
TICULAR FONT, STYLE, SIZE, OR COLOR.

NO CLAIM IS MADE TO THE EXCLUSIVE RIGHT TO USE "ADOPTION", APART FROM  
THE MARK AS SHOWN.

SER. NO. 85-527,056, FILED P.R. 1-27-2012; AM. S.R. 6-26-2012.

SETH A. RAPPAPORT, EXAMINING ATTORNEY



*David J. Kyffers*

Director of the United States Patent and Trademark Office

# United States of America

United States Patent and Trademark Office

## BLOODY POINT

**Reg. No. 4,200,326**

JOHN R. ANDERSON (UNITED STATES INDIVIDUAL)  
7624 N. ROAD 114  
TULELAKE, CA 96134 AND

**Registered Aug. 28, 2012**

**Int. Cl.: 33**

JEANNE F. ANDERSON (UNITED STATES INDIVIDUAL)  
7624 N. ROAD 114  
TULELAKE, CA 96134

**TRADEMARK**

FOR: WINES, IN CLASS 33 (U.S. CLS. 47 AND 49).

**SUPPLEMENTAL REGISTER**

FIRST USE 1-1-2009; IN COMMERCE 1-1-2009.

THE MARK CONSISTS OF STANDARD CHARACTERS WITHOUT CLAIM TO ANY PARTICULAR FONT, STYLE, SIZE, OR COLOR.

SER. NO. 85-528,279, FILED P.R. 1-30-2012; AM. S.R. 7-9-2012.

COLLEEN DOMBROW, EXAMINING ATTORNEY



*David J. Kybas*

Director of the United States Patent and Trademark Office

# United States of America

United States Patent and Trademark Office

## THE HUMAN RESPONSE

**Reg. No. 4,200,327**

AVEO PHARMACEUTICALS, INC. (DELAWARE CORPORATION)  
75 SIDNEY STREET  
CAMBRIDGE, MA 02139

**Registered Aug. 28, 2012**

**Int. Cl.: 42**

FOR: MEDICAL AND SCIENTIFIC RESEARCH, NAMELY, CONDUCTING CLINICAL TRIALS FOR OTHERS; PHARMACEUTICAL RESEARCH AND DEVELOPMENT; PROVIDING MEDICAL AND SCIENTIFIC RESEARCH INFORMATION IN THE FIELD OF PHARMACEUTICALS AND CLINICAL TRIALS, IN CLASS 42 (U.S. CLS. 100 AND 101).

**SERVICE MARK**

**SUPPLEMENTAL REGISTER** FIRST USE 6-19-2012; IN COMMERCE 6-19-2012.

THE MARK CONSISTS OF STANDARD CHARACTERS WITHOUT CLAIM TO ANY PARTICULAR FONT, STYLE, SIZE, OR COLOR.

OWNER OF U.S. REG. NOS. 3,358,242 AND 3,788,951.

SER. NO. 85-534,976, FILED P.R. 2-6-2012; AM. S.R. 6-20-2012.

WON TEAK OH, EXAMINING ATTORNEY



*David J. Kyros*

Director of the United States Patent and Trademark Office

# United States of America

United States Patent and Trademark Office

## NATIONAL SOLAR ASSOCIATION

**Reg. No. 4,200,328**

**Registered Aug. 28, 2012**

**Int. Cl.: 37**

**SERVICE MARK**

**SUPPLEMENTAL REGISTER**

NATIONAL SOLAR ASSOCIATION, LLC (MISSOURI LIMITED LIABILITY COMPANY)  
SECOND FLOOR  
13397 LAKEFRONT DRIVE  
EARTH CITY, MO 63045

FOR: INSTALLATION OF SOLAR ENERGY SYSTEMS EITHER DIRECTLY OR THROUGH  
AUTHORIZED DEALERS, IN CLASS 37 (U.S. CLS. 100, 103 AND 106).

FIRST USE 1-15-2012; IN COMMERCE 1-15-2012.

THE MARK CONSISTS OF STANDARD CHARACTERS WITHOUT CLAIM TO ANY PAR-  
TICULAR FONT, STYLE, SIZE, OR COLOR.

NO CLAIM IS MADE TO THE EXCLUSIVE RIGHT TO USE "ASSOCIATION", APART FROM  
THE MARK AS SHOWN.

SER. NO. 85-535,182, FILED P.R. 2-6-2012; AM. S.R. 6-11-2012.

DAWN HAN, EXAMINING ATTORNEY



*David J. Kyffers*

Director of the United States Patent and Trademark Office

# United States of America

United States Patent and Trademark Office

## BUILD-A-MEAL

**Reg. No. 4,200,329**

SLA MANAGEMENT LLC (FLORIDA LIMITED LIABILITY COMPANY)  
3217 CORRINE DRIVE  
ORLANDO, FL 32803

**Registered Aug. 28, 2012**

**Int. Cl.: 43**

FOR: CAFETERIA SERVICES; CONTRACT FOOD SERVICES; FOOD PREPARATION SERVICES; CATERING SERVICES, IN CLASS 43 (U.S. CLS. 100 AND 101).

**SERVICE MARK**

FIRST USE 5-2-2011; IN COMMERCE 8-1-2011.

**SUPPLEMENTAL REGISTER**

THE MARK CONSISTS OF STANDARD CHARACTERS WITHOUT CLAIM TO ANY PARTICULAR FONT, STYLE, SIZE, OR COLOR.

SER. NO. 85-539,005, FILED P.R. 2-10-2012; AM. S.R. 6-18-2012.

MARK RADEMACHER, EXAMINING ATTORNEY



*David J. Kyffers*

Director of the United States Patent and Trademark Office

# United States of America

United States Patent and Trademark Office

## DNACENTER.COM

**Reg. No. 4,200,330**

DNA DIAGNOSTIC CENTER, INC. (OHIO CORPORATION)

**Registered Aug. 28, 2012**

ONE DDC WAY  
FAIRFIELD, OH 45014

**Int. Cl.: 44**

FOR: PROVIDING A WEBSITE FEATURING INFORMATION ABOUT MEDICAL TESTING, NAMELY, DNA TESTING AND PATERNITY TESTING, IN CLASS 44 (U.S. CLS. 100 AND 101).

**SERVICE MARK**

FIRST USE 3-1-2007; IN COMMERCE 3-1-2007.

**SUPPLEMENTAL REGISTER**

THE MARK CONSISTS OF STANDARD CHARACTERS WITHOUT CLAIM TO ANY PARTICULAR FONT, STYLE, SIZE, OR COLOR.

OWNER OF U.S. REG. NOS. 3,205,185, 3,207,578, AND OTHERS.

SER. NO. 85-540,182, FILED P.R. 2-10-2012; AM. S.R. 6-28-2012.

ALAIN LAPTER, EXAMINING ATTORNEY



*David J. Kyffers*

Director of the United States Patent and Trademark Office



# United States of America

United States Patent and Trademark Office

# DNACENTER

**Reg. No. 4,200,331**

DNA DIAGNOSTIC CENTER, INC. (OHIO CORPORATION)

**Registered Aug. 28, 2012**

ONE DDC WAY  
FAIRFIELD, OH 45014

**Int. Cl.: 44**

FOR: PROVIDING A WEBSITE FEATURING INFORMATION ABOUT MEDICAL TESTING, NAMELY, DNA TESTING AND PATERNITY TESTING, IN CLASS 44 (U.S. CLS. 100 AND 101).

**SERVICE MARK**

FIRST USE 3-1-2007; IN COMMERCE 3-1-2007.

**SUPPLEMENTAL REGISTER**

THE MARK CONSISTS OF STANDARD CHARACTERS WITHOUT CLAIM TO ANY PARTICULAR FONT, STYLE, SIZE, OR COLOR.

OWNER OF U.S. REG. NOS. 3,205,185, 3,207,578, AND OTHERS.

SER. NO. 85-540,184, FILED P.R. 2-10-2012; AM. S.R. 6-28-2012.

ALAIN LAPTER, EXAMINING ATTORNEY



*David J. Kyffers*

Director of the United States Patent and Trademark Office

# United States of America

United States Patent and Trademark Office

## Dynamic Expansion Contraction Strategy

**Reg. No. 4,200,332**

BRUNET, ERIC E. (UNITED STATES INDIVIDUAL)  
36 LOST VILLAGE RD  
OGDENSBURG, NY 13669

**Registered Aug. 28, 2012**

**Int. Cl.: 36**

FOR: FINANCIAL PORTFOLIO ANALYSIS SERVICES; FINANCIAL PORTFOLIO MANAGEMENT; FINANCIAL SERVICES, NAMELY, A TOTAL PORTFOLIO OFFERING FOR HIGH NET WORTH CLIENTS CONSISTING OF BOTH SEPARATE ACCOUNTS AND MUTUAL FUNDS FOR EQUITY AND FIXED INCOME INVESTMENTS; FINANCIAL SERVICES, NAMELY, COORDINATION, WITHIN A SINGLE ACCOUNT, OF AN INVESTMENT PORTFOLIO'S MAINTENANCE, TRADING, REBALANCING, AND TAX MANAGEMENT NEEDS; MANAGEMENT OF PORTFOLIOS COMPRISING SECURITIES; MANAGEMENT OF SECURITIES PORTFOLIOS, IN CLASS 36 (U.S. CLS. 100, 101 AND 102).

**SERVICE MARK**

**SUPPLEMENTAL REGISTER**

FIRST USE 5-3-2011; IN COMMERCE 5-3-2011.

THE MARK CONSISTS OF STANDARD CHARACTERS WITHOUT CLAIM TO ANY PARTICULAR FONT, STYLE, SIZE, OR COLOR.

SER. NO. 85-540,321, FILED P.R. 2-11-2012; AM. S.R. 6-26-2012.

ESTHER BELENKER, EXAMINING ATTORNEY



*David J. Kypos*

Director of the United States Patent and Trademark Office

**United States of America**  
United States Patent and Trademark Office

# FLETCHER'S

**Reg. No. 4,200,333**

ABC LIQUORS, INC. (FLORIDA CORPORATION)  
P.O. BOX 593688

**Registered Aug. 28, 2012**

ORLANDO, FL 328593688

**Int. Cl.: 33**

FOR: DISTILLED SPIRITS, IN CLASS 33 (U.S. CLS. 47 AND 49).

**TRADEMARK**

FIRST USE 7-16-2009; IN COMMERCE 7-16-2009.

**SUPPLEMENTAL REGISTER**

THE MARK CONSISTS OF STANDARD CHARACTERS WITHOUT CLAIM TO ANY PARTICULAR FONT, STYLE, SIZE, OR COLOR.

SER. NO. 85-542,987, FILED P.R. 2-15-2012; AM. S.R. 6-28-2012.

MARK RADEMACHER, EXAMINING ATTORNEY



*David J. Kybas*

Director of the United States Patent and Trademark Office

# United States of America

United States Patent and Trademark Office



**Reg. No. 4,200,334**

DEMARIO ADLEY (UNITED STATES INDIVIDUAL)  
23 DEVON LN  
WILMER, TX 75172

**Registered Aug. 28, 2012**

**Int. Cl.: 25**

FOR: ATHLETIC APPAREL, NAMELY, SHIRTS, PANTS, JACKETS, FOOTWEAR, HATS AND CAPS, ATHLETIC UNIFORMS; ATHLETIC SHOES; BOXER BRIEFS; CARDIGANS; CLOTHING FOR BABIES, TODDLERS AND CHILDREN, TREATED WITH FIRE AND HEAT RETARDANTS, NAMELY, PAJAMAS, JACKETS, SHIRTS, PANTS, JUMPERS; COLLARED SHIRTS; DRESS SHIRTS; HATS FOR INFANTS, BABIES, TODDLERS AND CHILDREN; HEADBANDS; HOODED SWEAT SHIRTS; LONG-SLEEVED SHIRTS; PANTIES, SHORTS AND BRIEFS; POLO SHIRTS; RUGBY SHIRTS; SPORTS JERSEYS; T-SHIRTS; WOMEN'S SHOES; WOMEN'S UNDERWEAR, IN CLASS 25 (U.S. CLS. 22 AND 39).

**TRADEMARK**

**SUPPLEMENTAL REGISTER**

FIRST USE 8-22-2004; IN COMMERCE 1-15-2008.

THE MARK CONSISTS OF THE "BIIS" ABOVE THE WORDS "BOUND 2 SHINE" WITH HORIZONTAL LINES ABOVE AND BELOW THE TEXT.

SER. NO. 85-543,333, FILED P.R. 2-15-2012; AM. S.R. 6-28-2012.

CARYN GLASSER, EXAMINING ATTORNEY



*David J. Kyffers*

Director of the United States Patent and Trademark Office

# United States of America

United States Patent and Trademark Office

## CHANNEL MONITOR

**Reg. No. 4,200,335**

DYNAMITE DATA, LLC (NEVADA LIMITED LIABILITY COMPANY)  
2248 MERIDIAN BLVD., SUITE H  
MINDEN, NV 89423

**Registered Aug. 28, 2012**

**Int. Cl.: 42**

FOR: WEB-BASED SOFTWARE APPLICATION AND USER INTERFACE THAT PROVIDES REAL-TIME PRODUCT INFORMATION, IN CLASS 42 (U.S. CLS. 100 AND 101).

**SERVICE MARK**

FIRST USE 11-1-2008; IN COMMERCE 1-15-2009.

**SUPPLEMENTAL REGISTER**

THE MARK CONSISTS OF STANDARD CHARACTERS WITHOUT CLAIM TO ANY PARTICULAR FONT, STYLE, SIZE, OR COLOR.

SER. NO. 85-544,336, FILED P.R. 2-16-2012; AM. S.R. 6-19-2012.

EMILY CARLSEN, EXAMINING ATTORNEY



*David J. Kybas*

Director of the United States Patent and Trademark Office

# United States of America

United States Patent and Trademark Office

## SPINNING BABIES

**Reg. No. 4,200,336**

**Registered Aug. 28, 2012**

**Int. Cl.: 41**

**SERVICE MARK**

**SUPPLEMENTAL REGISTER**

MATERNITY HOUSE PUBLISHING, INC. (MINNESOTA CORPORATION)  
10545 HUMBOLDT AVE S  
MINNEAPOLIS, MN 55431

FOR: EDUCATIONAL SERVICES, NAMELY, CONDUCTING CLASSES, SEMINARS, CONFERENCES AND WORKSHOPS IN THE FIELD OF MATERNAL AND FETAL POSITIONING IN PREGNANCY AND DISTRIBUTION OF COURSE MATERIAL IN CONNECTION THEREWITH; EDUCATIONAL SERVICES, NAMELY, DEVELOPING, ARRANGING, AND CONDUCTING EDUCATIONAL CONFERENCES AND PROGRAMS AND PROVIDING COURSES OF INSTRUCTION IN THE FIELD OF PREGNANCY AND CHILDBIRTH; EDUCATIONAL SERVICES, NAMELY, PROVIDING CONTINUING PROFESSIONAL EDUCATION COURSES IN THE FIELD OF MIDWIFERY, IN CLASS 41 (U.S. CLS. 100, 101 AND 107).

FIRST USE 1-1-2001; IN COMMERCE 1-1-2005.

THE MARK CONSISTS OF STANDARD CHARACTERS WITHOUT CLAIM TO ANY PARTICULAR FONT, STYLE, SIZE, OR COLOR.

SER. NO. 85-546,296, FILED P.R. 2-17-2012; AM. S.R. 6-8-2012.

SUSAN RICHARDS, EXAMINING ATTORNEY



*David J. Kyffers*

Director of the United States Patent and Trademark Office

# United States of America

United States Patent and Trademark Office

**THE**  
**P**AVILION

**Reg. No. 4,200,337**

**Registered Aug. 28, 2012**

**Int. Cl.: 41**

**SERVICE MARK**

**SUPPLEMENTAL REGISTER**

SEMINOLE TRIBE OF FLORIDA (UNITED STATES FEDERALLY-RECOGNIZED INDIAN TRIBE)  
6300 STIRLING ROAD  
HOLLYWOOD, FL 33024

FOR: ENTERTAINMENT SERVICES IN THE NATURE OF LIVE COMEDY SHOWS AND LIVE MUSICAL PERFORMANCES, IN CLASS 41 (U.S. CLS. 100, 101 AND 107).

FIRST USE 1-20-2012; IN COMMERCE 2-2-2012.

THE MARK CONSISTS OF THE STYLIZED WORDS "THE PAVILION" WITH THE WORD "THE" IN RED ABOVE THE WORD "PAVILION" IN BLACK WITH THE LETTER "P" ON A RED BACKGROUND.

THE COLOR(S) RED AND BLACK IS/ARE CLAIMED AS A FEATURE OF THE MARK.

SER. NO. 85-547,366, FILED P.R. 2-20-2012; AM. S.R. 7-5-2012.

KATHLEEN M. VANSTON, EXAMINING ATTORNEY



*David J. Kybas*

Director of the United States Patent and Trademark Office

# United States of America

United States Patent and Trademark Office

## EQUESTRIAN AID FOUNDATION

**Reg. No. 4,200,338**

**Registered Aug. 28, 2012**

**Int. Cl.: 36**

**SERVICE MARK**

**SUPPLEMENTAL REGISTER**

EQUESTRIAN AID FOUNDATION, INC. (FLORIDA CORPORATION)  
SUITE 23-377  
11924 W. FOREST HILL BLVD  
WELLINGTON, FL 33414

FOR: MEMBERSHIP BASED ORGANIZATION FEATURING SERVICES TO ASSIST INDIVIDUALS IN THE EQUESTRIAN WORLD THAT HAVE SUFFERED A LIFE-THREATENING ILLNESS, CATASTROPHIC ACCIDENT OR INJURY BY PROVIDING DIRECT FINANCIAL SUPPORT FOR THEIR MEDICAL OR OTHER BASIC NEEDS, IN CLASS 36 (U.S. CLS. 100, 101 AND 102).

FIRST USE 2-21-2006; IN COMMERCE 2-21-2006.

THE MARK CONSISTS OF STANDARD CHARACTERS WITHOUT CLAIM TO ANY PARTICULAR FONT, STYLE, SIZE, OR COLOR.

OWNER OF U.S. REG. NO. 3,519,730.

SER. NO. 85-548,431, FILED P.R. 2-21-2012; AM. S.R. 6-29-2012.

LAURIE MAYES, EXAMINING ATTORNEY



*David J. Kyfos*

Director of the United States Patent and Trademark Office



# United States of America

United States Patent and Trademark Office

## AmericanSellerServer.com

**Reg. No. 4,200,339**

WILLIAM MEYERDIRK (UNITED STATES INDIVIDUAL)  
2606 ELLISE AVENUE  
AUSTIN, TX 78757

**Registered Aug. 28, 2012**

**Int. Cl.: 41**

FOR: EDUCATIONAL SERVICES, NAMELY, PROVIDING ON-LINE COURSES OF INSTRUCTION AND SELLER SERVER TRAINING IN THE FIELD OF SERVING ALCOHOLIC BEVERAGES AND DISTRIBUTION OF TRAINING MATERIAL IN CONNECTION THEREWITH. , IN CLASS 41 (U.S. CLS. 100, 101 AND 107).

**SERVICE MARK**

**SUPPLEMENTAL REGISTER** FIRST USE 2-1-2012; IN COMMERCE 6-1-2012.

THE MARK CONSISTS OF STANDARD CHARACTERS WITHOUT CLAIM TO ANY PARTICULAR FONT, STYLE, SIZE, OR COLOR.

SER. NO. 85-549,627, FILED P.R. 2-22-2012; AM. S.R. 6-11-2012.

EDWARD NELSON, EXAMINING ATTORNEY



*David J. Kyffers*

Director of the United States Patent and Trademark Office

# United States of America

United States Patent and Trademark Office

## BANK OF LABOR

**Reg. No. 4,200,340**

BROTHERHOOD BANCSHARES, INC. (KANSAS CORPORATION)  
756 MINNESOTA AVENUE  
KANSAS CITY, KS 66101

**Registered Aug. 28, 2012**

**Int. Cl.: 36**

FOR: BANKING SERVICES, IN CLASS 36 (U.S. CLS. 100, 101 AND 102).

**SERVICE MARK**

FIRST USE 2-20-2012; IN COMMERCE 2-20-2012.

**SUPPLEMENTAL REGISTER**

THE MARK CONSISTS OF STANDARD CHARACTERS WITHOUT CLAIM TO ANY PARTICULAR FONT, STYLE, SIZE, OR COLOR.

OWNER OF U.S. REG. NO. 4,116,500.

NO CLAIM IS MADE TO THE EXCLUSIVE RIGHT TO USE "BANK", APART FROM THE MARK AS SHOWN.

SER. NO. 85-550,702, FILED P.R. 2-23-2012; AM. S.R. 6-30-2012.

KATHLEEN KOLACZ, EXAMINING ATTORNEY



*David J. Kyffers*

Director of the United States Patent and Trademark Office

# United States of America

United States Patent and Trademark Office

## THREEPIECETEE

**Reg. No. 4,200,341**

TPT BASEBALL LLC (TEXAS LIMITED LIABILITY COMPANY)  
650 WEST BOUGH, SUITE 150-150  
HOUSTON, TX 77024

**Registered Aug. 28, 2012**

**Int. Cl.: 28**

FOR: SPORTS TRAINING EQUIPMENT, NAMELY, A MODULAR BASEBALL AND SOFT-BALL BATTING AND PITCHING TRAINING DEVICE FOR IMPROVING BALANCE , IN CLASS 28 (U.S. CLS. 22, 23, 38 AND 50).

**TRADEMARK**

FIRST USE 2-22-2011; IN COMMERCE 2-22-2011.

**SUPPLEMENTAL REGISTER**

THE MARK CONSISTS OF STANDARD CHARACTERS WITHOUT CLAIM TO ANY PARTICULAR FONT, STYLE, SIZE, OR COLOR.

SER. NO. 85-554,847, FILED P.R. 2-28-2012; AM. S.R. 7-6-2012.

JENNIFER RICHARDSON, EXAMINING ATTORNEY



*David J. Kybas*

Director of the United States Patent and Trademark Office

# United States of America

United States Patent and Trademark Office

## MARKETING + MILLENNIALS

**Reg. No. 4,200,342**

BARKLEY, INC. (MISSOURI CORPORATION)  
1740 MAIN STREET  
KANSAS CITY, MO 64108

**Registered Aug. 28, 2012**

**Int. Cl.: 41**

FOR: EDUCATIONAL SERVICES, NAMELY, DEVELOPING, ARRANGING, AND CONDUCTING EDUCATIONAL CONFERENCES AND PROGRAMS IN THE FIELD OF ADVERTISING AND MARKETING AND DISTRIBUTION OF EDUCATIONAL MATERIALS IN CONNECTION THEREWITH, IN CLASS 41 (U.S. CLS. 100, 101 AND 107).

**SERVICE MARK**

**SUPPLEMENTAL REGISTER** FIRST USE 4-0-2011; IN COMMERCE 4-0-2011.

THE MARK CONSISTS OF STANDARD CHARACTERS WITHOUT CLAIM TO ANY PARTICULAR FONT, STYLE, SIZE, OR COLOR.

SER. NO. 85-554,898, FILED P.R. 2-28-2012; AM. S.R. 6-29-2012.

AMY ALFIERI, EXAMINING ATTORNEY



*David J. Kybas*

Director of the United States Patent and Trademark Office

# United States of America

United States Patent and Trademark Office

**MILWAUKEE**  
**POWER SUPPLY**

**Reg. No. 4,200,343**

COMMERCIAL BARGAINS INC (WISCONSIN CORPORATION)  
2005 S 54TH STREET  
WEST ALLIS, WI 53219

**Registered Aug. 28, 2012**

**Int. Cl.: 7**

FOR: AIR POWERED TOOLS, NAMELY, NAILERS; ELECTRIC WELDING MACHINES;  
GAS POWER GENERATORS; GENERATORS OF ELECTRICITY; MACHINES AND MACHINE  
TOOLS FOR THE CUTTING AND FORMING OF MATERIALS, IN CLASS 7 (U.S. CLS. 13,  
19, 21, 23, 31, 34 AND 35).

**TRADEMARK**

**SUPPLEMENTAL REGISTER** FIRST USE 3-8-2011; IN COMMERCE 8-12-2011.

THE MARK CONSISTS OF THE STYLIZED TEXT "MILWAUKEE POWER SUPPLY" IN  
GREY WITH A RED AND BLACK LINE IN THE MIDDLE.

THE COLOR(S) RED, GREY AND BLACK IS/ARE CLAIMED AS A FEATURE OF THE  
MARK.

SER. NO. 85-555,572, FILED P.R. 2-28-2012; AM. S.R. 6-22-2012.

AMY C. KEAN, EXAMINING ATTORNEY



*David J. Kappas*

Director of the United States Patent and Trademark Office

# United States of America

United States Patent and Trademark Office

## W9ONLINE.COM

**Reg. No. 4,200,344**

ALLEN L. GENETTI (UNITED STATES INDIVIDUAL)  
20799 E. COMSTOCK ROAD  
LINDEN, CA 95236

**Registered Aug. 28, 2012**

**Int. Cl.: 35**

FOR: PROVIDING A WEB-BASED ONLINE PORTAL THAT ALLOWS CUSTOMERS TO POST W-9 FORMS TO BE VIEWED BY OTHERS, IN CLASS 35 (U.S. CLS. 100, 101 AND 102).

**SERVICE MARK**

FIRST USE 10-1-2006; IN COMMERCE 10-1-2006.

**SUPPLEMENTAL REGISTER**

THE MARK CONSISTS OF STANDARD CHARACTERS WITHOUT CLAIM TO ANY PARTICULAR FONT, STYLE, SIZE, OR COLOR.

SER. NO. 85-557,301, FILED P.R. 3-1-2012; AM. S.R. 6-14-2012.

YAT SYE, LEE, EXAMINING ATTORNEY



*David J. Kyffers*

Director of the United States Patent and Trademark Office

# United States of America

United States Patent and Trademark Office

## Cape Cod: Where a Little Peace of Heaven Meets Earth

**Reg. No. 4,200,345**

CARR, SCOTT (UNITED STATES INDIVIDUAL)  
91 WORCESTER-PROVIDENCE TURNPIKE  
SUTTON, MA 01590

**Registered Aug. 28, 2012**

**Int. Cl.: 25**

FOR: SHORT-SLEEVED OR LONG-SLEEVED T-SHIRTS; T-SHIRTS, IN CLASS 25 (U.S. CLS. 22 AND 39).

**TRADEMARK**

FIRST USE 5-31-2009; IN COMMERCE 7-27-2011.

**SUPPLEMENTAL REGISTER**

THE MARK CONSISTS OF STANDARD CHARACTERS WITHOUT CLAIM TO ANY PARTICULAR FONT, STYLE, SIZE, OR COLOR.

OWNER OF U.S. REG. NO. 3,674,690.

SER. NO. 85-561,802, FILED P.R. 3-6-2012; AM. S.R. 6-20-2012.

EMILY CARLSEN, EXAMINING ATTORNEY



*David J. Kybas*

Director of the United States Patent and Trademark Office

# United States of America

United States Patent and Trademark Office

## Lending Manager

**Reg. No. 4,200,346**

**Registered Aug. 28, 2012**

**Int. Cl.: 9**

**TRADEMARK**

**SUPPLEMENTAL REGISTER**

LENDING MANAGER LLC (DELAWARE LIMITED LIABILITY COMPANY)  
40 E. MAIN ST.  
SUITE 413  
NEWARK, DE 19711

FOR: COMPUTER SOFTWARE THAT PROVIDES WEB-BASED ACCESS TO APPLICATIONS AND SERVICES THROUGH A WEB OPERATING SYSTEM OR PORTAL INTERFACE , IN CLASS 9 (U.S. CLS. 21, 23, 26, 36 AND 38).

FIRST USE 1-18-2012; IN COMMERCE 1-18-2012.

THE MARK CONSISTS OF STANDARD CHARACTERS WITHOUT CLAIM TO ANY PARTICULAR FONT, STYLE, SIZE, OR COLOR.

NO CLAIM IS MADE TO THE EXCLUSIVE RIGHT TO USE "MANAGER", APART FROM THE MARK AS SHOWN.

SER. NO. 85-562,209, FILED P.R. 3-6-2012; AM. S.R. 6-21-2012.

SUE LAWRENCE, EXAMINING ATTORNEY



*David J. Kybas*

Director of the United States Patent and Trademark Office



# United States of America

United States Patent and Trademark Office

## VISION BENEFIT MAXIMIZER

**Reg. No. 4,200,347**

**Registered Aug. 28, 2012**

**Int. Cl.: 36**

**SERVICE MARK**

**SUPPLEMENTAL REGISTER**

NATIONAL VISION ADMINISTRATORS, LLC (NEW JERSEY LIMITED LIABILITY COMPANY)  
1200 ROUTE 46 WEST  
CLIFTON, NJ 07013

FOR: ADMINISTRATION OF PRE-PAID VISION CARE BENEFIT PLANS FOR INSURANCE CARRIERS AND EMPLOYERS, IN CLASS 36 (U.S. CLS. 100, 101 AND 102).

FIRST USE 10-6-2011; IN COMMERCE 10-6-2011.

THE MARK CONSISTS OF STANDARD CHARACTERS WITHOUT CLAIM TO ANY PARTICULAR FONT, STYLE, SIZE, OR COLOR.

NO CLAIM IS MADE TO THE EXCLUSIVE RIGHT TO USE "VISION BENEFIT", APART FROM THE MARK AS SHOWN.

SER. NO. 85-562,987, FILED P.R. 3-7-2012; AM. S.R. 7-10-2012.

SUE LAWRENCE, EXAMINING ATTORNEY



*David J. Kyffers*

Director of the United States Patent and Trademark Office

# United States of America

United States Patent and Trademark Office

## Effect Specialist

**Reg. No. 4,200,348**

ZIGMONT MAGIC F/X INC (FLORIDA CORPORATION)  
1206 BARONWOOD PLACE

**Registered Aug. 28, 2012**

BRANDON, FL 33510

**Int. Cl.: 41**

FOR: ENTERTAINMENT, NAMELY, PREPARATION OF SPECIAL EFFECTS, IN CLASS 41  
(U.S. CLS. 100, 101 AND 107).

**SERVICE MARK**

FIRST USE 2-10-2004; IN COMMERCE 2-10-2004.

**SUPPLEMENTAL REGISTER**

THE MARK CONSISTS OF STANDARD CHARACTERS WITHOUT CLAIM TO ANY PARTICULAR FONT, STYLE, SIZE, OR COLOR.

SER. NO. 85-564,629, FILED P.R. 3-8-2012; AM. S.R. 6-27-2012.

LINDA MICKLEBURGH, EXAMINING ATTORNEY



*David J. Kybas*

Director of the United States Patent and Trademark Office

# United States of America

United States Patent and Trademark Office

## SAFETY INSPECTION LIVE

**Reg. No. 4,200,349**

CHEMSW, INC. (CALIFORNIA CORPORATION)  
4771 MANGELS BLVD.

**Registered Aug. 28, 2012**

FAIRFIELD, CA 945341464

**Int. Cl.: 42**

FOR: PROVIDING NON-DOWNLOADABLE ON-LINE COMPUTER PROGRAMS FOR ON-LINE, ON-DEMAND CAPTURE AND MANAGEMENT OF SAFETY INSPECTION DATA, IN CLASS 42 (U.S. CLS. 100 AND 101).

**SERVICE MARK**

FIRST USE 2-29-2012; IN COMMERCE 2-29-2012.

**SUPPLEMENTAL REGISTER**

THE MARK CONSISTS OF STANDARD CHARACTERS WITHOUT CLAIM TO ANY PARTICULAR FONT, STYLE, SIZE, OR COLOR.

SER. NO. 85-565,367, FILED P.R. 3-9-2012; AM. S.R. 6-22-2012.

MICHELE SWAIN, EXAMINING ATTORNEY



*David J. Kyffers*

Director of the United States Patent and Trademark Office

# United States of America

United States Patent and Trademark Office

## GYMTOOLKIT

**Reg. No. 4,200,350**

**Registered Aug. 28, 2012**

**Int. Cl.: 8**

**TRADEMARK**

**SUPPLEMENTAL REGISTER**

HAI, JUSTIN (UNITED STATES INDIVIDUAL)  
2683 VIA DE LA VALLE  
STE. G - 319  
DEL MAR, CA 92014

FOR: METAL MODULAR MOBILE TOOLBOX WITH LOCKING COMPARTMENTS COMPRISED OF CUTTING TOOLS, NAMELY, KNIVES, CUTTERS AND SAWS, SCREW AND BOLT REMOVE TOOLS, SCREWDRIVERS, SOCKETS AND ALLEN WRENCHES IN STANDARD AND METRIC, SOCKET EXTENSION, WRENCHES, NAMELY, STANDARD, ADJUSTABLE IN METRIC AND STANDARD SIZES, MOBILE WENCH TRAY/BRACKET, SOCKET DRIVER ATTACHMENT TOOLS, PLIERS, PIPE/GOOSE NECK WRENCH, REVERSIBLE C-RING OPENER/REMOVER, 2 AND 3 JAW BEARING PULLERS, ALLEN KEYS, PEDAL WRENCHES, BOTTOM BRACKET, HANDLE BAR ADJUSTER, CRANK PULLER, ISIS, CROWBARS, METAL HAMMER, RUBBER HAMMER, BRUSH SEATING ALIGNMENT TOOLS SUCH AS COMMUTATOR STONE, TELESCOPING MAGNETIC PICK UP DEVICE/ADJUSTABLE MIRROR, HEAVY DUTY WHEELS, TELESCOPING HANDLE AND REMOVABLE PROJECT TRAY, TRAVEL ADAPTERS PLUGS, SPARE FUSES, ANTI-STATIC STRAP, TAPS AND DIES, LEVELING TOOLS, POWER TOOL ACCESSORIES BITS, MULTI-PURPOSE METAL DRILL BITS, UP DOWN CONVERTER, NAMELY, VOLTAGE CONVERTER, POWER TOOL BATTERY CHARGER, FLASH LIGHT, POWER TOOLS, MAGNETIC PARTS TRAY, SAFETY EQUIPMENT AND ELECTRICAL DIAGNOSTIC DEVICES TO MEASURE CURRENT DRAWS, PROPRIETARY REFERENCE HANDBOOK, CUSTOM FOAM INSERTS AND TOOL IDENTIFIERS, BRANDING AND CO-BRANDING LABELS, IN CLASS 8 (U.S. CLS. 23, 28 AND 44).

FIRST USE 11-1-2010; IN COMMERCE 11-1-2010.

THE MARK CONSISTS OF STANDARD CHARACTERS WITHOUT CLAIM TO ANY PARTICULAR FONT, STYLE, SIZE, OR COLOR.

SER. NO. 85-566,413, FILED P.R. 3-12-2012; AM. S.R. 6-25-2012.

RAUL CORDOVA, EXAMINING ATTORNEY



*David J. Kyffers*

Director of the United States Patent and Trademark Office

United States of America  
United States Patent and Trademark Office

MORADO

**Reg. No. 4,200,351**

AMERICA'S COLLECTIBLES NETWORK, INC. (TENNESSEE CORPORATION)  
9600 PARKSIDE DR.

**Registered Aug. 28, 2012**

KNOXVILLE, TN 37922

**Int. Cl.: 14**

FOR: JEWELRY AND GEMSTONES, IN CLASS 14 (U.S. CLS. 2, 27, 28 AND 50).

FIRST USE 3-9-2012; IN COMMERCE 3-9-2012.

**TRADEMARK**

THE MARK CONSISTS OF STANDARD CHARACTERS WITHOUT CLAIM TO ANY PARTICULAR FONT, STYLE, SIZE, OR COLOR.

**SUPPLEMENTAL REGISTER**

THE ENGLISH TRANSLATION OF "MORADO" IN THE MARK IS "PURPLE".

SER. NO. 85-568,414, FILED P.R. 3-13-2012; AM. S.R. 6-29-2012.

NICHOLAS ALTREE, EXAMINING ATTORNEY



*David J. Kyffers*

Director of the United States Patent and Trademark Office

# United States of America

United States Patent and Trademark Office

## PatientHomePage

**Reg. No. 4,200,352**

**Registered Aug. 28, 2012**

**Int. Cl.: 9**

**TRADEMARK**

**SUPPLEMENTAL REGISTER**

SIKKA SOFTWARE CORPORATION (CALIFORNIA CORPORATION)  
830 HILLVIEW COURT SUITE 290  
MILPITAS, CA 95035

FOR: WEB-BASED COMPUTER SOFTWARE THAT PROVIDES FOR COMMUNICATION BETWEEN PATIENTS AND HEALTH CARE PROVIDERS, AND THAT ALLOWS FOR PATIENT SCHEDULING, APPOINTMENT REMINDERS AND SENDING ELECTRONIC STATEMENTS TO PATIENTS, MAKING ONLINE PAYMENTS, CHECKING INSURANCE BALANCES, CHECKING LABORATORY AND PRESCRIPTION INFORMATION, FOLLOWING PROVIDERS ON SOCIAL NETWORKS, AND ADDING NEW PROVIDERS AND REFERRALS, THROUGH A PATIENT PORTAL OR WEB-BASED OPERATING SYSTEM, IN CLASS 9 (U.S. CLS. 21, 23, 26, 36 AND 38).

FIRST USE 10-20-2011; IN COMMERCE 2-1-2012.

THE MARK CONSISTS OF STANDARD CHARACTERS WITHOUT CLAIM TO ANY PARTICULAR FONT, STYLE, SIZE, OR COLOR.

OWNER OF U.S. REG. NO. 4,018,483.

SER. NO. 85-568,545, FILED 3-13-2012.

ESTHER BELENKER, EXAMINING ATTORNEY



*David J. Kyros*

Director of the United States Patent and Trademark Office

# United States of America

United States Patent and Trademark Office

## HBCU Awards

**Reg. No. 4,200,353**

**Registered Aug. 28, 2012**

**Int. Cl.: 41**

**SERVICE MARK**

**SUPPLEMENTAL REGISTER**

THE CENTER FOR HBCU MEDIA ADVOCACY INC. (MARYLAND CORPORATION), AKA  
THE CENTER FOR HBCU MEDIA ADVOCACY,  
824 LOWE RD.  
MIDDLE RIVER, MD 21220

FOR: EDUCATIONAL SERVICES, NAMELY, PROVIDING INCENTIVES STUDENTS,  
FACULTY, ALUMNI, ADMINISTRATORS AND SUPPORTERS OF HISTORICALLY BLACK  
COLLEGES AND UNIVERSITIES TO DEMONSTRATE EXCELLENCE IN THE FIELD OF  
ACADEMICS, ATHLETICS, LEADERSHIP AND COMMUNITY SERVICE THROUGH THE  
ISSUANCE OF AWARDS, IN CLASS 41 (U.S. CLS. 100, 101 AND 107).

FIRST USE 7-1-2010; IN COMMERCE 3-1-2011.

THE MARK CONSISTS OF STANDARD CHARACTERS WITHOUT CLAIM TO ANY PAR-  
TICULAR FONT, STYLE, SIZE, OR COLOR.

NO CLAIM IS MADE TO THE EXCLUSIVE RIGHT TO USE "AWARDS", APART FROM  
THE MARK AS SHOWN.

SER. NO. 85-568,660, FILED P.R. 3-13-2012; AM. S.R. 6-28-2012.

JOHN E. MICHOS, EXAMINING ATTORNEY



*David J. Kyffers*

Director of the United States Patent and Trademark Office

# United States of America

United States Patent and Trademark Office

## INGLÉS AL MINUTO

**Reg. No. 4,200,354**

TRIALTEA USA (FLORIDA CORPORATION)  
804 S DOUGLAS RD, STE.#375  
CORAL GABLES, FL 33134

**Registered Aug. 28, 2012**

**Int. Cl.: 16**

FOR: EDUCATIONAL KITS SOLD AS A UNIT IN THE FIELD OF ENGLISH AS A SECOND LANGUAGE INSTRUCTION CONSISTING PRIMARILY OF PRINTED INSTRUCTIONAL MATERIALS AND ALSO INCLUDING AUDIO CDS, IN CLASS 16 (U.S. CLS. 2, 5, 22, 23, 29, 37, 38 AND 50).

**TRADEMARK**

**SUPPLEMENTAL REGISTER** FIRST USE 7-14-2008; IN COMMERCE 7-14-2008.

THE MARK CONSISTS OF STANDARD CHARACTERS WITHOUT CLAIM TO ANY PARTICULAR FONT, STYLE, SIZE, OR COLOR.

THE ENGLISH TRANSLATION OF "INGLES AL MINUTO" IN THE MARK IS "ENGLISH IN A MINUTE".

SER. NO. 85-568,782, FILED P.R. 3-14-2012; AM. S.R. 6-27-2012.

ANDREA K. NADELMAN, EXAMINING ATTORNEY



*David J. Kyros*

Director of the United States Patent and Trademark Office



# United States of America

United States Patent and Trademark Office

## PETROLEUM STRUCTURAL ENGINEERING

**Reg. No. 4,200,355**

SAFI QUALITY SOFTWARE INC (CANADA CORPORATION)  
3393, CHEMIN SAINTE-FOY

**Registered Aug. 28, 2012**

SAINTE-FOY, QUEBEC, CANADA G1X1S7

**Int. Cl.: 9**

FOR: ENGINEERING SOFTWARE FOR THE ANALYSIS, DESIGN, DRAWING AND ESTIMATION OF THE DRILLING STRUCTURES FOR GAS AND PETROLEUM FOR THE OFFSHORE AND ONSHORE STRUCTURES AND RIGS, IN CLASS 9 (U.S. CLS. 21, 23, 26, 36 AND 38).

**TRADEMARK**

**SUPPLEMENTAL REGISTER**

THE MARK CONSISTS OF STANDARD CHARACTERS WITHOUT CLAIM TO ANY PARTICULAR FONT, STYLE, SIZE, OR COLOR.

OWNER OF CANADA REG. NO. TMA780013, DATED 10-18-2010, EXPIRES 10-18-2025.

SER. NO. 85-569,048, FILED P.R. 3-14-2012; AM. S.R. 6-21-2012.

ANDREA HACK, EXAMINING ATTORNEY



*David J. Kybas*

Director of the United States Patent and Trademark Office

# United States of America

United States Patent and Trademark Office

## STOP MAKING EXCUSES

**Reg. No. 4,200,356**

FORMIA, BONNIE (UNITED STATES INDIVIDUAL)  
33123 TYNDALL RD.

**Registered Aug. 28, 2012**

AGUA DULCE, CA 91390 AND

**Int. Cl.: 14**

FORMIA, JOHN (UNITED STATES INDIVIDUAL)  
33123 TYNDALL RD.  
AGUA DULCE, CA 91390

**TRADEMARK**

**SUPPLEMENTAL REGISTER**

FOR: BRACELETS MADE OF RUBBER SILICON, IN CLASS 14 (U.S. CLS. 2, 27, 28 AND 50).

FIRST USE 1-1-2012; IN COMMERCE 3-1-2012.

THE MARK CONSISTS OF STANDARD CHARACTERS WITHOUT CLAIM TO ANY PARTICULAR FONT, STYLE, SIZE, OR COLOR.

SER. NO. 85-569,182, FILED P.R. 3-14-2012; AM. S.R. 6-22-2012.

DAVID YONTEF, EXAMINING ATTORNEY



*David J. Kyffers*

Director of the United States Patent and Trademark Office

# United States of America

United States Patent and Trademark Office

## Intelligent Merchant Services

**Reg. No. 4,200,357**

**Registered Aug. 28, 2012**

**Int. Cl.: 36**

**SERVICE MARK**

**SUPPLEMENTAL REGISTER**

METRO BANCARD LLC (MICHIGAN LIMITED LIABILITY COMPANY), DBA METRO BANCARD,  
P.O. BOX 36  
BLOOMFIELD HILLS, MI 48303

FOR: MERCHANT SERVICES, NAMELY, PAYMENT TRANSACTION PROCESSING SERVICES, IN CLASS 36 (U.S. CLS. 100, 101 AND 102).

FIRST USE 5-1-2006; IN COMMERCE 5-1-2006.

THE MARK CONSISTS OF STANDARD CHARACTERS WITHOUT CLAIM TO ANY PARTICULAR FONT, STYLE, SIZE, OR COLOR.

NO CLAIM IS MADE TO THE EXCLUSIVE RIGHT TO USE "MERCHANT SERVICES", APART FROM THE MARK AS SHOWN.

SER. NO. 85-570,292, FILED 3-15-2012.

RONALD MCMORROW, EXAMINING ATTORNEY



*David J. Kyfos*

Director of the United States Patent and Trademark Office

# United States of America

United States Patent and Trademark Office

## 365 BAIL BONDS

**Reg. No. 4,200,358**

MUHAMMAD, AQEEL (UNITED STATES INDIVIDUAL)  
3419 TORRANCE BLVD  
TORRANCE, CA 90503

**Registered Aug. 28, 2012**

**Int. Cl.: 36**

FOR: BAIL BONDING, IN CLASS 36 (U.S. CLS. 100, 101 AND 102).

**SERVICE MARK**

FIRST USE 3-1-2011; IN COMMERCE 4-1-2011.

**SUPPLEMENTAL REGISTER**

THE MARK CONSISTS OF STANDARD CHARACTERS WITHOUT CLAIM TO ANY PARTICULAR FONT, STYLE, SIZE, OR COLOR.

NO CLAIM IS MADE TO THE EXCLUSIVE RIGHT TO USE "BAIL BONDS", APART FROM THE MARK AS SHOWN.

SER. NO. 85-571,559, FILED P.R. 3-16-2012; AM. S.R. 6-27-2012.

TRICIA SONNEBORN, EXAMINING ATTORNEY



*David J. Kyffers*

Director of the United States Patent and Trademark Office

# United States of America

United States Patent and Trademark Office

## Delaware Notary Association

**Reg. No. 4,200,359**

ASHLEY, MICHAEL T (UNITED STATES INDIVIDUAL)  
820 CAUSEZ AVE  
CLAYMONT, DE 197031002

**Registered Aug. 28, 2012**

**Int. Cl.: 45**

FOR: NOTARY PUBLIC SERVICES, IN CLASS 45 (U.S. CLS. 100 AND 101).

**SERVICE MARK**

FIRST USE 12-1-2009; IN COMMERCE 12-1-2009.

**SUPPLEMENTAL REGISTER**

THE MARK CONSISTS OF STANDARD CHARACTERS WITHOUT CLAIM TO ANY PARTICULAR FONT, STYLE, SIZE, OR COLOR.

NO CLAIM IS MADE TO THE EXCLUSIVE RIGHT TO USE "NOTARY ASSOCIATION", APART FROM THE MARK AS SHOWN.

SER. NO. 85-572,061, FILED P.R. 3-16-2012; AM. S.R. 7-2-2012.

GINA FINK, EXAMINING ATTORNEY



*David J. Kybas*

Director of the United States Patent and Trademark Office

# United States of America

United States Patent and Trademark Office

# NOLA

**Reg. No. 4,200,360**

**Registered Aug. 28, 2012**

**Int. Cl.: 32**

NEW ORLEANS LAGER & ALE BREWING COMPANY, LLC (LOUISIANA LIMITED LIABILITY COMPANY)  
3001 TCHOUPITOULAS STREET  
NEW ORLEANS, LA 70115

FOR: BEER, IN CLASS 32 (U.S. CLS. 45, 46 AND 48).

**TRADEMARK**

FIRST USE 3-3-2009; IN COMMERCE 3-10-2010.

**SUPPLEMENTAL REGISTER**

THE MARK CONSISTS OF STANDARD CHARACTERS WITHOUT CLAIM TO ANY PARTICULAR FONT, STYLE, SIZE, OR COLOR.

SER. NO. 85-572,109, FILED P.R. 3-16-2012; AM. S.R. 6-27-2012.

NICHOLAS COLEMAN, EXAMINING ATTORNEY



*David J. Kybas*

Director of the United States Patent and Trademark Office

# United States of America

United States Patent and Trademark Office

## Anti Leg Cramps

**Reg. No. 4,200,361**

NAC MARKETING COMPANY, LLC (DELAWARE LIMITED LIABILITY COMPANY)  
260 SMITH STREET

**Registered Aug. 28, 2012**

FARMINGDALE, NY 11725

**Int. Cl.: 5**

FOR: DIETARY AND NUTRITIONAL SUPPLEMENTS; PAIN RELIEF MEDICATION, IN CLASS 5 (U.S. CLS. 6, 18, 44, 46, 51 AND 52).

**TRADEMARK**

FIRST USE 8-9-2011; IN COMMERCE 8-9-2011.

**SUPPLEMENTAL REGISTER**

THE MARK CONSISTS OF STANDARD CHARACTERS WITHOUT CLAIM TO ANY PARTICULAR FONT, STYLE, SIZE, OR COLOR.

SER. NO. 85-572,118, FILED P.R. 3-16-2012; AM. S.R. 3-16-2012.

ROBIN CHOSID, EXAMINING ATTORNEY



*David J. Kyros*

Director of the United States Patent and Trademark Office

# United States of America

United States Patent and Trademark Office

## The Midwest National Youth Football Championships

**Reg. No. 4,200,362**

NICHOLAS, KEITH (UNITED STATES INDIVIDUAL)  
4007 NORTHAMPTON ROAD  
CLEVELAND HEIGHTS, OH 44121 AND

**Registered Aug. 28, 2012**

**Int. Cl.: 41**

NICHOLAS, ALANNA (UNITED STATES INDIVIDUAL)  
4007 NORTHAMPTON ROAD  
CLEVELAND HEIGHTS, OH 44121

**SERVICE MARK**

**SUPPLEMENTAL REGISTER**

FOR: ENTERTAINMENT IN THE NATURE OF FOOTBALL TOURNAMENTS, IN CLASS 41  
(U.S. CLS. 100, 101 AND 107).

FIRST USE 11-1-2005; IN COMMERCE 11-1-2005.

THE MARK CONSISTS OF STANDARD CHARACTERS WITHOUT CLAIM TO ANY PARTICULAR FONT, STYLE, SIZE, OR COLOR.

NO CLAIM IS MADE TO THE EXCLUSIVE RIGHT TO USE "FOOTBALL CHAMPIONSHIPS", APART FROM THE MARK AS SHOWN.

SER. NO. 85-573,232, FILED P.R. 3-19-2012; AM. S.R. 6-27-2012.

ALICE BENMAMAN, EXAMINING ATTORNEY



*David J. Kybas*

Director of the United States Patent and Trademark Office



# United States of America

United States Patent and Trademark Office

# Pocket Socks

**Reg. No. 4,200,363**

**Registered Aug. 28, 2012**

**Int. Cl.: 25**

PAPEL, EVAN T. (CALIFORNIA SOLE PROPRIETORSHIP), DBA ZIPITGEAR.COM,  
950 AVIATION BLVD  
STE F  
HERMOSA BEACH, CA 90254

FOR: HOSIERY, IN CLASS 25 (U.S. CLS. 22 AND 39).

**TRADEMARK**

FIRST USE 1-1-1975; IN COMMERCE 6-15-2002.

**SUPPLEMENTAL REGISTER**

THE MARK CONSISTS OF STANDARD CHARACTERS WITHOUT CLAIM TO ANY PARTICULAR FONT, STYLE, SIZE, OR COLOR.

NO CLAIM IS MADE TO THE EXCLUSIVE RIGHT TO USE "SOCKS", APART FROM THE MARK AS SHOWN.

SER. NO. 85-573,863, FILED 3-19-2012.

AISHA CLARKE, EXAMINING ATTORNEY



*David J. Kyros*

Director of the United States Patent and Trademark Office

# United States of America

United States Patent and Trademark Office

## MEDICAL CLAIMS COMPLIANCE

**Reg. No. 4,200,364**

ACCESS INNOVATIONS, INC. (NEW MEXICO CORPORATION)  
4725 INDIAN SCHOOL RD. NE SUITE#100  
ALBUQUERQUE, NM 87110

**Registered Aug. 28, 2012**

**Int. Cl.: 42**

FOR: PROVIDING ON-LINE, NON-DOWNLOADABLE, INTERNET-BASED SOFTWARE APPLICATION FOR MEDICAL BILLING FOR PHYSICIANS AND HEALTH CARE INSTITUTIONS , IN CLASS 42 (U.S. CLS. 100 AND 101).

**SERVICE MARK**

FIRST USE 2-8-2012; IN COMMERCE 2-8-2012.

**SUPPLEMENTAL REGISTER**

THE MARK CONSISTS OF STANDARD CHARACTERS WITHOUT CLAIM TO ANY PARTICULAR FONT, STYLE, SIZE, OR COLOR.

SER. NO. 85-574,341, FILED P.R. 3-20-2012; AM. S.R. 6-28-2012.

RENEE MCCRAY, EXAMINING ATTORNEY



*David J. Kyffers*

Director of the United States Patent and Trademark Office

# United States of America

United States Patent and Trademark Office

## Driving Alliance

**Reg. No. 4,200,365**

DRIVING ALLIANCE (CALIFORNIA CORPORATION), DBA DRIVING ALLIANCE,  
5152 LANKERSHIM BLVD  
NORTH HOLLYWOOD, CA 91601

**Registered Aug. 28, 2012**

**Int. Cl.: 39**

FOR: TRANSPORT OF PERSONS, EXCLUDING CAR RESERVATION AND CAR RENTAL SERVICES, IN CLASS 39 (U.S. CLS. 100 AND 105).

**SERVICE MARK**

FIRST USE 10-1-2011; IN COMMERCE 10-1-2011.

**SUPPLEMENTAL REGISTER**

THE MARK CONSISTS OF STANDARD CHARACTERS WITHOUT CLAIM TO ANY PARTICULAR FONT, STYLE, SIZE, OR COLOR.

NO CLAIM IS MADE TO THE EXCLUSIVE RIGHT TO USE "DRIVING", APART FROM THE MARK AS SHOWN.

SER. NO. 85-574,630, FILED P.R. 3-20-2012; AM. S.R. 7-2-2012.

CARYN GLASSER, EXAMINING ATTORNEY



*David J. Kybas*

Director of the United States Patent and Trademark Office

United States of America  
United States Patent and Trademark Office

# IOCACHE

**Reg. No. 4,200,366**

FUSION-IO, INC. (DELAWARE CORPORATION)  
2855 E. COTTONWOOD PARKWAY, BOX 100  
SALT LAKE CITY, UT 84121

**Registered Aug. 28, 2012**

**Int. Cl.: 9**

FOR: COMPUTER HARDWARE AND PERIPHERALS, IN CLASS 9 (U.S. CLS. 21, 23, 26, 36 AND 38).

**TRADEMARK**

FIRST USE 10-30-2011; IN COMMERCE 1-12-2012.

**SUPPLEMENTAL REGISTER**

THE MARK CONSISTS OF STANDARD CHARACTERS WITHOUT CLAIM TO ANY PARTICULAR FONT, STYLE, SIZE, OR COLOR.

OWNER OF U.S. REG. NO. 4,155,983.

SER. NO. 85-574,759, FILED P.R. 3-20-2012; AM. S.R. 6-27-2012.

ESTHER BELENKER, EXAMINING ATTORNEY



*David J. Kybas*

Director of the United States Patent and Trademark Office

# United States of America

United States Patent and Trademark Office

## ultimate door security

**Reg. No. 4,200,367**

ARMOR CONCEPTS LLC (DELAWARE LIMITED LIABILITY COMPANY)  
6115 ROBERTSON AVENUE  
NASHVILLE, TN 37209

**Registered Aug. 28, 2012**

**Int. Cl.: 6**

FOR: DOOR CASINGS OF METAL; DOOR FITTINGS OF METAL; DOOR FRAMES OF METAL; DOOR JAMBS OF METAL; DOORS AND WINDOWS OF METAL; DOORS OF METAL; DOORS OF METAL FOR INDOOR USE, IN CLASS 6 (U.S. CLS. 2, 12, 13, 14, 23, 25 AND 50).

**TRADEMARK**

**SUPPLEMENTAL REGISTER** FIRST USE 8-1-2008; IN COMMERCE 8-1-2008.

THE MARK CONSISTS OF STANDARD CHARACTERS WITHOUT CLAIM TO ANY PARTICULAR FONT, STYLE, SIZE, OR COLOR.

OWNER OF U.S. REG. NO. 3,823,441.

SER. NO. 85-574,957, FILED P.R. 3-20-2012; AM. S.R. 7-5-2012.

RAMONA ORTIGA, EXAMINING ATTORNEY



*David J. Kyffers*

Director of the United States Patent and Trademark Office

# United States of America

United States Patent and Trademark Office

## ONE HOUR AUTHORITY

**Reg. No. 4,200,368**

RIDEOUT, KENNETH J. (UNITED STATES INDIVIDUAL), DBA ONE HOUR AUTHORITY,  
2524 RAVINESIDE LN N  
HOWELL, OH 48843

**Registered Aug. 28, 2012**

**Int. Cl.: 35**

FOR: BUSINESS ASSISTANCE, ADVISORY AND CONSULTING SERVICES IN THE FIELD  
OF TRANSPORTATION, IN CLASS 35 (U.S. CLS. 100, 101 AND 102).

**SERVICE MARK**

FIRST USE 0-0-2008; IN COMMERCE 0-0-2008.

**SUPPLEMENTAL REGISTER**

SER. NO. 85-577,409, FILED P.R. 3-22-2012; AM. S.R. 6-27-2012.

KATHRYN COWARD, EXAMINING ATTORNEY



*David J. Kyffers*

Director of the United States Patent and Trademark Office

# United States of America

United States Patent and Trademark Office

## Philly Team Store

**Reg. No. 4,200,369**

WRIGLEYVILLE SPORTS, INC. (ILLINOIS CORPORATION)  
101 EASTERN AVENUE  
BENSENVILLE, IL 60106

**Registered Aug. 28, 2012**

**Int. Cl.: 35**

FOR: ON-LINE RETAIL STORE SERVICES FEATURING SPORTS TEAMS CLOTHING, MEMORABILIA, AND MERCHANDISE, IN CLASS 35 (U.S. CLS. 100, 101 AND 102).

**SERVICE MARK**

FIRST USE 5-23-2011; IN COMMERCE 5-23-2011.

**SUPPLEMENTAL REGISTER**

THE MARK CONSISTS OF STANDARD CHARACTERS WITHOUT CLAIM TO ANY PARTICULAR FONT, STYLE, SIZE, OR COLOR.

NO CLAIM IS MADE TO THE EXCLUSIVE RIGHT TO USE "STORE", APART FROM THE MARK AS SHOWN.

SER. NO. 85-578,030, FILED P.R. 3-23-2012; AM. S.R. 7-18-2012.

ASMAT KHAN, EXAMINING ATTORNEY



*David J. Kyffers*

Director of the United States Patent and Trademark Office

# United States of America

United States Patent and Trademark Office

## Showcase Creator

**Reg. No. 4,200,370**

EVENTGRABBER IP, LLC (FLORIDA LIMITED LIABILITY COMPANY)  
3975 CESARE STREET  
ORLANDO, FL 32839

**Registered Aug. 28, 2012**

**Int. Cl.: 42**

FOR: PROVIDING A WEBSITE FEATURING TECHNOLOGY THAT ENABLES USERS TO CREATE TARGETED ADVERTISING WITH INTEGRATED SOCIAL MEDIA CONNECTIONS FOR THE PURPOSES OF SELLING TICKETS TO EVENTS, IN CLASS 42 (U.S. CLS. 100 AND 101).

**SERVICE MARK**

**SUPPLEMENTAL REGISTER** FIRST USE 8-1-2011; IN COMMERCE 8-1-2011.

THE MARK CONSISTS OF STANDARD CHARACTERS WITHOUT CLAIM TO ANY PARTICULAR FONT, STYLE, SIZE, OR COLOR.

NO CLAIM IS MADE TO THE EXCLUSIVE RIGHT TO USE "CREATOR", APART FROM THE MARK AS SHOWN.

SER. NO. 85-578,149, FILED P.R. 3-23-2012; AM. S.R. 6-28-2012.

SCOTT BIBB, EXAMINING ATTORNEY



*David J. Kyffers*

Director of the United States Patent and Trademark Office



# United States of America

United States Patent and Trademark Office

## Civic Webware

**Reg. No. 4,200,371**

SCHWECKE, TIM P. (UNITED STATES INDIVIDUAL)  
135 MILTON STREET

**Registered Aug. 28, 2012** LAKE MILLS, WI 53551

**Int. Cl.: 42**

FOR: WEBSITE DESIGN AND DEVELOPMENT FOR OTHERS, IN CLASS 42 (U.S. CLS. 100 AND 101).

**SERVICE MARK**

FIRST USE 1-1-2010; IN COMMERCE 4-1-2011.

**SUPPLEMENTAL REGISTER**

THE MARK CONSISTS OF STANDARD CHARACTERS WITHOUT CLAIM TO ANY PARTICULAR FONT, STYLE, SIZE, OR COLOR.

NO CLAIM IS MADE TO THE EXCLUSIVE RIGHT TO USE "WEBWARE", APART FROM THE MARK AS SHOWN.

SER. NO. 85-579,214, FILED P.R. 3-24-2012; AM. S.R. 7-5-2012.

JIM RINGLE, EXAMINING ATTORNEY



*David J. Kybas*

Director of the United States Patent and Trademark Office

# United States of America

United States Patent and Trademark Office

# DOGSBUTTER

**Reg. No. 4,200,372**

KEEVER, ROCKY (UNITED STATES INDIVIDUAL)

**Registered Aug. 28, 2012**

STE F  
2621 PICO BLVD  
SANTA MONICA, CA 90405

**Int. Cl.: 31**

FOR: PET TREATS, IN CLASS 31 (U.S. CLS. 1 AND 46).

**TRADEMARK**

FIRST USE 1-1-2010; IN COMMERCE 6-1-2011.

**SUPPLEMENTAL REGISTER**

THE MARK CONSISTS OF STANDARD CHARACTERS WITHOUT CLAIM TO ANY PARTICULAR FONT, STYLE, SIZE, OR COLOR.

SER. NO. 85-579,724, FILED P.R. 3-26-2012; AM. S.R. 6-25-2012.

TARA PATE, EXAMINING ATTORNEY



*David J. Kybas*

Director of the United States Patent and Trademark Office

# United States of America

United States Patent and Trademark Office

## Environmentally Correct Solutions

**Reg. No. 4,200,373**

ENVIRONMENTALLY CORRECT SOLUTIONS INC (NEW YORK CORPORATION)  
28 BARNSDALE AVE  
WEST SENECA, NY 142241102

**Registered Aug. 28, 2012**

**Int. Cl.: 40**

FOR: MOLD REMEDIATION SERVICES, IN CLASS 40 (U.S. CLS. 100, 103 AND 106).

**SERVICE MARK**

FIRST USE 3-15-2001; IN COMMERCE 4-5-2001.

**SUPPLEMENTAL REGISTER**

THE MARK CONSISTS OF STANDARD CHARACTERS WITHOUT CLAIM TO ANY PARTICULAR FONT, STYLE, SIZE, OR COLOR.

SER. NO. 85-580,730, FILED P.R. 3-27-2012; AM. S.R. 7-5-2012.

KATHY DE JONGE, EXAMINING ATTORNEY



*David J. Kyffers*

Director of the United States Patent and Trademark Office

# United States of America

United States Patent and Trademark Office

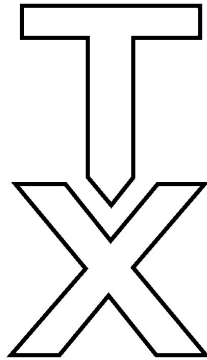

**Reg. No. 4,200,374**

**Registered Aug. 28, 2012**

**Int. Cl.: 33**

FIRESTONE & ROBERTSON DISTILLING COMPANY (TEXAS LIMITED LIABILITY COMPANY)  
901 W. VICKERY  
FORT WORTH, TX 76104

FOR: DISTILLED SPIRITS, IN CLASS 33 (U.S. CLS. 47 AND 49).

**TRADEMARK**

FIRST USE 1-1-2012; IN COMMERCE 1-1-2012.

**SUPPLEMENTAL REGISTER**

THE MARK CONSISTS OF THE STYLIZED TEXT "T" ABOVE AND "X" BELOW.

SER. NO. 85-580,902, FILED P.R. 3-27-2012; AM. S.R. 7-5-2012.

SETH A. RAPPAPORT, EXAMINING ATTORNEY



*David J. Kyffers*

Director of the United States Patent and Trademark Office

# United States of America

United States Patent and Trademark Office

## Secured Storage

**Reg. No. 4,200,375**

PHOENIX NAP, LLC (ARIZONA LIMITED LIABILITY COMPANY)  
2353 WEST UNIVERSITY DRIVE  
TEMPE, AZ 85281

**Registered Aug. 28, 2012**

**Int. Cl.: 38**

FOR: ELECTRONIC TRANSMISSION OF DIGITAL STREAMING MEDIA DATA FEATURING ENCRYPTION AND DECRYPTION, IN CLASS 38 (U.S. CLS. 100, 101 AND 104).

**SERVICE MARK**

FIRST USE 3-1-2012; IN COMMERCE 3-1-2012.

**SUPPLEMENTAL REGISTER**

THE MARK CONSISTS OF STANDARD CHARACTERS WITHOUT CLAIM TO ANY PARTICULAR FONT, STYLE, SIZE, OR COLOR.

SER. NO. 85-581,244, FILED P.R. 3-27-2012; AM. S.R. 7-11-2012.

TINA MAI, EXAMINING ATTORNEY



*David J. Kybas*

Director of the United States Patent and Trademark Office

# United States of America

United States Patent and Trademark Office

## South Beach Boxing

**Reg. No. 4,200,376**

**Registered Aug. 28, 2012**

**Int. Cl.: 41**

SOUTH FLORIDA BOXING COMPANY (FLORIDA CORPORATION), DBA SOUTH BEACH BOXING,  
715 WASHINGTON AVENUE  
2ND FLOOR  
MIAMI BEACH, FL 33139

**SERVICE MARK**

**SUPPLEMENTAL REGISTER**

FOR: HEALTH CLUB SERVICES, NAMELY, PROVIDING INSTRUCTION AND EQUIPMENT IN THE FIELD OF PHYSICAL EXERCISE; PERSONAL FITNESS TRAINING SERVICES AND CONSULTANCY; PHYSICAL FITNESS STUDIO SERVICES, NAMELY, PROVIDING EXERCISE CLASSES, BODY SCULPTING CLASSES, AND GROUP FITNESS CLASSES; PROVIDING CLASSES, WORKSHOPS, SEMINARS AND CAMPS IN THE FIELDS OF FITNESS, EXERCISE, BOXING, KICK BOXING AND MIXED MARTIAL ARTS, IN CLASS 41 (U.S. CLS. 100, 101 AND 107).

FIRST USE 3-5-2012; IN COMMERCE 3-5-2012.

THE MARK CONSISTS OF STANDARD CHARACTERS WITHOUT CLAIM TO ANY PARTICULAR FONT, STYLE, SIZE, OR COLOR.

NO CLAIM IS MADE TO THE EXCLUSIVE RIGHT TO USE "BOXING", APART FROM THE MARK AS SHOWN.

SER. NO. 85-583,111, FILED P.R. 3-29-2012; AM. S.R. 6-25-2012.

NICHOLAS ALTREE, EXAMINING ATTORNEY



*David J. Kyffers*

Director of the United States Patent and Trademark Office

**United States of America**  
United States Patent and Trademark Office

# PsycWIKI

**Reg. No. 4,200,377**

AMERICAN PSYCHOLOGICAL ASSOCIATION (D.C. NON-PROFIT CORPORATION)  
750 FIRST STREET, N.E.

**Registered Aug. 28, 2012**

WASHINGTON, DC 200024242

**Int. Cl.: 42**

FOR: COMPUTER SERVICES, NAMELY, HOSTING AN ONLINE COMMUNITY FOR USERS TO PARTICIPATE IN DISCUSSION FORUMS AND LINK TO INFORMATION IN THE FIELD OF PROFESSIONAL PSYCHOLOGY, IN CLASS 42 (U.S. CLS. 100 AND 101).

**SERVICE MARK**

FIRST USE 6-13-2012; IN COMMERCE 6-13-2012.

**SUPPLEMENTAL REGISTER**

THE MARK CONSISTS OF STANDARD CHARACTERS WITHOUT CLAIM TO ANY PARTICULAR FONT, STYLE, SIZE, OR COLOR.

SER. NO. 85-583,548, FILED P.R. 3-29-2012; AM. S.R. 6-29-2012.

ELISSA GARBER KON, EXAMINING ATTORNEY



*David J. Kyjars*

Director of the United States Patent and Trademark Office

# United States of America

United States Patent and Trademark Office

## Mixtapes & Pancakes

**Reg. No. 4,200,378**

THOMPSON, MAERIA D. (UNITED STATES INDIVIDUAL)  
2995 GRAY RD. SE  
SMYRNA, GA 30082 AND

**Registered Aug. 28, 2012**

**Int. Cl.: 41**

TAYLOR, TAMIRA (UNITED STATES INDIVIDUAL)  
2995 GRAY RD. SE  
SMYRNA, GA 30082 AND

**SERVICE MARK**

**SUPPLEMENTAL REGISTER**

MCNEILL, BRITTANY (UNITED STATES INDIVIDUAL)  
2995 GRAY RD. SE  
SMYRNA, GA 30082

FOR: ARRANGING AND CONDUCTING SPECIAL EVENTS FOR SOCIAL ENTERTAINMENT PURPOSES, IN CLASS 41 (U.S. CLS. 100, 101 AND 107).

FIRST USE 6-27-2011; IN COMMERCE 8-18-2011.

THE MARK CONSISTS OF STANDARD CHARACTERS WITHOUT CLAIM TO ANY PARTICULAR FONT, STYLE, SIZE, OR COLOR.

SER. NO. 85-584,243, FILED P.R. 3-29-2012; AM. S.R. 7-10-2012.

KRISTIN DAHLING, EXAMINING ATTORNEY



*David J. Kybas*

Director of the United States Patent and Trademark Office



# United States of America

United States Patent and Trademark Office

## Grandpa Gardener Growing Gardens Growing Children

**Reg. No. 4,200,379**

VAN NOSTRAND, WILLARD RANDOLPH, III (UNITED STATES INDIVIDUAL)  
3737 E. CALLE CORTEZ  
TUCSON, AZ 85716

**Registered Aug. 28, 2012**

**Int. Cl.: 25**

FOR: APRONS; CHILDREN'S AND INFANTS' CLOTH BIBS; HATS; SCRUBS NOT FOR MEDICAL PURPOSES; SHIRTS; SWEATSHIRTS; T-SHIRTS; TOPS, IN CLASS 25 (U.S. CLS. 22 AND 39).

**TRADEMARK**

FIRST USE 7-16-2008; IN COMMERCE 7-16-2008.

**SUPPLEMENTAL REGISTER**

THE MARK CONSISTS OF STANDARD CHARACTERS WITHOUT CLAIM TO ANY PARTICULAR FONT, STYLE, SIZE, OR COLOR.

OWNER OF U.S. REG. NO. 3,725,500.

SER. NO. 85-585,101, FILED P.R. 3-30-2012; AM. S.R. 6-11-2012.

JAMES LOVELACE, EXAMINING ATTORNEY



*David J. Kyffers*

Director of the United States Patent and Trademark Office

# United States of America

United States Patent and Trademark Office

## BANCORP FX

**Reg. No. 4,200,380**

**Registered Aug. 28, 2012**

**Int. Cl.: 36**

INTERNATIONAL METALS TRADING & INVESTMENTS, LTD. (ALASKA CORPORATION),  
AKA BFX,  
SUITE 1400  
980 N. MICHIGAN AVENUE  
CHICAGO, IL 60611

**SERVICE MARK**

FOR: FOREIGN EXCHANGE TRANSACTIONS, IN CLASS 36 (U.S. CLS. 100, 101 AND 102).

**SUPPLEMENTAL REGISTER**

FIRST USE 1-26-2012; IN COMMERCE 1-26-2012.

THE MARK CONSISTS OF STANDARD CHARACTERS WITHOUT CLAIM TO ANY PARTICULAR FONT, STYLE, SIZE, OR COLOR.

SER. NO. 85-588,408, FILED P.R. 4-4-2012; AM. S.R. 7-20-2012.

TEJBIR SINGH, EXAMINING ATTORNEY



*David J. Kyffers*

Director of the United States Patent and Trademark Office

# United States of America

United States Patent and Trademark Office

# KINOMESCAN

**Reg. No. 4,200,381**

**Registered Aug. 28, 2012**

**Int. Cl.: 42**

**SERVICE MARK**

**SUPPLEMENTAL REGISTER**

DISCOVERX CORPORATION (DELAWARE CORPORATION)  
SUITE 100  
42501 ALBRAE STREET  
FREMONT, CA 94538

FOR: SCIENTIFIC AND TECHNOLOGICAL SERVICES, NAMELY, COMPOUND SCREENING AND PROFILING IN THE FIELD OF DRUG DISCOVERY FOR SCIENTIFIC RESEARCH AND ANALYSIS, IN CLASS 42 (U.S. CLS. 100 AND 101).

FIRST USE 8-1-2007; IN COMMERCE 8-1-2007.

THE MARK CONSISTS OF STANDARD CHARACTERS WITHOUT CLAIM TO ANY PARTICULAR FONT, STYLE, SIZE, OR COLOR.

SER. NO. 85-590,202, FILED P.R. 4-5-2012; AM. S.R. 6-28-2012.

TARAH HARDY, EXAMINING ATTORNEY



*David J. Kyjars*

Director of the United States Patent and Trademark Office