

United States of America

United States Patent and Trademark Office

NEWSNOW

Reg. No. 4,097,422

NEWSNOW PUBLISHING LIMITED (UNITED KINGDOM CORPORATION)

Registered Feb. 14, 2012

89 LILLIE ROAD
LONDON SW6 IUD, ENGLAND

Int. Cl.: 42

FOR: PROVIDING A WEBSITE FEATURING A SEARCH ENGINE FOR NEWS, IN CLASS 42 (U.S. CLS. 100 AND 101).

SERVICE MARK

FIRST USE 9-27-1997; IN COMMERCE 9-27-1997.

PRINCIPAL REGISTER

SER. NO. 76-081,651, FILED 7-3-2000.

DANNEAN HETZEL, EXAMINING ATTORNEY



David J. Kybas

Director of the United States Patent and Trademark Office

United States of America

United States Patent and Trademark Office

HOT ROD

Reg. No. 4,097,423

CODET NEWPORT CORPORATION (VERMONT CORPORATION)

Registered Feb. 14, 2012

294 CRAWFORD ROAD
NEWPORT, VT 05855

Int. Cl.: 25

FOR: CLOTHING, NAMELY, SHIRTS, T-SHIRTS, PANTS, JEANS, SHORTS, JACKETS, COVERALLS, OVERALLS, SWEATERS, FOOTWEAR, BOOTS, SHOES AND SANDALS, IN CLASS 25 (U.S. CLS. 22 AND 39).

TRADEMARK

FIRST USE 5-1-1993; IN COMMERCE 5-1-1993.

PRINCIPAL REGISTER

OWNER OF U.S. REG. NO. 1,461,066.

SER. NO. 76-514,463, FILED 5-14-2003.

ALEXANDER L. POWERS, EXAMINING ATTORNEY



David J. Kyffers

Director of the United States Patent and Trademark Office

United States of America

United States Patent and Trademark Office



Reg. No. 4,097,424

Registered Feb. 14, 2012

Int. Cl.: 9

TRADEMARK

PRINCIPAL REGISTER

TSUI, PHILIP Y.W. (CANADA INDIVIDUAL)
36 AUPUI WAN STREET
ROOM 03B, 13F, VERISTRONG IND. CTR.
FO TAN, HONG KONG

FOR: ELECTRONIC AND OPTICAL COMMUNICATIONS DEVICES, NAMELY, TRANSCIEVERS, TRANSMITTERS, RECEIVERS AND SENSORS, ALL FOR USE IN CONNECTION WITH DOOR AND GATE LOCKS AND OPENERS, SECURITY AND ALARM SYSTEMS, AND LIGHTING SYSTEMS; ELECTRONIC GARAGE DOOR OPENER, OPTICAL GARAGE DOOR OPENER, ELECTRONIC DOOR OPENER, OPTICAL DOOR OPENER, ELECTRONIC GATE OPENER, OPTICAL GATE OPENER, ELECTRONIC DOOR LOCKS, OPTICAL DOOR LOCKS, ELECTRONIC GATE LOCKS, OPTICAL GATE LOCKS, ELECTROMAGNETIC DOOR AND GATE LOCKS; SECURITY AND ALARM SYSTEMS, NAMELY, ELECTRONIC SECURITY MONITORING CONTROL PANELS, TRANSMITTERS, RECEIVERS, TRANSCIEVERS, SECURITY SENSORS, AUTOMATIC DIALERS, REMOTE CONTROLLER FOR GARAGE DOORS; REMOTE CONTROLLED AUTOMATIC DIALERS, AUTOMATIC VOICE MESSAGE HARDWARE AND AUTOMATIC TELEPHONE CONFERENCING HARDWARE ALL FOR USE IN CONNECTION WITH DOOR AND GATE LOCKS AND OPENERS, SECURITY AND ALARM SYSTEMS, AND LIGHTING SYSTEMS, IN CLASS 9 (U.S. CLS. 21, 23, 26, 36 AND 38).

FIRST USE 10-1-1994; IN COMMERCE 10-1-1994.

OWNER OF U.S. REG. NOS. 2,472,617 AND 2,885,793.

SER. NO. 76-572,887, FILED 1-30-2004.

BERYL GARDNER, EXAMINING ATTORNEY



David J. Kyffers

Director of the United States Patent and Trademark Office

United States of America

United States Patent and Trademark Office

ITERA

Reg. No. 4,097,425

Registered Feb. 14, 2012

Int. Cls.: 9 and 42

TRADEMARK

SERVICE MARK

PRINCIPAL REGISTER

VISION SOLUTIONS, INC. (DELAWARE CORPORATION)
15300 BARRANCA PARKWAY
IRVINE, CA 92618

FOR: COMPUTER SOFTWARE PROGRAMS, AND SYSTEMS CONSISTING PRIMARILY OF SERVER COMPUTERS FOR USE IN DISASTER RECOVERY, SECURITY, DATA AUDITING, SYSTEM MANAGEMENT, REPORTING, PERFORMANCE TUNING, DATA CONVERSION, DATA MANAGEMENT, TESTING, SYSTEM CONFIGURATION, SYSTEM ANALYSIS, AND COMPUTER DATA BACKUP, IN CLASS 9 (U.S. CLS. 21, 23, 26, 36 AND 38).

FIRST USE 1-10-2001; IN COMMERCE 1-10-2001.

FOR: INFORMATION TECHNOLOGY CONSULTATION; TECHNICAL SUPPORT, NAMELY, PROVIDING BACK-UP COMPUTER PROGRAMS AND FACILITIES; INTEGRATION OF COMPUTER SYSTEMS AND NETWORKS; DATA CONVERSION OF COMPUTER PROGRAM DATA AND INFORMATION; RECOVERY OF COMPUTER DATA, IN CLASS 42 (U.S. CLS. 100 AND 101).

FIRST USE 1-10-2001; IN COMMERCE 1-10-2001.

THE MARK CONSISTS OF STANDARD CHARACTERS WITHOUT CLAIM TO ANY PARTICULAR FONT, STYLE, SIZE, OR COLOR.

SER. NO. 76-643,303, FILED 7-21-2005.

MICHAEL SOUDERS, EXAMINING ATTORNEY



David J. Kybas

Director of the United States Patent and Trademark Office

United States of America

United States Patent and Trademark Office

HITMAN

Reg. No. 4,097,426

Registered Feb. 14, 2012

Int. Cl.: 25

TRADEMARK

PRINCIPAL REGISTER

TAPOUT, LLC (CALIFORNIA LIMITED LIABILITY COMPANY)
21800 BARTON ROAD
SUITE 105
GRAND TERRACE, CA 92313

FOR: CLOTHING, NAMELY, TEE-SHIRTS, TANK TOPS, MUSCLE SHIRTS, SWEATSHIRTS, COLLARED SHIRTS, BASEBALL HATS, BEANIES AND GLOVES PROMOTING MIXED MARTIAL ARTS, IN CLASS 25 (U.S. CLS. 22 AND 39).

FIRST USE 3-29-1997; IN COMMERCE 3-30-1997.

THE MARK CONSISTS OF STANDARD CHARACTERS WITHOUT CLAIM TO ANY PARTICULAR FONT, STYLE, SIZE, OR COLOR.

SER. NO. 76-654,153, FILED 1-27-2006.

SETH A. RAPPAPORT, EXAMINING ATTORNEY



David J. Kyjars

Director of the United States Patent and Trademark Office

United States of America

United States Patent and Trademark Office

GLOBAL PEACE LOVER

Reg. No. 4,097,427

SHAFIK, AASEF (UNITED STATES INDIVIDUAL)

Registered Feb. 14, 2012

6614 COLUMBIA PIKE
ANNANDALE, VA 22003

Int. Cl.: 35

FOR: ONLINE RETAIL STORE SERVICES FEATURING: SHIRTS, HATS, JACKETS, PANTS, SHOES, APRONS, DOG T-SHIRTS, TEDDY BEARS, DRINK COASTERS, DECORATIVE WALL TILES, ATHLETIC WEAR, NAMELY, SWEATSHIRTS AND ATHLETIC UNIFORMS, BAGS, NAMELY, TOTE BAGS AND MESSENGER BAGS, GREETING CARDS, CALENDARS, THROW PILLOWS, LAPEL PINS, AND WALL CLOCKS, IN CLASS 35 (U.S. CLS. 100, 101 AND 102).

SERVICE MARK

PRINCIPAL REGISTER

FIRST USE 4-1-2007; IN COMMERCE 4-1-2007.

THE MARK CONSISTS OF STANDARD CHARACTERS WITHOUT CLAIM TO ANY PARTICULAR FONT, STYLE, SIZE, OR COLOR.

SER. NO. 76-686,845, FILED 2-15-2008.

BRIAN NEVILLE, EXAMINING ATTORNEY



David J. Kyffers

Director of the United States Patent and Trademark Office

United States of America

United States Patent and Trademark Office

OLIVER-TOLAS

Reg. No. 4,097,428

Registered Feb. 14, 2012

Int. Cls.: 1, 6, 16 and 17

TRADEMARK

PRINCIPAL REGISTER

OLIVER-TOLAS HEALTHCARE PACKAGING, LLC (DELAWARE LIMITED LIABILITY COMPANY)

445 SIXTH STREET NW
GRAND RAPIDS, MI 49504

FOR: ADHESIVES FOR GENERAL INDUSTRIAL USE, NAMELY, ADHESIVES AND HEAT-SEAL COATINGS FOR USE IN PACKAGING, IN CLASS 1 (U.S. CLS. 1, 5, 6, 10, 26 AND 46).

FIRST USE 4-23-2009; IN COMMERCE 4-23-2009.

FOR: PACKAGING MATERIALS FOR MEDICAL DEVICES, NAMELY, ALUMINUM FOIL FOR PACKING AND ALUMINUM FOIL POUCHES FOR PACKING, IN CLASS 6 (U.S. CLS. 2, 12, 13, 14, 23, 25 AND 50).

FIRST USE 4-23-2009; IN COMMERCE 4-23-2009.

FOR: PACKAGING MATERIALS FOR MEDICAL DEVICES, NAMELY, PACKING PAPER, SYNTHETIC PACKING PAPER, PAPER AND SYNTHETIC PAPER CLOSURES FOR SEALING CONTAINERS, PAPER AND SYNTHETIC PAPER BAGS, ENVELOPES AND POUCHES FOR PACKING, PLASTIC POUCHES AND BAGS FOR PACKING, IN CLASS 16 (U.S. CLS. 2, 5, 22, 23, 29, 37, 38 AND 50).

FIRST USE 4-23-2009; IN COMMERCE 4-23-2009.

FOR: PACKAGING MATERIALS FOR MEDICAL DEVICES, NAMELY, PLASTIC FILM FOR PACKING; SHEETS OF MAN-MADE FIBERS FOR USE AS LIDS, ADHESIVE COATED SHEET MATERIAL OF MAN-MADE FIBERS SUITABLE FOR PACKAGING, PLASTIC IN THE FORM OF SHEETS FOR USE IN MANUFACTURING LIDS, IN CLASS 17 (U.S. CLS. 1, 5, 12, 13, 35 AND 50).

FIRST USE 4-23-2009; IN COMMERCE 4-23-2009.

THE MARK CONSISTS OF STANDARD CHARACTERS WITHOUT CLAIM TO ANY PARTICULAR FONT, STYLE, SIZE, OR COLOR.

SER. NO. 76-702,412, FILED 4-8-2010.



David J. Kyros

Director of the United States Patent and Trademark Office

Reg. No. 4,097,428 MIDGE BUTLER, EXAMINING ATTORNEY

United States of America
United States Patent and Trademark Office

EPIKLOR

Reg. No. 4,097,429

EPIC PHARMA, LLC (NEW YORK LIMITED LIABILITY COMPANY)
227-15 N. CONDUIT AVENUE
LAURELTON, NY 11413

Registered Feb. 14, 2012

Int. Cl.: 5

FOR: PHARMACEUTICAL PREPARATIONS, NAMELY, POTASSIUM CHLORIDE FOR THE TREATMENT OF POTASSIUM DEPLETION AND FOR THE PREVENTION OF HYPOKALEMIA, IN CLASS 5 (U.S. CLS. 6, 18, 44, 46, 51 AND 52).

TRADEMARK

FIRST USE 3-17-2010; IN COMMERCE 3-22-2010.

PRINCIPAL REGISTER

THE MARK CONSISTS OF STANDARD CHARACTERS WITHOUT CLAIM TO ANY PARTICULAR FONT, STYLE, SIZE, OR COLOR.

THE WORDING "EPIKLOR" HAS NO MEANING IN A FOREIGN LANGUAGE.

SER. NO. 76-702,912, FILED 5-12-2010.

CHARISMA HAMPTON, EXAMINING ATTORNEY



David J. Kyffers

Director of the United States Patent and Trademark Office

United States of America

United States Patent and Trademark Office



Reg. No. 4,097,430

Registered Feb. 14, 2012

Int. Cl.: 35

SERVICE MARK

PRINCIPAL REGISTER

BROKER EXCHANGE NETWORK, LLC (MINNESOTA LIMITED LIABILITY COMPANY)
32 SEVENTH AVENUE NE
ROCHESTER, MN 55906

FOR: MARKETING, ADVERTISING AND PROMOTING THE GOODS AND SERVICES OF OTHERS IN THE FIELD OF ON-LINE TRADING SERVICES, NAMELY, ADVERTISING SERVICES VIA PRINT MEDIA AND THE INTERNET; BRANDING SERVICES, NAMELY, CONSULTING, DEVELOPMENT, MANAGEMENT AND MARKETING OF BRANDS FOR BUSINESSES; CORPORATE IDENTITY DEVELOPMENT SERVICES; ARRANGING AND CONDUCTING TRADE SHOWS IN THE FIELD OF TECHNOLOGY PRODUCTS AND SERVICES; SALES VOLUME TRACKING FOR OTHERS; INVENTORY MONITORING SERVICES; SALES PROMOTION SERVICES, IN CLASS 35 (U.S. CLS. 100, 101 AND 102).

FIRST USE 3-4-2010; IN COMMERCE 4-1-2010.

OWNER OF U.S. REG. NOS. 3,203,361, 3,296,055, AND 3,300,577.

NO CLAIM IS MADE TO THE EXCLUSIVE RIGHT TO USE "RESELLERSOLUTIONS.COM SOLUTIONS FOR TECHNOLOGY COMPANIES A MEMBER OF THE BROKER EXCHANGE NETWORK", APART FROM THE MARK AS SHOWN.

THE MARK CONSISTS OF A THREE-BLADE PINWHEEL DESIGN FOLLOWED BY THE STYLIZED WORDING "RESELLERSOLUTIONS.COM" ON ONE LINE, "SOLUTIONS FOR TECHNOLOGY COMPANIES" ON THE LINE BENEATH IT, AND "A MEMBER OF THE BROKER EXCHANGE NETWORK" ON THE BOTTOM LINE.

SER. NO. 76-704,941, FILED 10-18-2010.

BRENDAN REGAN, EXAMINING ATTORNEY



David J. Kybas

Director of the United States Patent and Trademark Office

United States of America

United States Patent and Trademark Office

TEAM WHITETAIL

Reg. No. 4,097,431

BARRY R REECHER (UNITED STATES INDIVIDUAL)
929 JACK ROAD
ORRTANNA, PA 17353

Registered Feb. 14, 2012

Int. Cl.: 39

FOR: ORGANIZATION OF TRIPS FEATURING ANIMAL HUNTS, IN CLASS 39 (U.S. CLS. 100 AND 105).

SERVICE MARK

FIRST USE 5-16-1996; IN COMMERCE 5-19-1996.

PRINCIPAL REGISTER

THE MARK CONSISTS OF STANDARD CHARACTERS WITHOUT CLAIM TO ANY PARTICULAR FONT, STYLE, SIZE, OR COLOR.

NO CLAIM IS MADE TO THE EXCLUSIVE RIGHT TO USE "WHITETAIL", APART FROM THE MARK AS SHOWN.

SER. NO. 76-705,385, FILED 11-15-2010.

KATHERINE E. HALMEN, EXAMINING ATTORNEY



David J. Kybas

Director of the United States Patent and Trademark Office

United States of America

United States Patent and Trademark Office

NFP

Reg. No. 4,097,432

NATIONAL FINANCIAL PARTNERS CORP. (DELAWARE CORPORATION)
340 MADISON AVENUE, 20TH FLOOR
NEW YORK, NY 10173

Registered Feb. 14, 2012

Int. Cls.: 35 and 36

FOR: ADVERTISING AND MARKETING SERVICES IN THE FIELD OF INSURANCE; AND BUSINESS CONSULTATION SERVICES FOR FINANCIAL ORGANIZATIONS IN THE FIELDS OF BUSINESS PORTFOLIO MANAGEMENT, ANALYZING AND COMPILING DATA FOR MEASURING THE PERFORMANCE OF FINANCIAL MARKETS, BUSINESS FEASIBILITY PROPOSAL GENERATION, TRACKING AND MONITORING INSURANCE COMPLIANCE AND BUSINESS RISK MANAGEMENT, IN CLASS 35 (U.S. CLS. 100, 101 AND 102).

SERVICE MARK

PRINCIPAL REGISTER

FIRST USE 9-20-2010; IN COMMERCE 9-20-2010.

FOR: BROKERAGE AND CONSULTING SERVICES FOR EMPLOYEE BENEFITS CONCERNING INSURANCE AND FINANCE, NAMELY, HEALTH INSURANCE, ANCILLARY INSURANCE AND RETIREMENT PLANS; BROKERAGE, CONSULTING AND ADMINISTRATIVE SERVICES FOR EXECUTIVE BENEFIT PLANS CONCERNING INSURANCE AND FINANCE; BROKERAGE SERVICES FOR PROPERTY AND CASUALTY INSURANCE; BROKERAGE SERVICES FOR ANNUITIES, DISABILITY, LONG TERM CARE AND LIFE INSURANCE; INSURANCE BROKERAGE SERVICES FOR FINANCIAL INSTITUTIONS; INSURANCE AGENCY SERVICES; ADVISORY SERVICES IN THE FIELDS OF INVESTMENT, WEALTH MANAGEMENT, RETIREMENT PLANNING AND LIFE INSURANCE SETTLEMENT; ADVISORY SERVICES IN THE FIELDS OF BROKER-DEALERS INSURANCE BROKERAGE, REGISTERED FINANCIAL INVESTMENTS, MUTUAL FUNDS, SECURITIES, ANNUITIES, ALTERNATIVE FINANCIAL INVESTMENTS, HEDGE FUNDS, OPTIONS, AND SEPARATE RETIREMENT ACCOUNT MANAGEMENT; AND FINANCIAL DUE DILIGENCE SERVICES FOR INVESTMENT PRODUCTS AND MANAGERS, IN CLASS 36 (U.S. CLS. 100, 101 AND 102).

FIRST USE 9-20-2010; IN COMMERCE 9-20-2010.

OWNER OF U.S. REG. NOS. 2,422,912 AND 2,742,420.

THE MARK CONSISTS OF THE WORDING "NFP" IN STYLIZED FONT.

SER. NO. 76-705,997, FILED 1-14-2011.



David J. Kyffers

Director of the United States Patent and Trademark Office

Reg. No. 4,097,432 TASNEEM HUSSAIN, EXAMINING ATTORNEY

United States of America

United States Patent and Trademark Office



Reg. No. 4,097,433

Registered Feb. 14, 2012

Int. Cls.: 35 and 36

SERVICE MARK

PRINCIPAL REGISTER

NATIONAL FINANCIAL PARTNERS CORP. (DELAWARE CORPORATION)
340 MADISON AVENUE, 20TH FLOOR
NEW YORK, NY 10173

FOR: ADVERTISING AND MARKETING SERVICES IN THE FIELD OF INSURANCE; AND BUSINESS CONSULTATION SERVICES FOR FINANCIAL ORGANIZATIONS IN THE FIELDS OF BUSINESS PORTFOLIO MANAGEMENT, ANALYZING AND COMPILING DATA FOR MEASURING THE PERFORMANCE OF FINANCIAL MARKETS, BUSINESS FEASIBILITY PROPOSAL GENERATION, TRACKING AND MONITORING INSURANCE COMPLIANCE AND BUSINESS RISK MANAGEMENT, IN CLASS 35 (U.S. CLS. 100, 101 AND 102).

FIRST USE 9-20-2010; IN COMMERCE 9-20-2010.

FOR: BROKERAGE AND CONSULTING SERVICES FOR EMPLOYEE BENEFITS CONCERNING INSURANCE AND FINANCE, NAMELY, HEALTH INSURANCE, ANCILLARY INSURANCE AND RETIREMENT PLANS; BROKERAGE, CONSULTING AND ADMINISTRATIVE SERVICES FOR EXECUTIVE BENEFIT PLANS CONCERNING INSURANCE AND FINANCE; BROKERAGE SERVICES FOR PROPERTY AND CASUALTY INSURANCE; BROKERAGE SERVICES FOR ANNUITIES, DISABILITY, LONG TERM CARE AND LIFE INSURANCE; INSURANCE BROKERAGE SERVICES FOR FINANCIAL INSTITUTIONS; INSURANCE AGENCY SERVICES; ADVISORY SERVICES IN THE FIELDS OF INVESTMENT, WEALTH MANAGEMENT, RETIREMENT PLANNING AND LIFE INSURANCE SETTLEMENT; ADVISORY SERVICES IN THE FIELDS OF BROKER-DEALERS INSURANCE BROKERAGE, REGISTERED FINANCIAL INVESTMENTS, MUTUAL FUNDS, SECURITIES, ANNUITIES, ALTERNATIVE FINANCIAL INVESTMENTS, HEDGE FUNDS, OPTIONS, AND SEPARATE RETIREMENT ACCOUNT MANAGEMENT; AND FINANCIAL DUE DILIGENCE SERVICES FOR INVESTMENT PRODUCTS AND MANAGERS, IN CLASS 36 (U.S. CLS. 100, 101 AND 102).

FIRST USE 9-20-2010; IN COMMERCE 9-20-2010.

OWNER OF U.S. REG. NOS. 2,422,912 AND 2,742,420.

THE MARK CONSISTS OF THE STYLIZED WORDING "NFP" TO THE RIGHT OF A DESIGN OF TWO INTERLOCKING SHAPES THAT FORM A HEXAGON.



David J. Kyffers

Director of the United States Patent and Trademark Office

Reg. No. 4,097,433 SER. NO. 76-706,001, FILED 1-14-2011.

TASNEEM HUSSAIN, EXAMINING ATTORNEY

United States of America

United States Patent and Trademark Office



Reg. No. 4,097,434

NGUYEN, TUONG (UNITED STATES INDIVIDUAL)
10132 TYLER CT
WESTMINSTER, CA 926835760

Registered Feb. 14, 2012

Int. Cl.: 5

FOR: NUTRITIONAL AND DIETARY SUPPLEMENTS CONTAINING OMEGAS DERIVED FROM FISH OIL AND KRILL OIL, IN CLASS 5 (U.S. CLS. 6, 18, 44, 46, 51 AND 52).

TRADEMARK

FIRST USE 1-26-2011; IN COMMERCE 1-26-2011.

PRINCIPAL REGISTER

NO CLAIM IS MADE TO THE EXCLUSIVE RIGHT TO USE "OMEGA-3" AND "KRILL OIL & FISH OIL", APART FROM THE MARK AS SHOWN.

THE COLOR(S) RED, WHITE AND BLACK IS/ARE CLAIMED AS A FEATURE OF THE MARK.

THE MARK CONSISTS OF THE WORD "SUPER" OVER THE WORD "MEGA", BOTH IN WHITE, TO THE LEFT OF A WHITE BOX WITH THE RED WORDING "3X", OUTLINED IN BLACK, OVER THE SMALLER RED WORDING "OMEGA-3", ALL WITHIN A RED RECTANGLE BACKGROUND.

SER. NO. 76-706,205, FILED 1-31-2011.

LAURA KOVALSKY, EXAMINING ATTORNEY



David J. Kyros

Director of the United States Patent and Trademark Office

United States of America

United States Patent and Trademark Office

REPAQ

Reg. No. 4,097,435

Registered Feb. 14, 2012

Int. Cl.: 37

SERVICE MARK

PRINCIPAL REGISTER

DOUBLEDAY ACQUISITIONS, LLC (OHIO LIMITED LIABILITY COMPANY)
2900 DRYDEN ROAD
DAYTON, OH 45439

FOR: REPAIRING, CLEANING, AND REFURBISHING VACUUM INSULATED SHIPPING CONTAINERS FOR TRANSPORTING TEMPERATURE SENSITIVE MATERIALS, IN CLASS 37 (U.S. CLS. 100, 103 AND 106).

FIRST USE 9-0-2008; IN COMMERCE 9-0-2008.

THE MARK CONSISTS OF STANDARD CHARACTERS WITHOUT CLAIM TO ANY PARTICULAR FONT, STYLE, SIZE, OR COLOR.

SER. NO. 76-706,302, FILED 2-7-2011.

GINA FINK, EXAMINING ATTORNEY



David J. Kybas

Director of the United States Patent and Trademark Office

United States of America

United States Patent and Trademark Office

U H O U S T O N
U A L U M N I
A S S O C I A T I O N

Reg. No. 4,097,436

Registered Feb. 14, 2012

**Int. Cls.: 16, 25, 35, 36
and 41**

TRADEMARK

SERVICE MARK

PRINCIPAL REGISTER

THE UNIVERSITY OF HOUSTON SYSTEM (TEXAS A PUBLIC INSTITUTION OF HIGHER EDUCATION)
4800 CALHOUN ROAD
HOUSTON, TX 77204

FOR: PRINT MATERIALS, NAMELY, MAGAZINES, PAMPHLETS AND BROCHURES IN THE FIELD OF ALUMNI NEWS AND ALUMNI ASSOCIATION SERVICES, BUMPER STICKERS, PENS, PEN SETS COMPRISED OF PENS AND PENCILS, PENCILS, ERASERS, PENCIL TOPPERS, NAMELY, DECORATIVE PENCIL-TOP ORNAMENTS, LOOSE LEAF BINDERS, BOOKMARKS, BOOK COVERS, PHOTOGRAPHIC ALBUMS, APPOINTMENT BOOKS, ART PHOTOGRAPHS, NAMELY, PHOTOGRAPHS THAT HAVE BEEN COMPUTER MANIPULATED AND ENHANCED TO CONTAIN GRAPHIC ELEMENTS, PHOTOGRAPHS, ADDRESS BOOKS, PAPER BANNERS, CLIP BOARDS, MAGNETIC BOARDS, NOTEPADS, NOTE PAD HOLDERS, SCRAPBOOKS, CATALOGS IN THE FIELD OF ALUMNI GOODS, NEWSLETTERS IN THE FIELD OF ALUMNI EVENTS, NEWS AND ASSOCIATION SERVICES, NOTEBOOKS, COMPOSITION BOOKS, PICTURE BOOKS, STATIONERY-TYPE PORTFOLIOS, PAPER GIFT WRAP, CALENDARS, BLANK CARDS, GIFT CARDS, GREETING CARDS, BUSINESS CARDS, WRITING PAPER AND NOTEPAPER, POSTCARDS, DECALS, PAPER LABELS, BANK CHECKS, CHECKBOOK COVERS, RUBBER STAMPS, BOOKS IN THE FIELD OF ALUMNI HISTORY AND MEMBERS, BINDERS, LITHOGRAPHS AND PRINTS, PREPAID TELEPHONE CALLING CARDS, NOT MAGNETICALLY ENCODED, CREDIT CARDS WITHOUT MAGNETIC ENCODING, TRANSFERABLE TEMPORARY TATTOOS, STICKERS, POSTERS, PARTY GOODS, NAMELY, PAPER PARTY FAVORS, PAPER NAPKINS, AND PAPER PARTY DECORATIONS, DESK ACCESSORIES, NAMELY, BASKETS, DESK PADS, FILE TRAYS, DESKTOP ORGANIZERS, DESKTOP PLANNERS, DESKTOP REVOLVING ROTARY CARD FILES, DESK CALENDARS, PRINTED PAPER LABELS FOR BOTTLED WATER, IN CLASS 16 (U.S. CLS. 2, 5, 22, 23, 29, 37, 38 AND 50).

FIRST USE 8-3-2010; IN COMMERCE 8-3-2010.

FOR: CLOTHING, NAMELY, SHIRTS, PANTS, HATS, SWEAT PANTS, SWEAT SHIRTS, JACKETS, SOCKS, SWEATERS, UNDERWEAR, PAJAMAS, SHOES, AND SLIPPERS, IN CLASS 25 (U.S. CLS. 22 AND 39).

FIRST USE 8-3-2010; IN COMMERCE 8-3-2010.



David J. Kyffers

Director of the United States Patent and Trademark Office

Reg. No. 4,097,436 FOR: PROVIDING INFORMATION TO ALUMNI AND MEMBERS AND FRIENDS OF A UNIVERSITY REGARDING BUSINESS NETWORKING AND ASSOCIATION SERVICES, NAMELY, PROMOTING THE INTERESTS OF THE ALUMNI OF A UNIVERSITY; PROVIDING INFORMATION VIA THE INTERNET TO ALUMNI AND MEMBERS AND FRIENDS OF A UNIVERSITY REGARDING BUSINESS NETWORKING AND ASSOCIATION SERVICES, NAMELY, PROMOTING THE INTERESTS OF THE ALUMNI OF A UNIVERSITY; LOBBYING SERVICES, NAMELY, PROMOTING THE INTERESTS OF A UNIVERSITY; ADVERTISING SERVICES, NAMELY, PROMOTING THE GOODS AND SERVICES OF OTHERS FOR OTHERS THROUGH UNIVERSITY PRINT AND WEB PUBLICATIONS, IN CLASS 35 (U.S. CLS. 100, 101 AND 102).

FIRST USE 8-3-2010; IN COMMERCE 8-3-2010.

FOR: PROVIDING INFORMATION TO ALUMNI AND MEMBERS AND FRIENDS OF A UNIVERSITY IN THE FIELD OF SCHOLARSHIP OPPORTUNITIES; PROVIDING INFORMATION VIA THE INTERNET TO ALUMNI AND MEMBERS AND FRIENDS OF A UNIVERSITY IN THE FIELD OF SCHOLARSHIP OPPORTUNITIES, IN CLASS 36 (U.S. CLS. 100, 101 AND 102).

FIRST USE 8-3-2010; IN COMMERCE 8-3-2010.

FOR: PROVIDING INFORMATION TO ALUMNI AND MEMBERS AND FRIENDS OF A UNIVERSITY IN THE FIELDS OF ENTERTAINMENT AND EDUCATIONAL OPPORTUNITIES; PROVIDING INFORMATION VIA THE INTERNET TO ALUMNI, MEMBERS AND FRIENDS OF A UNIVERSITY IN THE FIELDS OF ENTERTAINMENT AND EDUCATIONAL OPPORTUNITIES ONLINE, IN CLASS 41 (U.S. CLS. 100, 101 AND 107).

FIRST USE 8-3-2010; IN COMMERCE 8-3-2010.

OWNER OF U.S. REG. NOS. 747,078, 2,539,372 AND OTHERS.

NO CLAIM IS MADE TO THE EXCLUSIVE RIGHT TO USE "HOUSTON ALUMNI ASSOCIATION", APART FROM THE MARK AS SHOWN.

THE MARK CONSISTS OF THE WORD "HOUSTON" ABOVE THE WORD "ALUMNI", WHICH IS ABOVE THE WORD "ASSOCIATION". THE LETTERS "U" AND "H" DIAGONALLY OVERLAP EACH OTHER AND APPEAR TO THE LEFT SIDE OF THE MARK. THE FONT IS STYLIZED.

SER. NO. 76-706,321, FILED 2-8-2011.

BILL DAWE, EXAMINING ATTORNEY

United States of America

United States Patent and Trademark Office

WHO LOVES YOU?

Reg. No. 4,097,437

SHARON KLEIN PRODUCTIONS, INC. (NEW YORK CORPORATION)
1650 BROADWAY, SUITE 304A
NEW YORK, NY 10019

Registered Feb. 14, 2012

Int. Cl.: 41

FOR: LIVE MUSICAL PERFORMANCES BY A MUSICAL SINGING GROUP, IN CLASS 41
(U.S. CLS. 100, 101 AND 107).

SERVICE MARK

FIRST USE 2-1-2011; IN COMMERCE 2-1-2011.

PRINCIPAL REGISTER

THE MARK CONSISTS OF STANDARD CHARACTERS WITHOUT CLAIM TO ANY PARTICULAR FONT, STYLE, SIZE, OR COLOR.

SER. NO. 76-707,775, FILED 5-31-2011.

JASON TURNER, EXAMINING ATTORNEY



David J. Kybas

Director of the United States Patent and Trademark Office

United States of America

United States Patent and Trademark Office

BODY BAR

Reg. No. 4,097,438

Registered Feb. 14, 2012

Int. Cl.: 3

TRADEMARK

PRINCIPAL REGISTER

GLIPTONE MANUFACTURING, INC. (NEW YORK CORPORATION)
1740 JULIA GOLDBACH AVENUE
RONKONKOMA, NY 11779

FOR: POLISHING, SCOURING, AND ABRASIVE PREPARATIONS, NAMELY, PAINT SURFACE PREPARATION USED TO RIP OFF AND REMOVE SMALL CONTAMINANTS SUCH AS EMBEDDED DIRT, BUG RESIDUE, HARDENED TREE SAP, INDUSTRIAL FALLOUT, RAIL DUST, AND ANY OTHER PARTICLES THAT MIGHT INTERFERE WITH THE EFFECTIVE WAXING, PAINTING, AND OTHER TREATMENTS OF VEHICLES EXTERIORS, IN CLASS 3 (U.S. CLS. 1, 4, 6, 50, 51 AND 52).

FIRST USE 9-15-2004; IN COMMERCE 9-15-2004.

NO CLAIM IS MADE TO THE EXCLUSIVE RIGHT TO USE "BAR", APART FROM THE MARK AS SHOWN.

SER. NO. 76-707,834, FILED 6-3-2011.

ROSELLE HERRERA, EXAMINING ATTORNEY



David J. Kyffers

Director of the United States Patent and Trademark Office

United States of America

United States Patent and Trademark Office

SEAFOOD SNACKERS

Reg. No. 4,097,439

Registered Feb. 14, 2012

Int. Cl.: 29

TRADEMARK

PRINCIPAL REGISTER

TRANS-OCEAN PRODUCTS, INC. (WASHINGTON CORPORATION)
350 WEST ORCHARD DRIVE
BELLINGHAM, WA 98225

FOR: SURIMI SEAFOOD, IN CLASS 29 (U.S. CL. 46).

FIRST USE 5-1-2011; IN COMMERCE 5-1-2011.

THE MARK CONSISTS OF STANDARD CHARACTERS WITHOUT CLAIM TO ANY PARTICULAR FONT, STYLE, SIZE, OR COLOR.

NO CLAIM IS MADE TO THE EXCLUSIVE RIGHT TO USE "SEAFOOD", APART FROM THE MARK AS SHOWN.

SER. NO. 76-707,866, FILED 6-6-2011.

TINA BROWN, EXAMINING ATTORNEY



David J. Kyffers

Director of the United States Patent and Trademark Office

United States of America

United States Patent and Trademark Office



Reg. No. 4,097,440

Registered Feb. 14, 2012

Int. Cl.: 39

SERVICE MARK

PRINCIPAL REGISTER

ELETSON CORPORATION (LIBERIA CORPORATION)
118 KOLOKOTRONI STREET
185-35 PIRAEUS, GREECE

FOR: TRANSPORTATION OF GOODS BY SHIP, IN CLASS 39 (U.S. CLS. 100 AND 105).

FIRST USE 6-0-2008; IN COMMERCE 6-0-2008.

OWNER OF U.S. REG. NO. 2,437,223.

THE MARK CONSISTS OF THE WORD "ELETSON" BENEATH A QUADRANGLE CONTAINING LINES AND A STAR, AND ABOVE TWO QUADRANGLES CONTAINING LINES.

SER. NO. 76-707,911, FILED 6-9-2011.

FRED CARL, EXAMINING ATTORNEY



David J. Kyffers

Director of the United States Patent and Trademark Office

United States of America
United States Patent and Trademark Office

EQUINOX

Reg. No. 4,097,441

AMERIMAX BUILDING PRODUCTS, INC. (DELAWARE CORPORATION)
5208 TENNYSON PARKWAY, SUITE 100
PLANO, TX 75024

Registered Feb. 14, 2012

Int. Cl.: 6

FOR: METAL PREFABRICATED LOUVERED ROOFS, IN CLASS 6 (U.S. CLS. 2, 12, 13, 14, 23, 25 AND 50).

TRADEMARK

FIRST USE 5-0-2009; IN COMMERCE 11-0-2010.

PRINCIPAL REGISTER

THE MARK CONSISTS OF STANDARD CHARACTERS WITHOUT CLAIM TO ANY PARTICULAR FONT, STYLE, SIZE, OR COLOR.

SER. NO. 76-708,069, FILED 6-21-2011.

MICHAEL ENGEL, EXAMINING ATTORNEY



David J. Kybas

Director of the United States Patent and Trademark Office

United States of America

United States Patent and Trademark Office

SMOKE DREAMS

Reg. No. 4,097,442

ZEUS, INC (ILLINOIS CORPORATION)
4560 NORTH BROADWAY
CHICAGO, IL 60640

Registered Feb. 14, 2012

Int. Cl.: 35

FOR: RETAIL STORE SERVICES AND ONLINE RETAIL STORE SERVICES BOTH FEATURING SMOKING ACCESSORIES AND SMOKING RELATED ITEMS, IN CLASS 35 (U.S. CLS. 100, 101 AND 102).

SERVICE MARK

FIRST USE 9-29-2005; IN COMMERCE 9-29-2005.

PRINCIPAL REGISTER

THE MARK CONSISTS OF STANDARD CHARACTERS WITHOUT CLAIM TO ANY PARTICULAR FONT, STYLE, SIZE, OR COLOR.

NO CLAIM IS MADE TO THE EXCLUSIVE RIGHT TO USE "SMOKE", APART FROM THE MARK AS SHOWN.

SER. NO. 76-708,109, FILED 6-23-2011.

SEAN CROWLEY, EXAMINING ATTORNEY



David J. Kybas

Director of the United States Patent and Trademark Office

United States of America

United States Patent and Trademark Office

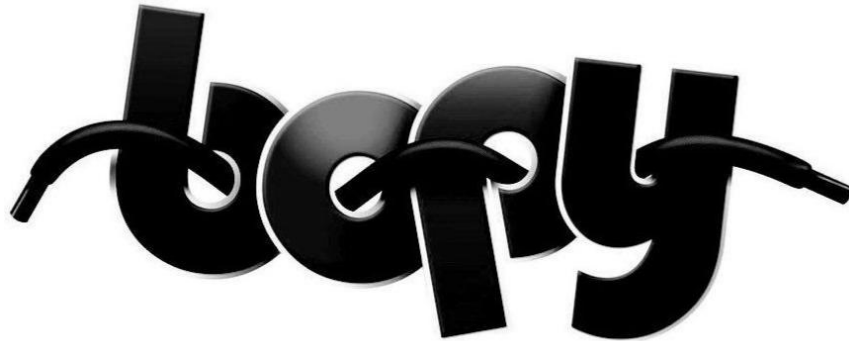

Reg. No. 4,097,443

Registered Feb. 14, 2012

Int. Cl.: 25

TRADEMARK

PRINCIPAL REGISTER

HUMEAU-BEAUPREAU S.A.S. (FRANCE SIMPLIFIED SHARES COMPANY)
7, RUE FROIDE FONTAINE - BP 50002
49602 BEAUPREAU CEDEX, FRANCE

FOR: FOOTWEAR, IN CLASS 25 (U.S. CLS. 22 AND 39).

FIRST USE 0-0-2009; IN COMMERCE 0-0-2009.

OWNER OF U.S. REG. NOS. 2,842,695, 3,029,259, AND 3,038,742.

THE MARK CONSISTS OF THE WORD "BOPY" IN STYLIZED LETTERING AND AN INTEGRATED DESIGN OF A SHOELACE THAT APPEARS TO BE WOVEN THROUGH THE LETTERS.

SER. NO. 76-708,143, FILED 6-24-2011.

JUDITH HELFMAN, EXAMINING ATTORNEY



David J. Kybas

Director of the United States Patent and Trademark Office

United States of America

United States Patent and Trademark Office

AXXIO PIZZA

Reg. No. 4,097,444

SLICES HOLDINGS LLC (ARIZONA LIMITED LIABILITY COMPANY)
528 E. JOSEPH WAY
GILBERT, AZ 85295

Registered Feb. 14, 2012

Int. Cl.: 43

FOR: RESTAURANT SERVICES, IN CLASS 43 (U.S. CLS. 100 AND 101).

SERVICE MARK

FIRST USE 4-27-2011; IN COMMERCE 4-27-2011.

PRINCIPAL REGISTER

THE MARK CONSISTS OF STANDARD CHARACTERS WITHOUT CLAIM TO ANY PARTICULAR FONT, STYLE, SIZE, OR COLOR.

NO CLAIM IS MADE TO THE EXCLUSIVE RIGHT TO USE "PIZZA", APART FROM THE MARK AS SHOWN.

SER. NO. 76-708,145, FILED 6-27-2011.

SARA BENJAMIN, EXAMINING ATTORNEY



David J. Kyffers

Director of the United States Patent and Trademark Office

United States of America

United States Patent and Trademark Office

CHANNEL LOCK II

Reg. No. 4,097,445

EROSION PREVENTION PRODUCTS, LLC (TEXAS LIMITED LIABILITY COMPANY)
510 WISCONSIN

Registered Feb. 14, 2012

SOUTH HOUSTON, TX 77587

Int. Cl.: 19

FOR: VERTICAL INTERLOCKING CONCRETE BLOCKS USED FOR EROSION CONTROL MATS, IN CLASS 19 (U.S. CLS. 1, 12, 33 AND 50).

TRADEMARK

FIRST USE 6-0-2009; IN COMMERCE 6-0-2009.

PRINCIPAL REGISTER

THE MARK CONSISTS OF STANDARD CHARACTERS WITHOUT CLAIM TO ANY PARTICULAR FONT, STYLE, SIZE, OR COLOR.

OWNER OF U.S. REG. NOS. 2,213,362 AND 3,961,982.

NO CLAIM IS MADE TO THE EXCLUSIVE RIGHT TO USE "II", APART FROM THE MARK AS SHOWN.

SER. NO. 76-708,162, FILED 6-27-2011.

ANNE E. GUSTASON, EXAMINING ATTORNEY



David J. Kyffers

Director of the United States Patent and Trademark Office

United States of America

United States Patent and Trademark Office

CHANNEL FLEX

Reg. No. 4,097,446

EROSION PREVENTION PRODUCTS, LLC (TEXAS LIMITED LIABILITY COMPANY)
510 WISCONSIN

Registered Feb. 14, 2012

SOUTH HOUSTON, TX 77587

Int. Cl.: 19

FOR: CONCRETE BLOCKS CABLED TOGETHER FOR EROSION CONTROL MATS, IN CLASS 19 (U.S. CLS. 1, 12, 33 AND 50).

TRADEMARK

FIRST USE 6-18-2011; IN COMMERCE 6-18-2011.

PRINCIPAL REGISTER

THE MARK CONSISTS OF STANDARD CHARACTERS WITHOUT CLAIM TO ANY PARTICULAR FONT, STYLE, SIZE, OR COLOR.

OWNER OF U.S. REG. NOS. 2,213,362 AND 3,961,982.

NO CLAIM IS MADE TO THE EXCLUSIVE RIGHT TO USE "FLEX", APART FROM THE MARK AS SHOWN.

SER. NO. 76-708,163, FILED 6-27-2011.

ANNE E. GUSTASON, EXAMINING ATTORNEY



David J. Kyffers

Director of the United States Patent and Trademark Office

United States of America

United States Patent and Trademark Office

ALLERGY MASTER

Reg. No. 4,097,447

Registered Feb. 14, 2012

Int. Cl.: 5

TRADEMARK

PRINCIPAL REGISTER

GLOBAL LIFE TECHNOLOGIES CORP (DELAWARE CORPORATION)
4608 N. PARK AVE., 2ND FLOOR
CHEVY CHASE, MD 20815

FOR: NASAL SPRAY SOLUTION FOR RELIEVING NASAL ALLERGY SYMPTOMS, REDUCING INFLAMMATION AND BOOSTING ANTIOXIDANT PROTECTION, IN CLASS 5 (U.S. CLS. 6, 18, 44, 46, 51 AND 52).

FIRST USE 7-0-2010; IN COMMERCE 7-0-2010.

THE MARK CONSISTS OF STANDARD CHARACTERS WITHOUT CLAIM TO ANY PARTICULAR FONT, STYLE, SIZE, OR COLOR.

NO CLAIM IS MADE TO THE EXCLUSIVE RIGHT TO USE "ALLERGY", APART FROM THE MARK AS SHOWN.

SER. NO. 76-708,168, FILED 6-27-2011.

ELLEN B. AWRICH, EXAMINING ATTORNEY



David J. Kyjars

Director of the United States Patent and Trademark Office

United States of America

United States Patent and Trademark Office

add
lib

Reg. No. 4,097,448

DREAMBRANDS, INC (ARIZONA CORPORATION)
11645 NORTH CAVE CREEK ROAD
PHOENIX, AZ 85020

Registered Feb. 14, 2012

Int. Cl.: 5

FOR: DIETARY SUPPLEMENTS, NUTRITIONAL SUPPLEMENTS, IN CLASS 5 (U.S. CLS. 6, 18, 44, 46, 51 AND 52).

TRADEMARK

FIRST USE 6-12-2008; IN COMMERCE 6-12-2008.

PRINCIPAL REGISTER

OWNER OF U.S. REG. NO. 3,756,392.

THE MARK CONSISTS OF THE WORDING "ADD" POSITIONED ABOVE THE MUCH LARGER, BOLDER WORDING "LIB", WITH ALL LETTERS IN THE MARK BEING PRESENTED IN LOWERCASE.

SER. NO. 76-708,174, FILED 6-27-2011.

JORDAN BAKER, EXAMINING ATTORNEY



David J. Kyffers

Director of the United States Patent and Trademark Office

United States of America

United States Patent and Trademark Office

WORLD NATION

Reg. No. 4,097,449

HARING, CYNTHIA R. (UNITED STATES INDIVIDUAL)
P.O. BOX 5331
SPRING HILL, FL 34611

Registered Feb. 14, 2012

Int. Cls.: 9 and 25

FOR: PRERECORDED CDS, VIDEO TAPES, CASSETTES AND DVDS FEATURING MUSIC,
IN CLASS 9 (U.S. CLS. 21, 23, 26, 36 AND 38).

TRADEMARK

FIRST USE 10-24-1992; IN COMMERCE 10-24-1992.

PRINCIPAL REGISTER

FOR: CLOTHING, NAMELY, SHIRTS, IN CLASS 25 (U.S. CLS. 22 AND 39).

FIRST USE 10-24-1992; IN COMMERCE 10-24-1992.

THE MARK CONSISTS OF STANDARD CHARACTERS WITHOUT CLAIM TO ANY PARTICULAR FONT, STYLE, SIZE, OR COLOR.

OWNER OF U.S. REG. NO. 1,906,032.

SER. NO. 76-708,241, FILED 7-6-2011.

ANN E. SAPPENFIELD, EXAMINING ATTORNEY



David J. Kyffers

Director of the United States Patent and Trademark Office

United States of America

United States Patent and Trademark Office

TILE SHIELD

Reg. No. 4,097,450

UNELKO CORPORATION (ARIZONA CORPORATION)
14641 NORTH 74TH STREET
SCOTTSDALE, AZ 85260

Registered Feb. 14, 2012

Int. Cl.: 1

FOR: WATER AND DIRT REPELLANT POLYMER COATING FOR GLASS, PORCELAIN AND CERAMIC, IN CLASS 1 (U.S. CLS. 1, 5, 6, 10, 26 AND 46).

TRADEMARK

FIRST USE 2-24-1999; IN COMMERCE 2-24-1999.

PRINCIPAL REGISTER

THE MARK CONSISTS OF STANDARD CHARACTERS WITHOUT CLAIM TO ANY PARTICULAR FONT, STYLE, SIZE, OR COLOR.

OWNER OF U.S. REG. NOS. 1,370,776, 3,325,364 AND OTHERS.

NO CLAIM IS MADE TO THE EXCLUSIVE RIGHT TO USE "TILE", APART FROM THE MARK AS SHOWN.

SER. NO. 76-708,251, FILED 7-6-2011.

JAMES STEIN, EXAMINING ATTORNEY



David J. Kyffers

Director of the United States Patent and Trademark Office

United States of America

United States Patent and Trademark Office

J . A . WOOLLAM CO .

Reg. No. 4,097,451

J.A. WOOLLAM CO., INC. (NEBRASKA CORPORATION)
645 M ST.

Registered Feb. 14, 2012

LINCOLN, NE 68508

Int. Cl.: 42

FOR: TECHNICAL SERVICES PERFORMED IN THE FIELD OF DESIGN OF ELLIPSOMETERS, POLARIMETERS AND SPECTROPHOTOMETERS WHICH UTILIZE ELECTROMAGNETIC RADIATION TO INVESTIGATE SAMPLES , IN CLASS 42 (U.S. CLS. 100 AND 101).

SERVICE MARK

FIRST USE 3-0-1988; IN COMMERCE 3-0-1998.

PRINCIPAL REGISTER

THE MARK CONSISTS OF STANDARD CHARACTERS WITHOUT CLAIM TO ANY PARTICULAR FONT, STYLE, SIZE, OR COLOR.

NO CLAIM IS MADE TO THE EXCLUSIVE RIGHT TO USE "CO.", APART FROM THE MARK AS SHOWN.

THE NAME "J.A. WOOLLAM" IDENTIFIES A LIVING INDIVIDUAL WHOSE CONSENT IS OF RECORD.

SER. NO. 76-708,405, FILED 7-19-2011.

KAPIL BHANOT, EXAMINING ATTORNEY



David J. Kyjars

Director of the United States Patent and Trademark Office

United States of America

United States Patent and Trademark Office

I WILL

Reg. No. 4,097,452

Registered Feb. 14, 2012

Int. Cl.: 45

SERVICE MARK

PRINCIPAL REGISTER

MY GOOD DEED (CALIFORNIA CORPORATION)
19000 MACARTHUR BOULEVARD
IRVINE, CA 92612

FOR: PERSONAL AND SOCIAL SERVICES IN THE NATURE OF ENCOURAGING PEOPLE TO ENGAGE IN GOOD DEEDS AND TRIBUTES IN REMEMBRANCE OF 9/11/01, IN CLASS 45 (U.S. CLS. 100 AND 101).

FIRST USE 7-14-2011; IN COMMERCE 7-14-2011.

THE MARK CONSISTS OF STANDARD CHARACTERS WITHOUT CLAIM TO ANY PARTICULAR FONT, STYLE, SIZE, OR COLOR.

SER. NO. 76-708,643, FILED 8-8-2011.

ESTHER BELENKER, EXAMINING ATTORNEY



David J. Kyffers

Director of the United States Patent and Trademark Office

United States of America

United States Patent and Trademark Office

SayaTV

Reg. No. 4,097,453

SYABAS TECHNOLOGY, INC. (CALIFORNIA CORPORATION)
41829 ALBRAE ST UNIT # 209
FREMONT, CA 94538

Registered Feb. 14, 2012

Int. Cl.: 38

FOR: AUDIO AND VIDEO BROADCASTING SERVICES OVER THE INTERNET; INTERNET BROADCASTING SERVICES; VIDEO BROADCASTING, IN CLASS 38 (U.S. CLS. 100, 101 AND 104).

SERVICE MARK

FIRST USE 1-15-2007; IN COMMERCE 1-15-2007.

PRINCIPAL REGISTER

THE MARK CONSISTS OF STANDARD CHARACTERS WITHOUT CLAIM TO ANY PARTICULAR FONT, STYLE, SIZE, OR COLOR.

THE ENGLISH TRANSLATION OF "SAYA" IN THE MARK IS I, ME, MINE, JOY, OR SKIRT.

SER. NO. 77-183,149, FILED 5-16-2007.

BRIAN CALLAGHAN, EXAMINING ATTORNEY



David J. Kyffers

Director of the United States Patent and Trademark Office

United States of America

United States Patent and Trademark Office



Reg. No. 4,097,454

Registered Feb. 14, 2012

Int. Cl.: 38

SERVICE MARK

PRINCIPAL REGISTER

SYABAS TECHNOLOGY, INC. (CALIFORNIA CORPORATION)
41829 ALBRAE ST UNIT # 209
FREMONT, CA 94538

FOR: AUDIO AND VIDEO BROADCASTING SERVICES OVER THE INTERNET; INTERNET BROADCASTING SERVICES; VIDEO BROADCASTING, IN CLASS 38 (U.S. CLS. 100, 101 AND 104).

FIRST USE 1-15-2007; IN COMMERCE 1-15-2007.

NO CLAIM IS MADE TO THE EXCLUSIVE RIGHT TO USE "INTERNET TV SOCIAL NETWORK", APART FROM THE MARK AS SHOWN.

THE MARK CONSISTS OF THE STYLIZED TERM "SAYATV", WITH THE LETTERS "TV" CONTAINED WITHIN A TELEVISION WITH TWO ANTENNAS, ALL ABOVE THE STYLIZED WORDS "INTERNET TV SOCIAL NETWORK".

THE ENGLISH TRANSLATION OF "SAYA" IN THE MARK IS I, ME, MINE, JOY, OR SKIRT.

SER. NO. 77-183,150, FILED 5-16-2007.

BRIAN CALLAGHAN, EXAMINING ATTORNEY



David J. Kyros

Director of the United States Patent and Trademark Office

United States of America

United States Patent and Trademark Office

PHOENIX INTERNATIONAL

Reg. No. 4,097,455

Registered Feb. 14, 2012

Int. Cl.: 40

SERVICE MARK

PRINCIPAL REGISTER

DEERE & COMPANY (DELAWARE CORPORATION)
TRADEMARK LAW GROUP
ONE JOHN DEERE PLACE
MOLINE, IL 61265

FOR: MANUFACTURE OF ELECTRONIC CONTROLS, DISPLAYS, USER INTERFACES, SENSORS, AND ELECTRONIC SYSTEMS TO THE ORDER AND SPECIFICATION OF OTHERS, IN CLASS 40 (U.S. CLS. 100, 103 AND 106).

FIRST USE 9-30-1987; IN COMMERCE 9-30-1987.

THE MARK CONSISTS OF STANDARD CHARACTERS WITHOUT CLAIM TO ANY PARTICULAR FONT, STYLE, SIZE, OR COLOR.

NO CLAIM IS MADE TO THE EXCLUSIVE RIGHT TO USE "INTERNATIONAL", APART FROM THE MARK AS SHOWN.

SER. NO. 77-210,808, FILED 6-20-2007.

JOHN KELLY, EXAMINING ATTORNEY



David J. Kyffers

Director of the United States Patent and Trademark Office

United States of America

United States Patent and Trademark Office

GRAVITY

Reg. No. 4,097,456

Registered Feb. 14, 2012

Int. Cl.: 33

TRADEMARK

PRINCIPAL REGISTER

QUINN, LORENZO ALESSANDRO (UNITED STATES INDIVIDUAL)
PASSEIG DE LA MUNTANYA, 16
CASTELLDEFELS
BARCELONA, SPAIN 08860

FOR: WINES, IN CLASS 33 (U.S. CLS. 47 AND 49).

THE MARK CONSISTS OF STANDARD CHARACTERS WITHOUT CLAIM TO ANY PARTICULAR FONT, STYLE, SIZE, OR COLOR.

PRIORITY CLAIMED UNDER SEC. 44(D) ON SPAIN APPLICATION NO. 2.779.166, FILED 6-22-2007, REG. NO. 2.779.166, DATED 1-24-2008, EXPIRES 6-22-2017.

SER. NO. 77-235,797, FILED 7-23-2007.

KARANENDRA S. CHHINA, EXAMINING ATTORNEY



David J. Kyros

Director of the United States Patent and Trademark Office

United States of America

United States Patent and Trademark Office

CANADIAN ROCKS

Reg. No. 4,097,457

Registered Feb. 14, 2012

Int. Cl.: 14

TRADEMARK

PRINCIPAL REGISTER

WORLDWIDE DIAMOND TRADEMARKS LIMITED (CANADA CORPORATION)
1066 WEST HASTINGS
SUITE 2160
VANCOUVER, CANADA V6E3X1

FOR: DIAMONDS, IN CLASS 14 (U.S. CLS. 2, 27, 28 AND 50).

FIRST USE 5-0-2006; IN COMMERCE 5-0-2006.

THE MARK CONSISTS OF STANDARD CHARACTERS WITHOUT CLAIM TO ANY PARTICULAR FONT, STYLE, SIZE, OR COLOR.

PRIORITY CLAIMED UNDER SEC. 44(D) ON CANADA APPLICATION NO. 1,339,666, FILED 3-16-2007.

NO CLAIM IS MADE TO THE EXCLUSIVE RIGHT TO USE "ROCKS", APART FROM THE MARK AS SHOWN.

SEC. 2(F).

SER. NO. 77-281,537, FILED 9-17-2007.

MARK PILARO, EXAMINING ATTORNEY



David J. Kyffers

Director of the United States Patent and Trademark Office

United States of America

United States Patent and Trademark Office



Reg. No. 4,097,458

MAXDEF LLC (CALIFORNIA LIMITED LIABILITY COMPANY)
524 SAN ANSELMO AVE STE. 212
SAN ANSELMO, CA 94960

Registered Feb. 14, 2012

Int. Cl.: 9

FOR: DIGITAL MEDIA, NAMELY, DVDS FEATURING FILM CONTENT CONTAINING OUTDOOR SCENES FOR RELAXATION RECORDED IN HIGH DEFINITION, IN CLASS 9 (U.S. CLS. 21, 23, 26, 36 AND 38).

TRADEMARK

FIRST USE 3-1-2007; IN COMMERCE 4-1-2007.

PRINCIPAL REGISTER

THE MARK CONSISTS OF RED CIRCLE WITH WHITE GRIFFON; "HDCANDY" IS WHITE.

THE COLOR(S) RED AND WHITE IS/ARE CLAIMED AS A FEATURE OF THE MARK.

SER. NO. 77-313,973, FILED 10-25-2007.

MICHELLE DUBOIS, EXAMINING ATTORNEY



David J. Kybas

Director of the United States Patent and Trademark Office

United States of America

United States Patent and Trademark Office



Reg. No. 4,097,459

Registered Feb. 14, 2012

Int. Cls.: 39, 41 and 43

SERVICE MARK

PRINCIPAL REGISTER

PRINCESS AMERICANA, SARL (LUXEMBOURG PRIVATE LIMITED LIABILITY COMPANY)
1, ALLÉE SCHEFFER
LUXEMBOURG, LUXEMBOURG L-2520

FOR: TRAVEL AGENCY SERVICES, NAMELY, BOOKING OF SEATS FOR TRAVEL; ORGANIZATION OF TRAVEL, IN CLASS 39 (U.S. CLS. 100 AND 105).

FOR: ENTERTAINMENT SERVICES, NAMELY, CASINO SERVICES, ORGANIZING AND CONDUCTING NIGHTCLUB SHOWS, CONTESTS, DANCES, PARTIES, KARAOKE CONTESTS, LIVE MUSICAL PERFORMANCE AND ACTIVITIES FOR CHILDREN IN THE NATURE OF DANCE INSTRUCTION; ORGANIZING COMMUNITY SPORTING AND CULTURAL EVENTS, IN CLASS 41 (U.S. CLS. 100, 101 AND 107).

FOR: HOTEL SERVICES, IN CLASS 43 (U.S. CLS. 100 AND 101).

PRIORITY CLAIMED UNDER SEC. 44(D) ON SPAIN APPLICATION NO. 2793328, FILED 10-5-2007, REG. NO. 2793328, DATED 11-1-2008, EXPIRES 11-1-2018.

THE COLOR(S) GOLD AND BLUE IS/ARE CLAIMED AS A FEATURE OF THE MARK.

THE MARK CONSISTS OF THE WORD "OASIS" IN BLUE BELOW A STYLIZED DESIGN OF A DAFFODIL IN THE COLOR GOLD.

SER. NO. 77-316,596, FILED 10-30-2007.

DANIEL BRODY, EXAMINING ATTORNEY



David J. Kybas

Director of the United States Patent and Trademark Office

United States of America

United States Patent and Trademark Office

PIXI

Reg. No. 4,097,460

Registered Feb. 14, 2012

Int. Cls.: 3 and 21

TRADEMARK

PRINCIPAL REGISTER

SJOVIK LIMITED (ST.KITTS-NEVIS CORPORATION)
GROUND FL, DIXCART HOUSE, SIR WILLIAM PL
ST. PETER PORT, GUERNSEY

FOR: COSMETICS; SOAPS; PERFUMERY; ESSENTIAL OILS; TOILET SOAPS; NON-MEDICATED SKIN CARE PREPARATIONS; HAIR LOTIONS; HAIR CARE PREPARATIONS, IN CLASS 3 (U.S. CLS. 1, 4, 6, 50, 51 AND 52).

FIRST USE 5-5-1999; IN COMMERCE 8-18-1999.

FOR: COSMETIC BRUSHES, IN CLASS 21 (U.S. CLS. 2, 13, 23, 29, 30, 33, 40 AND 50).

FIRST USE 5-5-1999; IN COMMERCE 8-18-1999.

THE MARK CONSISTS OF STANDARD CHARACTERS WITHOUT CLAIM TO ANY PARTICULAR FONT, STYLE, SIZE, OR COLOR.

OWNER OF U.S. REG. NO. 2,604,970.

SER. NO. 77-321,849, FILED 11-5-2007.

PAULA MAHONEY, EXAMINING ATTORNEY



David J. Kyffers

Director of the United States Patent and Trademark Office

United States of America

United States Patent and Trademark Office

STEP UP

Reg. No. 4,097,461

DETROIT DIESEL CORPORATION (DELAWARE CORPORATION)
13400 OUTER DRIVE WEST
DETROIT, MI 482394001

Registered Feb. 14, 2012

Int. Cl.: 37

FOR: VEHICLE ENGINE MAINTENANCE AND OVERHAUL SERVICES FOR DETROIT DIESEL ENGINES, IN CLASS 37 (U.S. CLS. 100, 103 AND 106).

SERVICE MARK

FIRST USE 12-31-2002; IN COMMERCE 12-31-2002.

PRINCIPAL REGISTER

THE MARK CONSISTS OF STANDARD CHARACTERS WITHOUT CLAIM TO ANY PARTICULAR FONT, STYLE, SIZE, OR COLOR.

SER. NO. 77-328,149, FILED 11-13-2007.

INGRID C. EULIN, EXAMINING ATTORNEY



David J. Kyffers

Director of the United States Patent and Trademark Office

United States of America

United States Patent and Trademark Office

DATA DEPOSIT BOX

Reg. No. 4,097,462

Registered Feb. 14, 2012

Int. Cls.: 9, 39 and 42

TRADEMARK

SERVICE MARK

PRINCIPAL REGISTER

ACPANA BUSINESS SYSTEMS INC. (CANADA CORPORATION)
1 EGLINTON AVENUE EAST
SUITE 407
TORONTO, CANADA M4P3A1

FOR: COMPUTER SOFTWARE FOR USE IN DATA PROTECTION, ENCRYPTION, COMPRESSION, AND ON-LINE INFORMATION MANAGEMENT FOR DESKTOP, MOBILE, AND WIRELESS DEVICES, IN CLASS 9 (U.S. CLS. 21, 23, 26, 36 AND 38).

FIRST USE 1-7-2004; IN COMMERCE 3-8-2004.

FOR: STORAGE OF ELECTRONIC MEDIA, NAMELY, IMAGES, TEXT AND AUDIO DATA, IN CLASS 39 (U.S. CLS. 100 AND 105).

FIRST USE 1-7-2004; IN COMMERCE 3-8-2004.

FOR: SECURE BACK-UP SERVICES FOR COMPUTER DATA, PROVIDED VIA THE INTERNET, IN CLASS 42 (U.S. CLS. 100 AND 101).

FIRST USE 1-7-2004; IN COMMERCE 3-8-2004.

THE MARK CONSISTS OF STANDARD CHARACTERS WITHOUT CLAIM TO ANY PARTICULAR FONT, STYLE, SIZE, OR COLOR.

NO CLAIM IS MADE TO THE EXCLUSIVE RIGHT TO USE "DATA", APART FROM THE MARK AS SHOWN.

SER. NO. 77-330,802, FILED 11-15-2007.

JOHN DALIER, EXAMINING ATTORNEY



David J. Kybas

Director of the United States Patent and Trademark Office

United States of America

United States Patent and Trademark Office

BLACKCURRANTRICH

Reg. No. 4,097,463

INOVOBIOLOGIC INC. (CANADA CORPORATION)
SUITE 409, 104-1240 KENSINGTON RD. NW
CALGARY, CANADA T2N4X7

Registered Feb. 14, 2012

Int. Cl.: 5

FOR: DIETARY AND NUTRITIONAL SUPPLEMENTS MADE IN WHOLE OR SUBSTANTIAL PART OF BLACK CURRENT; DIETARY FOOD SUPPLEMENTS MADE IN WHOLE OR SUBSTANTIAL PART OF BLACK CURRENT, IN CLASS 5 (U.S. CLS. 6, 18, 44, 46, 51 AND 52).

TRADEMARK

PRINCIPAL REGISTER

THE MARK CONSISTS OF STANDARD CHARACTERS WITHOUT CLAIM TO ANY PARTICULAR FONT, STYLE, SIZE, OR COLOR.

PRIORITY CLAIMED UNDER SEC. 44(D) ON CANADA APPLICATION NO. 1373593, FILED 11-26-2007, REG. NO. TMA782366, DATED 11-15-2010, EXPIRES 11-15-2025.

SER. NO. 77-337,053, FILED 11-26-2007.

JULIE WATSON, EXAMINING ATTORNEY



David J. Kybas

Director of the United States Patent and Trademark Office

United States of America

United States Patent and Trademark Office

BODY TRENDS

Reg. No. 4,097,464

RWACHSBERG HOLDINGS INC. (CANADA CORPORATION)
20 GRANITERIDGE ROAD

Registered Feb. 14, 2012

CONCORD, ONTARIO, CANADA L4K5M8

Int. Cls.: 1, 3, 4, 5 and 21

FOR: CHEMICAL PREPARATIONS FOR REMOVING DEPOSITS OF BICARBONATES, CARBONATES AND HYDROXIDES OF CALCIUM, MAGNESIUM AND IRON FROM CERAMIC, METAL, PORCELAIN, CEMENT, BRICK, CHROME AND STEEL SURFACES, IN CLASS 1 (U.S. CLS. 1, 5, 6, 10, 26 AND 46).

TRADEMARK

PRINCIPAL REGISTER

FOR: NON-MEDICATED PERSONAL CARE PRODUCTS, NAMELY, SHAMPOOS AND HAIR CONDITIONERS, SKIN MOISTURIZERS, HUMAN BODY CONDITIONING AND SKIN TREATMENT LOTIONS, HUMAN BODY CONDITIONING AND SKIN TREATMENT CREAMS, ANTI-AGING AND STRETCH MARK CREAMS, LOTIONS AND CREAMS FOR HANDS, NAILS, SKIN, FACE, HAIR, VARICOSE VEINS, FOOT AND LEG MUSCLES AND JOINTS, DEPILATORY LOTIONS AND CREAMS, SHAVING LOTIONS AND CREAMS; NON-MEDICATED SKIN CARE PREPARATIONS, NAMELY, LOTIONS AND CREAMS FOR TREATING DRY AND DAMAGED SKIN, ANTI-AGING, FIRMING, ANTI-WRINKLE, STRETCH MARKS, UNDER EYE AND EYELID FIRMING; GELS, NAMELY, DEPILATORY GELS, SHAVING GELS, SHOWER GELS, SKIN MOISTURIZING AND ANTI-AGING GELS, NON-MEDICATED STRETCH MARK GELS, OILS, NAMELY, BATH OILS, BODY OILS, COSMETIC OILS, AND NUTRITIONAL OILS FOR COSMETIC PURPOSES, NON-MEDICATED HUMAN BODY SERUMS, PETROLEUM JELLY FOR COSMETIC PURPOSES, SOAPS, LIQUID SOAPS, BAR SOAPS, ANTI-BACTERIAL LIQUID SOAPS, ANTI-BACTERIAL BAR SOAPS, HUMAN BODY SPRAYS, REFRESHER BODY SPRAYS, BODY WASHING SOAPS, BUBBLE BATH, BODY AND FACIAL SCRUBS, MASKS, NAMELY, BEAUTY MASKS, FACIAL MASKS, BODY MASKS, GEL EYE MASKS, SKIN MASKS, AND SKIN MOISTURIZER MASKS, NON-MEDICATED FACIAL PEELS, NON-MEDICATED SKIN CARE PREPARATIONS, AND WRINKLE REMOVING SKIN CARE PREPARATIONS, COSMETIC SUN PROTECTION CREAMS AND LOTIONS, SUN CREAMS AND LOTIONS (WITH OR WITHOUT SPF), SUN BLOCK, SUNLESS TANNING CREAMS AND LOTIONS, TALCUM POWDERS; DEODORANTS; NON-MEDICATED ANTIBACTERIAL MOUTHWASH; ALL PURPOSE CLEANERS; FLOOR CLEANERS; GLASS CLEANERS; SOLVENTS; LAUNDRY BLEACH; HOUSEHOLD BLEACH; FABRIC SOFTENER; LAUNDRY DETERGENTS AND SOAPS; DISH DETERGENTS AND SOAPS; IMPREGNATED AND PRE-MOISTENED CLEANING SHEETS, SPONGES AND TOWELETTES; PERSONAL DEODORANTS, DEODORIZERS FOR PETS, IN CLASS 3 (U.S. CLS. 1, 4, 6, 50, 51 AND 52).



David J. Kyros

Director of the United States Patent and Trademark Office

Reg. No. 4,097,464 FOR: HOUSEHOLD LUBRICANTS, IN CLASS 4 (U.S. CLS. 1, 6 AND 15).

FOR: NON-MEDICATED SKIN TREATMENTS FOR HUMAN USE FOR ANTI-AGING, ANTI-WRINKLES, SKIN CONDITIONING AND SKIN FIRING, NAMELY, VITAMINS IN THE FORM OF DAYTIME AND NIGHTTIME PILLS, CAPSULES, GEL CAPS AND TABLETS; HAND SANITIZING PREPARATIONS; BARS FOR HUMAN CONSUMPTION, NAMELY, MEAL REPLACEMENT BARS, VITAMINS AND MINERALS FORMED AND PACKAGED AS BARS; MEAL REPLACEMENT POWDERS; SHAKES FOR HUMAN CONSUMPTION, NAMELY, MEAL REPLACEMENT SHAKES, VITAMINS FOR HUMAN CONSUMPTION; NUTRACEUTICALS FOR HUMAN USE FOR ANTI-AGING, ANTI-WRINKLES, SKIN CONDITIONING, SKIN FIRING, WEIGHT LOSS AND WEIGHT MAINTENANCE, NAMELY, PILLS, CAPSULES, GEL CAPS AND TABLETS; ANTIBACTERIAL HAND LOTIONS, ANTIBACTERIAL ALCOHOL SKIN SANITIZER GEL, ANTIBACTERIAL SPRAY; ANTIMICROBIALS FOR DERMATOLOGICAL USE; ANTIMICROBIAL COATINGS TO TREAT THE GROWTH OF MOLD, MILDEW, BACTERIA AND FUNGUS ON VARIOUS SURFACES; CAR DEODORIZER; HOUSEHOLD DEODORIZER; AIR DEODORIZER; ALL-PURPOSE DISINFECTANTS; ROOM FRESHENER SPRAYS, IN CLASS 5 (U.S. CLS. 6, 18, 44, 46, 51 AND 52).

FOR: CLEANING CLOTHS, IN CLASS 21 (U.S. CLS. 2, 13, 23, 29, 30, 33, 40 AND 50).

THE MARK CONSISTS OF STANDARD CHARACTERS WITHOUT CLAIM TO ANY PARTICULAR FONT, STYLE, SIZE, OR COLOR.

PRIORITY CLAIMED UNDER SEC. 44(D) ON CANADA APPLICATION NO. 1378508, FILED 1-9-2008, REG. NO. TMA786,678, DATED 1-7-2011, EXPIRES 1-7-2026.

NO CLAIM IS MADE TO THE EXCLUSIVE RIGHT TO USE "BODY" FOR INTERNATIONAL CLASSES 3 AND 5, APART FROM THE MARK AS SHOWN.

SER. NO. 77-374,928, FILED 1-18-2008.

KHANH LE, EXAMINING ATTORNEY

United States of America

United States Patent and Trademark Office

UNITRON

Reg. No. 4,097,465

Registered Feb. 14, 2012

Int. Cl.: 9

TRADEMARK

PRINCIPAL REGISTER

CYLON CONTROLS LIMITED (IRELAND COMPANY)
CLONSHAUGH BUSINESS & TECHNOLOGY PARK
CLONSHAUGH, DUBLIN 17, IRELAND

FOR: ELECTRICAL AND ELECTRONIC APPARATUS, EQUIPMENT AND INSTRUMENTS, NAMELY, CONTROLLERS FOR CONTROLLING UTILITY USAGE, NAMELY, AIR CONDITIONING, LIGHTING, HEATING, VENTILATION, ELECTRICITY, FUEL GAS AND FUEL OIL TO A BUILDING; INTERFACES FOR ELECTRONIC CIRCUITS; BI-DIRECTIONAL CONFIGURABLE INTERFACES FOR COMPUTERS, MICROPROCESSORS AND MICRO-CONTROLLERS; SOFTWARE, NAMELY, SOFTWARE CONFIGURABLE BI-DIRECTIONAL INTERFACES FOR COMPUTERS, MICROPROCESSORS AND MICRO-CONTROLLERS; AND PARTS AND FITTINGS FOR ALL THE AFORESAID GOODS, IN CLASS 9 (U.S. CLS. 21, 23, 26, 36 AND 38).

THE MARK CONSISTS OF STANDARD CHARACTERS WITHOUT CLAIM TO ANY PARTICULAR FONT, STYLE, SIZE, OR COLOR.

PRIORITY CLAIMED UNDER SEC. 44(D) ON ERPN CMNTY TM OFC APPLICATION NO. 006643142, FILED 2-5-2008, REG. NO. 006643142, DATED 9-3-2011, EXPIRES 2-5-2018.

SER. NO. 77-390,309, FILED 2-6-2008.

LESLEY LAMOTHE, EXAMINING ATTORNEY



David J. Kyffers

Director of the United States Patent and Trademark Office

United States of America

United States Patent and Trademark Office

THE MENTOR Software to aid you in Your(Hero's) Journey into SUPER WEALTH

Reg. No. 4,097,466

Registered Feb. 14, 2012

Int. Cl.: 9

TRADEMARK

PRINCIPAL REGISTER

WEERARATNE, INDRAJTIH ANDREW (UNITED STATES INDIVIDUAL)
WWW.SWHERE.COM, WWW.UCCSW.COM
7135 COLLINS AVE NO. 624
MIAMI BEACH, FL 33141

FOR: CHILDREN'S EDUCATIONAL SOFTWARE; COMPUTER GAME SOFTWARE; EDUCATIONAL SOFTWARE FEATURING INSTRUCTION IN WEALTH BUILDING , IN CLASS 9 (U.S. CLS. 21, 23, 26, 36 AND 38).

FIRST USE 1-1-2008; IN COMMERCE 2-1-2008.

THE MARK CONSISTS OF STANDARD CHARACTERS WITHOUT CLAIM TO ANY PARTICULAR FONT, STYLE, SIZE, OR COLOR.

SER. NO. 77-391,858, FILED 2-7-2008.

ALICIA COLLINS, EXAMINING ATTORNEY



David J. Kyffers

Director of the United States Patent and Trademark Office

United States of America

United States Patent and Trademark Office

BLOCKPARTY

Reg. No. 4,097,467

NEXON CO., LTD. (JAPAN CORPORATION)

Registered Feb. 14, 2012

2-3-1 SHINKAWA, CHUO-KU
TOKYO, JAPAN

Int. Cls.: 9, 38 and 41

FOR: VIDEO GAMES, NAMELY, GAME CARTRIDGES, GAME DISCS FOR PLAY ON PERSONAL COMPUTERS; COMPUTER PROGRAMS FOR VIDEO GAMES; PRERECORDED COMPACT DISCS CONTAINING VIDEO GAME AND COMPUTER GAME SOFTWARE AND AUDIO CONTENT RELATING TO COMPUTER GAMES AND VIDEO GAMES; PRERECORDED VIDEO DVDS FEATURING GAMES; MOTION PICTURE FILMS ABOUT GAMES; ELECTRONIC AMUSEMENT APPARATUS, NAMELY, ELECTRONIC GAME EQUIPMENT IN THE NATURE OF JOY STICK UNITS FOR PLAYING VIDEO GAMES, VIDEO GAME CARTRIDGES, VIDEO GAME MACHINES FOR USE WITH TELEVISIONS, EXTERNAL DISPLAY SCREEN OR MONITOR AND PARTS THEREFOR, NAMELY, CONTROLLERS FOR CONTROLLING THE LOCATION OF ELEMENTS OF A VIDEO GAME DISPLAY, IN CLASS 9 (U.S. CLS. 21, 23, 26, 36 AND 38).

TRADEMARK

SERVICE MARK

PRINCIPAL REGISTER

FOR: PROVIDING ONLINE CHAT ROOMS FOR TRANSMISSION OF MESSAGES AMONG COMPUTER USERS CONCERNING TOPICS OF COMPUTER GAMING ENTERTAINMENT; PROVIDING ONLINE ELECTRONIC BULLETIN BOARDS FOR TRANSMISSION OF MESSAGES AMONG COMPUTER USERS CONCERNING TOPICS OF COMPUTER GAMING ENTERTAINMENT, IN CLASS 38 (U.S. CLS. 100, 101 AND 104).

FOR: ENTERTAINMENT SERVICES, NAMELY, PROVIDING AN ONLINE COMPUTER GAME; PROVIDING ONLINE INFORMATION IN THE FIELD OF COMPUTER GAMING ENTERTAINMENT, IN CLASS 41 (U.S. CLS. 100, 101 AND 107).



THE MARK CONSISTS OF STANDARD CHARACTERS WITHOUT CLAIM TO ANY PARTICULAR FONT, STYLE, SIZE, OR COLOR.

PRIORITY CLAIMED UNDER SEC. 44(D) ON CANADA APPLICATION NO. 1,391,845, FILED 4-17-2008, REG. NO. TMA796457, DATED 5-2-2011, EXPIRES 5-2-2026.

SER. NO. 77-459,439, FILED 4-28-2008.

David J. Kypos

CARYN GLASSER, EXAMINING ATTORNEY

United States of America

United States Patent and Trademark Office

LOCKSMITH CENTRAL

Reg. No. 4,097,468

LOCKSMITH CENTRAL, INC. (CALIFORNIA CORPORATION)
9580 OAK AVE., SUITE 7-222
FOLSOM, CA 95630

Registered Feb. 14, 2012

Int. Cl.: 45

FOR: LOCKSMITHING, NAMELY, OPENING OF LOCKS, IN CLASS 45 (U.S. CLS. 100 AND 101).

SERVICE MARK

FIRST USE 1-1-1996; IN COMMERCE 1-1-1996.

PRINCIPAL REGISTER

THE MARK CONSISTS OF STANDARD CHARACTERS WITHOUT CLAIM TO ANY PARTICULAR FONT, STYLE, SIZE, OR COLOR.

NO CLAIM IS MADE TO THE EXCLUSIVE RIGHT TO USE "LOCKSMITH", APART FROM THE MARK AS SHOWN.

SER. NO. 77-468,783, FILED 5-8-2008.

JULIE WATSON, EXAMINING ATTORNEY



David J. Kyffers

Director of the United States Patent and Trademark Office

United States of America

United States Patent and Trademark Office

REHAB

Reg. No. 4,097,469

Registered Feb. 14, 2012

Int. Cl.: 3

TRADEMARK

PRINCIPAL REGISTER

COSMETIC WARRIORS (UNITED KINGDOM COMPANY)
POOLE
29 HIGH STREET
DORSET BH15 1AB, UNITED KINGDOM

FOR: HAIR CARE PREPARATIONS, IN CLASS 3 (U.S. CLS. 1, 4, 6, 50, 51 AND 52).

FIRST USE 0-0-2003; IN COMMERCE 0-0-2003.

THE MARK CONSISTS OF STANDARD CHARACTERS WITHOUT CLAIM TO ANY PARTICULAR FONT, STYLE, SIZE, OR COLOR.

SER. NO. 77-474,850, FILED 5-15-2008.

ODESSA BIBBINS, EXAMINING ATTORNEY



David J. Kyffers

Director of the United States Patent and Trademark Office

United States of America

United States Patent and Trademark Office



Reg. No. 4,097,470

Registered Feb. 14, 2012

Int. Cls.: 9, 10, 42 and 44

TRADEMARK

SERVICE MARK

PRINCIPAL REGISTER

TOUMAZ UK LIMITED (UNITED KINGDOM PRIVATE LIMITED COMPANY)
KITTWELL HOUSE, THE WARREN
RADLETT, HERTFORDSHIRE, UNITED KINGDOM WD7 7DU

FOR: DEVICES AND APPARATUS FOR SENSING, MONITORING, RECORDING AND TRANSMITTING OF SIGNALS AND INFORMATION, NAMELY, WIRELESS SENSORS AND COMMUNICATION PLATFORMS FOR USE IN THE CONTINUOUS, REMOTE MONITORING OF AN INDIVIDUAL'S TEMPERATURE, BLOOD GLUCOSE LEVELS, PHYSICAL ACTIVITY, OXYGEN LEVELS, PHYSIOLOGICAL AND BIOCHEMICAL MARKERS AND/OR OTHER VITAL SIGNS; SPECIALIZED ADHESIVE BANDAGES COMPRISED OF SMALL SENSORS, THIN BATTERIES, AND ANTENNAS FOR USE WITH WIRELESS SENSORS AND COMMUNICATION PLATFORMS FOR USE IN THE CONTINUOUS, REMOTE MONITORING OF AN INDIVIDUAL'S TEMPERATURE, BLOOD GLUCOSE LEVELS, PHYSICAL ACTIVITY, OXYGEN LEVELS, PHYSIOLOGICAL AND BIOCHEMICAL MARKERS AND/OR OTHER VITAL SIGNS; APPARATUS FOR RECEIVING AND PROCESSING SIGNALS AND INFORMATION, NAMELY, WIRELESS SENSORS AND COMMUNICATION PLATFORMS FOR USE IN THE CONTINUOUS, REMOTE MONITORING OF AN INDIVIDUAL'S TEMPERATURE, BLOOD GLUCOSE LEVELS, PHYSICAL ACTIVITY, OXYGEN LEVELS, PHYSIOLOGICAL AND BIOCHEMICAL MARKERS AND/OR OTHER VITAL SIGNS; SPECIALTY ADHESIVE BANDAGES COMPRISED OF SMALL SENSORS, THIN BATTERIES, AND ANTENNAS FOR USE WITH WIRELESS SENSORS AND COMMUNICATION PLATFORMS FOR USE IN THE CONTINUOUS, REMOTE MONITORING OF AN INDIVIDUAL'S TEMPERATURE, BLOOD GLUCOSE LEVELS, PHYSICAL ACTIVITY, OXYGEN LEVELS, PHYSIOLOGICAL AND BIOCHEMICAL MARKERS AND/OR OTHER VITAL SIGNS; WIRELESS COMMUNICATION DEVICES, NAMELY, WIRELESS SENSORS AND COMMUNICATION PLATFORMS FOR USE IN THE CONTINUOUS, REMOTE MONITORING OF AN INDIVIDUAL'S TEMPERATURE, BLOOD GLUCOSE LEVELS, PHYSICAL ACTIVITY, OXYGEN LEVELS, PHYSIOLOGICAL AND BIOCHEMICAL MARKERS AND/OR OTHER VITAL SIGNS; PDAS, WIRELESS SMART PHONES AND MODEMS; ELECTRIC OR ELECTRONIC BIOSENSORS, CHEMICAL SENSORS, AND OPTICAL SENSORS FOR USE IN WIRELESS BODY MONITORING; BODY WEARABLE AND/OR IMPLANTABLE WIRELESS SENSORS THAT INTERFACE WITH MOBILE TELEPHONES, PDAS AND COMPUTERS FOR USE IN CONTINUOUS VITAL SIGN, BIO-CHEMICAL AND PHYSIOLOGICAL MONITORING, AND RECEIVING AND PROCESSING APPARATUS THEREFOR, NAMELY, BASE STATIONS AND MOBILE COMPUTING AND OPERATING PLATFORMS CONSISTING OF DATA TRANSCEIVERS, WIRELESS NETWORKS AND GATEWAYS FOR COLLECTION



David J. Kyjars

Director of the United States Patent and Trademark Office

Reg. No. 4,097,470 AND MANAGEMENT OF PHYSIOLOGICAL AND MEDICAL DATA, IN CLASS 9 (U.S. CLS. 21, 23, 26, 36 AND 38).

FOR: MEDICAL DEVICES AND APPARATUS, NAMELY, WIRELESS SENSORS AND COMMUNICATION PLATFORMS FOR USE IN THE CONTINUOUS, REMOTE MONITORING OF AN INDIVIDUAL'S TEMPERATURE, BLOOD GLUCOSE LEVELS, PHYSICAL ACTIVITY, OXYGEN LEVELS, OR OTHER VITAL SIGNS; MEDICAL DIAGNOSTIC AND SENSING DEVICES AND APPARATUS, NAMELY, SENSORS THAT CAN BE ATTACHED TO THE BODY WITH A STICKING PLASTER TO ENABLE NON-INTRUSIVE, CONTINUOUS MONITORING AND ANALYSIS OF AN INDIVIDUAL'S TEMPERATURE, BLOOD GLUCOSE LEVELS, PHYSICAL ACTIVITY, OXYGEN LEVELS, OR OTHER VITAL SIGNS; MEDICAL DEVICES AND INSTRUMENTS INCORPORATING WIRELESS COMMUNICATION DEVICES AND SENSORS, BIOSENSORS, CHEMICAL SENSORS AND OPTICAL SENSORS, IN CLASS 10 (U.S. CLS. 26, 39 AND 44).

FOR: DESIGN AND DEVELOPMENT FOR OTHERS OF APPARATUS AND DEVICES FOR SENSING, MONITORING, RECORDING, TRANSMITTING, RECEIVING, AND PROCESSING SIGNALS AND INFORMATION; DESIGN AND DEVELOPMENT FOR OTHERS OF WIRELESS COMMUNICATION DEVICES, BIOSENSORS, CHEMICAL SENSORS, AND ELECTRICAL AND OPTICAL SENSORS; RESEARCH AND CONSULTANCY SERVICES RELATING TO THE DESIGN AND DEVELOPMENT OF APPARATUS AND DEVICES FOR SENSING, MONITORING, RECORDING, TRANSMITTING, RECEIVING, AND PROCESSING SIGNALS AND INFORMATION; RESEARCH AND CONSULTANCY SERVICES RELATING TO THE DESIGN AND DEVELOPMENT OF WIRELESS COMMUNICATION DEVICES, BIOSENSORS, CHEMICAL SENSORS, AND ELECTRICAL AND OPTICAL SENSORS; ANALYSIS OF SCIENTIFIC AND PHYSIOLOGICAL DATA DERIVED FROM SENSORS, BIOSENSORS, CHEMICAL AND OPTICAL SENSORS; INFORMATION, ADVISORY, AND CONSULTANCY SERVICES RELATING TO THE ANALYSIS, COLLECTION AND MANAGEMENT OF SCIENTIFIC DATA, IN CLASS 42 (U.S. CLS. 100 AND 101).

FOR: COLLECTION, PREPARATION, COMPOSITION, PROCESSING, ACQUISITION, AND PROVISION OF MEDICAL, PHYSIOLOGICAL, AND BIO-CHEMICAL INFORMATION AND DATA; AND CONSULTANCY SERVICES RELATING TO THE COLLECTION, PREPARATION, COMPOSITION, PROCESSING, ACQUISITION, ANALYSIS AND MANAGEMENT OF MEDICAL, PHYSIOLOGICAL, AND BIO-CHEMICAL INFORMATION AND DATA, IN CLASS 44 (U.S. CLS. 100 AND 101).

PRIORITY CLAIMED UNDER SEC. 44(D) ON ERPN CMNTY TM OFC APPLICATION NO. 6973275, FILED 6-9-2008, REG. NO. 006973275, DATED 7-10-2009, EXPIRES 6-9-2018.

THE COLOR(S) RED, GREY, BLACK, WHITE IS/ARE CLAIMED AS A FEATURE OF THE MARK.

THE MARK CONSISTS OF THE COLORS RED, GRAY, BLACK AND WHITE, WITH THE COLOR BLACK APPEARING IN THE WORDING "SENSIUM" AND THE OUTER CIRCLE OF THE DESIGN, THE COLOR WHITE APPEARS IN THE INNER CIRCLE OF THE DESIGN AND SEPARATES THE TWO YIN AND YANG-FASHIONED SWIRLS, THE LEFT SWIRL APPEARING IN RED AND THE RIGHT SWIRL APPEARING IN GRAY.

SER. NO. 77-497,497, FILED 6-12-2008.

RON FAIRBANKS, EXAMINING ATTORNEY

United States of America
United States Patent and Trademark Office

XENONICS

Reg. No. 4,097,471

XENONICS, INC. (DELAWARE CORPORATION)
3186 LIONSHEAD AVENUE
CARLSBAD, CA 92010

Registered Feb. 14, 2012

Int. Cl.: 11

FOR: SEARCHLIGHTS, SPOTLIGHTS AND FLASHLIGHTS, IN CLASS 11 (U.S. CLS. 13, 21, 23, 31 AND 34).

TRADEMARK

FIRST USE 7-0-1998; IN COMMERCE 7-0-1999.

PRINCIPAL REGISTER

THE MARK CONSISTS OF STANDARD CHARACTERS WITHOUT CLAIM TO ANY PARTICULAR FONT, STYLE, SIZE, OR COLOR.

OWNER OF U.S. REG. NO. 2,457,767.

SER. NO. 77-500,903, FILED 6-17-2008.

MARC LEIPZIG, EXAMINING ATTORNEY



David J. Kyffers

Director of the United States Patent and Trademark Office

United States of America

United States Patent and Trademark Office

PETMD ESPAÑOL

Reg. No. 4,097,472

Registered Feb. 14, 2012

Int. Cl.: 44

SERVICE MARK

PRINCIPAL REGISTER

PFD ACQUISITION CORP. (DELAWARE CORPORATION)
2250 HICKORY ROAD
SUITE 400
PLYMOUTH MEETING, PA 19462

FOR: PROVIDING ON-LINE INFORMATION VIA THE INTERNET IN THE FIELDS OF ANIMALS AND PETS, RELATING TO BREEDING, SELECTION OF THE ANIMALS AND PETS, CARE, GROOMING, FEEDING AND NUTRITION, IN CLASS 44 (U.S. CLS. 100 AND 101).

FIRST USE 7-19-2006; IN COMMERCE 7-19-2006.

THE MARK CONSISTS OF STANDARD CHARACTERS WITHOUT CLAIM TO ANY PARTICULAR FONT, STYLE, SIZE, OR COLOR.

PRIORITY CLAIMED UNDER SEC. 44(D) ON SPAIN APPLICATION NO. 007016769, FILED 4-26-2008.

NO CLAIM IS MADE TO THE EXCLUSIVE RIGHT TO USE "ESPAÑOL", APART FROM THE MARK AS SHOWN.

SER. NO. 77-518,364, FILED 7-9-2008.

KAREN BRACEY, EXAMINING ATTORNEY



David J. Kybas

Director of the United States Patent and Trademark Office

United States of America

United States Patent and Trademark Office

EF-SERIES

Reg. No. 4,097,473

Registered Feb. 14, 2012

Int. Cl.: 2

TRADEMARK

PRINCIPAL REGISTER

PROTECH CHEMICALS LTD./PROTECH CHIMIE LTEE (CANADA LIMITED LIABILITY COMPANY)
7600 OUEST HENRI-BOURASSA
SAINT-LAURENT, QUEBEC, CANADA H4S1W3

FOR: POWDER COATINGS AND POWDER PAINTS CONSISTING OF RESINS AND PIGMENTS FOR APPLICATION TO METAL SUBSTRATES AS A PROTECTANT OR FINISH, IN CLASS 2 (U.S. CLS. 6, 11 AND 16).

THE MARK CONSISTS OF STANDARD CHARACTERS WITHOUT CLAIM TO ANY PARTICULAR FONT, STYLE, SIZE, OR COLOR.

PRIORITY CLAIMED UNDER SEC. 44(D) ON CANADA APPLICATION NO. 1407400, FILED 8-15-2008, REG. NO. TMA805,393, DATED 8-29-2011, EXPIRES 8-29-2026.

SER. NO. 77-554,655, FILED 8-25-2008.

JEFFREY LOOK, EXAMINING ATTORNEY



David J. Kyffers

Director of the United States Patent and Trademark Office

United States of America

United States Patent and Trademark Office

WHERE EXERCISE GETS FUN!

Reg. No. 4,097,474

HYPERKIN INC. (CALIFORNIA CORPORATION)
1918 FRANK STILES STREET
SOUTH EL MONTE, CA 91733

Registered Feb. 14, 2012

Int. Cl.: 9

FOR: VIDEO GAME DANCE PAD, NAMELY, VIDEO GAME INTERACTIVE CONTROL FLOOR PADS OR MATS, IN CLASS 9 (U.S. CLS. 21, 23, 26, 36 AND 38).

TRADEMARK

FIRST USE 5-30-2004; IN COMMERCE 5-30-2004.

PRINCIPAL REGISTER

THE MARK CONSISTS OF STANDARD CHARACTERS WITHOUT CLAIM TO ANY PARTICULAR FONT, STYLE, SIZE, OR COLOR.

OWNER OF U.S. REG. NO. 3,126,664.

SER. NO. 77-556,886, FILED 8-27-2008.

RUDY R. SINGLETON, EXAMINING ATTORNEY



David J. Kyffers

Director of the United States Patent and Trademark Office

United States of America

United States Patent and Trademark Office

UNCOMMON GROUND

Reg. No. 4,097,475

UNCOMMON GROUND, INC. (ILLINOIS CORPORATION)

Registered Feb. 14, 2012

1214 GRACE
CHICAGO, IL 60613

Int. Cl.: 43

FOR: RESTAURANT AND BAR SERVICES, IN CLASS 43 (U.S. CLS. 100 AND 101).

SERVICE MARK

FIRST USE 7-1-1991; IN COMMERCE 7-1-1991.

PRINCIPAL REGISTER

THE MARK CONSISTS OF STANDARD CHARACTERS WITHOUT CLAIM TO ANY PARTICULAR FONT, STYLE, SIZE, OR COLOR.

REGISTRATION LIMITED TO THE AREA COMPRISING THE ENTIRE UNITED STATES EXCEPT THE DISTRICT OF COLUMBIA, MAINE, NEW HAMPSHIRE, VERMONT, MASSACHUSETTS, RHODE ISLAND, CONNECTICUT, NEW YORK, NEW JERSEY, PENNSYLVANIA, DELAWARE, MARYLAND, VIRGINIA, WEST VIRGINIA, NORTH CAROLINA, SOUTH CAROLINA, GEORGIA, FLORIDA, ALABAMA, MISSISSIPPI, LOUISIANA AND TEXAS PURSUANT TO CONCURRENT USE PROCEEDING NO. 94002021. CONCURRENT USE WITH REGISTRATION NO. 2929897

OWNER OF U.S. REG. NO. 3,529,545.

SER. NO. 77-586,993, FILED 10-7-2008.

LINDA POWELL, EXAMINING ATTORNEY



David J. Kyffers

Director of the United States Patent and Trademark Office

United States of America

United States Patent and Trademark Office

NATURALICIOSO

Reg. No. 4,097,476

MUSCLELAB LLC (CONNECTICUT LIMITED LIABILITY COMPANY)
4 ACORN LANE
FARMINGTON, CT 06032

Registered Feb. 14, 2012

Int. Cl.: 30

FOR: GRAIN-BASED FOOD BARS ALSO CONTAINING DRIED NUTS, NUTS, AND SEEDS,
IN CLASS 30 (U.S. CL. 46).

TRADEMARK

FIRST USE 1-7-2007; IN COMMERCE 1-7-2007.

PRINCIPAL REGISTER

THE MARK CONSISTS OF STANDARD CHARACTERS WITHOUT CLAIM TO ANY PARTICULAR FONT, STYLE, SIZE, OR COLOR.

SER. NO. 77-610,152, FILED 11-7-2008.

HOWARD SMIGA, EXAMINING ATTORNEY



David J. Kybas

Director of the United States Patent and Trademark Office

United States of America

United States Patent and Trademark Office

halia

Reg. No. 4,097,477

Registered Feb. 14, 2012

Int. Cl.: 35

SERVICE MARK

PRINCIPAL REGISTER

1400446 ALBERTA LTD. (CANADA CORPORATION)
SUITE 200
17410 - 107 AVENUE
EDMONTON, CANADA T5S1E9

FOR: DISTRIBUTORSHIP SERVICES IN THE FIELD OF JEWELRY, WATCHES, PEARLS AND GEMSTONES, IN CLASS 35 (U.S. CLS. 100, 101 AND 102).

PRIORITY CLAIMED UNDER SEC. 44(D) ON CANADA APPLICATION NO. 1396271, FILED 5-20-2008, REG. NO. TMA798,074, DATED 5-19-2011, EXPIRES 5-19-2026.

THE MARK CONSISTS OF THE LETTERS "HALIA" IN A STYLIZED FONT WITH THE DOT OVER THE LETTER "I" IN A SWIRL DESIGN.

SER. NO. 77-618,340, FILED 11-20-2008.

KHANH LE, EXAMINING ATTORNEY



David J. Kybas

Director of the United States Patent and Trademark Office

United States of America

United States Patent and Trademark Office

PRODVIEW

Reg. No. 4,097,478

PELTON COMPUTER ENTERPRISES LTD. (CANADA CORPORATION)
SUITE 450, 1000-7TH AVENUE S.W.
CALGARY, ALBERTA, CANADA T2P5L5

Registered Feb. 14, 2012

Int. Cls.: 9, 41 and 42

FOR: COMPUTER SOFTWARE FOR APPLICATION AND DATABASE INTEGRATION FOR USE IN THE OIL AND GAS INDUSTRY, NAMELY, A DATABASE SOFTWARE APPLICATION USED TO TRACK AND MANAGE INFORMATION AND DATA GENERATED DURING OIL, GAS AND WATER EXPLORATION AND PRODUCTION ACTIVITIES, IN CLASS 9 (U.S. CLS. 21, 23, 26, 36 AND 38).

TRADEMARK

SERVICE MARK

PRINCIPAL REGISTER

FOR: COMPUTER EDUCATION TRAINING SERVICES IN THE FIELD OF COMPUTER SOFTWARE USED IN THE OIL, GAS, AND WATER INDUSTRIES, NAMELY, TRAINING FOR COMPUTER SYSTEMS ADMINISTRATORS AND USERS CONCERNING INSTALLATION, IMPLEMENTATION, CUSTOMIZATION AND USE OF COMPUTER SOFTWARE AND DEVELOPMENT OF COMPUTER USERS TRAINING, IN CLASS 41 (U.S. CLS. 100, 101 AND 107).

FOR: CONSULTING SERVICES CONCERNING THE OPERATION OF COMPUTER SOFTWARE USED IN OIL, GAS AND WATER INDUSTRIES IN THE FOLLOWING FIELDS, NAMELY, CONSOLIDATION OF CUSTOMERS' DATA, CUSTOMIZATION OF SOFTWARE USER MANUALS AND DOCUMENTATION, CUSTOMIZATION OF USER INTERFACE SOFTWARE, CUSTOMIZATION OF COMPUTER GENERATED PRINTED REPORTS; COMPUTER SERVICES RELATING TO COMPUTER SOFTWARE USED IN OIL, GAS AND WATER INDUSTRIES IN THE FOLLOWING FIELDS, NAMELY, CUSTOMIZATION OF SOFTWARE FOR THE CONSOLIDATION OF CUSTOMERS' DATA, CUSTOMIZATION OF SOFTWARE USER MANUALS AND DOCUMENTATION, CUSTOMIZATION OF USER INTERFACE SOFTWARE, CUSTOMIZATION OF SOFTWARE FOR THE GENERATION OF PRINTED REPORTS; SUPPORT AND MAINTENANCE SERVICES RELATING TO COMPUTER SOFTWARE USED IN OIL, GAS AND WATER INDUSTRIES, NAMELY, HELP DESK AND ONLINE CUSTOMER SUPPORT SERVICES, COMPUTER SOFTWARE MAINTENANCE AND UPGRADE SERVICES, IN CLASS 42 (U.S. CLS. 100 AND 101).



David J. Kyffers

Director of the United States Patent and Trademark Office

THE MARK CONSISTS OF STANDARD CHARACTERS WITHOUT CLAIM TO ANY PARTICULAR FONT, STYLE, SIZE, OR COLOR.

PRIORITY CLAIMED UNDER SEC. 44(D) ON CANADA APPLICATION NO. 1418898, FILED 11-20-2008, REG. NO. TMA805603, DATED 8-30-2011, EXPIRES 8-30-2026.

Reg. No. 4,097,478 OWNER OF U.S. REG. NOS. 2,871,394, 3,302,199, AND 3,306,993.

SER. NO. 77-625,534, FILED 12-3-2008.

MICHAEL ENGEL, EXAMINING ATTORNEY

United States of America

United States Patent and Trademark Office

iCrack

Reg. No. 4,097,479

DIGITAL FILM TOOLS (CALIFORNIA LIMITED LIABILITY COMPANY)
24 COLUMBINE COURT
BOZEMAN, MT 59715

Registered Feb. 14, 2012

Int. Cl.: 9

FOR: DOWNLOADABLE COMPUTER GRAPHICS SOFTWARE, IN CLASS 9 (U.S. CLS. 21, 23, 26, 36 AND 38).

TRADEMARK

FIRST USE 12-12-2008; IN COMMERCE 12-12-2008.

PRINCIPAL REGISTER

THE MARK CONSISTS OF STANDARD CHARACTERS WITHOUT CLAIM TO ANY PARTICULAR FONT, STYLE, SIZE, OR COLOR.

SER. NO. 77-632,750, FILED 12-14-2008.

LINDA POWELL, EXAMINING ATTORNEY



David J. Kyffers

Director of the United States Patent and Trademark Office

United States of America

United States Patent and Trademark Office



Reg. No. 4,097,480

GRUBB, FREDRICK (UNITED STATES INDIVIDUAL)
2728 HOLLY BROOK CT.
BEDFORD, TX 76021

Registered Feb. 14, 2012

Int. Cl.: 35

FOR: RETAIL STORE SERVICES FEATURING PRESCRIPTION AND NON PRESCRIPTION EYEGLASSES AND ACCESSORIES, IN CLASS 35 (U.S. CLS. 100, 101 AND 102).

SERVICE MARK

FIRST USE 11-1-2004; IN COMMERCE 6-1-2008.

PRINCIPAL REGISTER

NO CLAIM IS MADE TO THE EXCLUSIVE RIGHT TO USE "LENS PRO", APART FROM THE MARK AS SHOWN.

THE MARK CONSISTS OF AN EYEBALL WITH "LENS PROVISION" FOLLOWING.

SER. NO. 77-634,569, FILED 12-16-2008.

NATALIE POLZER, EXAMINING ATTORNEY



David J. Kyffers

Director of the United States Patent and Trademark Office

United States of America

United States Patent and Trademark Office

TRANZFORM

Reg. No. 4,097,481

Registered Feb. 14, 2012

Int. Cls.: 5 and 35

TRADEMARK

SERVICE MARK

PRINCIPAL REGISTER

TRANZFORM NUTRITION TECHNOLOGIES, INC. (CALIFORNIA CORPORATION)
SUITE 102
3381 N. BOND
FRESNO, CA 93726

FOR: NUTRITIONAL SUPPLEMENTS, IN CLASS 5 (U.S. CLS. 6, 18, 44, 46, 51 AND 52).

FIRST USE 1-15-2007; IN COMMERCE 1-15-2007.

FOR: RETAIL STORES FEATURING NUTRITIONAL SUPPLEMENTS, IN CLASS 35 (U.S. CLS. 100, 101 AND 102).

FIRST USE 8-1-2007; IN COMMERCE 8-1-2007.

THE MARK CONSISTS OF STANDARD CHARACTERS WITHOUT CLAIM TO ANY PARTICULAR FONT, STYLE, SIZE, OR COLOR.

SER. NO. 77-638,454, FILED 12-22-2008.

KATHRYN COWARD, EXAMINING ATTORNEY



David J. Kybas

Director of the United States Patent and Trademark Office

United States of America

United States Patent and Trademark Office

BR11 CRYPTOgard

Reg. No. 4,097,482

Registered Feb. 14, 2012

Int. Cls.: 6 and 9

TRADEMARK

PRINCIPAL REGISTER

LA GARD DO BRASIL LTDA (BRAZIL SOCIEDADE POR QUOTAS DE RESPONSABILIDADE LIMITADA (LTDA))
AVENIDA CAPITAO CASA, 1485/1487
SAO BERNARDO DO CAMPO, BRAZIL 09812

FOR: (BASED ON 44(E) PURSUANT TO BRAZILIAN FOREIGN REGISTRATION NUMBER 901396915) GATE HARDWARE, NAMELY, METAL GATE LATCHES; METAL LOCKS; METAL LOCKS AND KEYS THEREFOR; METAL LOCKS FOR SAFES; METAL LOCKSETS; METAL PADLOCKS, IN CLASS 6 (U.S. CLS. 2, 12, 13, 14, 23, 25 AND 50).

FOR: (BASED ON 44(E) PURSUANT TO BRAZILIAN FOREIGN REGISTRATION NUMBER 828168237) ACCESS CONTROL AND ALARM MONITORING SYSTEMS; ALARM INSTALLATIONS AND ALARMS; AUTOMATED SECURITY GATES; AUTOMATED SELF CONTAINED ELECTRONIC SURVEILLANCE DEVICES THAT CAN BE DEPLOYED TO GATHER EVIDENCE OR INTELLIGENCE IN REMOTE LOCATIONS; ELECTRIC CIRCUIT CLOSERS; ELECTRIC DOOR CLOSING SYSTEM; ELECTRIC DOOR OPENERS AND CLOSERS; ELECTRIC DOOR OPENING AND CLOSING SYSTEM; ELECTRIC DOOR OPENING SYSTEM; ELECTRIC GATE OPERATORS; ELECTRONIC DOOR OPENING AND CLOSING SYSTEM; ELECTRONIC LOCKS; ELECTRONIC SAFES; ELECTRONIC TIMERS; ELECTRONICALLY-OPERATED DOOR LATCHES, IN CLASS 9 (U.S. CLS. 21, 23, 26, 36 AND 38).

THE MARK CONSISTS OF STANDARD CHARACTERS WITHOUT CLAIM TO ANY PARTICULAR FONT, STYLE, SIZE, OR COLOR.

PRIORITY CLAIMED UNDER SEC. 44(D) ON BRAZIL APPLICATION NO. 901396915, FILED 1-8-2009, REG. NO. 901396915, DATED 8-16-2011, EXPIRES 8-16-2021.

OWNER OF BRAZIL REG. NO. 828168237, DATED 4-22-2008, EXPIRES 4-22-2018.

SER. NO. 77-646,486, FILED 1-9-2009.

AMY HELLA, EXAMINING ATTORNEY



David J. Kyffers

Director of the United States Patent and Trademark Office

United States of America

United States Patent and Trademark Office



Reg. No. 4,097,483

Registered Feb. 14, 2012

Int. Cl.: 36

CAIXA CENTRAL - CAIXA CENTRAL DE CRÉDITO AGRÍCOLA MÚTUO, CRL (PORTUGAL CRL (COOPERATIVA DE RESPONSABILIDADE LIMITADA): LIMITED LIABILITY BUSINESS COOPERATIVE)
RUA CASTILHO 233/233^a
LISBOA, PORTUGAL 1099004

SERVICE MARK

PRINCIPAL REGISTER

FOR: INSURANCE SERVICES, NAMELY, INSURANCE AND FINANCIAL INFORMATION AND CONSULTANCY SERVICES, PROVIDING INFORMATION IN INSURANCE MATTERS; FINANCIAL INFORMATION AND FINANCIAL ADVICE IN THE FIELDS OF ACCOUNTING, ECONOMICS, BUSINESS MANAGEMENT, BANKING, FINANCE, FINANCIAL INVESTMENTS, AND FINANCIAL VALUATIONS; FINANCIAL AFFAIRS, NAMELY, BANKING SERVICES, FINANCIAL MANAGEMENT, FINANCIAL INVESTMENT ADVISORY SERVICES AND FINANCIAL VALUATION OF PERSONAL PROPERTY AND REAL ESTATE; REAL ESTATE AFFAIRS, NAMELY, FINANCING OF REAL ESTATE DEVELOPMENT PROJECTS, REAL ESTATE FINANCING, INVESTMENT AND LENDING SERVICES; BANKING SERVICES; FINANCIAL INVESTMENT IN THE FIELD OF REAL ESTATE AND SECURITIES, IN CLASS 36 (U.S. CLS. 100, 101 AND 102).

OWNER OF PORTUGAL REG. NO. 434543, DATED 9-18-2008, EXPIRES 9-18-2018.

THE COLOR(S) GREEN AND TAN IS/ARE CLAIMED AS A FEATURE OF THE MARK.

NO CLAIM IS MADE TO THE EXCLUSIVE RIGHT TO USE "CONSULT", APART FROM THE MARK AS SHOWN.

THE MARK CONSISTS OF A THREE-LEAF DESIGN WITH THE LEFT LEAF IN TAN AND THE RIGHT TWO LEAVES AND STEM IN GREEN TO THE LEFT OF THE LETTERING "CA CONSULT" WHERE "CA" IS IN GREEN AND "CONSULT" IS IN TAN. THE WHITE BEHIND THE MARK IS BACKGROUND AREA WHICH IS NOT PART OF THE MARK.

SER. NO. 77-657,460, FILED 1-27-2009.

REBECCA GILBERT, EXAMINING ATTORNEY



David J. Kyffers

Director of the United States Patent and Trademark Office

United States of America

United States Patent and Trademark Office



Reg. No. 4,097,484

Registered Feb. 14, 2012

Int. Cl.: 36

CAIXA CENTRAL - CAIXA CENTRAL DE CRÉDITO AGRÍCOLA MÚTUO, CRL (PORTUGAL CRL (COOPERATIVA DE RESPONSABILIDADE LIMITADA): LIMITED LIABILITY BUSINESS COOPERATIVE)
RUA CASTILHO 233/233^a
LISBOA, PORTUGAL 1099004

SERVICE MARK

PRINCIPAL REGISTER

FOR: INSURANCE SERVICES, NAMELY, INSURANCE AND FINANCIAL INFORMATION AND CONSULTANCY SERVICES, PROVIDING INFORMATION IN INSURANCE MATTERS; FINANCIAL INFORMATION AND FINANCIAL ADVICE IN THE FIELDS OF ACCOUNTING, ECONOMICS, BUSINESS MANAGEMENT, BANKING, FINANCE, FINANCIAL INVESTMENTS, AND FINANCIAL VALUATIONS; FINANCIAL AFFAIRS, NAMELY, BANKING SERVICES, FINANCIAL MANAGEMENT, FINANCIAL INVESTMENT ADVISORY SERVICES AND FINANCIAL VALUATION OF PERSONAL PROPERTY AND REAL ESTATE; REAL ESTATE AFFAIRS, NAMELY, FINANCING OF REAL ESTATE DEVELOPMENT PROJECTS, REAL ESTATE FINANCING, INVESTMENT AND LENDING SERVICES; BANKING SERVICES; FINANCIAL INVESTMENT IN THE FIELD OF REAL ESTATE AND SECURITIES, IN CLASS 36 (U.S. CLS. 100, 101 AND 102).

OWNER OF PORTUGAL REG. NO. 434541, DATED 10-1-2008, EXPIRES 10-1-2018.

THE COLOR(S) GREEN AND COOL GRAY IS/ARE CLAIMED AS A FEATURE OF THE MARK.

NO CLAIM IS MADE TO THE EXCLUSIVE RIGHT TO USE "GEST", APART FROM THE MARK AS SHOWN.

THE MARK CONSISTS OF A THREE-LEAF DESIGN WITH THE LEFT TWO LEAVES IN GREEN AND THE RIGHT LEAF AND STEM IN COOL GRAY TO THE LEFT OF THE LETTERING "CA GEST" WHERE "CA" IS IN GREEN AND "GEST" IS IN COOL GRAY. THE WHITE BEHIND THE MARK IS BACKGROUND AREA WHICH IS NOT A PART OF THE MARK.

THE ENGLISH TRANSLATION OF "GEST" IN THE MARK IS "MANAGEMENT".

SER. NO. 77-657,461, FILED 1-27-2009.

REBECCA GILBERT, EXAMINING ATTORNEY



David J. Kyffers

Director of the United States Patent and Trademark Office

United States of America

United States Patent and Trademark Office



Reg. No. 4,097,485

HITS A MILLION, LLC (GEORGIA LIMITED LIABILITY COMPANY)
P.O. BOX 741332

Registered Feb. 14, 2012

RIVERDALE, GA 30274

Int. Cl.: 41

SERVICE MARK

PRINCIPAL REGISTER

FOR: ARRANGING AND CONDUCTING OF CONCERTS; AUDIO AND VIDEO RECORDING SERVICES; AUDIO RECORDING AND PRODUCTION; COMPOSITION OF MUSIC FOR OTHERS; CONSULTATION AND ADVICE REGARDING MUSICAL SELECTIONS AND ARRANGEMENTS FOR SOUND RECORDINGS AND LIVE PERFORMANCES; CONTINUING EDUCATION SERVICES, NAMELY, PROVIDING LIVE AND ON-LINE CONTINUING PROFESSIONAL EDUCATION SEMINARS IN THE FIELD OF MUSIC, SONGWRITING, MUSIC PUBLISHING, MULTIMEDIA, MUSIC AND ENTERTAINMENT BUSINESS; DIGITAL VIDEO, AUDIO, AND MULTIMEDIA PUBLISHING SERVICES; EDITING OR RECORDING OF SOUNDS AND IMAGES; EDUCATION SERVICES, NAMELY, PROVIDING TUTORING IN THE FIELDS OF MUSIC, SONGWRITING, MULTIMEDIA, MUSIC AND ENTERTAINMENT BUSINESS; EDUCATIONAL AND ENTERTAINMENT SERVICES, NAMELY, PROVIDING MOTIVATIONAL SPEAKING SERVICES IN THE FIELD OF MUSIC AND ENTERTAINMENT BUSINESS; ENTERTAINMENT AND EDUCATION SERVICES IN THE NATURE OF LIVE DANCE AND MUSICAL PERFORMANCES; ENTERTAINMENT AND EDUCATIONAL SERVICES, NAMELY, PROVIDING A WEBSITE THAT DISPLAYS VARIOUS REQUESTS, REVIEWS, RECOMMENDATIONS, RANKINGS, TRACKINGS, VOTES, AND INFORMATION RELATING TO UNCREATED, UNRELEASED, NEW, SPECIAL, POPULAR, AND RARE PRODUCTS, SERVICES, AND EVENTS IN THE FIELDS OF POP CULTURE, ENTERTAINMENT, EDUCATION, LIFESTYLE, AND SPORTS, ALL EXCLUSIVELY FOR NON-BUSINESS AND NON-COMMERCIAL TRANSACTIONS AND PURPOSES; ENTERTAINMENT AND EDUCATIONAL SERVICES, NAMELY, PROVIDING ADVICE AND INFORMATION FOR MUSIC, VIDEO AND FILM CONCEPT AND SCRIPT DEVELOPMENT; ENTERTAINMENT IN THE NATURE OF LIVE RADIO PERSONALITY PERFORMANCES; ENTERTAINMENT IN THE NATURE OF VISUAL AND AUDIO PERFORMANCES, AND MUSICAL, VARIETY, NEWS AND COMEDY SHOWS; ENTERTAINMENT IN THE NATURE OF VISUAL AND AUDIO PERFORMANCES, NAMELY, MUSICAL BAND, ROCK GROUP, GYMNASTIC, DANCE, AND BALLET PERFORMANCES; ENTERTAINMENT SERVICES IN THE NATURE OF AN ON-GOING REALITY BASED TELEVISION PROGRAM; ENTERTAINMENT SERVICES IN THE NATURE OF LIVE MUSICAL PERFORMANCES; ENTERTAINMENT SERVICES, NAMELY, LIVE, TELEVISED AND MOVIE APPEARANCES BY A PROFESSIONAL ENTERTAINER; ENTERTAINMENT SERVICES, NAMELY, AN ON-LINE ACTIVITY WHERE YOU CREATE YOUR OWN MUSIC VIDEOS; ENTERTAINMENT SERVICES, NAMELY, MULTIMEDIA PRODUCTION SERVICES; ENTERTAINMENT SERVICES, NAMELY, NON-



David J. Kyjars

Director of the United States Patent and Trademark Office

Reg. No. 4,097,485 DOWNLOADABLE RINGTONES, PRE-RECORDED MUSIC, VIDEO AND GRAPHICS PRESENTED TO MOBILE COMMUNICATIONS DEVICES VIA A GLOBAL COMPUTER NETWORK AND WIRELESS NETWORKS; ENTERTAINMENT SERVICES, NAMELY, PERSONAL APPEARANCES BY A MUSICIAN, ARTIST, SONGWRITER, PRODUCER, STAR, CELEBRITY, ATHLETE, EDUCATOR, AUTHOR, TEACHER; ENTERTAINMENT SERVICES, NAMELY, PROVIDING A RADIO PROGRAM IN THE FIELD OF THE MUSIC AND ENTERTAINMENT BUSINESS VIA A GLOBAL COMPUTER NETWORK; ENTERTAINMENT SERVICES, NAMELY, PROVIDING A TELEVISION PROGRAM IN THE FIELD OF MUSIC AND ENTERTAINMENT BUSINESS VIA A GLOBAL COMPUTER NETWORK; ENTERTAINMENT SERVICES, NAMELY, PROVIDING A WEB SITE FEATURING MUSICAL PERFORMANCES, MUSICAL VIDEOS, RELATED FILM CLIPS, PHOTOGRAPHS, AND OTHER MULTIMEDIA MATERIALS FEATURING SONGWRITERS, ARTISTS, MUSICIANS, ATHLETES, STARS, CELEBRITIES, PRODUCERS, ACTORS, AUTHORS, TEACHERS; ENTERTAINMENT SERVICES, NAMELY, PROVIDING A WEB SITE FEATURING USER-GENERATED VIDEOS ON A WIDE VARIETY OF TOPICS AND SUBJECTS; ENTERTAINMENT SERVICES, NAMELY, PROVIDING PRERECORDED MUSIC, INFORMATION IN THE FIELD OF MUSIC, AND COMMENTARY AND ARTICLES ABOUT MUSIC, ALL ON-LINE VIA A GLOBAL COMPUTER NETWORK; ENTERTAINMENT, NAMELY, LIVE MUSIC CONCERTS; ENTERTAINMENT, NAMELY, LIVE PERFORMANCES BY A MUSICAL BAND; FILM AND VIDEO PRODUCTION; FILM AND VIDEO PRODUCTION CONSULTING SERVICES; MEDIA PRODUCTION SERVICES, NAMELY, VIDEO AND FILM PRODUCTION; MOBILE MEDIA AND ENTERTAINMENT SERVICES IN THE NATURE OF CONTENT PREPARATION; MOBILE MEDIA AND ENTERTAINMENT SERVICES IN THE NATURE OF CONTENT PREPARATION, POST-PRODUCTION; MOTION PICTURE SONG PRODUCTION; MULTIMEDIA ENTERTAINMENT SERVICES IN THE NATURE OF RECORDING, PRODUCTION AND POST-PRODUCTION SERVICES IN THE FIELDS OF MUSIC, VIDEO, AND FILMS; MULTIMEDIA PUBLISHING OF BOOKS, MAGAZINES, JOURNALS, SOFTWARE, GAMES, MUSIC, AND ELECTRONIC PUBLICATIONS; MUSIC COMPOSITION AND TRANSCRIPTION FOR OTHERS; MUSIC PRODUCTION SERVICES; MUSIC PUBLISHING SERVICES; MUSIC SELECTION SERVICES FOR USE IN TELEVISION, FILM, RADIO AND VIDEO GAMES; MUSIC VIDEO PRODUCTION; POST-PRODUCTION EDITING SERVICES IN THE FIELD OF MUSIC, VIDEOS AND FILMS; PRESENTATION OF LIVE SHOW PERFORMANCES; PRESENTATION OF MUSICAL PERFORMANCE; PRODUCTION AND DISTRIBUTION OF TELEVISION SHOWS AND MOVIES; PRODUCTION OF RADIO AND TELEVISION PROGRAMS; PRODUCTION OF SOUND AND MUSIC VIDEO RECORDINGS; PRODUCTION OF SOUND RECORDINGS; PRODUCTION OF VIDEO CASSETTES; PRODUCTION OF VIDEO DISCS AND TAPES; PRODUCTION OF VIDEO DISCS FOR OTHERS; PRODUCTION OF VISUAL EFFECTS FOR VIDEOS, DVDS, TELEVISION AND FOR INTERNET WEB SITES; PROVIDING AN INTERNET WEBSITE PORTAL FEATURING LINKS TO MUSICAL ARTIST WEBSITES AND MUSIC PERFORMANCE TICKET INFORMATION; PROVIDING INFORMATION, NEWS AND COMMENTARY IN THE FIELD OF ENTERTAINMENT; RADIO ENTERTAINMENT PRODUCTION; RECORD MASTER PRODUCTION; RECORD PRODUCTION; RECORDING STUDIO SERVICES; RECORDING STUDIOS; SONG WRITING SERVICES; SOUND RECORDING STUDIOS; VIDEO RECORDING SERVICES; VIDEO TAPE RECORDING FOR OTHERS, IN CLASS 41 (U.S. CLS. 100, 101 AND 107).

FIRST USE 10-3-2007; IN COMMERCE 12-30-2007.

THE MARK CONSISTS OF DARK ORANGE BACKGROUND. BLACK SWIRL THAT FADES OUT. THE LETTERS "HM" APPEAR BLENDED TO THE RIGHT OF THE SWIRL, "H" IS BLACK AND "M" IS WHITE. BELOW "HM", THE PHRASE "HITS A MILLION" WRITTEN WITH NO SPACES IN BETWEEN THE WORDS APPEARS IN SMALLER FONT, "HITS" WRITTEN IN BLACK AND "A MILLION" WRITTEN IN WHITE.

THE COLOR(S) ORANGE, BLACK, WHITE IS/ARE CLAIMED AS A FEATURE OF THE MARK.

SER. NO. 77-659,796, FILED 1-29-2009.

Reg. No. 4,097,485 BARBARA BROWN, EXAMINING ATTORNEY

United States of America

United States Patent and Trademark Office



Reg. No. 4,097,486

LG ELECTRONICS INC. (REPUBLIC OF KOREA CORPORATION)
20, YOIDO-DONG, YONGDUNGPO-GU
SEOUL, REPUBLIC OF KOREA

Registered Feb. 14, 2012

Int. Cl.: 9

FOR: TELEVISION RECEIVERS; PLASMA DISPLAY PANEL (PDP) TELEVISIONS; LIQUID CRYSTAL DISPLAY (LCD) TELEVISIONS; DIGITAL VERSATILE VIDEO DISC (DVD) PLAYERS; PICTURE PROJECTORS; COMPUTER MONITORS; UNIVERSAL SERIAL BUS (USB) DRIVES; DIGITAL MPEG AUDIO LAYER-3 (MP3) PLAYERS; HEADSETS FOR CELLULAR PHONES; PORTABLE COMMUNICATIONS APPARATUS, NAMELY, HANDSETS; WALKIE-TALKIES, SATELLITE TELEPHONES AND PERSONAL DIGITAL ASSISTANCE (PDA); CELLULAR PHONES; COMPUTERS; HOME THEATER SYSTEMS COMPRISING DVD PLAYERS AND AUDIO SPEAKERS; AUDIO COMPONENTS, NAMELY, AUDIO AMPLIFIERS, RECEIVERS AND SPEAKERS; APPARATUS FOR RECORDING OR REPRODUCTION OF SOUND OR IMAGES FOR USE IN TELECOMMUNICATION; APPARATUS FOR RECORDING OR REPRODUCTION OF SOUND FOR IMAGES, IN CLASS 9 (U.S. CLS. 21, 23, 26, 36 AND 38).

TRADEMARK

PRINCIPAL REGISTER

FIRST USE 2-10-2009; IN COMMERCE 2-10-2009.

OWNER OF TAIWAN REG. NO. 01361969, DATED 5-16-2009, EXPIRES 5-15-2019.

NO CLAIM IS MADE TO THE EXCLUSIVE RIGHT TO USE "INTELLIGENT SENSOR", APART FROM THE MARK AS SHOWN.

THE MARK CONSISTS OF A SHADED HORIZONTAL RECTANGLE WITH THE WORD "INTELLIGENT" APPEARING ABOVE THE WORD "SENSOR" TO THE LEFT OF A MISCELLANEOUS MULTI-CIRCLE DESIGN SUPERIMPOSED IN THE RECTANGLE.

SER. NO. 77-667,363, FILED 2-10-2009.

KELLY TRUSILO, EXAMINING ATTORNEY



David J. Kybas

Director of the United States Patent and Trademark Office

United States of America

United States Patent and Trademark Office



Reg. No. 4,097,487

Registered Feb. 14, 2012

Int. Cls.: 9 and 42

TRADEMARK

SERVICE MARK

PRINCIPAL REGISTER

FRONTIER TECHNOLOGY, INC. (CALIFORNIA CORPORATION)
ATTN: CONTRACTS MANAGER
75 AERO CAMINO, SUITE A
GOLETA, CA 93117

FOR: COMPUTER SOFTWARE FOR DECISION SUPPORT OF ACQUISITION AND OPERATIONAL ADVANCED SYSTEMS FOR THE DEPARTMENT OF DEFENSE AND COMMERCIAL CUSTOMERS, IN CLASS 9 (U.S. CLS. 21, 23, 26, 36 AND 38).

FIRST USE 7-31-2002; IN COMMERCE 10-3-2002.

FOR: ENGINEERING SERVICES, NAMELY, ENGINEERING FOR THE BUSINESS ANALYSIS TO SUPPORT CUSTOMIZATION OF SOFTWARE FOR THE DECISION SUPPORT PROCESS INVOLVING HIGH TECHNOLOGY ADVANCED SYSTEMS FOR THE DEPARTMENT OF DEFENSE AND COMMERCIAL CUSTOMERS, IN CLASS 42 (U.S. CLS. 100 AND 101).

FIRST USE 7-31-2002; IN COMMERCE 10-3-2002.

THE MARK CONSISTS OF A CIRCLE WITH POINTED OBJECT SLIGHTLY LEFT OF CENTER AND "FTI" IS WRITTEN OVER THE RIGHT SIDE OF THE CIRCLE.

SER. NO. 77-695,593, FILED 3-20-2009.

ALICE BENMAMAN, EXAMINING ATTORNEY



David J. Kybas

Director of the United States Patent and Trademark Office

United States of America

United States Patent and Trademark Office

DEDICATED OUTDOOR AIR SOLUTIONS

Reg. No. 4,097,488

Registered Feb. 14, 2012

Int. Cls.: 16 and 37

TRADEMARK

SERVICE MARK

PRINCIPAL REGISTER

VENMAR CES INC. (CANADA CORPORATION)
1502 D QUEBEC AVENUE
SASKATOON, SK, CANADA S7K1V7

FOR: OPERATION AND INSTALLATION MANUALS, PRODUCT DATA MANUALS, AND BROCHURES FEATURING INFORMATION IN THE FIELD OF HEAT AND ENERGY RECOVERY VENTILATION; PAPER TRADE SHOW BACKDROPS AND PAPER BANNERS; PRINTED PAPER SIGNS; ADVERTISING PAMPHLETS AND PRINTED PUBLICATIONS, NAMELY, JOURNAL, MAGAZINE, BROCHURES, NEWSLETTERS IN THE FIELD OF HEAT AND ENERGY RECOVERY VENTILATION, IN CLASS 16 (U.S. CLS. 2, 5, 22, 23, 29, 37, 38 AND 50).

FIRST USE 4-1-2009; IN COMMERCE 4-1-2009.

FOR: PROVIDING A WEB SITE FEATURING INFORMATION IN THE FIELD OF BUILDING VENTILATION, IN CLASS 37 (U.S. CLS. 100, 103 AND 106).

FIRST USE 4-1-2009; IN COMMERCE 4-1-2009.

THE MARK CONSISTS OF STANDARD CHARACTERS WITHOUT CLAIM TO ANY PARTICULAR FONT, STYLE, SIZE, OR COLOR.

OWNER OF CANADA REG. NO. TMA771,098, DATED 7-2-2010, EXPIRES 7-2-2025.

NO CLAIM IS MADE TO THE EXCLUSIVE RIGHT TO USE "OUTDOOR AIR SOLUTIONS", APART FROM THE MARK AS SHOWN.

SER. NO. 77-698,046, FILED 3-24-2009.

TINA L. SNAPP, EXAMINING ATTORNEY



David J. Kyffers

Director of the United States Patent and Trademark Office

United States of America

United States Patent and Trademark Office



Reg. No. 4,097,489

Registered Feb. 14, 2012

Int. Cl.: 41

SERVICE MARK

PRINCIPAL REGISTER

COURAGE 2 ENCOURAGE LLC (INDIANA LIMITED LIABILITY COMPANY)
1361 TRESMOTT DRIVE
WESTFIELD, IN 46074

FOR: ENTERTAINMENT AND EDUCATIONAL SERVICES PROMOTING POSITIVE MOTIVATION AND INSPIRATION FOR YOUTH TO STRIVE TO BE ABOVE AVERAGE, NAMELY, PROVIDING A WEBSITE CONTAINING INFORMATION IN THE FIELDS OF FITNESS AND ENTERTAINMENT, IN CLASS 41 (U.S. CLS. 100, 101 AND 107).

FIRST USE 2-22-2010; IN COMMERCE 2-22-2010.

THE MARK CONSISTS OF THE TERM "MEAN" WITHIN AN "X" SURROUNDED BY A BORDER.

SER. NO. 77-707,388, FILED 4-6-2009.

BRIAN PINO, EXAMINING ATTORNEY



David J. Kyffers

Director of the United States Patent and Trademark Office

United States of America

United States Patent and Trademark Office

RENAISSANCE REGULATORY SERVICES

Reg. No. 4,097,490

Registered Feb. 14, 2012

Int. Cl.: 35

SERVICE MARK

PRINCIPAL REGISTER

RENAISSANCE REGULATORY SERVICES, INC. (FLORIDA CORPORATION)
POST OFFICE BOX 2646
BOCA RATON, FL 33427

FOR: BUSINESS MANAGEMENT CONSULTING SERVICES, NAMELY, COMPLIANCE RELATED EXAMINATIONS, PREPARING SUPERVISORY PROCEDURES, ESTABLISHING INTERNAL CONTROLS, PREPARING AND FILING FINANCIAL REPORTS, GUIDING THE REGISTRATION PROCESS, FILING REGULATORY APPLICATIONS AND NOTICES, OFFERED TO FINANCIAL INSTITUTIONS, BROKER-DEALERS, INVESTMENT ADVISORS, HEDGE FUNDS, INVESTMENT COMPANIES, REGULATORY AGENCIES, GOVERNMENT AGENCIES, SELF-REGULATORY ORGANIZATIONS, LAW FIRMS, ACCOUNTING FIRMS, AND OTHER PROFESSIONAL SERVICES FIRMS, IN CLASS 35 (U.S. CLS. 100, 101 AND 102).

FIRST USE 2-18-2006; IN COMMERCE 2-18-2006.

THE MARK CONSISTS OF STANDARD CHARACTERS WITHOUT CLAIM TO ANY PARTICULAR FONT, STYLE, SIZE, OR COLOR.

NO CLAIM IS MADE TO THE EXCLUSIVE RIGHT TO USE "REGULATORY SERVICES", APART FROM THE MARK AS SHOWN.

SER. NO. 77-715,594, FILED 4-16-2009.

MICHELE SWAIN, EXAMINING ATTORNEY



David J. Kybas

Director of the United States Patent and Trademark Office

United States of America

United States Patent and Trademark Office

ATRIUM INNOVATIONS

Reg. No. 4,097,491

Registered Feb. 14, 2012

Int. Cls.: 5 and 40

TRADEMARK

SERVICE MARK

PRINCIPAL REGISTER

ATRIUM INNOVATIONS INC. (CANADA CORPORATION)
1405, BOUL. DU PARC TECHNOLOGIQUE
QUEBEC, QUEBEC, CANADA G1P4P5

FOR: NUTRITIONAL SUPPLEMENTS, IN CLASS 5 (U.S. CLS. 6, 18, 44, 46, 51 AND 52).

FOR: MANUFACTURING SERVICES FOR THIRD PARTIES OF NUTRITIONAL SUPPLEMENTS, IN CLASS 40 (U.S. CLS. 100, 103 AND 106).

THE MARK CONSISTS OF STANDARD CHARACTERS WITHOUT CLAIM TO ANY PARTICULAR FONT, STYLE, SIZE, OR COLOR.

PRIORITY CLAIMED UNDER SEC. 44(D) ON CANADA APPLICATION NO. 1434149, FILED 4-9-2009, REG. NO. TMA808,243, DATED 10-4-2011, EXPIRES 10-4-2026.

OWNER OF U.S. REG. NO. 3,188,423.

SER. NO. 77-716,620, FILED 4-17-2009.

JESSICA FATHY, EXAMINING ATTORNEY



David J. Kybas

Director of the United States Patent and Trademark Office

United States of America

United States Patent and Trademark Office

μ Coater

Reg. No. 4,097,492

YASUI SEIKI COMPANY LTD. (JAPAN CORPORATION)
8-6, HIGASHIYAMA 2-CHOME
MEGURO-KU, TOKYO, JAPAN

Registered Feb. 14, 2012

Int. Cl.: 7

FOR: THIN-FILM DEPOSITION MACHINES FOR SEMICONDUCTORS; COATING MACHINES FOR COATING MATERIALS ON THE SURFACE OF THIN FILM; COATING MACHINES THAT COAT BASE MATERIAL ON THE SURFACE OF THIN FILM USING ROTO-GRAVURE ROLL; THIN FILM DEPOSITING MACHINES FOR SEMICONDUCTORS, IN CLASS 7 (U.S. CLS. 13, 19, 21, 23, 31, 34 AND 35).

TRADEMARK

PRINCIPAL REGISTER

PRIORITY CLAIMED UNDER SEC. 44(D) ON JAPAN APPLICATION NO. 2009-006473, FILED 2-2-2009, REG. NO. 5412297, DATED 5-20-2011, EXPIRES 5-20-2021.

THE MARK CONSISTS OF A GREEK ALPHABET "MU" NEXT TO THE ENGLISH WORD "COATER".

SER. NO. 77-720,085, FILED 4-22-2009.

RAUL CORDOVA, EXAMINING ATTORNEY



David J. Kybas

Director of the United States Patent and Trademark Office

United States of America

United States Patent and Trademark Office



Reg. No. 4,097,493

Registered Feb. 14, 2012

Int. Cl.: 29

TRADEMARK

PRINCIPAL REGISTER

PEACEWORKS HOLDINGS LLC (DELAWARE LIMITED LIABILITY COMPANY)
PO BOX 1393 OLD CHELSEA STATION
NEW YORK, NY 10113

FOR: NUTRITION BARS, NAMELY, NUT AND SEED BASED SNACK BARS; PROCESSED FRUIT-AND NUT-BASED FOOD BARS, NUT BASED SNACK FOOD BARS, FRUIT BASED SNACK FOOD BARS ALSO CONTAINING NUTS, GRAINS, CEREALS AND DRIED FRUIT, IN CLASS 29 (U.S. CL. 46).

FIRST USE 2-18-2003; IN COMMERCE 2-18-2003.

OWNER OF U.S. REG. NO. 2,984,772.

NO CLAIM IS MADE TO THE EXCLUSIVE RIGHT TO USE "FRUIT + NUT" AND THE NONDISTINCTIVE PACKAGING CONFIGURATION, APART FROM THE MARK AS SHOWN.

THE MARK CONSISTS OF THE PRODUCT PACKAGING TRADE DRESS FOR THE PRESENTATION OF READY TO EAT FOOD BARS AND THE TERMS "KIND FRUIT + NUT" ON THE PRODUCT PACKAGING. THE PACKAGING CONFIGURATION CONSISTS OF TWO LARGE TRANSPARENT PANELS OR WINDOWS THROUGH WHICH THE PRODUCT IS SEEN, THIS PANEL IS DIVIDED BY A NARROW BAND PLACED IN THE MIDDLE OF THE TRANSPARENT WINDOW. THE TERMS "FRUIT + NUT" APPEAR WITHIN THE BAND AND AT THE RIGHT HAND SIDE; AT EITHER END OF THE NARROW BAND IS A SOLID RECTANGULAR PANEL WHICH EXTENDS FROM THE TOP TO THE BOTTOM OF THE PACKAGING. THE WORD "KIND" APPEARS ON THE RIGHT OF THE PACKAGING ABOVE THE NARROW BAND AND THE WORDS "FRUIT + NUT". FOUR SMALLER VERTICAL RECTANGULAR BARS APPEAR ABOVE THE BOLD LETTERS "KIND". THE MATTER SHOWN IN BROKEN LINES IS NOT PART OF THE MARK AND SERVES ONLY TO SHOW THE POSITION OR PLACEMENT OF THE MARK.

SER. NO. 77-721,453, FILED 4-24-2009.

ELLEN PERKINS, EXAMINING ATTORNEY



David J. Kyjars

Director of the United States Patent and Trademark Office

United States of America

United States Patent and Trademark Office

Eggs 'n Things

Reg. No. 4,097,494

Registered Feb. 14, 2012

Int. Cl.: 30

TRADEMARK

PRINCIPAL REGISTER

ENT HOLDINGS LLC (HAWAII LIMITED LIABILITY COMPANY), DBA EGGS 'N THINGS
343 SARATOGA ROAD
HONOLULU, HI 96815

FOR: COFFEE; PANCAKE MIXES, IN CLASS 30 (U.S. CL. 46).

FIRST USE 5-1-1988; IN COMMERCE 5-1-1988.

THE MARK CONSISTS OF STANDARD CHARACTERS WITHOUT CLAIM TO ANY PARTICULAR FONT, STYLE, SIZE, OR COLOR.

NO CLAIM IS MADE TO THE EXCLUSIVE RIGHT TO USE "EGGS", APART FROM THE MARK AS SHOWN.

SER. NO. 77-723,165, FILED 4-27-2009.

JOHN HWANG, EXAMINING ATTORNEY



David J. Kyffers

Director of the United States Patent and Trademark Office

United States of America

United States Patent and Trademark Office

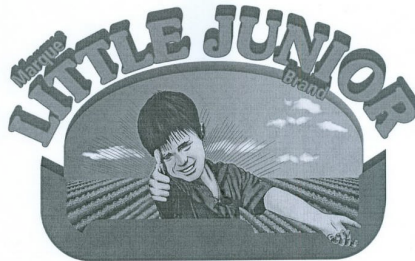

Reg. No. 4,097,495

Registered Feb. 14, 2012

Int. Cls.: 29, 31 and 35

TRADEMARK

SERVICE MARK

PRINCIPAL REGISTER

CENTRE MARAÎCHER EUGENE GUINOIS JR. INC. (CANADA CORPORATION)
555 RANG 4, STE-CLOTILDE-DE-CHÂTEAUGUAY
QUÉBEC, CANADA J0L1W0

FOR: PROCESSED VEGETABLES, IN CLASS 29 (U.S. CL. 46).

FOR: FRESH VEGETABLES, IN CLASS 31 (U.S. CLS. 1 AND 46).

FOR: DISTRIBUTORSHIPS FEATURING VEGETABLES AND PROCESSED VEGETABLES,
IN CLASS 35 (U.S. CLS. 100, 101 AND 102).

PRIORITY CLAIMED UNDER SEC. 44(D) ON CANADA APPLICATION NO. 1,417,511, FILED
11-7-2008, REG. NO. TMA800,777, DATED 6-23-2011, EXPIRES 6-23-2026.

NO CLAIM IS MADE TO THE EXCLUSIVE RIGHT TO USE "MARQUE" AND "BRAND",
APART FROM THE MARK AS SHOWN.

THE LIKENESS (OR, "PORTRAIT") IN THE MARK IDENTIFIES A LIVING INDIVIDUAL
WHOSE CONSENT IS OF RECORD.

THE MARK CONSISTS OF A BOY IN A FIELD. THE WORDING "MARQUE LITTLE JUNIOR
BRAND" APPEARS ABOVE THE DESIGN.

SER. NO. 77-731,807, FILED 5-7-2009.

REBECCA SMITH, EXAMINING ATTORNEY



David J. Kybas

Director of the United States Patent and Trademark Office

United States of America

United States Patent and Trademark Office



Reg. No. 4,097,496

Registered Feb. 14, 2012

Int. Cl.: 9

TRADEMARK

PRINCIPAL REGISTER

BID SOLVE, INCORPORATED (NEVADA CORPORATION)
SUITE 201
10760B AMBASSADOR DR
MANASSAS, VA 20109

FOR: COMPUTER PROGRAMS FOR USING THE INTERNET AND THE WORLD WIDE WEB; COMPUTER SEARCH ENGINE SOFTWARE, IN CLASS 9 (U.S. CLS. 21, 23, 26, 36 AND 38).

FIRST USE 12-16-2008; IN COMMERCE 12-16-2008.

THE MARK CONSISTS OF A STYLIZED WHITE HAND WITH THE INDEX FINGER POINTING LEFT SUPERIMPOSED ON TOP OF A GREEN 8-POINT STAR THAT SITS ON TOP OF A BLACK SHADOW OF THAT STAR.

THE COLOR(S) GREEN, BLACK, AND WHITE IS/ARE CLAIMED AS A FEATURE OF THE MARK.

SER. NO. 77-736,601, FILED 5-14-2009.

SETH A. RAPPAPORT, EXAMINING ATTORNEY



David J. Kyffers

Director of the United States Patent and Trademark Office

United States of America

United States Patent and Trademark Office



Reg. No. 4,097,497

Registered Feb. 14, 2012

Int. Cl.: 43

SERVICE MARK

PRINCIPAL REGISTER

PICAYUNE RANCHERIA OF THE CHUKCHANSI INDIANS (UNITED STATES
FEDERALLY-RECOGNIZED INDIAN TRIBE)
46575 ROAD 417 #A
COARSEGOLD, CA 93614

FOR: RESTAURANT SERVICES FEATURING A 1950S THEMED DINER, IN CLASS 43 (U.S.
CLS. 100 AND 101).

FIRST USE 6-25-2003; IN COMMERCE 6-25-2003.

NO CLAIM IS MADE TO THE EXCLUSIVE RIGHT TO USE "DINER", APART FROM THE
MARK AS SHOWN.

THE COLOR(S) BLUE, DARK BLUE, PURPLE, RED, YELLOW, GREY AND BLACK IS/ARE
CLAIMED AS A FEATURE OF THE MARK.

THE MARK CONSISTS OF A CURVED PALETTE-SHAPED LOGO OUTLINED IN DARK
BLUE WHICH TRANSITIONS FROM THE COLOR PURPLE TO BLUE FROM LEFT TO
RIGHT WITH SIX GREY LINES OUTLINED IN BLACK EQUALLY SEPARATED FROM
ONE ANOTHER SET OVER THE LOGO WITH THE WORD "DEUCES" SET ON THE FIRST
TOP THREE LINES SLIGHTLY COLORED YELLOW, OUTLINED IN RED AND OUTLINED
IN GREY WITH THE WORD "DINER" SET JUST BELOW THE WORD "DEUCES" ON THE
FOURTH, FIFTH AND SIXTH LINES SLIGHTLY COLORED YELLOW, OUTLINED IN RED
AND OUTLINED IN GREY. THE COLOR WHITE REPRESENTS TRANSPARENT AREAS
AND IS NOT PART OF THE MARK.

SER. NO. 77-750,982, FILED 6-3-2009.

KATHLEEN M. VANSTON, EXAMINING ATTORNEY



David J. Kybas

Director of the United States Patent and Trademark Office

United States of America
United States Patent and Trademark Office

CARDITONE

Reg. No. 4,097,498

AYUSH HERBS, INC. (WASHINGTON CORPORATION)
2239 152ND AVE NE
REDMOND, WA 98052

Registered Feb. 14, 2012

Int. Cl.: 5

FOR: DIETARY SUPPLEMENTS, IN CLASS 5 (U.S. CLS. 6, 18, 44, 46, 51 AND 52).

TRADEMARK

FIRST USE 0-0-1993; IN COMMERCE 0-0-1993.

PRINCIPAL REGISTER

THE MARK CONSISTS OF STANDARD CHARACTERS WITHOUT CLAIM TO ANY PARTICULAR FONT, STYLE, SIZE, OR COLOR.

SER. NO. 77-766,988, FILED 6-24-2009.

JOHN SCHUYLER YARD, EXAMINING ATTORNEY



David J. Kyfos

Director of the United States Patent and Trademark Office

United States of America

United States Patent and Trademark Office

HYPER REAL

Reg. No. 4,097,499

Registered Feb. 14, 2012

Int. Cl.: 9

TRADEMARK

PRINCIPAL REGISTER

SAMSUNG ELECTRONICS CO., LTD. (REPUBLIC OF KOREA CORPORATION)
416, MAETAN-DONG, YEONGTONG-GU
SUWON-SI, GYEONGGI-DO, REPUBLIC OF KOREA

FOR: DVD PLAYERS; HOME THEATER SYSTEM COMPRISING OF TELEVISION RECEIVERS, AUDIO AMPLIFIERS AND AUDIO SPEAKERS; TELEVISION RECEIVERS, IN CLASS 9 (U.S. CLS. 21, 23, 26, 36 AND 38).

FIRST USE 8-5-2009; IN COMMERCE 8-5-2009.

THE MARK CONSISTS OF STANDARD CHARACTERS WITHOUT CLAIM TO ANY PARTICULAR FONT, STYLE, SIZE, OR COLOR.

PRIORITY CLAIMED UNDER SEC. 44(D) ON REPUBLIC OF KOREA APPLICATION NO. 2009-0035813, FILED 7-27-2009.

SER. NO. 77-790,068, FILED 7-27-2009.

ELLEN PERKINS, EXAMINING ATTORNEY



David J. Kybas

Director of the United States Patent and Trademark Office

United States of America

United States Patent and Trademark Office

CSI COLLISION SPECIALIST

Reg. No. 4,097,500

Registered Feb. 14, 2012

Int. Cl.: 37

SERVICE MARK

PRINCIPAL REGISTER

CSI COLLISION SPECIALIST, INC. (TEXAS CORPORATION)
5138 HIGHWAY 6 NORTH
HOUSTON, TX 77084

FOR: VEHICLE BODY REPAIR SERVICES, IN CLASS 37 (U.S. CLS. 100, 103 AND 106).

FIRST USE 12-2-1984; IN COMMERCE 12-2-1984.

THE MARK CONSISTS OF STANDARD CHARACTERS WITHOUT CLAIM TO ANY PARTICULAR FONT, STYLE, SIZE, OR COLOR.

NO CLAIM IS MADE TO THE EXCLUSIVE RIGHT TO USE "COLLISION SPECIALIST", APART FROM THE MARK AS SHOWN.

SER. NO. 77-797,113, FILED 8-4-2009.

BRIAN CALLAGHAN, EXAMINING ATTORNEY



David J. Kyffers

Director of the United States Patent and Trademark Office

United States of America

United States Patent and Trademark Office

ICAN Innovated Creation of Art Now

Reg. No. 4,097,501

BARELA, PATRICIA (UNITED STATES INDIVIDUAL)
2132 S. XAVIER ST.
DENVER, CO 80219 AND

Registered Feb. 14, 2012

Int. Cl.: 21

JARAMILLO, KRIS (UNITED STATES INDIVIDUAL)
2132 S. XAVIER ST.
DENVER, CO 80219

TRADEMARK

PRINCIPAL REGISTER

FOR: WORKS OF ART MADE OF GLASS, IN CLASS 21 (U.S. CLS. 2, 13, 23, 29, 30, 33, 40 AND 50).

FIRST USE 8-8-2009; IN COMMERCE 8-8-2009.

THE MARK CONSISTS OF STANDARD CHARACTERS WITHOUT CLAIM TO ANY PARTICULAR FONT, STYLE, SIZE, OR COLOR.

SER. NO. 77-804,540, FILED 8-14-2009.

COLLEEN KEARNEY, EXAMINING ATTORNEY



David J. Kyffers

Director of the United States Patent and Trademark Office

United States of America

United States Patent and Trademark Office

MED-ENG

Reg. No. 4,097,502

ALLEN-VANGUARD CORPORATION (CANADA CORPORATION)
2400 ST. LAURENT BLVD.

Registered Feb. 14, 2012

OTTAWA ONTARIO, CANADA K1G6C4

Int. Cl.: 9

FOR: PROTECTIVE CLOTHING, NAMELY, BODY PROTECTIVE SUITS, PROTECTIVE HELMETS, PROTECTIVE INDUSTRIAL GLOVES AND BOOTS FOR USE BY BOMB AND MINE DISPOSAL PERSONNEL AND FIRE FIGHTERS; PERSONAL PROTECTIVE CLOTHING FOR THE HANDS AND FEET OF DEMINING AND MINE CLEARANCE PERSONNEL, NAMELY, CONICAL HAND PROTECTORS, OVERHAND HAND PROTECTORS, RAISED FOOT PROTECTION PLATFORM FOR WALKING; PERSONAL PROTECTIVE CLOTHING USED TO REDUCE RISK OF INJURY FROM BLAST AND BALLISTIC THREATS, NAMELY, MODULAR INTEGRATED SUITS, NAMELY, UPPER BODY VESTS, REMOVABLE SLEEVES, TROUSERS, GROIN PROTECTORS, NECK PROTECTORS, HELMET-MOUNTED RIGID FACIAL PROTECTORS; PROTECTIVE CLOTHING USED IN IMPROVISED EXPLOSIVE DEVICE DISPOSAL, NAMELY, BOMB DISPOSAL SUITS, BOMB DISPOSAL HELMETS WITH VISORS; SEARCH SUITS, NAMELY, BODY PROTECTIVE SUITS DESIGNED FOR USE WHEN SEARCHING FOR IMPROVISED EXPLOSIVE DEVICES; BODY PROTECTIVE ARMOUR FOR MILITARY AND LAW ENFORCEMENT PERSONNEL FACING BALLISTIC AND IDE (IMPROVISED EXPLOSIVE DEVICES) THREATS; PERSONAL PROTECTIVE EQUIPMENT USED TO PROTECT PERSONNEL FROM HEAT STRESS, NAMELY, PROTECTIVE CLOTHING IN THE NATURE OF COOLING VESTS AND LIQUID CIRCULATING GARMENTS EQUIPPED WITH MECHANICAL CHILLERS, ICE-BASED CHILLERS, TETHERS AND CONNECTORS, IN CLASS 9 (U.S. CLS. 21, 23, 26, 36 AND 38).

TRADEMARK

PRINCIPAL REGISTER



FIRST USE 6-0-1993; IN COMMERCE 6-0-1993.

THE MARK CONSISTS OF STANDARD CHARACTERS WITHOUT CLAIM TO ANY PARTICULAR FONT, STYLE, SIZE, OR COLOR.

PRIORITY CLAIMED UNDER SEC. 44(D) ON CANADA APPLICATION NO. 1430980, FILED 3-13-2009, REG. NO. TMA762999, DATED 3-31-2010, EXPIRES 3-31-2025.

OWNER OF U.S. REG. NO. 2,792,328.

SER. NO. 77-813,385, FILED 8-26-2009.

Laurie Mayes, Examining Attorney

David J. Kyros

Director of the United States Patent and Trademark Office

United States of America

United States Patent and Trademark Office



Reg. No. 4,097,503

Registered Feb. 14, 2012

Int. Cls.: 9 and 41

TRADEMARK

SERVICE MARK

PRINCIPAL REGISTER

TAMARA CIMMERIAN (UNITED STATES INDIVIDUAL), AKA KATZEN
5959 TOPANGA CANYON BOULEVARD, #305
WOODLAND HILLS, CA 91367

FOR: DOWNLOADABLE MULTIMEDIA FILE CONTAINING ARTWORK, TEXT, AUDIO, VIDEO, GAMES, AND INTERNET WEB LINKS RELATING TO INDIVIDUAL OR GROUP VOCAL AND INSTRUMENTAL PERFORMER(S); MUSICAL SOUND RECORDINGS; MUSICAL VIDEO RECORDINGS; PRE-RECORDED ELECTRONIC AND DIGITAL MEDIA FEATURING INDIVIDUAL OR GROUP VOCAL AND INSTRUMENTAL PERFORMANCES, IN CLASS 9 (U.S. CLS. 21, 23, 26, 36 AND 38).

FIRST USE 1-1-2009; IN COMMERCE 5-1-2009.

FOR: ENTERTAINMENT IN THE NATURE OF LIVE INDIVIDUAL OR GROUP MUSICAL PERFORMANCES BY INDIVIDUAL OR GROUP; ENTERTAINMENT SERVICES IN THE NATURE OF LIVE MUSICAL PERFORMANCES; ENTERTAINMENT, NAMELY, LIVE PERFORMANCES BY A MUSICAL BAND, IN CLASS 41 (U.S. CLS. 100, 101 AND 107).

FIRST USE 1-5-2009; IN COMMERCE 5-1-2009.

THE NAME "KATZEN" DOES NOT IDENTIFY A LIVING INDIVIDUAL.

THE MARK CONSISTS OF HANDWRITTEN-STYLE FONT DEPICTING THE WORD "KATZEN" WITH AN OVERSIZED LETTER "Z"; ON BOTH SIDES OF THE WORD "KATZEN" APPEARS A HANDWRITTEN-STYLE FIVE POINTED STAR; EACH STAR IS ENCLOSED WITHIN A CIRCLE.

SER. NO. 77-817,764, FILED 9-1-2009.

KRISTIN CARLSON, EXAMINING ATTORNEY



David J. Kyjars

Director of the United States Patent and Trademark Office

United States of America

United States Patent and Trademark Office

Prep Dreams

◆ ◆ ◆ ◆ ◆ Sports

Reg. No. 4,097,504

Registered Feb. 14, 2012

Int. Cl.: 41

SERVICE MARK

PRINCIPAL REGISTER

JOHNSON, JR., CLIFFORD K. (UNITED STATES INDIVIDUAL), DBA PREP DREAMS
SPORTS
14000 LEEDY STREET
FILLMORE, CA 91342

FOR: PROVIDING ON-LINE MAGAZINES IN THE FIELD OF MIDDLE SCHOOL, HIGH SCHOOL, AND JUNIOR COLLEGE SPORTS AND ACADEMICS, IN CLASS 41 (U.S. CLS. 100, 101 AND 107).

FIRST USE 7-1-2009; IN COMMERCE 7-1-2009.

NO CLAIM IS MADE TO THE EXCLUSIVE RIGHT TO USE "PREP" OR "SPORTS", APART FROM THE MARK AS SHOWN.

THE MARK CONSISTS OF THE WORDS "PREP DREAMS", WITH THE BOTTOM LINE OF THE "S" IN "DREAMS" EXTENDING BACK AND UNDERLINING THE WORD "DREAMS"; UNDERNEATH THE WORD "DREAMS" APPEARS THE WORD "SPORTS" IN A HANDWRITTEN FONT; UNDERNEATH THE WORDS "PREP DREAMS" AND TO THE LEFT OF THE WORD "SPORTS" APPEAR FIVE IDENTICAL FOUR-POINTED STARS.

SER. NO. 77-820,127, FILED 9-4-2009.

CORY BOONE, EXAMINING ATTORNEY



David J. Kyffers

Director of the United States Patent and Trademark Office

United States of America

United States Patent and Trademark Office

KOMPRESSOR LITE

Reg. No. 4,097,505

LG ELECTRONICS INC. (REPUBLIC OF KOREA CORPORATION)
20, YOIDO-DONG, YONGDUNGPO-GU
SEOUL, REPUBLIC OF KOREA

Registered Feb. 14, 2012

Int. Cl.: 7

FOR: ELECTRIC VACUUM CLEANERS, IN CLASS 7 (U.S. CLS. 13, 19, 21, 23, 31, 34 AND 35).

TRADEMARK

THE MARK CONSISTS OF STANDARD CHARACTERS WITHOUT CLAIM TO ANY PARTICULAR FONT, STYLE, SIZE, OR COLOR.

PRINCIPAL REGISTER

PRIORITY CLAIMED UNDER SEC. 44(D) ON REPUBLIC OF KOREA APPLICATION NO. 40-2009-0038, FILED 8-11-2009, REG. NO. 0842852, DATED 11-12-2010, EXPIRES 11-12-2020.

OWNER OF U.S. REG. NO. 3,631,943.

NO CLAIM IS MADE TO THE EXCLUSIVE RIGHT TO USE "LITE", APART FROM THE MARK AS SHOWN.

THE ENGLISH TRANSLATION OF "KOMPRESSOR" IN THE MARK IS "COMPRESSOR".

SEC. 2(F) AS TO "KOMPRESSOR".

SER. NO. 77-821,880, FILED 9-8-2009.

KRISTINA MORRIS, EXAMINING ATTORNEY



David J. Kybas

Director of the United States Patent and Trademark Office

United States of America

United States Patent and Trademark Office



Reg. No. 4,097,506

Registered Feb. 14, 2012

**Int. Cls.: 16, 35, 38, 41
and 42**

TRADEMARK

SERVICE MARK

PRINCIPAL REGISTER

GONAMIC GMBH (FED REP GERMANY LIMITED LIABILITY COMPANY)
DOMPLATZ 3
93047 REGENSBURG, FED REP GERMANY

FOR: NEWSPAPERS; PHOTOGRAPHIC AND PRINTED MATTER, NAMELY, BOOKS, JOURNALS, MAGAZINES, PAMPHLETS, CATALOGUES AND PERIODICALS ALL IN THE FIELD OF CURRENT EVENTS AND JOURNALISM; ADVERTISING PAMPHLETS FOR OTHERS; SHEET MUSIC; TELEPHONE CALLING CARDS, NOT MAGNETICALLY ENCODED; CREDIT CARDS WITHOUT MAGNETIC CODING; COLOR PRINTS; PHOTOGRAPHS; PICTURES; GRAPHIC REPRESENTATIONS; MANUALS IN THE FIELD OF JOURNALISM; POSTERS; GREETING CARDS; POST CARDS; PICTURE CARDS; IRON-ON TRANSFERS; STICKERS; PHOTOGRAPH ALBUMS; SCRAPBOOK ALBUMS; STICKERS; ADHESIVE TAPES FOR DECORATIVE PURPOSES; STATIONERY; WRITING IMPLEMENTS; DRAWING, PAINTING AND MODELING GOODS, NAMELY, MODELING CLAY, PAINT BRUSHES AND DRAWING PENCILS; DRAWING IMPLEMENTS; PAINTING IMPLEMENTS, NAMELY, PAINTING PALETTES; PAINT BRUSHES; ADHESIVES AND ADHESIVE STRIPS FOR STATIONERY OR HOUSEHOLD PURPOSES; OFFICE REQUISITES, NAMELY, OFFICE PAPER DRILL MACHINES; PRINTED INSTRUCTIONAL AND TEACHING MATERIALS IN THE FIELD OF JOURNALISM; DIARIES; CALENDARS; BOOKMARKS; PAPER COASTER FOR BEER GLASSES; ADDRESS STAMPS; DOCUMENT FILES FOR STATIONERY; FOLDERS FOR PAPERS; PAPER NAPKINS; PAPER TABLECLOTHS; TABLECLOTHS OF CELLULOSE; PACKAGING CONTAINERS OF PAPER; POLYPROPYLENE FOIL FOR PACKING; PLASTIC BUBBLE PACKS FOR WRAPPING OR PACKAGING; PLASTIC BAGS FOR PACKAGING; CARDBOARD PACKAGING BOXES IN COLLAPSIBLE FORM; ADHESIVE TAPES FOR STATIONERY PURPOSES, IN CLASS 16 (U.S. CLS. 2, 5, 22, 23, 29, 37, 38 AND 50).



David J. Kyffers

Director of the United States Patent and Trademark Office

FOR: PRODUCT MERCHANDISING; SALES PROMOTION FOR OTHERS; ARRANGING, MONITORING AND CONDUCTING INCENTIVE REWARD PROGRAMS TO PROMOTE THE SALE OF PRINTED PERIODICALS; ARRANGING AND CONDUCTING SALES FOR OTHERS OF PRINTED PERIODICALS; PROVIDING A WEBSITE USED TO PLACE ON-LINE COMMERCIAL ORDERS IN THE FIELD OF NEWSPAPERS; TELEPHONE ORDER-TAKING SERVICES FOR OTHERS; ARRANGING OF CONTRACTS FOR THE BUYING AND SELLING OF GOODS AND THE PROVIDING OF SERVICES FOR OTHERS; ARRANGING AND CONDUCTING OF EXPOS FOR BUSINESS AND ADVERTISING PURPOSES; PRESENTATION OF BUSINESS PROSPECTUSES ON THE INTERNET; BUSINESS MANAGEMENT; BUSINESS MANAGEMENT CONSULTANCY; BUSINESS ORGANISATION AND MANAGE-

Reg. No. 4,097,506 MENT CONSULTING SERVICES; PROFESSIONAL BUSINESS AND ORGANISATIONAL CONSULTANCY; BUSINESS ADMINISTRATION; BUSINESS CONSULTANCY; PERSONNEL MANAGEMENT CONSULTANCY; ORGANISATIONAL PROJECT MANAGEMENT IN THE FIELD OF ELECTRONIC DATA PROCESSING; FRANCHISING, NAMELY, CONSULTATION AND ASSISTANCE IN BUSINESS MANAGEMENT, ORGANIZATION AND PROMOTION; ELECTRONIC DATA COLLECTION SERVICES FOR BUSINESS PURPOSES IN THE FIELDS OF NEWS AND JOURNALISM; DATABASE MANAGEMENT, NAMELY, COLLATING AND SYSTEMATIC ORDERING OF DATA IN A COMPUTER DATA BASE; DATABASE MANAGEMENT, NAMELY, MAINTENANCE OF DATA IN COMPUTER DATABASES; AUCTIONEERING AND ONLINE AUCTIONEERING; ADVERTISING AGENCIES; ADVERTISING; DIRECT MAIL ADVERTISING; ADVERTISING SERVICES, NAMELY, PROMOTING AND MARKETING THE GOODS AND SERVICES OF OTHERS THROUGH ALL PUBLIC COMMUNICATION MEANS; PRODUCT DEMONSTRATIONS; ADVERTISING SERVICES, NAMELY, UPDATING OF ADVERTISING MATERIAL FOR OTHERS; PRESENTATION OF GOODS AND SERVICES, NAMELY, PRESENTATION OF GOODS AND SERVICES ON COMMUNICATION MEDIA FOR RETAIL PURPOSES; MARKETING RESEARCH; PUBLIC RELATIONS; PROMOTING THE GOODS AND SERVICES OF OTHERS BY ARRANGING FOR SPONSORS TO AFFILIATE THEIR GOODS AND SERVICES WITH A JOURNALISM COMPETITION; COMMERCIAL LOBBYING SERVICES, NAMELY, REPRESENTATION OF THE BUSINESS INTERESTS OF THIRD PARTIES TO POLICY MAKERS; ORGANISATION OF EXHIBITIONS AND TRADE FAIRS FOR COMMERCIAL OR ADVERTISING PURPOSES; PROVIDING CONSUMER ADVICE; PROVIDING OFFICE FUNCTIONS; PROCUREMENT, NAMELY, PURCHASING PRINTED PUBLICATIONS AND PUBLISHING SERVICES FOR OTHERS; ARRANGING OF BUYING AND SELLING CONTRACTS FOR THIRD PARTIES OVER THE INTERNET; ON-LINE RETAIL STORE SERVICES FEATURING A WIDE VARIETY OF CONSUMER GOODS OF OTHERS; INFORMATION MANAGEMENT SERVICES, NAMELY, PREPARING OF INVOICES OVER THE INTERNET; ELECTRONIC PROCESSING OF ORDERS FOR OTHERS, IN CLASS 35 (U.S. CLS. 100, 101 AND 102).

FOR: PROVIDING AN INTERNET NEWS PORTAL FEATURING LINKS TO NEWS STORIES, WEBLOGS AND ARTICLES IN THE FIELD OF CURRENT EVENTS; COMMUNICATION SERVICES, NAMELY, AUTOMATED TRANSMISSION OF NEWS WEBPAGE CONTENT VIA THE INTERNET TO OTHER INTERNET PORTALS; PROVIDING INTERNET CHAT-ROOMS; PROVIDING ON-LINE FORUMS FOR TRANSMISSION OF MESSAGES AMONG COMPUTER USERS; PROVIDING CHAT LINES UTILIZING THE INTERNET; PROVIDING ACCESS TO DATABASES; TELEPHONE SERVICES FOR HOTLINES AND CALL CENTERS; NEWS AGENCY SERVICES FOR ELECTRONIC TRANSMISSION, NAMELY, DELIVERY OF MESSAGES AND INFORMATION BY ELECTRONIC TRANSMISSION FOR ON-LINE NEWS AGENCIES; PROVIDING OF INTERNET ACCESS; NEWS AGENCY SERVICES, NAMELY, THE TRANSMISSION OF NEWS ITEMS FOR USE IN TELEVISION, RADIO AND INTERNET NEWS BROADCASTS; COMMUNICATION SERVICES, NAMELY, ELECTRONIC TRANSMISSION OF DATA AND DOCUMENTS AMONG USERS OF COMPUTERS FOR OPEN AND CLOSED USER NETS; RADIO BROADCASTING; TELEVISION BROADCASTING; INTERNET PROVIDER SERVICES; BROADCASTING OF RADIO AND TELEVISION PROGRAMS VIA COMPUTER NETWORKS; BROADCAST COMMUNICATION SERVICES, NAMELY, TRANSMITTING TEXT MESSAGES TO DESIGNATED RECIPIENTS FOR OTHERS; COMMUNICATION SERVICES, NAMELY, TRANSMISSION OF VOICE, AUDIO, INFORMATION, NEWS AND VISUAL IMAGES BY THE INTERNET AND DATA NETWORKS; ELECTRONIC MAIL AND MESSAGING SERVICES; INTERNET BASED MESSAGE SENDING AND RECEIVING SERVICES; WEB MESSAGING; PROVIDING ACCESS TO THE INTERNET; PROVIDING ON-LINE FORUMS FOR TRANSMISSION OF MESSAGES AMONG COMPUTER USERS CONCERNING CURRENT NEWS EVENTS; BROADCASTING SERVICES OF FILMS AND TELEVISION PROGRAMS PROVIDED VIA A VIDEO-ON-DEMAND SERVICE, IN CLASS 38 (U.S. CLS. 100, 101 AND 104).

FOR: EDUCATION SERVICES, NAMELY, PROVIDING CONFERENCES, SEMINARS, WORKSHOPS IN THE FIELD OF COMPUTER PROGRAMMING, COMPUTER MAINTENANCE, THE USE OF ELECTRICAL AND ELECTRONIC DATA PROCESSING DEVICES,

Reg. No. 4,097,506 DATA PROCESSING PROGRAMS AND TECHNOLOGY EMPLOYED BY NEWS AGENCIES; BUSINESS TRAINING; FILM PRODUCTION, TELEVISION SHOW PRODUCTION AND RADIO ENTERTAINMENT PRODUCTION; SOUND RECORDING STUDIOS SERVICES; TELEVISION STUDIO FILMING SERVICES; FILM RENTAL; GAMING SERVICES IN THE NATURE OF CASINO GAMING; ARRANGING AND CONDUCTING OF CULTURAL, ENTERTAINMENT AND SPORTING EVENTS, NAMELY, MUSEUMS TOURS AND SOCCER MATCHES; ENTERTAINMENT SERVICES IN THE NATURE OF LIVE MUSICAL PERFORMANCES; PHOTOGRAPHY; ARRANGING AND CONDUCTING TRAINING CONFERENCES, CONGRESSES, SYMPOSIUMS, SEMINARS, WORKSHOPS IN THE FIELD OF NEWS REPORTING; ENTERTAINMENT SERVICES, NAMELY, PROVIDING GAMES OF CHANCE VIA THE INTERNET; PUBLISHING OF BOOKS AND REVIEWS; ONLINE ELECTRONIC PUBLISHING OF BOOKS AND NEWSPAPERS; PROVIDING ON-LINE NON-DOWNLOADABLE ELECTRONIC DICTIONARIES; ONLINE ELECTRONIC PUBLISHING OF ELECTRONIC BOOKS AND PERIODICALS; DIGITAL IMAGE SERVICES, NAMELY, EDITING OR RECORDING OF IMAGES; PHOTOGRAPHIC REPORTING AND OPERATING OF LOTTERIES; INTERNET MUSIC PUBLISHING SERVICES; INTERNET DESKTOP PUBLISHING FOR OTHERS; INTERNET DIGITAL VIDEO, AUDIO, AND MULTIMEDIA PUBLISHING SERVICES, IN CLASS 41 (U.S. CLS. 100, 101 AND 107).

FOR: NON-DOWNLOADABLE COMPUTER SOFTWARE, NAMELY, ELECTRONIC FINANCIAL PLATFORM THAT ACCOMMODATES MULTIPLE TYPES OF PAYMENT AND DEBT TRANSACTIONS IN AN INTEGRATED MOBILE PHONE, PDA, AND WEB BASED ENVIRONMENT; COMPUTER SERVICES, NAMELY, PROVIDING SEARCH PLATFORMS TO ALLOW USERS TO REQUEST CONTENT FROM AND RECEIVE CONTENT TO A MOBILE DEVICE; PROVIDING ONLINE NON-DOWNLOADABLE SOFTWARE FOR USE IN DATABASE MANAGEMENT IN THE FIELD OF JOURNALISM; CREATING WEB PAGES FOR OTHERS; HOSTING WEBSITES ON THE INTERNET; PROVIDING SEARCH ENGINES FOR THE INTERNET; RENTAL OF WEB SERVERS; RENTAL OF A DATABASE SERVER TO THIRD PARTIES, IN CLASS 42 (U.S. CLS. 100 AND 101).

PRIORITY CLAIMED UNDER SEC. 44(D) ON FED REP GERMANY APPLICATION NO. 008352701, FILED 6-10-2009, REG. NO. 008352701, DATED 12-23-2009, EXPIRES 6-10-2019.

THE COLOR(S) RED, GRAY, WHITE IS/ARE CLAIMED AS A FEATURE OF THE MARK.

OWNER OF U.S. REG. NO. 3,472,569.

THE MARK CONSISTS OF THE WORDING "SHORTNEWS" IN STYLIZED WHITE FONT WITHIN A HORIZONTAL RED RECTANGLE. THE LEFT CORNERS OF THE RECTANGLE ARE ROUNDED. THE RIGHT END OF THE RECTANGLE HAS A GRAY LINE THAT OUTLINES THE RIGHT END OF THE RECTANGLE, CURVES AT THE TOP CORNER OF THE RECTANGLE AND EXTENDS TO FORM A HORIZONTAL LINE. THREE SEPARATE GRAY LINES OF DECREASING SIZE ARE BELOW IT. THE MARK IN ITS ENTIRETY APPEARS ON A TRANSPARENT BACKGROUND.

SER. NO. 77-824,111, FILED 9-10-2009.

GRETCHEN ULRICH, EXAMINING ATTORNEY

United States of America

United States Patent and Trademark Office



Reg. No. 4,097,507

Registered Feb. 14, 2012

Int. Cl.: 9

TRADEMARK

PRINCIPAL REGISTER

HELIOS INTERACTIVE, INC. (DELAWARE CORPORATION)
1 PURLIEU PLACE, SUITE 100
WINTER PARK, FL 32792

FOR: COMPUTER GRAPHICS SOFTWARE; COMPUTER SOFTWARE DEVELOPMENT TOOLS; COMPUTER SOFTWARE FOR THE DATABASING, VISUALIZATION, MANIPULATION, VIRTUAL REALITY IMMERSION AND INTEGRATION OF GEOGRAPHIC INFORMATION WITH ON-LINE MEMBER COMMUNITIES; COMPUTER SOFTWARE, NAMELY, GAME ENGINE SOFTWARE FOR VIDEO GAME DEVELOPMENT AND OPERATION; COMPUTER SOFTWARE, NAMELY, SOFTWARE DEVELOPMENT TOOLS FOR THE CREATION OF MOBILE INTERNET APPLICATIONS AND CLIENT INTERFACES; GRAPHICAL USER INTERFACE SOFTWARE, IN CLASS 9 (U.S. CLS. 21, 23, 26, 36 AND 38).

FIRST USE 2-15-2002; IN COMMERCE 3-15-2006.

THE MARK CONSISTS OF A HOLLOW DOWNWARD FACING TRIANGLE WITH A HEXAGON MERGED INTO EACH OF THE 3 CORNERS OF THE TRIANGLE. THE WORD "GAMECORE" IS STYLIZED USING STOPD FONT.

SER. NO. 77-827,568, FILED 9-16-2009.

ERNEST SHOSHO, EXAMINING ATTORNEY



David J. Kyffers

Director of the United States Patent and Trademark Office

United States of America

United States Patent and Trademark Office

OBELISCO

Reg. No. 4,097,508

Registered Feb. 14, 2012

Int. Cl.: 33

TRADEMARK

PRINCIPAL REGISTER

OBELISCO ESTATES, LLC (WASHINGTON LIMITED LIABILITY COMPANY)
2202 SULLIVAN DRIVE, NW
GIG HARBOR, WA 98335

FOR: WINE, IN CLASS 33 (U.S. CLS. 47 AND 49).

FIRST USE 6-1-2009; IN COMMERCE 9-24-2009.

THE MARK CONSISTS OF STANDARD CHARACTERS WITHOUT CLAIM TO ANY PARTICULAR FONT, STYLE, SIZE, OR COLOR.

THE ENGLISH TRANSLATION OF "OBELISCO" IN THE MARK IS "OBELISK".

SER. NO. 77-835,554, FILED 9-25-2009.

RICHARD WHITE, EXAMINING ATTORNEY



David J. Kyffers

Director of the United States Patent and Trademark Office

United States of America

United States Patent and Trademark Office

DCENTI

Reg. No. 4,097,509

WAH HUNG INTERNATIONAL MACHINERY, INC. (CALIFORNIA CORPORATION)
283 E. GARVEY AVENUE
MONTEREY PARK, CA 91755

Registered Feb. 14, 2012

Int. Cl.: 12

FOR: TIRES, IN CLASS 12 (U.S. CLS. 19, 21, 23, 31, 35 AND 44).

TRADEMARK

FIRST USE 12-15-2008; IN COMMERCE 12-15-2008.

PRINCIPAL REGISTER

THE MARK CONSISTS OF STANDARD CHARACTERS WITHOUT CLAIM TO ANY PARTICULAR FONT, STYLE, SIZE, OR COLOR.

OWNER OF U.S. REG. NO. 3,875,671.

THE WORDING "DCENTI" HAS NO MEANING IN A FOREIGN LANGUAGE.

SER. NO. 77-844,392, FILED 10-8-2009.

RON FAIRBANKS, EXAMINING ATTORNEY



David J. Kybas

Director of the United States Patent and Trademark Office

United States of America

United States Patent and Trademark Office

CLICKR

Reg. No. 4,097,510

Registered Feb. 14, 2012

Int. Cls.: 9 and 41

TRADEMARK

SERVICE MARK

PRINCIPAL REGISTER

NTREEV SOFT CO., LTD. (REPUBLIC OF KOREA CORPORATION)
EUNTOP TOWER, 735-10, YEOKSAM-DONG
GANGAM-GU, SEOUL, REPUBLIC OF KOREA

FOR: BLANK CD-ROM FOR PRE-RECORDED COMPUTER PROGRAMS; TELEVISION GAME SETS, NAMELY, VIDEO GAME MACHINES FOR USE WITH TELEVISIONS, GAMES ADAPTED FOR USE WITH TELEVISION RECEIVERS; ELECTRONIC COMPUTER AMUSEMENT APPARATUS ADAPTED FOR USE WITH TELEVISION RECEIVERS ONLY; DOWNLOADABLE COMPUTER SOFTWARE FOR USE WITH ONLINE GAMES FROM A GLOBAL COMPUTER NETWORK; DOWNLOADABLE COMPUTER PROGRAMS FOR USE WITH ONLINE GAMES FROM A GLOBAL COMPUTER NETWORK; RECORDED COMPUTER PROGRAMS, NAMELY, COMPUTER OPERATING PROGRAMS, COMPUTER PROGRAMS FOR USE IN DATABASE MANAGEMENT, FOR USE AS A SPREADSHEET, FOR WORD PROCESSING; COMPUTER GAME PROGRAMS; COMPUTER OPERATING RECORDED PROGRAMS; RECORDED COMPUTER GAME SOFTWARE FOR USE WITH ONLINE GAMES AND MOBILE GAMES; AMUSEMENT APPARATUS ADAPTED FOR USE WITH TELEVISION RECEIVERS ONLY; VIDEO GAME CARTRIDGES; BLANK CD-ROMS FOR SOUND OR VIDEO RECORDING, IN CLASS 9 (U.S. CLS. 21, 23, 26, 36 AND 38).

FOR: ENTERTAINMENT SERVICES, NAMELY, PROVIDING ON-LINE COMPUTER GAMES; PROVIDING COMPUTER GAMES FOR USE NETWORK-WIDE BY NETWORK USERS; PROVIDING ON-LINE VIDEO AND ELECTRONIC GAMES BY MEANS OF MOBILE COMMUNICATION DEVICES, IN CLASS 41 (U.S. CLS. 100, 101 AND 107).

THE MARK CONSISTS OF STANDARD CHARACTERS WITHOUT CLAIM TO ANY PARTICULAR FONT, STYLE, SIZE, OR COLOR.

PRIORITY CLAIMED UNDER SEC. 44(D) ON REPUBLIC OF KOREA APPLICATION NO. 2009-0019702, FILED 8-25-2009, REG. NO. 0209090, DATED 4-11-2011, EXPIRES 4-11-2021.

PRIORITY CLAIMED UNDER SEC. 44(D) ON REPUBLIC OF KOREA APPLICATION NO. 2009-0041006, FILED 8-25-2009, REG. NO. 0860423, DATED 4-11-2011, EXPIRES 4-11-2021.

SER. NO. 77-844,864, FILED 10-8-2009.

ROBIN MITTLER, EXAMINING ATTORNEY



David J. Kyffers

Director of the United States Patent and Trademark Office

United States of America

United States Patent and Trademark Office



Reg. No. 4,097,511

WAH HUNG INTERNATIONAL MACHINERY, INC. (CALIFORNIA CORPORATION)
283 E. GARVEY AVENUE
MONTEREY PARK, CA 81755

Registered Feb. 14, 2012

Int. Cl.: 12

FOR: WHEEL RIMS, IN CLASS 12 (U.S. CLS. 19, 21, 23, 31, 35 AND 44).

FIRST USE 12-15-2008; IN COMMERCE 12-15-2008.

TRADEMARK

THE MARK CONSISTS OF THE STYLIZED TERMS "D" IN RED AND "CENTI" IN BLUE.
THE COLOR WHITE REPRESENTS THE BACKGROUND AND IS NOT PART OF THE MARK.

PRINCIPAL REGISTER

THE COLOR(S) RED AND BLUE IS/ARE CLAIMED AS A FEATURE OF THE MARK.

THE WORDING "D CENTI" AND "CENTI" HAVE NO MEANING IN A FOREIGN LANGUAGE.

SER. NO. 77-847,047, FILED 10-12-2009.

BRIAN PINO, EXAMINING ATTORNEY



David J. Kyffers

Director of the United States Patent and Trademark Office

United States of America

United States Patent and Trademark Office



Reg. No. 4,097,512

Registered Feb. 14, 2012

Int. Cl.: 37

SERVICE MARK

PRINCIPAL REGISTER

UNIVERSITY CONTRACTING CORPORATION LIMITED (CANADA CORPORATION)
SUITE #200
5687 WEST STREET
HALIFAX, NOVA SCOTIA, CANADA B3K1H6

FOR: HOUSE PAINTING; PAINTING; PAINTING AND VARNISHING; PAINTING IN THE FIELD OF PARKING LOT LINE PAINTING AND MARKINGS; WALLPAPER HANGING, IN CLASS 37 (U.S. CLS. 100, 103 AND 106).

OWNER OF CANADA REG. NO. TMA513724, DATED 7-30-1999, EXPIRES 7-30-2014.

NO CLAIM IS MADE TO THE EXCLUSIVE RIGHT TO USE "PAINTING", APART FROM THE MARK AS SHOWN.

THE MARK CONSISTS OF THE WORDS "ELITE TRADE" AND "PAINTING" SEPARATED BY A HORIZONTAL LINE WITHIN AN OVAL.

SER. NO. 77-865,039, FILED 11-4-2009.

KATHERINE CONNOLLY, EXAMINING ATTORNEY



David J. Kybas

Director of the United States Patent and Trademark Office

United States of America

United States Patent and Trademark Office

RIZOPIA

Reg. No. 4,097,513

2212753 ONTARIO INC. (CANADA CORPORATION)
330 MIDDLEFIELD ROAD

Registered Feb. 14, 2012

TORONTO, ONTARIO, CANADA M1S5B1

Int. Cl.: 30

FOR: PASTA; RICE PASTA; GLUTEN FREE PASTA; CORN PASTA, IN CLASS 30 (U.S. CL. 46).

TRADEMARK

FIRST USE 9-0-2002; IN COMMERCE 9-0-2002.

PRINCIPAL REGISTER

THE MARK CONSISTS OF STANDARD CHARACTERS WITHOUT CLAIM TO ANY PARTICULAR FONT, STYLE, SIZE, OR COLOR.

PRIORITY CLAIMED UNDER SEC. 44(D) ON CANADA APPLICATION NO. 1457829, FILED 11-3-2009, REG. NO. TMA805,865, DATED 9-1-2011, EXPIRES 9-1-2026.

THE WORD(S) "RIZOPIA" HAS NO MEANING IN A FOREIGN LANGUAGE.

SER. NO. 77-873,274, FILED 11-16-2009.

MARY CRAWFORD, EXAMINING ATTORNEY



David J. Kybas

Director of the United States Patent and Trademark Office

United States of America

United States Patent and Trademark Office

ezdockers

Reg. No. 4,097,514

WILLIAM JAYNE (UNITED STATES INDIVIDUAL)
21 TUTHILL POINT ROAD
EAST MORICHES, NY 11940

Registered Feb. 14, 2012

Int. Cl.: 22

FOR: ROPES; ROPES FOR MARINE USE, IN CLASS 22 (U.S. CLS. 1, 2, 7, 19, 22, 42 AND 50).

TRADEMARK

FIRST USE 4-25-2009; IN COMMERCE 4-25-2009.

PRINCIPAL REGISTER

THE MARK CONSISTS OF STANDARD CHARACTERS WITHOUT CLAIM TO ANY PARTICULAR FONT, STYLE, SIZE, OR COLOR.

SER. NO. 77-874,910, FILED 11-17-2009.

TINA L. SNAPP, EXAMINING ATTORNEY



David J. Kybas

Director of the United States Patent and Trademark Office

United States of America

United States Patent and Trademark Office

SAN JUAN DE LOS OLIVOS

Reg. No. 4,097,515

SAN JUAN DE LOS OLIVOS S.A. (ARGENTINA CORPORATION)
FRAY JUSTO SARMIENTO 2350 OLIVOS
BUENOS AIRES, ARGENTINA

Registered Feb. 14, 2012

Int. Cl.: 29

FOR: OLIVE OIL, IN CLASS 29 (U.S. CL. 46).

TRADEMARK

THE MARK CONSISTS OF STANDARD CHARACTERS WITHOUT CLAIM TO ANY PARTICULAR FONT, STYLE, SIZE, OR COLOR.

PRINCIPAL REGISTER

OWNER OF ARGENTINA REG. NO. 1.772.859, DATED 9-12-2000, RENEWED AS REG. NO. 2415625, DATED 9-12-2000, EXPIRES 12-20-2020.

OWNER OF U.S. REG. NO. 2,849,352.

THE ENGLISH TRANSLATION OF "SAN JUAN DE LOS OLIVOS" IN THE MARK IS "SAINT JOHN OF THE OLIVES".

SER. NO. 77-880,579, FILED 11-25-2009.

KELLY CHOE, EXAMINING ATTORNEY



David J. Kybas

Director of the United States Patent and Trademark Office

United States of America

United States Patent and Trademark Office

NUBLEXA

Reg. No. 4,097,516

BAYER AKTIENGESELLSCHAFT (FED REP GERMANY JOINT STOCK COMPANY)
D-51368

Registered Feb. 14, 2012

LEVERKUSEN-BAYERWERK, FED REP GERMANY

Int. Cl.: 5

FOR: PHARMACEUTICAL PREPARATIONS AND SUBSTANCES FOR THE TREATMENT OF PULMONARY HYPERTENSION, CARDIOVASCULAR DISEASES, HEMOPHILIA, OVERACTIVE BLADDER, CANCER, ANTICOAGULANTS AND PLATELET AGGREGATION INHIBITORS, ANTI-INFECTIVE PHARMACEUTICAL PREPARATIONS, AND ANTIVIRAL PREPARATIONS, IN CLASS 5 (U.S. CLS. 6, 18, 44, 46, 51 AND 52).

TRADEMARK

PRINCIPAL REGISTER

THE MARK CONSISTS OF STANDARD CHARACTERS WITHOUT CLAIM TO ANY PARTICULAR FONT, STYLE, SIZE, OR COLOR.

OWNER OF FED REP GERMANY REG. NO. 302009019415, DATED 5-11-2009, EXPIRES 3-31-2019.

SER. NO. 77-882,208, FILED 11-30-2009.

ELLEN BURNS, EXAMINING ATTORNEY



David J. Kypos

Director of the United States Patent and Trademark Office

United States of America

United States Patent and Trademark Office

NOBLEXA

Reg. No. 4,097,517

BAYER AKTIENGESELLSCHAFT (FED REP GERMANY JOINT STOCK COMPANY)
D-51368

Registered Feb. 14, 2012

LEVERKUSEN-BAYERWERK, FED REP GERMANY

Int. Cl.: 5

FOR: PHARMACEUTICAL PREPARATIONS AND SUBSTANCES FOR THE TREATMENT OF PULMONARY HYPERTENSION, CARDIOVASCULAR DISEASES, HEMOPHILIA, OVERACTIVE BLADDER, CANCER, ANTICOAGULANTS AND PLATELET AGGREGATION INHIBITORS, ANTI-INFECTIVE PHARMACEUTICAL PREPARATIONS, AND ANTIVIRAL PREPARATIONS, IN CLASS 5 (U.S. CLS. 6, 18, 44, 46, 51 AND 52).

TRADEMARK

PRINCIPAL REGISTER

THE MARK CONSISTS OF STANDARD CHARACTERS WITHOUT CLAIM TO ANY PARTICULAR FONT, STYLE, SIZE, OR COLOR.

OWNER OF FED REP GERMANY REG. NO. 302009049453, DATED 9-10-2009, EXPIRES 8-31-2019.

SER. NO. 77-882,281, FILED 11-30-2009.

ELLEN BURNS, EXAMINING ATTORNEY



David J. Kyffers

Director of the United States Patent and Trademark Office

United States of America

United States Patent and Trademark Office

One Vault Voice

Reg. No. 4,097,518

Registered Feb. 14, 2012

Int. Cl.: 9

SRA INTERNATIONAL, INC. (DELAWARE CORPORATION), DBA SRA INTERNATIONAL,
INC.

FLN 2
4300 FAIR LAKES COURT
FAIRFAX, VA 22033

TRADEMARK

FOR: COMPUTER SOFTWARE TO PROMOTE SECURE, ENCRYPTED TELECOMMUNICATIONS, IN CLASS 9 (U.S. CLS. 21, 23, 26, 36 AND 38).

PRINCIPAL REGISTER

FIRST USE 11-1-2009; IN COMMERCE 11-1-2009.

THE MARK CONSISTS OF STANDARD CHARACTERS WITHOUT CLAIM TO ANY PARTICULAR FONT, STYLE, SIZE, OR COLOR.

SER. NO. 77-884,056, FILED 12-2-2009.

KATHERINE STOIDES, EXAMINING ATTORNEY



David J. Kyffers

Director of the United States Patent and Trademark Office

United States of America

United States Patent and Trademark Office

AVILA'S EL RANCHITO

Reg. No. 4,097,519

AVILA'S EL RANCHITO, INC. (CALIFORNIA CORPORATION)
2800 NEWPORT BOULEVARD
NEWPORT BEACH, CA 92663

Registered Feb. 14, 2012

Int. Cl.: 43

FOR: RESTAURANT, BAR AND CATERING SERVICES, IN CLASS 43 (U.S. CLS. 100 AND 101).

SERVICE MARK

FIRST USE 11-11-1987; IN COMMERCE 12-31-1987.

PRINCIPAL REGISTER

THE MARK CONSISTS OF THE WORDING "AVILA'S EL RANCHITO" IN STYLIZED FONT.

THE ENGLISH TRANSLATION OF "EL RANCHITO" IN THE MARK IS "THE LITTLE RANCH".

SER. NO. 77-888,546, FILED 12-8-2009.

KIM SAITO, EXAMINING ATTORNEY



David J. Kybas

Director of the United States Patent and Trademark Office

United States of America

United States Patent and Trademark Office

SMARTSMOKER

Reg. No. 4,097,520

MCM HOLDINGS, LLC (NEW YORK LIMITED LIABILITY COMPANY)
255 ROCHESTER STREET
SALAMANCA, NY 14779

Registered Feb. 14, 2012

Int. Cl.: 35

FOR: ONLINE RETAIL STORE SERVICES FEATURING TOBACCO PRODUCTS AND RELATED ACCESSORIES, IN CLASS 35 (U.S. CLS. 100, 101 AND 102).

SERVICE MARK

FIRST USE 12-20-2004; IN COMMERCE 12-20-2004.

PRINCIPAL REGISTER

THE MARK CONSISTS OF STANDARD CHARACTERS WITHOUT CLAIM TO ANY PARTICULAR FONT, STYLE, SIZE, OR COLOR.

SER. NO. 77-895,911, FILED 12-17-2009.

ELISSA GARBER KON, EXAMINING ATTORNEY



David J. Kybas

Director of the United States Patent and Trademark Office

United States of America

United States Patent and Trademark Office

DOUBLE HOLD'EM

Reg. No. 4,097,521

Registered Feb. 14, 2012

Int. Cl.: 41

SERVICE MARK

PRINCIPAL REGISTER

TABLEBRAIN CORP. (NEW YORK CORPORATION)
SUITE 304
925 WESTCHESTER AVENUE
WHITE PLAINS, NY 10604

FOR: ENTERTAINMENT IN THE NATURE OF PROVIDING ONLINE CARD GAMES, IN CLASS 41 (U.S. CLS. 100, 101 AND 107).

FIRST USE 11-0-2006; IN COMMERCE 11-0-2006.

THE MARK CONSISTS OF STANDARD CHARACTERS WITHOUT CLAIM TO ANY PARTICULAR FONT, STYLE, SIZE, OR COLOR.

NO CLAIM IS MADE TO THE EXCLUSIVE RIGHT TO USE "HOLD'EM", APART FROM THE MARK AS SHOWN.

SER. NO. 77-900,942, FILED 12-24-2009.

BERNICE MIDDLETON, EXAMINING ATTORNEY



David J. Kybas

Director of the United States Patent and Trademark Office

United States of America

United States Patent and Trademark Office



Producing Bio-Diesel for a Greener World

Reg. No. 4,097,522

Registered Feb. 14, 2012

Int. Cl.: 4

TRADEMARK

PRINCIPAL REGISTER

PRISTINE DIESEL, LLC (NEVADA LIMITED LIABILITY COMPANY)
4401 77 ST.
VERO BEACH, FL 32967

FOR: BIODIESEL FUEL, IN CLASS 4 (U.S. CLS. 1, 6 AND 15).

FIRST USE 12-9-2009; IN COMMERCE 12-30-2009.

NO CLAIM IS MADE TO THE EXCLUSIVE RIGHT TO USE "DIESEL" AND "PRODUCING BIO-DIESEL FOR A GREENER WORLD", APART FROM THE MARK AS SHOWN.

THE COLOR(S) GREEN, BLACK, GOLD, AND SILVER IS/ARE CLAIMED AS A FEATURE OF THE MARK.

THE MARK CONSISTS OF A GREEN, BLACK, GOLD AND SILVER FUELING NOZZLE ATTACHED TO A GREEN LEAF IN THE FORM OF A CIRCLE WITH THE WORDS "PRISTINE DIESEL" IN THE CENTER. A TAG LINE UNDERNEATH THE LEAF WITH THE WORDS "PRODUCING BIO-DIESEL FOR A GREENER WORLD". THERE ARE GREEN DROPS ON THE LEAF AND COMING OUT OF THE NOZZLE. ALL OF THE LANGUAGE IS IN GREEN.

SER. NO. 77-904,554, FILED 1-4-2010.

LAURIE MAYES, EXAMINING ATTORNEY



David J. Kyffers

Director of the United States Patent and Trademark Office

United States of America

United States Patent and Trademark Office

Cisco webex

Reg. No. 4,097,523

Registered Feb. 14, 2012

Int. Cl.: 38

SERVICE MARK

PRINCIPAL REGISTER

CISCO TECHNOLOGY, INC. (CALIFORNIA CORPORATION)
170 WEST TASMAN DRIVE
SAN JOSE, CA 95134

FOR: TELECOMMUNICATION SERVICES, NAMELY, TRANSMISSION OF INFORMATION, DATA, DOCUMENTS, AUDIO, VIDEO, IMAGES AND SOFTWARE APPLICATIONS VIA THE INTERNET; TELECOMMUNICATION SERVICES, NAMELY, PROVIDING WEB-BASED MULTIMEDIA TELECONFERENCING AND VIDEOCONFERENCING, THAT ALLOW SIMULTANEOUS AND ASYNCHRONOUS VIEWING, SHARING, EDITING, AND DISCUSSION OF DOCUMENTS, DATA, VIDEO AND IMAGES BY PARTICIPANTS VIA A WEB BROWSER; PROVIDING ONLINE ACCESS TO INFORMATION PERTAINING TO THE EFFECTIVENESS OF TELECOMMUNICATIONS ACTIVITIES, NAMELY WEB-BASED TELECONFERENCES, VIDEOCONFERENCES, AND MEETINGS; TELECOMMUNICATION SERVICES, NAMELY, PROVIDING CUSTOMERS AND THEIR EMPLOYEES WITH SECURE REMOTE ACCESS VIA THE INTERNET TO PRIVATE COMPUTER NETWORKS; TELECOMMUNICATIONS SERVICES, NAMELY, PROVIDING ONLINE COLLABORATION SERVICES ALLOWING REMOTE USERS TO ACCESS JOINTLY-SHARED DOCUMENTS, DATA, CALENDARS, ELECTRONIC WHITEBOARDS, TASK LISTS, ADDRESS BOOKS, AND DISCUSSION FORUMS; CONSULTATION SERVICES IN THE FIELD OF TELECOMMUNICATIONS PLANNING FOR BUSINESS CONTINUITY; ELECTRONIC MAIL COMMUNICATION SERVICES, VOICE OVER INTERNET PROTOCOL (VOIP) COMMUNICATION SERVICES, AND INTERNET BROADCASTING SERVICES, NAMELY, BROADCASTING AND STREAMING OF AUDIO AND VIDEO RECORDINGS OF LIVE EVENTS AND MEETINGS TO REMOTE ATTENDEES, AND ONLINE DISTRIBUTION OF MATERIALS IN CONNECTION THEREWITH; PROVIDING ON-LINE FORUMS FOR TRANSMISSION OF MESSAGES AMONG COMPUTER USERS CONCERNING THE DEVELOPMENT, PLANNING, AND CONDUCTING OF MULTIMEDIA PRESENTATIONS, ONLINE MEETINGS, ONLINE EVENTS, ONLINE TRAINING, ONLINE SALES, AND ONLINE MARKETING; PROVIDING ON-LINE CHAT ROOMS AND ELECTRONIC BULLETIN BOARDS FOR TRANSMISSION OF MESSAGES AMONG USERS IN THE FIELD OF GENERAL INTEREST, IN CLASS 38 (U.S. CLS. 100, 101 AND 104).



David J. Kappas

FIRST USE 9-30-2008; IN COMMERCE 9-30-2008.

OWNER OF U.S. REG. NOS. 2,959,329, 3,759,451 AND OTHERS.

Reg. No. 4,097,523 THE COLOR(S) BLACK, GREEN AND BLUE IS/ARE CLAIMED AS A FEATURE OF THE MARK.

THE MARK CONSISTS OF THE FOLLOWING: THE WORDING "CISCO" IN BLACK, "WEB" IN GREEN AND "EX" IN BLUE. THE "WEB" AND "EX" PORTION IS PRESENTED AS ONE TERM.

SER. NO. 77-904,721, FILED 1-4-2010.

INGRID C. EULIN, EXAMINING ATTORNEY

United States of America

United States Patent and Trademark Office



Reg. No. 4,097,524

Registered Feb. 14, 2012

Int. Cls.: 25 and 41

TRADEMARK

SERVICE MARK

PRINCIPAL REGISTER

TRUSTEES OF THE CALIFORNIA STATE UNIVERSITY, THE (CALIFORNIA STATE AGENCY), AKA CALIFORNIA POLYTECHNIC STATE UNIVERSITY
1 GRAND AVENUE
SAN LUIS OBISPO, CA 93407

FOR: HOODED SWEAT SHIRTS; JACKETS; POLO SHIRTS; SHORT-SLEEVED OR LONG-SLEEVED T-SHIRTS; WINDSHIRTS, IN CLASS 25 (U.S. CLS. 22 AND 39).

FIRST USE 7-1-2008; IN COMMERCE 7-1-2008.

FOR: ARRANGING AND CONDUCTING ATHLETIC COMPETITIONS; EDUCATION SERVICES IN THE NATURE OF COURSES AT THE UNIVERSITY LEVEL; EDUCATIONAL RESEARCH; EDUCATIONAL SERVICES, NAMELY, PROVIDING COURSES OF INSTRUCTION AT THE UNDERGRADUATE, GRADUATE, AND PROFESSIONAL LEVEL; ORGANIZING CULTURAL AND ARTS EVENTS, IN CLASS 41 (U.S. CLS. 100, 101 AND 107).

FIRST USE 7-1-2008; IN COMMERCE 7-1-2008.

OWNER OF U.S. REG. NOS. 3,048,371, 3,056,980 AND OTHERS.

THE MARK CONSISTS OF THE WORDS "CAL POLY MUSTANGS" AND HORSE DESIGN.

SEC. 2(F) AS TO "CAL POLY".

SER. NO. 77-908,743, FILED 1-11-2010.

ELI HELLMAN, EXAMINING ATTORNEY



David J. Kybas

Director of the United States Patent and Trademark Office

United States of America

United States Patent and Trademark Office

MONTEREY

Reg. No. 4,097,525

Registered Feb. 14, 2012

Int. Cls.: 9, 38 and 42

TRADEMARK

SERVICE MARK

PRINCIPAL REGISTER

CLOUDSOFT CORPORATION LIMITED (SCOTLAND COMPANY)
13 DRYDEN PLACE
EDINBURGH, UNITED KINGDOM EH91RP

FOR: CALCULATING MACHINES AND DATA PROCESSING EQUIPMENT AND COMPUTERS; COMPUTERS, COMPUTER EQUIPMENT, NAMELY, NETWORK ROUTERS, DATA PROCESSORS, MICROPROCESSORS, WIRED AND WIRELESS BASE STATIONS, WIRED AND WIRELESS HANDSETS, DESKTOP AND PORTABLE COMPUTERS, ELECTRONIC MEMORY INTEGRATED CIRCUIT CHIPS FOR NETWORK SWITCHING AND TRANSMISSION EQUIPMENT, MODEMS, OPTICAL DISC DRIVES, MAGNETIC DIGITAL DISC DRIVES, BLANK OPTICAL DATA CARRIERS AND COMPUTER HARDWARE; COMPUTER SERVERS; PC'S; HAND-HELD PC'S AND POCKET COMPUTERS; DATA AND INFORMATION RETRIEVAL SYSTEMS, COMPRISING INPUT DEVICES FOR COMPUTERS, APPARATUS FOR TRANSMISSION OF COMMUNICATIONS AND DATA, AS WELL AS DIGITAL SIGNAL PROCESSORS; HAND-HELD DATA AND INFORMATION RETRIEVAL SYSTEMS COMPRISING INPUT DEVICES FOR COMPUTERS, APPARATUS FOR TRANSMISSION OF COMMUNICATIONS AND DATA, AS WELL AS DIGITAL SIGNAL PROCESSORS; DATA QUERYING, DATA DISTRIBUTION AND DATA PRESENTATION SYSTEMS COMPRISING INPUT DEVICES FOR COMPUTERS, APPARATUS FOR TRANSMISSION OF COMMUNICATIONS AND DATA, AS WELL AS DIGITAL SIGNAL PROCESSORS; MOBILE PHONES; WIRELESS PHONES; PAGERS; COMPUTER SOFTWARE AND COMPUTER PROGRAMS FOR MANAGING THE DISTRIBUTED EXECUTION OF IT MANAGEMENT PROCESSES OR APPLICATION COMPONENTS WITHIN A DISTRIBUTED NETWORKING ENVIRONMENT, INCLUDING DESIGN, EXECUTION AND MONITORING FUNCTIONALITY; COMPUTER SOFTWARE FOR USE IN IT SUPPORT OPERATIONS FOR AUTOMATING OPERATIONAL PROCEDURES FOR IT MANAGEMENT, NAMELY, CONFIGURATION, START-UP/SHUT-DOWN, FAIL OVER, DISASTER RECOVERY, DYNAMIC CHANGES TO ROUTING OR LOCATION OF PROCESSING, AND DYNAMIC CAPACITY MANAGEMENT; COMPUTER SOFTWARE AND COMPUTER PROGRAMS FOR PROVIDING A DEVELOPMENT FORM TO EXTEND A DISTRIBUTED EXECUTION CAPABILITIES OF EXISTING AND NEWLY-DEVELOPED APPLICATIONS, NAMELY, DYNAMIC CLUSTERING, ORCHESTRATED FAIL OVER AND DYNAMIC CAPACITY MANAGEMENT; COMPUTER SOFTWARE AND COMPUTER PROGRAMS FOR USE IN ENTERPRISE APPLICATION INTEGRATION, NAMELY, TO ENABLE SECURE DELIVERY OF AN APPLICATION ON A GLOBAL COMPUTER NETWORK; COMPUTER SOFTWARE AND COMPUTER PROGRAMS FOR USE IN ENTERPRISE APPLICATION INTEGRATION, NAMELY, TO ENABLE SECURE DELIVERY OF INFORMATION, DATA, SOFTWARE AND NETWORK SERVICES BETWEEN DISPARATE



David J. Kyffers

Director of the United States Patent and Trademark Office

Reg. No. 4,097,525 SOFTWARE APPLICATIONS AND SYSTEMS OVER COMPUTER NETWORKS; COMPUTER HARDWARE AND COMMUNICATION SOFTWARE FOR USE IN CONDUCTING AND PROCESSING ONLINE BUSINESS TRANSACTIONS; COMPUTER SOFTWARE AND COMPUTER PROGRAMS FOR USE IN MANAGING ONLINE BUSINESS AND OPERATIONAL NETWORKS; COMPUTER SOFTWARE AND COMPUTER PROGRAMS FOR USE IN NETWORK MONITORING AND MANAGEMENT; COMPUTER SOFTWARE FOR USE IN INTEGRATING DATABASES, EMAIL, SEARCH ENGINES, CONTENT MANAGEMENT, KNOWLEDGE MANAGEMENT AND APPLICATIONS ON A GLOBAL COMPUTER NETWORK; COMPUTER SOFTWARE FOR USE IN DESIGNING AND DEVELOPING SOFTWARE OR SYSTEMS, IN CLASS 9 (U.S. CLS. 21, 23, 26, 36 AND 38).

FOR: TELECOMMUNICATIONS ACCESS SERVICES; PROVIDING ACCESS TO COMMUNICATION LINKS AND COMMUNICATION NETWORKS; PROVIDING ACCESS TO TELECOMMUNICATIONS NETWORKS FOR THE PROVISION OF COMMUNICATIONS LINKS; TRANSFER OF DATA AND INFORMATION VIA TELECOMMUNICATIONS SYSTEMS; PROVIDING TELECOMMUNICATIONS NETWORKS FOR TRANSMISSION OF DATA AND INFORMATION; TELECOMMUNICATIONS CONSULTANCY SERVICES; CONSULTANCY AND ADVISORY SERVICES RELATING TO CLOUD COMPUTING, IN CLASS 38 (U.S. CLS. 100, 101 AND 104).

FOR: CLOUD HOSTING PROVIDER SERVICES; SCIENTIFIC AND INDUSTRIAL RESEARCH IN THE AREAS OF COMPUTER SYSTEMS ARCHITECTURE, DESIGN, IMPLEMENTATION, COMPUTATION, DATA STORAGE AND DATA RETRIEVAL; COMPUTER PROGRAMMING; DESIGN AND WRITING OF COMPUTER SOFTWARE; RENTAL OF COMPUTERS AND COMPUTER SOFTWARE; COMPUTER SYSTEMS ANALYSIS; DATA RETRIEVAL SERVICES; REPAIR OF COMPUTER SOFTWARE; RENTAL COMPUTERS AND COMPUTER SOFTWARE; COMPUTER SYSTEMS ANALYSIS; CONSULTANCY SERVICES IN THE FIELD OF TELECOMMUNICATIONS TECHNOLOGY AND COMMUNICATION NETWORKS; CONSULTATION AND ADVISORY SERVICES RELATING TO THE DESIGN, SELECTION, IMPLEMENTATION AND USE OF COMPUTER HARDWARE AND COMPUTER SOFTWARE, IN CLASS 42 (U.S. CLS. 100 AND 101).

THE MARK CONSISTS OF STANDARD CHARACTERS WITHOUT CLAIM TO ANY PARTICULAR FONT, STYLE, SIZE, OR COLOR.

OWNER OF ERPN CMNTY TM OFC REG. NO. 008800732, DATED 6-28-2010, EXPIRES 1-8-2020.

SER. NO. 77-909,723, FILED 1-12-2010.

ELLEN PERKINS, EXAMINING ATTORNEY

United States of America

United States Patent and Trademark Office



Reg. No. 4,097,526

Registered Feb. 14, 2012

Int. Cls.: 35 and 41

SERVICE MARK

PRINCIPAL REGISTER

USA FEDERATION FOR SPORT CHEERING (TEXAS NONPROFIT CORPORATION)
6745 LENOX CENTER COURT, SUITE 300
MEMPHIS, TN 38115

FOR: ASSOCIATION SERVICES, NAMELY, PROMOTING THE INTERESTS OF CHEER-LEADERS AND THE CHEERLEADING INDUSTRY, IN CLASS 35 (U.S. CLS. 100, 101 AND 102).

FIRST USE 6-1-2008; IN COMMERCE 6-1-2008.

FOR: ENCOURAGING AMATEUR SPORTS AND PHYSICAL EDUCATION BY PROVIDING GOVERNANCE, RULES AND REGULATIONS, AND SANCTIONS FOR CHEERLEADING COMPETITIONS; EDUCATIONAL SERVICES, NAMELY, PROVIDING EDUCATIONAL SEMINARS AND INFORMATION IN THE FIELD OF CHEERLEADING; ENCOURAGING AMATEUR SPORTS AND PHYSICAL EDUCATION BY CONDUCTING CHEERLEADING COMPETITIONS, IN CLASS 41 (U.S. CLS. 100, 101 AND 107).

FIRST USE 6-1-2008; IN COMMERCE 6-1-2008.

OWNER OF U.S. REG. NOS. 3,584,951 AND 3,589,342.

NO CLAIM IS MADE TO THE EXCLUSIVE RIGHT TO USE "USA" OR "CHEER", APART FROM THE MARK AS SHOWN.

THE MARK CONSISTS OF THE WORD "USA" ABOVE THE WORD "CHEER", BOTH IN STYLIZED FORM AND UNDERNEATH STYLIZED WINGS PARTIALLY ENCIRCLING AN OVAL.

SER. NO. 77-910,821, FILED 1-13-2010.

AMEEN IMAM, EXAMINING ATTORNEY



David J. Kybas

Director of the United States Patent and Trademark Office

United States of America

United States Patent and Trademark Office



Reg. No. 4,097,527

CONF PLASTIC S.R.L. (ITALY LIMITED LIABILITY COMPANY)
VIA CASAGLIA, 44/A

Registered Feb. 14, 2012

TRAVAGLIATO (BS), ITALY 25039

Int. Cls.: 6, 9 and 42

FOR: ALUMINUM SAFES, METAL SECURITY CONTAINERS FOR THE STORAGE OF GOODS, METAL LOCKS, IN CLASS 6 (U.S. CLS. 2, 12, 13, 14, 23, 25 AND 50).

TRADEMARK

FOR: ELECTRIC AND ELECTRONIC LOCKS, SOFTWARE AND COMPUTER PROGRAMS FOR AUTOMATIC OPENING OF CONTAINERS' LIDS, IN CLASS 9 (U.S. CLS. 21, 23, 26, 36 AND 38).

SERVICE MARK

PRINCIPAL REGISTER

FOR: SCIENTIFIC SERVICES, NAMELY, SCIENTIFIC RESEARCH IN THE FIELD OF DOCUMENT DESTRUCTION MACHINES, SAFES, SECURITY CONTAINERS, LOCKS AND LOCKING MECHANISMS AND TECHNOLOGICAL SERVICES, NAMELY, PROVIDING TECHNOLOGICAL INFORMATION IN THE FIELD OF DOCUMENT DESTRUCTION MACHINES, SAFES, SECURITY CONTAINERS, LOCKS AND LOCKING MECHANISMS; SCIENTIFIC AND TECHNOLOGY RESEARCH SERVICES IN THE FIELD OF DOCUMENT DESTRUCTION MACHINES, SAFES, SECURITY CONTAINERS, LOCKS AND LOCKING MECHANISMS; DESIGN FOR OTHERS IN THE FIELD OF DOCUMENT DESTRUCTION MACHINES, SAFES, SECURITY CONTAINERS, LOCKS AND LOCKING MECHANISMS RELATING THERETO IN THE FIELD OF CONFIDENTIAL DOCUMENTS DESTRUCTION; DESIGN AND DEVELOPMENT OF COMPUTER HARDWARE AND SOFTWARE, IN CLASS 42 (U.S. CLS. 100 AND 101).



PRIORITY CLAIMED UNDER SEC. 44(D) ON ITALY APPLICATION NO. 2009C000367, FILED 7-15-2009, REG. NO. 0001376023, DATED 11-23-2010, EXPIRES 7-15-2019.

THE COLOR(S) RED, BLACK AND ORANGE IS/ARE CLAIMED AS A FEATURE OF THE MARK.

NO CLAIM IS MADE TO THE EXCLUSIVE RIGHT TO USE "CONFIDENTIAL DATA DESTRUCTION ELECTRONIC SYSTEM", APART FROM THE MARK AS SHOWN.

David J. Kyffers

THE MARK CONSISTS OF THE STYLIZED WORDING "CODDES" WITH THE SECOND "D" APPEARING IN RED AND THE REST OF THE LETTERS APPEARING IN BLACK. BELOW THE "C" ARE FIVE SQUARES IN A HORIZONTAL ROW, APPEARING LEFT TO RIGHT IN VARYING SHADES OF RED, WITH THE RIGHT MOST SQUARE APPEARING

Reg. No. 4,097,527 IN ORANGE. TO THE RIGHT OF THIS ORANGE SQUARE IS THE WORDING "CONFIDENTIAL DATA" IN BLACK. BELOW AND TO THE RIGHT OF THE SECOND "A" IN "DATA" IS A RED SQUARE. TO THE RIGHT OF THIS SQUARE IS THE WORDING "DESTRUCTION ELECTRONIC SYSTEM" IN BLACK.

SER. NO. 77-912,615, FILED 1-15-2010.

SETH A. RAPPAPORT, EXAMINING ATTORNEY

United States of America

United States Patent and Trademark Office

SUPPLYCARE

Reg. No. 4,097,528

Registered Feb. 14, 2012

Int. Cls.: 9, 39 and 42

TRADEMARK

SERVICE MARK

PRINCIPAL REGISTER

ENDRESS+HAUSER PROCESS SOLUTIONS AG (SWITZERLAND CORPORATION)
KAGENSTRASSE 2
REINACH, SWITZERLAND CH-4153

FOR: COMPUTER PROGRAM FOR CONTROLLING AND OPERATING OF ELECTRONIC MEASUREMENT APPARATUSES, PARTICULARLY LEVEL MEASUREMENT APPARATUSES, COMPUTER PROGRAM FOR ANALYZING MEASURED DATA OF ELECTRONIC MEASUREMENT APPARATUSES, PARTICULARLY LEVEL MEASUREMENT APPARATUSES, COMPUTER PROGRAM FOR PROVIDING INFORMATION ABOUT STORAGES, COMPUTER PROGRAM FOR OPERATING A DATABASE OF STORAGE DATA, IN CLASS 9 (U.S. CLS. 21, 23, 26, 36 AND 38).

FIRST USE 3-0-2005; IN COMMERCE 3-0-2005.

FOR: PROVIDING INFORMATION ABOUT STORAGE KEEPING, PROVIDING STORAGE INFORMATION, PROVIDING TRANSPORT INFORMATION, IN CLASS 39 (U.S. CLS. 100 AND 105).

FIRST USE 3-0-2005; IN COMMERCE 3-0-2005.

FOR: DEVELOPING AND CUSTOMIZING OF USER-SPECIFIC COMPUTER PROGRAMS FOR CONTROLLING AND OPERATING OF ELECTRONIC MEASUREMENT APPARATUSES, PARTICULARLY LEVEL MEASUREMENT APPARATUSES, OF COMPUTER PROGRAMS FOR ANALYZING MEASURED DATA OF ELECTRONIC MEASUREMENT APPARATUSES, PARTICULARLY LEVEL MEASUREMENT APPARATUSES, OF COMPUTER PROGRAMS FOR PROVIDING INFORMATION ABOUT STORAGES, OF COMPUTER PROGRAMS FOR OPERATING A DATABASE OF STORAGE DATA, IN CLASS 42 (U.S. CLS. 100 AND 101).

FIRST USE 3-0-2005; IN COMMERCE 3-0-2005.

THE MARK CONSISTS OF STANDARD CHARACTERS WITHOUT CLAIM TO ANY PARTICULAR FONT, STYLE, SIZE, OR COLOR.

PRIORITY CLAIMED UNDER SEC. 44(D) ON SWITZERLAND APPLICATION NO. 00444/2009, FILED 7-16-2009.

SER. NO. 77-913,955, FILED 1-18-2010.



David J. Kyffers

Director of the United States Patent and Trademark Office

Reg. No. 4,097,528 MICHAEL KEATING, EXAMINING ATTORNEY

United States of America

United States Patent and Trademark Office

RIBER50

Reg. No. 4,097,529

Registered Feb. 14, 2012

Int. Cls.: 5, 29 and 30

TRADEMARK

PRINCIPAL REGISTER

CJ CHEILJEDANG CORPORATION (REPUBLIC OF KOREA CORPORATION)
292, SSANGNIM-DONG, JUNG-GU
SEOUL, REPUBLIC OF KOREA

FOR: NUTRITIONAL SUPPLEMENTS WITH DIETARY FIBER FROM RICE BRAN; FOOD ADDITIVES, NAMELY, DIETARY FIBER FROM RICE BRAN FOR USE IN THE MANUFACTURE OF A WIDE VARIETY OF FOODS, IN CLASS 5 (U.S. CLS. 6, 18, 44, 46, 51 AND 52).

FOR: MEAT PRODUCTS, NAMELY, HAMBURGER PATTIES, SAUSAGES, BACON, HAM, MEAT JELLIES AND MEAT EXTRACTS WITH DIETARY FIBER FROM RICE BRAN USED AS A FOOD FILLER AND EXTENDER, IN CLASS 29 (U.S. CL. 46).

FOR: RICE BRAN, RICE BRAN POWDER, IN CLASS 30 (U.S. CL. 46).

THE MARK CONSISTS OF STANDARD CHARACTERS WITHOUT CLAIM TO ANY PARTICULAR FONT, STYLE, SIZE, OR COLOR.

PRIORITY CLAIMED UNDER SEC. 44(D) ON REPUBLIC OF KOREA APPLICATION NO. 40-2010-2134, FILED 1-14-2010, REG. NO. 0851520, DATED 1-28-2011, EXPIRES 1-28-2021.

SER. NO. 77-914,500, FILED 1-19-2010.

CHRIS WELLS, EXAMINING ATTORNEY



David J. Kybas

Director of the United States Patent and Trademark Office

United States of America

United States Patent and Trademark Office

MY INNER SPACE MAGAZINE

Reg. No. 4,097,530

BAINS ULTRA INC. (CANADA CORPORATION)
956, CHEMIN OLIVIER

Registered Feb. 14, 2012

SAINT-NICOLAS (QUEBEC), CANADA G7A2N1

Int. Cl.: 16

FOR: MAGAZINE IN THE FIELD OF SPA PRODUCTS AND THEIR ASSOCIATED BENEFITS RELATED TO HOME DESIGN, HEALTH, FITNESS, AND LIFESTYLE , IN CLASS 16 (U.S. CLS. 2, 5, 22, 23, 29, 37, 38 AND 50).

TRADEMARK

THE MARK CONSISTS OF STANDARD CHARACTERS WITHOUT CLAIM TO ANY PARTICULAR FONT, STYLE, SIZE, OR COLOR.

PRINCIPAL REGISTER

PRIORITY CLAIMED UNDER SEC. 44(D) ON CANADA APPLICATION NO. 1465097, FILED 1-8-2010, REG. NO. TMA801199, DATED 6-30-2011, EXPIRES 1-8-2015.

NO CLAIM IS MADE TO THE EXCLUSIVE RIGHT TO USE "MAGAZINE", APART FROM THE MARK AS SHOWN.

SER. NO. 77-915,452, FILED 1-20-2010.

SETH A. RAPPAPORT, EXAMINING ATTORNEY



David J. Kyffers

Director of the United States Patent and Trademark Office

United States of America

United States Patent and Trademark Office

OceanBluePuntaCanaResort.com

Reg. No. 4,097,531

ALVAREZ, GEORGE (UNITED STATES INDIVIDUAL)
4201 S.W. 11TH STREET
CORAL GABLES, FL 33134

Registered Feb. 14, 2012

Int. Cl.: 43

FOR: TRAVEL SERVICES, NAMELY, MAKING RESERVATIONS AND BOOKINGS FOR TEMPORARY LODGING; MAKING HOTEL AND LODGING RESERVATIONS FOR INDIVIDUALS AND GROUPS VIA A GLOBAL COMPUTER NETWORK, IN CLASS 43 (U.S. CLS. 100 AND 101).

SERVICE MARK

PRINCIPAL REGISTER

FIRST USE 3-6-2007; IN COMMERCE 3-6-2007.

THE MARK CONSISTS OF STANDARD CHARACTERS WITHOUT CLAIM TO ANY PARTICULAR FONT, STYLE, SIZE, OR COLOR.

SER. NO. 77-922,262, FILED 1-28-2010.

MARGARET POWER, EXAMINING ATTORNEY



David J. Kyffers

Director of the United States Patent and Trademark Office

United States of America

United States Patent and Trademark Office

GreenSpot

Reg. No. 4,097,532

GREENSPOT GLOBAL, LLC (COLORADO LIMITED LIABILITY COMPANY)
2390 IVANHOE ST.
DENVER, CO 80207

Registered Feb. 14, 2012

Int. Cls.: 36, 37 and 42

FOR: REAL ESTATE BROKERAGE SERVICES; PROPERTY MANAGEMENT SERVICES FOR COMMERCIAL BUILDINGS, NAMELY, OFFICE, RETAIL, MIXED-USE, INDUSTRIAL, MANUFACTURING, WAREHOUSING AND STORAGE BUILDINGS, OFFICE CONDOMINIUMS, SHOPPING MALLS AND SHOPPING CENTERS, RESTAURANTS, AND PARKING FACILITIES; PROPERTY MANAGEMENT SERVICES FOR RESIDENTIAL BUILDINGS, NAMELY, MULTI-FAMILY, CONDOMINIUM, SINGLE-FAMILY HOMES, DUPLEX, TRIPLEX AND QUADRAPLEX UNITS, TOWNHOUSES, ROWHOUSES, BROWNSTONES, LOFTS AND APARTMENTS; REAL ESTATE ACQUISITION SERVICES; REAL ESTATE ASSESSMENT SERVICES, IN CLASS 36 (U.S. CLS. 100, 101 AND 102).

SERVICE MARK

PRINCIPAL REGISTER

FIRST USE 1-1-2010; IN COMMERCE 4-1-2010.

FOR: CONSTRUCTION AND RENOVATION SERVICES, NAMELY, PROVIDING ENERGY EFFICIENT RETROFITS AND UPGRADES TO BUILDINGS TO FOSTER AND ENHANCE ENVIRONMENTALLY CONSCIOUS BENEFITS, IN CLASS 37 (U.S. CLS. 100, 103 AND 106).

FIRST USE 1-1-2010; IN COMMERCE 4-1-2010.

FOR: CONSULTING SERVICES IN THE FIELD OF ENVIRONMENTAL PLANNING; ENVIRONMENTAL SUSTAINABILITY CONSULTING SERVICES IN THE FIELD OF ENERGY EFFICIENCY, IN CLASS 42 (U.S. CLS. 100 AND 101).

FIRST USE 1-1-2010; IN COMMERCE 4-1-2010.

THE MARK CONSISTS OF STANDARD CHARACTERS WITHOUT CLAIM TO ANY PARTICULAR FONT, STYLE, SIZE, OR COLOR.

SER. NO. 77-922,543, FILED 1-28-2010.

ALYSSA STEEL, EXAMINING ATTORNEY



David J. Kyffers

Director of the United States Patent and Trademark Office

United States of America

United States Patent and Trademark Office

THE MAIN LINE ANTIQUES SHOW

Reg. No. 4,097,533

SURREY SERVICES FOR SENIORS, INC. (PENNSYLVANIA NON-PROFIT CORPORATION)
28 BRIDGE AVENUE
BERWYN, PA 19312

Registered Feb. 14, 2012

Int. Cl.: 35

FOR: ORGANIZING, PROMOTING AND CONDUCTING EXHIBITIONS AND TRADESHOWS FOR BUSINESS PURPOSES FEATURING BOOTHS AND DISPLAYS RELATING TO ANTIQUES AND COLLECTIBLES, IN CLASS 35 (U.S. CLS. 100, 101 AND 102).

SERVICE MARK

FIRST USE 11-0-2006; IN COMMERCE 11-0-2006.

PRINCIPAL REGISTER

THE MARK CONSISTS OF STANDARD CHARACTERS WITHOUT CLAIM TO ANY PARTICULAR FONT, STYLE, SIZE, OR COLOR.

NO CLAIM IS MADE TO THE EXCLUSIVE RIGHT TO USE "ANTIQUES SHOW", APART FROM THE MARK AS SHOWN.

SEC. 2(F).

SER. NO. 77-927,684, FILED 2-4-2010.

VERNA BETH RIRIE, EXAMINING ATTORNEY



David J. Kyffers

Director of the United States Patent and Trademark Office

United States of America

United States Patent and Trademark Office

Powerful New Ideas For Freight Management

Reg. No. 4,097,534

Registered Feb. 14, 2012

Int. Cls.: 35, 39 and 42

SERVICE MARK

PRINCIPAL REGISTER

C.H. ROBINSON WORLDWIDE, INC. (DELAWARE CORPORATION)
14701 CHARLSON ROAD
EDEN PRAIRIE, MN 55347

FOR: TRANSPORTATION LOGISTICS SERVICES, NAMELY, ARRANGING, PLANNING, MANAGING AND SCHEDULING THE TRANSPORTATION OF GOODS FOR OTHERS; PROCUREMENT, NAMELY, THE PURCHASE OF AGRICULTURAL PRODUCE AND RELATED PRODUCTS FOR OTHERS; BUSINESS ANALYSIS, NAMELY, ANALYZING TRANSPORTATION, LOGISTICS, SHIPPING AND DISTRIBUTION DATA TO HELP RETAILERS MAXIMIZE SALES, EVALUATING SALES DATA AND USING THAT DATA TO DESIGN SALES STRATEGIES, GOALS AND OBJECTIVES, AND COORDINATION AND DEVELOPMENT OF MARKETING STRATEGIES AND CONCEPTS, IN CLASS 35 (U.S. CLS. 100, 101 AND 102).

FIRST USE 6-1-2009; IN COMMERCE 6-1-2009.

FOR: SUPPLY CHAIN, LOGISTICS AND REVERSE LOGISTICS SERVICES, NAMELY, STORAGE, TRANSPORTATION AND DELIVERY OF DOCUMENTS, PACKAGES, RAW MATERIALS, AND OTHER FREIGHT FOR OTHERS BY AIR, RAIL, SHIP OR TRUCK; STORAGE, TRANSPORTATION, AND DELIVERY OF AGRICULTURAL PRODUCE AND RELATED PRODUCTS FOR OTHERS, IN CLASS 39 (U.S. CLS. 100 AND 105).

FIRST USE 6-1-2009; IN COMMERCE 6-1-2009.

FOR: PROVIDING A WEB SITE WHERE CUSTOMERS AND SHIPPERS CAN ENTER AND UPDATE SHIPMENT INFORMATION, NAMELY, SHIPMENT PROCESSING, PREPARING SHIPPING DOCUMENTS AND INVOICES, AND TRACKING DOCUMENTS, PACKAGES AND FREIGHT, IN CLASS 42 (U.S. CLS. 100 AND 101).

FIRST USE 6-1-2009; IN COMMERCE 6-1-2009.

THE MARK CONSISTS OF STANDARD CHARACTERS WITHOUT CLAIM TO ANY PARTICULAR FONT, STYLE, SIZE, OR COLOR.

SER. NO. 77-931,369, FILED 2-9-2010.

GISELLE AGOSTO, EXAMINING ATTORNEY



David J. Kyros

Director of the United States Patent and Trademark Office

United States of America

United States Patent and Trademark Office

too too i had problems to do
collect something that's not art

Reg. No. 4,097,535

DKMA CO. LIMITED (HONG KONG LIMITED LIABILITY COMPANY)

Registered Feb. 14, 2012

63 HOI YUEN ROAD, 3/F FOOK CHEONG BLDG
KWUN TONG, KOWLOON, HONG KONG

Int. Cl.: 25

FOR: CLOTHING, NAMELY, SHIRTS, SLEEVES WORN SEPARATE AND APART FROM BLOUSES, SHIRTS AND OTHER TOPS; BLOUSES, SKIRTS, OVERALLS, SWEATERS, KNITWEAR, NAMELY, KNIT JACKETS, KNIT SHIRTS, KNIT BLOUSES, KNIT SKIRTS, KNIT SUITS, KNIT PANTS; PANTS, TROUSERS, SUITS, JACKETS, COATS, TEE-SHIRTS, DRESSES, PULLOVERS, UNDERWEAR, GYM WEAR, NAMELY, GYM PANTS, GYM SHORTS, GYM SUITS, GYM SHIRTS, GYM T-SHIRTS, GYM TOPS, GYM BOTTOMS; BRASSIERES, SHAWLS, JEANS, CLOTHING OF DENIM, NAMELY, SHIRTS OF DENIM, BLOUSES OF DENIM, SKIRTS OF DENIM, OVERALLS OF DENIM, PANTS OF DENIM, SUITS OF DENIM, JACKETS OF DENIM, COATS OF DENIM, DRESSES OF DENIM; CLOTHING OF LEATHER, NAMELY, SHIRTS OF LEATHER, SKIRTS OF LEATHER, PANTS OF LEATHER, SUITS OF LEATHER, JACKETS OF LEATHER, COATS OF LEATHER, DRESSES OF LEATHER; CLOTHING OF IMITATIONS OF LEATHER, NAMELY, SHIRTS OF IMITATIONS OF LEATHER, SKIRTS OF IMITATIONS OF LEATHER, PANTS OF IMITATIONS OF LEATHER, SUITS OF IMITATIONS OF LEATHER, JACKETS OF IMITATIONS OF LEATHER, COATS OF IMITATIONS OF LEATHER, DRESSES OF IMITATIONS OF LEATHER; HEADGEAR, NAMELY, HATS; FOOTWEAR, NAMELY, SOCKS, BOOTS, SHOES, SANDALS; GLOVES; BELTS; SCARVES, IN CLASS 25 (U.S. CLS. 22 AND 39).

TRADEMARK

PRINCIPAL REGISTER

OWNER OF ERPN CMNTY TM OFC REG. NO. 008880023, DATED 8-2-2010, EXPIRES 2-12-2020.

THE MARK CONSISTS OF WORDING "COLLECT SOMETHING THAT'S NOT ART" AND ITS MIRROR IMAGE.

SER. NO. 77-936,124, FILED 2-15-2010.

ROBERT C. CLARK JR., EXAMINING ATTORNEY



David J. Kypos

Director of the United States Patent and Trademark Office

United States of America

United States Patent and Trademark Office

Cvac

Reg. No. 4,097,536

Registered Feb. 14, 2012

Int. Cl.: 5

TRADEMARK

PRINCIPAL REGISTER

CANCER VAC PTY LTD (AUSTRALIA PROPRIETARY LIMITED COMPANY)
SUITE 1, 1233 HIGH STREET
ARMADALE VICTORIA 3143, AUSTRALIA

FOR: PHARMACEUTICAL PREPARATIONS AND SUBSTANCES FOR THE TREATMENT OF CANCER; VACCINES; MEDICATED SERUMS FOR THE TREATMENT OF CANCER; ALL OF THE AFOREMENTIONED BEING FOR HUMAN USE, IN CLASS 5 (U.S. CLS. 6, 18, 44, 46, 51 AND 52).

PRIORITY CLAIMED UNDER SEC. 44(D) ON AUSTRALIA APPLICATION NO. 1315870, FILED 8-19-2009, REG. NO. 1315870, DATED 11-5-2010, EXPIRES 8-19-2019.

THE MARK CONSISTS OF THE LETTERS "CVAC", WITH THE LETTER "C" CAPITALIZED, FOLLOWED BY THE LETTERS "V", "A", AND "C" IN LOWER CASE.

SER. NO. 77-936,296, FILED 2-16-2010.

KATHERINE CHANG, EXAMINING ATTORNEY



David J. Kybas

Director of the United States Patent and Trademark Office

United States of America

United States Patent and Trademark Office

CARBOCAL

Reg. No. 4,097,537

EURO-PHARM INTERNATIONAL CANADA INC. (CANADA CORPORATION)
9450, BOUL. LANGELIER

Registered Feb. 14, 2012

MONTREAL, QUEBEC, CANADA H1P3H8

Int. Cl.: 5

FOR: VITAMINS AND MINERALS IN TABLET AND CAPSULE FORM FOR USE AS HUMAN NUTRITIONAL AND DIETARY SUPPLEMENTS, IN CLASS 5 (U.S. CLS. 6, 18, 44, 46, 51 AND 52).

TRADEMARK

THE MARK CONSISTS OF STANDARD CHARACTERS WITHOUT CLAIM TO ANY PARTICULAR FONT, STYLE, SIZE, OR COLOR.

PRINCIPAL REGISTER

PRIORITY CLAIMED UNDER SEC. 44(D) ON CANADA APPLICATION NO. 1454356, FILED 10-6-2009, REG. NO. TMA802,397, DATED 7-19-2011, EXPIRES 7-19-2026.

OWNER OF U.S. REG. NO. 2,947,235.

SER. NO. 77-938,946, FILED 2-18-2010.

RUSS HERMAN, EXAMINING ATTORNEY



David J. Kyfos

Director of the United States Patent and Trademark Office

United States of America

United States Patent and Trademark Office

PINPOINTER

Reg. No. 4,097,538

Registered Feb. 14, 2012

Int. Cl.: 9

TRADEMARK

PRINCIPAL REGISTER

SENSTAR CORPORATION (CANADA CORPORATION)
PRI-TEC INDUSTRIAL PARK
119 JOHN CAVANAUGH DRIVE
CARP, ONTARIO, CANADA K0A1L0

FOR: MECHANICAL VIBRATION FENCE-MOUNTED SENSOR WITH RANGING CAPABILITY, IN CLASS 9 (U.S. CLS. 21, 23, 26, 36 AND 38).

THE MARK CONSISTS OF STANDARD CHARACTERS WITHOUT CLAIM TO ANY PARTICULAR FONT, STYLE, SIZE, OR COLOR.

PRIORITY CLAIMED UNDER SEC. 44(D) ON CANADA APPLICATION NO. 1470047, FILED 2-18-2010, REG. NO. TMA785692, DATED 12-21-2010, EXPIRES 12-21-2025.

SER. NO. 77-945,083, FILED 2-25-2010.

MICHELE SWAIN, EXAMINING ATTORNEY



David J. Kyffers

Director of the United States Patent and Trademark Office

United States of America

United States Patent and Trademark Office



Reg. No. 4,097,539

ANTECTRADE & IT CONSULTING INC. (CANADA CORPORATION)
106 FERRIER ST.

Registered Feb. 14, 2012

MARKHAM, ONTARIO, CANADA L3R2Z5

Int. Cls.: 6, 9 and 35

FOR: METAL MOUNTS FOR LCD, LED, AND PLASMA TVS, IN CLASS 6 (U.S. CLS. 2, 12, 13, 14, 23, 25 AND 50).

TRADEMARK

FOR: AUTO-DARKENING WELDING HELMETS; HDTV PARTS, NAMELY, HDTV ANTENNAS, HDTV AMPLIFIERS, HDTV CABLES; PROJECTION SCREENS, IN CLASS 9 (U.S. CLS. 21, 23, 26, 36 AND 38).

SERVICE MARK

PRINCIPAL REGISTER

FOR: RETAIL STORE, IMPORT AGENCY AND ONLINE RETAIL STORE SERVICES FEATURING AUTO-DARKENING WELDING HELMETS; HDTV PARTS, NAMELY, HDTV ANTENNAS, PROJECTIONS SCREENS, PROJECTOR MOUNTS, LCD AND PLASMA TV WALL MOUNTS, HDTV CABLES, IN CLASS 35 (U.S. CLS. 100, 101 AND 102).

PRIORITY CLAIMED UNDER SEC. 44(D) ON CANADA APPLICATION NO. 1450096, FILED 8-31-2009, REG. NO. TMA788307, DATED 1-21-2011, EXPIRES 1-21-2027.

THE MARK CONSISTS OF THE WORD "ANTRA" WITH A LEAF INCORPORATED IN THE LETTER "A".

SER. NO. 77-945,088, FILED 2-25-2010.

KATHLEEN M. VANSTON, EXAMINING ATTORNEY



David J. Kybas

Director of the United States Patent and Trademark Office

United States of America

United States Patent and Trademark Office



Reg. No. 4,097,540

Registered Feb. 14, 2012

Int. Cl.: 43

SERVICE MARK

PRINCIPAL REGISTER

SHELL ISLAND HOMEOWNERS ASSOCIATION, INC. (NORTH CAROLINA CORPORATION)
P.O. BOX 420
2700 NORTH LUMINA AVENUE
WRIGHTSVILLE BEACH, NC 28480

FOR: HOTELS, IN CLASS 43 (U.S. CLS. 100 AND 101).

FIRST USE 5-1-2008; IN COMMERCE 5-1-2008.

THE MARK CONSISTS OF A STYLIZED BLACK AND WHITE SHELL OVER INTERSECTING WAVES OF BLACK OVER THE SCRIPT OF "SHELL ISLAND" IN BLACK.

SER. NO. 77-946,635, FILED 2-27-2010.

ANNE FARRELL, EXAMINING ATTORNEY



David J. Kybas

Director of the United States Patent and Trademark Office

United States of America

United States Patent and Trademark Office

DNP

Reg. No. 4,097,541

DNP IMS AMERICA CORPORATION (DELAWARE CORPORATION)
4524 ENTERPRISE DRIVE, N.W.
CONCORD, NC 28027

Registered Feb. 14, 2012

Int. Cl.: 16

FOR: PRINTER RIBBONS, IN CLASS 16 (U.S. CLS. 2, 5, 22, 23, 29, 37, 38 AND 50).

TRADEMARK

FIRST USE 7-1-2008; IN COMMERCE 7-1-2008.

PRINCIPAL REGISTER

THE MARK CONSISTS OF STANDARD CHARACTERS WITHOUT CLAIM TO ANY PARTICULAR FONT, STYLE, SIZE, OR COLOR.

SER. NO. 77-957,760, FILED 3-12-2010.

DEZMONA MIZELLE, EXAMINING ATTORNEY



David J. Kyffers

Director of the United States Patent and Trademark Office

United States of America

United States Patent and Trademark Office

PROAIR

Reg. No. 4,097,542

Registered Feb. 14, 2012

Int. Cl.: 7

TRADEMARK

PRINCIPAL REGISTER

PROVENTIA EMISSION CONTROL OY (FINLAND LIMITED LIABILITY COMPANY)
TIETOTIE 1
OULUNSALO, FINLAND 90460

FOR: ENGINE EXHAUST PURIFICATION SYSTEMS COMPRISING FILTERS AND CATALYSTS; EMISSION FILTERING APPARATUS FOR ENGINES; EMISSION FILTERS; VEHICLE ENGINE EMISSION CONTROL APPARATUS AND SYSTEMS COMPRISING FILTERS AND CATALYSTS, IN CLASS 7 (U.S. CLS. 13, 19, 21, 23, 31, 34 AND 35).

THE MARK CONSISTS OF STANDARD CHARACTERS WITHOUT CLAIM TO ANY PARTICULAR FONT, STYLE, SIZE, OR COLOR.

OWNER OF ERPN CMNTY TM OFC REG. NO. 8952012, DATED 2-17-2011, EXPIRES 3-15-2020.

SER. NO. 77-959,059, FILED 3-15-2010.

KEVON CHISOLM, EXAMINING ATTORNEY



David J. Kybas

Director of the United States Patent and Trademark Office

United States of America

United States Patent and Trademark Office

Charlotte Mason Community School

Reg. No. 4,097,543

Registered Feb. 14, 2012

Int. Cl.: 41

SERVICE MARK

PRINCIPAL REGISTER

CHARLOTTE MASON ASSOCIATION OF DETROIT (MICHIGAN CORPORATION), DBA
CHARLOTTE MASON COMMUNITY SCHOOL
3816 TOLEDO AVENUE
DETROIT, MI 48216

FOR: PROVIDING COURSES OF INSTRUCTION AT THE K-12 LEVEL, IN CLASS 41 (U.S.
CLS. 100, 101 AND 107).

FIRST USE 3-15-2010; IN COMMERCE 3-15-2010.

THE MARK CONSISTS OF STANDARD CHARACTERS WITHOUT CLAIM TO ANY PAR-
TICULAR FONT, STYLE, SIZE, OR COLOR.

NO CLAIM IS MADE TO THE EXCLUSIVE RIGHT TO USE "COMMUNITY SCHOOL",
APART FROM THE MARK AS SHOWN.

THE NAME "CHARLOTTE MASON" DOES NOT IDENTIFY A LIVING INDIVIDUAL.

SER. NO. 77-959,160, FILED 3-15-2010.

MARIA-VICTORIA SUAREZ, EXAMINING ATTORNEY



David J. Kyffers

Director of the United States Patent and Trademark Office

United States of America

United States Patent and Trademark Office

chew chew

Reg. No. 4,097,544

CHAPMAN, KAREN (UNITED KINGDOM INDIVIDUAL)
11 MAIN ST.

Registered Feb. 14, 2012

GULLANE, SCOTLAND EH31 2DP

Int. Cls.: 21 and 28

FOR: HOUSEHOLD CONTAINERS FOR FOOD; EATING AID FOR CHILDREN, NAMELY, A FEEDING KIT CONSISTING PRIMARILY OF HOUSEHOLD FOOD AND BEVERAGE CONTAINERS SHAPED LIKE A TRAIN WITH SEPARATE CONTAINERS EACH A DIFFERENT SHAPE FOR DIFFERENT FOOD STUFFS, IN CLASS 21 (U.S. CLS. 2, 13, 23, 29, 30, 33, 40 AND 50).

TRADEMARK

PRINCIPAL REGISTER

FOR: CHILDREN'S TOYS AND PLAYTHINGS, NAMELY, A TOY TRAIN AND ACCESSORIES, NAMELY, SEPARABLE TRAIN CARS EACH A DIFFERENT SHAPE FOR CARRYING DIFFERENT THINGS, IN CLASS 28 (U.S. CLS. 22, 23, 38 AND 50).

THE MARK CONSISTS OF STANDARD CHARACTERS WITHOUT CLAIM TO ANY PARTICULAR FONT, STYLE, SIZE, OR COLOR.

PRIORITY CLAIMED UNDER SEC. 44(D) ON UNITED KINGDOM APPLICATION NO. 2527288, FILED 9-29-2009, REG. NO. 2527288, DATED 9-29-2009, EXPIRES 9-29-2019.

SER. NO. 77-965,202, FILED 3-22-2010.

MARLENE BELL, EXAMINING ATTORNEY



David J. Kybas

Director of the United States Patent and Trademark Office

United States of America

United States Patent and Trademark Office

Chicken
Maison

Reg. No. 4,097,545

MEDITERRANEAN MAISON, INC (CALIFORNIA CORPORATION), DBA CHICKEN MAISON
2709 MANHATTAN BEACH BLVD
REDONDO BEACH, CA 90278

Registered Feb. 14, 2012

Int. Cl.: 43

FOR: RESTAURANT SERVICES, IN CLASS 43 (U.S. CLS. 100 AND 101).

SERVICE MARK

FIRST USE 4-0-2005; IN COMMERCE 4-0-2005.

PRINCIPAL REGISTER

NO CLAIM IS MADE TO THE EXCLUSIVE RIGHT TO USE "CHICKEN", APART FROM THE MARK AS SHOWN.

THE COLOR(S) YELLOW, GREEN AND RED IS/ARE CLAIMED AS A FEATURE OF THE MARK.

THE MARK CONSISTS OF THE WORD "CHICKEN" IN YELLOW AND OUTLINED IN GREEN WITH A RED HEART ABOVE THE LETTER "I" AND THE WORD "MAISON" IN GREEN.

THE ENGLISH TRANSLATION OF THE WORD "MAISON" IN THE MARK IS "HOUSE".

SEC. 2(F) AS TO "CHICKEN MAISON".

SER. NO. 77-965,238, FILED 3-22-2010.

KATHLEEN LORENZO, EXAMINING ATTORNEY



David J. Kybas

Director of the United States Patent and Trademark Office

United States of America

United States Patent and Trademark Office

RED NOSE DAY

Reg. No. 4,097,546

Registered Feb. 14, 2012

Int. Cl.: 28

TRADEMARK

PRINCIPAL REGISTER

COMIC RELIEF LIMITED (UNITED KINGDOM CORPORATION)
5TH FLOOR
89 ALBERT EMBANKMENT
LONDON, UNITED KINGDOM SE1 7TP

FOR: TOYS, GAMES AND PLAYTHINGS, NAMELY, CARD GAMES; BOARD GAMES; SKILL AND ACTION GAMES; ELECTRONIC HAND-HELD GAMES; MECHANICAL TOYS; INFLATABLE TOYS; DOLLS; PUPPETS; PRACTICAL JOKE DEVICES IN THE NATURE OF WHOOPEE CUSHIONS; PLAY BALLOONS; PUZZLES; MODELING CLAY; JIGSAWS; TOY COSMETICS; FALSE TOY NOSES; CHILDREN'S TOY MASKS, ACTION FIGURES; TOY VEHICLES; PLAYING CARDS; TOY WIGS, IN CLASS 28 (U.S. CLS. 22, 23, 38 AND 50).

THE MARK CONSISTS OF STANDARD CHARACTERS WITHOUT CLAIM TO ANY PARTICULAR FONT, STYLE, SIZE, OR COLOR.

OWNER OF ERPN CMNTY TM OFC REG. NO. 000200709, DATED 6-12-1998, RENEWED AS REG. NO. 000200709, DATED 4-2-2006, EXPIRES 4-2-2016.

OWNER OF U.S. REG. NO. 2,803,075.

SER. NO. 78-400,277, FILED 4-12-2004.

BRIDGETT SMITH, EXAMINING ATTORNEY



David J. Kyffers

Director of the United States Patent and Trademark Office

United States of America

United States Patent and Trademark Office

CENTRACT

Reg. No. 4,097,547

Registered Feb. 14, 2012

**Int. Cls.: 35, 36, 42 and
43**

SERVICE MARK

PRINCIPAL REGISTER

CENTRACT SETTLEMENT SERVICES INC./SERVICES AUX PRETEURS CENTRACT INC.
(CANADA CORPORATION)
39 WYNFORD DRIVE
SUITE 400
DON MILLS, CANADA M3C3K5

FOR: FRANCHISE CONSULTING; FRANCHISE SERVICES, NAMELY, OFFERING TECHNICAL ASSISTANCE IN THE ESTABLISHMENT OF REAL ESTATE BROKERAGE FIRMS, CONDUCTING MARKET STUDIES FOR FRANCHISE LOCATIONS; MAINTAINING AND SUPERVISING FRANCHISES, AND ALL SUPPORT SERVICES INCIDENTAL TO THE OPERATION OF THE FRANCHISE BUSINESS, NAMELY, TECHNICAL ADVICE AND ASSISTANCE IN THE ADVERTISING AND PROMOTING OF THE SERVICES OF FRANCHISEES; INTERNET AND INTRANET SERVICES, NAMELY, PROVIDING AN ONLINE COMPUTER DATABASE FEATURING CONSUMER INFORMATION IN THE FIELD OF CUSTOMER RELATIONSHIP MANAGEMENT; EMPLOYEE RELOCATION AND INFORMATION SERVICES, NAMELY, PROVIDING INFORMATION ABOUT AN EVALUATION OF COMMUNITY RESOURCES FOR THE FAMILIES OF RELOCATING EMPLOYEES; BUSINESS CONSULTING SERVICES RELATING TO THE EVALUATION, DEVELOPMENT AND ADMINISTRATION OF EMPLOYEE RELOCATION PROGRAMS; EXPENSE MANAGEMENT FOR RELOCATING EMPLOYEES, NAMELY, THE COLLECTION OF RECEIPTS RELATED TO MOVING EXPENSES INCURRED BY EMPLOYEES AND THE ADMINISTRATION OF REIMBURSEMENT OF THE SAME, IN CLASS 35 (U.S. CLS. 100, 101 AND 102).



David J. Kyffers

Director of the United States Patent and Trademark Office

FOR: REAL ESTATE SERVICES, NAMELY, REAL ESTATE BROKERAGE SERVICES, DISTRESSED PROPERTY BROKERAGE SERVICES, FEATURING FORECLOSURE PROPERTIES AND POWER OF SALE, AND RESIDENTIAL AND COMMERCIAL REAL PROPERTY APPRAISALS AND VALUATION; PROVIDING INFORMATION, ADVICE AND COUNSELING IN THE AREAS OF REAL PROPERTY RECOVERY IN CONNECTION WITH DISTRESSED LOANS SECURED BY REAL ESTATE; SERVICES RELATED TO COMMISSION FACTORING, NAMELY, PROVIDING FINANCING TO REAL ESTATE AGENTS AND SALES PERSONS BY DISCOUNTING THEIR REAL ESTATE COMMISSIONS RECEIVABLE; RELOCATION SERVICES, NAMELY, THE PROVISION OF REAL PROPERTY VALUATION AND APPRAISAL REVIEW; THE PROVISION OF HOME BROKERAGE SERVICES, NAMELY, GUARANTEED HOME SALE AND HOME SALE ASSISTANCE FOR RELOCATING EMPLOYEES; THE PROVISION OF PROPERTY MANAGEMENT SERVICES, NAMELY, VACANCY MANAGEMENT, TENANCY MANAGEMENT, AND LEASE CANCELLATION; RELOCATION SERVICES, NAMELY, ASSISTING RELOCATING EMPLOYEES BY PROVIDING ADVICE

Reg. No. 4,097,547 AND COUNSELING IN PURCHASING REAL PROPERTY AND/OR SECURING THE RENTAL OF APARTMENTS, HOMES AND RESIDENTIAL HOUSING, IN CLASS 36 (U.S. CLS. 100, 101 AND 102).

FOR: REAL ESTATE RELATED FINANCIAL SERVICES, NAMELY, CLOSING SERVICES FOR MORTGAGE LOANS, IN CLASS 42 (U.S. CLS. 100 AND 101).

FOR: RELOCATION SERVICES, NAMELY, THE PROVISION OF TEMPORARY ACCOMMODATIONS; ELDERCARE SERVICES FOR ELDERLY RELATIVES, IN CLASS 43 (U.S. CLS. 100 AND 101).

THE MARK CONSISTS OF STANDARD CHARACTERS WITHOUT CLAIM TO ANY PARTICULAR FONT, STYLE, SIZE, OR COLOR.

PRIORITY CLAIMED UNDER SEC. 44(D) ON CANADA APPLICATION NO. 1201099, FILED 1-8-2004, REG. NO. TMA666020, DATED 6-14-2006, EXPIRES 6-14-2021.

SER. NO. 78-447,083, FILED 7-7-2004.

FRANK LATTUCA, EXAMINING ATTORNEY

United States of America

United States Patent and Trademark Office

REVOLVER

Reg. No. 4,097,548

Registered Feb. 14, 2012

Int. Cl.: 7

TRADEMARK

PRINCIPAL REGISTER

POSITEC GROUP LIMITED (CHINA CORPORATION)
28TH FLOOR, BANK OF EAST ASIA HARBOUR
HONG KONG, CHINA

FOR: AGRICULTURAL MACHINES, NAMELY, LAWN MOWERS, POWER-OPERATED GRASS TRIMMERS, POWER-OPERATED HEDGE TRIMMERS, HARVESTERS, SEEDERS, CULTIVATORS; WOODWORKING MACHINES, NAMELY, ELECTRIC ROUTERS, ELECTRIC PLANERS; POWER-OPERATED SAWS, NAMELY, CIRCULAR SAWS, MITER SAWS, JIG SAWS, RECIPROCATING SAWS, TABLE SAWS, CHAIN SAWS; SAW BLADES FOR POWER SAWS; DRILLING MACHINES, NAMELY, HAMMER DRILLS; DRILL BITS FOR POWER DRILLS, DRILL CHUCKS FOR POWER DRILLS, ROUTER BITS; DRILL PRESSES; ELECTRIC HAMMERS; ELECTRIC SANDERS, ELECTRIC GRINDERS, POWER-OPERATED BENCH GRINDERS, POWER-OPERATED ELECTRIC ANGLE GRINDERS, ELECTRIC SCREWDRIVERS, SCREWDRIVER BITS FOR USE WITH POWER SCREWDRIVERS, POWER-OPERATED STAPLE GUNS, POWER-OPERATED NAILING GUNS; ELECTRIC SHEARS, GRASS SHEARS; ELECTRIC SPRAY GUNS; POWER-OPERATED CUTTING MACHINES; ELECTRIC WRENCHES; ELECTRIC POLISHERS, ELECTRIC SHOE POLISHERS, ELECTRIC BUFFERS; CRANES, WOOD LATHES, MACHINE AND MACHINE TOOLS FOR THE CUTTING AND FORMING OF MATERIALS AND DIE-CUTTING MACHINES; MOTOR AND ENGINES NOT FOR LAND VEHICLES; GARDEN PUMPS, NAMELY, IRRIGATION WATER PUMPS; JET PUMPS; VACUUM PUMPS; COMPRESSED AIR PUMPS; ELECTRIC CLEANING MACHINES, NAMELY, HIGH PRESSURE WASHERS; VACUUM CLEANERS; ELECTRIC WAX-POLISHING MACHINES FOR DOMESTIC PURPOSES; BAGS FOR VACUUM CLEANERS; FLOOR WASHING MACHINES; ELECTRIC WELDING MACHINES; ELECTRIC PLASTICS WELDERS; SHREDDING MACHINES; POWER-OPERATED LEAF BLOWERS; ABRASIVE WHEELS FOR POWER-OPERATED GRINDERS; POWER-OPERATED REAMERS; FLEXOGRAPHIC PRINTING MACHINES; CLOTHES WASHING MACHINES; ABRASIVE DISCS FOR POWER-OPERATED GRINDERS; SANDING DISCS, SANDING SHEETS, SANDING PAPERS, AND SANDING BELTS FOR POWER-OPERATED SANDERS; CHAINS FOR CHAIN SAWS, IN CLASS 7 (U.S. CLS. 13, 19, 21, 23, 31, 34 AND 35).



David J. Kyros

Director of the United States Patent and Trademark Office

PRIORITY CLAIMED UNDER SEC. 44(D) ON CHINA APPLICATION NO. 4043873, FILED 4-29-2004, REG. NO. 4043873, DATED 1-28-2009, EXPIRES 1-27-2019.

PRIORITY CLAIMED UNDER SEC. 44(D) ON CHINA APPLICATION NO. 4043872, FILED 4-29-2004, REG. NO. 4043872, DATED 5-21-2006, EXPIRES 5-20-2016.

Reg. No. 4,097,548 SER. NO. 78-486,779, FILED 9-21-2004.

DAWN FELDMAN, EXAMINING ATTORNEY

United States of America

United States Patent and Trademark Office

FEDERAL CAREER COACH

Reg. No. 4,097,549

THE RESUME PLACE, INC. (MARYLAND CORPORATION)
89 MELLOR AVENUE
BALTIMORE, MD 21228

Registered Feb. 14, 2012

Int. Cl.: 38

FOR: ONLINE FORUM AND MESSAGE BOARD FOR DISCUSSION OF ISSUES IN THE FIELD OF RESUME WRITING, CAREER DEVELOPMENT AND FEDERAL EMPLOYMENT, IN CLASS 38 (U.S. CLS. 100, 101 AND 104).

SERVICE MARK

FIRST USE 1-4-2003; IN COMMERCE 1-4-2003.

PRINCIPAL REGISTER

THE MARK CONSISTS OF STANDARD CHARACTERS WITHOUT CLAIM TO ANY PARTICULAR FONT, STYLE, SIZE, OR COLOR.

NO CLAIM IS MADE TO THE EXCLUSIVE RIGHT TO USE "FEDERAL CAREER", APART FROM THE MARK AS SHOWN.

SER. NO. 78-620,038, FILED 4-29-2005.

GRETTA YAO, EXAMINING ATTORNEY



David J. Kybas

Director of the United States Patent and Trademark Office

United States of America

United States Patent and Trademark Office

ZEROFOOTPRINT

Reg. No. 4,097,550

Registered Feb. 14, 2012

**Int. Cls.: 16, 35, 36, 40,
41, 42 and 45**

TRADEMARK

SERVICE MARK

PRINCIPAL REGISTER

0FOOTPRINT INC. (CANADA CORPORATION)
862 RICHMOND STREET WEST
TORONTO, ONTARIO M6J 1C9

FOR: PRINTED MATERIALS, NAMELY, BOOKS, PERIODICALS, PAMPHLETS, AND EDUCATIONAL MATERIALS IN THE FIELDS OF ENVIRONMENTAL ISSUES, RECYCLING, ECOLOGY, CONSERVATION, CLIMATE, RENEWABLE ENERGY, AND SUSTAINABLE BUSINESS; STATIONERY; PAPER; PLASTIC OR PAPER BAGS FOR MERCHANDISE PACKAGING; PAPER ENVELOPES FOR PACKAGING; PAPER FOR WRAPPING AND PACKAGING; EDUCATIONAL PUBLICATIONS, NAMELY, WORKBOOKS, TEXTBOOKS, ACTIVITY BOOKS, STORY BOOKS, PUZZLE BOOKS, CROSSWORD PUZZLES, TEACHER GUIDES, MANUALS, POSTERS, AND EDUCATIONAL BOOKLETS IN THE FIELDS OF ENVIRONMENTAL ISSUES, RECYCLING, ECOLOGY, CONSERVATION, CLIMATE, RENEWABLE ENERGY, AND SUSTAINABLE BUSINESS, IN CLASS 16 (U.S. CLS. 2, 5, 22, 23, 29, 37, 38 AND 50).

FOR: ADVERTISING SERVICES, NAMELY, PROMOTING AND MARKETING THE GOODS AND SERVICES OF OTHERS IN THE FIELDS OF ENVIRONMENTAL ISSUES, CARBON OFFSETTING, RECYCLING, ECOLOGY, CONSERVATION, CLIMATE, RENEWABLE ENERGY, AND SUSTAINABLE BUSINESS; CONSULTING SERVICES IN THE FIELD OF SUSTAINABLE BUSINESS SOLUTIONS; PROVIDING WEBSITES AND ONLINE DATABASES IN THE FIELD ENERGY USAGE MANAGEMENT; CONSULTING IN THE FIELD OF ENERGY USE MANAGEMENT; PROVIDING ONLINE DIRECTORY INFORMATION SERVICE FEATURING INFORMATION IN THE FIELD OF ENVIRONMENTAL ISSUES, RECYCLING, ECOLOGY, CONSERVATION, CLIMATE, RENEWABLE ENERGY, AND SUSTAINABLE BUSINESS; BUSINESS CONSULTING IN THE FIELD OF SUSTAINABLE BUSINESS; PROVIDING WEBSITE AND ONLINE DATABASE IN THE FIELD OF BUSINESS MANAGEMENT OF SUSTAINABLE BUSINESS; CONSULTING IN THE FIELDS OF SUSTAINABLE BUSINESS AND ENERGY USE MANAGEMENT FOR THE ACCOUNTING INDUSTRY; CONSULTING IN THE FIELDS OF SUSTAINABLE BUSINESS AND ENERGY USE MANAGEMENT FOR THE LEGAL INDUSTRY; COMPUTER SERVICES, NAMELY, PROVIDING AN ONLINE DIRECTORY INFORMATION SERVICE FEATURING INFORMATION REGARDING ENVIRONMENTAL ISSUES, RECYCLING, ECOLOGY, CONSERVATION, CLIMATE, RENEWABLE ENERGY, AND SUSTAINABLE BUSINESS; PROVIDING WEBSITES AND ONLINE COMPUTER DATABASES IN THE FIELD OF SUSTAINABLE BUSINESS SOLUTIONS; PROVIDING WEBSITES AND ONLINE COMPUTER DATABASES IN THE FIELD OF ENERGY USAGE MANAGEMENT RELATED TO RENEWABLE ENERGY;



David J. Kyffers

Director of the United States Patent and Trademark Office

Reg. No. 4,097,550 PROVIDING WEBSITES AND ONLINE COMPUTER DATABASES IN THE FIELD OF ENERGY USAGE CONSERVATION TO IMPROVE ENERGY EFFICIENCY; CONSULTING SERVICES IN THE FIELD OF ENERGY USAGE CONSERVATION TO IMPROVE ENERGY EFFICIENCY, IN CLASS 35 (U.S. CLS. 100, 101 AND 102).

FOR: FINANCIAL CONSULTATION TO HOMEOWNERS, BUSINESSES, INSTITUTIONS, AND GOVERNMENT IN THE FIELDS OF ENVIRONMENTAL ISSUES, RECYCLING, ECOLOGY, CONSERVATION, CLIMATE, RENEWABLE ENERGY, AND SUSTAINABLE BUSINESS; FINANCIAL CONSULTATION TO HOMEOWNERS, BUSINESSES, INSTITUTIONS, AND GOVERNMENT IN THE FIELD OF RENEWABLE ENERGY RESOURCES; PROVIDING LOANS TO HOMEOWNERS FOR THE BUILDING AND MODIFICATION OF HOMES WITH RENEWABLE ENERGY RESOURCES; INSURANCE CONSULTATION; REAL ESTATE CONSULTATION; FINANCIAL CONSULTATION; BROKERAGE AND TRADING OF CARBON, DECARBONIZATION, AND ENERGY CREDITS AND SERVICES, IN CLASS 36 (U.S. CLS. 100, 101 AND 102).

FOR: PROVIDING WEBSITES AND ONLINE COMPUTER DATABASES IN THE FIELD OF RECYCLING; CONSULTING IN THE FIELD OF RECYCLING, IN CLASS 40 (U.S. CLS. 100, 103 AND 106).

FOR: EDUCATIONAL SERVICES, NAMELY, SEMINARS, CLASSES, AND WORKSHOPS IN THE FIELDS OF ENVIRONMENTAL ISSUES, RECYCLING, ECOLOGY, CONSERVATION, CLIMATE, RENEWABLE ENERGY, AND SUSTAINABLE BUSINESS, IN CLASS 41 (U.S. CLS. 100, 101 AND 107).

FOR: COMPUTER SERVICES, NAMELY, ONLINE NON-DOWNLOADABLE GRAPHICAL USER INTERFACE SOFTWARE IN THE FIELDS OF ENVIRONMENTAL ISSUES, RECYCLING, ECOLOGY, CONSERVATION, CLIMATE, RENEWABLE ENERGY, AND SUSTAINABLE BUSINESS; PROVIDING WEBSITES AND ONLINE DATABASES IN THE FIELD ENVIRONMENTAL ASSESSMENT, COMPLIANCE AND PLANNING, AND ENERGY CONSERVATION; ENVIRONMENTAL CONSULTING SERVICES; TECHNICAL CONSULTING IN THE FIELD OF ENERGY CONSERVATION; CONSULTING SERVICES IN THE FIELD OF SCIENTIFIC RESEARCH ON THE IMPACT OF CLIMATE CHANGE; PROVIDING WEBSITES AND ONLINE DATABASES IN THE FIELD OF SCIENTIFIC RESEARCH ON THE IMPACT OF CLIMATE CHANGE; CONSULTING SERVICES IN THE FIELD OF ENVIRONMENTAL ASSESSMENT, NAMELY, PROVIDING ONLINE CALCULATORS IN THE FIELDS OF ENVIRONMENTAL ISSUES, RECYCLING, ECOLOGY, CONSERVATION, CLIMATE, RENEWABLE ENERGY, AND SUSTAINABLE BUSINESS TO MEASURE CARBON USE AND ITS IMPACTS ON THE WORLD AND THE ENVIRONMENT; PROVIDING WEBSITES AND ONLINE COMPUTER DATABASES IN THE FIELD OF SCIENTIFIC RESEARCH REGARDING ENVIRONMENTAL ISSUES, RECYCLING, ECOLOGY, CONSERVATION, CLIMATE, RENEWABLE ENERGY, AND SUSTAINABLE BUSINESS; PROVIDING WEBSITES AND ONLINE COMPUTER DATABASES IN THE FIELD OF ENVIRONMENTAL INFORMATION ABOUT CLIMATE CHANGE AND BIO-DIVERSITY; PROVIDING WEBSITES AND ONLINE DATABASES IN THE FIELDS OF ENVIRONMENTAL ASSESSMENT AND PLANNING; PROVIDING WEBSITES AND ONLINE COMPUTER DATABASES IN THE FIELD OF ENGINEERING SERVICES RELATED TO ENVIRONMENTAL COMPLIANCE; TECHNICAL CONSULTING IN THE FIELD OF ENVIRONMENTAL ENGINEERING; TECHNICAL CONSULTING IN THE FIELD OF ENVIRONMENTAL SCIENCE, IN CLASS 42 (U.S. CLS. 100 AND 101).

FOR: PROVIDING WEBSITES AND ONLINE DATABASES FOR REVIEWING STANDARDS AND PRACTICES TO ASSURE COMPLIANCE WITH LAWS AND REGULATIONS IN THE FIELD OF ENVIRONMENTAL ISSUES, RECYCLING, ECOLOGICAL ISSUES, ENVIRONMENTAL CONSERVATION, CLIMATE CHANGE, RENEWABLE ENERGY, AND SUSTAINABLE BUSINESS, IN CLASS 45 (U.S. CLS. 100 AND 101).

Reg. No. 4,097,550 THE MARK CONSISTS OF STANDARD CHARACTERS WITHOUT CLAIM TO ANY PARTICULAR FONT, STYLE, SIZE, OR COLOR.

PRIORITY CLAIMED UNDER SEC. 44(D) ON CANADA APPLICATION NO. 1280520, FILED 11-22-2005, REG. NO. TMA776613, DATED 9-8-2010, EXPIRES 9-8-2025.

SER. NO. 78-761,904, FILED 11-28-2005.

MARK SPARACINO, EXAMINING ATTORNEY

United States of America

United States Patent and Trademark Office

Marquis MultiPartners High Growth Portfolio

Reg. No. 4,097,551

DUNDEE CORPORATION (CANADA CORPORATION)
1 ADELAIDE STREET EAST, 28TH FLOOR
TORONTO, ONTARIO, CANADA M5C 2V9

Registered Feb. 14, 2012

Int. Cl.: 36

FOR: MUTUAL FUND SERVICES, NAMELY, MUTUAL FUND BROKERAGE, MUTUAL FUND DISTRIBUTION AND THE ADMINISTRATION AND MANAGEMENT OF MUTUAL FUNDS, IN CLASS 36 (U.S. CLS. 100, 101 AND 102).

SERVICE MARK

THE MARK CONSISTS OF STANDARD CHARACTERS WITHOUT CLAIM TO ANY PARTICULAR FONT, STYLE, SIZE, OR COLOR.

PRINCIPAL REGISTER

OWNER OF CANADA REG. NO. 792050, DATED 3-3-2011, EXPIRES 3-3-2026.

OWNER OF U.S. REG. NO. 3,012,520.

NO CLAIM IS MADE TO THE EXCLUSIVE RIGHT TO USE "HIGH GROWTH PORTFOLIO", APART FROM THE MARK AS SHOWN.

SER. NO. 78-766,967, FILED 12-5-2005.

GISELLE AGOSTO, EXAMINING ATTORNEY



David J. Kybas

Director of the United States Patent and Trademark Office

United States of America

United States Patent and Trademark Office

SIMPLY ENJOY

Reg. No. 4,097,552

AHOLD LICENSING SA (SWITZERLAND CORPORATION)
2 RUE DE JEAN-PETITOT
GENEVA, SWITZERLAND 1204

Registered Feb. 14, 2012

Int. Cl.: 32

FOR: LEMONADE, IN CLASS 32 (U.S. CLS. 45, 46 AND 48).

TRADEMARK

FIRST USE 5-0-2007; IN COMMERCE 5-0-2007.

PRINCIPAL REGISTER

THE MARK CONSISTS OF STANDARD CHARACTERS WITHOUT CLAIM TO ANY PARTICULAR FONT, STYLE, SIZE, OR COLOR.

SER. NO. 78-980,927, FILED 5-4-2006.

PAUL E. FAHRENKOPF, EXAMINING ATTORNEY



David J. Kybas

Director of the United States Patent and Trademark Office

United States of America

United States Patent and Trademark Office

æ
Elégance

PARIS

Reg. No. 4,097,553

Registered Feb. 14, 2012

Int. Cl.: 3

TRADEMARK

PRINCIPAL REGISTER

ELEGANCE PARIS (FRANCE SOCIÉTÉ PAR ACTIONS SIMPLIFIÉE EN CAPITAL)
24 RUE DU 4 SEPTEMBRE
F-75002 PARIS
FRANCE

FOR: PERFUMERY, ESSENTIAL OILS, COSMETICS, HAIR LOTIONS; SOAPS, IN CLASS
3 (U.S. CLS. 1, 4, 6, 50, 51 AND 52).

NO CLAIM IS MADE TO THE EXCLUSIVE RIGHT TO USE "PARIS", APART FROM THE
MARK AS SHOWN.

OWNER OF INTERNATIONAL REGISTRATION 0596447 DATED 1-9-1993, EXPIRES 1-9-
2013.

THE ENGLISH TRANSLATION OF "ELÉGANCE" IN THE MARK IS ELEGANCE.

SER. NO. 79-057,117, FILED 12-27-2007.

LIEF MARTIN, EXAMINING ATTORNEY



David J. Kybas

Director of the United States Patent and Trademark Office

United States of America

United States Patent and Trademark Office

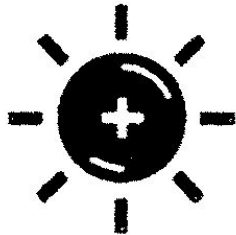

safe to wear

Reg. No. 4,097,554

Registered Feb. 14, 2012

**Int. Cls.: 3, 8, 9, 12, 14,
18, 20, 21, 24, 25, 26, 28
and 42**

TRADEMARK

SERVICE MARK

PRINCIPAL REGISTER

INDUSTRIA DE DISEÑO TEXTIL, S.A.; (INDITEX, S.A.) (SPAIN SOCIEDAD ANÓNIMA)
AVENIDA DE LA DIPUTACIÓN
EDIFICIO INDITEX
E-15142 ARTEIXO (A CORUÑA), SPAIN

FOR: BLEACHING PREPARATIONS AND OTHER SUBSTANCES FOR LAUNDRY USE, NAMELY, GENERAL PURPOSE DETERGENT, BLEACH, FABRIC SOFTENER, STAIN REMOVER, STARCH AND COLOR BRIGHTENING CHEMICALS; CLEANING, POLISHING, SCOURING AND ABRASIVE PREPARATIONS; SOAPS, PERFUMERY; ESSENTIAL OILS; COSMETICS; HAIR LOTIONS; DENTIFRICES; SHAVING PREPARATIONS; TOILET WATER; COTTON STICKS FOR COSMETIC PURPOSES; BEAUTY MASKS; SUN-TANNING PREPARATIONS; COSMETIC PREPARATIONS FOR SKIN CARE; HAIR COLORANTS AND HAIR DYES; SHOE POLISH AND CREAM; SHOE POLISHING WAX; SHAMPOOS; COSMETIC KITS, NAMELY, MAKE-UP KITS COMPRISED OF LIPSTICK, LIP GLOSS, EYE SHADOW, BLUSH, EYELINER AND COSMETIC PENCILS, EYEWEAR CLEANING KITS COMPRISED OF CLEANING FLUID AND A CLEANING CLOTH, AND HAIR CARE KITS COMPRISED OF SHAMPOO, CONDITIONER AND HAIR GELS; DEPILATORIES; MAKE-UP REMOVING PREPARATIONS; DEODORANTS FOR PERSONAL USE; LIPSTICKS; COSMETIC PENCILS; HAIR SPRAY AND NAIL VARNISH; NAIL LACQUER-REMOVING PREPARATIONS; TISSUES IMPREGNATED WITH COSMETIC LOTIONS; PAPER TISSUES OR CLOTHS IMPREGNATED OR MOISTENED FOR CLEANING; AFTER-SHAVE LOTIONS; LOTIONS FOR COSMETIC PURPOSES; MAKE-UP PREPARATIONS; POMADES FOR COSMETIC PURPOSES; STAIN REMOVERS; SACHETS FOR PERFUMING LINEN; NAIL CARE PREPARATIONS; SHOEMAKERS' POLISHING WAX AND COBBLERS' WAX; HAIR DECOLORANTS FOR COSMETIC PURPOSES; PERFUMED EXTRACTS OF FLOWERS FOR PERFUMES; INCENSE; SCENTED WOOD; DECORATIVE TRANSFERS FOR COSMETIC PURPOSES; FALSE EYELASHES AND FALSE NAILS; PUMICE STONE FOR PERSONAL USE; POTPOURRI; COSMETIC PREPARATIONS FOR SLIMMING PURPOSES; COSMETIC PREPARATIONS FOR BATHS, NAMELY, BUBBLE BATH, BATH LOTION, BATH BEADS, BATH OILS AND BATH GELS; HAIR WAVING PREPARATIONS; LAUNDRY PREPARATIONS, NAMELY, ESSENTIAL OIL AS PERFUME FOR LAUNDRY PURPOSES; NON-MEDICATED TOILETRIES; NON-MEDICATED TOILETRIES; MOUTHWASHES, NOT FOR MEDICAL PURPOSES; BATH SALTS, NOT FOR MEDICAL PURPOSES; SANITARY PREPARATIONS OTHER THAN TOILETRIES, NAMELY, NAIL SANITIZING PREPARATIONS; OILS FOR TOILET PURPOSES, NAMELY, COSMETIC OILS AND AROMATHERAPY OILS; SUN-TANNING PREPARATIONS; EAU DE COLOGNE; DEODORANT SOAP; TALCUM POWDER FOR TOILET USE; NON-SLIPPING WAX FOR FLOORS; NON-SLIPPING LIQUIDS FOR



David J. Kappas

Director of the United States Patent and Trademark Office

Reg. No. 4,097,554 FLOORS; CANNED PRESSURIZED AIR FOR CLEANING AND DUSTING PURPOSES; DENTAL BLEACHING GELS; CLOTHS IMPREGNATED WITH A DETERGENT FOR CLEANING; PREPARATIONS TO MAKE SHINY THE LEAVES OF PLANTS; JOSS STICKS, IN CLASS 3 (U.S. CLS. 1, 4, 6, 50, 51 AND 52).

FOR: HAND TOOLS, NAMELY, FILES, KNIFE SHARPENERS, HAMMERS, RASPS AND SCISSORS; CUTLERY, NAMELY, KNIVES AND TABLE FORKS; SIDE ARMS, NOT INCLUDING FIREARMS, NAMELY, HUNTING KNIVES AND SWORDS; RAZORS; NON-ELECTRIC CAN OPENERS; OYSTER OPENERS, NON-ELECTRIC CURLING IRONS; ELECTROLYSIS APPARATUS FOR HAIR REMOVAL; ELECTRIC AND NON-ELECTRIC FIRE IRONS; NUTCRACKERS; TOOL BELTS; NAIL CLIPPERS; ELECTRIC OR NON-ELECTRIC PIZZA CUTTERS; NON-ELECTRIC VEGETABLE SLICERS; SCALING KNIVES; MANICURE SETS; ELECTRIC MANICURE SETS; PEDICURE SETS; RAZOR CASES; GARDEN TOOLS, NAMELY, CULTIVATORS, HOES, SHOVELS, GARDENING SHEARS AND SCISSORS, TROWELS AND WEEDING FORKS; HAND-OPERATED RAZOR BLADES; LASTS FOR SHOE-MAKING; NAIL FILES; HAIR CLIPPERS FOR PERSONAL USE; ELECTRIC AND NON-ELECTRIC EGG SLICERS; NON-ELECTRIC CHEESE SLICERS; NON-ELECTRIC BEARD CLIPPERS; MORTARS FOR POUNDING SUBSTANCES; RAZOR CASES; HAND-OPERATED MEAT CHOPPERS; HAIR-REMOVING TWEEZERS; NAIL NIPPERS; CUTICLE NIPPERS; HAND-OPERATED VEGETABLE CHOPPERS; SUGAR TONGS; EYELASH CURLERS, IN CLASS 8 (U.S. CLS. 23, 28 AND 44).

FOR: APPARATUS AND INSTRUMENTS FOR CONDUCTING, SWITCHING, TRANSFORMING, ACCUMULATING, REGULATING OR CONTROLLING ELECTRICITY, NAMELY, MICROPROCESSORS, CIRCUIT BOARDS, ELECTRICAL CONDUCTORS, ACCUMULATORS, ELECTRIC SWITCHES AND ELECTRICAL TRANSFORMERS; APPARATUS FOR RECORDING, TRANSMISSION OR REPRODUCTION OF SOUND OR IMAGES; BLANK MAGNETIC DATA CARRIERS; BLANK MAGNETIC RECORDING DISCS; AUTOMATIC VENDING MACHINES AND MECHANISMS FOR COIN-OPERATED APPARATUS; CASH REGISTERS; CALCULATING MACHINES; DATA PROCESSING EQUIPMENT AND COMPUTERS; COMPUTER PERIPHERAL DEVICES; FIRE-EXTINGUISHING APPARATUS; ANTI-GLARE GLASSES; PINCE-NEZ; OPTICAL LENSES; PINCE-NEZ CHAINS; PINCE-NEZ CORDS; MEASURING TAPES; SPECTACLES; SPECTACLE GLASSES; SPECTACLES CASES; SPECTACLE FRAMES; PINCE-NEZ MOUNTINGS; SUNGLASSES; PINCE-NEZ CASES AND CONTAINERS FOR CONTACT LENSES; GLOVES FOR DIVERS; DIVING SUITS; MAGNETIC CARDS; MAGNETICALLY ENCODED IDENTITY CARDS; ELECTRONIC AGENDAS; TELEPHONE APPARATUS; WEIGHBRIDGES; DIRECTIONAL COMPASSES; AUTOMATED BILLING MACHINES FOR PROCESSING ACCOUNT INFORMATION; TELESCOPES; CHRONOGRAPHS FOR USE AS TIME RECORDING APPARATUS; MEASURING SPOONS; PEDOMETERS; AUDIO-VIDEO COMPACT DISCS FEATURING MUSIC, FILMS AND IMAGES; READ-ONLY MEMORY COMPACT DISCS FEATURING MUSIC; OPTICAL MIRRORS; SWIM FLOATS FOR BATHING AND SWIMMING FOR SAFETY PURPOSES; BINOCULARS; PRINTERS FOR USE WITH COMPUTERS; TEMPERATURE INDICATORS; COMPUTER GAME PROGRAMS; CASSETTE PLAYERS; BAR CODE READERS; SIGNAL LANTERNS IN THE NATURE OF BEACON LIGHTS AND LUMINOUS SAFETY BEACONS; MAGNIFYING GLASSES; DICTATING MACHINES; INVOICING MACHINES, NAMELY, CREDIT CARD READERS AND CURRENCY COUNTING MACHINES; WEIGHTS, NAMELY, WEIGHT BELTS FOR DIVING AND WEIGHING MACHINES; ELECTRIC BATTERIES; GALVANIC BATTERIES; ELECTRIC FLAT IRONS; COMPUTER SOFTWARE FOR GAMES, SCREEN SAVERS, WORD PROCESSING AND DATABASE MANAGEMENT; COMPUTER OPERATING PROGRAMS, RECORDED; COMPUTER MICE; ELECTRONIC POCKET TRANSLATORS; ELECTRONIC TRANSISTORS; THERMOMETERS NOT FOR MEDICAL PURPOSES; APPARATUS FOR GAMES ADAPTED FOR USE WITH AN EXTERNAL DISPLAY SCREEN OR MONITOR; INTERCOMMUNICATION APPARATUS, NAMELY, COMMUNICATIONS HEADSETS FOR USE WITH COMMUNICATION RADIOS, INTERCOM SYSTEMS OR OTHER COMMUNICATIONS NETWORK TRANSCEIVERS, COMMUNICATION HUBS; PRERECORDED VIDEO CASSETTES FEATURING ANIMATED CARTOONS; TEACHING APPARATUS, NAMELY, CHILDREN'S EDUCATION COMPUTER SOFTWARE; BABY

Reg. No. 4,097,554 MONITORS; WALKIE-TALKIES; EGG TIMERS; AMUSEMENT APPARATUS ADAPTED FOR USE WITH AN EXTERNAL DISPLAY SCREEN OR MONITOR; DNA CHIPS; DVD PLAYERS; AUTOMATED TELLER MACHINES (ATM); HANDS FREE KITS FOR PHONES; CLOTHING FOR USE IN LABORATORIES; MAGNETICALLY ENCODED IDENTIFICATION BRACELETS, IN CLASS 9 (U.S. CLS. 21, 23, 26, 36 AND 38).

FOR: SAFETY SEATS FOR CHILDREN FOR VEHICLES; HEAD-RESTS FOR SEATS FOR MOTOR CARS; SEAT COVERS FOR VEHICLES; BICYCLES AND STRUCTURAL PARTS THEREFOR; BABY CARRIAGES AND STRUCTURAL PARTS THEREFOR; STROLLERS AND STRUCTURAL PARTS THEREFOR; SLEIGHS; KICK SLEDGES FOR TRANSPORT PURPOSES; SCOOTERS; MASTS FOR BOATS; COVERS FOR VEHICLE STEERING WHEELS, IN CLASS 12 (U.S. CLS. 19, 21, 23, 31, 35 AND 44).

FOR: PRECIOUS METALS AND THEIR ALLOYS; JEWELRY; PRECIOUS STONES; HOROLOGICAL AND CHRONOMETRIC INSTRUMENTS; ORNAMENTAL PINS; TIE PINS; WORKS OF ART OF PRECIOUS METAL; FANCY KEY RINGS OF PRECIOUS METAL; MEDALS; COLLECTIBLE AND COMMEMORATIVE COINS; BADGES OF PRECIOUS METAL; ORNAMENTS OF PRECIOUS METAL FOR SHOES AND HATS; CUFFLINKS; JEWELRY BOXES, IN CLASS 14 (U.S. CLS. 2, 27, 28 AND 50).

FOR: LEATHER AND IMITATION LEATHER; ANIMAL SKINS; TRUNKS AND TRAVELLING BAGS; UMBRELLAS, PARASOLS AND WALKING STICKS; WHIPS, HARNESS AND SADDLERY; BAGS FOR CLIMBERS, NAMELY, BACKPACKS, ALL-PURPOSE CARRYING BAGS; BAGS FOR CAMPERS, NAMELY, BARREL BAGS, DUFFEL BAGS; BEACH BAGS; HANDBAG FRAMES; FRAMES FOR UMBRELLAS OR PARASOLS; MOUNTAIN HIKING POLES; BAGS, NAMELY, BAGS FOR SPORTS, ENVELOPES AND POUCHES OF LEATHER FOR PACKAGING, BELT BAGS, CLUTCH BAGS AND COSMETIC BAGS SOLD EMPTY; HANDBAGS; HANDBAGS; TRAVELLING BAGS; TRAVELLING LUGGAGE SETS; LEATHER KEY CASES; ATTACHÉ CASES; PURSES; SCHOOL BAGS; GARMENT BAGS FOR TRAVEL; HAT BOXES OF LEATHER; SLING BAGS FOR CARRYING INFANTS; WHEELED SHOPPING BAGS; BOXES OF LEATHER OR LEATHER BOARD; BOXES OF VULCANIZED FIBRE, NAMELY, HAT BOXES FOR TRAVEL NOT OF PAPER OR CARDBOARD; BRIEFCASES; POCKET WALLETS; VANITY CASES, NOT FITTED; COLLARS FOR ANIMALS; LEATHER LEASHES; LEATHER LEASHES; UMBRELLA COVERS; COVERS FOR HORSE-SADDLES; RUCKSACKS; HORSE BLANKETS; HAVERSACKS; REINS FOR HORSES; RIDING SADDLES, IN CLASS 18 (U.S. CLS. 1, 2, 3, 22 AND 41).

FOR: FURNITURE; MIRRORS; PICTURE FRAMES; NON-ELECTRIC FANS FOR PERSONAL USE; PILLOWS; CURTAIN RINGS; WOOD AND PLASTIC CRATES; CUPBOARDS; LECTERNS; BENCHES; TABLE TOPS; SCREENS; FRAMES, NAMELY, FURNITURE FRAMES, MIRROR FRAMES AND BED FRAMES; FURNITURE CHEST; CASES OF WOOD OR PLASTIC FOR BOOKS; CHESTS FOR TOYS; BEDS; FURNITURE PARTS, NAMELY, HEAD-RESTS; TEA TROLLEYS; BOTTLE RACKS; NON-METALLIC BAKER'S BREAD BASKETS; CUSHIONS; MATTRESSES; CHESTS OF DRAWERS; BAMBOO CURTAINS; COTS; DECORATIVE WIND CHIMES; DECORATIVE MOBILES; DIVANS; RACKS FOR USE AS FURNITURE, NAMELY, DISPLAY RACKS, HAT RACKS, COAT RACKS, TOWEL RACKS, KEY RACKS, MAGAZINE RACKS, PLANT RACKS AND PLATE RACKS; FURNITURE INDEX CABINETS; FURNITURE FITTINGS, NOT OF METAL, AND BED FITTINGS, NAMELY, BED HEADBOARDS AND BED RAILS; DECK CHAIRS; PLANT STANDS; DRESSMAKER'S DUMMIES; TABLES; WORKS OF ART OF WOOD, WAX, PLASTER OR PLASTIC; STRAWS FOR DRINKING; UMBRELLA STANDS; PLAYPENS FOR BABIES; CLOTHES DISPLAY STANDS AND HAT STANDS; COAT STANDS; DESKS; SLEEPING BAGS FOR CAMPING; SEATS; ARMCHAIRS; SOFAS; KEY CABINETS; FOOTSTOOLS; CORKS FOR BOTTLES; EMBROIDERY FRAMES; HIGH CHAIRS FOR BABIES; INFANT WALKERS; LOUNGE CHAIRS; DOOR HANDLES NOT OF METAL; HAND-HELD TOILET MIRRORS; MATS FOR INFANT PLAYPENS; TOWEL SUPPORTS, NAMELY, TOWEL HOOKS NOT OF METAL AND TOWEL STANDS, IN CLASS 20 (U.S. CLS. 2, 13, 22, 25, 32 AND 50).

Reg. No. 4,097,554 FOR: HAIR COMBS; BATH SPONGES; BRUSHES, NAMELY, HAIR BRUSHES, COSMETIC BRUSHES, SHAVING BRUSHES AND SHOE BRUSHES; BRUSH-MAKING MATERIALS; STEEL WOOL FOR CLEANING; UNWORKED OR SEMI-WORKED GLASS EXCEPT CONSTRUCTION GLASS; BEVERAGE GLASSWARE, DECORATIVE PORCELAIN AND EARTHENWARE IN THE NATURE OF FIGURINES, ORNAMENTS, PLATES, VASES, BOWLS AND DESKTOP STATUARY; BOTTLE OPENERS; OIL BOTTLES SOLD EMPTY; COCKTAIL SHAKERS; CANDLE SNUFFERS; SUGAR BOWLS; TRAYS; PORTABLE BABY BATH TUBS; CLOTHS FOR WASHING FLOORS; GLASS BOWLS; TEA BALLS; CANDY DISHES; BOTTLES SOLD EMPTY; POTTERY DISHES; COFFEE MACHINES IN THE NATURE OF HAND-OPERATED COFFEE GRINDERS; BOXES OF GLASS; METAL BOXES FOR DISPENSING PAPER TOWELS; COOKIE JARS; LUNCH BOXES; TEA CADDIES; NON-ELECTRIC BOTTLE WARMERS FOR BABIES; SHOE HORNS; NON-ELECTRIC CANDELABRAS; WINE TASTERS; FLYCATCHERS; TABLE CENTERPIECES IN THE NATURE OF VASES; PLANT BASKETS; TEA STRAINERS; TROUSER STRETCHERS; ICE BUCKETS; TIE PRESSES; COMB CASES; IRONING BOARD COVERS; GARDENING GLOVES; GLOVES FOR DOMESTIC USE; POLISHING GLOVES; SHOE TREES; PIGGY BANKS NOT OF METAL; SOAP DISHES; CARAFES; BIRD CAGES FOR DOMESTIC BIRDS; BUTTER DISHES; TOILET CASES; WORKS OF ART MADE OF PORCELAIN; TERRA-COTTA AND GLASS; TOOTHPICK CONTAINERS; CARPET BEATERS; BREAD BOXES; DUSTING CLOTHS AND RAGS; PEPPER POTS; CLOTHES PEGS AND WASHING LINES; PLATES; FEATHER-DUSTERS; FACE POWDER CASES IN THE NATURE OF VANITY CASES; SHAVING BRUSH HOLDERS; SPONGE HOLDERS; TOILET ROLL HOLDERS; TROUSER PRESSES; PERFUME SPRAYERS AND VAPORIZERS SOLD EMPTY; NON-ELECTRIC GRATERS FOR HOUSEHOLD PURPOSES; CRUMB TRAYS; COASTERS FOR BOTTLES NOT OF PAPER AND NOT BEING TABLE LINEN; TRIVETS; BOOT JACKS; SALT CELLARS; CLOTHES DRYING RACKS; COFFEE AND TEA SERVICES; NAPKIN HOLDERS; WASHING AND IRONING BOARDS; BREAD BOARDS; CARVING BOARDS; CUPS; SHIRT STRETCHERS; TEA POTS; FLOWER POTS; TOILET UTENSILS; TABLEWARE; DRINKING GLASSES; THERMALLY INSULATED CONTAINERS FOR FOOD AND BEVERAGES; TOOTHBRUSHES; ELECTRIC TOOTHBRUSHES; DENTAL FLOSS; NON-ELECTRIC JUICERS; EGGCUPS; SALAD BOWLS; TOWEL RACKS; SAUCERS; SOUP BOWLS; URNS; GOBLETS; CANDLE HOLDERS; LARGE CUPS; JUGS; FLASKS, DISPOSABLE TABLE PLATES; BARS AND RINGS FOR HOLDING TOWELS; HOUSEHOLD AQUARIUMS; COVERS FOR HOUSEHOLD AQUARIUMS; HOUSEHOLD TERRARIUMS, IN CLASS 21 (U.S. CLS. 2, 13, 23, 29, 30, 33, 40 AND 50).

FOR: TEXTILES AND TEXTILE GOODS, NAMELY, BED SHEETS, BED BLANKETS, PILLOW COVERS, PILLOW SHAMS, DUST RUFFLES, DUVET COVERS, QUILTS, COMFORTERS, AFGHANS, CRIB BUMPERS, BED SPREADS, PLACEMATS, NAPKINS, OVEN MITTS, POT HOLDERS, TEA TOWELS, TABLE CLOTHS NOT MADE OF PAPER; BATH LINEN NOT INCLUDING CLOTHING; TISSUES OF TEXTILE FOR REMOVING MAKE-UP; LABELS OF TEXTILE; TEXTILE USED AS LINING FOR CLOTHING; TOILET GLOVES, NAMELY, BATH GLOVES; WALL HANGINGS OF TEXTILE; HANDKERCHIEFS OF TEXTILE; CURTAINS OF TEXTILE OR PLASTIC; HOUSEHOLD LINEN; HAND TOWELS OF TEXTILE; TRAVELING RUGS; NET CURTAINS; CURTAIN HOLDERS OF TEXTILE MATERIALS, NAMELY, CURTAIN TIE BACKS; BANNERS; FABRIC FLAGS; UNFITTED PROTECTIVE FURNITURE COVERS NOT OF PAPER; COVERS FOR CUSHIONS; MOSQUITO NETS; TEXTILE CLOTHS FOR CLEANING GLASS; BILLIARD CLOTH; TRACED CLOTHS FOR EMBROIDERY; UPHOLSTERY FABRICS; FACE TOWELS OF TEXTILE; SLEEPING BAGS, IN CLASS 24 (U.S. CLS. 42 AND 50).

FOR: MEN'S, WOMEN'S AND CHILDREN'S READY-TO-WEAR CLOTHING, NAMELY, OVERALLS, TOPS, VESTS, UNDERSHIRTS, UNDERPANTS, TROUSERS, SHIRTS, DRESSES, SUNDRESSES, SLACKS, PANTS, BLOUSES, SHIRTS, T-SHIRTS, SWEATERS, WAISTCOATS, PULLOVERS, CARDIGANS, JERSEYS, JACKETS, SUITS, TUXEDOS, OVERCOATS, COATS, HUNTING JACKETS, TRACK SUITS, ASCOTS AND PONCHOS; FOOTWEAR, NOT INCLUDING ORTHOPEDIC FOOTWEAR; HEADGEAR, NAMELY, HATS, SCARVES, KERCHIEFS, EAR MUFFS, CAPS, HEADBANDS, CAP VISORS AND CAP PEAKS; CLOTHING FOR MOTORISTS AND CYCLISTS, NAMELY, JACKETS AND MOTORCYCLE GLOVES; BIBS, NOT

Reg. No. 4,097,554 OF PAPER; BATHROBES; SWIMWEAR; BATHING CAPS AND SANDALS; BOAS; UNDERWEAR; SCARVES; SPORTS FOOTWEAR FOR SPORTS; BEACH FOOTWEAR; HOODS; SHAWLS; BELTS FOR CLOTHING; MONEY BELTS; WET SUITS; TIES; CORSETS; FUR STOLE; GIRDLES; FOULARDS; GLOVES; WATERPROOF CLOTHING, NAMELY, RAINCOATS; MANTILLAS; STOCKINGS; SOCKS; NECKERCHIEFS; TEXTILE NAPPIES; FUR COATS; PAJAMAS; SOLES FOR FOOTWEAR; HEELS; VEILS; BRACES IN THE NATURE OF SUSPENDERS; PAPER CLOTHING, NAMELY, PAPER HATS, PAPER SHOES AND PAPER UNDERWEAR; LEOTARDS; LAYETTES; COLLARS; MITTENS; INSOLES; BOW TIES; PAREUS; WRISTBANDS FOR CLOTHING; DRESS SHIELDS; CARNIVAL COSTUMES, NOT INCLUDING COSTUME MASKS; SLEEP MASKS, IN CLASS 25 (U.S. CLS. 22 AND 39).

FOR: LACE AND EMBROIDERY, RIBBONS AND BRAID, BUTTONS, HOOKS AND EYELETS; SEWING PINS AND SEWING NEEDLES; ARTIFICIAL FLOWERS; LACE TRIMMINGS; NEEDLE CUSHIONS; SHOE ORNAMENTS AND HAT ORNAMENTS NOT OF PRECIOUS METAL; NEEDLES; PINS, NAMELY, SAFETY PINS, ORNAMENTAL NOVELTY PINS, SETTING PINS AND WAVING PINS FOR THE HAIR; HAIR ORNAMENTS; HAIR BANDS; BRASSARDS; REINS FOR GUIDING CHILDREN; BROOCHES AS CLOTHING ACCESSORIES; SEWING BOXES; BELT CLASPS; SHOE LACES; WREATHS OF ARTIFICIAL FLOWERS; TEA COSIES; ORNAMENTAL NOVELTY BADGES AS BUTTONS; SEWING THIMBLES; BOWS FOR THE HAIR; NEEDLE CASES; BUCKLES AS CLOTHING ACCESSORIES; METAL SHOE FASTENERS; SHOULDER PADS FOR CLOTHING; HAIR PINS; ORNAMENTAL NOVELTY BADGES FOR WEAR, NOT OF PRECIOUS METAL; ORNAMENTAL NOVELTY BADGES IN THE NATURE OF ORSEDEWS; EMBROIDERY, NAMELY, EMBROIDERED MONOGRAM TABS FOR MARKING LINEN; BODKINS; BARRETTES; ARTS AND CRAFTS FINDINGS, NAMELY, POMPOMS; ZIP FASTENERS; COMPETITORS' NUMBERS NOT OF TEXTILE, IN CLASS 26 (U.S. CLS. 37, 39, 40, 42 AND 50).

FOR: GAMES AND PLAYTHINGS, NAMELY, ARCADE GAMES, BOARD GAMES, CARD GAMES, DICE GAMES, DART GAMES, CHESS GAMES, PUZZLE GAMES, PLAY HOUSES AND PLAY FIGURES; CHRISTMAS TREE DECORATIONS; FISHING TACKLE; FISHING RODS; TOY MASKS; THEATRICAL MASKS; PARTY FAVORS IN THE NATURE OF SMALL TOYS, CRACKERS AND NOISEMAKERS; PUPPETS; ELECTRONIC GAMES OTHER THAN THOSE ADAPTED FOR USE WITH AN EXTERNAL DISPLAY SCREEN OR MONITOR; MACHINES FOR PHYSICAL EXERCISE; ARTIFICIAL CHRISTMAS TREES OF SYNTHETIC MATERIAL; KITES; BABY RATTLES; KALEIDOSCOPES; ROCKING HORSES; BUILDING GAMES; AUTOMATIC AND COIN-OPERATED AMUSEMENT MACHINES; PLAYING CARDS; TEDDY BEARS; DOLLS; DOLLS' CLOTHES; APPARATUS FOR ELECTRONIC GAMES OTHER THAN THOSE ADAPTED FOR USE WITH AN EXTERNAL DISPLAY SCREEN OR MONITOR; ELECTRONIC TARGETS FOR GAMES AND SPORTS, IN CLASS 28 (U.S. CLS. 22, 23, 38 AND 50).

FOR: SCIENTIFIC RESEARCH AND DESIGN SERVICES IN THE FIELDS OF TEXTILE MATERIALS, APPAREL, FOOTWEAR, COSMETICS, EYEWEAR, JEWELRY, LEATHER GOODS, AND LUGGAGE; INDUSTRIAL DESIGN AND RELATED ANALYSIS AND RESEARCH SERVICES IN THE FIELDS OF TEXTILE MATERIALS, APPAREL, FOOTWEAR, HOME FURNISHINGS, COSMETICS, EYEWEAR, JEWELRY, LEATHER GOODS, AND LUGGAGE; COMPUTER HARDWARE AND SOFTWARE DESIGN AND DEVELOPMENT; CHEMICAL ANALYSIS; QUALITY CONTROL FOR OTHERS; MATERIAL TESTING; CALIBRATION, NAMELY, MEASURING; RESEARCH AND DEVELOPMENT FOR OTHERS OF NEW PRODUCTS; COSMETIC RESEARCH; SURVEYING; TEXTILE TESTING; MECHANICAL RESEARCH; PACKAGING DESIGN; BACTERIOLOGICAL RESEARCH; BIOLOGICAL RESEARCH; PHYSICS RESEARCH; CONSULTANCY IN THE FIELD OF DEVELOPING ENVIRONMENTALLY SOUND PRODUCTS AND PROCESSES; ENVIRONMENTAL PROTECTION RESEARCH, IN CLASS 42 (U.S. CLS. 100 AND 101).

OWNER OF U.S. REG. NOS. 3,436,302 AND 3,520,770.

PRIORITY DATE OF 12-27-2007 IS CLAIMED.

Reg. No. 4,097,554 OWNER OF INTERNATIONAL REGISTRATION 0986154 DATED 5-22-2008, EXPIRES 5-22-2018.

THE MARK CONSISTS OF A DESIGN RESEMBLING THE SUN WITH A PLUS SIGN IN THE MIDDLE WITH THE WORDS "SAFE TO WEAR" TO THE RIGHT OF THE DESIGN.

SER. NO. 79-062,557, FILED 5-22-2008.

TINA MAI, EXAMINING ATTORNEY

United States of America

United States Patent and Trademark Office

RAD PRE PRIMARY IN DANCE

Reg. No. 4,097,555

ROYAL ACADEMY OF DANCE (UNITED KINGDOM PLC)
36 BATTERSEA SQUARE

Registered Feb. 14, 2012

LONDON SW11 3RA, UNITED KINGDOM

Int. Cls.: 9, 16, 25 and 41

FOR: APPARATUS FOR RECORDING, TRANSMISSION OR REPRODUCTION OF SOUND OR IMAGES; PRE-RECORDED MAGNETIC DATA CARRIERS, PRE-RECORDED OPTICAL AND MAGNETIC RECORDING DISCS, PRE-RECORDED AUDIO AND VIDEO CASSETTES, PRE-RECORDED CDS AND DVDS, PRE-RECORDED VIDEO TAPES, CASSETTES AND OPTICAL DISKS, PRE-RECORDED SOUND AND VIDEO RECORDINGS, PRE-RECORDED LASER DISCS, PRE-RECORDED DIGITAL VERSATILE DISCS, PRE-RECORDED AUDIO AND VIDEO TAPES ALL FEATURING MUSIC AND DANCE, IN CLASS 9 (U.S. CLS. 21, 23, 26, 36 AND 38).

TRADEMARK

SERVICE MARK

PRINCIPAL REGISTER

FOR: PRINTED MATTER, NAMELY, INFORMATIONAL FLYERS IN THE FIELDS OF MUSIC AND DANCE AND POSTERS; PRINTED PUBLICATIONS, NAMELY, BROCHURES, BOOKLETS, MAGAZINES, MANUALS, LEAFLETS AND BOOKS IN THE FIELDS OF MUSIC AND DANCE; PRINTED VISUALS IN THE NATURE OF ADVERTISING AND PROMOTIONAL MATERIAL OF PAPER OR CARDBOARD; PRINTED TEACHING MATERIALS IN THE FIELDS OF MUSIC AND DANCE; PRINTED TEACHING MATERIALS IN THE NATURE OF EDUCATIONAL EXAMINATIONS IN THE FIELDS OF MUSIC AND DANCE; PRINTED MATTER FOR EDUCATIONAL PURPOSES, NAMELY, BROCHURES, BOOKLETS, MAGAZINES, MANUALS, LEAFLETS AND BOOKS IN THE FIELDS OF MUSIC AND DANCE; PRINTED INSTRUCTIONAL AND TEACHING MATERIALS IN THE FIELDS OF MUSIC AND DANCE, IN CLASS 16 (U.S. CLS. 2, 5, 22, 23, 29, 37, 38 AND 50).



FOR: BALLET AND DANCING SHOES; ARTICLES OF CLOTHING FOR USE IN BALLET AND DANCING, NAMELY, LEOTARDS, TIGHTS, SOCKS, SHORTS, T-SHIRTS, TOPS, SKIRTS, DANCE SKIRTS, SHIRTS, IN CLASS 25 (U.S. CLS. 22 AND 39).

FOR: EDUCATION SERVICES, NAMELY, PROVIDING ONE-ON-ONE MENTORING IN THE FIELDS OF MUSIC AND DANCE, PROVIDING TUTORIAL SESSIONS IN THE FIELDS OF MUSIC AND DANCE, PROVIDING LIVE AND ON-LINE CLASSES, SEMINARS AND WORKSHOPS IN THE FIELDS OF MUSIC AND DANCE, PROVIDING CLASSES, SEMINARS AND WORKSHOPS IN THE FIELDS OF MUSIC AND DANCE; PROVIDING OF TRAINING AND ENTERTAINMENT IN THE FIELDS OF MUSIC, MOVEMENT AND DANCE, NAMELY, DANCE INSTRUCTION FOR CHILDREN, AND ENTERTAINMENT AND EDUCATION SERVICES IN THE NATURE OF LIVE DANCE AND MUSICAL PERFORMANCES; PER-

David J. Kybas

Director of the United States Patent and Trademark Office

Reg. No. 4,097,555 FORMANCES, NAMELY, ENTERTAINMENT IN THE NATURE OF DANCE PERFORMANCES; SCHOOL SERVICES, NAMELY, SUMMER BALLET SCHOOLS AND SUMMER DANCE SCHOOLS AND WORKSHOPS IN THE FIELDS OF BALLET AND DANCE; BALLET CLASSES; INSTRUCTION IN BALLET; ENTERTAINMENT IN THE NATURE OF BALLET SHOWS; PRESENTATION OF LIVE PERFORMANCES IN THE NATURE OF BALLETS; PROVISION OF DANCE CLASSES; DANCE INSTRUCTION; DANCE HALL SERVICES, NAMELY, PROVIDING DANCE HALLS; PRODUCTION OF ENTERTAINMENT SHOWS FEATURING DANCERS; TEACHER TRAINING SERVICES, NAMELY, TRAINING TEACHERS IN THE FIELDS OF MUSIC AND DANCE; EDUCATIONAL SERVICES PROVIDED FOR TEACHERS OF CHILDREN, NAMELY, PROVIDING CLASSES, SEMINARS, WORKSHOPS AND ONE-ON-ONE MENTORING AND TUITION BEING INSTRUCTION IN THE FIELDS OF MUSIC AND DANCE; PROVISION OF EDUCATIONAL EXAMINATIONS; ORGANIZATION OF EDUCATIONAL EXAMINATIONS TO GRADE LEVEL OF ACHIEVEMENT; RENTAL OF DANCE STUDIOS; PRODUCTION OF VIDEO, AUDIO, SOUND AND MUSICAL RECORDINGS; NON-DOWNLOADABLE ELECTRONIC PUBLICATIONS IN THE NATURE OF BROCHURES, BOOKLETS, MAGAZINES, MANUALS, LEAFLETS AND BOOKS IN THE FIELDS OF MUSIC AND DANCE; PROVIDING ON-LINE ELECTRONIC PUBLICATIONS IN THE NATURE OF BOOKLETS, MAGAZINES, MANUALS, LEAFLETS AND BOOKS IN THE FIELDS OF MUSIC AND DANCE ON-LINE PUBLICATION OF NON-DOWNLOADABLE ELECTRONIC BOOKS AND JOURNALS IN THE FIELDS OF MUSIC AND DANCE; PROVIDING A WEB SITE FEATURING NON-DOWNLOADABLE PUBLICATIONS IN THE NATURE OF BOOKLETS, MAGAZINES, MANUALS, LEAFLETS AND BOOKS IN THE FIELDS OF MUSIC AND DANCE; PROVIDING INFORMATION ON EDUCATION AND ENTERTAINMENT; ORGANIZING AND CONDUCTING OF EDUCATIONAL CONFERENCES, EDUCATIONAL SEMINARS, EDUCATIONAL EXHIBITIONS AND EDUCATIONAL SYMPOSIUMS, TRAINING COURSES, EDUCATIONAL LECTURES, EDUCATIONAL WORKSHOPS, AND EDUCATIONAL PRESENTATIONS IN THE FIELDS OF MUSIC AND DANCE; ARRANGING OF FESTIVALS FOR CULTURAL, EDUCATIONAL AND ENTERTAINMENT PURPOSES, NAMELY, MUSIC AND DANCE FESTIVALS; ARRANGING OF COMPETITIONS FOR CULTURAL, EDUCATIONAL AND ENTERTAINMENT SERVICES, NAMELY, MUSIC AND DANCE COMPETITIONS; ARRANGING OF COMPETITIONS FOR TRAINING PURPOSES, NAMELY, MUSIC AND DANCE COMPETITIONS; ORGANIZING OF DANCING COMPETITIONS; ADVISORY AND CONSULTANCY IN THE FIELD OF DANCE EDUCATION, IN CLASS 41 (U.S. CLS. 100, 101 AND 107).

THE MARK CONSISTS OF STANDARD CHARACTERS WITHOUT CLAIM TO ANY PARTICULAR FONT, STYLE, SIZE, OR COLOR.

PRIORITY DATE OF 6-18-2008 IS CLAIMED.

OWNER OF INTERNATIONAL REGISTRATION 0996266 DATED 12-17-2008, EXPIRES 12-17-2018.

OWNER OF U.S. REG. NO. 3,498,784.

NO CLAIM IS MADE TO THE EXCLUSIVE RIGHT TO USE "PRE PRIMARY IN DANCE", APART FROM THE MARK AS SHOWN.

SER. NO. 79-066,350, FILED 12-17-2008.

MYRIAH HABEEB, EXAMINING ATTORNEY

United States of America

United States Patent and Trademark Office

RAD PRIMARY IN DANCE

Reg. No. 4,097,556

ROYAL ACADEMY OF DANCE (UNITED KINGDOM PLC)
36 BATTERSEA SQUARE

Registered Feb. 14, 2012

LONDON SW11 3RA, UNITED KINGDOM

Int. Cls.: 9, 16, 25 and 41

FOR: APPARATUS FOR RECORDING, TRANSMISSION OR REPRODUCTION OF SOUND OR IMAGES; PRE-RECORDED MAGNETIC DATA CARRIERS, PRE-RECORDED OPTICAL AND MAGNETIC RECORDING DISCS, PRE-RECORDED AUDIO AND VIDEO TAPES, PRE-RECORDED AUDIO AND VIDEO CASSETTES, PRE-RECORDED CDS AND DVDS, PRE-RECORDED VIDEO TAPES, CASSETTES AND OPTICAL DISKS, PRE-RECORDED SOUND AND VIDEO RECORDINGS, PRE-RECORDED LASER DISCS, PRE-RECORDED DIGITAL VERSATILE DISCS, ALL FEATURING MUSIC AND DANCE, IN CLASS 9 (U.S. CLS. 21, 23, 26, 36 AND 38).

TRADEMARK

SERVICE MARK

PRINCIPAL REGISTER

FOR: PRINTED MATTER, NAMELY, INFORMATIONAL FLYERS IN THE FIELDS OF MUSIC AND DANCE AND POSTERS; PRINTED PUBLICATIONS, NAMELY, BROCHURES, BOOKLETS, MAGAZINES, MANUALS, LEAFLETS AND BOOKS IN THE FIELDS OF MUSIC AND DANCE; PRINTED VISUALS IN THE NATURE OF ADVERTISING AND PROMOTIONAL MATERIAL OF PAPER OR CARDBOARD; PRINTED TEACHING MATERIALS IN THE FIELDS OF MUSIC AND DANCE; PRINTED TEACHING MATERIALS IN THE NATURE OF EDUCATIONAL EXAMINATIONS IN THE FIELDS OF MUSIC AND DANCE; PRINTED MATTER FOR EDUCATIONAL PURPOSES, NAMELY, BROCHURES, BOOKLETS, MAGAZINES, MANUALS, LEAFLETS AND BOOKS IN THE FIELDS OF MUSIC AND DANCE; PRINTED INSTRUCTIONAL AND TEACHING MATERIALS IN THE FIELDS OF MUSIC AND DANCE, IN CLASS 16 (U.S. CLS. 2, 5, 22, 23, 29, 37, 38 AND 50).



FOR: BALLET AND DANCING SHOES; ARTICLES OF CLOTHING FOR USE IN BALLET AND DANCING, NAMELY, LEOTARDS, TIGHTS, SOCKS, SHORTS, T-SHIRTS, TOPS, SKIRTS, DANCE SKIRTS, SHIRTS, IN CLASS 25 (U.S. CLS. 22 AND 39).

FOR: EDUCATION SERVICES, NAMELY, PROVIDING ONE-ON-ONE MENTORING IN THE FIELDS OF MUSIC AND DANCE, PROVIDING TUTORIAL SESSIONS IN THE FIELDS OF MUSIC AND DANCE, PROVIDING LIVE AND ON-LINE CLASSES, SEMINARS AND WORKSHOPS IN THE FIELDS OF MUSIC AND DANCE, PROVIDING CLASSES, SEMINARS AND WORKSHOPS IN THE FIELDS OF MUSIC AND DANCE; PROVIDING OF TRAINING AND ENTERTAINMENT IN THE FIELDS OF MUSIC, MOVEMENT AND DANCE, NAMELY, DANCE INSTRUCTION FOR CHILDREN, AND ENTERTAINMENT AND EDUCATION SERVICES IN THE NATURE OF LIVE DANCE AND MUSICAL PERFORMANCES; PER-

David J. Kyros

Director of the United States Patent and Trademark Office

Reg. No. 4,097,556 FORMANCES, NAMELY, ENTERTAINMENT IN THE NATURE OF DANCE PERFORMANCES; SCHOOL SERVICES, NAMELY, SUMMER BALLET SCHOOLS AND SUMMER DANCE SCHOOLS AND WORKSHOPS IN THE FIELDS OF BALLET AND DANCE; BALLET CLASSES; INSTRUCTION IN BALLET; ENTERTAINMENT IN THE NATURE OF BALLET SHOWS; PRESENTATION OF LIVE PERFORMANCES IN THE NATURE OF BALLETS; PROVISION OF DANCE CLASSES; DANCE INSTRUCTION; DANCE HALL SERVICES, NAMELY, PROVIDING DANCE HALLS; PRODUCTION OF ENTERTAINMENT SHOWS FEATURING DANCERS; TEACHER TRAINING SERVICES, NAMELY, TRAINING TEACHERS IN THE FIELDS OF MUSIC AND DANCE; EDUCATIONAL SERVICES PROVIDED FOR TEACHERS OF CHILDREN, NAMELY, PROVIDING CLASSES, SEMINARS, WORKSHOPS AND ONE-ON-ONE MENTORING AND TUITION BEING INSTRUCTION IN THE FIELDS OF MUSIC AND DANCE; PROVISION OF EDUCATIONAL EXAMINATIONS; ORGANIZATION OF EDUCATIONAL EXAMINATIONS TO GRADE LEVEL OF ACHIEVEMENT; RENTAL OF DANCE STUDIOS; PRODUCTION OF VIDEO, AUDIO, SOUND AND MUSICAL RECORDINGS; NON-DOWNLOADABLE ELECTRONIC PUBLICATIONS IN THE NATURE OF BROCHURES, BOOKLETS, MAGAZINES, MANUALS, LEAFLETS AND BOOKS IN THE FIELDS OF MUSIC AND DANCE; PROVIDING ON-LINE ELECTRONIC PUBLICATIONS IN THE NATURE OF BOOKLETS, MAGAZINES, MANUALS, LEAFLETS AND BOOKS IN THE FIELDS OF MUSIC AND DANCE ON-LINE PUBLICATION OF NON-DOWNLOADABLE ELECTRONIC BOOKS AND JOURNALS IN THE FIELDS OF MUSIC AND DANCE; PROVIDING A WEB SITE FEATURING NON-DOWNLOADABLE PUBLICATIONS IN THE NATURE OF BOOKLETS, MAGAZINES, MANUALS, LEAFLETS AND BOOKS IN THE FIELDS OF MUSIC AND DANCE; PROVIDING INFORMATION ON EDUCATION AND ENTERTAINMENT; ORGANIZING AND CONDUCTING OF EDUCATIONAL CONFERENCES, EDUCATIONAL SEMINARS, EDUCATIONAL EXHIBITIONS AND EDUCATIONAL SYMPOSIUMS, TRAINING COURSES, EDUCATIONAL LECTURES, EDUCATIONAL WORKSHOPS, AND EDUCATIONAL PRESENTATIONS IN THE FIELDS OF MUSIC AND DANCE; ARRANGING OF FESTIVALS FOR CULTURAL, EDUCATIONAL AND ENTERTAINMENT PURPOSES, NAMELY, MUSIC AND DANCE FESTIVALS; ARRANGING OF COMPETITIONS FOR CULTURAL, EDUCATIONAL AND ENTERTAINMENT SERVICES, NAMELY, MUSIC AND DANCE COMPETITIONS; ARRANGING OF COMPETITIONS FOR TRAINING PURPOSES, NAMELY, MUSIC AND DANCE COMPETITIONS; ORGANIZING OF DANCING COMPETITIONS; ADVISORY AND CONSULTANCY IN THE FIELD OF DANCE EDUCATION, IN CLASS 41 (U.S. CLS. 100, 101 AND 107).

THE MARK CONSISTS OF STANDARD CHARACTERS WITHOUT CLAIM TO ANY PARTICULAR FONT, STYLE, SIZE, OR COLOR.

PRIORITY DATE OF 6-18-2008 IS CLAIMED.

OWNER OF INTERNATIONAL REGISTRATION 0997947 DATED 12-17-2008, EXPIRES 12-17-2018.

OWNER OF U.S. REG. NO. 3,498,784.

NO CLAIM IS MADE TO THE EXCLUSIVE RIGHT TO USE "PRIMARY IN DANCE", APART FROM THE MARK AS SHOWN.

SER. NO. 79-066,978, FILED 12-17-2008.

MYRIAH HABEEB, EXAMINING ATTORNEY

United States of America

United States Patent and Trademark Office

Vero Vitae

Reg. No. 4,097,557

Registered Feb. 14, 2012

Int. Cl.: 33

TRADEMARK

PRINCIPAL REGISTER

GRANDE VITAE GMBH (FED REP GERMANY LIMITED LIABILITY COMPANY)
ANNENHEIDER ALLEE 97
27751 DELMENHORST
FED REP GERMANY

FOR: ALCOHOLIC BEVERAGES EXCEPT BEERS, IN CLASS 33 (U.S. CLS. 47 AND 49).

THE MARK CONSISTS OF STANDARD CHARACTERS WITHOUT CLAIM TO ANY PARTICULAR FONT, STYLE, SIZE, OR COLOR.

PRIORITY DATE OF 1-15-2009 IS CLAIMED.

OWNER OF INTERNATIONAL REGISTRATION 1004360 DATED 5-7-2009, EXPIRES 5-7-2019.

THE ENGLISH TRANSLATION OF THE WORD "VERO" IN THE MARK IS TRUE, REAL, TRUTHFUL, VERACIOUS, VERITABLE, VIRTUAL, PERFECT, ACTUAL, SHEER. THE ENGLISH TRANSLATION OF THE WORD "VITAE" IN THE MARK IS LIFE OR VINE.

SER. NO. 79-069,548, FILED 5-7-2009.

FONG HSU, EXAMINING ATTORNEY



David J. Kyfos

Director of the United States Patent and Trademark Office

United States of America

United States Patent and Trademark Office

Your Novo Nordisk Connection

Reg. No. 4,097,558

Registered Feb. 14, 2012

Int. Cls.: 41 and 44

SERVICE MARK

PRINCIPAL REGISTER

NOVO NORDISK A/S (DENMARK LIMITED LIABILITY COMPANY)
NOVO ALLÉ
DK-2880 BAGSVAERD
DENMARK

FOR: EDUCATIONAL SERVICES, NAMELY, PROVIDING CLASSES, SEMINARS, CONFERENCES, WORKSHOPS IN THE FIELD OF HORMONE THERAPY, IN CLASS 41 (U.S. CLS. 100, 101 AND 107).

FOR: MEDICAL SERVICES, NAMELY, PROVIDING COUNSELLING AND INFORMATION IN THE FIELD OF HORMONE THERAPY, IN CLASS 44 (U.S. CLS. 100 AND 101).

THE MARK CONSISTS OF STANDARD CHARACTERS WITHOUT CLAIM TO ANY PARTICULAR FONT, STYLE, SIZE, OR COLOR.

PRIORITY DATE OF 12-8-2008 IS CLAIMED.

OWNER OF INTERNATIONAL REGISTRATION 1004727 DATED 4-21-2009, EXPIRES 4-21-2019.

OWNER OF U.S. REG. NOS. 1,637,355 AND 2,694,527.

THE ENGLISH TRANSLATION OF THE WORDS "NOVO NOR DISK" IN THE MARK IS "NEW NORDIC".

SER. NO. 79-069,654, FILED 4-21-2009.

MEGHAN REINHART, EXAMINING ATTORNEY



David J. Kybas

Director of the United States Patent and Trademark Office

United States of America

United States Patent and Trademark Office



Reg. No. 4,097,559

VENETA CUCINE S.P.A. (ITALY JOINT STOCK COMPANY)
VIA PARIS BORDONE, 84

Registered Feb. 14, 2012

I-31056 RONCADE FRAZ. BIANCADE (TREVISO), ITALY

Int. Cl.: 20

FOR: FURNITURE; METALLIC FURNITURE; KITCHEN FURNITURE; CUPBOARDS; KITCHEN CUPBOARDS, WALL CUPBOARDS, SIDEBOARDS, CABINETS, BEING FURNITURE; TEA CABINETS, DISPLAY STANDS, FURNITURE, NAMELY, SHOWCASES; ADDITIONAL STOREYS, NAMELY, WALL UNITS FOR HEIGHTENING KITCHEN FURNITURE IN THE FORM OF ADDITIONAL SHELVES AND/OR KITCHEN CABINETS; BENCHES, SETTEES, CHAIRS, EASY CHAIRS, STOOLS; SHELVES, BOOK SHELVES, BOOKCASES; TABLES, BEING FURNITURE; DINING TABLES; DRESSERS; NON-METAL FURNITURE FITTINGS, EDGINGS OF PLASTIC FOR FURNITURE, PARTITIONS OF WOOD FOR FURNITURE, PANELS OF WOOD FOR FURNITURE, DOORS FOR FURNITURE, FURNITURE SHELVES; BASES, BEING FURNITURE PARTS; COLUMNS, BEING FURNITURE PARTS, IN CLASS 20 (U.S. CLS. 2, 13, 22, 25, 32 AND 50).

TRADEMARK

PRINCIPAL REGISTER

THE MARK CONSISTS OF THE WORDING "VENETA CUCINE" IN A STYLIZED FONT, SUPERIMPOSED ON A STYLIZED RECTANGULAR BACKGROUND RESEMBLING A REFLECTIVE METAL LABEL WITH TAPERED EDGES.

OWNER OF INTERNATIONAL REGISTRATION 0911024 DATED 9-18-2006, EXPIRES 9-18-2016.



THE ENGLISH TRANSLATION OF THE WORD "VENETA" IN THE MARK IS "OF VENETO REGION" AND THE ENGLISH TRANSLATION OF THE WORD "CUCINE" IS "KITCHENS".

SEC. 2(F) AS TO "VENETA CUCINE".

SER. NO. 79-069,763, FILED 4-8-2008.

COLLEEN KEARNEY, EXAMINING ATTORNEY

David J. Kybas

Director of the United States Patent and Trademark Office

United States of America

United States Patent and Trademark Office

CUSTOM 77

Reg. No. 4,097,560

Registered Feb. 14, 2012

Int. Cls.: 9 and 15

TRADEMARK

PRINCIPAL REGISTER

FRENCH GEEKS (FRANCE SARL)
26 RUE SERGENT BLANDAN
F-69001 LYON
FRANCE

FOR: APPARATUS AND INSTRUMENTS FOR CONDUCTING, DISTRIBUTING, TRANSFORMING, ACCUMULATING, REGULATING OR CONTROLLING ELECTRICITY, NAMELY, ELECTRIC CONDUCTORS; APPARATUS FOR RECORDING, TRANSMITTING, REPRODUCING OR PROCESSING SOUND OR IMAGES; COMPUTER SOFTWARE FOR PROCESSING DIGITAL MUSIC FILES; GAMEWARE COMPUTER PERIPHERALS; SENSORS FOR MEASURING PROXIMITY; SPECTACLE CASES; APPARATUS AND INSTRUMENTS FOR REPRODUCING, RETRIEVING AND MANIPULATING SOUNDS; MICRO-AMPLIFIERS; SCIENTIFIC, SURVEYING, ELECTRICAL, WIRELESS ELECTRICAL, PHOTOGRAPHIC, CINEMATOGRAPHIC, OPTICAL, WEIGHING AND MEASURING, SIGNALLING, CHECKING, LIFE-SAVING AND TEACHING APPARATUS AND INSTRUMENTS, NAMELY, AMPLIFIERS, COMPUTERS, COMPUTER GAME PROGRAMS; ELECTRONIC AMPLIFIERS DESIGNED FOR PRIVATE INDIVIDUALS AND PROFESSIONALS; PREAMPLIFIERS; AMPLIFIERS FOR MUSICAL INSTRUMENTS, COMPONENT PARTS OF THE AMPLIFIERS SPECIFIED ABOVE, NAMELY, SPARE PARTS AND INTERNAL AND EXTERNAL REPLACEMENT PARTS FOR USING THESE AMPLIFIERS; ALL LOUDSPEAKER UNITS; SPEAKER CABINETS OR CLOSED OR SEMI-CLOSED SPEAKER BOXES; ACTIVE LOUDSPEAKERS; LOUDSPEAKERS, NAMELY, SUBWOOFERS, BASE CABINETS; CONVERTERS AND POWER SUPPLY UNITS; POWER LAMPS; PRE-AMPLIFIER LAMPS; TUBES; AMPLIFIER CONTROL PEDALS, NAMELY, FOOT SWITCHES, CONTROL AND ACCESS FOOT CONTROLS; ELECTRICAL CAPACITORS; ELECTRICAL RESISTANCES; DIODES; TRANSISTORS; ELECTRICAL CABLES AND WIRES; FUSES AND FUSE BOXES; ELECTRICAL APPLIANCES, NAMELY, DIRECT ACTIVE RECORDING BOXES; ELECTRICAL CONVERTERS AND SIGNAL PROCESSING CONVERTERS; CROSSOVER NETS FOR SOUND DEVICES, GALVANIC CELLS; EQUALIZERS; GRAPHIC EQUALIZERS USING TAPES; SOUND MIXERS; MICROPHONES; MICROPHONES; SOUND BOXES, ECHO CHAMBERS IN THE NATURE OF A PART OF THE AMPLIFIER; SOUND EFFECT PEDALS FOR MUSICAL INSTRUMENTS; APPARATUS WITH AUDIO ELECTRONIC EFFECTS; AUDIO MIXING TABLES AND CONSOLES; AUDIO MIXING BOOTHS IN A SOUND RECORDING STUDIO; SOUND ADAPTATION APPARATUS FOR USE WITH MUSICAL INSTRUMENTS; TUNERS AND ELECTRONIC TUNERS FOR MUSICAL INSTRUMENTS; SIMULATION SOFTWARE FOR SOUND EFFECTS AND AMPLIFICATION; COMPUTER SOFTWARE FOR MUSIC SYNTHESIZING; COMPUTER SOFTWARE FOR MANIPULATING DIGITAL AUDIO IN-



David J. Kybas

Director of the United States Patent and Trademark Office

Reg. No. 4,097,560 FORMATION FOR USE IN AUDIO MEDIA APPLICATIONS; ELECTRICAL APPARATUS AND INSTRUMENTS FOR SIGNALLING; APPARATUS FOR PROCESSING, RECORDING AND TRANSMITTING AUDIO SIGNALS; CONTROL APPARATUS FOR AUDIO SIGNALS; DIGITAL SIGNAL PROCESSORS, SOUNDS, TETRAPHONIC AND VOICE DATA SOUNDS SOLD AS UNIT; ELECTRICAL COMPONENTS FOR ELECTRIC GUITARS AND BASSES; MICROPHONES FOR ELECTRIC GUITARS AND BASSES; MICROPHONES AND SENSORS, SIGNAL TRANSMITTERS AND WIRELESS MICROPHONES FOR MUSICAL INSTRUMENTS; TRAINING AND TEACHING APPARATUS AND INSTRUMENTS, NAMELY, EDUCATIONAL SOFTWARE IN THE FIELD OF AUDIO MIXING; INSTRUCTION MANUALS IN THE SHAPE OF COMPUTER PROGRAMS SOLD AS A BUNDLE WITH THE AFOREMENTIONED GOODS; TRAINING MANUALS RECORDED ON COMPUTER MEDIA FEATURING ELECTRONICS; DOWNLOADABLE ELECTRONIC PUBLICATIONS IN THE NATURE OF INSTRUCTION MANUALS IN THE FIELD OF MUSIC AND AUDIO MIXING; ELECTRONIC PUBLICATIONS, NAMELY, ELECTRONIC MAGAZINES IN THE FIELD OF MUSIC RECORDED ON COMPUTER MEDIA; CONTROL PANELS FOR LIGHTING APPARATUS AND INSTRUMENTS; ELECTRICAL APPARATUS AND MONITORING SYSTEM FOR SPECIFY FUNCTION, CONTROLLING AND MONITORING AUDIO FOR USE IN A RECORDING STUDIO; ACOUSTIC AND ELECTRONIC BATTERIES, IN CLASS 9 (U.S. CLS. 21, 23, 26, 36 AND 38).

FOR: ELECTRIC MUSICAL INSTRUMENTS; STRING MUSICAL INSTRUMENTS, IN PARTICULAR ELECTRIC AND ACOUSTIC, CLASSICAL OR FOLK GUITARS AND BASSES; MUSICAL INSTRUMENTS; CORDS FOR MUSICAL INSTRUMENTS; SOUND EFFECTS BELLOWS AND PEDALS FOR MUSICAL INSTRUMENTS; SHOULDER STRAPS AND BELTS FOR GUITARS AND MUSICAL INSTRUMENTS; FRETTED MUSICAL INSTRUMENTS; BANJOS; MANDOLINS; UKULELES; STEEL GUITARS; RESONATOR GUITARS; INSTRUMENTS, GUITARS AND BASSES OF THE SEMI-ACOUSTIC AND ELECTRIC TYPES; PLECTRUMS; GUITAR PICKS; MEDIATORS; CAPOS; KITS FOR TUNING MUSICAL INSTRUMENTS COMPRISING TUNERS FOR MUSICAL INSTRUMENTS; PERCUSSION INSTRUMENTS; CYMBALS; KEYBOARDS AND SYNTHESIZERS WHETHER ANALOGUE, ELECTRICAL OR ELECTRONIC; PIANOS; CASES, BAGS, BOXES AND RACKS TAILOR MADE FOR MUSICAL INSTRUMENTS; PARTS, NAMELY, SPARE PARTS FOR MUSICAL INSTRUMENTS; MUSICAL INSTRUMENTS; ELECTRONIC MUSICAL INSTRUMENTS, MUSIC STANDS; CASES AND BOXES FOR MUSICAL INSTRUMENTS, IN CLASS 15 (U.S. CLS. 2, 21 AND 36).

NO CLAIM IS MADE TO THE EXCLUSIVE RIGHT TO USE "CUSTOM", APART FROM THE MARK AS SHOWN.

OWNER OF INTERNATIONAL REGISTRATION 1008912 DATED 1-28-2009, EXPIRES 1-28-2019.

SER. NO. 79-071,352, FILED 1-28-2009.

PATRICIA EVANKO, EXAMINING ATTORNEY

United States of America
United States Patent and Trademark Office

STIRRR

Reg. No. 4,097,561

Registered Feb. 14, 2012

Int. Cl.: 35

SERVICE MARK

PRINCIPAL REGISTER

STIRRR B.V. (NETHERLANDS BESLOTEN VENNOOTSCHAP)
GEUZENKADE 39-3
NL-1056 KL AMSTERDAM
NETHERLANDS

FOR: BUSINESS ASSISTANCE IN BUSINESS MANAGEMENT REGARDING THE COMMERCIALIZATION OF GOODS AND SERVICES THROUGH THE INTERNET; BUSINESS ADMINISTRATION REGARDING THE SETTLEMENT OF CONTACTS FOR THE SALE AND RENT OF GOODS AND SERVICES THROUGH THE INTERNET; PUBLIC RELATION SERVICES, NAMELY, MEDIATION BY MAKING BUSINESS CONTACTS THROUGH THE INTERNET; DISTRIBUTION OF ADVERTISEMENTS FOR THIRD PARTIES VIA AN ONLINE ELECTRONIC COMMUNICATIONS NETWORK; MEDIATION OF ADVERTISING VIA INTERNET; COMPUTERIZED DATABASE MANAGEMENT VIA INTERNET; ALL THE AFOREMENTIONED SERVICES FOR MEDIATION BETWEEN BUYERS AND SELLERS IN THE FIELD OF ORGANIZING EVENTS, IN CLASS 35 (U.S. CLS. 100, 101 AND 102).

THE MARK CONSISTS OF STANDARD CHARACTERS WITHOUT CLAIM TO ANY PARTICULAR FONT, STYLE, SIZE, OR COLOR.

PRIORITY DATE OF 5-4-2009 IS CLAIMED.

OWNER OF INTERNATIONAL REGISTRATION 1016009 DATED 8-20-2009, EXPIRES 8-20-2019.

SER. NO. 79-073,898, FILED 8-20-2009.

LEIGH LOWRY, EXAMINING ATTORNEY



David J. Kyfos

Director of the United States Patent and Trademark Office

United States of America

United States Patent and Trademark Office

MARINOL

Reg. No. 4,097,562

Registered Feb. 14, 2012

Int. Cls.: 29, 30 and 32

TRADEMARK

PRINCIPAL REGISTER

LIPID NUTRITION B.V. (NETHERLANDS PRIVATE LIMITED COMPANY)
HOGEWEG 1
NL-1521 AZ WORMERVEER
NETHERLANDS

FOR: EDIBLE OILS AND FATS, ALSO IN POWDERED FORM; FATS FOR PREPARATION OF EDIBLE OILS AND FATS; MEAT, FISH, POULTRY AND GAME; MEAT EXTRACTS; PRESERVED, FROZEN, DRIED AND COOKED FRUITS AND VEGETABLES; JELLIES, JAMS, COMPOTES; EGGS, MILK AND MILK PRODUCTS EXCLUDING ICE CREAM, ICE MILK AND FROZEN YOGURT; BROTH AND BROTH PREPARATIONS, SOUPS AND SOUP PREPARATIONS; FOOD SUPPLEMENTS, NOT FOR MEDICAL USE, NOT INCLUDED IN OTHER CLASSES, NAMELY, NUTRITIONAL OILS FOR FOOD PURPOSES, DAIRY-BASED FOOD BEVERAGES, PROTEINS FOR USE AS A FOOD ADDITIVE, IN CLASS 29 (U.S. CL. 46).

FOR: COFFEE, TEA, COCOA, SUGAR, RICE, TAPIOCA, SAGO, ARTIFICIAL COFFEE; FLOUR AND PREPARATIONS MADE FROM CEREALS, NAMELY, BREAKFAST CEREALS, CEREAL BASED SNACK FOODS, READY TO EAT CEREAL DERIVED FOOD BARS, PASTA, PROCESSED CEREALS; BREAD, PASTRY AND CONFECTIONERY, NAMELY, CANDY, SUGAR FREE CANDY, CHOCOLATE AND CANDY BARS; ICES; HONEY, TREACLE; YEAST, BAKING-POWDER; SALT, MUSTARD; VINEGAR, SAUCES; SPICES, ICE; FOOD SUPPLEMENTS, NOT FOR MEDICAL USE, NOT INCLUDED IN OTHER CLASSES, NAMELY, FOOD FLAVORINGS, FOOD ADDITIVES FOR NON-NUTRITIONAL PURPOSES FOR USE AS A FLAVORING, IN CLASS 30 (U.S. CL. 46).

FOR: MINERAL AND AERATED WATERS AND OTHER NON-ALCOHOLIC DRINKS, NAMELY, COLAS, CARBONATED BEVERAGES, LEMONADE, GINGER BEER, GINGER ALE, SODA WATER, NON-ALCOHOLIC COCKTAILS; FRUIT DRINKS AND FRUIT JUICES; SYRUPS AND OTHER PREPARATIONS FOR MAKING BEVERAGES, NAMELY, CONCENTRATES AND MIXES FOR FRUIT DRINKS, IN CLASS 32 (U.S. CLS. 45, 46 AND 48).

THE MARK CONSISTS OF STANDARD CHARACTERS WITHOUT CLAIM TO ANY PARTICULAR FONT, STYLE, SIZE, OR COLOR.

PRIORITY DATE OF 3-10-2009 IS CLAIMED.



David J. Kyjars

Director of the United States Patent and Trademark Office

Reg. No. 4,097,562 OWNER OF INTERNATIONAL REGISTRATION 1016340 DATED 9-10-2009, EXPIRES 9-10-2019.

OWNER OF U.S. REG. NO. 2,296,353.

SER. NO. 79-074,011, FILED 9-10-2009.

DEZMONA MIZELLE, EXAMINING ATTORNEY

United States of America

United States Patent and Trademark Office



Reg. No. 4,097,563

Registered Feb. 14, 2012

**Int. Cls.: 6, 7, 9, 11, 35,
37, 40 and 42**

TRADEMARK

SERVICE MARK

PRINCIPAL REGISTER

SMS GMBH (FED REP GERMANY LIMITED LIABILITY JOINT STOCK COMPANY)
EDUARD-SCHLOEMANN-STRASSE 4
40237 DÜSSELDORF
FED REP GERMANY

FOR: COMMON METALS AND THEIR ALLOYS, NAMELY, CAST IRON, STEEL, COPPER INGOTS, ALUMINUM INGOTS, IRON ALLOYS, STEEL ALLOYS, COPPER ALLOYS AND ALUMINUM ALLOYS; METAL BUILDING MATERIALS, NAMELY, STRUCTURAL STEELS, SHEET PILING, SECTIONAL BEAMS AND PIPES MADE OF METAL; NON-ELECTRIC CABLES AND WIRES OF COMMON METAL; PIPES AND TUBES OF METAL, IN CLASS 6 (U.S. CLS. 2, 12, 13, 14, 23, 25 AND 50).

FOR: MACHINES FOR THE TREATMENT, PROCESSING, AND PRODUCTION OF METALS AND PLASTICS, NAMELY, MILLING MACHINES AND GRINDING MACHINES, AND MACHINES UTILIZING ROTATIONAL MOTION FOR HIGH ENERGY SURFACE FINISHING AND MATERIAL TREATMENT, IN PARTICULAR, HEAVY, MEDIUM AND LIGHT SECTION ROLLING MILLS, COLD AND HOT MILLS, STRIP AND WIDE STRIP MILLS, PLATE AND SHEET MILLS, BLOOMING, SLABBING AND BILLET MILLS, UNIVERSAL MILLS, PLANETARY MILLS, MULTI-PURPOSE COLD MILLS, ROD, BAR AND TUBE MILLS, CONTINUOUS MILLS, REVERSING MILLS, PILGRIM MILLS, DETACHING MILLS AND MILLS FOR THE ROLLING OF STEEL, IRON, ALUMINUM AND COPPER OR FOR THE ROLLING OF ALLOYS OF THE SAME, AND STRUCTURAL PARTS FOR THE AFOREMENTIONED ROLLING MILLS; ROLLING MILLS FOR WIRE, STEEL ROD ROLLING MILLS, BLOOM ROLLING MILLS, RAIL ROLLING MILLS, AND SECTION ROLLING MILLS, WIRE DRAWING MACHINES, WIRE RING PRESSES, WIRE REELING MACHINES; MACHINES FOR MANUFACTURING, PROCESSING AND WORKING SEAMLESS AND WELDED METAL PIPES, NAMELY, PIPE EXPANDING MACHINES, LARGE PIPE MANUFACTURING MACHINES, HOT AND COLD PIPE ROLLING MILLS, PRESSES, IN PARTICULAR, EXTRUSION PRESSES, IMPACT EXTRUSION, COLD EXTRUSION AND BACK-FLOW EXTRUSION PRESSES, CABLE SHEATHING PRESSES, STRAIGHTENING AND BENDING PRESSES, PLATE SHAPING PRESSES, DEEP-DRAWING PRESSES, MULTI-STAGE PRESSES, HYDRAULIC METAL POWDER PRESSES, AND STRUCTURAL PARTS THEREFOR; FORGING MACHINES, IN PARTICULAR, OPEN-DIE FORGING MACHINES, AUTOMATIC FORGING HAMMERS, FORGING PRESSES, PIERCING PRESSES AND COUNTER BLOW HAMMERS, AND STRUCTURAL PARTS FOR THE AFOREMENTIONED FORGING MACHINES; CASTING MACHINES, IN PARTICULAR, CONTINUOUS STEEL SLAB CASTING MACHINES AND MACHINES FOR THE CONTINUOUS CASTING OF METALS, PLASTIC EXTRUSION



David J. Kybas

Director of the United States Patent and Trademark Office

Reg. No. 4,097,563 AND PLASTIC MOLDING MACHINES, AND STRUCTURAL PARTS FOR THE AFOREMENTIONED CASTING MACHINES; ELECTRICITY GENERATORS, NAMELY, POWER GENERATION MACHINES FOR ROLLING, PRESSING, FORGING AND CASTING INSTALLATIONS; HYDRAULIC DRIVING MACHINES; SUPPORTING CHAIN CONVEYORS AND HOISTS, ROLLER TABLES, TILTERS, SCALE WASHERS, AND CLEANING MACHINES FOR CLEANING ROLLER CONVEYORS; CONVEYORS FOR THE CONVEYING OF ROLLED, PRESSED, FORGED AND CAST ARTICLES TO AND FROM ROLLING, PRESSING, FORGING AND CASTING INSTALLATIONS; ELECTRIC WELDING MACHINES, IN PARTICULAR, PIPE WELDING MACHINES, BUTT-WELDING MACHINES; CUTTING MACHINES, IN PARTICULAR, PIPE BLADES, FLAME CUTTING MACHINES; HOISTS, CONVEYORS AND LOADING MACHINES FOR FILLING BLAST FURNACES WITH IRON ORE, COKE AND LIMESTONE AND EMPTYING IRON AND SLAG FROM BLAST FURNACES; MACHINES FOR TILTING, PIVOTING, AND MOVING CONVERTERS AND LADLES, ALL OF THE ABOVE MENTIONED MACHINES FOR THE TREATMENT, PROCESSING AND PRODUCTION OF METALS AND PLASTICS; MACHINES FOR THE CHEMICAL INDUSTRY, NAMELY, CHEMICAL FIBER DRYING MACHINES, EXTRACTING MACHINES FOR CHEMICAL PROCESSING; MACHINES FOR AGRICULTURE, NAMELY, COMBINES, HARVESTERS, THRESHERS, AND POWER TILLERS; MACHINES FOR MINING, IN PARTICULAR, EXCAVATORS, CUTTERS, EARTH AND MINING WASTE MOVERS, ORELOADERS, CUTTERS AND CONVEYORS; MACHINES FOR OPERATING MINING SHAFTS, NAMELY, HOISTS, LOADING SKIPS, WINDLASSES, AND INCLINED CONVEYORS; MACHINES FOR MINING, NAMELY, WINDING ENGINES; MACHINES FOR MINING, NAMELY, WINDING TOWERS; MACHINES FOR MINING, NAMELY, HEAD FRAMES POSITIONED OVER A MINE SHAFT FOR SUPPORTING HOISTS FOR MINING, BUCKET CONVEYORS, CONVEYOR BELTS, MINE CAR FILLERS AND UNLOADING MACHINES; HYDRAULIC AND PNEUMATIC CONVEYORS AND SOLIDS TRANSPORTERS; PIPELINE CONVEYORS; WASTE DISPOSAL COMMINUTERS, CONVEYORS, LEAD-LINED HOISTS AND CONVEYORS FOR LOADING CONTAINERS WITH RADIO-ACTIVE WASTE, TRANSPORTERS FOR RADIOACTIVE WASTE CONTAINERS; METAL COIL HANDLERS, NAMELY, METAL COIL WINDERS, METAL COIL CONVEYORS, METAL COIL PACKAGERS, METAL COIL STACKERS; CRANES, HOISTS AND CLAMPS AND STRUCTURAL PARTS THEREOF; MACHINE TOOLS FOR THE STEEL MILL INDUSTRY, NAMELY, GRINDING MACHINES; MACHINES FOR USE IN THE REPLACEMENT OF ROLLING MILLS USED FOR ROLLING METAL; MOTORS AND ENGINES EXCEPT FOR LAND VEHICLES, NAMELY, ELECTRIC MOTORS OR ELECTRIC GEAR MOTORS FOR MACHINES; MACHINE COUPLING AND TRANSMISSION COMPONENTS, NAMELY, HYDRAULIC AND MECHANICAL TRANSMISSIONS FOR MACHINERY AND STRUCTURAL PARTS THEREFOR; SPECIFICALLY EXCLUDING MACHINE TOOLS, NAMELY, SYSTEMS OF NITROGEN GAS SPRINGS, PNEUMATIC CYLINDERS, DELAY CYLINDERS, CONTROLLED RETURN CYLINDERS, CAMS OR OTHER FLUID POWER PRODUCTS AND ACCESSORIES SUCH AS SURGE TANKS, CONTROL PANELS, PRESSURE MONITORS, SPECIALTY DELAY CYLINDERS, ACCUMULATORS, FITTINGS, HOSE, TUBING, SWITCHES, MOUNTS, RISERS, PARALLELS AND OTHER COMPONENTS MOUNTED TO A PLATE OR MANIFOLD PLATE AND COMPONENTS THEREOF FOR USE IN METAL STAMPING, METAL WORKING, PLASTIC MOLDING, PUNCHING, COINING, SHEARING, SPECIALTY MACHINES, AND AUTOMOTIVE APPLICATIONS, IN CLASS 7 (U.S. CLS. 13, 19, 21, 23, 31, 34 AND 35).

FOR: WEIGHING, MEASURING, SIGNALING, AND CHECKING APPARATUS AND INSTRUMENTS FOR CONDUCTING, SWITCHING, TRANSFORMING, ACCUMULATING, REGULATING OR CONTROLLING ELECTRICITY, NAMELY, STRIP TENSION DYNAMOMETERS, STRIP FLATNESS METERS, THERMOMETERS, SPEEDOMETERS, PRESSURE GAUGES, ANGLE GAUGES, DISTANCE METERS, ROUGHNESS GAUGES, AND ELECTRIC AND ELECTRONIC CONTROLLERS FOR MACHINES IN THE NATURE OF FLATNESS CONTROLLERS, ROUGHNESS CONTROLLERS, PRESSURE CONTROLLERS AND TENSIONING CONTROLLERS FOR INFLUENCING THE PROPERTIES OF ROLLED STEEL; ELECTRONIC CONTROL PANELS FOR ROLLING MILLS, ELECTRICAL AND MAGNETIC DETECTORS FOR MONITORING THE PROPERTIES OF ROLLED STEEL; FREQUENCY METERS; CALCULATING MACHINES; DATA PROCESSORS, AND COMPUTERS FOR USE IN OPERATING

Reg. No. 4,097,563 AND CONTROLLING OPERATIONS OF METALLURGICAL PLANTS AND ROLLING MILLS; PRERECORDED MAGNETIC DATA CARRIERS FEATURING COMPUTER APPLICATION SOFTWARE FOR CONTROLLING AND REGULATING MACHINES AND MACHINE TOOLS FOR THE METAL INDUSTRY; COMPUTERS FEATURING PROGRAMS FOR CONTROLLING ROLLING MILLS, FURNACE PLANTS, CONTINUOUS CASTING MACHINES; COMPUTER PROGRAMS FOR CONTROLLING AND REGULATING MACHINES FOR THE METALLURGICAL INDUSTRY, MACHINES FOR THE STEEL INDUSTRY, CONTINUOUS CASTING MACHINES, ROLLING MACHINES, FORGING MACHINES, PRESSING MACHINES AND MACHINES FOR PROCESSING SYNTHETIC MATERIALS, IN CLASS 9 (U.S. CLS. 21, 23, 26, 36 AND 38).

FOR: APPARATUS FOR HEATING, STEAM GENERATING, COOKING, REFRIGERATING, DRYING, VENTILATING, AND WATER SUPPLY PURPOSES, NAMELY, FURNACES FOR METALLURGICAL PLANTS, STEEL MILLS, CONTINUOUS CASTING PLANTS, AND FORGING AND PRESSING PLANTS; INDUSTRIAL WATER RECIRCULATION COOLING AND HEATING SYSTEMS FOR ROLLING, PRESSING, FORGING AND CASTING INSTALLATIONS, COMPRISING FURNACES, COOLING TOWERS, COOLING FANS, HEAT INSULATION, WATER ROLL COOLERS, STRIP PREHEATERS, SPRAY WATER COOLING SECTIONS SPRAYERS, AND SLAB COOLING WHEELS; OIL AND WATER TREATMENT, COOLING, AND PURIFYING SYSTEMS FOR ROLLING, PRESSING, FORGING AND CASTING INSTALLATIONS IN THE METALLURGICAL AND STEEL MILL INDUSTRIES, COMPRISING SEPARATORS FOR THE CLEANING AND PURIFICATION OF LIQUIDS, WATER SEPARATORS, WATER FILTERS, COOLANT PURIFYING DEVICES, WATER NEUTRALIZATION PLANTS, AND WASHING BRUSHING MACHINES; APPARATUS FOR HEATING, NAMELY, WATER HEATERS FOR INDUSTRIAL PURPOSES, HEAT SINKS FOR USE IN INDUSTRIAL HEATING APPARATUS, ELECTRIC HEATING PANELS USED FOR INDOOR HEATING PURPOSES; ELECTRIC HEATERS AND FURNACES FOR ROLLING STOCK, NAMELY, FOR ROLLING METAL PRODUCTS SUBJECT TO ROLLING IN A ROLLING MILL, AND FOR CONTINUOUS CASTING PLANTS; STEAM GENERATORS; REFRIGERATED MERCHANDISE DISPLAY CASES; AIR COOLING APPARATUS FOR USE IN THE METALLURGICAL AND STEEL MILL INDUSTRIES IN THE NATURE OF DEVICES FOR COOLING THE ENVIRONMENT IN AN INDUSTRIAL SETTING; VENTILATING AND DRYING FANS FOR COMMERCIAL AND INDUSTRIAL USE; VENTILATING LOUVERS; COOLING WATER CIRCUIT INSTALLATIONS, NAMELY, WATER COOLING TOWERS; AIR COOLERS FOR METALLURGICAL PLANTS, STEEL MILLS, CONTINUOUS CASTING PLANTS, ROLLING MILLS, AND FORGING AND PRESSING PLANTS; SMELTING MACHINES; INDUSTRIAL AIR FILTER MACHINES FOR USE WITH ROLLING, PRESSING, FORGING, AND CASTING INSTALLATIONS, IN CLASS 11 (U.S. CLS. 13, 21, 23, 31 AND 34).

FOR: ADVERTISING SERVICES; BUSINESS MANAGEMENT CONSULTANCY; BUSINESS ADMINISTRATION; PROVIDING OFFICE FUNCTIONS, IN CLASS 35 (U.S. CLS. 100, 101 AND 102).

FOR: INSTALLATION AND REPAIR OF INDUSTRIAL AND MACHINERY SYSTEMS, NAMELY, MACHINES FOR THE METALLURGICAL INDUSTRY, MACHINES FOR THE STEEL MILL INDUSTRY, CONTINUOUS CASTING MACHINES, ROLLING MACHINES FOR THE ROLLING OF METALS, FORGING MACHINES, PRESSES FOR METALS, MACHINES FOR THE WORKING AND PROCESSING OF PLASTICS, MACHINE TOOLS, ENGINES AND MOTORS, EXCEPT ENGINES FOR LAND VEHICLES, CLUTCHES AND COUPLINGS AND DEVICES FOR POWER TRANSFER, EXCEPT FOR LAND VEHICLES, IN CLASS 37 (U.S. CLS. 100, 103 AND 106).

FOR: TREATMENT OF MATERIALS, NAMELY, METAL TREATING, ROLLING, FORGING, GRINDING, PARTS MOLDING, SWAGING, TEMPERING, CASTING, MILLING, PLANING, COATING, CUTTING, TURNING, SURFACE REFINING BY ABRASION, AND PLATING OF METALS TO THE ORDER AND SPECIFICATION OF OTHERS, IN CLASS 40 (U.S. CLS. 100, 103 AND 106).

Reg. No. 4,097,563 FOR: SCIENTIFIC RESEARCH IN THE FIELD OF THE TREATMENT, PROCESSING, AND PRODUCTION OF METALS AND PLASTICS; TECHNOLOGICAL CONSULTING SERVICES IN THE FIELD OF THE TREATMENT, PROCESSING, AND PRODUCTION OF METALS AND PLASTICS; DESIGN AND DEVELOPMENT OF COMPUTERS AND COMPUTER SOFTWARE FOR OTHERS; TECHNICAL CONSULTANCY IN RELATION TO THE OPERATION OF MACHINES FOR THE METALLURGICAL INDUSTRY, MACHINES FOR THE STEEL MILL INDUSTRY, CONTINUOUS CASTING PLANTS, ROLLING MACHINES, FORGING MACHINES, PRESSING MACHINES, TECHNICAL CONSULTANCY FOR THE METALLURGICAL INDUSTRY REGARDING TESTING, ANALYSIS AND EVALUATION OF MACHINERY FOR THE STEEL MILL INDUSTRY, INCLUDING CONTINUOUS CASTING PLANTS, ROLLING MACHINES, FORGING MACHINES, PRESSING MACHINES, IN CLASS 42 (U.S. CLS. 100 AND 101).

OWNER OF U.S. REG. NOS. 1,330,533, 3,913,201 AND OTHERS.

PRIORITY DATE OF 4-7-2009 IS CLAIMED.

OWNER OF INTERNATIONAL REGISTRATION 1019417 DATED 9-29-2009, EXPIRES 9-29-2019.

THE COLOR(S) BLACK, RED, AND BLUE IS/ARE CLAIMED AS A FEATURE OF THE MARK.

NO CLAIM IS MADE TO THE EXCLUSIVE RIGHT TO USE "GROUP" , APART FROM THE MARK AS SHOWN.

THE MARK CONSISTS OF THE WORDING "SMS GROUP" IN A BLACK STYLIZED FONT. BETWEEN THE WORDING "SMS" AND "GROUP" IS A DESIGN OF A BLACK, SOLID CIRCLE WITHIN A LARGER, INCOMPLETE RED CIRCLE, WHICH IS IN TURN WITHIN A LARGER, INCOMPLETE BLUE CIRCLE, WHICH IS IN TURN WITHIN A LARGER, INCOMPLETE RED CIRCLE. THE COLOR WHITE REPRESENTS BACKGROUND AND TRANSPARENT AREAS AND IS NOT PART OF THE MARK.

SER. NO. 79-075,360, FILED 9-29-2009.

JAMES MACFARLANE, EXAMINING ATTORNEY

United States of America

United States Patent and Trademark Office

SMS group

Reg. No. 4,097,564

Registered Feb. 14, 2012

**Int. Cls.: 6, 7, 9, 11, 35,
37, 40 and 42**

TRADEMARK

SERVICE MARK

PRINCIPAL REGISTER

SMS GMBH (FED REP GERMANY LIMITED LIABILITY JOINT STOCK COMPANY)
EDUARD-SCHLOEMANN-STRASSE 4
40237 DÜSSELDORF
FED REP GERMANY

FOR: COMMON METALS AND THEIR ALLOYS, NAMELY, CAST IRON, STEEL, COPPER INGOTS, ALUMINUM INGOTS, IRON ALLOYS, STEEL ALLOYS, COPPER ALLOYS AND ALUMINUM ALLOYS; METAL BUILDING MATERIALS, NAMELY, STRUCTURAL STEELS, SHEET PILING, SECTIONAL BEAMS AND PIPES MADE OF METAL; NON-ELECTRIC CABLES AND WIRES OF COMMON METAL; PIPES AND TUBES OF METAL, IN CLASS 6 (U.S. CLS. 2, 12, 13, 14, 23, 25 AND 50).

FOR: MACHINES FOR THE TREATMENT, PROCESSING, AND PRODUCTION OF METALS AND PLASTICS, NAMELY, MILLING MACHINES AND GRINDING MACHINES, AND MACHINES UTILIZING ROTATIONAL MOTION FOR HIGH ENERGY SURFACE FINISHING AND MATERIAL TREATMENT, IN PARTICULAR, HEAVY, MEDIUM AND LIGHT SECTION ROLLING MILLS, COLD AND HOT MILLS, STRIP AND WIDE STRIP MILLS, PLATE AND SHEET MILLS, BLOOMING, SLABBING AND BILLET MILLS, UNIVERSAL MILLS, PLANETARY MILLS, MULTI-PURPOSE COLD MILLS, ROD, BAR AND TUBE MILLS, CONTINUOUS MILLS, REVERSING MILLS, PILGRIM MILLS, DETACHING MILLS AND MILLS FOR THE ROLLING OF STEEL, IRON, ALUMINUM AND COPPER OR FOR THE ROLLING OF ALLOYS OF THE SAME, AND STRUCTURAL PARTS FOR THE AFOREMENTIONED ROLLING MILLS; ROLLING MILLS FOR WIRE, STEEL ROD ROLLING MILLS, BLOOM ROLLING MILLS, RAIL ROLLING MILLS, AND SECTION ROLLING MILLS, WIRE DRAWING MACHINES, WIRE RING PRESSES, WIRE REELING MACHINES; MACHINES FOR MANUFACTURING, PROCESSING AND WORKING SEAMLESS AND WELDED METAL PIPES, NAMELY, PIPE EXPANDING MACHINES, LARGE PIPE MANUFACTURING MACHINES, HOT AND COLD PIPE ROLLING MILLS, PRESSES, IN PARTICULAR, EXTRUSION PRESSES, IMPACT EXTRUSION, COLD EXTRUSION AND BACK-FLOW EXTRUSION PRESSES, CABLE SHEATHING PRESSES, STRAIGHTENING AND BENDING PRESSES, PLATE SHAPING PRESSES, DEEP-DRAWING PRESSES, MULTI-STAGE PRESSES, HYDRAULIC METAL POWDER PRESSES, AND STRUCTURAL PARTS THEREFOR; FORGING MACHINES, IN PARTICULAR, OPEN-DIE FORGING MACHINES, AUTOMATIC FORGING HAMMERS, FORGING PRESSES, PIERCING PRESSES AND COUNTER BLOW HAMMERS, AND STRUCTURAL PARTS FOR THE AFOREMENTIONED FORGING MACHINES; CASTING MACHINES, IN PARTICULAR, CONTINUOUS STEEL SLAB CASTING MACHINES AND MACHINES FOR THE CONTINUOUS CASTING OF METALS, PLASTIC EXTRUSION



David J. Kybas

Director of the United States Patent and Trademark Office

Reg. No. 4,097,564 AND PLASTIC MOLDING MACHINES, AND STRUCTURAL PARTS FOR THE AFOREMENTIONED CASTING MACHINES; ELECTRICITY GENERATORS, NAMELY, POWER GENERATION MACHINES FOR ROLLING, PRESSING, FORGING AND CASTING INSTALLATIONS; HYDRAULIC DRIVING MACHINES; SUPPORTING CHAIN CONVEYORS AND HOISTS, ROLLER TABLES, TILTERS, SCALE WASHERS, AND CLEANING MACHINES FOR CLEANING ROLLER CONVEYORS; CONVEYORS FOR THE CONVEYING OF ROLLED, PRESSED, FORGED AND CAST ARTICLES TO AND FROM ROLLING, PRESSING, FORGING AND CASTING INSTALLATIONS; ELECTRIC WELDING MACHINES, IN PARTICULAR, PIPE WELDING MACHINES, BUTT-WELDING MACHINES; CUTTING MACHINES, IN PARTICULAR, PIPE BLADES, FLAME CUTTING MACHINES; HOISTS, CONVEYORS AND LOADING MACHINES FOR FILLING BLAST FURNACES WITH IRON ORE, COKE AND LIMESTONE AND EMPTYING IRON AND SLAG FROM BLAST FURNACES; MACHINES FOR TILTING, PIVOTING, AND MOVING CONVERTERS AND LADLES, ALL OF THE ABOVE MENTIONED MACHINES FOR THE TREATMENT, PROCESSING AND PRODUCTION OF METALS AND PLASTICS; MACHINES FOR THE CHEMICAL INDUSTRY, NAMELY, CHEMICAL FIBER DRYING MACHINES, EXTRACTING MACHINES FOR CHEMICAL PROCESSING; MACHINES FOR AGRICULTURE, NAMELY, COMBINES, HARVESTERS, THRESHERS, AND POWER TILLERS; MACHINES FOR MINING, IN PARTICULAR, EXCAVATORS, CUTTERS, EARTH AND MINING WASTE MOVERS, ORELOADERS, CUTTERS AND CONVEYORS; MACHINES FOR OPERATING MINING SHAFTS, NAMELY, HOISTS, LOADING SKIPS, WINDLASSES, AND INCLINED CONVEYORS; MACHINES FOR MINING, NAMELY, WINDING ENGINES; MACHINES FOR MINING, NAMELY, WINDING TOWERS; MACHINES FOR MINING, NAMELY, HEAD FRAMES POSITIONED OVER A MINE SHAFT FOR SUPPORTING HOISTS FOR MINING, BUCKET CONVEYORS, CONVEYOR BELTS, MINE CAR FILLERS AND UNLOADING MACHINES; HYDRAULIC AND PNEUMATIC CONVEYORS AND SOLIDS TRANSPORTERS; PIPELINE CONVEYORS; WASTE DISPOSAL COMMINUTERS, CONVEYORS, LEAD-LINED HOISTS AND CONVEYORS FOR LOADING CONTAINERS WITH RADIO-ACTIVE WASTE, TRANSPORTERS FOR RADIOACTIVE WASTE CONTAINERS; METAL COIL HANDLERS, NAMELY, METAL COIL WINDERS, METAL COIL CONVEYORS, METAL COIL PACKAGERS, METAL COIL STACKERS; CRANES, HOISTS AND CLAMPS AND STRUCTURAL PARTS THEREOF; MACHINE TOOLS FOR THE STEEL MILL INDUSTRY, NAMELY, GRINDING MACHINES; MACHINES FOR USE IN THE REPLACEMENT OF ROLLING MILLS USED FOR ROLLING METAL; MOTORS AND ENGINES EXCEPT FOR LAND VEHICLES, NAMELY, ELECTRIC MOTORS OR ELECTRIC GEAR MOTORS FOR MACHINES; MACHINE COUPLING AND TRANSMISSION COMPONENTS, NAMELY, HYDRAULIC AND MECHANICAL TRANSMISSIONS FOR MACHINERY AND STRUCTURAL PARTS THEREFOR; SPECIFICALLY EXCLUDING MACHINE TOOLS, NAMELY, SYSTEMS OF NITROGEN GAS SPRINGS, PNEUMATIC CYLINDERS, DELAY CYLINDERS, CONTROLLED RETURN CYLINDERS, CAMS OR OTHER FLUID POWER PRODUCTS AND ACCESSORIES SUCH AS SURGE TANKS, CONTROL PANELS, PRESSURE MONITORS, SPECIALTY DELAY CYLINDERS, ACCUMULATORS, FITTINGS, HOSE, TUBING, SWITCHES, MOUNTS, RISERS, PARALLELS AND OTHER COMPONENTS MOUNTED TO A PLATE OR MANIFOLD PLATE AND COMPONENTS THEREOF FOR USE IN METAL STAMPING, METAL WORKING, PLASTIC MOLDING, PUNCHING, COINING, SHEARING, SPECIALTY MACHINES, AND AUTOMOTIVE APPLICATIONS, IN CLASS 7 (U.S. CLS. 13, 19, 21, 23, 31, 34 AND 35).

FOR: WEIGHING, MEASURING, SIGNALING, AND CHECKING APPARATUS AND INSTRUMENTS FOR CONDUCTING, SWITCHING, TRANSFORMING, ACCUMULATING, REGULATING OR CONTROLLING ELECTRICITY, NAMELY, STRIP TENSION DYNAMOMETERS, STRIP FLATNESS METERS, THERMOMETERS, SPEEDOMETERS, PRESSURE GAUGES, ANGLE GAUGES, DISTANCE METERS, ROUGHNESS GAUGES, AND ELECTRIC AND ELECTRONIC CONTROLLERS FOR MACHINES IN THE NATURE OF FLATNESS CONTROLLERS, ROUGHNESS CONTROLLERS, PRESSURE CONTROLLERS AND TENSIONING CONTROLLERS FOR INFLUENCING THE PROPERTIES OF ROLLED STEEL; ELECTRONIC CONTROL PANELS FOR ROLLING MILLS, ELECTRICAL AND MAGNETIC DETECTORS FOR MONITORING THE PROPERTIES OF ROLLED STEEL; FREQUENCY METERS; CALCULATING MACHINES; DATA PROCESSORS, AND COMPUTERS FOR USE IN OPERATING

Reg. No. 4,097,564 AND CONTROLLING OPERATIONS OF METALLURGICAL PLANTS AND ROLLING MILLS; PRERECORDED MAGNETIC DATA CARRIERS FEATURING COMPUTER APPLICATION SOFTWARE FOR CONTROLLING AND REGULATING MACHINES AND MACHINE TOOLS FOR THE METAL INDUSTRY; COMPUTERS FEATURING PROGRAMS FOR CONTROLLING ROLLING MILLS, FURNACE PLANTS, CONTINUOUS CASTING MACHINES; COMPUTER PROGRAMS FOR CONTROLLING AND REGULATING MACHINES FOR THE METALLURGICAL INDUSTRY, MACHINES FOR THE STEEL INDUSTRY, CONTINUOUS CASTING MACHINES, ROLLING MACHINES, FORGING MACHINES, PRESSING MACHINES AND MACHINES FOR PROCESSING SYNTHETIC MATERIALS, IN CLASS 9 (U.S. CLS. 21, 23, 26, 36 AND 38).

FOR: APPARATUS FOR HEATING, STEAM GENERATING, COOKING, REFRIGERATING, DRYING, VENTILATING, AND WATER SUPPLY PURPOSES, NAMELY, FURNACES FOR METALLURGICAL PLANTS, STEEL MILLS, CONTINUOUS CASTING PLANTS, AND FORGING AND PRESSING PLANTS; INDUSTRIAL WATER RECIRCULATION COOLING AND HEATING SYSTEMS FOR ROLLING, PRESSING, FORGING AND CASTING INSTALLATIONS, COMPRISING FURNACES, COOLING TOWERS, COOLING FANS, HEAT INSULATION, WATER ROLL COOLERS, STRIP PREHEATERS, SPRAY WATER COOLING SECTIONS SPRAYERS, AND SLAB COOLING WHEELS; OIL AND WATER TREATMENT, COOLING, AND PURIFYING SYSTEMS FOR ROLLING, PRESSING, FORGING AND CASTING INSTALLATIONS IN THE METALLURGICAL AND STEEL MILL INDUSTRIES, COMPRISING SEPARATORS FOR THE CLEANING AND PURIFICATION OF LIQUIDS, WATER SEPARATORS, WATER FILTERS, COOLANT PURIFYING DEVICES, WATER NEUTRALIZATION PLANTS, AND WASHING BRUSHING MACHINES; APPARATUS FOR HEATING, NAMELY, WATER HEATERS FOR INDUSTRIAL PURPOSES, HEAT SINKS FOR USE IN INDUSTRIAL HEATING APPARATUS, ELECTRIC HEATING PANELS USED FOR INDOOR HEATING PURPOSES; ELECTRIC HEATERS AND FURNACES FOR ROLLING STOCK, NAMELY, FOR ROLLING METAL PRODUCTS SUBJECT TO ROLLING IN A ROLLING MILL, AND FOR CONTINUOUS CASTING PLANTS; STEAM GENERATORS; REFRIGERATED MERCHANDISE DISPLAY CASES; AIR COOLING APPARATUS FOR USE IN THE METALLURGICAL AND STEEL MILL INDUSTRIES IN THE NATURE OF DEVICES FOR COOLING THE ENVIRONMENT IN AN INDUSTRIAL SETTING; VENTILATING AND DRYING FANS FOR COMMERCIAL AND INDUSTRIAL USE; VENTILATING LOUVERS; COOLING WATER CIRCUIT INSTALLATIONS, NAMELY, WATER COOLING TOWERS; AIR COOLERS FOR METALLURGICAL PLANTS, STEEL MILLS, CONTINUOUS CASTING PLANTS, ROLLING MILLS, AND FORGING AND PRESSING PLANTS; SMELTING MACHINES; INDUSTRIAL AIR FILTER MACHINES FOR USE WITH ROLLING, PRESSING, FORGING, AND CASTING INSTALLATIONS, IN CLASS 11 (U.S. CLS. 13, 21, 23, 31 AND 34).

FOR: ADVERTISING SERVICES; BUSINESS MANAGEMENT CONSULTANCY; BUSINESS ADMINISTRATION; PROVIDING OFFICE FUNCTIONS, IN CLASS 35 (U.S. CLS. 100, 101 AND 102).

FOR: INSTALLATION AND REPAIR OF INDUSTRIAL AND MACHINERY SYSTEMS, NAMELY, MACHINES FOR THE METALLURGICAL INDUSTRY, MACHINES FOR THE STEEL MILL INDUSTRY, CONTINUOUS CASTING MACHINES, ROLLING MACHINES FOR THE ROLLING OF METALS, FORGING MACHINES, PRESSES FOR METALS, MACHINES FOR THE WORKING AND PROCESSING OF PLASTICS, MACHINE TOOLS, ENGINES AND MOTORS, EXCEPT ENGINES FOR LAND VEHICLES, CLUTCHES AND COUPLINGS AND DEVICES FOR POWER TRANSFER, EXCEPT FOR LAND VEHICLES, IN CLASS 37 (U.S. CLS. 100, 103 AND 106).

FOR: TREATMENT OF MATERIALS, NAMELY, METAL TREATING, ROLLING, FORGING, GRINDING, PARTS MOLDING, SWAGING, TEMPERING, CASTING, MILLING, PLANING, COATING, CUTTING, TURNING, SURFACE REFINING BY ABRASION, AND PLATING OF METALS TO THE ORDER AND SPECIFICATION OF OTHERS, IN CLASS 40 (U.S. CLS. 100, 103 AND 106).

Reg. No. 4,097,564 FOR: SCIENTIFIC RESEARCH IN THE FIELD OF THE TREATMENT, PROCESSING, AND PRODUCTION OF METALS AND PLASTICS; TECHNOLOGICAL CONSULTING SERVICES IN THE FIELD OF THE TREATMENT, PROCESSING, AND PRODUCTION OF METALS AND PLASTICS; DESIGN AND DEVELOPMENT OF COMPUTERS AND COMPUTER SOFTWARE FOR OTHERS; TECHNICAL CONSULTANCY IN RELATION TO THE OPERATION OF MACHINES FOR THE METALLURGICAL INDUSTRY, MACHINES FOR THE STEEL MILL INDUSTRY, CONTINUOUS CASTING PLANTS, ROLLING MACHINES, FORGING MACHINES, PRESSING MACHINES, TECHNICAL CONSULTANCY FOR THE METALLURGICAL INDUSTRY REGARDING TESTING, ANALYSIS AND EVALUATION OF MACHINERY FOR THE STEEL MILL INDUSTRY, INCLUDING CONTINUOUS CASTING PLANTS, ROLLING MACHINES, FORGING MACHINES, PRESSING MACHINES, IN CLASS 42 (U.S. CLS. 100 AND 101).

OWNER OF U.S. REG. NOS. 1,330,533, 3,913,201 AND OTHERS.

PRIORITY DATE OF 4-7-2009 IS CLAIMED.

OWNER OF INTERNATIONAL REGISTRATION 1019581 DATED 9-29-2009, EXPIRES 9-29-2019.

NO CLAIM IS MADE TO THE EXCLUSIVE RIGHT TO USE "GROUP" , APART FROM THE MARK AS SHOWN.

THE MARK CONSISTS OF THE WORDING "SMS GROUP" IN STYLIZED FONT. BETWEEN THE WORDING "SMS" AND "GROUP" IS A DESIGN OF A SOLID CIRCLE WITHIN A LARGER, INCOMPLETE CIRCLE, WHICH IS IN TURN WITHIN A LARGER, INCOMPLETE CIRCLE, WHICH IS IN TURN WITHIN A LARGER, INCOMPLETE CIRCLE.

SER. NO. 79-075,413, FILED 9-29-2009.

JAMES MACFARLANE, EXAMINING ATTORNEY

United States of America

United States Patent and Trademark Office

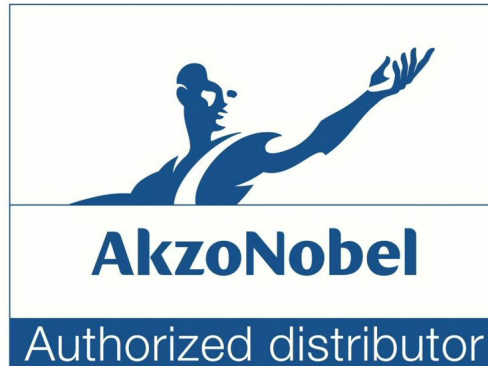

Reg. No. 4,097,565

Registered Feb. 14, 2012

**Int. Cls.: 1, 2, 3, 4, 5, 7,
9, 16, 17, 19, 30, 37, 40,
41 and 42**

TRADEMARK

SERVICE MARK

PRINCIPAL REGISTER

AKZO NOBEL N.V. (NETHERLANDS CORPORATION)
VELPERWEG 76
NL-6824 BM ARNHEM, NETHERLANDS

FOR: CHEMICALS FOR INDUSTRIAL, PHOTOGRAPHIC AND SCIENTIFIC PURPOSES, AS WELL AS FOR AGRICULTURAL, HORTICULTURAL AND FORESTRY PURPOSES, EXCEPT FUNGICIDES, HERBICIDES, INSECTICIDES AND PARASITICIDES; CHEMICAL ADDITIVES FOR FUNGICIDES, HERBICIDES, INSECTICIDES AND PARASITICIDES; SURFACTANTS FOR INDUSTRIAL USE, NAMELY, FOR USE IN TEXTILE TREATMENT PRODUCTS, TEXTILE CARE PRODUCTS, ORGANOCCLAYS, AGROCHEMICALS, OIL FIELD OPERATIONS, INDUSTRIAL CLEANING PRODUCTS, INSTITUTIONAL CLEANING PRODUCTS, HOUSEHOLD CLEANING PRODUCTS, PIGMENTS, PERSONAL CARE PRODUCTS, EMULSION POLYMERIZATION, SYSTEMS FOR ROAD PAVING, AND FLOTATION AGENTS FOR PURIFICATION OF MINERALS; SYNTHETIC RESINS AS RAW MATERIALS; DETERGENTS FOR INDUSTRIAL USE; WETTING AGENTS; CHEMICAL PRODUCTS FOR CLARIFYING COLORS AND DYES FOR INDUSTRIAL USE; CHEMICAL WETTING AGENTS; CHEMICAL PREPARATIONS FOR OIL PIGMENTS FOR INDUSTRIAL USE; CHEMICAL REAGENTS FOR USE IN THE MANUFACTURE OF CHEMICAL PRODUCTS AND FOR USE IN SCIENTIFIC RESEARCH; CHEMICAL PRODUCTS FOR WATERPROOFING TEXTILES, EXCIPIENTS, BEARERS AND SUBSTRATES, NOT FOR MEDICAL APPLICATIONS, FOR INDUSTRIAL, AGRICULTURAL, HORTICULTURAL AND FORESTRY PURPOSES; CHEMICAL PREPARATIONS, CHEMICAL COMPOUNDS AND MIXTURES, EMULSIFIERS, EMULSIFYING AGENTS, SOLVENTS, DISPERSANTS AND SUSPENSIONS FOR USE IN INDUSTRY; GLYCERIDES, FATTY ACIDS, GELATIN FOR INDUSTRIAL PURPOSES, NAMELY, FOR USE IN THE MANUFACTURE OF SURFACTANTS; STARCH AND MODIFIED STARCH FOR INDUSTRIAL USE, NAMELY, A POWDER LAYER FOR MANUFACTURING AND PACKAGING PROCESSES AND PROCEDURES, RESISTANT STARCH, ENCAPSULATION PRODUCTS, PAPER, PRINTING INKS, AND POLYMERS, INCLUDING REDISPERSIBLE POLYMER POWDERS; SYNTHETIC RESINS AND PLASTICS AS RAW MATERIALS; GLUES AND ADHESIVES FOR INDUSTRIAL USE AND USE IN THE BUILDING INDUSTRY, NAMELY, INDUSTRIAL AND CONSTRUCTION; WALL COVERING ADHESIVES; WOOD HARDENING CHEMICAL PREPARATIONS; CHEMICAL ADDITIVES FOR GLUES AND ADHESIVES, IN CLASS 1 (U.S. CLS. 1, 5, 6, 10, 26 AND 46).



David J. Kypas

Director of the United States Patent and Trademark Office

FOR: PAINTS, VARNISHES, LACQUERS; POWDER PAINTS, TIMBER COATINGS IN THE NATURE OF PAINTS, VARNISHES, LACQUERS; ENAMEL PAINTS; COIL COATINGS, NAMELY, COATING COMPOSITIONS IN THE NATURE OF PAINT FOR INDUSTRIAL

Reg. No. 4,097,565 APPLICATIONS; HARDENERS, SICATIVES, NAMELY, DRYING AGENTS, THINNERS, BASIC DYES, ALL BEING ADDITIVES FOR PAINTS, VARNISHES AND LACQUERS; PRESERVATIVES AGAINST RUST AND AGAINST DETERIORATION OF WOOD IN THE NATURE OF COATINGS; PRIMERS; WOOD STAINS; MASTIC IN THE NATURE OF NATURAL RESINS; INKS, NAMELY, PRINTING INKS, PRINTING INK PASTES, WOOD STAINS; NATURAL RESINS AS RAW MATERIALS, METALS IN FOIL AND POWDER FORM FOR PAINTERS, DECORATORS, PRINTERS AND ARTISTS, SILICONE-BASED COATINGS IN THE NATURE OF PAINTS, IN CLASS 2 (U.S. CLS. 6, 11 AND 16).

FOR: BLEACHING PREPARATIONS FOR INDUSTRIAL AND HOUSEHOLD USE; SUGAR SOAP; PAINT-REMOVING SOAPS; GENERAL PURPOSE CLEANING COMPOUNDS FOR REMOVING DEPOSITS OTHER THAN AS PART OF MANUFACTURING PROCESSES; PAINTS AND VARNISH REMOVERS; PREPARATIONS FOR CLEANING FLOOR TILES, CONCRETE, PAVING AND NATURAL STONE; PREPARATIONS AND MIXTURES FOR REMOVING SEALANTS; POLISHES AND ABRASIVES, NAMELY, DEGREASING PREPARATIONS FOR GENERAL CLEANING FOR INDUSTRIAL AND HOUSEHOLD USE; LAUNDRY STARCH; DOMESTIC CLEANING PREPARATIONS FOR HOUSEHOLD AND INDUSTRIAL USE, IN CLASS 3 (U.S. CLS. 1, 4, 6, 50, 51 AND 52).

FOR: MINERAL OILS FOR INDUSTRIAL PURPOSES, IN CLASS 4 (U.S. CLS. 1, 6 AND 15).

FOR: ALL PURPOSE DISINFECTANTS; BIOCIDES; MINERAL FOOD SUPPLEMENTS FOR HUMAN AND VETERINARY USE, IN CLASS 5 (U.S. CLS. 6, 18, 44, 46, 51 AND 52).

FOR: MIXERS, NAMELY, PAINT MIXERS; PAINT SPRAYING EQUIPMENT, NAMELY, POWER OPERATED SPRAYERS AND PAINT SPRAYING GUNS, IN CLASS 7 (U.S. CLS. 13, 19, 21, 23, 31, 34 AND 35).

FOR: COMPUTER SOFTWARE, NAMELY, ADMINISTRATIVE AND MANAGEMENT SUPPORT SOFTWARE AND INFORMATION SUPPLY SOFTWARE FOR USE IN ORGANIZING AND MANAGING CUSTOMER CAR REPAIR DATA, PAINT MIXING MACHINES, CREATING DATABASES IN THE FIELD OF COLOR COLLECTIONS, AND SOFTWARE USED TO MONITOR THE STATUS OF THE CONTROL PAPER RETENTION IN INDUSTRIAL PAPER MAKING MACHINERY; COMPUTER SOFTWARE FOR CREATING DATABASES AND ANALYZING DATA IN THE FIELD OF MARKET RESEARCH; DATA PROCESSING EQUIPMENT, NAMELY, COMPUTERS FOR MONITORING AND CONTROLLING MANUFACTURING PROCESSES; DOWNLOADABLE, ELECTRONIC DATABASE IN THE FIELD OF CONSUMER TRENDS; DOWNLOADABLE ELECTRONIC PUBLICATIONS, NAMELY, MAGAZINES AND BOOKS IN THE CHEMICALS AND COATINGS INDUSTRIES, IN CLASS 9 (U.S. CLS. 21, 23, 26, 36 AND 38).

FOR: PRINTED MATTER, NAMELY, CORPORATE MAGAZINES; PRINTED PUBLICATIONS ON THE FINISHING, DECORATIONS AND FURNISHING OF BUILDINGS, NAMELY, MAGAZINES AND BOOKS; GLUES FOR HOUSEHOLD USE AND ADHESIVES FOR DOMESTIC AND OFFICE USE; MATERIALS FOR ARTISTS, NAMELY, ARTISTS' PASTELS, PENCILS AND PAINT BRUSHES; BRUSHES FOR APPLYING PAINT, GLUE, SEALANTS, OILS; MATERIALS FOR PAINTERS, NAMELY, FINISHING AND DECORATING TOOLS FOR USE WHEN PAINTING AND TOOLS FOR CHANGING THE APPEARANCE OF WET PAINT LAYERS; LARGE AND SMALL PAINTBRUSHES; PAINT ROLLERS; SPONGES FOR APPLYING PAINT; PALETTES FOR PAINTERS; SELF-ADHESIVE MASKING TAPE, IN CLASS 16 (U.S. CLS. 2, 5, 22, 23, 29, 37, 38 AND 50).

FOR: PACKING, STOPPING, FILLING AND INSULATING MATERIAL, NAMELY, INSULATING PLASTER; RESIN-BASED COMPOUNDS FOR SEALING WOOD AND FILLING HOLES, CRACKS, SPLITS AND OTHER IMPERFECTIONS FOR USE IN BUILDING AND CONSTRUCTION; INSULATING VARNISHES; ADHESIVE SEALING AGENTS, NAMELY, ADHESIVE SEALANTS AND ROOF SEALANTS, GLASS SEALANT, FIBERGLASS SEALANT, RUBBER SEALANT, CERAMIC TILE SEALANT, MASONRY SEALANT, WINDOW AND

Reg. No. 4,097,565 DOOR SEALANT, METAL SEALANT, CONCRETE SEALANT, BRICK SEALANT, ACRYLIC SEALANT, SIDING SEALANT, WOOD SEALANT, VINYL SEALANT, MOLDING SEALANT, AND PORCELAIN SEALANT AND BUILDING MATERIALS SEALANT; SEALANTS FOR FILLING HOLES, NAMELY, CAULKING, EXPANDING FOAM SEALANT FOR USE IN BUILDING AND CONSTRUCTION; EXPANDING FOAM INSULATION FOR USE IN BUILDING AND CONSTRUCTION; FILLER IN THE FORM OF EXPANDING FOAM COMPOSITIONS FOR FILLING HOLES AND CAVITIES FOR BUILDING PURPOSES, IN CLASS 17 (U.S. CLS. 1, 5, 12, 13, 35 AND 50).

FOR: CEMENT MIXTURES; CEMENT AND MORTAR FOR FILLING HOLES; NON-METALLIC BUILDING MATERIALS, NAMELY, CEMENT, CONCRETE, GROUT, AND MORTAR FOR FILLING, REPAIRING AND TOUCHING UP CRACKS, SPLITS, CAVITIES AND OTHER IMPERFECTIONS IN WALLS, FLOORS, CEILINGS AND OTHER SURFACES; CONSTRUCTION MASTIC ADHESIVE FOR CEILING, WALL AND FLOOR TILES; MORTAR AND PLASTER PREPARATIONS; MORTAR FOR USE AS A COATING; COATINGS IN THE FORM OF PLASTER OF PARIS FOR BUILDING PURPOSES, IN CLASS 19 (U.S. CLS. 1, 12, 33 AND 50).

FOR: SALT, IN CLASS 30 (U.S. CL. 46).

FOR: BUILDING CONSTRUCTION; REPAIR, INSTALLATION, AND MAINTENANCE, NAMELY, CAR AND VEHICLE REPAIR AND MAINTENANCE, VEHICLE REPAIR SERVICES, INSTALLATION OF AUTOMOTIVE ACCESSORIES, AUTOMOTIVE DETAILING, AND PREVENTIVE ANTI-CORROSION TREATMENT OF VEHICLES; MAINTENANCE OF INDUSTRIAL PROCESSING EQUIPMENT, IN CLASS 37 (U.S. CLS. 100, 103 AND 106).

FOR: PAINT MIXING SERVICES; COLORING, NAMELY, TINTING PAINTS, VARNISHES, LACQUERS AND STAINS; PROVIDING INFORMATION AND GIVING ADVICE ON MIXING PAINTS AND ON COLORING, NAMELY, TINTING PAINTS, VARNISHES, LACQUERS AND STAINS, IN CLASS 40 (U.S. CLS. 100, 103 AND 106).

FOR: EDUCATION SERVICES, NAMELY, PROVIDING OF TRAINING AND COURSES OF INSTRUCTION IN THE FIELD OF AUTOMOTIVE REPAIR, COATINGS INDUSTRY, PAPER AND PULP INDUSTRY, AND CHEMICAL INDUSTRY; CONSULTATION SERVICES IN THE FIELD OF TRAINING AUTOMOTIVE REPAIR PERSONNEL, COATINGS INDUSTRY PERSONNEL, PAPER AND PULP INDUSTRY PERSONNEL AND CHEMICAL INDUSTRY PERSONNEL, IN CLASS 41 (U.S. CLS. 100, 101 AND 107).

FOR: TECHNOLOGICAL SERVICES, NAMELY, PROVIDING CONSULTATION SERVICES FOR TECHNOLOGY SUPERVISION AND INSPECTION IN THE FIELD OF VEHICLE DAMAGE; COMPUTER SOFTWARE CONSULTATION SERVICES IN THE NATURE OF DEVELOPING, IMPLEMENTING, MAINTAINING, UPDATING AND PROVIDING ADVICE ON SOFTWARE IN THE FIELD OF REPAIR OF VEHICLE DAMAGE AND VEHICLE REPAIR, AND TECHNICAL MONITORING SERVICES FOR OTHERS FOR THE OPERATION OF THE PRODUCTION PROCESS IN THE PAPER AND TISSUE PAPER PRODUCTION INDUSTRIES; SCIENTIFIC AND INDUSTRIAL RESEARCH, IN THE FIELD OF MEASURING THE PERFORMANCE OF PULP BLEACHING PROCESSES FOR OTHERS; CHEMICAL ANALYSIS AND RESEARCH SERVICES IN THE FIELDS OF PULP BLEACHING AND PAPER AND TISSUE PAPER PRODUCTION; PROVIDING TECHNOLOGICAL AND SCIENTIFIC INFORMATION ABOUT THE EXPLOITATION OF NATURAL, BIOLOGICAL RAW MATERIAL RESOURCES; PROVIDING INFORMATION AND CONSULTING IN THE FIELD OF INTERIOR DESIGN REGARDING THE USE AND APPLICATION OF COLORS, PAINTS, VARNISHES, LACQUERS AND STAINS; TECHNICAL ADVICE ON PAINT MATCHING IN THE NATURE OF COLOR ANALYSIS FOR THE PURPOSES OF MATCHING COLORS TO AID IN THE SELECTION OF FURNISHING FOR HOMES AND BUILDINGS AND THE SELECTION OF COLORS FOR PAINTS, VARNISHES, LACQUERS AND STAINS AND ARCHITECTURAL ADVICE ON PAINT MATCHING IN THE NATURE OF COLOR ANALYSIS FOR THE PURPOSES OF MATCHING COLORS TO AID IN THE SELECTION OF FURNISHING FOR HOMES

Reg. No. 4,097,565 AND BUILDINGS AND THE SELECTION OF COLORS FOR PAINTS, VARNISHES, LACQUERS AND STAINS; PROFESSIONAL NEW PRODUCT DESIGN FOR OTHERS; CHEMICAL ANALYSIS, PRODUCT DESIGN AND DEVELOPMENT IN THE FIELD OF CHEMICAL PRODUCTS AND PAINTS, VARNISHES, LACQUERS AND STAINS; INTERIOR AND EXTERIOR ARCHITECTURAL DESIGN AND CONSULTANCY ON SUCH MATTERS; DESIGN OF COMPUTER SOFTWARE; DESIGNING OF INTERIORS, HOME FURNISHINGS, FURNITURE, INTERIOR DECORATING, DESIGN OF INTERIOR DÉCOR; AND COLOR ANALYSIS FOR THE PURPOSE OF INTERIOR DESIGN; INDUSTRIAL AND GRAPHIC DESIGN, IN CLASS 42 (U.S. CLS. 100 AND 101).

OWNER OF U.S. REG. NOS. 1,924,943 AND 3,079,821.

PRIORITY DATE OF 7-10-2009 IS CLAIMED.

OWNER OF INTERNATIONAL REGISTRATION 1019863 DATED 7-29-2009, EXPIRES 7-29-2019.

THE COLOR(S) BLUE AND WHITE IS/ARE CLAIMED AS A FEATURE OF THE MARK.

NO CLAIM IS MADE TO THE EXCLUSIVE RIGHT TO USE "AUTHORIZED DISTRIBUTOR", APART FROM THE MARK AS SHOWN.

THE MARK CONSISTS OF A DESIGN OF A MAN FROM THE CHEST UP WITH ONE ARM OUTSTRETCHED IN BLUE AND WHITE, ABOVE THE WORD "AKZONOBEL" IN BLUE, ABOVE THE WORDS "AUTHORIZED DISTRIBUTOR" IN WHITE ON A BLUE RECTANGLE.

SER. NO. 79-075,493, FILED 7-29-2009.

ALLISON HOLTZ, EXAMINING ATTORNEY

United States of America

United States Patent and Trademark Office



Reg. No. 4,097,566

Registered Feb. 14, 2012

Int. Cl.: 5

TRADEMARK

PRINCIPAL REGISTER

NUTRISSET (FRANCE SOCIÉTÉ PAR ACTIONS SIMPLIFIÉE)
BOIS RICARD
F-76770 MALAUNAY, FRANCE

FOR: PHARMACEUTICAL PRODUCTS FOR THE PREVENTION AND TREATMENT OF MALNUTRITION, DIETETIC FOODS ADAPTED FOR MEDICAL USE; BABY FOOD; FOOD PREPARATIONS FOR MEDICAL USE INTENDED FOR THE PREVENTION OF AND FIGHT AGAINST MALNUTRITION, NAMELY, FOODS FOR INDIVIDUALS WITH SPECIAL DIETARY REQUIREMENTS NECESSITATED BY MEDICAL TREATMENTS; FOODSTUFFS FOR POPULATION GROUPS AT RISK, NAMELY, FOR THE PREVENTION AND TREATMENT OF MALNUTRITION; DIETARY FOOD SUPPLEMENTS AND NUTRITIONAL SUPPLEMENTS IN PASTE, CAPSULE, TABLET, PASTILLE AND SACHET FORM; LIQUID OR POWDER FOR MEDICAL USE, NAMELY, DIETARY FOOD SUPPLEMENTS AND NUTRITIONAL SUPPLEMENTS FOR THE PREVENTION AND TREATMENT OF MALNUTRITION, IN CLASS 5 (U.S. CLS. 6, 18, 44, 46, 51 AND 52).

OWNER OF U.S. REG. NO. 2,980,857.

PRIORITY DATE OF 2-4-2009 IS CLAIMED.

OWNER OF INTERNATIONAL REGISTRATION 1020017 DATED 8-4-2009, EXPIRES 8-4-2019.

THE COLOR(S) RED, SILVER AND WHITE IS/ARE CLAIMED AS A FEATURE OF THE MARK.

NO CLAIM IS MADE TO THE EXCLUSIVE RIGHT TO USE "NUT", "READY-TO-USE THERAPEUTIC FOOD", "RUTF F-100 FORMULA", "1 SACHET = 500 KCAL", "1 SACHET", THE SHAPE OF THE APPLICANT'S PACKAGE AND THE PRODUCT USE TWO-PART INSTRUCTIONAL PICTORIAL OF THE OPEN PACKAGE AND PERSON EATING THE PRODUCT, APART FROM THE MARK AS SHOWN.

THE MARK CONSISTS OF A SILVER PACKAGE WITH A RED AND WHITE LABEL, A PICTOGRAM OF OPENING INSTRUCTIONS ACROSS THE BOTTOM OF THE PACKAGE, AND VERTICAL SEALING LINES ON THE LEFT AND RIGHT BORDERS. THE TOP OF THE LABEL IS SHADED RED WITH WHITE WORDING "PLUMPY" AND "NUT" AND WITH A WHITE PEANUT DESIGN WITH A MISCELLANEOUS WHITE LINE DESIGN. THE MARK



David J. Kyros

Director of the United States Patent and Trademark Office

Reg. No. 4,097,566 ALSO INCLUDES ONE RED AND WHITE OVAL WITH THE WHITE WORDING "NUTRISET" INSIDE. IN ADDITION, THE ENGLISH WORDING "READY-TO-USE THERAPEUTIC FOOD" APPEARS IN RED, UNDERLINED IN SILVER, AND THE FRENCH TRANSLATION "ALIMENT THÉRAPEUTIQUE PRÊT À CONSOMMER" AND THE SPANISH TRANSLATION "ALIMENTO THERAPÉUTICO LISTO PARA CONSUMIR" APPEARS IN RED BELOW THE ENGLISH WORDING. THE WORDING "RUTF F-100 FORMULA" IN PARENTHESES APPEARS IN SILVER. THE WORDING "1 SACHET = 500 KCAL" APPEARS IN RED ON A WHITE RECTANGULAR BACKGROUND OUTLINED IN RED, ALL SUPERIMPOSED OVER THE WHITE PORTION OF THE LABEL. IN ADDITION, ON THE BOTTOM SILVER PACKAGING APPEAR TWO NUMBERED DRAWINGS IN A PICTOGRAM TO SHOW THE USE OF THE PRODUCT. THE FIRST DRAWING HAS THE WHITE NUMBER "1" INSIDE A RED COLORED CIRCLE AND THE DRAWING OF THE PACKAGE IS IN RED LINES COLORED IN WHITE WITH THE WORDING "PLUMPY NUT" IN RED AND THE DRAWING OF A RED PEANUT DESIGN WITH A MISCELLANEOUS LINE DESIGN. THE RIGHT BOTTOM CORNER IS DRAWN AS JAGGED WITH BROKEN LINES IN RED. THE SECOND DRAWING HAS THE WHITE NUMBER "2" INSIDE A RED COLORED CIRCLE, AND THE DRAWING IN RED LINES OF A PERSON EATING FROM THE CORNER OF THE PACKAGE DESCRIBED IN THE FIRST DRAWING; THE PICTOGRAM IS ON A SILVER BACKGROUND AND THE UN-SHADED PORTIONS APPEAR IN SILVER. THE ENTIRE LABEL IS REPEATED AND SOME PORTIONS ARE INCOMPLETE, REPRESENTING THE END OF THE PACKAGE, AND SOME APPEAR MULTIPLE TIMES. THE BROKEN/DASHED LINES ARE NOT PART OF THE MARK AND ARE USED ONLY TO SHOW THE POSITION OR PLACEMENT OF THE MARK.

THE ENGLISH TRANSLATION OF "ALIMENT THÉRAPEUTIQUE PRÊT À CONSOMMER" AND OF "ALIMENTO THERAPÉUTICO LISTO PARA CONSUMIR" IN THE MARK IS "READY-TO-USE THERAPEUTIC FOOD", AND THE ENGLISH TRANSLATION OF "SACHET" IS "SACHET".

SER. NO. 79-075,565, FILED 8-4-2009.

INGRID C. EULIN, EXAMINING ATTORNEY

United States of America

United States Patent and Trademark Office

SOPHIS

Reg. No. 4,097,567

Registered Feb. 14, 2012

Int. Cls.: 9, 36 and 42

TRADEMARK

SERVICE MARK

PRINCIPAL REGISTER

SOPHIS TECHNOLOGY (IRELAND) LIMITED (IRELAND COMPANY)
61-62 FITZWILLIAM LANE
DUBLIN 2
IRELAND

FOR: COMPUTER SOFTWARE FOR USE IN FINANCIAL MANAGEMENT SPECIFICALLY FOR THE MANAGEMENT OF FINANCIAL DATABASES AND INVESTMENT PORTFOLIOS, FINANCIAL ASSETS IN VARIOUS ASSET CLASSES AND FINANCIAL ASSET PORTFOLIOS; COMPUTER SOFTWARE FOR FINANCIAL ANALYSIS, NAMELY, FOR ANALYZING FINANCIAL DATA, CASH MANAGEMENT AND RISK MANAGEMENT, COMPUTER SOFTWARE FOR PERSONAL FINANCIAL ANALYSIS, NAMELY, FOR ANALYZING PERSONAL FINANCIAL DATA; COMPUTER SOFTWARE FOR PAYROLL MANAGEMENT, NAMELY, SOFTWARE FOR PAYROLL PROCESSING AND REPORTING; COMPUTER SOFTWARE FOR FACILITATING SECURE CREDIT CARD TRANSACTIONS; COMPUTER SOFTWARE IN THE FIELD OF RISK MANAGEMENT, FINANCIAL PORTFOLIO ANALYSIS, FINANCIAL INVESTMENT AND HEDGE FUNDS, FOR AGGREGATION, REPORTING AND COMPLIANCE PURPOSES; COMPUTER SOFTWARE, COMPUTER PROGRAMS, COMPUTER OPERATING PROGRAMS, DOWNLOADABLE COMPUTER SOFTWARE, APPLICATION SOFTWARE, COMMUNICATION SOFTWARE, COMPUTER E-COMMERCE SOFTWARE, COMPUTER INTERFACE SOFTWARE, ALL THE AFORESAID FOR RISK AND PORTFOLIO MANAGEMENT IN THE FIELD OF FINANCIAL SERVICES; COMPUTER SOFTWARE DEVELOPMENT TOOLS, NAMELY, COMPUTER SOFTWARE USED FOR DEVELOPING COMPUTER SOFTWARE FOR FINANCIAL ANALYSIS AND RISK AND PORTFOLIO MANAGEMENT; COMPUTER SOFTWARE PACKAGES, NAMELY, COMPUTER SOFTWARE FOR RISK AND PORTFOLIO MANAGEMENT IN THE FIELD OF FINANCIAL SERVICES; COMPUTER SOFTWARE PLATFORMS, NAMELY, COMPUTER SOFTWARE PLATFORMS FOR RISK AND PORTFOLIO MANAGEMENT IN THE FIELD OF FINANCIAL SERVICES; INTERFACE SOFTWARE, NAMELY, INTERFACE SOFTWARE FOR RISK AND PORTFOLIO MANAGEMENT IN THE FIELD OF FINANCIAL SERVICES; SECURITY DEVICES FOR COMPUTER SOFTWARE, NAMELY, PASSWORD GENERATION SOFTWARE, AND ALL OF THE AFOREMENTIONED GOODS FOR USE IN THE FIELD OF FINANCE, RISK MANAGEMENT AND INVESTMENT, IN CLASS 9 (U.S. CLS. 21, 23, 26, 36 AND 38).



David J. Kyjars

Director of the United States Patent and Trademark Office

FOR: FINANCIAL SERVICES, NAMELY, FINANCIAL ADVISORY AND CONSULTANCY SERVICES; BROKERAGE SERVICES, NAMELY, CAPITAL INVESTMENT SERVICES; FINANCIAL EVALUATION SERVICES, NAMELY, FINANCIAL EVALUATION FOR INSURANCE AND FINANCIAL RISK ALLOCATION PURPOSES, FINANCIAL APPRAISAL SER-

Reg. No. 4,097,567 VICES IN THE NATURE OF COST EVALUATIONS; FINANCIAL MANAGEMENT, FINANCIAL INFORMATION PROCESSING; FINANCING SERVICES; CONSULTANCY, ADVISORY AND INFORMATION SERVICES FOR ALL OF THE ABOVE SERVICES, IN CLASS 36 (U.S. CLS. 100, 101 AND 102).

FOR: COMPUTER PROGRAMMING SERVICES; COMPUTER SOFTWARE DESIGN; INSTALLATION OF COMPUTER SOFTWARE; MAINTENANCE AND REPAIR OF COMPUTER SOFTWARE; UPDATING OF COMPUTER SOFTWARE; COMPUTER PROGRAMMING SERVICES IN THE NATURE OF EDITING OF COMPUTER SOFTWARE AND COMPUTER PROGRAMS; COMPUTER SOFTWARE CONSULTANCY; RECOVERY OF COMPUTER DATA; COMPUTER SYSTEM DESIGN; COMPUTER SYSTEMS ANALYSIS; DATA CONVERSION OF COMPUTER PROGRAMS AND DATA, NOT PHYSICAL CONVERSION; HOSTING COMPUTER SITES, NAMELY, HOSTING ON-LINE WEBSITES FOR OTHERS TO ACCESS WEB-BASED COMPUTER APPLICATIONS FOR RISK AND PORTFOLIO MANAGEMENT IN THE FIELD OF FINANCIAL SERVICES; COMPUTER SYSTEMS AND COMPUTER HARDWARE DESIGN; COMPUTER SOFTWARE RENTAL; COMPUTER PROGRAMMING FOR OTHERS; COMPUTER SOFTWARE DESIGN FOR OTHERS; COMPUTER SOFTWARE RESEARCH; COMPUTER SOFTWARE ANALYSIS; CUSTOMIZATION OF COMPUTER HARDWARE AND SOFTWARE; CONSULTANCY, ADVISORY AND INFORMATION SERVICES FOR ALL OF THE ABOVE SERVICES, IN CLASS 42 (U.S. CLS. 100 AND 101).

THE MARK CONSISTS OF STANDARD CHARACTERS WITHOUT CLAIM TO ANY PARTICULAR FONT, STYLE, SIZE, OR COLOR.

PRIORITY DATE OF 9-8-2009 IS CLAIMED.

OWNER OF INTERNATIONAL REGISTRATION 1021623 DATED 9-16-2009, EXPIRES 9-16-2019.

OWNER OF U.S. REG. NO. 3,234,283.

SER. NO. 79-076,121, FILED 9-16-2009.

EVELYN BRADLEY, EXAMINING ATTORNEY

United States of America

United States Patent and Trademark Office

LIFE SENSE

Reg. No. 4,097,568

Registered Feb. 14, 2012

Int. Cl.: 9

TRADEMARK

PRINCIPAL REGISTER

ZHONGSHAN TRANSTEK; ELECTRONICS CO., LTD. (CHINA CORPORATION)
JINBIAO, MINZHONG
ZHONGSHAN; GUANGDONG
CHINA

FOR: BODY MEASUREMENT DEVICES FOR HOME USE, NAMELY, BATHROOM SCALE, BODY HEIGHT METER, TAPE MEASURE FOR MEASURING CHEST CIRCUMFERENCE, WAISTLINE AND BIPLANE; DEVICES TO MEASURE AMOUNT OF EXERCISE AND CALORIES BURNED, NAMELY, PEDOMETER; KITCHEN SCALES, IN CLASS 9 (U.S. CLS. 21, 23, 26, 36 AND 38).

THE MARK CONSISTS OF THE WORDING "LIFE SENSE" WITH AN UPSIDE DOWN EXCLAMATION POINT "!" IN PLACE OF THE "I" IN "LIFE".

PRIORITY DATE OF 9-1-2009 IS CLAIMED.

OWNER OF INTERNATIONAL REGISTRATION 1024116 DATED 10-30-2009, EXPIRES 10-30-2019.

SER. NO. 79-077,034, FILED 10-30-2009.

MAYUR VAGHANI, EXAMINING ATTORNEY



David J. Kyffers

Director of the United States Patent and Trademark Office

United States of America

United States Patent and Trademark Office

NULL STERN THE ONLY STAR IS YOU

Reg. No. 4,097,569

Registered Feb. 14, 2012

Int. Cls.: 25 and 43

TRADEMARK

SERVICE MARK

PRINCIPAL REGISTER

RIKLIN PATRIK (SWITZERLAND INDIVIDUAL)
ZWINGLISTRASSE 13
CH-9000 ST. GALLEN, SWITZERLAND AND

RIKLIN FRANK (SWITZERLAND INDIVIDUAL)
BURGSTRASSE 43
CH-9000 ST. GALLEN, SWITZERLAND AND

DANIEL RENÉ CHARBONNIER (SWITZERLAND INDIVIDUAL)
CHEMIN DU LEVANT 153
CH-1005 LAUSANNE, SWITZERLAND

FOR: CLOTHING, NAMELY, SHIRTS, PANTS, JACKETS; FOOTWEAR, HEADWEAR, IN CLASS 25 (U.S. CLS. 22 AND 39).

FOR: CATERING AND TEMPORARY ACCOMMODATION OF GUESTS IN UNUSED BUILDINGS, PARTICULARLY IN RECONVERTED AND/OR NEWLY DEDICATED BUNKERS OR OTHER CIVIL DEFENSE FACILITIES, IN CLASS 43 (U.S. CLS. 100 AND 101).

THE MARK CONSISTS OF STANDARD CHARACTERS WITHOUT CLAIM TO ANY PARTICULAR FONT, STYLE, SIZE, OR COLOR.

PRIORITY DATE OF 7-8-2009 IS CLAIMED.

OWNER OF INTERNATIONAL REGISTRATION 1029432 DATED 12-11-2009, EXPIRES 12-11-2019.

THE ENGLISH TRANSLATION OF "NULL STERN" IN THE MARK IS "ZERO STAR".

SER. NO. 79-079,132, FILED 12-11-2009.

DANIEL CAPSHAW, EXAMINING ATTORNEY



David J. Kyffers

Director of the United States Patent and Trademark Office

United States of America

United States Patent and Trademark Office

CREDA

Reg. No. 4,097,570

Registered Feb. 14, 2012

Int. Cls.: 7, 9, 11 and 37

TRADEMARK

SERVICE MARK

PRINCIPAL REGISTER

INDESIT COMPANY UK LIMITED (UNITED KINGDOM LIMITED LIABILITY COMPANY)
MORLEY WAY
PETERBOROUGH, CAMBRIDGESHIRE PE2 9JB
UNITED KINGDOM

FOR: WASHING MACHINES FOR CLOTHES; CLOTHES DRYING MACHINES; VACUUM CLEANERS; ELECTRIC WAXING AND POLISHING MACHINES FOR HOUSEHOLD PURPOSES; DISHWASHERS; WASTE COMPACTORS AND FOOD WASTE DISPOSAL APPARATUS; STEAM CLEANING MACHINES, IN CLASS 7 (U.S. CLS. 13, 19, 21, 23, 31, 34 AND 35).

FOR: ELECTRIC IRONS, IN CLASS 9 (U.S. CLS. 21, 23, 26, 36 AND 38).

FOR: ELECTRIC LIGHTING FIXTURES; ELECTRIC, OIL-FUELED AND GAS SPACE HEATERS; MICROWAVE OVENS; REFRIGERATED CABINETS FOR FOOD; REFRIGERATORS; FREEZERS FOR FOOD; REFRIGERATOR CONDENSERS; ICE DISPENSING MACHINES AND REFRIGERATED DRINK DISPENSING MACHINES; ELECTRIC FANS; AIR CONDITIONING APPARATUS; AIR CONDITIONING INSTALLATIONS; EXHAUST HOODS FOR KITCHENS; GAS AND ELECTRIC RANGES, STOVES AND OVENS FOR COOKING; CERAMIC STOVES; ELECTRIC PRESSURE COOKERS; COOKING OVENS FOR INSTALLATION INTO COUNTERS; ELECTRIC BARBECUE GRILLS FOR ELECTRIC STOVES; ELECTRIC TOASTERS; ELECTRIC KETTLES; ELECTRIC COFFEE MAKERS; HAIR DRYERS; ELECTRIC HOT AIR HAND DRYERS; WATER COOLERS AND HEATERS; HUMIDIFIERS, DEHUMIDIFIERS; ELECTRONIC AIR CLEANING APPARATUS; WATER PURIFYING APPARATUS, MACHINES AND INSTALLATIONS, NAMELY, WATER FILTERS AND WATER FILTERS FOR REFRIGERATORS; WATER STERILIZERS; HEATING INSTALLATIONS; ELECTRIC HEATING FANS; BOILERS FOR HEATING INSTALLATIONS; RADIATORS AND ELECTRIC FAN HEATERS FOR HOUSEHOLD USE; ELECTRIC FIRES, NAMELY, IMITATION FLAME EFFECT FIRES, ELECTRIC RADIANT HEATERS; ELECTRIC FLOOR HEATING SYSTEMS, NAMELY, CABLES, ELECTRIC MATS AND SENSORS FOR FLOOR HEATING SYSTEMS SOLD AS A UNIT, IN CLASS 11 (U.S. CLS. 13, 21, 23, 31 AND 34).

FOR: INSTALLATION AND REPAIR SERVICES FOR HOUSEHOLD EQUIPMENT, NAMELY, WASHING MACHINES, DISHWASHERS, WASHING MACHINES FOR CLOTHES, CLOTHES DRYING MACHINES, COOKERS, REFRIGERATORS, FREEZERS, COMBINED REFRIGERATOR-FREEZERS, HEATERS AND RADIATORS, IN CLASS 37 (U.S. CLS. 100, 103 AND 106).



David J. Kypos

Director of the United States Patent and Trademark Office

Reg. No. 4,097,570 THE MARK CONSISTS OF STANDARD CHARACTERS WITHOUT CLAIM TO ANY PARTICULAR FONT, STYLE, SIZE, OR COLOR.

PRIORITY DATE OF 12-9-2009 IS CLAIMED.

OWNER OF INTERNATIONAL REGISTRATION 1032094 DATED 12-17-2009, EXPIRES 12-17-2019.

THE ENGLISH TRANSLATION OF "CREDA" IN THE MARK IS "BELIEVE".

SER. NO. 79-080,141, FILED 12-17-2009.

CHRISTOPHER BUONGIORNO, EXAMINING ATTORNEY

United States of America

United States Patent and Trademark Office



Reg. No. 4,097,571

Registered Feb. 14, 2012

**Int. Cls.: 7, 16, 17, 40
and 42**

TRADEMARK

SERVICE MARK

PRINCIPAL REGISTER

HBW-GUBESCH KUNSTSTOFF-ENGINEERING GMBH (FED REP GERMANY LIMITED LIABILITY COMPANY)

BAHNHOFSWALD 2
91448 EMSKIRCHEN
FED REP GERMANY

FOR: PLASTICS AND METAL FOILS AND FOILS WORKING MACHINES; MACHINES FOR INJECTION MOLDING; MOLD MAKING MACHINES, NAMELY, MILLING MACHINES, TURNING MACHINES, DRILLING MACHINES, GRINDING MACHINES, SPARK EROSION MACHINES, AND WIRE EROSION MACHINES; MACHINES UTILIZING ROTATIONAL MOTION FOR HIGH ENERGY FOIL SURFACES FINISHING, NAMELY, IN-MOLD DECORATION MACHINES AND INSERT-MOLDING MACHINES AND THEIR COMPONENT PARTS, NAMELY, FOIL FEEDERS, INJECTION MOLDS, VACUUM PUMPS, AND MACHINE HOUSINGS; DIE-STAMPING MACHINES; PLASTIC INJECTION MOLDING MACHINES AND THEIR TOOLS BEING VACUUM PUMPS AND MACHINE HOUSINGS; INJECTION MOLDING MACHINES AND THEIR TOOLS BEING VACUUM PUMPS AND MACHINE HOUSINGS; INJECTION MOLDING DIE-STAMPING MACHINES; AND CASTING MOLD MACHINES, IN CLASS 7 (U.S. CLS. 13, 19, 21, 23, 31, 34 AND 35).

FOR: PLASTIC FILM NOT FOR COMMERCIAL OR INDUSTRIAL PURPOSES, IN CLASS 16 (U.S. CLS. 2, 5, 22, 23, 29, 37, 38 AND 50).

FOR: PLASTICS IN EXTRUDED FORM FOR USE IN MANUFACTURE, ESPECIALLY INJECTION MOULDED PLASTIC PARTS; PACKING AND INSULATING MATERIALS; SEMI-PROCESSED PLASTIC IN THE FORMS OF FILMS, SHEETS, TUBES, BARS, OR RODS; SYNTHETIC PLASTIC AS SEMI-FINISHED PRODUCTS IN THE FORM OF FOILS, IN CLASS 17 (U.S. CLS. 1, 5, 12, 13, 35 AND 50).

FOR: INJECTION MOLDING OF PLASTICS FOR OTHERS; INJECTION MOLDING OF PLASTICS FOR OTHERS ACCORDING TO THEIR INSTRUCTION; TECHNICAL CONSULTANCY IN THE FIELD OF MATERIAL TREATMENT, NAMELY, CONCERNING PLASTICS AND PARTS THEREOF, TREATMENT OF PLASTIC MOLDING, INJECTION MOLDING AND INJECTION PRESSURE, THEIR FORMS, PARTS, DECORATION, COATING, IN CLASS 40 (U.S. CLS. 100, 103 AND 106).

FOR: TECHNOLOGICAL CONSULTATION IN THE TECHNOLOGY FIELD OF PLASTIC MOLDING INJECTION AND PRODUCT DEVELOPMENT OF PLASTIC PRODUCTS; INDUS-



David J. Kyffers

Director of the United States Patent and Trademark Office

Reg. No. 4,097,571 TRIAL RESEARCH SERVICES IN THE FIELD OF PLASTIC MOLDING INJECTING TECHNOLOGIES; SURVEYING; INDUSTRIAL DESIGN; NEW PRODUCT DESIGN AND DEVELOPMENT FOR OTHERS OF PLASTIC PARTS AND COMPONENTS FOR AUTOMOBILES AND ENTERTAINMENT ELECTRONICS, MACHINES, TOOLS, FORMS AND APPLIANCES, FOR PLASTICS WORKING INDUSTRY AND AUTOMOBILE INDUSTRY; ENGINEERING; MATERIAL TESTING OF PLASTIC PRODUCTS; QUALITY TESTING IN THE NATURE OF QUALITY CONTROL FOR OTHERS OF PLASTIC PRODUCTS; DESIGN AND DEVELOPMENT OF COMPUTER HARDWARE AND COMPUTER SOFTWARE, IN CLASS 42 (U.S. CLS. 100 AND 101).

NO CLAIM IS MADE TO THE EXCLUSIVE RIGHT TO USE "IMD" FOR INTERNATIONAL CLASSES 007, 016, AND 017, AND "IMD PRO" FOR INTERNATIONAL CLASSES 040 AND 042, APART FROM THE MARK AS SHOWN.

PRIORITY DATE OF 8-18-2009 IS CLAIMED.

OWNER OF INTERNATIONAL REGISTRATION 1038713 DATED 12-15-2009, EXPIRES 12-15-2019.

THE COLOR(S) WHITE, LIGHT BLUE AND DARK BLUE IS/ARE CLAIMED AS A FEATURE OF THE MARK.

THE MARK CONSISTS OF A DARK BLUE QUADRILATERAL CONTAINING A SMALLER WHITE SQUARE WITH A DARK BLUE BACKGROUND AND A WHITE GRID-LIKE DESIGN WITH THE DARK BLUE WORDING "HBW" ON A WHITE BACKGROUND AND WITH THE WHITE WORDING "GUBESCH" AND THE LIGHT BLUE WORD "PRO" OUTLINED WITH WHITE.

SER. NO. 79-082,562, FILED 12-15-2009.

LAURA HAMMEL, EXAMINING ATTORNEY

United States of America

United States Patent and Trademark Office

Superendo

Reg. No. 4,097,572

Registered Feb. 14, 2012

Int. Cl.: 10

TRADEMARK

PRINCIPAL REGISTER

B&L BIOTECH, INC. (REPUBLIC OF KOREA CORPORATION)
502, GUNGJUN TOWER
727-3, GOJAN-DONG
DANWON-GU, ANSAN-SI, GYEONGGI-DO, REPUBLIC OF KOREA

FOR: MICROSCOPES FOR OPERATIONS; INSTRUMENT CASES FOR USE BY DENTISTS, NAMELY, CASES FITTED FOR DENTAL INSTRUMENTS FOR USE BY DENTISTS; LASERS FOR MEDICAL PURPOSES; TELEMETRY DEVICES FOR MEDICAL APPLICATIONS; FORCEPS FOR DENTAL TECHNICAL PURPOSES; MIRRORS FOR DENTISTS; DENTAL FOUNDATION SUPPORTS; X-RAY APPLIANCES FOR DENTAL AND MEDICAL USE; DENTAL BURRS, NAMELY, A PIECE OF EQUIPMENT FOR DRILLING HOLES IN THE TEETH OF PATIENTS; BROACH FOR DENTAL PURPOSES; HEATED POLYMERIZATION UNITS FOR DENTAL RESTORATION COMPOUNDS; DENTAL CHAIRS; DENTAL APPARATUS, NAMELY, ENDODONTIC OBTURATORS USED TO FILL A HOLE OR CAVITY; DENTAL PLUGGERS; DENTAL PLUGGER STANDS; DENTAL CONDENSERS, NAMELY, DENTAL INSTRUMENTS FOR ROOT CANALS, USED TO COMPACT OR CONDENSE A RESTORATIVE MATERIAL INTO A PREPARED CAVITY; TORQUE WRENCH FOR USE IN ENDOSURGERY; DENTAL STERILIZERS USED TO CLEAN THE ENDS OF DENTAL TOOLS USING ULTRASOUND; DENTAL IMPLANTS; DENTAL BRIDGES; DENTAL DRILLS; DENTAL HANDPIECES; DENTAL SCALERS; DENTAL BROACHES; DENTAL SPATULAS; DENTAL EXCAVATORS IN THE NATURE OF DENTAL SPOON EXCAVATORS; DENTAL TRAYS IN THE NATURE OF DENTAL BITE TRAYS, DENTAL IMPRESSION TRAYS; DENTAL INSTRUMENTS IN THE NATURE OF CAULKING GUN FOR USE IN ENDOSURGERY; DENTAL SYRINGES; MIXING PALLETS FOR DENTISTRY MATERIALS; DENTAL BRUSHES, DENTAL IMPRESSION MIXING TIPS; DENTAL CANNULAS, NAMELY, FLEXIBLE TUBE CONTAINING A TROCER AT ONE END, THAT IS INSERTED INTO A BODILY CAVITY, DUCT, OR VESSEL TO DRAIN FLUID OR ADMINISTER A SUBSTANCE FOR USE IN DENTAL SURGERY; APPARATUS USED TO DISPENSE DENTAL COMPOSITE MATERIALS, FOR USE IN DENTAL SURGERY AND DENTAL EXAMINATION OF PATIENTS, SOLD EMPTY; DENTAL CHAIRS FOR EXAMINATION AND TREATMENT; ELECTRIC DENTAL APPARATUS, NAMELY, A SURGICAL APPARATUS FOR DENTAL USE, FOR TREATMENT OF THE MOUTH CAVITY USING ELECTROSTIMULATION, ELECTROTHERAPY, MAGNETOTHERAPY, PHOTOTHERAPY, WAVE THERAPY, AND RESONANCE THERAPY; CUTTING AND GRINDING DISCS FOR DENTAL APPLICATIONS; CUT-OFF AND ABRASIVE WHEELS FOR DENTAL PURPOSES; POLYMERIZATION APPARATUS FOR DENTAL PURPOSES; TREATMENT BEDS FOR DENTAL PURPOSES; DENTISTS' ARMCHAIRS; THERAPEUTIC BATH APPARATUS AND INSTRUMENTS;



David J. Kyjars

Director of the United States Patent and Trademark Office

Reg. No. 4,097,572 DENTAL SCALERS; ORTHODONTIC MACHINES AND INSTRUMENTS FOR DENTAL PURPOSES; ORTHODONTIC APPLIANCES, IN CLASS 10 (U.S. CLS. 26, 39 AND 44).

THE MARK CONSISTS OF STANDARD CHARACTERS WITHOUT CLAIM TO ANY PARTICULAR FONT, STYLE, SIZE, OR COLOR.

OWNER OF INTERNATIONAL REGISTRATION 1030666 DATED 11-6-2009, EXPIRES 11-6-2019.

SER. NO. 79-082,807, FILED 4-30-2010.

AMY ALFIERI, EXAMINING ATTORNEY

United States of America

United States Patent and Trademark Office

media.Analysis



Reg. No. 4,097,573

Registered Feb. 14, 2012

Int. Cls.: 35, 38 and 42

PRIME; RESEARCH INTERNATIONAL AG & CO KG (FED REP GERMANY LIMITED PARTNERSHIP WITH A STOCK CORPORATION AS GENERAL PARTNER)
KAISERSTRASSE 22
55116 MAINZ
FED REP GERMANY

SERVICE MARK

PRINCIPAL REGISTER

FOR: PROVISION OF BUSINESS INFORMATION VIA COMPUTER RESEARCH; COMPILATION AND SYSTEMIZATION OF BUSINESS INFORMATION INTO DATA-BASES, PARTLY IN REAL-TIME, ESPECIALLY IN AND VIA THE INTERNET; RESEARCH OF MEDIA INFORMATION FOR ADVERTISING, ADVERTISING RESEARCH AND MARKETING PURPOSES IN THE INTERNET, VIA A COMPUTER SUPPORTED INFORMATION SERVICE, PARTLY IN REAL-TIME; COMPILATION, SYSTEMIZATION AND UPDATING OF MEDIA INFORMATION IN COMPUTER DATABASES VIA A COMPUTER SUPPORTED INFORMATION SERVICE, PARTLY IN REAL-TIME, IN CLASS 35 (U.S. CLS. 100, 101 AND 102).

FOR: RENTAL OF ACCESS TIME TO DATABASES CONTAINING AN INTERACTIVE INFORMATION SERVICE IN THE INTERNET, RELATED TO MEDIA INFORMATION AND MEDIA NEWS, PARTLY IN REAL TIME; MESSAGE COLLECTION AND TRANSMISSION OF MEDIA INFORMATION, PARTLY IN REAL-TIME WITHIN THE SCOPE OF A NEWS AGENCY; PROVIDING ACCESS TO A GLOBAL COMPUTER NETWORK FEATURING MEDIA INFORMATION AND MEDIA NEWS, PARTLY IN REAL-TIME; ELECTRONIC TRANSMISSION OF DATA, ESPECIALLY OF TEXTS AND PICTURES VIA THE INTERNET, IN CLASS 38 (U.S. CLS. 100, 101 AND 104).

FOR: MEDIA ANALYSIS VIA INTERNET FOR INFORMATION PURPOSES, ESPECIALLY MEDIA RESPONSE ANALYSIS FOR INFORMATION PURPOSES, NAMELY, PROVIDING TEMPORARY USE OF ONLINE NON-DOWNLOADABLE SOFTWARE FOR MONITORING OF MEDIA; MEDIA MONITORING IN THE INTERNET VIA TECHNOLOGICAL SERVICES, PARTLY IN REAL-TIME, NAMELY, PROVIDING TEMPORARY USE OF ONLINE NON-DOWNLOADABLE SOFTWARE FOR MONITORING OF MEDIA; PROVIDERS SERVICES, NAMELY, UPDATING OF MEDIA ANALYSIS SOFTWARE WITHIN THE SCOPE OF AN INTERACTIVE INFORMATION SERVICE, RELATED TO MEDIA INFORMATION AND MEDIA NEWS, PARTLY IN REAL TIME, IN CLASS 42 (U.S. CLS. 100 AND 101).

NO CLAIM IS MADE TO THE EXCLUSIVE RIGHT TO USE "MEDIA.ANALYSIS", APART FROM THE MARK AS SHOWN.



David J. Kyjars

Director of the United States Patent and Trademark Office

Reg. No. 4,097,573 PRIORITY DATE OF 9-3-2009 IS CLAIMED.

OWNER OF INTERNATIONAL REGISTRATION 1039678 DATED 3-2-2010, EXPIRES 3-2-2020.

THE COLOR(S) CLARET AND GREY IS/ARE CLAIMED AS A FEATURE OF THE MARK.

THE MARK CONSISTS OF THE WORDING "MEDIA.ANALYSIS" IN THE COLOR CLARET OVER A GREY RECTANGULAR BACKGROUND. A CIRCLE DESIGN IS TO THE RIGHT OF THE WORDING WITH THE DESIGN OF HORIZONTAL AND VERTICAL BARS IN THE COLOR CLARET.

SER. NO. 79-082,903, FILED 3-2-2010.

DAVID HOFFMAN, EXAMINING ATTORNEY

United States of America

United States Patent and Trademark Office

MediPad

Reg. No. 4,097,574

Registered Feb. 14, 2012

Int. Cls.: 9, 37 and 42

BEWATEC KOMMUNIKATIONSTECHNIK GMBH (FED REP GERMANY GESELLSCHAFT
MIT BESCHRÄNKTER HAFTUNG (GMBH))
ORKOTTEN, 65
48291 TELGTE
FED REP GERMANY

TRADEMARK

SERVICE MARK

PRINCIPAL REGISTER

FOR: COMPUTER HARDWARE FOR CONNECTING CRT DISPLAYS, LCD DISPLAYS, TFT DISPLAYS, AND OLED DISPLAYS, MULTIMEDIA PROJECTORS CONNECTED TO COMPUTER NETWORKS; DIGITAL/ANALOG CONVERSION COMPUTER HARDWARE; ELECTRIC RECEPTION AND SIGNAL OUTPUT COMPUTER HARDWARE FOR TRANSPORTING AND AGGREGATING VOICE, SOUND, DATA, PICTURE, AND VIDEO COMMUNICATIONS ACROSS MULTIPLE NETWORK INFRASTRUCTURES AND COMMUNICATIONS PROTOCOLS; CATHODE RAY TUBE (CRT), LCD, THIN-FILM TRANSISTOR (TFT), AND ORGANIC LIGHT EMITTING DIODES (OLED) MONITORS, COMPUTERS; COMPUTER HARDWARE FOR TRANSMITTING SOUND, PICTURES OR DATA; ACCESSORIES AND MOUNTING SYSTEMS FOR COMPUTER HARDWARE, NAMELY, SINGLE AND MULTI-PART SWIVEL, TELESCOPIC, ARTICULATED, AND BENDING MOUNTING RACKS FOR COMPUTER HARDWARE, IN CLASS 9 (U.S. CLS. 21, 23, 26, 36 AND 38).

FOR: MOUNTING, MAINTENANCE AND REPAIR OF COMPUTER AND NETWORK HARDWARE, IN CLASS 37 (U.S. CLS. 100, 103 AND 106).

FOR: TECHNICAL CONSULTING IN RELATION TO COMMUNICATION AND ENTERTAINMENT DEVICES AND DATA NETWORK TECHNOLOGY, NAMELY, TECHNICAL CONSULTING SERVICES IN THE FIELD OF COMPUTER-BASED INFORMATION SYSTEMS FOR USE BY PATIENTS OF HOSPITALS AND NURSING FACILITIES, IN CLASS 42 (U.S. CLS. 100 AND 101).

THE MARK CONSISTS OF STANDARD CHARACTERS WITHOUT CLAIM TO ANY PARTICULAR FONT, STYLE, SIZE, OR COLOR.

PRIORITY DATE OF 2-23-2010 IS CLAIMED.

OWNER OF INTERNATIONAL REGISTRATION 1039781 DATED 4-8-2010, EXPIRES 4-8-2020.

SER. NO. 79-082,932, FILED 4-8-2010.



David J. Kyffers

Director of the United States Patent and Trademark Office

Reg. No. 4,097,574 CHARISMA HAMPTON, EXAMINING ATTORNEY

United States of America

United States Patent and Trademark Office



Reg. No. 4,097,575

Registered Feb. 14, 2012

Int. Cl.: 29

TRADEMARK

PRINCIPAL REGISTER

BEIJING FUYINONG CHESTNUTS CO., LTD (CHINA CORPORATION)
633, ZHENZHONGZHUANG
MIAOCHENG,; HUAIROU;
100048 BEIJING, CHINA

FOR: CHESTNUTS, PROCESSED; MARMALADE; NUTS, PREPARED; FROZEN FRUITS;
PROCESSED CANNED MUSHROOMS; CANNED COOKED MEAT; CANNED VEGETABLES;
CANNED FRUIT; DEHYDRATED VEGETABLE; QUICK-FROZEN VEGETABLES; PRO-
CESSED CANNED PEAS, IN CLASS 29 (U.S. CL. 46).

NO CLAIM IS MADE TO THE EXCLUSIVE RIGHT TO USE THE NON-LATIN CHARACTERS
THAT TRANSLITERATE TO FU (WHICH MEANS RICH) AND NONG (WHICH MEANS
FARMING), APART FROM THE MARK AS SHOWN.

OWNER OF INTERNATIONAL REGISTRATION 1041265 DATED 4-2-2010, EXPIRES 4-2-
2020.

THE TRANSLITERATION OF THE NON-LATIN CHARACTERS IN THE MARK IS: FU YI
NONG.

THE ENGLISH TRANSLATION OF THE FOREIGN WORD(S) IN THE MARK IS: RICH, A
HUNDRED MILLION AND FARMING; FYN AND THE THREE CHARACTERS HAVE NO
MEANING IN A FOREIGN LANGUAGE.

SER. NO. 79-083,490, FILED 4-2-2010.

PAUL E. FAHRENKOPF, EXAMINING ATTORNEY



David J. Kypos

Director of the United States Patent and Trademark Office

United States of America

United States Patent and Trademark Office

SHIRTCITY.

Reg. No. 4,097,576

Registered Feb. 14, 2012

Int. Cls.: 16 and 35

TRADEMARK

SERVICE MARK

PRINCIPAL REGISTER

CHRISTIAN SCHNEIDER (FED REP GERMANY INDIVIDUAL), DBA SHIRTCITY
ELSA-BRANDSTRÖM-STR. 27
89231 NEU-ULM, FED REP GERMANY

FOR: PRINTED GOODS, NAMELY, PRIVATE CUSTOMER PHOTOGRAPHS AND PRINTED PRODUCT CATALOGUES FEATURING TEXTILES, CUPS, MUGS, BUTTONS AND MOUSE PADS, PRINTED WITH CUSTOMER DESIGNS OR TEXTS, IN CLASS 16 (U.S. CLS. 2, 5, 22, 23, 29, 37, 38 AND 50).

FOR: DISTRIBUTION OF PRODUCTS FOR ADVERTISING PURPOSES, NAMELY, TEXTILES, CUPS, MUGS, BUTTONS AND MOUSE PADS, IN CLASS 35 (U.S. CLS. 100, 101 AND 102).

THE MARK CONSISTS OF STANDARD CHARACTERS WITHOUT CLAIM TO ANY PARTICULAR FONT, STYLE, SIZE, OR COLOR.

OWNER OF INTERNATIONAL REGISTRATION 0919339 DATED 11-30-2006, EXPIRES 11-30-2016.

SER. NO. 79-083,492, FILED 8-22-2008.

JULIE GUTTADAURO, EXAMINING ATTORNEY



David J. Kyfos

Director of the United States Patent and Trademark Office

United States of America

United States Patent and Trademark Office

KELK

Reg. No. 4,097,577

Registered Feb. 14, 2012

Int. Cls.: 7 and 9

TRADEMARK

PRINCIPAL REGISTER

KELK LTD. (JAPAN CORPORATION)
3-25-1 SHINOMIYA
HIRATSUKA-SHI; KANAGAWA-KEN 254-8543
JAPAN

FOR: CHEMICAL PROCESSING MACHINES AND APPARATUS, NAMELY, ISOTHERMAL MACHINES AND APPARATUS, DEIONIZED WATER HEATING MACHINES AND APPARATUS FOR CHEMICAL PROCESSING, HOT WATER SUPPLYING MACHINES AND APPARATUS FOR CHEMICAL PROCESSING, COOLING AND HEATING MACHINES AND APPARATUS FOR CHEMICAL PROCESSING, PRECISION AIR CONDITIONING MACHINES AND APPARATUS FOR CHEMICAL PROCESSING, THERMOELECTRIC DEHUMIDIFYING MACHINES AND APPARATUS FOR CHEMICAL PROCESSING, IN CLASS 7 (U.S. CLS. 13, 19, 21, 23, 31, 34 AND 35).

FOR: OPTICAL COMMUNICATION DEVICES, NAMELY, HIGH SENSITIVITY CCD CAMERAS, AND THERMOELECTRIC GENERATORS FOR OPTICAL COMMUNICATION DEVICES, IN CLASS 9 (U.S. CLS. 21, 23, 26, 36 AND 38).

THE MARK CONSISTS OF STANDARD CHARACTERS WITHOUT CLAIM TO ANY PARTICULAR FONT, STYLE, SIZE, OR COLOR.

OWNER OF INTERNATIONAL REGISTRATION 1041631 DATED 3-19-2010, EXPIRES 3-19-2020.

SER. NO. 79-083,641, FILED 3-19-2010.

ANDREA HACK, EXAMINING ATTORNEY



David J. Kypos

Director of the United States Patent and Trademark Office

United States of America

United States Patent and Trademark Office

BELLA SARA

Reg. No. 4,097,578

Registered Feb. 14, 2012

**Int. Cls.: 6, 8, 9, 12, 20,
21, 24, 26, 27, 29, 30 and
32**

TRADEMARK

PRINCIPAL REGISTER

CONCEPT CARD APS (DENMARK PRIVATE LIMITED COMPANY)
HUSMANDSALLEEN 10
DK-5884 GUDME, DENMARK

FOR: COMMON METALS AND THEIR ALLOYS; METAL BUILDING MATERIALS, NAMELY, METAL BUILDING FLASHING, CLADDING OF METAL FOR BUILDING; TRANSPORTABLE BUILDINGS OF METAL; MATERIALS OF METAL FOR RAILWAY TRACKS; NON-ELECTRIC CABLE AND WIRES OF METAL; IRONMONGERY, NAMELY, SMALL ITEMS OF METAL HARDWARE IN THE NATURE OF NAILS, SCREWS, BOLTS, BUCKLES OF COMMON METAL, METAL GATE LATCHES; PIPES AND TUBES OF METAL; METAL SAFES; GOODS OF METALS NOT INCLUDED IN OTHER CLASSES, NAMELY, METAL SAFETY DOORS, CASINGS OF METAL; ORES, NAMELY, IRON ORES, COPPER ORES; RINGS OF COMMON METAL FOR KEYS, IN CLASS 6 (U.S. CLS. 2, 12, 13, 14, 23, 25 AND 50).

FOR: HAND OPERATED HAND TOOLS AND IMPLEMENTS, NAMELY, MANUAL DRILLS, HAMMERS, SCREWDRIVERS, DRAW TAPE REELS, ABRADING TOOLS; CUTLERY, NAMELY, FORKS, SPOONS, KNIVES; SIDE ARMS NOT INCLUDING FIREARMS, NAMELY, HUNTING KNIVES, SWORDS; RAZORS, IN CLASS 8 (U.S. CLS. 23, 28 AND 44).

FOR: SCIENTIFIC, NAUTICAL, SURVEYING, PHOTOGRAPHIC, CINEMATOGRAPHIC, OPTICAL, WEIGHING, MEASURING, SIGNALLING, CHECKING, LIFE-SAVING AND TEACHING APPARATUS AND INSTRUMENTS, NAMELY, CAMERAS, SCALES, COMPUTERS, DATA PROCESSORS; APPARATUS AND INSTRUMENTS FOR CONDUCTING, SWITCHING, TRANSFORMING, ACCUMULATING, REGULATING OR CONTROLLING ELECTRICITY, NAMELY, ELECTRIC WIRES AND CABLES, ELECTRIC TRANSFORMERS; APPARATUS FOR RECORDING, TRANSMISSION OR REPRODUCTION OF SOUNDS OR IMAGES; BLANK MAGNETIC DATA CARRIERS, BLANK RECORDING DISCS; VENDING MACHINES AND MECHANISMS FOR COIN-OPERATED APPARATUS; CASH REGISTERS, CALCULATING MACHINES, DATA PROCESSING EQUIPMENT AND COMPUTERS; FIRE-EXTINGUISHING APPARATUS, AUDIO BOOKS IN THE FIELD OF HISTORY, ART, FANTASY, MYSTERY AND FICTION EITHER ON ELECTRONIC MEDIA OR DOWNLOADABLE; INTERACTIVE VIDEO GAME SOFTWARE AND COMPUTER GAME CONSOLES FOR USE WITH AN EXTERNAL DISPLAY SCREEN OR MONITOR, COMPUTERS AND MOBILE PHONES; DOWNLOADABLE INTERACTIVE WEB-BASED GAME SOFTWARE, DOWNLOADABLE BACKGROUND IMAGES IN THE NATURE OF WALLPAPER FOR COMPUTERS AND MOBILE PHONES, DOWNLOADABLE RINGTONES, SPECTACLES AND SUNGLASSES, PROTECTIVE HELMETS, SWIMMING JACKETS, NAMELY, SWIM



David J. Kyros

Director of the United States Patent and Trademark Office

Reg. No. 4,097,578 FLOATS FOR SAFETY PURPOSES, LIFEJACKETS, EXPOSED CINEMATOGRAPHIC FILMS, ANIMATED CARTOONS RECORDED ON DISCS AND TAPES AND; DECORATIVE MAGNETS, DVDS AND CD-ROMS CONTAINING MOTION PICTURE FILMS, ANIMATED CARTOONS AND TELEVISION FILMS OR SERIALISATIONS; MOUSE MATS AND PADS, IN CLASS 9 (U.S. CLS. 21, 23, 26, 36 AND 38).

FOR: VEHICLES, NAMELY, AMPHIBIOUS VEHICLES, ALL-TERRAIN VEHICLES, BICYCLES, AND WAGONS; APPARATUS FOR LOCOMOTION BY LAND, AIR OR WATER, NAMELY, AIRPLANES, BOATS, AUTOMOBILES, SUN-BLINDS ADAPTED FOR AUTOMOBILES, VEHICLE SEATS, VEHICLE ACCESSORIES, NAMELY, AUTOMOBILE ROOF RACKS, AUTOMOBILE WHEEL SHIELDS, VEHICLE REAR SEAT PROTECTORS AND REAR SEAT CONTAINERS WITH SPACE IN WHICH TO ARRANGE ITEMS, IN CLASS 12 (U.S. CLS. 19, 21, 23, 31, 35 AND 44).

FOR: FURNITURE, MIRRORS, PICTURE FRAMES; GOODS NOT INCLUDED IN OTHER CLASSES OF WOOD, CORK, REED, CANE, WICKER, HORN, BONE, IVORY, WHALE BONE, SHELL, AMBER, MOTHER OF PEARL, MEERSCHAUM AND SUBSTITUTES FOR ALL OF THESE MATERIALS, OR OF PLASTICS, NAMELY, FURNITURE, STATUES OF BONE, WOOD FIGURINES; PHOTOGRAPH FRAMES; BEDDING EXCEPT LINEN, NAMELY, BED FRAMES, MATTRESSES; CUSHIONS, SLATTED INDOOR BLINDS, TRAVEL BEDS FOR CHILDREN, WALL AND ROOM DECORATIONS, NAMELY, SOFT SCULPTURE WALL DECORATIONS, WOOD FIGURINES; STORAGE BOXES AND/OR BINS OF WOOD OR PLASTIC, AIR MATTRESSES, NON-METAL COAT HOOKS AND SHELVES, DECORATIVE WALL PLAQUES OF WOOD, AND PLASTIC, PLASTIC NAMEPLATES, NUMBERPLATES, NOT OF METAL, DECORATIONS FOR CAKES MADE OF PLASTIC OR FABRIC, SLEEPING BAGS, TABLES, TOY BOXES, PARASOL BASES, NAMELY, PARASOL STANDS, VENETIAN BLINDS, DECORATIVE MOBILES, CURTAIN RODS; NON-METAL KEY-RINGS NOT INCLUDED IN OTHER CLASSES, IN CLASS 20 (U.S. CLS. 2, 13, 22, 25, 32 AND 50).

FOR: HOUSEHOLD UTENSILS, NAMELY, GRATERS, SPATULAS; CONTAINERS FOR HOUSEHOLD USE; COMBS AND SPONGES, NAMELY, BATH SPONGES, CLEANING SPONGES; BRUSHES, NAMELY, BATH BRUSHES, PAINT BRUSHES; BRUSH-MAKING MATERIALS; ARTICLES FOR CLEANING PURPOSES, NAMELY, MOPS AND BROOMS; METAL SCOURING PADS; UNWORKED OR SEMI-WORKED GLASS EXCEPT GLASS USED IN BUILDINGS; BEVERAGE GLASSWARE; PORCELAIN AND EARTHENWARE, NAMELY, PORCELAIN MUGS, EARTHENWARE DOORKNOBS; BREAKFAST SERVICES, NAMELY, PLATES, TEAPOTS; TABLEWARE OTHER THAN KNIVES, FORKS, AND SPOONS FOR HOUSEHOLD PURPOSES, NAMELY, PLATES, BOWLS, MUGS; PARTY ACCESSORIES, NAMELY, PLATES AND DRINKING GLASSES OF PLASTIC, PLASTIC PLATES, IN CLASS 21 (U.S. CLS. 2, 13, 23, 29, 30, 33, 40 AND 50).

FOR: TABLEMATS NOT OF PAPER, PLASTIC FLAGS, PLASTIC PENNANTS; CURTAINS OF TEXTILE AND/OR PLASTIC, IN CLASS 24 (U.S. CLS. 42 AND 50).

FOR: LACE AND EMBROIDERY, RIBBONS AND BRAID, BUTTONS, HOOKS AND EYES, PINS, NAMELY, SAFETY PINS, SEWING PINS AND NEEDLES, ARTIFICIAL FLOWERS, HAIR CLIPS, HAIR ORNAMENTS AND HAIR ELASTICS OR BANDS, IN CLASS 26 (U.S. CLS. 37, 39, 40, 42 AND 50).

FOR: CARPETS, RUGS, MATS AND MATTING, NAMELY, FLOOR MATS, GOZA RUSH MATS, STRAW MATS, LINOLEUM AND COVERINGS FOR EXISTING FLOORS, NON-TEXTILE WALL HANGINGS; FLOOR MATS FOR GAMES, WALLPAPER, IN CLASS 27 (U.S. CLS. 19, 20, 37, 42 AND 50).

FOR: MEAT, FISH, POULTRY AND GAME; MEAT EXTRACTS; PRESERVED FROZEN, DRIED AND COOKED FRUITS AND VEGETABLES; JELLIES, JAMS, COMPOTES; EGGS, MILK AND MILK PRODUCTS, EXCLUDING ICE CREAM, ICE MILK AND FROZEN

Reg. No. 4,097,578 YOGURT; EDIBLE OILS AND FATS, FRUIT-BASED SNACK FOOD, POTATO CRISPS, IN CLASS 29 (U.S. CL. 46).

FOR: COFFEE, TEA, COCOA, SUGAR, RICE, TAPIOCA, SAGO, ARTIFICIAL COFFEE, CONFECTIONERY, NAMELY, CONFECTIONERY MADE OF SUGAR, CONFECTIONARY CHIPS FOR BAKING, FLAVORED ICES, HONEY, TREACLE, YEAST, BAKING-POWDER, SALT, MUSTARD, VINEGAR, SAUCES IN THE NATURE OF CONDIMENTS, SPICES, ICE; GRAIN-BASED CHIPS, EDIBLE DECORATIONS FOR CAKES, CEREAL BASED SNACK BARS, CHEWING GUM, CHOCOLATE-BASED BEVERAGES, COCOA-BASED BEVERAGES, ICE CREAM WAFERS AND CONES, COOKIES; CEREAL-BASED SNACK BARS; COOKIES, FLAVOURED, SWEETENED GELATINE DESSERTS, FROZEN CONFECTIONERY; FROZEN YOGURT, ICE, ICE MILK, LIQUORICE; MARSHMALLOWS, OAT MEAL; PANCAKES, PANCAKE MIXTURE, CAKES, SYRUP FOR FLAPJACKS, POPCORN, WAFFLES, IN CLASS 30 (U.S. CL. 46).

FOR: MINERAL AND AERATED WATERS AND OTHER NON-ALCOHOLIC DRINKS, NAMELY, COCONUT-BASED NON-ALCOHOLIC BEVERAGES, NON-ALCOHOLIC BEER; FRUIT DRINKS AND FRUIT JUICES; SYRUPS AND OTHER PREPARATIONS FOR MAKING BEVERAGES, NAMELY, NON-ALCOHOLIC FRUIT EXTRACTS, POWDERS USED IN THE PREPARATION OF FRUIT-BASED BEVERAGES, IN CLASS 32 (U.S. CLS. 45, 46 AND 48).

THE MARK CONSISTS OF STANDARD CHARACTERS WITHOUT CLAIM TO ANY PARTICULAR FONT, STYLE, SIZE, OR COLOR.

PRIORITY DATE OF 4-28-2009 IS CLAIMED.

OWNER OF INTERNATIONAL REGISTRATION 1042197 DATED 10-28-2009, EXPIRES 10-28-2019.

OWNER OF U.S. REG. NOS. 3,835,134 AND 3,835,135.

THE ENGLISH TRANSLATION OF "BELLA" IN THE MARK IS "BEAUTIFUL".

SER. NO. 79-083,816, FILED 10-28-2009.

ALLISON SCHRODY, EXAMINING ATTORNEY

United States of America

United States Patent and Trademark Office

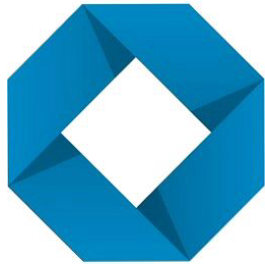

OPTICS BALZERS

Reg. No. 4,097,579

Registered Feb. 14, 2012

Int. Cls.: 9 and 35

TRADEMARK

SERVICE MARK

PRINCIPAL REGISTER

OPTICS BALZERS AG (LIECHTENSTEIN JOINT STOCK COMPANY (AG))
NEUGRÜT 35
FL-9496 BALZERS, LIECHTENSTEIN

FOR: OPTICAL, OPTO-ELECTRICAL, OPTO-ELECTRONIC AND OPTO-BIOLOGICAL SYSTEMS AND COMPONENTS, NAMELY, THIN FILM OPTICAL FILTERS, OPTICAL REFLECTORS, OPTICAL MIRRORS, OPTICAL LENSES, PRISMS, OPTICAL LIDS IN THE NATURE OF OPTICAL WINDOWS, PATTERNED COMPONENTS IN THE NATURE OF OPTICAL FILTERS, OPTICAL MIRRORS, ALL THE AFOREMENTIONED PRODUCTS DERIVED FROM THE PRINCIPALITY OF LIECHTENSTEIN, IN CLASS 9 (U.S. CLS. 21, 23, 26, 36 AND 38).

FOR: RETAIL STORE SERVICES IN THE FIELD OF OPTICAL, OPTO-ELECTRICAL, OPTO-ELECTRONIC AND OPTO-BIOLOGICAL SYSTEMS AND COMPONENTS, IN CLASS 35 (U.S. CLS. 100, 101 AND 102).

NO CLAIM IS MADE TO THE EXCLUSIVE RIGHT TO USE "OPTICS", APART FROM THE MARK AS SHOWN.

OWNER OF INTERNATIONAL REGISTRATION 1014034 DATED 4-30-2009, EXPIRES 4-30-2019.

THE COLOR(S) BLUE, BLACK IS/ARE CLAIMED AS A FEATURE OF THE MARK.

THE MARK CONSISTS OF A BLUE DIAMOND SHAPE WITH A SQUARE HOLLOW CENTER TO THE LEFT OF THE BLACK WORDING "OPTICS BALZERS"; THE BACKGROUND OF THE MARK IS TRANSPARENT.

THE ENGLISH TRANSLATION OF "BALZERS" IS "THE NAME OF A SMALL VILLAGE LOCATED IN SOUTHERN LIECHTENSTEIN".

SER. NO. 79-084,050, FILED 12-4-2009.

ANDREA HACK, EXAMINING ATTORNEY



David J. Kyffers

Director of the United States Patent and Trademark Office

United States of America

United States Patent and Trademark Office

MARIA BJÖRNSON

Reg. No. 4,097,580

Registered Feb. 14, 2012

**Int. Cls.: 9, 35, 36, 41
and 42**

TRADEMARK

SERVICE MARK

PRINCIPAL REGISTER

PRODAN ROMANIAN CULTURAL FOUNDATION (LIECHTENSTEIN CHARITABLE FOUNDATION)
LOVA CENTER
P.O. BOX 1150
VADUZ, LIECHTENSTEIN FL9490

FOR: AUDIO AND VIDEO TAPES; CDS AND DVDS ALL FEATURING MUSIC AND MUSICAL THEATRE PERFORMANCES; MUSICAL SOUND AND VIDEO RECORDINGS; PHONOGRAPH RECORDS FEATURING THEATRE OPERA AND BALLET; OPERA GLASSES; MAGNIFYING GLASSES AND SUNGLASSES; CASES FOR OPERA GLASSES; MAGNIFYING GLASSES AND SUNGLASSES; CHAINS FOR SPECTACLES AND EYE GLASSES; CINEMATOGRAPHIC FILMS OF MUSICAL, THEATRICAL PERFORMANCES; DOWNLOADABLE ELECTRONIC PUBLICATIONS IN THE NATURE OF SHEET MUSIC, BOOKS AND PAMPHLETS IN THE FIELD OF MUSIC AND MUSICAL THEATRE AND HISTORICAL DOCUMENTS IN THE FIELD OF MUSIC AND MUSICAL THEATRE; AND DECORATIVE MAGNETS, IN CLASS 9 (U.S. CLS. 21, 23, 26, 36 AND 38).

FOR: ADVERTISING SERVICES; BUSINESS MANAGEMENT; BUSINESS ADMINISTRATION CONSULTANCY; RETAIL STORE SERVICES AND ON-LINE RETAIL STORE SERVICES FEATURING CDS AND DVDS, OPERA GLASSES, MAGNIFYING GLASSES, SUNGLASSES, PHOTOGRAPHS, STATIONERY, ARTIST MATERIALS, BOOKS, POSTERS, MAGAZINES, EMBROIDERY, KNITTING AND CLOTHES PATTERNS, MANUSCRIPTS, SHEET MUSIC, GREETING CARDS AND POST CARDS, PERSONAL ORGANIZER, NAPKINS, NOTE BOOKS, THEATRE SCENERY, CUSHIONS AND PILLOWS, PICTURE FRAMES, FIRE SCREENS AND FIRE GUARDS, MIRRORS, MIRROR TILES, BASKETS, PICNIC BASKETS, HAMMERS, CLOTHES HOOK, HAT STANDS, UMBRELLA STANDS, EMBROIDERY FRAMES, FANS, TABLEWARE, GLASS WARE, PORCELAIN, STONWARE AND CHINAWARE, CERAMIC AND POTTERY WARE, TEA SERVICES AND COFFEE SERVICES, CANDLE STICKS, CANDLE HOLDERS, CANDELABRAS, COASTERS, NAPKIN HOLDERS, COMBS, SPONGES AND BRUSHES, CUTLERY HOLDERS, TEXTILES, BED AND TABLE COVERS, FABRICS FOR USE IN UPHOLSTERY, TABLE LINEN, TABLE NAPKINS, TABLE MATS AND COASTERS, BATH LINEN, HOUSEHOLD LINEN, TEA TOWELS, BED CLOTHES, BED LINEN, BED SPREADS, SLEEPING BAGS, PILLOW CASES, COVERS FOR QUILTS AND EIDERDOWNS, CLOTHING, FOOTWEAR, HEADGEAR, LACE AND EMBROIDERY, RIBBONS AND BRAID, BUTTONS, HOOKS, EYES, PINS AND NEEDLES, ARTIFICIAL FLOWERS, HABERDASHERY, TAPES, TRIMMINGS, ORNAMENTS FOR THE HAIR, ORNAMENTS FOR SHOES, SEWING BOXES AND SEWING ACCESSORIES, PINS, NEEDLES,



David J. Kypos

Director of the United States Patent and Trademark Office

Reg. No. 4,097,580 HOOKS, TEA COSY AND COVERS, EGG COSY AND COVERS ARTIFICIAL FLOWERS, IN CLASS 35 (U.S. CLS. 100, 101 AND 102).

FOR: TRUSTEE SERVICES; APPRAISAL SERVICES IN THE FIELDS OF THEATRICAL SETS, THEATRICAL DESIGNS, COSTUMES AND JEWELRY; FINANCIAL VALUATIONS; CHARITABLE FOUNDATION SERVICES, NAMELY, PROVIDING SPONSORSHIPS FOR AND PROVIDING FUND RAISING ACTIVITIES AND FINANCIAL SUPPORT FOR CULTURAL PROJECTS, NAMELY, MATTERS RELATED TO SET AND COSTUME DESIGNERS AND FACILITIES RELATED TO SET AND COSTUME DESIGN; PROVIDING FINANCIAL SUPPORT FOR TRAINING AND APPRENTICESHIPS AND SPONSORSHIP OF COSTUME AND SET DESIGNERS, AND PROVIDING TRAVEL GRANTS AND SUBSISTENCE AND SUBSIDIES FOR THEATRICAL PRODUCTIONS, IN CLASS 36 (U.S. CLS. 100, 101 AND 102).

FOR: PROVIDING EDUCATIONAL INFORMATION RELATING TO THE LIFE AND WORK OF A THEATRE, OPERA AND BALLET SET AND COSTUME DESIGNER; CONDUCTING CLASSES, SEMINARS AND WORK SHOPS IN THE FIELD OF THEATRICAL ENTERTAINMENT, SET DESIGN AND COSTUME DESIGN; ENTERTAINMENT SERVICES, NAMELY, PROVIDING ADVICE AND INFORMATION IN THE FIELDS OF MUSIC, VIDEO AND FILM CONCEPT, CONCERTS AND SCRIPT DEVELOPMENT; ENTERTAINMENT SERVICES, NAMELY, LIVE THEATRICAL, DANCE AND MUSICAL PERFORMANCES; ENTERTAINMENT SERVICES, NAMELY, THE PRESENTATION OF SEMINARS, LECTURES, WORKSHOPS, PANEL DISCUSSIONS, ALL IN THE FIELD OF THEATRICAL ENTERTAINMENT AND DESIGN; ENTERTAINMENT SERVICES, NAMELY, FASHION SHOWS, ENTERTAINMENT SERVICES IN THE NATURE OF THEATRE PRODUCTIONS; ENTERTAINMENT SERVICES IN THE NATURE OF VISUAL AND AUDIO PERFORMANCES, AND MUSICAL, VARIETY, COMEDY SHOWS, DANCE, AND BALLET PERFORMANCES; ENTERTAINMENT SERVICES, NAMELY, PRODUCTION OF SPECIAL EFFECTS INCLUDING MODEL-MAKING SERVICES AND RELATED PHYSICAL PRODUCTION ELEMENTS FOR USE IN MOTION PICTURES; ORGANIZATION OF EXHIBITIONS, SEMINARS AND WORKSHOPS FOR CULTURAL OR EDUCATIONAL PURPOSES; PRODUCTIONS AND DIRECTION OF MUSICAL THEATRE, OPERA AND PLAYS AND OF AUDIO, VIDEO AND CINEMATOGRAPHIC RECORDINGS; NON-DOWNLOADABLE ELECTRONIC PUBLICATIONS IN THE NATURE OF BOOKS, MUSICAL NOTATIONS AND PAMPHLETS IN THE FIELD OF THEATRE, SET DESIGN, COSTUME DESIGN AND MUSICAL THEATRE; BOOK AND MUSIC PUBLISHING SERVICES; PROVISION OF NON-DOWNLOADABLE ON-LINE ELECTRONIC PUBLICATIONS IN THE NATURE OF BOOKS RELATING TO THEATRICAL PERFORMANCES, THEATRICAL DESIGN, SET AND COSTUME DESIGN; PROVISION OF THEATRICAL AND MUSIC THEATRE MUSEUMS; ARRANGING EXHIBITIONS FOR CULTURAL AND EDUCATIONAL PURPOSES; PROVISION AND RENTAL OF THEATRE SETS AND SCENERY; THEATRICAL AND MUSICAL THEATRE MUSEUM CURATOR SERVICES; LIBRARY SERVICES, NAMELY, ARCHIVE AND REFERENCE SERVICES FEATURING THE LIFE AND WORK OF A THEATRE OPERA AND BALLET SET AND COSTUME DESIGNER; SYNDICATION SERVICES FEATURING PHOTOGRAPHS RELATING TO THE LIFE AND WORK OF A THEATRE, OPERA, BALLET AND SET COSTUME DESIGNER; COMMERCIAL LICENSING TO THIRD PARTIES OF PHOTOGRAPHS RELATING TO THE LIFE AND WORK OF A THEATRE, OPERA AND BALLET SET AND COSTUME DESIGNER, IN CLASS 41 (U.S. CLS. 100, 101 AND 107).

FOR: DESIGN CONSULTANCY RELATING TO THEATRICAL SETS AND COSTUMES; PRODUCT DESIGN SERVICES FOR OTHERS; CLOTHING DESIGN FOR OTHERS; THEATRE DESIGN SERVICES; THEATRICAL SET AND SCENERY DESIGN SERVICES; TEXTILE DESIGN SERVICES; AND HISTORICAL RESEARCH SERVICES, IN CLASS 42 (U.S. CLS. 100 AND 101).

THE MARK CONSISTS OF STANDARD CHARACTERS WITHOUT CLAIM TO ANY PARTICULAR FONT, STYLE, SIZE, OR COLOR.

PRIORITY DATE OF 6-19-2009 IS CLAIMED.

Reg. No. 4,097,580 OWNER OF INTERNATIONAL REGISTRATION 1043024 DATED 12-14-2009, EXPIRES 12-14-2019.

THE NAME(S), PORTRAIT(S), AND/OR SIGNATURE(S) SHOWN IN THE MARK DOES NOT IDENTIFY A PARTICULAR LIVING INDIVIDUAL.

SER. NO. 79-084,155, FILED 12-14-2009.

REGINA DRUMMOND, EXAMINING ATTORNEY

United States of America

United States Patent and Trademark Office



Reg. No. 4,097,581

Registered Feb. 14, 2012

**Int. Cls.: 9, 16, 35, 38
and 41**

TRADEMARK

SERVICE MARK

PRINCIPAL REGISTER

EURO RSCG LONDON LIMITED (ENGLAND PRIVATE LIMITED COMPANY)
CONCORDE HOUSE, 10-12 LONDON ROAD
MAIDSTONE, KENT ME16 8QF
UNITED KINGDOM

FOR: DIGITAL AUDIO AND VIDEO RECORDERS AND PLAYERS FOR RECORDING, REPRODUCING AND TRANSMITTING SOUND, VIDEO, DATA, AND DIGITAL IMAGES, GRAPHICS AND TEXT FILES; PRE-RECORDED DVDS AND VIDEO TAPES FEATURING MOTIVATIONAL SPEECHES; PRE-RECORDED COMPACT DISCS FEATURING MUSIC; BLANK RECORDABLE OPTICAL DISCS; COMPACT DISCS FEATURING MUSIC, MOTIVATIONAL SPEECHES, INFORMATION ON WORLDWIDE AFFAIRS, ECONOMICS, BUSINESS, GOVERNMENT, PUBLIC POLICY AND FOREIGN POLICY; BLANK FLOPPY COMPUTER DISCS; SOUND RECORDINGS FEATURING MUSIC AND MOTIVATIONAL SPEECHES; ENHANCED SOUND AND VISUAL RECORDINGS FEATURING, MOTIVATIONAL SPEECHES, INFORMATION ON WORLDWIDE AFFAIRS, ECONOMICS, BUSINESS, GOVERNMENT, PUBLIC POLICY AND FOREIGN POLICY; INTERACTIVE SOUND AND VISUAL RECORDINGS FEATURING MOTIVATIONAL SPEECHES, INFORMATION ON WORLDWIDE AFFAIRS, ECONOMICS, BUSINESS, GOVERNMENT, PUBLIC POLICY AND FOREIGN POLICY; PRE-RECORDED DIGITAL VIDEO DISCS FEATURING MOTIVATIONAL SPEECHES, INFORMATION ON WORLDWIDE AFFAIRS, ECONOMICS, BUSINESS, GOVERNMENT, PUBLIC POLICY AND FOREIGN POLICY; GRAMOPHONE RECORDS FEATURING MOTIVATIONAL SPEECHES, INFORMATION ON WORLDWIDE AFFAIRS, ECONOMICS, BUSINESS, GOVERNMENT, PUBLIC POLICY AND FOREIGN POLICY; BLANK AUDIO TAPES; BLANK AUDIO TAPE CASSETTES; BLANK VIDEO TAPES; LASER DISCS FEATURING MOTIVATIONAL SPEECHES, INFORMATION ON WORLDWIDE AFFAIRS, ECONOMICS, BUSINESS, GOVERNMENT, PUBLIC POLICY AND FOREIGN POLICY; INTERACTIVE COMPACT DISCS FEATURING SOUND AND VISUAL RECORDINGS OF MOTIVATIONAL SPEECHES, INFORMATION ON WORLDWIDE AFFAIRS, ECONOMICS, BUSINESS, GOVERNMENT, PUBLIC POLICY AND FOREIGN POLICY; BLANK CD-ROMS FOR SOUND OR VIDEO RECORDING; BLANK SUPER AUDIO COMPACT DISCS; BLANK RECORDABLE DVDS; DOWNLOADABLE PODCASTS IN THE FIELD OF MOTIVATIONAL SPEECHES, INFORMATION ON WORLDWIDE AFFAIRS, ECONOMICS, BUSINESS, GOVERNMENT, PUBLIC POLICY AND FOREIGN POLICY; DIGITAL MUSIC DOWNLOADABLE FROM THE INTERNET; AUDIO APPARATUS AND INSTRUMENTS, NAMELY, RADIOS; MP3 PLAYERS; PERSONAL DIGITAL ASSISTANTS; ELECTRONIC GAME PROGRAMS; DEVICES FOR STORING INFORMATION, DATA, IMAGES AND SOUND, NAMELY, BLANK HARD DRIVES FOR COMPUTERS; DOWNLOADABLE MULTIMEDIA FILE CONTAINING



David J. Kappas

Director of the United States Patent and Trademark Office

Reg. No. 4,097,581 ARTWORK, TEXT AND AUDIO RELATING TO MOTIVATIONAL SPEECHES, INFORMATION ON WORLDWIDE AFFAIRS, ECONOMICS, BUSINESS, GOVERNMENT, PUBLIC POLICY AND FOREIGN POLICY; SOUND AND VISUAL RECORDINGS FEATURING MOTIVATIONAL SPEECHES, INFORMATION ON WORLDWIDE AFFAIRS, ECONOMICS, BUSINESS, GOVERNMENT, PUBLIC POLICY AND FOREIGN POLICY; SOUND AND VISUAL RECORDING MEDIA, NAMELY, BLANK RECORDABLE DVDS; COMPUTER GAME SOFTWARE; VIDEO GAME SOFTWARE; VIRTUAL REALITY SYSTEMS COMPRISING COMPUTER HARDWARE; COMPUTER SOFTWARE FOR USE IN DOWNLOADING, TRANSMITTING, RECEIVING, EDITING, EXTRACTING, ENCODING, DECODING, PLAYING, STORING AND ORGANIZING DATA INCLUDING AUDIO AND VIDEO DATA; SOUND AND VIDEO RECORDINGS FEATURING MOTIVATIONAL SPEECHES, INFORMATION ON WORLDWIDE AFFAIRS, ECONOMICS, BUSINESS, GOVERNMENT, PUBLIC POLICY AND FOREIGN POLICY; MULTIMEDIA SOFTWARE RECORDED ON CD-ROM FEATURING MOTIVATIONAL SPEECHES, INFORMATION ON WORLDWIDE AFFAIRS, ECONOMICS, BUSINESS, GOVERNMENT, PUBLIC POLICY AND FOREIGN POLICY; DIGITAL AUDIO AND VIDEO RECORDERS AND PLAYERS FOR THE DOWNLOADING, TRANSMITTING, ENCODING, DECODING, EDITING, PLAYING AND STORAGE OF DATA INCLUDING AUDIO AND VIDEO RECORDINGS, NAMELY, MOTIVATIONAL SPEECHES, INFORMATION ON WORLDWIDE AFFAIRS, ECONOMICS, BUSINESS, GOVERNMENT, PUBLIC POLICY AND FOREIGN POLICY; DOWNLOADABLE ELECTRONIC PUBLICATIONS IN THE NATURE OF MAGAZINES IN THE FIELD OF WORLDWIDE AFFAIRS, ECONOMICS, BUSINESS, GOVERNMENT, PUBLIC POLICY AND FOREIGN POLICY; INTERACTIVE COMPUTER GAME SOFTWARE; DOWNLOADABLE DIGITAL MUSIC AND ELECTRONIC MAGAZINES IN THE FIELD OF MUSIC DOWNLOADABLE VIA AN ON-LINE COMPUTER NETWORK, IN CLASS 9 (U.S. CLS. 21, 23, 26, 36 AND 38).

FOR: PAPER, CARDBOARD AND GOODS MADE FROM THESE MATERIALS, NAMELY, BOOKS, BROCHURES, CATALOGS, GUIDE BOOKS, INFORMATION SHEETS, JOURNALS, LEAFLETS, MAGAZINES, NEWSLETTERS, PAMPHLETS, PERIODICALS, PRINTED INSTRUCTIONAL AND TEACHING MATERIALS IN THE FIELD OF WORLDWIDE AFFAIRS, ECONOMICS, BUSINESS, GOVERNMENT, PUBLIC POLICY AND FOREIGN POLICY; ADVERTISING SIGNS OF PAPER OR CARDBOARD; COMICS; NEWSPAPERS; PHOTOGRAPHS; STATIONERY; PHOTOGRAPHIC PRINTS AND PRINTED VISUALS IN THE NATURE OF PRINTED GRAPHIC ARTWORK, PRINTED CLIP ART, ILLUSTRATIONS, NEWS PHOTOGRAPHS, AND STILL PHOTOGRAPHS TAKEN FROM DIGITAL ANIMATION, VIDEO CLIPS AND FILM FOOTAGE; PHOTOGRAPHIC PRINTS BOTH MOUNTED AND UNMOUNTED; POSTERS; POSTCARDS; PICTURES; DIARIES; DRAWING INSTRUMENTS; GREETING CARDS; ADDRESS BOOKS; EVENT PROGRAMS; PRINTED TICKETS; CALENDARS; SIGNED PHOTOGRAPHS; PHOTOGRAPHIC ALBUMS; AUTOGRAPH ALBUMS; NEWS BULLETINS; NOTE PADS; NOTE BOOKS; STICKERS; DECALCOMANIAS; FILE FOLDERS; STUDY GUIDES; TRAVEL GUIDE BOOKS; RECORD TOKEN CARDS, NAMELY, ENVELOPES OR FOLDED PIECES OF PAPER OR CARDBOARD WHEREIN A RECORD TOKEN MAY BE PLACED; GIFT TOKEN CARDS, NAMELY, ENVELOPES OR FOLDED PIECES OF PAPER OR CARDBOARD WHEREIN A GIFT TOKEN MAY BE PLACED; WRAPPING PAPER; WRITING IMPLEMENTS; PENS; BALLPOINT PENS; FOUNTAIN PENS; PENCILS; DRAFTING RULERS; ERASERS; PENCIL SHARPENERS; PEN AND PENCIL CASES; PICTURE CARDS; PICTURE BOOKS; SONG BOOKS; SHEET MUSIC; CARDBOARD AND PAPER BADGES; PAPER NAME BADGES; PAPER FLAGS, IN CLASS 16 (U.S. CLS. 2, 5, 22, 23, 29, 37, 38 AND 50).

FOR: ADVERTISING; BUSINESS MANAGEMENT; BUSINESS ADMINISTRATION; PROVIDING OFFICE FUNCTIONS; ADVERTISING SERVICES PROVIDED VIA THE INTERNET; PRODUCTION OF TELEVISION AND RADIO ADVERTISEMENTS; CONDUCTING, ARRANGING AND ORGANIZING TRADE FAIRS FOR COMMERCIAL AND ADVERTISING PURPOSES; PUBLIC OPINION POLLING; MARKET OPINION POLLING STUDIES; PROVISION OF BUSINESS INFORMATION; ADVERTISING AND INFORMATION DISTRIBUTION SERVICES, NAMELY, PROVIDING ADVERTISING SPACE ON THE INTERNET; PROMOTING THE GOODS AND SERVICES OF OTHERS OVER THE INTERNET; COMPILATION

Reg. No. 4,097,581 AND SYSTEMIZATION OF INFORMATION INTO ON-LINE COMPUTER DATABASES FOR OTHERS IN THE FIELD OF COLLEGIATE LIFE, GENERAL INTEREST, CLASSIFIEDS, VIRTUAL COMMUNITY, SOCIAL NETWORKING, PHOTO SHARING, VIDEO SHARING, AND TRANSMISSION OF PHOTOGRAPHIC IMAGES; MARKET STUDY; DISSEMINATION OF ADVERTISEMENTS; DESIGN OF ADVERTISING MATERIALS FOR OTHERS; SALES PROMOTION FOR THIRD PARTIES; ADVERTISING TEXT PUBLICATION SERVICES; RENTAL OF ADVERTISING SPACE; PUBLIC RELATIONS; PRESS RELATIONS IN THE NATURE OF PUBLICITY AGENT SERVICES; ORGANIZATION OF EXHIBITIONS FOR COMMERCIAL AND ADVERTISING PURPOSES; MARKETING AND MERCHANDISING SERVICES, NAMELY, ORDER FULFILLMENT SERVICES; SPONSORSHIP SEARCH; ADVERTISING BY TRANSMISSION OF ON-LINE PUBLICITY FOR THIRD PARTIES THROUGH ELECTRONIC COMMUNICATIONS NETWORKS; ONLINE ADVERTISING ON COMPUTER COMMUNICATION NETWORKS; PUBLISHING OF ADVERTISING TEXTS; DESIGN AND DEVELOPMENT OF ADVERTISING CAMPAIGNS FOR OTHERS; PRESENTATION OF GOODS ON COMMUNICATIONS MEDIA, FOR RETAIL PURPOSES; BUSINESS MARKETING CONSULTING SERVICES; BUSINESS STRATEGY DEVELOPMENT SERVICES; CONDUCTING MARKET SURVEYS RELATING TO BUSINESS PROMOTIONAL STRATEGY; SERVICES CONSISTING OF THE COLLECTION, TRANSCRIPTION, COMPILATION AND SYSTEMIZATION OF WRITTEN COMMUNICATIONS AND DATA INTO COMPUTER DATABASES FOR OTHERS, NAMELY, RESEARCH STATISTICS, DATA, BUSINESS INFORMATION, SOCIAL SURVEY DATA AND FINANCIAL INFORMATION; BUSINESS INVESTIGATIONS OF MARKETING STRATEGY; INFORMATION, CONSULTANCY AND ADVISORY SERVICES, ALL RELATING TO THE AFORESAID, IN CLASS 35 (U.S. CLS. 100, 101 AND 102).

FOR: COMMUNICATION SERVICES, NAMELY, TRANSMISSION OF VOICE, AUDIO, VISUAL IMAGES AND DATA BY TELECOMMUNICATIONS NETWORKS, WIRELESS COMMUNICATION NETWORKS, THE INTERNET, INFORMATION SERVICES NETWORKS AND DATA NETWORKS; AUDIO AND VIDEO BROADCASTING SERVICES; TELEVISION AND RADIO BROADCASTING; COMMUNICATION VIA RADIO, TELEVISION AND MOBILE TELEPHONE TRANSMISSIONS; PROVIDING ON-LINE CHAT ROOMS, FORUMS AND ELECTRONIC BULLETIN BOARDS FOR TRANSMISSION OF MESSAGES AMONG USERS IN THE FIELD OF GENERAL INTEREST; COMMUNICATIONS BY COMPUTER TERMINALS; INFORMATION TRANSMISSION VIA ELECTRONIC COMMUNICATIONS NETWORKS, PARTICULARLY IN THE FIELDS OF ENTERTAINMENT, CELEBRITIES, FILMS, TELEVISION, MUSIC, SPORT, PHOTOGRAPHY, EDUCATION, POLITICS AND CURRENT EVENTS; ELECTRONIC TRANSMISSION OF SOUND AND PICTURES; INFORMATION TRANSMISSION VIA ELECTRONIC COMMUNICATIONS NETWORKS, INCLUDING WEB SITE FORWARDING SERVICES; PROVIDING INTERNET ACCESS TO AN ONLINE DISCUSSION WEBSITE; COMPUTER AIDED TRANSMISSION OF MESSAGES AND IMAGES; ELECTRONIC MAIL; ELECTRONIC TRANSMISSION OF MAIL AND MESSAGES; TRANSFER OF DATA BY TELECOMMUNICATIONS, NAMELY, TRANSFERRING AND DISSEMINATING INFORMATION AND DATA VIA COMPUTER NETWORKS AND THE INTERNET; MOBILE TELEPHONE SERVICES, INCLUDING TEXT AND VOICE MESSAGING AND PROVIDING WIRELESS INTERNET ACCESS TO DOWNLOADABLE VIDEOS, GAMES, RING TONES, DATA FILES, GRAPHICS AND GRAPHIC AND MUSIC; TELECOMMUNICATION SERVICES, NAMELY, PROVIDING INTERNET ACCESS VIA WIRELESS NETWORKS TO SITES OFFERING MOBILE TELEPHONE RING TONES; TELECOMMUNICATIONS SERVICES, NAMELY, PROVIDING INTERNET ACCESS TO BLOGS, CHAT ROOMS, BULLETIN BOARDS AND ONLINE DISCUSSION SERVICES; INTERNET ACCESS PROVIDER SERVICES; PROVIDING E-MAIL SERVICES; PROVIDING USER ACCESS TO THE INTERNET; RADIO AND TELEVISION BROADCASTING; PROVIDING CONSULTATION AND ADVISORY SERVICES IN THE FIELD OF TELECOMMUNICATIONS, IN CLASS 38 (U.S. CLS. 100, 101 AND 104).

FOR: EDUCATION SERVICES, NAMELY, PROVIDING CLASSES, SEMINARS AND WORKSHOPS IN THE FIELDS OF WORLDWIDE AFFAIRS, ECONOMICS, BUSINESS, GOVERNMENT, PUBLIC POLICY AND FOREIGN POLICY; ORGANIZING LIVE AND ON-LINE EDUCATIONAL CONFERENCES IN THE FIELDS OF WORLDWIDE AFFAIRS, ECO-

Reg. No. 4,097,581 NOMICS, BUSINESS, GOVERNMENT, PUBLIC POLICY AND FOREIGN POLICY; ARRANGING EDUCATIONAL ENTERTAINMENT IN THE NATURE OF LECTURES FOR HIRE IN THE FIELDS OF WORLDWIDE AFFAIRS, ECONOMICS, BUSINESS, GOVERNMENT, PUBLIC POLICY AND FOREIGN POLICY; EDUCATIONAL SERVICES, NAMELY, ORGANIZING ON-LINE EDUCATIONAL EXHIBITIONS AND PROVIDING ONLINE EDUCATIONAL DISPLAYS AND EXHIBITS IN THE FIELDS OF WORLDWIDE AFFAIRS, ECONOMICS, BUSINESS, GOVERNMENT, PUBLIC POLICY AND FOREIGN POLICY; PROVIDING OF TRAINING SERVICES IN THE FIELD OF PUBLIC SPEAKING ON THE SUBJECTS OF WORLDWIDE AFFAIRS, ECONOMICS, BUSINESS, GOVERNMENT, PUBLIC POLICY AND FOREIGN POLICY; ENTERTAINMENT SERVICES IN THE NATURE OF PERSONAL APPEARANCES BY A MOVIE STARS, SPORTS CELEBRITIES AND MUSICIANS; ORGANIZING LIVE EXHIBITIONS, CONFERENCES AND SEMINARS IN THE FIELDS OF EDUCATION, CULTURE, SPORTS AND ENTERTAINMENT FOR NON-BUSINESS AND NON-COMMERCIAL PURPOSES; PUBLICATION OF BOOKS AND MAGAZINES; ENTERTAINMENT SERVICES, NAMELY, PROVIDING INFORMATION ABOUT A RECORDING ARTIST VIA AN ONLINE NETWORK; PRESENTATION OF LIVE SHOW PERFORMANCES; ORGANIZING COMMUNITY SPORTING AND CULTURAL EVENTS; PROVIDING RECOGNITION AND INCENTIVES BY THE WAY OF AWARDS TO DEMONSTRATE EXCELLENCE IN THE FIELD OF MOTIVATIONAL AND PUBLIC SPEAKING, WORLDWIDE AFFAIRS, ECONOMICS, BUSINESS, GOVERNMENT, PUBLIC POLICY AND FOREIGN POLICY; ENTERTAINMENT, NAMELY, A CONTINUING VARIETY, NEWS, AND COMEDY SHOW BROADCAST OVER TELEVISION, SATELLITE, AUDIO, AND VIDEO MEDIA; SPORTING AND CULTURAL ACTIVITIES, NAMELY, ART EXHIBITIONS, ETHNIC DANCE PERFORMANCES; ORGANIZATION OF SPORTS COMPETITIONS; PRODUCTION AND DISTRIBUTION OF MOTION PICTURES; ENTERTAINMENT SERVICES, NAMELY, DISPLAYING A SERIES OF FILMS; PRESENTATION OF LIVE SHOW PERFORMANCES; ENTERTAINMENT, NAMELY, LIVE MUSIC CONCERTS; ARRANGING OF CONTESTS; ORGANIZATION OF EXHIBITIONS FOR CULTURAL, ENTERTAINMENT AND EDUCATIONAL PURPOSES; ENTERTAINMENT SERVICES, NAMELY, ORGANIZING LIVE MUSICAL CONCERTS; RESERVATION OF TICKETS FOR ENTERTAINMENT, SPORTS EVENTS AND CULTURAL EXHIBITIONS; PROVISION OF CINEMA AND THEATRE FACILITIES; FILM, SOUND AND VIDEO RECORDING, PRODUCTION AND EDITING SERVICES; BOOK PUBLISHING; PUBLICATION OF PRINTED MATTER, BOOKS AND PERIODICAL PUBLICATIONS; THEATRICAL AGENCY SERVICES; ENTERTAINMENT TICKET AGENCY SERVICES FOR PERFORMING ARTISTS; FAN CLUB SERVICES; INFORMATION, CONSULTANCY AND ADVISORY SERVICES RELATING TO ALL THE AFORESAID SERVICES INCLUDING SUCH SERVICES PROVIDED ONLINE OR VIA THE INTERNET OR EXTRANETS, IN CLASS 41 (U.S. CLS. 100, 101 AND 107).

THE MARK CONSISTS OF THE WORDING "ONE YOUNG WORLD" IN STYLIZED FONT. THE WORD "ONE" IS PRESENTED IN A LARGE FONT RESEMBLING OVERLAPPING RIBBONS IN BLUE WITH BLACK SHADOW HIGHLIGHTS. THE WORDING "YOUNG WORLD" APPEARS IN A SMALLER BLUE STYLIZED FONT WITHIN THE LARGER LETTER "O".

OWNER OF INTERNATIONAL REGISTRATION 1043497 DATED 1-27-2010, EXPIRES 1-27-2020.

THE COLOR(S) BLUE AND BLACK IS/ARE CLAIMED AS A FEATURE OF THE MARK.

SER. NO. 79-084,387, FILED 1-27-2010.

STEVEN PEREZ, EXAMINING ATTORNEY

United States of America

United States Patent and Trademark Office

Chat  win

Reg. No. 4,097,582

Registered Feb. 14, 2012

Int. Cl.: 25

TRADEMARK

PRINCIPAL REGISTER

BRAIN MANAGEMENT S.R.L. (ITALY CORPORATION)
VIA F. BARTOLOMMEI, 4
I-50129 FIRENZE
ITALY AND

PESPOW CONFEZIONI S.P.A. (ITALY CORPORATION)
VIA PODGORA, 47
I-31033 CASTELFRANCO VENETO (TV)
ITALY

FOR: CLOTHING, NAMELY, JACKETS, COATS, OVERCOATS, RAINCOATS, PARKAS, BLOUSONS, WAISTCOATS, SUITS, SKIRTS, TROUSERS, PANTS, BREECHES, GLOVES, SOCKS, STOCKINGS, SHAWLS, SCARVES; BELTS, KNITWEAR, NAMELY, PULLOVERS, VESTS, CAMISOLES, DRESSES FOR WOMEN, T-SHIRTS, SHIRTS, SWEATERS, CARDIGANS, BLOUSES AND UNDERWEAR; FOOTWEAR, NAMELY, CASUAL AND SPORTING SHOES, BOOTS, SLIPPERS AND SANDALS; CAPS, HATS, IN CLASS 25 (U.S. CLS. 22 AND 39).

THE MARK CONSISTS OF THE STYLIZED WORDING "CHAT C WIN" WITH THE SINGLE LETTER "C" APPEARING IN THE UPPER PORTION OF A VERTICALLY-ORIENTED RECTANGLE.

PRIORITY DATE OF 12-21-2009 IS CLAIMED.

OWNER OF INTERNATIONAL REGISTRATION 1044276 DATED 6-18-2010, EXPIRES 6-18-2020.

SER. NO. 79-084,710, FILED 6-18-2010.

NELSON SNYDER, EXAMINING ATTORNEY



David J. Kyffers

Director of the United States Patent and Trademark Office

United States of America

United States Patent and Trademark Office



Reg. No. 4,097,583

MAPORAMA SOLUTIONS (FRANCE SOCIÉTÉ PAR ACTIONS SIMPLIFIÉE)
174 QUAI DE JEMMAPES
F-75010 PARIS, FRANCE

Registered Feb. 14, 2012

Int. Cls.: 35, 38 and 42

FOR: ADVERTISING; BUSINESS MANAGEMENT AND ORGANIZATION CONSULTANCY; COMPUTERIZED FILE MANAGEMENT; ON-LINE ADVERTISING ON A COMPUTER NETWORK; RENTAL OF ADVERTISING TIME ON COMMUNICATION MEDIA; PUBLICATION OF PUBLICITY TEXTS; RENTAL OF ADVERTISING SPACE; DISSEMINATION OF ADVERTISING MATTER, IN CLASS 35 (U.S. CLS. 100, 101 AND 102).

SERVICE MARK

PRINCIPAL REGISTER

FOR: TELECOMMUNICATIONS, NAMELY, TRANSMISSION OF DIGITAL MAPPING INFORMATION AND DATA VIA THE WEB AND MOBILE MAPPING SOLUTIONS; INFORMATION ABOUT TELECOMMUNICATION; COMMUNICATIONS VIA COMPUTER TERMINALS AND VIA FIBER-OPTIC NETWORKS; ELECTRONIC BULLETIN BOARD SERVICES; PROVIDING TELECOMMUNICATIONS CONNECTIONS TO A GLOBAL COMPUTER NETWORK; RENTAL OF ACCESS TIME TO GLOBAL COMPUTER NETWORKS, IN CLASS 38 (U.S. CLS. 100, 101 AND 104).

FOR: EVALUATIONS, ASSESSMENTS AND RESEARCH IN THE FIELDS OF SCIENCE AND TECHNOLOGY PROVIDED BY ENGINEERS; DESIGN AND DEVELOPMENT OF COMPUTER HARDWARE AND SOFTWARE; RESEARCH AND DEVELOPMENT SERVICES WITH REGARD TO NEW PRODUCTS FOR THIRD PARTIES; TECHNICAL PROJECT STUDIES IN THE FIELD OF DEVELOPMENT OF COMPUTER HARDWARE AND SOFTWARE; DEVELOPMENT, DESIGN, INSTALLATION, MAINTENANCE, UPDATING AND RENTAL OF COMPUTER SOFTWARE; COMPUTER PROGRAMMING SERVICES; CONSULTANCY IN THE FIELD OF COMPUTER HARDWARE; DATA CONVERSION OF COMPUTER PROGRAMS AND ELECTRONIC DATA; CONVERSION OF DATA OR DOCUMENTS FROM PHYSICAL TO ELECTRONIC MEDIA, IN CLASS 42 (U.S. CLS. 100 AND 101).



OWNER OF U.S. REG. NO. 3,223,301.

PRIORITY DATE OF 3-15-2010 IS CLAIMED.

David J. Kyjars

OWNER OF INTERNATIONAL REGISTRATION 1045198 DATED 5-11-2010, EXPIRES 5-11-2020.

Director of the United States Patent and Trademark Office

THE COLOR(S) BLUE AND BLACK IS/ARE CLAIMED AS A FEATURE OF THE MARK.

Reg. No. 4,097,583 THE MARK CONSISTS OF THE WORDING "MAPORAMA" IN BLACK WITH AN ABSTRACT FIGURE OF A PERSON IN BLUE STEPPING OVER THE FIRST LETTER "M".

SER. NO. 79-085,055, FILED 5-11-2010.

MARILYN IZZI, EXAMINING ATTORNEY

United States of America

United States Patent and Trademark Office

Bierbaum-Proenen

Reg. No. 4,097,584

BIERBAUM-PROENEN GMBH & CO. KG (FED REP GERMANY GMBH & CO. KG)
DOMSTR. 55-73

Registered Feb. 14, 2012

50668 KÖLN, FED REP GERMANY

Int. Cl.: 25

FOR: CLOTHING, NAMELY, BLOUSES, BELTS, SCARVES, SHIRTS, PANTS, JACKETS, JEANS, SMOCKS, OVERALLS, COATS, SWEATERS, JUMPSUITS, SKIRTS, APRONS, SHORTS, SOCKS, SWEATSHIRTS, T-SHIRTS, VESTS, WIND, RAIN AND COLD WEATHER GEAR FOR OUTDOOR WORKERS IN THE NATURE OF JACKETS AND TROUSERS; FOOTWEAR; HEADGEAR, NAMELY, HATS AND CAPS, IN CLASS 25 (U.S. CLS. 22 AND 39).

TRADEMARK

PRINCIPAL REGISTER

THE MARK CONSISTS OF STANDARD CHARACTERS WITHOUT CLAIM TO ANY PARTICULAR FONT, STYLE, SIZE, OR COLOR.

PRIORITY DATE OF 1-29-2010 IS CLAIMED.

OWNER OF INTERNATIONAL REGISTRATION 1045607 DATED 7-6-2010, EXPIRES 7-6-2020.

SER. NO. 79-085,275, FILED 7-6-2010.

ANDREA HACK, EXAMINING ATTORNEY



David J. Kybas

Director of the United States Patent and Trademark Office

United States of America

United States Patent and Trademark Office



Reg. No. 4,097,585

Registered Feb. 14, 2012

Int. Cl.: 18

TRADEMARK

PRINCIPAL REGISTER

ZHEJIANG HONGYI CASE LEATHER CO., LTD. (CHINA CORPORATION)
DAITOU DEVELOPMENT AREA
XIANJIANG TOWN,; RUIAN; 325200 ZHEJIANGPROVINCE
CHINA

FOR: LUGGAGE AND TRUNKS; VALISES; CASES OF LEATHER OR LEATHERBOARD;
SUITCASES; IMITATION LEATHER CASES; CANVAS CASES; PURSES; HANDBAGS;
LEATHER BAGS; BRIEFCASES, IN CLASS 18 (U.S. CLS. 1, 2, 3, 22 AND 41).

THE MARK CONSISTS OF A U-SHAPED DESIGN ATOP A CIRCULAR DESIGN BETWEEN
TWO STYLIZED ASIAN CHARACTERS ATOP THE WORDING "HONGYI".

OWNER OF INTERNATIONAL REGISTRATION 1045831 DATED 7-13-2010, EXPIRES 7-13-
2020.

THE NON-LATIN CHARACTERS IN THE MARK TRANSLITERATE TO "HONGYI" AND
THIS HAS NO MEANING IN A FOREIGN LANGUAGE.

THE WORDING "HONGYI" HAS NO MEANING IN A FOREIGN LANGUAGE.

SER. NO. 79-085,360, FILED 7-13-2010.

FONG HSU, EXAMINING ATTORNEY



David J. Kyffers

Director of the United States Patent and Trademark Office

United States of America

United States Patent and Trademark Office



Reg. No. 4,097,586

Registered Feb. 14, 2012

Int. Cls.: 16 and 28

TRADEMARK

PRINCIPAL REGISTER

HINKLER BOOKS PTY LTD (AUSTRALIA CORPORATION)
44-55 FAIRCHILD STREET
HEATHERTON, AUSTRALIA VIC 3202

FOR: BOOKS FOR INFANTS, CHILDREN AND YOUNG ADULTS; CHILDREN'S BOOKS; MAGAZINES FOR INFANTS, CHILDREN AND YOUNG ADULTS; MAGAZINES FOR EDUCATION AND ENTERTAINMENT OF INFANTS, CHILDREN AND YOUNG ADULTS; ALBUMS FOR IMAGES, PHOTOGRAPHS AND OTHER MATERIALS; SCRAPBOOKS; COLOURING BOOKS; NOTEBOOKS; ADDRESS BOOKS; DATE BOOKS; AUTOGRAPH BOOKS; DIARIES; GUIDE BOOKS FOR EDUCATION AND ENTERTAINMENT OF INFANTS, CHILDREN AND YOUNG ADULTS; MAPS; BOOKBINDINGS; PLASTIC MATERIALS FOR PACKAGING, NAMELY, PLASTIC BAGS FOR PACKAGING AND PLASTIC BUBBLE PACKS FOR PACKAGING; PAPER PLACEMATS; PAPER COASTERS; WRITING INSTRUMENTS; PENS AND PENCILS; WRITING PAPER; NOTE PAPER; GAME BOOKS FOR INFANTS, CHILDREN AND YOUNG ADULTS; RULE BOOKS; SCORE CARDS AND SCORE PADS, IN CLASS 16 (U.S. CLS. 2, 5, 22, 23, 29, 37, 38 AND 50).

FOR: GAMES, NAMELY, BOARD GAMES, TARGET GAMES, MANIPULATIVE PUZZLES, OCCUPATIONAL THERAPY GAMES, MANIPULATIVE GAMES; TOYS, NAMELY, MECHANICAL TOYS, PLUSH TOYS, PLASTIC CHARACTER TOYS, EDUCATIONAL TOYS, ELECTRONIC EDUCATIONAL GAME MACHINES FOR CHILDREN, OCCUPATIONAL THERAPY TOYS, NAMELY, SOFT SCULPTURE TOYS; PLAYTHINGS, NAMELY, DOLLS, FOOT BALLS, BEACH BALLS, BASKET BALLS, HAND BALLS, PLAYGROUND BALLS, RUBBER BALLS, SOCCER BALLS, TENNIS BALLS, SOFT TENNIS BALLS, RACKET BALLS; CHILDREN'S MULTI-ACTIVITY TOYS; PLAYING CARDS; PUZZLES; NOVELTIES FOR PARTIES, NAMELY, PAPER AND PLASTIC PARTY HATS, PAPER CHRISTMAS TREE DECORATIONS AND PAPER STREAMERS; PARTY HATS; COSTUMES BEING CHILDREN'S PLAYTHINGS; FANCY DRESS OUTFITS BEING CHILDREN'S PLAYTHINGS; PLAY APPARATUS FOR USE IN CHILDREN'S NURSERIES, NAMELY, EDUCATIONAL TOYS, CHILDREN'S MULTI-ACTIVITY TOYS; TOYS IN THE FORM OF DRAWING APPARATUS FOR CHILDREN, IN CLASS 28 (U.S. CLS. 22, 23, 38 AND 50).

PRIORITY DATE OF 3-3-2010 IS CLAIMED.

OWNER OF INTERNATIONAL REGISTRATION 1046010 DATED 6-8-2010, EXPIRES 6-8-2020.



David J. Kappas

Director of the United States Patent and Trademark Office

Reg. No. 4,097,586 SER. NO. 79-085,440, FILED 6-8-2010.

PAUL E. FAHRENKOPF, EXAMINING ATTORNEY

United States of America

United States Patent and Trademark Office

leanergy

Reg. No. 4,097,587

Registered Feb. 14, 2012

**Int. Cls.: 9, 11, 40, 41
and 42**

TRADEMARK

SERVICE MARK

PRINCIPAL REGISTER

OKAVANGO ENERGY (FRANCE SOCIÉTÉ PAR ACTIONS SIMPLIFIÉE (SAS))
57 ESPLANADE DU GÉNÉRAL DE GAULLE
PARIS LA DÉFENSE, FRANCE F92081

FOR: SCIENTIFIC, SURVEYING, MEASURING, SIGNALING, CHECKING, TEACHING APPARATUS AND INSTRUMENTS, NAMELY, ELECTRIC SENSOR, AUTOMATIC VALVES, THERMOMETERS, POWER ANALYZER, FLOW METERS, PRESSURE METERS, ULTRA SOUND FLOWMETER, ULTRA SOUND DETECTORS, INFRARED CAMERAS, PROGRAMMABLE LOGIC CONTROLLER (PLC) FOR ENERGY CONTROL AND MONITORING, COMPUTER SOFTWARE FOR ENERGY DATA ANALYSIS, COMPUTER SOFTWARE FOR ENERGY DATA OPTIMIZATION, COMPUTER SOFTWARE FOR ENERGY MONITORING AND REPORTING, COMPUTER SOFTWARE FOR ENERGY PURCHASE OPTIMIZATION, ALARM MONITORING SYSTEMS; APPARATUS AND INSTRUMENTS FOR CONDUCTING, SWITCHING, TRANSFORMING, ACCUMULATING, REGULATING OR CONTROLLING ELECTRICITY, NAMELY, ELECTRICAL CABLES, CAPACITORS, ELECTRICAL INDUCTOR, HARMONIC FILTERS, CIRCUIT BREAKERS, ELECTRICAL SWITCHES, MOTOR DRIVE, CONTROL UNITS FOR REGULATING START UP ELECTRICAL MOTORS, BATTERIES, OFF GRID SYSTEMS COMPRISING GENERATOR, PHOTOVOLTAIC PANE, IN CLASS 9 (U.S. CLS. 21, 23, 26, 36 AND 38).

FOR: APPARATUS FOR LIGHTING, HEATING, STEAM GENERATING, COOKING, REFRIGERATING, DRYING, VENTILATING, WATER SUPPLY PURPOSES, NAMELY, LOW CONSUMPTION LAMP, ELECTRIC SPACE HEATERS, AIR HEATER IN THE NATURE OF ELECTRIC SPACE HEATERS, WATER HEATERS, ELECTRICAL BOILERS, GAS BOILERS, FUEL BOILERS, COMBINED HEAT AND POWER (CHP), INFRARED HEATER, INDUCTION HEATER, ELECTRIC PORTABLE HEATER, SOLAR WATER HEATER, HEAT PUMP, STEAM GENERATOR, INDUSTRIAL COOKING OVEN, GAS FURNACE, INDUSTRIAL DRYER FOR DEHUMIDIFYING, EVAPORATOR, COMPRESSOR CHILLERS FOR INDUSTRIAL PRODUCT PREPARATION AND STORAGE, COMPRESSOR CHILLERS FOR AIR CONDITIONING, ABSORPTION LIQUID CHILLERS, CENTRIFUGAL LIQUID COOLED CHILLERS, HELICAL ROTARY HVAC LIQUID CHILLERS, SCROLL AIR COOLED CHILLER, COOLING TOWERS, ELECTRIC FAN, AIR-CONDITIONING APPARATUS AND INSTALLATIONS; FREEZERS, AIR OR WATER PURIFYING APPARATUS AND MACHINES; STERILIZERS, IN CLASS 11 (U.S. CLS. 13, 21, 23, 31 AND 34).

FOR: PRODUCTION OF ENERGY, IN CLASS 40 (U.S. CLS. 100, 103 AND 106).



David J. Kybas

Director of the United States Patent and Trademark Office

Reg. No. 4,097,587 FOR: PROVIDING OF TRAINING AND COACHING IN THE FIELD OF ENERGY, ENERGY EFFICIENCY, GREEN HOUSE GAS, CO2 EMISSION, GLOBAL WARMING, CLIMATE CHANGE, LEAN MANUFACTURING, INDUSTRIAL PERFORMANCE, COST REDUCTION, PURCHASE OPTIMIZATION, SOURCING, ENERGY MARKETS; PUBLICATION OF BOOKS; EDUCATIONAL SERVICES, NAMELY, CLASSES, SEMINARS, WORKSHOPS, TRAINING PERIOD IN THE FIELD OF ENERGY, GREEN HOUSE GAS, CO2 EMISSION, GLOBAL WARMING, CLIMATE CHANGE, LEAN MANUFACTURING, INDUSTRIAL PERFORMANCE, COST REDUCTION, PURCHASE OPTIMIZATION, SOURCING, ENERGY MARKETS; CONFERENCES AND CONGRESSES IN THE FIELD OF ENERGY, GREEN HOUSE GAS, CO2 EMISSION, GLOBAL WARMING, CLIMATE CHANGE, LEAN MANUFACTURING, INDUSTRIAL PERFORMANCE, COST REDUCTION, PURCHASE OPTIMIZATION, SOURCING; PUBLICATION OF ELECTRONIC BOOKS AND JOURNALS ON-LINE, IN CLASS 41 (U.S. CLS. 100, 101 AND 107).

FOR: ENGINEERING SERVICES, NAMELY, PROVIDING EVALUATIONS, ASSESSMENTS AND RESEARCH IN THE FIELDS OF SCIENCE AND TECHNOLOGY PROVIDED BY ENGINEERS; DESIGN AND DEVELOPMENT OF COMPUTER HARDWARE AND SOFTWARE; SCIENTIFIC AND INDUSTRIAL RESEARCH AND NEW PRODUCT DEVELOPMENT FOR OTHER IN THE FIELD OF ENERGY, GREENHOUSE GAS, CO2 EMISSION, GLOBAL WARMING, CLIMATE CHANGE, LEAN MANUFACTURING, INDUSTRIAL PERFORMANCE, COST REDUCTION, PURCHASE OPTIMIZATION, SOURCING, ENERGY MARKETS; TECHNICAL PROJECT STUDIES, NAMELY, ENGINEERING SERVICES IN THE NATURE OF TECHNICAL PROJECT PLANNING IN THE FIELD OF ENERGY AND MANUFACTURING; SCIENTIFIC AND TECHNOLOGICAL SERVICES, NAMELY, PROVIDING ENERGY AUDITS, NAMELY, TECHNICAL ANALYSIS OF INDUSTRIAL AND BUILDING SITES FOR THE PURPOSE OF IMPROVING ENERGY EFFICIENCY; TECHNOLOGICAL SERVICES, NAMELY, TECHNICAL ANALYSIS OF ENERGY EFFICIENCY SYSTEM, TECHNICAL ANALYSIS OF ENERGY EFFICIENCY IN PRODUCTION PLANTS, TECHNICAL STUDIES OF LOW ENERGY CONSUMPTION BUILDING, TECHNICAL ANALYSIS IN POSITIVE ENERGY BUILDING, TECHNICAL ANALYSIS OF SYSTEM FOR LOW EMISSION OF GREENHOUSE GAS, TECHNICAL ANALYSIS OF RENEWABLE ENERGY SYSTEMS; DEVELOPMENT, INSTALLATION, MAINTENANCE, UPDATING OR RENTAL OF SOFTWARE; COMPUTER PROGRAMMING, CONSULTANCY IN THE FIELD OF COMPUTER HARDWARE; DATA CONVERSION OF COMPUTER PROGRAM DATA, IN CLASS 42 (U.S. CLS. 100 AND 101).

THE MARK CONSISTS OF STANDARD CHARACTERS WITHOUT CLAIM TO ANY PARTICULAR FONT, STYLE, SIZE, OR COLOR.

PRIORITY DATE OF 12-18-2009 IS CLAIMED.

OWNER OF INTERNATIONAL REGISTRATION 1046019 DATED 6-16-2010, EXPIRES 6-16-2020.

SER. NO. 79-085,444, FILED 6-16-2010.

CHRIS DONINGER, EXAMINING ATTORNEY

United States of America
United States Patent and Trademark Office

SNA

Reg. No. 4,097,588

Registered Feb. 14, 2012

Int. Cl.: 6

TRADEMARK

PRINCIPAL REGISTER

PETAR ZLATAR (AUSTRALIA INDIVIDUAL)
32 PRIME DRIVE
SEVEN HILLS NSW 2147
AUSTRALIA

FOR: METAL PANELS FOR RAISED ACCESS FLOORING, METAL PEDESTALS FOR SUPPORTING RAISED ACCESS FLOOR PANELS, METAL FLOORS, AND METAL PARTS, METAL ACCESSORIES AND METAL FITTINGS THEREFOR, IN CLASS 6 (U.S. CLS. 2, 12, 13, 14, 23, 25 AND 50).

THE MARK CONSISTS OF STANDARD CHARACTERS WITHOUT CLAIM TO ANY PARTICULAR FONT, STYLE, SIZE, OR COLOR.

PRIORITY DATE OF 4-19-2010 IS CLAIMED.

OWNER OF INTERNATIONAL REGISTRATION 1046296 DATED 7-9-2010, EXPIRES 7-9-2020.

SER. NO. 79-085,540, FILED 7-9-2010.

DANIEL CAPSHAW, EXAMINING ATTORNEY



David J. Kyffers

Director of the United States Patent and Trademark Office

United States of America

United States Patent and Trademark Office

ANZ

Reg. No. 4,097,589

Registered Feb. 14, 2012

Int. Cls.: 9 and 36

AUSTRALIA AND NEW ZEALAND BANKING GROUP LIMITED (AUSTRALIA AN AUSTRALIAN PUBLIC COMPANY, LIMITED BY SHARES)
ANZ CENTRE MELBOURNE, LEVEL 9,
833 COLLINS STREET DOCKLANDS VIC 3008
AUSTRALIA

TRADEMARK

SERVICE MARK

PRINCIPAL REGISTER

FOR: COMPUTER SOFTWARE FOR THE PROVISION OF BANKING AND FINANCIAL SERVICES, NAMELY, FACILITATING ELECTRONIC FUNDS TRANSFERS, FOREIGN EXCHANGE TRANSACTIONS, AND BILL PAYMENTS; MAGNETICALLY ENCODED DEBIT, CREDIT AND KEY CARDS, BLANK ELECTRONIC CHIP CARDS, AUTOMATIC TELLER MACHINES, ELECTRONIC FUNDS TRANSFER POINT OF SALE MACHINES, CREDIT CARD READER VERIFICATION MACHINES, BLANK MAGNETIC DATA CARRIERS, BLANK RECORDING DISCS AND OTHER ELECTRIC, ELECTRONIC, OPTICAL OR OPTOELECTRONIC DEVICES FOR STORING AND PROCESSING DATA, NAMELY, USB HARDWARE, CD ROMS AND DVDS, IN CLASS 9 (U.S. CLS. 21, 23, 26, 36 AND 38).

FOR: FINANCIAL SERVICES, NAMELY, BANKING SERVICES, ELECTRONIC FUNDS TRANSFER SERVICES, INTERNET BANKING SERVICES, CHECKING ACCOUNT SERVICES, SAVINGS ACCOUNT SERVICES, CREDIT CARD SERVICES, INSURANCE UNDERWRITING FOR HOME, ACCIDENT, PROPERTY, TRAVEL, LIFE AND MEDICAL INSURANCE AND BROKERAGE SERVICES, DEBIT CARD SERVICES, EXCHANGING MONEY, FINANCIAL INFORMATION, FINANCIAL MANAGEMENT, FINANCING, FUND INVESTMENTS, HOME BANKING, HIRE-PURCHASE FINANCING, MORTGAGE, REAL ESTATE, BUSINESS, COMMERCIAL AND CONSUMER LENDING, MORTGAGE BANKING, SAFE DEPOSIT BOX SERVICES, ISSUING TRAVELLERS' CHEQUES, IN CLASS 36 (U.S. CLS. 100, 101 AND 102).



OWNER OF U.S. REG. NOS. 2,929,930, 3,433,194, AND 3,548,988.

OWNER OF INTERNATIONAL REGISTRATION 1015739 DATED 9-9-2009, EXPIRES 9-9-2019.

THE MARK CONSISTS OF THREE LETTERS "ANZ" WITH A HORIZONTAL LINE INTERSECTING THE LETTERS.

SER. NO. 79-085,690, FILED 3-15-2010.

David J. Kyffers

Director of the United States Patent and Trademark Office

Reg. No. 4,097,589 SIMON TENG, EXAMINING ATTORNEY

United States of America

United States Patent and Trademark Office

ANZ

Reg. No. 4,097,590

Registered Feb. 14, 2012

Int. Cls.: 9 and 36

AUSTRALIA AND NEW ZEALAND BANKING GROUP LIMITED (AUSTRALIA AN AUSTRALIAN PUBLIC COMPANY, LIMITED BY SHARES)
ANZ CENTRE MELBOURNE, LEVEL 9,
833 COLLINS STREET DOCKLANDS, VICTORIA 3008
AUSTRALIA

TRADEMARK

SERVICE MARK

PRINCIPAL REGISTER

FOR: COMPUTER SOFTWARE FOR THE PROVISION OF BANKING AND FINANCIAL SERVICES, NAMELY, FACILITATING ELECTRONIC FUNDS TRANSFERS, FOREIGN EXCHANGE TRANSACTIONS, AND BILL PAYMENTS; MAGNETICALLY ENCODED DEBIT, CREDIT AND KEY CARDS, BLANK ELECTRONIC CHIP CARDS, AUTOMATIC TELLER MACHINES, ELECTRONIC FUNDS TRANSFER POINT OF SALE MACHINES, CREDIT CARD READER VERIFICATION MACHINES, BLANK MAGNETIC DATA CARRIERS, BLANK RECORDING DISCS AND OTHER ELECTRIC, ELECTRONIC, OPTICAL OR OPTOELECTRONIC DEVICES FOR STORING AND PROCESSING DATA, NAMELY, USB HARDWARE, CD ROMS AND DVDS, IN CLASS 9 (U.S. CLS. 21, 23, 26, 36 AND 38).

FOR: FINANCIAL SERVICES, NAMELY, BANKING SERVICES, ELECTRONIC FUNDS TRANSFER SERVICES, INTERNET BANKING SERVICES, CHECKING ACCOUNT SERVICES, SAVINGS ACCOUNT SERVICES, CREDIT CARD SERVICES, INSURANCE UNDERWRITING FOR HOME, ACCIDENT, PROPERTY, TRAVEL, LIFE AND MEDICAL INSURANCE AND BROKERAGE SERVICES, DEBIT CARD SERVICES, EXCHANGING MONEY, FINANCIAL INFORMATION, FINANCIAL MANAGEMENT, FINANCING, FUND INVESTMENTS, HOME BANKING, HIRE-PURCHASE FINANCING, MORTGAGE, REAL ESTATE, BUSINESS, COMMERCIAL AND CONSUMER LENDING, MORTGAGE BANKING, SAFE DEPOSIT BOX SERVICES, ISSUING TRAVELLERS' CHEQUES, IN CLASS 36 (U.S. CLS. 100, 101 AND 102).

THE MARK CONSISTS OF STANDARD CHARACTERS WITHOUT CLAIM TO ANY PARTICULAR FONT, STYLE, SIZE, OR COLOR.

OWNER OF INTERNATIONAL REGISTRATION 1016791 DATED 9-8-2009, EXPIRES 9-8-2019.

OWNER OF U.S. REG. NOS. 2,929,930, 3,433,194, AND 3,548,988.

SER. NO. 79-085,691, FILED 3-15-2010.



David J. Kyjars

Director of the United States Patent and Trademark Office

Reg. No. 4,097,590 SIMON TENG, EXAMINING ATTORNEY

United States of America

United States Patent and Trademark Office

INV I O N

Reg. No. 4,097,591

Registered Feb. 14, 2012

Int. Cls.: 11, 20, 37 and 42

TRADEMARK

SERVICE MARK

PRINCIPAL REGISTER

SCHLETTERER INTERNATIONAL GROUP GMBH (AUSTRIA LIMITED LIABILITY COMPANY)

RIED 19C

A-6235 REITH IM ALPBACHTAL, AUSTRIA

FOR: LIGHTING APPARATUS, NAMELY, LIGHTING INSTALLATIONS, LIGHTING FOR WELLNESS COUCHES; LIGHTING APPARATUS FOR SPA FACILITIES; HEATING APPARATUS, NAMELY, STOVES FOR SAUNA, STEAM ROOMS; STEAM HEATING APPARATUS; SANITARY INSTALLATIONS IN THE NATURE OF STEAM ROOMS, STEAM CABINS, STEAM SHOWERS, LANCONIUMS, TEPIDARIUMS AND SAUNAS FOR USE IN SPA FACILITIES, IN CLASS 11 (U.S. CLS. 13, 21, 23, 31 AND 34).

FOR: COUCHES; WELLNESS COUCHES IN THE NATURE OF ERGONOMIC COUCHES FOR USE IN SEATED MESSAGES, IN CLASS 20 (U.S. CLS. 2, 13, 22, 25, 32 AND 50).

FOR: CONSTRUCTION AND REPAIR OF BUILDINGS; INSTALLATION OF STEAM ROOMS, INDOOR AND OUTDOOR POOLS, WHIRLPOOLS, POOLS FOR FOOT BATHS, POOLS FOR FOOT REFLEXOLOGY BATHS, TREATMENT POOLS, POOLS FOR KNEIPISM, STEAM CABINS, STEAM SHOWERS, SAUNAS, LACONIUMS, TEPIDARIUMS, ALL FOR USE IN SPA FACILITIES, IN CLASS 37 (U.S. CLS. 100, 103 AND 106).

FOR: SCIENTIFIC AND TECHNOLOGIC SERVICES, NAMELY, SCIENTIFIC RESEARCH IN THE FIELD OF SPA EQUIPMENTS AND SPA PRODUCTS; DESIGN SERVICES; INDUSTRIAL ANALYSIS AND RESEARCH SERVICES IN THE FIELD OF SPA EQUIPMENT AND SPA PRODUCTS; DESIGN AND DEVELOPMENT OF COMPUTER HARDWARE AND SOFTWARE IN THE FIELD OF SPA EQUIPMENT AND SPA PRODUCTS, IN CLASS 42 (U.S. CLS. 100 AND 101).

THE MARK CONSISTS OF STANDARD CHARACTERS WITHOUT CLAIM TO ANY PARTICULAR FONT, STYLE, SIZE, OR COLOR.

PRIORITY DATE OF 8-17-2009 IS CLAIMED.

OWNER OF INTERNATIONAL REGISTRATION 1038436 DATED 2-16-2010, EXPIRES 2-16-2020.

SER. NO. 79-086,030, FILED 2-16-2010.



David J. Kyros

Director of the United States Patent and Trademark Office

Reg. No. 4,097,591 EMILY CHUO, EXAMINING ATTORNEY

United States of America

United States Patent and Trademark Office



Reg. No. 4,097,592

VOLKSWAGEN AKTIENGESELLSCHAFT (FED REP GERMANY JOINT STOCK COMPANY)
38440 WOLFSBURG

Registered Feb. 14, 2012

FED REP GERMANY

Int. Cls.: 9, 16, 41 and 42

FOR: TEACHING APPARATUS AND INSTRUMENTS, NAMELY, COMPUTER HARDWARE AND EDUCATIONAL RECORDED COMPUTER PROGRAMS AND SOFTWARE FEATURING INSTRUCTION IN THE FIELD OF AUTOMOTIVE TECHNOLOGY, TECHNIQUE, ENGINEERING, MAINTENANCE AND REPAIR, IN CLASS 9 (U.S. CLS. 21, 23, 26, 36 AND 38).

TRADEMARK

SERVICE MARK

FOR: PRINTED MATTER, NAMELY, PRINTED INSTRUCTIONAL AND TEACHING MATERIAL IN THE FIELD OF THE AUTOMOTIVE INDUSTRY; PRINTED PUBLICATIONS, NAMELY, MAGAZINES AND NEWSLETTERS IN THE FIELD OF THE AUTOMOTIVE INDUSTRY, IN CLASS 16 (U.S. CLS. 2, 5, 22, 23, 29, 37, 38 AND 50).

PRINCIPAL REGISTER

FOR: TEACHING AND ARRANGING AND CONDUCTING OF EDUCATIONAL CONFERENCES, CONGRESSES AND SYMPOSIUMS ALL IN THE FIELD OF THE AUTOMOTIVE INDUSTRY, IN CLASS 41 (U.S. CLS. 100, 101 AND 107).

FOR: SCIENTIFIC AND TECHNOLOGICAL SERVICES, NAMELY, SCIENTIFIC, TECHNOLOGICAL AND INDUSTRIAL RESEARCH, ANALYSIS AND TESTING IN THE FIELD OF THE AUTOMOTIVE INDUSTRY, IN CLASS 42 (U.S. CLS. 100 AND 101).

THE MARK CONSISTS OF THE STYLIZED LETTERS "UI" COMBINED AS ONE LETTER.

OWNER OF INTERNATIONAL REGISTRATION 0877270 DATED 12-23-2005, EXPIRES 12-23-2015.

SER. NO. 79-086,358, FILED 7-19-2010.

MARY BOAGNI, EXAMINING ATTORNEY



David J. Kybas

Director of the United States Patent and Trademark Office

United States of America
United States Patent and Trademark Office

Hiflow

Reg. No. 4,097,593

Registered Feb. 14, 2012

Int. Cl.: 11

TRADEMARK

PRINCIPAL REGISTER

RVT PROCESS EQUIPMENT GMBH (FED REP GERMANY GMBH)
PAUL-RAUSCHERT-STR. 6
96349 STEINWIESEN
FED REP GERMANY

FOR: EQUIPMENT FOR MASS TRANSFER AND/OR HEAT EXCHANGE COLUMNS, NAMELY, TOWER PACKING MADE OF PLASTIC, CERAMIC OR METAL FOR MASS TRANSFER EQUIPMENT AND MASS TRANSFER COLUMNS USED FOR DISTILLATION, RECTIFICATION, FILTRATION, COOLING, CONDENSING, SCRUBBING, ABSORPTION, AND DECONTAMINATION PROCESSES AND THAT ARE USED IN DISTILLATION EQUIPMENT, DISTILLATION COLUMNS, FLUE GAS DUST COLLECTOR EQUIPMENT, GAS DECONTAMINATION EQUIPMENT, EXHAUST AIR DECONTAMINATION EQUIPMENT, RECTIFYING EQUIPMENT, REFINERY EQUIPMENT, EVAPORATOR EQUIPMENT, SEWAGE CLARIFICATION EQUIPMENT, AMMONIA STRIPPING EQUIPMENT, GAS SEPARATORS, MASS TRANSFER EQUIPMENT FOR GASEOUS AND LIQUID MEDIA AND GAS COOLING APPARATUS, IN CLASS 11 (U.S. CLS. 13, 21, 23, 31 AND 34).

PRIORITY DATE OF 1-22-2010 IS CLAIMED.

OWNER OF INTERNATIONAL REGISTRATION 1048586 DATED 6-5-2010, EXPIRES 6-5-2020.

SER. NO. 79-086,424, FILED 6-5-2010.

KATHLEEN M. VANSTON, EXAMINING ATTORNEY



David J. Kyffers

Director of the United States Patent and Trademark Office

United States of America

United States Patent and Trademark Office

RIVERSIMPLE

Reg. No. 4,097,594

Registered Feb. 14, 2012

**Int. Cls.: 12, 35, 37 and
39**

TRADEMARK

SERVICE MARK

PRINCIPAL REGISTER

RIVERSIMPLE LLP (UNITED KINGDOM LIMITED LIABILITY PARTNERSHIP)
STANSBATCH
STAUNTON-ON-ARROW LEOMINSTER
HEREFORDSHIRE HR6 9LG, UNITED KINGDOM

FOR: LAND VEHICLES AND PARTS OF LAND VEHICLES INCLUDED IN THIS CLASS, NAMELY, AIR BAGS, ANTI-SKID CHAINS, ALARMS, NAMELY, ANTI-THEFT ALARMS AND BACK-UP WARNING ALARMS, ANTI-THEFT DEVICES, LAND VEHICLE BODIES, CARBON FIBRE LAND VEHICLE BODIES, AUTOMOBILE CHAINS, AUTOMOBILE CHASSIS, AUTOMOBILE HOODS, AXLES, BRAKES, BRAKE LININGS, BRAKE SEGMENTS, BRAKE SHOES, BRAKE PADS, BUMPER, CAPS FOR REFUELLING TANKS, CASINGS FOR TIRES, CLUTCHES, COUPLINGS, NAMELY, TRAILER COUPLINGS, COVERS FOR STEERING WHEELS, COVERS FOR SEATS, DASHBOARDS, DOORS, DRIVING CHAINS, DRIVING MOTORS, NAMELY, AUTOMOBILE ENGINES, DRIVE BELTS, ELECTRIC MOTORS, ELECTRIC DRIVE SYSTEMS CONTAINING MOTOR INVERTERS, CONVERTORS, AND POWER ELECTRONICS, ELEVATING TAILGATES, ENERGY STORAGE SYSTEMS, NAMELY, FUEL STORAGE CELLS, ENGINES AND HYDROGEN-FUELLED ENGINES, FREEWHEELS, GEAR BOXES, GEARING, GEARS, HEADRESTS, HOODS FOR VEHICLE ENGINES, HOODS FOR VEHICLES, HORNS, HUB CAPS, WHEEL HUBS, HYDRAULIC CIRCUITS, FUEL STORAGE CELLS, INNER TUBES, INDICATING SIGNALS, LUGGAGE CARRIERS FOR VEHICLES, LUGGAGE NETS FOR VEHICLES, MIRRORS, NAMELY, REAR VIEW MIRRORS, VANITY MIRRORS AND SIDE VIEW MIRRORS, MOTORS, MUDGUARDS, ELECTRONIC PASSENGER INFORMATION SYSTEMS INSTALLED IN DASHBOARDS, PEDALS, POWER TAILGATES, FUEL TANKS, REDUCTION GEARS, REPAIR OUTFITS FOR INNER TUBES, REVERSING ALARMS, RIMS FOR WHEELS, ROWLOCKS, SADDLES, NAMELY, SADDLES FOR BICYCLES, SAFETY BELTS, SAFETY SEATS, SEATS, SECURITY HARNESS, SHOCK ABSORBERS, SHOCK ABSORBING SPRINGS, SIGNALS, NAMELY, DIRECTIONAL SIGNALS, SPIKES FOR TIRES, SPOKES, SPOKE CLIPS, STEERING WHEELS, STUDS FOR TIRES, SUN-BLINDS, SUSPENSION SHOCK ABSORBERS, SUSPENSION SPRINGS, TAILBOARD LIFTS, TAILGATES, TIRES, TORQUE CONVERTERS, TORSION BARS, TRAILER HITCHES, TRAILERS, TRANSMISSION CHAINS, TRANSMISSION SHAFTS, TRANSMISSIONS, TREADS FOR RE-TREADING TIRES, TREADS, TURBINES, NAMELY, AIR TURBINES AND HYDRAULIC TURBINES, TURN SIGNALS, UNDERCARRIAGES, UPHOLSTERY FOR VEHICLES, VALVES FOR TIRES, VEHICLE ANTI-GLARE DEVICES, WARNING SYSTEMS FOR DETECTION OF OBJECTS, WHEEL, WINDOWS, WINDSCREENS, WINDSCREEN WIPERS, WINDSCREEN WIPER BLADES, WINDSHIELDS, WINDSHIELD



David J. Kyjars

Director of the United States Patent and Trademark Office

Reg. No. 4,097,594 WIPERS, WINDSHIELD WIPER BLADES, IN CLASS 12 (U.S. CLS. 19, 21, 23, 31, 35 AND 44).

FOR: BUSINESS, PERSONNEL AND INDUSTRIAL MANAGEMENT CONSULTANCY; ANALYSIS AND GUIDANCE ON BUSINESS MANAGEMENT, IN CLASS 35 (U.S. CLS. 100, 101 AND 102).

FOR: REPAIRING OR MAINTENANCE OF MOTORCAR; REPAIRING OR MAINTENANCE OF ELECTRICAL DISTRIBUTION OR CONTROL APPARATUS AND INSTRUMENTS , IN CLASS 37 (U.S. CLS. 100, 103 AND 106).

FOR: AUTOMOBILE VEHICLES LEASING SERVICES, IN CLASS 39 (U.S. CLS. 100 AND 105).

THE MARK CONSISTS OF STANDARD CHARACTERS WITHOUT CLAIM TO ANY PARTICULAR FONT, STYLE, SIZE, OR COLOR.

PRIORITY DATE OF 2-18-2010 IS CLAIMED.

OWNER OF INTERNATIONAL REGISTRATION 1049074 DATED 5-7-2010, EXPIRES 5-7-2020.

SER. NO. 79-086,614, FILED 5-7-2010.

MATTHEW EINSTEIN, EXAMINING ATTORNEY

United States of America

United States Patent and Trademark Office

METISSO

Reg. No. 4,097,595

Registered Feb. 14, 2012

Int. Cl.: 8

TRADEMARK

PRINCIPAL REGISTER

ANDREAS JAKUBOWSKI (FED REP GERMANY INDIVIDUAL)
ADALBERT-STIFTER-RING 14
69493 HIRSCHBERG, FED REP GERMANY AND

MARKUS JAKUBOWSKI (FED REP GERMANY INDIVIDUAL)
I 7, 1
68159 MANNHEIM, FED REP GERMANY AND

GUSTAV THEWS (FED REP GERMANY INDIVIDUAL)
AM WEIHERACKER 8
69469 WEINHEIM-HOHENSACHSEN, FED REP GERMANY AND

KARL THEWS (FED REP GERMANY INDIVIDUAL)
IM RIESHÜBEL 11
67482 FREIMERSHEIM, FED REP GERMANY AND

MICHAEL RASCH (FED REP GERMANY INDIVIDUAL)
FRIEDRICH-HAENDEL-STRASSE 18
68542 HEDDESHEIM, FED REP GERMANY

FOR: HOLDING ACCESSORIES FOR HOLDING HAND TOOLS, IN PARTICULAR FOR HOLDING CARPENTER'S GAUGES AND FOLDED RULERS, NAMELY, TOOL HOLDERS, TOOL BELTS, AND TOOL POUCHES FOR ATTACHMENT TO TOOL BELTS; HOLDING ACCESSORIES FOR HAND TOOL BELTS, NAMELY, TOOL HOLDERS AND TOOL POUCHES FOR ATTACHMENT TO TOOL BELTS, AFORESAID GOODS MADE OF METAL, PLASTIC OR WOOD OR A COMBINATION THEREOF; TOOL HOLDERS AND TOOL POUCHES FOR ATTACHMENT TO TOOL BELTS FOR FASTENING A TAPE MEASURE OR A RULER ON A TOOL BELT; TOOL HOLDERS, TOOL BELTS, AND TOOL POUCHES FOR ATTACHMENT TO TOOL BELTS WITH AN INTEGRATED PEN HOLDER, IN CLASS 8 (U.S. CLS. 23, 28 AND 44).

THE WORDING "METISSO" HAS NO MEANING IN A FOREIGN LANGUAGE.

PRIORITY DATE OF 11-13-2009 IS CLAIMED.

OWNER OF INTERNATIONAL REGISTRATION 1049317 DATED 5-12-2010, EXPIRES 5-12-2020.



David J. Kyros

Director of the United States Patent and Trademark Office

Reg. No. 4,097,595 SER. NO. 79-086,691, FILED 5-12-2010.

ADA HAN, EXAMINING ATTORNEY

United States of America
United States Patent and Trademark Office

APPAWARE

Reg. No. 4,097,596

Registered Feb. 14, 2012

Int. Cl.: 9

ETH ZÜRICH (SWITZERLAND PUBLIC UNIVERSITY LOCATED IN ZÜRICH,
SWITZERLAND)
RÄMISTRASSE 101 / ETH TRANSFER
HG E43-49; CH-8092 ZÜRICH
SWITZERLAND

TRADEMARK

PRINCIPAL REGISTER

FOR: DOWNLOADABLE COMPUTER SOFTWARE FROM A PUBLICLY ACCESSIBLE
COMPUTER NETWORK FOR THE PURPOSE OF TRACKING AND SHARING OTHER
DOWNLOADABLE COMPUTER SOFTWARE FROM A PUBLICLY ACCESSIBLE COMPUTER
NETWORK AND FOR USE IN CONJUNCTION WITH MOBILE COMMUNICATION DEVICES,
IN CLASS 9 (U.S. CLS. 21, 23, 26, 36 AND 38).

THE MARK CONSISTS OF STANDARD CHARACTERS WITHOUT CLAIM TO ANY PAR-
TICULAR FONT, STYLE, SIZE, OR COLOR.

PRIORITY DATE OF 3-5-2010 IS CLAIMED.

OWNER OF INTERNATIONAL REGISTRATION 1049821 DATED 8-30-2010, EXPIRES 8-30-
2020.

SER. NO. 79-086,894, FILED 8-30-2010.

MICHELE SWAIN, EXAMINING ATTORNEY



David J. Kybas

Director of the United States Patent and Trademark Office

United States of America

United States Patent and Trademark Office

swaromed

Reg. No. 4,097,597

Registered Feb. 14, 2012

Int. Cls.: 5 and 10

TRADEMARK

PRINCIPAL REGISTER

NESSLER MEDIZINTECHNIK GMBH (AUSTRIA GESELLSCHAFT MIT BESCHRÄNKTER HAFTUNG (GMBH))
EGGER-LIENZ-STR. 1D
INNSBRUCK, AUSTRIA A6020

FOR: PHARMACEUTICAL PREPARATIONS FOR THE TREATMENT AND PREVENTION OF PYREXIA, CHILBLAINS, FROSTBITES, BUNIONS, PERSPIRATION, DANDRUFF, BURNS; MEDICAL PLASTERS; MATERIALS FOR DRESSINGS, IN PARTICULAR BALMS FOR MEDICAL PURPOSES; BALSAMIC PREPARATIONS FOR MEDICAL PURPOSES, NAMELY, GURJUN BALSAM, MEDICATED SKIN BALSAMS; BANDAGES FOR DRESSINGS; ADHESIVE TAPES FOR MEDICAL PURPOSES; ANTISEPTIC COTTON FOR MEDICAL PURPOSES; ASEPTIC COTTON FOR MEDICAL PURPOSES; COTTON FOR MEDICAL PURPOSES; GAUZE FOR DRESSING; CHEWING GUM FOR MEDICAL PURPOSES; SANITARY STERILIZING PREPARATIONS; DIAGNOSTIC PREPARATIONS FOR MEDICAL PURPOSES; CHEMICAL CONDUCTORS FOR ELECTROCARDIOGRAPH ELECTRODES; ALL FOREGOING GOODS FOR USAGE WITH ELECTROCARDIOGRAPH ELECTRODES AND DISPOSABLE ELECTROCARDIOGRAPH ELECTRODES, IN CLASS 5 (U.S. CLS. 6, 18, 44, 46, 51 AND 52).

FOR: SURGICAL, MEDICAL, DENTAL AND VETERINARY APPARATUS AND INSTRUMENTS, IN PARTICULAR TESTING APPARATUS FOR MEDICAL PURPOSES, NAMELY, BLOOD TESTING APPARATUS, EYE TESTING APPARATUS; DIAGNOSTIC APPARATUS FOR MEDICAL PURPOSES, NAMELY, ULTRASONIC MEDICAL DIAGNOSTIC APPARATUS, ULTRASOUND DIAGNOSTIC APPARATUS, MRI DIAGNOSTIC APPARATUS; ELECTRODES FOR MEDICAL USE; ELECTROCARDIOGRAPHS; MEDICAL APPARATUS AND INSTRUMENTS, NAMELY, MEDICAL APPARATUS AND INSTRUMENTS FOR DIAGNOSTIC RADIO PHARMACEUTICAL USE, AEROSOL DISPENSERS, ACUPUNCTURE NEEDLES, NEEDLES FOR MEDICAL PURPOSES, RESPIRATORS FOR ARTIFICIAL RESPIRATION, BLOOD PRESSURE MEASURING APPARATUS, DEFIBRILLATORS, DIALYZERS, SYRINGES FOR INJECTIONS, INHALERS, INJECTORS FOR MEDICAL FLUIDS, ANESTHETIC DELIVERY APPARATUS, RADIOLOGICAL APPARATUS FOR MEDICAL PURPOSES, X-RAY APPARATUS FOR MEDICAL PURPOSES, PROBES FOR MEDICAL PURPOSES; ELECTROCARDIOGRAPH ELECTRODES FOR MEDICAL USE; DISPOSABLE ELECTROCARDIOGRAPH ELECTRODES FOR MEDICAL USE, IN CLASS 10 (U.S. CLS. 26, 39 AND 44).



David J. Kyjars

Director of the United States Patent and Trademark Office

THE MARK CONSISTS OF THE STYLIZED WORDING "SWAROMED".

Reg. No. 4,097,597 PRIORITY DATE OF 10-8-2009 IS CLAIMED.

OWNER OF INTERNATIONAL REGISTRATION 1050005 DATED 4-8-2010, EXPIRES 4-8-2020.

SER. NO. 79-086,953, FILED 4-8-2010.

LEIGH LOWRY, EXAMINING ATTORNEY

United States of America

United States Patent and Trademark Office



Reg. No. 4,097,598

Registered Feb. 14, 2012

**Int. Cls.: 2, 3, 4, 9, 18, 20,
24, 25, 28, 32 and 35**

GABOR FOOTWEAR GMBH (FED REP GERMANY LIMITED LIABILITY COMPANY)
MARIENBERGER STR. 31
83024 ROSENHEIM
FED REP GERMANY

FOR: COLORING MATTER FOR SHOES, NAMELY, COLORANTS AND DYE FOR SHOES,
IN CLASS 2 (U.S. CLS. 6, 11 AND 16).

TRADEMARK

FOR: SHOE CREAMS, IN CLASS 3 (U.S. CLS. 1, 4, 6, 50, 51 AND 52).

SERVICE MARK

FOR: SHOE GREASE, IN CLASS 4 (U.S. CLS. 1, 6 AND 15).

PRINCIPAL REGISTER

FOR: SPECTACLES; SPECTACLE FRAMES, SPECTACLE GLASSES, PINCE-NEZ EYE-
GLASSES, SUNGLASSES, SPECTACLE CASES, IN CLASS 9 (U.S. CLS. 21, 23, 26, 36 AND
38).

FOR: LEATHER AND IMITATION OF LEATHER, AND GOODS MADE OF THESE MATER-
IALS AND NOT INCLUDED IN OTHER CLASSES, NAMELY, ATTACHE CASES, BAGS,
BRIEFCASES, BRIEFCASE-TYPE BUSINESS FOLDERS, CASES, BANDS, GARMENT BAGS
FOR TRAVEL, SPORTS BAGS, GENERAL PURPOSE TROLLEY BAGS, KEY CASES, KEY
CHAINS, WALLETS, CREDIT CARD CASES, CREDIT CARD HOLDERS, HANDBAGS,
POUCHES, PURSES, SHOPPING BAGS; SKINS AND HIDES; SUITCASES AND SMALL
CARRYING CASES, ESPECIALLY ALL-PURPOSE CARRYING BAGS AND WOMEN'S
HANDBAGS IF NOT INCLUDED IN OTHER CLASSES; WALLETS, PURSES, KEY POUCHES
OF LEATHER, UMBRELLAS, SUNSHADES PARASOLS, WALKING STICKS, WHIPS,
HARNESSES AND SADDLERY; LUGGAGE TAGS OF LEATHER, LUGGAGE NAME TAGS
OF LEATHER, IN CLASS 18 (U.S. CLS. 1, 2, 3, 22 AND 41).

FOR: FURNITURE, MIRRORS, PICTURE FRAMES; GOODS NOT INCLUDED IN OTHER
CLASSES MADE OF WOOD, CORK, CANE, RUSH, WILLOW, HORN, BONE, IVORY,
WHALEBONE, TORTOISESHELL, AMBER, MOTHER-OF-PEARL, NACRE, MEERSCHAUM
AND THEIR SUBSTITUTES, AND OF PLASTICS MATERIALS, NAMELY, DECORATIVE
BOXES, FIGURINES, FURNITURE PARTS, PICTURE FRAME MOLDINGS, ORNAMENTS,
PLAQUES, NON-METAL KEY HOLDERS, PLASTIC KEY CHAINS, PLASTIC KEY RINGS,
PLASTIC KEY TAGS, SCULPTURES, SHOE CABINETS, SHOE RACKS, UMBRELLA
STANDS, WALL PLAQUES AND WORKS OF ART, IN CLASS 20 (U.S. CLS. 2, 13, 22, 25, 32
AND 50).



David J. Kybas

Director of the United States Patent and Trademark Office

Reg. No. 4,097,598 FOR: TEXTILE AND TEXTILE GOODS, NOT INCLUDED IN OTHER CASES, NAMELY, TRAVELLING RUGS, QUILTS, BED COVERS, TABLE CLOTHS, BATH LINEN, BED LINEN, TABLE LINEN AND THROWS, IN CLASS 24 (U.S. CLS. 42 AND 50).

FOR: ARTICLES OF CLOTHING, NAMELY, SHIRTS, T-SHIRTS, PANTS, CAPRIS, SHORTS, SKIRTS, DRESSES, SWEATERS, TOPS, JACKETS, COATS, SOCKS, SLEEPWEAR, UNDERWEAR AND WRISTBANDS; FOOTWEAR; HEADGEAR, NAMELY, HATS, CAPS, CAP VISORS, IN CLASS 25 (U.S. CLS. 22 AND 39).

FOR: GAMES, NAMELY, BOARD GAMES, BUILDING GAMES, CARD GAMES, PARTY GAMES, TABLETOP GAMES; TOYS, NAMELY, ACTION FIGURES, BATH TOYS, CASES FOR TOY VEHICLES AND FOR TOY STRUCTURES, CONSTRUCTION SETS, CRIB TOYS, DOLLS, DRAWING TOYS, INFANT TOYS, STUFFED TOYS, TOY VEHICLES AND ACCESSORIES THEREFOR, WATER TOYS; ARTICLES FOR GYMNASTICS AND SPORTS, NOT INCLUDED IN OTHER CLASSES, NAMELY, GYMNASTIC APPARATUS, BALLS FOR SPORTS, BAGS AND CASE SPECIALLY ADAPTED FOR SPORTS EQUIPMENT; SPORTS FITNESS RESTRAINT STRAPS FOR RUNNING IN TANDEM OR PAIRS, KIDNEY BELTS FOR SPORTS, WEIGHT LIFTING BELTS, IN CLASS 28 (U.S. CLS. 22, 23, 38 AND 50).

FOR: BEERS, MINERAL WATERS AND OTHER ALCOHOL FREE BEVERAGES, NAMELY, NON-ALCOHOLIC BEER, NON-ALCOHOLIC WINE, FRUIT-FLAVORED BEVERAGES, FRUIT BEVERAGES, FRUIT JUICES, ENERGY DRINKS, FLAVORED WATERS, SPRING WATER, SOFT DRINKS; SYRUPS FOR BEVERAGES AND PREPARATIONS FOR BEVERAGES, NAMELY, SYRUP SUBSTITUTES, CONCENTRATES AND POWDERS USED IN THE PREPARATION OF ENERGY DRINKS, FRUIT FLAVORED BEVERAGES, FRUIT DRINKS AND SOFT DRINKS; ESSENCES FOR MAKING FLAVORED MINERAL WATER, NON-ALCOHOLIC BEVERAGES, SOFT DRINKS AND LIQUEURS, NOT IN THE NATURE OF ESSENTIAL OILS, IN CLASS 32 (U.S. CLS. 45, 46 AND 48).

FOR: RETAIL AND WHOLESALE STORE SERVICES, NAMELY, RETAIL AND WHOLESALE SERVICES THROUGH MAIL ORDER CATALOGUES AND BY MEANS OF ELECTRONIC MEDIA, NAMELY, THROUGH WEB SITES AND TELEVISION SHOPPING PROGRAMMES IN THE FIELD OF POLISHES, AND DRESSINGS FOR FOOTWEAR, INCLUDING SHOE CREAMS, SHOE DRESSINGS, SHOE GREASE, AND COLORING MATERIALS FOR FOOTWEAR, ARTICLES OF CLOTHING, FOOTWEAR AND HEADGEAR, GOODS MADE OF LEATHERS OR ARTIFICIAL LEATHERS INCLUDING LEATHER LINING MATERIALS FOR FOOTWEAR, SKINS AND HIDES, SUITCASES AND SMALL HAND CASES, INCLUDING BAGS, WOMEN'S HANDBAGS, WALLETS, PURSES, KEY POUCHES, SUNSHADES, UMBRELLAS, SHOE BRUSHES, WEAVING MATERIALS, FABRICS, BED COVERS, TABLE CLOTHS, GAMES, TOYS, ARTICLES FOR GYMNASTICS AND SPORTS, AND BEVERAGES OF ALL KINDS, IN CLASS 35 (U.S. CLS. 100, 101 AND 102).

THE MARK CONSISTS OF THE DESIGN OF A WHITE SNIPE ON A GREEN TRIANGLE WITH ROUNDED CORNERS AND CURVED SIDES.

PRIORITY DATE OF 11-26-2009 IS CLAIMED.

OWNER OF INTERNATIONAL REGISTRATION 1050190 DATED 4-29-2010, EXPIRES 4-29-2020.

THE COLOR(S) GREEN AND WHITE IS/ARE CLAIMED AS A FEATURE OF THE MARK.

SER. NO. 79-087,013, FILED 4-29-2010.

JAMES MACFARLANE, EXAMINING ATTORNEY

United States of America

United States Patent and Trademark Office

CLEPTOMANICX

Reg. No. 4,097,599

Registered Feb. 14, 2012

Int. Cls.: 25 and 28

TRADEMARK

PRINCIPAL REGISTER

PITT FEIL (FED REP GERMANY INDIVIDUAL)
BUDAPESTER STR. 49
20359 HAMBURG
FED REP GERMANY

FOR: CLOTHING, NAMELY, BOXER SHORTS, T-SHIRTS, SWEATERS, TROUSERS; FOOTWEAR; HEADWEAR; HATS; CAPS; SPORTS SHOES; SNEAKERS, IN CLASS 25 (U.S. CLS. 22 AND 39).

FOR: GAMES AND PLAYTHINGS, NAMELY, VINYL TOY FIGURES AND VINYL DOLLS; SKATEBOARDS; SURFBOARDS; BODYBOARDS; SNOWBOARDS, IN CLASS 28 (U.S. CLS. 22, 23, 38 AND 50).

THE MARK CONSISTS OF STANDARD CHARACTERS WITHOUT CLAIM TO ANY PARTICULAR FONT, STYLE, SIZE, OR COLOR.

OWNER OF INTERNATIONAL REGISTRATION 1050245 DATED 8-31-2010, EXPIRES 8-31-2020.

SER. NO. 79-087,026, FILED 8-31-2010.

CORY BOONE, EXAMINING ATTORNEY



David J. Kyffers

Director of the United States Patent and Trademark Office

United States of America

United States Patent and Trademark Office

THE SMURFS

Reg. No. 4,097,600

STUDIO PEYO S.A. (SWITZERLAND JOINT STOCK COMPANY)

Registered Feb. 14, 2012

CHEMIN FRANK-THOMAS 36
GENÈVE, SWITZERLAND CH1208

**Int. Cls.: 3, 9, 14, 16, 18,
21, 24, 25, 28, 29, 30, 32
and 41**

FOR: BLEACHING PREPARATIONS AND LAUNDRY DETERGENTS FOR LAUNDRY USE; CLEANING, POLISHING, SCOURING AND ABRASIVE PREPARATIONS; SOAPS; PERFUMERY, ESSENTIAL OILS, COSMETICS, HAIR LOTIONS; DENTIFRICES, IN CLASS 3 (U.S. CLS. 1, 4, 6, 50, 51 AND 52).

TRADEMARK

FOR: NAUTICAL APPARATUS AND INSTRUMENTS, NAMELY, MAGNETIC COMPASSES; SURVEYING INSTRUMENTS; PHOTOGRAPHIC APPARATUS AND INSTRUMENTS, NAMELY, CAMERAS; CINEMATOGRAPHIC CAMERAS AND EXPOSED CINEMATOGRAPHIC FILM; OPTICAL APPARATUS AND INSTRUMENTS, NAMELY, OPTICAL FRAMES, OPTICAL GLASSES AND OPTICAL LENSES; WEIGHING APPARATUS AND INSTRUMENTS, NAMELY, WEIGHING SCALES; MEASURING APPARATUS AND INSTRUMENTS, NAMELY, MEASURING CUPS; SIGNALING APPARATUS AND INSTRUMENTS, NAMELY, SIGNAL BELLS, SIGNAL WHISTLES AND CALL BELLS; CHECKING APPARATUS AND INSTRUMENTS, NAMELY, COMPUTERS; LIFE-SAVING APPARATUS AND INSTRUMENTS, NAMELY, SWIM FLOATS FOR SAFETY PURPOSES, INFLATABLE FLOTATION DEVICES, AND FLOTATION VESTS; AND TEACHING APPARATUS AND INSTRUMENTS, NAMELY, CHILDREN'S EDUCATIONAL SOFTWARE; APPARATUS AND INSTRUMENTS FOR CONDUCTING, SWITCHING, TRANSFORMING, ACCUMULATING, REGULATING OR CONTROLLING ELECTRICITY; APPARATUS FOR RECORDING, TRANSMISSION OR REPRODUCTION OF SOUND OR IMAGES; PRE-RECORDED MAGNETIC DATA CARRIERS FEATURING ANIMATED CARTOONS, PRE-RECORDED RECORDING DISCS FEATURING ANIMATED CARTOONS; PRE-RECORDED AUDIO, VISUAL, AND AUDIOVISUAL MAGNETIC AND DIGITAL DATA CARRIERS FEATURING MUSIC AND ANIMATION AND ELECTRONIC GAME PROGRAMS, AUTOMATIC VENDING MACHINES AND MECHANISMS FOR COIN-OPERATED APPARATUS; CASH REGISTERS, CALCULATING MACHINES, DATA PROCESSING EQUIPMENT AND COMPUTERS; FIRE EXTINGUISHING APPARATUS, IN CLASS 9 (U.S. CLS. 21, 23, 26, 36 AND 38).

SERVICE MARK

PRINCIPAL REGISTER



David J. Kappas

FOR: PRECIOUS METALS AND THEIR ALLOYS AND GOODS MADE OF PRECIOUS METALS OR COATED THEREWITH, NAMELY, FIGURINES, KEY RINGS, COINS AND MEDALS; JEWELRY, PRECIOUS STONES; HOROLOGICAL AND CHRONOMETRIC INSTRUMENTS, IN CLASS 14 (U.S. CLS. 2, 27, 28 AND 50).

Reg. No. 4,097,600 FOR: PAPER, CARDBOARD AND GOODS MADE FROM THESE MATERIALS, NAMELY, POSTERS, PAPER FLAGS, ADVERTISING BOARDS OF CARDBOARD OR PAPER, PAPER NAPKINS, PAPER DECORATIVE GARLAND FOR PARTIES, PAPER PARTY BAGS, PAPER PARTY DECORATIONS; PAPER PARTY FAVORS; PARTY GOODIE BAGS OF PAPER OR PLASTIC; PARTY ORNAMENTS OF PAPER, GIFT WRAP MADE OF PAPER, PAPER GIFT WRAP BOWS, GIFT BOXES, TISSUE PAPER, PAPER TABLE CLOTHS, PAPER PLACEMATS, TOILET TISSUE, BOXES, CARTONS, STORAGE CONTAINERS AND PACKAGING CONTAINERS MADE OF PAPER OR CARDBOARD, HATBOXES OF PAPER OR CARDBOARD; PRINTED MATTER, NAMELY, GREETING CARDS, INVITATIONS, ANNOUNCEMENT CARDS, THANK YOU NOTES, POSTCARDS, PRINTED TICKETS, STICKERS AND TRANSFERS, COLORING BOOKS, EMBROIDERY DESIGN PATTERNS PRINTED ON PAPER, ILLUSTRATIONS, PORTRAITS, PHOTOGRAPH ALBUMS, STAMP ALBUMS, STICKER ALBUMS, DRAWING PAPER, DRAWING PADS, PAPER MACHE, WATERCOLOR BOARDS, WATERCOLOR PICTURES, ARTS AND CRAFT PAINT KITS, PAINT BOXES AND BRUSHES, CANVAS FOR PAINTING, EASELS, MODELING CLAY, MODELING COMPOUNDS, MODELING PASTE, PRINT ENGRAVINGS, PRINTS IN THE NATURE OF PHOTOGRAPHS, LITHOGRAPHS AND PICTURES, FACIAL TISSUE, BOOKS IN THE FIELD OF CHILDREN'S BOOKS, COMICS, CARTOON STRIPS, CATALOGS IN THE FIELD OF TOYS AND GAMES, MAGAZINES, PERIODICALS AND NEWSLETTERS IN THE FIELD OF CHILDREN'S AND COLLECTORS' ENTERTAINMENT, COMIC BOOKS AND CARTOONS; BOOKBINDING MATERIAL; PHOTOGRAPHS; STATIONERY; ADHESIVES FOR STATIONERY OR HOUSEHOLD PURPOSES; ARTISTS' PASTELS; ARTISTS' BRUSHES; TYPEWRITERS AND OFFICE REQUISITES EXCEPT FURNITURE, NAMELY, STAPLERS; PAPER PACKAGING ENVELOPES, PLASTIC PACKAGING ENVELOPES, BLANK JOURNAL BOOKS, DIARIES, NOTEPADS, RUBBER STAMPS, INKING PADS, PAPER LABELS, PAPER CLIPS, PAPER CLIP HOLDERS, TELEPHONE AND ADDRESS BOOKS, FILE FOLDERS FILE BOXES FOR STORAGE OF MAGAZINES, BOOKMARKERS, WRITING PAPER, PAPER STATIONERY, PENS, PENCILS, MARKERS, CRAYONS, ERASERS, PENCIL SHARPENERS, CRAYON SHARPENERS, PENCIL CASES, DRAWING RULERS, BINDERS, GLUE FOR STATIONERY OR HOUSEHOLD USE, CORRECTION FLUID FOR DOCUMENTS, CHALK, CHALKBOARDS, CHALK ERASERS, DRY ERASE WRITING BOARDS AND WRITING SURFACES; PRINTED INSTRUCTIONAL AND TEACHING MATERIAL, NAMELY, TEACHING TILES AND FLASH CARDS; PLASTIC MATERIALS FOR PACKAGING, NAMELY, PLASTIC BUBBLE PACKS AND PLASTIC BAGS FOR PACKAGING; PRINTING TYPE; PRINTING BLOCKS, IN CLASS 16 (U.S. CLS. 2, 5, 22, 23, 29, 37, 38 AND 50).

FOR: LEATHER AND IMITATION LEATHER, GOODS MADE OF THESE MATERIALS, NAMELY, LEATHER BAGS, SCHOOL BAGS, HANDBAGS, MESSENGER BAGS, DUFFLE BAGS, TOTE BAGS, SPORT BAGS, REUSABLE SHOPPING BAGS, DIAPER BAGS, COSMETIC BAGS SOLD EMPTY, COIN PURSES, WALLETS, POUCHES OF LEATHER, POUCHES OF TEXTILE, LUGGAGE, LUGGAGE TAGS, KEY CASES, BACKPACKS WITH ROLLING WHEELS, SLING BAGS AND SLING BAGS FOR CARRYING INFANTS; ANIMAL SKINS; TRUNKS AND SUITCASES; UMBRELLAS, PARASOLS AND WALKING STICKS; WHIPS AND SADDLERY, IN CLASS 18 (U.S. CLS. 1, 2, 3, 22 AND 41).

FOR: HOUSEHOLD OR KITCHEN UTENSILS, NAMELY, SPATULAS, GRATERS, SIEVES, STRAINERS, TURNERS, SKIMMERS, KITCHEN TONGS, BOTTLE OPENERS, JAR OPENERS; CONTAINERS FOR HOUSEHOLD USE, WASTE BASKETS, TOILET PAPER HOLDERS, TOILET PAPER DISPENSERS, SHOWER CADDIES, WIRE BASKETS, NAPKIN HOLDERS, NAPKIN RINGS, SOAP DISPENSERS, LOTION CONTAINERS SOLD EMPTY FOR DOMESTIC USE, DISPENSERS FOR FACIAL TISSUES, ICE CUBE MOLDS, CUP CAKE MOLDS, LUNCH BOXES, SANDWICH BOXES, PLASTIC COASTERS, DISPOSABLE DINNERWARE, NAMELY, PLATES, BOWLS AND SERVING TRAYS, DISPOSABLE SERVING SPOONS, PAPER AND PLASTIC CUPS; SPORT BOTTLES SOLD EMPTY; FLASKS, THERMAL INSULATED BAGS FOR FOOD OR BEVERAGES, THERMAL INSULATED CONTAINERS FOR FOOD OR BEVERAGES, TOOTHBRUSHES ELECTRIC AND NON-ELECTRIC, TOOTHBRUSH HOLDERS, TOOTHBRUSH CASES, COMBS, SPONGES FOR HOUSEHOLD PURPOSES; CLEANING BRUSHES FOR HOUSEHOLD USE; BRUSH-MAKING MATERIALS; CLEANING

Reg. No. 4,097,600 EQUIPMENT, NAMELY, MOPS, BROOMS, SCRUBBING BRUSHES, TOILET BRUSHES, GARDENING GLOVES; STEEL WOOL; UNWORKED OR SEMI-WORKED GLASS EXCEPT BUILDING GLASS; SCULPTURES OF GLASS, PORCELAIN AND EARTHENWARE; PRODUCTS MADE OF GLASSWARE, PORCELAIN AND EARTHENWARE NOT INCLUDED IN OTHER CLASSES, NAMELY, BABY BATH TUBS, COOKIE JARS, GLASS JARS, BOTTLES SOLD EMPTY, FLOWER POTS, VASES, BOTTLE GOURDS, PLATES, DISHES, BOWLS, CUPS, MUGS, DRINKING GLASSES, DRINKING GLASSES, NAMELY, TUMBLERS, IN CLASS 21 (U.S. CLS. 2, 13, 23, 29, 30, 33, 40 AND 50).

FOR: TEXTILES AND TEXTILE GOODS, NAMELY, CURTAINS, DRAPES, WALL HANGINGS OF TEXTILE, BED LINEN, BED SHEETS, BED BLANKETS, BLANKET THROWS, THROWS, BED COVERS, MATTRESS COVERS, BEDSPREADS, COMFORTERS, QUILTS, DUST-RUFFLES, BED CANOPIES, PILLOW CASES, PILLOW SHAMS, TOWELS, WASH CLOTHS, WASHING MITTS, HANDKERCHIEFS, BEACH BLANKETS, FABRICS FOR TEXTILE USE; TABLECLOTHS OF TEXTILES, TABLE LINEN, TEXTILE PLACE MATS, TEXTILE TABLE NAPKINS, TEXTILE COASTERS, FABRIC TABLE RUNNERS, FABRIC TABLE TOPPERS, IN CLASS 24 (U.S. CLS. 42 AND 50).

FOR: CLOTHING, NAMELY, BLOUSES, SHIRTS, PANTS, SKIRTS, DRESSES, SOCKS, STOCKINGS, SLEEPWEAR, LOUNGEWEAR, UNDERWEAR, SWIMWEAR, BEACHWEAR, SCARVES, GLOVES, MITTENS, SWEATERS AND JACKETS; FOOTWEAR; HEADGEAR, NAMELY, HATS AND CAPS; COSTUMES FOR USE IN CHILDREN'S DRESS UP PLAY; HALLOWEEN COSTUMES AND MASKS SOLD IN CONNECTION THEREWITH, IN CLASS 25 (U.S. CLS. 22 AND 39).

FOR: GAMES AND TOYS, NAMELY, DOLLS AND ACCESSORIES THEREFOR, SOFT SCULPTURE TOYS, TOY ACTION FIGURES AND ACCESSORIES THEREFOR; STUFFED AND PLUSH TOYS, PUPPETS, MODELED PLASTIC TOY FIGURINES, CHILDREN'S MULTIPLE ACTIVITY TOYS, PLAYSETS FOR DOLLS, TOY CONSTRUCTION SETS, MUSICAL TOYS, TOY VEHICLES, RIDEABLE TOY VEHICLES, TOY MODEL VEHICLES AND RELATED ACCESSORIES SOLD AS UNITS, TOY VEHICLES WITH TRANSFORMING PARTS, STAND ALONE VIDEO GAME MACHINES, HAND HELD UNITS FOR PLAYING VIDEO GAMES OTHER THAN THOSE ADAPTED FOR USE WITH AN EXTERNAL DISPLAY SCREEN OR MONITOR, INFLATABLE TOYS, KITES, RADIO CONTROLLED TOY VEHICLES, REMOTE CONTROL TOYS, NAMELY, CARS, AIRPLANES, BOATS, PERSONAL JET BOATS AND WATER SCOOTERS; SKATEBOARDS, SKATEBOARD DECKS, ROLLER SKATES, TOY GARDENING SETS, TOY HANDYMAN SETS, SWIM FLOATS FOR RECREATIONAL USE, INFLATABLE FLOAT MATTRESSES FOR RECREATIONAL USE, BEACH BALLS, PLAY SWIMMING POOLS, INFLATABLE POOLS FOR RECREATIONAL USE, SWIMMING AIDS, NAMELY, POOL RINGS, POOL NOODLES AND ARM FLOATS FOR RECREATIONAL USE, TOY BOATS, SWINGS, BALLOONS, WATER TOYS, PARTY FAVORS IN THE NATURE OF SMALL TOYS, BATH TOYS, BENDABLE TOYS, CRIB TOYS, INFANT TOYS, EDUCATIONAL TOYS FOR TEACHING MATH PRINCIPLES TO CHILDREN, NAMELY, MANIPULATIVE BLOCKS FOR DISPLAYING PATTERNS AND GROUPINGS, ELECTRONIC EDUCATIONAL GAME MACHINES FOR CHILDREN, TOY ROBOTS, ARCADE GAMES, COSTUME MASKS, DOLL COSTUMES, BALLS FOR GAMES, BALLS FOR SPORTS, SPLASH BALLS, BAGS SPECIALLY ADAPTED FOR SPORTS EQUIPMENT, INFLATABLE BOP BAGS, FLOATING RECREATIONAL LOUNGE CHAIRS, HOCKEY STICKS, HOCKEY PUCKS, GOLF BALLS, GOLF CLUBS, TARGETS, TARGET GAMES, ELECTRONIC TARGETS FOR GAMES AND SPORTS, DARTS, DART BOARDS, ELECTRONIC DART GAMES, TENNIS BALLS, TENNIS NETS, TENNIS RACKETS, TABLE TENNIS BALLS, TABLE TENNIS NETS AND TABLE TENNIS PADDLES, TOY HOOP SETS, BASKETBALL HOOPS, BASKETBALLS, BASEBALL BASES, BASEBALL BATS, BASEBALL BATTING TEES, BASEBALL GLOVES, BASEBALL MITTS AND BASEBALLS, PADDLE BALLS, PADDLES FOR USE IN PADDLE BALL GAMES, BOWLING BALLS, BOWLING BALL COVERS, BOWLING PINS, ACTION SKILL GAMES, BOARD GAMES, CARD GAMES, TRADING CARD GAMES, PARTY GAMES, JIGSAW AND MANIPULATIVE PUZZLES, PUZZLES, TOY CANDY DISPENSERS; GYM-

Reg. No. 4,097,600 NASTIC APPARATUS; DECORATIONS FOR CHRISTMAS TREES, IN CLASS 28 (U.S. CLS. 22, 23, 38 AND 50).

FOR: MEAT, FISH, POULTRY AND GAME; MEAT EXTRACTS; PRESERVED, FROZEN, DRIED AND COOKED FRUITS AND VEGETABLES; JELLIES, JAMS, COMPOTES; EGGS, MILK AND DAIRY PRODUCTS EXCLUDING ICE CREAM, ICE MILK AND FROZEN YOGURT; EDIBLE OILS AND FATS, IN CLASS 29 (U.S. CL. 46).

FOR: COFFEE, TEA, COCOA, SUGAR, RICE, TAPIOCA, SAGO, ARTIFICIAL COFFEE; FLOURS AND PREPARATIONS MADE FROM CEREALS, NAMELY, BREAKFAST CEREALS, CEREAL BASED SNACK FOOD; BREAD; PASTRY; CONFECTIONERY, NAMELY, CANDY; ICES; HONEY, TREACLE; YEAST, BAKING-POWDER; SALT, MUSTARD; VINEGAR, SAUCES AS CONDIMENTS; SPICES; ICE FOR REFRESHMENT, IN CLASS 30 (U.S. CL. 46).

FOR: BEER; MINERAL AND AERATED WATERS AND NON-ALCOHOLIC BEVERAGES, NAMELY, SOFT DRINKS, FRUIT FLAVORED SOFT DRINKS, ENERGY DRINKS AND SPORT DRINKS; FRUIT DRINKS AND FRUIT JUICES; FROZEN FRUIT DRINKS; SYRUPS FOR MAKING BEVERAGES, IN CLASS 32 (U.S. CLS. 45, 46 AND 48).

FOR: EDUCATION SERVICES IN THE NATURE OF EARLY CHILDHOOD INSTRUCTION; TRAINING, NAMELY, PROVIDING BRAIN TRAINING GAMES ON-LINE AND IN MOBILE WIRELESS FORM; ENTERTAINMENT SERVICES IN THE NATURE OF ON-GOING TELEVISION PROGRAMS IN THE FIELD OF CHILDREN'S ENTERTAINMENT; ENTERTAINMENT SERVICES, NAMELY, PRESENTATION OF LIVE SHOW PERFORMANCES; ORGANIZING COMMUNITY SPORTING AND CULTURAL EVENTS, IN CLASS 41 (U.S. CLS. 100, 101 AND 107).

THE MARK CONSISTS OF STANDARD CHARACTERS WITHOUT CLAIM TO ANY PARTICULAR FONT, STYLE, SIZE, OR COLOR.

OWNER OF INTERNATIONAL REGISTRATION 1031512 DATED 11-25-2009, EXPIRES 11-25-2019.

OWNER OF U.S. REG. NOS. 1,209,160, 2,701,891 AND OTHERS.

SER. NO. 79-087,102, FILED 9-2-2010.

TASNEEM HUSSAIN, EXAMINING ATTORNEY

United States of America

United States Patent and Trademark Office



Reg. No. 4,097,601

Registered Feb. 14, 2012

**Int. Cls.: 3, 9, 14, 16, 18,
21, 24, 25, 28, 29, 30, 32
and 41**

STUDIO PEYO S.A. (SWITZERLAND JOINT STOCK COMPANY)
CHEMIN FRANK-THOMAS 36
GENÈVE, SWITZERLAND CH1208

FOR: BLEACHING PREPARATIONS AND LAUNDRY DETERGENTS FOR LAUNDRY USE; CLEANING, POLISHING, SCOURING AND ABRASIVE PREPARATIONS; SOAPS; PERFUMERY, ESSENTIAL OILS, COSMETICS, HAIR LOTIONS; DENTIFRICES, IN CLASS 3 (U.S. CLS. 1, 4, 6, 50, 51 AND 52).

TRADEMARK

SERVICE MARK

PRINCIPAL REGISTER

FOR: NAUTICAL APPARATUS AND INSTRUMENTS, NAMELY, MAGNETIC COMPASSES; SURVEYING INSTRUMENTS; PHOTOGRAPHIC APPARATUS AND INSTRUMENTS, NAMELY, CAMERAS; CINEMATOGRAPHIC CAMERAS AND EXPOSED CINEMATOGRAPHIC FILM; OPTICAL APPARATUS AND INSTRUMENTS, NAMELY, OPTICAL FRAMES, OPTICAL GLASSES AND OPTICAL LENSES; WEIGHING APPARATUS AND INSTRUMENTS, NAMELY, WEIGHING SCALES; MEASURING APPARATUS AND INSTRUMENTS, NAMELY, MEASURING CUPS; SIGNALING APPARATUS AND INSTRUMENTS, NAMELY, SIGNAL BELLS, SIGNAL WHISTLES AND CALL BELLS; CHECKING APPARATUS AND INSTRUMENTS, NAMELY, COMPUTERS; LIFE-SAVING APPARATUS AND INSTRUMENTS, NAMELY, SWIM FLOATS FOR SAFETY PURPOSES, INFLATABLE FLOTATION DEVICES, AND FLOTATION VESTS; AND TEACHING APPARATUS AND INSTRUMENTS, NAMELY, CHILDREN'S EDUCATIONAL SOFTWARE; APPARATUS AND INSTRUMENTS FOR CONDUCTING, SWITCHING, TRANSFORMING, ACCUMULATING, REGULATING OR CONTROLLING ELECTRICITY; APPARATUS FOR RECORDING, TRANSMISSION OR REPRODUCTION OF SOUND OR IMAGES; PRE-RECORDED MAGNETIC DATA CARRIERS FEATURING ANIMATED CARTOONS, PRE-RECORDED RECORDING DISCS FEATURING ANIMATED CARTOONS; PRE-RECORDED AUDIO, VISUAL, AND AUDIOVISUAL MAGNETIC AND DIGITAL DATA CARRIERS FEATURING MUSIC AND ANIMATION AND ELECTRONIC GAME PROGRAMS, AUTOMATIC VENDING MACHINES AND MECHANISMS FOR COIN-OPERATED APPARATUS; CASH REGISTERS, CALCULATING MACHINES, DATA PROCESSING EQUIPMENT AND COMPUTERS; FIRE EXTINGUISHING APPARATUS, IN CLASS 9 (U.S. CLS. 21, 23, 26, 36 AND 38).



David J. Kybas

FOR: PRECIOUS METALS AND THEIR ALLOYS AND GOODS MADE OF PRECIOUS METALS OR COATED THEREWITH, NAMELY, FIGURINES, KEY RINGS, COINS AND MEDALS; JEWELRY, PRECIOUS STONES; HOROLOGICAL AND CHRONOMETRIC INSTRUMENTS, IN CLASS 14 (U.S. CLS. 2, 27, 28 AND 50).

Reg. No. 4,097,601 FOR: PAPER, CARDBOARD AND GOODS MADE FROM THESE MATERIALS, NAMELY, POSTERS, PAPER FLAGS, ADVERTISING BOARDS OF CARDBOARD OR PAPER, PAPER NAPKINS, PAPER DECORATIVE GARLAND FOR PARTIES, PAPER PARTY BAGS, PAPER PARTY DECORATIONS; PAPER PARTY FAVORS; PARTY GOODIE BAGS OF PAPER OR PLASTIC; PARTY ORNAMENTS OF PAPER, GIFT WRAP MADE OF PAPER, PAPER GIFT WRAP BOWS, GIFT BOXES, TISSUE PAPER, PAPER TABLE CLOTHS, PAPER PLACEMATS, TOILET TISSUE, BOXES, CARTONS, STORAGE CONTAINERS AND PACKAGING CONTAINERS MADE OF PAPER OR CARDBOARD, HATBOXES OF PAPER OR CARDBOARD; PRINTED MATTER, NAMELY, GREETING CARDS, INVITATIONS, ANNOUNCEMENT CARDS, THANK YOU NOTES, POSTCARDS, PRINTED TICKETS, STICKERS AND TRANSFERS, COLORING BOOKS, EMBROIDERY DESIGN PATTERNS PRINTED ON PAPER, ILLUSTRATIONS, PORTRAITS, PHOTOGRAPH ALBUMS, STAMP ALBUMS, STICKER ALBUMS, DRAWING PAPER, DRAWING PADS, PAPER MACHE, WATERCOLOR BOARDS, WATERCOLOR PICTURES, ARTS AND CRAFT PAINT KITS, PAINT BOXES AND BRUSHES, CANVAS FOR PAINTING, EASELS, MODELING CLAY, MODELING COMPOUNDS, MODELING PASTE, PRINT ENGRAVINGS, PRINTS IN THE NATURE OF PHOTOGRAPHS, LITHOGRAPHS AND PICTURES, FACIAL TISSUE, BOOKS IN THE FIELD OF CHILDREN'S BOOKS, COMICS, CARTOON STRIPS, CATALOGS IN THE FIELD OF TOYS AND GAMES, MAGAZINES, PERIODICALS AND NEWSLETTERS IN THE FIELD OF CHILDREN'S AND COLLECTORS' ENTERTAINMENT, COMIC BOOKS AND CARTOONS; BOOKBINDING MATERIAL; PHOTOGRAPHS; STATIONERY; ADHESIVES FOR STATIONERY OR HOUSEHOLD PURPOSES; ARTISTS' PASTELS; ARTISTS' BRUSHES; TYPEWRITERS AND OFFICE REQUISITES EXCEPT FURNITURE, NAMELY, STAPLERS; PAPER PACKAGING ENVELOPES, PLASTIC PACKAGING ENVELOPES, BLANK JOURNAL BOOKS, DIARIES, NOTEPADS, RUBBER STAMPS, INKING PADS, PAPER LABELS, PAPER CLIPS, PAPER CLIP HOLDERS, TELEPHONE AND ADDRESS BOOKS, FILE FOLDERS FILE BOXES FOR STORAGE OF MAGAZINES, BOOKMARKERS, WRITING PAPER, PAPER STATIONERY, PENS, PENCILS, MARKERS, CRAYONS, ERASERS, PENCIL SHARPENERS, CRAYON SHARPENERS, PENCIL CASES, DRAWING RULERS, BINDERS, GLUE FOR STATIONERY OR HOUSEHOLD USE, CORRECTION FLUID FOR DOCUMENTS, CHALK, CHALKBOARDS, CHALK ERASERS, DRY ERASE WRITING BOARDS AND WRITING SURFACES; PRINTED INSTRUCTIONAL AND TEACHING MATERIAL, NAMELY, TEACHING TILES AND FLASH CARDS; PLASTIC MATERIALS FOR PACKAGING, NAMELY, PLASTIC BUBBLE PACKS AND PLASTIC BAGS FOR PACKAGING; PRINTING TYPE; PRINTING BLOCKS, IN CLASS 16 (U.S. CLS. 2, 5, 22, 23, 29, 37, 38 AND 50).

FOR: LEATHER AND IMITATION LEATHER, GOODS MADE OF THESE MATERIALS, NAMELY, LEATHER BAGS, SCHOOL BAGS, HANDBAGS, MESSENGER BAGS, DUFFLE BAGS, TOTE BAGS, SPORT BAGS, REUSABLE SHOPPING BAGS, DIAPER BAGS, COSMETIC BAGS SOLD EMPTY, COIN PURSES, WALLETS, POUCHES OF LEATHER, POUCHES OF TEXTILE, LUGGAGE, LUGGAGE TAGS, KEY CASES, BACKPACKS WITH ROLLING WHEELS, SLING BAGS AND SLING BAGS FOR CARRYING INFANTS; ANIMAL SKINS; TRUNKS AND SUITCASES; UMBRELLAS, PARASOLS AND WALKING STICKS; WHIPS AND SADDLERY, IN CLASS 18 (U.S. CLS. 1, 2, 3, 22 AND 41).

FOR: HOUSEHOLD OR KITCHEN UTENSILS, NAMELY, SPATULAS, GRATERS, SIEVES, STRAINERS, TURNERS, SKIMMERS, KITCHEN TONGS, BOTTLE OPENERS, JAR OPENERS; CONTAINERS FOR HOUSEHOLD USE, WASTE BASKETS, TOILET PAPER HOLDERS, TOILET PAPER DISPENSERS, SHOWER CADDIES, WIRE BASKETS, NAPKIN HOLDERS, NAPKIN RINGS, SOAP DISPENSERS, LOTION CONTAINERS SOLD EMPTY FOR DOMESTIC USE, DISPENSERS FOR FACIAL TISSUES, ICE CUBE MOLDS, CUP CAKE MOLDS, LUNCH BOXES, SANDWICH BOXES, PLASTIC COASTERS, DISPOSABLE DINNERWARE, NAMELY, PLATES, BOWLS AND SERVING TRAYS, DISPOSABLE SERVING SPOONS, PAPER AND PLASTIC CUPS; SPORT BOTTLES SOLD EMPTY; FLASKS, THERMAL INSULATED BAGS FOR FOOD OR BEVERAGES, THERMAL INSULATED CONTAINERS FOR FOOD OR BEVERAGES, TOOTHBRUSHES ELECTRIC AND NON-ELECTRIC, TOOTHBRUSH HOLDERS, TOOTHBRUSH CASES, COMBS, SPONGES FOR HOUSEHOLD PURPOSES; CLEANING BRUSHES FOR HOUSEHOLD USE; BRUSH-MAKING MATERIALS; CLEANING

Reg. No. 4,097,601 EQUIPMENT, NAMELY, MOPS, BROOMS, SCRUBBING BRUSHES, TOILET BRUSHES, GARDENING GLOVES; STEEL WOOL; UNWORKED OR SEMI-WORKED GLASS EXCEPT BUILDING GLASS; SCULPTURES OF GLASS, PORCELAIN AND EARTHENWARE; PRODUCTS MADE OF GLASSWARE, PORCELAIN AND EARTHENWARE NOT INCLUDED IN OTHER CLASSES, NAMELY, BABY BATH TUBS, COOKIE JARS, GLASS JARS, BOTTLES SOLD EMPTY, FLOWER POTS, VASES, BOTTLE GOURDS, PLATES, DISHES, BOWLS, CUPS, MUGS, DRINKING GLASSES, DRINKING GLASSES, NAMELY, TUMBLERS, IN CLASS 21 (U.S. CLS. 2, 13, 23, 29, 30, 33, 40 AND 50).

FOR: TEXTILES AND TEXTILE GOODS, NAMELY, CURTAINS, DRAPES, WALL HANGINGS OF TEXTILE, BED LINEN, BED SHEETS, BED BLANKETS, BLANKET TROWS, TROWS, BED COVERS, MATTRESS COVERS, BEDSPREADS, COMFORTERS, QUILTS, DUST-RUFFLES, BED CANOPIES, PILLOW CASES, PILLOW SHAMS, TOWELS, WASH CLOTHS, WASHING MITTS, HANDKERCHIEFS, BEACH BLANKETS, FABRICS FOR TEXTILE USE; TABLECLOTHS OF TEXTILES, TABLE LINEN, TEXTILE PLACE MATS, TEXTILE TABLE NAPKINS, TEXTILE COASTERS, FABRIC TABLE RUNNERS, FABRIC TABLE TOPPERS, IN CLASS 24 (U.S. CLS. 42 AND 50).

FOR: CLOTHING, NAMELY, BLOUSES, SHIRTS, PANTS, SKIRTS, DRESSES, SOCKS, STOCKINGS, SLEEPWEAR, LOUNGEWEAR, UNDERWEAR, SWIMWEAR, BEACHWEAR, SCARVES, GLOVES, MITTENS, SWEATERS AND JACKETS; FOOTWEAR; HEADGEAR, NAMELY, HATS AND CAPS; COSTUMES FOR USE IN CHILDREN'S DRESS UP PLAY; HALLOWEEN COSTUMES AND MASKS SOLD IN CONNECTION THEREWITH, IN CLASS 25 (U.S. CLS. 22 AND 39).

FOR: GAMES AND TOYS, NAMELY, DOLLS AND ACCESSORIES THEREFOR, SOFT SCULPTURE TOYS, TOY ACTION FIGURES AND ACCESSORIES THEREFOR; STUFFED AND PLUSH TOYS, PUPPETS, MODELED PLASTIC TOY FIGURINES, CHILDREN'S MULTIPLE ACTIVITY TOYS, PLAYSETS FOR DOLLS, TOY CONSTRUCTION SETS, MUSICAL TOYS, TOY VEHICLES, RIDEABLE TOY VEHICLES, TOY MODEL VEHICLES AND RELATED ACCESSORIES SOLD AS UNITS, TOY VEHICLES WITH TRANSFORMING PARTS, STAND ALONE VIDEO GAME MACHINES, HAND HELD UNITS FOR PLAYING VIDEO GAMES OTHER THAN THOSE ADAPTED FOR USE WITH AN EXTERNAL DISPLAY SCREEN OR MONITOR, INFLATABLE TOYS, KITES, RADIO CONTROLLED TOY VEHICLES, REMOTE CONTROL TOYS, NAMELY, CARS, AIRPLANES, BOATS, PERSONAL JET BOATS AND WATER SCOOTERS; SKATEBOARDS, SKATEBOARD DECKS, ROLLER SKATES, TOY GARDENING SETS, TOY HANDYMAN SETS, SWIM FLOATS FOR RECREATIONAL USE, INFLATABLE FLOAT MATTRESSES FOR RECREATIONAL USE, BEACH BALLS, PLAY SWIMMING POOLS, INFLATABLE POOLS FOR RECREATIONAL USE, SWIMMING AIDS, NAMELY, POOL RINGS, POOL NOODLES AND ARM FLOATS FOR RECREATIONAL USE, TOY BOATS, SWINGS, BALLOONS, WATER TOYS, PARTY FAVORS IN THE NATURE OF SMALL TOYS, BATH TOYS, BENDABLE TOYS, CRIB TOYS, INFANT TOYS, EDUCATIONAL TOYS FOR TEACHING MATH PRINCIPLES TO CHILDREN, NAMELY, MANIPULATIVE BLOCKS FOR DISPLAYING PATTERNS AND GROUPINGS, ELECTRONIC EDUCATIONAL GAME MACHINES FOR CHILDREN, TOY ROBOTS, ARCADE GAMES, COSTUME MASKS, DOLL COSTUMES, BALLS FOR GAMES, BALLS FOR SPORTS, SPLASH BALLS, BAGS SPECIALLY ADAPTED FOR SPORTS EQUIPMENT, INFLATABLE BOP BAGS, FLOATING RECREATIONAL LOUNGE CHAIRS, HOCKEY STICKS, HOCKEY PUCKS, GOLF BALLS, GOLF CLUBS, TARGETS, TARGET GAMES, ELECTRONIC TARGETS FOR GAMES AND SPORTS, DARTS, DART BOARDS, ELECTRONIC DART GAMES, TENNIS BALLS, TENNIS NETS, TENNIS RACKETS, TABLE TENNIS BALLS, TABLE TENNIS NETS AND TABLE TENNIS PADDLES, TOY HOOP SETS, BASKETBALL HOOPS, BASKETBALLS, BASEBALL BASES, BASEBALL BATS, BASEBALL BATTING TEES, BASEBALL GLOVES, BASEBALL MITTS AND BASEBALLS, PADDLE BALLS, PADDLES FOR USE IN PADDLE BALL GAMES, BOWLING BALLS, BOWLING BALL COVERS, BOWLING PINS, ACTION SKILL GAMES, BOARD GAMES, CARD GAMES, TRADING CARD GAMES, PARTY GAMES, JIGSAW AND MANIPULATIVE PUZZLES, PUZZLES, TOY CANDY DISPENSERS; GYM-

Reg. No. 4,097,601 NASTIC APPARATUS; DECORATIONS FOR CHRISTMAS TREES, IN CLASS 28 (U.S. CLS. 22, 23, 38 AND 50).

FOR: MEAT, FISH, POULTRY AND GAME; MEAT EXTRACTS; PRESERVED, FROZEN, DRIED AND COOKED FRUITS AND VEGETABLES; JELLIES, JAMS, COMPOTES; EGGS, MILK AND DAIRY PRODUCTS EXCLUDING ICE CREAM, ICE MILK AND FROZEN YOGURT; EDIBLE OILS AND FATS, IN CLASS 29 (U.S. CL. 46).

FOR: COFFEE, TEA, COCOA, SUGAR, RICE, TAPIOCA, SAGO, ARTIFICIAL COFFEE; FLOURS AND PREPARATIONS MADE FROM CEREALS, NAMELY, BREAKFAST CEREALS, CEREAL BASED SNACK FOOD; BREAD; PASTRY; CONFECTIONERY, NAMELY, CANDY; ICES; HONEY, TREACLE; YEAST, BAKING-POWDER; SALT, MUSTARD; VINEGAR, SAUCES AS CONDIMENTS; SPICES; ICE FOR REFRESHMENT, IN CLASS 30 (U.S. CL. 46).

FOR: BEER; MINERAL AND AERATED WATERS AND NON-ALCOHOLIC BEVERAGES, NAMELY, SOFT DRINKS, FRUIT FLAVORED SOFT DRINKS, ENERGY DRINKS AND SPORT DRINKS; FRUIT DRINKS AND FRUIT JUICES; FROZEN FRUIT DRINKS; SYRUPS FOR MAKING BEVERAGES, IN CLASS 32 (U.S. CLS. 45, 46 AND 48).

FOR: EDUCATION SERVICES IN THE NATURE OF EARLY CHILDHOOD INSTRUCTION; TRAINING, NAMELY, PROVIDING BRAIN TRAINING GAMES ON-LINE AND IN MOBILE WIRELESS FORM; ENTERTAINMENT SERVICES IN THE NATURE OF ON-GOING TELEVISION PROGRAMS IN THE FIELD OF CHILDREN'S ENTERTAINMENT; ENTERTAINMENT SERVICES, NAMELY, PRESENTATION OF LIVE SHOW PERFORMANCES; ORGANIZING COMMUNITY SPORTING AND CULTURAL EVENTS, IN CLASS 41 (U.S. CLS. 100, 101 AND 107).

OWNER OF U.S. REG. NOS. 1,265,701 AND 2,701,892.

OWNER OF INTERNATIONAL REGISTRATION 1032847 DATED 11-25-2009, EXPIRES 11-25-2019.

THE MARK CONSISTS OF A STYLIZED CARICATURE OF A SMILING ELFIN CREATURE WITH A HAT, PANTS, AND SHOES POINTING AT SOMETHING.

SER. NO. 79-087,103, FILED 9-2-2010.

TASNEEM HUSSAIN, EXAMINING ATTORNEY

United States of America
United States Patent and Trademark Office

EVE SA

Reg. No. 4,097,602

Registered Feb. 14, 2012

Int. Cl.: 5

TRADEMARK

PRINCIPAL REGISTER

AFFYMAX PHARMA LIMITED (UNITED KINGDOM LIMITED COMPANY)
THE BROADGATE TOWER
3RD FLOOR,; 20 PRIMROSE STREET; LONDON EC2A 2RS
UNITED KINGDOM

FOR: PHARMACEUTICALS FOR USE IN STIMULATING HUMAN BLOOD CELL PRODUCTION; PHARMACEUTICALS FOR THE TREATMENT OF CANCER, ANEMIA, ISCHEMIA, MYOCARDIAL INFARCTION, CONGESTIVE HEART FAILURE, RENAL FAILURE, ANOXIA-INDUCED CELLULAR DEGENERATION, HYPOXIA-INDUCED CELLULAR DEGENERATION AND STROKE, IN CLASS 5 (U.S. CLS. 6, 18, 44, 46, 51 AND 52).

THE MARK CONSISTS OF STANDARD CHARACTERS WITHOUT CLAIM TO ANY PARTICULAR FONT, STYLE, SIZE, OR COLOR.

PRIORITY DATE OF 4-30-2010 IS CLAIMED.

OWNER OF INTERNATIONAL REGISTRATION 1050836 DATED 6-19-2010, EXPIRES 6-19-2020.

SER. NO. 79-087,258, FILED 6-19-2010.

MARY I. SPARROW, EXAMINING ATTORNEY



David J. Kyjars

Director of the United States Patent and Trademark Office

United States of America

United States Patent and Trademark Office

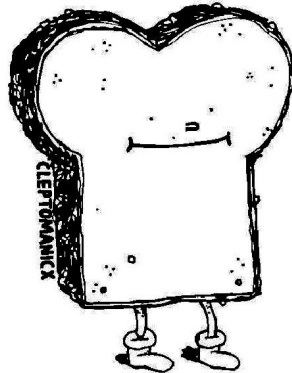

Reg. No. 4,097,603

Registered Feb. 14, 2012

Int. Cls.: 25 and 28

TRADEMARK

PRINCIPAL REGISTER

PITT FEIL
BUDAPESTER STR. 49
20359 HAMBURG
FED REP GERMANY

FOR: CLOTHING, NAMELY, BOXER SHORTS, T-SHIRTS, SWEATERS, TROUSERS; FOOTWEAR; HEADWEAR; HATS; CAPS; SPORTS SHOES; SNEAKERS, IN CLASS 25 (U.S. CLS. 22 AND 39).

FOR: GAMES AND PLAYTHINGS, NAMELY, VINYL TOY FIGURES AND VINYL DOLLS; SKATEBOARDS; SURFBOARDS; BODYBOARDS; SNOWBOARDS, IN CLASS 28 (U.S. CLS. 22, 23, 38 AND 50).

THE MARK CONSISTS OF THE WORD "CLEPTOMANIX" AND A DESIGN OF A SANDWICH BREAD WITH HUMAN ATTRIBUTES.

OWNER OF INTERNATIONAL REGISTRATION 1051931 DATED 8-31-2010, EXPIRES 8-31-2020.

SER. NO. 79-087,637, FILED 8-31-2010.

CORY BOONE, EXAMINING ATTORNEY



David J. Kybas

Director of the United States Patent and Trademark Office

United States of America

United States Patent and Trademark Office

ILSA

Reg. No. 4,097,604

Registered Feb. 14, 2012

Int. Cls.: 8, 11 and 21

TRADEMARK

PRINCIPAL REGISTER

ILSA SRL (ITALY LIMITED LIABILITY COMPANY)
C.SO PASTRENGO, 46
I-10093 COLLEGNO (TO)
ITALY

FOR: HAND OPERATED SHARPENING TOOLS AND INSTRUMENTS; HAND OPERATED TOOLS AND INSTRUMENTS, NAMELY, CHISELS, HAND-OPERATED CUFFING TOOLS AND HAND-OPERATED RIVETING TOOLS; KNIVES, FORKS AND SPOONS; WHITE WEAPONS, NAMELY, KNIVES, DAGGERS AND SWORDS; RAZORS; CAN OPENER; NUTCRACKERS, IN CLASS 8 (U.S. CLS. 23, 28 AND 44).

FOR: SMALL HOUSEHOLD APPLIANCES, NAMELY, ELECTRIC ESPRESSO COFFEE MAKERS, ELECTRIC KETTLES, ELECTRIC COFFEE MACHINES, FOOD ELECTRIC WARMERS, IN CLASS 11 (U.S. CLS. 13, 21, 23, 31 AND 34).

FOR: HOUSEHOLD OR KITCHEN CONTAINERS; HOUSEHOLD OR KITCHEN UTENSILS, NAMELY, COMBS AND CLEANING SPONGES; DISHWASHING BRUSHES, FLOOR BRUSHES, CLEANING BRUSHES FOR HOUSEHOLD USE; BRUSH-MAKING MATERIALS; ARTICLES FOR CLEANING PURPOSE, NAMELY, STEEL WOOL AND CLOTHS FOR CLEANING; UNWORKED OR SEMIPROCESSED GLASS; BEVERAGE GLASSWARE, PORCELAIN MUGS AND EARTHENWARE BASIN AND EARTHENWARE MUGS; SMALL BASKETS FOR DOMESTIC USE, NOT OF METAL; TRAYS FOR DOMESTIC USE; PLASTIC CONTAINERS FOR DOMESTIC USE; KITCHEN LADLES, SERVING LADLES; THERMAL INSULATED CONTAINERS FOR DRINKS, NON-ELECTRIC EGG BEATERS FOR DOMESTIC USE, BOWLS, SUGAR BOWLS, BUTTER DISHES, NON-ELECTRICAL COFFEE GRINDERS, HAND-OPERATED COFFEE GRINDER; HOUSEHOLD UTENSILS, NAMELY, PLASTIC CAPS, GLASS STOPPERS, CAN OPENERS, BOTTLE OPENERS, CORKSCREWS, CARAFES, NON-ELECTRIC COFFEE MAKERS, MOCHA TEA KETTLES, TEAPOTS, TEA STRAINERS, POTS, MIXERS, NON-ELECTRIC EGG BEATERS TO BE USED IN KITCHEN, NON-ELECTRIC EGG BEATERS, CARPET BEATER, HAND OPERATED VEGETABLE MILLS FOR DOMESTIC USE, GRATERS, FRUIT DISHES, BREADSTICK BASKETS, BREAD BASKETS FOR DOMESTIC USE, SAUCEPANS, NON-ELECTRIC PRESSURE COOKERS, GRILLS, FRYING PANS, SAUCE PANS, BAKING-PANS, COOKING PLATES, OPEN FLAME STOVE ADAPTER, SALAD BOWLS, SALT AND PEPPER SHAKERS, COCKTAIL SHAKERS, BUCKETS, ICE BUCKETS, DOUBLE WALL BOTTLE COOLER, ICE TONG, JAPANESE STYLE WOODEN PESTLES, CITRUS-FRUIT SQUEEZERS, SIEVES, STRAINERS, GLASS JARS, COOKIE JARS, INSULATING JARS, OIL CRUET STANDS NOT OF PRECIOUS METAL, OIL CRUET STANDS



David J. Kyjars

Director of the United States Patent and Trademark Office

Reg. No. 4,097,604 OF PRECIOUS METAL, NAPKIN HOLDERS, SAUCE BOATS, EGG CUPS; CRYSTAL WARE, NAMELY, GLASSES, BOTTLES, REFRIGERATING BOTTLES, AND TANKARDS ALL OF CRYSTAL; TABLEWARE AND DINNER SETS, NAMELY, BOWLS, COVERED DISHES, GLASS JARS, BOWLS, CUPS, DISHES AND SMALL DISHES, IN CLASS 21 (U.S. CLS. 2, 13, 23, 29, 30, 33, 40 AND 50).

THE MARK CONSISTS OF STANDARD CHARACTERS WITHOUT CLAIM TO ANY PARTICULAR FONT, STYLE, SIZE, OR COLOR.

PRIORITY DATE OF 1-29-2010 IS CLAIMED.

OWNER OF INTERNATIONAL REGISTRATION 1052798 DATED 6-21-2010, EXPIRES 6-21-2020.

SER. NO. 79-087,970, FILED 6-21-2010.

JANICE KIM, EXAMINING ATTORNEY

United States of America

United States Patent and Trademark Office



Reg. No. 4,097,605

Registered Feb. 14, 2012

Int. Cl.: 30

JIANGSU MINGDING ECOLOGY TEA TECHNOLOGY CO., LTD. (CHINA CORPORATION)
SHIMEN VILLAGE
TAIHUA TOWN.; YIXING CITY; 214200 JIANGSU PROVINCE
CHINA

FOR: TEA, IN CLASS 30 (U.S. CL. 46).

TRADEMARK

NO CLAIM IS MADE TO THE EXCLUSIVE RIGHT TO USE THE NON-LATIN CHARACTERS THAT TRANSLITERATE TO MING, APART FROM THE MARK AS SHOWN.

PRINCIPAL REGISTER

OWNER OF INTERNATIONAL REGISTRATION 1052828 DATED 9-14-2010, EXPIRES 9-14-2020.

THE TRANSLITERATION OF THE NON-LATIN CHARACTERS IN THE MARK IS: MING DING.

THE ENGLISH TRANSLATION OF THE FOREIGN WORD(S) IN THE MARK IS: THE FIRST CHINESE CHARACTER WHOSE TRANSLITERATION IS MING MEANS TEA; THE SECOND CHINESE CHARACTER WHOSE TRANSLITERATION IS DING MEANS AN ANCIENT COOKING VESSEL; THE COMBINATION OF THE TWO CHINESE CHARACTERS HAS NO SIGNIFICANCE IN THE RELEVANT TRADE OR INDUSTRY, AND HAS NO GEOGRAPHICAL SIGNIFICANCE, AND HAS NO MEANING IN A FOREIGN LANGUAGE, AND HAS NO SIGNIFICANCE AS APPLIED TO THE GOODS.



SER. NO. 79-087,983, FILED 9-14-2010.

MARCIE MILONE, EXAMINING ATTORNEY

David J. Kybas

Director of the United States Patent and Trademark Office

United States of America

United States Patent and Trademark Office



Reg. No. 4,097,606

Registered Feb. 14, 2012

Int. Cl.: 17

TRADEMARK

PRINCIPAL REGISTER

NORRES SCHLAUCHTECHNIK GMBH & CO. KG (FED REP GERMANY GMBH & CO. KG)
FREILIGRATHSTR. 38
45881 GELSENKIRCHEN
FED REP GERMANY

FOR: NON METAL HOSES FOR USE IN INDUSTRIAL APPLICATIONS; NON METAL HOSES FOR USE IN THE CHEMICAL INDUSTRY; NON METAL HOSES FOR USE IN THE FOOD INDUSTRY; PLASTIC HOSES, IN PARTICULAR FLEXIBLE PLASTIC HOSES FOR USE IN INDUSTRIAL APPLICATIONS; PLASTIC HOSES, IN PARTICULAR FLEXIBLE PLASTIC HOSES FOR USE IN THE CHEMICAL INDUSTRY; PLASTIC HOSES IN PARTICULAR FLEXIBLE PLASTIC HOSES FOR USE IN THE FOOD INDUSTRY; PLASTIC WOUND HOSES, PLASTIC SPIRAL HOSES, PLASTIC SPIRAL HOSES WITH SUPPORT COILS FOR USE IN INDUSTRIAL APPLICATIONS; PLASTIC WOUND HOSES, PLASTIC SPIRAL HOSES, PLASTIC SPIRAL HOSES WITH SUPPORT COILS FOR USE IN THE CHEMICAL INDUSTRY; PLASTIC WOUND HOSES, PLASTIC SPIRAL HOSES, PLASTIC SPIRAL HOSES WITH SUPPORT COILS FOR USE IN THE FOOD INDUSTRY; PLASTIC EXTRACTION HOSES, PLASTIC FEET HOSES AND NON-METAL CONNECTION PIECES FOR HOSES FOR USE IN INDUSTRIAL APPLICATIONS; PLASTIC EXTRACTION HOSES, PLASTIC FEET HOSES AND NON-METAL CONNECTION PIECES FOR HOSES FOR USE IN THE CHEMICAL INDUSTRY; PLASTIC EXTRACTION HOSES, PLASTIC FEET HOSES AND NON-METAL CONNECTION PIECES FOR HOSES FOR USE IN THE FOOD INDUSTRY, IN CLASS 17 (U.S. CLS. 1, 5, 12, 13, 35 AND 50).

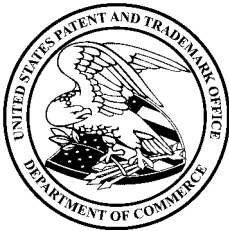

THE MARK CONSISTS OF A BLUE STYLIZED LETTER "N".

OWNER OF INTERNATIONAL REGISTRATION 0895995 DATED 8-3-2006, EXPIRES 8-3-2016.

THE COLOR(S) BLUE IS/ARE CLAIMED AS A FEATURE OF THE MARK.

SER. NO. 79-088,057, FILED 10-1-2010.

KRISTIN CARLSON, EXAMINING ATTORNEY

David J. Kyffers

Director of the United States Patent and Trademark Office

United States of America

United States Patent and Trademark Office

CNV

Reg. No. 4,097,607

D+H MECHATRONIC AG (FED REP GERMANY CORPORATION)
GEORG-SASSE-STR. 28-32

Registered Feb. 14, 2012

22949 AMMERSBEK, FED REP GERMANY

Int. Cls.: 9, 11, 37 and 42

FOR: ELECTRIC AND ELECTRONIC CONTROL DEVICES FOR MACHINES, MOTORS AND ENGINES, NAMELY, ACTUATORS FOR WINDOWS AND DOORS AND AUTOMATIC LOCKING DEVICES FOR DOORS AND ELECTRIC MOTORS; REMOTE CONTROL DEVICES, NAMELY, SMOKE DETECTORS, ALARMS FOR FIRE, SMOKE, WATER, HUMIDITY AND HEAT, AND ELECTRONIC SENSORS FOR SENSING SMOKE, FIRE, HUMIDITY, WATER AND TEMPERATURE; FIRE ALARM SYSTEMS COMPRISING FIRE, SMOKE, WATER, HUMIDITY AND HEAT DETECTORS AND SENSORS, MANUAL PULL STATIONS, FIRE ALARM CONTROL PANELS, FIRE ALARM SYSTEM CONTROLLERS, ANNUNCIATORS; SIGNALING DEVICES, NAMELY, HORNS, BELLS, AND STROBES, IN CLASS 9 (U.S. CLS. 21, 23, 26, 36 AND 38).

TRADEMARK

SERVICE MARK

PRINCIPAL REGISTER

FOR: SMOKE EXTRACTORS IN THE NATURE OF VENTILATION FANS, AND SMOKE EXTRACTION SYSTEMS COMPRISING VENTILATION LOUVERS AND HOODS, DRIVE UNITS FOR OPENING AND CLOSING WINDOWS AND VENTILATION FLAPS, ELECTRONIC CONTROL UNITS, POWER SUPPLY UNITS, SENSORS AND TRIGGERS, OPERATING PANELS, THE FOREGOING ALL FOR COMMERCIAL AND INDUSTRIAL USE; INTERIOR ENVIRONMENT CONTROL SYSTEMS FOR COMMERCIAL BUILDINGS, NAMELY, VENTILATORS, IN CLASS 11 (U.S. CLS. 13, 21, 23, 31 AND 34).

FOR: INSTALLATION, REPAIR AND MAINTENANCE OF FIRE ALARM INSTALLATIONS AND FIRE EXTINGUISHING INSTALLATIONS, IN CLASS 37 (U.S. CLS. 100, 103 AND 106).

FOR: DESIGN OF FIRE ALARM, SMOKE EXTRACTION, FIRE EXTINGUISHING AND AIR-CONDITIONING INSTALLATIONS, IN CLASS 42 (U.S. CLS. 100 AND 101).

THE MARK CONSISTS OF STANDARD CHARACTERS WITHOUT CLAIM TO ANY PARTICULAR FONT, STYLE, SIZE, OR COLOR.

PRIORITY DATE OF 6-25-2010 IS CLAIMED.

OWNER OF INTERNATIONAL REGISTRATION 1054777 DATED 7-7-2010, EXPIRES 7-7-2020.



David J. Kappas

Director of the United States Patent and Trademark Office

Reg. No. 4,097,607 SER. NO. 79-088,668, FILED 7-7-2010.

LIEF MARTIN, EXAMINING ATTORNEY

United States of America

United States Patent and Trademark Office



Reg. No. 4,097,608

Registered Feb. 14, 2012

Int. Cl.: 11

TRADEMARK

PRINCIPAL REGISTER

BULLARD GMBH (FED REP GERMANY LIMITED LIABILITY COMPANY)
LILIENTHALSTRABE 12
53424 REMAGEN
FED REP GERMANY

FOR: LIGHTING DEVICES, NAMELY, LAMPS FOR FIRE-FIGHTING SAFETY HELMETS AND WORK SAFETY HELMETS, IN CLASS 11 (U.S. CLS. 13, 21, 23, 31 AND 34).

THE MARK CONSISTS OF THE STYLIZED WORDING "MAGMA" WITH AN OVER-ARCHING BAND DESIGN TO THE RIGHT OF THE WORDING.

PRIORITY DATE OF 2-22-2010 IS CLAIMED.

OWNER OF INTERNATIONAL REGISTRATION 1055346 DATED 8-11-2010, EXPIRES 8-11-2020.

SER. NO. 79-088,868, FILED 8-11-2010.

TIMOTHY FINNEGAN, EXAMINING ATTORNEY



David J. Kyffers

Director of the United States Patent and Trademark Office

United States of America

United States Patent and Trademark Office

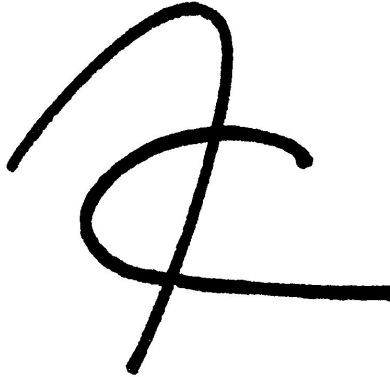

Reg. No. 4,097,609

Registered Feb. 14, 2012

Int. Cl.: 9

ADELS-CONTACT ELEKTROTECHNISCHE FABRIK GMBH & CO. KG (FED REP GERMANY
GMBH & CO. KG)
BUCHHOLZSTRASSE 40-46
51469 BERGISCH GLADBACH
FED REP GERMANY

TRADEMARK

PRINCIPAL REGISTER

FOR: ELECTRIC AND ELECTRONIC APPARATUS, NAMELY, ELECTRICAL CONNECTORS, ELECTRIC CONTACTS, TERMINAL CLAMPS IN THE NATURE OF ELECTRICAL CONNECTORS, ELECTRICAL TERMINAL BLOCKS, PLUG-IN CONNECTORS, ELECTRIC PLUGS, ELECTRIC SOCKETS AND MAGNETIC CONTACTS, FUSES, ELECTRICAL RELAYS, COMMUTATORS, PROTECTIVE CAPS IN THE NATURE OF COMPONENT PARTS OF ELECTRICAL CONNECTORS, MAINS LEAD CLEATS, NAMELY, STRAIN RELIEFS TO BE USED WITH ELECTRICAL CONNECTORS TO RETAIN CABLES AND CONDUCTORS IN THE CONNECTORS; MOUNTING RAILS, NAMELY, RAILS TO BE FIXED ON TRANSFORMERS, SWITCH AND CONTROL CABINETS AND OTHER ELECTRICAL EQUIPMENT TO HOLD TERMINAL BLOCKS AND CONNECTORS; ELECTRIC INSTALLATION MATERIAL, NAMELY, PLASTIC CONDUIT FOR USE IN ELECTRICAL INSTALLATIONS, ELECTRIC SWITCHES, CIRCUIT BREAKERS, IN CLASS 9 (U.S. CLS. 21, 23, 26, 36 AND 38).

THE MARK CONSISTS OF THE HIGHLY STYLIZED LETTERS "AC" WHERE THE "A" IS A VERTICAL CURVE AND THE "C" CROSSES THE "A" HORIZONTALLY.

OWNER OF INTERNATIONAL REGISTRATION 1055880 DATED 10-6-2010, EXPIRES 10-6-2020.

SER. NO. 79-089,045, FILED 10-6-2010.

TASNEEM HUSSAIN, EXAMINING ATTORNEY



David J. Kyffers

Director of the United States Patent and Trademark Office

United States of America

United States Patent and Trademark Office

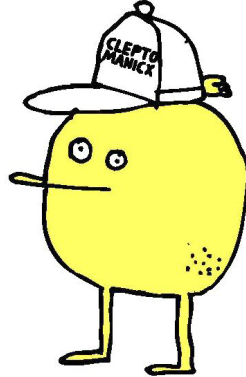

Reg. No. 4,097,610

Registered Feb. 14, 2012

Int. Cls.: 25 and 28

TRADEMARK

PRINCIPAL REGISTER

PITT FEIL
BUDAPESTER STR. 49
20359 HAMBURG
FED REP GERMANY

FOR: CLOTHING, NAMELY, BOXER SHORTS, T-SHIRTS, SWEATERS, TROUSERS; FOOTWEAR; HEADWEAR; HATS; CAPS; SPORTS SHOES; SNEAKERS, IN CLASS 25 (U.S. CLS. 22 AND 39).

FOR: GAMES AND PLAYTHINGS, NAMELY, VINYL TOY FIGURES AND VINYL DOLLS; SKATEBOARDS; SURFBOARDS; BODYBOARDS; SNOWBOARDS, IN CLASS 28 (U.S. CLS. 22, 23, 38 AND 50).

THE MARK CONSISTS OF A DESIGN OF A PIECE OF YELLOW FRUIT WITH HUMAN ATTRIBUTES, INCLUDING WHITE EYES AND A LONG POINTY NOSE. THE FRUIT WEARS A BLACK AND WHITE BASEBALL CAP BEARING THE WORD "CLEPTOMANICX".

OWNER OF INTERNATIONAL REGISTRATION 1056482 DATED 8-31-2010, EXPIRES 8-31-2020.

THE COLOR(S) YELLOW, BLACK, AND WHITE IS/ARE CLAIMED AS A FEATURE OF THE MARK.

SER. NO. 79-089,279, FILED 8-31-2010.

CORY BOONE, EXAMINING ATTORNEY



David J. Kybas

Director of the United States Patent and Trademark Office

United States of America

United States Patent and Trademark Office

NUDE FOOD DAY

Reg. No. 4,097,611

Registered Feb. 14, 2012

Int. Cl.: 41

SERVICE MARK

PRINCIPAL REGISTER

SMASH ENTERPRISES PTY LTD (AUSTRALIA INCORPORATED COMPANY)
33 REDLAND DRIVE
MITCHAM VIC 3132
AUSTRALIA

FOR: EDUCATIONAL SERVICES, NAMELY, PROGRAMS TO ASSIST CHILDREN IN MAKING HEALTHY AND ENVIRONMENTALLY FRIENDLY FOOD CHOICES, IN CLASS 41 (U.S. CLS. 100, 101 AND 107).

THE MARK CONSISTS OF STANDARD CHARACTERS WITHOUT CLAIM TO ANY PARTICULAR FONT, STYLE, SIZE, OR COLOR.

PRIORITY DATE OF 6-8-2010 IS CLAIMED.

OWNER OF INTERNATIONAL REGISTRATION 1057026 DATED 10-18-2010, EXPIRES 10-18-2020.

NO CLAIM IS MADE TO THE EXCLUSIVE RIGHT TO USE "FOOD DAY", APART FROM THE MARK AS SHOWN.

SER. NO. 79-089,510, FILED 10-18-2010.

GINA HAYES, EXAMINING ATTORNEY



David J. Kyffers

Director of the United States Patent and Trademark Office

United States of America

United States Patent and Trademark Office

OMADA

Reg. No. 4,097,612

Registered Feb. 14, 2012

Int. Cls.: 9, 35 and 42

TRADEMARK

SERVICE MARK

PRINCIPAL REGISTER

OMADA A/S (DENMARK CORPORATION)
ØSTERBROGADE 135, 1
DK-2100 COPENHAGEN Ø
DENMARK

FOR: APPARATUS FOR RECORDING, TRANSMISSION OR REPRODUCTION OF SOUND, DATA OR IMAGES; DATA PROCESSING EQUIPMENT, INCLUDING COMPUTER HARDWARE, COMPUTER SOFTWARE FOR USE IN CONNECTION WITH INTEGRATED BUSINESS SOLUTIONS, INCLUDING SOFTWARE SOLUTIONS FOR ECONOMIC, FINANCIAL AND SERVICE MANAGEMENT, ADMINISTRATION, ACCOUNTING, INVENTORY CONTROL, PRODUCTION, E-COMMERCE, CUSTOMER RELATIONSHIP MANAGEMENT, SUPPLY CHAIN MANAGEMENT, KNOWLEDGE MANAGEMENT, ENTERPRISE RESOURCE MANAGEMENT, AND FOR DATABASE MANAGEMENT; SOFTWARE FOR USE IN CONNECTION WITH APPLICATION SERVICE PROVIDER SERVICES, NAMELY, SOFTWARE FACILITATING AND DIRECTING THE RENTAL OF COMPUTER PROGRAMS OR APPLICATIONS FOR FACILITATING COLLECTION AND PROCESSING OF DATA TO A CENTRAL DATABASE VIA LOCAL AND GLOBAL COMPUTER NETWORK, SOFTWARE FOR USE FOR ELECTRONIC COMMUNICATION AND FOR USE FOR CELLULAR COMMUNICATION TO PROVIDE INTEGRATION AND MONITORING OF PERSONAL AND BUSINESS ELECTRONIC DEVICES; COMPUTER INSTRUCTION MANUALS FOR THE ABOVEMENTIONED GOODS ALL SOLD AS A UNIT; STRUCTURAL PARTS AND FITTINGS FOR ALL THE AFORESAID GOODS NOT INCLUDED IN OTHER CLASSES, IN CLASS 9 (U.S. CLS. 21, 23, 26, 36 AND 38).



David J. Kyjars

Director of the United States Patent and Trademark Office

FOR: BUSINESS MANAGEMENT AND ADMINISTRATION; PROVIDING OFFICE FUNCTIONS; ADVERTISING, INCLUDING ADVERTISING ON LOCAL AND GLOBAL COMPUTER NETWORKS; PROVIDING AND RENTAL OF SPACE ON INTERNET WEBSITES FOR ADVERTISING AND DISPLAY OF BUSINESS INFORMATION; COLLECTION, COMPILATION AND SYSTEMATISATION OF INFORMATION INTO COMPUTER DATABASES FOR BUSINESS AND ENTERPRISE MANAGEMENT; ORGANISATION OF DISPLAYS AND EXHIBITIONS, FOR COMMERCIAL PURPOSES, OF GOODS ON LOCAL AND GLOBAL COMPUTER NETWORKS; BUSINESS INFORMATION PROVIDED ON LOCAL AND GLOBAL COMPUTER NETWORKS; TELEMARKETING; ADMINISTRATION OF DIGITALLY-STORED DATA AS DATA MANAGED FILES; RETAIL, ONLINE RETAIL AND WHOLESALE STORE SERVICES FEATURING SCIENTIFIC, ELECTRIC AND OPTICAL APPARATUS AND INSTRUMENTS, APPARATUS FOR RECORDING, TRANSMISSION OR REPRODUCTION OF SOUND, DATA OR IMAGES, MAGNETIC AND OPTICAL DATA CARRIERS, DATA

Reg. No. 4,097,612 PROCESSING EQUIPMENT, INCLUDING COMPUTER HARDWARE AND SOFTWARE, SOFTWARE RECORDED ON TAPE, DISCS OR OTHER MEDIA, SOFTWARE FOR USE IN CONNECTION WITH INTEGRATED BUSINESS SOLUTIONS, INCLUDING SOFTWARE SOLUTIONS FOR MANAGEMENT, INCLUDING ECONOMIC, FINANCIAL AND SERVICE MANAGEMENT, ADMINISTRATION, ACCOUNTING, INVENTORY CONTROL, PRODUCTION, E-COMMERCE, CUSTOMER RELATIONSHIP MANAGEMENT, SUPPLY CHAIN MANAGEMENT, KNOWLEDGE MANAGEMENT, ENTERPRISE RESOURCE MANAGEMENT AND FOR DATABASE MANAGEMENT, SOFTWARE FOR USE IN CONNECTION WITH APPLICATION SERVICE PROVIDER SERVICES SUCH AS RENTAL OF COMPUTER PROGRAMMES OR APPLICATIONS FOR COMPUTER PROGRAMMES FACILITATING COLLECTION AND PROCESSING OF DATA TO A CENTRAL DATABASE VIA LOCAL AND GLOBAL COMPUTER NETWORK, SOFTWARE FOR USE FOR ELECTRONIC COMMUNICATION AND FOR USE FOR CELLULAR COMMUNICATION, ELECTRONIC USE MANUALS FOR THE ABOVEMENTIONED GOODS; RETAIL, ONLINE RETAIL AND WHOLESALE STORE SERVICES FEATURING PAPER TAPES AND CARDS FOR RECORDING COMPUTER PROGRAMS AND COMPUTER MANUALS, IN CLASS 35 (U.S. CLS. 100, 101 AND 102).

FOR: COMPUTER PROGRAMMING; DEVELOPMENT OF COMPUTER SOFTWARE, INCLUDING SOFTWARE FOR USE IN CONNECTION WITH INTEGRATED BUSINESS SOLUTIONS; RENTAL OF COMPUTER PROGRAMS OR APPLICATION SOFTWARE FOR COMPUTER PROGRAMS FOR USE WITH ACCESS TO SERVICE PROVIDER SERVICES FACILITATING THE COLLECTION AND PROCESSING OF DATA TO A CENTRAL DATABASE VIA LOCAL AND GLOBAL COMPUTER NETWORKS; PROFESSIONAL NON-BUSINESS CONSULTANCY, NAMELY, CONSULTANCY AND SUPPORT CONCERNING COMPUTER SOFTWARE AND HARDWARE AND CONSULTANCY IN THE FIELD OF COMPUTER AND ELECTRONIC DATA SECURITY AND SCIENTIFIC RESEARCH, IN CLASS 42 (U.S. CLS. 100 AND 101).

THE MARK CONSISTS OF STANDARD CHARACTERS WITHOUT CLAIM TO ANY PARTICULAR FONT, STYLE, SIZE, OR COLOR.

PRIORITY DATE OF 12-4-2009 IS CLAIMED.

OWNER OF INTERNATIONAL REGISTRATION 1057167 DATED 6-3-2010, EXPIRES 6-3-2020.

THE WORD(S) "OMADA" HAS NO MEANING IN A FOREIGN LANGUAGE.

SER. NO. 79-089,571, FILED 6-3-2010.

WILLIAM ROSSMAN, EXAMINING ATTORNEY

United States of America
United States Patent and Trademark Office

BLUE-R

Reg. No. 4,097,613

ITE, NAAMLOZE VENNOOTSCHAP (BELGIUM NAAMLOZE VENNOOTSCHAP (NV))
EUROPARK OOST 24

Registered Feb. 14, 2012

B-9100 SINT-NIKLAAS, BELGIUM

Int. Cl.: 11

FOR: REFRIGERATION INSTALLATIONS, PARTS THEREFOR AND PARTS INCLUDED
IN THIS CLASS, NAMELY, DRYERS, VIBRATION AND SHOCK ABSORBERS SOLD AS A
UNIT WITH THE REFRIGERATION INSTALLATIONS AND REPLACEMENT PARTS
THEREOF, IN CLASS 11 (U.S. CLS. 13, 21, 23, 31 AND 34).

TRADEMARK

PRINCIPAL REGISTER

THE MARK CONSISTS OF STANDARD CHARACTERS WITHOUT CLAIM TO ANY PAR-
TICULAR FONT, STYLE, SIZE, OR COLOR.

PRIORITY DATE OF 7-7-2010 IS CLAIMED.

OWNER OF INTERNATIONAL REGISTRATION 1057376 DATED 10-26-2010, EXPIRES 10-
26-2020.

SER. NO. 79-089,652, FILED 10-26-2010.

TINA BROWN, EXAMINING ATTORNEY



David J. Kyffers

Director of the United States Patent and Trademark Office

United States of America

United States Patent and Trademark Office

PRESSPARTY

Reg. No. 4,097,614

Registered Feb. 14, 2012

**Int. Cls.: 9, 38, 41, 42
and 45**

TRADEMARK

SERVICE MARK

PRINCIPAL REGISTER

PRESSPARTY (UNITED KINGDOM UNINCORPORATED PARTNERSHIP)
27 GOSFIELD STREET
LONDON W1W 6HH
UNITED KINGDOM

FOR: APPARATUS FOR RECORDING, TRANSMISSION OR REPRODUCTION OF SOUND OR IMAGES; AUDIO RECORDINGS FEATURING MUSIC; VIDEO RECORDINGS FEATURING MUSIC; DOWNLOADABLE AUDIO AND VIDEO RECORDINGS FEATURING MUSIC; PRERECORDED MUSIC ON CD, DVD AND OTHER MEDIA, NAMELY, DIGITAL RECORDERS, VIDEO TAPES, LASER DISCS, MP3'S, VINYL, AND USB'S; DIGITAL MUSIC DOWNLOADABLE FROM THE INTERNET, IN CLASS 9 (U.S. CLS. 21, 23, 26, 36 AND 38).

FOR: TELECOMMUNICATIONS SERVICES, NAMELY, TELECOMMUNICATION ACCESS SERVICES; PROVISION OF ON-LINE COMMUNICATIONS SERVICES, NAMELY, INTERNET ACCESS PROVIDER SERVICES; COMMUNICATIONS VIA A GLOBAL COMPUTER NETWORK OR THE INTERNET, NAMELY, PROVIDING ON-LINE COMMUNICATIONS LINKS WHICH TRANSFER THE WEB SITE USER TO OTHER LOCAL AND GLOBAL WEB PAGES; ELECTRONIC MAIL, MESSAGE SENDING AND RECEIVING SERVICES; PROVISION OF ACCESS TO WEB PAGES, NAMELY, DIGITAL MUSIC WEBSITES ON THE INTERNET, AND PROVIDING REMOTE INTERNET ACCESS; TRANSMISSION AND DISTRIBUTION OF DATA OR AUDIO VISUAL IMAGES VIA A GLOBAL COMPUTER NETWORK OR THE INTERNET; RENTAL OF ACCESS TIME TO COMPUTER DATABASES VIA GLOBAL COMPUTER NETWORKS; PROVIDING INTERNET CHAT ROOMS; PROVISION OF ONLINE FORUMS FOR THE DISCUSSION OF AND EXCHANGE OF VIEWS AND INFORMATION CONCERNING ENTERTAINMENT, MUSIC, CULTURAL ISSUES, NEWS AND CURRENT AFFAIRS; INFORMATION, ADVICE AND CONSULTANCY SERVICES RELATING TO ALL THE AFORESAID; ELECTRONIC DATA TRANSMISSION AND INSTANT MESSAGING SERVICES, IN CLASS 38 (U.S. CLS. 100, 101 AND 104).

FOR: PROVIDING ON-LINE INFORMATION IN THE FIELD OF CURRENT EVENT NEWS AND ENTERTAINMENT VIA THE INTERNET; PROVIDING AN ON-LINE COMPUTER DATABASE FEATURING CURRENT EVENT NEWS AND ENTERTAINMENT; ENTERTAINMENT SERVICES IN THE NATURE OF AUDIO VISUAL ENTERTAINMENT, NAMELY, VISUAL AND AUDIO PERFORMANCES BY AN ACTOR OR MUSICIAN TRANSMITTED VIA WIRELESS COMMUNICATION DEVICES; ON-LINE ELECTRONIC PUBLISHING OF NEWSLETTERS, INFORMATIONAL CIRCULARS, PERIODICALS AND BOOKS; PRODUCTION AND DISTRIBUTION OF AUDIO VISUAL ENTERTAINMENT, NAMELY, MUSIC



David J. Kybas

Director of the United States Patent and Trademark Office

Reg. No. 4,097,614 TRANSMITTED VIA WIRELESS COMMUNICATION DEVICES; ENTERTAINMENT SERVICES, NAMELY, PROVIDING ON-LINE CURRENT EVENT NEWS AND COMPUTER GAMES; PROVISION OF SOCIAL CLUB SERVICES, NAMELY, ARRANGING, ORGANIZING, AND HOSTING SOCIAL EVENTS, GET-TOGETHERS, AND PARTIES FOR WEBSITE USERS, CLUB MEMBERS AND FOR MUSICIANS, ACTORS AND THEIR REPRESENTATIVES AND AGENTS; PUBLICATION OF ON-LINE JOURNALS, NAMELY, FEATURING PERSONAL INFORMATION AND OPINIONS; PROVISION OF ONLINE NEWS IN THE FIELDS OF CULTURAL, ARTS AND ENTERTAINMENT PURPOSES; ORGANISING AND ARRANGING OF ENTERTAINMENT EVENTS, NAMELY, SOCIAL ENTERTAINMENT EVENTS AND LIVE MUSIC SHOWS; MUSIC PUBLISHING SERVICES; PRODUCTION OF MUSICAL RECORDINGS; PROVISION OF ON-LINE NON-DOWNLOADABLE ELECTRONIC PUBLICATIONS IN THE NATURE OF NEWSLETTERS, INFORMATIONAL CIRCULARS, PERIODICALS AND BOOKS IN THE FIELD OF MUSIC AND ENTERTAINMENT, AND NON-DOWNLOADABLE PRERECORDED DIGITAL MUSIC FROM THE INTERNET; PRODUCTION AND DISTRIBUTION OF PRE-RECORDED VIDEO CASSETTES AND DISCS, AUDIO CASSETTES, AUDIO TAPES, AUDIO COMPACT DISCS AND PHONOGRAPH RECORDS, ALL IN THE FIELD OF MUSIC; ELECTRONIC GAMES SERVICES PROVIDED ONLINE BY MEANS OF A COMPUTER NETWORK OR THE INTERNET; INFORMATION, ADVICE AND CONSULTANCY SERVICES RELATING TO ALL THE AFORESAID, IN CLASS 41 (U.S. CLS. 100, 101 AND 107).

FOR: HOSTING AN INTERACTIVE WEBSITE FOR OTHERS AND PROVIDING ONLINE NON-DOWNLOADABLE SOFTWARE FOR UPLOADING, DOWNLOADING, POSTING, SHOWING, DISPLAYING, TAGGING, SHARING AND TRANSMITTING MESSAGES, COMMENTS, MULTIMEDIA CONTENT, VIDEOS, MOVIES, FILMS, PHOTOS, AUDIO CONTENT, ANIMATION, PICTURES, IMAGES, TEXT, INFORMATION, AND OTHER USER-GENERATED CONTENT ON SAID INTERACTIVE WEBSITE; HOSTING AN INTERACTIVE WEBSITE FOR OTHERS AND PROVIDING ONLINE NON-DOWNLOADABLE SOFTWARE THAT ENABLE USERS TO POST, SEARCH, WATCH, SHARE, CRITICIZE, RATE, AND COMMENT ON, AND POST MESSAGES, COMMENTS, MULTIMEDIA CONTENT, VIDEOS, MOVIES, FILMS, PHOTOS, AUDIO CONTENT, ANIMATION, PICTURES, IMAGES, TEXT, INFORMATION, AND OTHER USER-GENERATED CONTENT ON SAID INTERACTIVE WEBSITE VIA A GLOBAL COMPUTER NETWORK AND OTHER COMPUTER AND COMMUNICATIONS NETWORKS; COMPUTER SERVICES IN THE NATURE OF CUSTOMIZED WEB PAGES FEATURING USER-DEFINED INFORMATION, PERSONAL PROFILES AND INFORMATION; PROVIDING TEMPORARY USE THROUGH A WEBSITE OF NON-DOWNLOADABLE SOFTWARE FOR USE IN THE FIELD OF MUSIC FOR CREATING AND EDITING MUSIC, AND FOR MUSIC COMPOSITION AND PROCESSING DIGITAL MUSIC FILES; HOSTING AN ONLINE WEBSITE COMMUNITY FOR REGISTERED USERS TO SHARE INFORMATION, PHOTOS, AUDIO AND VIDEO CONTENT ABOUT THEMSELVES, THEIR LIKES AND DISLIKES AND DAILY ACTIVITIES, TO GET FEEDBACK FROM THEIR PEERS, TO FORM VIRTUAL COMMUNITIES, AND TO ENGAGE IN SOCIAL NETWORKING, IN CLASS 42 (U.S. CLS. 100 AND 101).

FOR: PERSONAL AND SOCIAL SERVICES RENDERED BY OTHERS TO MEET THE NEEDS OF INDIVIDUALS, NAMELY, SOCIAL INTRODUCTIONS; ONLINE SOCIAL NETWORKING SERVICES, IN CLASS 45 (U.S. CLS. 100 AND 101).

THE MARK CONSISTS OF STANDARD CHARACTERS WITHOUT CLAIM TO ANY PARTICULAR FONT, STYLE, SIZE, OR COLOR.

PRIORITY DATE OF 12-3-2009 IS CLAIMED.

OWNER OF INTERNATIONAL REGISTRATION 1058366 DATED 6-1-2010, EXPIRES 6-1-2020.

SER. NO. 79-090,014, FILED 6-1-2010.

Reg. No. 4,097,614 ANDREA K. NADELMAN, EXAMINING ATTORNEY

United States of America

United States Patent and Trademark Office

STM32L

Reg. No. 4,097,615

Registered Feb. 14, 2012

Int. Cl.: 9

TRADEMARK

PRINCIPAL REGISTER

STMICROELECTRONICS N.V. (NETHERLANDS LIMITED LIABILITY COMPANY)
SCHIPOL BOULEVARD 265
A'DAM AIRP.; NL-1118 BH LUCHTHAVEN SCHIPOL
NETHERLANDS

FOR: INTEGRATED CIRCUITS, SEMICONDUCTORS, MICROCONTROLLERS, MICROPROCESSORS, EMBEDDED MICROPROCESSORS, IN CLASS 9 (U.S. CLS. 21, 23, 26, 36 AND 38).

OWNER OF U.S. REG. NOS. 2,652,109, 3,576,474 AND OTHERS.

PRIORITY DATE OF 4-22-2010 IS CLAIMED.

OWNER OF INTERNATIONAL REGISTRATION 1059777 DATED 10-20-2010, EXPIRES 10-20-2020.

SER. NO. 79-090,475, FILED 10-20-2010.

JEAN IM, EXAMINING ATTORNEY



David J. Kyffers

Director of the United States Patent and Trademark Office

United States of America

United States Patent and Trademark Office

isq

Reg. No. 4,097,616

OSSTELL AB (SWEDEN JOINT STOCK COMPANY)
GAMLESTADSVÄGEN 3B
SE-415 02 GÖTEBORG, SWEDEN

Registered Feb. 14, 2012

Int. Cl.: 10

FOR: DENTAL APPARATUS AND INSTRUMENTS, NAMELY, ELECTRIC INSTRUMENTS FOR MEASURING THE STABILITY OF DENTAL IMPLANTS, IN CLASS 10 (U.S. CLS. 26, 39 AND 44).

TRADEMARK

THE MARK CONSISTS OF THE LETTERING "ISQ". THE COLOR RED APPEARS IN THE DOT OVER THE LETTER "I" AND THE COLOR BLACK APPEARS IN ALL REMAINING LETTERING.

PRINCIPAL REGISTER

PRIORITY DATE OF 5-20-2010 IS CLAIMED.

OWNER OF INTERNATIONAL REGISTRATION 1060072 DATED 11-15-2010, EXPIRES 11-15-2020.

THE COLOR(S) RED AND BLACK IS/ARE CLAIMED AS A FEATURE OF THE MARK.

SEC. 2(F).

SER. NO. 79-090,596, FILED 11-15-2010.

KATHERINE E. HALMEN, EXAMINING ATTORNEY



David J. Kybas

Director of the United States Patent and Trademark Office

United States of America

United States Patent and Trademark Office

ARLIGHT

Reg. No. 4,097,617

Registered Feb. 14, 2012

**Int. Cls.: 6, 9, 10, 11, 19
and 35**

ARLIGHT GENEL HIZMET TASARIM ELEKTROMEKANIK IMALAT TAAHHÜT SANAYI
VE TICARET LIMITED SİRKETİ (TURKEY LIMITED COMPANY)
SARAY MAH. ATOM CAD. 205
SOK. NO:4
ANKARA, TURKEY

TRADEMARK

SERVICE MARK

PRINCIPAL REGISTER

FOR: NON-PRECIOUS METAL ORES; COMMON METALS AND THEIR ALLOYS; AND SEMI-MANUFACTURED PRODUCTS, NAMELY, ALUMINUM AND LEAD INGOTS, GALVANIZED STEEL SHEETS AND METAL WELDING RODS; METAL MATERIALS USED FOR CONSTRUCTION, NAMELY, BRACES, SUPPORTS AND SHORES; METAL MATERIALS USED FOR SHELTERING, SAVING, PROTECTING, COVERING, WRAPPING, SURROUNDING, STORING AND ESTABLISHING PURPOSE, NAMELY, METAL LADDERS, STORAGE SHELTERS AND SHEDS, ROOFING TILES AND PANELS, SAFES, AND ALUMINUM FOIL; METAL MATERIALS USED FOR SIFTING, FILTERING AND SIMILAR PURPOSES, NAMELY, WIRE MESH; METAL DOORS AND WINDOWS; METAL SHUTTERS FOR WINDOWS AND BUILDING EXTERIORS; JALOUSIES OF METAL, CASES IN THE NATURE OF METAL FRAMES FOR JALOUSIES AND METAL HANDLES THEREOF, EXCLUDING LOCKS; METAL CABLES AND WIRES NOT FOR ELECTRICAL PURPOSES; IRONMONGERY, IRON GATES, PELLETIZED IRON AND WROUGHT IRON DECORATIVE ARTWORK; SMALL ITEMS OF METAL HARDWARE, NAMELY, SCREWS, NAILS, RIVETS, AND SPRINGS; AIR CONDITIONING DUCTS OF METAL; METAL PIPES; CHIMNEY HEADS FOR USE WITH VENTILATING, HEATING AND AIR CONDITIONING INSTALLATIONS, NAMELY, METAL CHIMNEY CAPS; NON-LUMINOUS AND NON-MECHANICAL METAL SIGNS FOR INDICATION AND ADVERTISING PURPOSES, NAMELY, SIGNBOARDS, PANELS, REGISTRATION PLATES; METAL PIPES FOR LIQUID AND GAS TRANSFER AND CONNECTING PARTS THEREOF, NAMELY, DRILLING PIPES; METAL MONEY SAFES; RAILWAY MATERIALS MADE OF METAL, NAMELY, RAILROAD TIES AND TRACKS; METAL CROWN POSTS AND FLOATS, NAMELY, METAL CROWN POSTS FOR BUILDING AND METAL FENCE POSTS; BUOYS OF METAL; ANCHORS FOR SEA VEHICLES; METAL MOULDS FOR CASTING EXCEPT FOR MACHINE PARTS; WORKS OF ART MADE OF COMMON METALS AND OF THEIR ALLOYS; METAL COVERS, NAMELY, MANHOLE COVERS AND METAL VENT COVERS FOR HVAC DUCTS; METAL BOTTLE CAPS; METAL POLES; METAL PALLETS FOR LIFTING, LOADING AND TRANSPORTING; METAL ROPES; METAL HOOKS CORDS, COLUMNS, BRACES, BANDS AND STRAPS FOR LIFTING AND TRANSPORTING OF LOADS AND CARGOS IN THE NATURE OF CONSTRUCTION ELEMENTS AND HARDWARE, IN CLASS 6 (U.S. CLS. 2, 12, 13, 14, 23, 25 AND 50).



David J. Kyffers

Director of the United States Patent and Trademark Office

Reg. No. 4,097,617 FOR: APPARATUS AND INSTRUMENTS USED FOR MEASUREMENT AND ESTIMATION IN SCIENTIFIC LABORATORIES, NAMELY, MEASURING LASERS, CLINICAL LABORATORY ANALYZER FOR BLOOD AND OTHER BODILY FLUIDS, AND SPECTROSCOPES; APPARATUS FOR RECORDING, TRANSMISSION OR REPRODUCTION OF SOUND AND IMAGES, NAMELY, APPARATUS, HARDWARE, SOFTWARE AND PERIPHERALS FOR DATA PROCESSING, COMMUNICATION AND REPRODUCTION; ANTENNAS; SATELLITE ANTENNAS; AMPLIFIERS AND PARTS THEREOF; AUTOMATIC VENDING MACHINES; AUTOMATIC TICKET DISPENSERS; CASH MACHINES, NAMELY, CASH REGISTERS AND AUTOMATED TELLER MACHINES; ELECTRONIC ELEMENTS USED IN ELECTRONIC APPARATUS, NAMELY, CIRCUITS AND POWER CABLES AND ADAPTORS; COUNTERS FOR MEASURING THE CONSUMPTION OF THE UNIT OF TIME, NAMELY, HOURGLASS, ELECTRONIC TIMER; TIMERS; PROTECTIVE CLOTHING, NAMELY, DISPOSABLE GARMENT FOR PROTECTION AGAINST SPONTANEOUS FLASH IN INDUSTRIAL AND MANUFACTURING ENVIRONMENTS, CLOTHING ESPECIALLY MADE FOR USE IN LABORATORIES, PADDED CLOTHING FOR PROTECTION AGAINST BODILY HARM AND BLUNT FORCE TRAUMA, CLOTHING FOR PROTECTION AGAINST FIRE, IRRADIATION AND ACCIDENTS; LIFE SAVING AND PROTECTING EQUIPMENT, NAMELY, LIFE JACKETS, FIRE RESISTANT GLOVES, BULLET-PROOF VESTS; APPARATUS FOR TRANSMISSION, TRANSDUCTION, STORAGE AND CONTROL OF ELECTRIC ENERGY, NAMELY, CABLES AND POWER SUPPLY USED IN ELECTRIC AND ELECTRONICS; ALARM APPARATUS, EXCEPT VEHICLE ALARMS, NAMELY, BURGLAR ALARMS, PERSONAL SECURITY ALARMS, SOUND ALARMS, SMOKE ALARMS AND FIRE ALARMS; ELECTRICAL BELLS, NAMELY, ELECTRIC DOOR BELLS, CALL BELLS, ELECTRONIC WARNING BELLS AND SIGNAL BELLS; IRONS, NAMELY, ELECTRIC IRONS; ELECTRICAL AND STEAM IRONS; PRESS IRONS, NAMELY, ELECTRIC PRESS IRONS; SIGNALING APPARATUS, NAMELY, SIGNAL BELLS, SIGNAL WHISTLES, AND TRAFFIC LIGHTS; INDICATORS USED FOR TRAFFIC PURPOSES, NAMELY, TRAFFIC LIGHTS, REFLECTORS FOR TRAFFIC SIGNALS, VEHICLE TRAFFIC SIGNALS, AND SAFETY TRAFFIC CONES; FIRE ENGINES; FIRE-EXTINGUISHING APPARATUS AND DEVICES; ELECTRICAL WELDING APPARATUS, NAMELY, WELDING ELECTRODES; RADARS; SUBMARINE RADARS, NAMELY, SONAR; ELECTRIC DEVICES FOR DESTROYING FLIES AND INSECTS; AUTOMATIC DOORS, NAMELY, ELECTRIC, ELECTRONIC DOOR OPENERS AND CLOSERS, ELECTRIC DOOR OPENERS AND CLOSERS, OR ELECTRONIC DOOR OPENING AND CLOSING SYSTEM; AUTOMATIC TURNSTILES; ELECTRIC, ELECTRONIC AND REMOTE CONTROL DOOR OPENING-CLOSING INSTALLATIONS FOR BUILDINGS; APPARATUS FOR ELECTROLYSIS AND GALVANIZATION FOR USE IN ELECTROPLATING; ANODES; CATHODES; MAGNETS; DECORATIVE MAGNETS, IN CLASS 9 (U.S. CLS. 21, 23, 26, 36 AND 38).

FOR: SURGICAL, MEDICAL, DENTAL AND VETERINARY APPARATUS, NAMELY, SURGICAL BLADES AND RETRACTORS, MEDICAL INSTRUMENTS FOR PERFORMING BIOPSIES, DENTAL DRILLS AND MIRRORS, AND VETERINARY SURGICAL KNIVES AND EXAMINATION GLOVES; DEVICES AND FURNITURE ESPECIALLY MADE FOR MEDICAL PURPOSES, NAMELY, MEDICAL PATIENT TREATMENT CHAIRS, MEDICAL LASERS, AND OPERATING TABLES; ARTIFICIAL LIMBS AND ORGANS; MEDICAL ORTHOPEDIC MATERIALS, NAMELY, BRACES, SUPPORTS, BELTS, CUSHIONS, JOINT IMPLANTS, FOOTWEAR, SOLES, AND SPLINTS; CLOTHING FOR SURGERY ROOMS, NAMELY, GOWNS, CAPS, SURGICAL MASKS, AND SHOE COVERS; STERILE COVERS, NAMELY, SURGICAL DRAPES AND COVERINGS FOR MEDICAL EXAM TABLES; APPARATUS AND MATERIALS FOR SEXUAL PURPOSES, NAMELY, SEX DOLLS, VIBRATORS, AND CONDOMS; BIRTH CONTROL INSTRUMENTS, NAMELY, CONDOM; FEEDING BOTTLES; FEEDING BOTTLE NIPPLES; PACIFIERS; TEETHING RINGS, IN CLASS 10 (U.S. CLS. 26, 39 AND 44).

FOR: LIGHTING APPARATUS, NAMELY, LAMPS, FLASHLIGHTS, LIGHTING INSTALLATIONS, VEHICLE HEADLIGHTS, TAIL LIGHTS, BACK UP LIGHTS, TURN SIGNAL LIGHT BULBS, AND LIGHT BULBS FOR THE INTERIOR OF VEHICLES; APPARATUS FOR HEATING AND STEAM PRODUCING INSTALLATIONS, NAMELY, SOLID, LIQUID OIL

Reg. No. 4,097,617 AND GAS FUEL AND ELECTRIC STOVES, ELECTRIC COOK STOVES; AIR-CONDITIONING DEVICES, AND CLIMATIZATION DEVICES, NAMELY, CLIMATE CONTROL DEFROSTERS, AIR CONDITIONERS, ELECTRIC HEATERS FOR COMMERCIAL USE, AND HEATERS FOR VEHICLES; COOLING APPARATUS, NAMELY, COOLING EVAPORATORS, REFRIGERATORS; FREEZERS; ELECTRIC AND GAS APPARATUS, NAMELY, ELECTRIC STOVES, GAS STOVES, ELECTRIC OVENS, GAS COOKING OVENS FOR HOUSEHOLD PURPOSES, AND COOKTOPS, GAS GRILLS AND RANGES; MACHINES AND DEVICES USED FOR COOKING, DRYING AND BOILING, EXCLUDING USE FOR PERSONAL PURPOSES, NAMELY, COMMERCIAL COOKING OVENS, INDUSTRIAL DRYERS FOR HEATING AND DEHUMIDIFYING, AND INDUSTRIAL BOILERS; SANITARY APPARATUS AND INSTALLATIONS, NAMELY, BATHTUBS, SHOWERS, SINKS, ELECTRIC HAND DRYING APPARATUS FOR WASHROOMS, AND TOILETS; WATER SOFTENING APPARATUS; WATER PURIFYING APPARATUS; WATER PURIFYING INSTALLATIONS; SEWAGE PURIFYING INSTALLATIONS; APPARATUS FOR BEAUTY SALON PURPOSES IN THIS CLASS, NAMELY, HAND DRYING MACHINES, NAIL DRYING MACHINES, HAIR DRYING MACHINES, AND HAIR STEAMER MACHINES; ELECTRICAL COVERLETS AND ELECTRICAL QUILTS NOT FOR MEDICAL PURPOSES; HEATING PILLOWS, NAMELY, ELECTRIC HEATED PILLOWS NOT FOR MEDICAL PURPOSES; ELECTRICAL FOOT HEATERS; HOT WATER BOTTLES; FILTERS AND FILTER-MOTOR COMBINATIONS FOR AQUARIUMS; PASTEURIZING AND STERILIZING MACHINES FOR USE IN THE FOOD AND BEVERAGE INDUSTRY; INDUSTRIAL TYPE COOKING, DRYING AND COOLING INSTALLATIONS, NAMELY, COOKING OVENS, CLOTHING DRYERS, AND WALK-IN COOLERS, IN CLASS 11 (U.S. CLS. 13, 21, 23, 31 AND 34).

FOR: STYLIZED BUILDING, CONSTRUCTION, AND ROAD CONSTRUCTION MATERIALS MADE OF CONCRETE, GYPSUM, EARTH, CLAY, SAND, NATURAL STONE, ARTIFICIAL STONE, WOODEN, PLASTIC OR SYNTHETIC MATERIALS, NAMELY, CONCRETE PAVING STONES, BLOCK AND TILES, GYPSUM TILES, EARTHENWARE PIPES, CLAY ROOFING TILES, SANDSTONE PIPES, NATURAL STONE SLABS AND TILES, ARTIFICIAL STONE TILES, WOOD MOLDINGS, POSTS AND TRIM, PLASTIC WALLBOARDS AND FLOORBOARDS, AND SYNTHETIC COUNTERTOPS FOR FURTHER INSTALLATION; BUILDING PARTS, NAMELY, WOOD BOARDS, CONCRETE BLOCKS AND SLABS, NON-METAL BUILDING FLASHING, AND GLASS PANELS FOR BUILDING CONSTRUCTION; BUILDINGS, NAMELY, NON-METAL STORAGE SHEDS, PREFABRICATED NON-METAL BUILDINGS; POLES, NAMELY, WOODEN UTILITY POLES, NON-METAL UTILITY POLES, AND NON-METAL FENCE POLES; BARRIERS, NAMELY, PORTABLE NON-METAL TRAFFIC BARRIERS, CRASH BARRIERS NOT OF METAL, NOISE BARRIERS MADE OF WOOD, PORTABLE NON-METAL FREE STANDING BARRIERS, NON-METAL BARRIERS FOR PEDESTRIAN TRAFFIC CONTROL, NON-METAL FENCING IN THE NATURE OF AN INDUSTRIAL SAFETY BARRIER, PLASTIC REINFORCED WALL PANELS FOR USE AS SOUND AND LIGHT BARRIERS; MONUMENTS OF STONE, CONCRETE AND MARBLE; STATUES MADE OF CONCRETE STONE AND MARBLE; NATURAL OR SYNTHETIC SURFACE COVERINGS IN FORM OF LAYERS OR BANDS, NAMELY, NON-METAL COVERINGS FOR CEILINGS, MULTIPLE LAYER DRYWALL; SYNTHETIC COATINGS MADE ADHERED THROUGH HEAT, NAMELY, BITUMINOUS ROOF COATINGS; PITCHY CARDBOARD FOR ROOFS, NAMELY, ROOFING UNDERLAYMENT; PITCHY COVERINGS, NAMELY, NON-METAL ROOFING TILES, NON-METAL FLOORING UNDERLAYMENTS; GLASS PRODUCTS FOR CONSTRUCTIONS, NAMELY, GLASS ROOFING TILES AND WINDOW GLASS; NON-METAL PREFABRICATED SWIMMING POOLS; AQUARIUM SANDS, IN CLASS 19 (U.S. CLS. 1, 12, 33 AND 50).

FOR: ADVERTISING, MARKETING AND PUBLIC RELATIONS SERVICES, AND ORGANIZATION OF EXHIBITIONS AND FAIRS FOR TRADE PURPOSES; OFFICE SERVICES, NAMELY, OFFICE SUPPORT STAFF SERVICES AND OFFICE ADMINISTRATION SERVICES; BUSINESS ADMINISTRATION, MANAGEMENT AND ACCOUNTING, AND CONSULTANCY IN THE FIELDS OF BUSINESS ADMINISTRATION, MANAGEMENT, AND ACCOUNTING, AND IMPORT-EXPORT AGENCY SERVICES; ARRANGING OF CONTRACTS FOR OTHERS FOR THE BUYING AND SELLING OF GOODS; ORGANIZATION AND AR-

Reg. No. 4,097,617 RANGEMENT OF PUBLIC AUCTIONS; BRINGING TOGETHER FOR THE BENEFIT OF OTHERS, OF A VARIETY OF GOODS ENABLING CUSTOMERS TO CONVENIENTLY VIEW AND PURCHASE THOSE GOODS, NAMELY, RETAIL AND WHOLESALE STORE SERVICES, ONLINE RETAIL STORE SERVICES, AND ELECTRONIC AND MAIL ORDER CATALOG SERVICES ALL FEATURING BUILDING AND CONSTRUCTION MATERIALS, LIGHTING AND HEATING EQUIPMENT, AND AUTOMOTIVE ACCESSORIES, IN CLASS 35 (U.S. CLS. 100, 101 AND 102).

THE MARK CONSISTS OF THE WORDING "ARLIGHT" IN STYLIZED BLACK TEXT AND A RED SQUARE WITH ROUNDED CORNERS HAVING AN UPTURNED LOWER LEFT CORNER IN THE COLOR BLACK.

OWNER OF INTERNATIONAL REGISTRATION 1060278 DATED 4-20-2010, EXPIRES 4-20-2020.

THE COLOR(S) RED AND BLACK IS/ARE CLAIMED AS A FEATURE OF THE MARK.

SER. NO. 79-090,687, FILED 4-20-2010.

APRIL ROACH, EXAMINING ATTORNEY

United States of America

United States Patent and Trademark Office

ORB YX

Reg. No. 4,097,618

Registered Feb. 14, 2012

Int. Cls.: 9 and 18

TRADEMARK

PRINCIPAL REGISTER

20:20 MOBILE GROUP LIMITED (UNITED KINGDOM LIMITED COMPANY)
CAUDWELL TOWER,
WESTON ROAD; CREWE, CHESHIRE CW1 6BU
UNITED KINGDOM

FOR: MOBILE PHONES; MOBILE PHONES, NAMELY, SMART PHONES; MOBILE PHONE AND MP3 ACCESSORIES, NAMELY, CHARGERS, IN-CAR CHARGERS, BATTERIES, SPEAKERS, WIRELESS HEADSETS, POWER ADAPTERS, AND DOCKING STATIONS FOR MOBILE PHONES; CASES FOR HOLDING OR CARRYING MOBILE PHONES AND COMPUTERS; SCREEN PROTECTORS, FITTED PLASTIC FILMS KNOWN AS SKINS, FACE-PLATES FOR MOBILE PHONES AND MP3 PLAYERS; CONNECTION CABLES; ELECTRONIC DISPLAY SCREENS; COMPUTER MONITORS; RADIO TRANSMITTERS; DONGLES; DIGITAL PHOTO FRAMES FOR DISPLAYING DIGITAL PICTURES, VIDEO CLIPS AND MUSIC, IN CLASS 9 (U.S. CLS. 21, 23, 26, 36 AND 38).

FOR: LEATHER CASES AND CASES OF IMITATION LEATHER, IN CLASS 18 (U.S. CLS. 1, 2, 3, 22 AND 41).

THE MARK CONSISTS OF STANDARD CHARACTERS WITHOUT CLAIM TO ANY PARTICULAR FONT, STYLE, SIZE, OR COLOR.

OWNER OF INTERNATIONAL REGISTRATION 1041977 DATED 5-14-2010, EXPIRES 5-14-2020.

SER. NO. 79-090,808, FILED 11-23-2010.

ALEXANDER L. POWERS, EXAMINING ATTORNEY



David J. Kyffers

Director of the United States Patent and Trademark Office

United States of America

United States Patent and Trademark Office



Reg. No. 4,097,619

Registered Feb. 14, 2012

Int. Cl.: 28

TRADEMARK

PRINCIPAL REGISTER

GUANGDONG FIVESTAR TOYS CO., LTD. (CHINA LIMITED COMPANY)
XING YUE DONG RD.
LAI MEI INDUSTRIAL DISTRICT,; CHENGHAI,;SHANTOU; GUANGDONG PROVINCE
CHINA

FOR: TOY BUILDING BLOCKS; DOLLS; DOLL HOUSES; SPINNING TOPS; TOY MOBILES;
PLUSH TOYS; TOY VEHICLES; INTELLIGENT TOYS, NAMELY, TO ROBOTS; TOY
CAMERAS, IN CLASS 28 (U.S. CLS. 22, 23, 38 AND 50).

OWNER OF INTERNATIONAL REGISTRATION 1061670 DATED 11-12-2010, EXPIRES 11-
12-2020.

SER. NO. 79-091,247, FILED 11-12-2010.

MARY BOAGNI, EXAMINING ATTORNEY



David J. Kyffers

Director of the United States Patent and Trademark Office

United States of America

United States Patent and Trademark Office

aunts & uncles

Reg. No. 4,097,620

Registered Feb. 14, 2012

Int. Cl.: 18

TRADEMARK

PRINCIPAL REGISTER

AUNTS&UNCLES GMBH & CO. KG (FED REP GERMANY GMBH & CO. KG)
RICHARDSTRASSE 72
47506 NEUKIRCHEN-VLUYN, FED REP GERMANY

FOR: LEATHER AND IMITATIONS OF LEATHER; GOODS MADE OF LEATHER AND IMITATION LEATHER, NAMELY, HANDBAGS, PURSES, WALLETS AND BRIEFCASES; HAND LUGGAGE; SCHOOL BAGS; DOCUMENT BAGS, NAMELY, BRIEFCASES FOR DOCUMENTS; ALL PURPOSE CARRYING SACKS; SHOPPING BAGS, NAMELY, CANVAS SHOPPING BAGS, LEATHER SHOPPING BAGS, MESH SHOPPING BAGS, REUSABLE SHOPPING BAGS AND WHEELED SHOPPING BAGS; WAIST PACKS, BRIEFCASES; RUCKSACKS; MULTIPURPOSE SPORTS BAGS; HOLDALLS; SUITCASES; VALISES; KIT BAGS; SACHELS; COSMETIC PURSES SOLD EMPTY; BATH BAGS, NAMELY, SHAVING BAGS SOLD EMPTY AND COSMETIC BAGS SOLD EMPTY; KEY CASES; WALLETS; PURSES, IN CLASS 18 (U.S. CLS. 1, 2, 3, 22 AND 41).

THE MARK CONSISTS OF STANDARD CHARACTERS WITHOUT CLAIM TO ANY PARTICULAR FONT, STYLE, SIZE, OR COLOR.

OWNER OF INTERNATIONAL REGISTRATION 1061782 DATED 11-24-2010, EXPIRES 11-24-2020.

SER. NO. 79-091,286, FILED 11-24-2010.

BERNICE MIDDLETON, EXAMINING ATTORNEY



David J. Kyffers

Director of the United States Patent and Trademark Office

United States of America
United States Patent and Trademark Office

VCM

Reg. No. 4,097,621

ABB TURBO SYSTEMS AG (SWITZERLAND AKTIENGESELLSCHAFT)
BRUGGERSTRASSE 71A
CH-5400 BADEN, SWITZERLAND

Registered Feb. 14, 2012

Int. Cl.: 7

FOR: INTERNAL COMBUSTION ENGINES, FOR POWER-DRIVEN MACHINES OTHER THAN LAND VEHICLES, AND COMPONENTS THEREOF, NAMELY, TIMING BELTS AND OTHER MONITORING UNITS, NAMELY, VALVE CONTROL LOGIC, FOR VALVE TIMINGS AND VALVE LIFTS, THE LATTER COMPRISED OF CAM SHAFTS, VALVE LEVERS, VALVE STEMS AND VALVE TAPPETS, AND HYDRAULIC REGULATING ELEMENTS, NAMELY, ELECTRO-HYDRAULIC ACTUATORS, SOLENOID VALVES, HYDRAULIC PISTONS, VALVES, ACCUMULATORS, PLAY COMPENSATORS, NAMELY, HYDRAULIC CYLINDERS AND PISTONS, AND PLAY ADJUSTERS, NAMELY, HYDRAULIC CYLINDERS AND PISTONS, IN CLASS 7 (U.S. CLS. 13, 19, 21, 23, 31, 34 AND 35).

TRADEMARK

PRINCIPAL REGISTER

THE MARK CONSISTS OF STANDARD CHARACTERS WITHOUT CLAIM TO ANY PARTICULAR FONT, STYLE, SIZE, OR COLOR.

PRIORITY DATE OF 5-26-2010 IS CLAIMED.

OWNER OF INTERNATIONAL REGISTRATION 1062024 DATED 11-9-2010, EXPIRES 11-9-2020.

SER. NO. 79-091,391, FILED 11-9-2010.

RONALD DELGIZZI, EXAMINING ATTORNEY



David J. Kybas

Director of the United States Patent and Trademark Office

United States of America

United States Patent and Trademark Office

SAGEMINES

Reg. No. 4,097,622

Registered Feb. 14, 2012

Int. Cls.: 1, 37 and 42

TRADEMARK

SERVICE MARK

PRINCIPAL REGISTER

DIAMOCO (FRANCE SARL)
46 RUE JEAN JAURÈS
F-42300 ROANNE
FRANCE

FOR: INDUSTRIAL CHEMICALS; CHEMICAL COMPOSITIONS FOR REPAIRING LEAKS, FOR THE REPAIR OF CONDUITS AND PIPES, WATERPROOFING OF CONDUITS AND PIPES FOR WATER, GAS AND HYDROCARBONS; ADHESIVES FOR INDUSTRIAL USE; GLUES FOR INDUSTRIAL USE; CAR BODY FILLERS; PUTTIES, NAMELY, OIL CEMENT; GLUES OTHER THAN FOR STATIONERY OR HOUSEHOLD USE, NAMELY, GLUES USED IN CHEMICAL INDUSTRY; CONTACT CEMENT, NAMELY, CEMENT FOR LOST CIRCULATION AND WATER SHUTOFF CEMENT; CHEMICAL METAL TEMPERING PREPARATIONS FOR FACILITATING THE ALLOYING OF METALS; CHEMICAL PREPARATIONS, NAMELY, CHEMICAL REAGENT FOR ANALYSES IN LABORATORIES, OTHER THAN FOR MEDICAL OR VETERINARY USE; FLUXING AGENTS, NAMELY, SOLDERING FLUXES AND BRAZING AND WELDING CHEMICALS; PROTECTIVE GASES FOR WELDING; REFRIGERANTS, NAMELY, COOLANTS; METAL HARDENING PREPARATIONS, NAMELY, METAL TEMPERING PREPARATIONS; DETERGENTS FOR INDUSTRIAL USE FOR USE IN MANUFACTURING PROCESSES; GAS PURIFYING PREPARATIONS; CHEMICAL PREPARATIONS IN THE NATURE OF FILTERING MATERIALS USED IN GEOLOGICAL EXPLORATION; SYNTHETIC MATERIALS, NAMELY, CHEMICAL COMPOSITION FOR SOLIDIFICATION OF FLUIDS AND FOR ABSORBING OIL, HYDROCARBONS, WATER, AND GAS SPILLS; PETROLEUM DISPERSANTS; CHEMICAL ADDITIVES FOR DRILLING MUDS; DRILLING MUDS FOR USE IN OIL WELL DRILLING, IN CLASS 1 (U.S. CLS. 1, 5, 6, 10, 26 AND 46).



FOR: DAMP-PROOFING; INSULATION, NAMELY, INSTALLATION OF BUILDING INSULATION; DRILLING OF WELLS; MINING EXTRACTION; PIPELINE INSTALLATION AND MAINTENANCE; CONSTRUCTION OF TREATMENT PLANTS; INSTALLATION AND MAINTENANCE OF PIPELINES; SET-UP SERVICES, NAMELY, BUILDING SERVICES OF GAS PRODUCTION AND EXTRACTION FACILITIES, AND INSTALLATION SERVICES OF GAS PRODUCTION AND EXTRACTION FACILITIES; MAINTENANCE OF MACHINES USED IN THE PRODUCTION AND EXTRACTION OF GAS; CONSTRUCTION AND INSTALLATION OF UNITS, NAMELY, WELLS, TRANSPORT NETWORKS, PUMPING STATIONS, PILOT STATIONS, IN CLASS 37 (U.S. CLS. 100, 103 AND 106).

David J. Kyffers

Director of the United States Patent and Trademark Office

Reg. No. 4,097,622 FOR: CHEMISTRY CONSULTATION SERVICES; CHEMICAL ANALYSIS; RESEARCH AND DEVELOPMENT OF NEW PRODUCTS FOR THIRD PARTIES, NAMELY, THE DEVELOPMENT OF CHEMICAL COMPOSITIONS FOR INDUSTRIAL USE FOR STOPPING LEAKS; TECHNICAL PROJECT STUDIES, NAMELY, CONDUCTING FEASIBILITY STUDIES; ENGINEERING SERVICES; OIL-WELL TESTING; QUALITY CONTROL FOR OTHERS; INDUSTRIAL DESIGN; MATERIALS TESTING; MEASURING, NAMELY, CALIBRATION; LAND SURVEYING; OIL PROSPECTING; GEOLOGICAL PROSPECTING; RESEARCH IN THE FIELD OF CHEMISTRY AND PHYSICS; MECHANICAL RESEARCH; GEOLOGICAL RESEARCH; ENGINEERING SERVICES, NAMELY, SURVEYING; OIL-FIELD SURVEYS; GEOLOGICAL SURVEYS; UNDERWATER EXPLORATION; ANALYSIS FOR OIL-FIELD EXPLOITATION; ANALYSIS FOR THE INSTALLATION OF COMPUTER SYSTEMS; DESIGN AND DEVELOPMENT OF COMPUTER SOFTWARE; RESEARCH IN THE FIELD OF ENVIRONMENTAL PROTECTION; TECHNICAL RESEARCH IN THE FIELD OF CHEMISTRY; CONSTRUCTION DRAFTING; CONSTRUCTION DRAFTING CONSULTING, IN CLASS 42 (U.S. CLS. 100 AND 101).

THE MARK CONSISTS OF STANDARD CHARACTERS WITHOUT CLAIM TO ANY PARTICULAR FONT, STYLE, SIZE, OR COLOR.

PRIORITY DATE OF 12-31-2009 IS CLAIMED.

OWNER OF INTERNATIONAL REGISTRATION 1062679 DATED 6-30-2010, EXPIRES 6-30-2020.

THE WORDING "SAGEMINES" HAS NO MEANING IN A FOREIGN LANGUAGE.

SER. NO. 79-091,687, FILED 6-30-2010.

CARRIE GENOVESE, EXAMINING ATTORNEY

United States of America

United States Patent and Trademark Office

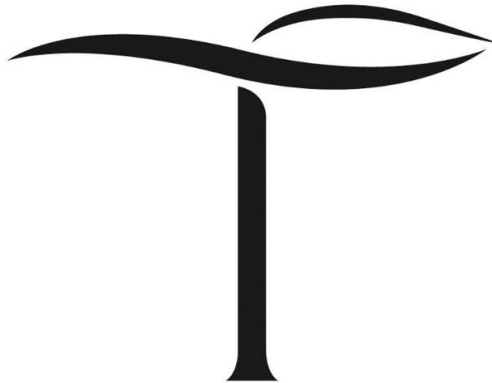

Reg. No. 4,097,623

Registered Feb. 14, 2012

Int. Cls.: 11 and 30

TRADEMARK

PRINCIPAL REGISTER

TPRESSO SA
ROUTE DU VILLAGE 76
CH-1040 SAINT-BARTHÉLEMY
SWITZERLAND

FOR: MACHINES FOR THE PREPARATION OF HOT BEVERAGES, PARTICULARLY MACHINES FOR INJECTING HOT WATER AND PRESSURIZED STEAM FOR THE PREPARATION, FROM CAPSULES, OF NON-MEDICINAL INFUSIONS AND TEAS, IN CLASS 11 (U.S. CLS. 13, 21, 23, 31 AND 34).

FOR: TEAS; NON-MEDICINAL HERBAL INFUSIONS AND HERBAL TEAS; TEA EXTRACTS; TEA-BASED PREPARATIONS AND BEVERAGES; NON-MEDICINAL INFUSIONS, HERBAL TEAS AND TEAS IN CAPSULES, PREPARATIONS AND BEVERAGES MADE WITH NON-MEDICINAL TEA IN CAPSULES, IN CLASS 30 (U.S. CL. 46).

THE MARK CONSISTS OF THE STYLIZED LETTER "T" IN WHICH THERE IS A CURVED LINE ABOVE THE RIGHT TOP SIDE OF THE LETTER "T".

PRIORITY DATE OF 6-16-2010 IS CLAIMED.

OWNER OF INTERNATIONAL REGISTRATION 1062690 DATED 12-15-2010, EXPIRES 12-15-2020.

SER. NO. 79-091,694, FILED 12-15-2010.

MICHAEL TANNER, EXAMINING ATTORNEY



David J. Kybas

Director of the United States Patent and Trademark Office

United States of America

United States Patent and Trademark Office

LIBRATONE

Reg. No. 4,097,624

Registered Feb. 14, 2012

Int. Cls.: 9 and 37

TRADEMARK

SERVICE MARK

PRINCIPAL REGISTER

LIBRATONE A/S (DENMARK PUBLIC LIMITED COMPANY)
MILEPARKEN 20E
DK-2740 SKOVLUNDE
DENMARK

FOR: ELECTRIC AND ELECTRONIC APPARATUS, INSTRUMENTS AND EQUIPMENT FOR USE IN CONNECTION WITH THE RECORDING, TRANSMISSION, REPRODUCTION, RECEPTION, CONTROL, OPERATING AND AMPLIFICATION OF SOUND OR IMAGES, NAMELY, LOUDSPEAKERS, LOUDSPEAKER SYSTEMS, STEREO TUNERS, AMPLIFIERS, DVD AND COMPACT DISC PLAYERS AND RECORDERS, MICROPHONES AND SOUND MIXERS; ANALOGUE AND DIGITAL PRODUCTS FOR AUDIO ROOM CORRECTION, NAMELY, DISTRIBUTION AMPLIFIERS FOR AUDIO AND VIDEO SIGNALS; AUDIO AND SIGNAL PROCESSING APPARATUS, NAMELY, DIGITAL SIGNAL PROCESSORS; AUDIO ELECTRONIC COMPONENTS, NAMELY, SURROUND SOUND SYSTEMS; PARTS AND FITTINGS FOR ALL THE AFORESAID GOODS, NAMELY, HEADPHONES, SUBWOOFERS, REMOTE CONTROL UNITS FOR LOUDSPEAKERS, LOUDSPEAKER SYSTEMS AND AMPLIFIERS, AERIALS, CONVERTERS AND TELEVISION DECODERS; COMPUTER HARDWARE AND APPLICATION SOFTWARE FOR THE RECORDING, TRANSMISSION, REPRODUCTION, RECEPTION, CONTROL, OPERATING AND AMPLIFICATION OF SOUND OR IMAGES OVER LOUDSPEAKERS AND LOUDSPEAKER UNITS/SYSTEMS, TUNERS, AMPLIFIERS, DVD AND COMPACT DISC PLAYERS, MICROPHONES AND SOUND MIXERS; ELECTRIC AND ELECTRONIC APPARATUS, INSTRUMENTS AND EQUIPMENT, NAMELY, LOUDSPEAKERS FOR COMPUTERS, LAPTOPS, HANDHELD COMPUTERS, TELEPHONES, PORTABLE TELEPHONES, MOBILE DIGITAL ELECTRONIC DEVICES FOR THE SENDING AND RECEIVING OF TELEPHONE CALLS, E-MAILS, VIDEO, MUSIC AND OTHER DIGITAL DATA, AND FOR MP3 AND OTHER DIGITAL FORMAT AUDIO AND VIDEO PLAYERS, IN CLASS 9 (U.S. CLS. 21, 23, 26, 36 AND 38).

FOR: REPAIR AND INSTALLATION SERVICES WITH RESPECT TO ELECTRIC AND ELECTRONIC APPARATUS, INSTRUMENTS AND EQUIPMENT, NAMELY, REPAIR AND INSTALLATION OF LOUDSPEAKERS AND LOUDSPEAKER UNITS/SYSTEMS, TUNERS, AMPLIFIERS, DVD AND COMPACT DISC PLAYERS AND RECORDERS, MICROPHONES AND SOUND MIXERS AS WELL AS PARTS AND ACCESSORIES FOR SUCH GOODS, IN CLASS 37 (U.S. CLS. 100, 103 AND 106).

THE MARK CONSISTS OF STANDARD CHARACTERS WITHOUT CLAIM TO ANY PARTICULAR FONT, STYLE, SIZE, OR COLOR.



David J. Kyffers

Director of the United States Patent and Trademark Office

Reg. No. 4,097,624 OWNER OF INTERNATIONAL REGISTRATION 1062825 DATED 11-12-2010, EXPIRES 11-12-2020.

SER. NO. 79-091,746, FILED 11-12-2010.

MARY BOAGNI, EXAMINING ATTORNEY

United States of America

United States Patent and Trademark Office

CONTRAX 3D

Reg. No. 4,097,625

Registered Feb. 14, 2012

Int. Cls.: 5 and 10

TRADEMARK

PRINCIPAL REGISTER

DIRK P. LEENHEER (NETHERLANDS INDIVIDUAL)
KERKSTRAAT 34
NL-3341 LE HENDRIK-IDO-AMBACHT
NETHERLANDS

FOR: PHARMACEUTICAL PREPARATIONS AND SUBSTANCES USED FOR ORAL TREATMENT, NAMELY, MEDICATED BRUSH-ON ORAL CARE GELS, MEDICATED DENTAL RINSES, FLUID FOR THE TOPICAL FLUORIDATION OF TOOTH ENAMEL AND DECAY PREVENTION; SANITARY PREPARATIONS FOR MEDICAL PURPOSES, DIAGNOSTIC PREPARATIONS AND SUBSTANCES FOR MEDICAL PURPOSES; CONTRAST AGENTS, NAMELY, X-RAY CONTRAST AGENTS FOR MEDICAL IMAGING, DIETETIC SUBSTANCES FOR MEDICAL USE; TOOTH FILLINGS AND DENTAL IMPRESSION MATERIALS; DISINFECTANTS FOR SANITARY PURPOSES, IN CLASS 5 (U.S. CLS. 6, 18, 44, 46, 51 AND 52).

FOR: SURGICAL, MEDICAL, DENTAL APPARATUS AND INSTRUMENTS AND DENTAL ELECTRIC APPARATUS AND INSTRUMENTS, NAMELY, ELECTRIC TOOTHBRUSHES, WATER FLOSS APPARATUS, APPARATUS FOR DENTISTRY, NAMELY, PICKS, MIRRORS, DRILLS, PROFESSIONAL DENTAL CLEANING APPARATUS, X-RAY APPARATUS FOR DENTAL IMAGING, X-RAY APPLIANCES FOR DENTAL USE, IN CLASS 10 (U.S. CLS. 26, 39 AND 44).

THE MARK CONSISTS OF STANDARD CHARACTERS WITHOUT CLAIM TO ANY PARTICULAR FONT, STYLE, SIZE, OR COLOR.

PRIORITY DATE OF 5-10-2010 IS CLAIMED.

OWNER OF INTERNATIONAL REGISTRATION 1062902 DATED 10-26-2010, EXPIRES 10-26-2020.

NO CLAIM IS MADE TO THE EXCLUSIVE RIGHT TO USE "3D" FOR X-RAY APPARATUS FOR DENTAL IMAGING AND X-RAY APPLIANCES FOR DENTAL USE, APART FROM THE MARK AS SHOWN.

SER. NO. 79-091,768, FILED 10-26-2010.

KEVON CHISOLM, EXAMINING ATTORNEY



David J. Kyffers

Director of the United States Patent and Trademark Office

United States of America

United States Patent and Trademark Office



Motta Alfredo

Reg. No. 4,097,626

Registered Feb. 14, 2012

Int. Cls.: 18 and 25

TRADEMARK

PRINCIPAL REGISTER

MOTTA ALFREDO S.P.A. (ITALY JOINT STOCK COMPANY)
VIA LUCIANO MANARA, 3
I-20092 CINISELLO BALSAMO (MI)
ITALY

FOR: TRUNKS, TRAVELLING BAGS, UMBRELLAS, HANDBAGS, SUITCASES, CLUTCH BAGS, VANITY CASES SOLD EMPTY, PURSES, BILLFOLDS, ATTACHE CASES, WALLETS, BRIEFCASES, KEY-CASES, PASSPORT WALLETS, NAMELY, WALLETS WITH CARD COMPARTMENTS, WALLETS AND WALLET INSERTS; CREDIT CARD WALLETS; BUSINESS CARD HOLDERS IN THE NATURE OF WALLETS, IN CLASS 18 (U.S. CLS. 1, 2, 3, 22 AND 41).

FOR: CLOTHING, NAMELY, PANTS, TROUSERS, SWEATERS, SWEAT SHIRTS, TOPS, T-SHIRTS, BLOUSES, JACKETS, COATS, JERSEYS, BELTS, SOCKS; COATS, MANTLES, RAINCOATS, DUSTERS, FURS, NAMELY, FUR COATS, FUR MUFFS, FUR STOLEES, DRESSES, SUITS, SKIRTS, JACKETS, KNITWEAR, NAMELY, KNIT DRESSES, KNIT JACKETS, KNIT SKIRTS, KNIT TOPS; TROUSERS, SHORTS SETS, BERMUDAS, NAMELY, BERMUDA SHORTS; JEANS, WAISTCOATS, SHIRTS, T-SHIRTS, TOPS, BLOUSES, JERSEYS, SWEATERS, BLAZERS, CARDIGANS, STOCKINGS, SOCKS, UNDERWEAR, CORSETS, BRASSIERE, UNDERPANTS, NIGHT GOWNS, SHIFTS, PAJAMAS, BATHROBES, BATHING SUITS, BEACH WRAPS, SUN SUITS, SPORTS JACKETS, WATERPROOF CLOTHING, NAMELY, WATER PROOF BOOTS, WATERPROOF JACKETS AND PANTS, WET SUITS FOR WATER-SKIING AND SUB-AQUA; WIND RESISTANT JACKETS, ANORAKS, SWEAT SUITS, TIES, NECKTIES, SCARVES, SHAWLS, MUFFLERS, FOULARDS, CAPS, HATS, HOODS, GLOVES, SASHES, BELTS; FOOTWEAR, BEACH FOOTWEAR, ATHLETIC FOOTWEAR, BOOTS, SHOES AND SLIPPERS, IN CLASS 25 (U.S. CLS. 22 AND 39).



THE NAME(S), PORTRAIT(S), AND/OR SIGNATURE(S) SHOWN IN THE MARK IDENTIFIES "MOTTA ALFREDO", WHOSE CONSENT(S) TO REGISTER IS MADE OF RECORD.

PRIORITY DATE OF 9-21-2010 IS CLAIMED.

OWNER OF INTERNATIONAL REGISTRATION 1063026 DATED 9-30-2010, EXPIRES 9-30-2020.

David J. Kybas

Director of the United States Patent and Trademark Office

Reg. No. 4,097,626 THE MARK CONSISTS OF THE DESIGN OF A DEER SUPERIMPOSED ON THE DESIGN OF A GEOMETRIC DESIGN REPRESENTING A SHIELD WITH THE STYLIZED SCRIPT WORDING "MOTTA ALFREDO" FEATURED BELOW.

THE ENGLISH TRANSLATION OF "ALFREDO" IN THE MARK IS "ALFRED".

SER. NO. 79-091,807, FILED 9-30-2010.

CHARISMA HAMPTON, EXAMINING ATTORNEY

United States of America

United States Patent and Trademark Office

APIPOL

Reg. No. 4,097,627

Registered Feb. 14, 2012

Int. Cls.: 3, 5 and 30

TRADEMARK

PRINCIPAL REGISTER

BELOUNEH JOSEPH (FRANCE INDIVIDUAL)
RUE EDMOND ROGER
F-75015 PARIS
FRANCE

FOR: PERFUMES, ESSENTIAL OILS, COSMETICS, HAIR LOTIONS; DENTIFRICES; DEPILATORY PREPARATIONS; LIPSTICKS; BEAUTY MASKS, IN CLASS 3 (U.S. CLS. 1, 4, 6, 50, 51 AND 52).

FOR: FOOD FOR BABIES; MEDICINAL HERBS; ALL THESE GOODS NOT CONCERNING THE FIELD OF IN-VITRO DIAGNOSIS, IN CLASS 5 (U.S. CLS. 6, 18, 44, 46, 51 AND 52).

FOR: HONEY, TREACLE, IN CLASS 30 (U.S. CL. 46).

PRIORITY DATE OF 5-17-2010 IS CLAIMED.

OWNER OF INTERNATIONAL REGISTRATION 1063373 DATED 11-17-2010, EXPIRES 11-17-2020.

SER. NO. 79-091,928, FILED 11-17-2010.

APRIL ROACH, EXAMINING ATTORNEY



David J. Kyffers

Director of the United States Patent and Trademark Office

United States of America
United States Patent and Trademark Office

Krieghoff

Reg. No. 4,097,628

Registered Feb. 14, 2012

Int. Cl.: 13

TRADEMARK

PRINCIPAL REGISTER

H. KRIEGHOFF GMBH (FED REP GERMANY LIMITED LIABILITY COMPANY)
BOSCHSTR. 22
89079 ULM
FED REP GERMANY

FOR: HUNTING AND SPORTS WEAPONS, NAMELY, FIREARMS; MORRIS TUBES, NAMELY, SMALL BORE TUBES FOR INSERTION IN HEAVIER CALIBER GUNS AND RIFLES FOR PRACTICE ON MINIATURE RANGES; SIDE ARMS, NAMELY, PISTOLS; AMMUNITION AND PROJECTILES, IN CLASS 13 (U.S. CLS. 2 AND 9).

SEC. 2(F).

OWNER OF INTERNATIONAL REGISTRATION 0896677 DATED 7-3-2006, EXPIRES 7-3-2016.

SER. NO. 79-091,952, FILED 12-20-2010.

LIEF MARTIN, EXAMINING ATTORNEY



David J. Kyffers

Director of the United States Patent and Trademark Office

United States of America

United States Patent and Trademark Office

DUST IT

Reg. No. 4,097,629

Registered Feb. 14, 2012

Int. Cl.: 3

TRADEMARK

PRINCIPAL REGISTER

HENKEL FRANCE (FRANCE CORPORATION)
161 RUE DE SILLY
F-92100 BOULOGNE BILLANCOURT
FRANCE

FOR: SOAPS, PERFUMERY, ESSENTIAL OILS, COSMETICS; PREPARATIONS FOR THE CARE, CLEANING, DYEING, COLORING, BLEACHING, STYLING, FIXING AND PERMANENT WAVING OF HAIR; HAIR LOTIONS AND HAIR SHAMPOOS FOR COSMETIC PURPOSES, IN CLASS 3 (U.S. CLS. 1, 4, 6, 50, 51 AND 52).

THE MARK CONSISTS OF STANDARD CHARACTERS WITHOUT CLAIM TO ANY PARTICULAR FONT, STYLE, SIZE, OR COLOR.

OWNER OF INTERNATIONAL REGISTRATION 1063741 DATED 11-8-2010, EXPIRES 11-8-2020.

SER. NO. 79-092,067, FILED 11-8-2010.

MICHAEL TANNER, EXAMINING ATTORNEY



David J. Kyffers

Director of the United States Patent and Trademark Office

United States of America
United States Patent and Trademark Office

MinaCare

Reg. No. 4,097,630

Registered Feb. 14, 2012

Int. Cl.: 1

TRADEMARK

PRINCIPAL REGISTER

MINASOLVE (FRANCE SAS)
145 CHEMIN DES LILAS
F-59310 BEUVRY-LA-FORET
FRANCE

FOR: CHEMICAL SUBSTANCES FOR PRESERVING FOODSTUFFS, IN CLASS 1 (U.S. CLS. 1, 5, 6, 10, 26 AND 46).

PRIORITY DATE OF 9-7-2010 IS CLAIMED.

OWNER OF INTERNATIONAL REGISTRATION 1064054 DATED 11-17-2010, EXPIRES 11-17-2020.

SER. NO. 79-092,190, FILED 11-17-2010.

APRIL ROACH, EXAMINING ATTORNEY



David J. Kybas

Director of the United States Patent and Trademark Office

United States of America

United States Patent and Trademark Office



Reg. No. 4,097,631

Registered Feb. 14, 2012

Int. Cls.: 9, 11, 37 and 42

UNION INSTRUMENTS GMBH (FED REP GERMANY GMBH)
ZEPPELINSTR. 42
76185 KARLSRUHE
FED REP GERMANY

TRADEMARK

SERVICE MARK

PRINCIPAL REGISTER

FOR: TECHNICAL APPARATUS AND EQUIPMENT FOR ANALYSING LIQUIDS OR GASES, IN PARTICULAR COMBUSTIBLE OR NON-COMBUSTIBLE PROCESS GASES OR WATER; TECHNICAL APPARATUS AND EQUIPMENT FOR THE DISCREET OR CONTINUOUS MEASURING OF LIQUID OR GAS PROPERTIES, IN PARTICULAR FOR MEASURING STATE VARIABLES OR GAS COMPOSITIONS; TECHNICAL APPARATUS AND EQUIPMENT FOR THE DISCREET OR CONTINUOUS MEASURING OF THE PRESSURE, TEMPERATURE, QUANTITY, HEAT VALUE, CALORIFIC VALUE, WOBBE INDEX OR DENSITY OF GASES; GAS CALORIMETERS; TECHNICAL APPARATUS AND EQUIPMENT FOR THE DISCREET OR CONTINUOUS MEASURING OF THE PRESSURE, TEMPERATURE, QUANTITY OR DENSITY OF LIQUIDS, IN PARTICULAR WATER; TECHNICAL ELECTRIC CHECKING APPARATUS, NAMELY, PRESSURE REGULATORS FOR GASES; PRESSURE INDICATORS, IN PARTICULAR STRIP CHART RECORDERS, FOR MEASURING AND RECORDING THE PRESSURE AND TEMPERATURE OF LIQUIDS OR GASES; DATA LOGGERS, INCLUDING MULTI-CHANNEL DATA LOGGERS, FOR THE MEASURING, DISPLAYING, STORAGE AND TRANSMISSION OF DATA ON LIQUID OR GAS PROPERTIES, IN THE NATURE OF STATE VARIABLES; PRESSURE DATA LOGGERS FOR THE MEASURING, DISPLAY, STORAGE AND TRANSMISSION OF GAS PRESSURES AND WATER PRESSURES; LEAK TESTING CASES CONTAINING TECHNICAL APPARATUS FOR CONDUCTING PRESSURE TESTS ON GAS OR WATER PIPELINES; ELECTRIC APPARATUS FOR TESTING INSULATION AND LOCALISING AND REPAIRING CORROSION DAMAGE TO TANKS AND PIPELINES, IN PARTICULAR PLASTIC-COATED TANKS AND PIPELINES; COMPUTER SOFTWARE, IN PARTICULAR FOR EVALUATING MEASUREMENT DATA IN CONNECTION WITH ALL THE AFORESAID GOODS; EVALUATION SOFTWARE FOR EVALUATING MEASUREMENT DATA, IN PARTICULAR WITHIN THE FRAMEWORK OF MEASUREMENT DATA FROM GAS OR LIQUID ANALYSES; CASINGS FOR HOUSING ONE OR SEVERAL OF THE AFORESAID DEVICES. CALORIMETER CASINGS FOR HOUSING GAS CALORIMETERS; ESSENTIAL PARTS AND ACCESSORIES FOR ALL THE AFORESAID GOODS, IN CLASS 9 (U.S. CLS. 21, 23, 26, 36 AND 38).



David J. Kybas

FOR: REGULATING ACCESSORIES FOR GAS APPARATUS/GAS PIPES, NAMELY, PRESSURE REGULATORS FOR GASES; APPARATUS FOR GAS PURIFYING; GAS COOLERS

Reg. No. 4,097,631 FOR LOWERING THE DEW POINT AND FOR CONDENSATE SEPARATION , IN CLASS 11 (U.S. CLS. 13, 21, 23, 31 AND 34).

FOR: INSTALLATION OF TECHNICAL ANALYSIS SYSTEMS CONSISTING OF SEVERAL INDIVIDUAL ANALYSIS DEVICES FOR ANALYSING LIQUIDS, WATER OR GASES, FOR OTHERS; MAINTENANCE AND REPAIR OF TECHNICAL APPARATUS AND EQUIPMENT FOR ANALYSING LIQUIDS OR GASES, IN PARTICULAR FOR ANALYSING COMBUSTIBLE OR NON-COMBUSTIBLE PROCESS GASES OR WATER; MAINTENANCE AND REPAIR OF TECHNICAL APPARATUS AND EQUIPMENT FOR THE DISCREET OR CONTINUOUS MEASURING OF LIQUID OR GAS PROPERTIES, IN PARTICULAR FOR MEASURING STATE VARIABLES OR GAS COMPOSITIONS; MAINTENANCE AND REPAIR OF PRESSURE REGULATORS FOR GASES; MAINTENANCE AND REPAIR OF APPARATUS FOR GAS PURIFYING; MAINTENANCE AND REPAIR OF GAS COOLERS FOR LOWERING THE DEW POINT AND FOR CONDENSATE SEPARATION; MAINTENANCE AND REPAIR OF PRESSURE INDICATORS, IN PARTICULAR STRIP CHART RECORDERS, FOR MEASURING AND RECORDING THE PRESSURE AND TEMPERATURE OF LIQUIDS OR GASES; MAINTENANCE AND REPAIR OF DATA LOGGERS, INCLUDING MULTI-CHANNEL DATA LOGGERS, FOR THE MEASURING, DISPLAYING, STORAGE AND TRANSMISSION OF DATA ON LIQUID OR GAS PROPERTIES, IN PARTICULAR STATE VARIABLES; MAINTENANCE AND REPAIR OF PRESSURE DATA LOGGERS FOR THE MEASURING, DISPLAY, STORAGE AND TRANSMISSION OF GAS PRESSURES AND WATER PRESSURES; MAINTENANCE AND REPAIR OF LEAK TESTING CASES WITH APPARATUS FOR CONDUCTING PRESSURE TESTS ON GAS OR WATER PIPELINES; MAINTENANCE AND REPAIR OF INSULATION TESTERS FOR LOCALISING AND REPAIRING CORROSION DAMAGE TO TANKS AND PIPELINES, IN PARTICULAR PLASTIC-COATED TANKS AND PIPELINES, IN CLASS 37 (U.S. CLS. 100, 103 AND 106).

FOR: MAINTENANCE OF EVALUATION SOFTWARE FOR EVALUATING MEASUREMENT DATA, IN PARTICULAR WITHIN THE FRAMEWORK OF MEASUREMENT DATA FROM GAS OR LIQUID ANALYSES; SCIENTIFIC AND TECHNOLOGICAL SERVICES, INDUSTRIAL ANALYSIS, INCLUDING FOR THE DEVELOPMENT OF SYSTEM SOLUTIONS IN THE FIELD OF THE DEVELOPMENT OF APPARATUS AND EQUIPMENT FOR ANALYSING LIQUIDS OR GASES, IN PARTICULAR COMBUSTIBLE OR NON-COMBUSTIBLE PROCESS GASES OR WATER, AND DEVELOPMENT OF APPARATUS AND EQUIPMENT FOR THE MEASURING, STORAGE AND TRANSMISSION OF PRESSURE, TEMPERATURE AND QUANTITY OF GASES OR LIQUIDS; DESIGN AND DEVELOPMENT OF COMPUTER HARDWARE AND COMPUTER SOFTWARE FOR EVALUATING MEASUREMENT DATA FROM APPARATUS AND EQUIPMENT FOR ANALYSING GASES OR LIQUIDS, IN PARTICULAR WATER, FROM APPARATUS AND EQUIPMENT FOR THE MEASURING, STORAGE AND TRANSMISSION OF THE PRESSURE, TEMPERATURE AND QUANTITY OF GASES OR LIQUIDS; PRODUCT DEVELOPMENT, NAMELY, DEVELOPMENT OF CASINGS FOR HOUSING WATER OR GAS ANALYSIS APPARATUS, IN PARTICULAR FOR HOUSING GAS CALORIMETERS, FOR OTHERS; INSTALLATION OF COMPUTER SOFTWARE ANALYSIS SYSTEMS FOR ANALYSING LIQUIDS, IN PARTICULAR WATER OR GASES, FROM MULTIPLE INDIVIDUAL ANALYSIS DEVICES, IN CLASS 42 (U.S. CLS. 100 AND 101).

NO CLAIM IS MADE TO THE EXCLUSIVE RIGHT TO USE "INSTRUMENTS", APART FROM THE MARK AS SHOWN.

PRIORITY DATE OF 2-3-2010 IS CLAIMED.

OWNER OF INTERNATIONAL REGISTRATION 1064055 DATED 6-21-2010, EXPIRES 6-21-2020.

THE MARK CONSISTS OF A SHADED RECTANGLE WITH A "±" SYMBOL IN THE UPPER LEFT CORNER. TO THE RIGHT OF THIS SYMBOL ARE THE SCRIPT LETTERS "UN".

Reg. No. 4,097,631 BELOW THE SYMBOL AND THESE LETTERS IS THE TERMS "UNION". BENEATH THE TERM "UNION" IS THE TERM "INSTRUMENTS".

SER. NO. 79-092,191, FILED 6-21-2010.

MICHAEL WIENER, EXAMINING ATTORNEY

United States of America

United States Patent and Trademark Office

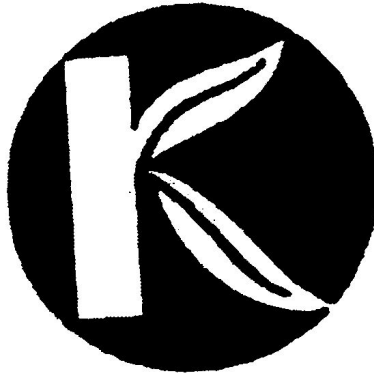

Reg. No. 4,097,632

Registered Feb. 14, 2012

Int. Cls.: 3, 30 and 32

TRADEMARK

PRINCIPAL REGISTER

LUXURY IMPORT S.R.L. (ITALY LIMITED LIABILITY COMPANY)
CORSO MILANO, 43
I-35139 PADOVA
ITALY

FOR: ESSENTIAL OILS FOR FLAVORING BEVERAGES; ESSENTIAL OILS; BEAUTY SOAPS, PERFUMES, TOILET WATER, PERSONAL DEODORANTS, INCENSES, ESSENTIAL OILS FOR PERSONAL USE, BODY LOTIONS, SHOWER GEL, BATH OILS, BATH PEARLS, NON-MEDICATED BATH SALTS, SHAVING CREAM, AFTERSHAVE LOTIONS, EYE SHADOWS, COSMETIC PENCILS, FOUNDATION MAKE-UP, FACE POWDERS, TALCUM POWDER, ROUGES, LIPSTICKS, MASCARAS, SKIN CLEANSING CREAMS, SKIN CLEANSING LOTIONS, SUN SCREEN PREPARATION, NAIL POLISH, BEAUTY MASKS, FACIAL SCRUBS, FACE CREAMS, BODY CREAMS; COSMETIC CREAMS, LOTIONS AND GELS ALL FOR WEIGHT REDUCTION OR SLIMMING PURPOSES; SHAMPOOS FOR PETS; HAIR SHAMPOOS, HAIR SPRAYS, HAIR COLOUR REMOVERS, HAIR COLORANTS, HAIR DYE, HAIR RINSES, HAIR LIGHTENERS, HAIR CONDITIONERS, HAIR MOISTURISERS, PERMANENT WAVE PREPARATIONS, HAIR STYLING FOAMS AND GELS; HAIR LOTIONS, IN CLASS 3 (U.S. CLS. 1, 4, 6, 50, 51 AND 52).

FOR: HERBAL INFUSIONS; TEA FOR INFUSIONS; FLAVORINGS, OTHER THAN ESSENTIAL OILS, FOR BEVERAGES; MIXES IN THE NATURE OF CONCENTRATE, SYRUPS OR POWDERS USED IN THE PREPARATION OF TEA BASED BEVERAGES; COFFEE-BASED BEVERAGES; COFFEE AND TEA; COCOA; SUGAR AND SUGAR SUBSTITUTES; ARTIFICIAL COFFEE OR VEGETABLE PREPARATIONS FOR USE AS COFFEE; CONDIMENTS, NAMELY, SAUCES; SPICES, IN CLASS 30 (U.S. CL. 46).

FOR: HIBISCUS FLOWER FLAVORED CONCENTRATES USED IN THE PREPARATION OF SOFT DRINKS; ESSENCES FOR USE IN MAKING SOFT DRINKS, NOT BEING ESSENTIAL OILS; NON-ALCOHOLIC HIBISCUS EXTRACTS FOR USE AS AN INGREDIENT IN BEVERAGES; HIBISCUS FLAVORED SOFT DRINKS; NON-ALCOHOLIC SOFT DRINKS MADE FROM AN INFUSION OF HIBISCUS FLOWERS; NON-ALCOHOLIC SOFT DRINKS, FRUIT DRINKS AND FRUIT JUICES; NON-ALCOHOLIC FRUIT-BASED BEVERAGES; NON-ALCOHOLIC NON-MEDICAL FRUIT FLAVORED DRINKS WITH ADDED ANTIOXIDANTS AND VITAMINS; NON-ALCOHOLIC ENERGY DRINKS; NON-ALCOHOLIC FRUIT JUICE BEVERAGES; MINERAL WATERS AND AERATED WATERS FOR MAKING BEVERAGES; VEGETABLE JUICES; NON-ALCOHOLIC FRUIT NECTARS AND EXTRACTS USED IN THE PREPARATION OF BEVERAGES; LEMONADES; SHERBETS; ISOTONIC



David J. Kybas

Director of the United States Patent and Trademark Office

Reg. No. 4,097,632 BEVERAGES, NON-ALCOHOLIC COCKTAILS; SYRUPS FOR BEVERAGES; FLAVORED WATERS, IN CLASS 32 (U.S. CLS. 45, 46 AND 48).

THE MARK CONSISTS OF A CIRCULAR SIGN INSIDE WHICH THE FANCY LETTER "K" IS PLACED; THIS LETTER BEING CHARACTERISED BY THE VERTICAL ELEMENT OF A RECTANGULAR SHAPE AND BY TWO OBLIQUE ELEMENTS COMPOSED OF TWO STYLIZED LEAVES.

PRIORITY DATE OF 5-26-2010 IS CLAIMED.

OWNER OF INTERNATIONAL REGISTRATION 1065346 DATED 8-2-2010, EXPIRES 8-2-2020.

SER. NO. 79-092,644, FILED 8-2-2010.

EMILY CHUO, EXAMINING ATTORNEY

United States of America

United States Patent and Trademark Office

SYMBIANT

Reg. No. 4,097,633

Registered Feb. 14, 2012

Int. Cls.: 16, 42 and 44

TRADEMARK

SERVICE MARK

PRINCIPAL REGISTER

STICHTING ZAANS MEDISCH CENTRUM (NETHERLANDS STICHTING)
KONINGIN JULIANAPLEIN 58
NL-1502 DV ZAANDAM
NETHERLANDS AND

STICHTING MEDISCH CENTRUM ALKMAAR
WILHELMINALAAN 12
NL-1815 JD ALKMAAR
NETHERLANDS AND

STICHTING ALGEMEEN ZIEKENHUIS WESTFRIES GASTHUIS
MAELSONSTRAAT 3
NL-1624 NP HOORN
NETHERLANDS

FOR: PRINTED MATTER, PHOTOGRAPHS, INSTRUCTIONAL AND TEACHING MATERIAL (EXCEPT APPARATUS) FOR THE PRESENTATION OF ANATOMICAL AND PATHOLOGICAL PROPERTIES AND OF THE CHEMICAL, BIOCHEMICAL, PHYSICAL AND PHYSIOLOGICAL PROCESSES AS PART OF THE EVALUATION OF THE SAFETY OF DRUGS (MEDICINES), IN CLASS 16 (U.S. CLS. 2, 5, 22, 23, 29, 37, 38 AND 50).

FOR: SCIENTIFIC RESEARCH FOR MEDICAL PURPOSES; ANALYSIS AND EVALUATION OF THE RESULTS OF PATHOLOGICAL AND TOXICOLOGICAL RESEARCH FOR THE PURPOSE OF, INTER ALIA, THE SAFETY ASPECTS OF DRUGS (MEDICINES), AS WELL AS ADVICE ON THE RESULTS THEREOF; SERVICES OF A LABORATORY; LABORATORY RESEARCH, INCLUDING IN THE FIELD OF MICROBIOLOGY AND INFECTIOUS DISEASES; MEDICAL LABORATORY RESEARCH; TECHNICAL CONSULTANCY ABOUT THE DESIGN OF INTERIOR OF LABORATORIES AND TECHNICAL CONSULTANCY ABOUT THE USE AND APPLICATION OF LABORATORY EQUIPMENT; DIAGNOSTIC TESTS, IDENTIFICATION OF THE SIDE-EFFECTS AND CARCINOGENIC PROPERTIES OF DRUGS (MEDICINES); EVALUATION OF CLINICAL TESTS; RESEARCH WITH REGARD TO THE SAFETY AND SIDE-EFFECTS OF DRUGS (MEDICINES), AS WELL AS THE CARCINOGENIC PROPERTIES OF DRUGS (MEDICINES); RESEARCH RELATING TO RISK ANALYSES OF RISK ANALYSES OF DRUGS (MEDICINES), IN CLASS 42 (U.S. CLS. 100 AND 101).

FOR: MEDICAL SERVICES; MEDICAL RESEARCH; MEDICAL AND DIAGNOSTIC SERVICES RELATED TO THE SAFETY ASPECTS OF DRUGS (MEDICINES); MEDICAL CON-



David J. Kyjars

Director of the United States Patent and Trademark Office

Reg. No. 4,097,633 SULTANCY; SERVICES OF PATHOLOGISTS; CONSULTANCY WITH REGARD TO THE SAFETY AND SIDE-EFFECTS OF DRUGS (MEDICINES), AS WELL AS THE CARCINOGENIC PROPERTIES OF DRUGS (MEDICINES), IN CLASS 44 (U.S. CLS. 100 AND 101).

THE MARK CONSISTS OF STANDARD CHARACTERS WITHOUT CLAIM TO ANY PARTICULAR FONT, STYLE, SIZE, OR COLOR.

PRIORITY DATE OF 10-16-2009 IS CLAIMED.

OWNER OF INTERNATIONAL REGISTRATION 1065408 DATED 4-8-2010, EXPIRES 4-8-2020.

SER. NO. 79-092,663, FILED 4-8-2010.

JULIE GUTTADAURO, EXAMINING ATTORNEY

United States of America
United States Patent and Trademark Office

Ergomove

Reg. No. 4,097,634

Registered Feb. 14, 2012

Int. Cls.: 10 and 25

TRADEMARK

PRINCIPAL REGISTER

BAUERFEIND AG (FED REP GERMANY STOCK CORPORATION)
TRIEBESER STRAÙE 16
07937 ZEULENRODA-TRIEBES
FED REP GERMANY

FOR: ORTHOPAEDIC ARTICLES, NAMELY, SUPPORT BANDAGES, MEDICAL COMPRESSION STOCKINGS, PROSTHESES FOR ALL JOINTS OF THE HUMAN BODY, ORTHOSES FOR ALL PARTS OF THE HUMAN BODY, INSERTS, IN PARTICULAR ORTHOPAEDIC SHOE INSERTS, INSERT MOLDING BLANKS, IN PARTICULAR PADDED INSERT MOLDING BLANKS, HALF-SHELL MOLDING BLANKS; ORTHOPAEDIC FOOT RESTS AND TOE SPREADERS; ORTHOPAEDIC SHOES AND PARTS THEREFOR, IN CLASS 10 (U.S. CLS. 26, 39 AND 44).

FOR: SHOES, PARTS FOR SHOES, NAMELY, SOLES, INSOLES, HEELS AND FOOTWEAR UPPERS, IN CLASS 25 (U.S. CLS. 22 AND 39).

THE MARK CONSISTS OF STANDARD CHARACTERS WITHOUT CLAIM TO ANY PARTICULAR FONT, STYLE, SIZE, OR COLOR.

PRIORITY DATE OF 5-26-2010 IS CLAIMED.

OWNER OF INTERNATIONAL REGISTRATION 1065412 DATED 11-24-2010, EXPIRES 11-24-2020.

SER. NO. 79-092,665, FILED 11-24-2010.

MICHAEL WIENER, EXAMINING ATTORNEY



David J. Kyjars

Director of the United States Patent and Trademark Office

United States of America

United States Patent and Trademark Office

More than Silicon

Reg. No. 4,097,635

Registered Feb. 14, 2012

Int. Cls.: 9 and 42

TRADEMARK

SERVICE MARK

PRINCIPAL REGISTER

AUSTRIAMICROSYSTEMS AG (AUSTRIA AKTIENGESELLSCHAFT)
SCHLOß PREMSTÄTTEN,
TOBELBADERSTR. 30; A-8141 UNTERPREMSTÄTTEN
AUSTRIA

FOR: A/D CONVERTERS; AUDIO AMPLIFIERS; ANALOG AUDIO FRONT-ENDS; ANALOG SWITCHES; AUDIO/VIDEO PLAYER ICS; WIRING BUSES; DATA CONVERTERS; DC/DC CONVERTERS; POTENTIOMETERS; DISPLAY AND LED DRIVERS; FLEXRAY/AUTOMOTIVE WIRING BUSES; INDUSTRIAL WIRING BUSES; ELECTRICAL AND DATA INTERFACES; LOW DROPOUT REGULATORS; LOW VOLTAGE DIFFERENTIAL SIGNALERS; PRECISION MEASURING APPARATUS FOR MEASURING ELECTRICAL QUANTITIES; SUPERVISORS AND COMPARATORS FOR POWER MANAGEMENT CIRCUITRY; PHONES; PORTABLE AUDIO DEVICES, NAMELY, MP3-PLAYERS, AAC-PLAYERS, WMA-PLAYERS, OGG-PLAYERS, MP4-PLAYERS AND MOBILE PHONES; POWER MANAGEMENT DEVICES, NAMELY, PMUS, LIGHTING, SUPERVISORS AND COMPARATORS, LDOS, DC/DC CONVERTERS, LED DRIVERS AND BACKLIGHTS; RF PRODUCTS, NAMELY, HIGH AND LOW FREQUENCY RECEIVERS, TRANSMITTERS AND TRANSCEIVERS; ROTARY ENCODERS; DATA ACQUISITION FRONT-ENDS, NAMELY, LOW POWER A/D CONVERTERS AND HIGH PERFORMANCE A/D CONVERTERS; SILICON WAFERS; SEMICONDUCTOR POWER ELEMENTS; TRANSISTORS; DIODES; INTEGRATED CIRCUITS; MICROPROCESSORS; MICROCOMPUTERS; ELECTRONIC SENSORS FOR ELECTRICITY, LIGHT, HEAT, TEMPERATURE, PRESSURE; TEST EQUIPMENT FOR TESTING ELECTRONIC CIRCUITS AND DEVICES, NAMELY, CIRCUIT TESTERS, CONTINUITY TEST APPARATUS FOR ELECTRICAL CIRCUITS; ELECTRIC APPARATUS FOR THE INPUT, PROCESSING, TRANSMISSION, STORAGE AND OUTPUT OF DATA, NAMELY, COMPUTER PERIPHERALS AND HARD DRIVES; DATA PROCESSING PROGRAMS, NAMELY, COMPUTER SOFTWARE FOR USE IN DATABASE MANAGEMENT, WORD PROCESSING; DATA PROCESSORS AND COMPUTERS, IN CLASS 9 (U.S. CLS. 21, 23, 26, 36 AND 38).

FOR: SCIENTIFIC AND TECHNICAL CONSULTING AND RESEARCH SERVICES IN THE FIELD OF ELECTRO-TECHNIQUE AND ELECTRONICS; INDUSTRIAL ANALYSIS AND RESEARCH SERVICES IN THE FIELD OF ELECTRO-TECHNIQUE AND ELECTRONICS; DESIGN OF AND TECHNICAL CONSULTATION RELATED TO ENGINEERING SERVICES REGARDING THE PRODUCTION OF A/D CONVERTERS, AUDIO AMPLIFIERS, ANALOG AUDIO FRONT-ENDS, ANALOG SWITCHES, AUDIO/VIDEO PLAYER ICS, WIRING BUS SYSTEMS, DATA CONVERTERS, DC/DC CONVERTERS, POTENTIOMETERS, DISPLAY AND LED DRIVERS, FLEXRAY/AUTOMOTIVE WIRING BUS, INDUSTRIAL WIRING BUS,



David J. Kyffers

Director of the United States Patent and Trademark Office

Reg. No. 4,097,635 ELECTRICAL AND DATA INTERFACES, LOW DROPOUT REGULATORS, LOW VOLTAGE DIFFERENTIAL SIGNALERS, PRECISION MEASURING APPARATUS FOR MEASURING ELECTRICAL QUANTITIES, SUPERVISORS AND COMPARATORS FOR POWER MANAGEMENT CIRCUITRY, PHONES, PORTABLE AUDIO DEVICES, NAMELY, MP3-PLAYERS, AAC-PLAYERS, WMA-PLAYERS, OGG-PLAYERS, MP4-PLAYERS AND MOBILE PHONES, POWER MANAGEMENT DEVICES, NAMELY, PMUS, LIGHTING, SUPERVISORS AND COMPARATORS, LOW DROPOUT REGULATORS, DC/DC CONVERTERS, LED DRIVERS AND BACKLIGHT, RF PRODUCTS, NAMELY, HIGH AND LOW FREQUENCY RECEIVERS, TRANSMITTERS AND TRANSCEIVERS, ROTARY ENCODERS, DATA ACQUISITION FRONT-ENDS, NAMELY, LOW POWER A/D CONVERTERS AND HIGH PERFORMANCE A/D CONVERTORS, SILICON WAFERS, SEMICONDUCTOR POWER ELEMENTS, TRANSISTORS, DIODES, INTEGRATED CIRCUITS, MICROPROCESSORS, MICROCOMPUTERS, ELECTRONIC SENSORS FOR ELECTRICITY, LIGHT, HEAT, TEMPERATURE, PRESSURE, TEST EQUIPMENT FOR TESTING ELECTRONIC CIRCUITS AND DEVICES, NAMELY, CIRCUIT TESTERS, CONTINUITY TEST APPARATUS FOR ELECTRICAL CIRCUITS, ELECTRIC APPARATUS FOR THE INPUT, PROCESSING, TRANSMISSION, STORAGE AND OUTPUT OF DATA, NAMELY, COMPUTER PERIPHERALS AND HARD DRIVES, DATA PROCESSING PROGRAMS, NAMELY, COMPUTER SOFTWARE FOR USE IN DATABASE MANAGEMENT, WORD PROCESSING, DATA PROCESSORS AND COMPUTERS; DESIGN OF NEW PRODUCTS FOR OTHERS IN THE FIELDS OF SCIENTIFIC, NAUTICAL, SURVEYING, PHOTOGRAPHIC, CINEMATOGRAPHIC, OPTICAL, WEIGHING, MEASURING, SIGNALING, SUPERVISIONS, LIFE-SAVING AND TEACHING APPARATUS AND INSTRUMENTS, APPARATUS AND INSTRUMENTS FOR CONDUCTING, SWITCHING, TRANSFORMING, ACCUMULATING, REGULATING AND CONTROLLING ELECTRICITY, ELECTROTECHNICAL AND ELECTRONIC APPARATUS, INSTRUMENTS AND DEVICES, SEMICONDUCTOR ELEMENTS, TRANSISTORS, DIODES, INTEGRATED CIRCUITS, MICROPROCESSORS AND MICROCOMPUTERS, ELECTRONIC SENSORS, TEST EQUIPMENT FOR TESTING ELECTRONIC CIRCUITS AND DEVICES, ELECTROTECHNICAL DEVICES AND COMPONENTS IN THE FIELD OF INFORMATION AND COMMUNICATION TECHNOLOGY, ELECTRIC APPARATUS FOR THE INPUT, PROCESSING, TRANSMISSION, STORAGE AND OUTPUT OF DATA, DATA PROCESSING PROGRAMS, APPARATUS FOR RECORDING, TRANSMISSION OR REPRODUCTION OF SOUND OR IMAGES, DATA PROCESSING EQUIPMENT AND COMPUTERS; AND TECHNICAL SUPPORT WITH REGARD TO DESIGN, DEVELOPMENT AND MANUFACTURE OF PRODUCTS IN THE FIELDS OF SCIENTIFIC, NAUTICAL, SURVEYING, PHOTOGRAPHIC, CINEMATOGRAPHIC, OPTICAL, WEIGHING, MEASURING, SIGNALING, SUPERVISION, LIFE-SAVING AND TEACHING APPARATUS AND INSTRUMENTS, APPARATUS AND INSTRUMENTS FOR CONDUCTING, SWITCHING, TRANSFORMING, ACCUMULATING, REGULATING AND CONTROLLING ELECTRICITY, ELECTROTECHNICAL AND ELECTRONIC APPARATUS, INSTRUMENTS AND DEVICES, SEMICONDUCTOR ELEMENTS, TRANSISTORS, DIODE, INTEGRATED CIRCUITS, MICROPROCESSORS AND MICROCOMPUTERS, ELECTRONIC SENSORS, TEST EQUIPMENT FOR TESTING ELECTRONIC CIRCUITS AND DEVICES, ELECTROTECHNICAL DEVICES AND COMPONENTS IN THE FIELD OF INFORMATION AND COMMUNICATION TECHNOLOGY, ELECTRIC APPARATUS FOR THE INPUT, PROCESSING, TRANSMISSION, STORAGE AND OUTPUT OF DATA, DATA PROCESSING PROGRAMS, APPARATUS FOR RECORDING, TRANSMISSION OR REPRODUCTION OF SOUND OR IMAGES, DATA PROCESSING EQUIPMENT AND COMPUTERS, IN CLASS 42 (U.S. CLS. 100 AND 101).

THE MARK CONSISTS OF STANDARD CHARACTERS WITHOUT CLAIM TO ANY PARTICULAR FONT, STYLE, SIZE, OR COLOR.

PRIORITY DATE OF 11-11-2010 IS CLAIMED.

OWNER OF INTERNATIONAL REGISTRATION 1065465 DATED 11-26-2010, EXPIRES 11-26-2020.

Reg. No. 4,097,635 NO CLAIM IS MADE TO THE EXCLUSIVE RIGHT TO USE "SILICON", APART FROM THE MARK AS SHOWN.

SER. NO. 79-092,682, FILED 11-26-2010.

JOSETTE BEVERLY, EXAMINING ATTORNEY

United States of America

United States Patent and Trademark Office

DANCING LIGHT

Reg. No. 4,097,636

Registered Feb. 14, 2012

Int. Cl.: 14

TRADEMARK

PRINCIPAL REGISTER

RICHEMONT INTERNATIONAL SA (SWITZERLAND SOCIÉTÉ ANONYME (SA))
ROUTE DES BICHES 10
CH-1752 VILLARS-SUR-GLÂNE
SWITZERLAND

FOR: CUFF LINKS, TIE CLIPS, RINGS, BRACELETS, EARRINGS, NECKLACES, BROOCHES, KEY HOLDERS OF PRECIOUS METALS, WATCHES, CHRONOMETERS, CLOCKS, WATCH BANDS, JEWELRY BOXES OF PRECIOUS METAL FOR WATCHES AND JEWELRY, IN CLASS 14 (U.S. CLS. 2, 27, 28 AND 50).

THE MARK CONSISTS OF STANDARD CHARACTERS WITHOUT CLAIM TO ANY PARTICULAR FONT, STYLE, SIZE, OR COLOR.

PRIORITY DATE OF 8-18-2010 IS CLAIMED.

OWNER OF INTERNATIONAL REGISTRATION 1065662 DATED 1-18-2011, EXPIRES 1-18-2021.

SER. NO. 79-092,754, FILED 1-18-2011.

MICHELE SWAIN, EXAMINING ATTORNEY



David J. Kybas

Director of the United States Patent and Trademark Office

United States of America

United States Patent and Trademark Office

ULTRAGLIDE

Reg. No. 4,097,637

Registered Feb. 14, 2012

Int. Cls.: 9 and 11

TRADEMARK

PRINCIPAL REGISTER

CALOR (FRANCE SOCIÉTÉ PAR ACTIONS SIMPLIFIÉE)
PLACE AMBROISE COURTOIS
F-69008 LYON
FRANCE

FOR: ELECTRIC FLAT IRONS FOR LAUNDRY AND COMPONENT PARTS FOR ELECTRIC FLAT IRONS FOR LAUNDRY, IN CLASS 9 (U.S. CLS. 21, 23, 26, 36 AND 38).

FOR: STEAM GENERATORS FOR HOUSEHOLD USE; CLOTHES DRYERS; ELECTRIC RADIATORS FOR HOUSEHOLD USE; ELECTRIC FANS FOR HOUSEHOLD USE; AIR PURIFIERS USING IONIZATION TECHNOLOGY FOR HOUSEHOLD USE; ELECTRIC ROOM DEODORIZING UNITS; AIR CONDITIONERS; HUMIDIFIERS AND DEHUMIDIFIERS FOR HOUSEHOLD USE, IN CLASS 11 (U.S. CLS. 13, 21, 23, 31 AND 34).

THE MARK CONSISTS OF STANDARD CHARACTERS WITHOUT CLAIM TO ANY PARTICULAR FONT, STYLE, SIZE, OR COLOR.

PRIORITY DATE OF 7-29-2010 IS CLAIMED.

OWNER OF INTERNATIONAL REGISTRATION 1065692 DATED 12-20-2010, EXPIRES 12-20-2020.

OWNER OF U.S. REG. NO. 2,272,165.

SER. NO. 79-092,773, FILED 12-20-2010.

DAWN FELDMAN, EXAMINING ATTORNEY



David J. Kybas

Director of the United States Patent and Trademark Office

United States of America

United States Patent and Trademark Office

GO-LESS

Reg. No. 4,097,638

Registered Feb. 14, 2012

Int. Cls.: 5 and 29

TRADEMARK

PRINCIPAL REGISTER

FRUTAROM NETHERLANDS B.V. (NETHERLANDS BESLOTEN VENNOOTSCHAP (B.V.))
LANDJUWEEL 5
NL-3905 PE VEENENDAAL
NETHERLANDS

FOR: FOOD SUPPLEMENTS FOR MEDICAL PURPOSES; FOOD FOR MEDICALLY RESTRICTED DIETS, NAMELY, VEGETABLE EXTRACTS AND FOOD PRODUCTS MADE FROM VEGETABLE EXTRACTS FOR MEDICAL PURPOSES; VEGETABLE EXTRACTS AND PRODUCTS MADE FROM VEGETABLE EXTRACTS IN THE NATURE OF FOOD SUPPLEMENTS FOR MEDICAL PURPOSES, IN CLASS 5 (U.S. CLS. 6, 18, 44, 46, 51 AND 52).

FOR: FOOD SUPPLEMENTS OF VEGETABLE OR ANIMAL ORIGIN, NAMELY, EXTRACTS OF VEGETABLES AND ESSENCES OF VEGETABLES, VEGETABLE-BASED MEAT SUBSTITUTES, LIPIDS AND PROTEIN FOR USE AS A FOOD ADDITIVE, NOT FOR MEDICAL USE, IN CLASS 29 (U.S. CL. 46).

THE MARK CONSISTS OF STANDARD CHARACTERS WITHOUT CLAIM TO ANY PARTICULAR FONT, STYLE, SIZE, OR COLOR.

PRIORITY DATE OF 7-19-2010 IS CLAIMED.

OWNER OF INTERNATIONAL REGISTRATION 1065748 DATED 1-7-2011, EXPIRES 1-7-2021.

SER. NO. 79-092,792, FILED 1-7-2011.

NICHOLAS COLEMAN, EXAMINING ATTORNEY



David J. Kyfos

Director of the United States Patent and Trademark Office

United States of America

United States Patent and Trademark Office

FREEDOM TO MOVE

Reg. No. 4,097,639

Registered Feb. 14, 2012

Int. Cls.: 9, 38 and 39

TRADEMARK

SERVICE MARK

PRINCIPAL REGISTER

TOMTOM INTERNATIONAL B.V. (NETHERLANDS BESLOTEN VENNOOTSCHAP)
REMBRANDTPLEIN 35
NL-1017 CT AMSTERDAM
NETHERLANDS

FOR: COMPUTER HARDWARE AND SOFTWARE FOR USE WITH SATELLITE AND GPS NAVIGATION SYSTEMS FOR NAVIGATION PURPOSES; COMPUTER SOFTWARE FOR USE WITH ROUTE PLANNERS, ELECTRONIC MAPS AND DIGITAL DICTIONARIES FOR NAVIGATION AND TRANSLATION PURPOSES; SOFTWARE FOR TRAVEL INFORMATION SYSTEMS FOR PROVIDING OR DISPLAYING TRAVEL ADVICE AND INFORMATION ON PETROL STATIONS, CAR PARKS, RESTAURANTS, CAR DEALERS AND OTHER TRAVEL AND TRANSPORT RELATED INFORMATION; SOFTWARE FOR INFORMATION MANAGEMENT FOR THE TRANSPORT AND TRAFFIC SECTOR; SOFTWARE FOR VIEWING ELECTRONIC MAPS; DOWNLOADABLE ELECTRONIC MAPS; SOFTWARE FOR OPERATING ROUTE PLANNERS; ROUTE PLANNERS IN THE FORM OF HAND-HELD PERSONAL COMPUTERS; SOFTWARE FOR OPERATING ELECTRONIC DIGITAL DICTIONARIES; DOWNLOADABLE ELECTRONIC DICTIONARIES; LOCATION, ORIENTATION AND NAVIGATION, AND GLOBAL POSITIONING SYSTEMS (GPS) CONSISTING OF COMPUTERS, COMPUTER SOFTWARE, TRANSMITTERS, GLOBAL POSITIONING SYSTEM RECEIVERS (GPS) AND SATELLITE RECEIVERS, NETWORK LINK FOR INTERFACE SYSTEMS, PATCH CABLES, AND PARTS AND ACCESSORIES THEREFOR; HOLDERS SPECIFICALLY DESIGNED FOR HAND-HELD COMPUTERS; SATELLITE AND RADIO TRANSMITTER AND RECEIVER APPARATUS TECHNOLOGY, NAMELY, PROCESSORS, MOBILE TELEPHONES AND RECEIVERS; TELECOMMUNICATIONS INSTALLATIONS, NETWORKS AND APPARATUS, NAMELY, MOUNTING RACKS ESPECIALLY FITTED FOR TELECOMMUNICATIONS HARDWARE AND TELECOMMUNICATION SWITCHES; COMPUTER TERMINALS, ALL IN PARTICULAR FOR THE USE OF NAVIGATION SYSTEMS, ROUTE PLANNERS, AND DIGITAL MAPS; EMPTY MAGNETIC DATA CARRIERS AND DATA RECORDING DISCS; SOUND AND IMAGE APPARATUS, NAMELY, DOWNLOADABLE MAPS; SOUND AND IMAGE APPARATUS, NAMELY, SOUND AND IMAGE RECEIVERS AND PROCESSORS; HAND-HELD PERSONAL COMPUTERS; PERSONAL DIGITAL ASSISTANTS (PDAS); PRE-RECORDED FLASH-MEMORY CARDS, HARD-DRIVES AND SD-CARDS FEATURING ELECTRONIC MAPS AND DIGITAL DICTIONARIES FOR NAVIGATION AND TRANSLATION PURPOSES, IN CLASS 9 (U.S. CLS. 21, 23, 26, 36 AND 38).



David J. Kyjars

Director of the United States Patent and Trademark Office

Reg. No. 4,097,639 FOR: SECURE AND NON-SECURE TELECOMMUNICATIONS SERVICES, NAMELY, TRANSMISSION AND DELIVERY OF DIGITAL DATA, PHOTOGRAPHS, AUDIO FILES, DATA, INFORMATION AND IMAGE SIGNALS BY MEANS OF COMPUTERS, CABLE RADIO AND SATELLITE TRANSFER, ALL IN PARTICULAR FOR NAVIGATION SYSTEMS, ROUTE PLANNERS AND THE USE OF ELECTRONIC MAPS; SECURE OR NON-SECURE TELECOMMUNICATIONS SERVICES, NAMELY, TRANSMISSION AND DELIVERY OF DIGITAL DATA, PHOTOGRAPHS, AUDIO FILES, DATA, INFORMATION AND IMAGE SIGNALS FROM AND TO ELECTRONIC STORAGE SITES, ALL IN PARTICULAR FOR NAVIGATION SYSTEMS, ROUTE PLANNERS AND THE USE OF ELECTRONIC MAPS; WIRELESS TRANSFER OF DATA, IN THE FORM OF TELETEXT, THE INTERNET, DIGITAL MOBILE TELEPHONY (GSM) AND WIRELESS APPLICATION PROTOCOLS (WAP); WIRELESS TRANSMISSION OF DIGITAL DATA; ELECTRONIC TRANSMISSION OF DATA AND DOCUMENTS VIA COMPUTER TERMINALS; RENTAL OF TELECOMMUNICATIONS EQUIPMENT AND APPARATUS; TELECOMMUNICATION SERVICES, NAMELY, PROVIDING OF TEMPORARY ACCESS TO NON-DOWNLOADABLE SOFTWARE PROVIDING MAP IMAGES AND GEOGRAPHICAL AND ITINERARY INFORMATION OBTAINED WITH THE AID OF A GLOBAL POSITIONING SYSTEM (GPS) TO ENABLE OTHERS TO DETERMINE LOCATIONS OR DIRECTIONS ACCURATELY; TECHNICAL CONSULTANCY IN CONNECTION WITH THE ABOVE SERVICES CLAIMED, IN CLASS 38 (U.S. CLS. 100, 101 AND 104).

FOR: PROVIDING OF NAVIGATION AND INFORMATION SERVICES, NAMELY, INFORMATION RELATING TO TRAFFIC AND TRAFFIC JAMS; PROVISION OF INFORMATION RELATING TO TRAVEL; PROVIDING OF INFORMATION TO TRAVELLERS REGARDING FARES, TIMETABLES AND PUBLIC TRANSPORT; TRAVEL AGENCY SERVICES, NAMELY, BOOKING THE RENTAL OF CARS, BOATS AND OTHER VEHICLES; ALL THE AFORESAID SERVICES ALSO PROVIDED VIA A COMMUNICATIONS NETWORK OR A CELLULAR TELEPHONE OR WIRELESS NAVIGATION SYSTEM, IN CLASS 39 (U.S. CLS. 100 AND 105).

THE MARK CONSISTS OF STANDARD CHARACTERS WITHOUT CLAIM TO ANY PARTICULAR FONT, STYLE, SIZE, OR COLOR.

PRIORITY DATE OF 7-8-2010 IS CLAIMED.

OWNER OF INTERNATIONAL REGISTRATION 1066080 DATED 12-27-2010, EXPIRES 12-27-2020.

OWNER OF U.S. REG. NOS. 3,116,868, 3,145,105 AND OTHERS.

SER. NO. 79-092,921, FILED 12-27-2010.

KRISTIN DAHLING, EXAMINING ATTORNEY

United States of America

United States Patent and Trademark Office

BOOKAPP

Reg. No. 4,097,640

Registered Feb. 14, 2012

Int. Cls.: 9 and 41

TRADEMARK

SERVICE MARK

PRINCIPAL REGISTER

OZWE SÀRL (SWITZERLAND SOCIÉTÉ À RESPONSABILITÉ LIMITÉE)
PSE-C
LAUSANNE, SWITZERLAND CH1015

FOR: DOWNLOADABLE ELECTRONIC PUBLICATIONS IN THE NATURE OF DICTIONARIES AND GENERAL INTEREST NEWSPAPERS, MAGAZINES, NEWSLETTERS, BOOKS, BROCHURES, PAMPHLETS, MANUALS, JOURNALS AND GUIDES ON A VARIETY OF SUBJECTS, IN CLASS 9 (U.S. CLS. 21, 23, 26, 36 AND 38).

FOR: WRITING OF TEXTS OTHER THAN PUBLICITY TEXTS, PUBLICATION OF TEXTS OTHER THAN PUBLICITY TEXTS, IN CLASS 41 (U.S. CLS. 100, 101 AND 107).

THE MARK CONSISTS OF STANDARD CHARACTERS WITHOUT CLAIM TO ANY PARTICULAR FONT, STYLE, SIZE, OR COLOR.

PRIORITY DATE OF 7-29-2010 IS CLAIMED.

OWNER OF INTERNATIONAL REGISTRATION 1066184 DATED 12-16-2010, EXPIRES 12-16-2020.

SER. NO. 79-092,958, FILED 12-16-2010.

KRISTINA MORRIS, EXAMINING ATTORNEY



David J. Kyffers

Director of the United States Patent and Trademark Office

United States of America

United States Patent and Trademark Office

ACTIVERIDE

Reg. No. 4,097,641

Registered Feb. 14, 2012

Int. Cls.: 9 and 11

KONINKLIJKE PHILIPS ELECTRONICS N.V. (NETHERLANDS A PUBLIC LIMITED LIABILITY COMPANY)
GROENEWOUDSEWEG 1
NL-5621 BA EINDHOVEN
NETHERLANDS

TRADEMARK

PRINCIPAL REGISTER

FOR: ELECTRIC AND ELECTRONIC APPARATUS FOR OPERATING AND CONTROL OF LIGHTING SYSTEMS, NAMELY, LIGHT AND MOTION SENSORS; BALLASTS FOR LIGHTING PURPOSES; LIGHT EMITTING DIODES (LEDS), LASER DIODES AND ZENER DIODES; SOFTWARE FOR CONTROLLING LIGHTING SYSTEMS, IN CLASS 9 (U.S. CLS. 21, 23, 26, 36 AND 38).

FOR: ELECTRIC LAMPS, LIGHTING FIXTURES AND LIGHTING INSTALLATIONS, NAMELY, BICYCLE LIGHTS, VEHICLE LIGHTS AND CAR LAMPS; LIGHTING FIXTURES AND LIGHTING INSTALLATIONS FITTED WITH LED LIGHT SOURCES; PARTS OF THE AFORESAID GOODS, IN CLASS 11 (U.S. CLS. 13, 21, 23, 31 AND 34).

THE MARK CONSISTS OF STANDARD CHARACTERS WITHOUT CLAIM TO ANY PARTICULAR FONT, STYLE, SIZE, OR COLOR.

PRIORITY DATE OF 6-21-2010 IS CLAIMED.

OWNER OF INTERNATIONAL REGISTRATION 1066335 DATED 12-17-2010, EXPIRES 12-17-2020.

SER. NO. 79-093,002, FILED 12-17-2010.

JENNIFER VASQUEZ, EXAMINING ATTORNEY



David J. Kybas

Director of the United States Patent and Trademark Office

United States of America

United States Patent and Trademark Office

TYCOONNAIRE

Reg. No. 4,097,642

Registered Feb. 14, 2012

**Int. Cls.: 5, 18, 29, 30, 42
and 44**

TRADEMARK

SERVICE MARK

PRINCIPAL REGISTER

TYCOONNAIRE HOLDING SA (LUXEMBOURG SA)
AVENUE JP PESCATORE
L-2324 LUXEMBOURG
LUXEMBOURG

FOR: DIETARY AND NUTRITIONAL SUPPLEMENTS; VITAMIN AND MINERAL SUPPLEMENTS, IN CLASS 5 (U.S. CLS. 6, 18, 44, 46, 51 AND 52).

FOR: LEATHER AND IMITATIONS OF LEATHER, AND GOODS MADE OF THESE MATERIALS AND NOT INCLUDED IN OTHER CLASSES, NAMELY, BAGS, BACKPACKS, CASES, PURSES; ANIMAL SKINS; TRUNKS AND TRAVELING BAGS; UMBRELLAS, PARASOLS AND WALKING STICKS; WHIPS, HARNESS AND SADDLERY, IN CLASS 18 (U.S. CLS. 1, 2, 3, 22 AND 41).

FOR: MEAT, FISH, POULTRY AND GAME; MEAT EXTRACTS; PRESERVED, FROZEN, DRIED AND COOKED FRUITS AND VEGETABLES; JELLIES, JAMS, COMPOTES; EGGS, MILK AND MILK PRODUCTS EXCLUDING ICE CREAM, ICE MILK AND FROZEN YOGURT; EDIBLE OILS AND FATS, IN CLASS 29 (U.S. CL. 46).

FOR: COFFEE, TEA, COCOA, SUGAR, RICE, TAPIOCA, SAGO, ARTIFICIAL COFFEE; FLOUR AND PREPARATIONS MADE FROM CEREALS, NAMELY, BREAKFAST CEREAL, BREAD, PASTRY AND CONFECTIONERY, NAMELY, PASTILLES, FRUIT ICES; HONEY, TREACLE; YEAST, BAKING-POWDER; SALT, MUSTARD; VINEGAR, SAUCES; CONDIMENTS, NAMELY, PEPPER SAUCE; SPICES; ICE FOR REFRESHMENT, IN CLASS 30 (U.S. CL. 46).

FOR: SCIENTIFIC AND TECHNOLOGICAL SERVICES, NAMELY, SCIENTIFIC RESEARCH, ANALYSIS, TESTING IN THE FIELD OF SPORTS, CAR, MOTORBIKE AND RACING COMPETITIONS; SCIENTIFIC AND TECHNOLOGICAL SERVICES, NAMELY, RESEARCH AND DESIGN IN THE FIELD OF SPORTS, CAR, MOTORBIKE AND RACING COMPETITIONS; INDUSTRIAL ANALYSIS AND RESEARCH SERVICES, NAMELY, CHEMICAL ANALYSIS, ELECTRIC METER READING AND DATA ANALYSIS IN THE FIELD OF SPORTS, CAR, MOTORBIKE AND RACING COMPETITIONS; DESIGN AND DEVELOPMENT OF COMPUTERS AND SOFTWARE, IN CLASS 42 (U.S. CLS. 100 AND 101).

FOR: MEDICAL SERVICES; VETERINARY SERVICES; HYGIENIC AND BEAUTY CARE FOR HUMAN BEINGS OR ANIMALS; AGRICULTURAL ADVICE; AGRICULTURAL SER-



David J. Kyjars

Director of the United States Patent and Trademark Office

Reg. No. 4,097,642 VICES, NAMELY, COMPOST SPREADING; PROVIDING INFORMATION IN THE FIELD OF VINEYARD HORTICULTURE, IN CLASS 44 (U.S. CLS. 100 AND 101).

THE MARK CONSISTS OF STANDARD CHARACTERS WITHOUT CLAIM TO ANY PARTICULAR FONT, STYLE, SIZE, OR COLOR.

PRIORITY DATE OF 10-7-2010 IS CLAIMED.

OWNER OF INTERNATIONAL REGISTRATION 1066515 DATED 11-29-2010, EXPIRES 11-29-2020.

SER. NO. 79-093,051, FILED 11-29-2010.

LAKEISHA LEWIS, EXAMINING ATTORNEY

United States of America

United States Patent and Trademark Office

Blue.maxx

Reg. No. 4,097,643

Registered Feb. 14, 2012

Int. Cls.: 7 and 12

TRADEMARK

PRINCIPAL REGISTER

HENGST GMBH & CO. KG (FED REP GERMANY KOMMANDITGESELLSCHAFT)
NIENKAMP 55-85
48147 MÜNSTER
FED REP GERMANY

FOR: ENGINES NOT FOR LAND VEHICLES AND PARTS THEREFOR, NAMELY, OIL-WATER SEPARATORS AND FUEL FILTERS AND PARTS THEREFOR, NAMELY, FILTER ELEMENTS, IN CLASS 7 (U.S. CLS. 13, 19, 21, 23, 31, 34 AND 35).

FOR: MOTORS AND ENGINES FOR LAND VEHICLES; APPARATUS FOR LOCOMOTION BY LAND, AIR OR WATER AND PARTS THEREFOR, NAMELY, OIL-WATER SEPARATORS AND FUEL FILTERS AND PARTS THEREFOR, NAMELY, FILTER ELEMENTS, IN CLASS 12 (U.S. CLS. 19, 21, 23, 31, 35 AND 44).

THE MARK CONSISTS OF STANDARD CHARACTERS WITHOUT CLAIM TO ANY PARTICULAR FONT, STYLE, SIZE, OR COLOR.

PRIORITY DATE OF 4-15-2010 IS CLAIMED.

OWNER OF INTERNATIONAL REGISTRATION 1067754 DATED 10-14-2010, EXPIRES 10-14-2020.

SER. NO. 79-093,803, FILED 10-14-2010.

MICHAEL ENGEL, EXAMINING ATTORNEY



David J. Kybas

Director of the United States Patent and Trademark Office

United States of America

United States Patent and Trademark Office



Reg. No. 4,097,644

Registered Feb. 14, 2012

Int. Cl.: 29

CASEIFICIO DELL'ALTA LANGA S.R.L. (ITALY LIMITED LIABILITY COMPANY)
CORSO VITTORIO EMANUELE II, 92
I-10121 TORINO
ITALY

FOR: MILK, CHEESE, CREAM, YOGURT, IN CLASS 29 (U.S. CL. 46).

TRADEMARK

THE MARK CONSISTS OF A DEPICTION OF ROLLING HILLS IN SHADES OF BROWN, GREEN, AND BLACK.

PRINCIPAL REGISTER

OWNER OF INTERNATIONAL REGISTRATION 1067809 DATED 12-30-2010, EXPIRES 12-30-2020.

THE COLOR(S) GREEN, BROWN AND BLACK IS/ARE CLAIMED AS A FEATURE OF THE MARK.

SER. NO. 79-093,830, FILED 12-30-2010.

HELENE LIWINSKI, EXAMINING ATTORNEY



David J. Kybas

Director of the United States Patent and Trademark Office

United States of America

United States Patent and Trademark Office

SEPALENT

Reg. No. 4,097,645

Registered Feb. 14, 2012

Int. Cls.: 9 and 17

TRADEMARK

PRINCIPAL REGISTER

MITSUBISHI PLASTICS, INC. (JAPAN CORPORATION)
2-2, NIHONBASHIHONGOKUCHO 1-CHOME
CHUO-KU; TOKYO 103-0021
JAPAN

FOR: LITHIUM ION BATTERIES; LITHIUM ION RECHARGEABLE BATTERIES; BATTERIES; DRY AND ELECTRICAL CELLS AND THEIR PARTS; TELECOMMUNICATION DEVICES AND APPARATUS, NAMELY, TELEPHONES, CELL PHONES AND ELECTRIC CAPACITORS, AND THEIR PARTS USING ELECTRICITY FROM LITHIUM ION BATTERIES; ELECTRONIC MACHINES AND APPARATUS, NAMELY, DIGITAL CAMERAS, DVD PLAYERS, STAND ALONE DISPLAYS FOR MEDICAL IMAGES, PLASMA DISPLAY PANELS, ELECTRONIC DISPLAY BOARDS AND PLASMA DISPLAY BOARDS, AND THEIR PARTS USING ELECTRICITY FROM LITHIUM ION BATTERIES, IN CLASS 9 (U.S. CLS. 21, 23, 26, 36 AND 38).

FOR: ELECTRICAL INSULATORS, NAMELY, ELECTRIC, THERMAL AND ACOUSTIC INSULATORS, AND ELECTRICAL CERAMIC INSULATORS; ELECTRICAL INSULATING TAPES; ELECTRICAL INSULATING RUBBER PRODUCTS; PLASTIC FILM FOR USE IN THE MANUFACTURE OF LITHIUM ION BATTERIES; PLASTIC SHEETS FOR USE IN THE MANUFACTURE OF LITHIUM ION BATTERIES; PLASTIC FILM FOR USE IN THE MANUFACTURE OF BATTERY SEPARATORS; PLASTIC SHEETS FOR USE IN THE MANUFACTURE OF BATTERY SEPARATORS; SEMI-WORKED SYNTHETIC PLASTIC AND SYNTHETIC RESINS AS SEMI-FINISHED PRODUCTS IN FORM OF PELLETS, RODS, FOILS, FOAMS, FIBERS, FILMS AND SHEETS, IN CLASS 17 (U.S. CLS. 1, 5, 12, 13, 35 AND 50).

THE MARK CONSISTS OF STANDARD CHARACTERS WITHOUT CLAIM TO ANY PARTICULAR FONT, STYLE, SIZE, OR COLOR.

PRIORITY DATE OF 1-7-2011 IS CLAIMED.

OWNER OF INTERNATIONAL REGISTRATION 1067942 DATED 1-14-2011, EXPIRES 1-14-2021.

SER. NO. 79-093,871, FILED 1-14-2011.

BARBARA BROWN, EXAMINING ATTORNEY



David J. Kyffers

Director of the United States Patent and Trademark Office

United States of America

United States Patent and Trademark Office

BENUTA

Reg. No. 4,097,646

Registered Feb. 14, 2012

Int. Cl.: 30

TRADEMARK

PRINCIPAL REGISTER

BETA GIDA SANAYI VE TICARET ANONIM SIRKETI (TURKEY JOINT STOCK COMPANY)
CEMALPASA MAHALLESİ
FUZULI CADDESİ, 14. SOKAK GÜLSA APARTMANI. NO:5/A; ADANA
TURKEY

FOR: COFFEE, COCOA, ARTIFICIAL COFFEE, VEGETAL PREPARATIONS FOR USE AS
COFFEE SUBSTITUTES, COCOA-BASED BEVERAGES, COFFEE-BASED BEVERAGES;
TAPIOCA, SAGO; TEA, ICED TEA; GRANULATED SUGAR, CUBE SUGAR, POWDERED
SUGAR; CHOCOLATE FOR CONFECTIONERY, CHOCOLATE, CANDIES, IN CLASS 30
(U.S. CL. 46).

THE MARK CONSISTS OF THE STYLIZED WORDING "BENUTA" WITH THE OUTER
PARTS OF THE WORDING "BENUTA" IN THE COLOR YELLOW AND THE INNER PARTS
OF THE LETTERS IN THE COLORS RED, BROWN AND GOLDEN.

OWNER OF INTERNATIONAL REGISTRATION 1068003 DATED 12-1-2010, EXPIRES 12-
1-2020.

THE COLOR(S) YELLOW, RED, BROWN AND GOLDEN IS/ARE CLAIMED AS A FEATURE
OF THE MARK.

THE WORDING "BENUTA" HAS NO MEANING IN A FOREIGN LANGUAGE.

SER. NO. 79-093,887, FILED 12-1-2010.

ROBERT STRUCK, EXAMINING ATTORNEY



David J. Kyffers

Director of the United States Patent and Trademark Office

United States of America

United States Patent and Trademark Office



Reg. No. 4,097,647

Registered Feb. 14, 2012

Int. Cl.: 36

RAIFFEISEN ZENTRALBANK ÖSTERREICH AKTIENGESELLSCHAFT (AUSTRIA PUBLIC LIMITED COMPANY)
AM STADTPARK 9
A-1030 WIEN
AUSTRIA

SERVICE MARK

PRINCIPAL REGISTER

FOR: FINANCIAL AFFAIRS AND MONETARY AFFAIRS, NAMELY, BANKING SERVICES AND FINANCIAL SERVICES COMPRISING DEPOSIT-TAKING, UNSECURED AND SECURED LENDING FOR INDUSTRIAL, COMMERCIAL AND REAL ESTATE PROJECTS, CASH MANAGEMENT SERVICES, INVESTMENT BANKING AND TRADE FINANCING FOR IMPORTS AND EXPORTS AND DOMESTIC TRANSACTIONS, IN CLASS 36 (U.S. CLS. 100, 101 AND 102).

OWNER OF U.S. REG. NOS. 2,092,810 AND 3,011,554.

PRIORITY DATE OF 7-8-2010 IS CLAIMED.

OWNER OF INTERNATIONAL REGISTRATION 1068214 DATED 12-3-2010, EXPIRES 12-3-2020.

THE COLOR(S) BLACK AND YELLOW IS/ARE CLAIMED AS A FEATURE OF THE MARK.

NO CLAIM IS MADE TO THE EXCLUSIVE RIGHT TO USE "BANK INTERNATIONAL", APART FROM THE MARK AS SHOWN.

THE MARK CONSISTS OF THE LITERAL ELEMENTS "RAIFFEISEN BANK INTERNATIONAL" IN BLACK WITH THE DESIGN OF A SQUARE OUTLINED IN BLACK TO THE LEFT; INSIDE THE SQUARE IS A STYLIZED GABLE CROSS IN THE FORM OF TWO HORSE-HEADS IN BLACK; THE BACKGROUND OF THE SQUARE IS IN YELLOW.

SER. NO. 79-093,992, FILED 12-3-2010.

CHRISIE B. KING, EXAMINING ATTORNEY



David J. Kyffers

Director of the United States Patent and Trademark Office

United States of America

United States Patent and Trademark Office

GAMEKEEPER

Reg. No. 4,097,648

Registered Feb. 14, 2012

Int. Cl.: 29

TRADEMARK

PRINCIPAL REGISTER

CROPWELL BISHOP CREAMERY LIMITED (UNITED KINGDOM LIMITED COMPANY)
NOTTINGHAM ROAD,
CROPWELL BISHOP; NOTTINGHAM NG12 3BQ
UNITED KINGDOM

FOR: CHEESE AND CHEESE FOOD; CHEESE SUBSTITUTES; DAIRY PRODUCTS EXCLUDING ICE CREAM, ICE MILK AND FROZEN YOGURT, IN CLASS 29 (U.S. CL. 46).

THE MARK CONSISTS OF STANDARD CHARACTERS WITHOUT CLAIM TO ANY PARTICULAR FONT, STYLE, SIZE, OR COLOR.

OWNER OF INTERNATIONAL REGISTRATION 1068265 DATED 12-10-2010, EXPIRES 12-10-2020.

SER. NO. 79-094,015, FILED 12-10-2010.

ROBERT STRUCK, EXAMINING ATTORNEY



David J. Kyffers

Director of the United States Patent and Trademark Office

United States of America

United States Patent and Trademark Office



Reg. No. 4,097,649

AMB I.T. B.V. (NETHERLANDS BESLOTEN VENNOOTSCHAP)
ZUIDERHOUTLAAN 4

Registered Feb. 14, 2012

NL-2012 PJ HAARLEM, NETHERLANDS

Int. Cls.: 9, 38, 41 and 42

FOR: COMPUTER HARDWARE AND SOFTWARE FOR TIMEKEEPING, IDENTIFICATION OF PARTICIPANTS IN RACES AND PRACTICE SESSIONS AND COMMUNICATION OF RACE AND PRACTICE STATISTICS DURING AND AFTER THE RACES AND PRACTICE SESSIONS FOR VARIOUS SPORTS, IN CLASS 9 (U.S. CLS. 21, 23, 26, 36 AND 38).

TRADEMARK

SERVICE MARK

FOR: PROVIDING ACCESS TO COMPUTER DATABASES RELATING TO ALL TYPES OF SPORT, IN CLASS 38 (U.S. CLS. 100, 101 AND 104).

PRINCIPAL REGISTER

FOR: TIME REGISTRATION OF PARTICIPANTS IN VARIOUS SPORT EVENTS, NAMELY TIMEKEEPING OF PARTICIPANTS IN SPORTING COMPETITIONS AND PRACTICE SESSIONS; PROVIDING SPORTS STATISTICS AND RELATED CONSULTANCY TO PARTICIPANTS IN RACES AND PRACTICE SESSIONS WITH RESPECT TO THE TIMEKEEPING OF RACE RESULTS AND RESULTS OF PRACTICE SESSIONS, WITH RESPECT TO THEIR IDENTIFICATION DURING RACES AND PRACTICE SESSIONS, AND TO ENABLE COMMUNICATION BETWEEN PARTICIPANTS AND RACE OFFICIALS IN VARIOUS SPORTS, IN CLASS 41 (U.S. CLS. 100, 101 AND 107).

FOR: UPDATING OF SOFTWARE USED IN REGISTRATION, IDENTIFICATION, TIMEKEEPING AND COMMUNICATION IN VARIOUS SPORTS, IN CLASS 42 (U.S. CLS. 100 AND 101).



THE MARK CONSISTS OF STYLIZED LETTER "Y".

PRIORITY DATE OF 4-26-2010 IS CLAIMED.

OWNER OF INTERNATIONAL REGISTRATION 1068413 DATED 10-26-2010, EXPIRES 10-26-2020.

SER. NO. 79-094,073, FILED 10-26-2010.

BARNEY CHARLON, EXAMINING ATTORNEY

David J. Kypos

Director of the United States Patent and Trademark Office

United States of America
United States Patent and Trademark Office

HELIOS

Reg. No. 4,097,650

Registered Feb. 14, 2012

Int. Cl.: 29

TRADEMARK

PRINCIPAL REGISTER

DULCES Y CONSERVAS HELIOS, S.A. (SPAIN SOCIEDAD ANÓNIMA)
CTRA. BURGOS-PORTUGAL, KM. 129
E-47009 VALLADOLID
SPAIN

FOR: OLIVES; CANNED FISH; CODFISH; PREPARED BROTHS; MEATS IN LIQUID FORM; CAVIAR; CANNED FRUIT; CANNED VEGETABLES; BOTTLED FRUIT; BOTTLED VEGETABLE; LEGUMES; PRESERVED VEGETABLES AND MEATS; CHORIZO SAUSAGE; SAUSAGE; FOIE GRAS; JELLIES; DRIED FRUIT; SOUP EXTRACT CUBES; SALTED FISH; JAM; MARMALADE; SUGAR-FREE JAM; SUGAR-FREE MARMALADE; PICKLES; PROCESSED MUSHROOMS, IN CLASS 29 (U.S. CL. 46).

THE MARK CONSISTS OF STANDARD CHARACTERS WITHOUT CLAIM TO ANY PARTICULAR FONT, STYLE, SIZE, OR COLOR.

OWNER OF INTERNATIONAL REGISTRATION 1068423 DATED 12-30-2010, EXPIRES 12-30-2020.

OWNER OF U.S. REG. NO. 3,468,393.

SER. NO. 79-094,076, FILED 12-30-2010.

LEIGH CAROLINE CASE, EXAMINING ATTORNEY



David J. Kyfos

Director of the United States Patent and Trademark Office

United States of America

United States Patent and Trademark Office



Reg. No. 4,097,651

Registered Feb. 14, 2012

Int. Cls.: 32 and 33

TRADEMARK

PRINCIPAL REGISTER

ALESSANDRO BERTUZZI (ITALY INDIVIDUAL)
VIA BORGO SPUVIGLIA, 36
I-40026 IMOLA (BO), ITALY

FOR: BEERS; MINERAL AND AERATED WATERS AND OTHER NON-ALCOHOLIC DRINKS, NAMELY, ISOTONIC DRINKS; FRUIT DRINKS AND FRUIT JUICES; SYRUPS AND OTHER PREPARATIONS FOR MAKING BEVERAGES, NAMELY, FRUIT DRINKS, IN CLASS 32 (U.S. CLS. 45, 46 AND 48).

FOR: ALCOHOLIC BEVERAGES (EXCEPT BEERS), IN CLASS 33 (U.S. CLS. 47 AND 49).

THE MARK CONSISTS OF THE STYLIZED REPRODUCTION OF A SHIELD INSIDE WHICH THE LETTERS "KN" ARE PLACED; UNDER SAID LETTERS THERE IS THE STYLIZED WRITING "KRISINERA", REPRODUCED IN SMALLER CHARACTERS; THE LOWER POINT OF THE SHIELD IS CHARACTERIZED BY THREE BANDS; THE MARK MAY BE REPRODUCED IN EVERY COLOR AND IN EVERY COMBINATIONS OF COLOR.

PRIORITY DATE OF 7-21-2010 IS CLAIMED.

OWNER OF INTERNATIONAL REGISTRATION 1068558 DATED 1-21-2011, EXPIRES 1-21-2021.

THE WORD "KRISINERA" IN THE MARK HAS NO MEANING IN A FOREIGN LANGUAGE.

SER. NO. 79-094,112, FILED 1-21-2011.

JOHN WILKE, EXAMINING ATTORNEY



David J. Kybas

Director of the United States Patent and Trademark Office

United States of America

United States Patent and Trademark Office

TU 2011 VIE

Reg. No. 4,097,652

Registered Feb. 14, 2012

Int. Cls.: 35 and 42

SERVICE MARK

PRINCIPAL REGISTER

SBI MANAGEMENT GMBH (AUSTRIA PRIVATE LIMITED COMPANY)
RENNGASSE 17
A-1010 VIENNA
AUSTRIA

FOR: ADVERTISING; BUSINESS MANAGEMENT; BUSINESS ADMINISTRATION; OFFICE FUNCTIONS; PUBLIC RELATIONS; ADVERTISEMENT SERVICES BY TELEVISION AND RADIO; PUBLICATION OF PUBLICITY TEXTS; CONSULTANCY REGARDING ADVERTISING STRATEGIES FOR THE USE OF MEDIA FOR ADVERTISING PURPOSES; ADVERTISEMENT SERVICES BY MAIL FOR CUSTOMER ACQUISITION PURPOSES; MARKETING RESEARCH; ADVERTISING AGENCY SERVICES, NAMELY, ONLINE ADVERTISING ON A COMPUTER NETWORK; ORGANIZING AND CONDUCTING OF PROMOTIONS USING AUDIOVISUAL MEDIA; PERSONNEL RECRUITMENT; BILL-POSTING, NAMELY, BILL PRESENTMENT SERVICES; PLANNING OF ADVERTISING TACTICS; ADVERTISING SERVICES FOR OTHERS IN THE NATURE OF PRESENTATION OF BUSINESSES ON THE INTERNET AND OTHER MEDIA; PRESENTATION OF GOODS ON COMMUNICATION MEDIA FOR RETAIL PURPOSES, NAMELY, ONLINE RETAIL ORDERING SERVICES FEATURING CLOTHING, ELECTRONICS, JEWELRY AND BOOKS; PRODUCTION OF RADIO ADVERTISING; PROMOTING THE GOODS AND SERVICES OF OTHERS BY ARRANGING FOR BUSINESSES TO AFFILIATE THEIR GOODS AND SERVICES WITH THE GOODS AND SERVICES OF THIRD PARTIES BY MEANS OF SPONSORSHIP RELATIONSHIPS; ADVERTISEMENT SERVICES BY MAIL; DISTRIBUTION OF ADVERTISING MATERIAL; ADVERTISING BY THE DISTRIBUTION OF PROMOTIONAL MATERIALS; ONLINE ADVERTISING FOR OTHERS, IN CLASS 35 (U.S. CLS. 100, 101 AND 102).



FOR: SCIENTIFIC AND TECHNOLOGICAL RESEARCH SERVICES; DESIGN RELATED THERETO, NAMELY, DESIGN OF TEXTILES, INTERIOR DÉCOR AND COMPUTER NETWORKS; INDUSTRIAL CHEMICAL ANALYSIS AND SCIENTIFIC RESEARCH SERVICES; DESIGN AND DEVELOPMENT OF COMPUTER HARDWARE AND SOFTWARE, IN CLASS 42 (U.S. CLS. 100 AND 101).

THE MARK CONSISTS OF STANDARD CHARACTERS WITHOUT CLAIM TO ANY PARTICULAR FONT, STYLE, SIZE, OR COLOR.

David J. Kyjars

PRIORITY DATE OF 6-4-2010 IS CLAIMED.

Reg. No. 4,097,652 OWNER OF INTERNATIONAL REGISTRATION 1068792 DATED 11-30-2010, EXPIRES 11-30-2020.

NO CLAIM IS MADE TO THE EXCLUSIVE RIGHT TO USE "2011", APART FROM THE MARK AS SHOWN.

THE ENGLISH TRANSLATION OF "TU" IN THE MARK IS "YOU" AND THE ENGLISH TRANSLATION OF "VIE" IN THE MARK IS "LIFE".

SER. NO. 79-094,194, FILED 11-30-2010.

TRACY FLETCHER, EXAMINING ATTORNEY

United States of America

United States Patent and Trademark Office

SANYO

Reg. No. 4,097,653

Registered Feb. 14, 2012

Int. Cls.: 7, 9, 10 and 11

TRADEMARK

PRINCIPAL REGISTER

SANYO ELECTRIC CO., LTD. (JAPAN CORPORATION)
5-5, KEIHAN-HONDORI 2-CHOME
MORIGUCHI-SHI; OSAKA 570-8677
JAPAN

FOR: PACKAGING OR WRAPPING MACHINES AND APPARATUS; AUTOMATIC MACHINES AND APPARATUS FOR DISPENSING AND PACKING OF MEDICINES; POWDERED MEDICINE PACKING MACHINES AND APPARATUS; TABLET PACKING MACHINES AND APPARATUS; MACHINES AND APPARATUS FOR CLEANING CHEMICAL MACHINES AND APPARATUS, IN CLASS 7 (U.S. CLS. 13, 19, 21, 23, 31, 34 AND 35).

FOR: LABORATORY INCUBATORS; LABORATORY INCUBATORS WITH A BUILT-IN MICROSCOPE; CELL CULTURING CONTAINERS FOR LABORATORY USE, NAMELY, DISPOSABLE PLASTIC BIOREACTORS FOR CELL CULTURING; SHAKING MACHINES AND APPARATUS FOR LABORATORY USE; LED LIGHT SOURCE SYSTEMS COMPRISING LIGHT SENSORS AND SWITCHES FOR LABORATORY USE; GROWTH CHAMBERS FOR LABORATORY USE, NAMELY, PROGRAMMABLE ENVIRONMENTAL TESTING CHAMBERS THAT CONTROL TEMPERATURE, LIGHT, AND HUMIDITY FOR USE IN THE FIELD OF FOOD INSPECTION, WATER TREATMENT, MICROBIOLOGY, CHEMICAL TESTING; PLANT GROWTH CHAMBERS FOR LABORATORY USE, NAMELY, PROGRAMMABLE ENVIRONMENTAL TESTING CHAMBERS THAT CONTROL TEMPERATURE, LIGHT AND HUMIDITY; COMPUTER SOFTWARE FOR USE IN DATABASE MANAGEMENT; SOFTWARE FOR SUPPORTING PHARMACEUTICAL SERVICES FOR REGISTRATION AND MANAGEMENT OF PRESCRIPTION INFORMATION; SOFTWARE FOR MONITORING OF MEDICINE PRESCRIPTION; SOFTWARE FOR MONITORING OF MEDICINE DISPENSING; SOFTWARE FOR CONTROLLING AND MANAGING ELECTRONIC MEDICAL CHARTS, IN CLASS 9 (U.S. CLS. 21, 23, 26, 36 AND 38).

FOR: INCUBATORS FOR MEDICAL USE; SHAKING MACHINES AND APPARATUS FOR MEDICAL USE; ELECTRIC MASSAGE APPARATUS; MASSAGE CHAIRS, IN CLASS 10 (U.S. CLS. 26, 39 AND 44).

FOR: STEAMERS FOR CHEMICAL PROCESSING; DISTILLERS FOR CHEMICAL PROCESSING; HEAT EXCHANGERS; AIR-CONDITIONING APPARATUS AND INSTALLATIONS; FREEZING MACHINES AND APPARATUS; HEATING OR COOLING PACKS FILLED WITH CHEMICAL SUBSTANCES READY TO REACT WHEN REQUIRED TO WARM OR COOL THE BODY; APPARATUS FOR REFRIGERATION OF FOOD FOR INDUSTRIAL USE; ULTRA-



David J. Kyros

Director of the United States Patent and Trademark Office

Reg. No. 4,097,653 LOW TEMPERATURE FREEZERS NOT FOR LABORATORY NOR MEDICAL USE; STERILIZERS NOT FOR LABORATORY NOR MEDICAL USE; LED LIGHT SOURCE FIXTURES NOT FOR LABORATORY NOR MEDICAL USE; REFRIGERATORS; FREEZERS; FREEZERS FOR INDUSTRIAL USE; BLAST FREEZERS FOR INDUSTRIAL PURPOSES; BATHTUBS FOR NURSING CARE USE; AIR-PURIFIERS; ICE MAKING MACHINES AND APPARATUS; REFRIGERATING CABINETS FOR MEDICAL USE; REFRIGERATING APPARATUS FOR MEDICAL USE; REFRIGERATING APPARATUS FOR TRANSPORT/STORAGE OF BLOOD, PHARMACEUTICAL PREPARATIONS, VACCINES AND ORGANS; REFRIGERATING APPARATUS FOR STORAGE OF BLOOD FOR MEDICAL USE; REFRIGERATING APPARATUS FOR STORAGE OF MEDICINES FOR MEDICAL USE; REFRIGERATING SHOWCASES FOR STORAGE OF MEDICINES AND CHEMICALS; BIOMEDICAL FREEZERS FOR MEDICAL USE; ULTRA-LOW TEMPERATURE FREEZERS FOR MEDICAL USE; FREEZERS FOR MEDICAL USE; HIGH-PRESSURE STEAM STERILIZERS FOR MEDICAL USE; DRY-HEAT STERILIZERS FOR MEDICAL USE; REFRIGERATING CABINETS FOR LABORATORY USE; REFRIGERATING APPARATUS FOR LABORATORY USE; REFRIGERATING APPARATUS FOR STORAGE OF BLOOD FOR LABORATORY USE; REFRIGERATING APPARATUS FOR STORAGE OF MEDICINES AND CHEMICALS FOR LABORATORY USE; BIOMEDICAL FREEZERS FOR LABORATORY USE; ULTRA-LOW TEMPERATURE FREEZERS FOR LABORATORY USE; FREEZERS FOR LABORATORY USE; REFRIGERATING SHOWCASES FOR LABORATORY USE; REFRIGERATING SHOWCASES FOR STORAGE OF CHEMICALS; ICE MAKING MACHINES AND APPARATUS FOR LABORATORY USE; STERILIZERS FOR LABORATORY USE; HIGH-PRESSURE STEAM STERILIZERS FOR LABORATORY USE; DRY-HEAT STERILIZERS FOR LABORATORY USE, IN CLASS 11 (U.S. CLS. 13, 21, 23, 31 AND 34).

OWNER OF U.S. REG. NOS. 695,970, 1,188,379 AND OTHERS.

OWNER OF INTERNATIONAL REGISTRATION 1069000 DATED 9-10-2010, EXPIRES 9-10-2020.

THE MARK CONSISTS OF THE WORD "SANYO" IN STYLIZED TEXT. THE LETTER "N" HAS FIVE LINES ON EACH VERTICAL PART OF THE LETTER.

SER. NO. 79-094,304, FILED 9-10-2010.

SCOTT BIBB, EXAMINING ATTORNEY

United States of America

United States Patent and Trademark Office

E N E W E L L

Reg. No. 4,097,654

Registered Feb. 14, 2012

Int. Cls.: 7 and 9

TRADEMARK

PRINCIPAL REGISTER

KABUSHIKI KAISHA YASKAWA DENKI (JAPAN CORPORATION)
2-1, KUROSAKI-SHIROISHI
YAHATANISHI-KU.; KITAKYUSHU-SHI; FUKUOKA806-0004
JAPAN

FOR: NON-ELECTRIC PRIME MOVERS, NOT FOR LAND VEHICLES, NAMELY, ENGINES OTHER THAN FOR LAND VEHICLES, WATER MILLS AND WIND MILLS; PARTS FOR NON-ELECTRIC PRIME MOVERS FOR LAND VEHICLES, NAMELY, MECHANICAL ENGINE PARTS FOR LAND VEHICLES; WATER MILLS; WIND MILLS; PNEUMATIC OR HYDRAULIC MACHINES AND INSTRUMENTS, NAMELY, PUMPS, VACUUM PUMPS, BLOWERS, COMPRESSORS; STARTERS FOR MOTORS AND ENGINES; ELECTRIC AC MOTORS AND DC MOTORS OTHER THAN FOR LAND VEHICLES; ALTERNATORS; DC GENERATORS; HYDRAULIC POWER GENERATING UNIT; SOLAR-POWERED ELECTRICITY GENERATORS; WIND-POWERED ELECTRICITY GENERATORS, IN CLASS 7 (U.S. CLS. 13, 19, 21, 23, 31, 34 AND 35).

FOR: MEASURING OR TESTING DEVICES AND INSTRUMENTS, NAMELY, INSTRUMENTS FOR MEASURING LENGTH, DISTANCE MEASURING APPARATUS, BRAKE FLUID TESTERS, POSITION DETECTORS, ENCODERS, SPEED INDICATORS, ACCELEROMETERS, ANEMETERS, ANEMOSCEPES, WATER FLOW INDICATORS, WATER GAUGE METERS, PRESSURE GAUGE, TEMPERATURE INDICATORS, VOLTMETERS, AMMETERS, POWER MEASUREMENT APPARATUS; POWER DISTRIBUTION OR CONTROL DEVICES AND APPARATUS, NAMELY, ELECTRIC SWITCHES, CIRCUIT BREAKERS, POWER CONTROLLERS, MOTOR CONTROL APPARATUS, NAMELY, INVERTERS, CYCLOCONVERTERS, DRIVE CONTROL APPARATUS, NAMELY, PROGRAMMABLE LOGIC CONTROLLERS (PLC), SINGLE BOARD CONTROLLERS, POWER GENERATION CONTROL APPARATUS, NAMELY, INVERTERS WITH REGENERATION CONVERTERS, CYCLOCONVERTERS, POWER CONVERSION DEVICES, POWER CONVERTERS, POWER INVERTERS; ROTARY CONVERTERS; PHASE MODIFIERS; BATTERIES AND CELLS; ELECTRONIC MACHINES, APPARATUS AND THEIR PARTS, NAMELY, COMPUTER HARDWARE, CALCULATING MACHINES, ELECTRONIC CONTROL SYSTEMS FOR MACHINES, COMPUTER OPERATING PROGRAMS, COMPUTER PERIPHERAL DEVICES, CIRCUITS, INTERFACES FOR COMPUTERS, IN CLASS 9 (U.S. CLS. 21, 23, 26, 36 AND 38).



David J. Kyffers

THE MARK CONSISTS OF STANDARD CHARACTERS WITHOUT CLAIM TO ANY PARTICULAR FONT, STYLE, SIZE, OR COLOR.

Director of the United States Patent and Trademark Office

Reg. No. 4,097,654 PRIORITY DATE OF 10-8-2010 IS CLAIMED.

OWNER OF INTERNATIONAL REGISTRATION 1069001 DATED 1-21-2011, EXPIRES 1-21-2021.

SER. NO. 79-094,305, FILED 1-21-2011.

LINDA E. BLOHM, EXAMINING ATTORNEY

United States of America

United States Patent and Trademark Office

CIBAS

Reg. No. 4,097,655

Registered Feb. 14, 2012

Int. Cl.: 7

TRADEMARK

PRINCIPAL REGISTER

TANJUNG CITECH UK LIMITED (UNITED KINGDOM LIMITED LIABILITY COMPANY)
GROUND FLOOR, SALISBURY HOUSE
SAXON WAY, PRIORY PARK WEST; HESSLE, EAST YORKSHIRE HU13 9PB
UNITED KINGDOM

FOR: HEAT EXCHANGERS BEING PARTS OF MACHINES, INSTALLATIONS CONSISTING OF HEAT EXCHANGERS BEING PARTS OF MACHINES, AND HEAT EXCHANGERS BEING PARTS OF MACHINES AS COMPONENT PARTS OF A STEAM OPERATED POWER GENERATOR FOR RECOVERING HEAT GENERATED FROM PRODUCTION PROCESSES IN THE CHEMICAL, PETROCHEMICAL, METALLURGICAL OR GLASS INDUSTRIES OR FOR RECOVERING HEAT IN ELECTRIC POWER STATIONS; HIGH TEMPERATURE HEATERS BEING PARTS OF MACHINES, INSTALLATIONS CONSISTING OF THE HIGH TEMPERATURE HEATERS BEING PARTS OF MACHINES, AND HIGH TEMPERATURE HEATERS BEING PARTS OF MACHINES AS COMPONENT PARTS OF A STEAM OPERATED POWER GENERATOR USED FOR GASEOUS OR LIQUID SUBSTANCES OR FOR AIR, AND FOR METALLURGY MANUFACTURING OR GLASS PRODUCTION PROCESSES; RECUPERATORS BEING PARTS OF MACHINES, INSTALLATIONS CONSISTING OF RECUPERATORS BEING PARTS OF MACHINES, AND RECUPERATORS BEING PARTS OF MACHINES AS COMPONENT PARTS OF A STEAM OPERATED POWER GENERATOR FOR THE METALLURGY INDUSTRY, MELTING FURNACES FOR CHEMICAL, PETROCHEMICAL OR MINERAL WOOL PRODUCTION PROCESSES OR FOR FLUIDISED BED SLUDGE COMBUSTION FURNACES; HEAT EXCHANGERS BEING PARTS OF MACHINES, INSTALLATIONS CONSISTING OF HEAT EXCHANGERS BEING PARTS OF MACHINES, AND HEAT EXCHANGERS BEING PARTS OF MACHINES AS COMPONENT PARTS OF A STEAM OPERATED POWER GENERATOR FOR PREHEATING AIR OR FUEL; HEAT EXCHANGERS BEING PARTS OF MACHINES, INSTALLATIONS CONSISTING OF HEAT EXCHANGERS BEING PARTS OF MACHINES, AND HEAT EXCHANGERS BEING PARTS OF MACHINES AS COMPONENT PARTS OF A STEAM OPERATED POWER GENERATOR FOR RECOVERING HEAT LOST BY GAS TURBINES, GAS ENGINES OR DIESEL ENGINES; STEAM ENGINES; GENERATORS OF ELECTRICITY; GAS TURBINE ENGINES FOR ENERGY PRODUCTION NOT FOR LAND VEHICLES; DIESEL ENGINES AND GAS ENGINES FOR ENERGY PRODUCTION NOT FOR LAND VEHICLES, IN CLASS 7 (U.S. CLS. 13, 19, 21, 23, 31, 34 AND 35).



David J. Kyjars

THE MARK CONSISTS OF STANDARD CHARACTERS WITHOUT CLAIM TO ANY PARTICULAR FONT, STYLE, SIZE, OR COLOR.

Director of the United States Patent and Trademark Office

Reg. No. 4,097,655 OWNER OF INTERNATIONAL REGISTRATION 1069071 DATED 11-23-2010, EXPIRES 11-23-2020.

OWNER OF U.S. REG. NO. 3,710,550.

SER. NO. 79-094,334, FILED 11-23-2010.

KRISTINA MORRIS, EXAMINING ATTORNEY

United States of America

United States Patent and Trademark Office

PROA-MILL

Reg. No. 4,097,656

Registered Feb. 14, 2012

Int. Cl.: 7

TRADEMARK

PRINCIPAL REGISTER

KORLOY INC. (REPUBLIC OF KOREA CORPORATION)
953-1, DOKSAN-DONG
GEUMCHEON-GU; SEOUL
REPUBLIC OF KOREA

FOR: METALWORKING MACHINES; INDUSTRIAL MACHINE PRESSES; THREADING MACHINES; METALWORKING MACHINES, NAMELY, MACHINING CENTERS; DRILLING MACHINES; GRINDING MACHINES; ENGRAVING MACHINES; MACHINING TOOLS FOR CUTTING AWAY EXCESS MATERIAL FROM A PERIMETER OF A MACHINE PART; PNEUMATIC DRILLS; ELECTRICAL DRILLS; DRILLING BITS BEING PARTS OF MACHINES; DRILL CHUCKS BEING PARTS OF MACHINES; BITS BEING PARTS OF LATHES AND MILLING MACHINES; POWER-OPERATED SCREWDRIVERS FOR MACHINES; TAPS BEING PARTS OF MACHINES; LAPPING MACHINES FOR METALWORKING; MILLING CUTTERS FOR MILLING MACHINES, IN CLASS 7 (U.S. CLS. 13, 19, 21, 23, 31, 34 AND 35).

THE MARK CONSISTS OF STANDARD CHARACTERS WITHOUT CLAIM TO ANY PARTICULAR FONT, STYLE, SIZE, OR COLOR.

OWNER OF INTERNATIONAL REGISTRATION 1069168 DATED 12-10-2010, EXPIRES 12-10-2020.

SER. NO. 79-094,361, FILED 12-10-2010.

COLLEEN KEARNEY, EXAMINING ATTORNEY



David J. Kybas

Director of the United States Patent and Trademark Office

United States of America

United States Patent and Trademark Office

KOLOY

Reg. No. 4,097,657

Registered Feb. 14, 2012

Int. Cl.: 7

TRADEMARK

PRINCIPAL REGISTER

KORLOY INC. (REPUBLIC OF KOREA CORPORATION)
953-1, DOKSAN-DONG
GEUMCHEON-GU; SEOUL
REPUBLIC OF KOREA

FOR: METALWORKING MACHINES; INDUSTRIAL MACHINE PRESSES; THREADING MACHINES; METALWORKING MACHINES, NAMELY, MACHINING CENTERS; DRILLING MACHINES; GRINDING MACHINES; ENGRAVING MACHINES; MACHINING TOOLS FOR CUTTING AWAY EXCESS MATERIAL FROM A PERIMETER OF A MACHINE PART; PNEUMATIC DRILLS; ELECTRICAL DRILLS; DRILLING BITS BEING PARTS OF MACHINES; DRILL CHUCKS BEING PARTS OF MACHINES; BITS BEING PARTS OF LATHES AND MILLING MACHINES; POWER-OPERATED SCREWDRIVERS FOR MACHINES; TAPS BEING PARTS OF MACHINES; LAPPING MACHINES FOR METALWORKING; MILLING CUTTERS FOR MILLING MACHINES, IN CLASS 7 (U.S. CLS. 13, 19, 21, 23, 31, 34 AND 35).

THE MARK CONSISTS OF STANDARD CHARACTERS WITHOUT CLAIM TO ANY PARTICULAR FONT, STYLE, SIZE, OR COLOR.

OWNER OF INTERNATIONAL REGISTRATION 1069169 DATED 12-6-2010, EXPIRES 12-6-2020.

SER. NO. 79-094,362, FILED 12-6-2010.

COLLEEN KEARNEY, EXAMINING ATTORNEY



David J. Kyros

Director of the United States Patent and Trademark Office

United States of America

United States Patent and Trademark Office

HRMD

Reg. No. 4,097,658

Registered Feb. 14, 2012

Int. Cl.: 7

TRADEMARK

PRINCIPAL REGISTER

KORLOY INC. (REPUBLIC OF KOREA CORPORATION)
953-1, DOKSAN-DONG
GEUMCHEON-GU
SEOUL, REPUBLIC OF KOREA

FOR: METALWORKING MACHINES; INDUSTRIAL MACHINE PRESSES; THREADING MACHINES; METALWORKING MACHINES, NAMELY, MACHINING CENTERS; DRILLING MACHINES; GRINDING MACHINES; ENGRAVING MACHINES; MACHINING TOOLS FOR CUTTING AWAY EXCESS MATERIAL FROM A PERIMETER OF A MACHINE PART; PNEUMATIC DRILLS; ELECTRICAL DRILLS; DRILLING BITS BEING PARTS OF MACHINES; DRILL CHUCKS BEING PARTS OF MACHINES; BITS BEING PARTS OF LATHES AND MILLING MACHINES; POWER-OPERATED SCREWDRIVERS FOR MACHINES; TAPS BEING PARTS OF MACHINES; LAPPING MACHINES FOR METALWORKING; MILLING CUTTERS FOR MILLING MACHINES, IN CLASS 7 (U.S. CLS. 13, 19, 21, 23, 31, 34 AND 35).

THE MARK CONSISTS OF STANDARD CHARACTERS WITHOUT CLAIM TO ANY PARTICULAR FONT, STYLE, SIZE, OR COLOR.

OWNER OF INTERNATIONAL REGISTRATION 1069171 DATED 12-8-2010, EXPIRES 12-8-2020.

SER. NO. 79-094,364, FILED 12-8-2010.

COLLEEN KEARNEY, EXAMINING ATTORNEY



David J. Kypos

Director of the United States Patent and Trademark Office

United States of America

United States Patent and Trademark Office

TOUR DE L'ILE

Reg. No. 4,097,659

Registered Feb. 14, 2012

Int. Cl.: 14

TRADEMARK

PRINCIPAL REGISTER

RICHEMONT INTERNATIONAL SA (SWITZERLAND SOCIÉTÉ ANONYME (SA))
ROUTE DES BICHES 10
CH-1752 VILLARS-SUR-GLÂNE
SWITZERLAND

FOR: WATCHES, CHRONOMETERS, WALL CLOCKS, IN CLASS 14 (U.S. CLS. 2, 27, 28 AND 50).

THE MARK CONSISTS OF STANDARD CHARACTERS WITHOUT CLAIM TO ANY PARTICULAR FONT, STYLE, SIZE, OR COLOR.

OWNER OF INTERNATIONAL REGISTRATION 0804813 DATED 6-10-2003, EXPIRES 6-10-2013.

THE ENGLISH TRANSLATION OF "TOUR DE L'ILE" IN THE MARK IS "TOUR OF THE ISLAND".

SER. NO. 79-094,487, FILED 1-11-2011.

MICHELE SWAIN, EXAMINING ATTORNEY



David J. Kybas

Director of the United States Patent and Trademark Office

United States of America

United States Patent and Trademark Office

GANCINO SPARKLING

Reg. No. 4,097,660

Registered Feb. 14, 2012

Int. Cl.: 14

TRADEMARK

PRINCIPAL REGISTER

SALVATORE FERRAGAMO S.P.A. (ITALY JOINT STOCK COMPANY)
VIA DEI TORNABUONI, 2
I-50123 FIRENZE
ITALY

FOR: CLOCKS, WATCHES, WRISTWATCHES, DIVING WATCHES, POCKET WATCHES, WATCH BANDS AND STRAPS, WATCH CHAINS, WATCH CASES, CHRONOGRAPHS FOR USE AS TIMEPIECES AND FOR USE AS WATCHES, CHRONOMETERS, IN CLASS 14 (U.S. CLS. 2, 27, 28 AND 50).

THE MARK CONSISTS OF STANDARD CHARACTERS WITHOUT CLAIM TO ANY PARTICULAR FONT, STYLE, SIZE, OR COLOR.

OWNER OF INTERNATIONAL REGISTRATION 1069650 DATED 11-25-2010, EXPIRES 11-25-2020.

OWNER OF U.S. REG. NO. 3,631,593.

THE ENGLISH TRANSLATION OF "GANCINO" IN THE MARK IS "LITTLE HOOK".

SER. NO. 79-094,563, FILED 11-25-2010.

JULIE VEPPUMTHARA, EXAMINING ATTORNEY



David J. Kyffers

Director of the United States Patent and Trademark Office

United States of America

United States Patent and Trademark Office

NEOMAX

Reg. No. 4,097,661

Registered Feb. 14, 2012

**Int. Cls.: 6, 7, 9, 10, 12
and 16**

TRADEMARK

PRINCIPAL REGISTER

HITACHI KINZOKU KABUSHIKI KAISHA (HITACHI METALS, LTD.) (JAPAN CORPORATION)

2-1 SHIBAURA 1-CHOME
MINATO-KU; TOKYO 105-8614
JAPAN

FOR: CLAD METALS CONSISTING OF PRESSURE-WELDED STAINLESS STEELS, IRONS AND STEELS, AND NONFERROUS METALS AND THEIR ALLOYS; IRONS AND STEEL; CLAD METALS CONSISTING OF PRESSURE-WELDED NICKEL ALLOYS, COPPER ALLOYS, CHROME ALLOYS, TITANIUM ALLOYS, AND NONFERROUS METALS AND THEIR ALLOYS; BRAZING ALLOY FILLER METALS, IN CLASS 6 (U.S. CLS. 2, 12, 13, 14, 23, 25 AND 50).

FOR: ELECTRIC GENERATORS FOR WIND TURBINES; DAMPING MACHINES USING PERMANENT MAGNETS FOR BRIDGE CABLES; DAMPING MACHINES FOR BRIDGE CABLES; PRINTING AND BOOKBINDING MACHINES AND APPARATUS, NAMELY, TORQUE LIMITERS USING PERMANENT MAGNETS FOR PAPER FEED DEVICES IN PRINTING MACHINES; METALWORKING MACHINES AND MACHINE TOOLS, NAMELY, STAGES FOR METALWORKING MACHINES AND MACHINE TOOLS USING LINEAR MOTORS INCLUDING BUILT-IN PERMANENT MAGNETS; LOADING-UNLOADING MACHINES USING PERMANENT MAGNETS; LOADING-UNLOADING MACHINES; CONCRETE CONSTRUCTION MACHINES; LINEAR MOTORS USING PERMANENT MAGNETS FOR SEMICONDUCTOR MANUFACTURING MACHINES AND SYSTEMS; LINEAR MOTORS FOR SEMICONDUCTOR MANUFACTURING MACHINES AND SYSTEMS; ELECTROMAGNETIC ACTUATORS USING PERMANENT MAGNETS FOR SEMICONDUCTOR MANUFACTURING MACHINES AND SYSTEMS; ELECTROMAGNETIC ACTUATORS FOR SEMICONDUCTOR MANUFACTURING MACHINES AND SYSTEMS; MAGNETIC FIELD GENERATING DEVICES FOR SPUTTERING FOR MANUFACTURING OF SEMICONDUCTORS, LCDS AND SOLAR BATTERIES; SEMICONDUCTOR MANUFACTURING MACHINES AND SYSTEMS; STARTERS FOR MOTORS AND ENGINES; AC MOTORS AND DC MOTORS OTHER THAN FOR LAND VEHICLES; COMPONENTS FOR AC MOTORS AND DC MOTORS FOR LAND VEHICLES, NAMELY, STATORS AND ROTORS; WASTE SEPARATING MACHINES USING PERMANENT MAGNETS FOR SEPARATING ALUMINUM WASTE, MAGNETIC METALS AND NONMETALS; WASTE SEPARATING MACHINES; WASTE COMPACTING MACHINES; WASTE CRUSHING MACHINES; PARTS FOR NON-ELECTRIC MOTORS FOR LAND VEHICLES NAMELY, MAGNETS AND ROTORS FOR LINEAR MOTORS USING PERMANENT MAGNETS FOR RAILWAY ROLLING STOCKS, ROTORS FOR



David J. Kyffers

Director of the United States Patent and Trademark Office

Reg. No. 4,097,661 MOTORS USING PERMANENT MAGNETS FOR HYBRID ELECTRIC-POWERED BICYCLES, AND ROTORS FOR MOTORS USING PERMANENT MAGNETS FOR ELECTRIC AUTOMOBILES OR HYBRID ELECTRIC AUTOMOBILES; NON-ELECTRIC MOTORS, NOT FOR LAND VEHICLES, FOR PRINTING MACHINES, METALWORKING MACHINES, SEMI-CONDUCTOR MANUFACTURE MACHINES, WASTE SEPARATING MACHINES, TELECOMMUNICATION MACHINES FOR OPTICAL DISC DRIVES, METAL PROCESSING MACHINES AND PLASTIC PROCESSING MACHINES; PNEUMATIC AND HYDRAULIC MACHINES, NAMELY, PUMPS, VACUUM PUMPS, BLOWERS AND COMPRESSORS; TRANSMISSION COMPONENTS NAMELY, MAGNETIC COUPLINGS FOR NON-CONTACT TRANSMISSION OF ROTARY TORQUE FOR PUMPS, MANUFACTURING MACHINES AND COMPUTERS; MACHINE ELEMENTS NOT FOR LAND VEHICLES NAMELY, SHAFT COUPLINGS, POWER TRANSMISSIONS AND GEARINGS FOR MACHINES, IN CLASS 7 (U.S. CLS. 13, 19, 21, 23, 31, 34 AND 35).

FOR: BATTERIES AND CELLS, NAMELY, DRYCELLS, STORAGE BATTERIES AND SOLAR BATTERIES; ELECTRIC OR MAGNETIC METERS AND TESTERS, NAMELY, MAGNETOMETERS, WATT HOUR METERS, VOLTMETERS, AMMETERS AND WATTMETERS; ELECTRIC WIRES AND CABLES; PHOTOGRAPHIC INSTRUMENTS, APPARATUS AND THEIR PARTS, NAMELY, CAMERAS AND STRUCTURAL PARTS THEREOF; OPTICAL APPARATUS AND INSTRUMENTS, NAMELY, TELESCOPES AND MICROSCOPES; TELECOMMUNICATION MACHINES AND APPARATUS, NAMELY, VOICE COIL MOTORS USING PERMANENT MAGNETS FOR OPTICAL DISK DRIVES FOR REPRODUCTION OF MUSIC OR IMAGES; TORQUE LIMITERS USING PERMANENT MAGNETS FOR PAPER FEED DEVICES IN FACSIMILE MACHINES; MAGNETIC DAMPERS CONSISTING OF A COMBINATION OF PLURAL PERMANENT MAGNETS FOR OPENING INSERTION SITES OF DISC AND CASSETTE DEVICES; ELECTRONIC MACHINES AND APPARATUS, NAMELY, UNDULATORS FOR PRODUCING SYNCHROTRON RADIATION INCLUDING X-RAY USING PERMANENT MAGNETS; VOICE COIL MOTORS USING PERMANENT MAGNETS FOR POSITIONING ACTUATORS FOR MAGNETIC HEADS OF MAGNETIC DISCS; VOICE COIL MOTORS USING PERMANENT MAGNETS FOR OPTICAL DISC DRIVES IN COMPUTERS; ELECTRONIC SUBSTRATES FOR THIN FILM MAGNETIC HEADS OF MAGNETIC DISKS; TONER ABSORPTION EQUIPMENT USING PERMANENT MAGNETS IN ELECTROSTATIC COPYING MACHINES; TORQUE LIMITERS USING PERMANENT MAGNETS FOR PAPER FEED DEVICES IN PRINTERS FOR ELECTROSTATIC COPYING MACHINES OR COMPUTERS; SPACER RINGS OF CERAMICS USING PERMANENT MAGNETS FOR LAMINATED MAGNETIC DISKS; PERMANENT MAGNETS; MAGNETIC POWDER FOR PERMANENT MAGNETS; MAGNETIC CORES; RESISTANCE WIRES; ELECTRODES; ELECTRIC POWER DISTRIBUTION OR CONTROL MACHINES AND APPARATUS, NAMELY, SWITCHING POWER SUPPLY TRANSFORMERS; SWITCHING POWER SUPPLY CHOKE COILS; SWITCHING POWER SUPPLY INDUCTORS; DC/DC CONVERTERS; ROTARY CONVERTERS AND PHASE MODIFIERS, IN CLASS 9 (U.S. CLS. 21, 23, 26, 36 AND 38).

FOR: MEDICAL MACHINES AND APPARATUS, NAMELY, MAGNETIC RESONANCE IMAGING DIAGNOSTIC APPARATUS USING PERMANENT MAGNETS; MRI DIAGNOSTIC APPARATUS, TOMOGRAPHY MACHINES, NAMELY, COMPUTED TOMOGRAPHY (CT) APPARATUS; MEDICAL ULTRASOUND APPARATUS, AND PROBES FOR MEDICAL PURPOSES, IN CLASS 10 (U.S. CLS. 26, 39 AND 44).

FOR: NON-ELECTRIC MOTORS FOR RAILWAY ROLLING STOCKS; NON ELECTRIC MOTORS FOR BICYCLES; NON-ELECTRIC MOTORS FOR ELECTRIC AUTOMOBILES; NON-ELECTRIC MOTORS FOR LAND VEHICLES; AC MOTORS AND DC MOTORS FOR LINEAR-MOTOR RAILWAY ROLLING STOCKS, LINEAR-MOTOR ELECTRIC AUTOMOBILES AND LINEAR-MOTOR HYBRID ELECTRIC AUTOMOBILES; AC MOTORS AND DC MOTORS FOR LAND VEHICLES; POWER STEERING UNITS USING PERMANENT MAGNETS FOR AUTOMOBILES; BRAKES USING PERMANENT MAGNETS FOR AUTOMOBILES; TRANSMISSION COMPONENTS, NAMELY, MAGNETIC COUPLINGS FOR NON-CONTACT

Reg. No. 4,097,661 TRANSMISSION OF ROTARY TORQUE FOR LAND VEHICLES; TRANSMISSION MECHANISMS FOR LAND VEHICLES, IN CLASS 12 (U.S. CLS. 19, 21, 23, 31, 35 AND 44).

FOR: FIGURINES AND STATUETTES MADE OF PAPER AND MAGNETS; PRINTED MATTER IN THE NATURE OF CALENDARS, CATALOGS, BOOKS AND PAMPHLETS IN THE FIELDS OF MAGNETIC MATERIALS AND EQUIPMENT, CERAMICS AND MATERIALS FOR ELECTRONIC EQUIPMENT, IN CLASS 16 (U.S. CLS. 2, 5, 22, 23, 29, 37, 38 AND 50).

OWNER OF U.S. REG. NOS. 3,078,643, 3,108,708 AND OTHERS.

OWNER OF INTERNATIONAL REGISTRATION 1069707 DATED 9-22-2010, EXPIRES 9-22-2020.

THE MARK CONSISTS OF THE WORDING "NEOMAX" IN STYLIZED FONT.

SER. NO. 79-094,579, FILED 9-22-2010.

STEVEN JACKSON, EXAMINING ATTORNEY

United States of America

United States Patent and Trademark Office

SUNSHOTS

Reg. No. 4,097,662

Registered Feb. 14, 2012

Int. Cl.: 3

TRADEMARK

PRINCIPAL REGISTER

MAXWELTON LIMITED (UNITED KINGDOM CORPORATION)
8 NEW FIELDS, 2 STINSFORD ROAD
NUFFIELD, POOLE, UNITED KINGDOM BH17 0NF

FOR: COSMETIC AND TOILETRY PRODUCTS, NAMELY, SUNSCREEN PREPARATIONS; SUN-TANNING PREPARATIONS; NON-MEDICATED SKIN CARE PREPARATIONS; SKIN CREAMS, MOISTURIZERS, LOTIONS AND GELS; COSMETIC PREPARATIONS AGAINST SUNBURN; SELF-TANNING PREPARATIONS; AFTER-SUN CREAMS, AFTER-SUN OILS, AFTER-SUN LOTIONS, AFTER-SUN MILKS, AFTER-SUN GELS, IN CLASS 3 (U.S. CLS. 1, 4, 6, 50, 51 AND 52).

THE MARK CONSISTS OF STANDARD CHARACTERS WITHOUT CLAIM TO ANY PARTICULAR FONT, STYLE, SIZE, OR COLOR.

OWNER OF INTERNATIONAL REGISTRATION 1069849 DATED 2-10-2011, EXPIRES 2-10-2021.

SER. NO. 79-094,620, FILED 2-10-2011.

TIMOTHY FINNEGAN, EXAMINING ATTORNEY



David J. Kyffers

Director of the United States Patent and Trademark Office

United States of America

United States Patent and Trademark Office



OXY'PHARM

Reg. No. 4,097,663

Registered Feb. 14, 2012

Int. Cls.: 5 and 10

TRADEMARK

PRINCIPAL REGISTER

OXY'PHARM (FRANCE LIMITED LIABILITY COMPANY)
917 RUE MARCEL PAUL
CHAMPIGNY-SUR-MARNE, FRANCE F94500

FOR: AERIAL DISINFECTION PREPARATIONS IN THE NATURE OF ALL-PURPOSE DISINFECTANT WITH DEODORIZING, INSECTICIDE, ACARICIDE PROPERTIES, ALL THE AFOREMENTIONED GOODS RELATING TO THE PHARMACEUTICAL INDUSTRY, IN CLASS 5 (U.S. CLS. 6, 18, 44, 46, 51 AND 52).

FOR: APPARATUS FOR AERIAL DISINFECTION IN THE NATURE OF AEROSOL DISPENSERS FOR MEDICAL USE WITH DISINFECTANT, DEODORIZING, INSECTICIDE, ACARICIDE PROPERTIES, ALL THE AFOREMENTIONED GOODS RELATING TO THE PHARMACEUTICAL INDUSTRY, IN CLASS 10 (U.S. CLS. 26, 39 AND 44).

THE MARK CONSISTS OF THE WORDING "OXY'PHARM" IN WHITE EXCEPT THE LETTER "Y" WHICH IS ORANGE, THREE DROPLETS IN BLUE, ORANGE AND GREEN WITH WHITE CIRCULAR AND OVAL DESIGNS WITHIN, ALL OF THE FOREGOING WITHIN A BLACK RECTANGLE.

OWNER OF INTERNATIONAL REGISTRATION 1069901 DATED 12-22-2010, EXPIRES 12-22-2020.

THE COLOR(S) BLACK, WHITE, BLUE, ORANGE AND GREEN IS/ARE CLAIMED AS A FEATURE OF THE MARK.

THE WORD(S) "OXY'PHARM" HAS NO MEANING IN A FOREIGN LANGUAGE.

SER. NO. 79-094,649, FILED 12-22-2010.

MELISSA VALLILLO, EXAMINING ATTORNEY



David J. Kybas

Director of the United States Patent and Trademark Office

United States of America

United States Patent and Trademark Office

viClean

Reg. No. 4,097,664

Registered Feb. 14, 2012

Int. Cls.: 9 and 11

TRADEMARK

PRINCIPAL REGISTER

VILLEROY & BOCH AG (FED REP GERMANY CORPORATION)
P.O. BOX 1120
66688 METTLACH, FED REP GERMANY

FOR: APPARATUS AND INSTRUMENTS, NAMELY, CONDUCTORS, CONNECTORS, CONVERTORS, ACCUMULATORS, SENSORS, REGULATORS, CONTROLLERS FOR CONDUCTING, CONNECTING, CONVERTING, STORAGE, REGULATION AND CONTROLLING OF ELECTRICITY; REMOTE CONTROLS FOR SANITARY EQUIPMENT, TOILETS, IN CLASS 9 (U.S. CLS. 21, 23, 26, 36 AND 38).

FOR: TOILET SEATS WITH MULTIPLE FUNCTIONS, NAMELY, HEATING, DEODORISING, WASHING AND/OR DRYING; TOILETS; TOILET BOWLS; TOILET SEATS; WATER FLUSHING INSTALLATIONS FOR TOILETS COMPRISED OF FLUSH LEVERS AND VALVES; FLUSHING TANKS FOR TOILETS; SANITATION FIXTURES, NAMELY, URINALS; COVERS FOR SANITATION FIXTURES IN THE NATURE OF URINALS; MIXER TAPS FOR WATER PIPES; REGULATING ACCESSORIES FOR WATER CONDUITS INSTALLATIONS, WATER SUPPLY INSTALLATIONS AND WATER DISTRIBUTION INSTALLATIONS; SANITARY APPARATUS AND INSTALLATIONS, NAMELY, WASH-HAND BASINS, WASH-HAND BOWLS, BATH TUBS, WATER CLOSETS, LAVATORIES, SHOWER ENCLOSURES, SINKS, BIDETS AND URINALS; PLUMBING FITTINGS, NAMELY, BIBS, COCKS, VALVES FOR WASH-HAND BASINS, SINKS, BATH TUBS, SHOWERS; BIDETS; SHOWERS; SHOWER ENCLOSURES, NAMELY, SHOWER CUBICLES; SHOWER TUBS; PLUMBING FITTINGS, NAMELY, MANUALLY CONTROLLABLE VALVES AND MIXING VALVES FOR SANITARY WATER SUPPLY; REGULATING ACCESSORIES FOR WATER APPARATUS AND WATER PIPES; WARM WATER SQUIRTER AS PART OF A TOILET STOOL UNIT; FLUSHING APPARATUS FOR TOILETS, NAMELY, AUTOMATIC FLUSH VALVES ACTIVATED BY A SENSOR; HEATING INSTALLATIONS; AIR COOLING APPARATUS; DRYING APPARATUS FOR USE IN HEATING AND VENTILATION SYSTEMS; VENTILATION INSTALLATIONS AND APPARATUS FOR AIR HEATING AND COOLING; AIR FILTERING INSTALLATIONS FEATURING AIR DEODORISING APPARATUS; AIR FILTERING INSTALLATIONS; VENTILATION, NAMELY, AIR-CONDITIONING INSTALLATIONS AND APPARATUS; PARTS AND COMPONENTS FOR ALL AFOREMENTIONED GOODS AS FARAS INCLUDED IN THIS CLASS, IN CLASS 11 (U.S. CLS. 13, 21, 23, 31 AND 34).



David J. Kyjars

THE MARK CONSISTS OF STANDARD CHARACTERS WITHOUT CLAIM TO ANY PARTICULAR FONT, STYLE, SIZE, OR COLOR.

Reg. No. 4,097,664 PRIORITY DATE OF 6-2-2010 IS CLAIMED.

OWNER OF INTERNATIONAL REGISTRATION 1070058 DATED 8-26-2010, EXPIRES 8-26-2020.

THE WORDING "VICLEAN" HAS NO MEANING IN A FOREIGN LANGUAGE.

SER. NO. 79-094,704, FILED 8-26-2010.

KATHLEEN M. VANSTON, EXAMINING ATTORNEY

United States of America

United States Patent and Trademark Office

KALANDRAKA

Reg. No. 4,097,665

Registered Feb. 14, 2012

**Int. Cls.: 25, 28, 39, 41
and 43**

TRADEMARK

SERVICE MARK

PRINCIPAL REGISTER

NIK LEUTHOLD (SWITZERLAND INDIVIDUAL)
SEIDENSTRASSE 12
CH-8400 WINTERTHUR
SWITZERLAND

FOR: CLOTHING, NAMELY, SHIRTS, PANTS, SHORTS, JACKETS, OVERCOATS, BELTS;
FOOTWEAR; HEADGEAR, NAMELY, CAPS, IN CLASS 25 (U.S. CLS. 22 AND 39).

FOR: SPORTS ARTICLES IN THE FIELD OF CLIMBING, NAMELY, MOUNTAINEERING
HOOKS, BINDING STRAPS AND CLIMBING CAMS, AND ANCHORS MADE OF METAL,
IN CLASS 28 (U.S. CLS. 22, 23, 38 AND 50).

FOR: ARRANGING OF TOURS, IN CLASS 39 (U.S. CLS. 100 AND 105).

FOR: ENTERTAINMENT, NAMELY, ORGANIZING AND CONDUCTING LIVE MUSICAL
CONCERTS, CULTURAL FAIRS, LIVE COMEDY SHOWS; ORGANIZING COMMUNITY
SPORTING AND CULTURAL ACTIVITIES, IN CLASS 41 (U.S. CLS. 100, 101 AND 107).

FOR: SERVICES FOR PROVIDING FOOD AND DRINK; PROVIDING TEMPORARY ACCOM-
MODATION, IN CLASS 43 (U.S. CLS. 100 AND 101).

THE MARK CONSISTS OF STANDARD CHARACTERS WITHOUT CLAIM TO ANY PAR-
TICULAR FONT, STYLE, SIZE, OR COLOR.

PRIORITY DATE OF 7-30-2010 IS CLAIMED.

OWNER OF INTERNATIONAL REGISTRATION 1070113 DATED 1-28-2011, EXPIRES 1-28-
2021.

THE WORDING "KALANDRAKA" HAS NO MEANING IN A FOREIGN LANGUAGE.

SER. NO. 79-094,730, FILED 1-28-2011.

DOMINIC FATHY, EXAMINING ATTORNEY



David J. Kyffers

Director of the United States Patent and Trademark Office

United States of America
United States Patent and Trademark Office

UNIPLAS

Reg. No. 4,097,666

OCTAPHARMA AG (SWITZERLAND SOCIÉTÉ ANONYME)
SEIDENSTRASSE 2

Registered Feb. 14, 2012

CH-8853 LACHEN SZ, SWITZERLAND

Int. Cl.: 5

FOR: PHARMACEUTICAL PRODUCTS, NAMELY, BLOOD PREPARATIONS, NAMELY, BLOOD PLASMA FOR MEDICAL PURPOSES AND BLOOD PLASMA PREPARATIONS, IN CLASS 5 (U.S. CLS. 6, 18, 44, 46, 51 AND 52).

TRADEMARK

THE MARK CONSISTS OF STANDARD CHARACTERS WITHOUT CLAIM TO ANY PARTICULAR FONT, STYLE, SIZE, OR COLOR.

PRINCIPAL REGISTER

OWNER OF INTERNATIONAL REGISTRATION 0701727 DATED 9-29-1998, EXPIRES 9-29-2018.

OWNER OF U.S. REG. NO. 3,724,813.

SER. NO. 79-094,776, FILED 8-20-2010.

MATTHEW EINSTEIN, EXAMINING ATTORNEY



David J. Kyfos

Director of the United States Patent and Trademark Office

United States of America
United States Patent and Trademark Office

ELLEN

Reg. No. 4,097,667

ELLEN AB (SWEDEN AKTIEBOLAG (AB))
SVÄRDVÄGEN 27

Registered Feb. 14, 2012

SE-182 33 DANDERYD, SWEDEN

Int. Cls.: 1 and 5

FOR: CULTURES OF MICRO-ORGANISMS, MICROBIOLOGICAL SUBSTANCES, NAMELY, LACTIC ACID PRODUCING BACTERIA FOR USE IN RESEARCH AND MANUFACTURE OF PHARMACEUTICAL PRODUCTS AND NOT FOR MEDICAL OR VETERINARY USE, IN CLASS 1 (U.S. CLS. 1, 5, 6, 10, 26 AND 46).

TRADEMARK

PRINCIPAL REGISTER

FOR: PHARMACEUTICAL PREPARATIONS FOR THE TREATMENT OF BACTERIAL VAGINOSES, MICROBIOLOGICAL DISORDER, DISCHARGES AND ODORS AND PH-REGULATION, NAMELY, PROBIOTICS AND VAGINAL INSERTS; MICRO-ORGANISMS AND MICRO-BIOLOGICAL SUBSTANCES FOR MEDICAL USE, NAMELY, TAMPONS, OVULES, SUPPOSITORIES, VAGIATORS, CRÈME, LOTION, GEL, TABLETS, CAPSULES FOR THE TREATMENT OF BACTERIAL VAGINOSES, MICROBIOLOGICAL DISORDER, DISCHARGES AND ODORS AND PH-REGULATION; LACTIC ACID PRODUCED BACTERIA FOR MEDICAL USE, NAMELY, TAMPONS, OVULES, SUPPOSITORIES, VAGIATORS, CRÈME, LOTION, GEL, TABLETS, CAPSULES FOR THE TREATMENT OF BACTERIAL VAGINOSES, MICROBIOLOGICAL DISORDER, DISCHARGES AND ODORS AND PH-REGULATION; DIETETIC SUBSTANCES, NAMELY, FOOD AND BEVERAGES ADAPTED FOR MEDICAL USE, FOOD FOR BABIES; MEDICAL PLASTERS; TAMPONS AND SANITARY PRODUCTS, NAMELY, NAPKINS AND PADS; MATERIAL FOR STOPPING TEETH, DENTAL WAX, ALL PURPOSES DISINFECTANTS; PREPARATIONS FOR DESTROYING VERMIN; FUNGICIDES, HERBICIDES, IN CLASS 5 (U.S. CLS. 6, 18, 44, 46, 51 AND 52).



OWNER OF U.S. REG. NO. 2,778,974.

OWNER OF INTERNATIONAL REGISTRATION 0765882 DATED 7-11-2001, EXPIRES 7-11-2021.

SER. NO. 79-094,779, FILED 3-10-2011.

DAVID HOFFMAN, EXAMINING ATTORNEY

David J. Kyffers

Director of the United States Patent and Trademark Office

United States of America
United States Patent and Trademark Office

寛永堂

KAN-EIDO

Reg. No. 4,097,668

Registered Feb. 14, 2012

Int. Cl.: 30

TRADEMARK

PRINCIPAL REGISTER

KANEIDO CO., LTD. (JAPAN CORPORATION)
3-2, KITAAOYAMA 1-CHOME
MINATO-KU; TOKYO 107-0061
JAPAN

FOR: JAPANESE CONFECTIONERY KNOWN AS WAGASHI, NAMELY, CAKES, RICE CRACKERS, DUMPLINGS, COOKIES, FRUIT JELLY CANDY, SWEET ADZUKI-BEAN JELLY (MIZU-YOKAN), STEAMED YEAST BUN WITH FILLINGS, AND PASTRIES; BREAD AND BUNS, IN CLASS 30 (U.S. CL. 46).

THE NAME(S), PORTRAIT(S), AND/OR SIGNATURE(S) SHOWN IN THE MARK DOES NOT IDENTIFY A PARTICULAR LIVING INDIVIDUAL.

PRIORITY DATE OF 10-21-2010 IS CLAIMED.

OWNER OF INTERNATIONAL REGISTRATION 1070731 DATED 2-17-2011, EXPIRES 2-17-2021.

THE NON-LATIN CHARACTERS IN THE MARK TRANSLITERATE TO "KAN- EIDO" AND THIS HAS NO MEANING IN A FOREIGN LANGUAGE.

THE MARK CONSISTS OF THE STYLIZED WORDS "KAN-EIDO". ABOVE THIS ARE THREE STYLIZED KANJI CHARACTERS THAT TRANSLITERATE INTO "KAN-EIDO".

THE WORDING "KAN-EIDO" AND ITS KANJI EQUIVALENT HAS NO MEANING IN A FOREIGN LANGUAGE.

SER. NO. 79-094,969, FILED 2-17-2011.

SIMON TENG, EXAMINING ATTORNEY



David J. Kybas

Director of the United States Patent and Trademark Office

United States of America

United States Patent and Trademark Office

VEHCO

Reg. No. 4,097,669

Registered Feb. 14, 2012

Int. Cls.: 9 and 38

TRADEMARK

SERVICE MARK

PRINCIPAL REGISTER

VEHCO AB (SWEDEN LIMITED LIABILITY COMPANY)
FALKENBERGSGATAN 3
SE-412 85 GÖTEBORG
SWEDEN

FOR: APPARATUS FOR RECORDING, TRANSMISSION OR REPRODUCTION OF SOUND OR IMAGES, AUDIO AND VIDEO RECEIVERS, COMPUTERS, COMPUTER PROGRAMS IN THE NATURE OF DOWNLOADABLE SOFTWARE FOR OBTAINING MORE EFFICIENT COMMUNICATION AND IMPROVED ECONOMY; ELECTRIC MONITORING APPARATUS, NAMELY, RECORDING EQUIPMENT IN THE NATURE OF GLOBAL POSITIONING SATELLITE RECEIVERS FOR MONITORING VEHICLES AND CRAFT; MILEAGE RECORDERS FOR VEHICLES AND CRAFT, NAMELY, ODOMETERS; COMPUTER HARDWARE MONITORS; COMPUTER SOFTWARE RECORDED ON PALM TOP COMPUTER FEATURING FUEL COSTS FOR IMPROVED DRIVING ECONOMY, RECORDED COMPUTER OPERATING PROGRAMS, SATELLITE NAVIGATION EQUIPMENT, NAMELY, GLOBAL POSITIONING SYSTEM, IN CLASS 9 (U.S. CLS. 21, 23, 26, 36 AND 38).

FOR: COMPUTER-AIDED TRANSMISSION OF MESSAGES AND IMAGES, COMMUNICATIONS BY COMPUTER TERMINALS, SATELLITE TRANSMISSION, PROVIDING TELECOMMUNICATIONS CONNECTIONS TO A GLOBAL COMPUTER NETWORK, PROVIDING MULTIPLE USER ACCESS TO COMPUTER PROGRAMS ON DATA NETWORKS, IN CLASS 38 (U.S. CLS. 100, 101 AND 104).

THE MARK CONSISTS OF STANDARD CHARACTERS WITHOUT CLAIM TO ANY PARTICULAR FONT, STYLE, SIZE, OR COLOR.

OWNER OF INTERNATIONAL REGISTRATION 1070738 DATED 2-24-2011, EXPIRES 2-24-2021.

THE WORDING "VEHCO" HAS NO MEANING IN A FOREIGN LANGUAGE.

SER. NO. 79-094,974, FILED 2-24-2011.

CHRISTINA SOBRAL, EXAMINING ATTORNEY



David J. Kyffers

Director of the United States Patent and Trademark Office

United States of America

United States Patent and Trademark Office

OIS

Reg. No. 4,097,670

Registered Feb. 14, 2012

Int. Cls.: 3 and 7

TRADEMARK

PRINCIPAL REGISTER

ROBERT BOSCH GMBH (FED REP GERMANY GESELLSCHAFT MIT BESCHRÄNKTER HAFTUNG (GMBH))
70469 STUTTGART
FED REP GERMANY

FOR: ABRASIVES, NAMELY, ABRASIVE PAPER, ABRASIVE SHEETS AND ABRASIVE STRIPS FOR USE WITH ELECTRICALLY OPERATED POWER TOOLS, IN CLASS 3 (U.S. CLS. 1, 4, 6, 50, 51 AND 52).

FOR: DRILLING MACHINES; POWER-OPERATED HAMMER DRILLS; BENCH DRILLING MACHINES; DRILL CHUCKS FOR POWER DRILLS; POWER-OPERATED DRILL HAMMERS AND CHISEL HAMMERS; POWER-OPERATED CORDLESS SCREWDRIVERS; GROOVE MILLING MACHINES; POWER-OPERATED GRINDING, CUTTING AND ROUGHING MACHINES, NAMELY, ORBITAL SANDERS, ANGLE GRINDERS, TRIANGULAR GRINDERS, ECCENTRIC GRINDERS, BELT GRINDERS, ANGLE POLISHERS, AND STRAIGHT GRINDERS; MACHINE TOOLS, NAMELY, ELECTRICALLY-OPERATED PLATE SHEARS; POWER-OPERATED GLUE GUNS; MACHINE TOOLS, NAMELY, ELECTRICALLY-OPERATED TACKERS; ELECTRICALLY-OPERATED SAWS; MACHINES, NAMELY, CIRCULAR SAWS; MACHINES, NAMELY, POWER-OPERATED JIGSAWS; MACHINES, NAMELY, POWER-OPERATED LOPPING SAWS AND MITRE BOX SAWS; MACHINES, NAMELY, POWER-OPERATED SABRE SAWS; BAND SAW MACHINES; PLANING MACHINES; MILLING MACHINES; BENCH BELT SANDING MACHINES; NON-ELECTRIC PARTS, TOOLS AND ADAPTERS FOR THE AFOREMENTIONED GOODS, NAMELY, SAW BLADES, SANDING PADS, CULLING BLADES, SCRAPING BLADES AND POLISHING PADS, IN CLASS 7 (U.S. CLS. 13, 19, 21, 23, 31, 34 AND 35).



THE MARK CONSISTS OF STANDARD CHARACTERS WITHOUT CLAIM TO ANY PARTICULAR FONT, STYLE, SIZE, OR COLOR.

PRIORITY DATE OF 7-23-2010 IS CLAIMED.

OWNER OF INTERNATIONAL REGISTRATION 1070754 DATED 1-18-2011, EXPIRES 1-18-2021.

SER. NO. 79-094,979, FILED 1-18-2011.

BERNICE MIDDLETON, EXAMINING ATTORNEY

David J. Kyros

Director of the United States Patent and Trademark Office

United States of America

United States Patent and Trademark Office

INFITEL

Reg. No. 4,097,671

ELEPHANT TALK GLOBAL HOLDING BV (NETHERLANDS LIMITED LIABILITY COMPANY)

Registered Feb. 14, 2012

SCHIPHOL BOULEVARD 249
NL-1118 BH LUCHTHAVEN SCHIPHOL

Int. Cls.: 9, 37, 38 and 42

NETHERLANDS

TRADEMARK

SERVICE MARK

PRINCIPAL REGISTER

FOR: SOFTWARE FOR USE IN DATABASE MANAGEMENT, FOR USE AS A SPREADSHEET, FOR WORD PROCESSING; COMPUTER HARDWARE, COMPUTER PERIPHERAL EQUIPMENT, NAMELY, TRANSFORMERS, BALUNS, CABLES USED IN CONNECTION WITH COMPUTERS; TELECOMMUNICATIONS EQUIPMENT, NAMELY, FIBER-OPTIC TRANSCIEVERS, FIBER OPTIC REPEATERS, CONVERTERS AND OPTIMIZERS, WAVE DIVISION MULTIPLEXERS, FREE-SPACE OPTICS TRANSMISSION SYSTEMS, SWITCHES INCLUDING ETHERNET SWITCHES AND ROUTERS, FIBER-TO-THE-HOME AND ETHERNET-OVER-VDSL ACCESS AGGREGATORS, TERMINATORS AND REPEATERS, AND REMOTE PRESENCE MANAGEMENT PRODUCTS, NAMELY, SWITCHES, AND CONSOLE, ALARM, SENSOR AND POWER MANAGEMENT DEVICES; COMPUTER TERMINALS; WORD-PROCESSING APPARATUS, NAMELY, WORD PROCESSOR; DEVICES FOR STORAGE AND DISPLAY OF DATA, NAMELY, WIRELESS DIGITAL ELECTRONIC APPARATUS TO SECURE AND PROTECT DATA AND IMAGES ON ALL FORMS OF WIRELESS EQUIPMENT INCLUDING MOBILE TELECOMMUNICATIONS EQUIPMENT; ELECTRONIC DATA CARRIERS CONTAINING STORED TYPOGRAPHIC TYPEFACES OF ALPHANUMERIC CHARACTERS, PRINTERS FONTS AND/OR TYPOGRAPHICAL SYMBOLS; BLANK DIGITAL DATA CARRIERS; BLANK CD-ROMS FOR SOUND AND VIDEO RECORDINGS; BLANK DATA CARRIERS IN THE FORM OF TAPES, DISCS, CDS; DOWNLOADABLE ELECTRONIC PUBLICATIONS, NAMELY, REPORTS, AND MANUALS FEATURING TELECOM AND MOBILE NETWORK SERVICES; COMPUTER SOFTWARE AND HARDWARE FOR ESTABLISHING CONNECTIONS BETWEEN DATA FILES, COMPUTER NETWORKS AND THE INTERNET OR OTHER CABLE NETWORKS, IN CLASS 9 (U.S. CLS. 21, 23, 26, 36 AND 38).



FOR: INSTALLATION AND MAINTENANCE OF TELECOMMUNICATION EQUIPMENT, COMPUTER PERIPHERAL DEVICES AND COMPUTER HARDWARE, IN CLASS 37 (U.S. CLS. 100, 103 AND 106).

David J. Kyjars

FOR: TELECOMMUNICATIONS ACCESS SERVICES; TRANSFER, TRANSMISSION AND/OR RECEPTION OF DATA VIA CABLE, RADIO-ELECTRIC CHANNELS OR OPTICAL OR OTHER ELECTROMAGNETIC SYSTEMS, NAMELY, PROVIDING COMPUTER USERS WITH ACCESS TO COMPUTER NETWORKS AND THEIR SERVICES IN THE NATURE OF

Director of the United States Patent and Trademark Office

Reg. No. 4,097,671 TELECOM AND MOBILE NETWORK SERVICES, IN CLASS 38 (U.S. CLS. 100, 101 AND 104).

FOR: CONSULTANCY IN THE FIELD OF COMPUTER PROGRAMMING, COMPUTER SECURITY, COMPUTER PERIPHERAL DEVICES, COMPUTER SOFTWARE, TELECOM NETWORKS, MOBILE NETWORKS AND SYSTEM MANAGEMENT IN THE FIELD OF ON-LINE SYSTEM MANAGEMENT SERVICES THAT ALLOW USERS TO REMOTELY VIEW, MONITOR, PROGRAM, OPERATE AND CONTROL LARGE AND SMALL APPLIANCES IN HOMES AND OFFICES; COMPUTER PROGRAMMING, COMPUTER SOFTWARE DEVELOPMENT AND COMPUTER ENGINEERING; AUTOMATION SERVICES, NAMELY, CONSULTING SERVICES IN THE FIELD OF OFFICE AND WORKPLACE AUTOMATION CONSULTANCY IN THE FIELD OF INFORMATION TECHNOLOGY; COMPUTER SOFTWARE DEVELOPMENT AND IMPLEMENTATION; ADAPTIVE AND PERSPECTIVE MAINTENANCE OF SOFTWARE; DEVELOPMENT OF COMPUTER SYSTEMS, NAMELY, DESIGN AND DEVELOPMENT OF ONLINE SOFTWARE SYSTEMS COMPUTER SYSTEMS ANALYSIS; COMPUTER SOFTWARE INSTALLATION AND MAINTENANCE, IN CLASS 42 (U.S. CLS. 100 AND 101).

THE MARK CONSISTS OF STANDARD CHARACTERS WITHOUT CLAIM TO ANY PARTICULAR FONT, STYLE, SIZE, OR COLOR.

PRIORITY DATE OF 4-14-2010 IS CLAIMED.

OWNER OF INTERNATIONAL REGISTRATION 1070911 DATED 10-11-2010, EXPIRES 10-11-2020.

SER. NO. 79-095,033, FILED 10-11-2010.

MICHAEL WIENER, EXAMINING ATTORNEY

United States of America
United States Patent and Trademark Office

CHRONOS

Reg. No. 4,097,672

Registered Feb. 14, 2012

Int. Cl.: 10

BERNAFON AG (SWITZERLAND SOCIÉTÉ ANONYME (SA)/INCORPORATED COMPANY
UNDER THE LAWS OF SWITZERLAND)
MORGENSTRASSE 131
CH-3018 BERN
SWITZERLAND

TRADEMARK

PRINCIPAL REGISTER

FOR: HEARING AIDS, IN CLASS 10 (U.S. CLS. 26, 39 AND 44).

THE MARK CONSISTS OF STANDARD CHARACTERS WITHOUT CLAIM TO ANY PARTICULAR FONT, STYLE, SIZE, OR COLOR.

PRIORITY DATE OF 9-22-2010 IS CLAIMED.

OWNER OF INTERNATIONAL REGISTRATION 1071711 DATED 3-15-2011, EXPIRES 3-15-2021.

SER. NO. 79-095,280, FILED 3-15-2011.

ELIZABETH KAJUBI, EXAMINING ATTORNEY



David J. Kyffers

Director of the United States Patent and Trademark Office

United States of America

United States Patent and Trademark Office



Reg. No. 4,097,673

Registered Feb. 14, 2012

Int. Cls.: 9, 35, 38 and 42

TRADEMARK

SERVICE MARK

PRINCIPAL REGISTER

MYWHO, INC. (REPUBLIC OF KOREA CORPORATION)
2FL., DONGSEONG BLDG., 558-3 SINSA-DONG
GANGNAM-GU., SEOUL 135-890
REPUBLIC OF KOREA

FOR: COMPUTER SOFTWARE DEVELOPMENT TOOLS; COMPUTER SOFTWARE FOR USE AS AN APPLICATION PROGRAMMING INTERFACE (API); APPLICATION PROGRAMMING INTERFACE (API) FOR COMPUTER SOFTWARE WHICH FACILITATES ONLINE SERVICES FOR SOCIAL NETWORKING, BUILDING SOCIAL NETWORKING APPLICATIONS AND ALLOWING DATA RETRIEVAL, UPLOADING, DOWNLOADING, ACCESS AND MANAGEMENT; RECORDED COMPUTER SOFTWARE TO ENABLE UPLOADING, POSTING, SHOWING, DISPLAYING, TAGGING, BLOGGING, SHARING OR PROVIDING ELECTRONIC MEDIA OR INFORMATION OVER THE INTERNET OR OTHER COMMUNICATIONS NETWORK, IN CLASS 9 (U.S. CLS. 21, 23, 26, 36 AND 38).

FOR: ONLINE RETAIL STORE SERVICES FEATURING COMPUTER GAME SOFTWARE; ONLINE WHOLESALE STORE SERVICES FEATURING COMPUTER GAME SOFTWARE; ONLINE ARRANGING OF COMPUTER GAME SOFTWARE SERVICES WITH THIRD PARTIES; RETAIL STORE SERVICES FEATURING COMPUTER GAME SOFTWARE; WHOLESALE STORE SERVICES FEATURING COMPUTER GAME SOFTWARE; ARRANGING CONTRACTUAL COMPUTER GAME SOFTWARE SERVICES WITH THIRD PARTIES; RETAIL STORE SERVICES FEATURING COMPUTER GAME SOFTWARE VIA ELECTRONIC COMMERCE; WHOLESALE STORE SERVICES FEATURING COMPUTER GAME SOFTWARE VIA ELECTRONIC COMMERCE; ARRANGING CONTRACTUAL COMPUTER GAME SOFTWARE SERVICES WITH THIRD PARTIES VIA ELECTRONIC COMMERCE, IN CLASS 35 (U.S. CLS. 100, 101 AND 102).

FOR: ELECTRONIC MESSAGE SERVICES; ELECTRONIC MAIL SERVICES; TRANSMISSION OF SHORT MESSAGE SERVICES; DATA COMMUNICATION SERVICES BY ELECTRONIC MAIL; ELECTRONIC BULLETIN BOARD SERVICES; PROVIDING INTERNET CHAT ROOMS; MESSAGE SENDING SERVICES; TELECOMMUNICATIONS SERVICES, NAMELY, TRANSMISSION OF DATA VIA WIRELESS NETWORKS; SECURE E-MAIL SERVICES; PROVISION OF ACCESS TO ONLINE DATABASES IN THE FIELD OF COMPUTER GAMES; TRANSMISSION OF DATA, SOUND AND IMAGES BY SATELLITE; VOICE MAIL SERVICES; PROVISION OF EMAIL SERVICES; PROVISION OF MULTIPLE-USER ACCESS TO THE INTERNET; PROVISION OF CHAT ROOM VIA THE INTERNET; DATA COMMUNICATION SERVICES VIA THE INTERNET; TRANSMISSION OF MOVING PICTURES VIA THE IN-



David J. Kyjars

Director of the United States Patent and Trademark Office

Reg. No. 4,097,673 TERNET; TRANSMISSION OF MESSAGES AND IMAGES VIA THE INTERNET; TRANSMISSION OF IMAGES AND VOICE VIA THE INTERNET; ELECTRONIC MESSAGE SENDING SERVICES; COMMUNICATIONS SERVICES, NAMELY, ELECTRONIC TRANSMISSION OF DATA AMONG USERS OF COMPUTERS; TRANSMISSION OF MESSAGES AND IMAGES VIA COMPUTER; COMMUNICATIONS BY COMPUTER TERMINALS; TRANSMISSION AND RECEPTION OF DATABASE INFORMATION VIA TELECOMMUNICATION NETWORK, IN CLASS 38 (U.S. CLS. 100, 101 AND 104).

FOR: APPLICATION SERVICE PROVIDER (ASP), NAMELY, PROVIDING COMPUTER SOFTWARE TO ENABLE UPLOADING, DOWNLOADING, STREAMING, POSTING, DISPLAYING, BLOGGING, LINKING, SHARING ELECTRONIC MEDIA OR INFORMATION VIA COMMUNICATION NETWORK; PROGRAMMING OF MULTIMEDIA APPLICATIONS; DEVELOPMENT OF DATA PROCESSING PROGRAMS; DEVELOPMENT OF GAME SOFTWARE; DEVELOPMENT OF COMPUTER SOFTWARE; COMPUTER PROGRAMMING; DESIGN AND ADVISORY SERVICES IN THE FIELD OF COMPUTER SOFTWARE; COMPUTER SYSTEM DESIGN; ADVISORY SERVICES IN THE FIELD OF COMPUTER SOFTWARE DEVELOPMENT; MAINTENANCE OF COMPUTER SOFTWARE; RESEARCH OF COMPUTER SOFTWARE; UPDATING OF COMPUTER SOFTWARE; REPAIR OF COMPUTER SOFTWARE; INSTALLATION OF COMPUTER SOFTWARE; COMPUTER SOFTWARE DESIGN; RENTAL OF COMPUTER SOFTWARE; DEVELOPMENT OF COMPUTER SOFTWARE; CONSULTANCY IN THE FIELD OF COMPUTER SECURITY; COMPUTER VIRUS PROTECTION SERVICES; COMPUTER GAME PROGRAMMING; MAINTENANCE OF COMPUTER GAME SOFTWARE; COPYING OF COMPUTER GAME SOFTWARE; DEVELOPMENT OF COMPUTER GAME SOFTWARE; PROVIDING SEARCH ENGINES FOR THE INTERNET; RENTAL OF APPLICATION SOFTWARE; DESIGN OF WEB PAGES; HOSTING OF WEB SITES; CREATING AND MAINTAINING WEB SITES FOR OTHERS; MAINTENANCE OF WEB SITES; DESIGN OF WEB SITES; APPLICATION SERVICE PROVIDER, NAMELY, MANAGING WEB SITES OF OTHERS; DEVELOPMENT OF WEB SITES, IN CLASS 42 (U.S. CLS. 100 AND 101).

THE MARK CONSISTS OF THE WORDING "MY WHO" AND DESIGN WITH THE TERM "MY" APPEARING IN A YELLOW-GREEN CIRCLE AND THE WORDING "WHO" APPEARING IN THE COLOR BLUE WITH A STYLIZED BLUE QUESTION MARK APPEARING ABOVE THE LETTER. THE WHITE IN THE MARK MERELY CONSTITUTES BACKGROUND AND IS NOT A FEATURE OF THE MARK.

PRIORITY DATE OF 9-9-2010 IS CLAIMED.

OWNER OF INTERNATIONAL REGISTRATION 1072651 DATED 10-20-2010, EXPIRES 10-20-2020.

THE COLOR(S) BLUE AND YELLOW-GREEN IS/ARE CLAIMED AS A FEATURE OF THE MARK.

SER. NO. 79-095,599, FILED 10-20-2010.

KAREN SEVERSON, EXAMINING ATTORNEY

United States of America

United States Patent and Trademark Office

The logo for 'Incuji' features the word 'Incuji' in a light blue, sans-serif font. The letter 'i' is stylized with a red dot above it and a red dot at the end of its tail.

Reg. No. 4,097,674

Registered Feb. 14, 2012

Int. Cls.: 9 and 10

TRADEMARK

PRINCIPAL REGISTER

ATOM MEDICAL CORPORATION (JAPAN CORPORATION)
18-15, HONGO 3-CHOME
BUNKYO-KU; TOKYO 113-0033
JAPAN

FOR: MEASURING OR TESTING MACHINES OR INSTRUMENTS, NAMELY, INSPECTION SYSTEMS FOR INCUBATORS AND INFANT WARMERS, COMPRISING SENSORS OF TEMPERATURE, HUMIDITY AND OXYGEN LEVEL, AND COMPUTER PROGRAMS FOR MANAGING DATA OF TEMPERATURE, HUMIDITY AND OXYGEN LEVEL, IN CLASS 9 (U.S. CLS. 21, 23, 26, 36 AND 38).

FOR: MEDICAL APPARATUS AND INSTRUMENTS, NAMELY, INFANT INCUBATORS, WARMING DEVICES FOR STABILIZING INFANT BODY TEMPERATURE, INFUSION PUMPS FOR ADMINISTERING BENEFICIAL AGENTS INTO THE BODY, SYRINGE PUMPS FOR ADMINISTERING BENEFICIAL AGENTS INTO THE BODY, MEDICAL EXAMINATION TABLES; HOSPITAL BABY DELIVERY BEDS, ULTRASONIC NEBULIZERS FOR RESPIRATION THERAPY, IN CLASS 10 (U.S. CLS. 26, 39 AND 44).

OWNER OF U.S. REG. NO. 3,936,910.

PRIORITY DATE OF 2-10-2011 IS CLAIMED.

OWNER OF INTERNATIONAL REGISTRATION 1072860 DATED 2-25-2011, EXPIRES 2-25-2021.

THE COLOR(S) LIGHT GREEN AND RED IS/ARE CLAIMED AS A FEATURE OF THE MARK.

THE MARK CONSISTS OF LETTERS "INCU" IN LIGHT GREEN AND THE STYLIZED LETTER "I" WHICH IS LIGHT GREEN WITH A RED DOT.

SER. NO. 79-095,703, FILED 2-25-2011.

GRETTA YAO, EXAMINING ATTORNEY



David J. Kyffers

Director of the United States Patent and Trademark Office

United States of America

United States Patent and Trademark Office

Infa Warmer 

Reg. No. 4,097,675

Registered Feb. 14, 2012

Int. Cl.: 10

TRADEMARK

PRINCIPAL REGISTER

ATOM MEDICAL CORPORATION (JAPAN CORPORATION)
18-15, HONGO 3-CHOME
BUNKYO-KU; TOKYO 113-0033
JAPAN

FOR: MEDICAL APPARATUS AND INSTRUMENTS, NAMELY, INFANT INCUBATORS, WARMING DEVICES FOR STABILIZING INFANT BODY TEMPERATURE, INFUSION PUMPS FOR ADMINISTERING BENEFICIAL AGENTS INTO THE BODY, SYRINGE PUMPS FOR ADMINISTERING BENEFICIAL AGENTS INTO THE BODY, MEDICAL EXAMINATION TABLES; HOSPITAL BABY DELIVERY BEDS, ULTRASONIC NEBULIZERS FOR RESPIRATION THERAPY, IN CLASS 10 (U.S. CLS. 26, 39 AND 44).

NO CLAIM IS MADE TO THE EXCLUSIVE RIGHT TO USE "WARMER", APART FROM THE MARK AS SHOWN.

PRIORITY DATE OF 2-10-2011 IS CLAIMED.

OWNER OF INTERNATIONAL REGISTRATION 1073303 DATED 2-21-2011, EXPIRES 2-21-2021.

THE COLOR(S) LIGHT GREEN AND RED IS/ARE CLAIMED AS A FEATURE OF THE MARK.

THE MARK CONSISTS OF LETTERS "INFA WARMER" IN LIGHT GREEN AND THE STYLIZED LETTER "I" WHICH IS LIGHT GREEN WITH A RED DOT.

SER. NO. 79-095,865, FILED 2-21-2011.

GRETTA YAO, EXAMINING ATTORNEY



David J. Kybas

Director of the United States Patent and Trademark Office

United States of America
United States Patent and Trademark Office

Calprene

Reg. No. 4,097,676

Registered Feb. 14, 2012

Int. Cls.: 1 and 17

TRADEMARK

PRINCIPAL REGISTER

DYNASOL ELASTOMEROS, S.A. (SPAIN SOCIEDAD ANÓNIMA)
PASEO DE LA CASTELLANA, 280
E-28046 MADRID
SPAIN

FOR: ETHYLENE-VINYL ACETATE RESINS; CHEMICALS FOR USE IN INDUSTRY, SCIENCE; UNPROCESSED ARTIFICIAL RESINS, UNPROCESSED PLASTICS; ADHESIVES USED IN INDUSTRY, IN CLASS 1 (U.S. CLS. 1, 5, 6, 10, 26 AND 46).

FOR: CAOUTCHOUC; GUTTA-PERCHA AND RUBBER; ARTICLES MADE FROM GUTTA-PERCHA AND RUBBER, NAMELY, RUBBER PACKING FOR SHIPPING CONTAINERS; LIQUID RUBBER; RECLAIMED RUBBER; RINGS OF RUBBER FOR USE IN PIPES AND CONNECTIONS; RUBBER BANDS FOR COMMERCIAL AND INDUSTRIAL USES; RUBBER DERIVATIVES; RUBBER MATERIAL FOR RECAPPING TIRES; RUBBER SLEEVES FOR PROTECTING PART OF MACHINERY; RUBBER SOLUTIONS; RUBBER TUBES AND PIPES; SHOCK ABSORBING RUBBER BUFFERS FOR INDUSTRIAL MACHINERY; SYNTHETIC RUBBER; VALVES OF RUBBER OR VULCANIZED FIBER; PLASTIC IN SEMI-WORKED FORM FOR USE IN MANUFACTURING; MATERIALS FOR INSULATING AND CAULKING, IN CLASS 17 (U.S. CLS. 1, 5, 12, 13, 35 AND 50).

OWNER OF U.S. REG. NO. 1,881,032.

OWNER OF INTERNATIONAL REGISTRATION 1073326 DATED 1-31-2011, EXPIRES 1-31-2021.

THE COLOR(S) DARK BLUE IS/ARE CLAIMED AS A FEATURE OF THE MARK.

THE MARK CONSISTS OF THE WORD "CALPRENE" IN STYLIZED DARK BLUE FONT, WITH A SERIES OF DIAGONAL STRIPES APPEARING ON THE LEFT SIDE OF THE LETTER "C".

SER. NO. 79-095,875, FILED 1-31-2011.

LIEF MARTIN, EXAMINING ATTORNEY



David J. Kypos

Director of the United States Patent and Trademark Office

United States of America

United States Patent and Trademark Office

BODYSMART

Reg. No. 4,097,677

Registered Feb. 14, 2012

Int. Cl.: 10

TRADEMARK

PRINCIPAL REGISTER

COLOPLAST A/S TRADEMARK DEPARTMENT (DENMARK CORPORATION)
HOLTEDAM 1
DK-3050 HUMLEBÆKK
DENMARK

FOR: OSTOMY BAGS AND PARTS AND FILLINGS THEREFORE, NOT INCLUDED IN OTHER CLASSES, NAMELY, BAGS, ATTACHMENT RINGS, CLOSURE RINGS, SKIN PROTECTING SHEETS, BASE PLATES, FILTERS, VALVES, COUPLERS, INTEGRATED CLOSURES AND INTEGRATED OUTLETS, IN CLASS 10 (U.S. CLS. 26, 39 AND 44).

THE MARK CONSISTS OF STANDARD CHARACTERS WITHOUT CLAIM TO ANY PARTICULAR FONT, STYLE, SIZE, OR COLOR.

PRIORITY DATE OF 9-21-2010 IS CLAIMED.

OWNER OF INTERNATIONAL REGISTRATION 1073337 DATED 2-18-2011, EXPIRES 2-18-2021.

SER. NO. 79-095,878, FILED 2-18-2011.

RENEE MCCRAY, EXAMINING ATTORNEY



David J. Kyffers

Director of the United States Patent and Trademark Office

United States of America

United States Patent and Trademark Office

AMORVERO PROFUMO



Reg. No. 4,097,678

Registered Feb. 14, 2012

Int. Cl.: 3

TRADEMARK

PRINCIPAL REGISTER

HASSLER ROMA S.P.A. (ITALY JOINT-STOCK COMPANY)
PIAZZA TRINITÀ DEI MONTI, 6
I-00187 ROMA
ITALY

FOR: SOAP, ANTI-PERSPIRANT SOAP, DEODORANT SOAP, DISINFECTANT SOAP, PERFUMES, AFTER-SHAVE LOTIONS, HAIR LOTIONS, SHAMPOOS, ESSENTIAL OILS, COSMETIC CREAMS, LIPSTICKS, MAKE-UP POWDER, NAIL VARNISH, DENTIFRICES, IN CLASS 3 (U.S. CLS. 1, 4, 6, 50, 51 AND 52).

OWNER OF U.S. REG. NOS. 3,651,402 AND 3,899,308.

OWNER OF INTERNATIONAL REGISTRATION 0747681 DATED 10-11-2000, EXPIRES 10-11-2020.

NO CLAIM IS MADE TO THE EXCLUSIVE RIGHT TO USE "PROFUMO", APART FROM THE MARK AS SHOWN.

THE MARK CONSISTS OF THE WORDING "AMORVERO" IN LARGE STYLIZED FONT WITH THE WORDING "PROFUMO" IN SMALLER FONT BELOW AND BELOW ALL THE WORDING IS A HIGHLY STYLIZED TRIANGULAR GEOMETRIC FIGURE MADE UP OF DIAMONDS AND CURVED LINES.

THE ENGLISH TRANSLATION OF "AMORVERO PROFUMO" IN THE MARK IS TRUE LOVE PERFUME.

SER. NO. 79-095,928, FILED 2-3-2011.

JANICE L. MCMORROW, EXAMINING ATTORNEY



David J. Kyros

Director of the United States Patent and Trademark Office

United States of America
United States Patent and Trademark Office

Incu-i

Reg. No. 4,097,679

Registered Feb. 14, 2012

Int. Cl.: 9

TRADEMARK

PRINCIPAL REGISTER

ATOM MEDICAL CORPORATION (JAPAN CORPORATION)
18-15, HONGO 3-CHOME
BUNKYO-KU; TOKYO 113-0033
JAPAN

FOR: MEASURING OR TESTING MACHINES OR INSTRUMENTS, NAMELY, INSPECTION SYSTEMS FOR INCUBATORS AND INFANT WARMERS, COMPRISING SENSORS OF TEMPERATURE, HUMIDITY AND OXYGEN LEVEL, AND COMPUTER PROGRAMS FOR MANAGING DATA OF TEMPERATURE, HUMIDITY AND OXYGEN LEVEL, IN CLASS 9 (U.S. CLS. 21, 23, 26, 36 AND 38).

OWNER OF U.S. REG. NO. 3,936,910.

PRIORITY DATE OF 1-25-2011 IS CLAIMED.

OWNER OF INTERNATIONAL REGISTRATION 1073581 DATED 2-25-2011, EXPIRES 2-25-2021.

SER. NO. 79-096,010, FILED 2-25-2011.

GRETTA YAO, EXAMINING ATTORNEY



David J. Kybas

Director of the United States Patent and Trademark Office

United States of America
United States Patent and Trademark Office

MIINTO

Reg. No. 4,097,680

Registered Feb. 14, 2012

Int. Cls.: 35 and 41

SERVICE MARK

PRINCIPAL REGISTER

MIINTO AP8 (DENMARK CORPORATION)
GLÜCKATADTSVAJ 2, 1 TV
KØBENHAVN Ø
DENMARK

FOR: RETAIL SERVICES, NAMELY, ONLINE RETAIL STORE SERVICES FEATURING CLOTHING, FOOTWEAR, HEADGEAR, BELTS, BAGS, PURSES, SUITCASES, VANITY CASES, PERFUMERY, BEAUTY PRODUCTS, WATCHES, JEWELLERY, SPECTACLES, HAIR ORNAMENTS, SPORTING ARTICLES, ELECTRONIC ARTICLES, FURNITURE, FURNISHINGS AND TOYS, IN CLASS 35 (U.S. CLS. 100, 101 AND 102).

FOR: ONLINE JOURNALS, NAMELY, BLOGS FEATURING FASHION; NEWS REPORTER SERVICES IN CONNECTION WITH FASHION VIA THE INTERNET, IN CLASS 41 (U.S. CLS. 100, 101 AND 107).

THE MARK CONSISTS OF STANDARD CHARACTERS WITHOUT CLAIM TO ANY PARTICULAR FONT, STYLE, SIZE, OR COLOR.

PRIORITY DATE OF 1-7-2011 IS CLAIMED.

OWNER OF INTERNATIONAL REGISTRATION 1074235 DATED 3-16-2011, EXPIRES 3-16-2021.

SER. NO. 79-096,308, FILED 3-16-2011.

KATHERINE E. HALMEN, EXAMINING ATTORNEY



David J. Kyffers

Director of the United States Patent and Trademark Office

United States of America
United States Patent and Trademark Office

piezobrush

Reg. No. 4,097,681

Registered Feb. 14, 2012

Int. Cls.: 7, 9 and 40

TRADEMARK

SERVICE MARK

PRINCIPAL REGISTER

MASCHINENFABRIK REINHAUSEN GMBH (FED REP GERMANY LIMITED LIABILITY COMPANY)
FALKENSTEINSTRASSE 8
REGENSBURG, FED REP GERMANY 93059

FOR: MACHINES AND INSTALLATIONS CONSTRUCTED THEREFROM FOR SURFACE TREATMENT, NAMELY, FOR CLEANING, ACTIVATING AND COATING, AND FOR THE TREATMENT OF WORK PIECES, ALL USING ATMOSPHERIC GAS DISCHARGE, NAMELY, COMPRESSOR CLEANING MACHINES, GAS COMPRESSORS, POWER-OPERATED SPRAYERS AND MACHINE PARTS, NAMELY, NOZZLES WHICH ARE PARTS OF POWER-OPERATED SPRAYER, IN CLASS 7 (U.S. CLS. 13, 19, 21, 23, 31, 34 AND 35).

FOR: ELECTRIC APPARATUS FOR SURFACE CONDITIONING, COATING AND WORKING USING GAS DISCHARGE, NAMELY, ELECTROSTATIC COATING MACHINES, IN CLASS 9 (U.S. CLS. 21, 23, 26, 36 AND 38).

FOR: GENERATING PHYSICAL STATES OF AGGREGATION, NAMELY, GENERATION OF ATMOSPHERIC GAS DISCHARGE; SURFACE TREATMENT USING ATMOSPHERIC GAS DISCHARGE, NAMELY, GLASS BLOWING, GLASS POLISHING, GLASS TEMPERING AND GLASS TINTING, IN CLASS 40 (U.S. CLS. 100, 103 AND 106).

THE MARK CONSISTS OF STANDARD CHARACTERS WITHOUT CLAIM TO ANY PARTICULAR FONT, STYLE, SIZE, OR COLOR.

OWNER OF INTERNATIONAL REGISTRATION 1074735 DATED 4-4-2011, EXPIRES 4-4-2021.

SER. NO. 79-096,495, FILED 4-4-2011.

NATALIE POLZER, EXAMINING ATTORNEY



David J. Kybas

Director of the United States Patent and Trademark Office

United States of America

United States Patent and Trademark Office

CROISSOMAT

Reg. No. 4,097,682

Registered Feb. 14, 2012

Int. Cl.: 7

TRADEMARK

PRINCIPAL REGISTER

RONDO BURG DORF AG (SWITZERLAND JOINT STOCK COMPANY)
HEIMISWILSTRASSE 42
CH-3400 BURG DORF, SWITZERLAND

FOR: MACHINES FOR THE FOOD INDUSTRY, FOR BAKERIES, CONFECTIONERY SHOPS AND THE HOTEL INDUSTRY, NAMELY, MACHINES FOR MAKING AND PROCESSING FARINACEOUS FOOD PASTES, DOUGH CUTTING MACHINES, BREAD CUTTING MACHINES, KNEADING MACHINES, MIXING MACHINES, AGITATORS, DEGREASING MACHINES, CONVEYOR BELTS, MOTORS FOR MACHINES FOR MANUFACTURING AND PROCESSING FARINACEOUS FOOD PASTES, AND REPLACEMENT ELECTRICAL AND ELECTRONIC CONTROLS FOR MACHINES FOR MANUFACTURING AND PROCESSING FARINACEOUS FOOD PASTES, IN CLASS 7 (U.S. CLS. 13, 19, 21, 23, 31, 34 AND 35).

THE MARK CONSISTS OF STANDARD CHARACTERS WITHOUT CLAIM TO ANY PARTICULAR FONT, STYLE, SIZE, OR COLOR.

PRIORITY DATE OF 2-17-2011 IS CLAIMED.

OWNER OF INTERNATIONAL REGISTRATION 1075065 DATED 3-15-2011, EXPIRES 3-15-2021.

THE WORDING "CROISSOMAT" HAS NO MEANING IN A FOREIGN LANGUAGE.

SER. NO. 79-096,644, FILED 3-15-2011.

MAYUR VAGHANI, EXAMINING ATTORNEY



David J. Kybas

Director of the United States Patent and Trademark Office

United States of America

United States Patent and Trademark Office

NORMAPREN

Reg. No. 4,097,683

Registered Feb. 14, 2012

Int. Cls.: 1 and 17

TRADEMARK

PRINCIPAL REGISTER

NORMA GERMANY GMBH (FED REP GERMANY LIMITED LIABILITY COMPANY)
EDISONSTRASSE 4
63477 MAINTAL
FED REP GERMANY

FOR: THERMOPLASTIC SYNTHETIC MATERIAL, UNPROCESSED, IN PARTICULAR IN THE FORM OF GRANULES OR POWDER, IN CLASS 1 (U.S. CLS. 1, 5, 6, 10, 26 AND 46).

FOR: THERMOPLASTIC SYNTHETIC MATERIAL AS SEMI-FINISHED PRODUCTS, IN PARTICULAR IN GRANULE OR POWDER FORM FOR USE IN MANUFACTURING, IN CLASS 17 (U.S. CLS. 1, 5, 12, 13, 35 AND 50).

THE MARK CONSISTS OF STANDARD CHARACTERS WITHOUT CLAIM TO ANY PARTICULAR FONT, STYLE, SIZE, OR COLOR.

PRIORITY DATE OF 7-8-2010 IS CLAIMED.

OWNER OF INTERNATIONAL REGISTRATION 1076726 DATED 1-7-2011, EXPIRES 1-7-2021.

OWNER OF U.S. REG. NOS. 1,185,419, 2,432,658 AND OTHERS.

SER. NO. 79-097,221, FILED 1-7-2011.

LINDA MICKLEBURGH, EXAMINING ATTORNEY



David J. Kyfos

Director of the United States Patent and Trademark Office

United States of America
United States Patent and Trademark Office

Xylinep

Reg. No. 4,097,684

RESDEVCO LTD. (ISRAEL PRIVATE LIMITED CORPORATION)
P.O.B. 3338
91033 JERUSALEM, ISRAEL

Registered Feb. 14, 2012

Int. Cls.: 3 and 5

FOR: COSMETICS, IN CLASS 3 (U.S. CLS. 1, 4, 6, 50, 51 AND 52).

TRADEMARK

FOR: PHARMACEUTICAL AND VETERINARY PREPARATIONS AND SUBSTANCES FOR SKIN CARE AND FOR THE TREATMENT OF DAMAGED SKIN, IN CLASS 5 (U.S. CLS. 6, 18, 44, 46, 51 AND 52).

PRINCIPAL REGISTER

THE MARK CONSISTS OF STANDARD CHARACTERS WITHOUT CLAIM TO ANY PARTICULAR FONT, STYLE, SIZE, OR COLOR.

OWNER OF INTERNATIONAL REGISTRATION 1076887 DATED 4-11-2011, EXPIRES 4-11-2021.

SER. NO. 79-097,304, FILED 4-11-2011.

YAT SYE, LEE, EXAMINING ATTORNEY



David J. Kyffers

Director of the United States Patent and Trademark Office

United States of America

United States Patent and Trademark Office

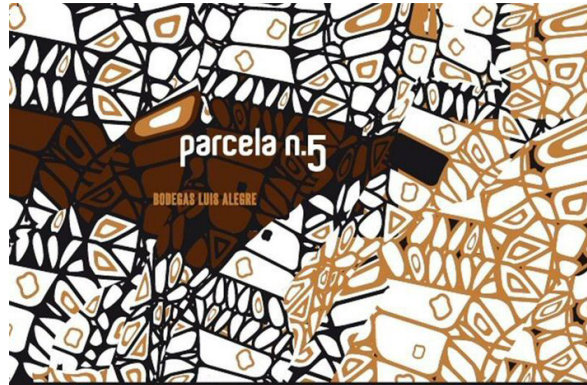

Reg. No. 4,097,685

Registered Feb. 14, 2012

Int. Cl.: 33

TRADEMARK

PRINCIPAL REGISTER

BODEGAS LUIS ALEGRE, S.A. (SPAIN SOCIEDAD ANÓNIMA)
CTRA. NAVARIDAS S/N
E-01300 LAGUARDIA (ALAVA), SPAIN

FOR: WINE, IN CLASS 33 (U.S. CLS. 47 AND 49).

OWNER OF U.S. REG. NO. 3,362,646.

OWNER OF INTERNATIONAL REGISTRATION 1077988 DATED 5-16-2011, EXPIRES 5-16-2021.

THE COLOR(S) BLACK, WHITE, LIGHT BROWN AND DARK BROWN IS/ARE CLAIMED AS A FEATURE OF THE MARK.

NO CLAIM IS MADE TO THE EXCLUSIVE RIGHT TO USE "BODEGAS", APART FROM THE MARK AS SHOWN.

THE NAME "LUIS ALEGRE" IDENTIFIES A LIVING INDIVIDUAL WHOSE CONSENT IS OF RECORD.

THE MARK CONSISTS OF THE WORDS "PARCELA N.5" IN WHITE STYLIZED FONT AND THE WORDS "BODEGAS LUIS ALEGRE" IN LIGHT BROWN STYLIZED FONT PRESENTED ON AN ABSTRACT DARK BROWN AND BLACK SHAPE WHICH IS SURROUNDED BY A PATTERN OF LIGHT BROWN AND BLACK SHAPES ON A WHITE BACKGROUND.

THE ENGLISH TRANSLATION OF THE FOREIGN WORD "PARCELA" IS "PLOT" AND THE TRANSLATION OF "BODEGAS" IS "WINERIES".

SER. NO. 79-097,666, FILED 5-16-2011.

ERNEST SHOSHO, EXAMINING ATTORNEY



David J. Kybas

Director of the United States Patent and Trademark Office

United States of America

United States Patent and Trademark Office



Reg. No. 4,097,686

MAURO ANGELO CONFETTI (ITALY INDIVIDUAL)
VIA FIASSELLA, 1/18

Registered Feb. 14, 2012

I-16121 GENOVA, ITALY AND

Int. Cls.: 35, 36 and 39

ODRAUDE YASNIEL PEREZ AREVALO (CUBA INDIVIDUAL)
VIA FIASSELLA, 1/18
I-16121 GENOVA, ITALY

SERVICE MARK

PRINCIPAL REGISTER

FOR: IMPORT AND EXPORT AGENCY SERVICES; GOODS IMPORT-EXPORT AGENCY SERVICES, IN CLASS 35 (U.S. CLS. 100, 101 AND 102).

FOR: CUSTOMS BROKERAGE; PAYMENT AND RECOVERY OF CUSTOMS IMPORT DUTIES FOR OTHERS, IN CLASS 36 (U.S. CLS. 100, 101 AND 102).

FOR: TRANSPORT SERVICES, NAMELY, TRANSPORT OF GOODS; CARGO HANDLING; FREIGHT SERVICES, NAMELY, SHIPPING OF GOODS; UNLOADING OF CARGO; IMPORT AND EXPORT CARGO HANDLING SERVICES, IN CLASS 39 (U.S. CLS. 100 AND 105).

NO CLAIM IS MADE TO THE EXCLUSIVE RIGHT TO USE "INTERNATIONAL", APART FROM THE MARK AS SHOWN.

PRIORITY DATE OF 3-24-2011 IS CLAIMED.

OWNER OF INTERNATIONAL REGISTRATION 1078088 DATED 4-12-2011, EXPIRES 4-12-2021.

THE MARK CONSISTS OF THE STYLIZED WORDING "AWAY INTERNATIONAL", WHERE THE TERM "AWAY" APPEARS UNDERNEATH A STYLIZED AND UNDERLINED GRAPHIC OF A GLOBE.

SER. NO. 79-097,694, FILED 4-12-2011.

ALYSSA STEEL, EXAMINING ATTORNEY



David J. Kybas

Director of the United States Patent and Trademark Office

United States of America

United States Patent and Trademark Office

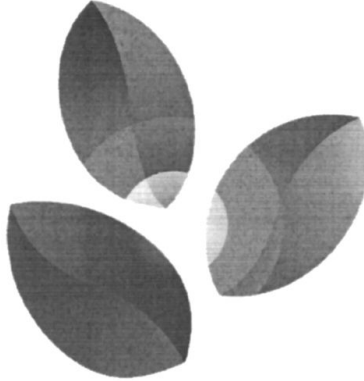

Reg. No. 4,097,687

Registered Feb. 14, 2012

Int. Cl.: 11

TRADEMARK

PRINCIPAL REGISTER

BEIJING LAMPEARL PHOTOELECTRIC CO., LTD. (CHINA CORPORATION)
A1 R & D BUILDING
NO.28 JINGHAI 2ND ROAD, ECONOMIC AND TECHNOLOGICAL ZONE
BEIJING, CHINA

FOR: LIGHTING APPARATUS, NAMELY, LIGHTING INSTALLATIONS; LAMPS; STREET LAMPS; LIGHTS FOR VEHICLES; LIGHTING APPARATUS FOR VEHICLES; LIGHTING INSTALLATIONS FOR AIR VEHICLES, NAMELY, LIGHTS FOR VEHICLES; PROJECTOR LAMPS; LUMINOUS HOUSE NUMBERS; LIGHT BULBS FOR DIRECTIONAL SIGNALS FOR VEHICLES, IN CLASS 11 (U.S. CLS. 13, 21, 23, 31 AND 34).

THE MARK CONSISTS OF THREE OVAL-SHAPED DESIGNS RESEMBLING LEAVES WITH NERVES APPEARING ALONG THE CENTER OF THE OVAL-SHAPED DESIGNS AND ARRANGED IN A TRIANGULAR PATTERN WITH A CIRCULAR AUREOLA DESIGN OVERLAPPING THE OVAL DESIGNS IN THE CENTER.

PRIORITY DATE OF 10-22-2010 IS CLAIMED.

OWNER OF INTERNATIONAL REGISTRATION 1078201 DATED 4-5-2011, EXPIRES 4-5-2021.

SER. NO. 79-097,725, FILED 4-5-2011.

GENE MACIOL, EXAMINING ATTORNEY



David J. Kyffers

Director of the United States Patent and Trademark Office

United States of America

United States Patent and Trademark Office



Reg. No. 4,097,688

Registered Feb. 14, 2012

Int. Cl.: 25

TRADEMARK

PRINCIPAL REGISTER

WENZHOU SUNLUCK INDUSTRIAL LIMITED (CHINA CORPORATION)
C508 DISTRICT, 12TH ROAD
3RD AVENUE, BINHAI PARK, WENZHOU ECO & TECH DEVELOPMENT ZONE
325000 ZHEJIANG, CHINA

FOR: LEATHER SHOES; HOSIERY; SHOES; SOLES FOR FOOTWEAR; INSOLES; BOOTS;
FITTINGS OF METAL FOR SHOES AND BOOTS, IN CLASS 25 (U.S. CLS. 22 AND 39).

THE MARK CONSISTS OF THE LETTER "Z" IN STYLIZED FONT IN A SHADED SQUARE
DESIGN.

OWNER OF INTERNATIONAL REGISTRATION 1078569 DATED 5-17-2011, EXPIRES 5-17-
2021.

SER. NO. 79-097,852, FILED 5-17-2011.

WILLIAM ROSSMAN, EXAMINING ATTORNEY



David J. Kyfos

Director of the United States Patent and Trademark Office

United States of America

United States Patent and Trademark Office

MY FINGERPRINT IS MY PIN

Reg. No. 4,097,689

Registered Feb. 14, 2012

Int. Cls.: 6, 9 and 45

TRADEMARK

SERVICE MARK

PRINCIPAL REGISTER

MU HUA INVESTMENTS LIMITED (HONG KONG LIMITED COMPANY (LTD.))
SUITE 701, 7TH FLOOR LAP FAI BUILDING
6-8 POTTINGER STREET, CENTRAL;
HONG-KONG, CHINA

FOR: METAL LOCKS AND LOCK GOODS, NAMELY, MECHANICAL LOCKS, MECHANICAL COMBINATION LOCKS, SPRING LOCKS, LOCK TUMBLERS, LOCK CASES, LOCK CYLINDERS, STRIKING PLATES, KEYS AND KEY BLANKS; METAL DOOR HARDWARE, NAMELY, METAL SPRING-LOADED NON ELECTRIC DOOR CLOSERS; EMERGENCY AND PANIC DEVICES FOR DOORS AND WINDOWS, NAMELY, METAL LOCKS FOR DOORS AND WINDOWS, METAL DOOR BOLTS, METAL DOOR CHAINS, METAL CLASPS FOR DOOR SECURITY HARDWARE; METAL PARTS, FITTINGS AND MOUNTINGS FOR DOORS AND WINDOWS AS WELL AS OTHER DOOR AND WINDOW HARDWARE, NAMELY, DOOR STOPS, DOOR KICK PLATES, DOOR HINGES, WINDOW LOCKS; METAL STRUCTURAL PARTS FOR THE AFORESAID GOODS; ALL OF THE AFORESAID GOODS BEING OF METAL OR PREDOMINANTLY OF METAL; SMALL ITEMS OF METAL HARDWARE, NAMELY, SCREWS, HOOKS AND SPRINGS, IN CLASS 6 (U.S. CLS. 2, 12, 13, 14, 23, 25 AND 50).

FOR: ELECTRIC, ELECTRONIC AND ELECTRO-MECHANICAL LOCKS AND LOCK GOODS, NAMELY, ELECTRONIC LOCK CYLINDERS, ELECTRIC STRIKING PLATES, DOOR MAGNETS, ELECTRONIC KEYS, ELECTRIC LOCKS, ELECTRONIC LOCKS, ELECTRO-MECHANICAL LOCKS, CARD-OPERATED ELECTRONIC LOCKS; KEY CARDS, NAMELY, ELECTRONIC OR MAGNETIC ACCESS CONTROL CARDS AND SMART CARDS; ELECTRONIC UNITS FOR PROGRAMMING LOCKS, LOCK CYLINDERS, KEYS, KEY CARDS AND KEY CARD READERS; ELECTRO-MECHANICAL AND ELECTRO-HYDRAULIC DOOR OPENERS, DOOR CLOSERS AND DOOR OPERATORS; ELECTRIC AND ELECTRO-MECHANICAL DOOR AND WINDOW HARDWARE, NAMELY, AUTOMATIC CONTROLLERS FOR OPENING DOORS AND WINDOWS OR OBTAINING ACCESS TO A COMPUTER OPERATED FACILITY FOR BUSINESS TRANSACTIONS, OR ELECTRONIC TRANSACTIONS OR COMMUNICATIONS; ELECTRONIC AND MAGNETIC SENSORS FOR OPENING DOORS AND WINDOWS OR OBTAINING ACCESS TO A COMPUTER OPERATED FACILITY FOR BUSINESS TRANSACTIONS OR ELECTRONIC TRANSACTIONS OR COMMUNICATIONS; ELECTRONIC LOCKING ELEMENTS WITH IN BUILT DATA STORAGE OR DATA PROCESSING CAPABILITIES, ELECTRONIC LOCK CYLINDERS WITH IN BUILT SECURITY CODES CHANGEABLE UPON INSERTION OF A KEY; CHANGE CODE MECHANICAL CYLINDERS FOR LOCKS BEING ELECTRONIC CYLINDERS CONTROLLED BY A BIO-



David J. Kyffers

Director of the United States Patent and Trademark Office

Reg. No. 4,097,689 METRIC KEY; CHANGE CODE ELECTRO-MECHANICAL CYLINDERS FOR LOCKS; INTEGRATED CIRCUITS; MAGNETIC IDENTITY CARDS; MAGNETIC OPTICAL OR BIOMETRIC DATA STORAGE AND PROCESSING CAPABILITIES; KEYS CONTAINING BIOMETRIC SENSORS, APPARATUS AND INSTRUMENTS FOR SIGNALLING AND CHECKING AND/OR CONTROLLING PEOPLES MOVEMENT WITHIN ENTRANCE TO AND EXIT FROM BUILDINGS AND THROUGH DOORS AND GATES, NAMELY, ELECTRONIC SECURITY TAGS AND LABELS, ACOUSTIC TAGS, MAGNETIC TAGS, BIOMETRIC SENSORS, ELECTRONIC SENSORS, MICROPROCESSORS COMPUTER OPERATED KEYS; MAGNETIC AND ELECTRONIC IDENTITY CARDS; PRE-RECORDED MAGNETIC DATA CARRIERS FOR OPENING DOORS OR WINDOWS OR OBTAINING ACCESS TO A COMPUTER OPERATED FACILITY FOR BUSINESS TRANSACTIONS OR ELECTRONIC TRANSACTIONS OR COMMUNICATIONS AND COMPUTER SOFTWARE FOR CHECKING AND/OR CONTROLLING PEOPLES MOVEMENT WITHIN ENTRANCE TO AND EXIT FROM BUILDINGS AND THROUGH DOORS AND GATES AND/OR FOR USE WITH GATES AND OPENING DOORS OR WINDOWS OR OBTAINING ACCESS TO A COMPUTER OPERATED FACILITY FOR BUSINESS TRANSACTIONS OR ELECTRONIC TRANSACTIONS OR COMMUNICATIONS, IN CLASS 9 (U.S. CLS. 21, 23, 26, 36 AND 38).

FOR: SECURITY SERVICES FOR THE PROTECTION OF PROPERTY AND INDIVIDUALS; SECURITY CONSULTANCY, IN CLASS 45 (U.S. CLS. 100 AND 101).

THE MARK CONSISTS OF STANDARD CHARACTERS WITHOUT CLAIM TO ANY PARTICULAR FONT, STYLE, SIZE, OR COLOR.

PRIORITY DATE OF 9-28-2010 IS CLAIMED.

OWNER OF INTERNATIONAL REGISTRATION 1079132 DATED 3-16-2011, EXPIRES 3-16-2021.

SER. NO. 79-098,028, FILED 3-16-2011.

ROBIN CHOSID, EXAMINING ATTORNEY

United States of America

United States Patent and Trademark Office



Reg. No. 4,097,690

Registered Feb. 14, 2012

Int. Cls.: 9 and 42

TRADEMARK

SERVICE MARK

PRINCIPAL REGISTER

CRUNDRING, BESLOTEN VENNOOTSCHAP (NETHERLANDS LIMITED LIABILITY COMPANY)
KENNEMERLAAN 161 A
IJMUIDEN, NETHERLANDS NL1972 EM

FOR: APPARATUS FOR RECORDING, TRANSMISSION OR REPRODUCTION OF SOUND OR IMAGES; BLANK MAGNETIC DATA CARRIES; DATA PROCESSING EQUIPMENT AND COMPUTERS, IN CLASS 9 (U.S. CLS. 21, 23, 26, 36 AND 38).

FOR: DESIGN AND DEVELOPMENT OF COMPUTER SOFTWARE PARTICULARLY FOR USE IN THE REAL TIME WEATHER DISPLAY AS WELL AS WEATHER FORECASTS, IN CLASS 42 (U.S. CLS. 100 AND 101).

NO CLAIM IS MADE TO THE EXCLUSIVE RIGHT TO USE "WEATHER", APART FROM THE MARK AS SHOWN.

PRIORITY DATE OF 1-11-2011 IS CLAIMED.

OWNER OF INTERNATIONAL REGISTRATION 1079309 DATED 3-31-2011, EXPIRES 3-31-2021.

THE MARK CONSISTS OF THE LITERAL ELEMENT "WEATHER" ON A RECTANGULAR BACKGROUND; INTERSECTING THE RIGHT TOP OF THE "R" IS THE DESIGN OF A CIRCLE WITH A PLUS SIGN IN THE MIDDLE AND BARS THAT LOOK LIKE RAYS AROUND THE UPPER RIGHT THREE QUARTERS OF THE CIRCLE.

SER. NO. 79-098,125, FILED 3-31-2011.

CHRISIE B. KING, EXAMINING ATTORNEY



David J. Kybas

Director of the United States Patent and Trademark Office

United States of America

United States Patent and Trademark Office

eMini-Wright

Reg. No. 4,097,691

Registered Feb. 14, 2012

Int. Cl.: 10

TRADEMARK

PRINCIPAL REGISTER

CLEMENT CLARKE INTERNATIONAL LIMITED (UNITED KINGDOM LIMITED COMPANY)
EDINBURGH WAY
HARLOW, ESSEX CM20 2TT
UNITED KINGDOM

FOR: MEDICAL DEVICES, NAMELY, SPIROMETERS FOR MEASURING LUNG FUNCTION AND PARTS AND FITTINGS THEREFOR; PEAK FLOW METERS FOR MEASURING THE FLOW OF AIR THROUGH THE NOSE AND THE MOUTH AND FOR MEASURING LUNG FUNCTIONS AND PARTS AND FITTINGS THEREFOR; MEDICAL APPARATUS FOR MEASURING THE FLOW OF AIR THROUGH THE MOUTH AND NOSE AND PARTS AND FITTINGS THEREFOR; MEDICAL APPARATUS FOR MEASURING LUNG FUNCTIONS, NAMELY, PEAK FLOW METERS AND FLOW RATE METERS AND PARTS AND FITTINGS THEREFOR, IN CLASS 10 (U.S. CLS. 26, 39 AND 44).

THE MARK CONSISTS OF STANDARD CHARACTERS WITHOUT CLAIM TO ANY PARTICULAR FONT, STYLE, SIZE, OR COLOR.

PRIORITY DATE OF 12-2-2010 IS CLAIMED.

OWNER OF INTERNATIONAL REGISTRATION 1079384 DATED 5-12-2011, EXPIRES 5-12-2021.

SER. NO. 79-098,160, FILED 5-12-2011.

JANICE KIM, EXAMINING ATTORNEY



David J. Kyffers

Director of the United States Patent and Trademark Office

United States of America

United States Patent and Trademark Office

LIFE 21

Reg. No. 4,097,692

Registered Feb. 14, 2012

Int. Cls.: 5, 10 and 44

TRADEMARK

SERVICE MARK

PRINCIPAL REGISTER

MILTENYI BIOTEC GMBH (FED REP GERMANY GMBH)
FRIEDRICH-EBERT-STR. 68
51429 BERGISCH GLADBACH
FED REP GERMANY

FOR: PHARMACEUTICAL PREPARATIONS, PARTICULARLY PHARMACEUTICAL PREPARATIONS FOR EXTRACORPOREAL PLASMA THERAPY, IMMUNOLOGICAL PREPARATIONS, PREPARATIONS FOR APHERESIS, SOLUTIONS FOR EXTRACORPOREAL PLASMA THERAPY, PREPARATIONS FOR ANTICOAGULATION, IN CLASS 5 (U.S. CLS. 6, 18, 44, 46, 51 AND 52).

FOR: MEDICAL INSTRUMENTS AND APPARATUS, PARTICULARLY APPARATUS AND ABSORBERS FOR USE IN EXTRACORPOREAL PLASMA THERAPY, PLASTIC CONTAINERS AND BAGS ESPECIALLY MADE FOR MEDICAL WASTE, FILTERS AND TUBING SETS FOR MEDICAL PURPOSES, NAMELY, BLOOD FILTERS, IN CLASS 10 (U.S. CLS. 26, 39 AND 44).

FOR: MEDICAL SERVICES, PARTICULARLY IN THE FIELD OF EXTRACORPOREAL PLASMA THERAPY, IN CLASS 44 (U.S. CLS. 100 AND 101).

THE MARK CONSISTS OF STANDARD CHARACTERS WITHOUT CLAIM TO ANY PARTICULAR FONT, STYLE, SIZE, OR COLOR.

PRIORITY DATE OF 8-26-2010 IS CLAIMED.

OWNER OF INTERNATIONAL REGISTRATION 1079556 DATED 2-21-2011, EXPIRES 2-21-2021.

SER. NO. 79-098,212, FILED 2-21-2011.

CHRISIE B. KING, EXAMINING ATTORNEY



David J. Kypos

Director of the United States Patent and Trademark Office

United States of America
United States Patent and Trademark Office

my-self

Reg. No. 4,097,693

Registered Feb. 14, 2012

Int. Cl.: 20

TRADEMARK

PRINCIPAL REGISTER

DAUPHIN ENTWICKLUNGS- U. BETEILIGUNGS-GMBH (FED REP GERMANY CORPORATION)
INDUSTRIESTRASSE 11
91217 HERSBRUCK, FED REP GERMANY

FOR: OFFICE FURNITURE, OFFICE CHAIRS, VISITORS' CHAIRS, VISITORS' ARMCHAIRS, CONFERENCE CHAIRS, OFFICE ARMCHAIRS, STOOLS, TABLES AND PARTS OF THE AFORESAID GOODS, NAMELY, CHAIR LEGS, ARM RESTS, CHAIR CUSHIONS, CHAIR PADS, BACKRESTS, CASTORS, PEDESTALS, IN CLASS 20 (U.S. CLS. 2, 13, 22, 25, 32 AND 50).

THE MARK CONSISTS OF STANDARD CHARACTERS WITHOUT CLAIM TO ANY PARTICULAR FONT, STYLE, SIZE, OR COLOR.

PRIORITY DATE OF 10-14-2010 IS CLAIMED.

OWNER OF INTERNATIONAL REGISTRATION 1079988 DATED 4-12-2011, EXPIRES 4-12-2021.

SER. NO. 79-098,401, FILED 4-12-2011.

ANDREW LEASER, EXAMINING ATTORNEY



David J. Kyffers

Director of the United States Patent and Trademark Office

United States of America
United States Patent and Trademark Office

MARIA OLE

Reg. No. 4,097,694

LES GRANDS CHAIS DE FRANCE (FRANCE S.A.S.)
1, RUE DE LA DIVISION LECLERC
F-67290 PETERSBACH, FRANCE

Registered Feb. 14, 2012

Int. Cl.: 33

FOR: ALCOHOLIC BEVERAGES EXCEPT BEER, IN CLASS 33 (U.S. CLS. 47 AND 49).

TRADEMARK

THE MARK CONSISTS OF STANDARD CHARACTERS WITHOUT CLAIM TO ANY PARTICULAR FONT, STYLE, SIZE, OR COLOR.

PRINCIPAL REGISTER

OWNER OF INTERNATIONAL REGISTRATION 1080061 DATED 5-25-2011, EXPIRES 5-25-2021.

THE NAME(S), PORTRAIT(S), AND/OR SIGNATURE(S) SHOWN IN THE MARK DOES NOT IDENTIFY A PARTICULAR LIVING INDIVIDUAL.

SER. NO. 79-098,429, FILED 5-25-2011.

MAYUR VAGHANI, EXAMINING ATTORNEY



David J. Kyffers

Director of the United States Patent and Trademark Office

United States of America

United States Patent and Trademark Office

LILI GAUFRETTE

Reg. No. 4,097,695

Registered Feb. 14, 2012

Int. Cl.: 28

TRADEMARK

PRINCIPAL REGISTER

DAUPHITEX (FRANCE SOCIÉTÉ PAR ACTIONS SIMPLIFIÉE)
466 RUE DES MERCIÈRES
F-69140 RILLIEUX LA PAPE
FRANCE

FOR: BOARD GAMES, BENDABLE TOYS, DOLLS, PLUSH TOYS, TEDDY BEARS, IN
CLASS 28 (U.S. CLS. 22, 23, 38 AND 50).

OWNER OF U.S. REG. NO. 2,295,323.

PRIORITY DATE OF 12-9-2010 IS CLAIMED.

OWNER OF INTERNATIONAL REGISTRATION 1080186 DATED 5-20-2011, EXPIRES 5-20-
2021.

THE NAME "LILLI GAUFRETTE" DOES NOT IDENTIFY A LIVING INDIVIDUAL.

SER. NO. 79-098,473, FILED 5-20-2011.

ANTHONY RINKER, EXAMINING ATTORNEY



David J. Kybas

Director of the United States Patent and Trademark Office

United States of America

United States Patent and Trademark Office

Lola.K 

Reg. No. 4,097,696

Registered Feb. 14, 2012

Int. Cls.: 14, 40 and 42

TRADEMARK

SERVICE MARK

PRINCIPAL REGISTER

MADEMOISELLE LOLA BUFFAGNI (ITALY INDIVIDUAL)
15, BOULEVARD LOUIS II
MC-98000 MONACO
MONACO

FOR: JEWELRY, JEWELRY PRODUCTS, NAMELY, RINGS, BRACELETS, BROOCHES, CHAINS, NECKLACES, EARRINGS, PINS, MEDALLIONS, YARN AND THREAD OF GOLD, ORNAMENTS; CASKETS OR BOXES FOR JEWELRY; KEY RINGS OF PRECIOUS METAL; SILVER ORNAMENTS IN THE NATURE OF JEWELRY, SPUN SILVER, SILVER THREAD; PEARLS; PRECIOUS STONES, SEMI-PRECIOUS STONES, THREAD AND YARN OF PRECIOUS METAL, PRECIOUS METALS AND THEIR ALLOYS; HOROLOGICAL AND CHRONOMETRIC INSTRUMENTS, WATCHES, WRISTWATCHES; DIAMONDS; PLATINUM; IMITATION JEWELLERY; WATCH CLASPS, IN CLASS 14 (U.S. CLS. 2, 27, 28 AND 50).

FOR: SOLDERING, BURNISHING BY ABRASION, SHAVING, REFINING, ENGRAVING, GALVANIZING, GILDING, CASTING, MOLDING AND PLATING OF METALS; NICKEL PLATING; GOLD-PLATING; SILVER-PLATING, IN CLASS 40 (U.S. CLS. 100, 103 AND 106).

FOR: RESEARCH AND DEVELOPMENT OF NEW PRODUCTS FOR OTHERS; GRAPHIC ARTS DESIGNING; STYLING SERVICES PROVIDED BY JEWELRY DESIGNERS, NAMELY, JEWELRY DESIGN; DESIGN AND DEVELOPMENT OF JEWELRY; MATERIAL TESTING, IN CLASS 42 (U.S. CLS. 100 AND 101).

THE NAME(S), PORTRAIT(S), AND/OR SIGNATURE(S) SHOWN IN THE MARK DOES NOT IDENTIFY A PARTICULAR LIVING INDIVIDUAL.

PRIORITY DATE OF 2-16-2011 IS CLAIMED.

OWNER OF INTERNATIONAL REGISTRATION 1080413 DATED 4-20-2011, EXPIRES 4-20-2021.

THE COLOR(S) PINK AND BLACK IS/ARE CLAIMED AS A FEATURE OF THE MARK.

THE MARK COMPRISES THE WORDS "LOLA" AND "K" WRITTEN IN BLACK, WITH A PINK CROWN APPEARING ABOVE THE LETTER "K".

SER. NO. 79-098,576, FILED 4-20-2011.



David J. Kyffers

Director of the United States Patent and Trademark Office

Reg. No. 4,097,696 ERNEST SHOSHO, EXAMINING ATTORNEY

United States of America

United States Patent and Trademark Office

The Compost Heap Ltd

Reg. No. 4,097,697

Registered Feb. 14, 2012

Int. Cls.: 16, 25 and 28

TRADEMARK

PRINCIPAL REGISTER

THE COMPOST HEAP LIMITED (UNITED KINGDOM LIMITED COMPANY)
1 WEST PARK FARM BUILDING
COOS LANE; HANDCROSS
WEST SUSSEX RH17 6AD, UNITED KINGDOM

FOR: PAPER, CARDBOARD AND GOODS MADE FROM THESE MATERIALS, NAMELY, GREETING CARDS AND POST CARDS, PRINTED MATTER, NAMELY, GREETING CARDS AND POST CARDS, CHRISTMAS CARDS, PRINTS, ILLUSTRATIONS, CARTOON PRINTS AND CHILDREN'S STORYBOOKS, PHOTOGRAPHS AND STATIONERY, IN CLASS 16 (U.S. CLS. 2, 5, 22, 23, 29, 37, 38 AND 50).

FOR: CLOTHING, NAMELY, SHIRTS, PANTS, T-SHIRTS, HOODED SWEAT SHIRTS, T-SHIRTS, FOOTWEAR, HEADGEAR, NAMELY, HATS, BASEBALL CAPS AND CAPS, IN CLASS 25 (U.S. CLS. 22 AND 39).

FOR: GAMES AND PLAYTHINGS, NAMELY, FIGURES, ACTION FIGURE TOYS, COLLECTABLE TOY FIGURINES AND STUFFED TOYS, AND DECORATIONS FOR CHRISTMAS TREES, IN CLASS 28 (U.S. CLS. 22, 23, 38 AND 50).

NO CLAIM IS MADE TO THE EXCLUSIVE RIGHT TO USE "LTD", APART FROM THE MARK AS SHOWN.

OWNER OF INTERNATIONAL REGISTRATION 1080992 DATED 2-26-2011, EXPIRES 2-26-2021.

THE COLOR(S) WHITE, GREEN, AND YELLOW IS/ARE CLAIMED AS A FEATURE OF THE MARK.

THE MARK CONSISTS OF THE WORDING "THE COMPOST HEAP LTD", IN WHICH "THE", "HEAP", AND "LTD" ARE GREEN, AND IN "COMPOST", THE LETTERS "C", "MP", AND "ST" ARE GREEN AND THE TWO O'S ARE WHITE DAISIES WITH YELLOW CENTERS.

SER. NO. 79-098,764, FILED 2-26-2011.

RAMONA ORTIGA, EXAMINING ATTORNEY



David J. Kyffers

Director of the United States Patent and Trademark Office

United States of America

United States Patent and Trademark Office

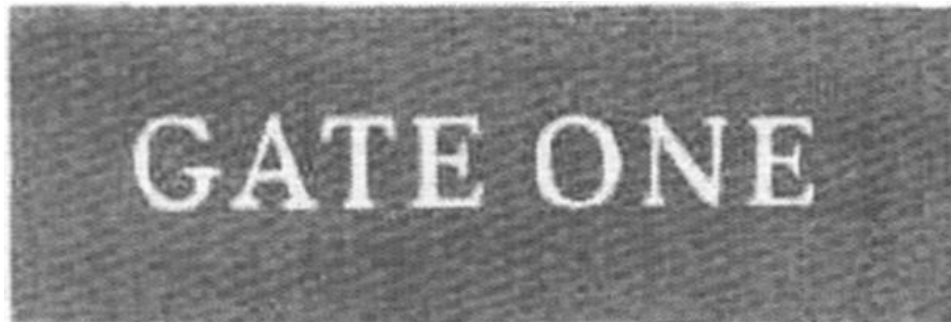

Reg. No. 4,097,698

Registered Feb. 14, 2012

Int. Cl.: 25

NINGBO SKYTEX IMPORT & EXPORT CO., LTD. (CHINA CORPORATION)
ROOM 24-8, NO. 1018 MIN'AN ROAD
(NO. 1-3, BUILDING A.; XINTIANDI EAST AREA),; JIANGDONG DISTRICT, NINGBO;
ZHEJIANG
CHINA

TRADEMARK

PRINCIPAL REGISTER

FOR: CLOTHING, NAMELY, SKIRTS, JACKETS, COATS, TOPS, BLOUSES, T-SHIRTS, SWEATSHIRTS, SHIRTS, SUITS, VESTS, UNDERWEAR, DRESSES, SWEATERS, SWEAT-PANTS, SHORTS AND PANTS; KNITWEAR AS CLOTHING, NAMELY, KNIT BOTTOMS, KNIT DRESSES, KNIT JACKETS, KNIT SHIRTS, KNIT SKIRTS, KNIT TOPS, KNITTED UNDERWEAR; JACKETS; CHILDREN'S AND INFANTS' APPAREL, NAMELY, JUMPERS, OVERALL SLEEPWEAR, PAJAMAS, ROMPERS, ONE-PIECE GARMENTS, JACKETS, SHIRTS AND PANTS; CLOTHING OF LEATHER, NAMELY, LEATHER COATS, LEATHER JACKETS, LEATHER PANTS, LEATHER SHIRTS, LEATHER SKIRTS, LEATHER VESTS, SUITS OF LEATHER AND TROUSERS OF LEATHER; SPORTS JERSEYS; DOWN JACKETS; DOWN SUITS; BODY LINEN, IN CLASS 25 (U.S. CLS. 22 AND 39).

THE MARK CONSISTS OF THE WORDING "GATE ONE" ON A DARK BACKGROUND.

OWNER OF INTERNATIONAL REGISTRATION 1081142 DATED 5-13-2011, EXPIRES 5-13-2021.

SER. NO. 79-098,819, FILED 5-13-2011.

DAVID HOFFMAN, EXAMINING ATTORNEY



David J. Kyffers

Director of the United States Patent and Trademark Office

United States of America

United States Patent and Trademark Office

GATT

Reg. No. 4,097,699

Registered Feb. 14, 2012

Int. Cl.: 5

TRADEMARK

PRINCIPAL REGISTER

BENDER ANALYTICAL HOLDING B.V. (NETHERLANDS BESLOTEN VENNOOTSCHAP)
BEUKSTRAAT 73
NL-3581 XE UTRECHT
NETHERLANDS

FOR: MEDICAL TAPES AND ADHESIVES FOR USE ON HUMAN TISSUE AND/OR ORGANS,
IN CLASS 5 (U.S. CLS. 6, 18, 44, 46, 51 AND 52).

THE MARK CONSISTS OF STANDARD CHARACTERS WITHOUT CLAIM TO ANY PAR-
TICULAR FONT, STYLE, SIZE, OR COLOR.

PRIORITY DATE OF 10-1-2010 IS CLAIMED.

OWNER OF INTERNATIONAL REGISTRATION 1081318 DATED 3-9-2011, EXPIRES 3-9-
2021.

SER. NO. 79-098,871, FILED 3-9-2011.

KIMBERLY PERRY, EXAMINING ATTORNEY



David J. Kyjars

Director of the United States Patent and Trademark Office

United States of America
United States Patent and Trademark Office

FLORANID

Reg. No. 4,097,700

Registered Feb. 14, 2012

Int. Cl.: 1

TRADEMARK

PRINCIPAL REGISTER

COMPO GMBH & CO.KG (FED REP GERMANY LIMITED PARTNERSHIP WITH A LIMITED LIABILITY COMPANY AS GENERAL PARTNER)
GILDENSTRASSE 38
48157 MÜNSTER
FED REP GERMANY

FOR: FERTILIZERS, IN CLASS 1 (U.S. CLS. 1, 5, 6, 10, 26 AND 46).

OWNER OF INTERNATIONAL REGISTRATION 0224057 DATED 9-25-1959, EXPIRES 9-25-2019.

SER. NO. 79-098,919, FILED 4-9-2011.

INGRID C. EULIN, EXAMINING ATTORNEY



David J. Kyffers

Director of the United States Patent and Trademark Office

United States of America

United States Patent and Trademark Office

VALCAM

Reg. No. 4,097,701

Registered Feb. 14, 2012

Int. Cl.: 7

TRADEMARK

PRINCIPAL REGISTER

SANKYO OILLESS INDUSTRY, INC. (JAPAN CORPORATION)
1-5, NISSHIN-CHO 1-CHOME
FUCHU-SHI
TOKYO 183-0036, JAPAN

FOR: METALWORKING MACHINES AND TOOLS, NAMELY, MOULDS AND DIES FOR METAL-FORMING, IN CLASS 7 (U.S. CLS. 13, 19, 21, 23, 31, 34 AND 35).

THE MARK CONSISTS OF THE STYLIZED WORD "VALCAM" HAVING A HORIZONTAL LINE RUNNING THROUGH THE CENTER OF THE WORDS.

PRIORITY DATE OF 5-31-2011 IS CLAIMED.

OWNER OF INTERNATIONAL REGISTRATION 1081880 DATED 6-6-2011, EXPIRES 6-6-2021.

SER. NO. 79-099,079, FILED 6-6-2011.

MAYUR VAGHANI, EXAMINING ATTORNEY



David J. Kyffers

Director of the United States Patent and Trademark Office

United States of America
United States Patent and Trademark Office

家泰
Jiatai

Reg. No. 4,097,702

Registered Feb. 14, 2012

Int. Cl.: 9

ZHEJIANG JIATAI ELECTRICAL APPLIANCE MANUFACTURE CO., LTD. (CHINA CORPORATION)
D-1, XIANYANGCHEN INDUSTRIAL ZONE
HONGQIAO TOWN., YUEQING CITY; 325608 ZHEJIANG
CHINA

TRADEMARK

PRINCIPAL REGISTER

FOR: COMPUTERS; PRINTERS; INTERPHONES; TEMPERATURE CONTROLLERS FOR USE IN HOUSEHOLD ELECTRICAL APPLIANCE, NAMELY, ELECTRIC IRONS AND ELECTRIC KETTLE; THERMOSTATS; FLAT IRONS, ELECTRIC; REMOTE CONTROL APPARATUS FOR RADIOS, TELEVISION AND STEREOS; IC CARD READERS; GPS SATELLITE POSITIONING DEVICE; WIRELESS COMMUNICATIONS EQUIPMENTS, NAMELY, CELL PHONES, IN CLASS 9 (U.S. CLS. 21, 23, 26, 36 AND 38).

THE MARK CONSISTS OF THE WORDING "JIATAI" BELOW THE DESIGN OF ASIA CHARACTERS WITH THE SAME MEANING.

OWNER OF INTERNATIONAL REGISTRATION 1082228 DATED 5-13-2011, EXPIRES 5-13-2021.

THE TRANSLITERATION OF THE NON-LATIN CHARACTERS IN THE MARK IS: JIA TAI.

THE ENGLISH TRANSLATION OF THE FOREIGN WORD(S) IN THE MARK IS: THE FIRST CHARACTER MEANS HOME, THE SECOND ONE MEANS PEACEFUL; THE COMBINATION OF THE TWO CHINESE CHARACTERS HAS NO MEANING.

SER. NO. 79-099,198, FILED 5-13-2011.

DAVID HOFFMAN, EXAMINING ATTORNEY



David J. Kyffers

Director of the United States Patent and Trademark Office

United States of America

United States Patent and Trademark Office

JIAOZU

Reg. No. 4,097,703

Registered Feb. 14, 2012

Int. Cl.: 25

TRADEMARK

PRINCIPAL REGISTER

WENZHOU SUNLUCK INDUSTRIAL LIMITED (CHINA CORPORATION)
C508 DISTRICT, 12TH ROAD
3RD AVENUE, BINHAI PARK, WENZHOU ECO & TECH DEVELOPMENT ZONE
325000 ZHEJIANG, CHINA

FOR: LEATHER SHOES; SHOES; SOLES FOR FOOTWEAR; METAL FITTINGS FOR SHOES AND BOOTS; SPORTS SHOES; FOOTBALL SHOES; SLIPPERS, IN CLASS 25 (U.S. CLS. 22 AND 39).

THE MARK CONSISTS OF THE WORDING "JIAOZU" IN STYLIZED FONT.

OWNER OF INTERNATIONAL REGISTRATION 1082475 DATED 6-15-2011, EXPIRES 6-15-2021.

THE WORDING "JIAOZU" HAS NO MEANING IN FOREIGN LANGUAGE.

SER. NO. 79-099,333, FILED 6-15-2011.

WILLIAM ROSSMAN, EXAMINING ATTORNEY



David J. Kyros

Director of the United States Patent and Trademark Office

United States of America

United States Patent and Trademark Office

PALMENTO

Reg. No. 4,097,704

Registered Feb. 14, 2012

Int. Cl.: 33

COLLI DELLA MURGIA S.S.A. (ITALY PARTNERSHIP)
CASS. POSTALE 87
CONTRADA ZINGARIELLO;
GRAVINA IN PUGLIA (BA), ITALY

FOR: WINE, IN CLASS 33 (U.S. CLS. 47 AND 49).

TRADEMARK

THE MARK CONSISTS OF THE WORD "PALMENTO" REPRESENTED IN STYLIZED FONT.

PRINCIPAL REGISTER

OWNER OF INTERNATIONAL REGISTRATION 1082950 DATED 5-20-2011, EXPIRES 5-20-2021.

THE ENGLISH TRANSLATION OF "PALMENTO" IN THE MARK IS "MILLSTONE".

SER. NO. 79-099,509, FILED 5-20-2011.

WARREN L. OLANDRIA, EXAMINING ATTORNEY



David J. Kybas

Director of the United States Patent and Trademark Office

United States of America

United States Patent and Trademark Office

ATTIMO
L'Eau Florale

Reg. No. 4,097,705

Registered Feb. 14, 2012

Int. Cl.: 3

TRADEMARK

PRINCIPAL REGISTER

SALVATORE FERRAGAMO S.P.A. (ITALY JOINT STOCK COMPANY)
VIA DEI TORNABUONI, 2
I-50123 FIRENZE
ITALY

FOR: PERFUMES, EAU DE PARFUM, COLOGNE, TOILET WATER, AFTER SHAVE, SHAVING LOTIONS, SHAVING CREAMS, SHAMPOOS, HAIR CONDITIONERS, ESSENTIAL OILS, COLD CREAM, PERSONAL DEODORANTS, ANTIPERSPIRANTS, SKIN CLEANSING LOTIONS, SKIN MOISTURIZER, BODY OIL, SKIN EMOLLIENTS, SOAPS FOR PERSONAL USE, BATH SOAPS, BATH AND SHOWER GEL, BODY LOTIONS, SKIN LOTIONS, IN CLASS 3 (U.S. CLS. 1, 4, 6, 50, 51 AND 52).

NO CLAIM IS MADE TO THE EXCLUSIVE RIGHT TO USE "L'EAU FLORALE", APART FROM THE MARK AS SHOWN.

PRIORITY DATE OF 1-25-2011 IS CLAIMED.

OWNER OF INTERNATIONAL REGISTRATION 1083046 DATED 4-8-2011, EXPIRES 4-8-2021.

THE COLOR(S) RED (PANTONE CODE 202C) AND PINK IS/ARE CLAIMED AS A FEATURE OF THE MARK.

THE MARK CONSISTS OF THE WORDING "ATTIMO L'EAU FLORALE" ON TWO LINES; ON THE FIRST LINE THE WORD "ATTIMO" IS WRITTEN IN RED (PANTONE CODE 202C) AND IN FANCY CHARACTERS; UNDERNEATH, ON THE SECOND LINE, THE WORDS "L'EAU FLORALE" ARE WRITTEN IN PINK AND IN ITALIC.

THE ENGLISH TRANSLATION OF "ATTIMO L'EAU FLORALE " IS "MOMENT FLORAL WATER".

SER. NO. 79-099,548, FILED 4-8-2011.

KRISTINA MORRIS, EXAMINING ATTORNEY



David J. Kyffers

Director of the United States Patent and Trademark Office

United States of America

United States Patent and Trademark Office



Reg. No. 4,097,706

Registered Feb. 14, 2012

Int. Cl.: 9

TRADEMARK

PRINCIPAL REGISTER

NINGBO ULICA SOLAR SCIENCE & TECHNOLOGY CO., LTD. (CHINA CORPORATION)
NO. 1 SHANSHAN ROAD
WANGCHUN INDUSTRIAL ZONE., NINGBO; ZHEJIANG
CHINA

FOR: POLYCRYSTALLINE SILICON WAFERS; MONOCRYSTALLINE SILICON WAFERS;
SOLAR BATTERIES; BATTERIES FOR LIGHTING; BATTERY CHARGERS; EPITAXIAL
WAFERS OF SILICON; CURRENT RECTIFIERS; ELECTRICITY INVERTERS, IN CLASS 9
(U.S. CLS. 21, 23, 26, 36 AND 38).

THE MARK CONSISTS OF THE WORD "ULICA" UNDERLINED BY EIGHT PARALLELO-
GRAMS AND A DESIGN OF A SUN TO THE UPPER RIGHT OF THE LETTER A IN "ULICA".

OWNER OF INTERNATIONAL REGISTRATION 1083104 DATED 5-13-2011, EXPIRES 5-13-
2021.

THE WORDING "ULICA" HAS NO MEANING IN A FOREIGN LANGUAGE.

SER. NO. 79-099,575, FILED 5-13-2011.

DAVID HOFFMAN, EXAMINING ATTORNEY



David J. Kyffers

Director of the United States Patent and Trademark Office

United States of America

United States Patent and Trademark Office

mytheresa.com

Reg. No. 4,097,707

Registered Feb. 14, 2012

Int. Cl.: 35

SERVICE MARK

PRINCIPAL REGISTER

MYTHERESA.COM GMBH (FED REP GERMANY LIMITED LIABILITY COMPANY)
FRIEDENSTR. 22B
81671 MÜNCHEN, FED REP GERMANY

FOR: RETAIL STORE SERVICES FEATURING CLOTHING, FOOTWEAR, HEADGEAR, LEATHER GOODS, BAGS, SPECTACLES AND/OR JEWELRY; ONLINE RETAIL STORE AND CATALOGUE ORDERING SERVICES IN THE FIELD OF CLOTHING, FOOTWEAR, HEADGEAR, LEATHER GOODS, BAGS, SPECTACLES AND/OR JEWELRY; THE BRINGING TOGETHER AND DISPLAYING OF CLOTHING, FOOTWEAR, HEADGEAR, LEATHER GOODS, BAGS, SPECTACLES AND/OR JEWELRY ENABLING CUSTOMERS CONVENIENTLY TO VIEW AND TO PURCHASE SUCH GOODS, IN CLASS 35 (U.S. CLS. 100, 101 AND 102).

THE MARK CONSISTS OF STANDARD CHARACTERS WITHOUT CLAIM TO ANY PARTICULAR FONT, STYLE, SIZE, OR COLOR.

OWNER OF INTERNATIONAL REGISTRATION 0914889 DATED 10-5-2006, EXPIRES 10-5-2016.

SER. NO. 79-099,691, FILED 8-25-2010.

PAM WILLIS, EXAMINING ATTORNEY



David J. Kybas

Director of the United States Patent and Trademark Office

United States of America

United States Patent and Trademark Office

m may's may

Reg. No. 4,097,708

Registered Feb. 14, 2012

Int. Cl.: 25

TRADEMARK

PRINCIPAL REGISTER

I.D.LOOK LTD. (REPUBLIC OF KOREA CORPORATION)
SEONGBO BLDG., 19 NONHYEON 1-DONG
GANGNAM-GU, SEOUL
REPUBLIC OF KOREA

FOR: LEATHER SHOES; LONG COATS; CARDIGANS; SKIRTS; JACKETS; BATHING SUITS;
CAPS HEADWEAR; LEATHER BELTS; CEREMONIAL DRESSES; SCARFS; JUMPERS;
SHORTS, IN CLASS 25 (U.S. CLS. 22 AND 39).

OWNER OF INTERNATIONAL REGISTRATION 1083405 DATED 6-27-2011, EXPIRES 6-27-2021.

SER. NO. 79-099,735, FILED 6-27-2011.

KELLY TRUSILO, EXAMINING ATTORNEY



David J. Kyffers

Director of the United States Patent and Trademark Office

United States of America
United States Patent and Trademark Office

Luvion

Reg. No. 4,097,709

Registered Feb. 14, 2012

Int. Cls.: 8, 9 and 11

TRADEMARK

PRINCIPAL REGISTER

EGERIUM BV (NETHERLANDS BESLOTEN VENNOOTSCHAP (B.V.))
KLEVERINGWEG 25
NL-2616 LZ DELFT
NETHERLANDS

FOR: HAND TOOLS AND IMPLEMENTS, HAND-OPERATED, NAMELY, HAMMERS, FILES, AWLS; CUTLERY; SIDE ARMS, NOT INCLUDING FIREARMS, NAMELY, SWORDS, HUNTING KNIVES; RAZORS, IN CLASS 8 (U.S. CLS. 23, 28 AND 44).

FOR: SCIENTIFIC, NAUTICAL, SURVEYING, ELECTRIC, PHOTOGRAPHIC, CINEMATOGRAPHIC, OPTICAL, WEIGHING, MEASURING, SIGNALLING, CHECKING, SUPERVISION, LIFE-SAVING AND TEACHING APPARATUS AND INSTRUMENTS, NAMELY, BABY MONITORS, THERMOMETERS, WEIGHING SCALES, SMOKE ALARMS; APPARATUS FOR RECORDING, TRANSMISSION OR REPRODUCTION OF SOUND OR IMAGES; BLANK MAGNETIC DATA CARRIERS, PRERECORDED MAGNETIC DATA CARRIERS FEATURING SOFTWARE FOR AND INFORMATION ABOUT BABY MONITORS; BLANK RECORDING DISCS; PRERECORDED RECORDING DISCS FEATURING SOFTWARE FOR AND INFORMATION ABOUT BABY MONITORS; AUTOMATIC VENDING MACHINES AND MECHANISMS FOR COIN-OPERATED APPARATUS; CASH REGISTERS, CALCULATING MACHINES, DATA PROCESSING EQUIPMENT AND COMPUTERS; FIRE-EXTINGUISHING APPARATUS, IN CLASS 9 (U.S. CLS. 21, 23, 26, 36 AND 38).

FOR: APPARATUS FOR LIGHTING, HEATING, STEAM GENERATING, COOKING, REFRIGERATING, DRYING, VENTILATING, WATER SUPPLY AND SANITARY PURPOSES, NAMELY HUMIDIFIERS, ELECTRIC SPACE HEATERS, LAMPS, IN CLASS 11 (U.S. CLS. 13, 21, 23, 31 AND 34).

THE MARK CONSISTS OF STANDARD CHARACTERS WITHOUT CLAIM TO ANY PARTICULAR FONT, STYLE, SIZE, OR COLOR.

OWNER OF INTERNATIONAL REGISTRATION 1083677 DATED 6-3-2011, EXPIRES 6-3-2021.

THE WORDING "LUVION" HAS NO MEANING IN A FOREIGN LANGUAGE.

SER. NO. 79-099,828, FILED 6-3-2011.



David J. Kyros

Director of the United States Patent and Trademark Office

Reg. No. 4,097,709 APRIL HESIK, EXAMINING ATTORNEY

United States of America

United States Patent and Trademark Office



Reg. No. 4,097,710

Registered Feb. 14, 2012

Int. Cl.: 12

TRADEMARK

PRINCIPAL REGISTER

CONTINENTAL REIFEN DEUTSCHLAND GMBH (FED REP GERMANY LIMITED LIABILITY COMPANY)
VAHRENWALDER STR. 9
30165 HANNOVER
FED REP GERMANY

FOR: VEHICLE TIRES, TUBES FOR VEHICLE TIRES, IN CLASS 12 (U.S. CLS. 19, 21, 23, 31, 35 AND 44).

NO CLAIM IS MADE TO THE EXCLUSIVE RIGHT TO USE "TRACTION", APART FROM THE MARK AS SHOWN.

PRIORITY DATE OF 5-23-2011 IS CLAIMED.

OWNER OF INTERNATIONAL REGISTRATION 1083745 DATED 5-23-2011, EXPIRES 5-23-2021.

THE COLOR(S) GREY, WHITE AND ORANGE IS/ARE CLAIMED AS A FEATURE OF THE MARK.

THE LETTERS "TRACTION SKIN" ARE WHITE; THE CIRCLE IN THE MIDDLE IS IN GREY; THE RINGS AROUND THE CIRCLE ARE IN GREY AND ORANGE; AT THE BOTTOM IS THE COLOUR GREY/BLACK.

THE MARK CONSISTS OF THE WORDING "TRACTION SKIN" ACCOMPANIED BY A DESIGN OF A PORTION OF A TIRE AND CONCENTRIC CIRCLES. THE LETTERS "TRACTION SKIN" ARE WHITE; THE CIRCLE IN THE MIDDLE IS IN GREY; THE RINGS AROUND THE CIRCLE ARE IN GREY AND ORANGE; AT THE BOTTOM IS THE COLOR GREY/BLACK. THE DESIGNS OF PARTS OF TIRES APPEAR IN GREY.

SER. NO. 79-099,855, FILED 5-23-2011.

DORITT L. CARROLL, EXAMINING ATTORNEY



David J. Kyffers

Director of the United States Patent and Trademark Office

United States of America

United States Patent and Trademark Office

"Dinosaur Petting Zoo"

Reg. No. 4,097,711

Registered Feb. 14, 2012

Int. Cl.: 41

SERVICE MARK

PRINCIPAL REGISTER

ERTH-VISUAL & PHYSICAL INCORPORATED (AUSTRALIA INCORPORATED
ASSOCIATION)
245 WILSON STREET
EVELEIGH NSW 2015
AUSTRALIA

FOR: THEATRE PRODUCTIONS, IN CLASS 41 (U.S. CLS. 100, 101 AND 107).

THE MARK CONSISTS OF STANDARD CHARACTERS WITHOUT CLAIM TO ANY PARTICULAR FONT, STYLE, SIZE, OR COLOR.

OWNER OF INTERNATIONAL REGISTRATION 1084290 DATED 6-27-2011, EXPIRES 6-27-2021.

SER. NO. 79-100,065, FILED 6-27-2011.

KELLY TRUSILO, EXAMINING ATTORNEY



David J. Kybas

Director of the United States Patent and Trademark Office

United States of America

United States Patent and Trademark Office



Reg. No. 4,097,712

Registered Feb. 14, 2012

Int. Cls.: 9, 10 and 42

TRADEMARK

SERVICE MARK

PRINCIPAL REGISTER

SOFAR SPA (ITALY JOINT STOCK COMPANY)
VIA FIRENZE, 40
I-20060 TREZZANO ROSA (MI)
ITALY

FOR: COMPUTER HARDWARE AND COMPUTER SOFTWARE ALL FOR USE WITH REMOTE CONTROLLED SURGICAL PROCEDURES FOR REMOTE OPERATING MANIPULATOR ARMS USING MOVE COMMANDS ISSUED BY HAPTIC MASTER ARMS; COMPUTER HARDWARE AND COMPUTER SOFTWARE ALL FOR USE WITH REMOTE CONTROLLED SURGICAL PROCEDURES FOR FILTERING AND GEOMETRICALLY TRANSFORMING MOVE COMMANDS ISSUED BY HAPTIC MASTER ARMS AND SENSORS MOUNTED ON MANIPULATOR ARMS AND ON HAPTIC MASTER ARMS; COMPUTER HARDWARE AND COMPUTER SOFTWARE ALL FOR USE WITH REMOTE CONTROLLED SURGICAL PROCEDURES FOR DETECTING REAL TIME MOVEMENT OR PRESSURE BY SENSORS MOUNTED ON MANIPULATORS AND HAPTIC MASTER ARMS; COMPUTER HARDWARE AND COMPUTER SOFTWARE ALL FOR USE WITH REMOTE CONTROLLED SURGICAL PROCEDURES FOR SETTING-UP AND CALIBRATING SENSORS AND MANIPULATOR ARMS; COMPUTER HARDWARE AND COMPUTER SOFTWARE ALL FOR USE WITH REMOTE CONTROLLED SURGICAL PROCEDURES FOR FACILITATING REAL-TIME COMMUNICATION BETWEEN COMPUTERS; COMPUTER HARDWARE AND COMPUTER SOFTWARE ALL FOR USE WITH REMOTE CONTROLLED SURGICAL PROCEDURES FOR GRAPHICAL USER INTERFACES; COMPUTER HARDWARE AND COMPUTER SOFTWARE ALL FOR USE WITH REMOTE CONTROLLED SURGICAL PROCEDURES FOR SIMULATING MANIPULATOR ARM BEHAVIOUR AND SURGICAL INSTRUMENTS INTERACTION WITH TISSUES; COMPUTER HARDWARE AND COMPUTER SOFTWARE ALL FOR USE WITH REMOTE CONTROLLED SURGICAL PROCEDURES FOR PROGRAMMING PROCEDURES TO CHANGE INSTRUMENTS, INSERTING INSTRUMENTS IN THE PATIENT BODY AND MANUALLY OPERATING MANIPULATING ARMS THROUGH SENSORY INFORMATION; COMPUTER HARDWARE AND COMPUTER SOFTWARE ALL FOR USE WITH REMOTE CONTROLLED SURGICAL PROCEDURES FOR SIGNALLING ABNORMAL FORCES APPLIED ON TISSUES, DETECTING ELECTRICAL AND MECHANICAL FAULTS AND SOFTWARE AND HARDWARE FAILURES, AND SIGNALLING COLLISIONS BETWEEN MANIPULATOR ARMS AND BETWEEN THE ARM AND A HUMAN OPERATOR; COMPUTER HARDWARE AND COMPUTER SOFTWARE ALL FOR USE WITH REMOTE CONTROLLED SURGICAL PROCEDURES FOR RECORDING IN REAL TIME DATA FROM SENSORS, MANIPULATOR ARMS AND HAPTIC MASTER ARMS, IN CLASS 9 (U.S. CLS. 21, 23, 26, 36 AND 38).



David J. Kyjars

Director of the United States Patent and Trademark Office

Reg. No. 4,097,712 FOR: MEDICAL EQUIPMENT FOR USE IN REMOTE CONTROLLED SURGICAL PROCEDURES, NAMELY, ROBOTIC MANIPULATOR ARMS EQUIPPED WITH SENSORS FOR DETECTING PRESSURE OR FORCE, CALIBRATION, PERSONNEL SAFETY; THE ABOVE ALSO FEATURING SURGICAL TOOLS IDENTIFICATION ACTUATORS FOR SURGICAL INSTRUMENTS, A MOVABLE BASE FEATURING A POWER CABINET, AND A HAPTIC MASTER ARM WITH FOOT SWITCHES; MEDICAL ELECTRONIC EQUIPMENT AND SURGICAL INSTRUMENTS, NAMELY, SURGICAL DRAPES, TROCARS, MEDICAL BIOPSY BRUSHES, ROBOTIC MANIPULATOR ARMS EQUIPPED FOR PERFORMING MINIMAL INVASIVE SURGERY, ENDOSCOPES, ULTRASOUND PROBES, ELECTROCAUTERY TOOLS, CLIP APPLIERS AND CLIPS, TACK APPLIERS AND TACKS, CANNULAE, SCALPELS, SCALPEL BLADES, DISSECTORS, FORCEPS SCISSORS, CLAMPS, GRASPERS, STAPLERS, HEATERS AND CALIBRATORS, INSUFFLATORS, SUCTION PROBES, IRRIGATION PROBES, NEEDLE HOLDERS AND LIGATURE CARRIERS ALL FOR USE IN REMOTE SURGICAL PROCEDURES, IN CLASS 10 (U.S. CLS. 26, 39 AND 44).

FOR: DESIGN AND DEVELOPMENT OF COMPUTER SOFTWARE USED IN THE MEDICAL AND SCIENTIFIC FIELDS AND USED WITH APPARATUS FOR REMOTE CONTROLLED SURGERY, IN CLASS 42 (U.S. CLS. 100 AND 101).

THE MARK CONSISTS OF A RECTANGULAR SHAPE, INSIDE OF WHICH THERE ARE ON THE RIGHT THE WORDS "TELELAP ALF X" AND ON THE LEFT A FANCY PICTURE OF HUMMINGBIRD.

PRIORITY DATE OF 5-5-2011 IS CLAIMED.

OWNER OF INTERNATIONAL REGISTRATION 1084442 DATED 5-9-2011, EXPIRES 5-9-2021.

THE WORDING "TELELAP" OR "ALF" HAS NO MEANING IN A FOREIGN LANGUAGE.

SER. NO. 79-100,123, FILED 5-9-2011.

DAVID TOOLEY, EXAMINING ATTORNEY

United States of America

United States Patent and Trademark Office

OLIFEEL

Reg. No. 4,097,713

Registered Feb. 14, 2012

Int. Cl.: 1

TRADEMARK

PRINCIPAL REGISTER

BRASCA AMEDEO E C. S.R.L (ITALY SOCIETÀ A RESPONSABILITÀ LIMITATA)
VIA MONTE GENEROSO, 6/A
I-20155 MILANO (MI)
ITALY

FOR: CHEMICALS PRODUCT FOR USE AS INGREDIENTS IN THE FIELD OF COSMETICS,
IN CLASS 1 (U.S. CLS. 1, 5, 6, 10, 26 AND 46).

THE MARK CONSISTS OF STANDARD CHARACTERS WITHOUT CLAIM TO ANY PAR-
TICULAR FONT, STYLE, SIZE, OR COLOR.

PRIORITY DATE OF 2-24-2011 IS CLAIMED.

OWNER OF INTERNATIONAL REGISTRATION 1084519 DATED 7-5-2011, EXPIRES 7-5-
2021.

SER. NO. 79-100,158, FILED 7-5-2011.

APRIL ROACH, EXAMINING ATTORNEY



David J. Kypos

Director of the United States Patent and Trademark Office

United States of America
United States Patent and Trademark Office

PARACAST

Reg. No. 4,097,714

Registered Feb. 14, 2012

Int. Cl.: 4

TRADEMARK

PRINCIPAL REGISTER

PARAMELT B.V. (NETHERLANDS B.V.)
COSTERSTRAAT 18
NL-1704 RJ HEERHUGOWAARD
NETHERLANDS

FOR: WAXES FOR INDUSTRIAL USE IN AN INVESTMENT CASTING PROCESS, IN CLASS 4 (U.S. CLS. 1, 6 AND 15).

THE MARK CONSISTS OF STANDARD CHARACTERS WITHOUT CLAIM TO ANY PARTICULAR FONT, STYLE, SIZE, OR COLOR.

OWNER OF INTERNATIONAL REGISTRATION 1006632 DATED 4-23-2009, EXPIRES 4-23-2019.

SER. NO. 79-100,322, FILED 6-27-2011.

KELLY TRUSILO, EXAMINING ATTORNEY



David J. Kyffers

Director of the United States Patent and Trademark Office

United States of America

United States Patent and Trademark Office

HiDrive

Reg. No. 4,097,715

Registered Feb. 14, 2012

**Int. Cls.: 35, 38, 39, 42
and 45**

SERVICE MARK

PRINCIPAL REGISTER

STRATO AG (FED REP GERMANY AKTIENGESELLSCHAFT NACH DEUTSCHEM RECHT
("AG"))
PASCALSTRASSE 10
10587 BERLIN, FED REP GERMANY

FOR: PRODUCT MARKETING SERVICES FOR OTHERS; ADVERTISING SERVICES; ADVERTISING ON THE INTERNET FOR OTHERS, NAMELY, ARRANGING OF ADVERTISING SPACE, IN PARTICULAR ON INTERNET PAGES; SYSTEMATIZATION OF DATA IN COMPUTER DATABASES; COMPUTER FILE MANAGEMENT, IN CLASS 35 (U.S. CLS. 100, 101 AND 102).

FOR: TELECOMMUNICATIONS SERVICES FOR OTHERS, NAMELY, TELECOMMUNICATIONS BY E-MAIL, TELEPHONE COMMUNICATION, TRANSMISSION OF FAX SERVICES, STREAMING OF AUDIO, VIDEO AND AUDIOVISUAL MATERIAL ON THE INTERNET; PROVIDING INTERNET CHAT ROOMS; INTERNET PROVIDER SERVICES, NAMELY PROVIDING TELECOMMUNICATIONS CONNECTIONS AMONG WEB SERVERS; BROADCASTING AND TRANSMISSION OF ELECTRONIC DATA, NAMELY, FILES, IMAGES, AUDIO INFORMATION, GRAPHICS, USING INTERNET, RADIO, TELECOMMUNICATIONS APPARATUS OR ELECTRONIC MEDIA; RENTAL OF ACCESS TIME TO GLOBAL COMPUTER NETWORKS; PROVIDING TELECOMMUNICATION CONNECTIONS TO THE INTERNET OR DATABASES; ELECTRONIC TRANSMISSION OF COMPUTER PROGRAMS VIA THE INTERNET, IN CLASS 38 (U.S. CLS. 100, 101 AND 104).

FOR: PHYSICAL STORAGE OF ELECTRONICALLY STORED DATA AND DOCUMENTS , IN CLASS 39 (U.S. CLS. 100 AND 105).

FOR: RENTAL OF WEB SERVERS; HOSTING OF WEB SITES; COMPUTER SECURITY SERVICE, NAMELY, RESTRICTING ACCESS TO AND BY COMPUTER NETWORKS TO AND OF UNDESIRED WEB SITES, MEDIA AND INDIVIDUALS AND FACILITIES; DESIGNING AND DEVELOPING WEBPAGES ON THE INTERNET; RECORDING DATA FOR OTHERS ON OPTICAL, DIGITAL AND MAGNETIC MEDIA FOR ELECTRONIC STORAGE; COMPUTER SERVICES, NAMELY, PROVIDING VIRTUAL AND NON VIRTUAL APPLICATION SERVERS, WEB SERVERS, FILE SERVERS, CO-LOCATION SERVERS, LOAD BALANCING SERVERS, REDUNDANCY SERVERS, MEDIA SERVERS AND DATABASE SERVERS OF VARIABLE CAPACITY TO THIRD PARTY COMPUTING AND DATA STORAGE FACILITIES, IN CLASS 42 (U.S. CLS. 100 AND 101).



David J. Kybas

Director of the United States Patent and Trademark Office

Reg. No. 4,097,715 FOR: DOMAIN NAME REGISTRATION SERVICES; LICENSING OF COMPUTERS, COMPUTER SYSTEMS, COMPUTER PROGRAMS AND COMPUTER SOFTWARE, IN CLASS 45 (U.S. CLS. 100 AND 101).

THE MARK CONSISTS OF STANDARD CHARACTERS WITHOUT CLAIM TO ANY PARTICULAR FONT, STYLE, SIZE, OR COLOR.

OWNER OF INTERNATIONAL REGISTRATION 1084987 DATED 4-11-2011, EXPIRES 4-11-2021.

SER. NO. 79-100,370, FILED 4-11-2011.

PAUL MORENO, EXAMINING ATTORNEY

United States of America

United States Patent and Trademark Office

ALF-X

Reg. No. 4,097,716

Registered Feb. 14, 2012

Int. Cls.: 9, 10 and 42

TRADEMARK

SERVICE MARK

PRINCIPAL REGISTER

SOFAR SPA (ITALY JOINT STOCK COMPANY)
VIA FIRENZE, 40
I-20060 TREZZANO ROSA (MI)
ITALY

FOR: COMPUTER HARDWARE AND COMPUTER SOFTWARE ALL FOR USE WITH REMOTE CONTROLLED SURGICAL PROCEDURES FOR REMOTE OPERATING MANIPULATOR ARMS USING MOVE COMMANDS ISSUED BY HAPTIC MASTER ARMS; COMPUTER HARDWARE AND COMPUTER SOFTWARE ALL FOR USE WITH REMOTE CONTROLLED SURGICAL PROCEDURES FOR FILTERING AND GEOMETRICALLY TRANSFORMING MOVE COMMANDS ISSUED BY HAPTIC MASTER ARMS AND SENSORS MOUNTED ON MANIPULATOR ARMS AND ON HAPTIC MASTER ARMS; COMPUTER HARDWARE AND COMPUTER SOFTWARE ALL FOR USE WITH REMOTE CONTROLLED SURGICAL PROCEDURES FOR DETECTING REAL TIME MOVEMENT OR PRESSURE BY SENSORS MOUNTED ON MANIPULATORS AND HAPTIC MASTER ARMS; COMPUTER HARDWARE AND COMPUTER SOFTWARE ALL FOR USE WITH REMOTE CONTROLLED SURGICAL PROCEDURES FOR SETTING-UP AND CALIBRATING SENSORS AND MANIPULATOR ARMS; COMPUTER HARDWARE AND COMPUTER SOFTWARE ALL FOR USE WITH REMOTE CONTROLLED SURGICAL PROCEDURES FOR FACILITATING REAL-TIME COMMUNICATION BETWEEN COMPUTERS; COMPUTER HARDWARE AND COMPUTER SOFTWARE ALL FOR USE WITH REMOTE CONTROLLED SURGICAL PROCEDURES FOR GRAPHICAL USER INTERFACES; COMPUTER HARDWARE AND COMPUTER SOFTWARE ALL FOR USE WITH REMOTE CONTROLLED SURGICAL PROCEDURES FOR SIMULATING MANIPULATOR ARM BEHAVIOUR AND SURGICAL INSTRUMENTS INTERACTION WITH TISSUES; COMPUTER HARDWARE AND COMPUTER SOFTWARE ALL FOR USE WITH REMOTE CONTROLLED SURGICAL PROCEDURES FOR PROGRAMMING PROCEDURES TO CHANGE INSTRUMENTS, INSERTING INSTRUMENTS IN THE PATIENT BODY AND MANUALLY OPERATING MANIPULATING ARMS THROUGH SENSORY INFORMATION; COMPUTER HARDWARE AND COMPUTER SOFTWARE ALL FOR USE WITH REMOTE CONTROLLED SURGICAL PROCEDURES FOR SIGNALLING ABNORMAL FORCES APPLIED ON TISSUES, DETECTING ELECTRICAL AND MECHANICAL FAULTS AND SOFTWARE AND HARDWARE FAILURES AND SIGNALLING COLLISIONS BETWEEN MANIPULATOR ARMS AND BETWEEN THE ARM AND A HUMAN OPERATOR; COMPUTER HARDWARE AND COMPUTER SOFTWARE ALL FOR USE WITH REMOTE CONTROLLED SURGICAL PROCEDURES FOR RECORDING IN REAL TIME DATA FROM SENSORS, MANIPULATOR ARMS AND HAPTIC MASTER ARMS, IN CLASS 9 (U.S. CLS. 21, 23, 26, 36 AND 38).



David J. Kyjars

Director of the United States Patent and Trademark Office

Reg. No. 4,097,716 FOR: MEDICAL EQUIPMENT FOR USE IN REMOTE CONTROLLED SURGICAL PROCEDURES, NAMELY, ROBOTIC MANIPULATOR ARMS EQUIPPED WITH SENSORS FOR DETECTING PRESSURE OR FORCE, CALIBRATION, PERSONNEL SAFETY; THE ABOVE ALSO FEATURING SURGICAL TOOLS IDENTIFICATION ACTUATORS FOR SURGICAL INSTRUMENTS, A MOVABLE BASE FEATURING A POWER CABINET, AND A HAPTIC MASTER ARM WITH FOOT SWITCHES; MEDICAL ELECTRONIC EQUIPMENT AND SURGICAL INSTRUMENTS, NAMELY, SURGICAL DRAPES, TROCARS, MEDICAL BIOPSY BRUSHES, ROBOTIC MANIPULATOR ARMS EQUIPPED FOR PERFORMING MINIMAL INVASIVE SURGERY, ENDOSCOPES, ULTRASOUND PROBES, ELECTROCAUTERY TOOLS, CLIP APPLIERS AND CLIPS, TACK APPLIERS AND TACKS, CANNULAE, SCALPELS, SCALPEL BLADES, DISSECTORS, FORCEPS SCISSORS, CLAMPS, GRASPERS, STAPLERS, HEATERS AND CALIBRATORS, INSUFFLATORS, SUCTION PROBES, IRRIGATION PROBES, NEEDLE HOLDERS AND LIGATURE CARRIERS ALL FOR USE IN REMOTE SURGICAL PROCEDURES, IN CLASS 10 (U.S. CLS. 26, 39 AND 44).

FOR: DESIGN AND DEVELOPMENT OF COMPUTER SOFTWARE USED IN THE MEDICAL AND SCIENTIFIC FIELDS AND USED WITH APPARATUS FOR REMOTE CONTROLLED SURGERY, IN CLASS 42 (U.S. CLS. 100 AND 101).

THE MARK CONSISTS OF STANDARD CHARACTERS WITHOUT CLAIM TO ANY PARTICULAR FONT, STYLE, SIZE, OR COLOR.

PRIORITY DATE OF 4-14-2011 IS CLAIMED.

OWNER OF INTERNATIONAL REGISTRATION 1084993 DATED 4-22-2011, EXPIRES 4-22-2021.

THE WORDING "ALF" HAS NO MEANING IN A FOREIGN LANGUAGE.

SER. NO. 79-100,373, FILED 4-22-2011.

DAVID TOOLEY, EXAMINING ATTORNEY

United States of America

United States Patent and Trademark Office

TELELAP ALF-X

Reg. No. 4,097,717

Registered Feb. 14, 2012

Int. Cls.: 9, 10 and 42

TRADEMARK

SERVICE MARK

PRINCIPAL REGISTER

SOFAR SPA (ITALY JOINT STOCK COMPANY)
VIA FIRENZE, 40
I-20060 TREZZANO ROSA (MI)
ITALY

FOR: COMPUTER HARDWARE AND COMPUTER SOFTWARE ALL FOR USE WITH REMOTE CONTROLLED SURGICAL PROCEDURES FOR REMOTE OPERATING MANIPULATOR ARMS USING MOVE COMMANDS ISSUED BY HAPTIC MASTER ARMS; COMPUTER HARDWARE AND COMPUTER SOFTWARE ALL FOR USE WITH REMOTE CONTROLLED SURGICAL PROCEDURES FOR FILTERING AND GEOMETRICALLY TRANSFORMING MOVE COMMANDS ISSUED BY HAPTIC MASTER ARMS AND SENSORS MOUNTED ON MANIPULATOR ARMS AND ON HAPTIC MASTER ARMS; COMPUTER HARDWARE AND COMPUTER SOFTWARE ALL FOR USE WITH REMOTE CONTROLLED SURGICAL PROCEDURES FOR DETECTING REAL TIME MOVEMENT OR PRESSURE BY SENSORS MOUNTED ON MANIPULATORS AND HAPTIC MASTER ARMS; COMPUTER HARDWARE AND COMPUTER SOFTWARE ALL FOR USE WITH REMOTE CONTROLLED SURGICAL PROCEDURES FOR SETTING-UP AND CALIBRATING SENSORS AND MANIPULATOR ARMS; COMPUTER HARDWARE AND COMPUTER SOFTWARE ALL FOR USE WITH REMOTE CONTROLLED SURGICAL PROCEDURES FOR FACILITATING REAL-TIME COMMUNICATION BETWEEN COMPUTERS; COMPUTER HARDWARE AND COMPUTER SOFTWARE ALL FOR USE WITH REMOTE CONTROLLED SURGICAL PROCEDURES FOR GRAPHICAL USER INTERFACES; COMPUTER HARDWARE AND COMPUTER SOFTWARE ALL FOR USE WITH REMOTE CONTROLLED SURGICAL PROCEDURES FOR SIMULATING MANIPULATOR ARM BEHAVIOUR AND SURGICAL INSTRUMENTS INTERACTION WITH TISSUES; COMPUTER HARDWARE AND COMPUTER SOFTWARE ALL FOR USE WITH REMOTE CONTROLLED SURGICAL PROCEDURES FOR PROGRAMMING PROCEDURES TO CHANGE INSTRUMENTS, INSERTING INSTRUMENTS IN THE PATIENT BODY AND MANUALLY OPERATING MANIPULATING ARMS THROUGH SENSORY INFORMATION; COMPUTER HARDWARE AND COMPUTER SOFTWARE ALL FOR USE WITH REMOTE CONTROLLED SURGICAL PROCEDURES FOR SIGNALLING ABNORMAL FORCES APPLIED ON TISSUES, DETECTING ELECTRICAL AND MECHANICAL FAULTS AND SOFTWARE AND HARDWARE FAILURES AND SIGNALLING COLLISIONS BETWEEN MANIPULATOR ARMS AND BETWEEN THE ARM AND A HUMAN OPERATOR; COMPUTER HARDWARE AND COMPUTER SOFTWARE ALL FOR USE WITH REMOTE CONTROLLED SURGICAL PROCEDURES FOR RECORDING IN REAL TIME DATA FROM SENSORS, MANIPULATOR ARMS AND HAPTIC MASTER ARMS, IN CLASS 9 (U.S. CLS. 21, 23, 26, 36 AND 38).



David J. Kyffers

Director of the United States Patent and Trademark Office

Reg. No. 4,097,717 FOR: MEDICAL EQUIPMENT FOR USE IN REMOTE CONTROLLED SURGICAL PROCEDURES, NAMELY, ROBOTIC MANIPULATOR ARMS EQUIPPED WITH SENSORS FOR DETECTING PRESSURE OR FORCE, CALIBRATION, PERSONNEL SAFETY; SURGICAL TOOLS IDENTIFICATION ACTUATORS FOR SURGICAL INSTRUMENTS, A MOVABLE BASE FEATURING A POWER CABINET; HAPTIC MASTER ARM WITH FOOT SWITCHES; MEDICAL ELECTRONIC EQUIPMENT AND SURGICAL INSTRUMENTS, NAMELY, SURGICAL DRAPES, TROCARS, MEDICAL BIOPSY BRUSHES, ROBOTIC MANIPULATOR ARMS EQUIPPED FOR PERFORMING MINIMAL INVASIVE SURGERY, ENDOSCOPES, ULTRASOUND PROBES, ELECTRO-CAUTERY TOOLS, CLIP APPLIERS AND CLIPS, TACK APPLIERS AND TACKS, CANNULAE, SCALPELS, SCALPEL BLADES, DISSECTORS, FORCEPS SCISSORS, CLAMPS, GRASPERS, STAPLERS, HEATERS AND CALIBRATORS, INSUFFLATORS, SUCTION PROBES, IRRIGATION PROBES, NEEDLE HOLDER S AND LIGATURE CARRIERS ALL FOR USE IN REMOTE SURGICAL PROCEDURES, IN CLASS 10 (U.S. CLS. 26, 39 AND 44).

FOR: DESIGN AND DEVELOPMENT OF COMPUTER SOFTWARE USED IN THE MEDICAL AND SCIENTIFIC FIELDS AND USED WITH APPARATUS FOR REMOTE CONTROLLED SURGERY, IN CLASS 42 (U.S. CLS. 100 AND 101).

THE MARK CONSISTS OF STANDARD CHARACTERS WITHOUT CLAIM TO ANY PARTICULAR FONT, STYLE, SIZE, OR COLOR.

PRIORITY DATE OF 4-14-2011 IS CLAIMED.

OWNER OF INTERNATIONAL REGISTRATION 1084994 DATED 4-22-2011, EXPIRES 4-22-2021.

THE WORDING "TELELAP" OR "ALF" HAS NO MEANING IN A FOREIGN LANGUAGE.

SER. NO. 79-100,374, FILED 4-22-2011.

DAVID TOOLEY, EXAMINING ATTORNEY

United States of America

United States Patent and Trademark Office

TELELAP

Reg. No. 4,097,718

Registered Feb. 14, 2012

Int. Cls.: 9, 10 and 42

TRADEMARK

SERVICE MARK

PRINCIPAL REGISTER

SOFAR SPA (ITALY JOINT STOCK COMPANY)
VIA FIRENZE, 40
I-20060 TREZZANO ROSA (MI)
ITALY

FOR: COMPUTER HARDWARE AND COMPUTER SOFTWARE ALL FOR USE WITH REMOTE CONTROLLED SURGICAL PROCEDURES FOR REMOTE OPERATING MANIPULATOR ARMS USING MOVE COMMANDS ISSUED BY HAPTIC MASTER ARMS; COMPUTER HARDWARE AND COMPUTER SOFTWARE ALL FOR USE WITH REMOTE CONTROLLED SURGICAL PROCEDURES FOR FILTERING AND GEOMETRICALLY TRANSFORMING MOVE COMMANDS ISSUED BY HAPTIC MASTER ARMS AND SENSORS MOUNTED ON MANIPULATOR ARMS AND ON HAPTIC MASTER ARMS; COMPUTER HARDWARE AND COMPUTER SOFTWARE ALL FOR USE WITH REMOTE CONTROLLED SURGICAL PROCEDURES FOR DETECTING REAL TIME MOVEMENT OR PRESSURE BY SENSORS MOUNTED ON MANIPULATORS AND HAPTIC MASTER ARMS; COMPUTER HARDWARE AND COMPUTER SOFTWARE ALL FOR USE WITH REMOTE CONTROLLED SURGICAL PROCEDURES FOR SETTING-UP AND CALIBRATING SENSORS AND MANIPULATOR ARMS; COMPUTER HARDWARE AND COMPUTER SOFTWARE ALL FOR USE WITH REMOTE CONTROLLED SURGICAL PROCEDURES FOR FACILITATING REAL-TIME COMMUNICATION BETWEEN COMPUTERS; COMPUTER HARDWARE AND COMPUTER SOFTWARE ALL FOR USE WITH REMOTE CONTROLLED SURGICAL PROCEDURES FOR GRAPHICAL USER INTERFACES; COMPUTER HARDWARE AND COMPUTER SOFTWARE ALL FOR USE WITH REMOTE CONTROLLED SURGICAL PROCEDURES FOR SIMULATING MANIPULATOR ARM BEHAVIOUR AND SURGICAL INSTRUMENTS INTERACTION WITH TISSUES; COMPUTER HARDWARE AND COMPUTER SOFTWARE ALL FOR USE WITH REMOTE CONTROLLED SURGICAL PROCEDURES FOR PROGRAMMING PROCEDURES TO CHANGE INSTRUMENTS, INSERTING INSTRUMENTS IN THE PATIENT BODY AND MANUALLY OPERATING MANIPULATING ARMS THROUGH SENSORY INFORMATION; COMPUTER HARDWARE AND COMPUTER SOFTWARE ALL FOR USE WITH REMOTE CONTROLLED SURGICAL PROCEDURES FOR SIGNALLING ABNORMAL FORCES APPLIED ON TISSUES, DETECTING ELECTRICAL AND MECHANICAL FAULTS AND SOFTWARE AND HARDWARE FAILURES AND SIGNALLING COLLISIONS BETWEEN MANIPULATOR ARMS AND BETWEEN THE ARM AND A HUMAN OPERATOR; COMPUTER HARDWARE AND COMPUTER SOFTWARE ALL FOR USE WITH REMOTE CONTROLLED SURGICAL PROCEDURES FOR RECORDING IN REAL TIME DATA FROM SENSORS, MANIPULATOR ARMS AND HAPTIC MASTER ARMS, IN CLASS 9 (U.S. CLS. 21, 23, 26, 36 AND 38).



David J. Kyffers

Director of the United States Patent and Trademark Office

Reg. No. 4,097,718 FOR: MEDICAL EQUIPMENT FOR USE IN REMOTE CONTROLLED SURGICAL PROCEDURES, NAMELY, ROBOTIC MANIPULATOR ARMS EQUIPPED WITH SENSORS FOR DETECTING PRESSURE OR FORCE, CALIBRATION, PERSONNEL SAFETY; THE ABOVE ALSO FEATURING SURGICAL TOOLS IDENTIFICATION ACTUATORS FOR SURGICAL INSTRUMENTS, A MOVABLE BASE FEATURING A POWER CABINET, AND A HAPTIC MASTER ARM WITH FOOT SWITCHES; MEDICAL ELECTRONIC EQUIPMENT AND SURGICAL INSTRUMENTS, NAMELY, SURGICAL DRAPES, TROCARS, MEDICAL BIOPSY BRUSHES, ROBOTIC MANIPULATOR ARMS EQUIPPED FOR PERFORMING MINIMAL INVASIVE SURGERY, ENDOSCOPES, ULTRASOUND PROBES, ELECTROCAUTERY TOOLS, CLIP APPLIERS AND CLIPS, TACK APPLIERS AND TACKS, CANNULAE, SCALPELS, SCALPEL BLADES, DISSECTORS, FORCEPS SCISSORS, CLAMPS, GRASPERS, STAPLERS, HEATERS AND CALIBRATORS, INSUFFLATORS, SUCTION PROBES, IRRIGATION PROBES, NEEDLE HOLDERS AND LIGATURE CARRIERS ALL FOR USE IN REMOTE SURGICAL PROCEDURES, IN CLASS 10 (U.S. CLS. 26, 39 AND 44).

FOR: DESIGN AND DEVELOPMENT OF COMPUTER SOFTWARE USED IN THE MEDICAL AND SCIENTIFIC FIELDS AND USED WITH APPARATUS FOR REMOTE CONTROLLED SURGERY, IN CLASS 42 (U.S. CLS. 100 AND 101).

THE MARK CONSISTS OF STANDARD CHARACTERS WITHOUT CLAIM TO ANY PARTICULAR FONT, STYLE, SIZE, OR COLOR.

PRIORITY DATE OF 4-14-2011 IS CLAIMED.

OWNER OF INTERNATIONAL REGISTRATION 1084995 DATED 4-22-2011, EXPIRES 4-22-2021.

THE WORDING "TELELAP" HAS NO MEANING IN A FOREIGN LANGUAGE.

SER. NO. 79-100,375, FILED 4-22-2011.

DAVID TOOLEY, EXAMINING ATTORNEY

United States of America

United States Patent and Trademark Office

ALMOST PLAIN

Reg. No. 4,097,719

Registered Feb. 14, 2012

Int. Cl.: 25

TRADEMARK

PRINCIPAL REGISTER

ERICA.FIN S.R.L. (ITALY LIMITED LIABILITY COMPANY)
VIA MASSIMO D'AZEGLIO, 14
I-21052 BUSTO ARSIZIO
ITALY

FOR: NECKWEAR, HEADWEAR, SHAWLS, SCARVES, KEFFIYEH, BANDANAS, IN CLASS 25 (U.S. CLS. 22 AND 39).

THE MARK CONSISTS OF STANDARD CHARACTERS WITHOUT CLAIM TO ANY PARTICULAR FONT, STYLE, SIZE, OR COLOR.

OWNER OF INTERNATIONAL REGISTRATION 1085307 DATED 7-1-2011, EXPIRES 7-1-2021.

SER. NO. 79-100,487, FILED 7-1-2011.

KATHRYN COWARD, EXAMINING ATTORNEY



David J. Kyffers

Director of the United States Patent and Trademark Office

United States of America

United States Patent and Trademark Office

LISC

Reg. No. 4,097,720

Registered Feb. 14, 2012

Int. Cl.: 4

TRADEMARK

PRINCIPAL REGISTER

RHEINBRAUN BRENNSTOFF GMBH (FED REP GERMANY LIMITED LIABILITY COMPANY)
STÜTTGENWEG 2
KÖLN, FED REP GERMANY 50935

FOR: LIGNITE COKE, IN CLASS 4 (U.S. CLS. 1, 6 AND 15).

THE MARK CONSISTS OF STANDARD CHARACTERS WITHOUT CLAIM TO ANY PARTICULAR FONT, STYLE, SIZE, OR COLOR.

PRIORITY DATE OF 4-26-2011 IS CLAIMED.

OWNER OF INTERNATIONAL REGISTRATION 1085680 DATED 5-31-2011, EXPIRES 5-31-2021.

SER. NO. 79-100,656, FILED 5-31-2011.

CHRISIE B. KING, EXAMINING ATTORNEY



David J. Kybas

Director of the United States Patent and Trademark Office

United States of America
United States Patent and Trademark Office

SALY

Reg. No. 4,097,721

Registered Feb. 14, 2012

Int. Cl.: 6

TRADEMARK

PRINCIPAL REGISTER

KNOLLAN LTD. (ISRAEL PRIVATE LIMITED LIABILITY COMPANY)
P.O.B. 189
RAMAT ISHAI
ISRAEL

FOR: METAL LOCKS, NAMELY, METAL PADLOCKS, METAL LAMINATED LOCKS, METAL COLORED PADLOCK SETS, METAL LOCKS FOR STORAGE CONTAINERS; METAL SECURITY LOCK CYLINDERS METAL CABLE WIRE; METAL COMBINATION LOCKS; METAL LOCKS FOR BUILT-IN LOCKERS; METAL DOOR LOCKS; METAL SAFES; SAFE DEPOSIT BOXES; METAL CABLE LOCKS, ALL OF THE AFOREMENTIONED GOODS BEING MADE OF METAL, IN CLASS 6 (U.S. CLS. 2, 12, 13, 14, 23, 25 AND 50).

THE MARK CONSISTS OF STANDARD CHARACTERS WITHOUT CLAIM TO ANY PARTICULAR FONT, STYLE, SIZE, OR COLOR.

PRIORITY DATE OF 10-4-2010 IS CLAIMED.

OWNER OF INTERNATIONAL REGISTRATION 1085753 DATED 3-31-2011, EXPIRES 3-31-2021.

THE WORDING "SALY" HAS NO MEANING IN A FOREIGN LANGUAGE.

SER. NO. 79-100,691, FILED 3-31-2011.

RONALD DELGIZZI, EXAMINING ATTORNEY



David J. Kyffers

Director of the United States Patent and Trademark Office

United States of America
United States Patent and Trademark Office

REINARES

Reg. No. 4,097,722

Registered Feb. 14, 2012

Int. Cl.: 33

TRADEMARK

PRINCIPAL REGISTER

BODEGAS EGUREN, S.A. (SPAIN SOCIEDAD ANÓNIMA)
TRAVESIA NORTE S/N
E-01013 VITORIA (ALAVA)
SPAIN

FOR: ALCOHOLIC BEVERAGES, NAMELY, WINES, IN CLASS 33 (U.S. CLS. 47 AND 49).

THE MARK CONSISTS OF STANDARD CHARACTERS WITHOUT CLAIM TO ANY PARTICULAR FONT, STYLE, SIZE, OR COLOR.

OWNER OF INTERNATIONAL REGISTRATION 1086106 DATED 6-29-2011, EXPIRES 6-29-2021.

SER. NO. 79-100,803, FILED 6-29-2011.

MARILYN IZZI, EXAMINING ATTORNEY



David J. Kyffers

Director of the United States Patent and Trademark Office

United States of America

United States Patent and Trademark Office



Reg. No. 4,097,723

Registered Feb. 14, 2012

Int. Cl.: 6

TRADEMARK

PRINCIPAL REGISTER

KNOLLAN LTD. (ISRAEL PRIVATE LIMITED LIABILITY COMPANY)
P.O.B. 189
RAMAT ISHAI, ISRAEL

FOR: METAL LOCKS, NAMELY, METAL PADLOCKS, LAMINATED LOCKS, COLORED PADLOCK SETS, METAL LOCKS FOR STORAGE CONTAINERS; SECURITY LOCK CYLINDERS OF METAL; METAL CABLE WIRE; COMBINATION LOCKS; BUILT-IN LOCKER LOCKS; METAL DOOR LOCKS; METAL SAFES; SAFE DEPOSIT BOXES; CABLE LOCKS, ALL ABOVEMENTIONED GOODS MADE OF METAL AND INCLUDED IN THIS CLASS, IN CLASS 6 (U.S. CLS. 2, 12, 13, 14, 23, 25 AND 50).

THE MARK CONSISTS OF A CIRCLE ENCLOSED BY FOUR TRIANGLES.

PRIORITY DATE OF 10-4-2010 IS CLAIMED.

OWNER OF INTERNATIONAL REGISTRATION 1086185 DATED 3-31-2011, EXPIRES 3-31-2021.

SER. NO. 79-100,835, FILED 3-31-2011.

SHANNON TWOHIG, EXAMINING ATTORNEY



David J. Kybas

Director of the United States Patent and Trademark Office

United States of America

United States Patent and Trademark Office

Knollan

Reg. No. 4,097,724

KNOLLAN LTD. (ISRAEL PRIVATE LIMITED LIABILITY COMPANY)
P.O.B. 189

Registered Feb. 14, 2012

RAMAT ISHAI, ISRAEL

Int. Cl.: 6

FOR: METAL LOCKS, NAMELY, METAL PADLOCKS, LAMINATED LOCKS, COLORED PADLOCK SETS, METAL LOCKS FOR STORAGE CONTAINERS; SECURITY LOCK CYLINDERS OF METAL; METAL CABLE WIRE; COMBINATION LOCKS; BUILT-IN LOCKER LOCKS; METAL DOOR LOCKS; METAL SAFES; SAFE DEPOSIT BOXES; CABLE LOCKS, ALL ABOVEMENTIONED GOODS MADE OF METAL AND INCLUDED IN THIS CLASS, IN CLASS 6 (U.S. CLS. 2, 12, 13, 14, 23, 25 AND 50).

TRADEMARK

PRINCIPAL REGISTER

THE MARK CONSISTS OF THE WORD "KNOLLAN" TO THE LEFT OF A CIRCLE ENCLOSED BY FOUR TRIANGLES.

PRIORITY DATE OF 10-4-2010 IS CLAIMED.

OWNER OF INTERNATIONAL REGISTRATION 1086186 DATED 3-31-2011, EXPIRES 3-31-2021.

SER. NO. 79-100,836, FILED 3-31-2011.

SHANNON TWOHIG, EXAMINING ATTORNEY



David J. Kyffers

Director of the United States Patent and Trademark Office

United States of America
United States Patent and Trademark Office

Proflex

Reg. No. 4,097,725

Registered Feb. 14, 2012

Int. Cl.: 10

TRADEMARK

PRINCIPAL REGISTER

BASTION PACIFIC PTY LTD (AUSTRALIA PROPRIETARY LIMITED COMPANY (PTY LTD))
14 MCPHERSON ROAD
SMEATON GRANGE NSW 2567
AUSTRALIA

FOR: DENTAL GLOVES; GLOVES FOR MASSAGE; GLOVES FOR MEDICAL PURPOSES; GLOVES FOR MEDICAL USE; GLOVES FOR USE IN HOSPITALS; LATEX MEDICAL GLOVES; MEDICAL GLOVES; MEDICAL EXAMINATION GLOVES; PROTECTIVE GLOVES FOR MEDICAL USE; SURGICAL GLOVES, IN CLASS 10 (U.S. CLS. 26, 39 AND 44).

THE MARK CONSISTS OF STANDARD CHARACTERS WITHOUT CLAIM TO ANY PARTICULAR FONT, STYLE, SIZE, OR COLOR.

OWNER OF INTERNATIONAL REGISTRATION 1086328 DATED 6-29-2011, EXPIRES 6-29-2021.

SER. NO. 79-100,899, FILED 6-29-2011.

MARILYN IZZI, EXAMINING ATTORNEY



David J. Kyffers

Director of the United States Patent and Trademark Office

United States of America

United States Patent and Trademark Office

Dual Incu i

Reg. No. 4,097,726

Registered Feb. 14, 2012

Int. Cl.: 10

TRADEMARK

PRINCIPAL REGISTER

ATOM MEDICAL CORPORATION (JAPAN CORPORATION)
18-15, HONGO 3-CHOME
BUNKYO-KU
TOKYO 113-0033, JAPAN

FOR: MEDICAL APPARATUS AND INSTRUMENTS, NAMELY, INFANT INCUBATORS, WARMING DEVICES FOR STABILIZING INFANT BODY TEMPERATURE, INFUSION PUMPS FOR ADMINISTERING BENEFICIAL AGENTS INTO THE BODY, MEDICAL SYRINGE PUMPS FOR ADMINISTERING BENEFICIAL AGENTS INTO THE BODY, MEDICAL EXAMINATION TABLES, HOSPITAL BABY DELIVERY BEDS, ULTRASONIC NEBULIZERS FOR RESPIRATION THERAPY, IN CLASS 10 (U.S. CLS. 26, 39 AND 44).

THE MARK CONSISTS OF STANDARD CHARACTERS WITHOUT CLAIM TO ANY PARTICULAR FONT, STYLE, SIZE, OR COLOR.

PRIORITY DATE OF 3-11-2011 IS CLAIMED.

OWNER OF INTERNATIONAL REGISTRATION 1086667 DATED 4-6-2011, EXPIRES 4-6-2021.

OWNER OF U.S. REG. NO. 3,936,910.

NO CLAIM IS MADE TO THE EXCLUSIVE RIGHT TO USE "DUAL", APART FROM THE MARK AS SHOWN.

SER. NO. 79-101,013, FILED 4-6-2011.

CAROLINE WOOD, EXAMINING ATTORNEY



David J. Kypos

Director of the United States Patent and Trademark Office

United States of America

United States Patent and Trademark Office

Infa Warmer i

Reg. No. 4,097,727

Registered Feb. 14, 2012

Int. Cl.: 10

TRADEMARK

PRINCIPAL REGISTER

ATOM MEDICAL CORPORATION (JAPAN CORPORATION)
18-15, HONGO 3-CHOME
BUNKYO-KU
TOKYO 113-0033, JAPAN

FOR: MEDICAL APPARATUS AND INSTRUMENTS, NAMELY, INFANT INCUBATORS, WARMING DEVICES FOR STABILIZING INFANT BODY TEMPERATURE, INFUSION PUMPS FOR ADMINISTERING BENEFICIAL AGENTS INTO THE BODY, MEDICAL SYRINGE PUMPS FOR ADMINISTERING BENEFICIAL AGENTS INTO THE BODY, MEDICAL EXAMINATION TABLES, HOSPITAL BABY DELIVERY BEDS, ULTRASONIC NEBULIZERS FOR RESPIRATION THERAPY, IN CLASS 10 (U.S. CLS. 26, 39 AND 44).

THE MARK CONSISTS OF STANDARD CHARACTERS WITHOUT CLAIM TO ANY PARTICULAR FONT, STYLE, SIZE, OR COLOR.

PRIORITY DATE OF 3-11-2011 IS CLAIMED.

OWNER OF INTERNATIONAL REGISTRATION 1086668 DATED 4-6-2011, EXPIRES 4-6-2021.

NO CLAIM IS MADE TO THE EXCLUSIVE RIGHT TO USE "WARMER", APART FROM THE MARK AS SHOWN.

SER. NO. 79-101,014, FILED 4-6-2011.

CAROLINE WOOD, EXAMINING ATTORNEY



David J. Kyffers

Director of the United States Patent and Trademark Office

United States of America

United States Patent and Trademark Office

Dual Incu*i*

Reg. No. 4,097,728

Registered Feb. 14, 2012

Int. Cl.: 10

TRADEMARK

PRINCIPAL REGISTER

ATOM MEDICAL CORPORATION (JAPAN CORPORATION)
18-15, HONGO 3-CHOME
BUNKYO-KU; TOKYO 113-0033
JAPAN

FOR: MEDICAL APPARATUS AND INSTRUMENTS, NAMELY, INFANT INCUBATORS, WARMING DEVICES FOR STABILIZING INFANT BODY TEMPERATURE, INFUSION PUMPS FOR ADMINISTERING BENEFICIAL AGENTS INTO THE BODY, MEDICAL SYRINGE PUMPS FOR ADMINISTERING BENEFICIAL AGENTS INTO THE BODY, MEDICAL EXAMINATION TABLES, HOSPITAL BABY DELIVERY BEDS, ULTRASONIC NEBULIZERS FOR RESPIRATION THERAPY, IN CLASS 10 (U.S. CLS. 26, 39 AND 44).

OWNER OF U.S. REG. NO. 3,936,910.

PRIORITY DATE OF 3-11-2011 IS CLAIMED.

OWNER OF INTERNATIONAL REGISTRATION 1086669 DATED 4-6-2011, EXPIRES 4-6-2021.

THE COLOR(S) LIGHT GREEN AND RED IS/ARE CLAIMED AS A FEATURE OF THE MARK.

THE MARK CONSISTS OF LETTERS "DUAL INCU" IN LIGHT GREEN AND THE STYLIZED LETTER "I" WHICH IS LIGHT GREEN WITH A RED DOT.

NO CLAIM IS MADE TO THE EXCLUSIVE RIGHT TO USE "DUAL", APART FROM THE MARK AS SHOWN.

SER. NO. 79-101,015, FILED 4-6-2011.

CAROLINE WOOD, EXAMINING ATTORNEY



David J. Kybas

Director of the United States Patent and Trademark Office

United States of America
United States Patent and Trademark Office

GUERTE

Reg. No. 4,097,729

Registered Feb. 14, 2012

Int. Cl.: 9

TRADEMARK

PRINCIPAL REGISTER

ZHEJIANG GUCHI ELECTRONICS CO., LTD. (CHINA CORPORATION)
NO. 3, JIANXI ROAD,
JIANCHUAN VILLAGE,; XINJIAN TOWN,; JINYUN COUNTY; ZHEJIANG PROVINCE
CHINA

FOR: SEMICONDUCTORS; SEMICONDUCTOR DEVICES; MONOCRYSTALLINE SILICON
WAFERS; ELECTRIC LIGHT DIMMERS; CURRENT RECTIFIERS; LOW-VOLTAGE ELEC-
TRICAL POWER SUPPLIES; ELECTRIC APPARATUS FOR COMMUTATION, NAMELY,
COMMUTATORS; BATTERY CHARGERS; VOLTAGE REGULATORS; VOLTAGE STABIL-
IZING POWER SUPPLY, IN CLASS 9 (U.S. CLS. 21, 23, 26, 36 AND 38).

OWNER OF INTERNATIONAL REGISTRATION 1087455 DATED 7-5-2011, EXPIRES 7-5-
2021.

SER. NO. 79-101,326, FILED 7-5-2011.

REBECCA SMITH, EXAMINING ATTORNEY



David J. Kybas

Director of the United States Patent and Trademark Office

United States of America

United States Patent and Trademark Office

ROCKASSIST

Reg. No. 4,097,730

Registered Feb. 14, 2012

Int. Cl.: 42

SERVICE MARK

PRINCIPAL REGISTER

ROCKWOOL INTERNATIONAL A/S (DENMARK LIMITED COMPANY)
HOVEDGADEN 584
DK-2640 HEDEHUSENE
DENMARK

FOR: SCIENTIFIC AND TECHNOLOGICAL CONSULTANCY IN THE FIELD OF COMPUTER SOFTWARE AND COMPUTER HARDWARE; RECOVERY OF COMPUTER DATA; UPDATING OF COMPUTER SOFTWARE AND OF COMPUTER HARDWARE; COMPUTER PROGRAMMING, IN PARTICULAR REGARDING INDUSTRIAL AND BUILDING CONSTRUCTION, IN CLASS 42 (U.S. CLS. 100 AND 101).

THE MARK CONSISTS OF STANDARD CHARACTERS WITHOUT CLAIM TO ANY PARTICULAR FONT, STYLE, SIZE, OR COLOR.

PRIORITY DATE OF 1-10-2011 IS CLAIMED.

OWNER OF INTERNATIONAL REGISTRATION 1087488 DATED 6-29-2011, EXPIRES 6-29-2021.

SER. NO. 79-101,339, FILED 6-29-2011.

BRIAN PINO, EXAMINING ATTORNEY



David J. Kyffers

Director of the United States Patent and Trademark Office

United States of America

United States Patent and Trademark Office



Reg. No. 4,097,731

Registered Feb. 14, 2012

Int. Cl.: 18

TRADEMARK

PRINCIPAL REGISTER

SHANGHAI CONWOOD INTERNATIONAL CO., LTD. (CHINA CORPORATION)
18FL BUILDING B
NO.660 MINSHENG ROAD; SHANGHAI
CHINA

FOR: ANIMAL SKINS; IMITATION LEATHER; PURSES; SCHOOL BAGS; HANDBAGS;
ATTACH CASES; LEATHERWARE, NAMELY, TRAVELLING SETS COMPRISED OF
VANITY CASES SOLD EMPTY; COSMETIC CASES SOLD EMPTY; HAVERSACKS; UM-
BRELLAS, IN CLASS 18 (U.S. CLS. 1, 2, 3, 22 AND 41).

THE MARK CONSISTS OF STYLIZED LETTERS "YOO" SURROUNDED BY A TRIANGLE
DEVICE.

OWNER OF INTERNATIONAL REGISTRATION 1088257 DATED 7-12-2011, EXPIRES 7-12-
2021.

SER. NO. 79-101,651, FILED 7-12-2011.

LYDIA BELZER, EXAMINING ATTORNEY



David J. Kybas

Director of the United States Patent and Trademark Office

United States of America

United States Patent and Trademark Office

WIEBOLD COCKTAILS TO EAT

Reg. No. 4,097,732

Registered Feb. 14, 2012

Int. Cl.: 30

WIEBOLD-CONFISERIE GMBH & CO. KG (FED REP GERMANY LIMITED PARTNERSHIP
WITH A LIMITED LIABILITY COMPANY AS GENERAL PARTNER)
ERNST-ABBE-STR. 2
25337 ELM SHORN
FED REP GERMANY

TRADEMARK

PRINCIPAL REGISTER

FOR: CONFECTIONERY IN THE NATURE OF FONDANTS, CONFECTIONERY MADE OF SUGAR, CONFECTIONERY, NAMELY CHOCOLATES, CARAMELS, NOUGAT, MARZIPAN, TRUFFLES AND PRALINES, IN CLASS 30 (U.S. CL. 46).

THE MARK CONSISTS OF STANDARD CHARACTERS WITHOUT CLAIM TO ANY PARTICULAR FONT, STYLE, SIZE, OR COLOR.

PRIORITY DATE OF 2-10-2011 IS CLAIMED.

OWNER OF INTERNATIONAL REGISTRATION 1089793 DATED 7-1-2011, EXPIRES 7-1-2021.

SER. NO. 79-102,185, FILED 7-1-2011.

ASMAT KHAN, EXAMINING ATTORNEY



David J. Kybas

Director of the United States Patent and Trademark Office

United States of America

United States Patent and Trademark Office

VINYL MAX

Reg. No. 4,097,733

Registered Feb. 14, 2012

Int. Cl.: 3

TRADEMARK

PRINCIPAL REGISTER

COTY GERMANY GMBH (FED REP GERMANY GMBH)
FORT MALAKOFF PARK,
RHEINSTRASSE 4E; 55116 MAINZ
FED REP GERMANY

FOR: COSMETICS, IN CLASS 3 (U.S. CLS. 1, 4, 6, 50, 51 AND 52).

THE MARK CONSISTS OF STANDARD CHARACTERS WITHOUT CLAIM TO ANY PARTICULAR FONT, STYLE, SIZE, OR COLOR.

PRIORITY DATE OF 3-24-2011 IS CLAIMED.

OWNER OF INTERNATIONAL REGISTRATION 1090591 DATED 8-8-2011, EXPIRES 8-8-2021.

SER. NO. 79-102,488, FILED 8-8-2011.

ANDREA K. NADELMAN, EXAMINING ATTORNEY



David J. Kyffers

Director of the United States Patent and Trademark Office

United States of America

United States Patent and Trademark Office

FOUR LINES

Reg. No. 4,097,734

AGRÍCOLA CASTELLANA, SDAD. COOP. (SPAIN SOCIEDAD COOPERATIVA)
CTRA. RODILANA, S/N
E-47491 LA SECA (VALLADOLID)
SPAIN

Registered Feb. 14, 2012

Int. Cl.: 33

FOR: WINE, IN CLASS 33 (U.S. CLS. 47 AND 49).

TRADEMARK

PRIORITY DATE OF 5-5-2011 IS CLAIMED.

PRINCIPAL REGISTER

OWNER OF INTERNATIONAL REGISTRATION 1092003 DATED 5-6-2011, EXPIRES 5-6-2021.

SER. NO. 79-103,035, FILED 5-6-2011.

KRISTIN DAHLING, EXAMINING ATTORNEY



David J. Kybas

Director of the United States Patent and Trademark Office

United States of America

United States Patent and Trademark Office

TEAEAT

Reg. No. 4,097,735

Registered Feb. 14, 2012

Int. Cl.: 30

WIEBOLD-CONFISERIE GMBH & CO. KG (FED REP GERMANY LIMITED PARTNERSHIP
WITH A LIMITED LIABILITY COMPANY AS GENERAL PARTNER)
ERNST-ABBE-STR. 2
25337 ELSHORN
FED REP GERMANY

TRADEMARK

PRINCIPAL REGISTER

FOR: CONFECTIONERY IN THE NATURE OF FONDANTS, CONFECTIONERY MADE OF SUGAR, CONFECTIONERY, NAMELY CHOCOLATES, CARAMELS, NOUGAT, MARZIPAN, TRUFFLES AND PRALINES, IN CLASS 30 (U.S. CL. 46).

THE MARK CONSISTS OF STANDARD CHARACTERS WITHOUT CLAIM TO ANY PARTICULAR FONT, STYLE, SIZE, OR COLOR.

PRIORITY DATE OF 2-9-2011 IS CLAIMED.

OWNER OF INTERNATIONAL REGISTRATION 1092012 DATED 7-1-2011, EXPIRES 7-1-2021.

SER. NO. 79-103,041, FILED 7-1-2011.

ASMAT KHAN, EXAMINING ATTORNEY



David J. Kyffers

Director of the United States Patent and Trademark Office

United States of America
United States Patent and Trademark Office

Puridur

Reg. No. 4,097,736

Registered Feb. 14, 2012

Int. Cl.: 2

TRADEMARK

PRINCIPAL REGISTER

VOTTELER LACKFABRIK GMBH & CO. KG (FED REP GERMANY GMBH & CO. KG)
SCHWIEBERDINGER STRASSE 97 + 102
70825 KORNTAL-MÜNCHINGEN
FED REP GERMANY

FOR: LACQUERS, PRIMER AS PAINTS, ALL GOODS EXCLUSIVELY FOR WOOD PROCESSING, IN CLASS 2 (U.S. CLS. 6, 11 AND 16).

THE MARK CONSISTS OF STANDARD CHARACTERS WITHOUT CLAIM TO ANY PARTICULAR FONT, STYLE, SIZE, OR COLOR.

OWNER OF INTERNATIONAL REGISTRATION 1092350 DATED 5-31-2011, EXPIRES 5-31-2021.

SER. NO. 79-103,150, FILED 5-31-2011.

APRIL HESIK, EXAMINING ATTORNEY



David J. Kybas

Director of the United States Patent and Trademark Office

United States of America
United States Patent and Trademark Office

Ventus
imagine more

Reg. No. 4,097,737

Registered Feb. 14, 2012

Int. Cl.: 38

SERVICE MARK

PRINCIPAL REGISTER

VENTUS NETWORKS (CONNECTICUT LIMITED LIABILITY COMPANY)
MAIL BOX 8
10 NORDEN PLACE
NORWALK, CT 06855

FOR: TELECOMMUNICATION SERVICES, NAMELY, TRANSMISSION OF VOICE, DATA, GRAPHICS, IMAGES, AUDIO AND VIDEO BY MEANS OF TELECOMMUNICATIONS NETWORKS, WIRELESS COMMUNICATION NETWORKS, AND THE INTERNET, IN CLASS 38 (U.S. CLS. 100, 101 AND 104).

FIRST USE 2-1-2010; IN COMMERCE 2-1-2010.

OWNER OF U.S. REG. NOS. 3,291,712 AND 3,386,184.

THE COLOR(S) BLUE AND ORANGE IS/ARE CLAIMED AS A FEATURE OF THE MARK.

THE MARK CONSISTS OF WORD "VENTUS" IN A BOLD, BLOCK PRINT IN THE COLOR BLUE. ABOVE THE WORD "VENTUS" IS AN ARROW SHAPE, POINTING UP AND TO THE RIGHT, CONSISTING OF TEN ORANGE AND BLUE SQUARES. BELOW THE WORD "VENTUS" ARE THE WORDS "IMAGINE MORE" IN ORANGE.

THE ENGLISH TRANSLATION OF "VENTUS" IN THE MARK IS WIND.

SER. NO. 85-000,622, FILED 3-29-2010.

EUGENIA MARTIN, EXAMINING ATTORNEY



David J. Kyffers

Director of the United States Patent and Trademark Office

United States of America

United States Patent and Trademark Office

SCORPION 

Reg. No. 4,097,738

KENNEY, JAKE (UNITED STATES INDIVIDUAL)
30511 LINCOLNSHIRE E
BEVERLY HILLS, MI 48025

Registered Feb. 14, 2012

Int. Cl.: 28

FOR: LACROSSE STICKS, IN CLASS 28 (U.S. CLS. 22, 23, 38 AND 50).

TRADEMARK

FIRST USE 1-0-2007; IN COMMERCE 1-0-2007.

PRINCIPAL REGISTER

THE MARK CONSISTS OF THE CAPITALIZED WORD "SCORPION" IN A STYLIZED FONT, FOLLOWED BY A PICTURE OF A DIGITALLY RENDERED SCORPION DRAWING INSIDE A CIRCLE WITH THE TOP OPEN, POINTED UPWARDS. THE MARK FOR THE PICTURE OF THE SCORPION GIVES THE RENDERING OF THE ANIMAL SCORPION THE LOOK OF BEING INSIDE TWO PARENTHETICAL PINCERS, ENCIRCLING THE SCORPION.

SER. NO. 85-001,389, FILED 3-29-2010.

DAVID COLLIER, EXAMINING ATTORNEY



David J. Kyffers

Director of the United States Patent and Trademark Office

United States of America

United States Patent and Trademark Office

SQUARE FOOT GARDENING

Reg. No. 4,097,739

Registered Feb. 14, 2012

Int. Cls.: 21 and 35

TRADEMARK

SERVICE MARK

PRINCIPAL REGISTER

SQUARE FOOT GARDENING FOUNDATION (UTAH CORPORATION)
3615 WOLF CREEK DR. SUITE #W12
EDEN, UT 84310

FOR: PLANTERS FOR FLOWERS AND PLANTS, IN CLASS 21 (U.S. CLS. 2, 13, 23, 29, 30, 33, 40 AND 50).

FIRST USE 1-3-2011; IN COMMERCE 1-3-2011.

FOR: ONLINE RETAIL STORE SERVICES FEATURING GARDENING TOOLS, GARDENING SOILS, AND PLANTS, IN CLASS 35 (U.S. CLS. 100, 101 AND 102).

FIRST USE 1-3-2011; IN COMMERCE 1-3-2011.

THE MARK CONSISTS OF STANDARD CHARACTERS WITHOUT CLAIM TO ANY PARTICULAR FONT, STYLE, SIZE, OR COLOR.

OWNER OF U.S. REG. NO. 2,784,380.

NO CLAIM IS MADE TO THE EXCLUSIVE RIGHT TO USE "GARDENING", APART FROM THE MARK AS SHOWN.

SEC. 2(F).

SER. NO. 85-003,391, FILED 3-31-2010.

DANNEAN HETZEL, EXAMINING ATTORNEY



David J. Kyffers

Director of the United States Patent and Trademark Office

United States of America

United States Patent and Trademark Office

TEAMRAISER

Reg. No. 4,097,740

Registered Feb. 14, 2012

Int. Cl.: 9

TRADEMARK

PRINCIPAL REGISTER

CONVIO, INC. (DELAWARE CORPORATION)
11400 BURNET ROAD
BLDG. 5, SUITE 200
AUSTIN, TX 78758

FOR: DOWNLOADABLE PUBLICATIONS IN THE NATURE OF PAMPHLETS, BROCHURES, BOOKLETS, TRAINING MATERIALS AND NEWSLETTERS IN THE FIELDS OF FUND-RAISING, SPECIAL EVENT PLANNING AND ADVOCACY ACTIVITIES, IN CLASS 9 (U.S. CLS. 21, 23, 26, 36 AND 38).

FIRST USE 12-31-2001; IN COMMERCE 9-13-2011.

THE MARK CONSISTS OF STANDARD CHARACTERS WITHOUT CLAIM TO ANY PARTICULAR FONT, STYLE, SIZE, OR COLOR.

OWNER OF U.S. REG. NOS. 3,765,945 AND 3,830,203.

SER. NO. 85-008,284, FILED 4-7-2010.

CHARISMA HAMPTON, EXAMINING ATTORNEY



David J. Kyffers

Director of the United States Patent and Trademark Office

United States of America

United States Patent and Trademark Office

GINSEOL K

Reg. No. 4,097,741

Registered Feb. 14, 2012

Int. Cl.: 29

TRADEMARK

PRINCIPAL REGISTER

CJ CHEILJEDANG CORPORATION (REPUBLIC OF KOREA CORPORATION)
292, SSANGNIM-DONG, JUNG-GU
SEOUL, REPUBLIC OF KOREA

FOR: PRESERVED GINSENG FOR USE AS A VEGETABLE; PROCESSED GINSENG FOR USE AS A VEGETABLE, IN CLASS 29 (U.S. CL. 46).

THE MARK CONSISTS OF STANDARD CHARACTERS WITHOUT CLAIM TO ANY PARTICULAR FONT, STYLE, SIZE, OR COLOR.

PRIORITY CLAIMED UNDER SEC. 44(D) ON REPUBLIC OF KOREA APPLICATION NO. 40-2010-1847, FILED 4-8-2010, REG. NO. 0866411, DATED 5-27-2011, EXPIRES 5-27-2021.

SER. NO. 85-009,616, FILED 4-8-2010.

KHANH LE, EXAMINING ATTORNEY



David J. Kyffers

Director of the United States Patent and Trademark Office

United States of America

United States Patent and Trademark Office

GINSEOL K

Reg. No. 4,097,742

Registered Feb. 14, 2012

Int. Cl.: 32

TRADEMARK

PRINCIPAL REGISTER

CJ CHEILJEDANG CORPORATION (REPUBLIC OF KOREA CORPORATION)
292, SSANGNIM-DONG, JUNG-GU
SEOUL, REPUBLIC OF KOREA

FOR: GINSENG POWDERS FOR MAKING NON-ALCOHOLIC BEVERAGES; GINSENG EXTRACTS FOR MAKING NON-ALCOHOLIC BEVERAGES; GINSENG JUICES (BEVERAGES), IN CLASS 32 (U.S. CLS. 45, 46 AND 48).

THE MARK CONSISTS OF STANDARD CHARACTERS WITHOUT CLAIM TO ANY PARTICULAR FONT, STYLE, SIZE, OR COLOR.

PRIORITY CLAIMED UNDER SEC. 44(D) ON REPUBLIC OF KOREA APPLICATION NO. 40-2010-1847, FILED 4-8-2010, REG. NO. 0866412, DATED 5-27-2011, EXPIRES 5-27-2021.

SER. NO. 85-009,649, FILED 4-8-2010.

KHANH LE, EXAMINING ATTORNEY



David J. Kybas

Director of the United States Patent and Trademark Office

United States of America

United States Patent and Trademark Office



Reg. No. 4,097,743

FOOD HOLDING S.A. (ARGENTINA CORPORATION)
SAN MARTÍN DE TOURS 2881
BUENOS AIRES, ARGENTINA C1425DNA

Registered Feb. 14, 2012

Int. Cl.: 30

FOR: DULCE DE LECHE; PASTRIES IN THE NATURE OF ALFAJORES, NAMELY, SANDWICH COOKIES, IN CLASS 30 (U.S. CL. 46).

TRADEMARK

PRIORITY CLAIMED UNDER SEC. 44(D) ON ARGENTINA APPLICATION NO. 2991070, FILED 3-30-2010, REG. NO. 2419666, DATED 1-21-2011, EXPIRES 1-21-2021.

PRINCIPAL REGISTER

THE COLOR(S) RED AND WHITE IS/ARE CLAIMED AS A FEATURE OF THE MARK.

THE MARK CONSISTS OF THE WORD "NEVARES" IN CAPITAL STYLIZED LETTER INSIDE AN IRREGULAR RECTANGLE. THE COLOR WHITE APPEARS IN THE WORD "NEVARES" AND THE COLOR RED APPEARS IN THE IRREGULAR RECTANGLE.

THE ENGLISH TRANSLATION OF "NEVARES" IN THE MARK IS "YOU WILL SNOW". THE WORDING "NEVARES" HAS NO MEANING IN A FOREIGN LANGUAGE.

SER. NO. 85-012,173, FILED 4-12-2010.

BERYL GARDNER, EXAMINING ATTORNEY



David J. Kyffers

Director of the United States Patent and Trademark Office

United States of America

United States Patent and Trademark Office

PINK COOKIE

Reg. No. 4,097,744

Registered Feb. 14, 2012

Int. Cl.: 14

TRADEMARK

PRINCIPAL REGISTER

PINK COOKIE DESIGN, LLC (DELAWARE LIMITED LIABILITY COMPANY)
6TH FLOOR
10 EAST 34TH STREET
NEW YORK, NY 10016

FOR: WATCHES, IN CLASS 14 (U.S. CLS. 2, 27, 28 AND 50).

FIRST USE 3-0-2010; IN COMMERCE 3-0-2010.

THE MARK CONSISTS OF STANDARD CHARACTERS WITHOUT CLAIM TO ANY PARTICULAR FONT, STYLE, SIZE, OR COLOR.

OWNER OF U.S. REG. NO. 2,967,112.

SER. NO. 85-012,419, FILED 4-13-2010.

TIMOTHY FINNEGAN, EXAMINING ATTORNEY



David J. Kyffers

Director of the United States Patent and Trademark Office

United States of America

United States Patent and Trademark Office



Reg. No. 4,097,745

Registered Feb. 14, 2012

**Int. Cls.: 9, 35, 38, 39
and 41**

TRADEMARK

SERVICE MARK

PRINCIPAL REGISTER

FLIGHT FOCUS PTE. LTD. (SINGAPORE CORPORATION)
#06-09 HONEYWELL BUILDING
17 CHANGI BUSINESS PARK CENTRAL 1
SINGAPORE, SINGAPORE 486073

FOR: COMPUTER KEYBOARDS; COMPUTER PERIPHERAL DEVICES; COMPUTERS; PRINTERS FOR USE WITH COMPUTERS; CONNECTIONS FOR ELECTRIC LINES, ELECTRIC CONNECTORS; ELECTRIC CONTROL PANELS; ELECTRIC CONVERTERS; ACOUSTIC COUPLERS, NAMELY, DATA PROCESSING EQUIPMENT; MAGNETIC AND OPTICAL DATA MEDIA FOR ELECTRONIC STORAGE, NAMELY, AIR FLIGHT RELATED DATA, NAMELY, METEOROLOGICAL, ROUTING, TRAFFIC AND NAVIGATION; ELECTRONIC DATA CARRIERS, NAMELY, USB-STICKS; DISK DRIVES FOR COMPUTERS; ELECTRIC INSTALLATIONS FOR AIRCRAFTS, NAMELY, WIRE BUNDLES AND CONNECTORS; MAGNETIC IDENTITY CARDS, RFID IDENTITY CARDS; INTERCOMMUNICATION APPARATUS, NAMELY, FIBER OPTIC CABLE; INTERFACES FOR COMPUTERS; LAPTOP COMPUTERS; MAGNETIC DATA MEDIA FEATURING AIR FLIGHT RELATED DATA, NAMELY, METEOROLOGICAL, ROUTING, TRAFFIC AND NAVIGATION; MAGNETIC ENCODERS; MAGNETIC TAPE UNITS FOR COMPUTERS; COMPUTER MONITORS; COMPUTER MOUSE; NAVIGATION APPARATUS FOR AIRCRAFTS, NAMELY, ON-BOARD COMPUTERS; NOTEBOOK COMPUTERS; ELECTRONIC NOTICE BOARDS; OPTICAL CHARACTER READERS; BLANK OPTICAL DATA CARRIERS; BLANK OPTICAL DISCS; RADIOS, TRANSCEIVERS, RADIO RELAYS, AND RADIO REPEATERS FOR COMPUTER COMMUNICATION PURPOSES; AIRCRAFT RADIOS AND TRANSCEIVERS; SATELLITE NAVIGATIONAL AND COMMUNICATION APPARATUS; SCANNERS, NAMELY, DATA PROCESSING EQUIPMENT; BLANK SMART CARDS AND BLANK INTEGRATED CIRCUIT CARDS, IN CLASS 9 (U.S. CLS. 21, 23, 26, 36 AND 38).

FOR: BUSINESS ORGANIZATION CONSULTANCY FOR THE COMMERCIAL FLIGHT TRANSPORTATION INDUSTRY; COMMERCIAL MANAGEMENT ASSISTANCE FOR THE COMMERCIAL FLIGHT TRANSPORTATION INDUSTRY; COMPILATION OF FLIGHT DATA INFORMATION INTO COMPUTER DATABASES; COMPILATION OF FLIGHT STATISTICS; PROFESSIONAL BUSINESS CONSULTANCY FOR THE COMMERCIAL FLIGHT TRANSPORTATION INDUSTRY; COST PRICE ANALYSIS; ECONOMIC FORECASTING FOR THE COMMERCIAL FLIGHT TRANSPORTATION INDUSTRY; BUSINESS EFFICIENCY ANALYSIS FOR THE COMMERCIAL FLIGHT TRANSPORTATION INDUSTRY; COMPUTERIZED FILE MANAGEMENT; PERSONNEL MANAGEMENT CONSULTANCY FOR THE COMMERCIAL FLIGHT TRANSPORTATION INDUSTRY; NEWS CLIPPING



David J. Kyjars

Director of the United States Patent and Trademark Office

Reg. No. 4,097,745 SERVICES; PRICE COMPARISON SERVICES FOR THE COMMERCIAL FLIGHT TRANSPORTATION INDUSTRY; PROCUREMENT SERVICES FOR OTHERS IN THE AREA OF COMMERCIAL FLIGHT TRANSPORTATION INDUSTRY, PURCHASING GOODS AND SERVICES FOR OTHER BUSINESSES IN THE AREA OF COMMERCIAL FLIGHT TRANSPORTATION INDUSTRY; ADMINISTRATIVE PROCESSING OF PURCHASE ORDERS IN THE AREA OF COMMERCIAL FLIGHT TRANSPORTATION INDUSTRY, NAMELY, FOR AIRCRAFT FUEL; DRAWING UP OF STATEMENTS OF ACCOUNTS; COMPILATION OF STATISTICS FOR THE COMMERCIAL FLIGHT TRANSPORTATION INDUSTRY; ARRANGING SUBSCRIPTIONS TO TELECOMMUNICATION SERVICES FOR OTHERS IN THE AREA OF COMMERCIAL FLIGHT TRANSPORTATION INDUSTRY; PROVIDING FUEL MANAGEMENT SERVICES IN THE FIELD OF AVIATION; TRACKING, LOCATING AND MONITORING AIRCRAFT FOR COMMERCIAL PURPOSES, IN CLASS 35 (U.S. CLS. 100, 101 AND 102).

FOR: COMPUTER AIDED TRANSMISSION OF MESSAGES AND IMAGES; COMMUNICATIONS BY COMPUTER TERMINALS; ELECTRONIC BULLETIN BOARD SERVICES, NAMELY, TELECOMMUNICATIONS SERVICES FOR AIRCRAFTS; ELECTRONIC MAIL; PROVIDING ACCESS TO DATABASES; PROVIDING TELECOMMUNICATION CHANNELS FOR AIRCRAFT SERVICES; PROVIDING TELECOMMUNICATIONS CONNECTIONS TO A GLOBAL COMPUTER NETWORK; PROVIDING USER ACCESS TO A GLOBAL COMPUTER NETWORK SERVICE PROVIDERS; RENTAL OF ACCESS TIME TO GLOBAL COMPUTER NETWORKS; SATELLITE TRANSMISSION; PROVIDING TELECOMMUNICATION CHANNELS AIRCRAFT DISPATCHING AND NAVIGATION; TELECOMMUNICATIONS ROUTING AND JUNCTION SERVICES; COMPUTER AIDED TRANSMISSION OF MESSAGES AND IMAGES, IN CLASS 38 (U.S. CLS. 100, 101 AND 104).

FOR: RENTAL OF ON-BOARD COMPUTER APPARATUS FOR AIRCRAFT, NAMELY, PROVIDING MAPPING, FLIGHT AND ROUTING NAVIGATIONAL AID; AIR NAVIGATION PLANNING SERVICES FOR PILOTS, IN CLASS 39 (U.S. CLS. 100 AND 105).

FOR: PUBLICATION OF BOOKS ON AIRCRAFT NAVIGATION AND OPERATIONAL DATA; PUBLISHING OF BOOK AIR FLIGHT PLANS, AIR NAVIGATION PLANS, FUEL CONSUMPTION ANALYSIS AND AIR FLIGHT TRACKING; DIGITAL IMAGING SERVICES; PROFESSIONAL TRAINING IN THE AREA OF NAVIGATING AND OPERATING AIRCRAFTS; PUBLICATION OF ELECTRONIC BOOKS AND JOURNALS ON-LINE; ARRANGING AND CONDUCTING OF PROFESSIONAL TRAINING SEMINARS; PUBLICATION OF TEXTS AND TEXT BOOKS, IN CLASS 41 (U.S. CLS. 100, 101 AND 107).

PRIORITY CLAIMED UNDER SEC. 44(D) ON SINGAPORE APPLICATION NO. T0911577H, FILED 10-13-2009, REG. NO. T0911577H, DATED 10-13-2009, EXPIRES 10-13-2019.

THE COLOR(S) RED AND BLUE IS/ARE CLAIMED AS A FEATURE OF THE MARK.

PRIORITY CLAIMED UNDER SEC. 44(D) ON SINGAPORE APPLICATION NO. T0911575A, FILED 10-13-2009, REG. NO. T0911575A, DATED 10-13-2009, EXPIRES 10-13-2019.

PRIORITY CLAIMED UNDER SEC. 44(D) ON SINGAPORE APPLICATION NO. T0911574C, FILED 10-13-2009, REG. NO. T0911574C, DATED 10-13-2009, EXPIRES 10-13-2019.

PRIORITY CLAIMED UNDER SEC. 44(D) ON SINGAPORE APPLICATION NO. T0911572G, FILED 10-13-2009, REG. NO. T0911572G, DATED 10-13-2009, EXPIRES 10-13-2019.

NO CLAIM IS MADE TO THE EXCLUSIVE RIGHT TO USE "FLIGHT", APART FROM THE MARK AS SHOWN.

THE MARK CONSISTS OF A RED TRIANGLE, A BLUE TRIANGLE, THE WORDS "FLIGHT FOCUS" IN BLUE WITH THE "I" STYLIZED IN COLORS BLUE AND RED.

Reg. No. 4,097,745 SER. NO. 85-012,446, FILED 4-13-2010.

EDWARD NELSON, EXAMINING ATTORNEY

United States of America

United States Patent and Trademark Office

WorldFlix

Reg. No. 4,097,746

Registered Feb. 14, 2012

Int. Cl.: 41

SERVICE MARK

PRINCIPAL REGISTER

WORLDFLIX (NEVADA CORPORATION)
430
4170 ADMIRALTY WAY
MARINA DEL REY, CA 90292

FOR: PRODUCTION AND DISTRIBUTION OF TELEVISION SHOWS AND MOVIES, IN CLASS 41 (U.S. CLS. 100, 101 AND 107).

FIRST USE 2-1-2007; IN COMMERCE 2-15-2007.

THE MARK CONSISTS OF STANDARD CHARACTERS WITHOUT CLAIM TO ANY PARTICULAR FONT, STYLE, SIZE, OR COLOR.

SER. NO. 85-014,118, FILED 4-14-2010.

EMILY CHUO, EXAMINING ATTORNEY



David J. Kybas

Director of the United States Patent and Trademark Office

United States of America

United States Patent and Trademark Office

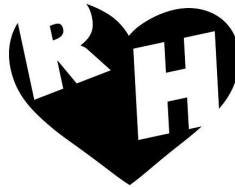

REAL HORRORSHOW
RECORDS

Reg. No. 4,097,747

Registered Feb. 14, 2012

Int. Cl.: 9

TRADEMARK

PRINCIPAL REGISTER

LEANLOVE PTY LIMITED (AUSTRALIA CORPORATION)
P.O. BOX 41
ERSKINEVILLE, AUSTRALIA NSW2043 AND

SESTER MUSIC PTY LIMITED (AUSTRALIA CORPORATION)
P.O. BOX 41
ERSKINEVILLE, AUSTRALIA NSW2043 AND

TOOB PTY LIMITED (AUSTRALIA CORPORATION)
P.O. BOX 41
ERSKINEVILLE, AUSTRALIA NSW2043

FOR: AUDIO AND VIDEO RECORDINGS FEATURING MUSIC AND ARTISTIC PERFORMANCES; DIGITAL MEDIA, NAMELY, PRE-RECORDED VIDEO CASSETTES, DIGITAL VIDEO DISCS, DIGITAL VERSATILE DISCS, DOWNLOADABLE AUDIO AND VIDEO RECORDINGS, DVDS, AND HIGH DEFINITION DIGITAL DISCS FEATURING MUSICAL PERFORMANCES; DOWNLOADABLE MUSICAL SOUND RECORDINGS; MUSICAL SOUND RECORDINGS; MUSICAL VIDEO RECORDINGS; PHONOGRAPH RECORDS FEATURING MUSIC; PRE-RECORDED CDS, VIDEO TAPES, LASER DISKS AND DVDS FEATURING MUSICAL PERFORMANCES; PRE-RECORDED DIGITAL MEDIA FEATURING MUSICAL PERFORMANCES; PRE-RECORDED ELECTRONIC AND DIGITAL MEDIA FEATURING MUSICAL PERFORMANCES; SOUND RECORDINGS FEATURING MUSICAL PERFORMANCES, IN CLASS 9 (U.S. CLS. 21, 23, 26, 36 AND 38).

FIRST USE 8-1-2009; IN COMMERCE 8-1-2009.

NO CLAIM IS MADE TO THE EXCLUSIVE RIGHT TO USE "RECORDS", APART FROM THE MARK AS SHOWN.

THE MARK CONSISTS OF A HEART SHAPED BACKGROUND WITH THE CAPITAL LETTER "R" ON THE LEFT SIDE AND THE CAPITAL LETTER "H" ON THE RIGHT SIDE, AND WITH THE WORDS "REAL HORRORSHOW RECORDS" APPEARING BENEATH IT.

SER. NO. 85-014,210, FILED 4-14-2010.

ANGELA DUONG, EXAMINING ATTORNEY



David J. Kybas

Director of the United States Patent and Trademark Office

United States of America

United States Patent and Trademark Office

WOORI ASIAN FOODS

Reg. No. 4,097,748

Registered Feb. 14, 2012

Int. Cl.: 29

TRADEMARK

PRINCIPAL REGISTER

WOORI ASIAN FOODS, LLC (WASHINGTON LIMITED LIABILITY COMPANY), DBA
WOORI ASIAN FOODS
10729 A ST S # B
TACOMA, WA 984446023

FOR: FERMENTED VEGETABLES; RADISH CUBED KIMCHI; WATERY RADISH KIMCHI,
IN CLASS 29 (U.S. CL. 46).

FIRST USE 12-7-2004; IN COMMERCE 12-7-2004.

THE MARK CONSISTS OF STANDARD CHARACTERS WITHOUT CLAIM TO ANY PAR-
TICULAR FONT, STYLE, SIZE, OR COLOR.

NO CLAIM IS MADE TO THE EXCLUSIVE RIGHT TO USE "ASIAN FOODS", APART FROM
THE MARK AS SHOWN.

THE ENGLISH TRANSLATION OF "WOORI" IN THE MARK IS "WE" OR "US".

SER. NO. 85-016,245, FILED 4-16-2010.

AMY ALFIERI, EXAMINING ATTORNEY



David J. Kybas

Director of the United States Patent and Trademark Office

United States of America

United States Patent and Trademark Office

ASMgrid

Reg. No. 4,097,749

ACCENT S.P.A. (ITALY SHARE CAPITAL COMPANY)
485 OREGON AVENUE
PALO ALTO, CA 94301

Registered Feb. 14, 2012

Int. Cl.: 9

FOR: SEMICONDUCTORS AND PLATFORMS, COMPRISED OF EMBEDDED SOFTWARE FOR RESPECTIVE SEMICONDUCTOR DEVICE, AND HARDWARE AND SOFTWARE DEVELOPMENT TOOLS ENABLING USERS TO DEVELOP APPLICATION SOFTWARE FOR PLATFORM, IN CLASS 9 (U.S. CLS. 21, 23, 26, 36 AND 38).

TRADEMARK

PRINCIPAL REGISTER

FIRST USE 9-1-2009; IN COMMERCE 9-1-2009.

THE MARK CONSISTS OF STANDARD CHARACTERS WITHOUT CLAIM TO ANY PARTICULAR FONT, STYLE, SIZE, OR COLOR.

SER. NO. 85-018,892, FILED 4-20-2010.

MARK PILARO, EXAMINING ATTORNEY



David J. Kyffers

Director of the United States Patent and Trademark Office

United States of America

United States Patent and Trademark Office

RIDE FOREVER

Reg. No. 4,097,750

Registered Feb. 14, 2012

Int. Cl.: 25

TRADEMARK

PRINCIPAL REGISTER

GOOD SPORTS, INC. (CONNECTICUT CORPORATION)
349 PROGRESS DR
MANCHESTER, CT 06045

FOR: CLOTHING, NAMELY, TEE SHIRTS, SWEAT SHIRTS, HOODED SWEAT SHIRTS, TANK-TOPS, SLEEVELESS SHIRTS, HATS, CAPS, UNDERWEAR, JACKETS, BANDANNAS, GLOVES; CLOTHING, NAMELY, RIDING AND LIFESTYLE APPAREL FOR WOMEN, NAMELY, TEE SHIRTS, SWEAT SHIRTS, HOODED SWEAT SHIRTS, TANK-TOPS, SLEEVELESS SHIRTS, HATS, CAPS, UNDERWEAR, JACKETS ALL OF THE FOREGOING EXCLUDING CLOTHING DESIGNED OR PROMOTED SPECIFICALLY FOR WINTER SPORTS SUCH AS SKIING OR SNOWBOARDING, IN CLASS 25 (U.S. CLS. 22 AND 39).

FIRST USE 6-1-2009; IN COMMERCE 6-1-2009.

THE MARK CONSISTS OF STANDARD CHARACTERS WITHOUT CLAIM TO ANY PARTICULAR FONT, STYLE, SIZE, OR COLOR.

SER. NO. 85-019,001, FILED 4-21-2010.

FRANK LATTUCA, EXAMINING ATTORNEY



David J. Kyfos

Director of the United States Patent and Trademark Office

United States of America

United States Patent and Trademark Office

NATION'S FOOTBALL CLASSIC

Reg. No. 4,097,751

WASHINGTON CONVENTION AND SPORTS AUTHORITY (D.C. CORPORATION)
2400 EAST CAPITOL STREET, SE
WASHINGTON, DC 20003

Registered Feb. 14, 2012

Int. Cls.: 35 and 41

FOR: PROMOTING THE GOODS AND SERVICES OF OTHERS BY ARRANGING FOR SPONSORS TO AFFILIATE THEIR GOODS AND SERVICES WITH COLLEGIATE FOOTBALL GAMES AND RELATED FESTIVALS AND EVENTS, IN CLASS 35 (U.S. CLS. 100, 101 AND 102).

SERVICE MARK

PRINCIPAL REGISTER

FIRST USE 10-0-2009; IN COMMERCE 10-0-2009.

FOR: ENTERTAINMENT SERVICES, NAMELY, ORGANIZING AND CONDUCTING COLLEGIATE FOOTBALL GAMES, FESTIVALS AND RELATED EVENTS, IN CLASS 41 (U.S. CLS. 100, 101 AND 107).

FIRST USE 10-0-2009; IN COMMERCE 10-0-2009.

THE MARK CONSISTS OF STANDARD CHARACTERS WITHOUT CLAIM TO ANY PARTICULAR FONT, STYLE, SIZE, OR COLOR.

NO CLAIM IS MADE TO THE EXCLUSIVE RIGHT TO USE "FOOTBALL CLASSIC", APART FROM THE MARK AS SHOWN.

SER. NO. 85-019,715, FILED 4-21-2010.

RON FAIRBANKS, EXAMINING ATTORNEY



David J. Kyffers

Director of the United States Patent and Trademark Office

United States of America
United States Patent and Trademark Office

UltraCMOS

Reg. No. 4,097,752

PEREGRINE SEMICONDUCTOR CORPORATION (DELAWARE CORPORATION)
9380 CARROLL PARK DRIVE
SAN DIEGO, CA 92121

Registered Feb. 14, 2012

Int. Cl.: 9

FOR: SEMICONDUCTOR CHIPS; SEMICONDUCTOR DEVICES; SEMICONDUCTORS, IN CLASS 9 (U.S. CLS. 21, 23, 26, 36 AND 38).

TRADEMARK

FIRST USE 1-1-2004; IN COMMERCE 3-1-2004.

PRINCIPAL REGISTER

THE MARK CONSISTS OF STANDARD CHARACTERS WITHOUT CLAIM TO ANY PARTICULAR FONT, STYLE, SIZE, OR COLOR.

SEC. 2(F).

SER. NO. 85-022,320, FILED 4-23-2010.

ROBERT C. CLARK JR., EXAMINING ATTORNEY



David J. Kyffers

Director of the United States Patent and Trademark Office

United States of America

United States Patent and Trademark Office



Reg. No. 4,097,753

Registered Feb. 14, 2012

Int. Cl.: 29

TRADEMARK

PRINCIPAL REGISTER

QUANTUM FOODS, LLC (DELAWARE LIMITED LIABILITY COMPANY)
750 SOUTH SCHMIDT ROAD
BOLINGBROOK, IL 60440

FOR: PROCESSED POULTRY SOLD IN PORTIONS; FULLY COOKED ENTREES CONSISTING PRIMARILY OF POULTRY, IN CLASS 29 (U.S. CL. 46).

FIRST USE 8-1-2009; IN COMMERCE 8-1-2009.

OWNER OF U.S. REG. NOS. 3,013,149, 3,245,334, AND 3,889,904.

THE COLOR(S) BLUE, YELLOW, ORANGE, RED, WHITE, GOLD AND GRAY IS/ARE CLAIMED AS A FEATURE OF THE MARK.

NO CLAIM IS MADE TO THE EXCLUSIVE RIGHT TO USE "PREMIUM POULTRY", "BRAND" AND THE PHOTOGRAPH OF THE GRILLED CHICKEN, APART FROM THE MARK AS SHOWN.

THE MARK CONSISTS OF BLUE BACKGROUND COLORS WHICH VARY FROM DARKER TO LIGHTER HUES. IN THE CENTER IS A RECTANGLE OUTLINED IN GRAY AND GOLD. WITHIN THE RECTANGLE IS A PICTURE OF GRILLED CHICKEN AND THE WORDS "PREMIUM POULTRY" IN THE SHADE OF YELLOW, ORANGE AND WHITE LETTERS. ON THE LEFT SIDE OF THE RECTANGLE IS A STYLIZED DESIGN OF A GOLD GLOBE WITH POINTS AROUND THE CIRCUMFERENCE AND A RED BANNER WITH THE WORDS "COMMITTED TO QUALITY" IN WHITE LETTERS AND A BLUE RIBBON EXTENDING FROM THE BOTTOM OF THE GLOBE. ABOVE THE RECTANGLE ARE THE WORDS "GENUINE GOLD LABEL" IN WHITE LETTERS AND BELOW THE RECTANGLE ARE STYLIZED CIRCULAR DESIGNS IN WHITE AND THE WORDS "MIDWESTERN BRAND" IN WHITE LETTERS.

SEC. 2(F) AS TO "MIDWESTERN".

SER. NO. 85-023,213, FILED 4-26-2010.

JOHN HWANG, EXAMINING ATTORNEY



David J. Kybas

Director of the United States Patent and Trademark Office

United States of America

United States Patent and Trademark Office

EVER AFTER

Reg. No. 4,097,754

Registered Feb. 14, 2012

Int. Cl.: 35

SERVICE MARK

PRINCIPAL REGISTER

EVER AFTER (FLORIDA LIMITED LIABILITY COMPANY)
SUITE 100 B
2977 MCFARLANE ROAD
COCONUT GROVE, FL 33133

FOR: ON-LINE RETAIL STORE SERVICES FEATURING COUTURE BRIDAL GOWNS, EVENING GOWNS, GOWNS, SHOES AND ACCESSORIES EXCEPT FINE JEWELRY; RETAIL STORE SERVICES FEATURING COUTURE BRIDAL GOWNS, EVENING GOWNS, GOWNS, SHOES AND ACCESSORIES EXCEPT FINE JEWELRY, IN CLASS 35 (U.S. CLS. 100, 101 AND 102).

FIRST USE 10-5-2002; IN COMMERCE 10-5-2002.

THE MARK CONSISTS OF STANDARD CHARACTERS WITHOUT CLAIM TO ANY PARTICULAR FONT, STYLE, SIZE, OR COLOR.

SER. NO. 85-024,004, FILED 4-27-2010.

LINDA ESTRADA, EXAMINING ATTORNEY



David J. Kyffers

Director of the United States Patent and Trademark Office

United States of America

United States Patent and Trademark Office



Reg. No. 4,097,755

Registered Feb. 14, 2012

Int. Cls.: 32 and 35

TRADEMARK

SERVICE MARK

PRINCIPAL REGISTER

INDUSTRIA AMAZONIA LTDA (BRAZIL LIMITED LIABILITY COMPANY)
ZIP BR-68440-000
RUA SIQUEIRA MENDES 1785, BAIRRO CENTRO
ABAETETUBA, PARA STATE, BRAZIL AND

GUARANA AMAZONIA S.L. (SPAIN LIMITED LIABILITY COMPANY)
ZIP E-08222
C/ SOLER Y PALET 2, 1, 3
TERRASSA (BARCELONA), SPAIN

FOR: CONCENTRATES, SYRUPS OR POWDERS USED IN THE PREPARATION OF SOFT DRINKS , GUARANA DRINKS, FRUIT FLAVORED SOFT DRINKS AND SOFT DRINKS AND FRUIT JUICES, IN CLASS 32 (U.S. CLS. 45, 46 AND 48).

FIRST USE 6-1-1957, THE MARK WAS FIRST USED ANYWHERE IN A DIFFERENT FORM OTHER THAN THAT SOUGHT TO BE REGISTERED AT LEAST AS EARLY AS 01/01/1957; IN COMMERCE 6-1-1957, THE MARK WAS FIRST USED IN COMMERCE IN A DIFFERENT FORM OTHER THAN THAT SOUGHT TO BE REGISTERED AT LEAST AS EARLY AS 01/01/1957.

FOR: ADVERTISING AND ADVERTISEMENT SERVICES; BUSINESS MANAGEMENT; BUSINESS ADMINISTRATION AND OFFICE WORK; SALES PROMOTION FOR OTHERS; IMPORT AND EXPORT AGENCIES; ORGANIZATION OF EXHIBITIONS AND TRADE FAIRS FOR BUSINESS AND PROMOTIONAL PURPOSES, IN CLASS 35 (U.S. CLS. 100, 101 AND 102).

FIRST USE 1-1-1957, THE MARK WAS FIRST USED ANYWHERE IN A DIFFERENT FORM OTHER THAN THAT SOUGHT TO BE REGISTERED AT LEAST AS EARLY AS 01/01/1957 ; IN COMMERCE 1-1-1957, THE MARK WAS FIRST USED IN COMMERCE IN A DIFFERENT FORM OTHER THAN THAT SOUGHT TO BE REGISTERED AT LEAST AS EARLY AS 01/01/1957.

OWNER OF BRAZIL REG. NO. 822851679, DATED 5-12-2000, EXPIRES 1-18-2018.

THE COLOR(S) BLACK, DARK GREEN, LIGHT GREEN, BLUE, WHITE, GOLD, YELLOW AND RED IS/ARE CLAIMED AS A FEATURE OF THE MARK.



David J. Kappas

Director of the United States Patent and Trademark Office

Reg. No. 4,097,755 NO CLAIM IS MADE TO THE EXCLUSIVE RIGHT TO USE "GUARANA" AND "ORIGINAL DESDE 1957", APART FROM THE MARK AS SHOWN.

THE STIPPLING IS FOR SHADING PURPOSES ONLY.

THE MARK CONSISTS OF THE STYLIZED WORDING "GUARANA" IN WHITE OUTLINED IN DARK GREEN; "AMAZONIA" IN WHITE OUTLINED IN BLUE AND BLACK AND "ORIGINAL DESDE 1957" IN BLACK; ALL ON A RECTANGLE WITH LIGHT GREEN, DARK GREEN AND WHITE WAVES, GREEN AND YELLOW BUBBLES OUTLINED IN BLACK; RED AND YELLOW BERRIES WITH GREEN LEAVES; THE WORDING "ORIGINAL DESDE 1957" IS ON A GOLD AND WHITE SEAL WITH A BLACK DOTTED BORDER AND THE DESIGN OF A RED AND WHITE FLAG WITH A BLACK DOT IN THE CENTER.

THE ENGLISH TRANSLATION OF "ORIGINAL DESDE 1957" IN THE MARK IS "ORIGINAL SINCE 1957".

SEC. 2(F) AS TO "AMAZONIA".

SER. NO. 85-028,165, FILED 5-2-2010.

HOWARD B. LEVINE, EXAMINING ATTORNEY

United States of America

United States Patent and Trademark Office



Reg. No. 4,097,756

Registered Feb. 14, 2012

Int. Cl.: 29

TRADEMARK

PRINCIPAL REGISTER

FRIESLAND BRANDS BV (NETHERLANDS PRIVATE LIMITED LIABILITY COMPANY)
BLANKENSTEIN 142
7943 PE MEPPEL, NETHERLANDS

FOR: CHEESE, IN CLASS 29 (U.S. CL. 46).

FIRST USE 0-0-2009; IN COMMERCE 0-0-2009.

PRIORITY CLAIMED UNDER SEC. 44(D) ON BENELUX APPLICATION NO. 1191558, FILED 11-6-2009, REG. NO. 872337, DATED 2-10-2010, EXPIRES 11-6-2019.

THE COLOR(S) YELLOW, BROWN, AND BLACK IS/ARE CLAIMED AS A FEATURE OF THE MARK.

OWNER OF U.S. REG. NO. 1,531,038.

NO CLAIM IS MADE TO THE EXCLUSIVE RIGHT TO USE "DUTCH", APART FROM THE MARK AS SHOWN.

THE MARK CONSISTS OF A "DUTCH" ABOVE AND TO THE RIGHT OF THE STYLIZED WORDING "MASTERPIECE" WITH ALL OF THE WORDING IN YELLOW WITH BROWN SHADING AND OUTLINED IN BLACK. BELOW THE FIRST PART OF THE WORD "MASTERPIECE" IS A DESIGN OF A SCALLOPED EDGED CIRCLE WITH A RECTANGLE COMING OUT OF THE RIGHT SIDE OF THE CIRCLE EXTENDING BELOW THE WORD "MASTERPIECE". THE CIRCLE AND RECTANGLE DESIGNS ARE IN YELLOW WITH BROWN SHADING AND OUTLINED IN BLACK.

SER. NO. 85-029,599, FILED 5-4-2010.

KELLEY WELLS, EXAMINING ATTORNEY



David J. Kybas

Director of the United States Patent and Trademark Office

United States of America

United States Patent and Trademark Office

INTERNATIONAL NOISE AWARENESS DAY

Reg. No. 4,097,757

Registered Feb. 14, 2012

Int. Cl.: 35

CENTER FOR HEARING AND COMMUNICATION (NEW YORK NON-PROFIT CORPORATION)
6TH FLOOR
50 BROADWAY
NEW YORK, NY 10004

SERVICE MARK

PRINCIPAL REGISTER

FOR: PROMOTING PUBLIC AWARENESS OF ISSUES WHICH CONCERN THE HARD OF HEARING, HEALTH AND THE QUALITY OF LIFE; PROMOTING HEARING CONSERVATION AND NOISE AWARENESS, IN CLASS 35 (U.S. CLS. 100, 101 AND 102).

FIRST USE 4-0-1996; IN COMMERCE 4-0-1996.

THE MARK CONSISTS OF STANDARD CHARACTERS WITHOUT CLAIM TO ANY PARTICULAR FONT, STYLE, SIZE, OR COLOR.

SEC. 2(F).

SER. NO. 85-030,799, FILED 5-5-2010.

ZACHARY BELLO, EXAMINING ATTORNEY



David J. Kyffers

Director of the United States Patent and Trademark Office

United States of America

United States Patent and Trademark Office

TACTICS.COM

Reg. No. 4,097,758

EFUEGO CORP. (OREGON CORPORATION)

Registered Feb. 14, 2012

345 W. 4TH AVE.
EUGENE, OR 97401

Int. Cl.: 35

FOR: ONLINE RETAIL STORE SERVICES, RETAIL STORE SERVICES, AND MAIL ORDER CATALOG SERVICES FEATURING FOOTWEAR, CLOTHING EXCLUDING UNDERWEAR, EYEWEAR, WATCHES, AUDIO ACCESSORIES, CLOTHING ACCESSORIES, PACKS, BAGS, AND SPORTING EQUIPMENT, ALL DESIGNED FOR SNOWBOARDING, SURFING, AND SKATEBOARDING, IN CLASS 35 (U.S. CLS. 100, 101 AND 102).

SERVICE MARK

PRINCIPAL REGISTER

FIRST USE 3-1-2006; IN COMMERCE 3-1-2006.

OWNER OF U.S. REG. NO. 2,941,976.

THE MARK CONSISTS OF A STYLIZED LETTER "T" FOLLOWED BY THE STYLIZED WORDING "TACTICS.COM".

SER. NO. 85-031,339, FILED 5-6-2010.

KELLEY WELLS, EXAMINING ATTORNEY



David J. Kyffers

Director of the United States Patent and Trademark Office

United States of America

United States Patent and Trademark Office



FB COILS

Reg. No. 4,097,759

Registered Feb. 14, 2012

Int. Cl.: 11

TRADEMARK

PRINCIPAL REGISTER

BOHN DE MEXICO, S. A. DE C. V. (MEXICO SOCIEDAD ANONIMA (SA DE CV)))
COL. BOSQUES DE LAS LOMAS
BOSQUES DE ALISOS 47-A, PISO 5
MÉXICO, DF, MEXICO C.P.05120

FOR: COILS AS PARTS OF DISTILLING, HEATING AND COOLING INSTALLATIONS, IN CLASS 11 (U.S. CLS. 13, 21, 23, 31 AND 34).

PRIORITY CLAIMED UNDER SEC. 44(D) ON MEXICO APPLICATION NO. 1045879, FILED 11-6-2009, REG. NO. 1136117, DATED 12-16-2009, EXPIRES 11-6-2019.

THE COLOR(S) BLUE AND BLACK IS/ARE CLAIMED AS A FEATURE OF THE MARK.

NO CLAIM IS MADE TO THE EXCLUSIVE RIGHT TO USE "COILS", APART FROM THE MARK AS SHOWN.

THE MARK CONSISTS OF THE WORDING "FB COILS" WITH THE WORDING "FB" IN BLACK AND "COILS" IN BLUE TO THE RIGHT OF A STYLIZED FLAME DESIGN IN BLUE.

SER. NO. 85-032,252, FILED 5-6-2010.

KRISTIN DAHLING, EXAMINING ATTORNEY



David J. Kyffers

Director of the United States Patent and Trademark Office

United States of America

United States Patent and Trademark Office

Atussa

Reg. No. 4,097,760

Registered Feb. 14, 2012

Int. Cls.: 25 and 35

DARYOUSH BAHAR (CALIFORNIA SOLE PROPRIETORSHIP), DBA ATUSSA, ATUSSA COUTURE
WWW.ATUSSA.COM/ WWW.ATUSSASTORE.COM
575B DOLORES STREET
SAN FRANCISCO, CA 94110

TRADEMARK

SERVICE MARK

PRINCIPAL REGISTER

FOR: ADULT NOVELTY GAG CLOTHING ITEM, NAMELY, SOCKS; BABY LAYETTES FOR CLOTHING; BELTS; BELTS FOR CLOTHING; BELTS MADE OUT OF CLOTH; BIBS NOT OF CLOTH OR PAPER; BOTTOMS; CHILDREN'S AND INFANTS' CLOTH BIBS; CHILDREN'S CLOTH EATING BIBS; CLOTHING FOR ATHLETIC USE, NAMELY, PADDED ELBOW COMPRESSION SLEEVES BEING PART OF AN ATHLETIC GARMENT; CLOTHING FOR ATHLETIC USE, NAMELY, PADDED PANTS; CLOTHING FOR ATHLETIC USE, NAMELY, PADDED SHIRTS; CLOTHING FOR ATHLETIC USE, NAMELY, PADDED SHORTS; CLOTHING FOR WEAR IN JUDO PRACTICES; CLOTHING FOR WEAR IN WRESTLING GAMES; CLOTHING ITEMS, NAMELY, ADHESIVE POCKETS THAT MAY BE AFFIXED DIRECTLY TO THE BODY AS A DECORATIVE PIECE OF CLOTHING WITH UTILITY; CLOTHING ITEMS, NAMELY, ADHESIVE POCKETS THAT MAY BE AFFIXED DIRECTLY TO THE INSIDE OF CLOTHING FOR STORAGE AND SAFEKEEPING OF PERSONAL ITEMS; CLOTHING SHIELDS, NAMELY, PADS APPLIED TO THE UNDERARMS OF SHIRTS, BLOUSES AND SWEATERS; CLOTHING, NAMELY, ARM WARMERS; CLOTHING, NAMELY, BASE LAYERS; CLOTHING, NAMELY, FOLK COSTUMES; CLOTHING, NAMELY, HAND-WARMERS; CLOTHING, NAMELY, KHAKIS; CLOTHING, NAMELY, KNEE WARMERS; CLOTHING, NAMELY, MATERNITY BANDS; CLOTHING, NAMELY, NECK TUBES; CLOTHING, NAMELY, THOBES; CLOTHING, NAMELY, WRAP-AROUNDS; CORSETS; DUSTERS; EYESHADES; FABRIC SOLD AS AN INTEGRAL COMPONENT OF FINISHED CLOTHING ITEMS, NAMELY, SHORTS, TOPS, SKIRTS, DRESSES; FIGURE SKATING CLOTHING, NAMELY, SHORTS, TOPS, SKIRTS, DRESSES; FOULARDS; GLOVES AS CLOTHING; HEADBANDS FOR CLOTHING; HOODS; INFANT AND TODDLER ONE PIECE CLOTHING; INFANT CLOTH DIAPERS; JACKETS; JERSEYS; LEATHER BELTS; MANTLES; MUFFLERS; NON-DISPOSABLE CLOTH TRAINING PANTS; PAPER HATS FOR USE AS CLOTHING ITEMS; PARTS OF CLOTHING, NAMELY, GUSSETS FOR TIGHTS, GUSSETS FOR STOCKINGS, GUSSETS FOR BATHING SUITS, GUSSETS FOR UNDERWEAR, GUSSETS FOR LEOTARDS AND GUSSETS FOR FOOTLETS; PARTS OF CLOTHING, NAMELY, UNDERARM GUSSETS; PARTY HATS; PERSPIRATION ABSORBENT UNDERWEAR CLOTHING; POCKET SQUARES; SHIRTS; SHORT SETS; SHOULDER WRAPS; SHOULDER WRAPS FOR CLOTHING; SWADDLING CLOTHES; TIES; TOPS; TRAVEL CLOTHING CONTAINED IN A PACKAGE COMPRISING REVERSIBLE JACKETS, PANTS,



David J. Kyffers

Director of the United States Patent and Trademark Office

Reg. No. 4,097,760 SKIRTS, TOPS AND A BELT OR SCARF; TRIATHLON CLOTHING, NAMELY, TRIATHLON TIGHTS, TRIATHLON SHORTS, TRIATHLON SINGLET, TRIATHLON SHIRTS, TRIATHLON SUITS; UNDERARM CLOTHING SHIELDS; WEARABLE GARMENTS AND CLOTHING, NAMELY, SHIRTS; WRAPS, IN CLASS 25 (U.S. CLS. 22 AND 39).

FIRST USE 1-1-2008; IN COMMERCE 1-1-2008.

FOR: CATALOG ORDERING SERVICE FEATURING SHORTS, TOPS, SKIRTS, DRESSES; ON-LINE WHOLESALE AND RETAIL STORE SERVICES FEATURING SHORTS, TOPS, SKIRTS, DRESSES; DISCOUNT STORES IN THE FIELD OF SHORTS, TOPS, SKIRTS, DRESSES; DISTRIBUTORSHIP SERVICES IN THE FIELD OF SHORTS, TOPS, SKIRTS, DRESSES; IMPORT AGENCY SERVICES IN THE FIELD OF SHORTS, TOPS, SKIRTS, DRESSES; MAIL ORDER CATALOG SERVICES FEATURING SHORTS, TOPS, SKIRTS, DRESSES; MAIL ORDER SERVICES FEATURING SHORTS, TOPS, SKIRTS, DRESSES; ON-LINE RETAIL CONSIGNMENT STORES FEATURING SHORTS, TOPS, SKIRTS, DRESSES, TOYS, FASHION ATTIRE, POSTERS; RETAIL CLOTHING BOUTIQUES; RETAIL CLOTHING STORES; RETAIL CONSIGNMENT STORES FEATURING SHORTS, TOPS, SKIRTS, DRESSES; RETAIL CONSIGNMENT STORES IN THE FIELD OF SHORTS, TOPS, SKIRTS, DRESSES; RETAIL DISCOUNT STORE SERVICES IN THE FIELD OF SHORTS, TOPS, SKIRTS, DRESSES; RETAIL STORE SERVICES FEATURING VIRTUAL GOODS, NAMELY, SHORTS, TOPS, SKIRTS, DRESSES FOR USE IN ONLINE VIRTUAL WORLDS; RETAIL STORES FEATURING SHORTS, TOPS, SKIRTS, DRESSES; RETAIL SHORTS, TOPS, SKIRTS, DRESSES; SECOND HAND DEALERSHIPS FEATURING SHORTS, TOPS, SKIRTS, DRESSES; WHOLESALE AND RETAIL STORE SERVICES FEATURING SHORTS, TOPS, SKIRTS, DRESSES; WHOLESALE DISTRIBUTORSHIPS FEATURING SHORTS, TOPS, SKIRTS, DRESSES; WHOLESALE STORES FEATURING SHORTS, TOPS, SKIRTS, DRESSES, IN CLASS 35 (U.S. CLS. 100, 101 AND 102).

FIRST USE 1-1-2009; IN COMMERCE 1-1-2009.

THE MARK CONSISTS OF STANDARD CHARACTERS WITHOUT CLAIM TO ANY PARTICULAR FONT, STYLE, SIZE, OR COLOR.

SER. NO. 85-032,460, FILED 5-7-2010.

MARILYN IZZI, EXAMINING ATTORNEY

United States of America

United States Patent and Trademark Office

Dovarri

Reg. No. 4,097,761

Registered Feb. 14, 2012

Int. Cl.: 42

SERVICE MARK

PRINCIPAL REGISTER

DOVARRI, INC. (NEVADA CORPORATION)
5718 WESTHEIMER RD., SUITE 1440
HOUSTON, TX 77057

FOR: PROVIDING ON-LINE NON-DOWNLOADABLE COMPUTER SOFTWARE FOR USE IN CUSTOMER RELATIONSHIP MANAGEMENT (CRM), IN CLASS 42 (U.S. CLS. 100 AND 101).

FIRST USE 12-16-2008; IN COMMERCE 12-18-2008.

THE MARK CONSISTS OF THE WORDING "DOVARRI" WITH THE LETTER "O" APPEARING STYLIZED AND IN GREEN WITH THE REST OF THE LETTERS IN GRAY.

THE COLOR(S) GRAY AND GREEN IS/ARE CLAIMED AS A FEATURE OF THE MARK.

SER. NO. 85-032,541, FILED 5-7-2010.

KATHERINE CONNOLLY, EXAMINING ATTORNEY



David J. Kyffers

Director of the United States Patent and Trademark Office

United States of America

United States Patent and Trademark Office

KnowIT!

Reg. No. 4,097,762

ANEXEON, LLC (NEVADA LIMITED LIABILITY COMPANY)

Registered Feb. 14, 2012

6865 W. CHARLESTON BLVD., SUITE A
LAS VEGAS, NV 89117

Int. Cl.: 42

FOR: COMPUTER SERVICES, NAMELY, PROVIDING A WEB-BASED SYSTEM AND ON-LINE PORTAL FEATURING ON-LINE NON-DOWNLOADABLE TECHNICAL, OFFICE, OR BUSINESS PRODUCTIVITY SOFTWARE THAT ENABLES USERS TO ACCESS AND PROVIDE EMPLOYEE TRAINING, EDUCATIONAL, TESTING, AND CERTIFICATION MATERIALS USED IN THE BUSINESS SECTOR, IN CLASS 42 (U.S. CLS. 100 AND 101).

SERVICE MARK

PRINCIPAL REGISTER

FIRST USE 3-1-2010; IN COMMERCE 3-1-2010.

THE MARK CONSISTS OF STANDARD CHARACTERS WITHOUT CLAIM TO ANY PARTICULAR FONT, STYLE, SIZE, OR COLOR.

SER. NO. 85-033,074, FILED 5-7-2010.

ROBERT STRUCK, EXAMINING ATTORNEY



David J. Kyffers

Director of the United States Patent and Trademark Office

United States of America

United States Patent and Trademark Office



Reg. No. 4,097,763

Registered Feb. 14, 2012

Int. Cl.: 41

SERVICE MARK

PRINCIPAL REGISTER

ETRAFFIC SOLUTIONS INC. (CANADA CORPORATION)
SUITE 100
710 REDBRICK STREET
VICTORIA, B.C., CANADA V8T5J3

FOR: EDUCATION SERVICES, NAMELY, PROVIDING ON-LINE COURSES AND PROGRAMS IN THE FIELDS OF BUSINESS MANAGEMENT, CUSTOMER SERVICES, MARKETING, BUSINESS DEVELOPMENT, HUMAN RESOURCES, DESKTOP COMPUTING SKILLS, COMPUTER PROGRAMMING SKILLS, ADMINISTRATIVE SUPPORT, BUSINESS ANALYSIS, BUSINESS COMMUNICATION, BUSINESS WRITING, BUSINESS CONSULTING, LEADERSHIP, PERSONNEL DEVELOPMENT, SIX SIGMA, SUPPLY CHAIN MANAGEMENT, INVESTING, ESTATE PLANNING, PROJECT MANAGEMENT, TEAMWORK, WORKPLACE HEALTH AND SAFETY AND DISTRIBUTION OF COURSE MATERIALS IN CONNECTION WITH ALL OF THE FOREGOING, IN CLASS 41 (U.S. CLS. 100, 101 AND 107).

FIRST USE 11-15-2009; IN COMMERCE 11-15-2009.

OWNER OF U.S. REG. NOS. 2,884,190, 3,268,466 AND OTHERS.

THE COLOR(S) GREEN AND BLUE IS/ARE CLAIMED AS A FEATURE OF THE MARK.

NO CLAIM IS MADE TO THE EXCLUSIVE RIGHT TO USE "LEARNING NETWORK", APART FROM THE MARK AS SHOWN.

THE MARK CONSISTS OF THE WORDS "ETRAFFIC LEARNING NETWORK" IN UPPER CASE. THE WORDS "ETRAFFIC" AND "NETWORK" ARE BLUE. THE WORD "LEARNING" IS GREEN. THE DESIGN IS A STYLIZED SPHERE COMPRISING VERTICAL AND HORIZONTAL LOOPS. THE OUTER LOOP IS GREEN AND THE INNER LOOPS ARE BLUE.

SER. NO. 85-033,775, FILED 5-9-2010.

SARA BENJAMIN, EXAMINING ATTORNEY



David J. Kybas

Director of the United States Patent and Trademark Office

United States of America

United States Patent and Trademark Office



Reg. No. 4,097,764

Registered Feb. 14, 2012

Int. Cl.: 35

SERVICE MARK

PRINCIPAL REGISTER

W.W. GRAINGER, INC. (ILLINOIS CORPORATION)
100 GRAINGER PARKWAY
LAKE FOREST, IL 60045

FOR: DISTRIBUTORSHIP SERVICES IN THE FIELD OF INDUSTRIAL, INSTITUTIONAL, COMMERCIAL AND JANITORIAL EQUIPMENT AND SERVICES; WHOLESALE DISTRIBUTORSHIP SERVICES IN THE FIELD OF INDUSTRIAL, INSTITUTIONAL, COMMERCIAL AND JANITORIAL EQUIPMENT AND SERVICES; MAIL ORDER CATALOG, TELEPHONE AND COMPUTERIZED ON-LINE ORDERING SERVICES FOR PRODUCTS IN THE FIELD OF INDUSTRIAL, INSTITUTIONAL, COMMERCIAL AND JANITORIAL EQUIPMENT AND SERVICES, IN CLASS 35 (U.S. CLS. 100, 101 AND 102).

FIRST USE 2-1-2009; IN COMMERCE 2-1-2009.

OWNER OF U.S. REG. NOS. 1,559,199, 1,747,557, AND 2,519,045.

THE COLOR(S) WHITE, RED AND BLACK IS/ARE CLAIMED AS A FEATURE OF THE MARK.

THE MARK CONSISTS OF A 3-SIDED DEPICTION OF A SHIPPING BOX WITH A WHITE TOP; ON EACH SIDE OF THE BOX IS THE WORD "GRAINGER" IN BLACK ACROSS THE TOP, ABOVE A BLACK RECTANGULAR CARRIER BAR IN WHICH THE WORDING "FOR THE ONES WHO GET IT DONE" APPEARS IN WHITE, WITH THE CARRIER BAR APPEARING TO THE RIGHT OF FIVE BLACK RECTANGLES WHICH INCREASE IN SIZE FROM LEFT TO RIGHT, ALL ABOVE A LARGE RED RECTANGLE, AND ALL ATOP A WHITE BACKGROUND; THE MATTER SHOWN IN BROKEN OR DOTTED LINES IS NOT A PART OF THE MARK AND SERVES ONLY TO SHOW THE POSITION OR PLACEMENT OF THE MARK.

SER. NO. 85-034,181, FILED 5-10-2010.

KAELIE KUNG, EXAMINING ATTORNEY



David J. Kybas

Director of the United States Patent and Trademark Office

United States of America

United States Patent and Trademark Office

iKnow

Reg. No. 4,097,765

Registered Feb. 14, 2012

Int. Cl.: 28

TRADEMARK

PRINCIPAL REGISTER

GENERATION NEXT EDUCATION, INC. (CALIFORNIA CORPORATION)
1214 ARCHER STREET
SAN DIEGO, CA 92109

FOR: EDUCATIONAL CARD GAMES, IN CLASS 28 (U.S. CLS. 22, 23, 38 AND 50).

FIRST USE 11-14-2008; IN COMMERCE 11-14-2008.

THE MARK CONSISTS OF STANDARD CHARACTERS WITHOUT CLAIM TO ANY PARTICULAR FONT, STYLE, SIZE, OR COLOR.

OWNER OF U.S. REG. NO. 3,848,968.

SER. NO. 85-035,950, FILED 5-11-2010.

DAVID ELTON, EXAMINING ATTORNEY



David J. Kyffers

Director of the United States Patent and Trademark Office

United States of America

United States Patent and Trademark Office



Reg. No. 4,097,766

XM ENTERPRISE CO.,LTD. (TAIWAN LIMITED COMPANY (LTD.))
NO. 190, SECTION 2, JHANGSIN RD.

Registered Feb. 14, 2012

HEMEI TOWNSHIP, CHANGHU, TAIWAN

Int. Cl.: 15

FOR: MUSICAL INSTRUMENT PRODUCTS, NAMELY, ELECTRIC AND ELECTRONIC MUSICAL INSTRUMENTS, DRUMS, DRUM HEADS, DRUM PEDALS, DRUMSTICKS, MUSICAL INSTRUMENT STANDS AND MUSIC SYNTHESIZERS FOR DRUMMER AND ARTISTS, IN CLASS 15 (U.S. CLS. 2, 21 AND 36).

TRADEMARK

PRINCIPAL REGISTER

FIRST USE 11-10-2008; IN COMMERCE 11-10-2008.

NO CLAIM IS MADE TO THE EXCLUSIVE RIGHT TO USE "XM ELEC DRUM", APART FROM THE MARK AS SHOWN.

THE MARK CONSISTS OF OVAL WHEREIN THE WORDS "XM" IS WRITTEN INSIDE THE OVAL AND THE PART OF "X" OF THE WORD "XM" IS OUTSIDE THE OVAL AND THE WORD "ELEC DRUM" IS WRITTEN BELOW THE WORD "XM" WHEREIN, THE LETTERS "ELECD" ARE INSIDE THE OVAL AND "RUM" ARE OUTSIDE THE OVAL.

SER. NO. 85-036,041, FILED 5-12-2010.

MYRIAH HABEEB, EXAMINING ATTORNEY



David J. Kyffers

Director of the United States Patent and Trademark Office

United States of America

United States Patent and Trademark Office

BLU SKY

Reg. No. 4,097,767

BLUSKY RESTORATION CONTRACTORS, INC. (COLORADO CORPORATION)
9767 EAST EASTER AVE.
CENTENNIAL, CO 800123747

Registered Feb. 14, 2012

Int. Cls.: 35 and 37

FOR: EMERGENCY PREPAREDNESS PLANNING, NAMELY, BUSINESS PLANNING AND BUSINESS CONTINUITY CONSULTING, IN CLASS 35 (U.S. CLS. 100, 101 AND 102).

SERVICE MARK

FIRST USE 5-0-2004; IN COMMERCE 5-0-2004.

PRINCIPAL REGISTER

FOR: RESTORATION AND REPAIR SERVICES OF RESIDENTIAL AND COMMERCIAL BUILDINGS DAMAGED BY WATER, FIRE, SMOKE AND MOLD; BIOHAZARD BIOLOGICAL CLEAN-UP SERVICES; ENVIRONMENTAL AND HAZARD RESPONSE SERVICES, NAMELY, RESTORATION SERVICES IN THE FIELD OF WATER, SMOKE AND FIRE DAMAGE; RECONSTRUCTION, REPAIR AND REPLACEMENT OF BUILDINGS, STRUCTURES AND ROOFING IN RESPONSE TO WATER, FIRE AND MOLD EMERGENCIES, IN CLASS 37 (U.S. CLS. 100, 103 AND 106).

FIRST USE 5-0-2004; IN COMMERCE 5-0-2004.

THE MARK CONSISTS OF STANDARD CHARACTERS WITHOUT CLAIM TO ANY PARTICULAR FONT, STYLE, SIZE, OR COLOR.

SER. NO. 85-038,853, FILED 5-14-2010.

MARIA-VICTORIA SUAREZ, EXAMINING ATTORNEY



David J. Kybas

Director of the United States Patent and Trademark Office

United States of America

United States Patent and Trademark Office



Reg. No. 4,097,768

Registered Feb. 14, 2012

Int. Cls.: 35 and 37

SERVICE MARK

PRINCIPAL REGISTER

BLUSKY RESTORATION CONTRACTORS, INC. (COLORADO CORPORATION)
9767 EAST EASTER AVE.
CENTENNIAL, CO 800123747

FOR: EMERGENCY PREPAREDNESS PLANNING, NAMELY, BUSINESS PLANNING AND BUSINESS CONTINUITY CONSULTING, IN CLASS 35 (U.S. CLS. 100, 101 AND 102).

FIRST USE 5-0-2005; IN COMMERCE 5-0-2005.

FOR: RESTORATION AND REPAIR SERVICES OF RESIDENTIAL AND COMMERCIAL BUILDINGS DAMAGED BY WATER, FIRE, SMOKE AND MOLD; BIOHAZARD BIOLOGICAL CLEAN-UP SERVICES; ENVIRONMENTAL AND HAZARD RESPONSE SERVICES, NAMELY, RESTORATION SERVICES IN THE FIELD OF WATER, SMOKE AND FIRE DAMAGE; RECONSTRUCTION, REPAIR AND REPLACEMENT OF BUILDINGS, STRUCTURES AND ROOFING IN RESPONSE TO WATER, FIRE AND MOLD EMERGENCIES, IN CLASS 37 (U.S. CLS. 100, 103 AND 106).

FIRST USE 5-0-2005; IN COMMERCE 5-0-2005.

THE MARK CONSISTS OF THE WORDS "BLU SKY" CENTERED IN A PARTIAL OVAL MERGED INTO A CLOUD SILHOUETTE.

SER. NO. 85-038,866, FILED 5-14-2010.

MARIA-VICTORIA SUAREZ, EXAMINING ATTORNEY



David J. Kyffers

Director of the United States Patent and Trademark Office

United States of America

United States Patent and Trademark Office

SCOTT DIXON

Reg. No. 4,097,769

DIXON, SCOTT (NEW ZEALAND INDIVIDUAL)
12471 N. NAVAJO CT.
CAMBY, IN 46113

Registered Feb. 14, 2012

Int. Cls.: 9, 25, 28 and 41

FOR: FULL SIZE REPLICA AUTOMOBILE RACING HELMETS, IN CLASS 9 (U.S. CLS. 21, 23, 26, 36 AND 38).

TRADEMARK

FIRST USE 7-5-2005; IN COMMERCE 7-5-2005.

SERVICE MARK

FOR: CAPS; SHIRTS, IN CLASS 25 (U.S. CLS. 22 AND 39).

PRINCIPAL REGISTER

FIRST USE 7-5-2005; IN COMMERCE 7-5-2005.

FOR: MODEL CARS; TOY REPLICA AUTOMOBILE RACING HELMETS, IN CLASS 28 (U.S. CLS. 22, 23, 38 AND 50).

FIRST USE 7-5-2005; IN COMMERCE 7-5-2005.

FOR: ENTERTAINMENT SERVICES, NAMELY, PERFORMING AND COMPETING IN MOTOR SPORTS EVENTS, IN CLASS 41 (U.S. CLS. 100, 101 AND 107).

FIRST USE 7-5-2005; IN COMMERCE 7-5-2005.

THE MARK CONSISTS OF STANDARD CHARACTERS WITHOUT CLAIM TO ANY PARTICULAR FONT, STYLE, SIZE, OR COLOR.

THE NAME(S), PORTRAIT(S), AND/OR SIGNATURE(S) SHOWN IN THE MARK IDENTIFIES "SCOTT DIXON", WHOSE CONSENT(S) TO REGISTER IS MADE OF RECORD.

SER. NO. 85-040,333, FILED 5-17-2010.

JEFFREY LOOK, EXAMINING ATTORNEY



David J. Kyros

Director of the United States Patent and Trademark Office

United States of America

United States Patent and Trademark Office

ABBY

Reg. No. 4,097,770

Registered Feb. 14, 2012

Int. Cl.: 25

TRADEMARK

PRINCIPAL REGISTER

ASICS CORPORATION (JAPAN CORPORATION)
1-1, MINATOJIMA-NAKAMACHI 7-CHOME
CHUO-KU, KOBE, JAPAN 650-8555

FOR: ATHLETIC APPAREL, NAMELY, BRAS, SHORTS, SKORTS, CAPRIS, PANTS AND JACKETS; SHIMMELS, NAMELY, RUNNING TOPS, IN CLASS 25 (U.S. CLS. 22 AND 39).

FIRST USE 12-31-2008; IN COMMERCE 12-31-2008.

THE MARK CONSISTS OF STANDARD CHARACTERS WITHOUT CLAIM TO ANY PARTICULAR FONT, STYLE, SIZE, OR COLOR.

SER. NO. 85-041,347, FILED 5-18-2010.

KAPIL BHANOT, EXAMINING ATTORNEY



David J. Kybas

Director of the United States Patent and Trademark Office

United States of America

United States Patent and Trademark Office

SOOF UNITED WE PLAY

Reg. No. 4,097,771

BETH FALLON (UNITED STATES INDIVIDUAL)
513 PADEN STREET
ENDICOTT, NY 13760

Registered Feb. 14, 2012

Int. Cl.: 25

FOR: CLOTHING, NAMELY, BASEBALL CAPS, BATHING SUITS, BEACHWEAR, BLOUSES, CAPS, FOUL WEATHER GEAR, GOLF SHIRTS, GYM SHORTS, HEAD WEAR, HEAD BANDS, JACKETS, JOGGING SUITS, KNIT SHIRTS, LOUNGEWEAR, MITTENS, NIGHT GOWNS, NIGHT SHIRTS, OVERCOATS, PAJAMAS, PANTS, PANTSUITS, PARKAS, POLO SHIRTS, PONCHOS, PULLOVERS, QUILTED VESTS, RAIN COATS, RAIN SUITS, RAINWEAR, SCARVES, SHIRTS, SHORT SETS, SHORTS, SLACKS, SLEEPWEAR, SOCKS, SPORT COATS, SPORT SHIRTS, SUITES, SUN VISORS, SWEAT SHORTS, SWEAT SHIRTS, SWEAT BANDS, SWEAT SUITS, SWEAT PANTS, SWEATERS, SWIM TRUNKS, SWIM WEAR, SWIMSUITS, T-SHIRTS, TANK TOPS, TENNIS WEAR, TIES, TOPCOATS, TOPS, TANK TOPS, TRACK-SUITS, TURTLENECK SWEATERS, TURTLENECKS, UNDERSHIRTS, V-NECK SWEATERS, VESTS, VISORS, WAISTCOATS, WARM UP SUITS, WIND RESISTANT JACKETS, WIND SHIRTS, WRIST BANDS, HEADGEAR, NAMELY, HATS, CAPS, IN CLASS 25 (U.S. CLS. 22 AND 39).

TRADEMARK

PRINCIPAL REGISTER

FIRST USE 5-11-2010; IN COMMERCE 5-11-2010.

THE MARK CONSISTS OF STANDARD CHARACTERS WITHOUT CLAIM TO ANY PARTICULAR FONT, STYLE, SIZE, OR COLOR.

OWNER OF U.S. REG. NOS. 3,617,955 AND 3,713,635.

SER. NO. 85-043,321, FILED 5-20-2010.

BENJAMIN OKEKE, EXAMINING ATTORNEY



David J. Kybas

Director of the United States Patent and Trademark Office

United States of America

United States Patent and Trademark Office

SYNCAPSE

Reg. No. 4,097,772

Registered Feb. 14, 2012

Int. Cls.: 35 and 42

SERVICE MARK

PRINCIPAL REGISTER

SYNCAPSE CORP. (CANADA CORPORATION)
SUITE 301
20 DUNCAN STREET
TORONTO, ONTARIO, CANADA M5H3G8

FOR: DESIGN AND DEVELOPMENT OF ADVERTISING, MARKETING AND PROMOTIONAL CAMPAIGNS FOR OTHERS USING ONLINE INTERACTIVE MEDIA; BRAND EVALUATION SERVICES, NAMELY, EVALUATING INTERNET MEDIA AND MARKETING OF GOODS AND SERVICES OF OTHERS; CONSULTING SERVICES, NAMELY, PROVIDING MULTIPLE MEDIA INTERNET MARKETING STRATEGIES; ONLINE MARKET AND SOCIAL MEDIA ANALYSIS, NAMELY, ANALYZING AND COMPILING DATA TO MEASURE THE EFFECT OF ADVERTISING INITIATIVES THROUGH ONLINE MARKET AND SOCIAL MEDIA OUTLETS, IN CLASS 35 (U.S. CLS. 100, 101 AND 102).

FIRST USE 11-30-2007; IN COMMERCE 11-30-2007.

FOR: A SUITE OF SOFTWARE-AS-A-SERVICE APPLICATIONS TO ENABLE USERS TO CONSULT IN THE FIELD OF DESIGN, DEVELOPMENT, INTEGRATION, IMPLEMENTATION OF SOCIAL MEDIA SOFTWARE TOOLS FOR ALLOWING GROUPS TO GENERATE CONTACT, ENGAGE IN PEER-TO-PEER CONVERSATIONS, AND EXCHANGE CONTENT; A SUITE OF SOFTWARE-AS-A-SERVICE APPLICATIONS TO ENABLE USERS TO DESIGN, DEVELOP, IMPLEMENT AND INTEGRATE SOCIAL MEDIA SOFTWARE TOOLS INTO MULTIPLE SYSTEMS AND NETWORKS USED TO ALLOWING GROUPS TO GENERATE CONTACT, ENGAGE IN PEER-TO-PEER CONVERSATIONS, AND EXCHANGE CONTENT; A SUITE OF SOFTWARE-AS-A-SERVICE APPLICATIONS FOR COMPUTER MONITORING AND MEASURING SERVICES WHICH TRACK SOCIAL MEDIA SOFTWARE TOOL PERFORMANCE, IN CLASS 42 (U.S. CLS. 100 AND 101).

FIRST USE 11-30-2007; IN COMMERCE 11-30-2007.

THE MARK CONSISTS OF STANDARD CHARACTERS WITHOUT CLAIM TO ANY PARTICULAR FONT, STYLE, SIZE, OR COLOR.

SER. NO. 85-044,110, FILED 5-20-2010.

LINDA E. BLOHM, EXAMINING ATTORNEY



David J. Kyffers

Director of the United States Patent and Trademark Office

United States of America

United States Patent and Trademark Office

L2PRAM

Reg. No. 4,097,773

Registered Feb. 14, 2012

Int. Cl.: 9

TRADEMARK

PRINCIPAL REGISTER

SAMSUNG ELECTRONICS CO., LTD. (REPUBLIC OF KOREA CORPORATION)
416 MAETAN-DONG, YEONGTONG-GU, SUWON-SI
GYEONGGI-DO, REPUBLIC OF KOREA

FOR: SEMI-CONDUCTORS, MICROCHANNEL WAFERS, INTEGRATED CIRCUITS, FLASH MEMORY CARD, BLANK OPTICAL DISK, THIN-FILM-TRANSISTOR LIQUID CRYSTAL DISPLAY PANELS, PLASMA DISPLAY PANELS, LIQUID CRYSTAL DISPLAY (LCD) MONITORS, ELECTRONIC PHOTOCOPIERS, ELECTRONIC AGENDAS, COMPUTERS, NOTEBOOK COMPUTERS, COMPUTER MONITORS, DISK DRIVES FOR COMPUTERS, OPTICAL DISC DRIVES, PRINTERS FOR USE WITH COMPUTERS, COMPUTER KEYBOARDS, COMPUTER MOUSE, PERSONAL DIGITAL ASSISTANTS (PDA), POCKET CALCULATORS, CD-ROM DRIVES, RADIO PAGERS, DVD PLAYERS, MP3 PLAYERS, VIDEO DISK PLAYERS, COMPACT DISC PLAYERS, MODEMS, HEADPHONES, TELEVISION RECEIVERS, TELEPHONES, DRY CELLS AND BATTERIES, CHARGERS FOR BATTERIES, CELL PHONE CASES, ELECTRIC FLAT IRONS, CASH REGISTERS, VIDEO CAMERAS, CAMCORDERS, TELESCOPES, IN CLASS 9 (U.S. CLS. 21, 23, 26, 36 AND 38).

THE MARK CONSISTS OF STANDARD CHARACTERS WITHOUT CLAIM TO ANY PARTICULAR FONT, STYLE, SIZE, OR COLOR.

PRIORITY CLAIMED UNDER SEC. 44(D) ON REPUBLIC OF KOREA APPLICATION NO. 40-2010-0026, FILED 5-18-2010, REG. NO. 40-0875785, DATED 8-9-2011, EXPIRES 8-9-2021.

SER. NO. 85-045,017, FILED 5-21-2010.

ROBERT STRUCK, EXAMINING ATTORNEY



David J. Kypos

Director of the United States Patent and Trademark Office

United States of America

United States Patent and Trademark Office

EASY PLUG

Reg. No. 4,097,774

SILPRO, LLC (MASSACHUSETTS LIMITED LIABILITY COMPANY)
2 NEW ENGLAND WAY
AYER, MA 014321514

Registered Feb. 14, 2012

Int. Cl.: 19

FOR: CEMENT MIXES; AND PATCHING COMPOUND MADE OF A CEMENT BASE, IN CLASS 19 (U.S. CLS. 1, 12, 33 AND 50).

TRADEMARK

FIRST USE 0-0-1953; IN COMMERCE 0-0-1953.

PRINCIPAL REGISTER

THE MARK CONSISTS OF STANDARD CHARACTERS WITHOUT CLAIM TO ANY PARTICULAR FONT, STYLE, SIZE, OR COLOR.

SER. NO. 85-045,334, FILED 5-21-2010.

JANICE KIM, EXAMINING ATTORNEY



David J. Kyffers

Director of the United States Patent and Trademark Office

United States of America

United States Patent and Trademark Office

ACE PRESS

Reg. No. 4,097,775

JACKSON-BEAR GROUP, INC. (FLORIDA CORPORATION), DBA ACE PRESS
2133 BROADWAY

Registered Feb. 14, 2012

FORT MYERS, FL 33901

Int. Cl.: 16

FOR: STATIONERY, PRINTED INVITATIONS, LETTERHEAD PAPER, BUSINESS CARDS, BROCHURE PAPER, PAPER BANNERS, BOOKLET PAPER, CALENDARS, CATALOG PAPER, NOTE PADS, ENVELOPES, GREETING CARDS, POSTCARDS, POSTERS, PRESENTATION FOLDERS, ANNUAL REPORT PAPER, PRINTED TICKETS, BUSINESS FORMS, BANK CHECKS, PAPER BUSINESS INVOICES, PRINTED BUSINESS INVOICES, PRINTED STATEMENTS, NEWSLETTER PAPER AND/OR PRESCRIPTION PADS; ADVERTISING SPECIALTY ITEMS, NAMELY, PENS AND PAPER BAGS, IN CLASS 16 (U.S. CLS. 2, 5, 22, 23, 29, 37, 38 AND 50).

TRADEMARK

PRINCIPAL REGISTER

FIRST USE 12-31-1971; IN COMMERCE 12-31-1971.

THE MARK CONSISTS OF STANDARD CHARACTERS WITHOUT CLAIM TO ANY PARTICULAR FONT, STYLE, SIZE, OR COLOR.

NO CLAIM IS MADE TO THE EXCLUSIVE RIGHT TO USE "PRESS", APART FROM THE MARK AS SHOWN.

SER. NO. 85-046,241, FILED 5-24-2010.

MIDGE BUTLER, EXAMINING ATTORNEY



David J. Kyros

Director of the United States Patent and Trademark Office

United States of America

United States Patent and Trademark Office

SYMMETRY

Reg. No. 4,097,776

Registered Feb. 14, 2012

Int. Cl.: 9

TRADEMARK

PRINCIPAL REGISTER

GENLYTE THOMAS GROUP LLC (DELAWARE LIMITED LIABILITY COMPANY)
3 BURLINGTON WOODS DRIVE
BURLINGTON, MA 01803

FOR: EXIT AND EMERGENCY LIGHTING PRODUCTS, NAMELY, EMERGENCY LIGHTING UNIT EQUIPMENT, NAMELY, EMERGENCY WARNING LIGHTS AND ILLUMINATED EXIT SIGNS, IN CLASS 9 (U.S. CLS. 21, 23, 26, 36 AND 38).

FIRST USE 5-31-1999; IN COMMERCE 5-31-1999.

THE MARK CONSISTS OF STANDARD CHARACTERS WITHOUT CLAIM TO ANY PARTICULAR FONT, STYLE, SIZE, OR COLOR.

SER. NO. 85-046,289, FILED 5-24-2010.

ALEX KEAM, EXAMINING ATTORNEY



David J. Kybas

Director of the United States Patent and Trademark Office

United States of America

United States Patent and Trademark Office

Levanté



Reg. No. 4,097,777

Registered Feb. 14, 2012

Int. Cl.: 11

TRADEMARK

PRINCIPAL REGISTER

CITY ELECTRICAL FACTORS LIMITED (UNITED KINGDOM LIMITED COMPANY (LTD.))
141 FARMER WARD ROAD, KENILWORTH
WARWICKSHIRE, UNITED KINGDOM CV82SU

FOR: HEATING EQUIPMENT, NAMELY, ELECTRIC UNDERFLOOR HEATING MATS, ELECTRIC UNDERFLOOR HEATING CABLES, ELECTRIC UNDERFLOOR HEATING FOILS, CARBON FILM MATS FOR ELECTRIC UNDERFLOOR HEATING; HEATERS, NAMELY, WATER HEATERS, KEROSENE HEATERS, IMMERSION HEATERS, ELECTRIC SPACE HEATERS, ELECTRIC UNDERFLOOR HEATERS, INFRARED HEATERS USED TO HEAT HOUSEHOLDS AND BUILDINGS, ELECTRICAL HEATED TOWEL RAILS, TUBULAR HEATERS, ELECTRIC MIRROR HEATERS; ELECTRIC HEATERS, NAMELY, CONVECTOR HEATERS AND FAN HEATERS; ELECTRIC WALL MOUNTED PANEL HEATERS; ELECTRIC FREESTANDING PANEL HEATERS; ELECTRIC WALL MOUNTED OVER-DOOR HEATERS; RADIATORS; AIRFLOW PRODUCTS, NAMELY, ELECTRIC FANS, ELECTRIC HEATING FANS, ELECTRIC HAND DRYERS, ELECTRIC HAIR DRYERS; AIR CIRCULATORS, NAMELY, FORCED AIR CIRCULATORS FOR VENTILATING KITCHEN AREAS, ELECTRIC OSCILLATING AIR CIRCULATORS; EVAPORATIVE AIR COOLERS; AIR-CONDITIONING UNITS; FANS, NAMELY, CEILING FANS, ELECTRIC FANS, ELECTRIC HEATING FANS, PORTABLE ELECTRIC FANS, IN CLASS 11 (U.S. CLS. 13, 21, 23, 31 AND 34).

OWNER OF UNITED KINGDOM REG. NO. 2419727, DATED 9-29-2006, EXPIRES 4-5-2016.

THE COLOR GRAY REPRESENTS SHADING AND IS NOT PART OF THE MARK.

THE MARK CONSISTS OF THE WORD "LEVANTÉ" WITH TWO WAVY LINES UNDERNEATH .

THE ENGLISH TRANSLATION OF "LEVANTÉ" IN THE MARK IS I LIFTED OR I ROSE.

SER. NO. 85-047,416, FILED 5-25-2010.

ERIN FALK, EXAMINING ATTORNEY



David J. Kybas

Director of the United States Patent and Trademark Office

United States of America

United States Patent and Trademark Office

HEALTHCARE NAVIGATION SPECIALISTS

Reg. No. 4,097,778

LIVINGWELL CARE NAVIGATION, INC. (NEW YORK CORPORATION)
30 FIFTH AVENUE, SUITE 16A
NEW YORK, NY 10011

Registered Feb. 14, 2012

Int. Cls.: 35 and 45

FOR: PROVIDING CUSTOMER SERVICE IN THE FIELD OF HEALTH CARE, NAMELY, ASSISTING INDIVIDUALS SEEKING HEALTH CARE, NAMELY, PROVIDING MEDICAL REFERRALS TO PHYSICIANS, NURSES, SOCIAL WORKERS, PSYCHOTHERAPISTS, PHARMACISTS, NUTRITIONISTS, ELDER CARE ATTORNEYS, SKILLED NURSING FACILITIES, HOSPICES, HOME CARE AGENCIES AND MEDICAL FACILITIES; RANGING FOR ACCESS TO HEALTH CARE SERVICES, PROVIDING PERSONAL ASSISTANCE IN EVALUATING HEALTH CARE OPTIONS FOR OTHERS, NAMELY, HEALTH CARE UTILIZATION MANAGEMENT SERVICES, HEALTH CARE UTILIZATION AND REVIEW SERVICES; PROVIDING CUSTOMER SERVICE IN THE FIELD OF HEALTH CARE, NAMELY, ARRANGING FOR ACCESS TO HEALTH CARE SERVICES BY ARRANGING FOR OTHERS TO HAVE ACCESS TO THE MEDICAL SERVICES OF OTHERS, BUT NOT PROVIDING HEALTH CARE ITSELF, IN CLASS 35 (U.S. CLS. 100, 101 AND 102).

SERVICE MARK

PRINCIPAL REGISTER

FIRST USE 3-21-2005; IN COMMERCE 3-21-2005.

FOR: PROVIDING EMOTIONAL AND SPIRITUAL COUNSELING AND PATIENT ADVOCATE SERVICES IN THE HEALTH CARE FIELD, BUT NOT HEALTH CARE ITSELF, IN CLASS 45 (U.S. CLS. 100 AND 101).

FIRST USE 3-21-2005; IN COMMERCE 3-21-2005.

THE MARK CONSISTS OF STANDARD CHARACTERS WITHOUT CLAIM TO ANY PARTICULAR FONT, STYLE, SIZE, OR COLOR.

NO CLAIM IS MADE TO THE EXCLUSIVE RIGHT TO USE "HEALTHCARE" AND "SPECIALISTS", APART FROM THE MARK AS SHOWN.

SER. NO. 85-047,638, FILED 5-25-2010.

DOMINICK J. SALEMI, EXAMINING ATTORNEY



David J. Kyffers

Director of the United States Patent and Trademark Office

United States of America

United States Patent and Trademark Office

TATA WATER PLUS

Reg. No. 4,097,779

Registered Feb. 14, 2012

Int. Cls.: 16 and 32

TRADEMARK

PRINCIPAL REGISTER

TATA SONS LIMITED (INDIA LIMITED COMPANY (LTD.))
BOMBAY HOUSE
24 HOMI MODY STREET
MUMBAI, INDIA 400001

FOR: ADVERTISEMENT AND PROMOTIONAL PAMPHLETS, IN CLASS 16 (U.S. CLS. 2, 5, 22, 23, 29, 37, 38 AND 50).

FOR: MINERAL WATER, AERATED WATER, FRUIT DRINKS AND NON ALCOHOLIC WATER BEVERAGES, IN CLASS 32 (U.S. CLS. 45, 46 AND 48).

THE MARK CONSISTS OF STANDARD CHARACTERS WITHOUT CLAIM TO ANY PARTICULAR FONT, STYLE, SIZE, OR COLOR.

OWNER OF INDIA REG. NO. 1842813, DATED 7-22-2009, EXPIRES 7-22-2019.

OWNER OF INDIA REG. NO. 1842812, DATED 7-22-2009, EXPIRES 7-22-2019.

OWNER OF U.S. REG. NO. 789,432.

NO CLAIM IS MADE TO THE EXCLUSIVE RIGHT TO USE "WATER", APART FROM THE MARK AS SHOWN.

SER. NO. 85-050,351, FILED 5-28-2010.

GRETТА YAO, EXAMINING ATTORNEY



David J. Kyffers

Director of the United States Patent and Trademark Office

United States of America
United States Patent and Trademark Office

OSPREY

Reg. No. 4,097,780

OSPREY PACKS, INC. (COLORADO CORPORATION)
115 W. PROGRESS CIRCLE
CORTEZ, CO 81321

Registered Feb. 14, 2012

Int. Cl.: 21

FOR: RESERVOIRS, NAMELY, PERSONAL BEVERAGE STORAGE CONTAINERS FOR USE WITH BACKPACKS; PERSONAL HYDRATION SYSTEMS COMPRISING A DRINKING RESERVOIR, A DRINKING TUBE, AND A MOUTHPIECE, IN CLASS 21 (U.S. CLS. 2, 13, 23, 29, 30, 33, 40 AND 50).

TRADEMARK

PRINCIPAL REGISTER

FIRST USE 7-10-2009; IN COMMERCE 7-10-2009.

THE MARK CONSISTS OF STANDARD CHARACTERS WITHOUT CLAIM TO ANY PARTICULAR FONT, STYLE, SIZE, OR COLOR.

OWNER OF U.S. REG. NOS. 2,571,330 AND 3,054,327.

SER. NO. 85-050,614, FILED 5-28-2010.

ANNE FARRELL, EXAMINING ATTORNEY



David J. Kybas

Director of the United States Patent and Trademark Office

United States of America

United States Patent and Trademark Office



Reg. No. 4,097,781

Registered Feb. 14, 2012

Int. Cls.: 10 and 20

TRADEMARK

PRINCIPAL REGISTER

PIERRE FABRE DERMO-COSMETIQUE (FRANCE SOCIÉTÉ PAR ACTIONS SIMPLIFIÉE (SAS))
45, PLACE ABEL GANCE
BOULOGNE, FRANCE 92100

FOR: STERILE SUPPLY SYSTEM COMPRISED OF AN EMPTY CONTAINER FOR HOLDING PHARMACEUTICAL PRODUCTS; THE AFOREMENTIONED FOR MEDICAL USE; STERILE SUPPLY SYSTEM COMPRISED OF AN EMPTY CONTAINER FOR HOLDING DERMATOLOGICALS, IN CLASS 10 (U.S. CLS. 26, 39 AND 44).

FOR: PLASTIC CONTAINER HAVING A CLOSURE SYSTEM ALLOWING THE PRODUCT CONTAINED THEREIN TO REMAIN STERILE AFTER USE; A PLASTIC SUPPLY SYSTEM COMPRISED OF A PLASTIC CONTAINER AND AIRTIGHT DISPENSER WHICH MAINTAINS A STERILE ENVIRONMENT FOR PRODUCT CONTAINED THEREIN; ALL OF THE AFOREMENTIONED FOR COMMERCIAL USE, IN CLASS 20 (U.S. CLS. 2, 13, 22, 25, 32 AND 50).

PRIORITY CLAIMED UNDER SEC. 44(D) ON FRANCE APPLICATION NO. 093695477, FILED 12-2-2009, REG. NO. 093695477, DATED 12-2-2009, EXPIRES 12-2-2019.

THE MARK CONSISTS OF THE LETTERS "D.E.F.I" APPEARING ABOVE A DESIGN ELEMENT COMPRISED OF GRAPHIC REPRESENTATION OF A DISPENSER SEALING SYSTEM. BELOW THE DESIGN ELEMENT APPEARS THE WORDING "DEVICE EXCLUSIVE FORMULA INTEGRITY".

SER. NO. 85-051,705, FILED 6-1-2010.

ELI HELLMAN, EXAMINING ATTORNEY



David J. Kybas

Director of the United States Patent and Trademark Office

United States of America

United States Patent and Trademark Office



Reg. No. 4,097,782

Registered Feb. 14, 2012

Int. Cl.: 31

TRADEMARK

PRINCIPAL REGISTER

ICC USA, INC. (KENTUCKY CORPORATION)
101 S. FIFTH STREET
3500 NATIONAL CITY TOWER
LOUISVILLE, KY 40202

FOR: ORGANIC ANIMAL FEED INGREDIENTS, NAMELY, YEAST-BASED ADDITIVES,
IN CLASS 31 (U.S. CLS. 1 AND 46).

FIRST USE 0-0-2008; IN COMMERCE 0-0-2008.

NO CLAIM IS MADE TO THE EXCLUSIVE RIGHT TO USE "COMPLEX YEAST SELENIUM"
AND "ORGANIC SELENIUM - 2000 PPM", APART FROM THE MARK AS SHOWN.

THE COLOR(S) GREEN, BLACK, DARK BLUE AND LIGHT BLUE IS/ARE CLAIMED AS
A FEATURE OF THE MARK.

THE MARK CONSISTS OF THE WORDING "COMPLEX YEAST SELENIUM ORGANIC
SELENIUM - 2000 PPM" IN A STYLIZED FONT WITH A DESIGN THAT CONSISTS OF ONE
LARGE INCOMPLETE CIRCLE AND ONE SMALL COMPLETE CIRCLE. THE WORDING
"COMPLEX YEAST SELENIUM" IS IN THE COLOR GREEN, THE WORDING "ORGANIC
SELENIUM - 2000 PPM" IS IN THE COLOR BLACK, AND THE DESIGN IS IN THE COLORS
DARK BLUE AND LIGHT BLUE.

SER. NO. 85-051,888, FILED 6-1-2010.

RENEE MCCRAY, EXAMINING ATTORNEY



David J. Kybas

Director of the United States Patent and Trademark Office

United States of America

United States Patent and Trademark Office

CeraNiveau

Reg. No. 4,097,783

DALLMER GMBH & CO KG (FED REP GERMANY GMBH & CO. KG)
WIEBELSHEIDESTRASSE 25

Registered Feb. 14, 2012

ARNSBERG, FED REP GERMANY 59757

Int. Cl.: 11

FOR: PLUMBING FITTINGS, NAMELY, FLOOR DRAIN FITTINGS, IN CLASS 11 (U.S. CLS. 13, 21, 23, 31 AND 34).

TRADEMARK

THE MARK CONSISTS OF STANDARD CHARACTERS WITHOUT CLAIM TO ANY PARTICULAR FONT, STYLE, SIZE, OR COLOR.

PRINCIPAL REGISTER

OWNER OF ERPN CMNTY TM OFC REG. NO. 002950715, DATED 10-29-2004, EXPIRES 11-29-2012.

THE WORDING "CERANIVEAU" HAS NO MEANING IN A FOREIGN LANGUAGE.

SER. NO. 85-052,832, FILED 6-2-2010.

LINDA ORNDORFF, EXAMINING ATTORNEY



David J. Kyffers

Director of the United States Patent and Trademark Office

United States of America

United States Patent and Trademark Office

BIO-ATTRACT

Reg. No. 4,097,784

Registered Feb. 14, 2012

Int. Cl.: 5

TRADEMARK

PRINCIPAL REGISTER

BIOGLOBAL LIMITED (AUSTRALIA UNLISTED PUBLIC COMPANY)
12 ELECTRONICS STREET
EIGHT MILE PLAINS
QUEENSLAND, AUSTRALIA 4113

FOR: INSECT REPELLANTS, INSECTICIDES FOR AGRICULTURAL USE, ATTRACTANTS
FOR INSECT PESTS OF AGRICULTURE, IN CLASS 5 (U.S. CLS. 6, 18, 44, 46, 51 AND 52).

THE MARK CONSISTS OF STANDARD CHARACTERS WITHOUT CLAIM TO ANY PAR-
TICULAR FONT, STYLE, SIZE, OR COLOR.

OWNER OF AUSTRALIA REG. NO. 935875, DATED 11-28-2002, EXPIRES 11-28-2012.

SER. NO. 85-052,898, FILED 6-2-2010.

CARRIE GENOVESE, EXAMINING ATTORNEY



David J. Kyffers

Director of the United States Patent and Trademark Office

United States of America

United States Patent and Trademark Office



sumosoftware

Reg. No. 4,097,785

Registered Feb. 14, 2012

Int. Cl.: 42

SERVICE MARK

PRINCIPAL REGISTER

SUMO SOFTWARE CORPORATION (FLORIDA CORPORATION)
421
101 OLD COACHMAN RD
CLEARWATER, FL 33765

FOR: COMPUTER SOFTWARE DEVELOPMENT, IN CLASS 42 (U.S. CLS. 100 AND 101).

FIRST USE 8-7-2009; IN COMMERCE 8-7-2009.

THE MARK CONSISTS OF A SUMO WRESTLER STANDING ON ONE LEG WITH THE STYLIZED TEXT "SUMOSOFTWARE".

SER. NO. 85-053,296, FILED 6-2-2010.

MICHAEL ENGEL, EXAMINING ATTORNEY



David J. Kybas

Director of the United States Patent and Trademark Office

United States of America

United States Patent and Trademark Office



Reg. No. 4,097,786

COMICS FOR KIDS, INC. (OHIO NON-PROFIT CORPORATION)
P.O. BOX 606196
CLEVELAND, OH 44106

Registered Feb. 14, 2012

Int. Cl.: 36

FOR: CHARITABLE FUNDRAISING SERVICES; CHARITABLE FUNDRAISING SERVICES BY MEANS OF COMEDIC SHOWS, PERFORMANCES BY COMEDIANS AND ENTERTAINMENT EVENTS; CHARITABLE FUNDRAISING SERVICES BY MEANS OF COMEDIC SHOWS, PERFORMANCES BY COMEDIANS AND ENTERTAINMENT EVENTS FOR RAISING MONEY FOR HOSPITALS AND ORGANIZATIONS THAT SUPPORT CHILDREN, IN CLASS 36 (U.S. CLS. 100, 101 AND 102).

SERVICE MARK

PRINCIPAL REGISTER

FIRST USE 5-0-2009; IN COMMERCE 5-0-2009.

OWNER OF U.S. REG. NO. 4,000,961.

THE MARK CONSISTS OF A CIRCLE WITH A HUMAN CARICATURE HOLDING A MICROPHONE PARTIALLY INSIDE AND PARTIALLY OUTSIDE THE CIRCLE AND THE WORDS "COMICS FOR KIDS" INSIDE THE CIRCLE AND BELOW THE HUMAN CARICATURE.

SEC. 2(F) AS TO "COMICS FOR KIDS".

SER. NO. 85-053,759, FILED 6-3-2010.

ROBERT STRUCK, EXAMINING ATTORNEY



David J. Kybas

Director of the United States Patent and Trademark Office

United States of America

United States Patent and Trademark Office

ROAD RIDER

Reg. No. 4,097,787

DYNAMIC TIRE CORP. (CANADA CORPORATION)
155 DELTA PARK BLVD.

Registered Feb. 14, 2012

BRAMPTON, CANADA L6T5M8

Int. Cl.: 12

FOR: TRAILER TIRES, EXCLUDING MOTORCYCLE TIRES AND TIRE ACCESSORIES, IN CLASS 12 (U.S. CLS. 19, 21, 23, 31, 35 AND 44).

TRADEMARK

FIRST USE 5-15-2007; IN COMMERCE 5-15-2007.

PRINCIPAL REGISTER

THE MARK CONSISTS OF STANDARD CHARACTERS WITHOUT CLAIM TO ANY PARTICULAR FONT, STYLE, SIZE, OR COLOR.

SER. NO. 85-054,623, FILED 6-4-2010.

DAVID TAYLOR, EXAMINING ATTORNEY



David J. Kybas

Director of the United States Patent and Trademark Office

United States of America

United States Patent and Trademark Office

BAYAL

Reg. No. 4,097,788

Registered Feb. 14, 2012

Int. Cl.: 6

TRADEMARK

PRINCIPAL REGISTER

BAYER AKTIENGESELLSCHAFT (FED REP GERMANY JOINT STOCK COMPANY)
KAISER-WILHELM-ALLEE
51373 LEVERKUSEN, FED REP GERMANY

FOR: COMMON METALS AND THEIR ALLOYS; METAL BUILDING MATERIALS, NAMELY, I-BEAMS, BOLTS, SCREWS, METAL FITTINGS, FASTENERS, WINDOW FRAMES, DOORS, FACADE ELEMENTS, HANDLES, METAL LOCKS; GOODS OF COMMON METAL, NAMELY, SAFES, GENERAL PURPOSE METAL STORAGE CONTAINERS, NON-LUMINOUS AND NON-MECHANICAL METAL SIGNS, METAL IDENTIFICATION BRACELETS, WROUGHT IRON DECORATIVE ARTWORK; NON-ELECTRIC CABLES AND WIRES OF COMMON METAL; HIGH-TENACITY ALUMINUM, NAMELY, SHEETS, PLATES, FOILS, INGOTS, BILLETS, RODS, IN CLASS 6 (U.S. CLS. 2, 12, 13, 14, 23, 25 AND 50).

THE MARK CONSISTS OF STANDARD CHARACTERS WITHOUT CLAIM TO ANY PARTICULAR FONT, STYLE, SIZE, OR COLOR.

PRIORITY CLAIMED UNDER SEC. 44(D) ON FED REP GERMANY APPLICATION NO. 302009072996, FILED 12-11-2009, REG. NO. 302009072996, DATED 12-22-2009, EXPIRES 12-31-2019.

SER. NO. 85-054,735, FILED 6-4-2010.

WILLIAM P. SHANAHAN, EXAMINING ATTORNEY



David J. Kybas

Director of the United States Patent and Trademark Office

United States of America

United States Patent and Trademark Office

dribble ons

Reg. No. 4,097,789

LEVIN, KEZIAH (UNITED KINGDOM INDIVIDUAL)
74 MOUNT PLEASANT ROAD

Registered Feb. 14, 2012

LONDON, UNITED KINGDOM NW10 3EJ

Int. Cl.: 25

FOR: BIBS NOT OF PAPER; BABY'S BIBS NOT OF PAPER; BIBS MADE OF TEXTILE MATERIAL, IN CLASS 25 (U.S. CLS. 22 AND 39).

TRADEMARK

PRIORITY CLAIMED UNDER SEC. 44(D) ON ERPN CMNTY TM OFC APPLICATION NO. 009139577, FILED 5-28-2010, REG. NO. 009139577, DATED 11-12-2010, EXPIRES 5-28-2020.

PRINCIPAL REGISTER

THE MARK CONSISTS OF THE STYLIZED PHRASE "DRIBBLE ONS" WITH THE STYLIZED UN-SHADED RAISED LETTER "O" WITH FIVE SHADED CIRCLES PRINTED IN A CURVED MANNER AND DECREASING IN SIZE REPRESENTING A BABY'S FOOT WITH TOES, IN THE TERM, "ONS".

SER. NO. 85-054,935, FILED 6-4-2010.

ODESSA BIBBINS, EXAMINING ATTORNEY



David J. Kyffers

Director of the United States Patent and Trademark Office

United States of America

United States Patent and Trademark Office



Reg. No. 4,097,790

Registered Feb. 14, 2012

Int. Cl.: 9

TRADEMARK

PRINCIPAL REGISTER

GHET-O-VISION ENTERTAINMENT, LLC (NEW YORK LIMITED LIABILITY COMPANY)
SUITE 111
999 EMERY STREET
ATLANTA, GA 30318

FOR: DIGITAL MEDIA, NAMELY, PRE-RECORDED VIDEO CASSETTES, DIGITAL VIDEO DISCS, DIGITAL VERSATILE DISCS, DOWNLOADABLE AUDIO AND VIDEO RECORDINGS, MOTION PICTURES, DVDS, AND HIGH DEFINITION DIGITAL DISCS FEATURING MUSIC, MUSIC VIDEOS, DRAMATIC AND COMEDIC WORKS; DOWNLOADABLE MUSICAL SOUND RECORDINGS; MUSICAL SOUND RECORDINGS; MUSICAL VIDEO RECORDINGS PHONOGRAPH RECORDS FEATURING MUSIC; PRE-RECORDED CDS, VIDEO TAPES, LASERDISKS AND DVDS FEATURING MUSIC AND MUSIC VIDEOS; PRE-RECORDED ELECTRONIC AND DIGITAL MEDIA FEATURING MUSIC AND VIDEO IMAGES AND MUSIC VIDEOS; SOUND RECORDINGS FEATURING MUSIC; INTERACTIVE AND ON-DEMAND PROGRAMS, EAR PHONES AND OTHER DEVICES USED TO LISTEN TO MUSIC AND VIEW MOTION PICTURES; MP3 PLAYERS; TELEVISIONS; COMPUTERS; MOBILE PHONES AND DOWNLOADABLE CONTENT FOR MOBILE TRANSMISSIONS, IN CLASS 9 (U.S. CLS. 21, 23, 26, 36 AND 38).

FIRST USE 8-13-1999; IN COMMERCE 8-13-1999.

NO CLAIM IS MADE TO THE EXCLUSIVE RIGHT TO USE "ENTERTAINMENT", APART FROM THE MARK AS SHOWN.

THE MARK CONSISTS OF ABSTRACT TELEVISION WITH CLOTHES HANGER USED AS AN ANTENNA SURROUNDED BY ABSTRACT CONCENTRIC CIRCLES AND THE PHRASE "GHET-O-VISION ENTERTAINMENT".

SER. NO. 85-056,442, FILED 6-7-2010.

MICHAEL ENGEL, EXAMINING ATTORNEY



David J. Kybas

Director of the United States Patent and Trademark Office

United States of America

United States Patent and Trademark Office

TR-15

Reg. No. 4,097,791

Registered Feb. 14, 2012

Int. Cl.: 13

TRADEMARK

PRINCIPAL REGISTER

THOR GLOBAL DEFENSE GROUP, INC. (ARKANSAS CORPORATION), AKA THOR, THOR
GLOBAL DEFENSE GROUP
1206 KNESEK LANE
VAN BUREN, AR 72956

FOR: AUTOMATIC RIFLES; MILITARY RIFLES; RIFLES; SPORTING RIFLES, IN CLASS
13 (U.S. CLS. 2 AND 9).

FIRST USE 4-1-2003; IN COMMERCE 9-5-2007.

THE MARK CONSISTS OF STANDARD CHARACTERS WITHOUT CLAIM TO ANY PAR-
TICULAR FONT, STYLE, SIZE, OR COLOR.

SER. NO. 85-060,306, FILED 6-11-2010.

PATRICIA EVANKO, EXAMINING ATTORNEY



David J. Kyjars

Director of the United States Patent and Trademark Office

United States of America

United States Patent and Trademark Office



Reg. No. 4,097,792

VIRGINIA BUILDING SOLUTIONS, LLC (VIRGINIA LIMITED LIABILITY COMPANY)
834 S. CHURCH LANE, P.O. BOX 820
TAPPAHANNOCK, VA 22560

Registered Feb. 14, 2012

Int. Cl.: 37

FOR: RESIDENTIAL BUILDING CONSTRUCTION; CUSTOM CONSTRUCTION OF MODULAR HOMES, IN CLASS 37 (U.S. CLS. 100, 103 AND 106).

SERVICE MARK

FIRST USE 7-31-2007; IN COMMERCE 7-31-2007.

PRINCIPAL REGISTER

NO CLAIM IS MADE TO THE EXCLUSIVE RIGHT TO USE "VIRGINIA BUILDING SOLUTIONS", APART FROM THE MARK AS SHOWN.

THE MARK CONSISTS OF A DRAWING OF A HOUSE WITHIN AN OVAL AND THE WORDS "VIRGINIA BUILDING SOLUTIONS" BENEATH THE HOUSE DRAWING.

SER. NO. 85-062,097, FILED 6-14-2010.

SOPHIA S. KIM, EXAMINING ATTORNEY



David J. Kybas

Director of the United States Patent and Trademark Office

United States of America

United States Patent and Trademark Office

EMODERATION

Reg. No. 4,097,793

Registered Feb. 14, 2012

Int. Cl.: 35

SERVICE MARK

PRINCIPAL REGISTER

EMODERATION LIMITED (UNITED KINGDOM LIMITED COMPANY (LTD.))
24 GREVILLE STREET
LONDON, UNITED KINGDOM EC1N8SS

FOR: BUSINESS CONSULTATION SERVICES; BUSINESS CONSULTING SERVICES, NAMELY, SOCIAL MEDIA AND ONLINE CONTENT MANAGEMENT AND MONITORING SERVICES AND ONLINE COMMUNITY MANAGEMENT AND MONITORING SERVICES PROVIDED TO OTHERS; MONITORING AND MANAGING ONLINE AND INTERACTIVE MEDIA AND ONLINE INTERACTIVE COMMUNITIES FOR CUSTOMER-SPECIFIED TOPICS, CONTENT AND LEGAL COMPLIANCE FOR BUSINESS PURPOSES; SOCIAL MEDIA MANAGEMENT AND MONITORING SERVICES FOR BUSINESS PURPOSES, IN CLASS 35 (U.S. CLS. 100, 101 AND 102).

FIRST USE 12-31-2002; IN COMMERCE 8-31-2005.

THE MARK CONSISTS OF STANDARD CHARACTERS WITHOUT CLAIM TO ANY PARTICULAR FONT, STYLE, SIZE, OR COLOR.

SEC. 2(F).

SER. NO. 85-066,724, FILED 6-18-2010.

JULIE GUTTADAURO, EXAMINING ATTORNEY



David J. Kyffers

Director of the United States Patent and Trademark Office

United States of America

United States Patent and Trademark Office

ELEKTRA

Reg. No. 4,097,794

ELEKTRA ENTERTAINMENT GROUP INC. (DELAWARE CORPORATION)
75 ROCKEFELLER PLAZA
NEW YORK, NY 10019

Registered Feb. 14, 2012

Int. Cls.: 9, 35, 41 and 42

FOR: (BASED ON USE IN COMMERCE) (BASED ON 44(D) PRIORITY APPLICATION) MUSICAL SOUND RECORDINGS; DOWNLOADABLE MUSICAL SOUND RECORDINGS; DOWNLOADABLE RING TONES, VOICE TONES AND GRAPHICS VIA THE INTERNET AND WIRELESS DEVICES, IN CLASS 9 (U.S. CLS. 21, 23, 26, 36 AND 38).

TRADEMARK

SERVICE MARK

FIRST USE 3-0-1951; IN COMMERCE 3-0-1951.

PRINCIPAL REGISTER

FOR: (BASED ON USE IN COMMERCE) (BASED ON 44(D) PRIORITY APPLICATION) ONLINE RETAIL STORE SERVICES FEATURING MUSICAL SOUND RECORDINGS AND VIDEO RECORDINGS, POSTERS AND CLOTHING, IN CLASS 35 (U.S. CLS. 100, 101 AND 102).

FIRST USE 0-0-2003; IN COMMERCE 0-0-2003.

FOR: (BASED ON USE IN COMMERCE) (BASED ON 44(D) PRIORITY APPLICATION) ENTERTAINMENT SERVICES, NAMELY PROVIDING NON-DOWNLOADABLE PRERECORDED MUSIC AND VIDEOS FEATURING MUSIC, MUSICAL ARTISTS, AND COMEDY PROGRAMS; ENTERTAINMENT SERVICES FEATURING INFORMATION IN THE FIELD OF MUSIC, MUSICAL ARTISTS, AND COMEDY ONLINE VIA A GLOBAL COMPUTER NETWORK; PROVIDING ONLINE INFORMATION IN THE FIELD OF MUSIC AND MUSICAL ARTISTS VIA THE INTERNET; PROVIDING A WEBSITE FEATURING NON-DOWNLOADABLE MUSICAL SOUND RECORDINGS, MUSICAL VIDEOS, PHOTOGRAPHS, ARTWORK, AND OTHER MULTIMEDIA MATERIALS FEATURING MUSICAL ENTERTAINMENT AND MUSICAL ARTISTS; PROVIDING NON-DOWNLOADABLE MULTIMEDIA FILES CONTAINING ARTWORK, TEXT, AUDIO, VIDEO AND INTERNET WEB LINKS TO WEBSITES OF OTHERS FEATURING MUSIC AND MUSICAL ARTISTS; PROVIDING NEWSLETTERS IN THE FIELD OF MUSIC AND MUSICAL ARTISTS VIA E-MAIL; PROVIDING LINKS TO WEB SITES OF OTHERS FEATURING MUSIC AND MUSICAL ARTISTS, IN CLASS 41 (U.S. CLS. 100, 101 AND 107).



David J. Kyffers

FIRST USE 0-0-2003; IN COMMERCE 0-0-2003.

Reg. No. 4,097,794 FOR: (BASED ON USE IN COMMERCE) COMPUTER SERVICES, NAMELY, CREATING AN ON-LINE COMMUNITY FOR REGISTERED USERS TO PARTICIPATE IN DISCUSSIONS, GET FEEDBACK FROM THEIR PEERS, FORM VIRTUAL COMMUNITIES AND ENGAGE IN SOCIAL NETWORKING, IN CLASS 42 (U.S. CLS. 100 AND 101).

FIRST USE 6-1-2009; IN COMMERCE 6-1-2009.

THE MARK CONSISTS OF STANDARD CHARACTERS WITHOUT CLAIM TO ANY PARTICULAR FONT, STYLE, SIZE, OR COLOR.

PRIORITY CLAIMED UNDER SEC. 44(D) ON ERPN CMNTY TM OFC APPLICATION NO. 008784084, FILED 12-24-2009.

OWNER OF U.S. REG. NOS. 1,328,138, 1,633,872 AND OTHERS.

SER. NO. 85-069,690, FILED 6-23-2010.

CHERYL CLAYTON, EXAMINING ATTORNEY

United States of America

United States Patent and Trademark Office

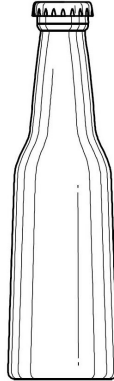

Reg. No. 4,097,795

Registered Feb. 14, 2012

Int. Cl.: 30

TRADEMARK

PRINCIPAL REGISTER

TWANG PARTNERS, LTD (TEXAS LIMITED PARTNERSHIP)
6255 W.T. MONTGOMERY RD.
SAN ANTONIO, TX 78252

FOR: FLAVORED SALT; SALT-BASED SPICES, IN CLASS 30 (U.S. CL. 46).

FIRST USE 3-31-1999; IN COMMERCE 3-31-1999.

THE MARK CONSISTS OF A THREE-DIMENSIONAL REPRESENTATION OF A MINIATURE BEER BOTTLE, WHICH IS A CONTAINER FOR THE GOODS. THE CONTAINER IS A SALT SHAKER THAT RESEMBLES A MINIATURE BEER BOTTLE. THE SALT SHAKER IS GENERALLY CYLINDRICAL AND IS TAPERED FROM A WIDER BASE TO A NARROWER UPPER PORTION, WITH A FURTHER NARROWING FORMING A NECK AT THE TOP OF THE SHAKER. THE SHAKER LID IS FLAT ON TOP, WITH INDENTED RIDGES AROUND THE CIRCUMFERENCE TO RESEMBLE A MINIATURE BEER BOTTLE CAP.

SEC. 2(F).

SER. NO. 85-070,559, FILED 6-24-2010.

LIEF MARTIN, EXAMINING ATTORNEY



David J. Kypos

Director of the United States Patent and Trademark Office

United States of America

United States Patent and Trademark Office

WaterEco

Reg. No. 4,097,796

Registered Feb. 14, 2012

Int. Cl.: 11

TRADEMARK

PRINCIPAL REGISTER

CONSOLIDATED MACHINE CORPORATION (MASSACHUSETTS CORPORATION)
76 ASHFORD ST.
BOSTON, MA 02134

FOR: STEAM AND WATER PROCESSING EQUIPMENT SPECIALLY ADAPTED FOR USE WITH ELECTRIC AUTOCLAVES FOR REDUCING FLUID TEMPERATURE WHILE MINIMIZING WATER CONSUMPTION, NAMELY, A SYSTEM CONSISTING OF A RESERVOIR, PIPES, VALVES, AND SENSORS THAT COOL EFFLUENT USING A COMBINATION OF AIR, PREVIOUSLY COOLED EFFLUENT AND WATER, SAID EQUIPMENT ONLY FOR USE IN LABORATORIES AND NOT FOR THE PURPOSE OF CREATING, TREATING, FILTERING, PURIFYING, STERILIZING OR CONDITIONING DOMESTIC OR COMMERCIAL WATER, IN CLASS 11 (U.S. CLS. 13, 21, 23, 31 AND 34).

FIRST USE 9-1-2009; IN COMMERCE 9-1-2009.

THE MARK CONSISTS OF STANDARD CHARACTERS WITHOUT CLAIM TO ANY PARTICULAR FONT, STYLE, SIZE, OR COLOR.

SER. NO. 85-073,163, FILED 6-28-2010.

PATRICIA EVANKO, EXAMINING ATTORNEY



David J. Kypos

Director of the United States Patent and Trademark Office

United States of America

United States Patent and Trademark Office



Reg. No. 4,097,797

Registered Feb. 14, 2012

Int. Cls.: 9 and 11

TRADEMARK

PRINCIPAL REGISTER

CITY ELECTRICAL FACTORS LIMITED (UNITED KINGDOM LIMITED COMPANY (LTD.))
141 FARMER WARD ROAD, KENILWORTH
WARWICKSHIRE, UNITED KINGDOM CV82SU

FOR: ELECTRICAL AND ELECTRONIC APPARATUS AND DEVICES FOR USE IN THE FIELD OF HOME AUTOMATION, NAMELY, ELECTRICAL AND ELECTRONIC CONTROLS, NAMELY, REMOTE CONTROLS FOR LIGHTING, HEATING, VENTILATION, SECURITY SYSTEMS, ACCESS SYSTEMS, DOORS AND GATES, ELECTRICAL APPLIANCES, AUDIO SYSTEMS AND EQUIPMENT; SWITCHES, NAMELY, ELECTRIC SWITCHES, POWER SWITCHES, LIGHT SWITCHES, TEMPERATURE SWITCHES; SECURITY DEVICES, NAMELY, OCCUPANCY DETECTORS, NAMELY, ELECTRONIC DEVICES WHICH DETECT THE PRESENCE OF OCCUPANTS AND CONTROL THE LIGHTING SYSTEM ACCORDINGLY; PASSIVE INFRA-RED SENSORS FOR USE IN ELECTRONIC LIGHTING, SECURITY AND ACCESS CONTROL APPLICATIONS; MICROWAVE SENSORS FOR USE IN ELECTRONIC LIGHTING AND INTRUSION DETECTION APPLICATIONS; OCCUPANCY SENSORS, NAMELY, ELECTRONIC DEVICES WHICH DETECT THE PRESENCE OF OCCUPANTS AND CONTROL THE LIGHTING SYSTEM ACCORDINGLY; VACANCY SENSORS, NAMELY, ELECTRONIC DEVICES WHICH DETECT THE ABSENCE OF OCCUPANTS AND CONTROL THE LIGHTING SYSTEM ACCORDINGLY; LIGHTING AND SECURITY CONTROL PANELS; HEATING CONTROL DEVICES IN THE NATURE OF HEATING CONTROL PANELS; CONSUMER ELECTRONIC PRODUCTS, NAMELY, POWER CONVERSION DEVICES; PLUG ADAPTORS; DETECTORS, NAMELY, ELECTRONIC MOTION DETECTORS, ELECTRONIC GLASS BREAK DETECTORS, FIRE AND SMOKE DETECTORS, GAS DETECTORS FOR DETECTING THE PRESENCE OF GAS; DIGITAL, TEMPERATURE, RADIO AND TELEPHONE TRANSMITTERS; REMOTE CONTROL TRANSMITTERS FOR RADIO-CONTROLLED DEVICES; THERMOSTATS; TIMERS; LIGHTING BALLASTS; ELECTRONIC BALLASTS, NAMELY, ELECTRONIC BALLASTS FOR HALOGEN LIGHTS, ELECTRONIC FLUORESCENT LAMP BALLASTS FOR ELECTRIC LIGHTS, BALLASTS FOR FLUORESCENT TUBES; ELECTRICAL AND ELECTRONIC DEVICES FOR USE IN ENERGY CONSERVATION AND REDUCTION, NAMELY, LINEAR CONVERTERS, NAMELY, POWER SUPPLY CONNECTORS AND ADAPTORS FOR USE WITH HIGH FREQUENCY TUBES, ELECTRONIC BALLASTS AND OCCUPANCY DETECTORS; SOLAR PANELS FOR ELECTRICITY GENERATION, NAMELY, SOLAR PANELS FOR THE PRODUCTION OF ELECTRICITY; PHOTO CELLS, NAMELY, PHOTOELECTRIC CELLS AND PHOTO VOLTAIC CELLS; ELECTRONIC DEVICES, NAMELY, ENERGY METERS FOR TRACKING AND MONITORING ENERGY USAGE; SOLAR PHOTOVOLTAIC PANELS,



David J. Kybas

Director of the United States Patent and Trademark Office

Reg. No. 4,097,797 NAMELY, PHOTOVOLTAIC SOLAR PANELS FOR THE PRODUCTION OF ELECTRICITY, IN CLASS 9 (U.S. CLS. 21, 23, 26, 36 AND 38).

FOR: LIGHTING, NAMELY, LIGHTING FIXTURES, LIGHTING TRACKS AND LIGHTING APPARATUS, NAMELY, LIGHTING INSTALLATIONS; LED LIGHTING, NAMELY, LED LIGHTING FIXTURES AND LED LAMPS; LIGHT BULBS; LAMPS; COMPACT FLUORESCENT LAMPS; FLUORESCENT CONVERSION KITS COMPRISING FLUORESCENT LAMPS AND LINEAR CONVERTERS; SOLAR LIGHTING FIXTURES, NAMELY, INDOOR AND OUTDOOR SOLAR POWERED LIGHTING UNITS AND FIXTURES; HEATING APPARATUS, NAMELY, CENTRAL HEATING RADIATORS, HEATING INSTALLATIONS, HEATING BOILERS; ELECTRIC HEATING APPARATUS, NAMELY, ELECTRIC HEATING FANS, ELECTRIC SPACE HEATERS, INFRARED HEATERS USED TO HEAT HOUSEHOLDS AND BUILDINGS, ELECTRIC WALL MOUNTED PANEL HEATERS, ELECTRIC FREESTANDING PANEL HEATERS; UNDER FLOOR HEATING APPARATUS, NAMELY, ELECTRIC UNDER FLOOR HEATERS, ELECTRIC UNDER FLOOR HEATING MATS, ELECTRIC UNDER FLOOR HEATING CABLES, ELECTRIC UNDER FLOOR HEATING FOILS, CARBON FILM MATS FOR ELECTRIC UNDER FLOOR HEATING; SOLAR HEATING APPARATUS, NAMELY, SOLAR THERMAL AIR SYSTEMS FOR HEATING PURPOSES; SOLAR HEAT COLLECTION PANELS, IN CLASS 11 (U.S. CLS. 13, 21, 23, 31 AND 34).

OWNER OF UNITED KINGDOM REG. NO. 2550666, DATED 9-17-2010, EXPIRES 6-16-2020.

THE MARK CONSISTS OF THE WORDING "E-MATIC", WHERE THE "E" IS ENCIRCLED BY TWO CONCENTRIC ELLIPSES. THE LARGER OF THE TWO ELLIPSES FEATURES A SPHERE.

SER. NO. 85-073,795, FILED 6-29-2010.

ERIN FALK, EXAMINING ATTORNEY

United States of America

United States Patent and Trademark Office



Reg. No. 4,097,798

Registered Feb. 14, 2012

Int. Cls.: 9 and 11

TRADEMARK

PRINCIPAL REGISTER

CITY ELECTRICAL FACTORS LIMITED (UNITED KINGDOM LIMITED COMPANY (LTD.))
141 FARMER WARD ROAD, KENILWORTH
WARWICKSHIRE, UNITED KINGDOM CV82SU

FOR: ELECTRICAL AND ELECTRONIC APPARATUS AND DEVICES FOR USE IN THE FIELD OF HOME AUTOMATION, NAMELY, ELECTRICAL AND ELECTRONIC CONTROLS, NAMELY, REMOTE CONTROLS FOR LIGHTING, HEATING, VENTILATION, SECURITY SYSTEMS, ACCESS SYSTEMS, DOORS AND GATES, ELECTRICAL APPLIANCES, AUDIO SYSTEMS AND EQUIPMENT; SWITCHES, NAMELY, ELECTRIC SWITCHES, POWER SWITCHES, LIGHT SWITCHES, TEMPERATURE SWITCHES; SECURITY DEVICES, NAMELY, OCCUPANCY DETECTORS, NAMELY, ELECTRONIC DEVICES WHICH DETECT THE PRESENCE OF OCCUPANTS AND CONTROL THE LIGHTING SYSTEM ACCORDINGLY; PASSIVE INFRA-RED SENSORS FOR USE IN ELECTRONIC LIGHTING, SECURITY AND ACCESS CONTROL APPLICATIONS; MICROWAVE SENSORS FOR USE IN ELECTRONIC LIGHTING AND INTRUSION DETECTION APPLICATIONS; OCCUPANCY SENSORS, NAMELY, ELECTRONIC DEVICES WHICH DETECT THE PRESENCE OF OCCUPANTS AND CONTROL THE LIGHTING SYSTEM ACCORDINGLY; VACANCY SENSORS, NAMELY, ELECTRONIC DEVICES WHICH DETECT THE ABSENCE OF OCCUPANTS AND CONTROL THE LIGHTING SYSTEM ACCORDINGLY; LIGHTING AND SECURITY CONTROL PANELS; HEATING CONTROL DEVICES IN THE NATURE OF HEATING CONTROL PANELS; CONSUMER ELECTRONIC PRODUCTS, NAMELY, POWER CONVERSION DEVICES; PLUG ADAPTORS; DETECTORS, NAMELY, ELECTRONIC MOTION DETECTORS, ELECTRONIC GLASS BREAK DETECTORS, FIRE AND SMOKE DETECTORS, GAS DETECTORS FOR DETECTING THE PRESENCE OF GAS; DIGITAL, TEMPERATURE, RADIO AND TELEPHONE TRANSMITTERS; REMOTE CONTROL TRANSMITTERS FOR RADIO-CONTROLLED DEVICES; THERMOSTATS; TIMERS; LIGHTING BALLASTS; ELECTRONIC BALLASTS, NAMELY, ELECTRONIC BALLASTS FOR HALOGEN LIGHTS, ELECTRONIC FLUORESCENT LAMP BALLASTS FOR ELECTRIC LIGHTS, BALLASTS FOR FLUORESCENT TUBES; ELECTRICAL AND ELECTRONIC DEVICES FOR USE IN ENERGY CONSERVATION AND REDUCTION, NAMELY, LINEAR CONVERTERS, NAMELY, POWER SUPPLY CONNECTORS AND ADAPTORS FOR USE WITH HIGH FREQUENCY TUBES, ELECTRONIC BALLASTS AND OCCUPANCY DETECTORS; SOLAR PANELS FOR ELECTRICITY GENERATION, NAMELY, SOLAR PANELS FOR THE PRODUCTION OF ELECTRICITY; PHOTO CELLS, NAMELY, PHOTOELECTRIC CELLS AND PHOTO VOLTAIC CELLS; ELECTRONIC DEVICES, NAMELY, ENERGY METERS FOR TRACKING AND MONITORING ENERGY USAGE; SOLAR PHOTOVOLTAIC PANELS,



David J. Kybas

Director of the United States Patent and Trademark Office

Reg. No. 4,097,798 NAMELY, PHOTOVOLTAIC SOLAR PANELS FOR THE PRODUCTION OF ELECTRICITY, IN CLASS 9 (U.S. CLS. 21, 23, 26, 36 AND 38).

FOR: LIGHTING, NAMELY, LIGHTING FIXTURES, LIGHTING TRACKS AND LIGHTING APPARATUS, NAMELY, LIGHTING INSTALLATIONS; LED LIGHTING, NAMELY, LED LIGHTING FIXTURES AND LED LAMPS; LIGHT BULBS; LAMPS; COMPACT FLUORESCENT LAMPS; FLUORESCENT CONVERSION KITS COMPRISING FLUORESCENT LAMPS AND LINEAR CONVERTERS; SOLAR LIGHTING FIXTURES, NAMELY, INDOOR AND OUTDOOR SOLAR POWERED LIGHTING UNITS AND FIXTURES; HEATING APPARATUS, NAMELY, CENTRAL HEATING RADIATORS, HEATING INSTALLATIONS, HEATING BOILERS; ELECTRIC HEATING APPARATUS, NAMELY, ELECTRIC HEATING FANS, ELECTRIC SPACE HEATERS, INFRARED HEATERS USED TO HEAT HOUSEHOLDS AND BUILDINGS, ELECTRIC WALL MOUNTED PANEL HEATERS, ELECTRIC FREESTANDING PANEL HEATERS; UNDER FLOOR HEATING APPARATUS, NAMELY, ELECTRIC UNDER FLOOR HEATERS, ELECTRIC UNDER FLOOR HEATING MATS, ELECTRIC UNDER FLOOR HEATING CABLES, ELECTRIC UNDER FLOOR HEATING FOILS, CARBON FILM MATS FOR ELECTRIC UNDER FLOOR HEATING; SOLAR HEATING APPARATUS, NAMELY, SOLAR THERMAL AIR SYSTEMS FOR HEATING PURPOSES; SOLAR HEAT COLLECTION PANELS, IN CLASS 11 (U.S. CLS. 13, 21, 23, 31 AND 34).

OWNER OF UNITED KINGDOM REG. NO. 2550665, DATED 9-17-2010, EXPIRES 6-16-2020.

NO CLAIM IS MADE TO THE EXCLUSIVE RIGHT TO USE "ENERGY MANAGEMENT SOLUTIONS", APART FROM THE MARK AS SHOWN.

THE MARK CONSISTS OF THE WORDING "E-MATIC", WHERE THE "E" IS ENCIRCLED BY TWO CONCENTRIC ELLIPSES. THE LARGER OF THE TWO ELLIPSES FEATURES A SPHERE. THE WORDING "ENERGY MANAGEMENT SOLUTIONS" IS FEATURED UNDERNEATH "E-MATIC", IN SMALLER TYPE.

SER. NO. 85-073,797, FILED 6-29-2010.

ERIN FALK, EXAMINING ATTORNEY

United States of America

United States Patent and Trademark Office

Clearly b+B

Reg. No. 4,097,799

FLOWERS, INC. (GEORGIA CORPORATION)
325 CLEVELAND ROAD
BOGART, GA 30622

Registered Feb. 14, 2012

Int. Cls.: 28 and 35

FOR: BALLOONS, IN CLASS 28 (U.S. CLS. 22, 23, 38 AND 50).

TRADEMARK

FIRST USE 5-11-2010; IN COMMERCE 5-11-2010.

SERVICE MARK

FOR: DISTRIBUTORSHIP SERVICES IN THE FIELD OF BALLOONS, IN CLASS 35 (U.S. CLS. 100, 101 AND 102).

PRINCIPAL REGISTER

FIRST USE 5-11-2010; IN COMMERCE 5-11-2010.

THE MARK CONSISTS OF STANDARD CHARACTERS WITHOUT CLAIM TO ANY PARTICULAR FONT, STYLE, SIZE, OR COLOR.

OWNER OF U.S. REG. NO. 3,628,860.

SER. NO. 85-074,593, FILED 6-30-2010.

MARK RADEMACHER, EXAMINING ATTORNEY



David J. Kyffers

Director of the United States Patent and Trademark Office

United States of America

United States Patent and Trademark Office

TWISTfest

Reg. No. 4,097,800

FLOWERS, INC. (GEORGIA CORPORATION)
325 CLEVELAND ROAD
BOGART, GA 30622

Registered Feb. 14, 2012

Int. Cl.: 41

FOR: PROVIDING BALLOON SCULPTURE CONTEST EVENTS, IN CLASS 41 (U.S. CLS. 100, 101 AND 107).

SERVICE MARK

FIRST USE 7-31-2007; IN COMMERCE 7-31-2007.

PRINCIPAL REGISTER

THE MARK CONSISTS OF STANDARD CHARACTERS WITHOUT CLAIM TO ANY PARTICULAR FONT, STYLE, SIZE, OR COLOR.

SER. NO. 85-074,604, FILED 6-30-2010.

MARK RADEMACHER, EXAMINING ATTORNEY



David J. Kybas

Director of the United States Patent and Trademark Office

United States of America

United States Patent and Trademark Office

ENDUROCID

Reg. No. 4,097,801

Registered Feb. 14, 2012

Int. Cls.: 1, 5 and 24

TRADEMARK

PRINCIPAL REGISTER

BIO TECHNICS LIMITED (UNITED KINGDOM PRIVATE LIMITED COMPANY)
LINTON BUSINESS PARK
GOURDON, ABERDEENSHIRE, UNITED KINGDOM DD100NH

FOR: CHEMICAL PREPARATIONS FOR USE IN INDUSTRY; CHEMICAL PREPARATIONS FOR SCIENTIFIC PURPOSES; CHEMICAL PREPARATIONS FOR IMPREGNATING, BINDING, COATING OR TREATING OF TEXTILES, NON-WOVENS AND FABRICS; CHEMICAL FORMULATIONS CONTAINING BIGUANIDE POLYMERS, QUATERNARY AMMONIUM SALTS, ISOTHIAZOLONE COMPOUNDS AND/OR SILICONES; CHEMICAL PREPARATIONS FOR CLEANING OR STERILISING PURPOSES IN THE FOOD PROCESSING INDUSTRY; BIOLOGICAL PREPARATIONS, OTHER THAN FOR MEDICAL OR VETERINARY USE, NAMELY, BIOLOGICAL SOLUTIONS OR POWDERS COMPRISED OF BIOLOGICALLY ACTIVE ENZYMES AND MICROORGANISMS FOR DIGESTING ORGANIC WASTE; DETERGENTS FOR USE IN INDUSTRIAL PROCESSES; ODOR IMPROVING AGENTS, NAMELY, ODOR ELIMINATING TABLETS OR POWDERS COMPRISED OF MICROORGANISMS AND ENZYMES TO BE DISSOLVED IN WATER AND USED TO DIGEST ORGANIC WASTE, IN CLASS 1 (U.S. CLS. 1, 5, 6, 10, 26 AND 46).

FOR: SANITARY PREPARATIONS FOR MEDICAL USE; CHEMICAL REAGENTS FOR MEDICAL OR VETERINARY USE; CHEMICAL PREPARATIONS FOR SANITARY USE; ALL-PURPOSE DISINFECTANTS; ALL-PURPOSE DISINFECTANTS FOR INHIBITING THE GROWTH OF BACTERIA, VIRUSES, SPORES, FUNGI, ALGAE AND/OR MICROBES; DISINFECTANTS FOR HYGIENIC PURPOSES; DISINFECTANTS FOR SANITARY PURPOSES; BIOCIDES; SPORICIDES; BACTERICIDES; FUNGICIDES; VIRUCIDE; ALGICIDES; HERBICIDES; GERMICIDES; ANTISEPTIC PREPARATIONS; STERILIZING PREPARATIONS; DETERGENTS FOR MEDICAL OR VETERINARY USE; SANITARY PREPARATIONS FOR MEDICAL USE CONTAINING BIOCIDES, SPORICIDES, BACTERICIDES, FUNGICIDES, VIRUCIDES, ALGICIDES, HERBICIDES, GERMICIDES, ANTI-MICROBIAL PREPARATIONS AND/OR DISINFECTANT PREPARATIONS; MEDICATED PRE-MOISTENED WIPES FOR MEDICAL OR SURGICAL USE; MEDICATED PRE-MOISTENED WIPES FOR HYGIENIC MEDICAL PURPOSES; MEDICATED PRE-MOISTENED WIPES FOR HYGIENIC SURGICAL PURPOSES; PRE-MOISTENED MEDICATED WIPES; SANITIZING WIPES; MEDICATED PRE-MOISTENED WIPES IMPREGNATED WITH BIOCIDES, SPORICIDES, BACTERICIDES, FUNGICIDES, VIRUCIDES, ALGICIDES, HERBICIDES, GERMICIDES, ANTI-MICROBIAL PREPARATIONS AND/OR DISINFECTANT PREPARATIONS; MEDICATED SKIN CLEANSERS AND WIPES; SKIN SANITIZERS FOR MEDICAL HYGIENE PURPOSES; MEDICAL CLEANSERS OF SKIN AND WOUNDS; HAND WASH, BEING DISINFECTING,



David J. Kyffers

Director of the United States Patent and Trademark Office

Reg. No. 4,097,801 ANTI-MICROBIAL, BIOCIDAL, SPORICIDAL, BACTERICIDAL, FUNGICIDAL, VIRUCIDAL, ALGICIDAL, HERBICIDAL AND/OR GERMICIDAL; PREPARATIONS FOR THE NEUTRALISING OF ODORS FOR USE ON FLOORS, WALLS, CARPETS, TEXTILES, VEHICLE INTERIORS, DRAINS OR TRASH CANS; PREPARATIONS FOR THE NEUTRALISING OF ODORS FOR USE ON VARIOUS SURFACES; ODOR ABSORBING MATERIALS FOR USE ON FLOORS, WALLS, CARPETS, TEXTILES, VEHICLE INTERIORS, DRAINS OR TRASH CANS; ODOR ABSORBING MATERIALS FOR USE ON VARIOUS SURFACES; AIR FRESHENING PREPARATIONS, IN CLASS 5 (U.S. CLS. 6, 18, 44, 46, 51 AND 52).

FOR: NON-WOVEN FABRIC, NAMELY, NON-WOVEN POLYPROPYLENE FABRIC; CURTAIN FABRIC; CURTAINS; CURTAINS MADE OF TEXTILE MATERIAL; FABRIC CURTAINS; CURTAINS MADE OF NON-WOVEN FABRIC; CURTAINS MADE OF PLASTIC; CURTAINS FOR USE IN HOSPITALS; DISPOSABLE CURTAINS: NON-WOVEN DISPOSABLE CURTAINS; NON-WOVEN DISPOSABLE CURTAINS FOR USE IN HOSPITALS; CURTAINS IMPREGNATED WITH, COATED WITH OR TREATED WITH ANTI-MICROBIAL PREPARATIONS, BIOCIDES, SPORICIDES, BACTERICIDES, FUNGICIDES, VIRUCIDES, ALGICIDES, HERBICIDES AND/OR GERMICIDES; NON-WOVEN POLYPROPYLENE FABRIC IMPREGNATED WITH, COATED WITH OR TREATED WITH ANTI-MICROBIAL PREPARATIONS, BIOCIDES, SPORICIDES, BACTERICIDES, FUNGICIDES, VIRUCIDES, ALGICIDES, HERBICIDES AND/OR GERMICIDES; PARTS AND FITTINGS FOR ALL THE AFORESAID GOODS, IN CLASS 24 (U.S. CLS. 42 AND 50).

THE MARK CONSISTS OF STANDARD CHARACTERS WITHOUT CLAIM TO ANY PARTICULAR FONT, STYLE, SIZE, OR COLOR.

PRIORITY CLAIMED UNDER SEC. 44(D) ON ERPN CMNTY TM OFC APPLICATION NO. 9216367, FILED 7-2-2010, REG. NO. 9216367, DATED 12-13-2010, EXPIRES 1-7-2020.

OWNER OF UNITED KINGDOM REG. NO. 2314666, DATED 1-23-2004, EXPIRES 1-23-2014.

SER. NO. 85-076,969, FILED 7-2-2010.

WARREN L. OLANDRIA, EXAMINING ATTORNEY

United States of America

United States Patent and Trademark Office

n.ow
new outdoorwear
www.newoutwear.com



Reg. No. 4,097,802

GABRIEL ABERGEL (FRANCE INDIVIDUAL)
90 BOULEVARD FLANDRIN
PARIS, FRANCE 75016

Registered Feb. 14, 2012

Int. Cl.: 25

FOR: CLOTHES, NAMELY, TROUSERS, PULLOVERS AND SWEATERS, BOXER BRIEFS, PANTIES, BOXER SHORTS, TEE-SHIRTS, SWEAT-SHIRTS, SHIRTS, PARKAS, JACKETS, LEATHER JACKETS, BLOUSONS, POLO SHIRTS, BERMUDA SHORTS, SWIMMING SUITS, SINGLET, SOCKS, HATS, NAMELY, CAPS, SHOES, NAMELY, CASUAL SHOES, BEACH SHOES, TONGUES FOR SHOES AND BOOTS, IN CLASS 25 (U.S. CLS. 22 AND 39).

TRADEMARK

PRINCIPAL REGISTER

PRIORITY CLAIMED UNDER SEC. 44(D) ON FRANCE APPLICATION NO. 103703324, FILED 1-8-2010, REG. NO. 103703324, DATED 1-8-2010, EXPIRES 1-8-2020.

THE COLOR(S) LIGHT BLUE, GREEN, DARK BLUE, ORANGE, PINK, RED, YELLOW, DARK PURPLE AND BLACK IS/ARE CLAIMED AS A FEATURE OF THE MARK.

NO CLAIM IS MADE TO THE EXCLUSIVE RIGHT TO USE "NEW OUTWEAR" AND "WWW.NEWOUTWEAR.COM", APART FROM THE MARK AS SHOWN.

THE MARK CONSISTS OF THE FOLLOWING: THE WORDING "N.O.W NEW OUTWEAR WWW.NEWOUTWEAR.COM" IN LIGHT BLUE NEXT TO THE IMAGE OF 9 SQUARES IN THREE LINES ABOVE EACH OTHER WITH THE SQUARES IN THE TOP LINE BEING LIGHT BLUE, GREEN AND DARK BLUE; THE SQUARES IN THE MIDDLE LINE BEING ORANGE, PINK AND RED; AND THE SQUARES IN THE BOTTOM LINE BEING YELLOW, DARK PURPLE AND BLACK, WITH THE YELLOW SQUARE IN THE THIRD LINE BEING PARTIALLY SET-OFF TO THE LOWER LEFT FROM THE THIRD LINE.

SER. NO. 85-078,504, FILED 7-6-2010.

STEVEN JACKSON, EXAMINING ATTORNEY



David J. Kybas

Director of the United States Patent and Trademark Office

United States of America

United States Patent and Trademark Office

UNCONDITIONAL

Reg. No. 4,097,803

THE WASHINGTON ANIMAL RESCUE LEAGUE. (D.C. NON-PROFIT CORPORATION)
71 OGLETHORPE STREET, NW
WASHINGTON, DC 20011

Registered Feb. 14, 2012

Int. Cl.: 36

FOR: CHARITABLE FUNDRAISING, IN CLASS 36 (U.S. CLS. 100, 101 AND 102).

SERVICE MARK

FIRST USE 6-1-2010; IN COMMERCE 6-1-2010.

PRINCIPAL REGISTER

THE MARK CONSISTS OF STANDARD CHARACTERS WITHOUT CLAIM TO ANY PARTICULAR FONT, STYLE, SIZE, OR COLOR.

SER. NO. 85-078,508, FILED 7-6-2010.

KATHLEEN M. VANSTON, EXAMINING ATTORNEY



David J. Kybas

Director of the United States Patent and Trademark Office

United States of America

United States Patent and Trademark Office

HOT SHOT

Reg. No. 4,097,804

W.C. BRADLEY CO. (GEORGIA CORPORATION)
1017 FRONT AVE.
COLUMBUS, GA 31904

Registered Feb. 14, 2012

Int. Cl.: 11

FOR: UNIVERSAL-FIT IGNITION SYSTEM FOR OUTDOOR GAS GRILLS, IN CLASS 11
(U.S. CLS. 13, 21, 23, 31 AND 34).

TRADEMARK

FIRST USE 7-8-2002; IN COMMERCE 7-8-2002.

PRINCIPAL REGISTER

THE MARK CONSISTS OF STANDARD CHARACTERS WITHOUT CLAIM TO ANY PARTICULAR FONT, STYLE, SIZE, OR COLOR.

SER. NO. 85-079,492, FILED 7-7-2010.

GEOFFREY FOSDICK, EXAMINING ATTORNEY



David J. Kybas

Director of the United States Patent and Trademark Office

United States of America

United States Patent and Trademark Office

COLLAFILM

Reg. No. 4,097,805

Registered Feb. 14, 2012

Int. Cls.: 5 and 42

TRADEMARK

SERVICE MARK

PRINCIPAL REGISTER

INNOCOLL TECHNOLOGIES LIMITED (IRELAND COMPANY)
GALLOWSTOWN
IDA BUSINESS & TECHNOLOGY PARK
CO. ROSCOMMON, IRELAND

FOR: PHARMACEUTICAL, VETERINARY AND SANITARY PREPARATIONS FOR THE TREATMENT OF WOUNDS, BURNS AND SURGERY ON THE HUMAN AND NON-HUMAN BODY; MEDICATED AND NON-MEDICATED DRESSINGS, WADDINGS, FOAMS, FILMS, MEMBRANES, SPONGES, MEDICATED COMPRESSORS, BANDAGES AND FOILS; CREAMS, LOTIONS AND GELS MADE OF OR INCORPORATING COLLAGEN FOR TOPICAL USE; SURGICAL IMPLANTS COMPRISING ORGANIC MATERIAL, NAMELY, COLLAGEN FOR USE IN SKIN REPAIR AND SKIN IMPROVEMENT; SURGICAL AND MEDICAL IMPLANT DEVICES COMPRISING ORGANIC MATERIAL COMPOSED OF COLLAGEN, IN CLASS 5 (U.S. CLS. 6, 18, 44, 46, 51 AND 52).

FOR: MEDICAL AND SCIENTIFIC RESEARCH SERVICES IN THE FIELD OF COLLAGEN BASED DRUG DELIVERY SYSTEMS; MEDICAL AND SCIENTIFIC RESEARCH SERVICES FOR MEDICAL, VETERINARY AND PHARMACEUTICAL PURPOSES, SCIENTIFIC RESEARCH, NAMELY, CHEMISTRY AND BIOCHEMISTRY, CONSULTANCY SERVICES RELATING TO SCIENTIFIC RESEARCH INTO THE DEVELOPMENT OF MEDICAL AND SURGICAL PRODUCTS, CONTRACT SCIENTIFIC RESEARCH SERVICES, SCIENTIFIC RESEARCH AND DEVELOPMENT OF MEDICAL AND SURGICAL PRODUCTS FOR OTHERS, LABORATORY SCIENTIFIC RESEARCH SERVICES RELATING TO MEDICAL AND SURGICAL PRODUCTS, INDUSTRIAL ANALYSIS SERVICES, NAMELY, COLLAGEN BASED ANALYSIS SERVICES FOR MEDICAL, VETERINARY AND PHARMACEUTICAL PURPOSES, IN CLASS 42 (U.S. CLS. 100 AND 101).

THE MARK CONSISTS OF STANDARD CHARACTERS WITHOUT CLAIM TO ANY PARTICULAR FONT, STYLE, SIZE, OR COLOR.

OWNER OF ERPN CMNTY TM OFC REG. NO. 009233404, DATED 12-22-2010, EXPIRES 7-8-2020.

SER. NO. 85-080,526, FILED 7-8-2010.

JOHN WILKE, EXAMINING ATTORNEY



David J. Kyfos

Director of the United States Patent and Trademark Office

United States of America

United States Patent and Trademark Office

SUMIFRU

Reg. No. 4,097,806

Registered Feb. 14, 2012

**Int. Cls.: 29, 30, 31 and
32**

SUMIFRU SINGAPORE PTE. LTD. (SINGAPORE PROPRIETARY LIMITED COMPANY (P/L OR PTY. LTD.))
101 THOMSON ROAD
#09-03 UNITED SQUARE
307591, SINGAPORE

FOR: CANNED FRUITS; FROZEN FRUITS; DRIED FRUITS; PRESERVED FRUITS; FRUIT CHIPS; FRUIT JELLIES; FRUIT JAMS, IN CLASS 29 (U.S. CL. 46).

TRADEMARK

FOR: FRUIT JELLIES; FRUIT ICE CREAM; FLAVOURINGS MADE FROM FRUITS, IN CLASS 30 (U.S. CL. 46).

PRINCIPAL REGISTER

FOR: FRESH FRUITS, IN CLASS 31 (U.S. CLS. 1 AND 46).

FOR: FRUIT JUICES; FRUIT DRINKS, IN CLASS 32 (U.S. CLS. 45, 46 AND 48).

THE MARK CONSISTS OF STANDARD CHARACTERS WITHOUT CLAIM TO ANY PARTICULAR FONT, STYLE, SIZE, OR COLOR.

PRIORITY CLAIMED UNDER SEC. 44(D) ON SINGAPORE APPLICATION NO. T1006051E, FILED 5-13-2010, REG. NO. T1006051E, DATED 5-13-2010, EXPIRES 5-13-2020.

SER. NO. 85-081,133, FILED 7-9-2010.

BRENDAN REGAN, EXAMINING ATTORNEY



David J. Kybas

Director of the United States Patent and Trademark Office

United States of America

United States Patent and Trademark Office

WWW.SHIPLEYWINS.COM

Reg. No. 4,097,807

Registered Feb. 14, 2012

Int. Cl.: 35

SERVICE MARK

PRINCIPAL REGISTER

SHIPLEY BUSINESS DEVELOPMENT SERVICES, INC. (UTAH CORPORATION), DBA
SHIPLEY ASSOCIATES
532 NORTH 900 WEST
KAYSVILLE, UT 84037

FOR: BUSINESS CONSULTING AND INFORMATION SERVICES; CONSULTING SERVICES
IN THE FIELD OF MARKETING OF EDUCATIONAL TRAINING; MANAGEMENT AND
BUSINESS CONSULTING SERVICES IN THE FIELD OF BUSINESS DEVELOPMENT,
PROPOSAL DEVELOPMENT, CAPTURE PLANNING, PROPOSAL WRITING, COMMUNIC-
ATION SKILLS, AND PROCESS IMPROVEMENT; PROFESSIONAL BUSINESS CONSULT-
ING, IN CLASS 35 (U.S. CLS. 100, 101 AND 102).

FIRST USE 11-26-1997; IN COMMERCE 11-26-1997.

THE MARK CONSISTS OF STANDARD CHARACTERS WITHOUT CLAIM TO ANY PAR-
TICULAR FONT, STYLE, SIZE, OR COLOR.

SER. NO. 85-081,923, FILED 7-10-2010.

ESTHER A. BORSUK, EXAMINING ATTORNEY



David J. Kyffers

Director of the United States Patent and Trademark Office

United States of America

United States Patent and Trademark Office

CLOTHES FOR THE REGENERATION

Reg. No. 4,097,808

REGENERATION PARTNERS, LLC (DELAWARE LIMITED LIABILITY COMPANY)
135 WEST 26TH STREET (10TH FLOOR)

Registered Feb. 14, 2012

NEW YORK, NY 10010

Int. Cl.: 25

FOR: SHIRTS; SWEAT SHIRTS, IN CLASS 25 (U.S. CLS. 22 AND 39).

TRADEMARK

FIRST USE 9-1-2007; IN COMMERCE 9-1-2007.

PRINCIPAL REGISTER

THE MARK CONSISTS OF STANDARD CHARACTERS WITHOUT CLAIM TO ANY PARTICULAR FONT, STYLE, SIZE, OR COLOR.

NO CLAIM IS MADE TO THE EXCLUSIVE RIGHT TO USE "CLOTHES", APART FROM THE MARK AS SHOWN.

SER. NO. 85-083,908, FILED 7-13-2010.

TINA L. SNAPP, EXAMINING ATTORNEY



David J. Kyffers

Director of the United States Patent and Trademark Office

United States of America

United States Patent and Trademark Office

Physicians Without Value

Reg. No. 4,097,809

PAUL FANNY (UNITED STATES INDIVIDUAL)
34 MAMMOTH ROAD, UNIT 24
HOOKSETT, NH 03106

Registered Feb. 14, 2012

Int. Cl.: 41

FOR: EDUCATIONAL SERVICES IN THE SPIRITUAL FIELD, NAMELY, PLANNING AND CONDUCTING CLASSES AND COURSES IN SPIRITUAL AND NATURAL HEALTH, HOLISTIC NUTRITION, HOLISTIC HEALING, AND DISTRIBUTION OF COURSE MATERIAL IN CONNECTION THEREWITH, IN CLASS 41 (U.S. CLS. 100, 101 AND 107).

SERVICE MARK

PRINCIPAL REGISTER

FIRST USE 7-12-2010; IN COMMERCE 7-16-2010.

THE MARK CONSISTS OF STANDARD CHARACTERS WITHOUT CLAIM TO ANY PARTICULAR FONT, STYLE, SIZE, OR COLOR.

SER. NO. 85-086,352, FILED 7-16-2010.

RON FAIRBANKS, EXAMINING ATTORNEY



David J. Kyffers

Director of the United States Patent and Trademark Office

United States of America
United States Patent and Trademark Office

DILECT

Reg. No. 4,097,810

Registered Feb. 14, 2012

Int. Cl.: 9

TRADEMARK

PRINCIPAL REGISTER

MITSUBISHI ELECTRIC CORPORATION (JAPAN CORPORATION)
7-3 MARUNOUCHI 2-CHOME
CHIYODA-KU, TOKYO, JAPAN

FOR: PRINTED CIRCUITS; PRINTED WIRING BOARDS, IN CLASS 9 (U.S. CLS. 21, 23, 26, 36 AND 38).

THE MARK CONSISTS OF STANDARD CHARACTERS WITHOUT CLAIM TO ANY PARTICULAR FONT, STYLE, SIZE, OR COLOR.

OWNER OF JAPAN REG. NO. 5340393, DATED 7-23-2010, EXPIRES 7-23-2020.

SER. NO. 85-086,758, FILED 7-16-2010.

KELLY TRUSILO, EXAMINING ATTORNEY



David J. Kyffers

Director of the United States Patent and Trademark Office

United States of America

United States Patent and Trademark Office

BUSRATES.COM

Reg. No. 4,097,811

Registered Feb. 14, 2012

Int. Cl.: 39

SERVICE MARK

PRINCIPAL REGISTER

UNITED MOTORCOACH ASSOCIATION (D.C. CORPORATION)
4TH FLOOR
113 SOUTH WEST STREET
ALEXANDRIA, VA 22314

FOR: BUS, VAN, LIMOUSINE, TROLLEY, MINIBUS AND COACH CHARTERING SERVICES;
INFORMATION ON CHARTERING BUSES, VANS, LIMOUSINES, TROLLEYS, MINIBUSES
AND COACHES , IN CLASS 39 (U.S. CLS. 100 AND 105).

FIRST USE 1-7-2004; IN COMMERCE 11-1-2004.

THE MARK CONSISTS OF STANDARD CHARACTERS WITHOUT CLAIM TO ANY PAR-
TICULAR FONT, STYLE, SIZE, OR COLOR.

NO CLAIM IS MADE TO THE EXCLUSIVE RIGHT TO USE ".COM", APART FROM THE
MARK AS SHOWN.

SEC. 2(F).

SER. NO. 85-088,120, FILED 7-19-2010.

LESLIE RICHARDS, EXAMINING ATTORNEY



David J. Kyfos

Director of the United States Patent and Trademark Office

United States of America

United States Patent and Trademark Office

PERFORMANCE IN MOTION

Reg. No. 4,097,812

PUTNAM INVESTMENTS, LLC (DELAWARE LIMITED LIABILITY COMPANY)
ONE POST OFFICE SQUARE
BOSTON, MA 02109

Registered Feb. 14, 2012

Int. Cls.: 36 and 41

FOR: FINANCIAL SPONSORSHIP OF ENTERTAINMENT, CULTURAL, AND SPORTING EVENTS; CHARITABLE SERVICES, NAMELY, FINANCIAL SPONSORSHIP OF ENTERTAINMENT, CULTURAL, AND SPORTING EVENTS, IN CLASS 36 (U.S. CLS. 100, 101 AND 102).

SERVICE MARK

PRINCIPAL REGISTER

FIRST USE 7-21-2010; IN COMMERCE 9-10-2010.

FOR: ENTERTAINMENT SERVICES, NAMELY, ARRANGING COMMUNITY SPORTING, CULTURAL, AND ENTERTAINMENT COMPETITIONS, NAMELY, HORSE SHOW AND EQUESTRIAN COMPETITIONS, ALPINE SKIING COMPETITIONS, AND SNOWBOARDING COMPETITIONS FOR CHARITABLE FUNDRAISING PURPOSES IN WHICH PRIZES ARE AWARDED; ARRANGING OF EXHIBITIONS FOR CULTURAL OR ENTERTAINMENT OR SPORTING PURPOSES; ORGANIZATION OF COMMUNITY EVENTS, NAMELY, SPORTING EVENTS, CULTURAL EVENTS, AND SPORT COMPETITIONS, NAMELY, HORSE SHOW AND EQUESTRIAN COMPETITIONS, ALPINE SKIING COMPETITIONS, AND SNOWBOARDING COMPETITIONS; ENTERTAINMENT EVENTS IN THE NATURE OF LIVE VISUAL AND AUDIO PERFORMANCES, NAMELY, DRAMA PLAYS, BALLET AND DANCE PERFORMANCES, ORCHESTRA PERFORMANCES, ATHLETIC EXHIBITIONS, LIVE MUSICAL GROUP PERFORMANCES, COMEDY SHOWS, MUSICAL VARIETY SHOWS, IN CLASS 41 (U.S. CLS. 100, 101 AND 107).

FIRST USE 7-21-2010; IN COMMERCE 9-10-2010.

THE MARK CONSISTS OF STANDARD CHARACTERS WITHOUT CLAIM TO ANY PARTICULAR FONT, STYLE, SIZE, OR COLOR.

SER. NO. 85-089,176, FILED 7-21-2010.

LINDSEY RUBIN, EXAMINING ATTORNEY



David J. Kybas

Director of the United States Patent and Trademark Office

United States of America

United States Patent and Trademark Office



Reg. No. 4,097,813

Registered Feb. 14, 2012

Int. Cl.: 3

TRADEMARK

PRINCIPAL REGISTER

PHILOSOPHY, INC. (ARIZONA CORPORATION)
3809 EAST WATKINS STREET
PHOENIX, AZ 85034

FOR: BAR SOAP; BODY POWDER; BODY SCRUB; BODY SPRAYS; COSMETIC FACIAL BLOTTING PAPERS; COSMETIC PADS; COSMETIC PENCILS; COSMETICS; DEPILATORIES; FACIAL CLEANSERS; FACIAL SCRUBS; FRAGRANCES; HAIR CARE PREPARATIONS; NAIL CARE PREPARATIONS; NON-MEDICATED BATH PREPARATIONS; NON-MEDICATED LIP CARE PREPARATIONS; NON-MEDICATED SKIN CARE PREPARATIONS; NON-MEDICATED SUN CARE PREPARATIONS; NON-MEDICATED TOILETRIES; PERSONAL DEODORANTS; SCENTED ROOM SPRAYS; SHAVING PREPARATIONS, IN CLASS 3 (U.S. CLS. 1, 4, 6, 50, 51 AND 52).

FIRST USE 6-0-1996; IN COMMERCE 6-0-1996.

THE NAME(S), PORTRAIT(S), AND/OR SIGNATURE(S) SHOWN IN THE MARK IDENTIFIES "MICHELE CARLINO", WHOSE CONSENT(S) TO REGISTER IS MADE OF RECORD.

THE MARK CONSISTS OF AN IMAGE OF A DARK-HAIRED, DARK-EYED LITTLE GIRL WEARING A FLUFFY SWEATER, DARK SKIRT, AND LIGHT SHOES AND SOCKS; THE GIRL STANDS AT A SLIGHT ANGLE, BENDING FORWARD OVER HER CLASPED HANDS, SMILING, AND GAZING STRAIGHT AHEAD.

SER. NO. 85-089,940, FILED 7-21-2010.

CHRISTINE COOPER, EXAMINING ATTORNEY



David J. Kyffers

Director of the United States Patent and Trademark Office

United States of America

United States Patent and Trademark Office

DS Pharma Animal Health

Reg. No. 4,097,814

Registered Feb. 14, 2012

Int. Cls.: 5 and 31

TRADEMARK

PRINCIPAL REGISTER

DAINIPPON SUMITOMO PHARMA CO., LTD. (JAPAN CORPORATION)
6-8, DOSHOMACHI 2-CHOME, CHUO-KU
OSAKA-SHI, OSAKA, JAPAN

FOR: VETERINARY PREPARATIONS, NAMELY, ANALGESICS, GENERAL ANESTHETICS, TOPICAL ANESTHETICS, VACCINES, PESTICIDES, ANIMAL REPELLENTS, INSECT REPELLENTS, PARASITICIDES AND MEDICAL DIAGNOSTIC REAGENTS; VETERINARY PREPARATIONS FOR THE TREATMENT OF INFECTIOUS DISEASES, DIGESTIVE DISEASES, CARDIOVASCULAR DISEASE, INFLAMMATORY DISEASES, EYE DISEASES, SKIN DISEASES, OTOLARYNGOLOGIC DISEASES AND ARTHRITIS, IN CLASS 5 (U.S. CLS. 6, 18, 44, 46, 51 AND 52).

FOR: ANIMAL FOODSTUFFS; ADDITIVES TO ANIMAL FEED, NOT FOR MEDICAL PURPOSES, IN CLASS 31 (U.S. CLS. 1 AND 46).

THE MARK CONSISTS OF STANDARD CHARACTERS WITHOUT CLAIM TO ANY PARTICULAR FONT, STYLE, SIZE, OR COLOR.

PRIORITY CLAIMED UNDER SEC. 44(D) ON JAPAN APPLICATION NO. 2010-005844, FILED 1-28-2010, REG. NO. 5344044, DATED 8-26-2010, EXPIRES 8-26-2020.

NO CLAIM IS MADE TO THE EXCLUSIVE RIGHT TO USE "PHARMA ANIMAL HEALTH", APART FROM THE MARK AS SHOWN.

SER. NO. 85-091,491, FILED 7-23-2010.

BENJAMIN OKEKE, EXAMINING ATTORNEY



David J. Kyros

Director of the United States Patent and Trademark Office

United States of America

United States Patent and Trademark Office

ORA PERSONALITY PROFILER

Reg. No. 4,097,815

GOLDEN, LLC (FLORIDA LIMITED LIABILITY COMPANY)
8422 SEDONIA CIRCLE
FORT MYERS, FL 33967

Registered Feb. 14, 2012

Int. Cl.: 44

FOR: PSYCHOLOGICAL ASSESSMENT SERVICES, NAMELY, PROVIDING ONLINE PERSONALITY ASSESSMENTS IN THE FIELD OF EDUCATIONAL AND CAREER PLANNING, LEADERSHIP AND PROFESSIONAL DEVELOPMENT FOR PSYCHOLOGICAL PURPOSES, IN CLASS 44 (U.S. CLS. 100 AND 101).

SERVICE MARK

PRINCIPAL REGISTER

FIRST USE 10-16-2000; IN COMMERCE 10-16-2000.

THE MARK CONSISTS OF STANDARD CHARACTERS WITHOUT CLAIM TO ANY PARTICULAR FONT, STYLE, SIZE, OR COLOR.

NO CLAIM IS MADE TO THE EXCLUSIVE RIGHT TO USE "PERSONALITY PROFILER", APART FROM THE MARK AS SHOWN.

SER. NO. 85-092,920, FILED 7-26-2010.

SETH A. RAPPAPORT, EXAMINING ATTORNEY



David J. Kyffers

Director of the United States Patent and Trademark Office

United States of America

United States Patent and Trademark Office

MENTOR MYRIDE

Reg. No. 4,097,816

Registered Feb. 14, 2012

Int. Cl.: 42

SERVICE MARK

PRINCIPAL REGISTER

MENTOR ENGINEERING INC. (CANADA CORPORATION)
10, 2175 29TH STREET N.E.
CALGARY, ALBERTA, CANADA T1Y7H8

FOR: PROVIDING ON-LINE INTERACTIVE ACCESS TO A WEBSITE FOR REAL TIME BUS LOCATIONS, DEPARTURES, TRIP PLANNING AND TRIP ROUTING; PROVIDING INFORMATION BY MEANS OF AN INTERACTIVE ON-LINE WEBSITE ON A GLOBAL COMPUTER NETWORK IN THE FIELD OF BUS TRANSPORTATION, IN CLASS 42 (U.S. CLS. 100 AND 101).

THE MARK CONSISTS OF STANDARD CHARACTERS WITHOUT CLAIM TO ANY PARTICULAR FONT, STYLE, SIZE, OR COLOR.

PRIORITY CLAIMED UNDER SEC. 44(D) ON CANADA APPLICATION NO. 1489549, FILED 7-21-2010, REG. NO. TMA803123, DATED 7-28-2011, EXPIRES 7-28-2026.

SER. NO. 85-093,744, FILED 7-27-2010.

ROSELLE HERRERA, EXAMINING ATTORNEY



David J. Kybas

Director of the United States Patent and Trademark Office

United States of America

United States Patent and Trademark Office

ECOLAB

Reg. No. 4,097,817

Registered Feb. 14, 2012

Int. Cl.: 24

TRADEMARK

PRINCIPAL REGISTER

ECOLAB USA INC. (DELAWARE CORPORATION)
ESC-F7610
370 WABASHA STREET NORTH
SAINT PAUL, MN 55102

FOR: DISH MACHINE CURTAINS, NAMELY, SPLASH CURTAINS FOR DISH WASHING AND WARE WASHING MACHINES FOR COMMERCIAL, INSTITUTIONAL, AND INDUSTRIAL USE; OVEN MITTS; HAND TOWELS; WOVEN WATER SOLUBLE FABRICS, NAMELY, A WATER-SOLUBLE BI-LAMINATE MATERIAL HAVING A LAYER OF WATER-SOLUBLE NONWOVEN FABRIC FORMED OF POLYVINYL ALCOHOL FIBERS BONDED TO A LAYER OF WATER-SOLUBLE POLYVINYL ALCOHOL FILM, FOR USE IN FURTHER MANUFACTURING OF INDUSTRIAL OR NUCLEAR PRODUCTS, NAMELY, EQUIPMENT COVERS, MACHINERY COVERS, AND BUILDING STRUCTURE COVERS; WOVEN AND NON-WOVEN FABRICS, AND WOVEN FABRIC AND FILM COMPOSITES COMPOSED PRIMARILY OF FABRIC FOR USE IN FURTHER MANUFACTURING OF INDUSTRIAL OR NUCLEAR PRODUCTS, NAMELY, EQUIPMENT COVERS, MACHINERY COVERS, AND BUILDING STRUCTURE COVERS; WOVEN AND NON-WOVEN FABRICS, FILMS, AND FABRIC AND FILM COMPOSITES COMPOSED PRIMARILY OF FABRIC FOR USE IN COVERING AND PROTECTING SENSITIVE EQUIPMENT AND PACKAGING FROM CONTAMINATES; WOVEN AND NON-WOVEN HAND TOWELS; WOVEN AND NON-WOVEN FABRICS, FILMS, AND FABRIC AND FILM COMPOSITES FOR USE IN THE MANUFACTURE OF CLOTHING, NAMELY, GLOVES AND GLOVE LINERS, WOVEN AND NON-WOVEN INDUSTRIAL GOWNS, COVERALLS, HEAD COVERS, HARD HAT COVERS, HOODS, LAB COATS, T-SHIRTS, DEGRADABLE PLASTIC UNDERGARMENTS, BOOTIES, AND BOOT LINERS, IN CLASS 24 (U.S. CLS. 42 AND 50).



FIRST USE 7-9-1997; IN COMMERCE 7-9-1997.

THE MARK CONSISTS OF STANDARD CHARACTERS WITHOUT CLAIM TO ANY PARTICULAR FONT, STYLE, SIZE, OR COLOR.

OWNER OF U.S. REG. NOS. 1,497,423, 1,538,458 AND OTHERS.

SER. NO. 85-094,673, FILED 7-28-2010.

JIM RINGLE, EXAMINING ATTORNEY

David J. Kyffers

Director of the United States Patent and Trademark Office

United States of America

United States Patent and Trademark Office

THE NATIONAL DISABILITY ADVOCATES

Reg. No. 4,097,818

Registered Feb. 14, 2012

Int. Cl.: 45

SERVICE MARK

PRINCIPAL REGISTER

BINDER & BINDER - THE NATIONAL SOCIAL SECURITY DISABILITY ADVOCATES LLC
(DELAWARE LIMITED LIABILITY COMPANY)
300 RABRO DRIVE EAST
HAUPPAUGE, NY 11788

FOR: LEGAL, PARALEGAL, AND NON-ATTORNEY REPRESENTATIVE ADVOCACY
SERVICES FOR CLAIMANTS OF GOVERNMENT DISABILITY BENEFITS, IN CLASS 45
(U.S. CLS. 100 AND 101).

FIRST USE 5-27-2010; IN COMMERCE 5-27-2010.

THE MARK CONSISTS OF STANDARD CHARACTERS WITHOUT CLAIM TO ANY PAR-
TICULAR FONT, STYLE, SIZE, OR COLOR.

OWNER OF U.S. REG. NOS. 2,037,672 AND 3,838,231.

NO CLAIM IS MADE TO THE EXCLUSIVE RIGHT TO USE "DISABILITY ADVOCATES",
APART FROM THE MARK AS SHOWN.

SEC. 2(F).

SER. NO. 85-095,615, FILED 7-29-2010.

BENJAMIN OKEKE, EXAMINING ATTORNEY



David J. Kybas

Director of the United States Patent and Trademark Office

United States of America

United States Patent and Trademark Office

Sleep Design

Reg. No. 4,097,819

Registered Feb. 14, 2012

Int. Cls.: 10 and 44

TRADEMARK

SERVICE MARK

PRINCIPAL REGISTER

OMRON HEALTHCARE CO., LTD. (JAPAN CORPORATION)
24, YAMANOUCHI YAMANOSHITA-CHO
UKYO-KU, KYOTO-SHI
KYOTO 615-0084, JAPAN

FOR: MEDICAL SLEEP ANALYZER, NAMELY, A DEVICE FOR RECORDING DISTURBANCES WHILE ASLEEP AND ANALYZING ONE'S SLEEP PATTERNS, FOR MONITORING SLEEP CONDITIONS, AND/OR FOR MEASURING SLEEPING TIME BY MEASURING MOVEMENT OF ONE'S CHEST, CHANGE OF POSITION AND SNORE; MEDICAL APPARATUS AND INSTRUMENTS, NAMELY, REMOTE DATA COLLECTING APPARATUS AND INSTRUMENTS FOR USE IN SLEEPING DISORDER ANALYSIS, IN CLASS 10 (U.S. CLS. 26, 39 AND 44).

FOR: HEALTH CARE SERVICES, NAMELY, COLLECTING DATA ON ONE'S SLEEP PATTERN AND ANALYZING THE SAME FOR TREATMENT AND DIAGNOSTIC PURPOSES; HEALTH AND MEDICAL SCREENING SERVICES IN THE FIELD OF SLEEPING DISORDERS; HEALTHCARE SERVICES, NAMELY, TREATMENT OF PATIENTS WITH SLEEPING DISORDERS; PROVIDING HEALTH AND MEDICAL INFORMATION, IN CLASS 44 (U.S. CLS. 100 AND 101).

THE MARK CONSISTS OF STANDARD CHARACTERS WITHOUT CLAIM TO ANY PARTICULAR FONT, STYLE, SIZE, OR COLOR.

PRIORITY CLAIMED UNDER SEC. 44(D) ON JAPAN APPLICATION NO. 2010-031466, FILED 4-20-2010, REG. NO. 5382990, DATED 1-14-2011, EXPIRES 1-14-2021.

NO CLAIM IS MADE TO THE EXCLUSIVE RIGHT TO USE "SLEEP" , APART FROM THE MARK AS SHOWN.

SER. NO. 85-095,797, FILED 7-29-2010.

LINDA ORNDORFF, EXAMINING ATTORNEY



David J. Kyffers

Director of the United States Patent and Trademark Office

United States of America

United States Patent and Trademark Office



Reg. No. 4,097,820

CASH ON TIME S.A.R.L. (LUXEMBOURG LIMITED LIABILITY COMPANY)

Registered Feb. 14, 2012

1, RUE NICOLAS SIMMER
L-2538, LUXEMBOURG

Int. Cl.: 9

FOR: COMPUTER SOFTWARE FOR USE IN THE AUTOMATION AND OPTIMIZATION OF COLLECTION OF ACCOUNT RECEIVABLE PROCESSES, TO PROVIDE CASH FLOW IMPROVEMENT, IN CLASS 9 (U.S. CLS. 21, 23, 26, 36 AND 38).

TRADEMARK

FIRST USE 6-29-2010; IN COMMERCE 6-29-2010.

PRINCIPAL REGISTER

THE MARK CONSISTS OF THE WORDING "CASHONTIME" PRECEDED BY THREE RECTANGULAR SHAPES ONE ABOVE THE OTHER.

SER. NO. 85-095,992, FILED 7-29-2010.

LOURDES AYALA, EXAMINING ATTORNEY



David J. Kybas

Director of the United States Patent and Trademark Office

United States of America

United States Patent and Trademark Office



Reg. No. 4,097,821

Registered Feb. 14, 2012

Int. Cl.: 21

TRADEMARK

PRINCIPAL REGISTER

COBB, JAMES W. (UNITED STATES INDIVIDUAL), DBA BOOTSTER
70 SOUTH BROADWAY
TARRYTOWN, NY 10591

FOR: SHOE HORNS, IN CLASS 21 (U.S. CLS. 2, 13, 23, 29, 30, 33, 40 AND 50).

FIRST USE 11-23-2009; IN COMMERCE 11-23-2009.

NO CLAIM IS MADE TO THE EXCLUSIVE RIGHT TO USE "BOOTS ON EASY", "BOOTSTER@OPTIMUM.NET" AND "TARRYTOWN, NY 10591", APART FROM THE MARK AS SHOWN.

THE COLOR(S) RED, BLUE, YELLOW AND BLACK IS/ARE CLAIMED AS A FEATURE OF THE MARK.

THE MARK CONSISTS OF SIX CONCENTRIC OVALS WITH THE STYLIZED PHRASE "BOOTS ON EASY" ABOVE THE STYLIZED TERM "BOOTSTER" ABOVE THE STYLIZED EMAIL ADDRESS "BOOTSTER@OPTIMUM.NET" ABOVE THE STYLIZED PHRASE "TARRYTOWN, NY 10591" ALL DISPLAYED IN THE CENTER OVAL; THE SIX CONCENTRIC OVALS APPEAR IN THE COLORS BLACK, YELLOW, RED, BLUE, RED AND YELLOW FROM THE OUTERMOST OVAL TO THE CENTER; THE COLOR RED ALSO APPEARS IN THE STYLIZED TERM "BOOTSTER"; THE COLOR BLUE ALSO APPEARS IN THE STYLIZED PHRASE "BOOTS ON EASY", THE STYLIZED EMAIL ADDRESS "BOOTSTER@OPTIMUM.NET" AND THE STYLIZED PHRASE "TARRYTOWN, NY 10591".

THE WORDING "BOOTSTER" HAS NO MEANING IN A FOREIGN LANGUAGE.

SER. NO. 85-096,434, FILED 7-30-2010.

MYRIAH HABEEB, EXAMINING ATTORNEY



David J. Kybas

Director of the United States Patent and Trademark Office

United States of America

United States Patent and Trademark Office

CUSTOMWOOD

Reg. No. 4,097,822

DAIKEN NEW ZEALAND LIMITED (NEW ZEALAND COMPANY)
UPPER SEFTON RD.

Registered Feb. 14, 2012

ASHLEY, RANGIORA, NEW ZEALAND

Int. Cls.: 19 and 20

FOR: BUILDING MATERIALS MADE WHOLLY OR PREDOMINANTLY OF WOOD, NAMELY, FIBERBOARD; BUILDING MATERIALS MADE WHOLLY OR PREDOMINANTLY OF WOOD, NAMELY, COMPOSITE PANELS COMPOSED PRIMARILY OF NON-METAL MATERIALS, IN CLASS 19 (U.S. CLS. 1, 12, 33 AND 50).

TRADEMARK

PRINCIPAL REGISTER

FOR: WOOD PRODUCTS, NAMELY, FIBERBOARD FOR USE IN FURTHER MANUFACTURE, IN CLASS 20 (U.S. CLS. 2, 13, 22, 25, 32 AND 50).

FIRST USE 3-13-1976; IN COMMERCE 12-31-1993.

THE MARK CONSISTS OF STANDARD CHARACTERS WITHOUT CLAIM TO ANY PARTICULAR FONT, STYLE, SIZE, OR COLOR.

OWNER OF NEW ZEALAND REG. NO. 136762, DATED 6-3-1986, EXPIRES 4-9-2016.

SER. NO. 85-102,604, FILED 8-7-2010.

BRENDAN REGAN, EXAMINING ATTORNEY



David J. Kyjars

Director of the United States Patent and Trademark Office

United States of America

United States Patent and Trademark Office



Reg. No. 4,097,823

DAIKEN NEW ZEALAND LIMITED (NEW ZEALAND COMPANY)
UPPER SEFTON RD.

Registered Feb. 14, 2012

ASHLEY, RANGIORA, NEW ZEALAND

Int. Cls.: 19 and 20

FOR: BUILDING MATERIALS OF TIMBER, NAMELY, FIBERBOARD; BUILDING MATERIALS, NAMELY, COMPOSITE WOODEN PANELS, IN CLASS 19 (U.S. CLS. 1, 12, 33 AND 50).

TRADEMARK

FOR: WOOD PRODUCTS, NAMELY, FIBERBOARD FOR USE IN FURTHER MANUFACTURE, IN CLASS 20 (U.S. CLS. 2, 13, 22, 25, 32 AND 50).

PRINCIPAL REGISTER

FIRST USE 3-13-1976; IN COMMERCE 12-31-1993.

OWNER OF NEW ZEALAND REG. NO. 113173, DATED 10-12-1977, EXPIRES 9-18-2020.

THE MARK CONSISTS OF THE WORD "CUSTOMWOOD" ABOVE WHICH IS A STYLIZED PINE TREE PARTIALLY ENCLOSED IN A CIRCLE.

SER. NO. 85-102,606, FILED 8-7-2010.

BRENDAN REGAN, EXAMINING ATTORNEY



David J. Kyffers

Director of the United States Patent and Trademark Office

United States of America

United States Patent and Trademark Office

BLAST BOX

Reg. No. 4,097,824

Registered Feb. 14, 2012

Int. Cls.: 35 and 38

SERVICE MARK

PRINCIPAL REGISTER

RIVALROO, INC. (TEXAS CORPORATION)
251 O'CONNOR RIDGE BLVD., SUITE 370
IRVING, TX 75038

FOR: ADVERTISING AND ADVERTISEMENT SERVICES; PROVIDING CONSUMER INFORMATION IN THE FIELD OF SPORTS, SPORTING EVENTS AND SPORTS PERSONALITIES; PROVIDING ON-LINE ADVERTISING SPACE FOR OTHERS VIA A GLOBAL COMPUTER NETWORK; PROMOTING THE GOODS AND SERVICES OF OTHERS OVER THE INTERNET; PROMOTING THE GOODS AND SERVICES OF OTHERS BY PROVIDING HYPERTEXT LINKS TO THE WEB SITES OF OTHERS; PROVIDING ON-LINE COMPUTER DATABASES AND ON-LINE SEARCHABLE DATABASES IN THE FIELDS OF NATIONAL AND INTERNATIONAL POLITICS, IN CLASS 35 (U.S. CLS. 100, 101 AND 102).

FIRST USE 9-1-2009; IN COMMERCE 9-1-2009.

FOR: ON-LINE CHAT ROOM SERVICES; PROVIDING ONLINE CHAT ROOMS AND ELECTRONIC BULLETIN BOARDS FOR REGISTERED USERS FOR TRANSMISSION OF MESSAGES AND OPINIONS CONCERNING SPORTS, ATHLETICS, TEAM AFFILIATIONS, SCHOOL AFFILIATIONS, POLITICS, POLITICAL RACES AND/OR OTHER COMPETITIVE SITUATIONS; PROVISION OF ON-LINE FORUMS FOR THE TRANSMISSION OF OPINIONS, NEWS, PHOTOGRAPHIC IMAGES, AUDIO CLIPS AND VIDEO CLIPS RELATING TO SPORTS, ATHLETICS, POLITICS AND/OR OTHER COMPETITIVE SITUATIONS; PROVISION OF ON-LINE FORUMS FOR COMMUNICATIONS ON TOPICS OF SPORTS, ATHLETICS, POLITICS AND/OR OTHER COMPETITIVE SITUATIONS, IN CLASS 38 (U.S. CLS. 100, 101 AND 104).

FIRST USE 9-1-2009; IN COMMERCE 9-1-2009.

THE MARK CONSISTS OF STANDARD CHARACTERS WITHOUT CLAIM TO ANY PARTICULAR FONT, STYLE, SIZE, OR COLOR.

SER. NO. 85-102,727, FILED 8-8-2010.

JOHN DALIER, EXAMINING ATTORNEY



David J. Kyffers

Director of the United States Patent and Trademark Office

United States of America

United States Patent and Trademark Office

PowerSAR

Reg. No. 4,097,825

Registered Feb. 14, 2012

Int. Cls.: 9, 12 and 42

TRADEMARK

SERVICE MARK

PRINCIPAL REGISTER

CONTINENTAL AUTOMOTIVE GMBH (FED REP GERMANY LIMITED LIABILITY COMPANY)
VAHRENWALDER STRABE 9
HANNOVER, FED REP GERMANY 30165

FOR: CHARGERS FOR ELECTRIC BATTERIES; VOLTAGE REGULATORS FOR VEHICLES; AUTOMATIC INDICATORS OF LOW PRESSURE IN VEHICLE TIRES; PRINTED CIRCUITS; SPEED CHECKING APPARATUS FOR VEHICLES; COMPUTER SOFTWARE, RECORDED FOR INTERNAL VEHICLE COMMUNICATION APPLICATIONS, IN CLASS 9 (U.S. CLS. 21, 23, 26, 36 AND 38).

FOR: DRIVING MOTORS FOR LAND VEHICLES; MOTOR BUSES; ELECTRIC LAND VEHICLES, NAMELY, COMMERCIAL AND NONCOMMERCIAL VEHICLES OF ALL KIND, NAMELY, CARS, BUSES, VANS, LORRIES, LIFT TRUCKS, CRAWLERS; MOTOR CARS; AUTOMOBILES; ENGINES FOR LAND VEHICLES; VANS; LORRIES; MOTORCYCLES; MOTORS FOR BICYCLES AND MOTORCYCLES; ELECTRONIC CONTROL APPARATUS FOR AUTOMATIC STEERING OF LAND VEHICLES, NAMELY, CARS, BUSES, VANS, LORRIES, IN CLASS 12 (U.S. CLS. 19, 21, 23, 31, 35 AND 44).

FOR: COMPUTER SOFTWARE CONSULTANCY; COMPUTER SYSTEM DESIGN; COMPUTER SOFTWARE DESIGN; COMPUTER PROGRAMMING; MAINTENANCE OF COMPUTER SOFTWARE, IN CLASS 42 (U.S. CLS. 100 AND 101).

THE MARK CONSISTS OF STANDARD CHARACTERS WITHOUT CLAIM TO ANY PARTICULAR FONT, STYLE, SIZE, OR COLOR.

PRIORITY CLAIMED UNDER SEC. 44(D) ON ERPN CMNTY TM OFC APPLICATION NO. 008907404, FILED 2-24-2010, REG. NO. 008907404, DATED 9-27-2010, EXPIRES 2-24-2020.

SER. NO. 85-106,430, FILED 8-12-2010.

TOBY BULLOFF, EXAMINING ATTORNEY



David J. Kyffers

Director of the United States Patent and Trademark Office

United States of America

United States Patent and Trademark Office

MASTERCOMB

Reg. No. 4,097,826

MONET BEAUTY PRODUCTS LTD. (CANADA CORPORATION)
585 50TH AVE W
VANCOUVER, BC, CANADA V6P1A1

Registered Feb. 14, 2012

Int. Cl.: 21

FOR: HAIR COMBS, IN CLASS 21 (U.S. CLS. 2, 13, 23, 29, 30, 33, 40 AND 50).

TRADEMARK

THE MARK CONSISTS OF STANDARD CHARACTERS WITHOUT CLAIM TO ANY PARTICULAR FONT, STYLE, SIZE, OR COLOR.

PRINCIPAL REGISTER

PRIORITY CLAIMED UNDER SEC. 44(D) ON CANADA APPLICATION NO. 1491800, FILED 8-11-2010, REG. NO. 1491800, DATED 8-10-2010, EXPIRES 8-10-2021.

SER. NO. 85-106,524, FILED 8-12-2010.

C. DIONNE CLYBURN, EXAMINING ATTORNEY



David J. Kyffers

Director of the United States Patent and Trademark Office

United States of America

United States Patent and Trademark Office

cloud
CSA security
alliance

Reg. No. 4,097,827

CLOUD SECURITY ALLIANCE (NEVADA CORPORATION)
2553 CRESCENT ST
FERNDALE, WA 98248

Registered Feb. 14, 2012

Int. Cl.: 35

FOR: PROMOTING THE USE OF THE SECURITY ASSURANCE BEST PRACTICES OF OTHERS IN THE FIELD OF CLOUD COMPUTING, IN CLASS 35 (U.S. CLS. 100, 101 AND 102).

SERVICE MARK

FIRST USE 3-31-2009; IN COMMERCE 3-31-2009.

PRINCIPAL REGISTER

NO CLAIM IS MADE TO THE EXCLUSIVE RIGHT TO USE "CLOUD SECURITY ALLIANCE", APART FROM THE MARK AS SHOWN.

THE MARK CONSISTS OF THE LETTERS "CSA" IN A STYLIZED FORM NEXT TO THE WORDS "CLOUD SECURITY ALLIANCE".

SER. NO. 85-109,211, FILED 8-17-2010.

HEATHER THOMPSON, EXAMINING ATTORNEY



David J. Kyffers

Director of the United States Patent and Trademark Office

United States of America

United States Patent and Trademark Office

Solutions in the Cloud Delivered as a Service.

Reg. No. 4,097,828

Registered Feb. 14, 2012

Int. Cl.: 42

SERVICE MARK

PRINCIPAL REGISTER

CD ASSOCIATES, LLC (SOUTH CAROLINA LIMITED LIABILITY COMPANY), DBA CARD
DOWN SOFTWARE
1401 MAIN STREET, STE 700
COLUMBIA, SC 29201

FOR: TECHNICAL SUPPORT SERVICES, NAMELY, REMOTE ADMINISTRATION AND
MANAGEMENT OF IN-HOUSE AND HOSTED DATACENTER DEVICES, DATABASES
AND SOFTWARE APPLICATIONS, IN CLASS 42 (U.S. CLS. 100 AND 101).

FIRST USE 2-16-2010; IN COMMERCE 2-16-2010.

THE MARK CONSISTS OF STANDARD CHARACTERS WITHOUT CLAIM TO ANY PAR-
TICULAR FONT, STYLE, SIZE, OR COLOR.

SER. NO. 85-110,495, FILED 8-18-2010.

CHRISIE B. KING, EXAMINING ATTORNEY



David J. Kyffers

Director of the United States Patent and Trademark Office

United States of America

United States Patent and Trademark Office

Card Down Software

Reg. No. 4,097,829

Registered Feb. 14, 2012

Int. Cl.: 42

SERVICE MARK

PRINCIPAL REGISTER

CD ASSOCIATES, LLC (SOUTH CAROLINA LIMITED LIABILITY COMPANY), DBA CARD
DOWN SOFTWARE
1401 MAIN STREET, STE 700
COLUMBIA, SC 29201

FOR: TECHNICAL SUPPORT SERVICES, NAMELY, REMOTE ADMINISTRATION AND
MANAGEMENT OF IN-HOUSE AND HOSTED DATACENTER DEVICES, DATABASES
AND SOFTWARE APPLICATIONS, IN CLASS 42 (U.S. CLS. 100 AND 101).

FIRST USE 2-16-2010; IN COMMERCE 2-16-2010.

THE MARK CONSISTS OF STANDARD CHARACTERS WITHOUT CLAIM TO ANY PAR-
TICULAR FONT, STYLE, SIZE, OR COLOR.

NO CLAIM IS MADE TO THE EXCLUSIVE RIGHT TO USE "SOFTWARE", APART FROM
THE MARK AS SHOWN.

SER. NO. 85-110,526, FILED 8-18-2010.

CHRISIE B. KING, EXAMINING ATTORNEY



David J. Kyffers

Director of the United States Patent and Trademark Office

United States of America

United States Patent and Trademark Office



Reg. No. 4,097,830

Registered Feb. 14, 2012

Int. Cl.: 20

TRADEMARK

PRINCIPAL REGISTER

NATURES PUREST LIMITED (HONG KONG CORPORATION)
11/F, WANG CHEONG ENTERPRISE CENTER,
NO. 69 CHAI WAN KOK STREET, TSUEN WAN
NEW TERRITORIES, HONG KONG

FOR: FURNITURE, MIRRORS, PICTURE FRAMES; GOODS MADE OF WOOD, CORK, REED, CANE, WICKER, HORN, BONE, IVORY, WHALEBONE, SHELL, AMBER, MOTHER-OF-PEARL, MEERSCHAUM AND SUBSTITUTES FOR ALL THESE MATERIALS, OR OF PLASTICS, NAMELY, PLAYPENS FOR BABIES, BASSINETTES, COTS, BEDSTEADS OF WOOD, CHAIRS, BABIES' CHAIRS, BABIES' CRIBS, BABY BOUNCERS, PORTABLE BABY BATH SEATS FOR USE IN BATH TUBS, SOFAS, HIGH CHAIRS FOR BABIES, STORAGE AND ORGANIZATION SYSTEMS COMPRISED OF BASKETS AS BABY FURNITURE THAT ARE USED FOR STORING OR ORGANIZING BABY RELATED ITEMS, PILLOWS, MATTRESSES, MATS FOR INFANT PLAYPENS, INFANT WALKERS, BEDS FOR BABIES AND INFANTS, BABIES' SLEEPING BAGS, BABY CHANGING TABLES, BABY BOLSTERS, NON-METAL SAFETY GATES FOR BABIES AND CHILDREN, IN CLASS 20 (U.S. CLS. 2, 13, 22, 25, 32 AND 50).

FIRST USE 12-31-2007; IN COMMERCE 3-30-2008.

THE MARK CONSISTS OF THREE VERTICALLY POSITIONED LEAVES WITH THE WORD "NATURES" IN A RECTANGLE BELOW, WITH THE WORD "PUREST" BELOW.

SER. NO. 85-114,121, FILED 8-23-2010.

NAKIA HENRY, EXAMINING ATTORNEY



David J. Kybas

Director of the United States Patent and Trademark Office

United States of America

United States Patent and Trademark Office

REGINA MUNDI

Reg. No. 4,097,831

SAMGSIM INC. (OREGON CORPORATION)

Registered Feb. 14, 2012

PO BOX 820035
PORTLAND, OR 97282

Int. Cls.: 36 and 43

FOR: FINANCIAL CONSULTING, IN CLASS 36 (U.S. CLS. 100, 101 AND 102).

SERVICE MARK

FIRST USE 1-6-2010; IN COMMERCE 1-6-2010.

PRINCIPAL REGISTER

FOR: CONSULTING SERVICES IN THE FIELD OF HOSPITALITY , IN CLASS 43 (U.S. CLS. 100 AND 101).

FIRST USE 1-6-2010; IN COMMERCE 1-6-2010.

THE MARK CONSISTS OF STANDARD CHARACTERS WITHOUT CLAIM TO ANY PARTICULAR FONT, STYLE, SIZE, OR COLOR.

THE ENGLISH TRANSLATION OF "MUNDI" IN THE MARK IS "WORLD".

SER. NO. 85-114,622, FILED 8-24-2010.

PAULA MAHONEY, EXAMINING ATTORNEY



David J. Kyffers

Director of the United States Patent and Trademark Office

United States of America

United States Patent and Trademark Office

NUTRIFUSION

Reg. No. 4,097,832

NUTRIFUSION, LLC (DELAWARE LIMITED LIABILITY COMPANY)
2780 ORCHARD KNOB
ATLANTA, GA 30339

Registered Feb. 14, 2012

Int. Cl.: 5

FOR: NUTRIENT FOOD ADDITIVE POWDER FOR USE IN SUPPLEMENTING FOOD PRODUCTS FOR HUMAN CONSUMPTION FOR HEALTHFUL ADVANTAGES; DIETARY AND NUTRITIONAL SUPPLEMENTS; DIETARY AND NUTRITIONAL SUPPLEMENTS FOR HUMAN CONSUMPTION; DIETARY FOOD SUPPLEMENTS, IN CLASS 5 (U.S. CLS. 6, 18, 44, 46, 51 AND 52).

TRADEMARK

PRINCIPAL REGISTER

FIRST USE 3-31-2009; IN COMMERCE 3-31-2009.

THE MARK CONSISTS OF STANDARD CHARACTERS WITHOUT CLAIM TO ANY PARTICULAR FONT, STYLE, SIZE, OR COLOR.

SER. NO. 85-118,463, FILED 8-30-2010.

MARIA-VICTORIA SUAREZ, EXAMINING ATTORNEY



David J. Kyros

Director of the United States Patent and Trademark Office

United States of America

United States Patent and Trademark Office

The logo for "ThinkPets" features the word "Think" in a bold, sans-serif font, followed by "Pets" in a similar font. A dotted line arches over the "P" and "e" in "Pets", ending in a solid black ball.

Reg. No. 4,097,833

Registered Feb. 14, 2012

Int. Cl.: 35

SERVICE MARK

PRINCIPAL REGISTER

THINKPETS, INC. (CALIFORNIA CORPORATION)
1500 OLYMPIC BOULEVARD
SANTA MONICA, CA 90404

FOR: MARKETING SERVICES ON BEHALF OF VETERINARIES; BUSINESS CONSULTING SERVICES FOR VETERINARIANS AS RELATED TO THEIR FIELD OF PRACTICE, IN CLASS 35 (U.S. CLS. 100, 101 AND 102).

FIRST USE 1-14-2011; IN COMMERCE 1-14-2011.

THE MARK CONSISTS OF THE WORDS "THINKPETS" WITH A DOTTED LINE FROM THE "I" IN "THINK" TO THE "P", "T" AND "S" IN "PETS" AND ENDING WITH A BALL AT THE END OF THE WORD.

SER. NO. 85-120,140, FILED 8-31-2010.

INGRID C. EULIN, EXAMINING ATTORNEY



David J. Kyffers

Director of the United States Patent and Trademark Office

United States of America

United States Patent and Trademark Office



Reg. No. 4,097,834

Registered Feb. 14, 2012

Int. Cls.: 3 and 21

TRADEMARK

PRINCIPAL REGISTER

READEEMING BEAUTY INC. (CALIFORNIA CORPORATION), DBA BEAUTYBLENDER
899 SOUTH RAINBOW BLVD.
SUITE 612
LAS VEGAS, NV 89145

FOR: COSMETIC AND MAKEUP RELATED PRODUCTS, NAMELY, CLEANSERS FOR CLEANING MAKEUP SPONGES, BRUSHES, AND COSMETIC SPONGE APPLICATORS, IN CLASS 3 (U.S. CLS. 1, 4, 6, 50, 51 AND 52).

FIRST USE 7-1-2004; IN COMMERCE 7-1-2004.

FOR: COSMETICS AND MAKEUP APPLICATION PRODUCTS, NAMELY, FACIAL SPONGES, COSMETIC SPONGE APPLICATORS, AND MAKEUP SPONGE CONTAINERS, IN CLASS 21 (U.S. CLS. 2, 13, 23, 29, 30, 33, 40 AND 50).

FIRST USE 7-1-2004; IN COMMERCE 7-1-2004.

THE MARK CONSISTS OF FOUR BLACK OVAL FIGURES ON TOP OF A PLURALITY OF OVERLAPPING COLORED CIRCLES WHICH IN TURN FORM A CIRCULAR DESIGN. THE COLORED CIRCLES ON THE RIGHT SIDE ARE IN SHADES OF THE COLORS GREEN AND BLUE. THE COLORED CIRCLES ON THE TOP ARE IN SHADES OF THE COLORS YELLOW AND ORANGE. THE COLORED CIRCLES ON THE LEFT ARE IN SHADES OF THE COLORS ORANGE, PINK, AND PURPLE. THE COLORED CIRCLES ON THE BOTTOM ARE IN SHADES OF THE COLOR PURPLE. THE COLOR WHITE REPRESENTS BACKGROUND OR TRANSPARENT AREA AND IS NOT PART OF THE MARK.

THE COLOR(S) BLUE, PURPLE, RED, PINK, ORANGE, YELLOW, GREEN, AND BLACK IS/ARE CLAIMED AS A FEATURE OF THE MARK.

SER. NO. 85-121,156, FILED 9-1-2010.

LINDA ESTRADA, EXAMINING ATTORNEY



David J. Kybas

Director of the United States Patent and Trademark Office

United States of America

United States Patent and Trademark Office

Pet Defender

Reg. No. 4,097,835

WILLEY, GLENN M. (UNITED STATES INDIVIDUAL)
8930 NESTLE AVENUE
NORTHRIDGE, CA 91325

Registered Feb. 14, 2012

Int. Cl.: 13

FOR: STUN GUNS SPECIFICALLY FOR USE ON ANIMALS, IN CLASS 13 (U.S. CLS. 2 AND 9).

TRADEMARK

FIRST USE 11-7-2007; IN COMMERCE 6-21-2010.

PRINCIPAL REGISTER

THE MARK CONSISTS OF STANDARD CHARACTERS WITHOUT CLAIM TO ANY PARTICULAR FONT, STYLE, SIZE, OR COLOR.

NO CLAIM IS MADE TO THE EXCLUSIVE RIGHT TO USE "PET", APART FROM THE MARK AS SHOWN.

SER. NO. 85-121,335, FILED 9-1-2010.

COURTNEY ALVAREZ, EXAMINING ATTORNEY



David J. Kyros

Director of the United States Patent and Trademark Office

United States of America

United States Patent and Trademark Office

SMARTSTART

Reg. No. 4,097,836

SPECTRUM CONTROL, INC. (PENNSYLVANIA CORPORATION)
1900 WEST COLLEGE AVENUE
STATE COLLEGE, PA 16801

Registered Feb. 14, 2012

Int. Cl.: 9

FOR: COMPUTER CONTROLLED INTELLIGENT POWER DISTRIBUTION UNITS AND BASIC POWER DISTRIBUTION UNITS FOR BOTH ALTERNATING CURRENT AND DIRECT CURRENT APPLICATIONS WITH FUNCTIONS OF REMOTE CONTROL, SEQUENTIAL DELIVERY OF POWER TO OUTLETS, AND/OR MONITORING OF POWER LOAD, VOLTAGE, CURRENT, TEMPERATURE AND/OR OTHER VARIABLES, IN CLASS 9 (U.S. CLS. 21, 23, 26, 36 AND 38).

TRADEMARK

PRINCIPAL REGISTER

FIRST USE 5-17-2000; IN COMMERCE 5-17-2000.

THE MARK CONSISTS OF STANDARD CHARACTERS WITHOUT CLAIM TO ANY PARTICULAR FONT, STYLE, SIZE, OR COLOR.

OWNER OF U.S. REG. NOS. 2,830,947 AND 2,852,129.

SEC. 2(F).

SER. NO. 85-122,876, FILED 9-3-2010.

EMILY CARLSEN, EXAMINING ATTORNEY



David J. Kyffers

Director of the United States Patent and Trademark Office

United States of America

United States Patent and Trademark Office

SMART START

Reg. No. 4,097,837

Registered Feb. 14, 2012

Int. Cl.: 9

TRADEMARK

PRINCIPAL REGISTER

SPECTRUM CONTROL, INC. (PENNSYLVANIA CORPORATION)
1900 WEST COLLEGE AVENUE
STATE COLLEGE, PA 16801

FOR: COMPUTER CONTROLLED INTELLIGENT POWER DISTRIBUTION UNITS AND BASIC POWER DISTRIBUTION UNITS FOR BOTH ALTERNATING CURRENT AND DIRECT CURRENT APPLICATIONS WITH FUNCTIONS OF REMOTE CONTROL, SEQUENTIAL DELIVERY OF POWER TO OUTLETS, AND/OR MONITORING OF POWER LOAD, VOLTAGE, CURRENT, TEMPERATURE AND/OR OTHER VARIABLES, IN CLASS 9 (U.S. CLS. 21, 23, 26, 36 AND 38).

FIRST USE 5-17-2000; IN COMMERCE 5-17-2000.

THE MARK CONSISTS OF STANDARD CHARACTERS WITHOUT CLAIM TO ANY PARTICULAR FONT, STYLE, SIZE, OR COLOR.

OWNER OF U.S. REG. NOS. 2,830,947 AND 2,852,129.

SEC. 2(F).

SER. NO. 85-122,936, FILED 9-3-2010.

EMILY CARLSEN, EXAMINING ATTORNEY



David J. Kyffers

Director of the United States Patent and Trademark Office

United States of America

United States Patent and Trademark Office

QUICK & KOSHER

Reg. No. 4,097,838

GELLER CREATIVE, INC. (NEW YORK CORPORATION)
4 SPRING ROCK PL.
SPRING VALLEY, NY 10977

Registered Feb. 14, 2012

Int. Cl.: 16

FOR: COOK BOOKS AND RECIPE BOOKS FEATURING INFORMATION ON KOSHER COOKING AND KOSHER FOODS, IN CLASS 16 (U.S. CLS. 2, 5, 22, 23, 29, 37, 38 AND 50).

TRADEMARK

FIRST USE 0-0-2007; IN COMMERCE 11-0-2007.

PRINCIPAL REGISTER

THE MARK CONSISTS OF STANDARD CHARACTERS WITHOUT CLAIM TO ANY PARTICULAR FONT, STYLE, SIZE, OR COLOR.

SEC. 2(F).

SER. NO. 85-124,506, FILED 9-7-2010.

NATALIE POLZER, EXAMINING ATTORNEY



David J. Kyffers

Director of the United States Patent and Trademark Office

United States of America

United States Patent and Trademark Office

EQUITY PACKAGING, INC.



Reg. No. 4,097,839

Registered Feb. 14, 2012

Int. Cls.: 35, 36 and 42

SERVICE MARK

PRINCIPAL REGISTER

CHUGHTAI, ZAHID M. (UNITED STATES INDIVIDUAL), DBA EQUITY PACKAGING, INC.
321 ROUTE 202/206 SOUTH, PO BOX 660
PLUCKEMIN, NJ 07978

FOR: BRANDING SERVICES, NAMELY, CONSULTING, DEVELOPMENT, MANAGEMENT AND MARKETING OF BRANDS FOR BUSINESSES, IN CLASS 35 (U.S. CLS. 100, 101 AND 102).

FIRST USE 10-14-2008; IN COMMERCE 1-1-2009.

FOR: CONSULTING ON THE SUBJECT OF INTELLECTUAL PROPERTY VALUATION, IN CLASS 36 (U.S. CLS. 100, 101 AND 102).

FIRST USE 6-10-2010; IN COMMERCE 6-10-2010.

FOR: CONSULTING SERVICES FOR OTHERS IN THE FIELD OF DESIGN, PLANNING, AND IMPLEMENTATION PROJECT MANAGEMENT OF PACKAGING DESIGN, DEVELOPMENT, AND ENGINEERING; DESIGN SERVICES FOR PACKAGING; PACKAGING DESIGN; PACKAGING DESIGN FOR OTHERS; RESEARCH AND DEVELOPMENT AND CONSULTATION RELATED THERETO IN THE FIELD OF PACKAGING DESIGN, DEVELOPMENT, AND ENGINEERING, IN CLASS 42 (U.S. CLS. 100 AND 101).

FIRST USE 8-1-1991; IN COMMERCE 8-1-1991.

NO CLAIM IS MADE TO THE EXCLUSIVE RIGHT TO USE "PACKAGING, INC.", APART FROM THE MARK AS SHOWN.

THE MARK CONSISTS OF THE NAME OF THE COMPANY, "EQUITY PACKAGING, INC." AND AN IMAGE OF THE COMPANY LOGO, WHICH IS MADE UP OF A STYLIZED LETTER "E" AND A STYLIZED LETTER "P", JOINED TO MAKE THE INITIALS, "EP" COMBINED TOGETHER WITH A DIAMOND IN THE MIDDLE.

SER. NO. 85-124,784, FILED 9-8-2010.

ANGELA M. MICHELI, EXAMINING ATTORNEY



David J. Kyffers

Director of the United States Patent and Trademark Office

United States of America

United States Patent and Trademark Office

Desert Sky Records

Reg. No. 4,097,840

Registered Feb. 14, 2012

Int. Cls.: 9 and 41

TRADEMARK

SERVICE MARK

PRINCIPAL REGISTER

DESERT SKY RECORDS (ARIZONA LIMITED LIABILITY COMPANY)
SUITE 106
633 E. RAY ROAD
GILBERT, AZ 85296

FOR: AUDIO AND VIDEO RECORDINGS FEATURING MUSIC AND ARTISTIC PERFORMANCES, IN CLASS 9 (U.S. CLS. 21, 23, 26, 36 AND 38).

FIRST USE 6-15-2010; IN COMMERCE 6-15-2010.

FOR: ENTERTAINMENT SERVICES IN THE NATURE OF RECORDING, PRODUCTION AND POST-PRODUCTION SERVICES IN THE FIELD OF MUSIC, IN CLASS 41 (U.S. CLS. 100, 101 AND 107).

FIRST USE 6-15-2010; IN COMMERCE 6-15-2010.

THE MARK CONSISTS OF STANDARD CHARACTERS WITHOUT CLAIM TO ANY PARTICULAR FONT, STYLE, SIZE, OR COLOR.

NO CLAIM IS MADE TO THE EXCLUSIVE RIGHT TO USE "RECORDS", APART FROM THE MARK AS SHOWN.

SER. NO. 85-126,220, FILED 9-9-2010.

REBECCA POVARCHUK, EXAMINING ATTORNEY



David J. Kybas

Director of the United States Patent and Trademark Office

United States of America

United States Patent and Trademark Office

CENTOLIRE

Reg. No. 4,097,841

LSC RESTAURANT MANAGEMENT GROUP, INC. (DELAWARE CORPORATION)
127 SEVENTH AVENUE
NEW YORK, NY 10011

Registered Feb. 14, 2012

Int. Cl.: 43

FOR: RESTAURANTS, IN CLASS 43 (U.S. CLS. 100 AND 101).

SERVICE MARK

FIRST USE 1-0-2001; IN COMMERCE 3-21-2001.

PRINCIPAL REGISTER

THE MARK CONSISTS OF STANDARD CHARACTERS WITHOUT CLAIM TO ANY PARTICULAR FONT, STYLE, SIZE, OR COLOR.

THE ENGLISH TRANSLATION OF "CENTOLIRE" IN THE MARK IS "ONE HUNDRED LIRE".

SER. NO. 85-126,296, FILED 9-9-2010.

WILLIAM ROSSMAN, EXAMINING ATTORNEY



David J. Kyffers

Director of the United States Patent and Trademark Office

United States of America

United States Patent and Trademark Office

WINDOW TAILORS "Best installed price on quality name brands"

Reg. No. 4,097,842

Registered Feb. 14, 2012

Int. Cl.: 35

SERVICE MARK

PRINCIPAL REGISTER

WINDOW TAILORS, LLC (VIRGINIA LIMITED LIABILITY COMPANY), DBA WINDOW TAILORS
20 GLEBE LANE
SCOTTSVILLE, VA 24590

FOR: RESELLER SERVICES, NAMELY, DISTRIBUTORSHIP SERVICES IN THE FIELD OF WINDOW COVERINGS, IN CLASS 35 (U.S. CLS. 100, 101 AND 102).

FIRST USE 7-1-2009; IN COMMERCE 7-1-2009.

THE MARK CONSISTS OF STANDARD CHARACTERS WITHOUT CLAIM TO ANY PARTICULAR FONT, STYLE, SIZE, OR COLOR.

NO CLAIM IS MADE TO THE EXCLUSIVE RIGHT TO USE "WINDOW" AND "BEST INSTALLED PRICE ON QUALITY NAME BRANDS", APART FROM THE MARK AS SHOWN.

SER. NO. 85-128,684, FILED 9-13-2010.

LINDA E. BLOHM, EXAMINING ATTORNEY



David J. Kyfos

Director of the United States Patent and Trademark Office

United States of America

United States Patent and Trademark Office

ecological

Reg. No. 4,097,843

Registered Feb. 14, 2012

**Int. Cls.: 35, 36, 37, 41,
42 and 45**

SERVICE MARK

PRINCIPAL REGISTER

ECOLOGICAL, LLC (DELAWARE LIMITED LIABILITY COMPANY)
12TH FLOOR
160 VARICK STREET
NEW YORK, NY 10013

FOR: BUSINESS CONSULTING AND ADVISORY SERVICES FOR BUSINESS PURPOSES, ENERGY RESOURCE EFFICIENCY AND ENERGY RESOURCE EFFICIENCY AND SUSTAINABILITY SOLUTIONS; BUSINESS ADVISORY SERVICES IN THE FIELDS OF URBAN PLANNING DESIGN; BUSINESS CONSULTING AND ADVISORY SERVICES IN THE FIELD OF ENERGY RESOURCE MANAGEMENT AND ENVIRONMENTAL ENHANCEMENT VIA REGULATION COMPLIANCE; REGENERATIVE PROJECTS, NAMELY, LAND USE SOLUTIONS AND DEVELOPMENTS THAT IMPROVE THE QUALITY OF LAND, COMMISSIONING, NAMELY, VERIFYING THAT BUILDING'S BASE SYSTEMS ARE WORKING OPTIMALLY; BILL VALIDATION, NAMELY, UTILITY BILL MANAGEMENT SERVICES, NAMELY, TRACKING, REPORTING, ANALYZING AND DELIVERING ENERGY INFORMATION IN THE FORM OF UTILITY BILLS AND UTILITY METER DATA RATE SCHEDULES; CONDUCTING ENERGY AUDITS OF COMMERCIAL AND INSTITUTIONAL FACILITIES FOR THE PURPOSE OF IMPROVING ENERGY EFFICIENCY; ENERGY USAGE MANAGEMENT SERVICES; LEADERSHIP IN ENERGY AND ENVIRONMENTAL DESIGN (LEED) PORTFOLIO SERVICES, NAMELY, PROVIDING PROJECT MANAGEMENT AND ADMINISTRATION SERVICES; POWER PURCHASING IN THE NATURE OF PROCUREMENT SERVICES, NAMELY, PROCUREMENT OF CONTRACTS FOR OTHERS FOR THE PURCHASE OF ENERGY, IN CLASS 35 (U.S. CLS. 100, 101 AND 102).

FIRST USE 6-0-2008; IN COMMERCE 0-0-2009.

FOR: REAL ESTATE INVESTMENT SERVICES IN THE NATURE OF PURCHASING AND SELLING OF REAL ESTATE FOR OTHERS; LAND ACQUISITION SERVICES; PROVIDING INVESTMENT ADVICE; FINANCING OF REAL ESTATE DEVELOPMENT PROJECTS; REAL ESTATE MANAGEMENT CONSULTATION; REAL ESTATE VALUATION SERVICES; REAL ESTATE SERVICES, NAMELY, RENTAL, BROKERAGE, LEASING AND MANAGEMENT OF COMMERCIAL PROPERTY, OFFICES AND OFFICE SPACE; FINANCIAL SERVICES, NAMELY, CONDUCTING RETURN ON INVESTMENTS (ROI) ANALYSIS OF PURCHASE, DEVELOPMENT AND SALE OF REAL ESTATE ASSETS, IN CLASS 36 (U.S. CLS. 100, 101 AND 102).

FIRST USE 6-0-2008; IN COMMERCE 0-0-2009.



David J. Kyffers

Director of the United States Patent and Trademark Office

Reg. No. 4,097,843 FOR: REAL ESTATE SITE SELECTION SERVICES; REAL ESTATE DEVELOPMENT; RESIDENTIAL AND BUILDING CONSTRUCTION CONSULTING; LAND DEVELOPMENT SERVICES, NAMELY, PLANNING AND LAYING OUT OF RESIDENTIAL AND COMMERCIAL BUILDINGS AND COMMUNITIES; DEVELOPMENT OF REAL PROPERTY, NAMELY, REPAIR, IMPROVEMENT, AND NEW CONSTRUCTION, IN CLASS 37 (U.S. CLS. 100, 103 AND 106).

FIRST USE 6-0-2008; IN COMMERCE 0-0-2009.

FOR: EDUCATIONAL SERVICES, NAMELY, PROVIDING WORKSHOPS, SEMINARS AND TRAINING IN THE FIELDS OF REAL ESTATE AND BUILDING SUSTAINABILITY; EDUCATION AND ENTERTAINMENT SERVICES, NAMELY, INITIATING COMPETITIONS BETWEEN BUILDINGS IN FURTHERANCE OF PROVIDING TRAINING IN THE FIELDS OF REAL ESTATE AND BUILDING SUSTAINABILITY AND ENCOURAGING EFFORTS TO IMPROVE RESOURCE EFFICIENCY IN BUILDINGS, IN CLASS 41 (U.S. CLS. 100, 101 AND 107).

FIRST USE 6-0-2008; IN COMMERCE 0-0-2009.

FOR: ENGINEERING AND HABITAT RESTORATION DESIGN SERVICES IN THE FIELD OF ENVIRONMENTAL ENHANCEMENT AND PRESERVATION; ARCHITECTURAL AND ENGINEERING SERVICES; PROVIDING METERING, MONITORING, AND DATA ANALYSIS SERVICES IN THE NATURE OF COLLECTING METERED DATA OF ENERGY USAGE AND WATER USAGE AND OF FUEL OIL, GAS, ELECTRIC, AND STEAM ENERGY AND BENCHMARKING AND ANALYZING METERED AND MONITORED DATA TO CREATE A BASELINE OF PERFORMANCE TO IDENTIFY AREAS TO IMPROVE EFFICIENCY; CARBON FOOTPRINT MEASURING AND ANALYSIS SERVICES; LAND USE PLANNING SERVICES, IN CLASS 42 (U.S. CLS. 100 AND 101).

FIRST USE 6-0-2008; IN COMMERCE 0-0-2009.

FOR: PERMITTING, NAMELY, OBTAINING ENVIRONMENTAL, DESIGN, ZONING AND OTHER GOVERNMENTAL PERMITS FOR DEVELOPMENT PROJECTS; REVIEWING STANDARDS AND PRACTICES TO ASSURE COMPLIANCE WITH ENVIRONMENTAL AND ZONING LAWS AND REGULATIONS, IN CLASS 45 (U.S. CLS. 100 AND 101).

FIRST USE 6-0-2008; IN COMMERCE 0-0-2009.

NO CLAIM IS MADE TO THE EXCLUSIVE RIGHT TO USE "ECOLOGICAL", APART FROM THE MARK AS SHOWN.

THE MARK CONSISTS OF THE WORD "ECOLOGICAL" IN STYLIZED LETTERS WITH A LEAF DESIGN ABOVE THE LETTER "O".

SER. NO. 85-129,278, FILED 9-14-2010.

NAPOLEON SHARMA, EXAMINING ATTORNEY

United States of America

United States Patent and Trademark Office



Reg. No. 4,097,844

Registered Feb. 14, 2012

Int. Cls.: 38 and 41

SERVICE MARK

PRINCIPAL REGISTER

CTI TELEVISION INCORPORATION (TAIWAN CORPORATION)
7F, NO.132, DALI ST., WANHUA DISTRICT
TAIPEI CITY, TAIWAN 10801

FOR: BROADCASTING OF TELEVISION NEWS PROGRAMS; TELEVISION BROADCASTING; INTERNET TELEVISION BROADCASTING, IN CLASS 38 (U.S. CLS. 100, 101 AND 104).

FIRST USE 3-31-2003; IN COMMERCE 3-31-2003.

FOR: RENTAL OF PRE-RECORDED VIDEOS THAT MAY BE DOWNLOADED FROM AN INTERNET WEB SITE; ENTERTAINMENT INFORMATION; FILM AND VIDEO FILM PRODUCTION; ENTERTAINMENT SERVICES, NAMELY, PRODUCTION OF TELEVISION PROGRAMS AND RADIO ENTERTAINMENT PROGRAMS; PREPARING SUBTITLES FOR MOVIES; AUDIO AND VIDEO RECORDING SERVICES; MICROFILMING FOR OTHERS; PHOTOGRAPHIC REPORTING; NEWS REPORTERS SERVICES, IN CLASS 41 (U.S. CLS. 100, 101 AND 107).

FIRST USE 3-31-2003; IN COMMERCE 3-31-2003.

THE MARK CONSISTS OF "CTI" CREATED WITHIN A SEMICIRCLE SURROUND WITH AN OVAL ABOVE THE SURROUND DOTTING THE "I".

SER. NO. 85-129,407, FILED 9-14-2010.

JASON TURNER, EXAMINING ATTORNEY



David J. Kybas

Director of the United States Patent and Trademark Office

United States of America

United States Patent and Trademark Office



Reg. No. 4,097,845

Registered Feb. 14, 2012

Int. Cls.: 33, 38 and 43

TRADEMARK

SERVICE MARK

PRINCIPAL REGISTER

ORGANICA BOUTIQUE COMPANY (MEXICO CORPORATION)
CALZADA SAN PEDRO #102-6
COLONIA DEL VALLE
SAN PEDRO GARZA GARCIA, MEXICO NL66220

FOR: ALCOHOLIC BEVERAGES, EXCEPT FOR BEERS, IN CLASS 33 (U.S. CLS. 47 AND 49).

FOR: PROVIDING AN INTERNET NEWS PORTAL FEATURING LINKS TO NEWS STORIES AND ARTICLES IN THE FIELD OF CURRENT EVENTS; ENTERTAINMENT, NAMELY, A CONTINUING NEWS SHOW BROADCAST OVER THE INTERNET, IN CLASS 38 (U.S. CLS. 100, 101 AND 104).

FOR: PROVIDING FOOD AND BEVERAGES FOR CONSUMPTION ON AND OFF THE PREMISES; CATERING FOR THE PROVISION OF FOOD AND BEVERAGES; PROVIDING BANQUET FACILITIES; ARRANGING TEMPORARY HOUSING ACCOMMODATIONS, IN CLASS 43 (U.S. CLS. 100 AND 101).

OWNER OF MEXICO REG. NO. 1107865, DATED 6-23-2009, EXPIRES 6-23-2019.

THE MARK CONSISTS OF THREE STYLIZED CAPITAL LETTERS "OBC" REPRESENTED AS FOLLOWS: THE LEFT SIDE OF THE "O" IS DARKER THAN THE RIGHT AND THE RIGHT SIDE OF THE "C" IS DARKER THAN THE LEFT, AND THE LIGHTER PORTIONS OF BOTH LETTERS COMBINE TO CREATE A LIGHT "B" BETWEEN THE OVERLAP OF THE "O" AND "C". TO THE RIGHT OF AND ABOVE THE "C" IS A SMALL DESIGN CONSISTING OF MULTIPLE INTERSECTING CIRCLES.

SER. NO. 85-130,058, FILED 9-15-2010.

JILL C. ALT, EXAMINING ATTORNEY



David J. Kyjars

Director of the United States Patent and Trademark Office

United States of America

United States Patent and Trademark Office

BOUNCEDOWN

Reg. No. 4,097,846

Registered Feb. 14, 2012

**Int. Cls.: 9, 16, 25, 28
and 41**

TRADEMARK

SERVICE MARK

PRINCIPAL REGISTER

JAGEX LIMITED (UNITED KINGDOM CORPORATION)
COWLEY ROAD
ST. JOHN'S INNOVATION CENTRE
CAMBRIDGE, UNITED KINGDOM CB40WS

FOR: DOWNLOADABLE MOBILE TELEPHONE RING TONES; DOWNLOADABLE COMPUTER SCREEN-SAVER SOFTWARE; DOWNLOADABLE COMPUTER WALLPAPER SOFTWARE; COMPUTER GAME PROGRAMS; VIDEO GAME PROGRAMS; INTERACTIVE ENTERTAINMENT SOFTWARE FOR PLAYING COMPUTER GAMES, VIDEO GAMES AND GAMES VIA THE INTERNET, IN CLASS 9 (U.S. CLS. 21, 23, 26, 36 AND 38).

FOR: BOOKS, LEAFLETS, BROCHURES, PLAYER'S GUIDES, AND PRINTED INSTRUCTIONAL AND TEACHING MATERIALS, EXCEPT APPARATUS, ALL IN THE FIELDS OF ON-LINE COMPUTER GAMES AND MULTI-USER COMPUTER GAMES PROVIDED VIA LOCAL COMPUTER NETWORKS, GLOBAL COMPUTER NETWORKS, AND THE INTERNET; POSTERS, IN CLASS 16 (U.S. CLS. 2, 5, 22, 23, 29, 37, 38 AND 50).

FOR: PROMOTIONAL ARTICLES OF CLOTHING RELATED TO COMPUTER, ELECTRONIC AND VIDEO GAMES, NAMELY, HOODED SWEATSHIRTS, T-SHIRTS, HATS, CAPS, IN CLASS 25 (U.S. CLS. 22 AND 39).

FOR: TOYS, NAMELY, STUFFED TOY ANIMALS, PLASTIC CHARACTER TOYS, MODELED PLASTIC TOY FIGURINES, ACTION FIGURES AND ACCESSORIES THEREFOR, BOARD GAMES AND PLAYING CARDS, ALL OF THE FOREGOING RELATED TO COMPUTER GAMES AND VIDEO GAMES, IN CLASS 28 (U.S. CLS. 22, 23, 38 AND 50).

FOR: ENTERTAINMENT SERVICES, NAMELY, PROVIDING ONLINE COMPUTER GAMES; ENTERTAINMENT SERVICES, NAMELY, PROVIDING ONLINE ELECTRONIC GAMES; ENTERTAINMENT SERVICES, NAMELY, PROVIDING GAMES OF CHANCE VIA THE INTERNET; ENTERTAINMENT SERVICES, NAMELY, PROVISION OF ONLINE COMPUTER, VIDEO AND ELECTRONIC GAMES BY MEANS OF LOCAL COMPUTER NETWORKS, GLOBAL COMPUTER NETWORKS, THE INTERNET, CABLE OR WIRE COMMUNICATIONS SERVICES, WIRELESS TELECOMMUNICATIONS SERVICES AND BROADBAND TELECOMMUNICATIONS SERVICES, IN CLASS 41 (U.S. CLS. 100, 101 AND 107).

THE MARK CONSISTS OF STANDARD CHARACTERS WITHOUT CLAIM TO ANY PARTICULAR FONT, STYLE, SIZE, OR COLOR.



David J. Kyjars

Director of the United States Patent and Trademark Office

Reg. No. 4,097,846 PRIORITY CLAIMED UNDER SEC. 44(D) ON UNITED KINGDOM APPLICATION NO. 2542160, FILED 3-17-2010, REG. NO. 2542160, DATED 7-2-2010, EXPIRES 3-17-2020.

SER. NO. 85-130,756, FILED 9-16-2010.

CAROLINE WOOD, EXAMINING ATTORNEY

United States of America

United States Patent and Trademark Office



Reg. No. 4,097,847

Registered Feb. 14, 2012

**Int. Cls.: 9, 16, 25, 28
and 41**

TRADEMARK

SERVICE MARK

PRINCIPAL REGISTER

JAGEX LIMITED (UNITED KINGDOM CORPORATION)
COWLEY ROAD
ST. JOHN'S INNOVATION CENTRE
CAMBRIDGE, UNITED KINGDOM CB40WS

FOR: DOWNLOADABLE MOBILE TELEPHONE RING TONES; DOWNLOADABLE COMPUTER SCREEN-SAVER SOFTWARE; DOWNLOADABLE COMPUTER WALLPAPER SOFTWARE; COMPUTER GAME PROGRAMS; VIDEO GAME PROGRAMS; INTERACTIVE ENTERTAINMENT SOFTWARE FOR PLAYING COMPUTER GAMES, VIDEO GAMES AND GAMES VIA THE INTERNET, IN CLASS 9 (U.S. CLS. 21, 23, 26, 36 AND 38).

FOR: BOOKS, LEAFLETS, BROCHURES, PLAYER'S GUIDES AND PRINTED INSTRUCTIONAL AND TEACHING MATERIALS, EXCEPT APPARATUS, ALL IN THE FIELDS OF ON-LINE COMPUTER GAMES AND MULTI-USER COMPUTER GAMES PROVIDED VIA LOCAL COMPUTER NETWORKS, GLOBAL COMPUTER NETWORKS, AND THE INTERNET; POSTERS, IN CLASS 16 (U.S. CLS. 2, 5, 22, 23, 29, 37, 38 AND 50).

FOR: PROMOTIONAL ARTICLES OF CLOTHING RELATED TO COMPUTER, ELECTRONIC AND VIDEO GAMES, NAMELY, HOODED SWEATSHIRTS, T-SHIRTS, HATS, CAPS, IN CLASS 25 (U.S. CLS. 22 AND 39).

FOR: TOYS, NAMELY, STUFFED TOY ANIMALS, PLASTIC CHARACTER TOYS, MODELED PLASTIC TOY FIGURINES, ACTION FIGURES AND ACCESSORIES THEREFOR, BOARD GAMES AND PLAYING CARDS, ALL OF THE FOREGOING RELATED TO COMPUTER GAMES AND VIDEO GAMES, IN CLASS 28 (U.S. CLS. 22, 23, 38 AND 50).

FOR: ENTERTAINMENT SERVICES, NAMELY, PROVIDING ONLINE COMPUTER GAMES; ENTERTAINMENT SERVICES, NAMELY, PROVIDING ONLINE ELECTRONIC GAMES; ENTERTAINMENT SERVICES, NAMELY, PROVIDING GAMES OF CHANCE VIA THE INTERNET; ENTERTAINMENT SERVICES, NAMELY, PROVISION OF ONLINE COMPUTER, VIDEO AND ELECTRONIC GAMES BY MEANS OF LOCAL COMPUTER NETWORKS, GLOBAL COMPUTER NETWORKS, THE INTERNET, CABLE OR WIRE COMMUNICATIONS SERVICES, WIRELESS TELECOMMUNICATIONS SERVICES AND BROADBAND TELECOMMUNICATIONS SERVICES, IN CLASS 41 (U.S. CLS. 100, 101 AND 107).



David J. Kappas

Director of the United States Patent and Trademark Office

PRIORITY CLAIMED UNDER SEC. 44(D) ON UNITED KINGDOM APPLICATION NO. 2542161, FILED 3-17-2010, REG. NO. 2542161, DATED 7-2-2010, EXPIRES 3-17-2020.

Reg. No. 4,097,847 THE MARK CONSISTS OF STYLIZED LETTERS FORMING THE WORD "BOUNCEDOWN", OVER A STRIPED ARROW THAT STARTS FROM THE RIGHT AND ANGLES DOWN TO THE LEFT, WITH THREE CHARACTERS MADE UP OF SHAPES AND EYES, TWO OF WHICH FORM THE "O"'S IN "BOUNCEDOWN". THE COLOR GRAY IN THE MARK REPRESENTS SHADING AND IS NOT PART OF THE MARK.

SER. NO. 85-130,758, FILED 9-16-2010.

CAROLINE WOOD, EXAMINING ATTORNEY

United States of America

United States Patent and Trademark Office

SonarGraph

Reg. No. 4,097,848

Registered Feb. 14, 2012

Int. Cl.: 9

TRADEMARK

PRINCIPAL REGISTER

HELLO2MORROW GMBH (GESELLSCHAFT MIT BESCHRÄNKTER HAFTUNG) (FED REP GERMANY GESELLSCHAFT MIT BESCHRÄNKTER HAFTUNG (GMBH))
PARKSTR. 1
POTSDAM, FED REP GERMANY D-14469

FOR: COMPUTER PROGRAMS FOR MEASURING AND MONITORING TECHNICAL QUALITY, STRUCTURE AND ARCHITECTURE OF SOFTWARE SYSTEMS; COMPUTER SOFTWARE DEVELOPMENT TOOLS; COMPUTER SOFTWARE FOR COMPUTER SYSTEM AND APPLICATION DEVELOPMENT, DEPLOYMENT AND MANAGEMENT; COMPUTER SOFTWARE FOR MEASURING AND MONITORING TECHNICAL QUALITY, STRUCTURE AND ARCHITECTURE OF SOFTWARE SYSTEMS, IN CLASS 9 (U.S. CLS. 21, 23, 26, 36 AND 38).

THE MARK CONSISTS OF STANDARD CHARACTERS WITHOUT CLAIM TO ANY PARTICULAR FONT, STYLE, SIZE, OR COLOR.

PRIORITY CLAIMED UNDER SEC. 44(D) ON ERPN CMNTY TM OFC APPLICATION NO. 009123613, FILED 5-21-2010, REG. NO. 009123613, DATED 9-2-2011, EXPIRES 5-21-2020.

SER. NO. 85-130,782, FILED 9-16-2010.

YAT SYE, LEE, EXAMINING ATTORNEY



David J. Kyffers

Director of the United States Patent and Trademark Office

United States of America

United States Patent and Trademark Office

Diklö Tsani

Reg. No. 4,097,849

Registered Feb. 14, 2012

Int. Cl.: 32

TRADEMARK

PRINCIPAL REGISTER

PLANET ECO PROYECTS SOCIEDAD ANONIMA (COSTA RICA CORPORATION)
150 METERS SOUTH FORM THE CENTRAL CEMENT
ALAJUELA, COSTA RICA

FOR: BEERS, MINERAL AND AERATED WATERS AND OTHER NON ALCOHOLIC DRINKS, NAMELY, ISOTONIC NON-ALCOHOLIC DRINKS, ENERGY SHOTS, BEVERAGES CONTAINING FRUIT JUICES, NON-ALCOHOLIC FRUIT EXTRACTS USED IN THE PREPARATION OF BEVERAGES, NON-ALCOHOLIC FRUIT JUICE BEVERAGES, VEGETABLE JUICES, VEGETABLE-FRUIT JUICES AND SMOOTHIES, SOFT DRINKS, SPORTS DRINKS, NAMELY, ENERGY DRINKS; CONCENTRATES AND POWDERS USED IN THE PREPARATION OF ENERGY DRINKS AND FRUIT-FLAVORED BEVERAGES; FRUIT DRINKS AND FRUIT JUICES, SYRUPS AND OTHER PREPARATIONS FOR MAKING SOFT DRINKS AND TEA-FLAVORED BEVERAGES, IN CLASS 32 (U.S. CLS. 45, 46 AND 48).

PRIORITY CLAIMED UNDER SEC. 44(D) ON COSTA RICA APPLICATION NO. 2010-0006310, FILED 7-14-2010, REG. NO. 204655, DATED 10-25-2010, EXPIRES 10-25-2020.

THE COLOR(S) BLUE IS/ARE CLAIMED AS A FEATURE OF THE MARK.

THE MARK CONSISTS OF THE WORDS "DÍKLÖ TSANI" IN BLUE STYLIZED LETTERING.

THE ENGLISH TRANSLATION OF "DIKLO TSANI" IN THE MARK IS "SPRING WATER" IN CABECAR A COSTA RICAN INDIGENOUS DIALECT.

SER. NO. 85-131,863, FILED 9-17-2010.

DEBRA LEE, EXAMINING ATTORNEY



David J. Kyffers

Director of the United States Patent and Trademark Office

United States of America

United States Patent and Trademark Office

ProForm

Reg. No. 4,097,850

PROFORM LANDSCAPE LLC (GEORGIA LIMITED LIABILITY COMPANY)
897 GLENBROOK DRIVE
ATLANTA, GA 30318

Registered Feb. 14, 2012

Int. Cl.: 44

FOR: LAWN CARE SERVICES; LAWN MOWING SERVICES, IN CLASS 44 (U.S. CLS. 100 AND 101).

SERVICE MARK

FIRST USE 5-1-2010; IN COMMERCE 5-1-2010.

PRINCIPAL REGISTER

THE MARK CONSISTS OF STANDARD CHARACTERS WITHOUT CLAIM TO ANY PARTICULAR FONT, STYLE, SIZE, OR COLOR.

SER. NO. 85-132,241, FILED 9-17-2010.

HANNO RITTNER, EXAMINING ATTORNEY



David J. Kybas

Director of the United States Patent and Trademark Office

United States of America

United States Patent and Trademark Office

5D SMART CITY

Reg. No. 4,097,851

SCREAMPOINT HOLDINGS, INC (DELAWARE CORPORATION)
5516 W. FOSTER AVENUE
CHICAGO, IL 60630

Registered Feb. 14, 2012

**Int. Cls.: 35, 36, 37 and
42**

FOR: BUSINESS ADVISORY SERVICES IN THE FIELDS OF ARCHITECTURE, INTERIOR DESIGN AND URBAN PLANNING DESIGN; BUSINESS CONSULTATION SERVICES, NAMELY, BUSINESS PROCESS IMPROVEMENT AND ENTERPRISE ARCHITECTURE DESIGN; PROJECT MANAGEMENT SERVICES FOR OTHERS FOR BUSINESS PURPOSES IN THE FIELDS OF ARCHITECTURE, INTERIOR DESIGN, URBAN PLANNING DESIGN, IN CLASS 35 (U.S. CLS. 100, 101 AND 102).

SERVICE MARK

PRINCIPAL REGISTER

FIRST USE 4-19-2010; IN COMMERCE 4-19-2010.

FOR: APPRAISAL AND EVALUATION OF REAL ESTATE; ASSESSMENT AND MANAGEMENT OF REAL ESTATE; BUILDING MANAGEMENT; EVALUATION OF REAL PROPERTY; REAL ESTATE MANAGEMENT CONSULTATION; REAL ESTATE MANAGEMENT SERVICES; REAL ESTATE SERVICE, NAMELY, RENTAL PROPERTY MANAGEMENT, IN CLASS 36 (U.S. CLS. 100, 101 AND 102).

FIRST USE 4-19-2010; IN COMMERCE 4-19-2010.

FOR: CONSTRUCTION PLANNING; CONSTRUCTION PROJECT MANAGEMENT SERVICES; CONSTRUCTION, MAINTENANCE AND RENOVATION OF PROPERTY; REAL ESTATE DEVELOPMENT; RESIDENTIAL AND BUILDING CONSTRUCTION CONSULTING; RESIDENTIAL AND COMMERCIAL BUILDING CONSTRUCTION, IN CLASS 37 (U.S. CLS. 100, 103 AND 106).

FIRST USE 4-19-2010; IN COMMERCE 4-19-2010.

FOR: CONSULTING SERVICES IN THE FIELD OF ARCHITECTURAL DESIGN; DESIGN AND DEVELOPMENT OF VISUALIZATION TECHNOLOGIES FOR ADVERTISEMENT OF REAL-ESTATE, COMMERCIAL PRODUCT AND BUSINESS OF OTHERS; DRAWING UP OF PLANS AND ENGINEERING DRAWINGS; GRAPHIC ILLUSTRATION AND DRAWING SERVICES, NAMELY, PROVIDING GRAPHIC ILLUSTRATIONS AND DRAWINGS OF COMMERCIAL AND INDUSTRIAL BUILDING DESIGNS, AND CONVERTING BUILDING DESIGNS OR MARKUPS TO ELECTRONIC CAD DRAWINGS; URBAN DESIGN PLANNING SERVICES, IN CLASS 42 (U.S. CLS. 100 AND 101).



David J. Kyffers

Director of the United States Patent and Trademark Office

Reg. No. 4,097,851 FIRST USE 4-19-2010; IN COMMERCE 4-19-2010.

THE MARK CONSISTS OF STANDARD CHARACTERS WITHOUT CLAIM TO ANY PARTICULAR FONT, STYLE, SIZE, OR COLOR.

NO CLAIM IS MADE TO THE EXCLUSIVE RIGHT TO USE "SMART CITY", APART FROM THE MARK AS SHOWN.

SER. NO. 85-133,073, FILED 9-20-2010.

AISHA SALEM, EXAMINING ATTORNEY

United States of America

United States Patent and Trademark Office

5D SMART WORLD

Reg. No. 4,097,852

SCREAMPOINT HOLDINGS, INC (DELAWARE CORPORATION)
5516 W. FOSTER AVENUE
CHICAGO, IL 60630

Registered Feb. 14, 2012

Int. Cls.: 35, 36, 37 and 42

FOR: ADVISORY SERVICES FOR OTHERS FOR BUSINESS PURPOSES IN THE FIELDS OF ARCHITECTURE, INTERIOR DESIGN AND URBAN PLANNING DESIGN; PROJECT MANAGEMENT SERVICES FOR OTHERS FOR BUSINESS PURPOSES IN THE FIELDS OF ARCHITECTURE, INTERIOR DESIGN, URBAN PLANNING DESIGN, IN CLASS 35 (U.S. CLS. 100, 101 AND 102).

SERVICE MARK

PRINCIPAL REGISTER

FIRST USE 4-19-2010; IN COMMERCE 4-19-2010.

FOR: BUILDING MANAGEMENT, IN CLASS 36 (U.S. CLS. 100, 101 AND 102).

FIRST USE 4-19-2010; IN COMMERCE 4-19-2010.

FOR: CONSTRUCTION PLANNING; CONSTRUCTION SERVICES, NAMELY, PLANNING, LAYING OUT AND CUSTOM CONSTRUCTION OF COMMERCIAL BUILDINGS; TECHNICAL CONSULTATION IN THE FIELD OF BUILDING CONSTRUCTION, IN CLASS 37 (U.S. CLS. 100, 103 AND 106).

FIRST USE 4-19-2010; IN COMMERCE 4-19-2010.

FOR: ENGINEERING SERVICES FOR BUILDING AND PROPERTY CONDITION ASSESSMENT, FACILITY MANAGEMENT, REPAIR AND RESTORATION, BUILDING INSTRUMENTATION AND MONITORING, AND ENVIRONMENTAL CONSULTING; GRAPHIC ILLUSTRATION AND DRAWING SERVICES, NAMELY, PROVIDING GRAPHIC ILLUSTRATIONS AND DRAWINGS OF COMMERCIAL AND INDUSTRIAL BUILDING DESIGNS, AND CONVERTING BUILDING DESIGNS OR MARKUPS TO ELECTRONIC CAD DRAWINGS; PLANNING OF BUILDINGS AND INFRASTRUCTURE SYSTEMS FOR BUILDINGS; URBAN DESIGN PLANNING SERVICES; URBAN PLANNING, IN CLASS 42 (U.S. CLS. 100 AND 101).

FIRST USE 4-19-2010; IN COMMERCE 4-19-2010.

THE MARK CONSISTS OF STANDARD CHARACTERS WITHOUT CLAIM TO ANY PARTICULAR FONT, STYLE, SIZE, OR COLOR.



David J. Kyjars

Director of the United States Patent and Trademark Office

Reg. No. 4,097,852 NO CLAIM IS MADE TO THE EXCLUSIVE RIGHT TO USE "SMART WORLD", APART FROM THE MARK AS SHOWN.

SER. NO. 85-133,077, FILED 9-20-2010.

AISHA SALEM, EXAMINING ATTORNEY

United States of America

United States Patent and Trademark Office

5D SMART BUILDING

Reg. No. 4,097,853

Registered Feb. 14, 2012

**Int. Cls.: 9, 35, 36, 37
and 42**

TRADEMARK

SERVICE MARK

PRINCIPAL REGISTER

SCREAMPOINT HOLDINGS, INC (DELAWARE CORPORATION)
5516 W. FOSTER AVENUE
CHICAGO, IL 60630

FOR: COMPUTER SOFTWARE FOR THE DATABASING, VISUALIZATION, MANIPULATION, VIRTUAL REALITY IMMERSION AND INTEGRATION OF GEOGRAPHIC INFORMATION WITH ON-LINE MEMBER COMMUNITIES, IN CLASS 9 (U.S. CLS. 21, 23, 26, 36 AND 38).

FIRST USE 4-19-2010; IN COMMERCE 4-19-2010.

FOR: ADVISORY SERVICES FOR OTHERS FOR BUSINESS PURPOSES IN THE FIELDS OF ARCHITECTURE, INTERIOR DESIGN AND URBAN PLANNING DESIGN; PROJECT MANAGEMENT SERVICES FOR OTHERS FOR BUSINESS PURPOSES IN THE FIELDS OF ARCHITECTURE, INTERIOR DESIGN, URBAN PLANNING DESIGN, IN CLASS 35 (U.S. CLS. 100, 101 AND 102).

FIRST USE 4-19-2010; IN COMMERCE 4-19-2010.

FOR: BUILDING MANAGEMENT, IN CLASS 36 (U.S. CLS. 100, 101 AND 102).

FIRST USE 4-19-2010; IN COMMERCE 4-19-2010.

FOR: CONSTRUCTION PLANNING; CONSTRUCTION SERVICES, NAMELY, PLANNING, LAYING OUT AND CUSTOM CONSTRUCTION OF COMMERCIAL BUILDINGS; CONSULTING IN THE FIELD OF BUILDING CONSTRUCTION; TECHNICAL CONSULTATION IN THE FIELD OF BUILDING CONSTRUCTION, IN CLASS 37 (U.S. CLS. 100, 103 AND 106).

FIRST USE 4-19-2010; IN COMMERCE 4-19-2010.

FOR: ENGINEERING SERVICES FOR BUILDING AND PROPERTY CONDITION ASSESSMENT, FACILITY MANAGEMENT, REPAIR AND RESTORATION, BUILDING INSTRUMENTATION AND MONITORING, AND ENVIRONMENTAL CONSULTING; GRAPHIC ILLUSTRATION AND DRAWING SERVICES, NAMELY, PROVIDING GRAPHIC ILLUSTRATIONS AND DRAWINGS OF COMMERCIAL AND INDUSTRIAL BUILDING DESIGNS, AND CONVERTING BUILDING DESIGNS OR MARKUPS TO ELECTRONIC CAD DRAWINGS; PLANNING OF BUILDINGS AND INFRASTRUCTURE SYSTEMS FOR BUILDINGS;



David J. Kyffers

Director of the United States Patent and Trademark Office

Reg. No. 4,097,853 URBAN DESIGN PLANNING SERVICES; URBAN PLANNING, IN CLASS 42 (U.S. CLS. 100 AND 101).

FIRST USE 4-19-2010; IN COMMERCE 4-19-2010.

THE MARK CONSISTS OF STANDARD CHARACTERS WITHOUT CLAIM TO ANY PARTICULAR FONT, STYLE, SIZE, OR COLOR.

NO CLAIM IS MADE TO THE EXCLUSIVE RIGHT TO USE "SMART BUILDING", APART FROM THE MARK AS SHOWN.

SER. NO. 85-133,088, FILED 9-20-2010.

AISHA SALEM, EXAMINING ATTORNEY

United States of America

United States Patent and Trademark Office



Reg. No. 4,097,854

Registered Feb. 14, 2012

Int. Cl.: 37

SERVICE MARK

PRINCIPAL REGISTER

ROCKS ROOFING INCORPORATED (COLORADO CORPORATION)
3820 QUAY STREET
WHEAT RIDGE, CO 80033

FOR: ROOFING SERVICES, IN CLASS 37 (U.S. CLS. 100, 103 AND 106).

FIRST USE 4-1-2010; IN COMMERCE 4-1-2010.

THE MARK CONSISTS OF BLUE HOUSE WITH GOLD-SHADOWED BLUE "R" INSIDE HOUSE, FIVE GOLD STARS ABOVE BLUE HOUSE.

THE COLOR(S) GOLD AND BLUE IS/ARE CLAIMED AS A FEATURE OF THE MARK.

SER. NO. 85-133,337, FILED 9-20-2010.

TINA L. SNAPP, EXAMINING ATTORNEY



David J. Kyffers

Director of the United States Patent and Trademark Office

United States of America

United States Patent and Trademark Office

LABPORT

Reg. No. 4,097,855

Registered Feb. 14, 2012

Int. Cls.: 9 and 10

TRADEMARK

PRINCIPAL REGISTER

FISHER & PAYKEL HEALTHCARE LIMITED (NEW ZEALAND LIMITED LIABILITY COMPANY)
15 MAURICE PAYKEL PLACE, EAST TAMAKI
AUCKLAND 2013, NEW ZEALAND

FOR: APPARATUS FOR RECORDING, PROCESSING, TRANSMISSION OR REPRODUCTION OF SOUND, IMAGES OR DATA, FOR USE WITH MEDICAL EQUIPMENT; DATA PROCESSORS; APPARATUS FOR TRANSMISSION OF COMMUNICATION; ELECTRONIC APPARATUS FOR THE REMOTE CONTROL OF CONTINUOUS POSITIVE AIRWAY PRESSURE (CPAP) DEVICES; COMPUTER NETWORK INTERFACE DEVICES FOR USE WITH MEDICAL EQUIPMENT, FOR RECEIVING, ANALYZING, PROCESSING, TRANSMITTING OR DISPLAYING MEDICAL DATA; ISOLATED COMMUNICATION INTERFACE UNITS, CONSISTING OF ISOLATED COMMUNICATION INTERFACE (ICI) COMPUTER HARDWARE, FOR USE WITH MEDICAL EQUIPMENT, FOR RECEIVING, ANALYZING, PROCESSING, TRANSMITTING OR DISPLAYING MEDICAL DATA; PERIPHERAL INTERFACE UNITS FOR COMPUTERS CONSISTING OF PERIPHERAL COMPONENT INTERFACE (PCI) HARDWARE; AUTOMATED PROCESS CONTROL SYSTEM, NAMELY, COMPUTER HARDWARE AND SOFTWARE USED TO MONITOR THE STATUS OF RESPIRATORY MEDICAL APPARATUS; COMPUTER NETWORK INTERFACE DEVICES AND ELECTRONIC DISPLAY INTERFACES FOR TERMINALS; ELECTRIC CABLES, NAMELY, ELECTRIC INTERFACE CABLES; MAGNETIC DATA CARRIERS, NAMELY, BLANK MAGNETIC DATA CARRIERS ONTO WHICH MEDICAL DATA CAN BE RECORDED AND PRE-RECORDED MAGNETIC DATA CARRIERS FEATURING MEDICAL DATA; COMPUTER HARDWARE AND COMPUTER PERIPHERALS; COMPUTER SOFTWARE FOR USE IN POSITIVE PRESSURE THERAPY AND SLEEP THERAPY; COMPUTER SOFTWARE AND COMPUTER PROGRAMS, FOR USE WITH MEDICAL EQUIPMENT, FOR RECEIVING, ANALYZING, PROCESSING, TRANSMITTING OR DISPLAYING MEDICAL DATA; CONNECTION CABLES AND CABLE CONNECTORS FOR ALL THE AFORESAID GOODS; ELECTRONIC PUBLICATIONS, NAMELY, OPERATION TRAINING MANUALS RECORDED ON COMPUTER MEDIA FOR THE AFOREMENTIONED GOODS; PARTS AND FITTINGS FOR THE AFOREMENTIONED GOODS; INSTRUCTION MANUALS SOLD AS A UNIT WITH THE AFOREMENTIONED GOODS, IN CLASS 9 (U.S. CLS. 21, 23, 26, 36 AND 38).



David J. Kyffers

Director of the United States Patent and Trademark Office

FOR: MEDICAL HUMIDIFICATION APPARATUS; MEDICAL APPARATUS FOR THE DIAGNOSIS AND TREATMENT OF OBSTRUCTIVE SLEEP APNEA; MEDICAL APPARATUS, NAMELY, INVASIVE AND NON-INVASIVE VENTILATION APPARATUS AND INSTRUMENTS; MEDICAL APPARATUS AND INSTRUMENTS FOR POSITIVE AIRWAY PRESSURE

Reg. No. 4,097,855 THERAPY; METERS FOR MEDICAL USE, NAMELY, FOR POSITIVE AIRWAY PRESSURE THERAPY; HUMIDIFIERS FOR MEDICAL USE; BREATHING MASKS FOR USE IN TREATING OBSTRUCTIVE SLEEP APNEA; FACIAL MASKS, ORAL MASKS, NASAL MASKS, NASAL CANNULA, MOUTHPIECES, HEADGEAR, ALL BEING FOR MEDICAL PURPOSES; PARTS AND FITTINGS FOR ALL THE AFOREMENTIONED GOODS, IN CLASS 10 (U.S. CLS. 26, 39 AND 44).

THE MARK CONSISTS OF STANDARD CHARACTERS WITHOUT CLAIM TO ANY PARTICULAR FONT, STYLE, SIZE, OR COLOR.

OWNER OF NEW ZEALAND REG. NO. 827904, DATED 7-27-2010, EXPIRES 7-27-2020.

SER. NO. 85-133,477, FILED 9-20-2010.

KEVIN DINALLO, EXAMINING ATTORNEY

United States of America

United States Patent and Trademark Office

AXE

Reg. No. 4,097,856

Registered Feb. 14, 2012

Int. Cl.: 9

TRADEMARK

PRINCIPAL REGISTER

FTEN, INC. (DELAWARE CORPORATION)
SUITE 900
143 UNION BOULEVARD
LAKEWOOD, CO 80228

FOR: COMPUTER NETWORK SWITCHES AND COMPUTER HUBS, ROUTERS AND BRIDGES WHICH PROVIDE THE ABILITY TO PURPOSEFULLY ENABLE AND/OR DISABLE THE FLOW OF DATA TO AND/OR FROM A DEVICE ON THE NETWORK, SPECIFICALLY FOR USE BY PARTICIPANTS OR THEIR REGULATORS IN THE SECURITIES TRADING INDUSTRY TO EXERT CONTROLS ON SECURITIES TRADING WHEN CERTAIN CRITERIA ARE PRESENT, IN CLASS 9 (U.S. CLS. 21, 23, 26, 36 AND 38).

FIRST USE 2-19-2010; IN COMMERCE 9-1-2010.

THE MARK CONSISTS OF STANDARD CHARACTERS WITHOUT CLAIM TO ANY PARTICULAR FONT, STYLE, SIZE, OR COLOR.

SER. NO. 85-134,432, FILED 9-21-2010.

HOWARD B. LEVINE, EXAMINING ATTORNEY



David J. Kyros

Director of the United States Patent and Trademark Office

United States of America

United States Patent and Trademark Office

WHITELINE

Reg. No. 4,097,857

Registered Feb. 14, 2012

Int. Cl.: 12

COMSERV (NO. 3036) PTY LIMITED (AUSTRALIA PROPRIETARY LIMITED COMPANY
(P/L OR PTY. LTD.))
UNIT 2
4 WARRINGAH CLOSE
SOMERSBY NSW 2250, AUSTRALIA

TRADEMARK

PRINCIPAL REGISTER

FOR: MOTOR VEHICLE SPARE PARTS, FITTINGS AND ACCESSORIES INCLUDED IN THIS CLASS, NAMELY, COIL SPRINGS FOR VEHICLE SUSPENSION, SUSPENSION SPRINGS, SUSPENSION DAMPERS, SUSPENSION SHOCK ABSORBERS, AIR PUMPS, SUSPENSION STRUTS, SUSPENSION STRUT AND CHASSIS BRACING, SWAY BARS, TORSION BARS, ANTI-ROLL BARS FOR VEHICLES IN THIS CLASS; STEERING APPARATUS, NAMELY, STEERING WHEELS AND BRAKES; CAMBER AND CASTER CORRECTION PRODUCTS COMPOSED OF BOLTS, BUSHINGS, NUTS, SLEEVES AND TUBES; POLYURETHANE BUSHINGS FOR USE IN VEHICLE STEERING AND SUSPENSION SYSTEMS; ADJUSTABLE SUSPENSION AND COIL-OVER SUSPENSION SYSTEMS FOR VEHICLES; ELECTRONIC STABILITY CONTROL PROGRAM AND DYNAMIC STABILITY CONTROL APPARATUS, SOLD AS A UNIT, TO ALLOW BETTER CONTROL AND MANEUVERABILITY OF AUTOMOTIVE VEHICLES, IN CLASS 12 (U.S. CLS. 19, 21, 23, 31, 35 AND 44).

THE MARK CONSISTS OF STANDARD CHARACTERS WITHOUT CLAIM TO ANY PARTICULAR FONT, STYLE, SIZE, OR COLOR.

PRIORITY CLAIMED UNDER SEC. 44(D) ON AUSTRALIA APPLICATION NO. 1384962, FILED 9-22-2010, REG. NO. 1384962, DATED 8-17-2011, EXPIRES 9-22-2020.

OWNER OF U.S. REG. NO. 3,616,280.

SER. NO. 85-141,974, FILED 9-30-2010.

GENE MACIOL, EXAMINING ATTORNEY



David J. Kyffers

Director of the United States Patent and Trademark Office

United States of America
United States Patent and Trademark Office

中天頻道

Reg. No. 4,097,858

Registered Feb. 14, 2012

Int. Cls.: 38 and 41

SERVICE MARK

PRINCIPAL REGISTER

CTI TELEVISION INCORPORATION (TAIWAN CORPORATION)
7F
NO.132, DALI ST., WANHUA DISTRICT
TAIPEI CITY, TAIWAN 10801

FOR: BROADCASTING OF TELEVISION NEWS PROGRAMS; TELEVISION BROADCASTING; INTERNET TELEVISION BROADCASTING, IN CLASS 38 (U.S. CLS. 100, 101 AND 104).

FIRST USE 3-31-2003; IN COMMERCE 3-31-2003.

FOR: RENTAL OF PRE-RECORDED VIDEOS THAT MAY BE DOWNLOADED FROM AN INTERNET WEB SITE; ENTERTAINMENT INFORMATION; FILM AND VIDEO FILM PRODUCTION; ENTERTAINMENT SERVICES, NAMELY, PRODUCTION OF TELEVISION PROGRAMS AND RADIO ENTERTAINMENT PROGRAMS; PREPARING SUBTITLES FOR MOVIES; AUDIO AND VIDEO RECORDING SERVICES; MICROFILMING FOR OTHERS; PHOTOGRAPHIC REPORTING; NEWS REPORTERS SERVICES, IN CLASS 41 (U.S. CLS. 100, 101 AND 107).

FIRST USE 3-31-2003; IN COMMERCE 3-31-2003.

NO CLAIM IS MADE TO THE EXCLUSIVE RIGHT TO USE THE NON-LATIN CHARACTERS THAT TRANSLITERATE TO "PINDAO", APART FROM THE MARK AS SHOWN.

THE NON-LATIN CHARACTERS IN THE MARK TRANSLITERATE TO ZHONG TIAN PINDAO AND THIS MEANS "CENTER", "SKY" AND "TELEVISION CHANNEL" IN ENGLISH.

THE MARK CONSISTS OF FOUR CHINESE CHARACTERS WHICH TRANSLATE AS FOLLOWS: "SKY", "CENTER" AND "TELEVISION CHANNEL".

SER. NO. 85-142,337, FILED 9-30-2010.

JASON TURNER, EXAMINING ATTORNEY



David J. Kyros

Director of the United States Patent and Trademark Office

United States of America

United States Patent and Trademark Office

EVERGREEN FILMS

Reg. No. 4,097,859

Registered Feb. 14, 2012

Int. Cls.: 9 and 41

TRADEMARK

SERVICE MARK

PRINCIPAL REGISTER

EVERGREEN FILMS, INC. (ALASKA CORPORATION)
5890 WEST JEFFERSON BOULEVARD, SUITE Q
LOS ANGELES, CA 90016

FOR: MOTION PICTURE FILMS IN 2D AND 3D FEATURING COMEDY, DRAMA, MUSICALS, ACTION, ADVENTURE, SUSPENSE, HORROR, WESTERNS, DETECTIVE STORIES, SPORTS EVENTS, DOCUMENTARIES, ANIMATIONS AND EDUCATIONAL TOPICS, NAMELY, HISTORY, SCIENCE, MATHEMATICS, FOREIGN LANGUAGES, LITERATURE, GEOGRAPHY, SOCIOLOGY, PSYCHOLOGY, ECONOMICS, MUSIC, ART AND ENGINEERING; TELEVISION FILMS IN 2D AND 3D FEATURING COMEDY, DRAMA, MUSICALS, ACTION, ADVENTURE, SUSPENSE, HORROR, WESTERNS, DETECTIVE STORIES, SPORTS EVENTS, DOCUMENTARIES, ANIMATIONS AND EDUCATIONAL TOPICS, NAMELY, HISTORY, SCIENCE, MATHEMATICS, FOREIGN LANGUAGES, LITERATURE, GEOGRAPHY, SOCIOLOGY, PSYCHOLOGY, ECONOMICS, MUSIC, ART AND ENGINEERING; PRE-RECORDED VIDEO CASSETTES AND DISCS IN 2D AND 3D FEATURING COMEDY, DRAMA, MUSICALS, ACTION, ADVENTURE, SUSPENSE, HORROR, WESTERNS, DETECTIVE STORIES, SPORTS EVENTS, DOCUMENTARIES, ANIMATIONS AND EDUCATIONAL TOPICS, NAMELY, HISTORY, SCIENCE, MATHEMATICS, FOREIGN LANGUAGES, LITERATURE, GEOGRAPHY, SOCIOLOGY, PSYCHOLOGY, ECONOMICS, MUSIC, ART AND ENGINEERING; PRE-RECORDED AUDIO DISCS AND NON-DISC DIGITAL MEDIA FEATURING MUSICAL AND SPOKEN PERFORMANCES FEATURING COMEDY, DRAMA, MUSICALS, ACTION, ADVENTURE, SUSPENSE, HORROR, WESTERNS, DETECTIVE STORIES, SPORTS EVENTS, DOCUMENTARIES, ANIMATIONS AND EDUCATIONAL TOPICS, NAMELY, HISTORY, SCIENCE, MATHEMATICS, FOREIGN LANGUAGES, LITERATURE, GEOGRAPHY, SOCIOLOGY, PSYCHOLOGY, ECONOMICS, MUSIC, ART AND ENGINEERING; COMPUTER GAME CARTRIDGES; COMPUTER GAMES ON DISCS; DOWNLOADABLE GAME SOFTWARE ACCESSIBLE VIA WIRED AND WIRELESS COMPUTER NETWORKS, IN CLASS 9 (U.S. CLS. 21, 23, 26, 36 AND 38).



FIRST USE 10-21-1999; IN COMMERCE 10-21-1999.

David J. Kyffers

Director of the United States Patent and Trademark Office

FOR: PRODUCTION OF PRE-RECORDED VIDEO CASSETTES, DVDS, PRE-RECORDED AUDIO DISCS, PRE-RECORDED NON-DISC DIGITAL STORAGE MEDIA AND MUSIC BY MEANS OF A GLOBAL COMPUTER NETWORK AND COMMUNICATIONS NETWORKS IN 2D AND 3D; PRODUCTION AND DISTRIBUTION OF MOTION PICTURES, TRAILERS, AND TELEVISION PROGRAMMING BY MEANS OF A GLOBAL COMPUTER NETWORK AND COMMUNICATIONS NETWORKS IN 2D AND 3D; PROVIDING INFORMATION IN

Reg. No. 4,097,859 THE FIELDS OF ENTERTAINMENT, MOTION PICTURES AND MUSIC OVER COMPUTER NETWORKS AND GLOBAL COMMUNICATION NETWORKS; PROVIDING ONLINE COMPUTER GAMES; MOTION PICTURE AND TELEVISION STUDIO SERVICES; RECORDING, MODIFYING OR EDITING SERVICES FOR FILM, SOUND AND VIDEO; ENTERTAINMENT SERVICES, NAMELY, PROVIDING VIDEO GAMES FOR PLAY ONLINE, ON WIRELESS DEVICES, ON COMPUTERS, OR ON GAME CONSOLES; ENTERTAINMENT SERVICES IN THE FORM OF PRODUCTION AND DISTRIBUTION OF ANIMATION, VISUAL EFFECTS, AND COMPUTER GRAPHICS FOR MOTION PICTURES AND TELEVISION; PRODUCTION OF ANIMATED MOTION PICTURES, IN CLASS 41 (U.S. CLS. 100, 101 AND 107).

FIRST USE 10-21-1999; IN COMMERCE 10-21-1999.

THE MARK CONSISTS OF STANDARD CHARACTERS WITHOUT CLAIM TO ANY PARTICULAR FONT, STYLE, SIZE, OR COLOR.

NO CLAIM IS MADE TO THE EXCLUSIVE RIGHT TO USE "FILMS", APART FROM THE MARK AS SHOWN.

SER. NO. 85-142,692, FILED 9-30-2010.

KAREN SEVERSON, EXAMINING ATTORNEY

United States of America

United States Patent and Trademark Office



Reg. No. 4,097,860

Registered Feb. 14, 2012

Int. Cls.: 39 and 42

SERVICE MARK

PRINCIPAL REGISTER

FILESERVE HOLDINGS LTD (BR. VIRGIN ISLANDS CORPORATION)
POTCULLIS TRUSTNET CHAMBERS, PO BOS 3444
ROAD TOWN
TORTOLA, BR. VIRGIN ISLANDS

FOR: ELECTRONIC DOCUMENT ARCHIVING SERVICES; ELECTRONIC STORAGE OF DATA, IN CLASS 39 (U.S. CLS. 100 AND 105).

FIRST USE 3-20-2010; IN COMMERCE 3-20-2010.

FOR: SOFTWARE AS A SERVICE (SAAS) SERVICES, NAMELY, HOSTING SOFTWARE FOR USE BY OTHERS FOR USE IN DATABASE MANAGEMENT, FOR USE AS A SPREADSHEET, FOR WORD PROCESSING, FOR UPLOADING AND DOWNLOADING MUSIC AND VIDEO FOR SHARING WITH OTHERS FOR ENTERTAINMENT PURPOSES; COMPUTER SERVICES, NAMELY, PROVIDING A WEB-BASED SYSTEM AND ONLINE PORTAL FEATURING ON-LINE NON-DOWNLOADABLE SOFTWARE THAT ENABLES USERS TO ACCESS TRAINING AND EDUCATION MATERIALS IN THE FIELD OF INFORMATION TECHNOLOGY, MANAGEMENT, ACCOUNTING AND FINANCE; COMPUTER SERVICE, NAMELY, ACTING AS AN APPLICATION SERVICE PROVIDER IN THE FIELD OF KNOWLEDGE MANAGEMENT TO HOST COMPUTER APPLICATION SOFTWARE FOR THE STORAGE AND SHARING OF DATA AND INFORMATION; DESIGN AND DEVELOPMENT OF COMPUTER HARDWARE AND SOFTWARE; APPLICATION SERVICE PROVIDER, NAMELY, HOSTING COMPUTER SOFTWARE APPLICATIONS OF OTHERS, IN CLASS 42 (U.S. CLS. 100 AND 101).

FIRST USE 3-20-2010; IN COMMERCE 3-20-2010.

THE MARK CONSISTS OF FOUR TABBED FILE FOLDERS IN THE COLORS OF YELLOW, BLUE, RED AND GREEN, SUPERIMPOSED WITH THE WORD "FILESERVE", THE BOTTOM HALF OF THE LETTERS APPEARING IN DARK BROWN AND THE TOP HALF OF THE LETTERS APPEARING IN LIGHT BROWN.

THE COLOR(S) DARK BROWN, LIGHT BROWN, YELLOW, BLUE, RED AND GREEN IS/ARE CLAIMED AS A FEATURE OF THE MARK.

SER. NO. 85-143,521, FILED S.R. 10-1-2010 AM. P.R. 3-2-2011.



David J. Kyffers

Director of the United States Patent and Trademark Office

Reg. No. 4,097,860 ROBERT C. CLARK JR., EXAMINING ATTORNEY

United States of America

United States Patent and Trademark Office



Reg. No. 4,097,861

Registered Feb. 14, 2012

Int. Cls.: 9, 41 and 42

TRADEMARK

SERVICE MARK

PRINCIPAL REGISTER

WEBTECH WIRELESS INC. (CANADA CORPORATION)
215 - 4299 CANADA WAY
BURNABY, BC, CANADA V5G1H3

FOR: VEHICLE LOCATOR AND RECOVERY DEVICE PROGRAMMED TO USE GLOBAL POSITIONING SYSTEMS (GPS) WITH WIRELESS COMMUNICATION NETWORKS TO DELIVER WIRELESS VEHICLE TRACKING AND LOCATION INFORMATION, IN CLASS 9 (U.S. CLS. 21, 23, 26, 36 AND 38).

FOR: TRAINING SERVICES IN THE FIELD OF COMPUTER HARDWARE AND SOFTWARE SYSTEMS, IN CLASS 41 (U.S. CLS. 100, 101 AND 107).

FOR: CONSULTING SERVICES IN THE FIELD OF DESIGN, SELECTION, IMPLEMENTATION AND USE OF COMPUTER HARDWARE AND SOFTWARE SYSTEMS FOR OTHERS; TECHNICAL SUPPORT SERVICES, NAMELY, TROUBLESHOOTING IN THE NATURE OF DIAGNOSING OF COMPUTER HARDWARE AND SOFTWARE PROBLEMS, IN CLASS 42 (U.S. CLS. 100 AND 101).

PRIORITY CLAIMED UNDER SEC. 44(D) ON CANADA APPLICATION NO. 1,498,007, FILED 9-30-2010, REG. NO. TMA807148, DATED 9-21-2011, EXPIRES 9-21-2026.

THE MARK CONSISTS OF A SHADED BOX WITH ROUNDED CORNERS CONTAINING THE STYLIZED LETTER "W".

SER. NO. 85-143,546, FILED 10-1-2010.

YAT SYE, LEE, EXAMINING ATTORNEY



David J. Kyros

Director of the United States Patent and Trademark Office

United States of America

United States Patent and Trademark Office

PHILADELPHIA MARATHON

Reg. No. 4,097,862

FUND FOR PHILADELPHIA, INC. (PENNSYLVANIA NON-PROFIT CORPORATION)
1515 ARCH STREET, 12TH FLOOR
PHILADELPHIA, PA 19102

Registered Feb. 14, 2012

Int. Cls.: 25, 35 and 41

FOR: CLOTHING, NAMELY, SHIRTS, TEE-SHIRTS, TANK TOPS, CAMISOLES, ATHLETIC JERSEYS, JACKETS, VESTS, SWEATSHIRTS, HATS, CAPS, VISORS, JACKETS, PULLOVERS, SWEATERS, SWEAT PANTS, SWEAT SHORTS, SWEAT BANDS AND SWEAT SUITS, IN CLASS 25 (U.S. CLS. 22 AND 39).

TRADEMARK

SERVICE MARK

FIRST USE 11-18-1994; IN COMMERCE 11-18-1994.

PRINCIPAL REGISTER

FOR: PROMOTING BUSINESS AND TOURISM RELATED TO THE PHILADELPHIA METROPOLITAN AREA THROUGH ACTIVITIES INCLUDING FESTIVALS, EXPOSITIONS, AND THE LIKE, IN THE AREA OF HEALTH AND FITNESS; PROMOTIONAL SPONSORSHIP OF RUNNING EVENTS FOR ADULTS AND CHILDREN, IN CLASS 35 (U.S. CLS. 100, 101 AND 102).

FIRST USE 9-1-1994; IN COMMERCE 9-1-1994.

FOR: ENTERTAINMENT SERVICES, NAMELY, CONDUCTING RUNNING EVENTS FOR ADULTS AND CHILDREN, IN CLASS 41 (U.S. CLS. 100, 101 AND 107).

FIRST USE 9-1-1994; IN COMMERCE 9-1-1994.

THE MARK CONSISTS OF STANDARD CHARACTERS WITHOUT CLAIM TO ANY PARTICULAR FONT, STYLE, SIZE, OR COLOR.

NO CLAIM IS MADE TO THE EXCLUSIVE RIGHT TO USE "MARATHON", APART FROM THE MARK AS SHOWN.

SEC. 2(F).

SER. NO. 85-144,062, FILED 10-4-2010.

PRISCILLA MILTON, EXAMINING ATTORNEY



David J. Kyffers

Director of the United States Patent and Trademark Office

United States of America

United States Patent and Trademark Office



Reg. No. 4,097,863

Registered Feb. 14, 2012

Int. Cls.: 25, 35 and 41

TRADEMARK

SERVICE MARK

PRINCIPAL REGISTER

FUND FOR PHILADELPHIA, INC. (PENNSYLVANIA NON-PROFIT CORPORATION)
1515 ARCH STREET, 12TH FLOOR
PHILADELPHIA, PA 19102

FOR: CLOTHING, NAMELY, SHIRTS, TEE-SHIRTS, TANK TOPS, CAMISOLES, ATHLETIC JERSEYS, JACKETS, VESTS, SWEATSHIRTS, HATS, CAPS, VISORS, JACKETS, PULLOVERS, SWEATERS, SWEAT PANTS, SWEAT SHORTS, SWEAT BANDS AND SWEAT SUITS, IN CLASS 25 (U.S. CLS. 22 AND 39).

FIRST USE 1-0-2006; IN COMMERCE 11-17-2006.

FOR: PROMOTING BUSINESS AND TOURISM RELATED TO THE PHILADELPHIA METROPOLITAN AREA THROUGH ACTIVITIES INCLUDING FESTIVALS, EXPOSITIONS, AND THE LIKE, IN THE AREA OF HEALTH AND FITNESS; PROMOTIONAL SPONSORSHIP OF RUNNING EVENTS FOR ADULTS AND CHILDREN, IN CLASS 35 (U.S. CLS. 100, 101 AND 102).

FIRST USE 1-0-2006; IN COMMERCE 11-17-2006.

FOR: ENTERTAINMENT SERVICES, NAMELY, CONDUCTING RUNNING EVENTS FOR ADULTS AND CHILDREN, IN CLASS 41 (U.S. CLS. 100, 101 AND 107).

FIRST USE 1-0-2006; IN COMMERCE 11-17-2006.

NO CLAIM IS MADE TO THE EXCLUSIVE RIGHT TO USE "PHILADELPHIA" AS TO CL 25; "PHILADELPHIA MARATHON", "26.2", "13.1", OR "8K" AS TO CL 35 & 41, APART FROM THE MARK AS SHOWN.

THE MARK CONSISTS OF THE WORD "PHILADELPHIA" ABOVE THE WORD "MARATHON. 26.2 13.1" AND "8K" DIVIDED BY STAR FIGURES APPEAR BELOW THE WORD "MARATHON". TO THE LEFT OF THE WORDS IS AN ABSTRACT FOOT DESIGN TOPPED BY A STAR FIGURE. TO THE LEFT OF THE FOOT DESIGN ARE TWO RACING STRIPES.

SER. NO. 85-144,078, FILED 10-4-2010.

PRISCILLA MILTON, EXAMINING ATTORNEY



David J. Kyffers

Director of the United States Patent and Trademark Office

United States of America

United States Patent and Trademark Office



Reg. No. 4,097,864

Registered Feb. 14, 2012

Int. Cls.: 29, 31 and 32

TRADEMARK

PRINCIPAL REGISTER

LUBERA AG (SWITZERLAND AKTIENGESELLSCHAFT)
LAGERSTRASSE
BUCHS, SWITZERLAND 9470

FOR: PRESERVED, FROZEN, DRIED AND COOKED FRUITS AND VEGETABLES; JELLIES, JAMS, COMPOTES, IN CLASS 29 (U.S. CL. 46).

FOR: SEEDS AND UNPROCESSED SEEDS FOR AGRICULTURAL PURPOSES; FRESH FRUITS AND VEGETABLES; FRUIT SEEDS; CROP SEEDS; LIVE PLANTS AND LIVE FLOWERS, IN CLASS 31 (U.S. CLS. 1 AND 46).

FOR: MINERAL AND AERATED WATERS; FRUIT DRINKS AND FRUIT JUICES; AND SYRUPS FOR MAKING BEVERAGES, IN CLASS 32 (U.S. CLS. 45, 46 AND 48).

OWNER OF ERPN CMNTY TM OFC REG. NO. 008894081, DATED 7-27-2010, EXPIRES 2-18-2020.

THE COLOR(S) RED, BEIGE, BROWN, AND WHITE IS/ARE CLAIMED AS A FEATURE OF THE MARK.

THE MARK CONSISTS OF A STYLIZED CORE OF AN APPLE FEATURING BROWN AND BEIGE SEEDS IN THE CENTER, WHITE AND RED AROUND THE CORE AND RED SPOTTED WITH WHITE ON THE OUTSIDE BORDER OF THE CORE.

SER. NO. 85-144,111, FILED 10-4-2010.

BERYL GARDNER, EXAMINING ATTORNEY



David J. Kybas

Director of the United States Patent and Trademark Office

United States of America

United States Patent and Trademark Office

ALWAYS AIR. ALWAYS THERE.

Reg. No. 4,097,865

SULLAIR CORPORATION (INDIANA CORPORATION)
3700 E. MICHIGAN BLVD.

Registered Feb. 14, 2012

MICHIGAN CITY, IN 463609990

**Int. Cls.: 4, 7, 8, 9, 11, 35,
37, 41 and 42**

FOR: INDUSTRIAL LUBRICANTS FOR USE IN COMPRESSORS AND VACUUM PUMPS;
GENUINE REPLACEMENT PARTS FOR COMPRESSED AIR EQUIPMENT, NAMELY, IN-
DUSTRIAL LUBRICANTS, IN CLASS 4 (U.S. CLS. 1, 6 AND 15).

TRADEMARK

FIRST USE 6-27-2005; IN COMMERCE 6-27-2005.

SERVICE MARK

FOR: AIR COMPRESSORS; VACUUM COMPRESSORS; COMPRESSED AIR OPERATED
TAMPERS, NAMELY, PNEUMATIC BACKFILL PAVING BREAKERS, NAMELY, PNEU-
MATIC HAMMERS; TRENCHERS, NAMELY, EARTH MOVING MACHINES; ROCK DRILLS;
GENUINE REPLACEMENT PARTS FOR COMPRESSED AIR EQUIPMENT, NAMELY, FIL-
TERS, AND SEPARATORS; AIR INLET FILTERS FOR MACHINES, NAMELY, FOR INDUS-
TRIAL AIR COMPRESSORS; PNEUMATIC TOOLS, NAMELY, CLAY DIGGERS, IN CLASS
7 (U.S. CLS. 13, 19, 21, 23, 31, 34 AND 35).

PRINCIPAL REGISTER

FIRST USE 6-27-2005; IN COMMERCE 6-27-2005.

FOR: HAND TOOLS, NAMELY, CLAY DIGGERS, IN CLASS 8 (U.S. CLS. 23, 28 AND 44).

FIRST USE 6-27-2005; IN COMMERCE 6-27-2005.

FOR: COMPRESSED AIR DATA LOGGING AND ANALYSIS SYSTEM CONSISTING OF
DATA COLLECTION LOGGER, SENSORS FOR SENSING AIR FLOW, AIR PRESSURE,
POWER (MEASURED IN AMPS AND KW), TEMPERATURE, AND DEW POINT, A BATTERY,
BATTERY CHARGERS, AND DATA COLLECTION SOFTWARE; COMPRESSED AIR
AUDITING EQUIPMENT, NAMELY, ELECTRONIC DATALOGGERS, SENSORS AND
SOFTWARE; COMPRESSED AIR SYSTEM REMOTE MONITORING EQUIPMENT, NAMELY,
WEB-ENABLED, REMOTE-MONITORING HARDWARE COMPRISED OF INTERFACE
CARDS AND SENSORS, IN CLASS 9 (U.S. CLS. 21, 23, 26, 36 AND 38).



David J. Kyfos

FIRST USE 6-27-2005; IN COMMERCE 6-27-2005.

FOR: DRYERS FOR THE REMOVAL OF WATER VAPOR FROM COMPRESSED AIR, IN
CLASS 11 (U.S. CLS. 13, 21, 23, 31 AND 34).

Director of the United States Patent and Trademark Office

Reg. No. 4,097,865 FIRST USE 6-27-2005; IN COMMERCE 6-27-2005.

FOR: BUSINESS MANAGEMENT CONSULTATION SERVICES RELATING TO THE OPERATION OF COMPRESSED AIR SYSTEMS, IN CLASS 35 (U.S. CLS. 100, 101 AND 102).

FIRST USE 6-27-2005; IN COMMERCE 6-27-2005.

FOR: MACHINERY MAINTENANCE AND REPAIR, NAMELY, THE MAINTENANCE AND REPAIR OF AIR AND REFRIGERATION COMPRESSORS, VACUUM SYSTEMS AND RELATED EQUIPMENT, IN CLASS 37 (U.S. CLS. 100, 103 AND 106).

FIRST USE 6-27-2005; IN COMMERCE 6-27-2005.

FOR: EDUCATIONAL SEMINARS AND TRAINING OF OTHERS IN THE OPERATION, MAINTENANCE AND REPAIR OF AIR AND REFRIGERATION COMPRESSORS, VACUUM SYSTEMS AND RELATED EQUIPMENT, IN CLASS 41 (U.S. CLS. 100, 101 AND 107).

FIRST USE 6-27-2005; IN COMMERCE 6-27-2005.

FOR: ENGINEERING AND TECHNOLOGY CONSULTATION IN THE FIELD OF COMPRESSED AIR SYSTEMS; DESIGN AND DEVELOPMENT OF COMPRESSED AIR SYSTEMS, IN CLASS 42 (U.S. CLS. 100 AND 101).

FIRST USE 6-27-2005; IN COMMERCE 6-27-2005.

THE MARK CONSISTS OF STANDARD CHARACTERS WITHOUT CLAIM TO ANY PARTICULAR FONT, STYLE, SIZE, OR COLOR.

SER. NO. 85-145,309, FILED 10-5-2010.

RICHARD WHITE, EXAMINING ATTORNEY

United States of America

United States Patent and Trademark Office



Reg. No. 4,097,866

Registered Feb. 14, 2012

Int. Cl.: 35

SERVICE MARK

PRINCIPAL REGISTER

BENETEMPS, INC. (NEW HAMPSHIRE CORPORATION), DBA BTHR SOLUTIONS
SUITE 305
200 HIGHLAND AVE
NEEDHAM, MA 02494

FOR: EMPLOYMENT HIRING, RECRUITING, PLACEMENT, STAFFING AND CAREER NETWORKING SERVICES; HUMAN RESOURCE CONSULTING SERVICES IN CONNECTION WITH EMPLOYER TO EMPLOYEE COMMUNICATIONS REGARDING EMPLOYEE COMPENSATION, BENEFITS PROGRAMS OFFERED BY EMPLOYERS TO EMPLOYEES AND EMPLOYEE ENROLLMENT IN SUCH PROGRAMS, IN CLASS 35 (U.S. CLS. 100, 101 AND 102).

FIRST USE 9-1-2010; IN COMMERCE 9-1-2010.

THE MARK CONSISTS OF A WHITE SILHOUETTE OF TWO HUMAN FIGURES AGAINST A DARK BLUE RECTANGULAR BACKGROUND; TO THE RIGHT THEREOF ARE THE LETTERS "BTHR" WITH "BT" IN DARK BLUE AND "HR" IN LIGHT BLUE; UNDERNEATH "BTHR" IS THE WORD "SOLUTIONS" IN BLACK.

THE COLOR(S) DARK BLUE, LIGHT BLUE, BLACK AND WHITE IS/ARE CLAIMED AS A FEATURE OF THE MARK.

SER. NO. 85-147,150, FILED 10-7-2010.

JAMES STEIN, EXAMINING ATTORNEY



David J. Kappas

Director of the United States Patent and Trademark Office

United States of America

United States Patent and Trademark Office

Mobile Phone Examiner Plus

Reg. No. 4,097,867

Registered Feb. 14, 2012

Int. Cl.: 9

TRADEMARK

PRINCIPAL REGISTER

ACCESSDATA GROUP LLC (DELAWARE LIMITED LIABILITY COMPANY)
ATTN: LEGAL DEPARTMENT
384 SOUTH 400 WEST, SUITE 200
LINDON, UT 84042

FOR: COMPUTER PROGRAMS FOR THE ENABLING OF ACCESS OR ENTRANCE CONTROL; COMPUTER SOFTWARE FOR APPLICATION AND DATABASE INTEGRATION; COMPUTER SOFTWARE FOR CREATING SEARCHABLE DATABASES OF INFORMATION AND DATA; COMPUTER SOFTWARE FOR ORGANIZING AND VIEWING DIGITAL IMAGES AND PHOTOGRAPHS; COMPUTER SOFTWARE FOR THE COLLECTION, EDITING, ORGANIZING, MODIFYING, BOOK MARKING, TRANSMISSION, STORAGE AND SHARING OF DATA AND INFORMATION, IN CLASS 9 (U.S. CLS. 21, 23, 26, 36 AND 38).

FIRST USE 7-21-2010; IN COMMERCE 7-21-2010.

THE MARK CONSISTS OF STANDARD CHARACTERS WITHOUT CLAIM TO ANY PARTICULAR FONT, STYLE, SIZE, OR COLOR.

NO CLAIM IS MADE TO THE EXCLUSIVE RIGHT TO USE "MOBILE PHONE EXAMINER", APART FROM THE MARK AS SHOWN.

SER. NO. 85-147,692, FILED 10-7-2010.

MARY CRAWFORD, EXAMINING ATTORNEY



David J. Kybas

Director of the United States Patent and Trademark Office

United States of America

United States Patent and Trademark Office

SoZo

Reg. No. 4,097,868

Registered Feb. 14, 2012

Int. Cl.: 30

TRADEMARK

PRINCIPAL REGISTER

SOZO GLOBAL, LLC (NEVADA LIMITED LIABILITY COMPANY)
8312 STERLING ST
IRVING, TX 75063

FOR: COFFEE BASED BEVERAGES, IN CLASS 30 (U.S. CL. 46).

FIRST USE 11-5-2010; IN COMMERCE 11-5-2010.

THE MARK CONSISTS OF STANDARD CHARACTERS WITHOUT CLAIM TO ANY PARTICULAR FONT, STYLE, SIZE, OR COLOR.

OWNER OF U.S. REG. NO. 3,448,834.

THE ENGLISH TRANSLATION OF "SOZO" IS "TO SAVE, KEEP SAFE AND SOUND, TO RESCUE FROM DANGER OR DESTRUCTION" OR "TO MAKE WELL, HEAL, RESTORE TO HEALTH".

SER. NO. 85-148,416, FILED 10-8-2010.

BRIAN PINO, EXAMINING ATTORNEY



David J. Kybas

Director of the United States Patent and Trademark Office

United States of America

United States Patent and Trademark Office



Reg. No. 4,097,869

Registered Feb. 14, 2012

Int. Cls.: 9 and 41

TRADEMARK

SERVICE MARK

PRINCIPAL REGISTER

AIBELIEVE CO., LTD. (TAIWAN CORPORATION)
3F, NO. 71, JHOU-ZIH ST., NEI-HU DIST.
TAIPE CITY, TAIWAN

FOR: CARRYING CASES SPECIALLY ADAPTED FOR POCKET CALCULATORS AND CELL PHONES; BAGS AND CASES SPECIALLY ADAPTED FOR HOLDING OR CARRYING PORTABLE TELEPHONES AND TELEPHONE EQUIPMENT AND ACCESSORIES; PROTECTIVE CARRYING CASES FOR PORTABLE MUSIC PLAYERS, NAMELY, MP3 PLAYERS; PROTECTIVE COVERS AND CASES FOR CELL PHONES, LAPTOPS AND PORTABLE MEDIA PLAYERS; COMPUTER CURSOR CONTROL DEVICES, NAMELY, COMPUTER MOUSE; PRERECORDED COMPUTER PROGRAM DISKS FOR USE IN DATABASE MANAGEMENT; COMPUTER SOFTWARE FOR USE IN VOICE RECOGNITION AND EXECUTING VOICE COMMANDS; COMPUTER GAME JOYSTICKS; COMPUTER JOYSTICKS; COMPUTER GAME CARTRIDGES AND DISCS; COMPUTER GAME SOFTWARE; DOWNLOADABLE ELECTRONIC MUSIC VIA THE INTERNET; DOWNLOADABLE ELECTRONIC VIDEO VIA THE INTERNET; DOWNLOADABLE ELECTRONIC FILE CONTAINING ARTWORK, TEXT, AUDIO, VIDEO, GAMES; ELECTRONIC PUBLICATIONS, NAMELY, DOWNLOADABLE ELECTRONIC DIGITAL BOOKS FEATURING COMPUTER GAMES, VIDEO GAMES, RECORDED ON COMPUTER MEDIA WHICH IS ACCESSED VIA THE INTERNET, IN CLASS 9 (U.S. CLS. 21, 23, 26, 36 AND 38).

FIRST USE 5-1-2010; IN COMMERCE 5-1-2010.

FOR: PROVIDING ONLINE PUBLICATIONS, NAMELY, ELECTRONIC DIGITAL BOOKS, IN THE FIELD OF COMPUTER GAMES, IN CLASS 41 (U.S. CLS. 100, 101 AND 107).

FIRST USE 5-1-2010; IN COMMERCE 5-1-2010.

THE MARK CONSISTS OF A CIRCLE AND AN INCOMPLETE CIRCLE; TWO OVAL SHAPES THAT CONSISTS OF TWO SHADED CIRCLES; AND THE WORD FOR "AIWI".

THE WORDING "AIWI" HAS NO MEANING IN A FOREIGN LANGUAGE.

SER. NO. 85-148,664, FILED 10-8-2010.

CHRISTINA SOBRAL, EXAMINING ATTORNEY



David J. Kappas

Director of the United States Patent and Trademark Office

United States of America

United States Patent and Trademark Office

Booch

Reg. No. 4,097,870

KELLY SNAVELY (UNITED STATES INDIVIDUAL), DBA BOOCH
318 SHADY CREEK LANE
NASHVILLE, TN 37211

Registered Feb. 14, 2012

Int. Cl.: 30

FOR: BEVERAGES MADE OF TEA; BEVERAGES WITH A TEA BASE; TEA; TEA OF SALTY KELP POWDER (KOMBU-CHA); TEA-BASED BEVERAGES; TEA-BASED BEVERAGES WITH FRUIT FLAVORING, IN CLASS 30 (U.S. CL. 46).

TRADEMARK

FIRST USE 7-26-2009; IN COMMERCE 1-1-2010.

PRINCIPAL REGISTER

THE MARK CONSISTS OF STANDARD CHARACTERS WITHOUT CLAIM TO ANY PARTICULAR FONT, STYLE, SIZE, OR COLOR.

SER. NO. 85-149,824, FILED 10-11-2010.

MICHAEL ENGEL, EXAMINING ATTORNEY



David J. Kyfos

Director of the United States Patent and Trademark Office

United States of America
United States Patent and Trademark Office

RUBINSTAR

Reg. No. 4,097,871

LICHTENAUER, JOACHIM (FED REP GERMANY INDIVIDUAL)
HAUPTSTRASSE 80A

Registered Feb. 14, 2012

LEIMEN, FED REP GERMANY 69181

Int. Cl.: 31

FOR: FRESH FRUIT, LIVE PLANTS AND APPLE TREES, IN CLASS 31 (U.S. CLS. 1 AND 46).

TRADEMARK

FIRST USE 5-0-1992; IN COMMERCE 5-0-1992.

PRINCIPAL REGISTER

THE MARK CONSISTS OF STANDARD CHARACTERS WITHOUT CLAIM TO ANY PARTICULAR FONT, STYLE, SIZE, OR COLOR.

SER. NO. 85-150,336, FILED 10-12-2010.

MARK SPARACINO, EXAMINING ATTORNEY



David J. Kybas

Director of the United States Patent and Trademark Office

United States of America

United States Patent and Trademark Office

JACOBS LADDER

Reg. No. 4,097,872

Registered Feb. 14, 2012

Int. Cls.: 9, 25 and 41

TRADEMARK

SERVICE MARK

PRINCIPAL REGISTER

JACOBS LADDER MUSIC LLC (FLORIDA LIMITED LIABILITY COMPANY)
527 WEST 46 ST
MIAMI BEACH, FL 33140

FOR: COMPACT DISCS FEATURING MUSIC; COMPUTER SOFTWARE FEATURING MUSICAL SOUND RECORDINGS AND MUSICAL VIDEO RECORDINGS; DOWNLOADABLE MP3 FILES, MP3 RECORDINGS, ON-LINE DISCUSSION BOARDS, WEBCASTS, WEBINARS AND PODCASTS FEATURING MUSIC, AUDIO BOOKS IN THE FIELD OF LIVE AND RECORDED MUSIC, INTERVIEWS, NEWS, DISCUSSIONS AND SPOKEN-WORD PERFORMANCES, AND NEWS BROADCASTS; DOWNLOADABLE MUSICAL SOUND RECORDINGS; DOWNLOADABLE RINGTONES, VIDEO FILES, STILL IMAGE FILES, LIVE AND RECORDED MUSIC, INTERVIEWS, NEWS, DISCUSSIONS AND SPOKEN-WORD PERFORMANCES VIA THE INTERNET AND WIRELESS DEVICES; ELECTRONIC PUBLICATIONS, NAMELY, NEWSLETTERS, MAGAZINES, NEWSPAPERS, NEWS UPDATES, FEATURE UPDATES, INTERVIEWS, BOOKS, CALENDARS, SCHEDULING MATERIALS, IMAGE COLLECTIONS, VIDEO COLLECTIONS, WEBINARS AND FILES CONTAINING IMAGES, TEXT, SOUND AND VIDEO FEATURING LIVE AND RECORDED MUSIC, INTERVIEWS, NEWS, DISCUSSIONS AND SPOKEN-WORD PERFORMANCES RECORDED ON COMPUTER MEDIA; MUSIC HEADPHONES; MUSICAL SOUND RECORDINGS; MUSICAL VIDEO RECORDINGS; PRE-RECORDED ELECTRONIC AND DIGITAL MEDIA FEATURING LIVE AND RECORDED MUSIC, INTERVIEWS, NEWS, DISCUSSIONS AND SPOKEN-WORD PERFORMANCES; PRE-RECORDED FLASH DRIVES FEATURING LIVE AND RECORDED MUSIC, INTERVIEWS, NEWS, DISCUSSIONS AND SPOKEN-WORD PERFORMANCES; VINYL COVERS SPECIALLY ADAPTED FOR CELL PHONES, MP3 PLAYERS, LAPTOPS, COMPUTERS, PORTABLE SATELLITE RADIOS, PERSONAL DIGITAL ASSISTANTS, REMOTE CONTROLS, AND TELEVISION SATELLITE RECORDERS; VISUAL AND AUDIO RECORDINGS FEATURING LIVE AND RECORDED MUSIC, INTERVIEWS, NEWS, DISCUSSIONS AND SPOKEN-WORD PERFORMANCES, IN CLASS 9 (U.S. CLS. 21, 23, 26, 36 AND 38).

FIRST USE 6-1-2002; IN COMMERCE 6-1-2002.

FOR: ATHLETIC APPAREL, NAMELY, SHIRTS, PANTS, JACKETS, FOOTWEAR, HATS AND CAPS, ATHLETIC UNIFORMS; CAMP SHIRTS; COLLARED SHIRTS; GLOVES AS CLOTHING; HATS; HOODED SWEAT SHIRTS; JACKETS; JERSEYS; LEATHER BELTS; NIGHT SHIRTS; OVER SHIRTS; PAPER HATS FOR USE AS CLOTHING ITEMS; SHIRTS; SHIRTS FOR INFANTS, BABIES, TODDLERS AND CHILDREN; SHOES; SOCKS; T-SHIRTS; TIES; TOPS; UNDERWEAR; WRAPS, IN CLASS 25 (U.S. CLS. 22 AND 39).



David J. Kyffers

Director of the United States Patent and Trademark Office

Reg. No. 4,097,872 FIRST USE 6-1-2002; IN COMMERCE 6-1-2002.

FOR: ENTERTAINMENT IN THE NATURE OF LIVE MUSICAL PERFORMANCES; ENTERTAINMENT SERVICES, NAMELY, PROVIDING A WEB SITE FEATURING NON-DOWNLOADABLE MUSICAL PERFORMANCES, MUSICAL VIDEOS, RELATED FILM CLIPS, PHOTOGRAPHS, AND OTHER MULTIMEDIA MATERIALS FEATURING MUSICAL PERFORMANCES; ENTERTAINMENT, NAMELY, LIVE PERFORMANCES BY A MUSICAL BAND; PROVISION OF INFORMATION RELATING TO LIVE PERFORMANCES, ROAD SHOWS, LIVE STAGE EVENTS, THEATRICAL PERFORMANCES, LIVE MUSIC CONCERTS AND AUDIENCE PARTICIPATION IN SUCH EVENTS, IN CLASS 41 (U.S. CLS. 100, 101 AND 107).

FIRST USE 7-1-2001; IN COMMERCE 10-20-2001.

THE MARK CONSISTS OF STANDARD CHARACTERS WITHOUT CLAIM TO ANY PARTICULAR FONT, STYLE, SIZE, OR COLOR.

SER. NO. 85-151,306, FILED 10-13-2010.

DAVID H. STINE, EXAMINING ATTORNEY

United States of America

United States Patent and Trademark Office

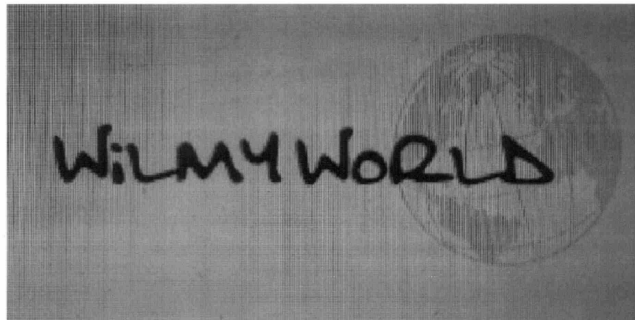

Reg. No. 4,097,873

STAUFFER, ADAM LEE (UNITED STATES INDIVIDUAL)
9 PARTRIDGE ROAD
WILMINGTON, NC 28412

Registered Feb. 14, 2012

Int. Cl.: 25

FOR: ATHLETIC APPAREL, NAMELY, SHIRTS, PANTS, JACKETS, FOOTWEAR, HATS AND CAPS, ATHLETIC UNIFORMS, IN CLASS 25 (U.S. CLS. 22 AND 39).

TRADEMARK

FIRST USE 9-30-2010; IN COMMERCE 9-30-2010.

PRINCIPAL REGISTER

THE MARK CONSISTS OF THE NAME/WORD "WILMYWORLD", WITH THE LAST THREE LETTERS OF THE NAME IMPOSED OVER A STYLIZED IMAGE OF A GLOBE.

SER. NO. 85-154,808, FILED 10-18-2010.

TRACY WHITTAKER-BROWN, EXAMINING ATTORNEY



David J. Kybas

Director of the United States Patent and Trademark Office

United States of America

United States Patent and Trademark Office

360 SERVICES

Reg. No. 4,097,874

Registered Feb. 14, 2012

Int. Cl.: 37

SERVICE MARK

PRINCIPAL REGISTER

MCDS VENTURES, LLC (INDIANA LIMITED LIABILITY COMPANY)
1040 E. NEW YORK STREET
INDIANAPOLIS, IN 46202

FOR: CLEANING OF INDUSTRIAL KITCHEN EXHAUST SYSTEMS; CLEANING OF COMMERCIAL ROOFTOP GREASE CONTAINMENT SYSTEMS, IN CLASS 37 (U.S. CLS. 100, 103 AND 106).

FIRST USE 11-15-2005; IN COMMERCE 11-15-2005.

THE MARK CONSISTS OF STANDARD CHARACTERS WITHOUT CLAIM TO ANY PARTICULAR FONT, STYLE, SIZE, OR COLOR.

NO CLAIM IS MADE TO THE EXCLUSIVE RIGHT TO USE "SERVICES", APART FROM THE MARK AS SHOWN.

SER. NO. 85-156,304, FILED 10-19-2010.

BARNEY CHARLON, EXAMINING ATTORNEY



David J. Kyffers

Director of the United States Patent and Trademark Office

United States of America

United States Patent and Trademark Office

**Kings
Way**

Reg. No. 4,097,875

Registered Feb. 14, 2012

Int. Cl.: 29

TRADEMARK

PRINCIPAL REGISTER

MRS. SEAFOOD, INC. (CALIFORNIA CORPORATION)
SUITE# 214
2920 WEST OLIVE AVENUE
BURBANK, CA 91505

FOR: FROZEN SEAFOOD, IN CLASS 29 (U.S. CL. 46).

FIRST USE 3-1-2001; IN COMMERCE 3-1-2001.

THE MARK CONSISTS OF A CROWN SITS ABOVE THE "K" IN THE WORDING "KINGS WAY".

SER. NO. 85-157,465, FILED 10-20-2010.

ARETHA SOMERVILLE, EXAMINING ATTORNEY



David J. Kyffers

Director of the United States Patent and Trademark Office

United States of America

United States Patent and Trademark Office

FIRE ON THE MOUNTAIN

Reg. No. 4,097,876

FOTM FRANCHISE, INC. (OREGON CORPORATION)
5855 NE 11TH AVE.
PORTLAND, OR 97211

Registered Feb. 14, 2012

Int. Cl.: 43

FOR: RESTAURANT SERVICES FEATURING BUFFALO CHICKEN WINGS, BARBECUE SAUCES, CHICKEN SANDWICHES, CHICKEN SALADS, IN CLASS 43 (U.S. CLS. 100 AND 101).

SERVICE MARK

FIRST USE 1-1-2005; IN COMMERCE 1-1-2005.

PRINCIPAL REGISTER

THE MARK CONSISTS OF STANDARD CHARACTERS WITHOUT CLAIM TO ANY PARTICULAR FONT, STYLE, SIZE, OR COLOR.

SER. NO. 85-159,058, FILED 10-22-2010.

BENJAMIN OKEKE, EXAMINING ATTORNEY



David J. Kyffers

Director of the United States Patent and Trademark Office

United States of America

United States Patent and Trademark Office



Reg. No. 4,097,877

FOTM FRANCHISE, INC. (OREGON CORPORATION)

Registered Feb. 14, 2012

5855 NE 11TH AVE.
PORTLAND, OR 97211

Int. Cl.: 43

FOR: RESTAURANT SERVICES FEATURING BUFFALO CHICKEN WINGS, BARBECUE SAUCES, CHICKEN SANDWICHES, CHICKEN SALADS, IN CLASS 43 (U.S. CLS. 100 AND 101).

SERVICE MARK

FIRST USE 1-1-2005; IN COMMERCE 1-1-2005.

PRINCIPAL REGISTER

NO CLAIM IS MADE TO THE EXCLUSIVE RIGHT TO USE "BUFFALO WINGS", APART FROM THE MARK AS SHOWN.

THE MARK CONSISTS OF A DARK CIRCLE OUTLINE WITH A LIGHTER INNER CIRCLE CONTAINING THE STYLIZED WORDING "FIRE ON THE MOUNTAIN BUFFALO WINGS" IN AN ARCHED ARRANGEMENT; ABOVE THIS TEXT IS THE DESIGN OF A VOLCANO ERUPTING IN FLAMES.

SER. NO. 85-159,076, FILED 10-22-2010.

BENJAMIN OKEKE, EXAMINING ATTORNEY



David J. Kybas

Director of the United States Patent and Trademark Office

United States of America

United States Patent and Trademark Office

Revenue Accelerator

Reg. No. 4,097,878

SALZ, LEE B. (UNITED STATES INDIVIDUAL)
9784 TROY LANE
MAPLE GROVE, MN 55311

Registered Feb. 14, 2012

Int. Cls.: 35 and 42

FOR: BUSINESS SERVICES, NAMELY, FORMULATION OF BEST PRACTICES FOR ONBOARDING SALES PEOPLE AND SALES MANAGERS, IN CLASS 35 (U.S. CLS. 100, 101 AND 102).

SERVICE MARK

FIRST USE 6-24-2008; IN COMMERCE 6-24-2008.

PRINCIPAL REGISTER

FOR: TEMPORARY USE OF A WEB-BASED SOFTWARE APPLICATION FOR USE IN DEVELOPING AND IMPLEMENTING USER-BASED PROGRAMS AND EXAMS FOR ONBOARDING SALES PEOPLE AND SALES MANAGERS, IN CLASS 42 (U.S. CLS. 100 AND 101).

FIRST USE 6-24-2008; IN COMMERCE 6-24-2008.

THE MARK CONSISTS OF STANDARD CHARACTERS WITHOUT CLAIM TO ANY PARTICULAR FONT, STYLE, SIZE, OR COLOR.

SER. NO. 85-159,810, FILED 10-24-2010.

TINA L. SNAPP, EXAMINING ATTORNEY



David J. Kybas

Director of the United States Patent and Trademark Office

United States of America

United States Patent and Trademark Office

Elbit CyberShield NCDS

Reg. No. 4,097,879

Registered Feb. 14, 2012

Int. Cl.: 9

TRADEMARK

PRINCIPAL REGISTER

ELBIT SYSTEMS LTD. (ISRAEL CORPORATION)
ADVANCED TECHNOLOGY CENTER
P.O. BOX 539
HAIFA, ISRAEL 31053

FOR: DEVICES AND INSTRUMENTS, NAMELY, AUTOMATED SELF CONTAINED ELECTRONIC SURVEILLANCE DEVICES THAT CAN BE DEPLOYED TO GATHER EVIDENCE OR INTELLIGENCE IN REMOTE LOCATIONS, APPARATUS FOR TRANSMISSION AND RECEIVING OF COMMUNICATION, ELECTRIC NAVIGATIONAL INSTRUMENTS, LOGIC ANALYZERS, ENCODING AND DECODING INSTRUMENTS, OPTICAL TRANSMITTERS AND COMPUTER HARDWARE AND SOFTWARE, ALL FOR USE IN THE CYBER DEFENSE OF GOVERNMENT, MILITARY AND CIVILIAN ASSETS AND NETWORKS, NAMELY, FOR USE IN INTELLIGENCE GATHERING, MANAGEMENT AND ANALYSIS OF CYBER EVENTS, MONITORING AND AGGREGATING NATIONAL CYBER EVENTS IN REAL TIME AND COORDINATING REAL TIME RESPONSE, CLASSIFICATION, ASSESSMENT AND MAPPING OF VULNERABILITIES TO CYBER ATTACKS, TRAINING AND CYBER SIMULATION FOR IMPROVING DEFENSE AGAINST CYBER THREATS, IN CLASS 9 (U.S. CLS. 21, 23, 26, 36 AND 38).

THE MARK CONSISTS OF STANDARD CHARACTERS WITHOUT CLAIM TO ANY PARTICULAR FONT, STYLE, SIZE, OR COLOR.

PRIORITY CLAIMED UNDER SEC. 44(D) ON ISRAEL APPLICATION NO. 229483, FILED 4-27-2010.

OWNER OF ISRAEL REG. NO. 229483, DATED 7-10-2011, EXPIRES 4-27-2020.

SER. NO. 85-159,936, FILED 10-25-2010.

ELLEN BURNS, EXAMINING ATTORNEY



David J. Kybas

Director of the United States Patent and Trademark Office

United States of America

United States Patent and Trademark Office



Reg. No. 4,097,880

ZOE & JACK LLC (TEXAS LIMITED LIABILITY COMPANY)
5137 BIRCHMAN AVENUE
FORT WORTH, TX 76107

Registered Feb. 14, 2012

Int. Cl.: 16

FOR: PAPER SHOPPING BAGS AND GIFT BOXES, IN CLASS 16 (U.S. CLS. 2, 5, 22, 23, 29, 37, 38 AND 50).

TRADEMARK

FIRST USE 11-11-2007; IN COMMERCE 11-11-2007.

PRINCIPAL REGISTER

THE MARK CONSISTS OF A CIRCULAR BACKGROUND ON WHICH APPEARS THE SILHOUETTE OF THE BACK OF A GIRL AND BOY WHO APPEAR TO BE WALKING INTO THE DISTANCE. THE GIRL IS POSITIONED TO THE LEFT OF THE BOY. HER RIGHT ARM IS EXTENDED SO THAT HER RIGHT HAND CONNECTS WITH THE BOY'S LEFT HAND. THE GIRL HAS SHOULDER-LENGTH HAIR AND IS WEARING A KNEE-LENGTH DRESS. THE BOY HAS TOUSLED HAIR AND IS WEARING PANTS AND A SHIRT, WHICH ARE DIVIDED BY WHAT APPEARS TO BE A BELT. THERE IS A POCKET ON THE RIGHT HIP OF THE BOY'S PANTS. THE WORDING "ZOE + JACK" APPEARS BELOW THE GIRL AND BOY.

SER. NO. 85-160,034, FILED 10-25-2010.

KATHERINE CHANG, EXAMINING ATTORNEY



David J. Kybas

Director of the United States Patent and Trademark Office

United States of America

United States Patent and Trademark Office



National Association of Chemical Distributors

Reg. No. 4,097,881

Registered Feb. 14, 2012

Int. Cl.: 35

SERVICE MARK

PRINCIPAL REGISTER

NATIONAL ASSOCIATION OF CHEMICAL DISTRIBUTORS (ILLINOIS NON-PROFIT CORPORATION)
SUITE 700
1555 WILSON BLVD.
ARLINGTON, VA 22209

FOR: ASSOCIATION SERVICES, NAMELY, PROMOTING THE INTERESTS OF THE CHEMICAL DISTRIBUTION INDUSTRY BY ENHANCING AND COMMUNICATING ENVIRONMENTAL, HEALTH, SECURITY AND SAFETY PRACTICES AND PROFESSIONALISM IN THE CHEMICAL DISTRIBUTION INDUSTRY, IN CLASS 35 (U.S. CLS. 100, 101 AND 102).

FIRST USE 8-18-2010; IN COMMERCE 8-18-2010.

OWNER OF U.S. REG. NOS. 1,760,464 AND 3,356,826.

NO CLAIM IS MADE TO THE EXCLUSIVE RIGHT TO USE "ASSOCIATION", APART FROM THE MARK AS SHOWN.

THE MARK CONSISTS OF THE LETTERS "NACD" WITH MOLECULAR LINKS THROUGH THE LETTERS. BELOW THE LETTERS "NACD" ARE THE WORDS "NATIONAL ASSOCIATION OF CHEMICAL DISTRIBUTORS".

SEC. 2(F) AS TO "NATIONAL ASSOCIATION OF CHEMICAL DISTRIBUTORS".

SER. NO. 85-160,959, FILED 10-26-2010.

MICHAEL GAAFAR, EXAMINING ATTORNEY



David J. Kyffers

Director of the United States Patent and Trademark Office

United States of America

United States Patent and Trademark Office

UNTAMED SPORTS TV

Reg. No. 4,097,882

Registered Feb. 14, 2012

Int. Cls.: 38 and 41

SERVICE MARK

PRINCIPAL REGISTER

UNTAMED SPORTS, LLC (FLORIDA LIMITED LIABILITY COMPANY)
SUITE 250
560 VILLAGE BLVD.
WEST PALM BEACH, FL 33409

FOR: SERVICES IN THE NATURE OF TRANSMISSION OF PROGRAMS RELATED TO SPORTS, EXTREME ACTION SPORTS AND THE OUTDOORS AND DISTRIBUTED VIA BROADCAST TELEVISION, CABLE TELEVISION, SATELLITE, MOBILE WIRELESS DEVICES, WIRELESS, INTERNET, AND BROADBAND, IN CLASS 38 (U.S. CLS. 100, 101 AND 104).

FIRST USE 8-0-2008; IN COMMERCE 8-0-2008.

FOR: ENTERTAINMENT SERVICES, NAMELY, CONTINUING PROGRAMS IN THE AREA OF SPORTS, EXTREME ACTION SPORTS AND THE OUTDOORS AND DISTRIBUTED VIA BROADCAST TELEVISION, CABLE TELEVISION, SATELLITE, MOBILE WIRELESS DEVICES, WIRELESS, INTERNET, AND BROADBAND, IN CLASS 41 (U.S. CLS. 100, 101 AND 107).

FIRST USE 8-0-2008; IN COMMERCE 8-0-2008.

THE MARK CONSISTS OF STANDARD CHARACTERS WITHOUT CLAIM TO ANY PARTICULAR FONT, STYLE, SIZE, OR COLOR.

NO CLAIM IS MADE TO THE EXCLUSIVE RIGHT TO USE "SPORTS TV", APART FROM THE MARK AS SHOWN.

SER. NO. 85-161,022, FILED 10-26-2010.

LIEF MARTIN, EXAMINING ATTORNEY



David J. Kyffers

Director of the United States Patent and Trademark Office

United States of America

United States Patent and Trademark Office

UNTAMED SPORTS^{tv}

Reg. No. 4,097,883

Registered Feb. 14, 2012

Int. Cls.: 38 and 41

SERVICE MARK

PRINCIPAL REGISTER

UNTAMED SPORTS, LLC (FLORIDA LIMITED LIABILITY COMPANY)
SUITE 250
560 VILLAGE BLVD.
WEST PALM BEACH, FL 33409

FOR: SERVICES IN THE NATURE OF TRANSMISSION OF PROGRAMS RELATED TO SPORTS, EXTREME ACTION SPORTS AND THE OUTDOORS AND DISTRIBUTED VIA BROADCAST TELEVISION, CABLE TELEVISION, SATELLITE, MOBILE WIRELESS DEVICES, WIRELESS, INTERNET, AND BROADBAND, IN CLASS 38 (U.S. CLS. 100, 101 AND 104).

FIRST USE 8-0-2008; IN COMMERCE 8-0-2008.

FOR: ENTERTAINMENT SERVICES, NAMELY, CONTINUING PROGRAMS IN THE AREA OF SPORTS, EXTREME ACTION SPORTS AND THE OUTDOORS AND DISTRIBUTED VIA BROADCAST TELEVISION, CABLE TELEVISION, SATELLITE, MOBILE WIRELESS DEVICES, WIRELESS, INTERNET, AND BROADBAND, IN CLASS 41 (U.S. CLS. 100, 101 AND 107).

FIRST USE 8-0-2008; IN COMMERCE 8-0-2008.

NO CLAIM IS MADE TO THE EXCLUSIVE RIGHT TO USE "SPORTS TV", APART FROM THE MARK AS SHOWN.

THE MARK CONSISTS OF THE WORDING "UNTAMED SPORTS TV" IN A STYLIZED FONT, WITH "TV" APPEARING INSIDE A CIRCLE.

SER. NO. 85-161,123, FILED 10-26-2010.

LIEF MARTIN, EXAMINING ATTORNEY



David J. Kypos

Director of the United States Patent and Trademark Office

United States of America

United States Patent and Trademark Office

Chip PC Technologies

Reg. No. 4,097,884

Registered Feb. 14, 2012

Int. Cl.: 9

TRADEMARK

PRINCIPAL REGISTER

CHIP PC (ISRAEL) LTD. (ISRAEL CORPORATION)
NAHUM HAT 5, HAIFA, P.O.BOX 4
NAHUM HAT 5, HAIFA, P.O.BOX 4
TIRAT CARMEL, ISRAEL 39100

FOR: COMPUTER TERMINALS, IN CLASS 9 (U.S. CLS. 21, 23, 26, 36 AND 38).

FIRST USE 10-1-2001; IN COMMERCE 1-1-2002.

THE MARK CONSISTS OF STANDARD CHARACTERS WITHOUT CLAIM TO ANY PARTICULAR FONT, STYLE, SIZE, OR COLOR.

NO CLAIM IS MADE TO THE EXCLUSIVE RIGHT TO USE "PC TECHNOLOGIES", APART FROM THE MARK AS SHOWN.

SER. NO. 85-162,131, FILED 10-27-2010.

DAWN HAN, EXAMINING ATTORNEY



David J. Kyffers

Director of the United States Patent and Trademark Office

United States of America

United States Patent and Trademark Office

BOONDOCK SAINTS

Reg. No. 4,097,885

Registered Feb. 14, 2012

Int. Cl.: 9

TRADEMARK

PRINCIPAL REGISTER

BOONDOCK SAINTS, LLC (CALIFORNIA LIMITED LIABILITY COMPANY)
4470 WEST SUNSET BOULEVARD, SUITE 281
LOS ANGELES, CA 90027

FOR: COMPUTER APPLICATION SOFTWARE FOR MOBILE PHONES, NAMELY, SOFTWARE FOR ELECTRONIC GAMES; COMPUTER GAME PROGRAMS; COMPUTER GAME SOFTWARE; COMPUTER GAME SOFTWARE FOR USE ON MOBILE AND CELLULAR PHONES; DOWNLOADABLE COMPUTER GAME PROGRAMS; DOWNLOADABLE ELECTRONIC GAMES, SOUNDS, AND RINGTONES VIA THE INTERNET AND WIRELESS DEVICES; INTERACTIVE GAME PROGRAMS; MUSICAL SOUND RECORDINGS; PRE-RECORDED CDS FEATURING MUSIC; PRE-RECORDED DVDS FEATURING MOTION PICTURES, DOCUMENTARIES AND OTHER AUDIO-VISUAL WORKS; RECORDED COMPUTER GAME PROGRAMS; SOUND RECORDINGS FEATURING MUSIC AND MOTION PICTURE SOUNDTRACKS; VIDEO AND COMPUTER GAME PROGRAMS , IN CLASS 9 (U.S. CLS. 21, 23, 26, 36 AND 38).

FIRST USE 10-29-2009; IN COMMERCE 10-29-2009.

THE MARK CONSISTS OF STANDARD CHARACTERS WITHOUT CLAIM TO ANY PARTICULAR FONT, STYLE, SIZE, OR COLOR.

OWNER OF U.S. REG. NOS. 3,510,053, 3,522,615, AND 3,909,394.

SER. NO. 85-162,838, FILED 10-27-2010.

RONALD MCMORROW, EXAMINING ATTORNEY



David J. Kyros

Director of the United States Patent and Trademark Office

United States of America

United States Patent and Trademark Office

ORBISACCESS

Reg. No. 4,097,886

Registered Feb. 14, 2012

Int. Cl.: 36

SERVICE MARK

PRINCIPAL REGISTER

ORBIS HOLDINGS LIMITED (BERMUDA CORPORATION)
ORBIS HOUSE, 25 FRONT STREET
HAMILTON, BERMUDA HM11

FOR: MANAGEMENT OF CAPITAL INVESTMENT FUND; CAPITAL INVESTMENT SERVICES; FINANCIAL INVESTMENT SERVICES IN THE FIELD OF MUTUAL FUNDS; FINANCIAL PORTFOLIO MANAGEMENT SERVICES; HEDGE FUND INVESTMENT MANAGEMENT AND ADMINISTRATION SERVICES; MUTUAL FUND BROKERAGE; MUTUAL FUND DISTRIBUTION; ESTABLISHING MUTUAL FUNDS FOR OTHERS; INVESTMENT ADVISORY SERVICES; BROKERAGE SERVICES IN THE FIELD OF INVESTMENT FUNDS; FINANCIAL MANAGEMENT AND ANALYSIS SERVICES; INFORMATION, ADVISORY AND CONSULTANCY SERVICES RELATING TO ALL THE AFORESAID FINANCIAL SERVICES; ALL OF THE ABOVE FINANCIAL SERVICES CAPABLE OF BEING PROVIDED ON-LINE FROM A COMPUTER DATABASE OR VIA THE INTERNET , IN CLASS 36 (U.S. CLS. 100, 101 AND 102).

THE MARK CONSISTS OF STANDARD CHARACTERS WITHOUT CLAIM TO ANY PARTICULAR FONT, STYLE, SIZE, OR COLOR.

PRIORITY CLAIMED UNDER SEC. 44(D) ON ERPN CMNTY TM OFC APPLICATION NO. 9478645, FILED 10-25-2010, REG. NO. 009478645, DATED 3-8-2011, EXPIRES 10-27-2020.

OWNER OF U.S. REG. NO. 1,971,216.

SER. NO. 85-162,940, FILED 10-27-2010.

ODESSA BIBBINS, EXAMINING ATTORNEY



David J. Kyros

Director of the United States Patent and Trademark Office

United States of America

United States Patent and Trademark Office

ORBIS-ACCESS

Reg. No. 4,097,887

Registered Feb. 14, 2012

Int. Cl.: 36

SERVICE MARK

PRINCIPAL REGISTER

ORBIS HOLDINGS LIMITED (BERMUDA CORPORATION)
ORBIS HOUSE, 25 FRONT STREET
HAMILTON, BERMUDA HM11

FOR: MANAGEMENT OF CAPITAL INVESTMENT FUND; CAPITAL INVESTMENT SERVICES; FINANCIAL INVESTMENT SERVICES IN THE FIELD OF MUTUAL FUNDS; FINANCIAL PORTFOLIO MANAGEMENT SERVICES; HEDGE FUND INVESTMENT MANAGEMENT AND ADMINISTRATION SERVICES; MUTUAL FUND BROKERAGE; MUTUAL FUND DISTRIBUTION; ESTABLISHING MUTUAL FUNDS FOR OTHERS; INVESTMENT ADVISORY SERVICES; BROKERAGE SERVICES IN THE FIELD OF INVESTMENT FUNDS; FINANCIAL MANAGEMENT AND ANALYSIS SERVICES; INFORMATION, ADVISORY AND CONSULTANCY SERVICES RELATING TO ALL THE AFORESAID FINANCIAL SERVICES; ALL OF THE ABOVE FINANCIAL SERVICES CAPABLE OF BEING PROVIDED ON-LINE FROM A COMPUTER DATABASE OR VIA THE INTERNET , IN CLASS 36 (U.S. CLS. 100, 101 AND 102).

THE MARK CONSISTS OF STANDARD CHARACTERS WITHOUT CLAIM TO ANY PARTICULAR FONT, STYLE, SIZE, OR COLOR.

PRIORITY CLAIMED UNDER SEC. 44(D) ON ERPN CMNTY TM OFC APPLICATION NO. 9478694, FILED 10-25-2010, REG. NO. 009478694, DATED 3-8-2011, EXPIRES 10-27-2020.

OWNER OF U.S. REG. NO. 1,971,216.

SER. NO. 85-162,947, FILED 10-27-2010.

ODESSA BIBBINS, EXAMINING ATTORNEY



David J. Kyros

Director of the United States Patent and Trademark Office

United States of America

United States Patent and Trademark Office

PIM

Reg. No. 4,097,888

Registered Feb. 14, 2012

Int. Cl.: 1

TRADEMARK

PRINCIPAL REGISTER

PRODO LABORATORIES, INC. (CALIFORNIA CORPORATION)
32A MAUCHLY
IRVINE, CA 92618

FOR: ISLET-SPECIFIC LIQUID CULTURE MEDIA CONSISTING OF MULTIPLE CELL CULTURES, ACID-BASE COMPONENTS, HORMONE COMPONENTS, AMINO ACID COMPONENTS, FATTY ACID COMPONENTS, VITAMINS AND MINERALS MANUFACTURED FOR TISSUE CULTURE USE, ALL FOR CULTIVATING HUMAN CELLS FOR USE IN IMMEDIATELY RECOVERING HUMAN ISLETS IN PERFORMING BOTH IN VITRO AND IN VIVO GENETIC ENGINEERING TESTING, IN CLASS 1 (U.S. CLS. 1, 5, 6, 10, 26 AND 46).

FIRST USE 9-1-2006; IN COMMERCE 7-1-2007.

THE MARK CONSISTS OF STANDARD CHARACTERS WITHOUT CLAIM TO ANY PARTICULAR FONT, STYLE, SIZE, OR COLOR.

SER. NO. 85-163,104, FILED 10-27-2010.

DAWN HAN, EXAMINING ATTORNEY



David J. Kyffers

Director of the United States Patent and Trademark Office

United States of America

United States Patent and Trademark Office

TINY TWIRLS

Reg. No. 4,097,889

KINKY-CURLY HAIR CARE, LLC (DELAWARE LIMITED LIABILITY COMPANY)
289 SOUTH ROBERTSON BOULEVARD #374
BEVERLY HILLS, CA 90211

Registered Feb. 14, 2012

Int. Cl.: 3

FOR: HAIR CARE PREPARATIONS FOR CHILDREN, IN CLASS 3 (U.S. CLS. 1, 4, 6, 50, 51 AND 52).

TRADEMARK

FIRST USE 2-0-2009; IN COMMERCE 10-0-2009.

PRINCIPAL REGISTER

THE MARK CONSISTS OF STANDARD CHARACTERS WITHOUT CLAIM TO ANY PARTICULAR FONT, STYLE, SIZE, OR COLOR.

SER. NO. 85-163,381, FILED 10-28-2010.

ANGELA M. MICHELI, EXAMINING ATTORNEY



David J. Kyffers

Director of the United States Patent and Trademark Office

United States of America

United States Patent and Trademark Office



Reg. No. 4,097,890

Registered Feb. 14, 2012

Int. Cls.: 12 and 25

TRADEMARK

PRINCIPAL REGISTER

YETI CYCLING, LLC (DELAWARE LIMITED LIABILITY COMPANY)
600 CORPORATE CIRCLE, UNIT D
GOLDEN, CO 80401

FOR: BICYCLES; BICYCLE COMPONENTS AND ACCESSORIES, NAMELY, BICYCLE FRAMES, BICYCLE HANDLEBARS, BICYCLE HANDLEBAR GRIPS, AND WATER BOTTLE HOLDERS FOR AFFIXATION TO BICYCLES, IN CLASS 12 (U.S. CLS. 19, 21, 23, 31, 35 AND 44).

FIRST USE 4-30-2009; IN COMMERCE 4-30-2009.

FOR: CLOTHING, NAMELY, SHIRTS, JERSEYS, SHORTS, PANTS, HATS, CAPS, SWEAT-SHIRTS, SOCKS, JACKETS, IN CLASS 25 (U.S. CLS. 22 AND 39).

FIRST USE 4-30-2009; IN COMMERCE 4-30-2009.

OWNER OF U.S. REG. NO. 3,323,853.

THE MARK CONSISTS OF THE WORD "YETI" IN STYLIZED LETTERING.

SER. NO. 85-163,649, FILED 10-28-2010.

SUSAN STIGLITZ, EXAMINING ATTORNEY



David J. Kyffers

Director of the United States Patent and Trademark Office

United States of America

United States Patent and Trademark Office

BIOMED VENTURES

Reg. No. 4,097,891

BIOMED REALTY TRUST, INC. (MARYLAND CORPORATION)
17190 BERNARDO CENTER DRIVE
SAN DIEGO, CA 92128

Registered Feb. 14, 2012

Int. Cls.: 36 and 37

FOR: REAL ESTATE ACQUISITION, LEASING, AND MANAGEMENT SERVICES; REAL ESTATE INVESTMENT SERVICES; REAL ESTATE INVESTMENT TRUST SERVICES , IN CLASS 36 (U.S. CLS. 100, 101 AND 102).

SERVICE MARK

FIRST USE 8-9-2011; IN COMMERCE 8-9-2011.

PRINCIPAL REGISTER

FOR: REAL ESTATE DEVELOPMENT, IN CLASS 37 (U.S. CLS. 100, 103 AND 106).

FIRST USE 8-9-2011; IN COMMERCE 8-9-2011.

THE MARK CONSISTS OF STANDARD CHARACTERS WITHOUT CLAIM TO ANY PARTICULAR FONT, STYLE, SIZE, OR COLOR.

OWNER OF U.S. REG. NOS. 2,996,195 AND 3,086,831.

NO CLAIM IS MADE TO THE EXCLUSIVE RIGHT TO USE "VENTURES", APART FROM THE MARK AS SHOWN.

SEC. 2(F) AS TO "BIOMED" .

SER. NO. 85-164,670, FILED 10-29-2010.

JAY BESCH, EXAMINING ATTORNEY



David J. Kyffers

Director of the United States Patent and Trademark Office

United States of America

United States Patent and Trademark Office



Patriot Life

INSURANCE

A Member of Frankenmuth Insurance

Reg. No. 4,097,892

PATRIOT LIFE INSURANCE COMPANY (MICHIGAN CORPORATION)
1 MUTUAL AVENUE

Registered Feb. 14, 2012

FRANKENMUTH, MI 487870001

Int. Cl.: 36

FOR: INSURANCE SERVICES, NAMELY, UNDERWRITING, ISSUING AND ADMINISTRATION OF LIFE INSURANCE, IN CLASS 36 (U.S. CLS. 100, 101 AND 102).

SERVICE MARK

FIRST USE 11-30-2010; IN COMMERCE 11-30-2010.

PRINCIPAL REGISTER

OWNER OF U.S. REG. NOS. 1,737,044, 3,623,508 AND OTHERS.

NO CLAIM IS MADE TO THE EXCLUSIVE RIGHT TO USE "LIFE INSURANCE" AND "A MEMBER OF FRANKENMUTH INSURANCE", APART FROM THE MARK AS SHOWN.

THE MARK CONSISTS OF A HORIZONTAL DIAMOND WITH DIAGONAL STRIPES RUNNING UPWARD FROM RIGHT TO LEFT, CONTAINED WITHIN A CIRCLE. TO THE RIGHT OF THE DIAMOND/CIRCLE DESIGN ARE THE WORDS "PATRIOT LIFE" UNDERLINED BY A SOLID LINE UNDER WHICH AND RIGHT JUSTIFIED IS THE WORD "INSURANCE". CENTERED BELOW THE DESIGN ELEMENT IS THE WORDING "A MEMBER OF FRANKENMUTH INSURANCE".

SER. NO. 85-166,334, FILED 11-1-2010.

EUGENIA MARTIN, EXAMINING ATTORNEY



David J. Kybas

Director of the United States Patent and Trademark Office

United States of America

United States Patent and Trademark Office



Reg. No. 4,097,893

Registered Feb. 14, 2012

Int. Cl.: 30

TRADEMARK

PRINCIPAL REGISTER

POCO DOLCE CONFECTIONS, INC. (CALIFORNIA CORPORATION)
1020 ILLINOIS STREET
SAN FRANCISCO, CA 94107

FOR: CARAMELS; CHOCOLATE AND CHOCOLATES; CHOCOLATE BARS; CHOCOLATE CANDIES; CHOCOLATE COVERED NUTS; CHOCOLATE COVERED ROASTED COFFEE BEANS; CHOCOLATE TRUFFLES; CHOCOLATES AND CHOCOLATE BASED READY TO EAT CANDIES AND SNACKS; CONFECTIONERIES, NAMELY, SNACK FOODS, NAMELY, CHOCOLATE; FILLED CHOCOLATE; NOUGAT; SNACK FOODS, NAMELY, CHOCOLATE-BASED SNACK FOODS; TOFFEES, IN CLASS 30 (U.S. CL. 46).

FIRST USE 3-3-2003; IN COMMERCE 3-3-2003.

OWNER OF U.S. REG. NO. 3,977,406.

NO CLAIM IS MADE TO THE EXCLUSIVE RIGHT TO USE "DOLCE", APART FROM THE MARK AS SHOWN.

THE MARK CONSISTS OF INSIDE OF A FILLED IN RECTANGLE THE WORD "POCO" IN THE UPPER PORTION STARTING SLIGHTLY OFF CENTER TO THE RIGHT ALL LOWER CASE IN BLOCK/BUBBLE FONT WITH THE LEFT SIDE OF THE "P" ELONGATED STRETCHING DOWN APPROXIMATELY $\frac{3}{4}$ OF THE WAY DOWN ENDING SLIGHTLY ABOVE THE "O" IN "DOLCE" BELOW. THE WORD "DOLCE" IN THE LOWER PORTION STARTING CLOSE TO THE LEFT EDGE OF THE RECTANGLE ALL LOWER CASE IN BLOCK/BUBBLE FONT. THE RIGHT SIDE OF THE "D" IS ELONGATED STRETCHING $\frac{3}{4}$ OF THE WAY UP ENDING SLIGHTLY TO THE LEFT BELOW THE "P" IN "POCO". THE "L" IS ELONGATED STRETCHING $\frac{3}{4}$ OF THE WAY UP ENDING SLIGHTLY TO THE RIGHT BELOW THE "P" IN "POCO".

THE ENGLISH TRANSLATION OF "POCO DOLCE" IN THE MARK IS "LITTLE SWEET".

SER. NO. 85-167,502, FILED 11-2-2010.

GINA HAYES, EXAMINING ATTORNEY



David J. Kyffers

Director of the United States Patent and Trademark Office

United States of America

United States Patent and Trademark Office

MINSUP

Reg. No. 4,097,894

Registered Feb. 14, 2012

Int. Cl.: 7

TRADEMARK

PRINCIPAL REGISTER

DIXON (ASIA PACIFIC) PTY LTD (AUSTRALIA PROPRIETARY LIMITED COMPANY (P/L OR PTY. LTD.))
170 FRANCIS ROAD
WINGFIELD SA, AUSTRALIA 5013

FOR: MACHINE TOOLS FOR MINING MACHINERY, NAMELY, ROCK DRILLS, AIR LEGS, FLUID TRANSFERS, OIL LUBRICATION EQUIPMENT, AND ROOF SUPPORTS, IN CLASS 7 (U.S. CLS. 13, 19, 21, 23, 31, 34 AND 35).

THE MARK CONSISTS OF STANDARD CHARACTERS WITHOUT CLAIM TO ANY PARTICULAR FONT, STYLE, SIZE, OR COLOR.

OWNER OF AUSTRALIA REG. NO. 210791, DATED 6-9-1967, EXPIRES 6-9-2012.

SER. NO. 85-168,020, FILED 11-3-2010.

MARGARET POWER, EXAMINING ATTORNEY



David J. Kybas

Director of the United States Patent and Trademark Office

United States of America

United States Patent and Trademark Office



Reg. No. 4,097,895

2FUNNYTSHIRTS, LLC, (GEORGIA LIMITED LIABILITY COMPANY)
5585 CLAIRE ROSE LANE
ATLANTA, GA 30327

Registered Feb. 14, 2012

Int. Cl.: 25

FOR: BODY SHIRTS; COLLARED SHIRTS; LONG-SLEEVED SHIRTS; OPEN-NECKED SHIRTS; SHIRTS; SHIRTS AND SHORT-SLEEVED SHIRTS; SHORT-SLEEVED OR LONG-SLEEVED T-SHIRTS; SHORT-SLEEVED SHIRTS; SPORTS SHIRTS; SPORTS SHIRTS WITH SHORT SLEEVES; SWEAT SHIRTS; T-SHIRTS; TEE SHIRTS, IN CLASS 25 (U.S. CLS. 22 AND 39).

TRADEMARK

PRINCIPAL REGISTER

FIRST USE 11-1-2010; IN COMMERCE 11-3-2010.

THE MARK CONSISTS OF THE NUMBER "2" AND THE WORD "FUNNY" AND ".COM" IN RED WHILE THE WORD "T-SHIRTS" IS IN BLACK. THE MARK ALSO INCLUDES THE PICTURE OF A PERSON LAUGHING DRAWN IN BLACK WITH A RED TONGUE. THE COLOR WHITE REPRESENTS TRANSPARENT AREAS AND IS NOT PART OF THE MARK.

THE COLOR(S) RED AND BLACK IS/ARE CLAIMED AS A FEATURE OF THE MARK.

SER. NO. 85-168,420, FILED 11-3-2010.

TIMOTHY FINNEGAN, EXAMINING ATTORNEY



David J. Kybas

Director of the United States Patent and Trademark Office

United States of America

United States Patent and Trademark Office



MAVENTUS

Reg. No. 4,097,896

MATTHEW HOLDEN (AUSTRALIA INDIVIDUAL)
17A JALAN SELANTING
SINGAPORE, SINGAPORE 598403

Registered Feb. 14, 2012

Int. Cls.: 9, 35 and 41

FOR: COMPUTER SOFTWARE AND COMPUTER PROGRAMS, ALL FOR STORAGE, COLLATION, AND ANALYSIS OF CUSTOMER AND MARKET DATA; MAGNETIC DISCS, DVDS, CDS, AND OTHER PRERECORDED MAGNETIC DATA CARRIERS, ALL CONTAINING COMPUTER PROGRAMS OR COMPUTER SOFTWARE FOR STORAGE, COLLATION, AND ANALYSIS OF CUSTOMER AND MARKET DATA, IN CLASS 9 (U.S. CLS. 21, 23, 26, 36 AND 38).

TRADEMARK

SERVICE MARK

PRINCIPAL REGISTER

FOR: ADMINISTRATION OF BUSINESS AFFAIRS; ADVICE AND CONSULTATION SERVICES REGARDING BUSINESS MANAGEMENT, ORGANIZATION AND PLANNING; BUSINESS MANAGEMENT ADVISORY SERVICES REGARDING MARKETING AND FRANCHISING; CONSULTANCY RELATING TO THE ESTABLISHMENT AND RUNNING OF BUSINESSES; BUSINESS MANAGEMENT, SALES AND MARKETING CONSULTING DURING COMPANY ACQUISITIONS; MARKET ANALYSES; COMPANY VALUATIONS, NAMELY, COST AND PRICING METHODOLOGIES; STRATEGIC MANAGEMENT, BUSINESS PLANNING AND MARKETING TECHNIQUES; CONSULTING AND ADVISORY SERVICES TO EXECUTIVES; BUSINESS DATA ANALYSIS SERVICES; BUSINESS INVESTIGATIONS; CONDUCTING FORUMS AND EXHIBITIONS FOR BUSINESS PURPOSES, IN CLASS 35 (U.S. CLS. 100, 101 AND 102).



FOR: EDUCATIONAL SERVICES, NAMELY, PROVIDING CLASSES AND TRAINING RELATING TO BUSINESS MANAGEMENT AND BUSINESS PRACTICES AND DEVELOPING CURRICULUM FOR OTHERS IN THE FIELD OF SALES, SALES PLANNING AND SALES MANAGEMENT AND DISTRIBUTION OF TEACHING MATERIALS AND TRAINING COURSE DOCUMENTATION IN CONNECTION THEREWITH; CONDUCTING EDUCATIONAL CONFERENCES PROVIDING BUSINESS TRAINING PROGRAMS IN THE AREAS OF SALES, BUSINESS STRATEGY, BUSINESS DEVELOPMENT, SALES PLANNING AND SALES MANAGEMENT, IN CLASS 41 (U.S. CLS. 100, 101 AND 107).

OWNER OF AUSTRALIA REG. NO. 1391528, DATED 10-29-2010, EXPIRES 10-29-2020.

David J. Kyffers

THE COLOR(S) BLACK, ORANGE, AND WHITE IS/ARE CLAIMED AS A FEATURE OF THE MARK.

Reg. No. 4,097,896 THE MARK CONSISTS OF THE WORD "MAVENTUS" IN BLACK BELOW TWO ARROWS IN ORANGE WITH WHITE SPACE BETWEEN THE ARROWS THAT FORMS A SIDEWAYS "M" IN WHITE.

SER. NO. 85-168,790, FILED 11-4-2010.

JOHN E. MICHOS, EXAMINING ATTORNEY

United States of America

United States Patent and Trademark Office

SCOOTERS 4 HOOTERS

Reg. No. 4,097,897

LIBBY'S LEGACY BREAST CANCER FOUNDATION, INC. (FLORIDA CORPORATION)
1718 S. ORANGE AVE.
ORLANDO, FL 32806

Registered Feb. 14, 2012

Int. Cls.: 25 and 36

FOR: CLOTHING, NAMELY, T-SHIRTS, HATS AND SWEATSHIRTS, IN CLASS 25 (U.S. CLS. 22 AND 39).

TRADEMARK

FIRST USE 2-28-2007; IN COMMERCE 2-28-2007.

SERVICE MARK

FOR: CHARITABLE FUNDRAISING SERVICES, NAMELY, FUNDRAISING FOR BREAST CANCER AWARENESS, RESEARCH, EDUCATION AND SERVICES, IN CLASS 36 (U.S. CLS. 100, 101 AND 102).

PRINCIPAL REGISTER

FIRST USE 2-28-2007; IN COMMERCE 2-28-2007.

THE MARK CONSISTS OF STANDARD CHARACTERS WITHOUT CLAIM TO ANY PARTICULAR FONT, STYLE, SIZE, OR COLOR.

SER. NO. 85-168,823, FILED 11-4-2010.

NATALIE POLZER, EXAMINING ATTORNEY



David J. Kypos

Director of the United States Patent and Trademark Office

United States of America

United States Patent and Trademark Office

INFIPLEX

Reg. No. 4,097,898

EVERYDAY SHORTS INCORPORATED (CANADA CORPORATION)
6019 3RD STREET S.E.

Registered Feb. 14, 2012

CALGARY, ALBERTA, CANADA T2H1K3

Int. Cl.: 3

FOR: SUN TAN PRODUCTS, NAMELY, SUN TAN LOTIONS, OILS, GELS AND CREAMS; SKIN CARE PRODUCTS, NAMELY, MOISTURIZERS, LOTIONS AND CREAMS, NON-MEDICATED SKIN SERUMS, AND SKIN BRONZERS, IN CLASS 3 (U.S. CLS. 1, 4, 6, 50, 51 AND 52).

TRADEMARK

PRINCIPAL REGISTER

THE MARK CONSISTS OF STANDARD CHARACTERS WITHOUT CLAIM TO ANY PARTICULAR FONT, STYLE, SIZE, OR COLOR.

PRIORITY CLAIMED UNDER SEC. 44(D) ON CANADA APPLICATION NO. 1500773, FILED 10-29-2010, REG. NO. TMA807,857, DATED 9-28-2011, EXPIRES 9-28-2026.

SER. NO. 85-169,698, FILED 11-4-2010.

SETH A. RAPPAPORT, EXAMINING ATTORNEY



David J. Kyffers

Director of the United States Patent and Trademark Office

United States of America

United States Patent and Trademark Office

MAXBAR

Reg. No. 4,097,899

Registered Feb. 14, 2012

Int. Cl.: 20

TRADEMARK

PRINCIPAL REGISTER

NEATFREAK GROUP, INC. (CANADA CORPORATION)
5320 TIMBERLEA BOULEVARD
MISSISSAUGA, ONTARIO, CANADA L4W2S6

FOR: EXPANDABLE CLOSET BARS AS PART OF A HOME CLOSET STORAGE SYSTEM FOR HANGING CLOTHES, FOOTWEAR, HATS, AND ACCESSORIES, IN CLASS 20 (U.S. CLS. 2, 13, 22, 25, 32 AND 50).

FIRST USE 3-0-2010; IN COMMERCE 12-10-2010.

THE MARK CONSISTS OF STANDARD CHARACTERS WITHOUT CLAIM TO ANY PARTICULAR FONT, STYLE, SIZE, OR COLOR.

PRIORITY CLAIMED UNDER SEC. 44(D) ON CANADA APPLICATION NO. 1482678, FILED 5-27-2010.

SER. NO. 85-170,066, FILED 11-5-2010.

LIEF MARTIN, EXAMINING ATTORNEY



David J. Kybas

Director of the United States Patent and Trademark Office

United States of America

United States Patent and Trademark Office



Reg. No. 4,097,900

Registered Feb. 14, 2012

Int. Cl.: 41

SERVICE MARK

PRINCIPAL REGISTER

REDSTAR AIR SHOWS, INC. (CALIFORNIA CORPORATION)
5592 DRAKES DRIVE
DISCOVERY BAY, CA 94505

FOR: ENTERTAINMENT, NAMELY, ARRANGING ENTERTAINMENT EXHIBITIONS IN THE NATURE OF AIRCRAFT SHOWS FEATURING AIRCRAFT PERFORMANCE AND DEMONSTRATION; PROVIDING EDUCATIONAL INFORMATION SERVICES RELATED TO AIRCRAFT PERFORMANCE AND DEMONSTRATION SERVICES; PROVIDING A WEBSITE FEATURING EDUCATIONAL AND ENTERTAINMENT INFORMATION, PHOTOS AND VIDEO IN THE FIELD OF AIRCRAFT PERFORMANCES AND DEMONSTRATIONS, IN CLASS 41 (U.S. CLS. 100, 101 AND 107).

FIRST USE 3-31-2009; IN COMMERCE 3-31-2009.

NO CLAIM IS MADE TO THE EXCLUSIVE RIGHT TO USE "JET TEAM", APART FROM THE MARK AS SHOWN.

THE MARK CONSISTS OF A FIVE-POINTED CONCENTRIC STAR WITH A BANDED OUTLINE AND WITH THE WORD "PATRIOTS" WITH A STAR IN THE LETTER "O" ABOVE THE WORDING "JET TEAM", EACH IN STYLIZED FONT, ACROSS THE MIDDLE OF THE STAR WITH THE SILHOUETTES OF SIX JETS WITH JET TRAILS CLUSTERED OVER AND TO THE RIGHT OF THE TOP POINT OF THE STAR.

SER. NO. 85-171,663, FILED 11-8-2010.

WILLIAM ROSSMAN, EXAMINING ATTORNEY



David J. Kybas

Director of the United States Patent and Trademark Office

United States of America

United States Patent and Trademark Office

GRAND FLANNEL

Reg. No. 4,097,901

Registered Feb. 14, 2012

Int. Cl.: 24

TRADEMARK

PRINCIPAL REGISTER

FAB INDUSTRIES CORP. (DELAWARE CORPORATION)
SUITE 412 NORTH
98 CUTTER MILL ROAD,
GREAT NECK, NY 11021

FOR: COMFORTERS, BED SHEETS, BED BLANKETS, BABY BLANKETS, AND PILLOW CASES. ALL GOODS ARE MADE IN SIGNIFICANT PART OF FLANNEL, IN CLASS 24 (U.S. CLS. 42 AND 50).

FIRST USE 8-30-1979; IN COMMERCE 8-30-1979.

THE MARK CONSISTS OF STANDARD CHARACTERS WITHOUT CLAIM TO ANY PARTICULAR FONT, STYLE, SIZE, OR COLOR.

OWNER OF U.S. REG. NOS. 1,124,311 AND 1,346,269.

NO CLAIM IS MADE TO THE EXCLUSIVE RIGHT TO USE "FLANNEL", APART FROM THE MARK AS SHOWN.

SER. NO. 85-171,849, FILED 11-8-2010.

KEVON CHISOLM, EXAMINING ATTORNEY



David J. Kyffers

Director of the United States Patent and Trademark Office

United States of America

United States Patent and Trademark Office

The High Bar

Reg. No. 4,097,902

Registered Feb. 14, 2012

Int. Cls.: 35, 41 and 42

SERVICE MARK

PRINCIPAL REGISTER

THE HIGH BAR, LLC (MASSACHUSETTS LIMITED LIABILITY COMPANY)
82 SHAKER ROAD
HARVARD, MA 01451

FOR: EDUCATION LEADERSHIP DEVELOPMENT; MANAGEMENT AND BUSINESS CONSULTING SERVICES IN THE FIELD OF EDUCATION, LEADERSHIP AND NON-PROFIT BOARD GOVERNANCE, IN CLASS 35 (U.S. CLS. 100, 101 AND 102).

FIRST USE 6-1-2010; IN COMMERCE 6-1-2010.

FOR: EDUCATION SERVICES, NAMELY, PROVIDING ON-LINE WORKSHOPS, EVALUATIONS, CLASSES AND SEMINARS IN THE FIELD OF SCHOOL LEADERSHIP AND BOARD GOVERNANCE; EDUCATION SERVICES, NAMELY, PROVIDING WORKSHOPS, EVALUATIONS, CLASSES AND SEMINARS IN THE FIELDS OF SCHOOL LEADERSHIP AND BOARD GOVERNANCE, IN CLASS 41 (U.S. CLS. 100, 101 AND 107).

FIRST USE 6-1-2010; IN COMMERCE 6-1-2010.

FOR: COMPUTER SERVICES, NAMELY, PROVIDING A WEB-BASED SYSTEM AND ON-LINE PORTAL FEATURING ON-LINE NON-DOWNLOADABLE SOFTWARE THAT ENABLES USERS TO ACCESS TRAINING, EDUCATION, TESTING AND CERTIFICATION MATERIALS IN THE FIELD OF EDUCATION, LEADERSHIP AND BOARD GOVERNANCE, IN CLASS 42 (U.S. CLS. 100 AND 101).

FIRST USE 10-28-2010; IN COMMERCE 10-28-2010.

THE MARK CONSISTS OF STANDARD CHARACTERS WITHOUT CLAIM TO ANY PARTICULAR FONT, STYLE, SIZE, OR COLOR.

SER. NO. 85-172,214, FILED 11-9-2010.

JESSICA FATHY, EXAMINING ATTORNEY



David J. Kyjars

Director of the United States Patent and Trademark Office

United States of America

United States Patent and Trademark Office

DURABUILT MEDICAL

Reg. No. 4,097,903

ASBILLE, TONY L. (UNITED STATES INDIVIDUAL)
1901 E. 50TH ST.
TEXARKANA, AR 71854

Registered Feb. 14, 2012

Int. Cl.: 10

FOR: MEDICAL PATIENT EXAMINATION AND TREATMENT TABLES FOR RADIOLOGICAL, SURGICAL, PAIN MANAGEMENT, UROLOGICAL, GYNECOLOGICAL, VASCULAR, AND CARDIOVASCULAR USES, IN CLASS 10 (U.S. CLS. 26, 39 AND 44).

TRADEMARK

FIRST USE 4-17-2002; IN COMMERCE 8-12-2002.

PRINCIPAL REGISTER

THE MARK CONSISTS OF STANDARD CHARACTERS WITHOUT CLAIM TO ANY PARTICULAR FONT, STYLE, SIZE, OR COLOR.

OWNER OF U.S. REG. NO. 3,133,000.

NO CLAIM IS MADE TO THE EXCLUSIVE RIGHT TO USE "MEDICAL", APART FROM THE MARK AS SHOWN.

SER. NO. 85-172,737, FILED 11-9-2010.

CIMMERIAN COLEMAN, EXAMINING ATTORNEY



David J. Kyfos

Director of the United States Patent and Trademark Office

United States of America

United States Patent and Trademark Office

SIERRA MADRE PROVISION CO.

Reg. No. 4,097,904

Registered Feb. 14, 2012

Int. Cl.: 29

TRADEMARK

PRINCIPAL REGISTER

SCHAFT, JAMES (UNITED STATES INDIVIDUAL), DBA SIERRA MADRE PROVISION COMPANY
519 E. LEADORA AVENUE
GLEN DORA, CA 91741

FOR: BEEF JERKY; JERKY, IN CLASS 29 (U.S. CL. 46).

FIRST USE 6-1-1998; IN COMMERCE 6-1-1998.

THE MARK CONSISTS OF STANDARD CHARACTERS WITHOUT CLAIM TO ANY PARTICULAR FONT, STYLE, SIZE, OR COLOR.

NO CLAIM IS MADE TO THE EXCLUSIVE RIGHT TO USE "PROVISION CO.", APART FROM THE MARK AS SHOWN.

SEC. 2(F).

SER. NO. 85-172,842, FILED 11-9-2010.

JANET LEE, EXAMINING ATTORNEY



David J. Kyffers

Director of the United States Patent and Trademark Office

United States of America

United States Patent and Trademark Office

OIL SPONGE

Reg. No. 4,097,905

Registered Feb. 14, 2012

Int. Cl.: 1

TRADEMARK

PRINCIPAL REGISTER

PHASE III, INC. (ARIZONA CORPORATION)
PHASE III, INC.
315 E. WARNER RD. SUITE 3
CHANDLER, AZ 85225

FOR: GRANULAR ABSORBENT MINERAL-BASED COMPOSITION FOR ABSORBING SPILLS FROM FLOORS, IN CLASS 1 (U.S. CLS. 1, 5, 6, 10, 26 AND 46).

FIRST USE 12-31-1994; IN COMMERCE 12-31-1994.

THE MARK CONSISTS OF STANDARD CHARACTERS WITHOUT CLAIM TO ANY PARTICULAR FONT, STYLE, SIZE, OR COLOR.

SEC. 2(F).

SER. NO. 85-172,870, FILED 11-9-2010.

ANNE FARRELL, EXAMINING ATTORNEY



David J. Kyffers

Director of the United States Patent and Trademark Office

United States of America

United States Patent and Trademark Office



Reg. No. 4,097,906

Registered Feb. 14, 2012

Int. Cl.: 44

SERVICE MARK

PRINCIPAL REGISTER

NATION'S HOME INFUSION, LLC (MARYLAND LIMITED LIABILITY COMPANY)
SUITE H
11515 CRONRIDGE DRIVE
OWINGS MILLS, MD 21117

FOR: HOME HEALTH CARE SERVICES; LEASING HOME INFUSION MEDICAL EQUIPMENT AND SUPPLIES; PREPARATION AND DISPENSING HOME INFUSION MEDICATIONS, IN CLASS 44, IN CLASS 44 (U.S. CLS. 100 AND 101).

FIRST USE 2-14-2006; IN COMMERCE 2-14-2006.

NO CLAIM IS MADE TO THE EXCLUSIVE RIGHT TO USE "HOME INFUSION, LLC" AND THE OUTLINE OF THE MAP OF THE UNITED STATES, APART FROM THE MARK AS SHOWN.

THE MARK CONSISTS OF A DEPICTION OF THE CONTINENTAL UNITED STATES FILLED IN WITH SHADED STRIPES AND WITH SHADED STARS ON A SHADED BACKGROUND IN THE UPPER LEFT HAND CORNER OF THE DEPICTION OF THE CONTINENTAL UNITED STATES LIKE A STYLIZED AMERICAN FLAG, WITH A SHADED WAVY LINE RUNNING THROUGH THE IMAGE OVERLAID BY THE WORDING "NATION'S HOME INFUSION, LLC".

SER. NO. 85-173,710, FILED 11-10-2010.

GINA FINK, EXAMINING ATTORNEY



David J. Kyjars

Director of the United States Patent and Trademark Office

United States of America

United States Patent and Trademark Office

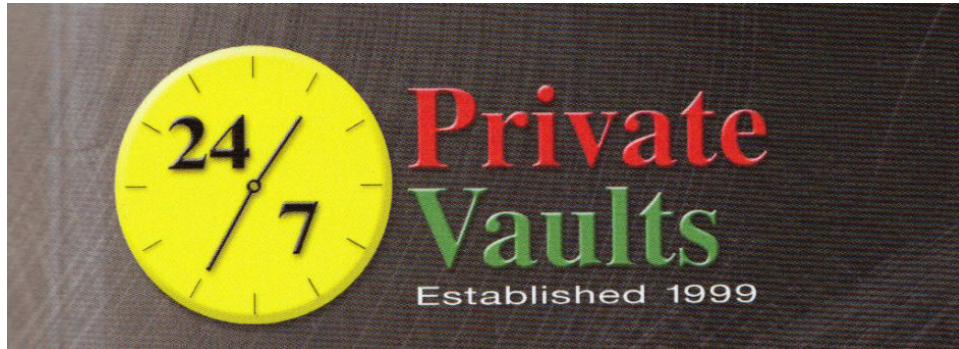

Reg. No. 4,097,907

Registered Feb. 14, 2012

Int. Cl.: 36

SERVICE MARK

PRINCIPAL REGISTER

SOVEREIGN SECURITY SYSTEMS, INC. (NEVADA CORPORATION)
P. O. BOX 81015
3110 EAST SUNRISE ROAD SUITE H
LAS VEGAS, NV 89120

FOR: SAFETY DEPOSIT BOX SERVICES, IN CLASS 36 (U.S. CLS. 100, 101 AND 102).

FIRST USE 7-1-1999; IN COMMERCE 7-1-1999.

NO CLAIM IS MADE TO THE EXCLUSIVE RIGHT TO USE "24 7", "PRIVATE VAULTS", AND "ESTABLISHED 1999", APART FROM THE MARK AS SHOWN.

THE COLOR(S) RED, YELLOW, GREEN, BLACK, GRAY, AND WHITE IS/ARE CLAIMED AS A FEATURE OF THE MARK.

THE MARK CONSISTS OF A YELLOW CLOCK FACE WITH BLACK HOUR AND MINUTE INDICATORS AND THE BLACK NUMBERS "24" AND "7" WITH THE WORD "PRIVATE" IN RED AND "VAULTS" IN GREEN TO THE RIGHT OF THE CLOCK. THE WORDING "ESTABLISHED 1999" APPEARS IN WHITE AND THE RECTANGULAR BACKGROUND APPEARS IN GRAY.

SER. NO. 85-173,988, FILED 11-10-2010.

KRISTINA MORRIS, EXAMINING ATTORNEY



David J. Kybas

Director of the United States Patent and Trademark Office

United States of America

United States Patent and Trademark Office

THE PERFORMER

Reg. No. 4,097,908

CO BUILDING SYSTEMS AND MANUFACTURING, INC. (UTAH CORPORATION)
320 WEST 100 NORTH
EPHRAIM, UT 84627

Registered Feb. 14, 2012

Int. Cl.: 17

FOR: BUILDING MATERIALS, NAMELY, METAL REINFORCED THERMAL INSULATION BLOCKS FOR USE IN ROOFING AND WALLS EXCLUSIVELY IN THE METAL BUILDING INDUSTRY , IN CLASS 17 (U.S. CLS. 1, 5, 12, 13, 35 AND 50).

TRADEMARK

FIRST USE 9-1-2010; IN COMMERCE 9-1-2010.

PRINCIPAL REGISTER

THE MARK CONSISTS OF STANDARD CHARACTERS WITHOUT CLAIM TO ANY PARTICULAR FONT, STYLE, SIZE, OR COLOR.

SER. NO. 85-174,963, FILED 11-11-2010.

JUSTINE D. PARKER, EXAMINING ATTORNEY



David J. Kybas

Director of the United States Patent and Trademark Office

United States of America

United States Patent and Trademark Office

ROYAL MATCH 21

Reg. No. 4,097,909

SHUFFLE MASTER, INC. (MONTANA CORPORATION)
1106 PALMS AIRPORT DRIVE
LAS VEGAS, NV 89119

Registered Feb. 14, 2012

Int. Cl.: 9

FOR: NON-DOWNLOADABLE COMPUTER SOFTWARE AND FIRMWARE FOR GAMES OF CHANCE PLAYED ON COMPUTERIZED GAMING PLATFORMS, NAMELY, A GAMING TABLE PLATFORM WITH A VIDEO DISPLAY AND ELECTRONIC PLAYER CONTROLS ENABLING CREDIT WAGERING, IN CLASS 9 (U.S. CLS. 21, 23, 26, 36 AND 38).

TRADEMARK

PRINCIPAL REGISTER

FIRST USE 9-30-2009; IN COMMERCE 9-30-2009.

THE MARK CONSISTS OF STANDARD CHARACTERS WITHOUT CLAIM TO ANY PARTICULAR FONT, STYLE, SIZE, OR COLOR.

OWNER OF U.S. REG. NOS. 3,059,521, 3,335,935, AND 3,696,620.

NO CLAIM IS MADE TO THE EXCLUSIVE RIGHT TO USE "21", APART FROM THE MARK AS SHOWN.

SER. NO. 85-177,354, FILED 11-15-2010.

NAPOLEON SHARMA, EXAMINING ATTORNEY



David J. Kyffers

Director of the United States Patent and Trademark Office

United States of America

United States Patent and Trademark Office

BET THE SET "21"

Reg. No. 4,097,910

SHUFFLE MASTER, INC. (MINNESOTA CORPORATION)
1106 PALMS AIRPORT DRIVE
LAS VEGAS, NV 89119

Registered Feb. 14, 2012

Int. Cl.: 9

FOR: NON-DOWNLOADABLE COMPUTER SOFTWARE AND FIRMWARE FOR GAMES OF CHANCE PLAYED ON COMPUTERIZED GAMING PLATFORMS, NAMELY, A GAMING TABLE PLATFORM WITH A VIDEO DISPLAY AND ELECTRONIC PLAYER CONTROLS ENABLING CREDIT WAGERING, IN CLASS 9 (U.S. CLS. 21, 23, 26, 36 AND 38).

TRADEMARK

PRINCIPAL REGISTER

FIRST USE 11-17-2009; IN COMMERCE 11-17-2009.

THE MARK CONSISTS OF STANDARD CHARACTERS WITHOUT CLAIM TO ANY PARTICULAR FONT, STYLE, SIZE, OR COLOR.

NO CLAIM IS MADE TO THE EXCLUSIVE RIGHT TO USE "21", APART FROM THE MARK AS SHOWN.

SER. NO. 85-177,367, FILED 11-15-2010.

NAPOLEON SHARMA, EXAMINING ATTORNEY



David J. Kybas

Director of the United States Patent and Trademark Office

United States of America
United States Patent and Trademark Office

KUSH BOYS

Reg. No. 4,097,911

Registered Feb. 14, 2012

Int. Cl.: 25

TRADEMARK

PRINCIPAL REGISTER

KB MEDIA GROUP, LLC (CALIFORNIA LIMITED LIABILITY COMPANY)
#315
555 MISSION ROCK ST.
SAN FRANCISCO, CA 94158

FOR: HATS; T-SHIRTS; TOPS, IN CLASS 25 (U.S. CLS. 22 AND 39).

FIRST USE 1-0-2008; IN COMMERCE 1-0-2008.

THE MARK CONSISTS OF STANDARD CHARACTERS WITHOUT CLAIM TO ANY PARTICULAR FONT, STYLE, SIZE, OR COLOR.

NO CLAIM IS MADE TO THE EXCLUSIVE RIGHT TO USE "BOYS", APART FROM THE MARK AS SHOWN.

SER. NO. 85-177,614, FILED 11-16-2010.

ANGELA DUONG, EXAMINING ATTORNEY



David J. Kybas

Director of the United States Patent and Trademark Office

United States of America

United States Patent and Trademark Office

CHEMIPLASTICA

Reg. No. 4,097,912

Registered Feb. 14, 2012

Int. Cls.: 1 and 42

TRADEMARK

SERVICE MARK

PRINCIPAL REGISTER

CHEMIPLASTICA HOLDING PTE. LTD. (SINGAPORE LIMITED LIABILITY COMPANY)
3 ANSON ROAD, #27-01 SPRINGLEAF TOWER
SINGAPORE, SINGAPORE 079909

FOR: THERMOSETTING MOULDING PREPARATIONS AND COMPOUNDS; THERMOSETTING MOULDING POWDER MADE OF MELAMINE-FORMALDEHYDE PLASTICS, UREA-FORMALDEHYDE PLASTICS AND MELAMINE-UREA-FORMALDEHYDE; THERMOSETTING PLASTICS IN LIQUID STATE, NAMELY, AMINO PLASTICS; AMINO COMPOUNDS FOR INDUSTRIAL USE, IN CLASS 1 (U.S. CLS. 1, 5, 6, 10, 26 AND 46).

FOR: SCIENTIFIC AND TECHNOLOGICAL SERVICES, NAMELY, SCIENTIFIC AND TECHNOLOGICAL RESEARCH AND ARCHITECTURAL AND INDUSTRIAL DESIGN IN THE FIELD OF CONSTRUCTION OF FACTORIES FOR PRODUCTION OF THERMOSETTING MOULDING PREPARATIONS AND COMPOUNDS, THERMOSETTING MOULDING POWDER, THERMOSETTING PLASTICS IN LIQUID STATE AND AMINO COMPOUNDS FOR INDUSTRIAL USE, IN CLASS 42 (U.S. CLS. 100 AND 101).

THE MARK CONSISTS OF STANDARD CHARACTERS WITHOUT CLAIM TO ANY PARTICULAR FONT, STYLE, SIZE, OR COLOR.

PRIORITY CLAIMED UNDER SEC. 44(D) ON SINGAPORE APPLICATION NO. T1006168F, FILED 5-17-2010, REG. NO. T1006168F, DATED 5-17-2010, EXPIRES 5-17-2020.

SER. NO. 85-178,654, FILED 11-17-2010.

TASNEEM HUSSAIN, EXAMINING ATTORNEY



David J. Kybas

Director of the United States Patent and Trademark Office

United States of America

United States Patent and Trademark Office

Jungle Treats

Reg. No. 4,097,913

JUNGLE TREATS, INC. (NEW YORK CORPORATION)
21 JUNIPER PLACE
HUNTINGTON, NY 11743

Registered Feb. 14, 2012

Int. Cl.: 29

FOR: VEGETABLE CHIPS, IN CLASS 29 (U.S. CL. 46).

TRADEMARK

FIRST USE 6-15-2007; IN COMMERCE 11-18-2008.

PRINCIPAL REGISTER

THE MARK CONSISTS OF STANDARD CHARACTERS WITHOUT CLAIM TO ANY PARTICULAR FONT, STYLE, SIZE, OR COLOR.

SER. NO. 85-178,897, FILED 11-17-2010.

TRACY WHITTAKER-BROWN, EXAMINING ATTORNEY



David J. Kybas

Director of the United States Patent and Trademark Office

United States of America

United States Patent and Trademark Office

Sounds Track 4 Change

Reg. No. 4,097,914

CONNAUGHT TECHNOLOGY CORPORATION (DELAWARE CORPORATION)

Registered Feb. 14, 2012

3711 KENNETT PIKE
GREENVILLE, DE 19807

Int. Cl.: 35

FOR: PROMOTING PUBLIC AWARENESS OF THE DANGERS OF PERTUSSIS AND THE NEED FOR INDIVIDUALS TO BE VACCINATED BY PROVIDING A WEB SITE AT WHICH USERS CAN LINK TO DOWNLOADABLE PRERECORDED MUSIC; PROVIDING A WEBSITE FEATURING LINKS TO THE WEBSITE OF OTHERS TO PURCHASE DOWNLOADABLE PRERECORDED MUSIC FOR RETAIL PURPOSES TO INCREASE PUBLIC AWARENESS OF THE DANGERS OF PERTUSSIS AND THE NEED FOR INDIVIDUALS TO BE VACCINATED, IN CLASS 35 (U.S. CLS. 100, 101 AND 102).

SERVICE MARK

PRINCIPAL REGISTER

FIRST USE 4-22-2010; IN COMMERCE 4-22-2010.

THE MARK CONSISTS OF STANDARD CHARACTERS WITHOUT CLAIM TO ANY PARTICULAR FONT, STYLE, SIZE, OR COLOR.

SER. NO. 85-179,241, FILED 11-17-2010.

LANA PHAM, EXAMINING ATTORNEY



David J. Kyjars

Director of the United States Patent and Trademark Office

United States of America

United States Patent and Trademark Office



THE RESOLUTION PROJECT

Reg. No. 4,097,915

Registered Feb. 14, 2012

**Int. Cls.: 35, 36, 41 and
45**

SERVICE MARK

PRINCIPAL REGISTER

THE RESOLUTION PROJECT, INC. (NEW YORK NON-PROFIT CORPORATION)
6415 ROOSEVELT AVENUE
WOODSIDE, NY 113773643

FOR: PROVIDING BUSINESS COUNSELING IN THE FIELD OF SOCIAL ENTREPRENEURSHIP; MARKETING AND CONSULTING SERVICES RELATED TO BUSINESS ADVISORY IN THE FIELD OF SOCIAL ENTREPRENEURSHIP; PROMOTING PUBLIC AWARENESS IN THE FIELD OF SOCIAL ENTREPRENEURSHIP, IN CLASS 35 (U.S. CLS. 100, 101 AND 102).

FIRST USE 3-14-2010; IN COMMERCE 3-14-2010.

FOR: CHARITABLE SERVICES, NAMELY, CHARITABLE FUNDRAISING FOR USE IN ORGANIZING AND DEVELOPING PROJECTS THAT PROMOTE GLOBAL AWARENESS OF THOSE IN NEED OF ASSISTANCE, IN CLASS 36 (U.S. CLS. 100, 101 AND 102).

FIRST USE 3-14-2010; IN COMMERCE 3-14-2010.

FOR: PROVIDING EDUCATIONAL RESOURCES, NAMELY, WORKSHOPS AND SEMINARS IN THE FIELD OF CAREER DEVELOPMENT AND LEADERSHIP TRAINING; PROVIDING COUNSELING AND MENTORSHIP IN THE FIELD OF CAREER DEVELOPMENT; PROVIDING EDUCATIONAL MENTORSHIP IN THE FIELD OF SOCIAL ENTREPRENEURSHIP, IN CLASS 41 (U.S. CLS. 100, 101 AND 107).

FIRST USE 3-14-2010; IN COMMERCE 3-14-2010.

FOR: COMMUNITY OUTREACH SERVICES PROVIDED TO YOUNG LEADERS, NAMELY, ON-LINE SOCIAL NETWORKING SERVICES; PROVIDING INFORMATION CONCERNING CHARITABLE CAUSES AND HUMANITARIAN EFFORTS IN THE FIELD OF SOCIAL JUSTICE, IN CLASS 45 (U.S. CLS. 100 AND 101).

FIRST USE 3-14-2010; IN COMMERCE 3-14-2010.

NO CLAIM IS MADE TO THE EXCLUSIVE RIGHT TO USE "PROJECT", APART FROM THE MARK AS SHOWN.



David J. Kyjars

Director of the United States Patent and Trademark Office

Reg. No. 4,097,915 THE MARK CONSISTS OF THE WORDS "THE RESOLUTION PROJECT" WITH A STYLIZED GLOBE DESIGN ABOVE THE WORDS.

SER. NO. 85-179,953, FILED 11-18-2010.

GISELLE AGOSTO, EXAMINING ATTORNEY

United States of America

United States Patent and Trademark Office

THE RESOLUTION PROJECT

Reg. No. 4,097,916

Registered Feb. 14, 2012

Int. Cls.: 35, 36, 41 and 45

SERVICE MARK

PRINCIPAL REGISTER

THE RESOLUTION PROJECT, INC. (NEW YORK NON-PROFIT CORPORATION)
6415 ROOSEVELT AVENUE
WOODSIDE, NY 113773643

FOR: PROVIDING BUSINESS COUNSELING IN THE FIELD OF SOCIAL ENTREPRENEURSHIP; MARKETING AND CONSULTING SERVICES RELATED TO BUSINESS ADVISORY IN THE FIELD OF SOCIAL ENTREPRENEURSHIP; PROMOTING PUBLIC AWARENESS IN THE FIELD OF SOCIAL ENTREPRENEURSHIP, IN CLASS 35 (U.S. CLS. 100, 101 AND 102).

FIRST USE 3-25-2007; IN COMMERCE 3-25-2007.

FOR: CHARITABLE SERVICES, NAMELY, CHARITABLE FUNDRAISING FOR USE IN ORGANIZING AND DEVELOPING PROJECTS THAT PROMOTE GLOBAL AWARENESS OF THOSE IN NEED OF ASSISTANCE, IN CLASS 36 (U.S. CLS. 100, 101 AND 102).

FIRST USE 3-25-2007; IN COMMERCE 3-25-2007.

FOR: PROVIDING EDUCATIONAL RESOURCES, NAMELY, WORKSHOPS AND SEMINARS IN THE FIELD OF CAREER DEVELOPMENT AND LEADERSHIP TRAINING; PROVIDING COUNSELING AND MENTORSHIP IN THE FIELD OF CAREER DEVELOPMENT; PROVIDING EDUCATIONAL MENTORSHIP IN THE FIELD OF SOCIAL ENTREPRENEURSHIP, IN CLASS 41 (U.S. CLS. 100, 101 AND 107).

FIRST USE 3-25-2007; IN COMMERCE 3-25-2007.

FOR: COMMUNITY OUTREACH SERVICES PROVIDED TO YOUNG LEADERS, NAMELY, ON-LINE SOCIAL NETWORKING SERVICES; PROVIDING INFORMATION CONCERNING CHARITABLE CAUSES AND HUMANITARIAN EFFORTS IN THE FIELD OF SOCIAL JUSTICE, IN CLASS 45 (U.S. CLS. 100 AND 101).

FIRST USE 3-25-2007; IN COMMERCE 3-25-2007.

THE MARK CONSISTS OF STANDARD CHARACTERS WITHOUT CLAIM TO ANY PARTICULAR FONT, STYLE, SIZE, OR COLOR.



David J. Kyffers

Director of the United States Patent and Trademark Office

Reg. No. 4,097,916 NO CLAIM IS MADE TO THE EXCLUSIVE RIGHT TO USE "PROJECT", APART FROM THE MARK AS SHOWN.

SER. NO. 85-179,956, FILED 11-18-2010.

GISELLE AGOSTO, EXAMINING ATTORNEY

United States of America

United States Patent and Trademark Office

MIDNIGHT ECLIPSE

Reg. No. 4,097,917

U.S. COSMETICS CORPORATION (CONNECTICUT CORPORATION)
110 LOUISA VIENS DRIVE
DAYVILLE, CT 06241

Registered Feb. 14, 2012

Int. Cl.: 2

FOR: PIGMENTS, NAMELY, MINERAL OR SYNTHETIC PIGMENTS FOR USE IN THE MANUFACTURE OF COSMETICS, PERSONAL CARE, AND SUNSCREEN PRODUCTS, IN CLASS 2 (U.S. CLS. 6, 11 AND 16).

TRADEMARK

FIRST USE 11-10-2010; IN COMMERCE 11-10-2010.

PRINCIPAL REGISTER

THE MARK CONSISTS OF STANDARD CHARACTERS WITHOUT CLAIM TO ANY PARTICULAR FONT, STYLE, SIZE, OR COLOR.

SER. NO. 85-179,982, FILED 11-18-2010.

BERYL GARDNER, EXAMINING ATTORNEY



David J. Kybas

Director of the United States Patent and Trademark Office

United States of America

United States Patent and Trademark Office



Reg. No. 4,097,918

Registered Feb. 14, 2012

**Int. Cls.: 9, 35, 37, 38, 41
and 42**

TRADEMARK

SERVICE MARK

PRINCIPAL REGISTER

HEADLIGHT AUDIO VISUAL INC. (MAINE CORPORATION)
74 EVERGREEN DRIVE, PO BOX 1316
PORTLAND, ME 04103

FOR: AUDIO EQUIPMENT AND SYSTEMS, NAMELY, SPEAKERS, AMPLIFIERS, EQUALIZERS, CROSSOVERS AND SPEAKER HOUSINGS; VIDEO EQUIPMENT AND SYSTEMS, NAMELY, VIDEO CAMERAS AND VIDEO PROJECTORS; VIDEO AND COMPUTER PROJECTION EQUIPMENT AND SYSTEMS, COMPRISED OF VIDEO PROJECTORS AND COMPUTER HARDWARE; LIQUID CRYSTAL DISPLAY TECHNOLOGY, NAMELY, LCD PANELS, LCD MONITORS, LCD PROJECTORS, FLAT PANEL DISPLAY TELEVISIONS, COMPUTER MONITORS, SPEAKERS, AMPLIFIERS, EQUALIZERS, CROSSOVERS, SPEAKER HOUSINGS, VIDEO CAMERAS, VIDEO PROJECTORS AND COMPUTER HARDWARE, IN CLASS 9 (U.S. CLS. 21, 23, 26, 36 AND 38).

FIRST USE 1-5-2010; IN COMMERCE 1-5-2010.

FOR: PRODUCTION OF VIDEO AND AUDIO COMMERCIALS; POST-PRODUCTION EDITING SERVICES FOR VIDEO AND AUDIO COMMERCIALS; PRODUCTION OF PROMOTIONAL VIDEOTAPES, VIDEO DISCS AND AUDIO VISUAL RECORDINGS; RETAIL STORE SERVICES FEATURING AUDIO EQUIPMENT AND SYSTEMS, VIDEO EQUIPMENT AND SYSTEMS, AUDIO VISUAL EQUIPMENT AND SYSTEMS, VIDEO AND COMPUTER PROJECTION EQUIPMENT AND SYSTEMS, LIQUID CRYSTAL DISPLAY TECHNOLOGY, AND FLAT PANEL DISPLAY SYSTEMS; AND PREPARATION AND PRESENTATION OF VIDEO FILES, DIGITAL PRESENTATION SLIDE PROJECTS AND PHOTO MONTAGES, IN CLASS 35 (U.S. CLS. 100, 101 AND 102).

FIRST USE 1-5-2010; IN COMMERCE 1-5-2010.

FOR: INSTALLATION, MAINTENANCE AND REPAIR OF AUDIO EQUIPMENT AND SYSTEMS, VIDEO EQUIPMENT AND SYSTEMS, AUDIO VISUAL EQUIPMENT AND SYSTEMS, VIDEO AND COMPUTER PROJECTION EQUIPMENT AND SYSTEMS, LIQUID CRYSTAL DISPLAY TECHNOLOGY, FLAT PANEL DISPLAY SYSTEMS, AND AUDIOVISUAL ROOM CONTROL SYSTEMS, IN CLASS 37 (U.S. CLS. 100, 103 AND 106).

FIRST USE 1-5-2010; IN COMMERCE 1-5-2010.



David J. Kybas

Director of the United States Patent and Trademark Office

Reg. No. 4,097,918 FOR: PROVIDING FACILITIES AND EQUIPMENT FOR TELECONFERENCING, AUDIO CONFERENCING AND VIDEO CONFERENCING; TELECONFERENCING, AUDIO CONFERENCING, AND VIDEO CONFERENCING SERVICES, IN CLASS 38 (U.S. CLS. 100, 101 AND 104).

FIRST USE 1-5-2010; IN COMMERCE 1-5-2010.

FOR: AUDIO AND VIDEO RECORDING SERVICES; AUDIO AND VIDEO PRODUCTION SERVICES; PRODUCTION OF VIDEO DISCS FOR OTHERS; RENTAL SERVICES FOR AUDIO EQUIPMENT AND SYSTEMS, VIDEO EQUIPMENT AND SYSTEMS, AUDIO VISUAL EQUIPMENT AND SYSTEMS, VIDEO AND COMPUTER PROJECTION EQUIPMENT AND SYSTEMS, LIQUID CRYSTAL DISPLAY TECHNOLOGY, AND FLAT PANEL DISPLAY SYSTEMS; RENTAL OF FACILITIES AND EQUIPMENT IN THE PRODUCTION OF AUDIO VISUAL PROGRAMS; RENTAL OF FACILITIES AND AUDIO EQUIPMENT AND SYSTEMS, VIDEO EQUIPMENT AND SYSTEMS, AUDIO VISUAL EQUIPMENT AND SYSTEMS, VIDEO AND COMPUTER PROJECTION EQUIPMENT AND SYSTEMS, LIQUID CRYSTAL DISPLAY TECHNOLOGY, AND FLAT PANEL DISPLAY SYSTEMS; OPERATION OF AUDIO EQUIPMENT AND SYSTEMS, VIDEO EQUIPMENT AND SYSTEMS, AUDIO VISUAL EQUIPMENT AND SYSTEMS, VIDEO AND COMPUTER PROJECTION EQUIPMENT AND SYSTEMS, LIQUID CRYSTAL DISPLAY TECHNOLOGY, AND FLAT PANEL DISPLAY SYSTEMS FOR OTHERS; TRAINING SERVICES IN THE USE AND OPERATION OF AUDIO EQUIPMENT AND SYSTEMS, VIDEO EQUIPMENT AND SYSTEMS, AUDIO VISUAL EQUIPMENT AND SYSTEMS, VIDEO AND COMPUTER PROJECTION EQUIPMENT AND SYSTEMS, LIQUID CRYSTAL DISPLAY TECHNOLOGY, AND FLAT PANEL DISPLAY SYSTEMS; RENTAL OF AUDIO EQUIPMENT AND SYSTEMS, VIDEO EQUIPMENT AND SYSTEMS, AUDIO VISUAL EQUIPMENT AND SYSTEMS, VIDEO AND COMPUTER PROJECTION EQUIPMENT AND SYSTEMS, LIQUID CRYSTAL DISPLAY TECHNOLOGY, AND FLAT PANEL DISPLAY SYSTEMS; VIDEO AND COMPUTER PROJECTION SERVICES FOR OTHERS; PRODUCTION OF VIDEOTAPES, VIDEO DISCS, VIDEO FILES, AND AUDIO VISUAL RECORDINGS, IN CLASS 41 (U.S. CLS. 100, 101 AND 107).

FIRST USE 1-5-2010; IN COMMERCE 1-5-2010.

FOR: DIGITAL TRANSFER AND SERVICES FOR TRANSFERRING CASSETTE TAPES, VIDEOS AND FILM TO DVD; DESIGN OF AUDIO EQUIPMENT AND SYSTEMS, VIDEO EQUIPMENT AND SYSTEMS, AUDIO VISUAL EQUIPMENT AND SYSTEMS, VIDEO AND COMPUTER PROJECTION EQUIPMENT AND SYSTEMS, LIQUID CRYSTAL DISPLAY TECHNOLOGY, FLAT PANEL DISPLAY SYSTEMS, AND AUDIOVISUAL ROOM CONTROL SYSTEMS; TECHNICAL CONSULTING SERVICES IN THE FIELD OF AUDIO-VISUAL EQUIPMENT AND SYSTEMS; CUSTOM DESIGN AND ENGINEERING OF AUDIO EQUIPMENT AND SYSTEMS, VIDEO EQUIPMENT AND SYSTEMS, AUDIO VISUAL EQUIPMENT AND SYSTEMS, VIDEO AND COMPUTER PROJECTION EQUIPMENT AND SYSTEMS, LIQUID CRYSTAL DISPLAY TECHNOLOGY, FLAT PANEL DISPLAY SYSTEMS, AND AUDIOVISUAL ROOM CONTROL SYSTEMS; AND ENGINEERING SERVICES IN THE FIELD OF AUDIO-VISUAL TECHNOLOGY, IN CLASS 42 (U.S. CLS. 100 AND 101).

FIRST USE 1-5-2010; IN COMMERCE 1-5-2010.

OWNER OF U.S. REG. NO. 2,477,243.

NO CLAIM IS MADE TO THE EXCLUSIVE RIGHT TO USE "AUDIO VISUAL VIDEO", APART FROM THE MARK AS SHOWN.

THE MARK CONSISTS OF THE WORD "HEADLIGHT" IN A STYLIZED FONT ABOVE THE WORDS "AUDIO VISUAL VIDEO" IN A DIFFERENT STYLIZED FONT AND A STYLIZED DESIGN OF THE TOP PORTION OF A LIGHTHOUSE.

SER. NO. 85-180,117, FILED 11-18-2010.

Reg. No. 4,097,918 CURTIS FRENCH, EXAMINING ATTORNEY

United States of America

United States Patent and Trademark Office

WASATCH CUP

Reg. No. 4,097,919

WASATCH CUP RUGBY, LLC (UTAH LIMITED LIABILITY COMPANY)
11302 S. GLEN CROFT LANE
SANDY, UT 84070

Registered Feb. 14, 2012

Int. Cl.: 41

FOR: ENTERTAINMENT AND EDUCATIONAL SERVICES, NAMELY, ORGANIZING AND STAGING AN ATHLETIC COMPETITION, SPECIFICALLY ORGANIZING AND STAGING A COLLEGE RUGBY GAME AND RELATED EVENTS AND ACTIVITIES, IN CLASS 41 (U.S. CLS. 100, 101 AND 107).

SERVICE MARK

PRINCIPAL REGISTER

FIRST USE 3-1-2004; IN COMMERCE 3-1-2004.

THE MARK CONSISTS OF STANDARD CHARACTERS WITHOUT CLAIM TO ANY PARTICULAR FONT, STYLE, SIZE, OR COLOR.

NO CLAIM IS MADE TO THE EXCLUSIVE RIGHT TO USE "CUP", APART FROM THE MARK AS SHOWN.

SEC. 2(F).

SER. NO. 85-180,255, FILED 11-18-2010.

BRIDGETT SMITH, EXAMINING ATTORNEY



David J. Kyffers

Director of the United States Patent and Trademark Office

United States of America

United States Patent and Trademark Office

CORDON BLEU

Reg. No. 4,097,920

Registered Feb. 14, 2012

Int. Cl.: 33

TRADEMARK

PRINCIPAL REGISTER

MARTELL & CO. (FRANCE SOCIÉTÉ ANONYME (SA))
PLACE EDOUARD MARTELL
COGNAC, FRANCE 16100

FOR: COGNAC, IN CLASS 33 (U.S. CLS. 47 AND 49).

FIRST USE 0-0-1912; IN COMMERCE 4-0-1917.

THE MARK CONSISTS OF STANDARD CHARACTERS WITHOUT CLAIM TO ANY PARTICULAR FONT, STYLE, SIZE, OR COLOR.

OWNER OF U.S. REG. NOS. 1,665,193 AND 3,127,069.

THE ENGLISH TRANSLATION OF "CORDON BLEU" IN THE MARK IS "BLUE RIBBON".

SER. NO. 85-180,474, FILED 11-18-2010.

ANNE E. GUSTASON, EXAMINING ATTORNEY



David J. Kybas

Director of the United States Patent and Trademark Office

United States of America

United States Patent and Trademark Office

SOCIAL RECOGNITION

Reg. No. 4,097,921

GLOBOFORCE LIMITED (IRELAND LIMITED COMPANY (LTD.))
6 BECKETT WAY WEST BUSINESS PARK
DUBLIN, IRELAND 12

Registered Feb. 14, 2012

Int. Cl.: 42

FOR: SOFTWARE AS A SERVICE FEATURING SOFTWARE THAT PROVIDES NEWS FEEDS AND ONLINE NETWORKING IN THE FIELD OF ONLINE REWARDS PROGRAMS , IN CLASS 42 (U.S. CLS. 100 AND 101).

SERVICE MARK

FIRST USE 4-7-2010; IN COMMERCE 5-15-2010.

PRINCIPAL REGISTER

THE MARK CONSISTS OF STANDARD CHARACTERS WITHOUT CLAIM TO ANY PARTICULAR FONT, STYLE, SIZE, OR COLOR.

SER. NO. 85-180,764, FILED 11-19-2010.

JESSICA A. POWERS, EXAMINING ATTORNEY



David J. Kybas

Director of the United States Patent and Trademark Office

United States of America

United States Patent and Trademark Office

C LA CANADIENNE MONTRÉAL

Reg. No. 4,097,922

Registered Feb. 14, 2012

Int. Cls.: 14, 18 and 25

TRADEMARK

PRINCIPAL REGISTER

PEN-JAN HOLDINGS INC./LES PLACEMENTS PEN-JAN INC. (CANADA CORPORATION)
21 AVENUE ROSEMOUNT
WESTMOUNT, QUEBEC, CANADA H3Y3G6

FOR: JEWELLERY, IN CLASS 14 (U.S. CLS. 2, 27, 28 AND 50).

FIRST USE 8-1-2007; IN COMMERCE 8-1-2007.

FOR: HANDBAGS, IN CLASS 18 (U.S. CLS. 1, 2, 3, 22 AND 41).

FIRST USE 8-1-2007; IN COMMERCE 8-1-2007.

FOR: FOOTWEAR, NAMELY, SHOES, BOOTS AND SLIPPERS; ACCESSORIES, NAMELY, SCARVES, FUR SCARVES, GLOVES AND BELTS; OUTERWEAR, NAMELY, COATS, FUR COATS AND FUR CAPES, IN CLASS 25 (U.S. CLS. 22 AND 39).

FIRST USE 8-1-2007; IN COMMERCE 8-1-2007.

THE MARK CONSISTS OF STANDARD CHARACTERS WITHOUT CLAIM TO ANY PARTICULAR FONT, STYLE, SIZE, OR COLOR.

PRIORITY CLAIMED UNDER SEC. 44(D) ON CANADA APPLICATION NO. 1500435, FILED 10-20-2010, REG. NO. TMA806025, DATED 9-2-2011, EXPIRES 9-2-2026.

OWNER OF U.S. REG. NOS. 2,288,398, 3,010,495 AND OTHERS.

NO CLAIM IS MADE TO THE EXCLUSIVE RIGHT TO USE "MONTREAL", APART FROM THE MARK AS SHOWN.

THE ENGLISH TRANSLATION OF "LA CANADIENNE" IN THE MARK IS "THE CANADIAN".

SER. NO. 85-181,334, FILED 11-19-2010.

LIEF MARTIN, EXAMINING ATTORNEY



David J. Kyffers

Director of the United States Patent and Trademark Office

United States of America

United States Patent and Trademark Office

Jovana

Reg. No. 4,097,923

Registered Feb. 14, 2012

Int. Cl.: 14

TRADEMARK

PRINCIPAL REGISTER

JOVANA, INC. (NEVADA CORPORATION)
10120 GOLD MINE ROAD
RENO, NV 89521

FOR: JEWELRY, IN CLASS 14 (U.S. CLS. 2, 27, 28 AND 50).

FIRST USE 11-20-2010; IN COMMERCE 11-20-2010.

THE NAME(S), PORTRAIT(S), AND/OR SIGNATURE(S) SHOWN IN THE MARK DOES NOT IDENTIFY A PARTICULAR LIVING INDIVIDUAL.

THE MARK CONSISTS OF THE WORD "JOVANA".

SER. NO. 85-181,980, FILED S.R. 11-21-2010 AM. P.R. 7-15-2011.

JOHN KELLY, EXAMINING ATTORNEY



David J. Kyffers

Director of the United States Patent and Trademark Office

United States of America

United States Patent and Trademark Office

FRITES 'N' MEATS

Reg. No. 4,097,924

FRITESNMEATS ENTERPRISES, INC. (NEW YORK CORPORATION)
57-53 78TH STREET

Registered Feb. 14, 2012 MIDDLE VILLAGE, NY 11379

Int. Cl.: 43

FOR: RESTAURANT SERVICES, NAMELY, MOBILE CAFÉ SERVICES FOR PROVIDING FOOD AND DRINK; CATERING SERVICES FEATURING MOBILE CAFÉ SERVICES FOR PROVIDING FOOD AND DRINK, IN CLASS 43 (U.S. CLS. 100 AND 101).

SERVICE MARK

FIRST USE 10-31-2009; IN COMMERCE 10-31-2009.

PRINCIPAL REGISTER

THE MARK CONSISTS OF STANDARD CHARACTERS WITHOUT CLAIM TO ANY PARTICULAR FONT, STYLE, SIZE, OR COLOR.

THE ENGLISH TRANSLATION OF "FRITES" IN THE MARK IS "FRENCH FRIES".

SER. NO. 85-182,135, FILED 11-22-2010.

SIMON TENG, EXAMINING ATTORNEY



David J. Kybas

Director of the United States Patent and Trademark Office

United States of America

United States Patent and Trademark Office



the mixx

Reg. No. 4,097,925

Registered Feb. 14, 2012

Int. Cl.: 35

SERVICE MARK

PRINCIPAL REGISTER

MIXX GRAPHICS, INC. (NEW YORK CORPORATION), DBA THE MIXX
SUITE 1403
350 SEVENTH AVENUE
NEW YORK, NY 10001

FOR: ADVERTISING AND PUBLICITY SERVICES, NAMELY, PROMOTING THE GOODS, SERVICES, BRAND IDENTITY AND COMMERCIAL INFORMATION AND NEWS OF THIRD PARTIES THROUGH PRINT, AUDIO, VIDEO, DIGITAL AND ON-LINE MEDIUM, IN CLASS 35 (U.S. CLS. 100, 101 AND 102).

FIRST USE 8-0-2010; IN COMMERCE 8-0-2010.

THE MARK CONSISTS OF A STYLIZED CAPITAL LETTER "M", COMPRISED OF A YELLOW TRAPEZOID ON THE FAR LEFT, A BLACK TRIANGLE ON TOP LEFT, A GRAY RHOMBUS ON THE INSIDE LEFT, A PURPLE TRIANGLE ON THE CENTER BOTTOM, A PINK RHOMBUS ON THE INSIDE RIGHT, A RED TRIANGLE ON THE UPPER RIGHT, AND AN ORANGE TRAPEZOID ON THE FAR RIGHT. THE WORDS "THE MIXX" APPEAR IN GRAY.

THE COLOR(S) YELLOW, BLACK, GRAY, PURPLE, PINK, RED, AND ORANGE IS/ARE CLAIMED AS A FEATURE OF THE MARK.

SER. NO. 85-183,451, FILED 11-23-2010.

KHANH LE, EXAMINING ATTORNEY



David J. Kybas

Director of the United States Patent and Trademark Office

United States of America

United States Patent and Trademark Office



VINO DE LA TIERRA DE
MURCIA

Reg. No. 4,097,926

Registered Feb. 14, 2012

Int. Cl.: 33

TRADEMARK

PRINCIPAL REGISTER

ASOCIACION VINO DE LA TIERRA DE MURCIA (SPAIN CORPORATION)
PL. DE LA ALCOHOLERA, 3, CENTRO SOCIO
CULTURAL ROQUE BAÑOS, 2ª PL. SALA LA
CURIOSA, JUMILLA, SPAIN 30520

FOR: WINES FROM THE MURCIA REGION MEETING THE STANDARD OF VINO DE LA TIERRA, IN CLASS 33 (U.S. CLS. 47 AND 49).

PRIORITY CLAIMED UNDER SEC. 44(D) ON ERPN CMNTY TM OFC APPLICATION NO. 9510397, FILED 11-10-2010, REG. NO. 9510397, DATED 4-26-2011, EXPIRES 11-10-2020.

THE COLOR(S) BURGUNDY AND BLACK IS/ARE CLAIMED AS A FEATURE OF THE MARK.

NO CLAIM IS MADE TO THE EXCLUSIVE RIGHT TO USE "VINO DE LA TIERRA DE MURCIA", APART FROM THE MARK AS SHOWN.

THE MARK CONSISTS OF THE BLACK WORDING "VINO DE LA TIERRA DE MURCIA" BENEATH A DESIGN COMPRISING A BLACK STYLIZED CHECK MARK TO THE LEFT OF BURGUNDY STYLIZED MOUNTAINS. A BURGUNDY STYLIZED LIQUID DROP ALSO APPEARS ABOVE THE BLACK CHECK MARK DESIGN.

THE ENGLISH TRANSLATION OF "VINO DE LA TIER RA DE MURCIA" IN THE MARK IS "WINE FROM THE LAND OF MURCIA".

SER. NO. 85-183,732, FILED 11-23-2010.

NELSON SNYDER, EXAMINING ATTORNEY



David J. Kybas

Director of the United States Patent and Trademark Office

United States of America

United States Patent and Trademark Office

RENZULLI LESSON LIBRARY

Reg. No. 4,097,927

RENZULLI LEARNING SYSTEMS, LLC (CONNECTICUT LIMITED LIABILITY COMPANY)
66 OAKENGATES
AVON, CT 06001

Registered Feb. 14, 2012

Int. Cl.: 9

FOR: SOFTWARE FOR SUBSCRIBING SCHOOL SYSTEMS, PROVIDING ACCESS TO WEB-BASED FOLDERS SELECTED FROM A PROPRIETARY DATA BASE, AND GENERATING UNIQUE AND SPECIFIC STUDENT ASSIGNMENTS USING INPUTS FROM A STUDENT'S LEARNING PROFILE OF PERSONAL STRENGTHS AND INTERESTS, AND FROM TEACHER'S ACADEMIC CRITERIA, PLUS GENERATING STUDENT COMPLETION STATUS REPORTS, IN CLASS 9 (U.S. CLS. 21, 23, 26, 36 AND 38).

TRADEMARK

PRINCIPAL REGISTER

FIRST USE 7-8-2010; IN COMMERCE 7-8-2010.

THE MARK CONSISTS OF STANDARD CHARACTERS WITHOUT CLAIM TO ANY PARTICULAR FONT, STYLE, SIZE, OR COLOR.

OWNER OF U.S. REG. NOS. 3,285,949, 3,620,427, AND 3,667,544.

NO CLAIM IS MADE TO THE EXCLUSIVE RIGHT TO USE "LESSON LIBRARY", APART FROM THE MARK AS SHOWN.

SER. NO. 85-183,869, FILED 11-23-2010.

DOMINIC J. FERRAIUOLO, EXAMINING ATTORNEY



David J. Kybas

Director of the United States Patent and Trademark Office

United States of America

United States Patent and Trademark Office

DoubleTake Consignment Boutique

Reg. No. 4,097,928

MARCI KESSLER (UNITED STATES INDIVIDUAL)
27 VANDERBILT DRIVE
LIVINGSTON, NJ 07039

Registered Feb. 14, 2012

Int. Cl.: 35

FOR: RETAIL CONSIGNMENT STORES FEATURING NEW, USED AND NEARLY NEW CLOTHING, BELTS, SCARVES, FOOTWEAR, FURS, HANDBAGS, LUGGAGE AND OTHER FASHION ACCESSORIES, IN CLASS 35 (U.S. CLS. 100, 101 AND 102).

SERVICE MARK

FIRST USE 5-30-1992; IN COMMERCE 5-30-1992.

PRINCIPAL REGISTER

THE MARK CONSISTS OF STANDARD CHARACTERS WITHOUT CLAIM TO ANY PARTICULAR FONT, STYLE, SIZE, OR COLOR.

NO CLAIM IS MADE TO THE EXCLUSIVE RIGHT TO USE "CONSIGNMENT BOUTIQUE", APART FROM THE MARK AS SHOWN.

SER. NO. 85-184,521, FILED 11-24-2010.

KHANH LE, EXAMINING ATTORNEY



David J. Kyffers

Director of the United States Patent and Trademark Office

United States of America

United States Patent and Trademark Office

INSPIRE

Reg. No. 4,097,929

Registered Feb. 14, 2012

Int. Cl.: 16

TRADEMARK

PRINCIPAL REGISTER

PRINCETON THEOLOGICAL SEMINARY (NEW JERSEY NON-PROFIT CORPORATION)
P.O. BOX 821
64 MERCER STREET
PRINCETON, NJ 085420803

FOR: PUBLICATIONS, NAMELY, MAGAZINES CONCERNING TOPICS OF GENERAL INTEREST TO SEMINARY STUDENTS, ALUMNI AND CONTRIBUTORS, IN CLASS 16 (U.S. CLS. 2, 5, 22, 23, 29, 37, 38 AND 50).

FIRST USE 5-0-1995; IN COMMERCE 5-0-1995.

THE MARK CONSISTS OF STANDARD CHARACTERS WITHOUT CLAIM TO ANY PARTICULAR FONT, STYLE, SIZE, OR COLOR.

SER. NO. 85-184,788, FILED 11-24-2010.

SALLY SHIH, EXAMINING ATTORNEY



David J. Kybas

Director of the United States Patent and Trademark Office

United States of America

United States Patent and Trademark Office



Reg. No. 4,097,930

Registered Feb. 14, 2012

Int. Cls.: 35, 41 and 45

SERVICE MARK

PRINCIPAL REGISTER

LEGAL SERVICES CORPORATION (D.C. NON-PROFIT CORPORATION)
3333 K STREET NW
THIRD FLOOR
WASHINGTON, DC 20007

FOR: BUSINESS ENQUIRIES AND INVESTIGATIONS; BUSINESS MANAGEMENT CONSULTING SERVICES FOR THE MANAGEMENT AND ADMINISTRATION OF DELIVERING CIVIL LEGAL SERVICES FOR LOW-INCOME PEOPLE; PROVIDING BUSINESS INFORMATION ON-LINE RELATING TO THE BUSINESS MANAGEMENT AND ADMINISTRATION OF DELIVERING CIVIL LEGAL SERVICES FOR LOW-INCOME PEOPLE; ACCOUNT AUDITING SERVICES FOR CHARITABLE FUNDING OF GRANTS TO NON-PROFIT ENTITIES FOR THE PROVISION OF CIVIL LEGAL SERVICES FOR LOW-INCOME PEOPLE; PROVIDING INFORMATION ON-LINE RELATING TO BUSINESS MANAGEMENT AND THE BUSINESS MANAGEMENT AND ADMINISTRATION OF DELIVERING CIVIL LEGAL SERVICES FOR LOW-INCOME PEOPLE; POLITICAL CONSULTANCY, IN CLASS 35 (U.S. CLS. 100, 101 AND 102).

FIRST USE 1-8-2010; IN COMMERCE 1-8-2010.

FOR: PROVISION AND MANAGEMENT OF TRAINING SERVICES IN THE FIELDS OF PREVENTING FRAUD, WASTE AND ABUSE IN THE FIELD OF FREE OR LOW-COST CIVIL LEGAL SERVICES, IN CLASS 41 (U.S. CLS. 100, 101 AND 107).

FIRST USE 1-8-2010; IN COMMERCE 1-8-2010.

FOR: PROVIDING INFORMATION REGARDING LEGAL SERVICES AND DELIVERY OF CIVIL FREE AND LOW-COST CIVIL LEGAL SERVICES; LEGAL SERVICES, NAMELY, LEGAL COMPLIANCE AND AUDIT CONSULTATION RELATING TO THE CHARITABLE FUNDING OF GRANTS, CONTRACTS AND OTHER RELATED ACTIVITIES; REVIEWING STANDARDS AND PRACTICES TO ENSURE COMPLIANCE WITH CIVIL AND CRIMINAL FRAUD LAWS AND REGULATIONS, OTHER CRIMINAL LAWS, AND OTHER LAWS AND REGULATIONS GOVERNING THE DELIVERY OF CIVIL FREE AND LOW COST LEGAL SERVICES; LEGAL SERVICES, NAMELY, INVESTIGATING THE ALLEGATIONS OF WHISTLE BLOWERS REGARDING FRAUD, WASTE AND ABUSE IN THE DELIVERY OF FREE AND LOW-COST CIVIL LEGAL SERVICES; PROVIDING ON-LINE LEGAL INFORMATION IN THE FIELDS OF PREVENTING FRAUD, WASTE AND ABUSE IN THE FIELD OF FREE OR LOW-COST CIVIL LEGAL SERVICES, IN CLASS 45 (U.S. CLS. 100 AND 101).



David J. Kyjars

Director of the United States Patent and Trademark Office

Reg. No. 4,097,930 FIRST USE 1-8-2010; IN COMMERCE 1-8-2010.

NO CLAIM IS MADE TO THE EXCLUSIVE RIGHT TO USE "OFFICE OF INSPECTOR GENERAL LEGAL SERVICES CORPORATION", APART FROM THE MARK AS SHOWN.

THE MARK CONSISTS OF THREE SETS OF TWO HORIZONTAL BARS AND A STYLIZED SCALE OF JUSTICE DESIGN ARRANGED IN A PINWHEEL SHAPE AND SURROUNDED BY A CIRCLE. THE WORDING "OFFICE OF INSPECTOR GENERAL LEGAL SERVICES CORPORATION" APPEARS IN THE CIRCLE.

SER. NO. 85-185,145, FILED 11-24-2010.

ELI HELLMAN, EXAMINING ATTORNEY

United States of America

United States Patent and Trademark Office

FUNKE STIXX

Reg. No. 4,097,931

JAMAL ANDERSON (UNITED STATES INDIVIDUAL)
6511 CALIFORNIA AVE
BELL, CA 90201

Registered Feb. 14, 2012

Int. Cl.: 3

FOR: BODY SPRAY USED AS A PERSONAL DEODORANT AND AS FRAGRANCE; FRAGRANCE EMITTING WICKS FOR ROOM FRAGRANCE; FRAGRANCE SACHETS; FRAGRANCED BODY CARE PREPARATIONS, NAMELY, BODY SCRUBS AND SHOWER GELS; FRAGRANCED FACE CARE PREPARATIONS, NAMELY, FACIAL CLEANERS AND MOISTURIZERS; FRAGRANCED FACIAL MOISTURIZER; FRAGRANCED SKIN CARE PREPARATIONS, NAMELY, SKIN MOISTURIZERS, BODY OILS; FRAGRANCES; FRAGRANCES AND PERFUMERY; FRAGRANCES FOR AUTOMOBILES; FRAGRANCES FOR PERSONAL USE; PET FRAGRANCES; PRE-SCENTED STRIPS AND CARDS FOR SAMPLING FRAGRANCES; REFILLS FOR ELECTRIC ROOM FRAGRANCE DISPENSERS; ROOM FRAGRANCE REFILLS FOR NON-ELECTRIC ROOM FRAGRANCE DISPENSERS; ROOM FRAGRANCES; ROOM FRAGRANCING PREPARATIONS; SACHET-LIKE EYE PILLOWS CONTAINING FRAGRANCES, IN CLASS 3 (U.S. CLS. 1, 4, 6, 50, 51 AND 52).

TRADEMARK

PRINCIPAL REGISTER

FIRST USE 9-6-1993; IN COMMERCE 9-7-1993.

THE MARK CONSISTS OF STANDARD CHARACTERS WITHOUT CLAIM TO ANY PARTICULAR FONT, STYLE, SIZE, OR COLOR.

NO CLAIM IS MADE TO THE EXCLUSIVE RIGHT TO USE "STICKS", APART FROM THE MARK AS SHOWN.

SER. NO. 85-185,190, FILED 11-24-2010.

SANDRA BUJA, EXAMINING ATTORNEY



David J. Kyros

Director of the United States Patent and Trademark Office

United States of America

United States Patent and Trademark Office



Reg. No. 4,097,932

Registered Feb. 14, 2012

Int. Cl.: 35

SERVICE MARK

PRINCIPAL REGISTER

BENTLEY PATRICK, INC. (OREGON CORPORATION)
SUITE 660
1801 NW UPSHUR ST
PORTLAND, OR 97209

FOR: MARKETING AND ADVERTISING; CUSTOMER LOYALTY SERVICES AND CUSTOMER CLUB SERVICES, FOR COMMERCIAL, PROMOTIONAL AND/OR ADVERTISING PURPOSES; DISSEMINATION OF ADVERTISING FOR OTHERS VIA AN ONLINE COMMUNICATIONS NETWORK ON THE INTERNET AND VIA TELEVISION, RADIO, PRINT, PHONE, OUTDOOR, ELECTRONIC AND MULTIMEDIA ADVERTISING CAMPAIGNS; RENTAL OF ADVERTISING SPACE ON WEB SITES, IN CLASS 35 (U.S. CLS. 100, 101 AND 102).

FIRST USE 4-1-2007; IN COMMERCE 6-13-2007.

OWNER OF U.S. REG. NO. 3,930,243.

THE COLOR(S) GREEN, BLACK, WHITE, AND RED IS/ARE CLAIMED AS A FEATURE OF THE MARK.

NO CLAIM IS MADE TO THE EXCLUSIVE RIGHT TO USE "OREGON" OR THE PICTORIAL REPRESENTATION OF THE STATE OF OREGON, APART FROM THE MARK AS SHOWN.

THE MARK CONSISTS OF THE WORD "CHOOSE" IN WHITE LETTERS ON A GREEN HORIZONTAL BACKGROUND, ABOVE THE WORD "LOCAL" IN WHITE LETTERS ON A BLACK HORIZONTAL BACKGROUND. THERE IS A RED BALL IN THE UPPER RIGHT-HAND CORNER WITH A GREEN IMAGE OF THE STATE OF OREGON IMPOSED OVER IT BEARING THE WORD "OREGON" IN DARK GREEN.

SER. NO. 85-185,214, FILED 11-24-2010.

SUE LAWRENCE, EXAMINING ATTORNEY



David J. Kyffers

Director of the United States Patent and Trademark Office

United States of America

United States Patent and Trademark Office

TRISTATE CAPITAL DIRECT

Reg. No. 4,097,933

Registered Feb. 14, 2012

Int. Cl.: 36

SERVICE MARK

PRINCIPAL REGISTER

TRISTATE CAPITAL HOLDINGS, INC. (PENNSYLVANIA CORPORATION)
301 GRANT STREET
ONE OXFORD CENTRE, SUITE 2700
PITTSBURGH, PA 15219

FOR: BANKING, IN CLASS 36 (U.S. CLS. 100, 101 AND 102).

FIRST USE 9-26-2007; IN COMMERCE 9-26-2007.

THE MARK CONSISTS OF STANDARD CHARACTERS WITHOUT CLAIM TO ANY PARTICULAR FONT, STYLE, SIZE, OR COLOR.

OWNER OF U.S. REG. NOS. 3,367,121, 3,367,122, AND 3,367,123.

NO CLAIM IS MADE TO THE EXCLUSIVE RIGHT TO USE "CAPITAL DIRECT", APART FROM THE MARK AS SHOWN.

SER. NO. 85-186,338, FILED 11-29-2010.

DAVID YONTEF, EXAMINING ATTORNEY



David J. Kyfos

Director of the United States Patent and Trademark Office

United States of America

United States Patent and Trademark Office

ALLEGRO

Reg. No. 4,097,934

ISHIHARA SANGYO KAISHA, LTD. (JAPAN CORPORATION)
3-15, EDOBORI, 1-CHOME, NISHI-KU
OSAKA-SHI, OSAKA, JAPAN

Registered Feb. 14, 2012

Int. Cl.: 5

FOR: FUNGICIDES, IN CLASS 5 (U.S. CLS. 6, 18, 44, 46, 51 AND 52).

TRADEMARK

FIRST USE 10-14-2004; IN COMMERCE 10-14-2004.

PRINCIPAL REGISTER

THE MARK CONSISTS OF STANDARD CHARACTERS WITHOUT CLAIM TO ANY PARTICULAR FONT, STYLE, SIZE, OR COLOR.

SER. NO. 85-186,383, FILED 11-29-2010.

SARA BENJAMIN, EXAMINING ATTORNEY



David J. Kybas

Director of the United States Patent and Trademark Office

United States of America

United States Patent and Trademark Office

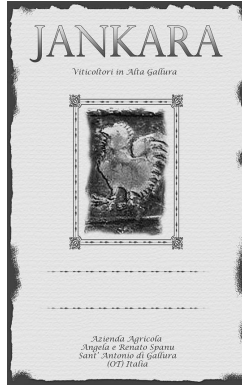

Reg. No. 4,097,935

Registered Feb. 14, 2012

Int. Cl.: 33

TRADEMARK

PRINCIPAL REGISTER

SPANU, RENATO LEO (UNITED STATES INDIVIDUAL)
12613 COLONY PRESERVE DRIVE
BOYNTON BEACH, FL 33436

FOR: WHITE WINE, IN CLASS 33 (U.S. CLS. 47 AND 49).

FIRST USE 11-1-2010; IN COMMERCE 11-1-2010.

NO CLAIM IS MADE TO THE EXCLUSIVE RIGHT TO USE "JANKARA VITICOLTORI IN ALTA GALLURA AZIENDA AGRICOLA ANGELA E RENATO SPANU SANT' ANTONIO DI GALLURA (OT) ITALIA", APART FROM THE MARK AS SHOWN.

THE STIPPLING IS FOR SHADING PURPOSES ONLY.

THE MARK CONSISTS OF A LARGE RECTANGLE SHAPE WITH THE WORDING "JANKARA VITICOLTORI IN ALTA GALLURA" AT THE TOP WITH A RECTANGLE SHAPE WITH A ROOSTER INSIDE WITH THE WORDS UNDERNEATH "AZIENDA AGRICOLA ANGELA E RENATO SPANU SANT' ANTONIO DI GALLURA (OT) ITALIA".

THE ENGLISH TRANSLATION OF "JANKARA VITICOLTORI IN ALTA GALLURA AZIENDA AGRICOLA ANGELA E RENATO SPANU SANT' ANTONIO DI GALLURA (OT) ITALIA" IN THE MARK IS "JANKARA VITICULTURE IN THE HIGHLAND OF GALLURA - VERMENTINO OF GALLURA- AGRICULTURAL BUSINESS- SAINT ANTHONY OF GALLURA OT= OLBIA, TEMPIO ITALY".

SER. NO. 85-186,620, FILED 11-29-2010.

JACQUELINE A. LAVINE, EXAMINING ATTORNEY



David J. Kybas

Director of the United States Patent and Trademark Office

United States of America

United States Patent and Trademark Office

FRT

Reg. No. 4,097,936

Registered Feb. 14, 2012

Int. Cls.: 36 and 45

SERVICE MARK

PRINCIPAL REGISTER

FINANCIAL RECOVERY TECHNOLOGIES LLC (DELAWARE LIMITED LIABILITY COMPANY)
4TH FLOOR
ONE CABOT ROAD
MEDFORD, MA 02155

FOR: FINANCIAL ADVISORY AND CONSULTANCY SERVICES; FINANCIAL ADVISORY AND CONSULTANCY SERVICES, NAMELY, ASSISTING OTHERS IN MAXIMIZING THE FINANCIAL RECOVERIES FROM SECURITY CLASS ACTION LAWSUIT SETTLEMENTS, IN CLASS 36 (U.S. CLS. 100, 101 AND 102).

FIRST USE 6-0-2008; IN COMMERCE 6-0-2008.

FOR: PROVIDING INFORMATION VIA A WEBSITE ON THE INTERNET REGARDING AVAILABLE CLASS ACTION LAWSUIT SETTLEMENTS, IN CLASS 45 (U.S. CLS. 100 AND 101).

FIRST USE 6-0-2008; IN COMMERCE 6-0-2008.

THE MARK CONSISTS OF STANDARD CHARACTERS WITHOUT CLAIM TO ANY PARTICULAR FONT, STYLE, SIZE, OR COLOR.

SER. NO. 85-186,738, FILED 11-29-2010.

BARBARA A. GOLD, EXAMINING ATTORNEY



David J. Kybas

Director of the United States Patent and Trademark Office

United States of America

United States Patent and Trademark Office

ACCOUNTWATCH

Reg. No. 4,097,937

Registered Feb. 14, 2012

Int. Cl.: 36

SERVICE MARK

PRINCIPAL REGISTER

FINANCIAL RECOVERY TECHNOLOGIES LLC (DELAWARE LIMITED LIABILITY COMPANY)
4TH FLOOR
ONE CABOT ROAD
MEDFORD, MA 02155

FOR: FINANCIAL ADVISORY AND CONSULTANCY SERVICES; FINANCIAL ADVISORY AND CONSULTANCY SERVICES, NAMELY, ASSISTING OTHERS IN MAXIMIZING THE FINANCIAL RECOVERIES FROM SECURITY CLASS ACTION LAWSUIT SETTLEMENTS, IN CLASS 36 (U.S. CLS. 100, 101 AND 102).

FIRST USE 6-0-2008; IN COMMERCE 6-0-2008.

THE MARK CONSISTS OF STANDARD CHARACTERS WITHOUT CLAIM TO ANY PARTICULAR FONT, STYLE, SIZE, OR COLOR.

SER. NO. 85-186,748, FILED 11-29-2010.

BARBARA A. GOLD, EXAMINING ATTORNEY



David J. Kybas

Director of the United States Patent and Trademark Office

United States of America

United States Patent and Trademark Office

DANDY

Reg. No. 4,097,938

DANDY INTERNATIONAL AB (SWEDEN AKTIEBOLAG)
BOX 55694

Registered Feb. 14, 2012

102 15 STOCKHOLM, SWEDEN

Int. Cl.: 9

FOR: MUSICAL SOUND RECORDINGS AND AUDIOVISUAL RECORDINGS FEATURING MUSIC; SOUND RECORDINGS AND AUDIOVISUAL RECORDINGS FEATURING MOTION PICTURE FILMS, TELEVISION PROGRAMS, TELEVISION SPECIALS, MUSIC VIDEOS, DOCUMENTARIES, AND ANIMATION; SUNGLASSES; CASES FOR SUNGLASSES SOLD EMPTY; DECORATIVE MAGNETS; CELL PHONE CASES AND COVERS; DECORATIVE LIGHT SWITCH PLATE COVERS; ELECTRIC SIGNS; COMPUTER MOUSE PADS; LAPTOP CASES; STORAGE CASES FOR COMPACT DISCS, DVDS, AND COMPUTER DISCS, IN CLASS 9 (U.S. CLS. 21, 23, 26, 36 AND 38).

TRADEMARK

PRINCIPAL REGISTER

THE MARK CONSISTS OF STANDARD CHARACTERS WITHOUT CLAIM TO ANY PARTICULAR FONT, STYLE, SIZE, OR COLOR.

OWNER OF ERPN CMNTY TM OFC REG. NO. 005582432, DATED 12-14-2006, EXPIRES 12-14-2016.

SER. NO. 85-186,993, FILED 11-30-2010.

BRIDGETT SMITH, EXAMINING ATTORNEY



David J. Kyffers

Director of the United States Patent and Trademark Office

United States of America

United States Patent and Trademark Office

DANDY

Reg. No. 4,097,939

DANDY INTERNATIONAL AB (SWEDEN AKTIEBOLAG)
BOX 55694

Registered Feb. 14, 2012

102 15 STOCKHOLM, SWEDEN

Int. Cl.: 16

FOR: PAPER GOODS AND PRINTED MATTER, NAMELY, NONFICTION BOOKS, MAGAZINES, MAGAZINE SECTIONS, BOOKLETS, BROCHURES, BULLETINS, CIRCULARS, NEWSLETTERS, PAMPHLETS AND INFORMATIONAL FLYERS IN THE FIELD OF MUSIC; SOUVENIR BOOKS FOR MUSICAL CONCERTS; SONG BOOKS; SHEET MUSIC BOOKS; PICTURE BOOKS; FAN CLUB NEWSLETTERS; PRINTED TICKETS; PRINTED INVITATIONS; POSTERS; PHOTO ALBUMS; GREETING CARDS; STATIONERY; NOTE-PADS; MAPS; POSTCARDS; BLANK WRITING JOURNALS; PAPER BANNERS; LITHOGRAPHS; STICKERS; DECALS; CALENDARS; PENS; PENCILS; UNMOUNTED PHOTOGRAPHS; ART PRINTS; AND PAPER COASTERS, IN CLASS 16 (U.S. CLS. 2, 5, 22, 23, 29, 37, 38 AND 50).

TRADEMARK

PRINCIPAL REGISTER

THE MARK CONSISTS OF STANDARD CHARACTERS WITHOUT CLAIM TO ANY PARTICULAR FONT, STYLE, SIZE, OR COLOR.

OWNER OF ERPN CMNTY TM OFC REG. NO. 005582432, DATED 12-14-2006, EXPIRES 12-14-2016.

SER. NO. 85-186,995, FILED 11-30-2010.

BRIDGETT SMITH, EXAMINING ATTORNEY



David J. Kyffers

Director of the United States Patent and Trademark Office

United States of America

United States Patent and Trademark Office

440 EXPRESS

Reg. No. 4,097,940

ILLINOIS TOOL WORKS INC. (DELAWARE CORPORATION)
3600 WEST LAKE AVENUE
GLENVIEW, IL 60026

Registered Feb. 14, 2012

Int. Cl.: 1

FOR: POLYESTER FILLERS FOR USE TO REPAIR METAL, PLASTIC AND FIBERGLASS SURFACES; NON-ABRASIVE SMOOTHING COMPOUNDS FOR USE IN THE REPAIR AND FILLING OF HOLES AND FLAWS IN VEHICLE BODY SURFACES, IN CLASS 1 (U.S. CLS. 1, 5, 6, 10, 26 AND 46).

TRADEMARK

PRINCIPAL REGISTER

FIRST USE 11-19-2010; IN COMMERCE 11-19-2010.

THE MARK CONSISTS OF STANDARD CHARACTERS WITHOUT CLAIM TO ANY PARTICULAR FONT, STYLE, SIZE, OR COLOR.

SER. NO. 85-187,231, FILED 11-30-2010.

LESLEY LAMOTHE, EXAMINING ATTORNEY



David J. Kyffers

Director of the United States Patent and Trademark Office

United States of America

United States Patent and Trademark Office

THE ORIGINAL MARKETING APP

Reg. No. 4,097,941

CORPORATE GRAPHICS OF AMERICA, INC. (ILLINOIS CORPORATION)
5312 N. ELSTON AVENUE
CHICAGO, IL 60630

Registered Feb. 14, 2012

Int. Cl.: 40

FOR: PRINTING SERVICES, IN CLASS 40 (U.S. CLS. 100, 103 AND 106).

SERVICE MARK

FIRST USE 11-3-2010; IN COMMERCE 11-3-2010.

PRINCIPAL REGISTER

THE MARK CONSISTS OF STANDARD CHARACTERS WITHOUT CLAIM TO ANY PARTICULAR FONT, STYLE, SIZE, OR COLOR.

SER. NO. 85-187,356, FILED 11-30-2010.

NATALIE POLZER, EXAMINING ATTORNEY



David J. Kybas

Director of the United States Patent and Trademark Office

United States of America

United States Patent and Trademark Office

I Am Couture

Reg. No. 4,097,942

DEIRDRE KENNEDY (CALIFORNIA SOLE PROPRIETORSHIP), DBA THE EYES OF EVE
418 2ND AVE, #303

Registered Feb. 14, 2012

SAN FRANCISCO, CA 94118

Int. Cl.: 14

FOR: BODY JEWELRY; BROOCHES; COSTUME JEWELRY; DIAMOND JEWELRY; GEMSTONE JEWELRY; HAIR JEWELRY IN THE NATURE OF JEWELRY FOR USE IN THE HAIR; JEWELRY; JEWELRY AND IMITATION JEWELRY; JEWELRY FOR ATTACHMENT TO CLOTHING; JEWELRY FOR THE HEAD; JEWELRY IN THE NATURE OF ARMBANDS; JEWELRY, NAMELY, ANKLETS; JEWELRY, NAMELY, ARM CUFFS; LEATHER JEWELRY AND ACCESSORY BOXES; PRECIOUS AND SEMI-PRECIOUS CRYSTAL STONES AND BEADS FOR USE IN JEWELRY; RINGS; WOMEN'S JEWELRY, IN CLASS 14 (U.S. CLS. 2, 27, 28 AND 50).

TRADEMARK

PRINCIPAL REGISTER

FIRST USE 3-11-2010; IN COMMERCE 10-10-2010.

THE MARK CONSISTS OF STANDARD CHARACTERS WITHOUT CLAIM TO ANY PARTICULAR FONT, STYLE, SIZE, OR COLOR.

NO CLAIM IS MADE TO THE EXCLUSIVE RIGHT TO USE "COUTURE", APART FROM THE MARK AS SHOWN.

SER. NO. 85-187,506, FILED 11-30-2010.

FRED CARL, EXAMINING ATTORNEY



David J. Kyffers

Director of the United States Patent and Trademark Office

United States of America

United States Patent and Trademark Office

SILEXTREME

Reg. No. 4,097,943

Registered Feb. 14, 2012

Int. Cl.: 2

TRADEMARK

PRINCIPAL REGISTER

SOCIEDAD QUIMICA ALEMANA S.A. (PERU CORPORATION)
AV. REVOLUCION 842 - ZONA INDUSTRIAL
VENTANILLA-CALLAO-LIMA, PERU

FOR: SERIGRAPHIC INKS TO USE IN TEXTILE; PAINTS; COATINGS ADDED TO INKS OR PAINTS TO IMPROVE SOME PROPERTIES OF FABRICS, CARDBOARDS, PLASTICS AND PAPERS , IN CLASS 2 (U.S. CLS. 6, 11 AND 16).

FIRST USE 7-0-2010; IN COMMERCE 7-0-2010.

THE MARK CONSISTS OF STANDARD CHARACTERS WITHOUT CLAIM TO ANY PARTICULAR FONT, STYLE, SIZE, OR COLOR.

PRIORITY CLAIMED UNDER SEC. 44(D) ON PERU APPLICATION NO. 4363262010, FILED 10-27-2010.

SER. NO. 85-187,536, FILED 11-30-2010.

CURTIS FRENCH, EXAMINING ATTORNEY



David J. Kypos

Director of the United States Patent and Trademark Office

United States of America

United States Patent and Trademark Office



Reg. No. 4,097,944

Registered Feb. 14, 2012

Int. Cls.: 9 and 41

TRADEMARK

SERVICE MARK

PRINCIPAL REGISTER

FLYING PIG PRODUCTIONS (CALIFORNIA LIMITED LIABILITY COMPANY)
2951 SATURN STREET, UNIT D
BREA, CA 92821

FOR: DOWNLOADABLE MUSIC, MUSICAL VIDEOS, RELATED FILM CLIPS, PHOTOGRAPHS, AND OTHER MULTIMEDIA MATERIALS FEATURING DOWNLOADABLE MUSIC, IN CLASS 9 (U.S. CLS. 21, 23, 26, 36 AND 38).

FIRST USE 6-1-2010; IN COMMERCE 6-1-2010.

FOR: ENTERTAINMENT SERVICES, NAMELY, LIVE PERFORMANCES BY A MUSICAL GROUP; PRODUCTION OF SOUND AND MUSIC VIDEO RECORDINGS; PROVIDING A WEBSITE FEATURING NON-DOWNLOADABLE MUSIC PERFORMANCES, MUSICAL VIDEOS, RELATED FILM CLIPS, PHOTOGRAPHS, AND OTHER MULTIMEDIA MATERIALS FEATURING MUSICAL PERFORMANCES, IN CLASS 41 (U.S. CLS. 100, 101 AND 107).

FIRST USE 6-1-2010; IN COMMERCE 6-1-2010.

THE MARK CONSISTS OF THE LETTERS "ML" WITH STYLIZED CURVED LINES AROUND THE LETTERS. THE STYLIZED CURVED LINES BRANCH OFF THE LEFT SIDE OF THE LETTER "M" AND THE RIGHT SIDE OF THE LETTER "L" TO FORM THE OUTLINED SHAPE OF A SIDE PROFILE OF A WOMAN'S FACE.

SER. NO. 85-187,542, FILED 11-30-2010.

SUSAN STIGLITZ, EXAMINING ATTORNEY



David J. Kybas

Director of the United States Patent and Trademark Office

United States of America

United States Patent and Trademark Office

RIVER RAGS

Reg. No. 4,097,945

Registered Feb. 14, 2012

Int. Cl.: 25

TRADEMARK

PRINCIPAL REGISTER

RIVER BEND TRADING CO. (MONTANA CORPORATION)
609 N. DIAMOND STREET BOX 1393
COLUMBUS, MT 59019

FOR: ANKLE SOCKS; ANKLETS; ANTI-PERSPIRANT SOCKS; ATHLETIC APPAREL, NAMELY, SHIRTS, PANTS, JACKETS, FOOTWEAR, HATS AND CAPS, ATHLETIC UNIFORMS; BASEBALL CAPS AND HATS; BERMUDA SHORTS; BIB SHORTS; BOARD SHORTS; BOXER SHORTS; BUCKET CAPS; BUTTON DOWN SHIRTS; CAMOUFLAGE GLOVES; CAMOUFLAGE JACKETS; CAMOUFLAGE PANTS; CAMOUFLAGE SHIRTS; CAMP SHIRTS; CAP VISORS; CAPRI PANTS; CAPS; CAPS WITH VISORS; CARGO PANTS; CHILDREN'S AND INFANT'S APPAREL, NAMELY, JUMPERS, OVERALL SLEEPWEAR, PAJAMAS, ROMPERS AND ONE-PIECE GARMENTS; CHILDREN'S AND INFANTS' APPAREL TREATED WITH FIRE AND HEAT RETARDANTS, NAMELY, JUMPERS, OVERALL SLEEPWEAR, PAJAMAS, ROMPERS AND ONE-PIECE GARMENTS; CLOTHING FOR BABIES, TODDLERS AND CHILDREN, TREATED WITH FIRE AND HEAT RETARDANTS, NAMELY, PAJAMAS, JACKETS, SHIRTS, PANTS, JUMPERS; COLLARED SHIRTS; CYCLING SHORTS; DENIM JACKETS; DENIMS; DOWN JACKETS; DRESS PANTS; DRESS SHIRTS; FISHERMEN'S JACKETS; FISHING SHIRTS; FLEECE SHORTS; GIFT PACKAGES SOLD AS A UNIT CONSISTING PRIMARILY OF A SWEATSHIRT AND ALSO INCLUDING A PHOTO FRAME, A COFFEE MUG, AND A TOTE BAG; GLOVES; GLOVES AS CLOTHING; GLOVES FOR APPAREL; GLOVES INCLUDING THOSE MADE OF SKIN, HIDE OR FUR; GOLF CAPS; GOLF PANTS, SHIRTS AND SKIRTS; GOLF SHIRTS; GOLF SHORTS; GYM PANTS; GYM SHORTS; HEAD SCARVES; HEAVY JACKETS; HOODED SWEATSHIRTS; HUNTING JACKETS; HUNTING PANTS; HUNTING SHIRTS; JACKET LINERS; JACKETS; JOGGING PANTS; KNIT JACKETS; KNIT SHIRTS; KNITTED CAPS; KNITTED GLOVES; KNOT CAPS; LIGHT-REFLECTING JACKETS; LONG JACKETS; LONG-SLEEVED SHIRTS; LOUNGE PANTS; MEN'S AND WOMEN'S JACKETS, COATS, TROUSERS, VESTS; MEN'S SOCKS; MOISTURE-WICKING SPORTS PANTS; MOISTURE-WICKING SPORTS SHIRTS; MOTORCYCLE GLOVES; MOTORCYCLE JACKETS; NIGHT SHIRTS; OPEN-NECKED SHIRTS; OUTDOOR GLOVES; OUTER JACKETS; OVER SHIRTS; PADDED JACKETS; PAJAMA BOTTOMS; PAJAMAS; PAJAMAS TREATED WITH FIRE AND HEAT RETARDANTS; PANTIES, SHORTS AND BRIEFS; PANTS; PIQUE SHIRTS; POLO SHIRTS; RAIN JACKETS; RAINPROOF JACKETS; REVERSIBLE JACKETS; RIDING GLOVES; RUGBY SHORTS; SCARVES; SHELL JACKETS; SHIRT FRONTS; SHIRT YOKES; SHIRTS; SHIRTS AND SHORT-SLEEVED SHIRTS; SHIRTS AND SLIPS; SHIRTS FOR INFANTS, BABIES, TODDLERS AND CHILDREN; SHORT SETS; SHORT TROUSERS; SHORT-SLEEVED OR LONG-SLEEVED T-SHIRTS; SHORT-SLEEVED SHIRTS; SHORTS; SILK SCARVES; SKI



David J. Kybas

Director of the United States Patent and Trademark Office

Reg. No. 4,097,945 GLOVES; SKI JACKETS; SKI PANTS; SLEEP PANTS; SLEEP SHIRTS; SLEEVED OR SLEEVELESS JACKETS; SLIDING SHORTS; SLIPPER SOCKS; SNOW PANTS; SNOWBOARD GLOVES; SNOWBOARD JACKETS; SNOWBOARD PANTS; SOCKS AND STOCKINGS; SPORT SHIRTS; SPORTS CAPS AND HATS; SPORTS JACKETS; SPORTS PANTS; STRETCH PANTS; SUEDE JACKETS; SWEAT JACKETS; SWEAT PANTS; SWEAT SHIRTS; SWEAT SHORTS; SWEATSHIRTS; T-SHIRTS; TRAVEL CLOTHING CONTAINED IN A PACKAGE COMPRISING REVERSIBLE JACKETS, PANTS, SKIRTS, TOPS AND A BELT OR SCARF; TURTLE NECK SHIRTS; UNDERWEAR, NAMELY, BOY SHORTS; WALKING SHORTS; WIND PANTS; WIND RESISTANT JACKETS; WIND SHIRTS; WIND-JACKETS; WOOLLEN SOCKS, IN CLASS 25 (U.S. CLS. 22 AND 39).

FIRST USE 10-15-2003; IN COMMERCE 10-15-2003.

THE MARK CONSISTS OF STANDARD CHARACTERS WITHOUT CLAIM TO ANY PARTICULAR FONT, STYLE, SIZE, OR COLOR.

NO CLAIM IS MADE TO THE EXCLUSIVE RIGHT TO USE "RAGS", APART FROM THE MARK AS SHOWN.

SER. NO. 85-187,845, FILED 12-1-2010.

CHRISTOPHER BUONGIORNO, EXAMINING ATTORNEY

United States of America

United States Patent and Trademark Office

MAPCHECK

Reg. No. 4,097,946

SUN NUCLEAR CORP. (FLORIDA CORPORATION)
425-A PINEDA CT.

Registered Feb. 14, 2012 MELBOURNE, FL 32940

Int. Cl.: 10

FOR: MEDICAL APPARATUS, NAMELY, TWO DIMENSIONAL DETECTOR ARRAYS FOR ANALYZING AND VERIFYING RADIOTHERAPY DOSE DISTRIBUTIONS, IN CLASS 10 (U.S. CLS. 26, 39 AND 44).

TRADEMARK

FIRST USE 9-0-2002; IN COMMERCE 9-0-2002.

PRINCIPAL REGISTER

THE MARK CONSISTS OF STANDARD CHARACTERS WITHOUT CLAIM TO ANY PARTICULAR FONT, STYLE, SIZE, OR COLOR.

SER. NO. 85-188,206, FILED 12-1-2010.

LAKEISHA LEWIS, EXAMINING ATTORNEY



David J. Kyffers

Director of the United States Patent and Trademark Office

United States of America

United States Patent and Trademark Office

BRITISHAMERICAN BUSINESS

Reg. No. 4,097,947

BRITISHAMERICAN BUSINESS INC. (DELAWARE CORPORATION)

Registered Feb. 14, 2012

52 VANDERBILT AVENUE
NEW YORK, NY 10017

Int. Cl.: 35

FOR: PROMOTING BUSINESS AND COMMERCE BETWEEN THE UNITED KINGDOM AND THE UNITED STATES, IN CLASS 35 (U.S. CLS. 100, 101 AND 102).

SERVICE MARK

FIRST USE 10-3-2001; IN COMMERCE 10-3-2001.

PRINCIPAL REGISTER

THE MARK CONSISTS OF STANDARD CHARACTERS WITHOUT CLAIM TO ANY PARTICULAR FONT, STYLE, SIZE, OR COLOR.

NO CLAIM IS MADE TO THE EXCLUSIVE RIGHT TO USE "BUSINESS", APART FROM THE MARK AS SHOWN.

SEC. 2(F).

SER. NO. 85-188,446, FILED 12-1-2010.

LOURDES AYALA, EXAMINING ATTORNEY



David J. Kyjars

Director of the United States Patent and Trademark Office

United States of America

United States Patent and Trademark Office

TOMS

Reg. No. 4,097,948

Registered Feb. 14, 2012

Int. Cl.: 25

TRADEMARK

PRINCIPAL REGISTER

MYCOSKIE, LLC (CALIFORNIA LIMITED LIABILITY COMPANY)
STAGE C
3025 OLYMPIC BOULEVARD
SANTA MONICA, CA 90404

FOR: CLOTHING, NAMELY, ONE PIECE GARMENTS FOR INFANTS AND BABIES, IN CLASS 25 (U.S. CLS. 22 AND 39).

FIRST USE 11-15-2008; IN COMMERCE 11-15-2008.

THE MARK CONSISTS OF STANDARD CHARACTERS WITHOUT CLAIM TO ANY PARTICULAR FONT, STYLE, SIZE, OR COLOR.

OWNER OF U.S. REG. NO. 3,765,503.

SER. NO. 85-189,009, FILED 12-2-2010.

MIDGE BUTLER, EXAMINING ATTORNEY



David J. Kybas

Director of the United States Patent and Trademark Office

United States of America

United States Patent and Trademark Office

CLEAN BREAK

Reg. No. 4,097,949

LEVINE, ASHER (UNITED STATES INDIVIDUAL)
1102 MONTROSE AVENUE
NASHVILLE, TN 37204

Registered Feb. 14, 2012

Int. Cl.: 41

FOR: ARRANGING AND CONDUCTING SPECIAL EVENTS FOR SOCIAL ENTERTAINMENT PURPOSES AMONG TEENAGERS AND YOUNG ADULTS IN AN ALCOHOL AND DRUG FREE ENVIRONMENT, NAMELY, PROMOTING, ORGANIZING AND CONDUCTING WEEKLONG TRIPS DURING THE TIME FRAME IN WHICH HIGH SCHOOL AND COLLEGE STUDENTS TYPICALLY ARE ON BREAK FROM SCHOOL THAT ARE ALCOHOL AND DRUG FREE, IN CLASS 41 (U.S. CLS. 100, 101 AND 107).

SERVICE MARK

PRINCIPAL REGISTER

FIRST USE 3-15-2009; IN COMMERCE 3-15-2009.

THE MARK CONSISTS OF STANDARD CHARACTERS WITHOUT CLAIM TO ANY PARTICULAR FONT, STYLE, SIZE, OR COLOR.

SER. NO. 85-189,501, FILED 12-2-2010.

PAUL MORENO, EXAMINING ATTORNEY



David J. Kyffers

Director of the United States Patent and Trademark Office

United States of America
United States Patent and Trademark Office

WINconomy
®

Reg. No. 4,097,950

WIN WIN SAVINGS, INC. (FLORIDA CORPORATION)
5037 BELLFLOWER CT.
MELBOURNE, FL 32940

Registered Feb. 14, 2012

Int. Cl.: 36

FOR: CHARITABLE FUNDRAISING WHERE CONSUMERS SELECT THE NON-PROFIT OR SCHOLARSHIP FUND THAT WILL RECEIVE A DONATION FROM THEIR PURCHASE OF A DISCOUNTED GIFT CARD OR GIFT CERTIFICATE, IN CLASS 36 (U.S. CLS. 100, 101 AND 102).

SERVICE MARK

PRINCIPAL REGISTER

FIRST USE 11-26-2010; IN COMMERCE 12-1-2010.

THE MARK CONSISTS OF THE STYLIZED WORDING "WINCONOMY" WITH "CONOMY" UNDERLINED ALL PLACED ABOVE A STYLIZED LETTER "E".

SEC. 2(F).

SER. NO. 85-190,492, FILED 12-3-2010.

LESLIE RICHARDS, EXAMINING ATTORNEY



David J. Kyffers

Director of the United States Patent and Trademark Office

United States of America

United States Patent and Trademark Office

Strictly Business MC (Motorcycle Club)

Reg. No. 4,097,951

DAVIS, EDDIE L. (UNITED STATES INDIVIDUAL), DBA STRICTLY BUSINESS MC
6351 ELLENWOOD DRIVE
REX, GA 30273 AND

Registered Feb. 14, 2012

Int. Cl.: 41

PINKNEY, ELIJAH A. (UNITED STATES INDIVIDUAL), DBA STRICTLY BUSINESS MC
1012 STORY MILL CT
HEPHZIBAH, GA 30815

SERVICE MARK

PRINCIPAL REGISTER

FOR: ORGANIZING MOTORCYCLE RIDING AND SAFETY EVENTS THE PROCEEDS OF WHICH ARE DONATED TO CHARITY, IN CLASS 41 (U.S. CLS. 100, 101 AND 107).

FIRST USE 12-3-2010; IN COMMERCE 9-23-2011.

THE MARK CONSISTS OF STANDARD CHARACTERS WITHOUT CLAIM TO ANY PARTICULAR FONT, STYLE, SIZE, OR COLOR.

NO CLAIM IS MADE TO THE EXCLUSIVE RIGHT TO USE "MC (MOTORCYCLE CLUB)", APART FROM THE MARK AS SHOWN.

SER. NO. 85-190,621, FILED 12-3-2010.

CARYN GLASSER, EXAMINING ATTORNEY



David J. Kyffers

Director of the United States Patent and Trademark Office

United States of America

United States Patent and Trademark Office

ONE VESSEL

Reg. No. 4,097,952

Registered Feb. 14, 2012

Int. Cl.: 21

TRADEMARK

PRINCIPAL REGISTER

KATRI, INC. (WASHINGTON CORPORATION)
5700 6TH AVENUE SOUTH
107
SEATTLE, WA 98108

FOR: NON-DISPOSABLE, SEALABLE HOT AND COLD BEVERAGWARE, AND NON-DISPOSABLE, SEALABLE, INSULATED HOT AND COLD BEVERAGE CONTAINERS FOR DOMESTIC USE , IN CLASS 21 (U.S. CLS. 2, 13, 23, 29, 30, 33, 40 AND 50).

FIRST USE 11-9-2010; IN COMMERCE 11-9-2010.

THE MARK CONSISTS OF STANDARD CHARACTERS WITHOUT CLAIM TO ANY PARTICULAR FONT, STYLE, SIZE, OR COLOR.

NO CLAIM IS MADE TO THE EXCLUSIVE RIGHT TO USE "VESSEL", APART FROM THE MARK AS SHOWN.

SER. NO. 85-191,399, FILED 12-6-2010.

GEOFFREY FOSDICK, EXAMINING ATTORNEY



David J. Kyffers

Director of the United States Patent and Trademark Office

United States of America

United States Patent and Trademark Office



Reg. No. 4,097,953

Registered Feb. 14, 2012

Int. Cl.: 37

SERVICE MARK

PRINCIPAL REGISTER

PERFORMANCE ROOFING, LLC (FLORIDA LIMITED LIABILITY COMPANY)
2235 MERCATOR DRIVE
ORLANDO, FL 32807

FOR: COMPREHENSIVE PREVENTATIVE MAINTENANCE SERVICE FOR ROOFING SYSTEMS; ROOFING CONSULTATION; ROOFING CONTRACTING; ROOFING INSTALLATION; ROOFING REPAIR; ROOFING SERVICES, IN CLASS 37 (U.S. CLS. 100, 103 AND 106).

FIRST USE 4-30-2009; IN COMMERCE 4-30-2009.

NO CLAIM IS MADE TO THE EXCLUSIVE RIGHT TO USE "ROOFING", APART FROM THE MARK AS SHOWN.

THE COLOR(S) BLACK, WHITE AND YELLOW IS/ARE CLAIMED AS A FEATURE OF THE MARK.

THE MARK CONSISTS OF THE WORD "PERFORMANCE" IN YELLOW OUTLINED IN BLACK WITH A CHECKERED WAVY FLAG BEHIND IT. UNDERNEATH THAT, THE WORD "ROOFING" IN WHITE. UNDER THAT IN SMALLER LETTERS, THE WORDS "PERFORMANCE DRIVES SUCCESS" IN WHITE. THE REMAINING COLOR BLACK REPRESENTS CONTRAST BACKGROUND AND DOES NOT FORM PART OF THE MARK.

SER. NO. 85-191,452, FILED 12-6-2010.

TRACY FLETCHER, EXAMINING ATTORNEY



David J. Kybas

Director of the United States Patent and Trademark Office

United States of America

United States Patent and Trademark Office

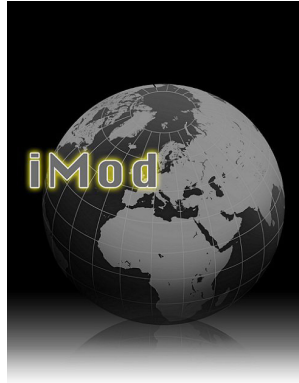

Reg. No. 4,097,954

Registered Feb. 14, 2012

Int. Cl.: 41

SERVICE MARK

PRINCIPAL REGISTER

CURRICULUM TECHNOLOGY LLC (COLORADO LIMITED LIABILITY COMPANY)
SUITE 115
3520 SEAGATE WAY
OCEANSIDE, CA 92056

FOR: COMPUTER EDUCATION TRAINING, IN CLASS 41 (U.S. CLS. 100, 101 AND 107).

FIRST USE 1-1-2010; IN COMMERCE 1-1-2010.

NO CLAIM IS MADE TO THE EXCLUSIVE RIGHT TO USE "IMOD", APART FROM THE MARK AS SHOWN.

THE COLOR(S) BLACK, WHITE, GRAY, AND YELLOW IS/ARE CLAIMED AS A FEATURE OF THE MARK.

THE MARK CONSISTS OF A WORLD GLOBE IN SHADES OF BLACK, WHITE, AND GRAY WITH A SHADOW OF THE GLOBE BENEATH THE MAIN GLOBE AND THE LITERAL ELEMENTS "IMOD" IN GRAY LETTERS OUTLINED IN WHITE WITH A YELLOW SHADOW GLOW OF THE LETTERS SUPERIMPOSED OVER THE TOP ONE-THIRD OF THE GLOBE ON THE LEFT SIDE.

SER. NO. 85-191,537, FILED 12-6-2010.

BARNEY CHARLON, EXAMINING ATTORNEY



David J. Kybas

Director of the United States Patent and Trademark Office

United States of America

United States Patent and Trademark Office

LELO

Reg. No. 4,097,955

Registered Feb. 14, 2012

Int. Cl.: 35

SERVICE MARK

PRINCIPAL REGISTER

LELO INC. (CALIFORNIA CORPORATION)
4320 STEVENS CREEK BLVD. SUITE 205
SAN JOSE,, CA 95129

FOR: BUSINESS MANAGEMENT CONSULTING WITH RELATION TO STRATEGY, MARKETING, PRODUCTION, PERSONNEL AND RETAIL SALE MATTERS; ON-LINE RETAIL STORE SERVICES FEATURING A WIDE VARIETY OF CONSUMER GOODS OF OTHERS; RETAIL APPAREL STORES; RETAIL CLOTHING BOUTIQUES, IN CLASS 35 (U.S. CLS. 100, 101 AND 102).

FIRST USE 1-1-2003; IN COMMERCE 1-1-2003.

THE MARK CONSISTS OF STANDARD CHARACTERS WITHOUT CLAIM TO ANY PARTICULAR FONT, STYLE, SIZE, OR COLOR.

SER. NO. 85-191,817, FILED 12-7-2010.

ASMAT KHAN, EXAMINING ATTORNEY



David J. Kyffers

Director of the United States Patent and Trademark Office

United States of America

United States Patent and Trademark Office



Reg. No. 4,097,956

Registered Feb. 14, 2012

Int. Cl.: 29

CAMARONES DEL PACIFICO, S.A. (NICARAGUA CORPORATION)
HOSPITAL CENTRAL MANAGUA 20 VARAS ABAJO
COLONIA CENTROAMERICA NO. C-195
MANAGUA, NICARAGUA

FOR: SHRIMP, IN CLASS 29 (U.S. CL. 46).

TRADEMARK

FIRST USE 3-8-1997; IN COMMERCE 3-8-1997.

PRINCIPAL REGISTER

NO CLAIM IS MADE TO THE EXCLUSIVE RIGHT TO USE "MANGLES ALTOS NICARAGUA", APART FROM THE MARK AS SHOWN.

THE COLOR(S) YELLOW AND BLUE IS/ARE CLAIMED AS A FEATURE OF THE MARK.

THE MARK CONSISTS OF TWO CONCENTRIC BLUE CIRCLES WITH THE WORDING "MARYMAR" AND "MANGLES ALTOS NICARAGUA" IN BLUE WITHIN THE CIRCLES; AT THE CENTER OF THE MARK IS AN IRREGULAR SHAPE OUTLINED IN BLUE WITH BLUE RECTANGLES IN THE LOWER PORTION OF THE SHAPE; AT THE TOP OF THE RECTANGLES IS A SETTING SUN IN YELLOW AND OUTLINED IN BLUE; SUPERIMPOSED ON THE IRREGULAR SHAPE IS A SHRIMP IN YELLOW AND OUTLINED IN BLUE. THE WHITE IN THE MARK REPRESENTS TRANSPARENT BACKGROUND AREAS AND IS NOT CLAIMED AS A FEATURE OF THE MARK.

THE WORDING "MARYMAR" HAS NO MEANING IN A FOREIGN LANGUAGE.

SER. NO. 85-192,218, FILED 12-7-2010.

CHARLOTTE CORWIN, EXAMINING ATTORNEY



David J. Kybas

Director of the United States Patent and Trademark Office

United States of America

United States Patent and Trademark Office

IntelliFOCUS

Reg. No. 4,097,957

Registered Feb. 14, 2012

Int. Cl.: 9

TRADEMARK

PRINCIPAL REGISTER

COMVERGE, INC. (DELAWARE CORPORATION)
SUITE 300
5390 TRIANGLE PARKWAY
NORCROSS, GA 30092

FOR: DISPLAY DEVICES FOR HEATING, COOLING, AND ENERGY MANAGEMENT; WIRELESS METER READING INSTRUMENTS; THERMOSTATS; APPARATUS FOR TRANSMISSION OF COMMUNICATION AND STORAGE OF INFORMATION, NAMELY, THROUGH METERS, REMOTE TRANSMITTER CONTROLLERS, OR METER DATA STORAGE DEVICES RELATED TO PRICING, CONSUMER USAGE, BILLING AND LOAD FORECASTING, IN CLASS 9 (U.S. CLS. 21, 23, 26, 36 AND 38).

FIRST USE 10-18-2010; IN COMMERCE 10-18-2010.

THE MARK CONSISTS OF STANDARD CHARACTERS WITHOUT CLAIM TO ANY PARTICULAR FONT, STYLE, SIZE, OR COLOR.

SER. NO. 85-192,626, FILED 12-7-2010.

KATHY DE JONGE, EXAMINING ATTORNEY



David J. Kyffers

Director of the United States Patent and Trademark Office

United States of America

United States Patent and Trademark Office



Reg. No. 4,097,958

Registered Feb. 14, 2012

Int. Cl.: 41

SERVICE MARK

PRINCIPAL REGISTER

THE BOBBY LAWRENCE INSTITUTE OF KENPO KARATE, INC. (UTAH CORPORATION)
976 SOUTH STATE
OREM, UT 84058

FOR: MARTIAL ARTS INSTRUCTION, IN CLASS 41 (U.S. CLS. 100, 101 AND 107).

FIRST USE 1-1-1988; IN COMMERCE 1-1-1988.

NO CLAIM IS MADE TO THE EXCLUSIVE RIGHT TO USE "KARATE", APART FROM THE MARK AS SHOWN.

THE NAME "BOBBY LAWRENCE" IDENTIFIES THE STAGE NAME OF "ROBERT DEAN LAWRENCE", A LIVING INDIVIDUAL WHOSE CONSENT IS OF RECORD.

THE MARK CONSISTS OF AN IMAGE OF A MAN DEMONSTRATING A HIGH SIDE KICK IN GUARDING STANCE WITH THE WORDS "BOBBY LAWRENCE KARATE" IN STYLIZED FORM TO THE RIGHT HAND SIDE OF THE IMAGE. SEVEN EVENLY SPACED LIGHT, HORIZONTAL STRIPES OR LINES GO ACROSS THE DARK PORTION OF THE IMAGE OF THE MAN.

SER. NO. 85-193,312, FILED 12-8-2010.

NANCY CLARKE, EXAMINING ATTORNEY



David J. Kybas

Director of the United States Patent and Trademark Office

United States of America

United States Patent and Trademark Office

GOLDEN APPLE

Reg. No. 4,097,959

BERENTZEN-GRUPPE AKTIENGESELLSCHAFT (FED REP GERMANY CORPORATION)
RITTERSTRASSE 7

Registered Feb. 14, 2012

49740 HASELUENNE, FED REP GERMANY

Int. Cl.: 33

FOR: LIQUEUR, IN CLASS 33 (U.S. CLS. 47 AND 49).

TRADEMARK

THE MARK CONSISTS OF STANDARD CHARACTERS WITHOUT CLAIM TO ANY PARTICULAR FONT, STYLE, SIZE, OR COLOR.

PRINCIPAL REGISTER

OWNER OF ERPN CMNTY TM OFC REG. NO. 428557, DATED 10-30-1998, EXPIRES 12-2-2016.

NO CLAIM IS MADE TO THE EXCLUSIVE RIGHT TO USE "APPLE", APART FROM THE MARK AS SHOWN.

SER. NO. 85-193,346, FILED 12-8-2010.

DARRYL SPRUILL, EXAMINING ATTORNEY



David J. Kyffers

Director of the United States Patent and Trademark Office

United States of America

United States Patent and Trademark Office

szzzl

Reg. No. 4,097,960

Registered Feb. 14, 2012

Int. Cl.: 42

SERVICE MARK

PRINCIPAL REGISTER

SMITH, DAVID A. (UNITED STATES INDIVIDUAL)
104 SOUTH TAMILYNN CIRCLE
CARY, NC 27513

FOR: COMPUTER SERVICE, NAMELY, ACTING AS AN APPLICATION SERVICE PROVIDER IN THE FIELD OF KNOWLEDGE MANAGEMENT TO HOST COMPUTER APPLICATION SOFTWARE FOR CREATING SEARCHABLE DATABASES OF INFORMATION AND DATA; COMPUTER SERVICE, NAMELY, ACTING AS AN APPLICATION SERVICE PROVIDER IN THE FIELD OF KNOWLEDGE MANAGEMENT TO HOST COMPUTER APPLICATION SOFTWARE FOR SEARCHING AND RETRIEVING INFORMATION FROM DATABASES AND COMPUTER NETWORKS; COMPUTER SERVICE, NAMELY, ACTING AS AN APPLICATION SERVICE PROVIDER IN THE FIELD OF KNOWLEDGE MANAGEMENT TO HOST COMPUTER APPLICATION SOFTWARE FOR THE COLLECTION, EDITING, ORGANIZING, MODIFYING, BOOK MARKING, TRANSMISSION, STORAGE AND SHARING OF DATA AND INFORMATION; COMPUTER SERVICES, NAMELY, PROVIDING A WEB-BASED SYSTEM AND ONLINE PORTAL FOR CUSTOMERS TO REMOTELY MANAGE, ADMINISTER, MODIFY AND CONTROL THEIR END USER COMPUTER DEVICES, DATA AND SOFTWARE APPLICATIONS; COMPUTER SERVICES, NAMELY, PROVIDING SEARCH ENGINES FOR OBTAINING DATA ON A GLOBAL COMPUTER NETWORK; COMPUTER SERVICES, NAMELY, PROVIDING SEARCH PLATFORMS TO ALLOW USERS TO REQUEST CONTENT FROM AND RECEIVE CONTENT TO A MOBILE DEVICE; COMPUTER SERVICES, NAMELY, SEARCH ENGINE OPTIMIZATION; COMPUTER SOFTWARE DEVELOPMENT; COMPUTER SOFTWARE DEVELOPMENT IN THE FIELD OF MOBILE APPLICATIONS; DESIGN AND DEVELOPMENT OF COMPUTER SOFTWARE; DESIGN AND DEVELOPMENT OF ON-LINE COMPUTER SOFTWARE SYSTEMS; DESIGN AND WRITING OF COMPUTER SOFTWARE; DESIGN, DEVELOPMENT AND IMPLEMENTATION OF SOFTWARE; DEVELOPING AND UPDATING COMPUTER SOFTWARE; DEVELOPING COMPUTER SOFTWARE; DEVELOPMENT OF SOFTWARE FOR SECURE NETWORK OPERATIONS; DEVELOPMENT, MAINTENANCE AND UPDATING OF A TELECOMMUNICATION NETWORK SEARCH ENGINE; DEVELOPMENT, UPDATING AND MAINTENANCE OF SOFTWARE AND DATA BASES; HOSTING THE SOFTWARE, WEBSITES AND OTHER COMPUTER APPLICATIONS OF OTHERS ON A VIRTUAL PRIVATE SERVER; PROVIDING A WEB SITE FEATURING TECHNOLOGY THAT ENABLES INTERNET USERS TO CREATE, BOOKMARK, ANNOTATE, AND PUBLICLY SHARE DATA; PROVIDING A WEBSITE FEATURING A MEDIA AGGREGATOR AND SEARCH ENGINE FOR INTERNET CONTENT; PROVIDING A WEBSITE FEATURING TECHNOLOGY THAT ENABLES USERS TO LIST, SHARE AND VIEW INFORMATION DESCRIBING THE GEOGRAPHIC LOCATION OF



David J. Kybas

Director of the United States Patent and Trademark Office

Reg. No. 4,097,960 VARIOUS INTERESTS OF THE USER; PROVIDING A WEBSITE THAT FEATURES TECHNOLOGY THAT ENABLES THE SECURE EXCHANGE OF INFORMATION BY USERS; PROVIDING CUSTOMER-DEFINED GENERATED CONTENT AND CONTENT OF OTHERS AUTOMATICALLY SELECTED AND CUSTOMIZED BASED ON THE KNOWN OR ESTIMATED GEOGRAPHICAL LOCATION OF AN INTERNET, MOBILE TELEPHONE OR OTHER WIRED OR WIRELESS DIGITAL NETWORK BASED CUSTOMER; PROVIDING CUSTOMIZED ON-LINE WEB PAGES AND DATA FEEDS FEATURING USER-DEFINED INFORMATION, WHICH INCLUDES BLOG POSTS, NEW MEDIA CONTENT, OTHER ON-LINE CONTENT, AND ON-LINE WEB LINKS TO OTHER WEBSITES; PROVIDING CUSTOMIZED ON-LINE WEB PAGES FEATURING USER-DEFINED INFORMATION, WHICH INCLUDES SEARCH ENGINES AND ON-LINE WEB LINKS TO OTHER WEB SITES; PROVIDING INFORMATION RELATING TO ON-LINE NON-DOWNLOADABLE SOFTWARE TO FACILITATE ELECTRONIC COMMUNICATION BETWEEN INDIVIDUALS PROVIDED VIA THE INTERNET; PROVIDING SPECIFIC INFORMATION AS REQUESTED BY CUSTOMERS VIA THE INTERNET; PROVISION OF INTERNET SEARCH ENGINES; PROVISION OF SEARCH ENGINES FOR THE INTERNET; RESEARCH AND DEVELOPMENT OF COMPUTER SOFTWARE; SEARCHING AND RETRIEVING INFORMATION, SITES, AND OTHER RESOURCES AVAILABLE ON COMPUTER NETWORKS FOR OTHERS; SOCIAL BOOKMARKING WEBSITE SERVICES, NAMELY, PROVIDING A WEBSITE FEATURING TECHNOLOGY THAT ENABLES USERS TO ORGANIZE, STORE, MANAGE, SHARE AND SEARCH FOR BOOKMARKS OF RESOURCES ONLINE; SOFTWARE DESIGN AND DEVELOPMENT, IN CLASS 42 (U.S. CLS. 100 AND 101).

FIRST USE 3-1-2010; IN COMMERCE 3-1-2010.

THE MARK CONSISTS OF STANDARD CHARACTERS WITHOUT CLAIM TO ANY PARTICULAR FONT, STYLE, SIZE, OR COLOR.

THE WORDING "SZZZL" HAS NO MEANING IN A FOREIGN LANGUAGE.

SER. NO. 85-194,732, FILED 12-9-2010.

MICHAEL GAAFAR, EXAMINING ATTORNEY

United States of America

United States Patent and Trademark Office



**UPSTART
CROW**
Bookstore &
Coffeehouse

Reg. No. 4,097,961

Registered Feb. 14, 2012

Int. Cls.: 35 and 43

SERVICE MARK

PRINCIPAL REGISTER

INTERNATIONAL DESERT AND COFFEE (CALIFORNIA LIMITED LIABILITY COMPANY)
835 WEST HARBOR DRIVE #C
SAN DIEGO, CA 92101

FOR: RETAIL BOOK STORE SERVICES; RETAIL STORE SERVICES AND ON-LINE RETAIL STORE SERVICES FEATURING BOOKS AND A WIDE VARIETY OF CONSUMER GOODS, IN CLASS 35 (U.S. CLS. 100, 101 AND 102).

FIRST USE 1-5-1980; IN COMMERCE 1-5-1980.

FOR: RESTAURANT SERVICES, COFFEE SHOPS, SNACK BAR SERVICES, IN CLASS 43 (U.S. CLS. 100 AND 101).

FIRST USE 1-5-1980; IN COMMERCE 1-5-1980.

NO CLAIM IS MADE TO THE EXCLUSIVE RIGHT TO USE "BOOKSTORE & COFFEEHOUSE", APART FROM THE MARK AS SHOWN.

THE MARK CONSISTS OF A CROW/BIRD SITTING ON TOP OF THE WORDING "UPSTART CROW BOOKSTORE & COFFEEHOUSE".

SER. NO. 85-194,740, FILED 12-9-2010.

STEVEN JACKSON, EXAMINING ATTORNEY



David J. Kybas

Director of the United States Patent and Trademark Office

United States of America

United States Patent and Trademark Office

H & M GOPHER CONTROL

Reg. No. 4,097,962

ALLEN HURLBURT (UNITED STATES INDIVIDUAL), DBA H & M GOPHER CONTROL
1979 COUNTY ROAD 106
TULELAKE, CA 96134

Registered Feb. 14, 2012

Int. Cl.: 11

FOR: RODENT CONTROL EQUIPMENT, NAMELY, OUTDOOR AUTOMATED EXHAUST GAS SYSTEM FOR RODENT CONTROL COMPRISING AN ENGINE, COMPRESSOR PUMP, PRESSURE TANK, AIR HOSES, AND HAND-HELD WANDS, IN CLASS 11 (U.S. CLS. 13, 21, 23, 31 AND 34).

TRADEMARK

PRINCIPAL REGISTER

FIRST USE 11-1-2005; IN COMMERCE 12-0-2006.

THE MARK CONSISTS OF STANDARD CHARACTERS WITHOUT CLAIM TO ANY PARTICULAR FONT, STYLE, SIZE, OR COLOR.

NO CLAIM IS MADE TO THE EXCLUSIVE RIGHT TO USE "GOPHER CONTROL", APART FROM THE MARK AS SHOWN.

SER. NO. 85-194,897, FILED 12-10-2010.

COLLEEN DOMBROW, EXAMINING ATTORNEY



David J. Kybas

Director of the United States Patent and Trademark Office

United States of America
United States Patent and Trademark Office

**MOBILE
MARINER**

Reg. No. 4,097,963

Registered Feb. 14, 2012

Int. Cl.: 9

TRADEMARK

PRINCIPAL REGISTER

MOBILE MARINER, LLC (CONNECTICUT LIMITED LIABILITY COMPANY)
86 DANIEL BROWN DRIVE
MYSTIC, CT 06355

FOR: COMPUTER APPLICATION SOFTWARE FOR MOBILE PHONES, NAMELY, COMPUTER SOFTWARE FOR THE PROVISION OF INFORMATION IN THE FIELD OF INFORMATION RELATING TO TIDES, WEATHER FORECASTS, METEOROLOGICAL OBSERVATIONS, SUNRISE AND SUNSET INFORMATION, MOONRISE, MOONSET AND MOON-PHASE INFORMATION, CURRENTS, NAVIGATIONAL, HARBOR AND PORT SERVICES INFORMATION, AND ANY OTHER MARINE RELATED INFORMATION, IN CLASS 9 (U.S. CLS. 21, 23, 26, 36 AND 38).

FIRST USE 3-1-2010; IN COMMERCE 3-18-2010.

NO CLAIM IS MADE TO THE EXCLUSIVE RIGHT TO USE "MOBILE", APART FROM THE MARK AS SHOWN.

SER. NO. 85-194,919, FILED 12-10-2010.

MATTHEW KLINE, EXAMINING ATTORNEY



David J. Kybas

Director of the United States Patent and Trademark Office

United States of America

United States Patent and Trademark Office

"UNCANNY"

Reg. No. 4,097,964

SMOKER FRIENDLY INTERNATIONAL LLC (COLORADO LIMITED LIABILITY COMPANY)
5303 SPINE RD., #101
BOULDER, CO 80301

Registered Feb. 14, 2012

Int. Cl.: 34

FOR: MOIST SNUFF, IN CLASS 34 (U.S. CLS. 2, 8, 9 AND 17).

TRADEMARK

FIRST USE 11-1-2010; IN COMMERCE 11-1-2010.

PRINCIPAL REGISTER

THE MARK CONSISTS OF STANDARD CHARACTERS WITHOUT CLAIM TO ANY PARTICULAR FONT, STYLE, SIZE, OR COLOR.

SER. NO. 85-194,930, FILED 12-10-2010.

VERNA BETH RIRIE, EXAMINING ATTORNEY



David J. Kyffers

Director of the United States Patent and Trademark Office

United States of America

United States Patent and Trademark Office

L.E.A.P. I

Reg. No. 4,097,965

Registered Feb. 14, 2012

Int. Cl.: 41

SERVICE MARK

PRINCIPAL REGISTER

MWR HOLDINGS, LLC (DELAWARE LIMITED LIABILITY COMPANY)
SUITE 700
4855 TECHNOLOGY WAY
BOCA RATON, FL 33431

FOR: EDUCATION, NAMELY, DEVELOPING CURRICULUM FOR TEACHERS AND PROVIDING ACADEMIC COURSES OF INSTRUCTION AT THE PRESCHOOL AND ELEMENTARY LEVELS IN A CHILD CARE CENTER, IN CLASS 41 (U.S. CLS. 100, 101 AND 107).

FIRST USE 6-1-2002; IN COMMERCE 6-1-2002.

THE MARK CONSISTS OF STANDARD CHARACTERS WITHOUT CLAIM TO ANY PARTICULAR FONT, STYLE, SIZE, OR COLOR.

OWNER OF U.S. REG. NO. 3,334,428.

SER. NO. 85-195,268, FILED 12-10-2010.

MATTHEW MCDOWELL, EXAMINING ATTORNEY



David J. Kybas

Director of the United States Patent and Trademark Office

United States of America

United States Patent and Trademark Office

L.E.A.P. II

Reg. No. 4,097,966

Registered Feb. 14, 2012

Int. Cl.: 41

SERVICE MARK

PRINCIPAL REGISTER

MWR HOLDINGS LLC (DELAWARE LIMITED LIABILITY COMPANY)
SUITE 700
4855 TECHNOLOGY WAY
BOCA RATON, FL 33431

FOR: EDUCATION, NAMELY, DEVELOPING CURRICULUM FOR TEACHERS AND PROVIDING ACADEMIC COURSES OF INSTRUCTION AT THE PRESCHOOL AND ELEMENTARY LEVELS IN A CHILD CARE CENTER, IN CLASS 41 (U.S. CLS. 100, 101 AND 107).

FIRST USE 6-1-2002; IN COMMERCE 6-1-2002.

THE MARK CONSISTS OF STANDARD CHARACTERS WITHOUT CLAIM TO ANY PARTICULAR FONT, STYLE, SIZE, OR COLOR.

OWNER OF U.S. REG. NO. 3,334,428.

SER. NO. 85-195,285, FILED 12-10-2010.

MATTHEW MCDOWELL, EXAMINING ATTORNEY



David J. Kyfos

Director of the United States Patent and Trademark Office

United States of America

United States Patent and Trademark Office

LIFELOVERS

Reg. No. 4,097,967

Registered Feb. 14, 2012

Int. Cls.: 18, 25 and 35

TRADEMARK

SERVICE MARK

PRINCIPAL REGISTER

CAMPER, S.L. (SPAIN SOCIEDAD LIMITADA)
POLÍGONO INDUSTRIAL, S/N
INCA, BALEARES, SPAIN 07300

FOR: ANIMAL SKINS AND HIDES; BAGS FOR SPORTS; BRIEFCASES; FUR; HANDBAGS; HARNESSES AND SADDLERY; IMITATION LEATHER; LEATHER; PARASOLS; PURSES; RUCKSACKS; SUITCASES; TANNED LEATHER; TRUNKS; UMBRELLAS AND THEIR PARTS; WALKING STICKS; WALLETS; WHIPS, IN CLASS 18 (U.S. CLS. 1, 2, 3, 22 AND 41).

FOR: ANORAK; BEACHWEAR; BELTS; BERMUDA SHORTS; BIKINIS; BLOUSES; BOXER SHORTS; CARDIGANS; COATS; FOOTWEAR; FUR JACKETS; GLOVES; GOLF SHIRTS; HEADWEAR; JACKETS; JEANS; JERSEYS; JUMPSUITS; NECKTIES; POLO SHIRTS; SCARVES; SKIRTS; SOCKS; SPORT COATS; SWEAT SHIRTS; SWIMWEAR; T-SHIRTS; TENNIS WEAR; TROUSERS; UNDERSHIRTS; UNDERWEAR, IN CLASS 25 (U.S. CLS. 22 AND 39).

FOR: ADVERTISING AND PROMOTION SERVICES AND RELATED CONSULTING; ADVERTISING SERVICES; BUSINESS ADMINISTRATION AND MANAGEMENT; BUSINESS MANAGEMENT ASSISTANCE TO INDUSTRIAL OR COMMERCIAL COMPANIES; COMMERCIAL BUSINESS MANAGEMENT; ON-LINE RETAIL STORE SERVICES FEATURING GOODS MADE OF LEATHER AND IMITATIONS OF LEATHER, ANIMAL SKINS, HIDES, BAGS, TRUNKS, SUITCASES, HANDBAGS, SPORTING BAGS, RUCKSACKS, BRIEFCASES, WALLETS, PURSES, CASES FOR EYE GLASSES AND SUNGLASSES, UMBRELLAS AND THEIR PARTS, PARASOLS, WALKING STICKS, WHIPS, HARNESSES AND SADDLERY, CLOTHING, FOOTWEAR, HEADGEAR, MAGAZINES, PUBLICATIONS, SPORTING ARTICLES, PERFUMES AND COSMETICS, PINS, TROPHIES, SPECTACLES, SUNGLASSES, JEWELRY, IMITATION JEWELRY, CLOCKS CHRONOMETERS, BOATS; WHOLESALE AND RETAIL STORE SERVICES FEATURING GOODS MADE OF LEATHER AND IMITATIONS OF LEATHER, ANIMAL SKINS, HIDES, BAGS, TRUNKS, SUITCASES, HANDBAGS, SPORTING BAGS, RUCKSACKS, BRIEFCASES, WALLETS, PURSES, UMBRELLAS AND THEIR PARTS, CASES FOR EYE GLASSES AND SUNGLASSES, PARASOLS, WALKING STICKS, WHIPS, HARNESSES AND SADDLERY, CLOTHING, FOOTWEAR, HEADGEAR, MAGAZINES, PUBLICATIONS, SPORTING ARTICLES, PERFUMES AND COSMETICS, PINS, TROPHIES, SPECTACLES, SUNGLASSES, JEWELRY, IMITATION JEWELRY, CLOCKS, CHRONOMETERS, BOATS, IN CLASS 35 (U.S. CLS. 100, 101 AND 102).



David J. Kyffers

Director of the United States Patent and Trademark Office

Reg. No. 4,097,967 THE MARK CONSISTS OF STANDARD CHARACTERS WITHOUT CLAIM TO ANY PARTICULAR FONT, STYLE, SIZE, OR COLOR.

OWNER OF ERPN CMNTY TM OFC REG. NO. 9540048, DATED 5-6-2011, EXPIRES 11-22-2020.

SER. NO. 85-195,325, FILED 12-10-2010.

DOMINICK J. SALEMI, EXAMINING ATTORNEY

United States of America

United States Patent and Trademark Office

Come See Us Last

Reg. No. 4,097,968

STEVE G. LEVY (UNITED STATES INDIVIDUAL), AKA ST LUCIE JEWELRY, INC.
9168 SOUTH US 1

Registered Feb. 14, 2012

PORT ST LUCIE, FL 34952

Int. Cl.: 35

FOR: RETAIL JEWELRY STORES; SCRAP DEALERSHIPS; WHOLESALE AND RETAIL STORE SERVICES FEATURING JEWELRY AND SCRAP GOLD, IN CLASS 35 (U.S. CLS. 100, 101 AND 102).

SERVICE MARK

FIRST USE 12-4-2007; IN COMMERCE 12-4-2007.

PRINCIPAL REGISTER

THE MARK CONSISTS OF STANDARD CHARACTERS WITHOUT CLAIM TO ANY PARTICULAR FONT, STYLE, SIZE, OR COLOR.

SER. NO. 85-195,893, FILED 12-11-2010.

DAWN HAN, EXAMINING ATTORNEY



David J. Kyffers

Director of the United States Patent and Trademark Office

United States of America

United States Patent and Trademark Office



Reg. No. 4,097,969

Registered Feb. 14, 2012

Int. Cl.: 42

SERVICE MARK

PRINCIPAL REGISTER

SUMPRAXIS LLC (FLORIDA LIMITED LIABILITY COMPANY), DBA SUMPRAXIS LLC
555 HERITAGE DRIVE SUITE 110
JUPITER, FL 33458

FOR: CONDUCTING ENGINEERING SURVEYS; CONSULTING IN THE FIELD OF STRUCTURAL ENGINEERING; CONSULTING IN THE FIELDS OF ENGINEERING AND ARCHITECTURE; CONSULTING SERVICES IN THE FIELD OF IMPROVEMENT OF ENGINEERING PROCESSES; CONSULTING SERVICES IN THE FIELD OF INDUSTRIAL ENGINEERING; CONSULTING SERVICES IN THE FIELD OF THE DESIGN ENGINEERING; DESIGN OF ENGINEERING PRODUCTS; DRAWING UP OF PLANS AND ENGINEERING DRAWINGS; ENGINEERING; ENGINEERING SERVICES FOR THE CONSTRUCTION OF WATER TREATMENT AND PURIFICATION PLANTS, SOLID WASTE TREATMENT PLANTS AND OTHER MUNICIPAL INFRASTRUCTURE FACILITIES; MECHANICAL ENGINEERING; PRODUCT DEVELOPMENT AND ENGINEERING SERVICES FOR OTHERS; STRUCTURAL ENGINEERING DESIGN SERVICES; SURVEYING AND ENGINEERING, IN CLASS 42 (U.S. CLS. 100 AND 101).

FIRST USE 9-19-2003; IN COMMERCE 9-19-2003.

THE MARK CONSISTS OF THE WORD "SUMPRAXIS" COMBINED WITH A SERIES OF TRIANGLES COMBINED TO FORM A MISCELLANEOUS DESIGN.

SER. NO. 85-196,103, FILED 12-13-2010.

BRIDGETT SMITH, EXAMINING ATTORNEY



David J. Kyffers

Director of the United States Patent and Trademark Office

United States of America

United States Patent and Trademark Office

*Incentive*EHR

Reg. No. 4,097,970

BILL2COLLECT L.L.C. (CALIFORNIA LIMITED LIABILITY COMPANY)
320 SUPERIOR AVE STE 340
NEWPORT BEACH, CA 92663

Registered Feb. 14, 2012

Int. Cl.: 42

FOR: COMPUTER SERVICES, NAMELY, PROVIDING A WEB-BASED SYSTEM AND ON-LINE PORTAL FOR CUSTOMERS TO REMOTELY MANAGE, ADMINISTER, MODIFY AND CONTROL THEIR END USER COMPUTER DEVICES, DATA AND SOFTWARE APPLICATIONS; PROVIDING ON-LINE, NON-DOWNLOADABLE, INTERNET-BASED SOFTWARE APPLICATION FOR MEDICAL BILLING FOR PHYSICIANS AND HEALTH CARE INSTITUTIONS, IN CLASS 42 (U.S. CLS. 100 AND 101).

SERVICE MARK

PRINCIPAL REGISTER

FIRST USE 12-7-2010; IN COMMERCE 12-7-2010.

THE MARK CONSISTS OF THE WORDING "INCENTIVEEHR" WITH THE ITALICIZED TERM "INCENTIVE" IN THE COLOR BURGUNDY AND THE ACRONYM "EHR" APPEARING IN BLACK CAPITAL LETTERS.

THE COLOR(S) BURGUNDY AND BLACK IS/ARE CLAIMED AS A FEATURE OF THE MARK.

SER. NO. 85-196,309, FILED 12-13-2010.

JEFFERY COWARD, EXAMINING ATTORNEY



David J. Kybas

Director of the United States Patent and Trademark Office

United States of America

United States Patent and Trademark Office

MERCURY

Reg. No. 4,097,971

SALOMON AUTOMATION GMBH (AUSTRIA LIMITED LIABILITY COMPANY)
FRIESACHSTRASSE 15
FRIESACH, AUSTRIA 8114

Registered Feb. 14, 2012

Int. Cls.: 7, 9 and 39

FOR: MATERIAL HANDLING MACHINES, NAMELY, PALLETIZERS, CASE ELEVATORS, AUTOMATIC PALLET DISPENSING MACHINES AND AUTOMATIC SLIP SHEET DISPENSING MACHINES; MACHINES AND MACHINE TOOLS FOR AUTOMATIC PREPARATION AND ORDER PROCESSING, NAMELY, ORDER-PICKING FROM AN ASSORTMENT OF GOODS, IN CLASS 7 (U.S. CLS. 13, 19, 21, 23, 31, 34 AND 35).

TRADEMARK

SERVICE MARK

PRINCIPAL REGISTER

FOR: COMPUTER HARDWARE AND COMPUTER SOFTWARE FOR STORAGE AND RETRIEVAL OF GOODS AND FOR CONTROL OF CONVEYORS AND ORDER-PICKING DEVICES, IN CLASS 9 (U.S. CLS. 21, 23, 26, 36 AND 38).

FOR: PACKAGING ARTICLES FOR TRANSPORTATION; PACKAGING ARTICLES TO THE ORDER AND SPECIFICATION OF OTHERS; TRANSPORT AND DELIVERY OF GOODS BEFORE SHIPMENT; TRANSPORT AND STORAGE OF GOODS BEFORE SHIPMENT; PACKAGING AND STORING GOODS; STORAGE, KEEPING AND RETRIEVING GOODS IN A WAREHOUSE IN THE FIELD OF INTRALOGISTICS; PACKAGING GOODS BEFORE SHIPMENT, IN CLASS 39 (U.S. CLS. 100 AND 105).

THE MARK CONSISTS OF STANDARD CHARACTERS WITHOUT CLAIM TO ANY PARTICULAR FONT, STYLE, SIZE, OR COLOR.

PRIORITY CLAIMED UNDER SEC. 44(D) ON ERPN CMNTY TM OFC APPLICATION NO. 009251786, FILED 6-30-2010, REG. NO. 009251786, DATED 12-6-2010, EXPIRES 6-30-2020.

SER. NO. 85-196,939, FILED 12-13-2010.

HOWARD SMIGA, EXAMINING ATTORNEY



David J. Kyffers

Director of the United States Patent and Trademark Office

United States of America

United States Patent and Trademark Office

FLOODAMERICA

Reg. No. 4,097,972

HONEST CLEANING, INC. (COLORADO CORPORATION)
20464 E LAYTON AVE.

Registered Feb. 14, 2012

AURORA, CO 80015

Int. Cl.: 37

FOR: DISASTER DAMAGE REMEDIATION, NAMELY, REPAIR AND RECONSTRUCTION SERVICES FOR HOMES AND BUILDINGS, IN CLASS 37 (U.S. CLS. 100, 103 AND 106).

SERVICE MARK

FIRST USE 10-0-1999; IN COMMERCE 1-24-2002.

PRINCIPAL REGISTER

THE MARK CONSISTS OF STANDARD CHARACTERS WITHOUT CLAIM TO ANY PARTICULAR FONT, STYLE, SIZE, OR COLOR.

SEC. 2(F).

SER. NO. 85-197,317, FILED 12-14-2010.

MICHAEL WEBSTER, EXAMINING ATTORNEY



David J. Kybas

Director of the United States Patent and Trademark Office

United States of America

United States Patent and Trademark Office

FIRE ON THE MOUNTAIN BUFFALO WINGS

Reg. No. 4,097,973

FOTM FRANCHISE, INC. (OREGON CORPORATION)
5855 NE 11TH AVE.
PORTLAND, OR 97211

Registered Feb. 14, 2012

Int. Cl.: 43

FOR: RESTAURANT SERVICES FEATURING BUFFALO CHICKEN WINGS, BARBECUE SAUCES, CHICKEN SANDWICHES, CHICKEN SALADS, IN CLASS 43 (U.S. CLS. 100 AND 101).

SERVICE MARK

FIRST USE 1-1-2005; IN COMMERCE 1-1-2005.

PRINCIPAL REGISTER

THE MARK CONSISTS OF STANDARD CHARACTERS WITHOUT CLAIM TO ANY PARTICULAR FONT, STYLE, SIZE, OR COLOR.

NO CLAIM IS MADE TO THE EXCLUSIVE RIGHT TO USE "BUFFALO WINGS", APART FROM THE MARK AS SHOWN.

SER. NO. 85-197,836, FILED 12-14-2010.

BENJAMIN OKEKE, EXAMINING ATTORNEY



David J. Kyffers

Director of the United States Patent and Trademark Office

United States of America

United States Patent and Trademark Office

SPLITP

Reg. No. 4,097,974

Registered Feb. 14, 2012

Int. Cls.: 9 and 41

TRADEMARK

SERVICE MARK

PRINCIPAL REGISTER

SK TELECOM AMERICAS, INC. (DELAWARE CORPORATION)
100 MATHILDA PLACE
SUNNYVALE, CA 94086

FOR: COMPUTER GAME SOFTWARE; ELECTRONIC GAME SOFTWARE; COMPUTER GAME SOFTWARE DOWNLOADABLE VIA AN ELECTRONIC OR OPTICAL COMMUNICATIONS NETWORK AND VIA WIRELESS AND ELECTRONIC MOBILE DEVICES; COMPUTER SOFTWARE FOR USE IN POSTING, TRANSMITTING, RECEIVING, RETRIEVING, ORGANIZING, SEARCHING AND MANAGING TEXT, PHOTOS, GRAPHICS, AND DATA TO WEB SITES; COMPUTER SOFTWARE FOR PROCESSING AND TRANSMITTING TEXT, PHOTOS, AND DATA FOR EDUCATIONAL AND ENTERTAINMENT APPLICATIONS; DOWNLOADABLE COMPUTER SOFTWARE FOR MOBILE PHONES THAT ENABLES USERS TO DOWNLOAD, SHARE, AND SEND TEXT, PHOTOGRAPHS, GRAPHICS FILES, AND DATA TO OTHER USERS OF MOBILE PHONES; COMPUTER SOFTWARE FOR COMMUNICATING WITH USERS OF HAND-HELD COMPUTERS; COMPUTER SOFTWARE FOR WIRELESS CONTENT DELIVERY, IN CLASS 9 (U.S. CLS. 21, 23, 26, 36 AND 38).

FIRST USE 12-15-2009; IN COMMERCE 12-15-2009.

FOR: PROVIDING A WEBSITE FEATURING INFORMATION IN THE FIELD OF COMPUTER GAMES; PROVIDING A WEBSITE FEATURING INFORMATION ABOUT VIDEO GAME APPLICATIONS FOR MOBILE PHONES AND HAND-HELD COMPUTERS, IN CLASS 41 (U.S. CLS. 100, 101 AND 107).

FIRST USE 12-15-2009; IN COMMERCE 12-15-2009.

THE MARK CONSISTS OF STANDARD CHARACTERS WITHOUT CLAIM TO ANY PARTICULAR FONT, STYLE, SIZE, OR COLOR.

SER. NO. 85-198,403, FILED 12-15-2010.

ANTHONY RINKER, EXAMINING ATTORNEY



David J. Kyffers

Director of the United States Patent and Trademark Office

United States of America

United States Patent and Trademark Office



Reg. No. 4,097,975

Registered Feb. 14, 2012

**Int. Cls.: 16, 35, 37, 38
and 42**

TRIOTEL COMMUNICATIONS, INC. (SOUTH DAKOTA CORPORATION)
3300 SOUTH NEBRASKA STREET
SALEM, SD 57058

FOR: PRINTED TELEPHONE DIRECTORIES, IN CLASS 16 (U.S. CLS. 2, 5, 22, 23, 29, 37, 38 AND 50).

FIRST USE 7-1-1999; IN COMMERCE 8-1-1999.

TRADEMARK

SERVICE MARK

PRINCIPAL REGISTER

FOR: RETAIL STORE SERVICES FEATURING HOME AND PERSONAL SURVEILLANCE CAMERAS AND MONITORING SYSTEMS; MAIL ORDER SERVICES FEATURING HOME AND PERSONAL SURVEILLANCE CAMERAS AND MONITORING SYSTEMS; ON-LINE RETAIL STORE SERVICES FEATURING HOME AND PERSONAL SURVEILLANCE CAMERAS AND MONITORING SYSTEMS, IN CLASS 35 (U.S. CLS. 100, 101 AND 102).

FIRST USE 12-18-2009; IN COMMERCE 7-1-2010.

FOR: REPAIR OR MAINTENANCE OF TELECOMMUNICATION MACHINES AND APPARATUS; TELECOMMUNICATION WIRING; INSTALLATION OF HOME AND PERSONAL SURVEILLANCE CAMERAS AND MONITORING SYSTEMS, IN CLASS 37 (U.S. CLS. 100, 103 AND 106).

FIRST USE 7-1-1999; IN COMMERCE 8-1-1999.



David J. Kybas

Director of the United States Patent and Trademark Office

FOR: TELECOMMUNICATIONS SERVICES, NAMELY, LOCAL AND LONG-DISTANCE TRANSMISSION OF VOICE, DATA, AND GRAPHICS BY MEANS OF TELEPHONE, TELEGRAPHIC, CABLE, AND SATELLITE TRANSMISSIONS; LEASING OF TELECOMMUNICATION SYSTEMS AND LINES; LEASING OF TELECOMMUNICATIONS EQUIPMENT; RENTAL OF TELECOMMUNICATION EQUIPMENT INCLUDING TELEPHONES AND FACSIMILE APPARATUS; TELECOMMUNICATIONS BY E-MAIL; TELECOMMUNICATIONS GATEWAY SERVICES, NAMELY, ROUTING AND JUNCTION SERVICES; TELECOMMUNICATION SERVICES, NAMELY, ISDN SERVICES, CALL HUNTING SERVICES AND PROVIDING FIBER-OPTIC NETWORK SERVICES; TELECOMMUNICATIONS RESELLER SERVICES, NAMELY, PROVIDING LONG-DISTANCE TELECOMMUNICATION SERVICES; INTERCEPTING AND PREVENTING UNSOLICITED TELEMARKETER CALLS; TRANSFER OF DATA BY TELECOMMUNICATIONS; TRANSMISSION AND RECEPTION OF DATABASE INFORMATION VIA TELECOMMUNICATIONS NETWORKS AND

Reg. No. 4,097,975 TRANSMISSION OF INFORMATION ON OPTICAL TELECOMMUNICATION NETWORKS; TELECOMMUNICATIONS ACCESS SERVICE; SIGNAL TRANSMISSION FOR ELECTRONIC COMMERCE VIA TELECOMMUNICATION AND DATA COMMUNICATION SYSTEMS; ELECTRONIC EXCHANGE OF DATA STORED IN DATABASES ACCESSIBLE VIA TELECOMMUNICATION NETWORKS; HIGH BIT-RATE DATA TRANSMISSION SERVICES FOR TELECOMMUNICATION NETWORK OPERATORS; PROVIDING ACCESS TO TELECOMMUNICATION NETWORKS; PROVIDING ELECTRONIC TELECOMMUNICATION CONNECTIONS AND TELECOMMUNICATION CONNECTIONS TO A GLOBAL COMPUTER NETWORK; PROVIDING THIRD PARTY USERS WITH ACCESS TO TELECOMMUNICATION INFRASTRUCTURE; INTERNET SERVICES, NAMELY, TRANSMITTING STREAMED SOUND AND AUDIO-VISUAL RECORDINGS VIA THE INTERNET; PROVIDING REMOTE INTERNET ACCESS; PROVIDING MULTIPLE USER DIAL-UP AND DEDICATED ACCESS TO THE INTERNET, STREAMING OF AUDIO AND VIDEO MATERIAL ON THE INTERNET, IN CLASS 38 (U.S. CLS. 100, 101 AND 104).

FIRST USE 12-18-2009; IN COMMERCE 7-1-2010.

FOR: INTERNET SERVICES, NAMELY, MONITORING, TESTING, ANALYZING, AND REPORTING ON THE INTERNET TRAFFIC CONTROL AND CONTENT CONTROL OF THE WEBSITE OF OTHERS; DESIGN, CREATION, HOSTING AND MAINTENANCE OF INTERNET SITES FOR THIRD PARTIES; AND HOSTING OF DIGITAL CONTENT ON THE INTERNET, IN CLASS 42 (U.S. CLS. 100 AND 101).

FIRST USE 7-1-1999; IN COMMERCE 8-1-1999.

NO CLAIM IS MADE TO THE EXCLUSIVE RIGHT TO USE THE GEOGRAPHICALLY DESCRIPTIVE DESIGN OF THE MAP OF THE STATE OF SOUTH DAKOTA, APART FROM THE MARK AS SHOWN.

THE MARK CONSISTS OF A SOLID IMAGE IN THE SHAPE OF THE STATE OF SOUTH DAKOTA WITH A RING IN A DIAGONAL ORBIT AROUND THE IMAGE THAT IS SLANTED FROM THE LOWER LEFT OF THE IMAGE TO THE UPPER RIGHT OF THE IMAGE.

SER. NO. 85-198,742, FILED 12-15-2010.

JANET LEE, EXAMINING ATTORNEY

United States of America

United States Patent and Trademark Office

CLARITY Rx

Reg. No. 4,097,976

Registered Feb. 14, 2012

Int. Cl.: 3

TRADEMARK

PRINCIPAL REGISTER

CLARITY CLINICAL SKIN CARE INC (CALIFORNIA CORPORATION)
SUITE 107
3537 OLD CONEJO ROAD
NEWBURY PARK, CA 91320

FOR: COSMETIC CREAMS FOR SKIN CARE; COSMETIC MASKS; COSMETIC PADS; COSMETIC PREPARATIONS FOR SKIN RENEWAL; COSMETIC SUNSCREEN PREPARATIONS; COSMETICS AND COSMETIC PREPARATIONS; FACE CREAMS FOR COSMETIC USE; PRIVATE LABEL COSMETICS; SKIN AND BODY TOPICAL LOTIONS, CREAMS AND OILS FOR COSMETIC USE; TOPICAL SKIN SPRAYS FOR COSMETIC PURPOSES; WRINKLE-MINIMIZING COSMETIC PREPARATIONS FOR TOPICAL FACIAL USE, IN CLASS 3 (U.S. CLS. 1, 4, 6, 50, 51 AND 52).

FIRST USE 5-1-2008; IN COMMERCE 7-1-2008.

THE MARK CONSISTS OF STANDARD CHARACTERS WITHOUT CLAIM TO ANY PARTICULAR FONT, STYLE, SIZE, OR COLOR.

NO CLAIM IS MADE TO THE EXCLUSIVE RIGHT TO USE "RX", APART FROM THE MARK AS SHOWN.

SER. NO. 85-198,766, FILED 12-15-2010.

FRED CARL, EXAMINING ATTORNEY



David J. Kypos

Director of the United States Patent and Trademark Office

United States of America

United States Patent and Trademark Office

EMBARX

Reg. No. 4,097,977

INVENTIV HEALTH, INC. (DELAWARE CORPORATION)
500 ATRIUM DRIVE
SOMERSET, NJ 08873

Registered Feb. 14, 2012

Int. Cl.: 35

FOR: BUSINESS CONSULTING SERVICES IN THE FIELDS OF MARKETING, CONSUMER STRATEGY, MANAGED MARKET STRATEGY AND PUBLIC POLICY RESEARCH FOR THE PHARMACEUTICAL INDUSTRY, IN CLASS 35 (U.S. CLS. 100, 101 AND 102).

SERVICE MARK

FIRST USE 10-1-2010; IN COMMERCE 10-1-2010.

PRINCIPAL REGISTER

THE MARK CONSISTS OF STANDARD CHARACTERS WITHOUT CLAIM TO ANY PARTICULAR FONT, STYLE, SIZE, OR COLOR.

SER. NO. 85-198,791, FILED 12-15-2010.

STEVEN JACKSON, EXAMINING ATTORNEY



David J. Kyffers

Director of the United States Patent and Trademark Office

United States of America

United States Patent and Trademark Office

LYVE

Reg. No. 4,097,978

Registered Feb. 14, 2012

Int. Cls.: 11, 37 and 40

TRADEMARK

SERVICE MARK

PRINCIPAL REGISTER

POINT SOURCE SOLUTIONS LIMITED (NEW ZEALAND COMPANY)
UNIT 2, 7 DONNELLY STREET
HAVELOCK NORTH, NEW ZEALAND

FOR: WATER TREATMENT SYSTEMS AND UNITS, NAMELY, WASTEWATER TREATMENT SYSTEMS AND UNITS; BIOLOGICAL WASTEWATER AND SEWERAGE TREATMENT SYSTEMS AND UNITS, IN CLASS 11 (U.S. CLS. 13, 21, 23, 31 AND 34).

FIRST USE 12-0-2007; IN COMMERCE 12-0-2007.

FOR: INSTALLATION, MAINTENANCE AND REPAIR OF WATER TREATMENT APPARATUS, EQUIPMENT, SYSTEMS AND UNITS, NAMELY, WASTEWATER TREATMENT APPARATUS, EQUIPMENT, SYSTEMS AND UNITS, SEPTIC TANKS, CONCRETE TANK STRUCTURES, PUMPS, FILTRATION AND PURIFICATION APPARATUS, FILTERS, APPARATUS FOR SEPARATING SOLID MATERIALS FROM LIQUIDS OR GASES, SKIMMERS, CLARIFIERS AND POLLUTANT TRAPS; ADVISORY AND CONSULTANCY SERVICES IN RELATION TO THE FOREGOING, IN CLASS 37 (U.S. CLS. 100, 103 AND 106).

FIRST USE 12-0-2007; IN COMMERCE 12-0-2007.

FOR: SUSTAINABLE ON-SITE WATER RECYCLING AND WASTEWATER TREATMENT SERVICES; WATER, WASTEWATER AND SEWERAGE FILTERING SERVICES, NAMELY, SEPARATING SOLID MATERIALS FROM AIR AND WATER, STERILIZATION, PURIFICATION, RECYCLING AND PROCESSING SERVICES, IN CLASS 40 (U.S. CLS. 100, 103 AND 106).

FIRST USE 12-0-2007; IN COMMERCE 12-0-2007.

THE MARK CONSISTS OF STANDARD CHARACTERS WITHOUT CLAIM TO ANY PARTICULAR FONT, STYLE, SIZE, OR COLOR.

SER. NO. 85-198,905, FILED 12-15-2010.

STEVEN JACKSON, EXAMINING ATTORNEY



David J. Kypos

Director of the United States Patent and Trademark Office

United States of America

United States Patent and Trademark Office



Reg. No. 4,097,979

Registered Feb. 14, 2012

Int. Cls.: 36 and 41

SERVICE MARK

PRINCIPAL REGISTER

SAVANNAH'S ORGANIC RANCH, INC. (CALIFORNIA NON-PROFIT CORPORATION)
SUITE 100
92 ARGONAUT
ALISO VIEJO, CA 92656

FOR: CHARITABLE FUNDRAISING SERVICES; CHARITABLE FUNDRAISING SERVICES IN CONNECTION WITH CANCER PREVENTION AND EDUCATION; CHARITABLE FUNDRAISING SERVICES IN CONNECTION WITH PLANTING GARDENS AND LANDSCAPING; CHARITABLE FUNDRAISING SERVICES IN CONNECTION WITH EDUCATING THE PUBLIC REGARDING ORGANIC GARDENING, ORGANIC FOODS AND NUTRITION, IN CLASS 36 (U.S. CLS. 100, 101 AND 102).

FIRST USE 8-0-2007; IN COMMERCE 8-0-2007.

FOR: EDUCATIONAL SERVICES, NAMELY, PROVIDING SEMINARS AND WORKSHOPS ON TOPICS RELATING TO CANCER, CANCER PREVENTION AND CANCER SURVIVAL AND DISTRIBUTING EDUCATIONAL MATERIALS IN CONNECTION THEREWITH; EDUCATIONAL SERVICES, NAMELY, PROVIDING SEMINARS AND WORKSHOPS ON THE TOPICS OF GARDENING, ORGANIC GARDENING AND LANDSCAPING AND DISTRIBUTING EDUCATIONAL MATERIALS IN CONNECTION THEREWITH; EDUCATIONAL SERVICES, NAMELY, PROVIDING SEMINARS AND WORKSHOPS ON THE TOPICS OF NUTRITION AND ORGANIC FOODS AND DISTRIBUTING EDUCATIONAL MATERIALS IN CONNECTION THEREWITH, IN CLASS 41 (U.S. CLS. 100, 101 AND 107).

FIRST USE 8-0-2007; IN COMMERCE 8-0-2007.

NO CLAIM IS MADE TO THE EXCLUSIVE RIGHT TO USE "ORGANIC", APART FROM THE MARK AS SHOWN.

THE NAME "SAVANNAH" REFERS TO A DECEASED INDIVIDUAL FOR WHOM THE MARK WAS ESTABLISHED AS A MEMORIAL.

THE MARK CONSISTS OF AN ILLUSTRATED BARN, ABOVE THE PHRASE "SAVANNAH'S ORGANIC RANCH", WITH AN ILLUSTRATED BUTTERFLY ABOVE THE WORD "ORGANIC", WITH A CURVED LINE RUNNING FROM THE BUTTERFLY AND UNDER THE TEXT PHRASE.



David J. Kyjars

Director of the United States Patent and Trademark Office

Reg. No. 4,097,979 SER. NO. 85-198,918, FILED 12-15-2010.

PAUL F. GAST, EXAMINING ATTORNEY

United States of America

United States Patent and Trademark Office

CIC PLUS

Reg. No. 4,097,980

Registered Feb. 14, 2012

Int. Cls.: 35 and 42

SERVICE MARK

PRINCIPAL REGISTER

CIC PLUS, INC. (INDIANA CORPORATION)
7321 RIDGEWAY AVENUE
SKOKIE, IL 60076

FOR: BUSINESS PROCESS OUTSOURCING SERVICES IN THE FIELD OF EMPLOYEE TAX FORM PREPARATION AND MANAGEMENT; BUSINESS PROCESS OUTSOURCING SERVICES IN THE FIELD OF PAYROLL AND PAY STUB INFORMATION AND MANAGEMENT; BUSINESS PROCESS OUTSOURCING SERVICES IN THE FIELD OF HUMAN RESOURCES AND EMPLOYEE FORMS MANAGEMENT, IN CLASS 35 (U.S. CLS. 100, 101 AND 102).

FIRST USE 9-0-1999; IN COMMERCE 9-0-1999.

FOR: DATA WAREHOUSING IN CONNECTION WITH BUSINESS PROCESS OUTSOURCING SERVICES IN THE FIELDS OF TAX FORM PREPARATION AND MANAGEMENT, PAYROLL AND PAY STUB INFORMATION AND MANAGEMENT, AND HUMAN RESOURCES AND FORMS MANAGEMENT; PROVIDING A DEDICATED WEBSITE OR PORTAL THAT GIVES AUTHORIZED USERS THE ABILITY TO ACCESS AND MANAGE SECURE INFORMATION RELATING TO THEIR OWN TAX FORMS, PAYROLL, PAY STUBS, AND FORMS AND POLICIES RELATING TO THE HIRING AND MANAGEMENT OF EMPLOYEES, IN CLASS 42 (U.S. CLS. 100 AND 101).

FIRST USE 9-0-1999; IN COMMERCE 9-0-1999.

THE MARK CONSISTS OF STANDARD CHARACTERS WITHOUT CLAIM TO ANY PARTICULAR FONT, STYLE, SIZE, OR COLOR.

SER. NO. 85-199,077, FILED 12-15-2010.

JENNIFER VASQUEZ, EXAMINING ATTORNEY



David J. Kypos

Director of the United States Patent and Trademark Office

United States of America

United States Patent and Trademark Office

METALSMITHS STERLING

Reg. No. 4,097,981

Registered Feb. 14, 2012

Int. Cl.: 14

TRADEMARK

PRINCIPAL REGISTER

1400446 ALBERTA LTD. (CANADA CORPORATION)
SUITE 200
17410 - 107 AVENUE
EDMONTON, ALBERTA, CANADA T5S1E9

FOR: JEWELRY, NAMELY, STERLING SILVER JEWELRY IN THE NATURE OF RINGS, EARRINGS, CHARMS, BRACELETS, BANGLES, RING BANDS, NECKLACES, PENDANTS, PINS, BROOCHES, AND BODY JEWELRY, WITH OR WITHOUT BEADS, PEARLS, AND PRECIOUS AND SEMI-PRECIOUS GEMSTONES; WATCHES MADE OF STERLING SILVER, IN CLASS 14 (U.S. CLS. 2, 27, 28 AND 50).

FIRST USE 12-1-2009; IN COMMERCE 12-1-2009.

OWNER OF U.S. REG. NOS. 2,794,547, 2,951,247, AND 3,207,296.

NO CLAIM IS MADE TO THE EXCLUSIVE RIGHT TO USE "STERLING", APART FROM THE MARK AS SHOWN.

THE MARK CONSISTS OF THE WORD "METALSMITHS" WITH THE WORD "STERLING" UNDERNEATH, ALL IN STYLIZED FONT.

SEC. 2(F) AS TO "METALSMITHS".

SER. NO. 85-199,253, FILED 12-16-2010.

RONALD DELGIZZI, EXAMINING ATTORNEY



David J. Kyffers

Director of the United States Patent and Trademark Office

United States of America

United States Patent and Trademark Office

SAVANNAH'S ORGANIC RANCH

Reg. No. 4,097,982

Registered Feb. 14, 2012

Int. Cls.: 36 and 41

SERVICE MARK

PRINCIPAL REGISTER

SAVANNAH'S ORGANIC RANCH, INC. (CALIFORNIA NON-PROFIT CORPORATION)
SUITE 100
92 ARGONAUT
ALISO VIEJO, CA 92656

FOR: CHARITABLE FUNDRAISING SERVICES; CHARITABLE FUNDRAISING SERVICES IN CONNECTION WITH CANCER PREVENTION AND EDUCATION; CHARITABLE FUNDRAISING SERVICES IN CONNECTION WITH PLANTING GARDENS AND LANDSCAPING; CHARITABLE FUNDRAISING SERVICES IN CONNECTION WITH EDUCATING THE PUBLIC REGARDING ORGANIC GARDENING, ORGANIC FOODS AND NUTRITION, IN CLASS 36 (U.S. CLS. 100, 101 AND 102).

FIRST USE 6-0-2007; IN COMMERCE 6-0-2007.

FOR: EDUCATIONAL SERVICES, NAMELY, PROVIDING SEMINARS AND WORKSHOPS ON TOPICS RELATING TO CANCER, CANCER PREVENTION AND CANCER SURVIVAL AND DISTRIBUTING EDUCATIONAL MATERIALS IN CONNECTION THEREWITH; EDUCATIONAL SERVICES, NAMELY, PROVIDING SEMINARS AND WORKSHOPS ON THE TOPICS OF GARDENING, ORGANIC GARDENING AND LANDSCAPING AND DISTRIBUTING EDUCATIONAL MATERIALS IN CONNECTION THEREWITH; EDUCATIONAL SERVICES, NAMELY, PROVIDING SEMINARS AND WORKSHOPS ON THE TOPICS OF NUTRITION AND ORGANIC FOODS AND DISTRIBUTING EDUCATIONAL MATERIALS IN CONNECTION THEREWITH, IN CLASS 41 (U.S. CLS. 100, 101 AND 107).

FIRST USE 6-0-2007; IN COMMERCE 6-0-2007.

THE MARK CONSISTS OF STANDARD CHARACTERS WITHOUT CLAIM TO ANY PARTICULAR FONT, STYLE, SIZE, OR COLOR.

NO CLAIM IS MADE TO THE EXCLUSIVE RIGHT TO USE "ORGANIC", APART FROM THE MARK AS SHOWN.

THE NAME "SAVANNAH" REFERS TO A DECEASED INDIVIDUAL FOR WHOM THE MARK WAS ESTABLISHED AS A MEMORIAL.

SER. NO. 85-199,385, FILED 12-16-2010.



David J. Kyffers

Director of the United States Patent and Trademark Office

Reg. No. 4,097,982 PAUL F. GAST, EXAMINING ATTORNEY

United States of America

United States Patent and Trademark Office



Reg. No. 4,097,983

Registered Feb. 14, 2012

Int. Cl.: 28

TRADEMARK

PRINCIPAL REGISTER

MAX PRECISION AEROSPACE, LLC (COLORADO LIMITED LIABILITY COMPANY), DBA
MAX PRECISION AEROSPACE
2310 BOBWHITE LANE
LONGMONT, CO 80504

FOR: TOY ROCKETS, IN CLASS 28 (U.S. CLS. 22, 23, 38 AND 50).

FIRST USE 6-30-2010; IN COMMERCE 6-30-2010.

THE MARK CONSISTS OF THE WORDS "MAX PRECISION AEROSPACE" IN CONCENTRIC OVALS WITH EACH WORD ON TOP OF THE NEXT AND WITH "MAX" SEPARATED FROM "PRECISION AEROSPACE" BY AN ARC WITH A SMALL CIRCLE IN THE MIDDLE OF IT AND ALL WORDS IN STYLIZED FONT.

SER. NO. 85-199,735, FILED 12-16-2010.

ANDREA BUTLER, EXAMINING ATTORNEY



David J. Kybas

Director of the United States Patent and Trademark Office

United States of America

United States Patent and Trademark Office



MEXICOSHOWROOM

Reg. No. 4,097,984

Registered Feb. 14, 2012

Int. Cl.: 35

SERVICE MARK

PRINCIPAL REGISTER

SERVICIOS ESPECIALIZADOS MEXICO SHOWROOM S.A. DE C.V (MEXICO CORPORATION)
PASEO DE LOS TAMARINDOS 400 B PISO 30,
MEXICO, D.F., MEXICO 05120

FOR: PROVIDING A REAL ESTATE WEBSITE WHICH PROMOTES MEXICAN REAL ESTATE DEVELOPMENTS, IN CLASS 35 (U.S. CLS. 100, 101 AND 102).

FIRST USE 10-10-2010; IN COMMERCE 10-10-2010.

NO CLAIM IS MADE TO THE EXCLUSIVE RIGHT TO USE "MEXICOSHOWROOM", APART FROM THE MARK AS SHOWN.

THE COLOR(S) GREEN, YELLOW AND RED IS/ARE CLAIMED AS A FEATURE OF THE MARK.

THE MARK CONSISTS OF TWO RECTANGULAR BLOCKS SIDE BY SIDE ON END TAPERED SYMMETRICALLY AT THE TOP WITH RED, YELLOW AND GREEN COLORS FROM TOP TO BOTTOM AND THE WORD "MEXICOSHOWROOM" IN GREEN LETTERS UNDERNEATH THE RECTANGULAR BLOCKS.

SER. NO. 85-200,100, FILED 12-16-2010.

MARIA-VICTORIA SUAREZ, EXAMINING ATTORNEY



David J. Kybas

Director of the United States Patent and Trademark Office

United States of America

United States Patent and Trademark Office



Reg. No. 4,097,985

Registered Feb. 14, 2012

Int. Cls.: 35 and 36

SERVICE MARK

PRINCIPAL REGISTER

INTRINSIC VALUE INVESTORS (IVI) LLP (UNITED KINGDOM LIMITED LIABILITY PARTNERSHIP)
42-44 PORTMAN ROAD, READING
BERKSHIRE RG30 1EA, UNITED KINGDOM

FOR: BUSINESS MANAGEMENT; BUSINESS ADMINISTRATION; PROVIDING OFFICE FUNCTIONS; BUSINESS ORGANIZATION AND BUSINESS ECONOMICS CONSULTANCY; INTERIM BUSINESS MANAGEMENT; BUSINESS MANAGEMENT CONSULTANCY SERVICES, NAMELY, MANAGING COMMERCIAL PROJECTS FOR BUSINESS PURPOSES; BUSINESS MANAGEMENT OF COMPANIES, ENTERPRISES, INSTITUTIONS AND ORGANIZATIONS, IN CLASS 35 (U.S. CLS. 100, 101 AND 102).

FIRST USE 1-19-2006; IN COMMERCE 1-21-2006.

FOR: FINANCIAL AFFAIRS, NAMELY, FINANCIAL INFORMATION, MANAGEMENT AND ANALYSIS SERVICES; INVESTMENT MANAGEMENT; FINANCIAL ANALYSIS AND BUDGET ESTIMATE PLANNING; FINANCIAL ADVICE AND CONSULTANCY SERVICES; FISCAL VALUATIONS CONSULTATION; FINANCIAL ASSET MANAGEMENT IN THE FIELD OF SECURITIES, PUBLICLY-LISTED INVESTMENT FUNDS, AND SEPARATELY MANAGED CLIENT ACCOUNTS; FINANCIAL MANAGEMENT OF COMPANIES, ENTERPRISES AND INSTITUTIONS, IN CLASS 36 (U.S. CLS. 100, 101 AND 102).

FIRST USE 1-19-2006; IN COMMERCE 1-21-2006.

NO CLAIM IS MADE TO THE EXCLUSIVE RIGHT TO USE "INVESTORS", APART FROM THE MARK AS SHOWN.

THE COLOR(S) BLUE AND GRAY IS/ARE CLAIMED AS A FEATURE OF THE MARK.

THE MARK CONSISTS OF AN IMAGE OF THREE V-LIKE SHAPES POSITIONED NEXT TO EACH OTHER, NOT TOUCHING, TO FORM A SEMI-CIRCLE. THE FIRST, GRAY-COLORED, SHAPE LIES ON ITS SIDE, THE OPENING OF THE SHAPE FACING LEFT, AND WITH THE UPPER PART OF THE SHAPE FORMING AN "I"; THE SECOND, BLUE-COLORED, SHAPE IS IN THE CENTER WITH THE OPENING OF THE SHAPE FACING UPWARD, FORMING A "V"; THE THIRD, GRAY-COLORED, SHAPE LIES ON ITS SIDE, THE OPENING OF THE SHAPE FACING RIGHT, AND WITH THE UPPER PART OF THE SHAPE FORMING AN "I"; BENEATH THE IMAGE, PRINTED IN BLUE UPPERCASE LETTERS ARE THE



David J. Kyffers

Director of the United States Patent and Trademark Office

Reg. No. 4,097,985 WORDS "INTRINSIC", "VALUE" AND "INVESTORS", EACH WORD PLACED ONE ABOVE THE OTHER WITH A SOLID GRAY LINE PLACED BENEATH THE WORDS "INTRINSIC" AND "VALUE".

SEC. 2(F) AS TO "INTRINSIC VALUE INVESTORS".

SER. NO. 85-200,580, FILED 12-17-2010.

SIMON TENG, EXAMINING ATTORNEY

United States of America

United States Patent and Trademark Office



Reg. No. 4,097,986

Registered Feb. 14, 2012

Int. Cl.: 29

TRADEMARK

PRINCIPAL REGISTER

BEN E. KEITH COMPANY (TEXAS CORPORATION)
601 EAST SEVENTH STREET
FORT WORTH, TX 76102

FOR: BEEF, PORK, POULTRY, LAMB, VEAL, DUCK, GAME HENS, IN CLASS 29 (U.S. CL. 46).

FIRST USE 11-15-2010; IN COMMERCE 11-15-2010.

THE MARK CONSISTS OF THE NAME "KEITH" IN BLACK WITH LIGHT GREEN SHADING, ABOVE THREE TREES; ONE WHITE WITH A LIGHT GREEN OUTLINE AND A GREY TRUNK, ONE GREEN WITH A DARKER GREEN OUTLINE AND A GREY TRUNK, AND ONE GREY WITH NO OUTLINE. THE TREE DESIGN APPEARS OVER A LIGHT GREEN RIBBON DESIGN REPRESENTING GRASS OVER THE BLACK WORD "VALLEY" INSIDE A GREEN LONG RECTANGULAR CURVED BOX WITH A WHITE AND LIGHT GREEN BORDER.

THE COLOR(S) LIGHT GREEN, DARK GREEN, BLACK, GREY AND WHITE IS/ARE CLAIMED AS A FEATURE OF THE MARK.

SER. NO. 85-200,916, FILED 12-17-2010.

JEFFERY COWARD, EXAMINING ATTORNEY



David J. Kybas

Director of the United States Patent and Trademark Office

United States of America

United States Patent and Trademark Office

CORTERA CPR PULSE

Reg. No. 4,097,987

Registered Feb. 14, 2012

Int. Cls.: 35 and 36

SERVICE MARK

PRINCIPAL REGISTER

CORTERA, INC. (DELAWARE CORPORATION)
SUITE 500
777 YAMATO ROAD
BOCA RATON, FL 33431

FOR: ONLINE BUSINESS INFORMATION SERVICES, NAMELY, PROVIDING AN ONLINE SYSTEM THAT MONITORS INFORMATION RELATING TO THE OPERATIONAL STATUS OF COMPANIES AND ENTITIES AND DELIVERS TO SUBSCRIBERS UPDATES, ALERTS AND NOTIFICATIONS OF CHANGES IN THE OPERATIONAL STATUS OF THOSE COMPANIES AND ENTITIES, IN CLASS 35 (U.S. CLS. 100, 101 AND 102).

FIRST USE 5-30-2009; IN COMMERCE 5-30-2009.

FOR: PROVIDING AN ONLINE SYSTEM THAT MONITORS INFORMATION RELATING TO THE FINANCIAL STATUS OF COMPANIES AND ENTITIES FEATURING CREDIT REPORTING, BUSINESS CREDIT INFORMATION, AND FINANCIAL INFORMATION AND DELIVERS TO SUBSCRIBERS UPDATES, ALERTS AND NOTIFICATIONS OF CHANGES IN THE FINANCIAL STATUS OF THOSE COMPANIES AND ENTITIES, IN CLASS 36 (U.S. CLS. 100, 101 AND 102).

FIRST USE 5-30-2009; IN COMMERCE 5-30-2009.

THE MARK CONSISTS OF STANDARD CHARACTERS WITHOUT CLAIM TO ANY PARTICULAR FONT, STYLE, SIZE, OR COLOR.

OWNER OF U.S. REG. NOS. 3,628,419, 3,737,588, AND 3,798,241.

SER. NO. 85-201,270, FILED 12-18-2010.

EMILY CHUO, EXAMINING ATTORNEY



David J. Kybas

Director of the United States Patent and Trademark Office

United States of America

United States Patent and Trademark Office

IT'S BETTER TO GIVE AND RECEIVE

Reg. No. 4,097,988

LANDRY'S TRADEMARK, INC. (DELAWARE CORPORATION)
1510 WEST LOOP SOUTH
HOUSTON, TX 77027

Registered Feb. 14, 2012

Int. Cl.: 43

FOR: RESTAURANT AND BAR SERVICES, IN CLASS 43 (U.S. CLS. 100 AND 101).

SERVICE MARK

FIRST USE 9-0-2009; IN COMMERCE 9-0-2009.

PRINCIPAL REGISTER

THE MARK CONSISTS OF STANDARD CHARACTERS WITHOUT CLAIM TO ANY PARTICULAR FONT, STYLE, SIZE, OR COLOR.

SER. NO. 85-201,531, FILED 12-20-2010.

BARNEY CHARLON, EXAMINING ATTORNEY



David J. Kyffers

Director of the United States Patent and Trademark Office

United States of America

United States Patent and Trademark Office

COLLĒGIX

Reg. No. 4,097,989

APTRON CORPORATION (NEW JERSEY CORPORATION)
25 HANOVER ROAD

Registered Feb. 14, 2012

FLORHAM PARK, NJ 07932

Int. Cl.: 9

FOR: COMPUTER SOFTWARE FOR USE IN DATA PROCESSING, ADMINISTRATIVE INFORMATION SYSTEMS, AND ENTERPRISE RESOURCE PLANNING FOR SCHOOLS, COLLEGES, AND UNIVERSITIES, IN CLASS 9 (U.S. CLS. 21, 23, 26, 36 AND 38).

TRADEMARK

FIRST USE 1-13-2010; IN COMMERCE 1-13-2010.

PRINCIPAL REGISTER

THE MARK CONSISTS OF STANDARD CHARACTERS WITHOUT CLAIM TO ANY PARTICULAR FONT, STYLE, SIZE, OR COLOR.

SER. NO. 85-201,679, FILED 12-20-2010.

WARREN L. OLANDRIA, EXAMINING ATTORNEY



David J. Kyffers

Director of the United States Patent and Trademark Office

United States of America

United States Patent and Trademark Office

MODERN APIZZA

Reg. No. 4,097,990

MODERN APIZZA, INC. (CONNECTICUT CORPORATION)
874 STATE STREET
NEW HAVEN, CT 06511

Registered Feb. 14, 2012

Int. Cl.: 43

FOR: RESTAURANT SERVICES, IN CLASS 43 (U.S. CLS. 100 AND 101).

SERVICE MARK

FIRST USE 0-0-1947; IN COMMERCE 0-0-1947.

PRINCIPAL REGISTER

THE MARK CONSISTS OF STANDARD CHARACTERS WITHOUT CLAIM TO ANY PARTICULAR FONT, STYLE, SIZE, OR COLOR.

NO CLAIM IS MADE TO THE EXCLUSIVE RIGHT TO USE "APIZZA", APART FROM THE MARK AS SHOWN.

SER. NO. 85-201,754, FILED 12-20-2010.

JANICE L. MCMORROW, EXAMINING ATTORNEY



David J. Kyffers

Director of the United States Patent and Trademark Office

United States of America

United States Patent and Trademark Office

Stroz Review

Reg. No. 4,097,991

STROZ FRIEDBERG, LLC (NEW YORK LIMITED LIABILITY COMPANY)
32 AVENUE OF THE AMERICAS, 4TH FLOOR
NEW YORK, NY 10013

Registered Feb. 14, 2012

Int. Cls.: 39 and 42

FOR: ELECTRONIC STORAGE OF FILES AND DOCUMENTS, IN CLASS 39 (U.S. CLS. 100 AND 105).

SERVICE MARK

FIRST USE 2-6-2009; IN COMMERCE 2-6-2009.

PRINCIPAL REGISTER

FOR: CONDUCTING ELECTRONIC DISCOVERY SERVICES VIA GLOBAL COMPUTER NETWORKS FOR LAWYERS AND CORPORATIONS; ELECTRONIC LEGAL DISCOVERY CONSULTING SERVICES, IN CLASS 42 (U.S. CLS. 100 AND 101).

FIRST USE 2-6-2009; IN COMMERCE 2-6-2009.

THE MARK CONSISTS OF STANDARD CHARACTERS WITHOUT CLAIM TO ANY PARTICULAR FONT, STYLE, SIZE, OR COLOR.

SER. NO. 85-201,883, FILED 12-20-2010.

JEAN IM, EXAMINING ATTORNEY



David J. Kybas

Director of the United States Patent and Trademark Office

United States of America

United States Patent and Trademark Office

SERIES 2000

Reg. No. 4,097,992

MTD PRODUCTS INC (DELAWARE CORPORATION)
5903 GRAFTON ROAD
VALLEY CITY, OH 44280

Registered Feb. 14, 2012

Int. Cl.: 12

FOR: LAWN AND GARDEN TRACTORS, IN CLASS 12 (U.S. CLS. 19, 21, 23, 31, 35 AND 44).

TRADEMARK

FIRST USE 4-0-1993; IN COMMERCE 4-0-1993.

PRINCIPAL REGISTER

THE MARK CONSISTS OF STANDARD CHARACTERS WITHOUT CLAIM TO ANY PARTICULAR FONT, STYLE, SIZE, OR COLOR.

OWNER OF U.S. REG. NO. 2,375,941.

NO CLAIM IS MADE TO THE EXCLUSIVE RIGHT TO USE "SERIES", APART FROM THE MARK AS SHOWN.

SER. NO. 85-201,968, FILED 12-20-2010.

ALLISON SCHRODY, EXAMINING ATTORNEY



David J. Kybas

Director of the United States Patent and Trademark Office

United States of America

United States Patent and Trademark Office

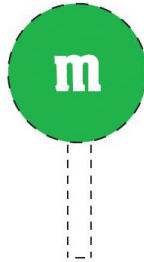

Reg. No. 4,097,993

Registered Feb. 14, 2012

Int. Cl.: 30

TRADEMARK

PRINCIPAL REGISTER

MARS, INCORPORATED (DELAWARE CORPORATION)
6885 ELM STREET
MCLEAN, VA 221013883

FOR: ICE CREAM BARS, IN CLASS 30 (U.S. CL. 46).

FIRST USE 2-0-2008; IN COMMERCE 2-0-2008.

THE MARK CONSISTS OF A STYLIZED LETTER "M" IN WHITE APPLIED TO THE SURFACE OF AN ICE CREAM BAR, WITH THE COLOR GREEN APPLIED TO THE SURFACE OF THE ICE CREAM BAR. THE MATTER SHOWN IN BROKEN OR DOTTED LINES IS NOT PART OF THE MARK AND SERVES ONLY TO SHOW THE POSITION OR PLACEMENT OF THE MARK.

THE COLOR(S) GREEN AND WHITE IS/ARE CLAIMED AS A FEATURE OF THE MARK.

SER. NO. 85-202,022, FILED 12-20-2010.

ALICE BENMAMAN, EXAMINING ATTORNEY



David J. Kyffers

Director of the United States Patent and Trademark Office

United States of America

United States Patent and Trademark Office

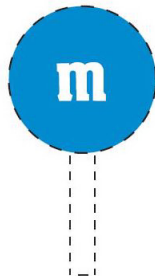

Reg. No. 4,097,994

Registered Feb. 14, 2012

Int. Cl.: 30

TRADEMARK

PRINCIPAL REGISTER

MARS, INCORPORATED (DELAWARE CORPORATION)
6885 ELM STREET
MCLEAN, VA 221013883

FOR: ICE CREAM BARS, IN CLASS 30 (U.S. CL. 46).

FIRST USE 2-0-2008; IN COMMERCE 2-0-2008.

THE MARK CONSISTS OF A STYLIZED LETTER "M" IN WHITE APPLIED TO THE SURFACE OF AN ICE CREAM BAR, WITH THE COLOR BLUE APPLIED TO THE SURFACE OF THE ICE CREAM BAR. THE MATTER SHOWN IN BROKEN OR DOTTED LINES IS NOT PART OF THE MARK AND SERVES ONLY TO SHOW THE POSITION OR PLACEMENT OF THE MARK.

THE COLOR(S) BLUE AND WHITE IS/ARE CLAIMED AS A FEATURE OF THE MARK.

SER. NO. 85-202,039, FILED 12-20-2010.

ALICE BENMAMAN, EXAMINING ATTORNEY



David J. Kybas

Director of the United States Patent and Trademark Office

United States of America

United States Patent and Trademark Office

HHU

Reg. No. 4,097,995

Registered Feb. 14, 2012

Int. Cl.: 11

TRADEMARK

PRINCIPAL REGISTER

SAFEWAY HYGIENE SERVICES LIMITED (UNITED KINGDOM LIMITED COMPANY
(LTD.))
14 ROCKLIFFE AVENUE
BATH, UNITED KINGDOM BA26QP

FOR: AUTOMATED HAND WASHING APPARATUS WITH FAUCET AND SINK; TOUCH-
LESS HAND CLEANING APPARATUS; TOUCHLESS HAND DRYING APPARATUS; PARTS
AND FITTINGS FOR THE AFORESAID GOODS, IN CLASS 11 (U.S. CLS. 13, 21, 23, 31 AND
34).

THE MARK CONSISTS OF STANDARD CHARACTERS WITHOUT CLAIM TO ANY PAR-
TICULAR FONT, STYLE, SIZE, OR COLOR.

PRIORITY CLAIMED UNDER SEC. 44(D) ON ERPN CMNTY TM OFC APPLICATION NO.
009607946, FILED 12-17-2010, REG. NO. 009607946, DATED 5-27-2011, EXPIRES 5-27-2021.

SER. NO. 85-202,071, FILED 12-20-2010.

ANGELA M. MICHELI, EXAMINING ATTORNEY



David J. Kybas

Director of the United States Patent and Trademark Office

United States of America

United States Patent and Trademark Office



Reg. No. 4,097,996

Registered Feb. 14, 2012

Int. Cl.: 9

TRADEMARK

PRINCIPAL REGISTER

CHILDREN'S NATIONAL MEDICAL CENTER (D.C. NON-PROFIT CORPORATION)
111 MICHIGAN AVE., N.W.
WASHINGTON, DC 20010

FOR: PRERECORDED DVDS PROMOTING HOME SAFETY AWARENESS AND INJURY PREVENTION; DOWNLOADABLE VIDEOS PROMOTING HOME SAFETY AWARENESS AND INJURY PREVENTION, IN CLASS 9 (U.S. CLS. 21, 23, 26, 36 AND 38).

FIRST USE 10-1-2005; IN COMMERCE 10-1-2005.

OWNER OF U.S. REG. NOS. 3,025,260 AND 3,038,940.

NO CLAIM IS MADE TO THE EXCLUSIVE RIGHT TO USE "COUNCIL", APART FROM THE MARK AS SHOWN.

THE MARK CONSISTS OF THE WORDS "HOME SAFETY COUNCIL" UNDER A HOUSE WITH A MAN, WOMAN, AND CHILD THE CARICATURES FORM AND THE FORMS OF THE MAN AND WOMAN MAKING A HEART.

SEC. 2(F) AS TO "HOME SAFETY".

SER. NO. 85-202,523, FILED 12-21-2010.

FLORENTINA BLANDU, EXAMINING ATTORNEY



David J. Kybas

Director of the United States Patent and Trademark Office

United States of America

United States Patent and Trademark Office

Isis Taylor

Reg. No. 4,097,997

Registered Feb. 14, 2012

Int. Cl.: 41

SERVICE MARK

PRINCIPAL REGISTER

BAKER, ASRIELA (UNITED STATES INDIVIDUAL), AKA ISIS TAYLOR
#15
256 SOUTH ROBERTSON STREET
BEVERLY HILLS, CA 90211

FOR: ENTERTAINMENT SERVICES IN THE NATURE OF LIVE ACTING, DANCING PERFORMANCES AND MODELING FOR ADULT PERFORMANCES AND PUBLIC PERFORMANCES OF A STAR OF ADULT MOVIES; ENTERTAINMENT SERVICES, NAMELY, PROVIDING ADULT ENTERTAINMENT VISUAL IMAGES AND LIVE ADULT ORIENTED ENTERTAINMENT VIA A GLOBAL COMPUTER NETWORK; ENTERTAINMENT SERVICES, NAMELY, LIVE AND RECORDED ADULT ENTERTAINMENT PERFORMANCES VIA BROADCAST TELEVISION, SATELLITE, CABLE, RADIO, BROADBAND AND GLOBAL COMPUTER NETWORKS, IN CLASS 41 (U.S. CLS. 100, 101 AND 107).

FIRST USE 8-19-2008; IN COMMERCE 3-26-2009.

THE MARK CONSISTS OF STANDARD CHARACTERS WITHOUT CLAIM TO ANY PARTICULAR FONT, STYLE, SIZE, OR COLOR.

THE NAME(S), PORTRAIT(S), AND/OR SIGNATURE(S) SHOWN IN THE MARK IDENTIFIES ASRIELA BAKER, WHOSE CONSENT(S) TO REGISTER IS MADE OF RECORD.

SER. NO. 85-202,697, FILED 12-21-2010.

DAVID ELTON, EXAMINING ATTORNEY



David J. Kyfos

Director of the United States Patent and Trademark Office

United States of America

United States Patent and Trademark Office

UNIVERSAL HAPKIDO ASSOCIATION

Reg. No. 4,097,998

Registered Feb. 14, 2012

Int. Cl.: 41

SERVICE MARK

PRINCIPAL REGISTER

CHOI, JUNG KI (REPUBLIC OF KOREA INDIVIDUAL)
3603 WINSTROME CT.
KATY, TX 77449 AND

CHOI, WHAN KI (UNITED STATES INDIVIDUAL)
3603 WINSTROME CT.
KATY, TX 77449

FOR: OPERATING OF MARTIAL ARTS' SCHOOLS; ORGANIZING LIVE MIXED MARTIAL ARTS EVENTS AND COMPETITIONS; PRESENTATION OF MIXED MARTIAL ARTS (MMA) EVENTS; PROVIDING CLASSES, WORKSHOPS, SEMINARS AND CAMPS IN THE FIELDS OF FITNESS, EXERCISE, BOXING, KICK BOXING AND MIXED MARTIAL ARTS; PROVIDING GENERAL FITNESS AND MIXED MARTIAL ARTS FACILITIES THAT REQUIRE MEMBERSHIPS AND ARE FOCUSED IN THE FIELDS OF GENERAL FITNESS, EXERCISE, AND MIXED MARTIAL ARTS, IN CLASS 41 (U.S. CLS. 100, 101 AND 107).

FIRST USE 1-1-1973; IN COMMERCE 1-1-1973.

THE MARK CONSISTS OF STANDARD CHARACTERS WITHOUT CLAIM TO ANY PARTICULAR FONT, STYLE, SIZE, OR COLOR.

NO CLAIM IS MADE TO THE EXCLUSIVE RIGHT TO USE "HAPKIDO ASSOCIATION", APART FROM THE MARK AS SHOWN.

SER. NO. 85-202,704, FILED 12-21-2010.

JOHN SCHUYLER YARD, EXAMINING ATTORNEY



David J. Kyros

Director of the United States Patent and Trademark Office

United States of America

United States Patent and Trademark Office

Elegant Eraser

Reg. No. 4,097,999

HESS ENVIRONMENTAL, LLC (OKLAHOMA LIMITED LIABILITY COMPANY)
12350 COYOTE TRAIL
EDMOND, OK 73034

Registered Feb. 14, 2012

Int. Cl.: 16

FOR: DECORATIVELY FRAMED DRY ERASE BOARDS THAT CAN BE PLACED VERTICALLY OR HORIZONTALLY ON COUNTER-TOPS, MAGNETICALLY ATTACHED TO REFRIGERATORS, OR ATTACHED TO WALLS WITH ADHESIVE, IN CLASS 16 (U.S. CLS. 2, 5, 22, 23, 29, 37, 38 AND 50).

TRADEMARK

PRINCIPAL REGISTER

FIRST USE 3-14-2009; IN COMMERCE 6-1-2009.

THE MARK CONSISTS OF STANDARD CHARACTERS WITHOUT CLAIM TO ANY PARTICULAR FONT, STYLE, SIZE, OR COLOR.

NO CLAIM IS MADE TO THE EXCLUSIVE RIGHT TO USE "ERASER", APART FROM THE MARK AS SHOWN.

SER. NO. 85-202,773, FILED 12-21-2010.

DAVID ELTON, EXAMINING ATTORNEY



David J. Kyros

Director of the United States Patent and Trademark Office

United States of America

United States Patent and Trademark Office

Made Again in the USA!

Reg. No. 4,098,000

GILMAN, RALPH (UNITED STATES INDIVIDUAL)
2412 APPELY WAY
SAN JOSE, CA 95124

Registered Feb. 14, 2012

Int. Cl.: 41

FOR: ENTERTAINMENT SERVICES, NAMELY, AN ON-GOING SERIES FEATURING DOCUMENTARIES ON HOW TO BRING MANUFACTURING BACK TO THE USA PROVIDED THROUGH TELEVISION, WEBCASTS, PRINT, RADIO BROADCASTS, IN CLASS 41 (U.S. CLS. 100, 101 AND 107).

SERVICE MARK

PRINCIPAL REGISTER

FIRST USE 12-1-2010; IN COMMERCE 12-1-2010.

THE MARK CONSISTS OF STANDARD CHARACTERS WITHOUT CLAIM TO ANY PARTICULAR FONT, STYLE, SIZE, OR COLOR.

SER. NO. 85-202,946, FILED 12-21-2010.

AISHA SALEM, EXAMINING ATTORNEY



David J. Kyffers

Director of the United States Patent and Trademark Office

United States of America

United States Patent and Trademark Office

FERRERO MOMENTS

Reg. No. 4,098,001

SOREMARTEC S.A. (BELGIUM CORPORATION)

Registered Feb. 14, 2012

RUE JOSEPH NETZER, 5
ARLON, BELGIUM 6700

Int. Cl.: 30

FOR: CANDY, IN CLASS 30 (U.S. CL. 46).

TRADEMARK

THE MARK CONSISTS OF STANDARD CHARACTERS WITHOUT CLAIM TO ANY PARTICULAR FONT, STYLE, SIZE, OR COLOR.

PRINCIPAL REGISTER

OWNER OF BENELUX REG. NO. 518252, DATED 2-1-1993, EXPIRES 6-19-2012.

OWNER OF U.S. REG. NOS. 2,637,970, 3,570,145 AND OTHERS.

SER. NO. 85-203,161, FILED 12-21-2010.

REBECCA EISINGER, EXAMINING ATTORNEY



David J. Kyffers

Director of the United States Patent and Trademark Office

United States of America

United States Patent and Trademark Office



OUTRIGGER

Reg. No. 4,098,002

OUTRIGGER HOTELS HAWAII (HAWAII LIMITED PARTNERSHIP)
2375 KUHIO AVENUE
HONOLULU, HI 96815

Registered Feb. 14, 2012

Int. Cl.: 43

FOR: PROVIDING TEMPORARY ACCOMMODATIONS; HOTEL AND MOTEL SERVICES; RESORT LODGING SERVICES; RESERVATION SERVICES FOR TEMPORARY ACCOMMODATIONS; HOTEL AND TEMPORARY ACCOMMODATION INFORMATION SERVICES, IN CLASS 43 (U.S. CLS. 100 AND 101).

SERVICE MARK

PRINCIPAL REGISTER

FIRST USE 8-0-1987; IN COMMERCE 8-0-1987.

OWNER OF U.S. REG. NOS. 1,562,706, 2,045,381 AND OTHERS.

THE MARK CONSISTS OF A CIRCULAR DESIGN OF A SAIL ON WATER OVER THE WORD "OUTRIGGER".

SER. NO. 85-203,434, FILED 12-21-2010.

NICHOLAS COLEMAN, EXAMINING ATTORNEY



David J. Kyffers

Director of the United States Patent and Trademark Office

United States of America

United States Patent and Trademark Office



Reg. No. 4,098,003

Registered Feb. 14, 2012

Int. Cl.: 37

SERVICE MARK

PRINCIPAL REGISTER

INTEGRA REMODELING & CONSTRUCTION INCORPORATED (OREGON CORPORATION),
DBA INTEGRA CONSTRUCTION GROUP
7983 SW CIRRUS DRIVE
BEAVERTON, OR 97008

FOR: BUILDING CONSTRUCTION; BUILDING CONSTRUCTION AND REPAIR; BUILDING CONSTRUCTION SERVICES; BUILDING CONSTRUCTION SUPERVISION; BUILDING CONSTRUCTION, REMODELING AND REPAIR; CARPENTRY CONTRACTOR SERVICES; CONSTRUCTING DECKS; CONSTRUCTING PORCHES; CONSTRUCTING SUNROOMS; CONSTRUCTION AND INSTALLATION OF MASONRY WALLS AND STRUCTURES; CONSTRUCTION AND RENOVATION OF BUILDINGS; CONSTRUCTION AND REPAIR OF BUILDINGS; CONSTRUCTION OF BUILDINGS; CONSTRUCTION PLANNING; CONSTRUCTION PROJECT MANAGEMENT SERVICES; CONSTRUCTION SERVICES, NAMELY, PLANNING, LAYING OUT AND CUSTOM CONSTRUCTION OF COMMERCIAL BUILDINGS; CONSTRUCTION SUPERVISION; CUSTOM CONSTRUCTION AND BUILDING RENOVATION; CUSTOM CONSTRUCTION OF HOMES; DRYWALL AND PAINTING CONTRACTOR SERVICES; DRYWALL CONTRACTOR SERVICES; FRAMING CONTRACTOR SERVICES; GENERAL BUILDING CONTRACTOR SERVICES; GENERAL CONSTRUCTION CONTRACTING; GENERAL CONTRACTING SERVICES IN THE FIELD OF FLOORING; GENERAL CONTRACTOR SERVICES, NAMELY, PLUMBING, HEATING AND AIR CONDITIONING, CARPENTRY, DRYWALL, PAINTING, ELECTRICAL, BUILDING AND FRAMING CONTRACTOR SERVICES; HOUSE BUILDING AND REPAIR; HOUSING SERVICES, NAMELY, REPAIR, IMPROVEMENT, AND CONSTRUCTION OF RESIDENTIAL REAL PROPERTY; PAINTING AND APPLYING COATINGS TO BUILDING INTERIORS AND BUILDING EXTERIORS; PAINTING AND VARNISHING; PAINTING CONTRACTOR SERVICES; PLASTERING CONTRACTOR SERVICES; PLUMBING CONTRACTOR SERVICES, IN CLASS 37 (U.S. CLS. 100, 103 AND 106).

FIRST USE 11-30-2010; IN COMMERCE 11-30-2010.

NO CLAIM IS MADE TO THE EXCLUSIVE RIGHT TO USE "CONSTRUCTION GROUP", APART FROM THE MARK AS SHOWN.

THE COLOR(S) BROWN, GRAY, FOREST GREEN, LIME GREEN, AND MUSTARD YELLOW IS/ARE CLAIMED AS A FEATURE OF THE MARK.



David J. Kyjars

Director of the United States Patent and Trademark Office

Reg. No. 4,098,003 THE MARK CONSISTS OF THE TERM "INTEGRA" IN BROWN, ABOVE THE TERMS "CONSTRUCTION GROUP" IN GRAY, ALL BELOW A FANCIFUL DESIGN OF A ROOF REPRESENTED BY PARALLELOGRAMS IN FOREST GREEN, LIME GREEN, AND MUSTARD YELLOW.

SER. NO. 85-203,470, FILED 12-21-2010.

HELENE LIWINSKI, EXAMINING ATTORNEY

United States of America

United States Patent and Trademark Office

JASON STEPHENS

Reg. No. 4,098,004

Registered Feb. 14, 2012

Int. Cl.: 33

TRADEMARK

PRINCIPAL REGISTER

SAPID WINES INC (CALIFORNIA CORPORATION)
11775 WATSONVILLE ROAD
GILROY, CA 95020

FOR: WINE, IN CLASS 33 (U.S. CLS. 47 AND 49).

FIRST USE 6-28-2002; IN COMMERCE 8-15-2008.

THE MARK CONSISTS OF STANDARD CHARACTERS WITHOUT CLAIM TO ANY PARTICULAR FONT, STYLE, SIZE, OR COLOR.

THE NAME SHOWN IN THE MARK DOES NOT IDENTIFY A PARTICULAR LIVING INDIVIDUAL.

SER. NO. 85-203,554, FILED 12-22-2010.

INGA ERVIN, EXAMINING ATTORNEY



David J. Kybas

Director of the United States Patent and Trademark Office

United States of America

United States Patent and Trademark Office

PROJECT INDEPENDENCE

Reg. No. 4,098,005

Registered Feb. 14, 2012

Int. Cl.: 45

SERVICE MARK

PRINCIPAL REGISTER

PROJECT INDEPENDENCE (CALIFORNIA CORPORATION)
3505 CADILLAC, O103
COSTA MESA, CA 92626

FOR: ORGANIZING AND CONDUCTING BEHAVIORAL SUPPORT GROUPS FOR PEOPLE WITH DEVELOPMENTAL DISABILITIES; SOCIAL SERVICE, NAMELY, DAY SERVICES IN THE NATURE COMPANIONSHIP SERVICES AND NON-MEDICAL IN-HOME PERSONAL CARE ASSISTANCE FOR PEOPLE WITH DEVELOPMENTAL DISABILITIES, IN CLASS 45 (U.S. CLS. 100 AND 101).

FIRST USE 6-16-1978; IN COMMERCE 6-16-1978.

THE MARK CONSISTS OF STANDARD CHARACTERS WITHOUT CLAIM TO ANY PARTICULAR FONT, STYLE, SIZE, OR COLOR.

SER. NO. 85-203,555, FILED 12-22-2010.

BARBARA RUTLAND, EXAMINING ATTORNEY



David J. Kyffers

Director of the United States Patent and Trademark Office

United States of America

United States Patent and Trademark Office

KENNY VANCE & THE PLANOTONES

Reg. No. 4,098,006

RED GIANT, INC. (NEW YORK CORPORATION)
130 BEACH 137TH STREET
ROCKAWAY, NY 11694

Registered Feb. 14, 2012

Int. Cl.: 41

FOR: ENTERTAINMENT IN THE NATURE OF LIVE PERFORMANCES BY MUSICAL ARTISTS, IN CLASS 41 (U.S. CLS. 100, 101 AND 107).

SERVICE MARK

FIRST USE 1-1-1992; IN COMMERCE 1-1-1992.

PRINCIPAL REGISTER

THE MARK CONSISTS OF STANDARD CHARACTERS WITHOUT CLAIM TO ANY PARTICULAR FONT, STYLE, SIZE, OR COLOR.

OWNER OF U.S. REG. NO. 2,945,516.

THE NAME SHOWN IN THE MARK IDENTIFIES "KENNY VANCE" WHOSE CONSENT IS MADE OF RECORD.

SER. NO. 85-203,604, FILED 12-22-2010.

BERNICE MIDDLETON, EXAMINING ATTORNEY



David J. Kyffers

Director of the United States Patent and Trademark Office

United States of America

United States Patent and Trademark Office

KENNY VANCE & THE PLANOTONES

Reg. No. 4,098,007

RED GIANT, INC. (NEW YORK CORPORATION)
130 BEACH 137TH STREET
ROCKAWAY, NY 11694

Registered Feb. 14, 2012

Int. Cl.: 9

FOR: AUDIO RECORDINGS FEATURING PERFORMANCES BY MUSICAL ARTISTS, IN CLASS 9 (U.S. CLS. 21, 23, 26, 36 AND 38).

TRADEMARK

FIRST USE 1-1-1992; IN COMMERCE 1-1-1992.

PRINCIPAL REGISTER

THE MARK CONSISTS OF STANDARD CHARACTERS WITHOUT CLAIM TO ANY PARTICULAR FONT, STYLE, SIZE, OR COLOR.

OWNER OF U.S. REG. NO. 2,945,516.

THE NAME SHOWN IN THE MARK IDENTIFIES "KENNY VANCE" WHOSE CONSENT IS MADE OF RECORD.

SER. NO. 85-203,617, FILED 12-22-2010.

BERNICE MIDDLETON, EXAMINING ATTORNEY



David J. Kybas

Director of the United States Patent and Trademark Office

United States of America

United States Patent and Trademark Office

Conduit Consulting

Reg. No. 4,098,008

Registered Feb. 14, 2012

Int. Cls.: 35, 36 and 41

SERVICE MARK

PRINCIPAL REGISTER

CONDUIT CONSULTING LLC (CALIFORNIA LIMITED LIABILITY COMPANY)
2530 WILSHIRE BLVD., SECOND FLOOR
SANTA MONICA, CA 90403

FOR: BUSINESS CONSULTING SERVICES, NAMELY, FEE-BASED BUSINESS STRATEGY AND GENERAL MANAGEMENT SERVICES CONSISTING OF ADVISING ON, CUSTOMIZING TOOLS PERTAINING TO AND PERFORMING: DECISION-FRAMING, OPPORTUNITY AND RISK ASSESSMENT, STRATEGY DEVELOPMENT, STRATEGIC PLANNING, BUDGETING, ORGANIZATION DESIGN, BUSINESS MODEL DEVELOPMENT, BUSINESS RESEARCH AND EVALUATION, BUSINESS PROCESS RE-ENGINEERING, WORKFORCE DEVELOPMENT AND SUCCESSION PLANNING, AND PERFORMANCE MANAGEMENT; CONDUCTING MARKETING, OPERATIONAL PERFORMANCE AND ECONOMIC STUDIES, NAMELY, MARKET RESEARCH, SURVEYS, COMPETITIVE ANALYSIS, TREND ANALYSIS, BUSINESS FEASIBILITY STUDIES, BENCHMARKING STUDIES, ECONOMIC FORECASTING AND ANALYSIS; BRAND POSITIONING SERVICES; ADVERTISING AND MARKETING SERVICES IN THE NATURE OF CONCEIVING, PLANNING AND COORDINATING EXECUTION OF MARKETING CAMPAIGNS, DESIGNING AND CREATING MARKETING COLLATERAL AND PERFORMING PRODUCT PLACEMENT; PUBLIC RELATIONS IN THE NATURE OF CORPORATE AND INVESTOR RELATIONS COMMUNICATIONS; BUSINESS MODEL DEVELOPMENT AND BUSINESS PLAN WRITING FOR OTHERS; GRANT PROPOSAL WRITING FOR FOR-PROFIT PRIVATE ENTERPRISES, PUBLIC CORPORATIONS, NON-PROFIT ORGANIZATIONS, EDUCATIONAL INSTITUTIONS AND OTHER COMMUNITY ORGANIZATIONS; MANAGEMENT CONSULTING AND ADVISORY SERVICES IN THE AREAS OF CORPORATE GROWTH STRATEGY, NEW BUSINESS VENTURE DEVELOPMENT AND FORMATION, PRODUCT AND SERVICE DEVELOPMENT AND INNOVATION STRATEGY, OPERATIONS STRATEGY, TALENT MANAGEMENT AND DEVELOPMENT STRATEGIES, INNOVATION AND GROWTH PROCESSES, AND ORGANIZATIONAL TRANSFORMATION; BUSINESS ASSISTANCE, ADVISORY SERVICES AND CONSULTANCY PERTAINING TO WORKFORCE DEVELOPMENT PLANNING, WORKFORCE DEVELOPMENT REGULATION COMPLIANCE, PERFORMANCE MANAGEMENT SYSTEM DESIGN, PERFORMANCE MEASUREMENT AND ANALYSIS, REQUEST FOR PROPOSAL DESIGN AND PREPARATION, REQUEST FOR PROPOSAL RESPONSE, AND DESIGN AND PREPARATION OF BUSINESS REPORTS; BUSINESS CONSULTATION, NAMELY, CORPORATE TRANSACTION ADVISORY AND SUPPORT RELATING TO MERGER AND ACQUISITION STRATEGY, EXIT STRATEGY, NEGOTIATION OF COMMERCIAL TRANSACTIONS FOR OTHERS, AND MEDIATION AND CONCLUSION OF COMMERCIAL TRANSACTIONS FOR OTHERS; CORPORATE GOVERNANCE POLICY DEVELOPMENT, NAMELY,



David J. Kyjars

Director of the United States Patent and Trademark Office

Reg. No. 4,098,008 PROVIDING MANAGEMENT CONSULTING AND ADVISORY SERVICES PERTAINING TO CORPORATE VALUES, GLOBAL BUSINESS ETHICS STANDARDS, QUALITY GOALS, SUSTAINABILITY GOALS AND MEASURES, HUMAN RIGHTS RESPONSIBILITIES, EMPLOYMENT PRACTICES, FAIR OPERATING PRACTICES, ENVIRONMENTAL VALUES AND IMPACT GOALS, COMMUNITY DEVELOPMENT GOALS, COMMUNITY SOCIAL RESPONSIBILITIES, POLITICAL INVOLVEMENT, LOBBYING ACTIVITIES, MARKETING POLICIES, FINANCING POLICIES, CASH MANAGEMENT POLICIES, GOOD CORPORATE CITIZENSHIP GOALS, RISK MANAGEMENT MODEL DEVELOPMENT AND VALIDATION, ACCEPTABLE DEGREE OF ENTERPRISE RISK, RISK MANAGEMENT GUIDELINES, ACCEPTABLE DEVIATION FROM PERFORMANCE BENCHMARKS, BOARD MEMBER RESPONSIBILITIES, EXECUTIVE AND SENIOR MANAGEMENT RESPONSIBILITIES, BOARD MEMBER COMPOSITION, EXECUTIVE AND SENIOR MANAGEMENT COMPOSITION, BOARD MEMBER COMPENSATION, AND EXECUTIVE AND SENIOR MANAGEMENT COMPENSATION; PROGRAM MANAGEMENT SERVICES, NAMELY, PROVIDING BUSINESS MANAGEMENT ASSISTANCE, ADVISORY SERVICES AND CONSULTANCY ENCOMPASSING PLANNING, BUDGETING, SCHEDULING, SECURING RESOURCES, MONITORING AND REPORTING PROGRESS, MANAGING PROJECT INTERDEPENDENCIES, FACILITATING CROSS-PROJECT TEAM COMMUNICATIONS, FACILITATING DECISION-MAKING AND ISSUE RESOLUTION, IN RELATION TO MULTIPLE INTER-RELATED STRATEGIC PLANNING, NEW VENTURE DEVELOPMENT, ORGANIZATION DESIGN, NEW VENTURE DEVELOPMENT, SERVICE/PRODUCT DEVELOPMENT AND INNOVATION, BUSINESS PROCESS RE-ENGINEERING, STRATEGIC SOURCING, PROCUREMENT, SUPPLY CHAIN MANAGEMENT, MARKETING, HUMAN RESOURCE MANAGEMENT, FINANCIAL REPORTING, MANAGEMENT REPORTING, QUALITY CONTROL, CUSTOMER SERVICE, AND MERGER AND ACQUISITION DUE DILIGENCE PROJECTS; PROJECT MANAGEMENT SERVICES, NAMELY, PROVIDING BUSINESS MANAGEMENT ASSISTANCE, ADVISORY SERVICES AND CONSULTANCY ENCOMPASSING PLANNING, BUDGETING, SCHEDULING, SECURING RESOURCES, MONITORING AND REPORTING PROGRESS, AND FACILITATING DECISION-MAKING AND ISSUE RESOLUTION PERTAINING TO INDIVIDUAL STRATEGIC PLANNING, NEW VENTURE DEVELOPMENT, ORGANIZATION DESIGN, NEW VENTURE DEVELOPMENT, SERVICE/PRODUCT DEVELOPMENT AND INNOVATION, BUSINESS PROCESS RE-ENGINEERING, STRATEGIC SOURCING, PROCUREMENT, SUPPLY CHAIN MANAGEMENT, MARKETING, HUMAN RESOURCE MANAGEMENT, FINANCIAL REPORTING, MANAGEMENT REPORTING, QUALITY CONTROL, CUSTOMER SERVICE, AND MERGER AND ACQUISITION DUE DILIGENCE PROJECTS; AND BUSINESS MANAGEMENT CONSULTATION, NAMELY, PROVIDING CLIENT MANAGEMENT AND ALLIANCE PARTNER MANAGEMENT FOR OTHERS, IN CLASS 35 (U.S. CLS. 100, 101 AND 102).

FIRST USE 6-21-2002; IN COMMERCE 6-21-2002.

FOR: CORPORATE FINANCE SERVICES, NAMELY, CONSULTATION IN THE FIELDS OF CAPITAL STRUCTURE, CAPITAL INVESTMENT AND CORPORATE PORTFOLIO MANAGEMENT; BUSINESS FISCAL ASSET AND ENTERPRISE VALUATION; AND FINANCIAL DUE DILIGENCE SERVICES, IN CLASS 36 (U.S. CLS. 100, 101 AND 102).

FIRST USE 6-21-2002; IN COMMERCE 6-21-2002.

FOR: BUSINESS EDUCATION AND TRAINING SERVICES, NAMELY, CONCEIVING, DEVELOPING AND FACILITATING CUSTOMIZED TRAINING AND DEVELOPMENT PROGRAMS FOR PERSONNEL OF OTHERS PERTAINING TO LEADERSHIP, MANAGEMENT AND BUSINESS PROCESSES; CONCEIVING, DEVELOPING AND DELIVERING CLASSES, SEMINARS, WORKSHOPS, KEYNOTE PRESENTATIONS AND PUBLISHED MATERIALS TO EMPLOYEE AND EXECUTIVE PERSONNEL OF OTHERS AS WELL AS INDIVIDUALS IN THE FIELDS OF BUSINESS MANAGEMENT, ENTREPRENEURSHIP, INTRAPRENEURSHIP, BUSINESS STRATEGY, BUSINESS PROCESSES, CREATIVITY, SERVICE AND PRODUCT DEVELOPMENT AND INNOVATION, CORPORATE AND BUSINESS TRANSACTIONS AND CAREER MANAGEMENT; PROVIDING EXECUTIVE COACHING SERVICES;

Reg. No. 4,098,008 AND COACHING IN THE FIELDS OF ENTREPRENEURSHIP, INTRAPRENEURSHIP, BUSINESS MANAGEMENT, CREATIVITY, SERVICE AND PRODUCT DEVELOPMENT AND INNOVATION, AND CAREER MANAGEMENT IN BUSINESS FUNCTIONS, IN CLASS 41 (U.S. CLS. 100, 101 AND 107).

FIRST USE 6-21-2002; IN COMMERCE 6-21-2002.

THE MARK CONSISTS OF STANDARD CHARACTERS WITHOUT CLAIM TO ANY PARTICULAR FONT, STYLE, SIZE, OR COLOR.

NO CLAIM IS MADE TO THE EXCLUSIVE RIGHT TO USE "CONSULTING", APART FROM THE MARK AS SHOWN.

SER. NO. 85-203,750, FILED 12-22-2010.

MARK T. MULLEN, EXAMINING ATTORNEY

United States of America

United States Patent and Trademark Office

Conduit Consulting Business Innovation Series

Reg. No. 4,098,009

Registered Feb. 14, 2012

Int. Cl.: 41

SERVICE MARK

PRINCIPAL REGISTER

CONDUIT CAPITAL LLC (CALIFORNIA LIMITED LIABILITY COMPANY)
2530 WILSHIRE BLVD., SECOND FLOOR
SANTA MONICA, CA 90403

FOR: EDUCATION SERVICES, NAMELY, CONCEIVING, DESIGNING, PREPARING AND PROVIDING SEMINARS, WORKSHOPS, KEYNOTE PRESENTATIONS, TRAINING COURSES, TRAINING PROGRAMS, AND PUBLISHED MATERIALS IN THE FIELDS OF BUSINESS STRATEGY, GENERAL MANAGEMENT, AND CAREER MANAGEMENT DISTRIBUTED IN CONNECTION THEREWITH, IN CLASS 41 (U.S. CLS. 100, 101 AND 107).

FIRST USE 12-3-2004; IN COMMERCE 12-3-2004.

THE MARK CONSISTS OF STANDARD CHARACTERS WITHOUT CLAIM TO ANY PARTICULAR FONT, STYLE, SIZE, OR COLOR.

NO CLAIM IS MADE TO THE EXCLUSIVE RIGHT TO USE "CONSULTING BUSINESS INNOVATION SERIES", APART FROM THE MARK AS SHOWN.

SER. NO. 85-203,775, FILED 12-22-2010.

ADA HAN, EXAMINING ATTORNEY



David J. Kyffers

Director of the United States Patent and Trademark Office

United States of America

United States Patent and Trademark Office

Onboard Interiors

Reg. No. 4,098,010

Registered Feb. 14, 2012

Int. Cls.: 16, 24 and 42

TRADEMARK

SERVICE MARK

PRINCIPAL REGISTER

PLAUCHE', KRISHA (UNITED STATES INDIVIDUAL), DBA ONBOARD INTERIORS
P.O. BOX 1420, MARBLEHEAD, MA01945
1 CLARK LANE
MARBLEHEAD, MA 01945

FOR: BLANK OR PARTIALLY PRINTED PAPER LABELS; BLANK OR PARTIALLY PRINTED POSTCARDS; BUSINESS CARDS; ENVELOPES FOR STATIONERY USE; FILING FOLDERS, PAPER LABELS AND PRINTED INSTRUCTIONAL MATERIALS FOR ORGANIZING PERSONAL FILES; LABEL PAPER; LETTERHEAD PAPER; NOTE PAPER; NOTE PAPERS; NOTEBOOK PAPER; OFFICE PAPER STATIONERY; OFFICE STATIONERY; PAPER; PAPER AND CARDBOARD; PAPER ENVELOPES FOR PACKAGING; PAPER FILE JACKETS; PAPER FOLDERS; PAPER LABELS; PAPER STATIONERY; PAPER STATIONERY WITH INSPIRATIONAL MESSAGES IMPRINTED THEREON; PAPER TAGS; PRINTED PAPER LABELS; PRINTING PAPER; SHIPPING LABELS; STATIONERY; STATIONERY WRITING PAPER AND ENVELOPES; STICKERS; WRITING PAPER, IN CLASS 16 (U.S. CLS. 2, 5, 22, 23, 29, 37, 38 AND 50).

FIRST USE 0-0-2004; IN COMMERCE 0-0-2004.

FOR: CLOTH LABELS; LABELS OF CLOTH, IN CLASS 24 (U.S. CLS. 42 AND 50).

FIRST USE 0-0-2004; IN COMMERCE 0-0-2004.

FOR: INTERIOR DECORATING; INTERIOR DECORATION CONSULTATION; INTERIOR DESIGN SERVICES; INTERIOR DESIGN SERVICES IN THE NATURE OF AROMA CONSULTING SERVICES IN THE SELECTION AND USE OF AROMAS FOR HOTELS, CASINOS, RESORTS, CONFERENCE FACILITIES, RETAIL STORES, SPORTS AND FITNESS CENTERS, SPAS, HEALTH CARE FACILITIES, RESIDENTIAL BUILDINGS AND PRIVATE RESIDENCES; INTERIOR DESIGN SERVICES INCLUDING SPACE PLANNING, FURNITURE SELECTION, MATERIAL AND SURFACE SELECTION; INTERIOR STYLING SERVICES, IN CLASS 42 (U.S. CLS. 100 AND 101).

FIRST USE 0-0-2004; IN COMMERCE 0-0-2004.

THE MARK CONSISTS OF STANDARD CHARACTERS WITHOUT CLAIM TO ANY PARTICULAR FONT, STYLE, SIZE, OR COLOR.



David J. Kyffers

Director of the United States Patent and Trademark Office

Reg. No. 4,098,010 NO CLAIM IS MADE TO THE EXCLUSIVE RIGHT TO USE "INTERIORS", APART FROM THE MARK AS SHOWN.

SEC. 2(F).

SER. NO. 85-203,850, FILED 12-22-2010.

BRIAN CALLAGHAN, EXAMINING ATTORNEY

United States of America

United States Patent and Trademark Office

BISCUITS CAFE



Reg. No. 4,098,011

Registered Feb. 14, 2012

Int. Cl.: 43

SERVICE MARK

PRINCIPAL REGISTER

BISCUITS CAFE, INC. (OREGON CORPORATION)
1315 JACKSON STREET
OREGON CITY, OR 97045

FOR: CAFE AND RESTAURANT SERVICES, IN CLASS 43 (U.S. CLS. 100 AND 101).

FIRST USE 0-0-1998; IN COMMERCE 0-0-2002.

NO CLAIM IS MADE TO THE EXCLUSIVE RIGHT TO USE "CAFE" , APART FROM THE MARK AS SHOWN.

THE MARK CONSISTS OF THE LITERAL ELEMENT AND A FANCIFUL REPRESENTATION OF A COOK WEARING A CHEF'S HAT.

SEC. 2(F) AS TO "BISCUITS CAFE".

SER. NO. 85-203,881, FILED 12-22-2010.

SUE LAWRENCE, EXAMINING ATTORNEY



David J. Kyffers

Director of the United States Patent and Trademark Office

United States of America

United States Patent and Trademark Office

ZEP ORANGE BOOST

Reg. No. 4,098,012

ZEP IP HOLDING LLC (GEORGIA LIMITED LIABILITY COMPANY)
1310 SEABOARD INDUSTRIAL BOULEVARD
ATLANTA, GA 30318

Registered Feb. 14, 2012

Int. Cl.: 1

FOR: CHEMICAL PREPARATIONS, NAMELY, DEGREASING AND CLEANING SOLVENTS CONTAINING CITRUS FRUIT COMPOSITION MADE IN SIGNIFICANT PART OF ORANGES; CHEMICALS FOR ODOR CONTROL AND WASTEWATER TREATMENT APPLICATIONS CONTAINING CITRUS FRUIT COMPOSITION MADE IN SIGNIFICANT PART OF ORANGES, IN CLASS 1 (U.S. CLS. 1, 5, 6, 10, 26 AND 46).

TRADEMARK

PRINCIPAL REGISTER

FIRST USE 11-18-2010; IN COMMERCE 11-18-2010.

THE MARK CONSISTS OF STANDARD CHARACTERS WITHOUT CLAIM TO ANY PARTICULAR FONT, STYLE, SIZE, OR COLOR.

OWNER OF U.S. REG. NOS. 681,037, 2,743,915 AND OTHERS.

NO CLAIM IS MADE TO THE EXCLUSIVE RIGHT TO USE "ORANGE", APART FROM THE MARK AS SHOWN.

SER. NO. 85-204,136, FILED 12-22-2010.

MICHAEL SOUDERS, EXAMINING ATTORNEY



David J. Kyros

Director of the United States Patent and Trademark Office

United States of America

United States Patent and Trademark Office

ZEP ORANGE BOOST

Reg. No. 4,098,013

Registered Feb. 14, 2012

Int. Cl.: 3

TRADEMARK

PRINCIPAL REGISTER

ZEP IP HOLDING LLC (GEORGIA LIMITED LIABILITY COMPANY)
1310 SEABOARD INDUSTRIAL BOULEVARD
ATLANTA, GA 30318

FOR: CLEANING PREPARATIONS FOR CLEANSING DRAINS CONTAINING CITRUS FRUIT COMPOSITION MADE IN SIGNIFICANT PART OF ORANGES; ALL-PURPOSE CLEANERS CONTAINING CITRUS FRUIT COMPOSITION MADE IN SIGNIFICANT PART OF ORANGES FOR REMOVING ADHESIVE, GUM, TAR, ASPHALT, AND GRAFFITI; CARPET CLEANERS CONTAINING CITRUS FRUIT COMPOSITION MADE IN SIGNIFICANT PART OF ORANGES, IN CLASS 3 (U.S. CLS. 1, 4, 6, 50, 51 AND 52).

FIRST USE 11-18-2010; IN COMMERCE 11-18-2010.

THE MARK CONSISTS OF STANDARD CHARACTERS WITHOUT CLAIM TO ANY PARTICULAR FONT, STYLE, SIZE, OR COLOR.

OWNER OF U.S. REG. NOS. 681,037, 2,743,915 AND OTHERS.

NO CLAIM IS MADE TO THE EXCLUSIVE RIGHT TO USE "ORANGE", APART FROM THE MARK AS SHOWN.

SER. NO. 85-204,166, FILED 12-22-2010.

MICHAEL SOUDERS, EXAMINING ATTORNEY



David J. Kyffers

Director of the United States Patent and Trademark Office

United States of America

United States Patent and Trademark Office

ICE DESIGN FACTORY

Reg. No. 4,098,014

Registered Feb. 14, 2012

Int. Cls.: 6, 24, 25 and 28

TRADEMARK

PRINCIPAL REGISTER

ICE DESIGN FACTORY, INC. (ILLINOIS CORPORATION)
C-403
2023 W. CARROLL AVENUE
CHICAGO, IL 60612

FOR: METAL CHRISTMAS STOCKING HANGERS IN THE NATURE OF HOOKS, IN CLASS 6 (U.S. CLS. 2, 12, 13, 14, 23, 25 AND 50).

FIRST USE 0-0-2002; IN COMMERCE 0-0-2002.

FOR: BATH TOWELS; BATH LINENS; TABLE LINENS, IN CLASS 24 (U.S. CLS. 42 AND 50).

FIRST USE 0-0-2002; IN COMMERCE 0-0-2002.

FOR: SANTA HATS, IN CLASS 25 (U.S. CLS. 22 AND 39).

FIRST USE 0-0-2002; IN COMMERCE 0-0-2002.

FOR: PRE-LIT AND NON-LIT ARTIFICIAL CHRISTMAS TREES; PLASTIC CHRISTMAS ORNAMENTS; GLASS CHRISTMAS ORNAMENTS; CHRISTMAS STOCKINGS; CHRISTMAS TREE SKIRTS, IN CLASS 28 (U.S. CLS. 22, 23, 38 AND 50).

FIRST USE 0-0-2002; IN COMMERCE 0-0-2002.

THE MARK CONSISTS OF STANDARD CHARACTERS WITHOUT CLAIM TO ANY PARTICULAR FONT, STYLE, SIZE, OR COLOR.

NO CLAIM IS MADE TO THE EXCLUSIVE RIGHT TO USE "DESIGN FACTORY", APART FROM THE MARK AS SHOWN.

SER. NO. 85-204,204, FILED 12-22-2010.

ALYSSA STEEL, EXAMINING ATTORNEY



David J. Kyffers

Director of the United States Patent and Trademark Office

United States of America
United States Patent and Trademark Office

STARLITE

Reg. No. 4,098,015

Registered Feb. 14, 2012

Int. Cls.: 26 and 28

TRADEMARK

PRINCIPAL REGISTER

ICE DESIGN FACTORY, INC. (ILLINOIS CORPORATION)
C-403
2023 W. CARROLL AVENUE
CHICAGO, IL 60612

FOR: DECORATED AND NON-DECORATED ARTIFICIAL WREATHS AND GARLANDS,
IN CLASS 26 (U.S. CLS. 37, 39, 40, 42 AND 50).

FIRST USE 0-0-2002; IN COMMERCE 0-0-2002.

FOR: PRE-LIT AND NON-LIT ARTIFICIAL CHRISTMAS TREES, IN CLASS 28 (U.S. CLS.
22, 23, 38 AND 50).

FIRST USE 0-0-2002; IN COMMERCE 0-0-2002.

THE MARK CONSISTS OF STANDARD CHARACTERS WITHOUT CLAIM TO ANY PAR-
TICULAR FONT, STYLE, SIZE, OR COLOR.

SER. NO. 85-204,223, FILED 12-22-2010.

ALYSSA STEEL, EXAMINING ATTORNEY



David J. Kypos

Director of the United States Patent and Trademark Office

United States of America

United States Patent and Trademark Office

THE CREIG NORTHROP TEAM

Reg. No. 4,098,016

Registered Feb. 14, 2012

Int. Cl.: 36

SERVICE MARK

PRINCIPAL REGISTER

SELL FAST, INC. (MARYLAND CORPORATION)
SUITE F
12345 WAKE FOREST ROAD
CLARKSVILLE, MD 21029

FOR: REAL ESTATE AGENCY AND BROKERAGE SERVICES, IN CLASS 36 (U.S. CLS. 100, 101 AND 102).

FIRST USE 0-0-2005; IN COMMERCE 0-0-2005.

THE MARK CONSISTS OF STANDARD CHARACTERS WITHOUT CLAIM TO ANY PARTICULAR FONT, STYLE, SIZE, OR COLOR.

OWNER OF U.S. REG. NO. 2,423,308.

NO CLAIM IS MADE TO THE EXCLUSIVE RIGHT TO USE "TEAM", APART FROM THE MARK AS SHOWN.

THE NAME(S), PORTRAIT(S), AND/OR SIGNATURE(S) SHOWN IN THE MARK IDENTIFIES "CREIGHTON NORTHROP", WHOSE CONSENT(S) TO REGISTER IS MADE OF RECORD.

SER. NO. 85-204,378, FILED 12-22-2010.

SOPHIA S. KIM, EXAMINING ATTORNEY



David J. Kyffers

Director of the United States Patent and Trademark Office

United States of America

United States Patent and Trademark Office

BECCASTONE

Reg. No. 4,098,017

GENKAST LLC (D.C. LIMITED LIABILITY COMPANY)
1200 H. STREET, N.E.
WASHINGTON, DC 20002

Registered Feb. 14, 2012

Int. Cl.: 45

FOR: PROVIDING A WEBSITE FEATURING INFORMATION FOR AFRICAN AMERICAN MOTHERS IN THE FIELD OF PARENTING CONCERNING INTRAFAMILY RELATIONSHIPS, IN CLASS 45 (U.S. CLS. 100 AND 101).

SERVICE MARK

FIRST USE 11-5-2010; IN COMMERCE 11-5-2010.

PRINCIPAL REGISTER

THE MARK CONSISTS OF STANDARD CHARACTERS WITHOUT CLAIM TO ANY PARTICULAR FONT, STYLE, SIZE, OR COLOR.

SER. NO. 85-204,550, FILED 12-22-2010.

KHANH LE, EXAMINING ATTORNEY



David J. Kyffers

Director of the United States Patent and Trademark Office

United States of America

United States Patent and Trademark Office

Gotham City

Reg. No. 4,098,018

Registered Feb. 14, 2012

Int. Cl.: 41

SERVICE MARK

PRINCIPAL REGISTER

REAL REPUTABLES ENTERTAINMENT, LLC (CALIFORNIA LIMITED LIABILITY COMPANY)
11210 4TH STREET NUMBER 2201
RANCHO CUCAMONGA, CA 91730

FOR: ARRANGING AND CONDUCTING NIGHTCLUB ENTERTAINMENT EVENTS; ARRANGING AND CONDUCTING NIGHTCLUB PARTIES; DISC JOCKEYS FOR PARTIES AND SPECIAL EVENTS; ENTERTAINMENT SERVICES, NAMELY, CONDUCTING PARTIES, IN CLASS 41 (U.S. CLS. 100, 101 AND 107).

FIRST USE 3-6-2009; IN COMMERCE 3-6-2009.

THE MARK CONSISTS OF STANDARD CHARACTERS WITHOUT CLAIM TO ANY PARTICULAR FONT, STYLE, SIZE, OR COLOR.

SER. NO. 85-204,583, FILED 12-23-2010.

HANNO RITTNER, EXAMINING ATTORNEY



David J. Kyffers

Director of the United States Patent and Trademark Office

United States of America

United States Patent and Trademark Office

HonorThyMother

Reg. No. 4,098,019

SIEGEL OIL COMPANY (COLORADO CORPORATION)
1380 ZUNI ST.
DENVER, CO 80204

Registered Feb. 14, 2012

Int. Cl.: 4

FOR: MOTOR OILS; LUBRICANTS FOR MOTOR VEHICLES, IN CLASS 4 (U.S. CLS. 1, 6 AND 15).

TRADEMARK

FIRST USE 12-20-2010; IN COMMERCE 12-20-2010.

PRINCIPAL REGISTER

THE MARK CONSISTS OF THE WORDS "HONORTHY" WHEREIN THE COLOR BLACK APPEARS IN "HONORTHY", WHEREIN THE WORD "MOTHER" APPEARS IN ROYAL BLUE EXCEPT THE LETTER "O" FOR WHICH EARTH IN THE SHAPE OF A TEAR DROP IS SUBSTITUTED IN WHICH THE COLORS GREEN AND YELLOW GREEN APPEAR IN THE CONTINENTS, ROYAL BLUE APPEARS IN THE OCEANS, AND LIGHT BLUE APPEARS AS ATMOSPHERE SURROUNDING THE DROP.

THE COLOR(S) BLACK, BLUE, GREEN AND YELLOW-GREEN IS/ARE CLAIMED AS A FEATURE OF THE MARK.

SER. NO. 85-204,585, FILED 12-23-2010.

HANNO RITTNER, EXAMINING ATTORNEY



David J. Kyffers

Director of the United States Patent and Trademark Office

United States of America

United States Patent and Trademark Office

OUTRIGGER

Reg. No. 4,098,020

OUTRIGGER HOTELS HAWAII (HAWAII LIMITED PARTNERSHIP)
2375 KUHIO AVENUE
HONOLULU, HI 96815

Registered Feb. 14, 2012

Int. Cls.: 36, 37, 41 and 43

FOR: CONDOMINIUM AND VACATION APARTMENT MANAGEMENT SERVICES; REAL PROPERTY MANAGEMENT SERVICES; VACATION REAL ESTATE TIME SHARING SERVICES, IN CLASS 36 (U.S. CLS. 100, 101 AND 102).

SERVICE MARK

FIRST USE 10-0-1989; IN COMMERCE 10-0-1989.

PRINCIPAL REGISTER

FOR: REAL PROPERTY DEVELOPMENT SERVICES, NAMELY, PLANNING AND DEVELOPMENT OF SHOPPING CENTERS, HOTELS, CONDOMINIUMS AND RESORTS, IN CLASS 37 (U.S. CLS. 100, 103 AND 106).

FIRST USE 12-0-1963; IN COMMERCE 12-0-1963.

FOR: ARRANGING AND BOOKING OF ADMISSION TO ENTERTAINMENT EVENTS AND ACTIVITIES IN THE NATURE OF TICKET AGENCY SERVICES, IN CLASS 41 (U.S. CLS. 100, 101 AND 107).

FIRST USE 8-0-1988; IN COMMERCE 8-0-1988.

FOR: PROVIDING TEMPORARY ACCOMMODATIONS; HOTEL AND MOTEL SERVICES; RESORT LODGING SERVICES; RESERVATION SERVICES FOR TEMPORARY ACCOMMODATIONS; HOTEL AND TEMPORARY ACCOMMODATION INFORMATION SERVICES, IN CLASS 43 (U.S. CLS. 100 AND 101).

FIRST USE 12-0-1963; IN COMMERCE 12-0-1963.

THE MARK CONSISTS OF STANDARD CHARACTERS WITHOUT CLAIM TO ANY PARTICULAR FONT, STYLE, SIZE, OR COLOR.

OWNER OF U.S. REG. NOS. 1,566,472, 3,647,485 AND OTHERS.

SER. NO. 85-205,257, FILED 12-23-2010.

NICHOLAS COLEMAN, EXAMINING ATTORNEY

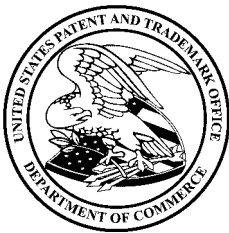

David J. Kyffers

Director of the United States Patent and Trademark Office

United States of America

United States Patent and Trademark Office



Reg. No. 4,098,021

OUTRIGGER HOTELS HAWAII (HAWAII LIMITED PARTNERSHIP)
2375 KUHIO AVENUE
HONOLULU, HI 96815

Registered Feb. 14, 2012

**Int. Cls.: 36, 37, 39, 41
and 43**

FOR: CONDOMINIUM AND VACATION APARTMENT MANAGEMENT SERVICES; REAL PROPERTY MANAGEMENT SERVICES; VACATION REAL ESTATE TIME SHARING SERVICES, IN CLASS 36 (U.S. CLS. 100, 101 AND 102).

SERVICE MARK

FIRST USE 10-0-1989; IN COMMERCE 10-0-1989.

PRINCIPAL REGISTER

FOR: REAL PROPERTY DEVELOPMENT SERVICES, NAMELY, PLANNING AND DEVELOPMENT OF SHOPPING CENTERS, HOTELS, CONDOMINIUMS AND RESORTS, IN CLASS 37 (U.S. CLS. 100, 103 AND 106).

FIRST USE 8-0-1987; IN COMMERCE 8-0-1987.

FOR: TRAVEL AND TOUR INFORMATION SERVICES; MAKING RESERVATIONS AND BOOKINGS FOR TRANSPORTATION AND TOURS; RENTAL OF EQUIPMENT FOR RECREATIONAL ACTIVITIES, NAMELY, PROVIDING CATAMARAN TOURS, IN CLASS 39 (U.S. CLS. 100 AND 105).

FIRST USE 8-0-1988; IN COMMERCE 8-0-1988.

FOR: PROVIDING FACILITIES FOR RECREATIONAL ACTIVITIES; ARRANGING AND BOOKING OF ADMISSION TO ENTERTAINMENT EVENTS AND ACTIVITIES IN THE NATURE OF TICKET AGENCY SERVICES, IN CLASS 41 (U.S. CLS. 100, 101 AND 107).

FIRST USE 8-0-1988; IN COMMERCE 8-0-1988.

FOR: PROVIDING TEMPORARY ACCOMMODATIONS; HOTEL AND MOTEL SERVICES; RESORT LODGING SERVICES; RESERVATION SERVICES FOR TEMPORARY ACCOMMODATIONS; HOTEL AND TEMPORARY ACCOMMODATION INFORMATION SERVICES; RESTAURANT AND BAR SERVICES, IN CLASS 43 (U.S. CLS. 100 AND 101).

FIRST USE 8-0-1987; IN COMMERCE 8-0-1987.

OWNER OF U.S. REG. NOS. 1,562,706, 2,872,626 AND OTHERS.



David J. Kyjars

Director of the United States Patent and Trademark Office

Reg. No. 4,098,021 THE MARK CONSISTS OF A CIRCULAR DESIGN OF A SAIL ON WATER.

SER. NO. 85-205,317, FILED 12-23-2010.

NICHOLAS COLEMAN, EXAMINING ATTORNEY

United States of America

United States Patent and Trademark Office

Delizioso

Reg. No. 4,098,022

Registered Feb. 14, 2012

Int. Cl.: 35

SERVICE MARK

PRINCIPAL REGISTER

AGRO TRADE INTERNATIONAL B.V. (NETHERLANDS LIMITED LIABILITY COMPANY)
PRINS BERNHARDPLEIN 200
AMSTERDAM, NETHERLANDS 1097JB

FOR: WHOLESALE AND RETAIL STORE SERVICES FEATURING A WIDE VARIETY OF CONSUMER GOODS OF OTHERS; SUPERMARKETS; ONLINE RETAIL STORE SERVICES FEATURING A WIDE VARIETY OF CONSUMER GOODS OF OTHERS; IMPORT-EXPORT AGENCIES; COST PRICE ANALYSIS; RENTAL OF ADVERTISING SPACE; ACCOUNTING; INVOICING; DEMONSTRATION OF GOODS; CONDUCTING MARKETING STUDIES; COMMERCIAL INFORMATION AND ADVICE FOR CONSUMERS (CONSUMER ADVICE SHOP); BUSINESS INVESTIGATIONS; MARKETING RESEARCH; BUSINESS MANAGEMENT AND ORGANIZATION CONSULTANCY; MANAGEMENT AND OPERATION ASSISTANCE TO COMMERCIAL BUSINESSES, NAMELY, IN THE FIELD OF WHOLESALE AND RETAIL STORES; MANAGEMENT ASSISTANCE IN THE FIELD OF WHOLESALE AND RETAIL STORES; PROFESSIONAL BUSINESS CONSULTANCY; ORGANIZATION OF EXHIBITIONS FOR COMMERCIAL OR ADVERTISING PURPOSES; ORGANIZATION OF TRADE FAIRS FOR COMMERCIAL OR ADVERTISING PURPOSES; SHOP WINDOW DRESSING AND DISPLAY ARRANGEMENT SERVICE; BUSINESS APPRAISALS; PAYROLL PREPARATION; BUSINESS ADMINISTRATION; BUSINESS MANAGEMENT ASSISTANCE; ASSISTANCE IN MANAGEMENT OF BUSINESS ACTIVITIES IN THE FIELD OF WHOLESALE AND RETAIL STORES; ASSISTANCE TO INDUSTRIAL OR COMMERCIAL ENTERPRISES IN THE RUNNING OF THEIR BUSINESS IN THE FIELD OF WHOLESALE AND RETAIL STORES; COMMERCIAL AND INDUSTRIAL MANAGEMENT ASSISTANCE; PRESENTATION OF GOODS ON COMMUNICATION MEDIA, FOR RETAIL PURPOSES; AUCTIONEERING; SALES PROMOTION FOR OTHERS; SALES PROMOTION FOR OTHERS, NAMELY, WHOLESALE AND RETAIL STORE SERVICES; SALES PROMOTION FOR OTHERS, NAMELY, PROMOTION SERVICES PROVIDED TO RETAIL STORES AND WHOLESALE OUTLETS THROUGH MAIL ORDER CATALOGUES AND BY MEANS OF ELECTRONIC MEDIA, WEB SITES, TELEVISION SHOPPING PROGRAMS; DISTRIBUTION OF SAMPLES; DISSEMINATION OF ADVERTISING MATTER; ADVERTISING; ON-LINE ADVERTISING ON A COMPUTER NETWORK; THE BRINGING TOGETHER, FOR THE BENEFIT OF OTHERS, OF A VARIETY OF GOODS, EXCLUDING THE TRANSPORT THEREOF, ENABLING CUSTOMERS TO CONVENIENTLY VIEW AND PURCHASE THOSE GOODS IN THE FIELD OF FOOD AND DRINK PRODUCTS AND INGREDIENTS; THE BRINGING TOGETHER, FOR THE BENEFIT OF OTHERS, OF A VARIETY OF GOODS, EXCLUDING THE TRANSPORT THEREOF, ENABLING CUSTOMERS TO CONVENIENTLY VIEW AND PURCHASE THOSE GOODS MAIL ORDER CATALOGUES OR BY AN INTERNET



David J. Kybas

Director of the United States Patent and Trademark Office

Reg. No. 4,098,022 WEBSITE OR ONLINE CATALOGUE OR TELEVISION SHOPPING PROGRAM; ADMINISTRATIVE ACCOUNTING SERVICES, NAMELY, DRAWING UP OF STATEMENTS OF ACCOUNTS; COMMERCIAL ADMINISTRATION OF THE LICENSING OF THE GOODS AND SERVICES OF OTHERS; ADMINISTRATIVE PROCESSING OF PURCHASE ORDERS; MODELING FOR ADVERTISING OR SALES PROMOTION; PRICE COMPARISON SERVICES; PROCUREMENT SERVICES FOR OTHERS, NAMELY, PURCHASING GOODS AND SERVICES FOR OTHER BUSINESS IN THE FIELD OF FOOD AND DRINK PRODUCTS; OUTSOURCING SERVICES; EFFICIENCY EXPERTS; FRANCHISING, NAMELY, OFFERING BUSINESS MANAGEMENT ASSISTANCE IN THE ESTABLISHMENT AND/OR OPERATION OF SUPERMARKETS AND DEPARTMENT STORES, IN CLASS 35 (U.S. CLS. 100, 101 AND 102).

THE MARK CONSISTS OF STANDARD CHARACTERS WITHOUT CLAIM TO ANY PARTICULAR FONT, STYLE, SIZE, OR COLOR.

PRIORITY CLAIMED UNDER SEC. 44(D) ON BENELUX APPLICATION NO. 1206195, FILED 7-8-2010, REG. NO. 0885536, DATED 11-10-2010, EXPIRES 7-8-2020.

THE WORDING "DELIZIO" HAS NO MEANING IN A FOREIGN LANGUAGE.

SER. NO. 85-205,888, FILED 12-27-2010.

PAULA MAHONEY, EXAMINING ATTORNEY

United States of America

United States Patent and Trademark Office

The Truth is in the Models

Reg. No. 4,098,023

NO MAGIC, INCORPORATED (TEXAS CORPORATION)

Registered Feb. 14, 2012

7304 ALMA DRIVE, SUITE 600

PLANO, TX 750253571

Int. Cl.: 9

FOR: COMPUTER PROGRAMS FOR MODELING, SIMULATION, AND ANALYSIS OF BUSINESS PROCESSES, SOFTWARE SYSTEMS, SOFTWARE ARCHITECTURE, AND BUSINESS ARCHITECTURE; COMPUTER PROGRAMS FOR MODELING AND ANALYSIS OF BUSINESS OR GOVERNMENT REQUIREMENTS, IN CLASS 9 (U.S. CLS. 21, 23, 26, 36 AND 38).

TRADEMARK

PRINCIPAL REGISTER

FIRST USE 11-9-2010; IN COMMERCE 11-30-2010.

THE MARK CONSISTS OF STANDARD CHARACTERS WITHOUT CLAIM TO ANY PARTICULAR FONT, STYLE, SIZE, OR COLOR.

NO CLAIM IS MADE TO THE EXCLUSIVE RIGHT TO USE "MODELS", APART FROM THE MARK AS SHOWN.

SER. NO. 85-206,185, FILED 12-27-2010.

NAKIA HENRY, EXAMINING ATTORNEY



David J. Kyffers

Director of the United States Patent and Trademark Office

United States of America

United States Patent and Trademark Office



Reg. No. 4,098,024

TOPSEE INTERNATIONAL CO., LIMITED (CHINA LIMITED LIABILITY COMPANY)
19A HONGFU CABINET CAIFU BUILDING
SHENZHEN, CHINA

Registered Feb. 14, 2012

Int. Cl.: 25

FOR: BATHING SUITS; BRACES; COATS; COSTUMES FOR USE IN ROLE-PLAYING GAMES; FOOTWEAR; GLOVES; HATS; HOSIERY; PYJAMAS; SHIRTS; SKIRTS; SUITS; TROUSERS, IN CLASS 25 (U.S. CLS. 22 AND 39).

TRADEMARK

FIRST USE 9-30-2009; IN COMMERCE 9-30-2009.

PRINCIPAL REGISTER

THE MARK CONSISTS OF ONE-EYED MAN'S SKULL, WEARING AN EYE PATCH AND A PIRATE'S HAT WITH A DESIGN OF TWO CROSSED SWORDS AND THE DESIGN OF FIRE ABOVE THE SWORDS, AND WITH THE HEAD BEING ON AN OCTOPUS BODY.

SER. NO. 85-206,292, FILED 12-28-2010.

JEAN IM, EXAMINING ATTORNEY



David J. Kybas

Director of the United States Patent and Trademark Office

United States of America

United States Patent and Trademark Office

BEST AGE EVER

Reg. No. 4,098,025

THE EILERT GROUP INC. (KENTUCKY CORPORATION)
11808 HALIFAX DRIVE
LOUISVILLE, KY 40245

Registered Feb. 14, 2012

Int. Cl.: 45

FOR: PROVIDING INFORMATION ABOUT LIFESTYLE AND FASHION, IN CLASS 45 (U.S. CLS. 100 AND 101).

SERVICE MARK

FIRST USE 8-0-2007; IN COMMERCE 8-0-2007.

PRINCIPAL REGISTER

THE MARK CONSISTS OF STANDARD CHARACTERS WITHOUT CLAIM TO ANY PARTICULAR FONT, STYLE, SIZE, OR COLOR.

SER. NO. 85-206,346, FILED 12-28-2010.

ANDREA K. NADELMAN, EXAMINING ATTORNEY



David J. Kyffers

Director of the United States Patent and Trademark Office

United States of America

United States Patent and Trademark Office



Reg. No. 4,098,026

Registered Feb. 14, 2012

Int. Cl.: 43

SERVICE MARK

PRINCIPAL REGISTER

BEROTH OIL COMPANY, INC. (NORTH CAROLINA CORPORATION)
PO BOX 4089
WINSTON SALEM, NC 27115

FOR: CARRY-OUT RESTAURANTS; DELICATESSENS; FAST-FOOD RESTAURANTS AND SNACK BARS, ALL EXCLUSIVE OF SIT DOWN RESTAURANTS, IN CLASS 43 (U.S. CLS. 100 AND 101).

FIRST USE 12-15-2010; IN COMMERCE 12-15-2010.

OWNER OF U.S. REG. NO. 2,994,898.

THE COLOR(S) RED, WHITE, BLUE AND BLACK IS/ARE CLAIMED AS A FEATURE OF THE MARK.

NO CLAIM IS MADE TO THE EXCLUSIVE RIGHT TO USE "DELI AND GRILL", APART FROM THE MARK AS SHOWN.

THE MARK CONSISTS OF THE NUMBER "4" IN WHITE WITH A RED, WHITE, AND BLUE STRIPE FOLLOWING THE "4" ALL ABOVE THE WORD "BROTHERS" IN WHITE THEN THE WORDS "DELI" OVER "&" OVER "GRILL" ALL IN A BACKGROUND OF BLACK.

SER. NO. 85-206,613, FILED 12-28-2010.

PAUL F. GAST, EXAMINING ATTORNEY



David J. Kyros

Director of the United States Patent and Trademark Office

United States of America
United States Patent and Trademark Office

GRAHAM

Reg. No. 4,098,027

Registered Feb. 14, 2012

Int. Cls.: 6 and 19

TRADEMARK

PRINCIPAL REGISTER

GRAHAM ARCHITECTURAL PRODUCTS CORPORATION (PENNSYLVANIA CORPORATION)
1551 MT. ROSE AVENUE
YORK, PA 174032909

FOR: METAL WINDOWS AND STRUCTURAL PARTS SOLD AS AN INTEGRAL COMPONENT THEREOF, IN CLASS 6 (U.S. CLS. 2, 12, 13, 14, 23, 25 AND 50).

FIRST USE 0-0-1980; IN COMMERCE 0-0-1980.

FOR: NON-METAL WINDOWS AND STRUCTURAL PARTS SOLD AS AN INTEGRAL COMPONENT THEREOF, IN CLASS 19 (U.S. CLS. 1, 12, 33 AND 50).

FIRST USE 0-0-1980; IN COMMERCE 0-0-1980.

THE MARK CONSISTS OF STANDARD CHARACTERS WITHOUT CLAIM TO ANY PARTICULAR FONT, STYLE, SIZE, OR COLOR.

SER. NO. 85-206,675, FILED 12-28-2010.

ALYSSA STEEL, EXAMINING ATTORNEY



David J. Kyjars

Director of the United States Patent and Trademark Office

United States of America

United States Patent and Trademark Office



Reg. No. 4,098,028

Registered Feb. 14, 2012

Int. Cl.: 18

TRADEMARK

PRINCIPAL REGISTER

LIAO, JUI LIEN (UNITED STATES INDIVIDUAL)
583 BROOK AVENUE
RIVERVALE, NJ 07675

FOR: LUGGAGE; TRAVEL BAGGAGE, IN CLASS 18 (U.S. CLS. 1, 2, 3, 22 AND 41).

FIRST USE 9-8-1994; IN COMMERCE 9-8-1994.

THE MARK CONSISTS OF THE LETTERS "C" AND "Y" IN A SOLID RECTANGLE WITH 4 ROUNDED CORNERS. THE RECTANGLE IS SLIGHTLY WIDER THAN IT IS TALL. THE LETTERS "C" AND "Y" ARE WRITTEN IN LARGE BLOCK LETTERS. THE LETTER "C" IS ELONGATED, AND THE LETTER "Y" IS MODIFIED SO THAT THE TIP OF THE UPPER LEFT HAND SIDE OF THE LETTER "Y" THAT EXTENDS TOWARD THE LETTER "C" IS CURVED WITH POINTED ENDS TO RESEMBLE A BIRD'S HEAD AND BEAK. THIS SAME PORTION OF THE LETTER "Y" CONTAINS AN EMPTY OVAL SHAPED SLOTTCH. IN THE MIDDLE OF THE OVAL SLOTTCH IS A BLACK DOT TO REPRESENT THE EYE.

SER. NO. 85-206,771, FILED 12-28-2010.

NANCY CLARKE, EXAMINING ATTORNEY



David J. Kybas

Director of the United States Patent and Trademark Office

United States of America

United States Patent and Trademark Office

NITRORADISH

Reg. No. 4,098,029

GS3 QUALITY SEED INC. (OREGON CORPORATION)
13535 DEARMOND RD.
MONMOUTH, OR 97361

Registered Feb. 14, 2012

Int. Cl.: 31

FOR: PLANT SEEDS, IN CLASS 31 (U.S. CLS. 1 AND 46).

TRADEMARK

FIRST USE 2-15-2011; IN COMMERCE 6-9-2011.

PRINCIPAL REGISTER

THE MARK CONSISTS OF STANDARD CHARACTERS WITHOUT CLAIM TO ANY PARTICULAR FONT, STYLE, SIZE, OR COLOR.

SER. NO. 85-206,820, FILED 12-28-2010.

RONALD DELGIZZI, EXAMINING ATTORNEY



David J. Kybas

Director of the United States Patent and Trademark Office

United States of America

United States Patent and Trademark Office

BREAKTHROUGH STAR

Reg. No. 4,098,030

BREAK THROUGH STAR, INC. (NEVADA CORPORATION)

Registered Feb. 14, 2012

6600 AMELIA EARHART CT., SUITE B
LAS VEGAS, NV 891193535

Int. Cls.: 35 and 42

FOR: EMPLOYMENT SERVICES IN THE NATURE OF TALENT CASTING IN THE FIELDS OF MUSIC, VIDEO, AND FILM; TALENT RECRUITING SERVICES IN THE FIELD OF ENTERTAINMENT, IN CLASS 35 (U.S. CLS. 100, 101 AND 102).

SERVICE MARK

FIRST USE 12-6-2010; IN COMMERCE 12-6-2010.

PRINCIPAL REGISTER

FOR: COMPUTER SERVICES, NAMELY, CREATING AN ON-LINE COMMUNITY WHERE REGISTERED USERS CAN PUBLISH AUDIO RECORDINGS, VIDEOS AND PHOTOGRAPHS SHOWCASING THEIR TALENT, GET FEEDBACK FROM THEIR PEERS AND OTHERS IN THE ENTERTAINMENT INDUSTRY, AND PARTICIPATE IN COMPETITIONS DESIGNED TO AWARD OPPORTUNITIES WITHIN THE ENTERTAINMENT INDUSTRY, IN CLASS 42 (U.S. CLS. 100 AND 101).

FIRST USE 12-6-2010; IN COMMERCE 12-6-2010.

THE MARK CONSISTS OF STANDARD CHARACTERS WITHOUT CLAIM TO ANY PARTICULAR FONT, STYLE, SIZE, OR COLOR.

SER. NO. 85-206,845, FILED 12-28-2010.

TAMARA FRAZIER, EXAMINING ATTORNEY



David J. Kyffers

Director of the United States Patent and Trademark Office

United States of America

United States Patent and Trademark Office

Inside Passage

Reg. No. 4,098,031

Registered Feb. 14, 2012

Int. Cl.: 35

SERVICE MARK

PRINCIPAL REGISTER

TONGASS TRADING COMPANY (ALASKA CORPORATION)
201 DOCK STREET
KETCHIKAN, AK 99901

FOR: RETAIL STORE SERVICES, NAMELY, CURIO AND GIFT SHOP SERVICES IN THE FIELD OF T-SHIRTS, SWEATSHIRTS, HATS, JEWELRY, CARDS, NATIVE ART WORK, PHOTOGRAPHS, FILM, RAIN GEAR, FOOD ITEMS, CURIOS, BOOKS, CLOCKS, MAPS, PICTURES, STUFFED ANIMALS, FIGURINES, SALMON, CANDY, ORNAMENTS, TOTEM POLES, KNIVES, AND STATUES, IN CLASS 35 (U.S. CLS. 100, 101 AND 102).

FIRST USE 5-1-2005; IN COMMERCE 5-1-2005.

THE MARK CONSISTS OF STANDARD CHARACTERS WITHOUT CLAIM TO ANY PARTICULAR FONT, STYLE, SIZE, OR COLOR.

SER. NO. 85-206,860, FILED 12-28-2010.

RENEE MCCRAY, EXAMINING ATTORNEY



David J. Kyffers

Director of the United States Patent and Trademark Office

United States of America

United States Patent and Trademark Office



Reg. No. 4,098,032

Registered Feb. 14, 2012

Int. Cl.: 35

SERVICE MARK

PRINCIPAL REGISTER

TONGASS TRADING COMPANY (ALASKA CORPORATION)
201 DOCK STREET
KETCHIKAN, AK 99901

FOR: RETAIL STORE SERVICES, NAMELY, CURIO AND GIFT SHOP SERVICES IN THE FIELD OF T-SHIRTS, SWEATSHIRTS, HATS, JEWELRY, CARDS, NATIVE ART WORK, PHOTOGRAPHS, FILM, RAIN GEAR, FOOD ITEMS, CURIOS, BOOKS, CLOCKS, MAPS, PICTURES, STUFFED ANIMALS, FIGURINES, SALMON, CANDY, ORNAMENTS, TOTEM POLES, KNIVES, AND STATUES, IN INTERNATIONAL CLASS 35, IN CLASS 35 (U.S. CLS. 100, 101 AND 102).

FIRST USE 5-1-2005; IN COMMERCE 5-1-2005.

NO CLAIM IS MADE TO THE EXCLUSIVE RIGHT TO USE "TONGASS TRADING" AND "ALASKA'S SHOPPING", APART FROM THE MARK AS SHOWN.

THE COLOR(S) BLACK, BLUE, RED AND YELLOW IS/ARE CLAIMED AS A FEATURE OF THE MARK.

THE MARK CONSISTS OF A STYLIZED CURVED SALMON IN THE COLOR BLACK OVER A BLUE TRIANGLE, WITH THE WORDS "TONGASS TRADING TRIANGLE" IN RED LETTERING, THE WORD "ALASKA'S" IN YELLOW LETTERING, AND THE WORDS "SHOPPING CAPITAL" IN RED LETTERING.

SER. NO. 85-206,890, FILED 12-28-2010.

RENEE MCCRAY, EXAMINING ATTORNEY



David J. Kyjars

Director of the United States Patent and Trademark Office

United States of America

United States Patent and Trademark Office

DEFENSEFIT

Reg. No. 4,098,033

ALPAYTAC, INC (ILLINOIS CORPORATION)
445 N WELLS, SUITE #401
CHICAGO, IL 60654

Registered Feb. 14, 2012

Int. Cl.: 9

FOR: RECORDED MEDIA, NAMELY, PRE-RECORDED VIDEO TAPES, COMPACT DISCS, DIGITAL AUDIO AND VIDEO DISCS, DVD'S, INTERACTIVE COMPACT DISCS, AND AUDIO TAPES FEATURING EXERCISE INSTRUCTION, MARTIAL ARTS INSTRUCTION, MUSIC, AND ADVICE ON WEIGHT CONTROL, HEALTH, DIETING, NUTRITION AND PERSONAL MOTIVATION, IN CLASS 9 (U.S. CLS. 21, 23, 26, 36 AND 38).

TRADEMARK

PRINCIPAL REGISTER

FIRST USE 9-1-2010; IN COMMERCE 9-1-2010.

THE MARK CONSISTS OF STANDARD CHARACTERS WITHOUT CLAIM TO ANY PARTICULAR FONT, STYLE, SIZE, OR COLOR.

SER. NO. 85-207,311, FILED 12-29-2010.

WENDY JUN, EXAMINING ATTORNEY



David J. Kyffers

Director of the United States Patent and Trademark Office

United States of America

United States Patent and Trademark Office



Reg. No. 4,098,034

MORGAN, MASON A. (FLORIDA LIMITED LIABILITY COMPANY)

Registered Feb. 14, 2012

P.O. BOX 953842
LAKE MARY, FL 32795

Int. Cl.: 36

FOR: COMMERCIAL AND RESIDENTIAL REAL ESTATE AGENCY SERVICES; PROVIDING A DATABASE OF INFORMATION ABOUT RESIDENTIAL REAL ESTATE LISTINGS IN DIFFERENT NEIGHBORHOODS AND COMMUNITIES, IN CLASS 36 (U.S. CLS. 100, 101 AND 102).

SERVICE MARK

PRINCIPAL REGISTER

FIRST USE 10-1-2007; IN COMMERCE 1-18-2008.

NO CLAIM IS MADE TO THE EXCLUSIVE RIGHT TO USE "HOMES OF CENTRAL FLORIDA", APART FROM THE MARK AS SHOWN.

THE COLOR(S) WHITE, BLACK, BLUE AND GOLD IS/ARE CLAIMED AS A FEATURE OF THE MARK.

THE MARK CONSISTS OF A LOGO THAT HAS THREE DARK BLUE INVERTED "V" ROOFS WITH BLACK ACCENTS WITH CHIMNEYS ON THE RIGHT SIDE OF EACH. BELOW THE APEX OF EACH ROOF IS A WINDOW MADE OF FOUR DARK BLUE AND WHITE SQUARES. BELOW EACH ROOF APEX IS A SHADE OF GOLD. THE THREE ROOFS JOINED TOGETHER ARE CENTERED OVER THE WORDS "HOMES OF CENTRAL FLORIDA" WHICH ARE ALSO IN DARK BLUE, WITH BLACK HIGHLIGHTS. BELOW "HOMES OF CENTRAL FLORIDA" IS A GOLD BAR FROM THE START TO THE FINISH OF ALL THE WORDS.



SER. NO. 85-207,679, FILED 12-30-2010.

DEZMONA MIZELLE, EXAMINING ATTORNEY

David J. Kybas

Director of the United States Patent and Trademark Office

United States of America

United States Patent and Trademark Office

CANFOR SOUTHERN PINE

Reg. No. 4,098,035

NEW SOUTH COMPANIES (DELAWARE CORPORATION)
3700 CLAY POND RD.
MYRTLE BEACH, SC 29579

Registered Feb. 14, 2012

Int. Cl.: 19

FOR: LUMBER, IN CLASS 19 (U.S. CLS. 1, 12, 33 AND 50).

TRADEMARK

FIRST USE 11-1-2010; IN COMMERCE 11-1-2010.

PRINCIPAL REGISTER

THE MARK CONSISTS OF STANDARD CHARACTERS WITHOUT CLAIM TO ANY PARTICULAR FONT, STYLE, SIZE, OR COLOR.

OWNER OF U.S. REG. NOS. 810,008 AND 968,490.

NO CLAIM IS MADE TO THE EXCLUSIVE RIGHT TO USE "SOUTHERN PINE", APART FROM THE MARK AS SHOWN.

SER. NO. 85-207,712, FILED 12-30-2010.

MICHAEL ENGEL, EXAMINING ATTORNEY



David J. Kyffers

Director of the United States Patent and Trademark Office

United States of America

United States Patent and Trademark Office



Reg. No. 4,098,036

Registered Feb. 14, 2012

Int. Cl.: 41

SERVICE MARK

PRINCIPAL REGISTER

EMBRACE ENTERPRISES, LLC (OHIO LIMITED LIABILITY COMPANY)
5628 WILLOWOOD COURT
TOLEDO, OH 43615

FOR: ARRANGING AND CONDUCTING SPECIAL EVENTS FOR SOCIAL ENTERTAINMENT PURPOSES; ARRANGING FOR TICKET RESERVATIONS FOR SHOWS AND OTHER ENTERTAINMENT EVENTS; ARRANGING, ORGANIZING, CONDUCTING, AND HOSTING SOCIAL ENTERTAINMENT EVENTS; CONSULTATION IN THE FIELD OF SPECIAL EVENT PLANNING FOR SOCIAL ENTERTAINMENT PURPOSES; ENTERTAINMENT INFORMATION SERVICES, NAMELY, PROVIDING INFORMATION AND NEWS RELEASES ABOUT A MUSICAL ARTIST; ENTERTAINMENT SERVICES, NAMELY, PERSONAL APPEARANCES BY A MUSIC, TELEVISION, ENTERTAINMENT, OR SPORTS STAR; SPECIAL EVENT PLANNING FOR SOCIAL ENTERTAINMENT PURPOSES, IN CLASS 41 (U.S. CLS. 100, 101 AND 107).

FIRST USE 1-10-2009; IN COMMERCE 4-13-2009.

NO CLAIM IS MADE TO THE EXCLUSIVE RIGHT TO USE "ENTERPRISES", APART FROM THE MARK AS SHOWN.

THE COLOR(S) PURPLE, GREY, WHITE, AND BLACK IS/ARE CLAIMED AS A FEATURE OF THE MARK.

THE MARK CONSISTS OF A DESIGN OF DOUBLE LETTER "E'S" IN STYLIZED FORM IN COLORS GREY, WHITE AND BLACK, AND OUTLINED IN COLOR PURPLE. THE WORDING "EMBRACE ENTERPRISES" IS UNDER THE DOUBLE LETTER "E'S". THE WORD "EMBRACE" IS IN PURPLE AND "ENTERPRISES" IN GREY.

SER. NO. 85-208,084, FILED 12-30-2010.

SOPHIA S. KIM, EXAMINING ATTORNEY



David J. Kybas

Director of the United States Patent and Trademark Office

United States of America

United States Patent and Trademark Office

SoftLux

Reg. No. 4,098,037

Registered Feb. 14, 2012

Int. Cls.: 24 and 25

TRADEMARK

PRINCIPAL REGISTER

OVERSEAS DEVELOPMENT CORP (MISSOURI CORPORATION)
16835 WEST BERNARDO DR., STE 215
SAN DIEGO, CA 92127

FOR: BABY BLANKETS; BED BLANKETS; BLANKET THROWS; THROWS; THROWS DESIGNED TO ALSO BE WRAPPED AROUND A PERSON, IN CLASS 24 (U.S. CLS. 42 AND 50).

FIRST USE 3-1-2009; IN COMMERCE 3-1-2009.

FOR: DRESSING GOWNS AND BATH ROBES; LOUNGEWEAR; ROBES, IN CLASS 25 (U.S. CLS. 22 AND 39).

FIRST USE 3-1-2009; IN COMMERCE 3-1-2009.

THE MARK CONSISTS OF THE WORD "SOFT" IN COLOR MEDIUM PINK, THE WORD "LUX" IS COLOR LIGHT GREEN.

THE COLOR(S) MEDIUM PINK AND LIGHT GREEN IS/ARE CLAIMED AS A FEATURE OF THE MARK.

SER. NO. 85-208,151, FILED 12-30-2010.

CHARLOTTE CORWIN, EXAMINING ATTORNEY



David J. Kybas

Director of the United States Patent and Trademark Office

United States of America

United States Patent and Trademark Office

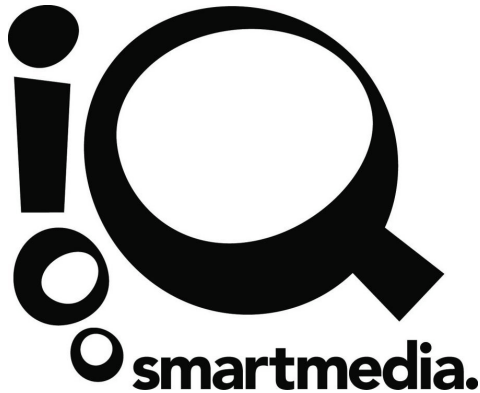

Reg. No. 4,098,038

Registered Feb. 14, 2012

Int. Cl.: 41

SERVICE MARK

PRINCIPAL REGISTER

WQED MULTIMEDIA (PENNSYLVANIA CORPORATION)
4802 FIFTH AVENUE
PITTSBURGH, PA 15213

FOR: PROVIDING A WEBSITE FEATURING INFORMATION IN THE FIELDS OF EDUCATION AND ENTERTAINMENT FOR CHILDREN; PROVIDING ON-LINE RESOURCE GUIDES FOR PARENTS AND EDUCATORS CONCERNING CHILDREN IN THE FIELDS OF EDUCATION AND ENTERTAINMENT; NON-DOWNLOADABLE ELECTRONIC PUBLICATIONS IN THE NATURE OF GUIDES IN THE FIELDS OF RESEARCH CONCERNING SCIENCE AND TECHNOLOGY, PRINT LITERACY, DIGITAL MEDIA LITERACY, NUMERACY, BEHAVIORAL WELLNESS, EXPRESSION, SOCIAL AND COMMUNITY RESPONSIBILITY AND GLOBAL CULTURE; ENTERTAINMENT SERVICES, NAMELY, PROVIDING A WEBSITE FEATURING NON-DOWNLOADABLE MUSICAL VIDEOS, RELATED FILM CLIPS, PHOTOGRAPHS, AND OTHER MULTIMEDIA MATERIALS, INCLUDING AUDIO MATERIALS, FEATURING GAMES AND RECREATION ACTIVITIES FOR CHILDREN, IN CLASS 41 (U.S. CLS. 100, 101 AND 107).

FIRST USE 9-1-2010; IN COMMERCE 9-1-2010.

THE MARK CONSISTS OF THE STYLIZED LETTERS "I" AND "Q" WITH TWO CIRCLES BENEATH THE LETTERS AND THE PHRASE "SMARTMEDIA" AT THE BOTTOM.

SER. NO. 85-208,218, FILED 12-30-2010.

ANGELA M. MICHELI, EXAMINING ATTORNEY



David J. Kybas

Director of the United States Patent and Trademark Office

United States of America

United States Patent and Trademark Office

MIRA

Reg. No. 4,098,039

Registered Feb. 14, 2012

Int. Cl.: 36

SERVICE MARK

PRINCIPAL REGISTER

MIRA SCHOLARS FOUNDATION (CALIFORNIA NONPROFIT PUBLIC BENEFIT CORPORATION)
1559B SLOAT BOULEVARD, SUITE 496
SAN FRANCISCO, CA 94132

FOR: CHARITABLE FUNDRAISING SERVICES; FUNDRAISING FOR THE BENEFIT OF THIRD PARTY NONPROFIT ORGANIZATIONS, IN CLASS 36 (U.S. CLS. 100, 101 AND 102).

FIRST USE 5-0-2010; IN COMMERCE 5-0-2010.

THE MARK CONSISTS OF STANDARD CHARACTERS WITHOUT CLAIM TO ANY PARTICULAR FONT, STYLE, SIZE, OR COLOR.

THE ENGLISH TRANSLATION OF THE WORD "MIRA" IN THE MARK IS "LOOK" IN SPANISH, "ASTONISHING" IN LATIN, "GREAT" IN SLAVIC AND "EXALTED" IN HEBREW.

SER. NO. 85-208,275, FILED 12-30-2010.

SEAN CROWLEY, EXAMINING ATTORNEY



David J. Kybas

Director of the United States Patent and Trademark Office

United States of America

United States Patent and Trademark Office

ThumbPass

Reg. No. 4,098,040

VENDMORE SYSTEMS, LLC (DELAWARE LIMITED LIABILITY COMPANY)
5 HIGH RIDGE PARK
STAMFORD, CT 06905

Registered Feb. 14, 2012

Int. Cls.: 9, 35 and 38

FOR: COMPUTER SOFTWARE FOR CONTROLLING AND MANAGING ACCESS TO VENDING MACHINES, IN CLASS 9 (U.S. CLS. 21, 23, 26, 36 AND 38).

TRADEMARK

FIRST USE 4-19-2005; IN COMMERCE 4-19-2005.

SERVICE MARK

FOR: PROVIDING AN ON-LINE PORTAL THAT PROVIDES CUSTOMERS ACCESS TO THEIR VENDING ACCOUNT INFORMATION, IN CLASS 35 (U.S. CLS. 100, 101 AND 102).

PRINCIPAL REGISTER

FIRST USE 4-19-2005; IN COMMERCE 4-19-2005.

FOR: PROVIDING USER ACCESS TO A GLOBAL COMPUTER NETWORK TO ACCESS VENDING MACHINE ACCOUNTS, IN CLASS 38 (U.S. CLS. 100, 101 AND 104).

FIRST USE 4-19-2005; IN COMMERCE 4-19-2005.

THE MARK CONSISTS OF STANDARD CHARACTERS WITHOUT CLAIM TO ANY PARTICULAR FONT, STYLE, SIZE, OR COLOR.

SER. NO. 85-208,409, FILED 12-31-2010.

ARETHA SOMERVILLE, EXAMINING ATTORNEY



David J. Kybas

Director of the United States Patent and Trademark Office

United States of America

United States Patent and Trademark Office

the un-marketing research company

Reg. No. 4,098,041

RBV3, LLC (PENNSYLVANIA LIMITED LIABILITY COMPANY)
400 MARYLAND DRIVE

Registered Feb. 14, 2012

FORT WASHINGTON, PA 190347544

Int. Cl.: 35

FOR: CONSULTING SERVICES, NAMELY, MANAGEMENT, MARKETING AND DECISION-SUPPORT CONSULTING IN THE INDUSTRIES OF HEALTHCARE, HEALTHCARE MANUFACTURING AND HEALTHCARE SUPPORT, IN CLASS 35 (U.S. CLS. 100, 101 AND 102).

SERVICE MARK

FIRST USE 10-26-2010; IN COMMERCE 10-26-2010.

PRINCIPAL REGISTER

THE MARK CONSISTS OF STANDARD CHARACTERS WITHOUT CLAIM TO ANY PARTICULAR FONT, STYLE, SIZE, OR COLOR.

NO CLAIM IS MADE TO THE EXCLUSIVE RIGHT TO USE "RESEARCH COMPANY", APART FROM THE MARK AS SHOWN.

SER. NO. 85-208,536, FILED 12-31-2010.

THOMAS MANOR, EXAMINING ATTORNEY



David J. Kyfos

Director of the United States Patent and Trademark Office

United States of America

United States Patent and Trademark Office



Pound Cake

Reg. No. 4,098,042

Registered Feb. 14, 2012

Int. Cl.: 25

TRADEMARK

PRINCIPAL REGISTER

CAKE FASHIONS, (POUND CAKE WOMEN'S WEAR) LLC. (CALIFORNIA LIMITED LIABILITY COMPANY), DBA POUNDCAKE WOMEN'S WEAR
9126 LUCCHESI DR
SACRAMENTO, CA 95829

FOR: ATHLETIC APPAREL, NAMELY, SHIRTS, PANTS, JACKETS, FOOTWEAR, HATS AND CAPS, ATHLETIC UNIFORMS; BLAZERS; BLOUSES; BODY SHIRTS; BRAS; FUR JACKETS; GYM SHORTS; HOODED SWEAT SHIRTS; JEANS; JEGGINGS, NAMELY, PANTS THAT ARE PARTIALLY JEANS AND PARTIALLY LEGGINGS; JERSEYS; KNIT BOTTOMS; SCARVES; SLEEVELESS JERSEYS; SPORTS BRA; SWEAT JACKETS; SWEAT PANTS; SWEAT SHIRTS; SWEAT SUITS; THONGS; WOMEN'S UNDERWEAR, IN CLASS 25 (U.S. CLS. 22 AND 39).

FIRST USE 3-10-2008; IN COMMERCE 3-10-2008.

THE MARK CONSISTS OF THE WORD "POUND CAKE" IN STYLIZED FORM WITH THE SILHOUETTE OF A THICK CURVACEOUS WOMAN WITHOUT HEAD AND LIMBS IN THE MIDDLE.

SER. NO. 85-208,825, FILED 1-2-2011.

KRISTINA MORRIS, EXAMINING ATTORNEY



David J. Kybas

Director of the United States Patent and Trademark Office

United States of America

United States Patent and Trademark Office

When 1 sun is not enough

Reg. No. 4,098,043

Registered Feb. 14, 2012

Int. Cl.: 9

TRADEMARK

PRINCIPAL REGISTER

ALPHA-OMEGA POWER TECHNOLOGIES, LTD. CO. (NEW MEXICO LIMITED LIABILITY COMPANY)
P.O. BOX 93670
ALBUQUERQUE, NM 871993670

FOR: EQUIPMENT IN THE NATURE OF LIGHT-EMITTING AND LIGHT-MONITORING UNITS FOR TESTING THE ELECTRICAL GENERATION CAPABILITIES OF SOLAR CELLS, IN CLASS 9 (U.S. CLS. 21, 23, 26, 36 AND 38).

FIRST USE 11-24-2009; IN COMMERCE 11-24-2009.

THE MARK CONSISTS OF STANDARD CHARACTERS WITHOUT CLAIM TO ANY PARTICULAR FONT, STYLE, SIZE, OR COLOR.

SER. NO. 85-209,181, FILED 1-3-2011.

JULIE GUTTADAURO, EXAMINING ATTORNEY



David J. Kyffers

Director of the United States Patent and Trademark Office

United States of America

United States Patent and Trademark Office

ALEXTON

Reg. No. 4,098,044

Registered Feb. 14, 2012

Int. Cls.: 35, 36 and 42

SERVICE MARK

PRINCIPAL REGISTER

ALEXTON INCORPORATED (NEVADA CORPORATION)
5600 GENERAL WASHINGTON DR, SUITE B201
ALEXANDRIA, VA 22312

FOR: FINANCIAL STATEMENT PREPARATION AND ANALYSIS FOR BUSINESSES; BUSINESS CONSULTING IN THE FIELD OF BUSINESS REENGINEERING; ANALYZING AND COMPILING DATA FOR MEASURING THE PERFORMANCE OF FINANCIAL MARKETS; BUSINESS PROJECT MANAGEMENT; BUSINESS PROGRAM MANAGEMENT; BUSINESS CONSULTATION RELATING TO INTERNAL CONTROLS MANAGEMENT AND REVIEW; ACCOUNTING SERVICES IN THE FINANCIAL INDUSTRY, IN CLASS 35 (U.S. CLS. 100, 101 AND 102).

FIRST USE 10-10-2005; IN COMMERCE 10-10-2005.

FOR: FINANCIAL MANAGEMENT; FINANCIAL AFFAIRS AND MONETARY AFFAIRS, NAMELY, FINANCIAL INFORMATION, MANAGEMENT AND ANALYSIS SERVICES; FINANCIAL ANALYSES; FINANCIAL ANALYSIS AND CONSULTATION; FINANCIAL CONSULTING; FINANCIAL ANALYSIS AND RESEARCH SERVICES; FINANCIAL CONSULTING SERVICES, NAMELY, EXPERT ANALYSIS IN FINANCE; FINANCIAL PLANNING; FINANCIAL ADVICE, NAMELY, BUDGET PLANNING; FINANCIAL SERVICES, NAMELY, CREDIT AGENCIES FEATURING CREDIT PROCESSING, NAMELY, CREDIT CHECKING, CREDIT ANALYZING, AND FINANCIAL REPORTING SERVICES, IN CLASS 36 (U.S. CLS. 100, 101 AND 102).

FIRST USE 10-10-2005; IN COMMERCE 10-10-2005.

FOR: CONSULTING IN THE FIELD OF INFORMATION TECHNOLOGY; INFORMATION TECHNOLOGY CONSULTATION SERVICES; INFORMATION TECHNOLOGY CONSULTATION; PLANNING, DESIGN AND MANAGEMENT OF INFORMATION TECHNOLOGY SYSTEMS; CONSULTING SERVICES IN THE FIELD OF DESIGN, SELECTION, IMPLEMENTATION AND USE OF COMPUTER HARDWARE AND SOFTWARE SYSTEMS FOR OTHERS; COMPUTER CONSULTING SERVICES FOR PLANNING, DESIGN, AND ANALYSIS OF INFORMATION PROCESSES, SYSTEMS, AND BUSINESS REENGINEERING; ANALYSIS AND DESIGN OF COMPUTER SYSTEMS, SOFTWARE AND INFORMATION SYSTEMS FOR OTHERS; DESIGN FOR OTHERS OF SOFTWARE APPLICATIONS ON LOCAL AND INTERNAL COMPUTER NETWORKS AND THE INTERNET; PROVIDING DESIGN AND DEVELOPMENT FOR OTHERS' COMPUTER NETWORKS; MAINTENANCE OF SOFTWARE



David J. Kyjars

Director of the United States Patent and Trademark Office

Reg. No. 4,098,044 AND SOFTWARE SYSTEMS; COMPUTER CONSULTATION ON THE COMPUTER-RELATED ASPECTS OF INFORMATION TECHNOLOGY SECURITY, IN CLASS 42 (U.S. CLS. 100 AND 101).

FIRST USE 10-10-2005; IN COMMERCE 10-10-2005.

THE MARK CONSISTS OF STANDARD CHARACTERS WITHOUT CLAIM TO ANY PARTICULAR FONT, STYLE, SIZE, OR COLOR.

SER. NO. 85-209,249, FILED 1-3-2011.

WENDY JUN, EXAMINING ATTORNEY

United States of America

United States Patent and Trademark Office

Alexton

Reg. No. 4,098,045

Registered Feb. 14, 2012

Int. Cls.: 35, 36 and 42

SERVICE MARK

PRINCIPAL REGISTER

ALEXTON INCORPORATED (NEVADA CORPORATION)
5600 GENERAL WASHINGTON DR, SUITE B201
ALEXANDRIA, VA 22312

FOR: FINANCIAL STATEMENT PREPARATION AND ANALYSIS FOR BUSINESSES; BUSINESS CONSULTING IN THE FIELD OF BUSINESS REENGINEERING; ANALYZING AND COMPILING DATA FOR MEASURING THE PERFORMANCE OF FINANCIAL MARKETS; BUSINESS PROJECT MANAGEMENT; BUSINESS PROGRAM MANAGEMENT; BUSINESS CONSULTATION RELATING TO INTERNAL CONTROLS MANAGEMENT AND REVIEW; ACCOUNTING SERVICES IN THE FINANCIAL INDUSTRY, IN CLASS 35 (U.S. CLS. 100, 101 AND 102).

FIRST USE 10-10-2005; IN COMMERCE 10-10-2005.

FOR: FINANCIAL MANAGEMENT; FINANCIAL AFFAIRS AND MONETARY AFFAIRS, NAMELY, FINANCIAL INFORMATION, MANAGEMENT AND ANALYSIS SERVICES; FINANCIAL ANALYSES; FINANCIAL ANALYSIS AND CONSULTATION; FINANCIAL CONSULTING; FINANCIAL ANALYSIS AND RESEARCH SERVICES; FINANCIAL CONSULTING SERVICES, NAMELY, EXPERT ANALYSIS IN FINANCE; FINANCIAL PLANNING; FINANCIAL ADVICE, NAMELY, BUDGET PLANNING; FINANCIAL SERVICES, NAMELY, CREDIT AGENCIES FEATURING CREDIT PROCESSING, NAMELY, CREDIT CHECKING, CREDIT ANALYZING, AND FINANCIAL REPORTING SERVICES, IN CLASS 36 (U.S. CLS. 100, 101 AND 102).

FIRST USE 10-10-2005; IN COMMERCE 10-10-2005.

FOR: CONSULTING IN THE FIELD OF INFORMATION TECHNOLOGY; INFORMATION TECHNOLOGY CONSULTATION SERVICES; INFORMATION TECHNOLOGY CONSULTATION; PLANNING, DESIGN AND MANAGEMENT OF INFORMATION TECHNOLOGY SYSTEMS; CONSULTING SERVICES IN THE FIELD OF DESIGN, SELECTION, IMPLEMENTATION AND USE OF COMPUTER HARDWARE AND SOFTWARE SYSTEMS FOR OTHERS; COMPUTER CONSULTING SERVICES FOR PLANNING, DESIGN, AND ANALYSIS OF INFORMATION PROCESSES, SYSTEMS, AND BUSINESS REENGINEERING; ANALYSIS AND DESIGN OF COMPUTER SYSTEMS, SOFTWARE AND INFORMATION SYSTEMS FOR OTHERS; DESIGN FOR OTHERS OF SOFTWARE APPLICATIONS ON LOCAL AND INTERNAL COMPUTER NETWORKS AND THE INTERNET; PROVIDING DESIGN AND DEVELOPMENT FOR OTHERS' COMPUTER NETWORKS; MAINTENANCE OF SOFTWARE



David J. Kyjars

Director of the United States Patent and Trademark Office

Reg. No. 4,098,045 AND SOFTWARE SYSTEMS; COMPUTER CONSULTATION ON THE COMPUTER-RELATED ASPECTS OF INFORMATION TECHNOLOGY SECURITY, IN CLASS 42 (U.S. CLS. 100 AND 101).

FIRST USE 10-10-2005; IN COMMERCE 10-10-2005.

THE MARK CONSISTS OF "ALEXTON" IN STYLIZED TEXT IN WHICH THE "O" IS COMPOSED OF A SPHERE WITH A TRANSCRIBED ORBIT.

SER. NO. 85-209,280, FILED 1-3-2011.

WENDY JUN, EXAMINING ATTORNEY

United States of America

United States Patent and Trademark Office



Reg. No. 4,098,046

Registered Feb. 14, 2012

Int. Cls.: 35, 36 and 42

SERVICE MARK

PRINCIPAL REGISTER

ALEXTON INCORPORATED (NEVADA CORPORATION)
5600 GENERAL WASHINGTON DR, SUITE B201
ALEXANDRIA, VA 22312

FOR: FINANCIAL STATEMENT PREPARATION AND ANALYSIS FOR BUSINESSES; BUSINESS CONSULTING IN THE FIELD OF BUSINESS REENGINEERING; ANALYZING AND COMPILING DATA FOR MEASURING THE PERFORMANCE OF FINANCIAL MARKETS; BUSINESS PROJECT MANAGEMENT; BUSINESS PROGRAM MANAGEMENT; BUSINESS CONSULTATION RELATING TO INTERNAL CONTROLS MANAGEMENT AND REVIEW; ACCOUNTING SERVICES IN THE FINANCIAL INDUSTRY, IN CLASS 35 (U.S. CLS. 100, 101 AND 102).

FIRST USE 10-10-2005; IN COMMERCE 10-10-2005.

FOR: FINANCIAL MANAGEMENT; FINANCIAL AFFAIRS AND MONETARY AFFAIRS, NAMELY, FINANCIAL INFORMATION, MANAGEMENT AND ANALYSIS SERVICES; FINANCIAL ANALYSES; FINANCIAL ANALYSIS AND CONSULTATION; FINANCIAL CONSULTING; FINANCIAL ANALYSIS AND RESEARCH SERVICES; FINANCIAL CONSULTING SERVICES, NAMELY, EXPERT ANALYSIS IN FINANCE; FINANCIAL PLANNING; FINANCIAL ADVICE, NAMELY, BUDGET PLANNING; FINANCIAL SERVICES, NAMELY, CREDIT AGENCIES FEATURING CREDIT PROCESSING, NAMELY, CREDIT CHECKING, CREDIT ANALYZING, AND FINANCIAL REPORTING SERVICES, IN CLASS 36 (U.S. CLS. 100, 101 AND 102).

FIRST USE 10-10-2005; IN COMMERCE 10-10-2005.

FOR: CONSULTING IN THE FIELD OF INFORMATION TECHNOLOGY; INFORMATION TECHNOLOGY CONSULTATION SERVICES; INFORMATION TECHNOLOGY CONSULTATION; PLANNING, DESIGN AND MANAGEMENT OF INFORMATION TECHNOLOGY SYSTEMS; CONSULTING SERVICES IN THE FIELD OF DESIGN, SELECTION, IMPLEMENTATION AND USE OF COMPUTER HARDWARE AND SOFTWARE SYSTEMS FOR OTHERS; COMPUTER CONSULTING SERVICES FOR PLANNING, DESIGN, AND ANALYSIS OF INFORMATION PROCESSES, SYSTEMS, AND BUSINESS REENGINEERING; ANALYSIS AND DESIGN OF COMPUTER SYSTEMS, SOFTWARE AND INFORMATION SYSTEMS FOR OTHERS; DESIGN FOR OTHERS OF SOFTWARE APPLICATIONS ON LOCAL AND INTERNAL COMPUTER NETWORKS AND THE INTERNET; PROVIDING DESIGN AND DEVELOPMENT FOR OTHERS' COMPUTER NETWORKS; MAINTENANCE OF SOFTWARE



David J. Kyjars

Director of the United States Patent and Trademark Office

Reg. No. 4,098,046 AND SOFTWARE SYSTEMS; COMPUTER CONSULTATION ON THE COMPUTER-RELATED ASPECTS OF INFORMATION TECHNOLOGY SECURITY, IN CLASS 42 (U.S. CLS. 100 AND 101).

FIRST USE 10-10-2005; IN COMMERCE 10-10-2005.

NO CLAIM IS MADE TO THE EXCLUSIVE RIGHT TO USE "FINANCIAL MANAGEMENT CONTROLS", "PROJECT MANAGEMENT", "MONITORING OF FINANCIAL MANAGEMENT SYSTEMS", "ACCOUNTING" AND "INFORMATION TECHNOLOGY SOLUTIONS", APART FROM THE MARK AS SHOWN.

THE MARK CONSISTS OF "ALEXTON" IN A CENTERED CIRCLE SURROUNDED BY A CIRCUIT OF ARROWS CONTAINING THE WORDS "INFORMATION TECHNOLOGY SOLUTIONS, FINANCIAL MANAGEMENT CONTROLS", "PROJECT MANAGEMENT", "ACCOUNTING", AND "MONITORING OF FINANCIAL MANAGEMENT SYSTEMS".

SER. NO. 85-209,290, FILED 1-3-2011.

WENDY JUN, EXAMINING ATTORNEY

United States of America
United States Patent and Trademark Office

FIBERFLEX

Reg. No. 4,098,047

Registered Feb. 14, 2012

Int. Cl.: 7

TRADEMARK

PRINCIPAL REGISTER

TOTAL ROD CONCEPTS, INC. (OKLAHOMA CORPORATION)
1400 WOODLOCH FOREST DRIVE
SUITE 170
THE WOODLANDS, TX 77380

FOR: FIBERGLASS SUCKER RODS FOR USE IN OIL OR GAS PRODUCING WELLS, IN CLASS 7 (U.S. CLS. 13, 19, 21, 23, 31, 34 AND 35).

FIRST USE 9-14-2011; IN COMMERCE 9-14-2011.

THE MARK CONSISTS OF STANDARD CHARACTERS WITHOUT CLAIM TO ANY PARTICULAR FONT, STYLE, SIZE, OR COLOR.

SER. NO. 85-209,769, FILED 1-4-2011.

SKYE YOUNG, EXAMINING ATTORNEY



David J. Kybas

Director of the United States Patent and Trademark Office

United States of America

United States Patent and Trademark Office

OUT!

Reg. No. 4,098,048

Registered Feb. 14, 2012

Int. Cl.: 21

TRADEMARK

PRINCIPAL REGISTER

OUT! INTERNATIONAL, INC. (TEXAS CORPORATION)
LEGAL DEPARTMENT
2727 CHEMSEARCH BLVD.
IRVING, TX 75062

FOR: PORTABLE DISPENSERS FOR PET WASTE BAGS THAT INCORPORATE AN LED FLASHLIGHT; PORTABLE DISPENSERS FOR PET WASTE BAGS, IN CLASS 21 (U.S. CLS. 2, 13, 23, 29, 30, 33, 40 AND 50).

FIRST USE 3-10-2010; IN COMMERCE 3-10-2010.

THE MARK CONSISTS OF STANDARD CHARACTERS WITHOUT CLAIM TO ANY PARTICULAR FONT, STYLE, SIZE, OR COLOR.

SER. NO. 85-210,077, FILED 1-4-2011.

ANTHONY RINKER, EXAMINING ATTORNEY



David J. Kybas

Director of the United States Patent and Trademark Office

United States of America

United States Patent and Trademark Office

OUT!

Reg. No. 4,098,049

Registered Feb. 14, 2012

Int. Cl.: 21

TRADEMARK

PRINCIPAL REGISTER

OUT! INTERNATIONAL, INC. (TEXAS CORPORATION)
LEGAL DEPARTMENT
2727 CHEMSEARCH BLVD.
IRVING, TX 75062

FOR: SCOOPS FOR THE DISPOSAL OF PET WASTE; PLASTIC TRAYS FOR HOLDING TRAINING PADS FOR HOUSEBREAKING PETS WHILE BEING USED BY PETS; PET HAIR AND LINT ROLLERS, IN CLASS 21 (U.S. CLS. 2, 13, 23, 29, 30, 33, 40 AND 50).

FIRST USE 4-10-2009; IN COMMERCE 4-10-2009.

THE MARK CONSISTS OF STANDARD CHARACTERS WITHOUT CLAIM TO ANY PARTICULAR FONT, STYLE, SIZE, OR COLOR.

SER. NO. 85-210,153, FILED 1-4-2011.

ANTHONY RINKER, EXAMINING ATTORNEY



David J. Kybas

Director of the United States Patent and Trademark Office

United States of America

United States Patent and Trademark Office

OUT!

Reg. No. 4,098,050

Registered Feb. 14, 2012

Int. Cl.: 5

TRADEMARK

PRINCIPAL REGISTER

OUT! INTERNATIONAL, INC. (TEXAS CORPORATION)
LEGAL DEPARTMENT
2727 CHEMSEARCH BLVD.
IRVING, TX 75062

FOR: PET HOUSING AID, NAMELY, A PHEROMONE TREATMENT SPRAY FOR ATTRACTING PETS TO ELIMINATE IN A SPECIFIC AREA, IN CLASS 5 (U.S. CLS. 6, 18, 44, 46, 51 AND 52).

FIRST USE 7-13-2007; IN COMMERCE 7-13-2007.

THE MARK CONSISTS OF STANDARD CHARACTERS WITHOUT CLAIM TO ANY PARTICULAR FONT, STYLE, SIZE, OR COLOR.

SER. NO. 85-210,161, FILED 1-4-2011.

ANTHONY RINKER, EXAMINING ATTORNEY



David J. Kybas

Director of the United States Patent and Trademark Office

United States of America

United States Patent and Trademark Office

OUT!

Reg. No. 4,098,051

Registered Feb. 14, 2012

Int. Cl.: 16

TRADEMARK

PRINCIPAL REGISTER

OUT! INTERNATIONAL, INC. (TEXAS CORPORATION)
LEGAL DEPARTMENT
2727 CHEMSEARCH BLVD.
IRVING, TX 75062

FOR: PET DISPOSABLE TRAINING PADS FOR HOUSEBREAKING; PLASTIC BAGS FOR DISPOSING OF PET WASTE, IN CLASS 16 (U.S. CLS. 2, 5, 22, 23, 29, 37, 38 AND 50).

FIRST USE 9-17-1996; IN COMMERCE 9-17-1996.

THE MARK CONSISTS OF STANDARD CHARACTERS WITHOUT CLAIM TO ANY PARTICULAR FONT, STYLE, SIZE, OR COLOR.

SER. NO. 85-210,167, FILED 1-4-2011.

ANTHONY RINKER, EXAMINING ATTORNEY



David J. Kyffers

Director of the United States Patent and Trademark Office

United States of America

United States Patent and Trademark Office



Reg. No. 4,098,052

Registered Feb. 14, 2012

Int. Cl.: 41

SERVICE MARK

PRINCIPAL REGISTER

KRIST, INC. (DELAWARE CORPORATION)
#400
2711 CENTERVILLE RD.
WILMINGTON, DE 19808

FOR: PROVIDING ON-LINE TRAINING COURSES IN THE FIELDS OF WORKPLACE SAFETY, SAFETY WHEN AROUND HAZARDOUS MATERIALS, AND KEEPING A COMPANY COMPLIANT WITH GOVERNMENT SAFETY STANDARDS, IN CLASS 41 (U.S. CLS. 100, 101 AND 107).

FIRST USE 6-1-2009; IN COMMERCE 6-1-2009.

NO CLAIM IS MADE TO THE EXCLUSIVE RIGHT TO USE "COMPLIANCE TRAINING ONLINE", APART FROM THE MARK AS SHOWN.

THE MARK CONSISTS OF THE WORDS "COMPLIANCE TRAINING ONLINE" ON A RECTANGULAR FIELD WITH A CHECK MARK APPEARING IN A BOX ON THE LEFT SIDE OF "COMPLIANCE TRAINING ONLINE".

SER. NO. 85-210,460, FILED 1-4-2011.

REGINA DRUMMOND, EXAMINING ATTORNEY



David J. Kyjars

Director of the United States Patent and Trademark Office

United States of America

United States Patent and Trademark Office

EQUAL INTERVAL SYSTEM

Reg. No. 4,098,053

MURPHY, LILITH (UNITED STATES INDIVIDUAL)
323 EAST MATILIA STREET, SUITE 110-275
OJAI, CA 93023

Registered Feb. 14, 2012

Int. Cl.: 41

FOR: EDUCATIONAL SERVICES, NAMELY, PROVIDING COURSES IN THE FIELD OF MUSIC, MUSIC THEORY AND MUSIC COMPOSITION AND DISTRIBUTION OF COURSE MATERIALS IN CONNECTION THEREWITH; BOOK PUBLISHING, IN CLASS 41 (U.S. CLS. 100, 101 AND 107).

SERVICE MARK

PRINCIPAL REGISTER

FIRST USE 0-0-1978; IN COMMERCE 0-0-1978.

THE MARK CONSISTS OF STANDARD CHARACTERS WITHOUT CLAIM TO ANY PARTICULAR FONT, STYLE, SIZE, OR COLOR.

SEC. 2(F).

SER. NO. 85-210,477, FILED 1-4-2011.

HAI-LY LAM, EXAMINING ATTORNEY



David J. Kyffers

Director of the United States Patent and Trademark Office

United States of America

United States Patent and Trademark Office

EQUAL INTERVAL SYSTEM

Reg. No. 4,098,054

MURPHY, LILITH (UNITED STATES INDIVIDUAL)
323 EAST MATILJA STREET, SUITE 110-275
OJAI, CA 93023

Registered Feb. 14, 2012

Int. Cl.: 16

FOR: SERIES OF BOOKS IN THE FIELD OF MUSIC, MUSIC THEORY AND MUSIC COMPOSITION, IN CLASS 16 (U.S. CLS. 2, 5, 22, 23, 29, 37, 38 AND 50).

TRADEMARK

FIRST USE 0-0-1978; IN COMMERCE 0-0-1978.

PRINCIPAL REGISTER

THE MARK CONSISTS OF STANDARD CHARACTERS WITHOUT CLAIM TO ANY PARTICULAR FONT, STYLE, SIZE, OR COLOR.

SEC. 2(F).

SER. NO. 85-210,480, FILED 1-4-2011.

HAI-LY LAM, EXAMINING ATTORNEY



David J. Kyffers

Director of the United States Patent and Trademark Office

United States of America

United States Patent and Trademark Office

the
Constitution
Quest
game

Reg. No. 4,098,055

Registered Feb. 14, 2012

Int. Cl.: 28

TRADEMARK

PRINCIPAL REGISTER

DAVID BARRET (UNITED STATES INDIVIDUAL)
29102 PROVIDENCE ROAD
TEMECULA, CA 92591 AND

BARRET, PAMELA M. (UNITED STATES INDIVIDUAL)
29102 PROVIDENCE ROAD
TEMECULA, CA 92591

FOR: BOARD GAMES, IN CLASS 28 (U.S. CLS. 22, 23, 38 AND 50).

FIRST USE 12-1-2010; IN COMMERCE 12-31-2010.

NO CLAIM IS MADE TO THE EXCLUSIVE RIGHT TO USE "CONSTITUTION" AND "GAME",
APART FROM THE MARK AS SHOWN.

THE COLOR(S) GOLD, BROWN AND BLACK IS/ARE CLAIMED AS A FEATURE OF THE
MARK.

THE MARK CONSISTS OF THE GOLD PARCHMENT COLORED INTERIOR STYLIZED
WORDING "THE CONSTITUTION QUEST GAME" WHICH IS OUTLINED IN BROWN AND
BLACK.

SER. NO. 85-210,546, FILED 1-5-2011.

BRENDAN MCCAULEY, EXAMINING ATTORNEY



David J. Kybas

Director of the United States Patent and Trademark Office

United States of America

United States Patent and Trademark Office

MOUNTAINVIEW SECURITIES

Reg. No. 4,098,056

Registered Feb. 14, 2012

Int. Cl.: 36

SERVICE MARK

PRINCIPAL REGISTER

MOUNTAINVIEW SECURITIES, LLC (DELAWARE LIMITED LIABILITY COMPANY)
SUITE 1001
999 18TH STREET
DENVER, CO 80202

FOR: SECURITIES BROKERAGE SERVICES, NAMELY, TRADING OF MUNICIPAL AND FIXED INCOME SECURITIES, IN CLASS 36 (U.S. CLS. 100, 101 AND 102).

FIRST USE 2-10-2009; IN COMMERCE 2-10-2009.

THE MARK CONSISTS OF STANDARD CHARACTERS WITHOUT CLAIM TO ANY PARTICULAR FONT, STYLE, SIZE, OR COLOR.

NO CLAIM IS MADE TO THE EXCLUSIVE RIGHT TO USE "SECURITIES", APART FROM THE MARK AS SHOWN.

SER. NO. 85-210,727, FILED 1-5-2011.

TINA BROWN, EXAMINING ATTORNEY



David J. Kyjars

Director of the United States Patent and Trademark Office

United States of America

United States Patent and Trademark Office



Evolve Platform

Reg. No. 4,098,057

Registered Feb. 14, 2012

Int. Cl.: 9

TRADEMARK

PRINCIPAL REGISTER

DOCUMATICS, INC. (DELAWARE CORPORATION)
31915 RANCHO CALIFORNIA RD.
TEMECULA, CA 92591

FOR: COMPUTER SOFTWARE FOR BUSINESS PROCESS MANAGEMENT FOR THE FINANCE, LEGAL, INSURANCE, ENGINEERING AND MANUFACTURING INDUSTRIES, IN CLASS 9 (U.S. CLS. 21, 23, 26, 36 AND 38).

FIRST USE 6-21-2010; IN COMMERCE 9-23-2010.

NO CLAIM IS MADE TO THE EXCLUSIVE RIGHT TO USE "PLATFORM", APART FROM THE MARK AS SHOWN.

THE COLOR(S) TEAL AND BLACK IS/ARE CLAIMED AS A FEATURE OF THE MARK.

THE MARK CONSISTS OF A TEAL BUTTERFLY UNDERNEATH WHICH APPEARS THE BLACK WORDING "EVOLVE PLATFORM".

SER. NO. 85-211,137, FILED 1-5-2011.

JOHN KELLY, EXAMINING ATTORNEY



David J. Kybas

Director of the United States Patent and Trademark Office

United States of America

United States Patent and Trademark Office

FITSOM

Reg. No. 4,098,058

GUIZAR, MARCO (UNITED STATES INDIVIDUAL)
181 ARNOLD GAMBLE CIR
SACRAMENTO, CA 95835

Registered Feb. 14, 2012

Int. Cl.: 9

FOR: DIGITAL MATERIALS, NAMELY, DOWNLOADABLE VIDEO RECORDINGS AND DVDS FEATURING FITNESS INSTRUCTION, IN CLASS 9 (U.S. CLS. 21, 23, 26, 36 AND 38).

TRADEMARK

FIRST USE 1-0-2010; IN COMMERCE 1-0-2010.

PRINCIPAL REGISTER

THE MARK CONSISTS OF STANDARD CHARACTERS WITHOUT CLAIM TO ANY PARTICULAR FONT, STYLE, SIZE, OR COLOR.

SER. NO. 85-211,179, FILED 1-5-2011.

NELSON SNYDER, EXAMINING ATTORNEY



David J. Kyffers

Director of the United States Patent and Trademark Office

United States of America

United States Patent and Trademark Office

Valley Roller Company, Inc.

Reg. No. 4,098,059

VALLEY ROLLER COMPANY, INC. (WISCONSIN CORPORATION)
1000 S. MAIN
MANSFIELD, TX 76063

Registered Feb. 14, 2012

Int. Cl.: 7

FOR: MACHINE PARTS, NAMELY, ROLLERS COATED WITH SYNTHETIC MATERIAL,
IN CLASS 7 (U.S. CLS. 13, 19, 21, 23, 31, 34 AND 35).

TRADEMARK

FIRST USE 7-11-1984; IN COMMERCE 7-11-1984.

PRINCIPAL REGISTER

THE MARK CONSISTS OF STANDARD CHARACTERS WITHOUT CLAIM TO ANY PAR-
TICULAR FONT, STYLE, SIZE, OR COLOR.

NO CLAIM IS MADE TO THE EXCLUSIVE RIGHT TO USE "ROLLER COMPANY, INC.",
APART FROM THE MARK AS SHOWN.

SER. NO. 85-211,184, FILED 1-5-2011.

TINA L. SNAPP, EXAMINING ATTORNEY



David J. Kyffers

Director of the United States Patent and Trademark Office

United States of America

United States Patent and Trademark Office

RUBBER COVERED ROLLS THAT LOVE TO RUN

Reg. No. 4,098,060

VALLEY ROLLER COMPANY, INC. (WISCONSIN CORPORATION)
1000 S. MAIN
MANSFIELD, TX 76063

Registered Feb. 14, 2012

Int. Cl.: 7

FOR: MACHINE PARTS, NAMELY, ROLLERS COATED WITH SYNTHETIC MATERIAL,
IN CLASS 7 (U.S. CLS. 13, 19, 21, 23, 31, 34 AND 35).

TRADEMARK

FIRST USE 1-1-1994; IN COMMERCE 1-1-1994.

PRINCIPAL REGISTER

THE MARK CONSISTS OF STANDARD CHARACTERS WITHOUT CLAIM TO ANY PAR-
TICULAR FONT, STYLE, SIZE, OR COLOR.

NO CLAIM IS MADE TO THE EXCLUSIVE RIGHT TO USE "RUBBER COVERED ROLLS",
APART FROM THE MARK AS SHOWN.

SER. NO. 85-211,201, FILED 1-5-2011.

TINA L. SNAPP, EXAMINING ATTORNEY



David J. Kyffers

Director of the United States Patent and Trademark Office

United States of America

United States Patent and Trademark Office

PREFERRED PLAYER CARD

Reg. No. 4,098,061

GUITAR CENTER, INC. (DELAWARE CORPORATION)
5795 LINDERO CANYON ROAD
WESTLAKE VILLAGE, CA 91362

Registered Feb. 14, 2012

Int. Cl.: 36

FOR: FINANCING OF PURCHASES, NAMELY, MUSICAL INSTRUMENTS AND ACCESSORIES, IN CLASS 36 (U.S. CLS. 100, 101 AND 102).

SERVICE MARK

FIRST USE 11-1-1999; IN COMMERCE 11-1-1999.

PRINCIPAL REGISTER

THE MARK CONSISTS OF STANDARD CHARACTERS WITHOUT CLAIM TO ANY PARTICULAR FONT, STYLE, SIZE, OR COLOR.

NO CLAIM IS MADE TO THE EXCLUSIVE RIGHT TO USE "PREFERRED" AND "CARD", APART FROM THE MARK AS SHOWN.

SER. NO. 85-211,288, FILED 1-5-2011.

ANNE E. GUSTASON, EXAMINING ATTORNEY



David J. Kyffers

Director of the United States Patent and Trademark Office

United States of America

United States Patent and Trademark Office

NETCONFERENCE YOUR OFFICE IN THE CLOUD

Reg. No. 4,098,062

Registered Feb. 14, 2012

Int. Cls.: 38 and 42

SERVICE MARK

PRINCIPAL REGISTER

NXTGEN.TV LLC (DELAWARE LIMITED LIABILITY COMPANY)
23679 CALABASAS ROAD, SUITE 785
CALABASAS, CA 91302

FOR: SHARED VIDEO ON DEMAND SYSTEM, NAMELY, SIMULTANEOUS STREAMING OF DATA AND VIDEO VIA THE INTERNET THAT ALLOWS TWO OR MORE PEOPLE TO WATCH THE MEDIA SIMULTANEOUSLY IN REALTIME; VIDEO AND TEXT CHAT SERVICES; ONLINE VIDEO CONFERENCING SERVICES; CONFERENCE CALLING SERVICES; VIDEO EMAIL SERVICES; VOICE OVER INTERNET PROTOCOL (VOIP) SERVICES; TELEPHONE CONFERENCING SERVICES; TEXT AND INSTANT MESSAGING, IN CLASS 38 (U.S. CLS. 100, 101 AND 104).

FIRST USE 10-26-2010; IN COMMERCE 10-26-2010.

FOR: COMPUTER SERVICES, NAMELY, HOSTING ONLINE SOCIAL NETWORKING AND VIRTUAL COMMUNITIES FOR REGISTERED USERS TO PARTICIPATE IN DISCUSSIONS, GET FEEDBACK FROM THEIR PEERS, FORM VIRTUAL COMMUNITIES, AND ENGAGE IN SOCIAL NETWORKING FEATURING SOCIAL MEDIA; SOFTWARE AS A SERVICE (SAAS) SERVICES, NAMELY, HOSTING SOFTWARE FOR USE BY OTHERS FOR USE IN THE FIELD OF COMMUNITY AND SOCIAL NETWORKING, AND SOCIAL MEDIA; SOFTWARE AS A SERVICE (SAAS) SERVICES, NAMELY, PROVIDING USERS WITH ACCESS TO COMPUTER SOFTWARE FOR ASYNCHRONOUS PROJECT MANAGEMENT TOOLS; ONLINE COMPUTER BACK-UP SERVICES FOR COMPUTER HARD DRIVE DATA; PROVIDING AN INTERACTIVE WEBSITE FEATURING TECHNOLOGY THAT ALLOWS USERS TO MANUALLY INPUT INFORMATION VIA THE INTERNET; PROVIDING A WEBSITE FEATURING TECHNOLOGY THAT ENABLES USERS TO SHARE AND STORE AN INTEGRATED CALENDAR VIA THE INTERNET IN REALTIME; PROVIDING TEMPORARY USE OF NON-DOWNLOADABLE COMPUTER SOFTWARE FOR THE CREATION OF DIGITAL SIGNATURES AND ELECTRONIC SIGNATURES; HOSTING ONLINE WEB FACILITIES FOR OTHERS TO ENGAGE IN SHARED DOCUMENT COLLABORATIONS; PROVIDING A WEBSITE FEATURING TECHNOLOGY THAT ENABLES USERS TO ENGAGE IN SCREEN AND APPLICATION SHARING AS WELL AS INTEGRATION WITH THIRD PARTY APPLICATIONS; PROVIDING TEMPORARY USE OF NON-DOWNLOADABLE COMPUTER SOFTWARE FOR PRIVATE LABELING OF SYSTEMS TO REFLECT MULTIPLE BRANDS; PROVIDING TEMPORARY USE OF NON-DOWNLOADABLE COMPUTER SOFTWARE FOR USE IN CREATING DIGITAL SIGNATURES TO CONFIRM DIGITAL ASSET DELIVERY; DIGITAL TRANSFER SERVICES FOR TRANSFERRING DIGITAL



David J. Kyffers

Director of the United States Patent and Trademark Office

Reg. No. 4,098,062 CONTENT IN THE NATURE OF DOCUMENT DATA TO DVD; PROVIDING NON-DOWNLOADABLE SOFTWARE THAT GIVES USERS THE CAPABILITY TO UPLOAD, STORE, ACCESS, MANAGE AND SHARE DATA, IN CLASS 42 (U.S. CLS. 100 AND 101).

FIRST USE 10-26-2010; IN COMMERCE 10-26-2010.

THE MARK CONSISTS OF STANDARD CHARACTERS WITHOUT CLAIM TO ANY PARTICULAR FONT, STYLE, SIZE, OR COLOR.

NO CLAIM IS MADE TO THE EXCLUSIVE RIGHT TO USE "NETCONFERENCE", APART FROM THE MARK AS SHOWN.

SER. NO. 85-211,643, FILED 1-6-2011.

LINDA ESTRADA, EXAMINING ATTORNEY

United States of America

United States Patent and Trademark Office

FRESHWATER RUM

Reg. No. 4,098,063

NEW HOLLAND BREWING COMPANY, LLC (MICHIGAN LIMITED LIABILITY COMPANY)
66 EAST 8TH STREET
HOLLAND, MI 49423

Registered Feb. 14, 2012

Int. Cl.: 33

FOR: DISTILLED SPIRITS, IN CLASS 33 (U.S. CLS. 47 AND 49).

TRADEMARK

FIRST USE 12-0-2008; IN COMMERCE 12-0-2008.

PRINCIPAL REGISTER

THE MARK CONSISTS OF STANDARD CHARACTERS WITHOUT CLAIM TO ANY PARTICULAR FONT, STYLE, SIZE, OR COLOR.

NO CLAIM IS MADE TO THE EXCLUSIVE RIGHT TO USE "RUM", APART FROM THE MARK AS SHOWN.

SER. NO. 85-211,990, FILED 1-6-2011.

GINA FINK, EXAMINING ATTORNEY



David J. Kyffers

Director of the United States Patent and Trademark Office

United States of America

United States Patent and Trademark Office

NEW AGE

Reg. No. 4,098,064

NEW AGE REAL ESTATE, LLC (COLORADO LIMITED LIABILITY COMPANY)
PO BOX 3517

Registered Feb. 14, 2012

GREENWOOD VILLAGE, CO 80155

Int. Cl.: 36

FOR: RENTAL PROPERTY MANAGEMENT; REAL ESTATE BROKERAGE; LEASING OF
REAL ESTATE FOR OTHERS, IN CLASS 36 (U.S. CLS. 100, 101 AND 102).

SERVICE MARK

FIRST USE 1-1-2010; IN COMMERCE 1-1-2010.

PRINCIPAL REGISTER

THE MARK CONSISTS OF STANDARD CHARACTERS WITHOUT CLAIM TO ANY PAR-
TICULAR FONT, STYLE, SIZE, OR COLOR.

OWNER OF U.S. REG. NO. 3,173,985.

SER. NO. 85-212,226, FILED 1-6-2011.

H. M. FISHER, EXAMINING ATTORNEY



David J. Kyffers

Director of the United States Patent and Trademark Office

United States of America

United States Patent and Trademark Office

BECOME A LEADER

Reg. No. 4,098,065

Registered Feb. 14, 2012

Int. Cl.: 41

SERVICE MARK

PRINCIPAL REGISTER

BECOME A LEADER LLC (MASSACHUSETTS LIMITED LIABILITY COMPANY)
14 CLARK STREET
BELMONT, MA 02478

FOR: EDUCATIONAL SERVICES, NAMELY, PROVIDING CONTINUING PROFESSIONAL EDUCATION COURSES IN THE FIELD OF LEADERSHIP DEVELOPMENT, IN CLASS 41 (U.S. CLS. 100, 101 AND 107).

FIRST USE 8-8-2009; IN COMMERCE 8-8-2009.

THE MARK CONSISTS OF STANDARD CHARACTERS WITHOUT CLAIM TO ANY PARTICULAR FONT, STYLE, SIZE, OR COLOR.

SER. NO. 85-212,441, FILED 1-7-2011.

KARANENDRA S. CHHINA, EXAMINING ATTORNEY



David J. Kybas

Director of the United States Patent and Trademark Office

United States of America

United States Patent and Trademark Office

THE WORLD AHEAD

Reg. No. 4,098,066

Registered Feb. 14, 2012

Int. Cl.: 16

TRADEMARK

PRINCIPAL REGISTER

LIVING CHURCH OF GOD (INTERNATIONAL), INC. (NORTH CAROLINA NON-PROFIT CORPORATION)
2301 CROWN CENTRE DRIVE
CHARLOTTE, NC 28227

FOR: BOOKLETS IN THE FIELD OF RELIGION, IN CLASS 16 (U.S. CLS. 2, 5, 22, 23, 29, 37, 38 AND 50).

FIRST USE 2-0-1993; IN COMMERCE 2-0-1993.

THE MARK CONSISTS OF STANDARD CHARACTERS WITHOUT CLAIM TO ANY PARTICULAR FONT, STYLE, SIZE, OR COLOR.

SER. NO. 85-213,068, FILED 1-7-2011.

JAY BESCH, EXAMINING ATTORNEY



David J. Kyffers

Director of the United States Patent and Trademark Office

United States of America

United States Patent and Trademark Office

PELICAN PUB & BREWERY

Reg. No. 4,098,067

PACIFIC CITY BREWING COMPANY (OREGON CORPORATION)
9005 NESTUCCA RIDGE ROAD
PACIFIC CITY, OR 97135

Registered Feb. 14, 2012

Int. Cls.: 32 and 43

FOR: BEER, ALE AND LAGER, IN CLASS 32 (U.S. CLS. 45, 46 AND 48).

TRADEMARK

FIRST USE 5-31-1996; IN COMMERCE 9-30-1998.

SERVICE MARK

FOR: BAR AND RESTAURANT SERVICES, IN CLASS 43 (U.S. CLS. 100 AND 101).

PRINCIPAL REGISTER

FIRST USE 5-31-1996; IN COMMERCE 9-30-1998.

THE MARK CONSISTS OF STANDARD CHARACTERS WITHOUT CLAIM TO ANY PARTICULAR FONT, STYLE, SIZE, OR COLOR.

NO CLAIM IS MADE TO THE EXCLUSIVE RIGHT TO USE "PUB & BREWERY", APART FROM THE MARK AS SHOWN.

SER. NO. 85-213,110, FILED 1-7-2011.

THEODORE MCBRIDE, EXAMINING ATTORNEY



David J. Kyfos

Director of the United States Patent and Trademark Office

United States of America

United States Patent and Trademark Office

SENSE-ATION

Reg. No. 4,098,068

SOFTOUCH CONCEPTS, INC. (CALIFORNIA CORPORATION)
29460 UNION CITY BOULEVARD
UNION CITY, CA 94587

Registered Feb. 14, 2012

Int. Cl.: 18

FOR: PET RESTRAINING DEVICES CONSISTING OF HARNESSSES FOR USE IN DOG WALKING, IN CLASS 18 (U.S. CLS. 1, 2, 3, 22 AND 41).

TRADEMARK

FIRST USE 9-30-2002; IN COMMERCE 9-30-2002.

PRINCIPAL REGISTER

THE MARK CONSISTS OF STANDARD CHARACTERS WITHOUT CLAIM TO ANY PARTICULAR FONT, STYLE, SIZE, OR COLOR.

SER. NO. 85-213,121, FILED 1-7-2011.

APRIL ROACH, EXAMINING ATTORNEY



David J. Kyffers

Director of the United States Patent and Trademark Office

United States of America

United States Patent and Trademark Office

CALCOIC

Reg. No. 4,098,069

Registered Feb. 14, 2012

Int. Cl.: 9

TRADEMARK

PRINCIPAL REGISTER

KEVIN MICHAEL PARISH CORRIGAN (WASHINGTON SOLE PROPRIETORSHIP), AKA
MICHAEL PARISH
2721 SW 314 ST.
FEDERAL WAY, WA 98023

FOR: AUDIO AND VIDEO RECORDINGS FEATURING MUSIC AND ARTISTIC PERFORMANCES; DIGITAL MUSIC DOWNLOADABLE FROM THE INTERNET; DOWNLOADABLE MULTIMEDIA FILE CONTAINING ARTWORK, TEXT, AUDIO, VIDEO, GAMES, AND INTERNET WEB LINKS RELATING TO SOCIAL NETWORKING, IN CLASS 9 (U.S. CLS. 21, 23, 26, 36 AND 38).

FIRST USE 7-2-2010; IN COMMERCE 9-9-2011.

THE MARK CONSISTS OF STANDARD CHARACTERS WITHOUT CLAIM TO ANY PARTICULAR FONT, STYLE, SIZE, OR COLOR.

SER. NO. 85-213,388, FILED 1-7-2011.

TASNEEM HUSSAIN, EXAMINING ATTORNEY



David J. Kyffers

Director of the United States Patent and Trademark Office

United States of America

United States Patent and Trademark Office



Reg. No. 4,098,070

UNLOCKED, INC. (WASHINGTON CORPORATION)
2255 HARBOR AVENUE SW
SEATTLE, WA 98126

Registered Feb. 14, 2012

Int. Cl.: 44

FOR: PERSONAL BEAUTY SALON SERVICES, IN CLASS 44 (U.S. CLS. 100 AND 101).

SERVICE MARK

FIRST USE 4-1-2008; IN COMMERCE 4-1-2008.

PRINCIPAL REGISTER

NO CLAIM IS MADE TO THE EXCLUSIVE RIGHT TO USE "SALON" , APART FROM THE MARK AS SHOWN.

THE MARK CONSISTS OF A RECTANGULAR BACKGROUND OVER WHICH APPEAR THE WORDS "PINUP SALON" IN LOWER CASE LETTERS. THE WORD "PINUP" IS ALL ON ONE LINE CENTERED LEFT, AND THE WORD "SALON" SITS BELOW AND TO THE RIGHT OF THE WORD "PINUP" IN SMALLER FONT, ALIGNED RIGHT.

SER. NO. 85-213,937, FILED 1-10-2011.

ALLISON SCHRODY, EXAMINING ATTORNEY



David J. Kyffers

Director of the United States Patent and Trademark Office

United States of America

United States Patent and Trademark Office

2003

Reg. No. 4,098,071

ATI PROPERTIES, INC. (DELAWARE CORPORATION)
1600 N.E. OLD SALEM ROAD
ALBANY, OR 97321

Registered Feb. 14, 2012

Int. Cl.: 6

FOR: STAINLESS STEEL IN MILL PRODUCT FORMS, NAMELY, PLATE, SHEET, STRIP, BAR, ROD, AND TUBULAR FORMS, IN CLASS 6 (U.S. CLS. 2, 12, 13, 14, 23, 25 AND 50).

TRADEMARK

FIRST USE 11-5-2002; IN COMMERCE 11-5-2002.

PRINCIPAL REGISTER

THE MARK CONSISTS OF STANDARD CHARACTERS WITHOUT CLAIM TO ANY PARTICULAR FONT, STYLE, SIZE, OR COLOR.

OWNER OF U.S. REG. NOS. 3,542,575 AND 3,709,548.

SER. NO. 85-214,033, FILED 1-10-2011.

NELSON SNYDER, EXAMINING ATTORNEY



David J. Kyffers

Director of the United States Patent and Trademark Office

United States of America

United States Patent and Trademark Office

2102

Reg. No. 4,098,072

ATI PROPERTIES, INC. (DELAWARE CORPORATION)
1600 N.E. OLD SALEM ROAD
ALBANY, OR 97321

Registered Feb. 14, 2012

Int. Cl.: 6

FOR: STAINLESS STEEL IN MILL PRODUCT FORMS, NAMELY, PLATE, SHEET, STRIP, BAR, ROD, AND TUBULAR FORMS, IN CLASS 6 (U.S. CLS. 2, 12, 13, 14, 23, 25 AND 50).

TRADEMARK

FIRST USE 3-12-2009; IN COMMERCE 3-12-2009.

PRINCIPAL REGISTER

THE MARK CONSISTS OF STANDARD CHARACTERS WITHOUT CLAIM TO ANY PARTICULAR FONT, STYLE, SIZE, OR COLOR.

OWNER OF U.S. REG. NO. 3,934,158.

SER. NO. 85-214,049, FILED 1-10-2011.

NELSON SNYDER, EXAMINING ATTORNEY



David J. Kyffers

Director of the United States Patent and Trademark Office

United States of America

United States Patent and Trademark Office

GAS MAX

Reg. No. 4,098,073

LO VI POR TV, LLC (FLORIDA LIMITED LIABILITY COMPANY)
3408 WEST 84TH STREET SUITE 308
HIALEAH, FL 33018

Registered Feb. 14, 2012

Int. Cl.: 7

FOR: ANTI-POLLUTION DEVICES FOR MOTORS AND ENGINES, IN CLASS 7 (U.S. CLS. 13, 19, 21, 23, 31, 34 AND 35).

TRADEMARK

FIRST USE 8-1-2003; IN COMMERCE 9-1-2003.

PRINCIPAL REGISTER

THE MARK CONSISTS OF STANDARD CHARACTERS WITHOUT CLAIM TO ANY PARTICULAR FONT, STYLE, SIZE, OR COLOR.

SER. NO. 85-214,432, FILED 1-10-2011.

MARIA-VICTORIA SUAREZ, EXAMINING ATTORNEY



David J. Kybas

Director of the United States Patent and Trademark Office

United States of America

United States Patent and Trademark Office



Reg. No. 4,098,074

Registered Feb. 14, 2012

Int. Cl.: 7

TRADEMARK

PRINCIPAL REGISTER

CHINAHANJI POWER CO., LTD. (CHINA LIMITED LIABILITY COMPANY)
DUFEN VILLAGE, GUOHUAN TOWN
HANJIANG DIST., PUTIAN CITY
FUJIAN, CHINA

FOR: DIESEL ENGINES FOR MACHINES; ENGINE INJECTORS; HYDRAULIC PUMPS;
INTERNAL COMBUSTION ENGINE PARTS, NAMELY, PISTONS; LUBRICATING PUMPS;
OIL PUMPS FOR LAND VEHICLES; OIL PUMPS FOR USE IN MOTORS AND ENGINES;
PISTON RINGS; PUMPS AS PARTS OF MACHINES, MOTORS AND ENGINES; TAPS, IN
CLASS 7 (U.S. CLS. 13, 19, 21, 23, 31, 34 AND 35).

FIRST USE 1-8-2008; IN COMMERCE 1-8-2008.

THE MARK CONSISTS OF STYLIZED WORD "FLUB".

THE ENGLISH TRANSLATION OF "FLÜB" IN THE MARK IS RIVERS.

SER. NO. 85-214,537, FILED 1-10-2011.

ANGELA DUONG, EXAMINING ATTORNEY



David J. Kyffers

Director of the United States Patent and Trademark Office

United States of America

United States Patent and Trademark Office

Pilot Central

Reg. No. 4,098,075

Registered Feb. 14, 2012

Int. Cl.: 35

SERVICE MARK

PRINCIPAL REGISTER

PILOT CENTRAL, LLC (GEORGIA LIMITED LIABILITY COMPANY)
3350 RIVERWOOD PARKWAY
SUITE GL-25
ATLANTA, GA 30339

FOR: CLUB SERVICES, NAMELY, PROMOTING THE INTERESTS OF AVIATION PROFESSIONALS AND ENTHUSIASTS, IN CLASS 35 (U.S. CLS. 100, 101 AND 102).

FIRST USE 3-24-2010; IN COMMERCE 10-1-2010.

THE MARK CONSISTS OF STANDARD CHARACTERS WITHOUT CLAIM TO ANY PARTICULAR FONT, STYLE, SIZE, OR COLOR.

NO CLAIM IS MADE TO THE EXCLUSIVE RIGHT TO USE "PILOT", APART FROM THE MARK AS SHOWN.

SER. NO. 85-214,783, FILED 1-11-2011.

GINA FINK, EXAMINING ATTORNEY



David J. Kyffers

Director of the United States Patent and Trademark Office

United States of America

United States Patent and Trademark Office

NuBuildZ

Reg. No. 4,098,076

NATIONWIDE PALLET AND CRATE, LLC (LOUISIANA LIMITED LIABILITY COMPANY)
755 BESTER ST.
SHREVEPORT, LA 71107

Registered Feb. 14, 2012

Int. Cl.: 20

FOR: NON-METAL PALLETS AND WOOD CRATES, SPECIFICALLY NON-METAL PALLETS AND WOOD CRATES BUILT USING RECYCLED WOOD, IN CLASS 20 (U.S. CLS. 2, 13, 22, 25, 32 AND 50).

TRADEMARK

FIRST USE 9-1-2010; IN COMMERCE 12-1-2010.

PRINCIPAL REGISTER

THE MARK CONSISTS OF STANDARD CHARACTERS WITHOUT CLAIM TO ANY PARTICULAR FONT, STYLE, SIZE, OR COLOR.

SER. NO. 85-214,898, FILED 1-11-2011.

ROBIN CHOSID, EXAMINING ATTORNEY



David J. Kyffers

Director of the United States Patent and Trademark Office

United States of America

United States Patent and Trademark Office

GODS & GENERALS

Reg. No. 4,098,077

RNL HOLDINGS, INC. (CALIFORNIA CORPORATION)

Registered Feb. 14, 2012

PO BOX 1682
VALLEY CENTER, CA 92082

Int. Cl.: 25

FOR: MEN'S, WOMEN'S, INFANT'S, TODDLER'S AND CHILDREN'S CLOTHING, NAMELY, T-SHIRTS, SHIRTS, POLO SHIRTS, SWEAT SHIRTS, JERSEYS, TANK TOPS, SHORTS, JACKETS, COATS, BELTS, CAPS, HATS, VISORS, BEANIES, FLEECE PULLOVERS, SWEATERS, JACKETS, JEANS, PANTS, OVERALLS, SWIM SUITS, TRUNKS, BANDANAS, SHOES, SANDALS, SOCKS, PAJAMAS, NIGHT GOWNS, SWEAT PANTS, UNDERWEAR, BRIEFS, PANTIES, BRAS, THERMAL UNDERWEAR, DRESSES, SKIRTS, BLOUSES, YOGA PANTS, CAPRI PANTS, ONE PIECE GARMENT FOR INFANTS AND TODDLERS WITH A SNAP CROTCH, BIBS, MITTENS, MATERNITY SHIRTS, MATERNITY DRESSES, HEAD-BANDS, WRISTBANDS, IN CLASS 25 (U.S. CLS. 22 AND 39).

TRADEMARK

PRINCIPAL REGISTER

FIRST USE 1-11-2011; IN COMMERCE 1-11-2011.

THE MARK CONSISTS OF STANDARD CHARACTERS WITHOUT CLAIM TO ANY PARTICULAR FONT, STYLE, SIZE, OR COLOR.

SER. NO. 85-214,976, FILED 1-11-2011.

EUGENIA MARTIN, EXAMINING ATTORNEY



David J. Kybas

Director of the United States Patent and Trademark Office

United States of America

United States Patent and Trademark Office

PRAN

Reg. No. 4,098,078

Registered Feb. 14, 2012

Int. Cls.: 29, 30 and 32

TRADEMARK

PRINCIPAL REGISTER

PRAN EXPORTS LTD (BANGLADESH LIMITED COMPANY (LTD.))
32-12 61ST ST
QUEENS, NY 11377

FOR: VEGETABLE-BASED SNACK FOODS; NUT-BASED SNACK FOODS; PICKLES; PICKLED GARLIC USED AS A VEGETABLE; PICKLED OLIVES; JELLIES AND JAMS; ULTRA-HIGH-TEMPERATURE PROCESSED MILK; PASTEURIZED MILK; FLAVORED MILK-BASED BEVERAGES WITH A HIGH MILK CONTENT; FRUIT-BASED RAW FOOD BARS; PROCESSED SOY BEANS USED AS A SNACK, IN CLASS 29 (U.S. CL. 46).

FIRST USE 1-1-2006; IN COMMERCE 1-1-2006.

FOR: WHEAT-BASED SNACK FOODS; MUSTARD OIL USED AS A SEASONING OR CONDIMENT; CRACKERS; CANDY; LOLLIPOPS; TOFFEES; CHOCOLATE; CHOCOLATE SYRUP; CHOCOLATE SAUCE; CHEWING GUM; BISCUITS AND BREAD; CAKES; WAFERS; SPICES; TEA; COFFEE; RICE; CHUTNEY, IN CLASS 30 (U.S. CL. 46).

FIRST USE 1-1-2006; IN COMMERCE 1-1-2006.

FOR: FRUIT DRINKS AND FRUIT JUICES; DRINKING WATER; NON-ALCOHOLIC CARBONATED BEVERAGES, IN CLASS 32 (U.S. CLS. 45, 46 AND 48).

FIRST USE 1-1-2006; IN COMMERCE 1-1-2006.

THE MARK CONSISTS OF STANDARD CHARACTERS WITHOUT CLAIM TO ANY PARTICULAR FONT, STYLE, SIZE, OR COLOR.

SER. NO. 85-215,295, FILED 1-11-2011.

PAULA MAHONEY, EXAMINING ATTORNEY



David J. Kyffers

Director of the United States Patent and Trademark Office

United States of America

United States Patent and Trademark Office

MAKING MONEY ALERT

Reg. No. 4,098,079

EAGLE PUBLISHING, INC. (MARYLAND CORPORATION)
1 MASSACHUSETTS AVENUE, N.W., SUITE 610
WASHINGTON, DC 20001

Registered Feb. 14, 2012

Int. Cl.: 41

FOR: ON-LINE PUBLICATION OF NEWSLETTERS RELATING TO FINANCE AND INVESTING, IN CLASS 41 (U.S. CLS. 100, 101 AND 107).

SERVICE MARK

FIRST USE 5-0-1999; IN COMMERCE 5-0-1999.

PRINCIPAL REGISTER

THE MARK CONSISTS OF STANDARD CHARACTERS WITHOUT CLAIM TO ANY PARTICULAR FONT, STYLE, SIZE, OR COLOR.

NO CLAIM IS MADE TO THE EXCLUSIVE RIGHT TO USE "ALERT", APART FROM THE MARK AS SHOWN.

SEC. 2(F).

SER. NO. 85-215,778, FILED 1-12-2011.

BENJAMIN OKEKE, EXAMINING ATTORNEY



David J. Kyffers

Director of the United States Patent and Trademark Office

United States of America

United States Patent and Trademark Office



Reg. No. 4,098,080

WATER ANALYSIS TECHNOLOGIES, INC. (KENTUCKY CORPORATION)
9250 BROOKFIELD COURT
FLORENCE, KY 41042

Registered Feb. 14, 2012

Int. Cl.: 5

FOR: ODOR NEUTRALIZING PREPARATIONS FOR GENERAL USE ON VARIOUS SURFACES, IN CLASS 5 (U.S. CLS. 6, 18, 44, 46, 51 AND 52).

TRADEMARK

FIRST USE 10-23-2003; IN COMMERCE 10-23-2003.

PRINCIPAL REGISTER

THE MARK CONSISTS OF THE TERM "ODOGARD" WHEREIN THE "ODO" PORTION IS WHITE ON A RED SHIELD SHAPE AND THE "GARD" PORTION IS BLACK.

THE COLOR(S) RED, WHITE, AND BLACK IS/ARE CLAIMED AS A FEATURE OF THE MARK.

SER. NO. 85-215,780, FILED 1-12-2011.

BARBARA BROWN, EXAMINING ATTORNEY



David J. Kyffers

Director of the United States Patent and Trademark Office

United States of America

United States Patent and Trademark Office

Sanitrol

Reg. No. 4,098,081

WATER ANALYSIS TECHNOLOGIES, INC. (KENTUCKY CORPORATION)
9250 BROOKFIELD COURT
FLORENCE, KY 41042

Registered Feb. 14, 2012

Int. Cl.: 5

FOR: ODOR NEUTRALIZING PREPARATIONS FOR GENERAL USE ON VARIOUS SUR-
FACES, IN CLASS 5 (U.S. CLS. 6, 18, 44, 46, 51 AND 52).

TRADEMARK

FIRST USE 12-31-2004; IN COMMERCE 12-31-2004.

PRINCIPAL REGISTER

THE MARK CONSISTS OF STANDARD CHARACTERS WITHOUT CLAIM TO ANY PAR-
TICULAR FONT, STYLE, SIZE, OR COLOR.

SER. NO. 85-215,790, FILED 1-12-2011.

BARBARA BROWN, EXAMINING ATTORNEY



David J. Kybas

Director of the United States Patent and Trademark Office

United States of America

United States Patent and Trademark Office

HIGH MONTHLY INCOME

Reg. No. 4,098,082

EAGLE PUBLISHING, INC. (MARYLAND CORPORATION)
1 MASSACHUSETTS AVENUE, N.W., SUITE 610
WASHINGTON, DC 20001

Registered Feb. 14, 2012

Int. Cls.: 16 and 41

FOR: FINANCIAL NEWSLETTERS, IN CLASS 16 (U.S. CLS. 2, 5, 22, 23, 29, 37, 38 AND 50).

FIRST USE 9-24-2004; IN COMMERCE 9-24-2004.

TRADEMARK

FOR: ON-LINE PUBLICATION OF NEWSLETTERS RELATING TO FINANCE AND INVESTING, IN CLASS 41 (U.S. CLS. 100, 101 AND 107).

SERVICE MARK

PRINCIPAL REGISTER

FIRST USE 9-24-2004; IN COMMERCE 9-24-2004.

THE MARK CONSISTS OF STANDARD CHARACTERS WITHOUT CLAIM TO ANY PARTICULAR FONT, STYLE, SIZE, OR COLOR.

SEC. 2(F).

SER. NO. 85-215,799, FILED 1-12-2011.

BENJAMIN OKEKE, EXAMINING ATTORNEY



David J. Kybas

Director of the United States Patent and Trademark Office

United States of America

United States Patent and Trademark Office

HEDGE FUND TRADER

Reg. No. 4,098,083

EAGLE PUBLISHING, INC. (MARYLAND CORPORATION)
1 MASSACHUSETTS AVENUE, N.W., SUITE 610
WASHINGTON, DC 20001

Registered Feb. 14, 2012

Int. Cl.: 41

FOR: ON-LINE PUBLICATION OF NEWSLETTERS RELATING TO FINANCE AND INVESTING, IN CLASS 41 (U.S. CLS. 100, 101 AND 107).

SERVICE MARK

FIRST USE 11-3-2003; IN COMMERCE 11-3-2003.

PRINCIPAL REGISTER

THE MARK CONSISTS OF STANDARD CHARACTERS WITHOUT CLAIM TO ANY PARTICULAR FONT, STYLE, SIZE, OR COLOR.

SEC. 2(F).

SER. NO. 85-215,814, FILED 1-12-2011.

BENJAMIN OKEKE, EXAMINING ATTORNEY



David J. Kyffers

Director of the United States Patent and Trademark Office

United States of America

United States Patent and Trademark Office

HIGH-INCOME ALERT

Reg. No. 4,098,084

EAGLE PUBLISHING, INC. (MARYLAND CORPORATION)
1 MASSACHUSETTS AVENUE, N.W., SUITE 610
WASHINGTON, DC 20001

Registered Feb. 14, 2012

Int. Cl.: 41

FOR: ON-LINE PUBLICATION OF NEWSLETTERS RELATING TO FINANCE AND INVESTING, IN CLASS 41 (U.S. CLS. 100, 101 AND 107).

SERVICE MARK

FIRST USE 9-8-2004; IN COMMERCE 9-8-2004.

PRINCIPAL REGISTER

THE MARK CONSISTS OF STANDARD CHARACTERS WITHOUT CLAIM TO ANY PARTICULAR FONT, STYLE, SIZE, OR COLOR.

NO CLAIM IS MADE TO THE EXCLUSIVE RIGHT TO USE "ALERT", APART FROM THE MARK AS SHOWN.

SEC. 2(F).

SER. NO. 85-215,836, FILED 1-12-2011.

BENJAMIN OKEKE, EXAMINING ATTORNEY



David J. Kyffers

Director of the United States Patent and Trademark Office

United States of America

United States Patent and Trademark Office

KAMOA

Reg. No. 4,098,085

KAMOA UKULELE COMPANY (HAWAII CORPORATION)
4-1310 KUHIO HIGHWAY
KAPA'A, HI 96746

Registered Feb. 14, 2012

Int. Cl.: 15

FOR: UKULELES SOLD IN RETAIL CHANNELS, IN CLASS 15 (U.S. CLS. 2, 21 AND 36).

TRADEMARK

FIRST USE 11-15-2006; IN COMMERCE 12-15-2006.

PRINCIPAL REGISTER

THE MARK CONSISTS OF STANDARD CHARACTERS WITHOUT CLAIM TO ANY PARTICULAR FONT, STYLE, SIZE, OR COLOR.

THE ENGLISH TRANSLATION OF "KAMOA" IN THE MARK IS HAWAIIAN FOR "SEA-SHELL".

SER. NO. 85-215,977, FILED 1-12-2011.

STEVEN PEREZ, EXAMINING ATTORNEY



David J. Kyffers

Director of the United States Patent and Trademark Office

United States of America

United States Patent and Trademark Office

BOBBY LAWRENCE KARATE

Reg. No. 4,098,086

THE BOBBY LAWRENCE INSTITUTE OF KENPO KARATE, INC. (UTAH CORPORATION)
976 SOUTH STATE
OREM, UT 84058

Registered Feb. 14, 2012

Int. Cl.: 41

FOR: MARTIAL ARTS INSTRUCTION, IN CLASS 41 (U.S. CLS. 100, 101 AND 107).

SERVICE MARK

FIRST USE 1-1-1988; IN COMMERCE 1-1-1988.

PRINCIPAL REGISTER

THE MARK CONSISTS OF STANDARD CHARACTERS WITHOUT CLAIM TO ANY PARTICULAR FONT, STYLE, SIZE, OR COLOR.

NO CLAIM IS MADE TO THE EXCLUSIVE RIGHT TO USE "KARATE", APART FROM THE MARK AS SHOWN.

THE NAME "BOBBY LAWRENCE" IDENTIFIES THE STAGE NAME OF "ROBERT DEAN LAWRENCE", A LIVING INDIVIDUAL WHOSE CONSENT IS OF RECORD.

SER. NO. 85-216,180, FILED 1-12-2011.

NANCY CLARKE, EXAMINING ATTORNEY



David J. Kyjars

Director of the United States Patent and Trademark Office

United States of America

United States Patent and Trademark Office

EVEREST CLINICAL RESEARCH SERVICES INC.

Reg. No. 4,098,087

Registered Feb. 14, 2012

Int. Cl.: 42

SERVICE MARK

PRINCIPAL REGISTER

EVEREST CLINICAL RESEARCH SERVICES INC. (CANADA CORPORATION)
SUITE 408, EAST TOWER
675 COCHRANE DRIVE
MARKHAM, ONTARIO, CANADA L3R0B8

FOR: BIOMEDICAL, PHARMACEUTICAL, BIOTECHNOLOGY AND HEALTH-RELATED RESEARCH STUDY SERVICES, NAMELY, CONDUCTING CLINICAL TRIALS IN THE FIELD OF CLINICAL TRIALS OF DRUGS, MEDICAL DEVICES AND OTHER INTERVENTIONS TO DETERMINE EFFICACY AND SAFETY, PARTICULARLY, PROVIDING THE SELECTION OF TRIAL SUBJECTS IN ACCORDANCE WITH RESEARCH DESIGN CRITERIA, TRIAL MANAGEMENT AND SITE MONITORING, MONITORING TRIAL PARTICIPANTS FOR ADVERSE REACTIONS AND PREPARATION AND PRESENTATION OF REPORTS OF ADVERSE REACTIONS, ADMINISTRATION OF CLINICAL TRIAL DATA AND SAFETY MONITORING BOARDS, COLLECTION AND MANAGEMENT OF STUDY DATA, CLINICAL DATA MANAGEMENT SERVICES AND MEDICAL CODING, ANALYSIS OF STUDY DATA INCLUDING SELECTION AND APPLICATION OF STATISTICAL TESTS TO STUDY DATA, PROVIDING BIOSTATISTICS AND STATISTICAL PROGRAMMING, DISPENSING DRUGS AND MANAGING DRUG INVENTORIES, MONITORING DESIGN AND CONDUCT OF TRIALS FOR COMPLIANCE WITH APPLICABLE REGULATIONS AND POLICIES AND PREPARATION AND PRESENTATION OF COMPLIANCE REPORTS, DEVELOPMENT AND MAINTENANCE OF INTERNET WEBSITES FOR REPORTING ON STUDIES, MEDICAL WRITING AND GRAPHIC DESIGN OF RESEARCH STUDY PROTOCOLS, PREPARATION OF REPORTS OF RESEARCH STUDIES AND ABSTRACTS OF REPORTS, PREPARATION AND PRESENTATION OF REPORTS TO STUDY SPONSORS AND REGULATORY AUTHORITIES, IN CLASS 42 (U.S. CLS. 100 AND 101).



FIRST USE 10-21-2003; IN COMMERCE 10-21-2003.

THE MARK CONSISTS OF STANDARD CHARACTERS WITHOUT CLAIM TO ANY PARTICULAR FONT, STYLE, SIZE, OR COLOR.

NO CLAIM IS MADE TO THE EXCLUSIVE RIGHT TO USE "CLINICAL RESEARCH SERVICES INC.", APART FROM THE MARK AS SHOWN.

SER. NO. 85-216,389, FILED 1-12-2011.

ALYSSA STEEL, EXAMINING ATTORNEY

David J. Kyros

Director of the United States Patent and Trademark Office

United States of America

United States Patent and Trademark Office

EVEREST CLINICAL RESEARCH

Reg. No. 4,098,088

Registered Feb. 14, 2012

Int. Cl.: 42

SERVICE MARK

PRINCIPAL REGISTER

EVEREST CLINICAL RESEARCH SERVICES INC. (CANADA CORPORATION)
SUITE 408, EAST TOWER
675 COCHRANE DRIVE
MARKHAM, ONTARIO, CANADA L3R0B8

FOR: BIOMEDICAL, PHARMACEUTICAL, BIOTECHNOLOGY AND HEALTH-RELATED RESEARCH STUDY SERVICES, NAMELY, CONDUCTING CLINICAL TRIALS IN THE FIELD OF CLINICAL TRIALS OF DRUGS, MEDICAL DEVICES AND OTHER INTERVENTIONS TO DETERMINE EFFICACY AND SAFETY, NAMELY, PARTICULARLY, PROVIDING THE SELECTION OF TRIAL SUBJECTS IN ACCORDANCE WITH RESEARCH DESIGN CRITERIA, TRIAL MANAGEMENT AND SITE MONITORING, MONITORING TRIAL PARTICIPANTS FOR ADVERSE REACTIONS AND PREPARATION AND PRESENTATION OF REPORTS OF ADVERSE REACTIONS, ADMINISTRATION OF CLINICAL TRIAL DATA AND SAFETY MONITORING BOARDS, COLLECTION AND MANAGEMENT OF STUDY DATA, CLINICAL DATA MANAGEMENT SERVICES AND MEDICAL CODING, ANALYSIS OF STUDY DATA INCLUDING SELECTION AND APPLICATION OF STATISTICAL TESTS TO STUDY DATA, PROVIDING BIostatISTICS AND STATISTICAL PROGRAMMING, DISPENSING DRUGS AND MANAGING DRUG INVENTORIES, MONITORING DESIGN AND CONDUCT OF TRIALS FOR COMPLIANCE WITH APPLICABLE REGULATIONS AND POLICIES AND PREPARATION AND PRESENTATION OF COMPLIANCE REPORTS, DEVELOPMENT AND MAINTENANCE OF INTERNET WEBSITES FOR REPORTING ON STUDIES, MEDICAL WRITING AND GRAPHIC DESIGN OF RESEARCH STUDY PROTOCOLS, PREPARATION OF REPORTS OF RESEARCH STUDIES AND ABSTRACTS OF REPORTS, PREPARATION AND PRESENTATION OF REPORTS TO STUDY SPONSORS AND REGULATORY AUTHORITIES, IN CLASS 42 (U.S. CLS. 100 AND 101).



FIRST USE 10-21-2003; IN COMMERCE 10-21-2003.

THE MARK CONSISTS OF STANDARD CHARACTERS WITHOUT CLAIM TO ANY PARTICULAR FONT, STYLE, SIZE, OR COLOR.

NO CLAIM IS MADE TO THE EXCLUSIVE RIGHT TO USE "CLINICAL RESEARCH", APART FROM THE MARK AS SHOWN.

SER. NO. 85-216,413, FILED 1-12-2011.

ALYSSA STEEL, EXAMINING ATTORNEY

David J. Kyros

Director of the United States Patent and Trademark Office

United States of America

United States Patent and Trademark Office

ALIENTOTV

Reg. No. 4,098,089

ALIENTO VISION HISPANIC FAMILY NETWORK, INC. (NEW YORK CORPORATION)
103-24 ROOSEVELT AVE. 3RD FL SUITE 301
CORONA, NY 11368

Registered Feb. 14, 2012

Int. Cl.: 38

FOR: SIMULCASTING BROADCAST TELEVISION OVER GLOBAL COMMUNICATION NETWORKS, THE INTERNET AND WIRELESS NETWORKS, IN CLASS 38 (U.S. CLS. 100, 101 AND 104).

SERVICE MARK

FIRST USE 1-1-2011; IN COMMERCE 1-1-2011.

PRINCIPAL REGISTER

THE MARK CONSISTS OF STANDARD CHARACTERS WITHOUT CLAIM TO ANY PARTICULAR FONT, STYLE, SIZE, OR COLOR.

THE ENGLISH TRANSLATION OF "ALIENTOTV" IN THE MARK IS BREATHTV.

SER. NO. 85-217,231, FILED 1-13-2011.

JOHN DWYER, EXAMINING ATTORNEY



David J. Kyffers

Director of the United States Patent and Trademark Office

United States of America

United States Patent and Trademark Office

FRANCESCA'S COLLECTIONS

Reg. No. 4,098,090

FRANCESCA'S COLLECTIONS, INC. (TEXAS CORPORATION)
3480 W. 12TH STREET
HOUSTON, TX 77008

Registered Feb. 14, 2012

**Int. Cls.: 14, 18, 25 and
35**

FOR: JEWELRY, IN CLASS 14 (U.S. CLS. 2, 27, 28 AND 50).

FIRST USE 0-0-1999; IN COMMERCE 0-0-1999.

TRADEMARK

FOR: HANDBAGS, COSMETIC CASES SOLD EMPTY, LEATHER CASES, OVERNIGHT CASES, TOILETRY CASES SOLD EMPTY, VANITY CASES SOLD EMPTY, BUSINESS CARD CASES, CALLING CARD CASES, KEY CASES, NAME CARD CASES, IN CLASS 18 (U.S. CLS. 1, 2, 3, 22 AND 41).

SERVICE MARK

PRINCIPAL REGISTER

FIRST USE 0-0-1999; IN COMMERCE 0-0-1999.

FOR: CLOTHING NAMELY, TOPS, BOTTOMS, JACKETS, PANTS, SHORTS, BERMUDA SHORTS, KHAKIS, LEGGINGS, SKIRTS, DRESSES, BLOUSES, SHAWLS, HEADWEAR AND FOOTWEAR, IN CLASS 25 (U.S. CLS. 22 AND 39).

FIRST USE 0-0-1999; IN COMMERCE 0-0-1999.

FOR: RETAIL STORE AND ONLINE RETAIL STORE SERVICES FEATURING JEWELRY, HANDBAGS, FASHION ACCESSORIES, FOOTWEAR AND CLOTHING, IN CLASS 35 (U.S. CLS. 100, 101 AND 102).

FIRST USE 0-0-1999; IN COMMERCE 0-0-1999.

THE MARK CONSISTS OF STANDARD CHARACTERS WITHOUT CLAIM TO ANY PARTICULAR FONT, STYLE, SIZE, OR COLOR.

OWNER OF U.S. REG. NO. 3,542,854.

NO CLAIM IS MADE TO THE EXCLUSIVE RIGHT TO USE "COLLECTIONS", APART FROM THE MARK AS SHOWN.

SER. NO. 85-217,245, FILED 1-13-2011.



David J. Kyffers

Director of the United States Patent and Trademark Office

Reg. No. 4,098,090 WON TEAK OH, EXAMINING ATTORNEY

United States of America

United States Patent and Trademark Office

ALIENTOVISION

Reg. No. 4,098,091

Registered Feb. 14, 2012

Int. Cl.: 38

SERVICE MARK

PRINCIPAL REGISTER

ALIENTO VISION HISPANIC FAMILY NETWORK, INC. (NEW YORK CORPORATION)
103-24 ROOSEVELT AVE. 3RD. FL. SUITE 30
CORONA, NY 11368

FOR: SIMULCASTING BROADCAST TELEVISION OVER GLOBAL COMMUNICATION NETWORKS, THE INTERNET AND WIRELESS NETWORKS, IN CLASS 38 (U.S. CLS. 100, 101 AND 104).

FIRST USE 1-1-2011; IN COMMERCE 1-1-2011.

THE MARK CONSISTS OF STANDARD CHARACTERS WITHOUT CLAIM TO ANY PARTICULAR FONT, STYLE, SIZE, OR COLOR.

THE ENGLISH TRANSLATION OF "ALIENTOVISION" IN THE MARK IS BREATHVISION.

SER. NO. 85-217,300, FILED 1-13-2011.

JOHN DWYER, EXAMINING ATTORNEY



David J. Kyffers

Director of the United States Patent and Trademark Office

United States of America

United States Patent and Trademark Office

TRIFIT

Reg. No. 4,098,092

Registered Feb. 14, 2012

Int. Cl.: 41

SERVICE MARK

PRINCIPAL REGISTER

TRIFIT LLC (CALIFORNIA LIMITED LIABILITY COMPANY)
2425 COLORADO AVE. #120
SANTA MONICA, CA 90404

FOR: PROVIDING FACILITIES FOR PHYSICAL FITNESS AND EXERCISE, AND FOR PHYSICAL FITNESS CONSULTATION; PROVIDING INSTRUCTION IN THE FIELD OF PHYSICAL FITNESS AND EXERCISE; PROVIDING PHYSICAL FITNESS EDUCATION, NAMELY, WORKSHOPS AND SEMINARS IN THE FIELDS OF PHYSICAL PERFORMANCE AND PHYSICAL FITNESS, IN CLASS 41 (U.S. CLS. 100, 101 AND 107).

FIRST USE 1-15-2000; IN COMMERCE 1-15-2000.

THE MARK CONSISTS OF STANDARD CHARACTERS WITHOUT CLAIM TO ANY PARTICULAR FONT, STYLE, SIZE, OR COLOR.

OWNER OF U.S. REG. NOS. 2,846,541 AND 3,647,455.

SER. NO. 85-217,338, FILED 1-13-2011.

MAYUR VAGHANI, EXAMINING ATTORNEY



David J. Kyros

Director of the United States Patent and Trademark Office

United States of America

United States Patent and Trademark Office

Angelic Healing Practitioner

Reg. No. 4,098,093

HUBBARD, MARTI (UNITED STATES INDIVIDUAL)
318 N. HOLLYWOOD
BURBANK, CA 91505

Registered Feb. 14, 2012

Int. Cl.: 41

FOR: EDUCATIONAL SERVICES, NAMELY, PROVIDING TRAINING IN THE FIELD OF ENERGY HEALING, IN CLASS 41 (U.S. CLS. 100, 101 AND 107).

SERVICE MARK

FIRST USE 1-1-2011; IN COMMERCE 1-1-2011.

PRINCIPAL REGISTER

THE MARK CONSISTS OF STANDARD CHARACTERS WITHOUT CLAIM TO ANY PARTICULAR FONT, STYLE, SIZE, OR COLOR.

NO CLAIM IS MADE TO THE EXCLUSIVE RIGHT TO USE "HEALING PRACTITIONER", APART FROM THE MARK AS SHOWN.

SER. NO. 85-217,523, FILED 1-13-2011.

MICHAEL ENGEL, EXAMINING ATTORNEY



David J. Kyffers

Director of the United States Patent and Trademark Office

United States of America

United States Patent and Trademark Office

Share the wisdom

Reg. No. 4,098,094

Registered Feb. 14, 2012

Int. Cl.: 41

SERVICE MARK

PRINCIPAL REGISTER

BECOMEALEADER LLC (MASSACHUSETTS LIMITED LIABILITY COMPANY)
14 CLARK STREET
BELMONT, MA 02478

FOR: BUSINESS EDUCATION AND TRAINING SERVICES, NAMELY, DEVELOPING AND FACILITATING CUSTOMIZED LEADERSHIP AND EXECUTIVE DEVELOPMENT PROGRAMS, PROVIDING EXECUTIVE COACHING SERVICES, AND PROVIDING BUSINESS EDUCATION PROGRAMS TO EMPLOYEES AND EXECUTIVES, IN CLASS 41 (U.S. CLS. 100, 101 AND 107).

FIRST USE 8-8-2009; IN COMMERCE 8-8-2009.

THE MARK CONSISTS OF STANDARD CHARACTERS WITHOUT CLAIM TO ANY PARTICULAR FONT, STYLE, SIZE, OR COLOR.

SER. NO. 85-217,562, FILED 1-13-2011.

CURTIS FRENCH, EXAMINING ATTORNEY



David J. Kyffers

Director of the United States Patent and Trademark Office

United States of America

United States Patent and Trademark Office

J-Loc

Reg. No. 4,098,095

Registered Feb. 14, 2012

Int. Cl.: 7

TRADEMARK

PRINCIPAL REGISTER

LUDOWICI AUSTRALIA PTY LTD (AUSTRALIA PROPRIETARY LIMITED COMPANY
(P/L OR PTY. LTD.))
67 RANDLE ROAD
PINKENBA, QUEENSLAND, AUSTRALIA 4008

FOR: POLYURETHANE SCREEN SYSTEMS BEING FILTERS, SIEVES, SIFTERS, AND SEPARATORS; ALL BEING PARTS OF MACHINES FOR USE IN THE MINING INDUSTRY, IN CLASS 7 (U.S. CLS. 13, 19, 21, 23, 31, 34 AND 35).

THE MARK CONSISTS OF STANDARD CHARACTERS WITHOUT CLAIM TO ANY PARTICULAR FONT, STYLE, SIZE, OR COLOR.

OWNER OF AUSTRALIA REG. NO. 1184632, DATED 6-26-2007, EXPIRES 6-26-2017.

SER. NO. 85-217,650, FILED 1-14-2011.

PAUL F. GAST, EXAMINING ATTORNEY



David J. Kybas

Director of the United States Patent and Trademark Office

United States of America

United States Patent and Trademark Office

COBRA

Reg. No. 4,098,096

Registered Feb. 14, 2012

Int. Cl.: 9

TRADEMARK

PRINCIPAL REGISTER

LEAD DATA INTERNATIONAL, INC. (CALIFORNIA CORPORATION)
16030 CARMENITA RD
CERRITOS, CA 90703

FOR: BLANK OPTICAL DISCS, IN CLASS 9 (U.S. CLS. 21, 23, 26, 36 AND 38).

FIRST USE 1-14-2011; IN COMMERCE 1-14-2011.

THE MARK CONSISTS OF STANDARD CHARACTERS WITHOUT CLAIM TO ANY PARTICULAR FONT, STYLE, SIZE, OR COLOR.

SER. NO. 85-218,227, FILED 1-14-2011.

SALLY SHIH, EXAMINING ATTORNEY



David J. Kyffers

Director of the United States Patent and Trademark Office

United States of America

United States Patent and Trademark Office

DOUBLE BLUE SEAL

Reg. No. 4,098,097

KITARU INNOVATIONS INC. (BARBADOS CORPORATION)
30E LOWER HALCYON HEIGHTS
LASCELLES, BARBADOS BB24119

Registered Feb. 14, 2012

Int. Cl.: 16

FOR: ADHESIVE TAPE AND ADHESIVE PACKAGING TAPE AND TAPE DISPENSERS FOR HOME AND OFFICE USE, IN CLASS 16 (U.S. CLS. 2, 5, 22, 23, 29, 37, 38 AND 50).

TRADEMARK

FIRST USE 5-31-2005; IN COMMERCE 5-31-2005.

PRINCIPAL REGISTER

THE MARK CONSISTS OF STANDARD CHARACTERS WITHOUT CLAIM TO ANY PARTICULAR FONT, STYLE, SIZE, OR COLOR.

NO CLAIM IS MADE TO THE EXCLUSIVE RIGHT TO USE "SEAL", APART FROM THE MARK AS SHOWN.

SER. NO. 85-218,298, FILED 1-14-2011.

MICHAEL WEBSTER, EXAMINING ATTORNEY



David J. Kyffers

Director of the United States Patent and Trademark Office

United States of America

United States Patent and Trademark Office



Reg. No. 4,098,098

Registered Feb. 14, 2012

Int. Cl.: 41

SERVICE MARK

PRINCIPAL REGISTER

CHOI, JUNG KI (REPUBLIC OF KOREA INDIVIDUAL)
3603 WINSTROME CT.
KATY, TX 77449 AND

CHOI, WHAN KI (UNITED STATES INDIVIDUAL)
3603 WINSTROME CT.
KATY, TX 77449

FOR: OPERATING OF MARTIAL ARTS' SCHOOLS; ORGANIZING LIVE MIXED MARTIAL ARTS EVENTS AND COMPETITIONS; PRESENTATION OF MIXED MARTIAL ARTS (MMA) EVENTS; PROVIDING CLASSES, WORKSHOPS, SEMINARS AND CAMPS IN THE FIELDS OF FITNESS, EXERCISE, BOXING, KICK BOXING AND MIXED MARTIAL ARTS; PROVIDING GENERAL FITNESS AND MIXED MARTIAL ARTS FACILITIES THAT REQUIRE MEMBERSHIPS AND ARE FOCUSED IN THE FIELDS OF GENERAL FITNESS, EXERCISE, AND MIXED MARTIAL ARTS, IN CLASS 41 (U.S. CLS. 100, 101 AND 107).

FIRST USE 1-1-2000; IN COMMERCE 1-1-2000.

NO CLAIM IS MADE TO THE EXCLUSIVE RIGHT TO USE "HAPKIDO FEDERATION", APART FROM THE MARK AS SHOWN.

THE COLOR(S) RED, YELLOW, WHITE AND BLUE IS/ARE CLAIMED AS A FEATURE OF THE MARK.

THE NON-LATIN CHARACTERS IN THE MARK TRANSLITERATE TO "HAP KI DO" AND THIS MEANS "HAPKIDO" IN ENGLISH.

THE MARK CONSISTS OF A YELLOW CIRCLE OF MINIMAL THICKNESS ENCOMPASSING A THICKER RED CIRCLE WITH THE WORDS "INTERCONTINENTAL HAPKIDO FEDERATION" IN WHITE LOCATED IN A SEMICIRCLE FASHION AT THE TOP HALF OF THE RED CIRCLE. SIX KOREAN CHARACTERS ARE THAN LOCATED AT THE BOTTOM CENTER OF THE CIRCLE IN BLUE. A YELLOW CIRCLE ENCIRCLES A WHITE GLOBE WITH THE CONTINENTS HIGHLIGHTED IN YELLOW. THE WHITE GLOBE HAS LONGITUDINAL GLOBAL YELLOW LINES OVER THE GLOBE. THERE ARE FIVE RED STARS ON THE TOP OF THE GLOBE. AN EAGLE IN BLUE COLOR WITH TWO OPEN WINGS AND IN ATTACK POSITION IS PLACED AT THE BOTTOM OF THE GLOBE STANDING ON A BLUE ARROW THAT IS POINTED TOWARDS 10 O'CLOCK.



David J. Kybas

Director of the United States Patent and Trademark Office

Reg. No. 4,098,098 SER. NO. 85-218,584, FILED 1-15-2011.

JOHN SCHUYLER YARD, EXAMINING ATTORNEY

United States of America

United States Patent and Trademark Office

RE-ALIGN

Reg. No. 4,098,099

Registered Feb. 14, 2012

Int. Cls.: 41 and 42

SERVICE MARK

PRINCIPAL REGISTER

BOEHRINGER INGELHEIM INTERNATIONAL GMBH (FED REP GERMANY CORPORATION)
55218
INGELHEIM, FED REP GERMANY

FOR: PUBLICATION OF PRINTED MATTER, NOT FOR PROMOTIONAL PURPOSES, REGARDING THE RESULTS OF CLINICAL TRIALS FOR PHARMACEUTICALS; PUBLISHING ELECTRONIC PUBLICATIONS, NOT FOR PROMOTIONAL PURPOSES, REGARDING THE RESULTS OF CLINICAL TRIALS FOR PHARMACEUTICALS, IN CLASS 41 (U.S. CLS. 100, 101 AND 107).

FOR: SCIENTIFIC AND MEDICAL RESEARCH, NAMELY, CONDUCTING CLINICAL TRIALS OF PHARMACEUTICALS, IN CLASS 42 (U.S. CLS. 100 AND 101).

THE MARK CONSISTS OF STANDARD CHARACTERS WITHOUT CLAIM TO ANY PARTICULAR FONT, STYLE, SIZE, OR COLOR.

PRIORITY CLAIMED UNDER SEC. 44(D) ON FED REP GERMANY APPLICATION NO. 302010053698, FILED 9-15-2010, REG. NO. 302010053698, DATED 11-8-2010, EXPIRES 9-30-2020.

SER. NO. 85-219,229, FILED 1-17-2011.

H. M. FISHER, EXAMINING ATTORNEY



David J. Kyffers

Director of the United States Patent and Trademark Office

United States of America

United States Patent and Trademark Office



Reg. No. 4,098,100

SUN TAN CITY, LLC (KENTUCKY LIMITED LIABILITY COMPANY)
101 CATALOG DRIVE
ELIZABETHTOWN, KY 42701

Registered Feb. 14, 2012

Int. Cl.: 44

FOR: SKIN TANNING SERVICE FOR HUMANS FOR COSMETIC PURPOSES, IN CLASS 44
(U.S. CLS. 100 AND 101).

SERVICE MARK

FIRST USE 1-5-2011; IN COMMERCE 1-5-2011.

PRINCIPAL REGISTER

OWNER OF U.S. REG. NOS. 3,580,468 AND 3,650,021.

NO CLAIM IS MADE TO THE EXCLUSIVE RIGHT TO USE "SUNLESS TANNING SPA",
APART FROM THE MARK AS SHOWN.

THE MARK CONSISTS OF A DARK CIRCLE CONTAINING THE WORDS "SHINE SUNLESS
TANNING SPA" SURROUNDED BY A SERIES OF RINGS.

SER. NO. 85-219,819, FILED 1-18-2011.

GINA FINK, EXAMINING ATTORNEY



David J. Kyffers

Director of the United States Patent and Trademark Office

United States of America

United States Patent and Trademark Office

SHINE

Reg. No. 4,098,101

Registered Feb. 14, 2012

Int. Cl.: 44

SERVICE MARK

PRINCIPAL REGISTER

SUN TAN CITY, LLC (KENTUCKY LIMITED LIABILITY COMPANY)
101 CATALOG DRIVE
ELIZABETHTOWN, KY 42701

FOR: SKIN TANNING SERVICE FOR HUMANS FOR COSMETIC PURPOSES, IN CLASS 44
(U.S. CLS. 100 AND 101).

FIRST USE 1-5-2011; IN COMMERCE 1-5-2011.

THE MARK CONSISTS OF STANDARD CHARACTERS WITHOUT CLAIM TO ANY PARTICULAR FONT, STYLE, SIZE, OR COLOR.

OWNER OF U.S. REG. NOS. 3,580,468 AND 3,650,021.

SER. NO. 85-219,836, FILED 1-18-2011.

GINA FINK, EXAMINING ATTORNEY



David J. Kybas

Director of the United States Patent and Trademark Office

United States of America

United States Patent and Trademark Office

STEELSKINZ

Reg. No. 4,098,102

Registered Feb. 14, 2012

Int. Cl.: 40

SERVICE MARK

PRINCIPAL REGISTER

STEEL SKINZ LLC (MICHIGAN LIMITED LIABILITY COMPANY), DBA STEEL SKINZ
GRAPHICS
4836 PINCKNEY ROAD
HOWELL, MI 48843

FOR: CUSTOM MANUFACTURE OF VEHICLE WRAPS, TRAILER WRAPS, MOTOR SPORTS WRAPS, FLEET GRAPHICS, DECALS, LETTERING, SIGNS, BANNERS, WINDOW GRAPHICS, FLOOR GRAPHICS, WALL MURALS, EVENT GRAPHICS, TRADE SHOW GRAPHICS, TOOL BOX GRAPHICS, CLOTHING AND APPAREL GRAPHICS; LARGE FORMAT PRINTING FOR OTHERS, IN CLASS 40 (U.S. CLS. 100, 103 AND 106).

FIRST USE 1-2-2008; IN COMMERCE 1-2-2008.

THE MARK CONSISTS OF STANDARD CHARACTERS WITHOUT CLAIM TO ANY PARTICULAR FONT, STYLE, SIZE, OR COLOR.

SER. NO. 85-219,854, FILED 1-18-2011.

LESLEY LAMOTHE, EXAMINING ATTORNEY



David J. Kybas

Director of the United States Patent and Trademark Office

United States of America

United States Patent and Trademark Office

Italy Hotline

Reg. No. 4,098,103

Registered Feb. 14, 2012

Int. Cl.: 39

SERVICE MARK

PRINCIPAL REGISTER

ITALY HOTLINE PRIVATE AND CUSTOM TOURS LLC (WASHINGTON LIMITED LIABILITY COMPANY)
5309 KUHN ST.
PORT TOWNSEND, WA 98368

FOR: ORGANIZATION OF EXCURSIONS, SIGHTSEEING TOURS, HOLIDAYS, TOURS AND TRAVEL, IN CLASS 39 (U.S. CLS. 100 AND 105).

FIRST USE 8-6-2003; IN COMMERCE 1-4-2008.

THE MARK CONSISTS OF STANDARD CHARACTERS WITHOUT CLAIM TO ANY PARTICULAR FONT, STYLE, SIZE, OR COLOR.

NO CLAIM IS MADE TO THE EXCLUSIVE RIGHT TO USE "ITALY", APART FROM THE MARK AS SHOWN.

SER. NO. 85-220,100, FILED 1-18-2011.

ALYSSA STEEL, EXAMINING ATTORNEY



David J. Kyffers

Director of the United States Patent and Trademark Office

United States of America

United States Patent and Trademark Office

COMMONWEALTH OIL

Reg. No. 4,098,104

Registered Feb. 14, 2012

Int. Cls.: 1 and 4

TRADEMARK

PRINCIPAL REGISTER

COMMONWEALTH OIL CORPORATION (CANADA CORPORATION)
P.O. BOX 370, 2080 FERRISS ROAD NORTH
HARROW, ONTARIO, CANADA N0R1G0

FOR: AUTOMATIC TRANSMISSION FLUID, RUST AND CORROSION INHIBITORS, SEMI-SYNTHETIC AND SYNTHETIC COOLANTS, TAPPING FLUIDS, CLEANERS AND DEGREASERS, ENGINE SHAMPOOS AND BIODEGRADABLE SOLVENTS, IN CLASS 1 (U.S. CLS. 1, 5, 6, 10, 26 AND 46).

FIRST USE 12-31-1993; IN COMMERCE 12-31-1993.

FOR: LUBRICANTS, OILS AND FLUIDS, NAMELY, HYDRAULIC OIL, GEAR OIL, WAY OIL, SPINDLE OIL, MOTOR OIL, AUTOMOTIVE GEAR OIL, MACHINING AND CUTTING OILS, LUBRICANT AND COOLANTS, NAMELY, ACTIVE AND INACTIVE CUTTING OILS, HONING AND GRINDING OILS, STAMPING AND VANISHING OILS, MACHINING COOLANTS AND MACHINE CUTTING OILS, ELECTRIC DISCHARGE MACHINING FLUIDS, IN CLASS 4 (U.S. CLS. 1, 6 AND 15).

FIRST USE 12-31-1991; IN COMMERCE 12-31-1991.

THE MARK CONSISTS OF STANDARD CHARACTERS WITHOUT CLAIM TO ANY PARTICULAR FONT, STYLE, SIZE, OR COLOR.

OWNER OF CANADA REG. NO. TMA531085, DATED 8-11-2000, EXPIRES 8-11-2015.

NO CLAIM IS MADE TO THE EXCLUSIVE RIGHT TO USE "OIL", APART FROM THE MARK AS SHOWN.

SER. NO. 85-220,338, FILED 1-18-2011.

JOHN DALIER, EXAMINING ATTORNEY



David J. Kypos

Director of the United States Patent and Trademark Office

United States of America

United States Patent and Trademark Office

ALEENE'S LEATHER & SUEDE GLUE

Reg. No. 4,098,105

Registered Feb. 14, 2012

Int. Cls.: 1 and 16

TRADEMARK

PRINCIPAL REGISTER

DUNCAN ENTERPRISES (CALIFORNIA CORPORATION), DBA ILOVETOCREATE
5673 E. SHIELDS AVE.
FRESNO, CA 93727

FOR: PERMANENT ADHESIVE IN THE NATURE OF A CEMENT, SPECIFICALLY FOR HOME-CRAFT APPLICATIONS FOR USE IN BONDING LEATHER, SUEDE, FRINGES AND BEADWORK TO FRINGES; PERMANENT ADHESIVE FOR USE BY DECORATORS, SPECIFICALLY FOR HOME-CRAFT APPLICATIONS FOR USE IN BONDING LEATHER, SUEDE, FRINGES AND BEADWORK TO FRINGES; PERMANENT ADHESIVE FOR USE IN THE CRAFT AND HOBBY INDUSTRIES FOR BONDING LEATHER, SUEDE, FRINGES AND BEADWORK TO FRINGES, IN CLASS 1 (U.S. CLS. 1, 5, 6, 10, 26 AND 46).

FIRST USE 5-20-1997; IN COMMERCE 5-20-1997.

FOR: PERMANENT ADHESIVE, SPECIFICALLY FOR HOME-CRAFT APPLICATIONS FOR USE IN BONDING LEATHER, SUEDE, FRINGES AND BEADWORK TO FRINGES; PERMANENT ADHESIVE, SPECIFICALLY FOR HOUSEHOLD USE IN REPAIRING LEATHER AND SUEDE, IN CLASS 16 (U.S. CLS. 2, 5, 22, 23, 29, 37, 38 AND 50).

FIRST USE 5-20-1997; IN COMMERCE 5-20-1997.

THE MARK CONSISTS OF STANDARD CHARACTERS WITHOUT CLAIM TO ANY PARTICULAR FONT, STYLE, SIZE, OR COLOR.

OWNER OF U.S. REG. NOS. 2,444,937, 3,893,998 AND OTHERS.

NO CLAIM IS MADE TO THE EXCLUSIVE RIGHT TO USE "LEATHER & SUEDE GLUE", APART FROM THE MARK AS SHOWN.

SER. NO. 85-220,347, FILED 1-18-2011.

MARY ROSSMAN, EXAMINING ATTORNEY



David J. Kyffers

Director of the United States Patent and Trademark Office

United States of America

United States Patent and Trademark Office

ALEENE'S SPRAY ACRYLIC SEALER

Reg. No. 4,098,106

DUNCAN ENTERPRISES (CALIFORNIA CORPORATION), DBA ILOVETOCREATE
5673 E. SHIELDS AVE.
FRESNO, CA 93727

Registered Feb. 14, 2012

Int. Cls.: 2 and 17

FOR: ALL-PURPOSE SPRAY ON PERMANENT CLEAR SEALER COATINGS FOR USE IN HOME-CRAFT APPLICATIONS AND HOUSEHOLD APPLICATIONS FOR SEALING AND COATING PAPER, CARDBOARD, BISQUE, PLASTER, PAINTED SURFACES, PRINTS, WOOD, GLASS, METAL AND PLASTER, IN CLASS 2 (U.S. CLS. 6, 11 AND 16).

TRADEMARK

PRINCIPAL REGISTER

FIRST USE 5-20-1997; IN COMMERCE 5-20-1997.

FOR: ALL-PURPOSE SPRAY ON PERMANENT CLEAR ACRYLIC BASED SEALANTS AND ADHESIVES FOR HOME-CRAFT APPLICATIONS AND HOUSEHOLD APPLICATIONS FOR SEALING AND COATING PAPER, CARDBOARD, BISQUE, PLASTER, PAINTED SURFACES, PRINTS, WOOD, GLASS, METAL AND PLASTER, IN CLASS 17 (U.S. CLS. 1, 5, 12, 13, 35 AND 50).

FIRST USE 5-20-1997; IN COMMERCE 5-20-1997.

THE MARK CONSISTS OF STANDARD CHARACTERS WITHOUT CLAIM TO ANY PARTICULAR FONT, STYLE, SIZE, OR COLOR.

OWNER OF U.S. REG. NOS. 2,444,937, 3,893,998 AND OTHERS.

NO CLAIM IS MADE TO THE EXCLUSIVE RIGHT TO USE "SPRAY ACRYLIC SEALER", APART FROM THE MARK AS SHOWN.

SER. NO. 85-220,365, FILED 1-18-2011.

MARY ROSSMAN, EXAMINING ATTORNEY



David J. Kyffers

Director of the United States Patent and Trademark Office

United States of America

United States Patent and Trademark Office

ALEENE'S PAPER GLAZE

Reg. No. 4,098,107

Registered Feb. 14, 2012

Int. Cls.: 1 and 16

TRADEMARK

PRINCIPAL REGISTER

DUNCAN ENTERPRISES (CALIFORNIA CORPORATION), DBA ILOVETOCREATE
5673 E. SHIELDS AVE.
FRESNO, CA 93727

FOR: ACID-FREE, CLEAR DIMENSIONAL EMBELLISHING ADHESIVE IN THE NATURE OF A CEMENT, SPECIFICALLY FOR HOME-CRAFT AND PAPER-CRAFT APPLICATIONS; ACID-FREE, CLEAR DIMENSIONAL EMBELLISHING ADHESIVE FOR USE BY DECORATORS, SPECIFICALLY FOR HOME-CRAFT AND PAPER-CRAFT APPLICATIONS; ACID-FREE, CLEAR DIMENSIONAL EMBELLISHING ADHESIVE FOR USE IN THE CRAFT AND HOBBY INDUSTRIES, IN CLASS 1 (U.S. CLS. 1, 5, 6, 10, 26 AND 46).

FIRST USE 5-15-1999; IN COMMERCE 5-15-1999.

FOR: ACID-FREE, CLEAR DIMENSIONAL EMBELLISHING ADHESIVE, SPECIFICALLY FOR HOME-CRAFT AND PAPER-CRAFT APPLICATIONS; ACID-FREE, CLEAR DIMENSIONAL EMBELLISHING ADHESIVE, SPECIFICALLY FOR HOUSEHOLD APPLICATIONS IN BONDING PAPER AND STATIONERY, IN CLASS 16 (U.S. CLS. 2, 5, 22, 23, 29, 37, 38 AND 50).

FIRST USE 5-15-1999; IN COMMERCE 5-15-1999.

THE MARK CONSISTS OF STANDARD CHARACTERS WITHOUT CLAIM TO ANY PARTICULAR FONT, STYLE, SIZE, OR COLOR.

OWNER OF U.S. REG. NOS. 2,444,937, 3,893,998 AND OTHERS.

NO CLAIM IS MADE TO THE EXCLUSIVE RIGHT TO USE "PAPER GLAZE", APART FROM THE MARK AS SHOWN.

SER. NO. 85-220,377, FILED 1-18-2011.

MARY ROSSMAN, EXAMINING ATTORNEY



David J. Kyffers

Director of the United States Patent and Trademark Office

United States of America

United States Patent and Trademark Office



Reg. No. 4,098,108

Registered Feb. 14, 2012

Int. Cls.: 17 and 42

TRADEMARK

SERVICE MARK

PRINCIPAL REGISTER

MONOSOL LLC (DELAWARE LIMITED LIABILITY COMPANY)
707 EAST 80TH PLACE
MERRILLVILLE, IN 46410

FOR: WATER SOLUBLE FILMS, NAMELY, WATER SOLUBLE PLASTIC FILMS FOR USE IN MANUFACTURING OF WATER SOLUBLE BAGS FOR HOUSEHOLD AND AGRICULTURAL USE, NAMELY, FOR USE IN PACKAGING FOR DETERGENTS AND AGRICHEMICALS, AND FOR GENERAL INDUSTRIAL USE; PLASTIC MATERIAL IN THE FORM OF FILM FOR USE IN MANUFACTURING; AND PLASTIC MATERIAL IN EXTRUDED FORM FOR USE IN PRODUCTION; POLYVINYL ALCOHOL WATER SOLUBLE FILM FOR USE AS A BACKING OR TOPPING TO SUPPORT EMBROIDERY ON TEXTILES AND APPAREL; WATER SOLUBLE FILMS, NAMELY, WATER SOLUBLE PLASTIC FILMS FOR USE AS A SUPPORT FOR EMBROIDERY OR SEWING ON TEXTILES AND APPAREL, AND AS A BACKING FOR EMBROIDERY OR SEWING ON TEXTILES AND APPAREL, IN CLASS 17 (U.S. CLS. 1, 5, 12, 13, 35 AND 50).

FIRST USE 6-8-2011; IN COMMERCE 6-14-2011.

FOR: PROVIDING TESTING AND ANALYSIS SERVICES FOR OTHERS OF WATER SOLUBLE FILMS, IN CLASS 42 (U.S. CLS. 100 AND 101).

FIRST USE 7-22-2011; IN COMMERCE 7-22-2011.

OWNER OF U.S. REG. NOS. 3,294,916 AND 3,554,767.

THE MARK CONSISTS OF A CIRCULAR ELEMENT WITHIN WHICH A BAND IS POSITIONED BEHIND A WATER DROP ELEMENT THAT INCLUDES A SUPERIMPOSED SPHERE WITH GRID LINES WITH AN ORBITAL RING SHOWN IN FRONT AND ON THE RIGHT SIDE OF THE WATER DROP ELEMENT.

SER. NO. 85-220,753, FILED 1-19-2011.

BILL DAWE, EXAMINING ATTORNEY



David J. Kyffers

Director of the United States Patent and Trademark Office

United States of America

United States Patent and Trademark Office

CENTERLINE SUPPLY

Reg. No. 4,098,109

CENTERLINE SUPPLY, LTD. (TEXAS LIMITED PARTNERSHIP)
530 JESSE STREET
GRAND PRAIRIE, TX 75051

Registered Feb. 14, 2012

Int. Cls.: 2, 6, 17, 35 and 40

FOR: PAINT FOR USE IN THE MANUFACTURE OF ROAD AND HIGHWAY MARKING COATINGS, IN CLASS 2 (U.S. CLS. 6, 11 AND 16).

FIRST USE 4-28-1988; IN COMMERCE 4-28-1988.

TRADEMARK

FOR: NON-LUMINOUS AND NON-MECHANICAL METAL SIGNS, IN CLASS 6 (U.S. CLS. 2, 12, 13, 14, 23, 25 AND 50).

SERVICE MARK

PRINCIPAL REGISTER

FIRST USE 4-28-1988; IN COMMERCE 4-28-1988.

FOR: PAVEMENT MARKING TAPE, IN CLASS 17 (U.S. CLS. 1, 5, 12, 13, 35 AND 50).

FIRST USE 4-28-1988; IN COMMERCE 4-28-1988.

FOR: RETAIL STORES FEATURING TRAFFIC DELINEATING DEVICES AND EQUIPMENT RELATED THERETO, NAMELY, TRAFFIC PAINT AND BEADS, TRAFFIC BUTTONS AND PAVEMENT MARKERS, PAVEMENT MARKING TAPES AND SYMBOLS, BITUMEN ADHESIVE APPLICATORS AND EPOXY DISPENSERS, AND ROAD AND HIGHWAY SIGNAGE, IN CLASS 35 (U.S. CLS. 100, 101 AND 102).

FIRST USE 4-28-1988; IN COMMERCE 4-28-1988.

FOR: CUSTOM MANUFACTURE OF TRAFFIC DELINEATING DEVICES AND EQUIPMENT RELATED THERETO, NAMELY, TRAFFIC PAINT, PAVEMENT MARKING TAPES AND SYMBOLS, BITUMEN ADHESIVE APPLICATORS AND EPOXY DISPENSERS, AND ROAD AND HIGHWAY SIGNAGE TO ORDER AND/OR SPECIFICATION OF OTHERS, IN CLASS 40 (U.S. CLS. 100, 103 AND 106).

FIRST USE 4-28-1988; IN COMMERCE 4-28-1988.

THE MARK CONSISTS OF STANDARD CHARACTERS WITHOUT CLAIM TO ANY PARTICULAR FONT, STYLE, SIZE, OR COLOR.

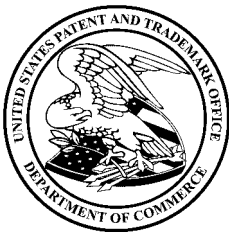

David J. Kybas

Director of the United States Patent and Trademark Office

Reg. No. 4,098,109 NO CLAIM IS MADE TO THE EXCLUSIVE RIGHT TO USE "SUPPLY", APART FROM THE MARK AS SHOWN.

SER. NO. 85-221,444, FILED 1-19-2011.

ANDREW RHIM, EXAMINING ATTORNEY

United States of America

United States Patent and Trademark Office

H₂OLAP

Reg. No. 4,098,110

Registered Feb. 14, 2012

Int. Cl.: 42

SERVICE MARK

PRINCIPAL REGISTER

H2OLAP LTD. (OHIO LIMITED LIABILITY COMPANY)
1121 WATERVIEW CT.
BLACKLICK, OH 43004

FOR: ADVANCED PRODUCT RESEARCH IN THE FIELD OF ARTIFICIAL INTELLIGENCE; ANALYSIS OF STREAM WATER QUALITY; APPLICATION SERVICE PROVIDER (ASP) FEATURING SOFTWARE FOR USE IN MANAGING, ANALYZING AND REPORTING WATER RESOURCE AND SUSTAINABILITY DATA; APPLICATION SERVICE PROVIDER (ASP), NAMELY, HOSTING COMPUTER SOFTWARE APPLICATIONS OF OTHERS; APPLICATION SERVICE PROVIDER FEATURING APPLICATION PROGRAMMING INTERFACE (API) SOFTWARE FOR ALLOWING DATA RETRIEVAL, UPLOAD, ACCESS AND MANAGEMENT; APPLICATION SERVICE PROVIDER FEATURING SOFTWARE FOR USE IN PROVIDING AN ON-LINE DATABASE IN THE FIELD OF TRANSACTION PROCESSING TO UPLOAD TRANSACTIONAL DATA, PROVIDE STATISTICAL ANALYSIS, AND PRODUCE NOTIFICATIONS AND REPORTS; CHEMICAL ANALYSIS; CLOUD COMPUTING FEATURING SOFTWARE FOR USE MANAGING, ANALYZING AND REPORTING WATER RESOURCE AND SUSTAINABILITY DATA; COMPUTER SERVICE, NAMELY, ACTING AS AN APPLICATION SERVICE PROVIDER IN THE FIELD OF INFORMATION MANAGEMENT TO HOST COMPUTER APPLICATION SOFTWARE FOR THE PURPOSE OF WATER RESOURCE AND SUSTAINABILITY DATA MANAGEMENT, ANALYSIS AND REPORTING; COMPUTER SERVICE, NAMELY, ACTING AS AN APPLICATION SERVICE PROVIDER IN THE FIELD OF KNOWLEDGE MANAGEMENT TO HOST COMPUTER APPLICATION SOFTWARE FOR CREATING SEARCHABLE DATABASES OF INFORMATION AND DATA; COMPUTER SERVICE, NAMELY, ACTING AS AN APPLICATION SERVICE PROVIDER IN THE FIELD OF KNOWLEDGE MANAGEMENT TO HOST COMPUTER APPLICATION SOFTWARE FOR SEARCHING AND RETRIEVING INFORMATION FROM DATABASES AND COMPUTER NETWORKS; COMPUTER SERVICE, NAMELY, ACTING AS AN APPLICATION SERVICE PROVIDER IN THE FIELD OF KNOWLEDGE MANAGEMENT TO HOST COMPUTER APPLICATION SOFTWARE FOR THE COLLECTION, EDITING, ORGANIZING, MODIFYING, BOOK MARKING, TRANSMISSION, STORAGE AND SHARING OF DATA AND INFORMATION; COMPUTER SERVICES IN THE NATURE OF CUSTOMIZED WEB PAGES AND OTHER DATA FEED FORMATS FEATURING USER-DEFINED INFORMATION; COMPUTER SERVICES IN THE NATURE OF CUSTOMIZED WEB PAGES FEATURING USER-DEFINED INFORMATION, PERSONAL PROFILES AND INFORMATION; COMPUTER SERVICES, NAMELY, CREATING AN ON-LINE COMMUNITY FOR REGISTERED USERS TO PARTICIPATE IN DISCUSSIONS, GET FEEDBACK FROM THEIR PEERS, FORM VIRTUAL COMMUNITIES, AND ENGAGE IN SOCIAL NETWORKING FEATURING WATER



David J. Kyjars

Director of the United States Patent and Trademark Office

Reg. No. 4,098,110 RESOURCE AND SUSTAINABILITY DATA MANAGEMENT, ANALYSIS AND REPORTING; COMPUTER SERVICES, NAMELY, HOSTING AND MAINTAINING AN ON-LINE WEB SITE FOR OTHERS TO MANAGE, ANALYZE AND REPORT ON WATER RESOURCE AND SUSTAINABILITY DATA; COMPUTER SERVICES, NAMELY, PROVIDING SEARCH ENGINES FOR OBTAINING DATA ON A GLOBAL COMPUTER NETWORK; COMPUTER SERVICES, NAMELY, PROVIDING SEARCH ENGINES FOR OBTAINING WATER RESOURCE AND SUSTAINABILITY DATA ON A GLOBAL COMPUTER NETWORK; COMPUTER SERVICES, NAMELY, PROVIDING SEARCH PLATFORMS TO ALLOW USERS TO REQUEST CONTENT FROM AND RECEIVE CONTENT TO A MOBILE DEVICE; COMPUTER SOFTWARE DEVELOPMENT IN THE FIELD OF WATER RESOURCE AND SUSTAINABILITY DATA MANAGEMENT, ANALYSIS AND REPORTING; CONSULTATION SERVICES IN THE FIELD OF HYDROLOGICAL RESEARCH; CONSULTING IN THE FIELD OF ENVIRONMENTAL PROTECTION, NAMELY, DETECTION OF CONTAMINANTS IN WATER; CONSULTING IN THE FIELD OF INFORMATION TECHNOLOGY; CONSULTING IN THE FIELD OF PRODUCT DEVELOPMENT IN THE FIELD OF WATER RESOURCE AND SUSTAINABILITY DATA MANAGEMENT, ANALYSIS AND REPORTING; CONSULTING IN THE FIELD OF SOFTWARE DEVELOPMENT AND PRODUCT DEVELOPMENT IN THE FIELD OF WATER RESOURCE AND SUSTAINABILITY DATA MANAGEMENT, ANALYSIS AND REPORTING; CONSULTING SERVICES FOR OTHERS IN THE FIELD OF DESIGN, PLANNING, AND IMPLEMENTATION PROJECT MANAGEMENT OF WATER RESOURCE AND SUSTAINABILITY DATA MANAGEMENT, ANALYSIS AND REPORTING; CONSULTING SERVICES IN THE FIELD OF PROVIDING ONLINE, NON-DOWNLOADABLE SOFTWARE AND APPLICATIONS; CONSULTING SERVICES IN THE FIELD OF SOFTWARE AS A SERVICE (SAAS); DATA CONVERSION OF COMPUTER PROGRAMS AND DATA, NOT PHYSICAL CONVERSION; DATA CONVERSION OF ELECTRONIC INFORMATION; DATA MIGRATION SERVICES; DATA MINING; DATA WAREHOUSING; DATABASE DESIGN AND DEVELOPMENT; DATABASE DEVELOPMENT SERVICES; DESIGN AND DEVELOPMENT OF SOFTWARE AND HARDWARE FOR WATER RESOURCE AND SUSTAINABILITY DATA MANAGEMENT, ANALYSIS AND REPORTING; DESIGN OF COMPUTER DATABASE; DESIGN OF INFORMATION GRAPHICS AND DATA VISUALIZATION MATERIALS; DEVELOPING COMPUTER SOFTWARE; DEVELOPMENT OF NEW TECHNOLOGY FOR OTHERS IN THE FIELD OF WATER RESOURCE AND SUSTAINABILITY DATA MANAGEMENT, ANALYSIS AND REPORTING; DEVELOPMENT, UPDATING AND MAINTENANCE OF SOFTWARE AND DATA BASES; ELECTRIC METER READING AND DATA ANALYSIS; ENVIRONMENTAL SERVICES, NAMELY, DETECTION OF CONTAMINANTS IN WATER; HYDROLOGIC STUDY OF SURFACE AND GROUND WATER; HYDROLOGICAL CALCULATIONS AND SIMULATIONS OF FLOOD FLOWS IN STREAMS, MARSHES, AND WETLANDS; HYDROLOGICAL RESEARCH; INNOVATION CONSULTING SERVICES, NAMELY, ADVISING OTHERS IN THE AREAS OF PRODUCT DEVELOPMENT; IT CONSULTING SERVICES; IT INTEGRATION SERVICES; METEOROLOGICAL FORECASTING; MONITORING OF STREAM WATER QUALITY; PLATFORM AS A SERVICE (PAAS) FEATURING COMPUTER SOFTWARE PLATFORMS FOR WATER RESOURCE AND SUSTAINABILITY DATA MANAGEMENT, ANALYSIS AND REPORTING; PRODUCT DESIGN AND DEVELOPMENT IN THE FIELD OF WATER RESOURCE AND SUSTAINABILITY DATA MANAGEMENT, ANALYSIS AND REPORTING; PRODUCT DEVELOPMENT IN THE FIELD OF WATER RESOURCE AND SUSTAINABILITY DATA MANAGEMENT, ANALYSIS AND REPORTING; PROVIDING A WEB SITE FEATURING TECHNOLOGY THAT ENABLES INTERNET USERS TO CREATE, BOOKMARK, ANNOTATE, AND PUBLICLY SHARE DATA; PROVIDING A WEB SITE FEATURING TECHNOLOGY THAT ENABLES USERS TO MANAGE WATER RESOURCE AND SUSTAINABILITY DATA MANAGEMENT, ANALYSIS AND REPORTING; PROVIDING A WEB SITE FEATURING WEATHER INFORMATION; PROVIDING A WEB SITE THAT FEATURES INFORMATION ON BEACH SCIENCE; PROVIDING A WEBSITE FEATURING ENVIRONMENTAL INFORMATION ABOUT CLIMATE CHANGE AND BIO-DIVERSITY; PROVIDING A WEBSITE FEATURING TECHNOLOGY THAT ENABLES SUBSCRIBERS TO TRANSFER FILES TO AND FROM A FILE TRANSFER PROTOCOL SERVER; PROVIDING A WEBSITE FEATURING TECHNOLOGY THAT ENABLES USERS TO LIST, SHARE AND VIEW INFORMATION DESCRIBING THE GEOGRAPHIC LOCATION OF VARIOUS INTERESTS OF THE USER; PROVIDING A

Reg. No. 4,098,110 WEBSITE FEATURING TECHNOLOGY THAT ENABLES USERS TO MANAGE, ANALYZE AND REPORT ON WATER RESOURCE AND SUSTAINABILITY DATA; PROVIDING AN ON-LINE NETWORK ENVIRONMENT THAT FEATURES TECHNOLOGY THAT ENABLES USERS TO SHARE DATA; PROVIDING AN ON-LINE SEARCHABLE DATABASE IN THE FIELD OF WATER RESOURCE AND SUSTAINABILITY MANAGEMENT FOR SCIENTIFIC RESEARCH PURPOSES; PROVIDING AN ONLINE NETWORK SERVICE THAT ENABLES USERS TO SHARE DATA IN THE FIELD OF WATER RESOURCE AND SUSTAINABILITY MANAGEMENT; PROVIDING AN ONLINE NON-DOWNLOADABLE INTERNET-BASED SYSTEM APPLICATION FEATURING TECHNOLOGY ENABLING USERS TO MANAGE, ANALYZE AND REPORT ON WATER RESOURCE AND SUSTAINABILITY DATA; PROVIDING CUSTOMER-DEFINED GENERATED CONTENT AND CONTENT OF OTHERS AUTOMATICALLY SELECTED AND CUSTOMIZED BASED ON THE KNOWN OR ESTIMATED GEOGRAPHICAL LOCATION OF AN INTERNET, MOBILE TELEPHONE OR OTHER WIRED OR WIRELESS DIGITAL NETWORK BASED CUSTOMER; PROVIDING CUSTOMIZED ON-LINE WEB PAGES AND DATA FEEDS FEATURING USER-DEFINED INFORMATION, WHICH INCLUDES BLOG POSTS, NEW MEDIA CONTENT, OTHER ON-LINE CONTENT, AND ON-LINE WEB LINKS TO OTHER WEBSITES; PROVIDING CUSTOMIZED ON-LINE WEB PAGES FEATURING USER-DEFINED INFORMATION, WHICH INCLUDES SEARCH ENGINES AND ON-LINE WEB LINKS TO OTHER WEB SITES; PROVIDING QUALITY ASSURANCE SERVICES IN THE FIELD OF WATER RESOURCE AND SUSTAINABILITY DATA MANAGEMENT, ANALYSIS AND REPORTING; PROVIDING SCIENTIFIC INFORMATION IN THE FIELDS OF CLIMATE CHANGE AND GLOBAL WARMING; PROVIDING WEATHER INFORMATION; QUALITY MANAGEMENT SERVICES, NAMELY, QUALITY EVALUATION AND ANALYSIS, QUALITY ASSURANCE, AND QUALITY CONTROL, IN THE FIELD OF WATER RESOURCE AND SUSTAINABILITY DATA MANAGEMENT, ANALYSIS AND REPORTING; RESEARCH AND DEVELOPMENT AND CONSULTATION RELATED THERETO IN THE FIELD OF WATER RESOURCE AND SUSTAINABILITY DATA MANAGEMENT, ANALYSIS AND REPORTING; RESEARCH AND DEVELOPMENT IN THE FIELD OF WATER RESOURCE AND SUSTAINABILITY DATA MANAGEMENT, ANALYSIS AND REPORTING; RESEARCH AND DEVELOPMENT OF TECHNOLOGY IN THE FIELD OF WATER RESOURCE AND SUSTAINABILITY DATA MANAGEMENT, ANALYSIS AND REPORTING; RESEARCH IN THE AREA OF ENVIRONMENTAL PROTECTION; RESEARCH IN THE FIELD OF CLIMATE CHANGE; RESEARCH IN THE FIELD OF ENVIRONMENTAL PROTECTION; RESEARCH IN THE FIELD OF HYDROGEOLOGY; RESEARCH IN THE FIELD OF NATURAL RESOURCES; RESEARCH RELATING TO ENVIRONMENTAL PROTECTION; SOFTWARE AS A SERVICE (SAAS) SERVICES FEATURING SOFTWARE FOR WATER RESOURCE AND SUSTAINABILITY DATA MANAGEMENT, ANALYSIS AND REPORTING; SOFTWARE AS A SERVICE (SAAS) SERVICES FEATURING SOFTWARE IN THE FIELD OF WATER RESOURCE AND SUSTAINABILITY DATA MANAGEMENT, ANALYSIS AND REPORTING; SOFTWARE AS A SERVICE (SAAS) SERVICES, NAMELY, HOSTING SOFTWARE FOR USE BY OTHERS FOR USE IN WATER RESOURCE AND SUSTAINABILITY DATA MANAGEMENT, ANALYSIS AND REPORTING; SOFTWARE DEVELOPMENT AND PRODUCT DEVELOPMENT IN THE FIELD OF WATER RESOURCE AND SUSTAINABILITY DATA MANAGEMENT, ANALYSIS AND REPORTING; SOFTWARE DEVELOPMENT IN THE FIELD OF WATER RESOURCE AND SUSTAINABILITY DATA MANAGEMENT, ANALYSIS AND REPORTING; TECHNICAL CONSULTANCY IN THE FIELD OF ENVIRONMENTAL SCIENCE; TECHNICAL CONSULTING IN THE FIELD OF ENVIRONMENTAL ENGINEERING; TECHNICAL CONSULTING IN THE FIELD OF POLLUTION DETECTION; TESTING OR RESEARCH ON PREVENTION OF POLLUTION; UTILITY METER READING SERVICES; WATER METER READING AND DATA ANALYSIS; WATER QUALITY CONTROL SERVICES; WEATHER FORECASTING; WEATHER INFORMATION SERVICES; WEATHER REPORTING; WETLAND HABITAT DEVELOPMENT AND PRESERVATION SERVICES, NAMELY, MONITORING, TESTING AND ANALYZING ECOLOGICAL SUCCESS IN THE FIELD OF ENVIRONMENTALLY SENSITIVE HABITAT CONSERVATION AND PRESERVATION OF NATIVE PLANTS AND WILDLIFE; WRITING OF DATA PROCESSING PROGRAMS, IN CLASS 42 (U.S. CLS. 100 AND 101).

FIRST USE 2-1-2010; IN COMMERCE 2-1-2010.

Reg. No. 4,098,110 THE MARK CONSISTS OF A NUMERIC SUBSCRIPT "2" RIGHT AFTER THE LETTER "H" AND BEFORE THE LETTER "O" IN "OLAP" ALL IN DARK BLUE.

THE COLOR(S) DARK BLUE IS/ARE CLAIMED AS A FEATURE OF THE MARK.

SER. NO. 85-221,522, FILED 1-19-2011.

SALLY SHIH, EXAMINING ATTORNEY

United States of America

United States Patent and Trademark Office



European Sperm Bank

Reg. No. 4,098,111

Registered Feb. 14, 2012

Int. Cl.: 44

SERVICE MARK

PRINCIPAL REGISTER

SEATTLE SPERM BANK, LLC (WASHINGTON LIMITED LIABILITY COMPANY), DBA
EUROPEAN SPERM BANK USA
4915 25TH AVE NE, SUITE 204
SEATTLE, WA 98105 AND

NORDIC CRYOBANK APS (DENMARK ANPARTSSELSKAB (APS)), DBA EUROPEAN
SPERM BANK
FALKONER ALLÉ 63, 2
COPENHAGEN, DENMARK

FOR: REPRODUCTIVE TISSUE BANKING, IN CLASS 44 (U.S. CLS. 100 AND 101).

FIRST USE 5-0-2007; IN COMMERCE 5-0-2007.

NO CLAIM IS MADE TO THE EXCLUSIVE RIGHT TO USE "EUROPEAN SPERM BANK",
APART FROM THE MARK AS SHOWN.

THE MARK CONSISTS OF THE WORDS "EUROPEAN SPERM BANK" WITH A WAVY
LINE OVER THE WORDS IN THE SHAPE OF THE OUTLINE OF A SPERM CELL.

SER. NO. 85-221,589, FILED 1-19-2011.

DAVID H. STINE, EXAMINING ATTORNEY



David J. Kyros

Director of the United States Patent and Trademark Office

United States of America

United States Patent and Trademark Office

LIGO

Reg. No. 4,098,112

LIBERTY GOLD FRUIT CO. (CALIFORNIA CORPORATION)
500 ECCLES AVENUE
SOUTH SAN FRANCISCO, CA 94080

Registered Feb. 14, 2012

Int. Cls.: 29 and 32

FOR: CANNED SARDINES; CANNED SQUID; CANNED MACKEREL; CANNED CORN;
CANNED FRUIT COCKTAIL; CANNED LUNCHEON MEAT, IN CLASS 29 (U.S. CL. 46).

TRADEMARK

FIRST USE 1-1-1991; IN COMMERCE 1-1-1991.

PRINCIPAL REGISTER

FOR: FRUIT FLAVORED BEVERAGE, NAMELY, CANNED MANDARIN ORANGE DRINK,
IN CLASS 32 (U.S. CLS. 45, 46 AND 48).

FIRST USE 1-1-1996; IN COMMERCE 1-1-1996.

THE MARK CONSISTS OF STANDARD CHARACTERS WITHOUT CLAIM TO ANY PAR-
TICULAR FONT, STYLE, SIZE, OR COLOR.

OWNER OF U.S. REG. NO. 330,490.

SER. NO. 85-222,162, FILED 1-20-2011.

DAVID HOFFMAN, EXAMINING ATTORNEY



David J. Kyffers

Director of the United States Patent and Trademark Office

United States of America

United States Patent and Trademark Office

SplitGear

Reg. No. 4,098,113

SPLITGEAR LLC (DELAWARE LIMITED LIABILITY COMPANY), DBA SPLITGEAR
2809 BOSTON ST, APT 373
BALTIMORE, MD 21224

Registered Feb. 14, 2012

Int. Cl.: 41

FOR: MOTION PICTURE AND VIDEO RENTAL SERVICES; MOTION PICTURE CAMERA RENTAL SERVICES; PHOTOGRAPHY; RENTAL AND COMPUTERIZED ON-LINE RENTAL SERVICES FEATURING INTERACTIVE SOFTWARE AND HARDWARE HOME ENTERTAINMENT AND CONSUMER ELECTRONICS IN THE NATURE OF MOTION PICTURES, FILMS, MOVIES, PRERECORDED DIGITAL VERSATILE DISCS (OR DVDS), PRERECORDED VIDEOTAPE CASSETTES, AUDIO, AUDIO RECORDINGS IN A VARIETY OF GENRES; RENTAL AND LEASING OF PROFESSIONAL SOUND EQUIPMENT AND PARTS; RENTAL OF AUDIO EQUIPMENT; RENTAL OF AUDIOVISUAL EQUIPMENT; RENTAL OF CAMERAS; RENTAL OF PHOTOGRAPHIC EQUIPMENT; RENTAL OF VIDEO CAMERAS; RENTAL SERVICES FOR AUDIO AND VIDEO EQUIPMENT, IN CLASS 41 (U.S. CLS. 100, 101 AND 107).

SERVICE MARK

PRINCIPAL REGISTER

FIRST USE 7-1-2010; IN COMMERCE 7-1-2010.

THE MARK CONSISTS OF STANDARD CHARACTERS WITHOUT CLAIM TO ANY PARTICULAR FONT, STYLE, SIZE, OR COLOR.

SER. NO. 85-222,308, FILED 1-20-2011.

JAMES A. RAUEN, EXAMINING ATTORNEY



David J. Kybas

Director of the United States Patent and Trademark Office

United States of America

United States Patent and Trademark Office

VARK

Reg. No. 4,098,114

Registered Feb. 14, 2012

Int. Cls.: 9, 16 and 41

TRADEMARK

SERVICE MARK

PRINCIPAL REGISTER

VARK-LEARN LTD (NEW ZEALAND CORPORATION)
50 IDRIS ROAD
CHRISTCHURCH, NEW ZEALAND

FOR: COMPUTER SOFTWARE FOR ASSESSING, ANALYZING AND PROVIDING STRATEGIES TO IMPROVE A PERSON'S LEARNING AND COMMUNICATION PREFERENCES; PRE-RECORDED CDS AND DVDS IN THE FIELD OF LEARNING AND COMMUNICATION PREFERENCES; APPARATUS FOR RECORDING, TRANSMISSION OR REPRODUCTION OF SOUNDS, IMAGES OR DATA; DOWNLOADABLE ELECTRONIC PUBLICATIONS, NAMELY, JOURNALS, NEWSLETTERS, BOOKS, AND QUESTIONNAIRES FOR ASSESSING, ANALYZING AND PROVIDING STRATEGIES TO IMPROVE A PERSON'S LEARNING AND COMMUNICATION PREFERENCES, IN CLASS 9 (U.S. CLS. 21, 23, 26, 36 AND 38).

FIRST USE 0-0-1987; IN COMMERCE 0-0-1991.

FOR: PRINTED MATTER, NAMELY, JOURNALS, NEWSLETTERS, BOOKS, AND QUESTIONNAIRES FOR ASSESSING, ANALYZING AND PROVIDING STRATEGIES TO IMPROVE A PERSON'S LEARNING AND COMMUNICATION PREFERENCES; PRINTED INSTRUCTIONAL, EDUCATIONAL AND TEACHING MATERIALS DESIGNED TO ASSESS, ANALYSE AND PROVIDE STRATEGIES TO IMPROVE A PERSON'S LEARNING AND COMMUNICATION PREFERENCES; BOOKS AND QUESTIONNAIRES DESIGNED FOR ASSESSING, ANALYZING AND PROVIDING STRATEGIES TO IMPROVE A PERSON'S LEARNING AND COMMUNICATION PREFERENCES, IN CLASS 16 (U.S. CLS. 2, 5, 22, 23, 29, 37, 38 AND 50).

FIRST USE 0-0-1987; IN COMMERCE 0-0-1991.

FOR: EDUCATIONAL CONSULTATION SERVICES, NAMELY, CONSULTATION RENDERED TO STUDENTS AND TEACHERS FOR ASSISTING, ANALYZING AND PROVIDING STRATEGIES TO IMPROVE ON A PERSON'S LEARNING AND COMMUNICATION PREFERENCES; THE PROVISION OF CONFERENCES AND WORKSHOPS IN THE FIELD OF LEARNING AND COMMUNICATION PREFERENCES; PROVIDING ONLINE PUBLICATIONS, NAMELY, JOURNALS, NEWSLETTERS, BOOKS, AND QUESTIONNAIRES IN THE FIELD OF LEARNING AND COMMUNICATION PREFERENCES; PROVIDING ONLINE PUBLICATIONS IN THE NATURE OF ELECTRONIC BOOKS IN THE FIELD OF LEARNING AND COMMUNICATION PREFERENCES; EDUCATIONAL TESTING SERVICES, NAMELY,



David J. Kyjars

Director of the United States Patent and Trademark Office

Reg. No. 4,098,114 CONSULTING AND ADVISORY SERVICES, RELATED TO THE ASSESSMENT AND ANALYSIS OF A PERSON'S LEARNING AND COMMUNICATION PREFERENCES, IN CLASS 41 (U.S. CLS. 100, 101 AND 107).

FIRST USE 0-0-1987; IN COMMERCE 0-0-1991.

THE MARK CONSISTS OF STANDARD CHARACTERS WITHOUT CLAIM TO ANY PARTICULAR FONT, STYLE, SIZE, OR COLOR.

SER. NO. 85-223,309, FILED 1-21-2011.

DORITT L. CARROLL, EXAMINING ATTORNEY

United States of America

United States Patent and Trademark Office

Krista de la Harpe

Reg. No. 4,098,115

DE LA HARPE, KRISTA (UNITED STATES INDIVIDUAL), AKA KRISTA DE LA HARPE
1189 TRANQUILLA DR.
DALLAS, TX 75218

Registered Feb. 14, 2012

Int. Cl.: 25

FOR: FOOTWEAR, IN CLASS 25 (U.S. CLS. 22 AND 39).

TRADEMARK

FIRST USE 7-21-1998; IN COMMERCE 7-21-1998.

PRINCIPAL REGISTER

THE MARK CONSISTS OF STANDARD CHARACTERS WITHOUT CLAIM TO ANY PARTICULAR FONT, STYLE, SIZE, OR COLOR.

THE NAME(S), PORTRAIT(S), AND/OR SIGNATURE(S) SHOWN IN THE MARK IDENTIFIES "KRISTA DE LA HARPE", WHOSE CONSENT(S) TO REGISTER IS MADE OF RECORD.

SER. NO. 85-223,658, FILED 1-21-2011.

STEVEN R. FINE, EXAMINING ATTORNEY



David J. Kybas

Director of the United States Patent and Trademark Office

United States of America

United States Patent and Trademark Office

Get Off Your Attitude

Reg. No. 4,098,116

Registered Feb. 14, 2012

Int. Cl.: 25

TRADEMARK

PRINCIPAL REGISTER

RYAN LOWE, LLC. (LOUISIANA LIMITED LIABILITY COMPANY)
BOX 102
3110 MAGAZINE ST
NEW ORLEANS, LA 70115

FOR: ANKLE SOCKS; ANKLETS; APPAREL FOR DANCERS, NAMELY, TEE SHIRTS, SWEATSHIRTS, PANTS, LEGGINGS, SHORTS AND JACKETS; ATHLETIC APPAREL, NAMELY, SHIRTS, PANTS, JACKETS, FOOTWEAR, HATS AND CAPS, ATHLETIC UNIFORMS; ATHLETIC TIGHTS; ATHLETIC UNIFORMS; BABY BIBS NOT OF PAPER; BABY BODYSUITS; BABY BOTTOMS; BABY TOPS; BASEBALL CAPS; BASEBALL CAPS AND HATS; BOARD SHORTS; BODY SHIRTS; BOOTS; BOOTS FOR MOTORCYCLING; BOOTS FOR SPORT; BOW TIES; BOXER SHORTS; BRIEFS; BUTTON DOWN SHIRTS; CAMP SHIRTS; CAP VISORS; CAPRI PANTS; CAPS; CAPS WITH VISORS; CARGO PANTS; CHEF'S HATS; CHILDREN'S AND INFANT'S APPAREL, NAMELY, JUMPERS, OVERALL SLEEPWEAR, PAJAMAS, ROMPERS AND ONE-PIECE GARMENTS; CHILDREN'S AND INFANTS' APPAREL TREATED WITH FIRE AND HEAT RETARDANTS, NAMELY, JUMPERS, OVERALL SLEEPWEAR, PAJAMAS, ROMPERS AND ONE-PIECE GARMENTS; CHILDREN'S AND INFANTS' CLOTH BIBS; CHILDREN'S CLOTH EATING BIBS; CHILDREN'S HEADWEAR; CLOTHING FOR BABIES, TODDLERS AND CHILDREN, TREATED WITH FIRE AND HEAT RETARDANTS, NAMELY, PAJAMAS, JACKETS, SHIRTS, PANTS, JUMPERS; CLOTHING, NAMELY, ATHLETIC SLEEVES; COLLARED SHIRTS; CREW NECK SWEATERS; CROP TOPS; CYCLISTS' JERSEYS; DENIM JACKETS; DRESS SHIRTS; EAR BANDS; EAR MUFFS; EAR WARMERS; FISHING SHIRTS; GLOVES; GLOVES AS CLOTHING; GLOVES FOR APPAREL; GOLF CAPS; GOLF PANTS, SHIRTS AND SKIRTS; GOLF SHIRTS; GOLF SHOES; GOLF SHORTS; GYM BOOTS; GYM PANTS; GYM SHORTS; GYM SUITS; HALTER TOPS; HATS; HATS FOR INFANTS, BABIES, TODDLERS AND CHILDREN; HEADBANDS; HEADBANDS AGAINST SWEATING; HEADBANDS FOR CLOTHING; HIKING BOOTS; HOODED PULLOVERS; HOODED SWEAT SHIRTS; HOODED SWEATSHIRTS; HOODS; HORSE-RIDING BOOTS; INFANT AND TODDLER ONE PIECE CLOTHING; INFANT DIAPER COVERS; INFANT SLEEPERS; INFANTS' SHOES AND BOOTS; JACKETS; JACKETS AND SOCKS; JEANS; JEGGINGS, NAMELY, PANTS THAT ARE PARTIALLY JEANS AND PARTIALLY LEGGINGS; JERSEYS; JOGGING PANTS; KNIT JACKETS; LACE BOOTS; LADIES' BOOTS; LADIES' UNDERWEAR; LEATHER BOOTS; LEATHER HATS; LEATHER JACKETS; LEATHER SHIRTS; LEISURE SHOES; LEOTARDS AND TIGHTS FOR WOMEN, MEN AND CHILDREN OF NYLON, COTTON OR OTHER TEXTILE FIBERS; LONG UNDERWEAR; LONG-SLEEVED SHIRTS; LOUNGE PANTS; MEN'S AND WOMEN'S JACKETS, COATS, TROUSERS, VESTS; MEN'S SOCKS; MEN'S



David J. Kyros

Director of the United States Patent and Trademark Office

Reg. No. 4,098,116 UNDERWEAR; MOCK TURTLE-NECK SWEATERS; MOTORCYCLE JACKETS; MUSCLE TOPS; NIGHT SHIRTS; ONE PIECE GARMENT FOR INFANTS AND TODDLERS; ONE-PIECE GARMENTS FOR CHILDREN; OPEN-NECKED SHIRTS; OUTER JACKETS; OVER SHIRTS; PAJAMA BOTTOMS; PAJAMAS; PANTIES, SHORTS AND BRIEFS; PANTS; PLASTIC BABY BIBS; POLO KNIT TOPS; POLO SHIRTS; RAIN BOOTS; RAIN HATS; RAINPROOF JACKETS; RIDING BOOTS; RUGBY SHIRTS; RUGBY TOPS; RUNNING SHOES; RUNNING SUITS; SANDALS AND BEACH SHOES; SCARFS; SHIRTS; SHIRTS AND SHORT-SLEEVED SHIRTS; SHIRTS FOR INFANTS, BABIES, TODDLERS AND CHILDREN; SHOES; SHORT-SLEEVED OR LONG-SLEEVED T-SHIRTS; SHORT-SLEEVED SHIRTS; SKI BOOTS; SKI JACKETS; SKI MASKS; SKI PANTS; SKI SUITS; SKIING SHOES; SKULL CAPS; SLEEP PANTS; SLEEP SHIRTS; SLEEVED OR SLEEVELESS JACKETS; SLEEVELESS JERSEYS; SLIDING SHORTS; SLIPPER SOCKS; SLIPPERS; SMALL HATS; SNOW BOOTS; SNOW PANTS; SNOWBOARD BOOTS; SNOWBOARD JACKETS; SOCCER BIBS; SOCCER BOOTS; SOCCER SHOES; SOCK SUSPENDERS; SOCKS; SOCKS AND STOCKINGS; SPORT SHIRTS; SPORTS CAPS AND HATS; SPORTS JACKETS; SPORTS JERSEYS; SPORTS PANTS; SPORTS SHIRTS WITH SHORT SLEEVES; STRETCH PANTS; SUEDE JACKETS; SWEAT BANDS; SWEAT JACKETS; SWEAT PANTS; SWEAT SHIRTS; SWEAT SHORTS; SWEAT SUITS; SWEATERS; SWIM CAPS; SWIM SUITS; SWIM TRUNKS; SWIM WEAR FOR GENTLEMEN AND LADIES; SWIMMING TRUNKS; T-SHIRTS; TANK TOPS; TANK-TOPS; TEE SHIRTS; TENNIS SHOES; THONGS; TIES; TRACK AND FIELD SHOES; TRACK JACKETS; TRAINING SHOES; TRAINING SUITS; TRIATHLON CLOTHING, NAMELY, TRIATHLON TIGHTS, TRIATHLON SHORTS, TRIATHLON SINGLET, TRIATHLON SHIRTS, TRIATHLON SUITS; TUBE TOPS; TURTLE NECK SHIRTS; TURTLE-NECK SWEATERS; UNDERWEAR; UNDERWEAR, NAMELY, BOY SHORTS; V-NECK SWEATERS; WALKING SHORTS; WATERPROOF JACKETS AND PANTS; WATERPROOF LEATHER BOOTS; WEARABLE GARMENTS AND CLOTHING, NAMELY, SHIRTS; WETSUITS FOR WATER-SKIING; WIND PANTS; WIND RESISTANT JACKETS; WIND SHIRTS; WIND-JACKETS; WINTER BOOTS; WOMEN'S HATS AND HOODS; WOMEN'S SHOES; WOMEN'S TOPS, NAMELY, CAMIS; WOMEN'S UNDERWEAR; WORK SHOES AND BOOTS; WORKING OVERALLS; WRISTBANDS; YOGA PANTS; YOGA SHIRTS, IN CLASS 25 (U.S. CLS. 22 AND 39).

FIRST USE 4-15-2010; IN COMMERCE 4-15-2010.

THE MARK CONSISTS OF STANDARD CHARACTERS WITHOUT CLAIM TO ANY PARTICULAR FONT, STYLE, SIZE, OR COLOR.

OWNER OF U.S. REG. NOS. 3,921,240 AND 8,503,582.

SER. NO. 85-223,851, FILED 1-22-2011.

FRANK LATTUCA, EXAMINING ATTORNEY

United States of America

United States Patent and Trademark Office

AFRICAN FOREST GOURMET COFFEE

Reg. No. 4,098,117

HOUSTON COFFEE EXCHANGE LLC (TEXAS LIMITED LIABILITY COMPANY)
11800 BIG JOHN BOULEVARD
HOUSTON, TX 77038

Registered Feb. 14, 2012

Int. Cl.: 30

FOR: ROASTED COFFEE BEANS, IN CLASS 30 (U.S. CL. 46).

TRADEMARK

FIRST USE 12-1-2010; IN COMMERCE 12-1-2010.

PRINCIPAL REGISTER

THE MARK CONSISTS OF STANDARD CHARACTERS WITHOUT CLAIM TO ANY PARTICULAR FONT, STYLE, SIZE, OR COLOR.

NO CLAIM IS MADE TO THE EXCLUSIVE RIGHT TO USE "AFRICAN" AND "GOURMET COFFEE", APART FROM THE MARK AS SHOWN.

SER. NO. 85-223,941, FILED 1-23-2011.

RICHARD WHITE, EXAMINING ATTORNEY



David J. Kyffers

Director of the United States Patent and Trademark Office

United States of America

United States Patent and Trademark Office



Reg. No. 4,098,118

Registered Feb. 14, 2012

Int. Cl.: 35

SERVICE MARK

PRINCIPAL REGISTER

THE GLIDE STORE, L.C. (LOUISIANA LIMITED LIABILITY COMPANY)
402 ZACHARY STREET
SCOTT, LA 70583

FOR: RETAIL, WHOLESALE, AND ONLINE STORE SERVICES FEATURING PROTECTIVE PADS USED WITH FURNITURE, NAMELY, PRE-CUT BALLS USED AS PADS ON THE LEGS OF CHAIRS, STOOLS, ADULT WALKERS, TABLES, AND DESKS, IN CLASS 35 (U.S. CLS. 100, 101 AND 102).

FIRST USE 3-22-2010; IN COMMERCE 5-15-2010.

NO CLAIM IS MADE TO THE EXCLUSIVE RIGHT TO USE "THE GLIDE STORE", APART FROM THE MARK AS SHOWN.

THE COLOR(S) RED AND BLACK IS/ARE CLAIMED AS A FEATURE OF THE MARK.

THE MARK CONSISTS OF THE STYLIZED WORDING "THE GLIDE STORE" APPEARING IN THE COLOR BLACK WITH "G" AND LAST "E" UNDERLINED IN BLACK, ABOVE THE WORDING "FLOOR PROTECTION IS OUR BUSINESS!" IN RED LETTERS, WITH MOTION TRIANGLES EXTENDING TO THE LEFT OF THE WORDING.

SER. NO. 85-224,175, FILED 1-24-2011.

GEOFFREY FOSDICK, EXAMINING ATTORNEY



David J. Kybas

Director of the United States Patent and Trademark Office

United States of America

United States Patent and Trademark Office



Reg. No. 4,098,119

Registered Feb. 14, 2012

Int. Cls.: 12 and 25

TRADEMARK

PRINCIPAL REGISTER

HEIDE PERFORMANCE PRODUCTS, INC. (MICHIGAN CORPORATION)
32430 INDUSTRIAL DRIVE
MADISON HEIGHTS, MI 48071

FOR: LAND VEHICLES AND STRUCTURAL PARTS THEREFOR; LAND VEHICLE PARTS, NAMELY, BUMPERS, SPOILERS, ROOF, DOOR AND SIDE PANELS, WIND DEFLECTORS, AND HEADLIGHT COVERS, IN CLASS 12 (U.S. CLS. 19, 21, 23, 31, 35 AND 44).

FIRST USE 6-30-2009; IN COMMERCE 6-30-2009.

FOR: CLOTHING, NAMELY, T-SHIRTS, IN CLASS 25 (U.S. CLS. 22 AND 39).

FIRST USE 1-24-2011; IN COMMERCE 1-24-2011.

THE MARK CONSISTS OF THE LETTER "H" WITH "HPP" DIRECTLY UNDERNEATH.

SER. NO. 85-224,550, FILED 1-24-2011.

ANNE FARRELL, EXAMINING ATTORNEY



David J. Kybas

Director of the United States Patent and Trademark Office

United States of America

United States Patent and Trademark Office

VILLA FARNIA

Reg. No. 4,098,120

Registered Feb. 14, 2012

Int. Cl.: 33

TRADEMARK

PRINCIPAL REGISTER

DIRECT WINES LIMITED (UNITED KINGDOM LIMITED LIABILITY COMPANY)
NEW AQUITAINE HOUSE EXETER WAY, THEALE
READING, BERKSHIRE, UNITED KINGDOM RG74PL

FOR: ALCOHOLIC BEVERAGES EXCEPT BEERS; WINES; SHERRY, IN CLASS 33 (U.S. CLS. 47 AND 49).

THE MARK CONSISTS OF STANDARD CHARACTERS WITHOUT CLAIM TO ANY PARTICULAR FONT, STYLE, SIZE, OR COLOR.

PRIORITY CLAIMED UNDER SEC. 44(D) ON ERPN CMNTY TM OFC APPLICATION NO. 9585324, FILED 12-9-2010, REG. NO. 009585365, DATED 4-19-2011, EXPIRES 4-19-2021.

THE ENGLISH TRANSLATION OF "FARNIA" IN THE MARK IS "OAK".

SER. NO. 85-225,853, FILED 1-25-2011.

MICHAEL ENGEL, EXAMINING ATTORNEY



David J. Kyffers

Director of the United States Patent and Trademark Office

United States of America

United States Patent and Trademark Office

VISIONARIO

Reg. No. 4,098,121

Registered Feb. 14, 2012

Int. Cl.: 33

TRADEMARK

PRINCIPAL REGISTER

DIRECT WINES LIMITED (UNITED KINGDOM LIMITED LIABILITY COMPANY)
NEW AQUITAINE HOUSE EXETER WAY, THEALE
READING, BERKSHIRE, UNITED KINGDOM RG74PL

FOR: ALCOHOLIC BEVERAGES EXCEPT BEERS; WINES; SHERRY, IN CLASS 33 (U.S. CLS. 47 AND 49).

THE MARK CONSISTS OF STANDARD CHARACTERS WITHOUT CLAIM TO ANY PARTICULAR FONT, STYLE, SIZE, OR COLOR.

PRIORITY CLAIMED UNDER SEC. 44(D) ON ERPN CMNTY TM OFC APPLICATION NO. 9585365, FILED 12-9-2010, REG. NO. 009585365, DATED 4-19-2011, EXPIRES 4-19-2021.

THE ENGLISH TRANSLATION OF "VISIONARIO" IN THE MARK IS "VISIONARY".

SER. NO. 85-225,887, FILED 1-25-2011.

MICHAEL ENGEL, EXAMINING ATTORNEY



David J. Kybas

Director of the United States Patent and Trademark Office

United States of America

United States Patent and Trademark Office

Out of the Danger Zone

Reg. No. 4,098,122

HCC CORP (TEXAS CORPORATION)

Registered Feb. 14, 2012

3011N IH-35
AUSTIN, TX 78722

Int. Cl.: 41

FOR: EDUCATIONAL SERVICES, NAMELY, PROVIDING LIVE CLASSES, SEMINARS, WORKSHOPS, PROFESSIONAL EDUCATION COURSES DISTRIBUTED AND TAUGHT ONLINE, OR THROUGH CDS OR DVDS, OR BY VIDEO CONFERENCE OR IN-PERSON OR THROUGH WEB PORTAL IN THE FIELD OF MEDICAL INNOVATION ADOPTION BY HEALTHCARE PRACTITIONERS AND CONSUMERS THAT CAN SAVE LIVES AND REDUCE PREVENTABLE HARM; AND DISTRIBUTION OF COURSE MATERIAL IN CONNECTION THEREWITH IN THE NATURE OF MOVIES, VIDEOS, BOOKS AND REPORTS, IN CLASS 41 (U.S. CLS. 100, 101 AND 107).

SERVICE MARK

PRINCIPAL REGISTER

FIRST USE 1-30-2011; IN COMMERCE 1-30-2011.

THE MARK CONSISTS OF STANDARD CHARACTERS WITHOUT CLAIM TO ANY PARTICULAR FONT, STYLE, SIZE, OR COLOR.

SER. NO. 85-225,946, FILED 1-25-2011.

JACLYN KIDWELL WALKER, EXAMINING ATTORNEY



David J. Kyros

Director of the United States Patent and Trademark Office

United States of America

United States Patent and Trademark Office

CAMGIAN MICROSYSTEMS

Reg. No. 4,098,123

Registered Feb. 14, 2012

Int. Cl.: 9

TRADEMARK

PRINCIPAL REGISTER

CAMGIAN MICROSYSTEMS CORPORATION (MISSISSIPPI CORPORATION)
SUITE 203
2500 MAITLAND CENTER PKWY
MAITLAND, FL 32751

FOR: TELECOMMUNICATIONS AND DATA NETWORKING HARDWARE, NAMELY, WIRELESS DEVICES FOR TRANSPORTING AND AGGREGATING VOICE, DATA, AND VIDEO COMMUNICATIONS ACROSS MULTIPLE NETWORK INFRASTRUCTURES AND COMMUNICATIONS PROTOCOLS; SENSORS, NAMELY, SENSING DEVICES FOR SENSING TEMPERATURE, LIQUID LEVELS, POSITION, DISTANCE, SPEED, VIBRATION, SEISMIC ACTIVITY, AND RADAR, IN CLASS 9 (U.S. CLS. 21, 23, 26, 36 AND 38).

FIRST USE 3-14-2008; IN COMMERCE 3-14-2008.

THE MARK CONSISTS OF STANDARD CHARACTERS WITHOUT CLAIM TO ANY PARTICULAR FONT, STYLE, SIZE, OR COLOR.

NO CLAIM IS MADE TO THE EXCLUSIVE RIGHT TO USE "MICROSYSTEMS" , APART FROM THE MARK AS SHOWN.

SER. NO. 85-226,383, FILED 1-26-2011.

MICHAEL ENGEL, EXAMINING ATTORNEY



David J. Kyffers

Director of the United States Patent and Trademark Office

United States of America

United States Patent and Trademark Office

The logo for "Affirmatives Organic" features a stylized letter "A" in green and brown. The crossbar of the "A" is a brown line that curves up from the right leg, loops around to the left leg, and then continues horizontally through the letters "FF" in "AFFIRMATIVES". The word "Affirmatives Organic" is written in a serif font, with "Affirmatives" in green and "Organic" in brown.

Reg. No. 4,098,124

IT'S NOT THAT BAD, INC (GEORGIA CORPORATION)
1729 MEADOW WAY
MORROW, GA 30260

Registered Feb. 14, 2012

Int. Cl.: 3

FOR: ORGANIC COSMETIC CREAMS FOR SKIN CARE, IN CLASS 3 (U.S. CLS. 1, 4, 6, 50, 51 AND 52).

TRADEMARK

FIRST USE 11-18-2010; IN COMMERCE 11-19-2010.

PRINCIPAL REGISTER

NO CLAIM IS MADE TO THE EXCLUSIVE RIGHT TO USE "ORGANIC", APART FROM THE MARK AS SHOWN.

THE COLOR(S) GREEN AND BROWN IS/ARE CLAIMED AS A FEATURE OF THE MARK.

THE MARK CONSISTS OF THE WORDING "AFFIRMATIVES ORGANIC" WHERE THE LETTERS "AFFIRM" ARE IN GREEN EXCEPT FOR THE CROSSBAR OF THE "A" AND THE LETTERS "ATIVES" AND THE WORD "ORGANIC" ARE BROWN. THE CROSS BAR OF THE FIRST LETTER "A" IN "AFFIRMATIVES" IS FORMED BY A BROWN LINE THAT CURVES UP FROM THE RIGHT LEG OF THE LETTER "A" AND CURVES HORIZONTALLY TO THE LEFT LEG AND LOOPS AROUND TO FORM THE CROSS BAR OF THE "A" IN "AFFIRMATIVES" AND CONTINUES AS A LINE THRU THE LETTERS "FF" AND STOPS AT THE FIRST LETTER "I".

SER. NO. 85-226,429, FILED 1-26-2011.

BERNICE MIDDLETON, EXAMINING ATTORNEY



David J. Kyros

Director of the United States Patent and Trademark Office

United States of America

United States Patent and Trademark Office

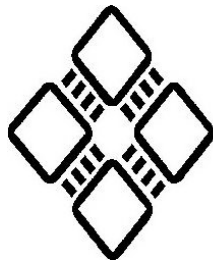

CAMGIAN
microsystems

Reg. No. 4,098,125

Registered Feb. 14, 2012

Int. Cl.: 9

TRADEMARK

PRINCIPAL REGISTER

CAMGIAN MICROSYSTEMS CORPORATION (MISSISSIPPI CORPORATION)
SUITE 203
2500 MAITLAND CENTER PKWY
MAITLAND, FL 32751

FOR: TELECOMMUNICATIONS AND DATA NETWORKING HARDWARE, NAMELY, WIRELESS DEVICES FOR TRANSPORTING AND AGGREGATING VOICE, DATA, AND VIDEO COMMUNICATIONS ACROSS MULTIPLE NETWORK INFRASTRUCTURES AND COMMUNICATIONS PROTOCOLS; SENSORS, NAMELY, SENSING DEVICES FOR SENSING TEMPERATURE, LIQUID LEVELS, POSITION, DISTANCE, SPEED, VIBRATION, SEISMIC ACTIVITY, AND RADAR, IN CLASS 9 (U.S. CLS. 21, 23, 26, 36 AND 38).

FIRST USE 3-14-2008; IN COMMERCE 3-14-2008.

NO CLAIM IS MADE TO THE EXCLUSIVE RIGHT TO USE "MICROSYSTEMS", APART FROM THE MARK AS SHOWN.

THE MARK CONSISTS OF THE WORDS "CAMGIAN MICROSYSTEMS" TO THE RIGHT OF A SYSTEM OF FOUR INTERCONNECTED DIAMOND SHAPES INTO A SINGLE DIAMOND SHAPE.

SER. NO. 85-226,439, FILED 1-26-2011.

MICHAEL ENGEL, EXAMINING ATTORNEY



David J. Kybas

Director of the United States Patent and Trademark Office

United States of America

United States Patent and Trademark Office

BUCK JUICE

Reg. No. 4,098,126

Registered Feb. 14, 2012

Int. Cl.: 28

TRADEMARK

PRINCIPAL REGISTER

EST, LLC (DELAWARE LIMITED LIABILITY COMPANY)
205 FAIR AVENUE
WINNSBORO, LA 71295

FOR: DEER ATTRACTANTS, IN CLASS 28 (U.S. CLS. 22, 23, 38 AND 50).

FIRST USE 1-1-2009; IN COMMERCE 2-11-2009.

THE MARK CONSISTS OF STANDARD CHARACTERS WITHOUT CLAIM TO ANY PARTICULAR FONT, STYLE, SIZE, OR COLOR.

NO CLAIM IS MADE TO THE EXCLUSIVE RIGHT TO USE "BUCK", APART FROM THE MARK AS SHOWN.

SER. NO. 85-226,731, FILED 1-26-2011.

RAMONA ORTIGA, EXAMINING ATTORNEY



David J. Kyffers

Director of the United States Patent and Trademark Office

United States of America

United States Patent and Trademark Office

K9 HEAT ALARM

Reg. No. 4,098,127

RADIOTRONICS, INC. (FLORIDA CORPORATION)
1556 CYPRESS DRIVE
JUPITER, FL 33469

Registered Feb. 14, 2012

Int. Cl.: 9

FOR: ELECTRONIC REMOTE CONTROL VEHICLE DOOR OPENER AND INTERIOR TEMPERATURE ALERT SYSTEM COMPRISING OF AN ELECTRONIC HIGH TEMPERATURE ALARM AND REMOTE CONTROL DOOR OPENER , IN CLASS 9 (U.S. CLS. 21, 23, 26, 36 AND 38).

TRADEMARK

PRINCIPAL REGISTER

FIRST USE 7-1-1996; IN COMMERCE 11-1-1996.

THE MARK CONSISTS OF STANDARD CHARACTERS WITHOUT CLAIM TO ANY PARTICULAR FONT, STYLE, SIZE, OR COLOR.

OWNER OF U.S. REG. NO. 2,924,486.

NO CLAIM IS MADE TO THE EXCLUSIVE RIGHT TO USE "HEAT ALARM", APART FROM THE MARK AS SHOWN.

SEC. 2(F).

SER. NO. 85-226,760, FILED 1-26-2011.

RAMONA ORTIGA, EXAMINING ATTORNEY



David J. Kyffers

Director of the United States Patent and Trademark Office

United States of America

United States Patent and Trademark Office



ENCORE

Reg. No. 4,098,128

Registered Feb. 14, 2012

Int. Cl.: 42

SERVICE MARK

PRINCIPAL REGISTER

NETSTEPS, LLC (UTAH LIMITED LIABILITY COMPANY)
SUITE 201
2435 W. 450 S.
PLEASANT GROVE, UT 84062

FOR: APPLICATION SERVICE PROVIDER FEATURING APPLICATION PROGRAMMING INTERFACE (API) E-COMMERCE NON-DOWNLOADABLE SOFTWARE FOR USE IN SCHEDULING SALES EVENTS AND PARTIES, ORGANIZING COMMISSION AND PAYMENT DATA, INTERFACING TO INVENTORY AND SHIPPING INFORMATION, INTERFACING TO PAYMENT PROCESSING AND TAX CALCULATIONS, INTERFACING TO LOGISTICS AND FULFILLMENT APPLICATIONS, FOR USE IN THE DIRECT SALES INDUSTRY, EXCLUDING SOFTWARE FOR PERSONAL USE, IN CLASS 42 (U.S. CLS. 100 AND 101).

FIRST USE 1-24-2011; IN COMMERCE 1-24-2011.

NO CLAIM IS MADE TO THE EXCLUSIVE RIGHT TO USE "E", APART FROM THE MARK AS SHOWN.

THE COLOR(S) GREEN, BLUE IS/ARE CLAIMED AS A FEATURE OF THE MARK.

THE MARK CONSISTS OF A LAYERED BRUSH STROKE LETTER "E" IN GREEN WITH THE WORD "ENCORE" IN BLUE BELOW.

SER. NO. 85-227,031, FILED S.R. 1-26-2011 AM. P.R. 4-22-2011.

CARYN GLASSER, EXAMINING ATTORNEY



David J. Kybas

Director of the United States Patent and Trademark Office

United States of America

United States Patent and Trademark Office

GO HEALTHY

Reg. No. 4,098,129

NBC UNIVERSAL MEDIA, LLC (DELAWARE LIMITED LIABILITY COMPANY)
30 ROCKEFELLER PLAZA
NEW YORK, NY 10112

Registered Feb. 14, 2012

Int. Cl.: 35

FOR: PROMOTING AWARENESS OF HEALTH-RELATED ISSUES, IN CLASS 35 (U.S. CLS. 100, 101 AND 102).

SERVICE MARK

FIRST USE 6-14-2010; IN COMMERCE 6-14-2010.

PRINCIPAL REGISTER

THE MARK CONSISTS OF STANDARD CHARACTERS WITHOUT CLAIM TO ANY PARTICULAR FONT, STYLE, SIZE, OR COLOR.

NO CLAIM IS MADE TO THE EXCLUSIVE RIGHT TO USE "HEALTHY", APART FROM THE MARK AS SHOWN.

SER. NO. 85-227,187, FILED 1-26-2011.

CORY BOONE, EXAMINING ATTORNEY



David J. Kyffers

Director of the United States Patent and Trademark Office

United States of America

United States Patent and Trademark Office

dvc
Teacher Workshops

Reg. No. 4,098,130

Registered Feb. 14, 2012

Int. Cl.: 41

SERVICE MARK

PRINCIPAL REGISTER

BRIAN TRAINOR (UNITED STATES INDIVIDUAL), DBA DVC TEACHER WORKSHOPS
14 CHICKADEE DRIVE
YORK, ME 03909

FOR: EDUCATIONAL SERVICES, NAMELY, CONDUCTING CLASSES, SEMINARS, CONFERENCES, WORKSHOPS, RETREATS, CAMPS AND FIELD TRIPS IN THE FIELD OF DESIGN AND VISUAL COMMUNICATIONS AND DISTRIBUTION OF TRAINING MATERIAL IN CONNECTION THEREWITH, IN CLASS 41 (U.S. CLS. 100, 101 AND 107).

FIRST USE 10-22-2010; IN COMMERCE 10-22-2010.

NO CLAIM IS MADE TO THE EXCLUSIVE RIGHT TO USE "TEACHER WORKSHOPS", APART FROM THE MARK AS SHOWN.

THE MARK CONSISTS OF THE LETTERS "DVC" WRITTEN IN LOWER CASE FONT, WRITTEN OVER THE WORD "TEACHER" IN BOLD AND "WORKSHOPS".

SER. NO. 85-227,682, FILED 1-27-2011.

FRANK LATTUCA, EXAMINING ATTORNEY



David J. Kyffers

Director of the United States Patent and Trademark Office

United States of America

United States Patent and Trademark Office

SAN DIEGO COUNTY CREDIT UNION

Reg. No. 4,098,131

SAN DIEGO COUNTY CREDIT UNION (CALIFORNIA CORPORATION)
6545 SEQUENCE DRIVE
SAN DIEGO, CA 92121

Registered Feb. 14, 2012

Int. Cl.: 36

FOR: BANKING; ON-LINE BANKING SERVICES; CREDIT UNION SERVICES; MORTGAGE BANKING; ELECTRONIC FUNDS TRANSFER; ELECTRONIC PAYMENT, NAMELY, ELECTRONIC PROCESSING AND TRANSMISSION OF BILL PAYMENT DATA; ACCOUNT PAYMENT AND MONITORING SERVICES, NAMELY, BILL PAYMENT SERVICES; FINANCIAL PORTFOLIO MANAGEMENT; FINANCIAL INFORMATION PROVIDED BY ELECTRONIC MEANS; FINANCIAL INFORMATION PROCESSING; INVESTMENT MANAGEMENT, CONSULTATION, AND BROKERAGE; AUTOMATED FINANCIAL CLEARING HOUSE; FINANCIAL CLEARING HOUSE; PROVIDING FINANCIAL ACCOUNT MANAGEMENT AND INFORMATION; PROVIDING FINANCIAL ACCOUNT BALANCING VIA A GLOBAL COMPUTER NETWORK AND TELECOMMUNICATIONS NETWORKS; PROVIDING WEB PAGES FEATURING INFORMATION ABOUT UTILITY BILL PAYMENT AND CONSOLIDATION SERVICES, IN CLASS 36 (U.S. CLS. 100, 101 AND 102).

SERVICE MARK

PRINCIPAL REGISTER

FIRST USE 3-1-1974; IN COMMERCE 3-1-1974.

THE MARK CONSISTS OF STANDARD CHARACTERS WITHOUT CLAIM TO ANY PARTICULAR FONT, STYLE, SIZE, OR COLOR.

OWNER OF U.S. REG. NO. 2,539,940.

NO CLAIM IS MADE TO THE EXCLUSIVE RIGHT TO USE "CREDIT UNION", APART FROM THE MARK AS SHOWN.

SEC. 2(F).

SER. NO. 85-227,797, FILED 1-27-2011.

MARTHA FROMM, EXAMINING ATTORNEY



David J. Kyffers

Director of the United States Patent and Trademark Office

United States of America

United States Patent and Trademark Office

Teenapalooza

Reg. No. 4,098,132

Registered Feb. 14, 2012

Int. Cl.: 41

SERVICE MARK

PRINCIPAL REGISTER

TEENAPALOOZA (VIRGINIA CORPORATION)
4205 LOOKOUT ROAD
VIRGINIA BEACH, VA 23455

FOR: ENTERTAINMENT, NAMELY, LIVE PERFORMANCES BY A MUSICAL BAND; ENTERTAINMENT, NAMELY, LIVE PERFORMANCES BY MUSICAL BANDS; ENTERTAINMENT, NAMELY, LIVE PERFORMANCES BY ROCK GROUPS; LIVE PERFORMANCES BY A MUSICAL GROUP; PROVISION OF INFORMATION RELATING TO LIVE PERFORMANCES, ROAD SHOWS, LIVE STAGE EVENTS, THEATRICAL PERFORMANCES, LIVE MUSIC CONCERTS AND AUDIENCE PARTICIPATION IN SUCH EVENTS, IN CLASS 41 (U.S. CLS. 100, 101 AND 107).

FIRST USE 9-28-2010; IN COMMERCE 9-28-2010.

THE MARK CONSISTS OF STANDARD CHARACTERS WITHOUT CLAIM TO ANY PARTICULAR FONT, STYLE, SIZE, OR COLOR.

SER. NO. 85-228,160, FILED 1-27-2011.

WILLIAM VERHOSEK, EXAMINING ATTORNEY



David J. Kyffers

Director of the United States Patent and Trademark Office

United States of America

United States Patent and Trademark Office



Reg. No. 4,098,133

Registered Feb. 14, 2012

Int. Cl.: 41

SERVICE MARK

PRINCIPAL REGISTER

PHOTOZIG, INC. (CALIFORNIA CORPORATION)
P.O. BOX 128
MOFFETT FIELD, CA 940350128

FOR: EDUCATIONAL SERVICES, NAMELY, CONDUCTING ONLINE TRAINING, WORK-BOOK-BASED TRAINING, VIDEO-BASED TRAINING, CLASSES, SEMINARS, CONFERENCES AND WORKSHOPS IN THE FIELD OF COMMUNICATION SKILLS, AND DISTRIBUTION OF TRAINING MATERIALS IN CONNECTION THEREWITH, IN CLASS 41 (U.S. CLS. 100, 101 AND 107).

FIRST USE 12-10-2009; IN COMMERCE 12-10-2009.

THE MARK CONSISTS OF THE "ICAREFAMILY" WORD WITH STYLIZED LETTERS, IN PARTICULAR THERE IS A STYLIZED LETTER "I" (FIRST "I") AS A SILHOUETTE OF A PERSON, AND A STYLIZED "I" (SECOND "I") WITH ITS DOT BEING A HEART SHAPE.

SER. NO. 85-228,312, FILED 1-27-2011.

TIMOTHY FINNEGAN, EXAMINING ATTORNEY



David J. Kybas

Director of the United States Patent and Trademark Office

United States of America

United States Patent and Trademark Office



iListUList.com

Reg. No. 4,098,134

HOME AND CREDIT OPTIONS, LLC (INDIANA LIMITED LIABILITY COMPANY)
49 BOONE VILLAGE, SUITE 305
ZIONSVILLE, IN 46077

Registered Feb. 14, 2012

Int. Cl.: 35

FOR: OPERATION OF AN ON-LINE MARKETPLACE FOR SELLERS OF GOODS AND/OR SERVICES, IN CLASS 35 (U.S. CLS. 100, 101 AND 102).

SERVICE MARK

FIRST USE 9-9-2011; IN COMMERCE 9-9-2011.

PRINCIPAL REGISTER

THE MARK CONSISTS OF THE WORDING "ILISTULIST.COM" UNDER AN IMAGE OF A LITTLE "I" INSIDE A LARGE "U", ALL IN A UNIQUE, STYLIZED DISPLAY.

SER. NO. 85-228,574, FILED 1-28-2011.

LINDA MICKLEBURGH, EXAMINING ATTORNEY



David J. Kybas

Director of the United States Patent and Trademark Office

United States of America

United States Patent and Trademark Office

TRUSTKLEEN

Reg. No. 4,098,135

Registered Feb. 14, 2012

Int. Cl.: 37

SERVICE MARK

PRINCIPAL REGISTER

ACAMPORA, CHARLES (UNITED STATES INDIVIDUAL)
1305 ACTON AVENUE
POWAY, CA 92064

FOR: CARPET, HARD SERVICE IN THE NATURE OF FLOORS, WALLS, PANELS AND COUNTERTOPS, AND OFFICE CLEANING SERVICES, IN CLASS 37 (U.S. CLS. 100, 103 AND 106).

FIRST USE 9-17-2010; IN COMMERCE 9-17-2010.

THE MARK CONSISTS OF STANDARD CHARACTERS WITHOUT CLAIM TO ANY PARTICULAR FONT, STYLE, SIZE, OR COLOR.

SER. NO. 85-228,671, FILED 1-28-2011.

DOMINIC FATHY, EXAMINING ATTORNEY



David J. Kyffers

Director of the United States Patent and Trademark Office

United States of America

United States Patent and Trademark Office

WOOT!

Reg. No. 4,098,136

Registered Feb. 14, 2012

Int. Cl.: 35

SERVICE MARK

PRINCIPAL REGISTER

WOOT SERVICES LLC (DELAWARE LIMITED LIABILITY COMPANY)
4121 INTERNATIONAL PARKWAY
CARROLLTON, TX 75007

FOR: ADVERTISING SERVICES VIA THE INTERNET; PROVIDING ADVERTISING SPACE ON THE INTERNET; PROMOTING THE GOODS AND SERVICES OF OTHERS THROUGH THE ADVERTISING, PROMOTION, AND DISTRIBUTION OF DISCOUNT OFFERS, SPECIAL PRICING PROMOTIONS, COUPONS, OR REBATES, IN CLASS 35 (U.S. CLS. 100, 101 AND 102).

FIRST USE 8-0-2005; IN COMMERCE 8-0-2005.

THE MARK CONSISTS OF STANDARD CHARACTERS WITHOUT CLAIM TO ANY PARTICULAR FONT, STYLE, SIZE, OR COLOR.

PRIORITY CLAIMED UNDER SEC. 44(D) ON ERPN CMNTY TM OFC APPLICATION NO. 009601089, FILED 12-15-2010.

OWNER OF U.S. REG. NOS. 3,012,788, 3,397,587, AND 3,811,816.

SER. NO. 85-229,975, FILED 1-31-2011.

EVELYN BRADLEY, EXAMINING ATTORNEY



David J. Kybas

Director of the United States Patent and Trademark Office

United States of America

United States Patent and Trademark Office



Reg. No. 4,098,137

Registered Feb. 14, 2012

Int. Cls.: 35 and 39

SERVICE MARK

PRINCIPAL REGISTER

NUCARE PHARMACEUTICALS, INC. (CALIFORNIA CORPORATION)
622 W. KATELLA AVENUE
ORANGE, CA 92867

FOR: BUSINESS SERVICES FOR OTHERS IN THE HEALTH CARE FIELD, NAMELY, COMPUTERIZED ON-LINE ORDERING TO REPLENISH DRUGS FOR PHARMACIES AND MEDICATION DISPENSING MACHINES; COMPUTERIZED DATABASE MANAGEMENT IN THE FIELD OF PHARMACEUTICAL LOT NUMBER AND EXPIRATION DATING; SALES VOLUME TRACKING; DISTRIBUTORSHIP SERVICES FEATURING PREPACKAGED PHARMACEUTICALS AND SUPPLIES, IN CLASS 35 (U.S. CLS. 100, 101 AND 102).

FIRST USE 1-16-2001; IN COMMERCE 2-16-2001.

FOR: PACKAGING PHARMACEUTICALS AND HEALTH CARE PRODUCTS TO THE ORDER AND SPECIFICATION OF OTHERS, IN CLASS 39 (U.S. CLS. 100 AND 105).

FIRST USE 1-16-2001; IN COMMERCE 2-16-2001.

NO CLAIM IS MADE TO THE EXCLUSIVE RIGHT TO USE "PHARMACEUTICALS, INC.", APART FROM THE MARK AS SHOWN.

THE MARK CONSISTS OF A CIRCLE WITH THE LETTER "N" INSIDE IT AND THE WORD "NUCARE" ON THE RIGHT SIDE. BELOW THIS ARE THE WORDS "PHARMACEUTICALS, INC.".

SER. NO. 85-230,074, FILED 1-31-2011.

CARYN GLASSER, EXAMINING ATTORNEY



David J. Kypos

Director of the United States Patent and Trademark Office

United States of America

United States Patent and Trademark Office

GL 63

Reg. No. 4,098,138

Registered Feb. 14, 2012

Int. Cls.: 12 and 28

TRADEMARK

PRINCIPAL REGISTER

DAIMLER AG (FED REP GERMANY CORPORATION)
MERCEDESSTRASSE 137
STUTTGART, FED REP GERMANY 70327

FOR: AUTOMOBILES AND THEIR STRUCTURAL PARTS, IN CLASS 12 (U.S. CLS. 19, 21, 23, 31, 35 AND 44).

FOR: TOY MODEL VEHICLES , IN CLASS 28 (U.S. CLS. 22, 23, 38 AND 50).

THE MARK CONSISTS OF STANDARD CHARACTERS WITHOUT CLAIM TO ANY PARTICULAR FONT, STYLE, SIZE, OR COLOR.

OWNER OF FED REP GERMANY REG. NO. 30345470, DATED 10-20-2003, EXPIRES 9-30-2013.

OWNER OF U.S. REG. NOS. 3,019,130, 3,025,269 AND OTHERS.

NO CLAIM IS MADE TO THE EXCLUSIVE RIGHT TO USE "63", APART FROM THE MARK AS SHOWN.

SER. NO. 85-230,359, FILED 1-31-2011.

ROBERT STRUCK, EXAMINING ATTORNEY



David J. Kybas

Director of the United States Patent and Trademark Office

United States of America

United States Patent and Trademark Office

The Wine Check

Reg. No. 4,098,139

ARK 54, LLC (CALIFORNIA LIMITED LIABILITY COMPANY), DBA THE WINE CHECK
PO BOX 220
GLEN ELLEN, CA 95442

Registered Feb. 14, 2012

Int. Cl.: 18

FOR: LUGGAGE, NAMELY, PADDED BAGS WITH HANDLES FOR CARRYING, HOLDING,
AND TRAVELING WITH WINE, IN CLASS 18 (U.S. CLS. 1, 2, 3, 22 AND 41).

TRADEMARK

FIRST USE 5-1-2010; IN COMMERCE 9-1-2010.

PRINCIPAL REGISTER

THE MARK CONSISTS OF STANDARD CHARACTERS WITHOUT CLAIM TO ANY PAR-
TICULAR FONT, STYLE, SIZE, OR COLOR.

NO CLAIM IS MADE TO THE EXCLUSIVE RIGHT TO USE "WINE", APART FROM THE
MARK AS SHOWN.

SER. NO. 85-230,615, FILED 1-31-2011.

SAMUEL E. SHARPER JR., EXAMINING ATTORNEY



David J. Kyffers

Director of the United States Patent and Trademark Office

United States of America

United States Patent and Trademark Office

SPIN

Reg. No. 4,098,140

Registered Feb. 14, 2012

Int. Cls.: 9 and 36

TRADEMARK

SERVICE MARK

PRINCIPAL REGISTER

INFOED INTERNATIONAL, INC. (NEW YORK CORPORATION)
SUITE 201
1873 WESTERN AVENUE
ALBANY, NY 122035028

FOR: SOFTWARE SEARCH ENGINE THAT ALLOWS CLIENTS, VIA A WEB-BASED INTERFACE, TO SEARCH A DATABASE OF FUNDING PROGRAMS AND OPPORTUNITIES, INCLUDING RESEARCH GRANTS, FELLOWSHIPS, PUBLICATION SUPPORT, SABBATICAL SUPPORT, CURRICULUM DEVELOPMENT AND FINANCIAL AID, LOCATE AND COMPARE SUCH FUNDING PROGRAMS AND OPPORTUNITIES, AND THEN EXPORT THOSE PROGRAMS AND OPPORTUNITIES FROM THE DATABASE, IN CLASS 9 (U.S. CLS. 21, 23, 26, 36 AND 38).

FIRST USE 12-1-1991; IN COMMERCE 12-1-1991.

FOR: PROVIDING AN ONLINE SEARCHABLE DATABASE TO SEARCH FOR AND COMPARE FUNDING PROGRAMS AND OPPORTUNITIES PROVIDED BY GOVERNMENT, PRIVATE AND NON-PROFIT SOURCES, INCLUDING RESEARCH GRANTS, FELLOWSHIPS, PUBLICATION SUPPORT, CURRICULUM DEVELOPMENT AND FINANCIAL AID, IN CLASS 36 (U.S. CLS. 100, 101 AND 102).

FIRST USE 12-1-1991; IN COMMERCE 12-1-1991.

THE MARK CONSISTS OF STANDARD CHARACTERS WITHOUT CLAIM TO ANY PARTICULAR FONT, STYLE, SIZE, OR COLOR.

SER. NO. 85-230,840, FILED 2-1-2011.

PAULA MAHONEY, EXAMINING ATTORNEY



David J. Kyros

Director of the United States Patent and Trademark Office

United States of America

United States Patent and Trademark Office

GOULD & LAMB

Reg. No. 4,098,141

Registered Feb. 14, 2012

Int. Cl.: 36

SERVICE MARK

PRINCIPAL REGISTER

GOULD & LAMB, LLC (FLORIDA LIMITED LIABILITY COMPANY)
101 RIVERFRONT BLVD., SUITE 100
BRADENTON, FL 34205

FOR: INSURANCE SERVICES, NAMELY, PROVIDING INFORMATION AND ON-LINE COMPUTER DATABASES FOR THE PURPOSE OF REVIEW AND VERIFICATION OF MEDICARE ELIGIBILITY STATUS; INSURANCE SERVICES, NAMELY, MEDICARE COMPLIANCE SETTLEMENT CONSULTING SERVICES; REPORTING SERVICES, NAMELY, PROVIDING INFORMATION IN INSURANCE MATTERS, SPECIFICALLY IN THE FIELD OF MEDICARE COMPLIANCE, IN CLASS 36 (U.S. CLS. 100, 101 AND 102).

FIRST USE 6-30-2001; IN COMMERCE 6-30-2001.

THE MARK CONSISTS OF STANDARD CHARACTERS WITHOUT CLAIM TO ANY PARTICULAR FONT, STYLE, SIZE, OR COLOR.

SER. NO. 85-230,944, FILED 2-1-2011.

ADA HAN, EXAMINING ATTORNEY



David J. Kyffers

Director of the United States Patent and Trademark Office

United States of America

United States Patent and Trademark Office

AcidipHy

Reg. No. 4,098,142

AQUA-AID, INC. (MARYLAND CORPORATION)
5484 S. OLD CARRIAGE ROAD
ROCKY MOUNT, NC 27803

Registered Feb. 14, 2012

Int. Cl.: 1

FOR: SOIL AND WATER ACIDIFYING AGENTS, IN CLASS 1 (U.S. CLS. 1, 5, 6, 10, 26 AND 46).

TRADEMARK

FIRST USE 8-0-2009; IN COMMERCE 8-0-2009.

PRINCIPAL REGISTER

NO CLAIM IS MADE TO THE EXCLUSIVE RIGHT TO USE "ACIDIFY", APART FROM THE MARK AS SHOWN.

THE COLOR(S) YELLOW, ORANGE, RED, BLACK AND WHITE IS/ARE CLAIMED AS A FEATURE OF THE MARK.

THE MARK CONSISTS OF THE STYLIZED WORDING "ACIDIPHY" DISPLAYED IN A COLOR PROGRESSION RANGING FROM YELLOW TO RED, EACH LETTER BEING BORDERED IN WHITE THEN BLACK.

SER. NO. 85-231,421, FILED 2-1-2011.

KYLE PEETE, EXAMINING ATTORNEY



David J. Kyfos

Director of the United States Patent and Trademark Office

United States of America

United States Patent and Trademark Office



Reg. No. 4,098,143

Registered Feb. 14, 2012

Int. Cls.: 35 and 37

SERVICE MARK

PRINCIPAL REGISTER

ALTEC INDUSTRIES, INC. (ALABAMA CORPORATION)
210 INVERNESS CENTER DRIVE
BIRMINGHAM, AL 35242

FOR: RETAIL STORE SERVICES FEATURING UTILITY EQUIPMENT, TELECOMMUNICATIONS EQUIPMENT, TREE-CARE EQUIPMENT AND CONSTRUCTION TRUCKS , IN CLASS 35 (U.S. CLS. 100, 101 AND 102).

FIRST USE 1-1-2010; IN COMMERCE 1-1-2010.

FOR: REPAIR OF UTILITY EQUIPMENT, TELECOMMUNICATIONS EQUIPMENT, TREE-CARE EQUIPMENT, AND CONSTRUCTION TRUCKS, IN CLASS 37 (U.S. CLS. 100, 103 AND 106).

FIRST USE 1-1-2010; IN COMMERCE 1-1-2010.

OWNER OF U.S. REG. NOS. 849,304, 3,072,790 AND OTHERS.

THE COLOR(S) GOLD AND BLACK IS/ARE CLAIMED AS A FEATURE OF THE MARK.

NO CLAIM IS MADE TO THE EXCLUSIVE RIGHT TO USE "WORLDWIDE LLC", APART FROM THE MARK AS SHOWN.

THE MARK CONSISTS OF A GOLD COLORED STYLIZED "A" WITH A CLEAR, STYLIZED "A" WITHIN IT, FOLLOWED BY THE STYLIZED WORD "ALTEC" IN BLACK LETTERS ON A CLEAR BACKGROUND. THE BASE OF THE MARK IS A GOLD RECTANGLE CENTERED BELOW THE "A" DESIGN AND WORD "ALTEC". WITHIN THE RECTANGLE IS THE BLACK WORDING "WORLDWIDE LLC". THE WORD "WORLDWIDE" IS IN LARGER CAPITALIZED LETTERING. THE ACRONYM "LLC" APPEARS IN SMALLER CAPITALIZED LETTERING.

SER. NO. 85-232,007, FILED 2-2-2011.

PAULA MAHONEY, EXAMINING ATTORNEY



David J. Kyffers

Director of the United States Patent and Trademark Office

United States of America

United States Patent and Trademark Office



Reg. No. 4,098,144

Registered Feb. 14, 2012

Int. Cl.: 41

SERVICE MARK

PRINCIPAL REGISTER

NANCY W. CHILDRESS (NEW HAMPSHIRE SOLE PROPRIETORSHIP), DBA PEERS
SHARING SUCCESS
7 STEVENS RD.
GILMANTON, NH 03237

FOR: EDUCATIONAL SERVICES, NAMELY, CONDUCTING WORKSHOPS AND SEMINARS FOR EDUCATORS IN IMPROVING STUDENT ACHIEVEMENT IN THE FIELD OF ELEMENTARY AND SECONDARY SCHOOL SUBJECTS, IN CLASS 41 (U.S. CLS. 100, 101 AND 107).

FIRST USE 1-26-2011; IN COMMERCE 1-26-2011.

THE MARK CONSISTS OF STANDARD CHARACTERS WITHOUT CLAIM TO ANY PARTICULAR FONT, STYLE, SIZE, OR COLOR.

SER. NO. 85-232,080, FILED 2-2-2011.

ANDREW LEASER, EXAMINING ATTORNEY



David J. Kyffers

Director of the United States Patent and Trademark Office

United States of America

United States Patent and Trademark Office

CLIENTRAK

Reg. No. 4,098,145

NUCO, INC. (PENNSYLVANIA CORPORATION)
3110 LENOX OVAL
PITTSBURGH, PA 15237

Registered Feb. 14, 2012

Int. Cl.: 9

FOR: COMPUTER SOFTWARE PROGRAMS USED TO MANAGE RECORDS AND INFORMATION OF BUSINESSES IN THE FIELDS OF PERSONAL GROOMING FOR PEOPLE AND DOMESTIC ANIMALS, AND INSTRUCTIONAL MANUALS, SOLD AS A UNIT, IN CLASS 9 (U.S. CLS. 21, 23, 26, 36 AND 38).

TRADEMARK

PRINCIPAL REGISTER

FIRST USE 6-1-1998; IN COMMERCE 6-1-1998.

THE MARK CONSISTS OF STANDARD CHARACTERS WITHOUT CLAIM TO ANY PARTICULAR FONT, STYLE, SIZE, OR COLOR.

SER. NO. 85-232,194, FILED 2-2-2011.

LAURIE MAYES, EXAMINING ATTORNEY



David J. Kyffers

Director of the United States Patent and Trademark Office

United States of America

United States Patent and Trademark Office

Fireshield

Reg. No. 4,098,146

COBRA AMERICA, LLC (TENNESSEE LIMITED LIABILITY COMPANY)
50 INDUSTRIAL DR.
BRISTOL, TN 37620

Registered Feb. 14, 2012

Int. Cl.: 7

FOR: CONVEYOR BELTS, IN CLASS 7 (U.S. CLS. 13, 19, 21, 23, 31, 34 AND 35).

TRADEMARK

FIRST USE 1-27-2011; IN COMMERCE 1-27-2011.

PRINCIPAL REGISTER

THE MARK CONSISTS OF STANDARD CHARACTERS WITHOUT CLAIM TO ANY PARTICULAR FONT, STYLE, SIZE, OR COLOR.

SER. NO. 85-232,465, FILED S.R. 2-2-2011 AM. P.R. 10-17-2011.

JUSTINE D. PARKER, EXAMINING ATTORNEY



David J. Kyffers

Director of the United States Patent and Trademark Office

United States of America

United States Patent and Trademark Office

DE RIGUEUR PROVISIONS

Reg. No. 4,098,147

EQUINOX HOLDINGS, INC. (DELAWARE CORPORATION)

Registered Feb. 14, 2012

895 BROADWAY, 3RD FLOOR
NEW YORK, NY 10003

Int. Cls.: 18 and 25

FOR: TOTE BAGS, GYM BAGS AND DUFFEL BAGS, IN CLASS 18 (U.S. CLS. 1, 2, 3, 22 AND 41).

TRADEMARK

FIRST USE 4-30-2011; IN COMMERCE 4-30-2011.

PRINCIPAL REGISTER

FOR: CLOTHING, NAMELY, T-SHIRTS, TOPS, SWEATSHIRTS, JACKETS, SWEATERS, SCARVES, PANTS, SHORTS AND TANKS, IN CLASS 25 (U.S. CLS. 22 AND 39).

FIRST USE 4-30-2011; IN COMMERCE 4-30-2011.

THE MARK CONSISTS OF STANDARD CHARACTERS WITHOUT CLAIM TO ANY PARTICULAR FONT, STYLE, SIZE, OR COLOR.

NO CLAIM IS MADE TO THE EXCLUSIVE RIGHT TO USE "PROVISIONS", APART FROM THE MARK AS SHOWN.

SER. NO. 85-232,469, FILED 2-2-2011.

ANDREA K. NADELMAN, EXAMINING ATTORNEY



David J. Kybas

Director of the United States Patent and Trademark Office

United States of America

United States Patent and Trademark Office



Reg. No. 4,098,148

Registered Feb. 14, 2012

Int. Cl.: 9

TRADEMARK

PRINCIPAL REGISTER

CHRIS GEE (UNITED STATES INDIVIDUAL)
30 WARREN AVE
TUCKAHOE, NY 10707

FOR: KIOSKS, NAMELY, COMPUTER-OPERATED ONSITE DIGITAL MEDIA KIOSKS COMPRISED OF COMPUTER HARDWARE AND SOFTWARE FOR USE IN A WIDE VARIETY OF APPLICATIONS, NAMELY, DIGITAL SIGNAGE FOR PUBLIC MARKETING CAMPAIGNS AND PLATFORMS AT ONSITE LIVE EVENTS, COLLECTION OF END USER RELEVANT INFORMATION AT ONSITE LIVE EVENTS, INTERACTING WITH MOBILE PHONE APPLICATIONS AT ONSITE LIVE EVENTS, AND TRANSACTIONS, NAMELY, DISTRIBUTION OF PHYSICAL AND/OR DIGITAL VOUCHERS AT ONSITE LIVE EVENTS, IN CLASS 9 (U.S. CLS. 21, 23, 26, 36 AND 38).

FIRST USE 9-1-2006; IN COMMERCE 10-1-2006.

THE MARK CONSISTS OF THE WORD "TOURTERMINAL" WRITTEN IN BLACK PRECEDED BY A VERTICAL YELLOW STRIPE, VERTICAL RED STRIPE, AND VERTICAL BLUE STRIPE.

THE COLOR(S) RED, BLUE, YELLOW AND BLACK IS/ARE CLAIMED AS A FEATURE OF THE MARK.

SER. NO. 85-232,861, FILED 2-3-2011.

FRANK LATTUCA, EXAMINING ATTORNEY



David J. Kyjars

Director of the United States Patent and Trademark Office

United States of America

United States Patent and Trademark Office

LIAIGRE

Reg. No. 4,098,149

Registered Feb. 14, 2012

Int. Cls.: 3, 4 and 5

TRADEMARK

PRINCIPAL REGISTER

CHRISTIAN LIAIGRE (FRANCE SOCIÉTÉ PAR ACTIONS SIMPLIFIÉE (SAS))
61 RUE DE VARENNE
PARIS, FRANCE 75007

FOR: PERFUMES, IN CLASS 3 (U.S. CLS. 1, 4, 6, 50, 51 AND 52).

FOR: PERFUMED CANDLES, IN CLASS 4 (U.S. CLS. 1, 6 AND 15).

FOR: ROOM DEODORANTS, ROOM DEODORIZERS, AIR DEODORANTS, AIR DEODORIZERS, HOUSEHOLD DEODORANTS, HOUSEHOLD DEODORIZERS, IN CLASS 5 (U.S. CLS. 6, 18, 44, 46, 51 AND 52).

THE MARK CONSISTS OF STANDARD CHARACTERS WITHOUT CLAIM TO ANY PARTICULAR FONT, STYLE, SIZE, OR COLOR.

OWNER OF FRANCE REG. NO. 3750190, DATED 6-30-2010, EXPIRES 6-30-2020.

OWNER OF U.S. REG. NO. 1,795,032.

SER. NO. 85-233,219, FILED 2-3-2011.

KEVIN CORWIN, EXAMINING ATTORNEY



David J. Kybas

Director of the United States Patent and Trademark Office

United States of America

United States Patent and Trademark Office

Car Pal

Reg. No. 4,098,150

CAR PAL, LLC (NORTH CAROLINA LIMITED LIABILITY COMPANY)
8215 SPRING FARM ROAD
MEBANE, NC 27302

Registered Feb. 14, 2012

Int. Cl.: 35

FOR: PROVIDING A WEBSITE FOR CONNECTING AUTOMOBILE BUYERS AND AUTOMOBILE SELLERS, IN CLASS 35 (U.S. CLS. 100, 101 AND 102).

SERVICE MARK

FIRST USE 10-1-2008; IN COMMERCE 12-1-2010.

PRINCIPAL REGISTER

THE MARK CONSISTS OF STANDARD CHARACTERS WITHOUT CLAIM TO ANY PARTICULAR FONT, STYLE, SIZE, OR COLOR.

NO CLAIM IS MADE TO THE EXCLUSIVE RIGHT TO USE "CAR", APART FROM THE MARK AS SHOWN.

SER. NO. 85-233,321, FILED 2-3-2011.

JOHN GARTNER, EXAMINING ATTORNEY



David J. Kyffers

Director of the United States Patent and Trademark Office

United States of America

United States Patent and Trademark Office



Reg. No. 4,098,151

APEX HOME & OFFICE CLEANING (PENNSYLVANIA LIMITED LIABILITY COMPANY)
8617 TEMPLE RD.
PHILADELPHIA, PA 19150

Registered Feb. 14, 2012

Int. Cl.: 37

FOR: CLEANING SERVICES OF BOTH HOME AND OFFICES, IN CLASS 37 (U.S. CLS. 100, 103 AND 106).

SERVICE MARK

FIRST USE 2-7-2011; IN COMMERCE 2-21-2011.

PRINCIPAL REGISTER

NO CLAIM IS MADE TO THE EXCLUSIVE RIGHT TO USE "HOME & OFFICE CLEANING", APART FROM THE MARK AS SHOWN.

THE MARK CONSISTS OF THE STYLIZED WORDING "APEX HOME & OFFICE CLEANING" WITH THE CENTER OF THE "A" IN "APEX" DISPLAYING A SPRAY BOTTLE DESIGN FACING RIGHT SPRAYING LIQUID.

SER. NO. 85-233,873, FILED 2-3-2011.

GEOFFREY FOSDICK, EXAMINING ATTORNEY



David J. Kybas

Director of the United States Patent and Trademark Office

United States of America

United States Patent and Trademark Office

Casa de Campo

Reg. No. 4,098,152

Registered Feb. 14, 2012

Int. Cls.: 43 and 44

SERVICE MARK

PRINCIPAL REGISTER

COSTASUR DOMINICANA, S.A. (DOMINICAN REP CORPORATION), DBA CASA DE CAMPO HOTEL AND RESORT
CASA DE CAMPO P.O. BOX 140
LA ROMANA, DOMINICAN REP

FOR: RESORT HOTEL AND RESORT LODGING SERVICES; PROVIDING TEMPORARY LODGING SERVICES IN THE NATURE OF HOTEL ROOMS; RENTAL OF PRIVATE VACATION HOMES AS TEMPORARY LIVING ACCOMMODATIONS FOR VACATION STAYS; RESTAURANT AND BAR SERVICES; CATERING SERVICES; PROVIDING SOCIAL MEETING, BANQUET AND SOCIAL FUNCTION FACILITIES; PROVISION OF CONFERENCE, EXHIBITION AND MEETING FACILITIES; RESERVATIONS SERVICES, NAMELY, PROVIDING INFORMATION WITH REGARD TO, AND MAKING RESERVATIONS AND BOOKINGS FOR, LODGING AND RESORT ACCOMMODATIONS AND MEAL SERVICES, IN CLASS 43 (U.S. CLS. 100 AND 101).

FIRST USE 1-1-1974; IN COMMERCE 1-1-1974.

FOR: BEAUTY SPA SERVICES, NAMELY, COSMETIC BODY AND HAIR CARE; DAY SPA SERVICES, NAMELY, NAIL CARE, MANICURES, PEDICURES AND NAIL ENHANCEMENTS; HEALTH SPA SERVICES FOR HEALTH AND WELLNESS OF THE BODY AND SPIRIT, NAMELY, PROVIDING MASSAGE, FACIAL AND BODY TREATMENT SERVICES, COSMETIC BODY CARE SERVICES, IN CLASS 44 (U.S. CLS. 100 AND 101).

FIRST USE 12-31-1988; IN COMMERCE 12-31-1988.

THE MARK CONSISTS OF STANDARD CHARACTERS WITHOUT CLAIM TO ANY PARTICULAR FONT, STYLE, SIZE, OR COLOR.

THE ENGLISH TRANSLATION OF "CASA DE CAMPO" IN THE MARK IS "COUNTRY HOUSE".

SER. NO. 85-234,449, FILED 2-4-2011.

JENNIFER MARTIN, EXAMINING ATTORNEY



David J. Kyffers

Director of the United States Patent and Trademark Office

United States of America

United States Patent and Trademark Office

LC Black

Reg. No. 4,098,153

Registered Feb. 14, 2012

Int. Cl.: 2

TRADEMARK

PRINCIPAL REGISTER

CLOSE THE LOOP TECHNOLOGIES PTY LTD (AUSTRALIA CORPORATION)
208 HUME HIGHWAY
SOMERTON, VIC, AUSTRALIA 3062

FOR: COLORANTS, IN CLASS 2 (U.S. CLS. 6, 11 AND 16).

FIRST USE 9-1-2010; IN COMMERCE 9-1-2010.

THE MARK CONSISTS OF STANDARD CHARACTERS WITHOUT CLAIM TO ANY PARTICULAR FONT, STYLE, SIZE, OR COLOR.

NO CLAIM IS MADE TO THE EXCLUSIVE RIGHT TO USE "BLACK", APART FROM THE MARK AS SHOWN.

SER. NO. 85-234,734, FILED 2-4-2011.

INGRID C. EULIN, EXAMINING ATTORNEY



David J. Kybas

Director of the United States Patent and Trademark Office

United States of America

United States Patent and Trademark Office

TOULOUSE GRADUATE SCHOOL

Reg. No. 4,098,154

UNIVERSITY OF NORTH TEXAS (TEXAS STATE UNIVERSITY)
1501 CHESTNUT STREET
DENTON, TX 76203

Registered Feb. 14, 2012

Int. Cl.: 41

FOR: EDUCATIONAL SERVICES, NAMELY, PROVIDING COURSES AND SEMINARS OF INSTRUCTION AT THE GRADUATE LEVEL, IN CLASS 41 (U.S. CLS. 100, 101 AND 107).

SERVICE MARK

FIRST USE 12-0-2009; IN COMMERCE 12-0-2009.

PRINCIPAL REGISTER

THE MARK CONSISTS OF STANDARD CHARACTERS WITHOUT CLAIM TO ANY PARTICULAR FONT, STYLE, SIZE, OR COLOR.

NO CLAIM IS MADE TO THE EXCLUSIVE RIGHT TO USE "GRADUATE SCHOOL", APART FROM THE MARK AS SHOWN.

SER. NO. 85-235,077, FILED 2-5-2011.

KAPIL BHANOT, EXAMINING ATTORNEY



David J. Kyffers

Director of the United States Patent and Trademark Office

United States of America

United States Patent and Trademark Office



Reg. No. 4,098,155

Registered Feb. 14, 2012

Int. Cl.: 41

SERVICE MARK

PRINCIPAL REGISTER

NELLIE BLY BOOKS LLC (WEST VIRGINIA LIMITED LIABILITY COMPANY), DBA
NELLIE BLY BOOKS
275
364 PATTESON DRIVE
MORGANTOWN, WV 26505

FOR: PUBLISHING OF BOOKS, E-BOOKS, AUDIO BOOKS, MUSIC AND ILLUSTRATIONS;
PUBLISHING OF BOOKS, MAGAZINES; PUBLISHING OF ELECTRONIC PUBLICATIONS,
IN CLASS 41 (U.S. CLS. 100, 101 AND 107).

FIRST USE 7-26-2010; IN COMMERCE 7-26-2010.

THE MARK CONSISTS OF THE SILHOUETTE OF A WOMAN'S HEAD WEARING A DE-
TECTIVE-STYLE CAP, WHO APPEARS TO BE HOLDING A FEATHER QUILL WITHIN AN
OVAL, ALL OUTLINED BY AN OVAL THAT CONTAINS FILIGREE SWIRLS ON THE
LOWER LEFT AND RIGHT SIDES SURROUNDING THE WOMAN AND QUILL.

SER. NO. 85-235,735, FILED 2-7-2011.

COLLEEN DOMBROW, EXAMINING ATTORNEY



David J. Kyffers

Director of the United States Patent and Trademark Office

United States of America

United States Patent and Trademark Office

NESMETA

Reg. No. 4,098,156

TAKEDA PHARMACEUTICAL COMPANY LIMITED (JAPAN CORPORATION)
1-1, DOSHOMACHI 4-CHOME
CHUO-KU, OSAKA, JAPAN

Registered Feb. 14, 2012

Int. Cl.: 5

FOR: PHARMACEUTICAL PREPARATIONS FOR THE TREATMENT AND PREVENTION
OF DIABETIC DISEASES, IN CLASS 5 (U.S. CLS. 6, 18, 44, 46, 51 AND 52).

TRADEMARK

THE MARK CONSISTS OF STANDARD CHARACTERS WITHOUT CLAIM TO ANY PAR-
TICULAR FONT, STYLE, SIZE, OR COLOR.

PRINCIPAL REGISTER

PRIORITY CLAIMED UNDER SEC. 44(D) ON JAPAN APPLICATION NO. 2011-001699,
FILED 1-13-2011, REG. NO. 5419691, DATED 6-17-2011, EXPIRES 6-17-2021.

THE WORDING "NESMETA" HAS NO MEANING IN A FOREIGN LANGUAGE.

SER. NO. 85-235,848, FILED 2-7-2011.

WON TEAK OH, EXAMINING ATTORNEY



David J. Kybas

Director of the United States Patent and Trademark Office

United States of America

United States Patent and Trademark Office

LC Black The Environmental Black

Reg. No. 4,098,157

Registered Feb. 14, 2012

Int. Cl.: 2

TRADEMARK

PRINCIPAL REGISTER

CLOSE THE LOOP TECHNOLOGIES PTY LTD (AUSTRALIA CORPORATION)
208 HUME HIGHWAY
SOMERTON, VIC, AUSTRALIA 3062

FOR: COLORANTS, IN CLASS 2 (U.S. CLS. 6, 11 AND 16).

FIRST USE 9-1-2010; IN COMMERCE 9-1-2010.

THE MARK CONSISTS OF STANDARD CHARACTERS WITHOUT CLAIM TO ANY PARTICULAR FONT, STYLE, SIZE, OR COLOR.

NO CLAIM IS MADE TO THE EXCLUSIVE RIGHT TO USE "BLACK", APART FROM THE MARK AS SHOWN.

SER. NO. 85-235,886, FILED 2-7-2011.

INGRID C. EULIN, EXAMINING ATTORNEY



David J. Kyffers

Director of the United States Patent and Trademark Office

United States of America

United States Patent and Trademark Office



Reg. No. 4,098,158

Registered Feb. 14, 2012

Int. Cl.: 35

SERVICE MARK

PRINCIPAL REGISTER

SELF-CARE ACADEMY, LLC (COLORADO LIMITED LIABILITY COMPANY), FORMERLY NURSEFIT, LLC
8499 S. NELSON ST.
LITTLETON, CO 80127

FOR: BUSINESS AND MANAGEMENT CONSULTING FOR HEALTHCARE PROVIDERS AND RELATED BUSINESSES; PROMOTING HEALTH AND ENVIRONMENTAL AWARENESS WITHIN PEOPLE SO THAT THEY CAN LEAD A CLEAN AND HEALTHY LIFE; PROVIDING ASSISTANCE, FITNESS EVALUATION AND CONSULTATION TO CORPORATE CLIENTS TO HELP THEIR EMPLOYEES MAKE HEALTH, WELLNESS AND NUTRITIONAL CHANGES IN THEIR DAILY LIVING TO INCREASE PRODUCTIVITY AND LOWER HEALTH CARE COSTS, IN CLASS 35 (U.S. CLS. 100, 101 AND 102).

FIRST USE 1-4-2010; IN COMMERCE 1-4-2010.

NO CLAIM IS MADE TO THE EXCLUSIVE RIGHT TO USE "ACADEMY", APART FROM THE MARK AS SHOWN.

THE COLOR(S) BLACK, RED, GOLD, AND KHAKI GREEN IS/ARE CLAIMED AS A FEATURE OF THE MARK.

THE MARK CONSISTS OF AN ABSTRACT DANCING PERSON IN BLACK - LEGS IN UPSIDE-DOWN U SHAPE, WITH THE LEG ON THE RIGHT SIDE OF THE DRAWING TWICE THE LENGTH OF THE LEG ON LEFT SIDE; ARMS IN RIGHT-SIDE-UP U SHAPE, WITH ARM ON THE RIGHT SIDE OF THE DRAWING TWICE THE LENGTH AS THE ARM ON THE LEFT; SMALL OVAL-SHAPED HEAD PLACED BETWEEN UPRAISED ARMS. HEART, FRACTURED INTO NINE IRREGULARLY-SHAPED PIECES, IS PLACED BETWEEN ARMS, ABOVE THE HEAD - THREE PIECES ARE BLACK, ONE PIECE IS GOLD, THREE PIECES ARE RED, AND TWO PIECES ARE KHAKI GREEN. THE WORDS "SELF-CARE ACADEMY" IN BLACK CAPITAL LETTERS, ARCH OVER THE ABSTRACT PERSON AND HEART. THE WORDS "HEALING STARTS HERE" FOLLOWED BY A PERIOD, ARE IN RED AND ARE WRITTEN IN SCRIPT ON THE RIGHT SIDE OF THE PERSON NEAR THE HIPS.



David J. Kyros

Director of the United States Patent and Trademark Office

SER. NO. 85-236,568, FILED 2-8-2011.

CHRISTINA SOBRAL, EXAMINING ATTORNEY

United States of America

United States Patent and Trademark Office

BRAND LEARNING



Reg. No. 4,098,159

Registered Feb. 14, 2012

Int. Cls.: 35 and 41

SERVICE MARK

PRINCIPAL REGISTER

THE BRAND LEARNING PARTNERS LIMITED (UNITED KINGDOM CORPORATION)
BURGOINE QUAY 8 LOWER TEDDINGTON ROAD
HAMPTONWICK, SURREY, UNITED KINGDOM KT14ER

FOR: BUSINESS CONSULTANCY SERVICES; COLLECTION, PROCESSING, COMPILATION AND ANALYSIS OF BUSINESS DATA; MARKETING SERVICES, NAMELY, MARKETING CONSULTANCY, MARKETING RESEARCH SERVICES, MARKETING PLAN DEVELOPMENT AND MARKETING CAPABILITY DEVELOPMENT SERVICES; PROVISION OF INFORMATION, ANALYSIS, CONSULTANCY, FORECASTING, ASSISTANCE AND INFORMATION RELATING TO MARKETING; CONDUCTING OF MARKETING STUDIES, IN CLASS 35 (U.S. CLS. 100, 101 AND 102).

FOR: MANAGEMENT EDUCATION, NAMELY, THE PROVISION OF CLASSES, WORKSHOPS, SEMINARS AND TRAINING PROGRAMMES; EDUCATION, NAMELY, THE PROVISION OF CLASSES, WORKSHOPS, SEMINARS AND TRAINING RELATING TO MARKETING, IN CLASS 41 (U.S. CLS. 100, 101 AND 107).

PRIORITY CLAIMED UNDER SEC. 44(D) ON ERPN CMNTY TM OFC APPLICATION NO. 009306465, FILED 8-10-2010, REG. NO. 009306465, DATED 1-21-2011, EXPIRES 8-10-2020.

THE COLOR(S) BLACK, LIGHT GRAY AND ORANGE IS/ARE CLAIMED AS A FEATURE OF THE MARK.

OWNER OF U.S. REG. NO. 3,260,192.

NO CLAIM IS MADE TO THE EXCLUSIVE RIGHT TO USE "BRAND LEARNING ACADEMY", APART FROM THE MARK AS SHOWN.

THE MARK CONSISTS OF THE WORDS "BRAND LEARNING" IN BLACK ABOVE AN ORANGE STYLIZED "A" WITH LIGHT GRAY SHADOW BEHIND IT, ABOVE THE WORD "ACADEMY" IN LIGHT GRAY.

SER. NO. 85-236,621, FILED 2-8-2011.

LEIGH CAROLINE CASE, EXAMINING ATTORNEY



David J. Kyffers

Director of the United States Patent and Trademark Office

United States of America

United States Patent and Trademark Office

BRAND LEARNING



Radar

Reg. No. 4,098,160

Registered Feb. 14, 2012

Int. Cls.: 9, 35 and 41

TRADEMARK

SERVICE MARK

PRINCIPAL REGISTER

THE BRAND LEARNING PARTNERS LIMITED (UNITED KINGDOM CORPORATION)
BURGOINE QUAY 8 LOWER TEDDINGTON ROAD
HAMPTONWICK, SURREY, UNITED KINGDOM KT14ER

FOR: SOFTWARE RELATING TO MARKETING AND MARKETING STUDIES; SOFTWARE RELATING TO THE COLLECTION, PROCESSING, COMPILATION AND ANALYSIS OF MARKETING INFORMATION AND DATA, IN CLASS 9 (U.S. CLS. 21, 23, 26, 36 AND 38).

FOR: BUSINESS CONSULTANCY SERVICES; COLLECTION, PROCESSING, COMPILATION AND ANALYSIS OF BUSINESS DATA; MARKETING SERVICES, NAMELY, MARKETING CONSULTANCY; PROVISION OF INFORMATION, ANALYSIS, CONSULTANCY, FORECASTING, ASSISTANCE AND INFORMATION RELATING TO MARKETING; CONDUCTING OF MARKETING STUDIES, IN CLASS 35 (U.S. CLS. 100, 101 AND 102).

FOR: MANAGEMENT EDUCATION, NAMELY, THE PROVISION OF CLASSES, WORKSHOPS, SEMINARS AND TRAINING PROGRAMMES; EDUCATION, NAMELY, THE PROVISION OF CLASSES, WORKSHOPS, SEMINARS AND TRAINING RELATING TO MARKETING, IN CLASS 41 (U.S. CLS. 100, 101 AND 107).

PRIORITY CLAIMED UNDER SEC. 44(D) ON ERPN CMNTY TM OFC APPLICATION NO. 009306481, FILED 8-10-2010, REG. NO. 009306481, DATED 1-21-2011, EXPIRES 8-10-2020.

THE COLOR(S) BLACK, LIGHT GRAY AND ORANGE IS/ARE CLAIMED AS A FEATURE OF THE MARK.

OWNER OF U.S. REG. NO. 3,260,192.

NO CLAIM IS MADE TO THE EXCLUSIVE RIGHT TO USE "BRAND LEARNING", APART FROM THE MARK AS SHOWN.

THE MARK CONSISTS OF THE WORDS "BRAND LEARNING" IN BLACK ABOVE A STYLIZED IMAGE OF A RADAR SWEEP ARM IN ORANGE ABOVE THE WORD "RADAR" IN LIGHT GRAY.

SER. NO. 85-236,707, FILED 2-8-2011.

LEIGH CAROLINE CASE, EXAMINING ATTORNEY



David J. Kypos

Director of the United States Patent and Trademark Office

United States of America

United States Patent and Trademark Office

SEA GYPSY

Reg. No. 4,098,161

Registered Feb. 14, 2012

Int. Cl.: 39

SERVICE MARK

PRINCIPAL REGISTER

PIRATE ADVENTURES CORPORATION (MASSACHUSETTS CORPORATION)
19 BERTRAM AVENUE
SO. DENNIS, MA 02660

FOR: BOAT CRUISES, IN CLASS 39 (U.S. CLS. 100 AND 105).

FIRST USE 6-1-1995; IN COMMERCE 6-1-1995.

THE MARK CONSISTS OF STANDARD CHARACTERS WITHOUT CLAIM TO ANY PARTICULAR FONT, STYLE, SIZE, OR COLOR.

NO CLAIM IS MADE TO THE EXCLUSIVE RIGHT TO USE "SEA", APART FROM THE MARK AS SHOWN.

SER. NO. 85-236,988, FILED 2-8-2011.

JORDAN BAKER, EXAMINING ATTORNEY



David J. Kybas

Director of the United States Patent and Trademark Office

United States of America

United States Patent and Trademark Office



Reg. No. 4,098,162

Registered Feb. 14, 2012

Int. Cl.: 36

SERVICE MARK

PRINCIPAL REGISTER

CDOC, INC. (DELAWARE CORPORATION)
11825 N. PENNSYLVANIA STREET
CARMEL, IN 46082

FOR: INSURANCE AND FINANCIAL SERVICES, NAMELY, UNDERWRITING LIFE AND HEALTH INSURANCE, AND FIXED ANNUITIES, IN CLASS 36 (U.S. CLS. 100, 101 AND 102).

FIRST USE 4-1-2010; IN COMMERCE 4-1-2010.

OWNER OF U.S. REG. NOS. 3,263,912, 3,263,914 AND OTHERS.

NO CLAIM IS MADE TO THE EXCLUSIVE RIGHT TO USE "NATIONAL", APART FROM THE MARK AS SHOWN.

THE MARK CONSISTS OF A STYLIZED LINE DRAWING OF A BUST OF WASHINGTON AND THE WORDS "WASHINGTON NATIONAL" IN STACKED FORMAT.

SER. NO. 85-237,473, FILED 2-9-2011.

ALICE BENMAMAN, EXAMINING ATTORNEY



David J. Kybas

Director of the United States Patent and Trademark Office

United States of America

United States Patent and Trademark Office



Reg. No. 4,098,163

Registered Feb. 14, 2012

Int. Cl.: 36

SERVICE MARK

PRINCIPAL REGISTER

CDOC, INC. (DELAWARE CORPORATION)
11825 N. PENNSYLVANIA STREET
CARMEL, IN 46082

FOR: INSURANCE AND FINANCIAL SERVICES, NAMELY, UNDERWRITING LIFE AND HEALTH INSURANCE, AND FIXED ANNUITIES, IN CLASS 36 (U.S. CLS. 100, 101 AND 102).

FIRST USE 4-1-2010; IN COMMERCE 4-1-2010.

OWNER OF U.S. REG. NOS. 3,263,912, 3,263,914 AND OTHERS.

THE COLOR(S) BLUE AND GRAY IS/ARE CLAIMED AS A FEATURE OF THE MARK.

NO CLAIM IS MADE TO THE EXCLUSIVE RIGHT TO USE "NATIONAL", APART FROM THE MARK AS SHOWN.

THE MARK CONSISTS OF A GRAY STYLIZED LINE DRAWING OF A BUST OF WASHINGTON AND THE WORDS "WASHINGTON NATIONAL" IN BLUE IN STACKED FORMAT.

SER. NO. 85-237,495, FILED 2-9-2011.

ALICE BENMAMAN, EXAMINING ATTORNEY



David J. Kybas

Director of the United States Patent and Trademark Office

United States of America

United States Patent and Trademark Office

MANIFEST EXCELLENCE

Reg. No. 4,098,164

Registered Feb. 14, 2012

Int. Cl.: 44

SERVICE MARK

PRINCIPAL REGISTER

MANIFEST EXCELLENCE, LLC (PENNSYLVANIA LIMITED LIABILITY COMPANY)
SUITE 170
208 EAGLE VALLEY
EAST STROUDSBURG, PA 18301

FOR: PROVIDING INFORMATION, COUNSELING, AND CONSULTATION TO GROUPS AND INDIVIDUALS IN THE FIELDS OF HEALTH AND WELLNESS OF THE BODY, MIND, AND SPIRIT, NAMELY, COMPREHENSIVELY ADDRESSING THE MAJOR FACTORS IMPACTING HEALTH AND OFFERING TOOLS AND STRATEGIES FOR INCREASING WELLNESS OF THE BODY, MIND, AND SPIRIT AND HEALTHY LIVING, IN CLASS 44 (U.S. CLS. 100 AND 101).

FIRST USE 3-6-2008; IN COMMERCE 3-6-2008.

THE MARK CONSISTS OF STANDARD CHARACTERS WITHOUT CLAIM TO ANY PARTICULAR FONT, STYLE, SIZE, OR COLOR.

SER. NO. 85-237,957, FILED 2-9-2011.

MARILYN IZZI, EXAMINING ATTORNEY



David J. Kyffers

Director of the United States Patent and Trademark Office

United States of America

United States Patent and Trademark Office

BUILT TO LAST

Reg. No. 4,098,165

COAST SPAS MANUFACTURING INC. (CANADA CORPORATION)
6315 202 STREET

Registered Feb. 14, 2012

LANGLEY, BC, CANADA V2Y1N1

Int. Cl.: 11

FOR: HOT TUBS, IN CLASS 11 (U.S. CLS. 13, 21, 23, 31 AND 34).

TRADEMARK

FIRST USE 10-31-1998; IN COMMERCE 10-31-1998.

PRINCIPAL REGISTER

THE MARK CONSISTS OF STANDARD CHARACTERS WITHOUT CLAIM TO ANY PARTICULAR FONT, STYLE, SIZE, OR COLOR.

SER. NO. 85-238,165, FILED S.R. 2-9-2011 AM. P.R. 9-20-2011.

ROBERT STRUCK, EXAMINING ATTORNEY



David J. Kyfos

Director of the United States Patent and Trademark Office

United States of America

United States Patent and Trademark Office

BIG NIGHT IN LITTLE HAITI

Reg. No. 4,098,166

Registered Feb. 14, 2012

Int. Cl.: 41

SERVICE MARK

PRINCIPAL REGISTER

THE RHYTHM FOUNDATION, INC. (FLORIDA CORPORATION)
P.O. BOX 398567
MIAMI, FL 33239

FOR: ENTERTAINMENT AND EDUCATION SERVICES IN THE NATURE OF LIVE DANCE AND MUSICAL PERFORMANCES; ENTERTAINMENT IN THE NATURE OF DANCE PERFORMANCES; ENTERTAINMENT IN THE NATURE OF LIVE PERFORMANCES BY MUSICIANS, MUSICAL BANDS AND GROUPS; ENTERTAINMENT IN THE NATURE OF LIVE STAGE PERFORMANCES IN THE NATURE OF CONCERTS OR LECTURE FOR HIRE IN THE FIELD OF MUSIC BY AN INDIVIDUAL; ENTERTAINMENT IN THE NATURE OF ORCHESTRA PERFORMANCES; ENTERTAINMENT IN THE NATURE OF VISUAL AND AUDIO PERFORMANCES BY MUSICIANS; ENTERTAINMENT IN THE NATURE OF VISUAL AND AUDIO PERFORMANCES, AND MUSICAL, VARIETY, NEWS AND COMEDY SHOWS; ENTERTAINMENT IN THE NATURE OF VISUAL AND AUDIO PERFORMANCES, NAMELY, MUSICAL BAND, ROCK GROUP, GYMNASTIC, DANCE, AND BALLET PERFORMANCES; ENTERTAINMENT IN THE NATURE OF VISUAL AND AUDIO PERFORMANCES, AND MUSICAL, VARIETY, NEWS AND COMEDY SHOWS; ENTERTAINMENT SERVICES IN THE NATURE OF LIVE MUSICAL PERFORMANCES; ENTERTAINMENT SERVICES IN THE NATURE OF PRESENTING LIVE MUSICAL PERFORMANCES; ENTERTAINMENT SERVICES, NAMELY, AN ON-GOING SERIES FEATURING LIVE MUSICAL PERFORMANCES PROVIDED THROUGH WEBCASTS; ENTERTAINMENT, NAMELY, LIVE MUSIC CONCERTS; ENTERTAINMENT, NAMELY, LIVE PERFORMANCES BY A MUSICAL BAND; ENTERTAINMENT, NAMELY, LIVE PERFORMANCES BY MUSICAL BANDS; LIVE PERFORMANCES BY A MUSICAL GROUP; LIVE PERFORMANCES FEATURING PRERECORDED VOCAL AND INSTRUMENTAL PERFORMANCES VIEWED ON A BIG SCREEN; PRESENTATION OF LIVE SHOW PERFORMANCES; PRESENTATION OF MUSICAL PERFORMANCE; PROVIDING AN EDUCATIONAL WEBSITE IN THE FIELDS OF MUSIC AND ENTERTAINMENT; PROVIDING AN INTERNET WEBSITE PORTAL IN THE FIELD OF MUSIC; PROVIDING FACILITIES FOR MOVIES, SHOWS, PLAYS, MUSIC OR EDUCATIONAL TRAINING, IN CLASS 41 (U.S. CLS. 100, 101 AND 107).

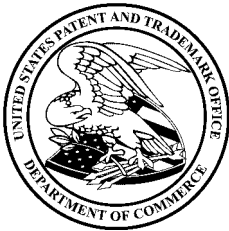

FIRST USE 1-1-2011; IN COMMERCE 1-1-2011.

David J. Kyros

THE MARK CONSISTS OF STANDARD CHARACTERS WITHOUT CLAIM TO ANY PARTICULAR FONT, STYLE, SIZE, OR COLOR.

SER. NO. 85-238,227, FILED 2-9-2011.

Reg. No. 4,098,166 ANDREW LEASER, EXAMINING ATTORNEY

Reg. No. 4,098,167 AN INHALEABLE AEROSOL; HANDHELD GAS POWERED VAPORIZERS FOR VAPORIZING VAPORIZABLE CONSTITUENTS OF HERBAL AND PLANT MATTER CONTAINED IN CIGAR OR CIGARETTE FORM FOR PRODUCING AN INHALEABLE AEROSOL; HANDHELD ELECTRICALLY POWERED VAPORIZERS FOR VAPORIZING VAPORIZABLE CONSTITUENTS OF HERBAL AND PLANT MATTER CONTAINED IN CIGAR OR CIGARETTE FORM FOR PRODUCING AN INHALEABLE AEROSOL; GAS POWERED VAPORIZERS FOR VAPORIZING VAPORIZABLE CONSTITUENTS OF HERBAL AND PLANT MATTER IN LIQUID, SOLID, FLAKE, PARTICULATE AND POWDER FORMS FOR PRODUCING AN INHALEABLE AEROSOL; ELECTRICALLY POWERED VAPORIZERS FOR VAPORIZING VAPORIZABLE CONSTITUENTS OF HERBAL AND PLANT MATTER IN LIQUID, SOLID, FLAKE, PARTICULATE AND POWDER FORMS FOR PRODUCING AN INHALEABLE AEROSOL; HANDHELD GAS POWERED VAPORIZERS FOR VAPORIZING VAPORIZABLE CONSTITUENTS OF TOBACCO FOR PRODUCING AN INHALEABLE AEROSOL; HANDHELD ELECTRICALLY POWERED VAPORIZERS FOR VAPORIZING VAPORIZABLE CONSTITUENTS OF TOBACCO FOR PRODUCING AN INHALEABLE AEROSOL; HANDHELD GAS POWERED VAPORIZERS FOR VAPORIZING VAPORIZABLE CONSTITUENTS OF TOBACCO CONTAINED IN CIGAR OR CIGARETTE FORM FOR PRODUCING AN INHALEABLE AEROSOL; HANDHELD ELECTRICALLY POWERED VAPORIZERS FOR VAPORIZING VAPORIZABLE CONSTITUENTS OF TOBACCO CONTAINED IN CIGAR OR CIGARETTE FORM FOR PRODUCING AN INHALEABLE AEROSOL; PARTS FOR VAPORIZERS USED FOR PRODUCING AN INHALEABLE AEROSOL, NAMELY, POUCHES FOR HERBAL AND PLANT MATTER FOR USE IN VAPORIZERS; PARTS FOR VAPORIZERS USED FOR PRODUCING AN INHALEABLE AEROSOL, NAMELY, POUCHES PARTLY OR WHOLLY OF PERMEABLE MEMBRANE MATERIAL FOR HERBAL AND PLANT MATTER FOR INSERTION IN VAPORIZERS; PARTS FOR VAPORIZERS USED FOR PRODUCING AN INHALEABLE AEROSOL, NAMELY, POUCHES FOR TOBACCO FOR USE IN VAPORIZERS; PARTS FOR VAPORIZERS USED FOR PRODUCING AN INHALEABLE AEROSOL, NAMELY, POUCHES PARTLY OR WHOLLY OF PERMEABLE MEMBRANE MATERIAL FOR TOBACCO FOR INSERTION IN VAPORIZERS; SMOKING PIPES, TOBACCO PIPES, SMOKELESS TOBACCO AND CIGARETTES CONTAINING TOBACCO SUBSTITUTES, NOT FOR MEDICAL PURPOSES; SMOKELESS CIGARETTE VAPORIZER PIPE; AND REPLACEMENT PARTS FOR ALL THE AFORESAID VAPORIZERS, NAMELY, REPLACEMENT MOUTHPIECES, REPLACEMENT CHAMBERS FOR VAPORIZABLE MATERIALS AND REPLACEMENT FILTERS, IN CLASS 34 (U.S. CLS. 2, 8, 9 AND 17).

THE MARK CONSISTS OF STANDARD CHARACTERS WITHOUT CLAIM TO ANY PARTICULAR FONT, STYLE, SIZE, OR COLOR.

PRIORITY CLAIMED UNDER SEC. 44(D) ON ERPN CMNTY TM OFC APPLICATION NO. 009723685, FILED 2-9-2011, REG. NO. 009723685, DATED 7-28-2011, EXPIRES 2-9-2021.

NO CLAIM IS MADE TO THE EXCLUSIVE RIGHT TO USE "SMOKELESS", APART FROM THE MARK AS SHOWN.

SER. NO. 85-239,007, FILED 2-10-2011.

INGA ERVIN, EXAMINING ATTORNEY

United States of America

United States Patent and Trademark Office



Reg. No. 4,098,168

Registered Feb. 14, 2012

Int. Cl.: 9

TRADEMARK

PRINCIPAL REGISTER

SUPERXON (CHENGDU) TECHNOLOGY LTD. (CHINA LIMITED LIABILITY COMPANY)
ROOM #101 AND 2/F, BUILDING #D7
SOUTH ROAD #216, HI-TECH ZONE
CHENGDU, SICHUAN PROV., CHINA

FOR: ELECTRONIC AND OPTICAL COMMUNICATIONS INSTRUMENTS AND COMPONENTS, NAMELY, OPTICAL TRANSMITTERS, OPTICAL RECEIVERS, OPTICAL DATA LINKS, OPTICAL TRANSCEIVERS, CABLE TELEVISION TRANSMITTERS, DIGITAL TRANSMITTERS, AND COMMUNICATION LINK TESTERS FOR TESTING COMMUNICATION LINKS; TELECOMMUNICATIONS HARDWARE, NAMELY, OPTICAL SUB-ASSEMBLY CONSISTING OF OPTICAL ISOLATORS, OPTICAL CIRCULATORS, POLARIZATION BEAM SPLITTERS AND POLARIZATION BEAM COMBINERS; COMPUTER HARDWARE AND SOFTWARE FOR THE MANAGEMENT, ANALYSIS, TROUBLESHOOTING, MEASURING AND MONITORING OF STORAGE AREA NETWORKS (SAN) AND COMPUTER NETWORKS; SOFTWARE FOR DEVELOPING, DEBUGGING, ANALYZING, AND MONITORING COMPUTER NETWORKS AND COMMUNICATION NETWORKS, NAMELY, ELECTRONIC, VOICE, AND DATA COMMUNICATIONS NETWORKS, IN CLASS 9 (U.S. CLS. 21, 23, 26, 36 AND 38).

FIRST USE 12-19-2007; IN COMMERCE 10-12-2009.

THE MARK CONSISTS OF THE TERM "SUPERXON" IN STYLIZED FORM WITH THE LETTER "O" REPRESENTED BY THE DESIGN OF A SPHERE WITH SOUND WAVES ABOVE AND BELOW IT.

SER. NO. 85-239,645, FILED 2-11-2011.

BARBARA A. GOLD, EXAMINING ATTORNEY



David J. Kyjars

Director of the United States Patent and Trademark Office

United States of America

United States Patent and Trademark Office



Reg. No. 4,098,169

Registered Feb. 14, 2012

Int. Cl.: 41

SERVICE MARK

PRINCIPAL REGISTER

JAMES MICHAEL BARKAN (UNITED STATES INDIVIDUAL), DBA THE BARKAN METHOD
HOT YOGA AFFILIATED STUDIO
1119 NORTH FEDERAL HIGHWAY
FORT LAUDERDALE, FL 33304

FOR: YOGA INSTRUCTION, NAMELY, INSTRUCTIONAL TRAINING IN THE FIELD OF ACROBATIC PERFORMANCE ON FABRIC, HOOP, TRAPEZE, AERIAL AND YOGA HAMMOCK, CORDE LISSE, NET, BUNGEE AND HOT YOGA, IN CLASS 41 (U.S. CLS. 100, 101 AND 107).

FIRST USE 1-2-1983, THE MARK WAS FIRST USED ANYWHERE IN A DIFFERENT FORM OTHER THAN THAT SOUGHT TO BE REGISTERED AT LEAST AS EARLY AS 01/02/1983.; IN COMMERCE 1-2-1983, THE MARK WAS FIRST USED IN COMMERCE IN A DIFFERENT FORM OTHER THAN THAT SOUGHT TO BE REGISTERED AT LEAST AS EARLY AS 01/02/2000..

NO CLAIM IS MADE TO THE EXCLUSIVE RIGHT TO USE "METHOD" OR "HOT YOGA" , APART FROM THE MARK AS SHOWN.

THE MARK CONSISTS OF A FACSIMILE OF FLAME AGAINST A PARTIALLY SHADED CIRCULAR BACKGROUND FIELD. THE WORDS "THE BARKAN METHOD HOT YOGA" APPEAR IN STYLIZED LETTERING SUPERIMPOSED OVER THE CIRCULAR FLAME DESIGN.

SER. NO. 85-240,026, FILED 2-11-2011.

JEFFREY LOOK, EXAMINING ATTORNEY



David J. Kyros

Director of the United States Patent and Trademark Office

United States of America

United States Patent and Trademark Office

E-Structors, Inc.

Reg. No. 4,098,170

E-STRUCTORS, INC. (MARYLAND CORPORATION)
7575 WASHINGTON BLVD.
ELKRIDGE, MD 21075

Registered Feb. 14, 2012

Int. Cls.: 37, 40 and 42

FOR: BOTTLE AND CAN COLLECTION FOR RECYCLING; INSTALLATION AND REPAIR OF COMPUTER HARDWARE; MAINTENANCE AND REPAIR OF COMPUTER HARDWARE; MAINTENANCE AND REPAIR OF COMPUTER NETWORKING HARDWARE; PAPER AND CARDBOARD COLLECTION FOR RECYCLING; REPAIR OF OFFICE MACHINES AND APPARATUS, IN CLASS 37 (U.S. CLS. 100, 103 AND 106).

SERVICE MARK

PRINCIPAL REGISTER

FIRST USE 1-1-2003; IN COMMERCE 1-1-2003.

FOR: DOCUMENT SHREDDING SERVICES; MATERIAL TREATMENT SERVICES IN CONNECTION WITH RECYCLING; METAL REFINING SERVICES, NAMELY, COPPER, GOLD, ALUMINUM, STEEL REFINING; PROVIDING MATERIAL TREATMENT INFORMATION; PROVIDING TECHNICAL INFORMATION IN THE FIELD OF WASTE MANAGEMENT; RECYCLING; RECYCLING OF WASTE; RECYCLING OF WASTE AND RUBBISH; RECYCLING OF WASTE AND TRASH; SORTING OF WASTE AND RECYCLABLE MATERIAL; WASTE MANAGEMENT, IN CLASS 40 (U.S. CLS. 100, 103 AND 106).

FIRST USE 1-1-2003; IN COMMERCE 1-1-2003.

FOR: COMPUTER CONSULTATION IN THE FIELD OF COMPUTER SECURITY; COMPUTER SECURITY SERVICE, NAMELY, HARD DRIVE ERASURE, IN CLASS 42 (U.S. CLS. 100 AND 101).

FIRST USE 1-1-2003; IN COMMERCE 1-1-2003.

NO CLAIM IS MADE TO THE EXCLUSIVE RIGHT TO USE "INC" , APART FROM THE MARK AS SHOWN.

THE COLOR(S) BLUE IS/ARE CLAIMED AS A FEATURE OF THE MARK.

THE MARK CONSISTS OF THE WORDS "E-STRUCTORS, INC." APPEARING IN A BLUE STYLIZED FONT ON A WHITE BACKGROUND. THE COLOR WHITE REPRESENTS TRANSPARENT AREA AND IS NOT TO BE CONSIDERED PART OF THE MARK.



David J. Kybas

Director of the United States Patent and Trademark Office

Reg. No. 4,098,170 SER. NO. 85-240,118, FILED 2-11-2011.

LAKEISHA LEWIS, EXAMINING ATTORNEY

United States of America

United States Patent and Trademark Office



Reg. No. 4,098,171

Registered Feb. 14, 2012

Int. Cls.: 37, 40 and 42

SERVICE MARK

PRINCIPAL REGISTER

E-STRUCTORS, INC. (MARYLAND CORPORATION)
7575 WASHINGTON BLVD
ELKRIDGE, MD 21075

FOR: BOTTLE AND CAN COLLECTION FOR RECYCLING; INSTALLATION AND REPAIR OF COMPUTER HARDWARE; MAINTENANCE AND REPAIR OF COMPUTER HARDWARE; MAINTENANCE AND REPAIR OF COMPUTER NETWORKING HARDWARE; PAPER AND CARDBOARD COLLECTION FOR RECYCLING; REPAIR OF OFFICE MACHINES AND APPARATUS, IN CLASS 37 (U.S. CLS. 100, 103 AND 106).

FIRST USE 1-1-2003; IN COMMERCE 1-1-2003.

FOR: DOCUMENT SHREDDING SERVICES; MATERIAL TREATMENT SERVICES IN CONNECTION WITH RECYCLING; METAL REFINING SERVICES, NAMELY, COPPER, ALUMINIUM, GOLD, STEEL REFINING; PROVIDING MATERIAL TREATMENT INFORMATION; RECYCLING; RECYCLING OF WASTE; RECYCLING OF WASTE AND RUBBISH; RECYCLING OF WASTE AND TRASH; SORTING OF WASTE AND RECYCLABLE MATERIAL; WASTE MANAGEMENT, IN CLASS 40 (U.S. CLS. 100, 103 AND 106).

FIRST USE 1-1-2003; IN COMMERCE 1-1-2003.

FOR: COMPUTER CONSULTATION IN THE FIELD OF COMPUTER SECURITY; COMPUTER SECURITY SERVICE, NAMELY, HARD DRIVE ERASURE, IN CLASS 42 (U.S. CLS. 100 AND 101).

FIRST USE 1-1-2003; IN COMMERCE 1-1-2003.

THE MARK CONSISTS OF 7 CIRCLES AND 1 RHOMBUS ARRANGED IN A LARGE CIRCLE. THE 4 CIRCLES ON THE LEFT ARE GREEN, AND THE 3 CIRCLES ON THE RIGHT ARE BLUE. THE RHOMBUS IS THE SAME COLOR BLUE AS THE 3 CIRCLES AND IS LOCATED IN THE BOTTOM RIGHT OF THE MARK. THE RHOMBUS HAS A WHITE CIRCLE LOCATED IN THE MIDDLE OF IT. THE COLOR WHITE REPRESENTS TRANSPARENT AREA AND IS NOT PART OF THE MARK.

THE COLOR(S) BLUE AND GREEN IS/ARE CLAIMED AS A FEATURE OF THE MARK.

SER. NO. 85-240,176, FILED 2-11-2011.



David J. Kyjars

Director of the United States Patent and Trademark Office

Reg. No. 4,098,171 LAKEISHA LEWIS, EXAMINING ATTORNEY

United States of America

United States Patent and Trademark Office

fiv

Reg. No. 4,098,172

LAWRENCE ERLICH (UNITED STATES INDIVIDUAL), DBA SCOTTCRAFT
2301 E. EVESHAM RD. SUITE 204
VOORHEES, NJ 08043

Registered Feb. 14, 2012

Int. Cl.: 42

FOR: COMPUTER SERVICES, NAMELY, PROVIDING SEARCH ENGINES FOR ENABLING ENTITIES TO SEARCH FOR INFORMATION AVAILABLE ON THE INTERNET ABOUT SUBJECTS, USING DESCRIPTIVE SEARCH CRITERIA, AND TO LOCATE VENDORS AND OTHER SUPPLIERS OF PRODUCTS AND SERVICES, AS SPECIFIED BY CATEGORICAL DESCRIPTIONS, IN CLASS 42 (U.S. CLS. 100 AND 101).

SERVICE MARK

PRINCIPAL REGISTER

FIRST USE 3-17-1999; IN COMMERCE 3-17-1999.

THE MARK CONSISTS OF STANDARD CHARACTERS WITHOUT CLAIM TO ANY PARTICULAR FONT, STYLE, SIZE, OR COLOR.

SER. NO. 85-240,187, FILED 2-11-2011.

LAURIE MAYES, EXAMINING ATTORNEY



David J. Kyffers

Director of the United States Patent and Trademark Office

United States of America

United States Patent and Trademark Office

barbra

Reg. No. 4,098,173

Registered Feb. 14, 2012

Int. Cl.: 42

SERVICE MARK

PRINCIPAL REGISTER

LAWRENCE ERLICH (UNITED STATES INDIVIDUAL), DBA SCOTTCRAFT
2301 E. EVESHAM RD. SUITE 204
VOORHEES, NJ 08043

FOR: COMPUTER NETWORK SEARCH ENGINE SERVICES, NAMELY, PROVIDING SERVICES ENABLING USERS TO SEARCH FOR INFORMATION AVAILABLE ON THE INTERNET ABOUT SUBJECTS, USING DESCRIPTIVE SEARCH CRITERIA, AND TO LOCATE VENDORS AND OTHER SUPPLIERS OF PRODUCTS AND SERVICES, AS SPECIFIED BY CATEGORICAL DESCRIPTIONS, IN CLASS 42 (U.S. CLS. 100 AND 101).

FIRST USE 12-16-1999; IN COMMERCE 12-16-1999.

THE MARK CONSISTS OF STANDARD CHARACTERS WITHOUT CLAIM TO ANY PARTICULAR FONT, STYLE, SIZE, OR COLOR.

SER. NO. 85-240,261, FILED 2-11-2011.

LAURIE MAYES, EXAMINING ATTORNEY



David J. Kyffers

Director of the United States Patent and Trademark Office

United States of America

United States Patent and Trademark Office

ZON

Reg. No. 4,098,174

Registered Feb. 14, 2012

Int. Cl.: 42

SERVICE MARK

PRINCIPAL REGISTER

LAWRENCE ERLICH (UNITED STATES INDIVIDUAL), DBA SCOTTCRAFT
2301 E. EVESHAM RD. SUITE 204
VOORHEES, NJ 08043

FOR: COMPUTER SERVICES, NAMELY, PROVIDING SEARCH ENGINES FOR ENABLING ENTITIES TO SEARCH FOR INFORMATION AVAILABLE ON THE INTERNET ABOUT SUBJECTS, USING DESCRIPTIVE SEARCH CRITERIA, AND TO LOCATE VENDORS AND OTHER SUPPLIERS OF PRODUCTS AND SERVICES, AS SPECIFIED BY CATEGORICAL DESCRIPTIONS, IN CLASS 42 (U.S. CLS. 100 AND 101).

FIRST USE 10-29-1998; IN COMMERCE 10-29-1998.

THE MARK CONSISTS OF STANDARD CHARACTERS WITHOUT CLAIM TO ANY PARTICULAR FONT, STYLE, SIZE, OR COLOR.

SER. NO. 85-240,282, FILED 2-11-2011.

LAURIE MAYES, EXAMINING ATTORNEY



David J. Kyffers

Director of the United States Patent and Trademark Office

Reg. No. 4,098,175 AN INHALEABLE AEROSOL; HANDHELD GAS POWERED VAPORIZERS FOR VAPORIZING VAPORIZABLE CONSTITUENTS OF HERBAL AND PLANT MATTER CONTAINED IN CIGAR OR CIGARETTE FORM FOR PRODUCING AN INHALEABLE AEROSOL; HANDHELD ELECTRICALLY POWERED VAPORIZERS FOR VAPORIZING VAPORIZABLE CONSTITUENTS OF HERBAL AND PLANT MATTER CONTAINED IN CIGAR OR CIGARETTE FORM FOR PRODUCING AN INHALEABLE AEROSOL; GAS POWERED VAPORIZERS FOR VAPORIZING VAPORIZABLE CONSTITUENTS OF HERBAL AND PLANT MATTER IN LIQUID, SOLID, FLAKE, PARTICULATE AND POWDER FORMS FOR PRODUCING AN INHALEABLE AEROSOL; ELECTRICALLY POWERED VAPORIZERS FOR VAPORIZING VAPORIZABLE CONSTITUENTS OF HERBAL AND PLANT MATTER IN LIQUID, SOLID, FLAKE, PARTICULATE AND POWDER FORMS FOR PRODUCING AN INHALEABLE AEROSOL; HANDHELD GAS POWERED VAPORIZERS FOR VAPORIZING VAPORIZABLE CONSTITUENTS OF TOBACCO FOR PRODUCING AN INHALEABLE AEROSOL; HANDHELD ELECTRICALLY POWERED VAPORIZERS FOR VAPORIZING VAPORIZABLE CONSTITUENTS OF TOBACCO FOR PRODUCING AN INHALEABLE AEROSOL; HANDHELD GAS POWERED VAPORIZERS FOR VAPORIZING VAPORIZABLE CONSTITUENTS OF TOBACCO CONTAINED IN CIGAR OR CIGARETTE FORM FOR PRODUCING AN INHALEABLE AEROSOL; HANDHELD ELECTRICALLY POWERED VAPORIZERS FOR VAPORIZING VAPORIZABLE CONSTITUENTS OF TOBACCO CONTAINED IN CIGAR OR CIGARETTE FORM FOR PRODUCING AN INHALEABLE AEROSOL; PARTS FOR VAPORIZERS USED FOR PRODUCING AN INHALEABLE AEROSOL, NAMELY, POUCHES FOR HERBAL AND PLANT MATTER FOR USE IN VAPORIZERS; PARTS FOR VAPORIZERS USED FOR PRODUCING AN INHALEABLE AEROSOL, NAMELY, POUCHES PARTLY OR WHOLLY OF PERMEABLE MEMBRANE MATERIAL FOR HERBAL AND PLANT MATTER FOR INSERTION IN VAPORIZERS; PARTS FOR VAPORIZERS USED FOR PRODUCING AN INHALEABLE AEROSOL, NAMELY, POUCHES FOR TOBACCO FOR USE IN VAPORIZERS; PARTS FOR VAPORIZERS USED FOR PRODUCING AN INHALEABLE AEROSOL, NAMELY, POUCHES PARTLY OR WHOLLY OF PERMEABLE MEMBRANE MATERIAL FOR TOBACCO FOR INSERTION IN VAPORIZERS; SMOKING PIPES, TOBACCO PIPES, SMOKELESS TOBACCO AND CIGARETTES CONTAINING TOBACCO SUBSTITUTES, NOT FOR MEDICAL PURPOSES; SMOKELESS CIGARETTE VAPORIZER PIPE; AND REPLACEMENT PARTS FOR ALL THE AFORESAID VAPORIZERS, NAMELY, REPLACEMENT MOUTHPIECES, REPLACEMENT CHAMBERS FOR VAPORIZABLE MATERIALS AND REPLACEMENT FILTERS, IN CLASS 34 (U.S. CLS. 2, 8, 9 AND 17).

THE MARK CONSISTS OF STANDARD CHARACTERS WITHOUT CLAIM TO ANY PARTICULAR FONT, STYLE, SIZE, OR COLOR.

PRIORITY CLAIMED UNDER SEC. 44(D) ON ERPN CMNTY TM OFC APPLICATION NO. 009727892, FILED 2-10-2011, REG. NO. 009727892, DATED 7-28-2011, EXPIRES 2-10-2021.

NO CLAIM IS MADE TO THE EXCLUSIVE RIGHT TO USE "HEAT", APART FROM THE MARK AS SHOWN.

SER. NO. 85-240,285, FILED 2-11-2011.

INGA ERVIN, EXAMINING ATTORNEY

United States of America

United States Patent and Trademark Office



Reg. No. 4,098,176

Registered Feb. 14, 2012

Int. Cl.: 32

TRADEMARK

PRINCIPAL REGISTER

F. L. LIMA CAVALCANTE DE OLIVEIRA (BRAZIL SOLE PROPRIETORSHIP)
BAIRRO ADRIANÓPOLIS
AV. MÁRIO YPIRANGA, 1300 - LOJA 12
MANAUS, AMAZONAS, BRAZIL 69057002

FOR: NON-ALCOHOLIC FRUIT EXTRACTS USED IN THE PREPARATION OF BEVERAGES; NON-ALCOHOLIC FRUIT JUICE BEVERAGES; FRUIT JUICES; FRUIT NECTARS, NON-ALCOHOLIC FRUIT JUICE BEVERAGES; NON-ALCOHOLIC BEVERAGES CONTAINING FRUIT JUICES; VEGETABLE JUICES, IN CLASS 32 (U.S. CLS. 45, 46 AND 48).

FIRST USE 9-24-2008; IN COMMERCE 8-8-2010.

NO CLAIM IS MADE TO THE EXCLUSIVE RIGHT TO USE "AMAZON FOREST", APART FROM THE MARK AS SHOWN.

THE COLOR(S) AMBER, DARK ORANGE, RED, REDDISH BROWN, MAGENTA, ORANGE, DARK AND LIGHT GREEN IS/ARE CLAIMED AS A FEATURE OF THE MARK.

THE MARK CONSISTS OF THE LITERAL ELEMENT "AMAZON FOREST" DISPLAYED IN SHADES OF AMBER AND OUTLINED IN DARK ORANGE. A CUP IN RED FEATURING TWO REDDISH BROWN CURVED STRIPES FILLED WITH A DRINK FEATURING A MAGENTA AND AMBER SWIRL AND A STRAW IN AMBER OUTLINED IN ORANGE APPEARS ON THE LEFT OF THE TEXTUAL PORTION. TWO STYLIZED DARK AND LIGHT GREEN LEAVES APPEAR AT THE BOTTOM OF THE CUP, ONE IN FRONT AND THE OTHER ON THE BACK OF THE CUP.

SER. NO. 85-240,615, FILED 2-11-2011.

LOURDES AYALA, EXAMINING ATTORNEY



David J. Kybas

Director of the United States Patent and Trademark Office

United States of America

United States Patent and Trademark Office

GLOBAL

FINANCIAL DATA

Reg. No. 4,098,177

GLOBAL FINANCIAL DATA, INC. (CALIFORNIA CORPORATION)
29122 RANCHO VIEJO ROAD, SUITE 213
SAN JUAN CAPISTRANO, CA 92675

Registered Feb. 14, 2012

Int. Cl.: 36

FOR: PROVIDING FINANCIAL INFORMATION, FINANCIAL RESEARCH, FINANCIAL INFORMATION AND RESEARCH PERTAINING TO SECURITIES AND SECURITIES MARKETS, AND FINANCIAL INFORMATION AND RESEARCH PERTAINING TO FINANCIAL INVESTMENTS, IN CLASS 36 (U.S. CLS. 100, 101 AND 102).

SERVICE MARK

PRINCIPAL REGISTER

FIRST USE 5-0-2010; IN COMMERCE 5-0-2010.

OWNER OF U.S. REG. NO. 4,000,750.

NO CLAIM IS MADE TO THE EXCLUSIVE RIGHT TO USE "FINANCIAL DATA", APART FROM THE MARK AS SHOWN.

THE MARK CONSISTS OF THE WORDS "GLOBAL FINANCIAL DATA" WITH A GLOBE AND MAGNIFYING GLASS DESIGN SUBSTITUTING FOR THE LETTER "O" IN THE WORD "GLOBAL".

SEC. 2(F) AS TO "GLOBAL FINANCIAL DATA" .

SER. NO. 85-240,730, FILED 2-11-2011.

TINA MAI, EXAMINING ATTORNEY



David J. Kyffers

Director of the United States Patent and Trademark Office

United States of America

United States Patent and Trademark Office

Anella

Reg. No. 4,098,178

Registered Feb. 14, 2012

Int. Cl.: 33

TRADEMARK

PRINCIPAL REGISTER

F. L. NAVARRO LTD (NEW YORK CORPORATION), DBA THE ARTISAN COLLECTION
365 BRIDGE ST, 8PRO
BROOKLYN, NY 11201

FOR: WINES, IN CLASS 33 (U.S. CLS. 47 AND 49).

FIRST USE 2-11-2011; IN COMMERCE 2-11-2011.

THE MARK CONSISTS OF STANDARD CHARACTERS WITHOUT CLAIM TO ANY PARTICULAR FONT, STYLE, SIZE, OR COLOR.

THE WORDING "ANELLA" HAS NO MEANING IN A FOREIGN LANGUAGE.

SER. NO. 85-240,839, FILED 2-12-2011.

JUSTINE D. PARKER, EXAMINING ATTORNEY



David J. Kyffers

Director of the United States Patent and Trademark Office

United States of America

United States Patent and Trademark Office

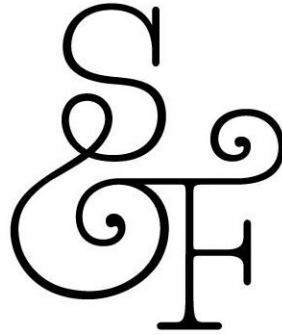

Reg. No. 4,098,179

MORGAN, KEA (UNITED STATES INDIVIDUAL)
222 CARLTON AVENUE #1
BROOKLYN, NY 11205

Registered Feb. 14, 2012

Int. Cl.: 42

FOR: DESIGN OF FLORAL DECORATIONS AND CUSTOM GIFTS FOR OCCASIONS AND EVENTS, IN CLASS 42 (U.S. CLS. 100 AND 101).

SERVICE MARK

FIRST USE 6-1-2010; IN COMMERCE 6-1-2010.

PRINCIPAL REGISTER

THE MARK CONSISTS OF STYLIZED TERM "S&F".

SER. NO. 85-241,084, FILED 2-13-2011.

HOWARD B. LEVINE, EXAMINING ATTORNEY



David J. Kybas

Director of the United States Patent and Trademark Office

United States of America

United States Patent and Trademark Office



Reg. No. 4,098,180

PALMS IMAGING CENTER, LLC (CALIFORNIA LIMITED LIABILITY COMPANY)
1901 OUTLET CENTER DRIVE, SUITE 120
OXNARD, CA 93036

Registered Feb. 14, 2012

Int. Cl.: 44

FOR: MEDICAL IMAGING SERVICES, NAMELY, CONSULTING SERVICES IN THE FIELD OF USING AND OPERATING MEDICAL IMAGING APPARATUS INCLUDING X-RAY, COMPUTED TOMOGRAPHY, MAGNETIC RESONANCE IMAGING, ULTRASOUND, AND POSITRON EMISSION TOMOGRAPHY APPARATUS, IN CLASS 44 (U.S. CLS. 100 AND 101).

SERVICE MARK

PRINCIPAL REGISTER

FIRST USE 5-1-2006; IN COMMERCE 5-1-2006.

NO CLAIM IS MADE TO THE EXCLUSIVE RIGHT TO USE "IMAGING CENTER", APART FROM THE MARK AS SHOWN.

THE MARK CONSISTS OF A STYLIZED DEPICTION OF PALM LEAVES ABOVE THE WORDS "PALMS IMAGING" CENTERED OVER A HORIZONTAL LINE INTERSECTED BY THE WORD "CENTER".

SER. NO. 85-241,337, FILED 2-14-2011.

JOHN E. MICHOS, EXAMINING ATTORNEY



David J. Kyffers

Director of the United States Patent and Trademark Office

United States of America

United States Patent and Trademark Office



Reg. No. 4,098,181

Registered Feb. 14, 2012

Int. Cl.: 35

SERVICE MARK

PRINCIPAL REGISTER

KEMPNER, MAURICE (UNITED STATES INDIVIDUAL)
2670 DIAMOND PL. # 511
SANTA CLARITA, CA 91350

FOR: INCOME TAX CONSULTATION; INCOME TAX PREPARATION; TAX ADVISORY SERVICES; TAX AND TAXATION PLANNING, ADVICE, INFORMATION AND CONSULTANCY SERVICES; TAX CONSULTATION; TAX FILING SERVICES; TAX LIEN MANAGEMENT SERVICES; TAX PREPARATION, IN CLASS 35 (U.S. CLS. 100, 101 AND 102).

FIRST USE 1-1-2011; IN COMMERCE 1-1-2011.

THE MARK CONSISTS OF A DRAWING OF A MAN HOLDING A MUSKET IN HIS RIGHT HAND. THE MAN IS WEARING A HAT AND BOOTS, AND HE IS GENERALLY DRESSED IN AS A COLONIAL SOLDIER IN THE AMERICAN REVOLUTIONARY WAR.

SER. NO. 85-241,832, FILED 2-14-2011.

KAREN K. BUSH, EXAMINING ATTORNEY



David J. Kybas

Director of the United States Patent and Trademark Office

United States of America

United States Patent and Trademark Office

I'M A LITTLE TEACUP

Reg. No. 4,098,182

I'M A LITTLE TEACUP (FLORIDA CORPORATION), DBA ANGELS' EYES
5271 NW 108 AVENUE
SUNRISE, FL 33351

Registered Feb. 14, 2012

Int. Cl.: 5

FOR: EDIBLE MEDICATED ANIMAL FOOD ADDITIVE FOR TREATING TEAR STAINING,
IN CLASS 5 (U.S. CLS. 6, 18, 44, 46, 51 AND 52).

TRADEMARK

FIRST USE 6-1-2005; IN COMMERCE 6-1-2005.

PRINCIPAL REGISTER

THE MARK CONSISTS OF STANDARD CHARACTERS WITHOUT CLAIM TO ANY PAR-
TICULAR FONT, STYLE, SIZE, OR COLOR.

SER. NO. 85-242,299, FILED 2-15-2011.

KEVON CHISOLM, EXAMINING ATTORNEY



David J. Kybas

Director of the United States Patent and Trademark Office

United States of America
United States Patent and Trademark Office

FRIENDIO

Reg. No. 4,098,183

CALUTECH, INC. (ILLINOIS CORPORATION)
15646 S 70TH CT
ORLAND PARK, IL 60462

Registered Feb. 14, 2012

Int. Cl.: 45

FOR: ON-LINE SOCIAL NETWORKING SERVICES, IN CLASS 45 (U.S. CLS. 100 AND 101).

SERVICE MARK

FIRST USE 1-7-2010; IN COMMERCE 1-7-2010.

PRINCIPAL REGISTER

THE MARK CONSISTS OF STANDARD CHARACTERS WITHOUT CLAIM TO ANY PARTICULAR FONT, STYLE, SIZE, OR COLOR.

SER. NO. 85-242,617, FILED 2-15-2011.

SAMUEL E. SHARPER JR., EXAMINING ATTORNEY



David J. Kyffers

Director of the United States Patent and Trademark Office

United States of America

United States Patent and Trademark Office

The logo for 'Krehalon' is written in a stylized, cursive font. The letter 'K' is significantly larger and more prominent than the other letters. The entire word is enclosed within a thin, horizontal oval border.

Reg. No. 4,098,184

Registered Feb. 14, 2012

Int. Cls.: 16 and 17

TRADEMARK

PRINCIPAL REGISTER

KUREHA CORPORATION (JAPAN CORPORATION)
3-3-2, NIHONBASHI-HAMACHO, CHUO-KU
TOKYO, JAPAN 103-8552

FOR: PLASTIC FILMS FOR WRAPPING; PLASTIC FOOD WRAPPING FILMS; PLASTIC BAGS FOR WRAPPING; FOOD WRAPPING PLASTIC BAGS; PLASTIC BAGS FOR WRAPPING RICE; PLASTIC FOOD STORAGE FILMS FOR WRAPPING FOOD; PLASTIC FOOD STORAGE BAGS; PLASTIC FOOD BAGS FOR FREEZER PRESERVATION; PLASTIC STORAGE BAGS WITH A ZIPPER FOR WRAPPING FOOD; PLASTIC BAGS TO PICKLE VEGETABLES; PLASTIC BAGS FOR MICROWAVE COOKING, IN CLASS 16 (U.S. CLS. 2, 5, 22, 23, 29, 37, 38 AND 50).

FOR: SEMI-PROCESSED PLASTIC IN THE FORM OF FILMS, SHEETS, TUBES, BARS OR RODS; PLASTIC SEMI-PROCESSED PRODUCTS FOR USE AS MATERIAL, IN CLASS 17 (U.S. CLS. 1, 5, 12, 13, 35 AND 50).

PRIORITY CLAIMED UNDER SEC. 44(D) ON JAPAN APPLICATION NO. 2011-009013, FILED 2-10-2011, REG. NO. 4091253, DATED 12-12-1997, EXPIRES 12-12-2017.

OWNER OF U.S. REG. NO. 859,711.

THE MARK CONSISTS OF THE WORD "KREHALON" IN STYLIZED LETTERING WITH THE LOWER LINE OF THE LETTER "K" EXTENDING BENEATH THE ENTIRE WORD AND LOOPING AROUND TO THE TOP OF THE WORD.

THE WORDING "KREHALON" HAS NO MEANING IN A FOREIGN LANGUAGE.

SER. NO. 85-242,731, FILED 2-15-2011.

SEAN CROWLEY, EXAMINING ATTORNEY

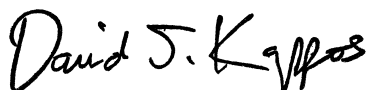
A handwritten signature in black ink that reads 'David J. Kyffers'.

Director of the United States Patent and Trademark Office

United States of America

United States Patent and Trademark Office

ROME

Reg. No. 4,098,185

Registered Feb. 14, 2012

Int. Cls.: 9 and 41

TRADEMARK

SERVICE MARK

PRINCIPAL REGISTER

ROME MUSICA, LLC (CALIFORNIA LIMITED LIABILITY COMPANY)
C/O FREUND AND BRACKEY, LLP
427 NORTH CAMDEN DRIVE
BEVERLY HILLS, CA 90210

FOR: COMPACT DISCS FEATURING MUSIC; DIGITAL MUSIC DOWNLOADABLE FROM THE INTERNET; DOWNLOADABLE MUSICAL SOUND RECORDINGS, IN CLASS 9 (U.S. CLS. 21, 23, 26, 36 AND 38).

FIRST USE 1-6-2005; IN COMMERCE 1-6-2005.

FOR: ENTERTAINMENT SERVICES IN THE NATURE OF LIVE MUSICAL PERFORMANCES; ENTERTAINMENT, NAMELY, LIVE MUSIC CONCERTS, IN CLASS 41 (U.S. CLS. 100, 101 AND 107).

FIRST USE 1-6-2005; IN COMMERCE 1-6-2005.

THE MARK CONSISTS OF STANDARD CHARACTERS WITHOUT CLAIM TO ANY PARTICULAR FONT, STYLE, SIZE, OR COLOR.

SER. NO. 85-243,147, FILED 2-15-2011.

KAREN K. BUSH, EXAMINING ATTORNEY



David J. Kybas

Director of the United States Patent and Trademark Office

United States of America

United States Patent and Trademark Office

Ya Heard Me

Reg. No. 4,098,186

Registered Feb. 14, 2012

Int. Cl.: 25

TRADEMARK

PRINCIPAL REGISTER

ROBERT, JOHN E AND ROBERT, GLENDA M (LOUISIANA PARTNERSHIP)
P.O. BOX 80057
BATON ROUGE, LA 70898

FOR: A-SHIRTS; ANKLETS; APPAREL FOR DANCERS, NAMELY, TEE SHIRTS, SWEAT-SHIRTS, PANTS, LEGGINGS, SHORTS AND JACKETS; ATHLETIC APPAREL, NAMELY, SHIRTS, PANTS, JACKETS, FOOTWEAR, HATS AND CAPS, ATHLETIC UNIFORMS; BASEBALL CAPS AND HATS; BODY SHIRTS; BOTTOMS; BUTTON DOWN SHIRTS; CAMOUFLAGE SHIRTS; CAMP SHIRTS; CHEF'S HATS; CLOTH BIBS FOR ADULT DINERS; CLOTHING FOR ATHLETIC USE, NAMELY, PADDED PANTS; CLOTHING FOR ATHLETIC USE, NAMELY, PADDED SHIRTS; CLOTHING FOR ATHLETIC USE, NAMELY, PADDED SHORTS; CLOTHING FOR BABIES, TODDLERS AND CHILDREN, TREATED WITH FIRE AND HEAT RETARDANTS, NAMELY, PAJAMAS, JACKETS, SHIRTS, PANTS, JUMPERS; CLOTHING FOR WEAR IN JUDO PRACTICES; CLOTHING FOR WEAR IN WRESTLING GAMES; CLOTHING SHIELDS, NAMELY, PADS APPLIED TO THE UNDERARMS OF SHIRTS, BLOUSES AND SWEATERS; CLOTHING, NAMELY, KHAKIS; CLOTHING, NAMELY, WRAP-AROUNDS; COLLARED SHIRTS; DRESS SHIRTS; DUSTERS; EAR BANDS; FISHING SHIRTS; FUR HATS; GLOVES AS CLOTHING; GOLF PANTS, SHIRTS AND SKIRTS; GOLF SHIRTS; HAT BANDS; HATS; HATS FOR INFANTS, BABIES, TODDLERS AND CHILDREN; HEAD SCARVES; HEAD SWEATBANDS; HEAD WEAR; HEAD-BANDS FOR CLOTHING; HEADGEAR, NAMELY, HATS, CAPS; HOODED SWEAT SHIRTS; HOODS; HUNTING SHIRTS; INFANT AND TODDLER ONE PIECE CLOTHING; JACKETS; JERSEYS; KNIT SHIRTS; LADIES' UNDERWEAR; LEATHER HATS; LEATHER SHIRTS; LONG UNDERWEAR; LONG-SLEEVED SHIRTS; MANTLES; MEN'S DRESS SOCKS; MEN'S SOCKS; MUFFLERS; NECK BANDS; NIGHT SHIRTS; OPEN-NECKED SHIRTS; OVER SHIRTS; PAPER HATS FOR USE AS CLOTHING ITEMS; PARTY HATS; PERSPIRATION ABSORBENT STRAP TO BE USED IN THE BILL OF A HAT; PIQUE SHIRTS; POLO SHIRTS; RAIN HATS; RUGBY SHIRTS; SASH BANDS FOR KIMONO (OBI); SCIENTIFIC AND TECHNOLOGICAL APPAREL, NAMELY, SHIRTS, PANTS, JACKETS, FOOTWEAR, HATS AND CAPS, UNIFORMS; SEDGE HATS (SUGE-GASA); SHIRT FRONTS; SHIRT YOKES; SHIRTS; SHIRTS AND SHORT-SLEEVED SHIRTS; SHIRTS AND SLIPS; SHIRTS FOR INFANTS, BABIES, TODDLERS AND CHILDREN; SHIRTS FOR SUITS; SHORT SETS; SHORT-SLEEVED OR LONG-SLEEVED T-SHIRTS; SHORT-SLEEVED SHIRTS; SHOULDER WRAPS; SHOULDER WRAPS FOR CLOTHING; SLEEP SHIRTS; SLEEVES WORN SEPARATE AND APART FROM BLOUSES, SHIRTS AND OTHER TOPS; SLIPPER SOCKS; SMALL HATS; SOCKS AND STOCKINGS; SPORT SHIRTS; SPORTS CAPS AND HATS; SPORTS SHIRTS; SPORTS SHIRTS WITH SHORT SLEEVES; SWEAT BANDS; SWEAT SHIRTS; T-SHIRTS;



David J. Kyjars

Director of the United States Patent and Trademark Office

Reg. No. 4,098,186 T-SHIRTS FOR BABIES, ADULTS, KIDS, WOMEN, MEN; TEE SHIRTS; THONGS; THONGS; TIES; TOBOGGAN HATS, PANTS AND CAPS; TOPS; TURTLE NECK SHIRTS; UNDERWEAR; UNDERWEAR, NAMELY, BOY SHORTS; WAIST BANDS; WATER SOCKS; WEARABLE GARMENTS AND CLOTHING, NAMELY, SHIRTS; WIND SHIRTS; WOMEN'S CLOTHING, NAMELY, SHIRTS, DRESSES, SKIRTS, BLOUSES; WOMEN'S HATS AND HOODS; WOMEN'S UNDERWEAR; WOOLLY HATS; WRAPS; YOGA SHIRTS, IN CLASS 25 (U.S. CLS. 22 AND 39).

FIRST USE 12-1-2005; IN COMMERCE 12-1-2005.

THE MARK CONSISTS OF STANDARD CHARACTERS WITHOUT CLAIM TO ANY PARTICULAR FONT, STYLE, SIZE, OR COLOR.

SER. NO. 85-243,322, FILED 2-16-2011.

KEVON CHISOLM, EXAMINING ATTORNEY

United States of America

United States Patent and Trademark Office



Reg. No. 4,098,187

Registered Feb. 14, 2012

Int. Cl.: 12

TRADEMARK

PRINCIPAL REGISTER

BIONDI VINTAGE MOTORS LLC (CONNECTICUT LIMITED LIABILITY COMPANY)
PO BOX 4726
1172 NORTH MAIN STREET
WATERBURY, CT 06704

FOR: BRAKE LININGS FOR MOTOR CARS; BRAKE SHOES FOR MOTOR CARS; BRAKES FOR MOTOR CARS; CARS; CHAINS FOR MOTOR CARS; CLUTCH MECHANISMS FOR MOTOR CARS; ELECTRIC MOTORS FOR MOTOR CARS; GEARBOXES FOR MOTOR CARS; HORNS FOR MOTOR CARS; MOTOR CAR CONVERTIBLE TOPS; MOTOR CAR DOORS; MOTOR CAR SEATS; MOTOR CAR WINDOWS; MOTOR CARS FOR TRANSPORT ON LAND; RACING CARS; SAFETY BELTS FOR VEHICLES FOR MOTOR CARS; SHOCK ABSORBING SPRINGS FOR MOTOR CARS; WHEEL RIMS FOR MOTOR CARS, IN CLASS 12 (U.S. CLS. 19, 21, 23, 31, 35 AND 44).

FIRST USE 12-14-2010; IN COMMERCE 2-3-2011.

NO CLAIM IS MADE TO THE EXCLUSIVE RIGHT TO USE "VINTAGE MOTORS", APART FROM THE MARK AS SHOWN.

THE COLOR(S) BLACK, GOLD AND GREY IS/ARE CLAIMED AS A FEATURE OF THE MARK.

THE MARK CONSISTS OF A BELL-SHAPED EARLY AUTOMOBILE RADIATOR OUTLINED IN GOLD WITH A GREY AND BLACK CENTER, ACROSS WHICH IS THE WORDING "BIONDI VINTAGE MOTORS" WRITTEN IN GOLD.

THE WORDING "BIONDI" HAS NO MEANING IN A FOREIGN LANGUAGE.

SER. NO. 85-244,724, FILED 2-17-2011.

TINA L. SNAPP, EXAMINING ATTORNEY



David J. Kybas

Director of the United States Patent and Trademark Office

United States of America

United States Patent and Trademark Office

THE HANOVER COMPANY

Reg. No. 4,098,188

Registered Feb. 14, 2012

Int. Cl.: 36

SERVICE MARK

PRINCIPAL REGISTER

THE HANOVER COMPANY (DELAWARE CORPORATION)
5847 SAN FELIPE #3600
HOUSTON, TX 77057

FOR: LEASING AND RENTAL OF APARTMENTS AND COMMERCIAL RETAIL SPACE;
REAL ESTATE SERVICES, NAMELY, CONDOMINIUM MANAGEMENT SERVICES;
MANAGEMENT OF APARTMENTS, IN CLASS 36 (U.S. CLS. 100, 101 AND 102).

FIRST USE 12-0-1984; IN COMMERCE 12-0-1984.

THE MARK CONSISTS OF STANDARD CHARACTERS WITHOUT CLAIM TO ANY PARTICULAR FONT, STYLE, SIZE, OR COLOR.

OWNER OF U.S. REG. NO. 4,021,761.

NO CLAIM IS MADE TO THE EXCLUSIVE RIGHT TO USE "COMPANY", APART FROM THE MARK AS SHOWN.

SEC. 2(F).

SER. NO. 85-246,520, FILED 2-18-2011.

DANNEAN HETZEL, EXAMINING ATTORNEY



David J. Kyfos

Director of the United States Patent and Trademark Office

United States of America

United States Patent and Trademark Office



Reg. No. 4,098,189

RAZOR USA LLC (DELAWARE LIMITED LIABILITY COMPANY)
16200-A CARMENITA ROAD
CERRITOS, CA 90703

Registered Feb. 14, 2012

Int. Cls.: 12 and 28

FOR: MOTORIZED SCOOTERS AND STRUCTURAL PARTS THEREFOR; SCOOTERS AND STRUCTURAL PARTS THEREFOR; ELECTRIC SCOOTERS AND STRUCTURAL PARTS THEREFOR; TWO-WHEELED MOTOR VEHICLES, IN CLASS 12 (U.S. CLS. 19, 21, 23, 31, 35 AND 44).

TRADEMARK

PRINCIPAL REGISTER

FIRST USE 10-0-2003; IN COMMERCE 10-0-2003.

FOR: TOY SCOOTERS AND ACCESSORIES THEREFOR; RIDE-ON TOYS AND ACCESSORIES THEREFOR; RIDEABLE TOYS AND ACCESSORIES THEREFOR, IN CLASS 28 (U.S. CLS. 22, 23, 38 AND 50).

FIRST USE 10-0-2003; IN COMMERCE 10-0-2003.

THE MARK CONSISTS OF "E100" IN A STYLIZED MANNER.

SER. NO. 85-246,788, FILED 2-18-2011.

H. M. FISHER, EXAMINING ATTORNEY



David J. Kyros

Director of the United States Patent and Trademark Office

United States of America

United States Patent and Trademark Office

THE WORKPLACE ENVIRONMENTALISTS

Reg. No. 4,098,190

Registered Feb. 14, 2012

Int. Cls.: 35 and 42

SERVICE MARK

PRINCIPAL REGISTER

CONTINENTAL OFFICE FURNITURE CORPORATION (OHIO CORPORATION)
2601 SILVER DRIVE
COLUMBUS, OH 43211

FOR: CONCEPT AND BRAND DEVELOPMENT CONSULTING SERVICES FOR INCORPORATING BRAND VALUES AND IDEALS INTO THE WORKPLACE, IN CLASS 35 (U.S. CLS. 100, 101 AND 102).

FIRST USE 1-17-2011; IN COMMERCE 1-17-2011.

FOR: DESIGN OF SPECIALTY INTERIOR ENVIRONMENT SETTINGS; INTERIOR DESIGN SERVICES, NAMELY, SPACE PLANNING, FURNITURE SELECTION, AND MATERIAL AND SURFACE SELECTION; PROVIDING GRAPHIC DESIGN AND GRAPHIC DESIGN PLANNING SERVICES TO CREATE SPECIALTY INTERIOR ENVIRONMENT SETTINGS, IN CLASS 42 (U.S. CLS. 100 AND 101).

FIRST USE 1-17-2011; IN COMMERCE 1-17-2011.

THE MARK CONSISTS OF STANDARD CHARACTERS WITHOUT CLAIM TO ANY PARTICULAR FONT, STYLE, SIZE, OR COLOR.

NO CLAIM IS MADE TO THE EXCLUSIVE RIGHT TO USE "WORKPLACE", APART FROM THE MARK AS SHOWN.

SER. NO. 85-247,533, FILED 2-21-2011.

KATHLEEN M. VANSTON, EXAMINING ATTORNEY



David J. Kyffers

Director of the United States Patent and Trademark Office

United States of America

United States Patent and Trademark Office

SIRONIS

Reg. No. 4,098,191

SIRONIS, INC. (CALIFORNIA CORPORATION)
2351 ARALIA ST

Registered Feb. 14, 2012

NEWPORT BEACH, CA 92660

Int. Cl.: 42

FOR: RESEARCH AND DEVELOPMENT IN THE FIELD OF MEDICAL AND HEMODYNAMIC MONITORING, IN CLASS 42 (U.S. CLS. 100 AND 101).

SERVICE MARK

FIRST USE 2-1-2011; IN COMMERCE 2-15-2011.

PRINCIPAL REGISTER

THE MARK CONSISTS OF STANDARD CHARACTERS WITHOUT CLAIM TO ANY PARTICULAR FONT, STYLE, SIZE, OR COLOR.

SER. NO. 85-247,720, FILED 2-21-2011.

TIMOTHY FINNEGAN, EXAMINING ATTORNEY



David J. Kybas

Director of the United States Patent and Trademark Office

United States of America

United States Patent and Trademark Office



Reg. No. 4,098,192

Registered Feb. 14, 2012

Int. Cls.: 9, 10, 42 and 44

TRADEMARK

SERVICE MARK

PRINCIPAL REGISTER

BEIJING TOP GRADE MEDICAL EQUIPMENT CO., LTD. (CHINA LIMITED LIABILITY COMPANY)
NO.11 YONGCHANG NORTH ROAD, BDA
BEIJING, CHINA

FOR: BETATRONS; COMPUTER OPERATING RECORDED PROGRAMS; COMPUTER OPERATING SOFTWARE; COMPUTER PROGRAMS FOR USING THE INTERNET AND THE WORLDWIDE WEB; CYCLOTRONS; DATA PROCESSORS; PARTICLE ACCELERATORS, IN CLASS 9 (U.S. CLS. 21, 23, 26, 36 AND 38).

FIRST USE 3-17-2009; IN COMMERCE 3-17-2009.

FOR: APPARATUS FOR BLOOD ANALYSIS; APPARATUS FOR CLINICAL DIAGNOSIS; MEDICAL DIAGNOSTIC APPARATUS, ANALYTICAL APPARATUS FOR MEDICAL PURPOSES AND BLOOD PRESSURE MEASURING APPARATUS; MEDICAL DIAGNOSTIC INSTRUMENTS FOR THE ANALYSIS OF BODY FLUIDS; PROTECTIVE CASES FOR MEDICAL INHALERS; RADIOLOGICAL APPARATUS FOR MEDICAL PURPOSES; RADIOTHERAPY APPARATUS; SURGICAL AND MEDICAL APPARATUS AND INSTRUMENTS FOR USE IN GENERAL SURGERY; ULTRASOUND DIAGNOSTIC APPARATUS; X-RAY DIAGNOSTIC APPARATUS, IN CLASS 10 (U.S. CLS. 26, 39 AND 44).

FIRST USE 9-1-2004; IN COMMERCE 9-1-2004.

FOR: DEVELOPING AND UPDATING COMPUTER SOFTWARE; ENGINEERING SERVICES IN THE FIELDS OF TRAFFIC AND TRANSPORTATION; ENGINEERING SURVEYING; MAINTENANCE OF COMPUTER SOFTWARE; PACKAGING DESIGN; SCIENTIFIC STUDY AND RESEARCH IN THE FIELDS OF MEDICINE, THE PREVENTION, TREATMENT AND MANAGEMENT OF ILLNESS, HEALTH CARE DELIVERY AND THE SCIENTIFIC ASPECTS OF HEALTH CARE POLICY, HEALTH CARE COST MANAGEMENT AND FINANCING AS THESE FIELDS IMPACT ON QUALITY OF HEALTH CARE; SERVICES FOR DESIGNING COMPUTER SOFTWARE; TESTING OR RESEARCH ON MACHINES, APPARATUS AND INSTRUMENTS, IN CLASS 42 (U.S. CLS. 100 AND 101).

FIRST USE 6-9-2008; IN COMMERCE 6-9-2008.

FOR: CHIROPRACTICS; CONSULTING SERVICES IN THE FIELDS OF DIAGNOSTIC MEDICAL TESTING AND NUTRITION; HOSPITALS; MEDICAL ASSISTANCE SERVICES;



David J. Kyjars

Director of the United States Patent and Trademark Office

Reg. No. 4,098,192 MEDICAL CLINICS; NURSING SERVICES; PHYSICAL THERAPY; PSYCHOLOGICAL COUNSELING; RENTAL OF SANITATION FACILITIES, IN CLASS 44 (U.S. CLS. 100 AND 101).

FIRST USE 7-18-2004; IN COMMERCE 7-18-2004.

NO CLAIM IS MADE TO THE EXCLUSIVE RIGHT TO USE THE NON-LATIN CHARACTERS THAT TRANSLITERATE TO "YI LIAO" AND WORDS "TOP GRADE HEALTHCARE", APART FROM THE MARK AS SHOWN.

THE NON-LATIN CHARACTERS IN THE MARK TRANSLITERATE TO "DA JI YI LIAO" AND THIS MEANS "DA JI MEDICAL TREATMENT" IN ENGLISH.

THE MARK CONSISTS OF A STYLIZED LETTER "R" WITH A SOLID DOT TO ITS UPPER LEFT. FOLLOWING THE "R" ARE FOUR CHINESE CHARACTERS, BELOW WHICH IS THE WORDING "TOP GRADE HEALTHCARE".

THE ENGLISH TRANSLATION OF "YI LIAO" IN THE MARK IS "MEDICAL TREATMENT". THE WORDING "DA JI" HAS NO MEANING IN A FOREIGN LANGUAGE.

SER. NO. 85-247,800, FILED 2-21-2011.

ALYSSA STEEL, EXAMINING ATTORNEY

United States of America

United States Patent and Trademark Office



Reg. No. 4,098,193

Registered Feb. 14, 2012

Int. Cls.: 29, 30 and 32

TRADEMARK

PRINCIPAL REGISTER

PRAN EXPORTS LTD (BANGLADESH LIMITED COMPANY (LTD.))
32-12 61ST ST
QUEENS, NY 11377

FOR: VEGETABLE-BASED SNACK FOODS; NUT-BASED SNACK FOODS; PICKLES; PICKLED GARLIC USED AS A VEGETABLE; PICKLED OLIVES; JELLIES AND JAMS; ULTRA-HIGH-TEMPERATURE PROCESSED MILK; PASTEURIZED MILK; FLAVORED MILK-BASED BEVERAGES WITH A HIGH MILK CONTENT; FRUIT-BASED RAW FOOD BARS; PROCESSED SOY BEANS USED AS A SNACK, IN CLASS 29 (U.S. CL. 46).

FIRST USE 1-1-2006; IN COMMERCE 1-1-2006.

FOR: WHEAT-BASED SNACK FOODS; MUSTARD OIL USED AS A SEASONING OR CONDIMENT; CRACKERS; CANDY; LOLLIPOPS; TOFFEES; CHOCOLATE; CHOCOLATE SYRUP; CHOCOLATE SAUCE; CHEWING GUM; BISCUITS AND BREAD; CAKES; WAFERS; SPICES; TEA; COFFEE; RICE; CHUTNEY, IN CLASS 30 (U.S. CL. 46).

FIRST USE 1-1-2006; IN COMMERCE 1-1-2006.

FOR: FRUIT DRINKS AND FRUIT JUICES; DRINKING WATER; NON-ALCOHOLIC CARBONATED BEVERAGES, IN CLASS 32 (U.S. CLS. 45, 46 AND 48).

FIRST USE 1-1-2006; IN COMMERCE 1-1-2006.

THE MARK CONSISTS OF THE TEXT "PRAN" LOCATED AT THE CENTER OF THE DRAWING IN WHITE; THE DRAWING IS CIRCULAR AND RESEMBLES A FLAME IN SHAPE; SURROUNDING THE TEXT IS THE COLOR RED WITH AN OUTLINE IN YELLOW.

THE COLOR(S) RED, WHITE AND YELLOW IS/ARE CLAIMED AS A FEATURE OF THE MARK.

SER. NO. 85-248,385, FILED 2-22-2011.

PAULA MAHONEY, EXAMINING ATTORNEY



David J. Kyffers

Director of the United States Patent and Trademark Office

United States of America

United States Patent and Trademark Office



Reg. No. 4,098,194

Registered Feb. 14, 2012

Int. Cls.: 29, 30 and 32

TRADEMARK

PRINCIPAL REGISTER

PRAN EXPORTS LTD (BANGLADESH LIMITED COMPANY (LTD.))
32-12 61ST ST
QUEENS, NY 11377

FOR: VEGETABLE-BASED SNACK FOODS; NUT-BASED SNACK FOODS; PICKLES; PICKLED GARLIC USED AS A VEGETABLE; PICKLED OLIVES; JELLIES AND JAMS; ULTRA-HIGH-TEMPERATURE PROCESSED MILK; PASTEURIZED MILK; FLAVORED MILK-BASED BEVERAGES WITH A HIGH MILK CONTENT; FRUIT-BASED RAW FOOD BARS; PROCESSED SOY BEANS USED AS A SNACK, IN CLASS 29 (U.S. CL. 46).

FIRST USE 1-1-2006; IN COMMERCE 1-1-2006.

FOR: WHEAT-BASED SNACK FOODS; MUSTARD OIL USED AS A SEASONING OR CONDIMENT; CRACKERS; CANDY; LOLLIPOPS; TOFFEES; CHOCOLATE; CHOCOLATE SYRUP; CHOCOLATE SAUCE; CHEWING GUM; BISCUITS AND BREAD; CAKES; WAFERS; SPICES; TEA; COFFEE; RICE; CHUTNEY, IN CLASS 30 (U.S. CL. 46).

FIRST USE 1-1-2006; IN COMMERCE 1-1-2006.

FOR: FRUIT DRINKS AND FRUIT JUICES; DRINKING WATER; NON-ALCOHOLIC CARBONATED BEVERAGES, IN CLASS 32 (U.S. CLS. 45, 46 AND 48).

FIRST USE 1-1-2006; IN COMMERCE 1-1-2006.

THE MARK CONSISTS OF THE TEXT "PRAN" IN BENGALI LOCATED AT THE CENTER OF THE DRAWING IN WHITE; THE DRAWING IS CIRCULAR AND RESEMBLES A FLAME IN SHAPE; SURROUNDING THE TEXT IS THE COLOR RED WITH AN OUTLINE IN YELLOW.

THE COLOR(S) RED, WHITE AND YELLOW IS/ARE CLAIMED AS A FEATURE OF THE MARK.

THE NON-LATIN CHARACTERS IN THE MARK TRANSLITERATE TO "PRAN" AND THIS HAS NO MEANING IN A FOREIGN LANGUAGE.

SER. NO. 85-248,438, FILED 2-22-2011.



David J. Kyffers

Director of the United States Patent and Trademark Office

Reg. No. 4,098,194 PAULA MAHONEY, EXAMINING ATTORNEY

United States of America

United States Patent and Trademark Office

VIDEO VITE

Reg. No. 4,098,195

Registered Feb. 14, 2012

Int. Cl.: 42

SERVICE MARK

PRINCIPAL REGISTER

MY VISN LLC (CALIFORNIA LIMITED LIABILITY COMPANY)
3399 BENNETT DRIVE, UNIT 30
LOS ANGELES, CA 90068

FOR: PREPARATION OF ELECTRONIC INVITATIONS; COMPUTER SERVICES, NAMELY, DESIGNING, CREATING AND MAINTAINING WEB SITES FOR OTHERS; PROVIDING PARTY AND EVENT PLANNING AND INVITATION INFORMATION PROVIDED BY USERS VIA AN ELECTRONICS COMMUNICATIONS NETWORK; COMPUTER SERVICES, NAMELY, PROVIDING A WEB SITE THAT AUTOMATES PARTY AND ENTERTAINMENT EVENT MANAGEMENT THAT CONSISTS OF GUEST LISTS, GUEST INFORMATION, RESTAURANT INFORMATION AND INVITATION CREATION AND DELIVERY, IN CLASS 42 (U.S. CLS. 100 AND 101).

FIRST USE 1-0-2011; IN COMMERCE 1-0-2011.

THE MARK CONSISTS OF STANDARD CHARACTERS WITHOUT CLAIM TO ANY PARTICULAR FONT, STYLE, SIZE, OR COLOR.

NO CLAIM IS MADE TO THE EXCLUSIVE RIGHT TO USE "VIDEO", APART FROM THE MARK AS SHOWN.

SER. NO. 85-248,506, FILED 2-22-2011.

AMY HELLA, EXAMINING ATTORNEY



David J. Kyffers

Director of the United States Patent and Trademark Office

United States of America

United States Patent and Trademark Office



Reg. No. 4,098,196

Registered Feb. 14, 2012

Int. Cl.: 44

SERVICE MARK

PRINCIPAL REGISTER

APRIL NEWBY (UNITED STATES INDIVIDUAL), DBA WINKIN' TWINKIES
123 EAST SHORE DRIVE
KEMAH, TX 77565

FOR: BODY WAXING SERVICES FOR HAIR REMOVAL IN HUMANS; COSMETIC SERVICES, NAMELY, NON-PERMANENT HAIR REMOVAL; PERSONAL HAIR REMOVAL SERVICES, IN CLASS 44 (U.S. CLS. 100 AND 101).

FIRST USE 1-1-2009; IN COMMERCE 1-1-2009.

THE MARK CONSISTS OF THE HEAD OF A GIRL WITH HER HAIR IN PIG TAILS WINKING AND SMILING AND THE WORDS "WINKIN' TWINKIES" TO THE RIGHT OF THE DESIGN. THE COLOR YELLOW APPEARS IN THE HAIR, THE COLOR TAN APPEARS AS THE SKIN COLOR, THE COLOR BLUE APPEARS IN THE EYE, THE COLOR WHITE APPEARS IN THE EYE AND TEETH, THE COLOR BLACK APPEARS AS THE OUTLINE OF THE FACE, HAIR AND FEATURES, AND THE COLOR RED APPEARS IN THE MOUTH AND WORDS "WINKIN' TWINKIES".

THE COLOR(S) YELLOW, TAN, BLUE, WHITE, RED AND BLACK IS/ARE CLAIMED AS A FEATURE OF THE MARK.

SER. NO. 85-248,584, FILED 2-22-2011.

CARYN GLASSER, EXAMINING ATTORNEY



David J. Kyros

Director of the United States Patent and Trademark Office

United States of America

United States Patent and Trademark Office

La Grande

Reg. No. 4,098,197

Registered Feb. 14, 2012

Int. Cl.: 32

TRADEMARK

PRINCIPAL REGISTER

PACIFIC CAPITAL, LLC (ARIZONA LIMITED LIABILITY COMPANY)
P.O. BOX 16298
70 S VAL VISTA DR., A3-418
PHOENIX, AZ 85060

FOR: FLAVORED WATERS; FRUIT BEVERAGES; FRUIT CONCENTRATES AND PUREES USED AS INGREDIENTS OF BEVERAGES; FRUIT DRINKS; FRUIT DRINKS AND FRUIT JUICES; FRUIT DRINKS AND JUICES; FRUIT FLAVORED DRINKS; FRUIT FLAVORED DRINKS; FRUIT-BASED BEVERAGES; FRUIT-FLAVORED BEVERAGES; FRUIT-FLAVORED BEVERAGES; POWDERS USED IN THE PREPARATION OF FRUIT-BASED BEVERAGES; SYRUP SUBSTITUTES FOR MAKING BEVERAGES; SYRUPS FOR BEVERAGES; SYRUPS FOR MAKING BEVERAGES; SYRUPS FOR MAKING FRUIT-FLAVORED DRINKS, IN CLASS 32 (U.S. CLS. 45, 46 AND 48).

FIRST USE 2-1-2011; IN COMMERCE 2-1-2011.

THE MARK CONSISTS OF STANDARD CHARACTERS WITHOUT CLAIM TO ANY PARTICULAR FONT, STYLE, SIZE, OR COLOR.

THE ENGLISH TRANSLATION OF "LA GRANDE" IN THE MARK IS "THE GREAT".

SER. NO. 85-249,254, FILED 2-23-2011.

DEIRDRE ROBERTSON, EXAMINING ATTORNEY



David J. Kybas

Director of the United States Patent and Trademark Office

United States of America

United States Patent and Trademark Office

SPRINTPAK

Reg. No. 4,098,198

SPRINTPAK, INC. (OHIO CORPORATION)
11820 BLACK RIVER SCHOOL ROAD
HOMERVILLE, OH 44235

Registered Feb. 14, 2012

Int. Cls.: 35, 39 and 40

FOR: ORDER FULFILLMENT SERVICES; INVENTORY MANAGEMENT, IN CLASS 35 (U.S. CLS. 100, 101 AND 102).

SERVICE MARK

FIRST USE 11-0-2006; IN COMMERCE 11-0-2006.

PRINCIPAL REGISTER

FOR: PACKAGING ARTICLES TO THE ORDER AND SPECIFICATION OF OTHERS, IN CLASS 39 (U.S. CLS. 100 AND 105).

FIRST USE 11-0-2006; IN COMMERCE 11-0-2006.

FOR: ASSEMBLY OF PRODUCTS FOR OTHERS; CUSTOM MANUFACTURE OF PALLETS AND CRATES TO THE ORDER AND SPECIFICATION OF OTHERS, IN CLASS 40 (U.S. CLS. 100, 103 AND 106).

FIRST USE 11-0-2006; IN COMMERCE 11-0-2006.

THE MARK CONSISTS OF STANDARD CHARACTERS WITHOUT CLAIM TO ANY PARTICULAR FONT, STYLE, SIZE, OR COLOR.

SER. NO. 85-250,506, FILED 2-24-2011.

PAULA MAHONEY, EXAMINING ATTORNEY



David J. Kybas

Director of the United States Patent and Trademark Office

United States of America

United States Patent and Trademark Office

AQUASPERSE

Reg. No. 4,098,199

Registered Feb. 14, 2012

Int. Cl.: 3

TRADEMARK

PRINCIPAL REGISTER

MAKI CREATIONS, INC (CALIFORNIA CORPORATION)
SUITE A 12781 TEMESCAL CANYON RD
23143 TEMESCAL CANYON RD
CORONA, CA 92883

FOR: COSMETIC MASSAGE CREAMS; MASSAGE CREAMS; MASSAGE GELS OTHER THAN FOR MEDICAL PURPOSES; MASSAGE LOTIONS; MASSAGE OILS, IN CLASS 3 (U.S. CLS. 1, 4, 6, 50, 51 AND 52).

FIRST USE 2-1-2011; IN COMMERCE 2-1-2011.

THE MARK CONSISTS OF STANDARD CHARACTERS WITHOUT CLAIM TO ANY PARTICULAR FONT, STYLE, SIZE, OR COLOR.

SER. NO. 85-250,804, FILED 2-24-2011.

ERIN FALK, EXAMINING ATTORNEY



David J. Kyffers

Director of the United States Patent and Trademark Office

United States of America

United States Patent and Trademark Office

NY2 Sportswear

Reg. No. 4,098,200

Registered Feb. 14, 2012

Int. Cl.: 25

TRADEMARK

PRINCIPAL REGISTER

SURIA LLC (CALIFORNIA LIMITED LIABILITY COMPANY), DBA NY2 SPORTSWEAR
556 N. DIAMOND BAR BLVD.
STE. 102
DIAMOND BAR, CA 91765

FOR: ATHLETIC APPAREL, NAMELY, SHIRTS, PANTS, JACKETS, FOOTWEAR, HATS
AND CAPS, ATHLETIC UNIFORMS, IN CLASS 25 (U.S. CLS. 22 AND 39).

FIRST USE 8-1-2010; IN COMMERCE 8-23-2010.

THE MARK CONSISTS OF STANDARD CHARACTERS WITHOUT CLAIM TO ANY PAR-
TICULAR FONT, STYLE, SIZE, OR COLOR.

NO CLAIM IS MADE TO THE EXCLUSIVE RIGHT TO USE "SPORTSWEAR", APART FROM
THE MARK AS SHOWN.

SER. NO. 85-250,969, FILED 2-24-2011.

TASNEEM HUSSAIN, EXAMINING ATTORNEY



David J. Kyffers

Director of the United States Patent and Trademark Office

United States of America

United States Patent and Trademark Office



Reg. No. 4,098,201

Registered Feb. 14, 2012

Int. Cl.: 20

TRADEMARK

PRINCIPAL REGISTER

JENNIFER RASINSKI (UNITED STATES INDIVIDUAL)
1336 UNION STREET
BROOKLYN, NY 11213

FOR: ACCENT PILLOWS; BED PILLOWS; DECORATIVE 3D PILLOWS AND CUSHIONS; FLOOR PILLOWS; NOVELTY PILLOWS; PILLOWS, IN CLASS 20 (U.S. CLS. 2, 13, 22, 25, 32 AND 50).

FIRST USE 6-30-2009; IN COMMERCE 6-30-2009.

THE MARK CONSISTS OF A WHITE BACKGROUND, WITH THE UPPERCASE LETTERS "VM" IN PURPLE, WITH THE SPACES LEFT AT THE TOP OF THE "V" AND THE BOTTOM OF THE "M" FILLED IN WITH THE COLOR YELLOW, AND THERE IS A FREE-STANDING YELLOW TRIANGLE SEPARATED BY A WHITE SPACE ABOVE THE TOP OF THE "M", PLUS TWO BLUE FREE-STANDING TRIANGLES - ONE TO THE RIGHT OF THE "M" AND ONE TO THE LEFT OF THE "V", BOTH THE LETTERS "VM" AND THE TRIANGLES ARE OUTLINED IN BLACK, BELOW THE LETTERS "VM" ARE TWO LINES OF BLACK LETTERING - THE FIRST READS: "VANILLA MEDALLIONS", AND THE SECOND LINE READS "HAND-CRAFTED WITH MAD LOVE".

THE COLOR(S) BLACK, WHITE, YELLOW, PURPLE, AND BLUE IS/ARE CLAIMED AS A FEATURE OF THE MARK.

SER. NO. 85-251,764, FILED 2-25-2011.

GIANCARLO CASTRO, EXAMINING ATTORNEY



David J. Kybas

Director of the United States Patent and Trademark Office

United States of America

United States Patent and Trademark Office



Reg. No. 4,098,202

MY HEALTH AND MONEY, LLC (DELAWARE LIMITED LIABILITY COMPANY)
1770 W. BERTEAU AVENUE, SUITE 506
CHICAGO, IL 60613

Registered Feb. 14, 2012

Int. Cl.: 35

FOR: PROVIDING A WEBSITE FEATURING A SEARCHABLE DIRECTORY PROVIDING PRICE COMPARISONS AND COST INFORMATION ABOUT HEALTHCARE GOODS AND SERVICES OF OTHERS; ONLINE REFERRAL SERVICES IN THE HEALTHCARE COMMUNITY, IN CLASS 35 (U.S. CLS. 100, 101 AND 102).

SERVICE MARK

PRINCIPAL REGISTER

FIRST USE 7-16-2009; IN COMMERCE 7-16-2009.

NO CLAIM IS MADE TO THE EXCLUSIVE RIGHT TO USE "HEALTH AND MONEY", APART FROM THE MARK AS SHOWN.

THE MARK CONSISTS OF THE STYLIZED WORDING "MY HEALTH AND MONEY" WITH THE WORDS "MY HEALTH" APPEARING IN LARGER TYPE THAN "AND MONEY". TO THE LEFT OF THE WORDS IS THE DESIGN OF A BOOK OR FOLDER, OPEN TO THE LEFT, WITH PAGES FLIPPING DOWN.

SER. NO. 85-251,944, FILED 2-25-2011.

JERI J. FICKES, EXAMINING ATTORNEY



David J. Kyjars

Director of the United States Patent and Trademark Office

United States of America

United States Patent and Trademark Office

One World Human Rescue

Reg. No. 4,098,203

Registered Feb. 14, 2012

Int. Cl.: 37

SERVICE MARK

PRINCIPAL REGISTER

ONE WORLD HUMAN RESCUE (TEXAS CORPORATION)
6080 S. HULEN ST.
SUITE 360
FORT WORTH, TX 76132

FOR: CHARITABLE SERVICES, NAMELY, RENOVATING AND CONSTRUCTING HOMES FOR LOW INCOME FAMILIES; CONSTRUCTION OF INFRASTRUCTURE, NEW OR DAMAGED BY DISASTERS, NAMELY, ROADS, WATER PURIFICATION PLANTS, WATER AND SEWAGE PIPES, UTILITIES, COMMERCIAL AND RESIDENTIAL BUILDINGS; HOUSING SERVICES, NAMELY, REPAIR, IMPROVEMENT, AND CONSTRUCTION OF RESIDENTIAL REAL PROPERTY, IN CLASS 37 (U.S. CLS. 100, 103 AND 106).

FIRST USE 11-5-2010; IN COMMERCE 12-31-2010.

THE MARK CONSISTS OF STANDARD CHARACTERS WITHOUT CLAIM TO ANY PARTICULAR FONT, STYLE, SIZE, OR COLOR.

SER. NO. 85-252,026, FILED 2-25-2011.

ZACHARY BELLO, EXAMINING ATTORNEY



David J. Kyffers

Director of the United States Patent and Trademark Office

United States of America

United States Patent and Trademark Office



Reg. No. 4,098,204

Registered Feb. 14, 2012

Int. Cl.: 41

SERVICE MARK

PRINCIPAL REGISTER

ZULU RACING, LLC (GEORGIA LIMITED LIABILITY COMPANY)
579 BERKELEY LANE
KENNESAW, GA 30144

FOR: SPORTS AND ENTERTAINMENT SERVICES, NAMELY, PROVIDING, ARRANGING, CONDUCTING, OPERATING, ROAD RUNNING, TRAIL RUNNING, RUNNING, CYCLING, MULTISPORT RACES AND PROVIDING RACE TIMING SERVICES FOR ROAD RUNNING, TRAIL RUNNING, RUNNING, CYCLING AND MULTISPORT RACES, IN CLASS 41 (U.S. CLS. 100, 101 AND 107).

FIRST USE 1-15-2010; IN COMMERCE 2-1-2010.

THE MARK CONSISTS OF A FORWARD-FACING ZEBRA'S HEAD AND NECK HAVING A FIERCE LOOK ON ITS FACE AND A LONG FLOWING MANE.

SER. NO. 85-252,406, FILED 2-25-2011.

JULIE GUTTADAURO, EXAMINING ATTORNEY



David J. Kybas

Director of the United States Patent and Trademark Office

United States of America

United States Patent and Trademark Office

MYTHMAKER

Reg. No. 4,098,205

JOSEPH CAMPBELL FOUNDATION (HAWAII CORPORATION)
180 DE BURGH DRIVE
SAN ANSELMO, CA 94960

Registered Feb. 14, 2012

Int. Cls.: 18, 25 and 26

FOR: MESSENGER BAGS AND TOTE BAGS, IN CLASS 18 (U.S. CLS. 1, 2, 3, 22 AND 41).

FIRST USE 6-11-2010; IN COMMERCE 6-11-2010.

TRADEMARK

FOR: CLOTHING, NAMELY, T-SHIRTS, POLO SHIRTS, TANK TOPS, SWEAT SHIRTS, AND HATS, IN CLASS 25 (U.S. CLS. 22 AND 39).

PRINCIPAL REGISTER

FIRST USE 6-11-2010; IN COMMERCE 6-11-2010.

FOR: BUTTONS, IN CLASS 26 (U.S. CLS. 37, 39, 40, 42 AND 50).

FIRST USE 6-11-2010; IN COMMERCE 6-11-2010.

THE MARK CONSISTS OF STANDARD CHARACTERS WITHOUT CLAIM TO ANY PARTICULAR FONT, STYLE, SIZE, OR COLOR.

SER. NO. 85-252,676, FILED 2-26-2011.

MARGARET POWER, EXAMINING ATTORNEY



David J. Kyffers

Director of the United States Patent and Trademark Office

United States of America

United States Patent and Trademark Office



Reg. No. 4,098,206

Registered Feb. 14, 2012

Int. Cl.: 42

SERVICE MARK

PRINCIPAL REGISTER

HOMEAWAY.COM, INC. (DELAWARE CORPORATION)
SUITE 300
1011 W. FIFTH STREET
AUSTIN, TX 78703

FOR: COMPUTER SERVICES, NAMELY, PROVIDING SEARCH PLATFORMS RELATED TO REAL ESTATE TO ALLOW USERS TO REQUEST CONTENT FROM AND RECEIVE CONTENT TO A COMPUTER OR MOBILE DEVICE; ASP FEATURING SOFTWARE FOR USE BY REAL ESTATE AND TRAVEL-BASED COMPANIES AND INDIVIDUALS TO ADVERTISE SPECIALS, MAKE RESERVATIONS, OFFER COUPONS, SPECIALS, DISCOUNTS, AND DIRECTIONS AND FOR USE IN INTERACTIVE CUSTOMER SERVICES RELATED TO THE RENTAL OR PURCHASE OF REAL ESTATE; DESIGN AND DEVELOPMENT OF VISUALIZATION TECHNOLOGIES FOR ADVERTISEMENT OF REAL-ESTATE AND BUSINESS OF OTHERS; APPLICATION SERVICE PROVIDER, NAMELY, HOSTING, MANAGING, DEVELOPING, ANALYZING, AND MAINTAINING APPLICATIONS, SOFTWARE, AND WEB SITES, OF OTHERS IN THE FIELDS OF ADVERTISING AND MARKETING; COMPUTER SERVICES, NAMELY, ACTING AS AN APPLICATION SERVICE PROVIDER IN THE FIELD OF KNOWLEDGE MANAGEMENT TO HOST COMPUTER APPLICATION SOFTWARE FOR CREATING SEARCHABLE DATABASES OF INFORMATION AND DATA; COMPUTER SERVICES IN THE NATURE OF CUSTOMIZED WEB PAGES FEATURING USER-DEFINED INFORMATION AND PERSONAL PROFILES; COMPUTER SERVICES, NAMELY, PROVIDING SEARCH ENGINES FOR OBTAINING DATA ON A GLOBAL COMPUTER NETWORK; PROVIDING A WEBSITE THAT GIVES USERS THE ABILITY TO CREATE CUSTOMIZED WEB PAGES FEATURING USER-DEFINED INFORMATION, IN CLASS 42 (U.S. CLS. 100 AND 101).



FIRST USE 12-15-2007; IN COMMERCE 1-19-2008.

OWNER OF U.S. REG. NOS. 2,820,989, 3,596,175 AND OTHERS.

THE MARK CONSISTS OF A PICTURE OF THE SUN RISING BEHIND A HOME WITH THE LITERAL ELEMENTS "VRBO FROM HOMEAWAY" TO THE RIGHT OF SUN RISING BEHIND THE HOME.

SER. NO. 85-253,297, FILED 2-28-2011.

KAPIL BHANOT, EXAMINING ATTORNEY

David J. Kappas

Director of the United States Patent and Trademark Office

United States of America

United States Patent and Trademark Office

AZALEA HEALTH INNOVATIONS

Reg. No. 4,098,207

Registered Feb. 14, 2012

Int. Cl.: 42

SERVICE MARK

PRINCIPAL REGISTER

AZALEA HEALTH INNOVATIONS, INC. (GEORGIA CORPORATION)
100 NORTH PATTERSON STREET
VALDOSTA, GA 31601

FOR: PROVIDING A WEBSITE FEATURING NON-DOWNLOADABLE SOFTWARE FOR MEDICAL PRACTICE MANAGEMENT, FOR MANAGEMENT OF MEDICAL LABORATORIES, FOR MANAGEMENT OF DATA RELATED TO DRUG AND ALCOHOL TESTING, AND FOR MANAGEMENT OF ELECTRONIC HEALTHCARE RECORDS, IN CLASS 42 (U.S. CLS. 100 AND 101).

FIRST USE 0-0-2008; IN COMMERCE 0-0-2008.

THE MARK CONSISTS OF STANDARD CHARACTERS WITHOUT CLAIM TO ANY PARTICULAR FONT, STYLE, SIZE, OR COLOR.

NO CLAIM IS MADE TO THE EXCLUSIVE RIGHT TO USE "HEALTH", APART FROM THE MARK AS SHOWN.

SER. NO. 85-255,390, FILED 3-2-2011.

KATHLEEN LORENZO, EXAMINING ATTORNEY



David J. Kyjars

Director of the United States Patent and Trademark Office

United States of America

United States Patent and Trademark Office

AZALEA HEALTH INNOVATIONS

Reg. No. 4,098,208

AZALEA HEALTH INNOVATIONS, INC. (GEORGIA CORPORATION)
100 NORTH PATTERSON STREET
VALDOSTA, GA 31601

Registered Feb. 14, 2012

Int. Cls.: 35 and 42

FOR: CONSULTING SERVICES IN THE FIELDS OF MEDICAL BILLING SERVICES AND MANAGEMENT OF MEDICAL PRACTICES AND MEDICAL LABORATORIES , IN CLASS 35 (U.S. CLS. 100, 101 AND 102).

SERVICE MARK

FIRST USE 0-0-2008; IN COMMERCE 0-0-2008.

PRINCIPAL REGISTER

FOR: COMPUTER HARDWARE AND SOFTWARE CONSULTING SERVICES IN THE FIELDS OF MEDICAL BILLING, MEDICAL MANAGEMENT, MEDICAL LABORATORIES, DRUG AND ALCOHOL TESTING, AND ELECTRONIC HEALTHCARE RECORDS, IN CLASS 42 (U.S. CLS. 100 AND 101).

FIRST USE 0-0-2008; IN COMMERCE 0-0-2008.

THE MARK CONSISTS OF STANDARD CHARACTERS WITHOUT CLAIM TO ANY PARTICULAR FONT, STYLE, SIZE, OR COLOR.

NO CLAIM IS MADE TO THE EXCLUSIVE RIGHT TO USE "HEALTH", APART FROM THE MARK AS SHOWN.

SER. NO. 85-255,393, FILED 3-2-2011.

KATHLEEN LORENZO, EXAMINING ATTORNEY



David J. Kyros

Director of the United States Patent and Trademark Office

United States of America

United States Patent and Trademark Office

WICKED

Reg. No. 4,098,209

Registered Feb. 14, 2012

Int. Cl.: 43

SERVICE MARK

PRINCIPAL REGISTER

SINELLI, JEFFREY (UNITED STATES INDIVIDUAL)
SUITE 180LL
1310 ELM STREET
DALLAS, TX 75202

FOR: RESTAURANT SERVICES FEATURING SANDWICHES, IN CLASS 43 (U.S. CLS. 100 AND 101).

FIRST USE 12-1-2003; IN COMMERCE 12-1-2003.

THE MARK CONSISTS OF STANDARD CHARACTERS WITHOUT CLAIM TO ANY PARTICULAR FONT, STYLE, SIZE, OR COLOR.

OWNER OF U.S. REG. NO. 3,439,536.

SER. NO. 85-256,713, FILED 3-3-2011.

GIANCARLO CASTRO, EXAMINING ATTORNEY



David J. Kyffers

Director of the United States Patent and Trademark Office

United States of America

United States Patent and Trademark Office

PARASHOCK

Reg. No. 4,098,210

KOTOBUKI & CO., LTD. (JAPAN CORPORATION)

Registered Feb. 14, 2012

OAZA KUJIRAI-138
KAWAGOE-SHI SAITAMA, JAPAN

Int. Cl.: 16

FOR: WRITING INSTRUMENTS, IN CLASS 16 (U.S. CLS. 2, 5, 22, 23, 29, 37, 38 AND 50).

TRADEMARK

THE MARK CONSISTS OF STANDARD CHARACTERS WITHOUT CLAIM TO ANY PARTICULAR FONT, STYLE, SIZE, OR COLOR.

PRINCIPAL REGISTER

OWNER OF JAPAN REG. NO. 2286980, DATED 12-26-1990, EXPIRES 12-26-2020.

SER. NO. 85-256,883, FILED 3-3-2011.

CHRISIE B. KING, EXAMINING ATTORNEY



David J. Kybas

Director of the United States Patent and Trademark Office

United States of America

United States Patent and Trademark Office

treats!

Reg. No. 4,098,211

Registered Feb. 14, 2012

Int. Cls.: 16 and 41

TRADEMARK

SERVICE MARK

PRINCIPAL REGISTER

THE WESTERMAN TRUST (CALIFORNIA TRUST)
838 NOWITA PLACE
VENICE, CA 90291

FOR: PRINTED MATTER, NAMELY, NEWSPAPERS, PHOTOGRAPHS, MAGAZINES, BOOKS, PRINTED PERIODICALS, NEWSLETTERS, AND BROCHURES ALL IN THE FIELDS OF SECURITIES, OPTIONS AND OTHER FINANCIAL INSTRUMENTS, IN CLASS 16 (U.S. CLS. 2, 5, 22, 23, 29, 37, 38 AND 50).

FIRST USE 3-2-2011; IN COMMERCE 3-2-2011.

FOR: PROVIDING ON-LINE NON-DOWNLOADABLE MAGAZINES IN THE FIELD OF HIGH QUALITY FASHION AND ADULT PHOTOGRAPHY, IN CLASS 41 (U.S. CLS. 100, 101 AND 107).

FIRST USE 3-2-2011; IN COMMERCE 3-2-2011.

SER. NO. 85-257,503, FILED 3-3-2011.

WANDA KAY PRICE, EXAMINING ATTORNEY



David J. Kyffers

Director of the United States Patent and Trademark Office

United States of America

United States Patent and Trademark Office



Reg. No. 4,098,212

Registered Feb. 14, 2012

Int. Cl.: 31

TRADEMARK

PRINCIPAL REGISTER

INVERSIONES MONCURI S.A. (CHILE CORPORATION)
NAPOLEON 3665 - LAS CONDES
SANTIAGO, CHILE

FOR: FRESH FRUIT; FRUITS, NAMELY, GRAPES, IN CLASS 31 (U.S. CLS. 1 AND 46).

FIRST USE 2-15-1962; IN COMMERCE 2-15-1962.

THE MARK CONSISTS OF A HEXAGONAL FIGURE INSIDE OF WHICH APPEARS THE WORD "LEPE" IN STYLIZED LETTERS. THE COLOR BLUE APPEARS IN THE HEXAGONAL FIGURE AND THE WORD "LEPE".

THE COLOR(S) BLUE IS/ARE CLAIMED AS A FEATURE OF THE MARK.

THE WORDING "LEPE" HAS NO MEANING IN A FOREIGN LANGUAGE.

SEC. 2(F).

SER. NO. 85-257,910, FILED 3-4-2011.

B. PARADEWELAI, EXAMINING ATTORNEY



David J. Kyffers

Director of the United States Patent and Trademark Office

United States of America

United States Patent and Trademark Office

BB&T SIMPLEPLUS

Reg. No. 4,098,213

BB&T CORPORATION (NORTH CAROLINA CORPORATION)

Registered Feb. 14, 2012

P.O. BOX 1255
WINSTON-SALEM, NC 271011255

Int. Cl.: 36

FOR: MERCHANT BANKING SERVICES; MERCHANT SERVICES, NAMELY, PAYMENT TRANSACTION PROCESSING SERVICES, IN CLASS 36 (U.S. CLS. 100, 101 AND 102).

SERVICE MARK

FIRST USE 2-22-2011; IN COMMERCE 2-22-2011.

PRINCIPAL REGISTER

THE MARK CONSISTS OF STANDARD CHARACTERS WITHOUT CLAIM TO ANY PARTICULAR FONT, STYLE, SIZE, OR COLOR.

OWNER OF U.S. REG. NOS. 3,091,256, 3,337,198 AND OTHERS.

SER. NO. 85-257,964, FILED 3-4-2011.

FLORENTINA BLANDU, EXAMINING ATTORNEY



David J. Kyffers

Director of the United States Patent and Trademark Office

United States of America

United States Patent and Trademark Office



Reg. No. 4,098,214

Registered Feb. 14, 2012

Int. Cl.: 30

FERMENTACIONES MEXICANAS, S.A. DE C.V. (MEXICO CORPORATION)
KM, 57.5 CARRETERA MEXICO-TOLUCA
COL. PARQUE INDUST. EX RANCH EL COECILLO
TOLUCA, ESTADO DE MEX., MEXICO 50200

FOR: YEAST, IN CLASS 30 (U.S. CL. 46).

TRADEMARK

OWNER OF MEXICO REG. NO. 1113225, DATED 7-31-2009, EXPIRES 6-10-2019.

PRINCIPAL REGISTER

THE COLOR(S) BLUE AND GREEN IS/ARE CLAIMED AS A FEATURE OF THE MARK.

OWNER OF U.S. REG. NO. 2,923,766.

THE MARK CONSISTS OF THE WORD "AZTECA" IN GREEN BELOW A STYLIZED BLUE STAR FEATURING A GREEN SPIRAL DESIGN INSIDE THE STAR. A BLUE FLOWER APPEARS IN THE LEFT UPPER CORNER OF THE MARK AND A GREEN CIRCLE APPEARS TO THE CENTER RIGHT OF THE STYLIZED STAR.

THE ENGLISH TRANSLATION OF "AZTECA" IN THE MARK IS "AZTEC".

SER. NO. 85-258,123, FILED 3-4-2011.

DANNEAN HETZEL, EXAMINING ATTORNEY



David J. Kyfos

Director of the United States Patent and Trademark Office

United States of America
United States Patent and Trademark Office

CHIPMAX

Reg. No. 4,098,215

CONTINENTAL BIOMASS INDUSTRIES, INC. (NEW HAMPSHIRE CORPORATION)
22 WHITTIER STREET
NEWTON, NH 03858

Registered Feb. 14, 2012

Int. Cl.: 7

FOR: CHIPPERS, NAMELY, WOOD CHIPPING MACHINES, IN CLASS 7 (U.S. CLS. 13, 19, 21, 23, 31, 34 AND 35).

TRADEMARK

FIRST USE 2-1-2010; IN COMMERCE 2-1-2010.

PRINCIPAL REGISTER

THE MARK CONSISTS OF STANDARD CHARACTERS WITHOUT CLAIM TO ANY PARTICULAR FONT, STYLE, SIZE, OR COLOR.

SER. NO. 85-259,379, FILED 3-7-2011.

CHARISMA HAMPTON, EXAMINING ATTORNEY



David J. Kybas

Director of the United States Patent and Trademark Office

United States of America

United States Patent and Trademark Office

Ratools

Reg. No. 4,098,216

Registered Feb. 14, 2012

Int. Cls.: 6, 7, 8 and 18

TRADEMARK

PRINCIPAL REGISTER

GRANITE MOUNTAIN INDUSTRIES LLC (NEW HAMPSHIRE LIMITED LIABILITY COMPANY)
PO BOX 1446
KENNEBUNKPORT, ME 04046

FOR: DOORS AND WINDOWS OF METAL, NAMELY, STEEL DOORS AND FRAMES, AND STEEL WINDOW FRAMES, IN CLASS 6 (U.S. CLS. 2, 12, 13, 14, 23, 25 AND 50).

FIRST USE 5-24-2004; IN COMMERCE 5-25-2004.

FOR: POWER TOOLS, NAMELY, HAND-HELD HYDRAULIC DOOR OPENING TOOLS, IN CLASS 7 (U.S. CLS. 13, 19, 21, 23, 31, 34 AND 35).

FIRST USE 5-24-2004; IN COMMERCE 5-25-2004.

FOR: HAND TOOLS, NAMELY, HAMMERS, PRYBARS, AND BOLT CUTTERS AND BATTERING RAMS; TOOL KITS COMPRISED OF HAMMERS, PRYBARS, BOLT CUTTERS AND BATTERING RAMS, IN CLASS 8 (U.S. CLS. 23, 28 AND 44).

FIRST USE 5-24-2004; IN COMMERCE 5-25-2004.

FOR: BACKPACKS, NAMELY, BACKPACKS THAT CARRY HAND TOOLS, IN CLASS 18 (U.S. CLS. 1, 2, 3, 22 AND 41).

FIRST USE 5-24-2004; IN COMMERCE 5-25-2004.

THE MARK CONSISTS OF STANDARD CHARACTERS WITHOUT CLAIM TO ANY PARTICULAR FONT, STYLE, SIZE, OR COLOR.

SER. NO. 85-259,542, FILED 3-7-2011.

PATRICIA EVANKO, EXAMINING ATTORNEY



David J. Kyjars

Director of the United States Patent and Trademark Office

United States of America

United States Patent and Trademark Office

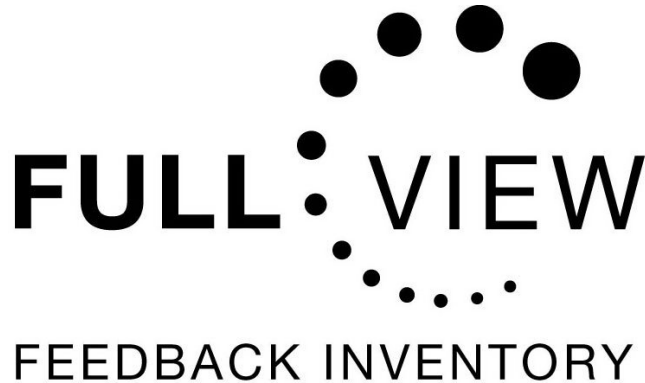

Reg. No. 4,098,217

Registered Feb. 14, 2012

Int. Cl.: 41

SERVICE MARK

PRINCIPAL REGISTER

ROSELLE, BRUCE E. (UNITED STATES INDIVIDUAL), DBA ROSELLE LEADERSHIP STRATEGIES, INC.
810 RIVER LANE
ANOKA, MN 55303

FOR: DEVELOPING TRAINING SYSTEMS AND LEARNING METHODOLOGIES FOR OTHERS; PROVIDING GROUP COACHING AND LEARNING FORUMS IN THE FIELD OF LEADERSHIP DEVELOPMENT, IN CLASS 41 (U.S. CLS. 100, 101 AND 107).

FIRST USE 5-1-1996; IN COMMERCE 5-1-1996.

NO CLAIM IS MADE TO THE EXCLUSIVE RIGHT TO USE "FEEDBACK INVENTORY", APART FROM THE MARK AS SHOWN.

THE MARK CONSISTS OF THE WORDS "FULLVIEW FEEDBACK INVENTORY" AND A SET OF DOTS INCREASING IN SIZE AND NEARLY COMPLETING A FULL CIRCLE WITHIN THE WORD "FULLVIEW".

SER. NO. 85-259,642, FILED 3-7-2011.

FLORENTINA BLANDU, EXAMINING ATTORNEY



David J. Kyros

Director of the United States Patent and Trademark Office

United States of America

United States Patent and Trademark Office

FEATHERLIGHT

Reg. No. 4,098,218

AGY HOLDING CORP. (DELAWARE CORPORATION)
2556 WAGENER ROAD
AIKEN, SC 29801

Registered Feb. 14, 2012

Int. Cl.: 21

FOR: GLASS ROVINGS, FILAMENTS AND STRANDS FOR NON-TEXTILE PURPOSES;
SEMI-WORKED GLASS FOR FURTHER MANUFACTURE AND PROCESSING IN THE
FORM OF GLASS ROVINGS, FILAMENTS AND STRANDS, IN CLASS 21 (U.S. CLS. 2, 13,
23, 29, 30, 33, 40 AND 50).

TRADEMARK

PRINCIPAL REGISTER

FIRST USE 2-25-2008; IN COMMERCE 7-24-2009.

THE MARK CONSISTS OF STANDARD CHARACTERS WITHOUT CLAIM TO ANY PAR-
TICULAR FONT, STYLE, SIZE, OR COLOR.

SER. NO. 85-259,818, FILED 3-7-2011.

KAREN K. BUSH, EXAMINING ATTORNEY



David J. Kyffers

Director of the United States Patent and Trademark Office

United States of America

United States Patent and Trademark Office

QUICKSILVER

Reg. No. 4,098,219

AGY HOLDING CORP. (DELAWARE CORPORATION)
2556 WAGENER ROAD
AIKEN, SC 29801

Registered Feb. 14, 2012

Int. Cl.: 21

FOR: GLASS ROVINGS, FILAMENTS AND STRANDS FOR NON-TEXTILE PURPOSES;
SEMI-WORKED GLASS FOR FURTHER MANUFACTURE AND PROCESSING IN THE
FORM OF GLASS ROVINGS, FILAMENTS AND STRANDS, IN CLASS 21 (U.S. CLS. 2, 13,
23, 29, 30, 33, 40 AND 50).

TRADEMARK

PRINCIPAL REGISTER

FIRST USE 2-25-2008; IN COMMERCE 10-14-2009.

THE MARK CONSISTS OF STANDARD CHARACTERS WITHOUT CLAIM TO ANY PAR-
TICULAR FONT, STYLE, SIZE, OR COLOR.

SER. NO. 85-259,826, FILED 3-7-2011.

KAREN K. BUSH, EXAMINING ATTORNEY



David J. Kyjars

Director of the United States Patent and Trademark Office

United States of America

United States Patent and Trademark Office

1st EQUI-DEBT SOLUTIONS

Reg. No. 4,098,220

Registered Feb. 14, 2012

Int. Cl.: 36

SERVICE MARK

PRINCIPAL REGISTER

1ST EQUI-DEBT SOLUTIONS, LLC (TEXAS LIMITED LIABILITY COMPANY)
SUITE 100
1701 WEST NORTHWEST HIGHWAY
GRAPEVINE, TX 76051

FOR: IDENTIFYING AND SOURCING CAPITAL FOR BORROWERS, NAMELY, DEBT AND EQUITY FINANCING ADVISORY SERVICES IN THE NATURE OF ASSISTING BORROWERS TO LOCATE THIRD PARTIES TO PROVIDE DEBT OR EQUITY CAPITAL; IDENTIFYING AND SOURCING OPPORTUNITIES FOR THE SALE OF REAL PROPERTY OR NOTES OF BORROWERS, NAMELY, DEBT AND EQUITY FINANCING ADVISORY SERVICES IN THE NATURE OF ASSISTING BORROWERS TO LOCATE THIRD PARTIES TO PROVIDE DEBT OR EQUITY CAPITAL FOR THE SALE OF REAL PROPERTY OR NOTES, IN CLASS 36 (U.S. CLS. 100, 101 AND 102).

FIRST USE 11-22-2010; IN COMMERCE 11-22-2010.

THE MARK CONSISTS OF STANDARD CHARACTERS WITHOUT CLAIM TO ANY PARTICULAR FONT, STYLE, SIZE, OR COLOR.

NO CLAIM IS MADE TO THE EXCLUSIVE RIGHT TO USE "SOLUTIONS", APART FROM THE MARK AS SHOWN.

SER. NO. 85-260,024, FILED 3-7-2011.

NANCY CLARKE, EXAMINING ATTORNEY



David J. Kybas

Director of the United States Patent and Trademark Office

United States of America

United States Patent and Trademark Office



Reg. No. 4,098,221

Registered Feb. 14, 2012

Int. Cl.: 36

SERVICE MARK

PRINCIPAL REGISTER

1ST EQUI-DEBT SOLUTIONS, LLC (TEXAS LIMITED LIABILITY COMPANY)
SUITE 100
1701 WEST NORTHWEST HIGHWAY
GRAPEVINE, TX 76051

FOR: IDENTIFYING AND SOURCING CAPITAL FOR BORROWERS, NAMELY, DEBT AND EQUITY FINANCING ADVISORY SERVICES IN THE NATURE OF ASSISTING BORROWERS TO LOCATE THIRD PARTIES TO PROVIDE DEBT OR EQUITY CAPITAL; IDENTIFYING AND SOURCING OPPORTUNITIES FOR THE SALE OF REAL PROPERTY OR NOTES OF BORROWERS, NAMELY, DEBT AND EQUITY FINANCING ADVISORY SERVICES IN THE NATURE OF ASSISTING BORROWERS TO LOCATE THIRD PARTIES TO PROVIDE DEBT OR EQUITY CAPITAL FOR THE SALE OF REAL PROPERTY OR NOTES, IN CLASS 36 (U.S. CLS. 100, 101 AND 102).

FIRST USE 11-22-2010; IN COMMERCE 11-22-2010.

NO CLAIM IS MADE TO THE EXCLUSIVE RIGHT TO USE "SOLUTIONS" , APART FROM THE MARK AS SHOWN.

THE COLOR(S) RED AND BLACK IS/ARE CLAIMED AS A FEATURE OF THE MARK.

THE MARK CONSISTS OF A CIRCLE AROUND THE WORD "1ST" WITH THE PHRASE "EQUI-DEBT SOLUTIONS" PARTIALLY INSIDE AND PARTIALLY EXTENDING OUTSIDE THAT CIRCLE. THE WORDING "1ST EQUI-DEBT SOLUTIONS" IS IN BLACK AND THE CIRCLE IS IN RED.

SER. NO. 85-260,026, FILED 3-7-2011.

NANCY CLARKE, EXAMINING ATTORNEY



David J. Kybas

Director of the United States Patent and Trademark Office

United States of America

United States Patent and Trademark Office

Naka

Reg. No. 4,098,222

SENARIO LLC (ILLINOIS LIMITED LIABILITY COMPANY)
1725 KILKENNY COURT
WOODSTOCK, IL 60098

Registered Feb. 14, 2012

Int. Cl.: 28

FOR: REMOTE CONTROL TOYS, NAMELY, ROBOTS, IN CLASS 28 (U.S. CLS. 22, 23, 38 AND 50).

TRADEMARK

FIRST USE 1-1-2010; IN COMMERCE 10-10-2010.

PRINCIPAL REGISTER

THE MARK CONSISTS OF STANDARD CHARACTERS WITHOUT CLAIM TO ANY PARTICULAR FONT, STYLE, SIZE, OR COLOR.

THE ENGLISH TRANSLATION OF "NAKA" IN THE MARK IS "INSIDE, MIDDLE, OR RELATIONSHIP".

SER. NO. 85-261,221, FILED 3-8-2011.

COLLEEN KEARNEY, EXAMINING ATTORNEY



David J. Kyffers

Director of the United States Patent and Trademark Office

United States of America
United States Patent and Trademark Office

Quadrello

Reg. No. 4,098,223

Registered Feb. 14, 2012

Int. Cl.: 29

TRADEMARK

PRINCIPAL REGISTER

AZIENDA AGRICOLA GRITTI BRUNO E ALFIO S.S. SOCIETA' AGRICOLA (ITALY PARTNERSHIP)
CASCINA RASEGA, VIA CREMA, 69
COLOGNO AL SERIO (BG), ITALY 24055

FOR: MILK; MILK PRODUCTS, NAMELY, CHEESE, IN CLASS 29 (U.S. CL. 46).

FIRST USE 5-0-2006; IN COMMERCE 2-4-2008.

THE MARK CONSISTS OF THE WORD "QUADRELLO" IN STYLIZED LETTERS. BENEATH THE WORDING IS A BLACK UNDERLINE.

THE ENGLISH TRANSLATION OF "QUADRELLO" IN THE MARK IS QUARRY TILE.

SER. NO. 85-261,913, FILED 3-9-2011.

JUSTINE D. PARKER, EXAMINING ATTORNEY



David J. Kyfos

Director of the United States Patent and Trademark Office

United States of America

United States Patent and Trademark Office

KITSCH

Reg. No. 4,098,224

KITSCH LLC (CALIFORNIA LIMITED LIABILITY COMPANY)
361 S. DOHENY DR
BEVERLY HILLS, CA 90211

Registered Feb. 14, 2012

Int. Cl.: 26

FOR: HAIR BANDS, IN CLASS 26 (U.S. CLS. 37, 39, 40, 42 AND 50).

TRADEMARK

FIRST USE 1-1-2011; IN COMMERCE 2-1-2011.

PRINCIPAL REGISTER

THE MARK CONSISTS OF "KITSCH" IS WRITTEN IN CAPITOL LETTERS WITH ART DECO SWIRL THAT DECORATES EACH INDIVIDUAL LETTER FROM THE TOP TO THE BOTTOM.

SER. NO. 85-262,201, FILED 3-9-2011.

ANNE MADDEN, EXAMINING ATTORNEY



David J. Kybas

Director of the United States Patent and Trademark Office

United States of America

United States Patent and Trademark Office

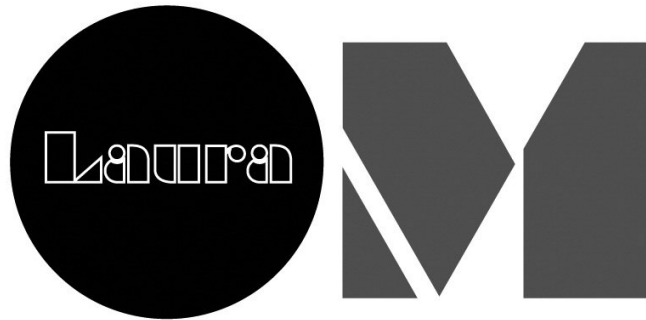

Reg. No. 4,098,225

Registered Feb. 14, 2012

Int. Cl.: 41

SERVICE MARK

PRINCIPAL REGISTER

FELICIANO-CRUZ, LAURA T. (PUERTO RICO INDIVIDUAL), DBA LAURA OM
1750 CALLE LOÍZA PMB 068
SAN JUAN, PUERTO RICO 009111819

FOR: ENTERTAINMENT SERVICES IN THE NATURE OF PRESENTING LIVE MUSICAL PERFORMANCES; ENTERTAINMENT SERVICES, NAMELY, CONDUCTING CONTESTS; ENTERTAINMENT SERVICES, NAMELY, CONDUCTING PARTIES; ENTERTAINMENT SERVICES, NAMELY, MULTIMEDIA PRODUCTION SERVICES; ENTERTAINMENT SERVICES, NAMELY, PROVIDING A WEB SITE FEATURING PHOTOGRAPHIC, VIDEO AND PROSE PRESENTATIONS FEATURING FASHION SHOWS FOR ENTERTAINMENT PURPOSES, BEAUTY CONTESTS, ENTERTAINMENT INFORMATION, ART EXHIBITIONS, NON-DOWNLOADABLE MUSICAL PERFORMANCES, NON-DOWNLOADABLE NATURE PHOTOGRAPHS, AND OTHER NON-DOWNLOADABLE MULTIMEDIA MATERIALS FEATURING VIDEO AND PROSE PRESENTATIONS FEATURING FASHION SHOWS FOR ENTERTAINMENT PURPOSES, BEAUTY CONTESTS, ENTERTAINMENT INFORMATION AND ART EXHIBITIONS; ENTERTAINMENT SERVICES, NAMELY, PROVIDING VIRTUAL ENVIRONMENTS IN WHICH USERS CAN INTERACT FOR RECREATIONAL, LEISURE OR ENTERTAINMENT PURPOSES; ENTERTAINMENT SERVICES, NAMELY, STORYTELLING; ENTERTAINMENT SERVICES, NAMELY, WINE AND FOOD TASTINGS; ORGANIZATION OF CULTURAL SHOWS; ORGANIZATION OF EVENTS FOR CULTURAL PURPOSES; ORGANIZATION OF SHOWS FOR CULTURAL PURPOSES; ORGANIZING AND HOSTING OF EVENTS FOR CULTURAL PURPOSES; ORGANIZING CULTURAL AND ARTS EVENTS; PROVISION OF INFORMATION RELATING TO THE ORGANIZING OF EDUCATIONAL, CULTURAL, SPORTING, OR ENTERTAINMENT EXHIBITIONS, IN CLASS 41 (U.S. CLS. 100, 101 AND 107).



FIRST USE 5-1-2009; IN COMMERCE 5-1-2009.

THE NAME(S), PORTRAIT(S), AND/OR SIGNATURE(S) SHOWN IN THE MARK IDENTIFIES LAURA T. FELICIANO-CRUZ, WHOSE CONSENT(S) TO REGISTER IS MADE OF RECORD.

THE MARK CONSISTS OF THE STYLIZED WORDING "LAURA OM", WITH THE LETTER "O" REPRESENTED BY A SHADED CIRCLE, WITH THE LETTER "M" REPRESENTED BY A SHADED RIGHT TRIANGLE AND TWO SHADED IRREGULAR PENTAGONS, AND WITH THE WORD "LAURA" APPEARING ACROSS THE LETTER "O".

David J. Kybas

Director of the United States Patent and Trademark Office

SER. NO. 85-262,535, FILED 3-9-2011.

Reg. No. 4,098,225 CYNTHIA TRIPI, EXAMINING ATTORNEY

United States of America

United States Patent and Trademark Office

iStrider

Reg. No. 4,098,226

Registered Feb. 14, 2012

Int. Cl.: 28

TRADEMARK

PRINCIPAL REGISTER

ENANEF LIMITED (UNITED KINGDOM LEGAL ENTITY OF THE UNITED KINGDOM)
BEECHWOOD HOUSE, KING GEORGES HILL
ABINGER BOTTOM
DORKING SURREY, UNITED KINGDOM RH56JW

FOR: EXERCISE APPARATUS, MACHINES, DEVICES AND EQUIPMENT, NAMELY, CROSS-TRAINERS, ELLIPTICAL TRAINERS, SKIING CROSS TRAINERS, SKI EXERCISE TRAINERS, AND TREADMILLS, IN CLASS 28 (U.S. CLS. 22, 23, 38 AND 50).

THE MARK CONSISTS OF STANDARD CHARACTERS WITHOUT CLAIM TO ANY PARTICULAR FONT, STYLE, SIZE, OR COLOR.

PRIORITY CLAIMED UNDER SEC. 44(D) ON ERPN CMNTY TM OFC APPLICATION NO. 009795105, FILED 3-8-2011.

OWNER OF ERPN CMNTY TM OFC REG. NO. 009795105, DATED 8-25-2011, EXPIRES 8-25-2021.

SER. NO. 85-263,167, FILED 3-10-2011.

PAUL MORENO, EXAMINING ATTORNEY



David J. Kyfos

Director of the United States Patent and Trademark Office

United States of America

United States Patent and Trademark Office

QualiCure

Reg. No. 4,098,227

Registered Feb. 14, 2012

Int. Cl.: 1

TRADEMARK

PRINCIPAL REGISTER

QUALIPOLY CHEMICAL CORPORATION (TAIWAN CORPORATION)
NO. 2, YEONG GONG 5TH ROAD
YONG AN DISTRICT
KAOHSIUNG CITY, TAIWAN

FOR: RESINS, NAMELY, RADIATION CURABLE UNPROCESSED SYNTHETIC RESINS,
ULTRA-VIOLET RESINS, UV RESINS, SYNTHETIC ULTRA-VIOLET RESINS , IN CLASS
1 (U.S. CLS. 1, 5, 6, 10, 26 AND 46).

FIRST USE 3-11-2010; IN COMMERCE 3-11-2010.

THE MARK CONSISTS OF STANDARD CHARACTERS WITHOUT CLAIM TO ANY PAR-
TICULAR FONT, STYLE, SIZE, OR COLOR.

SER. NO. 85-263,465, FILED 3-10-2011.

ZACHARY BELLO, EXAMINING ATTORNEY



David J. Kypos

Director of the United States Patent and Trademark Office

United States of America

United States Patent and Trademark Office



Reg. No. 4,098,228

Registered Feb. 14, 2012

Int. Cl.: 41

SERVICE MARK

PRINCIPAL REGISTER

E4 SOCCER LLC (SOUTH CAROLINA LIMITED LIABILITY COMPANY)
104 HULTON LN
SUMMERVILLE, SC 29485

FOR: SOCCER CAMPS, IN CLASS 41 (U.S. CLS. 100, 101 AND 107).

FIRST USE 4-9-2010; IN COMMERCE 4-9-2010.

NO CLAIM IS MADE TO THE EXCLUSIVE RIGHT TO USE "SOCCER" AND "PARK" AND THE REPRESENTATION OF A SOCCER BALL, APART FROM THE MARK AS SHOWN.

THE COLOR(S) BLACK, WHITE, RED, AND GOLD IS/ARE CLAIMED AS A FEATURE OF THE MARK.

THE MARK CONSISTS OF THE WORDING "E4" "THE ULTIMATE SOCCER EXPERIENCE SOCCER FUN PARK". THE LETTER "E" IS IN BLACK AND THE NUMBER "4" IS RAISED IN RED. THE TERM "SOCCER" IS IN BLACK WITH THE "O" BEING REPRESENTED BY A BLACK AND WHITE SOCCER BALL, THE WORDS "THE ULTIMATE" IN BLACK, "SOCCER" IN RED, "EXPERIENCE" IN GOLD, AND THE STYLIZED WORDS "SOCCER FUN PARK" IN BLACK.

SER. NO. 85-264,169, FILED S.R. 3-11-2011 AM. P.R. 9-27-2011.

CHERYL CLAYTON, EXAMINING ATTORNEY



David J. Kybas

Director of the United States Patent and Trademark Office

United States of America

United States Patent and Trademark Office



Reg. No. 4,098,229

Registered Feb. 14, 2012

Int. Cl.: 33

TRADEMARK

PRINCIPAL REGISTER

MEJOR TEQUILA COMPANY, LLC (CALIFORNIA LIMITED LIABILITY COMPANY)
366
2053 GRANT ROAD
LOS ALTOS, CA 94024

FOR: TEQUILA, IN CLASS 33 (U.S. CLS. 47 AND 49).

FIRST USE 6-17-2007; IN COMMERCE 2-17-2008.

OWNER OF U.S. REG. NO. 3,531,850.

THE COLOR(S) PINK AND GRAY IS/ARE CLAIMED AS A FEATURE OF THE MARK.

NO CLAIM IS MADE TO THE EXCLUSIVE RIGHT TO USE "PINK", APART FROM THE MARK AS SHOWN.

THE MARK CONSISTS OF A PINK AGAVE DESIGN WITH THE WORD "MEJOR" IN GRAY AND THE WORD "PINK" IN PINK.

THE ENGLISH TRANSLATION OF "MEJOR" IN THE MARK IS "BETTER.

SER. NO. 85-265,000, FILED 3-11-2011.

RONALD MCMORROW, EXAMINING ATTORNEY



David J. Kyros

Director of the United States Patent and Trademark Office

United States of America

United States Patent and Trademark Office



Reg. No. 4,098,230

Registered Feb. 14, 2012

Int. Cl.: 35

SERVICE MARK

PRINCIPAL REGISTER

LAW SPACE MATCH, LLC (GEORGIA LIMITED LIABILITY COMPANY), DBA
LAWSPACEMATCH
SUITE 2220
945 EAST PACES FERRY ROAD
ATLANTA, GA 30326

FOR: PROVIDING A WEB SITE FEATURING AN ONLINE MARKETPLACE FOR EXCHANGING GOODS AND SERVICES WITH OTHER USERS, IN CLASS 35 (U.S. CLS. 100, 101 AND 102).

FIRST USE 12-23-2009; IN COMMERCE 12-23-2009.

THE MARK CONSISTS OF A CURVED LINE DESIGN AND THE WORDING "LAWSPACE MATCH".

SER. NO. 85-265,439, FILED S.R. 3-12-2011 AM. P.R. 10-19-2011.

VERNA BETH RIRIE, EXAMINING ATTORNEY



David J. Kyffers

Director of the United States Patent and Trademark Office

United States of America
United States Patent and Trademark Office

KONA LIFE

Reg. No. 4,098,231

KONA LIFE, LLC (CONNECTICUT LIMITED LIABILITY COMPANY)
18 EDSTROM ROAD
MARLBOROUGH, CT 06447

Registered Feb. 14, 2012

Int. Cl.: 30

FOR: COFFEE, IN CLASS 30 (U.S. CL. 46).

TRADEMARK

FIRST USE 1-10-2011; IN COMMERCE 2-15-2011.

PRINCIPAL REGISTER

THE MARK CONSISTS OF STANDARD CHARACTERS WITHOUT CLAIM TO ANY PARTICULAR FONT, STYLE, SIZE, OR COLOR.

NO CLAIM IS MADE TO THE EXCLUSIVE RIGHT TO USE "KONA", APART FROM THE MARK AS SHOWN.

SER. NO. 85-266,262, FILED 3-14-2011.

KELLEY WELLS, EXAMINING ATTORNEY



David J. Kyffers

Director of the United States Patent and Trademark Office

United States of America

United States Patent and Trademark Office



Reg. No. 4,098,232

Registered Feb. 14, 2012

Int. Cl.: 10

TRADEMARK

PRINCIPAL REGISTER

HISAMITSU PHARMACEUTICAL CO., INC. (JAPAN CORPORATION)
408, TASHIRODAIKAN-MACHI
TOSU-SHI, SAGA, JAPAN 841-0017

FOR: GEL-TYPE COOLING PADS OR PATCHES FOR ABSORBING AND RADIATING SUDDEN HEAT FROM THE HUMAN BODY, IN CLASS 10 (U.S. CLS. 26, 39 AND 44).

PRIORITY CLAIMED UNDER SEC. 44(D) ON JAPAN APPLICATION NO. 2011-012064, FILED 2-22-2011, REG. NO. 5427429, DATED 7-22-2011, EXPIRES 7-22-2021.

THE COLOR(S) BLACK, WHITE, GREY, BEIGE, LIGHT BLUE, DARK BLUE, YELLOW, AND RED IS/ARE CLAIMED AS A FEATURE OF THE MARK.

OWNER OF U.S. REG. NOS. 2,703,254, 3,197,690 AND OTHERS.

NO CLAIM IS MADE TO THE EXCLUSIVE RIGHT TO USE "FEVER", APART FROM THE MARK AS SHOWN.

THE MARK CONSISTS OF A RECTANGLE. AT THE TOP APPEARS A BLACK RECTANGLE CARRYING THE WORD "HISAMITSU" IN STYLIZED WHITE LETTERING OVER ANOTHER RECTANGLE WITH A GREY BACKGROUND AND THE WORDS "BYE BYE FEVER" APPEARING IN BLACK WITHIN A YELLOW BACKGROUND DESIGN. DIRECTLY UNDERNEATH APPEARS THE WORDING "SUPER COOL" IN LIGHT BLUE AND LINED IN BLACK. IN THE BACKGROUND APPEARS A STYLIZED REPRESENTATION OF ICE IN WHITE, LIGHT BLUE, AND DARK BLUE ALONG WITH A STYLIZED IMAGE OF A PATCH APPEARING IN WHITE WITH A RED TALKING BUBBLE. AT THE BOTTOM RIGHT OF THE CARRIER RECTANGLE APPEARS A STYLIZED PICTURED OF A HUMAN FACE SHADED IN BEIGE, OUTLINED IN RED, WITH ALL THE FEATURES APPEARING IN RED, AND HAIR APPEARING IN YELLOW. THE FACE ALSO CONTAINS A STYLIZED WHITE PATCH ON THE FOREHEAD LINED IN DARK BLUE WITH THREE STYLIZED BOLTS APPEARING IN LIGHT BLUE AND LINED IN BLUE. THE STYLIZED PICTURED OF A HUMAN FACE ALL APPEARS ON A DARK BLUE MULTI POINT CIRCLE LINED IN WHITE.

SER. NO. 85-266,650, FILED 3-14-2011.

JACLYN KIDWELL WALKER, EXAMINING ATTORNEY



David J. Kyros

Director of the United States Patent and Trademark Office

United States of America

United States Patent and Trademark Office

Moguldom

Reg. No. 4,098,233

Registered Feb. 14, 2012

Int. Cls.: 35 and 41

SERVICE MARK

PRINCIPAL REGISTER

MOGULDOM MEDIA GROUP, LLC (NEW YORK LIMITED LIABILITY COMPANY)
8TH FLOOR
260 MADISON AVENUE
NEW YORK, NY 10016

FOR: ADVERTISING AND MARKETING, IN CLASS 35 (U.S. CLS. 100, 101 AND 102).

FIRST USE 8-21-2007; IN COMMERCE 9-1-2007.

FOR: DIGITAL VIDEO, AUDIO, AND MULTIMEDIA PUBLISHING SERVICES, IN CLASS 41 (U.S. CLS. 100, 101 AND 107).

FIRST USE 8-21-2007; IN COMMERCE 9-1-2007.

THE MARK CONSISTS OF STANDARD CHARACTERS WITHOUT CLAIM TO ANY PARTICULAR FONT, STYLE, SIZE, OR COLOR.

SER. NO. 85-267,221, FILED 3-15-2011.

ANDREW RHIM, EXAMINING ATTORNEY



David J. Kyffers

Director of the United States Patent and Trademark Office

United States of America

United States Patent and Trademark Office

CYCLOPOWER

Reg. No. 4,098,234

Registered Feb. 14, 2012

Int. Cls.: 5 and 30

TRADEMARK

PRINCIPAL REGISTER

MANUKA HEALTH NEW ZEALAND LIMITED (NEW ZEALAND LIMITED LIABILITY COMPANY)
1 CARLTON STREET
TE AWAMUTU, NEW ZEALAND

FOR: PHARMACEUTICAL AND VETERINARY PREPARATIONS AND SUBSTANCES, NAMELY, THERAPEUTIC AND DIETARY PREPARATIONS CONTAINING POLLEN, HONEY AND/OR OTHER BEE PRODUCTS FOR THE TREATMENT OF VIRAL, METABOLIC, ENDOCRINE, MUSCULOSKELETAL, CARDIOVASCULAR, CARDIOPULMONARY, GENITOURINARY, SEXUAL DYSFUNCTION, ONCOLOGICAL, HEPATOLOGICAL, OPHTHALMIC, RESPIRATORY, NEUROLOGICAL, GASTROINTESTINAL, HORMONAL, DERMATOLOGICAL, PSYCHIATRIC AND IMMUNE SYSTEM RELATED DISEASES AND DISORDERS; VITAMIN AND MINERAL SUPPLEMENTS MADE FROM OR CONTAINING ROYAL JELLY, PROPOLIS, POLLEN, BEESWAX, AND/OR HONEY; PHARMACEUTICAL PREPARATIONS BEING ANTIMICROBIAL AGENTS FOR WOUNDS, ORAL APPLICATION AND INTERNAL APPLICATION MADE FROM OR CONTAINING HONEY, POLLEN, COLLODION, PROPOLIS, ROYAL JELLY, BEE VENOM, AND/OR BEESWAX; PHARMACEUTICAL PREPARATIONS BEING ANTISEPTIC AGENTS FOR WOUNDS, ORAL APPLICATION AND INTERNAL APPLICATION MADE FROM OR CONTAINING HONEY, POLLEN, COLLODION, PROPOLIS, ROYAL JELLY, BEE VENOM, AND/OR BEESWAX; GAUZE FOR DRESSINGS, ADHESIVE MEDICAL PLASTERS, BANDAGES FOR DRESSINGS, ANTISEPTIC MEDICAL AND SURGICAL DRESSINGS, ANTISEPTIC MEDICAL AND SURGICAL BANDAGES, ANTISEPTIC MEDICAL AND SURGICAL GAUZES, TISSUES FOR WOUNDS, ALL IMPREGNATED OR COATED WITH PHARMACEUTICAL LOTIONS MADE FROM OR INCLUDING ROYAL JELLY, POLLEN, BEESWAX, AND/OR HONEY; PHARMACEUTICAL PREPARATIONS FOR SKINCARE MADE FROM OR INCLUDING ROYAL JELLY, POLLEN, BEESWAX, AND/OR HONEY; TEAS BEING ANTIMICROBIAL AND ANTISEPTIC FOR THERAPEUTIC, MEDICINAL AND DENTAL PURPOSES FOR INTERNAL APPLICATION MADE FROM OR INCLUDING HONEY, PROPOLIS, ROYAL JELLY, POLLEN, BEE VENOM, AND/OR BEESWAX; DRINKS BEING ANTIMICROBIAL AND ANTISEPTIC FOR THERAPEUTIC, MEDICINAL AND DENTAL PURPOSES FOR INTERNAL APPLICATION MADE FROM OR INCLUDING HONEY, PROPOLIS, ROYAL JELLY, POLLEN, BEE VENOM, AND/OR BEESWAX; TONICS BEING ANTIMICROBIAL AND ANTISEPTIC FOR THERAPEUTIC, MEDICINAL AND DENTAL PURPOSES FOR INTERNAL APPLICATION MADE FROM OR INCLUDING HONEY, PROPOLIS, ROYAL JELLY, POLLEN, BEE VENOM, AND/OR BEESWAX; DRINK INFUSIONS BEING ANTIMICROBIAL AND ANTISEPTIC FOR THERAPEUTIC, MEDICINAL AND DENTAL PURPOSES FOR INTERNAL APPLICATION



David J. Kyffers

Director of the United States Patent and Trademark Office

Reg. No. 4,098,234 MADE FROM OR INCLUDING HONEY, PROPOLIS, ROYAL JELLY, POLLEN, BEE VENOM, AND/OR BEESWAX; PASTILLES BEING ANTIMICROBIAL AND ANTISEPTIC FOR THERAPEUTIC, MEDICINAL AND DENTAL PURPOSES FOR INTERNAL APPLICATION MADE FROM OR INCLUDING HONEY, PROPOLIS, ROYAL JELLY, POLLEN, BEE VENOM, AND/OR BEESWAX; TABLETS BEING ANTIMICROBIAL AND ANTISEPTIC FOR THERAPEUTIC, MEDICINAL AND DENTAL PURPOSES FOR INTERNAL APPLICATION MADE FROM OR INCLUDING HONEY, PROPOLIS, ROYAL JELLY, POLLEN, BEE VENOM, AND/OR BEESWAX; TOPICAL MEDICATED SKIN LOTIONS FOR PHARMACEUTICAL AND VETERINARY PURPOSES MADE FROM OR INCLUDING ROYAL JELLY, PROPOLIS, POLLEN, BEESWAX, AND/OR HONEY; TOPICAL MEDICATED GELS FOR PHARMACEUTICAL AND VETERINARY PURPOSES MADE FROM OR INCLUDING ROYAL JELLY, PROPOLIS, POLLEN, BEESWAX, AND/OR HONEY FOR THE TREATMENT OF VIRAL, METABOLIC, ENDOCRINE, MUSCULOSKELETAL, CARDIOVASCULAR, CARDIOPULMONARY, GENITOURINARY, SEXUAL DYSFUNCTION, ONCOLOGICAL, HEPATOLOGICAL, OPHTHALMIC, RESPIRATORY, NEUROLOGICAL, GASTROINTESTINAL, HORMONAL, DERMATOLOGICAL, PSYCHIATRIC AND IMMUNE SYSTEM RELATED DISEASES AND DISORDERS; TOPICAL MEDICATED OINTMENTS FOR PHARMACEUTICAL AND VETERINARY PURPOSES MADE FROM OR INCLUDING ROYAL JELLY, PROPOLIS, POLLEN, BEESWAX, AND/OR HONEY FOR THE TREATMENT OF VIRAL, METABOLIC, ENDOCRINE, MUSCULOSKELETAL, CARDIOVASCULAR, CARDIOPULMONARY, GENITOURINARY, SEXUAL DYSFUNCTION, ONCOLOGICAL, HEPATOLOGICAL, OPHTHALMIC, RESPIRATORY, NEUROLOGICAL, GASTROINTESTINAL, HORMONAL, DERMATOLOGICAL, PSYCHIATRIC AND IMMUNE SYSTEM RELATED DISEASES AND DISORDERS; THE AFOREMENTIONED GOODS WITHIN THIS CLASS BEING MADE FROM, OR INCLUDING MANUKA HONEY, IN CLASS 5 (U.S. CLS. 6, 18, 44, 46, 51 AND 52).

FOR: PREPARED FOOD PRODUCTS CONTAINING HONEY, NAMELY, CAKES, COOKIES, BAGELS, CANDY; HONEY; PROPOLIS FOR HUMAN CONSUMPTION, ROYAL JELLY FOR HUMAN CONSUMPTION; HONEY BASED CONFECTIONERY TOFFEES, CHOCOLATES, ICES; BREAKFAST CEREALS MADE FROM WHEAT, OATS, RICE ALL INCLUDING HONEY; HONEY BASED SALAD DRESSINGS FOR SALADS, HONEY BASED SAUCES FOR SALADS, DESSERTS ALL FOR HUMAN CONSUMPTION AND ALL MADE FROM OR INCLUDING HONEY, PROPOLIS, ROYAL JELLY, POLLEN; THE AFOREMENTIONED GOODS WITHIN THIS CLASS BEING MADE FROM, OR INCLUDING MANUKA HONEY, IN CLASS 30 (U.S. CL. 46).

PRIORITY CLAIMED UNDER SEC. 44(D) ON NEW ZEALAND APPLICATION NO. 834839, FILED 12-14-2010, REG. NO. 834839, DATED 12-14-2010, EXPIRES 12-14-2020.

THE MARK CONSISTS OF THE WORD "CYCLOPOWER" WITH A LINE THROUGH THE CENTER OF THE LETTERS "C", "Y", "L", "C" AND "O", AND A SOLID CIRCLE INSIDE THE LETTER "O".

SER. NO. 85-268,262, FILED 3-16-2011.

DAVID TOOLEY, EXAMINING ATTORNEY

United States of America

United States Patent and Trademark Office



Reg. No. 4,098,235

JUNE BUG ENTERPRISES, INC. (CALIFORNIA CORPORATION)
9100 WILSHIRE BOULEVARD, SUITE 1000W
BEVERLY HILLS, CA 90212

Registered Feb. 14, 2012

Int. Cl.: 41

FOR: ENTERTAINMENT SERVICES, NAMELY, ORGANIZING AND CONDUCTING CARNIVALS; CHARITABLE SERVICES, NAMELY, PROVIDING GOODY BASKETS FILLED WITH TOYS TO UNDERPRIVILEGED CHILDREN AND THEIR PARENTS, IN CLASS 41 (U.S. CLS. 100, 101 AND 107).

SERVICE MARK

PRINCIPAL REGISTER

FIRST USE 7-0-2005, THE MARK WAS FIRST USED ANYWHERE IN A DIFFERENT FORM OTHER THAN THAT SOUGHT TO BE REGISTERED AT LEAST AS EARLY AS 00/00/1994; IN COMMERCE 7-0-2005, THE MARK WAS FIRST USED IN COMMERCE IN A DIFFERENT FORM OTHER THAN THAT SOUGHT TO BE REGISTERED AT LEAST AS EARLY AS 00/00/1994.

OWNER OF U.S. REG. NOS. 1,953,691, 3,290,429 AND OTHERS.

THE COLOR(S) BLUE, YELLOW AND WHITE IS/ARE CLAIMED AS A FEATURE OF THE MARK.

NO CLAIM IS MADE TO THE EXCLUSIVE RIGHT TO USE "KIDS MARDI GRAS HOSTED BY" AND "FOUNDATION", APART FROM THE MARK AS SHOWN.



THE MARK CONSISTS OF THE WORDS "KIDS MARDI GRAS", IN FANCIFUL LETTERS WITH THE WORD "KIDS" IN YELLOW COLORED LETTERS AND THE WORDS "MARDI GRAS" IN THE BLUE COLORED LETTERS EDGED IN THE COLOR YELLOW, SUPERIMPOSED OVER A FANCIFUL DESIGN OF A BASKETBALL IN THE COLORS BLUE AND WHITE AND EDGED IN THE COLOR YELLOW; WITH THE WORDS "MAGIC JOHNSON FOUNDATION" AND "HOSTED BY EARVIN MAGIC JOHNSON" IN BLUE COLORED LETTERS CIRCLING THE TOP AND BOTTOM OF THE FANCIFUL BASKETBALL DESIGN, WITH BLUE AND YELLOW COLORED STARS SEPARATING THE WORDS ON EITHER SIDE OF THE FANCIFUL BASKETBALL DESIGN.

David J. Kyffers

SER. NO. 85-268,527, FILED 3-16-2011.

ZACHARY BELLO, EXAMINING ATTORNEY

United States of America

United States Patent and Trademark Office

tunespeak

Reg. No. 4,098,236

TUNESPEAK, LLC (MISSOURI LIMITED LIABILITY COMPANY)
17533 SUMMIT VIEW PLACE COVE
GLENCOE, MO 63038

Registered Feb. 14, 2012

Int. Cl.: 42

FOR: PROVIDING A WEBSITE FEATURING TECHNOLOGY THAT ENABLES USERS TO PROMOTE THE MUSIC OF OTHERS WHEREBY THE USERS RECEIVE COMPENSATION FROM THE MUSICIANS FOR PROMOTING THEIR MUSIC, IN CLASS 42 (U.S. CLS. 100 AND 101).

SERVICE MARK

PRINCIPAL REGISTER

FIRST USE 3-1-2011; IN COMMERCE 5-1-2011.

THE MARK CONSISTS OF STANDARD CHARACTERS WITHOUT CLAIM TO ANY PARTICULAR FONT, STYLE, SIZE, OR COLOR.

SER. NO. 85-268,660, FILED 3-16-2011.

MARY CRAWFORD, EXAMINING ATTORNEY



David J. Kyffers

Director of the United States Patent and Trademark Office

United States of America

United States Patent and Trademark Office

Contacts Cleaner

Reg. No. 4,098,237

Registered Feb. 14, 2012

Int. Cl.: 9

TRADEMARK

PRINCIPAL REGISTER

BEAVER CREEK CONSULTING CORP (VIRGINIA CORPORATION)
1855 SAINT FRANCIS ST. #1906
RESTON, VA 20190

FOR: COMPUTER APPLICATION SOFTWARE FOR MOBILE PHONES, NAMELY, SOFTWARE FOR REMOVAL OF DUPLICATE CONTACTS FROM A MOBILE PHONE'S ADDRESS BOOK USED TO IDENTIFY DUPLICATE CONTACTS, MERGE THE CONTACT ATTRIBUTES, EMAIL ADDRESSES AND PHONES NUMBERS INTO ONE CONTACT AND THEN REMOVES THE DUPLICATE CONTACTS FROM THE ADDRESS BOOK, IN CLASS 9 (U.S. CLS. 21, 23, 26, 36 AND 38).

FIRST USE 11-1-2010; IN COMMERCE 11-1-2010.

THE MARK CONSISTS OF STANDARD CHARACTERS WITHOUT CLAIM TO ANY PARTICULAR FONT, STYLE, SIZE, OR COLOR.

NO CLAIM IS MADE TO THE EXCLUSIVE RIGHT TO USE "CONTACTS", APART FROM THE MARK AS SHOWN.

SER. NO. 85-269,383, FILED 3-17-2011.

FLORENTINA BLANDU, EXAMINING ATTORNEY



David J. Kyffers

Director of the United States Patent and Trademark Office

United States of America

United States Patent and Trademark Office



Reg. No. 4,098,238

Registered Feb. 14, 2012

Int. Cl.: 9

TRADEMARK

PRINCIPAL REGISTER

DESIGNATECH IP PTY. LTD. (AUSTRALIA CORPORATION)
42 BULCOCK STREET
CALOUNDRA, QUEENSLAND, AUSTRALIA 4551

FOR: ELECTRO-OPTICAL SWITCHES, TOUCH-CONTROLLED SWITCHES, ELECTRO-OPTICAL TOUCH SWITCHES, IN CLASS 9 (U.S. CLS. 21, 23, 26, 36 AND 38).

OWNER OF AUSTRALIA REG. NO. 1402223, DATED 12-29-2010, EXPIRES 12-29-2020.

THE COLOR(S) BLUE, GREEN, RED, YELLOW, PURPLE, AND LIGHT BLUE IS/ARE CLAIMED AS A FEATURE OF THE MARK.

THE MARK CONSISTS OF THE LETTER "D" AND A TRIANGULAR DESIGN COMPRISED OF THE COLORS BLUE, GREEN, RED, YELLOW, PURPLE AND LIGHT BLUE. THE COLOR BLUE APPEARS IN THE LOWER RIGHT SIDE OF THE TRIANGULAR DESIGN, THE COLOR GREEN APPEARS IN THE UPPER RIGHT SIDE OF THE TRIANGULAR DESIGN, THE COLOR RED APPEARS IN THE LEFT SIDE OF THE TRIANGULAR DESIGN, THE COLOR YELLOW APPEARS IN THE UPPER LEFT SIDE OF THE TRIANGULAR DESIGN, THE COLOR PURPLE APPEARS IN THE LOWER LEFT SIDE OF THE TRIANGULAR DESIGN, THE COLOR LIGHT BLUE APPEARS IN THE RIGHT SIDE OF THE TRIANGULAR DESIGN AND IN THE LETTER "D".

SER. NO. 85-269,533, FILED 3-17-2011.

MARGERY A. TIERNEY, EXAMINING ATTORNEY



David J. Kybas

Director of the United States Patent and Trademark Office

United States of America

United States Patent and Trademark Office

3D SLICER

Reg. No. 4,098,239

Registered Feb. 14, 2012

Int. Cl.: 9

TRADEMARK

PRINCIPAL REGISTER

THE BRIGHAM AND WOMEN'S HOSPITAL, INC. (MASSACHUSETTS CORPORATION)
75 FRANCIS STREET
BOSTON, MA 02115

FOR: COMPUTER SOFTWARE FOR DATA VISUALIZATION AND IMAGE ANALYSIS, FOR USE IN THE FIELDS OF MEDICINE AND SCIENTIFIC RESEARCH; DOWNLOADABLE SOFTWARE FOR DATA VISUALIZATION AND IMAGE ANALYSIS, FOR USE IN THE FIELDS OF MEDICINE AND SCIENTIFIC RESEARCH, IN CLASS 9 (U.S. CLS. 21, 23, 26, 36 AND 38).

FIRST USE 5-7-1999; IN COMMERCE 5-7-1999.

THE MARK CONSISTS OF STANDARD CHARACTERS WITHOUT CLAIM TO ANY PARTICULAR FONT, STYLE, SIZE, OR COLOR.

SEC. 2(F).

SER. NO. 85-269,905, FILED 3-17-2011.

DAWN HAN, EXAMINING ATTORNEY



David J. Kyffers

Director of the United States Patent and Trademark Office

United States of America

United States Patent and Trademark Office

WINE WOMEN & SHOES

Reg. No. 4,098,240

HONIG, ELAINE (UNITED STATES INDIVIDUAL)
2400 GROVE STREET
SONOMA, CA 95476

Registered Feb. 14, 2012

Int. Cl.: 41

FOR: EDUCATION SERVICES AND SPECIAL EVENTS, NAMELY, WINE TASTING AND APPRECIATION SEMINARS, IN CLASS 41 (U.S. CLS. 100, 101 AND 107).

SERVICE MARK

FIRST USE 7-30-2005; IN COMMERCE 7-30-2005.

PRINCIPAL REGISTER

THE MARK CONSISTS OF STANDARD CHARACTERS WITHOUT CLAIM TO ANY PARTICULAR FONT, STYLE, SIZE, OR COLOR.

OWNER OF U.S. REG. NO. 3,059,710.

SER. NO. 85-270,131, FILED 3-17-2011.

SHAUNIA CARLYLE, EXAMINING ATTORNEY



David J. Kyffers

Director of the United States Patent and Trademark Office

United States of America

United States Patent and Trademark Office

MY MIRACLE TEA

Reg. No. 4,098,241

ALLEN, CAROLYN (UNITED STATES INDIVIDUAL)
8004 DAFFODIL CT.
SPRINGFIELD, VA 22152

Registered Feb. 14, 2012

Int. Cl.: 5

FOR: HERBAL TEAS FOR MEDICINAL PURPOSES, IN CLASS 5 (U.S. CLS. 6, 18, 44, 46, 51 AND 52).

TRADEMARK

FIRST USE 3-9-2008; IN COMMERCE 3-1-2011.

PRINCIPAL REGISTER

THE MARK CONSISTS OF STANDARD CHARACTERS WITHOUT CLAIM TO ANY PARTICULAR FONT, STYLE, SIZE, OR COLOR.

NO CLAIM IS MADE TO THE EXCLUSIVE RIGHT TO USE "TEA", APART FROM THE MARK AS SHOWN.

SER. NO. 85-270,191, FILED 3-17-2011.

JILL C. ALT, EXAMINING ATTORNEY



David J. Kyffers

Director of the United States Patent and Trademark Office

United States of America

United States Patent and Trademark Office

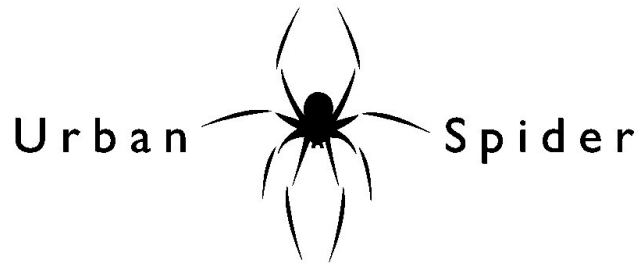

Reg. No. 4,098,242

ALEXANDER, JOSEPH (UNITED STATES INDIVIDUAL)
7433 CHIPPENHAM CT.
RALEIGH, NC 27613

Registered Feb. 14, 2012

Int. Cl.: 41

FOR: PHYSICAL FITNESS CONSULTATION EXCEPT AT THE COLLEGE OR UNIVERSITY LEVEL; PHYSICAL FITNESS INSTRUCTION EXCEPT AT THE COLLEGE OR UNIVERSITY LEVEL, IN CLASS 41 (U.S. CLS. 100, 101 AND 107).

SERVICE MARK

FIRST USE 6-9-2010; IN COMMERCE 6-10-2010.

PRINCIPAL REGISTER

THE MARK CONSISTS OF THE WORDING "URBAN SPIDER" WITH THE DESIGN OF A SPIDER APPEARING BETWEEN THE WORDS.

SER. NO. 85-271,351, FILED 3-18-2011.

MARTHA FROMM, EXAMINING ATTORNEY



David J. Kyffers

Director of the United States Patent and Trademark Office

United States of America

United States Patent and Trademark Office

SPOT STOPPER JIGS

Reg. No. 4,098,243

MCDONALD, STEPHEN (UNITED STATES INDIVIDUAL)
12121 WALNUT TERRACE
ALPHARETTA, GA 30004

Registered Feb. 14, 2012

Int. Cl.: 28

FOR: FISHING EQUIPMENTS, NAMELY, FISHING JIGS AND FISHING LURES, IN CLASS 28 (U.S. CLS. 22, 23, 38 AND 50).

TRADEMARK

FIRST USE 9-1-2009; IN COMMERCE 9-1-2010.

PRINCIPAL REGISTER

THE MARK CONSISTS OF STANDARD CHARACTERS WITHOUT CLAIM TO ANY PARTICULAR FONT, STYLE, SIZE, OR COLOR.

NO CLAIM IS MADE TO THE EXCLUSIVE RIGHT TO USE "SPOT" AND "JIGS", APART FROM THE MARK AS SHOWN.

SER. NO. 85-271,451, FILED 3-19-2011.

KATINA MISTER, EXAMINING ATTORNEY



David J. Kybas

Director of the United States Patent and Trademark Office

United States of America

United States Patent and Trademark Office

RS CITYLINER

Reg. No. 4,098,244

Registered Feb. 14, 2012

Int. Cl.: 7

TRADEMARK

PRINCIPAL REGISTER

RS LINING SYSTEMS, LLC (DELAWARE LIMITED LIABILITY COMPANY)
105 WOODWINDS INDUSTRIAL COURT
CARY, NC 27511

FOR: SYSTEM FOR REPAIRING PIPELINES COMPRISED OF VACUUM PUMPS, POWER-OPERATED PIPE CUTTERS, MECHANICAL AND POWER OPERATED CALIBRATION ROLLERS, ELECTRICAL UNITS FOR CONTROLLING THE TEMPERATURE OF THERMOSET RESINS, METAL HOSE FITTINGS, METAL PIPE CONNECTORS, METAL PIPE COUPLINGS, METAL PIPES, THERMOSET RESINS APPLICATORS, LINERS AND THERMOSET RESINS, ALL SOLD AS A UNIT FOR THE REPAIR OR RECONSTRUCTION OF EXISTING CONDUITS, PIPELINES, POTABLE WATER PIPES AND PASSAGEWAYS, IN CLASS 7 (U.S. CLS. 13, 19, 21, 23, 31, 34 AND 35).

FIRST USE 5-31-2005; IN COMMERCE 5-31-2005.

THE MARK CONSISTS OF STANDARD CHARACTERS WITHOUT CLAIM TO ANY PARTICULAR FONT, STYLE, SIZE, OR COLOR.

SER. NO. 85-273,339, FILED 3-22-2011.

C. DIONNE CLYBURN, EXAMINING ATTORNEY



David J. Kypos

Director of the United States Patent and Trademark Office

United States of America

United States Patent and Trademark Office



Reg. No. 4,098,245

Registered Feb. 14, 2012

Int. Cl.: 3

TRADEMARK

PRINCIPAL REGISTER

AFFILIATED CAPITAL (ARIZONA CORPORATION), DBA ODDYSEY DISTRIBUTION
P.O. BOX 198
DEKALB, IL 60115

FOR: INCENSE, IN CLASS 3 (U.S. CLS. 1, 4, 6, 50, 51 AND 52).

FIRST USE 11-15-2010; IN COMMERCE 11-15-2010.

NO CLAIM IS MADE TO THE EXCLUSIVE RIGHT TO USE "100% DAMIANA BASED PRODUCT" AND "AROMATHERAPY/INCENSE NOT FOR HUMAN CONSUMPTION", APART FROM THE MARK AS SHOWN.

THE COLOR(S) BLACK, RED, GREY, AND WHITE IS/ARE CLAIMED AS A FEATURE OF THE MARK.

THE MARK CONSISTS OF THE WORDING "RED MAGIC" WRITTEN IN CURSIVE IN THE COLORS RED AND BLACK. A ROSE APPEARS BETWEEN THE WORDS "RED" AND "MAGIC" AND IS RED, WITH A BLACK CENTER, BLACK SHADING AND GREY BORDER. THE ROSE APPEARS SUPERIMPOSED ON A GRAY "O" AND "D". THE BACKGROUND IS A SWIRL OF BLACK, WHITE AND GRAY WITH PORTIONS OF THREE DISTINCT SWIRL-LIKE BANKS APPEARING IN THE COLORS WHITE, GRAY AND BLACK. THE WORDING "100% DAMIANA BASED PRODUCT" APPEARS IN THE COLOR BLACK IN THE UPPER RIGHT CORNER AND THE WORDING "AROMATHERAPY/INCENSE NOT FOR HUMAN CONSUMPTION" APPEARS IN THE COLOR BLACK IN THE LOWER LEFT CORNER.

SER. NO. 85-273,433, FILED 3-22-2011.

MICHAEL SOUDERS, EXAMINING ATTORNEY



David J. Kyffers

Director of the United States Patent and Trademark Office

United States of America

United States Patent and Trademark Office

Mic by Apogee

Reg. No. 4,098,246

Registered Feb. 14, 2012

Int. Cl.: 9

TRADEMARK

PRINCIPAL REGISTER

APOGEE ELECTRONICS CORPORATION (CALIFORNIA CORPORATION)
1715 BERKELEY STREET
SANTA MONICA, CA 90404

FOR: AUDIO APPARATUS AND ELECTRONIC EQUIPMENT FOR CONVERTING SIGNALS AND FORMATS, NAMELY, DIGITAL SIGNAL PROCESSORS; DIGITAL SIGNAL PROCESSORS TO PROVIDE DIGITAL AUDIO SIGNAL MANIPULATION FOR USE WITH MUSICAL INSTRUMENTS; SOUND AMPLIFIERS; SWITCH CONTROL UNITS, NAMELY, ELECTRONIC PROXIMITY SENSORS AND SWITCHES; ANALOG TO DIGITAL CONVERTERS; DIGITAL TO ANALOG CONVERTERS; MICROPHONE PREAMPLIFIERS; DOWNLOADABLE DIGITAL AUDIO FILES FEATURING MUSIC AND ARTISTIC PERFORMANCES; COMPUTER HARDWARE AND SOFTWARE PROGRAMS FOR AUDIO RECORDING, PLAYBACK, PROCESSING AND MIXING; ELECTRONIC AUDIO MODIFIERS; SIGNAL PROCESSORS; USER INTERFACES FOR ELECTRONIC DEVICES; MICROPHONES; TONE MODULES; POWER CONTROLLERS; GUITAR EFFECTS PROCESSORS; AMPLIFIERS AND AUDIO SOUND SPEAKERS; COMPUTER HARDWARE FOR RECORDING, MODELING, REPRODUCING, AND TRANSMITTING SOUND; DIGITAL INTERFACES FOR RECORDING, MODELING, REPRODUCING, AND TRANSMITTING SOUND; AMPLIFIERS FOR MUSICAL INSTRUMENTS AND PARTS AND ACCESSORIES FOR USE IN CONNECTION THEREWITH; COMPUTER SOFTWARE, NAMELY, AUDIO MODIFICATION SOFTWARE, AUDIO RECORDING SOFTWARE, AUDIO MODELING SOFTWARE, AND AUDIO EDITING SOFTWARE; COMPUTER SOFTWARE TO GENERATE AND CONTROL MUSICAL TONES FROM MICROPHONES AND MUSICAL INSTRUMENTS; COMPUTER SOFTWARE FOR ACCESSING PRERECORDED MUSIC; COMPUTER SOFTWARE FOR USE IN DOWNLOADING, UPLOADING, ACCESSING, RECORDING, EDITING, STORING, AND PLAYING MUSIC, TONES AND SOUNDS AND FOR PROVIDING ACCESS TO WEBSITES CONTAINING LIBRARIES OF MUSIC, TONES AND SOUNDS; DOWNLOADABLE AUDIO RECORDINGS FEATURING MUSIC AND ARTISTIC PERFORMANCES; AUDIO PROCESSORS FOR THE AUDIO SIGNAL MANIPULATION OF REAL OR VIRTUAL MUSICAL INSTRUMENTS; SOUND AMPLIFIERS; ELECTRICAL APPARATUS FOR USE WITH GUITARS AND OTHER PURPOSES, NAMELY, LOUDSPEAKERS AND LOUDSPEAKER COMPONENTS AND ACCESSORIES, NAMELY, ELECTRIC CORDS, CONNECTORS, CABLES AND SWITCHES; AMPLIFIER CONTROLS FOR VOLUME, TONE AND EFFECTS, IN CLASS 9 (U.S. CLS. 21, 23, 26, 36 AND 38).



David J. Kyjars

FIRST USE 3-10-2011; IN COMMERCE 3-18-2011.

Reg. No. 4,098,246 THE MARK CONSISTS OF STANDARD CHARACTERS WITHOUT CLAIM TO ANY PARTICULAR FONT, STYLE, SIZE, OR COLOR.

OWNER OF U.S. REG. NOS. 3,757,540, 3,757,542, AND 3,979,965.

NO CLAIM IS MADE TO THE EXCLUSIVE RIGHT TO USE "MIC", APART FROM THE MARK AS SHOWN.

SER. NO. 85-273,439, FILED 3-22-2011.

NATALIE POLZER, EXAMINING ATTORNEY

United States of America

United States Patent and Trademark Office

EVERGUARD

Reg. No. 4,098,247

AMERICAN DEER PROOFING, INC. (RHODE ISLAND CORPORATION)
567 LIBERTY LANE
WEST KINGSTON, RI 02892

Registered Feb. 14, 2012

Int. Cl.: 5

FOR: ANIMAL REPELLENTS, NAMELY, DEER REPELLENTS; PREPARATIONS FOR REPELLING ANIMALS; EXCLUDING PESTICIDES, INSECTICIDES, AND INSECT REPELLENTS , IN CLASS 5 (U.S. CLS. 6, 18, 44, 46, 51 AND 52).

TRADEMARK

FIRST USE 3-21-2011; IN COMMERCE 3-21-2011.

PRINCIPAL REGISTER

THE MARK CONSISTS OF STANDARD CHARACTERS WITHOUT CLAIM TO ANY PARTICULAR FONT, STYLE, SIZE, OR COLOR.

SER. NO. 85-273,451, FILED 3-22-2011.

KATHERINE E. HALMEN, EXAMINING ATTORNEY



David J. Kybas

Director of the United States Patent and Trademark Office

United States of America

United States Patent and Trademark Office

KIMBERLY GRANT

Reg. No. 4,098,248

CROWN CRAFTS INFANT PRODUCTS, INC. (DELAWARE CORPORATION)
916 S. BURNSIDE
GONZALES, LA 70737

Registered Feb. 14, 2012

**Int. Cls.: 11, 16, 20 and
24**

FOR: LAMPS, IN CLASS 11 (U.S. CLS. 13, 21, 23, 31 AND 34).

FIRST USE 9-1-1998; IN COMMERCE 9-1-1998.

TRADEMARK

FOR: CHILDREN'S WALL STICKERS AND MURALS, IN CLASS 16 (U.S. CLS. 2, 5, 22, 23, 29, 37, 38 AND 50).

PRINCIPAL REGISTER

FIRST USE 9-1-1998; IN COMMERCE 9-1-1998.

FOR: DECORATIVE MOBILES, IN CLASS 20 (U.S. CLS. 2, 13, 22, 25, 32 AND 50).

FIRST USE 9-1-1998; IN COMMERCE 9-1-1998.

FOR: BABY BEDDING, NAMELY, BUNDLE BAGS, SWADDLING BLANKETS, CRIB BUMPERS, FITTED CRIB SHEETS, CRIB SKIRTS, CRIB BLANKETS, AND DIAPER CHANGING PAD COVERS NOT OF PAPER; BED SHEETS; COMFORTERS; CRIB BUMPERS; DUST RUFFLES; FABRIC DIAPER STACKERS, IN CLASS 24 (U.S. CLS. 42 AND 50).

FIRST USE 9-1-1998; IN COMMERCE 9-1-1998.

THE MARK CONSISTS OF STANDARD CHARACTERS WITHOUT CLAIM TO ANY PARTICULAR FONT, STYLE, SIZE, OR COLOR.

THE NAME SHOWN IN THE MARK IDENTIFIES "KIMBERLY GRANT" WHOSE CONSENT IS MADE OF RECORD.

SER. NO. 85-273,715, FILED 3-22-2011.

GEORGE LORENZO, EXAMINING ATTORNEY



David J. Kyros

Director of the United States Patent and Trademark Office

United States of America

United States Patent and Trademark Office



Reg. No. 4,098,249

WARE INDUSTRIES, INC. (NEW JERSEY CORPORATION), DBA MARINO\WARE
400 METUCHEN ROAD
SOUTH PLAINFIELD, NJ 07080

Registered Feb. 14, 2012

Int. Cl.: 6

FOR: BUILDING WALL FRAMING MADE PRIMARILY OF METAL, IN CLASS 6 (U.S. CLS. 2, 12, 13, 14, 23, 25 AND 50).

TRADEMARK

FIRST USE 10-0-2007; IN COMMERCE 10-0-2007.

PRINCIPAL REGISTER

OWNER OF U.S. REG. NOS. 3,441,443, 3,629,649, AND 3,750,357.

THE COLOR(S) BLACK, GRAY, RED, AND WHITE IS/ARE CLAIMED AS A FEATURE OF THE MARK.

THE MARK CONSISTS OF THE LITERAL ELEMENT "VIPERSTUD" IN STYLIZED BLOCK LETTERING OUTLINED IN BLACK AND FILLED WITH WHITE AND RED, THE LITERAL ELEMENT SUPERIMPOSED OVER THE IMAGE OF AN OPEN-MOUTHED BLACK AND GRAY SNAKE WITH RED EYES.

SER. NO. 85-274,069, FILED 3-23-2011.

DEIRDRE ROBERTSON, EXAMINING ATTORNEY



David J. Kybas

Director of the United States Patent and Trademark Office

United States of America

United States Patent and Trademark Office

EXO

Reg. No. 4,098,250

Registered Feb. 14, 2012

Int. Cl.: 43

SERVICE MARK

PRINCIPAL REGISTER

WHITESTONE MEDITERRANEAN GROUP INC. (NEW YORK CORPORATION), DBA EXO
1516 149 STREET
WHITESTONE, NY 11357

FOR: BAR AND RESTAURANT SERVICES; CAFE AND RESTAURANT SERVICES, IN
CLASS 43 (U.S. CLS. 100 AND 101).

FIRST USE 2-1-2010, THE MARK WAS FIRST USED ANYWHERE IN A DIFFERENT FORM
OTHER THAN THAT SOUGHT TO BE REGISTERED AT LEAST AS EARLY AS 01/05/2010.;
IN COMMERCE 7-1-2010, THE MARK WAS FIRST USED IN COMMERCE IN A DIFFERENT
FORM OTHER THAN THAT SOUGHT TO BE REGISTERED AT LEAST AS EARLY AS
07/01/2010..

THE MARK CONSISTS OF STANDARD CHARACTERS WITHOUT CLAIM TO ANY PAR-
TICULAR FONT, STYLE, SIZE, OR COLOR.

THE WORDING "EXO" HAS NO MEANING IN A FOREIGN LANGUAGE.

SER. NO. 85-275,182, FILED 3-23-2011.

NICHOLAS ALTREE, EXAMINING ATTORNEY



David J. Kyffers

Director of the United States Patent and Trademark Office

United States of America

United States Patent and Trademark Office

Association of Oil Pipe Lines

Reg. No. 4,098,251

Registered Feb. 14, 2012

Int. Cl.: 35

SERVICE MARK

PRINCIPAL REGISTER

ASSOCIATION OF OIL PIPE LINES (D.C. INCORPORATED ASSOCIATION), AKA AOPL
1808 EYE ST NW SUITE 300
WASHINGTON, DC 20006

FOR: TRADE ASSOCIATION SERVICES, NAMELY, PROMOTING THE INTERESTS OF
OPERATORS OF LIQUIDS PIPELINE COMPANIES, IN CLASS 35 (U.S. CLS. 100, 101 AND
102).

FIRST USE 12-7-1965; IN COMMERCE 12-7-1965.

THE MARK CONSISTS OF STANDARD CHARACTERS WITHOUT CLAIM TO ANY PAR-
TICULAR FONT, STYLE, SIZE, OR COLOR.

NO CLAIM IS MADE TO THE EXCLUSIVE RIGHT TO USE "ASSOCIATION" AND "PIPE
LINES", APART FROM THE MARK AS SHOWN.

SEC. 2(F).

SER. NO. 85-275,625, FILED 3-24-2011.

INGA ERVIN, EXAMINING ATTORNEY



David J. Kyffers

Director of the United States Patent and Trademark Office

United States of America

United States Patent and Trademark Office

"Blue Hand" Men without A Country

Reg. No. 4,098,252

LEE, JUN H (UNITED STATES INDIVIDUAL)
250 W 100TH ST APT 900
NEW YORK, NY 10025

Registered Feb. 14, 2012

Int. Cl.: 25

FOR: DENIMS, IN CLASS 25 (U.S. CLS. 22 AND 39).

TRADEMARK

FIRST USE 3-11-2011; IN COMMERCE 3-11-2011.

PRINCIPAL REGISTER

THE MARK CONSISTS OF STANDARD CHARACTERS WITHOUT CLAIM TO ANY PARTICULAR FONT, STYLE, SIZE, OR COLOR.

OWNER OF U.S. REG. NO. 3,758,519.

SER. NO. 85-276,049, FILED 3-24-2011.

LEIGH CAROLINE CASE, EXAMINING ATTORNEY



David J. Kyffers

Director of the United States Patent and Trademark Office

United States of America

United States Patent and Trademark Office



Reg. No. 4,098,253

Registered Feb. 14, 2012

Int. Cl.: 29

TRADEMARK

PRINCIPAL REGISTER

JALENDRA ARAGON, SL (SPAIN LIMITED LIABILITY COMPANY)
POLIGONO INDUSTRIAL RIO GALLEGO, CALLE B
PARCELA 2
SAN MATEO DE GALLEGO, SPAIN 50840

FOR: FISH; POULTRY AND WILD MEATS; PROCESSED FRUITS AND CANNED VEGETABLES DRY AND COOKED; JAMS, IN CLASS 29 (U.S. CL. 46).

PRIORITY CLAIMED UNDER SEC. 44(D) ON ERPN CMNTY TM OFC APPLICATION NO. 009631078, FILED 12-29-2010, REG. NO. 009631078, DATED 7-26-2011, EXPIRES 12-29-2020.

THE COLOR(S) RED AND WHITE IS/ARE CLAIMED AS A FEATURE OF THE MARK.

THE MARK CONSISTS OF A RECTANGLE COLORED RED AND THE WORD "CALYDE" IN WHITE UNDERLINED WITH A THICK WHITE LINE CURVE FROM ONE SIDE TO THE OTHER OF THE RECTANGLE.

SER. NO. 85-276,515, FILED 3-25-2011.

DAVID C. REIHNER, EXAMINING ATTORNEY



David J. Kybas

Director of the United States Patent and Trademark Office

United States of America

United States Patent and Trademark Office

FRESH START NUTRITION

Reg. No. 4,098,254

MELANIE ZOOK (UNITED STATES INDIVIDUAL)
4610 MERCHANT SQUARE PLACE
LANSDALE, PA 19446

Registered Feb. 14, 2012

Int. Cl.: 44

FOR: COUNSELING SERVICES IN THE FIELDS OF HEALTH, NUTRITION AND LIFESTYLE WELLNESS; FOOD NUTRITION CONSULTATION; PROVIDING A WEBSITE FEATURING INFORMATION ABOUT HEALTH, WELLNESS AND NUTRITION; PROVIDING HEALTHY LIFESTYLE AND NUTRITION SERVICES, NAMELY, PERSONAL ASSESSMENTS, PERSONALIZED ROUTINES, MAINTENANCE SCHEDULES, AND COUNSELING; PROVIDING INFORMATION, NEWS AND COMMENTARY IN THE FIELD OF NUTRITION, HEALTH AND WELLNESS, IN CLASS 44 (U.S. CLS. 100 AND 101).

SERVICE MARK

PRINCIPAL REGISTER

FIRST USE 8-0-2010; IN COMMERCE 8-0-2010.

THE MARK CONSISTS OF STANDARD CHARACTERS WITHOUT CLAIM TO ANY PARTICULAR FONT, STYLE, SIZE, OR COLOR.

NO CLAIM IS MADE TO THE EXCLUSIVE RIGHT TO USE "NUTRITION" , APART FROM THE MARK AS SHOWN.

SER. NO. 85-277,176, FILED 3-25-2011.

PATRICIA EVANKO, EXAMINING ATTORNEY



David J. Kyffers

Director of the United States Patent and Trademark Office

United States of America

United States Patent and Trademark Office

ave agave!

Reg. No. 4,098,255

BRICE FOODS, INC. (COLORADO CORPORATION), TA AVE AGAVE!
443 N. SNOWMASS CIRCLE
SUPERIOR, CO 80027

Registered Feb. 14, 2012

Int. Cl.: 29

FOR: FRUIT JELLIES; FRUIT PRESERVES; FRUIT SPREADS; FRUITS IN PRESERVED FORM; FRUITS, NAMELY, PRESERVED FRUITS; JAMS; JAMS AND MARMALADES; JELLIES; JELLIES AND JAMS; JELLIES FOR FOOD; JELLIES, JAMS; MARMALADES AND JAMS; MEAT, FRUIT AND VEGETABLE JELLIES, JAMS; MEAT, FRUIT AND VEGETABLE JELLIES, JAMS, EGGS; PRESERVED FRUIT AND VEGETABLES; PRESERVED FRUITS; SANDWICH SPREAD, NAMELY, JAM, JELLY, PRESERVE, FRUIT SPREAD; CANNED AND PRESERVED FRUITS; ALL OF THE FOREGOING SWEETENED WITH AGAVE, IN CLASS 29 (U.S. CL. 46).

TRADEMARK

PRINCIPAL REGISTER

FIRST USE 1-28-2011; IN COMMERCE 1-28-2011.

THE MARK CONSISTS OF STANDARD CHARACTERS WITHOUT CLAIM TO ANY PARTICULAR FONT, STYLE, SIZE, OR COLOR.

NO CLAIM IS MADE TO THE EXCLUSIVE RIGHT TO USE "AGAVE", APART FROM THE MARK AS SHOWN.

SER. NO. 85-277,581, FILED 3-25-2011.

SUNG IN, EXAMINING ATTORNEY



David J. Kypos

Director of the United States Patent and Trademark Office

United States of America

United States Patent and Trademark Office

Pink Bubblegum

Reg. No. 4,098,256

CURAH, AVA-MAE (UNITED STATES INDIVIDUAL)

Registered Feb. 14, 2012

1773 CORAL RIDGE DR
CORAL SPRINGS, FL 33071

Int. Cl.: 9

TRADEMARK

PRINCIPAL REGISTER

FOR: AUDIO AND VIDEO RECORDINGS FEATURING MUSIC AND ARTISTIC PERFORMANCES; AUDIO TAPES FEATURING MUSIC; CASES FOR MUSIC, AUDIO AND RELATED ELECTRONIC EQUIPMENT, NAMELY, CASES FOR AUDIO TUNERS, AUDIO RECEIVERS, AMPLIFIERS, TAPE PLAYERS, COMPACT DISC PLAYERS, MP3 CONTROLLERS/PLAYERS, AUDIO MIXERS, AUDIO SPEAKERS IN THE NATURE OF MUSIC STUDIO MONITORS, MICROPHONES, AUDIO SPEAKERS, COMPACT DISCS, AUDIO TAPES, PORTABLE COMPUTERS, ANTENNAS, PHONOGRAPHIC RECORD PLAYERS, AUDIO RECORDING EQUIPMENT, AND THE CABLES ASSOCIATED WITH ALL OF THE FOREGOING EQUIPMENT; CHILDREN'S EDUCATIONAL MUSIC CDS AND DVDS; COMPACT DISCS FEATURING MUSIC; COMPUTER SOFTWARE FEATURING MUSICAL SOUND RECORDINGS AND MUSICAL VIDEO RECORDINGS; DIGITAL MUSIC DOWNLOADABLE FROM THE INTERNET; DOWNLOADABLE MP3 FILES, MP3 RECORDINGS, ON-LINE DISCUSSION BOARDS, WEBCASTS, WEBINARS AND PODCASTS FEATURING MUSIC, AUDIO BOOKS IN THE FIELD OF MUSIC, AND NEWS BROADCASTS; DOWNLOADABLE MUSICAL SOUND RECORDINGS; DOWNLOADABLE RING TONES, GRAPHICS AND MUSIC VIA A GLOBAL COMPUTER NETWORK AND WIRELESS DEVICES; DOWNLOADABLE VIDEO RECORDINGS FEATURING MUSIC; DOWNLOADABLE MUSIC VIA THE INTERNET AND WIRELESS DEVICES; MUSICAL RECORDINGS; MUSICAL SOUND RECORDINGS; MUSICAL VIDEO RECORDINGS; SERIES OF MUSICAL SOUND RECORDINGS; SOUND RECORDINGS FEATURING MUSIC; VISUAL RECORDINGS AND AUDIOVISUAL RECORDINGS FEATURING MUSIC AND ANIMATION, IN CLASS 9 (U.S. CLS. 21, 23, 26, 36 AND 38).



FIRST USE 11-11-2009; IN COMMERCE 10-21-2010.

THE MARK CONSISTS OF STANDARD CHARACTERS WITHOUT CLAIM TO ANY PARTICULAR FONT, STYLE, SIZE, OR COLOR.

SER. NO. 85-277,735, FILED 3-26-2011.

HANNO RITTNER, EXAMINING ATTORNEY

David J. Kyffers

Director of the United States Patent and Trademark Office

United States of America

United States Patent and Trademark Office



Reg. No. 4,098,257

Registered Feb. 14, 2012

Int. Cl.: 8

TRADEMARK

PRINCIPAL REGISTER

LORD FOR TRADE & INDUSTRY S.A.E. (EGYPT JOINT STOCK COMPANY)
12 SAFIA ZAGHLOUL ST., EL SHARK
PORT SAIDI, EGYPT

FOR: REGULAR RAZORS WITH ONE, TWO OR THREE FIXED OR MOVABLE BLADES;
SHAVING BLADES; SHAVING BLADES WITH FIXED OR MOVABLE PLASTIC HAND;
CUTLERY AND KNIVES, IN CLASS 8 (U.S. CLS. 23, 28 AND 44).

OWNER OF EGYPT REG. NO. 152834, DATED 1-29-2006, EXPIRES 7-14-2012.

THE ARABIC CHARACTERS IN THE MARK TRANSLITERATE TO "SHARK" AND ARE
USED SOLELY FOR THEIR PHONETIC VALUE TO MIMIC THE ENGLISH WORDING
"SHARK" IN THE MARK, BUT, OTHERWISE, HAVE NO MEANING IN ARABIC.

THE MARK CONSISTS OF THE TRANSLITERATION OF THE WORD "SHARK" IN ARABIC
CHARACTERS APPEARING ABOVE THE WORD "SHARK" IN STYLIZED LATIN CHAR-
ACTERS WITH THE IMAGE OF A SHARK TO THE RIGHT OF THE LATIN WORD.

SER. NO. 85-278,804, FILED 3-28-2011.

KARANENDRA S. CHHINA, EXAMINING ATTORNEY



David J. Kyffers

Director of the United States Patent and Trademark Office

United States of America

United States Patent and Trademark Office

TANK 7 FARMHOUSE ALE

Reg. No. 4,098,258

Registered Feb. 14, 2012

Int. Cl.: 32

TRADEMARK

PRINCIPAL REGISTER

BOULEVARD BREWING ASSOCIATES LIMITED PARTNERSHIP (MISSOURI LIMITED PARTNERSHIP), DBA BOULEVARD BREWING COMPANY
2501 SOUTHWEST BOULEVARD
KANSAS CITY, MO 64108

FOR: BEER, ALE AND MALT LIQUOR, IN CLASS 32 (U.S. CLS. 45, 46 AND 48).

FIRST USE 11-1-2009; IN COMMERCE 11-1-2009.

THE MARK CONSISTS OF STANDARD CHARACTERS WITHOUT CLAIM TO ANY PARTICULAR FONT, STYLE, SIZE, OR COLOR.

NO CLAIM IS MADE TO THE EXCLUSIVE RIGHT TO USE "FARMHOUSE ALE", APART FROM THE MARK AS SHOWN.

SER. NO. 85-279,981, FILED 3-29-2011.

STEVEN PEREZ, EXAMINING ATTORNEY



David J. Kyffers

Director of the United States Patent and Trademark Office

United States of America

United States Patent and Trademark Office



Reg. No. 4,098,259

Registered Feb. 14, 2012

Int. Cls.: 29 and 30

TRADEMARK

PRINCIPAL REGISTER

SUN, TEH-SAN (CHINA INDIVIDUAL)
169 JINSHAJIANG ROAD YANTAI ECO/TCH ZONE
SHANDONG, CHINA

FOR: BEAN CURD; BUTTER; EDIBLE OILS; FISH; FROZEN VEGETABLES; PEANUT BUTTER; PREPARATIONS FOR MAKING BROTHS; PREPARED NUTS; PROCESSED MUSHROOMS; PROCESSED, EDIBLE SEAWEED; SALADS EXCEPT MACARONI, RICE, AND PASTA SALAD; SEA CUCUMBERS; SOUPS, IN CLASS 29 (U.S. CL. 46).

FIRST USE 2-1-1997; IN COMMERCE 2-1-1997.

FOR: FLOUR; FLOUR FOR FOOD; FOOD SEASONINGS; MEAT PIES; PROCESSED CEREALS; RICE; SALAD DRESSINGS; SAUCES; SOY BEAN PASTE; SOY SAUCE; SUGAR; TOMATO SAUCE; VINEGAR; YEAST, IN CLASS 30 (U.S. CL. 46).

FIRST USE 2-1-1997; IN COMMERCE 2-1-1997.

THE MARK CONSISTS OF A GREEN ROUNDED BOX, OUTLINED IN WHITE, CONTAINING 3 WHITE CHINESE PINYINS, WITH THE FIRST PINYIN SEPARATED FROM THE OTHERS BY A STYLISTIC FLOWER STEM, OUTLINED IN WHITE AND EXTENDING FROM THE BOTTOM OF THE BOX TO NEAR ITS TOP; CONNECTING TO A STYLISTIC FLOWER, OUTLINED IN WHITE AND EXTENDING FROM THE TOP OF THE BOX AND CONTAINING 5 INDIVIDUALLY COLORED PETALS, ALL OUTLINED IN WHITE WITH THE PETAL COLORS FROM LEFT TO RIGHT AS RED, ORANGE, YELLOW, LIGHT GREEN, AND GREEN; WITH 6 GREEN LEAVES, OUTLINED IN WHITE, APPEARING TO BE BLOWN FROM THE FLOWER AND EXTENDING FROM THE LIGHT GREEN PETAL, TO THE RIGHT OF THE MARK.

THE COLOR(S) GREEN, LIGHT GREEN, RED, ORANGE, YELLOW, AND WHITE IS/ARE CLAIMED AS A FEATURE OF THE MARK.

THE NON-LATIN CHARACTERS IN THE MARK TRANSLITERATE TO "CONG BAN LÜ", AND THIS MEANS THE "COMPANION OF SCALLION" IN ENGLISH.

SER. NO. 85-280,283, FILED 3-29-2011.

CHRISIE B. KING, EXAMINING ATTORNEY



David J. Kyros

Director of the United States Patent and Trademark Office

United States of America

United States Patent and Trademark Office

UX SPECIALIZED LOGISTICS

Reg. No. 4,098,260

EARLYBIRD DELIVERY SYSTEMS, LLC (NEW YORK LIMITED LIABILITY COMPANY)
229 WEST 36TH ST.

Registered Feb. 14, 2012

NEW YORK, NY 10018

Int. Cls.: 39 and 40

FOR: PICKUP, WAREHOUSING, TRANSPORT AND DELIVERY OF DOCUMENTS, PACKAGES AND FREIGHT; WAREHOUSE FULFILLMENT, NAMELY, STORAGE, DISTRIBUTION, PICKUP AND PACKAGING FOR SHIPMENT OF DOCUMENTS, PACKAGES AND OTHER FREIGHT FOR OTHERS, IN CLASS 39 (U.S. CLS. 100 AND 105).

SERVICE MARK

PRINCIPAL REGISTER

FIRST USE 12-1-2007; IN COMMERCE 12-1-2007.

FOR: ASSEMBLY OF PRODUCTS, EQUIPMENT AND FURNITURE FOR OTHERS, IN CLASS 40 (U.S. CLS. 100, 103 AND 106).

FIRST USE 12-1-2007; IN COMMERCE 12-1-2007.

THE MARK CONSISTS OF STANDARD CHARACTERS WITHOUT CLAIM TO ANY PARTICULAR FONT, STYLE, SIZE, OR COLOR.

NO CLAIM IS MADE TO THE EXCLUSIVE RIGHT TO USE "SPECIALIZED LOGISTICS", APART FROM THE MARK AS SHOWN.

SER. NO. 85-280,315, FILED 3-29-2011.

TINA BROWN, EXAMINING ATTORNEY



David J. Kybas

Director of the United States Patent and Trademark Office

United States of America

United States Patent and Trademark Office

sell or fix

Reg. No. 4,098,261

THIESSEN, BRADFORD J (HAWAII LIMITED LIABILITY COMPANY), DBA B2B LLC
6800 KALANIANAOLE HWY # 204
HONOLULU, HI 96825

Registered Feb. 14, 2012

Int. Cl.: 37

FOR: AUTOMOTIVE MAINTENANCE AND REPAIR, IN CLASS 37 (U.S. CLS. 100, 103 AND 106).

SERVICE MARK

FIRST USE 10-12-2010; IN COMMERCE 10-12-2010.

PRINCIPAL REGISTER

THE MARK CONSISTS OF STANDARD CHARACTERS WITHOUT CLAIM TO ANY PARTICULAR FONT, STYLE, SIZE, OR COLOR.

SER. NO. 85-281,474, FILED 3-30-2011.

PAULA MAHONEY, EXAMINING ATTORNEY



David J. Kybas

Director of the United States Patent and Trademark Office

United States of America

United States Patent and Trademark Office

PLANT BURGER

Reg. No. 4,098,262

Registered Feb. 14, 2012

Int. Cls.: 29 and 30

TRADEMARK

PRINCIPAL REGISTER

MNMCO (CALIFORNIA LIMITED LIABILITY COMPANY)
371 GREENDALE WAY
REDWOOD CITY, CA 94062

FOR: VEGGIE BURGER PATTIES, IN CLASS 29 (U.S. CL. 46).

FIRST USE 11-1-2007; IN COMMERCE 11-1-2007.

FOR: HAMBURGER SANDWICHES, IN CLASS 30 (U.S. CL. 46).

FIRST USE 11-1-2007; IN COMMERCE 11-1-2007.

THE MARK CONSISTS OF STANDARD CHARACTERS WITHOUT CLAIM TO ANY PARTICULAR FONT, STYLE, SIZE, OR COLOR.

NO CLAIM IS MADE TO THE EXCLUSIVE RIGHT TO USE "BURGER", APART FROM THE MARK AS SHOWN.

SER. NO. 85-281,830, FILED 3-30-2011.

SKYE YOUNG, EXAMINING ATTORNEY



David J. Kyffers

Director of the United States Patent and Trademark Office

United States of America

United States Patent and Trademark Office

BLING HIGHLIGHTS

Reg. No. 4,098,263

BLING HIGHLIGHTS (UTAH SOLE PROPRIETORSHIP)
132 WEST 2030 SOUTH
OREM, UT 84058

Registered Feb. 14, 2012

Int. Cl.: 26

FOR: ADD-IN AND ADD-ON HAIR STRANDS CONSTRUCTED PRIMARILY OF SYNTHETIC AND/OR HUMAN HAIR, IN CLASS 26 (U.S. CLS. 37, 39, 40, 42 AND 50).

TRADEMARK

FIRST USE 8-0-2009; IN COMMERCE 8-0-2009.

PRINCIPAL REGISTER

THE MARK CONSISTS OF STANDARD CHARACTERS WITHOUT CLAIM TO ANY PARTICULAR FONT, STYLE, SIZE, OR COLOR.

NO CLAIM IS MADE TO THE EXCLUSIVE RIGHT TO USE "HIGHLIGHTS", APART FROM THE MARK AS SHOWN.

SER. NO. 85-282,285, FILED 3-31-2011.

TRICIA SONNEBORN, EXAMINING ATTORNEY



David J. Kyffers

Director of the United States Patent and Trademark Office

United States of America

United States Patent and Trademark Office

FRUITGRASS

Reg. No. 4,098,264

THE FRUITGRASS COMPANY, LLC (GEORGIA CORPORATION)
P.O. BOX 3375
DECATUR, GA 30031

Registered Feb. 14, 2012

Int. Cl.: 5

FOR: DIETARY AND NUTRITIONAL SUPPLEMENTS, IN CLASS 5 (U.S. CLS. 6, 18, 44, 46, 51 AND 52).

TRADEMARK

FIRST USE 7-8-2010; IN COMMERCE 7-8-2010.

PRINCIPAL REGISTER

THE MARK CONSISTS OF STANDARD CHARACTERS WITHOUT CLAIM TO ANY PARTICULAR FONT, STYLE, SIZE, OR COLOR.

SER. NO. 85-282,717, FILED 3-31-2011.

BARNEY CHARLON, EXAMINING ATTORNEY



David J. Kyffers

Director of the United States Patent and Trademark Office

United States of America

United States Patent and Trademark Office

Wildlands Restoration Volunteers

Reg. No. 4,098,265

Registered Feb. 14, 2012

Int. Cl.: 35

SERVICE MARK

PRINCIPAL REGISTER

WILDLANDS RESTORATION VOLUNTEERS (COLORADO CORPORATION)
SUITE 201
3012 STERLING CIRCLE
BOULDER, CO 80301

FOR: CHARITABLE SERVICES, NAMELY, ORGANIZING AND CONDUCTING VOLUNTEER PROGRAMS AND COMMUNITY SERVICE PROJECTS, IN CLASS 35 (U.S. CLS. 100, 101 AND 102).

FIRST USE 3-1-2003; IN COMMERCE 3-1-2003.

THE MARK CONSISTS OF STANDARD CHARACTERS WITHOUT CLAIM TO ANY PARTICULAR FONT, STYLE, SIZE, OR COLOR.

NO CLAIM IS MADE TO THE EXCLUSIVE RIGHT TO USE "VOLUNTEERS", APART FROM THE MARK AS SHOWN.

SEC. 2(F).

SER. NO. 85-283,112, FILED 3-31-2011.

SUE LAWRENCE, EXAMINING ATTORNEY



David J. Kyffers

Director of the United States Patent and Trademark Office

United States of America

United States Patent and Trademark Office



Reg. No. 4,098,266

Registered Feb. 14, 2012

Int. Cl.: 28

TRADEMARK

PRINCIPAL REGISTER

SMITH, ROBERT (UNITED STATES INDIVIDUAL)
3788 MAPLEWOOD AVE.
LOS ANGELES, CA 90066

FOR: DICE GAMES, IN CLASS 28 (U.S. CLS. 22, 23, 38 AND 50).

FIRST USE 6-1-2011; IN COMMERCE 6-12-2011.

NO CLAIM IS MADE TO THE EXCLUSIVE RIGHT TO USE "GAME" AND "DICE", APART FROM THE MARK AS SHOWN.

THE MARK CONSISTS OF TWO CUBES, ONE WITH "180", "BIKE DICE" AND "BAR SPIN" ON THE THREE VISIBLE SIDES, THE OTHER WITH "360", "TAIL WHIP" AND A STYLIZED GEAR ON THE THREE VISIBLE SIDES. THERE IS A TRIANGLE ABOVE THE LEFT CUBE AND A TRIANGLE BELOW THE RIGHT CUBE WITH THE WORDING "PLAY THE GAME OF" SLANTED UPWARD ALONG A SIDE OF THE RIGHT TRIANGLE AND "B.I.K.E." SLANTED UPWARD BELOW THE SAME SIDE OF THE RIGHT TRIANGLE.

SER. NO. 85-283,124, FILED 3-31-2011.

ELISSA GARBER KON, EXAMINING ATTORNEY



David J. Kyffers

Director of the United States Patent and Trademark Office

United States of America

United States Patent and Trademark Office



Reg. No. 4,098,267

Registered Feb. 14, 2012

Int. Cl.: 35

SERVICE MARK

PRINCIPAL REGISTER

WILDLANDS RESTORATION VOLUNTEERS (COLORADO CORPORATION)
SUITE 201
3012 STERLING CIRCLE
BOULDER, CO 80301

FOR: CHARITABLE SERVICES, NAMELY, ORGANIZING AND CONDUCTING VOLUNTEER PROGRAMS AND COMMUNITY SERVICE PROJECTS, IN CLASS 35 (U.S. CLS. 100, 101 AND 102).

FIRST USE 3-1-2003; IN COMMERCE 3-1-2003.

NO CLAIM IS MADE TO THE EXCLUSIVE RIGHT TO USE "VOLUNTEERS", APART FROM THE MARK AS SHOWN.

THE COLOR(S) GREEN IS/ARE CLAIMED AS A FEATURE OF THE MARK.

THE MARK CONSISTS OF THE WORDING "WILDLANDS RESTORATION VOLUNTEERS" WITH "VOLUNTEERS" UNDERLINED, THE WORDING RUNS THROUGH THE MIDDLE OF A CIRCLE; IN THE UPPER PART OF THE CIRCLE ARE MOUNTAINS AND TREES, IN THE LOWER PART IS A AN OPEN HAND HOLDING A SEEDLING; THE WORDING AND THE OUTLINE OF THE CIRCLE AND DESIGN ARE IN GREEN.

SEC. 2(F) AS TO "WILDLANDS RESTORATION VOLUNTEERS".

SER. NO. 85-283,184, FILED 3-31-2011.

SUE LAWRENCE, EXAMINING ATTORNEY



David J. Kyros

Director of the United States Patent and Trademark Office

United States of America

United States Patent and Trademark Office

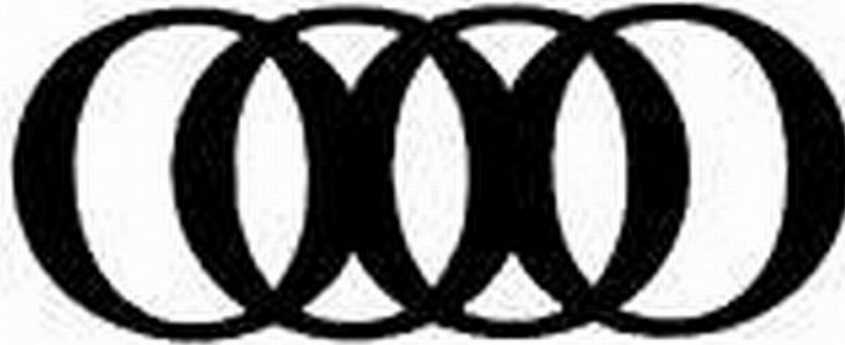

Reg. No. 4,098,268

Registered Feb. 14, 2012

Int. Cls.: 9, 36, 41 and 45

TRADEMARK

SERVICE MARK

PRINCIPAL REGISTER

OMNI FINANCIAL GROUP, INC. (NEW YORK CORPORATION), DBA THE OMNI GROUP
WATERTOWER OFFICE PARK, BUILDING F
1099 JAY STREET
ROCHESTER, NY 14611

FOR: PRE-RECORDED DVDS FOR EDUCATIONAL PURPOSES IN THE FIELD OF EMPLOYER-SPONSORED RETIREMENT PLANS; AND DOWNLOADABLE WEBINARS FOR EDUCATIONAL PURPOSES IN THE FIELD OF EMPLOYER-SPONSORED RETIREMENT PLANS; DOWNLOADABLE ELECTRONIC NEWSLETTERS IN THE FIELD OF EMPLOYER-SPONSORED RETIREMENT PLANS, IN CLASS 9 (U.S. CLS. 21, 23, 26, 36 AND 38).

FIRST USE 4-7-2009; IN COMMERCE 4-7-2009.

FOR: ADMINISTRATION OF EMPLOYER-SPONSORED FINANCIAL RETIREMENT PLANS, IN CLASS 36 (U.S. CLS. 100, 101 AND 102).

FIRST USE 0-0-1999; IN COMMERCE 0-0-1999.

FOR: EDUCATIONAL SERVICES, NAMELY, CONDUCTING SEMINARS IN THE FIELD OF EMPLOYER-SPONSORED RETIREMENT PLANS AND DISTRIBUTION OF PRINTED MATERIALS IN CONNECTION THEREWITH IN HARD COPY OR ELECTRONIC FORMAT ON THE SAME TOPIC, IN CLASS 41 (U.S. CLS. 100, 101 AND 107).

FIRST USE 4-7-2009; IN COMMERCE 4-7-2009.

FOR: REVIEWING STANDARDS AND PRACTICES TO ASSURE COMPLIANCE WITH LAWS AND REGULATIONS IN THE FIELD OF EMPLOYER-SPONSORED RETIREMENT PLANS, IN CLASS 45 (U.S. CLS. 100 AND 101).

FIRST USE 0-0-1999; IN COMMERCE 0-0-1999.

OWNER OF U.S. REG. NO. 2,361,311.

THE MARK CONSISTS OF FOUR STYLIZED, INTERLOCKING CIRCLES.

SER. NO. 85-283,832, FILED 4-1-2011.

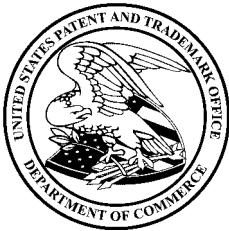

David J. Kyffers

Director of the United States Patent and Trademark Office

Reg. No. 4,098,268 JOHN SCHUYLER YARD, EXAMINING ATTORNEY

United States of America

United States Patent and Trademark Office

NYLOSHEET

Reg. No. 4,098,269

NYLOBOARD LLC (GEORGIA LIMITED LIABILITY COMPANY)
14187 INDUSTRIAL PARK BLVD.
COVINGTON, GA 30014

Registered Feb. 14, 2012

Int. Cl.: 19

FOR: BUILDING MATERIALS MANUFACTURED PRIMARILY FROM ENGINEERED NON-METAL COMPOSITE MATERIAL SUCH AS RECYCLED CARPET FIBERS AND VOC FREE BONDING RESINS, NAMELY, BUILDING SHEATHING, GARAGE DOOR SKINS, AND LAMINATE CORE MATERIAL, IN CLASS 19 (U.S. CLS. 1, 12, 33 AND 50).

TRADEMARK

PRINCIPAL REGISTER

FIRST USE 9-1-2011; IN COMMERCE 9-1-2011.

THE MARK CONSISTS OF STANDARD CHARACTERS WITHOUT CLAIM TO ANY PARTICULAR FONT, STYLE, SIZE, OR COLOR.

OWNER OF U.S. REG. NOS. 3,360,374, 3,886,327, AND 3,886,328.

SER. NO. 85-283,887, FILED 4-1-2011.

CHRISIE B. KING, EXAMINING ATTORNEY



David J. Kyffers

Director of the United States Patent and Trademark Office

United States of America

United States Patent and Trademark Office



Reg. No. 4,098,270

Registered Feb. 14, 2012

Int. Cl.: 35

SERVICE MARK

PRINCIPAL REGISTER

J. ANDREW MARSH COMMERCIAL (ARIZONA LIMITED LIABILITY COMPANY)
8350 E RAIN TREE DR
101
SCOTTSDALE, AZ 85260

FOR: ON-LINE RETAIL STORE SERVICES FEATURING NUTRACEUTICALS AND DIETARY SUPPLEMENTS, IN CLASS 35 (U.S. CLS. 100, 101 AND 102).

FIRST USE 10-23-2003; IN COMMERCE 10-23-2003.

NO CLAIM IS MADE TO THE EXCLUSIVE RIGHT TO USE "MEDICAL", APART FROM THE MARK AS SHOWN.

THE MARK CONSISTS OF THE STYLIZED TERMS "ENZYMUS MEDICAL" AND THREE POLYGONS WITH A HONEYCOMB DESIGN THROUGHOUT.

SER. NO. 85-284,180, FILED 4-1-2011.

HOWARD B. LEVINE, EXAMINING ATTORNEY



David J. Kyffers

Director of the United States Patent and Trademark Office

United States of America

United States Patent and Trademark Office

BRAND
EQUITY
SHARE
TRENDS

Reg. No. 4,098,271

FOOD SERVICE RESEARCH INSTITUTE, INC. (ILLINOIS CORPORATION)
6957 W. NORTH AVE.
OAK PARK, IL 60302

Registered Feb. 14, 2012

Int. Cl.: 35

FOR: CONDUCTING BUSINESS AND MARKET RESEARCH SURVEYS; CONDUCTING BUSINESS RESEARCH AND SURVEYS; CONDUCTING MARKET SURVEYS; CONDUCTING MARKETING STUDIES; MARKET ANALYSIS; MARKET ANALYSIS AND RESEARCH SERVICES; MARKET REPORTS AND STUDIES; MARKET RESEARCH; MARKET RESEARCH AND BUSINESS ANALYSES; MARKET RESEARCH CONSULTATION; MARKET RESEARCH SERVICES; MARKETING ANALYSIS SERVICES; MARKETING CONSULTATION IN THE FIELD OF RESTAURANT FOOD, IN CLASS 35 (U.S. CLS. 100, 101 AND 102).

SERVICE MARK

PRINCIPAL REGISTER

FIRST USE 7-1-1992; IN COMMERCE 7-1-1992.

NO CLAIM IS MADE TO THE EXCLUSIVE RIGHT TO USE "BRAND", APART FROM THE MARK AS SHOWN.

THE STIPPLING IS FOR SHADING PURPOSES ONLY.

THE MARK CONSISTS OF THE WORDS "BRAND EQUITY SHARE TRENDS" APPEARING VERTICALLY IN ORDER WHERE THE FIRST LETTER OF EACH WORD SPELLS "BEST".

SEC. 2(F).

SER. NO. 85-284,554, FILED 4-2-2011.

LINDA ORNDORFF, EXAMINING ATTORNEY



David J. Kyjars

Director of the United States Patent and Trademark Office

United States of America

United States Patent and Trademark Office



Reg. No. 4,098,272

DARIER & CLEEF GMBH (FED REP GERMANY LIMITED LIABILITY COMPANY)
PEUTESTR. 22

Registered Feb. 14, 2012

HAMBURG, FED REP GERMANY 20539

Int. Cl.: 34

FOR: ASHTRAYS; CIGAR CUTTERS; CIGARETTES; CIGARILLOS; CIGARS; MATCHES;
PIPE TOBACCO; TOBACCO, IN CLASS 34 (U.S. CLS. 2, 8, 9 AND 17).

TRADEMARK

FIRST USE 1-0-2008; IN COMMERCE 12-0-2009.

PRINCIPAL REGISTER

NO CLAIM IS MADE TO THE EXCLUSIVE RIGHT TO USE "MARCA", APART FROM THE
MARK AS SHOWN.

THE COLOR(S) BLUE, WHITE IS/ARE CLAIMED AS A FEATURE OF THE MARK.

THE MARK CONSISTS OF THE WORDING "MARCA FINA" IN STYLIZED LETTERS OF
WHITE COLOR POSITIONED IN A BLUE, CURVED BANNER. THE BANNER SHOWS TWO
BLUE ORNAMENTAL ELEMENTS LEFT AND RIGHT.

THE ENGLISH TRANSLATION OF "MARCA FINA" IN THE MARK IS "FINE MARK" OR
"FINE BRAND".

SER. NO. 85-284,577, FILED 4-2-2011.

ALYSSA STEEL, EXAMINING ATTORNEY



David J. Kyffers

Director of the United States Patent and Trademark Office

United States of America

United States Patent and Trademark Office

POSITIVE THREADS

Reg. No. 4,098,273

Registered Feb. 14, 2012

Int. Cl.: 25

TRADEMARK

PRINCIPAL REGISTER

POSITIVE THREADS MC LLC (COLORADO LIMITED LIABILITY COMPANY)
6090 AMES STREET
ARVADA, CO 80003

FOR: T-SHIRTS, IN CLASS 25 (U.S. CLS. 22 AND 39).

FIRST USE 1-2-2011; IN COMMERCE 2-11-2011.

THE MARK CONSISTS OF STANDARD CHARACTERS WITHOUT CLAIM TO ANY PARTICULAR FONT, STYLE, SIZE, OR COLOR.

NO CLAIM IS MADE TO THE EXCLUSIVE RIGHT TO USE "THREADS", APART FROM THE MARK AS SHOWN.

SER. NO. 85-284,726, FILED 4-3-2011.

AISHA CLARKE, EXAMINING ATTORNEY



David J. Kyffers

Director of the United States Patent and Trademark Office

United States of America

United States Patent and Trademark Office

b condoms

Reg. No. 4,098,274

PANDA, JASON K (UNITED STATES INDIVIDUAL)
237 WEST 120 ST., APT. 4
NEW YORK, NY 10027

Registered Feb. 14, 2012

Int. Cl.: 10

FOR: CONDOMS, IN CLASS 10 (U.S. CLS. 26, 39 AND 44).

TRADEMARK

FIRST USE 4-3-2011; IN COMMERCE 4-3-2011.

PRINCIPAL REGISTER

THE MARK CONSISTS OF STANDARD CHARACTERS WITHOUT CLAIM TO ANY PARTICULAR FONT, STYLE, SIZE, OR COLOR.

NO CLAIM IS MADE TO THE EXCLUSIVE RIGHT TO USE "CONDOMS", APART FROM THE MARK AS SHOWN.

SER. NO. 85-284,759, FILED 4-3-2011.

DAWN FELDMAN, EXAMINING ATTORNEY



David J. Kyffers

Director of the United States Patent and Trademark Office

United States of America

United States Patent and Trademark Office

ECO AIR

Reg. No. 4,098,275

Registered Feb. 14, 2012

Int. Cl.: 17

TRADEMARK

PRINCIPAL REGISTER

PRINSCO, INC. (MINNESOTA CORPORATION)
1717 16TH STREET N.E.
WILLMAR, MN 56201

FOR: FLEXIBLE NON-METAL AERATION PIPES THAT ARE PERFORATED AND CORRUGATED, ALL FOR USE IN AGRICULTURAL GRAIN STORAGE AND PRESERVATION APPLICATIONS, IN CLASS 17 (U.S. CLS. 1, 5, 12, 13, 35 AND 50).

FIRST USE 4-4-2011; IN COMMERCE 4-4-2011.

THE MARK CONSISTS OF STANDARD CHARACTERS WITHOUT CLAIM TO ANY PARTICULAR FONT, STYLE, SIZE, OR COLOR.

OWNER OF U.S. REG. NO. 2,890,909.

SER. NO. 85-285,173, FILED 4-4-2011.

MAUREEN DALL, EXAMINING ATTORNEY



David J. Kyffers

Director of the United States Patent and Trademark Office

United States of America

United States Patent and Trademark Office

Gertie Mae's

Reg. No. 4,098,276

Registered Feb. 14, 2012

Int. Cl.: 44

SERVICE MARK

PRINCIPAL REGISTER

SHERRY L. DONNELLY (GEORGIA SOLE PROPRIETORSHIP), DBA GERTIE MAE'S
P.O. BOX 812
CLARKESVILLE, GA 30523

FOR: FLORAL DESIGN SERVICES, IN CLASS 44 (U.S. CLS. 100 AND 101).

FIRST USE 1-1-2003; IN COMMERCE 1-1-2003.

THE MARK CONSISTS OF STANDARD CHARACTERS WITHOUT CLAIM TO ANY PARTICULAR FONT, STYLE, SIZE, OR COLOR.

THE NAME(S), PORTRAIT(S), AND/OR SIGNATURE(S) SHOWN IN THE MARK DOES NOT IDENTIFY A PARTICULAR LIVING INDIVIDUAL.

SER. NO. 85-285,362, FILED 4-4-2011.

SHAUNIA CARLYLE, EXAMINING ATTORNEY



David J. Kyffers

Director of the United States Patent and Trademark Office

United States of America

United States Patent and Trademark Office

CARIAD

Reg. No. 4,098,277

Registered Feb. 14, 2012

Int. Cl.: 14

TRADEMARK

PRINCIPAL REGISTER

CLOGAU GOLD OF WALES LTD (UNITED KINGDOM LIMITED COMPANY (LTD.))
NUMBER FIVE, KINMEL PARK ABERGELE ROAD
BODELWYDDAN RHYL, UNITED KINGDOM WALES LL18

FOR: JEWELLERY AND WATCHES, IN CLASS 14 (U.S. CLS. 2, 27, 28 AND 50).

THE MARK CONSISTS OF STANDARD CHARACTERS WITHOUT CLAIM TO ANY PARTICULAR FONT, STYLE, SIZE, OR COLOR.

OWNER OF ERPN CMNTY TM OFC REG. NO. 1985340, DATED 12-11-2001, EXPIRES 12-5-2020.

THE ENGLISH TRANSLATION OF "CARIAD" IN THE MARK IS "LOVE".

SER. NO. 85-285,498, FILED 4-4-2011.

KATHERINE CONNOLLY, EXAMINING ATTORNEY



David J. Kyffers

Director of the United States Patent and Trademark Office

United States of America

United States Patent and Trademark Office

unbeliEvable

E N T E R T A I N M E N T

Reg. No. 4,098,278

Registered Feb. 14, 2012

Int. Cl.: 41

SERVICE MARK

PRINCIPAL REGISTER

LONGORIA, EVA (UNITED STATES INDIVIDUAL)
C/O BLOOM HERGOTT DIEMER ROSENTHAL
150 SOUTH RODEO DRIVE, THIRD FLOOR
BEVERLY HILLS, CA 90212

FOR: PRODUCTION AND DISTRIBUTION OF MOTION PICTURES AND TELEVISION SHOWS; MULTIMEDIA PRODUCTION SERVICES, IN CLASS 41 (U.S. CLS. 100, 101 AND 107).

FIRST USE 10-0-2006; IN COMMERCE 10-0-2006.

NO CLAIM IS MADE TO THE EXCLUSIVE RIGHT TO USE "ENTERTAINMENT", APART FROM THE MARK AS SHOWN.

THE COLOR(S) BLACK AND RED IS/ARE CLAIMED AS A FEATURE OF THE MARK.

THE MARK CONSISTS OF THE WORD "UNBELIEVABLE" IN STYLIZED LETTERS, WITH THE "EVA" PORTION IN RED COLORED LETTERS AND THE "UNBELI" AND "BLE" PORTIONS IN BLACK COLORED LETTERS, STACKED OVER THE WORD "ENTERTAINMENT" IN UPPERCASE BLACK COLORED LETTERS.

SER. NO. 85-286,378, FILED 4-5-2011.

KELLY TRUSILO, EXAMINING ATTORNEY



David J. Kybas

Director of the United States Patent and Trademark Office

United States of America

United States Patent and Trademark Office

3D-Z

Reg. No. 4,098,279

D AND S CORLEY LIMITED (CANADA CORPORATION), DBA DSC LABORATORIES
3565 NASHUA DRIVE

Registered Feb. 14, 2012

MISSISSAUGA, ONTARIO, CANADA L4V1R1

Int. Cl.: 16

FOR: PRINTED CHARTS FEATURING CAMERA TEST PATTERNS, IN CLASS 16 (U.S. CLS. 2, 5, 22, 23, 29, 37, 38 AND 50).

TRADEMARK

FIRST USE 2-15-2011; IN COMMERCE 3-15-2011.

PRINCIPAL REGISTER

THE MARK CONSISTS OF STANDARD CHARACTERS WITHOUT CLAIM TO ANY PARTICULAR FONT, STYLE, SIZE, OR COLOR.

SER. NO. 85-286,604, FILED 4-5-2011.

SETH A. RAPPAPORT, EXAMINING ATTORNEY



David J. Kybas

Director of the United States Patent and Trademark Office

United States of America

United States Patent and Trademark Office

Helping Vets Save Pets

Reg. No. 4,098,280

AVALON MEDICAL LTD (MINNESOTA CORPORATION)
1060 CURVE CREST BLVD STE 102
STILLWATER, MN 55082

Registered Feb. 14, 2012

Int. Cl.: 10

FOR: SURGICAL APPARATUS AND INSTRUMENTS FOR MEDICAL, DENTAL OR VETERINARY USE, IN CLASS 10 (U.S. CLS. 26, 39 AND 44).

TRADEMARK

FIRST USE 1-2-2011; IN COMMERCE 1-2-2011.

PRINCIPAL REGISTER

THE MARK CONSISTS OF STANDARD CHARACTERS WITHOUT CLAIM TO ANY PARTICULAR FONT, STYLE, SIZE, OR COLOR.

SER. NO. 85-286,709, FILED 4-5-2011.

JAMES STEIN, EXAMINING ATTORNEY



David J. Kybas

Director of the United States Patent and Trademark Office

United States of America

United States Patent and Trademark Office

HEY IT'S ME

Reg. No. 4,098,281

OPTIME INC. (MICHIGAN CORPORATION)

Registered Feb. 14, 2012

2100 E. 15 MILE ROAD, SUITE C
STERLING HEIGHTS, MI 48310

Int. Cl.: 38

FOR: TELECOMMUNICATIONS SERVICES, NAMELY, ELECTRONIC TRANSMISSION OF MESSAGES, INFORMATION AND DATA FOR OTHERS; PROVIDING ACCESS TO ONLINE DATABASES; PROVIDING ONLINE FORUMS FOR INFORMATION RETRIEVAL AND COMMUNICATION, IN CLASS 38 (U.S. CLS. 100, 101 AND 104).

SERVICE MARK

PRINCIPAL REGISTER

FIRST USE 2-2-2011; IN COMMERCE 2-2-2011.

THE MARK CONSISTS OF STANDARD CHARACTERS WITHOUT CLAIM TO ANY PARTICULAR FONT, STYLE, SIZE, OR COLOR.

SER. NO. 85-286,793, FILED 4-5-2011.

RUDY R. SINGLETON, EXAMINING ATTORNEY



David J. Kyffers

Director of the United States Patent and Trademark Office

United States of America

United States Patent and Trademark Office



Reg. No. 4,098,282

LEUTHNER, BRIAN (UNITED STATES INDIVIDUAL)
211 WARREN STREET
NEWARK, NJ 07103

Registered Feb. 14, 2012

Int. Cl.: 42

FOR: RESEARCH AND DEVELOPMENT SERVICE, NAMELY, FOR PHARMACEUTICAL PRODUCTS, IN CLASS 42 (U.S. CLS. 100 AND 101).

SERVICE MARK

FIRST USE 3-16-2011; IN COMMERCE 3-16-2011.

PRINCIPAL REGISTER

NO CLAIM IS MADE TO THE EXCLUSIVE RIGHT TO USE "THERAPEUTICS, INC.", APART FROM THE MARK AS SHOWN.

THE MARK CONSISTS OF THE LITERAL ELEMENTS "EDGE THERAPEUTICS, INC."; A STYLIZE FACIAL PROFILE; AND A SET OF VARIOUS SIZE BOXES IN THE TOP OF SAID PROFILE.

SER. NO. 85-286,881, FILED 4-5-2011.

PAUL MORENO, EXAMINING ATTORNEY



David J. Kybas

Director of the United States Patent and Trademark Office

United States of America

United States Patent and Trademark Office

CLASH OF THE GIANTS

Reg. No. 4,098,283

TWENTIETH CENTURY FOX FILM CORPORATION (DELAWARE CORPORATION)
10201 WEST PICO BOULEVARD
LOS ANGELES, CA 90035

Registered Feb. 14, 2012

Int. Cl.: 41

FOR: ENTERTAINMENT SERVICES, NAMELY, PROVISION OF ON-GOING MULTIMEDIA PROGRAMS IN THE FIELD OF SOCCER AND NOT RELATING TO BASEBALL OR SOFTBALL OR TO IDENTIFY A SPORTS TEAM, IN CLASS 41 (U.S. CLS. 100, 101 AND 107).

SERVICE MARK

FIRST USE 2-28-2011; IN COMMERCE 2-28-2011.

PRINCIPAL REGISTER

THE MARK CONSISTS OF STANDARD CHARACTERS WITHOUT CLAIM TO ANY PARTICULAR FONT, STYLE, SIZE, OR COLOR.

SER. NO. 85-287,049, FILED 4-5-2011.

KIM SAITO, EXAMINING ATTORNEY



David J. Kyffers

Director of the United States Patent and Trademark Office

United States of America

United States Patent and Trademark Office

Gamerstable

Reg. No. 4,098,284

AUSLEY, ERIC RAYMOND (UNITED STATES INDIVIDUAL)
421 N. CEDAR ST
O FALLON, IL 62269

Registered Feb. 14, 2012

Int. Cl.: 9

FOR: DOWNLOADABLE PODCASTS IN THE FIELD OF TABLETOP GAMES, IN CLASS 9
(U.S. CLS. 21, 23, 26, 36 AND 38).

TRADEMARK

FIRST USE 3-30-2011; IN COMMERCE 3-30-2011.

PRINCIPAL REGISTER

THE MARK CONSISTS OF STANDARD CHARACTERS WITHOUT CLAIM TO ANY PARTICULAR FONT, STYLE, SIZE, OR COLOR.

SER. NO. 85-287,050, FILED 4-5-2011.

ELIZABETH KAJUBI, EXAMINING ATTORNEY



David J. Kybas

Director of the United States Patent and Trademark Office

United States of America

United States Patent and Trademark Office

ONE2CONNECT

Reg. No. 4,098,285

KEITH N. GOEKE (UNITED STATES INDIVIDUAL)
885 WOODSTOCK ROAD SUITE 430-148
ROSWELL, GA 30075

Registered Feb. 14, 2012

Int. Cl.: 38

FOR: PROVIDING TELEPHONE CONFERENCING SERVICES; PROVISION OF VIDEO CONFERENCING SERVICES; TELECOMMUNICATIONS CONSULTATION; TELECOMMUNICATIONS RESELLER SERVICES FOR BUSINESSES, NAMELY, PROVIDING LONG DISTANCE TELECOMMUNICATION SERVICES, VOICE TELECOMMUNICATION SERVICES, LOCAL TELEPHONE SERVICE, AND INTERNET ACCESS SERVICES, IN CLASS 38 (U.S. CLS. 100, 101 AND 104).

SERVICE MARK

PRINCIPAL REGISTER

FIRST USE 8-24-1999; IN COMMERCE 8-24-1999.

THE MARK CONSISTS OF STANDARD CHARACTERS WITHOUT CLAIM TO ANY PARTICULAR FONT, STYLE, SIZE, OR COLOR.

SER. NO. 85-287,469, FILED 4-6-2011.

ALLISON HOLTZ, EXAMINING ATTORNEY



David J. Kybas

Director of the United States Patent and Trademark Office

United States of America

United States Patent and Trademark Office

EMBA Y

Reg. No. 4,098,286

Registered Feb. 14, 2012

Int. Cl.: 19

TRADEMARK

PRINCIPAL REGISTER

MERLIN, GIUSEPPE (ITALY INDIVIDUAL)
VIA C. BATTISTI, 34
37053 CERE A (VR), ITALY AND

MERLIN, CARLO (ITALY INDIVIDUAL)
VIA S. VITO, 84
37053 CERE A (VR), ITALY

FOR: WOODEN BEAMS; WOODEN BOARDS; TIMBER; GLUE LAMINATED WOOD; SEMI-FINISHED WORKED WOOD; FLOORBOARDS OF WOOD; FLOOR TILES OF WOOD; WOOD PANELLING; NON-METAL DOORS; NON-METAL WINDOWS, IN CLASS 19 (U.S. CLS. 1, 12, 33 AND 50).

THE MARK CONSISTS OF STANDARD CHARACTERS WITHOUT CLAIM TO ANY PARTICULAR FONT, STYLE, SIZE, OR COLOR.

PRIORITY CLAIMED UNDER SEC. 44(D) ON ERPN CMNTY TM OFC APPLICATION NO. 009863689, FILED 4-4-2011, REG. NO. 009863689, DATED 8-4-2011, EXPIRES 4-4-2021.

SER. NO. 85-288,198, FILED 4-6-2011.

MICHAEL SOUDERS, EXAMINING ATTORNEY



David J. Kyffers

Director of the United States Patent and Trademark Office

United States of America

United States Patent and Trademark Office

GateLink

connecting airplane to airline

Reg. No. 4,098,287

AIR INFORMATICS LLC (DELAWARE LIMITED LIABILITY COMPANY)
445 PARK AVENUE, 10TH FLOOR
NEW YORK, NY 10022

Registered Feb. 14, 2012

Int. Cl.: 42

FOR: COMPUTER SERVICE, NAMELY, ACTING AS AN APPLICATION SERVICE PROVIDER IN THE FIELD OF KNOWLEDGE MANAGEMENT TO HOST COMPUTER APPLICATION SOFTWARE FOR THE COLLECTION, EDITING, ORGANIZING, MODIFYING, BOOK MARKING, TRANSMISSION, STORAGE AND SHARING OF DATA AND INFORMATION IN THE FIELD OF THE MANAGEMENT AND OPERATION OF AN AIRCRAFT AND OTHER VEHICLES; REMOTE DATA MANAGEMENT FOR WIRELESS DELIVERY OF COMPUTER SOFTWARE FOR USE IN THE MANAGEMENT AND OPERATION OF AIRCRAFT AND OTHER VEHICLES; REMOTE DATA MANAGEMENT FOR WIRELESS DELIVERY OF UPDATED COMPUTER APPLICATIONS, DATABASES, EMBEDDED SOFTWARE TO AIRCRAFT AND OTHER VEHICLES FOR THE PURPOSE OF THE MANAGEMENT AND OPERATION OF AN AIRCRAFT OR OTHER VEHICLE; PROVIDING ONLINE NON-DOWNLOADABLE SOFTWARE FOR THE PURPOSE OF MANAGEMENT AND OPERATION OF AN AIRCRAFT OR OTHER VEHICLE; APPLICATION SERVICE PROVIDER, NAMELY, PROVIDING, MANAGING, MAINTAINING AND HOSTING SOFTWARE AND WEB SITES IN THE FIELD OF AIRCRAFT AND VEHICLE MANAGEMENT AND OPERATIONS AND REMOTE DATA MANAGEMENT, DATA TRANSFER, DATA SYNCHRONIZATION, AND DATA COMMUNICATION FOR THE WIRELESS DELIVERY OF DATA AND SOFTWARE RELATED TO AIRCRAFT AND OTHER VEHICLES, IN CLASS 42 (U.S. CLS. 100 AND 101).

SERVICE MARK

PRINCIPAL REGISTER

FIRST USE 8-1-2010; IN COMMERCE 8-1-2010.

NO CLAIM IS MADE TO THE EXCLUSIVE RIGHT TO USE "GATELINK CONNECTING AIRPLANE TO AIRLINE", APART FROM THE MARK AS SHOWN.

THE COLOR(S) BLUE, RED, AND GRAY IS/ARE CLAIMED AS A FEATURE OF THE MARK.

THE MARK CONSISTS OF THE WORDING "GATELINK CONNECTING AIRPLANE TO AIRLINE". THE "G" AND "L" IN "GATELINK" ARE BLUE, WITH A RED ARROW IN THE CENTER OF THE "G" POINTING TO THE LEFT, A RED ARROW AT THE BASE OF THE "L" POINTING RIGHT, THE REMAINING LETTERS "ATE" AND "INK" ARE IN GRAY. THE PHRASE "CONNECTING AIRPLANE TO AIRLINE" IS IN GRAY WITHOUT ANY CAPITALIZATION.



David J. Kyjars

Director of the United States Patent and Trademark Office

Reg. No. 4,098,287 SER. NO. 85-288,490, FILED 4-7-2011.

YAT SYE, LEE, EXAMINING ATTORNEY

United States of America

United States Patent and Trademark Office

ECOFLO

Reg. No. 4,098,288

PRINSCO, INC. (MINNESOTA CORPORATION)
1717 16TH STREET N.E.
WILLMAR, MN 56201

Registered Feb. 14, 2012

Int. Cl.: 17

FOR: CORRUGATED POLYETHYLENE TUBING USED FOR UNDERGROUND DRAINAGE PURPOSES, AND EXCLUDING USE WITH WASTEWATER TREATMENT SYSTEMS, SEPTIC TANK AND/OR SEPTIC SYSTEM APPLICATIONS, IN CLASS 17 (U.S. CLS. 1, 5, 12, 13, 35 AND 50).

TRADEMARK

PRINCIPAL REGISTER

FIRST USE 9-4-2001; IN COMMERCE 2-7-2003.

THE MARK CONSISTS OF STANDARD CHARACTERS WITHOUT CLAIM TO ANY PARTICULAR FONT, STYLE, SIZE, OR COLOR.

OWNER OF U.S. REG. NO. 2,890,909.

SER. NO. 85-288,637, FILED 4-7-2011.

MAUREEN DALL, EXAMINING ATTORNEY



David J. Kyfos

Director of the United States Patent and Trademark Office

United States of America

United States Patent and Trademark Office

STARR

Reg. No. 4,098,289

Registered Feb. 14, 2012

Int. Cl.: 25

TRADEMARK

PRINCIPAL REGISTER

UNION FASHION, LTD. (TEXAS LIMITED PARTNERSHIP), DBA STARR WESTERN WEAR
112 E. OVERLAND
EL PASO, TX 79901

FOR: CAPS; JACKETS; JEANS; LONG-SLEEVED SHIRTS; POLO SHIRTS; SHORT-SLEEVED SHIRTS; T-SHIRTS, IN CLASS 25 (U.S. CLS. 22 AND 39).

FIRST USE 8-1-1991; IN COMMERCE 8-1-1991.

THE MARK CONSISTS OF STANDARD CHARACTERS WITHOUT CLAIM TO ANY PARTICULAR FONT, STYLE, SIZE, OR COLOR.

OWNER OF U.S. REG. NO. 2,996,865.

SEC. 2(F).

SER. NO. 85-288,772, FILED 4-7-2011.

TINA MAI, EXAMINING ATTORNEY



David J. Kyffers

Director of the United States Patent and Trademark Office

United States of America
United States Patent and Trademark Office

QUALIFLY

Reg. No. 4,098,290

CONCORD SERVICING CORPORATION (ARIZONA CORPORATION)
4725 N. SCOTTSDALE RD, SUITE 300
SCOTTSDALE, AZ 85251

Registered Feb. 14, 2012

Int. Cls.: 35 and 36

FOR: PROVIDING CONSUMER CREDIT INFORMATION TO THIRD PARTIES IN ORDER TO PRE-QUALIFY MARKETING LEADS IN THE TIMESHARE INDUSTRY, IN CLASS 35 (U.S. CLS. 100, 101 AND 102).

SERVICE MARK

FIRST USE 3-28-2011; IN COMMERCE 3-28-2011.

PRINCIPAL REGISTER

FOR: PROVIDING A WEB-BASED SYSTEM FOR DESKTOP OR MOBILE DEVICES FOR THIRD PARTIES TO ACCESS PRE-QUALIFICATION FINANCIAL INFORMATION BASED ON A CONSUMER'S CREDIT FILE, IN CLASS 36 (U.S. CLS. 100, 101 AND 102).

FIRST USE 3-28-2011; IN COMMERCE 3-28-2011.

THE MARK CONSISTS OF STANDARD CHARACTERS WITHOUT CLAIM TO ANY PARTICULAR FONT, STYLE, SIZE, OR COLOR.

SER. NO. 85-288,988, FILED 4-7-2011.

TIMOTHY FINNEGAN, EXAMINING ATTORNEY



David J. Kybas

Director of the United States Patent and Trademark Office

United States of America

United States Patent and Trademark Office

Ava Living

Reg. No. 4,098,291

Registered Feb. 14, 2012

Int. Cl.: 42

SERVICE MARK

PRINCIPAL REGISTER

AVA LIVING INTERNATIONAL INC. (DELAWARE CORPORATION), DBA AVA LIVING
110 W. OCEAN BLVD., SUITE 903
LONG BEACH, CA 90802

FOR: ARCHITECTURAL DESIGN; COLOR ANALYSIS FOR PURPOSES OF INTERIOR DESIGN; CONSULTATION IN THE FIELD OF ERGONOMICS, NAMELY, DESIGNING WORKPLACE FACILITIES AND EQUIPMENT TO OPTIMIZE EFFICIENCY AND SAFETY; CONSULTING SERVICES FOR THE DESIGN OF MASONRY WALLS AND STRUCTURES; CONSULTING SERVICES IN THE FIELD OF ARCHITECTURAL DESIGN; CONSULTING SERVICES IN THE FIELD OF THEME PARK ATTRACTION DESIGN; CREATING AND DESIGNING WEB PAGES FOR OTHERS; CREATING, DESIGNING AND MAINTAINING WEB SITES; DESIGN AND CREATING WEB SITES FOR OTHERS; DESIGN AND DEVELOPMENT AND CONSULTING SERVICES RELATED THERETO IN THE FIELD OF CUSTOM HOME THEATRE AUDIO AND VISUAL SYSTEMS; DESIGN AND DEVELOPMENT OF AUTOMATED CONTROLLER SYSTEMS, NAMELY, TEMPERATURE, HUMIDITY AND ELECTRICAL CONTROLLERS; DESIGN AND DEVELOPMENT OF AUTOMATED HOME CONTROLLER SYSTEMS, NAMELY, TEMPERATURE, HUMIDITY, AND ELECTRICAL CONTROLLERS; DESIGN AND MAINTENANCE OF WEB SITES FOR OTHERS; DESIGN AND STYLING OF MINIATURE ROOMS FOR DISPLAY PURPOSES; DESIGN OF HOME PAGES; DESIGN OF HOME PAGES AND WEB SITES; DESIGN OF HOMEPAGES AND WEBSITES; DESIGN OF INTERIOR DECOR; DESIGN OF MASONRY WALLS AND STRUCTURES; DESIGN OF SPECIALTY INTERIOR AND EXTERIOR ENVIRONMENT SETTINGS; DESIGN, CREATION, HOSTING, MAINTENANCE OF WEBSITES FOR OTHERS; DESIGNING INTERNET SITES FOR OTHERS; DESIGNING WEB PAGES FOR OTHERS; DESIGNING WEBSITES FOR ADVERTISING PURPOSES; DESIGNING WEBSITES FOR OTHERS; DESIGNING, CREATING, MAINTAINING AND HOSTING ONLINE RETAIL AND ELECTRONIC COMMERCE WEBSITES FOR OTHERS; DESIGNING, CREATING, MAINTAINING, AND HOSTING INTERIOR DESIGN WEBSITES FOR OTHERS; DEVELOPMENT, DESIGN AND UPDATING OF HOME PAGES; DOOR DESIGN SERVICES; FURNITURE DESIGN SERVICES; HOME STAGING CONSULTATION, NAMELY, TEMPORARY INTERIOR AND EXTERIOR HOME DECORATION CONSULTATION FOR THE PURPOSE OF MAKING HOMES MORE APPEALING TO PROSPECTIVE BUYERS; HOMEPAGE AND WEBPAGE DESIGN; HOSPITAL DESIGN SERVICES; INTERIOR DECORATING; INTERIOR DECORATION CONSULTATION; INTERIOR DESIGN SERVICES; INTERIOR DESIGN SERVICES IN THE NATURE OF AROMA CONSULTING SERVICES IN THE SELECTION AND USE OF AROMAS FOR HOTELS, CASINOS, RESORTS, CONFERENCE FACILITIES, RETAIL STORES, SPORTS AND FITNESS



David J. Kybas

Director of the United States Patent and Trademark Office

Reg. No. 4,098,291 CENTERS, SPAS, HEALTH CARE FACILITIES, RESIDENTIAL BUILDINGS AND PRIVATE RESIDENCES; INTERIOR DESIGN SERVICES INCLUDING SPACE PLANNING, FURNITURE SELECTION, MATERIAL AND SURFACE SELECTION; INTERIOR STYLING SERVICES; LANDSCAPE ARCHITECTURAL DESIGN; LANDSCAPE LIGHTING DESIGN; LIGHTING DESIGN AND TECHNOLOGY SPECIFICATION SERVICES PERTAINING TO PERMANENT OR TEMPORARY ARCHITECTURAL, THEATRICAL, ENTERTAINMENT, COMMERCIAL AND/OR RESIDENTIAL APPLICATIONS; PAINT MATCHING, NAMELY, COLOR ANALYSIS TO DETERMINE PROPER PAINT MIXTURE FOR MATCHING COLORS FOR INTERIOR DECORATING PURPOSES; PLANNING AND DESIGN OF HORSE-RIDING ARENAS; PLANNING AND DESIGNING AQUATICS FACILITIES; PLANNING AND LAYOUT DESIGN FOR THE INTERIOR SPACE OF RETAIL BUSINESS ESTABLISHMENTS; PLANNING AND LAYOUT DESIGN SERVICES FOR CLEANROOM ENVIRONMENTS; PROVIDING A WEBSITE FEATURING INFORMATION ABOUT GREEN ARCHITECTURE, INTERIOR DESIGN, SUSTAINABLE COMMUNITY PLANNING AND INFRASTRUCTURE DEVELOPMENT; PROVIDING A WEBSITE FEATURING INFORMATION IN THE FIELD OF INTERIOR DESIGN AND ARCHITECTURE FOR USE BY INTERIOR DESIGNERS AND ARCHITECTS; PROVIDING A WEBSITE FEATURING ON-LINE NON-DOWNLOADABLE SOFTWARE THAT ENABLES USERS TO PROVIDE INTERIOR DESIGN SERVICES; PROVIDING AN INTERNET WEBSITE PORTAL OFFERING INFORMATION IN THE FIELD OF COMPUTER AIDED DESIGN; PROVIDING DESIGN SERVICES FOR OTHERS IN THE FIELD OF THEME PARKS, MUSEUMS, AND MINIATURE GOLF COURSES; PROVIDING ENVIRONMENTALLY FRIENDLY AUTOMATION SOLUTIONS, NAMELY, SITE EVALUATIONS, CONTROL DESIGN ANALYSIS, AND INTEGRATED INSTALLATION SERVICES FOR MONITORING AND CONTROLLING RESPECTIVE INNOVATIVE DEVICES WITHIN A DESIGNATED AREA; PROVIDING GRAPHIC AND MULTIMEDIA DESIGN SERVICES FOR THE PURPOSE OF PROMOTING THE GOODS AND SERVICES OF OTHERS; PROVIDING GRAPHIC DESIGN SERVICES TO CREATE SPECIALTY INTERIOR ENVIRONMENT SETTINGS; RESIDENTIAL BUILDING DESIGN; ROOM DESIGN CONSISTING OF SELECTION OF ARTWORK, LIGHTING, AND FURNISHINGS FOR AN ENVIRONMENT DESIGNED TO HELP ACHIEVE MENTAL WELLNESS, INCLUDING STRESS MANAGEMENT AND RELAXATION, USING COMPUTER CONTROLLED ADVANCED SOUND WAVE TECHNOLOGY; SET DESIGN FOR THEATRICAL ENTERPRISES; SHOP INTERIOR DESIGN; STRUCTURAL ENGINEERING DESIGN SERVICES; SURVEY DESIGN AND RESEARCH; TEMPORARY INTERIOR AND EXTERIOR HOME DECORATION CONSULTATION, NAMELY, HOME STAGING CONSULTATION FOR THE PURPOSE OF MAKING HOMES MORE APPEALING TO PROSPECTIVE BUYERS; THEME PARK ATTRACTION DESIGN SERVICES; URBAN DESIGN PLANNING SERVICES; WEB SITE DESIGN, IN CLASS 42 (U.S. CLS. 100 AND 101).

FIRST USE 10-1-2005; IN COMMERCE 5-1-2007.

THE MARK CONSISTS OF STANDARD CHARACTERS WITHOUT CLAIM TO ANY PARTICULAR FONT, STYLE, SIZE, OR COLOR.

SER. NO. 85-289,177, FILED 4-7-2011.

LINDA M. KING, EXAMINING ATTORNEY

United States of America

United States Patent and Trademark Office

GROUP CORE

Reg. No. 4,098,292

THE STEP COMPANY (GEORGIA CORPORATION)
2130 NEWMARKET PARKWAY
MARIETTA, GA 30067

Registered Feb. 14, 2012

Int. Cl.: 41

FOR: PHYSICAL FITNESS INSTRUCTION SERVICES, IN CLASS 41 (U.S. CLS. 100, 101 AND 107).

SERVICE MARK

FIRST USE 8-24-2011; IN COMMERCE 8-24-2011.

PRINCIPAL REGISTER

THE MARK CONSISTS OF STANDARD CHARACTERS WITHOUT CLAIM TO ANY PARTICULAR FONT, STYLE, SIZE, OR COLOR.

OWNER OF U.S. REG. NOS. 3,079,240, 3,132,086 AND OTHERS.

NO CLAIM IS MADE TO THE EXCLUSIVE RIGHT TO USE "CORE", APART FROM THE MARK AS SHOWN.

SER. NO. 85-289,233, FILED 4-7-2011.

HENRY S. ZAK, EXAMINING ATTORNEY



David J. Kyffers

Director of the United States Patent and Trademark Office

United States of America

United States Patent and Trademark Office



Reg. No. 4,098,293

Registered Feb. 14, 2012

Int. Cl.: 10

TRADEMARK

PRINCIPAL REGISTER

BIORELIEF LLC (FLORIDA LIMITED LIABILITY COMPANY)
BIORELIEF.COM
6250 NW 27TH WAY
FORT LAUDERDALE, FL 33309

FOR: FEMALE URINARY CATHETER SYSTEM CONSISTING OF EXTERNAL CATHETERS AND LEG BAG, FOR THE PURPOSE OF PROVIDING A RESTROOM ALTERNATIVE , IN CLASS 10 (U.S. CLS. 26, 39 AND 44).

FIRST USE 11-18-2001; IN COMMERCE 12-28-2001.

NO CLAIM IS MADE TO THE EXCLUSIVE RIGHT TO USE THE PICTORIAL REPRESENTATION OF THE UNIVERSAL SYMBOL FOR THE WOMEN'S RESTROOM, APART FROM THE MARK AS SHOWN.

THE MARK CONSISTS OF THE STYLIZED WORDING "STADIUM" OVER "GAL" HAVING A PICTORIAL REPRESENTATION OF THE UNIVERSAL SYMBOL FOR THE WOMEN'S RESTROOM IN THE CENTER OF THE LETTER "D" ALL ON A TRIANGULAR BACKGROUND.

SEC. 2(F) AS TO "STADIUM GAL" .

SER. NO. 85-289,290, FILED 4-7-2011.

JULIE GUTTADAURO, EXAMINING ATTORNEY



David J. Kyffers

Director of the United States Patent and Trademark Office

United States of America

United States Patent and Trademark Office

Looplane

One World • Endless Destinations • Infinite Possibilities

Reg. No. 4,098,294

LOOPLANE, LLC (NEVADA LIMITED LIABILITY COMPANY)
2831 ST. ROSE PARKWAY
HENDERSON, NV 89052

Registered Feb. 14, 2012

Int. Cl.: 45

FOR: ON-LINE SOCIAL NETWORKING SERVICES, IN CLASS 45 (U.S. CLS. 100 AND 101).

SERVICE MARK

FIRST USE 8-10-2010; IN COMMERCE 8-10-2010.

PRINCIPAL REGISTER

THE MARK CONSISTS OF THE WORD "LOOPLANE" WITH THE WORDS "ONE WORLD-
ENDLESS DESTINATIONS-INFINITE POSSIBILITIES" DIRECTLY UNDERNEATH THE
WORD "LOOPLANE".

SER. NO. 85-289,331, FILED 4-7-2011.

TINA L. SNAPP, EXAMINING ATTORNEY



David J. Kyffers

Director of the United States Patent and Trademark Office

United States of America

United States Patent and Trademark Office

perpombellar

Reg. No. 4,098,296

Registered Feb. 14, 2012

Int. Cl.: 41

SERVICE MARK

PRINCIPAL REGISTER

NAUERT, ERIC J. (GEORGIA SOLE PROPRIETORSHIP), DBA PERPOMBELLAR
PRODUCTIONS
SUITE 1
734 EAST 45TH STREET
SAVANNAH, GA 31405

FOR: FILM AND VIDEO PRODUCTION, IN CLASS 41 (U.S. CLS. 100, 101 AND 107).

FIRST USE 5-12-2007; IN COMMERCE 5-12-2007.

THE MARK CONSISTS OF STANDARD CHARACTERS WITHOUT CLAIM TO ANY PARTICULAR FONT, STYLE, SIZE, OR COLOR.

SER. NO. 85-289,731, FILED 4-8-2011.

ANDREA HACK, EXAMINING ATTORNEY



David J. Kyffers

Director of the United States Patent and Trademark Office

United States of America

United States Patent and Trademark Office

CONSERO

Reg. No. 4,098,297

Registered Feb. 14, 2012

Int. Cl.: 35

SERVICE MARK

PRINCIPAL REGISTER

CONSERO GROUP LLC (MARYLAND LIMITED LIABILITY COMPANY)
4915 ST. ELMO AVE., SUITE 500
BETHESDA, MD 20814

FOR: CONDUCTING, ARRANGING AND ORGANIZING TRADE SHOWS AND TRADE FAIRS FOR COMMERCIAL AND ADVERTISING PURPOSES; ORGANIZING EXHIBITIONS FOR BUSINESS PURPOSES FOR EXECUTIVES IN A VARIETY OF INDUSTRIES, INCLUDING ACCOUNTING, ADVERTISING, AGRICULTURE, APPAREL AND TEXTILES, ARCHITECTURE, ASSET MANAGEMENT, AUTOMOTIVE, BANKING, BIOLOGY AND GENETICS, BUSINESS INTELLIGENCE AND DATA WAREHOUSING, BUSINESS PROCESS MANAGEMENT, BRAND MANAGEMENT AND DESIGN, COMPLIANCE AND DUE DILIGENCE, CONSTRUCTION, CONSUMER GOODS, CORPORATE COMMUNICATIONS, CORPORATE PERFORMANCE, CORPORATE STRATEGY, CUSTOMER MANAGEMENT, CULTURE AND DIVERSITY PRACTICES, DEFENSE, DIGITAL MEDIA, E-COMMERCE, ECONOMICS, EDUCATION, ENERGY, ENGINEERING, ENTERPRISE SOLUTIONS, FINANCE, FOOD AND BEVERAGE, GENERAL BUSINESS, GENERAL MEDICINE, GEOGRAPHIC INFORMATION SYSTEMS AND DEFENSE GEOSPATIAL INTELLIGENCE, GLOBALIZATION, GOVERNMENT, HEALTH CARE, HEDGE FUNDS, HOSPITALITY, HUMAN RESOURCES, INFORMATION MANAGEMENT, INFORMATION TECHNOLOGY, INFRASTRUCTURE, INNOVATION AND PRODUCT DEVELOPMENT, INVESTMENTS, LEGAL, LEISURE AND ENTERTAINMENT, LIFE SCIENCES, LINGUISTICS AND SPEECH PATHOLOGY, LOCALIZATION AND TRANSLATION SERVICES, MATH AND STATISTICS, MANAGEMENT TRAINING, MANUFACTURING, MARKET RESEARCH, MARKETING AND SALES, MINING, MOBILE, NEWSPAPER AND PRINT MEDIA, OIL AND GAS, PEACE AND CONFLICT RESOLUTION, PHARMACEUTICALS, PREPAID AND STORED VALUE, PRIVATE EQUITY, PROCUREMENT, PROFESSIONAL TRAINING, PROJECT MANAGEMENT, BEHAVIORAL AND SOCIAL SCIENCES, PUBLIC RELATIONS, REAL ESTATE, RETAIL, SECURITY AND RISK MANAGEMENT, SERVICE AND SUPPORT, SHARED SERVICES AND OUTSOURCING, RECREATION AND SPORTS, SIX SIGMA AND QUALITY, SUPPLY CHAIN, SUSTAINABLE DEVELOPMENT, TELECOMMUNICATIONS, MEDIA, TRANSPORTATION AND LOGISTICS, AND TRAVEL AND TOURISM; PLANNING AND CONDUCTING OF TRADE FAIRS, EXHIBITIONS AND PRESENTATIONS FOR ECONOMIC OR ADVERTISING PURPOSES, IN CLASS 35 (U.S. CLS. 100, 101 AND 102).



David J. Kyjars

FIRST USE 3-19-2010; IN COMMERCE 3-19-2010.

Reg. No. 4,098,297 THE MARK CONSISTS OF STANDARD CHARACTERS WITHOUT CLAIM TO ANY PARTICULAR FONT, STYLE, SIZE, OR COLOR.

THE ENGLISH TRANSLATION OF "CONSERO" IN THE MARK IS "JOIN", "BRING TOGETHER", OR "TO CONNECT".

SER. NO. 85-289,884, FILED 4-8-2011.

ALEX KEAM, EXAMINING ATTORNEY

United States of America

United States Patent and Trademark Office

DASHLANE

Reg. No. 4,098,298

DASHLANE SAS (FRANCE SOCIETE PAR ACTIONS SIMPLIFIEE)
105 RUE VOLTAIRE

Registered Feb. 14, 2012

PUTEAUX, FRANCE 92800

Int. Cls.: 9, 35, 38 and 42

FOR: DATA PROCESSING EQUIPMENT AND COMPUTERS; COMPUTER PROGRAMS FOR USING THE INTERNET AND THE WORLD WIDE WEB; COMPUTER SOFTWARE FOR ENHANCING THE CAPABILITIES OF WEB BROWSER SOFTWARE; DOWNLOADABLE SOFTWARE FOR ASSISTANCE IN THE USE OF A BROWSER TOOL BAR; DOWNLOADABLE INTERNET BROWSER PLUG-INS IN THE NATURE OF A MULTI-FUNCTION TOOL BAR PLUG-INS, IN CLASS 9 (U.S. CLS. 21, 23, 26, 36 AND 38).

TRADEMARK

SERVICE MARK

PRINCIPAL REGISTER

FOR: ADVERTISING AND MARKETING; DISSEMINATION OF ADVERTISING MATERIAL; COMPUTERIZED FILE MANAGEMENT; ON-LINE ADVERTISING AND MARKETING SERVICES, IN CLASS 35 (U.S. CLS. 100, 101 AND 102).

FOR: COMMUNICATION BY COMPUTER TERMINALS; COMMUNICATIONS BY MOBILE PHONES; ELECTRONIC BULLETIN BOARD SERVICES, IN CLASS 38 (U.S. CLS. 100, 101 AND 104).

FOR: DESIGN AND DEVELOPMENT OF COMPUTER HARDWARE AND SOFTWARE; SOFTWARE AS A SERVICE (SAAS) SERVICES FEATURING SOFTWARE FOR ASSISTING USERS IN THEIR WEB BROWSING ACTIVITIES; COMPUTER SERVICES, NAMELY, PROVIDING USE OF AN ON-LINE NON-DOWNLOADABLE CONTENT MANAGEMENT SOFTWARE FOR USE IN MANAGING AND FORMATTING USER INPUT, IN CLASS 42 (U.S. CLS. 100 AND 101).



THE MARK CONSISTS OF STANDARD CHARACTERS WITHOUT CLAIM TO ANY PARTICULAR FONT, STYLE, SIZE, OR COLOR.

PRIORITY CLAIMED UNDER SEC. 44(D) ON ERPN CMNTY TM OFC APPLICATION NO. 009797713, FILED 3-9-2011, REG. NO. 009797713, DATED 8-5-2011, EXPIRES 3-9-2021.

SER. NO. 85-290,031, FILED 4-8-2011.

David J. Kyffers

LINDA M. KING, EXAMINING ATTORNEY

United States of America

United States Patent and Trademark Office

SECURAFONE



Reg. No. 4,098,299

Registered Feb. 14, 2012

Int. Cl.: 9

TRADEMARK

PRINCIPAL REGISTER

SECURATRAC LLC (CALIFORNIA LIMITED LIABILITY COMPANY)
703 PIER AVENUE
SUITE B313
HERMOSA BEACH, CA 90254

FOR: COMPUTER APPLICATION SOFTWARE FOR TABLET COMPUTERS, PORTABLE MEDIA PLAYERS, CELL PHONES, MOBILE PHONES, MOBILE COMPUTERS, WIRELESSLY CONNECTED TABLET COMPUTERS, AND PORTABLE MEDIA PLAYERS, NAMELY, SOFTWARE FOR TRACKING AND MONITORING GEOGRAPHIC LOCATIONS OF DEVICES ON A TELECOMMUNICATIONS NETWORK OR BY GLOBAL POSITIONING SYSTEMS, AND FOR EMERGENCY RESPONSE NOTIFICATION SYSTEMS FOR CONNECTING TABLET COMPUTERS, PORTABLE MEDIA PLAYERS, CELL PHONES, MOBILE PHONES, MOBILE COMPUTERS, WIRELESSLY CONNECTED TABLET COMPUTERS, AND PORTABLE MEDIA PLAYERS TO AN EMERGENCY RESPONSE ENTITY THROUGH A COMMUNICATION NETWORK AND ALLOWING AUDIO AND DATA COMMUNICATION BETWEEN THE DEVICES AND THE ENTITY EMERGENCY RESPONSE SERVICES, AND FOR LOCATION BASED SERVICES, NAMELY, SOFTWARE FOR PROVIDING CUSTOMER-DEFINED GENERATED CONTENT AND CONTENT OF OTHERS AUTOMATICALLY SELECTED AND CUSTOMIZED BASED ON THE KNOWN OR ESTIMATED GEOGRAPHICAL LOCATION OF AN INTERNET, MOBILE TELEPHONE OR OTHER WIRED OR WIRELESS DIGITAL NETWORK BASED CUSTOMER, IN CLASS 9 (U.S. CLS. 21, 23, 26, 36 AND 38).

FIRST USE 2-1-2011; IN COMMERCE 2-1-2011.

THE MARK CONSISTS OF THE TERM "SECURAFONE" WITH THE "S" AND "F" APPEARING IN A LARGER FONT THAN THE OTHER LETTERS; "SECURA" APPEARS IN BLUE, "FONE" APPEARS IN GRAY; A STYLIZED DESIGN OF A SATELLITE DISH APPEARS ABOVE THE "NE" AND EXTENDS TO THE RIGHT, THE DISH AND ANTENNA IS IN BLUE AND 4 GRAY DOTS EXTEND IN A STRAIGHT LINE FROM THE DISH ANTENNA.

THE COLOR(S) REFLEXIVE BLUE AND GRAY IS/ARE CLAIMED AS A FEATURE OF THE MARK.

SER. NO. 85-290,197, FILED 4-8-2011.

ANTHONY RINKER, EXAMINING ATTORNEY



David J. Kyros

Director of the United States Patent and Trademark Office

United States of America
United States Patent and Trademark Office

OLIVENOL
plus⁺

Reg. No. 4,098,300

Registered Feb. 14, 2012

Int. Cls.: 1 and 5

TRADEMARK

PRINCIPAL REGISTER

CREAGRI, INC. (CALIFORNIA CORPORATION)
25565 WHITESELL STREET
HAYWARD, CA 94545

FOR: ANTIOXIDANTS AND PROTEINS USED IN THE MANUFACTURE OF COSMETICS, BEVERAGES, FOOD PRODUCTS AND FOOD SUPPLEMENTS, IN CLASS 1 (U.S. CLS. 1, 5, 6, 10, 26 AND 46).

FIRST USE 3-11-2011; IN COMMERCE 3-11-2011.

FOR: ANIMAL FEED SUPPLEMENTS; DIETARY AND NUTRITIONAL SUPPLEMENTS; DIETARY AND NUTRITIONAL SUPPLEMENTS CONTAINING OLIVE POLYPHENOLS; DIETARY AND NUTRITIONAL SUPPLEMENTS FOR ENDURANCE SPORTS; DIETARY BEVERAGE SUPPLEMENTS FOR HUMAN CONSUMPTION IN LIQUID AND DRY MIX FORM FOR THERAPEUTIC PURPOSES; DIETARY FOOD SUPPLEMENTS; DIETARY PET SUPPLEMENTS IN THE FORM OF PET TREATS; DIETARY SUPPLEMENT BEVERAGE FOR HUMANS; DIETARY SUPPLEMENTAL DRINKS; DIETARY SUPPLEMENTS; DIETARY SUPPLEMENTS FOR ANIMALS; DIETARY SUPPLEMENTS FOR CONTROLLING CHOLESTEROL; DIETARY SUPPLEMENTS FOR HUMAN CONSUMPTION; DIETARY SUPPLEMENTS FOR PETS; DIETARY SUPPLEMENTS FOR HUMANS; FOOD SUPPLEMENTS; FOOD SUPPLEMENTS, NAMELY, ANTI-OXIDANTS; LIQUID NUTRITIONAL SUPPLEMENT, IN CLASS 5 (U.S. CLS. 6, 18, 44, 46, 51 AND 52).

FIRST USE 3-11-2011; IN COMMERCE 3-11-2011.

THE MARK CONSISTS OF THE WORD "OLIVENOL" IN DARK, LARGE CAPITALIZED LETTERS. BELOW AND TO THE RIGHT SIDE OF THE WORD "OLIVENOL", THE WORD "PLUS" APPEARS IN LOWER CASE ITALICIZED FONT. JUST AFTER THE "S" IN "PLUS", AN ADDITION SYMBOL APPEARS IN SUPERSCRIPIT.

THE WORDING "OLIVENOL" PLUS HAS NO MEANING IN A FOREIGN LANGUAGE.

SER. NO. 85-290,213, FILED S.R. 4-8-2011 AM. P.R. 6-24-2011.

KATHERINE E. HALMEN, EXAMINING ATTORNEY



David J. Kyros

Director of the United States Patent and Trademark Office

United States of America

United States Patent and Trademark Office



Reg. No. 4,098,301

Registered Feb. 14, 2012

Int. Cl.: 30

TRADEMARK

PRINCIPAL REGISTER

PERFETTI VAN MELLE BENELUX B.V. (NETHERLANDS LIMITED LIABILITY COMPANY)
ZOETE INVAL 20
BREDA, NETHERLANDS 4815HK

FOR: CONFECTIONERY PRODUCTS, NAMELY, CHEWING GUM, BUBBLE GUM AND CANDIES, IN CLASS 30 (U.S. CL. 46).

FIRST USE 5-12-2011; IN COMMERCE 5-12-2011.

THE MARK CONSISTS OF A DARK BLUE BACKGROUND WITH THE GREEN LETTERS "UP" WHICH ARE OUTLINED IN GRAY, A GRAY NUMERAL "2" AND A GREEN "U" OUTLINED IN GRAY. TO THE RIGHT OF THE "U" IS A RED STRIPE AND A DARK BLUE STRIPE. A PINK ANGLED 3-D RECTANGLE OUTLINED IN WHITE IS ON TOP OF A GREEN 3-D ANGLED RECTANGLE OUTLINED IN WHITE APPEARS IN THE RED STRIP. A LIGHT BLUE ANGLED 3-D RECTANGLE OUTLINED IN WHITE IS ON TOP OF A DARK BLUE 3-D ANGLED RECTANGLE OUTLINED IN WHITE APPEARS IN THE DARK BLUE STRIPE. THE LITERAL ELEMENTS OF THE MARK ARE PHONETICALLY EQUIVALENT TO "UP TO YOU".

THE COLOR(S) DARK BLUE, LIGHT BLUE, RED, GREEN, PINK, WHITE AND GRAY IS/ARE CLAIMED AS A FEATURE OF THE MARK.

SER. NO. 85-290,309, FILED 4-8-2011.

RICHARD WHITE, EXAMINING ATTORNEY



David J. Kybas

Director of the United States Patent and Trademark Office

United States of America

United States Patent and Trademark Office

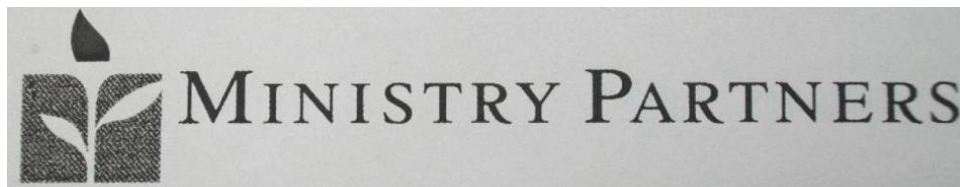

Reg. No. 4,098,302

Registered Feb. 14, 2012

Int. Cl.: 36

MINISTRY PARTNERS INVESTMENT COMPANY, LLC (CALIFORNIA LIMITED LIABILITY COMPANY)
SUITE 120
955 W. IMPERIAL HWY.
BREA, CA 92821

SERVICE MARK

PRINCIPAL REGISTER

FOR: FINANCIAL SERVICES, NAMELY, PROVIDING FINANCIAL SERVICES IN ASSISTING OTHERS IN COMPLETING FINANCING TRANSACTIONS, PROVIDING LOAN ORIGINATION AND UNDERWRITING SERVICES; BROKERAGE OF LOANS AND LOAN PORTFOLIOS; PROVIDING INVESTMENT PRODUCTS, SECURITIES AND SERVICES THAT LINK MINISTRY MINDED INVESTORS WITH MINISTRY PROJECTS, NAMELY, FINANCIAL INVESTMENT AND MORTGAGE LOAN FINANCING SERVICES, IN CLASS 36 (U.S. CLS. 100, 101 AND 102).

FIRST USE 10-22-1991; IN COMMERCE 10-22-1991.

OWNER OF U.S. REG. NO. 3,474,833.

NO CLAIM IS MADE TO THE EXCLUSIVE RIGHT TO USE "MINISTRY PARTNERS", APART FROM THE MARK AS SHOWN.

THE MARK CONSISTS OF A FLOWER WITH TWO SHADED LEAVES CENTERED INSIDE OF A PARTIALLY SHADED QUADRILATERAL AND THE SHADED TOP OF THE FLOWER IS ABOVE THE PARTIALLY SHADED QUADRILATERAL WHICH IS POSITIONED TO THE LEFT OF ONE LINE OF TEXT CONTAINING THE WORDS "MINISTRY PARTNERS" IN LARGE STYLIZED CAPITAL LETTERING.

SER. NO. 85-290,522, FILED 4-8-2011.

JENNY PARK, EXAMINING ATTORNEY



David J. Kyffers

Director of the United States Patent and Trademark Office

United States of America

United States Patent and Trademark Office

GET THE SKINNY WITH MOLLY

Reg. No. 4,098,303

KIMBALL, MOLLY (UNITED STATES INDIVIDUAL)
1517 RIDGELAKE DRIVE
METAIRIE, LA 70001

Registered Feb. 14, 2012

Int. Cl.: 41

FOR: ENTERTAINMENT SERVICES IN THE NATURE OF SPEAKING ENGAGEMENTS AND DISTRIBUTION OF MATERIALS RELATED THERETO AND ONGOING TELEVISION AND RADIO FEATURES, SEGMENTS AND PROGRAMS IN THE FIELDS OF DIET, EXERCISE, FITNESS, HEALTH AND WELLNESS BROADCAST OVER RADIO, TELEVISION, CABLE AND SATELLITE, VIDEO PODCASTS AND WEBCASTS; PUBLICATION OF PRINTED MATERIALS IN THE FIELDS OF DIET, EXERCISE, FITNESS, HEALTH AND WELLNESS; PROVIDING A WEBSITE FEATURING INFORMATION IN THE FIELD OF EXERCISE AND FITNESS, IN CLASS 41 (U.S. CLS. 100, 101 AND 107).

SERVICE MARK

PRINCIPAL REGISTER

FIRST USE 8-0-2009; IN COMMERCE 8-0-2009.

THE MARK CONSISTS OF STANDARD CHARACTERS WITHOUT CLAIM TO ANY PARTICULAR FONT, STYLE, SIZE, OR COLOR.

THE NAME(S), PORTRAIT(S), AND/OR SIGNATURE(S) SHOWN IN THE MARK IDENTIFIES "MOLLY KIMBALL", WHOSE CONSENT(S) TO REGISTER IS MADE OF RECORD.

SER. NO. 85-290,543, FILED 4-8-2011.

JENNY PARK, EXAMINING ATTORNEY



David J. Kybas

Director of the United States Patent and Trademark Office

United States of America

United States Patent and Trademark Office

LOVE IT, LIKE IT, HATE IT

Reg. No. 4,098,304

KIMBALL, MOLLY (UNITED STATES INDIVIDUAL)
1517 RIDGELAKE DRIVE
METAIRIE, LA 70001

Registered Feb. 14, 2012

Int. Cl.: 41

FOR: ENTERTAINMENT SERVICES IN THE NATURE OF SPEAKING ENGAGEMENTS AND DISTRIBUTION OF MATERIALS RELATED THERETO AND ONGOING TELEVISION AND RADIO FEATURES, SEGMENTS AND PROGRAMS IN THE FIELDS OF DIET, EXERCISE, FITNESS, HEALTH AND WELLNESS BROADCAST OVER RADIO, TELEVISION, CABLE AND SATELLITE, VIDEO PODCASTS AND WEBCASTS; PUBLICATION OF PRINTED MATERIALS IN THE FIELDS OF DIET, EXERCISE, FITNESS, HEALTH AND WELLNESS; PROVIDING A WEBSITE FEATURING INFORMATION IN THE FIELD OF EXERCISE AND FITNESS, IN CLASS 41 (U.S. CLS. 100, 101 AND 107).

SERVICE MARK

PRINCIPAL REGISTER

FIRST USE 8-0-2009; IN COMMERCE 8-0-2009.

THE MARK CONSISTS OF STANDARD CHARACTERS WITHOUT CLAIM TO ANY PARTICULAR FONT, STYLE, SIZE, OR COLOR.

SER. NO. 85-290,572, FILED 4-8-2011.

JENNY PARK, EXAMINING ATTORNEY



David J. Kybas

Director of the United States Patent and Trademark Office

United States of America

United States Patent and Trademark Office

ROCKET

Reg. No. 4,098,305

EGRANDBUY, INC (CALIFORNIA CORPORATION)
321 VINELAND AVE
INDUSTRY, CA 91746

Registered Feb. 14, 2012

Int. Cl.: 7

FOR: ELECTRIC MOTORS FOR TOYS AND HOBBY MODELS, IN CLASS 7 (U.S. CLS. 13, 19, 21, 23, 31, 34 AND 35).

TRADEMARK

FIRST USE 1-1-2011; IN COMMERCE 1-1-2011.

PRINCIPAL REGISTER

THE MARK CONSISTS OF STANDARD CHARACTERS WITHOUT CLAIM TO ANY PARTICULAR FONT, STYLE, SIZE, OR COLOR.

SER. NO. 85-290,775, FILED 4-8-2011.

JANICE L. MCMORROW, EXAMINING ATTORNEY



David J. Kyffers

Director of the United States Patent and Trademark Office

United States of America

United States Patent and Trademark Office

vxvi records

Reg. No. 4,098,306

MARK CRISTIANO (UNITED STATES INDIVIDUAL)

Registered Feb. 14, 2012

601 S. WASHINGTON #176
STILLWATER, OK 74074

Int. Cl.: 9

FOR: AUDIO AND VIDEO RECORDINGS FEATURING MUSIC AND ARTISTIC PERFORMANCES; DIGITAL MUSIC DOWNLOADABLE FROM THE INTERNET, IN CLASS 9 (U.S. CLS. 21, 23, 26, 36 AND 38).

TRADEMARK

FIRST USE 9-11-2011; IN COMMERCE 9-11-2011.

PRINCIPAL REGISTER

THE MARK CONSISTS OF STANDARD CHARACTERS WITHOUT CLAIM TO ANY PARTICULAR FONT, STYLE, SIZE, OR COLOR.

NO CLAIM IS MADE TO THE EXCLUSIVE RIGHT TO USE "RECORDS", APART FROM THE MARK AS SHOWN.

SER. NO. 85-291,079, FILED 4-9-2011.

DAVID C. REIHNER, EXAMINING ATTORNEY



David J. Kyffers

Director of the United States Patent and Trademark Office

United States of America

United States Patent and Trademark Office

Lucina Health Foundation

Reg. No. 4,098,307

S. BYRNE, MD INC (CALIFORNIA CORPORATION)

Registered Feb. 14, 2012

3505 POB
SARATOGA, CA 95070

Int. Cl.: 35

FOR: PROMOTING COLLABORATION WITHIN THE SCIENTIFIC, RESEARCH AND MEDICAL COMMUNITIES TO ACHIEVE ADVANCES IN THE FIELD OF HEALTHCARE, IN CLASS 35 (U.S. CLS. 100, 101 AND 102).

SERVICE MARK

FIRST USE 12-28-2010; IN COMMERCE 4-1-2011.

PRINCIPAL REGISTER

THE MARK CONSISTS OF STANDARD CHARACTERS WITHOUT CLAIM TO ANY PARTICULAR FONT, STYLE, SIZE, OR COLOR.

NO CLAIM IS MADE TO THE EXCLUSIVE RIGHT TO USE "HEALTH FOUNDATION", APART FROM THE MARK AS SHOWN.

SER. NO. 85-291,305, FILED 4-11-2011.

REBECCA SMITH, EXAMINING ATTORNEY



David J. Kyffers

Director of the United States Patent and Trademark Office

United States of America

United States Patent and Trademark Office

PROTRADA

Reg. No. 4,098,308

SITETRADA PTY LTD (AUSTRALIA PRIVATE LIMITED COMPANY)
LEVEL 9 368 SUSSEX STREET
SYDNEY, AUSTRALIA

Registered Feb. 14, 2012

Int. Cl.: 36

FOR: FINANCIAL VALUATION SERVICES OF DOMAIN NAMES; DOMAIN NAME
BROKERAGE SERVICES, IN CLASS 36 (U.S. CLS. 100, 101 AND 102).

SERVICE MARK

FIRST USE 3-1-2011; IN COMMERCE 4-1-2011.

PRINCIPAL REGISTER

THE MARK CONSISTS OF STANDARD CHARACTERS WITHOUT CLAIM TO ANY PAR-
TICULAR FONT, STYLE, SIZE, OR COLOR.

SER. NO. 85-291,971, FILED 4-11-2011.

JANICE KIM, EXAMINING ATTORNEY



David J. Kybas

Director of the United States Patent and Trademark Office

United States of America

United States Patent and Trademark Office

Accidental Health

Reg. No. 4,098,309

DAVE YOUNG COMMUNICATIONS, INC. (WASHINGTON CORPORATION)
40 MT PILCHUCK AVE. NW
ISSAQUAH, WA 98027

Registered Feb. 14, 2012

Int. Cl.: 44

FOR: PROVIDING HEALTH INFORMATION, IN CLASS 44 (U.S. CLS. 100 AND 101).

SERVICE MARK

FIRST USE 2-18-2001; IN COMMERCE 4-10-2011.

PRINCIPAL REGISTER

THE MARK CONSISTS OF STANDARD CHARACTERS WITHOUT CLAIM TO ANY PARTICULAR FONT, STYLE, SIZE, OR COLOR.

NO CLAIM IS MADE TO THE EXCLUSIVE RIGHT TO USE "HEALTH", APART FROM THE MARK AS SHOWN.

SER. NO. 85-293,106, FILED 4-12-2011.

JEAN IM, EXAMINING ATTORNEY



David J. Kyffers

Director of the United States Patent and Trademark Office

United States of America

United States Patent and Trademark Office

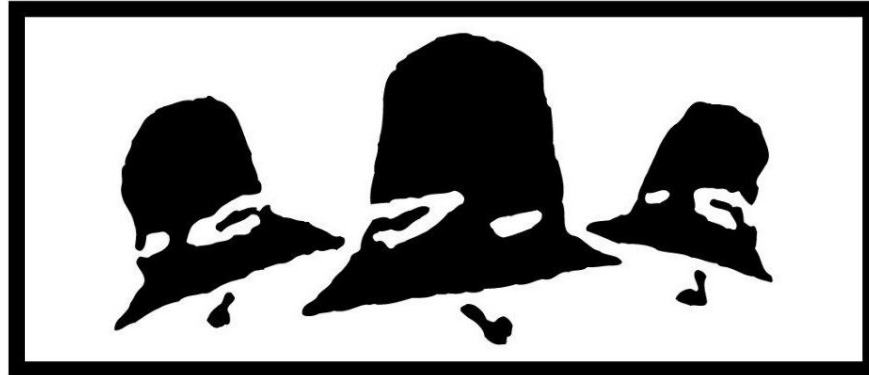

Reg. No. 4,098,310

Registered Feb. 14, 2012

**Int. Cls.: 16, 18, 20, 21,
24, 25, 28 and 32**

TRADEMARK

PRINCIPAL REGISTER

BELL'S BREWERY, INC. (MICHIGAN CORPORATION)
8938 KRUM AVENUE
GALESBURG, MI 49053

FOR: PAPER GOODS, NAMELY, POSTERS, STICKERS, BUMPER STICKERS, PAPER COASTERS, PRINTED NOVELTY BEER LABELS, TEMPORARY TATTOOS; PAPER MATERIALS AND PRINTED MATTER, NAMELY, POSTERS, STICKERS, BUMPER STICKERS, PAPER COASTERS, PRINTED NOVELTY BEER LABELS, TEMPORARY TATTOOS, IN CLASS 16 (U.S. CLS. 2, 5, 22, 23, 29, 37, 38 AND 50).

FIRST USE 9-19-1985; IN COMMERCE 9-19-1985.

FOR: MESSENGER BAGS; HANDBAGS; PURSES; WALLETS; UMBRELLAS; PATIO UMBRELLAS, IN CLASS 18 (U.S. CLS. 1, 2, 3, 22 AND 41).

FIRST USE 0-0-2007; IN COMMERCE 0-0-2007.

FOR: NONMETAL TAPS FOR KEGS; NONMETAL TAP GLOBES FOR KEGS, IN CLASS 20 (U.S. CLS. 2, 13, 22, 25, 32 AND 50).

FIRST USE 9-19-1985; IN COMMERCE 9-19-1985.

FOR: BEVERAGE GLASSWARE; BOTTLE OPENER; REUSABLE STAINLESS STEEL WATER BOTTLES SOLD EMPTY; REUSABLE PLASTIC WATER BOTTLES SOLD EMPTY; INSULATING SLEEVE HOLDERS FOR BEVERAGE BOTTLES; PLASTIC COASTERS, IN CLASS 21 (U.S. CLS. 2, 13, 23, 29, 30, 33, 40 AND 50).

FIRST USE 0-0-1990; IN COMMERCE 0-0-1990.

FOR: BEACH TOWELS; TOWELS, IN CLASS 24 (U.S. CLS. 42 AND 50).

FIRST USE 0-0-2009; IN COMMERCE 0-0-2009.

FOR: CLOTHING, NAMELY, SHIRTS, T-SHIRTS, SWEATSHIRTS, JACKETS, JERSEYS, SOCKS; BASEBALL CAPS AND HATS; SKULL CAPS; SCARVES, IN CLASS 25 (U.S. CLS. 22 AND 39).



David J. Kappas

Director of the United States Patent and Trademark Office

Reg. No. 4,098,310 FIRST USE 0-0-1989; IN COMMERCE 0-0-1989.

FOR: DISCS FOR PLAYING DISC GOLF; PLAYING CARDS, IN CLASS 28 (U.S. CLS. 22, 23, 38 AND 50).

FIRST USE 9-0-2007; IN COMMERCE 9-0-2007.

FOR: BEER; ALE; LAGER; STOUT; PORTER; MALT LIQUOR, IN CLASS 32 (U.S. CLS. 45, 46 AND 48).

FIRST USE 9-19-1985; IN COMMERCE 9-19-1985.

OWNER OF U.S. REG. NO. 2,749,090.

THE MARK CONSISTS OF THREE BELL DESIGNS WITHIN A RECTANGLE.

SER. NO. 85-293,212, FILED 4-12-2011.

KEVON CHISOLM, EXAMINING ATTORNEY

United States of America

United States Patent and Trademark Office

eTAP

Reg. No. 4,098,311

Registered Feb. 14, 2012

Int. Cls.: 9 and 42

TRADEMARK

SERVICE MARK

PRINCIPAL REGISTER

APPLABS TECHNOLOGIES PRIVATE LIMITED (INDIA CORPORATION)
6TH FLOOR, BLOCK 2, DLF CYBER CITY
HYDERABAD - 500 019, INDIA

FOR: COMPUTER SOFTWARE CONSISTING OF VARIOUS TOOLS TO DEVELOP AN ENTERPRISE-WIDE AUTOMATION PROGRAM , IN CLASS 9 (U.S. CLS. 21, 23, 26, 36 AND 38).

FIRST USE 5-8-2011; IN COMMERCE 5-8-2011.

FOR: DESIGN, DEVELOPMENT, INSTALLATION, MAINTENANCE, AND UPDATING OF COMPUTER SOFTWARE, IN CLASS 42 (U.S. CLS. 100 AND 101).

FIRST USE 5-8-2011; IN COMMERCE 5-8-2011.

THE MARK CONSISTS OF STANDARD CHARACTERS WITHOUT CLAIM TO ANY PARTICULAR FONT, STYLE, SIZE, OR COLOR.

PRIORITY CLAIMED UNDER SEC. 44(D) ON INDIA APPLICATION NO. 2128256, FILED 4-11-2011.

SER. NO. 85-293,833, FILED 4-13-2011.

SHANNON TWOHIG, EXAMINING ATTORNEY



David J. Kyros

Director of the United States Patent and Trademark Office

United States of America

United States Patent and Trademark Office



New Orleans
OUTREACH

Reg. No. 4,098,312

NEW ORLEANS OUTREACH (LOUISIANA CORPORATION)
4327 CANAL STREET
NEW ORLEANS, LA 70119

Registered Feb. 14, 2012

Int. Cl.: 41

FOR: EDUCATION SERVICES IN THE NATURE OF EARLY CHILDHOOD INSTRUCTION; EDUCATION SERVICES, NAMELY, MENTORING IN THE FIELD OF LIFE SKILLS AND HEALTHY HABITS; EDUCATION SERVICES, NAMELY, ONE-ON-ONE MENTORING IN THE FIELDS OF LIFE SKILLS AND HEALTHY HABITS; EDUCATION SERVICES, NAMELY, PROVIDING TUTORIAL SESSIONS IN THE FIELD(S) OF ELEMENTARY AND HIGH SCHOOL CORE ACADEMIC SUBJECTS; EDUCATION SERVICES, NAMELY, PROVIDING WORKSHOPS IN THE FIELD OF CAREER AWARENESS AND JOB READINESS, IN CLASS 41 (U.S. CLS. 100, 101 AND 107).

SERVICE MARK

PRINCIPAL REGISTER

FIRST USE 9-8-1994; IN COMMERCE 9-8-1994.

NO CLAIM IS MADE TO THE EXCLUSIVE RIGHT TO USE "NEW ORLEANS OUTREACH", APART FROM THE MARK AS SHOWN.

THE COLOR(S) RED, BLACK AND WHITE IS/ARE CLAIMED AS A FEATURE OF THE MARK.

THE MARK CONSISTS OF THE STYLIZED WORDS "NEW ORLEANS" IN BLACK LETTERING ABOVE A RED HORIZONTAL LINE, BELOW WHICH APPEARS THE WORDING "OUTREACH" IN BLACK LETTERING, TO THE LEFT OF WHICH APPEARS A RED SQUARE OUTLINED IN BLACK CONTAINING A FIGURE OF A PERSON IN BLACK WITH OUTSTRETCHED ARMS, AND ROWS OF FIGURES OF PEOPLE HOLDING HANDS IN WHITE IN THE BACKGROUND, AND THE IMAGE OF BLACK AND WHITE RAYS OR BEAMS EMANATING FROM THE FIGURE WITH OUTSTRETCHED ARMS.



SER. NO. 85-293,903, FILED 4-13-2011.

ERIN FALK, EXAMINING ATTORNEY

David J. Kybas

Director of the United States Patent and Trademark Office

United States of America

United States Patent and Trademark Office

TWO HEARTED ALE

Reg. No. 4,098,313

Registered Feb. 14, 2012

**Int. Cls.: 16, 20, 21, 25
and 32**

TRADEMARK

PRINCIPAL REGISTER

BELL'S BREWERY, INC. (MICHIGAN CORPORATION)
8938 KRUM AVENUE
GALESBURG, MI 49053

FOR: PAPER GOODS, NAMELY, POSTERS, STICKERS, PRINTED NOVELTY BEER LABELS;
PAPER MATERIALS AND PRINTED MATTER, NAMELY, POSTERS, STICKERS, PRINTED
NOVELTY BEER LABELS, IN CLASS 16 (U.S. CLS. 2, 5, 22, 23, 29, 37, 38 AND 50).

FIRST USE 8-7-1989; IN COMMERCE 8-7-1989.

FOR: NONMETAL TAPS FOR KEGS; NONMETAL TAP GLOBES FOR KEGS, IN CLASS 20
(U.S. CLS. 2, 13, 22, 25, 32 AND 50).

FIRST USE 8-7-1989; IN COMMERCE 8-7-1989.

FOR: BEVERAGE GLASSWARE; BOTTLE OPENER, IN CLASS 21 (U.S. CLS. 2, 13, 23, 29,
30, 33, 40 AND 50).

FIRST USE 0-0-2008; IN COMMERCE 0-0-2008.

FOR: CLOTHING, NAMELY, T-SHIRTS; HATS, IN CLASS 25 (U.S. CLS. 22 AND 39).

FIRST USE 0-0-1996; IN COMMERCE 0-0-1996.

FOR: BEER; ALE; MALT LIQUOR, IN CLASS 32 (U.S. CLS. 45, 46 AND 48).

FIRST USE 8-7-1989; IN COMMERCE 8-7-1989.

THE MARK CONSISTS OF STANDARD CHARACTERS WITHOUT CLAIM TO ANY PAR-
TICULAR FONT, STYLE, SIZE, OR COLOR.

OWNER OF U.S. REG. NO. 2,963,844.

NO CLAIM IS MADE TO THE EXCLUSIVE RIGHT TO USE "ALE", APART FROM THE
MARK AS SHOWN.

SER. NO. 85-294,255, FILED 4-13-2011.



David J. Kyfos

Director of the United States Patent and Trademark Office

Reg. No. 4,098,313 KEVON CHISOLM, EXAMINING ATTORNEY

United States of America

United States Patent and Trademark Office

FULL METAL JACKIE

Reg. No. 4,098,314

Registered Feb. 14, 2012

Int. Cl.: 41

SERVICE MARK

PRINCIPAL REGISTER

KAJZER, JACLYN (UNITED STATES INDIVIDUAL)
15TH FLOOR, (OFFICE 1510 KAMRAN)
1100 GLENDON AVENUE
LOS ANGELES, CA 900243513

FOR: ENTERTAINMENT SERVICES, NAMELY, THE PROVISION OF CONTINUING PROGRAMS AND SEGMENTS FEATURING MUSIC IN THE GENRES OF ROCK AND HEAVY METAL, DELIVERED BY RADIO, SATELLITE, THE INTERNET, AND TELEVISION, IN CLASS 41 (U.S. CLS. 100, 101 AND 107).

FIRST USE 10-25-2006; IN COMMERCE 10-25-2006.

THE MARK CONSISTS OF STANDARD CHARACTERS WITHOUT CLAIM TO ANY PARTICULAR FONT, STYLE, SIZE, OR COLOR.

THE NAME(S), PORTRAIT(S), AND/OR SIGNATURE(S) SHOWN IN THE MARK IDENTIFIES JACLYN KAJZER, WHOSE CONSENT(S) TO REGISTER IS MADE OF RECORD.

SER. NO. 85-294,603, FILED 4-13-2011.

MICHELE SWAIN, EXAMINING ATTORNEY



David J. Kybas

Director of the United States Patent and Trademark Office

United States of America

United States Patent and Trademark Office

RE-PAD

Reg. No. 4,098,315

DESIGN FORCE AB (SWEDEN PUBLIC LIMITED LIABILITY COMPANY)
HANHOLMSVÄGEN 41

Registered Feb. 14, 2012

NORRKÖPING, SWEDEN SE-60238

Int. Cl.: 16

FOR: PAPER; CARDBOARD, IN CLASS 16 (U.S. CLS. 2, 5, 22, 23, 29, 37, 38 AND 50).

TRADEMARK

THE MARK CONSISTS OF STANDARD CHARACTERS WITHOUT CLAIM TO ANY PARTICULAR FONT, STYLE, SIZE, OR COLOR.

PRINCIPAL REGISTER

PRIORITY CLAIMED UNDER SEC. 44(D) ON ERPN CMNTY TM OFC APPLICATION NO. 009509142, FILED 11-9-2010, REG. NO. 009509142, DATED 4-26-2011, EXPIRES 11-9-2020.

SER. NO. 85-295,033, FILED 4-14-2011.

REBECCA EISINGER, EXAMINING ATTORNEY



David J. Kyffers

Director of the United States Patent and Trademark Office

United States of America

United States Patent and Trademark Office



Reg. No. 4,098,316

PANDA, JASON K (UNITED STATES INDIVIDUAL)
237 WEST 120 STREET, APT. 4
NEW YORK, NY 10027

Registered Feb. 14, 2012

Int. Cl.: 10

FOR: CONDOMS, IN CLASS 10 (U.S. CLS. 26, 39 AND 44).

TRADEMARK

FIRST USE 4-15-2011; IN COMMERCE 4-15-2011.

PRINCIPAL REGISTER

THE MARK CONSISTS OF A STYLIZED LOWER CASE LETTER "B" FORMED FROM TWO BANDS.

SER. NO. 85-295,876, FILED 4-15-2011.

DAWN FELDMAN, EXAMINING ATTORNEY



David J. Kyffers

Director of the United States Patent and Trademark Office

United States of America

United States Patent and Trademark Office

wellbe.me 

Reg. No. 4,098,317

WELLBE LLC (WISCONSIN LIMITED LIABILITY COMPANY)
1221 WOODBRIDGE TRAIL
WAUNAKEE, WI 53597

Registered Feb. 14, 2012

Int. Cl.: 42

FOR: PROVIDING ONLINE NON-DOWNLOADABLE SOFTWARE FOR MEDICAL PROFESSIONALS IN THE FIELD OF PATIENT HEALTH MANAGEMENT, IN CLASS 42 (U.S. CLS. 100 AND 101).

SERVICE MARK

FIRST USE 1-1-2010; IN COMMERCE 5-1-2011.

PRINCIPAL REGISTER

THE MARK CONSISTS OF THE STYLIZED WORDING "WELLBE.ME" WITH A SPEECH BUBBLE CONTAINING A CHECK MARK TO THE UPPER RIGHT OF THE LETTERS "ME".

SER. NO. 85-296,175, FILED 4-15-2011.

DAVID TOOLEY, EXAMINING ATTORNEY



David J. Kyffers

Director of the United States Patent and Trademark Office

United States of America

United States Patent and Trademark Office

SUV CARGO CADDY

Reg. No. 4,098,318

INDIANA ROTOMOLDING, INC. (INDIANA CORPORATION), DBA ELKHART PLASTICS
3300 N. KENMORE DRIVE
SOUTH BEND, IN 46628

Registered Feb. 14, 2012

Int. Cl.: 12

FOR: STORAGE DRAWER SYSTEM ESPECIALLY ADAPTED TO FIT IN VEHICLES, NAMELY, A DRAWER THAT IS SUITABLE FOR PLACING IN THE REAR OF THE CARGO AREA OF A VEHICLE USED TO CARRY EQUIPMENT, TOOLS, SUPPLIES AND OTHER ITEMS, IN CLASS 12 (U.S. CLS. 19, 21, 23, 31, 35 AND 44).

TRADEMARK

PRINCIPAL REGISTER

FIRST USE 12-10-2002; IN COMMERCE 12-10-2002.

THE MARK CONSISTS OF STANDARD CHARACTERS WITHOUT CLAIM TO ANY PARTICULAR FONT, STYLE, SIZE, OR COLOR.

NO CLAIM IS MADE TO THE EXCLUSIVE RIGHT TO USE "CADDY", APART FROM THE MARK AS SHOWN.

SEC. 2(F).

SER. NO. 85-296,763, FILED 4-15-2011.

B. PARADEWELAI, EXAMINING ATTORNEY



David J. Kyfos

Director of the United States Patent and Trademark Office

United States of America

United States Patent and Trademark Office

INSPIRED BREWING

Reg. No. 4,098,319

Registered Feb. 14, 2012

**Int. Cls.: 16, 18, 21, 24,
25, 28 and 32**

TRADEMARK

PRINCIPAL REGISTER

BELL'S BREWERY, INC. (MICHIGAN CORPORATION)
8938 KRUM AVENUE
GALESBURG, MI 49053

FOR: PAPER GOODS, NAMELY, POSTERS, STICKERS, BUMPER STICKERS, PAPER COASTERS; PAPER MATERIALS AND PRINTED MATTER, NAMELY, POSTERS, STICKERS, BUMPER STICKERS, PAPER COASTERS, IN CLASS 16 (U.S. CLS. 2, 5, 22, 23, 29, 37, 38 AND 50).

FIRST USE 12-1-2003; IN COMMERCE 12-1-2003.

FOR: MESSENGER BAGS; HANDBAGS; PURSES; WALLETS; UMBRELLAS; PATIO UMBRELLAS, IN CLASS 18 (U.S. CLS. 1, 2, 3, 22 AND 41).

FIRST USE 0-0-2007; IN COMMERCE 0-0-2007.

FOR: BEVERAGE GLASSWARE; BOTTLE OPENER; REUSABLE STAINLESS STEEL WATER BOTTLES SOLD EMPTY; REUSABLE PLASTIC WATER BOTTLES SOLD EMPTY; INSULATING SLEEVE HOLDERS FOR BEVERAGE BOTTLES; PLASTIC COASTERS, IN CLASS 21 (U.S. CLS. 2, 13, 23, 29, 30, 33, 40 AND 50).

FIRST USE 12-1-2003; IN COMMERCE 12-1-2003.

FOR: BEACH TOWELS; TOWELS, IN CLASS 24 (U.S. CLS. 42 AND 50).

FIRST USE 0-0-2009; IN COMMERCE 0-0-2009.

FOR: CLOTHING, NAMELY, SHIRTS, T-SHIRTS, SWEATSHIRTS, JACKETS, JERSEYS, SOCKS; BASEBALL CAPS AND HATS; SKULL CAPS; SCARVES, IN CLASS 25 (U.S. CLS. 22 AND 39).

FIRST USE 0-0-2006; IN COMMERCE 0-0-2006.

FOR: DISCS FOR PLAYING DISC GOLF; PLAYING CARDS, IN CLASS 28 (U.S. CLS. 22, 23, 38 AND 50).

FIRST USE 9-0-2007; IN COMMERCE 9-0-2007.



David J. Kyffers

Director of the United States Patent and Trademark Office

Reg. No. 4,098,319 FOR: BEER; ALE; STOUT; PORTER; MALT LIQUOR, IN CLASS 32 (U.S. CLS. 45, 46 AND 48).

FIRST USE 12-1-2003; IN COMMERCE 12-1-2003.

THE MARK CONSISTS OF STANDARD CHARACTERS WITHOUT CLAIM TO ANY PARTICULAR FONT, STYLE, SIZE, OR COLOR.

OWNER OF U.S. REG. NO. 3,122,464.

NO CLAIM IS MADE TO THE EXCLUSIVE RIGHT TO USE "BREWING", APART FROM THE MARK AS SHOWN.

SER. NO. 85-296,771, FILED 4-15-2011.

KEVON CHISOLM, EXAMINING ATTORNEY

United States of America

United States Patent and Trademark Office

Steeplechase

Reg. No. 4,098,320

STEEPLECHASE, LLC (ILLINOIS LIMITED LIABILITY COMPANY)
322 S. GREEN STREET, SUITE 202
CHICAGO, IL 60607

Registered Feb. 14, 2012

Int. Cls.: 35 and 36

FOR: CONNECTING BUYERS AND SELLERS OF FINANCIAL ASSETS; FINANCIAL STATEMENT PREPARATION AND ANALYSIS FOR BUSINESSES; TAX ADVISORY SERVICES, IN CLASS 35 (U.S. CLS. 100, 101 AND 102).

SERVICE MARK

FIRST USE 11-1-2008; IN COMMERCE 11-1-2008.

PRINCIPAL REGISTER

FOR: FINANCIAL CONSULTING AND ADVISING IN THE FIELD OF MERGERS AND ACQUISITIONS, IN CLASS 36 (U.S. CLS. 100, 101 AND 102).

FIRST USE 11-1-2008; IN COMMERCE 11-1-2008.

THE MARK CONSISTS OF STANDARD CHARACTERS WITHOUT CLAIM TO ANY PARTICULAR FONT, STYLE, SIZE, OR COLOR.

SER. NO. 85-297,001, FILED 4-15-2011.

JANICE KIM, EXAMINING ATTORNEY



David J. Kyros

Director of the United States Patent and Trademark Office

United States of America

United States Patent and Trademark Office

GRACEFUL LADY LAP COVERS

Reg. No. 4,098,321

DAVIDSON DEBRA J (UNITED STATES INDIVIDUAL), TA DAVIDSON DEBRA J
7326 SOUTH STEWART AVENUE
CHICAGO, IL 60621

Registered Feb. 14, 2012

Int. Cl.: 25

FOR: WOMEN'S CLOTHING ACCESSORY, NAMELY, LEG AND LAP COVERS FOR ENCLOSING THE LEGS AND COVERING LAP AREA AND THIGHS OF A SEATED INDIVIDUAL, IN CLASS 25 (U.S. CLS. 22 AND 39).

TRADEMARK

FIRST USE 6-1-2008; IN COMMERCE 6-1-2008.

PRINCIPAL REGISTER

THE MARK CONSISTS OF STANDARD CHARACTERS WITHOUT CLAIM TO ANY PARTICULAR FONT, STYLE, SIZE, OR COLOR.

NO CLAIM IS MADE TO THE EXCLUSIVE RIGHT TO USE "LADY LAP COVERS", APART FROM THE MARK AS SHOWN.

SER. NO. 85-297,076, FILED 4-16-2011.

ELI HELLMAN, EXAMINING ATTORNEY



David J. Kyffers

Director of the United States Patent and Trademark Office

United States of America

United States Patent and Trademark Office



Reg. No. 4,098,322

Registered Feb. 14, 2012

Int. Cl.: 41

SERVICE MARK

PRINCIPAL REGISTER

SHAAIM FAMILY LLC (NEW YORK LIMITED LIABILITY COMPANY)
819 MARCY AVE.
819 MARCY AVE.
BROOKLYN, NY 11216

FOR: EDUCATIONAL SERVICES, NAMELY, CONDUCTING CLASSES, SEMINARS AND WORKSHOPS IN THE FIELD OF PERSONAL, CHARACTER, EDUCATIONAL AND CAREER DEVELOPMENT AND DISTRIBUTION OF PRINTED MATERIALS IN CONNECTION THEREWITH IN HARD COPY OR ELECTRONIC FORMAT ON THE SAME TOPICS, IN CLASS 41 (U.S. CLS. 100, 101 AND 107).

FIRST USE 4-15-2011; IN COMMERCE 4-15-2011.

OWNER OF U.S. REG. NO. 3,105,733.

THE COLOR(S) WHITE AND SKY BLUE IS/ARE CLAIMED AS A FEATURE OF THE MARK.

NO CLAIM IS MADE TO THE EXCLUSIVE RIGHT TO USE "EDUCATIONAL COMMUNITY DEVELOPMENT", APART FROM THE MARK AS SHOWN.

THE MARK CONSISTS OF TWO OUTSTRETCHED WHITE WINGS WITH SKY BLUE LINING AND SHADING WITH THE WORDS "WHITE WING EDUCATIONAL COMMUNITY DEVELOPMENT" IN SKY BLUE UNDERNEATH THE DESIGN.

SER. NO. 85-297,312, FILED 4-18-2011.

COLLEEN KEARNEY, EXAMINING ATTORNEY



David J. Kyjars

Director of the United States Patent and Trademark Office

United States of America

United States Patent and Trademark Office

CPLIVE

Reg. No. 4,098,323

Registered Feb. 14, 2012

Int. Cls.: 9 and 36

TRADEMARK

SERVICE MARK

PRINCIPAL REGISTER

WEBCETERA, L.P. (TEXAS LIMITED PARTNERSHIP)
601 SILVERON BLVD., SUITE 170
FLOWER MOUND, TX 75028

FOR: COMPUTER SOFTWARE, NAMELY, COMPUTER SOFTWARE FOR PROVIDING A WEB-BASED PORTAL TO PROVIDE INSURANCE AGENTS AND BROKERS QUOTE INFORMATION, IN CLASS 9 (U.S. CLS. 21, 23, 26, 36 AND 38).

FIRST USE 12-31-2007; IN COMMERCE 12-31-2007.

FOR: ONLINE INSURANCE-RELATED SERVICES, NAMELY, PROVIDING A WEB-BASED PORTAL TO PROVIDE INSURANCE AGENTS AND BROKERS QUOTE INFORMATION, IN CLASS 36 (U.S. CLS. 100, 101 AND 102).

FIRST USE 12-31-2007; IN COMMERCE 12-31-2007.

THE MARK CONSISTS OF STANDARD CHARACTERS WITHOUT CLAIM TO ANY PARTICULAR FONT, STYLE, SIZE, OR COLOR.

SER. NO. 85-298,553, FILED 4-19-2011.

JOHN WILKE, EXAMINING ATTORNEY



David J. Kypos

Director of the United States Patent and Trademark Office

United States of America

United States Patent and Trademark Office

ATHLEAN-Rx

Reg. No. 4,098,324

SPORTS PERFORMANCE FACTORY LLC (CONNECTICUT LIMITED LIABILITY COMPANY)
P.O BOX 5054
WESTPORT, CT 06881

Registered Feb. 14, 2012

Int. Cl.: 5

FOR: DIETARY AND NUTRITIONAL SUPPLEMENTS; DIETARY AND NUTRITIONAL SUPPLEMENTS FOR ENDURANCE SPORTS; DIETARY AND NUTRITIONAL SUPPLEMENTS USED FOR WEIGHT LOSS; DIETARY SUPPLEMENTS; DIETARY SUPPLEMENTS FOR HUMAN CONSUMPTION; DIETARY SUPPLEMENTS IN THE NATURE OF WEIGHT LOSS POWDERS; HEALTH FOOD SUPPLEMENTS; POWDERED NUTRITIONAL SUPPLEMENT DRINK MIX; PROTEIN SUPPLEMENTS; VITAMIN AND MINERAL SUPPLEMENTS; WEIGHT MANAGEMENT SUPPLEMENTS, IN CLASS 5 (U.S. CLS. 6, 18, 44, 46, 51 AND 52).

TRADEMARK

PRINCIPAL REGISTER

FIRST USE 4-6-2010; IN COMMERCE 4-8-2011.

THE MARK CONSISTS OF STANDARD CHARACTERS WITHOUT CLAIM TO ANY PARTICULAR FONT, STYLE, SIZE, OR COLOR.

OWNER OF U.S. REG. NO. 3,889,639.

SER. NO. 85-298,829, FILED 4-19-2011.

WILLIAM VERHOSEK, EXAMINING ATTORNEY



David J. Kyffers

Director of the United States Patent and Trademark Office

United States of America

United States Patent and Trademark Office



Reg. No. 4,098,325

Registered Feb. 14, 2012

Int. Cl.: 41

SERVICE MARK

PRINCIPAL REGISTER

BURST COLLECTIVE, LLC, THE (WISCONSIN LIMITED LIABILITY COMPANY)
1442 UNDERWOOD AVENUE
WAUWATOSA, WI 53213

FOR: MAINTAINING A LIBRARY OF RECORDED MUSIC, NAMELY PROVIDING ONLINE ELECTRONIC LIBRARY SERVICES WHICH FEATURE MUSIC RECORDINGS, IN CLASS 41 (U.S. CLS. 100, 101 AND 107).

FIRST USE 1-1-2011; IN COMMERCE 1-1-2011.

THE MARK CONSISTS OF THE LETTERS "UNDER" AND AN UNDERScore LINE UNDER THE "U". THE DARK SQUARE IS NOT PART OF THE MARK BUT MERELY BACKGROUND.

SER. NO. 85-299,246, FILED 4-19-2011.

JOHN DWYER, EXAMINING ATTORNEY



David J. Kybas

Director of the United States Patent and Trademark Office

United States of America

United States Patent and Trademark Office

Magic of the Night

Reg. No. 4,098,326

Registered Feb. 14, 2012

Int. Cl.: 41

SERVICE MARK

PRINCIPAL REGISTER

STEPHEN KNIGHT PRODUCTIONS, LTD. (OHIO LIMITED LIABILITY COMPANY), DBA
MAGIC OF THE KNIGHT
5555 BIG TIMBER CT
COLUMBUS, OH 43230

FOR: CONDUCTING ENTERTAINMENT EXHIBITIONS IN THE NATURE OF THEATER;
ENTERTAINMENT IN THE NATURE OF MAGIC SHOWS; ENTERTAINMENT IN THE
NATURE OF THEATER PRODUCTIONS, IN CLASS 41 (U.S. CLS. 100, 101 AND 107).

FIRST USE 1-1-2005; IN COMMERCE 1-1-2005.

THE MARK CONSISTS OF STANDARD CHARACTERS WITHOUT CLAIM TO ANY PAR-
TICULAR FONT, STYLE, SIZE, OR COLOR.

NO CLAIM IS MADE TO THE EXCLUSIVE RIGHT TO USE "MAGIC", APART FROM THE
MARK AS SHOWN.

SER. NO. 85-299,603, FILED 4-20-2011.

YAT SYE, LEE, EXAMINING ATTORNEY



David J. Kyffers

Director of the United States Patent and Trademark Office

United States of America

United States Patent and Trademark Office

CTC BATTERY

Reg. No. 4,098,327

Registered Feb. 14, 2012

Int. Cl.: 9

TRADEMARK

PRINCIPAL REGISTER

CTC BATTERY, INC. (CALIFORNIA CORPORATION)
21363 CABOT BLVD
HAYWARD, CA 94545

FOR: BATTERIES, IN CLASS 9 (U.S. CLS. 21, 23, 26, 36 AND 38).

FIRST USE 3-3-2010; IN COMMERCE 3-3-2010.

THE MARK CONSISTS OF STANDARD CHARACTERS WITHOUT CLAIM TO ANY PARTICULAR FONT, STYLE, SIZE, OR COLOR.

NO CLAIM IS MADE TO THE EXCLUSIVE RIGHT TO USE "BATTERY", APART FROM THE MARK AS SHOWN.

SER. NO. 85-299,970, FILED 4-20-2011.

GINA HAYES, EXAMINING ATTORNEY



David J. Kyffers

Director of the United States Patent and Trademark Office

United States of America

United States Patent and Trademark Office

Prince Olive

Reg. No. 4,098,328

Registered Feb. 14, 2012

Int. Cl.: 29

TRADEMARK

PRINCIPAL REGISTER

PRINCE OLIVE (CALIFORNIA CORPORATION)
384 CAMINO SOBRANTE
ORINDA, CA 94563

FOR: OLIVE OIL; OLIVE OILS, IN CLASS 29 (U.S. CL. 46).

FIRST USE 12-1-2009; IN COMMERCE 4-22-2011.

NO CLAIM IS MADE TO THE EXCLUSIVE RIGHT TO USE "OLIVE", APART FROM THE MARK AS SHOWN.

THE NAME "PRINCE OLIVE" DOES NOT IDENTIFY A LIVING INDIVIDUAL.

THE MARK CONSISTS OF THE STYLIZED WORDING OF "PRINCE OLIVE".

SER. NO. 85-302,311, FILED 4-22-2011.

JAY BESCH, EXAMINING ATTORNEY



David J. Kyffers

Director of the United States Patent and Trademark Office

United States of America

United States Patent and Trademark Office

VECTOR QUAD

Reg. No. 4,098,329

MODERN LINEAR INCORPORATED (CALIFORNIA CORPORATION)
18 ALTA TERRACE
CORTE MADERA, CA 94925

Registered Feb. 14, 2012

Int. Cl.: 7

FOR: MACHINE COMPONENT, NAMELY, A LINEAR GUIDE FOR USE IN FACTORY
AUTOMATION, IN CLASS 7 (U.S. CLS. 13, 19, 21, 23, 31, 34 AND 35).

TRADEMARK

FIRST USE 8-1-2007; IN COMMERCE 8-1-2007.

PRINCIPAL REGISTER

THE MARK CONSISTS OF STANDARD CHARACTERS WITHOUT CLAIM TO ANY PAR-
TICULAR FONT, STYLE, SIZE, OR COLOR.

SER. NO. 85-302,652, FILED 4-22-2011.

CHARLOTTE CORWIN, EXAMINING ATTORNEY



David J. Kyffers

Director of the United States Patent and Trademark Office

United States of America

United States Patent and Trademark Office

VECTOR TRIO

Reg. No. 4,098,330

MODERN LINEAR INCORPORATED (CALIFORNIA CORPORATION)
18 ALTA TERRACE
CORTE MADERA, CA 94925

Registered Feb. 14, 2012

Int. Cl.: 7

FOR: MACHINE COMPONENT, NAMELY, A LINEAR GUIDE FOR USE IN FACTORY AUTOMATION, IN CLASS 7 (U.S. CLS. 13, 19, 21, 23, 31, 34 AND 35).

TRADEMARK

FIRST USE 8-1-2007; IN COMMERCE 8-1-2007.

PRINCIPAL REGISTER

THE MARK CONSISTS OF STANDARD CHARACTERS WITHOUT CLAIM TO ANY PARTICULAR FONT, STYLE, SIZE, OR COLOR.

SER. NO. 85-302,686, FILED 4-22-2011.

CHARLOTTE CORWIN, EXAMINING ATTORNEY



David J. Kybas

Director of the United States Patent and Trademark Office

United States of America

United States Patent and Trademark Office

Studio LOL

Reg. No. 4,098,331

STUDIO LOL (CALIFORNIA SOLE PROPRIETORSHIP)

Registered Feb. 14, 2012

11634 VENTURA BLVD
STUDIO CITY, CA 91604

Int. Cl.: 41

FOR: EDUCATIONAL AND ENTERTAINMENT SERVICES, NAMELY, CONDUCTING CLASSES, CAMPS, WORKSHOPS, PRIVATE COACHING, TRAINING, SEMINARS, PERFORMANCE OPPORTUNITIES IN THE FIELD OF COMEDY AND DISTRIBUTION OF COURSE MATERIALS IN CONNECTION THEREWITH, AND EDUCATION CONSULTING RELATED THERETO, IN CLASS 41 (U.S. CLS. 100, 101 AND 107).

SERVICE MARK

PRINCIPAL REGISTER

FIRST USE 6-1-2010; IN COMMERCE 6-1-2010.

THE MARK CONSISTS OF STANDARD CHARACTERS WITHOUT CLAIM TO ANY PARTICULAR FONT, STYLE, SIZE, OR COLOR.

NO CLAIM IS MADE TO THE EXCLUSIVE RIGHT TO USE "STUDIO", APART FROM THE MARK AS SHOWN.

SER. NO. 85-302,819, FILED 4-23-2011.

MICHAEL ENGEL, EXAMINING ATTORNEY



David J. Kyros

Director of the United States Patent and Trademark Office

United States of America
United States Patent and Trademark Office

mydiamarks

Reg. No. 4,098,332

MYDIAMARKS INC (WYOMING CORPORATION)
2510 WARREN AVE.
CHEYENNE, WY 82001

Registered Feb. 14, 2012

Int. Cl.: 9

FOR: COMPUTER APPLICATION SOFTWARE FOR MOBILE PHONES, PORTABLE MEDIA PLAYERS, HAND-HELD AND DESKTOP COMPUTERS, AND INTERNET RECEIVERS, NAMELY, SOFTWARE FOR USE IN DATABASE MANAGEMENT, ELECTRONIC STORAGE, MEDIA PORTABILITY AND SHARING MEDIA MOMENTS VIA SOCIAL NETWORKING, IN CLASS 9 (U.S. CLS. 21, 23, 26, 36 AND 38).

TRADEMARK

PRINCIPAL REGISTER

FIRST USE 5-31-2010; IN COMMERCE 5-31-2010.

THE MARK CONSISTS OF STANDARD CHARACTERS WITHOUT CLAIM TO ANY PARTICULAR FONT, STYLE, SIZE, OR COLOR.

SER. NO. 85-303,123, FILED 4-24-2011.

SETH A. RAPPAPORT, EXAMINING ATTORNEY



David J. Kyffers

Director of the United States Patent and Trademark Office

United States of America

United States Patent and Trademark Office

SHEADS

Reg. No. 4,098,333

Registered Feb. 14, 2012

Int. Cl.: 30

TRADEMARK

PRINCIPAL REGISTER

SHEAD, LEON (COLORADO LIMITED LIABILITY COMPANY), DBA SHEAD'S RIBS & FISH HUT, LLC
43767 E. ILIFF TRAIL
BENNETT, CO 80102

FOR: BARBECUE SAUCE, IN CLASS 30 (U.S. CL. 46).

FIRST USE 2-3-1984; IN COMMERCE 7-1-2006.

THE MARK CONSISTS OF STANDARD CHARACTERS WITHOUT CLAIM TO ANY PARTICULAR FONT, STYLE, SIZE, OR COLOR.

SEC. 2(F).

SER. NO. 85-303,660, FILED 4-25-2011.

CHRISTOPHER BUONGIORNO, EXAMINING ATTORNEY



David J. Kybas

Director of the United States Patent and Trademark Office

United States of America

United States Patent and Trademark Office

CEE*CEE*QUCUMBER

Reg. No. 4,098,334

OUTLAW, MICHELE R (UNITED STATES INDIVIDUAL), DBA CEE-CEE-QFASHION
202 W. CUMMINGS ST.

Registered Feb. 14, 2012

LONG BEACH, CA 908052019

Int. Cl.: 25

FOR: APPAREL FOR DANCERS, NAMELY, TEE SHIRTS, SWEATSHIRTS, PANTS, LEGGINGS, SHORTS AND JACKETS; ATHLETIC APPAREL, NAMELY, SHIRTS, PANTS, JACKETS, FOOTWEAR, HATS AND CAPS, ATHLETIC UNIFORMS; CANVAS SHOES; CHILDREN'S AND INFANT'S APPAREL, NAMELY, JUMPERS, OVERALL SLEEPWEAR, PAJAMAS, ROMPERS AND ONE-PIECE GARMENTS; CLIMBING SHOES; CLOTHING FOR ATHLETIC USE, NAMELY, PADDED PANTS; CLOTHING FOR BABIES, TODDLERS AND CHILDREN, TREATED WITH FIRE AND HEAT RETARDANTS, NAMELY, PAJAMAS, JACKETS, SHIRTS, PANTS, JUMPERS; DANCE SHOES; INFANT AND TODDLER ONE PIECE CLOTHING; INFANTS' SHOES AND BOOTS; LEATHER SHOES; SANDALS AND BEACH SHOES; SHIRTS FOR INFANTS, BABIES, TODDLERS AND CHILDREN; SOCCER SHOES; TENNIS SHOES; WOMEN'S SHOES; WOMEN'S SHOES, NAMELY, FOLDABLE FLATS, IN CLASS 25 (U.S. CLS. 22 AND 39).

TRADEMARK

PRINCIPAL REGISTER

FIRST USE 10-0-1987; IN COMMERCE 10-0-1987.

OWNER OF U.S. REG. NO. 3,791,185.

THE MARK CONSISTS OF "CEE CEE QUCUMBER" IN STYLIZED LETTERING. THERE IS A STAR ON EACH SIDE OF THE MIDDLE WORD "CEE".

SER. NO. 85-303,898, FILED 4-25-2011.

KATHLEEN M. VANSTON, EXAMINING ATTORNEY



David J. Kyros

Director of the United States Patent and Trademark Office

United States of America

United States Patent and Trademark Office

ORDIFY

Reg. No. 4,098,335

Registered Feb. 14, 2012

Int. Cl.: 35

SERVICE MARK

PRINCIPAL REGISTER

GROCERY ORDER TRACKING INC. (KANSAS CORPORATION), DBA G.O.T. SYSTEMS
17883 S. GARNETT ST.
OLATHE, KS 66062

FOR: BUSINESS CONSULTATION SERVICES IN THE FIELDS OF SUPPLY CHAIN ANALYSIS AND REGULATION COMPLIANCE; INVENTORY AND SHELF ARRANGEMENT, NAMELY, REPLENISHING AND RESETTING ITEMS FOR SALE; INVENTORY CONTROL IN THE FIELD OF GROCERY STORES; INVENTORY MANAGEMENT IN THE FIELD OF GROCERY STORES; ON-LINE SERVICES, NAMELY, ORDERING AND INVENTORY MONITORING FOR ALL PRODUCTS SOLD IN GROCERY STORES; PROVIDING AN ON-LINE COMPUTER DATABASE IN THE FIELD OF LOCATING PRODUCTS, DESCRIBING PRODUCTS, RATING PRODUCTS, PRICING PRODUCTS AND COMPARING PRICES OF PRODUCTS, IN CLASS 35 (U.S. CLS. 100, 101 AND 102).

FIRST USE 2-1-2011; IN COMMERCE 2-1-2011.

THE MARK CONSISTS OF STANDARD CHARACTERS WITHOUT CLAIM TO ANY PARTICULAR FONT, STYLE, SIZE, OR COLOR.

SER. NO. 85-303,923, FILED 4-25-2011.

STEVEN JACKSON, EXAMINING ATTORNEY



David J. Kyfos

Director of the United States Patent and Trademark Office

United States of America

United States Patent and Trademark Office



REAL TITAN
Acquisitions, Inc

Reg. No. 4,098,336

Registered Feb. 14, 2012

Int. Cl.: 36

SERVICE MARK

PRINCIPAL REGISTER

REAL TITAN ACQUISITIONS, INC. (CALIFORNIA CORPORATION)
235
309 E. HILLCREST BLVD
INGLEWOOD, CA 90301

FOR: LAND INVESTMENT SERVICES; LAND INVESTMENT CONSULTATION SERVICES,
IN CLASS 36 (U.S. CLS. 100, 101 AND 102).

FIRST USE 11-23-2005; IN COMMERCE 10-4-2006.

NO CLAIM IS MADE TO THE EXCLUSIVE RIGHT TO USE "ACQUISITIONS, INC.", APART
FROM THE MARK AS SHOWN.

THE MARK CONSISTS OF A HALF SEMI-CIRCLE TOP WITH A DIAMOND PEAK AND
THE LETTER "R". BELOW THERE IS THE STYLIZED TEXT "REAL TITAN ACQUISITIONS,
INC" WITH A LINE IN THE MIDDLE.

SER. NO. 85-304,103, FILED 4-25-2011.

RONALD AIKENS, EXAMINING ATTORNEY



David J. Kyffers

Director of the United States Patent and Trademark Office

United States of America

United States Patent and Trademark Office

TIRX

Reg. No. 4,098,337

Registered Feb. 14, 2012

Int. Cl.: 6

TRADEMARK

PRINCIPAL REGISTER

PRAXIS POWDER TECHNOLOGIES, INC (NEW YORK CORPORATION)
604 QUEENSBURY AVE
QUEENSBURY, NY 12804

FOR: GRADE 5 TITANIUM ALLOY, NAMELY, MATERIAL MADE FROM TITANIUM METAL INJECTION MOLDING FOR USE IN MEDICAL IMPLANTS, IN CLASS 6 (U.S. CLS. 2, 12, 13, 14, 23, 25 AND 50).

FIRST USE 9-22-2010; IN COMMERCE 11-24-2010.

THE MARK CONSISTS OF STANDARD CHARACTERS WITHOUT CLAIM TO ANY PARTICULAR FONT, STYLE, SIZE, OR COLOR.

SER. NO. 85-304,303, FILED 4-25-2011.

TINA MAI, EXAMINING ATTORNEY



David J. Kyffers

Director of the United States Patent and Trademark Office

United States of America

United States Patent and Trademark Office

Natural Young Musician (NYM)

Reg. No. 4,098,338

ALDORT, NAOMI (UNITED STATES INDIVIDUAL)
PO BOX 1719
EASTSOUND, WA 98245

Registered Feb. 14, 2012

Int. Cl.: 41

FOR: EDUCATIONAL SERVICES, NAMELY, CONDUCTING ON LINE AND TELEPHONIC INSTRUCTION AND COURSES IN THE FIELD OF MUSIC, IN CLASS 41 (U.S. CLS. 100, 101 AND 107).

SERVICE MARK

FIRST USE 4-24-2011; IN COMMERCE 4-24-2011.

PRINCIPAL REGISTER

THE MARK CONSISTS OF STANDARD CHARACTERS WITHOUT CLAIM TO ANY PARTICULAR FONT, STYLE, SIZE, OR COLOR.

NO CLAIM IS MADE TO THE EXCLUSIVE RIGHT TO USE "YOUNG MUSICIAN", APART FROM THE MARK AS SHOWN.

SER. NO. 85-304,311, FILED 4-25-2011.

TINA MAI, EXAMINING ATTORNEY



David J. Kyffers

Director of the United States Patent and Trademark Office

United States of America

United States Patent and Trademark Office

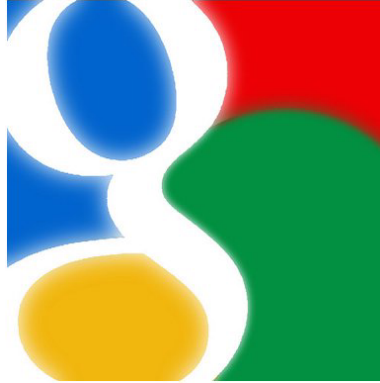

Reg. No. 4,098,339

Registered Feb. 14, 2012

Int. Cls.: 9 and 42

TRADEMARK

SERVICE MARK

PRINCIPAL REGISTER

GOOGLE INC. (DELAWARE CORPORATION)
1600 AMPHITHEATRE PARKWAY
MOUNTAIN VIEW, CA 94043

FOR: DOWNLOADABLE SOFTWARE FOR CREATING INDEXES OF INFORMATION, INDEXES OF WEB SITES AND INDEXES OF OTHER INFORMATION RESOURCES, IN CLASS 9 (U.S. CLS. 21, 23, 26, 36 AND 38).

FIRST USE 1-9-2009; IN COMMERCE 1-9-2009.

FOR: PROVISION OF SEARCH ENGINES FOR THE INTERNET; PROVIDING E-MAIL AUTHENTICATION SERVICES, NAMELY, PROVIDING AN ONLINE SERVICE THAT ALLOWS USERS TO SIGN ON TO MULTIPLE THIRD PARTY WEBSITES USING A SINGLE USER NAME AND PASSWORD, IN CLASS 42 (U.S. CLS. 100 AND 101).

FIRST USE 1-9-2009; IN COMMERCE 1-9-2009.

THE MARK CONSISTS OF A WHITE LOWER CASE "G" ON A SQUARE BACKGROUND WITH THE COLOR RED IN THE UPPER LEFT CORNER, GREEN IN THE LOWER RIGHT CORNER, YELLOW IN THE LOWER LEFT CORNER, AND BLUE IN THE UPPER LEFT CORNER.

THE COLOR(S) BLUE, RED, GREEN, YELLOW, AND WHITE IS/ARE CLAIMED AS A FEATURE OF THE MARK.

SER. NO. 85-304,939, FILED 4-26-2011.

LINDSEY RUBIN, EXAMINING ATTORNEY



David J. Kybas

Director of the United States Patent and Trademark Office

United States of America

United States Patent and Trademark Office



Reg. No. 4,098,340

Registered Feb. 14, 2012

Int. Cl.: 21

TRADEMARK

PRINCIPAL REGISTER

RUNWAY BLUE, LLC (UTAH LIMITED LIABILITY COMPANY)
35 SOUTH PFEIFFERHORN DRIVE
ALPINE, UT 84004

FOR: CONTAINERS FOR HOUSEHOLD OR KITCHEN USE, WITH SAID CONTAINERS BEING FOR USE WITH BEVERAGES, LIQUID FOODS, AND POWDERED FOODS; CONTAINERS, NAMELY, BOTTLES WITH NON-ELECTRIC INTERNAL AGITATORS FOR MIXING INGREDIENTS, WITH THE AFOREMENTIONED BEING FOR BEVERAGES, LIQUID FOODS, AND POWDERED FOODS AND ALL BEING SOLD EMPTY, IN CLASS 21 (U.S. CLS. 2, 13, 23, 29, 30, 33, 40 AND 50).

FIRST USE 1-4-2011; IN COMMERCE 1-4-2011.

OWNER OF U.S. REG. NO. 3,722,198.

THE MARK CONSISTS OF A SPIRAL TYPE BALL.

SER. NO. 85-305,315, FILED 4-26-2011.

KEVIN CORWIN, EXAMINING ATTORNEY



David J. Kybas

Director of the United States Patent and Trademark Office

United States of America

United States Patent and Trademark Office



Reg. No. 4,098,341

Registered Feb. 14, 2012

Int. Cl.: 35

SERVICE MARK

PRINCIPAL REGISTER

MEDIATE JOE P. (GEORGIA LIMITED LIABILITY COMPANY), DBA KOOKOO BEAR KIDS
530 ABBEYWOOD DRIVE
ROSWELL, GA 30075

FOR: MAIL ORDER CATALOG SERVICES FEATURING FURNITURE, BEDDING, HOME ACCESSORIES, TOYS, CLOTHING, BABY SHOWER AND GIFT REGISTRY AND GIFTS FOR INFANTS AND PRE TEEN CHILDREN AND TEENS; OPERATING AN ON-LINE SHOPPING SITE IN THE FIELD OF FURNITURE, BEDDING, HOME ACCESSORIES, TOYS, CLOTHING, BABY SHOWER AND GIFT REGISTRY AND GIFTS FOR INFANTS AND PRE TEEN CHILDREN AND TEENS, IN CLASS 35 (U.S. CLS. 100, 101 AND 102).

FIRST USE 6-15-2003; IN COMMERCE 9-23-2003.

NO CLAIM IS MADE TO THE EXCLUSIVE RIGHT TO USE "BABY & KIDS", APART FROM THE MARK AS SHOWN.

THE MARK CONSISTS OF THE WORDING "KOOKOO BEAR BABY & KIDS" IN STYLIZED FORM WITH A BEAR DESIGN NEXT TO THE FIRST "K" AND A BEAR DESIGN TO THE RIGHT OF "KIDS".

SER. NO. 85-306,346, FILED 4-27-2011.

ALLISON HOLTZ, EXAMINING ATTORNEY



David J. Kyffers

Director of the United States Patent and Trademark Office

United States of America

United States Patent and Trademark Office

HYDRO

Reg. No. 4,098,342

SIEMENS MEDICAL INSTRUMENTS PTE. LTD. (SINGAPORE CORPORATION)
BLOCK 28, AYER RAJAH CRESCENT NO. 06-08
SINGAPORE, SINGAPORE 139959

Registered Feb. 14, 2012

Int. Cl.: 10

FOR: MEDICAL HEARING AIDS AND PARTS THEREOF, IN CLASS 10 (U.S. CLS. 26, 39 AND 44).

TRADEMARK

THE MARK CONSISTS OF STANDARD CHARACTERS WITHOUT CLAIM TO ANY PARTICULAR FONT, STYLE, SIZE, OR COLOR.

PRINCIPAL REGISTER

PRIORITY CLAIMED UNDER SEC. 44(D) ON ERPN CMNTY TM OFC APPLICATION NO. 009525981, FILED 11-16-2010, REG. NO. 9525981, DATED 5-2-2011, EXPIRES 11-16-2020.

SER. NO. 85-306,505, FILED 4-27-2011.

RAUL CORDOVA, EXAMINING ATTORNEY



David J. Kybas

Director of the United States Patent and Trademark Office

United States of America

United States Patent and Trademark Office

EZsolar

Reg. No. 4,098,343

Registered Feb. 14, 2012

Int. Cls.: 9 and 11

TRADEMARK

PRINCIPAL REGISTER

SHENZHEN JIAWEI PHOTOVOLTAIC LIGHTING CO., LTD. (CHINA LIMITED COMPANY
(LTD.))
FUPING ROAD LONGGANG
XINFA INDUSTRIAL AREA
SHENZHEN, CHINA

FOR: SOLAR PANELS FOR PRODUCTION OF ELECTRICITY; INVERTERS; PROGRAM-
MABLE ELECTRONIC CONTROLLERS FOR SOLAR PANELS, IN CLASS 9 (U.S. CLS. 21,
23, 26, 36 AND 38).

FIRST USE 10-0-2006; IN COMMERCE 10-0-2006.

FOR: SOLAR LIGHTING FIXTURES, NAMELY, INDOOR AND OUTDOOR SOLAR POWERED
LIGHTING UNITS AND FIXTURES; SOLAR-POWERED ALL-WEATHER LIGHTS, IN CLASS
11 (U.S. CLS. 13, 21, 23, 31 AND 34).

FIRST USE 10-0-2006; IN COMMERCE 10-0-2006.

THE MARK CONSISTS OF STANDARD CHARACTERS WITHOUT CLAIM TO ANY PAR-
TICULAR FONT, STYLE, SIZE, OR COLOR.

OWNER OF U.S. REG. NO. 3,353,075.

SER. NO. 85-307,257, FILED 4-28-2011.

PATRICIA EVANKO, EXAMINING ATTORNEY



David J. Kybas

Director of the United States Patent and Trademark Office

United States of America

United States Patent and Trademark Office

ACCORD SERVICES

Reg. No. 4,098,344

Registered Feb. 14, 2012

Int. Cl.: 44

SERVICE MARK

PRINCIPAL REGISTER

ACCORD SERVICES, LLC (GEORGIA LIMITED LIABILITY COMPANY)
907 CHURCH STREET EXTENSION
MARIETTA, GA 30060

FOR: HEALTHCARE, IN CLASS 44 (U.S. CLS. 100 AND 101).

FIRST USE 10-1-2001; IN COMMERCE 10-1-2001.

THE MARK CONSISTS OF STANDARD CHARACTERS WITHOUT CLAIM TO ANY PARTICULAR FONT, STYLE, SIZE, OR COLOR.

NO CLAIM IS MADE TO THE EXCLUSIVE RIGHT TO USE "SERVICES", APART FROM THE MARK AS SHOWN.

SER. NO. 85-307,336, FILED 4-28-2011.

LESLIE RICHARDS, EXAMINING ATTORNEY



David J. Kyffers

Director of the United States Patent and Trademark Office

United States of America

United States Patent and Trademark Office



choristersguild

Reg. No. 4,098,345

Registered Feb. 14, 2012

Int. Cl.: 16

TRADEMARK

PRINCIPAL REGISTER

CHORISTERS GUILD (TEXAS NON-PROFIT ORGANIZATION)
12404 PARK CENTRAL DRIVE, SUITE 100
DALLAS, TX 75251

FOR: MUSIC SHEETS; SHEET MUSIC, IN CLASS 16 (U.S. CLS. 2, 5, 22, 23, 29, 37, 38 AND 50).

FIRST USE 12-15-2010; IN COMMERCE 12-15-2010.

NO CLAIM IS MADE TO THE EXCLUSIVE RIGHT TO USE "CHORISTERS GUILD", APART FROM THE MARK AS SHOWN.

THE COLOR(S) BLACK, MAGENTA, GREY IS/ARE CLAIMED AS A FEATURE OF THE MARK.

THE MARK CONSISTS OF THE STYLIZED WORDING "CG CHORISTERS GUILD" AND A DESIGN WITH A SOLID BLACK LINE RUNNING VERTICALLY DOWN THE LEFT WITH FIVE SOLID GREY LINES RUNNING PERPENDICULAR TO THE RIGHT OF THE VERTICAL LINE, WITH THE MAGENTA CURSIVE LETTERS "C" AND "G" IN THE MIDDLE OF THE FIVE LINES AS THOUGH THEY WERE MUSIC CLEFS ON A MUSIC STAFF, AND UNDERNEATH IT ALL, THE STYLIZED WORDS "CHORISTERSGUILD" IN ALL LOWERCASE WITH "CHORISTERS" BEING BLACK AND "GUILD" BEING GREY, NO SPACE BETWEEN THE TWO WORDS.

SER. NO. 85-307,506, FILED 4-28-2011.

JERI J. FICKES, EXAMINING ATTORNEY



David J. Kyffers

Director of the United States Patent and Trademark Office

United States of America

United States Patent and Trademark Office



Reg. No. 4,098,346

O'BURGERS INC (CALIFORNIA CORPORATION)
8593 SANTA MONICA BOULEVARD
WEST HOLLYWOOD, CA 90069

Registered Feb. 14, 2012

Int. Cl.: 43

FOR: FAST-FOOD RESTAURANTS, IN CLASS 43 (U.S. CLS. 100 AND 101).

SERVICE MARK

FIRST USE 3-30-2008; IN COMMERCE 3-30-2008.

PRINCIPAL REGISTER

NO CLAIM IS MADE TO THE EXCLUSIVE RIGHT TO USE "BURGER" , APART FROM THE MARK AS SHOWN.

THE COLOR(S) YELLOW, GREEN, AND ORANGE IS/ARE CLAIMED AS A FEATURE OF THE MARK.

THE MARK CONSISTS OF A STYLIZED YELLOW "O", A STYLIZED GREEN EXCLAMATION POINT, THE WORDING "BURGER" IN AN ORANGE STYLIZED FONT, AND A STYLIZED ORANGE AND GREEN DRAWING OF A BURGER/SANDWICH.

SER. NO. 85-307,927, FILED 4-29-2011.

PATRICIA EVANKO, EXAMINING ATTORNEY



David J. Kyjars

Director of the United States Patent and Trademark Office

United States of America

United States Patent and Trademark Office

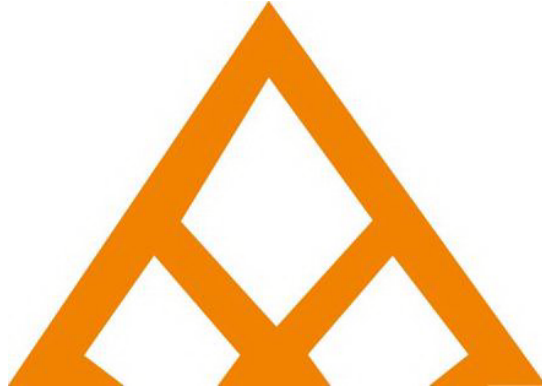

Reg. No. 4,098,347

Registered Feb. 14, 2012

Int. Cl.: 19

TRADEMARK

PRINCIPAL REGISTER

ALLIANCE MINERALS NORTHAMERICA, L.L.C. (IOWA LIMITED LIABILITY COMPANY)
1575 NW 106TH ST.
CLIVE, IA 50325

FOR: MARBLE; NATURAL STONE SLABS AND TILES, IN CLASS 19 (U.S. CLS. 1, 12, 33 AND 50).

FIRST USE 4-17-2007; IN COMMERCE 4-17-2007.

THE MARK CONSISTS OF INTERSECTING ORANGE LINES WHICH APPEAR TO FORM TWO SIDES OF A TRIANGLE AND A PORTION OF A THIRD SIDE WITH TWO INTERSECTING INTERIOR LINES CREATING DIAMOND SHAPES.

THE COLOR(S) ORANGE IS/ARE CLAIMED AS A FEATURE OF THE MARK.

SER. NO. 85-308,034, FILED 4-29-2011.

FRANK LATTUCA, EXAMINING ATTORNEY



David J. Kyffers

Director of the United States Patent and Trademark Office

United States of America

United States Patent and Trademark Office



Reg. No. 4,098,348

Registered Feb. 14, 2012

Int. Cl.: 28

TRADEMARK

PRINCIPAL REGISTER

LET'S GO (FRANCE LIMITED LIABILITY COMPANY)
18 RUE VALITON
92582 CLICHY CEDEX, FRANCE 92582

FOR: (BASED ON USE IN COMMERCE) CHILDREN'S EDUCATIONAL TOYS FOR DEVELOPING COGNITIVE SKILLS, COUNTING, NUMBERS, ALPHABETS, COLORS, SHAPES AND FINE MOTOR SKILLS; CHILDREN'S MULTIPLE ACTIVITY TOYS; CONSTRUCTION TOYS; EDUCATIONAL TOYS FOR TEACHING MATH PRINCIPLES TO CHILDREN, NAMELY, MANIPULATIVE BLOCKS FOR DISPLAYING PATTERNS AND GROUPINGS; MUSICAL TOYS; PULL TOYS; PUSH TOYS; RIDE-ON TOYS; RIDEABLE TOY VEHICLES; ROLE PLAYING TOYS IN THE NATURE OF PLAY SETS FOR CHILDREN TO IMITATE REAL LIFE OCCUPATIONS; STACKING TOYS; TOY BUILDING BLOCKS; TOY CONSTRUCTION BLOCKS; TOY CONSTRUCTION SETS; TOY HOUSES; TOY NOISEMAKERS; TOY PIANOS; TOY SETS OF CARPENTERS' TOOLS; TOY TOOLS; TOY XYLOPHONES (BASED ON 44(E)) CHILDREN'S EDUCATIONAL TOYS FOR DEVELOPING COGNITIVE SKILLS, COUNTING, NUMBERS, ALPHABETS, COLORS, SHAPES AND FINE MOTOR SKILLS.; CHILDREN'S MULTIPLE ACTIVITY TOYS; CONSTRUCTION TOYS; EDUCATIONAL TOYS FOR TEACHING MATH PRINCIPLES TO CHILDREN, NAMELY, MANIPULATIVE BLOCKS FOR DISPLAYING PATTERNS AND GROUPINGS; MUSICAL TOYS; PULL TOYS; PUSH TOYS; RIDE-ON TOYS; RIDEABLE TOY VEHICLES; ROLE PLAYING TOYS IN THE NATURE OF PLAY SETS FOR CHILDREN TO IMITATE REAL LIFE OCCUPATIONS; STACKING TOYS; TOY BUILDING BLOCKS; TOY CONSTRUCTION BLOCKS; TOY CONSTRUCTION SETS; TOY HOUSES; TOY NOISEMAKERS; TOY PIANOS; TOY SETS OF CARPENTERS' TOOLS; TOY TOOLS; TOY XYLOPHONES, IN CLASS 28 (U.S. CLS. 22, 23, 38 AND 50).

FIRST USE 8-1-2003; IN COMMERCE 8-1-2003.

OWNER OF FRANCE REG. NO. 002819811, DATED 8-21-2002, EXPIRES 8-21-2012.

THE COLOR(S) PURPLE, ORANGE, PINK AND WHITE IS/ARE CLAIMED AS A FEATURE OF THE MARK.

THE NAME(S), PORTRAIT(S), AND/OR SIGNATURE(S) SHOWN IN THE MARK DOES NOT IDENTIFY A PARTICULAR LIVING INDIVIDUAL.



David J. Kyjars

Director of the United States Patent and Trademark Office

Reg. No. 4,098,348 THE MARK CONSISTS OF THE LITERAL ELEMENT "BOIKIDO" REPRESENTED IN STYLIZED FONT IN THE COLOR PURPLE AND APPEARING BELOW A DESIGN CONSISTING OF A GRAPHIC REPRESENTATION OF A DOG'S HEAD, WHEREIN THE DOG'S FACE APPEARS IN THE COLOR ORANGE, THE DOG'S EARS AND NOSE APPEAR IN THE COLOR PURPLE, ITS EYES APPEAR IN THE COLOR PURPLE AND WHITE, ITS TONGUE APPEARS IN THE COLOR PINK, AND WHEREIN THE LITERAL ELEMENT AND THE DOG DESIGN ELEMENTS ARE SUPERIMPOSED UPON A TILTED WHITE-COLORED SQUARE BACKGROUND WITH ROUNDED CORNERS AND WHOSE BORDER APPEARS IN THE COLOR ORANGE.

THE WORDING "BOIKIDO" HAS NO MEANING IN A FOREIGN LANGUAGE.

SER. NO. 85-308,718, FILED 4-29-2011.

RONALD DELGIZZI, EXAMINING ATTORNEY

United States of America

United States Patent and Trademark Office



Reg. No. 4,098,349

Registered Feb. 14, 2012

Int. Cls.: 35, 36, 39 and 45

SERVICE MARK

PRINCIPAL REGISTER

NAUTILUS INTERNATIONAL HOLDING CORPORATION (CALIFORNIA CORPORATION)
720 EAST E. STREET
WILMINGTON, CA 90744

FOR: MARITIME BUSINESS FACILITIES MANAGEMENT OF TECHNICAL OPERATIONS OF LARGE CONTAINER, AUTO, DRY BULK, BREAKBULK, PASSENGER AND STEEL TERMINALS; TRANSPORTATION LOGISTICS SERVICES, NAMELY, ARRANGING THE TRANSPORTATION OF GOODS FOR OTHERS; VESSEL HUSBANDING AGENCY SERVICES, NAMELY, COORDINATING VESSEL-RELATED SERVICES ON BEHALF OF SEAFARING CLIENTS WHILE IN PORT, IN CLASS 35 (U.S. CLS. 100, 101 AND 102).

FIRST USE 12-1-2010; IN COMMERCE 12-1-2010.

FOR: THIRD PARTY INSURANCE CLAIMS ADMINISTRATION AND FINANCIAL RISK MANAGEMENT SERVICES FOR SELF-INSURED AND INSURED EMPLOYERS, INSURANCE COMPANIES, AND THE CALIFORNIA SELF INSURERS' SECURITY FUND, INCLUDING LONGSHORE AND STATE WORKERS' COMPENSATION PROGRAMS, IN CLASS 36 (U.S. CLS. 100, 101 AND 102).

FIRST USE 12-1-2010; IN COMMERCE 12-1-2010.

FOR: SHORE AND LANDSIDE SERVICES FOR PASSENGER CRUISE SHIPS, NAMELY, ARRANGING SHORESIDE EXCURSIONS AND CRUISE SHIP PASSENGER TRANSPORTATION; PASSENGER TRANSPORTATION AND LOGISTICS, NAMELY, TRANSPORTATION OF PASSENGERS TO AND FROM CRUISE SHIPS; CARGO STEVEDORING SERVICES; CRUISE SHIP PASSENGER TRANSFER AND CARGO HANDLING SERVICES, NAMELY, ARRANGING EMBARKATION AND DISEMBARKATION OF PASSENGERS, BAGGAGE, AND SHIP'S SUPPLIES; WAREHOUSING SERVICES; MARINE TERMINAL SERVICES, NAMELY, MARINE CARGO LOADING AND UNLOADING SERVICES FOR CONTAINER, DRY AND LIQUID BULK, BREAK BULK AND VEHICLE CARGO; AND OPERATING MARINE TERMINALS FOR CARGO AND PASSENGERS, NAMELY, MANAGING LARGE CARGO LOADING, UNLOADING, AND HANDLING FACILITIES BY WHICH MARINE CARGO AND PASSENGERS TRANSFER BETWEEN LANDSIDE AND SHIP MODES OF TRANSPORTATION, IN CLASS 39 (U.S. CLS. 100 AND 105).

FIRST USE 12-1-2010; IN COMMERCE 12-1-2010.



David J. Kyjars

Director of the United States Patent and Trademark Office

Reg. No. 4,098,349 FOR: VESSEL PASSENGER AND CARGO SECURITY SCREENING SERVICES, IN CLASS 45 (U.S. CLS. 100 AND 101).

FIRST USE 12-1-2010; IN COMMERCE 12-1-2010.

OWNER OF U.S. REG. NOS. 3,546,501 AND 3,582,567.

THE COLOR(S) YELLOW, WHITE, AND BLUE IS/ARE CLAIMED AS A FEATURE OF THE MARK.

THE MARK CONSISTS OF A RECTANGLE, CONTAINING A FANCIFUL "M" SHAPE IN WHITE AND BLUE EXTENDING FROM THE LEFT CORNER OF THE DRAWING TO THE RIGHT CORNER OF THE DRAWING. THE COLOR YELLOW IS SHOWN ABOVE LETTER "M" AND OUTLINED IN BLUE. THE COLOR WHITE BELOW THE LETTER "M" REPRESENTS BACKGROUND AND IS NOT PART OF THE MARK.

SER. NO. 85-308,994, FILED 4-29-2011.

DAVID HOFFMAN, EXAMINING ATTORNEY

United States of America

United States Patent and Trademark Office

METRO SHORE

Reg. No. 4,098,350

NAUTILUS INTERNATIONAL HOLDING CORPORATION (CALIFORNIA CORPORATION)
720 EAST E. STREET
WILMINGTON, CA 90744

Registered Feb. 14, 2012

Int. Cls.: 35, 39 and 45

FOR: VESSEL HUSBANDING AGENCY SERVICES, NAMELY, COORDINATING VESSEL-RELATED SERVICES ON BEHALF OF SEAFARING CLIENTS WHILE IN PORT , IN CLASS 35 (U.S. CLS. 100, 101 AND 102).

SERVICE MARK

FIRST USE 10-4-2005; IN COMMERCE 10-4-2005.

PRINCIPAL REGISTER

FOR: SHORE AND LANDSIDE SERVICES FOR PASSENGER CRUISE SHIPS, NAMELY, ARRANGING SHORESIDE EXCURSIONS AND CRUISE SHIP PASSENGER TRANSPORTATION; PASSENGER TRANSPORTATION AND LOGISTICS, NAMELY, TRANSPORTATION OF PASSENGERS TO AND FROM CRUISE SHIPS, IN CLASS 39 (U.S. CLS. 100 AND 105).

FIRST USE 10-4-2005; IN COMMERCE 10-4-2005.

FOR: VESSEL PASSENGER AND CARGO SECURITY SCREENING SERVICES , IN CLASS 45 (U.S. CLS. 100 AND 101).

FIRST USE 10-4-2005; IN COMMERCE 10-4-2005.

THE MARK CONSISTS OF STANDARD CHARACTERS WITHOUT CLAIM TO ANY PARTICULAR FONT, STYLE, SIZE, OR COLOR.

OWNER OF U.S. REG. NOS. 3,546,501, 3,582,567, AND 3,617,583.

NO CLAIM IS MADE TO THE EXCLUSIVE RIGHT TO USE "SHORE", APART FROM THE MARK AS SHOWN.

SEC. 2(F).

SER. NO. 85-308,996, FILED 4-29-2011.

DAVID HOFFMAN, EXAMINING ATTORNEY



David J. Kyffers

Director of the United States Patent and Trademark Office

United States of America

United States Patent and Trademark Office

METRO CRUISE

Reg. No. 4,098,351

NAUTILUS INTERNATIONAL HOLDING CORPORATION (CALIFORNIA CORPORATION)
720 EAST E. STREET
WILMINGTON, CA 90744

Registered Feb. 14, 2012

Int. Cls.: 35, 39 and 45

FOR: VESSEL HUSBANDING AGENCY SERVICES, NAMELY, COORDINATING VESSEL-RELATED SERVICES ON BEHALF OF SEAFARING CLIENTS WHILE IN PORT , IN CLASS 35 (U.S. CLS. 100, 101 AND 102).

SERVICE MARK

FIRST USE 3-29-2005; IN COMMERCE 3-29-2005.

PRINCIPAL REGISTER

FOR: SHORE AND LANDSIDE SERVICES FOR PASSENGER CRUISE SHIPS, NAMELY, ARRANGING SHORESIDE EXCURSIONS AND CRUISE SHIP PASSENGER TRANSPORTATION; PASSENGER TRANSPORTATION AND LOGISTICS, NAMELY, TRANSPORTATION OF PASSENGERS TO AND FROM CRUISE SHIPS, IN CLASS 39 (U.S. CLS. 100 AND 105).

FIRST USE 3-29-2005; IN COMMERCE 3-29-2005.

FOR: VESSEL PASSENGER AND CARGO SECURITY SCREENING SERVICES , IN CLASS 45 (U.S. CLS. 100 AND 101).

FIRST USE 3-29-2005; IN COMMERCE 3-29-2005.

THE MARK CONSISTS OF STANDARD CHARACTERS WITHOUT CLAIM TO ANY PARTICULAR FONT, STYLE, SIZE, OR COLOR.

OWNER OF U.S. REG. NOS. 3,546,501 AND 3,582,567.

NO CLAIM IS MADE TO THE EXCLUSIVE RIGHT TO USE "CRUISE", APART FROM THE MARK AS SHOWN.

SEC. 2(F).

SER. NO. 85-309,000, FILED 4-29-2011.

DAVID HOFFMAN, EXAMINING ATTORNEY



David J. Kyffers

Director of the United States Patent and Trademark Office

United States of America

United States Patent and Trademark Office

Pig Iron Bar-B-Q

Reg. No. 4,098,352

SEA DELI INC. (WASHINGTON CORPORATION), DBA PIG IRON BAR-B-Q
322 S.104TH ST.
SEATTLE, WA 98168

Registered Feb. 14, 2012

Int. Cls.: 30 and 43

FOR: BARBECUE SAUCE, IN CLASS 30 (U.S. CL. 46).

TRADEMARK

FIRST USE 2-3-2002; IN COMMERCE 1-1-2004.

SERVICE MARK

FOR: BAR AND RESTAURANT SERVICES, IN CLASS 43 (U.S. CLS. 100 AND 101).

PRINCIPAL REGISTER

FIRST USE 2-3-2002; IN COMMERCE 1-1-2004.

THE MARK CONSISTS OF STANDARD CHARACTERS WITHOUT CLAIM TO ANY PARTICULAR FONT, STYLE, SIZE, OR COLOR.

NO CLAIM IS MADE TO THE EXCLUSIVE RIGHT TO USE "BAR-B-Q", APART FROM THE MARK AS SHOWN.

SER. NO. 85-309,132, FILED 4-30-2011.

GINA HAYES, EXAMINING ATTORNEY



David J. Kybas

Director of the United States Patent and Trademark Office

United States of America

United States Patent and Trademark Office

Expense Smart

Reg. No. 4,098,353

Registered Feb. 14, 2012

Int. Cl.: 35

SERVICE MARK

PRINCIPAL REGISTER

BLUE SKY SOFTWARE SOLUTIONS, INC. (ARIZONA CORPORATION)
1230 WEST WASHINGTON STREET, SUITE 207
TEMPE, AZ 85281

FOR: UTILITY BILL MANAGEMENT SERVICES, NAMELY, TRACKING, REPORTING, ANALYZING AND DELIVERING ENERGY INFORMATION IN THE FORM OF UTILITY BILLS AND UTILITY METER DATA RATE SCHEDULES; BUSINESS CONSULTATION IN THE FIELD OF UTILITY EXPENSE MANAGEMENT; BUSINESS INFORMATION MANAGEMENT, NAMELY, ONLINE REPORTING OF BUSINESS INFORMATION RELATED TO BUSINESS EXPENSES, IN CLASS 35 (U.S. CLS. 100, 101 AND 102).

FIRST USE 2-15-2011; IN COMMERCE 4-15-2011.

THE MARK CONSISTS OF STANDARD CHARACTERS WITHOUT CLAIM TO ANY PARTICULAR FONT, STYLE, SIZE, OR COLOR.

NO CLAIM IS MADE TO THE EXCLUSIVE RIGHT TO USE "EXPENSE", APART FROM THE MARK AS SHOWN.

SER. NO. 85-309,175, FILED 4-30-2011.

SHAILA SETTLES, EXAMINING ATTORNEY



David J. Kybas

Director of the United States Patent and Trademark Office

United States of America

United States Patent and Trademark Office

Resident Smart

Reg. No. 4,098,354

Registered Feb. 14, 2012

Int. Cl.: 35

SERVICE MARK

PRINCIPAL REGISTER

BLUE SKY SOFTWARE SOLUTIONS, INC. (ARIZONA CORPORATION)
1230 WEST WASHINGTON STREET, SUITE 207
TEMPE, AZ 85281

FOR: UTILITY BILL MANAGEMENT SERVICES, NAMELY, TRACKING, REPORTING, ANALYZING AND DELIVERING ENERGY INFORMATION IN THE FORM OF UTILITY BILLS AND UTILITY METER DATA RATE SCHEDULES FOR RESIDENTIAL ACCOUNTS FOR PURPOSES OF BENCHMARKING SCORING; ENERGY USAGE MANAGEMENT INFORMATION SERVICES, NAMELY, ENERGY BENCHMARK SCORING; INFORMATION IN THE FIELD OF ENERGY EFFICIENCY, IN CLASS 35 (U.S. CLS. 100, 101 AND 102).

FIRST USE 2-15-2011; IN COMMERCE 4-15-2011.

THE MARK CONSISTS OF STANDARD CHARACTERS WITHOUT CLAIM TO ANY PARTICULAR FONT, STYLE, SIZE, OR COLOR.

NO CLAIM IS MADE TO THE EXCLUSIVE RIGHT TO USE "RESIDENT" , APART FROM THE MARK AS SHOWN.

SER. NO. 85-309,176, FILED 4-30-2011.

APRIL HESIK, EXAMINING ATTORNEY



David J. Kyfos

Director of the United States Patent and Trademark Office

United States of America

United States Patent and Trademark Office

Blue Sky Score

Reg. No. 4,098,355

Registered Feb. 14, 2012

Int. Cl.: 35

SERVICE MARK

PRINCIPAL REGISTER

BLUE SKY SOFTWARE SOLUTIONS, INC. (ARIZONA CORPORATION)
1230 WEST WASHINGTON STREET, SUITE 207
TEMPE, AZ 85281

FOR: UTILITY BILL MANAGEMENT SERVICES, NAMELY, TRACKING, REPORTING, ANALYZING AND DELIVERING ENERGY INFORMATION IN THE FORM OF UTILITY BILLS AND UTILITY METER DATA RATE SCHEDULES FOR PURPOSES OF BENCHMARKING AND COMPARING CURRENT OR HISTORICAL ENERGY USAGE TO OTHER USER-DEFINED COMPARABLES; ENERGY USAGE MANAGEMENT INFORMATION SERVICES, NAMELY, ENERGY BENCHMARKING AND COMPARING CURRENT OR HISTORICAL ENERGY USAGE TO OTHER USER-DEFINED COMPARABLES, IN CLASS 35 (U.S. CLS. 100, 101 AND 102).

FIRST USE 2-15-2011; IN COMMERCE 4-15-2011.

THE MARK CONSISTS OF STANDARD CHARACTERS WITHOUT CLAIM TO ANY PARTICULAR FONT, STYLE, SIZE, OR COLOR.

NO CLAIM IS MADE TO THE EXCLUSIVE RIGHT TO USE "SCORE", APART FROM THE MARK AS SHOWN.

SER. NO. 85-309,178, FILED 4-30-2011.

APRIL HESIK, EXAMINING ATTORNEY



David J. Kypos

Director of the United States Patent and Trademark Office

United States of America

United States Patent and Trademark Office

Conservation Score

Reg. No. 4,098,356

BLUE SKY SOFTWARE SOLUTIONS, INC. (ARIZONA CORPORATION)
1230 WEST WASHINGTON STREET, SUITE 207
TEMPE, AZ 85281

Registered Feb. 14, 2012

Int. Cl.: 35

FOR: UTILITY BILL MANAGEMENT SERVICES, NAMELY, TRACKING, REPORTING, ANALYZING AND DELIVERING ENERGY INFORMATION IN THE FORM OF UTILITY BILLS AND UTILITY METER DATA RATE SCHEDULES; PROVIDING A WEB-BASED ON-LINE PORTAL THAT PROVIDES CUSTOMER ACCESS TO ENERGY USAGE PATTERN INFORMATION FOR THE PURPOSE OF COMPARING AND DISPLAYING CURRENT ENERGY USAGE PATTERNS TO HISTORICAL TRENDS, IN CLASS 35 (U.S. CLS. 100, 101 AND 102).

SERVICE MARK

PRINCIPAL REGISTER

FIRST USE 2-15-2011; IN COMMERCE 4-15-2011.

THE MARK CONSISTS OF STANDARD CHARACTERS WITHOUT CLAIM TO ANY PARTICULAR FONT, STYLE, SIZE, OR COLOR.

SER. NO. 85-309,180, FILED 4-30-2011.

SHAILA SETTLES, EXAMINING ATTORNEY



David J. Kyffers

Director of the United States Patent and Trademark Office

United States of America

United States Patent and Trademark Office

Virtual Agility League

Reg. No. 4,098,357

TEAMWORKS DOG TRAINING (NORTH CAROLINA LIMITED LIABILITY COMPANY)
195 ROBBINS RD
YOUNGSVILLE, NC 27596

Registered Feb. 14, 2012

Int. Cl.: 41

FOR: PET TRAINING SERVICES, NAMELY, DOG AGILITY SKILLS TESTING, IN CLASS
41 (U.S. CLS. 100, 101 AND 107).

SERVICE MARK

FIRST USE 2-23-2011; IN COMMERCE 5-1-2011.

PRINCIPAL REGISTER

THE MARK CONSISTS OF STANDARD CHARACTERS WITHOUT CLAIM TO ANY PAR-
TICULAR FONT, STYLE, SIZE, OR COLOR.

NO CLAIM IS MADE TO THE EXCLUSIVE RIGHT TO USE "AGILITY", APART FROM THE
MARK AS SHOWN.

SER. NO. 85-309,340, FILED 5-1-2011.

TIMOTHY FINNEGAN, EXAMINING ATTORNEY



David J. Kybas

Director of the United States Patent and Trademark Office

United States of America

United States Patent and Trademark Office

FREEFIND

Reg. No. 4,098,358

Registered Feb. 14, 2012

Int. Cl.: 42

SERVICE MARK

PRINCIPAL REGISTER

FREEFIND.COM (CALIFORNIA CORPORATION)
PO BOX 535
SANTA CRUZ, CA 950610535

FOR: COMPUTER SERVICES, NAMELY, PROVIDING ONLINE NON-DOWNLOADABLE SOFTWARE FOR USE IN CREATING SEARCH ENGINES AND SITE MAPS FOR SEARCHING THE WEB SITES OF OTHERS, PROVIDING SEARCH ENGINES FOR OBTAINING DATA ON A GLOBAL COMPUTER NETWORK, MAINTAINING WEB SITES FOR OTHERS, IMPLEMENTING WEB SITES FOR OTHERS, AND HOSTING THE WEB SITES OF OTHERS ON A COMPUTER SERVER FOR A GLOBAL COMPUTER NETWORK, IN CLASS 42 (U.S. CLS. 100 AND 101).

FIRST USE 5-14-1998; IN COMMERCE 5-14-1998.

THE MARK CONSISTS OF STANDARD CHARACTERS WITHOUT CLAIM TO ANY PARTICULAR FONT, STYLE, SIZE, OR COLOR.

SER. NO. 85-309,824, FILED 5-2-2011.

SAIMA MAKHDOOM, EXAMINING ATTORNEY



David J. Kyffers

Director of the United States Patent and Trademark Office

United States of America

United States Patent and Trademark Office

Staffing One

Reg. No. 4,098,359

STAFFING ONE, INC. (GEORGIA CORPORATION)
125 CLAIREMONT AVENUE, SUITE 540
DECATUR, GA 30030

Registered Feb. 14, 2012

Int. Cl.: 35

FOR: EMPLOYMENT AGENCY SERVICES, NAMELY, PLACEMENT AND STAFFING SERVICES FOR TEMPORARY, TEMPORARY-TO-PERMANENT AND PERMANENT PERSONNEL, AND OTHER EMPLOYEE AND STAFFING RELATED SERVICES IN THE NATURE OF EMPLOYMENT STAFFING CONSULTATION, PLACEMENT OF STAFF, EMPLOYEE ADMINISTRATION SERVICES, EMPLOYEE RELOCATION AND INFORMATION, IN CLASS 35 (U.S. CLS. 100, 101 AND 102).

SERVICE MARK

PRINCIPAL REGISTER

FIRST USE 1-1-1996; IN COMMERCE 6-1-2001.

THE MARK CONSISTS OF STANDARD CHARACTERS WITHOUT CLAIM TO ANY PARTICULAR FONT, STYLE, SIZE, OR COLOR.

NO CLAIM IS MADE TO THE EXCLUSIVE RIGHT TO USE "STAFFING", APART FROM THE MARK AS SHOWN.

SER. NO. 85-309,949, FILED 5-2-2011.

ERNEST SHOSHO, EXAMINING ATTORNEY



David J. Kyfos

Director of the United States Patent and Trademark Office

United States of America

United States Patent and Trademark Office

INTELLILEVER

Reg. No. 4,098,360

Registered Feb. 14, 2012

Int. Cl.: 12

TRADEMARK

PRINCIPAL REGISTER

RENTHAL LIMITED (UNITED KINGDOM COMPANY)
BREDBURY PARK WAY, BREDBURY
STOCKPORT, CHESHIRE, UNITED KINGDOM SK62SN

FOR: LAND VEHICLES; MOTORCYCLES; BICYCLES; TRICYCLES; SCOOTERS; WATER JET PROPULSION DRIVEN BOATS; HANDLEBARS AND PARTS AND FITTINGS FOR THE AFORESAID GOODS, IN CLASS 12 (U.S. CLS. 19, 21, 23, 31, 35 AND 44).

THE MARK CONSISTS OF STANDARD CHARACTERS WITHOUT CLAIM TO ANY PARTICULAR FONT, STYLE, SIZE, OR COLOR.

PRIORITY CLAIMED UNDER SEC. 44(D) ON ERPN CMNTY TM OFC APPLICATION NO. 009745753, FILED 2-17-2011, REG. NO. 009745753, DATED 8-9-2011, EXPIRES 2-17-2021.

SER. NO. 85-310,643, FILED 5-3-2011.

ESTHER BELENKER, EXAMINING ATTORNEY



David J. Kyffers

Director of the United States Patent and Trademark Office

United States of America

United States Patent and Trademark Office

zuuka!

Reg. No. 4,098,361

Registered Feb. 14, 2012

**Int. Cls.: 9, 16, 35, 41
and 42**

TRADEMARK

SERVICE MARK

PRINCIPAL REGISTER

ZUUKA! GMBH (FED REP GERMANY GESELLSCHAFT MIT BESCHRÄNKTER HAFTUNG (GMBH))
CHRISTIAN-PLESS-STRASSE 11 - 13
OFFENBACH A.M., FED REP GERMANY 63069

FOR: COMPUTER APPLICATION SOFTWARE FOR MOBILE DEVICES, NAMELY, SOFTWARE FOR READING ELECTRONIC CONTENT AND VIEWING MULTI-MEDIA CONTENT; DOWNLOADABLE BOOKS AND STORIES AND VIA THE INTERNET AND WIRELESS DEVICES, IN CLASS 9 (U.S. CLS. 21, 23, 26, 36 AND 38).

FOR: STORY BOOKS; CHILDREN'S BOOKS; CHILDREN'S INTERACTIVE EDUCATIONAL BOOKS; PICTURE BOOKS, IN CLASS 16 (U.S. CLS. 2, 5, 22, 23, 29, 37, 38 AND 50).

FOR: ADVERTISING AND MARKETING CONSULTANCY, IN CLASS 35 (U.S. CLS. 100, 101 AND 102).

FOR: PUBLISHING OF BOOKS, E-BOOKS, MUSIC AND ILLUSTRATIONS; TRANSLATION; AUDIO RECORDING AND PRODUCTION; MUSIC PRODUCTION SERVICES; ANIMATION PRODUCTION SERVICES; MULTIMEDIA ENTERTAINMENT SOFTWARE PRODUCTION SERVICES, IN CLASS 41 (U.S. CLS. 100, 101 AND 107).

FOR: COMPUTER PROGRAMMING AND SOFTWARE DESIGN; COMPUTER SOFTWARE DEVELOPMENT IN THE FIELD OF MOBILE APPLICATIONS; GRAPHICS DESIGN, IN CLASS 42 (U.S. CLS. 100 AND 101).

THE MARK CONSISTS OF STANDARD CHARACTERS WITHOUT CLAIM TO ANY PARTICULAR FONT, STYLE, SIZE, OR COLOR.

PRIORITY CLAIMED UNDER SEC. 44(D) ON ERPN CMNTY TM OFC APPLICATION NO. 009892803, FILED 4-13-2011, REG. NO. 009892803, DATED 9-16-2011, EXPIRES 4-13-2021.

SER. NO. 85-310,843, FILED 5-3-2011.

THEODORE MCBRIDE, EXAMINING ATTORNEY



David J. Kyros

Director of the United States Patent and Trademark Office

United States of America

United States Patent and Trademark Office

SAL-EZE

Reg. No. 4,098,362

Registered Feb. 14, 2012

Int. Cl.: 25

TRADEMARK

PRINCIPAL REGISTER

SAL-EZE, LLC (CONNECTICUT LIMITED LIABILITY COMPANY)
43 BARNES ROAD
WASHINGTON, CT 06793

FOR: CLOTHING CONTAINING MAGNETIC CLOSURES FOR USE BY THE ELDERLY AND PHYSICALLY RESTRICTED, NAMELY, SHIRTS, BLOUSES, DRESSES AND PANTS, IN CLASS 25 (U.S. CLS. 22 AND 39).

FIRST USE 3-29-2011; IN COMMERCE 3-29-2011.

THE MARK CONSISTS OF STANDARD CHARACTERS WITHOUT CLAIM TO ANY PARTICULAR FONT, STYLE, SIZE, OR COLOR.

SER. NO. 85-310,882, FILED 5-3-2011.

VERNA BETH RIRIE, EXAMINING ATTORNEY



David J. Kyffers

Director of the United States Patent and Trademark Office

United States of America

United States Patent and Trademark Office

EVENTBOX

Reg. No. 4,098,363

VOICES HEARD MEDIA, INC. (TENNESSEE CORPORATION)
121 N. CONCORD STREET
KNOXVILLE, TN 37919

Registered Feb. 14, 2012

Int. Cl.: 9

FOR: SOFTWARE FOR CREATING, MANAGING, EDITING, MODERATING AND DISTRIBUTING INTERACTIVE ONLINE EVENTS, INCLUDING QUESTION AND ANSWER SESSIONS, POLLS, CONTESTS, CHATS AND OTHER SIMILAR INTERACTIVE ONLINE EVENTS, IN CLASS 9 (U.S. CLS. 21, 23, 26, 36 AND 38).

TRADEMARK

PRINCIPAL REGISTER

FIRST USE 4-26-2011; IN COMMERCE 4-26-2011.

THE MARK CONSISTS OF STANDARD CHARACTERS WITHOUT CLAIM TO ANY PARTICULAR FONT, STYLE, SIZE, OR COLOR.

SER. NO. 85-311,860, FILED 5-4-2011.

LINDSEY RUBIN, EXAMINING ATTORNEY



David J. Kyffers

Director of the United States Patent and Trademark Office

United States of America

United States Patent and Trademark Office

LIFT

Reg. No. 4,098,364

FAIRWAY IMPORT EXPORT, INC. (CALIFORNIA CORPORATION)
2130 E. GLADWICK STREET
RANCHO DOMINGUEZ, CA 90220

Registered Feb. 14, 2012

Int. Cl.: 18

FOR: TOOL BAGS SOLD EMPTY IN TOOL STORES AND SAFETY EQUIPMENT STORE,
IN CLASS 18 (U.S. CLS. 1, 2, 3, 22 AND 41).

TRADEMARK

FIRST USE 9-14-2005; IN COMMERCE 9-14-2005.

PRINCIPAL REGISTER

THE MARK CONSISTS OF STANDARD CHARACTERS WITHOUT CLAIM TO ANY PARTICULAR FONT, STYLE, SIZE, OR COLOR.

OWNER OF U.S. REG. NOS. 3,042,245, 3,245,332 AND OTHERS.

SER. NO. 85-311,930, FILED 5-4-2011.

INGA ERVIN, EXAMINING ATTORNEY



David J. Kybas

Director of the United States Patent and Trademark Office

United States of America

United States Patent and Trademark Office

StayinFront **Touch**_{CG}

Reg. No. 4,098,365

Registered Feb. 14, 2012

Int. Cl.: 9

TRADEMARK

PRINCIPAL REGISTER

STAYINFRONT, INC (NEW JERSEY CORPORATION)
RHONDA O'TOOLE
107 LITTLE FALLS ROAD
FAIRFIELD, NJ 07004

FOR: COMPUTER SOFTWARE FOR USE IN CUSTOMER RELATIONSHIP MANAGEMENT (CRM), IN CLASS 9 (U.S. CLS. 21, 23, 26, 36 AND 38).

FIRST USE 3-15-2011; IN COMMERCE 3-15-2011.

OWNER OF U.S. REG. NOS. 3,692,178, 3,692,349 AND OTHERS.

THE COLOR(S) WHITE, GREY, BLUE AND GOLD IS/ARE CLAIMED AS A FEATURE OF THE MARK.

NO CLAIM IS MADE TO THE EXCLUSIVE RIGHT TO USE "TOUCH CG", APART FROM THE MARK AS SHOWN.

THE MARK CONSISTS OF THE WORD "STAYINFRONT" IN GRAY TEXT, THE WORD "TOUCH" IN BOLD BLUE TEXT, WITH A MOBILE COMPUTER DEVICE IN BLUE AND WHITE APPEARING INSIDE THE LETTER "O" IN THE WORD "TOUCH", A GOLD SUN-BURST DESIGN APPEARING AT THE TOP OF THE LETTER "O" IN THE WORD "TOUCH", AND THE ABBREVIATION "CG" IN BOLD GRAY SUBSCRIPT TEXT. THE MARK IS AGAINST A WHITE BACKGROUND WHICH IS NOT PART OF THE MARK.

SER. NO. 85-312,157, FILED 5-4-2011.

DOUGLAS LEE, EXAMINING ATTORNEY



David J. Kybas

Director of the United States Patent and Trademark Office

United States of America
United States Patent and Trademark Office

BERLIN
gear

Reg. No. 4,098,366

Registered Feb. 14, 2012

Int. Cl.: 9

TRADEMARK

PRINCIPAL REGISTER

CELLNORTH ELECTRONICS, CORP. (TEXAS CORPORATION)
LEGAL AFFAIRS
8311 EASTPOINT DR #400
DALLAS, TX 75227

FOR: CARRYING CASES FOR CELL PHONES, GAMING HEADSETS FOR USE IN PLAYING VIDEO GAMES, 3D DIGITAL PHOTOGRAPH VIEWERS, 3D DIGITAL VIDEO VIEWERS, WIRELESS CELLULAR PHONE HEADSETS, IN CLASS 9 (U.S. CLS. 21, 23, 26, 36 AND 38).

FIRST USE 3-1-2011; IN COMMERCE 4-1-2011.

NO CLAIM IS MADE TO THE EXCLUSIVE RIGHT TO USE "GEAR", APART FROM THE MARK AS SHOWN.

THE MARK CONSISTS OF CAPITAL "B" WITH 2 DOTS ABOVE IT, FOLLOWED BY THE LETTERS.

SER. NO. 85-312,252, FILED 5-4-2011.

TEJBIR SINGH, EXAMINING ATTORNEY



David J. Kyffers

Director of the United States Patent and Trademark Office

United States of America

United States Patent and Trademark Office

IEEE POWER & ENERGY SOCIETY SCHOLARSHIP PLUS INITIATIVE

Reg. No. 4,098,367

Registered Feb. 14, 2012

Int. Cl.: 35

SERVICE MARK

PRINCIPAL REGISTER

THE INSTITUTE OF ELECTRICAL AND ELECTRONICS ENGINEERS, INC. (NEW YORK CORPORATION)
445 HOES LANE
PISCATAWAY, NJ 08855

FOR: PROMOTING STUDENTS' INTEREST IN EDUCATION IN THE FIELD OF POWER AND ENERGY ENGINEERING; CONNECTING ELECTRICAL ENGINEERING STUDENTS WITH OTHER PEOPLE AND ORGANIZATIONS IN THE FIELD OF POWER AND ENERGY ENGINEERING; INTERNSHIP PLACEMENT SERVICES, IN CLASS 35 (U.S. CLS. 100, 101 AND 102).

FIRST USE 3-31-2011; IN COMMERCE 3-31-2011.

THE MARK CONSISTS OF STANDARD CHARACTERS WITHOUT CLAIM TO ANY PARTICULAR FONT, STYLE, SIZE, OR COLOR.

OWNER OF U.S. REG. NOS. 3,688,449 AND 3,722,956.

NO CLAIM IS MADE TO THE EXCLUSIVE RIGHT TO USE "POWER & ENERGY SOCIETY", "SCHOLARSHIP" AND "INITIATIVE", APART FROM THE MARK AS SHOWN.

SER. NO. 85-312,446, FILED 5-4-2011.

CAROLYN CATALDO, EXAMINING ATTORNEY



David J. Kyjars

Director of the United States Patent and Trademark Office

United States of America

United States Patent and Trademark Office

IEEE POWER & ENERGY SOCIETY SCHOLARSHIP PLUS INITIATIVE

Reg. No. 4,098,368

Registered Feb. 14, 2012

Int. Cl.: 36

SERVICE MARK

PRINCIPAL REGISTER

THE INSTITUTE OF ELECTRICAL AND ELECTRONICS ENGINEERS, INC. (NEW YORK CORPORATION)
445 HOES LANE
PISCATAWAY, NJ 08855

FOR: PROVIDING EDUCATIONAL SCHOLARSHIPS, IN CLASS 36 (U.S. CLS. 100, 101 AND 102).

FIRST USE 3-31-2011; IN COMMERCE 3-31-2011.

THE MARK CONSISTS OF STANDARD CHARACTERS WITHOUT CLAIM TO ANY PARTICULAR FONT, STYLE, SIZE, OR COLOR.

OWNER OF U.S. REG. NOS. 3,688,449 AND 3,722,956.

NO CLAIM IS MADE TO THE EXCLUSIVE RIGHT TO USE "POWER & ENERGY SOCIETY", "SCHOLARSHIP" AND "INITIATIVE", APART FROM THE MARK AS SHOWN.

SER. NO. 85-312,469, FILED 5-4-2011.

CAROLYN CATALDO, EXAMINING ATTORNEY



David J. Kyjars

Director of the United States Patent and Trademark Office

United States of America

United States Patent and Trademark Office

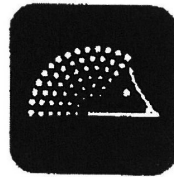

Reg. No. 4,098,369

Registered Feb. 14, 2012

Int. Cls.: 36 and 37

SERVICE MARK

PRINCIPAL REGISTER

BENI STABILI S.P.A. SIIQ (ITALY JOINT STOCK COMPANY)
VIA PIEMONTE, 38
ROME, ITALY 00187

FOR: REAL ESTATE SERVICES, NAMELY, RENTAL, BROKERAGE, LEASING AND MANAGEMENT OF RESIDENTIAL AND COMMERCIAL PROPERTY, OFFICES AND OFFICES SPACE; ASSESSMENT AND MANAGEMENT OF REAL ESTATE; LAND ACQUISITION, NAMELY, REAL ESTATE BROKERAGE; REAL ESTATE ACQUISITION SERVICES; REAL ESTATE APPRAISAL AND VALUATION; REAL ESTATE CONSULTATION; REAL ESTATE INVESTMENT SERVICES; REAL ESTATE INVESTMENT TRUST SERVICES; REAL ESTATE INVESTMENT TRUST MANAGEMENT SERVICES; REAL ESTATE INVESTMENT TRUST ADVISORY SERVICES; REAL ESTATE MANAGEMENT SERVICES; REAL ESTATE PROCUREMENT FOR OTHERS; REAL ESTATE TRUSTEE SERVICES; FINANCIAL AFFAIRS, NAMELY, REAL ESTATE NOTE BROKERAGE; FINANCIAL VALUATION OF PERSONAL PROPERTY AND REAL ESTATE; FINANCIAL VALUATION OF REAL ESTATE; FINANCIAL DUE DILIGENCE SERVICES IN THE FIELD OF REAL ESTATE; FINANCIAL INVESTMENT IN THE FIELD OF REAL ESTATE; REAL ESTATE INVESTMENT SERVICES IN THE NATURE OF PURCHASING AND SELLING OF REAL ESTATE FOR OTHERS; REAL ESTATE INSURANCE UNDERWRITING SERVICES, IN CLASS 36 (U.S. CLS. 100, 101 AND 102).

FOR: CONSTRUCTION, RENOVATION AND REPAIR SERVICES FOR RESIDENTIAL AND COMMERCIAL BUILDINGS; CONSULTING IN THE FIELD OF BUILDING CONSTRUCTION, IN CLASS 37 (U.S. CLS. 100, 103 AND 106).

PRIORITY CLAIMED UNDER SEC. 44(D) ON ERPN CMNTY TM OFC APPLICATION NO. 9930165, FILED 4-29-2011, REG. NO. 009930165, DATED 9-7-2011, EXPIRES 4-29-2021.

THE MARK CONSISTS OF THE PROFILE OF A HEDGEHOG WITHIN A SOLID SQUARE WITH ROUNDED CORNERS.

SER. NO. 85-312,552, FILED 5-4-2011.

ANGELA M. MICHELI, EXAMINING ATTORNEY



David J. Kyffers

Director of the United States Patent and Trademark Office

United States of America

United States Patent and Trademark Office

THE CORPS!

Reg. No. 4,098,370

Registered Feb. 14, 2012

Int. Cl.: 28

TRADEMARK

PRINCIPAL REGISTER

LANARD TOYS LIMITED (HONG KONG CORPORATION)
6TH FLOOR ENERGY PLAZA
92 GRANVILLE ROAD
TSIMSHATSUI, HONG KONG

FOR: TOYS, GAMES AND PLAYTHINGS, NAMELY, TOY ACTION FIGURES, TOY ACTION FIGURES AND TOY VEHICLE PLAYSETS AND ACCESSORIES; MINIATURE DIE-CAST VEHICLES; TOY AIRCRAFT; TOY VEHICLES; TOY WATERCRAFT; TOY BUILDINGS AND ACCESSORIES THEREFOR; PLAYSET BUILDINGS; MODEL CRAFT KITS OF TOY FIGURES; TOY ANIMALS; PROJECTILE TOYS IN THE NATURE OF TOYS THAT SHOOT DISCS, FOAM BALLS, FOAM DARTS, FOAM-SHAPED ROCKETS AND MISSILES; TOY WEAPONS; TOY COMBAT EQUIPMENT AND ACCESSORIES; FLYING DISCS, IN CLASS 28 (U.S. CLS. 22, 23, 38 AND 50).

FIRST USE 9-21-1988; IN COMMERCE 9-21-1988.

THE MARK CONSISTS OF STANDARD CHARACTERS WITHOUT CLAIM TO ANY PARTICULAR FONT, STYLE, SIZE, OR COLOR.

SER. NO. 85-312,837, FILED 5-5-2011.

INGA ERVIN, EXAMINING ATTORNEY



David J. Kyffers

Director of the United States Patent and Trademark Office

United States of America

United States Patent and Trademark Office

GETTING THE RIGHT THINGS DONE

Reg. No. 4,098,371

DAVID ALLEN & CO. (CALIFORNIA CORPORATION)
407F BRYANT CIRCLE
OJAI, CA 93023

Registered Feb. 14, 2012

Int. Cl.: 41

FOR: EDUCATIONAL AND TRAINING SERVICES, NAMELY, CONDUCTING TRAINING CLASSES AND COURSES FEATURING METHODS FOR IMPROVING INDIVIDUAL AND ORGANIZATIONAL PRODUCTIVITY, COMMUNICATIONS, WRITING, MARKETING SKILLS AND TIME MANAGEMENT SKILLS; TRAINING SERVICES, NAMELY, CONDUCTING AND ORGANIZING SEMINARS AND WORKSHOPS TO HELP OTHERS DEVELOP MANAGEMENT AND BUSINESS SKILLS, EFFICIENT WORK HABITS, PLANNING AND ORGANIZATIONAL TECHNIQUES, AND PERSONAL PRODUCTIVITY AND GROWTH; PROVIDING ONLINE CLASSES, SEMINARS, AND TRAINING SERVICES TO SUBSCRIBING MEMBERS IN THE FIELDS OF INDIVIDUAL AND BUSINESS PRODUCTIVITY, SELF IMPROVEMENT AND TIME MANAGEMENT, IN CLASS 41 (U.S. CLS. 100, 101 AND 107).

SERVICE MARK

PRINCIPAL REGISTER

FIRST USE 1-21-2011; IN COMMERCE 1-21-2011.

THE MARK CONSISTS OF STANDARD CHARACTERS WITHOUT CLAIM TO ANY PARTICULAR FONT, STYLE, SIZE, OR COLOR.

OWNER OF U.S. REG. NOS. 2,431,583 AND 3,022,721.

SER. NO. 85-313,259, FILED 5-5-2011.

LINDA ESTRADA, EXAMINING ATTORNEY



David J. Kyffers

Director of the United States Patent and Trademark Office

United States of America

United States Patent and Trademark Office

REMOTE MEDICAL INTERNATIONAL

Reg. No. 4,098,372

Registered Feb. 14, 2012

**Int. Cls.: 25, 35, 41 and
44**

REMOTE MEDICINE INC. (WASHINGTON CORPORATION)
SUITE 200
4259 23RD AVE WEST
SEATTLE, WA 98199

FOR: CLOTHING, NAMELY, T-SHIRTS, IN CLASS 25 (U.S. CLS. 22 AND 39).

FIRST USE 12-21-2004; IN COMMERCE 12-21-2004.

TRADEMARK

SERVICE MARK

PRINCIPAL REGISTER

FOR: BUSINESS CONSULTING, NAMELY, FOR INDIVIDUALS AND BUSINESSES WITH GEOGRAPHICALLY REMOTE BUSINESS INTERESTS; ON-LINE RETAIL STORE SERVICES FEATURING MEDICAL EQUIPMENT, NAMELY, MEDICAL REFERENCE BOOKS, OVER-THE-COUNTER MEDICATIONS, DENTAL SUPPLIES, EQUIPMENT BAGS AND CASES, FIRST AID KITS AND MODULES, SURGICAL EQUIPMENT, RESCUE EQUIPMENT, NURSING AND LONG TERM CARE EQUIPMENT, MONITORS AND DEFIBRILLATORS, APPAREL, PATCHES, AND UNIFORMS, MEDICAL CLINIC FURNITURE AND FIXTURES, IN CLASS 35 (U.S. CLS. 100, 101 AND 102).

FIRST USE 2-3-2003; IN COMMERCE 2-3-2003.

FOR: TRAINING AND TEACHING, NAMELY, TRAINING AND TEACHING IN THE FIELDS OF FIRST AID, EMERGENCY MEDICAL SERVICES, EMERGENCY RESPONSE SERVICE, EMERGENCY MEDICAL TECHNICIANS AS IT RELATES TO EMERGENCY SITUATIONS IN REMOTE GEOGRAPHIC SETTINGS, AND TRAINING AND TEACHING IN THE FIELDS OF FIRST AID, EMERGENCY MEDICAL SERVICES, EMERGENCY RESPONSE SERVICE, EMERGENCY MEDICAL TECHNICIANS AS IT RELATES TO EMERGENCY SITUATIONS IN REMOTE GEOGRAPHIC SETTINGS FOR PURPOSES OF CERTIFICATION AND RECERTIFICATION, IN CLASS 41 (U.S. CLS. 100, 101 AND 107).

FIRST USE 2-3-2003; IN COMMERCE 2-3-2003.

FOR: MEDICAL SERVICES, NAMELY, TELEMEDICINE AND EMERGENCY MEDICAL SERVICES PROVIDED DURING EVACUATION; ONSITE MEDICAL SERVICES, NAMELY, ONSITE MEDICAL AND EMERGENCY MEDICAL SERVICES AS A MEANS OF RESCUE SUPPORT, IN CLASS 44 (U.S. CLS. 100 AND 101).

FIRST USE 5-0-2004; IN COMMERCE 5-0-2004.



David J. Kyjars

Director of the United States Patent and Trademark Office

Reg. No. 4,098,372 THE MARK CONSISTS OF STANDARD CHARACTERS WITHOUT CLAIM TO ANY PARTICULAR FONT, STYLE, SIZE, OR COLOR.

NO CLAIM IS MADE TO THE EXCLUSIVE RIGHT TO USE "REMOTE MEDICAL", APART FROM THE MARK AS SHOWN.

SEC. 2(F).

SER. NO. 85-313,528, FILED 5-5-2011.

JAY BESCH, EXAMINING ATTORNEY

United States of America

United States Patent and Trademark Office



Reg. No. 4,098,373

WOOD, JOHN (UNITED STATES INDIVIDUAL)
9642 DESERT DAISY CT
LAS VEGAS, NV 89178

Registered Feb. 14, 2012

Int. Cl.: 25

FOR: CLOTHING AND HEADWEAR, NAMELY, T-SHIRTS, SHORTS, SWEATPANTS, SWEATSHIRTS, SWIMWEAR, JACKETS, BELTS, JEANS, WOVEN SHIRTS, KNIT SHIRTS, TANK TOPS, SOCKS, SWEATERS, HATS, BEANIES, CAPS; FOOTWEAR AND MIXED MARTIAL ARTS UNIFORMS, IN CLASS 25 (U.S. CLS. 22 AND 39).

TRADEMARK

PRINCIPAL REGISTER

FIRST USE 2-1-2011; IN COMMERCE 2-1-2011.

NO CLAIM IS MADE TO THE EXCLUSIVE RIGHT TO USE "SIN CITY", APART FROM THE MARK AS SHOWN.

THE MARK CONSISTS OF A SEAL COMPOSED OF TWO CONCENTRIC CIRCLES; WITHIN THE OUTER CIRCLE ARE THE WORDS "SIN CITY" AT THE TOP AND "SYNDICATE" AT THE BOTTOM; AT EITHER END OF THE CIRCLE ARE THREE FIVE POINTED STARS. THE INNER CIRCLE CONSISTS OF THE INVERTED STYLIZED LETTERS "S S"; HALF OF AN OPEN CROWN IS ON TOP OF EACH LETTER "S" AT THE BOTTOM OF THIS DESIGN IS A LAUREL LEAF CIRCLE AND A FIVE POINTED STAR AT THE BOTTOM OF THE CIRCLE.

SER. NO. 85-314,573, FILED 5-6-2011.

HENRY S. ZAK, EXAMINING ATTORNEY



David J. Kybas

Director of the United States Patent and Trademark Office

United States of America

United States Patent and Trademark Office



Reg. No. 4,098,374

Registered Feb. 14, 2012

Int. Cl.: 30

TRADEMARK

PRINCIPAL REGISTER

WINTER PARK HONEY LLC (FLORIDA LIMITED LIABILITY COMPANY), DBA WINTER PARK HONEY
7200 GRACE RD
ORLANDO, FL 32819

FOR: HONEY; HONEY, IN CLASS 30 (U.S. CL. 46).

FIRST USE 7-6-2005; IN COMMERCE 7-6-2005.

NO CLAIM IS MADE TO THE EXCLUSIVE RIGHT TO USE "WINTER PARK" AND "HONEY", APART FROM THE MARK AS SHOWN.

THE MARK CONSISTS OF A CARICATURE OF A HONEYBEE WITH A FAT STRIPED STOMACH, WINGS, SMILE, AND 2 DOTS FOR THE EYES. THE LEFT ANTENNA IS INCORPORATED WITH THE "W" STARTING THE WORD "WINTER". THE RIGHT ANTENNA IS INCORPORATED WITH THE "P" STARTING THE WORD "PARK". THE WORD "HONEY" IS WRITTEN TO THE RIGHT OF THE BEE.

SER. NO. 85-315,089, FILED 5-7-2011.

SALLY SHIH, EXAMINING ATTORNEY



David J. Kybas

Director of the United States Patent and Trademark Office

United States of America

United States Patent and Trademark Office



Reg. No. 4,098,375

FIVE CHEFS PROFESSIONAL KITCHEN CORPORATION (NEW JERSEY CORPORATION)
1041 SOUTH AVENUE
PLAINFIELD, NJ 07062

Registered Feb. 14, 2012

Int. Cl.: 43

FOR: RESTAURANT SERVICES FEATURING INDIAN CUISINE, INDIAN STYLE CHINESE CUISINE, AND SWEETS; RESTAURANT SERVICES INCLUDING, SIT-DOWN SERVICE, CARRYOUT SERVICES, FAST FOOD, SNACK BAR, CATERING, PROVIDING OF FOOD AND BEVERAGE ON AND OFF PREMISES, AND HOME DELIVERY, IN CLASS 43 (U.S. CLS. 100 AND 101).

SERVICE MARK

PRINCIPAL REGISTER

FIRST USE 10-1-2010; IN COMMERCE 10-1-2010.

NO CLAIM IS MADE TO THE EXCLUSIVE RIGHT TO USE "SPICE" AND "INDIAN CHINESE SWEETS", APART FROM THE MARK AS SHOWN.

THE COLOR(S) YELLOW, ORANGE, GRAY AND WHITE IS/ARE CLAIMED AS A FEATURE OF THE MARK.

THE MARK CONSISTS OF THE STYLIZED WORDING "SPICE ZONE" WITH THE TERM "SPICE" IN ORANGE AND THE TERM "ZONE" IN YELLOW. A GRAY HORIZONTAL BAR SEPARATES THE TWO TERMS AND CONTAINS THE WORDING "INDIAN · CHINESE · SWEETS" IN WHITE.

SER. NO. 85-315,205, FILED 5-8-2011.

JAMES STEIN, EXAMINING ATTORNEY



David J. Kybas

Director of the United States Patent and Trademark Office

United States of America

United States Patent and Trademark Office



Reg. No. 4,098,376

XPRESSYSTEMS, INC. (MINNESOTA CORPORATION)
407 4TH AVE. S.W.
NEW PRAGUE, MN 56701

Registered Feb. 14, 2012

Int. Cl.: 9

FOR: RADIO FREQUENCY IDENTIFICATION (RFID) READERS; RADIO FREQUENCY IDENTIFICATION (RFID) READERS, NAMELY, A RFID VEHICLE ENTRY READER THAT FUNCTIONS TO ALLOW FOR THE ENTRY AND EXIT OF VEHICLES INTO AND OUT OF PARKING FACILITIES BY RECOGNIZING THE RFID TRANSMISSION FROM DEVICES PLACED WITHIN VEHICLES; RADIO FREQUENCY IDENTIFICATION (RFID) READERS, NAMELY, A RFID VEHICLE ENTRY READER THAT WORKS BY PLACING AN ENTRY ACTIVATION RFID TAG ON THE VEHICLE AND A RFID ANTENNA BEING MOUNTED TO THE PARKING ENTRY STAND OR THE BUILDING ALLOWING CUSTOMERS TO GAIN ENTRY TO THE STRUCTURE WHEN THE RFID READER READS PRE-PROGRAMMED PARKING CODES AND BILLING INFORMATION FROM THE RFID TAG; RADIO FREQUENCY IDENTIFICATION (RFID) READERS, NAMELY, A RFID VEHICLE ENTRY READER THAT GATHERS AND STORES CUSTOMER INFORMATION, IN CLASS 9 (U.S. CLS. 21, 23, 26, 36 AND 38).

TRADEMARK

PRINCIPAL REGISTER

FIRST USE 1-13-2009; IN COMMERCE 12-13-2009.

NO CLAIM IS MADE TO THE EXCLUSIVE RIGHT TO USE "PARK" AND THE REPRESENTATION OF THE PARKING SYMBOL DESIGN, APART FROM THE MARK AS SHOWN.



THE MARK CONSISTS OF THE WORDING "XPRES PARK P" APPEARING IN STYLIZED FONT, THE WORDING "XPRES PARK P" APPEAR IN STACKED FORM WITH THE WORDING "XPRES" ABOVE THE WORDING "PARK", THE LETTER "P" APPEARS WITH A CIRCLE AROUND IT TO THE LOWER RIGHT CORNER OF THE "PARK" WORDING, A GRAPHIC OF A SPIRAL APPEARS AROUND THE UPPER RIGHT PORTION OF THE LETTER "X" APPEARING IN THE "XPRES" WORDING.

SER. NO. 85-315,492, FILED 5-9-2011.

ROBERT C. CLARK JR., EXAMINING ATTORNEY

David J. Kyffers

Director of the United States Patent and Trademark Office

United States of America
United States Patent and Trademark Office

BELLO SMILE
DENTAL CENTER

Reg. No. 4,098,377

DEMELO, FATIMA (UNITED STATES INDIVIDUAL)

Registered Feb. 14, 2012

1A
31-90 31ST STREET
ASTORIA, NY 11106

Int. Cl.: 44

FOR: DENTIST SERVICES, IN CLASS 44 (U.S. CLS. 100 AND 101).

SERVICE MARK

FIRST USE 9-15-1997; IN COMMERCE 9-15-1997.

PRINCIPAL REGISTER

NO CLAIM IS MADE TO THE EXCLUSIVE RIGHT TO USE "DENTAL CENTER", APART FROM THE MARK AS SHOWN.

THE MARK CONSISTS OF THE STYLIZED TEXT "BELLO SMILE DENTAL CENTER".

THE ENGLISH TRANSLATION OF "BELLO" IN THE MARK IS "BEAUTIFUL".

SER. NO. 85-315,508, FILED 5-9-2011.

TIMOTHY FINNEGAN, EXAMINING ATTORNEY



David J. Kybas

Director of the United States Patent and Trademark Office

United States of America

United States Patent and Trademark Office

KREEP-E

Reg. No. 4,098,378

INNOVATION FIRST, INC. (TEXAS CORPORATION)
1519 INTERSTATE 30 WEST
GREENVILLE, TX 75402

Registered Feb. 14, 2012

Int. Cl.: 28

FOR: TOYS, NAMELY, MECHANICAL CREATURES, PLAY SETS FOR MECHANICAL TOYS AND CREATURE RELATED ACCESSORIES COMPRISED OF TOY BUILDING SETS AND TOY BUILDINGS AND STRUCTURES , IN CLASS 28 (U.S. CLS. 22, 23, 38 AND 50).

TRADEMARK

FIRST USE 10-1-2010; IN COMMERCE 10-1-2010.

PRINCIPAL REGISTER

THE MARK CONSISTS OF STANDARD CHARACTERS WITHOUT CLAIM TO ANY PARTICULAR FONT, STYLE, SIZE, OR COLOR.

SER. NO. 85-315,683, FILED 5-9-2011.

ANTHONY RINKER, EXAMINING ATTORNEY



David J. Kybas

Director of the United States Patent and Trademark Office

United States of America

United States Patent and Trademark Office

THE WOMEN'S CODE

Reg. No. 4,098,379

Registered Feb. 14, 2012

Int. Cls.: 35 and 41

SERVICE MARK

PRINCIPAL REGISTER

CHELETTE ENTERPRISES, INC. (CALIFORNIA CORPORATION)
P.O. BOX 1293
CULVER CITY, CA 90232

FOR: BUSINESS CONSULTATION, NAMELY, BUSINESS CONSULTATION FOR EMPOWERED CONTEMPORARY WORKING MOTHERS; CAREER CONSULTATION AND TRAINING, NAMELY, PROVIDING CAREER INFORMATION AND TRAINING COURSES FOR EMPOWERED CONTEMPORARY WORKING MOTHERS, IN CLASS 35 (U.S. CLS. 100, 101 AND 102).

FIRST USE 3-25-2011; IN COMMERCE 3-25-2011.

FOR: CAREER CONSULTATION, NAMELY, CAREER COUNSELING IN THE NATURE OF PROVIDING ADVICE CONCERNING EDUCATION AND TRAINING OPTIONS TO PURSUE CAREER OPPORTUNITIES, WITH SAID SERVICES BEING FOR EMPOWERED CONTEMPORARY WORKING MOTHERS; CAREER CONSULTATION, NAMELY, VOCATIONAL GUIDANCE AND TRAINING COURSES FOR EMPOWERED CONTEMPORARY WORKING MOTHERS; TRAINING PROGRAMS IN THE FIELD OF WOMEN'S LEADERSHIP GENERALLY AND IN THE FIELD OF LEADERSHIP AS IT RELATES TO THE EMPOWERMENT OF WOMEN AND DISTRIBUTION OF EDUCATIONAL MATERIALS IN CONNECTION THEREWITH, IN CLASS 41 (U.S. CLS. 100, 101 AND 107).

FIRST USE 3-25-2011; IN COMMERCE 3-25-2011.

THE MARK CONSISTS OF STANDARD CHARACTERS WITHOUT CLAIM TO ANY PARTICULAR FONT, STYLE, SIZE, OR COLOR.

SER. NO. 85-316,544, FILED 5-10-2011.

KEVIN CORWIN, EXAMINING ATTORNEY



David J. Kypos

Director of the United States Patent and Trademark Office

United States of America

United States Patent and Trademark Office

garden on the go

Reg. No. 4,098,380

INDIANA UNIVERSITY HEALTH, INC. (INDIANA CORPORATION)
340 W. 10TH STREET, P.O. BOX 1367
INDIANAPOLIS, IN 462061367

Registered Feb. 14, 2012

Int. Cl.: 35

FOR: RETAIL GROCERY STORE SERVICES, IN CLASS 35 (U.S. CLS. 100, 101 AND 102).

SERVICE MARK

FIRST USE 5-6-2011; IN COMMERCE 5-6-2011.

PRINCIPAL REGISTER

THE MARK CONSISTS OF STANDARD CHARACTERS WITHOUT CLAIM TO ANY PARTICULAR FONT, STYLE, SIZE, OR COLOR.

SER. NO. 85-316,863, FILED 5-10-2011.

SUNG IN, EXAMINING ATTORNEY



David J. Kyffers

Director of the United States Patent and Trademark Office

United States of America

United States Patent and Trademark Office

MANGO MULCH ORGANIC COMPOST

Reg. No. 4,098,381

SOILAND CO., INC. (CALIFORNIA CORPORATION)
3450A REGIONAL PARKWAY
SANTA ROSA, CA 95403

Registered Feb. 14, 2012

Int. Cl.: 31

FOR: MULCH, IN CLASS 31 (U.S. CLS. 1 AND 46).

TRADEMARK

FIRST USE 10-9-1986; IN COMMERCE 10-9-1986.

PRINCIPAL REGISTER

THE MARK CONSISTS OF STANDARD CHARACTERS WITHOUT CLAIM TO ANY PARTICULAR FONT, STYLE, SIZE, OR COLOR.

NO CLAIM IS MADE TO THE EXCLUSIVE RIGHT TO USE "MULCH" AND "ORGANIC COMPOST", APART FROM THE MARK AS SHOWN.

SER. NO. 85-316,926, FILED 5-10-2011.

SUNG IN, EXAMINING ATTORNEY



David J. Kyffers

Director of the United States Patent and Trademark Office

United States of America

United States Patent and Trademark Office

MARLENE'S MAGIC GARDEN MIX

Reg. No. 4,098,382

SOILAND CO., INC. (CALIFORNIA CORPORATION)
3450A REGIONAL PARKWAY
SANTA ROSA, CA 95403

Registered Feb. 14, 2012

Int. Cl.: 1

FOR: PLANTING SOIL, IN CLASS 1 (U.S. CLS. 1, 5, 6, 10, 26 AND 46).

TRADEMARK

FIRST USE 3-1-2011; IN COMMERCE 3-1-2011.

PRINCIPAL REGISTER

THE MARK CONSISTS OF STANDARD CHARACTERS WITHOUT CLAIM TO ANY PARTICULAR FONT, STYLE, SIZE, OR COLOR.

NO CLAIM IS MADE TO THE EXCLUSIVE RIGHT TO USE "GARDEN MIX", APART FROM THE MARK AS SHOWN.

SER. NO. 85-316,932, FILED 5-10-2011.

SUNG IN, EXAMINING ATTORNEY



David J. Kyfos

Director of the United States Patent and Trademark Office

United States of America

United States Patent and Trademark Office

JULIOUS' CHOICE POTTING SOIL

Reg. No. 4,098,383

SOILAND CO., INC. (CALIFORNIA CORPORATION)
3450A REGIONAL PARKWAY
SANTA ROSA, CA 95403

Registered Feb. 14, 2012

Int. Cl.: 1

FOR: POTTING SOIL, IN CLASS 1 (U.S. CLS. 1, 5, 6, 10, 26 AND 46).

TRADEMARK

FIRST USE 3-1-2011; IN COMMERCE 3-1-2011.

PRINCIPAL REGISTER

THE MARK CONSISTS OF STANDARD CHARACTERS WITHOUT CLAIM TO ANY PARTICULAR FONT, STYLE, SIZE, OR COLOR.

NO CLAIM IS MADE TO THE EXCLUSIVE RIGHT TO USE "POTTING SOIL", APART FROM THE MARK AS SHOWN.

SER. NO. 85-316,939, FILED 5-10-2011.

SUNG IN, EXAMINING ATTORNEY



David J. Kyffers

Director of the United States Patent and Trademark Office

United States of America

United States Patent and Trademark Office

LASAGNA MULCH

Reg. No. 4,098,384

Registered Feb. 14, 2012

Int. Cl.: 31

TRADEMARK

PRINCIPAL REGISTER

SOILAND CO., INC. (CALIFORNIA CORPORATION)
3450A REGIONAL PARKWAY
SANTA ROSA, CA 95403

FOR: MULCH, IN CLASS 31 (U.S. CLS. 1 AND 46).

FIRST USE 4-30-2010; IN COMMERCE 4-30-2010.

THE MARK CONSISTS OF STANDARD CHARACTERS WITHOUT CLAIM TO ANY PARTICULAR FONT, STYLE, SIZE, OR COLOR.

NO CLAIM IS MADE TO THE EXCLUSIVE RIGHT TO USE "MULCH", APART FROM THE MARK AS SHOWN.

SER. NO. 85-317,493, FILED 5-10-2011.

BARBARA RUTLAND, EXAMINING ATTORNEY



David J. Kybas

Director of the United States Patent and Trademark Office

United States of America

United States Patent and Trademark Office

Pro Cheerleaders Club

Reg. No. 4,098,385

Registered Feb. 14, 2012

Int. Cl.: 25

TRADEMARK

PRINCIPAL REGISTER

CRAWFORD, MICHELE A (UNITED STATES INDIVIDUAL), DBA ALUMNI
CHEERLEADERS, LLC
8010 ST. CHARLES SQUARE
ROSWELL, GA 30075

FOR: ANKLETS; ATHLETIC UNIFORMS; BABY BOTTOMS; BABY TOPS; BALLOON PANTS; BANDANAS; BASEBALL CAPS; BATHING COSTUMES FOR WOMEN; BATHING SUITS; BATHING TRUNKS; BATHROBES; BEACH COVERUPS; BEACH FOOTWEAR; BEACH SHOES; BEACHWEAR; BELTS; BELTS MADE OF LEATHER; BERETS; BERMUDA SHORTS; BIB OVERALLS; BIKINIS; BLAZERS; BLOOMERS; BLOUSES; BOARD SHORTS; BOARDSHORTS; BODY SUITS; BOLEROS; BOOTIES; BOOTS; BOTTOMS; BOXER BRIEFS; BOXER SHORTS; BRALETTES; BRAS; BRASSIERES; BRIEFS; BUSTIERS; BUTTON-FRONT ALOHA SHIRTS; CAMISETTES; CAMISOLES; CAMP SHIRTS; CAP VISORS; CAPRI PANTS; CAPRIS; CAPS; CAPS WITH VISORS; CARDIGANS; A-SHIRTS; ANKLE BOOTS; ANKLE SOCKS; APRONS; ATHLETIC FOOTWEAR; ATHLETIC SHOES; BABY BIBS NOT OF PAPER; CARGO PANTS; CHEF'S HATS; CHEMISES; CHILDREN'S HEADWEAR; CLOGS; CLOTH BIBS FOR ADULT DINERS; COATS; COATS FOR MEN AND WOMEN; COATS MADE OF COTTON; COATS OF DENIM; CORSETS; COVERALLS; CREWNECK SWEATERS; CREWNECKS; CROP TOPS; CULOTTES; DENIM JACKETS; DENIMS; DOWN JACKETS; DRESS SHIRTS; DRESS SUITS; DRESSES; EAR MUFFS; EAR WARMERS; EARBANDS; FABRIC BELTS; FLEECE PULLOVERS; FLEECE SHORTS; FLIP FLOPS; FOOTWEAR FOR MEN AND WOMEN; FOOTWEAR, NAMELY, RUBBERS; FUR COATS AND JACKETS; G-STRINGS; GARTER BELTS; GARTERS; GAUCHOS; GLOVES; GOLF CAPS; GOLF SHIRTS; GYM SHORTS; GYM SUITS; HALLOWEEN COSTUMES; HALTER TOPS; HAT BANDS; HATS; HEAD SCARVES; HEAD SWEATBANDS; HEADBANDS; HEADWEAR; HEAVY JACKETS; HOODS; INFANT AND TODDLER ONE PIECE CLOTHING; INFANT SLEEPERS; INFANTS' SHOES AND BOOTS; INFANTWEAR; INSOLES; JACKETS; JEANS; JERSEYS; JOGGING OUTFITS; JOGGING PANTS; JOGGING SUITS; JUMPSUITS; KNICKERS; KNITTED CAPS; LAB COATS; LADIES' BOOTS; LADIES' SUITS; LADIES' UNDERWEAR; LEATHER BELTS; LEATHER COATS; LEATHER HEADWEAR; LEATHER JACKETS; LEATHER PANTS; LEATHER SHOES; LEGGINGS; LEOTARDS AND TIGHTS FOR WOMEN, MEN AND CHILDREN OF NYLON, COTTON OR OTHER TEXTILE FIBERS; LINGERIE; LONG JACKETS; LONG SLEEVED VESTS; LOUNGEWEAR; MATERNITY SLEEPWEAR; MEN AND WOMEN JACKETS, COATS, TROUSERS, VESTS; MEN'S SUITS, WOMEN'S SUITS; MINISKIRTS; MITTENS; MOCK TURTLE-NECK SWEATERS; MOCKNECKS; MULES; NECKTIES; NIGHT GOWNS; NIGHTWEAR; NURSE PANTS; OPEN-NECKED SHIRTS; OVER COATS; OVERCOATS; PAJAMAS; PANTIES, SHORTS AND BRIEFS; PANTS; PEDAL



David J. Kybas

Director of the United States Patent and Trademark Office

Reg. No. 4,098,385 PUSHERS; PEDICURE SANDALS; PLAY SUITS; POLO SHIRTS; PONCHOS; PULLOVERS; RAIN BOOTS; RAIN JACKETS; RAIN SLICKERS; RAINCOATS; RAINWEAR; ROBES; ROMPERS; SANDALS; SARONGS; SASHES; SCARVES; SCRUBS NOT FOR MEDICAL PURPOSES; SHIRTS; SHIRTS FOR SUITS; SHOES; SHORT SETS; SHORT-SLEEVED OR LONG-SLEEVED T-SHIRTS; SHORT-SLEEVED SHIRTS; SHORTS; SILK SCARVES; SKI JACKETS; SKI PANTS; SKI SUITS; SKIRT SUITS; SKIRTS AND DRESSES; SKORTS; SKULLIES; SLACKS; SLEEP MASKS; SLEEP SHIRTS; SLEEPWEAR; SLEEVED OR SLEEVELESS JACKETS; SLEEVELESS JERSEYS; SLIPPERS; SNEAKERS; SOCKS; SOLES; SPORT COATS; SPORTS BRA; SPORTS JERSEYS; SPORTS SHIRTS; SPORTS SHIRTS WITH SHORT SLEEVES; STRAPS FOR BRAS; SUEDE JACKETS; SUITS; SUITS OF LEATHER; SUN VISORS; SUSPENDER BELTS FOR WOMEN; SUSPENDERS; SWEAT BANDS; SWEAT PANTS; SWEAT SHIRTS; SWEAT SUITS; SWEATSOCKS; SWIM WEAR; SWIM WEAR FOR GENTLEMEN AND LADIES; SWIMSUITS; SWIMWEAR; T-SHIRTS; TANK TOPS; TANK-TOPS; TEDDIES; TEE SHIRTS; TENNIS WEAR; THONGS; TIES; TONGUE OR PULLSTRAP FOR SHOES AND BOOTS; TOP COATS; TOPS; TRACK PANTS; TRACK SUITS; TRACK-SUITS; TRENCH COATS; TUBE TOPS; TUNICS; TURTLENECK SWEATERS; TURTLE-NECKS; UNDER GARMENTS; UNDERGARMENTS; UNDERWEAR; UNIFORMS; UNITARDS; V-NECK SWEATERS; VESTS; VISORS; WAIST BELTS; WAISTBANDS; WALKING SHORTS; WARM UP SUITS; WATERPROOF JACKETS AND PANTS; WEDDING DRESSES; WIND PANTS; WIND-JACKETS; WOMEN'S SHOES; WOMEN'S UNDERWEAR; WRAPS; WRIST-BANDS; YOGA PANTS; YOGA SHIRTS; MUSCLE TOPS; SWEATERS; CANVAS SHOES; DANCE COSTUMES; FOOTWEAR; FOOTWEAR FOR WOMEN; MONEY BELTS; ONE PIECE GARMENT FOR INFANTS AND TODDLERS; PANTIES; PANTSUITS; RUGBY TOPS; SHOULDER WRAPS; SKI BOOT BAGS; SKI GLOVES, IN CLASS 25 (U.S. CLS. 22 AND 39).

FIRST USE 8-1-2010; IN COMMERCE 1-15-2011.

THE MARK CONSISTS OF STANDARD CHARACTERS WITHOUT CLAIM TO ANY PARTICULAR FONT, STYLE, SIZE, OR COLOR.

OWNER OF U.S. REG. NOS. 3,531,976, 3,994,074 AND OTHERS.

NO CLAIM IS MADE TO THE EXCLUSIVE RIGHT TO USE "PRO CHEERLEADERS", APART FROM THE MARK AS SHOWN.

SER. NO. 85-317,590, FILED 5-10-2011.

ANDREW RHIM, EXAMINING ATTORNEY

United States of America

United States Patent and Trademark Office

Skunks TV

Reg. No. 4,098,386

SHULL MINISTRIES INTERNATIONAL INC. (OKLAHOMA CORPORATION)

Registered Feb. 14, 2012

14454 S. POPLAR ST
GLENPOOL, OK 74033

Int. Cl.: 41

FOR: ENTERTAINMENT, NAMELY, A CONTINUING ENTERTAINMENT AND ARTS-BASED REALITY SHOW DESIGNED TO HELP YOUNG PEOPLE WITH ISSUES THEY FACE EVERYDAY, WITH A CHRISTIAN PERSPECTIVE, BROADCAST OVER TELEVISION, IN CLASS 41 (U.S. CLS. 100, 101 AND 107).

SERVICE MARK

PRINCIPAL REGISTER

FIRST USE 7-1-2009; IN COMMERCE 1-15-2010.

THE MARK CONSISTS OF STANDARD CHARACTERS WITHOUT CLAIM TO ANY PARTICULAR FONT, STYLE, SIZE, OR COLOR.

NO CLAIM IS MADE TO THE EXCLUSIVE RIGHT TO USE "TV", APART FROM THE MARK AS SHOWN.

SER. NO. 85-317,848, FILED 5-11-2011.

APRIL ROACH, EXAMINING ATTORNEY



David J. Kyffers

Director of the United States Patent and Trademark Office

United States of America

United States Patent and Trademark Office



Reg. No. 4,098,387

Registered Feb. 14, 2012

Int. Cl.: 3

TRADEMARK

PRINCIPAL REGISTER

BOMBER BETTY CUSTOM COSMETICS INC. (ILLINOIS CORPORATION)
P.O. BOX 135
ISLAND LAKE, IL 60042

FOR: COMPACTS CONTAINING MAKE-UP; CONCEALERS FOR UNDER EYE CIRCLES/BLEMISHES; COSMETICS AND MAKE-UP; EYE MAKE-UP; EYES MAKE-UP; FACIAL MAKE-UP; MAKE-UP; MAKE YOUR OWN LIP GLOSS KITS; MAKE-UP FOR THE FACE AND BODY; MAKE-UP KITS CONTAINING EYE SHADOWS AND BLUSH; MAKE-UP KITS CONTAINING EYE SHADOWS; MAKE-UP POWDER; MAKE-UP PREPARATIONS; MAKE-UP PREPARATIONS FOR THE FACE AND BODY; NATURAL MINERAL MAKE-UP; NON-MEDICATED SKIN CARE PREPARATIONS; NON-MEDICATED SKIN CARE PREPARATIONS, NAMELY, CREAMS; POWDER FOR MAKE-UP; LOOSE AND PRESSED POWDER MINERAL FOUNDATIONS; LOOSE AND PRESSED POWDER MINERAL BLUSH; LOOSE AND PRESSED POWDER MINERAL EYE SHADOW; PRESSED EYE SHADOW PALETTES; PRESSED POWDER FOUNDATION AND BLUSH; PRESSED POWDER EYE SHADOWS AND EYE LINERS; RE-FILLABLE SHAKE COSMETIC BRUSHES FILLED WITH LOOSE FACE POWDER; CREAM BLUSH; CREAM EYE SHADOW; LIP AND CHEEK STAINS; LIPSTICK; LIP GLOSS; CONCEALER AND EYE SHADOW PRIMER; EYEBROW TINT; BROW TINTS; LIQUID FOUNDATION; FOUNDATION PRIMER; TINTED FACIAL MOISTURIZER; LOOSE POWDER FOUNDATION; LOOSE POWDER BLUSH AND SHADOWS, IN CLASS 3 (U.S. CLS. 1, 4, 6, 50, 51 AND 52).

FIRST USE 6-1-2010; IN COMMERCE 6-1-2010.



David J. Kybas

Director of the United States Patent and Trademark Office

THE MARK CONSISTS OF A BUXOM WOMAN WITH CAUCASIAN SKIN COLOR AND DARK BROWN OR BRUNETTE HAIR WITH WHITE HIGHLIGHTS, SHOWN WITH HEAD, ARMS, AND TORSO FROM MID-BOSOM UPWARDS EXCEPT THE ELBOWS AND PORTIONS OF THE ARMS ADJACENT THE ELBOWS; THE WOMAN WEARING A SAILOR UNIFORM; THE WOMAN WEARING A WHITE SAILOR CAP; THE WOMAN WEARING A TANK TOP STYLE SAILOR MIDDY WITH BLACK STRIPING AND BLACK CUFFS; THE MIDDY HAVING RANK INSIGNIA ON THE RIGHT SLEEVE INCLUDING A BLACK EAGLE ATOP TWO RED CHEVRON STRIPES; THE WOMAN HAVING HER HEAD TURNED PARTIALLY TOWARD HER RIGHT AND THE LEFT OF THE IMAGE; THE WOMAN HAVING HER TORSO TURNED PARTIALLY TOWARD HER LEFT AND THE RIGHT OF THE IMAGE; THE WOMAN HAVING BOTH HANDS AND FOREARMS RAISED AND TO HER SIDES; THE WOMAN HAVING RED FINGERNAILS; THE WOMAN HOLDING A GOLD COLORED COMPACT WITH PINK CONTENTS IN HER RIGHT HAND; THE WOMAN

Reg. No. 4,098,387 HOLDING A GOLD COLORED LIPSTICK APPLICATOR CONTAINING RED LIPSTICK IN HER LEFT HAND, WITH ALL ELEMENTS OF THE MARK SUPERIMPOSED OVER A BLACK BACKGROUND.

THE COLOR(S) BROWN, GOLD, PINK, BLACK, CAUCASIAN SKIN COLOR, WHITE, AND RED IS/ARE CLAIMED AS A FEATURE OF THE MARK.

SER. NO. 85-318,020, FILED 5-11-2011.

BARBARA RUTLAND, EXAMINING ATTORNEY

United States of America

United States Patent and Trademark Office

LIZ O'BRIEN

Reg. No. 4,098,388

LIZ O'BRIEN NEW YORK, LLC (NEW YORK LIMITED LIABILITY COMPANY)
306 EAST 61 STREET
NEW YORK, NY 10065

Registered Feb. 14, 2012

Int. Cls.: 11 and 20

FOR: LIGHTING, NAMELY, TABLE LAMPS, FLOOR LAMPS, COMMODOES, CEILING FIXTURES, NAMELY, CEILING LIGHTS, IN CLASS 11 (U.S. CLS. 13, 21, 23, 31 AND 34).

TRADEMARK

FIRST USE 5-18-1995; IN COMMERCE 5-18-1995.

PRINCIPAL REGISTER

FOR: HOME FURNISHINGS, NAMELY, TABLES, NAMELY, DINING TABLES, LOW TABLES, SIDE TABLES, DESKS; CHAIRS, NAMELY, LOUNGE CHAIRS, SOFAS, BENCHES; BOOKCASES; CABINETS; MIRRORS; PICTURE FRAMES, IN CLASS 20 (U.S. CLS. 2, 13, 22, 25, 32 AND 50).

FIRST USE 5-18-1995; IN COMMERCE 5-18-1995.

THE MARK CONSISTS OF STANDARD CHARACTERS WITHOUT CLAIM TO ANY PARTICULAR FONT, STYLE, SIZE, OR COLOR.

THE NAME "LIZ O'BRIEN" IDENTIFIES A LIVING INDIVIDUAL WHOSE CONSENT IS OF RECORD.

SER. NO. 85-318,213, FILED 5-11-2011.

ERIN FALK, EXAMINING ATTORNEY



David J. Kybas

Director of the United States Patent and Trademark Office

United States of America

United States Patent and Trademark Office

GUSTAVSEN

Reg. No. 4,098,389

DOM INTERNATIONAL LIMITED (CANADA CORPORATION)
10 GOLDEN GATE COURT
TORONTO, ONTARIO, CANADA M1P3A5

Registered Feb. 14, 2012

Int. Cl.: 29

FOR: FOOD, NAMELY, FRESH, FROZEN, COOKED, PREPARED AND SMOKED SALMON,
IN CLASS 29 (U.S. CL. 46).

TRADEMARK

FIRST USE 1-31-1992; IN COMMERCE 1-31-2000.

PRINCIPAL REGISTER

THE MARK CONSISTS OF STANDARD CHARACTERS WITHOUT CLAIM TO ANY PARTICULAR FONT, STYLE, SIZE, OR COLOR.

OWNER OF U.S. REG. NO. 3,056,654.

SEC. 2(F).

SER. NO. 85-318,370, FILED 5-11-2011.

JEAN IM, EXAMINING ATTORNEY



David J. Kyffers

Director of the United States Patent and Trademark Office

United States of America

United States Patent and Trademark Office

Alliance Minerals

Reg. No. 4,098,390

ALLIANCE MINERALS NORTHAMERICA, L.L.C. (IOWA LIMITED LIABILITY COMPANY)
1575 NW 106TH ST.
CLIVE, IA 50325

Registered Feb. 14, 2012

Int. Cl.: 19

FOR: MARBLE; NATURAL STONE SLABS AND TILES, IN CLASS 19 (U.S. CLS. 1, 12, 33 AND 50).

TRADEMARK

FIRST USE 9-12-2006; IN COMMERCE 9-12-2006.

PRINCIPAL REGISTER

THE MARK CONSISTS OF STANDARD CHARACTERS WITHOUT CLAIM TO ANY PARTICULAR FONT, STYLE, SIZE, OR COLOR.

NO CLAIM IS MADE TO THE EXCLUSIVE RIGHT TO USE "MINERALS", APART FROM THE MARK AS SHOWN.

SER. NO. 85-318,684, FILED 5-11-2011.

FRANK LATTUCA, EXAMINING ATTORNEY



David J. Kyffers

Director of the United States Patent and Trademark Office

United States of America

United States Patent and Trademark Office

ONESTOP ECO

Reg. No. 4,098,391

TOMRA/CBSI, LLC (DELAWARE LIMITED LIABILITY COMPANY)
ONE CORPORATE DRIVE, SUITE 710
SHELTON, CT 06484

Registered Feb. 14, 2012

Int. Cl.: 9

FOR: REVERSE VENDING MACHINES THAT AUTOMATE THE RETURN OF EMPTY BOTTLES AND CANS; REVERSE VENDING MACHINES THAT AUTOMATE BEVERAGE CONTAINER RECYCLING BY ACCEPTING EMPTY CONTAINERS AND REFUNDING THE DEPOSIT TO THE CONSUMER; BEVERAGE CONTAINER REDEMPTION MACHINES THAT AUTOMATE AND ACCOUNT FOR THE RETURN OF USED BEVERAGE CONTAINERS, IN CLASS 9 (U.S. CLS. 21, 23, 26, 36 AND 38).

TRADEMARK

PRINCIPAL REGISTER

FIRST USE 1-31-2010; IN COMMERCE 4-15-2011.

THE MARK CONSISTS OF STANDARD CHARACTERS WITHOUT CLAIM TO ANY PARTICULAR FONT, STYLE, SIZE, OR COLOR.

OWNER OF U.S. REG. NO. 2,215,305.

NO CLAIM IS MADE TO THE EXCLUSIVE RIGHT TO USE "ECO" , APART FROM THE MARK AS SHOWN.

SER. NO. 85-319,323, FILED 5-12-2011.

MATTHEW MCDOWELL, EXAMINING ATTORNEY



David J. Kyffers

Director of the United States Patent and Trademark Office

United States of America

United States Patent and Trademark Office

VIVOSENSE

Reg. No. 4,098,392

Registered Feb. 14, 2012

Int. Cls.: 9 and 42

TRADEMARK

SERVICE MARK

PRINCIPAL REGISTER

VIVONOETICS INC. (DELAWARE CORPORATION)
3231 HUERFINO COURT
SAN DIEGO, CA 92117

FOR: COMPUTER SOFTWARE FOR VISUALIZATION AND ANALYSIS OF PHYSIOLOGICAL DATA, IN CLASS 9 (U.S. CLS. 21, 23, 26, 36 AND 38).

FIRST USE 10-22-2010; IN COMMERCE 10-22-2010.

FOR: COMPUTER SOFTWARE CUSTOMIZATION AND DEVELOPMENT IN THE FIELD OF PHYSIOLOGICAL RESEARCH, IN CLASS 42 (U.S. CLS. 100 AND 101).

FIRST USE 10-1-2010; IN COMMERCE 1-4-2011.

THE MARK CONSISTS OF STANDARD CHARACTERS WITHOUT CLAIM TO ANY PARTICULAR FONT, STYLE, SIZE, OR COLOR.

SER. NO. 85-319,392, FILED 5-12-2011.

MICHAEL WIENER, EXAMINING ATTORNEY



David J. Kyffers

Director of the United States Patent and Trademark Office

United States of America

United States Patent and Trademark Office

FIRST CALIFORNIA ESCROW

Reg. No. 4,098,393

Registered Feb. 14, 2012

Int. Cls.: 36 and 45

SERVICE MARK

PRINCIPAL REGISTER

TITLE RESOURCE GROUP LLC (DELAWARE LIMITED LIABILITY COMPANY)
3001 LEADENHALL ROAD
MT. LAUREL, NJ 08054

FOR: REAL ESTATE ESCROW SERVICES, IN CLASS 36 (U.S. CLS. 100, 101 AND 102).

FIRST USE 1-0-2006; IN COMMERCE 1-0-2006.

FOR: REAL ESTATE SETTLEMENT SERVICES; REAL ESTATE CLOSING SERVICES, IN CLASS 45 (U.S. CLS. 100 AND 101).

FIRST USE 1-0-2006; IN COMMERCE 1-0-2006.

THE MARK CONSISTS OF STANDARD CHARACTERS WITHOUT CLAIM TO ANY PARTICULAR FONT, STYLE, SIZE, OR COLOR.

NO CLAIM IS MADE TO THE EXCLUSIVE RIGHT TO USE "ESCROW", APART FROM THE MARK AS SHOWN.

SEC. 2(F).

SER. NO. 85-319,428, FILED 5-12-2011.

KATHERINE CHANG, EXAMINING ATTORNEY



David J. Kybas

Director of the United States Patent and Trademark Office

United States of America

United States Patent and Trademark Office

Beyond Surviving

Reg. No. 4,098,394

Registered Feb. 14, 2012

Int. Cl.: 41

SERVICE MARK

PRINCIPAL REGISTER

GRANT, RACHEL E. (CALIFORNIA SOLE PROPRIETORSHIP), DBA RACHEL GRANT
COACHING
1386 LA PLAYA STREET
SAN FRANCISCO, CA 94122

FOR: LIFE COACHING SERVICES IN THE FIELD OF TRAUMA RECOVERY, RELATION-
SHIPS, AND COMMUNICATION, IN CLASS 41 (U.S. CLS. 100, 101 AND 107).

FIRST USE 12-1-2010; IN COMMERCE 12-1-2010.

THE MARK CONSISTS OF STANDARD CHARACTERS WITHOUT CLAIM TO ANY PAR-
TICULAR FONT, STYLE, SIZE, OR COLOR.

SER. NO. 85-319,535, FILED 5-12-2011.

NORA BUCHANAN WILL, EXAMINING ATTORNEY



David J. Kyjars

Director of the United States Patent and Trademark Office

United States of America

United States Patent and Trademark Office

Mahalaya

Reg. No. 4,098,395

Registered Feb. 14, 2012

Int. Cls.: 35 and 37

SERVICE MARK

PRINCIPAL REGISTER

WILLIS, ERIC JONATHAN (UNITED STATES INDIVIDUAL), DBA MAHALAYA
1746 ASHBERRY DRIVE
PALMDALE, CA 93551

FOR: PROMOTING PUBLIC AWARENESS OF ECO-SPIRITUAL PRACTICES, SUSTAINABLE PROSPERITY, INTEGRITY OF OUR PLANETARY BIOLOGICAL SUPPORT SYSTEMS AND LOHAS (LIFESTYLES OF HEALTH AND SUSTAINABILITY), SUSTAINABLE PRODUCTS, SUSTAINABLE BUILDING METHODS AND MATERIALS USED IN CONSTRUCTION, SUSTAINABLE LAND USE DESIGN, PERMACULTURE, SUSTAINABLE LIFESTYLES, COMMUNITIES COMMITTED TO ENVIRONMENTALLY SOUND AND SUSTAINABLE USE OF RESOURCES FOR INDIVIDUALS AND FAMILIES THAT DESIRE A LIFESTYLE OF HEALTH AND SUSTAINABILITY IN HARMONY WITH THE ENVIRONMENT AND SUSTAINABLE TECHNOLOGIES, NAMELY, TECHNOLOGIES FOR THE HARNESSING AND UTILIZATION OF SOLAR, WIND, WATER AND GEOTHERMAL RESOURCES; WHOLESALE AND RETAIL STORE SERVICES AND ON-LINE WHOLESALE AND RETAIL STORE SERVICES FEATURING PRODUCTS FOR THE ENVIRONMENTALLY CONSCIOUS AND ECO-SPIRITUAL THAT FURTHER SUSTAINABLE PROSPERITY, INTEGRITY OF OUR PLANETARY BIOLOGICAL SUPPORT SYSTEMS AND LIFESTYLES OF HEALTH AND SUSTAINABILITY, NAMELY, CLOTHING, FASHION ACCESSORIES, HOUSE WARES, BEDDING, FURNITURE, ELECTRONICS, FOOD, DRINKS, DECORATIONS, LANDSCAPE PRODUCTS INCLUDING LIVE PLANTS AND SEEDS, TOOLS, STORAGE CONTAINERS, WATER FILTRATION APPARATUS, AND SUSTAINABLE TECHNOLOGIES, NAMELY, TECHNOLOGIES FOR THE HARNESSING AND UTILIZATION OF SOLAR, WIND, WATER AND GEOTHERMAL RESOURCES; REAL ESTATE MARKETING SERVICES IN THE FIELD OF PROMOTION AND DISSEMINATION OF ECO-SPIRITUAL SUSTAINABLE COMMUNITIES, RETREATS AND DEVELOPMENTS FOR INDIVIDUALS AND FAMILIES THAT DESIRE LIFESTYLES OF HEALTH AND SUSTAINABLE PROSPERITY IN HARMONY WITH THE ENVIRONMENT COMMITTED TO SUSTAINABLE LAND USE DESIGN, PERMACULTURE, ENVIRONMENTALLY SOUND AND SUSTAINABLE USE OF RESOURCES AND SUSTAINABLE TECHNOLOGIES, NAMELY, TECHNOLOGIES FOR THE HARNESSING AND UTILIZATION OF SOLAR, WIND, WATER AND GEOTHERMAL RESOURCES, IN CLASS 35 (U.S. CLS. 100, 101 AND 102).



David J. Kyffers

Director of the United States Patent and Trademark Office

FIRST USE 1-0-2011; IN COMMERCE 1-0-2011.

FOR: REAL ESTATE DEVELOPMENT SERVICES IN THE FIELD OF ECO-SPIRITUAL SUSTAINABLE COMMUNITIES FOR INDIVIDUALS AND FAMILIES THAT DESIRE

Reg. No. 4,098,395 LIFESTYLES OF HEALTH AND SUSTAINABLE PROSPERITY IN HARMONY WITH THE ENVIRONMENT COMMITTED TO SUSTAINABLE LAND USE DESIGN, PERMACULTURE, ENVIRONMENTALLY SOUND AND SUSTAINABLE USE OF RESOURCES AND SUSTAINABLE TECHNOLOGIES, NAMELY, TECHNOLOGIES FOR THE HARNESSING AND UTILIZATION OF SOLAR, WIND, WATER AND GEOTHERMAL RESOURCES, IN CLASS 37 (U.S. CLS. 100, 103 AND 106).

FIRST USE 1-0-2011; IN COMMERCE 1-0-2011.

THE MARK CONSISTS OF STANDARD CHARACTERS WITHOUT CLAIM TO ANY PARTICULAR FONT, STYLE, SIZE, OR COLOR.

THE WORDING "MAHALAYA" HAS NO MEANING IN A FOREIGN LANGUAGE.

SER. NO. 85-319,754, FILED 5-12-2011.

JAMES LOVELACE, EXAMINING ATTORNEY

United States of America

United States Patent and Trademark Office

Rapson

Reg. No. 4,098,396

Registered Feb. 14, 2012

Int. Cl.: 20

TRADEMARK

PRINCIPAL REGISTER

RALPH RAPSON & ASSOCIATES, INC. (MINNESOTA CORPORATION), DBA RAPSON
ARCHITECTS
409 CEDAR AVE SOUTH
MINNEAPOLIS, MN 55454

FOR: FURNITURE, IN CLASS 20 (U.S. CLS. 2, 13, 22, 25, 32 AND 50).

FIRST USE 12-31-1945; IN COMMERCE 12-31-1945.

THE MARK CONSISTS OF STANDARD CHARACTERS WITHOUT CLAIM TO ANY PARTICULAR FONT, STYLE, SIZE, OR COLOR.

SEC. 2(F).

SER. NO. 85-320,543, FILED 5-13-2011.

EMILY CARLSEN, EXAMINING ATTORNEY



David J. Kyffers

Director of the United States Patent and Trademark Office

United States of America

United States Patent and Trademark Office

IDENTIFIED



Child of God

Reg. No. 4,098,397

PONCE, JOSE (UNITED STATES INDIVIDUAL)

Registered Feb. 14, 2012

296 E. 4TH ST.

#101

Int. Cl.: 16

HIALEAH, FL 33010

TRADEMARK

FOR: FRAMED CHRISTIAN ART PRINTS IN A PUBLIC PROCLAMATION DOCUMENT OF FAITH, WITH ALTERED CHRISTIAN VERSES, REARRANGED INTO FIRST PERSON, IN CLASS 16 (U.S. CLS. 2, 5, 22, 23, 29, 37, 38 AND 50).

PRINCIPAL REGISTER

FIRST USE 4-1-2010; IN COMMERCE 4-1-2010.

THE MARK CONSISTS OF A DESIGN SIMILAR TO THE CHRISTIAN FISH LOGO BUT IT HAS ANOTHER TAIL PUT INTO THE OTHER END, MAKING IT INTENTIONALLY TO LOOK EXACTLY AS AN EYE. THE WORDING "IDENTIFIED" APPEARS TO THE LEFT OF THE DESIGN. THE WORDING "CHILD OF GOD" APPEARS TO THE RIGHT OF THE DESIGN.

SER. NO. 85-320,906, FILED 5-13-2011.

WILLIAM BRECKENFELD, EXAMINING ATTORNEY

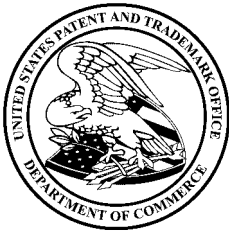

David J. Kyffers

Director of the United States Patent and Trademark Office

United States of America

United States Patent and Trademark Office

MPMA

Reg. No. 4,098,398

Registered Feb. 14, 2012

Int. Cls.: 35, 36 and 41

SERVICE MARK

PRINCIPAL REGISTER

NATIONAL MONTFORD POINT MARINE ASSOCIATION (PENNSYLVANIA NON-PROFIT CORPORATION)
P.O. BOX 64066
VIRGINIA BEACH, VA 23467

FOR: CHARITABLE SERVICES, NAMELY, ORGANIZING AND CONDUCTING VOLUNTEER PROGRAMS AND COMMUNITY SERVICE PROJECTS; ASSOCIATION SERVICES, NAMELY, ORGANIZING CHAPTERS OF A VETERANS ORGANIZATION AND PROMOTING THE INTERESTS OF THE MEMBERS THEREOF; ORGANIZATION OF ANNUAL MARINE ASSOCIATION BUSINESS CONVENTIONS, IN CLASS 35 (U.S. CLS. 100, 101 AND 102).

FIRST USE 0-0-1965; IN COMMERCE 1-0-1969.

FOR: PROVIDING EDUCATIONAL SCHOLARSHIPS, IN CLASS 36 (U.S. CLS. 100, 101 AND 102).

FIRST USE 0-0-1965; IN COMMERCE 1-0-1978.

FOR: ORGANIZATION OF ANNUAL MARINE ASSOCIATION EDUCATIONAL CONVENTIONS; PROVIDING ONLINE NEWSLETTERS CONTAINING CURRENT AND HISTORICAL INFORMATION ABOUT THE U.S. MARINES; ARRANGING AND CONDUCTING CONTESTS TO RAISE FUNDS FOR MILITARY VETERANS PROGRAMS; MUSEUM SERVICES; PROVIDING RECOGNITION BY WAY OF AWARDS TO PROMOTE COMMUNITY SERVICE, VOLUNTEER PROGRAMS AND YOUTH PROGRAMS; PROVIDING A WEBSITE FOR MARINES AND MARINE VETERANS FOR EDUCATIONAL AND ENTERTAINMENT PURPOSES IN THE FIELDS OF MILITARY ORGANIZATIONS AND CONVENTIONS, MILITARY HISTORY, MILITARY LIBRARIES AND MUSEUMS, AND CURRENT EVENTS AND NEWS, IN CLASS 41 (U.S. CLS. 100, 101 AND 107).

FIRST USE 0-0-1965; IN COMMERCE 3-15-2000.

THE MARK CONSISTS OF STANDARD CHARACTERS WITHOUT CLAIM TO ANY PARTICULAR FONT, STYLE, SIZE, OR COLOR.

SER. NO. 85-321,418, FILED 5-16-2011.

BRIAN PINO, EXAMINING ATTORNEY



David J. Kyffers

Director of the United States Patent and Trademark Office

United States of America

United States Patent and Trademark Office

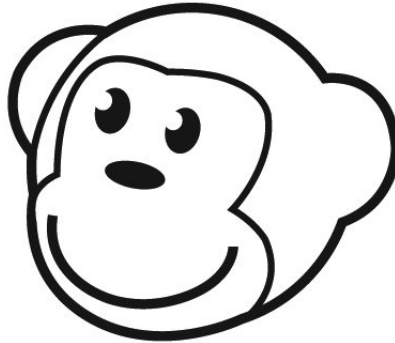

Reg. No. 4,098,399

Registered Feb. 14, 2012

Int. Cl.: 35

SERVICE MARK

PRINCIPAL REGISTER

THINKGEEK, INC. (DELAWARE CORPORATION)
11216 WAPLES MILL RD.
SUITE 100
FAIRFAX, VA 22030

FOR: ONLINE RETAIL STORE SERVICES TARGETED TO THE COMPUTER COMMUNITY FEATURING A VARIETY OF ITEMS, NAMELY, CLOTHING, BOOKS, TOYS, MUGS, GLASSWARE, LAMPS, ELECTRONICS, PAPER GOODS, FOOD STUFFS, BEVERAGES, HATS, KEY CHAINS AND RINGS, AND TOOLS; ONLINE RETAIL STORE SERVICES FEATURING A WIDE VARIETY OF CONSUMER GOODS OF OTHERS; ONLINE RETAIL STORE SERVICES IN THE FIELDS OF CONSUMER ELECTRONICS, CLOTHING AND GENERAL CONSUMER MERCHANDISE, IN CLASS 35 (U.S. CLS. 100, 101 AND 102).

FIRST USE 10-31-2002; IN COMMERCE 10-31-2002.

THE MARK CONSISTS OF A MONKEY FACE.

SER. NO. 85-321,535, FILED 5-16-2011.

EMILY CHUO, EXAMINING ATTORNEY



David J. Kyffers

Director of the United States Patent and Trademark Office

United States of America

United States Patent and Trademark Office



Reg. No. 4,098,400

Registered Feb. 14, 2012

Int. Cls.: 29 and 30

TRADEMARK

PRINCIPAL REGISTER

KOLAH, MINA (UNITED STATES INDIVIDUAL), DBA SORMINA FOODS
1232 NORMAN PLACE
LOS ANGELES, CA 90049

FOR: DRIED FRUITS; FRUIT SPREADS; JAMS; PICKLED VEGETABLES, IN CLASS 29 (U.S. CL. 46).

FIRST USE 5-11-2011; IN COMMERCE 5-11-2011.

FOR: FOOD SEASONINGS; FRUIT SAUCES EXCLUDING CRANBERRY SAUCE AND APPLE SAUCE; GRANOLA; SALAD DRESSINGS, IN CLASS 30 (U.S. CL. 46).

FIRST USE 5-11-2011; IN COMMERCE 5-11-2011.

THE MARK CONSISTS OF A BLACK AND WHITE HAND HOLDING A PURPLE FIG WITH A GREEN LEAF WITHIN A BLACK AND WHITE, LACE LIKE BORDER. BENEATH THE HAND IS THE WORDING GRACE & I ALSO IN BLACK.

THE COLOR(S) BLACK, WHITE, PURPLE, GREEN IS/ARE CLAIMED AS A FEATURE OF THE MARK.

SER. NO. 85-321,812, FILED 5-16-2011.

KATINA MISTER, EXAMINING ATTORNEY



David J. Kybas

Director of the United States Patent and Trademark Office

United States of America

United States Patent and Trademark Office

WAVE HILL BREADS

Reg. No. 4,098,401

Registered Feb. 14, 2012

Int. Cl.: 30

TRADEMARK

PRINCIPAL REGISTER

NEW ENGLAND BREAD COMPANY, LLC (CONNECTICUT LIMITED LIABILITY COMPANY)
196 DANBURY ROAD
WILTON, CT 06897

FOR: BREAD AND BREAD PRODUCTS, NAMELY, CROUTONS AND BREAD CHIPS, IN CLASS 30 (U.S. CL. 46).

FIRST USE 8-18-2005; IN COMMERCE 8-18-2005.

THE MARK CONSISTS OF STANDARD CHARACTERS WITHOUT CLAIM TO ANY PARTICULAR FONT, STYLE, SIZE, OR COLOR.

NO CLAIM IS MADE TO THE EXCLUSIVE RIGHT TO USE "BREADS", APART FROM THE MARK AS SHOWN.

SER. NO. 85-322,514, FILED 5-17-2011.

HAI-LY LAM, EXAMINING ATTORNEY



David J. Kybas

Director of the United States Patent and Trademark Office

United States of America

United States Patent and Trademark Office

LIFESAVER

Reg. No. 4,098,402

MID-CONTINENT INSTRUMENT COMPANY, INC. (KANSAS CORPORATION)
9400 E. 34TH STREET N.
WICHITA, KS 67226

Registered Feb. 14, 2012

Int. Cl.: 9

FOR: ATTITUDE INDICATOR GYRO, IN CLASS 9 (U.S. CLS. 21, 23, 26, 36 AND 38).

TRADEMARK

FIRST USE 8-27-2003; IN COMMERCE 8-28-2003.

PRINCIPAL REGISTER

THE MARK CONSISTS OF STANDARD CHARACTERS WITHOUT CLAIM TO ANY PARTICULAR FONT, STYLE, SIZE, OR COLOR.

SER. NO. 85-322,527, FILED 5-17-2011.

DOMINICK J. SALEMI, EXAMINING ATTORNEY



David J. Kybas

Director of the United States Patent and Trademark Office

United States of America

United States Patent and Trademark Office

LMD Realty

Reg. No. 4,098,403

Registered Feb. 14, 2012

Int. Cl.: 36

SERVICE MARK

PRINCIPAL REGISTER

DIAZ,LUIS,D (WISCONSIN SOLE PROPRIETORSHIP), DBA LMD REALTY
SUITE #3
8757 N. 72ND STREET
MILWAUKEE, WI 532232728

FOR: PROVIDING REAL ESTATE LISTINGS AND REAL ESTATE INFORMATION VIA THE INTERNET; REAL ESTATE BROKERAGE, IN CLASS 36 (U.S. CLS. 100, 101 AND 102).

FIRST USE 1-1-2007; IN COMMERCE 1-1-2007.

THE MARK CONSISTS OF STANDARD CHARACTERS WITHOUT CLAIM TO ANY PARTICULAR FONT, STYLE, SIZE, OR COLOR.

NO CLAIM IS MADE TO THE EXCLUSIVE RIGHT TO USE "REALTY", APART FROM THE MARK AS SHOWN.

SER. NO. 85-322,531, FILED 5-17-2011.

DOMINICK J. SALEMI, EXAMINING ATTORNEY



David J. Kybas

Director of the United States Patent and Trademark Office

United States of America

United States Patent and Trademark Office

BASS TUBS

Reg. No. 4,098,404

BASS TUBS OF OKLAHOMA, INC. (OKLAHOMA CORPORATION)
108 E. MAIN, P.O. BOX 170
STRATFORD, OK 74872

Registered Feb. 14, 2012

Int. Cl.: 41

SERVICE MARK

PRINCIPAL REGISTER

FOR: CONDUCTING EDUCATIONAL EXHIBITIONS IN THE NATURE OF HUNTING AND FISHING EXHIBITIONS AND DEMONSTRATIONS; EDUCATIONAL AND ENTERTAINMENT SERVICES, NAMELY, A CONTINUING PROGRAM ABOUT FISHING AND HUNTING ACCESSIBLE BY RADIO, TELEVISION, SATELLITE, AUDIO, VIDEO AND COMPUTER NETWORKS; EDUCATIONAL DEMONSTRATIONS; EDUCATIONAL SERVICES, NAMELY, CONDUCTING INFORMAL PROGRAMS IN THE FIELDS OF FISHING AND HUNTING, USING ON-LINE ACTIVITIES AND INTERACTIVE EXHIBITS, AND PRINTABLE MATERIALS DISTRIBUTED THEREWITH; EDUCATIONAL SERVICES, NAMELY, CONDUCTING ON-LINE EXHIBITIONS AND DISPLAYS AND INTERACTIVE EXHIBITS IN THE FIELD OF FISHING AND HUNTING; EDUCATIONAL SERVICES, NAMELY, CONDUCTING PROGRAMS IN THE FIELD OF FISHING AND HUNTING; EDUCATIONAL SERVICES, NAMELY, PROVIDING DISPLAYS AND EXHIBITS IN THE FIELD OF FISHING AND HUNTING; ENTERTAINMENT IN THE NATURE OF EXHIBITIONS AND DISPLAYS RELATED TO FISHING AND HUNTING; ENTERTAINMENT SERVICES, NAMELY, PERSONAL APPEARANCES BY A CELEBRITY OR EXPERT IN THE AREAS OF FISHING AND HUNTING; FISHING GUIDE SERVICES; ORGANIZATION OF SPORT FISHING COMPETITIONS; ORGANIZING EXHIBITIONS FOR FISHING AND HUNTING; PROVIDING A WEBSITE FEATURING INFORMATION ABOUT HUNTING AND FISHING; PROVIDING FACILITIES FOR RECREATIONAL ACTIVITIES, NAMELY, INTERACTIVE EXHIBITIONS AND DISPLAYS FOR FISHING AND HUNTING; PROVIDING INFORMATION IN THE FIELD OF HUNTING AND FISHING VIA THE INTERNET; PROVIDING INFORMATION ON FISHING TOURNAMENTS; PROVIDING INFORMATION ON RECREATIONAL FISHING; PROVIDING INFORMATION ON RECREATIONAL FISHING HOTSPOTS; PROVIDING INFORMATION ON RECREATIONAL FISHING, NAMELY, WHERE TO FIND CERTAIN KINDS OF FISH FOR FISHING PURPOSES, IN CLASS 41 (U.S. CLS. 100, 101 AND 107).



FIRST USE 2-1-1978; IN COMMERCE 2-1-1978.

THE MARK CONSISTS OF STANDARD CHARACTERS WITHOUT CLAIM TO ANY PARTICULAR FONT, STYLE, SIZE, OR COLOR.

NO CLAIM IS MADE TO THE EXCLUSIVE RIGHT TO USE "BASS", APART FROM THE MARK AS SHOWN.

David J. Kybas

Director of the United States Patent and Trademark Office

Reg. No. 4,098,404 SER. NO. 85-322,663, FILED 5-17-2011.

MICHAEL SOUDERS, EXAMINING ATTORNEY

United States of America

United States Patent and Trademark Office

D-Arts

Reg. No. 4,098,405

KABUSHIKI KAISHA BANDAI (JAPAN CORPORATION), AKA BANDAI CO., LTD.
4-8, KOMAGATA 1-CHOME
TAITO-KU, TOKYO, JAPAN

Registered Feb. 14, 2012

Int. Cl.: 28

FOR: TOY ACTION FIGURES AND ACCESSORIES THEREFOR, IN CLASS 28 (U.S. CLS. 22, 23, 38 AND 50).

TRADEMARK

FIRST USE 11-20-2010; IN COMMERCE 5-24-2011.

PRINCIPAL REGISTER

PRIORITY CLAIMED UNDER SEC. 44(D) ON JAPAN APPLICATION NO. 2010-092670, FILED 11-30-2010, REG. NO. 5403468, DATED 4-1-2011, EXPIRES 4-1-2021.

THE MARK CONSISTS OF THE WORD "D-ARTS" IN A STYLIZED FORM.

SER. NO. 85-323,375, FILED 5-17-2011.

TRACY WHITTAKER-BROWN, EXAMINING ATTORNEY



David J. Kybas

Director of the United States Patent and Trademark Office

United States of America

United States Patent and Trademark Office

BINAH

Reg. No. 4,098,406

Registered Feb. 14, 2012

Int. Cl.: 16

TRADEMARK

PRINCIPAL REGISTER

BINAH INC. (NEW YORK CORPORATION)
207 FOSTER AVENUE
BROOKLYN, NY 11230

FOR: PERIODICAL MAGAZINES IN THE FIELD OF JEWISH WOMEN'S ISSUES AND LIFESTYLE, IN CLASS 16 (U.S. CLS. 2, 5, 22, 23, 29, 37, 38 AND 50).

FIRST USE 9-4-2006; IN COMMERCE 9-4-2006.

THE MARK CONSISTS OF STANDARD CHARACTERS WITHOUT CLAIM TO ANY PARTICULAR FONT, STYLE, SIZE, OR COLOR.

THE ENGLISH TRANSLATION OF THE WORD "BINAH" IN THE MARK IS "WISDOM".

SER. NO. 85-323,728, FILED 5-18-2011.

JAY BESCH, EXAMINING ATTORNEY



David J. Kyffers

Director of the United States Patent and Trademark Office

United States of America

United States Patent and Trademark Office

P.S. I Love You Letters

Reg. No. 4,098,407

Registered Feb. 14, 2012

Int. Cl.: 16

TRADEMARK

PRINCIPAL REGISTER

P.S. I LOVE YOU LETTERS, LLC (CALIFORNIA LIMITED LIABILITY COMPANY)
1440 HOTEL CIRCLE N., STE. 365
SAN DIEGO, CA 92108

FOR: STATIONERY WRITING PAPER AND ENVELOPES, IN CLASS 16 (U.S. CLS. 2, 5, 22, 23, 29, 37, 38 AND 50).

FIRST USE 4-1-2011; IN COMMERCE 4-30-2011.

THE MARK CONSISTS OF STANDARD CHARACTERS WITHOUT CLAIM TO ANY PARTICULAR FONT, STYLE, SIZE, OR COLOR.

OWNER OF U.S. REG. NO. 3,282,370.

NO CLAIM IS MADE TO THE EXCLUSIVE RIGHT TO USE "LETTERS", APART FROM THE MARK AS SHOWN.

SER. NO. 85-323,738, FILED 5-18-2011.

JAY BESCH, EXAMINING ATTORNEY



David J. Kybas

Director of the United States Patent and Trademark Office

United States of America

United States Patent and Trademark Office

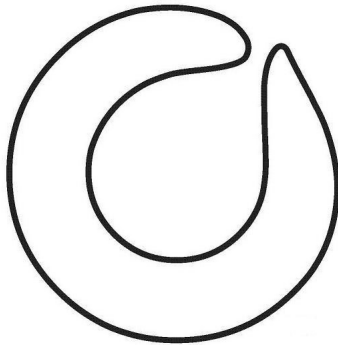

Reg. No. 4,098,408

Registered Feb. 14, 2012

Int. Cl.: 43

SERVICE MARK

PRINCIPAL REGISTER

ORANGE LEAF HOLDINGS LLC (OKLAHOMA LIMITED LIABILITY COMPANY), DBA
ORANGE LEAF FROZEN YOGURT
14313 N. MAY AVE., SUITE 100
OKLAHOMA CITY, OK 73134

FOR: RESTAURANT SERVICES, IN CLASS 43 (U.S. CLS. 100 AND 101).

FIRST USE 1-1-2010; IN COMMERCE 1-1-2010.

THE MARK CONSISTS OF A STYLIZED LETTER "O".

SER. NO. 85-324,012, FILED 5-18-2011.

ELLEN PERKINS, EXAMINING ATTORNEY



David J. Kybas

Director of the United States Patent and Trademark Office

United States of America

United States Patent and Trademark Office

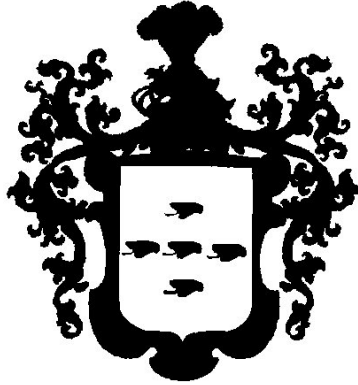

COUTURE BAE

Reg. No. 4,098,409

ALBAN, JONATHAN (UNITED STATES INDIVIDUAL)
4205 E REDWOOD LN
PHOENIX, AZ 85048

Registered Feb. 14, 2012

Int. Cls.: 25, 40 and 42

FOR: CLOTHING, NAMELY, SHIRTS, DRESSES, PANTS, SUITS, SHORTS, HATS, BLOUSES, TIES, JACKETS, SWEATERS, SKIRTS, AND BELTS, COATS, IN CLASS 25 (U.S. CLS. 22 AND 39).

TRADEMARK

FIRST USE 4-24-2011; IN COMMERCE 4-24-2011.

SERVICE MARK

FOR: CUSTOM FABRICATION AND PRODUCTION OF CLOTHING TO THE ORDER AND SPECIFICATION OF OTHERS, IN CLASS 40 (U.S. CLS. 100, 103 AND 106).

PRINCIPAL REGISTER

FIRST USE 4-24-2011; IN COMMERCE 4-24-2011.

FOR: DESIGN FOR OTHERS IN THE FIELD OF CLOTHING, IN CLASS 42 (U.S. CLS. 100 AND 101).

FIRST USE 4-24-2011; IN COMMERCE 4-24-2011.

NO CLAIM IS MADE TO THE EXCLUSIVE RIGHT TO USE "COUTURE", APART FROM THE MARK AS SHOWN.



THE MARK CONSISTS OF A GRAPHIC OF A KNIGHT'S HELMET ON TOP OF A SHIELD. THE SHIELD DISPLAYS FIVE SNAKE HEADS SHOWING THEIR TONGUES IN A HISSING POSE. FLORAL LIKE DECORATIONS COME OUT OF THE KNIGHT'S HELMET AND DOWN THE SIDE OF THE SHIELD. THE KNIGHTS HELMET HAS FEATHERED ADORNMENT ON TOP. TO THE RIGHT OF THE SHIELD AND HELMET, IS THE STYLIZED TEXT "COUTURE BAE" IN BOLD FONT.

SER. NO. 85-324,193, FILED 5-18-2011.

KELLEY WELLS, EXAMINING ATTORNEY

David J. Kyffers

Director of the United States Patent and Trademark Office

United States of America

United States Patent and Trademark Office



Reg. No. 4,098,410

CALEB JOHN SABAT (UNITED STATES INDIVIDUAL)
230 S. FIRST ST.
OCOE, FL 34761

Registered Feb. 14, 2012

Int. Cls.: 35 and 36

FOR: DATA COMPILING AND ANALYZING IN THE FIELD OF INSURANCE; INSURANCE LEAD COLLECTION AND MATCHING SERVICES, NAMELY, MATCHING CONSUMER REQUESTS FOR INSURANCE POLICY QUOTES COLLECTED OVER THE INTERNET TO PRE-QUALIFIED INSURANCE BROKERS, AGENTS AND AGENCIES INTERESTED IN THOSE REQUESTS; MANAGING THE OPERATIONS OF INSURANCE AGENCIES AND BROKERS ON AN OUTSOURCING BASIS; PROMOTION OF FINANCIAL AND INSURANCE SERVICES, ON BEHALF OF THIRD PARTIES; PROVIDING INSURANCE AGENT REFERRALS; PROVIDING SALES LEADS FOR THE AUTOMOTIVE FINANCE AND INSURANCE INDUSTRIES; TRACKING AND MONITORING INSURANCE COMPLIANCE, IN CLASS 35 (U.S. CLS. 100, 101 AND 102).

SERVICE MARK

PRINCIPAL REGISTER

FIRST USE 2-28-2010; IN COMMERCE 7-14-2010.

FOR: ADMINISTRATION OF EMPLOYEE BENEFIT PLANS CONCERNING INSURANCE AND FINANCE; ADMINISTRATION OF EMPLOYEE WELFARE BENEFIT PLANS CONCERNING INSURANCE AND FINANCE; BROKERAGE IN THE FIELD OF LIFE, DISABILITY, EMPLOYEE BENEFITS, HOME, ACCIDENT, CAR, PROPERTY INSURANCE; CLAIMS ADMINISTRATION SERVICES IN THE FIELD OF HEALTH INSURANCE; CONSULTING AND INFORMATION CONCERNING INSURANCE; CONSULTING SERVICES IN THE FIELD OF STATE AND FEDERAL EMPLOYEE BENEFIT PLANS CONCERNING INSURANCE AND FINANCE; DEBT CANCELLATION SERVICES USING PROCEEDS OF LIFE, DISABILITY AND UNEMPLOYMENT INSURANCE; DENTAL HEALTH INSURANCE ADMINISTRATION; FINANCIAL CONSULTANCY AND INSURANCE CONSULTANCY; FINANCIAL SERVICES, NAMELY, LIFE INSURANCE SETTLEMENT SERVICES; FINANCIAL SERVICES, NAMELY, PROVIDING AN INVESTMENT OPTION AVAILABLE FOR VARIABLE ANNUITY AND VARIABLE LIFE INSURANCE PRODUCTS; INSURANCE ADMINISTRATION; INSURANCE AGENCIES; INSURANCE AGENCY AND BROKERAGE; INSURANCE BROKERAGE; INSURANCE BROKERAGE SERVICES; INSURANCE CLAIMS ADMINISTRATION; INSURANCE CLAIMS PROCESSING; INSURANCE CONSULTANCY; INSURANCE CONSULTANCY SERVICES, NAMELY, PROVIDING ADVICE IN THE FIELD OF PROPERTY AND CASUALTY INSURANCE; INSURANCE CONSULTATION; INSURANCE INFORMATION; INSURANCE INFORMATION AND CONSULTANCY; INSURANCE SERVICES, NAMELY, INSURANCE ELIGIBILITY REVIEW AND VERIFICATION AND CONSULTATION IN THE INSURANCE



David J. Kyjars

Director of the United States Patent and Trademark Office

Reg. No. 4,098,410 INDUSTRY; INSURANCE SERVICES, NAMELY, VIATICAL SETTLEMENT SERVICES, LIFE SETTLEMENT SERVICES FOR INSURANCE POLICYHOLDERS, AND SENIOR SETTLEMENT SERVICES FOR INSURANCE POLICYHOLDERS; INSURANCE SERVICES, NAMELY, WRITING PROPERTY AND CASUALTY INSURANCE; INSURANCE SERVICES, PROVIDING PREMIUM RATE QUOTES VIA ON-LINE, TELEPHONE AND MAIL MEANS; LIFE INSURANCE BROKERAGE; PROCESSING, ADMINISTERING AND MANAGING EMPLOYEE BENEFIT PLANS CONCERNING INSURANCE AND FINANCE; PROVIDING A WEBSITE FEATURING EDUCATIONAL INFORMATION IN THE FIELD OF BUSINESS INSURANCE; PROVIDING DETAILED INFORMATION REGARDING AVAILABLE INSURANCE PRODUCTS FOR COMMERCIAL PROPERTY AND CASUALTY, PROFESSIONAL AND PERSONAL LINES; PROVIDING INFORMATION IN INSURANCE MATTERS; PROVIDING INFORMATION REGARDING POLICY RATES FOR ALL TYPES OF INSURANCE AND ELECTRONIC PROCESSING OF INSURANCE CLAIMS AND PAYMENT DATA OVER A WEB BASED COMPUTER NETWORK; PROVIDING VEHICLE INSURANCE RATE QUOTES, IN CLASS 36 (U.S. CLS. 100, 101 AND 102).

FIRST USE 2-28-2010; IN COMMERCE 7-14-2010.

NO CLAIM IS MADE TO THE EXCLUSIVE RIGHT TO USE "INSURANCE GROUP", APART FROM THE MARK AS SHOWN.

THE COLOR(S) BLUE, LIGHT BLUE, WHITE IS/ARE CLAIMED AS A FEATURE OF THE MARK.

THE MARK CONSISTS OF THE ACRONYM "SIG" IN WHITE WITH LIGHT BLUE, WHITE AND DARK BLUE DIAGONAL LINES BEHIND THE LETTERING. UNDER THE ACRONYM "SIG" IS WRITTEN "SABAT INSURANCE GROUP".

SER. NO. 85-324,343, FILED 5-18-2011.

REGINA DRUMMOND, EXAMINING ATTORNEY

United States of America

United States Patent and Trademark Office



Reg. No. 4,098,411

MEIER, CADY, D (UNITED STATES INDIVIDUAL)
RT 2 TRAUGH FORK ROAD BOX 193A
BRISTOL, WV 26426

Registered Feb. 14, 2012

Int. Cl.: 21

FOR: PORTABLE COOLERS, IN CLASS 21 (U.S. CLS. 2, 13, 23, 29, 30, 33, 40 AND 50).

TRADEMARK

FIRST USE 1-1-1999; IN COMMERCE 1-1-1999.

PRINCIPAL REGISTER

THE MARK CONSISTS OF THE STYLIZED WORDING "CADYDID" IN BLACK LETTERING WITH A GREEN DOT OVER THE LETTER "I" AND A DESIGN OF A GREEN KATYDID, ALL APPEARING ON A WHITE BACKGROUND.

THE COLOR(S) GREEN, BLACK AND WHITE IS/ARE CLAIMED AS A FEATURE OF THE MARK.

SER. NO. 85-324,524, FILED 5-19-2011.

NATALIE POLZER, EXAMINING ATTORNEY



David J. Kyffers

Director of the United States Patent and Trademark Office

United States of America

United States Patent and Trademark Office

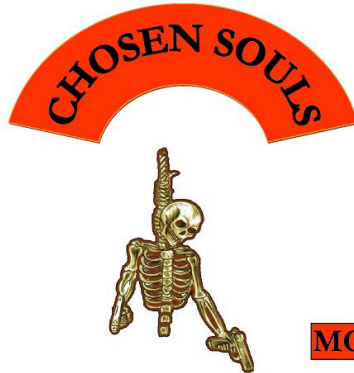

Reg. No. 4,098,412

Registered Feb. 14, 2012

Int. Cl.: 41

SERVICE MARK

PRINCIPAL REGISTER

CHOSEN SOULS MOTORCYCLE CLUB, INC. (NEW YORK CORPORATION)
4095 MAYWOOD DRIVE
SEAFORD, NY 11783

FOR: ENTERTAINMENT SERVICES IN THE NATURE OF ORGANIZING, ARRANGING AND CONDUCTING MOTORCYCLE RIDING EXCURSIONS, IN CLASS 41 (U.S. CLS. 100, 101 AND 107).

FIRST USE 5-0-2010; IN COMMERCE 5-0-2010.

NO CLAIM IS MADE TO THE EXCLUSIVE RIGHT TO USE "MC", APART FROM THE MARK AS SHOWN.

THE COLOR(S) ORANGE, BROWN, GOLD, WHITE AND BLACK IS/ARE CLAIMED AS A FEATURE OF THE MARK.

THE MARK CONSISTS OF A THICK PARTIAL CIRCLE OUTLINE IN ORANGE CONTAINING THE BLACK WORDS "CHOSEN SOULS". BELOW IS AN IMAGE OF A HUMAN SKELETON HANGING FROM A ROPE, HOLDING HAND GUNS IN EACH HAND, ALL IN SHADES OF BROWN AND GOLD WITH WHITE. THERE IS A LITTLE ORANGE BOX TO THE RIGHT BOTTOM CORNER OF THE LOGO CONTAINING THE BLACK LETTERS "MC".

SER. NO. 85-324,608, FILED 5-19-2011.

KATHERINE STOIDES, EXAMINING ATTORNEY



David J. Kybas

Director of the United States Patent and Trademark Office

United States of America

United States Patent and Trademark Office

Q QARDS

Reg. No. 4,098,413

HURLEY, DANIEL K (UNITED STATES INDIVIDUAL), DBA DANNY HURLEY
3247 GALAHAD DALLAS
DALLAS, TX 75229

Registered Feb. 14, 2012

Int. Cl.: 9

FOR: COMPUTER APPLICATION SOFTWARE FOR MOBILE PHONES, PORTABLE MEDIA PLAYERS, HANDHELD COMPUTER, NAMELY, SOFTWARE FOR CREATING AND SENDING CARD MESSAGES TO MOBILE DEVICE USERS, IN CLASS 9 (U.S. CLS. 21, 23, 26, 36 AND 38).

TRADEMARK

PRINCIPAL REGISTER

FIRST USE 5-19-2011; IN COMMERCE 5-19-2011.

THE MARK CONSISTS OF STANDARD CHARACTERS WITHOUT CLAIM TO ANY PARTICULAR FONT, STYLE, SIZE, OR COLOR.

SER. NO. 85-324,668, FILED S.R. 5-19-2011 AM. P.R. 9-20-2011.

STEPHANIE ALI, EXAMINING ATTORNEY



David J. Kyffers

Director of the United States Patent and Trademark Office

United States of America

United States Patent and Trademark Office



Reg. No. 4,098,414

Registered Feb. 14, 2012

Int. Cls.: 35 and 44

SERVICE MARK

PRINCIPAL REGISTER

ALPACA REGISTRY, INC. (COLORADO NON-PROFIT CORPORATION)
5901 NORTH 28TH STREET, SUITE 100
LINCOLN, NE 68504

FOR: PROVIDING A WEBSITE FEATURING INFORMATION IN THE FIELDS OF ALPACA REGISTRATION, ALPACA MARKETING AND BUSINESS MANAGEMENT OF ALPACA FARMS , IN CLASS 35 (U.S. CLS. 100, 101 AND 102).

FIRST USE 1-15-2011; IN COMMERCE 1-15-2011.

FOR: PROVIDING A WEBSITE FEATURING INFORMATION IN THE FIELD OF CARE OF ALPACAS, NAMELY, BREEDING, FEEDING, NUTRITION, GROOMING, AND VETERINARY SERVICES, IN CLASS 44 (U.S. CLS. 100 AND 101).

FIRST USE 1-15-2011; IN COMMERCE 1-15-2011.

OWNER OF U.S. REG. NOS. 3,566,885, 3,682,549 AND OTHERS.

NO CLAIM IS MADE TO THE EXCLUSIVE RIGHT TO USE "POWERED BY ALPACA REGISTRY INC.", APART FROM THE MARK AS SHOWN.

THE MARK CONSISTS OF TWO CONCENTRIC CIRCLES WITH TWO ALPACAS INSIDE THE INNER CIRCLE, THE REMAINDER OF WHICH IS SHADED, AND THE WORD "ARIACADEMY" TO THE RIGHT OF THE CIRCLE WITH THE "A" OF "ARI" OVERLAPPING THE CIRCLE. "ARI" APPEARS IN LOWERCASE LETTERS AND "ACADEMY" IN UPPERCASE LETTERS. BELOW "ARIACADEMY" ARE THE WORDS "POWERED BY ALPACA REGISTRY INC." IN LOWERCASE LETTERS.

SER. NO. 85-324,874, FILED 5-19-2011.

MATTHEW PAPPAS, EXAMINING ATTORNEY



David J. Kappas

Director of the United States Patent and Trademark Office

United States of America

United States Patent and Trademark Office



Reg. No. 4,098,415

ALPACA REGISTRY, INC. (COLORADO NON-PROFIT CORPORATION)
5901 NORTH 28TH STREET, SUITE 100
LINCOLN, NE 68504

Registered Feb. 14, 2012

Int. Cls.: 35 and 44

FOR: PROVIDING AN ONLINE SEARCHABLE DATABASE IN THE FIELD OF ALPACA PEDIGREE RECORDS, IN CLASS 35 (U.S. CLS. 100, 101 AND 102).

SERVICE MARK

FIRST USE 12-6-2010; IN COMMERCE 12-6-2010.

PRINCIPAL REGISTER

FOR: PROVIDING AN ONLINE SEARCHABLE DATABASE IN THE FIELD OF ALPACA BREEDERS, IN CLASS 44 (U.S. CLS. 100 AND 101).

FIRST USE 12-6-2010; IN COMMERCE 12-6-2010.

OWNER OF U.S. REG. NOS. 2,348,066, 3,679,098 AND OTHERS.

NO CLAIM IS MADE TO THE EXCLUSIVE RIGHT TO USE "POWERED BY ALPACA REGISTRY INC.", APART FROM THE MARK AS SHOWN.

THE MARK CONSISTS OF A CIRCLE CONTAINING SIX RECTANGULAR BOXES INTERCONNECTED WITH LINES, THE REMAINDER OF THE CIRCLE BEING SHADED, AND THE WORD "ARILIST" TO THE RIGHT OF THE CIRCLE WITH THE "A" OF "ARI" OVERLAPPING THE CIRCLE. "ARI" APPEARS IN LOWERCASE LETTERS AND "LIST" IN UPPERCASE LETTERS. BELOW "ARILIST" ARE THE WORDS "POWERED BY ALPACA REGISTRY INC." IN LOWERCASE LETTERS.



SER. NO. 85-325,063, FILED 5-19-2011.

MATTHEW PAPPAS, EXAMINING ATTORNEY

David J. Kappas

Director of the United States Patent and Trademark Office

United States of America

United States Patent and Trademark Office

CHIPPEES

Reg. No. 4,098,416

BRANCH ASSOCIATES, INC. (FLORIDA CORPORATION)
138 WINDWARD DR., P.O. BOX 547
OSPREY, FL 34229

Registered Feb. 14, 2012

Int. Cl.: 9

FOR: CODED ELECTRONIC CERAMIC CHIP CARD CONTAINING PROGRAMMING FOR INVENTORY CONTROL AND VALUE OF CHIP USED AS A PROMOTIONAL PRODUCT, AND LISTING NAME, VALUE, AND BAR CODE ON EXTERIOR OF CHIP, IN CLASS 9 (U.S. CLS. 21, 23, 26, 36 AND 38).

TRADEMARK

PRINCIPAL REGISTER

FIRST USE 6-1-2011; IN COMMERCE 9-10-2011.

THE MARK CONSISTS OF STANDARD CHARACTERS WITHOUT CLAIM TO ANY PARTICULAR FONT, STYLE, SIZE, OR COLOR.

SER. NO. 85-325,103, FILED 5-19-2011.

ANDREA HACK, EXAMINING ATTORNEY



David J. Kyffers

Director of the United States Patent and Trademark Office

United States of America

United States Patent and Trademark Office

WILD DNA

Reg. No. 4,098,417

Registered Feb. 14, 2012

Int. Cl.: 25

TRADEMARK

PRINCIPAL REGISTER

W.DNA FOOTWEAR, INC. (CALIFORNIA CORPORATION)
19445 E. WALNUT DRIVE NORTH
CITY OF INDUSTRY, CA 91789

FOR: SHOES, IN CLASS 25 (U.S. CLS. 22 AND 39).

FIRST USE 6-8-2010; IN COMMERCE 6-8-2010.

THE MARK CONSISTS OF STANDARD CHARACTERS WITHOUT CLAIM TO ANY PARTICULAR FONT, STYLE, SIZE, OR COLOR.

SER. NO. 85-325,372, FILED 5-19-2011.

TINA L. SNAPP, EXAMINING ATTORNEY



David J. Kyffers

Director of the United States Patent and Trademark Office

United States of America

United States Patent and Trademark Office

MUSHER MANAGEMENT

Reg. No. 4,098,418

Registered Feb. 14, 2012

Int. Cl.: 35

SERVICE MARK

PRINCIPAL REGISTER

FALTER, DAVID (UNITED STATES INDIVIDUAL)
525 WOODLAWN AVENUE
GLENCOE, IL 60022

FOR: BUSINESS MANAGEMENT AND BUSINESS ORGANIZATION CONSULTANCY; BUSINESS MANAGEMENT ASSISTANCE; BUSINESS MANAGEMENT CONSULTATION; ADVISORY SERVICES RELATING TO BUSINESS MANAGEMENT AND BUSINESS OPERATIONS; PERSONNEL MANAGEMENT CONSULTANCY; BUSINESS ORGANIZATION AND MANAGEMENT CONSULTANCY, IN CLASS 35 (U.S. CLS. 100, 101 AND 102).

FIRST USE 9-14-2010; IN COMMERCE 9-14-2010.

THE MARK CONSISTS OF STANDARD CHARACTERS WITHOUT CLAIM TO ANY PARTICULAR FONT, STYLE, SIZE, OR COLOR.

NO CLAIM IS MADE TO THE EXCLUSIVE RIGHT TO USE "MANAGEMENT", APART FROM THE MARK AS SHOWN.

SER. NO. 85-325,548, FILED 5-20-2011.

SUSAN RICHARDS, EXAMINING ATTORNEY



David J. Kybas

Director of the United States Patent and Trademark Office

United States of America

United States Patent and Trademark Office

Heartbreak Hotline

Reg. No. 4,098,419

HEARTBREAK HOTLINE, INC. (FLORIDA CORPORATION)

Registered Feb. 14, 2012

101 N. ADAMS DRIVE
SARASOTA, FL 34236

Int. Cl.: 45

FOR: CONSULTING IN THE FIELD OF PERSONAL RELATIONSHIPS; PROVIDING A WEB SITE FEATURING INFORMATION AND CONTENT IN THE FIELDS OF PERSONAL RELATIONSHIPS, PERSONAL GROWTH AND MOTIVATION, AND SELF-FULFILLMENT; PROVIDING A WEB SITE FEATURING INFORMATION ON LOVE, ROMANCE AND INTERPERSONAL RELATIONSHIPS, IN CLASS 45 (U.S. CLS. 100 AND 101).

SERVICE MARK

PRINCIPAL REGISTER

FIRST USE 6-14-2010; IN COMMERCE 5-1-2011.

THE MARK CONSISTS OF STANDARD CHARACTERS WITHOUT CLAIM TO ANY PARTICULAR FONT, STYLE, SIZE, OR COLOR.

NO CLAIM IS MADE TO THE EXCLUSIVE RIGHT TO USE "HOTLINE", APART FROM THE MARK AS SHOWN.

SER. NO. 85-325,692, FILED 5-20-2011.

KARANENDRA S. CHHINA, EXAMINING ATTORNEY



David J. Kyros

Director of the United States Patent and Trademark Office

United States of America

United States Patent and Trademark Office

ECOTEX

Reg. No. 4,098,420

ECOTEX HEALTHCARE LINEN SERVICE CORP. (WASHINGTON CORPORATION)
726 CHERRY STREET
SUMAS, WA 98295

Registered Feb. 14, 2012

Int. Cls.: 37 and 43

FOR: COMMERCIAL LAUNDRY SERVICES AND LAUNDERING MEDICAL LINEN SERVICES FOR HOSPITALS AND INSTITUTIONS, IN CLASS 37 (U.S. CLS. 100, 103 AND 106).

SERVICE MARK

FIRST USE 2-1-1997; IN COMMERCE 2-1-1997.

PRINCIPAL REGISTER

FOR: RENTAL OF BED AND BATH LINEN, IN PARTICULAR MEDICAL LINEN, FOR HOSPITALS AND INSTITUTIONS, IN CLASS 43 (U.S. CLS. 100 AND 101).

FIRST USE 2-1-1997; IN COMMERCE 2-1-1997.

THE MARK CONSISTS OF STANDARD CHARACTERS WITHOUT CLAIM TO ANY PARTICULAR FONT, STYLE, SIZE, OR COLOR.

SER. NO. 85-325,757, FILED 5-20-2011.

SUSAN RICHARDS, EXAMINING ATTORNEY



David J. Kybas

Director of the United States Patent and Trademark Office

United States of America

United States Patent and Trademark Office



Reg. No. 4,098,421

TAFOYA INC (CALIFORNIA CORPORATION)
11921 FIDEL AVE
WHITTIER, CA 90605

Registered Feb. 14, 2012

Int. Cl.: 37

FOR: ROOFING CONTRACTING; ROOFING SERVICES, IN CLASS 37 (U.S. CLS. 100, 103 AND 106).

SERVICE MARK

FIRST USE 7-7-2010; IN COMMERCE 1-1-2011.

PRINCIPAL REGISTER

NO CLAIM IS MADE TO THE EXCLUSIVE RIGHT TO USE "ROOFING CORPORATION", APART FROM THE MARK AS SHOWN.

THE MARK CONSISTS OF A RECTANGLE WITH THE STYLIZED TEXT "TAF". BELOW THERE IS THE STYLIZED TEXT "TAF ROOFING CORPORATION".

SER. NO. 85-325,884, FILED 5-20-2011.

HENRY S. ZAK, EXAMINING ATTORNEY



David J. Kybas

Director of the United States Patent and Trademark Office

United States of America

United States Patent and Trademark Office

PROADVANCED

Reg. No. 4,098,422

Registered Feb. 14, 2012

Int. Cls.: 22 and 28

TRADEMARK

PRINCIPAL REGISTER

SOCOOL GROUP LIMITED (HONG KONG CORPORATION)
ROOM 905 WORKINGBERG COMMERCIAL BLDG.
41-47 MARBLE ROAD
HONG KONG, CHINA

FOR: COMMERCIAL NETS; HANGING MESH NETS USED FOR STORING SPORTS BALLS; INSECT PROTECTION NETS; TWINE; CUSHIONING NOT OF RUBBER OR PLASTIC IN THE NATURE OF STUFFING; SAILS; TENTS; UNFITTED VEHICLE COVERS, IN CLASS 22 (U.S. CLS. 1, 2, 7, 19, 22, 42 AND 50).

FIRST USE 4-23-2011; IN COMMERCE 4-23-2011.

FOR: BASEBALL GLOVES; BATS FOR GAMES; BATTING GLOVES; GOLF CLUBS; BAGS SPECIALLY DESIGNED TO HOLD CRICKET EQUIPMENT; DIVOT REPAIR TOOLS; GAME TABLES; CARD GAMES; DICE GAMES; BOARD GAMES; MANIPULATIVE GAMES; BALLS FOR GAMES; GOLF GLOVES; GOLF BAGS WITH OR WITHOUT WHEELS; NETS FOR SPORTS; PROTECTIVE PADDING FOR PLAYING BASEBALL, GOLF; MANUALLY-OPERATED EXERCISE EQUIPMENT FOR PHYSICAL FITNESS PURPOSES; GOLF ACCESSORIES, NAMELY, CARRIERS AND DISPENSERS FOR GOLF BALLS; BAGS ESPECIALLY DESIGNED FOR SURFBOARDS; TARGETS; ELECTRONIC TARGETS FOR GAMES AND SPORTS; CHILDREN'S MULTIPLE ACTIVITY TOYS; INFANT TOYS, IN CLASS 28 (U.S. CLS. 22, 23, 38 AND 50).

FIRST USE 4-23-2011; IN COMMERCE 4-23-2011.

THE MARK CONSISTS OF "PROADVANCED" IN STYLIZED LETTERING.

SER. NO. 85-325,888, FILED 5-20-2011.

JENNIFER VASQUEZ, EXAMINING ATTORNEY



David J. Kyffers

Director of the United States Patent and Trademark Office

United States of America

United States Patent and Trademark Office



Reg. No. 4,098,423

SUMMIT IMPORT CORPORATION (NEW YORK CORPORATION)
100 SUMMIT PLACE
JERSEY CITY, NJ 07305

Registered Feb. 14, 2012

Int. Cls.: 29 and 30

FOR: BEAN CURD; FROZEN VEGETABLES; PROCESSED PEANUTS, IN CLASS 29 (U.S. CL. 46).

TRADEMARK

FIRST USE 9-2-2001; IN COMMERCE 9-2-2001.

PRINCIPAL REGISTER

FOR: BUNS; CHINESE STUFFED DUMPLINGS (GYOZA, COOKED); MOON CAKES; PASTRIES; RICE DUMPLINGS DRESSED WITH SWEET BEAN JAM (ANKORO), IN CLASS 30 (U.S. CL. 46).

FIRST USE 9-2-2001; IN COMMERCE 9-2-2001.

THE MARK CONSISTS OF "GONG DE LIN" WITH CHINESE WORDING IN A CIRCULAR PATTERN SURROUNDING THE DESIGN OF A TEMPLE.

THE NON-LATIN CHARACTERS IN THE MARK TRANSLITERATE TO "GONG DE LIN" AND THIS MEANS "TEMPLE OF CHARITY" IN ENGLISH.

SER. NO. 85-325,929, FILED 5-20-2011.

ASMAT KHAN, EXAMINING ATTORNEY



David J. Kybas

Director of the United States Patent and Trademark Office

United States of America

United States Patent and Trademark Office



Reg. No. 4,098,424

Registered Feb. 14, 2012

Int. Cl.: 41

SERVICE MARK

PRINCIPAL REGISTER

TAL, LIAN (UNITED STATES INDIVIDUAL)
200 EAST 17TH STREET, APT. #5C
NEW YORK, NY 10003

FOR: DANCE, ACROBATICS, AND FITNESS STUDIOS; PROVIDING FITNESS AND EXERCISE FACILITIES; INSTRUCTION IN THE FIELD OF DANCE, FITNESS, AND ACROBATICS; ENTERTAINMENT IN THE NATURE OF DANCE AND ACROBATIC PERFORMANCES, IN CLASS 41 (U.S. CLS. 100, 101 AND 107).

FIRST USE 4-14-2011; IN COMMERCE 4-14-2011.

NO CLAIM IS MADE TO THE EXCLUSIVE RIGHT TO USE "POLE", APART FROM THE MARK AS SHOWN.

THE MARK CONSISTS OF A STYLIZED IMAGE OF A WOMAN HANGING WITH ONE ARM ON A POLE, WHICH RISES FROM THE TOP OF THE CAPITAL LETTERS "BP", WITH A "+" ON TOP OF THE LETTERS IN THE MIDDLE OF THE LETTERS, ABOVE THE WORDS "BODY & POLE"; THE SQUARE IS BACKGROUND AND NOT A PART OF THE MARK.

SER. NO. 85-325,973, FILED 5-20-2011.

APRIL ROACH, EXAMINING ATTORNEY



David J. Kyffers

Director of the United States Patent and Trademark Office

United States of America

United States Patent and Trademark Office



Reg. No. 4,098,425

Registered Feb. 14, 2012

Int. Cl.: 41

SERVICE MARK

PRINCIPAL REGISTER

SAY ENTERPRISES (CALIFORNIA CORPORATION), DBA LINDERO LEARNING CENTER
10437 MCLENNAN AVENUE
GRANADA HILLS, CA 91344

FOR: EDUCATION SERVICES, NAMELY, PROVIDING MENTORING, TUTORING, CLASSES, SEMINARS AND WORKSHOPS IN THE FIELD OF K-12 ACADEMICS, IN CLASS 41 (U.S. CLS. 100, 101 AND 107).

FIRST USE 5-16-2011; IN COMMERCE 5-16-2011.

NO CLAIM IS MADE TO THE EXCLUSIVE RIGHT TO USE "LEARNING CENTER", APART FROM THE MARK AS SHOWN.

THE COLOR(S) BLUE, GREEN, AND GOLD IS/ARE CLAIMED AS A FEATURE OF THE MARK.

THE MARK CONSISTS OF THE WORD "LINDERO" IN BLUE WITH THE WORDS "LEARNING CENTER" BENEATH IT IN GREEN. LETTERS ARE IN MODIFIED HARABARA FONT. TO THE LEFT OF THE WORDS IS A BLUE STYLIZED FIGURE OF A PERSON WITH ARMS RAISED IN GLEE. A STYLIZED GOLD STAR IS AT THE TIP OF ONE OF THE ARMS, IMPLYING IT IS HELD IN THE HAND.

SER. NO. 85-326,433, FILED 5-20-2011.

JEFFREY LOOK, EXAMINING ATTORNEY



David J. Kybas

Director of the United States Patent and Trademark Office

United States of America

United States Patent and Trademark Office

oyin handmade

Reg. No. 4,098,426

Registered Feb. 14, 2012

Int. Cl.: 3

TRADEMARK

PRINCIPAL REGISTER

EXITTHEAPPLE, LLC (MARYLAND LIMITED LIABILITY COMPANY), TA OYIN
HANDMADE
6223 NORTHWOOD DR
BALTIMORE, MD 21212

FOR: 3-IN-1 ORGANIC SOAP BARS FOR USE AS SOAP, SHAMPOO AND CONDITIONER; BATH FIZZIES; BATH SOAPS IN LIQUID, SOLID OR GEL FORM; BODY SPRAY USED AS A PERSONAL DEODORANT AND AS FRAGRANCE; BODY WASH; COSMETIC HAIR DRESSING PREPARATIONS; DEODORANTS FOR BODY CARE; FACE AND BODY LOTIONS; HAIR OILS; HAIR POMADES; HAIR SHAMPOOS AND CONDITIONERS; HAIR SPRAY; HAIR STYLING PREPARATIONS; LIP BALM; NATURAL COCOA BUTTER BASED PERSONAL CARE PRODUCTS, NAMELY, BODY LOTION, SHOWER GEL, SOAP, BODY POLISH, BODY AND FOOT SCRUB AND NON-MEDICATED SKIN CREAMS; NON-MEDICATED BALMS FOR USE ON SKIN AND LIPS; NON-MEDICATED SKIN CARE CREAMS AND LOTIONS; NON-MEDICATED HAIR CARE PREPARATIONS; OILS FOR HAIR CONDITIONING; OILS FOR TOILETRY PURPOSES; PREPARATIONS FOR SETTING HAIR, IN CLASS 3 (U.S. CLS. 1, 4, 6, 50, 51 AND 52).

FIRST USE 0-0-2002; IN COMMERCE 6-0-2003.

THE MARK CONSISTS OF STANDARD CHARACTERS WITHOUT CLAIM TO ANY PARTICULAR FONT, STYLE, SIZE, OR COLOR.

THE ENGLISH TRANSLATION OF "OYIN" IN THE MARK IS "HONEY".

SEC. 2(F).

SER. NO. 85-326,664, FILED 5-21-2011.

PATRICIA EVANKO, EXAMINING ATTORNEY



David J. Kyffers

Director of the United States Patent and Trademark Office

United States of America

United States Patent and Trademark Office



Reg. No. 4,098,427

Registered Feb. 14, 2012

Int. Cl.: 25

TRADEMARK

PRINCIPAL REGISTER

ARARAT, AURA M. (UNITED STATES INDIVIDUAL)
SUITE 2D
6344 SAUNDERS STREET
REGO PARK, NY 11374

FOR: T-SHIRTS, IN CLASS 25 (U.S. CLS. 22 AND 39).

FIRST USE 2-1-2011; IN COMMERCE 2-1-2011.

THE MARK CONSISTS OF A STAR LOCATED ON THE BOTTOM LEFT CORNER. THE LETTER "E" LOCATED ON THE UPPER RIGHT CORNER. 3 VERTICAL THICK LINES ON THE LEFT SIDE. 3 HORIZONTAL THICK LINES ON THE RIGHT SIDE. THE WORDS "URBAN EAGLE" ARE LOCATED BELLOE THE STAR AND THE HORIZONTAL LINES.

SER. NO. 85-326,821, FILED 5-21-2011.

LINDA ESTRADA, EXAMINING ATTORNEY



David J. Kybas

Director of the United States Patent and Trademark Office

United States of America

United States Patent and Trademark Office

Julian Hü

Reg. No. 4,098,428

JULIAN HU, LLC (NORTH CAROLINA LIMITED LIABILITY COMPANY)
6106 BRICK LANDING DR.
MONROE, NC 28110

Registered Feb. 14, 2012

Int. Cl.: 25

FOR: SHOES, IN CLASS 25 (U.S. CLS. 22 AND 39).

TRADEMARK

FIRST USE 4-25-2011; IN COMMERCE 4-25-2011.

PRINCIPAL REGISTER

THE MARK CONSISTS OF STANDARD CHARACTERS WITHOUT CLAIM TO ANY PARTICULAR FONT, STYLE, SIZE, OR COLOR.

THE NAME(S), PORTRAIT(S), AND/OR SIGNATURE(S) SHOWN IN THE MARK DOES NOT IDENTIFY A PARTICULAR LIVING INDIVIDUAL.

SER. NO. 85-326,847, FILED 5-22-2011.

KELLEY WELLS, EXAMINING ATTORNEY



David J. Kyffers

Director of the United States Patent and Trademark Office

United States of America

United States Patent and Trademark Office

Legacy Living
Financial Strategies

Reg. No. 4,098,429

KENNEDY, JEFFREY T. (UNITED STATES INDIVIDUAL)
1031 EVANGELINE ROAD EAST
QUINCY, IL 62301

Registered Feb. 14, 2012

Int. Cl.: 36

FOR: FINANCIAL PLANNING SERVICES, IN CLASS 36 (U.S. CLS. 100, 101 AND 102).

SERVICE MARK

FIRST USE 4-12-2011; IN COMMERCE 4-12-2011.

PRINCIPAL REGISTER

NO CLAIM IS MADE TO THE EXCLUSIVE RIGHT TO USE "LEGACY" AND "FINANCIAL STRATEGIES", APART FROM THE MARK AS SHOWN.

THE COLOR(S) GOLD AND BLACK IS/ARE CLAIMED AS A FEATURE OF THE MARK.

THE MARK CONSISTS OF THE WORDS "LEGACY LIVING" IN A GOLD SCRIPT FONT WITH A BLACK UNDERLINE AND THE BLACK ITALICIZED WORDS "FINANCIAL STRATEGIES" BENEATH THE BLACK UNDERLINE.

SER. NO. 85-327,012, FILED 5-23-2011.

NELSON SNYDER, EXAMINING ATTORNEY



David J. Kybas

Director of the United States Patent and Trademark Office

United States of America

United States Patent and Trademark Office

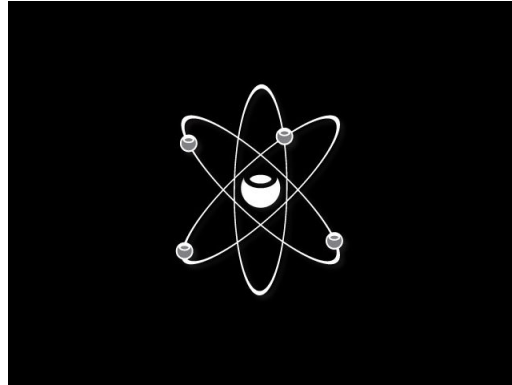

Reg. No. 4,098,430

BERENSON CORP (NEW YORK CORPORATION)
2495 MAIN ST., SUITE 111
BUFFALO, NY 14214

Registered Feb. 14, 2012

Int. Cl.: 6

FOR: COMMON METAL DRAWER PULLS; COMMON METAL PULLS; METAL HANDLES FOR KITCHEN AND BATH CABINETS; METAL KNOBS; METAL PULLS FOR KITCHEN AND BATH CABINETS, IN CLASS 6 (U.S. CLS. 2, 12, 13, 14, 23, 25 AND 50).

TRADEMARK

FIRST USE 4-25-2011; IN COMMERCE 4-25-2011.

PRINCIPAL REGISTER

THE MARK CONSISTS OF 3 ELLIPSES IN WHITE, ATTACHED TO EACH OF WHICH APPEARS A SMALL ICON IN GRAY AND WHITE, IN THE CENTER OF WHICH APPEARS A LARGER ICON IN WHITE AND BLACK, ALL ON A BLACK BACKGROUND.

THE COLOR(S) BLACK, WHITE AND GRAY IS/ARE CLAIMED AS A FEATURE OF THE MARK.

SER. NO. 85-327,039, FILED 5-23-2011.

EDWARD FENNESSY, EXAMINING ATTORNEY



David J. Kyffers

Director of the United States Patent and Trademark Office

United States of America

United States Patent and Trademark Office



SINGLE-CLICK CHECKOUT

Reg. No. 4,098,431

Registered Feb. 14, 2012

Int. Cls.: 36 and 42

SERVICE MARK

PRINCIPAL REGISTER

BILLING REVOLUTION CORP. (DELAWARE CORPORATION)
1409 POST ALLEY
SEATTLE, WA 98101

FOR: PROVIDING ELECTRONIC PROCESSING OF ELECTRONIC FUNDS TRANSFER, ACH, CREDIT CARD, DEBIT CARD, ELECTRONIC CHECK AND ELECTRONIC PAYMENTS, IN CLASS 36 (U.S. CLS. 100, 101 AND 102).

FIRST USE 7-18-2010; IN COMMERCE 10-5-2010.

FOR: PROVIDING TEMPORARY USE OF ON-LINE NON-DOWNLOADABLE SOFTWARE APPLICATIONS FOR HOSTING A SERVER ON A GLOBAL COMPUTER NETWORK FOR THE PURPOSE OF FACILITATING E-COMMERCE VIA A SERVER FOR MERCHANTS WHOSE CUSTOMERS MAKE MOBILE PURCHASES VIA CREDIT CARDS, IN CLASS 42 (U.S. CLS. 100 AND 101).

FIRST USE 7-18-2010; IN COMMERCE 10-5-2010.

NO CLAIM IS MADE TO THE EXCLUSIVE RIGHT TO USE "SINGLE-CLICK CHECKOUT", APART FROM THE MARK AS SHOWN.

THE MARK CONSISTS OF THE STYLIZED TEXT "SINGLE-CLICK" ABOVE THE STYLIZED TEXT "CHECKOUT". TO THE LEFT OF THE TEXT IS A SOLID VERTICAL RECTANGLE WITH AN EMPTY RECTANGULAR SPACE DISPLAYING A DOWNWARD-POINTING ARROW. BELOW THE ARROW IS AN EMPTY CIRCULAR SPACE IN THE RECTANGLE. THE IMAGE RESEMBLES A MOBILE PHONE DEVICE.

SER. NO. 85-327,061, FILED 5-23-2011.

SAMUEL E. SHARPER JR., EXAMINING ATTORNEY



David J. Kyffers

Director of the United States Patent and Trademark Office

United States of America

United States Patent and Trademark Office

INTELLECTUAL PROPERTY EXPERTISE IS JUST ONE OF OUR TRADEMARKS

Reg. No. 4,098,432

SAUNDERS & SILVERSTEIN LLP (MASSACHUSETTS LIMITED LIABILITY PARTNERSHIP)
14 CEDAR STREET, STE. 224
AMESBURY, MA 01913

Registered Feb. 14, 2012

Int. Cl.: 45

FOR: LEGAL SERVICES; LEGAL SERVICES, NAMELY, INTELLECTUAL PROPERTY
LEGAL SERVICES, IN CLASS 45 (U.S. CLS. 100 AND 101).

SERVICE MARK

FIRST USE 12-16-2009; IN COMMERCE 12-16-2009.

PRINCIPAL REGISTER

THE MARK CONSISTS OF STANDARD CHARACTERS WITHOUT CLAIM TO ANY PAR-
TICULAR FONT, STYLE, SIZE, OR COLOR.

NO CLAIM IS MADE TO THE EXCLUSIVE RIGHT TO USE "INTELLECTUAL PROPERTY",
APART FROM THE MARK AS SHOWN.

SER. NO. 85-327,197, FILED 5-23-2011.

PRISCILLA MILTON, EXAMINING ATTORNEY



David J. Kybas

Director of the United States Patent and Trademark Office

United States of America

United States Patent and Trademark Office

DNSOMATIC

An OpenDNS Service

Reg. No. 4,098,433

Registered Feb. 14, 2012

Int. Cl.: 42

SERVICE MARK

PRINCIPAL REGISTER

OPENDNS, INC. (DELAWARE CORPORATION)
410 TOWNSEND STREET, SUITE 250
SAN FRANCISCO, CA 94107

FOR: DOMAIN NAME SYSTEM (DNS) MANAGEMENT AND MAINTENANCE SERVICES, NAMELY, UPDATING DYNAMIC IP ADDRESSES WITH MULTIPLE DNS SERVICES ON BEHALF OF A USER VIA THE INTERNET; COMPUTER SERVICES, NAMELY, REDIRECTING ELECTRONIC MAIL TO CHANGED PERSONAL ELECTRONIC ADDRESSES BY UPDATING DYNAMIC IP ADDRESSES WITH MULTIPLE DNS SERVICES ON BEHALF OF A USER VIA THE INTERNET; ON-LINE BATCH COMPUTER SERVICES, NAMELY, UPDATING DYNAMIC IP ADDRESSES WITH MULTIPLE DNS SERVICES ON BEHALF OF A USER VIA THE INTERNET, IN CLASS 42 (U.S. CLS. 100 AND 101).

FIRST USE 12-2-2007; IN COMMERCE 12-2-2007.

OWNER OF U.S. REG. NO. 3,707,182.

NO CLAIM IS MADE TO THE EXCLUSIVE RIGHT TO USE "SERVICE", APART FROM THE MARK AS SHOWN.

THE MARK CONSISTS OF "DNSOMATIC" WITH THE "O" BEING A CONTINUOUS ARROW POINTING UPWARD OVER THE WORDS "AN OPENDNS SERVICES".

SEC. 2(F) AS TO "OPENDNS".

SER. NO. 85-327,324, FILED 5-23-2011.

TRACY CROSS, EXAMINING ATTORNEY



David J. Kyffers

Director of the United States Patent and Trademark Office

United States of America

United States Patent and Trademark Office



Reg. No. 4,098,434

OPENDNS, INC. (DELAWARE CORPORATION)
410 TOWNSEND STREET, SUITE 250
SAN FRANCISCO, CA 94107

Registered Feb. 14, 2012

Int. Cls.: 38 and 42

FOR: INTERNET NAVIGATION SERVICES, NAMELY, PROVISION OF ACCESS TO THE INTERNET, IN CLASS 38 (U.S. CLS. 100, 101 AND 104).

SERVICE MARK

FIRST USE 7-0-2006; IN COMMERCE 7-0-2006.

PRINCIPAL REGISTER

FOR: COMPUTER SECURITY SERVICES, NAMELY, RESTRICTING ACCESS TO AND BY COMPUTER NETWORKS TO AND OF UNDESIRED WEBSITES AND MEDIA, IN CLASS 42 (U.S. CLS. 100 AND 101).

FIRST USE 7-0-2006; IN COMMERCE 7-0-2006.

OWNER OF U.S. REG. NO. 3,707,182.

THE COLOR(S) ORANGE AND WHITE IS/ARE CLAIMED AS A FEATURE OF THE MARK.

THE MARK CONSISTS OF THE WORD "OPENDNS" IN WHITE INSIDE AN ORANGE ROUNDED CORNER RECTANGLE.

SEC. 2(F).

SER. NO. 85-327,345, FILED 5-23-2011.

TRACY CROSS, EXAMINING ATTORNEY



David J. Kybas

Director of the United States Patent and Trademark Office

United States of America

United States Patent and Trademark Office



Reg. No. 4,098,435

OPENDNS, INC. (DELAWARE CORPORATION)
410 TOWNSEND STREET, SUITE 250
SAN FRANCISCO, CA 94107

Registered Feb. 14, 2012

Int. Cls.: 38 and 42

FOR: INTERNET NAVIGATION SERVICES, NAMELY, PROVISION OF ACCESS TO THE INTERNET, IN CLASS 38 (U.S. CLS. 100, 101 AND 104).

SERVICE MARK

FIRST USE 7-0-2006; IN COMMERCE 7-0-2006.

PRINCIPAL REGISTER

FOR: COMPUTER SECURITY SERVICES, NAMELY, RESTRICTING ACCESS TO AND BY COMPUTER NETWORKS TO AND OF UNDESIRED WEBSITES AND MEDIA, IN CLASS 42 (U.S. CLS. 100 AND 101).

FIRST USE 7-0-2006; IN COMMERCE 7-0-2006.

THE MARK CONSISTS OF A WHITE "O" IN A ROUNDED LIGHT AND DARK ORANGE SQUARE.

THE COLOR(S) LIGHT ORANGE, DARK ORANGE AND WHITE IS/ARE CLAIMED AS A FEATURE OF THE MARK.

SER. NO. 85-327,365, FILED 5-23-2011.

TRACY CROSS, EXAMINING ATTORNEY



David J. Kyffers

Director of the United States Patent and Trademark Office

United States of America

United States Patent and Trademark Office



Reg. No. 4,098,436

OPENDNS, INC. (DELAWARE CORPORATION)
410 TOWNSEND STREET, SUITE 250
SAN FRANCISCO, CA 94107

Registered Feb. 14, 2012

Int. Cls.: 38 and 42

FOR: INTERNET NAVIGATION SERVICES, NAMELY, PROVISION OF ACCESS TO THE INTERNET, IN CLASS 38 (U.S. CLS. 100, 101 AND 104).

SERVICE MARK

FIRST USE 7-0-2006; IN COMMERCE 7-0-2006.

PRINCIPAL REGISTER

FOR: COMPUTER SECURITY SERVICES, NAMELY, RESTRICTING ACCESS TO AND BY COMPUTER NETWORKS TO AND OF UNDESIRED WEBSITES AND MEDIA, IN CLASS 42 (U.S. CLS. 100 AND 101).

FIRST USE 7-0-2006; IN COMMERCE 7-0-2006.

OWNER OF U.S. REG. NO. 3,707,182.

THE MARK CONSISTS OF THE WORD "OPENDNS" INSIDE A ROUNDED CORNER RECTANGLE.

SEC. 2(F).

SER. NO. 85-327,372, FILED 5-23-2011.

TRACY CROSS, EXAMINING ATTORNEY



David J. Kyjars

Director of the United States Patent and Trademark Office

United States of America

United States Patent and Trademark Office

Pro-Connex

Reg. No. 4,098,437

Registered Feb. 14, 2012

Int. Cls.: 6 and 9

TRADEMARK

PRINCIPAL REGISTER

SIGMA ELECTRIC MANUFACTURING CORPORATION (DELAWARE CORPORATION)
120 SIGMA DRIVE
GARNER, NC 27529

FOR: METAL CLASPS FOR INTERIOR WIRING; METAL CONDUIT; METAL PIPE CONNECTORS, AND ARE NOT USED FOR HEAT AND PLUMBING GOODS, IN CLASS 6 (U.S. CLS. 2, 12, 13, 14, 23, 25 AND 50).

FIRST USE 5-16-2011; IN COMMERCE 5-16-2011.

FOR: ELECTRIC CONNECTIONS AND CONNECTORS; ELECTRIC CONNECTORS; ELECTRICAL CONNECTORS, AND ARE NOT USED FOR HEAT AND PLUMBING GOODS, IN CLASS 9 (U.S. CLS. 21, 23, 26, 36 AND 38).

FIRST USE 5-16-2011; IN COMMERCE 5-16-2011.

THE MARK CONSISTS OF STANDARD CHARACTERS WITHOUT CLAIM TO ANY PARTICULAR FONT, STYLE, SIZE, OR COLOR.

SER. NO. 85-327,377, FILED 5-23-2011.

TRACY CROSS, EXAMINING ATTORNEY



David J. Kyfos

Director of the United States Patent and Trademark Office

United States of America

United States Patent and Trademark Office

HERTZ ON DEMAND

Reg. No. 4,098,438

HERTZ SYSTEM, INC. (DELAWARE CORPORATION)
225 BRAE BOULEVARD
PARK RIDGE, NJ 07656

Registered Feb. 14, 2012

Int. Cl.: 39

FOR: VEHICLE RENTAL SERVICES; ONLINE RESERVATIONS OF VEHICLE RENTAL SERVICES, IN CLASS 39 (U.S. CLS. 100 AND 105).

SERVICE MARK

FIRST USE 6-29-2011; IN COMMERCE 6-29-2011.

PRINCIPAL REGISTER

THE MARK CONSISTS OF STANDARD CHARACTERS WITHOUT CLAIM TO ANY PARTICULAR FONT, STYLE, SIZE, OR COLOR.

OWNER OF U.S. REG. NOS. 614,123, 1,230,391 AND OTHERS.

NO CLAIM IS MADE TO THE EXCLUSIVE RIGHT TO USE "ON DEMAND", APART FROM THE MARK AS SHOWN.

SER. NO. 85-327,436, FILED 5-23-2011.

DAYNA BROWNE, EXAMINING ATTORNEY



David J. Kyffers

Director of the United States Patent and Trademark Office

United States of America

United States Patent and Trademark Office

CALIFORNIA MOTORS

Reg. No. 4,098,439

CALIFORNIA MOTORS LLC (CALIFORNIA LIMITED LIABILITY COMPANY)
3991 CAMINO RANCHERO
CAMARILLO, CA 93012

Registered Feb. 14, 2012

Int. Cl.: 12

FOR: MANUFACTURED AUTOMOBILES AND STRUCTURAL PARTS THEREFOR, IN CLASS 12 (U.S. CLS. 19, 21, 23, 31, 35 AND 44).

TRADEMARK

FIRST USE 1-4-2003; IN COMMERCE 1-27-2003.

PRINCIPAL REGISTER

THE MARK CONSISTS OF STANDARD CHARACTERS WITHOUT CLAIM TO ANY PARTICULAR FONT, STYLE, SIZE, OR COLOR.

OWNER OF U.S. REG. NO. 2,955,961.

NO CLAIM IS MADE TO THE EXCLUSIVE RIGHT TO USE "MOTORS", APART FROM THE MARK AS SHOWN.

SEC. 2(F).

SER. NO. 85-327,497, FILED 5-23-2011.

WILLIAM ROSSMAN, EXAMINING ATTORNEY



David J. Kyfos

Director of the United States Patent and Trademark Office

United States of America

United States Patent and Trademark Office

La Comelona

Reg. No. 4,098,440

LA CALACA, INC. (OREGON CORPORATION)
2304 SE BELMONT ST.
PORTLAND, OR 97214

Registered Feb. 14, 2012

Int. Cl.: 30

FOR: SALSA, HOT SAUCE AND PEPPER SAUCE, IN CLASS 30 (U.S. CL. 46).

TRADEMARK

FIRST USE 10-14-2010; IN COMMERCE 10-14-2010.

PRINCIPAL REGISTER

THE MARK CONSISTS OF STANDARD CHARACTERS WITHOUT CLAIM TO ANY PARTICULAR FONT, STYLE, SIZE, OR COLOR.

THE ENGLISH TRANSLATION OF "LA COMELONA" IN THE MARK IS "THE JOYFUL EATER".

SER. NO. 85-327,916, FILED 5-23-2011.

RAMONA ORTIGA, EXAMINING ATTORNEY



David J. Kyffers

Director of the United States Patent and Trademark Office

United States of America

United States Patent and Trademark Office



Reg. No. 4,098,441

MIND LIMITLESS, LLC (RHODE ISLAND LIMITED LIABILITY COMPANY)
20 SHADY LEA ROAD
NORTH KINGSTOWN, RI 02852

Registered Feb. 14, 2012

Int. Cl.: 41

FOR: BUSINESS EDUCATION AND TRAINING SERVICES, NAMELY, DEVELOPING AND FACILITATING CUSTOMIZED LEADERSHIP AND EXECUTIVE DEVELOPMENT PROGRAMS, PROVIDING EXECUTIVE COACHING SERVICES, AND PROVIDING BUSINESS EDUCATION PROGRAMS TO EMPLOYEES AND EXECUTIVES, IN CLASS 41 (U.S. CLS. 100, 101 AND 107).

SERVICE MARK

PRINCIPAL REGISTER

FIRST USE 8-30-2010; IN COMMERCE 5-17-2011.

THE MARK CONSISTS OF "MIND LIMITLESS" IS IN A STYLIZED FONT WITH "MIND" IN GREY AND "LIMITLESS" IN BLUE ENDING IN AN IMAGE OF A BLUE PAPER AIRPLANE THAT CASTS A GREY SHADOW OF A REAL AIRPLANE AND "TURNING THE ORDINARY IN TO THE EXTRAORDINARY" IS DISPLAYED UNDERNEATH IN A STYLIZED BLUE FONT.

THE COLOR(S) GREY AND BLUE IS/ARE CLAIMED AS A FEATURE OF THE MARK.

SER. NO. 85-328,037, FILED 5-23-2011.

SANJEEV VOHRA, EXAMINING ATTORNEY



David J. Kybas

Director of the United States Patent and Trademark Office

United States of America

United States Patent and Trademark Office

ELLUMUS

Reg. No. 4,098,442

Registered Feb. 14, 2012

Int. Cl.: 42

SERVICE MARK

PRINCIPAL REGISTER

ELLUMUS LLC (WASHINGTON LIMITED LIABILITY COMPANY)
14421 SE 60TH STREET
BELLEVUE, WA 98006

FOR: ARCHITECTURAL CONSULTANCY; ARCHITECTURAL CONSULTATION; ARCHITECTURAL DESIGN; CONSULTING SERVICES IN THE FIELD OF ARCHITECTURAL DESIGN; INTERIOR DESIGN SERVICES; INTERIOR DESIGN SERVICES INCLUDING SPACE PLANNING, FURNITURE SELECTION, MATERIAL AND SURFACE SELECTION, IN CLASS 42 (U.S. CLS. 100 AND 101).

FIRST USE 2-1-2011; IN COMMERCE 2-1-2011.

THE MARK CONSISTS OF SEVEN INDIVIDUAL LETTERS SPELLING THE WORD "ELLUMUS". THE FIRST FOUR LETTERS "E", "L", "L" AND "U" ARE BLACK, BLOCK-STYLE LETTERS. THE LETTER "M" CONSIST OF A DETACHED CENTER STROKE, IN GREY, POSITIONED DIRECTLY BELOW AND UPSIDE-DOWN BLACK U SHAPE. THE LAST TWO LETTERS "U" AND "S" ARE GREY BLOCK-STYLE LETTERS.

THE COLOR(S) BLACK AND GREY IS/ARE CLAIMED AS A FEATURE OF THE MARK.

THE WORDING "ELLUMUS" HAS NO MEANING IN A FOREIGN LANGUAGE.

SER. NO. 85-328,098, FILED 5-23-2011.

SALLY SHIH, EXAMINING ATTORNEY



David J. Kybas

Director of the United States Patent and Trademark Office

United States of America

United States Patent and Trademark Office

INVESTORSHUB

Reg. No. 4,098,443

INVESTORSHUB.COM, INC. (FLORIDA CORPORATION)
1700 N. MONROE ST., STE 11-270
TALLAHASSEE, FL 32303

Registered Feb. 14, 2012

Int. Cl.: 35

FOR: PROVIDING AN INTERACTIVE WEB SITE IN THE FIELD OF BUSINESS NEWS AND INFORMATION ON CURRENT EVENTS AS THEY RELATE TO AND CAN IMPACT BUSINESSES, IN CLASS 35 (U.S. CLS. 100, 101 AND 102).

SERVICE MARK

FIRST USE 3-30-2000; IN COMMERCE 3-30-2000.

PRINCIPAL REGISTER

THE MARK CONSISTS OF STANDARD CHARACTERS WITHOUT CLAIM TO ANY PARTICULAR FONT, STYLE, SIZE, OR COLOR.

SER. NO. 85-328,295, FILED 5-24-2011.

PATRICIA EVANKO, EXAMINING ATTORNEY



David J. Kybas

Director of the United States Patent and Trademark Office

United States of America

United States Patent and Trademark Office



Reg. No. 4,098,444

GT DEVELOPMENT GROUP, INC. (ILLINOIS CORPORATION), DBA BOARD ROOM
343 W. ERIE STREET, FIRST FLOOR
CHICAGO, IL 60654

Registered Feb. 14, 2012

Int. Cl.: 41

FOR: ARRANGING AND CONDUCTING NIGHTCLUB ENTERTAINMENT EVENTS, IN CLASS 41 (U.S. CLS. 100, 101 AND 107).

SERVICE MARK

FIRST USE 4-2-2011; IN COMMERCE 4-2-2011.

PRINCIPAL REGISTER

NO CLAIM IS MADE TO THE EXCLUSIVE RIGHT TO USE "A BOUTIQUE NIGHTCLUB", APART FROM THE MARK AS SHOWN.

THE MARK CONSISTS OF THE WORDING "BOARD ROOM" IN LARGER FONT AND "A BOUTIQUE NIGHTCLUB" IN SMALLER FONT BENEATH SEPARATED BY A THIN LINE.

SER. NO. 85-328,370, FILED 5-24-2011.

KATINA MISTER, EXAMINING ATTORNEY



David J. Kybas

Director of the United States Patent and Trademark Office

United States of America

United States Patent and Trademark Office

MOBILE CLOSEOUT

Reg. No. 4,098,445

Registered Feb. 14, 2012

Int. Cl.: 9

TRADEMARK

PRINCIPAL REGISTER

WILLIAMS COMFORT AIR, INC. (INDIANA CORPORATION)
1077 THIRD AVE., SW
CARMEL, IN 46032

FOR: COMPUTER APPLICATION SOFTWARE FOR MOBILE PHONES, NAMELY, SOFTWARE FOR A CUSTOMIZABLE CHECKLIST FOR FINISHING A WORK RELATED TASK, IN CLASS 9 (U.S. CLS. 21, 23, 26, 36 AND 38).

FIRST USE 4-18-2011; IN COMMERCE 4-18-2011.

THE MARK CONSISTS OF STANDARD CHARACTERS WITHOUT CLAIM TO ANY PARTICULAR FONT, STYLE, SIZE, OR COLOR.

NO CLAIM IS MADE TO THE EXCLUSIVE RIGHT TO USE "MOBILE", APART FROM THE MARK AS SHOWN.

SER. NO. 85-328,402, FILED 5-24-2011.

REGINA DRUMMOND, EXAMINING ATTORNEY



David J. Kyffers

Director of the United States Patent and Trademark Office

United States of America

United States Patent and Trademark Office



Reg. No. 4,098,446

Registered Feb. 14, 2012

Int. Cl.: 9

TRADEMARK

PRINCIPAL REGISTER

IT WORX, INC. (DELAWARE CORPORATION)
SUITE 2006
406 FARMINGTON AVENUE
FARMINGTON, CT 06032

FOR: COMPUTER SOFTWARE FOR THE COLLECTION, EDITING, ORGANIZING, MODIFYING, BOOK MARKING, TRANSMISSION, STORAGE AND SHARING OF DATA AND INFORMATION FOR EDUCATORS IN THE FIELD OF INSTRUCTIONAL MANAGEMENT, PARTICULARLY, IN THE FIELD OF CURRICULUM DEVELOPMENT, ANALYTICAL LESSON PREPARATION, STUDENT ASSESSMENT, ADMINISTRATION, GRADING, ATTENDANCE, AND / OR COMMUNICATION WITH PARENTS AND STUDENTS, IN CLASS 9 (U.S. CLS. 21, 23, 26, 36 AND 38).

FIRST USE 10-5-2010; IN COMMERCE 10-5-2010.

THE MARK CONSISTS OF A SQUARE SHAPED CHALK BOARD WITH A LOWERCASE LETTER "T" IN THE CENTER OF THE BOARD, WITH A SINGLE PIECE OF CHALK AT THE END OF THE LETTER "T".

SER. NO. 85-328,421, FILED 5-24-2011.

SHAILA SETTLES, EXAMINING ATTORNEY



David J. Kyjars

Director of the United States Patent and Trademark Office

United States of America

United States Patent and Trademark Office

BETTER BURGER BUZZ

Reg. No. 4,098,447

Registered Feb. 14, 2012

Int. Cl.: 43

SERVICE MARK

PRINCIPAL REGISTER

AMERICA'S BETTER BURGER, LLC (DELAWARE LIMITED LIABILITY COMPANY), DBA
TOM AND EDDIE'S
SUITE 106
6805 HOBSON VALLEY DRIVE
WOODRIDGE, IL 60517

FOR: RESTAURANT SERVICES, IN CLASS 43 (U.S. CLS. 100 AND 101).

FIRST USE 4-16-2011; IN COMMERCE 4-16-2011.

THE MARK CONSISTS OF STANDARD CHARACTERS WITHOUT CLAIM TO ANY PARTICULAR FONT, STYLE, SIZE, OR COLOR.

NO CLAIM IS MADE TO THE EXCLUSIVE RIGHT TO USE "BETTER BURGER", APART FROM THE MARK AS SHOWN.

SER. NO. 85-328,451, FILED 5-24-2011.

DOMINICK J. SALEMI, EXAMINING ATTORNEY



David J. Kyffers

Director of the United States Patent and Trademark Office

United States of America

United States Patent and Trademark Office

TRIPLE SHOT WORLD ATLAS

Reg. No. 4,098,448

IL GALLO CEDRONE LTD. (NEW YORK LIMITED COMPANY (LTD.))
116 HAVEMEYER STREET
BROOKLYN, NY 11211

Registered Feb. 14, 2012

Int. Cl.: 43

FOR: CAFÉ SERVICES, IN CLASS 43 (U.S. CLS. 100 AND 101).

SERVICE MARK

FIRST USE 5-2-2011; IN COMMERCE 5-2-2011.

PRINCIPAL REGISTER

THE MARK CONSISTS OF STANDARD CHARACTERS WITHOUT CLAIM TO ANY PARTICULAR FONT, STYLE, SIZE, OR COLOR.

NO CLAIM IS MADE TO THE EXCLUSIVE RIGHT TO USE "TRIPLE SHOT", APART FROM THE MARK AS SHOWN.

SER. NO. 85-328,856, FILED 5-24-2011.

JESSICA FATHY, EXAMINING ATTORNEY



David J. Kybas

Director of the United States Patent and Trademark Office

United States of America

United States Patent and Trademark Office

Life Without Pests

Reg. No. 4,098,449

Registered Feb. 14, 2012

Int. Cl.: 37

SERVICE MARK

PRINCIPAL REGISTER

MYERS PEST & TERMITE SERVICES, INC. (TEXAS CORPORATION)
2928 BLUE QUAIL LN
BEDFORD, TX 76021

FOR: PEST CONTROL, IN CLASS 37 (U.S. CLS. 100, 103 AND 106).

FIRST USE 4-11-2011; IN COMMERCE 4-11-2011.

THE MARK CONSISTS OF STANDARD CHARACTERS WITHOUT CLAIM TO ANY PARTICULAR FONT, STYLE, SIZE, OR COLOR.

NO CLAIM IS MADE TO THE EXCLUSIVE RIGHT TO USE "PESTS", APART FROM THE MARK AS SHOWN.

SER. NO. 85-329,275, FILED 5-24-2011.

SUSAN RICHARDS, EXAMINING ATTORNEY



David J. Kyffers

Director of the United States Patent and Trademark Office

United States of America

United States Patent and Trademark Office



Reg. No. 4,098,450

MORE PARK (USA), LLC (NEVADA LIMITED LIABILITY COMPANY)
626 EAST BRANCH ROAD
PATTERSON, NY 12563

Registered Feb. 14, 2012

Int. Cl.: 39

FOR: CAR PARKING; PARKING GARAGES SERVICES; PROVISION OF CAR PARKING FACILITIES, IN CLASS 39 (U.S. CLS. 100 AND 105).

SERVICE MARK

FIRST USE 11-20-2008; IN COMMERCE 1-20-2009.

PRINCIPAL REGISTER

NO CLAIM IS MADE TO THE EXCLUSIVE RIGHT TO USE "PARK", APART FROM THE MARK AS SHOWN.

THE COLOR(S) RED, GRAY AND WHITE IS/ARE CLAIMED AS A FEATURE OF THE MARK.

THE MARK CONSISTS OF THE CAPITALIZED LETTERS "MP" WITH THE "M" BEING THE COLOR RED AND THE "P" BEING THE COLOR GRAY, IMBEDDED WITH THE IMAGES OF THE FRONTS OF TWO AUTOMOBILES ON TOP OF EACH OTHER WITH A LINE BETWEEN THEM WITH THE AUTOMOBILES BEING OF THE COLORS WHITE AND GRAY AND THE LINE BEING OF THE COLOR WHITE, AND THE CAPITALIZED WORDS "MORE PARK" UNDERNEATH THE "MP" WITH "MORE" BEING OF THE COLOR RED AND "PARK" BEING OF THE COLOR GRAY.

SER. NO. 85-329,510, FILED 5-25-2011.

CIMMERIAN COLEMAN, EXAMINING ATTORNEY



David J. Kyffers

Director of the United States Patent and Trademark Office

United States of America

United States Patent and Trademark Office

LIBRASSAY

Reg. No. 4,098,451

Registered Feb. 14, 2012

Int. Cls.: 35 and 45

SERVICE MARK

PRINCIPAL REGISTER

MPEG LA, LLC (DELAWARE LIMITED LIABILITY COMPANY)
SUITE 400 E
6312 S. FIDDLERS GREEN CIRCLE
GREENWOOD VILLAGE, CO 80111

FOR: MANAGEMENT OF INTELLECTUAL PROPERTY, IN CLASS 35 (U.S. CLS. 100, 101 AND 102).

FIRST USE 5-18-2011; IN COMMERCE 5-18-2011.

FOR: LICENSING OF INTELLECTUAL PROPERTY; INTELLECTUAL PROPERTY CONSULTATION AND PROVIDING INFORMATION ABOUT INTELLECTUAL PROPERTY AND INDUSTRIAL PROPERTY RIGHTS, IN CLASS 45 (U.S. CLS. 100 AND 101).

FIRST USE 5-18-2011; IN COMMERCE 5-18-2011.

THE MARK CONSISTS OF STANDARD CHARACTERS WITHOUT CLAIM TO ANY PARTICULAR FONT, STYLE, SIZE, OR COLOR.

SER. NO. 85-330,207, FILED 5-25-2011.

DOUGLAS LEE, EXAMINING ATTORNEY



David J. Kybas

Director of the United States Patent and Trademark Office

United States of America

United States Patent and Trademark Office

MIRATEK

Reg. No. 4,098,452

MIRATEK CORPORATION (TEXAS CORPORATION)
8201 LOCKHEED
EL PASO, TX 79925

Registered Feb. 14, 2012

Int. Cl.: 42

SERVICE MARK

PRINCIPAL REGISTER

FOR: APPLICATION SERVICE PROVIDER, NAMELY, HOSTING, MANAGING, DEVELOPING, AND MAINTAINING APPLICATIONS, SOFTWARE, AND WEB SITES, IN THE FIELDS OF PERSONAL PRODUCTIVITY, WIRELESS COMMUNICATION, MOBILE INFORMATION ACCESS, AND REMOTE DATA MANAGEMENT FOR WIRELESS DELIVERY OF CONTENT TO HANDHELD COMPUTERS, LAPTOPS AND MOBILE ELECTRONIC DEVICES; COMPUTER DISASTER RECOVERY PLANNING; COMPUTER FORENSIC SERVICES; COMPUTER HARDWARE AND SOFTWARE CONSULTING SERVICES; COMPUTER MONITORING SERVICE WHICH TRACKS HARDWARE PERFORMANCE AND PROCESSES AND SENDS OUT HISTORICAL REPORTS AND ALERTS; COMPUTER NETWORK CONFIGURATION SERVICES; COMPUTER NETWORK DESIGN FOR OTHERS; COMPUTER SERVICES, NAMELY, PROVIDING VIRTUAL AND NON VIRTUAL APPLICATION SERVERS, WEB SERVERS, FILE SERVERS, CO-LOCATION SERVERS, LOAD BALANCING SERVERS, REDUNDANCY SERVERS, MEDIA SERVERS AND DATABASE SERVERS OF VARIABLE CAPACITY TO THIRD PARTY COMPUTING AND DATA STORAGE FACILITIES; COMPUTER SERVICES, NAMELY, REMOTE MANAGEMENT OF THE INFORMATION TECHNOLOGY (IT) SYSTEMS OF OTHERS; COMPUTER TECHNICAL SUPPORT SERVICES, NAMELY, 24/7 SERVICE DESK/HELP DESK SERVICES FOR IT INFRASTRUCTURE, OPERATING SYSTEMS, DATABASE SYSTEMS, AND WEB APPLICATIONS; TECHNICAL CONSULTING SERVICES IN THE FIELDS OF DATACENTER ARCHITECTURE, PUBLIC AND PRIVATE CLOUD COMPUTING SOLUTIONS, AND EVALUATION AND IMPLEMENTATION OF INTERNET TECHNOLOGY AND SERVICES; TECHNICAL SUPPORT SERVICES, NAMELY, 24X7 MONITORING OF NETWORK SYSTEMS, SERVERS AND WEB AND DATABASE APPLICATIONS AND NOTIFICATION OF RELATED EVENTS AND ALERTS; TECHNICAL SUPPORT SERVICES, NAMELY, REMOTE AND ON-SITE INFRASTRUCTURE MANAGEMENT SERVICES FOR MONITORING, ADMINISTRATION AND MANAGEMENT OF PUBLIC AND PRIVATE CLOUD COMPUTING IT AND APPLICATION SYSTEMS; TECHNICAL SUPPORT SERVICES, NAMELY, TROUBLESHOOTING OF COMPUTER SOFTWARE PROBLEMS, IN CLASS 42 (U.S. CLS. 100 AND 101).



David J. Kyjars

Director of the United States Patent and Trademark Office

FIRST USE 7-1-2000; IN COMMERCE 7-1-2000.

THE MARK CONSISTS OF STANDARD CHARACTERS WITHOUT CLAIM TO ANY PARTICULAR FONT, STYLE, SIZE, OR COLOR.

Reg. No. 4,098,452 SER. NO. 85-330,404, FILED 5-25-2011.

CAROLYN CATALDO, EXAMINING ATTORNEY

United States of America

United States Patent and Trademark Office

MAINE CAMP EXPERIENCE

Reg. No. 4,098,453

MAINE CAMP EXPERIENCE LLC (MAINE LIMITED LIABILITY COMPANY)
601 WEST STREET

Registered Feb. 14, 2012

HARRISON, NY 10528

Int. Cl.: 35

FOR: MARKETING OF MAINE BASED SUMMER CAMPS FOR CHILDREN, TEENAGERS, FAMILIES AND ADULTS, IN CLASS 35 (U.S. CLS. 100, 101 AND 102).

SERVICE MARK

FIRST USE 4-1-2011; IN COMMERCE 4-1-2011.

PRINCIPAL REGISTER

THE MARK CONSISTS OF STANDARD CHARACTERS WITHOUT CLAIM TO ANY PARTICULAR FONT, STYLE, SIZE, OR COLOR.

NO CLAIM IS MADE TO THE EXCLUSIVE RIGHT TO USE "MAINE CAMP", APART FROM THE MARK AS SHOWN.

SER. NO. 85-330,755, FILED 5-26-2011.

FRANK LATTUCA, EXAMINING ATTORNEY



David J. Kybas

Director of the United States Patent and Trademark Office

United States of America

United States Patent and Trademark Office

The Savings Force

Reg. No. 4,098,454

CITIZENS BANK MINNESOTA (MINNESOTA CORPORATION)
105 NORTH MINNESOTA STREET
NEW ULM, MN 56073

Registered Feb. 14, 2012

Int. Cl.: 36

FOR: BANKING AND FINANCING SERVICES, IN CLASS 36 (U.S. CLS. 100, 101 AND 102).

SERVICE MARK

FIRST USE 3-25-2011; IN COMMERCE 3-25-2011.

PRINCIPAL REGISTER

THE MARK CONSISTS OF STANDARD CHARACTERS WITHOUT CLAIM TO ANY PARTICULAR FONT, STYLE, SIZE, OR COLOR.

SER. NO. 85-330,911, FILED 5-26-2011.

KRISTIN DAHLING, EXAMINING ATTORNEY



David J. Kybas

Director of the United States Patent and Trademark Office

United States of America

United States Patent and Trademark Office

Yourology

Reg. No. 4,098,455

ACTIENT PHARMACEUTICALS, LLC (DELAWARE LIMITED LIABILITY COMPANY)
150 S. SAUNDERS RD., SUITE 120

Registered Feb. 14, 2012

LAKE FOREST, IL 60045

Int. Cl.: 5

FOR: PHARMACEUTICALS FOR THE TREATMENT OF ERECTILE DYSFUNCTION, IN CLASS 5 (U.S. CLS. 6, 18, 44, 46, 51 AND 52).

TRADEMARK

FIRST USE 1-1-2011; IN COMMERCE 5-14-2011.

PRINCIPAL REGISTER

THE MARK CONSISTS OF STANDARD CHARACTERS WITHOUT CLAIM TO ANY PARTICULAR FONT, STYLE, SIZE, OR COLOR.

SER. NO. 85-331,274, FILED 5-26-2011.

CHRISTINE COOPER, EXAMINING ATTORNEY



David J. Kybas

Director of the United States Patent and Trademark Office

United States of America

United States Patent and Trademark Office

Fruit of Desire Argan Oil

Reg. No. 4,098,456

Registered Feb. 14, 2012

Int. Cl.: 3

TRADEMARK

PRINCIPAL REGISTER

REINDERS, PATRICIA S (UNITED STATES INDIVIDUAL)
APT. 8AD
7337 AUSTIN STREET
FOREST HILLS, NY 11375

FOR: AROMATIC ESSENTIAL OILS; AROMATIC OILS; BODY AND BEAUTY CARE COSMETICS; BODY OIL; BODY OILS; COSMETIC OILS; COSMETIC OLIVE OIL FOR THE FACE AND BODY; COSMETIC PREPARATIONS FOR BODY CARE; COSMETIC PREPARATIONS FOR SKIN CARE; COSMETIC PREPARATIONS FOR SKIN RENEWAL; COSMETIC PREPARATIONS FOR THE HAIR AND SCALP; COSMETIC SUN OILS; COSMETICS AND COSMETIC PREPARATIONS; COSMETICS IN GENERAL, INCLUDING PERFUMES; ESSENTIAL OILS; ESSENTIAL OILS FOR PERSONAL USE; ESSENTIAL OILS FOR USE IN THE MANUFACTURE OF SCENTED PRODUCTS; HAIR OILS; MASSAGE OIL; MASSAGE OILS; NATURAL ESSENTIAL OILS; NON-MEDICATED HAIR TREATMENT PREPARATIONS FOR COSMETIC PURPOSES; NON-MEDICATED HERBAL BODY CARE PRODUCTS, NAMELY, BODY OILS, SALVES, AND LIP BALMS; NUTRITIONAL OILS FOR COSMETIC PURPOSES; OIL BATHS FOR HAIR CARE; OILS FOR COSMETIC PURPOSES; OILS FOR HAIR CONDITIONING; OILS FOR PERFUMES AND SCENTS; OILS FOR TOILETRY PURPOSES; PERFUME OILS; PERFUME OILS FOR THE MANUFACTURE OF COSMETIC PREPARATIONS; PRIVATE LABEL COSMETICS; SCENTED OILS; SKIN AND BODY TOPICAL LOTIONS, CREAMS AND OILS FOR COSMETIC USE; ALL OF THE AFOREMENTIONED GOODS BEING MADE IN WHOLE OR IN SIGNIFICANT PART OF ARGAN OIL, IN CLASS 3 (U.S. CLS. 1, 4, 6, 50, 51 AND 52).

FIRST USE 4-23-2011; IN COMMERCE 5-26-2011.

THE MARK CONSISTS OF STANDARD CHARACTERS WITHOUT CLAIM TO ANY PARTICULAR FONT, STYLE, SIZE, OR COLOR.

NO CLAIM IS MADE TO THE EXCLUSIVE RIGHT TO USE "ARGAN OIL", APART FROM THE MARK AS SHOWN.

SER. NO. 85-331,291, FILED 5-26-2011.

KEVIN CORWIN, EXAMINING ATTORNEY



David J. Kyffers

Director of the United States Patent and Trademark Office

United States of America

United States Patent and Trademark Office

Zap View

Reg. No. 4,098,457

Registered Feb. 14, 2012

Int. Cl.: 9

TRADEMARK

PRINCIPAL REGISTER

MICRONOR INC. (CALIFORNIA CORPORATION)
750 MITCHELL ROAD
NEWBURY PARK, CA 91320

FOR: COMPUTER HARDWARE AND SOFTWARE SYSTEMS FOR SETUP, CONFIGURATION, OPERATION, DIAGNOSTICS AND TROUBLESHOOTING OF INDUSTRIAL SENSORS AND CONTROLS, IN CLASS 9 (U.S. CLS. 21, 23, 26, 36 AND 38).

FIRST USE 5-25-2011; IN COMMERCE 5-25-2011.

THE MARK CONSISTS OF STANDARD CHARACTERS WITHOUT CLAIM TO ANY PARTICULAR FONT, STYLE, SIZE, OR COLOR.

OWNER OF U.S. REG. NO. 3,005,896.

SER. NO. 85-331,381, FILED 5-26-2011.

LINDA MICKLEBURGH, EXAMINING ATTORNEY



David J. Kybas

Director of the United States Patent and Trademark Office

United States of America

United States Patent and Trademark Office



Reg. No. 4,098,458

3HB CORPORATION (MISSOURI CORPORATION), DBA HALE COMMUNICATIONS
1099 MILWAUKEE STREET, SUITE 135
SAINT LOUIS, MO 63122

Registered Feb. 14, 2012

Int. Cl.: 38

FOR: TELECOMMUNICATIONS RESELLER SERVICES FOR BUSINESSES, NAMELY, PROVIDING LONG DISTANCE TELECOMMUNICATION SERVICES, VOICE TELECOMMUNICATION SERVICES, LOCAL TELEPHONE SERVICE, AND INTERNET ACCESS SERVICES, IN CLASS 38 (U.S. CLS. 100, 101 AND 104).

SERVICE MARK

PRINCIPAL REGISTER

FIRST USE 9-1-2008; IN COMMERCE 9-1-2008.

NO CLAIM IS MADE TO THE EXCLUSIVE RIGHT TO USE "COMMUNICATIONS", APART FROM THE MARK AS SHOWN.

THE COLOR(S) BLUE, ORANGE, AND WHITE IS/ARE CLAIMED AS A FEATURE OF THE MARK.

THE MARK CONSISTS OF "HALE COMMUNICATIONS", WITH THE WORD "HALE" (BLUE) ABOVE THE WORDS "COMMUNICATIONS" (ORANGE), AND THE WORD "HALE" IN LARGER FONT THAN THE WORD "COMMUNICATIONS". "HALE COMMUNICATIONS" IS IN ALL CAPITAL LETTERS WITH THREE-QUARTERS OF AN ORBIT (BLUE) BEGINNING TO THE LEFT OF THE LETTER "H" IN "HALE" GOING THROUGH THE WORD "HALE", AROUND THE LAST LETTERS OF "COMMUNICATIONS", AND ENDING BELOW THE LETTER "I" IN "COMMUNICATIONS". UNDERNEATH THE WORD "COMMUNICATIONS", AN ORANGE BLOCK WITH ROUNDED EDGES CONTAINS THE WORDS "CUSTOMER COMMITMENT, TELECOM EXCELLENCE" (WHITE) IN ALL CAPITAL LETTERS.



SER. NO. 85-331,690, FILED 5-26-2011.

SOPHIA S. KIM, EXAMINING ATTORNEY

David J. Kybas

Director of the United States Patent and Trademark Office

United States of America

United States Patent and Trademark Office

TNB 88

Reg. No. 4,098,459

REDAVENUE CHEMICAL CORP OF AMERICA (NEW YORK CORPORATION)
95 MT. READ BLVD # 149
ROCHESTER, NY 14611

Registered Feb. 14, 2012

Int. Cl.: 1

FOR: CHEMICAL MIXTURES AND ADDITIVES FOR USE IN THE MANUFACTURE OF RUBBER PRODUCTS, IN CLASS 1 (U.S. CLS. 1, 5, 6, 10, 26 AND 46).

TRADEMARK

FIRST USE 1-1-2006; IN COMMERCE 1-1-2006.

PRINCIPAL REGISTER

THE MARK CONSISTS OF STANDARD CHARACTERS WITHOUT CLAIM TO ANY PARTICULAR FONT, STYLE, SIZE, OR COLOR.

NO CLAIM IS MADE TO THE EXCLUSIVE RIGHT TO USE "TNB", APART FROM THE MARK AS SHOWN.

SER. NO. 85-332,092, FILED 5-27-2011.

HEATHER BIDDULPH, EXAMINING ATTORNEY



David J. Kyffers

Director of the United States Patent and Trademark Office

United States of America

United States Patent and Trademark Office

Learnapolis

Reg. No. 4,098,460

Registered Feb. 14, 2012

Int. Cl.: 41

SERVICE MARK

PRINCIPAL REGISTER

LEARNAPOLIS, INC. (ILLINOIS CORPORATION)
549 BUFFALO AVENUE
CALUMET CITY, IL 60409

FOR: EDUCATION SERVICES, NAMELY, PROVIDING ON-LINE AND IN-PERSON SEMINARS AND WORKSHOPS IN THE FIELDS OF INFORMATION TECHNOLOGY, MANAGEMENT AND PROFESSIONAL SKILLS, CAREER AND EDUCATIONAL PLANNING, INTERPERSONAL RELATIONSHIPS, PERSONAL FINANCE, AND CAREGIVING; EDUCATIONAL SERVICES, NAMELY, DEVELOPING AND CONDUCTING TRAINING COURSES AND DISTRIBUTION OF TRAINING MATERIALS IN CONNECTION THEREWITH FOR SUBJECT MATTERS AS REQUESTED BY CUSTOMERS, IN CLASS 41 (U.S. CLS. 100, 101 AND 107).

FIRST USE 8-1-2008; IN COMMERCE 8-1-2008.

THE MARK CONSISTS OF STANDARD CHARACTERS WITHOUT CLAIM TO ANY PARTICULAR FONT, STYLE, SIZE, OR COLOR.

SER. NO. 85-332,479, FILED 5-27-2011.

JACQUELINE A. LAVINE, EXAMINING ATTORNEY



David J. Kyffers

Director of the United States Patent and Trademark Office

United States of America

United States Patent and Trademark Office



Reg. No. 4,098,461

COREY JOHN MASON (UNITED STATES INDIVIDUAL)
1334 LAWRENCE STREET
EL CERRITO, CA 94530

Registered Feb. 14, 2012

Int. Cl.: 41

FOR: ENTERTAINMENT SERVICES, NAMELY, PROVIDING AN ON-GOING RADIO PROGRAM IN THE FIELD OF MUSIC, VARIETY, PUBLIC AFFAIRS, NEWS AND COMEDY; ENTERTAINMENT SERVICES, NAMELY, PROVIDING RADIO PROGRAMS IN THE FIELD OF MUSIC, VARIETY, PUBLIC AFFAIRS, NEWS AND COMEDY VIA A GLOBAL COMPUTER NETWORK, IN CLASS 41 (U.S. CLS. 100, 101 AND 107).

SERVICE MARK

PRINCIPAL REGISTER

FIRST USE 10-15-1994; IN COMMERCE 12-13-1994.

OWNER OF U.S. REG. NOS. 2,051,270 AND 2,445,274.

THE MARK CONSISTS OF THE WORDS "WORLD ONE" IN LOWER CASE PRINT, WITH THE EXCEPTION OF THE SECOND LETTER "O" WHICH IS UPPER CASE, HAS A LARGE DOT IN THE MIDDLE AND CONTAINS 3 LINES EXTENDING OUTWARDS ON THE TOP AND 3 LINES EXTENDING OUTWARD ON THE BOTTOM. THE LETTER "E" IS IN THE SHAPE OF THE EURO INSIGNIA.

SER. NO. 85-332,834, FILED 5-27-2011.

FRED CARL, EXAMINING ATTORNEY



David J. Kyffers

Director of the United States Patent and Trademark Office

United States of America

United States Patent and Trademark Office

Stan Winston

Reg. No. 4,098,462

Registered Feb. 14, 2012

Int. Cl.: 41

SERVICE MARK

PRINCIPAL REGISTER

STAN WINSTON ENTERPRISES LLC (CALIFORNIA LIMITED LIABILITY COMPANY)
25440 PRADO DE AZUL
CALABASAS, CA 91302

FOR: CORRESPONDENCE SCHOOLS; EDUCATION COURSES IN THE FIELD OF VISUAL EFFECTS OFFERED THROUGH ONLINE, NON-DOWNLOADABLE VIDEOS AND INSTRUCTOR ASSISTANCE; EDUCATION IN THE FIELD OF VISUAL EFFECTS RENDERED THROUGH CORRESPONDENCE COURSES; EDUCATION IN THE FIELD OF VISUAL EFFECTS RENDERED THROUGH VIDEO CONFERENCE; EDUCATION SERVICES, NAMELY, PROVIDING WORKSHOPS IN THE FIELD OF VISUAL EFFECTS; EDUCATIONAL AND ENTERTAINMENT SERVICES, NAMELY, A CONTINUING PROGRAM ABOUT VISUAL EFFECTS ACCESSIBLE BY RADIO, TELEVISION, SATELLITE, AUDIO, VIDEO AND COMPUTER NETWORKS; ENTERTAINMENT SERVICES, NAMELY, PRODUCTION OF SPECIAL EFFECTS INCLUDING MODEL-MAKING SERVICES AND RELATED PHYSICAL PRODUCTION ELEMENTS FOR USE IN MOTION PICTURES; ENTERTAINMENT SERVICES, NAMELY, PRODUCTION OF SPECIAL EFFECTS INCLUDING MODEL-MAKING SERVICES, COMPUTER-GENERATED IMAGERY AND COMPUTER-GENERATED GRAPHICS FOR THE PRODUCTION OF MOTION PICTURES, VIDEOS, AND MOVIE TRAILERS; ENTERTAINMENT, NAMELY, PREPARATION OF SPECIAL EFFECTS; INTERACTIVE ON-LINE TRAINING SERVICES IN THE FIELD OF VISUAL EFFECTS; PRODUCTION OF DVDS FEATURING VISUAL EFFECTS; PRODUCTION OF VISUAL EFFECTS FOR VIDEOS, DVDS, TELEVISION AND FOR INTERNET WEB SITES; SPECIAL EFFECTS ANIMATION SERVICES FOR FILM AND VIDEO, IN CLASS 41 (U.S. CLS. 100, 101 AND 107).



FIRST USE 4-7-1946; IN COMMERCE 2-15-1972.

THE MARK CONSISTS OF STANDARD CHARACTERS WITHOUT CLAIM TO ANY PARTICULAR FONT, STYLE, SIZE, OR COLOR.

SER. NO. 85-332,859, FILED 5-27-2011.

MARILYN IZZI, EXAMINING ATTORNEY

David J. Kyros

Director of the United States Patent and Trademark Office

United States of America

United States Patent and Trademark Office

YAP

Reg. No. 4,098,463

THE MUSEUM OF MODERN ART (NEW YORK NON-PROFIT CORPORATION)
11 WEST 53RD STREET
NEW YORK, NY 10019

Registered Feb. 14, 2012

Int. Cl.: 41

FOR: ENTERTAINMENT IN THE NATURE OF COMPETITIONS FOR ARCHITECTS, IN CLASS 41 (U.S. CLS. 100, 101 AND 107).

SERVICE MARK

FIRST USE 0-0-2000; IN COMMERCE 0-0-2000.

PRINCIPAL REGISTER

THE MARK CONSISTS OF STANDARD CHARACTERS WITHOUT CLAIM TO ANY PARTICULAR FONT, STYLE, SIZE, OR COLOR.

SER. NO. 85-332,894, FILED 5-27-2011.

PATRICIA EVANKO, EXAMINING ATTORNEY



David J. Kybas

Director of the United States Patent and Trademark Office

United States of America

United States Patent and Trademark Office

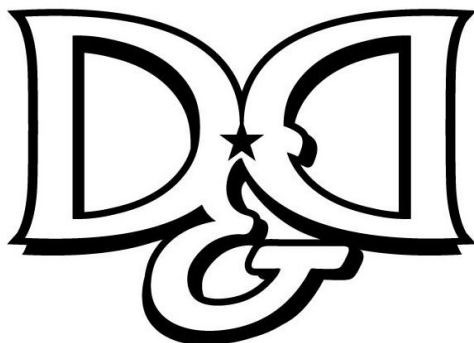

Reg. No. 4,098,464

D&D DESIGNS & SCREEN PRINTING, LLC (CALIFORNIA LIMITED LIABILITY COMPANY)
33476 ALVARADO NILES RD. #5
UNION CITY, CA 94587

Registered Feb. 14, 2012

Int. Cl.: 25

FOR: TOPS; WEARABLE GARMENTS AND CLOTHING, NAMELY, SHIRTS, IN CLASS 25
(U.S. CLS. 22 AND 39).

TRADEMARK

FIRST USE 1-1-2009; IN COMMERCE 1-1-2010.

PRINCIPAL REGISTER

THE MARK CONSISTS OF TWO "D'S FACING EACH OTHER WITH A STAR AND AMPERSAND CONNECTING THE "D'S.

SER. NO. 85-333,093, FILED 5-28-2011.

PRISCILLA MILTON, EXAMINING ATTORNEY



David J. Kyffers

Director of the United States Patent and Trademark Office

United States of America

United States Patent and Trademark Office

buddyvine

Reg. No. 4,098,465

GOPAL SACHDEVA (UNITED STATES INDIVIDUAL)
PO BOX 410182

Registered Feb. 14, 2012

SAN FRANCISCO, CA 94141

Int. Cl.: 42

SERVICE MARK

PRINCIPAL REGISTER

FOR: COMPUTER SERVICES, NAMELY, CREATING ON-LINE VIRTUAL COMMUNITIES FOR REGISTERED USERS TO ORGANIZE GROUPS AND EVENTS, PARTICIPATE IN DISCUSSIONS, AND ENGAGE IN SOCIAL, BUSINESS AND COMMUNITY NETWORKING; COMPUTER SERVICES, NAMELY, HOSTING ON-LINE WEB FACILITIES FOR OTHERS FOR ORGANIZING AND CONDUCTING MEETINGS, EVENTS AND INTERACTIVE DISCUSSIONS VIA COMMUNICATION NETWORKS; APPLICATION SERVICE PROVIDER (ASP) SERVICES, NAMELY, HOSTING COMPUTER SOFTWARE APPLICATIONS OF OTHERS; APPLICATION SERVICE PROVIDER (ASP) FEATURING SOFTWARE TO ENABLE OR FACILITATE THE UPLOADING, DOWNLOADING, STREAMING, POSTING, DISPLAYING, BLOGGING, LINKING, SHARING OF AUDIO, VIDEO, PHOTOGRAPHIC IMAGES, TEXT, GRAPHICS AND DATA; PROVIDING AN ONLINE NETWORK SERVICE THAT ENABLES USERS TO TRANSFER PERSONAL IDENTITY DATA TO AND SHARE PERSONAL IDENTITY DATA WITH AND AMONG MULTIPLE WEBSITES; PROVIDING A WEB SITE FEATURING TECHNOLOGY THAT ENABLES ONLINE USERS TO CREATE PERSONAL PROFILES FEATURING SOCIAL NETWORKING INFORMATION AND TO TRANSFER AND SHARE SUCH INFORMATION AMONG MULTIPLE WEBSITES; COMPUTER SERVICES, NAMELY, CREATING COMPUTER NETWORK-BASED INDEXES OF INFORMATION, WEBSITES AND RESOURCES; CREATING AN ONLINE VIRTUAL COMMUNITY FOR REGISTERED USERS TO TRANSMIT AUDIO, VIDEO, PHOTOGRAPHIC IMAGES, TEXT, GRAPHICS AND DATA; COMPUTER SERVICES, NAMELY, PROVIDING CUSTOMIZED WEB PAGES FEATURING USER-DEFINED INFORMATION; PEER-TO-BROWSER PHOTO SHARING SERVICES, NAMELY, PROVIDING A WEBSITE FEATURING TECHNOLOGY ENABLING USERS TO UPLOAD, VIEW, AND DOWNLOAD DIGITAL PHOTOS; PROVIDING A WEB SITE FEATURING TECHNOLOGY THAT ENABLES USERS TO UPLOAD AND SHARE VIDEO, PHOTOS, TEXT, GRAPHICS AND DATA; CREATING AND MAINTAINING BLOGS FOR OTHERS, IN CLASS 42 (U.S. CLS. 100 AND 101).



FIRST USE 5-1-2011; IN COMMERCE 5-1-2011.

David J. Kyros

THE MARK CONSISTS OF STANDARD CHARACTERS WITHOUT CLAIM TO ANY PARTICULAR FONT, STYLE, SIZE, OR COLOR.

SER. NO. 85-333,154, FILED 5-28-2011.

Reg. No. 4,098,465 HAI-LY LAM, EXAMINING ATTORNEY

United States of America

United States Patent and Trademark Office



Reg. No. 4,098,466

Registered Feb. 14, 2012

**Int. Cls.: 35, 36, 41, 43
and 44**

SERVICE MARK

PRINCIPAL REGISTER

BUSINESS AND PROFESSIONAL WOMEN'S FOUNDATION (D.C. CORPORATION)
1718 M STREET, NW #148
WASHINGTON, DC 20036

FOR: ARRANGING AND CONDUCTING BUSINESS CONFERENCES; PROMOTING PUBLIC AWARENESS OF THE NEEDS OF AND CHALLENGES FACED BY WOMEN MILITARY VETERANS AS THEY TRANSITION TO CIVILIAN LIFE; PROVIDING WOMEN MILITARY VETERANS WITH EMPLOYMENT INFORMATION AND EMPLOYMENT COUNSELING INFORMATION TO ASSIST AS THEY TRANSITION FROM MILITARY TO CIVILIAN LIFE; DEVELOPING PUBLIC POLICY; PUBLIC POLICY RESEARCH SERVICES; PUBLIC POLICY RESEARCH IN THE FIELD OF HOUSING FOR AND HOMELESSNESS OF WOMEN MILITARY VETERANS; PUBLIC POLICY RESEARCH IN THE FIELD OF ISSUES AFFECTING THE HEALTH, BEHAVIORAL HEALTH, AND MENTAL HEALTH OF WOMEN VETERANS; PROMOTING THE INTERESTS OF WOMEN VETERANS BY DEVELOPING PUBLIC AND PRIVATE SECTOR POLICY, STANDARDS, PROGRAMS, AND GUIDELINES IN THE FIELD OF WOMEN VETERANS' TRANSITIONING ACTIVITIES AND RESOURCES; BUSINESS SERVICES, NAMELY, FORMULATING BEST PRACTICES FOR ADDRESSING AND OVERCOMING WOMEN VETERANS' TRANSITION CHALLENGES; PROMOTING PUBLIC AWARENESS OF THE NEEDS FACED BY WOMEN MILITARY VETERANS IN THE AREAS OF HOUSING, EMPLOYMENT, AND REINTEGRATION INTO CIVILIAN COMMUNITIES; PROVIDING NETWORKING OPPORTUNITIES FOR INDIVIDUALS SEEKING EMPLOYMENT, IN CLASS 35 (U.S. CLS. 100, 101 AND 102).



FIRST USE 5-0-2010, THE MARK WAS FIRST USED ANYWHERE IN A DIFFERENT FORM OTHER THAN THAT SOUGHT TO BE REGISTERED AT LEAST AS EARLY AS 10/17/2005.; IN COMMERCE 5-0-2010, THE MARK WAS FIRST USED IN COMMERCE IN A DIFFERENT FORM OTHER THAN THAT SOUGHT TO BE REGISTERED AT LEAST AS EARLY AS 10/17/2005..

FOR: CHARITABLE FUNDRAISING FOR WOMEN'S VETERANS INITIATIVES; ADMINISTERING MONETARY CHARITABLE DONATIONS TO FUND WOMEN VETERANS' PROGRAMS; PROVIDING EDUCATIONAL SCHOLARSHIPS, IN CLASS 36 (U.S. CLS. 100, 101 AND 102).

David J. Kyffers

Director of the United States Patent and Trademark Office

FIRST USE 7-0-2010, THE MARK WAS FIRST USED ANYWHERE IN A DIFFERENT FORM OTHER THAN THAT SOUGHT TO BE REGISTERED AT LEAST AS EARLY AS 10/17/2005; IN COMMERCE 7-0-2010, THE MARK WAS FIRST USED IN COMMERCE IN A DIFFERENT

Reg. No. 4,098,466 FORM OTHER THAN THAT SOUGHT TO BE REGISTERED AT LEAST AS EARLY AS 10/17/2005.

FOR: EDUCATIONAL SERVICES, NAMELY, MENTORING WOMEN VETERANS TRANSITIONING TO CIVILIAN LIFE IN THE FIELDS OF EMPLOYMENT OPPORTUNITIES, HOUSING, HEALTH, BEHAVIORAL HEALTH, AND MENTAL HEALTH CARE, AND FAMILY AND COMMUNITY REINTEGRATION; EDUCATIONAL SERVICES, NAMELY, PROVIDING MENTORING TO WOMEN VETERANS IN THE FIELD OF EMPLOYMENT AND IN TRANSITIONING FROM MILITARY TO CIVILIAN LIFE; PROVIDING A WEBSITE FEATURING BLOGS ON THE SUBJECT OF WOMEN VETERANS AND THE PARTICULAR ISSUES THEY FACE AFTER MILITARY SERVICE AND IN THEIR TRANSITION TO AND REINTEGRATION IN CIVILIAN LIFE , IN CLASS 41 (U.S. CLS. 100, 101 AND 107).

FIRST USE 10-21-2010, THE MARK WAS FIRST USED ANYWHERE IN A DIFFERENT FORM OTHER THAN THAT SOUGHT TO BE REGISTERED AT LEAST AS EARLY AS 10/17/2005.; IN COMMERCE 10-21-2010, THE MARK WAS FIRST USED IN COMMERCE IN A DIFFERENT FORM OTHER THAN THAT SOUGHT TO BE REGISTERED AT LEAST AS EARLY AS 10/17/2005..

FOR: PROVIDING INFORMATION AND LINKS TO WEBSITES OF OTHERS VIA AN INTERNET WEBSITE FEATURING INFORMATION ABOUT OBSTACLES FACED BY WOMEN VETERANS TO FINDING AND MAINTAINING ADEQUATE HOUSING AND ABOUT HOMELESSNESS OF WOMEN VETERANS, IN CLASS 43 (U.S. CLS. 100 AND 101).

FIRST USE 5-0-2010; IN COMMERCE 5-0-2010.

FOR: PROVIDING INFORMATION AND LINKS TO WEBSITES OF OTHERS VIA AN INTERNET WEBSITE FEATURING INFORMATION ABOUT HEALTH, BEHAVIORAL HEALTH, AND MENTAL HEALTH OF WOMEN VETERANS, IN CLASS 44 (U.S. CLS. 100 AND 101).

FIRST USE 5-0-2010, THE MARK WAS FIRST USED ANYWHERE IN A DIFFERENT FORM OTHER THAN THAT SOUGHT TO BE REGISTERED AT LEAST AS EARLY AS 10/17/2005; IN COMMERCE 5-0-2010, THE MARK WAS FIRST USED IN COMMERCE IN A DIFFERENT FORM OTHER THAN THAT SOUGHT TO BE REGISTERED AT LEAST AS EARLY AS 10/17/2005.

OWNER OF U.S. REG. NOS. 2,862,172, 3,253,762 AND OTHERS.

NO CLAIM IS MADE TO THE EXCLUSIVE RIGHT TO USE "WOMEN VETERANS" AND "FOUNDATION", APART FROM THE MARK AS SHOWN.

THE MARK CONSISTS OF A DESIGN OF AN ARCH, IN WHICH THE PHRASE "JOINING FORCES" APPEARS CENTERED BETWEEN THREE STARS ON EACH SIDE OF THE PHRASE, AND UNDER WHICH THREE FIGURES APPEAR IN SILHOUETTE FORM. BENEATH THE SILHOUETTED FIGURES APPEARS ONE BAR WITH THE WORDS "FOR WOMEN VETERANS" AND "BPW", CENTERED BETWEEN THREE STARS ON EACH SIDE OF THE WORDS, AND A BAR BELOW, BEARING THE NAME "BPW FOUNDATION", WHICH IS CENTERED BETWEEN FOUR STARS ON EACH SIDE OF THE WORDS.

SER. NO. 85-333,358, FILED 5-30-2011.

KATHY DE JONGE, EXAMINING ATTORNEY

United States of America

United States Patent and Trademark Office

JOINING FORCES FOR WOMEN VETERANS

Reg. No. 4,098,467

Registered Feb. 14, 2012

**Int. Cls.: 35, 36, 41, 43
and 44**

SERVICE MARK

PRINCIPAL REGISTER

BUSINESS AND PROFESSIONAL WOMEN'S FOUNDATION (D.C. CORPORATION)
1718 M STREET, NW #148
WASHINGTON, DC 20036

FOR: ARRANGING AND CONDUCTING BUSINESS CONFERENCES; PROMOTING PUBLIC AWARENESS OF THE NEEDS OF AND CHALLENGES FACED BY WOMEN MILITARY VETERANS AS THEY TRANSITION TO CIVILIAN LIFE; PROVIDING WOMEN MILITARY VETERANS WITH EMPLOYMENT INFORMATION AND EMPLOYMENT COUNSELING INFORMATION TO ASSIST AS THEY TRANSITION FROM MILITARY TO CIVILIAN LIFE; DEVELOPING PUBLIC POLICY; PUBLIC POLICY RESEARCH SERVICES; PUBLIC POLICY RESEARCH IN THE FIELD OF HOUSING FOR AND HOMELESSNESS OF WOMEN MILITARY VETERANS; PUBLIC POLICY RESEARCH IN THE FIELD OF ISSUES AFFECTING THE HEALTH, BEHAVIORAL HEALTH, AND MENTAL HEALTH OF WOMEN VETERANS; PROMOTING THE INTERESTS OF WOMEN VETERANS BY DEVELOPING PUBLIC AND PRIVATE SECTOR POLICY, STANDARDS, PROGRAMS, AND GUIDELINES IN THE FIELD OF WOMEN VETERANS' TRANSITIONING ACTIVITIES AND RESOURCES; BUSINESS SERVICES, NAMELY, FORMULATING BEST PRACTICES FOR ADDRESSING AND OVERCOMING WOMEN VETERANS' TRANSITION CHALLENGES; PROMOTING PUBLIC AWARENESS OF THE NEEDS FACED BY WOMEN MILITARY VETERANS IN THE AREAS OF HOUSING, EMPLOYMENT, AND REINTEGRATION INTO CIVILIAN COMMUNITIES; PROVIDING NETWORKING OPPORTUNITIES FOR INDIVIDUALS SEEKING EMPLOYMENT, IN CLASS 35 (U.S. CLS. 100, 101 AND 102).



FIRST USE 5-0-2010, THE MARK WAS FIRST USED ANYWHERE IN A DIFFERENT FORM OTHER THAN THAT SOUGHT TO BE REGISTERED AT LEAST AS EARLY AS 10/17/2005.; IN COMMERCE 5-0-2010, THE MARK WAS FIRST USED IN COMMERCE IN A DIFFERENT FORM OTHER THAN THAT SOUGHT TO BE REGISTERED AT LEAST AS EARLY AS 10/17/2005..

FOR: CHARITABLE FUNDRAISING FOR WOMEN'S VETERANS INITIATIVES; ADMINISTERING MONETARY CHARITABLE DONATIONS TO FUND WOMEN VETERANS' PROGRAMS; PROVIDING EDUCATIONAL SCHOLARSHIPS, IN CLASS 36 (U.S. CLS. 100, 101 AND 102).

David J. Kyffers

Director of the United States Patent and Trademark Office

FIRST USE 7-0-2010, THE MARK WAS FIRST USED ANYWHERE IN A DIFFERENT FORM OTHER THAN THAT SOUGHT TO BE REGISTERED AT LEAST AS EARLY AS 10/17/2005; IN COMMERCE 7-0-2010, THE MARK WAS FIRST USED IN COMMERCE IN A DIFFERENT

Reg. No. 4,098,467 FORM OTHER THAN THAT SOUGHT TO BE REGISTERED AT LEAST AS EARLY AS 10/17/2005.

FOR: EDUCATIONAL SERVICES, NAMELY, MENTORING WOMEN VETERANS TRANSITIONING TO CIVILIAN LIFE IN THE FIELDS OF EMPLOYMENT OPPORTUNITIES, HOUSING, HEALTH, BEHAVIORAL HEALTH, AND MENTAL HEALTH CARE, AND FAMILY AND COMMUNITY REINTEGRATION; EDUCATIONAL SERVICES, NAMELY, PROVIDING MENTORING TO WOMEN VETERANS IN THE FIELD OF EMPLOYMENT AND IN TRANSITIONING FROM MILITARY TO CIVILIAN LIFE; PROVIDING A WEBSITE FEATURING BLOGS ON THE SUBJECT OF WOMEN VETERANS AND THE PARTICULAR ISSUES THEY FACE AFTER MILITARY SERVICE AND IN THEIR TRANSITION TO AND REINTEGRATION IN CIVILIAN LIFE , IN CLASS 41 (U.S. CLS. 100, 101 AND 107).

FIRST USE 10-21-2010, THE MARK WAS FIRST USED ANYWHERE IN A DIFFERENT FORM OTHER THAN THAT SOUGHT TO BE REGISTERED AT LEAST AS EARLY AS 10/17/2005.; IN COMMERCE 10-21-2010, THE MARK WAS FIRST USED IN COMMERCE IN A DIFFERENT FORM OTHER THAN THAT SOUGHT TO BE REGISTERED AT LEAST AS EARLY AS 10/17/2005..

FOR: PROVIDING INFORMATION AND LINKS TO WEBSITES OF OTHERS VIA AN INTERNET WEBSITE FEATURING INFORMATION ABOUT OBSTACLES FACED BY WOMEN VETERANS TO FINDING AND MAINTAINING ADEQUATE HOUSING AND ABOUT HOMELESSNESS OF WOMEN VETERANS, IN CLASS 43 (U.S. CLS. 100 AND 101).

FIRST USE 5-0-2010; IN COMMERCE 5-0-2010.

FOR: PROVIDING INFORMATION AND LINKS TO WEBSITES OF OTHERS VIA AN INTERNET WEBSITE FEATURING INFORMATION ABOUT HEALTH, BEHAVIORAL HEALTH, AND MENTAL HEALTH OF WOMEN VETERANS, IN CLASS 44 (U.S. CLS. 100 AND 101).

FIRST USE 5-0-2010, THE MARK WAS FIRST USED ANYWHERE IN A DIFFERENT FORM OTHER THAN THAT SOUGHT TO BE REGISTERED AT LEAST AS EARLY AS 10/17/2005; IN COMMERCE 5-0-2010, THE MARK WAS FIRST USED IN COMMERCE IN A DIFFERENT FORM OTHER THAN THAT SOUGHT TO BE REGISTERED AT LEAST AS EARLY AS 10/17/2005.

THE MARK CONSISTS OF STANDARD CHARACTERS WITHOUT CLAIM TO ANY PARTICULAR FONT, STYLE, SIZE, OR COLOR.

OWNER OF U.S. REG. NOS. 2,862,172, 3,253,762 AND OTHERS.

NO CLAIM IS MADE TO THE EXCLUSIVE RIGHT TO USE "WOMEN VETERANS", APART FROM THE MARK AS SHOWN.

SER. NO. 85-333,363, FILED 5-30-2011.

KATHY DE JONGE, EXAMINING ATTORNEY

United States of America

United States Patent and Trademark Office

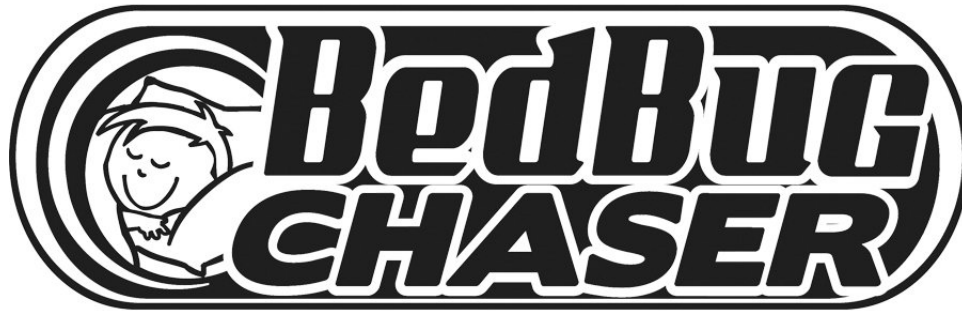

Reg. No. 4,098,468

BEDBUG CHASERS FRANCHISE CORPORATION (NEW JERSEY CORPORATION)
24 HICKORY LANE

Registered Feb. 14, 2012

LITTLE SILVER, NJ 07739

Int. Cl.: 11

FOR: ELECTRIC HEATERS FOR COMMERCIAL USE; PORTABLE ELECTRIC HEATERS,
IN CLASS 11 (U.S. CLS. 13, 21, 23, 31 AND 34).

TRADEMARK

FIRST USE 5-23-2011; IN COMMERCE 5-23-2011.

PRINCIPAL REGISTER

OWNER OF U.S. REG. NO. 3,981,172.

NO CLAIM IS MADE TO THE EXCLUSIVE RIGHT TO USE "BEDBUG", APART FROM THE
MARK AS SHOWN.

THE MARK CONSISTS OF THE WORDING "BEDBUG CHASER" IN A STYLIZED FONT
WITHIN CONCENTRIC OVALS. ALSO WITHIN THE OVALS ARE INCOMPLETE CIRCLES
THAT CONTAIN THE IMAGE OF A CHILD SLEEPING WITH ITS HEAD RESTING ON A
PILLOW AND A BLANKET COVERING ITS BODY.

SER. NO. 85-333,735, FILED 5-31-2011.

DEZMONA MIZELLE, EXAMINING ATTORNEY



David J. Kyffers

Director of the United States Patent and Trademark Office

United States of America

United States Patent and Trademark Office



Reg. No. 4,098,469

THE RAD GROUP, LLC (TEXAS LIMITED LIABILITY COMPANY)
427 HEATHER LANE
CONROE, TX 77385

Registered Feb. 14, 2012

Int. Cl.: 41

FOR: EDUCATION SERVICES, NAMELY, PROVIDING CLASSES AND COURSES IN THE FIELD OF WORKPLACE SAFETY, IN CLASS 41 (U.S. CLS. 100, 101 AND 107).

SERVICE MARK

FIRST USE 5-15-2011; IN COMMERCE 5-15-2011.

PRINCIPAL REGISTER

THE STIPLING IS FOR SHADING PURPOSES ONLY.

THE MARK CONSISTS OF A WATERMARK COMPASS BEHIND THE STYLIZED TEXT "SAFETYCOMPASS".

SER. NO. 85-333,761, FILED 5-31-2011.

RONALD AIKENS, EXAMINING ATTORNEY



David J. Kyffers

Director of the United States Patent and Trademark Office

United States of America

United States Patent and Trademark Office

TATUM'S WILDLIFE HEROES

Reg. No. 4,098,470

Registered Feb. 14, 2012

Int. Cl.: 41

SERVICE MARK

PRINCIPAL REGISTER

PETS & PLANTS, INC. (CALIFORNIA CORPORATION)
3553 DOWNING AVE.
GLENDALE, CA 91208

FOR: ENTERTAINMENT IN THE NATURE OF ON-GOING TELEVISION PROGRAMS IN THE FIELD OF WILDLIFE AND NATURE; ENTERTAINMENT IN THE NATURE OF INTERACTIVE GAMES; ENTERTAINMENT SERVICES, NAMELY, PROVIDING WEBCASTS IN THE FIELD OF WILDLIFE AND NATURE; ENTERTAINMENT, NAMELY, A CONTINUING WILDLIFE AND NATURE SHOW BROADCAST OVER THE INTERNET, TELEVISION, WEBCASTS; TELEVISION SHOW PRODUCTION, IN CLASS 41 (U.S. CLS. 100, 101 AND 107).

FIRST USE 1-0-2001; IN COMMERCE 1-0-2001.

THE MARK CONSISTS OF STANDARD CHARACTERS WITHOUT CLAIM TO ANY PARTICULAR FONT, STYLE, SIZE, OR COLOR.

NO CLAIM IS MADE TO THE EXCLUSIVE RIGHT TO USE "WILDLIFE HEROES", APART FROM THE MARK AS SHOWN.

SER. NO. 85-333,832, FILED 5-31-2011.

LESLEY LAMOTHE, EXAMINING ATTORNEY



David J. Kyffers

Director of the United States Patent and Trademark Office

United States of America

United States Patent and Trademark Office



Reg. No. 4,098,471

BEDBUG CHASERS FRANCHISE CORPORATION (NEW JERSEY CORPORATION)
24 HICKORY LANE

Registered Feb. 14, 2012

LITTLE SILVER, NJ 07739

Int. Cl.: 35

FOR: ADVICE IN THE RUNNING OF ESTABLISHMENTS AS FRANCHISES; ASSISTANCE IN BUSINESS MANAGEMENT AND PRODUCT COMMERCIALIZATION, WITHIN THE FRAMEWORK OF A FRANCHISE CONTRACT; ASSISTANCE IN FRANCHISED COMMERCIAL BUSINESS MANAGEMENT; BUSINESS MANAGEMENT ADVISORY SERVICES RELATING TO FRANCHISING; FRANCHISING, NAMELY, CONSULTATION AND ASSISTANCE IN BUSINESS MANAGEMENT, ORGANIZATION AND PROMOTION; FRANCHISING, NAMELY, OFFERING BUSINESS MANAGEMENT ASSISTANCE IN THE ESTABLISHMENT AND/OR OPERATION OF BUSINESSES THAT PROVIDE TEMPORARY HEAT TO RESIDENTIAL, COMMERCIAL AND INDUSTRIAL LOCATIONS, IN CLASS 35 (U.S. CLS. 100, 101 AND 102).

SERVICE MARK

PRINCIPAL REGISTER

FIRST USE 5-16-2011; IN COMMERCE 5-16-2011.

OWNER OF U.S. REG. NO. 3,981,172.

NO CLAIM IS MADE TO THE EXCLUSIVE RIGHT TO USE "BEDBUG", APART FROM THE MARK AS SHOWN.



THE MARK CONSISTS OF THE WORDING "BEDBUG CHASERS" IN A STYLIZED FONT WITHIN AN INCOMPLETE OVAL. ALSO WITHIN THE OVAL ARE INCOMPLETE CIRCLES THAT CONTAIN THE IMAGE OF A CHILD SLEEPING WITH ITS HEAD RESTING ON A PILLOW AND A BLANKET COVERING ITS BODY.

SER. NO. 85-333,877, FILED 5-31-2011.

DEZMONA MIZELLE, EXAMINING ATTORNEY

David J. Kybas

Director of the United States Patent and Trademark Office

United States of America

United States Patent and Trademark Office

HalfBreed

CLOTHING CO.

Reg. No. 4,098,472

HALFBREED CLOTHING CO. LLC (CALIFORNIA LIMITED LIABILITY COMPANY)
4482 BUCKEY WAY
ANTIOCH, CA 94531

Registered Feb. 14, 2012

Int. Cl.: 25

FOR: HATS; HOODED SWEATSHIRTS; LEGGINGS; PANTS; SWEAT PANTS; SWEAT SHIRTS; T-SHIRTS, IN CLASS 25 (U.S. CLS. 22 AND 39).

TRADEMARK

FIRST USE 3-1-2011; IN COMMERCE 3-15-2011.

PRINCIPAL REGISTER

NO CLAIM IS MADE TO THE EXCLUSIVE RIGHT TO USE "CLOTHING CO.", APART FROM THE MARK AS SHOWN.

THE MARK CONSISTS OF THE STYLIZED TEXT "HALFBREED" ABOVE THE STYLIZED TEXT "CLOTHING CO.".

SER. NO. 85-334,009, FILED 5-31-2011.

PATRICIA EVANKO, EXAMINING ATTORNEY



David J. Kyffers

Director of the United States Patent and Trademark Office

United States of America

United States Patent and Trademark Office

Anchorball

Reg. No. 4,098,473

HARDER, WILLARD J. (UNITED STATES INDIVIDUAL)
20355 EAVES WAY

Registered Feb. 14, 2012

FARMINGTON, MN 55624

Int. Cl.: 6

FOR: METAL RAILINGS FOR STAIRS, DECKS, AND BALCONIES, IN CLASS 6 (U.S. CLS. 2, 12, 13, 14, 23, 25 AND 50).

TRADEMARK

FIRST USE 8-23-2005; IN COMMERCE 8-23-2005.

PRINCIPAL REGISTER

THE MARK CONSISTS OF STANDARD CHARACTERS WITHOUT CLAIM TO ANY PARTICULAR FONT, STYLE, SIZE, OR COLOR.

SER. NO. 85-334,057, FILED 5-31-2011.

FRED CARL, EXAMINING ATTORNEY



David J. Kyfos

Director of the United States Patent and Trademark Office

United States of America

United States Patent and Trademark Office



Reg. No. 4,098,474

CREDIT CARD SERVICES, INC. (CALIFORNIA CORPORATION)
3055 WILSHIRE BLVD., 3RD FL
LOS ANGELES, CA 90010

Registered Feb. 14, 2012

Int. Cl.: 36

FOR: CREDIT CARD AND DEBIT CARD SERVICES; CREDIT CARD AND PAYMENT CARD SERVICES; CREDIT CARD PAYMENT PROCESSING SERVICES; CREDIT CARD TRANSACTION PROCESSING SERVICES, IN CLASS 36 (U.S. CLS. 100, 101 AND 102).

SERVICE MARK

FIRST USE 4-1-2011; IN COMMERCE 4-1-2011.

PRINCIPAL REGISTER

NO CLAIM IS MADE TO THE EXCLUSIVE RIGHT TO USE "REWARD", APART FROM THE MARK AS SHOWN.

THE COLOR(S) ORANGE, GREEN AND GRAY IS/ARE CLAIMED AS A FEATURE OF THE MARK.

THE MARK CONSISTS OF THE FOLLOWING: THE WORDING "REWARD SALAD" IN ORANGE AND GREEN RESPECTIVELY, ABOVE WHICH IS THE WORDING "THE MORE THE BETTER" IN GRAY AND AN ORANGE BOW DESIGN, AND BELOW WHICH IS A GRAY BOWL DESIGN.

SER. NO. 85-334,245, FILED 5-31-2011.

BARNEY CHARLON, EXAMINING ATTORNEY



David J. Kyros

Director of the United States Patent and Trademark Office

United States of America

United States Patent and Trademark Office

ICE Epilepsy

Reg. No. 4,098,475

Registered Feb. 14, 2012

Int. Cls.: 35 and 36

SERVICE MARK

PRINCIPAL REGISTER

ICE EPILEPSY ALLIANCE (NORTH CAROLINA NON-PROFIT CORPORATION), AKA
INTRACTABLE CHILDHOOD EPILEPSY ALLIANCE, ION CHANNEL EPILEPSY
ALLIANCE
464 HERITAGE DRIVE
LEWISVILLE, NC 27023

FOR: PUBLIC ADVOCACY TO PROMOTE AWARENESS OF EPILEPSY , IN CLASS 35 (U.S.
CLS. 100, 101 AND 102).

FIRST USE 11-1-2008; IN COMMERCE 11-1-2008.

FOR: CHARITABLE SERVICES, NAMELY, ORGANIZING FUNDRAISING SERVICES AND
EVENTS TO RAISE FUNDS IN THE FIELD OF EPILEPSY, IN CLASS 36 (U.S. CLS. 100, 101
AND 102).

FIRST USE 11-1-2008; IN COMMERCE 11-1-2008.

THE MARK CONSISTS OF STANDARD CHARACTERS WITHOUT CLAIM TO ANY PAR-
TICULAR FONT, STYLE, SIZE, OR COLOR.

NO CLAIM IS MADE TO THE EXCLUSIVE RIGHT TO USE "EPILEPSY" , APART FROM
THE MARK AS SHOWN.

SER. NO. 85-334,629, FILED 5-31-2011.

JEAN IM, EXAMINING ATTORNEY



David J. Kyffers

Director of the United States Patent and Trademark Office

United States of America

United States Patent and Trademark Office

Tide Rider

Reg. No. 4,098,476

Registered Feb. 14, 2012

Int. Cl.: 35

SERVICE MARK

PRINCIPAL REGISTER

OLENYCH, RICHARD P (UNITED STATES INDIVIDUAL)
5572 WAR ADMIRAL ROAD
VIRGINIA BEACH, VA 234624044

FOR: AD SERVING, NAMELY, PLACING ADVERTISEMENTS ON WEBSITES FOR OTHERS USING SPECIALIZED COMPUTER SOFTWARE; ADVERTISEMENT AND PUBLICITY SERVICES BY TELEVISION, RADIO, MAIL; ADVERTISEMENT FOR OTHERS ON THE INTERNET; ADVERTISEMENT HOARDING RENTAL; ADVERTISING AGENCIES SPECIALIZING IN PRINT AND THE INTERNET.; ADVERTISING AGENCIES, NAMELY, PROMOTING THE GOODS AND SERVICES OF OTHERS; ADVERTISING AGENCY SPECIALIZING IN THE DESIGN AND EXECUTION OF WORD OF MOUTH, VIRAL, BUZZ AND EXPERIENTIAL MARKETING PROGRAMS; ADVERTISING AND ADVERTISEMENT SERVICES; ADVERTISING AND BUSINESS SERVICES, NAMELY, SECURING AIRTIME ON ALL FORMS OF MEDIA COMMUNICATIONS STATIONS, SYSTEMS, NETWORKS, AND SERVICES FOR THE PURPOSE OF PROMOTING THE GOODS AND SERVICES OF OTHERS; ADVERTISING AND COMMERCIAL INFORMATION SERVICES, VIA THE INTERNET; ADVERTISING AND DIRECTORY SERVICES, NAMELY, PROMOTING THE SERVICES OF OTHERS BY PROVIDING A WEB PAGE FEATURING LINKS TO THE WEBSITES OF OTHERS; ADVERTISING AND MARKETING; ADVERTISING AND MARKETING SERVICES PROVIDED BY MEANS OF INDIRECT METHODS OF MARKETING COMMUNICATIONS, NAMELY, SOCIAL MEDIA, SEARCH ENGINE MARKETING, INQUIRY MARKETING, INTERNET MARKETING, MOBILE MARKETING, BLOGGING AND OTHER FORMS OF PASSIVE, SHARABLE OR VIRAL COMMUNICATIONS CHANNELS; ADVERTISING AND MARKETING SERVICES, NAMELY, PROMOTING THE GOODS AND SERVICES OF OTHERS; ADVERTISING AND PROMOTION SERVICES AND RELATED CONSULTING; ADVERTISING AND PROMOTIONAL SERVICES; ADVERTISING AND PUBLICITY SERVICES, NAMELY, PROMOTING THE GOODS, SERVICES, BRAND IDENTITY AND COMMERCIAL INFORMATION AND NEWS OF THIRD PARTIES THROUGH PRINT, AUDIO, VIDEO, DIGITAL AND ON-LINE MEDIUM; ADVERTISING COPYWRITING; ADVERTISING IN PERIODICALS, BROCHURES AND NEWSPAPERS; ADVERTISING ON THE INTERNET FOR OTHERS; ADVERTISING SERVICES; ADVERTISING SERVICES, NAMELY, CREATING CORPORATE AND BRAND IDENTITY FOR OTHERS; ADVERTISING SERVICES, NAMELY, PROMOTING AND MARKETING THE GOODS AND SERVICES OF OTHERS THROUGH ALL PUBLIC COMMUNICATION MEANS; ADVERTISING SERVICES, NAMELY, PROMOTING THE BRANDS, GOODS AND SERVICES OF OTHERS; ADVERTISING SERVICES, NAMELY, PROVIDING ADVERTISING SPACE IN A PERIODICAL; ADVERTISING THROUGH ALL PUBLIC COMMUNICATION MEANS; ADVERTISING VIA ELECTRONIC MEDIA AND SPECIFIC-



David J. Kyros

Director of the United States Patent and Trademark Office

Reg. No. 4,098,476 ALLY THE INTERNET; ADVERTISING, MARKETING AND PROMOTION SERVICES; ADVERTISING, MARKETING AND PROMOTION SERVICES, NAMELY, PROMOTING THE GOODS AND SERVICES OF OTHERS BY PROVIDING CUSTOMIZED EXHIBITS; ARRANGING AND CONDUCTING OF FAIRS AND EXHIBITIONS FOR BUSINESS AND ADVERTISING PURPOSES; BANNER ADVERTISING; BUSINESS MANAGEMENT AND CONSULTING SERVICES FOR THE HEALTH CARE INDUSTRY, NAMELY, CUSTOMER SERVICE, ACCOUNTING SERVICES, AND WEB-BASED ADVERTISING AND MARKETING SERVICES; COOPERATIVE ADVERTISING AND MARKETING; COOPERATIVE ADVERTISING AND MARKETING SERVICES BY WAY OF SOLICITATION, CUSTOMER SERVICE AND PROVIDING MARKETING INFORMATION VIA WEB SITES ON A GLOBAL COMPUTER NETWORK; CREATING AND UPDATING ADVERTISING MATERIAL; CUSTOMER LOYALTY SERVICES AND CUSTOMER CLUB SERVICES, FOR COMMERCIAL, PROMOTIONAL AND/OR ADVERTISING PURPOSES; DESIGN OF ADVERTISING BROCHURES FOR OTHERS; DESIGN OF ADVERTISING FLYERS FOR OTHERS; DESIGN OF ADVERTISING MATERIALS FOR OTHERS; DEVELOPING ADVERTISING CAMPAIGNS FOR OTHERS GEARED TOWARD ENVIRONMENTAL ISSUES; DEVELOPMENT, OPERATION AND ADMINISTRATION OF DIGITAL SIGNAGE SYSTEMS AND DIGITAL ADVERTISING SYSTEMS FOR OTHERS, NAMELY, PROVIDING ADVERTISING SPACE BY ELECTRONIC MEANS AND GLOBAL COMPUTER INFORMATION NETWORKS; DIRECT MAIL ADVERTISING SERVICES; DISSEMINATION OF ADVERTISING FOR OTHERS VIA THE INTERNET; DISSEMINATION OF ADVERTISING MATERIAL; DISSEMINATION OF ADVERTISING MATTER; DISTRIBUTION AND DISSEMINATION OF ADVERTISING MATERIALS; DISTRIBUTION OF ADVERTISING MATERIAL; DISTRIBUTION OF ADVERTISING MATERIALS; ELECTRONIC BILLBOARD ADVERTISING, IN CLASS 35 (U.S. CLS. 100, 101 AND 102).

FIRST USE 4-4-2011; IN COMMERCE 5-4-2011.

THE MARK CONSISTS OF STANDARD CHARACTERS WITHOUT CLAIM TO ANY PARTICULAR FONT, STYLE, SIZE, OR COLOR.

SER. NO. 85-334,683, FILED S.R. 6-1-2011 AM. P.R. 6-1-2011.

REBECCA POVARCHUK, EXAMINING ATTORNEY

United States of America

United States Patent and Trademark Office

PALOMA PARTNERS

Reg. No. 4,098,477

PALOMA PARTNERS MANAGEMENT COMPANY (DELAWARE CORPORATION)
2 AMERICAN LANE
GREENWICH, CT 068362571

Registered Feb. 14, 2012

Int. Cl.: 36

FOR: FINANCIAL SERVICES, NAMELY, FUND AND INVESTMENT MANAGEMENT SERVICES; FUND AND INVESTMENT ADVISORY SERVICES; AND WEALTH AND ASSET MANAGEMENT SERVICES, IN CLASS 36 (U.S. CLS. 100, 101 AND 102).

SERVICE MARK

FIRST USE 12-27-1983; IN COMMERCE 12-27-1983.

PRINCIPAL REGISTER

THE MARK CONSISTS OF STANDARD CHARACTERS WITHOUT CLAIM TO ANY PARTICULAR FONT, STYLE, SIZE, OR COLOR.

OWNER OF U.S. REG. NO. 1,733,527.

NO CLAIM IS MADE TO THE EXCLUSIVE RIGHT TO USE "PARTNERS", APART FROM THE MARK AS SHOWN.

SER. NO. 85-334,750, FILED 6-1-2011.

AISHA CLARKE, EXAMINING ATTORNEY



David J. Kyjars

Director of the United States Patent and Trademark Office

United States of America

United States Patent and Trademark Office

The Day That Changed My Life

Reg. No. 4,098,478

SOLUTIONS PRODUCTIONS (NEW YORK LIMITED LIABILITY COMPANY)
117 COLIGNI AVENUE

Registered Feb. 14, 2012

NEW ROCHELLE, NY 108012506

Int. Cl.: 9

FOR: AUDIO BOOKS IN THE FIELD OF CANCER, IN CLASS 9 (U.S. CLS. 21, 23, 26, 36 AND 38).

TRADEMARK

FIRST USE 4-8-2009; IN COMMERCE 4-8-2009.

PRINCIPAL REGISTER

THE MARK CONSISTS OF STANDARD CHARACTERS WITHOUT CLAIM TO ANY PARTICULAR FONT, STYLE, SIZE, OR COLOR.

SER. NO. 85-335,019, FILED 6-1-2011.

PAULA MAHONEY, EXAMINING ATTORNEY



David J. Kyffers

Director of the United States Patent and Trademark Office

United States of America

United States Patent and Trademark Office

BLUE ZONES

Reg. No. 4,098,479

Registered Feb. 14, 2012

Int. Cl.: 16

TRADEMARK

PRINCIPAL REGISTER

BLUE ZONES, LLC (DELAWARE LIMITED LIABILITY COMPANY)
724 NORTH 1ST STREET
MINNEAPOLIS, MN 55401

FOR: A SERIES OF BOOKS, WRITTEN ARTICLES, HANDOUTS AND WORKSHEETS IN THE FIELD OF HEALTHY LIFESTYLES, HAPPINESS AND LONGEVITY; BOOKS IN THE FIELD OF HEALTHY LIFESTYLES, HAPPINESS AND LONGEVITY; PRINTED INSTRUCTIONAL, EDUCATIONAL, AND TEACHING MATERIALS IN THE FIELD OF HEALTHY LIFESTYLES, HAPPINESS AND LONGEVITY; ALL OF THE FOREGOING GOODS ARE BASED ON RESEARCH INVOLVING CULTURES OF LONGEVITY AND WELLNESS, IN CLASS 16 (U.S. CLS. 2, 5, 22, 23, 29, 37, 38 AND 50).

FIRST USE 5-1-2005; IN COMMERCE 5-1-2005.

THE MARK CONSISTS OF STANDARD CHARACTERS WITHOUT CLAIM TO ANY PARTICULAR FONT, STYLE, SIZE, OR COLOR.

SER. NO. 85-335,274, FILED 6-1-2011.

JILL C. ALT, EXAMINING ATTORNEY



David J. Kyffers

Director of the United States Patent and Trademark Office

United States of America

United States Patent and Trademark Office

PADOPOLIS

Reg. No. 4,098,480

Registered Feb. 14, 2012

Int. Cls.: 35 and 42

SERVICE MARK

PRINCIPAL REGISTER

PADOPOLIS, INC. (DELAWARE CORPORATION)
1641 JAMESTOWN DRIVE
CUPERTINO, CA 94014

FOR: ADVERTISEMENT VIA MOBILE PHONE NETWORKS; ADVERTISING, PROMOTION AND MARKETING SERVICES IN THE NATURE OF E-MAIL BLAST CAMPAIGNS FOR OTHERS; ADVERTISING, PROMOTION, AND MARKETING SERVICES IN THE NATURE OF PROVIDING INFORMATION ABOUT RETAIL SHOPPING VIA A WEBSITE, EMAIL AND MOBILE PHONE APPLICATION; COMPUTERIZED ON-LINE RETAIL STORE SERVICES IN THE FIELD OF A WIDE VARIETY OF CONSUMER GOODS AND SERVICES; DISSEMINATION OF ADVERTISING FOR OTHERS VIA PUBLIC AND PRIVATE WIRELESS NETWORKS FOR DISPLAY ON MOBILE DEVICES; ELECTRONIC CATALOG SERVICES FEATURING A WIDE VARIETY OF CONSUMER GOODS AND SERVICES OF OTHERS; MARKETING, ADVERTISING, AND PROMOTING THE RETAIL GOODS AND SERVICES OF OTHERS TO WIRELESS ELECTRONIC DEVICES; MOBILE RETAIL STORE SERVICES FEATURING A WIDE VARIETY OF CONSUMER GOODS AND SERVICES OF OTHERS; ON-LINE RETAIL STORE SERVICES FEATURING A WIDE VARIETY OF CONSUMER GOODS OF OTHERS; ONLINE SERVICE FOR CONNECTING SOCIAL NETWORK USERS WITH RETAILERS FOR THE PURPOSE OF FACILITATING DISCOUNTED PURCHASES; PRESENTATION OF GOODS ON COMMUNICATION MEDIA FOR RETAIL PURPOSES; PROMOTING THE GOODS AND SERVICES OF OTHERS BY MEANS OF OPERATING AN ON-LINE SHOPPING MALL WITH LINKS TO THE RETAIL WEB SITES OF OTHERS; PROMOTING THE GOODS AND SERVICES OF OTHERS THROUGH ON-LINE ORDERING AND CATALOGING OF THOSE GOODS AND SERVICES; PROMOTIONAL SERVICES, NAMELY, DISTRIBUTION OF ADVERTISING FLYERS, COUPONS, CATALOGS AND PROMOTIONAL ITEMS OF OTHERS; WEB-BASED CATALOG SERVICES FEATURING A WIDE VARIETY OF CONSUMER GOODS AND SERVICES OF OTHERS, IN CLASS 35 (U.S. CLS. 100, 101 AND 102).

FIRST USE 4-20-2011; IN COMMERCE 4-20-2011.

FOR: APPLICATION SERVICE PROVIDER (ASP) FEATURING SOFTWARE FOR USE IN PROMOTING, SEARCHING AND SHOPPING FOR THE GOODS AND SERVICES OF OTHERS; DESIGN, DEVELOPMENT AND IMPLEMENTATION OF SOFTWARE; DEVELOPING AND UPDATING COMPUTER SOFTWARE; PROVIDING A WEBSITE FEATURING TECHNOLOGY THAT ENABLES USERS TO PROMOTE, SEARCH AND SHOP FOR GOODS AND SERVICES OF OTHERS; PROVIDING AN ONLINE NON-DOWNLOADABLE INTERNET-BASED SYS-



David J. Kyffers

Director of the United States Patent and Trademark Office

Reg. No. 4,098,480 TEM APPLICATION FEATURING TECHNOLOGY ENABLING USERS TO SHOP FOR GOODS AND SERVICES OF OTHERS; PROVIDING CUSTOMER-DEFINED GENERATED CONTENT AND CONTENT OF OTHERS AUTOMATICALLY SELECTED AND CUSTOMIZED BASED ON THE KNOWN OR ESTIMATED GEOGRAPHICAL LOCATION OF AN INTERNET, MOBILE TELEPHONE OR OTHER WIRED OR WIRELESS DIGITAL NETWORK BASED CUSTOMER; PROVIDING TEMPORARY USE OF A WEB-BASED SOFTWARE APPLICATION FOR SEARCHING AND SHOPPING FOR THE GOODS AND SERVICES OF OTHERS; PROVIDING TEMPORARY USE OF ON-LINE NONDOWNLOADABLE SOFTWARE AND APPLICATIONS FOR ONLINE RETAIL SHOPPING, IN CLASS 42 (U.S. CLS. 100 AND 101).

FIRST USE 4-20-2011; IN COMMERCE 4-20-2011.

THE MARK CONSISTS OF STANDARD CHARACTERS WITHOUT CLAIM TO ANY PARTICULAR FONT, STYLE, SIZE, OR COLOR.

SER. NO. 85-335,733, FILED 6-1-2011.

JEFFREY LOOK, EXAMINING ATTORNEY

United States of America

United States Patent and Trademark Office

The Nobility of Policing

Reg. No. 4,098,481

FRANKLIN COVEY CO. (UTAH CORPORATION)

Registered Feb. 14, 2012

2200 WEST PARKWAY BLVD.
SALT LAKE CITY, UT 84119

Int. Cl.: 41

FOR: EDUCATIONAL SERVICES, NAMELY, CONDUCTING SEMINARS, WORKSHOPS, LECTURES AND CLASSES IN THE FIELDS OF LEADERSHIP, LAW ENFORCEMENT, MANAGEMENT, COMMUNICATIONS, CORPORATE, PERSONAL AND PROFESSIONAL ASSESSMENT AND MEASUREMENT AND PERSONAL DEVELOPMENT, IN CLASS 41 (U.S. CLS. 100, 101 AND 107).

SERVICE MARK

PRINCIPAL REGISTER

FIRST USE 5-1-2010; IN COMMERCE 5-1-2010.

THE MARK CONSISTS OF STANDARD CHARACTERS WITHOUT CLAIM TO ANY PARTICULAR FONT, STYLE, SIZE, OR COLOR.

NO CLAIM IS MADE TO THE EXCLUSIVE RIGHT TO USE "POLICING", APART FROM THE MARK AS SHOWN.

SER. NO. 85-335,768, FILED 6-1-2011.

MARC LEIPZIG, EXAMINING ATTORNEY



David J. Kyffers

Director of the United States Patent and Trademark Office

United States of America

United States Patent and Trademark Office

MANINIS

Reg. No. 4,098,482

MANINIS, INC. (WASHINGTON LIMITED LIABILITY COMPANY)
1524 MAGNOLIA WAY WEST
SEATTLE, WA 98199

Registered Feb. 14, 2012

Int. Cl.: 5

FOR: GLUTEN-FREE FOOD TO ACCOMMODATE SPECIAL MEDICAL AND HEALTH CONDITIONS, IN CLASS 5 (U.S. CLS. 6, 18, 44, 46, 51 AND 52).

TRADEMARK

FIRST USE 3-13-2011; IN COMMERCE 3-13-2011.

PRINCIPAL REGISTER

THE MARK CONSISTS OF STANDARD CHARACTERS WITHOUT CLAIM TO ANY PARTICULAR FONT, STYLE, SIZE, OR COLOR.

THE ENGLISH TRANSLATION OF "MANINIS" IN THE MARK IS "LITTLE HANDS".

SER. NO. 85-335,789, FILED 6-1-2011.

SUNG IN, EXAMINING ATTORNEY



David J. Kyffers

Director of the United States Patent and Trademark Office

United States of America

United States Patent and Trademark Office

THE OUTPOST CLUB

Reg. No. 4,098,483

Registered Feb. 14, 2012

Int. Cl.: 41

SERVICE MARK

PRINCIPAL REGISTER

THE OUTPOST CLUB LLC (DELAWARE LIMITED LIABILITY COMPANY)
1700 WOODLANDS DRIVE
MAUMEE, OH 43537

FOR: GOLF COURSES; ORGANIZATION OF GOLF TOURNAMENTS; PROVIDING INFORMATION TO GOLFERS CONCERNING RESERVATION OF TEE TIMES AND RATES AT GOLF COURSES, IN CLASS 41 (U.S. CLS. 100, 101 AND 107).

FIRST USE 2-8-2010; IN COMMERCE 2-8-2010.

THE MARK CONSISTS OF STANDARD CHARACTERS WITHOUT CLAIM TO ANY PARTICULAR FONT, STYLE, SIZE, OR COLOR.

NO CLAIM IS MADE TO THE EXCLUSIVE RIGHT TO USE "CLUB", APART FROM THE MARK AS SHOWN.

SER. NO. 85-335,811, FILED 6-1-2011.

AMY ALFIERI, EXAMINING ATTORNEY



David J. Kyffers

Director of the United States Patent and Trademark Office

United States of America

United States Patent and Trademark Office



Reg. No. 4,098,484

Registered Feb. 14, 2012

Int. Cl.: 25

TRADEMARK

PRINCIPAL REGISTER

CAMERA SHY (GEORGIA LIMITED LIABILITY COMPANY)
4619 MILLHAVEN
4619 MILLHAVEN
MARTINEZ, GA 30907

FOR: SHORT-SLEEVED OR LONG-SLEEVED T-SHIRTS; T-SHIRTS, IN CLASS 25 (U.S. CLS. 22 AND 39).

FIRST USE 7-22-2010; IN COMMERCE 5-19-2011.

THE MARK CONSISTS OF A BOX WITH ROUNDED CORNERS, THE SILHOUETTE OF A CAMERA, A CIRCLE IN THE MIDDLE OF THE CAMERA SILHOUETTE TO REPRESENT THE LENS AND "CAMERA SHY" WRITTEN IN CURSIVE, TO THE LEFT OF THE BOX.

SER. NO. 85-335,859, FILED S.R. 6-2-2011 AM. P.R. 9-27-2011.

AMY ALFIERI, EXAMINING ATTORNEY



David J. Kybas

Director of the United States Patent and Trademark Office

United States of America

United States Patent and Trademark Office

MOTHLAB

Reg. No. 4,098,485

Registered Feb. 14, 2012

Int. Cl.: 41

SERVICE MARK

PRINCIPAL REGISTER

ABDULLA, AMEEN (UNITED STATES INDIVIDUAL)
STE. 501
718 WASHINGTON AVE. NORTH
MINNEAPOLIS, MN 55401

FOR: AUDIO AND VIDEO RECORDING, PRODUCTION AND POST-PRODUCTION SERVICES; ENTERTAINMENT SERVICES IN THE NATURE OF DEVELOPMENT, CREATION, PRODUCTION AND POST-PRODUCTION SERVICES OF MULTIMEDIA ENTERTAINMENT CONTENT, WHICH CONTENT MAY ALSO BE EDUCATIONAL; MULTIMEDIA ENTERTAINMENT SERVICES IN THE NATURE OF DEVELOPMENT, RECORDING, PRODUCTION AND POST-PRODUCTION SERVICES IN THE FIELDS OF MUSIC, VIDEO AND FILM; MUSIC COMPOSITION FOR OTHERS; PROVIDING VOICE OVERS FOR TAPES, RECORDS AND OTHER RECORDED MEDIA FOR ENTERTAINMENT AND EDUCATION PURPOSES, IN CLASS 41 (U.S. CLS. 100, 101 AND 107).

FIRST USE 10-19-2006; IN COMMERCE 4-23-2007.

THE MARK CONSISTS OF STANDARD CHARACTERS WITHOUT CLAIM TO ANY PARTICULAR FONT, STYLE, SIZE, OR COLOR.

SER. NO. 85-335,897, FILED 6-2-2011.

IRA J. GOODSaid, EXAMINING ATTORNEY



David J. Kyros

Director of the United States Patent and Trademark Office

United States of America

United States Patent and Trademark Office



Reg. No. 4,098,486

SEA PINES RESORT, LLC (VIRGINIA LIMITED LIABILITY COMPANY)
P. O. BOX 7000

Registered Feb. 14, 2012

HILTON HEAD ISLAND, SC 29938

Int. Cls.: 36, 41 and 43

FOR: REAL ESTATE SERVICES, NAMELY, VACATION HOME RENTAL MANAGEMENT SERVICES, IN CLASS 36 (U.S. CLS. 100, 101 AND 102).

SERVICE MARK

FIRST USE 3-1-2007; IN COMMERCE 3-1-2007.

PRINCIPAL REGISTER

FOR: GOLF CLUB SERVICES, IN CLASS 41 (U.S. CLS. 100, 101 AND 107).

FIRST USE 3-1-2007; IN COMMERCE 3-1-2007.

FOR: RESORT LODGING SERVICES; RESTAURANT SERVICES, IN CLASS 43 (U.S. CLS. 100 AND 101).

FIRST USE 3-1-2007; IN COMMERCE 3-1-2007.

OWNER OF U.S. REG. NOS. 2,804,427, 2,836,092, AND 2,913,641.

THE COLOR(S) RED, WHITE, GRAY AND BLACK IS/ARE CLAIMED AS A FEATURE OF THE MARK.

NO CLAIM IS MADE TO THE EXCLUSIVE RIGHT TO USE "RESORT", APART FROM THE MARK AS SHOWN.

THE MARK CONSISTS OF A RED AND WHITE STRIPED LIGHTHOUSE OUTLINED IN BLACK WITHIN A BLACK CIRCLE WITH GRAY CLOUDS BEHIND THE LIGHTHOUSE WITH THE WORDS "THE" TO THE LEFT OF THE LIGHTHOUSE THEN THE WORDS "SEAPINES RESORT" UNDERNEATH. ALL OF THE WORDING IS IN BLACK.

SER. NO. 85-335,928, FILED 6-2-2011.

SHAUNIA CARLYLE, EXAMINING ATTORNEY



David J. Kyffers

Director of the United States Patent and Trademark Office

United States of America

United States Patent and Trademark Office

HELEN'S HEART

Reg. No. 4,098,487

HELEN'S HEART LLC (TEXAS LIMITED LIABILITY COMPANY)
2945 CONGRESSMAN LANE
DALLAS, TX 75220

Registered Feb. 14, 2012

Int. Cls.: 14, 18, 25 and 26

FOR: COSTUME JEWELRY; SEQUINED AND JEWELLED COSTUME TIARAS, IN CLASS 14 (U.S. CLS. 2, 27, 28 AND 50).

FIRST USE 1-1-2007; IN COMMERCE 1-1-2007.

TRADEMARK

FOR: HANDBAGS; PURSES, IN CLASS 18 (U.S. CLS. 1, 2, 3, 22 AND 41).

PRINCIPAL REGISTER

FIRST USE 1-1-2007; IN COMMERCE 1-1-2007.

FOR: SHOES; HEADBANDS, IN CLASS 25 (U.S. CLS. 22 AND 39).

FIRST USE 1-1-2007; IN COMMERCE 1-1-2007.

FOR: HAIR ACCESSORIES, NAMELY, FEATHERED HAIR CLIPS, SEQUINED AND JEWELLED COSTUME HAIR CLIPS, IN CLASS 26 (U.S. CLS. 37, 39, 40, 42 AND 50).

FIRST USE 1-1-2007; IN COMMERCE 1-1-2007.

THE MARK CONSISTS OF STANDARD CHARACTERS WITHOUT CLAIM TO ANY PARTICULAR FONT, STYLE, SIZE, OR COLOR.

THE NAME(S), PORTRAIT(S), AND/OR SIGNATURE(S) SHOWN IN THE MARK IDENTIFIES "HELEN" ZHENG, WHOSE CONSENT(S) TO REGISTER IS MADE OF RECORD.

SER. NO. 85-336,486, FILED 6-2-2011.

TRICIA SONNEBORN, EXAMINING ATTORNEY



David J. Kybas

Director of the United States Patent and Trademark Office

United States of America

United States Patent and Trademark Office

CLINICAL SPRAGUE

Reg. No. 4,098,488

RASHMAN CORPORATION (CALIFORNIA CORPORATION), DBA PRESTIGE MEDICAL
8600 WILBUR AVENUE
NORTHRIDGE, CA 913244499

Registered Feb. 14, 2012

Int. Cl.: 10

FOR: STETHOSCOPES, IN CLASS 10 (U.S. CLS. 26, 39 AND 44).

TRADEMARK

FIRST USE 12-31-2008; IN COMMERCE 12-31-2008.

PRINCIPAL REGISTER

THE MARK CONSISTS OF STANDARD CHARACTERS WITHOUT CLAIM TO ANY PARTICULAR FONT, STYLE, SIZE, OR COLOR.

OWNER OF U.S. REG. NOS. 2,058,412, 2,242,108 AND OTHERS.

NO CLAIM IS MADE TO THE EXCLUSIVE RIGHT TO USE "CLINICAL", APART FROM THE MARK AS SHOWN.

SER. NO. 85-336,593, FILED 6-2-2011.

TINA BROWN, EXAMINING ATTORNEY



David J. Kyffers

Director of the United States Patent and Trademark Office

United States of America

United States Patent and Trademark Office

OWN A PIECE OF LOCAL HISTORY

Reg. No. 4,098,489

WEINER JR., WILLIAM G. (UNITED STATES INDIVIDUAL)
1322 SANTEE MILL ROAD
BETHLEHEM, PA 18017

Registered Feb. 14, 2012

Int. Cl.: 16

FOR: POSTCARDS, POSTCARD ART, IN CLASS 16 (U.S. CLS. 2, 5, 22, 23, 29, 37, 38 AND 50).

TRADEMARK

FIRST USE 4-29-2011; IN COMMERCE 5-24-2011.

PRINCIPAL REGISTER

THE MARK CONSISTS OF STANDARD CHARACTERS WITHOUT CLAIM TO ANY PARTICULAR FONT, STYLE, SIZE, OR COLOR.

SER. NO. 85-337,567, FILED 6-3-2011.

PATRICIA EVANKO, EXAMINING ATTORNEY



David J. Kybas

Director of the United States Patent and Trademark Office

United States of America

United States Patent and Trademark Office

EnviroKid

Reg. No. 4,098,490

LDI CORPORATION (NEW HAMPSHIRE CORPORATION)
3560 LAFAYETTE RD, BLDG 2, SUITE C
PORTSMOUTH, NH 03801

Registered Feb. 14, 2012

Int. Cl.: 20

FOR: BEAN BAG BEDS, BEAN BAG CHAIRS, BEAN BAG PILLOWS, AND NAP MATS CONTAINING SUBSTANTIAL ECO-FRIENDLY MATERIALS, IN CLASS 20 (U.S. CLS. 2, 13, 22, 25, 32 AND 50).

TRADEMARK

FIRST USE 4-12-2009; IN COMMERCE 8-7-2009.

PRINCIPAL REGISTER

THE MARK CONSISTS OF STANDARD CHARACTERS WITHOUT CLAIM TO ANY PARTICULAR FONT, STYLE, SIZE, OR COLOR.

SER. NO. 85-338,208, FILED 6-4-2011.

SIMON TENG, EXAMINING ATTORNEY



David J. Kyffers

Director of the United States Patent and Trademark Office

United States of America

United States Patent and Trademark Office

FUEL WAREHOUSE

Reg. No. 4,098,491

MALLARD OIL COMPANY (NORTH CAROLINA CORPORATION)
1502 MARTIN LUTHER KING JR. BLVD.
KINSTON, NC 28501

Registered Feb. 14, 2012

Int. Cl.: 35

FOR: RETAIL CONVENIENCE STORES, IN CLASS 35 (U.S. CLS. 100, 101 AND 102).

SERVICE MARK

FIRST USE 11-23-2002; IN COMMERCE 11-23-2002.

PRINCIPAL REGISTER

THE MARK CONSISTS OF STANDARD CHARACTERS WITHOUT CLAIM TO ANY PARTICULAR FONT, STYLE, SIZE, OR COLOR.

OWNER OF U.S. REG. NO. 2,961,584.

NO CLAIM IS MADE TO THE EXCLUSIVE RIGHT TO USE "WAREHOUSE", APART FROM THE MARK AS SHOWN.

SEC. 2(F).

SER. NO. 85-338,431, FILED 6-6-2011.

MARK SPARACINO, EXAMINING ATTORNEY



David J. Kyffers

Director of the United States Patent and Trademark Office

United States of America

United States Patent and Trademark Office

LEAD BUSINESS ACCELERATION

Reg. No. 4,098,492

Registered Feb. 14, 2012

Int. Cl.: 41

SERVICE MARK

PRINCIPAL REGISTER

HCOAC, LLC (DELAWARE LIMITED LIABILITY COMPANY)
SUITE 125
1122 S CAPITAL OF TEXAS HWY
AUSTIN, TX 78746

FOR: EDUCATION SERVICES, NAMELY, PROVIDING CLASSES, SEMINARS, WORKSHOPS, MENTORING AND COACHING IN THE FIELDS OF BUSINESS MANAGEMENT AND OPTIMIZATION, ENTREPRENEURSHIP, LEADERSHIP, TALENT DEVELOPMENT, TEAM BUILDING, IMPLEMENTATION AND PERFORMANCE, AND DISTRIBUTION OF COURSE MATERIALS IN CONNECTION THEREWITH, IN CLASS 41 (U.S. CLS. 100, 101 AND 107).

FIRST USE 3-1-2011; IN COMMERCE 3-1-2011.

THE MARK CONSISTS OF STANDARD CHARACTERS WITHOUT CLAIM TO ANY PARTICULAR FONT, STYLE, SIZE, OR COLOR.

NO CLAIM IS MADE TO THE EXCLUSIVE RIGHT TO USE "BUSINESS", APART FROM THE MARK AS SHOWN.

SER. NO. 85-338,569, FILED 6-6-2011.

JASON BLAIR, EXAMINING ATTORNEY



David J. Kybas

Director of the United States Patent and Trademark Office

United States of America

United States Patent and Trademark Office



Reg. No. 4,098,493

SATTAR, MIRAL (UNITED STATES INDIVIDUAL)
175 E. 96TH STREET, APT. 9K
NEW YORK, NY 10128

Registered Feb. 14, 2012

Int. Cl.: 41

FOR: ON-LINE JOURNALS, NAMELY, BLOGS FEATURING ENTERTAINMENT AND POP CULTURE; PROVIDING A WEBSITE FEATURING ENTERTAINMENT INFORMATION, IN CLASS 41 (U.S. CLS. 100, 101 AND 107).

SERVICE MARK

FIRST USE 4-0-2004; IN COMMERCE 4-0-2004.

PRINCIPAL REGISTER

THE MARK CONSISTS OF A STYLIZED FLOWER DESIGN THAT HAS SEVEN POINTED ARROWS UPWARD. THE THREE TOP ARROWS CLOSEST TO THE TOP AND CENTER EACH HAVE A DOT ABOVE. THERE IS ONE ARROW POINTING DOWN IN AND IT IS OUTLINED BY A CURLED V-LIKE SHAPE. TO THE RIGHT OF THE DESIGN IS THE STYLIZED WORD "DIVANEE".

THE ENGLISH TRANSLATION OF "DIVANEE" IN THE MARK IS "PASSIONATE".

SER. NO. 85-338,633, FILED 6-6-2011.

WILLIAM VERHOSEK, EXAMINING ATTORNEY



David J. Kyffers

Director of the United States Patent and Trademark Office

United States of America

United States Patent and Trademark Office

AMIEN

Reg. No. 4,098,494

Registered Feb. 14, 2012

Int. Cl.: 41

SERVICE MARK

PRINCIPAL REGISTER

MARK D. GOTTSEGEN (UNITED STATES INDIVIDUAL)
7694 EAST WASHINGTON STREET
CHAGRIN FALLS, OH 44023

FOR: EDUCATIONAL SERVICES, NAMELY, WORKSHOPS IN THE FIELD OF THE QUALITY AND SAFETY OF ARTISTS' MATERIALS IN THE NATURE OF ARTISTS' TOOLS, SOLVENTS, THINNERS, VARNISHES, COATINGS, COLORANTS, OIL PAINTS, WATERTHINNED TRADITIONAL PAINTS, TEMPERA PAINTS, ENCAUSTIC PAINTS, PASTEL PAINTS, COLOR PENCILS, MURAL PAINTS, DIGITAL MEDIA, DIGITAL IMAGERY; EDUCATIONAL SERVICES, NAMELY, WORKSHOPS IN THE FIELD OF THE PROTECTION, STORAGE AND SHIPPING OF ARTISTS' PAINTS AND MATERIALS; EDUCATIONAL SERVICES, NAMELY, WORKSHOPS IN THE FIELD OF TESTING TECHNIQUES FOR ARTISTS' MATERIALS; EDUCATIONAL SERVICES, NAMELY, WORKSHOPS IN THE FIELD OF THE PRESERVATION OF ARTWORK, THE DOCUMENTATION OF ARTWORK, AND THE CATALOGING OF ARTWORK, IN CLASS 41 (U.S. CLS. 100, 101 AND 107).

FIRST USE 0-0-2007; IN COMMERCE 0-0-2007.

THE MARK CONSISTS OF STANDARD CHARACTERS WITHOUT CLAIM TO ANY PARTICULAR FONT, STYLE, SIZE, OR COLOR.

SER. NO. 85-339,005, FILED 6-6-2011.

LINDA M. KING, EXAMINING ATTORNEY



David J. Kyffers

Director of the United States Patent and Trademark Office

United States of America

United States Patent and Trademark Office



Reg. No. 4,098,495

PENA, JOHN (UNITED STATES INDIVIDUAL)
932 S VAN HORNE
WEST COVINA, CA 91790

Registered Feb. 14, 2012

Int. Cl.: 41

FOR: PRESENTATION OF MIXED MARTIAL ARTS (MMA) EVENTS, IN CLASS 41 (U.S. CLS. 100, 101 AND 107).

SERVICE MARK

FIRST USE 9-20-2009; IN COMMERCE 9-20-2009.

PRINCIPAL REGISTER

NO CLAIM IS MADE TO THE EXCLUSIVE RIGHT TO USE "PRODUCTIONS", APART FROM THE MARK AS SHOWN.

THE MARK CONSISTS OF THE STYLIZED TEXT "JP" ABOVE THE STYLIZED TEXT "PRODUCTIONS" IN BETWEEN TWO HORIZONTAL LINES. UNDERNEATH IS THE STYLIZED TEXT "RESPECT" WHICH IS ABOVE THE STYLIZED TEXT "IN THE". UNDER "IN THE" IS THE STYLIZED TEXT "CAGE". UNDERNEATH THAT TEXT IN BETWEEN THE "A" AND "G" IN "CAGE" IS A STAR WITH TWO FISTS OVERLAPPING IT.

SER. NO. 85-339,247, FILED 6-6-2011.

LESLEY LAMOTHE, EXAMINING ATTORNEY



David J. Kybas

Director of the United States Patent and Trademark Office

United States of America

United States Patent and Trademark Office



Reg. No. 4,098,496

Registered Feb. 14, 2012

Int. Cl.: 35

SERVICE MARK

PRINCIPAL REGISTER

EBAGS, INC. (DELAWARE CORPORATION)
SUITE 160
5500 GREENWOOD PLAZA BOULEVARD
GREENWOOD VILLAGE, CO 80111

FOR: ONLINE RETAIL STORE SERVICES FEATURING BAGS FOR WOMEN; ONLINE RETAIL STORE SERVICES FEATURING, PURSES, BAGS, LUGGAGE, BACKPACKS, WALLETS AND ACCESSORIES, IN CLASS 35 (U.S. CLS. 100, 101 AND 102).

FIRST USE 3-25-2011; IN COMMERCE 7-28-2011.

NO CLAIM IS MADE TO THE EXCLUSIVE RIGHT TO USE "HANDBAGS.COM", APART FROM THE MARK AS SHOWN.

THE MARK CONSISTS OF A STRIPED BAG WITH A CLOSED FRONT FLAP, BUTTON AND HANDLES NEXT TO THE TEXT "HANDBAGS.COM".

SER. NO. 85-339,252, FILED 6-6-2011.

JUSTINE D. PARKER, EXAMINING ATTORNEY



David J. Kyros

Director of the United States Patent and Trademark Office

United States of America

United States Patent and Trademark Office

Heelcise

Reg. No. 4,098,497

Registered Feb. 14, 2012

Int. Cl.: 41

SERVICE MARK

PRINCIPAL REGISTER

BREEZE, NEVADA (UNITED STATES INDIVIDUAL), DBA QUEEN OF HOOKS MUSIC
SUITE C4
2125 FAIR OAKS BLVD.
SACRAMENTO, CA 95825

FOR: PROVIDING GROUP PHYSICAL FITNESS INSTRUCTION FEATURING INSTRUCTION ON BALANCE AND UTILIZING CORE STRENGTHENING TECHNIQUES IN RELATION TO ELEVATION WHILE LIFTING ONE'S BODY WEIGHT AND/OR IMPOSED BY THE ELEVATION OF SHOES, KNOWN AS "HIGH HEELS"; PROVIDING INSTRUCTION IN VARIOUS FACILITIES ON HOW TO MAINTAIN HEALTH AND WELL BEING WHEN WEARING HIGH HEELS, THE FOREGOING BEING PART OF THE NEVADA BREEZE FITNESS GRAVITY HEEL EXERCISING PROGRAM, IN CLASS 41 (U.S. CLS. 100, 101 AND 107).

FIRST USE 10-8-2000; IN COMMERCE 4-18-2011.

THE MARK CONSISTS OF STANDARD CHARACTERS WITHOUT CLAIM TO ANY PARTICULAR FONT, STYLE, SIZE, OR COLOR.

SER. NO. 85-339,262, FILED 6-6-2011.

MELISSA VALLILLO, EXAMINING ATTORNEY



David J. Kyffers

Director of the United States Patent and Trademark Office

United States of America

United States Patent and Trademark Office

sista sense

Reg. No. 4,098,498

LASHANDA HENRY (UNITED STATES INDIVIDUAL)

Registered Feb. 14, 2012

P.O. BOX 30047
GREENVILLE, NC 27833

Int. Cl.: 41

FOR: ON-LINE JOURNALS, NAMELY, BLOGS FEATURING BUSINESS, ENTREPRENEURS, EVENTS, AND CURRENT EVENTS; PROVIDING A WEB SITE FEATURING BLOGS AND NON-DOWNLOADABLE PUBLICATIONS IN THE NATURE OF ARTICLES, PICTURES, MAGAZINES AND FEATURES IN THE FIELDS OF BUSINESS, ENTREPRENEURS, EVENTS, AND CURRENT EVENTS, IN CLASS 41 (U.S. CLS. 100, 101 AND 107).

SERVICE MARK

PRINCIPAL REGISTER

FIRST USE 1-5-2007; IN COMMERCE 1-5-2007.

THE MARK CONSISTS OF STANDARD CHARACTERS WITHOUT CLAIM TO ANY PARTICULAR FONT, STYLE, SIZE, OR COLOR.

SER. NO. 85-339,364, FILED 6-6-2011.

H. M. FISHER, EXAMINING ATTORNEY



David J. Kyfos

Director of the United States Patent and Trademark Office

United States of America

United States Patent and Trademark Office

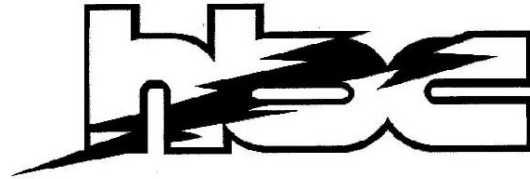

Reg. No. 4,098,499

Registered Feb. 14, 2012

Int. Cl.: 12

TRADEMARK

PRINCIPAL REGISTER

HBC PRODUCTS INC. (OHIO CORPORATION)
16205 CENFIELD STREET, N.E.
ALLIANCE, OH 446018805

FOR: AUTOMOBILE STRUCTURAL PARTS, NAMELY, TURBOCHARGERS AND VALVES;
RACING AND PERFORMANCE AFTER-MARKET AUTOMOBILE STRUCTURAL PARTS,
NAMELY, TURBOCHARGERS, BOOST CONTROLLERS AND ACCELERATION ENHANCERS,
IN CLASS 12 (U.S. CLS. 19, 21, 23, 31, 35 AND 44).

FIRST USE 2-1-2003; IN COMMERCE 2-1-2003.

OWNER OF U.S. REG. NO. 4,021,605.

THE MARK CONSISTS OF THE STYLIZED LETTERS "H", "B", AND "C" WITH A STYLIZED
LIGHTNING BOLT GOING THROUGH THE STYLIZED LETTERS "H", "B", AND "C".

SER. NO. 85-339,575, FILED 6-7-2011.

FLORENTINA BLANDU, EXAMINING ATTORNEY



David J. Kybas

Director of the United States Patent and Trademark Office

United States of America

United States Patent and Trademark Office

BOTTLEPOSH

Reg. No. 4,098,500

BOTTLEPOSH INC. (NEW YORK CORPORATION)
41 PARK AVENUE, APT 3B
NEW YORK, NY 10016

Registered Feb. 14, 2012

Int. Cl.: 35

FOR: PROMOTING THE GOODS AND SERVICES OF OTHERS BY PROVIDING AN INTERACTIVE WEBSITE WHERE USERS CAN INCREASE THE CURRENT VALUE OF AN ONLINE DISCOUNT BEING OFFERED BY PURCHASING THE GOODS AND SERVICES ASSOCIATED WITH THAT DISCOUNT IN THE FORM OF AN ONLINE COUPON, VOUCHER OR GIFT CARD, IN CLASS 35 (U.S. CLS. 100, 101 AND 102).

SERVICE MARK

PRINCIPAL REGISTER

FIRST USE 6-7-2011; IN COMMERCE 6-7-2011.

THE MARK CONSISTS OF STANDARD CHARACTERS WITHOUT CLAIM TO ANY PARTICULAR FONT, STYLE, SIZE, OR COLOR.

SER. NO. 85-339,595, FILED 6-7-2011.

LINDA MICKLEBURGH, EXAMINING ATTORNEY



David J. Kyros

Director of the United States Patent and Trademark Office

United States of America

United States Patent and Trademark Office



Reg. No. 4,098,501

Registered Feb. 14, 2012

Int. Cl.: 28

TRADEMARK

PRINCIPAL REGISTER

SPECIALTY HOUSE OF CREATION (NEW JERSEY CORPORATION)
1568 JESSE BRIDGE RD
PITTSBORO, NJ 08318

FOR: STUFFED AND PLUSH TOYS, IN CLASS 28 (U.S. CLS. 22, 23, 38 AND 50).

FIRST USE 3-15-2011; IN COMMERCE 4-7-2011.

THE MARK CONSISTS OF THE STYLIZED WORDS "CASH COW" WITH A DOLLAR SYMBOL IN PLACE OF THE LETTER "S" AND WITH AN IMAGE OF A COW INSIDE THE LETTER "O" WITH CURRENCY IN ITS MOUTH.

SER. NO. 85-339,651, FILED 6-7-2011.

JOHN E. MICHOS, EXAMINING ATTORNEY



David J. Kybas

Director of the United States Patent and Trademark Office

United States of America

United States Patent and Trademark Office



Reg. No. 4,098,502

Registered Feb. 14, 2012

Int. Cl.: 35

SERVICE MARK

PRINCIPAL REGISTER

GALANE, LLC (CALIFORNIA LIMITED LIABILITY COMPANY), DBA GALANE, LLC
PO BOX 50708
PASADENA, CA 91115

FOR: ONLINE SERVICE FOR CONNECTING SOCIAL NETWORK USERS WITH RETAILERS FOR THE PURPOSE OF FACILITATING DISCOUNTED PURCHASES; PROMOTING, ADVERTISING AND MARKETING OF THE BRANDS, PRODUCTS, SERVICES AND ONLINE WEBSITES OF INDIVIDUALS, BUSINESSES AND NONPROFIT ORGANIZATIONS; PROMOTIONAL SERVICES, NAMELY, PROVIDING A WEBSITE AT WHICH ARTISTS CAN SHOWCASE THEIR TALENTS VIA AN ONLINE PORTFOLIO; PROVIDING A SEARCHABLE ON-LINE ADVERTISING WEBSITE AND GUIDE FEATURING THE GOODS AND SERVICES OF OTHER VENDORS VIA THE INTERNET; PROVIDING A WEBSITE AT WHICH ENTREPRENEURS POST COMPANY PROFILES TO ATTRACT VENTURE CAPITAL; PROVIDING A WEBSITE FEATURING A REGISTRY OF MUSICAL INSTRUMENT INFORMATION; PROVIDING A WEBSITE FEATURING AN ONLINE MARKETPLACE FOR EXCHANGING GOODS AND SERVICES WITH OTHER USERS; PROVIDING A WEBSITE FEATURING INFORMATION AND LINKS RELATING TO THE MUSIC INDUSTRY, NAMELY, PROMOTION, MARKETING AND BUSINESS ADVICE TO MUSICIANS; PROVIDING A WEBSITE FOR CONNECTING SELLERS WITH BUYERS; PROVIDING A WEBSITE FOR USERS WITH SPECIFIC INFORMED RECOMMENDATIONS OF SPECIFIC CONSUMER PRODUCTS AND SERVICES VALIDATED BY THE USERS' INPUTTED PREFERENCES AND SOCIAL NETWORK; PROVIDING A WEBSITE WHERE OWNERS CAN POST ITEMS AND SERVICES AVAILABLE FOR RENT BY OTHERS; PROVIDING AN INTERNET WEBSITE PORTAL FEATURING LINKS TO MUSIC-RELATED MERCHANDISE FOR RETAIL PURPOSES; PROVIDING AN ONLINE MARKETING COLLABORATION NETWORK FOR SOCIAL MEDIA AND ONLINE MARKETING PROFESSIONALS FOR THE PURPOSE OF SYNDICATING CONTENT THROUGH THE NETWORK TO BE SHARED BY OTHERS, IN CLASS 35 (U.S. CLS. 100, 101 AND 102).



FIRST USE 5-1-2011; IN COMMERCE 6-1-2011.

NO CLAIM IS MADE TO THE EXCLUSIVE RIGHT TO USE "TALENT", APART FROM THE MARK AS SHOWN.

THE COLOR(S) DARK BLUE, WHITE IS/ARE CLAIMED AS A FEATURE OF THE MARK.

David J. Kyros

Director of the United States Patent and Trademark Office

Reg. No. 4,098,502 THE MARK CONSISTS OF THE WORDING "NEW TALENT PLACE.COM" IN WHITE STYLIZED FONT. THE TERM "NEW" APPEARS TO THE RIGHT OF THE TOP OF THE LETTER "T" IN "TALENT" AND THE WORDING "PLACE.COM" APPEARS BELOW THE "ENT" IN "TALENT". ALL OF THE WORDING APPEARS AGAINST A DARK BLUE BACKGROUND.

SER. NO. 85-339,753, FILED 6-7-2011.

DAVID I, EXAMINING ATTORNEY

United States of America

United States Patent and Trademark Office

BURTON HISTORY TREES

Reg. No. 4,098,503

FRANCHISE TREES, INC. (ILLINOIS CORPORATION)
1301 N ARTESIAN #2R CHICAGO
CHICAGO, IL 60622

Registered Feb. 14, 2012

Int. Cl.: 16

FOR: ART PICTURES; ART PRINTS; FRAMED ART PICTURES; FRAMED ART PRINTS;
POSTERS; POSTERS MADE OF PAPER; PRINTS, IN CLASS 16 (U.S. CLS. 2, 5, 22, 23, 29,
37, 38 AND 50).

TRADEMARK

FIRST USE 5-1-2011; IN COMMERCE 5-1-2011.

PRINCIPAL REGISTER

THE MARK CONSISTS OF STANDARD CHARACTERS WITHOUT CLAIM TO ANY PAR-
TICULAR FONT, STYLE, SIZE, OR COLOR.

NO CLAIM IS MADE TO THE EXCLUSIVE RIGHT TO USE "HISTORY TREES", APART
FROM THE MARK AS SHOWN.

THE NAME(S), PORTRAIT(S), AND/OR SIGNATURE(S) SHOWN IN THE MARK IDENTIFIES
BRUCE BURTON, WHOSE CONSENT(S) TO REGISTER IS MADE OF RECORD.

SER. NO. 85-339,784, FILED 6-7-2011.

LESLEY LAMOTHE, EXAMINING ATTORNEY



David J. Kybas

Director of the United States Patent and Trademark Office

United States of America

United States Patent and Trademark Office



Reg. No. 4,098,504

FRANKLIN BARBECUE, LLC (TEXAS LIMITED LIABILITY COMPANY)
4705 PROCK LANE
AUSTIN, TX 78721

Registered Feb. 14, 2012

Int. Cl.: 43

FOR: RESTAURANT SERVICES FEATURING BARBECUE, IN CLASS 43 (U.S. CLS. 100 AND 101).

SERVICE MARK

FIRST USE 11-1-2009; IN COMMERCE 12-1-2009.

PRINCIPAL REGISTER

NO CLAIM IS MADE TO THE EXCLUSIVE RIGHT TO USE "BARBECUE", APART FROM THE MARK AS SHOWN.

THE MARK CONSISTS OF THE WORDS "FRANKLIN BARBECUE" AS SHOWN WITH A FLAME DESIGN OVER THE DOT IN THE "I" IN THE WORD "FRANKLIN". THE WORDS APPEAR AGAINST A HORIZONTAL KIDNEY-SHAPED DESIGN BACKGROUND WITH ALL LETTERS IN THE WORD "BARBECUE" PROJECTING A THIN FILAMENT STRAIGHT TO THE BASE OF THE DESIGN.

SER. NO. 85-339,910, FILED 6-7-2011.

DOMINIC J. FERRAIUOLO, EXAMINING ATTORNEY



David J. Kybas

Director of the United States Patent and Trademark Office

United States of America

United States Patent and Trademark Office

EZ AGG

Reg. No. 4,098,505

Registered Feb. 14, 2012

Int. Cl.: 36

SERVICE MARK

PRINCIPAL REGISTER

EAST COAST UNDERWRITERS, LLC (SOUTH CAROLINA LIMITED LIABILITY COMPANY)
210
101 N. PINE ST
SPARTANBURG, SC 29302

FOR: INSURANCE UNDERWRITING IN THE FIELD OF HEALTH, IN CLASS 36 (U.S. CLS. 100, 101 AND 102).

FIRST USE 1-1-2006; IN COMMERCE 1-1-2006.

THE MARK CONSISTS OF STANDARD CHARACTERS WITHOUT CLAIM TO ANY PARTICULAR FONT, STYLE, SIZE, OR COLOR.

NO CLAIM IS MADE TO THE EXCLUSIVE RIGHT TO USE "AGG", APART FROM THE MARK AS SHOWN.

SER. NO. 85-340,002, FILED 6-7-2011.

JASON TURNER, EXAMINING ATTORNEY



David J. Kybas

Director of the United States Patent and Trademark Office

United States of America

United States Patent and Trademark Office

Your Mission. Our
Innovation. His Purpose.

Reg. No. 4,098,506

Registered Feb. 14, 2012

Int. Cls.: 35, 36 and 42

SERVICE MARK

PRINCIPAL REGISTER

MASTERWORKS, INCORPORATED (WASHINGTON CORPORATION)
19462 POWDER HILL PLACE NE
POULSBO, WA 98370

FOR: ADVERTISING AND MARKETING SERVICES, NAMELY, MARKETING RESEARCH, ADVERTISING AGENCY SERVICES INCLUDING ADVISING THE CLIENT REGARDING RENTED LISTS TO PURCHASE IN THE FIELD OF POTENTIAL DONORS; AND BUSINESS MANAGEMENT CONSULTATION; MARKETING AND CONSULTING SERVICES IN THE FIELD OF PROMOTING AND TRACKING THE GOODS, SERVICES, AND BRANDS OF OTHERS THROUGH ALL PUBLIC COMMUNICATION MEANS, PARTICULARLY SPECIALIZING IN THE USE OF DIGITAL MEDIA AND MOBILE SMS AND TEXT-BASED MESSAGING TO DRIVE CONSUMER INTEREST, ENGAGEMENT AND ACTION; MEDIA BUYING ADVICE, NAMELY, ADVISING THE CLIENT REGARDING HOW MUCH MEDIA TIME AND AT WHAT TIMES AND PLACES THE CLIENT SHOULD BE PURCHASING DISPLAY OR BANNER ADVERTISING PLACEMENT, IN CLASS 35 (U.S. CLS. 100, 101 AND 102).

FIRST USE 10-31-2009; IN COMMERCE 10-31-2009.

FOR: CHARITABLE FUNDRAISING, IN CLASS 36 (U.S. CLS. 100, 101 AND 102).

FIRST USE 7-31-2005; IN COMMERCE 7-31-2005.

FOR: CREATING AND DESIGNING WEB PAGES FOR OTHERS FOR MARKETING PURPOSES; WEBSITE DEVELOPMENT FOR OTHERS FOR MARKETING PURPOSES; WEBSITE USABILITY TESTING SERVICES; CONSULTATION SERVICES IN THE FIELD OF SEARCH ENGINE OPTIMIZATION, IN CLASS 42 (U.S. CLS. 100 AND 101).

FIRST USE 7-31-2005; IN COMMERCE 7-31-2005.

THE MARK CONSISTS OF STANDARD CHARACTERS WITHOUT CLAIM TO ANY PARTICULAR FONT, STYLE, SIZE, OR COLOR.

SER. NO. 85-340,021, FILED 6-7-2011.

ANDREA K. NADELMAN, EXAMINING ATTORNEY



David J. Kyffers

Director of the United States Patent and Trademark Office

United States of America

United States Patent and Trademark Office



Reg. No. 4,098,507

QUALITYHUB, INC. (FLORIDA CORPORATION)
5151 DORWIN PLACE
ORLANDO, FL 32814

Registered Feb. 14, 2012

Int. Cl.: 42

FOR: QUALITY MANAGEMENT SERVICES, NAMELY, QUALITY EVALUATION AND ANALYSIS, QUALITY ASSURANCE, AND QUALITY CONTROL, IN THE FIELD OF MEDICAL DEVICE, PHARMACEUTICAL AND BIOTECHNOLOGY, IN CLASS 42 (U.S. CLS. 100 AND 101).

SERVICE MARK

PRINCIPAL REGISTER

FIRST USE 9-15-2000; IN COMMERCE 12-1-2000.

THE MARK CONSISTS OF A YELLOW CHECK MARK IN A ROYAL BLUE SQUARE WITH JAGGED EDGES APPEARING TO THE RIGHT OF THE STYLIZED TEXT "QUALITYHUB" WITH "QUALITY" BEING ROYAL BLUE AND "HUB" BEING YELLOW.

THE COLOR(S) ROYAL BLUE AND YELLOW IS/ARE CLAIMED AS A FEATURE OF THE MARK.

SER. NO. 85-340,068, FILED 6-7-2011.

TRICIA SONNEBORN, EXAMINING ATTORNEY



David J. Kyffers

Director of the United States Patent and Trademark Office

United States of America

United States Patent and Trademark Office

Monster Game

Reg. No. 4,098,508

HELL SURVIVORS, INC. (MICHIGAN CORPORATION)

Registered Feb. 14, 2012

PO BOX 619
PINCKNEY, MI 48169

Int. Cl.: 41

FOR: ENTERTAINMENT SERVICES IN THE NATURE OF PROVIDING OUTDOOR FACILITIES FOR PLAYING PAINTBALL; PROVIDING FACILITIES FOR PLAYING PAINTBALL GAMES, IN CLASS 41 (U.S. CLS. 100, 101 AND 107).

SERVICE MARK

FIRST USE 6-1-1991; IN COMMERCE 6-1-1991.

PRINCIPAL REGISTER

THE MARK CONSISTS OF STANDARD CHARACTERS WITHOUT CLAIM TO ANY PARTICULAR FONT, STYLE, SIZE, OR COLOR.

NO CLAIM IS MADE TO THE EXCLUSIVE RIGHT TO USE "GAME", APART FROM THE MARK AS SHOWN.

SER. NO. 85-340,077, FILED 6-7-2011.

JOSETTE BEVERLY, EXAMINING ATTORNEY



David J. Kyfos

Director of the United States Patent and Trademark Office

United States of America

United States Patent and Trademark Office



Reg. No. 4,098,509

TUBB, DEBBIE (UNITED STATES INDIVIDUAL)
25803 OAKRIDGE FOREST LN
SPRING, TX 77386

Registered Feb. 14, 2012

Int. Cl.: 3

FOR: BAR SOAP; BATH SOAPS; BODY LOTIONS; LIP BALM, IN CLASS 3 (U.S. CLS. 1, 4, 6, 50, 51 AND 52).

TRADEMARK

FIRST USE 6-1-2002; IN COMMERCE 6-1-2002.

PRINCIPAL REGISTER

NO CLAIM IS MADE TO THE EXCLUSIVE RIGHT TO USE "HERBAL" AND "GOAT'S MILK SOAPS", APART FROM THE MARK AS SHOWN.

THE MARK CONSISTS OF TWO CONCENTRIC CIRCLES. INSIDE THE SMALLER CIRCLE IS A CARTOON HEAD OF A GOAT WITH STRIPED HORNS HOLDING A FLOWER IN ITS MOUTH. INSIDE THE TOP HALF OF THE RING THAT SURROUNDS THE SMALLER CIRCLE IS THE STYLIZED TEXT "THE HERBAL GOAT". INSIDE THE BOTTOM HALF OF THE RING IS THE STYLIZED TEXT "GOAT'S MILK SOAPS". A SMALL FLOWER SITS AT 3 O'CLOCK AND 9 O'CLOCK BETWEEN THESE PHRASES INSIDE THE OUTER RING.

SER. NO. 85-340,081, FILED 6-7-2011.

EMILY CARLSEN, EXAMINING ATTORNEY



David J. Kyffers

Director of the United States Patent and Trademark Office

United States of America

United States Patent and Trademark Office

Nova IVF

Reg. No. 4,098,510

Registered Feb. 14, 2012

Int. Cl.: 44

SERVICE MARK

PRINCIPAL REGISTER

RICHARD JOSEPH SCHMIDT, M.D., INC. (CALIFORNIA CORPORATION)
2500 HOSPITAL DR., BUILDING 2
MOUNTAIN VIEW, CA 94040

FOR: HUMAN FERTILITY TREATMENT SERVICES, IN CLASS 44 (U.S. CLS. 100 AND 101).

FIRST USE 1-2-1987; IN COMMERCE 1-2-1987.

THE MARK CONSISTS OF STANDARD CHARACTERS WITHOUT CLAIM TO ANY PARTICULAR FONT, STYLE, SIZE, OR COLOR.

NO CLAIM IS MADE TO THE EXCLUSIVE RIGHT TO USE "IVF", APART FROM THE MARK AS SHOWN.

SER. NO. 85-340,117, FILED 6-7-2011.

JOHN GARTNER, EXAMINING ATTORNEY



David J. Kyffers

Director of the United States Patent and Trademark Office

United States of America

United States Patent and Trademark Office

NOVA

Reg. No. 4,098,511

RICHARD JOSEPH SCHMIDT, M.D., INC. (CALIFORNIA CORPORATION)
2500 HOSPITAL DR., BUILDING 2, MOUNTAIN
MOUNTAIN VIEW, CA 94040

Registered Feb. 14, 2012

Int. Cl.: 44

FOR: HUMAN EGG DONATION SERVICES; HUMAN FERTILITY TREATMENT SERVICES;
HUMAN SPERM DONATION SERVICES, IN CLASS 44 (U.S. CLS. 100 AND 101).

SERVICE MARK

FIRST USE 1-2-1987; IN COMMERCE 1-2-1987.

PRINCIPAL REGISTER

THE MARK CONSISTS OF STANDARD CHARACTERS WITHOUT CLAIM TO ANY PARTICULAR FONT, STYLE, SIZE, OR COLOR.

SER. NO. 85-340,156, FILED 6-7-2011.

JOHN GARTNER, EXAMINING ATTORNEY



David J. Kyffers

Director of the United States Patent and Trademark Office

United States of America

United States Patent and Trademark Office

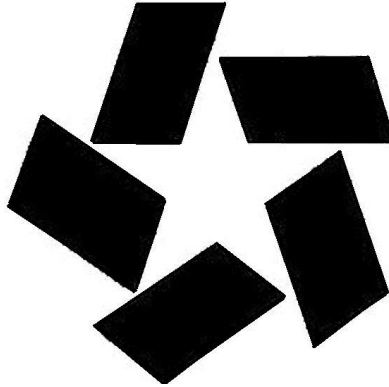

Reg. No. 4,098,512

Registered Feb. 14, 2012

Int. Cls.: 35 and 41

SERVICE MARK

PRINCIPAL REGISTER

THE E GROUP, INC. (VIRGINIA CORPORATION)
SUITE T100
11790 SUNRISE VALLEY DR.
RESTON, VA 20191

FOR: CONDUCTING EMPLOYEE INCENTIVE AWARD PROGRAMS TO PROMOTE PROFESSIONAL GROWTH AND DEVELOPMENT THROUGH RECOGNITION OF EMPLOYEE ACHIEVEMENTS IN ORDER TO ENGAGE WORKFORCES TO MAXIMIZE PERFORMANCE; PROVIDING RECOGNITION AND REWARD PROGRAMS IN THE NATURE OF EMPLOYEE INCENTIVE AWARD PROGRAMS TO PROMOTE EMPLOYEE RETENTION AND EMPLOYEE QUALITY AND PRODUCTIVITY PERFORMANCE; CONSULTING SERVICES IN THE FIELD OF HUMAN RESOURCES DEVELOPMENT FOR THE PROMOTION OF EMPLOYEE RETENTION AND INCREASED PRODUCTIVITY FOR EMPLOYEES AND EMPLOYERS, NAMELY, DESIGNING PROGRAMS TO ENHANCE A COMPANY'S CORPORATE CULTURE; BRAND POSITIONING SERVICES; MARKETING AND BRANDING SERVICES, NAMELY, PERFORMING BRAND STRATEGY OF COMPANY LOGOS, IN CLASS 35 (U.S. CLS. 100, 101 AND 102).

FIRST USE 0-0-1999; IN COMMERCE 0-0-1999.

FOR: PROVIDING RECOGNITION AND INCENTIVES BY WAY OF AWARDS TO DEMONSTRATE EXCELLENCE IN THE FIELDS OF EMPLOYEE SERVICE AND EMPLOYEE PRODUCTIVITY, IN CLASS 41 (U.S. CLS. 100, 101 AND 107).

FIRST USE 0-0-1999; IN COMMERCE 0-0-1999.

THE MARK CONSISTS OF FIVE PARALLELOGRAMS ARRANGED TO FORM THE OUTLINE OF A STAR.

SER. NO. 85-340,204, FILED 6-7-2011.

BRENDAN REGAN, EXAMINING ATTORNEY



David J. Kybas

Director of the United States Patent and Trademark Office

United States of America

United States Patent and Trademark Office



Reg. No. 4,098,513

Registered Feb. 14, 2012

Int. Cl.: 3

TRADEMARK

PRINCIPAL REGISTER

SERENE DREAMS, LLC (D.C. LIMITED LIABILITY COMPANY)
1612 FORT DUPONT STREET SE
WASHINGTON, DC 20020

FOR: AROMATIC BODY CARE PRODUCTS, NAMELY, BODY LOTION, SHOWER GEL, CUTICLE CREAM, SHAMPOO, CONDITIONER, NON-MEDICATED LIP BALM, SOAP, BODY POLISH, BODY AND FOOT SCRUB AND NON-MEDICATED FOOT CREAM, IN CLASS 3 (U.S. CLS. 1, 4, 6, 50, 51 AND 52).

FIRST USE 4-23-2011; IN COMMERCE 4-23-2011.

THE MARK CONSISTS OF THE STYLIZED WORDING "SERENE DREAMS" WITH "SERENE" APPEARING IN SCRIPT ABOVE "DREAMS" IN NON-SCRIPT. ABOVE THE WORDING APPEARS THE IMAGE OF A WOMAN WITH HER EYES CLOSED AND HAND BESIDE HER FACE. THE ENTIRE MARK APPEARS IN THE COLOR CHOCOLATE BROWN.

THE COLOR(S) CHOCOLATE BROWN IS/ARE CLAIMED AS A FEATURE OF THE MARK.

SER. NO. 85-340,266, FILED 6-7-2011.

MARCIE MILONE, EXAMINING ATTORNEY



David J. Kybas

Director of the United States Patent and Trademark Office

United States of America

United States Patent and Trademark Office

Thunder Frog

Reg. No. 4,098,514

M2 LURES, LLC (PENNSYLVANIA LIMITED LIABILITY COMPANY)
1430 YOCUMTOWN ROAD
ETTERS, PA 17319

Registered Feb. 14, 2012

Int. Cl.: 28

FOR: ARTIFICIAL FISHING BAIT; ARTIFICIAL FISHING LURES; FISHING LURE BOXES;
FISHING LURE PARTS; FISHING LURES; LURES FOR FISHING; LURES FOR HUNTING
OR FISHING, IN CLASS 28 (U.S. CLS. 22, 23, 38 AND 50).

TRADEMARK

FIRST USE 2-1-2011; IN COMMERCE 5-1-2011.

PRINCIPAL REGISTER

THE MARK CONSISTS OF STANDARD CHARACTERS WITHOUT CLAIM TO ANY PAR-
TICULAR FONT, STYLE, SIZE, OR COLOR.

NO CLAIM IS MADE TO THE EXCLUSIVE RIGHT TO USE "FROG", APART FROM THE
MARK AS SHOWN.

SER. NO. 85-340,473, FILED 6-7-2011.

ELLEN BURNS, EXAMINING ATTORNEY



David J. Kyros

Director of the United States Patent and Trademark Office

United States of America

United States Patent and Trademark Office

Underground Nutrition

Reg. No. 4,098,515

NORTH SEA SALES (NEW YORK LIMITED LIABILITY COMPANY)
47 TERRY AVE

Registered Feb. 14, 2012

AMITYVILLE, NY 11701

Int. Cl.: 5

FOR: DIETARY AND NUTRITIONAL SUPPLEMENTS FOR ENDURANCE SPORTS; DIETARY FOOD SUPPLEMENTS, IN CLASS 5 (U.S. CLS. 6, 18, 44, 46, 51 AND 52).

TRADEMARK

FIRST USE 1-1-2011; IN COMMERCE 2-28-2011.

PRINCIPAL REGISTER

THE MARK CONSISTS OF STANDARD CHARACTERS WITHOUT CLAIM TO ANY PARTICULAR FONT, STYLE, SIZE, OR COLOR.

NO CLAIM IS MADE TO THE EXCLUSIVE RIGHT TO USE "NUTRITION", APART FROM THE MARK AS SHOWN.

SER. NO. 85-340,475, FILED 6-7-2011.

FONG HSU, EXAMINING ATTORNEY



David J. Kyffers

Director of the United States Patent and Trademark Office

United States of America

United States Patent and Trademark Office

STICKAM

Reg. No. 4,098,516

ADVANCED VIDEO COMMUNICATIONS, INC. (CALIFORNIA CORPORATION)
633 W. 5TH STREET, SUITE 6800
LOS ANGELES, CA 90071

Registered Feb. 14, 2012

Int. Cl.: 38

FOR: STREAMING OF AUDIO, VISUAL AND AUDIOVISUAL MATERIALS ON THE INTERNET; STREAMING VIDEO, SLIDE SHOW, MUSIC, AND LIVE VIDEO CHAT ON YOUR PERSONAL WEB PAGES, ONLINE AUCTIONS, COMPANY WEB SITES AND ONLINE BLOGS, IN CLASS 38 (U.S. CLS. 100, 101 AND 104).

SERVICE MARK

PRINCIPAL REGISTER

FIRST USE 2-15-2006; IN COMMERCE 2-15-2006.

OWNER OF U.S. REG. NO. 3,205,925.

THE MARK CONSISTS OF THE LITERAL ELEMENT "STICKAM" IN A STYLIZED FORMAT WITH THE LETTER "C" BEING REPRESENTED BY A CRESCENT MOON SHAPE AND A SMALL SPHERE WITH HIGHLIGHT

SER. NO. 85-340,497, FILED 6-7-2011.

THOMAS MANOR, EXAMINING ATTORNEY



David J. Kyffers

Director of the United States Patent and Trademark Office

United States of America

United States Patent and Trademark Office

POWER RANGERS SAMURAI

Reg. No. 4,098,517

Registered Feb. 14, 2012

Int. Cl.: 41

SERVICE MARK

PRINCIPAL REGISTER

SCG POWER RANGERS LLC (CALIFORNIA LIMITED LIABILITY COMPANY)
10100 SANTA MONICA BLVD., SUITE 600
LOS ANGELES, CA 90067

FOR: ENTERTAINMENT SERVICES IN THE NATURE OF A LIVE-ACTION TELEVISION SERIES; ENTERTAINMENT SERVICES, NAMELY, PRODUCTION OF LIVE EVENTS FOR CHILDREN; ENTERTAINMENT SERVICES, NAMELY, COMPUTER ON-LINE SERVICES OFFERED OVER A WORLDWIDE COMMUNICATION NETWORK FEATURING GAMES AND INFORMATION RELATING TO TELEVISION SHOW PROGRAMS AND FAMILY ENTERTAINMENT VIA A GLOBAL COMMUNICATIONS NETWORK; ENTERTAINMENT SERVICES OFFERED ON-LINE OVER A WORLDWIDE COMMUNICATION NETWORK; PROVIDING A WEB SITE FEATURING VIDEO CLIPS, AND OTHER MULTIMEDIA MATERIALS, ALL RELATING TO TELEVISION SHOW PROGRAMS AND FAMILY ENTERTAINMENT VIA A GLOBAL COMMUNICATIONS NETWORK; AND ENTERTAINMENT INFORMATION IN THE NATURE OF INFORMATION ABOUT LIVE ACTION ENTERTAINMENT FOR CHILDREN, IN CLASS 41 (U.S. CLS. 100, 101 AND 107).

FIRST USE 2-7-2011; IN COMMERCE 2-7-2011.

THE MARK CONSISTS OF STANDARD CHARACTERS WITHOUT CLAIM TO ANY PARTICULAR FONT, STYLE, SIZE, OR COLOR.

OWNER OF U.S. REG. NOS. 1,893,768, 3,957,535 AND OTHERS.

SER. NO. 85-340,537, FILED 6-7-2011.

THOMAS MANOR, EXAMINING ATTORNEY



David J. Kyffers

Director of the United States Patent and Trademark Office

United States of America

United States Patent and Trademark Office



Reg. No. 4,098,518

Registered Feb. 14, 2012

Int. Cl.: 30

TRADEMARK

PRINCIPAL REGISTER

SAN SHU GONG FOOD CO., LTD. (TAIWAN CORPORATION)
NO. 55, GUOJI RD., TUCHENG DIST.,
NEW TAIPEI CITY, TAIWAN 236

FOR: POUNDED RICE CAKES; CANDIES; BISCUITS; PASTRIES; MOCHI CAKES; MOON CAKES; PANCAKES; RICE CRACKERS; PINEAPPLE PASTRIES; GREEN BEAN PASTRIES, IN CLASS 30 (U.S. CL. 46).

FIRST USE 4-19-2011; IN COMMERCE 4-27-2011.

NO CLAIM IS MADE TO THE EXCLUSIVE RIGHT TO USE "TAIWAN" AND THE JAPANESE CHARACTERS WHICH TRANSLATE TO "TAIWAN", APART FROM THE MARK AS SHOWN.

THE COLOR(S) RED, BROWN, AND BLACK IS/ARE CLAIMED AS A FEATURE OF THE MARK.

THE NON-LATIN CHARACTERS IN THE MARK TRANSLITERATE TO "TAIWAN SHU SHIN" AND THIS MEANS "TAIWAN HAND LETTER" IN ENGLISH.

THE MARK CONSISTS OF THE TWO CHINESE CHARACTERS IN BLACK, TWO RED SQUARES POSITIONED VERTICALLY ON TOP ON EACH OTHER ON THE LEFT OF THE CHINESE CHARACTERS, THE TWO RED SQUARES ARE SLIGHTLY OVERLAPPING THE BROWN DESIGN TO ITS LEFT, THE WORDS "TAIWAN SHU SHIN" IN BROWN BELOW THE CHINESE CHARACTERS AND DESIGN, AND BROWN JAPANESE CHARACTERS BELOW THE ENGLISH CHARACTERS.

THE ENGLISH TRANSLATION OF THE TWO CHINESE CHARACTERS WHICH TRANSLITERATE TO "SHU SHIN" IN THE MARK IS "HAND LETTER".

SER. NO. 85-340,614, FILED 6-8-2011.

MARK SHINER, EXAMINING ATTORNEY



David J. Kybas

Director of the United States Patent and Trademark Office

United States of America

United States Patent and Trademark Office

WATER WITH A CONSCIENCE

Reg. No. 4,098,519

Registered Feb. 14, 2012

Int. Cl.: 32

TRADEMARK

PRINCIPAL REGISTER

PURBLU BEVERAGES, INC. (PENNSYLVANIA CORPORATION)
SUITE 820
ONE OXFORD CENTRE
PITTSBURGH, PA 15219

FOR: BOTTLED WATER, IN CLASS 32 (U.S. CLS. 45, 46 AND 48).

FIRST USE 6-0-2008; IN COMMERCE 6-0-2008.

THE MARK CONSISTS OF STANDARD CHARACTERS WITHOUT CLAIM TO ANY PARTICULAR FONT, STYLE, SIZE, OR COLOR.

NO CLAIM IS MADE TO THE EXCLUSIVE RIGHT TO USE "WATER", APART FROM THE MARK AS SHOWN.

SER. NO. 85-340,656, FILED 6-8-2011.

FLORENTINA BLANDU, EXAMINING ATTORNEY



David J. Kyffers

Director of the United States Patent and Trademark Office

United States of America

United States Patent and Trademark Office

Distant Shores Media

Reg. No. 4,098,520

DISTANT SHORES MEDIA (MINNESOTA NON-PROFIT CORPORATION)
PO BOX 2314

Registered Feb. 14, 2012

MINNEAPOLIS, MN 553117314

Int. Cl.: 45

FOR: CHRISTIAN MINISTRY SERVICES, IN CLASS 45 (U.S. CLS. 100 AND 101).

SERVICE MARK

FIRST USE 3-18-2004; IN COMMERCE 3-18-2004.

PRINCIPAL REGISTER

THE MARK CONSISTS OF STANDARD CHARACTERS WITHOUT CLAIM TO ANY PARTICULAR FONT, STYLE, SIZE, OR COLOR.

NO CLAIM IS MADE TO THE EXCLUSIVE RIGHT TO USE "MEDIA", APART FROM THE MARK AS SHOWN.

SER. NO. 85-340,741, FILED 6-8-2011.

ALICE BENMAMAN, EXAMINING ATTORNEY



David J. Kyffers

Director of the United States Patent and Trademark Office

United States of America

United States Patent and Trademark Office



Reg. No. 4,098,521

Registered Feb. 14, 2012

Int. Cl.: 9

TRADEMARK

PRINCIPAL REGISTER

AMERICAN ASSOCIATION OF STATE HIGHWAY AND TRANSPORTATION OFFICIALS
(D.C. CORPORATION), AKA AASHTO
444 NORTH CAPITOL STREET, NW SUITE 249
WASHINGTON, DC 20001

FOR: COMPUTER SOFTWARE FOR THE TRANSPORTATION CONSTRUCTION INDUSTRY FOR MANAGING PROJECT INFORMATION AND AUTOMATING PROCESSES DURING THE EARLY PHASES OF A CONSTRUCTION PROJECT - INCLUDING COST ESTIMATING, PREPARATION OF PROPOSALS FOR BIDDING, MANAGEMENT OF THE BID LETTING PROCESS, AND MAKING AWARD DECISIONS, IN CLASS 9 (U.S. CLS. 21, 23, 26, 36 AND 38).

FIRST USE 11-26-2008; IN COMMERCE 11-26-2008.

OWNER OF U.S. REG. NO. 3,660,710.

NO CLAIM IS MADE TO THE EXCLUSIVE RIGHT TO USE "PRECONSTRUCTION PROPOSAL ESTIMATES LETTING AND AWARD SYSTEM", APART FROM THE MARK AS SHOWN.

THE MARK CONSISTS OF A 3D CIRCLE CUT INTO SPLIT QUARTERS BENEATH THE OFF-CENTER TERMS "TRNS-PORT", "PRECONSTRUCTION" AND "PROPOSAL, ESTIMATES, LETTING AND AWARD SYSTEM".

SER. NO. 85-340,760, FILED 6-8-2011.

KATHLEEN LORENZO, EXAMINING ATTORNEY



David J. Kyjars

Director of the United States Patent and Trademark Office

United States of America

United States Patent and Trademark Office



Decontamination Systems

Reg. No. 4,098,522

Registered Feb. 14, 2012

Int. Cl.: 7

TRADEMARK

PRINCIPAL REGISTER

PREFIX CORPORATION (MICHIGAN CORPORATION)
SUITE 100
1300 W. HAMLIN ROAD
ROCHESTER HILLS, MI 48309

FOR: WASH STATIONS CONSISTING OF LARGE SCALE WASHING MACHINES FOR USE ON CONSTRUCTION VEHICLES, LAND MANAGEMENT VEHICLES, ENVIRONMENTAL VEHICLES, AGRICULTURAL VEHICLES AND NAUTICAL VESSELS, IN CLASS 7 (U.S. CLS. 13, 19, 21, 23, 31, 34 AND 35).

FIRST USE 3-18-2011; IN COMMERCE 3-18-2011.

NO CLAIM IS MADE TO THE EXCLUSIVE RIGHT TO USE "DECONTAMINATION SYSTEMS", APART FROM THE MARK AS SHOWN.

THE MARK CONSISTS OF THE STYLIZED WORD "PREFIX" ABOVE THE DESIGN OF A BOAT FORMED IN PART BY THE STYLIZED WORD "CLEAN", TRAILED BY WAVES, AND RIDING ON LINE DIVIDED BY A TRIANGLE, ALL OVER THE WORDS "DECONTAMINATION SYSTEMS".

SER. NO. 85-340,815, FILED 6-8-2011.

HANNO RITTNER, EXAMINING ATTORNEY



David J. Kyffers

Director of the United States Patent and Trademark Office

United States of America

United States Patent and Trademark Office

Oxford Inn

Reg. No. 4,098,523

BANEY CORPORATION (OREGON CORPORATION), DBA OXFORD INN
475 NE BELLEVUE DRIVE, SUITE 210
BEND, OR 977017411

Registered Feb. 14, 2012

Int. Cl.: 43

FOR: HOTEL, MOTEL, RESTAURANT, BAR AND CATERING SERVICES, IN CLASS 43
(U.S. CLS. 100 AND 101).

SERVICE MARK

FIRST USE 1-1-1998; IN COMMERCE 1-1-1998.

PRINCIPAL REGISTER

THE MARK CONSISTS OF STANDARD CHARACTERS WITHOUT CLAIM TO ANY PARTICULAR FONT, STYLE, SIZE, OR COLOR.

OWNER OF U.S. REG. NOS. 3,076,619 AND 3,076,626.

NO CLAIM IS MADE TO THE EXCLUSIVE RIGHT TO USE "INN", APART FROM THE MARK AS SHOWN.

SER. NO. 85-340,835, FILED 6-8-2011.

WENDY GOODMAN, EXAMINING ATTORNEY



David J. Kybas

Director of the United States Patent and Trademark Office

United States of America

United States Patent and Trademark Office



Reg. No. 4,098,524

WALLS, TONYA R (UNITED STATES INDIVIDUAL)

Registered Feb. 14, 2012

P.O. BOX 78352
CHARLOTTE, NC 28271

Int. Cl.: 42

FOR: PROVIDING A WEBSITE THAT GIVES COMPUTER USERS THE ABILITY TO VIEW POETRY ONLINE, AND TO SUBMIT A POEM ONLINE WITH AN OPPORTUNITY FOR IT TO BE LOADED AND VIEWED ON A WEBSITE OR ON AN UPCOMING BOOK SERIES, IN CLASS 42 (U.S. CLS. 100 AND 101).

SERVICE MARK

PRINCIPAL REGISTER

FIRST USE 4-0-2011; IN COMMERCE 4-0-2011.

THE MARK CONSISTS OF AN ORANGE GLOBE WITH YELLOW LONGITUDINAL AND LATITUDINAL LINES, A BEIGE DEPICTION OF LAND, AND A DARK BLUE, GRAY AND LIGHT BLUE FEATHER APPEARING TO THE RIGHT OF THE WORDING "POETRYRELIEF" IN ORANGE.

THE COLOR(S) ORANGE, YELLOW, DARK BLUE, LIGHT BLUE, GRAY AND BEIGE IS/ARE CLAIMED AS A FEATURE OF THE MARK.

SER. NO. 85-340,923, FILED 6-8-2011.

JULIE VEPPUMTHARA, EXAMINING ATTORNEY



David J. Kyros

Director of the United States Patent and Trademark Office

United States of America

United States Patent and Trademark Office



"pet sitting and dog walking services"

Reg. No. 4,098,525

PETZ IN DA HOOD (CALIFORNIA SOLE PROPRIETORSHIP)
213 SKLAR STREET

Registered Feb. 14, 2012

LADERA RANCH, CA 92694

Int. Cls.: 44 and 45

FOR: PET CARE SERVICES, NAMELY, DOG WALKING, DOG BATHING, NON-MEDICATED PET GROOMING AND IN-HOME MEDICAL CARE, IN CLASS 44 (U.S. CLS. 100 AND 101).

SERVICE MARK

FIRST USE 6-7-2011; IN COMMERCE 6-7-2011.

PRINCIPAL REGISTER

FOR: PET SITTING, IN CLASS 45 (U.S. CLS. 100 AND 101).

FIRST USE 6-7-2011; IN COMMERCE 6-7-2011.

NO CLAIM IS MADE TO THE EXCLUSIVE RIGHT TO USE "PETS" AND "PET SITTING AND DOG WALKING SERVICES", APART FROM THE MARK AS SHOWN.

THE COLOR(S) BLACK, WHITE, BLUE, YELLOW, ORANGE, DARK GREEN, LIGHT GREEN, GRAY, BROWN, TAN, PINK AND RED IS/ARE CLAIMED AS A FEATURE OF THE MARK.

THE MARK CONSISTS OF THE WORDING "PETZ IN DA HOOD" IN STYLIZED BLACK LETTERS COVERED WITH VARIOUS ANIMALS AND THE WORDING "PET SITTING AND DOG WALKING SERVICES", APPEARING IN BLACK LETTERS UNDERNEATH THE LOGO, A YELLOW BIRD WITH AN ORANGE BEAK IS SITTING IN THE UPPER CASE LETTER "P", A GRAY AND WHITE RABBIT IS SITTING ON THE LOWER HALF OF A LOWERCASE LETTER "P", A LIGHT GREEN LIZARD IS SITTING ON THE TOP OF THE CROSS OF A LOWERCASE LETTER "T", A BROWN, TAN AND WHITE HAMSTER IS SITTING AT THE BOTTOM OF A LOWERCASE LETTER "T", A DARK GREEN AND WHITE TURTLE IS SITTING ON THE LOWER HALF OF A BLACK UPPER CASE LETTER "Z", A BROWN DOG WITH A GRAY MOUSE ON HIS HEAD IS STANDING WITH HIS ARMS RESTING ON A BLACK UPPER CASE LETTER "H", A TAN AND WHITE FERRET WEARING A BASEBALL CAP BACKWARDS IS STANDING ON TOP OF A LOWERCASE LETTER "O", A BLUE FISH WITH YELLOW FINS AND A RED MOUTH APPEARS IN THE CIRCLE OF A LOWERCASE LETTER "O" BELOW THE FERRET, A DARK GREEN FROG IS STANDING IN THE CIRCLE OF A LOWERCASE LETTER "O", A GRAY CAT WITH YELLOW EYES IS STANDING ON TOP OF A LOWERCASE LETTER "D", A PINK PIG IS STANDING IN THE DARK GREEN GRASS THAT IS IN FRONT OF THE WORD "HOOD".



David J. Kappas

Director of the United States Patent and Trademark Office

Reg. No. 4,098,525 SER. NO. 85-340,931, FILED 6-8-2011.

RONALD MCMORROW, EXAMINING ATTORNEY

United States of America

United States Patent and Trademark Office

Oxford Bistro

Reg. No. 4,098,526

BANEY CORPORATION (OREGON CORPORATION), DBA OXFORD BISTRO
475 NE BELLEVUE DRIVE, SUITE 210
BEND, OR 977017411

Registered Feb. 14, 2012

Int. Cl.: 43

FOR: HOTEL, MOTEL, RESTAURANT, BAR AND CATERING SERVICES, IN CLASS 43
(U.S. CLS. 100 AND 101).

SERVICE MARK

FIRST USE 12-20-2010; IN COMMERCE 12-20-2010.

PRINCIPAL REGISTER

THE MARK CONSISTS OF STANDARD CHARACTERS WITHOUT CLAIM TO ANY PARTICULAR FONT, STYLE, SIZE, OR COLOR.

OWNER OF U.S. REG. NOS. 3,076,619 AND 3,076,626.

NO CLAIM IS MADE TO THE EXCLUSIVE RIGHT TO USE "BISTRO", APART FROM THE MARK AS SHOWN.

SER. NO. 85-340,963, FILED 6-8-2011.

WENDY GOODMAN, EXAMINING ATTORNEY



David J. Kyffers

Director of the United States Patent and Trademark Office

United States of America

United States Patent and Trademark Office

MARBLE LANE

Reg. No. 4,098,527

AVENUE RESTAURANT, LLC (NEW YORK LIMITED LIABILITY COMPANY)
SUITE 42

Registered Feb. 14, 2012

NEW YORK, NY 10019

Int. Cl.: 43

FOR: COCKTAIL LOUNGE, BAR AND RESTAURANT SERVICES, IN CLASS 43 (U.S. CLS. 100 AND 101).

SERVICE MARK

FIRST USE 6-15-2011; IN COMMERCE 6-15-2011.

PRINCIPAL REGISTER

THE MARK CONSISTS OF STANDARD CHARACTERS WITHOUT CLAIM TO ANY PARTICULAR FONT, STYLE, SIZE, OR COLOR.

SER. NO. 85-340,966, FILED 6-8-2011.

MARLENE BELL, EXAMINING ATTORNEY



David J. Kybas

Director of the United States Patent and Trademark Office

United States of America

United States Patent and Trademark Office

ATTORNEYS HELPING ATTORNEYS

Reg. No. 4,098,528

Registered Feb. 14, 2012

Int. Cls.: 36 and 45

SERVICE MARK

PRINCIPAL REGISTER

THE TRUSTEES OF THE ATTORNEYS' TITLE INSURANCE FUND (FLORIDA BUSINESS TRUST)
6545 CORPORATE CENTRE BLVD., SUITE 200
ORLANDO, FL 32822

FOR: INSURANCE AGENCIES; INSURANCE AGENCY AND BROKERAGE; INSURANCE AND FINANCIAL INFORMATION AND CONSULTANCY SERVICES; INSURANCE BROKERAGE SERVICES; INSURANCE INFORMATION; INSURANCE INFORMATION AND CONSULTANCY; MORTGAGE BROKERAGE; PROVIDING AN INTERNET WEBSITE PORTAL OFFERING INFORMATION IN THE FIELDS OF REAL ESTATE CONCERNING THE PURCHASE AND SALE OF NEW AND RESALE HOMES AND CONDOS; REAL ESTATE CONSULTANCY; REAL ESTATE ESCROW SERVICES; REAL ESTATE TITLE INSURANCE UNDERWRITING SERVICES; REAL ESTATE TRUSTEE SERVICES, IN CLASS 36 (U.S. CLS. 100, 101 AND 102).

FIRST USE 5-5-2011; IN COMMERCE 5-5-2011.

FOR: REAL ESTATE CLOSING SERVICES; REAL ESTATE SETTLEMENT SERVICES, IN CLASS 45 (U.S. CLS. 100 AND 101).

FIRST USE 5-5-2011; IN COMMERCE 5-5-2011.

THE MARK CONSISTS OF STANDARD CHARACTERS WITHOUT CLAIM TO ANY PARTICULAR FONT, STYLE, SIZE, OR COLOR.

SER. NO. 85-340,969, FILED 6-8-2011.

KARANENDRA S. CHHINA, EXAMINING ATTORNEY



David J. Kybas

Director of the United States Patent and Trademark Office

United States of America

United States Patent and Trademark Office

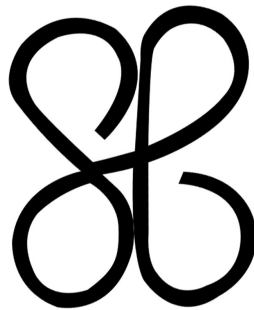

Reg. No. 4,098,529

Registered Feb. 14, 2012

Int. Cl.: 20

TRADEMARK

PRINCIPAL REGISTER

SEALY TECHNOLOGY, LLC (NORTH CAROLINA LIMITED LIABILITY COMPANY)
ONE OFFICE PARKWAY
TRINITY, NC 27370

FOR: MATTRESSES; BOX SPRINGS, IN CLASS 20 (U.S. CLS. 2, 13, 22, 25, 32 AND 50).

FIRST USE 4-15-2009; IN COMMERCE 4-15-2009.

OWNER OF U.S. REG. NO. 3,245,300.

THE MARK CONSISTS OF THE STYLIZED, CURSIVE LETTERS "S" AND "F".

SER. NO. 85-341,012, FILED 6-8-2011.

MARLENE BELL, EXAMINING ATTORNEY



David J. Kyffers

Director of the United States Patent and Trademark Office

United States of America

United States Patent and Trademark Office

RECOVERY PLUS

Reg. No. 4,098,530

THE SAINT CLOUD HOSPITAL (MINNESOTA CORPORATION)
1406 SIXTH AVENUE NORTH
ST. CLOUD, MN 56303

Registered Feb. 14, 2012

Int. Cl.: 44

FOR: REHABILITATION SERVICES FOR ALCOHOL AND DRUG ADDICTED PATIENTS,
IN CLASS 44 (U.S. CLS. 100 AND 101).

SERVICE MARK

FIRST USE 11-19-1989; IN COMMERCE 11-19-1989.

PRINCIPAL REGISTER

THE MARK CONSISTS OF STANDARD CHARACTERS WITHOUT CLAIM TO ANY PARTICULAR FONT, STYLE, SIZE, OR COLOR.

OWNER OF U.S. REG. NO. 1,653,287.

NO CLAIM IS MADE TO THE EXCLUSIVE RIGHT TO USE "RECOVERY", APART FROM THE MARK AS SHOWN.

SER. NO. 85-341,019, FILED 6-8-2011.

MARLENE BELL, EXAMINING ATTORNEY



David J. Kyffers

Director of the United States Patent and Trademark Office

United States of America

United States Patent and Trademark Office

CANINE TRAINING SYSTEMS

Reg. No. 4,098,531

Registered Feb. 14, 2012

Int. Cl.: 9

TRADEMARK

PRINCIPAL REGISTER

FOREST RUN PRODUCTIONS, INC. (MISSOURI CORPORATION), AKA CANINE TRAINING SYSTEMS CORPORATION
9325 E. ST. CHARLES RD.
COLUMBIA, MO 65202

FOR: AUDIO AND VIDEO RECORDINGS FEATURING EDUCATIONAL AND INSTRUCTIONAL CONTENT, NAMELY, THE TRAINING AND CARE OF SPORT, SERVICE AND PET ANIMALS; DIGITAL MEDIA, NAMELY, PRE-RECORDED DVDS AND CDS, FEATURING EDUCATIONAL AND INSTRUCTIONAL CONTENT, NAMELY, THE TRAINING AND CARE OF SPORT, SERVICE AND PET ANIMALS, IN CLASS 9 (U.S. CLS. 21, 23, 26, 36 AND 38).

FIRST USE 1-17-1989; IN COMMERCE 1-17-1989.

THE MARK CONSISTS OF STANDARD CHARACTERS WITHOUT CLAIM TO ANY PARTICULAR FONT, STYLE, SIZE, OR COLOR.

NO CLAIM IS MADE TO THE EXCLUSIVE RIGHT TO USE "TRAINING", APART FROM THE MARK AS SHOWN.

SEC. 2(F).

SER. NO. 85-341,107, FILED 6-8-2011.

BENJAMIN OKEKE, EXAMINING ATTORNEY



David J. Kyffers

Director of the United States Patent and Trademark Office

United States of America

United States Patent and Trademark Office



Reg. No. 4,098,532

Registered Feb. 14, 2012

Int. Cl.: 3

TRADEMARK

PRINCIPAL REGISTER

GARDEN OF EVE, L.L.C. (VIRGINIA LIMITED LIABILITY COMPANY), DBA GARDEN OF
EVE SKIN CARE
PO BOX 178
NORTH GARDEN, VA 22959

FOR: BODY CREAMS; EYE CREAM; FACIAL CLEANSERS; FACIAL CREAMS; FACIAL
MASKS; HAND CREAMS; MOISTURIZING CREAMS; SHAVING CREAMS; SKIN TONERS
, IN CLASS 3 (U.S. CLS. 1, 4, 6, 50, 51 AND 52).

FIRST USE 1-6-2011; IN COMMERCE 1-6-2011.

THE MARK CONSISTS OF A WOMAN'S FACE LOOKING INTO A FLOWER, ALL OF WHICH
IS ENCLOSED IN A CIRCLE.

SER. NO. 85-341,112, FILED 6-8-2011.

MARCIE MILONE, EXAMINING ATTORNEY



David J. Kyffers

Director of the United States Patent and Trademark Office

United States of America

United States Patent and Trademark Office



Reg. No. 4,098,533

Registered Feb. 14, 2012

Int. Cl.: 41

SERVICE MARK

PRINCIPAL REGISTER

MIK JACOBS, INC. (FLORIDA CORPORATION)
P.O. BOX 530550
DEBARY, FL 32753

FOR: EDUCATIONAL PROGRAMS, NAMELY, LIVE PERFORMANCES BY AN INDIVIDUAL PERFORMING ORIGINAL SCRIPTED MATERIAL, AND ORIGINAL LIVE MUSIC AND SCIENCE DEMONSTRATIONS, ALL IN THE FIELDS OF ELECTRICITY, FIRE AND FIRE SAFETY, MATTER AND ENERGY, FORCE AND MOTION, CONSERVATION OF ELECTRICAL POWER, WATER, ENVIRONMENTAL AWARENESS, RECYCLING, EARTH DAY AWARENESS, CLEAN WATER AND AIR, HEALTH AND HUMAN SERVICES, STORM PREPAREDNESS AND WEATHER, AUTOMOBILE AND BICYCLE SAFETY, AND UNIFORM ROAD REGULATIONS AND GENERAL SCIENCE, IN CLASS 41 (U.S. CLS. 100, 101 AND 107).

FIRST USE 0-0-2007; IN COMMERCE 0-0-2008.

THE MARK CONSISTS OF AN IMAGE OF A MAN WITH WHITE IN HIS FACE AND HANDS, ORANGE HAIR, WEARING A LIGHT BLUE LAB COAT OUTLINED IN ORANGE, WHITE SHIRT AND ORANGE GLASSES, HOLDING AN ORANGE BRIEFCASE. THE MAN IS IN FRONT OF A DARK BLUE DONUT-SHAPED CIRCLE OUTLINED IN ORANGE, WITH THE WORDS "PROFESSOR WHYS" IN WHITE WITHIN THE TOP PORTION OF THE CIRCLE. THE INTERIOR OF THE CIRCLE IS WHITE.

THE COLOR(S) BLUE, ORANGE AND WHITE IS/ARE CLAIMED AS A FEATURE OF THE MARK.

SER. NO. 85-341,133, FILED 6-8-2011.

REBECCA POVARCHUK, EXAMINING ATTORNEY



David J. Kybas

Director of the United States Patent and Trademark Office

United States of America

United States Patent and Trademark Office

Martini Republic

Reg. No. 4,098,534

CROY, RICHARD (UNITED STATES INDIVIDUAL)
481 20TH AVE.

Registered Feb. 14, 2012

INDIAN ROCKS BEACH, FL 33785

Int. Cl.: 43

FOR: BAR AND COCKTAIL LOUNGE SERVICES, IN CLASS 43 (U.S. CLS. 100 AND 101).

SERVICE MARK

FIRST USE 10-10-2010; IN COMMERCE 10-10-2010.

PRINCIPAL REGISTER

THE MARK CONSISTS OF STANDARD CHARACTERS WITHOUT CLAIM TO ANY PARTICULAR FONT, STYLE, SIZE, OR COLOR.

NO CLAIM IS MADE TO THE EXCLUSIVE RIGHT TO USE "MARTINI", APART FROM THE MARK AS SHOWN.

SER. NO. 85-341,212, FILED 6-8-2011.

JOHN SCHUYLER YARD, EXAMINING ATTORNEY



David J. Kyffers

Director of the United States Patent and Trademark Office

United States of America

United States Patent and Trademark Office



Reg. No. 4,098,535

Registered Feb. 14, 2012

Int. Cl.: 35

SERVICE MARK

PRINCIPAL REGISTER

GREG AND LORRIE GRAY (UNITED STATES INDIVIDUAL), DBA ELLA'S FROZEN YOGURT & MORE
520 N. STATE ROAD 135, SUITE A
GREENWOOD, IN 46142

FOR: SELF-SERVE YOGURT SHOP SERVICES, IN CLASS 35 (U.S. CLS. 100, 101 AND 102).

FIRST USE 2-17-2011; IN COMMERCE 4-23-2011.

NO CLAIM IS MADE TO THE EXCLUSIVE RIGHT TO USE "FROZEN YOGURT", APART FROM THE MARK AS SHOWN.

THE COLOR(S) PINK, GREEN, WHITE AND BLUE IS/ARE CLAIMED AS A FEATURE OF THE MARK.

THE MARK CONSISTS OF A STYLIZED FROZEN YOGURT SWIRL IN PINK AND LIGHT PINK WITH BLUE FLECKS, FOLLOWED BY THE STYLIZED WORD "ELLA'S" IN PINK, BOTH OF WHICH ARE ABOVE A GREEN SPANNER ON WHICH APPEARS THE WORDS "FROZEN YOGURT" IN WHITE, THE AMPERSAND IN PINK, AND THE WORD "MORE" IN WHITE.

SER. NO. 85-341,266, FILED 6-8-2011.

DOMINICK J. SALEMI, EXAMINING ATTORNEY



David J. Kyros

Director of the United States Patent and Trademark Office

United States of America

United States Patent and Trademark Office



TREES FOREVER

Reg. No. 4,098,536

TREES FOREVER (IOWA CORPORATION)
770 7TH AVE
MARION, IA 52302

Registered Feb. 14, 2012

Int. Cl.: 44

FOR: AFFORESTATION SERVICES, NAMELY, CONVERTING LAND TO FOREST BY PLANTING TREES OR THEIR SEEDS; TREE PLANTING FOR CARBON OFFSETTING PURPOSES, IN CLASS 44 (U.S. CLS. 100 AND 101).

SERVICE MARK

FIRST USE 4-15-2003; IN COMMERCE 4-15-2003.

PRINCIPAL REGISTER

NO CLAIM IS MADE TO THE EXCLUSIVE RIGHT TO USE "TREES", APART FROM THE MARK AS SHOWN.

THE MARK CONSISTS OF THE WORDING "TREES FOREVER", BORDERS ABOVE AND BELOW "TREES FOREVER", AND AN OAK TREE.

SER. NO. 85-341,298, FILED 6-8-2011.

TRACY CROSS, EXAMINING ATTORNEY



David J. Kyros

Director of the United States Patent and Trademark Office

United States of America

United States Patent and Trademark Office

FEED THEM WITH MUSIC

Reg. No. 4,098,537

FEED THEM WITH MUSIC, INC. (COLORADO NON-PROFIT CORPORATION)
P.O. BOX 1364
CARBONDALE, CO 81623

Registered Feb. 14, 2012

Int. Cl.: 36

FOR: CHARITABLE SERVICES, NAMELY, RAISING MONEY FOR HUNGER RELIEF ORGANIZATIONS, IN CLASS 36 (U.S. CLS. 100, 101 AND 102).

SERVICE MARK

FIRST USE 6-28-2008; IN COMMERCE 6-28-2008.

PRINCIPAL REGISTER

THE MARK CONSISTS OF STANDARD CHARACTERS WITHOUT CLAIM TO ANY PARTICULAR FONT, STYLE, SIZE, OR COLOR.

NO CLAIM IS MADE TO THE EXCLUSIVE RIGHT TO USE "MUSIC", APART FROM THE MARK AS SHOWN.

SER. NO. 85-341,301, FILED 6-8-2011.

TRACY CROSS, EXAMINING ATTORNEY



David J. Kyffers

Director of the United States Patent and Trademark Office

United States of America

United States Patent and Trademark Office

THE BREAD HOUSE AND GRANARY

Reg. No. 4,098,538

BREAD HOUSE OF ALBANY, LLC (GEORGIA LIMITED LIABILITY COMPANY)
1902 DAWSON ROAD
ALBANY, GA 31702

Registered Feb. 14, 2012

Int. Cl.: 30

FOR: BREAD; BREAD ROLLS; COOKIES; GRAIN-BASED FOOD BARS ALSO CONTAINING FIBER, IN CLASS 30 (U.S. CL. 46).

TRADEMARK

FIRST USE 8-30-2003; IN COMMERCE 8-30-2003.

PRINCIPAL REGISTER

THE MARK CONSISTS OF STANDARD CHARACTERS WITHOUT CLAIM TO ANY PARTICULAR FONT, STYLE, SIZE, OR COLOR.

NO CLAIM IS MADE TO THE EXCLUSIVE RIGHT TO USE "BREAD", APART FROM THE MARK AS SHOWN.

SER. NO. 85-341,331, FILED 6-8-2011.

KELLEY WELLS, EXAMINING ATTORNEY



David J. Kyffers

Director of the United States Patent and Trademark Office

United States of America

United States Patent and Trademark Office



MarketBook

Reg. No. 4,098,539

Registered Feb. 14, 2012

Int. Cl.: 16

TRADEMARK

PRINCIPAL REGISTER

SANDHILLS PUBLISHING COMPANY (NEBRASKA CORPORATION)
120 WEST HARVEST DRIVE
LINCOLN, NE 68521

FOR: NEWSPAPERS WHICH ADVERTISE AGRICULTURE, HEAVY MACHINERY, AND TRUCK AND TRAILER EQUIPMENT FOR SALE, IN CLASS 16 (U.S. CLS. 2, 5, 22, 23, 29, 37, 38 AND 50).

FIRST USE 5-0-2010; IN COMMERCE 5-0-2010.

OWNER OF U.S. REG. NOS. 4,004,848 AND 4,004,849.

THE MARK CONSISTS OF THE STYLIZED WORDING "MARKETBOOK" AND A DESIGN OF A MAPLE LEAF.

SER. NO. 85-341,341, FILED 6-8-2011.

MICHELE SWAIN, EXAMINING ATTORNEY



David J. Kyffers

Director of the United States Patent and Trademark Office

United States of America

United States Patent and Trademark Office

HOW BIG IS YOUR CRACK?

Reg. No. 4,098,540

EVERDRY MARKETING & MANAGEMENT, INC. (OHIO CORPORATION)
365 EAST HIGHLAND ROAD
MACEDONIA, OH 44056

Registered Feb. 14, 2012

Int. Cl.: 37

FOR: FOUNDATION WALL REPAIR AND BELOW GRADE BASEMENT WATERPROOFING SERVICES, IN CLASS 37 (U.S. CLS. 100, 103 AND 106).

SERVICE MARK

FIRST USE 1-31-2004; IN COMMERCE 1-31-2004.

PRINCIPAL REGISTER

THE MARK CONSISTS OF STANDARD CHARACTERS WITHOUT CLAIM TO ANY PARTICULAR FONT, STYLE, SIZE, OR COLOR.

SER. NO. 85-341,358, FILED 6-8-2011.

JUDITH HELFMAN, EXAMINING ATTORNEY



David J. Kybas

Director of the United States Patent and Trademark Office

United States of America

United States Patent and Trademark Office

OPT

Reg. No. 4,098,541

ODESSA PHYSICAL THERAPY, PC (TEXAS CORPORATION)

Registered Feb. 14, 2012

4407 N. GRANDVIEW

ODESSA, TX 79762

Int. Cl.: 44

FOR: OUTPATIENT PHYSICAL THERAPY, OCCUPATIONAL THERAPY, PHYSICAL REHABILITATION AND WELLNESS PROGRAMS; COMPREHENSIVE OUT-PATIENT PHYSICAL MEDICAL TESTING FOR DIAGNOSTIC PURPOSES AND PHYSICAL REHABILITATION SERVICES, NAMELY, HAND THERAPY, POOL THERAPY, WORK SIMULATION, WOUND CARE, SPLINTING, TAPING, BRACING, EXERCISE AND WELLNESS USING A VARIETY OF PHYSICAL MACHINERY SUCH AS TRACTION TABLES, ELECTRICAL STIMULATION, WHIRLPOOL, ULTRASOUND, ICE AND HEAT, IN CLASS 44 (U.S. CLS. 100 AND 101).

SERVICE MARK

PRINCIPAL REGISTER

FIRST USE 1-0-1995; IN COMMERCE 1-0-1995.

THE MARK CONSISTS OF STANDARD CHARACTERS WITHOUT CLAIM TO ANY PARTICULAR FONT, STYLE, SIZE, OR COLOR.

SER. NO. 85-341,455, FILED 6-8-2011.

DAVID HOFFMAN, EXAMINING ATTORNEY



David J. Kyfos

Director of the United States Patent and Trademark Office

United States of America

United States Patent and Trademark Office



Reg. No. 4,098,542

Registered Feb. 14, 2012

Int. Cl.: 18

TRADEMARK

PRINCIPAL REGISTER

CHUNMA USA., INC. (CALIFORNIA CORPORATION), DBA ALBA BAGS
2000 E. 25TH ST.
VERNON, CA 90058

FOR: HANDBAGS, TOTE BAGS, BACKPACKS, LUGGAGE, WALLETS AND PURSES, IN CLASS 18 (U.S. CLS. 1, 2, 3, 22 AND 41).

FIRST USE 8-1-2007; IN COMMERCE 9-20-2007.

THE MARK CONSISTS OF THE WORDING "ALBA BY CHUNMA" IN A STYLIZED FONT, NEXT TO THE DESIGN OF A POLO PLAYER ON A HORSE HOLDING TWO FLAGS.

THE ENGLISH TRANSLATION OF THE WORD "ALBA" IN THE MARK IS "DAWN".

THE ENGLISH TRANSLATION OF THE WORD "CHUNMA" IN THE MARK IS "PEGASUS".

SER. NO. 85-341,525, FILED S.R. 6-8-2011 AM. P.R. 10-20-2011.

JAMES MACFARLANE, EXAMINING ATTORNEY



David J. Kybas

Director of the United States Patent and Trademark Office

United States of America

United States Patent and Trademark Office



MISIÓN POSITIVA
INTERNACIONAL

Reg. No. 4,098,543

Registered Feb. 14, 2012

Int. Cl.: 45

SERVICE MARK

PRINCIPAL REGISTER

MISION POSITIVA INTERNACIONAL (CONNECTICUT CORPORATION)
17 FARREN AVE
NEW HAVEN, CT 06513

FOR: PROVIDING INFORMATION CONCERNING CHARITABLE CAUSES AND HUMANITARIAN EFFORTS IN THE FIELD OF SOCIAL JUSTICE, IN CLASS 45 (U.S. CLS. 100 AND 101).

FIRST USE 1-17-2001; IN COMMERCE 8-31-2010.

NO CLAIM IS MADE TO THE EXCLUSIVE RIGHT TO USE "INTERNACIONAL", APART FROM THE MARK AS SHOWN.

THE COLOR(S) GOLD, LIGHT GOLD, AND YELLOW IS/ARE CLAIMED AS A FEATURE OF THE MARK.

THE MARK CONSISTS OF A CIRCULAR DESIGN IN THE COLOR OF GOLD. WITHIN THE CIRCULAR DESIGN IS A GRID IN THE COLOR OF LIGHT GOLD. THE BORDER OF THE CIRCLE IS IN THE COLOR OF GOLD AND FADES TO YELLOW IN THE MIDDLE PORTION. DIRECTLY BELOW THE CIRCULAR DESIGN IS THE WORDING "MISION POSITIVA INTERNACIONAL" IN STYLIZED FONT AND IN THE COLOR OF GOLD.

THE ENGLISH TRANSLATION OF "MISION POSITIVA INTERNACIONAL" IN THE MARK IS "MISSION POSITIVE INTERNATIONAL".

SER. NO. 85-341,670, FILED 6-8-2011.

MICHAEL ENGEL, EXAMINING ATTORNEY



David J. Kybas

Director of the United States Patent and Trademark Office

United States of America

United States Patent and Trademark Office

Nature's Coolers

Reg. No. 4,098,544

Registered Feb. 14, 2012

Int. Cl.: 32

TRADEMARK

PRINCIPAL REGISTER

NATURAL FIVE, LLC (FLORIDA LIMITED LIABILITY COMPANY), DBA NATURE'S COOLERS
873 NE 30TH STREET
OAKLAND PARK, FL 33334

FOR: PREPARED ENTREES CONSISTING OF FRUIT DRINKS AND FRUIT JUICES, FRUIT-BASED BEVERAGES, NON-ALCOHOLIC BEVERAGES CONTAINING FRUIT JUICES, NON-ALCOHOLIC FRUIT JUICE BEVERAGES, VEGETABLE JUICES, VEGETABLE-FRUIT JUICES AND SMOOTHIES, IN CLASS 32 (U.S. CLS. 45, 46 AND 48).

FIRST USE 1-1-2001; IN COMMERCE 1-1-2001.

THE MARK CONSISTS OF STANDARD CHARACTERS WITHOUT CLAIM TO ANY PARTICULAR FONT, STYLE, SIZE, OR COLOR.

NO CLAIM IS MADE TO THE EXCLUSIVE RIGHT TO USE "COOLERS", APART FROM THE MARK AS SHOWN.

SER. NO. 85-341,858, FILED 6-9-2011.

ELLEN BURNS, EXAMINING ATTORNEY



David J. Kyfos

Director of the United States Patent and Trademark Office

United States of America

United States Patent and Trademark Office



Reg. No. 4,098,545

SPECTRUM HEALTH, INC. (FLORIDA CORPORATION)
5300 EAST AVENUE
WEST PALM BEACH, FL 33407

Registered Feb. 14, 2012

Int. Cl.: 36

FOR: CHARITABLE FUNDRAISING TO SUPPORT HOSPICE AND BEREAVEMENT SERVICE ORGANIZATIONS; PHILANTHROPIC SERVICES, NAMELY, FINANCIAL ENDOWMENT OF HOSPICE AND BEREAVEMENT SERVICE ORGANIZATIONS, IN CLASS 36 (U.S. CLS. 100, 101 AND 102).

SERVICE MARK

PRINCIPAL REGISTER

FIRST USE 8-1-2010; IN COMMERCE 8-1-2010.

NO CLAIM IS MADE TO THE EXCLUSIVE RIGHT TO USE "HOSPICE CARS", APART FROM THE MARK AS SHOWN.

THE COLOR(S) BLUE, GREEN AND WHITE IS/ARE CLAIMED AS A FEATURE OF THE MARK.

THE MARK CONSISTS OF THE WORDS "HOSPICE CARS", WITH "HOSPICE" IN BLUE AND "CARS" IN GREEN, ABOVE THE WORDS "RECYCLING FOR THE GREATER GOOD" IN BLUE. TO THE LEFT OF THE WORDS IS A BLUE CIRCLE WITH A GREEN BORDER. INSIDE THE CIRCLE ARE TWO WHITE HANDS ONE ON THE LEFT SIDE EXTENDING A WHITE KEY RING WITH A BLUE KEY AND A LARGER WHITE KEY TOWARDS THE HAND ON THE RIGHT SIDE.

SER. NO. 85-341,891, FILED 6-9-2011.

FLORENTINA BLANDU, EXAMINING ATTORNEY



David J. Kyros

Director of the United States Patent and Trademark Office

United States of America

United States Patent and Trademark Office



Reg. No. 4,098,546

CAPITAL CITY CUSTOMS, INC. (NORTH CAROLINA CORPORATION)
7801 LAKE WHEELER ROAD
RALEIGH, NC 27603

Registered Feb. 14, 2012

Int. Cls.: 37 and 40

FOR: RENOVATION AND RESTORATION IN THE FIELD OF VINTAGE AIRSTREAMS, RVS, TRACTORS AND CUSTOM CARS, IN CLASS 37 (U.S. CLS. 100, 103 AND 106).

SERVICE MARK

FIRST USE 1-9-2010; IN COMMERCE 1-9-2010.

PRINCIPAL REGISTER

FOR: CUSTOM FABRICATION IN THE FIELD OF VINTAGE AIRSTREAMS, RVS, TRACTORS AND CUSTOM CARS, IN CLASS 40 (U.S. CLS. 100, 103 AND 106).

FIRST USE 1-9-2010; IN COMMERCE 1-9-2010.

NO CLAIM IS MADE TO THE EXCLUSIVE RIGHT TO USE "CUSTOMS, INC.", APART FROM THE MARK AS SHOWN.

THE MARK CONSISTS OF A STYLIZED CRESCENT SHAPE SUGGESTING A CLASSIC CAR FIN DESIGN CONTAINING THE WORDS "CAPITAL CITY CUSTOMS INC" IN A STYLIZED SCRIPT THAT IS SHADED TO LOOK LIKE 3-D METAL TUBES; WITH A LINE EXTENDING FROM THE BOTTOM OF THE LETTER "C" IN THE WORDS "CAPITAL", "CITY" AND "INC" TO THE RIGHT; A LINE EXTENDING FROM THE LETTER "Y" IN "CITY" TO THE LEFT AND A LINE EXTENDING FROM THE LETTER "I" IN "INC" TO THE LEFT; TWO SHORT STYLIZED LINES ABOVE THE WORD TEXT AND TWO SHORT STYLIZED LINES BELOW THE WORD TEXT.



SER. NO. 85-341,910, FILED 6-9-2011.

TRACY CROSS, EXAMINING ATTORNEY

David J. Kybas

Director of the United States Patent and Trademark Office

United States of America

United States Patent and Trademark Office

CAPITAL CITY CUSTOMS, INC.

Reg. No. 4,098,547

CAPITAL CITY CUSTOMS, INC. (NORTH CAROLINA CORPORATION)
7801 LAKE WHEELER ROAD
RALEIGH, NC 27603

Registered Feb. 14, 2012

Int. Cls.: 37 and 40

FOR: RENOVATION AND RESTORATION IN THE FIELD OF VINTAGE AIRSTREAMS, RVS, TRACTORS AND CUSTOM CARS, IN CLASS 37 (U.S. CLS. 100, 103 AND 106).

SERVICE MARK

FIRST USE 1-9-2010; IN COMMERCE 1-9-2010.

PRINCIPAL REGISTER

FOR: CUSTOM FABRICATION IN THE FIELD OF VINTAGE AIRSTREAMS, RVS, TRACTORS AND CUSTOM CARS, IN CLASS 40 (U.S. CLS. 100, 103 AND 106).

FIRST USE 1-9-2010; IN COMMERCE 1-9-2010.

THE MARK CONSISTS OF STANDARD CHARACTERS WITHOUT CLAIM TO ANY PARTICULAR FONT, STYLE, SIZE, OR COLOR.

NO CLAIM IS MADE TO THE EXCLUSIVE RIGHT TO USE "CUSTOMS, INC.", APART FROM THE MARK AS SHOWN.

SER. NO. 85-341,934, FILED 6-9-2011.

TRACY CROSS, EXAMINING ATTORNEY



David J. Kyros

Director of the United States Patent and Trademark Office

United States of America

United States Patent and Trademark Office



Reg. No. 4,098,548

Registered Feb. 14, 2012

Int. Cl.: 41

SERVICE MARK

PRINCIPAL REGISTER

VEOLIA TRANSPORTATION SERVICES, INC. (DELAWARE CORPORATION)
14275 MIDWAY ROAD, SUITE 200
ADDISON, TX 75001

FOR: EDUCATIONAL AND TRAINING SERVICES, NAMELY, DEVELOPING, FACILITATING AND CONDUCTING IN-COMPANY CLASSES, SEMINARS AND WORKSHOPS IN THE FIELD OF TRANSPORTATION-FOCUSED WORKPLACE SAFETY, INCORPORATING PROGRESS MEASURES AND REWARDS AND RECOGNITION FOR SAFETY IMPROVEMENT, AND DISTRIBUTION OF TRAINING MATERIALS IN CONNECTION THEREWITH, IN CLASS 41 (U.S. CLS. 100, 101 AND 107).

FIRST USE 12-31-2008; IN COMMERCE 12-31-2008.

NO CLAIM IS MADE TO THE EXCLUSIVE RIGHT TO USE "DRIVE", APART FROM THE MARK AS SHOWN.

THE MARK CONSISTS OF THE WORD "DRIVE" OVER AN IMAGE OF A STYLIZED STEERING WHEEL WITHIN AN INVERTED TRIANGLE SUPERIMPOSED OVER A TRAPEZOID HAVING HORIZONTAL LINES EVOKING A WING DESIGN ABOVE WHICH APPEARS AN OBLONG OVAL WITH THE WORDS "WORK SAFE, LIVE SAFE".

SER. NO. 85-341,980, FILED 6-9-2011.

JEFFERY COWARD, EXAMINING ATTORNEY



David J. Kyjars

Director of the United States Patent and Trademark Office

United States of America

United States Patent and Trademark Office

IMAGEFIRST

Reg. No. 4,098,549

Registered Feb. 14, 2012

Int. Cls.: 37, 39 and 45

SERVICE MARK

PRINCIPAL REGISTER

IMAGEFIRST HEALTHCARE LAUNDRY SPECIALISTS, INC. (DELAWARE CORPORATION)
BUILDING 5, SUITE 503
100 MATSONFORD ROAD
RADNOR, PA 19087

FOR: LAUNDRY SERVICES FOR PATIENT GOWNS, SURGICAL GOWNS, SCRUB WEAR, LABORATORY COATS, SHEETS, BLANKETS, TOWELS, PILLOWCASES, MATTRESS PADS, ROBES, AND WRAPS IN THE MEDICAL AND HEALTHCARE INDUSTRIES, IN CLASS 37 (U.S. CLS. 100, 103 AND 106).

FIRST USE 12-31-1997; IN COMMERCE 12-31-1997.

FOR: LAUNDRY PICK-UP AND DELIVERY SERVICES, IN CLASS 39 (U.S. CLS. 100 AND 105).

FIRST USE 12-31-1997; IN COMMERCE 12-31-1997.

FOR: RENTAL OF PATIENT GOWNS, SURGICAL GOWNS, SCRUB WEAR, LABORATORY COATS, SHEETS, BLANKETS, TOWELS, PILLOWCASES, MATTRESS PADS, ROBES, AND WRAPS FOR USE IN THE MEDICAL AND HEALTHCARE INDUSTRIES, IN CLASS 45 (U.S. CLS. 100 AND 101).

FIRST USE 12-31-1997; IN COMMERCE 12-31-1997.

THE MARK CONSISTS OF STANDARD CHARACTERS WITHOUT CLAIM TO ANY PARTICULAR FONT, STYLE, SIZE, OR COLOR.

OWNER OF U.S. REG. NOS. 2,182,408, 2,808,203 AND OTHERS.

SER. NO. 85-342,062, FILED 6-9-2011.

HENRY S. ZAK, EXAMINING ATTORNEY



David J. Kyffers

Director of the United States Patent and Trademark Office

United States of America

United States Patent and Trademark Office

momo-la says

Reg. No. 4,098,550

GALLERY LODOE INC. (NEW YORK CORPORATION)
6406 MONTGOMERY STREET
RHINEBECK, NY 12572

Registered Feb. 14, 2012

Int. Cl.: 16

FOR: GREETINGS CARDS AND POSTCARDS, IN CLASS 16 (U.S. CLS. 2, 5, 22, 23, 29, 37, 38 AND 50).

TRADEMARK

FIRST USE 5-1-2011; IN COMMERCE 5-1-2011.

PRINCIPAL REGISTER

THE MARK CONSISTS OF THE WORDS "MOMO-LA SAYS" IN STYLIZED LETTERING.

THE ENGLISH TRANSLATION OF THE TIBETAN WORDING "MOMO-LA" IS "GRAND-MOTHER".

SER. NO. 85-342,084, FILED 6-9-2011.

KATHERINE STOIDES, EXAMINING ATTORNEY



David J. Kybas

Director of the United States Patent and Trademark Office

United States of America

United States Patent and Trademark Office

Folk Alley

Reg. No. 4,098,551

Registered Feb. 14, 2012

Int. Cl.: 41

SERVICE MARK

PRINCIPAL REGISTER

KENT STATE UNIVERSITY (OHIO STATE UNIVERSITY)
OFFICE OF GENERAL COUNSEL
P.O. BOX 5190
KENT, OH 44242

FOR: ENTERTAINMENT SERVICES, NAMELY, PROVIDING NONDOWNLOADABLE PRERECORDED MUSIC, INFORMATION IN THE FIELD OF MUSIC, AND COMMENTARY AND ARTICLES ABOUT MUSIC, ALL ON-LINE VIA A GLOBAL COMPUTER NETWORK; PROVIDING ON-LINE NEWSLETTERS IN THE FIELD OF FOLK MUSIC, IN CLASS 41 (U.S. CLS. 100, 101 AND 107).

FIRST USE 9-8-2004; IN COMMERCE 9-8-2004.

THE MARK CONSISTS OF STANDARD CHARACTERS WITHOUT CLAIM TO ANY PARTICULAR FONT, STYLE, SIZE, OR COLOR.

NO CLAIM IS MADE TO THE EXCLUSIVE RIGHT TO USE "FOLK", APART FROM THE MARK AS SHOWN.

SER. NO. 85-342,171, FILED 6-9-2011.

JESSICA FATHY, EXAMINING ATTORNEY



David J. Kyffers

Director of the United States Patent and Trademark Office

United States of America

United States Patent and Trademark Office



Reg. No. 4,098,552

Registered Feb. 14, 2012

Int. Cl.: 43

SERVICE MARK

PRINCIPAL REGISTER

S&B BURGER JOINT FRANCHISE SYSTEMS LLC (OKLAHOMA LIMITED LIABILITY COMPANY)
1101 W. WATERLOO ROAD
EDMOND, OK 73025

FOR: BAR AND RESTAURANT SERVICES, IN CLASS 43 (U.S. CLS. 100 AND 101).

FIRST USE 11-1-2009; IN COMMERCE 11-1-2009.

NO CLAIM IS MADE TO THE EXCLUSIVE RIGHT TO USE "BURGER JOINT" AND "GRILLED", APART FROM THE MARK AS SHOWN.

THE COLOR(S) BRICK RED AND DARK CREAM IS/ARE CLAIMED AS A FEATURE OF THE MARK.

THE MARK CONSISTS OF A CIRCLE IN THE COLOR BRICK RED WITH A DARK CREAM OUTLINE, WITHIN THE CIRCLE AT THE TOP IN A SLIGHT ARCING PATTERN ARE THE STYLIZED WORDS "S&B'S BURGER" IN THE COLOR DARK CREAM, BELOW THAT PHRASE IN A SLIGHT ANGLED PATTERN IS THE WORD "JOINT" IN THE COLOR DARK CREAM, BELOW THAT WORD IN A BAND IS THE WORD "GRILLED" IN THE COLOR DARK CREAM WITH TWO LINES ON EACH SIDE OF IT THAT LOOK LIKE FLAMES, BELOW THAT IN A SLIGHT UPWARD ARC ARE THE WORDS "HOME OF THE FATTY" IN THE COLOR DARK CREAM, WITH THREE LINES COMING FROM THE MIDDLE RIGHT OF THE CIRCLE GOING UPWARD WITH THE MIDDLE LINE BEING LONGER SURROUNDED BY TWO SHORTER FLAME LIKE LINES IN THE COLOR DARK CREAM AND TWO VERTICAL LINES ON THE MIDDLE LEFT OF THE CIRCLE IN THE COLOR DARK CREAM.

SER. NO. 85-342,202, FILED 6-9-2011.

PAM WILLIS, EXAMINING ATTORNEY



David J. Kybas

Director of the United States Patent and Trademark Office

United States of America
United States Patent and Trademark Office

ImageFIRST

Reg. No. 4,098,553

Registered Feb. 14, 2012

Int. Cls.: 37, 39 and 45

SERVICE MARK

PRINCIPAL REGISTER

IMAGEFIRST HEALTHCARE LAUNDRY SPECIALISTS, INC. (DELAWARE CORPORATION)
BUILDING 5, SUITE 503
100 MATSONFORD ROAD
RADNOR, PA 19087

FOR: LAUNDRY SERVICES FOR PATIENT GOWNS, SURGICAL GOWNS, SCRUB WEAR, LABORATORY COATS, SHEETS, BLANKETS, TOWELS, PILLOWCASES, MATTRESS PADS, ROBES, AND WRAPS IN THE MEDICAL AND HEALTHCARE INDUSTRIES, IN CLASS 37 (U.S. CLS. 100, 103 AND 106).

FIRST USE 12-31-1997; IN COMMERCE 12-31-1997.

FOR: LAUNDRY PICK-UP AND DELIVERY SERVICES, IN CLASS 39 (U.S. CLS. 100 AND 105).

FIRST USE 12-31-1997; IN COMMERCE 12-31-1997.

FOR: RENTAL OF PATIENT GOWNS, SURGICAL GOWNS, SCRUB WEAR, LABORATORY COATS, SHEETS, BLANKETS, TOWELS, PILLOWCASES, MATTRESS PADS, ROBES, AND WRAPS FOR USE IN THE MEDICAL AND HEALTHCARE INDUSTRIES, IN CLASS 45 (U.S. CLS. 100 AND 101).

FIRST USE 12-31-1997; IN COMMERCE 12-31-1997.

OWNER OF U.S. REG. NOS. 2,182,408, 2,808,203 AND OTHERS.

THE MARK CONSISTS OF THE COMPOUND WORD FORMED BY JOINING "FIRST" (ALL IN CAPITAL LETTERS) AFTER THE TERM "IMAGE" (WITH A CAPITAL I), IN STYLIZED FONT.

SER. NO. 85-342,257, FILED 6-9-2011.

HENRY S. ZAK, EXAMINING ATTORNEY



David J. Kyffers

Director of the United States Patent and Trademark Office

United States of America

United States Patent and Trademark Office



Reg. No. 4,098,554

Registered Feb. 14, 2012

Int. Cl.: 41

SERVICE MARK

PRINCIPAL REGISTER

CROJON, INC. (NEW YORK CORPORATION)
440 WOLF HILL ROAD
DIX HILLS, NY 11746

FOR: EDUCATIONAL AND ENTERTAINMENT SERVICES, NAMELY, CONDUCTING WORKSHOPS, SEMINARS AND SPEAKING ENGAGEMENTS IN THE FIELD OF CHILDREN'S ISSUES AND SERVICES AND DISTRIBUTION OF COURSE MATERIALS IN CONNECTION THEREWITH, AND EDUCATION CONSULTING RELATED THERETO, IN CLASS 41 (U.S. CLS. 100, 101 AND 107).

FIRST USE 12-31-2004; IN COMMERCE 12-31-2004.

OWNER OF U.S. REG. NO. 3,046,636.

THE COLOR(S) BLACK, BEIGE, BROWN AND YELLOW IS/ARE CLAIMED AS A FEATURE OF THE MARK.

THE MARKS CONSISTS OF THE ITALICIZED WORDING "MY CHILD, YOUR CHILD, OUR CHILDREN" IN BLACK WITHIN A DESIGN OUTLINED IN BLACK CONSISTING OF THREE JUXTAPOSED FACIAL PROFILES OF CHILDREN AT DIFFERING LEVELS. THE UPPER-MOST PROFILE AND AREA SURROUNDING IT APPEAR IN BEIGE, THE MIDDLE PROFILE AND AREA SURROUNDING IT APPEAR IN BROWN, AND THE LOWERMOST PROFILE AND AREA SURROUNDING IT APPEAR IN YELLOW.

SER. NO. 85-342,264, FILED 6-9-2011.

NICHOLAS ALTREE, EXAMINING ATTORNEY



David J. Kybas

Director of the United States Patent and Trademark Office

United States of America

United States Patent and Trademark Office

ITINSURE

Reg. No. 4,098,555

Registered Feb. 14, 2012

Int. Cl.: 36

SERVICE MARK

PRINCIPAL REGISTER

MAGUIRE INSURANCE AGENCY (PENNSYLVANIA CORPORATION)
SUITE 100
ONE BALA PLAZA
BALA CYNWYD, PA 19004

FOR: INSURANCE SERVICES FOR PROFESSIONALS, NAMELY, INSURANCE BROKERAGE, CONSULTATION, ADMINISTRATION, AND UNDERWRITING IN THE FIELD OF PROFESSIONAL LIABILITY, GENERAL LIABILITY, COMMERCIAL AUTOMOBILE, WORKERS' COMPENSATION, EMPLOYEE CRIME, COMPUTER, BUSINESS AND REAL PROPERTY INSURANCE; INSURANCE ADMINISTRATION AND UNDERWRITING IN THE FIELD OF PROFESSION-SPECIFIC ERRORS AND OMISSIONS INSURANCE ALL PROVIDED VIA A GLOBAL COMPUTER NETWORK, IN CLASS 36 (U.S. CLS. 100, 101 AND 102).

FIRST USE 2-14-2001; IN COMMERCE 3-5-2001.

THE MARK CONSISTS OF STANDARD CHARACTERS WITHOUT CLAIM TO ANY PARTICULAR FONT, STYLE, SIZE, OR COLOR.

OWNER OF U.S. REG. NO. 2,564,451.

SEC. 2(F).

SER. NO. 85-342,316, FILED 6-9-2011.

BRENDAN MCCAULEY, EXAMINING ATTORNEY



David J. Kyros

Director of the United States Patent and Trademark Office

United States of America

United States Patent and Trademark Office



red jacket
riviera beach resort

Reg. No. 4,098,556

DAVENPORT REALTY TRUST (MASSACHUSETTS TRUST)
20 NORTH MAIN STREET
SOUTH YARMOUTH, MA 02664

Registered Feb. 14, 2012

Int. Cl.: 43

FOR: HOTEL AND RESORT SERVICES, IN CLASS 43 (U.S. CLS. 100 AND 101).

SERVICE MARK

FIRST USE 2-29-2008; IN COMMERCE 2-29-2008.

PRINCIPAL REGISTER

NO CLAIM IS MADE TO THE EXCLUSIVE RIGHT TO USE "BEACH RESORT", APART FROM THE MARK AS SHOWN.

THE COLOR(S) RED, WHITE AND GREY IS/ARE CLAIMED AS A FEATURE OF THE MARK.

THE MARK CONSISTS OF A RED CIRCLE WITH THE STYLIZED, LOWER-CASE WHITE "R" AND "J" INSIDE THE CIRCLE. THE WORDS "RED JACKET RIVIERA BEACH RESORT" IN GREY ARE SHOWN TO THE RIGHT OF THE RED CIRCLE.

SER. NO. 85-342,412, FILED 6-9-2011.

RON FAIRBANKS, EXAMINING ATTORNEY



David J. Kybas

Director of the United States Patent and Trademark Office

United States of America

United States Patent and Trademark Office



Reg. No. 4,098,557

DAVENPORT REALTY TRUST (MASSACHUSETTS TRUST)
20 NORTH MAIN STREET
SOUTH YARMOUTH, MA 02664

Registered Feb. 14, 2012

Int. Cl.: 43

FOR: HOTEL AND RESORT SERVICES, IN CLASS 43 (U.S. CLS. 100 AND 101).

SERVICE MARK

FIRST USE 2-29-2008; IN COMMERCE 2-29-2008.

PRINCIPAL REGISTER

NO CLAIM IS MADE TO THE EXCLUSIVE RIGHT TO USE "BEACH RESORT", APART FROM THE MARK AS SHOWN.

THE COLOR(S) RED, WHITE AND GREY IS/ARE CLAIMED AS A FEATURE OF THE MARK.

THE MARK CONSISTS OF A RED CIRCLE WITH THE STYLIZED, LOWER-CASE WHITE "R" AND "J" INSIDE THE CIRCLE. THE WORDS "RED JACKET RIVIERA BEACH RESORT" IN GREY ARE SHOWN TO THE RIGHT OF THE RED CIRCLE.

SER. NO. 85-342,451, FILED 6-9-2011.

RON FAIRBANKS, EXAMINING ATTORNEY



David J. Kyffers

Director of the United States Patent and Trademark Office

United States of America

United States Patent and Trademark Office



Reg. No. 4,098,558

JACQUETTE, MARC ANDREW (UNITED STATES INDIVIDUAL)
3812 CREEK WAY COURT
PLANT CITY, FL 33563

Registered Feb. 14, 2012

Int. Cl.: 35

FOR: ORGANIZATION OF BUSINESS CONVENTIONS IN THE FIELD OF PROFESSIONAL TATTOOING; ARRANGING PERSONAL APPEARANCES BY PERSONS WORKING IN ENTERTAINMENT, IN CLASS 35 (U.S. CLS. 100, 101 AND 102).

SERVICE MARK

FIRST USE 1-1-2001; IN COMMERCE 1-1-2001.

PRINCIPAL REGISTER

NO CLAIM IS MADE TO THE EXCLUSIVE RIGHT TO USE "INK" AND "TATTOO FESTIVAL", APART FROM THE MARK AS SHOWN.

THE COLOR(S) PINK, PURPLE, WHITE, BLACK, YELLOW, RED, BLUE, AND GRAY IS/ARE CLAIMED AS A FEATURE OF THE MARK.

THE MARK CONSISTS OF THE WORDS "INK FUSION" IN PINK AND PURPLE, OUTLINED IN WHITE AND BLACK WITH A GRAY SHADOW. A TATTOO MACHINE BETWEEN THE WORDS APPEARS IN BLUE, BLACK, WHITE, AND GRAY, WITH A RED BUTTON ON THE HANDLE AND A YELLOW PAINT BRUSH WITH A RED TIP. BEHIND THE TATTOO MACHINE IS A BLACK INK SPATTER. THE WORDING "TATTOO FESTIVAL" APPEARS IN BLACK BELOW THE WORD "FUSION", AND AT THE BOTTOM OF THE MARK, THE WORDS "WHERE THE WORLDS OF TATTOOS AND POP CULTURE COLLIDE" APPEAR IN BLACK.

SER. NO. 85-342,489, FILED 6-9-2011.

LEIGH CAROLINE CASE, EXAMINING ATTORNEY



David J. Kybas

Director of the United States Patent and Trademark Office

United States of America

United States Patent and Trademark Office

THE VOICE FOR HISPANIC REAL ESTATE

Reg. No. 4,098,559

Registered Feb. 14, 2012

Int. Cl.: 35

SERVICE MARK

PRINCIPAL REGISTER

NATIONAL ASSOCIATION OF HISPANIC REAL ESTATE PROFESSIONALS (CALIFORNIA
NON-PROFIT CORPORATION)
5414 OBERLIN DRIVE, SUITE 230
SAN DIEGO, CA 92121

FOR: ASSOCIATION SERVICES, NAMELY, PROMOTING THE INTERESTS OF HISPANIC
REAL ESTATE PROFESSIONALS, IN CLASS 35 (U.S. CLS. 100, 101 AND 102).

FIRST USE 1-1-1999; IN COMMERCE 1-1-1999.

THE MARK CONSISTS OF STANDARD CHARACTERS WITHOUT CLAIM TO ANY PAR-
TICULAR FONT, STYLE, SIZE, OR COLOR.

SEC. 2(F) AS TO "HISPANIC REAL ESTATE".

SER. NO. 85-342,516, FILED 6-9-2011.

ESTHER BELENKER, EXAMINING ATTORNEY



David J. Kybas

Director of the United States Patent and Trademark Office

United States of America

United States Patent and Trademark Office

KNOCKOUT PEST CONTROL

Reg. No. 4,098,560

KNOCKOUT PEST CONTROL, INC. (NEW YORK CORPORATION)
1009 FRONT STREET
UNIONDALE, NY 11533

Registered Feb. 14, 2012

Int. Cl.: 37

FOR: PEST CONTROL, IN CLASS 37 (U.S. CLS. 100, 103 AND 106).

SERVICE MARK

FIRST USE 1-1-1984; IN COMMERCE 1-1-1984.

PRINCIPAL REGISTER

THE MARK CONSISTS OF STANDARD CHARACTERS WITHOUT CLAIM TO ANY PARTICULAR FONT, STYLE, SIZE, OR COLOR.

NO CLAIM IS MADE TO THE EXCLUSIVE RIGHT TO USE "PEST CONTROL", APART FROM THE MARK AS SHOWN.

SER. NO. 85-342,523, FILED 6-9-2011.

AMY C. KEAN, EXAMINING ATTORNEY



David J. Kyffers

Director of the United States Patent and Trademark Office

United States of America

United States Patent and Trademark Office

NATIONAL ASSOCIATION OF HISPANIC REAL ESTATE PROFESSIONALS

Reg. No. 4,098,561

Registered Feb. 14, 2012

Int. Cl.: 35

SERVICE MARK

PRINCIPAL REGISTER

NATIONAL ASSOCIATION OF HISPANIC REAL ESTATE PROFESSIONALS (CALIFORNIA
NON-PROFIT CORPORATION)
5414 OBERLIN DRIVE, SUITE 230
SAN DIEGO, CA 92121

FOR: ASSOCIATION SERVICES, NAMELY, PROMOTING THE INTERESTS OF HISPANIC
REAL ESTATE PROFESSIONALS, IN CLASS 35 (U.S. CLS. 100, 101 AND 102).

FIRST USE 1-1-1999; IN COMMERCE 1-1-1999.

THE MARK CONSISTS OF STANDARD CHARACTERS WITHOUT CLAIM TO ANY PAR-
TICULAR FONT, STYLE, SIZE, OR COLOR.

NO CLAIM IS MADE TO THE EXCLUSIVE RIGHT TO USE "ASSOCIATION", APART FROM
THE MARK AS SHOWN.

SEC. 2(F).

SER. NO. 85-342,533, FILED 6-9-2011.

ESTHER BELENKER, EXAMINING ATTORNEY



David J. Kyffers

Director of the United States Patent and Trademark Office

United States of America
United States Patent and Trademark Office

Indie Yoga

Reg. No. 4,098,562

INDIE YOGA (NEW YORK LIMITED LIABILITY COMPANY)
64 CENTERPORT RD.
GREENLAWN, NY 11740

Registered Feb. 14, 2012

Int. Cl.: 35

FOR: ON-LINE RETAIL STORE SERVICES FEATURING YOGA AND MEDITATION PRODUCTS, IN CLASS 35 (U.S. CLS. 100, 101 AND 102).

SERVICE MARK

FIRST USE 2-24-2011; IN COMMERCE 2-24-2011.

PRINCIPAL REGISTER

THE MARK CONSISTS OF STANDARD CHARACTERS WITHOUT CLAIM TO ANY PARTICULAR FONT, STYLE, SIZE, OR COLOR.

NO CLAIM IS MADE TO THE EXCLUSIVE RIGHT TO USE "YOGA", APART FROM THE MARK AS SHOWN.

SER. NO. 85-342,615, FILED 6-9-2011.

ROBIN MITTLER, EXAMINING ATTORNEY



David J. Kybas

Director of the United States Patent and Trademark Office

United States of America

United States Patent and Trademark Office



Reg. No. 4,098,563

Registered Feb. 14, 2012

Int. Cl.: 35

SERVICE MARK

PRINCIPAL REGISTER

APPLIED MEMETICS, LLC (VIRGINIA LIMITED LIABILITY COMPANY)
SUITE 1901
888 N. QUINCY ST
ARLINGTON, VA 22203

FOR: DEVELOPMENT OF MARKETING STRATEGIES, CONCEPTS AND TACTICS, NAMELY, AUDIENCE DEVELOPMENT, BRAND AWARENESS, ONLINE COMMUNITY BUILDING AND DIGITAL WORD OF MOUTH COMMUNICATIONS, IN CLASS 35 (U.S. CLS. 100, 101 AND 102).

FIRST USE 4-1-2011; IN COMMERCE 4-1-2011.

NO CLAIM IS MADE TO THE EXCLUSIVE RIGHT TO USE "APPLIED MEMETICS", APART FROM THE MARK AS SHOWN.

THE MARK CONSISTS OF A HELIX PLACED BETWEEN THE WORDS "APPLIED" AND "MEMETICS"; UNDERNEATH WHICH APPEARS THE TWO WORDS "INFLUENCED" AND "ENGINEERED", EACH WITH PERIOD PLACED AFTER THE WORD.

SER. NO. 85-342,634, FILED 6-9-2011.

ANGELA M. MICHELLI, EXAMINING ATTORNEY



David J. Kyjars

Director of the United States Patent and Trademark Office

United States of America

United States Patent and Trademark Office

A Mom's Catalog

Reg. No. 4,098,564

HEIM, NICOLE (UNITED STATES INDIVIDUAL)
181 CROSSWINDS DR
CHARLES TOWN, WV 25414

Registered Feb. 14, 2012

Int. Cl.: 35

FOR: ADVERTISING IN PERIODICALS, BROCHURES AND NEWSPAPERS; ADVERTISING ON THE INTERNET FOR OTHERS; ADVERTISING AGENCY, NAMELY, PROMOTING THE SERVICES OF SMALL BUSINESSES THROUGH THE DISTRIBUTION OF PRINTED PROMOTIONAL MATERIALS AND PERIODICALS, IN CLASS 35 (U.S. CLS. 100, 101 AND 102).

SERVICE MARK

PRINCIPAL REGISTER

FIRST USE 10-1-2008; IN COMMERCE 10-1-2008.

THE MARK CONSISTS OF STANDARD CHARACTERS WITHOUT CLAIM TO ANY PARTICULAR FONT, STYLE, SIZE, OR COLOR.

NO CLAIM IS MADE TO THE EXCLUSIVE RIGHT TO USE "CATALOG", APART FROM THE MARK AS SHOWN.

SER. NO. 85-342,640, FILED 6-9-2011.

ANGELA M. MICHELI, EXAMINING ATTORNEY



David J. Kyffers

Director of the United States Patent and Trademark Office

United States of America

United States Patent and Trademark Office



Reg. No. 4,098,565

AEROSPACE & MARINE INTERNATIONAL CORPORATION (CALIFORNIA CORPORATION)
6910 SANTA TERESA BLVD.
SAN JOSE, CA 95119

Registered Feb. 14, 2012

Int. Cl.: 39

FOR: VEHICLE ROUTING BY COMPUTER ON DATA NETWORKS, IN CLASS 39 (U.S. CLS. 100 AND 105).

SERVICE MARK

FIRST USE 1-31-2011; IN COMMERCE 1-31-2011.

PRINCIPAL REGISTER

NO CLAIM IS MADE TO THE EXCLUSIVE RIGHT TO USE "OCEANROUTES", APART FROM THE MARK AS SHOWN.

THE COLOR(S) WHITE, DARK BLUE AND LIGHT BLUE IS/ARE CLAIMED AS A FEATURE OF THE MARK.

THE MARK CONSISTS OF STYLIZED VERSION OF THE LETTERS "AMI" CONSISTING OF A DARK BLUE TRIANGLE REPRESENTING A STYLIZED CAPITAL "A" WITH THREE HORIZONTAL WHITE LINES INTERSECTING THROUGH IT, A STYLIZED CAPITAL "M" CONSISTING OF TWO JOINED RIGHT TRIANGLES WITH RIGHT ANGLES TO THE OUTSIDE AND INTERSECTED WITH TWO WAVY WHITE SINE LINES, AND A STYLIZED CAPITAL "I" CONSISTING OF A DARK BLUE RECTANGLE WITH THE LOWER END SLIGHTLY ANGLED, UNDER THIS IS A DARK BLUE WAVY LINE WITH TWO HUMPS AND A SPUR PROTRUDING FROM THE MIDDLE BOTTOM, UNDER THIS STYLIZED PORTION OF THE MARK, THE WORD "OCEANROUTES" APPEARS IN CAPITAL LETTERS AND IN DARK BLUE, AND THE MARK IS SET ON A WHITE BACKGROUND.



SER. NO. 85-342,646, FILED 6-9-2011.

ANGELA M. MICHELI, EXAMINING ATTORNEY

David J. Kybas

Director of the United States Patent and Trademark Office

United States of America

United States Patent and Trademark Office

J. JOSEPH CONSULTING, INC.

Reg. No. 4,098,566

J. JOSEPH CONSULTING, INC. (TEXAS CORPORATION)
21732 HARDY OAK BLVD., SUITE 101
SAN ANTONIO, TX 78258

Registered Feb. 14, 2012

Int. Cl.: 35

FOR: TAX CONSULTATION; TAX FILING SERVICES; TAX PREPARATION, IN CLASS 35
(U.S. CLS. 100, 101 AND 102).

SERVICE MARK

FIRST USE 11-30-2005; IN COMMERCE 11-30-2005.

PRINCIPAL REGISTER

THE MARK CONSISTS OF STANDARD CHARACTERS WITHOUT CLAIM TO ANY PARTICULAR FONT, STYLE, SIZE, OR COLOR.

NO CLAIM IS MADE TO THE EXCLUSIVE RIGHT TO USE "CONSULTING, INC.", APART FROM THE MARK AS SHOWN.

THE NAME "J. JOSEPH" SHOWN IN THE MARK DOES NOT IDENTIFY A LIVING INDIVIDUAL.

SER. NO. 85-342,650, FILED 6-9-2011.

ANGELA M. MICHELI, EXAMINING ATTORNEY



David J. Kybas

Director of the United States Patent and Trademark Office

United States of America

United States Patent and Trademark Office

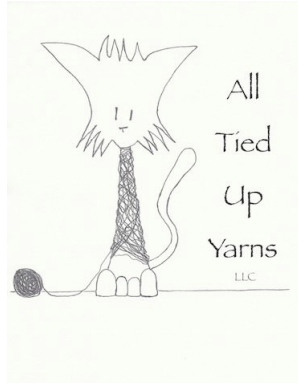

Reg. No. 4,098,567

Registered Feb. 14, 2012

Int. Cl.: 35

SERVICE MARK

PRINCIPAL REGISTER

ALL TIED UP YARNS, LLC (NEW YORK LIMITED LIABILITY COMPANY)
14 STATE STREET
AUBURN, NY 13021

FOR: RETAIL STORES FEATURING YARN, IN CLASS 35 (U.S. CLS. 100, 101 AND 102).

FIRST USE 10-1-2010; IN COMMERCE 10-1-2010.

NO CLAIM IS MADE TO THE EXCLUSIVE RIGHT TO USE "YARNS LLC", APART FROM THE MARK AS SHOWN.

THE MARK CONSISTS OF A STYLIZED CAT, FRONT VIEW, SITTING ERECT AND WRAPPED IN A BALL OF YARN WITH THE REMAINDER OF THE BALL OF YARN TO THE LEFT OF THE CAT AND THE WORDS "ALL TIED UP YARNS, LLC" TO THE RIGHT OF THE CAT.

SER. NO. 85-342,697, FILED 6-9-2011.

BARBARA BROWN, EXAMINING ATTORNEY



David J. Kyjars

Director of the United States Patent and Trademark Office

United States of America

United States Patent and Trademark Office



Reg. No. 4,098,568

THE DOG'S MEOW, LLC (UTAH LIMITED LIABILITY COMPANY)
2047 E. 3300 S.

Registered Feb. 14, 2012

SALT LAKE CITY, UT 84109

Int. Cl.: 35

FOR: ON-LINE WHOLESALE AND RETAIL STORE SERVICES FEATURING PET SUPPLIES;
RETAIL PET STORES, IN CLASS 35 (U.S. CLS. 100, 101 AND 102).

SERVICE MARK

FIRST USE 4-30-2009; IN COMMERCE 10-31-2009.

PRINCIPAL REGISTER

OWNER OF U.S. REG. NOS. 2,431,461, 2,455,159, AND 3,786,732.

NO CLAIM IS MADE TO THE EXCLUSIVE RIGHT TO USE "HEALTHY STUFF FOR
CANINES & FELINES", APART FROM THE MARK AS SHOWN.

THE MARK CONSISTS OF A DOG AND A CAT WITH THEIR PAWS RESTING ON AN UP-
TURNED BOWL, THE WORDS "THE DOG'S MEOW" APPEARING WITHIN THE OUTLINE
OF THE BOWL, AND THE WORDS "HEALTHY STUFF FOR CANINES & FELINES" AP-
PEARING UNDERNEATH THE BOWL.

SER. NO. 85-342,726, FILED 6-9-2011.

NICHOLAS ALTREE, EXAMINING ATTORNEY



David J. Kybas

Director of the United States Patent and Trademark Office

United States of America

United States Patent and Trademark Office



PBR HAWAII

Reg. No. 4,098,569

PBR HAWAII & ASSOCIATES, INC. (HAWAII CORPORATION)

Registered Feb. 14, 2012

1001 BISHOP ST., STE. 650
HONOLULU, HI 96813

Int. Cl.: 42

FOR: CONSULTING IN THE FIELD OF LAND USE PLANNING, ENVIRONMENTAL STUDIES, LANDSCAPE ARCHITECTURAL DESIGN, AND GRAPHIC DESIGN; CONSULTING SERVICES IN THE FIELD OF ENVIRONMENTAL ASSESSMENT AND PLANNING; GRAPHIC DESIGN; GRAPHIC DESIGN SERVICES; LAND USE PLANNING SERVICES; LANDSCAPE ARCHITECTURAL DESIGN, IN CLASS 42 (U.S. CLS. 100 AND 101).

SERVICE MARK

PRINCIPAL REGISTER

FIRST USE 11-21-2005; IN COMMERCE 11-21-2005.

NO CLAIM IS MADE TO THE EXCLUSIVE RIGHT TO USE "HAWAII", APART FROM THE MARK AS SHOWN.

THE MARK CONSISTS OF A GRAPHIC DISPLAYING A LEAF WITH VEINS FRAMED IN A RECTANGLE ALONGSIDE THE WORDS "PBR HAWAII".

SER. NO. 85-342,736, FILED 6-9-2011.

ODESSA BIBBINS, EXAMINING ATTORNEY



David J. Kyros

Director of the United States Patent and Trademark Office

United States of America

United States Patent and Trademark Office



Reg. No. 4,098,570

PUT ME BACK, LLC (NEW JERSEY LIMITED LIABILITY COMPANY)
745 MICHIGAN AVE
TOMS RIVER, NJ 08753

Registered Feb. 14, 2012

Int. Cl.: 16

FOR: STICKERS, IN CLASS 16 (U.S. CLS. 2, 5, 22, 23, 29, 37, 38 AND 50).

TRADEMARK

FIRST USE 8-1-2009; IN COMMERCE 8-1-2009.

PRINCIPAL REGISTER

THE MARK CONSISTS OF THE WORDING "PUT ME BACK" WITH AN ATLAS TYPE CHARACTER CARRYING A WEIGHT PLATE ON HIS SHOULDERS TO THE RIGHT.

SER. NO. 85-342,787, FILED 6-10-2011.

TAMARA FRAZIER, EXAMINING ATTORNEY



David J. Kyffers

Director of the United States Patent and Trademark Office

United States of America

United States Patent and Trademark Office

SCHLEP-ALL

Reg. No. 4,098,571

CHILKOOT TRAIL VENTURES LLC (COLORADO LIMITED LIABILITY COMPANY)
4171 S. SPRUCE STREET
DENVER, CO 80237

Registered Feb. 14, 2012

Int. Cl.: 18

FOR: ANIMAL LEASHES; ANIMAL LEASH HANDLE ACCESSORY ATTACHMENT SOLD AS A COMPONENT OF THE LEASH, IN CLASS 18 (U.S. CLS. 1, 2, 3, 22 AND 41).

TRADEMARK

FIRST USE 5-7-2011; IN COMMERCE 5-29-2011.

PRINCIPAL REGISTER

THE MARK CONSISTS OF STANDARD CHARACTERS WITHOUT CLAIM TO ANY PARTICULAR FONT, STYLE, SIZE, OR COLOR.

SER. NO. 85-342,871, FILED 6-10-2011.

CHRISIE B. KING, EXAMINING ATTORNEY



David J. Kybas

Director of the United States Patent and Trademark Office

United States of America

United States Patent and Trademark Office



Reg. No. 4,098,572

MADELYN RODRÍGUEZ CANCEL (UNITED STATES INDIVIDUAL)
P.O. BOX 6643

Registered Feb. 14, 2012

SAN JUAN, PUERTO RICO 00914

Int. Cl.: 41

FOR: ON-LINE JOURNALS, NAMELY, BLOGS FEATURING FOOD, IN CLASS 41 (U.S. CLS. 100, 101 AND 107).

SERVICE MARK

FIRST USE 11-7-2007; IN COMMERCE 11-7-2007.

PRINCIPAL REGISTER

NO CLAIM IS MADE TO THE EXCLUSIVE RIGHT TO USE "COOKING", APART FROM THE MARK AS SHOWN.

THE COLOR(S) GREEN, BROWN AND RED IS/ARE CLAIMED AS A FEATURE OF THE MARK.

THE MARK CONSISTS OF THE WORD "KARMA" IN GREEN FONT. NEXT TO IT, A BROWN VERTICAL CURVE WITH A RED DOT INSIDE. BELOW IT, THERE IS AN INVERTED PYRAMID OF GREEN DOTS. NEXT TO IT THE WORD "FREE" IN GREEN FONT. BELOW SAID WORD IS THE WORD "COOKING" IN SMALLER BROWN FONT.

SER. NO. 85-342,874, FILED 6-10-2011.

JENNY PARK, EXAMINING ATTORNEY



David J. Kyffers

Director of the United States Patent and Trademark Office

United States of America

United States Patent and Trademark Office

TERRASTREAMER

Reg. No. 4,098,573

ALLTEC CORPORATION (DELAWARE CORPORATION)
64 CATALYST DRIVE
CANTON, NC 28716

Registered Feb. 14, 2012

Int. Cl.: 9

FOR: LIGHTNING CONTROL DEVICES, NAMELY, EARLY STREAMER GENERATORS FOR ATTRACTING AND DIRECTING LIGHTNING, IN CLASS 9 (U.S. CLS. 21, 23, 26, 36 AND 38).

TRADEMARK

FIRST USE 6-27-2009; IN COMMERCE 6-27-2009.

PRINCIPAL REGISTER

THE MARK CONSISTS OF STANDARD CHARACTERS WITHOUT CLAIM TO ANY PARTICULAR FONT, STYLE, SIZE, OR COLOR.

SER. NO. 85-342,894, FILED 6-10-2011.

MATTHEW MCDOWELL, EXAMINING ATTORNEY



David J. Kybas

Director of the United States Patent and Trademark Office

United States of America
United States Patent and Trademark Office

TERRAFILL

Reg. No. 4,098,574

ALLTEC CORPORATION (DELAWARE CORPORATION)
64 CATALYST DRIVE
CANTON, NC 28716

Registered Feb. 14, 2012

Int. Cl.: 1

FOR: SOIL SUBSTITUTE IN THE NATURE OF LOW RESISTANCE ARTIFICIAL BACKFILL MATERIALS COMPOSED PRIMARILY OF CARBON FOR USE IN REDUCING THE EARTH RESISTANCE OF ELECTRICAL GROUNDING SYSTEMS, IN CLASS 1 (U.S. CLS. 1, 5, 6, 10, 26 AND 46).

TRADEMARK

PRINCIPAL REGISTER

FIRST USE 0-0-1996; IN COMMERCE 0-0-1996.

THE MARK CONSISTS OF STANDARD CHARACTERS WITHOUT CLAIM TO ANY PARTICULAR FONT, STYLE, SIZE, OR COLOR.

SER. NO. 85-342,901, FILED 6-10-2011.

MATTHEW MCDOWELL, EXAMINING ATTORNEY



David J. Kyffers

Director of the United States Patent and Trademark Office

United States of America

United States Patent and Trademark Office

GROUNDGUARDIAN

Reg. No. 4,098,575

ALLTEC CORPORATION (DELAWARE CORPORATION)
64 CATALYST DRIVE
CANTON, NC 28716

Registered Feb. 14, 2012

Int. Cl.: 9

FOR: ELECTRICAL MONITORING DEVICES FOR MONITORING A GROUNDING SYSTEM ASSOCIATED WITH A FLOATING ROOF TANK, A BUILDING, OR OTHER GROUNDED STRUCTURE FOR LIGHTNING PROTECTION, IN CLASS 9 (U.S. CLS. 21, 23, 26, 36 AND 38).

TRADEMARK

PRINCIPAL REGISTER

FIRST USE 0-0-2010; IN COMMERCE 0-0-2010.

THE MARK CONSISTS OF STANDARD CHARACTERS WITHOUT CLAIM TO ANY PARTICULAR FONT, STYLE, SIZE, OR COLOR.

SER. NO. 85-342,909, FILED 6-10-2011.

MATTHEW MCDOWELL, EXAMINING ATTORNEY



David J. Kyfos

Director of the United States Patent and Trademark Office

United States of America

United States Patent and Trademark Office

TERRAWELD

Reg. No. 4,098,576

ALLTEC CORPORATION (DELAWARE CORPORATION)
64 CATALYST DRIVE
CANTON, NC 28716

Registered Feb. 14, 2012

Int. Cl.: 9

FOR: EXOTHERMIC WELDING SYSTEM UTILIZING A MOLECULAR BONDING PROCESS COMPRISING A MOLD AND BONDING CHEMICALS FOR BONDING GROUNDING CABLES AND WIRES FOR LIGHTNING PROTECTION , IN CLASS 9 (U.S. CLS. 21, 23, 26, 36 AND 38).

TRADEMARK

PRINCIPAL REGISTER

FIRST USE 0-0-2008; IN COMMERCE 0-0-2008.

THE MARK CONSISTS OF STANDARD CHARACTERS WITHOUT CLAIM TO ANY PARTICULAR FONT, STYLE, SIZE, OR COLOR.

SER. NO. 85-342,915, FILED 6-10-2011.

MATTHEW MCDOWELL, EXAMINING ATTORNEY



David J. Kyffers

Director of the United States Patent and Trademark Office

United States of America

United States Patent and Trademark Office



Reg. No. 4,098,577

S.A.S.C.O. TRADING, INC. (NEW YORK CORPORATION)
1410 BROADWAY, SUITE 1908
NEW YORK, NY 10018

Registered Feb. 14, 2012

Int. Cl.: 25

FOR: TEE SHIRTS; POLO SHIRTS; SHORTS; COATS; WOVEN SHIRTS; PANTS; JACKETS;
LONG SLEEVE SHIRTS, IN CLASS 25 (U.S. CLS. 22 AND 39).

TRADEMARK

FIRST USE 8-1-2009; IN COMMERCE 9-1-2009.

PRINCIPAL REGISTER

THE MARK CONSISTS OF THE SHAPE OF A FLYING BIRD FACING THE RIGHT, WITH
WINGS OUTSTRETCHED, TAIL POINTED UP, AND FEATHERY TIPS ON THE WINGS
AND TAIL.

SER. NO. 85-342,930, FILED 6-10-2011.

NICHOLAS COLEMAN, EXAMINING ATTORNEY



David J. Kybas

Director of the United States Patent and Trademark Office

United States of America

United States Patent and Trademark Office

MobilityOn

Reg. No. 4,098,578

Registered Feb. 14, 2012

Int. Cls.: 9 and 35

TRADEMARK

SERVICE MARK

PRINCIPAL REGISTER

MOBILITYON, SAS (FRANCE CORPORATION), DBA MOBILITYON
203 AVENUE CHARLES DE GAULLE
NEUILLY SUR SEINE, FRANCE 92200

FOR: COMPUTER PROGRAMS FOR USING THE INTERNET AND THE WORLD WIDE WEB; COMPUTER SOFTWARE THAT PROVIDES WEB-BASED ACCESS TO APPLICATIONS AND SERVICES THROUGH A WEB OPERATING SYSTEM OR PORTAL INTERFACE, IN CLASS 9 (U.S. CLS. 21, 23, 26, 36 AND 38).

FIRST USE 5-5-2011; IN COMMERCE 5-5-2011.

FOR: INTERNET ADVERTISING SERVICES; PROMOTING THE GOODS AND SERVICES OF OTHERS BY MEANS OF DISTRIBUTING ADVERTISING ON THE INTERNET; PROVIDING A SEARCHABLE INTERNET DATABASE OF POTENTIAL HOME BUYERS WITH THE PURPOSE OF MATCHING HOME BUYERS WITH HOME SELLERS, IN CLASS 35 (U.S. CLS. 100, 101 AND 102).

FIRST USE 5-5-2011; IN COMMERCE 5-5-2011.

THE MARK CONSISTS OF STANDARD CHARACTERS WITHOUT CLAIM TO ANY PARTICULAR FONT, STYLE, SIZE, OR COLOR.

SER. NO. 85-342,943, FILED 6-10-2011.

PATRICIA EVANKO, EXAMINING ATTORNEY



David J. Kybas

Director of the United States Patent and Trademark Office

United States of America

United States Patent and Trademark Office



Reg. No. 4,098,579

Registered Feb. 14, 2012

Int. Cls.: 9 and 42

TRADEMARK

SERVICE MARK

PRINCIPAL REGISTER

SAIKO SYSTEMS LTD. LLC (CALIFORNIA LIMITED LIABILITY COMPANY)
SUITE C273
560 W MAIN ST.
ALHAMBRA, CA 91801

FOR: COMPUTER HARDWARE AND PERIPHERALS; ELECTRONIC COMPONENTS FOR COMPUTERS; HOME AND OFFICE AUTOMATION SYSTEMS COMPRISING WIRELESS AND WIRED CONTROLLERS, CONTROLLED DEVICES, AND SOFTWARE FOR LIGHTING, HVAC, SECURITY, SAFETY AND OTHER HOME AND OFFICE MONITORING AND CONTROL APPLICATIONS; INDUSTRIAL AUTOMATION CONTROLS, IN CLASS 9 (U.S. CLS. 21, 23, 26, 36 AND 38).

FIRST USE 6-1-2010; IN COMMERCE 6-1-2010.

FOR: DESIGN AND DEVELOPMENT OF COMPUTER HARDWARE AND PERIPHERALS, IN CLASS 42 (U.S. CLS. 100 AND 101).

FIRST USE 6-1-2010; IN COMMERCE 6-1-2010.

NO CLAIM IS MADE TO THE EXCLUSIVE RIGHT TO USE "SYSTEMS LTD", APART FROM THE MARK AS SHOWN.

THE MARK CONSISTS OF THE WORD "SAIKO" IN LARGE LETTERS WITH THE WORDS "SYSTEMS LTD" IN SMALL LETTERS UNDERNEATH THE WORD "SAIKO". THE UPPER PART OF THE LETTER "S" IN "SAIKO" EXTENDS OVER THE LETTERS "A" AND "I", CONNECTING THE "S" AND THE DOT OF THE "I" WITH A LINE. THE LETTER "A" IN "SAIKO" CONTAINS AN ARROW POINTING TO THE RIGHT IN THE CENTER OF THE "A", SIMILAR TO A CURVED ARROW IN THE SHAPE OF AN "A". A DIAMOND PATTERN CONSISTING OF 10 INDIVIDUAL SHAPES EXTENDING FROM THE LETTER "K" OF "SAIKO" OVER THE TOP AND AROUND THE RIGHT OF THE LETTER "O".

SER. NO. 85-343,041, FILED 6-10-2011.

JENNIFER MARTIN, EXAMINING ATTORNEY



David J. Kyffers

Director of the United States Patent and Trademark Office

United States of America

United States Patent and Trademark Office

Miss Teen Captivating

Reg. No. 4,098,580

MARTINEZ, RICKY (UNITED STATES INDIVIDUAL)
616 DURHAM LANE
DELAWARE, OH 43015

Registered Feb. 14, 2012

Int. Cl.: 41

FOR: ENTERTAINMENT SERVICES, NAMELY, BEAUTY PAGEANTS ON THE STATE, REGIONAL, AND NATIONAL LEVEL, IN CLASS 41 (U.S. CLS. 100, 101 AND 107).

SERVICE MARK

FIRST USE 10-30-2010; IN COMMERCE 10-30-2010.

PRINCIPAL REGISTER

THE MARK CONSISTS OF STANDARD CHARACTERS WITHOUT CLAIM TO ANY PARTICULAR FONT, STYLE, SIZE, OR COLOR.

NO CLAIM IS MADE TO THE EXCLUSIVE RIGHT TO USE "TEEN", APART FROM THE MARK AS SHOWN.

SER. NO. 85-343,077, FILED 6-10-2011.

PAUL E. FAHRENKOPF, EXAMINING ATTORNEY



David J. Kyffers

Director of the United States Patent and Trademark Office

United States of America

United States Patent and Trademark Office

DELTA DENTAL'S



Reg. No. 4,098,581

DELTA DENTAL OF VIRGINIA (VIRGINIA NON-STOCK CORPORATION)
4818 STARKEY ROAD SW
ROANOKE, VA 24014

Registered Feb. 14, 2012

Int. Cl.: 35

FOR: CHARITABLE SERVICES, NAMELY, COORDINATION OF MONETARY AND NON-MONETARY CONTRIBUTIONS TO CHARITIES AND NONPROFIT ORGANIZATIONS IN THE FIELD OF ORAL HEALTH, IN CLASS 35 (U.S. CLS. 100, 101 AND 102).

SERVICE MARK

FIRST USE 2-14-2011; IN COMMERCE 2-14-2011.

PRINCIPAL REGISTER

OWNER OF U.S. REG. NO. 2,617,756.

THE COLOR(S) BLACK, WHITE, AND ORANGE IS/ARE CLAIMED AS A FEATURE OF THE MARK.

NO CLAIM IS MADE TO THE EXCLUSIVE RIGHT TO USE "DENTAL'S" AND "IN THE COMMUNITY", APART FROM THE MARK AS SHOWN.

THE MARK CONSISTS OF A BLACK, ORANGE AND WHITE SQUARE WITH THE WHITE-COLORED WORD "SMART" IN THE BLACK PORTION OF THE SQUARE AND THE WHITE-COLORED WORD "SMILES" IN THE ORANGE PORTION OF THE SQUARE. THE ORANGE AND BLACK PORTIONS OF THE SQUARE ARE SEPARATED BY A CURVED HORIZONTAL WHITE LINE. ABOVE THE SQUARE ARE THE BLACK-COLORED WORDS "DELTA DENTAL'S" AND BELOW THE SQUARE ARE THE BLACK-COLORED WORDS "IN THE COMMUNITY".



SER. NO. 85-343,160, FILED 6-10-2011.

HENRY S. ZAK, EXAMINING ATTORNEY

David J. Kyjars

Director of the United States Patent and Trademark Office

United States of America

United States Patent and Trademark Office



Reg. No. 4,098,582

DELTA DENTAL OF VIRGINIA (VIRGINIA NON-STOCK CORPORATION)
4818 STARKEY ROAD SW
ROANOKE, VA 24014

Registered Feb. 14, 2012

Int. Cl.: 41

FOR: EDUCATIONAL SERVICES, NAMELY, PROVIDING DENTAL AND ORAL HEALTH CARE PROGRAMS TO CHILDREN, IN CLASS 41 (U.S. CLS. 100, 101 AND 107).

SERVICE MARK

FIRST USE 2-14-2011; IN COMMERCE 2-14-2011.

PRINCIPAL REGISTER

OWNER OF U.S. REG. NO. 2,617,756.

THE COLOR(S) BLACK, WHITE, AND BLUE IS/ARE CLAIMED AS A FEATURE OF THE MARK.

NO CLAIM IS MADE TO THE EXCLUSIVE RIGHT TO USE "DENTAL'S" AND "IN SCHOOL", APART FROM THE MARK AS SHOWN.

THE MARK CONSISTS OF A BLACK, BLUE AND WHITE SQUARE WITH THE WHITE-COLORED WORD "SMART" IN THE BLACK PORTION OF THE SQUARE AND THE WHITE-COLORED WORD "SMILES" IN THE BLUE PORTION OF THE SQUARE. THE BLUE AND BLACK PORTIONS OF THE SQUARE ARE SEPARATED BY A CURVED HORIZONTAL WHITE LINE. ABOVE THE SQUARE ARE THE BLACK-COLORED WORDS "DELTA DENTAL'S" AND BELOW THE SQUARE ARE THE BLACK-COLORED WORDS "IN SCHOOL".



SER. NO. 85-343,167, FILED 6-10-2011.

HENRY S. ZAK, EXAMINING ATTORNEY

David J. Kybas

Director of the United States Patent and Trademark Office

United States of America

United States Patent and Trademark Office



Reg. No. 4,098,583

Registered Feb. 14, 2012

Int. Cls.: 7, 40 and 42

TRADEMARK

SERVICE MARK

PRINCIPAL REGISTER

PENN UNITED TECHNOLOGIES, INC. (PENNSYLVANIA CORPORATION)
799 NORTH PIKE ROAD
CABOT, PA 16023

FOR: STAMPING MACHINES; DIES FOR USE WITH MACHINE TOOLS; GRINDING MACHINES; GRINDING TOOLS FOR GRINDING MACHINES; MACHINES AND MACHINE TOOLS FOR THE CUTTING AND FORMING OF MATERIALS; PRESS DIES FOR METAL FORMING; PUNCHING PRESSES; ROTARY GRINDING MACHINES; TOOL GRINDING MACHINES, IN CLASS 7 (U.S. CLS. 13, 19, 21, 23, 31, 34 AND 35).

FIRST USE 1-1-2007; IN COMMERCE 1-1-2007.

FOR: APPLYING FINISHES TO METAL; ASSEMBLY OF PRODUCTS FOR OTHERS; CUSTOM MANUFACTURE OF TOOLS AND COMPONENTS FOR METAL WORKING; ELECTRO AND METAL COATING, METAL TREATING AND CASTING, HARDENING OF METAL AND METAL PRODUCTS; GOLD PLATING; GRINDING; MANUFACTURING SERVICES FOR OTHERS IN THE FIELD OF DENTAL EQUIPMENT, MEDICAL EQUIPMENT, AUTOMOTIVE COMPONENTS, HAND TOOLS, RAZORS, WRITING UTENSILS, HUNTING AND GAMING EQUIPMENT, CANS, BATTERIES, COMMUNICATION COMPONENTS AND EQUIPMENT, COMPONENTS FOR OIL AND NATURAL GAS EXPLORATION; METAL FABRICATION AND FINISHING SERVICES; METAL LAMINATING; METAL PLATING; METAL PLATING AND LAMINATING; METAL STAMPING; METAL TEMPERING; METAL TREATMENT; PROTOTYPE FABRICATION OF NEW PRODUCTS FOR OTHERS; PROVIDING MATERIAL TREATMENT INFORMATION, IN CLASS 40 (U.S. CLS. 100, 103 AND 106).

FIRST USE 1-1-2007; IN COMMERCE 1-1-2007.

FOR: DESIGN AND TESTING FOR NEW PRODUCT DEVELOPMENT; DESIGN AND TESTING OF NEW PRODUCTS FOR OTHERS; DESIGNING OF MACHINES, APPARATUS, INSTRUMENTS OR SYSTEMS COMPOSED OF SUCH MACHINES, APPARATUS AND INSTRUMENTS; PRODUCT DEVELOPMENT; PRODUCT DEVELOPMENT FOR OTHERS; PRODUCT RESEARCH AND DEVELOPMENT; PRODUCT SAFETY TESTING; RESEARCH AND DEVELOPMENT FOR NEW PRODUCTS FOR OTHERS, IN CLASS 42 (U.S. CLS. 100 AND 101).

FIRST USE 1-1-2007; IN COMMERCE 1-1-2007.



David J. Kyffers

Director of the United States Patent and Trademark Office

Reg. No. 4,098,583 OWNER OF U.S. REG. NOS. 3,289,940, 3,358,509 AND OTHERS.

NO CLAIM IS MADE TO THE EXCLUSIVE RIGHT TO USE "PENN" OR "TECHNOLOGIES INC.", APART FROM THE MARK AS SHOWN.

THE MARK CONSISTS OF A SILHOUETTE OF A CUBE WITH A CIRCULAR HORIZONTAL PASSAGE DISPOSED AT THE LEFT AND THE WORDS "PENN UNITED" ON A FIRST LINE AND THE WORDS "TECHNOLOGIES INC." ON A SECOND LINE; THE WORDS "TECHNOLOGIES INC." BEING IN OUTLINED LETTERS.

SER. NO. 85-343,412, FILED 6-10-2011.

ROBIN CHOSID, EXAMINING ATTORNEY

United States of America

United States Patent and Trademark Office

VECCELI

Reg. No. 4,098,584

GOLAN, YORAM (UNITED STATES INDIVIDUAL)
366 5TH AVE., SUITE 612
NEW YORK, NY 10001

Registered Feb. 14, 2012

Int. Cl.: 18

FOR: HANDBAGS, PURSES AND WALLETS, IN CLASS 18 (U.S. CLS. 1, 2, 3, 22 AND 41).

TRADEMARK

FIRST USE 2-1-2006; IN COMMERCE 5-1-2006.

PRINCIPAL REGISTER

THE MARK CONSISTS OF STANDARD CHARACTERS WITHOUT CLAIM TO ANY PARTICULAR FONT, STYLE, SIZE, OR COLOR.

SER. NO. 85-343,523, FILED 6-10-2011.

GISELLE AGOSTO, EXAMINING ATTORNEY



David J. Kybas

Director of the United States Patent and Trademark Office

United States of America

United States Patent and Trademark Office

ABC ABSOLUTE BARBECUE COMPANY

Reg. No. 4,098,585

CATERING BY DANA, L.L.C. (CALIFORNIA LIMITED LIABILITY COMPANY)
3600 HAVEN AVE. SUITE 3
REDWOOD CITY, CA 94063

Registered Feb. 14, 2012

Int. Cl.: 43

FOR: RESTAURANT SERVICES, NAMELY, CATERING, IN CLASS 43 (U.S. CLS. 100 AND 101).

SERVICE MARK

FIRST USE 7-0-1989; IN COMMERCE 1-28-2003.

PRINCIPAL REGISTER

THE MARK CONSISTS OF STANDARD CHARACTERS WITHOUT CLAIM TO ANY PARTICULAR FONT, STYLE, SIZE, OR COLOR.

NO CLAIM IS MADE TO THE EXCLUSIVE RIGHT TO USE "BARBECUE COMPANY", APART FROM THE MARK AS SHOWN.

SER. NO. 85-343,582, FILED 6-10-2011.

STEPHANIE ALI, EXAMINING ATTORNEY



David J. Kybas

Director of the United States Patent and Trademark Office

United States of America

United States Patent and Trademark Office



Reg. No. 4,098,586

CATERING BY DANA, L.L.C. (CALIFORNIA LIMITED LIABILITY COMPANY)
3600 HAVEN AVE., SUITE 3
REDWOOD CITY, CA 94063

Registered Feb. 14, 2012

Int. Cl.: 43

FOR: RESTAURANT SERVICES, NAMELY, CATERING, IN CLASS 43 (U.S. CLS. 100 AND 101).

SERVICE MARK

FIRST USE 7-0-1989; IN COMMERCE 1-28-2003.

PRINCIPAL REGISTER

NO CLAIM IS MADE TO THE EXCLUSIVE RIGHT TO USE "BARBECUE COMPANY", APART FROM THE MARK AS SHOWN.

THE MARK CONSISTS OF THE WORDS "ABSOLUTE BARBECUE COMPANY" WITH THE LETTERS "A", "B" AND "C" EMPHASIZED IN EACH WORD WITH A COW IN A CHEF'S HAT HOLDING UTENSILS AND WEARING A CHECKERED APRON.

SER. NO. 85-343,598, FILED 6-10-2011.

STEPHANIE ALI, EXAMINING ATTORNEY



David J. Kybas

Director of the United States Patent and Trademark Office

United States of America

United States Patent and Trademark Office

Paper Dog Studio

Reg. No. 4,098,587

TAYLOR, JENNIFER (UNITED STATES INDIVIDUAL)
835 SOUTH HARVEY
OAK PARK, IL 60304 AND

Registered Feb. 14, 2012

Int. Cl.: 42

TUCKER, JEFF (UNITED STATES INDIVIDUAL)
835 SOUTH HARVEY
OAK PARK, IL 60304

SERVICE MARK

PRINCIPAL REGISTER

FOR: COMPUTER GRAPHICS SERVICES; GRAPHIC ILLUSTRATION SERVICES FOR OTHERS, IN CLASS 42 (U.S. CLS. 100 AND 101).

FIRST USE 1-1-2003; IN COMMERCE 1-1-2003.

THE MARK CONSISTS OF STANDARD CHARACTERS WITHOUT CLAIM TO ANY PARTICULAR FONT, STYLE, SIZE, OR COLOR.

NO CLAIM IS MADE TO THE EXCLUSIVE RIGHT TO USE "STUDIO", APART FROM THE MARK AS SHOWN.

SER. NO. 85-343,719, FILED 6-10-2011.

SHAILA SETTLES, EXAMINING ATTORNEY



David J. Kybas

Director of the United States Patent and Trademark Office

United States of America

United States Patent and Trademark Office

Lawyer Advice Now

Reg. No. 4,098,588

BOLT, DONALD B. (UNITED STATES INDIVIDUAL), DBA LAWYER ADVICE NOW
7835 S. 69TH E. AVE.
TULSA, OK 74133

Registered Feb. 14, 2012

Int. Cl.: 45

FOR: LEGAL CONSULTATION SERVICES; LEGAL SERVICES; PROVIDING AN ON-LINE INTERACTIVE DATABASE FEATURING LEGAL INFORMATION, IN CLASS 45 (U.S. CLS. 100 AND 101).

SERVICE MARK

FIRST USE 8-1-2010; IN COMMERCE 8-1-2010.

PRINCIPAL REGISTER

THE MARK CONSISTS OF STANDARD CHARACTERS WITHOUT CLAIM TO ANY PARTICULAR FONT, STYLE, SIZE, OR COLOR.

NO CLAIM IS MADE TO THE EXCLUSIVE RIGHT TO USE "LAWYER ADVICE", APART FROM THE MARK AS SHOWN.

SER. NO. 85-343,820, FILED 6-10-2011.

PATRICIA EVANKO, EXAMINING ATTORNEY



David J. Kybas

Director of the United States Patent and Trademark Office

United States of America

United States Patent and Trademark Office

LAVUK

Reg. No. 4,098,589

LAVUK (CALIFORNIA SOLE PROPRIETORSHIP)

Registered Feb. 14, 2012

117 W. 9TH STREET, SUITE 623
LOS ANGELES, CA 90015

Int. Cl.: 25

TRADEMARK

PRINCIPAL REGISTER

FOR: A-SHIRTS; APPAREL FOR DANCERS, NAMELY, TEE SHIRTS, SWEATSHIRTS, PANTS, LEGGINGS, SHORTS AND JACKETS; BALLOON PANTS; BED JACKETS; BELTS; BELTS FOR CLOTHING; BELTS MADE FROM IMITATION LEATHER; BELTS MADE OF LEATHER; BELTS MADE OUT OF CLOTH; BELTS OF TEXTILE; BELTS THAT ARE DESIGNED TO ACCOMMODATE PREGNANCY SIZE CHANGES; BODY SHIRTS; BOMBER JACKETS; CAMOUFLAGE SHIRTS; CAMOUFLAGE PANTS; CAMOUFLAGE SHIRTS; CAMP SHIRTS; CAPRI PANTS; CARGO PANTS; COATS; COATS FOR MEN AND WOMEN; COATS MADE OF COTTON; COATS OF DENIM; COLLARED SHIRTS; CROP PANTS; DENIM JACKETS; DENIMS; DOWN JACKETS; DRESS PANTS; DRESS SHIELDS; DRESS SHIRTS; DRESS SUITS; DRESSES; DRESSES MADE FROM SKINS; DRESSES THAT MAY ALSO BE USED AS TOWELS; DRESSING GOWNS; DUST COATS; EVENING DRESSES; FABRIC BELTS; FISHERMEN'S JACKETS; FISHING SHIRTS; FLOOD PANTS; FUR COATS; FUR COATS AND JACKETS; HEAVY COATS; HEAVY JACKETS; HOODED SWEAT SHIRTS; JACKETS; JEGGINGS, NAMELY, PANTS THAT ARE PARTIALLY JEANS AND PARTIALLY LEGGINGS; JOGGING PANTS; JUMPER DRESSES; KNIT DRESSES; KNIT JACKETS; KNIT SHIRTS; KNIT SKIRTS; LEATHER BELTS; LEATHER COATS; LEATHER JACKETS; LEATHER PANTS; LEATHER SHIRTS; LEATHER SKIRTS; LONG JACKETS; LONG-SLEEVED SHIRTS; LOUNGE PANTS; MOTORCYCLE JACKETS; NIGHT SHIRTS; OPEN-NECKED SHIRTS; OUTER JACKETS; OVER COATS; OVER SHIRTS; PADDED JACKETS; PANTS; PETTI-PANTS; PIQUE SHIRTS; POLO SHIRTS; RAIN COATS; RAIN JACKETS; RAINPROOF JACKETS; REVERSIBLE JACKETS; SHELL JACKETS; SHIRTS; SHIRTS AND SHORT-SLEEVED SHIRTS; SHIRTS AND SLIPS; SHIRTS FOR SUITS; SHORT-SLEEVED OR LONG-SLEEVED T-SHIRTS; SHORT-SLEEVED SHIRTS; SKIRTS; SKIRTS AND DRESSES; SLEEVED OR SLEEVELESS JACKETS; SLEEVES WORN SEPARATE AND APART FROM BLOUSES, SHIRTS AND OTHER TOPS; SMOKING JACKETS; STRETCH PANTS; STUFF JACKETS; SUIT COATS; SUSPENDER BELTS; SUSPENDER BELTS FOR MEN; SUSPENDER BELTS FOR WOMEN; SWEAT JACKETS; SWEAT PANTS; SWEAT SHIRTS; T-SHIRTS; TEE SHIRTS; TOP COATS; TRAVEL CLOTHING CONTAINED IN A PACKAGE COMPRISING REVERSIBLE JACKETS, PANTS, SKIRTS, TOPS AND A BELT OR SCARF; TRENCH COATS; TURTLE NECK SHIRTS; TUXEDO BELTS; WAIST BELTS; WATERPROOF JACKETS AND PANTS; WEARABLE GARMENTS AND CLOTHING, NAMELY, SHIRTS; WOMEN'S CLOTHING, NAMELY,



David J. Kyros

Director of the United States Patent and Trademark Office

Reg. No. 4,098,589 SHIRTS, DRESSES, SKIRTS, BLOUSES; WOVEN DRESSES; WOVEN SKIRTS; YOGA PANTS;
YOGA SHIRTS, IN CLASS 25 (U.S. CLS. 22 AND 39).

FIRST USE 5-20-2008; IN COMMERCE 7-15-2008.

THE MARK CONSISTS OF THE STYLIZED WORD "LAVUK".

SER. NO. 85-343,827, FILED 6-10-2011.

PATRICIA EVANKO, EXAMINING ATTORNEY

United States of America

United States Patent and Trademark Office



Reg. No. 4,098,590

VAN ELSLANDE, VRENY (CALIFORNIA SOLE PROPRIETORSHIP), DBA ZOT ZIN MUSIC
1776 N. SYCAMORE AVE. #319

Registered Feb. 14, 2012

LOS ANGELES, CA 90028

Int. Cl.: 41

FOR: ONE-ON-ONE MUSIC INSTRUCTION IN THE FIELDS OF GUITAR, MUSIC THEORY, IMPROVISATION, COMPOSITION, SONG-WRITING, AND MUSIC PERFORMANCE; RECORDING AND PRODUCTION IN THE FIELD OF MUSIC, IN CLASS 41 (U.S. CLS. 100, 101 AND 107).

SERVICE MARK

PRINCIPAL REGISTER

FIRST USE 6-30-2002; IN COMMERCE 9-21-2004.

NO CLAIM IS MADE TO THE EXCLUSIVE RIGHT TO USE "MUSIC", APART FROM THE MARK AS SHOWN.

THE COLOR(S) BLUE, YELLOW, BLACK IS/ARE CLAIMED AS A FEATURE OF THE MARK.

THE MARK CONSISTS OF THE WORDING "ZOT ZIN", IN BLUE LETTERS WITH A YELLOW HUE, WITH THE WORD "ZOT" IN ALL CAPITALS, AND THE LETTERS IN THE WORD "ZIN" SLANTED TO REFLECT JOY TO WORK WITH US; THE WORD "MUSIC" IN BLACK IS POSITIONED UNDERNEATH THE WORDS "ZOT ZIN" AND THERE IS A TREBLE CLEF AND 3 MUSIC NOTES IN BLUE ABOVE THE "O" AND BLUE HEADPHONES AROUND THAT LETTER.

THE ENGLISH TRANSLATION OF "ZOT" IS "BEING IN LOVE", "UNCONVENTIONAL", "CRAZY" OR ALSO "IMPRESSIVE"; THE ENGLISH TRANSLATION OF "ZIN" IS "MEANING", "SENTENCE", "LIKING" OR "SETTING YOUR MIND TO SOMETHING"; THE 2 WORDS COMBINED MEAN "TO BE IN LOVE" OR "TO BE CRAZY".



SER. NO. 85-343,836, FILED 6-10-2011.

NICHOLAS COLEMAN, EXAMINING ATTORNEY

David J. Kyros

Director of the United States Patent and Trademark Office

United States of America

United States Patent and Trademark Office

REVOLUTION HOOKAH TOBACCO LET LOOSE YOUR SENSES

Reg. No. 4,098,591

Registered Feb. 14, 2012

Int. Cl.: 34

TRADEMARK

PRINCIPAL REGISTER

BLACK DIMOND TOBACCO INC (ILLINOIS CORPORATION)
7548 W 99TH STREET
BRIDGEVIEW, IL 60455

FOR: HOOKAH TOBACCO, IN CLASS 34 (U.S. CLS. 2, 8, 9 AND 17).

FIRST USE 6-1-2011; IN COMMERCE 6-1-2011.

THE MARK CONSISTS OF STANDARD CHARACTERS WITHOUT CLAIM TO ANY PARTICULAR FONT, STYLE, SIZE, OR COLOR.

NO CLAIM IS MADE TO THE EXCLUSIVE RIGHT TO USE "HOOKAH TOBACCO", APART FROM THE MARK AS SHOWN.

SER. NO. 85-343,901, FILED 6-11-2011.

MICHAEL WIENER, EXAMINING ATTORNEY



David J. Kyros

Director of the United States Patent and Trademark Office

United States of America

United States Patent and Trademark Office

REICHERT TECHNOLOGIES

Reg. No. 4,098,592

Registered Feb. 14, 2012

Int. Cls.: 9, 10 and 37

TRADEMARK

SERVICE MARK

PRINCIPAL REGISTER

REICHERT, INC. (DELAWARE CORPORATION)
3362 WALDEN AVENUE
DEPEW, NY 14043

FOR: LENSMETERS FOR DETERMINING OPTICAL CHARACTERISTICS OF LENSES; REFRACTOMETERS; TRIAL EYEGLASS LENS SETS AND FRAMES FOR TRIAL EYEGLASS LENSES; CHART PROJECTORS; SCIENTIFIC LABORATORY INSTRUMENTS, NAMELY, ANALYTICAL SYSTEMS FOR MEASURING BIOMOLECULAR INTERACTIONS CONSISTING OF SURFACE PLASMON RESONANCE DETECTORS AND FLUID PUMPS SOLD THEREWITH; ULTRASOUND BIOMICROSCOPES, IN CLASS 9 (U.S. CLS. 21, 23, 26, 36 AND 38).

FIRST USE 1-27-2011; IN COMMERCE 1-27-2011.

FOR: OPHTHALMIC INSTRUMENTS FOR EXAMINING AND TESTING THE EYE AND DISPOSABLE ITEMS USED THEREWITH, NAMELY, REFRACTORS, TONOMETERS, DISPOSABLE TIP COVERS FOR TONOMETERS, SLIT LAMPS FOR USE IN MEDICAL EXAMINATION, VISUAL ACUITY CHART DISPLAY SYSTEMS CONSISTING OF A DISPLAY SCREEN, OPERATING SOFTWARE AND CONTROLLER USED IN DIRECT ASSOCIATION WITH MEDICAL DIAGNOSIS APPARATUS DURING THE PROCESS OF DIAGNOSING THE CONDITION OF AN INDIVIDUAL; KERATOMETERS AND OPHTHALMIC PERIMETERS FOR VISUAL FIELD TESTING, IN CLASS 10 (U.S. CLS. 26, 39 AND 44).

FIRST USE 10-4-2010; IN COMMERCE 10-4-2010.

FOR: REPAIR AND MAINTENANCE SERVICES FOR MICROSCOPES, IN CLASS 37 (U.S. CLS. 100, 103 AND 106).

FIRST USE 4-9-2010; IN COMMERCE 4-9-2010.

THE MARK CONSISTS OF STANDARD CHARACTERS WITHOUT CLAIM TO ANY PARTICULAR FONT, STYLE, SIZE, OR COLOR.

OWNER OF U.S. REG. NO. 2,069,419.

NO CLAIM IS MADE TO THE EXCLUSIVE RIGHT TO USE "TECHNOLOGIES", APART FROM THE MARK AS SHOWN.



David J. Kyjars

Director of the United States Patent and Trademark Office

Reg. No. 4,098,592 SER. NO. 85-344,010, FILED 6-12-2011.

JEFFREY LOOK, EXAMINING ATTORNEY

United States of America

United States Patent and Trademark Office

Career Champions

Reg. No. 4,098,593

Registered Feb. 14, 2012

Int. Cl.: 35

SERVICE MARK

PRINCIPAL REGISTER

FERNANDEZ, DEBORAH K. (UNITED STATES INDIVIDUAL), DBA CAREER CHAMPIONS
106 MAINSAIL DRIVE
CARY, NC 27511

FOR: CAREER PLACEMENT; CONSULTING SERVICES IN THE FIELD OF HUMAN RESOURCES DEVELOPMENT, NAMELY, FOR THE PROMOTION OF EMPLOYEE RETENTION, CAREER GROWTH, AND INCREASED PRODUCTIVITY FOR EMPLOYEES AND EMPLOYERS; CONSULTING SERVICES IN THE FIELD OF HUMAN RESOURCES DEVELOPMENT, NAMELY, UTILIZING TECHNOLOGY FOR THE PROMOTION OF EMPLOYEE RETENTION, CAREER GROWTH AND INCREASED PRODUCTIVITY FOR EMPLOYEES AND EMPLOYERS; EMPLOYMENT COUNSELING AND RECRUITING; EMPLOYMENT HIRING, RECRUITING, PLACEMENT, STAFFING AND CAREER NETWORKING SERVICES; PROMOTING PUBLIC INTEREST IN EDUCATION, RECOGNITION, CAREER ADVANCEMENT, AND LEADERSHIP FOR ELITE MANAGERS AND EXECUTIVES IN CORPORATIONS AND PROFESSIONAL SERVICE FIRMS; PROVIDING CAREER INFORMATION; PROVIDING EMPLOYMENT COUNSELING INFORMATION ON HOW TO SUCCESSFULLY TRANSITION JOBS; PROVIDING EMPLOYMENT COUNSELING INFORMATION ON HOW TO SUCCESSFULLY TRANSITION JOBS FOR MATURE WORKERS; PROVIDING ON-LINE EMPLOYMENT INFORMATION IN THE FIELD OF CAREERS, JOB RESOURCES, RESUMES; PROVIDING ON-LINE INTERACTIVE EMPLOYMENT COUNSELING AND RECRUITMENT SERVICES, IN CLASS 35 (U.S. CLS. 100, 101 AND 102).

FIRST USE 3-1-2011; IN COMMERCE 3-1-2011.

THE MARK CONSISTS OF STANDARD CHARACTERS WITHOUT CLAIM TO ANY PARTICULAR FONT, STYLE, SIZE, OR COLOR.

NO CLAIM IS MADE TO THE EXCLUSIVE RIGHT TO USE "CAREER", APART FROM THE MARK AS SHOWN.

SER. NO. 85-344,013, FILED 6-12-2011.

ELLEN PERKINS, EXAMINING ATTORNEY



David J. Kyros

Director of the United States Patent and Trademark Office

United States of America

United States Patent and Trademark Office



Reg. No. 4,098,594

REICHERT, INC. (DELAWARE CORPORATION)
3362 WALDEN AVENUE
DEPEW, NY 14043

Registered Feb. 14, 2012

Int. Cls.: 9, 10 and 37

FOR: LENSMETERS FOR DETERMINING OPTICAL CHARACTERISTICS OF LENSES; REFRACTOMETERS; TRIAL EYEGLASS LENS SETS AND FRAMES FOR TRIAL EYEGLASS LENSES; CHART PROJECTORS; SCIENTIFIC LABORATORY INSTRUMENTS, NAMELY, ANALYTICAL SYSTEMS FOR MEASURING BIOMOLECULAR INTERACTIONS CONSISTING OF SURFACE PLASMON RESONANCE DETECTORS AND FLUID PUMPS SOLD THEREWITH; ULTRASOUND BIOMICROSCOPES, IN CLASS 9 (U.S. CLS. 21, 23, 26, 36 AND 38).

TRADEMARK

SERVICE MARK

PRINCIPAL REGISTER

FIRST USE 1-27-2011; IN COMMERCE 1-27-2011.

FOR: OPHTHALMIC INSTRUMENTS FOR EXAMINING AND TESTING THE EYE AND DISPOSABLE ITEMS USED THEREWITH, NAMELY, REFRACTORS, TONOMETERS, DISPOSABLE TIP COVERS FOR TONOMETERS, SLIT LAMPS FOR USE IN MEDICAL EXAMINATION, VISUAL ACUITY CHART DISPLAY SYSTEMS CONSISTING OF A DISPLAY SCREEN, OPERATING SOFTWARE AND CONTROLLER USED IN DIRECT ASSOCIATION WITH MEDICAL DIAGNOSIS APPARATUS DURING THE PROCESS OF DIAGNOSING THE CONDITION OF AN INDIVIDUAL; KERATOMETERS AND OPHTHALMIC PERIMETERS FOR VISUAL FIELD TESTING, IN CLASS 10 (U.S. CLS. 26, 39 AND 44).

FIRST USE 10-4-2010; IN COMMERCE 10-4-2010.

FOR: REPAIR AND MAINTENANCE SERVICES FOR MICROSCOPES, IN CLASS 37 (U.S. CLS. 100, 103 AND 106).

FIRST USE 4-9-2010; IN COMMERCE 4-9-2010.

OWNER OF U.S. REG. NO. 2,069,419.

NO CLAIM IS MADE TO THE EXCLUSIVE RIGHT TO USE "TECHNOLOGIES", APART FROM THE MARK AS SHOWN.



David J. Kyjars

Director of the United States Patent and Trademark Office

Reg. No. 4,098,594 THE MARK CONSISTS OF THE WORD "REICHERT" ABOVE THE WORD "TECHNOLOGIES" IN A SMALLER FONT, WHEREIN AN ARC-SHAPED DESIGN ELEMENT REPRESENTING A CORNEA IS POSITIONED ABOVE THE WORD "REICHERT".

SER. NO. 85-344,014, FILED 6-12-2011.

JEFFREY LOOK, EXAMINING ATTORNEY

United States of America

United States Patent and Trademark Office

Globally Distributed Work

Reg. No. 4,098,595

Registered Feb. 14, 2012

Int. Cl.: 41

SERVICE MARK

PRINCIPAL REGISTER

GDW RESEARCH EDUCATION AND MANAGEMENT FOUNDATION (INDIA TRUST),
AKA GDW FOUNDATION
456 9A MAIN ROAD, BLOCK - 2, JAYANAGAR
BANGALORE, INDIA 560011

FOR: BUSINESS TRAINING; EDUCATION INFORMATION IN THE FIELD OF GLOBAL ENTERPRISE AND MANAGEMENT; EDUCATION SERVICES, NAMELY, PROVIDING CLASSES, SEMINARS AND WORKSHOPS IN THE FIELD OF GLOBAL ENTERPRISE AND MANAGEMENT IN EMERGING MARKETS; ON-LINE PUBLICATION OF ARTICLES AND DOCUMENTS IN THE FIELD OF GLOBAL ENTERPRISE AND MANAGEMENT; PUBLICATION OF PRINTED MATTER; TRAINING SERVICES IN THE FIELD OF GLOBAL ENTERPRISE AND MANAGEMENT IN EMERGING MARKETS, IN CLASS 41 (U.S. CLS. 100, 101 AND 107).

FIRST USE 2-26-2005; IN COMMERCE 1-9-2007.

THE MARK CONSISTS OF STANDARD CHARACTERS WITHOUT CLAIM TO ANY PARTICULAR FONT, STYLE, SIZE, OR COLOR.

NO CLAIM IS MADE TO THE EXCLUSIVE RIGHT TO USE "GLOBALLY" AND "WORK", APART FROM THE MARK AS SHOWN.

SER. NO. 85-344,137, FILED 6-12-2011.

DOMINICK J. SALEMI, EXAMINING ATTORNEY



David J. Kyros

Director of the United States Patent and Trademark Office

United States of America

United States Patent and Trademark Office



Reg. No. 4,098,596

JELLYBEANS, LLC (NEW YORK LIMITED LIABILITY COMPANY)
319 SOUTH HAMILTON STREET
PAINTED POST, NY 14870

Registered Feb. 14, 2012

Int. Cl.: 43

FOR: SERVING OF FOOD AND DRINK/BEVERAGES, IN CLASS 43 (U.S. CLS. 100 AND 101).

SERVICE MARK

FIRST USE 2-14-2002; IN COMMERCE 2-14-2002.

PRINCIPAL REGISTER

NO CLAIM IS MADE TO THE EXCLUSIVE RIGHT TO USE "THE RESTAURANT", APART FROM THE MARK AS SHOWN.

THE COLOR(S) YELLOW, RED, HOT PINK, BLACK, LIME GREEN, LIGHT BLUE, PURPLE, LIGHT PINK, BLUE, AND ORANGE IS/ARE CLAIMED AS A FEATURE OF THE MARK.

THE MARK CONSISTS OF THE WORDS "JELLY BEANS THE RESTAURANT" IN MULTI-COLORED LETTERING, ON A YELLOW BACKGROUND. IN ORDER OF APPEARANCE, THE COLORS OF THE LETTERS ARE: "J": RED; "E": HOT PINK; "L": BLACK; "L": LIME GREEN; "Y": LIGHT BLUE; "B": PURPLE; "E": LIGHT PINK; "A": BLUE; "N": LIME GREEN; "S": HOT PINK; "T": HOT PINK; "H": RED; "E": LIGHT BLUE; "R": LIME GREEN; "E": LIGHT BLUE; "S": HOT PINK; "T": RED; "A": BLACK; "U": BLUE; "R": LIME GREEN; "A": LIGHT PINK; "N": ORANGE; "T": HOT PINK. THE LETTERS "J" AND "Y" HAVE SMALL PURPLE CIRCLES, RESPECTIVELY, ON TOP AND ON THE RIGHT SIDE.



SER. NO. 85-344,182, FILED 6-13-2011.

H. M. FISHER, EXAMINING ATTORNEY

David J. Kypos

Director of the United States Patent and Trademark Office

United States of America

United States Patent and Trademark Office



Reg. No. 4,098,597

Registered Feb. 14, 2012

Int. Cl.: 36

SERVICE MARK

PRINCIPAL REGISTER

BENEVA FLOWERS AND GIFTS, INC. (FLORIDA CORPORATION)
6980 BENEVA ROAD
SARASOTA, FL 34238

FOR: CHARITABLE FUNDRAISING SERVICES, NAMELY, SHARING PROFITS FROM FLOWER SALES WITH NOT-FOR-PROFIT ORGANIZATIONS, IN CLASS 36 (U.S. CLS. 100, 101 AND 102).

FIRST USE 2-1-2011, THE MARK WAS FIRST USED ANYWHERE IN A DIFFERENT FORM OTHER THAN THAT SOUGHT TO BE REGISTERED AT LEAST AS EARLY AS 09/01/1997.; IN COMMERCE 2-1-2011, THE MARK WAS FIRST USED IN COMMERCE IN A DIFFERENT FORM OTHER THAN THAT SOUGHT TO BE REGISTERED AT LEAST AS EARLY AS 09/01/1997..

OWNER OF U.S. REG. NO. 2,869,179.

NO CLAIM IS MADE TO THE EXCLUSIVE RIGHT TO USE "BENEVA FLOWERS" AND "PROGRAM", APART FROM THE MARK AS SHOWN.

THE MARK CONSISTS OF A PAIR OF HANDS HELD OPEN WITH THE WORDS "BENEVA FLOWERS HELPING HANDS PROGRAM" WRITTEN OVER THEM.

SER. NO. 85-344,215, FILED 6-13-2011.

H. M. FISHER, EXAMINING ATTORNEY



David J. Kybas

Director of the United States Patent and Trademark Office

United States of America

United States Patent and Trademark Office

JAZZ'D TAPAS BAR

Reg. No. 4,098,598

JAZZ'D TAPAS BAR, LLC (GEORGIA LIMITED LIABILITY COMPANY)
52 BARNARD STREET
SAVANNAH, GA 31401

Registered Feb. 14, 2012

Int. Cl.: 43

FOR: BAR AND RESTAURANT SERVICES, IN CLASS 43 (U.S. CLS. 100 AND 101).

SERVICE MARK

FIRST USE 6-1-2003; IN COMMERCE 10-1-2003.

PRINCIPAL REGISTER

THE MARK CONSISTS OF STANDARD CHARACTERS WITHOUT CLAIM TO ANY PARTICULAR FONT, STYLE, SIZE, OR COLOR.

NO CLAIM IS MADE TO THE EXCLUSIVE RIGHT TO USE "TAPAS BAR", APART FROM THE MARK AS SHOWN.

SER. NO. 85-344,237, FILED 6-13-2011.

CHARLES L. JENKINS, EXAMINING ATTORNEY



David J. Kyffers

Director of the United States Patent and Trademark Office

United States of America
United States Patent and Trademark Office

IRISH AIR

Reg. No. 4,098,599

SNYDER, JASMIN (UNITED STATES INDIVIDUAL)
7315 BUNKER HILL CREST
INDIANAPOLIS, IN 46259

Registered Feb. 14, 2012

Int. Cl.: 37

FOR: MAINTENANCE OF RESIDENTIAL HEATING AND COOLING SYSTEMS, IN CLASS 37 (U.S. CLS. 100, 103 AND 106).

SERVICE MARK

FIRST USE 1-6-2008; IN COMMERCE 1-6-2008.

PRINCIPAL REGISTER

THE MARK CONSISTS OF STANDARD CHARACTERS WITHOUT CLAIM TO ANY PARTICULAR FONT, STYLE, SIZE, OR COLOR.

NO CLAIM IS MADE TO THE EXCLUSIVE RIGHT TO USE "AIR", APART FROM THE MARK AS SHOWN.

SER. NO. 85-344,284, FILED 6-13-2011.

KIM SAITO, EXAMINING ATTORNEY



David J. Kybas

Director of the United States Patent and Trademark Office

United States of America

United States Patent and Trademark Office



Reg. No. 4,098,600

SPECTRUM HEALTH, INC. (FLORIDA CORPORATION)
5300 EAST AVENUE
WEST PALM BEACH, FL 33407

Registered Feb. 14, 2012

Int. Cl.: 44

FOR: PALLIATIVE CARE SERVICES, IN CLASS 44 (U.S. CLS. 100 AND 101).

SERVICE MARK

FIRST USE 4-1-2011; IN COMMERCE 4-1-2011.

PRINCIPAL REGISTER

NO CLAIM IS MADE TO THE EXCLUSIVE RIGHT TO USE "SOUTH FLORIDA PALLIATIVE MEDICINE SPECIALISTS", APART FROM THE MARK AS SHOWN.

THE COLOR(S) BLUE, AQUA MARINE AND WHITE IS/ARE CLAIMED AS A FEATURE OF THE MARK.

THE MARK CONSISTS OF THE WORD "PALLIATIVE" BELOW THE WORDS "SOUTH FLORIDA" AND ABOVE THE WORDS "MEDICINE SPECIALISTS" AND THE WORDS "LIVING LIFE TO THE FULLEST" BELOW THE WORDS "MEDICINE SPECIALISTS" ALL IN BLUE. TO THE RIGHT OF THE WORDS "SOUTH FLORIDA PALLIATIVE" AND ABOVE THE WORD "SPECIALISTS" IS A WHITE HEART WITH AN ACQUAMARINE BORDER.

SER. NO. 85-344,369, FILED 6-13-2011.

FLORENTINA BLANDU, EXAMINING ATTORNEY



David J. Kyjars

Director of the United States Patent and Trademark Office

United States of America

United States Patent and Trademark Office

GELS IN ACTION

Reg. No. 4,098,601

RILLO HOLDINGS, LLC (FLORIDA LIMITED LIABILITY COMPANY), DBA NAILITE
4530 N HIATUS RD #109
SUNRISE, FL 33351

Registered Feb. 14, 2012

Int. Cl.: 3

FOR: NAIL GEL; NAIL POLISH, IN CLASS 3 (U.S. CLS. 1, 4, 6, 50, 51 AND 52).

TRADEMARK

FIRST USE 2-7-2011; IN COMMERCE 2-7-2011.

PRINCIPAL REGISTER

THE MARK CONSISTS OF STANDARD CHARACTERS WITHOUT CLAIM TO ANY PARTICULAR FONT, STYLE, SIZE, OR COLOR.

NO CLAIM IS MADE TO THE EXCLUSIVE RIGHT TO USE "GELS", APART FROM THE MARK AS SHOWN.

SER. NO. 85-344,374, FILED 6-13-2011.

ALICE BENMAMAN, EXAMINING ATTORNEY



David J. Kyffers

Director of the United States Patent and Trademark Office

United States of America
United States Patent and Trademark Office

TweeDial

Reg. No. 4,098,602

Registered Feb. 14, 2012

Int. Cl.: 45

SERVICE MARK

PRINCIPAL REGISTER

TWEEDIAL, LLC (ARKANSAS LIMITED LIABILITY COMPANY)
SUITE 200 C/O RANDY PULLIAM
11311 ARCADE DRIVE
LITTLE ROCK, AR 72212

FOR: PROVIDING ON-LINE COMPUTER DATABASES AND ON-LINE SEARCHABLE DATABASES IN THE FIELD OF SOCIAL NETWORKING WHERE THE USER CAN RANK, TRACK AND VOTE ON THE INFORMATION; PROVIDING A SOCIAL NETWORKING WEBSITE THAT DISPLAYS RANKINGS, TRACKING AND VOTES, IN CLASS 45 (U.S. CLS. 100 AND 101).

FIRST USE 5-30-2011; IN COMMERCE 6-7-2011.

THE MARK CONSISTS OF STANDARD CHARACTERS WITHOUT CLAIM TO ANY PARTICULAR FONT, STYLE, SIZE, OR COLOR.

SER. NO. 85-344,431, FILED 6-13-2011.

JENNIFER VASQUEZ, EXAMINING ATTORNEY



David J. Kyffers

Director of the United States Patent and Trademark Office

United States of America

United States Patent and Trademark Office



SEA SNIPERS

Reg. No. 4,098,603

HUNSINGER, RICH (UNITED STATES INDIVIDUAL)
310 MAYFIELD AVE
WEST CHESTER, PA 19380

Registered Feb. 14, 2012

Int. Cl.: 41

FOR: PROVIDING ON-LINE PUBLICATIONS IN THE NATURE OF NON-DOWNLOADABLE WALK-THROUGH AND STRATEGY GUIDES FOR VIDEO GAMES; PUBLICATION OF VIDEO GAME STRATEGY GUIDES, IN CLASS 41 (U.S. CLS. 100, 101 AND 107).

SERVICE MARK

FIRST USE 10-1-2002; IN COMMERCE 10-1-2003.

PRINCIPAL REGISTER

THE MARK CONSISTS OF THE STYLIZED WORDING "SEA SNIPERS" AND A GLOBE WITH AN ANCHOR AND A RIFLE.

SER. NO. 85-344,433, FILED 6-13-2011.

HOWARD B. LEVINE, EXAMINING ATTORNEY



David J. Kybas

Director of the United States Patent and Trademark Office

United States of America

United States Patent and Trademark Office

GUN-WERKZ

Reg. No. 4,098,604

FETT AFFEN TECHNOLOGIES, INC. (CALIFORNIA CORPORATION)
12558 7TH ST
YUCAIPA, CA 923992241

Registered Feb. 14, 2012

Int. Cl.: 3

FOR: GUN CLEANING AND PROTECTING PREPARATIONS, NAMELY, BIODEGRADABLE FLUID USED FOR THE CLEANING OF FIREARMS AND USED FOR THE PROTECTING THE METAL SURFACES OF A FIREARM, IN CLASS 3 (U.S. CLS. 1, 4, 6, 50, 51 AND 52).

TRADEMARK

FIRST USE 3-9-2011; IN COMMERCE 3-9-2011.

PRINCIPAL REGISTER

THE MARK CONSISTS OF STANDARD CHARACTERS WITHOUT CLAIM TO ANY PARTICULAR FONT, STYLE, SIZE, OR COLOR.

OWNER OF U.S. REG. NOS. 4,025,771, 4,025,774 AND OTHERS.

SER. NO. 85-344,436, FILED 6-13-2011.

SHARON MEIER, EXAMINING ATTORNEY



David J. Kyffers

Director of the United States Patent and Trademark Office

United States of America

United States Patent and Trademark Office

didheya

Reg. No. 4,098,605

Registered Feb. 14, 2012

Int. Cl.: 6

TRADEMARK

PRINCIPAL REGISTER

DECO DIDHEYA, S.L. (SPAIN CORPORATION)
EZURRIKI E-20 ARRETXE UGALDEA IND.
IRUN (GIPUZKOA), SPAIN 20305

FOR: METAL DOOR LATCHES; METAL TUBS; METAL HANDLES FOR DOORS AND FURNITURE; METAL CLOTHES HOOKS; METAL KNOBS, IN CLASS 6 (U.S. CLS. 2, 12, 13, 14, 23, 25 AND 50).

FIRST USE 12-31-2006; IN COMMERCE 6-30-2007.

THE MARK CONSISTS OF STANDARD CHARACTERS WITHOUT CLAIM TO ANY PARTICULAR FONT, STYLE, SIZE, OR COLOR.

THE WORDING "DIDHEYA" HAS NO MEANING IN A FOREIGN LANGUAGE.

SER. NO. 85-344,479, FILED 6-13-2011.

JOSETTE BEVERLY, EXAMINING ATTORNEY



David J. Kyffers

Director of the United States Patent and Trademark Office

United States of America

United States Patent and Trademark Office

HSS JOURNAL

Reg. No. 4,098,606

HOSPITAL FOR SPECIAL SURGERY (NEW YORK NON-PROFIT CORPORATION)
535 EAST 70TH STREET
NEW YORK, NY 10021

Registered Feb. 14, 2012

Int. Cl.: 16

FOR: PUBLICATIONS, NAMELY, JOURNALS IN THE FIELD OF ORTHOPAEDICS, RHEUMATOLOGY AND MUSCULOSKELETAL MEDICINE AND IN THE FIELD OF RESEARCH IN ORTHOPAEDICS, RHEUMATOLOGY AND MUSCULOSKELETAL MEDICINE, IN CLASS 16 (U.S. CLS. 2, 5, 22, 23, 29, 37, 38 AND 50).

TRADEMARK

PRINCIPAL REGISTER

FIRST USE 9-0-2005; IN COMMERCE 9-0-2005.

THE MARK CONSISTS OF STANDARD CHARACTERS WITHOUT CLAIM TO ANY PARTICULAR FONT, STYLE, SIZE, OR COLOR.

OWNER OF U.S. REG. NO. 1,838,935.

NO CLAIM IS MADE TO THE EXCLUSIVE RIGHT TO USE "JOURNAL", APART FROM THE MARK AS SHOWN.

SER. NO. 85-344,494, FILED 6-13-2011.

MAUREEN DALL, EXAMINING ATTORNEY



David J. Kybas

Director of the United States Patent and Trademark Office

United States of America

United States Patent and Trademark Office

PRINCIPAL TECHNOLOGY

Reg. No. 4,098,607

Registered Feb. 14, 2012

Int. Cls.: 7, 9 and 11

TRADEMARK

PRINCIPAL REGISTER

PRINCIPAL TECHNOLOGY, INC. (TEXAS CORPORATION)
1901 10TH STREET, SUITE 400
PLANO, TX 750748034

FOR: SKID-MOUNTED OIL AND NATURAL GAS EXTRACTING AND PROCESSING MACHINES, NAMELY, AMINE TREATING UNITS FOR THE REMOVAL OF ACID GAS COMPOUNDS FROM NATURAL GAS, PETROCHEMICAL, AND PETROLEUM REFINERY PROCESS STREAMS, SULFUR RECOVERY UNITS FOR THE CONVERSION OF HYDROGEN SULFIDE TO ELEMENTAL SULFUR, TAIL GAS TREATING UNITS FOR TREATING AND RECYCLING RESIDUAL HYDROGEN SULFIDE FROM THE SULFUR RECOVERY UNIT, AND THERMAL OXIDIZERS FOR THE OXIDATION OF HYDROGEN SULFIDE BEARING GAS STREAMS; GAS DIVERTER SYSTEMS CONSISTING OF PIPING, HEAT TRANSFER EQUIPMENT AND VALVES, IN CLASS 7 (U.S. CLS. 13, 19, 21, 23, 31, 34 AND 35).

FIRST USE 8-29-1997; IN COMMERCE 5-30-2005.

FOR: CONTINUOUS AND BATCH PROCESS ELECTRONIC CONTROL SYSTEMS USED IN A VARIETY OF OIL AND GAS EXPLORATION, REFINING AND TREATING, MANUFACTURING, AND CHEMICAL PLANTS AND PROCESSES; AUTOMATED MODULAR PROCESS EQUIPMENT USED IN OIL AND GAS REFINING AND GAS TREATING PLANTS; EMISSIONS MONITORING AND PROCESS CONTROL SYSTEMS CONSISTING OF FIELD INSTRUMENTS, CONTROLS AND INTERFACES, CONTROL PANELS, METERING AND REPORTING INSTRUMENTS, ELECTRONIC INSTRUMENTS AND CONTROLS, AND CONTROL SOFTWARE; ELECTRICAL INTEGRATED CONTROL SYSTEMS FOR USE IN THE FIELD OF OIL, GAS, CHEMICAL, PETROCHEMICAL, PROCESSES AND MANUFACTURING; AUTOMATED PROCESS CONTROL SYSTEMS, NAMELY, MICRO-PROCESSOR BASED HARDWARE AND SOFTWARE USED TO MONITOR THE STATUS OF INDUSTRIAL PROCESSES, NAMELY, OIL AND GAS PRODUCTION, TREATING, AND REFINING PROCESSING; AUTOMATED VALVES FOR USE IN SULFUR RECOVERY UNITS FOR THE CONVERSION OF HYDROGEN SULFIDE TO ELEMENTAL SULFUR AND RELATED BYPRODUCTS, IN CLASS 9 (U.S. CLS. 21, 23, 26, 36 AND 38).

FIRST USE 8-29-1997; IN COMMERCE 3-1-2000.

FOR: GAS BURNERS FOR INDUSTRIAL SULFUR RECOVERY UNITS, TAIL GAS TREATING UNITS, ACID GAS INCINERATION AND THERMAL OXIDIZER UNITS; BURNER MANAGEMENT SYSTEMS FOR OIL, GAS, CHEMICAL, AND PETROCHEMICAL HEATERS



David J. Kybas

Director of the United States Patent and Trademark Office

Reg. No. 4,098,607 AND PROCESSES INDUSTRIAL BOILERS, WASTE GAS INCINERATORS, AND THERMAL OXIDIZING UNITS; NATURAL GAS TREATING AND REFINERY PROCESS GAS TREATING SYSTEMS COMPRISED OF SOUR GAS TREATING EQUIPMENT, SULFUR RECOVERY AND ACID GAS CONVERSION EQUIPMENT, RESIDUAL SULFUR RECOVERY UNIT TAIL GAS TREATING UNITS, AND ACID GAS THERMAL OXIDERS SOLD AS A UNIT; GAS TREATING UNITS, SULFUR RECOVERY UNITS, AND TAIL GAS TREATING UNITS, FOR OIL, GAS, PETROCHEMICAL, AND CHEMICAL PROCESSES THAT GENERATE ACID BEARING GAS BYPRODUCTS COMPRISED OF SEPARATORS, VESSELS, PUMPS, BLOWERS, BURNERS, STORAGE TANKS, AND HEAT EXCHANGERS, ALL SOLD AS A UNIT, IN CLASS 11 (U.S. CLS. 13, 21, 23, 31 AND 34).

FIRST USE 8-29-1997; IN COMMERCE 1-16-2003.

THE MARK CONSISTS OF STANDARD CHARACTERS WITHOUT CLAIM TO ANY PARTICULAR FONT, STYLE, SIZE, OR COLOR.

NO CLAIM IS MADE TO THE EXCLUSIVE RIGHT TO USE "TECHNOLOGY", APART FROM THE MARK AS SHOWN.

SER. NO. 85-344,616, FILED 6-13-2011.

KELLY TRUSILO, EXAMINING ATTORNEY

United States of America

United States Patent and Trademark Office

CITYSOIL

Reg. No. 4,098,608

BEAVER LANDSCAPE LTD (CANADA LIMITED COMPANY (LTD.))
4-11720 VOYAGEUR WAY

Registered Feb. 14, 2012

RICHMOND, CANADA V6X3G9

Int. Cl.: 1

FOR: GROWING MEDIA FOR PLANTS, IN CLASS 1 (U.S. CLS. 1, 5, 6, 10, 26 AND 46).

TRADEMARK

FIRST USE 11-0-2010; IN COMMERCE 11-0-2010.

PRINCIPAL REGISTER

THE MARK CONSISTS OF STANDARD CHARACTERS WITHOUT CLAIM TO ANY PARTICULAR FONT, STYLE, SIZE, OR COLOR.

SER. NO. 85-344,659, FILED 6-13-2011.

CYNTHIA TRIPI, EXAMINING ATTORNEY



David J. Kyffers

Director of the United States Patent and Trademark Office

United States of America

United States Patent and Trademark Office



Reg. No. 4,098,609

ASQUINI, PETER (UNITED STATES INDIVIDUAL)
8327 WEAVER WOODS PL.
FISHERS, IN 46038

Registered Feb. 14, 2012

Int. Cl.: 25

FOR: ATHLETIC SHOES; BEACH SHOES; FOOTWEAR FOR MEN; FOOTWEAR FOR MEN AND WOMEN; HIKING BOOTS; LEATHER SHOES; LEISURE SHOES; SANDALS AND BEACH SHOES; SHOES; WATER REPELLING FOOTWEAR; WOMEN'S SHOES, IN CLASS 25 (U.S. CLS. 22 AND 39).

TRADEMARK

PRINCIPAL REGISTER

FIRST USE 1-11-2011; IN COMMERCE 1-11-2011.

THE MARK CONSISTS OF THE TERM "PIRO" IN A STYLIZED FONT. THE TERM "PIRO" IS STYLIZED IN A FOOT-LIKE SHAPE. THERE ARE FIVE OVALS THAT REPRESENT TOES.

SER. NO. 85-344,675, FILED 6-13-2011.

SUE LAWRENCE, EXAMINING ATTORNEY



David J. Kybas

Director of the United States Patent and Trademark Office

United States of America

United States Patent and Trademark Office

Spark 4d Happy Caps

Reg. No. 4,098,610

NICKELS, JEREMY (UNITED STATES INDIVIDUAL)
1075 COBB INTERNATIONAL PLACE
KENNESAW, GA 30152 AND

Registered Feb. 14, 2012

Int. Cl.: 5

NICKELS, JESSICA (UNITED STATES INDIVIDUAL)
1075 COBB INTERNATIONAL PLACE
KENNESAW, GA 30152

TRADEMARK

PRINCIPAL REGISTER

FOR: DIETARY AND NUTRITIONAL SUPPLEMENTS, IN CLASS 5 (U.S. CLS. 6, 18, 44, 46, 51 AND 52).

FIRST USE 10-9-2010; IN COMMERCE 10-9-2010.

THE MARK CONSISTS OF STANDARD CHARACTERS WITHOUT CLAIM TO ANY PARTICULAR FONT, STYLE, SIZE, OR COLOR.

NO CLAIM IS MADE TO THE EXCLUSIVE RIGHT TO USE "CAPS", APART FROM THE MARK AS SHOWN.

SER. NO. 85-344,732, FILED 6-13-2011.

FLORENTINA BLANDU, EXAMINING ATTORNEY



David J. Kybas

Director of the United States Patent and Trademark Office

United States of America

United States Patent and Trademark Office



Reg. No. 4,098,611

Registered Feb. 14, 2012

Int. Cl.: 35

SERVICE MARK

PRINCIPAL REGISTER

ARAB COMMUNITY CENTER FOR ECONOMIC AND SOCIAL SERVICES (MICHIGAN CORPORATION), DBA CENTER FOR ARAB AMERICAN PHILANTHROPY
2651 SAULINO COURT
DEARBORN, MI 48120

FOR: CHARITABLE SERVICES, NAMELY, ORGANIZING AND CONDUCTING VOLUNTEER PROGRAMS AND COMMUNITY SERVICE PROJECTS, IN CLASS 35 (U.S. CLS. 100, 101 AND 102).

FIRST USE 6-1-2005; IN COMMERCE 6-1-2005.

NO CLAIM IS MADE TO THE EXCLUSIVE RIGHT TO USE "CENTER", APART FROM THE MARK AS SHOWN.

THE COLOR(S) BLUE IS/ARE CLAIMED AS A FEATURE OF THE MARK.

THE MARK CONSISTS OF THE WORDS "CENTER FOR ARAB AMERICAN PHILANTHROPY" ALL IN CAPITAL LETTERS IN BLUE; TO THE LEFT OF THE WORDS IS THE LOGO, ALSO IN BLUE, WHICH CONSISTS OF THREE DIAMONDS, WITHIN EACH DIAMOND IS THE IMAGE OF A PERSON REPEATED FOUR TIMES TO CREATE A PATTERN.

SEC. 2(F) AS TO "CENTER FOR ARAB AMERICAN PHILANTHROPY".

SER. NO. 85-344,762, FILED 6-13-2011.

JOHN SCHUYLER YARD, EXAMINING ATTORNEY



David J. Kyros

Director of the United States Patent and Trademark Office

United States of America

United States Patent and Trademark Office

STEP 1 CREDIT

Reg. No. 4,098,612

Registered Feb. 14, 2012

Int. Cl.: 36

SERVICE MARK

PRINCIPAL REGISTER

STEP 1 CREDIT, LLC (CALIFORNIA LIMITED LIABILITY COMPANY), DBA STEP 1 CREDIT
SUITE 150
23 CORPORATE PLAZA DR
NEWPORT BEACH, CA 92660

FOR: FINANCIAL SERVICES, NAMELY, CREDIT REPAIR AND RESTORATION, IN CLASS
36 (U.S. CLS. 100, 101 AND 102).

FIRST USE 1-12-2011; IN COMMERCE 4-1-2011.

THE MARK CONSISTS OF STANDARD CHARACTERS WITHOUT CLAIM TO ANY PAR-
TICULAR FONT, STYLE, SIZE, OR COLOR.

NO CLAIM IS MADE TO THE EXCLUSIVE RIGHT TO USE "CREDIT", APART FROM THE
MARK AS SHOWN.

SER. NO. 85-344,808, FILED 6-13-2011.

ANN E. SAPPENFIELD, EXAMINING ATTORNEY



David J. Kybas

Director of the United States Patent and Trademark Office

United States of America

United States Patent and Trademark Office



Reg. No. 4,098,613

Registered Feb. 14, 2012

Int. Cl.: 13

TRADEMARK

PRINCIPAL REGISTER

NORTHROP GRUMMAN SYSTEMS CORPORATION (DELAWARE CORPORATION)
1840 CENTURY PARK EAST
LOS ANGELES, CA 90067

FOR: LASER GUIDED MUNITIONS, IN CLASS 13 (U.S. CLS. 2 AND 9).

FIRST USE 3-20-2003; IN COMMERCE 3-29-2003.

OWNER OF U.S. REG. NO. 3,934,737.

THE COLOR(S) BURGUNDY, BLUE, BLACK, YELLOW, ORANGE, GREEN AND SILVER IS/ARE CLAIMED AS A FEATURE OF THE MARK.

THE MARK CONSISTS OF THE FOLLOWING A "V" SHAPE IN THE COLOR BURGUNDY WITH A DARK BLUE SHADOW AND BLACK INTERIOR LINING, CONTAINING A HEAD OF A SNAKE WITH AN OPEN MOUTH IN THE COLORS LIGHT AND DARK BLUE AND BURGUNDY, THE WORDING "VIPER" WITH THE ENDS OF THE "V" AND "R" EXTENDED TO RESEMBLE FANGS IN DARK BLUE WITH A YELLOW SHADOW, AND THE WORDING "STRIKE" IN YELLOW WITH A HINT OF ORANGE WITH A BLACK SHADOW, THE "V" PARTIALLY COVERS A CIRCLE COMPOSED OF A BURGUNDY OUTLINE, A GREEN INNER BORDER CONTAINING THE WORDING "SILENT LETHAL SWIFT" IN YELLOW, AND A YELLOW INTERIOR WITH TWO DROPS OF VENOM DRIPPING FROM EACH OF THE LETTERS "V" AND "R" IN THE COLORS YELLOW AND BLACK, AND TWO SILVER AND BLACK MISSILES UNDER THE DROPS.

SER. NO. 85-344,828, FILED 6-13-2011.

APRIL ROACH, EXAMINING ATTORNEY



David J. Kybas

Director of the United States Patent and Trademark Office

United States of America

United States Patent and Trademark Office

Reel Solutions

Reg. No. 4,098,614

Registered Feb. 14, 2012

Int. Cl.: 45

SERVICE MARK

PRINCIPAL REGISTER

REEL SOLUTIONS (NEW MEXICO SOLE PROPRIETORSHIP)
3908 DURO COURT, NE
ALBUQUERQUE, NM 87110

FOR: PERSONAL CONCIERGE SERVICES FOR OTHERS COMPRISING MAKING REQUESTED PERSONAL ARRANGEMENTS AND RESERVATIONS, RUNNING ERRANDS AND PROVIDING CUSTOMER SPECIFIC INFORMATION TO MEET INDIVIDUAL NEEDS, ALL RENDERED IN BUSINESS ESTABLISHMENTS, OFFICE BUILDINGS, HOTELS, RESIDENTIAL COMPLEXES AND HOMES, IN CLASS 45 (U.S. CLS. 100 AND 101).

FIRST USE 5-25-2009; IN COMMERCE 5-25-2009.

THE MARK CONSISTS OF STANDARD CHARACTERS WITHOUT CLAIM TO ANY PARTICULAR FONT, STYLE, SIZE, OR COLOR.

SER. NO. 85-344,830, FILED 6-13-2011.

NORA BUCHANAN WILL, EXAMINING ATTORNEY



David J. Kyffers

Director of the United States Patent and Trademark Office

United States of America

United States Patent and Trademark Office

Equine CN

Reg. No. 4,098,615

NANO GROUP LLC (WYOMING LIMITED LIABILITY COMPANY)
2710 THOMES AVE.
CHEYENNE, WY 82001

Registered Feb. 14, 2012

Int. Cl.: 5

FOR: FEED SUPPLEMENTS FOR HORSES, IN CLASS 5 (U.S. CLS. 6, 18, 44, 46, 51 AND 52).

TRADEMARK

FIRST USE 11-1-2010; IN COMMERCE 11-1-2010.

PRINCIPAL REGISTER

THE MARK CONSISTS OF STANDARD CHARACTERS WITHOUT CLAIM TO ANY PARTICULAR FONT, STYLE, SIZE, OR COLOR.

NO CLAIM IS MADE TO THE EXCLUSIVE RIGHT TO USE "EQUINE", APART FROM THE MARK AS SHOWN.

SER. NO. 85-344,846, FILED 6-13-2011.

CHARLES L. JENKINS, EXAMINING ATTORNEY



David J. Kyffers

Director of the United States Patent and Trademark Office

United States of America

United States Patent and Trademark Office



Reg. No. 4,098,616

Registered Feb. 14, 2012

Int. Cl.: 37

SERVICE MARK

PRINCIPAL REGISTER

RESCUE RESPONSE GROUP, INC. (CALIFORNIA CORPORATION)
11022 W. GRISWOLD ROAD
PEORIA, AR 85345

FOR: COMMERCIAL AND RESIDENTIAL PLUMBING, SEWER, GREASE TRAP AND DRAIN CLEANING SERVICES; PLUMBING CONTRACTOR SERVICES; PLUMBING, DRAIN AND SEWER REPAIR SERVICES, IN CLASS 37 (U.S. CLS. 100, 103 AND 106).

FIRST USE 0-0-2008; IN COMMERCE 0-0-2008.

OWNER OF U.S. REG. NO. 3,714,864.

NO CLAIM IS MADE TO THE EXCLUSIVE RIGHT TO USE "PLUMBING", APART FROM THE MARK AS SHOWN.

THE MARK CONSISTS OF THE ARTISTIC RENDERING OF A HUMAN BEING RUNNING FOLLOWED BY THE STYLIZED WORDS "MR. DRAIN PLUMBING".

SER. NO. 85-344,853, FILED 6-13-2011.

TRACY CROSS, EXAMINING ATTORNEY



David J. Kyffers

Director of the United States Patent and Trademark Office

United States of America

United States Patent and Trademark Office

SMOKE CITY MARKET

Reg. No. 4,098,617

Registered Feb. 14, 2012

Int. Cl.: 43

SERVICE MARK

PRINCIPAL REGISTER

AUTHENTIC RESTAURANT CONCEPTS, INC. (CALIFORNIA CORPORATION)
2339 CORDOBAN LANE
SANTA MARIA, CA 93455

FOR: RESTAURANT AND CATERING SERVICES; RESTAURANT SERVICES, INCLUDING SIT-DOWN SERVICE OF FOOD AND TAKE-OUT RESTAURANT SERVICES; RESTAURANTS FEATURING HOME DELIVERY , IN CLASS 43 (U.S. CLS. 100 AND 101).

FIRST USE 11-4-2010; IN COMMERCE 11-4-2010.

THE MARK CONSISTS OF STANDARD CHARACTERS WITHOUT CLAIM TO ANY PARTICULAR FONT, STYLE, SIZE, OR COLOR.

NO CLAIM IS MADE TO THE EXCLUSIVE RIGHT TO USE "MARKET", APART FROM THE MARK AS SHOWN.

SER. NO. 85-344,875, FILED 6-13-2011.

MATTHEW MCDOWELL, EXAMINING ATTORNEY



David J. Kyros

Director of the United States Patent and Trademark Office

United States of America

United States Patent and Trademark Office

stringlet

Reg. No. 4,098,618

SHIEH, MALCOLM (UNITED STATES INDIVIDUAL)
2445 VANCOUVER AVE
SAN DIEGO, CA 92104

Registered Feb. 14, 2012

Int. Cl.: 14

FOR: BRACELETS MADE OUT OF TENNIS RACKET STRINGS, IN CLASS 14 (U.S. CLS. 2, 27, 28 AND 50).

TRADEMARK

FIRST USE 4-1-2011; IN COMMERCE 4-1-2011.

PRINCIPAL REGISTER

THE MARK CONSISTS OF STANDARD CHARACTERS WITHOUT CLAIM TO ANY PARTICULAR FONT, STYLE, SIZE, OR COLOR.

SER. NO. 85-344,876, FILED 6-13-2011.

MATTHEW MCDOWELL, EXAMINING ATTORNEY



David J. Kybas

Director of the United States Patent and Trademark Office

United States of America

United States Patent and Trademark Office

4SYNC.COM

Reg. No. 4,098,619

CHEN, DAVID Y (UNITED STATES INDIVIDUAL)
1511 W. RUSSELL COURT
ARLINGTON HEIGHTS, IL 60005 AND

Registered Feb. 14, 2012

Int. Cl.: 42

CHEN, STEVE Y (UNITED STATES INDIVIDUAL)
1511 W. RUSSELL COURT
ARLINGTON HEIGHTS, IL 60005

SERVICE MARK

PRINCIPAL REGISTER

FOR: PROVIDING A WEBSITE FEATURING ON-LINE NON-DOWNLOADABLE SOFTWARE THAT ENABLES USERS TO SYNCHRONIZE AND MAINTAIN CALENDAR DATA, IN CLASS 42 (U.S. CLS. 100 AND 101).

FIRST USE 3-1-1998; IN COMMERCE 3-1-1998.

THE MARK CONSISTS OF THE WORDING "4SYNC.COM". THE NUMBER 4 IS DARK RED AND LARGER THAN THE REMAINING LETTERING WHICH IS BLACK.

THE COLOR(S) BLACK AND DARK RED IS/ARE CLAIMED AS A FEATURE OF THE MARK.

SER. NO. 85-344,887, FILED 6-13-2011.

MATTHEW MCDOWELL, EXAMINING ATTORNEY



David J. Kybas

Director of the United States Patent and Trademark Office

United States of America

United States Patent and Trademark Office



Reg. No. 4,098,620

DOMAIN CONSULTING GROUP, INC. (CANADA CORPORATION)
23 BROOKGREENE CRESENT
RICHMOND HILL, ONTARIO, CANADA L4C0M1

Registered Feb. 14, 2012

Int. Cl.: 38

FOR: PROVIDING AN ON-LINE FORUM FOR DISCUSSING, BUYING, AND SELLING DOMAIN NAMES, IN CLASS 38 (U.S. CLS. 100, 101 AND 104).

SERVICE MARK

FIRST USE 6-1-2009; IN COMMERCE 6-1-2009.

PRINCIPAL REGISTER

NO CLAIM IS MADE TO THE EXCLUSIVE RIGHT TO USE "DNFORUM.COM", APART FROM THE MARK AS SHOWN.

THE COLOR(S) RED, GRAY, BLUE, AND WHITE IS/ARE CLAIMED AS A FEATURE OF THE MARK.

THE MARK CONSISTS OF THE LETTERS "DNFORUM", WHICH ARE FOLLOWED IMMEDIATELY BY THE LETTERS ".COM"; THE LETTERS "DNFORUM" ARE ALL ABOVE THE PHRASE "THE PLACE TO TALK DOMAINS"; THE LETTERS "DN" ARE RED INSIDE A WHITE BORDER; THE LETTERS "FORUM" ARE GRAY INSIDE OF A WHITE BORDER; THE DOT OR "." IS A RED CIRCLE IN OF A WHITE BORDER; THE LETTERS "COM" ARE GRAY INSIDE OF A WHITE BORDER; THE PHRASE "THE PLACE TO TALK DOMAINS" IS WHITE INSIDE A RED ELONGATED OVAL; ALL OF THE LETTERS ARE ON A BLUE BACKGROUND.

SER. NO. 85-344,901, FILED 6-13-2011.

FLORENTINA BLANDU, EXAMINING ATTORNEY



David J. Kybas

Director of the United States Patent and Trademark Office

United States of America

United States Patent and Trademark Office

CRAFT SUPPLIES USA

Reg. No. 4,098,621

CRAFT SUPPLIES USA (UTAH CORPORATION)
1287 E 1120 S
PROVO, UT 84606

Registered Feb. 14, 2012

Int. Cl.: 35

FOR: ON-LINE RETAIL STORE SERVICES FEATURING WOODTURNING TOOLS, WOODTURNING KITS AND WOODTURNING SUPPLIES; RETAIL STORE SERVICES FEATURING WOODTURNING TOOLS, WOODTURNING KITS AND WOODTURNING SUPPLIES, IN CLASS 35 (U.S. CLS. 100, 101 AND 102).

SERVICE MARK

PRINCIPAL REGISTER

FIRST USE 10-21-1982; IN COMMERCE 1-1-1983.

THE MARK CONSISTS OF STANDARD CHARACTERS WITHOUT CLAIM TO ANY PARTICULAR FONT, STYLE, SIZE, OR COLOR.

NO CLAIM IS MADE TO THE EXCLUSIVE RIGHT TO USE "CRAFT SUPPLIES", APART FROM THE MARK AS SHOWN.

SEC. 2(F).

SER. NO. 85-344,905, FILED 6-13-2011.

PRISCILLA MILTON, EXAMINING ATTORNEY



David J. Kyffers

Director of the United States Patent and Trademark Office

United States of America

United States Patent and Trademark Office



Reg. No. 4,098,622

Registered Feb. 14, 2012

Int. Cls.: 7, 9 and 11

TRADEMARK

PRINCIPAL REGISTER

PRINCIPAL TECHNOLOGY, INC. (TEXAS CORPORATION)
1901 10TH STREET, SUITE 400
PLANO, TX 750748034

FOR: SKID-MOUNTED OIL AND NATURAL GAS EXTRACTING AND PROCESSING MACHINES, NAMELY, AMINE TREATING UNITS FOR THE REMOVAL OF ACID GAS COMPOUNDS FROM NATURAL GAS, PETROCHEMICAL, AND PETROLEUM REFINERY PROCESS STREAMS, SULFUR RECOVERY UNITS FOR THE CONVERSION OF HYDROGEN SULFIDE TO ELEMENTAL SULFUR, TAIL GAS TREATING UNITS FOR TREATING AND RECYCLING RESIDUAL HYDROGEN SULFIDE FROM THE SULFUR RECOVERY UNIT, AND THERMAL OXIDIZERS FOR THE OXIDATION OF HYDROGEN SULFIDE BEARING GAS STREAMS; GAS DIVERTER SYSTEMS CONSISTING OF PIPING, HEAT TRANSFER EQUIPMENT AND VALVES, IN CLASS 7 (U.S. CLS. 13, 19, 21, 23, 31, 34 AND 35).

FIRST USE 9-18-2000; IN COMMERCE 5-30-2005.

FOR: CONTINUOUS AND BATCH PROCESS ELECTRONIC CONTROL SYSTEMS USED IN A VARIETY OF OIL AND GAS EXPLORATION, REFINING AND TREATING, MANUFACTURING, AND CHEMICAL PLANTS AND PROCESSES; AUTOMATED MODULAR PROCESS EQUIPMENT USED IN OIL AND GAS REFINING AND GAS TREATING PLANTS; EMISSIONS MONITORING AND PROCESS CONTROL SYSTEMS CONSISTING OF FIELD INSTRUMENTS, CONTROLS AND INTERFACES, CONTROL PANELS, METERING AND REPORTING INSTRUMENTS, ELECTRONIC INSTRUMENTS AND CONTROLS, AND CONTROL SOFTWARE; ELECTRICAL INTEGRATED CONTROL SYSTEMS FOR USE IN THE FIELD OF OIL, GAS, CHEMICAL, PETROCHEMICAL, PROCESSES AND MANUFACTURING; AUTOMATED PROCESS CONTROL SYSTEMS, NAMELY, MICRO-PROCESSOR BASED HARDWARE AND SOFTWARE USED TO MONITOR THE STATUS OF INDUSTRIAL PROCESSES, NAMELY, OIL AND GAS PRODUCTION, TREATING, AND REFINING PROCESSING; AUTOMATED VALVES FOR USE IN SULFUR RECOVERY UNITS FOR THE CONVERSION OF HYDROGEN SULFIDE TO ELEMENTAL SULFUR AND RELATED BYPRODUCTS, IN CLASS 9 (U.S. CLS. 21, 23, 26, 36 AND 38).

FIRST USE 9-18-2000; IN COMMERCE 9-18-2000.

FOR: GAS BURNERS FOR INDUSTRIAL SULFUR RECOVERY UNITS, TAIL GAS TREATING UNITS, ACID GAS INCINERATION AND THERMAL OXIDIZER UNITS; BURNER MANAGEMENT SYSTEMS FOR OIL, GAS, CHEMICAL, AND PETROCHEMICAL HEATERS



David J. Kyjars

Director of the United States Patent and Trademark Office

Reg. No. 4,098,622 AND PROCESSES INDUSTRIAL BOILERS, WASTE GAS INCINERATORS, AND THERMAL OXIDIZING UNITS; NATURAL GAS TREATING AND REFINERY PROCESS GAS TREATING SYSTEMS COMPRISED OF SOUR GAS TREATING EQUIPMENT, SULFUR RECOVERY AND ACID GAS CONVERSION EQUIPMENT, RESIDUAL SULFUR RECOVERY UNIT TAIL GAS TREATING UNITS, AND ACID GAS THERMAL OXIDERS SOLD AS A UNIT; GAS TREATING UNITS, SULFUR RECOVERY UNITS, AND TAIL GAS TREATING UNITS, FOR OIL, GAS, PETROCHEMICAL, AND CHEMICAL PROCESSES THAT GENERATE ACID BEARING GAS BYPRODUCTS COMPRISED OF SEPARATORS, VESSELS, PUMPS, BLOWERS, BURNERS, STORAGE TANKS, AND HEAT EXCHANGERS, ALL SOLD AS A UNIT, IN CLASS 11 (U.S. CLS. 13, 21, 23, 31 AND 34).

FIRST USE 9-18-2000; IN COMMERCE 1-16-2003.

NO CLAIM IS MADE TO THE EXCLUSIVE RIGHT TO USE "TECHNOLOGY", APART FROM THE MARK AS SHOWN.

THE MARK CONSISTS OF A STYLIZED CURVE RISING AND FALLING FROM LEFT TO RIGHT OVER A FIELD OF HORIZONTAL BARS RANGING IN HEIGHT FROM SMALL ON BOTTOM TO LARGE ON TOP LOCATED ON THE LEFT HAND SIDE OF THE WORD "PRINCIPAL" APPEARING OVER THE WORD "TECHNOLOGY".

SER. NO. 85-344,989, FILED 6-13-2011.

KELLY TRUSILO, EXAMINING ATTORNEY

United States of America

United States Patent and Trademark Office

Non-Toxic Kids

Reg. No. 4,098,623

FARBER, KATY (UNITED STATES INDIVIDUAL)
114 MOLLY SUPPLE HILL ROAD
MIDDLESEX, VT 05602

Registered Feb. 14, 2012

Int. Cl.: 41

FOR: ON-LINE JOURNALS, NAMELY, BLOGS FEATURING PARENTING INFORMATION, PROVIDING LINKS TO WEBSITES OF OTHERS FEATURING PARENTING INFORMATION, AND PROVIDING ON-LINE RESOURCE GUIDES CONCERNING CHILDREN IN THE FIELD OF PARENTING, IN CLASS 41 (U.S. CLS. 100, 101 AND 107).

SERVICE MARK

PRINCIPAL REGISTER

FIRST USE 10-31-2005; IN COMMERCE 10-31-2005.

THE MARK CONSISTS OF STANDARD CHARACTERS WITHOUT CLAIM TO ANY PARTICULAR FONT, STYLE, SIZE, OR COLOR.

NO CLAIM IS MADE TO THE EXCLUSIVE RIGHT TO USE "KIDS", APART FROM THE MARK AS SHOWN.

SER. NO. 85-345,137, FILED 6-13-2011.

FLORENTINA BLANDU, EXAMINING ATTORNEY



David J. Kyffers

Director of the United States Patent and Trademark Office

United States of America

United States Patent and Trademark Office

HOUSEMUFFIN COUTURE

Reg. No. 4,098,624

Registered Feb. 14, 2012

Int. Cl.: 25

TRADEMARK

PRINCIPAL REGISTER

CHING, JADE LYNNE (UNITED STATES INDIVIDUAL)
ASB TOWER, 18TH FLOOR
1001 BISHOP STREET
HONOLULU, HI 96813

FOR: APRONS, IN CLASS 25 (U.S. CLS. 22 AND 39).

FIRST USE 1-1-2011; IN COMMERCE 6-8-2011.

THE MARK CONSISTS OF STANDARD CHARACTERS WITHOUT CLAIM TO ANY PARTICULAR FONT, STYLE, SIZE, OR COLOR.

NO CLAIM IS MADE TO THE EXCLUSIVE RIGHT TO USE "COUTURE", APART FROM THE MARK AS SHOWN.

SER. NO. 85-345,152, FILED 6-13-2011.

FLORENTINA BLANDU, EXAMINING ATTORNEY



David J. Kyffers

Director of the United States Patent and Trademark Office

United States of America

United States Patent and Trademark Office

Worthmoore

Reg. No. 4,098,625

Registered Feb. 14, 2012

Int. Cl.: 36

SERVICE MARK

PRINCIPAL REGISTER

WORTHMOORE REALTY, LLC (GEORGIA LIMITED LIABILITY COMPANY)
82 FAIRGROUND ST. NE
MARIETTA, GA 30060

FOR: APPRAISAL AND EVALUATION OF REAL ESTATE; ARRANGING OF LEASES AND RENTAL AGREEMENTS FOR REAL ESTATE; ASSESSMENT AND MANAGEMENT OF REAL ESTATE; COMMERCIAL AND RESIDENTIAL REAL ESTATE AGENCY SERVICES; FINANCIAL VALUATION OF PERSONAL PROPERTY AND REAL ESTATE; LAND ACQUISITION, NAMELY, REAL ESTATE BROKERAGE; LEASE OF REAL ESTATE; LEASING OF REAL ESTATE; PROVIDING AN INTERNET WEBSITE PORTAL OFFERING INFORMATION IN THE FIELDS OF REAL ESTATE CONCERNING THE PURCHASE AND SALE OF NEW AND RESALE HOMES AND CONDOS; PROVIDING INFORMATION IN THE FIELD OF REAL ESTATE BY MEANS OF LINKING THE WEB SITE TO OTHER WEB SITES FEATURING REAL ESTATE INFORMATION; PROVIDING INFORMATION IN THE FIELD OF REAL ESTATE VIA THE INTERNET; PROVIDING REAL ESTATE LISTINGS AND REAL ESTATE INFORMATION VIA THE INTERNET; PROVIDING REAL ESTATE LISTINGS VIA THE INTERNET; REAL ESTATE ACQUISITION SERVICES; REAL ESTATE AGENCIES; REAL ESTATE APPRAISAL AND VALUATION; REAL ESTATE BROKERAGE; REAL ESTATE CONSULTATION; REAL ESTATE LISTING; REAL ESTATE RENTAL SERVICES, NAMELY, RENTAL OF RESIDENTIAL HOUSING; REAL ESTATE SERVICES, NAMELY, RENTAL, BROKERAGE, LEASING AND MANAGEMENT OF COMMERCIAL PROPERTY, OFFICES AND OFFICE SPACE; REAL ESTATE VALUATION SERVICES; REAL ESTATE VALUATIONS; RESIDENTIAL REAL ESTATE AGENCY SERVICES, IN CLASS 36 (U.S. CLS. 100, 101 AND 102).



FIRST USE 2-1-2007; IN COMMERCE 2-1-2007.

THE MARK CONSISTS OF STANDARD CHARACTERS WITHOUT CLAIM TO ANY PARTICULAR FONT, STYLE, SIZE, OR COLOR.

SER. NO. 85-345,274, FILED 6-14-2011.

JENNIFER MARTIN, EXAMINING ATTORNEY

David J. Kyjars

Director of the United States Patent and Trademark Office

United States of America

United States Patent and Trademark Office

BBL HOSPITALITY

Reg. No. 4,098,626

BBL HOSPITALITY, LLC (NEW YORK LIMITED LIABILITY COMPANY)
302 WASHINGTON AVENUE EXTENSION
ALBANY, NY 12203

Registered Feb. 14, 2012

Int. Cl.: 35

FOR: RESTAURANT MANAGEMENT FOR OTHERS; HOTEL MANAGEMENT FOR OTHERS,
IN CLASS 35 (U.S. CLS. 100, 101 AND 102).

SERVICE MARK

FIRST USE 4-30-2009; IN COMMERCE 4-30-2009.

PRINCIPAL REGISTER

THE MARK CONSISTS OF STANDARD CHARACTERS WITHOUT CLAIM TO ANY PAR-
TICULAR FONT, STYLE, SIZE, OR COLOR.

NO CLAIM IS MADE TO THE EXCLUSIVE RIGHT TO USE "HOSPITALITY", APART FROM
THE MARK AS SHOWN.

SER. NO. 85-345,290, FILED 6-14-2011.

ANDREA HACK, EXAMINING ATTORNEY



David J. Kyffers

Director of the United States Patent and Trademark Office

United States of America

United States Patent and Trademark Office

Flagler Hospital

Reg. No. 4,098,627

FLAGLER HOSPITAL, INC. (FLORIDA CORPORATION)
400 HEALTH PARK BLVD.
ST. AUGUSTINE, FL 32086

Registered Feb. 14, 2012

Int. Cl.: 44

FOR: HOSPITALS, IN CLASS 44 (U.S. CLS. 100 AND 101).

SERVICE MARK

FIRST USE 1-1-1905; IN COMMERCE 1-1-1905.

PRINCIPAL REGISTER

THE MARK CONSISTS OF STANDARD CHARACTERS WITHOUT CLAIM TO ANY PARTICULAR FONT, STYLE, SIZE, OR COLOR.

NO CLAIM IS MADE TO THE EXCLUSIVE RIGHT TO USE "HOSPITAL", APART FROM THE MARK AS SHOWN.

SER. NO. 85-345,321, FILED 6-14-2011.

DAVID HOFFMAN, EXAMINING ATTORNEY



David J. Kyffers

Director of the United States Patent and Trademark Office

United States of America

United States Patent and Trademark Office

HOT WOKS COOL SUSHI

Reg. No. 4,098,628

Registered Feb. 14, 2012

Int. Cl.: 43

SERVICE MARK

PRINCIPAL REGISTER

HOT WOKS COOL SUSHI, CORP. (ILLINOIS CORPORATION)
30 S. MICHIGAN AVENUE
CHICAGO, IL 60603

FOR: RESTAURANT SERVICES, IN CLASS 43 (U.S. CLS. 100 AND 101).

FIRST USE 7-1-2007; IN COMMERCE 7-1-2007.

THE MARK CONSISTS OF STANDARD CHARACTERS WITHOUT CLAIM TO ANY PARTICULAR FONT, STYLE, SIZE, OR COLOR.

OWNER OF U.S. REG. NO. 3,694,482.

NO CLAIM IS MADE TO THE EXCLUSIVE RIGHT TO USE "WOKS" AND "SUSHI", APART FROM THE MARK AS SHOWN.

SER. NO. 85-345,323, FILED 6-14-2011.

ESTHER BELENKER, EXAMINING ATTORNEY



David J. Kybas

Director of the United States Patent and Trademark Office

United States of America
United States Patent and Trademark Office



Reg. No. 4,098,629

FLAGLER HOSPITAL, INC. (FLORIDA CORPORATION)
400 HEALTH PARK BLVD.
ST. AUGUSTINE, FL 32086

Registered Feb. 14, 2012

Int. Cl.: 44

FOR: HOSPITALS, IN CLASS 44 (U.S. CLS. 100 AND 101).

SERVICE MARK

FIRST USE 5-20-2001; IN COMMERCE 5-20-2001.

PRINCIPAL REGISTER

NO CLAIM IS MADE TO THE EXCLUSIVE RIGHT TO USE "HOSPITAL" , APART FROM THE MARK AS SHOWN.

THE COLOR(S) BLACK AND BLUE IS/ARE CLAIMED AS A FEATURE OF THE MARK.

THE MARK CONSISTS OF A BLUE GRAPHIC ELEMENT, WHICH INCLUDES A RENDITION OF A CROSS IN A CIRCLE JUXTAPOSED TO THE LEFT OF THE WORDS "FLAGLER" IN BLACK WITH THE WORD "HOSPITAL" IN BLACK APPEARING UNDERNEATH THE WORD "FLAGLER".

SER. NO. 85-345,356, FILED 6-14-2011.

DAVID HOFFMAN, EXAMINING ATTORNEY



David J. Kybas

Director of the United States Patent and Trademark Office

United States of America
United States Patent and Trademark Office

KBB.COM

Reg. No. 4,098,630

Registered Feb. 14, 2012

Int. Cl.: 9

TRADEMARK

PRINCIPAL REGISTER

KELLEY BLUE BOOK CO., INC. (CALIFORNIA CORPORATION)
195 TECHNOLOGY DRIVE
IRVINE, CA 92618

FOR: COMPUTER APPLICATION SOFTWARE FOR MOBILE PHONES, PORTABLE MEDIA PLAYERS, HANDHELD COMPUTERS, NAMELY, SOFTWARE FEATURING INFORMATION IN THE FIELDS OF VEHICLE PRICING AND VEHICULAR INVENTORY MANAGEMENT, INFORMATION ON VEHICLES TO HELP GUIDE CONSUMERS IN THEIR PURCHASE OF A NEW OR USED VEHICLE, INFORMATION ABOUT VEHICLES FOR SALE, RANKINGS, RATINGS, AND REVIEWS IN THE FIELD OF VEHICLES; COMPUTER APPLICATION SOFTWARE FOR MOBILE PHONES, PORTABLE MEDIA PLAYERS, HANDHELD COMPUTERS, NAMELY, SOFTWARE TO ASSIST CUSTOMERS IN LOCATING AUTOMOTIVE DEALERS AND TO MATCH CONSUMER REQUESTS FOR VEHICLE PRICING AND INFORMATION TO AUTOMOTIVE DEALERS, IN CLASS 9 (U.S. CLS. 21, 23, 26, 36 AND 38).

FIRST USE 8-22-2008; IN COMMERCE 8-22-2008.

THE MARK CONSISTS OF STANDARD CHARACTERS WITHOUT CLAIM TO ANY PARTICULAR FONT, STYLE, SIZE, OR COLOR.

OWNER OF U.S. REG. NOS. 2,719,795 AND 3,211,238.

SER. NO. 85-345,472, FILED 6-14-2011.

SARA BENJAMIN, EXAMINING ATTORNEY



David J. Kyjars

Director of the United States Patent and Trademark Office

United States of America

United States Patent and Trademark Office

12/12 Plus

Reg. No. 4,098,631

Registered Feb. 14, 2012

Int. Cl.: 36

SERVICE MARK

PRINCIPAL REGISTER

EAST COAST UNDERWRITERS, LLC (SOUTH CAROLINA LIMITED LIABILITY COMPANY)
SUITE 210
101 N. PINE STREET
SPARTANBURG, SC 29302

FOR: INSURANCE UNDERWRITING IN THE FIELD OF HEALTH, IN CLASS 36 (U.S. CLS. 100, 101 AND 102).

FIRST USE 5-1-2011; IN COMMERCE 5-1-2011.

THE MARK CONSISTS OF STANDARD CHARACTERS WITHOUT CLAIM TO ANY PARTICULAR FONT, STYLE, SIZE, OR COLOR.

NO CLAIM IS MADE TO THE EXCLUSIVE RIGHT TO USE "12/12", APART FROM THE MARK AS SHOWN.

SER. NO. 85-345,525, FILED 6-14-2011.

JASON TURNER, EXAMINING ATTORNEY



David J. Kyffers

Director of the United States Patent and Trademark Office

United States of America

United States Patent and Trademark Office

Washed & Destroyed Goods

Reg. No. 4,098,632

MWR APPAREL GROUP, LLC (NEW JERSEY LIMITED LIABILITY COMPANY)
PO BOX 1470

Registered Feb. 14, 2012

NEW YORK, NY 10159

Int. Cl.: 25

FOR: SPORTSWEAR AND ACTIVEWEAR FOR MEN AND WOMEN, NAMELY, SHIRTS, TEE SHIRTS, JACKETS, COATS, PANTS, HOODED SWEATSHIRTS, VESTS, POLO KNIT TOPS, SWEATERS, WOVEN TOPS AND HATS, IN CLASS 25 (U.S. CLS. 22 AND 39).

TRADEMARK

FIRST USE 6-1-2011; IN COMMERCE 6-1-2011.

PRINCIPAL REGISTER

THE MARK CONSISTS OF STANDARD CHARACTERS WITHOUT CLAIM TO ANY PARTICULAR FONT, STYLE, SIZE, OR COLOR.

NO CLAIM IS MADE TO THE EXCLUSIVE RIGHT TO USE "WASHED" AND "GOODS", APART FROM THE MARK AS SHOWN.

SER. NO. 85-345,548, FILED 6-14-2011.

SIMON TENG, EXAMINING ATTORNEY



David J. Kyffers

Director of the United States Patent and Trademark Office

United States of America

United States Patent and Trademark Office

CALIFORNIA BLUE

Reg. No. 4,098,633

SMR CREATIONS, L.L.C. (TEXAS LIMITED LIABILITY COMPANY)
3735 ARC

Registered Feb. 14, 2012

HOUSTON, TX 77063

Int. Cl.: 30

FOR: SALSA; TORTILLA CHIPS, IN CLASS 30 (U.S. CL. 46).

TRADEMARK

FIRST USE 1-22-2011; IN COMMERCE 1-22-2011.

PRINCIPAL REGISTER

THE MARK CONSISTS OF STANDARD CHARACTERS WITHOUT CLAIM TO ANY PARTICULAR FONT, STYLE, SIZE, OR COLOR.

NO CLAIM IS MADE TO THE EXCLUSIVE RIGHT TO USE "CALIFORNIA", APART FROM THE MARK AS SHOWN.

SER. NO. 85-345,549, FILED 6-14-2011.

SIMON TENG, EXAMINING ATTORNEY



David J. Kyffers

Director of the United States Patent and Trademark Office

United States of America

United States Patent and Trademark Office



Reg. No. 4,098,634

MOTOR HOME SPECIALIST, L.P. (TEXAS LIMITED PARTNERSHIP)
5411 SOUTH INTERSTATE 35W
ALVARADO, TX 76009

Registered Feb. 14, 2012

Int. Cl.: 35

FOR: DEALERSHIPS IN THE FIELD OF RECREATIONAL VEHICLES, NAMELY, MOTOR HOMES, BUS CONVERSIONS AND TRAILERS, IN CLASS 35 (U.S. CLS. 100, 101 AND 102).

SERVICE MARK

FIRST USE 7-0-2010; IN COMMERCE 9-13-2010.

PRINCIPAL REGISTER

NO CLAIM IS MADE TO THE EXCLUSIVE RIGHT TO USE "MOTOR HOME SPECIALIST" AND THE REPRESENTATION OF THE EARTH, APART FROM THE MARK AS SHOWN.

THE COLOR(S) RED, BLUE, WHITE, BLACK, AND SILVER/GRAY IS/ARE CLAIMED AS A FEATURE OF THE MARK.

THE MARK CONSISTS OF A BLUE GLOBE WITH SILVER/GRAY OUTLINES OF THE CONTINENTS NORTH AMERICA, SOUTH AMERICA, AND PARTIAL OUTLINES OF EUROPE AND AFRICA. A STYLIZED RECTANGULAR BILLBOARD ON A SILVER/GRAY POLE IS ARISING FROM THE MIDDLE OF NORTH AMERICA. THE TOP THREE-QUARTERS OF THE RECTANGULAR BILLBOARD CONTAINING THE WORDS "MOTOR HOME SPECIALIST" IN WHITE, CAPITAL LETTERS AGAINST A BLUE BACKGROUND. THE BOTTOM QUARTER OF THE RECTANGULAR BILLBOARD, ON A WHITE BACKGROUND, ARE THE WORDS "WHERE THE WORLD SHOPS" IN RED, CAPITAL LETTERS. THE BOTTOM OF THE BILLBOARD HAS FOUR LIGHTS THAT ARE WHITE WITH ONE BLACK STRIPE AND ONE RED STRIPE GOING HORIZONTALLY.



SER. NO. 85-345,614, FILED 6-14-2011.

MATTHEW MCDOWELL, EXAMINING ATTORNEY

David J. Kybas

Director of the United States Patent and Trademark Office

United States of America
United States Patent and Trademark Office

Organicorp

Reg. No. 4,098,635

MCKITRICK, MARK A. (UNITED STATES INDIVIDUAL)
429 W. WEBERVIEW DRIVE
SUTTONS BAY, MI 49682

Registered Feb. 14, 2012

Int. Cl.: 4

FOR: BIOMASS, NAMELY, A LIGNOCELLULOSIC MATERIAL USED AS A FUEL FOR GENERATING ENERGY AND ELECTRICITY, IN CLASS 4 (U.S. CLS. 1, 6 AND 15).

TRADEMARK

FIRST USE 12-8-2008; IN COMMERCE 2-15-2009.

PRINCIPAL REGISTER

THE MARK CONSISTS OF STANDARD CHARACTERS WITHOUT CLAIM TO ANY PARTICULAR FONT, STYLE, SIZE, OR COLOR.

SER. NO. 85-345,620, FILED 6-14-2011.

JAMES STEIN, EXAMINING ATTORNEY



David J. Kyffers

Director of the United States Patent and Trademark Office

United States of America
United States Patent and Trademark Office

Crémo

Reg. No. 4,098,636

Registered Feb. 14, 2012

Int. Cl.: 34

TRADEMARK

PRINCIPAL REGISTER

ELAKE ENTERPRISE, LLC (FLORIDA LIMITED LIABILITY COMPANY), DBA CREMO
CIGARS
6635 SW 51 TERRACE
MIAMI, FL 33155

FOR: CIGAR AND CIGARETTE BOXES; CIGAR AND CIGARETTE BOXES NOT OF PRECIOUS METAL; CIGAR AND CIGARETTE BOXES OF PRECIOUS METAL; CIGAR BOXES; CIGAR BOXES NOT OF PRECIOUS METAL; CIGAR BOXES OF PRECIOUS METAL; CIGAR CASES; CIGAR CASES OF PRECIOUS METAL; CIGAR CUTTERS; CIGAR HOLDERS; CIGAR HOLDERS OF PRECIOUS METAL; CIGAR HUMIDIFIERS; CIGAR LIGHTERS; CIGAR TUBES; CIGAR WRAPS; CIGARS; FILTERED CIGARS AND CIGARETTES; HOLDERS FOR CIGAR AND CIGARETTE OF PRECIOUS METAL; HOLDERS FOR CIGARS AND CIGARETTES; HOLDERS OF CIGARS AND CIGARETTES OF PRECIOUS METAL; NON-ELECTRIC CIGAR LIGHTERS NOT OF PRECIOUS METAL; SMOKERS' ARTICLES, NAMELY, CIGAR STORAGE TUBES; SMOKERS' ARTICLES, NAMELY, CONTAINMENT CLIPS USED TO KEEP A CIGAR FROM FALLING APART; SMOKERS' ARTICLES, NAMELY, OUTDOOR CIGAR AND CIGARETTE DISPOSAL UNITS; SMOKERS' ARTICLES, NAMELY, OUTDOOR RECEPTACLES FOR CIGAR AND CIGARETTE ASH AND WASTE; TOBACCO, CIGARS AND CIGARETTES, IN CLASS 34 (U.S. CLS. 2, 8, 9 AND 17).

FIRST USE 6-13-2011; IN COMMERCE 6-13-2011.

THE MARK CONSISTS OF THE WORD "CREMO" IN STYLIZED FORM WITH SMOKE LINES DEPICTED AS AN ACCENT MARK ABOVE THE LETTER "E" IN THE WORD "CREMO".

SER. NO. 85-345,625, FILED 6-14-2011.

CHRISTINA SOBRAL, EXAMINING ATTORNEY



David J. Kybas

Director of the United States Patent and Trademark Office

United States of America

United States Patent and Trademark Office



Reg. No. 4,098,637

Registered Feb. 14, 2012

Int. Cl.: 43

SERVICE MARK

PRINCIPAL REGISTER

JOEY BAG A DONUTS, LLC (SOUTH CAROLINA LIMITED LIABILITY COMPANY)
1118 PARK WEST BOULEVARD, STE. B6
MT. PLEASANT, SC 29466

FOR: RESTAURANT SERVICES, IN CLASS 43 (U.S. CLS. 100 AND 101).

FIRST USE 12-5-2009; IN COMMERCE 12-5-2009.

OWNER OF U.S. REG. NO. 4,015,203.

NO CLAIM IS MADE TO THE EXCLUSIVE RIGHT TO USE "DONUTS", APART FROM THE MARK AS SHOWN.

THE MARK CONSISTS OF THE STYLIZED WORDING "JOEY BAG A DONUTS", WITH THE "O" IN "JOEY" THE DESIGN OF A DONUT; A STEAMING CUP OF COFFEE IS ABOVE THE "J" AND A CLOSED BAG IS BEHIND THE "EY."

SER. NO. 85-345,710, FILED 6-14-2011.

HOWARD B. LEVINE, EXAMINING ATTORNEY



David J. Kyffers

Director of the United States Patent and Trademark Office

United States of America

United States Patent and Trademark Office

NOTEABLES

Reg. No. 4,098,638

Registered Feb. 14, 2012

Int. Cl.: 9

TRADEMARK

PRINCIPAL REGISTER

TRIPPE MANUFACTURING COMPANY (ILLINOIS CORPORATION)
1111 W. 35TH STREET
CHICAGO, IL 60609

FOR: COMPUTER CARRYING CASES AND BAGS; COMPUTER PERIPHERALS; NOTEBOOK COMPUTER COOLING PADS; PORTABLE STANDS ESPECIALLY ADAPTED FOR HOLDING NOTEBOOK COMPUTERS; COMPUTER STANDS WITH ARTICULATING ARMS; CABLES, NAMELY, AUDIO CABLES, AUDIO/VIDEO CABLES, COMPUTER CABLES, DATA TRANSFER CABLES, EXTENSION CABLES AND USB CABLES; VOLTAGE SURGE PROTECTORS; VOLTAGE SURGE SUPPRESSORS, IN CLASS 9 (U.S. CLS. 21, 23, 26, 36 AND 38).

FIRST USE 5-0-2006; IN COMMERCE 5-0-2006.

THE MARK CONSISTS OF STANDARD CHARACTERS WITHOUT CLAIM TO ANY PARTICULAR FONT, STYLE, SIZE, OR COLOR.

SER. NO. 85-345,718, FILED 6-14-2011.

CHRISTINE COOPER, EXAMINING ATTORNEY



David J. Kyffers

Director of the United States Patent and Trademark Office

United States of America

United States Patent and Trademark Office

KRISHNAMURTI PUBLICATIONS OF AMERICA

Reg. No. 4,098,639

Registered Feb. 14, 2012

Int. Cl.: 9

TRADEMARK

PRINCIPAL REGISTER

KRISHNAMURTI FOUNDATION OF AMERICA (CALIFORNIA NON-PROFIT FOUNDATION)
POST OFFICE BOX 1560
OJAI, CA 93024

FOR: DIGITAL MEDIA, NAMELY, PRE-RECORDED VIDEO CASSETTES, DIGITAL VIDEO DISCS, DIGITAL VERSATILE DISCS, DOWNLOADABLE AUDIO AND VIDEO RECORDINGS, DVDS, AND HIGH DEFINITION DIGITAL DISCS FEATURING JIDDU KRISHNAMURTI'S WORKSHOPS, LECTURES, TALKS, DISCUSSIONS AND DIALOGUES, IN CLASS 9 (U.S. CLS. 21, 23, 26, 36 AND 38).

FIRST USE 1-0-1999; IN COMMERCE 1-0-1999.

THE MARK CONSISTS OF STANDARD CHARACTERS WITHOUT CLAIM TO ANY PARTICULAR FONT, STYLE, SIZE, OR COLOR.

NO CLAIM IS MADE TO THE EXCLUSIVE RIGHT TO USE "PUBLICATIONS OF AMERICA", APART FROM THE MARK AS SHOWN.

THE NAME(S), PORTRAIT(S), AND/OR SIGNATURE(S) SHOWN IN THE MARK DOES NOT IDENTIFY A PARTICULAR LIVING INDIVIDUAL.

SER. NO. 85-345,761, FILED 6-14-2011.

KARANENDRA S. CHHINA, EXAMINING ATTORNEY



David J. Kybas

Director of the United States Patent and Trademark Office

United States of America

United States Patent and Trademark Office

PEAR TREE FUNDS

Reg. No. 4,098,640

PEAR TREE ADVISORS, INC. (DELAWARE CORPORATION)
55 OLD BEDFORD ROAD
LINCOLN, MA 01773

Registered Feb. 14, 2012

Int. Cl.: 36

FOR: MUTUAL FUND INVESTMENT, IN CLASS 36 (U.S. CLS. 100, 101 AND 102).

SERVICE MARK

FIRST USE 5-26-2011; IN COMMERCE 5-26-2011.

PRINCIPAL REGISTER

THE MARK CONSISTS OF STANDARD CHARACTERS WITHOUT CLAIM TO ANY PARTICULAR FONT, STYLE, SIZE, OR COLOR.

NO CLAIM IS MADE TO THE EXCLUSIVE RIGHT TO USE "FUNDS", APART FROM THE MARK AS SHOWN.

SER. NO. 85-345,766, FILED 6-14-2011.

JORDAN BAKER, EXAMINING ATTORNEY



David J. Kyffers

Director of the United States Patent and Trademark Office

United States of America

United States Patent and Trademark Office

OSG
PHOENIX

Reg. No. 4,098,641

Registered Feb. 14, 2012

Int. Cl.: 7

TRADEMARK

PRINCIPAL REGISTER

OSG TAP & DIE, INC. (ILLINOIS CORPORATION)
676 FULLERTON AVENUE
GLENDALE HEIGHTS, IL 60137

FOR: CUTTING TOOLS IN THE NATURE OF BITS FOR MILLING AND THREADING MACHINES AND POWER DRILLS, IN CLASS 7 (U.S. CLS. 13, 19, 21, 23, 31, 34 AND 35).

FIRST USE 4-0-2010; IN COMMERCE 4-0-2010.

OWNER OF U.S. REG. NOS. 882,784, 1,176,834, AND 2,447,743.

THE MARK CONSISTS OF THE LETTERS OSG IS OVER OF THE WORD PHOENIX.

SER. NO. 85-345,770, FILED 6-14-2011.

PATRICIA EVANKO, EXAMINING ATTORNEY



David J. Kybas

Director of the United States Patent and Trademark Office

United States of America

United States Patent and Trademark Office

Bubboli

Reg. No. 4,098,642

Registered Feb. 14, 2012

Int. Cl.: 35

SERVICE MARK

PRINCIPAL REGISTER

BUBBOLI LLC (NEW YORK LIMITED LIABILITY COMPANY)
29D
55 WEST 26 ST
NEW YORK, NY 10010

FOR: PROVIDING RECOMMENDATIONS OF CHILDREN'S PRODUCT AND SERVICES TO CONSUMERS BASED ON USER PREFERENCES; PROMOTING THE GOODS OF OTHERS BY PROVIDING A SERVICE WHICH NOTIFIES USERS OF ITEMS WHICH MATCH THE USER PREFERENCES; PROVIDING ONLINE PLATFORMS FOR ADVERTISERS TO PROMOTE THEIR GOODS AND SERVICES, IN CLASS 35 (U.S. CLS. 100, 101 AND 102).

FIRST USE 3-16-2011; IN COMMERCE 3-16-2011.

THE MARK CONSISTS OF STANDARD CHARACTERS WITHOUT CLAIM TO ANY PARTICULAR FONT, STYLE, SIZE, OR COLOR.

SER. NO. 85-345,784, FILED 6-14-2011.

JANICE L. MCMORROW, EXAMINING ATTORNEY



David J. Kyffers

Director of the United States Patent and Trademark Office

United States of America

United States Patent and Trademark Office

PriscillaDawn

Reg. No. 4,098,643

BAER, PRISCILLA (UNITED STATES INDIVIDUAL)
3403 WOODVINE CIRCLE
HAUGHTON, LA 71037

Registered Feb. 14, 2012

Int. Cl.: 25

FOR: BOTTOMS; DRESSES; SHOES; TOPS, IN CLASS 25 (U.S. CLS. 22 AND 39).

TRADEMARK

FIRST USE 9-9-2009; IN COMMERCE 9-9-2009.

PRINCIPAL REGISTER

THE MARK CONSISTS OF STANDARD CHARACTERS WITHOUT CLAIM TO ANY PARTICULAR FONT, STYLE, SIZE, OR COLOR.

THE NAME "PRISCILLA DAWN" DOES NOT IDENTIFY A LIVING INDIVIDUAL.

SER. NO. 85-345,849, FILED 6-14-2011.

REBECCA POVARCHUK, EXAMINING ATTORNEY



David J. Kyffers

Director of the United States Patent and Trademark Office

United States of America

United States Patent and Trademark Office

SWMRIC

Reg. No. 4,098,644

SWMRIC, L.L.C. (MICHIGAN LIMITED LIABILITY COMPANY)
5830 VENTURE PARK DRIVE
KALAMAZOO, MI 49009

Registered Feb. 14, 2012

Int. Cl.: 36

FOR: REAL ESTATE DATABASE SERVICES, NAMELY, PROVIDING REAL ESTATE LISTINGS VIA THE INTERNET, IN CLASS 36 (U.S. CLS. 100, 101 AND 102).

SERVICE MARK

FIRST USE 5-29-1996; IN COMMERCE 10-1-1996.

PRINCIPAL REGISTER

THE MARK CONSISTS OF STANDARD CHARACTERS WITHOUT CLAIM TO ANY PARTICULAR FONT, STYLE, SIZE, OR COLOR.

SER. NO. 85-345,878, FILED 6-14-2011.

JENNIFER MARTIN, EXAMINING ATTORNEY



David J. Kybas

Director of the United States Patent and Trademark Office

United States of America

United States Patent and Trademark Office

GYRODATA

Reg. No. 4,098,645

Registered Feb. 14, 2012

Int. Cl.: 42

SERVICE MARK

PRINCIPAL REGISTER

GYRODATA INCORPORATED (TEXAS CORPORATION)
23000 NORTHWEST LAKE DRIVE
HOUSTON, TX 77095

FOR: CONDUCTING WELLBORE SURVEY SERVICES FOR THE OIL AND GAS, ENERGY, MINING, ENVIRONMENTAL AND CONSTRUCTION INDUSTRIES, PROVIDING WELLBORE MAPPING SERVICES; PROVIDING ELECTRONIC WELLBORE DATA COLLECTION SERVICES, NAMELY, PROVIDING SERVICES OF COLLECTING OF WELLBORE DIRECTION AND ORIENTATION DATA FROM WELLBORE MEASUREMENT DEVICES OF OTHERS IN THE OIL AND GAS, ENERGY, MINING, ENVIRONMENTAL AND CONSTRUCTION INDUSTRIES; PROVIDING WELLBORE DATA COLLECTION SERVICES FOR USE IN DIRECTIONAL DRILLING CONTROL IN THE OIL AND GAS, ENERGY, MINING, ENVIRONMENTAL AND CONSTRUCTION INDUSTRIES; PROVIDING WELLBORE DIRECTIONAL DRILLING CONTROL DATA COLLECTION SERVICES IN THE OIL AND GAS WELL DRILLING INDUSTRY, NAMELY, GYROSCOPIC MEASUREMENT OF DIRECTIONAL DRILLING CONTROL DATA, AND COMMUNICATION OF DIRECTIONAL DRILLING CONTROL DATA TO WELLBORE DRILLING OPERATORS; PROVIDING OIL AND GAS WELL RESERVOIR MEASUREMENT SERVICES IN THE OIL AND GAS WELL INDUSTRY, NAMELY, GYROSCOPIC MEASUREMENT OF DIRECTION AND ORIENTATION OF WELLBORES IN RELATION TO OIL AND GAS WELL RESERVOIR FORMATIONS; AND OIL FIELD SURVEY SERVICES, IN CLASS 42 (U.S. CLS. 100 AND 101).

FIRST USE 7-20-1983; IN COMMERCE 7-20-1983.

THE MARK CONSISTS OF STANDARD CHARACTERS WITHOUT CLAIM TO ANY PARTICULAR FONT, STYLE, SIZE, OR COLOR.

OWNER OF U.S. REG. NO. 1,338,471.

SER. NO. 85-345,973, FILED 6-14-2011.

LINDA MICKLEBURGH, EXAMINING ATTORNEY



David J. Kyffers

Director of the United States Patent and Trademark Office

United States of America

United States Patent and Trademark Office

WATERFORD EARLY LEARNING

Reg. No. 4,098,646

WATERFORD INSTITUTE, INC. (DELAWARE CORPORATION)
55 WEST 900 SOUTH
SALT LAKE CITY, UT 84101

Registered Feb. 14, 2012

Int. Cls.: 9 and 16

FOR: CHILDREN'S EDUCATIONAL MUSIC CDS AND DVDS; CHILDREN'S EDUCATIONAL SOFTWARE, IN CLASS 9 (U.S. CLS. 21, 23, 26, 36 AND 38).

TRADEMARK

FIRST USE 6-20-2007; IN COMMERCE 11-1-2007.

PRINCIPAL REGISTER

FOR: EDUCATIONAL PUBLICATIONS, NAMELY, TEACHER GUIDES, SONG CHARTS, VOCABULARY CARDS, AND WORKSHEETS IN THE FIELDS OF EMERGENT LITERACY SKILLS, READING AND WRITING, MATH, SCIENCE; PACKAGED KITS COMPRISING PRINTED INSTRUCTIONAL, EDUCATIONAL, AND TEACHING MATERIALS FOR EDUCATIONAL ACTIVITIES IN THE FIELD OF EMERGENT LITERACY SKILLS, IN CLASS 16 (U.S. CLS. 2, 5, 22, 23, 29, 37, 38 AND 50).

FIRST USE 6-20-2007; IN COMMERCE 11-1-2007.

THE MARK CONSISTS OF STANDARD CHARACTERS WITHOUT CLAIM TO ANY PARTICULAR FONT, STYLE, SIZE, OR COLOR.

OWNER OF U.S. REG. NOS. 1,844,162, 2,355,367 AND OTHERS.

NO CLAIM IS MADE TO THE EXCLUSIVE RIGHT TO USE "EARLY LEARNING", APART FROM THE MARK AS SHOWN.

SER. NO. 85-345,978, FILED 6-14-2011.

AISHA CLARKE, EXAMINING ATTORNEY



David J. Kyjars

Director of the United States Patent and Trademark Office

United States of America

United States Patent and Trademark Office



Reg. No. 4,098,647

FORT WORTH COUNTRY DAY SCHOOL, INC. (TEXAS CORPORATION)
4200 COUNTRY DAY LANE
FORT WORTH, TX 76109

Registered Feb. 14, 2012

Int. Cl.: 41

FOR: EDUCATIONAL SERVICES IN THE NATURE OF AN INDEPENDENT PRIVATE SCHOOL THAT PROVIDES COURSES OF INSTRUCTION FOR CHILDREN AND ADOLESCENTS AT THE PRIMARY AND SECONDARY LEVEL, IN CLASS 41 (U.S. CLS. 100, 101 AND 107).

SERVICE MARK

PRINCIPAL REGISTER

FIRST USE 10-31-2009; IN COMMERCE 10-31-2009.

THE MARK CONSISTS OF A BLUE FALCON HEAD WITH A RED EYE. WHITE IN THE DRAWING REPRESENTS A TRANSPARENT BACKGROUND.

THE COLOR(S) BLUE AND RED IS/ARE CLAIMED AS A FEATURE OF THE MARK.

SER. NO. 85-346,027, FILED 6-14-2011.

REBECCA EISINGER, EXAMINING ATTORNEY



David J. Kyffers

Director of the United States Patent and Trademark Office

United States of America

United States Patent and Trademark Office

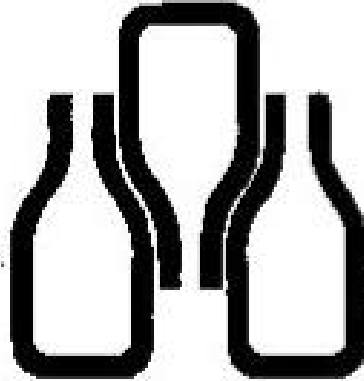

Reg. No. 4,098,648

Registered Feb. 14, 2012

Int. Cls.: 16 and 21

TRADEMARK

PRINCIPAL REGISTER

SAXCO INTERNATIONAL, LLC (DELAWARE LIMITED LIABILITY COMPANY)
200 GIBRALTAR ROAD
SUITE 101
HORSHAM, PA 19044

FOR: CARDBOARD CONTAINERS, IN CLASS 16 (U.S. CLS. 2, 5, 22, 23, 29, 37, 38 AND 50).

FIRST USE 1-0-1975; IN COMMERCE 6-0-1975.

FOR: GLASS BOTTLES, SOLD EMPTY, IN CLASS 21 (U.S. CLS. 2, 13, 23, 29, 30, 33, 40 AND 50).

FIRST USE 3-0-1986; IN COMMERCE 3-0-1986.

THE MARK CONSISTS OF THE FANCIFUL DESIGN OF INTERLOCKING BOTTLES.

SER. NO. 85-346,073, FILED 6-14-2011.

KELLEY WELLS, EXAMINING ATTORNEY



David J. Kyffers

Director of the United States Patent and Trademark Office

United States of America

United States Patent and Trademark Office



Reg. No. 4,098,649

RHEE BROS., INC. (MARYLAND CORPORATION)
7461 COCA COLA DRIVE
HANOVER, MD 21076

Registered Feb. 14, 2012

Int. Cl.: 30

FOR: RICE, IN CLASS 30 (U.S. CL. 46).

TRADEMARK

FIRST USE 4-8-2011; IN COMMERCE 4-8-2011.

PRINCIPAL REGISTER

NO CLAIM IS MADE TO THE EXCLUSIVE RIGHT TO USE "VIET", APART FROM THE MARK AS SHOWN.

THE COLOR(S) YELLOW, BLACK AND RED IS/ARE CLAIMED AS A FEATURE OF THE MARK.

THE MARK CONSISTS OF THE WORD "VIET" IS PRINTED IN STYLIZED BLACK LETTERS WITH RED DOT ON TOP OF THE LETTER "I"; THE LETTER "VIET" IS PRINTED OVER A YELLOW CIRCLE; THE WORD "WAY" IS PRINTED IN STYLIZED RED LETTERS BELOW THE WORD "VIET".

SER. NO. 85-346,143, FILED 6-14-2011.

APRIL ROACH, EXAMINING ATTORNEY



David J. Kyffers

Director of the United States Patent and Trademark Office

United States of America

United States Patent and Trademark Office

KANGAROO COVERS

Reg. No. 4,098,650

PURCELL, STEVEN G. (UNITED STATES INDIVIDUAL)
1809 WINDSOR MEADOW PASS
ANTIOCH, TN 37013 AND

Registered Feb. 14, 2012

Int. Cl.: 9

PURCELL, PAMELA (UNITED STATES INDIVIDUAL)
1809 WINDSOR MEADOW PASS
ANTIOCH, TN 37013

TRADEMARK

PRINCIPAL REGISTER

FOR: PROTECTIVE COVERS FOR AMPLIFIERS, NAMELY, PROTECTIVE COVERS FOR AMPLIFIERS ASSOCIATED WITH MUSICAL INSTRUMENTS AND/OR VOICE APPLICATIONS, IN CLASS 9 (U.S. CLS. 21, 23, 26, 36 AND 38).

FIRST USE 1-25-2002; IN COMMERCE 1-25-2002.

THE MARK CONSISTS OF STANDARD CHARACTERS WITHOUT CLAIM TO ANY PARTICULAR FONT, STYLE, SIZE, OR COLOR.

NO CLAIM IS MADE TO THE EXCLUSIVE RIGHT TO USE "COVERS", APART FROM THE MARK AS SHOWN.

SER. NO. 85-346,154, FILED 6-14-2011.

KELLY BOULTON, EXAMINING ATTORNEY



David J. Kyjars

Director of the United States Patent and Trademark Office

United States of America

United States Patent and Trademark Office



Reg. No. 4,098,651

Registered Feb. 14, 2012

Int. Cl.: 30

TRADEMARK

PRINCIPAL REGISTER

RHEE BROS., INC. (MARYLAND CORPORATION)
7461 COCA COLA DRIVE
HANOVER, MD 21076

FOR: FISH SAUCE, IN CLASS 30 (U.S. CL. 46).

FIRST USE 3-8-2011; IN COMMERCE 3-8-2011.

NO CLAIM IS MADE TO THE EXCLUSIVE RIGHT TO USE "VIET", APART FROM THE MARK AS SHOWN.

THE COLOR(S) YELLOW, BLACK AND RED IS/ARE CLAIMED AS A FEATURE OF THE MARK.

THE MARK CONSISTS OF A WORD "VIET" IS PRINTED IN STYLIZED BLACK LETTERS WITH RED DOT ON TOP OF THE LETTER "I"; THE WORD "VIET" IS PRINTED IN A YELLOW CIRCLE; AND THE WORD "WAY" IS PRINTED IN STYLIZED RED LETTER BLOW THE WORD "VIET".

SER. NO. 85-346,169, FILED 6-14-2011.

APRIL ROACH, EXAMINING ATTORNEY



David J. Kyffers

Director of the United States Patent and Trademark Office

United States of America

United States Patent and Trademark Office

SCENICPLY

Reg. No. 4,098,652

SABALITO, LLC (OREGON LIMITED LIABILITY COMPANY)
800 48TH STREET
SPRINGFIELD, OR 97478

Registered Feb. 14, 2012

Int. Cl.: 19

FOR: A MULTI-PLY PLYWOOD SHEET CONSTRUCTED WITH VARIOUS LAMINATED VENEERS FOR USE IN CONSTRUCTION OF SETS FOR THEATRICAL AND OTHER ENTERTAINMENT ENTERPRISES, IN CLASS 19 (U.S. CLS. 1, 12, 33 AND 50).

TRADEMARK

FIRST USE 6-1-2011; IN COMMERCE 6-1-2011.

PRINCIPAL REGISTER

THE MARK CONSISTS OF STANDARD CHARACTERS WITHOUT CLAIM TO ANY PARTICULAR FONT, STYLE, SIZE, OR COLOR.

SER. NO. 85-346,175, FILED 6-14-2011.

SETH A. RAPPAPORT, EXAMINING ATTORNEY



David J. Kyffers

Director of the United States Patent and Trademark Office

United States of America

United States Patent and Trademark Office

J. Krishnamurti

Reg. No. 4,098,653

KRISHNAMURTI FOUNDATION OF AMERICA (CALIFORNIA NON-PROFIT FOUNDATION)
POST OFFICE BOX 1560
OJAI, CA 93024

Registered Feb. 14, 2012

Int. Cl.: 16

FOR: PRINTED EDUCATIONAL MATERIALS IN THE FIELD OF THE LITERATURE, TEACHING AND PHILOSOPHY OF JIDDU KRISHNAMURTI, IN CLASS 16 (U.S. CLS. 2, 5, 22, 23, 29, 37, 38 AND 50).

TRADEMARK

FIRST USE 0-0-1969; IN COMMERCE 0-0-1969.

PRINCIPAL REGISTER

THE NAME(S), PORTRAIT(S), AND/OR SIGNATURE(S) SHOWN IN THE MARK DOES NOT IDENTIFY A PARTICULAR LIVING INDIVIDUAL.

THE MARK CONSISTS OF THE WORDS "J. KRISHNAMURTI" IN STYLIZED HANDWRITING FONT WITH AN UNDERLINE BELOW THE WORD "KRISHNAMURTI".

SER. NO. 85-346,205, FILED 6-14-2011.

KARANENDRA S. CHHINA, EXAMINING ATTORNEY



David J. Kyros

Director of the United States Patent and Trademark Office

United States of America

United States Patent and Trademark Office

KRISHNAMURTI FOUNDATION OF AMERICA

Reg. No. 4,098,654

KRISHNAMURTI FOUNDATION OF AMERICA (CALIFORNIA NON-PROFIT FOUNDATION)
POST OFFICE BOX 1560
OJAI, CA 93024

Registered Feb. 14, 2012

Int. Cl.: 9

FOR: DIGITAL MEDIA, NAMELY, PRE-RECORDED VIDEO CASSETTES, DIGITAL VIDEO DISCS, DIGITAL VERSATILE DISCS, DOWNLOADABLE AUDIO AND VIDEO RECORDINGS, DVDS, AND HIGH DEFINITION DIGITAL DISCS FEATURING JIDDU KRISHNAMURTI'S WORKSHOPS, LECTURES, TALKS, DISCUSSIONS AND DIALOGUES, IN CLASS 9 (U.S. CLS. 21, 23, 26, 36 AND 38).

TRADEMARK

PRINCIPAL REGISTER

FIRST USE 0-0-1971; IN COMMERCE 0-0-1971.

THE MARK CONSISTS OF STANDARD CHARACTERS WITHOUT CLAIM TO ANY PARTICULAR FONT, STYLE, SIZE, OR COLOR.

NO CLAIM IS MADE TO THE EXCLUSIVE RIGHT TO USE "FOUNDATION OF AMERICA", APART FROM THE MARK AS SHOWN.

THE NAME(S), PORTRAIT(S), AND/OR SIGNATURE(S) SHOWN IN THE MARK DOES NOT IDENTIFY A PARTICULAR LIVING INDIVIDUAL.

SER. NO. 85-346,229, FILED 6-14-2011.

KARANENDRA S. CHHINA, EXAMINING ATTORNEY



David J. Kybas

Director of the United States Patent and Trademark Office

United States of America

United States Patent and Trademark Office

KRISHNAMURTI FOUNDATION OF AMERICA

Reg. No. 4,098,655

KRISHNAMURTI FOUNDATION OF AMERICA (CALIFORNIA NON-PROFIT FOUNDATION)
POST OFFICE BOX 1560
OJAI, CA 93024

Registered Feb. 14, 2012

Int. Cl.: 41

FOR: EDUCATION SERVICES, NAMELY, PROVIDING CLASSES, LECTURES, SEMINARS, WORKSHOPS AND RETREATS IN THE FIELD OF THE LITERATURE, WRITINGS, TEACHINGS, PHILOSOPHY AND STUDIES OF KRISHNAMURTI, IN CLASS 41 (U.S. CLS. 100, 101 AND 107).

SERVICE MARK

PRINCIPAL REGISTER

FIRST USE 0-0-1969; IN COMMERCE 0-0-1969.

THE MARK CONSISTS OF STANDARD CHARACTERS WITHOUT CLAIM TO ANY PARTICULAR FONT, STYLE, SIZE, OR COLOR.

NO CLAIM IS MADE TO THE EXCLUSIVE RIGHT TO USE "FOUNDATION OF AMERICA", APART FROM THE MARK AS SHOWN.

THE NAME(S), PORTRAIT(S), AND/OR SIGNATURE(S) SHOWN IN THE MARK DOES NOT IDENTIFY A PARTICULAR LIVING INDIVIDUAL.

SER. NO. 85-346,236, FILED 6-14-2011.

KARANENDRA S. CHHINA, EXAMINING ATTORNEY



David J. Kybas

Director of the United States Patent and Trademark Office

United States of America

United States Patent and Trademark Office

OAK GROVE SCHOOL

Reg. No. 4,098,656

KRISHNAMURTI FOUNDATION OF AMERICA (CALIFORNIA NON-PROFIT FOUNDATION)
POST OFFICE BOX 1560
OJAI, CA 93024

Registered Feb. 14, 2012

Int. Cl.: 41

FOR: EDUCATION SERVICES, NAMELY, PROVIDING KINDERGARTEN THROUGH 12TH GRADE (K-12) CLASSROOM INSTRUCTION; EDUCATION SERVICES, NAMELY, PROVIDING CLASSES, LECTURES, SEMINARS, WORKSHOPS, AND RETREATS IN THE FIELDS OF THE LITERATURE, WRITINGS, TEACHINGS, PHILOSOPHY AND STUDIES OF JIDDU KRISHNAMURTI, IN CLASS 41 (U.S. CLS. 100, 101 AND 107).

SERVICE MARK

PRINCIPAL REGISTER

FIRST USE 9-0-1975; IN COMMERCE 9-0-1975.

THE MARK CONSISTS OF STANDARD CHARACTERS WITHOUT CLAIM TO ANY PARTICULAR FONT, STYLE, SIZE, OR COLOR.

NO CLAIM IS MADE TO THE EXCLUSIVE RIGHT TO USE "SCHOOL", APART FROM THE MARK AS SHOWN.

SER. NO. 85-346,248, FILED 6-14-2011.

KARANENDRA S. CHHINA, EXAMINING ATTORNEY



David J. Kypos

Director of the United States Patent and Trademark Office

United States of America

United States Patent and Trademark Office

KRISHNAMURTI FOUNDATION OF AMERICA

Reg. No. 4,098,657

KRISHNAMURTI FOUNDATION OF AMERICA (CALIFORNIA NON-PROFIT FOUNDATION)
POST OFFICE BOX 1560
OJAI, CA 93024

Registered Feb. 14, 2012

Int. Cl.: 35

FOR: ASSOCIATION SERVICES, NAMELY, AN ORGANIZATION FOR THE PROMOTION AND ADVANCEMENT OF TEACHINGS, CONTRIBUTIONS AND PHILOSOPHY OF JIDDU KRISHNAMURTI, IN CLASS 35 (U.S. CLS. 100, 101 AND 102).

SERVICE MARK

FIRST USE 0-0-1969; IN COMMERCE 0-0-1969.

PRINCIPAL REGISTER

THE MARK CONSISTS OF STANDARD CHARACTERS WITHOUT CLAIM TO ANY PARTICULAR FONT, STYLE, SIZE, OR COLOR.

NO CLAIM IS MADE TO THE EXCLUSIVE RIGHT TO USE "FOUNDATION OF AMERICA", APART FROM THE MARK AS SHOWN.

THE NAME(S), PORTRAIT(S), AND/OR SIGNATURE(S) SHOWN IN THE MARK DOES NOT IDENTIFY A PARTICULAR LIVING INDIVIDUAL.

SER. NO. 85-346,265, FILED 6-14-2011.

KARANENDRA S. CHHINA, EXAMINING ATTORNEY



David J. Kyros

Director of the United States Patent and Trademark Office

United States of America

United States Patent and Trademark Office

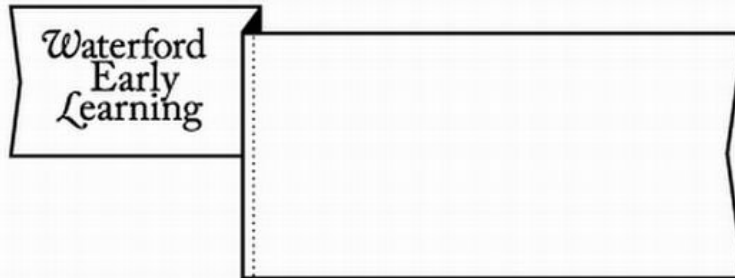

Reg. No. 4,098,658

WATERFORD INSTITUTE, INC. (DELAWARE CORPORATION)
55 WEST 900 SOUTH
SALT LAKE CITY, UT 84101

Registered Feb. 14, 2012

Int. Cls.: 9 and 16

FOR: CHILDREN'S EDUCATIONAL MUSIC CDS AND DVDS; CHILDREN'S EDUCATIONAL SOFTWARE, IN CLASS 9 (U.S. CLS. 21, 23, 26, 36 AND 38).

TRADEMARK

FIRST USE 6-20-2007; IN COMMERCE 11-1-2007.

PRINCIPAL REGISTER

FOR: EDUCATIONAL PUBLICATIONS, NAMELY, TEACHER GUIDES, SONG CHARTS, VOCABULARY CARDS, AND WORKSHEETS IN THE FIELDS OF EMERGENT LITERACY SKILLS, READING AND WRITING, MATH, SCIENCE; PACKAGED KITS COMPRISING PRINTED INSTRUCTIONAL, EDUCATIONAL, AND TEACHING MATERIALS FOR EDUCATIONAL ACTIVITIES IN THE FIELD OF EMERGENT LITERACY SKILLS, IN CLASS 16 (U.S. CLS. 2, 5, 22, 23, 29, 37, 38 AND 50).

FIRST USE 6-20-2007; IN COMMERCE 11-1-2007.

OWNER OF U.S. REG. NOS. 1,844,162, 2,355,367 AND OTHERS.

NO CLAIM IS MADE TO THE EXCLUSIVE RIGHT TO USE "EARLY LEARNING", APART FROM THE MARK AS SHOWN.

THE MARK CONSISTS OF A STYLIZED RIBBON HAVING TWO BENDS AND BEARING THE WORDS "WATERFORD EARLY LEARNING".

SER. NO. 85-346,278, FILED 6-14-2011.

AISHA CLARKE, EXAMINING ATTORNEY



David J. Kybas

Director of the United States Patent and Trademark Office

United States of America

United States Patent and Trademark Office



Reg. No. 4,098,659

WATERFORD INSTITUTE, INC. (DELAWARE CORPORATION)
55 WEST 900 SOUTH
SALT LAKE CITY, UT 84101

Registered Feb. 14, 2012

Int. Cls.: 9 and 16

FOR: CHILDREN'S EDUCATIONAL MUSIC CDS AND DVDS; CHILDREN'S EDUCATIONAL SOFTWARE, IN CLASS 9 (U.S. CLS. 21, 23, 26, 36 AND 38).

TRADEMARK

FIRST USE 3-8-2011; IN COMMERCE 4-1-2011.

PRINCIPAL REGISTER

FOR: EDUCATIONAL PUBLICATIONS, NAMELY, TEACHER GUIDES, SONG CHARTS, VOCABULARY CARDS, AND WORKSHEETS IN THE FIELDS OF EMERGENT LITERACY SKILLS, READING AND WRITING, MATH, SCIENCE; PACKAGED KITS COMPRISING PRINTED INSTRUCTIONAL, EDUCATIONAL, AND TEACHING MATERIALS FOR EDUCATIONAL ACTIVITIES IN THE FIELD OF EMERGENT LITERACY SKILLS, IN CLASS 16 (U.S. CLS. 2, 5, 22, 23, 29, 37, 38 AND 50).

FIRST USE 3-8-2011; IN COMMERCE 4-1-2011.

OWNER OF U.S. REG. NOS. 1,844,162, 2,355,367 AND OTHERS.

NO CLAIM IS MADE TO THE EXCLUSIVE RIGHT TO USE "EARLY LEARNING" AND "ENGLISH", APART FROM THE MARK AS SHOWN.

THE MARK CONSISTS OF A STYLIZED RIBBON HAVING TWO BENDS AND BEARING THE WORDS "WATERFORD EARLY LEARNING" AND "PLAY & GROW ENGLISH".

SER. NO. 85-346,296, FILED 6-14-2011.

AISHA CLARKE, EXAMINING ATTORNEY



David J. Kybas

Director of the United States Patent and Trademark Office

United States of America

United States Patent and Trademark Office

It's Chic Again!

Reg. No. 4,098,660

Registered Feb. 14, 2012

Int. Cl.: 35

SERVICE MARK

PRINCIPAL REGISTER

IT'S CHIC AGAIN! CONSIGNMENT, LLC (VIRGINIA LIMITED LIABILITY COMPANY),
DBA IT'S CHIC AGAIN! UPSCALE CONSIGNMENT
9119 PENNY BRIDGE COURT
MIDLOTHIAN, VA 23112

FOR: ON-LINE RETAIL STORE SERVICES FEATURING CONSIGNMENT SHOES, JEWELRY, CLOTHING, HANDBAGS AND ACCESSORIES; RETAIL APPAREL STORES; RETAIL CLOTHING BOUTIQUES; RETAIL CLOTHING STORES; RETAIL CONSIGNMENT STORES FEATURING SHOES, JEWELRY, CLOTHING, HANDBAGS AND ACCESSORIES; RETAIL CONSIGNMENT STORES IN THE FIELD OF SHOES, JEWELRY, CLOTHING, HANDBAGS AND ACCESSORIES, IN CLASS 35 (U.S. CLS. 100, 101 AND 102).

FIRST USE 2-15-2010; IN COMMERCE 3-15-2010.

THE MARK CONSISTS OF "IT'S CHIC AGAIN!" WRITTEN IN THE A.R. DECODE FONT.

SER. NO. 85-346,357, FILED 6-14-2011.

REGINA DRUMMOND, EXAMINING ATTORNEY



David J. Kyros

Director of the United States Patent and Trademark Office

United States of America

United States Patent and Trademark Office

LazaDerm Skincare Centre

Reg. No. 4,098,661

LORNELL HANSEN II MD (UNITED STATES INDIVIDUAL)
5011 S. LOUISE AVENUE
SIOUX FALLS, SD 57108

Registered Feb. 14, 2012

Int. Cl.: 44

FOR: MEDICAL CLINIC SERVICES, NAMELY, FACIALS, LASER HAIR REMOVAL, SKIN TREATMENTS, NAMELY, THE INJECTION OF NEUROMUSCULAR BLOCKING AGENTS TO REDUCE THE APPEARANCE OF FACIAL LINES AND WRINKLES, MEDICAL SERVICES, HEALTH SPA SERVICES, NAMELY, LASER TREATMENTS FOR ACNE, IN CLASS 44 (U.S. CLS. 100 AND 101).

SERVICE MARK

PRINCIPAL REGISTER

FIRST USE 1-31-2004; IN COMMERCE 1-31-2004.

THE MARK CONSISTS OF STANDARD CHARACTERS WITHOUT CLAIM TO ANY PARTICULAR FONT, STYLE, SIZE, OR COLOR.

NO CLAIM IS MADE TO THE EXCLUSIVE RIGHT TO USE "SKINCARE CENTRE", APART FROM THE MARK AS SHOWN.

SER. NO. 85-346,459, FILED 6-15-2011.

ANNE E. GUSTASON, EXAMINING ATTORNEY



David J. Kybas

Director of the United States Patent and Trademark Office

United States of America

United States Patent and Trademark Office



farmhouse wares
clean | simple | comfortable

Reg. No. 4,098,662

FARMHOUSE WARES, LLC (MASSACHUSETTS LIMITED LIABILITY COMPANY)
23 CHESTNUT PLAIN ROAD
WHATELY, MA 01093

Registered Feb. 14, 2012

Int. Cl.: 35

FOR: ONLINE RETAIL STORE SERVICES FEATURING A WIDE VARIETY OF CONSUMER GOODS OF OTHERS, IN CLASS 35 (U.S. CLS. 100, 101 AND 102).

SERVICE MARK

FIRST USE 7-15-2007; IN COMMERCE 7-15-2007.

PRINCIPAL REGISTER

NO CLAIM IS MADE TO THE EXCLUSIVE RIGHT TO USE "WARES", APART FROM THE MARK AS SHOWN.

THE MARK CONSISTS OF A RUDIMENTARY DRAWING OF A HOUSE TO THE LEFT OF THE WORDS "FARMHOUSE WARES" IN DISTINCTIVE LOWER CASE FONT AND ENTIRELY BELOW THE WORD "FARMHOUSE", THE THREE WORDS "CLEAN SIMPLE COMFORTABLE" SEPARATED BY BAR DIVIDERS.

SER. NO. 85-346,470, FILED 6-15-2011.

ANNE E. GUSTASON, EXAMINING ATTORNEY



David J. Kybas

Director of the United States Patent and Trademark Office

United States of America

United States Patent and Trademark Office

Crest Savings Bank

Reg. No. 4,098,663

Registered Feb. 14, 2012

Int. Cl.: 36

SERVICE MARK

PRINCIPAL REGISTER

CREST SAVINGS BANK CORPORATION (NEW JERSEY CORPORATION), DBA CREST SAVINGS BANK
3301 PACIFIC AVENUE
WILDWOOD, NJ 08260

FOR: BANK TENDERING, NAMELY, TENDERING OF MONEY; BANKING; BANKING AND FINANCING SERVICES; BANKING CONSULTATION; BANKING SERVICES; BANKING SERVICES FEATURING THE PROVISION OF CERTIFICATES OF DEPOSIT; HOME BANKING; INVESTMENT BANKING SERVICES; ISSUANCE OF BANK CHECKS; MERCHANT BANKING AND INVESTMENT BANKING SERVICES; MERCHANT BANKING SERVICES; MORTGAGE BANKING; ON-LINE BANKING SERVICES; ON-LINE BANKING SERVICES FEATURING ELECTRONIC ALERTS THAT ALERT CREDIT AND DEBIT CARD USERS WHEN A SINGLE TRANSACTION EXCEEDS A CERTAIN AMOUNT; PROVIDING BANK ACCOUNT INFORMATION BY TELEPHONE; SAVINGS BANK SERVICES; SAVINGS BANKS; TELEPHONE BANKING SERVICES, IN CLASS 36 (U.S. CLS. 100, 101 AND 102).

FIRST USE 10-17-2000; IN COMMERCE 10-17-2000.

THE MARK CONSISTS OF STANDARD CHARACTERS WITHOUT CLAIM TO ANY PARTICULAR FONT, STYLE, SIZE, OR COLOR.

NO CLAIM IS MADE TO THE EXCLUSIVE RIGHT TO USE "SAVINGS BANK", APART FROM THE MARK AS SHOWN.

SER. NO. 85-346,515, FILED 6-15-2011.

JAMES A. RAUEN, EXAMINING ATTORNEY



David J. Kyffers

Director of the United States Patent and Trademark Office

United States of America

United States Patent and Trademark Office

THEBUS

Reg. No. 4,098,664

THEBUS ENTERTAINMENT LLC (TEXAS LIMITED LIABILITY COMPANY)
3507 WEST RIDGE LANE
MANVEL, TX 77578

Registered Feb. 14, 2012

Int. Cl.: 41

FOR: ENTERTAINMENT SERVICES, NAMELY, PRODUCTION AND DISTRIBUTION OF SPORTS-RELATED, TALK AND SOCIAL INTERACTIVE PROGRAMMING AND SHOWS BROADCAST OVER TELEVISION, INTERNET, RADIO, SATELLITE, AND LIVE, IN CLASS 41 (U.S. CLS. 100, 101 AND 107).

SERVICE MARK

PRINCIPAL REGISTER

FIRST USE 5-1-2011; IN COMMERCE 5-1-2011.

THE MARK CONSISTS OF STANDARD CHARACTERS WITHOUT CLAIM TO ANY PARTICULAR FONT, STYLE, SIZE, OR COLOR.

SER. NO. 85-346,516, FILED 6-15-2011.

JAMES A. RAUEN, EXAMINING ATTORNEY



David J. Kybas

Director of the United States Patent and Trademark Office

United States of America

United States Patent and Trademark Office

SPICE LIBRARIAN

Reg. No. 4,098,665

JULIE THOMSEN (UNITED STATES INDIVIDUAL)
507 12TH AVE. SW
AUSTIN, MN 55912

Registered Feb. 14, 2012

Int. Cl.: 21

FOR: SPICE RACKS, IN CLASS 21 (U.S. CLS. 2, 13, 23, 29, 30, 33, 40 AND 50).

TRADEMARK

FIRST USE 3-18-2011; IN COMMERCE 3-18-2011.

PRINCIPAL REGISTER

THE MARK CONSISTS OF STANDARD CHARACTERS WITHOUT CLAIM TO ANY PARTICULAR FONT, STYLE, SIZE, OR COLOR.

NO CLAIM IS MADE TO THE EXCLUSIVE RIGHT TO USE "SPICE", APART FROM THE MARK AS SHOWN.

SER. NO. 85-346,628, FILED 6-15-2011.

FRANK LATTUCA, EXAMINING ATTORNEY



David J. Kyffers

Director of the United States Patent and Trademark Office

United States of America

United States Patent and Trademark Office



Reg. No. 4,098,666

Registered Feb. 14, 2012

Int. Cl.: 41

SERVICE MARK

PRINCIPAL REGISTER

ANNOYING ORANGE, LLC (CALIFORNIA CORPORATION)
2121 GRIFFITH PARK BLVD
LOS ANGELES, CA 90039

FOR: FILM AND VIDEO PRODUCTION, IN CLASS 41 (U.S. CLS. 100, 101 AND 107).

FIRST USE 6-13-2011; IN COMMERCE 6-13-2011.

THE MARK CONSISTS OF A YELLOW GRAPEFRUIT WITH A FACE CONSISTING OF BLACK AND WHITE EYES WITH A MOUTH CONSISTING OF PINK LIPS AND PINK TONGUE WITH WHITE TEETH AND BLACK SHADING.

THE COLOR(S) YELLOW, BLACK, PINK, AND WHITE IS/ARE CLAIMED AS A FEATURE OF THE MARK.

SER. NO. 85-346,645, FILED 6-15-2011.

MARK T. MULLEN, EXAMINING ATTORNEY



David J. Kyffers

Director of the United States Patent and Trademark Office

United States of America

United States Patent and Trademark Office



Reg. No. 4,098,667

Registered Feb. 14, 2012

Int. Cl.: 6

TRADEMARK

PRINCIPAL REGISTER

GULF COAST SUPPLY & MANUFACTURING, LLC (FLORIDA LIMITED LIABILITY COMPANY)
4020 SW 449TH ST.
HORSESHOE BEACH, FL 32648

FOR: METAL ROOFING, IN CLASS 6 (U.S. CLS. 2, 12, 13, 14, 23, 25 AND 50).

FIRST USE 6-1-2011; IN COMMERCE 6-1-2011.

NO CLAIM IS MADE TO THE EXCLUSIVE RIGHT TO USE "GULF COAST SUPPLY & MANUFACTURING", APART FROM THE MARK AS SHOWN.

THE MARK CONSISTS OF THE IMAGE OF A ROOF TOP ABOVE THE STYLIZED WORDS "GULF COAST" ABOVE THE WORDS "SUPPLY & MANUFACTURING".

SER. NO. 85-346,646, FILED 6-15-2011.

SCOTT BIBB, EXAMINING ATTORNEY



David J. Kyffers

Director of the United States Patent and Trademark Office

United States of America

United States Patent and Trademark Office



Reg. No. 4,098,668

Registered Feb. 14, 2012

Int. Cl.: 41

SERVICE MARK

PRINCIPAL REGISTER

ANNOYING ORANGE, LLC (CALIFORNIA LIMITED LIABILITY COMPANY)
2121 GRIFFITH PARK BLVD
LOS ANGELES, CA 90039

FOR: FILM AND VIDEO PRODUCTION, IN CLASS 41 (U.S. CLS. 100, 101 AND 107).

FIRST USE 6-13-2011; IN COMMERCE 6-13-2011.

THE MARK CONSISTS OF A STYLIZED LEMON WITH A FACE. THE LEMON IS YELLOW AND THE EYES, MOUTH AND TEETH ARE YELLOW AND BLACK

THE COLOR(S) YELLOW AND BLACK IS/ARE CLAIMED AS A FEATURE OF THE MARK.

SER. NO. 85-346,662, FILED 6-15-2011.

MARK T. MULLEN, EXAMINING ATTORNEY



David J. Kyffers

Director of the United States Patent and Trademark Office

United States of America
United States Patent and Trademark Office

Matrax

Reg. No. 4,098,669

MATRAX, INC. (DELAWARE CORPORATION)
11748 MAYFAIR FIELD DRIVE
LUTHERVILLE, MD 21093

Registered Feb. 14, 2012

Int. Cl.: 19

FOR: NON-METAL CONSTRUCTION MATERIALS, NAMELY, MODULAR, INTERLOCKING MATS, PRIMARILY MADE OF PLASTIC COMPOSITES, USED TO CREATE TEMPORARY ROADWAYS, SITE ACCESS, AND TRAVEL SURFACES FOR VEHICLES, IN CLASS 19 (U.S. CLS. 1, 12, 33 AND 50).

TRADEMARK

PRINCIPAL REGISTER

FIRST USE 3-5-2011; IN COMMERCE 3-5-2011.

OWNER OF U.S. REG. NO. 3,967,960.

THE COLOR(S) BLACK, WHITE, AND GREEN IS/ARE CLAIMED AS A FEATURE OF THE MARK.

THE MARK CONSISTS OF THE WORD "MATRAX" IN OPEN-BOXED LETTERS, WITH THE INTERIOR OF THE LETTERS WHITE, ALL LETTERS OUTLINED IN BLACK, AND WITH A GREEN ACCENT STRIPE ACROSS THE TOP OF THE FINAL FIVE LETTERS OF THE WORD.

SER. NO. 85-346,677, FILED 6-15-2011.

DANNEAN HETZEL, EXAMINING ATTORNEY



David J. Kyffers

Director of the United States Patent and Trademark Office

United States of America

United States Patent and Trademark Office



Reg. No. 4,098,670

Registered Feb. 14, 2012

Int. Cl.: 41

SERVICE MARK

PRINCIPAL REGISTER

ANNOYING ORANGE, LLC (CALIFORNIA CORPORATION)
2121 GRIFFITH PARK BLVD
LOS ANGELES, CA 90039

FOR: FILM AND VIDEO PRODUCTION, IN CLASS 41 (U.S. CLS. 100, 101 AND 107).

FIRST USE 6-13-2011; IN COMMERCE 6-13-2011.

THE MARK CONSISTS OF A BROWN AND GREEN PASSION FRUIT WITH A FACE CONSISTING OF BLUE, WHITE AND PINK EYES WITH BLACK EYELASHES AND A MOUTH THAT HAS RED LIPS AND WHITE TEETH WITH BLACK SHADING.

THE COLOR(S) BROWN, GREEN, BLUE, RED, WHITE, PINK AND BLACK IS/ARE CLAIMED AS A FEATURE OF THE MARK.

SER. NO. 85-346,690, FILED 6-15-2011.

MARK T. MULLEN, EXAMINING ATTORNEY



David J. Kyffers

Director of the United States Patent and Trademark Office

United States of America

United States Patent and Trademark Office

LEMON HAZE ENERGY JUICE

Reg. No. 4,098,671

OMG OUTKAST MEDIA GROUP (WYOMING LIMITED LIABILITY COMPANY)
600 ANTON BLVD., SUITE 900
COSTA MESA, CA 92626

Registered Feb. 14, 2012

Int. Cl.: 32

FOR: CARBONATED AND BLENDED ENERGY DRINKS, IN CLASS 32 (U.S. CLS. 45, 46 AND 48).

TRADEMARK

FIRST USE 5-13-2011; IN COMMERCE 6-11-2011.

PRINCIPAL REGISTER

THE MARK CONSISTS OF STANDARD CHARACTERS WITHOUT CLAIM TO ANY PARTICULAR FONT, STYLE, SIZE, OR COLOR.

NO CLAIM IS MADE TO THE EXCLUSIVE RIGHT TO USE "LEMON" AND "ENERGY JUICE", APART FROM THE MARK AS SHOWN.

SER. NO. 85-346,752, FILED 6-15-2011.

RAUL CORDOVA, EXAMINING ATTORNEY



David J. Kyffers

Director of the United States Patent and Trademark Office

United States of America

United States Patent and Trademark Office



Reg. No. 4,098,672

Registered Feb. 14, 2012

Int. Cl.: 30

TRADEMARK

PRINCIPAL REGISTER

THE LOLLICAKE QUEEN, LLC (FLORIDA LIMITED LIABILITY COMPANY)
1647 BONITA LANE
SARASOTA, FL 34239

FOR: CAKES; CANDIES; CANDY; CANDY CAKE DECORATIONS; CANDY DECORATIONS FOR CAKES; CUP CAKES; EDIBLE CAKE DECORATIONS; ICE-CREAM CAKES; ICED CAKES, IN CLASS 30 (U.S. CL. 46).

FIRST USE 1-20-2011; IN COMMERCE 1-20-2011.

NO CLAIM IS MADE TO THE EXCLUSIVE RIGHT TO USE "LOLLY CAKE", APART FROM THE MARK AS SHOWN.

THE COLOR(S) PINK AND BROWN IS/ARE CLAIMED AS A FEATURE OF THE MARK.

THE MARK CONSISTS OF THE LITERAL ELEMENT "THE LOLLICAKE QUEEN" IN BROWN FONT WITH THE WORDS STACKED ON TOP OF EACH OTHER, WITH A PINK CROWN OVER THE "O" IN "LOLLICAKE".

SER. NO. 85-346,776, FILED 6-15-2011.

TRICIA SONNEBORN, EXAMINING ATTORNEY



David J. Kybas

Director of the United States Patent and Trademark Office

United States of America

United States Patent and Trademark Office

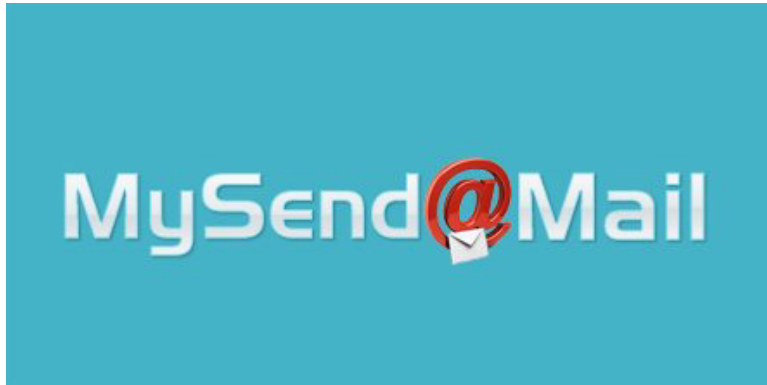

Reg. No. 4,098,673

UNO COMMUNICATIONS INC. (NEW YORK CORPORATION)
410 PARK AVENUE 15TH FLOOR
NEW YORK, NY 10022

Registered Feb. 14, 2012

Int. Cl.: 38

FOR: E-MAIL FORWARDING SERVICES, IN CLASS 38 (U.S. CLS. 100, 101 AND 104).

FIRST USE 1-1-2010; IN COMMERCE 1-1-2010.

SERVICE MARK

NO CLAIM IS MADE TO THE EXCLUSIVE RIGHT TO USE "MAIL", APART FROM THE MARK AS SHOWN.

PRINCIPAL REGISTER

THE COLOR(S) CYAN, WHITE, RED, AND BLACK IS/ARE CLAIMED AS A FEATURE OF THE MARK.

THE MARK CONSISTS OF THE WORD "MYSEND" IN WHITE EMBOSSED LETTERS, NEXT TO AN "@" SYMBOL IN RED EMBOSSED, WITH A STYLISTIC ENVELOPE DESIGN IN WHITE AND BLACK AT THE BOTTOM OF THE "@" SYMBOL, NEXT TO THE WORD, MAIL, IN WHITE EMBOSSED LETTERS; ALL AGAINST A CYAN BACKGROUND.

SER. NO. 85-346,782, FILED 6-15-2011.

MATTHEW MCDOWELL, EXAMINING ATTORNEY



David J. Kybas

Director of the United States Patent and Trademark Office

United States of America

United States Patent and Trademark Office

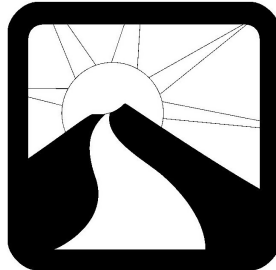

JANE'S WAY

Reg. No. 4,098,674

Registered Feb. 14, 2012

Int. Cl.: 29

TRADEMARK

PRINCIPAL REGISTER

LIEBERMAN, JANE (UNITED STATES INDIVIDUAL)
#7
13065 MINDANAO WAY
MARINA DEL REY, CA 90292

FOR: SOY CHEESE CRISPS, IN CLASS 29 (U.S. CL. 46).

FIRST USE 4-26-2011; IN COMMERCE 4-29-2011.

THE MARK CONSISTS OF A SUN AND A PATH LEADING UP TO THE SUN, AND THE TEXT "JANE'S WAY" BELOW.

SER. NO. 85-346,790, FILED 6-15-2011.

STEPHANIE ALI, EXAMINING ATTORNEY



David J. Kyffers

Director of the United States Patent and Trademark Office

United States of America

United States Patent and Trademark Office

Zinzin

Reg. No. 4,098,675

ZINZIN GROUP INC (CALIFORNIA CORPORATION)
210 STANFORD AVE.
KENSINGTON, CA 94708

Registered Feb. 14, 2012

Int. Cl.: 35

SERVICE MARK

PRINCIPAL REGISTER

FOR: ADVERTISING AGENCY SERVICES; CORPORATE IDENTITY DEVELOPMENT FOR OTHERS; NAMING AND BRANDING OF PRODUCTS AND SERVICES FOR OTHERS; MARKET RESEARCH SERVICES FOR OTHERS; CONDUCTING MARKET RESEARCH SURVEYS FOR OTHERS; MARKET ANALYSIS FOR OTHERS; DEVELOPMENT AND IMPLEMENTATION OF MARKETING STRATEGIES FOR OTHERS; CONSULTING SERVICES IN THE FIELDS OF ADVERTISING, MARKETING, CORPORATE IDENTITY DEVELOPMENT, PRODUCT BRANDING, STRATEGIC BRANDING, BRAND POSITION AND PRODUCT PROMOTION FOR OTHERS; CREATING, EVALUATING, AND MANAGING BRAND NAMES, TRADEMARKS, SERVICE MARKS AND BUSINESS NAMES FOR OTHERS; ADVERTISING AND MARKETING; BRAND IMAGERY CONSULTING SERVICES; BRANDING SERVICES, NAMELY, CONSULTING, DEVELOPMENT, MANAGEMENT AND MARKETING OF BRANDS FOR BUSINESSES; CREATIVE MARKETING DESIGN SERVICES; DESIGN OF ADVERTISING MATERIALS FOR OTHERS; ON-LINE RETAIL STORE SERVICES FEATURING A WIDE VARIETY OF CONSUMER GOODS OF OTHERS, IN CLASS 35 (U.S. CLS. 100, 101 AND 102).

FIRST USE 6-13-2011; IN COMMERCE 6-13-2011.

THE MARK CONSISTS OF STANDARD CHARACTERS WITHOUT CLAIM TO ANY PARTICULAR FONT, STYLE, SIZE, OR COLOR.

THE ENGLISH TRANSLATION OF "ZINZIN" IS "CRAZY," "CRACKED" OR "BIZARRE".

SER. NO. 85-346,833, FILED 6-15-2011.

NICHOLAS ALTREE, EXAMINING ATTORNEY



David J. Kypos

Director of the United States Patent and Trademark Office

United States of America

United States Patent and Trademark Office

GILMAN PERGAMENT LLP

Reg. No. 4,098,676

Registered Feb. 14, 2012

Int. Cl.: 45

SERVICE MARK

PRINCIPAL REGISTER

GILMAN PERGAMENT LLP (NEW JERSEY LIMITED LIABILITY PARTNERSHIP)
SUITE 204
1480 ROUTE 9 NORTH
WOODBIDGE, NJ 07095

FOR: CONSULTING IN THE FIELD OF INTELLECTUAL PROPERTY LICENSING; INTELLECTUAL PROPERTY CONSULTATION; LEGAL CONSULTATION SERVICES; LEGAL SERVICES; LEGAL SERVICES, NAMELY, INTELLECTUAL PROPERTY CONSULTING SERVICES IN THE FIELD OF IDENTIFICATION, STRATEGY, ANALYTICS, AND INVENTION; LEGAL SERVICES, NAMELY, PREPARATION OF APPLICATIONS FOR TRADEMARK REGISTRATION; LEGAL SERVICES, NAMELY, TRADEMARK MAINTENANCE SERVICES; LEGAL SERVICES, NAMELY, TRADEMARK SEARCHING AND CLEARANCE SERVICES; LICENSING OF INTELLECTUAL PROPERTY; LITIGATION CONSULTANCY; LITIGATION SERVICES; PATENT AND INDUSTRIAL PROPERTY CONSULTATION; PATENT LICENSING; PROVIDING ON-LINE INFORMATION IN THE FIELD OF INTELLECTUAL PROPERTY; PROVIDING ON-LINE INFORMATION IN THE FIELD OF INTELLECTUAL PROPERTY LEGAL SERVICES, IN CLASS 45 (U.S. CLS. 100 AND 101).

FIRST USE 3-13-2011; IN COMMERCE 3-13-2011.

THE MARK CONSISTS OF STANDARD CHARACTERS WITHOUT CLAIM TO ANY PARTICULAR FONT, STYLE, SIZE, OR COLOR.

NO CLAIM IS MADE TO THE EXCLUSIVE RIGHT TO USE "LLP", APART FROM THE MARK AS SHOWN.

SER. NO. 85-346,837, FILED 6-15-2011.

SHARON MEIER, EXAMINING ATTORNEY



David J. Kybas

Director of the United States Patent and Trademark Office

United States of America

United States Patent and Trademark Office



Reg. No. 4,098,677

Registered Feb. 14, 2012

Int. Cl.: 41

SERVICE MARK

PRINCIPAL REGISTER

MUSIC FOR ALL, INC. (ILLINOIS NON-PROFIT CORPORATION)
39 W. JACKSON PLACE, SUITE 150
INDIANAPOLIS, IN 462251011

FOR: EDUCATIONAL SERVICES, NAMELY, CONDUCTING COURSES, SEMINARS, WORKSHOPS, PROGRAMS, AND CONFERENCES AND DISTRIBUTING COURSE MATERIALS IN CONNECTION THEREWITH IN THE FIELDS OF MUSIC, MUSIC PERFORMANCE, MUSIC EDUCATION, LEADERSHIP; PROVIDING A WEBSITE FEATURING INFORMATION IN THE FIELDS OF MUSIC, MUSICAL PERFORMANCE, MUSIC EDUCATION, AND MUSIC AND MUSIC EDUCATION ADVOCACY; DEVELOPMENT AND DISSEMINATION OF EDUCATION MATERIALS IN THE FIELDS OF MUSIC, MUSIC PERFORMANCE, MUSIC EDUCATION, AND MUSIC AND MUSIC EDUCATION ADVOCACY; EDUCATIONAL AND ENTERTAINMENT SERVICES, NAMELY, CONDUCTING COURSES, SEMINARS, WORKSHOPS, PROGRAMS, AND CONFERENCES AND DISTRIBUTING COURSE MATERIALS IN CONNECTION THEREWITH IN THE FIELDS OF VISUAL ART, COLOR GUARDS, DANCE, MUSICAL PERFORMANCE, EXHIBITIONS, AND EVENTS, AND EDUCATION CONSULTING RELATED THERETO; ORGANIZING MUSICAL EVENTS; ENTERTAINMENT SERVICES, NAMELY, LIVE MUSICAL PERFORMANCES, CONTESTS, EXHIBITIONS, AND EVENTS; PRESENTATION OF LIVE SHOW PERFORMANCES; PROVISION OF INFORMATION RELATING TO MUSIC, MUSIC EDUCATION, VISUAL ART, COLOR GUARDS, DANCE, LEADERSHIP, MUSICAL PERFORMANCES, CONTESTS, EXHIBITIONS, AND EVENTS; PROVIDING A WEBSITE FEATURING INFORMATION IN THE FIELDS OF ENTERTAINMENT, VISUAL ART, COLOR GUARDS, DANCE, LEADERSHIP, MUSICAL PERFORMANCES, CONTESTS, EXHIBITIONS, AND EVENTS; DEVELOPMENT AND DISSEMINATION OF EDUCATION MATERIALS IN THE FIELDS OF VISUAL ART, COLOR GUARDS, DANCE, LEADERSHIP, MUSICAL PERFORMANCES, CONTESTS, EXHIBITIONS, AND EVENTS; PRODUCTION OF AUDIO AND AUDIOVISUAL RECORDINGS FEATURING MUSIC, VISUAL ART, COLOR GUARDS, DANCE, MUSICAL PERFORMANCES, CONTESTS, EXHIBITIONS, AND EVENTS, IN CLASS 41 (U.S. CLS. 100, 101 AND 107).



David J. Kybas

Director of the United States Patent and Trademark Office

FIRST USE 1-0-2004, THE MARK WAS FIRST USED ANYWHERE IN A DIFFERENT FORM OTHER THAN THAT SOUGHT TO BE REGISTERED AT LEAST AS EARLY AS 05/00/1995.; IN COMMERCE 1-0-2004, THE MARK WAS FIRST USED IN COMMERCE IN A DIFFERENT FORM OTHER THAN THAT SOUGHT TO BE REGISTERED AT LEAST AS EARLY AS 05/00/1995..

OWNER OF U.S. REG. NO. 2,534,324.

Reg. No. 4,098,677 THE COLOR(S) RED, GREEN AND BLUE IS/ARE CLAIMED AS A FEATURE OF THE MARK.

THE MARK CONSISTS OF HALF CIRCLE OUTLINE IN GREEN WITH A RED MUSICAL QUARTER NOTE IN THE MIDDLE ALL ABOVE THREE ROWS OF BLUE DOTS.

SER. NO. 85-346,899, FILED 6-15-2011.

SUZANNE BLANE, EXAMINING ATTORNEY

United States of America

United States Patent and Trademark Office



Reg. No. 4,098,678

ORCHARD SAUSAGES, INC. (NEW YORK CORPORATION)
340 JOHNSON AVE

Registered Feb. 14, 2012

BROOKLYN, NY 112062802

Int. Cl.: 29

FOR: DRIED MEAT; MEAT; MEAT; MEAT AND MEAT EXTRACTS; MEAT, FISH, POULTRY AND GAME; PACKAGED MEATS; PRESERVED MEATS AND SAUSAGES; SAUSAGES, IN CLASS 29 (U.S. CL. 46).

TRADEMARK

FIRST USE 8-14-1991; IN COMMERCE 3-1-2009.

PRINCIPAL REGISTER

NO CLAIM IS MADE TO THE EXCLUSIVE RIGHT TO USE "SAUSAGES, INC." AND THE NON-LATIN CHARACTERS THAT MEAN "SAUSAGES, INC.", APART FROM THE MARK AS SHOWN.

THE COLOR(S) RED, YELLOW, ORANGE, WHITE AND BLACK IS/ARE CLAIMED AS A FEATURE OF THE MARK.

THE NON-LATIN CHARACTERS IN THE MARK TRANSLITERATE TO "QI YOU LA WEI" AND THIS MEANS "ORCHARD SAUSAGES, INC." IN ENGLISH.

THE MARK CONSISTS OF A RECTANGULAR SHAPE WITH CURVED CORNERS AND SIDES WITH THE FOUR NON-LATIN CHARACTERS THAT MEAN "ORCHARD SAUSAGES, INC" CENTERED IN THE RECTANGULAR SHAPE AND THE WORDING "ORCHARD SAUSAGES INC." CENTERED BELOW THE NON-LATIN CHARACTERS. THERE IS A SCROLLING ABSTRACT CLOUD DESIGN ON THE LEFT AND RIGHT SIDES OF THE RECTANGULAR SHAPE. THE COLOR RED APPEARS IN THE NON-LATIN CHARACTERS AND THE WORDING "ORCHARD SAUSAGES INC." THE COLOR YELLOW APPEARS IN THE RECTANGLE AND THE SCROLLING CLOUD DESIGNS. THE COLOR ORANGE APPEARS IN THE CONCENTRIC LINES BORDERING THE RECTANGULAR SHAPE AND THE SHADING IN THE LEFT AND RIGHT SIDES OF THE RECTANGULAR SHAPE BEHIND THE SCROLLING CLOUD DESIGNS. THE COLOR WHITE APPEARS AROUND THE BORDER OF THE NON-LATIN CHARACTERS, AROUND THE BORDER OF THE WORDING "ORCHARD SAUSAGES INC.", IN THE RECTANGLE BEHIND THE LETTERS "ARD SAUSAGE" IN THE WORDING "ORCHARD SAUSAGES" AND IN THE TOP AND BOTTOM PORTIONS OF THE BORDER OF THE RECTANGULAR SHAPE. THE COLOR BLACK APPEARS IN THE BORDER OF THE RECTANGULAR SHAPE AND IN THE SHADOWING AROUND THE LETTERS IN THE WORDING "ORCHARD SAUSAGES INC."



David J. Kyjars

Director of the United States Patent and Trademark Office

Reg. No. 4,098,678 SER. NO. 85-346,917, FILED 6-15-2011.

TINA BROWN, EXAMINING ATTORNEY

United States of America

United States Patent and Trademark Office



Reg. No. 4,098,679

Registered Feb. 14, 2012

Int. Cl.: 29

TRADEMARK

PRINCIPAL REGISTER

MSEAFOOD (CALIFORNIA CORPORATION)
17934 POINT SUR STREET
FOUNTAIN VALLEY, CA 92708

FOR: FROZEN SEAFOOD, IN CLASS 29 (U.S. CL. 46).

FIRST USE 12-1-2002; IN COMMERCE 12-1-2002.

NO CLAIM IS MADE TO THE EXCLUSIVE RIGHT TO USE "SEAFOOD", APART FROM THE MARK AS SHOWN.

THE MARK CONSISTS OF A CAPITAL "M" FOLLOWED BY THE TEXT "SEAFOOD" AND A STYLIZED WAVE.

SER. NO. 85-346,970, FILED 6-15-2011.

JASON TURNER, EXAMINING ATTORNEY



David J. Kybas

Director of the United States Patent and Trademark Office

United States of America

United States Patent and Trademark Office

Kensington Farms

Reg. No. 4,098,680

C.H. ROBINSON WORLDWIDE, INC. (DELAWARE CORPORATION)
14701 CHARLSON ROAD
EDEN PRAIRIE, MN 55347

Registered Feb. 14, 2012

Int. Cl.: 31

FOR: FRESH VEGETABLES, NAMELY, GREEN BEANS, ASPARAGUS AND SNOW PEAS,
IN CLASS 31 (U.S. CLS. 1 AND 46).

TRADEMARK

FIRST USE 1-1-2009; IN COMMERCE 1-1-2009.

PRINCIPAL REGISTER

THE MARK CONSISTS OF STANDARD CHARACTERS WITHOUT CLAIM TO ANY PARTICULAR FONT, STYLE, SIZE, OR COLOR.

OWNER OF U.S. REG. NO. 2,982,230.

NO CLAIM IS MADE TO THE EXCLUSIVE RIGHT TO USE "FARMS", APART FROM THE MARK AS SHOWN.

SER. NO. 85-346,991, FILED 6-15-2011.

JENNY PARK, EXAMINING ATTORNEY



David J. Kyffers

Director of the United States Patent and Trademark Office

United States of America

United States Patent and Trademark Office



Reg. No. 4,098,681

Registered Feb. 14, 2012

Int. Cl.: 37

SERVICE MARK

PRINCIPAL REGISTER

MAGIC PEST MANAGEMENT LLC (NEW YORK LIMITED LIABILITY COMPANY)
5901 KISSENA BLVD
FLUSHING, NY 11355

FOR: EXTERMINATING CONSULTATION; PEST CONTROL; PEST CONTROL AND EXTERMINATION OTHER THAN FOR AGRICULTURAL PURPOSES; TERMITE AND PEST CONTROL; VERMIN EXTERMINATING; VERMIN EXTERMINATION OTHER THAN FOR AGRICULTURE, IN CLASS 37 (U.S. CLS. 100, 103 AND 106).

FIRST USE 1-1-2009; IN COMMERCE 1-1-2009.

THE MARK CONSISTS OF A STYLIZED STANDING MAN. ONE HAND IS OUTSTRETCHED TO THE SIDE. THE OTHER HAND IS RAISED OVER HIS HEAD. THE HAND OVER HIS HEAD IS BALANCING A GLOBE/BALL.

SER. NO. 85-347,004, FILED 6-15-2011.

SHANNON TWOHIG, EXAMINING ATTORNEY



David J. Kyffers

Director of the United States Patent and Trademark Office

United States of America

United States Patent and Trademark Office



Reg. No. 4,098,682

Registered Feb. 14, 2012

Int. Cls.: 35, 36 and 45

CHINA SOLUTIONS LLC (NEW YORK LIMITED LIABILITY COMPANY)
ATTN: NESTOR GOUNARIS
169 EAST 78TH STREET
NEW YORK, NY 10075

FOR: BUSINESS CONSULTATION, IN CLASS 35 (U.S. CLS. 100, 101 AND 102).

SERVICE MARK

FIRST USE 1-1-2010; IN COMMERCE 1-1-2010.

PRINCIPAL REGISTER

FOR: BUSINESS BROKERAGE, IN CLASS 36 (U.S. CLS. 100, 101 AND 102).

FIRST USE 1-1-2010; IN COMMERCE 1-1-2010.

FOR: LEGAL CONSULTATION SERVICES, IN CLASS 45 (U.S. CLS. 100 AND 101).

FIRST USE 1-1-2010; IN COMMERCE 1-1-2010.

THE MARK CONSISTS OF A LIGHTHOUSE WITH LIGHT EMANATING TOWARDS THE LEFT AND RIGHT, WITH ASIAN MOTIF WAVES ROILING AT THE BASE OF THE LIGHTHOUSE. THE ENTIRE SCENE OF THE LIGHTHOUSE, LIGHT AND WAVES IS SET IN A CIRCLE THAT IS FRAMED BY TWO VERY NARROW RINGS.

SER. NO. 85-347,025, FILED 6-15-2011.

JENNY PARK, EXAMINING ATTORNEY



David J. Kybas

Director of the United States Patent and Trademark Office

United States of America

United States Patent and Trademark Office

THE INSPIRER

Reg. No. 4,098,683

Registered Feb. 14, 2012

Int. Cl.: 41

SERVICE MARK

PRINCIPAL REGISTER

CATHY CIULLO ENTERPRISES, INC. (FLORIDA CORPORATION)
13574 VILLAGE PARK DRIVE, SUITE 220
ORLANDO, FL 32837

FOR: ON-LINE ELECTRONIC NEWSLETTERS DELIVERED BY E-MAIL FEATURING STORIES RELATING TO SURVIVORS OF HEALTH CONDITIONS AND HARDSHIPS; ON-LINE JOURNALS, NAMELY, BLOGS FEATURING STORIES RELATING TO SURVIVORS OF HEALTH CONDITIONS AND HARDSHIP ISSUES AND VOLUNTEERS FOR THOSE WITH HEALTH CONDITIONS AND HARDSHIP ISSUES; PROVIDING ON-LINE NEWSLETTERS IN THE FIELD OF OVERCOMING HEALTH CONDITIONS AND HARDSHIPS; PUBLISHING OF ELECTRONIC PUBLICATIONS, IN CLASS 41 (U.S. CLS. 100, 101 AND 107).

FIRST USE 5-1-2011; IN COMMERCE 5-1-2011.

THE MARK CONSISTS OF STANDARD CHARACTERS WITHOUT CLAIM TO ANY PARTICULAR FONT, STYLE, SIZE, OR COLOR.

OWNER OF U.S. REG. NO. 3,990,314.

SER. NO. 85-347,030, FILED 6-15-2011.

JENNY PARK, EXAMINING ATTORNEY



David J. Kyffers

Director of the United States Patent and Trademark Office

United States of America

United States Patent and Trademark Office



Reg. No. 4,098,684

PLANETAIR TURF PRODUCTS, LLC (MINNESOTA LIMITED LIABILITY COMPANY)
1065 24TH AVE. SW
OWATONNA, MN 55060

Registered Feb. 14, 2012

Int. Cl.: 7

FOR: TURF CARE EQUIPMENT, NAMELY, AERATORS, IN CLASS 7 (U.S. CLS. 13, 19, 21, 23, 31, 34 AND 35).

TRADEMARK

FIRST USE 1-0-2011; IN COMMERCE 1-0-2011.

PRINCIPAL REGISTER

OWNER OF U.S. REG. NO. 2,609,348.

THE COLOR(S) MEDIUM GREEN, DARK GREEN, LIGHT GREEN, BLUE AND WHITE IS/ARE CLAIMED AS A FEATURE OF THE MARK.

THE MARK CONSISTS OF A CIRCLE WITH A DARK GREEN AND MEDIUM GREEN BORDER ON A DARK GREEN BACKGROUND AND A LANDSCAPE INSIDE THE CIRCLE DEPICTING BLUE SKY AND LIGHT GREEN AND DARK GREEN GRASS OVERLAID WITH THE STYLIZED WORD "PLANETAIR" IN WHITE LETTERS.

SER. NO. 85-347,041, FILED 6-15-2011.

DANNEAN HETZEL, EXAMINING ATTORNEY



David J. Kyffers

Director of the United States Patent and Trademark Office

United States of America

United States Patent and Trademark Office

CAP-PACK

Reg. No. 4,098,685

CAP-PACK TRUCK PRODUCTS LLC (WISCONSIN LIMITED LIABILITY COMPANY)
340 BRIDGE STREET
BURLINGTON, WI 53105

Registered Feb. 14, 2012

Int. Cl.: 12

FOR: VEHICLE STORAGE ORGANIZERS MOUNTED IN THE REAR OF LAND VEHICLES
COMPOSED OF RACKS AND STORAGE DRAWERS, IN CLASS 12 (U.S. CLS. 19, 21, 23, 31,
35 AND 44).

TRADEMARK

FIRST USE 11-1-2010; IN COMMERCE 11-1-2010.

PRINCIPAL REGISTER

THE MARK CONSISTS OF STANDARD CHARACTERS WITHOUT CLAIM TO ANY PAR-
TICULAR FONT, STYLE, SIZE, OR COLOR.

SER. NO. 85-347,105, FILED 6-15-2011.

CHRISTOPHER BUONGIORNO, EXAMINING ATTORNEY



David J. Kyffers

Director of the United States Patent and Trademark Office

United States of America

United States Patent and Trademark Office

QUICKGIFTS

Reg. No. 4,098,686

Registered Feb. 14, 2012

Int. Cl.: 35

SERVICE MARK

PRINCIPAL REGISTER

QGAC, INC. (TEXAS CORPORATION)
SUITE 300
3701 NORTH LAMAR
AUSTIN, TX 78705

FOR: ONLINE RETAIL STORE SERVICES SPECIALIZING IN GIFT CARDS, GIFT VOUCHERS AND STORE CURRENCY OF OTHERS, IN CLASS 35 (U.S. CLS. 100, 101 AND 102).

FIRST USE 0-0-1997; IN COMMERCE 0-0-1997.

THE MARK CONSISTS OF STANDARD CHARACTERS WITHOUT CLAIM TO ANY PARTICULAR FONT, STYLE, SIZE, OR COLOR.

SER. NO. 85-347,115, FILED 6-15-2011.

ESTHER BELENKER, EXAMINING ATTORNEY



David J. Kybas

Director of the United States Patent and Trademark Office

United States of America

United States Patent and Trademark Office

ONELINK

Reg. No. 4,098,687

Registered Feb. 14, 2012

Int. Cl.: 35

SERVICE MARK

PRINCIPAL REGISTER

QGAC, INC. (TEXAS CORPORATION)
SUITE 300
3701 NORTH LAMAR
AUSTIN, TX 78705

FOR: ONLINE PROMOTIONAL SERVICES, NAMELY, PROMOTING AND ADVERTISING THE GIFT CARDS, GIFT VOUCHERS AND STORE CURRENCY OF OTHERS; ONLINE RETAIL STORE SERVICES FEATURING THE GIFT CARDS, GIFT VOUCHERS AND STORE CURRENCY OF OTHERS, IN CLASS 35 (U.S. CLS. 100, 101 AND 102).

FIRST USE 7-0-2007; IN COMMERCE 7-0-2007.

THE MARK CONSISTS OF STANDARD CHARACTERS WITHOUT CLAIM TO ANY PARTICULAR FONT, STYLE, SIZE, OR COLOR.

SER. NO. 85-347,190, FILED 6-15-2011.

ESTHER BELENKER, EXAMINING ATTORNEY



David J. Kyffers

Director of the United States Patent and Trademark Office

United States of America

United States Patent and Trademark Office

PR2 Racing

Reg. No. 4,098,688

PRECISION R2 LLC (PENNSYLVANIA LIMITED LIABILITY COMPANY)
2509 GETTYSBURG ROAD
CAMP HILL, PA 17011

Registered Feb. 14, 2012

Int. Cl.: 12

FOR: MOTORIZED DIRT BIKES FOR MOTOCROSS, IN CLASS 12 (U.S. CLS. 19, 21, 23, 31, 35 AND 44).

TRADEMARK

FIRST USE 1-1-1996; IN COMMERCE 1-1-1996.

PRINCIPAL REGISTER

THE MARK CONSISTS OF STANDARD CHARACTERS WITHOUT CLAIM TO ANY PARTICULAR FONT, STYLE, SIZE, OR COLOR.

NO CLAIM IS MADE TO THE EXCLUSIVE RIGHT TO USE "RACING", APART FROM THE MARK AS SHOWN.

SER. NO. 85-347,251, FILED 6-15-2011.

DOUGLAS LEE, EXAMINING ATTORNEY



David J. Kyffers

Director of the United States Patent and Trademark Office

United States of America

United States Patent and Trademark Office

TOME

Reg. No. 4,098,689

Registered Feb. 14, 2012

Int. Cl.: 25

TRADEMARK

PRINCIPAL REGISTER

SOVEREIGN CREATIVE GROUP LLC (NEW YORK LIMITED LIABILITY COMPANY)
SUITE 403A
195 CHRYSTIE STREET
NEW YORK, NY 10002

FOR: CLOTHING FOR WOMEN, NAMELY, COATS, CAPES, OVERCOATS, RAINCOATS, JACKETS, BLAZERS, SPORT COATS, DRESSES, EVENING GOWNS, SKIRTS, PANTS, SLACKS, JEANS, SWEATERS, JERSEYS, TOPS, BLOUSES, TUNICS, TANK TOPS, PANTIES, LINGERIE, BRASSIERES, CAMISOLES, SLIPS, LOUNGE WEAR, NIGHTGOWNS, NEGLIGES, ROBES, PAJAMAS, HOSIERY, TIGHTS, STOCKINGS, KNEE HIGHS, LEGGINGS, LEG WARMERS, SOCKS, HEAD WEAR, HATS, CAPS, HOODS, HEADBANDS, WRISTBANDS, SCARVES, SHAWLS, GLOVES, MITTENS, BELTS, SASHES, SWIMWEAR, BEACHWEAR, SARONGS, SKI WEAR, IN CLASS 25 (U.S. CLS. 22 AND 39).

FIRST USE 4-1-2011; IN COMMERCE 6-10-2011.

THE MARK CONSISTS OF THE STYLIZED WORD "TOME".

SER. NO. 85-347,275, FILED 6-15-2011.

DOUGLAS LEE, EXAMINING ATTORNEY



David J. Kyffers

Director of the United States Patent and Trademark Office

United States of America

United States Patent and Trademark Office

GET Z'D

Reg. No. 4,098,690

Registered Feb. 14, 2012

Int. Cl.: 41

SERVICE MARK

PRINCIPAL REGISTER

ROBERT W. CABELL (UNITED STATES INDIVIDUAL)
APT. 4-D
216 W. 102ND STREET
NEW YORK, NY 10025

FOR: ENTERTAINMENT IN THE NATURE OF THEATER PRODUCTIONS; MOTION PICTURE FILM PRODUCTION; PROVIDING ON-LINE MAGAZINES IN THE FIELD OF THEATRICAL PRODUCTIONS; CONSULTING SERVICES IN THE FIELD OF FILM, VIDEO, MUSIC PRODUCTION; CONSULTING SERVICES FOR THEATER PERFORMANCES, VIDEO AND FILM CONCEPT AND SCRIPT DEVELOPMENT, IN CLASS 41 (U.S. CLS. 100, 101 AND 107).

FIRST USE 4-1-1999; IN COMMERCE 4-1-1999.

THE MARK CONSISTS OF STANDARD CHARACTERS WITHOUT CLAIM TO ANY PARTICULAR FONT, STYLE, SIZE, OR COLOR.

SER. NO. 85-347,342, FILED 6-15-2011.

CARYN GLASSER, EXAMINING ATTORNEY



David J. Kyffers

Director of the United States Patent and Trademark Office

United States of America

United States Patent and Trademark Office

ILIA

Reg. No. 4,098,691

Registered Feb. 14, 2012

Int. Cls.: 3 and 35

TRADEMARK

SERVICE MARK

PRINCIPAL REGISTER

ILIA COSMETICS, INC. (CANADA CORPORATION)
8835 LAWRENCE WAY
WEST VANCOUVER, BC, CANADA V7W2T7

FOR: COSMETIC LIP PRODUCTS, NAMELY, TINTED LIP CONDITIONERS, LIP EXFOLIATORS, LIPSTICKS, LIP GLOSS, AND LIP SHIMMERS, IN CLASS 3 (U.S. CLS. 1, 4, 6, 50, 51 AND 52).

FIRST USE 5-0-2011; IN COMMERCE 5-0-2011.

FOR: ONLINE RETAIL STORE SERVICES FEATURING COSMETICS, IN CLASS 35 (U.S. CLS. 100, 101 AND 102).

FIRST USE 5-30-2011; IN COMMERCE 5-30-2011.

THE MARK CONSISTS OF STANDARD CHARACTERS WITHOUT CLAIM TO ANY PARTICULAR FONT, STYLE, SIZE, OR COLOR.

SER. NO. 85-347,378, FILED 6-15-2011.

ANGELA DUONG, EXAMINING ATTORNEY



David J. Kybas

Director of the United States Patent and Trademark Office

United States of America

United States Patent and Trademark Office

Wow Wow Waffle

Reg. No. 4,098,692

TODD CASSELBERRY (UNITED STATES INDIVIDUAL), DBA WOW WOW WAFFLE
930 DOMAIN WAY
REDDING, CA 96003

Registered Feb. 14, 2012

Int. Cl.: 30

FOR: FROZEN FLOUR-FREE FOODS, NAMELY, WAFFLES, PANCAKES, CREPES, SANDWICH WRAPS, MUFFINS AND GRIDDLE CAKE SANDWICHES WHICH ARE PROTEIN-ENRICHED; WAFFLES, IN CLASS 30 (U.S. CL. 46).

TRADEMARK

FIRST USE 3-10-2011; IN COMMERCE 4-4-2011.

PRINCIPAL REGISTER

THE MARK CONSISTS OF STANDARD CHARACTERS WITHOUT CLAIM TO ANY PARTICULAR FONT, STYLE, SIZE, OR COLOR.

NO CLAIM IS MADE TO THE EXCLUSIVE RIGHT TO USE "WAFFLE", APART FROM THE MARK AS SHOWN.

SER. NO. 85-347,398, FILED 6-15-2011.

RONALD DELGIZZI, EXAMINING ATTORNEY



David J. Kyffers

Director of the United States Patent and Trademark Office

United States of America

United States Patent and Trademark Office

HOUSE OF SHAKTI

Reg. No. 4,098,693

HOUSE OF SHAKTI, LLC. (NEVADA LIMITED LIABILITY COMPANY)
355 S. PECK DRIVE
BEVERLY HILLS, CA 90212

Registered Feb. 14, 2012

Int. Cl.: 14

FOR: GEMSTONE JEWELRY, BRACELETS, CHARMS, GEMSTONES, NECKLACES, EARRINGS, KEY CHAINS AS JEWELRY, IN CLASS 14 (U.S. CLS. 2, 27, 28 AND 50).

TRADEMARK

FIRST USE 1-1-2008; IN COMMERCE 3-1-2009.

PRINCIPAL REGISTER

THE MARK CONSISTS OF STANDARD CHARACTERS WITHOUT CLAIM TO ANY PARTICULAR FONT, STYLE, SIZE, OR COLOR.

THE ENGLISH TRANSLATION OF "SHAKTI" IN THE MARK IS "ENERGY".

SER. NO. 85-347,408, FILED 6-15-2011.

ANDREW RHIM, EXAMINING ATTORNEY



David J. Kyffers

Director of the United States Patent and Trademark Office

United States of America

United States Patent and Trademark Office

Southern Angler

Reg. No. 4,098,694

MCPOW, LLC (FLORIDA LIMITED LIABILITY COMPANY)
4695 SE DIXIE HIGHWAY
STUART, FL 34997

Registered Feb. 14, 2012

Int. Cl.: 35

FOR: RETAIL STORE AND ON-LINE RETAIL STORE SERVICES FEATURING FISHING-RELATED TACKLE, EQUIPMENT, ACCESSORIES, APPAREL, AND SUNGLASSES, IN CLASS 35 (U.S. CLS. 100, 101 AND 102).

SERVICE MARK

FIRST USE 11-15-1991; IN COMMERCE 11-15-1991.

PRINCIPAL REGISTER

THE MARK CONSISTS OF STANDARD CHARACTERS WITHOUT CLAIM TO ANY PARTICULAR FONT, STYLE, SIZE, OR COLOR.

NO CLAIM IS MADE TO THE EXCLUSIVE RIGHT TO USE "ANGLER", APART FROM THE MARK AS SHOWN.

SER. NO. 85-347,651, FILED 6-16-2011.

DOUGLAS LEE, EXAMINING ATTORNEY



David J. Kyffers

Director of the United States Patent and Trademark Office

United States of America
United States Patent and Trademark Office

Actino-Iron

Reg. No. 4,098,695

Registered Feb. 14, 2012

Int. Cl.: 5

TRADEMARK

PRINCIPAL REGISTER

NATURAL INDUSTRIES, INC. (US VIRGIN ISLANDS CORPORATION)
6223 THEALL RD
6223 THELL RD
HOUSTON, TX 77066

FOR: BIOLOGICAL FUNGICIDES CONTAINING IRON, IN CLASS 5 (U.S. CLS. 6, 18, 44, 46, 51 AND 52).

FIRST USE 1-1-1998; IN COMMERCE 1-1-1998.

THE MARK CONSISTS OF STANDARD CHARACTERS WITHOUT CLAIM TO ANY PARTICULAR FONT, STYLE, SIZE, OR COLOR.

SER. NO. 85-347,717, FILED 6-16-2011.

BARBARA RUTLAND, EXAMINING ATTORNEY



David J. Kybas

Director of the United States Patent and Trademark Office

United States of America

United States Patent and Trademark Office

MOUTH OF THE MIDWEST

Reg. No. 4,098,696

Registered Feb. 14, 2012

Int. Cl.: 41

SERVICE MARK

PRINCIPAL REGISTER

IOWA INDEPENDENT SPORTS SYNDICATORS, LLC (IOWA LIMITED LIABILITY COMPANY)
809 75TH STREET
WEST DES MOINES, IA 50266

FOR: ENTERTAINMENT AND EDUCATIONAL SERVICES, NAMELY, THE PRESENTATION OF ONGOING RADIO TALK SHOWS IN THE FIELD OF PUBLIC INTEREST CONCERNING SPORTS, IN CLASS 41 (U.S. CLS. 100, 101 AND 107).

FIRST USE 6-20-2009; IN COMMERCE 6-20-2009.

THE MARK CONSISTS OF STANDARD CHARACTERS WITHOUT CLAIM TO ANY PARTICULAR FONT, STYLE, SIZE, OR COLOR.

NO CLAIM IS MADE TO THE EXCLUSIVE RIGHT TO USE "MIDWEST", APART FROM THE MARK AS SHOWN.

SER. NO. 85-347,791, FILED 6-16-2011.

MICHAEL WIENER, EXAMINING ATTORNEY



David J. Kyffers

Director of the United States Patent and Trademark Office

United States of America

United States Patent and Trademark Office

SwitchtoClean.com

Reg. No. 4,098,697

SWITCHTOCLEAN, LLC (D.C. LIMITED LIABILITY COMPANY)

Registered Feb. 14, 2012

#3810
355 E. OHIO
CHICAGO, IL 60611

Int. Cl.: 35

SERVICE MARK

FOR: RETAIL ELECTRICITY PROVIDER SERVICES, NAMELY, PROVIDING A SERVICE THAT ALLOWS CUSTOMERS TO PURCHASE ENERGY, NAMELY, ELECTRICITY, AND RENEWABLE ENERGY, IN CLASS 35 (U.S. CLS. 100, 101 AND 102).

PRINCIPAL REGISTER

FIRST USE 4-19-2011; IN COMMERCE 4-19-2011.

NO CLAIM IS MADE TO THE EXCLUSIVE RIGHT TO USE ".COM", APART FROM THE MARK AS SHOWN.

THE COLOR(S) BLACK, DARK NAVY AND SKY BLUE IS/ARE CLAIMED AS A FEATURE OF THE MARK.

THE MARK CONSISTS OF THE STYLIZED WORDING "SWITCHTOCLEAN.COM". THE ".COM" PORTION IS ARRANGED VERTICALLY, READ FROM TOP TO BOTTOM. THE WORDS "SWITCH" AND ".COM" ARE IN BLACK TYPE; THE WORD "TO" IS IN DARK NAVY TYPE; AND, THE WORD "CLEAN" IS IN SKY BLUE TYPE. ACROSS THE TOP OF THE TEXT IS AN ARC THAT BEGINS IN BLACK AS THE DOT OF THE "I" IN THE WORD "SWITCH" AND FADES ACROSS THE BLUE SPECTRUM TO REACH A SKY BLUE COLOR OVER THE "A" IN THE WORD "CLEAN".

SER. NO. 85-348,051, FILED 6-16-2011.

KIM SAITO, EXAMINING ATTORNEY



David J. Kybas

Director of the United States Patent and Trademark Office

United States of America

United States Patent and Trademark Office

Infomax Collection System

Reg. No. 4,098,698

Registered Feb. 14, 2012

Int. Cl.: 36

SERVICE MARK

PRINCIPAL REGISTER

C2C RESOURCES, LLC (LOUISIANA LIMITED LIABILITY COMPANY)
SUITE 100
56 PERIMETER CENTER WEST
ATLANTA, GA 30346

FOR: DEBT COLLECTION SERVICES, IN CLASS 36 (U.S. CLS. 100, 101 AND 102).

FIRST USE 6-1-2002; IN COMMERCE 6-1-2002.

THE MARK CONSISTS OF STANDARD CHARACTERS WITHOUT CLAIM TO ANY PARTICULAR FONT, STYLE, SIZE, OR COLOR.

NO CLAIM IS MADE TO THE EXCLUSIVE RIGHT TO USE "COLLECTION SYSTEM", APART FROM THE MARK AS SHOWN.

SER. NO. 85-348,152, FILED 6-16-2011.

REBECCA SMITH, EXAMINING ATTORNEY



David J. Kyffers

Director of the United States Patent and Trademark Office

United States of America

United States Patent and Trademark Office

Profit Maximizer

Reg. No. 4,098,699

Registered Feb. 14, 2012

Int. Cl.: 36

SERVICE MARK

PRINCIPAL REGISTER

C2C RESOURCES, LLC (LOUISIANA LIMITED LIABILITY COMPANY)
SUITE 100
56 PERIMETER CENTER WEST
ATLANTA, GA 30346

FOR: DEBT COLLECTION SERVICES, IN CLASS 36 (U.S. CLS. 100, 101 AND 102).

FIRST USE 6-1-2002; IN COMMERCE 6-1-2002.

THE MARK CONSISTS OF STANDARD CHARACTERS WITHOUT CLAIM TO ANY PARTICULAR FONT, STYLE, SIZE, OR COLOR.

NO CLAIM IS MADE TO THE EXCLUSIVE RIGHT TO USE "PROFIT", APART FROM THE MARK AS SHOWN.

SER. NO. 85-348,158, FILED 6-16-2011.

REBECCA SMITH, EXAMINING ATTORNEY



David J. Kyffers

Director of the United States Patent and Trademark Office

United States of America

United States Patent and Trademark Office

C2C Resources

Reg. No. 4,098,700

Registered Feb. 14, 2012

Int. Cl.: 36

SERVICE MARK

PRINCIPAL REGISTER

C2C RESOURCES, LLC (LOUISIANA LIMITED LIABILITY COMPANY)
SUITE 100
56 PERIMETER CENTER WEST
ATLANTA, GA 30346

FOR: DEBT COLLECTION SERVICES, IN CLASS 36 (U.S. CLS. 100, 101 AND 102).

FIRST USE 6-1-2002; IN COMMERCE 6-1-2002.

THE MARK CONSISTS OF STANDARD CHARACTERS WITHOUT CLAIM TO ANY PARTICULAR FONT, STYLE, SIZE, OR COLOR.

NO CLAIM IS MADE TO THE EXCLUSIVE RIGHT TO USE "RESOURCES", APART FROM THE MARK AS SHOWN.

SER. NO. 85-348,166, FILED 6-17-2011.

REBECCA SMITH, EXAMINING ATTORNEY



David J. Kyffers

Director of the United States Patent and Trademark Office

United States of America

United States Patent and Trademark Office

CELLBUSTERS

Reg. No. 4,098,701

FORDE, DEREK N. (ARIZONA SOLE PROPRIETORSHIP), DBA CELLBUSTERS
3240 E. HIDDENVIEW DRIVE

Registered Feb. 14, 2012

PHOENIX, AZ 85048

Int. Cl.: 9

FOR: CELLULAR PHONE USAGE DETECTION SYSTEM COMPRISING A CAMERA AND A MOBILE PHONE SIGNAL RECEIVING DEVICE, IN CLASS 9 (U.S. CLS. 21, 23, 26, 36 AND 38).

TRADEMARK

FIRST USE 11-12-1999; IN COMMERCE 11-29-1999.

PRINCIPAL REGISTER

THE MARK CONSISTS OF STANDARD CHARACTERS WITHOUT CLAIM TO ANY PARTICULAR FONT, STYLE, SIZE, OR COLOR.

SER. NO. 85-348,172, FILED 6-16-2011.

JAMES MACFARLANE, EXAMINING ATTORNEY



David J. Kyffers

Director of the United States Patent and Trademark Office

United States of America

United States Patent and Trademark Office

Sophias Style.com

Reg. No. 4,098,702

Registered Feb. 14, 2012

Int. Cl.: 35

SERVICE MARK

PRINCIPAL REGISTER

SOPHIA'S STYLE BOUTIQUE, INC (NEBRASKA CORPORATION)
SUITE 100
14808 SHEPARD STREET
OMAHA, NE 68138

FOR: ON-LINE RETAIL STORE SERVICES FEATURING CHILDREN'S APPAREL AND WOMEN'S MATERNITY WEAR, MADE IN WHOLE OR IN SIGNIFICANT PART OF ARTIFICIAL, SYNTHETIC, OR COTTON FABRICS AND MATERIALS OR COMBINATIONS THEREOF AND NOT INCLUDING CASHMERE, AND ACCESSORIES, BABY GEAR, TOYS, AND GIFTS, IN CLASS 35 (U.S. CLS. 100, 101 AND 102).

FIRST USE 0-0-2003; IN COMMERCE 0-0-2003.

THE MARK CONSISTS OF STANDARD CHARACTERS WITHOUT CLAIM TO ANY PARTICULAR FONT, STYLE, SIZE, OR COLOR.

NO CLAIM IS MADE TO THE EXCLUSIVE RIGHT TO USE "STYLE.COM", APART FROM THE MARK AS SHOWN.

SER. NO. 85-348,244, FILED 6-16-2011.

CORY BOONE, EXAMINING ATTORNEY



David J. Kyffers

Director of the United States Patent and Trademark Office

United States of America

United States Patent and Trademark Office



Reg. No. 4,098,703

Registered Feb. 14, 2012

Int. Cl.: 43

SERVICE MARK

PRINCIPAL REGISTER

BURTON, JASON (UNITED STATES INDIVIDUAL), DBA CHUPACABRA CANTINA
7601 SHELTON ROAD
AUSTIN, TX 78725

FOR: RESTAURANT, BAR AND CATERING SERVICES, IN CLASS 43 (U.S. CLS. 100 AND 101).

FIRST USE 9-27-2006; IN COMMERCE 6-1-2009.

THE MARK CONSISTS OF THE WORD "CHUPACABRA" ABOVE THE DESIGN OF A GOAT HOLDING A SOMBRERO-STYLE HAT SURROUNDED BY FOUR CACTUSES.

THE ENGLISH TRANSLATION OF "CHUPACABRA" IN THE MARK IS "GOAT SUCKER".

SER. NO. 85-348,270, FILED 6-16-2011.

SHANNON TWOHIG, EXAMINING ATTORNEY



David J. Kyffers

Director of the United States Patent and Trademark Office

United States of America

United States Patent and Trademark Office

NESTEGG
wealth

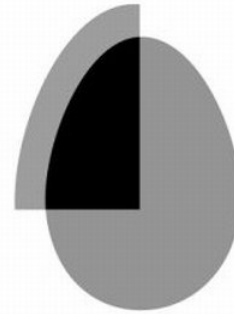

Reg. No. 4,098,704

NESTEGG WEALTH, INC. (DELAWARE CORPORATION)
113 WEST 75TH STREET, SUITE 2C
NEW YORK, NY 10023

Registered Feb. 14, 2012

Int. Cl.: 42

FOR: PROVIDING A WEBSITE FEATURING ONLINE NON-DOWNLOADABLE SOFTWARE THAT ENABLES USERS TO AGGREGATE PORTFOLIO INFORMATION AND GENERATE DIVERSIFICATION RECOMMENDATIONS FOR LONG-TERM FINANCIAL PLANNING, IN CLASS 42 (U.S. CLS. 100 AND 101).

SERVICE MARK

PRINCIPAL REGISTER

FIRST USE 6-13-2011, THE MARK WAS FIRST USED ANYWHERE IN A DIFFERENT FORM OTHER THAN THAT SOUGHT TO BE REGISTERED AT LEAST AS EARLY AS 04/30/2010.; IN COMMERCE 6-16-2011, THE MARK WAS FIRST USED IN COMMERCE IN A DIFFERENT FORM OTHER THAN THAT SOUGHT TO BE REGISTERED AT LEAST AS EARLY AS 04/30/2010..

NO CLAIM IS MADE TO THE EXCLUSIVE RIGHT TO USE "NEST EGG WEALTH", APART FROM THE MARK AS SHOWN.

THE MARK CONSISTS OF THE WORDING "NEST EGG" ABOVE THE WORD "WEALTH", ALL TO THE LEFT OF DESIGNS. THE DESIGN FEATURES A SHADED QUARTER OF AN OVAL SUPERIMPOSED OVER THE TOP LEFT PORTION OF A FULL EGG-SHAPED OVAL. THE SHADING IS DARKER WHERE THE TWO SHAPES OVERLAP, AND THE OVERALL DESIGN RESEMBLES A PIE CHART.



SER. NO. 85-348,275, FILED 6-16-2011.

CORY BOONE, EXAMINING ATTORNEY

David J. Kybas

Director of the United States Patent and Trademark Office

United States of America

United States Patent and Trademark Office

VOLR^R SALON

Reg. No. 4,098,705

TRINIFRAGOZO, LLC (ARIZONA LIMITED LIABILITY COMPANY)
1001 N. 3RD AVE., SUITE 5
PHOENIX, AZ 85003

Registered Feb. 14, 2012

Int. Cl.: 44

FOR: HAIR SALON SERVICES, IN CLASS 44 (U.S. CLS. 100 AND 101).

SERVICE MARK

FIRST USE 5-10-2011; IN COMMERCE 5-10-2011.

PRINCIPAL REGISTER

NO CLAIM IS MADE TO THE EXCLUSIVE RIGHT TO USE "SALON", APART FROM THE MARK AS SHOWN.

THE MARK CONSISTS OF THE WORDS "VOLR SALON" IN BLACK LETTERS WITH THE "R" AS A SUPERSCRIPT TO THE "L" IN "VOL" AND THE WORD "SALON" AS A SUBSCRIPT TO THE LETTER "R".

SER. NO. 85-348,340, FILED 6-16-2011.

COLLEEN DOMBROW, EXAMINING ATTORNEY



David J. Kyffers

Director of the United States Patent and Trademark Office

United States of America

United States Patent and Trademark Office



Reg. No. 4,098,706

Registered Feb. 14, 2012

Int. Cl.: 3

TRADEMARK

PRINCIPAL REGISTER

GMZ HOLDINGS, LLC (CALIFORNIA LIMITED LIABILITY COMPANY)
SUITE 850
15760 VENTURA BLVD.
ENCINO, CA 91367

FOR: NON-MEDICATED BREATH FRESHENING PREPARATIONS, NAMELY, BREATH FRESHENING COATED CAPSULES, BREATH FRESHENERS, BREATH MINTS, IN CLASS 3 (U.S. CLS. 1, 4, 6, 50, 51 AND 52).

FIRST USE 10-5-2009; IN COMMERCE 10-5-2009.

OWNER OF U.S. REG. NO. 3,726,513.

NO CLAIM IS MADE TO THE EXCLUSIVE RIGHT TO USE "BREATH", APART FROM THE MARK AS SHOWN.

THE MARK CONSISTS OF THE WORD "BREATH" ABOVE THE WORD "GEMZ" IN THE FOREGROUND WITH A BACKGROUND CONSISTING OF A DIAMOND SHAPE AND TWO CONCENTRIC JAGGED LINES EMANATING FROM THE CENTER.

SER. NO. 85-348,356, FILED 6-16-2011.

MATTHEW MCDOWELL, EXAMINING ATTORNEY



David J. Kybas

Director of the United States Patent and Trademark Office

United States of America

United States Patent and Trademark Office



Reg. No. 4,098,707

Registered Feb. 14, 2012

Int. Cl.: 35

SERVICE MARK

PRINCIPAL REGISTER

CENTERLINE DRIVERS, LLC (WASHINGTON LIMITED LIABILITY COMPANY)
1015 A STREET
TACOMA, WA 98402

FOR: EMPLOYMENT AGENCY SERVICES, NAMELY, FILLING THE TEMPORARY AND PERMANENT STAFFING NEEDS OF BUSINESSES; EMPLOYMENT COUNSELING AND RECRUITING; EMPLOYMENT STAFFING IN THE FIELD OF COMMERCIAL TRUCK DRIVING; TEMPORARY EMPLOYMENT AGENCIES, IN CLASS 35 (U.S. CLS. 100, 101 AND 102).

FIRST USE 12-14-2009; IN COMMERCE 12-14-2009.

OWNER OF U.S. REG. NO. 3,832,727.

THE MARK CONSISTS OF THE WORD "CENTERLINE" WITH THREE CURVED LINES TO THE LEFT. THE LOWER TWO LINES FORM A STYLIZED ROAD DESIGN POINTING TOWARDS THE WORD. THE MIDDLE LINES OF EACH "E" IN "CENTERLINE" IS HIGHLIGHTED TO CREATE THE ILLUSION THAT THEY ARE SECTIONS OF THE ROAD.

SER. NO. 85-348,357, FILED 6-16-2011.

MATTHEW MCDOWELL, EXAMINING ATTORNEY



David J. Kybas

Director of the United States Patent and Trademark Office

United States of America

United States Patent and Trademark Office



Reg. No. 4,098,708

OCEANIQUE, CORP (FLORIDA CORPORATION)
23511 SW 114 PL
MIAMI, FL 33032

Registered Feb. 14, 2012

Int. Cl.: 32

FOR: SPRING WATER, IN CLASS 32 (U.S. CLS. 45, 46 AND 48).

TRADEMARK

FIRST USE 3-30-2011; IN COMMERCE 3-30-2011.

PRINCIPAL REGISTER

NO CLAIM IS MADE TO THE EXCLUSIVE RIGHT TO USE "CARIBBEAN SPRING WATER",
APART FROM THE MARK AS SHOWN.

THE MARK CONSISTS OF SPECIAL AND STYLIZED LETTERS THAT FORM THE WORDS
"NI CARIBBEAN SPRING WATER" UNDER THE IMAGE OF A FLOWER.

SER. NO. 85-348,371, FILED 6-16-2011.

KRISTINA MORRIS, EXAMINING ATTORNEY



David J. Kybas

Director of the United States Patent and Trademark Office

United States of America

United States Patent and Trademark Office

Rebecca Brand

Reg. No. 4,098,709

BRAND, REBECCA (UNITED STATES INDIVIDUAL)
1125 VERONICA SPRINGS RD.
SANTA BARBARA, CA 93105

Registered Feb. 14, 2012

Int. Cl.: 41

FOR: CONDUCTING WORKSHOPS AND SEMINARS IN ART APPRECIATION AND ART INSTRUCTION; ENTERTAINMENT SERVICES IN THE NATURE OF AN ON-GOING REALITY BASED TELEVISION PROGRAM, IN CLASS 41 (U.S. CLS. 100, 101 AND 107).

SERVICE MARK

FIRST USE 3-17-2010; IN COMMERCE 3-17-2010.

PRINCIPAL REGISTER

THE MARK CONSISTS OF STANDARD CHARACTERS WITHOUT CLAIM TO ANY PARTICULAR FONT, STYLE, SIZE, OR COLOR.

THE NAME "REBECCA BRAND" IDENTIFIES A LIVING INDIVIDUAL WHOSE CONSENT IS OF RECORD.

SER. NO. 85-348,434, FILED 6-16-2011.

DOMINICK J. SALEMI, EXAMINING ATTORNEY



David J. Kyffers

Director of the United States Patent and Trademark Office

United States of America

United States Patent and Trademark Office

King's Super Waves & Hairdress Pomade

Reg. No. 4,098,710

TI HAIR CARE INC (NEVADA CORPORATION)
1471 STANLEY WAY
ESCONDIDO, CA 92027

Registered Feb. 14, 2012

Int. Cl.: 3

FOR: HAIR POMADES, IN CLASS 3 (U.S. CLS. 1, 4, 6, 50, 51 AND 52).

TRADEMARK

FIRST USE 8-9-2009; IN COMMERCE 8-9-2009.

PRINCIPAL REGISTER

THE MARK CONSISTS OF STANDARD CHARACTERS WITHOUT CLAIM TO ANY PARTICULAR FONT, STYLE, SIZE, OR COLOR.

NO CLAIM IS MADE TO THE EXCLUSIVE RIGHT TO USE "WAVES & HAIRDRESS POMADE", APART FROM THE MARK AS SHOWN.

SER. NO. 85-348,440, FILED 6-16-2011.

JULIE VEPPUMTHARA, EXAMINING ATTORNEY



David J. Kyffers

Director of the United States Patent and Trademark Office

United States of America

United States Patent and Trademark Office



Reg. No. 4,098,711

MARTIN, DAVID L (UNITED STATES INDIVIDUAL)
6559 RANDI AVE
WOODLAND HILLS, CA 91303

Registered Feb. 14, 2012

Int. Cl.: 25

FOR: SHIRTS, PANTS, HATS, SHOES, UNDERWEAR, SHORTS, AND DRESSES, IN CLASS 25 (U.S. CLS. 22 AND 39).

TRADEMARK

FIRST USE 1-1-2000; IN COMMERCE 3-30-2004.

PRINCIPAL REGISTER

THE MARK CONSISTS OF A STYLIZED LETTER "B" ABOVE A CROSSBONES DESIGN AND SOLID CIRCLE DESIGN ELEMENT.

SER. NO. 85-348,520, FILED 6-16-2011.

JULIE VEPPUMTHARA, EXAMINING ATTORNEY



David J. Kyffers

Director of the United States Patent and Trademark Office

United States of America

United States Patent and Trademark Office

Key Tracer

Reg. No. 4,098,712

CANADIAN TIME SYSTEMS, INC. (CANADA CORPORATION)
16 - 1833 COAST MERIDIAN
PORT COQUITLAM, BC, CANADA V3C6G5

Registered Feb. 14, 2012

Int. Cl.: 9

FOR: ELECTRONIC KEY CONTROL SYSTEMS CONSISTING OF COMPUTER PROGRAMS FOR MAINTAINING ACCOUNTABILITY OF KEYS, RFID ELECTRONIC KEY MANAGEMENT, ASSET AND KEY STORAGE, ELECTRONIC LOCKERS, AND GUARD TOUR SYSTEMS, IN CLASS 9 (U.S. CLS. 21, 23, 26, 36 AND 38).

TRADEMARK

PRINCIPAL REGISTER

FIRST USE 4-3-2008; IN COMMERCE 9-5-2010.

THE MARK CONSISTS OF STANDARD CHARACTERS WITHOUT CLAIM TO ANY PARTICULAR FONT, STYLE, SIZE, OR COLOR.

NO CLAIM IS MADE TO THE EXCLUSIVE RIGHT TO USE "KEY", APART FROM THE MARK AS SHOWN.

SER. NO. 85-348,542, FILED 6-16-2011.

MICHAEL WIENER, EXAMINING ATTORNEY



David J. Kyffers

Director of the United States Patent and Trademark Office

United States of America

United States Patent and Trademark Office



Reg. No. 4,098,713

Registered Feb. 14, 2012

Int. Cl.: 9

TRADEMARK

PRINCIPAL REGISTER

GOLDEN PROTECTIVE SERVICES (OREGON CORPORATION)
PO BOX 7167
SALEM, OR 97303

FOR: PROTECTIVE WORK GLOVES, IN CLASS 9 (U.S. CLS. 21, 23, 26, 36 AND 38).

FIRST USE 6-1-2011; IN COMMERCE 6-1-2011.

THE MARK CONSISTS OF THE STYLIZED WORD "OIL SHIELD" ON THE UPPER RIGHT HAND SIDE OF A NON-SPECIFIC DROP OF LIQUID.

SER. NO. 85-348,653, FILED 6-17-2011.

HEATHER BIDDULPH, EXAMINING ATTORNEY



David J. Kyffers

Director of the United States Patent and Trademark Office

United States of America

United States Patent and Trademark Office

CELLECT

Reg. No. 4,098,714

Registered Feb. 14, 2012

Int. Cl.: 5

TRADEMARK

PRINCIPAL REGISTER

IMAGES UNLIMITED PRODUCTS, INC. (NEW YORK CORPORATION), DBA CELLECT PRODUCTS
4747-20 NESCONSET HWY (RT 347)
PORT JEFFERSON STATION, NY 117762894

FOR: VITAMIN AND MINERAL SUPPLEMENTS; NUTRITIONAL SUPPLEMENTS, IN CLASS 5 (U.S. CLS. 6, 18, 44, 46, 51 AND 52).

FIRST USE 12-27-2001; IN COMMERCE 12-27-2001.

THE MARK CONSISTS OF STANDARD CHARACTERS WITHOUT CLAIM TO ANY PARTICULAR FONT, STYLE, SIZE, OR COLOR.

SER. NO. 85-348,885, FILED 6-17-2011.

AMY KELLY, EXAMINING ATTORNEY



David J. Kybas

Director of the United States Patent and Trademark Office

United States of America

United States Patent and Trademark Office

BRIXTON'S BAKED POTATO

Reg. No. 4,098,715

BRIXTON'S FRANCHISE COMPANY (UTAH CORPORATION)
298 24TH STREET, SUITE 340
OGDEN, UT 84401

Registered Feb. 14, 2012

Int. Cl.: 43

FOR: RESTAURANT SERVICES, NAMELY, PROVIDING OF FOOD AND BEVERAGES FOR CONSUMPTION ON AND OFF THE PREMISES, IN CLASS 43 (U.S. CLS. 100 AND 101).

SERVICE MARK

FIRST USE 9-21-2009; IN COMMERCE 10-1-2009.

PRINCIPAL REGISTER

THE MARK CONSISTS OF STANDARD CHARACTERS WITHOUT CLAIM TO ANY PARTICULAR FONT, STYLE, SIZE, OR COLOR.

NO CLAIM IS MADE TO THE EXCLUSIVE RIGHT TO USE "BAKED POTATO", APART FROM THE MARK AS SHOWN.

SER. NO. 85-348,957, FILED 6-17-2011.

JAMES STEIN, EXAMINING ATTORNEY



David J. Kybas

Director of the United States Patent and Trademark Office

United States of America

United States Patent and Trademark Office

RADAR PARTNERS

Reg. No. 4,098,716

RADAR MANAGEMENT LLC (DELAWARE LIMITED LIABILITY COMPANY)
737 BRYANT STREET
PALO ALTO, CA 94301

Registered Feb. 14, 2012

Int. Cl.: 36

FOR: PROVIDING VENTURE CAPITAL, DEVELOPMENT CAPITAL, PRIVATE EQUITY
AND INVESTMENT FUNDING, IN CLASS 36 (U.S. CLS. 100, 101 AND 102).

SERVICE MARK

FIRST USE 7-0-2004; IN COMMERCE 4-0-2005.

PRINCIPAL REGISTER

THE MARK CONSISTS OF STANDARD CHARACTERS WITHOUT CLAIM TO ANY PAR-
TICULAR FONT, STYLE, SIZE, OR COLOR.

NO CLAIM IS MADE TO THE EXCLUSIVE RIGHT TO USE "PARTNERS", APART FROM
THE MARK AS SHOWN.

SER. NO. 85-349,063, FILED 6-17-2011.

WILLIAM JACKSON, EXAMINING ATTORNEY



David J. Kybas

Director of the United States Patent and Trademark Office

United States of America

United States Patent and Trademark Office



Reg. No. 4,098,717

Registered Feb. 14, 2012

Int. Cl.: 42

SERVICE MARK

PRINCIPAL REGISTER

BRAND32 DESIGNS, INC. (UTAH CORPORATION)
#2
335 PIERPONT AVE.
SALT LAKE CITY, UT 84101

FOR: GRAPHIC DESIGN SERVICES; WEB SITE DESIGN; WEB SITE DEVELOPMENT FOR OTHERS, IN CLASS 42 (U.S. CLS. 100 AND 101).

FIRST USE 7-1-2003; IN COMMERCE 7-1-2003.

NO CLAIM IS MADE TO THE EXCLUSIVE RIGHT TO USE "BRAND", APART FROM THE MARK AS SHOWN.

THE MARK CONSISTS OF THE STYLIZED TEXT "BRAND" IN CAPITAL LETTERS ATOP THE LENGTH OF A STYLIZED NUMBER "32", SLIGHTLY OVERLAPPING.

SER. NO. 85-349,192, FILED 6-17-2011.

HOWARD B. LEVINE, EXAMINING ATTORNEY



David J. Kyffers

Director of the United States Patent and Trademark Office

United States of America

United States Patent and Trademark Office



Reg. No. 4,098,718

Registered Feb. 14, 2012

Int. Cls.: 40 and 42

SERVICE MARK

PRINCIPAL REGISTER

DIGITAL EVOLUTION, INC. (NEW YORK CORPORATION)
139 FULTON STREET, 4TH
NEW YORK, NY 10038

FOR: DIGITAL PHOTOGRAPHIC RETOUCHING; DIGITAL PHOTOGRAPHIC PRINTING SERVICES, NAMELY, PREPRESS PRINTING AND VISUAL GRAPHICS PRINTING OF PHOTOGRAPHS, IN CLASS 40 (U.S. CLS. 100, 103 AND 106).

FIRST USE 5-23-2011; IN COMMERCE 5-23-2011.

FOR: COMPUTER SERVICES, NAMELY, ELECTRONIC IMAGING OF DIGITAL PHOTOGRAPHS, IN CLASS 42 (U.S. CLS. 100 AND 101).

FIRST USE 5-23-2011; IN COMMERCE 5-23-2011.

THE MARK CONSISTS OF THE LOWERCASE LETTERS "D" AND "E" NEXT TO EACH OTHER IN A SHADOWBOX FONT WITH A PORTION OF THE LETTERS OVERLAPPING SUCH THAT THE MARK IS "DE".

SER. NO. 85-349,218, FILED 6-17-2011.

MATTHEW MCDOWELL, EXAMINING ATTORNEY



David J. Kybas

Director of the United States Patent and Trademark Office

United States of America

United States Patent and Trademark Office

Pier to Pier Brokers

Reg. No. 4,098,719

PIER TO PIER BROKERS, INC (CALIFORNIA CORPORATION)
252 PACIFIC COAST HIGHWAY
HERMOSA BEACH, CA 90254

Registered Feb. 14, 2012

Int. Cl.: 36

FOR: REAL ESTATE AGENCIES; REAL ESTATE APPRAISAL, IN CLASS 36 (U.S. CLS. 100, 101 AND 102).

SERVICE MARK

FIRST USE 1-1-2005; IN COMMERCE 1-1-2005.

PRINCIPAL REGISTER

THE MARK CONSISTS OF STANDARD CHARACTERS WITHOUT CLAIM TO ANY PARTICULAR FONT, STYLE, SIZE, OR COLOR.

NO CLAIM IS MADE TO THE EXCLUSIVE RIGHT TO USE "BROKERS", APART FROM THE MARK AS SHOWN.

SER. NO. 85-349,294, FILED 6-17-2011.

IRA J. GOODSAY, EXAMINING ATTORNEY



David J. Kyffers

Director of the United States Patent and Trademark Office

United States of America

United States Patent and Trademark Office

SALT LIFE FOOD SHACK

Reg. No. 4,098,720

Registered Feb. 14, 2012

Int. Cl.: 43

SERVICE MARK

PRINCIPAL REGISTER

SALT LIFE HOLDINGS, LLC (FLORIDA LIMITED LIABILITY COMPANY)
SUITE 300
13051 BEACH BOULEVARD
JACKSONVILLE, FL 32246

FOR: RESTAURANT AND BAR SERVICES, IN CLASS 43 (U.S. CLS. 100 AND 101).

FIRST USE 1-4-2010; IN COMMERCE 1-4-2010.

THE MARK CONSISTS OF STANDARD CHARACTERS WITHOUT CLAIM TO ANY PARTICULAR FONT, STYLE, SIZE, OR COLOR.

OWNER OF U.S. REG. NOS. 3,808,444, 3,843,123 AND OTHERS.

NO CLAIM IS MADE TO THE EXCLUSIVE RIGHT TO USE "FOOD", APART FROM THE MARK AS SHOWN.

SER. NO. 85-349,387, FILED 6-17-2011.

TIMOTHY FINNEGAN, EXAMINING ATTORNEY



David J. Kyffers

Director of the United States Patent and Trademark Office

United States of America

United States Patent and Trademark Office

alquimisolar

Reg. No. 4,098,721

ALQUIMI SOLAR, LLC (DELAWARE LIMITED LIABILITY COMPANY)
431 NORTH MIDLAND AVENUE
SADDLE BROOK, NJ 07663

Registered Feb. 14, 2012

Int. Cls.: 9, 37 and 42

FOR: APPARATUS FOR CONVERTING ELECTRONIC RADIATION TO ELECTRICAL ENERGY, NAMELY, PHOTOVOLTAIC SOLAR MODULES AND PHOTOVOLTAIC SOLAR HYBRID MODULES, FOR THE GENERATION OF ELECTRICITY, POWER AND HEAT, IN CLASS 9 (U.S. CLS. 21, 23, 26, 36 AND 38).

TRADEMARK

SERVICE MARK

FIRST USE 4-1-2011; IN COMMERCE 4-1-2011.

PRINCIPAL REGISTER

FOR: INSTALLATION OF SOLAR ENERGY SYSTEMS AND ALTERNATIVE ENERGY PRODUCTS, IN CLASS 37 (U.S. CLS. 100, 103 AND 106).

FIRST USE 4-1-2011; IN COMMERCE 4-1-2011.

FOR: TECHNOLOGICAL PLANNING OF SOLAR ENERGY BASED POWER SYSTEMS FOR COMMERCIAL, RESIDENTIAL, INDUSTRIAL, MUNICIPAL AND AGRICULTURAL USE; ENGINEERING CONSULTATION PERTAINING TO SOLAR ENERGY BASED POWER SYSTEMS AND ALTERNATIVE ENERGY SYSTEMS FOR COMMERCIAL, RESIDENTIAL, INDUSTRIAL, MUNICIPAL AND AGRICULTURAL USE, IN CLASS 42 (U.S. CLS. 100 AND 101).

FIRST USE 4-1-2011; IN COMMERCE 4-1-2011.

THE MARK CONSISTS OF THE WORD "ALQUIMISOLAR" IN LOWER CASE LETTERS WITH "ALQUIMI" IN BLACK LETTERS AND "SOLAR" IN YELLOW LETTERS, AN INFINITE SYMBOL OVER THE LETTERS "I", "M", "I" AND PARTIALLY OVER THE LETTER "S", WITH A BLACK DOT OVER THE FIRST LETTER "I" IN "ALQUIMISOLAR", AND A YELLOW DOT OVER THE SECOND LETTER "I" IN "ALQUIMISOLAR".

THE COLOR(S) BLACK AND YELLOW IS/ARE CLAIMED AS A FEATURE OF THE MARK.

SER. NO. 85-349,449, FILED 6-17-2011.

CYNTHIA TRIPI, EXAMINING ATTORNEY



David J. Kyros

Director of the United States Patent and Trademark Office

United States of America

United States Patent and Trademark Office

HICKORY'S BEST

Reg. No. 4,098,722

Registered Feb. 14, 2012

Int. Cl.: 29

TRADEMARK

PRINCIPAL REGISTER

ASBER HAWA (SYRIAN ARAB REP INDIVIDUAL), DBA ENJOY MEAT SNACKS
5815 TIMBERMIST PLACE
RANCHO CUCAMONGA, CA 91737

FOR: DRIED MEAT PRODUCTS, NAMELY, BEEF JERKY, IN CLASS 29 (U.S. CL. 46).

FIRST USE 1-13-2011; IN COMMERCE 1-13-2011.

THE MARK CONSISTS OF STANDARD CHARACTERS WITHOUT CLAIM TO ANY PARTICULAR FONT, STYLE, SIZE, OR COLOR.

NO CLAIM IS MADE TO THE EXCLUSIVE RIGHT TO USE "BEST", APART FROM THE MARK AS SHOWN.

SER. NO. 85-349,576, FILED 6-17-2011.

KIM SAITO, EXAMINING ATTORNEY



David J. Kyffers

Director of the United States Patent and Trademark Office

United States of America

United States Patent and Trademark Office

AUSTIN BOARD OF REALTORS

Reg. No. 4,098,723

AUSTIN BOARD OF REALTORS (TEXAS NON-PROFIT CORPORATION)
10900 STONELAKE BOULEVARD, SUITE 100
AUSTIN, TX 78759

Registered Feb. 14, 2012

Int. Cl.: 35

FOR: PROVIDING INFORMATION IN THE FIELD OF THE REAL ESTATE INDUSTRY, IN CLASS 35 (U.S. CLS. 100, 101 AND 102).

SERVICE MARK

FIRST USE 8-1-2004; IN COMMERCE 10-1-2004.

PRINCIPAL REGISTER

THE MARK CONSISTS OF STANDARD CHARACTERS WITHOUT CLAIM TO ANY PARTICULAR FONT, STYLE, SIZE, OR COLOR.

OWNER OF U.S. REG. NO. 3,453,807.

NO CLAIM IS MADE TO THE EXCLUSIVE RIGHT TO USE "AUSTIN", APART FROM THE MARK AS SHOWN.

SER. NO. 85-349,630, FILED 6-17-2011.

BENJAMIN OKEKE, EXAMINING ATTORNEY



David J. Kyffers

Director of the United States Patent and Trademark Office

United States of America

United States Patent and Trademark Office

RelMap

Reg. No. 4,098,724

Registered Feb. 14, 2012

Int. Cl.: 42

SERVICE MARK

PRINCIPAL REGISTER

RELMAP SOFTWARE INC. (ILLINOIS CORPORATION)
1251 COUNTRYSIDE LANE
SOUTH ELGIN, IL 60177

FOR: SOFTWARE AS A SERVICE (SAAS) SERVICES, NAMELY, HOSTING SOFTWARE FOR USE BY OTHERS FOR USE IN ANALYZING CORPORATE COMMUNICATIONS, SUCH AS EMAIL AND TEXT MESSAGES, AND IDENTIFYING PERSONAL RELATIONSHIPS FOR BUSINESS NETWORKING AND INFORMATION SECURITY PURPOSES, IN CLASS 42 (U.S. CLS. 100 AND 101).

FIRST USE 11-1-2010; IN COMMERCE 11-1-2010.

THE MARK CONSISTS OF STANDARD CHARACTERS WITHOUT CLAIM TO ANY PARTICULAR FONT, STYLE, SIZE, OR COLOR.

SER. NO. 85-349,637, FILED 6-17-2011.

MATTHEW MCDOWELL, EXAMINING ATTORNEY



David J. Kyffers

Director of the United States Patent and Trademark Office

United States of America

United States Patent and Trademark Office



Reg. No. 4,098,725

SERDA, JOHN C. (UNITED STATES INDIVIDUAL)
3 SOUTH ROYAL STREET
MOBILE, AL 36602

Registered Feb. 14, 2012

Int. Cl.: 43

FOR: COFFEE BARS; COFFEE SHOPS; COFFEE SUPPLY SERVICES FOR OFFICES; COFFEE-HOUSE AND SNACK-BAR SERVICES, IN CLASS 43 (U.S. CLS. 100 AND 101).

SERVICE MARK

FIRST USE 8-1-2008; IN COMMERCE 8-1-2008.

PRINCIPAL REGISTER

NO CLAIM IS MADE TO THE EXCLUSIVE RIGHT TO USE "COFFEE COMPANY", APART FROM THE MARK AS SHOWN.

THE COLOR(S) RED, GREEN, BLUE, YELLOW, BLACK, WHITE, GRAY, AND BURGUNDY IS/ARE CLAIMED AS A FEATURE OF THE MARK.

THE MARK CONSISTS OF THE WORDING "SERDA'S COFFEE COMPANY" IN BURGUNDY LETTERING WITH BLACK, GRAY AND WHITE OUTLINING, AND A BIRD DESIGN WITH A RED, BLACK, AND BLUE BODY, GREEN HEAD AND WINGS, AND YELLOW BEAK.

SER. NO. 85-349,638, FILED 6-17-2011.

MATTHEW MCDOWELL, EXAMINING ATTORNEY



David J. Kybas

Director of the United States Patent and Trademark Office

United States of America

United States Patent and Trademark Office

INFERNO FITNESS & SPORTS

Reg. No. 4,098,726

WHITE, PATRICK (UNITED STATES INDIVIDUAL)
800 NE TENNEY ROAD #110-427
VANCOUVER, WA 98685

Registered Feb. 14, 2012

Int. Cl.: 41

FOR: PROVIDING FITNESS AND EXERCISE FACILITIES, IN CLASS 41 (U.S. CLS. 100, 101 AND 107).

SERVICE MARK

FIRST USE 6-16-2011; IN COMMERCE 6-16-2011.

PRINCIPAL REGISTER

THE MARK CONSISTS OF STANDARD CHARACTERS WITHOUT CLAIM TO ANY PARTICULAR FONT, STYLE, SIZE, OR COLOR.

NO CLAIM IS MADE TO THE EXCLUSIVE RIGHT TO USE "FITNESS & SPORTS", APART FROM THE MARK AS SHOWN.

SER. NO. 85-349,639, FILED 6-17-2011.

MATTHEW MCDOWELL, EXAMINING ATTORNEY



David J. Kyros

Director of the United States Patent and Trademark Office

United States of America

United States Patent and Trademark Office



Reg. No. 4,098,727

BUTLER, TIM (UNITED STATES INDIVIDUAL)
15 DELWOOD RD
CHESTER, NJ 07927

Registered Feb. 14, 2012

Int. Cl.: 41

FOR: EDUCATIONAL SERVICES, NAMELY, PROVIDING TRAINING SERVICES FOR THOSE WITH AUTISM AND DEVELOPMENTAL DISORDERS IN THE FIELD OF DISMANTLING AND RECYCLING USED CONSUMER ELECTRONICS, IN CLASS 41 (U.S. CLS. 100, 101 AND 107).

SERVICE MARK

PRINCIPAL REGISTER

FIRST USE 9-23-2010; IN COMMERCE 9-23-2010.

NO CLAIM IS MADE TO THE EXCLUSIVE RIGHT TO USE "GREEN" OR "INC.", APART FROM THE MARK AS SHOWN.

THE MARK CONSISTS OF A MIX OF THE LEAVES MIMICKING THE RECYCLING SIGN WITH A PUZZLE PIECE. TO THE RIGHT THERE IS THE STYLIZED TEXT "GREEN VISION INC." UNDERLINED.

SER. NO. 85-349,679, FILED 6-17-2011.

CHARLOTTE CORWIN, EXAMINING ATTORNEY



David J. Kybas

Director of the United States Patent and Trademark Office

United States of America

United States Patent and Trademark Office



Reg. No. 4,098,728

AUSTIN BOARD OF REALTORS (TEXAS NON-PROFIT CORPORATION)
10900 STONELAKE BOULEVARD, SUITE 100
AUSTIN, TX 78759

Registered Feb. 14, 2012

Int. Cl.: 35

FOR: PROVIDING INFORMATION IN THE FIELD OF THE REAL ESTATE INDUSTRY, IN CLASS 35 (U.S. CLS. 100, 101 AND 102).

SERVICE MARK

FIRST USE 8-1-2004; IN COMMERCE 10-1-2004.

PRINCIPAL REGISTER

OWNER OF U.S. REG. NO. 3,453,807.

NO CLAIM IS MADE TO THE EXCLUSIVE RIGHT TO USE "AUSTIN", APART FROM THE MARK AS SHOWN.

THE MARK CONSISTS OF THE STYLIZED TEXT "AUSTIN BOARD OF REALTORS"; ABOVE THIS WORDING IS A TRIANGULAR DESIGN, WHERE THE BASE OF THE TRIANGLE INCLINES AND INTERSECTS THE RIGHT LEG OF THE TRIANGLE AT ABOUT ITS MIDPOINT.

SER. NO. 85-349,680, FILED 6-17-2011.

BENJAMIN OKEKE, EXAMINING ATTORNEY



David J. Kyffers

Director of the United States Patent and Trademark Office

United States of America

United States Patent and Trademark Office

THE SILVER CRAZE

Reg. No. 4,098,729

D B K ENTERPRISES, INC. (MISSOURI CORPORATION)
732 S. KISNER DRIVE
INDEPENDENCE, MO 64056

Registered Feb. 14, 2012

Int. Cl.: 35

FOR: RETAIL STORE SERVICES FEATURING SILVER JEWELRY AND ACCESSORIES, IN CLASS 35 (U.S. CLS. 100, 101 AND 102).

SERVICE MARK

FIRST USE 2-0-2011; IN COMMERCE 2-0-2011.

PRINCIPAL REGISTER

THE MARK CONSISTS OF STANDARD CHARACTERS WITHOUT CLAIM TO ANY PARTICULAR FONT, STYLE, SIZE, OR COLOR.

NO CLAIM IS MADE TO THE EXCLUSIVE RIGHT TO USE "SILVER", APART FROM THE MARK AS SHOWN.

SER. NO. 85-349,941, FILED 6-19-2011.

LINDSEY RUBIN, EXAMINING ATTORNEY



David J. Kybas

Director of the United States Patent and Trademark Office

United States of America

United States Patent and Trademark Office



Reg. No. 4,098,730

SEEFood MEDIA LLC (DELAWARE LIMITED LIABILITY COMPANY)
32 CLINTON STREET, 2ND FLOOR
NEW YORK, NY 10002

Registered Feb. 14, 2012

Int. Cl.: 41

FOR: ENTERTAINMENT SERVICES, NAMELY, PROVIDING A WEB SITE FEATURING PHOTOGRAPHIC, AUDIO, VIDEO AND PROSE PRESENTATIONS IN THE FIELD OF TELEVISION SHOWS ABOUT FOOD, COOKING, TRAVEL, AND LIFESTYLE; PROVIDING A WEBSITE FEATURING BLOGS AND NON-DOWNLOADABLE PUBLICATIONS IN THE NATURE OF ONLINE VIDEO MAGAZINES IN THE FIELDS OF FOOD, COOKING, TRAVEL, AND LIFESTYLE; PROVIDING A WEBSITE FEATURING RESOURCES, NAMELY, A WEBSITE FEATURING PRIMARILY NON-DOWNLOADABLE PUBLICATIONS IN THE NATURE OF ONLINE VIDEO MAGAZINE IN THE FIELD OF FOOD, COOKING, TRAVEL, AND LIFESTYLE, IN CLASS 41 (U.S. CLS. 100, 101 AND 107).

SERVICE MARK

PRINCIPAL REGISTER

FIRST USE 1-1-2010; IN COMMERCE 1-1-2010.

NO CLAIM IS MADE TO THE EXCLUSIVE RIGHT TO USE "EAT" AND "TV.COM", APART FROM THE MARK AS SHOWN.

THE COLOR(S) DARK RED AND WHITE IS/ARE CLAIMED AS A FEATURE OF THE MARK.

THE MARK CONSISTS OF A FORK, KNIFE, AND SPOON NEXT TO A STYLIZED TELEVISION SCREEN, ALL OF WHICH IS COLORED DARK RED. INSIDE THE TELEVISION SCREEN ARE THE WORDS "EAT TV.COM" IN WHITE.

SER. NO. 85-349,944, FILED 6-19-2011.

SIMON TENG, EXAMINING ATTORNEY



David J. Kybas

Director of the United States Patent and Trademark Office

United States of America

United States Patent and Trademark Office

Dreams Built True

Reg. No. 4,098,731

REINHARD, BERNARD K. (UNITED STATES INDIVIDUAL)
2868 LARKFIELD AVE.

Registered Feb. 14, 2012

ARCADIA, CA 91006

Int. Cl.: 37

FOR: BUILDING CONSTRUCTION SERVICES, IN CLASS 37 (U.S. CLS. 100, 103 AND 106).

SERVICE MARK

FIRST USE 1-1-2001; IN COMMERCE 1-1-2001.

PRINCIPAL REGISTER

THE MARK CONSISTS OF STANDARD CHARACTERS WITHOUT CLAIM TO ANY PARTICULAR FONT, STYLE, SIZE, OR COLOR.

SER. NO. 85-349,947, FILED 6-19-2011.

JOHN GARTNER, EXAMINING ATTORNEY



David J. Kyffers

Director of the United States Patent and Trademark Office

United States of America

United States Patent and Trademark Office

SEE **FOOD**
media

Reg. No. 4,098,732

SEEFood MEDIA LLC (DELAWARE LIMITED LIABILITY COMPANY)
32 CLINTON STREET, SECOND FLOOR
NEW YORK, NY 10002

Registered Feb. 14, 2012

Int. Cls.: 35 and 41

SERVICE MARK

PRINCIPAL REGISTER

FOR: ADVERTISING AGENCIES PROVIDING THE STRATEGY, DESIGN AND EXECUTION OF PROGRAMS TO PROMOTE BUSINESSES IN THE FOOD AND FOODSERVICE INDUSTRIES; ADVERTISING AGENCIES SPECIALIZING IN FOOD, BEVERAGE, NUTRITION, TRAVEL, AND LIFESTYLE; ADVERTISING AND PUBLICITY SERVICES, NAMELY, PROMOTING THE GOODS, SERVICES, BRAND IDENTITY AND COMMERCIAL INFORMATION AND NEWS OF THIRD PARTIES THROUGH PRINT, AUDIO, VIDEO, DIGITAL AND ON-LINE MEDIUM; ADVERTISING SERVICES, NAMELY, PROMOTING THE FOOD AND WINE OF OTHERS; CUSTOM WRITING SERVICES COMPRISING PUBLIC RELATIONS AND MARKETING MATERIALS FOR THE AUDIO, VIDEO AND TECHNOLOGY INDUSTRIES; EMPLOYMENT SERVICES IN THE NATURE OF TALENT CASTING IN THE FIELDS OF MUSIC, VIDEO, AND FILMS; MARKETING SERVICES, NAMELY, PROVIDING VIDEOS TO PROMOTE CONSUMER PRODUCTS; POST-PRODUCTION EDITING SERVICES FOR VIDEO AND AUDIO COMMERCIALS; PRODUCING AUDIO OR VIDEO INFOMERCIALS; PRODUCING PROMOTIONAL VIDEOTAPES, VIDEO DISCS, AND AUDIO VISUAL RECORDINGS; PROVIDING A WEB SITE FEATURING BUSINESS INFORMATION IN THE FORM OF AUDIO AND VIDEO INTERVIEWS, TRANSCRIPTS AND OTHER EDUCATIONAL MATERIALS, IN CLASS 35 (U.S. CLS. 100, 101 AND 102).

FIRST USE 1-1-2007; IN COMMERCE 1-1-2007.



David J. Kyjars

Director of the United States Patent and Trademark Office

FOR: AUDIO AND VIDEO RECORDING SERVICES; CONTINUING PUBLIC SERVICE PROGRAMS IN THE FIELD OF FOOD, BEVERAGE, NUTRITION, TRAVEL, AND LIFESTYLE PRODUCED AND DISTRIBUTED OVER TELEVISION, SATELLITE, FILM, AUDIO, VIDEO, INTERNET, AND 3-D VIRTUAL REALITY MEDIA; DIGITAL IMAGING SERVICES; DIGITAL VIDEO, AUDIO, AND MULTIMEDIA PUBLISHING SERVICES; EDUCATIONAL AND ENTERTAINMENT SERVICES, NAMELY, A CONTINUING PROGRAM ABOUT FOOD, BEVERAGE, NUTRITION, TRAVEL, AND LIFESTYLE ACCESSIBLE BY RADIO, TELEVISION, SATELLITE, AUDIO, VIDEO AND COMPUTER NETWORKS; ENTERTAINMENT AND EDUCATION SERVICES IN THE NATURE OF A SERIES OF SHORT SHOWS FEATURING FOOD, BEVERAGE, NUTRITION, TRAVEL, AND LIFESTYLE DISTRIBUTED TO MOBILE HANDSETS, WHICH MAY INCLUDE VIDEO, TEXT, PHOTOS, ILLUSTRATIONS OR HYPERTEXT; ENTERTAINMENT AND EDUCATIONAL SERVICES, NAMELY, PROVIDING A WEBSITE THAT DISPLAYS VARIOUS REQUESTS, REVIEWS, RECOM-

Reg. No. 4,098,732 MENDATIONS, RANKINGS, TRACKINGS, VOTES, AND INFORMATION RELATING TO UNCREATED, UNRELEASED, NEW, SPECIAL, POPULAR, AND RARE PRODUCTS, SERVICES, AND EVENTS IN THE FIELDS OF POP CULTURE, ENTERTAINMENT, EDUCATION, AND SPORTS, ALL EXCLUSIVELY FOR NON-BUSINESS AND NON-COMMERCIAL TRANSACTIONS AND PURPOSES; ENTERTAINMENT AND EDUCATIONAL SERVICES, NAMELY, PROVIDING ADVICE AND INFORMATION FOR MUSIC, VIDEO AND FILM CONCEPT AND SCRIPT DEVELOPMENT; ENTERTAINMENT IN THE NATURE OF AN ON-GOING SPECIAL VARIETY, NEWS, MUSIC OR COMEDY SHOW FEATURING FOOD, BEVERAGE, NUTRITION, TRAVEL, AND LIFESTYLE BROADCAST OVER TELEVISION, SATELLITE, AUDIO, AND VIDEO MEDIA; ENTERTAINMENT MEDIA PRODUCTION SERVICES FOR MOTION PICTURES, TELEVISION AND INTERNET; ENTERTAINMENT SERVICES IN THE NATURE OF DEVELOPMENT, CREATION, PRODUCTION AND POST-PRODUCTION SERVICES OF MULTIMEDIA ENTERTAINMENT CONTENT; ENTERTAINMENT SERVICES, NAMELY, MULTIMEDIA PRODUCTION SERVICES; ENTERTAINMENT SERVICES, NAMELY, PROVIDING A WEB SITE FEATURING PHOTOGRAPHIC, AUDIO, VIDEO AND PROSE PRESENTATIONS IN THE FIELD OF TELEVISION SHOWS ABOUT FOOD, BEVERAGE, NUTRITION, TRAVEL, AND LIFESTYLE; ENTERTAINMENT SERVICES, NAMELY, PROVIDING VIDEO PODCASTS IN THE FIELD OF FOOD, BEVERAGE, NUTRITION, TRAVEL, AND LIFESTYLE; ENTERTAINMENT, NAMELY, A CONTINUING FOOD, BEVERAGE, NUTRITION, TRAVEL, AND LIFESTYLE SHOW BROADCAST OVER TELEVISION, SATELLITE, AUDIO, AND VIDEO MEDIA; FILM AND VIDEO PRODUCTION; FILM AND VIDEO PRODUCTION CONSULTING SERVICES; MEDIA PRODUCTION SERVICES, NAMELY, VIDEO AND FILM PRODUCTION; MOTION PICTURE AND VIDEO RENTAL SERVICES; MOVIE STUDIOS; MULTIMEDIA ENTERTAINMENT SERVICES IN THE NATURE OF DEVELOPMENT, PRODUCTION AND POST-PRODUCTION SERVICES IN THE FIELDS OF VIDEO AND FILMS; MULTIMEDIA ENTERTAINMENT SERVICES IN THE NATURE OF RECORDING, PRODUCTION AND POST-PRODUCTION SERVICES IN THE FIELDS OF MUSIC, VIDEO, AND FILMS; MULTIMEDIA ENTERTAINMENT SOFTWARE PRODUCTION SERVICES; OPERATION OF VIDEO EQUIPMENT OR AUDIO EQUIPMENT ETC. FOR PRODUCTION OF RADIO OR TELEVISION PROGRAMS; PHOTOGRAPHY; PHOTOGRAPHY SERVICES; POST-PRODUCTION EDITING SERVICES IN THE FIELD OF MUSIC, VIDEOS AND FILM; PRODUCTION AND DISTRIBUTION OF TELEVISION SHOWS AND MOVIES; PRODUCTION AND DISTRIBUTION OF VIDEOS IN THE FIELD OF FOOD, BEVERAGE, NUTRITION, TRAVEL, AND LIFESTYLE; PRODUCTION OF RADIO AND TELEVISION PROGRAMS; PRODUCTION OF TELEVISION PROGRAMS; PROVIDING FACILITIES FOR PRODUCING VIDEO, CINEMA AND PHOTOGRAPHY PRODUCTIONS; RECORDING STUDIOS; RENTAL OF FACILITIES AND EQUIPMENT FOR THE PRODUCTION OF RADIO AND TELEVISION PROGRAMS, MUSICAL AND THEATRICAL PRODUCTIONS, NAMELY, PERFORMANCE VENUES, STUDIOS, SETS, DRESSING ROOMS; RENTAL OF FACILITIES AND EQUIPMENT FOR THE PRODUCTION OF TELEVISION PROGRAMS; RENTAL OF LIGHTING APPARATUS FOR THEATRICAL SETS OR TELEVISION STUDIOS; RENTAL OF VIDEO CAMERAS; RENTAL SERVICES FOR AUDIO AND VIDEO EQUIPMENT; TELEVISION SHOW PRODUCTION; TELEVISION, VIDEO AND MOVIE FILMING SERVICES; VIDEO EDITING; VIDEO MASTERING SERVICES; VIDEO PRODUCTION SERVICES; VIDEO RECORDING SERVICES, IN CLASS 41 (U.S. CLS. 100, 101 AND 107).

FIRST USE 1-1-2007; IN COMMERCE 1-1-2007.

NO CLAIM IS MADE TO THE EXCLUSIVE RIGHT TO USE "FOOD" AND "MEDIA", APART FROM THE MARK AS SHOWN.

THE COLOR(S) GREY AND ORANGE IS/ARE CLAIMED AS A FEATURE OF THE MARK.

THE MARK CONSISTS OF THE STYLIZED WORDS "SEE FOOD MEDIA". "SEE" IS COLORED GREY. "FOOD" IS COLORED ORANGE. THE CENTER OF THE FIRST "O" IN "FOOD" IS A STYLIZED SPOON DESIGN. THE SECOND "O" IS COMPLETELY ORANGE WITH A STYLIZED GREY FORK IN THE CENTER. BELOW THE WORD "FOOD" IS "MEDIA"

Reg. No. 4,098,732 IN GREY. THE HANDLE OF THE FORK MERGES WITH THE LETTER "M" IN THE WORD "MEDIA".

SER. NO. 85-349,979, FILED 6-19-2011.

SIMON TENG, EXAMINING ATTORNEY

United States of America

United States Patent and Trademark Office

PHILOSMITH

Reg. No. 4,098,733

Registered Feb. 14, 2012

Int. Cl.: 36

SERVICE MARK

PRINCIPAL REGISTER

PHILOSMITH CAPITAL CORPORATION (CONNECTICUT CORPORATION)
SUITE 500
SIX LANDMARK SQUARE
STAMFORD, CT 06901

FOR: FINANCIAL AND INVESTMENT SERVICES, NAMELY, ASSET AND INVESTMENT ACQUISITION, CONSULTATION, ADVISORY AND DEVELOPMENT; INVESTMENT ADVISORY SERVICES, IN CLASS 36 (U.S. CLS. 100, 101 AND 102).

FIRST USE 0-0-2000; IN COMMERCE 0-0-2000.

THE MARK CONSISTS OF THE STYLIZED WORD "PHILOSMITH" IN GRADATIONS OF THE COLOR BLUE.

THE COLOR(S) BLUE IS/ARE CLAIMED AS A FEATURE OF THE MARK.

SER. NO. 85-350,114, FILED 6-20-2011.

KIM SAITO, EXAMINING ATTORNEY



David J. Kybas

Director of the United States Patent and Trademark Office

United States of America

United States Patent and Trademark Office

JOINT FORCES SENSOR

Reg. No. 4,098,734

Registered Feb. 14, 2012

Int. Cl.: 9

TRADEMARK

PRINCIPAL REGISTER

RSIGNIA, INC. (MARYLAND CORPORATION)
SUITE O
9693 GERWIG LANE
COLUMBIA, MD 21046

FOR: COMPUTER HARDWARE; COMPUTER HARDWARE AND COMPUTER PERIPHERALS; COMPUTER PROGRAMS FOR NETWORK MONITORING AND FORENSICS ANALYSIS, DATA REPLICATION FOR MULTIPLE APPLICATIONS TO SIMULTANEOUSLY ANALYZE A DATA STREAM, TIME STAMPING, AND FOR ACQUIRING, RECORDING, ANALYZING, FILTERING, MODIFYING, SENDING AND STORING DATA WHILE SENDING REAL-TIME STATISTICS TO MONITORING APPLICATIONS; COMPUTER SOFTWARE AND HARDWARE FOR NETWORK MONITORING AND FORENSICS ANALYSIS, DATA REPLICATION FOR MULTIPLE APPLICATIONS TO SIMULTANEOUSLY ANALYZE A DATA STREAM, TIME STAMPING, AND FOR ACQUIRING, RECORDING, ANALYZING, FILTERING, MODIFYING, SENDING AND STORING DATA WHILE SENDING REAL-TIME STATISTICS TO MONITORING APPLICATIONS; COMPUTER SOFTWARE FOR ADMINISTRATION OF COMPUTER NETWORKS; COMPUTER SOFTWARE FOR ENCRYPTION; COMPUTER SOFTWARE FOR USE IN THE ENCRYPTION AND DECRYPTION OF DIGITAL FILES, INCLUDING AUDIO, VIDEO, TEXT, BINARY, STILL IMAGES, GRAPHICS AND MULTIMEDIA FILES; COMPUTER SOFTWARE FOR USE IN THE SAFEGUARDING OF DIGITAL FILES, INCLUDING AUDIO, VIDEO, TEXT, BINARY, STILL IMAGES, GRAPHICS AND MULTIMEDIA FILES; COMPUTER SOFTWARE FOR NETWORK MONITORING AND FORENSICS ANALYSIS, DATA REPLICATION FOR MULTIPLE APPLICATIONS TO SIMULTANEOUSLY ANALYZE A DATA STREAM, TIME STAMPING, AND FOR ACQUIRING, RECORDING, ANALYZING, FILTERING, MODIFYING, SENDING AND STORING DATA WHILE SENDING REAL-TIME STATISTICS TO MONITORING APPLICATIONS, IN CLASS 9 (U.S. CLS. 21, 23, 26, 36 AND 38).



FIRST USE 9-1-2009; IN COMMERCE 9-1-2009.

THE MARK CONSISTS OF STANDARD CHARACTERS WITHOUT CLAIM TO ANY PARTICULAR FONT, STYLE, SIZE, OR COLOR.

NO CLAIM IS MADE TO THE EXCLUSIVE RIGHT TO USE "SENSOR", APART FROM THE MARK AS SHOWN.

SER. NO. 85-350,176, FILED 6-20-2011.

David J. Kybas

Director of the United States Patent and Trademark Office

Reg. No. 4,098,734 REBECCA POVARCHUK, EXAMINING ATTORNEY

United States of America

United States Patent and Trademark Office

ARCHIVE OF AMERICANA

Reg. No. 4,098,735

Registered Feb. 14, 2012

Int. Cl.: 9

TRADEMARK

PRINCIPAL REGISTER

NEWSBANK, INC. (DELAWARE CORPORATION)
SUITE 600
5801 PELICAN BAY BOULEVARD
NAPLES, FL 341082734

FOR: ELECTRONIC DATABASE IN THE FIELD OF HISTORICAL INFORMATION RECORDED ON COMPUTER MEDIA, IN CLASS 9 (U.S. CLS. 21, 23, 26, 36 AND 38).

FIRST USE 4-5-2006; IN COMMERCE 4-5-2006.

THE MARK CONSISTS OF STANDARD CHARACTERS WITHOUT CLAIM TO ANY PARTICULAR FONT, STYLE, SIZE, OR COLOR.

OWNER OF U.S. REG. NOS. 3,094,537, 3,143,730, AND 3,704,215.

NO CLAIM IS MADE TO THE EXCLUSIVE RIGHT TO USE "ARCHIVE", APART FROM THE MARK AS SHOWN.

SEC. 2(F).

SER. NO. 85-350,182, FILED 6-20-2011.

MATTHEW MCDOWELL, EXAMINING ATTORNEY



David J. Kyffers

Director of the United States Patent and Trademark Office

United States of America

United States Patent and Trademark Office

JackColton

Reg. No. 4,098,736

Registered Feb. 14, 2012

Int. Cl.: 39

SERVICE MARK

PRINCIPAL REGISTER

WHELCHER, JACK COLTON (UNITED STATES INDIVIDUAL)
SUITE 239
8022 SOUTH RAINBOW BLVD.
LAS VEGAS, NV 89139

FOR: TRAVEL GUIDE AND TRAVEL INFORMATION SERVICES, IN CLASS 39 (U.S. CLS. 100 AND 105).

FIRST USE 4-1-2006; IN COMMERCE 2-1-2007.

THE MARK CONSISTS OF STANDARD CHARACTERS WITHOUT CLAIM TO ANY PARTICULAR FONT, STYLE, SIZE, OR COLOR.

THE NAME "JACK COLTON" IDENTIFIES A LIVING INDIVIDUAL WHOSE CONSENT IS OF RECORD.

SER. NO. 85-350,239, FILED 6-20-2011.

ANGELA M. MICHELI, EXAMINING ATTORNEY



David J. Kybas

Director of the United States Patent and Trademark Office

United States of America

United States Patent and Trademark Office

AEROCAV

Reg. No. 4,098,737

Registered Feb. 14, 2012

Int. Cl.: 39

SERVICE MARK

PRINCIPAL REGISTER

AEROCAMIONES DE VENEZUELA, C.A. (VENEZUELA CORPORATION)
EDIFICIO AEROCAV
AVENIDA RIO DE JANEIRO, LOS RUICES
CARACAS, VENEZUELA

FOR: SHIPPING AND DELIVERY SERVICES, NAMELY, PICKUP, TRANSPORTATION, AND DELIVERY OF PACKAGES AND LETTERS BY VARIOUS MODES OF TRANSPORTATION, IN CLASS 39 (U.S. CLS. 100 AND 105).

FIRST USE 4-8-1963; IN COMMERCE 7-18-2003.

THE MARK CONSISTS OF STANDARD CHARACTERS WITHOUT CLAIM TO ANY PARTICULAR FONT, STYLE, SIZE, OR COLOR.

SER. NO. 85-350,581, FILED 6-20-2011.

MARC LEIPZIG, EXAMINING ATTORNEY



David J. Kybas

Director of the United States Patent and Trademark Office

United States of America

United States Patent and Trademark Office

VALLEY OAK

Reg. No. 4,098,738

Registered Feb. 14, 2012

Int. Cl.: 8

TRADEMARK

PRINCIPAL REGISTER

DAVID, GRAU (CALIFORNIA SOLE PROPRIETORSHIP), DBA VALLEY OAK TOOL
COMPANY
773 SIERRA VIEW WAY
CHICO, CA 95926

FOR: GARDENING TOOLS, NAMELY, WHEEL HOES; HAND-OPERATED AGRICULTURAL
IMPLEMENTS, NAMELY, BROADFORKS; HOES, IN CLASS 8 (U.S. CLS. 23, 28 AND 44).

FIRST USE 1-1-2011; IN COMMERCE 1-1-2011.

THE MARK CONSISTS OF STANDARD CHARACTERS WITHOUT CLAIM TO ANY PAR-
TICULAR FONT, STYLE, SIZE, OR COLOR.

SER. NO. 85-350,593, FILED 6-20-2011.

ADA HAN, EXAMINING ATTORNEY



David J. Kyffers

Director of the United States Patent and Trademark Office

United States of America

United States Patent and Trademark Office



stellasingles

Reg. No. 4,098,739

Registered Feb. 14, 2012

Int. Cls.: 35, 44 and 45

STELLA SINGLES LLC (TEXAS LIMITED LIABILITY COMPANY)
#47023
14525 SW MILLIKAN WAY
BEAVERTON, OR 970052343

FOR: BUSINESS ADVICE AND INFORMATION, IN CLASS 35 (U.S. CLS. 100, 101 AND 102).

SERVICE MARK

FIRST USE 6-26-2010; IN COMMERCE 10-21-2010.

PRINCIPAL REGISTER

FOR: PROVIDING A WEBSITE FEATURING CONTENT REGARDING HEALTHY LIVING AND LIFESTYLE WELLNESS, IN CLASS 44 (U.S. CLS. 100 AND 101).

FIRST USE 6-26-2010; IN COMMERCE 10-21-2010.

FOR: INTERNET BASED SOCIAL NETWORKING, INTRODUCTION, AND DATING SERVICES, AS WELL AS PROVIDING ADVICE AND INFORMATION ON DATING, RELATIONSHIPS, AND SELF-HELP, IN CLASS 45 (U.S. CLS. 100 AND 101).

FIRST USE 6-26-2010; IN COMMERCE 10-21-2010.

THE STIPLING IS FOR SHADING PURPOSES ONLY.

THE MARK CONSISTS OF TWO UPWARD LAUNCHING AND INTERSECTING FLYING STARS, BOTH IN A VERTICAL RECTANGLE. TO THE RIGHT THERE IS THE STYLIZED TEXT "STELLA SINGLES".

SER. NO. 85-350,979, FILED 6-20-2011.

JANET LEE, EXAMINING ATTORNEY



David J. Kybas

Director of the United States Patent and Trademark Office

United States of America

United States Patent and Trademark Office

Susie Filmmaker

Reg. No. 4,098,740

YUHAS, STEPHANIE (UNITED STATES INDIVIDUAL)
1203 WEST ELM STREET
NORRISTOWN, PA 194013667

Registered Feb. 14, 2012

Int. Cl.: 41

FOR: ENTERTAINMENT SERVICES, NAMELY, PLANNING AND CONDUCTING A SERIES OF FILM FESTIVALS; FILM AND VIDEO PRODUCTION CONSULTING SERVICES, IN CLASS 41 (U.S. CLS. 100, 101 AND 107).

SERVICE MARK

FIRST USE 6-1-2009; IN COMMERCE 6-1-2009.

PRINCIPAL REGISTER

THE MARK CONSISTS OF STANDARD CHARACTERS WITHOUT CLAIM TO ANY PARTICULAR FONT, STYLE, SIZE, OR COLOR.

NO CLAIM IS MADE TO THE EXCLUSIVE RIGHT TO USE "FILMMAKER", APART FROM THE MARK AS SHOWN.

SER. NO. 85-351,163, FILED 6-20-2011.

MAYUR VAGHANI, EXAMINING ATTORNEY



David J. Kybas

Director of the United States Patent and Trademark Office

United States of America

United States Patent and Trademark Office



Reg. No. 4,098,741

Registered Feb. 14, 2012

Int. Cls.: 30 and 43

TRADEMARK

SERVICE MARK

PRINCIPAL REGISTER

SLOAN'S INC. (FLORIDA CORPORATION)
112 CLEMATIS STREET
WEST PALM BEACH, FL 33401

FOR: FROZEN DESSERTS, NAMELY, FRUIT ICE, ICE CREAM AND FROZEN YOGURT; BAKERY GOODS, NAMELY, COOKIES, PASTRIES AND CANDY; CHOCOLATE; CHOCOLATE COVERED NUTS AND PRETZELS, IN CLASS 30 (U.S. CL. 46).

FIRST USE 11-3-1999; IN COMMERCE 11-3-1999.

FOR: CARRY OUT AND EAT-IN RESTAURANTS FEATURING ICE CREAM, DESSERTS AND SNACK FOOD, IN CLASS 43 (U.S. CLS. 100 AND 101).

FIRST USE 11-3-1999; IN COMMERCE 11-3-1999.

OWNER OF U.S. REG. NOS. 2,523,569 AND 3,666,434.

THE MARK CONSISTS OF A CREST DESIGN. THE CREST CONTAINS FOUR SECTIONS. AN IMAGE OF A SLICE OF CAKE APPEARS IN THE TOP LEFT SECTION, AN IMAGE OF A SUNDAE IS DEPICTED IN THE TOP RIGHT SECTION, AN IMAGE OF A CUP OF COFFEE APPEARS IN THE BOTTOM LEFT SECTION AND GEOMETRIC SHAPES ARE IN THE BOTTOM RIGHT SECTION. APPEARING ON BOTH SIDES OF THE CREST ARE SCOOPS OF ICE CREAM. APPEARING BELOW THE CREST IS THE WORD "SLOAN'S" WITHIN A CURVED GEOMETRIC SHAPE, AND APPEARING ON EACH END IS AN IMAGE OF A BANANA.

SER. NO. 85-351,636, FILED 6-21-2011.

BRIDGETT SMITH, EXAMINING ATTORNEY



David J. Kybas

Director of the United States Patent and Trademark Office

United States of America

United States Patent and Trademark Office

PANTONIC STEEL ORCHESTRA

Reg. No. 4,098,742

THE PANTONIC STEEL ORCHESTRA, INC. (NEW YORK NON-PROFIT CORPORATION)
775 EAST 39 STREET
BROOKLYN, NY 11210

Registered Feb. 14, 2012

Int. Cl.: 41

FOR: LIVE PERFORMANCES BY A MUSICAL GROUP, IN CLASS 41 (U.S. CLS. 100, 101 AND 107).

SERVICE MARK

FIRST USE 0-0-1998; IN COMMERCE 0-0-1998.

PRINCIPAL REGISTER

THE MARK CONSISTS OF STANDARD CHARACTERS WITHOUT CLAIM TO ANY PARTICULAR FONT, STYLE, SIZE, OR COLOR.

NO CLAIM IS MADE TO THE EXCLUSIVE RIGHT TO USE "STEEL ORCHESTRA", APART FROM THE MARK AS SHOWN.

SER. NO. 85-351,920, FILED 6-21-2011.

ARETHA SOMERVILLE, EXAMINING ATTORNEY



David J. Kyffers

Director of the United States Patent and Trademark Office

United States of America

United States Patent and Trademark Office

Aerial Addicts

Reg. No. 4,098,743

NGUESSAN, SYLVIA (COTE D'IVOIRE INDIVIDUAL)

Registered Feb. 14, 2012

#2003
4500 THE WOODS DR.
SAN JOSE, CA 95136

Int. Cl.: 41

FOR: PHYSICAL FITNESS STUDIO SERVICES, NAMELY, PROVIDING EXERCISE CLASSES, BODY SCULPTING CLASSES, AND GROUP FITNESS CLASSES, IN CLASS 41 (U.S. CLS. 100, 101 AND 107).

SERVICE MARK

PRINCIPAL REGISTER

FIRST USE 5-15-2011; IN COMMERCE 5-15-2011.

THE MARK CONSISTS OF STANDARD CHARACTERS WITHOUT CLAIM TO ANY PARTICULAR FONT, STYLE, SIZE, OR COLOR.

NO CLAIM IS MADE TO THE EXCLUSIVE RIGHT TO USE "AERIAL", APART FROM THE MARK AS SHOWN.

SER. NO. 85-352,156, FILED 6-21-2011.

HELENE LIWINSKI, EXAMINING ATTORNEY



David J. Kyffers

Director of the United States Patent and Trademark Office

United States of America

United States Patent and Trademark Office

SEQUEL

Reg. No. 4,098,744

HELENA HOLDING COMPANY (DELAWARE CORPORATION)
300 DELAWARE AVENUE, 9TH FLOOR - DE 5403
WILMINGTON, DE 19801

Registered Feb. 14, 2012

Int. Cl.: 1

FOR: SPRAY ADJUVANT FOR AGRICULTURAL AND DOMESTIC USE, IN CLASS 1 (U.S. CLS. 1, 5, 6, 10, 26 AND 46).

TRADEMARK

FIRST USE 11-29-2007; IN COMMERCE 11-29-2007.

PRINCIPAL REGISTER

THE MARK CONSISTS OF STANDARD CHARACTERS WITHOUT CLAIM TO ANY PARTICULAR FONT, STYLE, SIZE, OR COLOR.

SER. NO. 85-352,258, FILED 6-21-2011.

GINA HAYES, EXAMINING ATTORNEY



David J. Kyffers

Director of the United States Patent and Trademark Office

United States of America

United States Patent and Trademark Office

ASSARA

Reg. No. 4,098,745

Registered Feb. 14, 2012

Int. Cl.: 44

SERVICE MARK

PRINCIPAL REGISTER

ASSARA HOLDINGS LLC (NEW YORK LIMITED LIABILITY COMPANY), AKA ASSARA LASER
23 W. 45TH ST., SECOND FLOOR
NEW YORK, NY 10036

FOR: LASER HAIR REMOVAL SERVICES; MEDICAL CLINIC PROVIDING WEIGHT LOSS SOLUTIONS, SERVICES AND PROGRAMS, NUTRITION COUNSELING, HORMONE THERAPY, INCLUDING, BIOIDENTICAL HORMONE REPLACEMENT, ANTI AGING THERAPY, AND NATURAL HORMONE THERAPY, MEDICAL AESTHETIC PROCEDURES, INCLUDING, LASER HAIR REMOVAL, LASER PEELS, BOTULINUM TOXIN TREATMENTS, MICRODERMABRASION, LIPOSUCTION, VEIN TREATMENTS, VEIN THERAPY, CELLULITE TREATMENTS, BODY CONTOURING TREATMENTS, INJECTABLE FILLER TREATMENTS, FACIALS, AND SKIN CARE; MEDICAL SPA SERVICES, NAMELY, MINIMALLY AND NON-INVASIVE COSMETIC AND BODY FITNESS THERAPIES; MICRODERMABRASION, NAMELY, A TOPICAL SKIN TREATMENT INVOLVING ABRASION OF THE SKIN WITH A HIGH-PRESSURE FLOW OF CRYSTALS, IN CLASS 44 (U.S. CLS. 100 AND 101).

FIRST USE 5-31-2006; IN COMMERCE 5-31-2006.

THE MARK CONSISTS OF STANDARD CHARACTERS WITHOUT CLAIM TO ANY PARTICULAR FONT, STYLE, SIZE, OR COLOR.

SER. NO. 85-352,827, FILED 6-22-2011.

LOURDES AYALA, EXAMINING ATTORNEY



David J. Kypos

Director of the United States Patent and Trademark Office

United States of America

United States Patent and Trademark Office

The Third Billion

Reg. No. 4,098,746

PHILLIPS, BRIAN P (UNITED STATES INDIVIDUAL), DBA THE THIRD BILLION
75 WEST END AVE SUITE P31D
NEW YORK, NY 10023

Registered Feb. 14, 2012

Int. Cl.: 36

FOR: CHARITABLE SERVICES, NAMELY, PROVIDING FINANCIAL SUPPORT TO DISADVANTAGED INDIVIDUALS IN THE UNITED STATES AND OTHER COUNTRIES FOR THE PURPOSE OF FACILITATING HEALTH, WELLNESS AND ECONOMIC DEVELOPMENT, IN CLASS 36 (U.S. CLS. 100, 101 AND 102).

SERVICE MARK

PRINCIPAL REGISTER

FIRST USE 5-31-2011; IN COMMERCE 6-22-2011.

THE MARK CONSISTS OF STANDARD CHARACTERS WITHOUT CLAIM TO ANY PARTICULAR FONT, STYLE, SIZE, OR COLOR.

SER. NO. 85-353,241, FILED 6-22-2011.

FRANK LATTUCA, EXAMINING ATTORNEY



David J. Kyffers

Director of the United States Patent and Trademark Office

United States of America

United States Patent and Trademark Office



Reg. No. 4,098,747

Registered Feb. 14, 2012

Int. Cl.: 16

TRADEMARK

PRINCIPAL REGISTER

SQUARE STYLES INC (TEXAS CORPORATION)
1021 KORY DRIVE
MESQUITE, TX 75149

FOR: BOXES, CARTONS, STORAGE CONTAINERS, AND PACKAGING CONTAINERS
MADE OF PAPER OR CARDBOARD, IN CLASS 16 (U.S. CLS. 2, 5, 22, 23, 29, 37, 38 AND
50).

FIRST USE 1-1-2011; IN COMMERCE 1-1-2011.

THE MARK CONSISTS OF A GEOMETRIC FIGURE REPRESENTING A PERSON WITH
THREE STRINGS OF HAIR, WITH THE LEFT EYE BEING MUCH LARGER THAN THE
RIGHT EYE, TWO ARMS, FOUR FINGERS, WITH A RECTANGULAR BODY AND LARGE
SMILE WITH SIX TEETH SHOWING.

SER. NO. 85-353,331, FILED 6-22-2011.

LINDA POWELL, EXAMINING ATTORNEY



David J. Kybas

Director of the United States Patent and Trademark Office

United States of America

United States Patent and Trademark Office

TURBOWERX

Reg. No. 4,098,748

REVIEL, MARC J (UNITED STATES INDIVIDUAL), DBA MOTORQUE CORP
2106 DAYFLOWER TRACE RD
CEDAR PARK, TX 78613

Registered Feb. 14, 2012

Int. Cl.: 7

FOR: AUTOMOTIVE PARTS, NAMELY, TURBOCHARGER SYSTEMS, IN CLASS 7 (U.S. CLS. 13, 19, 21, 23, 31, 34 AND 35).

TRADEMARK

FIRST USE 9-1-2007; IN COMMERCE 9-1-2007.

PRINCIPAL REGISTER

THE MARK CONSISTS OF STANDARD CHARACTERS WITHOUT CLAIM TO ANY PARTICULAR FONT, STYLE, SIZE, OR COLOR.

SER. NO. 85-353,560, FILED 6-22-2011.

KIMBERLY PERRY, EXAMINING ATTORNEY



David J. Kybas

Director of the United States Patent and Trademark Office

United States of America

United States Patent and Trademark Office

SALONSNAPSHOT

Reg. No. 4,098,749

SPOOR, CHERYL (UNITED STATES INDIVIDUAL)
133 SPINNAKER DRIVE
LEAGUE CITY, TX 77573

Registered Feb. 14, 2012

Int. Cl.: 35

FOR: CONSULTING SERVICES IN THE FIELD OF JOB PERFORMANCE ASSESSMENT FOR THE SALON INDUSTRY, IN CLASS 35 (U.S. CLS. 100, 101 AND 102).

SERVICE MARK

FIRST USE 1-4-2008; IN COMMERCE 1-4-2008.

PRINCIPAL REGISTER

THE MARK CONSISTS OF STANDARD CHARACTERS WITHOUT CLAIM TO ANY PARTICULAR FONT, STYLE, SIZE, OR COLOR.

SER. NO. 85-353,582, FILED 6-22-2011.

RAUL CORDOVA, EXAMINING ATTORNEY



David J. Kybas

Director of the United States Patent and Trademark Office

United States of America

United States Patent and Trademark Office

FRONTIER NATURAL PRODUCTS CO-OP

Reg. No. 4,098,750

FRONTIER DISTRIBUTION LLC (DELAWARE LIMITED LIABILITY COMPANY)

Registered Feb. 14, 2012

P.O. BOX 299
NORWAY, IA 52318

Int. Cl.: 35

FOR: ON-LINE WHOLESALE AND RETAIL STORE SERVICES FEATURING HERBS, SPICES, FOODS, TEAS, AND PERSONAL CARE PRODUCTS MADE WITH NATURAL INGREDIENTS, AND RECIPES FOR USE WITH NATURAL INGREDIENTS, IN CLASS 35 (U.S. CLS. 100, 101 AND 102).

SERVICE MARK

PRINCIPAL REGISTER

FIRST USE 1-1-2001; IN COMMERCE 1-1-2001.

THE MARK CONSISTS OF STANDARD CHARACTERS WITHOUT CLAIM TO ANY PARTICULAR FONT, STYLE, SIZE, OR COLOR.

NO CLAIM IS MADE TO THE EXCLUSIVE RIGHT TO USE "NATURAL PRODUCTS CO-OP", APART FROM THE MARK AS SHOWN.

SER. NO. 85-354,210, FILED 6-23-2011.

STEVEN R. FINE, EXAMINING ATTORNEY



David J. Kyffers

Director of the United States Patent and Trademark Office

United States of America

United States Patent and Trademark Office



Reg. No. 4,098,751

HERKO INTERNATIONAL, INC. (FLORIDA CORPORATION)
12975 S.W. 132 STREET
MIAMI, FL 33186

Registered Feb. 14, 2012

Int. Cl.: 7

FOR: SPARK PLUG IGNITION WIRES; AND IGNITION COILS BEING PARTS FOR LAND VEHICLE INTERNAL COMBUSTION ENGINES, IN CLASS 7 (U.S. CLS. 13, 19, 21, 23, 31, 34 AND 35).

TRADEMARK

FIRST USE 12-31-2006; IN COMMERCE 12-31-2006.

PRINCIPAL REGISTER

NO CLAIM IS MADE TO THE EXCLUSIVE RIGHT TO USE "IGNITION", APART FROM THE MARK AS SHOWN.

THE MARK CONSISTS OF THE WORDS "HERLUX" AND "IGNITION" APPEAR ONE ABOVE THE OTHER ONE, WITH THE LATTER BEING SHIFTED SLIGHTLY TO THE RIGHT, AND THE WORDS BEING PLACED INSIDE A PARALLELOGRAM.

SER. NO. 85-354,339, FILED 6-23-2011.

VERNA BETH RIRIE, EXAMINING ATTORNEY



David J. Kyffers

Director of the United States Patent and Trademark Office

United States of America

United States Patent and Trademark Office

GET DOWN IN YOUR DOG

Reg. No. 4,098,752

AMP MOVEMENT LLC (DELAWARE LIMITED LIABILITY COMPANY)

Registered Feb. 14, 2012

86 LEXINGTON AVENUE, 1B
BROOKLYN, NY 11238

Int. Cl.: 41

FOR: EDUCATIONAL SERVICES, NAMELY, CONDUCTING CLASSES, SEMINARS, WORKSHOPS, AND TRAINING IN THE FIELD OF YOGA AND DANCE INSTRUCTION AND DISTRIBUTING COURSE MATERIALS IN CONNECTION THEREWITH, IN CLASS 41 (U.S. CLS. 100, 101 AND 107).

SERVICE MARK

PRINCIPAL REGISTER

FIRST USE 3-1-2010; IN COMMERCE 5-1-2010.

THE MARK CONSISTS OF STANDARD CHARACTERS WITHOUT CLAIM TO ANY PARTICULAR FONT, STYLE, SIZE, OR COLOR.

SER. NO. 85-354,428, FILED 6-23-2011.

KRISTINA MORRIS, EXAMINING ATTORNEY



David J. Kyffers

Director of the United States Patent and Trademark Office

United States of America
United States Patent and Trademark Office

Wilma

Reg. No. 4,098,753

SHUN SHING BICYCLE CO., LTD. (TAIWAN CORPORATION)

Registered Feb. 14, 2012

3F-5, NO 262, SEC 2, HENAN RD
TAICHUNG CITY, TAIWAN 407

Int. Cl.: 12

FOR: BICYCLE CRANKSETS; BICYCLE CHAINRINGS; BICYCLE GEARS; BICYCLE PARTS, NAMELY, GEAR WHEELS; BICYCLE PARTS, NAMELY, SPROCKETS, IN CLASS 12 (U.S. CLS. 19, 21, 23, 31, 35 AND 44).

TRADEMARK

FIRST USE 3-24-2011; IN COMMERCE 4-24-2011.

PRINCIPAL REGISTER

THE NAME IN THE MARK "WILMA" DOES NOT IDENTIFY A LIVING INDIVIDUAL.

THE MARK CONSISTS OF "WILMA" IN STYLIZED LETTERING.

SER. NO. 85-354,462, FILED 6-23-2011.

KATHLEEN M. VANSTON, EXAMINING ATTORNEY



David J. Kybas

Director of the United States Patent and Trademark Office

United States of America

United States Patent and Trademark Office

Outside The Box Productions

Reg. No. 4,098,754

OUTSIDE THE BOX PRODUCTIONS, LLC (CALIFORNIA LIMITED LIABILITY COMPANY)
21702 HARDY OAK BLVD. #105
SAN ANTONIO, TX 78258

Registered Feb. 14, 2012

Int. Cl.: 35

FOR: ADVERTISING AND MARKETING SERVICES, NAMELY, PROMOTING THE GOODS AND SERVICES OF OTHERS; PROMOTING THE PARTIES AND SPECIAL EVENTS OF OTHERS; PUBLIC RELATIONS; SPECIAL EVENT PLANNING FOR BUSINESS PURPOSES, IN CLASS 35 (U.S. CLS. 100, 101 AND 102).

SERVICE MARK

PRINCIPAL REGISTER

FIRST USE 9-17-2010; IN COMMERCE 9-17-2010.

THE MARK CONSISTS OF STANDARD CHARACTERS WITHOUT CLAIM TO ANY PARTICULAR FONT, STYLE, SIZE, OR COLOR.

NO CLAIM IS MADE TO THE EXCLUSIVE RIGHT TO USE "PRODUCTIONS", APART FROM THE MARK AS SHOWN.

SER. NO. 85-354,565, FILED 6-23-2011.

EDWARD NELSON, EXAMINING ATTORNEY



David J. Kyfos

Director of the United States Patent and Trademark Office

United States of America

United States Patent and Trademark Office

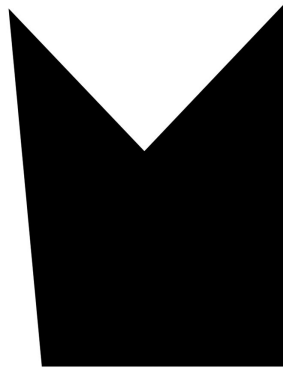

Reg. No. 4,098,755

OF END LLC (CALIFORNIA LIMITED LIABILITY COMPANY), DBA IGNOBLE
1820 MONTANA AVE #1
SANTA MONICA, CA 90403

Registered Feb. 14, 2012

Int. Cl.: 18

FOR: TRAVEL BAGS, HANDBAGS, BACKPACKS, WALLETS, IN CLASS 18 (U.S. CLS. 1, 2, 3, 22 AND 41).

TRADEMARK

FIRST USE 5-1-2010; IN COMMERCE 10-1-2010.

PRINCIPAL REGISTER

THE MARK CONSISTS OF A POLYGON COMPOSED OF FIVE EDGES AND FIVE VERTICES.

SER. NO. 85-354,899, FILED 6-23-2011.

TARA PATE, EXAMINING ATTORNEY



David J. Kyffers

Director of the United States Patent and Trademark Office

United States of America

United States Patent and Trademark Office

NUTRASORB



Reg. No. 4,098,756

ORGANIC LABORATORIES, INC. (FLORIDA CORPORATION)
2963 SE DOMINICA TERRACE
STUART, FL 34952

Registered Feb. 14, 2012

Int. Cl.: 1

FOR: FERTILIZERS; FERTILIZERS FOR AGRICULTURAL USE, IN CLASS 1 (U.S. CLS. 1, 5, 6, 10, 26 AND 46).

TRADEMARK

FIRST USE 10-21-1996; IN COMMERCE 10-21-1996.

PRINCIPAL REGISTER

THE MARK CONSISTS OF BLACK LETTERING "NUTRASORB" WITH A GREEN LEAF PLACED IN THE CENTER OF "NUTRA" AND "SORB".

THE COLOR(S) BLACK, GREEN IS/ARE CLAIMED AS A FEATURE OF THE MARK.

SER. NO. 85-355,048, FILED 6-24-2011.

RUDY R. SINGLETON, EXAMINING ATTORNEY



David J. Kyffers

Director of the United States Patent and Trademark Office

United States of America

United States Patent and Trademark Office



Reg. No. 4,098,757

Registered Feb. 14, 2012

Int. Cl.: 25

TRADEMARK

PRINCIPAL REGISTER

DEWINE SEEDS-SILVER DOLLAR BASEBALL, LLC (NORTH CAROLINA LIMITED LIABILITY COMPANY)
30 BUCHANAN PLACE
ASHEVILLE, NC 28001

FOR: CLOTHING, NAMELY, APRONS, ATHLETIC UNIFORMS, BANDANAS, BOXER SHORTS, CAPS, CLOTH BABY BIBS, COATS, GOLF SHIRTS, GYM SHORTS, GYM SUITS, HATS, JACKETS, JERSEYS, JOGGING SUITS, KNIT SHIRTS, PAJAMAS, POLO SHIRTS, PONCHOS, PULLOVERS, RAIN COATS, RAINWEAR, SWEATERS, SWEAT PANTS, SWEAT SHIRTS, SWEAT SUITS, SOCKS, SPORT SHIRTS, T-SHIRTS, TANK TOPS, TIES, VISORS, WIND RESISTANT JACKETS AND WRISTBANDS, IN CLASS 25 (U.S. CLS. 22 AND 39).

FIRST USE 11-9-2010; IN COMMERCE 11-9-2010.

OWNER OF U.S. REG. NOS. 2,029,636 AND 2,881,428.

NO CLAIM IS MADE TO THE EXCLUSIVE RIGHT TO USE "ASHEVILLE", APART FROM THE MARK AS SHOWN.

THE MARK CONSISTS OF THE WORDING "ASHEVILLE" BELOW WHICH APPEARS A CIRCULAR DESIGN DEPICTING A BASEBALL FLYING OVER A MOON AND STARS WITH THE WORDING "TOURISTS" FEATURING A STAR DOTTING THE LETTER "I" PARTIALLY SUPERIMPOSED OVER A MOUNTAIN RANGE, BATTER'S BOX AND HOME PLATE DESIGN.

SER. NO. 85-355,283, FILED 6-24-2011.

KELLY CHOE, EXAMINING ATTORNEY



David J. Kybas

Director of the United States Patent and Trademark Office

United States of America

United States Patent and Trademark Office

Christmas By Carlisle

Reg. No. 4,098,758

CARLISLE, LYNN (UNITED STATES INDIVIDUAL)
319 YORK STREET, SE
AIKEN, SC 29801

Registered Feb. 14, 2012

Int. Cl.: 11

FOR: CHRISTMAS BUBBLE LIGHTS FOR INTERIOR DISPLAY, IN CLASS 11 (U.S. CLS. 13, 21, 23, 31 AND 34).

TRADEMARK

FIRST USE 7-5-2011; IN COMMERCE 7-5-2011.

PRINCIPAL REGISTER

THE MARK CONSISTS OF STANDARD CHARACTERS WITHOUT CLAIM TO ANY PARTICULAR FONT, STYLE, SIZE, OR COLOR.

NO CLAIM IS MADE TO THE EXCLUSIVE RIGHT TO USE "CHRISTMAS", APART FROM THE MARK AS SHOWN.

SER. NO. 85-355,301, FILED 6-24-2011.

KELLY BOULTON, EXAMINING ATTORNEY



David J. Kyffers

Director of the United States Patent and Trademark Office

United States of America

United States Patent and Trademark Office

DORSAL

Reg. No. 4,098,759

DORSAL FIN CO. LLC (CALIFORNIA LIMITED LIABILITY COMPANY)
29101B THE OLD ROAD
VALENCIA, CA 91355

Registered Feb. 14, 2012

Int. Cls.: 25 and 28

FOR: CLOTHING, NAMELY, WETSUITS, SWIM WEAR, T-SHIRTS, SHORTS, HOODED SWEATSHIRTS, HOODED JACKETS, IN CLASS 25 (U.S. CLS. 22 AND 39).

TRADEMARK

FIRST USE 0-0-2002; IN COMMERCE 0-0-2002.

PRINCIPAL REGISTER

FOR: SURFBOARDS, SURFBOARD FINS, SURFBOARD FIN BOXES IN THE NATURE OF A BOX-LIKE STRUCTURE THAT PERMANENTLY FITS ONTO THE UNDERSIDE OF A SURFBOARD SUCH THAT INTERCHANGEABLE FINS CAN BE EASILY ATTACHED TO FIT THE BOX, SURFBOARD LEASHES, SURFBOARD WAX, SURFBOARD TRACTION PADS, BAGS ESPECIALLY DESIGNED FOR SURFBOARDS, IN CLASS 28 (U.S. CLS. 22, 23, 38 AND 50).

FIRST USE 0-0-2002; IN COMMERCE 0-0-2002.

THE MARK CONSISTS OF STANDARD CHARACTERS WITHOUT CLAIM TO ANY PARTICULAR FONT, STYLE, SIZE, OR COLOR.

SER. NO. 85-355,560, FILED 6-24-2011.

LINDSEY RUBIN, EXAMINING ATTORNEY



David J. Kybas

Director of the United States Patent and Trademark Office

United States of America

United States Patent and Trademark Office

LIVING WITNESSES

Reg. No. 4,098,760

Registered Feb. 14, 2012

Int. Cl.: 16

TRADEMARK

PRINCIPAL REGISTER

NATURALLY PHOTOGRAPHY BY MONNI, LLC (MICHIGAN LIMITED LIABILITY COMPANY)
2518 PONTIAC DRIVE
SYLVAN LAKE, MI 48320

FOR: GIFT SETS CONSISTING OF A BOOK IN THE FIELD OF PHOTOGRAPHY AND PORTRAITS OF HOLOCAUST SURVIVORS AND ALSO INCLUDING A DVD FEATURING HOLOCAUST SURVIVOR PORTRAITS SET TO MUSIC, IN CLASS 16 (U.S. CLS. 2, 5, 22, 23, 29, 37, 38 AND 50).

FIRST USE 9-0-2009; IN COMMERCE 9-0-2009.

THE MARK CONSISTS OF STANDARD CHARACTERS WITHOUT CLAIM TO ANY PARTICULAR FONT, STYLE, SIZE, OR COLOR.

SER. NO. 85-355,670, FILED 6-24-2011.

ZACHARY BELLO, EXAMINING ATTORNEY



David J. Kyffers

Director of the United States Patent and Trademark Office

United States of America

United States Patent and Trademark Office

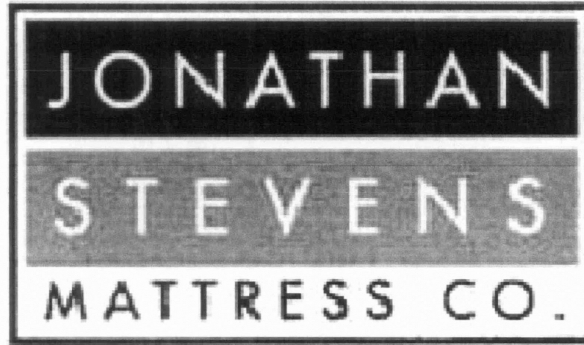

Reg. No. 4,098,761

JONATHAN STEVENS MATTRESS CO. (MICHIGAN CORPORATION)
3800 S. DIVISION
GRAND RAPIDS, MI 49548

Registered Feb. 14, 2012

Int. Cl.: 35

FOR: RETAIL STORE SERVICES FEATURING MATTRESSES AND BEDROOM FURNITURE,
IN CLASS 35 (U.S. CLS. 100, 101 AND 102).

SERVICE MARK

FIRST USE 6-26-2006; IN COMMERCE 6-26-2006.

PRINCIPAL REGISTER

OWNER OF U.S. REG. NO. 1,679,716.

NO CLAIM IS MADE TO THE EXCLUSIVE RIGHT TO USE "MATTRESS CO.", APART
FROM THE MARK AS SHOWN.

THE NAME "JONATHAN STEVENS" DOES NOT IDENTIFY A LIVING INDIVIDUAL.

THE MARK CONSISTS OF "JONATHAN" IN ONE BOX, ABOVE "STEVENS" IN ANOTHER
BOX, ABOVE "MATTRESS CO." IN ANOTHER BOX, ALL OF WHICH ARE CONTAINED
IN A RECTANGULAR OUTLINE.

SER. NO. 85-355,687, FILED 6-24-2011.

LINDA ESTRADA, EXAMINING ATTORNEY



David J. Kybas

Director of the United States Patent and Trademark Office

United States of America

United States Patent and Trademark Office



Reg. No. 4,098,762

Registered Feb. 14, 2012

Int. Cl.: 4

TRADEMARK

PRINCIPAL REGISTER

SMITH MOUNTAIN INDUSTRIES, INC. (DELAWARE CORPORATION)
1000 DILLARD DRIVE
FOREST, VA 24551

FOR: CANDLES; SCENTED CANDLES, IN CLASS 4 (U.S. CLS. 1, 6 AND 15).

FIRST USE 9-0-2009; IN COMMERCE 9-0-2009.

OWNER OF U.S. REG. NO. 3,832,697.

THE MARK CONSISTS OF AN IMAGE OF A LEAF HAVING A STEM AND A CENTRAL VEIN.

SER. NO. 85-355,856, FILED 6-24-2011.

MICHAEL TANNER, EXAMINING ATTORNEY



David J. Kyffers

Director of the United States Patent and Trademark Office

United States of America

United States Patent and Trademark Office



Reg. No. 4,098,763

Registered Feb. 14, 2012

Int. Cls.: 35 and 36

SERVICE MARK

PRINCIPAL REGISTER

ALLIED COMMERCIAL REAL ESTATE (CALIFORNIA CORPORATION)
3100 E. CEDAR STREET, SUITE 7
ONTARIO, CA 91761

FOR: ADVERTISING OF COMMERCIAL OR RESIDENTIAL REAL ESTATE; MATCHING CONSUMERS WITH REAL ESTATE PROFESSIONALS IN THE FIELD OF REAL ESTATE SERVICES VIA COMPUTER NETWORK; NEGOTIATION AND RENEGOTIATION FOR OTHERS OF LEASES AND SUBLEASES AND REAL ESTATE PURCHASE AGREEMENTS; PROVIDING REAL ESTATE LEADS FOR PROSPECTIVE PURCHASERS; PROVIDING REAL ESTATE VIDEO TOURS FOR MARKETING PURPOSES; REAL ESTATE ADVERTISING SERVICES; REAL ESTATE MARKETING ANALYSIS; REAL ESTATE MARKETING SERVICES IN THE FIELD OF COMMERCIAL REAL ESTATE; REAL ESTATE MARKETING SERVICES, NAMELY, ON-LINE SERVICES FEATURING TOURS OF RESIDENTIAL AND COMMERCIAL REAL ESTATE; REAL ESTATE SALES MANAGEMENT, IN CLASS 35 (U.S. CLS. 100, 101 AND 102).

FIRST USE 9-12-2005; IN COMMERCE 9-12-2005.

FOR: APPRAISAL AND EVALUATION OF REAL ESTATE; ARRANGING OF LEASES AND RENTAL AGREEMENTS FOR REAL ESTATE; ASSESSMENT AND MANAGEMENT OF REAL ESTATE; CLASSIFIED REAL ESTATE LISTINGS OF APARTMENT RENTALS AND HOUSING RENTALS; COMMERCIAL AND RESIDENTIAL REAL ESTATE AGENCY SERVICES; EVALUATION OF REAL PROPERTY; FINANCIAL DUE DILIGENCE SERVICES IN THE FIELD OF REAL ESTATE; LEASE OF REAL ESTATE; LEASING OF REAL ESTATE; LEASING OF REAL PROPERTY; PROVIDING INFORMATION IN THE FIELD OF REAL ESTATE VIA THE INTERNET; PROVIDING REAL ESTATE LISTINGS AND REAL ESTATE INFORMATION VIA THE INTERNET; PROVIDING REAL ESTATE LISTINGS VIA THE INTERNET; REAL ESTATE ACQUISITION SERVICES; REAL ESTATE AGENCIES; REAL ESTATE APPRAISAL; REAL ESTATE BROKERAGE; REAL ESTATE BROKERAGE SERVICES SPECIALIZING IN RESTAURANTS AND OTHER FOOD SERVICE RELATED BUSINESSES; REAL ESTATE CONSULTANCY; REAL ESTATE CONSULTATION; REAL ESTATE FINANCING SERVICES; REAL ESTATE INVESTMENT SERVICES; REAL ESTATE LISTING; REAL ESTATE LISTING SERVICES FOR HOUSING RENTALS AND APARTMENT RENTALS; REAL ESTATE MANAGEMENT CONSULTATION; REAL ESTATE MANAGEMENT SERVICES; REAL ESTATE SERVICES, NAMELY, RENTAL, BROKERAGE, LEASING AND MANAGEMENT OF COMMERCIAL PROPERTY, OFFICES AND OFFICE SPACE, IN CLASS 36 (U.S. CLS. 100, 101 AND 102).



David J. Kyros

Director of the United States Patent and Trademark Office

Reg. No. 4,098,763 FIRST USE 9-12-2005; IN COMMERCE 9-12-2005.

NO CLAIM IS MADE TO THE EXCLUSIVE RIGHT TO USE "COMMERCIAL REAL ESTATE", APART FROM THE MARK AS SHOWN.

THE COLOR(S) BLACK, YELLOW, WHITE AND GRAY IS/ARE CLAIMED AS A FEATURE OF THE MARK.

THE MARK CONSISTS OF A YELLOW-OVER-BLACK HORIZONTAL BAR CONFIGURATION SURROUNDED BY A WHITE RECTANGULAR BORDER. THE TOP BAR IS YELLOW SURROUNDED BY A BLACK RECTANGULAR BORDER AND THE BOTTOM BAR IS BLACK. THE TOP BAR SHOULD BE SEPARATED FROM THE BOTTOM BAR BY A WHITE HORIZONTAL LINE. THE YELLOW BAR HAS THE TEXT "ALLIED" IN BLACK FOLLOWED BY GRAY BUILDINGS IN THE CORNER. THE BLACK BAR HAS THE TEXT "COMMERCIAL REAL ESTATE" IN WHITE.

SER. NO. 85-355,891, FILED 6-24-2011.

SUSAN RICHARDS, EXAMINING ATTORNEY

United States of America

United States Patent and Trademark Office



Reg. No. 4,098,764

WICKLAND, SHERRIE L. (UNITED STATES INDIVIDUAL)
1689 WILLIAMS ST
CUYAHOGA FALLS, OH 44221

Registered Feb. 14, 2012

Int. Cl.: 28

FOR: TACTILE, STRESS, ANXIETY RELIEF TOY, IN CLASS 28 (U.S. CLS. 22, 23, 38 AND 50).

TRADEMARK

FIRST USE 6-9-2011; IN COMMERCE 6-9-2011.

PRINCIPAL REGISTER

THE MARK CONSISTS OF A KITE DESIGN WITH THE LETTERS "A", "S", "K" WITHIN THE KITE.

SER. NO. 85-355,975, FILED 6-24-2011.

DOUGLAS LEE, EXAMINING ATTORNEY



David J. Kybas

Director of the United States Patent and Trademark Office

United States of America

United States Patent and Trademark Office

But Loan

Reg. No. 4,098,765

Registered Feb. 14, 2012

Int. Cl.: 36

SERVICE MARK

PRINCIPAL REGISTER

AMERIFIRST FINANCIAL CORPORATION (MICHIGAN CORPORATION), DBA AMERIFIRST
HOME MORTGAGE
616 W. CENTRE AVENUE
PORTAGE, MI 49024

FOR: MORTGAGE BANKING SERVICES, NAMELY, ORIGATION, ACQUISITION, SERVICING, SECURITIZATION, BROKERAGE, AND REFINANCING OF RESIDENTIAL-REHABILITATION MORTGAGE LOANS, IN CLASS 36 (U.S. CLS. 100, 101 AND 102).

FIRST USE 1-24-2011; IN COMMERCE 1-24-2011.

THE MARK CONSISTS OF STANDARD CHARACTERS WITHOUT CLAIM TO ANY PARTICULAR FONT, STYLE, SIZE, OR COLOR.

NO CLAIM IS MADE TO THE EXCLUSIVE RIGHT TO USE "LOAN", APART FROM THE MARK AS SHOWN.

SER. NO. 85-356,146, FILED 6-24-2011.

H. M. FISHER, EXAMINING ATTORNEY



David J. Kyffers

Director of the United States Patent and Trademark Office

United States of America

United States Patent and Trademark Office

OLFACTIONARIES

Reg. No. 4,098,766

Registered Feb. 14, 2012

Int. Cl.: 30

TRADEMARK

PRINCIPAL REGISTER

OLFACTIONARIES, INC. (NEW YORK CORPORATION)
360 WEST 36TH STREET, 7S
NEW YORK, NY 10018

FOR: CANDIES; CANDY; CANDY BARS; CANDY CAKE DECORATIONS; CANDY COATED APPLES; CANDY COATED POPCORN; CANDY CONTAINING ALCOHOLIC BEVERAGE CONTENT AND FLAVOR; CANDY DECORATIONS FOR CAKES; CANDY FOR FOOD; CANDY MINTS; CANDY SPRINKLES; CANDY WITH CARAMEL; CANDY WITH COCOA; CANDY, NAMELY, DRAGÉES; CHOCOLATE CANDIES; CHOCOLATES AND CHOCOLATE BASED READY TO EAT CANDIES AND SNACKS; COTTON CANDY; GIFT BASKETS CONTAINING CANDY; GUMMY CANDIES; ICE CANDIES; PEPPERMINT CANDY; STARCH-BASED CANDIES (AME); SUGARLESS CANDIES; SWEETS, IN CLASS 30 (U.S. CL. 46).

FIRST USE 12-1-2010; IN COMMERCE 12-1-2010.

THE MARK CONSISTS OF STANDARD CHARACTERS WITHOUT CLAIM TO ANY PARTICULAR FONT, STYLE, SIZE, OR COLOR.

SER. NO. 85-356,551, FILED 6-27-2011.

AMY KERTGATE, EXAMINING ATTORNEY



David J. Kyros

Director of the United States Patent and Trademark Office

United States of America

United States Patent and Trademark Office



TRIDENT

Member Alteris Group

Reg. No. 4,098,767

Registered Feb. 14, 2012

Int. Cl.: 36

SERVICE MARK

PRINCIPAL REGISTER

ARGO GROUP INTERNATIONAL HOLDINGS, LTD. (BERMUDA CORPORATION)
110 PITTS BAY ROAD
PEMBROKE, BERMUDA HM08

FOR: INSURANCE SERVICES, NAMELY, INSURANCE AGENCY AND INSURANCE UNDERWRITING SERVICES IN THE FIELD OF PROPERTY, INLAND, MARINE, CRIME, GENERAL LIABILITY, PUBLIC OFFICIALS LIABILITY, LAW ENFORCEMENT LIABILITY, AUTOMOBILE LIABILITY, AUTOMOBILE PHYSICAL DAMAGE AND EXCESS LIABILITY INSURANCE COVERAGE FOR POLITICAL SUBDIVISIONS, NAMELY, CITIES, COUNTIES AND TOWNS, IN CLASS 36 (U.S. CLS. 100, 101 AND 102).

FIRST USE 12-20-2010; IN COMMERCE 12-20-2010.

OWNER OF U.S. REG. NOS. 2,479,808, 3,028,985, AND 3,546,428.

THE COLOR(S) BLUE AND YELLOW IS/ARE CLAIMED AS A FEATURE OF THE MARK.

NO CLAIM IS MADE TO THE EXCLUSIVE RIGHT TO USE "GROUP", APART FROM THE MARK AS SHOWN.

THE MARK CONSISTS OF A DRAWING OF A LIGHTHOUSE IN BLUE FEATURING YELLOW WAVE MARKS INDICATING LIGHT NEXT TO THE WORD "TRIDENT" IN CAPITAL LETTERS ABOVE THE ITALICIZED WORDS "MEMBER ALTERIS GROUP".

THE WORDING "ALTERIS" HAS NO MEANING IN A FOREIGN LANGUAGE.

SER. NO. 85-356,597, FILED 6-27-2011.

MAYUR VAGHANI, EXAMINING ATTORNEY



David J. Kybas

Director of the United States Patent and Trademark Office

United States of America

United States Patent and Trademark Office



Reg. No. 4,098,768

Registered Feb. 14, 2012

Int. Cl.: 16

TRADEMARK

PRINCIPAL REGISTER

STEVEN P. DEMME (UNITED STATES INDIVIDUAL)
518 WHEATFIELD DRIVE
LITITZ, PA 17543

FOR: EDUCATIONAL KITS SOLD AS A UNIT IN THE FIELD OF MATHEMATICS CONSISTING PRIMARILY OF EDUCATIONAL BOOKS, FLASH CARDS AND WORKSHEETS, AND ALSO INCLUDING AN EDUCATIONAL DVD, IN CLASS 16 (U.S. CLS. 2, 5, 22, 23, 29, 37, 38 AND 50).

FIRST USE 1-1-2004; IN COMMERCE 2-13-2004.

OWNER OF U.S. REG. NO. 3,896,879.

THE COLOR(S) GREEN IS/ARE CLAIMED AS A FEATURE OF THE MARK.

THE MARK CONSISTS OF TWO SHADED GREEN STACKING BLOCKS, ONE IN FRONT OF THE OTHER, EACH BLOCK IS DRAWN IN PERSPECTIVE AND EACH HAS A RAISED PORTION ON THEIR TOP SURFACES. NEITHER BLOCKS' BOTTOM SURFACES ARE PARALLEL WITH AN IMAGINED X-AXIS.

SER. NO. 85-356,636, FILED 6-27-2011.

VERNA BETH RIRIE, EXAMINING ATTORNEY



David J. Kybas

Director of the United States Patent and Trademark Office

United States of America

United States Patent and Trademark Office



Reg. No. 4,098,769

Registered Feb. 14, 2012

Int. Cl.: 21

TRADEMARK

PRINCIPAL REGISTER

MILLER, DAVID L. (UNITED STATES INDIVIDUAL)
PO BOX 12682
FT. HUACHUCA, AZ 85670

FOR: MUGS, IN CLASS 21 (U.S. CLS. 2, 13, 23, 29, 30, 33, 40 AND 50).

FIRST USE 4-0-2008; IN COMMERCE 5-0-2008.

OWNER OF U.S. REG. NO. 3,481,683.

THE COLOR(S) YELLOW, BLACK, WHITE AND TAN IS/ARE CLAIMED AS A FEATURE OF THE MARK.

THE MARK CONSISTS OF THE STYLIZED WORDING "TIMES IS HARD" IN BLACK LETTERING AND A YELLOW, BLACK AND WHITE STYLIZED CRYING FACE DESIGN. THE COLOR TAN APPEARS AS BACKGROUND SHADOWING THE WORDING AND DESIGN IN THE MARK.

SER. NO. 85-356,993, FILED 6-27-2011.

INGA ERVIN, EXAMINING ATTORNEY



David J. Kyffers

Director of the United States Patent and Trademark Office

United States of America

United States Patent and Trademark Office

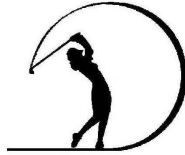

Reg. No. 4,098,770

Registered Feb. 14, 2012

Int. Cl.: 36

SERVICE MARK

PRINCIPAL REGISTER

SWINGIN' WITH A STAR, INC. (DELAWARE CORPORATION)
354 E. HILLENDALE ROAD
KENNETT SQUARE, PA 19348

FOR: CHARITABLE FUNDRAISING SERVICES; CHARITABLE SERVICES, NAMELY, PROVIDING FINANCIAL SUPPORT TO CHARITIES SUPPORTING WOMEN AND GIRLS, IN CLASS 36 (U.S. CLS. 100, 101 AND 102).

FIRST USE 12-31-1995; IN COMMERCE 12-31-1995.

THE MARK CONSISTS OF A DEPICTION OF A WOMAN HOLDING A GOLF CLUB AFTER A GOLF STROKE AND SHOWING AN ARC TRAVELED BY A HEAD OF THE GOLF CLUB DURING THE GOLF STROKE.

SER. NO. 85-357,179, FILED 6-27-2011.

GENE MACIOL, EXAMINING ATTORNEY



David J. Kyffers

Director of the United States Patent and Trademark Office

United States of America

United States Patent and Trademark Office

Delivering Pet Happiness

Reg. No. 4,098,771

CLICKVERGE LLC (DELAWARE LIMITED LIABILITY COMPANY)

Registered Feb. 14, 2012

3363 NE 163RD STREET #809
NORTH MIAMI BEACH, FL 33160

Int. Cl.: 35

FOR: ON-LINE RETAIL STORE SERVICES FEATURING PET FOOD, PET SUPPLIES AND PET ACCESSORIES, IN CLASS 35 (U.S. CLS. 100, 101 AND 102).

SERVICE MARK

FIRST USE 6-1-2011; IN COMMERCE 6-1-2011.

PRINCIPAL REGISTER

THE MARK CONSISTS OF STANDARD CHARACTERS WITHOUT CLAIM TO ANY PARTICULAR FONT, STYLE, SIZE, OR COLOR.

SER. NO. 85-357,238, FILED 6-27-2011.

KELLY TRUSILO, EXAMINING ATTORNEY



David J. Kybas

Director of the United States Patent and Trademark Office

United States of America

United States Patent and Trademark Office



Reg. No. 4,098,772

Registered Feb. 14, 2012

Int. Cl.: 43

SERVICE MARK

PRINCIPAL REGISTER

GUZMAN, OCTAVIO (UNITED STATES INDIVIDUAL)
101 UNIVERSITY AVE
SACRAMENTO, CA 95825

FOR: RESTAURANT, IN CLASS 43 (U.S. CLS. 100 AND 101).

FIRST USE 9-1-2010; IN COMMERCE 9-1-2010.

THE MARK CONSISTS OF THE WORDING "LA PENCA AZUL" TO THE RIGHT OF A DESIGN CONSISTING OF SEVEN SPEAR-SHAPED LEAVES EXTENDING FROM A SPIRAL BASE. THE WORDING "LA" APPEARS ABOVE THE WORDING "PENCA" AND THE WORDING "PENCA" APPEARS ABOVE THE WORDING "AZUL". STRAY MARKS APPEAR AROUND THE WORDING AND THE DESIGN ELEMENT.

THE ENGLISH TRANSLATION OF "LA PENCA AZUL" IN THE MARK IS "THE BLUE STALK".

SER. NO. 85-357,252, FILED 6-27-2011.

SETH A. RAPPAPORT, EXAMINING ATTORNEY



David J. Kybas

Director of the United States Patent and Trademark Office

United States of America

United States Patent and Trademark Office

chief learning officer

Reg. No. 4,098,773

Registered Feb. 14, 2012

Int. Cls.: 9 and 16

TRADEMARK

PRINCIPAL REGISTER

MEDIATEC PUBLISHING, INC. (ILLINOIS CORPORATION)
SUITE 1290
111 E. WACKER DRIVE
CHICAGO, IL 60601

FOR: ELECTRONIC DOWNLOADABLE PUBLICATIONS, NAMELY, MAGAZINES AND NEWSLETTERS IN THE FIELD OF CORPORATE TRAINING AND EDUCATION, IN CLASS 9 (U.S. CLS. 21, 23, 26, 36 AND 38).

FIRST USE 10-0-2004; IN COMMERCE 10-0-2004.

FOR: MAGAZINES AND NEWSLETTERS IN THE FIELD OF CORPORATE TRAINING AND EDUCATION, IN CLASS 16 (U.S. CLS. 2, 5, 22, 23, 29, 37, 38 AND 50).

FIRST USE 8-0-2002; IN COMMERCE 8-0-2002.

THE MARK CONSISTS OF STANDARD CHARACTERS WITHOUT CLAIM TO ANY PARTICULAR FONT, STYLE, SIZE, OR COLOR.

SEC. 2(F).

SER. NO. 85-357,391, FILED 6-27-2011.

BRIAN PINO, EXAMINING ATTORNEY



David J. Kyffers

Director of the United States Patent and Trademark Office

United States of America

United States Patent and Trademark Office

High Heels and Handshakes

Reg. No. 4,098,774

Registered Feb. 14, 2012

Int. Cl.: 35

SERVICE MARK

PRINCIPAL REGISTER

KILPATRICK, BONNIE (UNITED STATES INDIVIDUAL)
3232 CORAL WAY
APT. 1903
CORAL GABLES, FL 33145

FOR: EVENT PLANNING AND MANAGEMENT FOR MARKETING, BRANDING, PROMOTING OR ADVERTISING THE GOODS AND SERVICES OF OTHERS, IN CLASS 35 (U.S. CLS. 100, 101 AND 102).

FIRST USE 3-2-2011; IN COMMERCE 4-20-2011.

THE MARK CONSISTS OF STANDARD CHARACTERS WITHOUT CLAIM TO ANY PARTICULAR FONT, STYLE, SIZE, OR COLOR.

SER. NO. 85-357,838, FILED 6-28-2011.

JAY BESCH, EXAMINING ATTORNEY



David J. Kyffers

Director of the United States Patent and Trademark Office

United States of America

United States Patent and Trademark Office

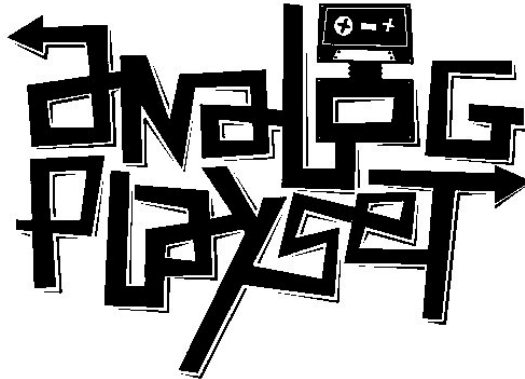

Reg. No. 4,098,775

Registered Feb. 14, 2012

Int. Cls.: 25 and 28

TRADEMARK

PRINCIPAL REGISTER

THAXTON, TONY (UNITED STATES INDIVIDUAL)
#211
416 E BROADWAY
GLENDALE, CA 91205

FOR: T-SHIRTS, IN CLASS 25 (U.S. CLS. 22 AND 39).

FIRST USE 5-1-2009; IN COMMERCE 5-1-2009.

FOR: COLLECTABLE TOY FIGURES, IN CLASS 28 (U.S. CLS. 22, 23, 38 AND 50).

FIRST USE 5-1-2009; IN COMMERCE 5-1-2009.

NO CLAIM IS MADE TO THE EXCLUSIVE RIGHT TO USE "PLAYSET" FOR INTERNATIONAL CLASS 28, APART FROM THE MARK AS SHOWN.

THE MARK CONSISTS OF THE WORD "ANALOG" ABOVE, "PLAYSET" BELOW, AND THE "O" IN "ANALOG" IS A ROBOT WITH A CASSETTE TAPE HEAD.

SER. NO. 85-357,943, FILED 6-28-2011.

MICHAEL ENGEL, EXAMINING ATTORNEY



David J. Kybas

Director of the United States Patent and Trademark Office

United States of America

United States Patent and Trademark Office



Reg. No. 4,098,776

Registered Feb. 14, 2012

Int. Cl.: 42

SERVICE MARK

PRINCIPAL REGISTER

ANELLO, JOHN (UNITED STATES INDIVIDUAL)
65 MONTCLAIR AVE
MONTCLAIR, NJ 07042

FOR: AUTOMOTIVE DIAGNOSTIC SERVICES FEATURING COMPUTER SOFTWARE FOR USE BY INDEPENDENT AUTOMOTIVE REPAIR PERSONNEL, IN CLASS 42 (U.S. CLS. 100 AND 101).

FIRST USE 2-15-1991; IN COMMERCE 2-15-1991.

NO CLAIM IS MADE TO THE EXCLUSIVE RIGHT TO USE "AUTO TECH", APART FROM THE MARK AS SHOWN.

THE COLOR(S) RED, BLACK, GRAY, BLUE, YELLOW AND GREEN IS/ARE CLAIMED AS A FEATURE OF THE MARK.

THE MARK CONSISTS OF THE WORDING "AUTO TECH" ABOVE A ROBOTIC CHARACTER ON ONE WHEEL, WITH THE WORDS "ON WHEELS" BELOW THE ROBOTIC CHARACTER. THE WORDING IN THE MARK IS IN RED WITH BLACK SHADING. THE ROBOTIC CHARACTER HAS A GRAY BODY WITH BLUE CIRCULAR DESIGNS ON THE SHOULDERS, A BLUE FACE WITH BLACK GLASSES AND WHITE TEETH, AS WELL AS A WHITE CHEST. THE TIRE IS BLACK AND GRAY WITH A BLUE INTERIOR. IN THE RIGHT HAND OF THE ROBOTIC CHARACTER IS A DIAGNOSTIC TOOL IN THE COLORS RED, GREEN, BLACK, BLUE AND YELLOW.

SER. NO. 85-357,953, FILED 6-28-2011.

DAVID MURRAY, EXAMINING ATTORNEY



David J. Kybas

Director of the United States Patent and Trademark Office

United States of America

United States Patent and Trademark Office

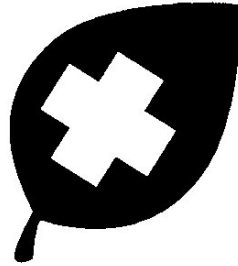

Reg. No. 4,098,777

Registered Feb. 14, 2012

Int. Cl.: 35

SERVICE MARK

PRINCIPAL REGISTER

DEDICATED REFERRAL SERVICES (TEXAS LIMITED LIABILITY COMPANY)
SUITE 160
5310 HARVEST HILL ROAD
DALLAS, TX 75230

FOR: BUSINESS MARKETING CONSULTING SERVICES; REFERRALS IN THE FIELD OF HEALTHCARE, IN CLASS 35 (U.S. CLS. 100, 101 AND 102).

FIRST USE 6-21-2011; IN COMMERCE 6-21-2011.

THE MARK CONSISTS OF A LEAF WITH A MEDICAL CROSS INSIDE IT.

SER. NO. 85-357,973, FILED 6-28-2011.

SEAN CROWLEY, EXAMINING ATTORNEY



David J. Kyffers

Director of the United States Patent and Trademark Office

United States of America

United States Patent and Trademark Office

CERTIFIED AUTOMATION PROFESSIONAL

Reg. No. 4,098,778

Registered Feb. 14, 2012

Int. Cl.: 41

SERVICE MARK

PRINCIPAL REGISTER

INTERNATIONAL SOCIETY OF AUTOMATION (NORTH CAROLINA NON-PROFIT CORPORATION)
67 ALEXANDER DRIVE, P.O. BOX 12277
RESEARCH TRIANGLE PARK
RALEIGH, NC 27709

FOR: EDUCATIONAL SERVICES, NAMELY, CONDUCTING SEMINARS, CONFERENCES AND CERTIFICATION PROGRAMS IN THE FIELD OF AUTOMATION, IN CLASS 41 (U.S. CLS. 100, 101 AND 107).

FIRST USE 10-21-2003; IN COMMERCE 10-21-2003.

THE MARK CONSISTS OF STANDARD CHARACTERS WITHOUT CLAIM TO ANY PARTICULAR FONT, STYLE, SIZE, OR COLOR.

OWNER OF U.S. REG. NO. 3,072,340.

SEC. 2(F).

SER. NO. 85-357,976, FILED 6-28-2011.

RAUL CORDOVA, EXAMINING ATTORNEY



David J. Kyffers

Director of the United States Patent and Trademark Office

United States of America

United States Patent and Trademark Office

A TOTAL COMMITMENT TO BETTER LIVING

Reg. No. 4,098,779

GID INVESTMENT ADVISERS CORPORATION (DELAWARE CORPORATION)
125 HIGH STREET, 27TH FLOOR
BOSTON, MA 02110

Registered Feb. 14, 2012

Int. Cls.: 36, 37 and 43

FOR: REAL ESTATE SERVICES, NAMELY, RENTAL, BROKERAGE, LEASING AND MANAGEMENT OF RESIDENTIAL AND COMMERCIAL PROPERTY, OFFICES AND OFFICE SPACE, IN CLASS 36 (U.S. CLS. 100, 101 AND 102).

SERVICE MARK

FIRST USE 6-0-2003; IN COMMERCE 6-0-2003.

PRINCIPAL REGISTER

FOR: BUILDING CONSTRUCTION AND DEVELOPMENT SERVICES, NAMELY REAL ESTATE DEVELOPMENT AND BUILDING REPAIR AND MAINTENANCE SERVICES, IN CLASS 37 (U.S. CLS. 100, 103 AND 106).

FIRST USE 6-0-2003; IN COMMERCE 6-0-2003.

FOR: PROVISION OF TEMPORARY HOUSING ACCOMMODATIONS, IN CLASS 43 (U.S. CLS. 100 AND 101).

FIRST USE 6-0-2003; IN COMMERCE 6-0-2003.

THE MARK CONSISTS OF STANDARD CHARACTERS WITHOUT CLAIM TO ANY PARTICULAR FONT, STYLE, SIZE, OR COLOR.

SER. NO. 85-358,021, FILED 6-28-2011.

WILLIAM JACKSON, EXAMINING ATTORNEY



David J. Kyffers

Director of the United States Patent and Trademark Office

United States of America

United States Patent and Trademark Office

THE TANDEM GROUP

Reg. No. 4,098,780

THE TANDEM GROUP, INC. (NORTH CAROLINA CORPORATION)
8336 TIFTON ROAD
CHARLOTTE, NC 28226

Registered Feb. 14, 2012

Int. Cl.: 36

FOR: INSURANCE AGENCY AND BROKERAGE, IN CLASS 36 (U.S. CLS. 100, 101 AND 102).

SERVICE MARK

FIRST USE 1-2-2007; IN COMMERCE 1-2-2007.

PRINCIPAL REGISTER

THE MARK CONSISTS OF STANDARD CHARACTERS WITHOUT CLAIM TO ANY PARTICULAR FONT, STYLE, SIZE, OR COLOR.

NO CLAIM IS MADE TO THE EXCLUSIVE RIGHT TO USE "GROUP", APART FROM THE MARK AS SHOWN.

SER. NO. 85-358,065, FILED 6-28-2011.

KELLY CHOE, EXAMINING ATTORNEY



David J. Kyffers

Director of the United States Patent and Trademark Office

United States of America

United States Patent and Trademark Office

RIDIS IND. RIDING IS DEEP IN SOUL

Reg. No. 4,098,781

BARKER, ASHLEY A. (UNITED STATES INDIVIDUAL)
4096 CONRAD DRIVE
SPRING VALLEY, CA 91977

Registered Feb. 14, 2012

Int. Cl.: 25

FOR: HATS; TOPS, IN CLASS 25 (U.S. CLS. 22 AND 39).

TRADEMARK

FIRST USE 6-26-2011; IN COMMERCE 6-26-2011.

PRINCIPAL REGISTER

THE MARK CONSISTS OF STANDARD CHARACTERS WITHOUT CLAIM TO ANY PARTICULAR FONT, STYLE, SIZE, OR COLOR.

SER. NO. 85-358,379, FILED 6-28-2011.

KATINA MISTER, EXAMINING ATTORNEY



David J. Kyffers

Director of the United States Patent and Trademark Office

United States of America

United States Patent and Trademark Office

TUB O' TOUGH

Reg. No. 4,098,782

FEDERAL PROCESS CORPORATION (OHIO CORPORATION)
4520 RICHMOND ROAD
CLEVELAND, OH 44128

Registered Feb. 14, 2012

Int. Cl.: 21

FOR: ALL-PURPOSE PRE-MOISTENED TOWELETTES FOR CLEANING, IN CLASS 21 (U.S. CLS. 2, 13, 23, 29, 30, 33, 40 AND 50).

TRADEMARK

FIRST USE 6-20-2011; IN COMMERCE 6-20-2011.

PRINCIPAL REGISTER

THE MARK CONSISTS OF STANDARD CHARACTERS WITHOUT CLAIM TO ANY PARTICULAR FONT, STYLE, SIZE, OR COLOR.

SER. NO. 85-358,623, FILED 6-28-2011.

DOMINICK J. SALEMI, EXAMINING ATTORNEY



David J. Kyffers

Director of the United States Patent and Trademark Office

United States of America

United States Patent and Trademark Office

INSURPRO

Reg. No. 4,098,783

Registered Feb. 14, 2012

Int. Cl.: 42

SERVICE MARK

PRINCIPAL REGISTER

AMERICAN HORIZON SOFTWARE, LLC (DELAWARE LIMITED LIABILITY COMPANY)
SUITE 450
68 SOUTH SERVICE ROAD
MELVILLE, NY 11747

FOR: PROVIDING ON-LINE NON-DOWNLOADABLE SOFTWARE FOR INSURANCE POLICY AND INSURANCE CLAIMS MANAGEMENT, IN CLASS 42 (U.S. CLS. 100 AND 101).

FIRST USE 1-0-2011; IN COMMERCE 1-0-2011.

THE MARK CONSISTS OF STANDARD CHARACTERS WITHOUT CLAIM TO ANY PARTICULAR FONT, STYLE, SIZE, OR COLOR.

SER. NO. 85-358,785, FILED S.R. 6-28-2011 AM. P.R. 7-22-2011.

KEVIN DINALLO, EXAMINING ATTORNEY



David J. Kyjars

Director of the United States Patent and Trademark Office

United States of America

United States Patent and Trademark Office

FlashQE

Reg. No. 4,098,784

TAU SCIENCE CORPORATION (OREGON CORPORATION)
15250 NW GREENBRIER PKY
BEAVERTON, OR 97006

Registered Feb. 14, 2012

Int. Cl.: 9

FOR: AN OPTICAL METROLOGY INSPECTION SYSTEM COMPRISED OF A LIGHT SOURCE, ONE OR MORE CAMERAS AND SENSORS IN COMMUNICATION WITH COMPUTER SOFTWARE AND HARDWARE; ELECTRO-OPTICAL INSTRUMENTS FOR USE IN INSPECTION AND MEASUREMENT OF INDUSTRIAL COMPONENTS; OPTICAL INSPECTION APPARATUS; OPTICAL INSPECTION APPARATUS FOR INDUSTRIAL USE; OPTICAL INSPECTION APPARATUS FOR INSPECTION OF SEMICONDUCTOR MATERIALS, NAMELY, SEMICONDUCTOR WAFERS, RETICLES, AND PHOTOMASKS, IN CLASS 9 (U.S. CLS. 21, 23, 26, 36 AND 38).

TRADEMARK

PRINCIPAL REGISTER

FIRST USE 10-1-2010; IN COMMERCE 10-1-2010.

THE MARK CONSISTS OF STANDARD CHARACTERS WITHOUT CLAIM TO ANY PARTICULAR FONT, STYLE, SIZE, OR COLOR.

SER. NO. 85-358,819, FILED 6-28-2011.

JOHN DALIER, EXAMINING ATTORNEY



David J. Kypos

Director of the United States Patent and Trademark Office

United States of America

United States Patent and Trademark Office



Reg. No. 4,098,785

Registered Feb. 14, 2012

Int. Cl.: 25

TRADEMARK

PRINCIPAL REGISTER

SHAHEEN, MOUNIR, EDDIE (UNITED STATES INDIVIDUAL), DBA T-BODY PROMOTIONS
1962 EAST PEMBROKE AVENUE
HAMPTON, VA 23663

FOR: HEADGEAR, NAMELY, BALL CAPS, LOW PROFILE CAPS, GOLF CAPS, KNIT CAPS;
HOODED SWEAT SHIRTS; SHORT-SLEEVED OR LONG-SLEEVED T-SHIRTS; SWEAT
JACKETS; SWEAT PANTS; SWEAT SHIRTS; SWEAT SHORTS; T-SHIRTS; T-SHIRTS FOR
MEN, WOMEN, CHILDREN, AND BABIES; TEE SHIRTS, IN CLASS 25 (U.S. CLS. 22 AND
39).

FIRST USE 6-1-1986; IN COMMERCE 11-30-1989.

THE MARK CONSISTS OF A CIRCLE WITH A GRAPHIC "Z" SUPERIMPOSED OVER IT
AND THE WORDING "NEUTRAL ZONE".

SER. NO. 85-358,839, FILED 6-28-2011.

TOBY BULLOFF, EXAMINING ATTORNEY



David J. Kyros

Director of the United States Patent and Trademark Office

United States of America

United States Patent and Trademark Office



Reg. No. 4,098,786

EMPOWERMENT POTENTIAL LLC (NEW JERSEY LIMITED LIABILITY COMPANY)
23 O'CONNOR CIR
WEST ORANGE, NJ 07052

Registered Feb. 14, 2012

Int. Cl.: 41

FOR: EDUCATIONAL SERVICES, NAMELY, CONDUCTING BUSINESS CORPORATE EXECUTIVE COACHING AND TRAINING IN THE FIELD OF INCREASING PRODUCTIVITY, EXPANDING CREATIVITY, IMPROVING FOCUS, PERFORMING AT A HIGHER LEVEL, AND ACHIEVING GREATER SUCCESS IN LIFE AND BUSINESS AND DISTRIBUTION OF PRINTED MATERIALS IN CONNECTION THEREWITH IN HARD COPY OR ELECTRONIC FORMAT ON THE SAME TOPICS; LIFE COACHING SERVICES IN THE FIELD OF INCREASING PRODUCTIVITY, EXPANDING CREATIVITY, IMPROVING FOCUS, PERFORMING AT A HIGHER LEVEL, AND ACHIEVING GREATER SUCCESS IN LIFE AND BUSINESS, IN CLASS 41 (U.S. CLS. 100, 101 AND 107).

SERVICE MARK

PRINCIPAL REGISTER

FIRST USE 3-0-2011; IN COMMERCE 3-0-2011.

THE MARK CONSISTS OF THE WORDING "EMPOWERMENT POTENTIAL" WITH THE IMAGE OF A TRIANGULAR FIGURE SURROUNDED BY A CIRCULAR DISK-LIKE FIGURE LOCATED IN BETWEEN THE WORDING.

SER. NO. 85-358,912, FILED 6-28-2011.

SARA BENJAMIN, EXAMINING ATTORNEY



David J. Kyjars

Director of the United States Patent and Trademark Office

United States of America

United States Patent and Trademark Office

ALLFIT

Reg. No. 4,098,787

Registered Feb. 14, 2012

Int. Cl.: 41

SERVICE MARK

PRINCIPAL REGISTER

ALL FITNESS SOLUTIONS, INC. (NORTH CAROLINA CORPORATION)
5414 LAMCO ST #8
MONTGOMERY, AL 36117

FOR: CONDUCTING FITNESS CLASSES; PERSONAL FITNESS TRAINING SERVICES AND CONSULTANCY; PHYSICAL FITNESS CONDITIONING CLASSES; PHYSICAL FITNESS INSTRUCTION; PHYSICAL FITNESS STUDIO SERVICES, NAMELY, PROVIDING GROUP EXERCISE INSTRUCTION, EQUIPMENT, AND FACILITIES; PROVIDING FITNESS AND EXERCISE FACILITIES, IN CLASS 41 (U.S. CLS. 100, 101 AND 107).

FIRST USE 0-0-2010; IN COMMERCE 0-0-2010.

THE MARK CONSISTS OF STANDARD CHARACTERS WITHOUT CLAIM TO ANY PARTICULAR FONT, STYLE, SIZE, OR COLOR.

SER. NO. 85-358,932, FILED 6-29-2011.

INGRID C. EULIN, EXAMINING ATTORNEY



David J. Kyffers

Director of the United States Patent and Trademark Office

United States of America

United States Patent and Trademark Office

SUPERSOLVE

Reg. No. 4,098,788

PIETECH, INC. (VIRGINIA CORPORATION)
1588 OAKBRIDGE TERRACE
POWHATAN, VA 23139

Registered Feb. 14, 2012

Int. Cl.: 42

FOR: PROVIDING ON-LINE, NON-DOWNLOADABLE SOFTWARE FOR THE CREATION, MARKETING AND PRESENTATION OF FINANCIAL PLANS FOR FINANCIAL ADVISORS AND CONSUMERS, IN CLASS 42 (U.S. CLS. 100 AND 101).

SERVICE MARK

FIRST USE 12-31-2005; IN COMMERCE 9-22-2008.

PRINCIPAL REGISTER

THE MARK CONSISTS OF STANDARD CHARACTERS WITHOUT CLAIM TO ANY PARTICULAR FONT, STYLE, SIZE, OR COLOR.

SER. NO. 85-358,940, FILED 6-29-2011.

AMY KELLY, EXAMINING ATTORNEY



David J. Kybas

Director of the United States Patent and Trademark Office

United States of America

United States Patent and Trademark Office

CELEBRATE BEING DIFFERENT

Reg. No. 4,098,789

MICHEAL MCCARTNEY (UNITED STATES INDIVIDUAL)
2012 PARK FALLS DRIVE
RALEIGH, NC 27614

Registered Feb. 14, 2012

Int. Cl.: 35

FOR: ON-LINE RETAIL STORE SERVICES FEATURING CLOTHING AND ACCESSORIES;
RETAIL STORE SERVICES FEATURING CLOTHING AND ACCESSORIES, IN CLASS 35
(U.S. CLS. 100, 101 AND 102).

SERVICE MARK

FIRST USE 4-3-2011; IN COMMERCE 4-3-2011.

PRINCIPAL REGISTER

THE MARK CONSISTS OF STANDARD CHARACTERS WITHOUT CLAIM TO ANY PARTICULAR FONT, STYLE, SIZE, OR COLOR.

SER. NO. 85-358,989, FILED 6-29-2011.

MICHELE SWAIN, EXAMINING ATTORNEY



David J. Kybas

Director of the United States Patent and Trademark Office

United States of America

United States Patent and Trademark Office

HIPAA TEXT

Reg. No. 4,098,790

TIGERTEXT, INC. (DELAWARE CORPORATION)
1310 MONTANA AVE, SECOND FLOOR
SANTA MONICA, CA 90403

Registered Feb. 14, 2012

Int. Cl.: 38

FOR: ELECTRONIC TRANSMISSION OF MESSAGES AND DATA; MESSAGE COLLECTION AND TRANSMISSION, IN CLASS 38 (U.S. CLS. 100, 101 AND 104).

SERVICE MARK

FIRST USE 3-1-2011; IN COMMERCE 3-1-2011.

PRINCIPAL REGISTER

THE MARK CONSISTS OF STANDARD CHARACTERS WITHOUT CLAIM TO ANY PARTICULAR FONT, STYLE, SIZE, OR COLOR.

SER. NO. 85-359,025, FILED 6-29-2011.

ASMAT KHAN, EXAMINING ATTORNEY



David J. Kyjars

Director of the United States Patent and Trademark Office

United States of America

United States Patent and Trademark Office

NONCHALANT DOT CALM

Reg. No. 4,098,791

PEREZ, RYAN A. (UNITED STATES INDIVIDUAL)
1413 PONDEROSA DR.

Registered Feb. 14, 2012

RALEIGH, NC 27603

Int. Cl.: 25

FOR: HATS; HOODED SWEAT SHIRTS; SHORT-SLEEVED OR LONG-SLEEVED T-SHIRTS;
TANK TOPS, IN CLASS 25 (U.S. CLS. 22 AND 39).

TRADEMARK

FIRST USE 6-28-2011; IN COMMERCE 6-28-2011.

PRINCIPAL REGISTER

THE MARK CONSISTS OF STANDARD CHARACTERS WITHOUT CLAIM TO ANY PARTICULAR FONT, STYLE, SIZE, OR COLOR.

SER. NO. 85-359,028, FILED 6-29-2011.

ASMAT KHAN, EXAMINING ATTORNEY



David J. Kybas

Director of the United States Patent and Trademark Office

United States of America

United States Patent and Trademark Office

AS WHEEL AS IT GETS!

Reg. No. 4,098,792

CALIFON PRODUCTIONS, INC. (CALIFORNIA CORPORATION)
10202 W. WASHINGTON BLVD.
CULVER CITY, CA 90232

Registered Feb. 14, 2012

Int. Cl.: 35

FOR: PROMOTING THE SALE OF GOODS AND SERVICES OF OTHERS THROUGH THE DISTRIBUTION OF PRINTED MATERIAL AND PROMOTIONAL CONTESTS, IN CLASS 35 (U.S. CLS. 100, 101 AND 102).

SERVICE MARK

FIRST USE 6-22-2011; IN COMMERCE 6-22-2011.

PRINCIPAL REGISTER

THE MARK CONSISTS OF STANDARD CHARACTERS WITHOUT CLAIM TO ANY PARTICULAR FONT, STYLE, SIZE, OR COLOR.

SER. NO. 85-359,038, FILED 6-29-2011.

CHERYL CLAYTON, EXAMINING ATTORNEY



David J. Kyffers

Director of the United States Patent and Trademark Office

United States of America

United States Patent and Trademark Office

Envera

Reg. No. 4,098,793

Registered Feb. 14, 2012

Int. Cl.: 45

SERVICE MARK

PRINCIPAL REGISTER

HIDDEN EYES LLC (FLORIDA LIMITED LIABILITY COMPANY), DBA ENVERA SYSTEMS
SUITE 306
7280 WEST PALMETTO PARK ROAD
BOCA RATON, FL 33433

FOR: HOME SECURITY MONITORING USING WIRELESS AND WIRED SENSORS FOR GLASS BREAKAGE, MOTION DETECTORS, CAMERAS, POOL ALARMS, WATER ALARMS AND SHUTOFF VALVES, GATE, DOOR AND WINDOW CONTACT SENSORS, SEVERE WEATHER ALARMS; MONITORING BURGLAR AND SECURITY ALARMS; MONITORING OF SECURITY SYSTEMS; SECURITY GUARD SERVICES; SECURITY GUARDING FOR FACILITIES; SECURITY SERVICES FOR BUILDINGS, NAMELY, PROVIDING PHYSICAL ACCESS TO PROPERTIES VIA A REMOTE CALL-IN LOCKING DEVICE; SURVEILLANCE SERVICES, IN CLASS 45 (U.S. CLS. 100 AND 101).

FIRST USE 8-31-2007; IN COMMERCE 8-31-2007.

THE MARK CONSISTS OF STANDARD CHARACTERS WITHOUT CLAIM TO ANY PARTICULAR FONT, STYLE, SIZE, OR COLOR.

SER. NO. 85-359,087, FILED 6-29-2011.

TRICIA SONNEBORN, EXAMINING ATTORNEY



David J. Kybas

Director of the United States Patent and Trademark Office

United States of America

United States Patent and Trademark Office

GET SMART ABOUT YOUR LIPS

Reg. No. 4,098,794

JBKELLY, LLC (FLORIDA LIMITED LIABILITY COMPANY)

Registered Feb. 14, 2012

P.O. BOX 546734
SURFSIDE, FL 33154

Int. Cl.: 3

FOR: NON-MEDICATED LIP CARE PREPARATIONS, NAMELY, LIP MOISTURIZERS AND LIP VOLUMIZERS DESIGNED TO ENHANCE THE APPEARANCE AND PLUMPNESS OF LIPS, IN CLASS 3 (U.S. CLS. 1, 4, 6, 50, 51 AND 52).

TRADEMARK

FIRST USE 6-24-2005; IN COMMERCE 6-24-2005.

PRINCIPAL REGISTER

THE MARK CONSISTS OF STANDARD CHARACTERS WITHOUT CLAIM TO ANY PARTICULAR FONT, STYLE, SIZE, OR COLOR.

SER. NO. 85-359,133, FILED 6-29-2011.

FONG HSU, EXAMINING ATTORNEY



David J. Kyffers

Director of the United States Patent and Trademark Office

United States of America

United States Patent and Trademark Office



Reg. No. 4,098,795

ZEN SPA ENTERPRISES INC. (PUERTO RICO CORPORATION)
1054 ASHFORD AVE.

Registered Feb. 14, 2012

SAN JUAN, PUERTO RICO 00907

Int. Cl.: 3

FOR: AROMATIC OILS; BAR SOAP; BODY POWDER; BODY SCRUB; BODY SPLASH; BODY WASH; BUBBLE BATH; CLEANING AND POLISHING PREPARATIONS; EXFOLIANTS FOR SKIN, FACE, HANDS AND FEET; FACE AND BODY CREAMS; FACIAL SCRUBS; HAIR CONDITIONER; HAIR GEL AND HAIR MOUSSE; HAIR SPRAY; LOTIONS FOR FACE AND BODY CARE; MASSAGE OILS; NON-MEDICATED SKIN CARE PREPARATION, NAMELY, BODY MIST; PERFUME; SHAMPOOS; SHOWER GEL, IN CLASS 3 (U.S. CLS. 1, 4, 6, 50, 51 AND 52).

TRADEMARK

PRINCIPAL REGISTER

FIRST USE 6-1-2011; IN COMMERCE 6-1-2011.

THE MARK CONSISTS OF GRAY BACKGROUND WITH GREEN PLANTS IN A BROWN POT ON A BLACK BACKGROUND WITH ROSYMINT IN WHITE STYLIZED FONT ON A YELLOW BACKGROUND WITH A CIRCLE WITH FLOWER WITHIN A LIGHT YELLOW COLOR. BELOW THIS IS LIGHT GRAY SLASH.

THE COLOR(S) GRAY, GREEN, BROWN, BLACK, YELLOW, LIGHT YELLOW, WHITE, LIGHT GRAY IS/ARE CLAIMED AS A FEATURE OF THE MARK.

SER. NO. 85-359,153, FILED 6-29-2011.

BRIDGETT SMITH, EXAMINING ATTORNEY



David J. Kyffers

Director of the United States Patent and Trademark Office

United States of America

United States Patent and Trademark Office

GT-Scan

Reg. No. 4,098,796

FUJIFILM CORPORATION (JAPAN CORPORATION)
26-30, NISHIAZABU 2-CHOME
MINATO-KU, TOKYO, JAPAN

Registered Feb. 14, 2012

Int. Cl.: 9

FOR: SUPPORT SOFTWARE FOR PRODUCING ELECTRONIC BOOKS, IN CLASS 9 (U.S. CLS. 21, 23, 26, 36 AND 38).

TRADEMARK

THE MARK CONSISTS OF STANDARD CHARACTERS WITHOUT CLAIM TO ANY PARTICULAR FONT, STYLE, SIZE, OR COLOR.

PRINCIPAL REGISTER

OWNER OF JAPAN REG. NO. 5399801, DATED 3-18-2011, EXPIRES 3-18-2021.

SER. NO. 85-359,159, FILED 6-29-2011.

KATHERINE E. HALMEN, EXAMINING ATTORNEY



David J. Kyffers

Director of the United States Patent and Trademark Office

United States of America

United States Patent and Trademark Office

GENUISTYLE

Reg. No. 4,098,797

APPLETON LEARNING CORPORATION (ALABAMA CORPORATION)
200 CLINTON AVE., STE. 402
HUNTSVILLE, AL 35801

Registered Feb. 14, 2012

Int. Cl.: 41

FOR: ASSESSMENT OF STUDENTS TO IDENTIFY THEIR UNIQUE PERSONALITY TRAITS, COMMUNICATION STYLES, AND PROBLEM SOLVING SKILLS THAT AFFECT THEIR LEARNING PROCESS , IN CLASS 41 (U.S. CLS. 100, 101 AND 107).

SERVICE MARK

FIRST USE 5-1-2010; IN COMMERCE 5-1-2010.

PRINCIPAL REGISTER

THE MARK CONSISTS OF STANDARD CHARACTERS WITHOUT CLAIM TO ANY PARTICULAR FONT, STYLE, SIZE, OR COLOR.

SER. NO. 85-359,186, FILED 6-29-2011.

CURTIS FRENCH, EXAMINING ATTORNEY



David J. Kyffers

Director of the United States Patent and Trademark Office

United States of America

United States Patent and Trademark Office



Reg. No. 4,098,798

TRI STATE TRUCK CENTER, INC. (MASSACHUSETTS CORPORATION)
411 HARTFORD TURNPIKE, ROUTE 20
SHREWSBURY, MA 01545

Registered Feb. 14, 2012

Int. Cl.: 35

FOR: DEALERSHIPS IN THE FIELD OF NEW AND USED TRUCKS, IN CLASS 35 (U.S. CLS. 100, 101 AND 102).

SERVICE MARK

FIRST USE 12-31-1990; IN COMMERCE 12-31-1990.

PRINCIPAL REGISTER

THE MARK CONSISTS OF A CAPITAL LETTER "T" IN A FANCIFUL BLOCK PRESENTATION WITH A GRAPHIC REPRESENTATION OF A HIGHWAY EXTENDING FROM A BASE OF THE "T" AND ASCENDING TO OVERLAP A RIGHT-SIDE PORTION OF THE TOP STEM OF THE "T", WHEREIN THE GRAPHIC REPRESENTATION OF THE HIGHWAY ALSO SWIRLS IN AN APPROXIMATE "S" SHAPE BETWEEN THE BASE OF THE "T" AND THE RIGHT-SIDE STEM OF THE "T", AND WHEREIN THE GRAPHIC REPRESENTATION OF THE HIGHWAY OVERLAPS A PORTION OF THE BASE OF THE "T" AND A PORTION OF THE RIGHT-SIDE STEM OF THE "T".

SER. NO. 85-359,235, FILED 6-29-2011.

WILLIAM BRECKENFELD, EXAMINING ATTORNEY



David J. Kybas

Director of the United States Patent and Trademark Office

United States of America

United States Patent and Trademark Office



Reg. No. 4,098,799

Registered Feb. 14, 2012

Int. Cls.: 18 and 25

TRADEMARK

PRINCIPAL REGISTER

BIG D ENTERPRISES, LLC (CALIFORNIA LIMITED LIABILITY COMPANY)
ONE VIA PRESEA
COTO DE CAZA, CA 92679

FOR: GOODS OF LEATHER AND IMITATION LEATHER, NAMELY, TRAVEL CASES, TRUNKS AND SUITCASES, CARRY-ON BAGS, LEATHER SHOPPING BAGS; SPORTS BAGS, GARMENT BAGS, BOOT BAGS, HAT BAGS FOR TRAVEL, COSMETIC BAGS SOLD EMPTY, DUFFEL BAGS, CLUTCH BAGS, BOOK BAGS, TOTE BAGS, CARRYALL BAGS, NET BAGS FOR SHOPPING, TRAVEL BAGS, BACKPACKS, HANDBAGS, CARRYING CASES FOR CLOTHING, SHOES, BOOTS, HATS AND ACCESSORIES, NAMELY, SUITCASES AND GEAR BAGS; WAISTBAGS, KEY CASES, PURSES, WALLETS, RUCKSACKS, VANITY CASES SOLD EMPTY, UMBRELLAS; EQUESTRIAN EQUIPMENT, NAMELY, HORSE BLANKETS, SADDLE PADS, SADDLE BAGS AND BRIDLE BAGS, IN CLASS 18 (U.S. CLS. 1, 2, 3, 22 AND 41).

FIRST USE 5-0-2009; IN COMMERCE 5-0-2009.

FOR: CLOTHING, NAMELY, SHIRTS, BLOUSES, TOPS, JEANS, TEE SHIRTS, SKIRTS, SWEATSHIRTS, SHORTS, PANTS, KNICKERS, HOSIERY, SOCKS, STOCKINGS, TIES, ASCOTS, OUTERWEAR, NAMELY, JACKETS, SWEATERS, VESTS, RAINCOATS, CAPES, SLICKERS, OVERALLS, SCARVES, MUFFLERS; PAJAMAS, HATS, CAPS, BELTS, GLOVES; FOOTWEAR, NAMELY, SHOES, SANDALS, BOOTS, SPORT SHOES; HEADWEAR, NAMELY, SUN VISORS; HEADGEAR, NAMELY, HATS AND CAPS; EQUESTRIAN CLOTHING, NAMELY, JODHPURS, BREECHES, SHOW SHIRTS, HUNT JACKETS, JERSEYS AND POLO STYLE SHIRTS, IN CLASS 25 (U.S. CLS. 22 AND 39).

FIRST USE 5-0-2009; IN COMMERCE 5-0-2009.

THE MARK CONSISTS OF AN IMAGE OF THE UPPER HALF OF A RUNNING HORSE ON A SHIELD IMAGE.

SER. NO. 85-359,318, FILED 6-29-2011.

GIANCARLO CASTRO, EXAMINING ATTORNEY



David J. Kyffers

Director of the United States Patent and Trademark Office

United States of America

United States Patent and Trademark Office



Reg. No. 4,098,800

Registered Feb. 14, 2012

Int. Cls.: 9, 16 and 25

TRADEMARK

PRINCIPAL REGISTER

DYNAVOX SYSTEMS LLC (DELAWARE LIMITED LIABILITY COMPANY)
2100 WHARTON STREET, SUITE 400
PITTSBURGH, PA 15203

FOR: COMPUTER SOFTWARE FOR GAMES AND EDUCATIONAL PUZZLES; CD-ROMS CONTAINING SOFTWARE VERSIONS OF THE FOLLOWING: GAMES, CHILDREN'S BOOKS, PHOTOCARDS, PICTURE COMMUNICATION SYMBOL SETS, WORKBOOKS, EDUCATIONAL INSTRUCTION BOOKS AND EDUCATIONAL TESTING MATERIALS, IN CLASS 9 (U.S. CLS. 21, 23, 26, 36 AND 38).

FIRST USE 1-13-2009; IN COMMERCE 1-13-2009.

FOR: PRINTED MATERIALS FOR TEACHING PERSONS WITH SPECIAL NEEDS, NAMELY, AUDITORY COMPREHENSION OF LANGUAGE TEST, VOCABULARY TEST, LANGUAGE DEVELOPMENT TEST, READING TEST, NONVERBAL INTELLIGENCE TEST, EARLY COMMUNICATION AND EMERGING LANGUAGE TEST, ONE-WORD PICTURE VOCABULARY TEST, READING BOOKS, INSTRUCTIONAL BOOKS, PHOTO CARDS, PICTURE COMMUNICATION SYMBOL SETS, WORKBOOKS, IN CLASS 16 (U.S. CLS. 2, 5, 22, 23, 29, 37, 38 AND 50).

FIRST USE 2-27-2009; IN COMMERCE 2-27-2009.

FOR: WEARING APPAREL, NAMELY, T-SHIRTS, GOLF SHIRTS, IN CLASS 25 (U.S. CLS. 22 AND 39).

FIRST USE 1-1-2008; IN COMMERCE 1-1-2008.

THE MARK CONSISTS OF A CARTOON FIGURE JUGGLING THREE CHILDREN'S TOY BLOCKS, EACH BLOCK BEARING A DIFFERENT IMAGE OF AN APPLE, A STAR, AND A HEART.

SER. NO. 85-359,373, FILED 6-29-2011.

MARCIE MILONE, EXAMINING ATTORNEY



David J. Kyffers

Director of the United States Patent and Trademark Office

United States of America

United States Patent and Trademark Office

FIDOR

Reg. No. 4,098,801

Registered Feb. 14, 2012

Int. Cl.: 9

TRADEMARK

PRINCIPAL REGISTER

SICK AG (FED REP GERMANY CORPORATION)
ERWIN-SICK-STRASSE 1
79183 WALDKIRCH, FED REP GERMANY

FOR: TRANSMISSOMETERS; OPACITY MONITORS; SCATTERED LIGHT METERS; SPECTROMETERS; PHOTOMETERS; DUST MONITORS BASED ON TRANSMISSION LIGHT, SCATTER LIGHT, OR COMBINATIONS OF TRANSMISSION LIGHT AND SCATTER LIGHT; FLAME IONIZATION DETECTORS; GAS ANALYZERS FOR LABORATORY AND INDUSTRIAL PURPOSES; ANALYZERS FOR ANALYZING HYDROCARBONS; LIQUID ANALYZERS AND WATER ANALYZERS; GAS AND LIQUID LEAK DETECTORS FOR DETECTION OF LEAKS IN GAS AND LIQUID PIPELINES; OXYGEN SENSORS FOR LABORATORY AND INDUSTRIAL PURPOSES; COMPUTER OPERATING SYSTEM PROGRAMS FOR MEASURING AND CONTROL TECHNOLOGY, IN CLASS 9 (U.S. CLS. 21, 23, 26, 36 AND 38).

THE MARK CONSISTS OF STANDARD CHARACTERS WITHOUT CLAIM TO ANY PARTICULAR FONT, STYLE, SIZE, OR COLOR.

PRIORITY CLAIMED UNDER SEC. 44(D) ON ERPN CMNTY TM OFC APPLICATION NO. 009765595, FILED 2-25-2011, REG. NO. 009765595, DATED 7-29-2011, EXPIRES 2-25-2021.

SER. NO. 85-359,382, FILED 6-29-2011.

REBECCA GILBERT, EXAMINING ATTORNEY



David J. Kypos

Director of the United States Patent and Trademark Office

United States of America
United States Patent and Trademark Office

ZOORKIN

Reg. No. 4,098,802

Registered Feb. 14, 2012

Int. Cl.: 35

SERVICE MARK

PRINCIPAL REGISTER

ZOORKING CORPORATION (CALIFORNIA CORPORATION)
STE E
20251 VENTURA BLVD
WOODLAND HILLS, CA 91364

FOR: PROMOTING THE GOODS AND SERVICES OF OTHERS BY MEANS OF DISTRIBUTING ADVERTISING ON THE INTERNET, IN CLASS 35 (U.S. CLS. 100, 101 AND 102).

FIRST USE 6-15-2011; IN COMMERCE 6-15-2011.

THE MARK CONSISTS OF STANDARD CHARACTERS WITHOUT CLAIM TO ANY PARTICULAR FONT, STYLE, SIZE, OR COLOR.

SER. NO. 85-359,394, FILED 6-29-2011.

THEODORE MCBRIDE, EXAMINING ATTORNEY



David J. Kyffers

Director of the United States Patent and Trademark Office

United States of America

United States Patent and Trademark Office



Reg. No. 4,098,803

TOYO FOOD (NEW YORK CORPORATION)
251 MAMARONECK AVENUE
MAMARONECK, NY 10543

Registered Feb. 14, 2012

Int. Cl.: 43

FOR: BAR AND RESTAURANT SERVICES, IN CLASS 43 (U.S. CLS. 100 AND 101).

SERVICE MARK

FIRST USE 12-31-2008; IN COMMERCE 2-17-2009.

PRINCIPAL REGISTER

THE MARK CONSISTS OF THE STYLIZED WORDS RED PLUM WITH THE STYLIZED WORD RED ABOVE A DEPICTION OF A RED CHOP STICK OUTLINED IN WHITE AND THE STYLIZED WORD PLUM ABOVE A DEPICTION OF A RED CHOP STOCK OUTLINED IN WHITE WITH THE TIPS OF THE CHOPSTICKS GOING DOWN AT A LEFT ANGLE DEPICTING THE CHOPSTICKS HOLDING A RED APPLE WITH A WHITE FLOURISH NEAR THE TOP OF THE APPLE TO GIVE THE EFFECT OF A SHINY RED APPLE WITH THE WHITE STEM OF THE RED APPLE OUTLINED IN RED.

THE COLOR(S) RED AND WHITE IS/ARE CLAIMED AS A FEATURE OF THE MARK.

SER. NO. 85-359,457, FILED 6-29-2011.

MICHELLE DUBOIS, EXAMINING ATTORNEY



David J. Kyffers

Director of the United States Patent and Trademark Office

United States of America

United States Patent and Trademark Office

LASOR

Reg. No. 4,098,804

Registered Feb. 14, 2012

Int. Cl.: 9

TRADEMARK

PRINCIPAL REGISTER

SICK AG (FED REP GERMANY CORPORATION)
ERWIN-SICK-STRASSE 1
79183 WALDKIRCH, FED REP GERMANY

FOR: TRANSMISSOMETERS; OPACITY MONITORS; SCATTERED LIGHT METERS; SPECTROMETERS; PHOTOMETERS; DUST MONITORS BASED ON TRANSMISSION LIGHT, SCATTER LIGHT, OR COMBINATIONS OF TRANSMISSION LIGHT AND SCATTER LIGHT; FLAME IONIZATION DETECTORS; GAS ANALYZERS FOR LABORATORY AND INDUSTRIAL PURPOSES; ANALYZERS FOR ANALYZING HYDROCARBONS; LIQUID ANALYZERS AND WATER ANALYZERS; GAS AND LIQUID LEAK DETECTORS FOR DETECTION OF LEAKS IN GAS AND LIQUID PIPELINES; OXYGEN SENSORS FOR LABORATORY AND INDUSTRIAL PURPOSES; COMPUTER OPERATING SYSTEM PROGRAMS FOR MEASURING AND CONTROL TECHNOLOGY, IN CLASS 9 (U.S. CLS. 21, 23, 26, 36 AND 38).

THE MARK CONSISTS OF STANDARD CHARACTERS WITHOUT CLAIM TO ANY PARTICULAR FONT, STYLE, SIZE, OR COLOR.

PRIORITY CLAIMED UNDER SEC. 44(D) ON ERPN CMNTY TM OFC APPLICATION NO. 009765777, FILED 2-25-2011, REG. NO. 009765777, DATED 7-29-2011, EXPIRES 2-25-2021.

SER. NO. 85-359,479, FILED 6-29-2011.

REBECCA GILBERT, EXAMINING ATTORNEY



David J. Kybas

Director of the United States Patent and Trademark Office

United States of America

United States Patent and Trademark Office

BIG RIVER

Reg. No. 4,098,805

BIG RIVER TELEPHONE COMPANY, LLC (DELAWARE LIMITED LIABILITY COMPANY)
24 SOUTH MINNESOTA STREET
CAPE GIRARDEAU, MO 637021608

Registered Feb. 14, 2012

Int. Cls.: 35 and 38

FOR: OPERATION AND ADMINISTRATION OF TELECOMMUNICATION SYSTEMS AND NETWORKS FOR OTHERS , IN CLASS 35 (U.S. CLS. 100, 101 AND 102).

SERVICE MARK

FIRST USE 7-0-2005; IN COMMERCE 7-0-2005.

PRINCIPAL REGISTER

FOR: TELECOMMUNICATION SERVICES, NAMELY, LOCAL AND LONG DISTANCE TRANSMISSION OF VOICE, DATA, GRAPHICS AND VIDEO BY MEANS OF BROADBAND, COPPER AND OPTICAL OR WIRELESS NETWORKS; AND INTERNET ACCESS PROVIDER SERVICES, IN CLASS 38 (U.S. CLS. 100, 101 AND 104).

FIRST USE 12-0-2001; IN COMMERCE 12-0-2001.

THE MARK CONSISTS OF STANDARD CHARACTERS WITHOUT CLAIM TO ANY PARTICULAR FONT, STYLE, SIZE, OR COLOR.

SER. NO. 85-359,519, FILED 6-29-2011.

ANNE MADDEN, EXAMINING ATTORNEY



David J. Kybas

Director of the United States Patent and Trademark Office

United States of America

United States Patent and Trademark Office

YOJIÉ

Reg. No. 4,098,806

Registered Feb. 14, 2012

Int. Cl.: 43

SERVICE MARK

PRINCIPAL REGISTER

YOJIE FRANCHISE, LLC (CALIFORNIA LIMITED LIABILITY COMPANY)
10329 PAINTER AVENUE
SANTA FE SPRINGS, CA 90670

FOR: RESTAURANT AND BAR SERVICES, IN CLASS 43 (U.S. CLS. 100 AND 101).

FIRST USE 4-1-2006; IN COMMERCE 4-1-2006.

THE MARK CONSISTS OF STANDARD CHARACTERS WITHOUT CLAIM TO ANY PARTICULAR FONT, STYLE, SIZE, OR COLOR.

THE WORDING YOJIÉ HAS NO MEANING IN A FOREIGN LANGUAGE.

SER. NO. 85-359,599, FILED 6-29-2011.

JENNY PARK, EXAMINING ATTORNEY



David J. Kybas

Director of the United States Patent and Trademark Office

United States of America
United States Patent and Trademark Office

UNCLE JOSH

Reg. No. 4,098,807

UNCLE JOSH BAIT COMPANY (WISCONSIN CORPORATION)
525 JEFFERSON STREET
FORT ATKINSON, WI 53538

Registered Feb. 14, 2012

Int. Cls.: 25 and 28

FOR: HATS; SHIRTS, IN CLASS 25 (U.S. CLS. 22 AND 39).

TRADEMARK

FIRST USE 0-0-2003; IN COMMERCE 0-0-2003.

PRINCIPAL REGISTER

FOR: FISHING TACKLE, IN CLASS 28 (U.S. CLS. 22, 23, 38 AND 50).

FIRST USE 3-1-1923; IN COMMERCE 3-1-1923.

THE MARK CONSISTS OF STANDARD CHARACTERS WITHOUT CLAIM TO ANY PARTICULAR FONT, STYLE, SIZE, OR COLOR.

THE NAME(S), PORTRAIT(S), AND/OR SIGNATURE(S) SHOWN IN THE MARK DOES NOT IDENTIFY A PARTICULAR LIVING INDIVIDUAL.

SER. NO. 85-359,608, FILED 6-29-2011.

ELLEN PERKINS, EXAMINING ATTORNEY



David J. Kyffers

Director of the United States Patent and Trademark Office

United States of America

United States Patent and Trademark Office



Reg. No. 4,098,808

Registered Feb. 14, 2012

Int. Cls.: 1, 2 and 35

TRADEMARK

SERVICE MARK

PRINCIPAL REGISTER

AUTOMOTIVE ART INTERNATIONAL INC. (BARBADOS CORPORATION)
WILDEY INDUSTRIAL ESTATE
PO BOX 72W
WILDEY, ST MICHAEL, BARBADOS

FOR: FILLERS FOR AUTOMOBILE BODIES, IN CLASS 1 (U.S. CLS. 1, 5, 6, 10, 26 AND 46).

FIRST USE 9-1-1990; IN COMMERCE 7-1-2002.

FOR: CLEAR AND PIGMENTED COATINGS USED IN THE NATURE OF PAINT; PAINT SEALANT FOR EXTERIOR SURFACES OF VEHICLE, IN CLASS 2 (U.S. CLS. 6, 11 AND 16).

FIRST USE 9-1-1990; IN COMMERCE 7-1-2002.

FOR: FRANCHISING, NAMELY, OFFERING BUSINESS MANAGEMENT ASSISTANCE IN THE ESTABLISHMENT AND/OR OPERATION OF STORES PROVIDING AUTOMOTIVE REFINISHING, AFTER-MARKET, AND ACCESSORY PRODUCTS AND SERVICES FOR MOTOR VEHICLES, IN CLASS 35 (U.S. CLS. 100, 101 AND 102).

FIRST USE 9-1-1990; IN COMMERCE 7-1-2002.

NO CLAIM IS MADE TO THE EXCLUSIVE RIGHT TO USE "AUTOMOTIVE", APART FROM THE MARK AS SHOWN.

THE COLOR(S) BLACK, TEAL AND PINK IS/ARE CLAIMED AS A FEATURE OF THE MARK.

THE MARK CONSISTS OF THE WORD "AUTOMOTIVE" IN TEAL BLOCK LETTERS AT THE TOP OF THE MARK, WITH THE WORD "ART" IN BLACK STYLIZED LETTERS DIRECTLY UNDER AND DIAGONAL TO THE WORD "AUTOMOTIVE"; BELOW THE WORD "ART" THERE IS A PINK BAND, AND BELOW THE PINK BAND THERE IS A SERIES OF TEAL BANDS THAT TAPER AT THE BOTTOM RIGHT CORNER OF THE MARK.



David J. Kyros

Director of the United States Patent and Trademark Office

SER. NO. 85-359,624, FILED 6-29-2011.

KAREN K. BUSH, EXAMINING ATTORNEY

United States of America

United States Patent and Trademark Office

Destination Dinners

Reg. No. 4,098,809

DESTINATION DINNERS, LLC (CALIFORNIA LIMITED LIABILITY COMPANY)
1933 DAVIS STREET, SUITE 209
SAN LEANDRO, CA 94577

Registered Feb. 14, 2012

Int. Cl.: 35

FOR: ON-LINE RETAIL STORE SERVICES FEATURING TRAVEL THEMED GIFT BOXES,
IN CLASS 35 (U.S. CLS. 100, 101 AND 102).

SERVICE MARK

FIRST USE 9-1-2005; IN COMMERCE 12-1-2005.

PRINCIPAL REGISTER

THE MARK CONSISTS OF STANDARD CHARACTERS WITHOUT CLAIM TO ANY PARTICULAR FONT, STYLE, SIZE, OR COLOR.

SER. NO. 85-359,634, FILED 6-29-2011.

JEFF DEFORD, EXAMINING ATTORNEY



David J. Kybas

Director of the United States Patent and Trademark Office

United States of America

United States Patent and Trademark Office

CADsortium

Reg. No. 4,098,810

GATZ, DAVID (UNITED STATES INDIVIDUAL)
4111 CHARLES AVE
GURNEE, IL 60031

Registered Feb. 14, 2012

Int. Cl.: 42

FOR: DESIGN MODELING AND RENDERING SERVICES, NAMELY, PROVIDING DIGITAL PROTOTYPING SERVICES USING COMPUTER AIDED DESIGN, IN CLASS 42 (U.S. CLS. 100 AND 101).

SERVICE MARK

FIRST USE 5-1-2011; IN COMMERCE 5-1-2011.

PRINCIPAL REGISTER

THE MARK CONSISTS OF STANDARD CHARACTERS WITHOUT CLAIM TO ANY PARTICULAR FONT, STYLE, SIZE, OR COLOR.

SER. NO. 85-359,639, FILED 6-29-2011.

JENNY PARK, EXAMINING ATTORNEY



David J. Kyffers

Director of the United States Patent and Trademark Office

United States of America

United States Patent and Trademark Office

AUTOMOTIVE ART

Reg. No. 4,098,811

Registered Feb. 14, 2012

Int. Cls.: 1, 2 and 35

AUTOMOTIVE ART INTERNATIONAL INC. (BARBADOS CORPORATION)
WILDEY INDUSTRIAL ESTATE
PO BOX 72W
WILDEY, ST MICHAEL, BARBADOS

FOR: FILLERS FOR AUTOMOBILE BODIES, IN CLASS 1 (U.S. CLS. 1, 5, 6, 10, 26 AND 46).

TRADEMARK

FIRST USE 9-1-1990; IN COMMERCE 7-1-2002.

SERVICE MARK

FOR: CLEAR AND PIGMENTED COATINGS USED IN THE NATURE OF PAINT; PAINT SEALANT FOR EXTERIOR SURFACES OF VEHICLE, IN CLASS 2 (U.S. CLS. 6, 11 AND 16).

PRINCIPAL REGISTER

FIRST USE 9-1-1990; IN COMMERCE 7-1-2002.

FOR: FRANCHISING, NAMELY, OFFERING BUSINESS MANAGEMENT ASSISTANCE IN THE ESTABLISHMENT AND/OR OPERATION OF STORES PROVIDING AUTOMOTIVE REFINISHING, AFTER-MARKET, AND ACCESSORY PRODUCTS AND SERVICES FOR MOTOR VEHICLES, IN CLASS 35 (U.S. CLS. 100, 101 AND 102).

FIRST USE 9-1-1990; IN COMMERCE 7-1-2002.

THE MARK CONSISTS OF STANDARD CHARACTERS WITHOUT CLAIM TO ANY PARTICULAR FONT, STYLE, SIZE, OR COLOR.

NO CLAIM IS MADE TO THE EXCLUSIVE RIGHT TO USE "AUTOMOTIVE", APART FROM THE MARK AS SHOWN.

SER. NO. 85-359,643, FILED 6-29-2011.

KAREN K. BUSH, EXAMINING ATTORNEY



David J. Kyros

Director of the United States Patent and Trademark Office

United States of America

United States Patent and Trademark Office

ZOWO-PLAST

Reg. No. 4,098,812

Registered Feb. 14, 2012

Int. Cl.: 2

TRADEMARK

PRINCIPAL REGISTER

KRINGS COATING SYSTEMS LLC (OHIO LIMITED LIABILITY COMPANY)
SUITE 111
7775 WALTON PARKWAY
NEW ALBANY, OH 43054

FOR: POLYURETHANE COATINGS FOR PVC, VINYL, FIBERGLASS AND ALUMINUM,
IN CLASS 2 (U.S. CLS. 6, 11 AND 16).

FIRST USE 8-31-2009; IN COMMERCE 8-31-2009.

THE MARK CONSISTS OF STANDARD CHARACTERS WITHOUT CLAIM TO ANY PAR-
TICULAR FONT, STYLE, SIZE, OR COLOR.

SER. NO. 85-359,671, FILED 6-29-2011.

CAROLYN CATALDO, EXAMINING ATTORNEY



David J. Kybas

Director of the United States Patent and Trademark Office

United States of America

United States Patent and Trademark Office

ROTARY LEADER

Reg. No. 4,098,813

Registered Feb. 14, 2012

Int. Cls.: 9 and 41

TRADEMARK

SERVICE MARK

PRINCIPAL REGISTER

ROTARY INTERNATIONAL (ILLINOIS CORPORATION)
LEGAL SERVICES DIVISION
1560 SHERMAN AVENUE
EVANSTON, IL 60201

FOR: DOWNLOADABLE ELECTRONIC NEWSLETTERS FEATURING ARTICLES, VIDEO AND IMAGES RELATING TO HUMANITARIAN, PHILANTHROPIC AND ASSOCIATION SERVICES, IN CLASS 9 (U.S. CLS. 21, 23, 26, 36 AND 38).

FIRST USE 1-22-2010; IN COMMERCE 1-22-2010.

FOR: PROVIDING ON-LINE NEWSLETTERS FEATURING ARTICLES, VIDEO AND IMAGES RELATING TO HUMANITARIAN, PHILANTHROPIC AND ASSOCIATION SERVICES, IN CLASS 41 (U.S. CLS. 100, 101 AND 107).

FIRST USE 1-22-2010; IN COMMERCE 1-22-2010.

THE MARK CONSISTS OF STANDARD CHARACTERS WITHOUT CLAIM TO ANY PARTICULAR FONT, STYLE, SIZE, OR COLOR.

OWNER OF U.S. REG. NOS. 2,303,790, 2,734,690 AND OTHERS.

SER. NO. 85-359,679, FILED 6-29-2011.

FRANK LATTUCA, EXAMINING ATTORNEY



David J. Kybas

Director of the United States Patent and Trademark Office

United States of America

United States Patent and Trademark Office

BAYGROUP INTERNATIONAL

Reg. No. 4,098,814

BAY GROUP INTERNATIONAL, INC. (CALIFORNIA CORPORATION)
2200 LARKSPUR LANDING CIRCLE
LARKSPUR, CA 94939

Registered Feb. 14, 2012

**Int. Cls.: 16, 35, 41 and
42**

FOR: PRINTED MATTER, NAMELY, EDUCATIONAL AND TEACHING MATERIALS IN THE FORM OF MANUALS, EXERCISES, PRINTED CHARTS, WORKSHEETS, AND LESSON PLANS, ALL IN THE FIELDS OF SALES PERFORMANCE AND EFFECTIVENESS, DEVELOPMENT OF SALES METHODS AND TECHNIQUES, PRICING, BEST PRACTICES, AUDITING AND READINESS ASSESSMENTS, NEGOTIATION TRAINING, AND CONFLICT MANAGEMENT, IN CLASS 16 (U.S. CLS. 2, 5, 22, 23, 29, 37, 38 AND 50).

TRADEMARK

SERVICE MARK

PRINCIPAL REGISTER

FIRST USE 0-0-1980; IN COMMERCE 0-0-1980.

FOR: MARKETING AND SALES CONSULTING SERVICES IN THE FIELDS OF SALES PERFORMANCE AND EFFECTIVENESS, DEVELOPMENT OF SALES METHODS AND TECHNIQUES, PRICING, BEST PRACTICES, AUDITING AND READINESS ASSESSMENTS, SALES NEGOTIATION, AND SALES CONFLICT MANAGEMENT; BUSINESS CONSULTING SERVICES; BUSINESS MANAGEMENT CONSULTING WITH RELATION TO SALES METHODOLOGY, MARKETING, PRODUCTION, PERSONNEL, AND BEST SALES PRACTICES; ANALYSIS AND ADVISORY SERVICES RELATING TO BUSINESS MANAGEMENT AND BUSINESS OPERATIONS; PROVIDING A WEBSITE FEATURING NON-DOWNLOADABLE INSTRUCTIONAL VIDEOS IN THE FIELD OF SALES NEGOTIATION, SALES PERFORMANCE AND EFFECTIVENESS, DEVELOPMENT OF SALES METHODS AND TECHNIQUES, BUSINESS CONFLICT MANAGEMENT AND BUSINESS CONFLICT RESOLUTION, IN CLASS 35 (U.S. CLS. 100, 101 AND 102).

FIRST USE 0-0-1980; IN COMMERCE 0-0-1980.

FOR: EDUCATIONAL SERVICES, NAMELY, PROVIDING WORKSHOPS, SEMINARS AND TRAINING SESSIONS IN THE FIELDS OF SALES PERFORMANCE AND EFFECTIVENESS, DEVELOPMENT OF SALES METHODS AND TECHNIQUES, PRICING, BEST PRACTICES, AUDITING AND READINESS ASSESSMENTS, NEGOTIATION SKILLS, CONFLICT MANAGEMENT AND CONFLICT RESOLUTION, AND DISTRIBUTING COURSE MATERIAL IN ASSOCIATION THEREWITH; PROVIDING EDUCATIONAL LESSONS VIA ELECTRONIC MAIL TO GRADUATES OF SALES EDUCATION WORKSHOPS IN THE FIELD OF SALES PERFORMANCE AND EFFECTIVENESS, DEVELOPMENT OF SALES METHODS AND TECHNIQUES, PRICING, BEST PRACTICES, AUDITING AND READINESS ASSESSMENTS,



David J. Kyjars

Director of the United States Patent and Trademark Office

Reg. No. 4,098,814 SALES NEGOTIATION, AND SALES CONFLICT MANAGEMENT; PROVIDING ONLINE TRAINING WORKSHOPS IN THE FIELDS OF SALES NEGOTIATION, SALES PERFORMANCE AND EFFECTIVENESS, DEVELOPMENT OF SALES METHODS AND TECHNIQUES, CONFLICT MANAGEMENT AND CONFLICT RESOLUTION, AND DISTRIBUTION OF TRAINING MATERIAL IN CONNECTION THEREWITH; EDUCATIONAL SERVICES, NAMELY, PROVIDING AN INTERNET WEBSITE PORTAL FEATURING LINKS TO EDUCATIONAL CONTENT, NAMELY, WEBINARS IN THE FIELDS OF SALES NEGOTIATION, SALES PERFORMANCE AND EFFECTIVENESS, THE DEVELOPMENT OF SALES METHODS AND TECHNIQUES, CONFLICT MANAGEMENT, AND CONFLICT RESOLUTION, AND DISTRIBUTING INFORMATIONAL AND COURSE MATERIAL ONLINE IN ASSOCIATION THEREWITH; ON-LINE JOURNALS, NAMELY, BLOGS FEATURING TRAINING IN THE FIELDS OF SALES NEGOTIATION, SALES PERFORMANCE AND EFFECTIVENESS, THE DEVELOPMENT OF SALES METHODS AND TECHNIQUES, CONFLICT MANAGEMENT, AND CONFLICT RESOLUTION; AND ONLINE EDUCATIONAL TESTING; TRAINING AND EDUCATIONAL SERVICES, NAMELY, PROVIDING ONLINE VIDEO INSTRUCTIONAL TRAINING PROGRAMS IN THE FIELDS OF SALES NEGOTIATION, SALES PERFORMANCE AND EFFECTIVENESS, THE DEVELOPMENT OF SALES METHODS AND TECHNIQUES, CONFLICT MANAGEMENT, AND CONFLICT RESOLUTION, IN CLASS 41 (U.S. CLS. 100, 101 AND 107).

FIRST USE 0-0-1980; IN COMMERCE 0-0-1980.

FOR: SOFTWARE AS A SERVICE (SAAS) SERVICES FEATURING SOFTWARE THAT PROVIDES A VIRTUAL COACHING PROCESS TO SUPPORT MANAGERS IN BUSINESS ORGANIZATIONS, THROUGH ADMINISTERING ONLINE EMPLOYEE TRAINING SESSIONS, ASSIGNING USERS TASKS TO SUPPORT THE APPLICATION OF LEARNING ON THE JOB, TRACKING EMPLOYEES' PROGRESS AND RESULTS, AND GUIDING MANAGERS IN SUPPLEMENTAL TRAINING TECHNIQUES, ALL IN THE FIELD OF SALES NEGOTIATION, SALES PERFORMANCE AND EFFECTIVENESS, DEVELOPMENT OF SALES METHODS AND TECHNIQUES, CONFLICT MANAGEMENT AND CONFLICT RESOLUTION; SOFTWARE AS A SERVICE (SAAS) SERVICES, NAMELY, HOSTING SOFTWARE FOR USE BY MANAGERS AND GRADUATES OF EDUCATIONAL WORKSHOPS, FEATURING TOOLS, MODELS, PLANNERS, MEDIA, MANAGEMENT AIDS, AND COACHING TIPS TO REINFORCE SKILLS AND TRAINING AND TO SUPPORT COLLABORATIVE ONLINE COMMUNICATION, ALL IN THE FIELDS OF SALES NEGOTIATION, SALES PERFORMANCE AND EFFECTIVENESS, THE DEVELOPMENT OF SALES METHODS AND TECHNIQUES, CONFLICT MANAGEMENT, AND CONFLICT RESOLUTION, IN CLASS 42 (U.S. CLS. 100 AND 101).

FIRST USE 6-3-2008; IN COMMERCE 6-3-2008.

THE MARK CONSISTS OF STANDARD CHARACTERS WITHOUT CLAIM TO ANY PARTICULAR FONT, STYLE, SIZE, OR COLOR.

OWNER OF U.S. REG. NO. 1,939,386.

NO CLAIM IS MADE TO THE EXCLUSIVE RIGHT TO USE "INTERNATIONAL", APART FROM THE MARK AS SHOWN.

SER. NO. 85-359,684, FILED 6-29-2011.

MICHAEL ENGEL, EXAMINING ATTORNEY

United States of America

United States Patent and Trademark Office



Reg. No. 4,098,815

LIFEMASK LLC (CALIFORNIA LIMITED LIABILITY COMPANY)
1875 WEST 220TH STREET
TORRANCE, CA 90501

Registered Feb. 14, 2012

Int. Cl.: 9

FOR: FIRE ESCAPE HOOD, IN CLASS 9 (U.S. CLS. 21, 23, 26, 36 AND 38).

TRADEMARK

FIRST USE 1-1-2011; IN COMMERCE 1-1-2011.

PRINCIPAL REGISTER

THE MARK CONSISTS OF MEDICAL HEART RATE METER ON THE TOP LEFT WITH TWO ELECTROCARDIOGRAMS (TOP HALF IS LIGHTER, BOTTOM HALF IN DARKER GRAYSCALE), IT ALSO CASTS A SHADOW IN LIGHT GRAY. NEXT TO IT HAS TWO PHRASES (ALL STARTING WITH CAPITAL LETTERS FOLLOWED BY LOWERCASE) WITH A PERIOD BETWEEN THEM "LIFES GOOD. LIVE SAFE," AND BELOW THAT THE COMPANY NAME IN ONE WORD, "LIFEMASK," WITH A CAPITAL "L".

SER. NO. 85-359,686, FILED 6-29-2011.

MICHAEL ENGEL, EXAMINING ATTORNEY



David J. Kybas

Director of the United States Patent and Trademark Office

United States of America

United States Patent and Trademark Office

univerzhop

Reg. No. 4,098,816

Registered Feb. 14, 2012

Int. Cl.: 35

SERVICE MARK

PRINCIPAL REGISTER

CARMODY, CHUCK (UNITED STATES INDIVIDUAL)
#3-103
25399 THE OLD ROAD
STEVENSON RANCH, CA 91381

FOR: ON-LINE RETAIL STORE SERVICES FEATURING CLOTHING, ACCESSORIES, HOUSEHOLD ACCESSORIES AND WARES, COMPUTER HARDWARE, PERIPHERALS, CONSUMER ELECTRONICS, ACCESSORIES, PRODUCTS FOR PERSONAL CARE, FRAGRANCE, JEWELRY, COSMETICS, BED AND BATH LINENS, HOME AND GARDEN FURNISHING, DECORATION, KITCHENWARE, GOURMET ITEMS, GIFTS, FOOTWEAR, SPORTING GOODS, TOYS, AND SEASONAL ITEMS, IN CLASS 35 (U.S. CLS. 100, 101 AND 102).

FIRST USE 3-1-2011; IN COMMERCE 3-1-2011.

THE MARK CONSISTS OF STANDARD CHARACTERS WITHOUT CLAIM TO ANY PARTICULAR FONT, STYLE, SIZE, OR COLOR.

SER. NO. 85-359,884, FILED 6-29-2011.

THEODORE MCBRIDE, EXAMINING ATTORNEY



David J. Kypos

Director of the United States Patent and Trademark Office

United States of America

United States Patent and Trademark Office

INSPIRE YOGA

Reg. No. 4,098,817

Registered Feb. 14, 2012

Int. Cl.: 41

SERVICE MARK

PRINCIPAL REGISTER

INSPIRE YOGA, LLC (TEXAS LIMITED LIABILITY COMPANY)
THE SHOPS AT HIGHLAND VILLAGE
1401 SHOAL CREEK DR. SUITE 268
HIGHLAND VILLAGE, TX 75077

FOR: YOGA INSTRUCTION, IN CLASS 41 (U.S. CLS. 100, 101 AND 107).

FIRST USE 12-16-2010; IN COMMERCE 6-17-2011.

THE MARK CONSISTS OF STANDARD CHARACTERS WITHOUT CLAIM TO ANY PARTICULAR FONT, STYLE, SIZE, OR COLOR.

NO CLAIM IS MADE TO THE EXCLUSIVE RIGHT TO USE "YOGA", APART FROM THE MARK AS SHOWN.

SER. NO. 85-359,934, FILED 6-29-2011.

TEJBIR SINGH, EXAMINING ATTORNEY



David J. Kybas

Director of the United States Patent and Trademark Office

United States of America

United States Patent and Trademark Office

Soluisce

Reg. No. 4,098,818

Registered Feb. 14, 2012

Int. Cl.: 9

TRADEMARK

PRINCIPAL REGISTER

SOLUISCE SOLUTIONS INC (ILLINOIS CORPORATION)
750 E CUNNINGHAM DR
PALATINE, IL 60074

FOR: COMPUTER SOFTWARE FOR USE IN DATABASE MANAGEMENT, DOCUMENTATION MANAGEMENT, AND CONTROL SYSTEMS, IN CLASS 9 (U.S. CLS. 21, 23, 26, 36 AND 38).

FIRST USE 10-15-2008; IN COMMERCE 10-15-2008.

THE MARK CONSISTS OF STANDARD CHARACTERS WITHOUT CLAIM TO ANY PARTICULAR FONT, STYLE, SIZE, OR COLOR.

SER. NO. 85-359,982, FILED 6-29-2011.

DEBRA LEE, EXAMINING ATTORNEY



David J. Kyffers

Director of the United States Patent and Trademark Office

United States of America

United States Patent and Trademark Office



Reg. No. 4,098,819

Registered Feb. 14, 2012

Int. Cl.: 30

TRADEMARK

PRINCIPAL REGISTER

CAFFE DEL DOGE VENEZIA INC (DELAWARE CORPORATION)
419 UNIVERSITY AVE
PALO ALTO, CA 94301

FOR: COFFEE, IN CLASS 30 (U.S. CL. 46).

FIRST USE 6-29-2011; IN COMMERCE 6-29-2011.

THE MARK CONSISTS OF A STYLISTIC RENDERING OF A RED VENETIAN GONDOLA CARRYING A GONDOLIER HOLDING AN OAR ON BOARD.

THE COLOR(S) RED IS/ARE CLAIMED AS A FEATURE OF THE MARK.

SER. NO. 85-360,118, FILED 6-30-2011.

KIMBERLY PERRY, EXAMINING ATTORNEY



David J. Kyffers

Director of the United States Patent and Trademark Office

United States of America

United States Patent and Trademark Office

Stick up for Love!

Reg. No. 4,098,820

ONE MEANING (NEW YORK PARTNERSHIP)

Registered Feb. 14, 2012

321 EAST 54TH ST., #10B
NEW YORK, NY 10022

Int. Cl.: 16

FOR: BUMPER STICKERS; CHILDREN'S WALL STICKERS AND MURALS; STICKERS;
STICKERS; STICKERS AND TRANSFERS, IN CLASS 16 (U.S. CLS. 2, 5, 22, 23, 29, 37, 38
AND 50).

TRADEMARK

FIRST USE 6-11-2011; IN COMMERCE 6-18-2011.

PRINCIPAL REGISTER

THE MARK CONSISTS OF STANDARD CHARACTERS WITHOUT CLAIM TO ANY PAR-
TICULAR FONT, STYLE, SIZE, OR COLOR.

SER. NO. 85-360,169, FILED 6-30-2011.

WON TEAK OH, EXAMINING ATTORNEY



David J. Kyffers

Director of the United States Patent and Trademark Office

United States of America

United States Patent and Trademark Office

CABECAHEALTH

Reg. No. 4,098,821

Registered Feb. 14, 2012

Int. Cl.: 44

SERVICE MARK

PRINCIPAL REGISTER

ANNA M. CABECA, D.O., P.C. (GEORGIA CORPORATION)
2712 PARKWOOD DRIVE
BRUNSWICK, GA 31520

FOR: OBSTETRIC AND GYNECOLOGY SERVICES; MEDICAL CLINIC PROVIDING WEIGHT LOSS SOLUTIONS, SERVICES AND PROGRAMS, NUTRITION COUNSELING, HORMONE THERAPY, INCLUDING, BIOIDENTICAL HORMONE REPLACEMENT, ANTI AGING THERAPY, AND NATURAL HORMONE THERAPY, MEDICAL AESTHETIC PROCEDURES, INCLUDING, LASER HAIR REMOVAL, LASER PEELS, BOTULINUM TOXIN TREATMENTS, MICRODERMABRASION, LIPOSUCTION, VEIN TREATMENTS, VEIN THERAPY, CELLULITE TREATMENTS, BODY CONTOURING TREATMENTS, INJECTABLE FILLER TREATMENTS, FACIALS, AND SKIN CARE; MASSAGE; REFLEXOLOGY SERVICES; HUMAN FERTILITY TREATMENT SERVICES, IN CLASS 44 (U.S. CLS. 100 AND 101).

FIRST USE 4-1-2006; IN COMMERCE 4-1-2006.

THE MARK CONSISTS OF STANDARD CHARACTERS WITHOUT CLAIM TO ANY PARTICULAR FONT, STYLE, SIZE, OR COLOR.

SEC. 2(F).

SER. NO. 85-360,187, FILED 6-30-2011.

ZHALEH DELANEY, EXAMINING ATTORNEY



David J. Kyros

Director of the United States Patent and Trademark Office

United States of America

United States Patent and Trademark Office

SMOOTH A'TUDE

Reg. No. 4,098,822

Registered Feb. 14, 2012

Int. Cl.: 25

TRADEMARK

PRINCIPAL REGISTER

HBI BRANDED APPAREL ENTERPRISES, LLC (DELAWARE LIMITED LIABILITY COMPANY)
1000 EAST HANES MILL ROAD
WINSTON-SALEM, NC 27105

FOR: SHAPEWEAR, NAMELY, TANK TOPS AND CAMISOLES, IN CLASS 25 (U.S. CLS. 22 AND 39).

FIRST USE 12-15-2010; IN COMMERCE 12-15-2010.

THE MARK CONSISTS OF STANDARD CHARACTERS WITHOUT CLAIM TO ANY PARTICULAR FONT, STYLE, SIZE, OR COLOR.

OWNER OF U.S. REG. NOS. 2,099,636 AND 3,613,545.

SER. NO. 85-360,258, FILED 6-30-2011.

SUSAN LESLIE DUBOIS, EXAMINING ATTORNEY



David J. Kyffers

Director of the United States Patent and Trademark Office

United States of America

United States Patent and Trademark Office



Reg. No. 4,098,823

Registered Feb. 14, 2012

Int. Cl.: 9

TRADEMARK

PRINCIPAL REGISTER

SOFTSTAR ENTERTAINMENT INC. (TAIWAN CORPORATION)
16F, 16F-3
NO. 166, CHENGYI ROAD, ZHONGHE DIST.,
NEW TAIPEI CITY 235., TAIWAN

FOR: COMPUTER GAME SOFTWARE; COMPUTER GAME SOFTWARE DOWNLOADABLE FROM A GLOBAL COMPUTER NETWORK; COMPUTER GAME SOFTWARE FOR USE ON MOBILE AND CELLULAR PHONES; ELECTRONIC GAME SOFTWARE FOR WIRELESS DEVICES; ELECTRONIC GAME SOFTWARE; INTERACTIVE GAME SOFTWARE; MOTION PICTURE FILMS FEATURING CHILDREN'S ENTERTAINMENT, IN CLASS 9 (U.S. CLS. 21, 23, 26, 36 AND 38).

FIRST USE 6-18-2011; IN COMMERCE 6-18-2011.

THE MARK CONSISTS OF A STYLIZED DRAWING OF A PINK PIGLET WITH A JET-LIKE YELLOW AND ORANGE EXHAUST TRAIL FLYING THROUGH THE WHITE CLOUDS OUTLINED IN BLUE NEXT TO THE STYLIZED WORDING "FLYING PIGGY". THE LETTERS F, L AND Y ARE FILLED WITH SHADES OF RED. THE I IN "FLYING" IS PINK AND N AND G ARE SHADES OF PURPLE. THE WORD "PIGGY" HAS YELLOW P AND I, ORANGE G AND RED Y.

THE COLOR(S) PINK, RED, PURPLE, BLUE, YELLOW, ORANGE AND WHITE IS/ARE CLAIMED AS A FEATURE OF THE MARK.

SER. NO. 85-360,294, FILED 6-30-2011.

SHAUNIA CARLYLE, EXAMINING ATTORNEY



David J. Kyjars

Director of the United States Patent and Trademark Office

United States of America

United States Patent and Trademark Office

ANSIRA

Reg. No. 4,098,824

ANSIRA PARTNERS, INC. (DELAWARE CORPORATION)
2300 LOCUST STREET
ST. LOUIS, MO 63103

Registered Feb. 14, 2012

Int. Cl.: 35

FOR: ADVERTISING AND MARKETING SERVICES PROVIDED BY MEANS OF INDIRECT METHODS OF MARKETING COMMUNICATIONS, NAMELY, SOCIAL MEDIA, SEARCH ENGINE MARKETING, INQUIRY MARKETING, INTERNET MARKETING, MOBILE MARKETING, BLOGGING AND OTHER FORMS OF PASSIVE, SHARABLE OR VIRAL COMMUNICATIONS CHANNELS; ADVERTISING AND MARKETING SERVICES, NAMELY, PROMOTING THE GOODS AND SERVICES OF OTHERS; BUSINESS MARKETING SERVICES; MARKETING SERVICES, NAMELY, CONDUCTING CONSUMER TRACKING BEHAVIOR RESEARCH AND CONSUMER TREND ANALYSIS; MARKETING SERVICES, NAMELY, CONSUMER MARKETING RESEARCH; PROMOTION AND MARKETING SERVICES AND RELATED CONSULTING, IN CLASS 35 (U.S. CLS. 100, 101 AND 102).

SERVICE MARK

PRINCIPAL REGISTER

FIRST USE 5-3-2011; IN COMMERCE 5-3-2011.

THE MARK CONSISTS OF STANDARD CHARACTERS WITHOUT CLAIM TO ANY PARTICULAR FONT, STYLE, SIZE, OR COLOR.

SER. NO. 85-360,309, FILED 6-30-2011.

THEODORE MCBRIDE, EXAMINING ATTORNEY



David J. Kyros

Director of the United States Patent and Trademark Office

United States of America

United States Patent and Trademark Office

Somathil

Reg. No. 4,098,825

PMG LABS, LLC (UTAH LIMITED LIABILITY COMPANY)
10653 S. RIVER FRONT PARKWAY #220
SOUTH JORDAN, UT 84020

Registered Feb. 14, 2012

Int. Cl.: 5

FOR: DIETARY FOOD SUPPLEMENTS, IN CLASS 5 (U.S. CLS. 6, 18, 44, 46, 51 AND 52).

TRADEMARK

FIRST USE 1-1-2011; IN COMMERCE 4-1-2011.

PRINCIPAL REGISTER

THE MARK CONSISTS OF STANDARD CHARACTERS WITHOUT CLAIM TO ANY PARTICULAR FONT, STYLE, SIZE, OR COLOR.

SER. NO. 85-360,318, FILED 6-30-2011.

SANJEEV VOHRA, EXAMINING ATTORNEY



David J. Kyffers

Director of the United States Patent and Trademark Office

United States of America

United States Patent and Trademark Office

North Park Beer Co.

Reg. No. 4,098,826

MCNAIR, KELSEY (UNITED STATES INDIVIDUAL), DBA NORTH PARK BEER CO.
3629 PERSHING AVE.

Registered Feb. 14, 2012

SAN DIEGO, CA 92104

Int. Cl.: 32

FOR: BEER, IN CLASS 32 (U.S. CLS. 45, 46 AND 48).

TRADEMARK

FIRST USE 8-23-2010; IN COMMERCE 8-23-2010.

PRINCIPAL REGISTER

THE MARK CONSISTS OF STANDARD CHARACTERS WITHOUT CLAIM TO ANY PARTICULAR FONT, STYLE, SIZE, OR COLOR.

NO CLAIM IS MADE TO THE EXCLUSIVE RIGHT TO USE "BEER CO.", APART FROM THE MARK AS SHOWN.

SER. NO. 85-360,326, FILED 6-30-2011.

GIANCARLO CASTRO, EXAMINING ATTORNEY



David J. Kyffers

Director of the United States Patent and Trademark Office

United States of America

United States Patent and Trademark Office

Arsin

Reg. No. 4,098,827

Registered Feb. 14, 2012

Int. Cl.: 41

SERVICE MARK

PRINCIPAL REGISTER

CLEMONS, VINTE (UNITED STATES INDIVIDUAL)
810 N. UNION ST.
PHILADELPHIA, PA 19104

FOR: MULTIMEDIA ENTERTAINMENT SERVICES IN THE NATURE OF RECORDING, PRODUCTION AND POST-PRODUCTION SERVICES IN THE FIELDS OF MUSIC, VIDEO, AND FILMS, IN CLASS 41 (U.S. CLS. 100, 101 AND 107).

FIRST USE 9-3-2001; IN COMMERCE 8-12-2004.

THE MARK CONSISTS OF STANDARD CHARACTERS WITHOUT CLAIM TO ANY PARTICULAR FONT, STYLE, SIZE, OR COLOR.

SER. NO. 85-360,355, FILED 6-30-2011.

KHANH LE, EXAMINING ATTORNEY



David J. Kybas

Director of the United States Patent and Trademark Office

United States of America

United States Patent and Trademark Office

Driftwood

Reg. No. 4,098,828

DRIFTWOOD (NEW YORK PARTNERSHIP)
623 EAST HILL RD.

Registered Feb. 14, 2012

BINGHAMTON, NY 13901

Int. Cl.: 41

FOR: ENTERTAINMENT IN THE NATURE OF VISUAL AND AUDIO PERFORMANCES, NAMELY, MUSICAL BAND, ROCK GROUP, GYMNASTIC, DANCE, AND BALLET PERFORMANCES, IN CLASS 41 (U.S. CLS. 100, 101 AND 107).

SERVICE MARK

FIRST USE 5-1-2006; IN COMMERCE 5-1-2006.

PRINCIPAL REGISTER

THE MARK CONSISTS OF STANDARD CHARACTERS WITHOUT CLAIM TO ANY PARTICULAR FONT, STYLE, SIZE, OR COLOR.

SER. NO. 85-360,361, FILED 6-30-2011.

MATTHEW KLINE, EXAMINING ATTORNEY



David J. Kyffers

Director of the United States Patent and Trademark Office

United States of America

United States Patent and Trademark Office



Reg. No. 4,098,829

MATA, LOUIS (UNITED STATES INDIVIDUAL)
8827 NE 161ST PLACE
KENMORE, WA 98028

Registered Feb. 14, 2012

Int. Cl.: 41

FOR: PROVIDING A WEBSITE FEATURING INFORMATION ON EXERCISE AND FITNESS,
IN CLASS 41 (U.S. CLS. 100, 101 AND 107).

SERVICE MARK

FIRST USE 5-0-2011; IN COMMERCE 5-0-2011.

PRINCIPAL REGISTER

THE MARK CONSISTS OF A SEMI-COMPLETE SPHERE CENTERED ON A CIRCLE WITH
THE LITERAL ELEMENT "TUNENGO" TO THE RIGHT.

SER. NO. 85-360,390, FILED 6-30-2011.

JOHN WILKE, EXAMINING ATTORNEY



David J. Kyffers

Director of the United States Patent and Trademark Office

United States of America
United States Patent and Trademark Office

POOPRINTS

Reg. No. 4,098,830

BIOPET VET LAB, INC. (TENNESSEE CORPORATION)
6701 BAUM DRIVE, SUITE 110
KNOXVILLE, TN 37919

Registered Feb. 14, 2012

Int. Cl.: 42

FOR: DNA ANALYSIS SERVICES FOR IDENTIFYING ANIMALS, IN CLASS 42 (U.S. CLS. 100 AND 101).

SERVICE MARK

FIRST USE 10-24-2010; IN COMMERCE 10-24-2010.

PRINCIPAL REGISTER

THE MARK CONSISTS OF STANDARD CHARACTERS WITHOUT CLAIM TO ANY PARTICULAR FONT, STYLE, SIZE, OR COLOR.

SER. NO. 85-360,402, FILED 6-30-2011.

COURTNEY ALVAREZ, EXAMINING ATTORNEY



David J. Kybas

Director of the United States Patent and Trademark Office

United States of America
United States Patent and Trademark Office

TEALsolar

Reg. No. 4,098,831

TEAL ELECTRONICS CORPORATION (CALIFORNIA CORPORATION)
10350 SORRENTO VALLEY ROAD
SAN DIEGO, CA 92121

Registered Feb. 14, 2012

Int. Cl.: 9

FOR: ELECTRONIC DEVICE FOR MONITORING AND OPTIMIZING PHOTOVOLTAIC ARRAYS, IN CLASS 9 (U.S. CLS. 21, 23, 26, 36 AND 38).

TRADEMARK

FIRST USE 6-8-2011; IN COMMERCE 6-8-2011.

PRINCIPAL REGISTER

THE MARK CONSISTS OF STANDARD CHARACTERS WITHOUT CLAIM TO ANY PARTICULAR FONT, STYLE, SIZE, OR COLOR.

SER. NO. 85-360,416, FILED 6-30-2011.

CHRIS WELLS, EXAMINING ATTORNEY



David J. Kybas

Director of the United States Patent and Trademark Office

United States of America

United States Patent and Trademark Office

Applosophy

Reg. No. 4,098,832

MERIDOR DANIEL (ISRAEL INDIVIDUAL)

Registered Feb. 14, 2012

318 EAST 9 TH STREET #14
NEW YORK, NY 10003

Int. Cl.: 42

FOR: APPLICATION SERVICE PROVIDER, NAMELY, HOSTING, MANAGING, DEVELOPING, ANALYZING, AND MAINTAINING APPLICATIONS, SOFTWARE, AND WEB SITES, OF OTHERS IN THE FIELDS OF ADVERTISING AND MARKETING; APPLICATION SERVICE PROVIDER, NAMELY, HOSTING, MANAGING, DEVELOPING, AND MAINTAINING APPLICATIONS, SOFTWARE, AND WEB SITES, IN THE FIELDS OF PERSONAL PRODUCTIVITY, WIRELESS COMMUNICATION, MOBILE INFORMATION ACCESS, AND REMOTE DATA MANAGEMENT FOR WIRELESS DELIVERY OF CONTENT TO HANDHELD COMPUTERS, LAPTOPS AND MOBILE ELECTRONIC DEVICES, IN CLASS 42 (U.S. CLS. 100 AND 101).

SERVICE MARK

PRINCIPAL REGISTER

FIRST USE 5-1-2011; IN COMMERCE 5-1-2011.

THE MARK CONSISTS OF STANDARD CHARACTERS WITHOUT CLAIM TO ANY PARTICULAR FONT, STYLE, SIZE, OR COLOR.

SER. NO. 85-360,427, FILED 6-30-2011.

SEAN CROWLEY, EXAMINING ATTORNEY



David J. Kyros

Director of the United States Patent and Trademark Office

United States of America

United States Patent and Trademark Office

FOOTBRIDGE

Reg. No. 4,098,833

Registered Feb. 14, 2012

Int. Cl.: 36

SERVICE MARK

PRINCIPAL REGISTER

FOOTBRIDGE FINANCIAL LLC (NEW JERSEY LIMITED LIABILITY COMPANY)
C/O JAMES PEPE
242 FRANKLIN TURNPIKE
MAHWAH, NJ 07430

FOR: FINANCING AND LOAN SERVICES, IN CLASS 36 (U.S. CLS. 100, 101 AND 102).

FIRST USE 6-1-2011; IN COMMERCE 6-1-2011.

THE MARK CONSISTS OF STANDARD CHARACTERS WITHOUT CLAIM TO ANY PARTICULAR FONT, STYLE, SIZE, OR COLOR.

SER. NO. 85-360,458, FILED 6-30-2011.

KIM SAITO, EXAMINING ATTORNEY



David J. Kyffers

Director of the United States Patent and Trademark Office

United States of America

United States Patent and Trademark Office

WHO DO YOU TRUST WITH YOUR SUCCESS?

Reg. No. 4,098,834

Registered Feb. 14, 2012

Int. Cl.: 36

SERVICE MARK

PRINCIPAL REGISTER

INDEPENDENT LIFE BROKERAGE CORP. (NEW JERSEY CORPORATION)
SUITE 1300
200 CONNELL DRIVE
BERKELEY HEIGHTS, NJ 07922

FOR: INSURANCE AGENCY AND BROKERAGE, IN CLASS 36 (U.S. CLS. 100, 101 AND 102).

FIRST USE 6-7-2010; IN COMMERCE 6-7-2010.

THE MARK CONSISTS OF STANDARD CHARACTERS WITHOUT CLAIM TO ANY PARTICULAR FONT, STYLE, SIZE, OR COLOR.

SER. NO. 85-360,472, FILED 6-30-2011.

KIM SAITO, EXAMINING ATTORNEY



David J. Kyffers

Director of the United States Patent and Trademark Office

United States of America

United States Patent and Trademark Office

MySavings

Reg. No. 4,098,835

Registered Feb. 14, 2012

Int. Cl.: 35

SERVICE MARK

PRINCIPAL REGISTER

MYSAVINGS, INC. (FLORIDA CORPORATION)
SUITE 10
5130 N FEDERAL HWY
FORT LAUDERDALE, FL 33308

FOR: PROMOTING THE GOODS AND SERVICES OF OTHERS BY PROVIDING A WEBSITE FEATURING COUPONS, REBATES, PRICE-COMPARISON INFORMATION, PRODUCT REVIEWS, LINKS TO THE RETAIL WEBSITES OF OTHERS, AND DISCOUNT INFORMATION, IN CLASS 35 (U.S. CLS. 100, 101 AND 102).

FIRST USE 1-10-2006; IN COMMERCE 1-10-2006.

THE MARK CONSISTS OF STANDARD CHARACTERS WITHOUT CLAIM TO ANY PARTICULAR FONT, STYLE, SIZE, OR COLOR.

SER. NO. 85-360,500, FILED 6-30-2011.

SHANNON TWOHIG, EXAMINING ATTORNEY



David J. Kyffers

Director of the United States Patent and Trademark Office

United States of America

United States Patent and Trademark Office

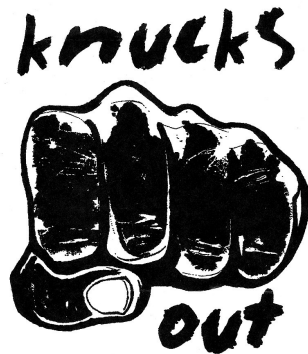

Reg. No. 4,098,836

Registered Feb. 14, 2012

Int. Cl.: 25

TRADEMARK

PRINCIPAL REGISTER

KNUCKS OUT, INC. (CALIFORNIA CORPORATION)
P.O. BOX 3
PISMO BEACH, CA 93448

FOR: HATS, SWEATSHIRTS, BOXER SHORTS, YOGA PANTS, POLO SHIRTS (FIRST USE AT LEAST AS EARLY AS 04/27/2008, FIRST USE IN COMMERCE AT LEAST AS EARLY AS 04/27/2008); T-SHIRTS, BEANIES, TANKTOPS, SWEATPANTS (FIRST USE AT LEAST AS EARLY AS 04/16/2011, FIRST USE IN COMMERCE AT LEAST AS EARLY AS 04/16/2011), IN CLASS 25 (U.S. CLS. 22 AND 39).

FIRST USE 4-27-2008; IN COMMERCE 4-27-2008.

THE MARK CONSISTS OF A DEPICTION OF A HUMAN FIST AND THE WORDS KNUCKS OUT.

SER. NO. 85-360,553, FILED 6-30-2011.

EMILY CARLSEN, EXAMINING ATTORNEY



David J. Kyjars

Director of the United States Patent and Trademark Office

United States of America

United States Patent and Trademark Office

KWKLY

Reg. No. 4,098,837

MARKET LEADER, INC. (WASHINGTON CORPORATION)
11332 NE 122ND WAY, SUITE 200
KIRKLAND, WA 98034

Registered Feb. 14, 2012

Int. Cl.: 35

FOR: ADVERTISING AND MARKETING; REAL ESTATE ADVERTISING SERVICES, IN CLASS 35 (U.S. CLS. 100, 101 AND 102).

SERVICE MARK

FIRST USE 8-31-2008; IN COMMERCE 8-31-2008.

PRINCIPAL REGISTER

THE MARK CONSISTS OF STANDARD CHARACTERS WITHOUT CLAIM TO ANY PARTICULAR FONT, STYLE, SIZE, OR COLOR.

SER. NO. 85-360,600, FILED 6-30-2011.

ELLEN B. AWRICH, EXAMINING ATTORNEY



David J. Kyffers

Director of the United States Patent and Trademark Office

United States of America

United States Patent and Trademark Office



Reg. No. 4,098,838

Registered Feb. 14, 2012

Int. Cls.: 35 and 40

SERVICE MARK

PRINCIPAL REGISTER

DAVELLE BY DAVID, LTD. (VIRGINIA CORPORATION), TA DAVELLE CLOTHIERS
11904 MARKET STREET
RESTON, VA 20190

FOR: RETAIL CLOTHING STORES, IN CLASS 35 (U.S. CLS. 100, 101 AND 102).

FIRST USE 3-31-2001; IN COMMERCE 3-31-2001.

FOR: TAILORING , IN CLASS 40 (U.S. CLS. 100, 103 AND 106).

FIRST USE 3-31-2001; IN COMMERCE 3-31-2001.

NO CLAIM IS MADE TO THE EXCLUSIVE RIGHT TO USE "CLOTHIERS", APART FROM THE MARK AS SHOWN.

THE NAME(S), PORTRAIT(S), AND/OR SIGNATURE(S) SHOWN IN THE MARK DOES NOT IDENTIFY A PARTICULAR LIVING INDIVIDUAL.

THE MARK CONSISTS OF AN UPPER CASE LETTER "D" FACING BACKWARDS FOLLOWED BY AN UPPER CASE LETTER "D" FACING FORWARDS, SEPARATED BY A SMALL SPACE IN WHICH THE OUTLINE OF A TIE APPEARS SUPERIMPOSED OVER PARTS OF THE VERTICAL LINES OF THE LETTERS "D"; THE TWO DS ARE ABOVE THE WORD "DAVELLE", WHICH IS ABOVE THE WORD "CLOTHIERS", WHICH IS IN WHITE TYPE ON A BLACK BACKGROUND.

SER. NO. 85-360,700, FILED 6-30-2011.

VIVIAN MICZNIK FIRST, EXAMINING ATTORNEY



David J. Kybas

Director of the United States Patent and Trademark Office

United States of America

United States Patent and Trademark Office

Lovepedal

Reg. No. 4,098,839

Registered Feb. 14, 2012

Int. Cl.: 15

TRADEMARK

PRINCIPAL REGISTER

LOVEPEDAL (MICHIGAN LIMITED LIABILITY COMPANY)
P.O. BOX 405
UNION LAKE, MI 483870405

FOR: GUITAR PEDALS, IN CLASS 15 (U.S. CLS. 2, 21 AND 36).

FIRST USE 9-20-2003; IN COMMERCE 1-4-2004.

THE MARK CONSISTS OF STANDARD CHARACTERS WITHOUT CLAIM TO ANY PARTICULAR FONT, STYLE, SIZE, OR COLOR.

SER. NO. 85-360,704, FILED 6-30-2011.

JOHN GARTNER, EXAMINING ATTORNEY



David J. Kyffers

Director of the United States Patent and Trademark Office

United States of America

United States Patent and Trademark Office

VerticalMate by Drape98

Reg. No. 4,098,840

DRAPE98 EXPRESS, LLC (FLORIDA LIMITED LIABILITY COMPANY)
282 CORINTHIAN PL
DESTIN, FL 32541

Registered Feb. 14, 2012

Int. Cl.: 24

FOR: FABRIC WINDOW COVERINGS AND TREATMENTS, NAMELY, DRAPERIES, IN CLASS 24 (U.S. CLS. 42 AND 50).

TRADEMARK

FIRST USE 1-15-2011; IN COMMERCE 4-22-2011.

PRINCIPAL REGISTER

THE MARK CONSISTS OF STANDARD CHARACTERS WITHOUT CLAIM TO ANY PARTICULAR FONT, STYLE, SIZE, OR COLOR.

SER. NO. 85-360,755, FILED 6-30-2011.

LAURIE MAYES, EXAMINING ATTORNEY



David J. Kyfos

Director of the United States Patent and Trademark Office

United States of America

United States Patent and Trademark Office

davelle

Reg. No. 4,098,841

Registered Feb. 14, 2012

Int. Cls.: 35 and 40

SERVICE MARK

PRINCIPAL REGISTER

DAVELLE BY DAVID, LTD. (VIRGINIA CORPORATION), DBA DAVELLE CLOTHIERS
11904 MARKET STREET
RESTON, VA 20190

FOR: RETAIL CLOTHING STORES, IN CLASS 35 (U.S. CLS. 100, 101 AND 102).

FIRST USE 3-31-2001; IN COMMERCE 3-31-2001.

FOR: TAILORING , IN CLASS 40 (U.S. CLS. 100, 103 AND 106).

FIRST USE 3-31-2001; IN COMMERCE 3-31-2001.

THE MARK CONSISTS OF STANDARD CHARACTERS WITHOUT CLAIM TO ANY PARTICULAR FONT, STYLE, SIZE, OR COLOR.

THE NAME(S), PORTRAIT(S), AND/OR SIGNATURE(S) SHOWN IN THE MARK DOES NOT IDENTIFY A PARTICULAR LIVING INDIVIDUAL.

SER. NO. 85-360,780, FILED 6-30-2011.

VIVIAN MICZNIK FIRST, EXAMINING ATTORNEY



David J. Kyffers

Director of the United States Patent and Trademark Office

United States of America

United States Patent and Trademark Office



Reg. No. 4,098,842

Registered Feb. 14, 2012

Int. Cls.: 35 and 40

SERVICE MARK

PRINCIPAL REGISTER

DAVELLE BY DAVID, LTD. (VIRGINIA CORPORATION), DBA DAVELLE CLOTHIERS
11904 MARKET STREET
RESTON, VA 20190

FOR: RETAIL CLOTHING STORES, IN CLASS 35 (U.S. CLS. 100, 101 AND 102).

FIRST USE 3-31-2001; IN COMMERCE 3-31-2001.

FOR: TAILORING , IN CLASS 40 (U.S. CLS. 100, 103 AND 106).

FIRST USE 3-31-2001; IN COMMERCE 3-31-2001.

THE MARK CONSISTS OF AN UPPER CASE LETTER "D" FACING BACKWARDS FOLLOWED BY AN UPPER CASE LETTER "D" FACING FORWARDS, SEPARATED BY A SMALL SPACE IN WHICH THE OUTLINE OF A TIE APPEARS SUPERIMPOSED OVER PARTS OF THE VERTICAL LINES OF THE LETTERS "D".

SER. NO. 85-360,920, FILED 6-30-2011.

VIVIAN MICZNIK FIRST, EXAMINING ATTORNEY



David J. Kybas

Director of the United States Patent and Trademark Office

United States of America

United States Patent and Trademark Office

Wild Ones

Reg. No. 4,098,843

JAN DEVINE LLC (MISSOURI LIMITED LIABILITY COMPANY)
ONE CONWAY WOODS LANE
LADUE, MO 63124

Registered Feb. 14, 2012

Int. Cl.: 31

FOR: CONSUMABLE PET CHEWS, IN CLASS 31 (U.S. CLS. 1 AND 46).

TRADEMARK

FIRST USE 3-9-2011; IN COMMERCE 6-1-2011.

PRINCIPAL REGISTER

THE MARK CONSISTS OF STANDARD CHARACTERS WITHOUT CLAIM TO ANY PARTICULAR FONT, STYLE, SIZE, OR COLOR.

SER. NO. 85-360,957, FILED 6-30-2011.

FRANK LATTUCA, EXAMINING ATTORNEY



David J. Kybas

Director of the United States Patent and Trademark Office

United States of America

United States Patent and Trademark Office

shine like the star you are 

Reg. No. 4,098,844

Registered Feb. 14, 2012

Int. Cl.: 14

TRADEMARK

PRINCIPAL REGISTER

GOLDFINE MANUFACTURERS PUBLIC CO., LTD. (THAILAND CORPORATION)
291 MOO 4, EXPORT PROCESSING ZONE 3
LAT KRABANG IND. ESTATE, CHALONGKRUNG RD
BANGKOK, THAILAND 10520

FOR: JEWELRY, IN CLASS 14 (U.S. CLS. 2, 27, 28 AND 50).

FIRST USE 3-1-2011; IN COMMERCE 3-1-2011.

THE MARK CONSISTS OF "SHINE LIKE THE STAR YOU ARE" IN A WAVE FORM FOLLOWED BY A STAR AT THE END.

SER. NO. 85-360,963, FILED 6-30-2011.

TINA MAI, EXAMINING ATTORNEY



David J. Kyffers

Director of the United States Patent and Trademark Office

United States of America

United States Patent and Trademark Office



ONE LOUDOUN

Reg. No. 4,098,845

ONE LOUDOUN HOLDINGS, LLC (DELAWARE LIMITED LIABILITY COMPANY)
8401 GREENSBORO DRIVE, SUITE 450
MCLEAN, VA 22012

Registered Feb. 14, 2012

Int. Cls.: 36 and 37

FOR: SHOPPING CENTER SERVICES, NAMELY, RENTAL OF SHOPPING CENTER SPACE,
IN CLASS 36 (U.S. CLS. 100, 101 AND 102).

SERVICE MARK

FIRST USE 2-18-2011; IN COMMERCE 2-18-2011.

PRINCIPAL REGISTER

FOR: CONSTRUCTION SERVICES, NAMELY, PLANNING, LAYING OUT AND CONSTRUCTION OF A PLANNED RESIDENTIAL COMMUNITY; REAL ESTATE DEVELOPMENT AND CONSTRUCTION OF COMMERCIAL, RESIDENTIAL AND HOTEL PROPERTY, IN CLASS 37 (U.S. CLS. 100, 103 AND 106).

FIRST USE 2-18-2011; IN COMMERCE 2-18-2011.

THE MARK CONSISTS OF A STYLIZED LETTER "O" WITH A BRUSH STROKE LINE GOING THROUGH THE CENTER OF IT.

SER. NO. 85-360,986, FILED 6-30-2011.

THEODORE MCBRIDE, EXAMINING ATTORNEY



David J. Kybas

Director of the United States Patent and Trademark Office

United States of America

United States Patent and Trademark Office

TOP LINE TRAINING. BOTTOM
LINE GROWTH.

Reg. No. 4,098,846

BVS, INC. (IOWA CORPORATION)
4060 GLASS ROAD NE
CEDAR RAPIDS, IA 52402

Registered Feb. 14, 2012

Int. Cl.: 41

FOR: TRAINING SERVICES IN THE FIELD OF BANKING FOR THE BANKING INDUSTRY,
IN CLASS 41 (U.S. CLS. 100, 101 AND 107).

SERVICE MARK

FIRST USE 2-1-2011; IN COMMERCE 2-1-2011.

PRINCIPAL REGISTER

THE MARK CONSISTS OF STANDARD CHARACTERS WITHOUT CLAIM TO ANY PAR-
TICULAR FONT, STYLE, SIZE, OR COLOR.

SER. NO. 85-360,988, FILED 6-30-2011.

RICHARD WHITE, EXAMINING ATTORNEY



David J. Kybas

Director of the United States Patent and Trademark Office

United States of America

United States Patent and Trademark Office



Reg. No. 4,098,847

Registered Feb. 14, 2012

Int. Cl.: 31

TRADEMARK

PRINCIPAL REGISTER

ORIGINS PET SOLUTIONS LLC (FLORIDA LIMITED LIABILITY COMPANY)
11190 WINDSOR PLACE CIRCLE
TAMPA, FL 33626

FOR: PET TREATS, IN CLASS 31 (U.S. CLS. 1 AND 46).

FIRST USE 1-1-2011; IN COMMERCE 3-1-2011.

THE MARK CONSISTS OF A DOG AND CAT SITTING ON GRASS WITH GRADIENTS RADIATING FROM THE GRASS HILL. ALL OF THIS IS SURROUNDED WITH A SQUARE AND THE STYLIZED TEXT "TERRA PAWS".

SER. NO. 85-361,006, FILED 6-30-2011.

BRIAN PINO, EXAMINING ATTORNEY



David J. Kybas

Director of the United States Patent and Trademark Office

United States of America

United States Patent and Trademark Office

24/7 ELITE

Reg. No. 4,098,848

Registered Feb. 14, 2012

Int. Cl.: 20

TRADEMARK

PRINCIPAL REGISTER

BLUMENTHAL DISTRIBUTING, INC. (CALIFORNIA CORPORATION), DBA OFFICE STAR
PRODUCTS
1901 SOUTH ARCHIBALD AVENUE
ONTARIO, CA 91761

FOR: CHAIRS, IN CLASS 20 (U.S. CLS. 2, 13, 22, 25, 32 AND 50).

FIRST USE 6-1-2011; IN COMMERCE 6-1-2011.

THE MARK CONSISTS OF STANDARD CHARACTERS WITHOUT CLAIM TO ANY PARTICULAR FONT, STYLE, SIZE, OR COLOR.

SER. NO. 85-361,016, FILED 6-30-2011.

DAWN FELDMAN, EXAMINING ATTORNEY



David J. Kybas

Director of the United States Patent and Trademark Office

United States of America

United States Patent and Trademark Office

LEMONDROP
backdrops & floordrops

Reg. No. 4,098,849

A-TEAMIT, LLC (MINNESOTA LIMITED LIABILITY COMPANY)
19801 226TH AVE
BIG LAKE, MN 55309

Registered Feb. 14, 2012

Int. Cl.: 42

FOR: CUSTOM DESIGN OF CANVAS, VINYL, AND POLYPAPER BACKDROPS AND FLOORDROPS FOR PHOTOGRAPHY, IN CLASS 42 (U.S. CLS. 100 AND 101).

SERVICE MARK

FIRST USE 11-1-2010; IN COMMERCE 11-1-2010.

PRINCIPAL REGISTER

NO CLAIM IS MADE TO THE EXCLUSIVE RIGHT TO USE "BACKDROPS & FLOORDROPS", APART FROM THE MARK AS SHOWN.

THE MARK CONSISTS OF THE STYLIZED WORDS "LEMONDROP BACKDROPS & FLOORDROPS".

SER. NO. 85-361,020, FILED 6-30-2011.

DAWN FELDMAN, EXAMINING ATTORNEY



David J. Kybas

Director of the United States Patent and Trademark Office

United States of America

United States Patent and Trademark Office

ARTVENTIVE

Reg. No. 4,098,850

ARTVENTIVE MEDICAL GROUP, INC. (NEVADA CORPORATION)
2766 GATEWAY ROAD
CARLSBAD, CA 92009

Registered Feb. 14, 2012

Int. Cl.: 10

FOR: MEDICAL DEVICES, NAMELY, ENDOLUMINAL OCCLUSION DEVICES, IN CLASS 10 (U.S. CLS. 26, 39 AND 44).

TRADEMARK

FIRST USE 6-17-2011; IN COMMERCE 6-17-2011.

PRINCIPAL REGISTER

THE MARK CONSISTS OF STANDARD CHARACTERS WITHOUT CLAIM TO ANY PARTICULAR FONT, STYLE, SIZE, OR COLOR.

SER. NO. 85-361,049, FILED 6-30-2011.

DOMINIC FATHY, EXAMINING ATTORNEY



David J. Kyffers

Director of the United States Patent and Trademark Office

United States of America

United States Patent and Trademark Office

CAPITAL TRANS PRIDE

Reg. No. 4,098,851

CAPITAL PRIDE ALLIANCE, INC. (D.C. CORPORATION)
PO BOX 2428
WASHINGTON, DC 20013

Registered Feb. 14, 2012

Int. Cls.: 36 and 41

FOR: CHARITABLE FUND RAISING SERVICES, IN CLASS 36 (U.S. CLS. 100, 101 AND 102).

SERVICE MARK

FIRST USE 1-0-2007; IN COMMERCE 1-0-2007.

PRINCIPAL REGISTER

FOR: EDUCATION AND ENTERTAINMENT SERVICES, NAMELY, ORGANIZING AND CONDUCTING COMMUNITY FESTIVALS, EVENTS, ART EXHIBITS, PARADES, STREET FAIRS, THEATER PERFORMANCES, MUSIC PERFORMANCES, POETRY READINGS, FORUMS, SEMINARS, PARTIES AND RALLIES WHICH FOSTER PRIDE IN A WIDE VARIETY OF SEXUAL ORIENTATIONS, NAMELY, LESBIAN, GAY, BISEXUAL AND TRANSGENDER IDENTITIES, IN CLASS 41 (U.S. CLS. 100, 101 AND 107).

FIRST USE 1-0-2007; IN COMMERCE 1-0-2007.

THE MARK CONSISTS OF STANDARD CHARACTERS WITHOUT CLAIM TO ANY PARTICULAR FONT, STYLE, SIZE, OR COLOR.

OWNER OF U.S. REG. NOS. 2,269,571 AND 3,751,757.

SER. NO. 85-361,076, FILED 6-30-2011.

DOMINIC J. FERRAIUOLO, EXAMINING ATTORNEY



David J. Kyffers

Director of the United States Patent and Trademark Office

United States of America

United States Patent and Trademark Office



Reg. No. 4,098,852

Registered Feb. 14, 2012

Int. Cls.: 29 and 30

TRADEMARK

PRINCIPAL REGISTER

B&G FOODS NORTH AMERICA, INC. (DELAWARE CORPORATION)
FOUR GATEHALL DRIVE
PARSIPPANY, NJ 07054

FOR: PICKLES; PICKLED VEGETABLES; PROCESSED PEPPERS; PROCESSED OLIVES;
PROCESSED ONIONS, IN CLASS 29 (U.S. CL. 46).

FIRST USE 6-9-2003; IN COMMERCE 6-9-2003.

FOR: RELISH; CAPERS, IN CLASS 30 (U.S. CL. 46).

FIRST USE 5-13-2003; IN COMMERCE 5-13-2003.

OWNER OF U.S. REG. NOS. 1,647,533, 2,159,048 AND OTHERS.

THE MARK CONSISTS OF THE LETTERS "B&G" WITHIN AN OVAL DESIGN.

SER. NO. 85-361,134, FILED 6-30-2011.

VERNA BETH RIRIE, EXAMINING ATTORNEY



David J. Kyffers

Director of the United States Patent and Trademark Office

United States of America

United States Patent and Trademark Office



Reg. No. 4,098,853

Registered Feb. 14, 2012

Int. Cl.: 41

SERVICE MARK

PRINCIPAL REGISTER

ALEXANDER MUNIZ (UNITED STATES INDIVIDUAL), DBA HOT BOX MUSIC
380 CAHUENGA DRIVE
OXNARD, CA 93035

FOR: ENTERTAINMENT SERVICES, NAMELY, MULTIMEDIA PRODUCTION SERVICES;
PRODUCTION OF SOUND AND MUSIC VIDEO RECORDINGS, IN CLASS 41 (U.S. CLS.
100, 101 AND 107).

FIRST USE 8-0-2009; IN COMMERCE 8-0-2009.

NO CLAIM IS MADE TO THE EXCLUSIVE RIGHT TO USE "MUSIC", APART FROM THE
MARK AS SHOWN.

THE MARK CONSISTS OF THE WORD HOT CENTERED ABOVE THE WORD BOX, BOTH
IN STYLIZED FONT AND INSIDE A SOLID SQUARE CARRIER. BELOW THE CARRIER
IS THE STYLIZED WORD MUSIC. THE TOP OF THE SQUARE CARRIER EXTENDS UP-
WARDS INTO FLAMES.

SER. NO. 85-361,144, FILED 6-30-2011.

PATRICIA EVANKO, EXAMINING ATTORNEY



David J. Kyffers

Director of the United States Patent and Trademark Office

United States of America

United States Patent and Trademark Office

MARKETFORMS

Reg. No. 4,098,854

MARKETFORMS LLC (COLORADO LIMITED LIABILITY COMPANY)

Registered Feb. 14, 2012

4643 SOUTH ULSTER, SUITE 800
DENVER, CO 80237

Int. Cl.: 42

FOR: PROVIDING A WEBSITE FEATURING TECHNOLOGY THAT ENABLES USERS TO PREPARE DOCUMENTS THAT ARE USED TO COMPLY WITH SECURITIES REGULATIONS, IN CLASS 42 (U.S. CLS. 100 AND 101).

SERVICE MARK

FIRST USE 6-1-2011; IN COMMERCE 6-1-2011.

PRINCIPAL REGISTER

THE MARK CONSISTS OF STANDARD CHARACTERS WITHOUT CLAIM TO ANY PARTICULAR FONT, STYLE, SIZE, OR COLOR.

SER. NO. 85-361,162, FILED 6-30-2011.

VERNA BETH RIRIE, EXAMINING ATTORNEY



David J. Kyffers

Director of the United States Patent and Trademark Office

United States of America

United States Patent and Trademark Office

House of Infinite Radness

Reg. No. 4,098,855

HOUSE OF INFINITE RADNESS LLC (CALIFORNIA LIMITED LIABILITY COMPANY)
1641 N LAS PALMAS AVE
HOLLYWOOD, CA 90028

Registered Feb. 14, 2012

Int. Cl.: 25

FOR: BODY SUITS; DANCE COSTUMES; DRESSES; PANTS; SHIRTS; SHOES, IN CLASS
25 (U.S. CLS. 22 AND 39).

TRADEMARK

FIRST USE 1-0-2009; IN COMMERCE 1-0-2009.

PRINCIPAL REGISTER

THE MARK CONSISTS OF STANDARD CHARACTERS WITHOUT CLAIM TO ANY PAR-
TICULAR FONT, STYLE, SIZE, OR COLOR.

SER. NO. 85-361,172, FILED 6-30-2011.

WON TEAK OH, EXAMINING ATTORNEY



David J. Kyfos

Director of the United States Patent and Trademark Office

United States of America

United States Patent and Trademark Office

LOTION D'AMOUR

Reg. No. 4,098,856

KINGMAN INDUSTRIES, INC. (NEVADA CORPORATION)
26370 BECKMAN COURT
MURRIETA, CA 92653

Registered Feb. 14, 2012

Int. Cl.: 3

FOR: MASSAGE LOTIONS, IN CLASS 3 (U.S. CLS. 1, 4, 6, 50, 51 AND 52).

TRADEMARK

FIRST USE 10-30-1984; IN COMMERCE 10-30-1984.

PRINCIPAL REGISTER

THE MARK CONSISTS OF STANDARD CHARACTERS WITHOUT CLAIM TO ANY PARTICULAR FONT, STYLE, SIZE, OR COLOR.

NO CLAIM IS MADE TO THE EXCLUSIVE RIGHT TO USE "LOTION", APART FROM THE MARK AS SHOWN.

THE ENGLISH TRANSLATION OF "D'AMOUR" IN THE MARK IS OF LOVE.

SER. NO. 85-361,266, FILED 6-30-2011.

KELLEY WELLS, EXAMINING ATTORNEY



David J. Kyffers

Director of the United States Patent and Trademark Office

United States of America

United States Patent and Trademark Office



Reg. No. 4,098,857

Registered Feb. 14, 2012

Int. Cl.: 41

SERVICE MARK

PRINCIPAL REGISTER

DEPLOYMENT MEDICINE CONSULTANTS (WASHINGTON CORPORATION), DBA
DEPLOYMENT MEDICINE INTERNATIONAL
PO BOX 1264
GIG HARBOR, WA 98335

FOR: MEDICAL TRAINING AND TEACHING; TRAINING SERVICES IN THE FIELD OF
COMBAT AND OPERATIONAL MEDICINE, IN CLASS 41 (U.S. CLS. 100, 101 AND 107).

FIRST USE 6-28-2006; IN COMMERCE 6-28-2006.

THE MARK CONSISTS OF A REPRESENTATION OF THE EARTH WITH BLUE OCEANS
AND WHITE HIGHLIGHTS. LINES OF LONGITUDE AND LATITUDE ARE MARKED IN
BLACK ON THE BLUE GLOBE. A BLACK DAGGER IS IN THE CENTER OF THE GLOBE
WITH WHITE MARKINGS ON THE BLADE AND HANDLE WITH A STYLIZED GREEN
SNAKE WITH WHITE HIGHLIGHTS WRAPPED AROUND THE DAGGER.

THE COLOR(S) WHITE, BLACK, BLUE AND GREEN IS/ARE CLAIMED AS A FEATURE
OF THE MARK.

SER. NO. 85-361,273, FILED 6-30-2011.

IRA J. GOODSaid, EXAMINING ATTORNEY



David J. Kypos

Director of the United States Patent and Trademark Office

United States of America

United States Patent and Trademark Office

ENDAMIDE

Reg. No. 4,098,858

Registered Feb. 14, 2012

Int. Cl.: 1

TRADEMARK

PRINCIPAL REGISTER

COAST SOUTHWEST, INC. (CALIFORNIA CORPORATION)
505 SOUTH MELROSE STREET
PLACENTIA, CA 92870

FOR: CHEMICAL INGREDIENTS FOR USE IN THE MANUFACTURE OF COSMETICS,
PERSONAL CARE PRODUCTS AND HOUSEHOLD PRODUCTS, IN CLASS 1 (U.S. CLS. 1,
5, 6, 10, 26 AND 46).

FIRST USE 11-0-2004; IN COMMERCE 11-0-2004.

THE MARK CONSISTS OF STANDARD CHARACTERS WITHOUT CLAIM TO ANY PAR-
TICULAR FONT, STYLE, SIZE, OR COLOR.

SER. NO. 85-361,337, FILED 7-1-2011.

CHRISTINA SOBRAL, EXAMINING ATTORNEY



David J. Kyffers

Director of the United States Patent and Trademark Office

United States of America

United States Patent and Trademark Office

ENDICARE

Reg. No. 4,098,859

Registered Feb. 14, 2012

Int. Cl.: 1

TRADEMARK

PRINCIPAL REGISTER

COAST SOUTHWEST, INC. (CALIFORNIA CORPORATION)
505 SOUTH MELROSE STREET
PLACENTIA, CA 92870

FOR: CHEMICAL INGREDIENTS FOR USE IN THE MANUFACTURE OF COSMETICS, PERSONAL CARE PRODUCTS AND HOUSEHOLD PRODUCTS, IN CLASS 1 (U.S. CLS. 1, 5, 6, 10, 26 AND 46).

FIRST USE 3-0-2003; IN COMMERCE 3-0-2003.

THE MARK CONSISTS OF STANDARD CHARACTERS WITHOUT CLAIM TO ANY PARTICULAR FONT, STYLE, SIZE, OR COLOR.

SER. NO. 85-361,340, FILED 7-1-2011.

CHRISTINA SOBRAL, EXAMINING ATTORNEY



David J. Kyffers

Director of the United States Patent and Trademark Office

United States of America

United States Patent and Trademark Office

ENDIMATE

Reg. No. 4,098,860

COAST SOUTHWEST, INC. (CALIFORNIA CORPORATION)
505 SOUTH MELROSE STREET
PLACENTIA, CA 92870

Registered Feb. 14, 2012

Int. Cl.: 1

FOR: CHEMICAL INGREDIENTS FOR USE IN THE MANUFACTURE OF COSMETICS, PERSONAL CARE PRODUCTS AND HOUSEHOLD PRODUCTS, IN CLASS 1 (U.S. CLS. 1, 5, 6, 10, 26 AND 46).

TRADEMARK

FIRST USE 3-0-2006; IN COMMERCE 3-0-2006.

PRINCIPAL REGISTER

THE MARK CONSISTS OF STANDARD CHARACTERS WITHOUT CLAIM TO ANY PARTICULAR FONT, STYLE, SIZE, OR COLOR.

SER. NO. 85-361,342, FILED 7-1-2011.

CHRISTINA SOBRAL, EXAMINING ATTORNEY



David J. Kyffers

Director of the United States Patent and Trademark Office

United States of America

United States Patent and Trademark Office

ENDIMER

Reg. No. 4,098,861

COAST SOUTHWEST, INC. (CALIFORNIA CORPORATION)
505 SOUTH MELROSE STREET
PLACENTIA, CA 92870

Registered Feb. 14, 2012

Int. Cl.: 1

FOR: CHEMICAL INGREDIENTS FOR USE IN THE MANUFACTURE OF COSMETICS, PERSONAL CARE PRODUCTS AND HOUSEHOLD PRODUCTS, IN CLASS 1 (U.S. CLS. 1, 5, 6, 10, 26 AND 46).

TRADEMARK

FIRST USE 3-0-2004; IN COMMERCE 3-0-2004.

PRINCIPAL REGISTER

THE MARK CONSISTS OF STANDARD CHARACTERS WITHOUT CLAIM TO ANY PARTICULAR FONT, STYLE, SIZE, OR COLOR.

SER. NO. 85-361,343, FILED 7-1-2011.

CHRISTINA SOBRAL, EXAMINING ATTORNEY



David J. Kyffers

Director of the United States Patent and Trademark Office

United States of America

United States Patent and Trademark Office

ENDIMULSE

Reg. No. 4,098,862

COAST SOUTHWEST, INC. (CALIFORNIA CORPORATION)
505 SOUTH MELROSE STREET
PLACENTIA, CA 92870

Registered Feb. 14, 2012

Int. Cl.: 1

FOR: CHEMICAL INGREDIENTS FOR USE IN THE MANUFACTURE OF COSMETICS, PERSONAL CARE PRODUCTS AND HOUSEHOLD PRODUCTS, IN CLASS 1 (U.S. CLS. 1, 5, 6, 10, 26 AND 46).

TRADEMARK

FIRST USE 10-0-2003; IN COMMERCE 10-0-2003.

PRINCIPAL REGISTER

THE MARK CONSISTS OF STANDARD CHARACTERS WITHOUT CLAIM TO ANY PARTICULAR FONT, STYLE, SIZE, OR COLOR.

SER. NO. 85-361,345, FILED 7-1-2011.

CHRISTINA SOBRAL, EXAMINING ATTORNEY



David J. Kyffers

Director of the United States Patent and Trademark Office

United States of America
United States Patent and Trademark Office

ENDINOL

Reg. No. 4,098,863

COAST SOUTHWEST, INC. (CALIFORNIA CORPORATION)
505 SOUTH MELROSE STREET
PLACENTIA, CA 92870

Registered Feb. 14, 2012

Int. Cl.: 1

FOR: CHEMICAL INGREDIENTS FOR USE IN THE MANUFACTURE OF COSMETICS, PERSONAL CARE PRODUCTS AND HOUSEHOLD PRODUCTS, IN CLASS 1 (U.S. CLS. 1, 5, 6, 10, 26 AND 46).

TRADEMARK

FIRST USE 9-0-2002; IN COMMERCE 9-0-2002.

PRINCIPAL REGISTER

THE MARK CONSISTS OF STANDARD CHARACTERS WITHOUT CLAIM TO ANY PARTICULAR FONT, STYLE, SIZE, OR COLOR.

SER. NO. 85-361,347, FILED 7-1-2011.

CHRISTINA SOBRAL, EXAMINING ATTORNEY



David J. Kyffers

Director of the United States Patent and Trademark Office

United States of America

United States Patent and Trademark Office

ENDITERIC

Reg. No. 4,098,864

COAST SOUTHWEST, INC. (CALIFORNIA CORPORATION)
505 SOUTH MELROSE STREET
PLACENTIA, CA 92870

Registered Feb. 14, 2012

Int. Cl.: 1

FOR: CHEMICAL INGREDIENTS FOR USE IN THE MANUFACTURE OF COSMETICS, PERSONAL CARE PRODUCTS AND HOUSEHOLD PRODUCTS, IN CLASS 1 (U.S. CLS. 1, 5, 6, 10, 26 AND 46).

TRADEMARK

FIRST USE 5-0-2002; IN COMMERCE 5-0-2002.

PRINCIPAL REGISTER

THE MARK CONSISTS OF STANDARD CHARACTERS WITHOUT CLAIM TO ANY PARTICULAR FONT, STYLE, SIZE, OR COLOR.

SER. NO. 85-361,355, FILED 7-1-2011.

CHRISTINA SOBRAL, EXAMINING ATTORNEY



David J. Kyffers

Director of the United States Patent and Trademark Office

United States of America

United States Patent and Trademark Office

LOST HEAVEN

Reg. No. 4,098,865

Registered Feb. 14, 2012

Int. Cl.: 43

SERVICE MARK

PRINCIPAL REGISTER

SHANGHAI HUAMATIANTANG RESTAURANT MANAGEMENT CO., LTD. (CHINA
LIMITED LIABILITY COMPANY)
40, GAOYOU ROAD, XUHUI DISTRICT
SHANGHAI 200031, CHINA

FOR: BAR SERVICES; CAFE; FAST-FOOD RESTAURANTS; HOTELS; PROVIDING
CAMPGROUND FACILITIES; PROVIDING HOTEL ACCOMMODATION; RENTAL OF
CHAIRS, TABLES, TABLE LINEN, GLASSWARE; RESTAURANT; SNACK BARS; TEA
ROOMS, IN CLASS 43 (U.S. CLS. 100 AND 101).

FIRST USE 2-1-2010; IN COMMERCE 4-10-2011.

THE MARK CONSISTS OF WORDS "LOST HEAVEN".

SER. NO. 85-361,358, FILED 7-1-2011.

HANNO RITTNER, EXAMINING ATTORNEY



David J. Kyffers

Director of the United States Patent and Trademark Office

United States of America
United States Patent and Trademark Office

ENDIGEL

Reg. No. 4,098,866

Registered Feb. 14, 2012

Int. Cl.: 1

TRADEMARK

PRINCIPAL REGISTER

COAST SOUTHWEST, INC. (CALIFORNIA CORPORATION)
505 SOUTH MELROSE STREET
PLACENTIA, CA 92870

FOR: CHEMICAL INGREDIENTS FOR USE IN THE MANUFACTURE OF COSMETICS,
PERSONAL CARE PRODUCTS AND HOUSEHOLD PRODUCTS, IN CLASS 1 (U.S. CLS. 1,
5, 6, 10, 26 AND 46).

FIRST USE 2-0-2003; IN COMMERCE 2-0-2003.

THE MARK CONSISTS OF STANDARD CHARACTERS WITHOUT CLAIM TO ANY PAR-
TICULAR FONT, STYLE, SIZE, OR COLOR.

SER. NO. 85-361,359, FILED 7-1-2011.

CHRISTINA SOBRAL, EXAMINING ATTORNEY



David J. Kyffers

Director of the United States Patent and Trademark Office

United States of America

United States Patent and Trademark Office

RFMX

Reg. No. 4,098,867

Registered Feb. 14, 2012

Int. Cl.: 25

TRADEMARK

PRINCIPAL REGISTER

RONALD J. FAISST (UNITED STATES INDIVIDUAL)
37430 APPLGATE ROAD
MURRIETA, CA 92563

FOR: HATS; PANTS; SHIRTS; SHOES; SOCKS, IN CLASS 25 (U.S. CLS. 22 AND 39).

FIRST USE 7-9-2009; IN COMMERCE 7-9-2009.

THE MARK CONSISTS OF STANDARD CHARACTERS WITHOUT CLAIM TO ANY PARTICULAR FONT, STYLE, SIZE, OR COLOR.

SER. NO. 85-361,404, FILED 7-1-2011.

GEORGE LORENZO, EXAMINING ATTORNEY



David J. Kybas

Director of the United States Patent and Trademark Office

United States of America

United States Patent and Trademark Office

KNOWLEDGE MATTERS

Reg. No. 4,098,868

Registered Feb. 14, 2012

Int. Cl.: 35

SERVICE MARK

PRINCIPAL REGISTER

CAPITAL PAINT SUPPLIES, LTD. (NEW YORK CORPORATION), DBA CAPITAL PAINT
CENTERS
2121 AVENUE U.
BROOKLYN, NY 11229

FOR: RETAIL STORE SERVICES FEATURING INTERIOR/EXTERIOR COATINGS AND
PAINTS, SPECIALTY INDUSTRIAL COATINGS AND PAINTS, INTERIOR/EXTERIOR
STAINS AND VARNISHES, FAUX/METALLIC FINISHING PRODUCTS, HARDWARE,
POWER TOOLS, POWER WASHERS, SPRAY EQUIPMENT, FLOOR SANDERS, WALLPAPER,
FABRICS, BLINDS, SHADES, FURNISHINGS, IN CLASS 35 (U.S. CLS. 100, 101 AND 102).

FIRST USE 4-0-2011; IN COMMERCE 4-0-2011.

THE MARK CONSISTS OF STANDARD CHARACTERS WITHOUT CLAIM TO ANY PAR-
TICULAR FONT, STYLE, SIZE, OR COLOR.

SER. NO. 85-361,406, FILED 7-1-2011.

ALEX KEAM, EXAMINING ATTORNEY



David J. Kybas

Director of the United States Patent and Trademark Office

United States of America

United States Patent and Trademark Office

XRAYMY401K.COM

Reg. No. 4,098,869

GLOBAL FINANCIAL PRIVATE CAPITAL, LLC (FLORIDA LIMITED LIABILITY COMPANY)
2080 RINGLING BOULEVARD
SARASOTA, FL 34237

Registered Feb. 14, 2012

Int. Cl.: 36

FOR: PROVIDING INFORMATION AND ADVICE IN THE FIELD OF FINANCE, FINANCIAL INVESTMENTS, FINANCIAL VALUATIONS, AND THE FINANCIAL ASPECTS OF RETIREMENT, IN CLASS 36 (U.S. CLS. 100, 101 AND 102).

SERVICE MARK

FIRST USE 3-17-2011; IN COMMERCE 3-23-2011.

PRINCIPAL REGISTER

THE MARK CONSISTS OF STANDARD CHARACTERS WITHOUT CLAIM TO ANY PARTICULAR FONT, STYLE, SIZE, OR COLOR.

SER. NO. 85-361,420, FILED 7-1-2011.

TINA MAI, EXAMINING ATTORNEY



David J. Kyffers

Director of the United States Patent and Trademark Office

United States of America

United States Patent and Trademark Office

iSmoothies Cafe

Reg. No. 4,098,870

NUTRITION 1000 LLC (FLORIDA LIMITED LIABILITY COMPANY)
11662 SAUNDERS AVE.

Registered Feb. 14, 2012

BONITA SPRINGS, FL 34135

Int. Cl.: 43

FOR: JUICE BAR SERVICES; RESTAURANT SERVICES FEATURING SMOOTHIES, IN CLASS 43 (U.S. CLS. 100 AND 101).

SERVICE MARK

FIRST USE 10-1-2010; IN COMMERCE 10-1-2010.

PRINCIPAL REGISTER

THE MARK CONSISTS OF STANDARD CHARACTERS WITHOUT CLAIM TO ANY PARTICULAR FONT, STYLE, SIZE, OR COLOR.

NO CLAIM IS MADE TO THE EXCLUSIVE RIGHT TO USE "CAFE", APART FROM THE MARK AS SHOWN.

SER. NO. 85-361,486, FILED 7-1-2011.

ALEX KEAM, EXAMINING ATTORNEY



David J. Kybas

Director of the United States Patent and Trademark Office

United States of America

United States Patent and Trademark Office



Reg. No. 4,098,871

B-CYCLE, LLC (DELAWARE LIMITED LIABILITY COMPANY)
801 WEST MADISON STREET
WATERLOO, WI 53594

Registered Feb. 14, 2012

Int. Cls.: 12, 35 and 39

FOR: BICYCLES AND STRUCTURAL PARTS OF BICYCLES, IN CLASS 12 (U.S. CLS. 19, 21, 23, 31, 35 AND 44).

TRADEMARK

FIRST USE 11-17-2008; IN COMMERCE 11-17-2008.

SERVICE MARK

FOR: COMMERCIAL ADMINISTRATION OF THE LICENSING OF BICYCLE RENTAL, REPAIR AND MAINTENANCE SERVICES; TRACKING, LOCATING AND MONITORING OF BICYCLES FOR COMMERCIAL PURPOSES; BUSINESS MANAGEMENT SERVICES, NAMELY, MANAGEMENT OF BICYCLE RENTAL FLEETS FOR OTHERS, IN CLASS 35 (U.S. CLS. 100, 101 AND 102).

PRINCIPAL REGISTER

FIRST USE 12-16-2008; IN COMMERCE 12-16-2008.

FOR: RENTAL OF BICYCLES AND BICYCLE ACCESSORIES; BICYCLE TRANSPORT; PROVIDING INFORMATION IN CONNECTION WITH THE RENTAL OF BICYCLES; COURIER SERVICES, IN CLASS 39 (U.S. CLS. 100 AND 105).

FIRST USE 12-16-2008; IN COMMERCE 12-16-2008.

OWNER OF U.S. REG. NO. 3,960,369.

THE MARK CONSISTS OF THE LETTER "B" IN A CIRCLE.

SER. NO. 85-361,521, FILED 7-1-2011.

MARK RADEMACHER, EXAMINING ATTORNEY



David J. Kybas

Director of the United States Patent and Trademark Office

United States of America

United States Patent and Trademark Office

MySmileRocks.com

Reg. No. 4,098,872

PRACTICE PERFECT MARKETING LLC (FLORIDA LIMITED LIABILITY COMPANY)
6450 2ND AVENUE N

Registered Feb. 14, 2012

SAINT PETERSBURG, FL 33710

Int. Cl.: 35

FOR: REFERRAL SERVICE FOR SELECTING AN ORTHODONTIST, IN CLASS 35 (U.S. CLS. 100, 101 AND 102).

SERVICE MARK

FIRST USE 10-0-2010; IN COMMERCE 10-0-2010.

PRINCIPAL REGISTER

THE MARK CONSISTS OF STANDARD CHARACTERS WITHOUT CLAIM TO ANY PARTICULAR FONT, STYLE, SIZE, OR COLOR.

SER. NO. 85-361,523, FILED 7-1-2011.

ALEXANDER L. POWERS, EXAMINING ATTORNEY



David J. Kyros

Director of the United States Patent and Trademark Office

United States of America

United States Patent and Trademark Office

OCTIVA

Reg. No. 4,098,873

GENERAL BINDING CORPORATION (OHIO CORPORATION)
300 TOWER PARKWAY
LINCOLNSHIRE, IL 60069

Registered Feb. 14, 2012

Int. Cl.: 17

FOR: PLASTIC THERMAL LAMINATING FILM FOR USE WITH PAPER DOCUMENTS AND SYNTHETIC GRAPHIC MEDIA, IN CLASS 17 (U.S. CLS. 1, 5, 12, 13, 35 AND 50).

TRADEMARK

FIRST USE 1-1-1996; IN COMMERCE 1-1-1996.

PRINCIPAL REGISTER

THE MARK CONSISTS OF STANDARD CHARACTERS WITHOUT CLAIM TO ANY PARTICULAR FONT, STYLE, SIZE, OR COLOR.

SER. NO. 85-361,534, FILED 7-1-2011.

ALEXANDER L. POWERS, EXAMINING ATTORNEY



David J. Kyros

Director of the United States Patent and Trademark Office

United States of America

United States Patent and Trademark Office

IT WON'T COST YOU ANYTHING
TO SEE IF WE CAN HELP

Reg. No. 4,098,874

Registered Feb. 14, 2012

Int. Cl.: 45

SERVICE MARK

PRINCIPAL REGISTER

MCWHIRTER BELLINGER & ASSOCIATES, P.A. (SOUTH CAROLINA PROFESSIONAL ASSOCIATION)
1807 HAMPTON STREET
COLUMBIA, SC 29201

FOR: LEGAL SERVICES, IN CLASS 45 (U.S. CLS. 100 AND 101).

FIRST USE 12-31-1990; IN COMMERCE 12-31-1990.

THE MARK CONSISTS OF STANDARD CHARACTERS WITHOUT CLAIM TO ANY PARTICULAR FONT, STYLE, SIZE, OR COLOR.

SER. NO. 85-361,553, FILED 7-1-2011.

DAVID MURRAY, EXAMINING ATTORNEY



David J. Kybas

Director of the United States Patent and Trademark Office

United States of America

United States Patent and Trademark Office

MLMipedia

Reg. No. 4,098,875

KADENCE CREATIONS, LLC (TEXAS LIMITED LIABILITY COMPANY)
1807 GOODSON COURT
ROUND ROCK, TX 78664

Registered Feb. 14, 2012

Int. Cl.: 9

FOR: COMPUTER APPLICATION SOFTWARE FOR MOBILE PHONES, PORTABLE MEDIA PLAYERS, HANDHELD COMPUTERS, AND TABLETS COMPUTERS, NAMELY, SOFTWARE FOR ORGANIZING AND COMPARING INFORMATION FROM NETWORK MARKETING COMPANIES, IN CLASS 9 (U.S. CLS. 21, 23, 26, 36 AND 38).

TRADEMARK

PRINCIPAL REGISTER

FIRST USE 3-1-2011; IN COMMERCE 5-25-2011.

THE MARK CONSISTS OF STANDARD CHARACTERS WITHOUT CLAIM TO ANY PARTICULAR FONT, STYLE, SIZE, OR COLOR.

SER. NO. 85-361,581, FILED 7-1-2011.

DAWN FELDMAN, EXAMINING ATTORNEY



David J. Kyffers

Director of the United States Patent and Trademark Office

United States of America

United States Patent and Trademark Office

Streams of Mercy

Reg. No. 4,098,876

STREAMS OF MERCY, INC. (CONNECTICUT CORPORATION)
320 SOUTH VILLAGE DRIVE
MCKINNEY, TX 75070

Registered Feb. 14, 2012

Int. Cl.: 36

FOR: CHARITABLE FUNDRAISING TO SUPPORT ORPHANS, WIDOWS, AND HOMELESS INDIVIDUALS BOTH DOMESTICALLY AND INTERNATIONALLY, IN CLASS 36 (U.S. CLS. 100, 101 AND 102).

SERVICE MARK

FIRST USE 4-14-2003; IN COMMERCE 4-14-2003.

PRINCIPAL REGISTER

THE MARK CONSISTS OF STANDARD CHARACTERS WITHOUT CLAIM TO ANY PARTICULAR FONT, STYLE, SIZE, OR COLOR.

SER. NO. 85-361,597, FILED 7-1-2011.

LOURDES AYALA, EXAMINING ATTORNEY



David J. Kybas

Director of the United States Patent and Trademark Office

United States of America

United States Patent and Trademark Office

PREVENTING STRATEGIC GRIDLOCK

Reg. No. 4,098,877

BUSINESS ADVANCEMENT INC (NEW JERSEY CORPORATION)
178 SYCAMORE TERRACE
GLEN ROCK, NJ 07452

Registered Feb. 14, 2012

Int. Cl.: 35

FOR: BUSINESS MANAGEMENT AND CONSULTATION SERVICES, NAMELY, BUSINESS CULTURAL ASSESSMENT, EXECUTIVE PLANNING AND BUSINESS CULTURAL INTEGRATION, IN CLASS 35 (U.S. CLS. 100, 101 AND 102).

SERVICE MARK

FIRST USE 8-12-1998; IN COMMERCE 8-12-1998.

PRINCIPAL REGISTER

THE MARK CONSISTS OF STANDARD CHARACTERS WITHOUT CLAIM TO ANY PARTICULAR FONT, STYLE, SIZE, OR COLOR.

SER. NO. 85-361,600, FILED 7-1-2011.

ELISSA GARBER KON, EXAMINING ATTORNEY



David J. Kyffers

Director of the United States Patent and Trademark Office

United States of America

United States Patent and Trademark Office

LuckyScreenCloth

Reg. No. 4,098,878

MCDONIEL, ESTELLE F. (UNITED STATES INDIVIDUAL)
1861 W. DESERT HIGHLANDS DR.
TUCSON, AZ 85737

Registered Feb. 14, 2012

Int. Cl.: 21

FOR: CLOTH FOR WIPING OR DUSTING, IN CLASS 21 (U.S. CLS. 2, 13, 23, 29, 30, 33, 40 AND 50).

TRADEMARK

FIRST USE 6-25-2011; IN COMMERCE 7-1-2011.

PRINCIPAL REGISTER

THE MARK CONSISTS OF STANDARD CHARACTERS WITHOUT CLAIM TO ANY PARTICULAR FONT, STYLE, SIZE, OR COLOR.

SER. NO. 85-361,638, FILED 7-1-2011.

GISELLE AGOSTO, EXAMINING ATTORNEY



David J. Kyffers

Director of the United States Patent and Trademark Office

United States of America
United States Patent and Trademark Office

QOOGGI

Reg. No. 4,098,879

Registered Feb. 14, 2012

Int. Cl.: 19

TRADEMARK

PRINCIPAL REGISTER

WENDY WOBBIES, LLC (ARIZONA LIMITED LIABILITY COMPANY)
10772 EAST RUNNING DEER TRAIL
155 SEAPORT BOULEVARD
SCOTTSDALE, AZ 85262

FOR: CLAY FIGURINES, IN CLASS 19 (U.S. CLS. 1, 12, 33 AND 50).

FIRST USE 6-19-2011; IN COMMERCE 6-19-2011.

THE MARK CONSISTS OF STANDARD CHARACTERS WITHOUT CLAIM TO ANY PARTICULAR FONT, STYLE, SIZE, OR COLOR.

SER. NO. 85-361,693, FILED 7-1-2011.

PATRICIA EVANKO, EXAMINING ATTORNEY



David J. Kyffers

Director of the United States Patent and Trademark Office

United States of America

United States Patent and Trademark Office

WildSmiles

Reg. No. 4,098,880

ALIGNCO ORTHODONTICS (NEBRASKA CORPORATION)
14441 DUPONT COURT #301
OMAHA, NE 68144

Registered Feb. 14, 2012

Int. Cl.: 10

FOR: ORTHODONTIC BRACKETS, IN CLASS 10 (U.S. CLS. 26, 39 AND 44).

TRADEMARK

FIRST USE 1-1-2002; IN COMMERCE 1-1-2002.

PRINCIPAL REGISTER

THE MARK CONSISTS OF STANDARD CHARACTERS WITHOUT CLAIM TO ANY PARTICULAR FONT, STYLE, SIZE, OR COLOR.

SER. NO. 85-361,695, FILED 7-1-2011.

DANNEAN HETZEL, EXAMINING ATTORNEY



David J. Kyffers

Director of the United States Patent and Trademark Office

United States of America

United States Patent and Trademark Office



Reg. No. 4,098,881

RAMSEY, DIANA R. (UNITED STATES INDIVIDUAL), AKA DIANA R. RAMSEY
P.O. BOX 82
CONVERSE, TX 78109

Registered Feb. 14, 2012

Int. Cls.: 25 and 44

FOR: T-SHIRTS, IN CLASS 25 (U.S. CLS. 22 AND 39).

TRADEMARK

FIRST USE 6-20-2011; IN COMMERCE 6-20-2011.

SERVICE MARK

FOR: BEAUTY CONSULTATION SERVICES , IN CLASS 44 (U.S. CLS. 100 AND 101).

PRINCIPAL REGISTER

FIRST USE 6-20-2011; IN COMMERCE 6-20-2011.

THE MARK CONSISTS OF THE STYLIZED SLOGAN "SISTERSWITHBEAUTY", WITH THE LETTER "W" BEING REPLACED BY A BUTTERFLY-DESIGN.

SER. NO. 85-361,720, FILED 7-1-2011.

STEVEN JACKSON, EXAMINING ATTORNEY



David J. Kyfos

Director of the United States Patent and Trademark Office

United States of America

United States Patent and Trademark Office

NO IMAGINATION REALITY

Reg. No. 4,098,882

Registered Feb. 14, 2012

Int. Cl.: 25

TRADEMARK

PRINCIPAL REGISTER

TOMLIN, BRIAN JERROD (UNITED STATES INDIVIDUAL), DBA NO IMAGINATION
REALITY
APT.43
2675 FLETCHER PRKWAY
SAN DIEGO, CA 92020

FOR: CLOTHING LINE, NAMELY, T-SHIRTS, PANTS, HATS AND JACKETS, IN CLASS 25
(U.S. CLS. 22 AND 39).

FIRST USE 1-1-2011; IN COMMERCE 5-20-2011.

THE MARK CONSISTS OF STANDARD CHARACTERS WITHOUT CLAIM TO ANY PAR-
TICULAR FONT, STYLE, SIZE, OR COLOR.

SER. NO. 85-361,728, FILED 7-1-2011.

AHSEN KHAN, EXAMINING ATTORNEY



David J. Kyffers

Director of the United States Patent and Trademark Office

United States of America

United States Patent and Trademark Office

The Learnalots

Reg. No. 4,098,883

BRIGHTSTART LEARNING (WASHINGTON LIMITED LIABILITY COMPANY)
7342 11TH AVE. NW
SEATTLE, WA 98117

Registered Feb. 14, 2012

Int. Cl.: 16

FOR: CHILDREN'S ACTIVITY BOOKS, IN CLASS 16 (U.S. CLS. 2, 5, 22, 23, 29, 37, 38 AND 50).

TRADEMARK

FIRST USE 11-9-2009; IN COMMERCE 6-19-2011.

PRINCIPAL REGISTER

THE MARK CONSISTS OF STANDARD CHARACTERS WITHOUT CLAIM TO ANY PARTICULAR FONT, STYLE, SIZE, OR COLOR.

SER. NO. 85-361,755, FILED 7-1-2011.

SETH A. RAPPAPORT, EXAMINING ATTORNEY



David J. Kybas

Director of the United States Patent and Trademark Office

United States of America

United States Patent and Trademark Office

COMFORT THINS

Reg. No. 4,098,884

STAT MEDICAL DEVICES, INC. (FLORIDA CORPORATION)
2056 N.E. 153 STREET
NORTH MIAMI BEACH, FL 33162

Registered Feb. 14, 2012

Int. Cl.: 10

FOR: LANCETS, IN CLASS 10 (U.S. CLS. 26, 39 AND 44).

TRADEMARK

FIRST USE 11-0-2002; IN COMMERCE 11-0-2002.

PRINCIPAL REGISTER

THE MARK CONSISTS OF STANDARD CHARACTERS WITHOUT CLAIM TO ANY PARTICULAR FONT, STYLE, SIZE, OR COLOR.

SER. NO. 85-361,761, FILED 7-1-2011.

RENEE MCCRAY, EXAMINING ATTORNEY



David J. Kybas

Director of the United States Patent and Trademark Office

United States of America

United States Patent and Trademark Office

AIR IN THE SQUARE

Reg. No. 4,098,885

MSG HOLDINGS, L.P. (DELAWARE LIMITED PARTNERSHIP)
TWO PENN PLAZA
NEW YORK, NY 10121

Registered Feb. 14, 2012

Int. Cls.: 25 and 41

FOR: CLOTHING, NAMELY, SHIRTS AND HATS, IN CLASS 25 (U.S. CLS. 22 AND 39).

FIRST USE 6-13-2011; IN COMMERCE 6-16-2011.

TRADEMARK

SERVICE MARK

FOR: ENTERTAINMENT IN THE NATURE OF EXTREME SPORTS COMPETITIONS AND EXHIBITIONS IN THE FIELDS OF SKATEBOARDING AND FREESTYLE BMX BIKING; ORGANIZING SPORTING EVENTS IN THE FIELDS OF SKATEBOARDING AND FREESTYLE BMX BIKING; ENTERTAINMENT SERVICES, NAMELY, ORGANIZING AND CONDUCTING ATHLETIC EVENTS RENDERED LIVE AND RECORDED FOR THE PURPOSE OF BROADCAST VIA TELEVISION, SATELLITE, AND THE INTERNET, IN CLASS 41 (U.S. CLS. 100, 101 AND 107).

PRINCIPAL REGISTER

FIRST USE 6-13-2011; IN COMMERCE 6-16-2011.

THE MARK CONSISTS OF STANDARD CHARACTERS WITHOUT CLAIM TO ANY PARTICULAR FONT, STYLE, SIZE, OR COLOR.

SER. NO. 85-361,792, FILED 7-1-2011.

GEORGE LORENZO, EXAMINING ATTORNEY



David J. Kybas

Director of the United States Patent and Trademark Office

United States of America

United States Patent and Trademark Office

THINK LOOK PLAN MOVE

Reg. No. 4,098,886

AHEAD, LLC (ILLINOIS LIMITED LIABILITY COMPANY)
150 S. WACKER DRIVE, SUITE 2520
CHICAGO, IL 60606

Registered Feb. 14, 2012

Int. Cls.: 35 and 42

FOR: VALUE-ADDED RESELLER SERVICES, NAMELY, DISTRIBUTORSHIP SERVICES IN THE FIELD OF HARDWARE AND SOFTWARE FOR INFORMATION TECHNOLOGY, DATA STORAGE, AND DATA SECURITY, IN CLASS 35 (U.S. CLS. 100, 101 AND 102).

SERVICE MARK

FIRST USE 6-0-2011; IN COMMERCE 6-0-2011.

PRINCIPAL REGISTER

FOR: COMPUTER INFORMATION TECHNOLOGY CONSULTATION IN THE FIELD OF DATA STORAGE AND DATA SECURITY; COMPUTER SYSTEMS INTEGRATION SERVICES AND CONSULTATION RELATED THERETO, IN CLASS 42 (U.S. CLS. 100 AND 101).

FIRST USE 6-0-2011; IN COMMERCE 6-0-2011.

THE MARK CONSISTS OF STANDARD CHARACTERS WITHOUT CLAIM TO ANY PARTICULAR FONT, STYLE, SIZE, OR COLOR.

SER. NO. 85-361,833, FILED 7-1-2011.

KATHLEEN M. VANSTON, EXAMINING ATTORNEY



David J. Kybas

Director of the United States Patent and Trademark Office

United States of America

United States Patent and Trademark Office

TAYLOR SWIFT

Reg. No. 4,098,887

Registered Feb. 14, 2012

Int. Cl.: 6

TRADEMARK

PRINCIPAL REGISTER

SWIFT, TAYLOR (UNITED STATES INDIVIDUAL)
C/O MILOM JOYCE HORSNELL CROW PLC
3310 WEST END AVENUE, SUITE 610
NASHVILLE, TN 37203

FOR: METAL KEY CHAINS, IN CLASS 6 (U.S. CLS. 2, 12, 13, 14, 23, 25 AND 50).

FIRST USE 8-26-2010; IN COMMERCE 8-26-2010.

THE MARK CONSISTS OF STANDARD CHARACTERS WITHOUT CLAIM TO ANY PARTICULAR FONT, STYLE, SIZE, OR COLOR.

OWNER OF U.S. REG. NOS. 3,809,269, 3,812,830 AND OTHERS.

THE NAME(S), PORTRAIT(S), AND/OR SIGNATURE(S) SHOWN IN THE MARK IDENTIFIES "TAYLOR SWIFT", WHOSE CONSENT(S) TO REGISTER IS MADE OF RECORD.

SER. NO. 85-361,852, FILED 7-1-2011.

DAVID TOOLEY, EXAMINING ATTORNEY



David J. Kyfos

Director of the United States Patent and Trademark Office

United States of America

United States Patent and Trademark Office

PUFFY PINE CONE

Reg. No. 4,098,888

Registered Feb. 14, 2012

Int. Cls.: 35 and 41

THE WOODLANDS LAND DEVELOPMENT COMPANY, L.P. (TEXAS LIMITED PARTNERSHIP)
11TH FLOOR
24 WATERWAY AVENUE
THE WOODLANDS, TX 77380

SERVICE MARK

PRINCIPAL REGISTER

FOR: PROMOTING COMMUNITY EVENTS, HIGHLIGHTING COMMUNITY DEDICATION TO NATURE, PROMOTING COMMUNITY DEDICATION TO A FORESTED ENVIRONMENT, PROMOTING FAMILY FRIENDLY HOMES AND NEIGHBORHOODS BY MEANS OF PERSONAL MASCOT APPEARANCES AND DISSEMINATION OF ADVERTISING AND PROMOTIONAL MATERIALS, IN CLASS 35 (U.S. CLS. 100, 101 AND 102).

FIRST USE 11-30-1998; IN COMMERCE 11-30-1998.

FOR: ENTERTAINMENT SERVICES IN THE NATURE OF PERSONAL APPEARANCES BY A COSTUMED MASCOT AT SPECIAL EVENTS, COMMUNITY EVENTS AND NEIGHBORHOOD FUNCTIONS TO PROMOTE THE FAMILY FRIENDLY NATURE OF THE COMMUNITY AND DEDICATION TO A FORESTED ENVIRONMENT, IN CLASS 41 (U.S. CLS. 100, 101 AND 107).

FIRST USE 11-30-1998; IN COMMERCE 11-30-1998.

THE MARK CONSISTS OF STANDARD CHARACTERS WITHOUT CLAIM TO ANY PARTICULAR FONT, STYLE, SIZE, OR COLOR.

SER. NO. 85-361,866, FILED 7-1-2011.

CAROLYN CATALDO, EXAMINING ATTORNEY



David J. Kyffers

Director of the United States Patent and Trademark Office

United States of America

United States Patent and Trademark Office

ASTRAVAR

Reg. No. 4,098,889

TOP SECRET NUTRITION LLC (FLORIDA LIMITED LIABILITY COMPANY)
1671 NW 144 TERRACE, #111
SUNRISE, FL 33323

Registered Feb. 14, 2012

Int. Cl.: 5

FOR: NUTRITIONAL SUPPLEMENTS; VITAMINS, IN CLASS 5 (U.S. CLS. 6, 18, 44, 46, 51 AND 52).

TRADEMARK

FIRST USE 11-0-2010; IN COMMERCE 11-0-2010.

PRINCIPAL REGISTER

THE MARK CONSISTS OF STANDARD CHARACTERS WITHOUT CLAIM TO ANY PARTICULAR FONT, STYLE, SIZE, OR COLOR.

SER. NO. 85-361,875, FILED 7-1-2011.

KATINA MISTER, EXAMINING ATTORNEY



David J. Kybas

Director of the United States Patent and Trademark Office

United States of America

United States Patent and Trademark Office

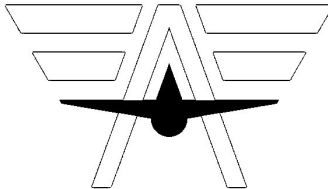

Reg. No. 4,098,890

Registered Feb. 14, 2012

Int. Cl.: 35

SERVICE MARK

PRINCIPAL REGISTER

AVILOOP LLC (DELAWARE LIMITED LIABILITY COMPANY)
11E
301 E 66TH ST
NEW YORK CITY, NY 10065

FOR: PROMOTING THE GOODS AND SERVICES OF OTHERS BY PROVIDING A WEBSITE FEATURING COUPONS, REBATES, PRICE-COMPARISON INFORMATION, PRODUCT REVIEWS, LINKS TO THE RETAIL WEBSITES OF OTHERS, AND DISCOUNT INFORMATION, IN CLASS 35 (U.S. CLS. 100, 101 AND 102).

FIRST USE 5-20-2011; IN COMMERCE 5-20-2011.

THE MARK CONSISTS OF A STYLIZED LETTER "A" WITH AN AIRPLANE ACROSS THE MIDDLE AND TWO TRAPEZOIDAL STRIPES ABOVE THE AIRPLANE WINGS ON EACH SIDE.

SER. NO. 85-361,878, FILED 7-1-2011.

SAIMA MAKHDOOM, EXAMINING ATTORNEY



David J. Kyffers

Director of the United States Patent and Trademark Office

United States of America

United States Patent and Trademark Office

SNAP

Reg. No. 4,098,891

Registered Feb. 14, 2012

Int. Cl.: 35

SERVICE MARK

PRINCIPAL REGISTER

SNAP SERVICES, LLC (DELAWARE LIMITED LIABILITY COMPANY), DBA SNAP
SECOND FLOOR
ONE BLUE HILL PLAZA, P.O. BOX 1546
PEARL RIVER, NY 10965

FOR: ADMINISTRATION OF A CONSUMER LOYALTY PROGRAM TO PROMOTE RESTAURANT SERVICES AND RETAIL SERVICES OF OTHERS, IN CLASS 35 (U.S. CLS. 100, 101 AND 102).

FIRST USE 2-9-2011; IN COMMERCE 2-9-2011.

THE MARK CONSISTS OF STANDARD CHARACTERS WITHOUT CLAIM TO ANY PARTICULAR FONT, STYLE, SIZE, OR COLOR.

SER. NO. 85-361,879, FILED 7-1-2011.

MARGERY A. TIERNEY, EXAMINING ATTORNEY



David J. Kybas

Director of the United States Patent and Trademark Office

United States of America

United States Patent and Trademark Office



Reg. No. 4,098,892

GENESYS SYSTEMS LLC (NORTH CAROLINA LIMITED LIABILITY COMPANY)
1300 TUNNEL ROAD
ASHEVILLE, NC 28805

Registered Feb. 14, 2012

Int. Cl.: 9

FOR: BALLASTS FOR GAS DISCHARGE LAMPS, IN CLASS 9 (U.S. CLS. 21, 23, 26, 36 AND 38).

TRADEMARK

FIRST USE 11-1-2009; IN COMMERCE 11-1-2009.

PRINCIPAL REGISTER

THE MARK CONSISTS OF TWO SEMI-CIRCLES WITH THE OPEN ENDS FACING TOWARDS EACH OTHER WITH THE UPPER PORTION OF THE RIGHT SEMI-CIRCLE IN THE CENTER OF THE LEFT SEMI-CIRCLE OPENING.

SER. NO. 85-361,883, FILED 7-1-2011.

TINA L. SNAPP, EXAMINING ATTORNEY



David J. Kyffers

Director of the United States Patent and Trademark Office

United States of America
United States Patent and Trademark Office

Pathways

Reg. No. 4,098,893

DIXIE CONSUMER PRODUCTS LLC (DELAWARE LIMITED LIABILITY COMPANY)
133 PEACHTREE STREET, NE
ATLANTA, GA 303035605

Registered Feb. 14, 2012

Int. Cl.: 21

FOR: PAPER TRAYS; SERVING PLATTERS, IN CLASS 21 (U.S. CLS. 2, 13, 23, 29, 30, 33, 40 AND 50).

TRADEMARK

FIRST USE 7-24-2011; IN COMMERCE 10-7-2011.

PRINCIPAL REGISTER

THE MARK CONSISTS OF THE WORD "PATHWAYS" WITH A STYLIZED FONT.

SER. NO. 85-361,889, FILED 7-1-2011.

SAIMA MAKHDOOM, EXAMINING ATTORNEY



David J. Kyros

Director of the United States Patent and Trademark Office

United States of America
United States Patent and Trademark Office

PATHWAYS

Reg. No. 4,098,894

DIXIE CONSUMER PRODUCTS LLC (DELAWARE LIMITED LIABILITY COMPANY)
133 PEACHTREE STREET, NE
ATLANTA, GA 303035605

Registered Feb. 14, 2012

Int. Cl.: 21

FOR: BOWLS; PAPER TRAYS; PLATES; SERVING PLATTERS, IN CLASS 21 (U.S. CLS. 2, 13, 23, 29, 30, 33, 40 AND 50).

TRADEMARK

FIRST USE 7-24-2011; IN COMMERCE 10-7-2011.

PRINCIPAL REGISTER

THE MARK CONSISTS OF STANDARD CHARACTERS WITHOUT CLAIM TO ANY PARTICULAR FONT, STYLE, SIZE, OR COLOR.

SER. NO. 85-361,898, FILED 7-1-2011.

SAIMA MAKHDOOM, EXAMINING ATTORNEY



David J. Kyffers

Director of the United States Patent and Trademark Office

United States of America

United States Patent and Trademark Office

PATHWAYS

Reg. No. 4,098,895

DIXIE CONSUMER PRODUCTS LLC (DELAWARE LIMITED LIABILITY COMPANY)
133 PEACHTREE STREET, NE
ATLANTA, GA 303035605

Registered Feb. 14, 2012

Int. Cl.: 16

FOR: PAPER TAKE-OUT CARTONS FOR FOOD, IN CLASS 16 (U.S. CLS. 2, 5, 22, 23, 29, 37, 38 AND 50).

TRADEMARK

FIRST USE 10-7-2011; IN COMMERCE 10-7-2011.

PRINCIPAL REGISTER

THE MARK CONSISTS OF STANDARD CHARACTERS WITHOUT CLAIM TO ANY PARTICULAR FONT, STYLE, SIZE, OR COLOR.

SER. NO. 85-361,900, FILED 7-1-2011.

SAIMA MAKHDOOM, EXAMINING ATTORNEY



David J. Kybas

Director of the United States Patent and Trademark Office

United States of America
United States Patent and Trademark Office

Pathways

Reg. No. 4,098,896

DIXIE CONSUMER PRODUCTS LLC (DELAWARE LIMITED LIABILITY COMPANY)
133 PEACHTREE STREET, NE
ATLANTA, GA 303035605

Registered Feb. 14, 2012

Int. Cl.: 16

FOR: PAPER TAKE-OUT CARTONS FOR FOOD, IN CLASS 16 (U.S. CLS. 2, 5, 22, 23, 29, 37, 38 AND 50).

TRADEMARK

FIRST USE 10-7-2011; IN COMMERCE 10-7-2011.

PRINCIPAL REGISTER

THE MARK CONSISTS OF THE WORD "PATHWAYS" WITH A STYLIZED FONT.

SER. NO. 85-361,915, FILED 7-1-2011.

SAIMA MAKHDOOM, EXAMINING ATTORNEY



David J. Kyffers

Director of the United States Patent and Trademark Office

United States of America

United States Patent and Trademark Office

Feel Younger Longer

Reg. No. 4,098,897

Registered Feb. 14, 2012

Int. Cl.: 32

TRADEMARK

PRINCIPAL REGISTER

GRAHAM & BUFFETT, LTD. (TEXAS LIMITED PARTNERSHIP)
5052 BRIDGE CREEK DRIVE
PLANO, TX 75093

FOR: WHOLE FOOD FRUIT PUREE BEVERAGE, IN CLASS 32 (U.S. CLS. 45, 46 AND 48).

FIRST USE 2-1-2011; IN COMMERCE 2-1-2011.

THE MARK CONSISTS OF STANDARD CHARACTERS WITHOUT CLAIM TO ANY PARTICULAR FONT, STYLE, SIZE, OR COLOR.

SER. NO. 85-361,932, FILED 7-1-2011.

TRACY FLETCHER, EXAMINING ATTORNEY



David J. Kyffers

Director of the United States Patent and Trademark Office

United States of America

United States Patent and Trademark Office

SURGX

Reg. No. 4,098,898

DENNIS SZYMAITIS DMD (UNITED STATES INDIVIDUAL)
1172 HARVARD ROAD
PITTSBURGH, PA 15205

Registered Feb. 14, 2012

Int. Cl.: 5

FOR: DENTAL COMPOUNDS USED IN THE TREATMENT OF PERIODONTAL DISEASE,
IN CLASS 5 (U.S. CLS. 6, 18, 44, 46, 51 AND 52).

TRADEMARK

FIRST USE 7-25-2011; IN COMMERCE 7-25-2011.

PRINCIPAL REGISTER

THE MARK CONSISTS OF STANDARD CHARACTERS WITHOUT CLAIM TO ANY PAR-
TICULAR FONT, STYLE, SIZE, OR COLOR.

SER. NO. 85-361,936, FILED 7-1-2011.

MATTHEW PAPPAS, EXAMINING ATTORNEY



David J. Kyffers

Director of the United States Patent and Trademark Office

United States of America

United States Patent and Trademark Office

PETROJAVA

Reg. No. 4,098,899

PETROJAVA INTERNATIONAL, INC. (TEXAS CORPORATION)
5240 TENNYSON PARKWAY, SUITE 201
PLANO, TX 75024

Registered Feb. 14, 2012

Int. Cl.: 40

FOR: GAS PRODUCTION SERVICES; OIL PRODUCTION SERVICES; OIL REFINING, IN CLASS 40 (U.S. CLS. 100, 103 AND 106).

SERVICE MARK

FIRST USE 3-1-2010; IN COMMERCE 3-1-2010.

PRINCIPAL REGISTER

THE MARK CONSISTS OF STANDARD CHARACTERS WITHOUT CLAIM TO ANY PARTICULAR FONT, STYLE, SIZE, OR COLOR.

SER. NO. 85-361,950, FILED 7-1-2011.

GEORGE LORENZO, EXAMINING ATTORNEY



David J. Kyffers

Director of the United States Patent and Trademark Office

United States of America

United States Patent and Trademark Office



Reg. No. 4,098,900

Registered Feb. 14, 2012

Int. Cl.: 36

SERVICE MARK

PRINCIPAL REGISTER

SCRUB-A-MUTT (WASHINGTON CORPORATION)
9120 62ND DR NE
MARYSVILLE, WA 98270

FOR: CHARITABLE FUNDRAISING SERVICES, IN CLASS 36 (U.S. CLS. 100, 101 AND 102).

FIRST USE 3-1-2009; IN COMMERCE 3-1-2009.

THE MARK CONSISTS OF A DOG WITH EARS AND A DUCK IN A BATHTUB WITH A SHOWER HEAD. THERE IS BUBBLES WITH THE STYLIZED TEXT "SCRUB-A-MUTT".

SER. NO. 85-361,969, FILED 7-1-2011.

MARGERY A. TIERNEY, EXAMINING ATTORNEY



David J. Kybas

Director of the United States Patent and Trademark Office

United States of America

United States Patent and Trademark Office

Sanctified Swag

Reg. No. 4,098,901

MOORE, YVONNE MICHELLE (UNITED STATES INDIVIDUAL)
5050 LAGUNA BLVD 112-360
ELK GROVE, CA 95758

Registered Feb. 14, 2012

Int. Cl.: 25

FOR: DENIMS; JEGGINGS, NAMELY, PANTS THAT ARE PARTIALLY JEANS AND PARTIALLY LEGGINGS; SHIRTS; SHORT-SLEEVED OR LONG-SLEEVED T-SHIRTS; SWEAT SHIRTS; T-SHIRTS, IN CLASS 25 (U.S. CLS. 22 AND 39).

TRADEMARK

FIRST USE 8-1-2009; IN COMMERCE 10-1-2010.

PRINCIPAL REGISTER

THE MARK CONSISTS OF STANDARD CHARACTERS WITHOUT CLAIM TO ANY PARTICULAR FONT, STYLE, SIZE, OR COLOR.

SER. NO. 85-361,975, FILED 7-1-2011.

JOHN WILKE, EXAMINING ATTORNEY



David J. Kyffers

Director of the United States Patent and Trademark Office

United States of America

United States Patent and Trademark Office

USA WAKEBOARD

Reg. No. 4,098,902

LEVINE, DAN (UNITED STATES INDIVIDUAL)
1501 S. STOUGHTON ROAD
MADISON, WI 53716

Registered Feb. 14, 2012

Int. Cl.: 41

FOR: ENTERTAINMENT SERVICES, NAMELY PROMOTING, ORGANIZING, AND SPONSORING WAKEBOARD COMPETITIONS, IN CLASS 41 (U.S. CLS. 100, 101 AND 107).

SERVICE MARK

FIRST USE 4-0-2004; IN COMMERCE 4-0-2004.

PRINCIPAL REGISTER

THE MARK CONSISTS OF STANDARD CHARACTERS WITHOUT CLAIM TO ANY PARTICULAR FONT, STYLE, SIZE, OR COLOR.

OWNER OF U.S. REG. NO. 3,115,469.

NO CLAIM IS MADE TO THE EXCLUSIVE RIGHT TO USE "WAKEBOARD", APART FROM THE MARK AS SHOWN.

SEC. 2(F).

SER. NO. 85-361,980, FILED 7-1-2011.

JOHN WILKE, EXAMINING ATTORNEY



David J. Kyfos

Director of the United States Patent and Trademark Office

United States of America

United States Patent and Trademark Office

PUFFY

Reg. No. 4,098,903

Registered Feb. 14, 2012

Int. Cls.: 35 and 41

THE WOODLANDS LAND DEVELOPMENT COMPANY, L.P. (TEXAS LIMITED PARTNERSHIP)
11TH FLOOR
24 WATERWAY AVENUE
THE WOODLANDS, TX 77380

SERVICE MARK

PRINCIPAL REGISTER

FOR: PROMOTING COMMUNITY EVENTS, HIGHLIGHTING COMMUNITY DEDICATION TO NATURE, PROMOTING COMMUNITY DEDICATION TO A FORESTED ENVIRONMENT, PROMOTING FAMILY FRIENDLY HOMES AND NEIGHBORHOODS BY MEANS OF PERSONAL MASCOT APPEARANCES AND DISSEMINATION OF ADVERTISING AND PROMOTIONAL MATERIALS, IN CLASS 35 (U.S. CLS. 100, 101 AND 102).

FIRST USE 11-30-1998; IN COMMERCE 11-30-1998.

FOR: ENTERTAINMENT SERVICES IN THE NATURE OF PERSONAL APPEARANCES BY A COSTUMED MASCOT AT SPECIAL EVENTS, COMMUNITY EVENTS AND NEIGHBORHOOD FUNCTIONS TO PROMOTE THE FAMILY FRIENDLY NATURE OF THE COMMUNITY AND DEDICATION TO A FORESTED ENVIRONMENT, IN CLASS 41 (U.S. CLS. 100, 101 AND 107).

FIRST USE 11-30-1998; IN COMMERCE 11-30-1998.

THE MARK CONSISTS OF STANDARD CHARACTERS WITHOUT CLAIM TO ANY PARTICULAR FONT, STYLE, SIZE, OR COLOR.

SER. NO. 85-361,981, FILED 7-1-2011.

CAROLYN CATALDO, EXAMINING ATTORNEY



David J. Kyffers

Director of the United States Patent and Trademark Office

United States of America

United States Patent and Trademark Office

FORTE

Reg. No. 4,098,904

ALIGNCO ORTHODONTICS (NEBRASKA CORPORATION)
14441 DUPONT COURT #301
OMAHA, NE 68144

Registered Feb. 14, 2012

Int. Cl.: 10

FOR: ORTHODONTIC BRACKETS, IN CLASS 10 (U.S. CLS. 26, 39 AND 44).

TRADEMARK

FIRST USE 1-1-2007; IN COMMERCE 1-1-2007.

PRINCIPAL REGISTER

THE MARK CONSISTS OF STANDARD CHARACTERS WITHOUT CLAIM TO ANY PARTICULAR FONT, STYLE, SIZE, OR COLOR.

SER. NO. 85-361,984, FILED 7-1-2011.

DANNEAN HETZEL, EXAMINING ATTORNEY



David J. Kyffers

Director of the United States Patent and Trademark Office

United States of America

United States Patent and Trademark Office

DSW

Reg. No. 4,098,905

Registered Feb. 14, 2012

Int. Cls.: 18 and 25

TRADEMARK

PRINCIPAL REGISTER

DSW SHOE WAREHOUSE, INC. (MISSOURI CORPORATION)
810 DSW DRIVE
COLUMBUS, OH 43219

FOR: HANDBAGS; PURSES; WALLETS, IN CLASS 18 (U.S. CLS. 1, 2, 3, 22 AND 41).

FIRST USE 5-0-2011; IN COMMERCE 5-0-2011.

FOR: FOOTWEAR , IN CLASS 25 (U.S. CLS. 22 AND 39).

FIRST USE 9-8-2011; IN COMMERCE 9-8-2011.

THE MARK CONSISTS OF STANDARD CHARACTERS WITHOUT CLAIM TO ANY PARTICULAR FONT, STYLE, SIZE, OR COLOR.

OWNER OF U.S. REG. NOS. 1,891,493, 2,842,819 AND OTHERS.

SER. NO. 85-361,988, FILED 7-1-2011.

RONALD AIKENS, EXAMINING ATTORNEY



David J. Kyffers

Director of the United States Patent and Trademark Office

United States of America

United States Patent and Trademark Office

BREXI

Reg. No. 4,098,906

Registered Feb. 14, 2012

Int. Cl.: 43

SERVICE MARK

PRINCIPAL REGISTER

DB BISTRO, LLC (COLORADO LIMITED LIABILITY COMPANY)
316 E. HOPKINS AVENUE
ASPEN, CO 81611

FOR: BAR AND RESTAURANT SERVICES, IN CLASS 43 (U.S. CLS. 100 AND 101).

FIRST USE 2-7-2009; IN COMMERCE 2-7-2009.

THE MARK CONSISTS OF STANDARD CHARACTERS WITHOUT CLAIM TO ANY PARTICULAR FONT, STYLE, SIZE, OR COLOR.

THE WORDING "BREXI" HAS NO MEANING IN A FOREIGN LANGUAGE.

SER. NO. 85-362,001, FILED 7-1-2011.

MATTHEW PAPPAS, EXAMINING ATTORNEY



David J. Kyffers

Director of the United States Patent and Trademark Office

United States of America

United States Patent and Trademark Office



Reg. No. 4,098,907

CHEN, LI-SHUANG (FLORIDA CORPORATION)
2660 NW 3RD AVE.
MIAMI, FL 33127

Registered Feb. 14, 2012

Int. Cl.: 25

TRADEMARK

PRINCIPAL REGISTER

FOR: A-SHIRTS; APPAREL FOR DANCERS, NAMELY, TEE SHIRTS, SWEATSHIRTS, PANTS, LEGGINGS, SHORTS AND JACKETS; ATHLETIC APPAREL, NAMELY, SHIRTS, PANTS, JACKETS, FOOTWEAR, HATS AND CAPS, ATHLETIC UNIFORMS; ATHLETIC SHOES; BALLET SHOES; BALLROOM DANCING SHOES; BASEBALL SHOES; BEACH SHOES; BOAT SHOES; BODY SHIRTS; BOWLING SHOES; BOXING SHOES; BUTTON DOWN SHIRTS; BUTTON-FRONT ALOHA SHIRTS; CAMOUFLAGE SHIRTS; CAMP SHIRTS; CANVAS SHOES; CLIMBING SHOES; CLOTHING FOR ATHLETIC USE, NAMELY, PADDED SHIRTS; CLOTHING FOR BABIES, TODDLERS AND CHILDREN, TREATED WITH FIRE AND HEAT RETARDANTS, NAMELY, PAJAMAS, JACKETS, SHIRTS, PANTS, JUMPERS; CLOTHING SHIELDS, NAMELY, PADS APPLIED TO THE UNDERARMS OF SHIRTS, BLOUSES AND SWEATERS; COLLARED SHIRTS; CYCLING SHOES; DANCE SHOES; DECK-SHOES; DRESS SHIRTS; DRIVERS; FISHING SHIRTS; FOOTBALL SHOES; GOLF PANTS, SHIRTS AND SKIRTS; GOLF SHIRTS; GOLF SHOES; GYMNAS TIC SHOES; HANDBALL SHOES; HOCKEY SHOES; HOODED SWEAT SHIRTS; HUNTING SHIRTS; INFANTS' SHOES AND BOOTS; INSOLES; KNIT SHIRTS; LEATHER SHIRTS; LEATHER SHOES; LEISURE SHOES; LONG-SLEEVED SHIRTS; MOISTURE-WICKING SPORTS SHIRTS; MOUNTAINEERING SHOES; NIGHT SHIRTS; OPEN-NECKED SHIRTS; OVER SHIRTS; PIQUE SHIRTS; POLO SHIRTS; RIDING SHOES; RUBBER SHOES; RUGBY SHIRTS; RUGBY SHOES; RUNNING SHOES; SANDALS AND BEACH SHOES; SCIENTIFIC AND TECHNOLOGICAL APPAREL, NAMELY, SHIRTS, PANTS, JACKETS, FOOTWEAR, HATS AND CAPS, UNIFORMS; SHIRT FRONTS; SHIRTS; SHIRTS AND SHORT-SLEEVED SHIRTS; SHIRTS AND SLIPS; SHIRTS FOR INFANTS, BABIES, TODDLERS AND CHILDREN; SHIRTS FOR SUITS; SHOE SOLES; SHOES; SHORT-SLEEVED OR LONG-SLEEVED T-SHIRTS; SHORT-SLEEVED SHIRTS; SKIING SHOES; SLEEP SHIRTS; SLEEVES WORN SEPARATE AND APART FROM BLOUSES, SHIRTS AND OTHER TOPS; SNAP CROTCH SHIRTS FOR INFANTS AND TODDLERS; SOCCER SHOES; SPORT SHIRTS; SPORTS SHIRTS; SPORTS SHIRTS WITH SHORT SLEEVES; SWEAT SHIRTS; T-SHIRTS; TAP SHOES; TEE SHIRTS; TENNIS SHOES; TRACK AND FIELD SHOES; TRAINING SHOES; TRIATHLON CLOTHING, NAMELY, TRIATHLON TIGHTS, TRIATHLON SHORTS, TRIATHLON SINGLET S, TRIATHLON SHIRTS, TRIATHLON SUITS; TURTLE NECK SHIRTS; VOLLEYBALL SHOES; WATER REPELLING LEATHER SHOES AND BOOTS; WATERPROOF LEATHER SHOES; WATERPROOF LEATHER SHOES AND BOOTS; WEARABLE GARMENTS AND CLOTHING, NAMELY, SHIRTS; WIND SHIRTS; WOMEN'S CLOTHING, NAMELY, SHIRTS, DRESSES,



David J. Kyros

Director of the United States Patent and Trademark Office

Reg. No. 4,098,907 SKIRTS, BLOUSES; WOMEN'S SHOES; WOMEN'S SHOES, NAMELY, FOLDABLE FLATS; WOODEN SHOES; WORK SHOES AND BOOTS; YOGA SHIRTS, IN CLASS 25 (U.S. CLS. 22 AND 39).

FIRST USE 2-1-2003; IN COMMERCE 2-1-2003.

THE MARK CONSISTS OF XBOK.

SER. NO. 85-362,012, FILED 7-1-2011.

JENNIFER MARTIN, EXAMINING ATTORNEY

United States of America

United States Patent and Trademark Office

Puffy



Reg. No. 4,098,908

Registered Feb. 14, 2012

Int. Cls.: 35 and 41

THE WOODLANDS LAND DEVELOPMENT COMPANY, L.P. (TEXAS LIMITED PARTNERSHIP)
11TH FLOOR
24 WATERWAY AVENUE
THE WOODLANDS, TX 77380

SERVICE MARK

PRINCIPAL REGISTER

FOR: PROMOTING COMMUNITY EVENTS, HIGHLIGHTING COMMUNITY DEDICATION TO NATURE, PROMOTING COMMUNITY DEDICATION TO A FORESTED ENVIRONMENT, PROMOTING FAMILY FRIENDLY HOMES AND NEIGHBORHOODS BY MEANS OF PERSONAL MASCOT APPEARANCES AND DISSEMINATION OF ADVERTISING AND PROMOTIONAL MATERIALS, IN CLASS 35 (U.S. CLS. 100, 101 AND 102).

FIRST USE 11-30-1999; IN COMMERCE 11-30-1999.

FOR: ENTERTAINMENT SERVICES IN THE NATURE OF PERSONAL APPEARANCES BY A COSTUMED MASCOT AT SPECIAL EVENTS, COMMUNITY EVENTS AND NEIGHBORHOOD FUNCTIONS TO PROMOTE THE FAMILY FRIENDLY NATURE OF THE COMMUNITY AND DEDICATION TO A FORESTED ENVIRONMENT, IN CLASS 41 (U.S. CLS. 100, 101 AND 107).

FIRST USE 11-30-1999; IN COMMERCE 11-30-1999.

THE MARK CONSISTS OF A CARTOON CHARACTER IN THE FORM OF A PINE CONE HAVING AN ACORN NOSE AND AUTUMN LEAF HANDS, WEARING SNEAKERS AND SOCKS DECORATED WITH PINE CONES AND TREES AND THE WORD "PUFFY".

SER. NO. 85-362,030, FILED 7-1-2011.

CAROLYN CATALDO, EXAMINING ATTORNEY



David J. Kybas

Director of the United States Patent and Trademark Office

United States of America

United States Patent and Trademark Office

BETTER MEN FOR A BETTER WORLD

Reg. No. 4,098,909

KCL PROPERTIES, INC. (INDIANA CORPORATION)

Registered Feb. 14, 2012

7439 WOODLAND DRIVE
INDIANAPOLIS, IN 46278

Int. Cl.: 35

FOR: ASSOCIATION SERVICES, NAMELY, ORGANIZING CHAPTERS OF A FRATERNITY AND PROMOTING THE INTERESTS OF THE MEMBERS THEREOF, IN CLASS 35 (U.S. CLS. 100, 101 AND 102).

SERVICE MARK

FIRST USE 3-0-2009; IN COMMERCE 3-0-2009.

PRINCIPAL REGISTER

THE MARK CONSISTS OF STANDARD CHARACTERS WITHOUT CLAIM TO ANY PARTICULAR FONT, STYLE, SIZE, OR COLOR.

SER. NO. 85-362,035, FILED 7-1-2011.

MARK SPARACINO, EXAMINING ATTORNEY



David J. Kyffers

Director of the United States Patent and Trademark Office

United States of America

United States Patent and Trademark Office

Puffy Pine Cone



Reg. No. 4,098,910

Registered Feb. 14, 2012

Int. Cls.: 35 and 41

THE WOODLANDS LAND DEVELOPMENT COMPANY, L.P. (TEXAS LIMITED PARTNERSHIP)
11TH FLOOR
24 WATERWAY AVENUE
THE WOODLANDS, TX 77380

SERVICE MARK

PRINCIPAL REGISTER

FOR: PROMOTING COMMUNITY EVENTS, HIGHLIGHTING COMMUNITY DEDICATION TO NATURE, PROMOTING COMMUNITY DEDICATION TO A FORESTED ENVIRONMENT, PROMOTING FAMILY FRIENDLY HOMES AND NEIGHBORHOODS BY MEANS OF PERSONAL MASCOT APPEARANCES AND DISSEMINATION OF ADVERTISING AND PROMOTIONAL MATERIALS, IN CLASS 35 (U.S. CLS. 100, 101 AND 102).

FIRST USE 11-30-1998; IN COMMERCE 11-30-1998.

FOR: ENTERTAINMENT SERVICES IN THE NATURE OF PERSONAL APPEARANCES BY A COSTUMED MASCOT AT SPECIAL EVENTS, COMMUNITY EVENTS AND NEIGHBORHOOD FUNCTIONS TO PROMOTE THE FAMILY FRIENDLY NATURE OF THE COMMUNITY AND DEDICATION TO A FORESTED ENVIRONMENT, IN CLASS 41 (U.S. CLS. 100, 101 AND 107).

FIRST USE 11-30-1998; IN COMMERCE 11-30-1998.

THE MARK CONSISTS OF A COSTUMED MASCOT CHARACTER IN THE FORM OF A PINE CONE HAVING AN ACORN NOSE AND AUTUMN LEAF HANDS, WEARING SNEAKERS AND SOCKS DECORATED WITH PINE CONES AND TREES AND THE WORDS "PUFFY PINE CONE".

SER. NO. 85-362,050, FILED 7-1-2011.

CAROLYN CATALDO, EXAMINING ATTORNEY



David J. Kybas

Director of the United States Patent and Trademark Office

United States of America

United States Patent and Trademark Office

Hygen8

Reg. No. 4,098,911

HYGEN8, LLC (TENNESSEE LIMITED LIABILITY COMPANY)
440 RIDGEFIELD WAY #409
NASHVILLE, TN 37205

Registered Feb. 14, 2012

Int. Cl.: 32

FOR: BOTTLED WATER, IN CLASS 32 (U.S. CLS. 45, 46 AND 48).

TRADEMARK

FIRST USE 4-1-2011; IN COMMERCE 4-1-2011.

PRINCIPAL REGISTER

THE MARK CONSISTS OF STANDARD CHARACTERS WITHOUT CLAIM TO ANY PARTICULAR FONT, STYLE, SIZE, OR COLOR.

SER. NO. 85-362,053, FILED 7-1-2011.

CAROLYN CATALDO, EXAMINING ATTORNEY



David J. Kyffers

Director of the United States Patent and Trademark Office

United States of America
United States Patent and Trademark Office

TOEBUDS

Reg. No. 4,098,912

Registered Feb. 14, 2012

Int. Cl.: 25

TRADEMARK

PRINCIPAL REGISTER

TOEBLOOMS, LLC (ARIZONA LIMITED LIABILITY COMPANY)
SUITE 1220
2400 EAST ARIZONA BILTMORE CIRCLE
PHOENIX, AZ 85016

FOR: ACCESSORIES FOR THE FEET, NAMELY, FOOTWEAR FOR INFANTS MADE OF FABRIC AND RIBBONS, IN CLASS 25 (U.S. CLS. 22 AND 39).

FIRST USE 5-22-2011; IN COMMERCE 5-22-2011.

THE MARK CONSISTS OF STANDARD CHARACTERS WITHOUT CLAIM TO ANY PARTICULAR FONT, STYLE, SIZE, OR COLOR.

SER. NO. 85-362,063, FILED 7-1-2011.

MATTHEW PAPPAS, EXAMINING ATTORNEY



David J. Kyffers

Director of the United States Patent and Trademark Office

United States of America

United States Patent and Trademark Office

FMXRAYSPECS

Reg. No. 4,098,913

WORKFLOW DATA SYSTEMS, LLC (OHIO LIMITED LIABILITY COMPANY)
659K LAKEVIEW PLAZA BLVD
WORTHINGTON, OH 43085

Registered Feb. 14, 2012

Int. Cl.: 9

FOR: COMPUTER SOFTWARE FOR USE IN ACCESSING METADATA WITHIN A DATABASE, IN CLASS 9 (U.S. CLS. 21, 23, 26, 36 AND 38).

TRADEMARK

FIRST USE 6-27-2011; IN COMMERCE 6-27-2011.

PRINCIPAL REGISTER

THE MARK CONSISTS OF STANDARD CHARACTERS WITHOUT CLAIM TO ANY PARTICULAR FONT, STYLE, SIZE, OR COLOR.

SER. NO. 85-362,070, FILED 7-1-2011.

WON TEAK OH, EXAMINING ATTORNEY



David J. Kyffers

Director of the United States Patent and Trademark Office

United States of America

United States Patent and Trademark Office

LINXXUS

Reg. No. 4,098,914

LINXXUS, LLC (DELAWARE LIMITED LIABILITY COMPANY)
PO BOX 58242
NASHVILLE, TN 37205

Registered Feb. 14, 2012

Int. Cl.: 35

FOR: PROMOTING THE SALE OF CREDIT CARD AND DEBIT CARD ACCOUNTS AND OTHER FINANCIAL PRODUCTS THROUGH THE ADMINISTRATION OF INCENTIVE AWARD PROGRAMS, IN CLASS 35 (U.S. CLS. 100, 101 AND 102).

SERVICE MARK

FIRST USE 3-2-2011; IN COMMERCE 4-13-2011.

PRINCIPAL REGISTER

THE MARK CONSISTS OF STANDARD CHARACTERS WITHOUT CLAIM TO ANY PARTICULAR FONT, STYLE, SIZE, OR COLOR.

SER. NO. 85-362,073, FILED 7-1-2011.

MATTHEW PAPPAS, EXAMINING ATTORNEY



David J. Kyffers

Director of the United States Patent and Trademark Office

United States of America

United States Patent and Trademark Office

AHE

Reg. No. 4,098,915

AMERICAN HOSPITAL ASSOCIATION (ILLINOIS NON-PROFIT CORPORATION)
155 N. WACKER DR., SUITE 400
CHICAGO, IL 60606

Registered Feb. 14, 2012

Int. Cl.: 35

FOR: ASSOCIATION SERVICES, NAMELY, PROMOTING THE INTERESTS OF PROFESSIONALS IN THE FIELDS OF ENVIRONMENTAL SERVICES, HOUSEKEEPING, WASTE AND PHARMACEUTICAL MANAGEMENT, AND LINEN/LAUNDRY SERVICES IN ALL HEALTHCARE INSTITUTIONS, IN CLASS 35 (U.S. CLS. 100, 101 AND 102).

SERVICE MARK

PRINCIPAL REGISTER

FIRST USE 9-27-2010; IN COMMERCE 9-27-2010.

THE MARK CONSISTS OF STANDARD CHARACTERS WITHOUT CLAIM TO ANY PARTICULAR FONT, STYLE, SIZE, OR COLOR.

SER. NO. 85-362,087, FILED 7-1-2011.

ROSELLE HERRERA, EXAMINING ATTORNEY



David J. Kyjars

Director of the United States Patent and Trademark Office

United States of America

United States Patent and Trademark Office

THE GREAT AMERICAN NO BULL CHALLENGE

Reg. No. 4,098,916

Registered Feb. 14, 2012

Int. Cl.: 41

SERVICE MARK

PRINCIPAL REGISTER

THE EDGINGTON GROUP, LLC (CALIFORNIA LIMITED LIABILITY COMPANY)
6600 KOLL CENTER PARKWAY, SUITE 100
PLEASANTON, CA 94566

FOR: ARRANGING OF CONTESTS; ENTERTAINMENT IN THE NATURE OF CONDUCTING AND ARRANGING CONTESTS IN WHICH STUDENTS CREATE A NO-BULLYING MOVEMENT IN THEIR SCHOOLS, AND DOCUMENT THE MOVEMENT BY CREATING A SHORT DOCUMENTARY; ENTERTAINMENT SERVICES, NAMELY, CONDUCTING CONTESTS, IN CLASS 41 (U.S. CLS. 100, 101 AND 107).

FIRST USE 6-0-2011; IN COMMERCE 6-0-2011.

THE MARK CONSISTS OF STANDARD CHARACTERS WITHOUT CLAIM TO ANY PARTICULAR FONT, STYLE, SIZE, OR COLOR.

SER. NO. 85-362,090, FILED 7-1-2011.

ALEXANDER L. POWERS, EXAMINING ATTORNEY



David J. Kyffers

Director of the United States Patent and Trademark Office

United States of America

United States Patent and Trademark Office

SILVERSTRIKE

Reg. No. 4,098,917

ARCANA, LLC (CALIFORNIA LIMITED LIABILITY COMPANY)
P.O. BOX 10787
NAPA, CA 94581

Registered Feb. 14, 2012

Int. Cl.: 33

FOR: WINE, IN CLASS 33 (U.S. CLS. 47 AND 49).

TRADEMARK

FIRST USE 6-16-2011; IN COMMERCE 6-16-2011.

PRINCIPAL REGISTER

THE MARK CONSISTS OF STANDARD CHARACTERS WITHOUT CLAIM TO ANY PARTICULAR FONT, STYLE, SIZE, OR COLOR.

SER. NO. 85-362,115, FILED 7-1-2011.

HENRY S. ZAK, EXAMINING ATTORNEY



David J. Kyffers

Director of the United States Patent and Trademark Office

United States of America

United States Patent and Trademark Office



Reg. No. 4,098,918

Registered Feb. 14, 2012

Int. Cl.: 9

TRADEMARK

PRINCIPAL REGISTER

T-MOBILE USA, INC. (DELAWARE CORPORATION)
12920 S.E. 38TH STREET
BELLEVUE, WA 98006

FOR: MOBILE DEVICE SOFTWARE FOR SUBSCRIBING TO RINGBACK SERVICES, PREVIEWING AND SELECTING MUSICAL, SPOKEN WORD AND OTHER AUDIO TRACKS AS RINGBACK TONES, AND MANAGING SUBSCRIPTION SETTINGS AND USER LIBRARIES OF SELECTED MUSICAL, SPOKEN WORD AND OTHER AUDIO TRACKS AS RINGBACK TONES, IN CLASS 9 (U.S. CLS. 21, 23, 26, 36 AND 38).

FIRST USE 8-21-2010; IN COMMERCE 8-21-2010.

THE MARK CONSISTS OF A PHONE HANDSET VIEWED IN PROFILE, PRESENTED IN GRAY AND POSITIONED AT THE LEFT, AND TWO MUSICAL NOTES PRESENTED IN MAGENTA, WITH THE MUSICAL NOTE ON THE RIGHT SLIGHTLY SMALLER THAN THE MUSICAL NOTE ON THE LEFT, POSITIONED TO THE RIGHT.

THE COLOR(S) MAGENTA AND GRAY IS/ARE CLAIMED AS A FEATURE OF THE MARK.

SER. NO. 85-362,143, FILED 7-1-2011.

LINDSEY RUBIN, EXAMINING ATTORNEY



David J. Kybas

Director of the United States Patent and Trademark Office

United States of America

United States Patent and Trademark Office

PLEDGE OF ASSURANCE

Reg. No. 4,098,919

Registered Feb. 14, 2012

Int. Cl.: 36

SERVICE MARK

PRINCIPAL REGISTER

PLYMOUTH ROCK ASSURANCE CORPORATION (MASSACHUSETTS CORPORATION)
695 ATLANTIC AVENUE
BOSTON, MA 02111

FOR: PERSONAL AND BUSINESS INSURANCE SERVICES, NAMELY, INSURANCE AGENCIES, INSURANCE UNDERWRITING, INSURANCE BROKERAGE, ISSUANCE OF INSURANCE POLICIES, INSURANCE CLAIMS PROCESSING, INSURANCE CLAIMS ADMINISTRATION, AND INSURANCE CLAIMS ADJUSTMENT, IN THE FIELDS OF HOMEOWNERS, PROPERTY, AND MOTOR VEHICLE INSURANCE, IN CLASS 36 (U.S. CLS. 100, 101 AND 102).

FIRST USE 6-30-2011; IN COMMERCE 6-30-2011.

THE MARK CONSISTS OF STANDARD CHARACTERS WITHOUT CLAIM TO ANY PARTICULAR FONT, STYLE, SIZE, OR COLOR.

SER. NO. 85-362,149, FILED 7-1-2011.

NAKIA HENRY, EXAMINING ATTORNEY



David J. Kyffers

Director of the United States Patent and Trademark Office

United States of America

United States Patent and Trademark Office

ChewMax

Reg. No. 4,098,920

BARAN, ROBERT (UNITED STATES INDIVIDUAL)
03003 N.M-40 HWY.
GOBLES, MI 49055

Registered Feb. 14, 2012

Int. Cl.: 18

FOR: RAWHIDE CHEWS FOR DOGS, IN CLASS 18 (U.S. CLS. 1, 2, 3, 22 AND 41).

TRADEMARK

FIRST USE 1-11-2011; IN COMMERCE 6-7-2011.

PRINCIPAL REGISTER

THE MARK CONSISTS OF STANDARD CHARACTERS WITHOUT CLAIM TO ANY PARTICULAR FONT, STYLE, SIZE, OR COLOR.

SER. NO. 85-362,160, FILED 7-1-2011.

WON TEAK OH, EXAMINING ATTORNEY



David J. Kyffers

Director of the United States Patent and Trademark Office

United States of America

United States Patent and Trademark Office

BE FOCAL BUY LOCAL

Reg. No. 4,098,921

KENT, JEFF (UNITED STATES INDIVIDUAL)
PO BOX 5171

Registered Feb. 14, 2012

MANSFIELD, OH 44901

Int. Cl.: 35

FOR: PROMOTING PUBLIC AWARENESS OF THE NEED FOR SUPPORTING LOCAL BUSINESSES, IN CLASS 35 (U.S. CLS. 100, 101 AND 102).

SERVICE MARK

FIRST USE 2-1-2011; IN COMMERCE 2-1-2011.

PRINCIPAL REGISTER

THE MARK CONSISTS OF STANDARD CHARACTERS WITHOUT CLAIM TO ANY PARTICULAR FONT, STYLE, SIZE, OR COLOR.

SER. NO. 85-362,183, FILED 7-1-2011.

MATTHEW PAPPAS, EXAMINING ATTORNEY



David J. Kyffers

Director of the United States Patent and Trademark Office

United States of America

United States Patent and Trademark Office

FISHLOPEDIA

Reg. No. 4,098,922

Registered Feb. 14, 2012

Int. Cl.: 9

TRADEMARK

PRINCIPAL REGISTER

DMOT, INC. (TENNESSEE CORPORATION)
434 DISTRIBUTION PARKWAY
COLLIERVILLE, TN 38187

FOR: DOWNLOADABLE SOFTWARE IN THE NATURE OF A MOBILE APPLICATION FOR OBTAINING INFORMATION RELATED TO FISH AND FISHING, IN CLASS 9 (U.S. CLS. 21, 23, 26, 36 AND 38).

FIRST USE 7-1-2011; IN COMMERCE 7-1-2011.

THE MARK CONSISTS OF STANDARD CHARACTERS WITHOUT CLAIM TO ANY PARTICULAR FONT, STYLE, SIZE, OR COLOR.

SER. NO. 85-362,184, FILED 7-1-2011.

SANJEEV VOHRA, EXAMINING ATTORNEY



David J. Kyffers

Director of the United States Patent and Trademark Office

United States of America

United States Patent and Trademark Office

Luck is how you Look at it

Reg. No. 4,098,923

MARKLE, ELIZABETH (UNITED STATES INDIVIDUAL)
151 O NEIL STREET
KINGSTON, NY 12401 AND

Registered Feb. 14, 2012

Int. Cl.: 14

MARKLE, DONALD (UNITED STATES INDIVIDUAL)
151 O NEIL STREET
KINGSTON, NY 12401

TRADEMARK

PRINCIPAL REGISTER

FOR: CHARMS IN PRECIOUS METALS OR COATED THEREWITH; FIGURINES OF PRECIOUS METAL, IN CLASS 14 (U.S. CLS. 2, 27, 28 AND 50).

FIRST USE 4-29-2006; IN COMMERCE 4-29-2006.

THE MARK CONSISTS OF STANDARD CHARACTERS WITHOUT CLAIM TO ANY PARTICULAR FONT, STYLE, SIZE, OR COLOR.

SER. NO. 85-362,188, FILED 7-1-2011.

MATTHEW PAPPAS, EXAMINING ATTORNEY



David J. Kypas

Director of the United States Patent and Trademark Office

United States of America

United States Patent and Trademark Office

B • R • E • X • I

Reg. No. 4,098,924

DB BISTRO, LLC (COLORADO LIMITED LIABILITY COMPANY)
316 E. HOPKINS AVENUE
ASPEN, CO 81611

Registered Feb. 14, 2012

Int. Cl.: 43

FOR: BAR AND RESTAURANT SERVICES, IN CLASS 43 (U.S. CLS. 100 AND 101).

SERVICE MARK

FIRST USE 2-7-2009; IN COMMERCE 2-7-2009.

PRINCIPAL REGISTER

THE MARK CONSISTS OF THE FANCIFUL WORD "BREXI" IN STYLIZED LETTERING PRESENTED IN AN ARCH WITH THE LETTERS COLORED IN RED WITH GOLD AND BLACK BORDERS AROUND EACH LETTER AND BLACK DIAMOND LIKE IMAGES SEPARATING EACH LETTER.

THE COLOR(S) RED, BLACK AND GOLD IS/ARE CLAIMED AS A FEATURE OF THE MARK.

THE WORDING "BREXI" HAS NO MEANING IN A FOREIGN LANGUAGE.

SER. NO. 85-362,192, FILED 7-1-2011.

MATTHEW PAPPAS, EXAMINING ATTORNEY



David J. Kyffers

Director of the United States Patent and Trademark Office

United States of America

United States Patent and Trademark Office

PJK

Reg. No. 4,098,925

P. J. K. FINE JEWELRY, INC. (FLORIDA CORPORATION)
P.O. BOX 3408
PALM BEACH, FL 33480

Registered Feb. 14, 2012

Int. Cl.: 14

FOR: JEWELRY, IN CLASS 14 (U.S. CLS. 2, 27, 28 AND 50).

TRADEMARK

FIRST USE 5-17-2011; IN COMMERCE 6-24-2011.

PRINCIPAL REGISTER

THE MARK CONSISTS OF THREE LETTERS. THOSE LETTERS BEING THE INITIALS "P J K" THE DESIGN ELEMENT IS COMBINED WITH THE LETTERS " P J K" THE DESIGN ELEMENT IS A DIAMOND SETTING LOOKING AT IT HEAD ON. THE CENTER "PRONG" IS TOPPED WITH THE SHAPE OF A "CLOVER/CLUB" SHAPE. THE DESIGN ELEMENT IS SPLIT INTO TWO SEGMENTS WITH BOTTOM/SECOND SEGMENT BEING A SOLID BLACK LINE. THE "DIAMOND SETTING" SHAPE IS SIMILAR TO THE LETTER "W" BUT IS NOT INTENDED TO BE USED AS A LETTER.

SER. NO. 85-362,212, FILED 7-1-2011.

PATRICIA EVANKO, EXAMINING ATTORNEY



David J. Kybas

Director of the United States Patent and Trademark Office

United States of America

United States Patent and Trademark Office

STRIPE-IT

Reg. No. 4,098,926

Registered Feb. 14, 2012

Int. Cl.: 2

TRADEMARK

PRINCIPAL REGISTER

GAME TIME SPORTS SYSTEMS, LLC (ILLINOIS LIMITED LIABILITY COMPANY)
3015 WHITE PINE DRIVE
NORTHBROOK, IL 60062

FOR: PAINTS, IN CLASS 2 (U.S. CLS. 6, 11 AND 16).

FIRST USE 7-1-2010; IN COMMERCE 1-1-2011.

THE MARK CONSISTS OF STANDARD CHARACTERS WITHOUT CLAIM TO ANY PARTICULAR FONT, STYLE, SIZE, OR COLOR.

SER. NO. 85-362,220, FILED 7-1-2011.

CAROLINE WOOD, EXAMINING ATTORNEY



David J. Kybas

Director of the United States Patent and Trademark Office

United States of America

United States Patent and Trademark Office

RED WILLOW

Reg. No. 4,098,927

Registered Feb. 14, 2012

Int. Cls.: 37 and 42

SERVICE MARK

PRINCIPAL REGISTER

RED WILLOW PRODUCTION, LLC (COLORADO LIMITED LIABILITY COMPANY)
P.O. BOX 369
14933 HIGHWAY 172
IGNACIO, CO 81137

FOR: DRILLING AND PUMPING OF OIL; DRILLING FOR CRUDE OIL; DRILLING OF DEEP OIL OR GAS WELLS; EXTRACTION OF OIL; OIL AND GAS DRILLING; OIL PUMPING AND EXTRACTION; OIL WELL CASING, TUBING, AND DRILL PIPE INSTALLATION; OIL WELL DRILLING, IN CLASS 37 (U.S. CLS. 100, 103 AND 106).

FIRST USE 0-0-1992; IN COMMERCE 0-0-1993.

FOR: EXPLORATION AND SEARCHING OF OIL AND GAS; GAS EXPLORATION; GEO-PHYSICAL EXPLORATION FOR THE OIL, GAS AND MINING INDUSTRIES; OIL EXPLORATION; OIL FIELD EXPLORATION; PETROLEUM EXPLORATION; UNDERWATER EXPLORATION, IN CLASS 42 (U.S. CLS. 100 AND 101).

FIRST USE 0-0-1992; IN COMMERCE 0-0-1993.

THE MARK CONSISTS OF STANDARD CHARACTERS WITHOUT CLAIM TO ANY PARTICULAR FONT, STYLE, SIZE, OR COLOR.

SER. NO. 85-362,235, FILED 7-1-2011.

JUDITH HELFMAN, EXAMINING ATTORNEY



David J. Kybas

Director of the United States Patent and Trademark Office

United States of America

United States Patent and Trademark Office

METHODICS

Reg. No. 4,098,928

Registered Feb. 14, 2012

Int. Cl.: 9

TRADEMARK

PRINCIPAL REGISTER

METHODICS LLC (CALIFORNIA LIMITED LIABILITY COMPANY)
NUMBER 506
2370 MARKET STREET
SAN FRANCISCO, CA 941141575

FOR: COMPUTER SOFTWARE FOR ELECTRONIC DESIGN AUTOMATION AND DESIGN
DATA MANAGEMENT, IN CLASS 9 (U.S. CLS. 21, 23, 26, 36 AND 38).

FIRST USE 9-0-2006; IN COMMERCE 9-0-2006.

THE MARK CONSISTS OF STANDARD CHARACTERS WITHOUT CLAIM TO ANY PAR-
TICULAR FONT, STYLE, SIZE, OR COLOR.

SER. NO. 85-362,273, FILED 7-1-2011.

KYLE PEETE, EXAMINING ATTORNEY



David J. Kyffers

Director of the United States Patent and Trademark Office

United States of America

United States Patent and Trademark Office

BLAZEFRAME

Reg. No. 4,098,929

BLAZEFRAME INDUSTRIES LTD. (WASHINGTON CORPORATION)
8805 148TH AVE NE BLDG E
REDMOND, WA 98052

Registered Feb. 14, 2012

Int. Cl.: 6

FOR: FIRE RESISTANT FRAMING MADE OF METAL, IN CLASS 6 (U.S. CLS. 2, 12, 13, 14, 23, 25 AND 50).

TRADEMARK

FIRST USE 4-0-2007; IN COMMERCE 6-0-2007.

PRINCIPAL REGISTER

THE MARK CONSISTS OF STANDARD CHARACTERS WITHOUT CLAIM TO ANY PARTICULAR FONT, STYLE, SIZE, OR COLOR.

SER. NO. 85-362,280, FILED 7-1-2011.

KYLE PEETE, EXAMINING ATTORNEY



David J. Kybas

Director of the United States Patent and Trademark Office

United States of America

United States Patent and Trademark Office



Reg. No. 4,098,930

Registered Feb. 14, 2012

Int. Cl.: 14

TRADEMARK

PRINCIPAL REGISTER

J.GOOD-IN, INC. (CALIFORNIA CORPORATION)
903 MARINER STREET
BREA, CA 92821

FOR: BODY JEWELRY; BRACELETS; BRACELETS AND JEWELRY FEATURING ELECTRONIC CHIPS FOR ATTRACTING ENERGY TO THE BODY WHEREIN THE ELECTRONIC CHIPS INCREASE IN POWER IN THE PRESENCE OF ELECTROMAGNETIC FIELDS, FOR THE PURPOSE OF RE-BALANCING THE HUMAN ENERGY FIELD; BROACHES; BRONZE JEWELRY; BROOCHES; CAMEOS; CHARMS; CHARMS FOR COLLAR JEWELRY AND BRACELET; COSTUME JEWELRY; DIAMOND JEWELRY; GEMSTONE JEWELRY; GOLD THREAD JEWELRY; HAIR JEWELRY IN THE NATURE OF JEWELRY FOR USE IN THE HAIR; IDENTIFICATION BRACELETS; JEWELRY; JEWELRY AND IMITATION JEWELRY; JEWELRY ARMOIRES; JEWELRY BOXES; JEWELRY BOXES NOT OF METAL; JEWELRY BOXES OF METAL; JEWELRY BOXES OF PRECIOUS METAL; JEWELRY BROOCHES; JEWELRY CASES; JEWELRY CASES NOT OF PRECIOUS METAL; JEWELRY CASES OF PRECIOUS METAL; JEWELRY CHAINS; JEWELRY FOR ATTACHMENT TO CLOTHING; JEWELRY FOR THE HEAD; JEWELRY IN THE NATURE OF ARMBANDS; JEWELRY ORGANIZERS; JEWELRY PINS FOR USE ON HATS; JEWELRY, NAMELY, AMULETS; JEWELRY, NAMELY, ANKLETS; JEWELRY, NAMELY, ARM CUFFS; JEWELRY, NAMELY, CROSSES; JEWELRY, NAMELY, DOG TAGS FOR WEAR BY HUMANS FOR DECORATIVE PURPOSES; JEWELRY, NAMELY, STONE PENDANTS; METAL WIRE FOR USE IN THE MAKING OF JEWELRY, NAMELY, JEWELRY CABLE; PET JEWELRY; PLASTIC BRACELETS IN THE NATURE OF JEWELRY; PRECIOUS AND SEMI-PRECIOUS CRYSTAL STONES AND BEADS FOR USE IN JEWELRY; RINGS; RINGS BEING JEWELRY; STAINLESS STEEL JEWELRY BRACELETS; WATCHES AND JEWELRY; WATCHES, CLOCKS, JEWELRY AND IMITATION JEWELRY; WOMEN'S JEWELRY, IN CLASS 14 (U.S. CLS. 2, 27, 28 AND 50).



FIRST USE 4-1-2011; IN COMMERCE 4-1-2011.

THE MARK CONSISTS OF A FORM OF THE LETTER "K" OUTLINED IN PARALLEL LINES ENCLOSED WITHIN A LARGER LETTER "C" OUTLINED ALSO IN PARALLEL LINES WHICH ARE BROKEN IN TWO POINTS WHERE THE "C" LINES MEET THE "K" LINES.

David J. Kyros

SER. NO. 85-362,294, FILED 7-1-2011.

ANDREW LEASER, EXAMINING ATTORNEY

United States of America

United States Patent and Trademark Office

Taylor Swift

Reg. No. 4,098,931

Registered Feb. 14, 2012

Int. Cl.: 6

TRADEMARK

PRINCIPAL REGISTER

SWIFT, TAYLOR (UNITED STATES INDIVIDUAL)
C/O MILOM JOYCE HORSNELL CROW PLC
3310 WEST END AVENUE, SUITE 610
NASHVILLE, TN 37203

FOR: METAL KEY CHAINS, IN CLASS 6 (U.S. CLS. 2, 12, 13, 14, 23, 25 AND 50).

FIRST USE 8-26-2010; IN COMMERCE 8-26-2010.

OWNER OF U.S. REG. NOS. 3,809,269, 3,812,830 AND OTHERS.

THE NAME(S), PORTRAIT(S), AND/OR SIGNATURE(S) SHOWN IN THE MARK IDENTIFIES "TAYLOR SWIFT", WHOSE CONSENT(S) TO REGISTER IS MADE OF RECORD.

THE MARK CONSISTS OF "TAYLOR SWIFT" APPEARING IN A STYLIZED FORM.

SER. NO. 85-362,310, FILED 7-1-2011.

DAVID TOOLEY, EXAMINING ATTORNEY



David J. Kyffers

Director of the United States Patent and Trademark Office

United States of America
United States Patent and Trademark Office

DonkeyLand

Reg. No. 4,098,932

KOKO, AMBER-LEVONNE (UNITED STATES INDIVIDUAL)
5225 CANYON CREST DR., SUITE 71-295
RIVERSIDE, CA 92507

Registered Feb. 14, 2012

Int. Cl.: 39

FOR: ANIMAL RESCUE SERVICES; PROVIDING A WEBSITE FEATURING INFORMATION ON ANIMAL RESCUE SERVICES, IN CLASS 39 (U.S. CLS. 100 AND 105).

SERVICE MARK

FIRST USE 7-1-2004; IN COMMERCE 7-7-2007.

PRINCIPAL REGISTER

THE MARK CONSISTS OF STANDARD CHARACTERS WITHOUT CLAIM TO ANY PARTICULAR FONT, STYLE, SIZE, OR COLOR.

SER. NO. 85-362,337, FILED 7-2-2011.

WILLIAM P. SHANAHAN, EXAMINING ATTORNEY



David J. Kyffers

Director of the United States Patent and Trademark Office

United States of America

United States Patent and Trademark Office

THE HAIR YOUR HEART DESIRES!

Reg. No. 4,098,933

CONWELL, GINA (UNITED STATES INDIVIDUAL)
6840 ROSWELL RD NE STE 2C
SANDY SPRINGS, GA 30328

Registered Feb. 14, 2012

Int. Cl.: 44

FOR: HAIR REPLACEMENT, HAIR ADDITION, AND HAIR EXTENSION SERVICES;
BEAUTY CONSULTATION SERVICES IN THE SELECTION AND USE OF HAIR EXTEN-
SIONS AND HAIR PIECES, IN CLASS 44 (U.S. CLS. 100 AND 101).

SERVICE MARK

FIRST USE 3-8-2010; IN COMMERCE 3-8-2010.

PRINCIPAL REGISTER

THE MARK CONSISTS OF STANDARD CHARACTERS WITHOUT CLAIM TO ANY PAR-
TICULAR FONT, STYLE, SIZE, OR COLOR.

SER. NO. 85-362,342, FILED 7-2-2011.

RUSS HERMAN, EXAMINING ATTORNEY



David J. Kybas

Director of the United States Patent and Trademark Office

United States of America

United States Patent and Trademark Office

EITCH

Reg. No. 4,098,934

HANNAH SMITH (UNITED STATES INDIVIDUAL), AKA EITCH
115 EAST 27TH STREET, APT 4B
NEW YORK, NY 10016

Registered Feb. 14, 2012

Int. Cl.: 41

FOR: ENTERTAINMENT IN THE NATURE OF LIVE PERFORMANCES BY A SINGER-
SONGWRITER, IN CLASS 41 (U.S. CLS. 100, 101 AND 107).

SERVICE MARK

FIRST USE 12-15-2009; IN COMMERCE 11-14-2010.

PRINCIPAL REGISTER

THE MARK CONSISTS OF STANDARD CHARACTERS WITHOUT CLAIM TO ANY PAR-
TICULAR FONT, STYLE, SIZE, OR COLOR.

SER. NO. 85-362,363, FILED 7-2-2011.

LAURIE MAYES, EXAMINING ATTORNEY



David J. Kybas

Director of the United States Patent and Trademark Office

United States of America

United States Patent and Trademark Office

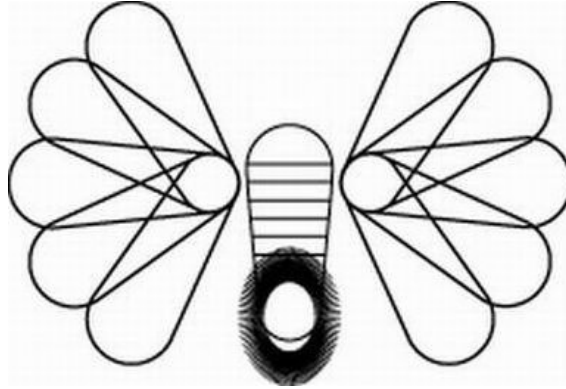

Reg. No. 4,098,935

Registered Feb. 14, 2012

Int. Cl.: 38

SERVICE MARK

PRINCIPAL REGISTER

THE CITY OF SALISBURY (NORTH CAROLINA MUNICIPAL CORPORATION)
P.O. BOX 479
SALISBURY, NC 28145

FOR: TELECOMMUNICATIONS SERVICES, NAMELY, PROVIDING FIBER OPTIC NETWORK SERVICES, IN CLASS 38 (U.S. CLS. 100, 101 AND 104).

FIRST USE 5-1-2011; IN COMMERCE 5-1-2011.

THE MARK CONSISTS OF A STYLIZED FIREFLY (LIGHTNING BUG).

SER. NO. 85-362,400, FILED 7-2-2011.

DAVID MURRAY, EXAMINING ATTORNEY



David J. Kyffers

Director of the United States Patent and Trademark Office

United States of America

United States Patent and Trademark Office

MAKE LIFE BRILLIANT

Reg. No. 4,098,936

THE CITY OF SALISBURY (NORTH CAROLINA MUNICIPAL CORPORATION)
P.O. BOX 479
SALISBURY, NC 28145

Registered Feb. 14, 2012

Int. Cl.: 38

FOR: TELECOMMUNICATIONS SERVICES, NAMELY, PROVIDING FIBER OPTIC NETWORK SERVICES, IN CLASS 38 (U.S. CLS. 100, 101 AND 104).

SERVICE MARK

FIRST USE 5-1-2011; IN COMMERCE 5-1-2011.

PRINCIPAL REGISTER

THE MARK CONSISTS OF STANDARD CHARACTERS WITHOUT CLAIM TO ANY PARTICULAR FONT, STYLE, SIZE, OR COLOR.

SER. NO. 85-362,401, FILED 7-2-2011.

DAVID MURRAY, EXAMINING ATTORNEY



David J. Kybas

Director of the United States Patent and Trademark Office

United States of America

United States Patent and Trademark Office

TRANSREV

Reg. No. 4,098,937

ALLEN, ANDRE (JAMAICA INDIVIDUAL)
10 POST OAK LANE
NATICK, MA 01760

Registered Feb. 14, 2012

Int. Cl.: 25

TRADEMARK

PRINCIPAL REGISTER

FOR: APPAREL FOR DANCERS, NAMELY, TEE SHIRTS, SWEATSHIRTS, PANTS, LEGGINGS, SHORTS AND JACKETS; ATHLETIC APPAREL, NAMELY, SHIRTS, PANTS, JACKETS, FOOTWEAR, HATS AND CAPS, ATHLETIC UNIFORMS; BALLOON PANTS; BELTS; BELTS FOR CLOTHING; BELTS MADE FROM IMITATION LEATHER; BELTS MADE OF LEATHER; BELTS MADE OUT OF CLOTH; BELTS OF TEXTILE; BELTS THAT ARE DESIGNED TO ACCOMMODATE PREGNANCY SIZE CHANGES; BERMUDA SHORTS; BOARD SHORTS; BOXING SHORTS; BUTTON DOWN SHIRTS; CAMOUFLAGE PANTS; CAMOUFLAGE SHIRTS; CAPRI PANTS; CARGO PANTS; CLOTHING EXTENSION USED TO EXTEND THE NORMAL SIZE RANGE OF CLOTHING ITEMS TO ACCOMMODATE PREGNANCY SIZE CHANGES; CLOTHING FOR ATHLETIC USE, NAMELY, PADDED ELBOW COMPRESSION SLEEVES BEING PART OF AN ATHLETIC GARMENT; CLOTHING FOR ATHLETIC USE, NAMELY, PADDED PANTS; CLOTHING FOR ATHLETIC USE, NAMELY, PADDED SHIRTS; CLOTHING FOR ATHLETIC USE, NAMELY, PADDED SHORTS; CLOTHING FOR BABIES, TODDLERS AND CHILDREN, TREATED WITH FIRE AND HEAT RETARDANTS, NAMELY, PAJAMAS, JACKETS, SHIRTS, PANTS, JUMPERS; CLOTHING FOR WEAR IN JUDO PRACTICES; CLOTHING FOR WEAR IN WRESTLING GAMES; CLOTHING ITEMS, NAMELY, ADHESIVE POCKETS THAT MAY BE AFFIXED DIRECTLY TO THE BODY AS A DECORATIVE PIECE OF CLOTHING WITH UTILITY; CLOTHING SHIELDS, NAMELY, PADS APPLIED TO THE UNDERARMS OF SHIRTS, BLOUSES AND SWEATERS; CLOTHING, NAMELY, ATHLETIC SLEEVES; CROP PANTS; CYCLING SHORTS; DENIMS; DRESS PANTS; DRESS SHIRTS; FABRIC BELTS; FLEECE SHORTS; GLOVES AS CLOTHING; GOLF PANTS, SHIRTS AND SKIRTS; GOLF SHIRTS; GOLF SHORTS; GYM PANTS; GYM SHORTS; HEADBANDS FOR CLOTHING; HOODED SWEAT SHIRTS; HOODS; HUNTING PANTS; HUNTING SHIRTS; INFANT AND TODDLER ONE PIECE CLOTHING; JACKETS; JERSEYS; JOGGING PANTS; KNIT SHIRTS; LEATHER BELTS; LEATHER PANTS; LEATHER SHIRTS; LEG SHIELDING DEVICE, ATTACHABLE TO AND DETACHABLE FROM A PERSON'S PANTS, COMPRISED OF PADDING TO SHIELD THE LEGS FROM FLYING DEBRIS WHEN MOWING WITH A STRING TRIMMER; LONG-SLEEVED SHIRTS; MATERNITY CLOTHING, NAMELY, DRESSES, SHIRTS, PANTS; MEN'S AND WOMEN'S JACKETS, COATS, TROUSERS, VESTS; MUFFLERS; NON-DISPOSABLE CLOTH TRAINING PANTS; PARTY HATS; POLO SHIRTS; RUGBY SHIRTS; RUGBY SHORTS; SHIRTS; SHIRTS AND SHORT-SLEEVED SHIRTS; SHIRTS AND SLIPS; SHIRTS FOR SUITS; SHORT SETS; SHORT TROUSERS; SHORT-SLEEVED OR LONG-



David J. Kybas

Director of the United States Patent and Trademark Office

Reg. No. 4,098,937 SLEEVED T-SHIRTS; SHORT-SLEEVED SHIRTS; SHORTS; SKI PANTS; SKI TROUSERS; SLIDING SHORTS; SNOW PANTS; SNOWBOARD PANTS; SNOWBOARD TROUSERS; SPORT SHIRTS; SPORTS PANTS; SPORTS SHIRTS; SPORTS SHIRTS WITH SHORT SLEEVES; STRETCH PANTS; SUN PROTECTIVE CLOTHING, NAMELY, HATS; SWEAT PANTS; SWEAT SHIRTS; SWEAT SHORTS; T-SHIRTS; TEE SHIRTS; TIES; TOPS; TRACK PANTS; TRAVEL CLOTHING CONTAINED IN A PACKAGE COMPRISING REVERSIBLE JACKETS, PANTS, SKIRTS, TOPS AND A BELT OR SCARF; TRIATHLON CLOTHING, NAMELY, TRIATHLON TIGHTS, TRIATHLON SHORTS, TRIATHLON SINGLET, TRIATHLON SHIRTS, TRIATHLON SUITS; TROUSERS; TROUSERS FOR SWEATING; TROUSERS OF LEATHER; TURTLE NECK SHIRTS; WAIST BELTS; WALKING SHORTS; WATERPROOF JACKETS AND PANTS; WEARABLE GARMENTS AND CLOTHING, NAMELY, SHIRTS; WOMEN'S CLOTHING, NAMELY, SHIRTS, DRESSES, SKIRTS, BLOUSES; WRAPS, IN CLASS 25 (U.S. CLS. 22 AND 39).

FIRST USE 6-15-2011; IN COMMERCE 7-1-2011.

THE MARK CONSISTS OF STANDARD CHARACTERS WITHOUT CLAIM TO ANY PARTICULAR FONT, STYLE, SIZE, OR COLOR.

SER. NO. 85-362,433, FILED 7-2-2011.

MARK SPARACINO, EXAMINING ATTORNEY

United States of America

United States Patent and Trademark Office



Reg. No. 4,098,938

CARLOS FONTOURA BORGES (UNITED STATES INDIVIDUAL)
10825 NW 17TH STREET # 104
MIAMI, FL 33172

Registered Feb. 14, 2012

Int. Cl.: 3

FOR: HAIR CARE CREAMS; HAIR CARE LOTIONS; HAIR COLOURING AND DYES; HAIR GEL AND HAIR MOUSSE; HAIR MASKS; HAIR OILS; HAIR RELAXING PREPARATIONS; HAIR SHAMPOOS AND CONDITIONERS; HAIR SPRAYS AND HAIR GELS, IN CLASS 3 (U.S. CLS. 1, 4, 6, 50, 51 AND 52).

TRADEMARK

PRINCIPAL REGISTER

FIRST USE 4-1-2011; IN COMMERCE 5-15-2011.

THE MARK CONSISTS OF THE WORD "ECKOZ" IN STYLIZED FONT AND THE DESIGN OF A LETTER "E" WITH THREE SPLIT ENDS AT THE TOP OF THE LETTER GIVEN A IMPRESSION OF ROTATION AND RESEMBLING A GLOBE.

SER. NO. 85-362,437, FILED 7-2-2011.

BRENDAN MCCAULEY, EXAMINING ATTORNEY



David J. Kybas

Director of the United States Patent and Trademark Office

United States of America

United States Patent and Trademark Office



CHAN
PACK

Reg. No. 4,098,939

Registered Feb. 14, 2012

Int. Cl.: 7

TRADEMARK

PRINCIPAL REGISTER

CHUEN AN MACHINERY INDUSTRIAL CO., LTD. (TAIWAN CORPORATION)
NO. 16
CHIU SIR LANE, CHIU SIR LI, PEITUN DIST.
TAICHUNG CITY, TAIWAN

FOR: AUTOMATIC CARTONER, NAMELY, PACKAGING MACHINES FOR FILING CARTONS; MACHINE OPERATED CARTON SEALERS; VACUUM PACKING MACHINES; HEAT SEALERS FOR USE WITH PACKAGING MACHINES; HIGH FREQUENCY HEAT SEALERS FOR USE WITH PACKAGING MACHINES; THERMAL SHRINKAGE PACKING MACHINES; POWER OPERATED MECHANICAL ARMS; CONVEYING BELTS; ELASTIC CONVEYING BELTS; AND SCREEN PRINTING MACHINES, IN CLASS 7 (U.S. CLS. 13, 19, 21, 23, 31, 34 AND 35).

FIRST USE 10-22-2010; IN COMMERCE 6-9-2011.

OWNER OF U.S. REG. NO. 3,037,284.

NO CLAIM IS MADE TO THE EXCLUSIVE RIGHT TO USE "PACK", APART FROM THE MARK AS SHOWN.

THE MARK CONSISTS OF THE STYLIZED WORDS "CHAN PACK" WITH A CARICATURE OF AN EARTH DESIGN BETWEEN THE LETTERS "C" AND "H" AND HAVING A RING PASSING AROUND THE EARTH DESIGN, WITH A LINE PASSING BENEATH THE LETTERS "HAN" AND ABOVE THE LETTERS "PACK".

SER. NO. 85-362,441, FILED 7-2-2011.

GEOFFREY FOSDICK, EXAMINING ATTORNEY



David J. Kybas

Director of the United States Patent and Trademark Office

United States of America

United States Patent and Trademark Office

Buffington Syndicate

Reg. No. 4,098,940

HACK, CHRISTY JOY (UNITED STATES INDIVIDUAL)
3324 VALLEY LEE S
LAUREL, MD 20724

Registered Feb. 14, 2012

Int. Cl.: 25

FOR: HATS, IN CLASS 25 (U.S. CLS. 22 AND 39).

TRADEMARK

FIRST USE 6-1-2011; IN COMMERCE 7-1-2011.

PRINCIPAL REGISTER

THE MARK CONSISTS OF THE COMPANY NAME BUFFINGTON SYNDICATE IN TATTOO-
STYLE SCRIPT. COLOR IS NOT A FEATURE OF THIS MARK.

SER. NO. 85-362,477, FILED 7-3-2011.

MIDGE BUTLER, EXAMINING ATTORNEY



David J. Kybas

Director of the United States Patent and Trademark Office

United States of America

United States Patent and Trademark Office

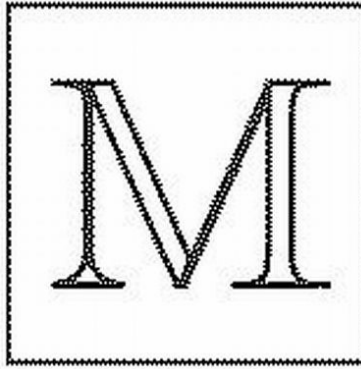

Reg. No. 4,098,941

Registered Feb. 14, 2012

Int. Cl.: 35

SERVICE MARK

PRINCIPAL REGISTER

MATHIS HOLDING, INC. (NEVADA CORPORATION)
3434 W. RENO
OKLAHOMA CITY, OK 73108

FOR: RETAIL FURNITURE STORES, IN CLASS 35 (U.S. CLS. 100, 101 AND 102).

FIRST USE 1-1-2011; IN COMMERCE 1-1-2011.

THE MARK CONSISTS OF THE LETTER "M" IN STYLIZED FORM.

SER. NO. 85-362,503, FILED 7-3-2011.

MARK T. MULLEN, EXAMINING ATTORNEY



David J. Kyffers

Director of the United States Patent and Trademark Office

United States of America

United States Patent and Trademark Office

WHO WANTS TO BE A RACE CAR DRIVER

Reg. No. 4,098,942

PULLIN, STEPHEN E. (CALIFORNIA CORPORATION), DBA PULLIN TELEVISION, INC.
1522 PALISADES DR

Registered Feb. 14, 2012

PACIFIC PALISADES, CA 90272

Int. Cl.: 41

FOR: ENTERTAINMENT SERVICES IN THE NATURE OF AN ON-GOING REALITY BASED
TELEVISION PROGRAM, IN CLASS 41 (U.S. CLS. 100, 101 AND 107).

SERVICE MARK

FIRST USE 6-20-2010; IN COMMERCE 7-28-2010.

PRINCIPAL REGISTER

THE MARK CONSISTS OF STANDARD CHARACTERS WITHOUT CLAIM TO ANY PAR-
TICULAR FONT, STYLE, SIZE, OR COLOR.

SER. NO. 85-362,508, FILED 7-3-2011.

MIDGE BUTLER, EXAMINING ATTORNEY



David J. Kyffers

Director of the United States Patent and Trademark Office

United States of America

United States Patent and Trademark Office

LIMELIGHT

Reg. No. 4,098,943

SORKIN TYPE CO. (MASSACHUSETTS CORPORATION)
143 MASS AVE, SUITE 5
BOSTON, MA 02115

Registered Feb. 14, 2012

Int. Cl.: 9

FOR: PRINTING FONTS THAT CAN BE DOWNLOADED PROVIDED BY MEANS OF ELECTRONIC TRANSMISSION; TYPEFACE FONTS RECORDED ON MAGNETIC MEDIA, IN CLASS 9 (U.S. CLS. 21, 23, 26, 36 AND 38).

TRADEMARK

FIRST USE 6-15-2011; IN COMMERCE 6-15-2011.

PRINCIPAL REGISTER

THE MARK CONSISTS OF STANDARD CHARACTERS WITHOUT CLAIM TO ANY PARTICULAR FONT, STYLE, SIZE, OR COLOR.

SER. NO. 85-362,514, FILED 7-3-2011.

KEVIN DINALLO, EXAMINING ATTORNEY



David J. Kybas

Director of the United States Patent and Trademark Office

United States of America

United States Patent and Trademark Office

ASSET

Reg. No. 4,098,944

Registered Feb. 14, 2012

Int. Cl.: 9

TRADEMARK

PRINCIPAL REGISTER

SORKIN TYPE CO. (MASSACHUSETTS CORPORATION)
143 MASS AVE, SUITE 5
BOSTON, MA 02115

FOR: PRINTING FONTS THAT CAN BE DOWNLOADED PROVIDED BY MEANS OF ELECTRONIC TRANSMISSION; TYPEFACE FONTS RECORDED ON MAGNETIC MEDIA, IN CLASS 9 (U.S. CLS. 21, 23, 26, 36 AND 38).

FIRST USE 6-28-2011; IN COMMERCE 6-28-2011.

THE MARK CONSISTS OF STANDARD CHARACTERS WITHOUT CLAIM TO ANY PARTICULAR FONT, STYLE, SIZE, OR COLOR.

SER. NO. 85-362,521, FILED 7-3-2011.

KEVIN DINALLO, EXAMINING ATTORNEY



David J. Kybas

Director of the United States Patent and Trademark Office

United States of America

United States Patent and Trademark Office

GRAVITAS

Reg. No. 4,098,945

SORKIN TYPE CO. (MASSACHUSETTS CORPORATION)
143 MASS AVE, SUITE 5
BOSTON, MA 02115

Registered Feb. 14, 2012

Int. Cl.: 9

FOR: PRINTING FONTS THAT CAN BE DOWNLOADED PROVIDED BY MEANS OF ELECTRONIC TRANSMISSION; TYPEFACE FONTS RECORDED ON MAGNETIC MEDIA, IN CLASS 9 (U.S. CLS. 21, 23, 26, 36 AND 38).

TRADEMARK

FIRST USE 6-28-2011; IN COMMERCE 6-28-2011.

PRINCIPAL REGISTER

THE MARK CONSISTS OF STANDARD CHARACTERS WITHOUT CLAIM TO ANY PARTICULAR FONT, STYLE, SIZE, OR COLOR.

SER. NO. 85-362,525, FILED 7-3-2011.

KEVIN DINALLO, EXAMINING ATTORNEY



David J. Kybas

Director of the United States Patent and Trademark Office

United States of America

United States Patent and Trademark Office

Mobile Home

Reg. No. 4,098,946

THE KYJEN COMPANY, INC. (COLORADO CORPORATION)
15514 EAST HINSDALE CIRCLE
CENTENNIAL, CO 80112

Registered Feb. 14, 2012

Int. Cl.: 20

FOR: PET CRATES, IN CLASS 20 (U.S. CLS. 2, 13, 22, 25, 32 AND 50).

TRADEMARK

FIRST USE 3-29-2010; IN COMMERCE 3-29-2010.

PRINCIPAL REGISTER

THE MARK CONSISTS OF STANDARD CHARACTERS WITHOUT CLAIM TO ANY PARTICULAR FONT, STYLE, SIZE, OR COLOR.

SER. NO. 85-362,547, FILED 7-3-2011.

BRIAN CALLAGHAN, EXAMINING ATTORNEY



David J. Kyjens

Director of the United States Patent and Trademark Office

United States of America

United States Patent and Trademark Office

FLIP2BFIT

Reg. No. 4,098,947

FLIP2BFIT, INC. (VERMONT CORPORATION)

Registered Feb. 14, 2012

330 HAVEN AVENUE #1M
NEW YORK, NY 10033

Int. Cl.: 28

FOR: BOARD GAMES; EQUIPMENT SOLD AS A UNIT FOR PLAYING BOARD GAMES; YOGA MATS; STRETCH BANDS USED FOR YOGA AND PHYSICAL FITNESS PURPOSES; SPORTING GOODS, NAMELY, A SPORTS TRAINING DEVICE TO IMPROVE STRENGTH, TONING, CONDITIONING, BALANCE, AND PROPRIOCEPTION; MANUALLY-OPERATED EXERCISE EQUIPMENT FOR PHYSICAL FITNESS PURPOSES, IN CLASS 28 (U.S. CLS. 22, 23, 38 AND 50).

TRADEMARK

PRINCIPAL REGISTER

FIRST USE 5-1-2010; IN COMMERCE 1-11-2011.

THE MARK CONSISTS OF STANDARD CHARACTERS WITHOUT CLAIM TO ANY PARTICULAR FONT, STYLE, SIZE, OR COLOR.

SER. NO. 85-362,581, FILED 7-4-2011.

BARBARA GAYNOR, EXAMINING ATTORNEY



David J. Kyffers

Director of the United States Patent and Trademark Office

United States of America

United States Patent and Trademark Office

XIUNIX

Reg. No. 4,098,948

Registered Feb. 14, 2012

Int. Cl.: 42

SERVICE MARK

PRINCIPAL REGISTER

CHONG TECK CHOY (MALAYSIA INDIVIDUAL)
P.O. BOX 396
SERIA
SERIA, BRUNEI DARUSSALAM KB1133

FOR: CLOUD SEEDING; COMPUTER CONSULTATION; COMPUTER GRAPHICS SERVICES; COMPUTER HARDWARE AND SOFTWARE DESIGN; COMPUTER NETWORK DESIGN FOR OTHERS; COMPUTER PROGRAMMING; COMPUTER PROGRAMMING AND SOFTWARE DESIGN; COMPUTER SECURITY CONSULTANCY; COMPUTER SERVICES, NAMELY, CLOUD HOSTING PROVIDER SERVICES; COMPUTER SERVICES, NAMELY, CREATING COMPUTER NETWORK-BASED INDEXES OF INFORMATION, WEBSITES AND RESOURCES; COMPUTER SERVICES, NAMELY, DATA RECOVERY SERVICES; COMPUTER SERVICES, NAMELY, DESIGNING AND IMPLEMENTING WEB SITES FOR OTHERS; COMPUTER SERVICES, NAMELY, INTEGRATION OF PRIVATE AND PUBLIC CLOUD COMPUTING ENVIRONMENTS; COMPUTER SERVICES, NAMELY, PROVIDING SEARCH ENGINES FOR OBTAINING DATA ON A GLOBAL COMPUTER NETWORK; COMPUTER SITE DESIGN; COMPUTER SOFTWARE DESIGN; CONSULTING SERVICES IN THE FIELD OF CLOUD COMPUTING; CONSULTING SERVICES IN THE FIELD OF COMPUTER-BASED INFORMATION SYSTEMS FOR BUSINESSES; CONSULTING SERVICES IN THE FIELD OF HOSTING COMPUTER SOFTWARE APPLICATIONS; CONSULTING SERVICES IN THE FIELD OF INDUSTRIAL ENGINEERING; CONVERSION OF DATA OR DOCUMENTS FROM PHYSICAL TO ELECTRONIC MEDIA; CREATING AND MAINTAINING INTERNET SITES FOR OTHERS; CREATING OF COMPUTER PROGRAMS; CUSTOMIZATION OF COMPUTER HARDWARE AND SOFTWARE; DATA CONVERSION OF ELECTRONIC INFORMATION; DATA MIGRATION SERVICES; DESIGN OF COMPUTER DATABASE; DESIGN OF HOME PAGES, COMPUTER SOFTWARE AND WEB SITES; DESIGN OF HOMEPAGES AND WEBSITES; DESIGN SERVICES FOR PACKAGING; DESIGNING AND DEVELOPING WEBPAGES ON THE INTERNET; DIGITAL TRANSFER SERVICES FOR TRANSFERRING HOME VIDEOS AND FILM TO DVD AND THE INTERNET; DISPLAYING THE WEB SITES AND IMAGES OF OTHERS ON A COMPUTER SERVER; DOCUMENT DATA TRANSFER FROM ONE COMPUTER FORMAT TO ANOTHER; ELECTRONIC DOCUMENT AND E-MAIL TIME-STAMPING SERVICES; FASHION DESIGN CONSULTING SERVICES; FILE SHARING SERVICES, NAMELY, PROVIDING A WEBSITE FEATURING TECHNOLOGY ENABLING USERS TO UPLOAD AND DOWNLOAD ELECTRONIC FILES; GRAPHIC DESIGN SERVICES; HOSTING THE SOFTWARE, WEBSITES AND OTHER COMPUTER APPLICATIONS OF OTHERS ON A VIRTUAL PRIVATE SERVER; HOSTING THE WEB SITES OF OTHERS ON A COMPUTER SERVER FOR A GLOBAL



David J. Kybas

Director of the United States Patent and Trademark Office

Reg. No. 4,098,948 COMPUTER NETWORK; HOSTING WEBSITES ON THE INTERNET; INDUSTRIAL DESIGN SERVICES; INSTALLATION AND MAINTENANCE OF COMPUTER SOFTWARE; IT CONSULTING SERVICES; MAPPING; ON-LINE SECURITY SERVICES, NAMELY, PROVIDING SECURITY AND ANONYMITY FOR ELECTRONICALLY TRANSMITTED CREDIT CARD TRANSACTIONS; PROVIDING A WEB SITE FEATURING TECHNOLOGY THAT ENABLES INTERNET USERS TO SHARE DOCUMENTS, IMAGES AND VIDEOS; PROVIDING A WEB SITE THAT GIVES COMPUTER USERS THE ABILITY TO UPLOAD, EXCHANGE AND SHARE PHOTOS, VIDEOS AND VIDEO LOGS; PROVIDING A WEBSITE ALLOWING USERS TO DOWNLOAD MUSIC AND MUSIC VIDEOS; PROVIDING A WEBSITE FEATURING A MEDIA AGGREGATOR AND SEARCH ENGINE FOR INTERNET CONTENT; PROVIDING CUSTOMIZED ON-LINE WEB PAGES FEATURING USER-DEFINED INFORMATION, WHICH INCLUDES SEARCH ENGINES AND ON-LINE WEB LINKS TO OTHER WEB SITES; PROVIDING VIRTUAL COMPUTER SYSTEMS AND VIRTUAL COMPUTER ENVIRONMENTS THROUGH CLOUD COMPUTING; PROVISION OF INTERNET SEARCH ENGINES; PUBLIC DOCUMENT RETRIEVAL; RECOVERY OF COMPUTER DATA; REMOTE COMPUTER BACKUP SERVICES; REMOTE ONLINE BACKUP OF COMPUTER DATA; RESEARCH, DEVELOPMENT, DESIGN AND UPGRADING OF COMPUTER SOFTWARE; SEARCHING AND RETRIEVING INFORMATION, SITES, AND OTHER RESOURCES AVAILABLE ON COMPUTER NETWORKS FOR OTHERS; TECHNICAL CONSULTING SERVICES IN THE FIELDS OF DATACENTER ARCHITECTURE, PUBLIC AND PRIVATE CLOUD COMPUTING SOLUTIONS, AND EVALUATION AND IMPLEMENTATION OF INTERNET TECHNOLOGY AND SERVICES; TECHNICAL SUPPORT SERVICES, NAMELY, REMOTE AND ON-SITE INFRASTRUCTURE MANAGEMENT SERVICES FOR MONITORING, ADMINISTRATION AND MANAGEMENT OF PUBLIC AND PRIVATE CLOUD COMPUTING IT AND APPLICATION SYSTEMS; WEB SITE HOSTING SERVICES; WEBSITE DESIGN AND DEVELOPMENT FOR OTHERS, IN CLASS 42 (U.S. CLS. 100 AND 101).

FIRST USE 8-29-2004; IN COMMERCE 7-4-2011.

THE MARK CONSISTS OF STANDARD CHARACTERS WITHOUT CLAIM TO ANY PARTICULAR FONT, STYLE, SIZE, OR COLOR.

SER. NO. 85-362,612, FILED 7-4-2011.

FONG HSU, EXAMINING ATTORNEY

United States of America

United States Patent and Trademark Office



Reg. No. 4,098,949

SURECRITIC INC (WYOMING CORPORATION)
PO BOX 51225
SEATTLE, WA 98115

Registered Feb. 14, 2012

Int. Cl.: 35

FOR: PROVIDING A WEB SITE WHERE USERS CAN POST RATINGS, REVIEWS AND RECOMMENDATIONS ON PRODUCTS AND SERVICES FOR COMMERCIAL PURPOSES, IN CLASS 35 (U.S. CLS. 100, 101 AND 102).

SERVICE MARK

FIRST USE 2-15-2011; IN COMMERCE 2-15-2011.

PRINCIPAL REGISTER

THE MARK CONSISTS OF A SOLID CIRCLE ABOVE A CHECK MARK WHICH IS MIRRORED OVER ANOTHER CHECK MARK AT ITS BOTTOM TO FORM A STYLIZED STICK FIGURE INSIDE OF A SQUARE. THE NAME "SURECRITIC" APPEARS NEXT TO THE DESIGN ELEMENT.

SER. NO. 85-362,626, FILED 7-4-2011.

RAMONA ORTIGA, EXAMINING ATTORNEY



David J. Kybas

Director of the United States Patent and Trademark Office

United States of America

United States Patent and Trademark Office

Link Up More

Reg. No. 4,098,950

Registered Feb. 14, 2012

Int. Cl.: 25

TRADEMARK

PRINCIPAL REGISTER

VITA, MICHAEL R. (UNITED STATES INDIVIDUAL)
APT 2B
97 CLINTON STREET
NEW YORK, NY 10022

FOR: ATHLETIC APPAREL, NAMELY, SHIRTS, PANTS, JACKETS, FOOTWEAR, HATS AND CAPS, ATHLETIC UNIFORMS; DENIM JACKETS; DENIMS; HEADBANDS; JACKETS AND SOCKS; JEANS; SCARFS; SHORT-SLEEVED OR LONG-SLEEVED T-SHIRTS; TRAVEL CLOTHING CONTAINED IN A PACKAGE COMPRISING REVERSIBLE JACKETS, PANTS, SKIRTS, TOPS AND A BELT OR SCARF, IN CLASS 25 (U.S. CLS. 22 AND 39).

FIRST USE 7-26-2005; IN COMMERCE 8-1-2007.

THE MARK CONSISTS OF STANDARD CHARACTERS WITHOUT CLAIM TO ANY PARTICULAR FONT, STYLE, SIZE, OR COLOR.

SER. NO. 85-362,644, FILED 7-4-2011.

RAMONA ORTIGA, EXAMINING ATTORNEY



David J. Kyffers

Director of the United States Patent and Trademark Office

United States of America

United States Patent and Trademark Office

NUCLIC

Reg. No. 4,098,951

ECOINTERIORS CORP. (NEW YORK CORPORATION)
1133 BROADWAY SUITE 706
NEW YORK, NY 10010

Registered Feb. 14, 2012

Int. Cl.: 19

FOR: SYNTHETIC FLOORING MATERIALS OR WALL-CLADDINGS, IN CLASS 19 (U.S. CLS. 1, 12, 33 AND 50).

TRADEMARK

FIRST USE 5-1-2011; IN COMMERCE 5-1-2011.

PRINCIPAL REGISTER

THE MARK CONSISTS OF STANDARD CHARACTERS WITHOUT CLAIM TO ANY PARTICULAR FONT, STYLE, SIZE, OR COLOR.

SER. NO. 85-362,648, FILED 7-4-2011.

MARK T. MULLEN, EXAMINING ATTORNEY



David J. Kybas

Director of the United States Patent and Trademark Office

United States of America

United States Patent and Trademark Office

SUBSETTER

Reg. No. 4,098,952

FSI FONTSHOP INTERNATIONAL GMBH (FED REP GERMANY CORPORATION)
BERGMANNSTR 102

Registered Feb. 14, 2012

10961 BERLIN, FED REP GERMANY

Int. Cl.: 42

FOR: PROVIDING TEMPORARY USE OF ON-LINE NON-DOWNLOADABLE SOFTWARE FOR OPTIMIZING THE CHARACTER SETS AND SOFTWARE PERFORMANCE OF TYPE FACE FONT SOFTWARE FOR USE AS WEBFONTS TRANSMITTED OVER A GLOBAL COMPUTER NETWORK, IN CLASS 42 (U.S. CLS. 100 AND 101).

SERVICE MARK

PRINCIPAL REGISTER

FIRST USE 7-1-2011; IN COMMERCE 7-1-2011.

THE MARK CONSISTS OF STANDARD CHARACTERS WITHOUT CLAIM TO ANY PARTICULAR FONT, STYLE, SIZE, OR COLOR.

SER. NO. 85-362,662, FILED 7-4-2011.

PAUL E. FAHRENKOPF, EXAMINING ATTORNEY



David J. Kyffers

Director of the United States Patent and Trademark Office

United States of America

United States Patent and Trademark Office

INVESTORSFRIEND.COM

Reg. No. 4,098,953

INVESTORSFRIEND INC. (CANADA CORPORATION)
11 WOLCOTT PLACE

Registered Feb. 14, 2012

ST. ALBERT, ALBERTA, CANADA T8N3P2

Int. Cl.: 36

FOR: OPERATION OF A WEBSITE FEATURING INVESTMENT INFORMATION AND ADVICE, IN CLASS 36 (U.S. CLS. 100, 101 AND 102).

SERVICE MARK

FIRST USE 9-30-2003; IN COMMERCE 3-31-2005.

PRINCIPAL REGISTER

THE MARK CONSISTS OF STANDARD CHARACTERS WITHOUT CLAIM TO ANY PARTICULAR FONT, STYLE, SIZE, OR COLOR.

SER. NO. 85-362,666, FILED 7-4-2011.

BARBARA GAYNOR, EXAMINING ATTORNEY



David J. Kyffers

Director of the United States Patent and Trademark Office

United States of America

United States Patent and Trademark Office



Reg. No. 4,098,954

Registered Feb. 14, 2012

Int. Cl.: 45

SERVICE MARK

PRINCIPAL REGISTER

GERBEN LAW FIRM, PLLC (D.C. PROFESSIONAL LIMITED LIABILITY COMPANY)
SUITE 650
1615 L STREET NW
WASHINGTON, DC 20036

FOR: LEGAL SERVICES, IN CLASS 45 (U.S. CLS. 100 AND 101).

FIRST USE 0-0-2008; IN COMMERCE 0-0-2008.

NO CLAIM IS MADE TO THE EXCLUSIVE RIGHT TO USE "LAW FIRM PLLC", APART FROM THE MARK AS SHOWN.

THE COLOR(S) BLUE, GRAY AND WHITE IS/ARE CLAIMED AS A FEATURE OF THE MARK.

THE MARK CONSISTS OF A STYLIZED LETTER "G" IN WHITE IN A BLUE SQUARE. THE STYLIZED WORD "GERBEN" IN BLUE APPEARING OVER THE STYLIZED WORDS "LAW FIRM PLLC" IN GRAY.

SER. NO. 85-362,691, FILED 7-4-2011.

DOUGLAS LEE, EXAMINING ATTORNEY



David J. Kybas

Director of the United States Patent and Trademark Office

United States of America

United States Patent and Trademark Office



Reg. No. 4,098,955

Registered Feb. 14, 2012

Int. Cl.: 14

TRADEMARK

PRINCIPAL REGISTER

OBJECT BREAST CANCER, LLC (NEW YORK LIMITED LIABILITY COMPANY)
6 ALLAPARTUS CIRCLE
OSSINING, NY 10562

FOR: JEWELRY, IN CLASS 14 (U.S. CLS. 2, 27, 28 AND 50).

FIRST USE 7-4-2011; IN COMMERCE 7-4-2011.

THE MARK CONSISTS OF STYLIZED OBC.

SER. NO. 85-362,700, FILED 7-4-2011.

DOUGLAS LEE, EXAMINING ATTORNEY



David J. Kyffers

Director of the United States Patent and Trademark Office

United States of America

United States Patent and Trademark Office

WHEN YOU NEED TO KNOW

Reg. No. 4,098,956

BRICKHOUSE ELECTRONICS LLC (NEW YORK LIMITED LIABILITY COMPANY)
980 AVENUE OF THE AMERICAS, THIRD FLOOR
NEW YORK, NY 10018

Registered Feb. 14, 2012

Int. Cl.: 35

FOR: RETAIL STORE AND ON-LINE RETAIL STORE SERVICES FEATURING TRACKING, SURVEILLANCE, SECURITY AND SAFETY DEVICES AND SOFTWARE , IN CLASS 35 (U.S. CLS. 100, 101 AND 102).

SERVICE MARK

FIRST USE 5-31-2011; IN COMMERCE 5-31-2011.

PRINCIPAL REGISTER

THE MARK CONSISTS OF STANDARD CHARACTERS WITHOUT CLAIM TO ANY PARTICULAR FONT, STYLE, SIZE, OR COLOR.

SER. NO. 85-362,712, FILED 7-4-2011.

DOUGLAS LEE, EXAMINING ATTORNEY



David J. Kyffers

Director of the United States Patent and Trademark Office

United States of America

United States Patent and Trademark Office

ADWAZ

Reg. No. 4,098,957

Registered Feb. 14, 2012

Int. Cl.: 38

SERVICE MARK

PRINCIPAL REGISTER

ANOUALD J MARC (UNITED STATES INDIVIDUAL)
ZERO GOVERNORS AVE, SUITE B2
MEDFORD, MA 02155

FOR: TEXT, AUDIO AND VIDEO BROADCASTING SERVICES OVER THE INTERNET OR OTHER COMMUNICATIONS NETWORK, NAMELY, UPLOADING, POSTING, DISPLAYING, AND ELECTRONICALLY TRANSMITTING INFORMATION IN THE FORM OF TEXT, AUDIO, AND VIDEO; PROVIDING FORUMS FOR TRANSMISSION OF MESSAGES AMONG COMPUTER USERS CONCERNING USER-DEFINED CONTENT; PROVIDING ON-LINE ELECTRONIC BULLETIN BOARDS FOR TRANSMISSION OF MESSAGES AMONG USERS IN THE FIELD OF GENERAL INTEREST, IN CLASS 38 (U.S. CLS. 100, 101 AND 104).

FIRST USE 3-1-2011; IN COMMERCE 3-1-2011.

THE MARK CONSISTS OF STANDARD CHARACTERS WITHOUT CLAIM TO ANY PARTICULAR FONT, STYLE, SIZE, OR COLOR.

SER. NO. 85-362,754, FILED 7-5-2011.

FRANK LATTUCA, EXAMINING ATTORNEY



David J. Kyffers

Director of the United States Patent and Trademark Office

United States of America

United States Patent and Trademark Office

BELLYBLING.NET

Reg. No. 4,098,958

CLICKSTOP, INC. (IOWA CORPORATION)
2535 BING MILLER LANE
URBANA, IA 52345

Registered Feb. 14, 2012

Int. Cl.: 35

FOR: ON-LINE RETAIL STORE SERVICES FEATURING JEWELRY, IN CLASS 35 (U.S. CLS. 100, 101 AND 102).

SERVICE MARK

FIRST USE 2-1-2006; IN COMMERCE 4-0-2006.

PRINCIPAL REGISTER

THE MARK CONSISTS OF STANDARD CHARACTERS WITHOUT CLAIM TO ANY PARTICULAR FONT, STYLE, SIZE, OR COLOR.

OWNER OF U.S. REG. NO. 3,949,622.

SEC. 2(F).

SER. NO. 85-362,777, FILED 7-5-2011.

TEJBIR SINGH, EXAMINING ATTORNEY



David J. Kybas

Director of the United States Patent and Trademark Office

United States of America

United States Patent and Trademark Office



BON CHOUIE

Reg. No. 4,098,959

Registered Feb. 14, 2012

Int. Cl.: 43

SERVICE MARK

PRINCIPAL REGISTER

BON CHOVIE (NEW YORK LIMITED LIABILITY COMPANY)
#2
191 ADELPHI STREET
BROOKLYN, NY 11205

FOR: FOOD PREPARATION SERVICES FEATURING ANCHOVIES, IN CLASS 43 (U.S. CLS. 100 AND 101).

FIRST USE 4-1-2011; IN COMMERCE 5-21-2011.

THE MARK CONSISTS OF THE STYLIZED TEXT "BON CHOVIE" WITH TWO FISH SILHOUETTES CROSSED BETWEEN THE WORDS "BON" AND "CHOVIE".

SER. NO. 85-362,793, FILED 7-5-2011.

ALYSSA STEEL, EXAMINING ATTORNEY



David J. Kybas

Director of the United States Patent and Trademark Office

United States of America

United States Patent and Trademark Office

the greener money

Reg. No. 4,098,960

Registered Feb. 14, 2012

Int. Cl.: 36

SERVICE MARK

PRINCIPAL REGISTER

CAPITAL BENEFIT, INC. (CALIFORNIA CORPORATION)
#203
2727 NEWPORT BOULEVARD
NEWPORT BEACH, CA 92663

FOR: REAL ESTATE INVESTMENT SERVICES, IN CLASS 36 (U.S. CLS. 100, 101 AND 102).

FIRST USE 6-15-2011; IN COMMERCE 6-15-2011.

THE MARK CONSISTS OF STANDARD CHARACTERS WITHOUT CLAIM TO ANY PARTICULAR FONT, STYLE, SIZE, OR COLOR.

SER. NO. 85-362,804, FILED 7-5-2011.

DAVID YONTEF, EXAMINING ATTORNEY



David J. Kyffers

Director of the United States Patent and Trademark Office

United States of America

United States Patent and Trademark Office

OBJECT BREAST CANCER

Reg. No. 4,098,961

OBJECT BREAST CANCER, LLC (NEW YORK LIMITED LIABILITY COMPANY)
6 ALLAPARTUS CIRCLE
OSSINING, NY 10562

Registered Feb. 14, 2012

Int. Cls.: 14 and 35

FOR: JEWELRY, IN CLASS 14 (U.S. CLS. 2, 27, 28 AND 50).

TRADEMARK

FIRST USE 7-4-2011; IN COMMERCE 7-4-2011.

SERVICE MARK

FOR: ON-LINE WHOLESALE AND RETAIL STORE SERVICES FEATURING JEWELRY, IN CLASS 35 (U.S. CLS. 100, 101 AND 102).

PRINCIPAL REGISTER

FIRST USE 7-4-2011; IN COMMERCE 7-4-2011.

THE MARK CONSISTS OF STANDARD CHARACTERS WITHOUT CLAIM TO ANY PARTICULAR FONT, STYLE, SIZE, OR COLOR.

SER. NO. 85-362,816, FILED 7-5-2011.

DOUGLAS LEE, EXAMINING ATTORNEY



David J. Kyfos

Director of the United States Patent and Trademark Office

United States of America

United States Patent and Trademark Office

INFRABIJOUX

Reg. No. 4,098,962

MAGICORAL S.R.L. (ITALY LIMITED LIABILITY COMPANY)
VIA LEONINO DA ZARA, 29

Registered Feb. 14, 2012

ALBIGNASEGO (PADOVA), ITALY 35020

Int. Cl.: 25

FOR: BEACH SHOES; FOOTWEAR; SABOTS; SANDAL-CLOGS; SANDALS; SLIPPERS;
WOMEN'S SHOES, IN CLASS 25 (U.S. CLS. 22 AND 39).

TRADEMARK

FIRST USE 2-0-2006; IN COMMERCE 2-0-2006.

PRINCIPAL REGISTER

THE MARK CONSISTS OF STANDARD CHARACTERS WITHOUT CLAIM TO ANY PARTICULAR FONT, STYLE, SIZE, OR COLOR.

SER. NO. 85-362,830, FILED 7-5-2011.

REBECCA GILBERT, EXAMINING ATTORNEY



David J. Kybas

Director of the United States Patent and Trademark Office

United States of America

United States Patent and Trademark Office

MOVE & GROOVE

Reg. No. 4,098,963

Registered Feb. 14, 2012

Int. Cls.: 9, 16 and 41

TRADEMARK

SERVICE MARK

PRINCIPAL REGISTER

KINDERMUSIK INTERNATIONAL, INC. (NORTH CAROLINA CORPORATION)
203 S. CHURCH STREET
GREENSBORO, NC 27401

FOR: PRERECORDED COMPACT DISCS FOR USE IN THE EDUCATION OF CHILDREN IN THE FIELD OF MUSIC , IN CLASS 9 (U.S. CLS. 21, 23, 26, 36 AND 38).

FIRST USE 4-0-2008; IN COMMERCE 4-0-2008.

FOR: EDUCATIONAL PUBLICATIONS, NAMELY, MAGAZINES AND TEACHER GUIDES IN THE FIELD OF MUSIC EDUCATION FOR CHILDREN, IN CLASS 16 (U.S. CLS. 2, 5, 22, 23, 29, 37, 38 AND 50).

FIRST USE 4-0-2008; IN COMMERCE 4-0-2008.

FOR: TEACHING MUSIC TO YOUNG CHILDREN, IN CLASS 41 (U.S. CLS. 100, 101 AND 107).

FIRST USE 4-0-2008; IN COMMERCE 4-0-2008.

THE MARK CONSISTS OF STANDARD CHARACTERS WITHOUT CLAIM TO ANY PARTICULAR FONT, STYLE, SIZE, OR COLOR.

SER. NO. 85-362,832, FILED 7-5-2011.

KAPIL BHANOT, EXAMINING ATTORNEY



David J. Kyffers

Director of the United States Patent and Trademark Office

United States of America

United States Patent and Trademark Office

STOMPING GROUND

Reg. No. 4,098,964

Registered Feb. 14, 2012

Int. Cl.: 41

SERVICE MARK

PRINCIPAL REGISTER

STOMPING GROUND PHOTO LLC (NEW YORK LIMITED LIABILITY COMPANY)
295 EAST 2ND STREET
BROOKLYN, NY 11218

FOR: PHOTOGRAPHY SERVICES, IN CLASS 41 (U.S. CLS. 100, 101 AND 107).

FIRST USE 8-3-2009; IN COMMERCE 11-7-2009.

THE MARK CONSISTS OF STANDARD CHARACTERS WITHOUT CLAIM TO ANY PARTICULAR FONT, STYLE, SIZE, OR COLOR.

SER. NO. 85-362,840, FILED 7-5-2011.

MARGERY A. TIERNEY, EXAMINING ATTORNEY



David J. Kybas

Director of the United States Patent and Trademark Office

United States of America

United States Patent and Trademark Office

STOMPING GROUND

Reg. No. 4,098,965

Registered Feb. 14, 2012

Int. Cl.: 16

TRADEMARK

PRINCIPAL REGISTER

STOMPING GROUND PHOTO LLC (NEW YORK LIMITED LIABILITY COMPANY)
295 EAST 2ND STREET
BROOKLYN, NY 11218

FOR: PHOTOGRAPHS, IN CLASS 16 (U.S. CLS. 2, 5, 22, 23, 29, 37, 38 AND 50).

FIRST USE 8-3-2009; IN COMMERCE 11-7-2009.

THE MARK CONSISTS OF STANDARD CHARACTERS WITHOUT CLAIM TO ANY PARTICULAR FONT, STYLE, SIZE, OR COLOR.

SER. NO. 85-362,854, FILED 7-5-2011.

MARGERY A. TIERNEY, EXAMINING ATTORNEY



David J. Kybas

Director of the United States Patent and Trademark Office

United States of America

United States Patent and Trademark Office



Reg. No. 4,098,966

Registered Feb. 14, 2012

Int. Cl.: 28

TRADEMARK

PRINCIPAL REGISTER

MITSUBISHI RAYON CO., LTD. (JAPAN CORPORATION)
6-41, KONAN 1-CHOME,
MINATO-KU, TOKYO, JAPAN

FOR: GOLF CLUB SHAFTS, IN CLASS 28 (U.S. CLS. 22, 23, 38 AND 50).

FIRST USE 4-0-2011; IN COMMERCE 4-0-2011.

OWNER OF U.S. REG. NOS. 3,799,800, 3,799,801, AND 3,811,159.

THE COLOR(S) WHITE, BLACK, AND RED IS/ARE CLAIMED AS A FEATURE OF THE MARK.

THE MARK CONSISTS OF A BLACK WYVERN OUTLINED WITH WHITE, RED, AND BLACK HOLDING A BLACK AND WHITE DIAMOND WITH ITS RIGHT CLAW, SUPERIMPOSED OVER A BLACK SHIELD, THE LOWER PORTION OF WHICH IS BEHIND THE WYVERN AND NOT VISIBLE, AND WITH THE SHIELD HAVING A WHITE CENTER AND A WHITE AND RED OUTLINE, WITH A STYLIZED WHITE LETTER "B" IN A BLACK CIRCLE WITH A WHITE AND RED OUTLINE IN THE UPPER PART OF THE SHIELD.

SER. NO. 85-362,859, FILED 7-5-2011.

KIMBERLY PERRY, EXAMINING ATTORNEY



David J. Kybas

Director of the United States Patent and Trademark Office

United States of America

United States Patent and Trademark Office



Reg. No. 4,098,967

Registered Feb. 14, 2012

Int. Cl.: 45

SERVICE MARK

PRINCIPAL REGISTER

THOUGHTFUL CARE INC (KANSAS CORPORATION), AKA THOUGHTFULCARE.COM
ALZHEIMER'S AND DEMENTIA HOME CARE
8340 MISSION RD, SUITE 118B
PRAIRIE VILLAGE, KS 66206

FOR: IN-HOME SUPPORT SERVICES TO SENIOR PERSONS, NAMELY, GERIATRIC CARE MANAGEMENT SERVICES IN THE NATURE OF THE COORDINATION OF NECESSARY SERVICES AND PERSONAL CARE FOR OLDER INDIVIDUALS; PERSONAL CARE ASSISTANCE OF ACTIVITIES OF DAILY LIVING, SUCH AS BATHING, GROOMING AND PERSONAL MOBILITY FOR MENTALLY OR PHYSICALLY CHALLENGED PEOPLE; SOCIAL SERVICE, NAMELY, COMPANIONSHIP SERVICES FOR SENIORS WITH ALZHEIMER'S OR DEMENTIA, IN CLASS 45 (U.S. CLS. 100 AND 101).

FIRST USE 6-27-2011; IN COMMERCE 6-27-2011.

THE MARK CONSISTS OF PROFILE SILHOUETTE OF TWO FIGURES FACING EACH OTHER, WITH THEIR ARMS REACHING OUT TO EACH OTHER.

SER. NO. 85-362,864, FILED 7-5-2011.

KIMBERLY PERRY, EXAMINING ATTORNEY



David J. Kybas

Director of the United States Patent and Trademark Office

United States of America

United States Patent and Trademark Office

INTEGRITY THE WAVE OF THE FUTURE

Reg. No. 4,098,968

TEGRIS (NEW YORK LIMITED LIABILITY COMPANY)
375 PARK AVENUE, FLOOR 16
NEW YORK CITY, NY 10152

Registered Feb. 14, 2012

Int. Cl.: 36

FOR: FINANCIAL SERVICES, NAMELY, PROVIDING FINANCIAL ADVISORY SERVICES ON MERGERS, ACQUISITIONS, RESTRUCTURING AND RELATED CORPORATE FINANCE MATTERS; PROVIDING FINANCIAL ANALYSIS AND CONSULTATION CONCERNING FINANCIAL EVALUATIONS AND FAIRNESS OPINIONS; VENTURE CAPITAL SERVICES, NAMELY, PROVIDING FINANCING TO EMERGING AND START-UP COMPANIES, IN CLASS 36 (U.S. CLS. 100, 101 AND 102).

SERVICE MARK

PRINCIPAL REGISTER

FIRST USE 12-10-2008; IN COMMERCE 12-10-2008.

THE MARK CONSISTS OF STANDARD CHARACTERS WITHOUT CLAIM TO ANY PARTICULAR FONT, STYLE, SIZE, OR COLOR.

SER. NO. 85-362,874, FILED 7-5-2011.

FRED CARL, EXAMINING ATTORNEY



David J. Kyffers

Director of the United States Patent and Trademark Office

United States of America

United States Patent and Trademark Office

STOMPING GROUND REINVENTING THE SCHOOL PICTURE

Reg. No. 4,098,969

Registered Feb. 14, 2012

Int. Cl.: 41

SERVICE MARK

PRINCIPAL REGISTER

STOMPING GROUND PHOTO LLC (NEW YORK LIMITED LIABILITY COMPANY)
295 EAST 2ND STREET
BROOKLYN, NY 11218

FOR: PHOTOGRAPHY SERVICES, IN CLASS 41 (U.S. CLS. 100, 101 AND 107).

FIRST USE 8-3-2009; IN COMMERCE 11-7-2009.

THE MARK CONSISTS OF STANDARD CHARACTERS WITHOUT CLAIM TO ANY PARTICULAR FONT, STYLE, SIZE, OR COLOR.

SER. NO. 85-362,881, FILED 7-5-2011.

MARGERY A. TIERNEY, EXAMINING ATTORNEY



David J. Kybas

Director of the United States Patent and Trademark Office

United States of America

United States Patent and Trademark Office

Oceanacence

Reg. No. 4,098,970

PACHE, STEPHEN (UNITED STATES INDIVIDUAL)
19635 GAIL AVENUE
OMAHA, NE 68135

Registered Feb. 14, 2012

Int. Cl.: 9

FOR: AUDIO RECORDINGS FEATURING MUSIC, IN CLASS 9 (U.S. CLS. 21, 23, 26, 36 AND 38).

TRADEMARK

FIRST USE 12-15-2010; IN COMMERCE 12-15-2010.

PRINCIPAL REGISTER

THE MARK CONSISTS OF STANDARD CHARACTERS WITHOUT CLAIM TO ANY PARTICULAR FONT, STYLE, SIZE, OR COLOR.

SER. NO. 85-362,882, FILED 7-5-2011.

MARGERY A. TIERNEY, EXAMINING ATTORNEY



David J. Kybas

Director of the United States Patent and Trademark Office

United States of America

United States Patent and Trademark Office

UVIAUS

Reg. No. 4,098,971

MODENCE (ARIZONA CORPORATION)
34738 N. 30TH DRIVE
PHOENIX, AZ 85086

Registered Feb. 14, 2012

Int. Cl.: 35

FOR: ADVERTISING AND MARKETING; BUSINESS MARKETING SERVICES, IN CLASS 35 (U.S. CLS. 100, 101 AND 102).

SERVICE MARK

FIRST USE 2-1-2011; IN COMMERCE 3-1-2011.

PRINCIPAL REGISTER

THE MARK CONSISTS OF STANDARD CHARACTERS WITHOUT CLAIM TO ANY PARTICULAR FONT, STYLE, SIZE, OR COLOR.

SER. NO. 85-362,967, FILED 7-5-2011.

JOHN WILKE, EXAMINING ATTORNEY



David J. Kybas

Director of the United States Patent and Trademark Office

United States of America

United States Patent and Trademark Office

You Can't Hear American Music Without Hearing Texas

Reg. No. 4,098,972

Registered Feb. 14, 2012

Int. Cl.: 35

SERVICE MARK

PRINCIPAL REGISTER

TEXAS MUSIC OFFICE (TEXAS STATE AGENCY)
P.O. BOX 13246, AUSTIN, TX 78711
1100 SAN JACINTO, AUSTIN, TX 78701
AUSTIN, TX 78711

FOR: CHAMBER OF COMMERCE SERVICES, NAMELY, PROMOTING BUSINESS AND TOURISM IN THE STATE OF TEXAS AREA, IN CLASS 35 (U.S. CLS. 100, 101 AND 102).

FIRST USE 11-19-1999; IN COMMERCE 11-19-1999.

THE MARK CONSISTS OF STANDARD CHARACTERS WITHOUT CLAIM TO ANY PARTICULAR FONT, STYLE, SIZE, OR COLOR.

SEC. 2(F).

SER. NO. 85-362,974, FILED 7-5-2011.

JOHN WILKE, EXAMINING ATTORNEY



David J. Kyffers

Director of the United States Patent and Trademark Office

United States of America

United States Patent and Trademark Office

TITLEEXPRESS

Reg. No. 4,098,973

TSS SOFTWARE CORPORATION (MARYLAND CORPORATION)
425 FOURTH STREET
ANNAPOLIS, MD 21403

Registered Feb. 14, 2012

Int. Cls.: 9 and 42

FOR: COMPUTER SOFTWARE FOR LEGAL AND REAL ESTATE OFFICE AUTOMATION,
IN CLASS 9 (U.S. CLS. 21, 23, 26, 36 AND 38).

TRADEMARK

FIRST USE 12-15-1997; IN COMMERCE 12-15-1997.

SERVICE MARK

FOR: COMPUTER SERVICES, NAMELY PROVIDING ACCESS TO COMPUTER SOFTWARE
AND DATA FOR LEGAL AND REAL ESTATE OFFICE AUTOMATION, IN CLASS 42 (U.S.
CLS. 100 AND 101).

PRINCIPAL REGISTER

FIRST USE 4-19-2011; IN COMMERCE 4-19-2011.

THE MARK CONSISTS OF STANDARD CHARACTERS WITHOUT CLAIM TO ANY PAR-
TICULAR FONT, STYLE, SIZE, OR COLOR.

OWNER OF U.S. REG. NO. 2,634,062.

SER. NO. 85-362,976, FILED 7-5-2011.

JOHN WILKE, EXAMINING ATTORNEY



David J. Kybas

Director of the United States Patent and Trademark Office

United States of America

United States Patent and Trademark Office

A Novel Idea

Reg. No. 4,098,974

A NOVEL IDEA LLC (TENNESSEE LIMITED LIABILITY COMPANY)
636 INDIAN RIDGE DR.
NASHVILLE, TN 37221

Registered Feb. 14, 2012

Int. Cl.: 41

FOR: EDUCATION SERVICES, NAMELY, PROVIDING MENTORING, TUTORING, EDITING, PROOFREADING, CLASSES, SEMINARS, AND WORKSHOPS IN THE FIELD OF CREATIVE WRITING, IN CLASS 41 (U.S. CLS. 100, 101 AND 107).

SERVICE MARK

FIRST USE 12-15-2010; IN COMMERCE 2-16-2011.

PRINCIPAL REGISTER

THE MARK CONSISTS OF STANDARD CHARACTERS WITHOUT CLAIM TO ANY PARTICULAR FONT, STYLE, SIZE, OR COLOR.

SER. NO. 85-362,989, FILED 7-5-2011.

SIMON TENG, EXAMINING ATTORNEY



David J. Kyffers

Director of the United States Patent and Trademark Office

United States of America

United States Patent and Trademark Office



Reg. No. 4,098,975

ENVIROLOGIX INC. (MAINE CORPORATION)
500 RIVERSIDE INDUSTRIAL PARKWAY
PORTLAND, ME 04103

Registered Feb. 14, 2012

Int. Cl.: 1

FOR: TESTING KITS COMPRISED PRIMARILY OF NICKING ENZYME AMPLIFICATION REACTION PREPARATION FOR RAPID GENETIC TESTING OF GRAINS AND PLANTS, NOT FOR MEDICAL USE, IN CLASS 1 (U.S. CLS. 1, 5, 6, 10, 26 AND 46).

TRADEMARK

FIRST USE 6-23-2011; IN COMMERCE 6-23-2011.

PRINCIPAL REGISTER

THE MARK CONSISTS OF THE LETTERING "DNABLE" DISPLAYED OVER A HELIX PATTERN.

SER. NO. 85-362,995, FILED 7-5-2011.

BARBARA RUTLAND, EXAMINING ATTORNEY



David J. Kyffers

Director of the United States Patent and Trademark Office

United States of America

United States Patent and Trademark Office

Riding the Current

Reg. No. 4,098,976

PELEREI, INC. (MARYLAND CORPORATION)
2379 BROAD RUN COURT
JEFFERSON, MD 21755

Registered Feb. 14, 2012

Int. Cl.: 35

FOR: BUSINESS CONSULTATION SERVICES, IN CLASS 35 (U.S. CLS. 100, 101 AND 102).

SERVICE MARK

FIRST USE 5-15-2010; IN COMMERCE 5-15-2010.

PRINCIPAL REGISTER

THE MARK CONSISTS OF STANDARD CHARACTERS WITHOUT CLAIM TO ANY PARTICULAR FONT, STYLE, SIZE, OR COLOR.

SER. NO. 85-363,032, FILED 7-5-2011.

JOHN WILKE, EXAMINING ATTORNEY



David J. Kybas

Director of the United States Patent and Trademark Office

United States of America

United States Patent and Trademark Office

WakeMed

Reg. No. 4,098,977

WAKEMED (NORTH CAROLINA NON-PROFIT CORPORATION)
3000 NEW BERN AVENUE
RALEIGH, NC 27610

Registered Feb. 14, 2012

Int. Cl.: 44

FOR: PROVIDING HOSPITAL, CLINICAL, SURGICAL AND NON-SURGICAL MEDICAL AND HEALTH CARE SERVICES ON IN-PATIENT AND OUT-PATIENT BASES, IN CLASS 44 (U.S. CLS. 100 AND 101).

SERVICE MARK

FIRST USE 4-1-1996; IN COMMERCE 4-1-1996.

PRINCIPAL REGISTER

THE MARK CONSISTS OF THE WORD "WAKEMED" WITH CIRCULAR DESIGN.

SER. NO. 85-363,123, FILED 7-5-2011.

DORITT L. CARROLL, EXAMINING ATTORNEY



David J. Kyffers

Director of the United States Patent and Trademark Office

United States of America

United States Patent and Trademark Office

We'll talk at your kitchen
table

Reg. No. 4,098,978

THE LAW OFFICES OF LARRY H. PARKER INC. (CALIFORNIA CORPORATION)
350 E. SAN ANTONIO DR.
LONG BEACH, CA 90807

Registered Feb. 14, 2012

Int. Cl.: 45

FOR: LEGAL SERVICES, IN CLASS 45 (U.S. CLS. 100 AND 101).

SERVICE MARK

FIRST USE 9-6-2011; IN COMMERCE 9-6-2011.

PRINCIPAL REGISTER

THE MARK CONSISTS OF STANDARD CHARACTERS WITHOUT CLAIM TO ANY PARTICULAR FONT, STYLE, SIZE, OR COLOR.

SER. NO. 85-363,131, FILED 7-5-2011.

DORITT L. CARROLL, EXAMINING ATTORNEY



David J. Kyffers

Director of the United States Patent and Trademark Office

United States of America

United States Patent and Trademark Office

RELIABLE CAPITAL. DELIVERING VALUE.

Reg. No. 4,098,979

VENTAS, INC. (DELAWARE CORPORATION)
111 SOUTH WACKER DRIVE, SUITE 4800
CHICAGO, IL 60606

Registered Feb. 14, 2012

Int. Cl.: 36

FOR: REAL ESTATE SERVICES, NAMELY, REAL ESTATE INVESTMENT, ACQUISITION AND MANAGEMENT SERVICES, REAL ESTATE INVESTMENT TRUST SERVICES; REAL ESTATE ADMINISTRATION, NAMELY, REAL ESTATE FINANCING AND LEASING SERVICES; REAL ESTATE FUND MANAGEMENT SERVICES, IN CLASS 36 (U.S. CLS. 100, 101 AND 102).

SERVICE MARK

PRINCIPAL REGISTER

FIRST USE 7-1-2011; IN COMMERCE 7-1-2011.

THE MARK CONSISTS OF STANDARD CHARACTERS WITHOUT CLAIM TO ANY PARTICULAR FONT, STYLE, SIZE, OR COLOR.

SER. NO. 85-363,146, FILED 7-5-2011.

MATTHEW EINSTEIN, EXAMINING ATTORNEY



David J. Kyffers

Director of the United States Patent and Trademark Office

United States of America
United States Patent and Trademark Office

GeoMaster

Reg. No. 4,098,980

GEOMASTER LLC (CONNECTICUT LIMITED LIABILITY COMPANY)
314 MOUNTAIN ROAD
WILTON, CT 06897

Registered Feb. 14, 2012

Int. Cl.: 37

FOR: INSTALLATION AND MAINTENANCE OF GEOTHERMAL HEATING AND COOLING SYSTEM, IN CLASS 37 (U.S. CLS. 100, 103 AND 106).

SERVICE MARK

FIRST USE 5-24-2011; IN COMMERCE 6-1-2011.

PRINCIPAL REGISTER

THE MARK CONSISTS OF STANDARD CHARACTERS WITHOUT CLAIM TO ANY PARTICULAR FONT, STYLE, SIZE, OR COLOR.

SER. NO. 85-363,171, FILED 7-5-2011.

DAVID COLLIER, EXAMINING ATTORNEY



David J. Kybas

Director of the United States Patent and Trademark Office

United States of America
United States Patent and Trademark Office

NAVARO

Reg. No. 4,098,981

COUNTY MATERIALS CORPORATION (WISCONSIN CORPORATION)
205 NORTH STREET
MARATHON, WI 54448

Registered Feb. 14, 2012

Int. Cl.: 19

FOR: RETAINING WALL UNITS COMPRISED OF MORTARLESS CONCRETE BLOCKS,
IN CLASS 19 (U.S. CLS. 1, 12, 33 AND 50).

TRADEMARK

FIRST USE 6-12-2006; IN COMMERCE 6-12-2006.

PRINCIPAL REGISTER

THE MARK CONSISTS OF STANDARD CHARACTERS WITHOUT CLAIM TO ANY PAR-
TICULAR FONT, STYLE, SIZE, OR COLOR.

SEC. 2(F).

SER. NO. 85-363,206, FILED 7-5-2011.

KATINA MISTER, EXAMINING ATTORNEY



David J. Kyffers

Director of the United States Patent and Trademark Office

United States of America

United States Patent and Trademark Office

DRESS YOUR KID WITH DIGNITY

Reg. No. 4,098,982

Registered Feb. 14, 2012

Int. Cl.: 25

TRADEMARK

PRINCIPAL REGISTER

LA MINIATURA, LLC (CALIFORNIA LIMITED LIABILITY COMPANY)
SUITE 1310
3000 OLYMPIC BLVD
SANTA MONICA, CA 90404

FOR: CHILDREN'S AND INFANT'S APPAREL, NAMELY, JUMPERS, OVERALL SLEEP-WEAR, PAJAMAS, ROMPERS, AND ONE-PIECE GARMENTS, CLOTH BIBS, SLEEPERS, INFANT WEARABLE BLANKETS, SHOES AND BOOTS, TROUSERS, SHIRTS, JACKETS, T-SHIRTS, DRESSES, BELTS, HATS AND SWEATERS, IN CLASS 25 (U.S. CLS. 22 AND 39).

FIRST USE 5-31-2011; IN COMMERCE 5-31-2011.

THE MARK CONSISTS OF STANDARD CHARACTERS WITHOUT CLAIM TO ANY PARTICULAR FONT, STYLE, SIZE, OR COLOR.

SER. NO. 85-363,232, FILED 7-5-2011.

KATHLEEN LORENZO, EXAMINING ATTORNEY



David J. Kybas

Director of the United States Patent and Trademark Office

United States of America

United States Patent and Trademark Office

bonro

Reg. No. 4,098,983

Registered Feb. 14, 2012

Int. Cl.: 35

SERVICE MARK

PRINCIPAL REGISTER

BONRO MEDICAL, INC. (GEORGIA CORPORATION)
BLDG. 100, STE. 16
4490 WASHINGTON ROAD
EVANS, GA 30809

FOR: ON-LINE RETAIL STORE SERVICES FEATURING DURABLE MEDICARE EQUIPMENT AND VACUUM THERAPY DEVICES, IN CLASS 35 (U.S. CLS. 100, 101 AND 102).

FIRST USE 5-1-2003; IN COMMERCE 5-1-2003.

THE MARK CONSISTS OF STANDARD CHARACTERS WITHOUT CLAIM TO ANY PARTICULAR FONT, STYLE, SIZE, OR COLOR.

SER. NO. 85-363,242, FILED 7-5-2011.

ELIZABETH KAJUBI, EXAMINING ATTORNEY



David J. Kyffers

Director of the United States Patent and Trademark Office

United States of America

United States Patent and Trademark Office

MILRES

Reg. No. 4,098,984

Registered Feb. 14, 2012

Int. Cl.: 41

SERVICE MARK

PRINCIPAL REGISTER

MILRES, LLC (DELAWARE LIMITED LIABILITY COMPANY)
THE MAHONEY CONSULTING GROUP
604 PARKER COURT
WILMINGTON, DE 19808

FOR: EDUCATIONAL SERVICES, NAMELY, CONDUCTING TRAINING COURSES IN THE FIELDS OF PROVIDING SERVICES TO MILITARY, VETERANS AND THEIR FAMILIES AND DISTRIBUTION OF TRAINING MATERIALS IN CONNECTION THEREWITH, IN CLASS 41 (U.S. CLS. 100, 101 AND 107).

FIRST USE 6-30-2011; IN COMMERCE 6-30-2011.

THE MARK CONSISTS OF STANDARD CHARACTERS WITHOUT CLAIM TO ANY PARTICULAR FONT, STYLE, SIZE, OR COLOR.

SER. NO. 85-363,270, FILED 7-5-2011.

KYLE PEETE, EXAMINING ATTORNEY



David J. Kyffers

Director of the United States Patent and Trademark Office

United States of America

United States Patent and Trademark Office

LUCKY PEACH

Reg. No. 4,098,985

Registered Feb. 14, 2012

Int. Cl.: 16

TRADEMARK

PRINCIPAL REGISTER

DAVID CHANG, LLC (NEW YORK LIMITED LIABILITY COMPANY)
SUITE 1211
853 BROADWAY
NEW YORK, NY 10003

FOR: MAGAZINES FEATURING RECIPES AND COMMENTARY ON FOOD, RESTAURANTS, BEVERAGES, ENTERTAINING AND TRAVEL, IN CLASS 16 (U.S. CLS. 2, 5, 22, 23, 29, 37, 38 AND 50).

FIRST USE 6-22-2011; IN COMMERCE 6-22-2011.

THE MARK CONSISTS OF STANDARD CHARACTERS WITHOUT CLAIM TO ANY PARTICULAR FONT, STYLE, SIZE, OR COLOR.

SER. NO. 85-363,278, FILED 7-5-2011.

KEVON CHISOLM, EXAMINING ATTORNEY



David J. Kyffers

Director of the United States Patent and Trademark Office

United States of America

United States Patent and Trademark Office

Your Life Your Way

Reg. No. 4,098,986

Registered Feb. 14, 2012

Int. Cl.: 35

SERVICE MARK

PRINCIPAL REGISTER

MATHER LIFEWAYS (ILLINOIS CORPORATION)
1603 ORRINGTON AVENUE
1603 ORRINGTON AVENUE
EVANSTON, IL 60201

FOR: BUSINESS MANAGEMENT AND OPERATION OF RETIREMENT COMMUNITIES
FOR OTHERS, IN CLASS 35 (U.S. CLS. 100, 101 AND 102).

FIRST USE 6-1-2011; IN COMMERCE 6-15-2011.

THE MARK CONSISTS OF STANDARD CHARACTERS WITHOUT CLAIM TO ANY PAR-
TICULAR FONT, STYLE, SIZE, OR COLOR.

SER. NO. 85-363,287, FILED 7-5-2011.

KATHY DE JONGE, EXAMINING ATTORNEY



David J. Kyffers

Director of the United States Patent and Trademark Office

United States of America

United States Patent and Trademark Office

needleheads

Reg. No. 4,098,987

Registered Feb. 14, 2012

Int. Cl.: 9

TRADEMARK

PRINCIPAL REGISTER

PARAMETRIC SYSTEMS INCORPORATED (GEORGIA CORPORATION), DBA
NEEDLEHEADS
2742 TOWNLEY CIRCLE
DORAVILLE, GA 30340

FOR: COMPUTER PROGRAMS RECORDED ON DATA MEDIA (SOFTWARE) DESIGNED
FOR USE IN CONSTRUCTION AND AUTOMATED MANUFACTURING (CAD/CAM) , IN
CLASS 9 (U.S. CLS. 21, 23, 26, 36 AND 38).

FIRST USE 7-29-1999; IN COMMERCE 7-29-1999.

THE MARK CONSISTS OF STANDARD CHARACTERS WITHOUT CLAIM TO ANY PAR-
TICULAR FONT, STYLE, SIZE, OR COLOR.

SER. NO. 85-363,333, FILED 7-5-2011.

MARC LEIPZIG, EXAMINING ATTORNEY



David J. Kyffers

Director of the United States Patent and Trademark Office

United States of America

United States Patent and Trademark Office

SBB

Reg. No. 4,098,988

Registered Feb. 14, 2012

Int. Cl.: 35

SERVICE MARK

PRINCIPAL REGISTER

STORAGE BRIDGE BAY WORKING GROUP, INC. (CALIFORNIA CORPORATION)
643 BAIR ISLAND ROAD, SUITE 103
REDWOOD CITY, CA 94063

FOR: ASSOCIATION SERVICES, NAMELY, PROMOTING THE INTERESTS OF THE COMPUTER INDUSTRY AND THE GROWTH AND DEVELOPMENT OF SPECIFICATIONS AND PROPOSED STANDARDS FOR STORAGE CONTROLLER SYSTEMS AND TECHNOLOGIES, IN CLASS 35 (U.S. CLS. 100, 101 AND 102).

FIRST USE 3-0-2005; IN COMMERCE 3-0-2005.

THE MARK CONSISTS OF STANDARD CHARACTERS WITHOUT CLAIM TO ANY PARTICULAR FONT, STYLE, SIZE, OR COLOR.

SER. NO. 85-363,363, FILED 7-5-2011.

JACLYN KIDWELL WALKER, EXAMINING ATTORNEY



David J. Kyffers

Director of the United States Patent and Trademark Office

United States of America

United States Patent and Trademark Office

OCEAN
COUNTRY®

Reg. No. 4,098,989

LOCAL MOTION INC. (HAWAII CORPORATION)
424 SUMNER STREET
HONOLULU, HI 96817

Registered Feb. 14, 2012

Int. Cl.: 25

FOR: CLOTHING, NAMELY TEE SHIRTS, CASUAL SHIRTS, WOMEN'S SHIRTS, TANK TOPS, SHORTS, CASUAL PANTS, SWIM TRUNKS, SWIMSUITS, HATS, VISORS AND CAPS, IN CLASS 25 (U.S. CLS. 22 AND 39).

TRADEMARK

FIRST USE 6-30-2011; IN COMMERCE 6-30-2011.

PRINCIPAL REGISTER

THE MARK CONSISTS OF THE WORDS OCEAN COUNTRY AND THE LETTER "C" WITHIN THE LETTER "O".

SER. NO. 85-363,379, FILED 7-5-2011.

ANTHONY RINKER, EXAMINING ATTORNEY



David J. Kybas

Director of the United States Patent and Trademark Office

United States of America

United States Patent and Trademark Office

SET A STEADY COURSE

Reg. No. 4,098,990

Registered Feb. 14, 2012

Int. Cl.: 36

SERVICE MARK

PRINCIPAL REGISTER

ADMIRALS BANK (UNITED STATES FEDERAL SAVINGS ASSOCIATION)
815 RESERVOIR AVENUE
CRANSTON, RI 02910

FOR: FINANCIAL SERVICES, NAMELY, BANKING SERVICES; INTERNET AND ONLINE BANKING SERVICES; PERSONAL AND COMMERCIAL BANKING SERVICES; CHECKING ACCOUNT SERVICES; SAVINGS ACCOUNT SERVICES; DIRECT DEPOSIT SERVICES; DEPOSIT SERVICES IN THE NATURE OF ACCEPTANCE OF DEPOSITS; SAFETY DEPOSIT BOX SERVICES; FINANCIAL TRANSACTION SERVICES, NAMELY, CERTIFICATES OF DEPOSIT; ONLINE BANKING; ONLINE BILL PAYMENT SERVICES; MONEY WIRE TRANSFER SERVICES; AUTOMATED TELLER MACHINE SERVICES; ELECTRONIC FUNDS TRANSFER SERVICES; CERTIFIED CHECK SERVICES; PROVIDING BANK ACCOUNT INFORMATION BY TELEPHONE, INTERNET OR ELECTRONIC MEANS; DEBIT CARD SERVICES; CONSUMER AND COMMERCIAL LENDING SERVICES, NAMELY, PROVIDING, ACQUIRING AND SERVICING COMMERCIAL AND RESIDENTIAL MORTGAGE LOANS (INCLUDING REFINANCINGS), CONSTRUCTION LOANS, HOME IMPROVEMENT LOANS, CAR LOANS, HOME EQUITY LOANS, ISSUING LETTERS OF CREDIT; INVESTMENT SERVICES, NAMELY, ASSET MANAGEMENT, IN CLASS 36 (U.S. CLS. 100, 101 AND 102).

FIRST USE 5-6-2011; IN COMMERCE 5-6-2011.

THE MARK CONSISTS OF STANDARD CHARACTERS WITHOUT CLAIM TO ANY PARTICULAR FONT, STYLE, SIZE, OR COLOR.

SER. NO. 85-363,385, FILED 7-5-2011.

WILLIAM P. SHANAHAN, EXAMINING ATTORNEY



David J. Kyros

Director of the United States Patent and Trademark Office

United States of America

United States Patent and Trademark Office

SocialChess

Reg. No. 4,098,991

CARLSON, LEE D (UNITED STATES INDIVIDUAL)
410 W TROPICAL TRCE
SAINT JOHNS, FL 32259

Registered Feb. 14, 2012

Int. Cl.: 9

FOR: COMPUTER GAME SOFTWARE, IN CLASS 9 (U.S. CLS. 21, 23, 26, 36 AND 38).

TRADEMARK

FIRST USE 1-1-2011; IN COMMERCE 6-29-2011.

PRINCIPAL REGISTER

THE MARK CONSISTS OF STANDARD CHARACTERS WITHOUT CLAIM TO ANY PARTICULAR FONT, STYLE, SIZE, OR COLOR.

SER. NO. 85-363,394, FILED 7-5-2011.

JACLYN KIDWELL WALKER, EXAMINING ATTORNEY



David J. Kyffers

Director of the United States Patent and Trademark Office

United States of America

United States Patent and Trademark Office

NU-WRAP

Reg. No. 4,098,992

CAL-JAVA INTERNATIONAL, INC. (CALIFORNIA CORPORATION)
19519 BUSINESS CENTER DRIVE
NORTHRIDGE, CA 91324

Registered Feb. 14, 2012

Int. Cl.: 30

FOR: ICING, IN CLASS 30 (U.S. CL. 46).

TRADEMARK

FIRST USE 3-1-2011; IN COMMERCE 3-1-2011.

PRINCIPAL REGISTER

THE MARK CONSISTS OF STANDARD CHARACTERS WITHOUT CLAIM TO ANY PARTICULAR FONT, STYLE, SIZE, OR COLOR.

SER. NO. 85-363,477, FILED 7-5-2011.

DAVID H. STINE, EXAMINING ATTORNEY



David J. Kyffers

Director of the United States Patent and Trademark Office

United States of America

United States Patent and Trademark Office

ShareSquared

Reg. No. 4,098,993

SHARESQUARED, INC. (CALIFORNIA CORPORATION)

Registered Feb. 14, 2012

2155 VERDUGO ROAD # 33
MONTROSE, CA 91020

Int. Cl.: 42

FOR: COMPUTER PROGRAMMING AND SOFTWARE DESIGN; COMPUTER SOFTWARE CONSULTING; COMPUTER SOFTWARE DESIGN; COMPUTER SOFTWARE DESIGN AND UPDATING; COMPUTER SOFTWARE DESIGN FOR OTHERS; COMPUTER SOFTWARE DESIGN, COMPUTER PROGRAMMING, OR MAINTENANCE OF COMPUTER SOFTWARE; CONSULTANCY IN THE FIELD OF SOFTWARE DESIGN; CUSTOMIZED SOFTWARE DEVELOPMENT SERVICES, IN CLASS 42 (U.S. CLS. 100 AND 101).

SERVICE MARK

PRINCIPAL REGISTER

FIRST USE 11-7-2004; IN COMMERCE 11-7-2004.

THE MARK CONSISTS OF STANDARD CHARACTERS WITHOUT CLAIM TO ANY PARTICULAR FONT, STYLE, SIZE, OR COLOR.

SER. NO. 85-363,479, FILED 7-5-2011.

DAVID H. STINE, EXAMINING ATTORNEY



David J. Kyffers

Director of the United States Patent and Trademark Office

United States of America

United States Patent and Trademark Office

Brookside

Reg. No. 4,098,994

Registered Feb. 14, 2012

Int. Cls.: 36 and 37

SERVICE MARK

PRINCIPAL REGISTER

NJE PROPERTIES, L.L.C. (MISSOURI LIMITED LIABILITY COMPANY)
SUITE 102
3301 BERRYWOOD DRIVE
COLUMBIA, MO 65203

FOR: APARTMENT HOUSE MANAGEMENT; HOUSING SERVICES, NAMELY, RENTAL OF STUDENT HOUSING; REAL ESTATE LISTING SERVICES FOR HOUSING RENTALS AND APARTMENT RENTALS; REAL ESTATE RENTAL SERVICES, NAMELY, RENTAL OF RESIDENTIAL HOUSING, IN CLASS 36 (U.S. CLS. 100, 101 AND 102).

FIRST USE 1-1-2002; IN COMMERCE 1-1-2002.

FOR: HOUSING SERVICES, NAMELY, DEVELOPMENT OF REAL PROPERTY, NAMELY, REPAIR, IMPROVEMENT, AND NEW CONSTRUCTION, IN CLASS 37 (U.S. CLS. 100, 103 AND 106).

FIRST USE 1-1-2002; IN COMMERCE 1-1-2002.

THE MARK CONSISTS OF STANDARD CHARACTERS WITHOUT CLAIM TO ANY PARTICULAR FONT, STYLE, SIZE, OR COLOR.

SER. NO. 85-363,480, FILED 7-5-2011.

JOHN WILKE, EXAMINING ATTORNEY



David J. Kybas

Director of the United States Patent and Trademark Office

United States of America

United States Patent and Trademark Office

VoxBloc

Reg. No. 4,098,995

VOXBLOC LLC (CALIFORNIA LIMITED LIABILITY COMPANY)
1704 S CHAPEL

Registered Feb. 14, 2012

ALHAMBRA, CA 91801

Int. Cl.: 42

FOR: APPLICATION SERVICE PROVIDER THAT PROVIDES USERS WITH HOSTING, MANAGING, DEVELOPING, ANALYZING, AND MAINTAINING APPLICATIONS, SOFTWARE, AND WEB SITES, OF OTHERS IN THE FIELDS OF ADVERTISING AND MARKETING, IN CLASS 42 (U.S. CLS. 100 AND 101).

SERVICE MARK

PRINCIPAL REGISTER

FIRST USE 6-1-2009; IN COMMERCE 11-1-2010.

THE MARK CONSISTS OF STANDARD CHARACTERS WITHOUT CLAIM TO ANY PARTICULAR FONT, STYLE, SIZE, OR COLOR.

SER. NO. 85-363,490, FILED 7-5-2011.

DAVID H. STINE, EXAMINING ATTORNEY



David J. Kyffers

Director of the United States Patent and Trademark Office

United States of America
United States Patent and Trademark Office

ZINBURGER

Reg. No. 4,098,996

FOX RESTAURANT CONCEPTS LLC (ARIZONA LIMITED LIABILITY COMPANY)
7135 EAST CAMELBACK ROAD, SUITE 260
SCOTTSDALE, AZ 85251

Registered Feb. 14, 2012

Int. Cl.: 30

FOR: HAMBURGER SANDWICHES, IN CLASS 30 (U.S. CL. 46).

TRADEMARK

FIRST USE 12-17-2007; IN COMMERCE 12-17-2007.

PRINCIPAL REGISTER

THE MARK CONSISTS OF STANDARD CHARACTERS WITHOUT CLAIM TO ANY PARTICULAR FONT, STYLE, SIZE, OR COLOR.

OWNER OF U.S. REG. NOS. 3,578,742, 3,582,319, AND 3,620,050.

SER. NO. 85-363,525, FILED 7-5-2011.

JUDITH HELFMAN, EXAMINING ATTORNEY



David J. Kyffers

Director of the United States Patent and Trademark Office

United States of America

United States Patent and Trademark Office

CITYgirl

Reg. No. 4,098,997

PAZAND, SHAROKINA (UNITED STATES INDIVIDUAL)
533 W BARRY AVE APT 7D
CHICAGO, IL 60657

Registered Feb. 14, 2012

Int. Cl.: 41

FOR: WEDDING PLANNING AND COORDINATION SERVICES, IN CLASS 41 (U.S. CLS. 100, 101 AND 107).

SERVICE MARK

FIRST USE 9-4-2010; IN COMMERCE 9-4-2010.

PRINCIPAL REGISTER

THE MARK CONSISTS OF THE STYLIZED TEXT "CITYGIRL".

SER. NO. 85-363,541, FILED 7-5-2011.

LINDA M. KING, EXAMINING ATTORNEY



David J. Kybas

Director of the United States Patent and Trademark Office

United States of America

United States Patent and Trademark Office

CURTISS

Reg. No. 4,098,998

CONFEDERATE MOTOR COMPANY (DELAWARE CORPORATION)
2325 BROOK MANOR DRIVE
MOUNTAIN BROOK, AL 35223

Registered Feb. 14, 2012

Int. Cl.: 12

FOR: MOTORCYCLES AND STRUCTURAL PARTS THEREFOR, IN CLASS 12 (U.S. CLS. 19, 21, 23, 31, 35 AND 44).

TRADEMARK

FIRST USE 7-4-2011; IN COMMERCE 7-4-2011.

PRINCIPAL REGISTER

THE MARK CONSISTS OF STANDARD CHARACTERS WITHOUT CLAIM TO ANY PARTICULAR FONT, STYLE, SIZE, OR COLOR.

SER. NO. 85-363,548, FILED 7-5-2011.

TRACY WHITTAKER-BROWN, EXAMINING ATTORNEY



David J. Kyfos

Director of the United States Patent and Trademark Office

United States of America

United States Patent and Trademark Office

MANIFESTO

Reg. No. 4,098,999

MAYBEE, RYAN (UNITED STATES INDIVIDUAL)

Registered Feb. 14, 2012

#2N
2006 BALTIMORE AVENUE
KANSAS CITY, MO 64108

Int. Cl.: 43

FOR: BAR AND COCKTAIL LOUNGE SERVICES, IN CLASS 43 (U.S. CLS. 100 AND 101).

SERVICE MARK

FIRST USE 4-10-2009; IN COMMERCE 4-10-2009.

PRINCIPAL REGISTER

THE MARK CONSISTS OF STANDARD CHARACTERS WITHOUT CLAIM TO ANY PARTICULAR FONT, STYLE, SIZE, OR COLOR.

SER. NO. 85-363,549, FILED 7-5-2011.

LINDA M. KING, EXAMINING ATTORNEY



David J. Kyffers

Director of the United States Patent and Trademark Office

United States of America

United States Patent and Trademark Office



Reg. No. 4,099,000

Registered Feb. 14, 2012

Int. Cl.: 39

SERVICE MARK

PRINCIPAL REGISTER

EXPRESS MESSENGER SYSTEMS, INC. (DELAWARE CORPORATION)
3401 EAST HARBOR DRIVE
PHOENIX, AZ 85034

FOR: MESSENGER AND PARCEL PICK UP AND DELIVERY SERVICES; OVERNIGHT PARCEL AND PACKAGE DELIVERY SERVICES; PACKAGING ARTICLES FOR TRANSPORTATION, IN CLASS 39 (U.S. CLS. 100 AND 105).

FIRST USE 2-1-2008; IN COMMERCE 2-1-2008.

OWNER OF U.S. REG. NOS. 2,976,142 AND 3,899,237.

THE MARK CONSISTS OF A FLYING PACKAGE WITH THE WORD "ONTRAC" BELOW.

SER. NO. 85-363,556, FILED 7-5-2011.

CHRISIE B. KING, EXAMINING ATTORNEY



David J. Kyffers

Director of the United States Patent and Trademark Office

United States of America

United States Patent and Trademark Office



Reg. No. 4,099,001

Registered Feb. 14, 2012

Int. Cls.: 41 and 44

SERVICE MARK

PRINCIPAL REGISTER

DYNAMIC THERAPEUTIC SERVICES, INC (NEW JERSEY CORPORATION)
52 FOREST AVENUE
PARAMUS, NJ 07652

FOR: EDUCATION SERVICES, NAMELY, PROVIDING CLASSES IN THE FIELD OF GENERAL EDUCATION FOR INDIVIDUALS WITH DEVELOPMENTAL DISABILITIES , IN CLASS 41 (U.S. CLS. 100, 101 AND 107).

FIRST USE 11-1-2005; IN COMMERCE 11-1-2005.

FOR: COGNITIVE THERAPY SERVICES; OCCUPATIONAL THERAPY SERVICES; PHYSICAL THERAPY; SPEECH THERAPY SERVICES, IN CLASS 44 (U.S. CLS. 100 AND 101).

FIRST USE 11-1-2005; IN COMMERCE 11-1-2005.

THE MARK CONSISTS OF A WOMAN, THEN CHILD, THEN MAN HOLDING HANDS WITH ONE HAND RAISED.

SER. NO. 85-363,569, FILED 7-5-2011.

ANNE E. GUSTASON, EXAMINING ATTORNEY



David J. Kybas

Director of the United States Patent and Trademark Office

United States of America

United States Patent and Trademark Office

noca

Reg. No. 4,099,002

Registered Feb. 14, 2012

Int. Cl.: 36

SERVICE MARK

PRINCIPAL REGISTER

NOCA, INC. (CALIFORNIA CORPORATION)
1263 EL CAMINO REAL
MENLO PARK, CA 94025

FOR: ELECTRONIC PAYMENT, NAMELY, ELECTRONIC PROCESSING AND TRANSMISSION OF BILL PAYMENT DATA; MERCHANT SERVICES, NAMELY, PAYMENT TRANSACTION PROCESSING SERVICES; PAYMENT PROCESSING SERVICES, NAMELY, CREDIT CARD AND DEBIT CARD TRANSACTION PROCESSING SERVICES; PROVIDING ELECTRONIC PROCESSING OF ACH AND CREDIT CARD TRANSACTIONS AND ELECTRONIC PAYMENTS VIA A GLOBAL COMPUTER NETWORK; PROVIDING ELECTRONIC PROCESSING OF ELECTRONIC FUNDS TRANSFER, ACH, CREDIT CARD, DEBIT CARD, ELECTRONIC CHECK AND ELECTRONIC PAYMENTS, IN CLASS 36 (U.S. CLS. 100, 101 AND 102).

FIRST USE 2-9-2009; IN COMMERCE 3-1-2010.

THE MARK CONSISTS OF STANDARD CHARACTERS WITHOUT CLAIM TO ANY PARTICULAR FONT, STYLE, SIZE, OR COLOR.

SER. NO. 85-363,591, FILED 7-5-2011.

KATHLEEN M. VANSTON, EXAMINING ATTORNEY



David J. Kybas

Director of the United States Patent and Trademark Office

United States of America

United States Patent and Trademark Office

ANS Xtreme

Reg. No. 4,099,003

Registered Feb. 14, 2012

Int. Cl.: 35

SERVICE MARK

PRINCIPAL REGISTER

ANS XTREME PERFORMANCE, INC. (CALIFORNIA CORPORATION)
UNIT 100
791 CHAMBERS LANE
SIMI VALLEY, CA 93065

FOR: ONLINE RETAIL STORE SERVICES FOR PAINTBALL GUNS AND PAINTBALL SUPPLIES, IN CLASS 35 (U.S. CLS. 100, 101 AND 102).

FIRST USE 1-1-1998; IN COMMERCE 1-1-1998.

THE MARK CONSISTS OF STANDARD CHARACTERS WITHOUT CLAIM TO ANY PARTICULAR FONT, STYLE, SIZE, OR COLOR.

SER. NO. 85-363,604, FILED 7-5-2011.

ZHALEH DELANEY, EXAMINING ATTORNEY



David J. Kyffers

Director of the United States Patent and Trademark Office

United States of America

United States Patent and Trademark Office

Vagrant Skateboards

Reg. No. 4,099,004

Registered Feb. 14, 2012

Int. Cl.: 28

TRADEMARK

PRINCIPAL REGISTER

MICHAEL FIERRO (UNITED STATES INDIVIDUAL), DBA VAGRANT SKATEBOARDS
A101
39930 WHITEWOOD AVE
MURRIETA, CA 92563

FOR: SKATEBOARDS, IN CLASS 28 (U.S. CLS. 22, 23, 38 AND 50).

FIRST USE 9-0-2009; IN COMMERCE 9-0-2009.

THE MARK CONSISTS OF STANDARD CHARACTERS WITHOUT CLAIM TO ANY PARTICULAR FONT, STYLE, SIZE, OR COLOR.

NO CLAIM IS MADE TO THE EXCLUSIVE RIGHT TO USE "SKATEBOARDS", APART FROM THE MARK AS SHOWN.

SER. NO. 85-363,610, FILED 7-5-2011.

KATINA MISTER, EXAMINING ATTORNEY



David J. Kybas

Director of the United States Patent and Trademark Office

United States of America

United States Patent and Trademark Office

ANSgear

Reg. No. 4,099,005

Registered Feb. 14, 2012

Int. Cl.: 35

SERVICE MARK

PRINCIPAL REGISTER

ANS XTREME PERFORMANCE, INC. (CALIFORNIA CORPORATION)
UNIT 100
791 CHAMBERS LANE
SIMI VALLEY, CA 93065

FOR: RETAIL STORE SERVICES FOR PAINTBALL GUNS AND PAINTBALL SUPPLIES;
ONLINE RETAIL STORE SERVICES FOR PAINTBALL GUNS AND PAINTBALL SUPPLIES
, IN CLASS 35 (U.S. CLS. 100, 101 AND 102).

FIRST USE 10-1-2005; IN COMMERCE 10-1-2005.

THE MARK CONSISTS OF STANDARD CHARACTERS WITHOUT CLAIM TO ANY PARTICULAR FONT, STYLE, SIZE, OR COLOR.

SER. NO. 85-363,612, FILED 7-5-2011.

ZHALEH DELANEY, EXAMINING ATTORNEY



David J. Kybas

Director of the United States Patent and Trademark Office

United States of America

United States Patent and Trademark Office

G ENTERTAINMENT

Reg. No. 4,099,006

Registered Feb. 14, 2012

Int. Cl.: 41

SERVICE MARK

PRINCIPAL REGISTER

G RECORDS (NEVADA CORPORATION)
SUITE 661
9030 W. SAHARA
LAS VEGAS, NV 89117

FOR: ENTERTAINMENT IN THE NATURE OF VISUAL AND AUDIO PERFORMANCES BY MUSICAL BANDS, COMEDIANS, ACTORS AND DANCERS.; ENTERTAINMENT SERVICES BY A MUSICAL ARTIST AND PRODUCER, NAMELY, MUSICAL COMPOSITION FOR OTHERS AND PRODUCTION OF MUSICAL SOUND RECORDINGS; ENTERTAINMENT SERVICES, NAMELY, CONDUCTING PARTIES; ENTERTAINMENT SERVICES, NAMELY, PROVIDING WEBCASTS IN THE FIELD OF MUSIC; MEDIA PRODUCTION SERVICES, NAMELY, VIDEO AND FILM PRODUCTION; MULTIMEDIA ENTERTAINMENT SERVICES IN THE NATURE OF RECORDING, PRODUCTION AND POST-PRODUCTION SERVICES IN THE FIELDS OF MUSIC, VIDEO, AND FILMS; MUSIC VIDEO PRODUCTION, IN CLASS 41 (U.S. CLS. 100, 101 AND 107).

FIRST USE 8-0-2003; IN COMMERCE 11-0-2003.

THE MARK CONSISTS OF STANDARD CHARACTERS WITHOUT CLAIM TO ANY PARTICULAR FONT, STYLE, SIZE, OR COLOR.

OWNER OF U.S. REG. NO. 3,578,802.

NO CLAIM IS MADE TO THE EXCLUSIVE RIGHT TO USE "ENTERTAINMENT", APART FROM THE MARK AS SHOWN.

SER. NO. 85-363,614, FILED 7-5-2011.

KATINA MISTER, EXAMINING ATTORNEY



David J. Kybas

Director of the United States Patent and Trademark Office

United States of America

United States Patent and Trademark Office

YOUR MONEY WORKING SMARTER

Reg. No. 4,099,007

ASSETWISE INVESTMENTS, INC. (CALIFORNIA CORPORATION)
7777 ALVARADO ROAD, SUITE 319
LA MESA, CA 91941

Registered Feb. 14, 2012

Int. Cl.: 36

FOR: FINANCIAL AND INVESTMENT SERVICES, NAMELY, PROVISION OF FINANCIAL ANALYSIS, CONSULTATION, PLANNING, ASSET AND PORTFOLIO MANAGEMENT, RETIREMENT PLANNING, RISK MANAGEMENT AND INVESTMENT SERVICES, IN CLASS 36 (U.S. CLS. 100, 101 AND 102).

SERVICE MARK

PRINCIPAL REGISTER

FIRST USE 5-25-2011; IN COMMERCE 5-25-2011.

THE MARK CONSISTS OF STANDARD CHARACTERS WITHOUT CLAIM TO ANY PARTICULAR FONT, STYLE, SIZE, OR COLOR.

SER. NO. 85-363,634, FILED 7-5-2011.

CHERYL CLAYTON, EXAMINING ATTORNEY



David J. Kyffers

Director of the United States Patent and Trademark Office

United States of America

United States Patent and Trademark Office

ASSETLOCK

Reg. No. 4,099,008

ASSETWISE INVESTMENTS, INC. (CALIFORNIA CORPORATION)
7777 ALVARADO ROAD, SUITE 319
LA MESA, CA 91941

Registered Feb. 14, 2012

Int. Cl.: 36

FOR: FINANCIAL PORTFOLIO ANALYSIS AND MANAGEMENT SERVICES, IN CLASS 36 (U.S. CLS. 100, 101 AND 102).

SERVICE MARK

FIRST USE 5-25-2011; IN COMMERCE 5-25-2011.

PRINCIPAL REGISTER

THE MARK CONSISTS OF STANDARD CHARACTERS WITHOUT CLAIM TO ANY PARTICULAR FONT, STYLE, SIZE, OR COLOR.

SER. NO. 85-363,638, FILED 7-5-2011.

CHERYL CLAYTON, EXAMINING ATTORNEY



David J. Kybas

Director of the United States Patent and Trademark Office

United States of America

United States Patent and Trademark Office

Just 4 Me

Reg. No. 4,099,009

Registered Feb. 14, 2012

Int. Cl.: 21

TRADEMARK

PRINCIPAL REGISTER

DR FRESH INC. (CALIFORNIA CORPORATION)
6645 CABALLERO BLVD
BUENA PARK, CA 90620

FOR: DENTAL CARE KIT COMPRISING TOOTHBRUSHES AND FLOSS; DENTAL FLOSS; DENTAL FLOSS; DENTAL FLOSS DISPENSERS; ELECTRIC TOOTHBRUSHES; ELECTRICAL TOOTHBRUSHES; HOME DENTAL CARE PRODUCTS FOR DOGS AND CATS, NAMELY, TOOTHBRUSH; MANUAL TOOTHBRUSHES; ORAL CARE KIT COMPRISING TOOTHBRUSHES AND FLOSS; TOOTHBRUSH CASES; TOOTHBRUSH HOLDERS; TOOTHBRUSHES; TOOTHBRUSHES; TOOTHBRUSHES, IN CLASS 21 (U.S. CLS. 2, 13, 23, 29, 30, 33, 40 AND 50).

FIRST USE 5-5-2010; IN COMMERCE 5-5-2010.

THE MARK CONSISTS OF STANDARD CHARACTERS WITHOUT CLAIM TO ANY PARTICULAR FONT, STYLE, SIZE, OR COLOR.

SER. NO. 85-363,643, FILED 7-5-2011.

CHERYL CLAYTON, EXAMINING ATTORNEY



David J. Kybas

Director of the United States Patent and Trademark Office

United States of America

United States Patent and Trademark Office

ERONS

Reg. No. 4,099,010

Registered Feb. 14, 2012

Int. Cl.: 25

TRADEMARK

PRINCIPAL REGISTER

ZHONGSHAN KONHON GARMENT LIMITED (CHINA LIMITED COMPANY (LTD.))
4/F KONHON BLDG, 9 XING BAO WEST ROAD
SHA XI, ZHONGSHAN
GUANGDONG PROVINCE, CHINA

FOR: HATS; JACKETS; PAJAMAS; PANTS; SHIRTS; SHOES; SKIRTS; SUITS; SWEATERS;
T-SHIRTS, IN CLASS 25 (U.S. CLS. 22 AND 39).

FIRST USE 12-1-1998; IN COMMERCE 1-1-2001.

THE MARK CONSISTS OF STANDARD CHARACTERS WITHOUT CLAIM TO ANY PAR-
TICULAR FONT, STYLE, SIZE, OR COLOR.

THE WORDING "ERONS" HAS NO MEANING IN A FOREIGN LANGUAGE.

SER. NO. 85-363,746, FILED 7-6-2011.

SIMON TENG, EXAMINING ATTORNEY



David J. Kyffers

Director of the United States Patent and Trademark Office

United States of America

United States Patent and Trademark Office

FUEL YOUR RIDE

Reg. No. 4,099,011

CHRISTENSEN, NATALIE (UNITED STATES INDIVIDUAL)
11455 SOUTH PLAYER RD
SANDY, UT 84092

Registered Feb. 14, 2012

Int. Cl.: 32

FOR: NON-ALCOHOLIC BEVERAGES, NAMELY, ENERGY DRINKS, IN CLASS 32 (U.S. CLS. 45, 46 AND 48).

TRADEMARK

FIRST USE 6-30-2011; IN COMMERCE 6-30-2011.

PRINCIPAL REGISTER

THE MARK CONSISTS OF STANDARD CHARACTERS WITHOUT CLAIM TO ANY PARTICULAR FONT, STYLE, SIZE, OR COLOR.

SER. NO. 85-363,767, FILED 7-6-2011.

GEORGE LORENZO, EXAMINING ATTORNEY



David J. Kyffers

Director of the United States Patent and Trademark Office

United States of America

United States Patent and Trademark Office

Big Dreams

Reg. No. 4,099,012

REAL BIG DREAMS, LLC (COLORADO LIMITED LIABILITY COMPANY)

Registered Feb. 14, 2012

P.O. BOX 99
FRANKLIN, MA 02038

Int. Cl.: 41

FOR: ENTERTAINMENT SERVICES, NAMELY, AN ON-GOING SERIES FEATURING DOCUMENTARY REALITY STYLE EPISODES AND SPINOFFS FOCUSING ON LIFE AFTER MASSIVE WEIGHT LOSS PROVIDED THROUGH TELEVISION, WEBCASTS, RADIO BROADCASTS AND ALL OTHER MEDIA, IN CLASS 41 (U.S. CLS. 100, 101 AND 107).

SERVICE MARK

PRINCIPAL REGISTER

FIRST USE 4-9-2011; IN COMMERCE 4-9-2011.

THE MARK CONSISTS OF STANDARD CHARACTERS WITHOUT CLAIM TO ANY PARTICULAR FONT, STYLE, SIZE, OR COLOR.

SER. NO. 85-363,789, FILED 7-6-2011.

TOBY BULLOFF, EXAMINING ATTORNEY



David J. Kyffers

Director of the United States Patent and Trademark Office

United States of America

United States Patent and Trademark Office

ACCREDICOM

Reg. No. 4,099,013

Registered Feb. 14, 2012

Int. Cl.: 42

SERVICE MARK

PRINCIPAL REGISTER

SS TECH, LLC (NORTH CAROLINA LIMITED LIABILITY COMPANY), DBA ZETTA
WORLDWIDE TECHNOLOGIES
406 BLACKWELL STREET, SUITE B030
DURHAM, NC 27713

FOR: SOFTWARE AS A SERVICE (SAAS) SERVICES FEATURING SOFTWARE TO ASSIST
HEALTHCARE PROVIDERS ACHIEVE AND MAINTAIN ACCREDITATION AND COMPLI-
ANCE, IN CLASS 42 (U.S. CLS. 100 AND 101).

FIRST USE 6-7-2009; IN COMMERCE 6-7-2009.

THE MARK CONSISTS OF STANDARD CHARACTERS WITHOUT CLAIM TO ANY PAR-
TICULAR FONT, STYLE, SIZE, OR COLOR.

SER. NO. 85-363,799, FILED 7-6-2011.

DAVID I, EXAMINING ATTORNEY



David J. Kyffers

Director of the United States Patent and Trademark Office

United States of America

United States Patent and Trademark Office

CAMPBELL SOLUTIONS

Reg. No. 4,099,014

CAMPBELL SOLUTIONS LLC (DELAWARE LIMITED LIABILITY COMPANY)
1707 N ST NW
WASHINGTON, DC 20036

Registered Feb. 14, 2012

Int. Cl.: 42

FOR: COMPUTER SERVICES, NAMELY, DATA RECOVERY SERVICES, IN CLASS 42 (U.S. CLS. 100 AND 101).

SERVICE MARK

FIRST USE 10-1-2003; IN COMMERCE 10-1-2003.

PRINCIPAL REGISTER

THE MARK CONSISTS OF STANDARD CHARACTERS WITHOUT CLAIM TO ANY PARTICULAR FONT, STYLE, SIZE, OR COLOR.

NO CLAIM IS MADE TO THE EXCLUSIVE RIGHT TO USE "SOLUTIONS", APART FROM THE MARK AS SHOWN.

SEC. 2(F).

SER. NO. 85-363,807, FILED 7-6-2011.

SALLY SHIH, EXAMINING ATTORNEY



David J. Kyffers

Director of the United States Patent and Trademark Office

United States of America

United States Patent and Trademark Office

ZOMMERFEST

Reg. No. 4,099,015

AUGUST SCHELL BREWING COMPANY (MINNESOTA CORPORATION)
1860 SCHELL ROAD
NEW ULM, MN 56073

Registered Feb. 14, 2012

Int. Cl.: 32

FOR: ALE, IN CLASS 32 (U.S. CLS. 45, 46 AND 48).

TRADEMARK

FIRST USE 6-1-1999; IN COMMERCE 6-1-1999.

PRINCIPAL REGISTER

THE MARK CONSISTS OF STANDARD CHARACTERS WITHOUT CLAIM TO ANY PARTICULAR FONT, STYLE, SIZE, OR COLOR.

SER. NO. 85-363,809, FILED 7-6-2011.

WON TEAK OH, EXAMINING ATTORNEY



David J. Kyffers

Director of the United States Patent and Trademark Office

United States of America

United States Patent and Trademark Office



a taste of perfection

Reg. No. 4,099,016

ARTISAN CATERING LLC (KANSAS LIMITED LIABILITY COMPANY)
128 E MADISON AVE.
DERBY, KS 67037

Registered Feb. 14, 2012

Int. Cl.: 43

FOR: CATERING SERVICES, IN CLASS 43 (U.S. CLS. 100 AND 101).

SERVICE MARK

FIRST USE 4-20-2010; IN COMMERCE 4-20-2010.

PRINCIPAL REGISTER

NO CLAIM IS MADE TO THE EXCLUSIVE RIGHT TO USE "ARTISAN" AND "CATERING CONCEPTS", APART FROM THE MARK AS SHOWN.

THE MARK CONSISTS OF THE WORD "ARTISAN" IN STYLIZED FORM, ABOVE A STYLIZED LETTER "A" WITHIN CONCENTRIC CIRCLES BETWEEN DESIGNS OF A FORK AND KNIFE, ABOVE THE WORD "CATERING" IN STYLIZED FORM, ABOVE THE WORD "CONCEPTS" IN STYLIZED FORM, ABOVE THE PHRASE "A TASTE OF PERFECTION" IN STYLIZED FORM.

SER. NO. 85-363,860, FILED 7-6-2011.

TEJBIR SINGH, EXAMINING ATTORNEY



David J. Kyffers

Director of the United States Patent and Trademark Office

United States of America

United States Patent and Trademark Office

RUSH NATURALLY ENLIGHTENED

Reg. No. 4,099,017

LR INDUSTRIES, INC. (COLORADO CORPORATION)
5078 COTTONWOOD DRIVE
BOULDER, CO 80301

Registered Feb. 14, 2012

Int. Cl.: 43

FOR: CAFE-RESTAURANTS; CARRY OUT RESTAURANTS, IN CLASS 43 (U.S. CLS. 100 AND 101).

SERVICE MARK

FIRST USE 12-1-2006; IN COMMERCE 12-1-2006.

PRINCIPAL REGISTER

THE MARK CONSISTS OF STANDARD CHARACTERS WITHOUT CLAIM TO ANY PARTICULAR FONT, STYLE, SIZE, OR COLOR.

OWNER OF U.S. REG. NO. 3,300,976.

SER. NO. 85-363,893, FILED 7-6-2011.

TINA MAI, EXAMINING ATTORNEY



David J. Kyffers

Director of the United States Patent and Trademark Office

United States of America

United States Patent and Trademark Office

EREBUS

Reg. No. 4,099,018

EREBUS ENTERTAINMENT, INC. (MICHIGAN CORPORATION)
18 SOUTH PERRY STREET
PONTIAC, MI 48342

Registered Feb. 14, 2012

Int. Cl.: 41

FOR: ENTERTAINMENT SERVICES, NAMELY, HAUNTED ATTRACTION SERVICES, IN CLASS 41 (U.S. CLS. 100, 101 AND 107).

SERVICE MARK

FIRST USE 9-0-2000; IN COMMERCE 9-0-2000.

PRINCIPAL REGISTER

THE MARK CONSISTS OF STANDARD CHARACTERS WITHOUT CLAIM TO ANY PARTICULAR FONT, STYLE, SIZE, OR COLOR.

SER. NO. 85-363,935, FILED 7-6-2011.

MICHAEL SOUDERS, EXAMINING ATTORNEY



David J. Kyffers

Director of the United States Patent and Trademark Office

United States of America

United States Patent and Trademark Office

SpaBiz

Reg. No. 4,099,019

Registered Feb. 14, 2012

Int. Cl.: 9

TRADEMARK

PRINCIPAL REGISTER

NEILL TECHNOLOGIES, INC. (LOUISIANA CORPORATION)
ATTN: JENNIFER LEE, GENERAL COUNSEL
303 SOUTH PINE STREET
HAMMOND, LA 70403

FOR: COMPUTER SOFTWARE FOR AUTOMATING BUSINESS ACTIVITIES, NAMELY, ACCOUNTING APPOINTMENT SCHEDULING AND BUSINESS PLANNING IN THE FIELD OF HAIR AND SKIN CARE, IN CLASS 9 (U.S. CLS. 21, 23, 26, 36 AND 38).

FIRST USE 10-1-1999; IN COMMERCE 10-1-1999.

THE MARK CONSISTS OF STANDARD CHARACTERS WITHOUT CLAIM TO ANY PARTICULAR FONT, STYLE, SIZE, OR COLOR.

OWNER OF U.S. REG. NOS. 2,425,651 AND 3,133,619.

SEC. 2(F).

SER. NO. 85-363,942, FILED 7-6-2011.

REBECCA GILBERT, EXAMINING ATTORNEY



David J. Kyffers

Director of the United States Patent and Trademark Office

United States of America
United States Patent and Trademark Office

KidzRocket

Reg. No. 4,099,020

KIDZROCKET.COM, INC. (FLORIDA CORPORATION)
1055 NW 121 LANE
CORAL SPRINGS, FL 33071

Registered Feb. 14, 2012

Int. Cl.: 45

FOR: PROVIDING A SOCIAL NETWORKING WEBSITE FOR ENTERTAINMENT PURPOSES,
IN CLASS 45 (U.S. CLS. 100 AND 101).

SERVICE MARK

FIRST USE 6-29-2010; IN COMMERCE 6-29-2010.

PRINCIPAL REGISTER

THE MARK CONSISTS OF STANDARD CHARACTERS WITHOUT CLAIM TO ANY PARTICULAR FONT, STYLE, SIZE, OR COLOR.

SER. NO. 85-363,943, FILED 7-6-2011.

NAAKWAMA ANKRAH, EXAMINING ATTORNEY



David J. Kyffers

Director of the United States Patent and Trademark Office

United States of America

United States Patent and Trademark Office

QBI

Reg. No. 4,099,021

QBI, LLC (DELAWARE LIMITED LIABILITY COMPANY), DBA QUALIFIED BENEFITS
21021 VENTURA BLVD., SUITE 100
WOODLAND HILLS, CA 91364

Registered Feb. 14, 2012

Int. Cl.: 36

FOR: FINANCIAL ADMINISTRATION OF RETIREMENT PLANS, IN CLASS 36 (U.S. CLS. 100, 101 AND 102).

SERVICE MARK

FIRST USE 2-0-2010; IN COMMERCE 2-0-2010.

PRINCIPAL REGISTER

THE MARK CONSISTS OF STANDARD CHARACTERS WITHOUT CLAIM TO ANY PARTICULAR FONT, STYLE, SIZE, OR COLOR.

SER. NO. 85-363,965, FILED 7-6-2011.

SETH A. RAPPAPORT, EXAMINING ATTORNEY



David J. Kyffers

Director of the United States Patent and Trademark Office

United States of America

United States Patent and Trademark Office

NOPALAMINO

Reg. No. 4,099,022

DE LUNA, FERNANDO, J (UNITED STATES INDIVIDUAL)
1920 S MAIN STREET 138
MCALLEN, TX 78503

Registered Feb. 14, 2012

Int. Cl.: 5

FOR: DIETARY AND NUTRITIONAL SUPPLEMENTS, IN CLASS 5 (U.S. CLS. 6, 18, 44, 46, 51 AND 52).

TRADEMARK

FIRST USE 3-1-2011; IN COMMERCE 3-5-2011.

PRINCIPAL REGISTER

THE MARK CONSISTS OF THE TRADEMARK "NOPALAMINO" DEPICTED WITH GREEN LETTERING.

THE COLOR(S) GREEN IS/ARE CLAIMED AS A FEATURE OF THE MARK.

SER. NO. 85-363,975, FILED 7-6-2011.

ZACHARY BELLO, EXAMINING ATTORNEY



David J. Kybas

Director of the United States Patent and Trademark Office

United States of America

United States Patent and Trademark Office

The Slide Ride

Reg. No. 4,099,023

Registered Feb. 14, 2012

Int. Cl.: 43

SERVICE MARK

PRINCIPAL REGISTER

VALENTINA FOOD TRUCKS, LLC (ILLINOIS LIMITED LIABILITY COMPANY), AKA THE
SLIDE RIDE
3E
4608 N MONTICELLO AVENUE
CHICAGO, IL 60625

FOR: PROVIDING OF FOOD AND DRINK VIA A MOBILE TRUCK, IN CLASS 43 (U.S. CLS.
100 AND 101).

FIRST USE 3-19-2011; IN COMMERCE 6-28-2011.

THE MARK CONSISTS OF STANDARD CHARACTERS WITHOUT CLAIM TO ANY PAR-
TICULAR FONT, STYLE, SIZE, OR COLOR.

SER. NO. 85-363,977, FILED 7-6-2011.

ZACHARY BELLO, EXAMINING ATTORNEY



David J. Kyffers

Director of the United States Patent and Trademark Office

United States of America
United States Patent and Trademark Office

魚太郎

Reg. No. 4,099,024

SUNRISE FOOD TRADING INC. (NEW JERSEY CORPORATION)
4 BUCHMAN COURT
BRIDGEWATER, NJ 08807

Registered Feb. 14, 2012

Int. Cl.: 29

FOR: FROZEN PRE-PACKAGED ENTREES CONSISTING PRIMARILY OF SEAFOOD;
SEAFOOD; SEAFOOD, NAMELY, CHILLED AND FROZEN FISH, SHRIMPS, SHELLFISH
AND SEAFOOD, IN CLASS 29 (U.S. CL. 46).

TRADEMARK

FIRST USE 4-1-2009; IN COMMERCE 4-1-2009.

PRINCIPAL REGISTER

THE MARK CONSISTS OF THREE CHINESE CHARACTERS.

THE NON-LATIN CHARACTERS IN THE MARK TRANSLITERATE TO UOTARO AND
THIS MEANS FIRST SON OF FISH IN ENGLISH.

THE ENGLISH TRANSLATION OF THREE CHINESE CHARACTERS IN THE MARK IS
FIRST SON OF FISH.

SER. NO. 85-364,010, FILED 7-6-2011.

HENRY S. ZAK, EXAMINING ATTORNEY



David J. Kyros

Director of the United States Patent and Trademark Office

United States of America

United States Patent and Trademark Office

The Nature of God

Reg. No. 4,099,025

Registered Feb. 14, 2012

Int. Cl.: 9

TRADEMARK

PRINCIPAL REGISTER

COLDWATER MEDIA, INC. (COLORADO CORPORATION)
300 GENERAL PALMER DRIVE
PALMER LAKE, CO 80133

FOR: CHILDREN'S EDUCATIONAL MUSIC CDS AND DVDS; DIGITAL MEDIA, NAMELY, PRE-RECORDED DVDS, DOWNLOADABLE AUDIO AND VIDEO RECORDINGS, AND CDS FEATURING AND PROMOTING A DIGITAL VIDEO SERIES ON SCIENCE AND NATURE.; DIGITAL MEDIA, NAMELY, PRE-RECORDED VIDEO CASSETTES, DIGITAL VIDEO DISCS, DIGITAL VERSATILE DISCS, DOWNLOADABLE AUDIO AND VIDEO RECORDINGS, DVDS, AND HIGH DEFINITION DIGITAL DISCS FEATURING A DIGITAL VIDEO SERIES ON SCIENCE AND NATURE.; DIGITAL MEDIA, NAMELY, DVDS AND DIGITAL VIDEO FILES FEATURING A VIDEO SERIES ON SCIENCE AND NATURE; DVDS FEATURING A SERIES OF DIGITAL VIDEO DISCS FEATURING SCIENCE AND NATURE PROGRAMMING; EDUCATIONAL KIT COMPRISING DVDS FEATURING SECONDARY LEVEL CURRICULUM ON ALL SCIENTIFIC DISCIPLINES, ALONG WITH TEACHER GUIDES, SOLD AS A UNIT, IN CLASS 9 (U.S. CLS. 21, 23, 26, 36 AND 38).

FIRST USE 4-1-2011; IN COMMERCE 6-1-2011.

THE MARK CONSISTS OF STANDARD CHARACTERS WITHOUT CLAIM TO ANY PARTICULAR FONT, STYLE, SIZE, OR COLOR.

SER. NO. 85-364,015, FILED 7-6-2011.

HENRY S. ZAK, EXAMINING ATTORNEY



David J. Kyffers

Director of the United States Patent and Trademark Office

United States of America

United States Patent and Trademark Office

SUGARLOAF MOUNTAIN

Reg. No. 4,099,026

SUGARLOAF MOUNTAIN, LLC (DELAWARE LIMITED LIABILITY COMPANY)
P.O. BOX 3989
NAPA, CA 94558

Registered Feb. 14, 2012

Int. Cl.: 33

FOR: ALCOHOLIC BEVERAGES EXCEPT BEERS, IN CLASS 33 (U.S. CLS. 47 AND 49).

TRADEMARK

FIRST USE 9-30-2005; IN COMMERCE 9-30-2005.

PRINCIPAL REGISTER

THE MARK CONSISTS OF STANDARD CHARACTERS WITHOUT CLAIM TO ANY PARTICULAR FONT, STYLE, SIZE, OR COLOR.

OWNER OF U.S. REG. NOS. 3,438,575 AND 3,532,767.

SEC. 2(F).

SER. NO. 85-364,056, FILED 7-6-2011.

CHRISTINA SOBRAL, EXAMINING ATTORNEY



David J. Kyffers

Director of the United States Patent and Trademark Office

United States of America

United States Patent and Trademark Office

ADOGA

Reg. No. 4,099,027

Registered Feb. 14, 2012

Int. Cl.: 35

SERVICE MARK

PRINCIPAL REGISTER

THE AMERICAN DEHYDRATED ONION AND GARLIC ASSOCIATION (CALIFORNIA CORPORATION)
1755 CREEKSIDE OAKS DR. #250
SACRAMENTO, CA 95833

FOR: ASSOCIATION SERVICES, NAMELY, PROMOTING THE INTERESTS OF DEHYDRATED ONION AND GARLIC MANUFACTURERS, IN CLASS 35 (U.S. CLS. 100, 101 AND 102).

FIRST USE 12-1-1997; IN COMMERCE 12-1-1997.

OWNER OF U.S. REG. NOS. 2,294,591 AND 2,294,592.

THE MARK CONSISTS OF THE ABBREVIATION "ADOGA", WHICH STANDS FOR AMERICAN DEHYDRATED ONION AND GARLIC ASSOCIATION. THE LETTER "O" IN "ADOGA" IS A STYLIZED REPRESENTATION OF A GARLIC CLOVE SUPERIMPOSED OVER AN ONION.

SER. NO. 85-364,079, FILED 7-6-2011.

FRANK LATTUCA, EXAMINING ATTORNEY



David J. Kyffers

Director of the United States Patent and Trademark Office

United States of America

United States Patent and Trademark Office

BUOY

Reg. No. 4,099,028

Registered Feb. 14, 2012

Int. Cl.: 34

TRADEMARK

PRINCIPAL REGISTER

ROUSECO, INC. (NORTH CAROLINA CORPORATION)
PO BOX 2495
KINGSTON, NC 28502

FOR: TOBACCO, IN CLASS 34 (U.S. CLS. 2, 8, 9 AND 17).

FIRST USE 4-18-2011; IN COMMERCE 4-18-2011.

THE MARK CONSISTS OF STANDARD CHARACTERS WITHOUT CLAIM TO ANY PARTICULAR FONT, STYLE, SIZE, OR COLOR.

SER. NO. 85-364,090, FILED 7-6-2011.

YAT SYE, LEE, EXAMINING ATTORNEY



David J. Kyffers

Director of the United States Patent and Trademark Office

United States of America

United States Patent and Trademark Office



Reg. No. 4,099,029

Registered Feb. 14, 2012

Int. Cl.: 44

SERVICE MARK

PRINCIPAL REGISTER

SIMON, ARMITY (UNITED STATES INDIVIDUAL)
9070 EAST DESERT COVE, SUITE 102
SCOTTSDALE, AZ 85260

FOR: OBSTETRIC AND GYNECOLOGY SERVICES, IN CLASS 44 (U.S. CLS. 100 AND 101).

FIRST USE 3-0-1999; IN COMMERCE 3-0-1999.

THE MARK CONSISTS OF A GRADIENT MAGENTA DROPLET, A GRADIENT COPPER DROPLET, FIVE MAGENTA SPOTS.

THE COLOR(S) MAGENTA AND COPPER, BOTH IN GRADIENT FORM IS/ARE CLAIMED AS A FEATURE OF THE MARK.

SER. NO. 85-364,181, FILED 7-6-2011.

ESTHER A. BORSUK, EXAMINING ATTORNEY



David J. Kyffers

Director of the United States Patent and Trademark Office

United States of America

United States Patent and Trademark Office

Solus

Reg. No. 4,099,030

CUI GLOBAL, INC. (COLORADO CORPORATION)

Registered Feb. 14, 2012

546 19 AVENUE NE
ST. PETERSBURG, FL 33704

Int. Cl.: 9

FOR: TOPOLOGY FOR POWER ELECTRONIC PRODUCTS, NAMELY: INTERMEDIATE BUS DC-DC CONVERTERS, POL (POINT OF LOAD) DC-DC CONVERTERS, EMBEDDED AC-DC POWER SUPPLIES, EMBEDDED DC-DC CONVERTERS, IN CLASS 9 (U.S. CLS. 21, 23, 26, 36 AND 38).

TRADEMARK

PRINCIPAL REGISTER

FIRST USE 3-7-2011; IN COMMERCE 7-1-2011.

THE MARK CONSISTS OF STANDARD CHARACTERS WITHOUT CLAIM TO ANY PARTICULAR FONT, STYLE, SIZE, OR COLOR.

SER. NO. 85-364,210, FILED 7-6-2011.

WILLIAM P. SHANAHAN, EXAMINING ATTORNEY



David J. Kyffers

Director of the United States Patent and Trademark Office

United States of America

United States Patent and Trademark Office

Triple Step Toward The Cure

Reg. No. 4,099,031

TRIPLE STEP TOWARD THE CURE (CALIFORNIA CORPORATION)

Registered Feb. 14, 2012

P.O. BOX 638
MILL VALLEY, CA 94942

Int. Cl.: 36

FOR: CHARITABLE FUNDRAISING SERVICES BY MEANS OF RUNNING AND WALKING EVENTS; CHARITABLE FUNDRAISING SERVICES FOR PROMOTING RESEARCH, EDUCATION AND OTHER ACTIVITIES RELATING TO TRIPLE NEGATIVE BREAST CANCER, IN CLASS 36 (U.S. CLS. 100, 101 AND 102).

SERVICE MARK

PRINCIPAL REGISTER

FIRST USE 3-29-2011; IN COMMERCE 3-29-2011.

THE MARK CONSISTS OF STANDARD CHARACTERS WITHOUT CLAIM TO ANY PARTICULAR FONT, STYLE, SIZE, OR COLOR.

SER. NO. 85-364,284, FILED 7-6-2011.

JENNIFER VASQUEZ, EXAMINING ATTORNEY



David J. Kyffers

Director of the United States Patent and Trademark Office

United States of America

United States Patent and Trademark Office

DEER BRAND

Reg. No. 4,099,032

AUGUST SCHELL BREWING COMPANY (MINNESOTA CORPORATION)
1860 SCHELL ROAD
NEW ULM, MN 56073

Registered Feb. 14, 2012

Int. Cl.: 32

FOR: BEER, IN CLASS 32 (U.S. CLS. 45, 46 AND 48).

TRADEMARK

FIRST USE 0-0-1860; IN COMMERCE 0-0-1860.

PRINCIPAL REGISTER

THE MARK CONSISTS OF STANDARD CHARACTERS WITHOUT CLAIM TO ANY PARTICULAR FONT, STYLE, SIZE, OR COLOR.

NO CLAIM IS MADE TO THE EXCLUSIVE RIGHT TO USE "BRAND", APART FROM THE MARK AS SHOWN.

SER. NO. 85-364,304, FILED 7-6-2011.

WON TEAK OH, EXAMINING ATTORNEY



David J. Kyffers

Director of the United States Patent and Trademark Office

United States of America

United States Patent and Trademark Office

FIZZIOLOGY

Reg. No. 4,099,033

Registered Feb. 14, 2012

Int. Cl.: 35

SERVICE MARK

PRINCIPAL REGISTER

FIZZIOLOGY LLC (INDIANA LIMITED LIABILITY COMPANY)
342 E. ST. JOSEPH STREET
INDIANAPOLIS, IN 46202

FOR: MARKET ANALYSIS AND RESEARCH SERVICES; MARKET RESEARCH CONSULTING SERVICES; SOCIAL MEDIA STRATEGY AND MARKETING CONSULTANCY , IN CLASS 35 (U.S. CLS. 100, 101 AND 102).

FIRST USE 10-7-2009; IN COMMERCE 10-7-2009.

THE MARK CONSISTS OF STANDARD CHARACTERS WITHOUT CLAIM TO ANY PARTICULAR FONT, STYLE, SIZE, OR COLOR.

SER. NO. 85-364,329, FILED 7-6-2011.

WILLIAM VERHOSEK, EXAMINING ATTORNEY



David J. Kyffers

Director of the United States Patent and Trademark Office

United States of America

United States Patent and Trademark Office

FIZZIOLOGY

Reg. No. 4,099,034

Registered Feb. 14, 2012

Int. Cl.: 42

SERVICE MARK

PRINCIPAL REGISTER

FIZZIOLOGY LLC (INDIANA LIMITED LIABILITY COMPANY)
342 E. ST. JOSEPH STREET
INDIANAPOLIS, IN 46202

FOR: DATA AUTOMATION AND COLLECTION SERVICE USING PROPRIETARY SOFTWARE TO EVALUATE, ANALYZE AND COLLECT DATA, IN CLASS 42 (U.S. CLS. 100 AND 101).

FIRST USE 10-7-2009; IN COMMERCE 10-7-2009.

THE MARK CONSISTS OF STANDARD CHARACTERS WITHOUT CLAIM TO ANY PARTICULAR FONT, STYLE, SIZE, OR COLOR.

SER. NO. 85-364,338, FILED 7-6-2011.

WILLIAM VERHOSEK, EXAMINING ATTORNEY



David J. Kyffers

Director of the United States Patent and Trademark Office

United States of America

United States Patent and Trademark Office



Portarod

Reg. No. 4,099,035

Registered Feb. 14, 2012

Int. Cl.: 28

TRADEMARK

PRINCIPAL REGISTER

SEEK OUTDOORS LLC (FLORIDA LIMITED LIABILITY COMPANY)
111
101 CENTURY 21 DRIVE
JACKSONVILLE, FL 32216

FOR: FISHING ROD HOLDERS; FISHING ROD RACKS, IN CLASS 28 (U.S. CLS. 22, 23, 38 AND 50).

FIRST USE 3-12-2010; IN COMMERCE 3-12-2010.

THE MARK CONSISTS OF THE STYLIZED TEXT "PORTAROD" WITH THE LETTER "P" REPRESENTING A FISHING ROD WITH A FISH AT THE END.

SER. NO. 85-364,343, FILED 7-6-2011.

WILLIAM VERHOSEK, EXAMINING ATTORNEY



David J. Kyffers

Director of the United States Patent and Trademark Office

United States of America
United States Patent and Trademark Office

FARMALL

Reg. No. 4,099,036

CNH AMERICA LLC (DELAWARE LIMITED LIABILITY COMPANY)
700 STATE STREET
RACINE, WI 53404

Registered Feb. 14, 2012

Int. Cl.: 12

FOR: AGRICULTURAL TRACTORS AND STRUCTURAL PARTS THEREOF, IN CLASS 12
(U.S. CLS. 19, 21, 23, 31, 35 AND 44).

TRADEMARK

FIRST USE 12-0-2003; IN COMMERCE 12-0-2003.

PRINCIPAL REGISTER

THE MARK CONSISTS OF STANDARD CHARACTERS WITHOUT CLAIM TO ANY PARTICULAR FONT, STYLE, SIZE, OR COLOR.

OWNER OF U.S. REG. NOS. 608,666, 3,103,319, AND 3,111,111.

SER. NO. 85-364,368, FILED 7-6-2011.

CARYN GLASSER, EXAMINING ATTORNEY



David J. Kyffers

Director of the United States Patent and Trademark Office

United States of America

United States Patent and Trademark Office



Reg. No. 4,099,037

Registered Feb. 14, 2012

Int. Cl.: 37

SERVICE MARK

PRINCIPAL REGISTER

ZEIER, ANTHONY (UNITED STATES INDIVIDUAL)
500 DENVER STREET
WICHITA FALLS, TX 76301

FOR: SWIMMING POOL CLEANING SERVICES; SWIMMING POOL MAINTENANCE; INSTALLATION OF VARIOUS SWIMMING POOL COMPONENTS, IN CLASS 37 (U.S. CLS. 100, 103 AND 106).

FIRST USE 1-1-2007; IN COMMERCE 1-1-2007.

THE MARK CONSISTS OF A WATER DROP WITH RIPPLES.

SER. NO. 85-364,374, FILED 7-6-2011.

SHANNON TWOHIG, EXAMINING ATTORNEY



David J. Kyffers

Director of the United States Patent and Trademark Office

United States of America

United States Patent and Trademark Office

Decantery

Reg. No. 4,099,038

MOVING OFF CAMPUS (MISSOURI LIMITED LIABILITY COMPANY)

Registered Feb. 14, 2012

5257 SHAW BLVD
ST. LOUIS, MO 63110

Int. Cl.: 35

FOR: ADVERTISING AND MARKETING SERVICES PROVIDED BY MEANS OF INDIRECT METHODS OF MARKETING COMMUNICATIONS, NAMELY, SOCIAL MEDIA, SEARCH ENGINE MARKETING, INQUIRY MARKETING, INTERNET MARKETING, MOBILE MARKETING, BLOGGING AND OTHER FORMS OF PASSIVE, SHARABLE OR VIRAL COMMUNICATIONS CHANNELS; CONSULTING SERVICES IN THE FIELD OF INTERNET MARKETING; INTERNET ADVERTISING SERVICES; SOCIAL MEDIA STRATEGY AND MARKETING CONSULTANCY FOCUSING ON HELPING CLIENTS CREATE AND EXTEND THEIR PRODUCT AND BRAND STRATEGIES BY BUILDING VIRALLY ENGAGING MARKETING SOLUTIONS, IN CLASS 35 (U.S. CLS. 100, 101 AND 102).

SERVICE MARK

PRINCIPAL REGISTER

FIRST USE 6-1-2011; IN COMMERCE 6-20-2011.

THE MARK CONSISTS OF STANDARD CHARACTERS WITHOUT CLAIM TO ANY PARTICULAR FONT, STYLE, SIZE, OR COLOR.

SER. NO. 85-364,395, FILED 7-6-2011.

BARBARA GAYNOR, EXAMINING ATTORNEY



David J. Kybas

Director of the United States Patent and Trademark Office

United States of America

United States Patent and Trademark Office

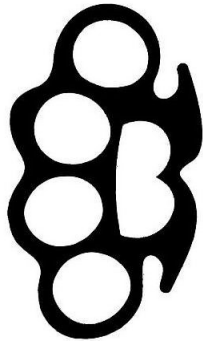

Reg. No. 4,099,039

BACKLASH BEER CO (DELAWARE LIMITED LIABILITY COMPANY)
12 ELKO ST #5
BRIGHTON, MA 02135

Registered Feb. 14, 2012

Int. Cl.: 32

FOR: BREWED MALT-BASED ALCOHOLIC BEVERAGE IN THE NATURE OF A BEER, IN CLASS 32 (U.S. CLS. 45, 46 AND 48).

TRADEMARK

FIRST USE 3-1-2009; IN COMMERCE 7-1-2011.

PRINCIPAL REGISTER

THE MARK CONSISTS OF AN IMAGE OF BRASS KNUCKLES WITH AN INLAID "B". SPECIFICALLY, 4 HOLES IN A CURVED VERTICAL ORIENTATION WITH THE IMAGE OF A LETTER "B" TO THE RIGHT OF SAID HOLES.

SER. NO. 85-364,413, FILED 7-6-2011.

MATTHEW PAPPAS, EXAMINING ATTORNEY



David J. Kyffers

Director of the United States Patent and Trademark Office

United States of America

United States Patent and Trademark Office

EDUCATION THAT WORKS

Reg. No. 4,099,040

Registered Feb. 14, 2012

Int. Cl.: 41

SERVICE MARK

PRINCIPAL REGISTER

THE BOARD OF TRUSTEES OF COMMUNITY COLLEGE DISTRICT NO. 508 COUNTY OF COOK (ILLINOIS BODY POLITIC AND CORPORATE)
226 W. JACKSON BLVD. 14TH FLOOR
CHICAGO, IL 60606

FOR: EDUCATIONAL SERVICES, NAMELY, PROVIDING COURSES OF INSTRUCTION AT THE COLLEGE LEVEL, IN CLASS 41 (U.S. CLS. 100, 101 AND 107).

FIRST USE 5-11-2011; IN COMMERCE 5-11-2011.

THE MARK CONSISTS OF STANDARD CHARACTERS WITHOUT CLAIM TO ANY PARTICULAR FONT, STYLE, SIZE, OR COLOR.

NO CLAIM IS MADE TO THE EXCLUSIVE RIGHT TO USE "EDUCATION", APART FROM THE MARK AS SHOWN.

SER. NO. 85-364,414, FILED 7-6-2011.

INGA ERVIN, EXAMINING ATTORNEY



David J. Kyffers

Director of the United States Patent and Trademark Office

United States of America

United States Patent and Trademark Office

Holiday

Reg. No. 4,099,041

R. W. GARCIA CO., INC. (CALIFORNIA CORPORATION)
521 PARROTT ST
SAN JOSE, CA 95112

Registered Feb. 14, 2012

Int. Cl.: 30

FOR: SNACK FOODS, NAMELY, ORGANIC TORTILLA CHIPS, IN CLASS 30 (U.S. CL. 46).

TRADEMARK

FIRST USE 10-15-2009; IN COMMERCE 11-2-2009.

PRINCIPAL REGISTER

THE MARK CONSISTS OF THE WORD "HOLIDAY" IN UPPER AND LOWER CASE WITH THE LETTERS "H", "L", "D" AND "Y" IN THE COLOR RED AND THE LETTERS "O", "I" AND "A" IN THE COLOR GREEN WITH A GREEN STAR OVER THE "I".

THE COLOR(S) RED AND GREEN IS/ARE CLAIMED AS A FEATURE OF THE MARK.

SER. NO. 85-364,428, FILED 7-6-2011.

DANIEL CAPSHAW, EXAMINING ATTORNEY



David J. Kyffers

Director of the United States Patent and Trademark Office

United States of America

United States Patent and Trademark Office

Liberty

Reg. No. 4,099,042

R.W. GARCIA CO., INC. (CALIFORNIA CORPORATION)
521 PARROTT ST.
SAN JOSE, CA 95112

Registered Feb. 14, 2012

Int. Cl.: 30

FOR: SNACK FOODS, NAMELY, ORGANIC TORTILLA CHIPS, IN CLASS 30 (U.S. CL. 46).

FIRST USE 5-1-2010; IN COMMERCE 6-4-2010.

TRADEMARK

THE MARK CONSISTS OF THE WORD "LIBERTY" IN UPPER AND LOWER CASE WITH THE LETTERS "L", "B", "R" AND "Y" IN THE COLOR BLUE AND THE LETTERS "I", "E" AND "T" IN THE COLOR RED WITH A RED STAR OVER THE LETTER "I".

PRINCIPAL REGISTER

THE COLOR(S) BLUE AND RED IS/ARE CLAIMED AS A FEATURE OF THE MARK.

SER. NO. 85-364,440, FILED 7-6-2011.

DANIEL CAPSHAW, EXAMINING ATTORNEY



David J. Kyffers

Director of the United States Patent and Trademark Office

United States of America

United States Patent and Trademark Office

FARMALL

Reg. No. 4,099,043

CNH AMERICA LLC (DELAWARE LIMITED LIABILITY COMPANY)
700 STATE STREET
RACINE, WI 53404

Registered Feb. 14, 2012

Int. Cl.: 28

FOR: TOY WAGONS, TOY HARROWS, TOY PLOWS, TOY TRACTORS AND TOY TRUCKS,
IN CLASS 28 (U.S. CLS. 22, 23, 38 AND 50).

TRADEMARK

FIRST USE 8-5-1987; IN COMMERCE 8-5-1987.

PRINCIPAL REGISTER

THE MARK CONSISTS OF STANDARD CHARACTERS WITHOUT CLAIM TO ANY PARTICULAR FONT, STYLE, SIZE, OR COLOR.

OWNER OF U.S. REG. NOS. 608,666, 3,103,319, AND 3,111,111.

SER. NO. 85-364,441, FILED 7-6-2011.

CARYN GLASSER, EXAMINING ATTORNEY



David J. Kybas

Director of the United States Patent and Trademark Office

United States of America

United States Patent and Trademark Office

BETRUE

Reg. No. 4,099,044

HARRISON, SUSAN L. (UNITED STATES INDIVIDUAL)
11002 TOPEKA AVENUE
LUBBOCK, TX 79424

Registered Feb. 14, 2012

Int. Cl.: 26

FOR: WIGS, IN CLASS 26 (U.S. CLS. 37, 39, 40, 42 AND 50).

TRADEMARK

FIRST USE 11-24-2010; IN COMMERCE 11-24-2010.

PRINCIPAL REGISTER

THE MARK CONSISTS OF STANDARD CHARACTERS WITHOUT CLAIM TO ANY PARTICULAR FONT, STYLE, SIZE, OR COLOR.

SER. NO. 85-364,442, FILED 7-6-2011.

BARNEY CHARLON, EXAMINING ATTORNEY



David J. Kyffers

Director of the United States Patent and Trademark Office

United States of America

United States Patent and Trademark Office

SOUND CHOICE

Reg. No. 4,099,045

SLEP-TONE ENTERTAINMENT CORPORATION (NORTH CAROLINA CORPORATION)
14100 SOUTH LAKES DR
CHARLOTTE, NC 28273

Registered Feb. 14, 2012

Int. Cl.: 41

FOR: CONDUCTING ENTERTAINMENT EXHIBITIONS IN THE NATURE OF KARAOKE SHOWS, IN CLASS 41 (U.S. CLS. 100, 101 AND 107).

SERVICE MARK

FIRST USE 7-1-1987; IN COMMERCE 7-21-2010.

PRINCIPAL REGISTER

THE MARK CONSISTS OF STANDARD CHARACTERS WITHOUT CLAIM TO ANY PARTICULAR FONT, STYLE, SIZE, OR COLOR.

OWNER OF U.S. REG. NOS. 1,923,448, 2,000,725, AND 2,026,912.

SER. NO. 85-364,445, FILED 7-6-2011.

DANIEL CAPSHAW, EXAMINING ATTORNEY



David J. Kyffers

Director of the United States Patent and Trademark Office

United States of America

United States Patent and Trademark Office

BELOVED

Reg. No. 4,099,046

HARRISON, SUSAN L. (UNITED STATES INDIVIDUAL)
11002 TOPEKA AVENUE
LUBBOCK, TX 79424

Registered Feb. 14, 2012

Int. Cl.: 26

FOR: WIGS, IN CLASS 26 (U.S. CLS. 37, 39, 40, 42 AND 50).

TRADEMARK

FIRST USE 11-24-2010; IN COMMERCE 11-24-2010.

PRINCIPAL REGISTER

THE MARK CONSISTS OF STANDARD CHARACTERS WITHOUT CLAIM TO ANY PARTICULAR FONT, STYLE, SIZE, OR COLOR.

SER. NO. 85-364,449, FILED 7-6-2011.

BARNEY CHARLON, EXAMINING ATTORNEY



David J. Kybas

Director of the United States Patent and Trademark Office

United States of America

United States Patent and Trademark Office



Reg. No. 4,099,047

Registered Feb. 14, 2012

Int. Cl.: 44

SERVICE MARK

PRINCIPAL REGISTER

SYRACUSE BRICK HOUSE, INC. (NEW YORK CORPORATION), DBA SYRACUSE
BEHAVIORAL HEALTHCARE
770 JAMES STREET
SYRACUSE, NY 13203

FOR: CHEMICAL DEPENDENCY AND SUBSTANCE ABUSE TREATMENT SERVICES;
REHABILITATION OF ALCOHOL ADDICTED PATIENTS; REHABILITATION OF DRUG
ADDICTED PATIENTS; REHABILITATION PATIENT CARE SERVICES, IN CLASS 44 (U.S.
CLS. 100 AND 101).

FIRST USE 4-10-2009; IN COMMERCE 4-10-2009.

THE MARK CONSISTS OF THE LETTERS "S B H" WITH AN ARC ABOVE AND A HORIZONTAL LINE BENEATH.

SER. NO. 85-364,467, FILED 7-6-2011.

TEJBIR SINGH, EXAMINING ATTORNEY



David J. Kyffers

Director of the United States Patent and Trademark Office

United States of America

United States Patent and Trademark Office

INSPIRATIONS

Reg. No. 4,099,048

CONVATEC INC. (DELAWARE CORPORATION)
200 HEADQUARTERS PARK DRIVE
SKILLMAN, NJ 08558

Registered Feb. 14, 2012

Int. Cl.: 41

FOR: PROVIDING NEWSLETTERS IN THE FIELD OF OSTOMY VIA E-MAIL, IN CLASS 41 (U.S. CLS. 100, 101 AND 107).

SERVICE MARK

FIRST USE 3-31-2010; IN COMMERCE 3-31-2010.

PRINCIPAL REGISTER

THE MARK CONSISTS OF STANDARD CHARACTERS WITHOUT CLAIM TO ANY PARTICULAR FONT, STYLE, SIZE, OR COLOR.

SER. NO. 85-364,468, FILED 7-6-2011.

TRACY WHITTAKER-BROWN, EXAMINING ATTORNEY



David J. Kybas

Director of the United States Patent and Trademark Office

United States of America

United States Patent and Trademark Office

Citrusbyte

Reg. No. 4,099,049

CITRUSBYTE, LLC (CALIFORNIA LIMITED LIABILITY COMPANY)
16467 OTSEGO STREET
ENCINO, CA 91436

Registered Feb. 14, 2012

Int. Cl.: 42

FOR: COMPUTER SOFTWARE DESIGN, COMPUTER PROGRAMMING, OR MAINTENANCE OF COMPUTER SOFTWARE; COMPUTER SOFTWARE DEVELOPMENT, COMPUTER PROGRAMMING AND MAINTENANCE OF COMPUTER SOFTWARE FOR DIGITAL DEVICES, IN CLASS 42 (U.S. CLS. 100 AND 101).

SERVICE MARK

PRINCIPAL REGISTER

FIRST USE 8-19-2007; IN COMMERCE 8-20-2007.

THE MARK CONSISTS OF STANDARD CHARACTERS WITHOUT CLAIM TO ANY PARTICULAR FONT, STYLE, SIZE, OR COLOR.

SER. NO. 85-364,492, FILED 7-6-2011.

STEVEN PEREZ, EXAMINING ATTORNEY



David J. Kyffers

Director of the United States Patent and Trademark Office

United States of America

United States Patent and Trademark Office

MITZU

Reg. No. 4,099,050

Registered Feb. 14, 2012

Int. Cl.: 9

TRADEMARK

PRINCIPAL REGISTER

GROUP COMRAP CORP. DE C.V. (MEXICO CORPORATION)
PELICANO NO. 79, COL. GRANJAS MODERNAS
DISTRITO FEDERAL, MEXICO C.P.07460

FOR: TWEETERS; SPEAKERS; PROFESSIONAL AUDIO SPEAKERS; MULTIMEDIA SPEAKERS; MID-RANGE STEREO SPEAKERS; WOOFER STEREO SPEAKERS; MICROPHONES; MICROPHONES FOR CB RADIOS; WIRELESS MICROPHONES; CD PLAYERS; AMPLIFIERS, CAR AMPLIFIERS, GUITAR AMPLIFIERS, AND PUBLIC ADDRESS SPEAKER AMPLIFIERS; ANTENNAS, CAR ANTENNAS, AND ANTENNAS FOR UHF/VHF SIGNALS USED IN TELEVISIONS, DIGITAL TELEVISIONS, FM RADIO, PERSONAL STEREOS, CAR STEREOS, HEADPHONES, AND WIRELESS HEADPHONES; COMPUTER ACCESSORIES, NAMELY, COMPUTER MOUSE, COMPUTER KEYBOARDS, COMPUTER MONITORS; ANTI-INTRUSION ALARMS AND BURGLAR ALARMS FOR WINDOWS AND DOORS; VEHICLE BREAKDOWN WARNING LAMPS; CALL BELLS, SIGNAL BELLS, ELECTRONIC WARNING BELLS; MULTIMETERS; ELECTRIC POWERED SOLDERING IRONS; MULTIMEDIA PROJECTORS, MOVIE PROJECTORS, LCD PROJECTORS USED TO DISPLAY ADVERTISEMENTS, CINEMATOGRAPHIC PROJECTORS, AND PICTURE PROJECTORS, IN CLASS 9 (U.S. CLS. 21, 23, 26, 36 AND 38).

FIRST USE 8-3-1992; IN COMMERCE 10-18-2003.

THE MARK CONSISTS OF STANDARD CHARACTERS WITHOUT CLAIM TO ANY PARTICULAR FONT, STYLE, SIZE, OR COLOR.

OWNER OF U.S. REG. NO. 3,962,035.

SER. NO. 85-364,535, FILED 7-6-2011.

KATHERINE CHANG, EXAMINING ATTORNEY



David J. Kypos

Director of the United States Patent and Trademark Office

United States of America

United States Patent and Trademark Office

Business First. Online Second.

Reg. No. 4,099,051

DARIN LYNCH (UNITED STATES INDIVIDUAL)
8243 VINCENT AVENUE SOUTH
BLOOMINGTON, MN 55437

Registered Feb. 14, 2012

Int. Cls.: 35 and 42

FOR: ADVERTISING AND MARKETING SERVICES PROVIDED BY MEANS OF INDIRECT METHODS OF MARKETING COMMUNICATIONS, NAMELY, SOCIAL MEDIA, SEARCH ENGINE MARKETING, INQUIRY MARKETING, INTERNET MARKETING, MOBILE MARKETING, BLOGGING AND OTHER FORMS OF PASSIVE, SHARABLE OR VIRAL COMMUNICATIONS CHANNELS; BRANDING SERVICES, NAMELY, CONSULTING, DEVELOPMENT, MANAGEMENT AND MARKETING OF BRANDS FOR BUSINESSES; COMMERCIAL ASSISTANCE RELATING TO SYSTEM IMPLEMENTATION AND SYSTEM INTEGRATION; PLANNING, DESIGN, DEVELOPMENT, MAINTENANCE, TRACKING AND REPORTING OF ONLINE MARKETING ACTIVITIES FOR THIRD PARTIES; PROMOTING, ADVERTISING AND MARKETING OF THE BRANDS, PRODUCTS, SERVICES AND ONLINE WEBSITES OF INDIVIDUALS, BUSINESSES AND NONPROFIT ORGANIZATIONS, IN CLASS 35 (U.S. CLS. 100, 101 AND 102).

SERVICE MARK

FIRST USE 4-5-2004; IN COMMERCE 4-5-2004.

PRINCIPAL REGISTER

FOR: COMPUTER SERVICES, NAMELY, SEARCH ENGINE OPTIMIZATION; PLANNING, DESIGN, DEVELOPMENT, MAINTENANCE AND OPTIMIZATION OF ONLINE WEBSITES FOR THIRD PARTIES, IN CLASS 42 (U.S. CLS. 100 AND 101).

FIRST USE 4-5-2004; IN COMMERCE 4-5-2004.



THE MARK CONSISTS OF STANDARD CHARACTERS WITHOUT CLAIM TO ANY PARTICULAR FONT, STYLE, SIZE, OR COLOR.

SER. NO. 85-364,549, FILED 7-6-2011.

JOHN DALIER, EXAMINING ATTORNEY

David J. Kybas

Director of the United States Patent and Trademark Office

United States of America

United States Patent and Trademark Office



Reg. No. 4,099,052

SLEP-TONE ENTERTAINMENT CORPORATION (NORTH CAROLINA CORPORATION)
14100 SOUTH LAKES DR
CHARLOTTE, NC 28273

Registered Feb. 14, 2012

Int. Cl.: 41

FOR: CONDUCTING ENTERTAINMENT EXHIBITIONS IN THE NATURE OF KARAOKE SHOWS, IN CLASS 41 (U.S. CLS. 100, 101 AND 107).

SERVICE MARK

FIRST USE 7-1-1987; IN COMMERCE 7-21-2010.

PRINCIPAL REGISTER

THE MARK CONSISTS OF THE WORDS "SOUND CHOICE" STYLIZED AND SUPERIMPOSED OVER A REPRESENTATION OF A MUSICAL STAFF.

SER. NO. 85-364,555, FILED 7-6-2011.

DANIEL CAPSHAW, EXAMINING ATTORNEY



David J. Kyros

Director of the United States Patent and Trademark Office

United States of America

United States Patent and Trademark Office

TOO FACED MATTE EYE

Reg. No. 4,099,053

TOO FACED COSMETICS, INC. (CALIFORNIA CORPORATION)
17361 ARMSTRONG AVENUE
IRVINE, CA 92614

Registered Feb. 14, 2012

Int. Cl.: 3

FOR: COSMETICS, IN CLASS 3 (U.S. CLS. 1, 4, 6, 50, 51 AND 52).

TRADEMARK

FIRST USE 6-1-2011; IN COMMERCE 6-1-2011.

PRINCIPAL REGISTER

THE MARK CONSISTS OF STANDARD CHARACTERS WITHOUT CLAIM TO ANY PARTICULAR FONT, STYLE, SIZE, OR COLOR.

OWNER OF U.S. REG. NOS. 2,265,543, 3,949,346, AND 4,018,301.

NO CLAIM IS MADE TO THE EXCLUSIVE RIGHT TO USE "MATTE EYE", APART FROM THE MARK AS SHOWN.

SER. NO. 85-364,587, FILED 7-6-2011.

TOBY BULLOFF, EXAMINING ATTORNEY



David J. Kyffers

Director of the United States Patent and Trademark Office

United States of America

United States Patent and Trademark Office



Reg. No. 4,099,054

ELIZABETH DAVIS (UNITED STATES INDIVIDUAL)
10313 LOS ALAMITOS BLVD.
LOS ALAMITOS, CA 90720

Registered Feb. 14, 2012

Int. Cl.: 16

FOR: DIRECTORIES FOR CHILDREN'S SERVICES, IN CLASS 16 (U.S. CLS. 2, 5, 22, 23, 29, 37, 38 AND 50).

TRADEMARK

FIRST USE 6-7-2011; IN COMMERCE 6-7-2011.

PRINCIPAL REGISTER

OWNER OF U.S. REG. NO. 2,492,519.

THE MARK CONSISTS OF A DESIGN OF A HANDPRINT.

SER. NO. 85-364,604, FILED 7-6-2011.

BRENDAN MCCAULEY, EXAMINING ATTORNEY



David J. Kyffers

Director of the United States Patent and Trademark Office

United States of America

United States Patent and Trademark Office



Reg. No. 4,099,055

KOURINOV, ALEXEI (RUSSIAN FED. INDIVIDUAL)
12220 SHAGBARK DRIVE
PLAINFIELD, IL 60585

Registered Feb. 14, 2012

Int. Cl.: 30

FOR: FROZEN YOGURT, IN CLASS 30 (U.S. CL. 46).

TRADEMARK

FIRST USE 3-1-2011; IN COMMERCE 3-1-2011.

PRINCIPAL REGISTER

THE MARK CONSISTS OF A BERRY MADE OF 7 CIRCLES TO THE LEFT OF THE "F", LATIN LETTERS FOR "FRO", THEN A DASH (CIRCLE), AND THEN A CYRILLIC "?" OR IN LATIN "E" WITH TWO DOTS OVER IT.

SER. NO. 85-364,612, FILED 7-6-2011.

JANICE L. MCMORROW, EXAMINING ATTORNEY



David J. Kybas

Director of the United States Patent and Trademark Office

United States of America

United States Patent and Trademark Office

TOO FACED SMOKEY EYE

Reg. No. 4,099,056

TOO FACED COSMETICS, INC. (CALIFORNIA CORPORATION)
17361 ARMSTRONG AVENUE
IRVINE, CA 92614

Registered Feb. 14, 2012

Int. Cl.: 3

FOR: COSMETICS, IN CLASS 3 (U.S. CLS. 1, 4, 6, 50, 51 AND 52).

TRADEMARK

FIRST USE 6-1-2011; IN COMMERCE 6-1-2011.

PRINCIPAL REGISTER

THE MARK CONSISTS OF STANDARD CHARACTERS WITHOUT CLAIM TO ANY PARTICULAR FONT, STYLE, SIZE, OR COLOR.

OWNER OF U.S. REG. NOS. 2,265,543, 3,949,346, AND 4,018,301.

NO CLAIM IS MADE TO THE EXCLUSIVE RIGHT TO USE "SMOKEY EYE", APART FROM THE MARK AS SHOWN.

SER. NO. 85-364,614, FILED 7-6-2011.

TOBY BULLOFF, EXAMINING ATTORNEY



David J. Kyffers

Director of the United States Patent and Trademark Office

United States of America

United States Patent and Trademark Office

WHENEVER BARS

Reg. No. 4,099,057

Registered Feb. 14, 2012

Int. Cl.: 30

TRADEMARK

PRINCIPAL REGISTER

PAMELA'S PRODUCTS, INC. (CALIFORNIA CORPORATION)
SUITE D
1 CAROUSEL LANE
UKIAH, CA 95482

FOR: COOKIES; GRAIN-BASED FOOD BARS ALSO CONTAINING FRUIT, NUTS AND CHOCOLATE; READY TO EAT, CEREAL DERIVED FOOD BARS, IN CLASS 30 (U.S. CL. 46).

FIRST USE 6-15-2011; IN COMMERCE 6-15-2011.

THE MARK CONSISTS OF STANDARD CHARACTERS WITHOUT CLAIM TO ANY PARTICULAR FONT, STYLE, SIZE, OR COLOR.

NO CLAIM IS MADE TO THE EXCLUSIVE RIGHT TO USE "BARS", APART FROM THE MARK AS SHOWN.

SER. NO. 85-364,620, FILED 7-6-2011.

COURTNEY ALVAREZ, EXAMINING ATTORNEY



David J. Kyffers

Director of the United States Patent and Trademark Office

United States of America

United States Patent and Trademark Office

ScoreTrax

Reg. No. 4,099,058

SCORETRAX LLC (NORTH CAROLINA LIMITED LIABILITY COMPANY)
3704 TREE SIDE COURT
RALEIGH, NC 27607

Registered Feb. 14, 2012

Int. Cl.: 38

FOR: TEXT MESSAGING SERVICES FOR TRANSMISSION OF SCORE UPDATES FOR HIGH SCHOOL, COLLEGE, PRO, AND AMATEUR SPORTS VIA SMS, IN CLASS 38 (U.S. CLS. 100, 101 AND 104).

SERVICE MARK

FIRST USE 12-23-2010; IN COMMERCE 4-15-2011.

PRINCIPAL REGISTER

THE MARK CONSISTS OF STANDARD CHARACTERS WITHOUT CLAIM TO ANY PARTICULAR FONT, STYLE, SIZE, OR COLOR.

SER. NO. 85-364,646, FILED 7-6-2011.

STEVEN PEREZ, EXAMINING ATTORNEY



David J. Kyffers

Director of the United States Patent and Trademark Office

United States of America

United States Patent and Trademark Office

Blis Soff

Reg. No. 4,099,059

MIND BODY SEMINARS (CALIFORNIA LIMITED LIABILITY COMPANY)
4311 PAVLOV AVE
SAN DIEGO, CA 92122

Registered Feb. 14, 2012

Int. Cls.: 16, 25 and 41

FOR: BOOKS IN THE FIELD OF HEALTH, MIND AND BODY; BUMPER STICKERS; PHOTOGRAPHS; POSTERS; STICKERS, IN CLASS 16 (U.S. CLS. 2, 5, 22, 23, 29, 37, 38 AND 50).

TRADEMARK

FIRST USE 12-1-2009; IN COMMERCE 12-1-2009.

SERVICE MARK

FOR: DRESSES; HATS; JACKETS; PANTS; SHIRTS; SHORTS; UNDERGARMENTS; YOGA PANTS; YOGA SHIRTS, IN CLASS 25 (U.S. CLS. 22 AND 39).

PRINCIPAL REGISTER

FIRST USE 12-1-2009; IN COMMERCE 12-1-2009.

FOR: EDUCATION SERVICES, NAMELY, PROVIDING SEMINARS AND WORKSHOPS IN THE FIELD OF HEALTH, MIND AND BODY; LIFE COACHING SERVICES IN THE FIELD OF HEALTH, MIND AND BODY; PHOTOGRAPHY SERVICES; YOGA INSTRUCTION, IN CLASS 41 (U.S. CLS. 100, 101 AND 107).

FIRST USE 12-1-2009; IN COMMERCE 12-1-2009.

THE MARK CONSISTS OF STANDARD CHARACTERS WITHOUT CLAIM TO ANY PARTICULAR FONT, STYLE, SIZE, OR COLOR.

SER. NO. 85-364,647, FILED 7-6-2011.

MIDGE BUTLER, EXAMINING ATTORNEY



David J. Kybas

Director of the United States Patent and Trademark Office

United States of America

United States Patent and Trademark Office



Reg. No. 4,099,060

Registered Feb. 14, 2012

Int. Cl.: 45

SERVICE MARK

PRINCIPAL REGISTER

GO2GUY (PENNSYLVANIA LIMITED LIABILITY COMPANY)
2232 S. BOUVIER ST.
PHILADELPHIA, PA 19145

FOR: PERSONAL CONCIERGE SERVICES FOR OTHERS COMPRISING MAKING REQUESTED PERSONAL ARRANGEMENTS AND RESERVATIONS, RUNNING ERRANDS AND PROVIDING CUSTOMER SPECIFIC INFORMATION TO MEET INDIVIDUAL NEEDS, ALL RENDERED IN BUSINESS ESTABLISHMENTS, OFFICE BUILDINGS, HOTELS, RESIDENTIAL COMPLEXES AND HOMES, IN CLASS 45 (U.S. CLS. 100 AND 101).

FIRST USE 2-15-2010; IN COMMERCE 2-15-2010.

THE MARK CONSISTS OF THE STYLIZED TEXT "GO2GUY" IN WHICH THE CHARACTERS "GO2" HAVE SPEED MARKS EMITTING FROM THEM POINTING TO THE LEFT. ABOVE THE "GUY" IN "GO2GUY" IS THE TOP HALF OF A STYLIZED SILHOUETTE OF A MALE IN A TUXEDO. THE FIGURE HAS HIS HANDS TO HIS BOW TIE AS IF STRAIGHTENING IT.

SER. NO. 85-364,656, FILED 7-6-2011.

MIDGE BUTLER, EXAMINING ATTORNEY



David J. Kybas

Director of the United States Patent and Trademark Office

United States of America

United States Patent and Trademark Office

The logo for Axilase features the word "Axilase" in a bold, sans-serif font. The letter "I" is replaced by a stylized asterisk or starburst symbol. A thin horizontal line runs through the middle of the letters "X", "I", and "L".

Reg. No. 4,099,061

REFLECTIONS OF LIVINGSTON, LLC (NEW JERSEY LIMITED LIABILITY COMPANY)
299 EAST NORTHFIELD ROAD
LIVINGSTON, NJ 07039

Registered Feb. 14, 2012

Int. Cl.: 44

FOR: MEDICAL SERVICES, NAMELY, PROVIDING LASER THERAPY TO REDUCE EXCESSIVE UNDERARM SWEATING, IN CLASS 44 (U.S. CLS. 100 AND 101).

SERVICE MARK

FIRST USE 3-11-2011; IN COMMERCE 3-11-2011.

PRINCIPAL REGISTER

THE STIPLING IS FOR SHADING PURPOSES ONLY.

THE MARK CONSISTS OF THE WORD "AXILASE" WITH THE DOT OVER THE LETTER "I" CONSISTING OF AN ASTERISK. A NARROW BAND BEGINS AT THE BASE OF THE "X" AND CONTINUES TO THE CENTER OF THE "E".

SER. NO. 85-364,657, FILED 7-6-2011.

KATHRYN COWARD, EXAMINING ATTORNEY



David J. Kybas

Director of the United States Patent and Trademark Office

United States of America

United States Patent and Trademark Office

eOD

Reg. No. 4,099,062

Registered Feb. 14, 2012

Int. Cl.: 36

SERVICE MARK

PRINCIPAL REGISTER

SIPREE, INC. (DELAWARE CORPORATION)
SUITE 150
665 THIRD STREET
SAN FRANCISCO, CA 94107

FOR: FINANCIAL TRANSACTION SERVICES, NAMELY, PROVIDING SECURE COMMERCIAL TRANSACTIONS AND PAYMENT OPTIONS; PROVIDING ELECTRONIC PROCESSING OF ELECTRONIC FUNDS TRANSFER, ACH, CREDIT CARD, DEBIT CARD, ELECTRONIC CHECK AND ELECTRONIC PAYMENTS, IN CLASS 36 (U.S. CLS. 100, 101 AND 102).

FIRST USE 7-1-2010; IN COMMERCE 1-1-2011.

THE MARK CONSISTS OF STANDARD CHARACTERS WITHOUT CLAIM TO ANY PARTICULAR FONT, STYLE, SIZE, OR COLOR.

SER. NO. 85-364,690, FILED 7-6-2011.

THOMAS MANOR, EXAMINING ATTORNEY



David J. Kybas

Director of the United States Patent and Trademark Office

United States of America

United States Patent and Trademark Office

Ariana's

Reg. No. 4,099,063

DIMATTINA, FRANK (UNITED STATES INDIVIDUAL)
4864 ARTHUR KILL ROAD
STATEN ISLAND, NY 10309

Registered Feb. 14, 2012

Int. Cl.: 43

FOR: CATERING SERVICES; RESTAURANT AND CATERING SERVICES, IN CLASS 43
(U.S. CLS. 100 AND 101).

SERVICE MARK

FIRST USE 12-1-1999; IN COMMERCE 12-1-1999.

PRINCIPAL REGISTER

THE MARK CONSISTS OF STANDARD CHARACTERS WITHOUT CLAIM TO ANY PARTICULAR FONT, STYLE, SIZE, OR COLOR.

SER. NO. 85-364,695, FILED 7-6-2011.

RUSS HERMAN, EXAMINING ATTORNEY



David J. Kybas

Director of the United States Patent and Trademark Office

United States of America

United States Patent and Trademark Office

Rod & Pipers

Reg. No. 4,099,064

Registered Feb. 14, 2012

Int. Cl.: 25

TRADEMARK

PRINCIPAL REGISTER

GARRIDO, JOVANA MOLINA (MEXICO INDIVIDUAL)
MONTEVIDEO
562 COL SAN BARTOLO ATEPEHUACAN
MEXICO DF, MEXICO CP06020

FOR: CAPS; HATS, IN CLASS 25 (U.S. CLS. 22 AND 39).

FIRST USE 12-31-1996; IN COMMERCE 12-31-1997.

THE MARK CONSISTS OF STANDARD CHARACTERS WITHOUT CLAIM TO ANY PARTICULAR FONT, STYLE, SIZE, OR COLOR.

SER. NO. 85-364,713, FILED 7-6-2011.

JAY FLOWERS, EXAMINING ATTORNEY



David J. Kyffers

Director of the United States Patent and Trademark Office

United States of America

United States Patent and Trademark Office

WARRIOR

Reg. No. 4,099,065

CATCO, INC. (CALIFORNIA CORPORATION)
22254 MAYALL STREET
CHATSWORTH, CA 91311

Registered Feb. 14, 2012

Int. Cl.: 28

FOR: PLAYING CARDS, IN CLASS 28 (U.S. CLS. 22, 23, 38 AND 50).

TRADEMARK

FIRST USE 6-6-2011; IN COMMERCE 6-6-2011.

PRINCIPAL REGISTER

THE MARK CONSISTS OF STANDARD CHARACTERS WITHOUT CLAIM TO ANY PARTICULAR FONT, STYLE, SIZE, OR COLOR.

SER. NO. 85-364,722, FILED 7-6-2011.

JAMES LOVELACE, EXAMINING ATTORNEY



David J. Kyffers

Director of the United States Patent and Trademark Office

United States of America

United States Patent and Trademark Office

TRITON

Reg. No. 4,099,066

CATCO, INC. (CALIFORNIA CORPORATION)
22254 MAYALL STREET
CHATSWORTH, CA 91311

Registered Feb. 14, 2012

Int. Cl.: 28

FOR: PLAYING CARDS, IN CLASS 28 (U.S. CLS. 22, 23, 38 AND 50).

TRADEMARK

FIRST USE 6-6-2011; IN COMMERCE 6-6-2011.

PRINCIPAL REGISTER

THE MARK CONSISTS OF STANDARD CHARACTERS WITHOUT CLAIM TO ANY PARTICULAR FONT, STYLE, SIZE, OR COLOR.

SER. NO. 85-364,724, FILED 7-6-2011.

JAMES LOVELACE, EXAMINING ATTORNEY



David J. Kyffers

Director of the United States Patent and Trademark Office

United States of America

United States Patent and Trademark Office

New Power

Reg. No. 4,099,067

Registered Feb. 14, 2012

Int. Cl.: 25

TRADEMARK

PRINCIPAL REGISTER

GARRIDO, JOVANA MOLINA (MEXICO INDIVIDUAL)
MONTEVIDEO
562 COL SAN BARTOLO ATEPEHUACAN
MEXICO DF, MEXICO CP06020

FOR: GLOVES, IN CLASS 25 (U.S. CLS. 22 AND 39).

FIRST USE 12-31-1995; IN COMMERCE 12-31-1996.

THE MARK CONSISTS OF STANDARD CHARACTERS WITHOUT CLAIM TO ANY PARTICULAR FONT, STYLE, SIZE, OR COLOR.

SER. NO. 85-364,739, FILED 7-6-2011.

JAY FLOWERS, EXAMINING ATTORNEY



David J. Kybas

Director of the United States Patent and Trademark Office

United States of America

United States Patent and Trademark Office

SHIPPING HAS A NEW HOME

Reg. No. 4,099,068

NEWGISTICS, INC. (TEXAS CORPORATION)
2700 VIA FORTUNA, SUITE 300
AUSTIN, TX 78746

Registered Feb. 14, 2012

Int. Cl.: 39

FOR: SUPPLY CHAIN LOGISTICS AND REVERSE LOGISTICS SERVICES, NAMELY, STORAGE, TRANSPORTATION AND DELIVERY OF GOODS FOR OTHERS BY AIR, RAIL, SHIP OR TRUCK; SHIPPING AND DELIVERY SERVICES, NAMELY, PICKUP, TRANSPORTATION, AND DELIVERY OF PACKAGES BY VARIOUS MODES OF TRANSPORTATION, IN CLASS 39 (U.S. CLS. 100 AND 105).

SERVICE MARK

PRINCIPAL REGISTER

FIRST USE 5-0-2011; IN COMMERCE 5-0-2011.

THE MARK CONSISTS OF STANDARD CHARACTERS WITHOUT CLAIM TO ANY PARTICULAR FONT, STYLE, SIZE, OR COLOR.

SER. NO. 85-364,742, FILED 7-6-2011.

JAY FLOWERS, EXAMINING ATTORNEY



David J. Kybas

Director of the United States Patent and Trademark Office

United States of America

United States Patent and Trademark Office

Tap into savings

Reg. No. 4,099,069

Registered Feb. 14, 2012

Int. Cl.: 35

SERVICE MARK

PRINCIPAL REGISTER

QONOMICS, INC. (CALIFORNIA CORPORATION)
ATTN: JAMES ELLIOTT
11400 W. OLYMPIC BLVD., SUITE 1700
LOS ANGELES, CA 90064

FOR: PROMOTING THE GOODS AND SERVICES OF OTHERS BY PROVIDING A WEBSITE FEATURING COUPONS, REBATES, PRICE-COMPARISON INFORMATION, PRODUCT REVIEWS, LINKS TO THE RETAIL WEBSITES OF OTHERS, AND DISCOUNT INFORMATION; PROMOTING THE GOODS OF OTHERS, NAMELY, PROVIDING INFORMATION REGARDING DISCOUNTS, COUPONS, REBATES, VOUCHERS AND SPECIAL OFFERS FOR THE GOODS OF OTHERS; PROMOTING THE SALE OF GOODS AND SERVICES OF OTHERS BY OFFERING THEIR COUPONS ONLINE AND VIA MOBILE; PROMOTIONAL SERVICES, NAMELY, PROMOTING THE GOODS OF OTHERS BY MEANS OF PROVIDING ONLINE COUPONS, IN CLASS 35 (U.S. CLS. 100, 101 AND 102).

FIRST USE 11-9-2009; IN COMMERCE 11-9-2009.

THE MARK CONSISTS OF STANDARD CHARACTERS WITHOUT CLAIM TO ANY PARTICULAR FONT, STYLE, SIZE, OR COLOR.

SER. NO. 85-364,767, FILED 7-6-2011.

KATINA MISTER, EXAMINING ATTORNEY



David J. Kyros

Director of the United States Patent and Trademark Office

United States of America

United States Patent and Trademark Office

HOT SAUCE TO HOOT ABOUT

Reg. No. 4,099,070

MONTANA MEX LLC (MONTANA LIMITED LIABILITY COMPANY)
3181 MAGENTA ROAD
BOZEMAN, MT 59718

Registered Feb. 14, 2012

Int. Cl.: 30

FOR: PICANTE SAUCE, IN CLASS 30 (U.S. CL. 46).

TRADEMARK

FIRST USE 6-18-2011; IN COMMERCE 6-18-2011.

PRINCIPAL REGISTER

THE MARK CONSISTS OF STANDARD CHARACTERS WITHOUT CLAIM TO ANY PARTICULAR FONT, STYLE, SIZE, OR COLOR.

SER. NO. 85-364,773, FILED 7-6-2011.

MARTHA FROMM, EXAMINING ATTORNEY



David J. Kybas

Director of the United States Patent and Trademark Office

United States of America

United States Patent and Trademark Office

TEDDY BEAR HAIR

Reg. No. 4,099,071

TOO FACED COSMETICS, INC. (CALIFORNIA CORPORATION)
17361 ARMSTRONG AVENUE
IRVINE, CA 92614

Registered Feb. 14, 2012

Int. Cl.: 21

FOR: COSMETIC BRUSHES, IN CLASS 21 (U.S. CLS. 2, 13, 23, 29, 30, 33, 40 AND 50).

TRADEMARK

FIRST USE 6-0-2003; IN COMMERCE 6-0-2003.

PRINCIPAL REGISTER

THE MARK CONSISTS OF STANDARD CHARACTERS WITHOUT CLAIM TO ANY PARTICULAR FONT, STYLE, SIZE, OR COLOR.

SER. NO. 85-364,787, FILED 7-6-2011.

KATHERINE CHANG, EXAMINING ATTORNEY



David J. Kyffers

Director of the United States Patent and Trademark Office

United States of America

United States Patent and Trademark Office

H&HN

Reg. No. 4,099,072

AMERICAN HOSPITAL ASSOCIATION (ILLINOIS NON-PROFIT CORPORATION)
155 N. WACKER DR., SUITE 400
CHICAGO, IL 60606

Registered Feb. 14, 2012

Int. Cls.: 16 and 41

FOR: PUBLICATIONS, NAMELY, A MAGAZINE DIRECTED TO HEALTH CARE EXECUTIVES CONCERNING MEDICAL, HOSPITAL AND HEALTH CARE ISSUES AND OTHER TOPICS OF CONCERN TO HEALTH CARE EXECUTIVES, IN CLASS 16 (U.S. CLS. 2, 5, 22, 23, 29, 37, 38 AND 50).

TRADEMARK

SERVICE MARK

FIRST USE 6-5-1993; IN COMMERCE 6-5-1993.

PRINCIPAL REGISTER

FOR: PROVIDING AN ONLINE MAGAZINE IN THE FIELD OF HOSPITALS AND HEALTH CARE DIRECTED TO HEALTH CARE EXECUTIVES, IN CLASS 41 (U.S. CLS. 100, 101 AND 107).

FIRST USE 6-5-1993; IN COMMERCE 6-5-1993.

THE MARK CONSISTS OF STANDARD CHARACTERS WITHOUT CLAIM TO ANY PARTICULAR FONT, STYLE, SIZE, OR COLOR.

SER. NO. 85-365,077, FILED 7-7-2011.

ROSELLE HERRERA, EXAMINING ATTORNEY



David J. Kybas

Director of the United States Patent and Trademark Office

United States of America
United States Patent and Trademark Office

POKERIST

Reg. No. 4,099,073

Registered Feb. 14, 2012

Int. Cl.: 41

SERVICE MARK

PRINCIPAL REGISTER

KAMAGAMES LTD (CYPRUS LIMITED LIABILITY COMPANY)
DIMOKRITOU 15, POTAMOS GERMASOGENIAS
PANARETOS ELIANA COMPLEX, OFFICE 104
LIMASSOL, CYPRUS 4041

FOR: ENTERTAINMENT SERVICES, NAMELY, PROVIDING ONLINE COMPUTER AND ELECTRONIC GAMES, ENHANCEMENTS WITHIN ONLINE COMPUTER GAMES, AND GAME APPLICATIONS WITHIN ONLINE COMPUTER GAMES; PROVIDING ONLINE REVIEWS OF COMPUTER GAMES, AND PROVIDING OF INFORMATION RELATING TO COMPUTER GAMES; PROVIDING AN INTERNET WEBSITE PORTAL IN THE FIELD OF COMPUTER GAMES AND GAMING. ENTERTAINMENT SERVICES, NAMELY, PROVIDING VIRTUAL ENVIRONMENTS IN WHICH USERS CAN INTERACT THROUGH SOCIAL GAMES FOR RECREATIONAL, LEISURE OR ENTERTAINMENT PURPOSES, IN CLASS 41 (U.S. CLS. 100, 101 AND 107).

FIRST USE 5-27-2010; IN COMMERCE 5-27-2010.

THE MARK CONSISTS OF STANDARD CHARACTERS WITHOUT CLAIM TO ANY PARTICULAR FONT, STYLE, SIZE, OR COLOR.

SER. NO. 85-365,261, FILED 7-7-2011.

NAAKWAMA ANKRAH, EXAMINING ATTORNEY



David J. Kyros

Director of the United States Patent and Trademark Office

United States of America

United States Patent and Trademark Office

POKERIST.COM

Reg. No. 4,099,074

Registered Feb. 14, 2012

Int. Cl.: 41

SERVICE MARK

PRINCIPAL REGISTER

KAMAGAMES LTD (CYPRUS LIMITED LIABILITY COMPANY)
DIMOKRITOU 15, POTAMOS GERMASOGENIAS
PANARETOS ELIANA COMPLEX, OFFICE 104
LIMASSOL, CYPRUS 4041

FOR: ENTERTAINMENT SERVICES, NAMELY, PROVIDING ONLINE COMPUTER AND ELECTRONIC GAMES, ENHANCEMENTS WITHIN ONLINE COMPUTER GAMES, AND GAME APPLICATIONS WITHIN ONLINE COMPUTER GAMES; PROVIDING ONLINE REVIEWS OF COMPUTER GAMES, AND PROVIDING OF INFORMATION RELATING TO COMPUTER GAMES; PROVIDING AN INTERNET WEBSITE PORTAL IN THE FIELD OF COMPUTER GAMES AND GAMING; ENTERTAINMENT SERVICES, NAMELY, PROVIDING VIRTUAL ENVIRONMENTS IN WHICH USERS CAN INTERACT THROUGH SOCIAL GAMES FOR RECREATIONAL, LEISURE OR ENTERTAINMENT PURPOSES, IN CLASS 41 (U.S. CLS. 100, 101 AND 107).

FIRST USE 5-27-2010; IN COMMERCE 5-27-2010.

THE MARK CONSISTS OF STANDARD CHARACTERS WITHOUT CLAIM TO ANY PARTICULAR FONT, STYLE, SIZE, OR COLOR.

SER. NO. 85-365,280, FILED 7-7-2011.

NAAKWAMA ANKRAH, EXAMINING ATTORNEY



David J. Kyros

Director of the United States Patent and Trademark Office

United States of America

United States Patent and Trademark Office

POKERIST

Reg. No. 4,099,075

Registered Feb. 14, 2012

Int. Cl.: 9

TRADEMARK

PRINCIPAL REGISTER

KAMAGAMES LTD (CYPRUS LIMITED LIABILITY COMPANY)
DIMOKRITOU 15, POTAMOS GERMASOGENIAS
PANARETOS ELIANA COMPLEX, OFFICE 104
LIMASSOL, CYPRUS 4041

FOR: ENTERTAINMENT SOFTWARE, NAMELY, SOFTWARE THAT IS USED FOR PROVIDING MULTI-PLAYER ACCESS TO AN ON-LINE GAME ENVIRONMENT; COMPUTER GAME SOFTWARE; INTERACTIVE COMPUTER GAME PROGRAMS; VIDEO GAME SOFTWARE; DOWNLOADABLE COMPUTER GAME SOFTWARE AND COMPUTER SOFTWARE PLATFORMS FOR SOCIAL NETWORKING; INTERACTIVE VIDEO GAME PROGRAMS; DOWNLOADABLE ELECTRONIC GAME PROGRAMS AND COMPUTER SOFTWARE PLATFORMS FOR SOCIAL NETWORKING THAT MAY BE ACCESSED VIA THE INTERNET, COMPUTERS AND WIRELESS DEVICES; COMPUTER SOFTWARE TO ENABLE UPLOADING, POSTING, SHOWING, DISPLAYING, TAGGING, BLOGGING, SHARING OR OTHERWISE PROVIDING ELECTRONIC MEDIA OR INFORMATION IN THE FIELDS OF VIRTUAL COMMUNITIES, ELECTRONIC GAMING, ENTERTAINMENT, AND GENERAL INTEREST VIA THE INTERNET OR OTHER COMMUNICATIONS NETWORKS WITH THIRD PARTIES, IN CLASS 9 (U.S. CLS. 21, 23, 26, 36 AND 38).

FIRST USE 5-27-2010; IN COMMERCE 5-27-2010.

THE MARK CONSISTS OF STANDARD CHARACTERS WITHOUT CLAIM TO ANY PARTICULAR FONT, STYLE, SIZE, OR COLOR.

SER. NO. 85-365,378, FILED 7-7-2011.

NAAKWAMA ANKRAH, EXAMINING ATTORNEY



David J. Kyffers

Director of the United States Patent and Trademark Office

United States of America

United States Patent and Trademark Office

POKERIST.COM

Reg. No. 4,099,076

Registered Feb. 14, 2012

Int. Cl.: 9

TRADEMARK

PRINCIPAL REGISTER

KAMAGAMES LTD (CYPRUS LIMITED LIABILITY COMPANY)
DIMOKRITOU 15, POTAMOS GERMASOGENIAS
PANARETOS ELIANA COMPLEX, OFFICE 104
LIMASSOL, CYPRUS 4041

FOR: ENTERTAINMENT SOFTWARE, NAMELY, SOFTWARE THAT IS USED FOR PROVIDING MULTI-PLAYER ACCESS TO AN ON-LINE GAME ENVIRONMENT; COMPUTER GAME SOFTWARE; INTERACTIVE COMPUTER GAME PROGRAMS; VIDEO GAME SOFTWARE; DOWNLOADABLE COMPUTER GAME SOFTWARE AND COMPUTER SOFTWARE PLATFORMS FOR SOCIAL NETWORKING; INTERACTIVE VIDEO GAME PROGRAMS; DOWNLOADABLE ELECTRONIC GAME PROGRAMS AND COMPUTER SOFTWARE PLATFORMS FOR SOCIAL NETWORKING THAT MAY BE ACCESSED VIA THE INTERNET, COMPUTERS AND WIRELESS DEVICES; COMPUTER SOFTWARE TO ENABLE UPLOADING, POSTING, SHOWING, DISPLAYING, TAGGING, BLOGGING, SHARING OR OTHERWISE PROVIDING ELECTRONIC MEDIA OR INFORMATION IN THE FIELDS OF VIRTUAL COMMUNITIES, ELECTRONIC GAMING, ENTERTAINMENT, AND GENERAL INTEREST VIA THE INTERNET OR OTHER COMMUNICATIONS NETWORKS WITH THIRD PARTIES, IN CLASS 9 (U.S. CLS. 21, 23, 26, 36 AND 38).

FIRST USE 5-27-2010; IN COMMERCE 5-27-2010.

THE MARK CONSISTS OF STANDARD CHARACTERS WITHOUT CLAIM TO ANY PARTICULAR FONT, STYLE, SIZE, OR COLOR.

SER. NO. 85-365,397, FILED 7-7-2011.

NAAKWAMA ANKRAH, EXAMINING ATTORNEY



David J. Kyros

Director of the United States Patent and Trademark Office

United States of America

United States Patent and Trademark Office

NETCHOICE

Reg. No. 4,099,077

Registered Feb. 14, 2012

**Int. Cls.: 8, 16, 17, 20
and 21**

TRADEMARK

PRINCIPAL REGISTER



David J. Kyros

Director of the United States Patent and Trademark Office

NETWORK SERVICES COMPANY (DELAWARE CORPORATION)
SUITE 200
1100 E. WOODFIELD ROAD
SCHAUMBURG, IL 60173

FOR: PLASTIC CUTLERY, IN CLASS 8 (U.S. CLS. 23, 28 AND 44).

FIRST USE 7-1-2008; IN COMMERCE 7-1-2008.

FOR: PLASTIC TRASH CAN LINERS FOR GENERAL USE AND PLASTIC FOOD STORAGE BAGS FOR GENERAL USE; PAPER COCKTAIL PARASOLS; CHOP HOLDERS, NAMELY, PAPER HOLDERS PLACED ON THE END OF MEAT CHOPS AS DECORATION, IN CLASS 16 (U.S. CLS. 2, 5, 22, 23, 29, 37, 38 AND 50).

FIRST USE 11-1-2009; IN COMMERCE 11-1-2009.

FOR: PLASTIC FOOD FILM FOR INDUSTRIAL AND COMMERCIAL USE, IN CLASS 17 (U.S. CLS. 1, 5, 12, 13, 35 AND 50).

FIRST USE 11-1-2009; IN COMMERCE 11-1-2009.

FOR: DRINKING STRAWS; PLASTIC AND FOAM FOODSERVICE PACKING CONTAINERS, IN CLASS 20 (U.S. CLS. 2, 13, 22, 25, 32 AND 50).

FIRST USE 11-1-2009; IN COMMERCE 11-1-2009.

FOR: BEVERAGE STIRRERS, PLASTIC CUPS AND LIDS, TOOTHPICKS, COOKING SKEWERS; STEAK MARKERS, NAMELY, PLASTIC COOKING SKEWERS TO INDICATE THE DONENESS OF A PIECE OF MEAT; COCKTAIL PICKS, CHOPSTICKS, IN CLASS 21 (U.S. CLS. 2, 13, 23, 29, 30, 33, 40 AND 50).

FIRST USE 4-1-2007; IN COMMERCE 4-1-2007.

THE MARK CONSISTS OF STANDARD CHARACTERS WITHOUT CLAIM TO ANY PARTICULAR FONT, STYLE, SIZE, OR COLOR.

OWNER OF U.S. REG. NOS. 3,747,506, 3,822,512, AND 3,850,665.

Reg. No. 4,099,077 SER. NO. 85-365,440, FILED 7-7-2011.

JOHN KELLY, EXAMINING ATTORNEY

United States of America

United States Patent and Trademark Office

CRUNCHBASE

Reg. No. 4,099,078

TECHCRUNCH, INC. (DELAWARE CORPORATION)
410 TOWNSEND STREET, SUITE 100
SAN FRANCISCO, CA 94107

Registered Feb. 14, 2012

Int. Cl.: 42

FOR: COMPUTER SERVICES, NAMELY, HOSTING AND MAINTAINING AN ONLINE WEBSITE FOR OTHERS TO EXCHANGE INFORMATION CONCERNING TECHNOLOGY, TECHNOLOGY COMPANIES, INTERNET PRODUCTS AND SERVICES, AND FINANCIAL ORGANIZATIONS, IN CLASS 42 (U.S. CLS. 100 AND 101).

SERVICE MARK

PRINCIPAL REGISTER

FIRST USE 7-17-2007; IN COMMERCE 7-17-2007.

THE MARK CONSISTS OF STANDARD CHARACTERS WITHOUT CLAIM TO ANY PARTICULAR FONT, STYLE, SIZE, OR COLOR.

SER. NO. 85-365,469, FILED 7-7-2011.

MARK RADEMACHER, EXAMINING ATTORNEY



David J. Kyffers

Director of the United States Patent and Trademark Office

United States of America

United States Patent and Trademark Office

ADVANCED STUDIES IN PHARMACY

Reg. No. 4,099,079

Registered Feb. 14, 2012

Int. Cl.: 16

TRADEMARK

PRINCIPAL REGISTER

THE HEALTHCARE MEDIA GROUP, LLC (NEW JERSEY LIMITED LIABILITY COMPANY)
SUITE NUMBER 11
2 DIVISION STREET
SOMERVILLE, NJ 08876

FOR: MEDICAL JOURNAL, IN CLASS 16 (U.S. CLS. 2, 5, 22, 23, 29, 37, 38 AND 50).

FIRST USE 11-15-2004; IN COMMERCE 11-15-2004.

THE MARK CONSISTS OF STANDARD CHARACTERS WITHOUT CLAIM TO ANY PARTICULAR FONT, STYLE, SIZE, OR COLOR.

OWNER OF U.S. REG. NO. 2,968,829.

SEC. 2(F).

SER. NO. 85-365,712, FILED 7-7-2011.

B. PARADEWELAI, EXAMINING ATTORNEY



David J. Kyffers

Director of the United States Patent and Trademark Office

United States of America

United States Patent and Trademark Office

HAIRUWEAR

Reg. No. 4,099,080

CELEBRITY SIGNATURES INTERNATIONAL, INC. (DELAWARE CORPORATION)
5900 EQUITABLE ROAD
KANSAS CITY, MO 64120

Registered Feb. 14, 2012

Int. Cl.: 21

FOR: HAIR BRUSHES; HAIR COMBS, IN CLASS 21 (U.S. CLS. 2, 13, 23, 29, 30, 33, 40 AND 50).

TRADEMARK

FIRST USE 0-0-2005; IN COMMERCE 0-0-2005.

PRINCIPAL REGISTER

THE MARK CONSISTS OF STANDARD CHARACTERS WITHOUT CLAIM TO ANY PARTICULAR FONT, STYLE, SIZE, OR COLOR.

OWNER OF U.S. REG. NOS. 2,599,430, 2,840,833, AND 3,628,040.

SER. NO. 85-365,726, FILED 7-7-2011.

ELIZABETH KAJUBI, EXAMINING ATTORNEY



David J. Kyffers

Director of the United States Patent and Trademark Office

United States of America

United States Patent and Trademark Office

POKERIST

Reg. No. 4,099,081

Registered Feb. 14, 2012

Int. Cl.: 38

SERVICE MARK

PRINCIPAL REGISTER

KAMAGAMES LTD (CYPRUS LIMITED LIABILITY COMPANY)
DIMOKRITOU 15, POTAMOS GERMASOGENIAS
PANARETOS ELIANA COMPLEX, OFFICE 104
LIMASSOL, CYPRUS 4041

FOR: TELECOMMUNICATIONS SERVICES, NAMELY, THE INTERNET, WIRELESS, ELECTRONIC, ELECTRIC, AND DIGITAL TRANSMISSION OF AUDIO, VIDEO, TEXT SIGNAL, IMAGE, DATA, AND MULTIMEDIA CONTENT VIA COMMUNICATIONS NETWORKS; PROVIDING ON-LINE CHAT ROOMS AND ELECTRONIC BULLETIN BOARDS FOR TRANSMISSION OF MESSAGES AMONG USERS IN THE FIELDS OF COMPUTER GAMING; PROVIDING ON-LINE CHAT ROOMS AND ELECTRONIC BULLETIN BOARDS FOR TRANSMISSION OF MESSAGES AMONG USERS IN FIELD OF GENERAL INTEREST AND SOCIAL NETWORKING, IN CLASS 38 (U.S. CLS. 100, 101 AND 104).

FIRST USE 5-27-2010; IN COMMERCE 5-27-2010.

THE MARK CONSISTS OF STANDARD CHARACTERS WITHOUT CLAIM TO ANY PARTICULAR FONT, STYLE, SIZE, OR COLOR.

SER. NO. 85-365,729, FILED 7-7-2011.

NAAKWAMA ANKRAH, EXAMINING ATTORNEY



David J. Kyros

Director of the United States Patent and Trademark Office

United States of America

United States Patent and Trademark Office

POKERIST.COM

Reg. No. 4,099,082

Registered Feb. 14, 2012

Int. Cl.: 38

SERVICE MARK

PRINCIPAL REGISTER

KAMAGAMES LTD (CYPRUS LIMITED LIABILITY COMPANY)
DIMOKRITOU 15, POTAMOS GERMASOGENIAS
PANARETOS ELIANA COMPLEX, OFFICE 104
LIMASSOL, CYPRUS 4041

FOR: TELECOMMUNICATIONS SERVICES, NAMELY, THE INTERNET, WIRELESS, ELECTRONIC, ELECTRIC, AND DIGITAL TRANSMISSION OF AUDIO, VIDEO, TEXT SIGNAL, IMAGE, DATA, AND MULTIMEDIA CONTENT VIA COMMUNICATIONS NETWORKS; PROVIDING ON-LINE CHAT ROOMS AND ELECTRONIC BULLETIN BOARDS FOR TRANSMISSION OF MESSAGES AMONG USERS IN THE FIELDS OF COMPUTER GAMING; PROVIDING ON-LINE CHAT ROOMS AND ELECTRONIC BULLETIN BOARDS FOR TRANSMISSION OF MESSAGES AMONG USERS IN FIELD OF GENERAL INTEREST AND SOCIAL NETWORKING, IN CLASS 38 (U.S. CLS. 100, 101 AND 104).

FIRST USE 5-27-2010; IN COMMERCE 5-27-2010.

THE MARK CONSISTS OF STANDARD CHARACTERS WITHOUT CLAIM TO ANY PARTICULAR FONT, STYLE, SIZE, OR COLOR.

SER. NO. 85-365,753, FILED 7-7-2011.

NAAKWAMA ANKRAH, EXAMINING ATTORNEY



David J. Kyros

Director of the United States Patent and Trademark Office

United States of America

United States Patent and Trademark Office

GALAVANTIER

Reg. No. 4,099,083

Registered Feb. 14, 2012

Int. Cl.: 39

SERVICE MARK

PRINCIPAL REGISTER

GALAVANTIER, INC. (DELAWARE CORPORATION)
SUITE 110-380
10620 SOUTHERN HIGHLANDS PKWY
LAS VEGAS, NV 89141

FOR: ORGANIZATION OF TRAVEL PACKAGES, ORGANIZATION OF TRAVEL EXPERIENCES, ORGANIZATION OF EXCURSIONS; TRAVEL AGENCY SERVICES, NAMELY, MAKING RESERVATIONS AND BOOKINGS FOR TRANSPORTATION AND HOTELS, TRAVEL AND TOUR TICKET RESERVATION SERVICE; ARRANGING AND COORDINATING TRAVEL ARRANGEMENTS FOR INDIVIDUALS AND GROUPS, IN CLASS 39 (U.S. CLS. 100 AND 105).

FIRST USE 9-23-2010; IN COMMERCE 9-23-2010.

THE MARK CONSISTS OF STANDARD CHARACTERS WITHOUT CLAIM TO ANY PARTICULAR FONT, STYLE, SIZE, OR COLOR.

SER. NO. 85-365,831, FILED 7-7-2011.

KATINA MISTER, EXAMINING ATTORNEY



David J. Kyffers

Director of the United States Patent and Trademark Office

United States of America

United States Patent and Trademark Office

WORLDVU

Reg. No. 4,099,084

XENNSOFT, LLC (UTAH LIMITED LIABILITY COMPANY)
10813 S. RIVER FRONT PARKWAY, SUITE 240
SOUTH JORDAN, UT 84095

Registered Feb. 14, 2012

Int. Cl.: 42

FOR: PROVIDING ON-LINE NON-DOWNLOADABLE DATABASE MANAGEMENT SOFTWARE FOR MANAGING ORGANIZATIONAL MEMBER INFORMATION, AND FOR MANAGING INFORMATION PERTINENT TO ORGANIZATIONAL MEMBER RELATIONSHIPS AND PROVIDING TEMPORARY USE OF NON-DOWNLOADABLE GRAPHICAL USER INTERFACE SOFTWARE FOR USE IN INTERACTING WITH ORGANIZATIONAL MEMBERS, IN CLASS 42 (U.S. CLS. 100 AND 101).

SERVICE MARK

PRINCIPAL REGISTER

FIRST USE 12-5-2006; IN COMMERCE 12-5-2006.

THE MARK CONSISTS OF STANDARD CHARACTERS WITHOUT CLAIM TO ANY PARTICULAR FONT, STYLE, SIZE, OR COLOR.

SER. NO. 85-365,900, FILED 7-7-2011.

KATHLEEN LORENZO, EXAMINING ATTORNEY



David J. Kyffers

Director of the United States Patent and Trademark Office

United States of America

United States Patent and Trademark Office

WUNDERPOLL

Reg. No. 4,099,085

Registered Feb. 14, 2012

Int. Cl.: 35

SERVICE MARK

PRINCIPAL REGISTER

THE WEATHER UNDERGROUND, INC. (MICHIGAN CORPORATION)
SUITE 240
300 NORTH FIFTH AVEVUE
ANN ARBOR, MI 48104

FOR: ON-LINE PUBLIC OPINION SURVEYS, IN CLASS 35 (U.S. CLS. 100, 101 AND 102).

FIRST USE 5-18-2010; IN COMMERCE 5-18-2010.

THE MARK CONSISTS OF STANDARD CHARACTERS WITHOUT CLAIM TO ANY PARTICULAR FONT, STYLE, SIZE, OR COLOR.

SER. NO. 85-365,903, FILED 7-7-2011.

MICHAEL SOUDERS, EXAMINING ATTORNEY



David J. Kyffers

Director of the United States Patent and Trademark Office

United States of America

United States Patent and Trademark Office

TEAM OFFICE

Reg. No. 4,099,086

Registered Feb. 14, 2012

Int. Cl.: 42

SERVICE MARK

PRINCIPAL REGISTER

XENNSOFT, LLC (UTAH LIMITED LIABILITY COMPANY)
10813 S. RIVER FRONT PARKWAY, SUITE 240
SOUTH JORDAN, UT 84095

FOR: PROVIDING ON-LINE NON-DOWNLOADABLE DATABASE MANAGEMENT SOFTWARE FOR MANAGING ORGANIZATIONAL MEMBER INFORMATION, AND FOR MANAGING INFORMATION PERTINENT TO ORGANIZATIONAL MEMBER RELATIONSHIPS AND PROVIDING TEMPORARY USE OF NON-DOWNLOADABLE GRAPHICAL USER INTERFACE SOFTWARE FOR USE IN INTERACTING WITH ORGANIZATIONAL MEMBERS, IN CLASS 42 (U.S. CLS. 100 AND 101).

FIRST USE 12-5-2006; IN COMMERCE 12-5-2006.

THE MARK CONSISTS OF STANDARD CHARACTERS WITHOUT CLAIM TO ANY PARTICULAR FONT, STYLE, SIZE, OR COLOR.

SER. NO. 85-365,909, FILED 7-7-2011.

KATHLEEN LORENZO, EXAMINING ATTORNEY



David J. Kyffers

Director of the United States Patent and Trademark Office

United States of America

United States Patent and Trademark Office

SHOTMAKER

Reg. No. 4,099,087

HARRISON SPORTS, INC. (CALIFORNIA CORPORATION)
13215 LOUVRE STREET
PACOIMA, CA 91331

Registered Feb. 14, 2012

Int. Cl.: 28

FOR: INSERT FOR USE WITH A GOLF CLUB OR GOLF SHAFT, IN CLASS 28 (U.S. CLS. 22, 23, 38 AND 50).

TRADEMARK

FIRST USE 2-19-2011; IN COMMERCE 2-19-2011.

PRINCIPAL REGISTER

THE MARK CONSISTS OF STANDARD CHARACTERS WITHOUT CLAIM TO ANY PARTICULAR FONT, STYLE, SIZE, OR COLOR.

SER. NO. 85-365,946, FILED 7-7-2011.

LAURIE KAUFMAN, EXAMINING ATTORNEY



David J. Kyffers

Director of the United States Patent and Trademark Office

United States of America

United States Patent and Trademark Office

STRAIGHTER IS LONGER

Reg. No. 4,099,088

HARRISON SPORTS, INC. (CALIFORNIA CORPORATION)

Registered Feb. 14, 2012

13215 LOUVRE STREET
PACOIMA, CA 91331

Int. Cl.: 28

FOR: INSERT FOR USE WITH A GOLF CLUB OR GOLF SHAFT, IN CLASS 28 (U.S. CLS. 22, 23, 38 AND 50).

TRADEMARK

FIRST USE 5-18-2011; IN COMMERCE 5-18-2011.

PRINCIPAL REGISTER

THE MARK CONSISTS OF STANDARD CHARACTERS WITHOUT CLAIM TO ANY PARTICULAR FONT, STYLE, SIZE, OR COLOR.

SER. NO. 85-365,955, FILED 7-7-2011.

LAURIE KAUFMAN, EXAMINING ATTORNEY



David J. Kyffers

Director of the United States Patent and Trademark Office

United States of America

United States Patent and Trademark Office

Changing Shoes

Reg. No. 4,099,089

STAYING IN THE GAME, LLC (NEW YORK LIMITED LIABILITY COMPANY)
555 PARK AVENUE
NEW YORK, NY 10065

Registered Feb. 14, 2012

Int. Cl.: 18

FOR: HANDBAGS, IN CLASS 18 (U.S. CLS. 1, 2, 3, 22 AND 41).

TRADEMARK

FIRST USE 3-15-2007; IN COMMERCE 9-20-2009.

PRINCIPAL REGISTER

THE MARK CONSISTS OF THE STYLIZED TEXT "CHANGING SHOES".

SER. NO. 85-365,956, FILED 7-7-2011.

LAURIE KAUFMAN, EXAMINING ATTORNEY



David J. Kyffers

Director of the United States Patent and Trademark Office

United States of America

United States Patent and Trademark Office

BeginRight

Reg. No. 4,099,090

BEGINRIGHT, INC. (OREGON CORPORATION)
10905 NE SANDY BLVD.
PORTLAND, OR 97220

Registered Feb. 14, 2012

Int. Cl.: 35

FOR: EMPLOYMENT AGENCY SERVICES, NAMELY, FILLING THE TEMPORARY AND PERMANENT STAFFING NEEDS OF BUSINESSES; EMPLOYMENT HIRING, RECRUITING, PLACEMENT, STAFFING AND CAREER NETWORKING SERVICES; PROVIDING AN EMPLOYER WITH CANDIDATES OR POTENTIAL EMPLOYEES TO FILL TEMPORARY, CONTRACT AND PERMANENT POSITIONS, IN CLASS 35 (U.S. CLS. 100, 101 AND 102).

SERVICE MARK

PRINCIPAL REGISTER

FIRST USE 3-17-1986; IN COMMERCE 3-17-1986.

THE MARK CONSISTS OF STANDARD CHARACTERS WITHOUT CLAIM TO ANY PARTICULAR FONT, STYLE, SIZE, OR COLOR.

SER. NO. 85-365,957, FILED 7-7-2011.

SUE LAWRENCE, EXAMINING ATTORNEY



David J. Kyffers

Director of the United States Patent and Trademark Office

United States of America

United States Patent and Trademark Office

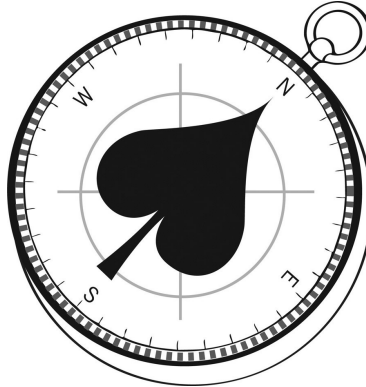

Reg. No. 4,099,091

Registered Feb. 14, 2012

Int. Cl.: 9

TRADEMARK

PRINCIPAL REGISTER

POKER PA, LLC (CALIFORNIA LIMITED LIABILITY COMPANY)
UNIT 110-382
645 WEST 9TH STREET
LOS ANGELES, CA 90015

FOR: COMPUTER APPLICATION SOFTWARE FOR WEB-BROWSER ENVIRONMENTS, NAMELY, SOFTWARE FOR MANAGING DATABASES LINKED TO A MARKETING AND ADVERTISING SERVICE; DOWNLOADABLE SOFTWARE IN THE NATURE OF A MOBILE APPLICATION FOR BROWSING GOODS AND SERVICES OF OTHERS, IN CLASS 9 (U.S. CLS. 21, 23, 26, 36 AND 38).

FIRST USE 9-30-2010; IN COMMERCE 2-22-2011.

THE MARK CONSISTS OF A COMPASS WITH THE POSITIONS FOR NORTH, WEST, SOUTH, AND EAST INDICATED, WITH THE NORTHERN DIRECTION POINTING TOWARDS THE UPPER-RIGHT BOUNDARY OF THE MARK, WITH THE SYMBOL FOR THE SUIT OF SPADES IN A TRADITIONAL WESTERN PLAYING CARD DECK PLACED PROMINENTLY IN THE CENTER OF THE COMPASS, WITH THE TOP POINT OF THE SPADE SYMBOL POINTING TOWARDS THE UPPER-RIGHT BOUNDARY OF THE MARK.

SER. NO. 85-365,969, FILED 7-7-2011.

SUSAN LESLIE DUBOIS, EXAMINING ATTORNEY



David J. Kyffers

Director of the United States Patent and Trademark Office

United States of America

United States Patent and Trademark Office

JEEPERS CREEPERS

Reg. No. 4,099,092

VALLEYBROOK INTERNATIONAL VENTURES INC. (CANADA CORPORATION)
1831 PEARDONVILLE ROAD
ABBOTSFORD, CANADA V4X2M3

Registered Feb. 14, 2012

Int. Cl.: 31

FOR: LIVE PLANTS NOT INCLUDING TIARELLA OR FOAMFLOWER, IN CLASS 31 (U.S. CLS. 1 AND 46).

TRADEMARK

FIRST USE 8-21-2002; IN COMMERCE 8-21-2002.

PRINCIPAL REGISTER

THE MARK CONSISTS OF STANDARD CHARACTERS WITHOUT CLAIM TO ANY PARTICULAR FONT, STYLE, SIZE, OR COLOR.

OWNER OF U.S. REG. NO. 2,961,935.

SER. NO. 85-366,010, FILED 7-7-2011.

ALLISON HOLTZ, EXAMINING ATTORNEY



David J. Kybas

Director of the United States Patent and Trademark Office

United States of America

United States Patent and Trademark Office

FOR THOSE WHO PLAN TO SUCCEED

Reg. No. 4,099,093

Registered Feb. 14, 2012

Int. Cl.: 45

SERVICE MARK

PRINCIPAL REGISTER

SCHWABE, WILLIAMSON & WYATT, P.C. (OREGON CORPORATION)
SUITES 1500-2000
1211 SW FIFTH AVENUE
PORTLAND, OR 97204

FOR: LEGAL SERVICES, IN CLASS 45 (U.S. CLS. 100 AND 101).

FIRST USE 1-0-2010; IN COMMERCE 1-0-2010.

THE MARK CONSISTS OF STANDARD CHARACTERS WITHOUT CLAIM TO ANY PARTICULAR FONT, STYLE, SIZE, OR COLOR.

SER. NO. 85-366,024, FILED 7-7-2011.

ERNEST SHOSHO, EXAMINING ATTORNEY



David J. Kyffers

Director of the United States Patent and Trademark Office

United States of America

United States Patent and Trademark Office

MAXIMIZE, CAPTURE, KEEP

Reg. No. 4,099,094

Registered Feb. 14, 2012

Int. Cl.: 45

SERVICE MARK

PRINCIPAL REGISTER

SCHWABE, WILLIAMSON & WYATT, P.C. (OREGON CORPORATION)
SUITES 1500-2000
1211 SW FIFTH AVENUE
PORTLAND, OR 97204

FOR: LEGAL SERVICES, IN CLASS 45 (U.S. CLS. 100 AND 101).

FIRST USE 1-0-2010; IN COMMERCE 1-0-2010.

THE MARK CONSISTS OF STANDARD CHARACTERS WITHOUT CLAIM TO ANY PARTICULAR FONT, STYLE, SIZE, OR COLOR.

SER. NO. 85-366,025, FILED 7-7-2011.

ERNEST SHOSHO, EXAMINING ATTORNEY



David J. Kyffers

Director of the United States Patent and Trademark Office

United States of America

United States Patent and Trademark Office

THE CRUNCHIES

Reg. No. 4,099,095

TECHCRUNCH, INC. (DELAWARE CORPORATION)

Registered Feb. 14, 2012

410 TOWNSEND STREET, SUITE 100
SAN FRANCISCO, CA 94107

Int. Cl.: 41

FOR: PROVIDING RECOGNITION AND INCENTIVES BY THE WAY OF AWARDS TO DEMONSTRATE EXCELLENCE IN THE FIELDS OF TECHNOLOGY, INTERNET PRODUCTS AND SERVICES, AND ENTREPRENEURSHIP, IN CLASS 41 (U.S. CLS. 100, 101 AND 107).

SERVICE MARK

FIRST USE 12-3-2007; IN COMMERCE 12-3-2007.

PRINCIPAL REGISTER

THE MARK CONSISTS OF STANDARD CHARACTERS WITHOUT CLAIM TO ANY PARTICULAR FONT, STYLE, SIZE, OR COLOR.

SER. NO. 85-366,070, FILED 7-7-2011.

MARK RADEMACHER, EXAMINING ATTORNEY



David J. Kyffers

Director of the United States Patent and Trademark Office

United States of America

United States Patent and Trademark Office

iband.me

Reg. No. 4,099,096

Registered Feb. 14, 2012

Int. Cl.: 45

SERVICE MARK

PRINCIPAL REGISTER

ZIMMERMAN AARON (INDIANA LIMITED LIABILITY COMPANY), DBA CCB NETWORKS
LLC
716 GLENWAY DRIVE
LOGANSPORT, IN 46947

FOR: PROVIDING A SOCIAL NETWORKING WEBSITE FOR ENTERTAINMENT PURPOSES,
IN CLASS 45 (U.S. CLS. 100 AND 101).

FIRST USE 7-7-2011; IN COMMERCE 7-7-2011.

THE MARK CONSISTS OF STANDARD CHARACTERS WITHOUT CLAIM TO ANY PAR-
TICULAR FONT, STYLE, SIZE, OR COLOR.

SER. NO. 85-366,110, FILED 7-8-2011.

ODESSA BIBBINS, EXAMINING ATTORNEY



David J. Kyffers

Director of the United States Patent and Trademark Office

United States of America

United States Patent and Trademark Office

SalonBiz

Reg. No. 4,099,097

Registered Feb. 14, 2012

Int. Cl.: 9

TRADEMARK

PRINCIPAL REGISTER

NEILL TECHNOLOGIES, INC. (LOUISIANA CORPORATION)
ATTN: JENNIFER LEE, GENERAL COUNSEL
303 SOUTH PINE STREET
HAMMOND, LA 70403

FOR: COMPUTER SOFTWARE FOR AUTOMATING BUSINESS ACTIVITIES, NAMELY, ACCOUNTING APPOINTMENT SCHEDULING AND BUSINESS PLANNING IN THE FIELD OF HAIR AND SKIN CARE, IN CLASS 9 (U.S. CLS. 21, 23, 26, 36 AND 38).

FIRST USE 10-1-1999; IN COMMERCE 10-1-1999.

THE MARK CONSISTS OF STANDARD CHARACTERS WITHOUT CLAIM TO ANY PARTICULAR FONT, STYLE, SIZE, OR COLOR.

SEC. 2(F).

SER. NO. 85-366,354, FILED 7-8-2011.

REBECCA GILBERT, EXAMINING ATTORNEY



David J. Kyffers

Director of the United States Patent and Trademark Office

United States of America

United States Patent and Trademark Office

CRUNCHUP

Reg. No. 4,099,098

TECHCRUNCH, INC. (DELAWARE CORPORATION)
410 TOWNSEND STREET, SUITE 100
SAN FRANCISCO, CA 94107

Registered Feb. 14, 2012

Int. Cl.: 41

FOR: ARRANGING AND CONDUCTING EDUCATIONAL CONFERENCES; ARRANGING AND CONDUCTING CONFERENCES AND SEMINARS IN THE FIELDS OF TECHNOLOGY, INTERNET PRODUCTS AND SERVICES, AND ENTREPRENEURSHIP, IN CLASS 41 (U.S. CLS. 100, 101 AND 107).

SERVICE MARK

PRINCIPAL REGISTER

FIRST USE 6-2-2009; IN COMMERCE 7-10-2009.

THE MARK CONSISTS OF STANDARD CHARACTERS WITHOUT CLAIM TO ANY PARTICULAR FONT, STYLE, SIZE, OR COLOR.

SER. NO. 85-366,454, FILED 7-8-2011.

MARK RADEMACHER, EXAMINING ATTORNEY



David J. Kyffers

Director of the United States Patent and Trademark Office

United States of America

United States Patent and Trademark Office

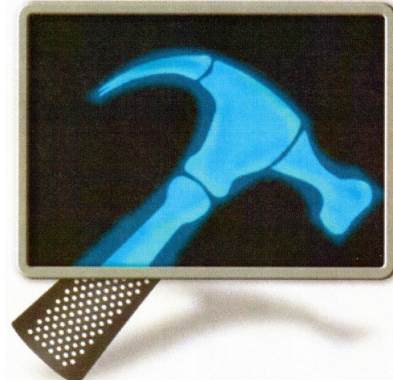

Reg. No. 4,099,099

Registered Feb. 14, 2012

Int. Cl.: 9

TRADEMARK

PRINCIPAL REGISTER

WORKFLOW DATA SYSTEMS, LLC (OHIO LIMITED LIABILITY COMPANY)
659K LAKEVIEW PLAZA BLVD
WORTHINGTON, OH 43085

FOR: COMPUTER SOFTWARE FOR USE IN ACCESSING METADATA WITHIN A DATABASE THAT MAY BE DOWNLOADED FROM A GLOBAL COMPUTER NETWORK, IN CLASS 9 (U.S. CLS. 21, 23, 26, 36 AND 38).

FIRST USE 6-27-2011; IN COMMERCE 6-27-2011.

THE MARK CONSISTS OF DEPICTION OF AN X-RAY OF A HAMMER. THE BODY OF THE HAMMER IS BLUE ON A BLACK BACKGROUND WITHIN A GRAY FRAME. THE HANDLE OF THE HAMMER IS BLACK WITH WHITE DOTS. THE HANDLE AND A NON-DISTINCT SHADOW OF A HAMMER APPEARS IN GRAY AGAINST A WHITE BACKGROUND.

THE COLOR(S) BLUE, GRAY, BLACK, AND WHITE IS/ARE CLAIMED AS A FEATURE OF THE MARK.

SER. NO. 85-366,701, FILED 7-8-2011.

WON TEAK OH, EXAMINING ATTORNEY



David J. Kypos

Director of the United States Patent and Trademark Office

United States of America

United States Patent and Trademark Office

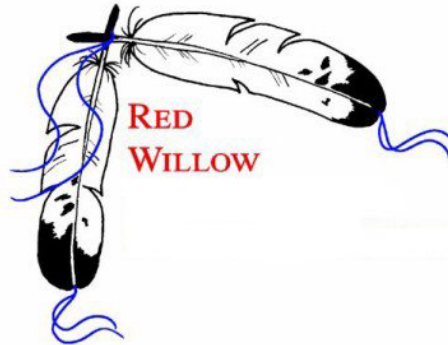

Reg. No. 4,099,100

Registered Feb. 14, 2012

Int. Cls.: 37 and 42

SERVICE MARK

PRINCIPAL REGISTER

RED WILLOW PRODUCTION, LLC (COLORADO LIMITED LIABILITY COMPANY)
P.O. BOX 369
14933 HIGHWAY 172
IGNACIO, CO 81137

FOR: DRILLING AND PUMPING OF OIL; DRILLING FOR CRUDE OIL; DRILLING OF DEEP OIL OR GAS WELLS; EXTRACTION OF OIL; OIL AND GAS DRILLING; OIL PUMPING AND EXTRACTION; OIL WELL CASING, TUBING, AND DRILL PIPE INSTALLATION; OIL WELL DRILLING, IN CLASS 37 (U.S. CLS. 100, 103 AND 106).

FIRST USE 0-0-1992; IN COMMERCE 0-0-1993.

FOR: EXPLORATION AND SEARCHING OF OIL AND GAS; GAS EXPLORATION; GEO-PHYSICAL EXPLORATION FOR THE OIL, GAS AND MINING INDUSTRIES; OIL EXPLORATION; OIL FIELD EXPLORATION; PETROLEUM EXPLORATION; UNDERWATER EXPLORATION, IN CLASS 42 (U.S. CLS. 100 AND 101).

FIRST USE 0-0-1992; IN COMMERCE 0-0-1993.

THE MARK CONSISTS OF THE WORDING RED WILLOW IN RED, FRAMED ON THE LEFT AND ABOVE BY TWO BLACK AND WHITE EAGLE FEATHERS CROSSED AT THE SHAFT IN THE UPPER LEFT HAND CORNER. THE FEATHERS ARE CROSSED AT A 90 DEGREE RIGHT ANGLE AT THE SHAFTS WITH ONE VANE RUNNING DOWN THE LEFT BORDER AND THE OTHER VANE ACROSS THE TOP BORDER. THE FEATHER SHAFTS APPEAR TO BE BOUND BY TWO BLUE STRINGS, WHICH EXTEND IN CURVES ACROSS THE FEATHER VANE DOWN THE LEFT BORDER. TWO BLUE STRINGS EXTEND IN CURVES FROM THE TIP OF THE VANE OR PLUME OF BOTH FEATHERS.

THE COLOR(S) BLACK, WHITE, RED AND BLUE IS/ARE CLAIMED AS A FEATURE OF THE MARK.

SER. NO. 85-367,046, FILED 7-8-2011.

JUDITH HELFMAN, EXAMINING ATTORNEY



David J. Kyffers

Director of the United States Patent and Trademark Office

United States of America

United States Patent and Trademark Office

REALPRESENCE

Reg. No. 4,099,101

Registered Feb. 14, 2012

Int. Cl.: 9

TRADEMARK

PRINCIPAL REGISTER

POLYCOM, INC. (DELAWARE CORPORATION)
4750 WILLOW ROAD
PLEASANTON, CA 94588

FOR: COMMUNICATIONS SERVERS; COMPUTER SOFTWARE AND HARDWARE FOR VOICE AND VIDEO CONFERENCING; TELECOMMUNICATIONS AND DATA NETWORKING HARDWARE, NAMELY, DEVICES FOR TRANSPORTING AND AGGREGATING VOICE, DATA, AND VIDEO COMMUNICATIONS ACROSS MULTIPLE NETWORK INFRASTRUCTURES AND COMMUNICATIONS PROTOCOLS, IN CLASS 9 (U.S. CLS. 21, 23, 26, 36 AND 38).

FIRST USE 3-31-2007; IN COMMERCE 3-31-2007.

THE MARK CONSISTS OF STANDARD CHARACTERS WITHOUT CLAIM TO ANY PARTICULAR FONT, STYLE, SIZE, OR COLOR.

SER. NO. 85-367,621, FILED 7-11-2011.

SEAN CROWLEY, EXAMINING ATTORNEY



David J. Kybas

Director of the United States Patent and Trademark Office

United States of America

United States Patent and Trademark Office

ZOOTS

Reg. No. 4,099,102

Registered Feb. 14, 2012

Int. Cl.: 30

TRADEMARK

PRINCIPAL REGISTER

CALIDOCIOUS, INC. (CALIFORNIA CORPORATION)
SUITE 107
333 COBALT WAY
SUNNYVALE, CA 94085

FOR: CANDY, IN CLASS 30 (U.S. CL. 46).

FIRST USE 6-19-2011; IN COMMERCE 6-19-2011.

THE MARK CONSISTS OF STANDARD CHARACTERS WITHOUT CLAIM TO ANY PARTICULAR FONT, STYLE, SIZE, OR COLOR.

SER. NO. 85-368,369, FILED 7-11-2011.

SHARON MEIER, EXAMINING ATTORNEY



David J. Kybas

Director of the United States Patent and Trademark Office

United States of America

United States Patent and Trademark Office

AGILE | STRATEGIC | DIFFERENT

Reg. No. 4,099,103

Registered Feb. 14, 2012

Int. Cl.: 35

SERVICE MARK

PRINCIPAL REGISTER

MOXIE MEDIA GROUP, LLC (COLORADO LIMITED LIABILITY COMPANY), DBA MOXIE
CREATIVE COMMUNICATIONS AGENCY
2305 WEST BERRY AVENUE
LITTLETON, CO 80120

FOR: PREPARATION AND REALIZATION OF MEDIA AND ADVERTISING PLANS AND
CONCEPTS, IN CLASS 35 (U.S. CLS. 100, 101 AND 102).

FIRST USE 5-6-2011; IN COMMERCE 5-6-2011.

THE MARK CONSISTS OF THE WORDS "AGILE" AND "STRATEGIC" IN UPPERCASE
BLACK LETTERS AGAINST A WHITE BACKGROUND FOLLOWED BY THE WORD
"DIFFERENT" IN UPPERCASE ORANGE LETTERS AGAINST A WHITE BACKGROUND
WITH A VERTICAL ORANGE LINE SEPARATING "AGILE" AND "STRATEGIC" AND A
VERTICAL ORANGE LINE SEPARATING THE WORDS "STRATEGIC" AND "DIFFERENT".

THE COLOR(S) ORANGE, BLACK, AND WHITE IS/ARE CLAIMED AS A FEATURE OF
THE MARK.

SER. NO. 85-369,024, FILED 7-12-2011.

PAM WILLIS, EXAMINING ATTORNEY



David J. Kyffers

Director of the United States Patent and Trademark Office

United States of America

United States Patent and Trademark Office

BIP GEAR

Reg. No. 4,099,104

Registered Feb. 14, 2012

Int. Cl.: 35

SERVICE MARK

PRINCIPAL REGISTER

SILVA, CHRIS (UNITED STATES INDIVIDUAL)
97 BAKER STREET
SEEKONK, MA 02771

FOR: RETAIL AND ONLINE RETAIL STORE SERVICES FEATURING MANUALLY-OPERATED EXERCISE EQUIPMENT FOR PHYSICAL THERAPY PURPOSES, BODY REHABILITATION APPARATUS FOR MEDICAL PURPOSES, FORCE AND MOTION TESTING APPARATUS FOR PHYSICAL REHABILITATION, PHYSICAL REHABILITATION, PHYSICAL THERAPY AND SPORTS MEDICINE EQUIPMENT ALL DESIGNED SPECIFICALLY FOR MEDICAL USE, NAMELY, A SPANDEX SENSORY-STIMULATING TUBULAR SLEEVE, PEN GRIPS, PLATFORM SWINGS, BALANCE THERAPY EQUIPMENT, BATHROOM AIDS, PLACEMATS, ADAPTIVE DINNERWARE, PATIENT SHOWER CHAIRS, MEDICAL AIDS AND REHABILITATION AND THERAPY SUPPLIES, IN CLASS 35 (U.S. CLS. 100, 101 AND 102).

FIRST USE 6-7-2011; IN COMMERCE 6-7-2011.

THE MARK CONSISTS OF STANDARD CHARACTERS WITHOUT CLAIM TO ANY PARTICULAR FONT, STYLE, SIZE, OR COLOR.

NO CLAIM IS MADE TO THE EXCLUSIVE RIGHT TO USE "GEAR", APART FROM THE MARK AS SHOWN.

SER. NO. 85-369,081, FILED 7-12-2011.

DOUGLAS LEE, EXAMINING ATTORNEY



David J. Kyros

Director of the United States Patent and Trademark Office

United States of America

United States Patent and Trademark Office

ABC ENGLISH & ME

Reg. No. 4,099,105

Registered Feb. 14, 2012

Int. Cls.: 9 and 41

TRADEMARK

SERVICE MARK

PRINCIPAL REGISTER

KINDERMUSIK INTERNATIONAL, INC. (NORTH CAROLINA CORPORATION)
203 SOUTH CHURCH STREET
GREENSBORO, NC 27401

FOR: ELECTRONIC DOWNLOADABLE PUBLICATIONS, NAMELY, TEACHER GUIDES AND BOOKS IN THE FIELD OF MUSIC EDUCATION FOR CHILDREN; DIGITAL CHILDREN'S MUSIC DOWNLOADABLE FROM THE INTERNET, IN CLASS 9 (U.S. CLS. 21, 23, 26, 36 AND 38).

FIRST USE 5-15-2011; IN COMMERCE 5-15-2011.

FOR: TEACHING MUSIC TO YOUNG CHILDREN; NON-DOWNLOADABLE ELECTRONIC PUBLICATIONS, NAMELY, TEACHER GUIDES AND BOOKS IN THE FIELD OF MUSIC EDUCATION FOR CHILDREN, IN CLASS 41 (U.S. CLS. 100, 101 AND 107).

FIRST USE 5-15-2011; IN COMMERCE 5-15-2011.

THE MARK CONSISTS OF STANDARD CHARACTERS WITHOUT CLAIM TO ANY PARTICULAR FONT, STYLE, SIZE, OR COLOR.

SER. NO. 85-370,481, FILED 7-13-2011.

KAPIL BHANOT, EXAMINING ATTORNEY



David J. Kybas

Director of the United States Patent and Trademark Office

United States of America

United States Patent and Trademark Office

FINEST

Reg. No. 4,099,106

WALGREEN CO. (ILLINOIS CORPORATION)
200 WILMOT ROAD
DEERFIELD, IL 60015

Registered Feb. 14, 2012

Int. Cl.: 5

FOR: VITAMINS AND DIETARY AND NUTRITIONAL SUPPLEMENTS, IN CLASS 5 (U.S. CLS. 6, 18, 44, 46, 51 AND 52).

TRADEMARK

FIRST USE 10-31-1997; IN COMMERCE 10-31-1997.

PRINCIPAL REGISTER

THE MARK CONSISTS OF STANDARD CHARACTERS WITHOUT CLAIM TO ANY PARTICULAR FONT, STYLE, SIZE, OR COLOR.

OWNER OF U.S. REG. NOS. 3,221,077 AND 3,221,078.

SEC. 2(F).

SER. NO. 85-370,577, FILED 7-13-2011.

VERNA BETH RIRIE, EXAMINING ATTORNEY



David J. Kybas

Director of the United States Patent and Trademark Office

United States of America

United States Patent and Trademark Office

DEVIL'S FOOD

Reg. No. 4,099,107

Registered Feb. 14, 2012

Int. Cl.: 33

TRADEMARK

PRINCIPAL REGISTER

THE WINE GROUP LLC (DELAWARE LIMITED LIABILITY COMPANY)
4596 S. TRACY BLVD.
TRACY, CA 95377

FOR: SPIRITS, IN CLASS 33 (U.S. CLS. 47 AND 49).

FIRST USE 4-1-2011; IN COMMERCE 4-1-2011.

THE MARK CONSISTS OF STANDARD CHARACTERS WITHOUT CLAIM TO ANY PARTICULAR FONT, STYLE, SIZE, OR COLOR.

SER. NO. 85-371,368, FILED 7-14-2011.

TARAH HARDY, EXAMINING ATTORNEY



David J. Kyffers

Director of the United States Patent and Trademark Office

United States of America

United States Patent and Trademark Office



Reg. No. 4,099,108

Registered Feb. 14, 2012

Int. Cl.: 9

TRADEMARK

PRINCIPAL REGISTER

T-MOBILE USA, INC. (DELAWARE CORPORATION)
12920 S.E. 38TH STREET
BELLEVUE, WA 98006

FOR: CELLULAR PHONES, IN CLASS 9 (U.S. CLS. 21, 23, 26, 36 AND 38).

FIRST USE 6-2-2010; IN COMMERCE 6-2-2010.

OWNER OF U.S. REG. NO. 3,908,772.

THE MARK CONSISTS OF A CIRCLE WITH THE WORD "MY" APPEARING WITHIN THE CIRCLE AND IN LOWER CASE LETTERS.

SER. NO. 85-372,653, FILED 7-15-2011.

LINDSEY RUBIN, EXAMINING ATTORNEY



David J. Kyffers

Director of the United States Patent and Trademark Office

United States of America

United States Patent and Trademark Office



Reg. No. 4,099,109

Registered Feb. 14, 2012

Int. Cl.: 9

TRADEMARK

PRINCIPAL REGISTER

T-MOBILE USA, INC. (DELAWARE CORPORATION)
12920 S.E. 38TH STREET
BELLEVUE, WA 98006

FOR: CELLULAR PHONE ACCESSORIES, NAMELY, CELLULAR PHONE COVERS, CELLULAR PHONE CASES, BELT CLIP CELLULAR PHONE HOLSTERS, CELLULAR PHONE POUCHES, RECHARGEABLE BATTERIES, BATTERY CHARGERS, CAR BATTERY CHARGERS, STEREO HEADPHONES, HEADSETS, EAR BUD COVERS, AND COMPUTER PERIPHERALS COMPATIBLE WITH CELLULAR PHONES, NAMELY, DOCKING STATIONS AND USB CABLES, IN CLASS 9 (U.S. CLS. 21, 23, 26, 36 AND 38).

FIRST USE 7-8-2009; IN COMMERCE 7-8-2009.

OWNER OF U.S. REG. NO. 3,908,772.

THE MARK CONSISTS OF A CIRCLE WITH THE WORD "MY" APPEARING WITHIN THE CIRCLE AND IN LOWER CASE LETTERS.

SER. NO. 85-372,670, FILED 7-15-2011.

LINDSEY RUBIN, EXAMINING ATTORNEY



David J. Kyjars

Director of the United States Patent and Trademark Office

United States of America

United States Patent and Trademark Office



Reg. No. 4,099,110

Registered Feb. 14, 2012

Int. Cl.: 9

TRADEMARK

PRINCIPAL REGISTER

T-MOBILE USA, INC. (DELAWARE CORPORATION)
12920 S.E. 38TH STREET
BELLEVUE, WA 98006

FOR: MOBILE DEVICE SOFTWARE FOR UPLOADING PICTURES, PHOTOS AND IMAGES TO A CLOUD-BASED REPOSITORY, IN CLASS 9 (U.S. CLS. 21, 23, 26, 36 AND 38).

FIRST USE 7-18-2011; IN COMMERCE 7-18-2011.

THE MARK CONSISTS OF A RECTANGULAR FIELD REPRESENTING A PHOTOGRAPH OF A HORIZON FEATURING A MOUNTAIN AND THE SUN, POSITIONED TOWARD THE LOWER RIGHT CORNER, AND SUPERIMPOSED OVER A DIAMOND SHAPED DESIGN COMPRISED OF FOUR CONNECTED SMALLER DIAMOND SHAPES.

SER. NO. 85-374,371, FILED 7-18-2011.

LINDSEY RUBIN, EXAMINING ATTORNEY



David J. Kyffers

Director of the United States Patent and Trademark Office

United States of America

United States Patent and Trademark Office

CHROMOGENISTE

Reg. No. 4,099,111

L'OREAL (FRANCE SOCIÉTÉ ANONYME (SA))

Registered Feb. 14, 2012

14 RUE ROYALE
PARIS, FRANCE 75008

Int. Cl.: 3

FOR: PERFUME; TOILET WATER; BATH AND SHOWER GELS AND SALTS NOT FOR MEDICAL PURPOSE; TOILET SOAPS, BODY DEODORANTS; COSMETICS, NAMELY, CREAMS, MILKS, LOTIONS, GELS AND POWDERS FOR THE FACE, THE BODY AND THE HANDS; NON-MEDICATED SUN CARE PREPARATIONS; MAKEUP PREPARATIONS; SHAMPOOS; PRODUCTS FOR HAIR STYLING AND HAIR CARE, NAMELY, GELS, SPRAYS, MOUSSES, BALMS, CREAM, SERUMS, WAX AND LOTIONS; HAIR LACQUERS; HAIR COLOURING AND HAIR DECOLORANT PREPARATIONS; PROTECTIVE COLORING PREPARATIONS FOR TREATED HAIR; PERMANENT WAVING AND CURLING PREPARATIONS; ESSENTIAL OILS FOR PERSONAL USE, IN CLASS 3 (U.S. CLS. 1, 4, 6, 50, 51 AND 52).

TRADEMARK

PRINCIPAL REGISTER

THE MARK CONSISTS OF STANDARD CHARACTERS WITHOUT CLAIM TO ANY PARTICULAR FONT, STYLE, SIZE, OR COLOR.

PRIORITY CLAIMED UNDER SEC. 44(D) ON FRANCE APPLICATION NO. 11/3805614, FILED 2-11-2011, REG. NO. 11/3805614, DATED 2-11-2011, EXPIRES 2-11-2021.

SER. NO. 85-374,617, FILED 7-19-2011.

RENEE MCCRAY, EXAMINING ATTORNEY



David J. Kyffers

Director of the United States Patent and Trademark Office

United States of America

United States Patent and Trademark Office

DERMA-MORPHOSE

Reg. No. 4,099,112

L'OREAL (FRANCE SOCIÉTÉ ANONYME (SA))

Registered Feb. 14, 2012

14 RUE ROYALE
PARIS, FRANCE 75008

Int. Cl.: 3

TRADEMARK

PRINCIPAL REGISTER

FOR: BATH AND SHOWER GELS AND SALTS NOT FOR MEDICAL PURPOSE; TOILET SOAPS; COSMETICS, NAMELY, CREAMS, MILKS, LOTIONS, GELS AND POWDERS FOR THE FACE, THE BODY AND THE HANDS; NON-MEDICATED SUN CARE PREPARATIONS; MAKEUP PREPARATIONS; SHAMPOOS; PRODUCTS FOR HAIR STYLING AND HAIR CARE, NAMELY, GELS, SPRAYS, MOUSSES, BALMS, CREAM, SERUMS, WAX AND LOTIONS; HAIR LACQUERS; HAIR COLOURING AND HAIR DECOLORANT PREPARATIONS; PROTECTIVE COLORING PREPARATIONS FOR TREATED HAIR; PERMANENT WAVING AND CURLING PREPARATIONS; ESSENTIAL OILS FOR PERSONAL USE, IN CLASS 3 (U.S. CLS. 1, 4, 6, 50, 51 AND 52).

THE MARK CONSISTS OF STANDARD CHARACTERS WITHOUT CLAIM TO ANY PARTICULAR FONT, STYLE, SIZE, OR COLOR.

PRIORITY CLAIMED UNDER SEC. 44(D) ON FRANCE APPLICATION NO. 11/3805622, FILED 2-11-2011, REG. NO. 11/3805622, DATED 2-11-2011, EXPIRES 2-11-2021.

SER. NO. 85-374,625, FILED 7-19-2011.

RENEE MCCRAY, EXAMINING ATTORNEY



David J. Kyros

Director of the United States Patent and Trademark Office

United States of America

United States Patent and Trademark Office



Reg. No. 4,099,113

Registered Feb. 14, 2012

Int. Cl.: 25

TRADEMARK

PRINCIPAL REGISTER

LA MINIATURA, LLC (CALIFORNIA LIMITED LIABILITY COMPANY)
SUITE 1310
3000 OLYMPIC BLVD.
SANTA MONICA, CA 90404

FOR: CHILDREN'S AND INFANT'S APPAREL, NAMELY, JUMPERS, OVERALL SLEEP-WEAR, PAJAMAS, ROMPERS, ONE-PIECE GARMENTS, CLOTH BIBS, INFANT WEARABLE BLANKETS, SHOES AND BOOTS, TROUSERS, SHIRTS, JACKETS, T-SHIRTS, DRESSES, BELTS, HATS, AND SWEATERS, IN CLASS 25 (U.S. CLS. 22 AND 39).

FIRST USE 6-1-2011; IN COMMERCE 6-1-2011.

THE MARK CONSISTS OF A REPRESENTATION OF A BULL IN FRONTAL VIEW, STANDING UPRIGHT.

SER. NO. 85-374,697, FILED 7-19-2011.

KATHLEEN LORENZO, EXAMINING ATTORNEY



David J. Kyffers

Director of the United States Patent and Trademark Office

United States of America

United States Patent and Trademark Office

Berenson

Reg. No. 4,099,114

BERENSON CORP (NEW YORK CORPORATION)
2495 MAIN ST., SUITE 111
BUFFALO, NY 14214

Registered Feb. 14, 2012

Int. Cl.: 6

FOR: COMMON METAL DRAWER PULLS; COMMON METAL PULLS; METAL BATHROOM HARDWARE, NAMELY, PULLS; METAL KNOBS; METAL PULLS FOR KITCHEN AND BATH CABINETS, IN CLASS 6 (U.S. CLS. 2, 12, 13, 14, 23, 25 AND 50).

TRADEMARK

FIRST USE 5-1-1988; IN COMMERCE 5-1-1988.

PRINCIPAL REGISTER

THE MARK CONSISTS OF STANDARD CHARACTERS WITHOUT CLAIM TO ANY PARTICULAR FONT, STYLE, SIZE, OR COLOR.

OWNER OF U.S. REG. NOS. 3,756,965 AND 3,884,467.

SEC. 2(F).

SER. NO. 85-374,807, FILED 7-19-2011.

EDWARD FENNESSY, EXAMINING ATTORNEY



David J. Kyffers

Director of the United States Patent and Trademark Office

United States of America

United States Patent and Trademark Office

TWIN GUARD

Reg. No. 4,099,115

SANYO NORTH AMERICA CORPORATION (DELAWARE CORPORATION)
2055 SANYO AVENUE
SAN DIEGO, CA 921546229

Registered Feb. 14, 2012

Int. Cl.: 11

FOR: INDUSTRIAL FREEZERS, IN CLASS 11 (U.S. CLS. 13, 21, 23, 31 AND 34).

TRADEMARK

FIRST USE 3-0-2010; IN COMMERCE 3-0-2010.

PRINCIPAL REGISTER

THE MARK CONSISTS OF STANDARD CHARACTERS WITHOUT CLAIM TO ANY PARTICULAR FONT, STYLE, SIZE, OR COLOR.

SER. NO. 85-375,500, FILED 7-19-2011.

JAY BESCH, EXAMINING ATTORNEY



David J. Kyffers

Director of the United States Patent and Trademark Office

United States of America

United States Patent and Trademark Office



Reg. No. 4,099,116

Registered Feb. 14, 2012

Int. Cls.: 9 and 41

TRADEMARK

SERVICE MARK

PRINCIPAL REGISTER

TELEVISA, S.A. DE C.V. (MEXICO CORPORATION)
EDIFICIO A PISO 4, COLONIA ZEDEC
AVENIDA VASCO DE QUIROGA 2000
SANTA FE, MEXICO 01210

FOR: PRE-RECORDED DIGITAL AND ELECTRONIC MEDIA, NAMELY CDS AND DVDS FEATURING AN ONGOING DRAMATIC TELEVISION SHOW, IN CLASS 9 (U.S. CLS. 21, 23, 26, 36 AND 38).

FOR: ENTERTAINMENT SERVICES IN THE NATURE OF A CONTINUING DRAMATIC SHOW BROADCAST OVER THE INTERNET AND AN ONGOING DRAMATIC TELEVISION PROGRAM, IN CLASS 41 (U.S. CLS. 100, 101 AND 107).

OWNER OF MEXICO REG. NO. 1231861, DATED 3-10-2011, EXPIRES 3-10-2021.

OWNER OF MEXICO REG. NO. 1229195, DATED 3-10-2011, EXPIRES 3-10-2021.

THE MARK CONSISTS OF THE DESIGNATION "LA FUERZA DEL DESTINO LA HISTORIA DE IVAN Y LUCIA" WITH A STYLIZED HEART DESIGN IN PLACE OF THE LETTER "O" OF "DESTINO".

THE ENGLISH TRANSLATION OF "LA FUERZA DEL DESTINO LA HISTORIA DE IVAN Y LUCIA" IN THE MARK IS THE FORCE OF DESTINY THE STORY OF IVAN AND LUCIA.

SER. NO. 85-375,573, FILED 7-19-2011.

JACLYN KIDWELL WALKER, EXAMINING ATTORNEY



David J. Kybas

Director of the United States Patent and Trademark Office

United States of America

United States Patent and Trademark Office



Reg. No. 4,099,117

MONTANA MEX LLC (MONTANA LIMITED LIABILITY COMPANY)
3181 MAGENTA ROAD
BOZEMAN, MT 59718

Registered Feb. 14, 2012

Int. Cl.: 30

FOR: FOOD CONDIMENT CONSISTING PRIMARILY OF KETCHUP AND SALSA; PICANTE SAUCE; SALSA; TOMATO-BASED SALSA, IN CLASS 30 (U.S. CL. 46).

TRADEMARK

FIRST USE 6-26-2010; IN COMMERCE 6-26-2010.

PRINCIPAL REGISTER

THE MARK CONSISTS OF A STYLIZED LETTER "M" WITH A FLAME ABOVE THE LETTER "M".

SER. NO. 85-376,611, FILED 7-20-2011.

MARTHA FROMM, EXAMINING ATTORNEY



David J. Kyffers

Director of the United States Patent and Trademark Office

United States of America

United States Patent and Trademark Office



Reg. No. 4,099,118

ECOLOGY COMMUNICATIONS GROUP, INC. (DELAWARE CORPORATION)

Registered Feb. 14, 2012

P.O. BOX 6847
ELLCOTT CITY, MD 21042

Int. Cl.: 41

FOR: ENTERTAINMENT SERVICES, NAMELY, PRODUCTION OF TELEVISION SHOWS; ENTERTAINMENT SERVICES, NAMELY, PROVIDING ONGOING TELEVISION PROGRAMS FEATURING SUBJECTS FOCUSED ON ECOLOGY AND THE ENVIRONMENT VIA A GLOBAL COMPUTER NETWORK; PRODUCTION OF RADIO OR TELEVISION PROGRAMS; ENTERTAINMENT IN THE NATURE OF ON-GOING TELEVISION PROGRAMS FOCUSED ON ECOLOGY AND THE ENVIRONMENT BROADCAST OVER TELEVISION, SATELLITE, AUDIO, AND VIDEO MEDIA, IN CLASS 41 (U.S. CLS. 100, 101 AND 107).

SERVICE MARK

PRINCIPAL REGISTER

FIRST USE 0-0-2004; IN COMMERCE 0-0-2004.

THE MARK CONSISTS OF THE LETTER "E" IN A PARTICULAR STYLIZED FONT.

SER. NO. 85-376,954, FILED 7-21-2011.

SUSAN RICHARDS, EXAMINING ATTORNEY



David J. Kybas

Director of the United States Patent and Trademark Office

United States of America

United States Patent and Trademark Office

POLE POSITION

Reg. No. 4,099,119

Registered Feb. 14, 2012

Int. Cl.: 12

TRADEMARK

PRINCIPAL REGISTER

BRIDGESTONE CORPORATION (JAPAN CORPORATION)
10-1, KYOBASHI 1-CHOME
CHUO-KU, TOKYO, JAPAN

FOR: TIRES, IN CLASS 12 (U.S. CLS. 19, 21, 23, 31, 35 AND 44).

FIRST USE 11-1-2005; IN COMMERCE 11-1-2005.

THE MARK CONSISTS OF STANDARD CHARACTERS WITHOUT CLAIM TO ANY PARTICULAR FONT, STYLE, SIZE, OR COLOR.

SER. NO. 85-377,637, FILED 7-21-2011.

KEVON CHISOLM, EXAMINING ATTORNEY



David J. Kyffers

Director of the United States Patent and Trademark Office

United States of America

United States Patent and Trademark Office

GILLIGAN'S ISLAND

Reg. No. 4,099,120

Registered Feb. 14, 2012

Int. Cl.: 9

TRADEMARK

PRINCIPAL REGISTER

TURNER ENTERTAINMENT CO. (DELAWARE CORPORATION)
BLDG 156
4000 WARNER BLVD.
BURBANK, CA 91522

FOR: PRE-RECORDED DVD'S FEATURING A COMEDIC TELEVISION SERIES, IN CLASS 9 (U.S. CLS. 21, 23, 26, 36 AND 38).

FIRST USE 2-3-2004; IN COMMERCE 2-3-2004.

THE MARK CONSISTS OF STANDARD CHARACTERS WITHOUT CLAIM TO ANY PARTICULAR FONT, STYLE, SIZE, OR COLOR.

OWNER OF U.S. REG. NO. 3,823,373.

SER. NO. 85-377,758, FILED 7-21-2011.

MICHAEL WIENER, EXAMINING ATTORNEY



David J. Kyffers

Director of the United States Patent and Trademark Office

United States of America

United States Patent and Trademark Office

GILLIGAN'S ISLAND

Reg. No. 4,099,121

Registered Feb. 14, 2012

Int. Cl.: 25

TRADEMARK

PRINCIPAL REGISTER

TURNER ENTERTAINMENT CO. (DELAWARE CORPORATION)
BLDG 156
4000 WARNER BLVD.
BURBANK, CA 91522

FOR: T-SHIRTS, IN CLASS 25 (U.S. CLS. 22 AND 39).

FIRST USE 3-31-2011; IN COMMERCE 3-31-2011.

THE MARK CONSISTS OF STANDARD CHARACTERS WITHOUT CLAIM TO ANY PARTICULAR FONT, STYLE, SIZE, OR COLOR.

OWNER OF U.S. REG. NO. 3,823,373.

SER. NO. 85-377,793, FILED 7-21-2011.

MICHAEL WIENER, EXAMINING ATTORNEY



David J. Kyffers

Director of the United States Patent and Trademark Office

United States of America

United States Patent and Trademark Office

OVO

Reg. No. 4,099,122

Registered Feb. 14, 2012

Int. Cl.: 9

TRADEMARK

PRINCIPAL REGISTER

SORKIN TYPE CO. (MASSACHUSETTS CORPORATION)
143 MASS AVE., SUITE 5
BOSTON, MA 02115

FOR: PRINTING FONTS THAT CAN BE DOWNLOADED PROVIDED BY MEANS OF ELECTRONIC TRANSMISSION; TYPEFACE FONTS RECORDED ON MAGNETIC MEDIA, IN CLASS 9 (U.S. CLS. 21, 23, 26, 36 AND 38).

FIRST USE 7-21-2011; IN COMMERCE 7-21-2011.

THE MARK CONSISTS OF STANDARD CHARACTERS WITHOUT CLAIM TO ANY PARTICULAR FONT, STYLE, SIZE, OR COLOR.

SER. NO. 85-378,261, FILED 7-22-2011.

KEVIN DINALLO, EXAMINING ATTORNEY



David J. Kybas

Director of the United States Patent and Trademark Office

United States of America

United States Patent and Trademark Office

FLAMESTRETCH

Reg. No. 4,099,123

MASSIF MOUNTAIN GEAR COMPANY, LLC (OREGON LIMITED LIABILITY COMPANY)
498 OAK STREET

Registered Feb. 14, 2012

ASHLAND, OR 97520

Int. Cl.: 9

FOR: FIRE RESISTANT CLOTHING, NAMELY, PANTS, PULLOVERS, LONG UNDERWEAR,
UNION SUITS, HEADWEAR, SOCKS, IN CLASS 9 (U.S. CLS. 21, 23, 26, 36 AND 38).

TRADEMARK

FIRST USE 9-24-2004; IN COMMERCE 9-24-2004.

PRINCIPAL REGISTER

THE MARK CONSISTS OF STANDARD CHARACTERS WITHOUT CLAIM TO ANY PAR-
TICULAR FONT, STYLE, SIZE, OR COLOR.

SER. NO. 85-378,440, FILED 7-22-2011.

B. PARADEWELAI, EXAMINING ATTORNEY



David J. Kyffers

Director of the United States Patent and Trademark Office

United States of America
United States Patent and Trademark Office

HOTJOHNS

Reg. No. 4,099,124

MASSIF MOUNTAIN GEAR COMPANY, LLC (OREGON LIMITED LIABILITY COMPANY)
498 OAK STREET
ASHLAND, OR 97520

Registered Feb. 14, 2012

Int. Cl.: 9

FOR: FIRE RESISTANT CLOTHING, NAMELY, CREW NECKS, LONG UNDERWEAR, TEE SHIRTS, LONG-SLEEVED TEE SHIRTS, IN CLASS 9 (U.S. CLS. 21, 23, 26, 36 AND 38).

TRADEMARK

FIRST USE 10-14-2003; IN COMMERCE 10-14-2003.

PRINCIPAL REGISTER

THE MARK CONSISTS OF STANDARD CHARACTERS WITHOUT CLAIM TO ANY PARTICULAR FONT, STYLE, SIZE, OR COLOR.

SER. NO. 85-378,454, FILED 7-22-2011.

B. PARADEWELAI, EXAMINING ATTORNEY



David J. Kyffers

Director of the United States Patent and Trademark Office

United States of America

United States Patent and Trademark Office

MASTERKEY

Reg. No. 4,099,125

MASTERCARD INTERNATIONAL INCORPORATED (DELAWARE CORPORATION)
2000 PURCHASE STREET
PURCHASE, NY 105772405

Registered Feb. 14, 2012

Int. Cl.: 36

FOR: CREDIT AND DEBIT CARD PAYMENT AUTHORIZATION AND TRANSACTION
PROCESSING SERVICES, IN CLASS 36 (U.S. CLS. 100, 101 AND 102).

SERVICE MARK

FIRST USE 6-24-2011; IN COMMERCE 6-24-2011.

PRINCIPAL REGISTER

THE MARK CONSISTS OF STANDARD CHARACTERS WITHOUT CLAIM TO ANY PAR-
TICULAR FONT, STYLE, SIZE, OR COLOR.

SER. NO. 85-378,798, FILED 7-22-2011.

ANN E. SAPPENFIELD, EXAMINING ATTORNEY



David J. Kyffers

Director of the United States Patent and Trademark Office

United States of America

United States Patent and Trademark Office

Driven By Pet Happiness

Reg. No. 4,099,126

CLICKVERGE LLC (DELAWARE LIMITED LIABILITY COMPANY)

Registered Feb. 14, 2012

3363 NE 163RD STREET #809
NORTH MIAMI BEACH, FL 33160

Int. Cl.: 35

FOR: ON-LINE RETAIL STORE SERVICES FEATURING PET FOOD, PET SUPPLIES AND PET ACCESSORIES, IN CLASS 35 (U.S. CLS. 100, 101 AND 102).

SERVICE MARK

FIRST USE 6-3-2011; IN COMMERCE 6-3-2011.

PRINCIPAL REGISTER

THE MARK CONSISTS OF STANDARD CHARACTERS WITHOUT CLAIM TO ANY PARTICULAR FONT, STYLE, SIZE, OR COLOR.

SER. NO. 85-379,640, FILED 7-25-2011.

KELLY TRUSILO, EXAMINING ATTORNEY



David J. Kybas

Director of the United States Patent and Trademark Office

United States of America

United States Patent and Trademark Office

UCSF

Reg. No. 4,099,127

THE REGENTS OF THE UNIVERSITY OF CALIFORNIA (CALIFORNIA CORPORATION)
1111 FRANKLIN ST., 8TH FLOOR
OAKLAND, CA 94607

Registered Feb. 14, 2012

**Int. Cls.: 6, 9, 16, 21, 25,
35, 41, 42 and 44**

FOR: METAL KEY RINGS AND CHAINS, IN CLASS 6 (U.S. CLS. 2, 12, 13, 14, 23, 25 AND 50).

FIRST USE 0-0-1969; IN COMMERCE 0-0-1969.

TRADEMARK

SERVICE MARK

FOR: MAGNETS; GRADUATED RULERS; EYE GLASSES CASES; SUN GLASSES CASES; PHONE CASES; AUDIO AND VIDEO RECORDINGS FEATURING GENERAL INFORMATION CONCERNING THE UNIVERSITY OF CALIFORNIA AT SAN FRANCISCO, IN CLASS 9 (U.S. CLS. 21, 23, 26, 36 AND 38).

PRINCIPAL REGISTER

FIRST USE 0-0-1969; IN COMMERCE 0-0-1969.

FOR: FOLDERS; BINDERS; NOTE BOOKS; NOTE PADS; NOTE PAPER AND HOLDERS; WRITING PAPER; ENVELOPES; LETTER OPENERS/KNIVES; MESSAGE BOARDS IN THE NATURE OF SLATE BOARDS FOR WRITING; PAPER WEIGHTS; PAPER CLIP TRAYS; BOOK ENDS; DECALS; STICKERS; BUMPER STICKERS; POSTERS; DAY PLANNERS; DESK TOP PLANNERS; PERSONAL DAILY PLANNERS; ADDRESS BOOKS; PERSONAL ADDRESS ORGANIZERS AND CASES; POSTCARDS; GREETING CARDS; PHOTO ALBUMS; BOOKMARKS; CALENDARS; MONEY CLIPS; PENCILS; PENS; PEN HOLDERS; COLORING BOOKS; NEWSLETTERS FEATURING INFORMATION ABOUT UNIVERSITY LIFE, UNIVERSITY ACTIVITIES, ACADEMIC, EDUCATIONAL AND ATHLETIC PROGRAMS, VISUAL, LITERARY AND PERFORMING ARTS PRESENTATIONS; PAMPHLETS FEATURING INFORMATION ABOUT UNIVERSITY LIFE, UNIVERSITY ACTIVITIES, ACADEMIC, EDUCATIONAL AND ATHLETIC PROGRAMS, VISUAL, LITERARY AND PERFORMING ARTS PRESENTATIONS; PERIODIC BROCHURES FEATURING INFORMATION ABOUT UNIVERSITY LIFE, UNIVERSITY ACTIVITIES, ACADEMIC, EDUCATIONAL AND ATHLETIC PROGRAMS, VISUAL, LITERARY AND PERFORMING ARTS PRESENTATIONS, IN CLASS 16 (U.S. CLS. 2, 5, 22, 23, 29, 37, 38 AND 50).

FIRST USE 0-0-1969; IN COMMERCE 0-0-1969.

FOR: BEVERAGE GLASSWARE; CUPS; COFFEE CUPS; PLASTIC CUPS; MUGS; DRINKING STEINS; PLASTIC WATER BOTTLES SOLD EMPTY; SHOT GLASSES; PORTABLE



David J. Kybas

Director of the United States Patent and Trademark Office

Reg. No. 4,099,127 BEVERAGE COOLERS; INSULATING SLEEVES HOLDERS FOR WATER BOTTLES; CORK SCREWS; SNACK BOWLS, IN CLASS 21 (U.S. CLS. 2, 13, 23, 29, 30, 33, 40 AND 50).

FIRST USE 0-0-1969; IN COMMERCE 0-0-1969.

FOR: CLOTHING, NAMELY, TOPS, BOTTOMS, BOXER SHORTS, SHIRTS, T-SHIRTS, POLO SHIRTS, SPORTS SHIRTS, TANK TOPS, SHORTS, SWEAT PANTS, SWEAT SHIRTS, WARM UP SUITS, SOCKS, COATS, NECK TIES, HEADWEAR, VISORS, CAPS, IN CLASS 25 (U.S. CLS. 22 AND 39).

FIRST USE 0-0-1969; IN COMMERCE 0-0-1969.

FOR: RETAIL STORE SERVICES FEATURING CLOTHING, BAGS, COMPUTERS, SOFTWARE, BOOKS, STATIONERY ITEMS, PAPER GOODS, GREETING CARDS, OFFICE SUPPLIES, CLOCKS, JEWELRY, KEY RINGS AND CHAINS, PICTURE FRAMES, GLASSWARE, STEINS, BANNERS, BLANKETS, SPORTING GOODS, FOOD, DRINKS, CANDY, COSMETICS, PERSONAL CARE ITEMS, FILM, PHOTO FINISHING, TOYS, GAMES, AND FLOWERS; MAIL ORDER CATALOG SERVICES AND COMPUTERIZED ONLINE ORDERING SERVICES FEATURING CLOTHING, BAGS, STATIONERY ITEMS, PAPER GOODS GREETING CARDS, OFFICE SUPPLIES, CLOCKS, JEWELRY, KEY RINGS AND CHAINS, PICTURE FRAMES, GLASSWARE, STEINS, BANNERS, BLANKETS, SPORTING GOODS, TOYS, GAMES, IN CLASS 35 (U.S. CLS. 100, 101 AND 102).

FIRST USE 0-0-1969; IN COMMERCE 0-0-1969.

FOR: EDUCATIONAL SERVICES, NAMELY, PROVIDING UNDERGRADUATE, GRADUATE AND DOCTORAL AND POSTDOCTORAL EDUCATIONAL PROGRAMS AND COURSES AT THE UNIVERSITY LEVEL; CONTINUING EDUCATION SERVICES IN THE AREAS OF MEDICINE, DENTISTRY, PHARMACY AND HEALTH SCIENCES, IN CLASS 41 (U.S. CLS. 100, 101 AND 107).

FIRST USE 0-0-1969; IN COMMERCE 0-0-1969.

FOR: MEDICAL AND SCIENTIFIC RESEARCH, NAMELY, CONDUCTING CLINICAL TRIALS; MEDICAL RESEARCH SERVICES; BIOMEDICAL RESEARCH SERVICES; BIOLOGICAL SCIENCE RESEARCH SERVICES; CLINICAL SCIENCE RESEARCH SERVICES; SOCIAL SCIENCE RESEARCH SERVICES; BEHAVIORAL SCIENCE RESEARCH SERVICES; POPULATION SCIENCE RESEARCH SERVICES, IN CLASS 42 (U.S. CLS. 100 AND 101).

FIRST USE 0-0-1969; IN COMMERCE 0-0-1969.

FOR: HOSPITALS; MEDICAL CLINICS, IN CLASS 44 (U.S. CLS. 100 AND 101).

FIRST USE 0-0-1969; IN COMMERCE 0-0-1969.

THE MARK CONSISTS OF STANDARD CHARACTERS WITHOUT CLAIM TO ANY PARTICULAR FONT, STYLE, SIZE, OR COLOR.

SER. NO. 85-380,464, FILED 7-25-2011.

DAVID TAYLOR, EXAMINING ATTORNEY

United States of America

United States Patent and Trademark Office

GO PRIMAL

Reg. No. 4,099,128

Registered Feb. 14, 2012

Int. Cl.: 41

SERVICE MARK

PRINCIPAL REGISTER

GO PRIMAL FITNESS, LLC (FLORIDA LIMITED LIABILITY COMPANY)
4650-A NW 39TH PLACE
GAINESVILLE, FL 32606

FOR: CONDUCTING FITNESS CLASSES; CONSULTING SERVICES IN THE FIELDS OF FITNESS AND EXERCISE; COUNSELING SERVICES IN THE FIELD OF PHYSICAL FITNESS; PERSONAL FITNESS TRAINING SERVICES AND CONSULTANCY; PERSONAL TRAINING PROVIDED IN CONNECTION WITH WEIGHT LOSS AND EXERCISE PROGRAMS; PERSONAL TRAINING SERVICES, NAMELY, STRENGTH AND CONDITIONING TRAINING; PHYSICAL FITNESS CONDITIONING CLASSES; PHYSICAL FITNESS CONSULTATION; PHYSICAL FITNESS INSTRUCTION; PHYSICAL FITNESS STUDIO SERVICES, NAMELY, PROVIDING EXERCISE CLASSES, BODY SCULPTING CLASSES, AND GROUP FITNESS CLASSES; PHYSICAL FITNESS TRAINING SERVICES CLASSES; CONSULTING SERVICES IN THE FIELDS OF FITNESS AND EXERCISE; COUNSELING SERVICES IN THE FIELD OF PHYSICAL FITNESS; PERSONAL FITNESS TRAINING SERVICES AND CONSULTANCY; PERSONAL TRAINING PROVIDED IN CONNECTION WITH WEIGHT LOSS AND EXERCISE PROGRAMS; PERSONAL TRAINING SERVICES, NAMELY, STRENGTH AND CONDITIONING TRAINING; PHYSICAL FITNESS CONDITIONING CLASSES; PHYSICAL FITNESS CONSULTATION; PHYSICAL FITNESS INSTRUCTION; PHYSICAL FITNESS STUDIO SERVICES, NAMELY, PROVIDING EXERCISE CLASSES, BODY SCULPTING CLASSES, AND GROUP FITNESS CLASSES; PHYSICAL FITNESS TRAINING SERVICES, IN CLASS 41 (U.S. CLS. 100, 101 AND 107).



FIRST USE 0-0-2008; IN COMMERCE 0-0-2008.

THE MARK CONSISTS OF STANDARD CHARACTERS WITHOUT CLAIM TO ANY PARTICULAR FONT, STYLE, SIZE, OR COLOR.

SER. NO. 85-380,923, FILED 7-26-2011.

TRACY WHITTAKER-BROWN, EXAMINING ATTORNEY

David J. Kypos

Director of the United States Patent and Trademark Office

United States of America

United States Patent and Trademark Office

Stepping Toward The Cure

Reg. No. 4,099,129

TRIPLE STEP TOWARD THE CURE (CALIFORNIA CORPORATION)
P.O. BOX 638
MILL VALLEY, CA 94942

Registered Feb. 14, 2012

Int. Cl.: 36

FOR: CHARITABLE FUNDRAISING SERVICES BY MEANS OF RUNNING AND WALKING EVENTS, IN CLASS 36 (U.S. CLS. 100, 101 AND 102).

SERVICE MARK

FIRST USE 6-21-2010; IN COMMERCE 9-7-2010.

PRINCIPAL REGISTER

THE MARK CONSISTS OF STANDARD CHARACTERS WITHOUT CLAIM TO ANY PARTICULAR FONT, STYLE, SIZE, OR COLOR.

SER. NO. 85-380,952, FILED 7-26-2011.

JENNIFER VASQUEZ, EXAMINING ATTORNEY



David J. Kybas

Director of the United States Patent and Trademark Office

United States of America

United States Patent and Trademark Office



Reg. No. 4,099,130

Registered Feb. 14, 2012

Int. Cl.: 36

SERVICE MARK

PRINCIPAL REGISTER

I'M COVERED L.L.C. (LOUISIANA LIMITED LIABILITY COMPANY)
511 EAST LANDRY STREET
OPELOUSAS, TX 70570

FOR: INSURANCE AGENCIES IN THE FIELD OF PROPERTY AND CASUALTY; INSURANCE SERVICES, PROVIDING PREMIUM RATE QUOTES VIA ON-LINE, TELEPHONE AND MAIL MEANS, IN CLASS 36 (U.S. CLS. 100, 101 AND 102).

FIRST USE 2-1-2011; IN COMMERCE 5-1-2011.

THE MARK CONSISTS OF ROOF OF HOUSE AND CHIMNEY WITH CAR UNDERNEATH.

SER. NO. 85-381,483, FILED 7-26-2011.

TARAH HARDY, EXAMINING ATTORNEY



David J. Kybas

Director of the United States Patent and Trademark Office

United States of America

United States Patent and Trademark Office

ENERPAC

Reg. No. 4,099,131

Registered Feb. 14, 2012

Int. Cls.: 7, 8 and 9

TRADEMARK

PRINCIPAL REGISTER

ACTUANT CORPORATION (WISCONSIN CORPORATION)
P.O. BOX 3241
MILWAUKEE, WI 532013241

FOR: POWER TOOLS AND INDUSTRIAL PRESSURE AND FORCE PRODUCING AND APPLYING TOOLS AND DEVICES, NAMELY, HYDRAULIC PUMPS, JACKS, PRESSES, CLAMPS, RAMS, CYLINDERS, PULLERS, PUNCHES, CUTTERS, SPREADERS, PIPE AND CONDUIT BENDERS, CABLE PULLERS, NUT SPLITTERS, AND TORQUE WRENCHES; POWER-OPERATED JACKS; PNEUMATIC AND ELECTRIC TORQUE WRENCH PUMPS; HYDRAULIC, PNEUMATIC, AND PILOT OPERATED DIRECTIONAL CONTROL VALVES, FLOW AND PRESSURE CONTROL VALVES, RELIEF VALVES, MECHANICAL SERVO VALVES, FILTERS, REGULATORS, SWIVEL JOINTS, COUPLINGS, HYDRAULIC CONNECTORS, HYDRAULIC CYLINDERS AND PUMPS AND HYDRAULIC FITTINGS AND COMPONENTS USED IN FLUID POWER AND PNEUMATIC CIRCUITS AND SYSTEMS, IN CLASS 7 (U.S. CLS. 13, 19, 21, 23, 31, 34 AND 35).

FIRST USE 8-22-1961; IN COMMERCE 8-22-1961.

FOR: HYDRAULIC HAND PUMPS; HIGH PRESSURE HAND PUMPS; HYDRAULIC FITTINGS AND COUPLERS; MANUALLY OPERATED CHECK VALVES; AND MANUALLY OPERATED JACKS, IN CLASS 8 (U.S. CLS. 23, 28 AND 44).

FIRST USE 8-22-1961; IN COMMERCE 8-22-1961.

FOR: ELECTRICAL CONTROLS PRIMARILY FOR FLUID PRESSURE SYSTEMS; ELECTRICALLY ACTUATED VALVES, SWITCHES AND SOLENOIDS; ELECTRIC AND AUTOMATIC TIMERS AND COUNTERS; ELECTRICAL AND ELECTRONIC PROGRAM CONTROLS FOR FLUID FORCE APPLICATIONS; ELECTRICAL CONTROLS FOR POWER-OPERATED JACKS; AND PRESSURE GAUGES, IN CLASS 9 (U.S. CLS. 21, 23, 26, 36 AND 38).

FIRST USE 8-24-1961; IN COMMERCE 8-24-1961.

THE MARK CONSISTS OF STANDARD CHARACTERS WITHOUT CLAIM TO ANY PARTICULAR FONT, STYLE, SIZE, OR COLOR.

OWNER OF U.S. REG. NOS. 743,740, 929,460, AND 1,988,154.



David J. Kyffers

Director of the United States Patent and Trademark Office

Reg. No. 4,099,131 SER. NO. 85-382,653, FILED 7-27-2011.

BRIAN NEVILLE, EXAMINING ATTORNEY

United States of America

United States Patent and Trademark Office

Big Tuft

Reg. No. 4,099,132

Registered Feb. 14, 2012

Int. Cl.: 21

TRADEMARK

PRINCIPAL REGISTER

DR FRESH INC. (NEW YORK CORPORATION)
6645 CABALLERO BLVD
BUENA PARK, CA 90620

FOR: COMPACTS CONTAINING DENTAL FLOSS AND ALSO INCLUDING LIP GLOSS; DENTAL CARE KIT COMPRISING TOOTHBRUSHES AND FLOSS; DENTAL FLOSS; DENTAL FLOSS; DENTAL FLOSS DISPENSERS; ELECTRIC TOOTHBRUSHES; ELECTRICAL TOOTHBRUSHES; HOME DENTAL CARE PRODUCTS FOR DOGS AND CATS, NAMELY, TOOTHBRUSH; MANUAL TOOTHBRUSHES; ORAL CARE KIT COMPRISING TOOTHBRUSHES AND FLOSS; TOOTHBRUSH CASES; TOOTHBRUSH HOLDERS; TOOTHBRUSHES; TOOTHBRUSHES; TOOTHBRUSHES, IN CLASS 21 (U.S. CLS. 2, 13, 23, 29, 30, 33, 40 AND 50).

FIRST USE 6-2-2010; IN COMMERCE 6-2-2010.

THE MARK CONSISTS OF STANDARD CHARACTERS WITHOUT CLAIM TO ANY PARTICULAR FONT, STYLE, SIZE, OR COLOR.

SER. NO. 85-382,911, FILED 7-27-2011.

CHERYL CLAYTON, EXAMINING ATTORNEY



David J. Kyffers

Director of the United States Patent and Trademark Office

United States of America

United States Patent and Trademark Office



Reg. No. 4,099,133

Registered Feb. 14, 2012

Int. Cl.: 36

SERVICE MARK

PRINCIPAL REGISTER

FIRST BUSEY CORPORATION (NEVADA CORPORATION)
201 W MAIN STREET
URBANA, IL 61801

FOR: BANKING, IN CLASS 36 (U.S. CLS. 100, 101 AND 102).

FIRST USE 6-23-2011; IN COMMERCE 6-23-2011.

OWNER OF U.S. REG. NOS. 3,153,643, 3,452,771, AND 3,457,634.

THE COLOR(S) BLUE, BLACK, AND WHITE IS/ARE CLAIMED AS A FEATURE OF THE MARK.

NO CLAIM IS MADE TO THE EXCLUSIVE RIGHT TO USE "BANK" AND "BEST BANK ON CAMPUS", APART FROM THE MARK AS SHOWN.

THE MARK CONSISTS OF THE BLOCK LETTERS "BBOC" IN WHITE WITHIN A BLUE RECTANGULAR BACKGROUND; THE TERM "BUSEY" IN BLACK IS IN THE VERTICAL SIDE OF THE FIRST "B"; THE TERM "BANK" IN BLACK IS IN THE VERTICAL SIDE OF THE SECOND "B"; THE BLOCK WORDING "BEST BANK ON CAMPUS" IN BLACK IS BELOW THE BLUE RECTANGLE.

SER. NO. 85-382,987, FILED 7-27-2011.

WILLIAM P. SHANAHAN, EXAMINING ATTORNEY



David J. Kybas

Director of the United States Patent and Trademark Office

United States of America

United States Patent and Trademark Office

RENESENZ

Reg. No. 4,099,134

Registered Feb. 14, 2012

Int. Cls.: 1 and 4

TRADEMARK

PRINCIPAL REGISTER

RENESENZ LLC (DELAWARE LIMITED LIABILITY COMPANY)
601 CRESTWOOD STREET
JACKSONVILLE, FL 322084478

FOR: CHEMICAL ADDITIVES PRODUCED FROM NATURALLY OCCURRING RENEWABLE AND SUSTAINABLE FEEDSTOCKS USED AS FRAGRANCES AND FLAVORINGS IN THE MANUFACTURE OF HOUSEHOLD AND PERSONAL CARE PRODUCTS, ORAL-CARE PRODUCTS, CONFECTIONERY AND BEVERAGES; INDUSTRIAL INTERMEDIATES USED AS INITIATORS IN RUBBER INDUSTRY AND IN OTHER INDUSTRIAL APPLICATIONS, IN CLASS 1 (U.S. CLS. 1, 5, 6, 10, 26 AND 46).

FIRST USE 12-22-2010; IN COMMERCE 12-22-2010.

FOR: FUELS AND BIOFUELS BLENDED WITH CHEMICALS AND/OR BIOLOGICAL PRODUCTS; FUELS FROM BIOLOGICAL SOURCES; TERPENE-BASED FUEL, IN CLASS 4 (U.S. CLS. 1, 6 AND 15).

FIRST USE 12-22-2010; IN COMMERCE 12-22-2010.

THE MARK CONSISTS OF STANDARD CHARACTERS WITHOUT CLAIM TO ANY PARTICULAR FONT, STYLE, SIZE, OR COLOR.

SER. NO. 85-383,368, FILED 7-28-2011.

JAY FLOWERS, EXAMINING ATTORNEY



David J. Kyffers

Director of the United States Patent and Trademark Office

United States of America

United States Patent and Trademark Office

INSTANT VACATION

Reg. No. 4,099,135

Registered Feb. 14, 2012

Int. Cl.: 3

TRADEMARK

PRINCIPAL REGISTER

AVON PRODUCTS, INC. (NEW YORK CORPORATION)
LEGAL DEPARTMENT, 3RD FLOOR
777 THIRD AVENUE
NEW YORK, NY 10017

FOR: FRAGRANCES, IN CLASS 3 (U.S. CLS. 1, 4, 6, 50, 51 AND 52).

FIRST USE 4-7-2005; IN COMMERCE 4-7-2005.

THE MARK CONSISTS OF STANDARD CHARACTERS WITHOUT CLAIM TO ANY PARTICULAR FONT, STYLE, SIZE, OR COLOR.

OWNER OF U.S. REG. NO. 2,990,413.

SER. NO. 85-384,244, FILED 7-29-2011.

STEVEN PEREZ, EXAMINING ATTORNEY



David J. Kybas

Director of the United States Patent and Trademark Office

United States of America

United States Patent and Trademark Office

Lift

Reg. No. 4,099,136

Registered Feb. 14, 2012

Int. Cl.: 18

TRADEMARK

PRINCIPAL REGISTER

SAMSONITE IP HOLDINGS S.À R.L. (LUXEMBOURG PRIVATE LIMITED LIABILITY COMPANY)
13-15 AVENUE DE LA LIBERTÉ
L-1931 LUXEMBOURG, LUXEMBOURG

FOR: LUGGAGE, SUITCASES, TRAVELING BAGS, OVERNIGHT CASES, IN CLASS 18 (U.S. CLS. 1, 2, 3, 22 AND 41).

FIRST USE 5-31-2011; IN COMMERCE 5-31-2011.

THE MARK CONSISTS OF THE WORD "LIFT" WITH THE LETTER "I" RAISED UP ABOVE THE OTHER LETTERS AND POSITIONED TO THE LEFT WITHIN THE CAPITAL LETTER "L".

SER. NO. 85-384,565, FILED 7-29-2011.

RON FAIRBANKS, EXAMINING ATTORNEY



David J. Kybas

Director of the United States Patent and Trademark Office

United States of America

United States Patent and Trademark Office

Easyslide

Reg. No. 4,099,137

DR FRESH INC. (CALIFORNIA CORPORATION)
6645 CABALLERO BLVD
BUENA PARK, CA 90620

Registered Feb. 14, 2012

Int. Cl.: 5

FOR: PERSONAL SEXUAL LUBRICANTS; SEXUAL STIMULANT GELS, IN CLASS 5 (U.S. CLS. 6, 18, 44, 46, 51 AND 52).

TRADEMARK

FIRST USE 5-18-2010; IN COMMERCE 5-18-2010.

PRINCIPAL REGISTER

THE MARK CONSISTS OF STANDARD CHARACTERS WITHOUT CLAIM TO ANY PARTICULAR FONT, STYLE, SIZE, OR COLOR.

SER. NO. 85-385,225, FILED 7-29-2011.

CHERYL CLAYTON, EXAMINING ATTORNEY



David J. Kybas

Director of the United States Patent and Trademark Office

United States of America

United States Patent and Trademark Office

BECAUSE THERE IS A DIFFERENCE IN BROKERS

Reg. No. 4,099,138

CENTRAL BANCOMPANY, INC. (MISSOURI CORPORATION)
238 MADISON STREET

Registered Feb. 14, 2012

JEFFERSON CITY, MO 65101

Int. Cl.: 36

FOR: FINANCIAL INVESTMENT BROKERAGE SERVICES, IN CLASS 36 (U.S. CLS. 100, 101 AND 102).

SERVICE MARK

FIRST USE 7-8-2011; IN COMMERCE 7-8-2011.

PRINCIPAL REGISTER

THE MARK CONSISTS OF STANDARD CHARACTERS WITHOUT CLAIM TO ANY PARTICULAR FONT, STYLE, SIZE, OR COLOR.

SER. NO. 85-388,609, FILED 8-3-2011.

WILLIAM P. SHANAHAN, EXAMINING ATTORNEY



David J. Kybas

Director of the United States Patent and Trademark Office

United States of America

United States Patent and Trademark Office

STRATERMIC

Reg. No. 4,099,139

Registered Feb. 14, 2012

Int. Cls.: 18, 20, 24 and 25

TRADEMARK

PRINCIPAL REGISTER

PROJETCLUB (FRANCE CORPORATION)
4, BOULEVARD DE MONS
VILLENEUVE D'ASC, FRANCE 59650

FOR: ALL-PURPOSE CARRYING BAGS, MESSENGER BAGS, ATHLETIC BAGS, DRAWSTRING BAGS, DUFFEL BAGS, TOTE BAGS, TRUNKS AND TRAVELLING BAGS, BACKPACKS, SPORTS BAGS, LUGGAGE, BELT BAGS, UMBRELLAS, HORSE BLANKETS, IN CLASS 18 (U.S. CLS. 1, 2, 3, 22 AND 41).

FOR: SLEEPING BAGS, SLEEPING BAG LINERS, CUSHIONS; AIR MATTRESSES FOR USE WHEN CAMPING, IN CLASS 20 (U.S. CLS. 2, 13, 22, 25, 32 AND 50).

FOR: FACE TOWELS, BATH SHEETS, BLANKETS, TOWELS, IN CLASS 24 (U.S. CLS. 42 AND 50).

FOR: FOOTWEAR, HEADWEAR, TOPS, BOTTOMS, VESTS, JACKETS, COATS, PULLOVERS, SWEATERS, TIGHTS, LEGGINGS, SHIRTS, PANTS, GLOVES, SOCKS, ANORAKS, MITTENS, SNOW SUITS, SKI WEAR, UNDERWEAR, BELTS, SCARVES, EAR MUFFS, HEADBANDS, WRISTBANDS, SKI BOOTS, COLLARS, SOLES FOR FOOTWEAR, SHORTS, BATHING SUITS, SWIM WEAR; ARM, HAND, LEG AND KNEE WARMERS, IN CLASS 25 (U.S. CLS. 22 AND 39).

THE MARK CONSISTS OF STANDARD CHARACTERS WITHOUT CLAIM TO ANY PARTICULAR FONT, STYLE, SIZE, OR COLOR.

OWNER OF ERPN CMNTY TM OFC REG. NO. 6781124, DATED 3-12-2009, EXPIRES 3-13-2018.

SER. NO. 85-389,928, FILED 8-4-2011.

KELLY TRUSILO, EXAMINING ATTORNEY



David J. Kypos

Director of the United States Patent and Trademark Office

United States of America

United States Patent and Trademark Office

bonro.com

Reg. No. 4,099,140

Registered Feb. 14, 2012

Int. Cl.: 35

SERVICE MARK

PRINCIPAL REGISTER

BONRO MEDICAL, INC. (GEORGIA CORPORATION)
BLDG. 100, STE. 16
4490 WASHINGTON ROAD
EVANS, GA 30809

FOR: RETAIL STORE SERVICES FEATURING MEDICAL EQUIPMENT AND VACUUM
ERECTION DEVICES, IN CLASS 35 (U.S. CLS. 100, 101 AND 102).

FIRST USE 5-1-2003; IN COMMERCE 5-1-2003.

THE MARK CONSISTS OF STANDARD CHARACTERS WITHOUT CLAIM TO ANY PAR-
TICULAR FONT, STYLE, SIZE, OR COLOR.

SER. NO. 85-390,079, FILED 8-4-2011.

ELIZABETH KAJUBI, EXAMINING ATTORNEY



David J. Kyffers

Director of the United States Patent and Trademark Office

United States of America

United States Patent and Trademark Office

Tek T4

Reg. No. 4,099,141

Registered Feb. 14, 2012

Int. Cl.: 9

TRADEMARK

PRINCIPAL REGISTER

DR FRESH INC. (CALIFORNIA CORPORATION)
6645 CABALLERO BLVD
BUENA PARK, CA 90620

FOR: BAGS AND CASES SPECIALLY ADAPTED FOR HOLDING OR CARRYING ELECTRIC HAIR CURLING IRONS; BAGS AND CASES SPECIALLY ADAPTED FOR HOLDING OR CARRYING PORTABLE TELEPHONES AND TELEPHONE EQUIPMENT AND ACCESSORIES; BATTERY CASES; BEEPER CARRYING CASES; CAMERA CASES; CARRYING CASES AND CONTAINERS FOR CONTACT LENSES; CARRYING CASES FOR CELL PHONES; CARRYING CASES FOR MOBILE COMPUTERS; CARRYING CASES FOR RADIO PAGERS; CARRYING CASES SPECIALLY ADAPTED FOR POCKET CALCULATORS AND CELLPHONES; CARRYING CASES, HOLDERS, PROTECTIVE CASES AND STANDS FEATURING POWER SUPPLY CONNECTORS, ADAPTORS, SPEAKERS AND BATTERY CHARGING DEVICES, SPECIALLY ADAPTED FOR USE WITH HANDHELD DIGITAL ELECTRONIC DEVICES; CASES FOR CHILDREN'S EYE GLASSES; CASES FOR DISKETTES AND COMPACT DISKS; CASES FOR EYEGLASSES AND SUNGLASSES; CASES FOR MOBILE PHONES; CASES FOR TELEPHONES; CD CASES; CELL PHONE BACKPLATES; CELL PHONE CASES; CELL PHONE COVERS; CELLULAR PHONE ACCESSORY CHARMS; CELLULAR PHONES; COMPUTER CARRYING CASES; DVD CASES; EYE GLASS CASES; EYEGLASS CASES; EYEWEAR CASES; LAPTOP CARRYING CASES; MOBILE PHONE STRAPS; SPECTACLE CASES; SPECTACLES, FRAMES AND CASES, IN CLASS 9 (U.S. CLS. 21, 23, 26, 36 AND 38).

FIRST USE 7-5-2011; IN COMMERCE 7-5-2011.

THE MARK CONSISTS OF STANDARD CHARACTERS WITHOUT CLAIM TO ANY PARTICULAR FONT, STYLE, SIZE, OR COLOR.

SER. NO. 85-390,101, FILED 8-4-2011.

CHERYL CLAYTON, EXAMINING ATTORNEY



David J. Kypos

Director of the United States Patent and Trademark Office

United States of America
United States Patent and Trademark Office

SWAGGER

Reg. No. 4,099,142

Registered Feb. 14, 2012

Int. Cl.: 9

TRADEMARK

PRINCIPAL REGISTER

SAKAR INTERNATIONAL, INC. (NEW YORK CORPORATION)
195 CARTER DRIVE
EDISON, NJ 08817

FOR: ACCESSORIES FOR MP3 PLAYERS, SMART PHONES AND PC TABLETS, NAMELY, PROTECTIVE AND CARRYING CASES, MOBILE TELEPHONE COVERS, MOBILE TELEPHONE CASES, BATTERIES, RECHARGEABLE BATTERIES, BATTERY CHARGERS, CHARGERS FOR ELECTRIC BATTERIES, HEADPHONES, STEREO HEADPHONES, IN-EAR HEADPHONES, STEREO SPEAKERS, AUDIO SPEAKERS FOR HOME, PERSONAL STEREO SPEAKERS, MICROPHONES, CAR AUDIO ADAPTERS, HEADSETS, REMOTE CONTROLS, CONNECTION CABLES, POWER ADAPTERS, DOCKING STATIONS, AND ADAPTER PLUGS; HEADPHONES; AUDIO SPEAKERS; MP3 PLAYERS, IN CLASS 9 (U.S. CLS. 21, 23, 26, 36 AND 38).

FIRST USE 2-1-2010; IN COMMERCE 2-1-2010.

THE MARK CONSISTS OF STANDARD CHARACTERS WITHOUT CLAIM TO ANY PARTICULAR FONT, STYLE, SIZE, OR COLOR.

SER. NO. 85-390,953, FILED 8-5-2011.

TRICIA SONNEBORN, EXAMINING ATTORNEY



David J. Kyfos

Director of the United States Patent and Trademark Office

United States of America

United States Patent and Trademark Office

WILDFIRE PROTECTION UNIT

Reg. No. 4,099,143

Registered Feb. 14, 2012

Int. Cls.: 36 and 40

SERVICE MARK

PRINCIPAL REGISTER

AKITA, INC. (DELAWARE CORPORATION)
SUITE 400
2711 CENTERVILLE ROAD
WILMINGTON, DE 19808

FOR: INSURANCE CONSULTANCY SERVICES, NAMELY, PROVIDING ADVICE IN THE FIELD OF PROPERTY AND CASUALTY INSURANCE, IN CLASS 36 (U.S. CLS. 100, 101 AND 102).

FIRST USE 6-21-2005; IN COMMERCE 6-21-2005.

FOR: FIREPROOFING OF LANDSCAPING AROUND A HOME, IN CLASS 40 (U.S. CLS. 100, 103 AND 106).

FIRST USE 6-21-2005; IN COMMERCE 6-21-2005.

THE MARK CONSISTS OF STANDARD CHARACTERS WITHOUT CLAIM TO ANY PARTICULAR FONT, STYLE, SIZE, OR COLOR.

OWNER OF U.S. REG. NO. 3,083,995.

SEC. 2(F).

SER. NO. 85-391,005, FILED 8-5-2011.

SUSAN RICHARDS, EXAMINING ATTORNEY



David J. Kybas

Director of the United States Patent and Trademark Office

United States of America

United States Patent and Trademark Office

METRIWIPES

Reg. No. 4,099,144

Registered Feb. 14, 2012

Int. Cl.: 5

TRADEMARK

PRINCIPAL REGISTER

METREX RESEARCH, LLC (WISCONSIN LIMITED LIABILITY COMPANY)
S. SWAIN SDS LEGAL DEPARTMENT
1717 WEST COLLINS AVENUE
ORANGE, CA 92867

FOR: BROAD SPECTRUM HOSPITAL GRADE SURFACE DISINFECTANT WIPES FOR
HEALTHCARE FACILITY USE , IN CLASS 5 (U.S. CLS. 6, 18, 44, 46, 51 AND 52).

FIRST USE 6-3-1998; IN COMMERCE 6-3-1998.

THE MARK CONSISTS OF STANDARD CHARACTERS WITHOUT CLAIM TO ANY PAR-
TICULAR FONT, STYLE, SIZE, OR COLOR.

SER. NO. 85-391,148, FILED S.R. 8-5-2011 AM. P.R. 9-28-2011.

TAMARA FRAZIER, EXAMINING ATTORNEY



David J. Kybas

Director of the United States Patent and Trademark Office

United States of America

United States Patent and Trademark Office

SCAN2PACS

Reg. No. 4,099,145

Registered Feb. 14, 2012

Int. Cl.: 9

TRADEMARK

PRINCIPAL REGISTER

COACTIV, LLC (CONNECTICUT LIMITED LIABILITY COMPANY)
900 ETHAN ALLEN HIGHWAY
RIDGEFIELD, CT 06877

FOR: COMPUTER SOFTWARE FOR DIGITIZING PAPER DOCUMENTS AND SAVING THEM IN DICOM FORMAT AND OTHER FORMATS VIEWABLE IN MEDICAL IMAGE VIEWING SYSTEMS , IN CLASS 9 (U.S. CLS. 21, 23, 26, 36 AND 38).

FIRST USE 9-21-2010; IN COMMERCE 9-21-2010.

THE MARK CONSISTS OF STANDARD CHARACTERS WITHOUT CLAIM TO ANY PARTICULAR FONT, STYLE, SIZE, OR COLOR.

OWNER OF U.S. REG. NOS. 2,916,419 AND 3,035,022.

SER. NO. 85-392,082, FILED 8-8-2011.

SALLY SHIH, EXAMINING ATTORNEY



David J. Kybas

Director of the United States Patent and Trademark Office

United States of America

United States Patent and Trademark Office

Lipluptuous

Reg. No. 4,099,146

Registered Feb. 14, 2012

Int. Cl.: 3

TRADEMARK

PRINCIPAL REGISTER

DR FRESH INC. (NEW YORK CORPORATION)
6645 CABALLERO BLVD
BUENA PARK, CA 90620

FOR: COSMETICS, NAMELY, LIP PRIMER; COSMETICS, NAMELY, LIP REPAIRERS; LIP BALM; LIP BALM; LIP CREAM; LIP GLOSS; LIP GLOSS PALATTE; LIP LINER; LIP POLISHER; NON-MEDICATED HERBAL BODY CARE PRODUCTS, NAMELY, BODY OILS, SALVES, AND LIP BALMS; NON-MEDICATED LIP BALM THAT DOES NOT CONTAIN BEESWAX; NON-MEDICATED LIP CARE PREPARATIONS; NON-MEDICATED LIP PROTECTORS, IN CLASS 3 (U.S. CLS. 1, 4, 6, 50, 51 AND 52).

FIRST USE 10-14-2010; IN COMMERCE 10-14-2010.

THE MARK CONSISTS OF STANDARD CHARACTERS WITHOUT CLAIM TO ANY PARTICULAR FONT, STYLE, SIZE, OR COLOR.

SER. NO. 85-392,567, FILED 8-8-2011.

CHERYL CLAYTON, EXAMINING ATTORNEY



David J. Kyffers

Director of the United States Patent and Trademark Office

United States of America

United States Patent and Trademark Office



Reg. No. 4,099,147

Registered Feb. 14, 2012

Int. Cl.: 31

TRADEMARK

PRINCIPAL REGISTER

DOW AGROSCIENCES LLC (DELAWARE LIMITED LIABILITY COMPANY)
9330 ZIONSVILLE ROAD
INDIANAPOLIS, IN 46268

FOR: AGRICULTURAL SEED, IN CLASS 31 (U.S. CLS. 1 AND 46).

FIRST USE 12-31-2009; IN COMMERCE 12-31-2009.

THE MARK CONSISTS OF KERNEL OF CORN WITH CIRCLE INSIDE WITH SOYBEAN INSIDE CIRCLE.

SER. NO. 85-392,872, FILED 8-9-2011.

NAKIA HENRY, EXAMINING ATTORNEY



David J. Kyffers

Director of the United States Patent and Trademark Office

United States of America

United States Patent and Trademark Office

KNÚ

Reg. No. 4,099,148

Registered Feb. 14, 2012

Int. Cl.: 20

TRADEMARK

PRINCIPAL REGISTER

ECON MANUFACTURING, LLC (INDIANA LIMITED LIABILITY COMPANY)
P.O. BOX 9
FERDINAND, IN 47352

FOR: HEALTH CARE FURNITURE, IN CLASS 20 (U.S. CLS. 2, 13, 22, 25, 32 AND 50).

FIRST USE 6-16-2011; IN COMMERCE 6-16-2011.

THE MARK CONSISTS OF STANDARD CHARACTERS WITHOUT CLAIM TO ANY PARTICULAR FONT, STYLE, SIZE, OR COLOR.

OWNER OF U.S. REG. NO. 3,349,221.

SER. NO. 85-392,952, FILED 8-9-2011.

KIMBERLY PERRY, EXAMINING ATTORNEY



David J. Kyffers

Director of the United States Patent and Trademark Office

United States of America

United States Patent and Trademark Office

NATALIE PAIGE BENTLEY

Reg. No. 4,099,149

NPB ENTERTAINMENT GROUP, LLC (PENNSYLVANIA LIMITED LIABILITY COMPANY)
262 LAPP ROAD
MALVERN, PA 19355

Registered Feb. 14, 2012

Int. Cls.: 35 and 41

FOR: ON-LINE RETAIL STORE SERVICES FEATURING CLOTHING, IN CLASS 35 (U.S. CLS. 100, 101 AND 102).

SERVICE MARK

FIRST USE 1-1-2011; IN COMMERCE 1-1-2011.

PRINCIPAL REGISTER

FOR: ENTERTAINMENT IN THE NATURE OF VISUAL AND AUDIO PERFORMANCES BY AN ACTOR; PROVIDING A WEBSITE FEATURING INFORMATION IN THE FIELD OF MUSIC AND ENTERTAINMENT, IN CLASS 41 (U.S. CLS. 100, 101 AND 107).

FIRST USE 1-1-2002; IN COMMERCE 1-1-2002.

THE MARK CONSISTS OF STANDARD CHARACTERS WITHOUT CLAIM TO ANY PARTICULAR FONT, STYLE, SIZE, OR COLOR.

THE NAME(S), PORTRAIT(S), AND/OR SIGNATURE(S) SHOWN IN THE MARK IDENTIFIES NATALIE PAIGE BENTLEY, WHOSE CONSENT(S) TO REGISTER IS MADE OF RECORD.

SER. NO. 85-393,174, FILED 8-9-2011.

ELLEN PERKINS, EXAMINING ATTORNEY



David J. Kybas

Director of the United States Patent and Trademark Office

United States of America

United States Patent and Trademark Office

COSTUMES IN MOTION

Reg. No. 4,099,150

Registered Feb. 14, 2012

Int. Cl.: 35

SERVICE MARK

PRINCIPAL REGISTER

PERFORM GROUP, LLC (DELAWARE LIMITED LIABILITY COMPANY)
333 E. SEVENTH AVENUE
YORK, PA 17404

FOR: COMPUTERIZED ON-LINE RETAIL STORE SERVICES IN THE FIELD OF APPAREL FOR DANCERS, MAJORETTES, CHEERLEADERS AND PARADE PERFORMANCE UNITS; MAIL ORDER CATALOG SERVICES FEATURING APPAREL FOR DANCERS, MAJORETTES, CHEERLEADERS AND PARADE PERFORMANCE UNITS, IN CLASS 35 (U.S. CLS. 100, 101 AND 102).

FIRST USE 8-10-2011; IN COMMERCE 8-10-2011.

THE MARK CONSISTS OF STANDARD CHARACTERS WITHOUT CLAIM TO ANY PARTICULAR FONT, STYLE, SIZE, OR COLOR.

SER. NO. 85-396,725, FILED 8-12-2011.

KAELIE KUNG, EXAMINING ATTORNEY



David J. Kyffers

Director of the United States Patent and Trademark Office

United States of America

United States Patent and Trademark Office

electric  orange

Reg. No. 4,099,151

ING DIRECT BANCORP (DELAWARE CORPORATION)
1 SOUTH ORANGE STREET
WILMINGTON, DE 19801

Registered Feb. 14, 2012

Int. Cl.: 36

FOR: FINANCIAL SERVICES, NAMELY, CHECKING ACCOUNT SERVICES; ON-LINE BILL PAY SERVICES; DEBIT CARD SERVICES; BANKING SERVICES, IN CLASS 36 (U.S. CLS. 100, 101 AND 102).

SERVICE MARK

FIRST USE 5-19-2009; IN COMMERCE 5-19-2009.

PRINCIPAL REGISTER

THE MARK CONSISTS OF THE WORD "ELECTRIC" IN LOWER CASE BLUE LETTERS FOLLOWED BY AN ORANGE LIGHTNING BOLT DESIGN FOLLOWED BY THE WORD "ORANGE" IN LOWER CASE ORANGE LETTERS.

THE COLOR(S) BLUE AND ORANGE IS/ARE CLAIMED AS A FEATURE OF THE MARK.

SER. NO. 85-398,098, FILED 8-15-2011.

SHANNON TWOHIG, EXAMINING ATTORNEY



David J. Kyffers

Director of the United States Patent and Trademark Office

United States of America

United States Patent and Trademark Office



Reg. No. 4,099,152

Registered Feb. 14, 2012

Int. Cls.: 36, 37 and 43

SERVICE MARK

PRINCIPAL REGISTER

GID INVESTMENT ADVISERS CORPORATION (DELAWARE CORPORATION)
125 HIGH STREET, 27TH FLOOR
BOSTON, MA 02110

FOR: REAL ESTATE SERVICES, NAMELY, RENTAL, BROKERAGE, LEASING AND MANAGEMENT OF RESIDENTIAL AND COMMERCIAL PROPERTY, OFFICES AND OFFICE SPACE, IN CLASS 36 (U.S. CLS. 100, 101 AND 102).

FIRST USE 10-0-2009; IN COMMERCE 10-0-2009.

FOR: BUILDING CONSTRUCTION AND DEVELOPMENT SERVICES, NAMELY REAL ESTATE DEVELOPMENT AND BUILDING REPAIR AND MAINTENANCE SERVICES, IN CLASS 37 (U.S. CLS. 100, 103 AND 106).

FIRST USE 10-0-2009; IN COMMERCE 10-0-2009.

FOR: PROVISION OF TEMPORARY HOUSING ACCOMMODATIONS, IN CLASS 43 (U.S. CLS. 100 AND 101).

FIRST USE 10-0-2009; IN COMMERCE 10-0-2009.

THE MARK CONSISTS OF THE LETTER W WITH A CURVED LINE ENCIRCLING THE RIGHT SIDE OF THE W AND A CURVED LINE ENCIRCLING THE LEFT SIDE OF THE W.

SER. NO. 85-398,161, FILED 8-15-2011.

WILLIAM JACKSON, EXAMINING ATTORNEY



David J. Kybas

Director of the United States Patent and Trademark Office

United States of America

United States Patent and Trademark Office

ALWAYS A LEAP AHEAD

Reg. No. 4,099,153

SKIP HOP, INC. (NEW YORK CORPORATION)
50 WEST 23RD STREET, 10TH FLOOR
NEW YORK, NY 10010

Registered Feb. 14, 2012

Int. Cl.: 16

FOR: LUNCH BAGS, IN CLASS 16 (U.S. CLS. 2, 5, 22, 23, 29, 37, 38 AND 50).

TRADEMARK

FIRST USE 5-1-2011; IN COMMERCE 5-1-2011.

PRINCIPAL REGISTER

THE MARK CONSISTS OF STANDARD CHARACTERS WITHOUT CLAIM TO ANY PARTICULAR FONT, STYLE, SIZE, OR COLOR.

SER. NO. 85-399,899, FILED 8-17-2011.

DEBRA LEE, EXAMINING ATTORNEY



David J. Kyffers

Director of the United States Patent and Trademark Office

United States of America

United States Patent and Trademark Office

STRONGER RESULTS FROM THE GROUND UP

Reg. No. 4,099,154

Registered Feb. 14, 2012

Int. Cls.: 36, 37 and 42

SERVICE MARK

PRINCIPAL REGISTER

FIVE BROTHERS MORTGAGE COMPANY SERVICES AND SECURING, INC. (MICHIGAN CORPORATION)
14156 EAST 11 MILE ROAD
WARREN, MI 48089

FOR: FINANCIAL SERVICES, NAMELY, LOSS MITIGATION SERVICES FOR UNDER OR NON-PERFORMING MORTGAGE LOANS IN THE FIELD OF DEFAULT AND DISTRESSED PROPERTIES, IN CLASS 36 (U.S. CLS. 100, 101 AND 102).

FIRST USE 2-0-2010; IN COMMERCE 2-0-2010.

FOR: REAL ESTATE PROPERTY CLEANING, REPAIR AND MAINTENANCE SERVICES FOR DEFAULT AND DISTRESSED PROPERTIES, IN CLASS 37 (U.S. CLS. 100, 103 AND 106).

FIRST USE 2-0-2010; IN COMMERCE 2-0-2010.

FOR: HOUSE INSPECTION OF DEFAULT AND DISTRESSED PROPERTIES; DATA AUTOMATION AND COLLECTION SERVICES USING PROPRIETARY SOFTWARE TO EVALUATE, ANALYZE AND COLLECT SERVICE DATA USED IN THE MANAGEMENT OF DEFAULT AND DISTRESSED PROPERTIES, IN CLASS 42 (U.S. CLS. 100 AND 101).

FIRST USE 2-0-2010; IN COMMERCE 2-0-2010.

THE MARK CONSISTS OF STANDARD CHARACTERS WITHOUT CLAIM TO ANY PARTICULAR FONT, STYLE, SIZE, OR COLOR.

SER. NO. 85-400,237, FILED 8-17-2011.

KIM MONINGHOFF, EXAMINING ATTORNEY



David J. Kybas

Director of the United States Patent and Trademark Office

United States of America

United States Patent and Trademark Office

Leading Others To Better Health

Reg. No. 4,099,155

Registered Feb. 14, 2012

Int. Cl.: 35

SERVICE MARK

PRINCIPAL REGISTER

GRAHAM & BUFFETT, LTD. (TEXAS LIMITED PARTNERSHIP)
5052 BRIDGE CREEK DRIVE
PLANO, TX 75093

FOR: BUSINESS MANAGEMENT SERVICES, NAMELY, ADMINISTRATION OF BUSINESS ENGAGED IN THE DEVELOPMENT, MANUFACTURE AND DISTRIBUTION OF DIETARY AND NUTRITIONAL SUPPLEMENTS, NUTRITIONALLY FORTIFIED JUICES AND BEVERAGES, AND WHOLE FOOD BEVERAGES, IN CLASS 35 (U.S. CLS. 100, 101 AND 102).

FIRST USE 1-12-2008; IN COMMERCE 1-12-2008.

THE MARK CONSISTS OF STANDARD CHARACTERS WITHOUT CLAIM TO ANY PARTICULAR FONT, STYLE, SIZE, OR COLOR.

SER. NO. 85-400,650, FILED 8-17-2011.

TRACY FLETCHER, EXAMINING ATTORNEY



David J. Kyffers

Director of the United States Patent and Trademark Office

United States of America

United States Patent and Trademark Office

THERMO-MEALS

Reg. No. 4,099,156

Registered Feb. 14, 2012

Int. Cls.: 5, 29 and 30

TRADEMARK

PRINCIPAL REGISTER

SLIMGENICS, LLC (COLORADO LIMITED LIABILITY COMPANY)
SECOND FLOOR
6568 SOUTH RACINE CIRCLE
CENTENNIAL, CO 80111

FOR: NUTRITIONAL SUPPLEMENTS FOR HUMAN CONSUMPTION FOR USE IN MAKING BEVERAGES FOR DIETARY AND NUTRITIONAL PURPOSES; NUTRITIONAL SUPPLEMENT IN THE NATURE OF A VITAMIN-FORTIFIED POWDER TO BE DISSOLVED IN LIQUID TO PRODUCE A HIGH-PROTEIN DRINK; DIETARY BEVERAGE SUPPLEMENTS FOR HUMAN CONSUMPTION IN DRY MIX FORM FOR DIETARY AND NUTRITIONAL PURPOSES; VITAMIN PREPARATIONS; NUTRITIONAL SUPPLEMENT IN THE NATURE OF A NUTRIENT-DENSE, PROTEIN-BASED DRINK MIX; VITAMIN FORTIFIED BEVERAGES; NUTRITIONAL SNACKS AND MEALS, NAMELY, MEAL REPLACEMENT SNACKS, MEAL REPLACEMENT DRINKS, MEAL REPLACEMENT SHAKES, MEAL REPLACEMENT POWDERS AND MEAL REPLACEMENT BARS; POWDERED NUTRITIONAL SUPPLEMENT DRINK MIXES; DIETARY AND NUTRITIONALLY FORTIFIED FOOD PRODUCTS IN THE NATURE OF CEREALS TO ACCOMMODATE SPECIAL DIETARY NEEDS, IN CLASS 5 (U.S. CLS. 6, 18, 44, 46, 51 AND 52).

FIRST USE 6-30-2011; IN COMMERCE 6-30-2011.

FOR: PREPARED MEALS AND ENTREES CONSISTING PRIMARILY OF VEGETABLES AND SOUPS, IN CLASS 29 (U.S. CL. 46).

FIRST USE 8-19-2011; IN COMMERCE 8-19-2011.

FOR: PREPARED MEALS AND ENTREES CONSISTING PRIMARILY OF PASTA, GRAINS, RICE OR BEANS, IN CLASS 30 (U.S. CL. 46).

FIRST USE 8-19-2011; IN COMMERCE 8-19-2011.

THE MARK CONSISTS OF STANDARD CHARACTERS WITHOUT CLAIM TO ANY PARTICULAR FONT, STYLE, SIZE, OR COLOR.

OWNER OF U.S. REG. NO. 3,913,739.

SER. NO. 85-402,247, FILED 8-19-2011.



David J. Kyjars

Director of the United States Patent and Trademark Office

Reg. No. 4,099,156 MICHAEL TANNER, EXAMINING ATTORNEY

United States of America

United States Patent and Trademark Office

OIKOS

Reg. No. 4,099,157

Registered Feb. 14, 2012

Int. Cl.: 30

TRADEMARK

PRINCIPAL REGISTER

STONYFIELD FARM, INC. (DELAWARE CORPORATION)
10 BURTON DRIVE
LONDONDERRY, NH 03053

FOR: FROZEN YOGURT, IN CLASS 30 (U.S. CL. 46).

FIRST USE 7-25-2011; IN COMMERCE 7-25-2011.

THE MARK CONSISTS OF STANDARD CHARACTERS WITHOUT CLAIM TO ANY PARTICULAR FONT, STYLE, SIZE, OR COLOR.

OWNER OF U.S. REG. NOS. 3,396,493 AND 3,874,812.

THE ENGLISH TRANSLATION OF "OIKOS" IN THE MARK IS "HOUSE" OR "HOUSEHOLD".

SER. NO. 85-404,914, FILED 8-23-2011.

FRANK LATTUCA, EXAMINING ATTORNEY



David J. Kyffers

Director of the United States Patent and Trademark Office

United States of America

United States Patent and Trademark Office

CREAM OF WHEAT

Reg. No. 4,099,158

Registered Feb. 14, 2012

Int. Cl.: 30

TRADEMARK

PRINCIPAL REGISTER

B&G FOODS NORTH AMERICA, INC. (DELAWARE CORPORATION)
SUITE 110
FOUR GATEHALL DRIVE
PARSIPPANY, NJ 07054

FOR: BREAKFAST CEREALS, NAMELY, HOT CEREAL, INSTANT HOT CEREAL, WHEAT FARINA, ENRICHED FARINA AND WHEAT BREAKFAST FOOD, NAMELY, PROCESSED WHEAT, IN CLASS 30 (U.S. CL. 46).

FIRST USE 2-27-2007; IN COMMERCE 2-27-2007.

OWNER OF U.S. REG. NOS. 34,067, 226,621 AND OTHERS.

THE MARK CONSISTS OF THE WORD "CREAM" WITH THE WORD "OF" BELOW IT IN SMALLER FONT AND THE WORD "WHEAT" BELOW THAT IN THE SAME SIZE FONT AS "CREAM", ALL IN A STYLIZED FONT.

SEC. 2(F).

SER. NO. 85-405,596, FILED 8-24-2011.

VERNA BETH RIRIE, EXAMINING ATTORNEY



David J. Kybas

Director of the United States Patent and Trademark Office

United States of America

United States Patent and Trademark Office

DENEVA

Reg. No. 4,099,159

OCZ TECHNOLOGY GROUP, INC. (DELAWARE CORPORATION)
6373 SAN IGNACIO AVE.
SAN JOSE, CA 95119

Registered Feb. 14, 2012

Int. Cl.: 9

FOR: SOLID STATE MASS STORAGE DEVICES IN THE NATURE OF A NONVOLATILE STORAGE MEDIUM THAT EMPLOYS INTEGRATED CIRCUITS; ELECTRONIC DATA STORAGE, NAMELY, BLANK ELECTRONIC STORAGE MEDIA, IN CLASS 9 (U.S. CLS. 21, 23, 26, 36 AND 38).

TRADEMARK

PRINCIPAL REGISTER

FIRST USE 6-1-2010; IN COMMERCE 6-1-2010.

THE MARK CONSISTS OF STANDARD CHARACTERS WITHOUT CLAIM TO ANY PARTICULAR FONT, STYLE, SIZE, OR COLOR.

SER. NO. 85-406,729, FILED 8-25-2011.

SUE LAWRENCE, EXAMINING ATTORNEY



David J. Kyffers

Director of the United States Patent and Trademark Office

United States of America

United States Patent and Trademark Office

TALOS

Reg. No. 4,099,160

OCZ TECHNOLOGY GROUP, INC. (DELAWARE CORPORATION)
6373 SAN IGNACIO AVE.
SAN JOSE, CA 95119

Registered Feb. 14, 2012

Int. Cl.: 9

FOR: SOLID STATE MASS STORAGE DEVICES IN THE NATURE OF A NONVOLATILE STORAGE MEDIUM THAT EMPLOYS INTEGRATED CIRCUITS; ELECTRONIC DATA STORAGE, NAMELY, BLANK ELECTRONIC STORAGE MEDIA, IN CLASS 9 (U.S. CLS. 21, 23, 26, 36 AND 38).

TRADEMARK

PRINCIPAL REGISTER

FIRST USE 5-12-2011; IN COMMERCE 5-12-2011.

THE MARK CONSISTS OF STANDARD CHARACTERS WITHOUT CLAIM TO ANY PARTICULAR FONT, STYLE, SIZE, OR COLOR.

SER. NO. 85-406,737, FILED 8-25-2011.

SUE LAWRENCE, EXAMINING ATTORNEY



David J. Kyffers

Director of the United States Patent and Trademark Office

United States of America

United States Patent and Trademark Office

VELODRIVE

Reg. No. 4,099,161

OCZ TECHNOLOGY GROUP, INC. (DELAWARE CORPORATION)
6373 SAN IGNACIO AVE.

Registered Feb. 14, 2012

SAN JOSE, CA 95119

Int. Cl.: 9

FOR: SOLID STATE MASS STORAGE DEVICES IN THE NATURE OF A NONVOLATILE STORAGE MEDIUM THAT EMPLOYS INTEGRATED CIRCUITS; ELECTRONIC DATA STORAGE, NAMELY, BLANK ELECTRONIC STORAGE MEDIA, IN CLASS 9 (U.S. CLS. 21, 23, 26, 36 AND 38).

TRADEMARK

PRINCIPAL REGISTER

FIRST USE 4-28-2011; IN COMMERCE 4-28-2011.

THE MARK CONSISTS OF STANDARD CHARACTERS WITHOUT CLAIM TO ANY PARTICULAR FONT, STYLE, SIZE, OR COLOR.

SER. NO. 85-406,742, FILED 8-25-2011.

SUE LAWRENCE, EXAMINING ATTORNEY



David J. Kyffers

Director of the United States Patent and Trademark Office

United States of America

United States Patent and Trademark Office

CREAM OF WHEAT

Reg. No. 4,099,162

Registered Feb. 14, 2012

Int. Cl.: 30

TRADEMARK

PRINCIPAL REGISTER

B&G FOODS NORTH AMERICA, INC. (DELAWARE CORPORATION)
SUITE 110
FOUR GATEHALL DRIVE
PARSIPPANY, NJ 07054

FOR: BREAKFAST CEREALS, NAMELY, HOT CEREAL, INSTANT HOT CEREAL, WHEAT FARINA, ENRICHED FARINA AND WHEAT BREAKFAST FOOD, NAMELY, PROCESSED WHEAT, IN CLASS 30 (U.S. CL. 46).

FIRST USE 3-1-1895; IN COMMERCE 3-1-1895.

THE MARK CONSISTS OF STANDARD CHARACTERS WITHOUT CLAIM TO ANY PARTICULAR FONT, STYLE, SIZE, OR COLOR.

OWNER OF U.S. REG. NOS. 34,067, 226,621 AND OTHERS.

SEC. 2(F).

SER. NO. 85-406,799, FILED 8-25-2011.

VERNA BETH RIRIE, EXAMINING ATTORNEY



David J. Kyffers

Director of the United States Patent and Trademark Office

United States of America

United States Patent and Trademark Office

YOU ARE HERE!

Reg. No. 4,099,163

ECOLOGY COMMUNICATIONS GROUP, INC. (DELAWARE CORPORATION)

Registered Feb. 14, 2012

P.O. BOX 6847
ELLCOTT CITY, MD 21042

Int. Cl.: 41

FOR: ENTERTAINMENT SERVICES, NAMELY, PRODUCTION OF TELEVISION SHOWS; ENTERTAINMENT SERVICES, NAMELY, PROVIDING ONGOING TELEVISION PROGRAMS FEATURING SUBJECTS FOCUSED ON ECOLOGY AND THE ENVIRONMENT VIA A GLOBAL COMPUTER NETWORK; PRODUCTION OF RADIO OR TELEVISION PROGRAMS; ENTERTAINMENT IN THE NATURE OF ON-GOING TELEVISION PROGRAMS FOCUSED ON ECOLOGY AND THE ENVIRONMENT BROADCAST OVER TELEVISION, SATELLITE, AUDIO, AND VIDEO MEDIA, IN CLASS 41 (U.S. CLS. 100, 101 AND 107).

SERVICE MARK

PRINCIPAL REGISTER

FIRST USE 4-30-2008; IN COMMERCE 4-30-2008.

THE MARK CONSISTS OF STANDARD CHARACTERS WITHOUT CLAIM TO ANY PARTICULAR FONT, STYLE, SIZE, OR COLOR.

SER. NO. 85-408,301, FILED 8-26-2011.

SUSAN RICHARDS, EXAMINING ATTORNEY



David J. Kyjars

Director of the United States Patent and Trademark Office

United States of America

United States Patent and Trademark Office

DIRECTDME

Reg. No. 4,099,164

Registered Feb. 14, 2012

Int. Cl.: 35

SERVICE MARK

PRINCIPAL REGISTER

AKITA, INC. (DELAWARE CORPORATION)
SUITE 400
2711 CENTERVILLE ROAD
WILMINGTON, DE 19808

FOR: HEALTH CARE COST CONTAINMENT; MEDICAL COST MANAGEMENT; ON-LINE
RETAIL STORE SERVICES FEATURING MEDICAL EQUIPMENT, IN CLASS 35 (U.S. CLS.
100, 101 AND 102).

FIRST USE 7-13-2000; IN COMMERCE 7-13-2000.

THE MARK CONSISTS OF STANDARD CHARACTERS WITHOUT CLAIM TO ANY PAR-
TICULAR FONT, STYLE, SIZE, OR COLOR.

SEC. 2(F).

SER. NO. 85-410,971, FILED 8-30-2011.

SUSAN RICHARDS, EXAMINING ATTORNEY



David J. Kyjars

Director of the United States Patent and Trademark Office

United States of America

United States Patent and Trademark Office



Reg. No. 4,099,165

Registered Feb. 14, 2012

Int. Cl.: 9

TRADEMARK

PRINCIPAL REGISTER

SOFTSTAR ENTERTAINMENT INC. (TAIWAN CORPORATION)
16F, 16F-3 NO. 166, CHENGYI ROAD
ZHONGHE DIST.
NEW TAIPEI CITY 235, TAIWAN

FOR: COMPUTER GAME SOFTWARE; COMPUTER GAME SOFTWARE DOWNLOADABLE FROM A GLOBAL COMPUTER NETWORK; COMPUTER GAME SOFTWARE FOR USE ON MOBILE AND CELLULAR PHONES; ELECTRONIC GAME SOFTWARE FOR WIRELESS DEVICES; ELECTRONIC GAME SOFTWARE; INTERACTIVE GAME SOFTWARE; MOTION PICTURE FILMS FEATURING CHILDREN'S ENTERTAINMENT, IN CLASS 9 (U.S. CLS. 21, 23, 26, 36 AND 38).

FIRST USE 7-1-2011; IN COMMERCE 7-1-2011.

THE MARK CONSISTS OF A STYLIZED DRAWING OF A PINK PIGLET WITH A JET-LIKE YELLOW AND ORANGE EXHAUST TRAIL FLYING THROUGH THE WHITE CLOUDS OUTLINED IN BLUE NEXT TO THE STYLIZED WORDING "FLYING PUPU". THE LETTERS F, L AND Y ARE FILLED WITH SHADES OF RED. THE I IN "FLYING" IS PINK AND N AND G ARE SHADES OF PURPLE. THE WORD "PUPU" HAS A YELLOW P AND U, AN ORANGE P AND A RED U.

THE COLOR(S) PINK, RED, PURPLE, BLUE, YELLOW, ORANGE AND WHITE IS/ARE CLAIMED AS A FEATURE OF THE MARK.

SER. NO. 85-412,128, FILED 8-31-2011.

SHAUNIA CARLYLE, EXAMINING ATTORNEY



David J. Kyjars

Director of the United States Patent and Trademark Office

United States of America

United States Patent and Trademark Office

LA DONA

Reg. No. 4,099,166

Registered Feb. 14, 2012

Int. Cl.: 16

TRADEMARK

PRINCIPAL REGISTER

LOCUS TELECOMMUNICATIONS, INC. (DELAWARE CORPORATION)
6TH FLOOR
2200 FLETCHER AVENUE
FORT LEE, NJ 07024

FOR: PRE-PAID TELEPHONE CALLING CARDS, NOT MAGNETICALLY ENCODED, IN CLASS 16 (U.S. CLS. 2, 5, 22, 23, 29, 37, 38 AND 50).

FIRST USE 6-1-2009; IN COMMERCE 6-1-2009.

THE MARK CONSISTS OF STANDARD CHARACTERS WITHOUT CLAIM TO ANY PARTICULAR FONT, STYLE, SIZE, OR COLOR.

THE ENGLISH TRANSLATION OF "LA DONA" IN THE MARK IS "THE LADY".

SER. NO. 85-412,668, FILED 9-1-2011.

ROBERT C. CLARK JR., EXAMINING ATTORNEY



David J. Kyffers

Director of the United States Patent and Trademark Office

United States of America

United States Patent and Trademark Office

PRICELESS NEW YORK

Reg. No. 4,099,167

Registered Feb. 14, 2012

Int. Cls.: 35 and 36

SERVICE MARK

PRINCIPAL REGISTER

MASTERCARD INTERNATIONAL INCORPORATED (DELAWARE CORPORATION)
2000 PURCHASE STREET
PURCHASE, NY 10577

FOR: PROMOTING THE GOODS AND SERVICES OF OTHERS BY MEANS OF COUPONS, DISCOUNTS, ADVERTISEMENTS, REWARDS AND INCENTIVES GENERATED IN CONNECTION WITH THE USE OF CREDIT AND DEBIT CARDS, ELECTRONIC LINKS TO MERCHANT AND RETAILER WEB SITES, AND THROUGH PROMOTIONAL CONTESTS, IN CLASS 35 (U.S. CLS. 100, 101 AND 102).

FIRST USE 7-11-2011; IN COMMERCE 7-11-2011.

FOR: FINANCIAL SERVICES, NAMELY, PAYMENT CARD SERVICES; CREDIT CARD AND DEBIT CARD SERVICES; ELECTRONIC PAYMENTS SERVICES, NAMELY, TRANSACTION AUTHORIZATION AND SETTLEMENT SERVICES, IN CLASS 36 (U.S. CLS. 100, 101 AND 102).

FIRST USE 7-11-2011; IN COMMERCE 7-11-2011.

THE MARK CONSISTS OF STANDARD CHARACTERS WITHOUT CLAIM TO ANY PARTICULAR FONT, STYLE, SIZE, OR COLOR.

OWNER OF U.S. REG. NOS. 2,370,508 AND 3,675,858.

NO CLAIM IS MADE TO THE EXCLUSIVE RIGHT TO USE "NEW YORK", APART FROM THE MARK AS SHOWN.

SER. NO. 85-412,683, FILED 9-1-2011.

ANN E. SAPPENFIELD, EXAMINING ATTORNEY



David J. Kyffers

Director of the United States Patent and Trademark Office

United States of America

United States Patent and Trademark Office

TASERMITY

Reg. No. 4,099,168

SANOFI (FRANCE CORPORATION)
174, AVENUE DE FRANCE
PARIS, FRANCE 75013

Registered Feb. 14, 2012

Int. Cl.: 5

FOR: PHARMACEUTICAL PREPARATIONS FOR THE PREVENTION AND TREATMENT OF CARDIOVASCULAR DISEASES, CANCER, THROMBOSIS, VIRAL INFECTIONS, BACTERIAL INFECTIONS, DISEASES OF THE CENTRAL NERVOUS SYSTEM, RESPIRATORY DISEASES; FOOD SUPPLEMENTS, DIETETIC SUPPLEMENTS AND FOOD ADAPTED FOR MEDICAL USE, IN CLASS 5 (U.S. CLS. 6, 18, 44, 46, 51 AND 52).

TRADEMARK

PRINCIPAL REGISTER

THE MARK CONSISTS OF STANDARD CHARACTERS WITHOUT CLAIM TO ANY PARTICULAR FONT, STYLE, SIZE, OR COLOR.

PRIORITY CLAIMED UNDER SEC. 44(D) ON FRANCE APPLICATION NO. 11/3814147, FILED 3-14-2011, REG. NO. 11/3814147, DATED 3-14-2011, EXPIRES 3-14-2021.

SER. NO. 85-415,489, FILED 9-6-2011.

FLORENTINA BLANDU, EXAMINING ATTORNEY



David J. Kybas

Director of the United States Patent and Trademark Office

United States of America

United States Patent and Trademark Office

AUTHIDICA

Reg. No. 4,099,169

SANOFI (FRANCE CORPORATION)
174, AVENUE DE FRANCE
PARIS, FRANCE 75013

Registered Feb. 14, 2012

Int. Cl.: 5

FOR: PHARMACEUTICAL PREPARATIONS FOR THE PREVENTION AND TREATMENT OF CARDIOVASCULAR DISEASES, CANCER, THROMBOSIS, VIRAL INFECTIONS, BACTERIAL INFECTIONS, DISEASES OF THE CENTRAL NERVOUS SYSTEM, RESPIRATORY DISEASES; FOOD SUPPLEMENTS, DIETETIC SUPPLEMENTS AND FOOD ADAPTED FOR MEDICAL USE, IN CLASS 5 (U.S. CLS. 6, 18, 44, 46, 51 AND 52).

TRADEMARK

PRINCIPAL REGISTER

THE MARK CONSISTS OF STANDARD CHARACTERS WITHOUT CLAIM TO ANY PARTICULAR FONT, STYLE, SIZE, OR COLOR.

PRIORITY CLAIMED UNDER SEC. 44(D) ON FRANCE APPLICATION NO. 11/3814149, FILED 3-14-2011, REG. NO. 11/3814149, DATED 3-14-2011, EXPIRES 3-14-2021.

SER. NO. 85-415,499, FILED 9-6-2011.

FLORENTINA BLANDU, EXAMINING ATTORNEY



David J. Kyffers

Director of the United States Patent and Trademark Office

United States of America

United States Patent and Trademark Office

ALEX RODRIGUEZ

Reg. No. 4,099,170

Registered Feb. 14, 2012

Int. Cl.: 14

TRADEMARK

PRINCIPAL REGISTER

AROD CORPORATION (FLORIDA CORPORATION)
C/O BOULEVARD MANAGEMENT, INC.
21731 VENTURA BLVD., SUITE 300
WOODLAND HILLS, CA 91364

FOR: CLOCKS; COMMEMORATIVE COINS, IN CLASS 14 (U.S. CLS. 2, 27, 28 AND 50).

FIRST USE 7-30-1994; IN COMMERCE 7-30-1994.

THE MARK CONSISTS OF STANDARD CHARACTERS WITHOUT CLAIM TO ANY PARTICULAR FONT, STYLE, SIZE, OR COLOR.

THE NAME(S), PORTRAIT(S), AND/OR SIGNATURE(S) SHOWN IN THE MARK IDENTIFIES "ALEX RODRIGUEZ", WHOSE CONSENT(S) TO REGISTER IS MADE OF RECORD.

SER. NO. 85-416,017, FILED 9-6-2011.

ZHALEH DELANEY, EXAMINING ATTORNEY



David J. Kybas

Director of the United States Patent and Trademark Office

United States of America

United States Patent and Trademark Office

ALEX RODRIGUEZ

Reg. No. 4,099,171

Registered Feb. 14, 2012

Int. Cl.: 16

TRADEMARK

PRINCIPAL REGISTER

AROD CORPORATION (FLORIDA CORPORATION)
C/O BOULEVARD MANAGEMENT, INC.
21731 VENTURA BLVD., SUITE 300
WOODLAND HILLS, CA 91364

FOR: POSTERS, PRINTS, PHOTOGRAPHS; COMMEMORATIVE PICTURE CARDS, COMMEMORATIVE TRADING CARDS, IN CLASS 16 (U.S. CLS. 2, 5, 22, 23, 29, 37, 38 AND 50).

FIRST USE 3-30-1993; IN COMMERCE 3-30-1993.

THE MARK CONSISTS OF STANDARD CHARACTERS WITHOUT CLAIM TO ANY PARTICULAR FONT, STYLE, SIZE, OR COLOR.

THE NAME(S), PORTRAIT(S), AND/OR SIGNATURE(S) SHOWN IN THE MARK IDENTIFIES "ALEX RODRIGUEZ", WHOSE CONSENT(S) TO REGISTER IS MADE OF RECORD.

SER. NO. 85-416,036, FILED 9-6-2011.

ZHALEH DELANEY, EXAMINING ATTORNEY



David J. Kybas

Director of the United States Patent and Trademark Office

United States of America

United States Patent and Trademark Office

ALEX RODRIGUEZ

Reg. No. 4,099,172

Registered Feb. 14, 2012

Int. Cl.: 25

TRADEMARK

PRINCIPAL REGISTER

AROD CORPORATION (FLORIDA CORPORATION)
C/O BOULEVARD MANAGEMENT, INC.
21731 VENTURA BLVD., SUITE 300
WOODLAND HILLS, CA 91364

FOR: T-SHIRTS; TOPS, IN CLASS 25 (U.S. CLS. 22 AND 39).

FIRST USE 7-31-1994; IN COMMERCE 7-31-1994.

THE MARK CONSISTS OF STANDARD CHARACTERS WITHOUT CLAIM TO ANY PARTICULAR FONT, STYLE, SIZE, OR COLOR.

THE NAME(S), PORTRAIT(S), AND/OR SIGNATURE(S) SHOWN IN THE MARK IDENTIFIES "ALEX RODRIGUEZ", WHOSE CONSENT(S) TO REGISTER IS MADE OF RECORD.

SER. NO. 85-416,057, FILED 9-6-2011.

ZHALEH DELANEY, EXAMINING ATTORNEY



David J. Kybas

Director of the United States Patent and Trademark Office

United States of America

United States Patent and Trademark Office

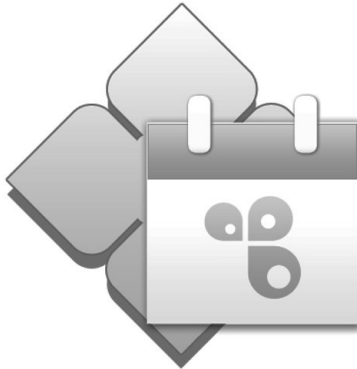

Reg. No. 4,099,173

Registered Feb. 14, 2012

Int. Cl.: 9

TRADEMARK

PRINCIPAL REGISTER

T-MOBILE USA, INC. (DELAWARE CORPORATION)
12920 S.E. 38TH STREET
BELLEVUE, WA 98006

FOR: COMPUTER SOFTWARE FOR USE IN THE ORGANIZATION, DAILY MANAGEMENT AND TIME MAXIMIZATION AND EFFICIENCY IN THE FIELD OF PARENTING, FAMILY AND HOUSEHOLD MANAGEMENT, NAMELY, CALENDARING, SCHEDULING, CREATING TASK LISTS, AND SENDING, TRANSFERRING, SHARING, MANAGING, VIEWING, AND EDITING ELECTRONIC MAIL MESSAGES, SMS MESSAGES AND MMS MESSAGES, IN CLASS 9 (U.S. CLS. 21, 23, 26, 36 AND 38).

FIRST USE 8-5-2011; IN COMMERCE 8-5-2011.

THE MARK CONSISTS OF A RECTANGULAR FIELD REPRESENTING A SINGLE CARD FROM A DESK TOP ROTATING CARD FILE WITH A TWO INDENTATIONS ON THE UPPER BORDER REPRESENTING ATTACHMENTS TO THE ROTATING CARD FILE, AN UPPER BORDER ON THE CARD, AND THE REMAINING LOWER PORTION OF THE CARD, AND IN THE CENTER OF THE CARD A DESIGN CONSISTING OF THREE ROUGHLY CIRCULAR AREAS WITH DOTS IN THE CENTER, ALL SUPERIMPOSED OVER A DIAMOND SHAPED DESIGN COMPRISED OF FOUR CONNECTED SMALLER DIAMOND SHAPES.

SER. NO. 85-418,102, FILED 9-8-2011.

LINDSEY RUBIN, EXAMINING ATTORNEY



David J. Kyjars

Director of the United States Patent and Trademark Office

United States of America

United States Patent and Trademark Office

SECURE. PROTECT. REPAIR.

Reg. No. 4,099,174

MIDSUN SPECIALTY PRODUCTS, INC. (CONNECTICUT CORPORATION)
135 REDSTONE STREET
SOUTHINGTON, CT 06489

Registered Feb. 14, 2012

Int. Cl.: 17

FOR: SILICONE TAPE FOR AUTOMOTIVE, COMMERCIAL AND INDUSTRIAL USE, IN CLASS 17 (U.S. CLS. 1, 5, 12, 13, 35 AND 50).

TRADEMARK

FIRST USE 11-4-2010; IN COMMERCE 11-4-2010.

PRINCIPAL REGISTER

THE MARK CONSISTS OF STANDARD CHARACTERS WITHOUT CLAIM TO ANY PARTICULAR FONT, STYLE, SIZE, OR COLOR.

SER. NO. 85-418,415, FILED 9-9-2011.

FONG HSU, EXAMINING ATTORNEY



David J. Kybas

Director of the United States Patent and Trademark Office

United States of America

United States Patent and Trademark Office

WHAT'S THE BIG DEAL?

Reg. No. 4,099,175

DSW SHOE WAREHOUSE, INC. (MISSOURI CORPORATION)
810 DSW DRIVE
COLUMBUS, OH 43219

Registered Feb. 14, 2012

Int. Cl.: 35

FOR: RETAIL STORE AND ON-LINE RETAIL STORE SERVICES FEATURING SHOES, HANDBAGS AND ACCESSORIES, IN CLASS 35 (U.S. CLS. 100, 101 AND 102).

SERVICE MARK

FIRST USE 9-0-2009; IN COMMERCE 9-0-2009.

PRINCIPAL REGISTER

THE MARK CONSISTS OF STANDARD CHARACTERS WITHOUT CLAIM TO ANY PARTICULAR FONT, STYLE, SIZE, OR COLOR.

OWNER OF U.S. REG. NO. 3,958,699.

SER. NO. 85-421,200, FILED 9-13-2011.

RONALD AIKENS, EXAMINING ATTORNEY



David J. Kybas

Director of the United States Patent and Trademark Office

United States of America

United States Patent and Trademark Office

ONESITE

Reg. No. 4,099,176

Registered Feb. 14, 2012

Int. Cl.: 42

SERVICE MARK

PRINCIPAL REGISTER

REALPAGE, INC. (DELAWARE CORPORATION)
4000 INTERNATIONAL PARKWAY
CARROLLTON, TX 75007

FOR: SOFTWARE AS A SERVICE (SAAS) SERVICES FEATURING SOFTWARE FOR AUTOMATING THE LEASING, RENTING, MANAGEMENT, AND ACCOUNTING OF HOUSING PROPERTIES, IN CLASS 42 (U.S. CLS. 100 AND 101).

FIRST USE 7-6-2000; IN COMMERCE 7-6-2000.

THE MARK CONSISTS OF STANDARD CHARACTERS WITHOUT CLAIM TO ANY PARTICULAR FONT, STYLE, SIZE, OR COLOR.

OWNER OF U.S. REG. NOS. 2,488,969 AND 2,498,962.

SER. NO. 85-422,198, FILED 9-14-2011.

APRIL ROACH, EXAMINING ATTORNEY



David J. Kyffers

Director of the United States Patent and Trademark Office

United States of America

United States Patent and Trademark Office

BACKPAGE

Reg. No. 4,099,177

Registered Feb. 14, 2012

Int. Cl.: 35

SERVICE MARK

PRINCIPAL REGISTER

VILLAGE VOICE MEDIA HOLDINGS, LLC (DELAWARE LIMITED LIABILITY COMPANY)
1201 EAST JEFFERSON STREET
PHOENIX, AZ 85034

FOR: ADVERTISING SERVICES, IN CLASS 35 (U.S. CLS. 100, 101 AND 102).

FIRST USE 8-13-2007; IN COMMERCE 8-13-2007.

THE MARK CONSISTS OF STANDARD CHARACTERS WITHOUT CLAIM TO ANY PARTICULAR FONT, STYLE, SIZE, OR COLOR.

OWNER OF U.S. REG. NOS. 2,106,481 AND 2,940,220.

SER. NO. 85-422,418, FILED 9-14-2011.

KATHRYN COWARD, EXAMINING ATTORNEY



David J. Kyffers

Director of the United States Patent and Trademark Office

United States of America

United States Patent and Trademark Office

TRUE BLOOD

Reg. No. 4,099,178

Registered Feb. 14, 2012

Int. Cl.: 9

TRADEMARK

PRINCIPAL REGISTER

HOME BOX OFFICE, INC. (DELAWARE CORPORATION)
1100 AVENUE OF THE AMERICAS
NEW YORK, NY 10036

FOR: PROTECTIVE CASES SPECIALLY ADAPTED FOR LAPTOP COMPUTERS, TABLET COMPUTERS, SMART PHONES AND OTHER PORTABLE ELECTRONIC DEVICES, NAMELY, MEDIA PLAYERS, PORTABLE ELECTRONIC GAME DEVICES, MOBILE PHONES, GLOBAL POSITIONING SYSTEMS AND PERSONAL DIGITAL ASSISTANTS; PLASTIC, RUBBER OR VINYL PROTECTIVE COVERINGS SPECIALLY ADAPTED FOR LAPTOP COMPUTERS, TABLET COMPUTERS, SMART PHONES AND OTHER PORTABLE ELECTRONIC DEVICES, NAMELY, MEDIA PLAYERS, PORTABLE ELECTRONIC GAME DEVICES, MOBILE PHONES, GLOBAL POSITIONING SYSTEMS AND PERSONAL DIGITAL ASSISTANTS; ELECTRONIC PENS; NEON SIGNS, IN CLASS 9 (U.S. CLS. 21, 23, 26, 36 AND 38).

FIRST USE 3-24-2011; IN COMMERCE 3-24-2011.

THE MARK CONSISTS OF STANDARD CHARACTERS WITHOUT CLAIM TO ANY PARTICULAR FONT, STYLE, SIZE, OR COLOR.

OWNER OF U.S. REG. NOS. 3,531,720, 3,808,527 AND OTHERS.

SER. NO. 85-422,481, FILED 9-14-2011.

SUSAN RICHARDS, EXAMINING ATTORNEY



David J. Kyros

Director of the United States Patent and Trademark Office

United States of America

United States Patent and Trademark Office

Orazyme-D

Reg. No. 4,099,179

Registered Feb. 14, 2012

Int. Cl.: 3

TRADEMARK

PRINCIPAL REGISTER

DR FRESH INC. (NEW YORK CORPORATION)
6645 CABALLERO BLVD
BUENA PARK, CA 90620

FOR: BREATH FRESHENER; BREATH FRESHENING CONFECTIONARY, NAMELY, DISSOLVABLE BREATH STRIPS, BREATH MINTS, CANDY AND GUM; BREATH FRESHENING SPRAYS; BREATH FRESHENING STRIPS; BREATH MINTS FOR USE AS A BREATH FRESHENER; DENTIFRICES AND MOUTHWASHES; MOUTHWASH; MOUTHWASHES; NON-MEDICATED MOUTHWASH AND GARGLE; NON-MEDICATED MOUTHWASHES; TOOTHPASTE; TOOTHPASTE AND MOUTHWASHES; TOOTHPASTES, IN CLASS 3 (U.S. CLS. 1, 4, 6, 50, 51 AND 52).

FIRST USE 8-11-2010; IN COMMERCE 8-11-2010.

THE MARK CONSISTS OF STANDARD CHARACTERS WITHOUT CLAIM TO ANY PARTICULAR FONT, STYLE, SIZE, OR COLOR.

SER. NO. 85-422,916, FILED 9-14-2011.

CHERYL CLAYTON, EXAMINING ATTORNEY



David J. Kyjars

Director of the United States Patent and Trademark Office

United States of America

United States Patent and Trademark Office



Reg. No. 4,099,180

Registered Feb. 14, 2012

Int. Cl.: 25

TRADEMARK

PRINCIPAL REGISTER

MSG HOLDINGS, L.P. (DELAWARE LIMITED PARTNERSHIP)
TWO PENN PLAZA
NEW YORK, NY 10121

FOR: CLOTHING, NAMELY HOSIERY, FOOTWEAR, BASKETBALL SHOES, BASKETBALL SNEAKERS, T-SHIRTS, SHIRTS, POLO SHIRTS, SWEATSHIRTS, SWEATPANTS, PANTS, TANK TOPS, JERSEYS, SHORTS, PAJAMAS, SPORT SHIRTS, RUGBY SHIRTS, SWEATERS, BELTS, TIES, NIGHTSHIRTS, HATS, CAPS, VISORS, WARM-UP SUITS, WARM-UP PANTS, WARM-UP TOPS/SHOOTING SHIRTS, JACKETS, WIND RESISTANT JACKETS, PARKAS, COATS, BABY BIBS NOT OF PAPER, HEAD BANDS, WRIST BANDS, APRONS, UNDER-GARMENTS, BOXER SHORTS, SLACKS, EAR MUFFS, GLOVES, MITTENS, SCARVES, WOVEN AND KNIT SHIRTS, JERSEY DRESSES, DRESSES, CHEERLEADING DRESSES AND UNIFORMS, SWIM WEAR, BATHING SUITS, SWIMSUITS, BIKINIS, TANKINIS, SWIM TRUNKS, BATHING TRUNKS, BOARD SHORTS, WET SUITS, BEACH COVER-UPS, BATHING SUIT COVER-UPS, BATHING SUIT WRAPS, SANDALS, BEACH SANDALS, BEACH HATS, SUN VISORS, SWIM CAPS, BATHING CAPS, NOVELTY HEADWEAR WITH ATTACHED WIGS, IN CLASS 25 (U.S. CLS. 22 AND 39).

FIRST USE 10-28-1995; IN COMMERCE 10-28-1995.

OWNER OF U.S. REG. NOS. 1,768,640, 3,035,311 AND OTHERS.

THE MARK CONSISTS OF THE STYLIZED WORDS NEW YORK KNICKS OVER THE DEPICTION OF A BASKETBALL ALL OVER AN UPSIDE DOWN TRIANGLE.

SEC. 2(F).

SER. NO. 85-423,362, FILED 9-15-2011.

GEORGE LORENZO, EXAMINING ATTORNEY



David J. Kybas

Director of the United States Patent and Trademark Office

United States of America

United States Patent and Trademark Office



Reg. No. 4,099,181

Registered Feb. 14, 2012

Int. Cl.: 28

TRADEMARK

PRINCIPAL REGISTER

MSG HOLDINGS, L.P. (DELAWARE LIMITED PARTNERSHIP)
TWO PENN PLAZA
NEW YORK, NY 10121

FOR: TOYS, GAMES AND SPORTING GOODS, NAMELY BASKETBALLS, GOLF BALLS, PLAYGROUND BALLS, SPORTS BALLS, RUBBER ACTION BALLS AND FOAM ACTION BALLS, PLUSH BALLS FOR GAMES, PLASTIC BALLS FOR GAMES, BASKETBALL NETS, BASKETBALL BACKBOARDS, MINIATURE BASKETBALL BACKBOARDS, PUMPS FOR INFLATING BASKETBALLS AND NEEDLES THEREFORE; GOLF CLUBS, GOLF BAGS, GOLF PUTTERS, GOLF ACCESSORIES, NAMELY, DIVOT REPAIR TOOLS, TEES, BALL MARKERS, GOLF BAG COVERS, CLUB HEAD COVERS, GOLF GLOVES, GOLF BALL SLEEVES, GOLF PUTTING GREENS, ELECTRONIC BASKETBALL TABLE TOP GAMES, BASKETBALL TABLE TOP GAMES, BASKETBALL BOARD GAMES, ACTION SKILL GAMES, ADULT'S AND CHILDREN'S PARTY GAMES, TRIVIA INFORMATION GAMES AND ELECTRONIC VIDEO ARCADE GAME MACHINES, BASKETBALL KIT COMPRISED OF A NET AND WHISTLE, DOLLS, DECORATIVE DOLLS, COLLECTIBLE DOLLS, TOY ACTION FIGURES, BOBBLEHEAD ACTION FIGURES, STUFFED TOYS, PLUSH TOYS, JIGSAW PUZZLES, TOY BUILDING BLOCKS, CHRISTMAS TREE ORNAMENTS AND CHRISTMAS STOCKINGS; TOY VEHICLES IN THE NATURE OF CARS, TRUCKS, TRAINS AND VANS, ALL CONTAINING BASKETBALL THEMES, NOVELTY FOAM TOYS IN THE SHAPES OF FINGERS AND TROPHIES, TOY TROPHIES, PLAYING CARDS, CARD GAMES, TOY NOISEMAKERS, PET TOYS; BEACH TOYS, NAMELY, BEACH BALLS, INFLATABLE BALLS, TOY PAILS, TOY SHOVELS, SAND TOYS, SAND BOX TOYS, WATER-SQUIRTING TOYS; POOL ACCESSORIES, NAMELY SWIM FLOATS, POOL FLOATS, TOY WATER RAFTS, FOAM FLOATS, SWIM RINGS, POOL RINGS, FOAM RINGS, BODY BOARDS, SURF BOARDS, SWIM FINS, SURF FINS, ARM FLOATS AND WATER WING SWIM AIDS FOR RECREATIONAL USE; VOLLEYBALL GAME KITS COMPRISED OF BALL, NET, SIDELINES AND WHISTLE, AND WATER POLO GAME KITS COMPRISED OF BALL, NET AND WHISTLE; DECORATIVE CLOTH WIND SOCKS, IN CLASS 28 (U.S. CLS. 22, 23, 38 AND 50).



FIRST USE 3-0-1998; IN COMMERCE 3-0-1998.

OWNER OF U.S. REG. NOS. 2,300,551, 2,823,084 AND OTHERS.

THE MARK CONSISTS OF A CIRCLE WITH THE STYLIZED LETTERS "NYK" IN SIDE THE CIRCLE.

David J. Kybas

Director of the United States Patent and Trademark Office

Reg. No. 4,099,181 SEC. 2(F).

SER. NO. 85-423,401, FILED 9-15-2011.

GEORGE LORENZO, EXAMINING ATTORNEY

United States of America

United States Patent and Trademark Office

Noto-are

Reg. No. 4,099,182

NOTO-ARE LLC (WASHINGTON LIMITED LIABILITY COMPANY)
10007 116TH AVE NE
KIRKLAND, WA 98033

Registered Feb. 14, 2012

Int. Cl.: 41

FOR: ONLINE ELECTRONIC PUBLISHING OF BOOKS AND PERIODICALS, IN CLASS 41
(U.S. CLS. 100, 101 AND 107).

SERVICE MARK

FIRST USE 5-29-2011; IN COMMERCE 5-29-2011.

PRINCIPAL REGISTER

THE MARK CONSISTS OF STANDARD CHARACTERS WITHOUT CLAIM TO ANY PARTICULAR FONT, STYLE, SIZE, OR COLOR.

SER. NO. 85-425,407, FILED 9-17-2011.

MICHAEL ENGEL, EXAMINING ATTORNEY



David J. Kyffers

Director of the United States Patent and Trademark Office

United States of America

United States Patent and Trademark Office



Reg. No. 4,099,183

SOUTHCARE, LLC (INDIANA LIMITED LIABILITY COMPANY)
595 FRANKLIN ROAD SE
MARIETTA, GA 30067

Registered Feb. 14, 2012

Int. Cl.: 45

FOR: FUNERAL ARRANGEMENT SERVICES; FUNERAL HOMES; FUNERAL SERVICE UNDERTAKING; FUNERAL SERVICES ACCOMPANYING CREMATION, IN CLASS 45 (U.S. CLS. 100 AND 101).

SERVICE MARK

FIRST USE 6-30-2010; IN COMMERCE 6-30-2010.

PRINCIPAL REGISTER

NO CLAIM IS MADE TO THE EXCLUSIVE RIGHT TO USE "CREMATION SOCIETY AND MEMORIAL CENTERS", APART FROM THE MARK AS SHOWN.

THE MARK CONSISTS OF A TREE NEXT TO THE WORD "SOUTHCARE"; BELOW THE TREE AND THE WORD "SOUTHCARE", IN SMALLER FONT, ARE THE WORDS "CREMATION SOCIETY AND MEMORIAL CENTERS".

SER. NO. 85-429,962, FILED 9-22-2011.

ANTHONY RINKER, EXAMINING ATTORNEY



David J. Kyffers

Director of the United States Patent and Trademark Office

United States of America

United States Patent and Trademark Office



Kyäni

Reg. No. 4,099,184

Registered Feb. 14, 2012

Int. Cl.: 35

SERVICE MARK

PRINCIPAL REGISTER

KYÄNI, INC. (IDAHO CORPORATION)
SUITE 350
1070 RIVERWALK DRIVE
IDAHO FALLS, ID 83402

FOR: MULTILEVEL MARKETING BUSINESS SERVICES, NAMELY, PROVIDING MARKETING AND BUSINESS MANAGEMENT CONSULTING SERVICES TO INDEPENDENT AGENTS ENGAGED IN DIRECT SALES OF NUTRITIONAL AND DIETARY SUPPLEMENTS AND FRUIT BEVERAGES; DISTRIBUTORSHIP SERVICES IN THE FIELDS OF NUTRITIONAL AND DIETARY SUPPLEMENTS AND FRUIT BEVERAGES; ONLINE RETAIL STORE SERVICES FEATURING NUTRITIONAL AND DIETARY SUPPLEMENTS AND FRUIT BEVERAGES, IN CLASS 35 (U.S. CLS. 100, 101 AND 102).

FIRST USE 4-1-2011; IN COMMERCE 4-1-2011.

OWNER OF U.S. REG. NOS. 3,111,790, 3,679,111 AND OTHERS.

THE MARK CONSISTS OF THE STYLIZED WORDING "KYÄNI". ABOVE THE LETTER "I" IN "KYÄNI" APPEARS THE DEPICTION OF A CIRCLE BROKEN INTO TWO UNEQUAL PARTS BY A WAVY LINE ALL OF WHICH PARTIALLY SURROUND A STYLIZED LEAF.

THE ENGLISH TRANSLATION OF THE TERM "KYÄNI" IN THE MARK IS "STRONG MEDICINE".

SER. NO. 85-431,141, FILED 9-24-2011.

MICHAEL TANNER, EXAMINING ATTORNEY



David J. Kyffers

Director of the United States Patent and Trademark Office

United States of America

United States Patent and Trademark Office

PARADISE LIVE

Reg. No. 4,099,185

Registered Feb. 14, 2012

Int. Cl.: 41

SERVICE MARK

PRINCIPAL REGISTER

SEMINOLE TRIBE OF FLORIDA (UNITED STATES FEDERALLY-RECOGNIZED INDIAN TRIBE)
6300 STIRLING ROAD
HOLLYWOOD, FL 33024

FOR: ENTERTAINMENT SERVICES IN THE NATURE OF LIVE MUSICAL PERFORMANCES AND COMEDY SHOWS, AT CASINO-COMPLEX PROPERTIES, IN CLASS 41 (U.S. CLS. 100, 101 AND 107).

FIRST USE 6-19-2008; IN COMMERCE 6-19-2008.

THE MARK CONSISTS OF STANDARD CHARACTERS WITHOUT CLAIM TO ANY PARTICULAR FONT, STYLE, SIZE, OR COLOR.

NO CLAIM IS MADE TO THE EXCLUSIVE RIGHT TO USE "LIVE", APART FROM THE MARK AS SHOWN.

SER. NO. 85-432,877, FILED 9-27-2011.

KATHY DE JONGE, EXAMINING ATTORNEY



David J. Kyffers

Director of the United States Patent and Trademark Office

United States of America

United States Patent and Trademark Office



Reg. No. 4,099,186

Registered Feb. 14, 2012

Int. Cl.: 35

SERVICE MARK

PRINCIPAL REGISTER

PASCUA YAQUI TRIBE (UNITED STATES FEDERALLY-RECOGNIZED INDIAN TRIBE)
7474 S. CAMINO DE OESTE
TUCSON, AZ 85746

FOR: SPECIAL EVENT PLANNING FOR BUSINESS PURPOSES; PROVIDING FACILITIES FOR BUSINESS MEETINGS, BUSINESS CONFERENCES, AND TRADE SHOWS, IN CLASS 35 (U.S. CLS. 100, 101 AND 102).

FIRST USE 7-15-2011; IN COMMERCE 7-15-2011.

THE MARK CONSISTS OF A RED DOMED BUILDING WITH BROWN, GOLD AND YELLOW ACCENTS IN FRONT OF BROWN AND GOLD MOUNTAINS AND A YELLOW SUN.

THE COLOR(S) BROWN, GOLD, YELLOW, AND RED IS/ARE CLAIMED AS A FEATURE OF THE MARK.

SER. NO. 85-436,660, FILED 9-30-2011.

KATHLEEN M. VANSTON, EXAMINING ATTORNEY



David J. Kybas

Director of the United States Patent and Trademark Office

United States of America

United States Patent and Trademark Office

ADVANCED STUDIES IN OPHTHALMOLOGY

Reg. No. 4,099,187

Registered Feb. 14, 2012

Int. Cl.: 16

TRADEMARK

PRINCIPAL REGISTER

THE HEALTHCARE MEDIA GROUP, LLC (NEW JERSEY LIMITED LIABILITY COMPANY)
SUITE NUMBER 11
2 DIVISION STREET
SOMERVILLE, NJ 08876

FOR: MEDICAL JOURNAL, IN CLASS 16 (U.S. CLS. 2, 5, 22, 23, 29, 37, 38 AND 50).

FIRST USE 10-15-2004; IN COMMERCE 10-15-2004.

THE MARK CONSISTS OF STANDARD CHARACTERS WITHOUT CLAIM TO ANY PARTICULAR FONT, STYLE, SIZE, OR COLOR.

OWNER OF U.S. REG. NO. 3,002,996.

SEC. 2(F).

SER. NO. 85-437,064, FILED 9-30-2011.

B. PARADEWELAI, EXAMINING ATTORNEY



David J. Kybas

Director of the United States Patent and Trademark Office

United States of America

United States Patent and Trademark Office

G.R.I.D.

Reg. No. 4,099,188

Registered Feb. 14, 2012

Int. Cls.: 35 and 36

SERVICE MARK

PRINCIPAL REGISTER

KING, ALEX (UNITED STATES INDIVIDUAL)
120 COCONUT DR.
FORT MYERS BEACH, FL 33931

FOR: PROVIDING DEMAND CREATION AND LEAD GENERATION ACTIVITIES AND SERVICES; REFERRALS IN THE FIELD OF REAL ESTATE BROKERAGE SERVICES, IN CLASS 35 (U.S. CLS. 100, 101 AND 102).

FIRST USE 7-0-2011; IN COMMERCE 9-9-2011.

FOR: REAL ESTATE LISTING ; LOCATING BUYERS FOR REAL ESTATE, IN CLASS 36 (U.S. CLS. 100, 101 AND 102).

FIRST USE 7-0-2011; IN COMMERCE 9-9-2011.

THE MARK CONSISTS OF STANDARD CHARACTERS WITHOUT CLAIM TO ANY PARTICULAR FONT, STYLE, SIZE, OR COLOR.

SER. NO. 85-444,752, FILED 10-11-2011.

FONG HSU, EXAMINING ATTORNEY



David J. Kybas

Director of the United States Patent and Trademark Office

United States of America

United States Patent and Trademark Office

PUMPIN' PUMPKIN EXOTIC PUMPKIN SMOOTHIE

Reg. No. 4,099,189

EVERETT BEAUFORT (UNITED STATES INDIVIDUAL)

Registered Feb. 14, 2012

95 GOLD ST
VALLEY STREAM, NY 11580

Int. Cl.: 32

FOR: PREPARED ENTREES CONSISTING OF FRUIT DRINKS AND FRUIT JUICES, FRUIT-BASED BEVERAGES, NON-ALCOHOLIC BEVERAGES CONTAINING FRUIT JUICES, NON-ALCOHOLIC FRUIT EXTRACTS USED IN THE PREPARATION OF BEVERAGES, NON-ALCOHOLIC FRUIT JUICE BEVERAGES, VEGETABLE JUICES, VEGETABLE-FRUIT JUICES AND SMOOTHIES, IN CLASS 32 (U.S. CLS. 45, 46 AND 48).

TRADEMARK

PRINCIPAL REGISTER

FIRST USE 7-1-2008; IN COMMERCE 9-1-2008.

THE MARK CONSISTS OF STANDARD CHARACTERS WITHOUT CLAIM TO ANY PARTICULAR FONT, STYLE, SIZE, OR COLOR.

OWNER OF U.S. REG. NO. 8,514,922.

NO CLAIM IS MADE TO THE EXCLUSIVE RIGHT TO USE "PUMPKIN SMOOTHIE", APART FROM THE MARK AS SHOWN.

SER. NO. 85-446,726, FILED 10-13-2011.

KIMBERLY PERRY, EXAMINING ATTORNEY



David J. Kyffers

Director of the United States Patent and Trademark Office

United States of America
United States Patent and Trademark Office

CRYPTOZOIC
ENTERTAINMENT

Reg. No. 4,099,190

Registered Feb. 14, 2012

Int. Cls.: 16 and 28

TRADEMARK

PRINCIPAL REGISTER

CRYPTOZOIC ENTERTAINMENT, LLC (CALIFORNIA LIMITED LIABILITY COMPANY)
16279 LAGUNA CANYON ROAD
IRVINE, CA 92618

FOR: PAPER GOODS, NAMELY, COMIC BOOKS, TRADING CARDS, COLORING BOOKS, ADHESIVE STICKERS, RUB-ON TRANSFERS, NOTEBOOKS AND STATIONERY-TYPE PORTFOLIOS; POSTERS, GREETING CARDS, CALENDARS; MANUALS FOR COMPUTER GAMES, ADVERTISEMENT BOARDS OF PAPER OR CARDBOARD, PICTURES, PHOTOGRAPHS AND PRINTS, IN CLASS 16 (U.S. CLS. 2, 5, 22, 23, 29, 37, 38 AND 50).

FIRST USE 7-1-2010; IN COMMERCE 7-1-2010.

FOR: TOYS, NAMELY, TOY ACTION FIGURES AND ACTION FIGURE ACCESSORIES; PLAYING CARDS, TRADING CARD GAMES, BOARD GAMES, IN CLASS 28 (U.S. CLS. 22, 23, 38 AND 50).

FIRST USE 7-1-2010; IN COMMERCE 7-1-2010.

NO CLAIM IS MADE TO THE EXCLUSIVE RIGHT TO USE "ENTERTAINMENT", APART FROM THE MARK AS SHOWN.

THE MARK CONSISTS OF THE WORD "CRYPTOZOIC" IN A STYLIZED FONT OVER THE WORD "ENTERTAINMENT" IN A STYLIZED FONT.

SER. NO. 85-975,087, FILED 8-4-2010.

REBECCA SMITH, EXAMINING ATTORNEY



David J. Kyros

Director of the United States Patent and Trademark Office

United States of America

United States Patent and Trademark Office

do you flip?

Reg. No. 4,099,191

CISCO TECHNOLOGY, INC. (CALIFORNIA CORPORATION)
170 W. TASMAN DR.
SAN JOSE, CA 95134

Registered Feb. 14, 2012

Int. Cl.: 45

FOR: ON-LINE SOCIAL NETWORKING SERVICES, IN CLASS 45 (U.S. CLS. 100 AND 101).

SERVICE MARK

FIRST USE 11-19-2009; IN COMMERCE 11-19-2009.

PRINCIPAL REGISTER

OWNER OF U.S. REG. NOS. 3,760,281, 3,812,161, AND 3,834,567.

THE COLOR(S) BLUE AND RED IS/ARE CLAIMED AS A FEATURE OF THE MARK.

THE MARK CONSISTS OF THE WORDING "DO YOU FLIP?" IN LOWER CASE LETTERS IN BLUE WITH A RED DOT ABOVE THE "I" IN THE WORD "FLIP".

SER. NO. 85-975,165, FILED 9-21-2010.

JOHN DWYER, EXAMINING ATTORNEY



David J. Kyffers

Director of the United States Patent and Trademark Office

United States of America

United States Patent and Trademark Office

DO YOU FLIP?

Reg. No. 4,099,192

CISCO TECHNOLOGY, INC. (CALIFORNIA CORPORATION)
170 W. TASMAN DR.
SAN JOSE, CA 95134

Registered Feb. 14, 2012

Int. Cl.: 45

FOR: ON-LINE SOCIAL NETWORKING SERVICES, IN CLASS 45 (U.S. CLS. 100 AND 101).

SERVICE MARK

FIRST USE 11-19-2009; IN COMMERCE 11-19-2009.

PRINCIPAL REGISTER

THE MARK CONSISTS OF STANDARD CHARACTERS WITHOUT CLAIM TO ANY PARTICULAR FONT, STYLE, SIZE, OR COLOR.

OWNER OF U.S. REG. NOS. 3,760,281, 3,834,567 AND OTHERS.

SER. NO. 85-975,166, FILED 9-21-2010.

JOHN DWYER, EXAMINING ATTORNEY



David J. Kyffers

Director of the United States Patent and Trademark Office

United States of America

United States Patent and Trademark Office

SUPREME KOSHER

Reg. No. 4,099,193

AGRI STAR MEAT & POULTRY, LLC (IOWA LIMITED LIABILITY COMPANY)
220 N. WEST ST.

Registered Feb. 14, 2012

POSTVILLE, IA 52162

Int. Cl.: 29

FOR: MEAT AND POULTRY PRODUCTS, NAMELY, BEEF, AND TURKEY; PROCESSED FOODS AND DELI PRODUCTS, NAMELY, SALAMI, TURKEY BREAST, TURKEY ROLL, FRANKFURTERS, BEEF, AND TURKEY, PASTRAMI; ALL OF THE AFOREMENTIONED GOODS BEING KOSHER, IN CLASS 29 (U.S. CL. 46).

TRADEMARK

PRINCIPAL REGISTER

FIRST USE 11-0-2005; IN COMMERCE 11-0-2005.

THE MARK CONSISTS OF STANDARD CHARACTERS WITHOUT CLAIM TO ANY PARTICULAR FONT, STYLE, SIZE, OR COLOR.

NO CLAIM IS MADE TO THE EXCLUSIVE RIGHT TO USE "KOSHER", APART FROM THE MARK AS SHOWN.

SEC. 2(F).

SER. NO. 85-975,173, FILED 6-21-2010.

BRIAN CALLAGHAN, EXAMINING ATTORNEY



David J. Kyffers

Director of the United States Patent and Trademark Office

United States of America

United States Patent and Trademark Office



Reg. No. 4,099,194

Registered Feb. 14, 2012

Int. Cl.: 5

TRADEMARK

PRINCIPAL REGISTER

NEW CENTURY, INC. (VIRGINIA CORPORATION)
ATTN.: MARY E. WITKOWSKI, PRESIDENT
410 MASSACHUSETTS AVENUE
NORFOLK, VA 235082114

FOR: BATH PREPARATIONS FOR MEDICAL PURPOSES CONTAINING PLANT-DERIVED MINERALS; DIETARY SUPPLEMENTS FOR HUMAN CONSUMPTION CONTAINING PLANT-DERIVED MINERALS; THERAPEUTIC MEDICATED BATH PREPARATIONS CONTAINING PLANT-DERIVED MINERALS, IN CLASS 5 (U.S. CLS. 6, 18, 44, 46, 51 AND 52).

FIRST USE 3-26-2008, THE MARK WAS FIRST USED ANYWHERE IN A DIFFERENT FORM OTHER THAN THAT SOUGHT TO BE REGISTERED AT LEAST AS EARLY AS 01/20/2000.; IN COMMERCE 3-26-2008, THE MARK WAS FIRST USED IN COMMERCE IN A DIFFERENT FORM OTHER THAN THAT SOUGHT TO BE REGISTERED AT LEAST AS EARLY AS 01/20/2000..

NO CLAIM IS MADE TO THE EXCLUSIVE RIGHT TO USE "100% NATURAL" AND "PLANT-DERIVED MINERALS", APART FROM THE MARK AS SHOWN.

THE MARK CONSISTS OF A STYLIZED DRAWING OF A PLANT WITH THE WORDS "RICH EARTH" WRITTEN ACROSS THE PLANT AND THE TERMS "100% NATURAL" AND "PLANT-DERIVED MINERALS" WRITTEN IN THE BORDER THAT SURROUNDS THE DRAWING.

SER. NO. 85-975,431, FILED 4-12-2011.

MICHAEL SOUDERS, EXAMINING ATTORNEY



David J. Kybas

Director of the United States Patent and Trademark Office

United States of America

United States Patent and Trademark Office

NATURALLY DELICIOUS - EXCEPTIONALLY EASY

Reg. No. 4,099,195

Registered Feb. 14, 2012

Int. Cl.: 29

TRADEMARK

PRINCIPAL REGISTER

PERDUE HOLDINGS, INC. (DELAWARE CORPORATION)
1105 N. MARKET ST.
SUITE 1300
WILMINGTON, DE 19801

FOR: POULTRY; SAUSAGES, FROZEN ENTREES CONSISTING PRIMARILY OF POULTRY;
PREPARED ENTREES CONSISTING PRIMARILY OF MEAT OR POULTRY, IN CLASS 29
(U.S. CL. 46).

FIRST USE 2-21-2011; IN COMMERCE 2-21-2011.

THE MARK CONSISTS OF STANDARD CHARACTERS WITHOUT CLAIM TO ANY PAR-
TICULAR FONT, STYLE, SIZE, OR COLOR.

SER. NO. 85-975,590, FILED 2-24-2011.

DAVID TAYLOR, EXAMINING ATTORNEY



David J. Kyffers

Director of the United States Patent and Trademark Office

United States of America

United States Patent and Trademark Office

BUILD A BASKET

Reg. No. 4,099,196

BUILD-A-BEAR RETAIL MANAGEMENT, INC. (DELAWARE CORPORATION)
1954 INNERBELT BUSINESS CENTER DRIVE
ST. LOUIS, MO 631145760

Registered Feb. 14, 2012

Int. Cl.: 35

FOR: RETAIL STORE SERVICES FEATURING CUSTOM DESIGNED GIFT BASKETS AND GIFTS AND ACCESSORIES, IN CLASS 35 (U.S. CLS. 100, 101 AND 102).

SERVICE MARK

FIRST USE 1-0-2005; IN COMMERCE 1-0-2005.

PRINCIPAL REGISTER

NO CLAIM IS MADE TO THE EXCLUSIVE RIGHT TO USE "BASKET", APART FROM THE MARK AS SHOWN.

SN 76-530,408, FILED 7-9-2003.

LESLEY LAMOTHE, EXAMINING ATTORNEY



David J. Kyffers

Director of the United States Patent and Trademark Office

United States of America

United States Patent and Trademark Office

DAILY TOOLS

Reg. No. 4,099,197

SIMPLEHUMAN LLC (CALIFORNIA LIMITED LIABILITY COMPANY)
19801 S. VERMONT AVE.
TORRANCE, CA 92502

Registered Feb. 14, 2012

Int. Cl.: 16

FOR: TRASH BAGS, IN CLASS 16 (U.S. CLS. 2, 5, 22, 23, 29, 37, 38 AND 50).

TRADEMARK

FIRST USE 2-0-2009; IN COMMERCE 2-0-2009.

PRINCIPAL REGISTER

THE MARK CONSISTS OF STANDARD CHARACTERS WITHOUT CLAIM TO ANY PARTICULAR FONT, STYLE, SIZE, OR COLOR.

NO CLAIM IS MADE TO THE EXCLUSIVE RIGHT TO USE "TOOLS", APART FROM THE MARK AS SHOWN.

SN 76-685,000, FILED 12-17-2007.

JOHN E. MICHOS, EXAMINING ATTORNEY



David J. Kyffers

Director of the United States Patent and Trademark Office

United States of America

United States Patent and Trademark Office

TRANSPACK

Reg. No. 4,099,198

Registered Feb. 14, 2012

Int. Cl.: 25

TRADEMARK

PRINCIPAL REGISTER

VISUAL IMPACT FILMS CORP. (NEW YORK CORPORATION)
131 VARICK STREET, SUITE 901
NEW YORK, NY 10016

FOR: CLOTHING, NAMELY, SHIRTS AND HATS, IN CLASS 25 (U.S. CLS. 22 AND 39).

FIRST USE 12-12-1998; IN COMMERCE 9-28-2011.

THE MARK CONSISTS OF STANDARD CHARACTERS WITHOUT CLAIM TO ANY PARTICULAR FONT, STYLE, SIZE, OR COLOR.

OWNER OF U.S. REG. NO. 1,904,996.

SN 76-685,088, FILED 12-19-2007.

CURTIS FRENCH, EXAMINING ATTORNEY



David J. Kyffers

Director of the United States Patent and Trademark Office

United States of America

United States Patent and Trademark Office

JOURNALZINE

Reg. No. 4,099,199

LIEBERT, MARY ANN (UNITED STATES INDIVIDUAL)
140 HUGUENOT STREET
NEW ROCHELLE, NY 10801

Registered Feb. 14, 2012

Int. Cl.: 16

FOR: PUBLICATIONS, NAMELY, MAGAZINES, BOOKS, JOURNALS, WRITTEN ARTICLES, DIARIES, HANDOUTS, WORKSHEETS, PAMPHLETS AND REVIEWS IN THE FIELDS OF SCIENCE, HEALTH AND CURRENT EVENTS AND NEWS, ALL OF WHICH WILL INCLUDE AS PART OF THEIR CONTENT PEER REVIEWS, NEWS INTERVIEWS, AND ROUND TABLE DISCUSSIONS, IN CLASS 16 (U.S. CLS. 2, 5, 22, 23, 29, 37, 38 AND 50).

TRADEMARK

PRINCIPAL REGISTER

FIRST USE 4-9-2009; IN COMMERCE 7-1-2009.

THE MARK CONSISTS OF STANDARD CHARACTERS WITHOUT CLAIM TO ANY PARTICULAR FONT, STYLE, SIZE, OR COLOR.

SN 76-685,637, FILED 1-10-2008.

TEJBIR SINGH, EXAMINING ATTORNEY



David J. Kybas

Director of the United States Patent and Trademark Office

United States of America

United States Patent and Trademark Office



Reg. No. 4,099,200

Registered Feb. 14, 2012

Int. Cl.: 35

SERVICE MARK

PRINCIPAL REGISTER

MI PUEBLO SAN JOSE, INC. (CALIFORNIA CORPORATION)
1745 STORY ROAD
SAN JOSE, CA 95112

FOR: RETAIL GROCERY STORE, IN CLASS 35 (U.S. CLS. 100, 101 AND 102).

FIRST USE 12-1-1991; IN COMMERCE 12-1-1991.

NO CLAIM IS MADE TO THE EXCLUSIVE RIGHT TO USE "FOOD CENTER", APART FROM THE MARK AS SHOWN.

THE COLOR(S) RED, GREEN, WHITE, AND YELLOW IS/ARE CLAIMED AS A FEATURE OF THE MARK.

THE COLORS RED, GREEN, AND WHITE APPEAR IN THE WORDING, WHERE THE LETTERS "MP" HAVE A RED CENTER WITH A GREEN OUTLINE AND NARROW WHITE SPACE BETWEEN THE RED CENTER AND GREEN OUTLINE, AND THE WORDS "FOOD CENTER" ARE IN GREEN. AN ARCHWAY, WHICH IS PART OF THE LOGO WHICH EXTENDS INTO A WALL UPON WHICH THE LETTERS "MP" APPEAR, IS SHADED IN GREEN, WITH A FACIAL COLOR OF YELLOW, AND WITH TRIM IN THE FORM OF BRICKS IN RED. THE MOUNTAINS AND STREAM WHICH ARE VISIBLE THROUGH THE ARCHWAY ARE GREEN AGAINST A WHITE BACKGROUND. THE BUILDING WHICH IS VISIBLE THROUGH THE ARCHWAY IS RED AGAINST A WHITE BACKGROUND.

SN 76-699,342, FILED 9-4-2009.

ROBIN CHOSID, EXAMINING ATTORNEY



David J. Kybas

Director of the United States Patent and Trademark Office

United States of America

United States Patent and Trademark Office

ECOFRESH

Reg. No. 4,099,201

Registered Feb. 14, 2012

Int. Cls.: 3, 5, 31, and 35

THE TRUSTEE OF THE MICHAEL BRANDT FAMILY TRUST (TEXAS TRUST)
3001 WHELOCK STREET
SUITE A
DALLAS, TX 75220

FOR: CARPET CLEANER, IN CLASS 3 (U.S. CLS. 1, 4, 6, 50, 51 AND 52).

TRADEMARK

FIRST USE 8-10-1988; IN COMMERCE 9-1-1988.

SERVICE MARK

FOR: CARPET DEODORIZERS; CAT LITTER FRESHENER; ALL PURPOSES DEODORIZING LIQUID CLEANER AND CONCENTRATE; POCKET-SIZED DEODORIZING SPRAY AND CLEANER; ODOR ABSORBING AND NEUTRALIZING BAGS FOR AIR FRESHENING, IN CLASS 5 (U.S. CLS. 6, 18, 44, 46, 51 AND 52).

PRINCIPAL REGISTER

FIRST USE 8-10-1988; IN COMMERCE 9-1-1988.

FOR: CAT LITTER WITH ODOR ABSORBING GRANULES, IN CLASS 31 (U.S. CLS. 1 AND 46).

FIRST USE 6-1-1991; IN COMMERCE 3-15-1992.

FOR: BUSINESS SERVICES, NAMELY, ASSISTING OTHERS IN THE ESTABLISHMENT IN AND OPERATION OF A BUSINESS IN THE FIELD OF CLEANING PRODUCTS AND SERVICES, IN CLASS 35 (U.S. CLS. 100, 101 AND 102).

FIRST USE 10-1-2009; IN COMMERCE 10-1-2009.

OWNER OF U.S. REG. NOS. 1,557,539, 1,632,840, AND 1,763,136.

SN 76-700,740, FILED 12-8-2009.

DAVID TOOLEY, EXAMINING ATTORNEY



David J. Kyffers

Director of the United States Patent and Trademark Office

United States of America

United States Patent and Trademark Office

KASTAWAYS

Reg. No. 4,099,202

KASTAWAYS DISPOSABLE COVERS, LLC (ARKANSAS LIMITED LIABILITY COMPANY)
6114 REPUBLICAN ROAD
JACKSONVILLE, AR 72076

Registered Feb. 14, 2012

Int. Cl.: 10

FOR: DISPOSABLE WATERPROOF COVERS FOR MEDICAL CASTS, IN CLASS 10 (U.S. CLS. 26, 39 AND 44).

TRADEMARK

FIRST USE 9-27-2010; IN COMMERCE 9-27-2010.

PRINCIPAL REGISTER

THE MARK CONSISTS OF STANDARD CHARACTERS WITHOUT CLAIM TO ANY PARTICULAR FONT, STYLE, SIZE, OR COLOR.

SN 76-700,954, FILED 12-22-2009.

JENNIFER DIXON, EXAMINING ATTORNEY



David J. Kybas

Director of the United States Patent and Trademark Office

United States of America

United States Patent and Trademark Office

RMC MORTGAGE

Reg. No. 4,099,203

Registered Feb. 14, 2012

Int. Cl.: 36

SERVICE MARK

PRINCIPAL REGISTER

RYLAND ORGANIZATION COMPANY (CALIFORNIA CORPORATION)
24025 PARK SORRENTO
CALABASAS, CA 91302

FOR: MORTGAGE FINANCING OF NEW RESIDENTIAL DWELLINGS USING IN-HOUSE LENDING PROGRAMS; PROVIDING INFORMATION VIA THE INTERNET AND WORLD-WIDE WEB RELATING TO MORTGAGE FINANCING OF NEW RESIDENTIAL DWELLINGS AND AVAILABLE IN-HOUSE LENDING PROGRAMS, IN CLASS 36 (U.S. CLS. 100, 101 AND 102).

FIRST USE 11-0-2009; IN COMMERCE 11-0-2009.

THE MARK CONSISTS OF STANDARD CHARACTERS WITHOUT CLAIM TO ANY PARTICULAR FONT, STYLE, SIZE, OR COLOR.

NO CLAIM IS MADE TO THE EXCLUSIVE RIGHT TO USE "MORTGAGE", APART FROM THE MARK AS SHOWN.

SN 76-702,462, FILED 4-12-2010.

ANDREW RHIM, EXAMINING ATTORNEY



David J. Kyffers

Director of the United States Patent and Trademark Office

United States of America

United States Patent and Trademark Office

CASINO BOURBON

Reg. No. 4,099,204

DEJA VU CONSULTING, INC. (MICHIGAN CORPORATION)
P.O. BOX 70159
LANSING, MI 48907

Registered Feb. 14, 2012

Int. Cl.: 41

FOR: ENTERTAINMENT SERVICES, NAMELY, PROVIDING LIVE VARIETY AND BURLESQUE SHOWS, IN CLASS 41 (U.S. CLS. 100, 101 AND 107).

SERVICE MARK

FIRST USE 5-30-2008; IN COMMERCE 5-30-2008.

PRINCIPAL REGISTER

THE MARK CONSISTS OF STANDARD CHARACTERS WITHOUT CLAIM TO ANY PARTICULAR FONT, STYLE, SIZE, OR COLOR.

SN 76-702,810, FILED 5-5-2010.

THOMAS MANOR, EXAMINING ATTORNEY



David J. Kyfos

Director of the United States Patent and Trademark Office

United States of America
United States Patent and Trademark Office

ZIPNICK

Reg. No. 4,099,205

ZIPNICK, RICHARD I. (UNITED STATES INDIVIDUAL)
6300 NORTH SAGEWOOD DRIVE
PARK CITY, UT 84098

Registered Feb. 14, 2012

Int. Cls.: 5 and 10

FOR: IMPLANTS COMPOSED OF LIVING TISSUE, IN CLASS 5 (U.S. CLS. 6, 18, 44, 46, 51 AND 52).

TRADEMARK

FIRST USE 11-1-2011; IN COMMERCE 11-1-2011.

PRINCIPAL REGISTER

FOR: MEDICAL DEVICES, NAMELY, MINIMALLY INVASIVE MEDICAL DEVICES, NAMELY, IMPLANTS COMPOSED OF ARTIFICIAL MATERIAL; SPINAL IMPLANTS COMPOSED OF ARTIFICIAL MATERIAL, IN CLASS 10 (U.S. CLS. 26, 39 AND 44).

FIRST USE 11-1-2011; IN COMMERCE 11-1-2011.

THE MARK CONSISTS OF STANDARD CHARACTERS WITHOUT CLAIM TO ANY PARTICULAR FONT, STYLE, SIZE, OR COLOR.

SN 76-703,275, FILED 6-7-2010.

LEIGH CAROLINE CASE, EXAMINING ATTORNEY



David J. Kyffers

Director of the United States Patent and Trademark Office

United States of America

United States Patent and Trademark Office

TONY C

Reg. No. 4,099,206

THREE PIECE LLC (DELAWARE LIMITED LIABILITY COMPANY)
916 LONGVIEW ROAD
KING OF PRUSSIA, PA 19406

Registered Feb. 14, 2012

Int. Cl.: 41

FOR: ENTERTAINMENT IN THE NATURE OF LIVE PERFORMANCES BY A MUSICAL GROUP AND MUSICAL ARTISTS; MUSIC PRODUCTION SERVICES; PRODUCTION OF SOUND AND MUSIC VIDEO RECORDINGS, IN CLASS 41 (U.S. CLS. 100, 101 AND 107).

SERVICE MARK

FIRST USE 9-10-2011; IN COMMERCE 9-10-2011.

PRINCIPAL REGISTER

THE MARK CONSISTS OF STANDARD CHARACTERS WITHOUT CLAIM TO ANY PARTICULAR FONT, STYLE, SIZE, OR COLOR.

THE NAME(S), PORTRAIT(S), AND/OR SIGNATURE(S) SHOWN IN THE MARK IDENTIFIES NASRI ATWEH, WHOSE CONSENT(S) TO REGISTER IS MADE OF RECORD.

SN 76-704,082, FILED 8-11-2010.

DAVID HOFFMAN, EXAMINING ATTORNEY



David J. Kyfos

Director of the United States Patent and Trademark Office

United States of America

United States Patent and Trademark Office

ERGOSCOPE

Reg. No. 4,099,207

Registered Feb. 14, 2012

Int. Cl.: 10

TRADEMARK

PRINCIPAL REGISTER

QUALITY CONTROL SOLUTIONS INC. (CALIFORNIA CORPORATION)
43339 BUSINESS PARK DRIVE
TEMECULA, CA 92590

FOR: SURGICAL MICROSCOPE, IN CLASS 10 (U.S. CLS. 26, 39 AND 44).

FIRST USE 1-1-2011; IN COMMERCE 6-17-2011.

THE MARK CONSISTS OF STANDARD CHARACTERS WITHOUT CLAIM TO ANY PARTICULAR FONT, STYLE, SIZE, OR COLOR.

SN 76-704,285, FILED 8-27-2010.

JULIE GUTTADAURO, EXAMINING ATTORNEY



David J. Kyffers

Director of the United States Patent and Trademark Office

United States of America

United States Patent and Trademark Office

MARCO POLO

Reg. No. 4,099,208

OLDE GRANDDAD INDUSTRIES, INC. (NEW JERSEY CORPORATION)
160 PASSAIC AVENUE
KEARNY, NJ 07032

Registered Feb. 14, 2012

Int. Cls.: 5, 11, and 27

FOR: FRAGRANCE PRODUCTS FOR LAND VEHICLES, AIRCRAFT, MARINE CRAFT, PERSONAL, COMMERCIAL, INDUSTRIAL AND HOME USE, NAMELY, AIR FRESHENERS, IN CLASS 5 (U.S. CLS. 6, 18, 44, 46, 51 AND 52).

TRADEMARK

FIRST USE 11-19-2011; IN COMMERCE 11-19-2011.

PRINCIPAL REGISTER

FOR: VEHICLE REFLECTORS BEARING ETHNIC LOGOS, INSIGNIAS, DESIGNS, AND ARTWORK, IN CLASS 11 (U.S. CLS. 13, 21, 23, 31 AND 34).

FIRST USE 11-19-2011; IN COMMERCE 11-19-2011.

FOR: FLOOR MATS FOR VEHICLES BEARING ETHNIC LOGOS, INSIGNIAS, DESIGNS, AND ARTWORK, IN CLASS 27 (U.S. CLS. 19, 20, 37, 42 AND 50).

FIRST USE 11-19-2011; IN COMMERCE 11-19-2011.

THE MARK CONSISTS OF STANDARD CHARACTERS WITHOUT CLAIM TO ANY PARTICULAR FONT, STYLE, SIZE, OR COLOR.

SN 76-704,529, FILED 9-14-2010.

NELSON SNYDER, EXAMINING ATTORNEY



David J. Kyffers

Director of the United States Patent and Trademark Office

United States of America

United States Patent and Trademark Office

CRAFTED BY NATURE

Reg. No. 4,099,209

OSHRY, SCOTT (UNITED STATES INDIVIDUAL)
560 BROADWAY, SUITE 507A
NEW YORK, NY 10012

Registered Feb. 14, 2012

Int. Cl.: 3

FOR: SKIN CARE PRODUCTS, NAMELY, SKIN CREAMS, SKIN LOTIONS AND SKIN SOAPS, IN CLASS 3 (U.S. CLS. 1, 4, 6, 50, 51 AND 52).

TRADEMARK

FIRST USE 6-1-2010; IN COMMERCE 9-1-2010.

PRINCIPAL REGISTER

THE MARK CONSISTS OF STANDARD CHARACTERS WITHOUT CLAIM TO ANY PARTICULAR FONT, STYLE, SIZE, OR COLOR.

SN 76-704,673, FILED 9-27-2010.

BILL DAWE, EXAMINING ATTORNEY



David J. Kyffers

Director of the United States Patent and Trademark Office

United States of America

United States Patent and Trademark Office

WAVE PROPULSION

Reg. No. 4,099,210

MASTER SPAS, INC. (INDIANA CORPORATION)
6927 LINCOLN PARKWAY
FORT WAYNE, IN 46804

Registered Feb. 14, 2012

Int. Cl.: 11

FOR: SPAS IN THE NATURE OF HEATED POOLS, IN CLASS 11 (U.S. CLS. 13, 21, 23, 31 AND 34).

TRADEMARK

FIRST USE 11-3-2010; IN COMMERCE 11-3-2010.

PRINCIPAL REGISTER

THE MARK CONSISTS OF STANDARD CHARACTERS WITHOUT CLAIM TO ANY PARTICULAR FONT, STYLE, SIZE, OR COLOR.

NO CLAIM IS MADE TO THE EXCLUSIVE RIGHT TO USE "PROPULSION", APART FROM THE MARK AS SHOWN.

SN 76-705,230, FILED 11-5-2010.

BRIAN NEVILLE, EXAMINING ATTORNEY



David J. Kyffers

Director of the United States Patent and Trademark Office

United States of America

United States Patent and Trademark Office

SPEEDYBRIGHT

Reg. No. 4,099,211

CROSSFORD INTERNATIONAL, LLC (CONNECTICUT LIMITED LIABILITY COMPANY)
420 WEST AVENUE
STAMFORD, CT 06902

Registered Feb. 14, 2012

Int. Cl.: 1

FOR: DE-SCALING CHEMICAL, IN CLASS 1 (U.S. CLS. 1, 5, 6, 10, 26 AND 46).

TRADEMARK

FIRST USE 1-3-2011; IN COMMERCE 1-3-2011.

PRINCIPAL REGISTER

THE MARK CONSISTS OF STANDARD CHARACTERS WITHOUT CLAIM TO ANY PARTICULAR FONT, STYLE, SIZE, OR COLOR.

SN 76-705,728, FILED 12-20-2010.

SAMUEL E. SHARPER JR., EXAMINING ATTORNEY



David J. Kyffers

Director of the United States Patent and Trademark Office

United States of America

United States Patent and Trademark Office

TWO BIRDS

Reg. No. 4,099,212

Registered Feb. 14, 2012

Int. Cl.: 33

TRADEMARK

PRINCIPAL REGISTER

ARISTA WINES, LLC (CALIFORNIA LIMITED LIABILITY COMPANY)
7015 WESTSIDE ROAD
HEALDSBURG, CA 95448

FOR: WINE, IN CLASS 33 (U.S. CLS. 47 AND 49).

FIRST USE 8-0-2011; IN COMMERCE 8-0-2011.

THE MARK CONSISTS OF STANDARD CHARACTERS WITHOUT CLAIM TO ANY PARTICULAR FONT, STYLE, SIZE, OR COLOR.

SN 76-706,246, FILED 2-2-2011.

ODESSA BIBBINS, EXAMINING ATTORNEY



David J. Kyffers

Director of the United States Patent and Trademark Office

United States of America

United States Patent and Trademark Office



Girls
Are
Really
Beautiful

Reg. No. 4,099,213

SHAKIR, ZARIFAH S. (UNITED STATES INDIVIDUAL)
2035 MEMORIAL DR. S.E. APT#203
ATLANTA, GA 303172522

Registered Feb. 14, 2012

Int. Cl.: 18

FOR: BACK PACKS FOR GIRLS, IN CLASS 18 (U.S. CLS. 1, 2, 3, 22 AND 41).

TRADEMARK

FIRST USE 3-1-2011; IN COMMERCE 5-1-2011.

PRINCIPAL REGISTER

THE MARK CONSISTS OF THE WORDING "B.R.A.G GIRLS ARE REALLY BEAUTIFUL" WITH THE LETTERS "B.R.A.G" AND "G" AND "A" AND "R" AND "B" BEING IN LARGER STENCIL LIKE FONT AND BOTH "B" AND "G" BEING REVERSED. THE DESIGN ELEMENT CONSISTS OF FOUR DAISIES ARISING FROM THE WORDING "B.R.A.G".

SN 76-706,306, FILED 2-7-2011.

GINA FINK, EXAMINING ATTORNEY



David J. Kybas

Director of the United States Patent and Trademark Office

United States of America
United States Patent and Trademark Office

QPREDICT

Reg. No. 4,099,214

QDX PATHOLOGY SERVICES (NEW JERSEY CORPORATION)
46 JACKSON DRIVE
CRANFORD, NJ 07016

Registered Feb. 14, 2012

Int. Cl.: 44

FOR: MEDICAL TESTING FOR DIAGNOSTIC OR TREATMENT PURPOSES, NAMELY, PROVIDING A VARIETY OF LABORATORY TESTS BASED IN ONCOLOGY USING MOLECULAR TECHNOLOGY, IN CLASS 44 (U.S. CLS. 100 AND 101).

SERVICE MARK

FIRST USE 4-11-2011; IN COMMERCE 5-13-2011.

PRINCIPAL REGISTER

THE MARK CONSISTS OF STANDARD CHARACTERS WITHOUT CLAIM TO ANY PARTICULAR FONT, STYLE, SIZE, OR COLOR.

SN 76-706,817, FILED 3-15-2011.

LINDA ESTRADA, EXAMINING ATTORNEY



David J. Kybas

Director of the United States Patent and Trademark Office

United States of America

United States Patent and Trademark Office

LINGUAFORUM

Reg. No. 4,099,215

Registered Feb. 14, 2012

Int. Cls.: 16 and 41

TRADEMARK

SERVICE MARK

PRINCIPAL REGISTER

TIME EDUCATION CO., LTD. (REPUBLIC OF KOREA CORPORATION)
949-3 DOGOK 1-DONG, GANGNAM-GU
SEOUL, REPUBLIC OF KOREA

FOR: BOOKS AND BOOKLETS IN THE FIELD OF ENGLISH LANGUAGE STUDY, AND PAPERS, NAMELY, LESSONS PRINTED ON PAPER IN THE FIELD OF ENGLISH LANGUAGE STUDY, IN CLASS 16 (U.S. CLS. 2, 5, 22, 23, 29, 37, 38 AND 50).

FIRST USE 5-2-2000; IN COMMERCE 5-0-2002.

FOR: PUBLICATION OF BOOKS IN THE FIELD OF ENGLISH LANGUAGE STUDY, IN CLASS 41 (U.S. CLS. 100, 101 AND 107).

FIRST USE 5-2-2000; IN COMMERCE 5-0-2002.

THE MARK CONSISTS OF STANDARD CHARACTERS WITHOUT CLAIM TO ANY PARTICULAR FONT, STYLE, SIZE, OR COLOR.

SN 77-056,614, FILED 12-4-2006.

KIM MONINGHOFF, EXAMINING ATTORNEY



David J. Kypos

Director of the United States Patent and Trademark Office

United States of America

United States Patent and Trademark Office



Reg. No. 4,099,216

Registered Feb. 14, 2012

Int. Cls.: 1 and 21

TRADEMARK

PRINCIPAL REGISTER

MYE CANADA OPERATIONS INC. (CANADA CORPORATION)
75 PLANT FARM BOULEVARD
P.O. BOX 265
BRANTFORD, ONTARIO, CANADA N3T5M8

FOR: (BASED ON 44(E)) LIQUID PLANT FOOD; GROWING MEDIA FOR PLANTS, NAMELY, PLANT AND FLOWER SEED STARTER MIX, AND FIBER PELLETS USED TO PROPAGATE SEEDLINGS, IN CLASS 1 (U.S. CLS. 1, 5, 6, 10, 26 AND 46).

FOR: HORTICULTURAL PRODUCTS, NAMELY, PLASTIC, FIBER AND MOLDED PULP PLANT AND GARDEN POTS AND SAUCERS, PLANT AND GARDEN BASKETS, TRAYS AND STANDS, PLANT AND GARDEN BEDDING PLANT CONTAINERS, PLANT AND GARDEN FLATS, PLANT AND GARDEN CARRIERS AND PLANT AND GARDEN STRIPS FOR THE DISPLAY OF PLANTS AND FLOWERS; HOSE GUARDS CONSISTING PRIMARILY OF PLASTIC BEADS SURROUNDING A METAL SPIKE FOR PROTECTING PLANTS FROM HOSES, PLASTIC PLANT TIES FOR HOME OR GARDEN USE, PLASTIC DOMES FOR PLANTS AND GARDEN FLOWERS FOR HOME OR GARDEN USE FOR MAINTAINING HUMIDITY AND CONSTANT TEMPERATURE; GARDENING KITS CONSISTING PRIMARILY OF PLASTIC CARRYING TRAYS FOR HOLDING AND TRANSPORTING PLANT POTS OR FLOWER POTS AND CONSISTING OF ONE OR MORE OF THE FOLLOWING: PLASTIC HUMIDITY DOMES FOR PLANTS AND GARDEN FLOWERS FOR HOME OR GARDEN USE FOR MAINTAINING HUMIDITY AND CONSTANT TEMPERATURE, PLASTIC POTS FOR TRANSPLANTED PLANTS, HANGING BASKETS, AND PLASTIC AND FIBER PROPAGATION CELL PACK INSERTS; PLASTIC AND FIBER PLANT AND GARDEN BOWLS, PLANTERS AND HANGING BASKETS; PLASTIC AND FIBER PROPAGATION CELL PACK INSERTS; AND PLASTIC IDENTIFICATION STAKES, IN CLASS 21 (U.S. CLS. 2, 13, 23, 29, 30, 33, 40 AND 50).

FIRST USE 0-0-1993; IN COMMERCE 0-0-1993.

PRIORITY CLAIMED UNDER SEC. 44(D) ON CANADA APPLICATION NO. 1308552, FILED 6-27-2006.

OWNER OF CANADA REG. NO. TMA714471, DATED 5-15-2008, EXPIRES 5-15-2023.

OWNER OF U.S. REG. NOS. 1,723,842, 2,326,668, AND 2,341,083.



David J. Kyffers

Director of the United States Patent and Trademark Office

Reg. No. 4,099,216 NO CLAIM IS MADE TO THE EXCLUSIVE RIGHT TO USE "PLANTERS", APART FROM THE MARK AS SHOWN.

THE MARK CONSISTS OF STYLIZED FLOWER PETALS ARRANGED ON A HALF CIRCLE ABOVE THE WORDS "PLANTERS' PRIDE".

SN 77-071,716, FILED 12-27-2006.

MICHAEL LITZAU, EXAMINING ATTORNEY

United States of America

United States Patent and Trademark Office



Reg. No. 4,099,217

Registered Feb. 14, 2012

Int. Cl.: 25

TRADEMARK

PRINCIPAL REGISTER

BERGER, LAUREN (UNITED STATES INDIVIDUAL)
37 ANGUS LANE
GREENWICH, CT 06831

FOR: SHIRTS, T-SHIRTS, IN CLASS 25 (U.S. CLS. 22 AND 39).

FIRST USE 11-18-2010; IN COMMERCE 11-18-2010.

OWNER OF U.S. REG. NO. 3,333,776.

SEC. 2(F).

THE MARK CONSISTS OF A CIRCULAR DESIGN WITH A STYLIZED REPRESENTATION OF TWO YOUNG WOMEN LINKING ARMS IN THE FOREGROUND, WITH STYLIZED REPRESENTATIONS OF PAVEMENT TO THE LEFT OF THE FIGURES AND GRASS AND FOLIAGE TO THE RIGHT OF THE FIGURES; THE BACKGROUND OF THE DESIGN IS COMPRISED OF STYLIZED REPRESENTATIONS OF BUILDINGS TO THE LEFT, MOUNTAINS AND TREES TO THE RIGHT AND THE SUN ABOVE THE TWO WOMEN. THE MARK IS NOT IN COLOR, AND BLACK AND GRAY ARE NOT FEATURES OF THE MARK.

SN 77-085,886, FILED 1-18-2007.

LOURDES AYALA, EXAMINING ATTORNEY



David J. Kybas

Director of the United States Patent and Trademark Office

United States of America

United States Patent and Trademark Office

POP DISASTER TOUR

Reg. No. 4,099,218

Registered Feb. 14, 2012

Int. Cl.: 41

SERVICE MARK

PRINCIPAL REGISTER

GREEN DAY, INC. (CALIFORNIA CORPORATION)
C/O ZEISLER, ZEISLER & RAWSON, LLP
1100 THIRD STREET
SAN RAFAEL, CA 94901

FOR: PROVIDING A WEBSITE ON GLOBAL COMPUTER NETWORKS FEATURING INFORMATION ON MUSIC, MUSICAL PERFORMANCES AND MUSICAL PERFORMERS , IN CLASS 41 (U.S. CLS. 100, 101 AND 107).

FIRST USE 10-12-2010; IN COMMERCE 10-12-2010.

THE MARK CONSISTS OF STANDARD CHARACTERS WITHOUT CLAIM TO ANY PARTICULAR FONT, STYLE, SIZE, OR COLOR.

NO CLAIM IS MADE TO THE EXCLUSIVE RIGHT TO USE "TOUR", APART FROM THE MARK AS SHOWN.

SN 77-092,496, FILED 1-26-2007.

Alice Benmaman, Examining Attorney



David J. Kybas

Director of the United States Patent and Trademark Office

United States of America

United States Patent and Trademark Office

JesusFreaks

Reg. No. 4,099,219

CIRCLE OF BELIEF (LOUISIANA CORPORATION)
4404 ST. PETER
NEW ORLEANS, LA 70119

Registered Feb. 14, 2012

Int. Cl.: 16

FOR: SCHOOL SUPPLIES, NAMELY, NOTEBOOKS, FOLDERS, NOTE PADS, PENCILS, PENS, PENCIL CASES, WRITING UTENSILS, BOOK COVERS, IN CLASS 16 (U.S. CLS. 2, 5, 22, 23, 29, 37, 38 AND 50).

TRADEMARK

FIRST USE 1-6-2012; IN COMMERCE 1-6-2012.

PRINCIPAL REGISTER

THE MARK CONSISTS OF STANDARD CHARACTERS WITHOUT CLAIM TO ANY PARTICULAR FONT, STYLE, SIZE, OR COLOR.

SN 77-103,072, FILED 2-8-2007.

BRIDGETT SMITH, EXAMINING ATTORNEY



David J. Kybas

Director of the United States Patent and Trademark Office

United States of America

United States Patent and Trademark Office

TUBO-WRAP

Reg. No. 4,099,220

Registered Feb. 14, 2012

Int. Cl.: 40

SERVICE MARK

PRINCIPAL REGISTER

VARCO I/P, INC. (DELAWARE CORPORATION)
7909 PARKWOOD CIRCLE DRIVE
HOUSTON, TX 77036

FOR: APPLYING PROTECTIVE COATINGS TO PIPE CONNECTIONS, DRILL PIPE, TUBING, CASING, LINE PIPE, PIPELINES, AND OTHER TUBULAR GOODS, IN CLASS 40 (U.S. CLS. 100, 103 AND 106).

FIRST USE 4-1-2007; IN COMMERCE 4-1-2007.

THE MARK CONSISTS OF STANDARD CHARACTERS WITHOUT CLAIM TO ANY PARTICULAR FONT, STYLE, SIZE, OR COLOR.

THE ENGLISH TRANSLATION OF THE WORD "TUBO" IN THE MARK IS "TUBE".

SN 77-109,419, FILED 2-16-2007.

MAUREEN DALL, EXAMINING ATTORNEY



David J. Kybas

Director of the United States Patent and Trademark Office

United States of America

United States Patent and Trademark Office

ΩmegaBlue

Reg. No. 4,099,221

MARK HEYWARD (WYOMING CORPORATION)
17524 SEIDNER ROAD
WINTER GARDEN, FL 34787

Registered Feb. 14, 2012

Int. Cl.: 31

FOR: CONSUMABLE PET CHEWS; DOG FOOD; EDIBLE FOOD FOR ANIMALS FOR CHEWING; FOOD FOR ANIMALS; PET FOOD, IN CLASS 31 (U.S. CLS. 1 AND 46).

TRADEMARK

FIRST USE 12-1-2011; IN COMMERCE 12-1-2011.

PRINCIPAL REGISTER

THE MARK CONSISTS OF GREEK LETTER "OMEGA" AND THE REST OF THE TEXT IN SPECIAL FONT WITH LIGHTER SHADES OF BLUE WITHIN THE TEXT.

THE COLOR(S) BLUE IS/ARE CLAIMED AS A FEATURE OF THE MARK.

SN 77-135,307, FILED 3-20-2007.

MARGERY A. TIERNEY, EXAMINING ATTORNEY



David J. Kyros

Director of the United States Patent and Trademark Office

United States of America

United States Patent and Trademark Office

SITTOO'S

Reg. No. 4,099,222

Registered Feb. 14, 2012

Int. Cls.: 29 and 30

TRADEMARK

PRINCIPAL REGISTER

SITTOO'S SYSTEMS, LLC (OHIO LIMITED LIABILITY COMPANY)
14518 DETROIT AVENUE
LAKEWOOD, OH 44107

FOR: TAHINI; KIBBIE; HUMMOS; BABA GANNOUJ; OLIVE OIL; PROCESSED TURNIPS; STUFFED GRAPE LEAVES; FALAFEL; SALADS EXCEPT MACARONI, RICE OR PASTA SALAD; FATTOUSH (SALAD CONSISTING OF CHOPPED LETTUCE, TOMATOES, CUCUMBERS, PEPPERS, ONIONS, MINT, PARSLEY, DRIED PITA BREAD, AND SUMAC); LEBANESE SALAD, CONSISTING OF TOMATOES, CUCUMBERS, GREEN PEPPERS, ONIONS, PARSLEY, LEMON JUICE, OLIVE OIL, DRY MINT, AND SPICES; PICKLES; MUJADDARA (COOKED AND SEASONED LENTILS, ONIONS, AND RICE); MAKDOUSS (STUFFED EGGPLANT); STUFFED GRAPE LEAVES, IN CLASS 29 (U.S. CL. 46).

FIRST USE 1-31-2009; IN COMMERCE 1-31-2009.

FOR: HOT SAUCE; GARLIC SAUCE; TABOULI; FOULE M DAMMAS (CHICKPEAS AND FAVA BEANS WITH GARLIC, LEMON JUICE, AND OLIVE OIL); TABOULI; BREAD; PITA BREAD; BAKLAVA; KNAFEH (DESSERT CONSISTING OF SWEETENED DOUGH AND CHEESE); TAHINI DRESSING, IN CLASS 30 (U.S. CL. 46).

FIRST USE 1-31-2009; IN COMMERCE 1-31-2009.

THE MARK CONSISTS OF STANDARD CHARACTERS WITHOUT CLAIM TO ANY PARTICULAR FONT, STYLE, SIZE, OR COLOR.

THE FOREIGN WORDING IN THE MARK TRANSLATES INTO ENGLISH AS GRANDMOTHER'S.

SN 77-147,955, FILED 4-3-2007.

PAUL E. FAHRENKOPF, EXAMINING ATTORNEY



David J. Kypos

Director of the United States Patent and Trademark Office

United States of America

United States Patent and Trademark Office



**COLLECTION
D'EUROPE**

Reg. No. 4,099,223

Registered Feb. 14, 2012

Int. Cl.: 30

TRADEMARK

PRINCIPAL REGISTER

CANADA BREAD FROZEN BAKERY LTD. (CANADA CORPORATION)
4000 INDUSTRIEL BLVD.
LAVAL, CANADA H7L1R9

FOR: BREAD; PARBAKED FROZEN BREAD, IN CLASS 30 (U.S. CL. 46).

FIRST USE 4-30-2007; IN COMMERCE 4-30-2007.

PRIORITY CLAIMED UNDER SEC. 44(D) ON CANADA APPLICATION NO. 1324894, FILED 11-20-2006, REG. NO. TMA719685, DATED 7-29-2008, EXPIRES 7-29-2023.

OWNER OF U.S. REG. NO. 3,204,936.

NO CLAIM IS MADE TO THE EXCLUSIVE RIGHT TO USE "COLLECTION D'EUROPE", APART FROM THE MARK AS SHOWN.

THE MARK CONSISTS OF A STYLIZED "E" WITHIN AN IRREGULAR SHAPE ABOVE THE REMAINING LITERAL ELEMENTS OF THE MARK.

THE ENGLISH TRANSLATION OF "COLLECTION D'EUROPE" IN THE MARK IS "COLLECTION OF EUROPE".

SN 77-150,315, FILED 4-6-2007.

BRIAN PINO, EXAMINING ATTORNEY



David J. Kyffers

Director of the United States Patent and Trademark Office

United States of America

United States Patent and Trademark Office

EPIQ SYSTEMS

Reg. No. 4,099,224

EPIQ SYSTEMS, INC. (MISSOURI CORPORATION)
501 KANSAS AVENUE
KANSAS CITY, KS 66105

Registered Feb. 14, 2012

Int. Cls.: 9, 35, and 42

FOR: COMPUTER HARDWARE AND SOFTWARE USED TO COLLECT, HOST, ANALYZE, FILTER, CREATE, STORE, TRACK, MANAGE, CONVERT, DE-DUPLICATE, PROCESS, REVIEW, CLUSTER AND PRODUCE, DATABASES, IMAGES, E-MAIL, FILES AND OTHER DOCUMENTS AND DATA REQUIRED FOR LEGAL AND GOVERNMENTAL INVESTIGATIONS, EDISCOVERY AND LITIGATION, AND TO LOCATE, TRACK, CREATE, PRODUCE, AND MANAGE, LEGAL CLAIMS, LEGAL CLAIMANTS, LEGAL REPORTS, LEGAL MAILINGS AND NOTIFICATIONS, ALL DIRECTED TO THE LEGAL AND FIDUCIARY SERVICES INDUSTRIES, IN CLASS 9 (U.S. CLS. 21, 23, 26, 36 AND 38).

TRADEMARK

SERVICE MARK

PRINCIPAL REGISTER

FIRST USE 0-0-2000; IN COMMERCE 0-0-2000.

FOR: COMPUTERIZED LEGAL DATABASES AND MANAGEMENT OF SAME; CASE AND DOCUMENT MANAGEMENT SERVICES FOR OTHERS IN THE LEGAL AND FIDUCIARY SERVICES INDUSTRIES, NAMELY, ACTING AS CLAIMS, CLASS ACTION, DATABASE, DOCUMENT, AND SETTLEMENT ADMINISTRATORS IN LAWSUITS, BANKRUPTCY AND CORPORATE RESTRUCTURING CASES, MASS TORT LITIGATION, INTERNAL CORPORATE AND GOVERNMENTAL INVESTIGATIONS; PREPARING DEVELOPING AND DISSEMINATING CLASS ACTION NOTICES AND NOTICE PLANS AND CREATING DEBTOR AND CREDITOR SCHEDULES AND STATEMENTS OF AFFAIRS FOR OTHERS IN THE BANKRUPTCY AND CORPORATE RESTRUCTURING FIELDS, IN CLASS 35 (U.S. CLS. 100, 101 AND 102).

FIRST USE 0-0-2000; IN COMMERCE 0-0-2000.

FOR: CONSULTING FOR OTHERS IN THE FIELDS OF SELECTING, IMPLEMENTING AND USING COMPUTER HARDWARE AND SOFTWARE SYSTEMS, AND IN THE FIELD OF TECHNICAL SUPPORT THEREFOR, DIRECTED TO THE LEGAL AND FIDUCIARY SERVICES INDUSTRIES; COMPUTER SOFTWARE DESIGN AND DEVELOPMENT; DESIGN, CREATION, IMPLEMENTATION AND MAINTENANCE OF WEB SITES FOR OTHERS DIRECTED TO THE LEGAL AND FIDUCIARY SERVICES INDUSTRIES, IN CLASS 42 (U.S. CLS. 100 AND 101).

FIRST USE 0-0-2000; IN COMMERCE 0-0-2000.



David J. Kybas

Director of the United States Patent and Trademark Office

Reg. No. 4,099,224 THE MARK CONSISTS OF STANDARD CHARACTERS WITHOUT CLAIM TO ANY PARTICULAR FONT, STYLE, SIZE, OR COLOR.

NO CLAIM IS MADE TO THE EXCLUSIVE RIGHT TO USE "SYSTEMS", APART FROM THE MARK AS SHOWN.

SN 77-150,977, FILED 4-6-2007.

ELISSA GARBER KON, EXAMINING ATTORNEY

United States of America

United States Patent and Trademark Office

HOWCAST

Reg. No. 4,099,225

Registered Feb. 14, 2012

Int. Cl.: 38

SERVICE MARK

PRINCIPAL REGISTER

HOWCAST MEDIA, INC. (DELAWARE CORPORATION)
518 BROADWAY
SUITE 2
NEW YORK, NY 10012

FOR: BROADCASTING SERVICES OVER THE INTERNET AND MOBILE PHONES; BROADCASTING SERVICES AND PROVISION OF TELECOMMUNICATION ACCESS TO AUDIO AND VIDEO CONTENT PROVIDED VIA CABLE, INTERNET PROTOCOL TELEVISION, VIDEO-ON-DEMAND SERVICE, THE INTERNET OR MOBILE DEVICES; MOBILE MEDIA AND ENTERTAINMENT SERVICES IN THE NATURE OF ELECTRONIC TRANSMISSION OF EDUCATIONAL AND ENTERTAINMENT CONTENT; PROVIDING ON-LINE CHAT ROOM SERVICES AND ELECTRONIC BULLETIN BOARDS FOR TRANSMISSION OF MESSAGES AND MEDIA CONTENT AMONG INTERNET AND MOBILE PHONE USERS IN THE FIELD OF GENERAL INTEREST; ELECTRONIC DATA TRANSMISSION, NAMELY, ELECTRONIC TRANSMISSION OF AUDIO AND VIDEO FILES VIA ELECTRONIC COMMUNICATIONS NETWORKS; ELECTRONIC TRANSMISSION OF DATA, IMAGES, MESSAGES, AND DOCUMENTS VIA COMPUTER TERMINALS AND NETWORKS; PROVIDING ON-LINE FORUMS FOR TRANSMISSION OF MESSAGES AMONG COMPUTER USERS CONCERNING EDUCATIONAL AND INSTRUCTIONAL MATERIALS ON TOPICS OF GENERAL INTEREST; ELECTRONIC DATA TRANSMISSION OF AUDIO AND VIDEO MATERIAL FOR STREAMING ONLINE TO MOBILE DEVICES AND VIA INTERNET WEBSITES, CABLE, OR SATELLITE, IN CLASS 38 (U.S. CLS. 100, 101 AND 104).

FIRST USE 2-6-2008; IN COMMERCE 2-6-2008.

THE MARK CONSISTS OF STANDARD CHARACTERS WITHOUT CLAIM TO ANY PARTICULAR FONT, STYLE, SIZE, OR COLOR.

SN 77-154,236, FILED 4-11-2007.

SIMON TENG, EXAMINING ATTORNEY



David J. Kyjars

Director of the United States Patent and Trademark Office

United States of America

United States Patent and Trademark Office

AICP CERTIFIED TRANSPORTATION PLANNER

Reg. No. 4,099,226

Registered Feb. 14, 2012

CERTIFICATION MARK

SERVICES

PRINCIPAL REGISTER

AMERICAN PLANNING ASSOCIATION (D.C. NON-PROFIT CORPORATION)
SUITE 1600
112 S. MICHIGAN AVE.
CHICAGO, IL 60603

FOR: TRANSPORTATION PLANNING, IN CLASS B (U.S. CL. B).

FIRST USE 7-0-2010; IN COMMERCE 7-0-2010.

THE MARK CONSISTS OF STANDARD CHARACTERS WITHOUT CLAIM TO ANY PARTICULAR FONT, STYLE, SIZE, OR COLOR.

NO CLAIM IS MADE TO THE EXCLUSIVE RIGHT TO USE "CERTIFIED TRANSPORTATION PLANNER", APART FROM THE MARK AS SHOWN.

THE CERTIFICATION MARK, AS INTENDED TO BE USED BY AUTHORIZED PERSONS, IS INTENDED TO CERTIFY THAT THE PERSON DISPLAYING THE MARK HAS COMPLETED EDUCATION COURSE WORK REQUIREMENTS AND WORK EXPERIENCE REQUIREMENTS OF THE CERTIFIER, HAS COMPLETED EXAMINATIONS ADMINISTERED BY THE CERTIFIER, HAS COMPLETED EXAMINATIONS ADMINISTERED BY THE CERTIFIER IN SATISFACTORY MANNER, HAS AGREED TO ADHERE TO THE CERTIFIER'S STANDARDS FOR PROFESSIONAL RESPONSIBILITY, CONTINUING EDUCATION AND OTHER POST-CERTIFICATION REQUIREMENTS..

SN 77-167,766, FILED 4-27-2007.

ROBIN CHOSID, EXAMINING ATTORNEY



David J. Kyffers

Director of the United States Patent and Trademark Office

United States of America

United States Patent and Trademark Office

MANHATTAN

Reg. No. 4,099,227

HUNTER DOUGLAS INC. (DELAWARE CORPORATION)

Registered Feb. 14, 2012

1 BLUE HILL PLAZA
PEARL RIVER, NY 10965

Int. Cl.: 20

FOR: WINDOW BLINDS MADE OF WOVEN AND NON-WOVEN FABRIC AND/OR SYNTHETIC MATERIAL; WINDOW SHADES MADE OF WOVEN AND NON-WOVEN FABRIC AND/OR SYNTHETIC MATERIAL, IN CLASS 20 (U.S. CLS. 2, 13, 22, 25, 32 AND 50).

TRADEMARK

FIRST USE 5-1-2010; IN COMMERCE 5-3-2011.

PRINCIPAL REGISTER

THE MARK CONSISTS OF STANDARD CHARACTERS WITHOUT CLAIM TO ANY PARTICULAR FONT, STYLE, SIZE, OR COLOR.

OWNER OF U.S. REG. NO. 2,055,842.

SN 77-168,032, FILED 4-27-2007.

CHARLES L. JENKINS, EXAMINING ATTORNEY



David J. Kyffers

Director of the United States Patent and Trademark Office

United States of America

United States Patent and Trademark Office

CUBAN COFFEE

Reg. No. 4,099,228

MIKE'S CIGARS DISTRIBUTORS INC. (FLORIDA CORPORATION)
1030 KANE CONCOURSE
BAY HARBOR, FL 33154

Registered Feb. 14, 2012

Int. Cl.: 34

FOR: CIGARS MADE FROM CUBAN SEED TOBACCO AND NOT FLAVORED WITH COFFEE, IN CLASS 34 (U.S. CLS. 2, 8, 9 AND 17).

TRADEMARK

FIRST USE 11-23-2011; IN COMMERCE 11-23-2011.

PRINCIPAL REGISTER

THE MARK CONSISTS OF STANDARD CHARACTERS WITHOUT CLAIM TO ANY PARTICULAR FONT, STYLE, SIZE, OR COLOR.

SN 77-174,231, FILED 5-7-2007.

DAVID C. REIHNER, EXAMINING ATTORNEY



David J. Kyfos

Director of the United States Patent and Trademark Office

United States of America

United States Patent and Trademark Office

TAMAR GELLER

Reg. No. 4,099,229

THE LOVED DOG LLC (CALIFORNIA LIMITED LIABILITY COMPANY)
2100 PONTIUS AVENUE
LOS ANGELES, CA 90025

Registered Feb. 14, 2012

Int. Cl.: 9

FOR: PRERECORDED DIGITAL VIDEO DISKS FEATURING PET CARE INFORMATION,
IN CLASS 9 (U.S. CLS. 21, 23, 26, 36 AND 38).

TRADEMARK

FIRST USE 9-1-2010; IN COMMERCE 9-1-2010.

PRINCIPAL REGISTER

THE MARK CONSISTS OF STANDARD CHARACTERS WITHOUT CLAIM TO ANY PARTICULAR FONT, STYLE, SIZE, OR COLOR.

THE NAME "TAMAR GELLER" IDENTIFIES A LIVING INDIVIDUAL WHOSE CONSENT IS OF RECORD.

SN 77-195,016, FILED 5-31-2007.

WILLIAM ROSSMAN, EXAMINING ATTORNEY



David J. Kyffers

Director of the United States Patent and Trademark Office

United States of America

United States Patent and Trademark Office

Go Green

Reg. No. 4,099,230

Registered Feb. 14, 2012

Int. Cl.: 37

SERVICE MARK

PRINCIPAL REGISTER

GO GREEN CONSTRUCTION, INC (CALIFORNIA CORPORATION)
9300 TEXHOMA AVE
NORTHRIDGE, CA 91325

FOR: BUILDING CONSTRUCTION AND REPAIR; BUILDING CONSTRUCTION SERVICES; BUILDING INSPECTION; CHARITABLE SERVICES, NAMELY, RENOVATING AND CONSTRUCTING HOMES FOR LOW INCOME FAMILIES; CONSTRUCTING DECKS; CONSTRUCTING PORCHES; CONSTRUCTING SUNROOMS; CONSTRUCTION AND RENOVATION OF BUILDINGS; CONSTRUCTION AND REPAIR OF BUILDINGS; CONSTRUCTION AND REPAIR OF MOVIE AND THEATRICAL SETS AND SCENERY; CONSTRUCTION CONSULTANCY; CONSTRUCTION CONSULTATION; CONSTRUCTION GRADING SERVICES; CONSTRUCTION MANAGEMENT; CONSTRUCTION OF AIRPORTS; CONSTRUCTION OF AQUATICS FACILITIES; CONSTRUCTION OF MEDICAL ESTABLISHMENTS; CONSTRUCTION OF ROADS, UNDERGROUND UTILITIES, AND HOUSING PADS; CONSTRUCTION OF TELECOMMUNICATION TOWERS; CONSTRUCTION OF SUSTAINABLE BUILDINGS; CONSTRUCTION PLANNING; CONSTRUCTION SERVICES, NAMELY, PLANNING, LAYING OUT AND CUSTOM CONSTRUCTION OF RESIDENTIAL AND COMMERCIAL COMMUNITIES; CONSTRUCTION SUPERVISION; CONSTRUCTION, MAINTENANCE AND RENOVATION OF PROPERTY; CONSULTATION IN BUILDING CONSTRUCTION SUPERVISION; CONSULTING IN THE FIELD OF BUILDING CONSTRUCTION; CONSULTING SERVICES FOR THE CONSTRUCTION OF WATER TREATMENT AND PURIFICATION PLANTS, SOLID WASTE TREATMENT PLANTS AND OTHER MUNICIPAL INFRASTRUCTURE FACILITIES; CRANE RENTAL AND LEASING FOR CONSTRUCTION PURPOSES; CUSTOM CONSTRUCTION AND BUILDING RENOVATION; CUSTOM CONSTRUCTION OF HOMES; GENERAL CONSTRUCTION CONTRACTING; HARBOR CONSTRUCTION; HOUSING SERVICES, NAMELY, DEVELOPMENT OF REAL PROPERTY, NAMELY, REPAIR, IMPROVEMENT, AND NEW CONSTRUCTION; HOUSING SERVICES, NAMELY, REPAIR, IMPROVEMENT, AND CONSTRUCTION OF RESIDENTIAL REAL PROPERTY; HYDRO-ELECTRIC FACTORY CONSTRUCTION; INFORMATION CONCERNING RENTAL OF EQUIPMENT FOR CONSTRUCTIONS AND BUILDINGS; INFORMATION WITH RELATION TO AIRCRAFT CONSTRUCTION, REPAIR AND MAINTENANCE; LAYING AND CONSTRUCTION OF PIPELINES; LEASING OF CONSTRUCTION EQUIPMENT; MARINE CONSTRUCTION; PIER CONSTRUCTION; RENTAL OF CONSTRUCTION AND BUILDING EQUIPMENT; RENTAL OF CONSTRUCTION EQUIPMENT; RENTAL OF CONSTRUCTION MACHINES AND APPARATUS; REPAIR OR MAINTENANCE OF CONSTRUCTION MACHINES AND APPARATUS; RESIDENTIAL AND BUILDING CONSTRUCTION CONSULTING; RESIDENTIAL AND COMMERCIAL BUILDING CONSTRUCTION; ROAD



David J. Kyros

Director of the United States Patent and Trademark Office

Reg. No. 4,099,230 CONSTRUCTION; SCAFFOLDING, EARTHWORKS OR CONCRETE CONSTRUCTION; STEEL STRUCTURE CONSTRUCTION WORKS; STREET CONSTRUCTION; UNDERWATER BUILDING AND CONSTRUCTION; WAREHOUSE CONSTRUCTION AND REPAIR, IN CLASS 37 (U.S. CLS. 100, 103 AND 106).

FIRST USE 8-24-2006; IN COMMERCE 8-24-2006.

THE MARK CONSISTS OF STANDARD CHARACTERS WITHOUT CLAIM TO ANY PARTICULAR FONT, STYLE, SIZE, OR COLOR.

OWNER OF U.S. REG. NO. 3,463,197.

SN 77-265,897, FILED 8-28-2007.

TIMOTHY FINNEGAN, EXAMINING ATTORNEY

United States of America

United States Patent and Trademark Office

TITAN

Reg. No. 4,099,231

J.R. CLANCY, INC. (NEW YORK CORPORATION)
7041 INTERSTATE ISLAND ROAD
SYRACUSE, NY 13209

Registered Feb. 14, 2012

Int. Cl.: 7

FOR: THEATRICAL RIGGING SYSTEM CONSISTING OF WINCH, BRAKE, HEADBLOCK, SUPPORT BEAM AND LIFTLINES, IN CLASS 7 (U.S. CLS. 13, 19, 21, 23, 31, 34 AND 35).

TRADEMARK

FIRST USE 2-0-2011; IN COMMERCE 2-0-2011.

PRINCIPAL REGISTER

THE MARK CONSISTS OF STANDARD CHARACTERS WITHOUT CLAIM TO ANY PARTICULAR FONT, STYLE, SIZE, OR COLOR.

SN 77-270,732, FILED 9-4-2007.

KATHY DE JONGE, EXAMINING ATTORNEY



David J. Kybas

Director of the United States Patent and Trademark Office

United States of America

United States Patent and Trademark Office

Un

Reg. No. 4,099,232

POMERANZ, NORM (UNITED STATES INDIVIDUAL)
PO BOX 67603
LOS ANGELES, CA 90067 AND

Registered Feb. 14, 2012

Int. Cl.: 3

ROSS, BRIAN L. (UNITED STATES INDIVIDUAL)
P.O. BOX 67603
LOS ANGELES, CA 90067

TRADEMARK

PRINCIPAL REGISTER

FOR: SKIN CLEANSERS, NAMELY, SOAPS AND SOAPLESS CLEANSERS , IN CLASS 3
(U.S. CLS. 1, 4, 6, 50, 51 AND 52).

FIRST USE 9-26-2011; IN COMMERCE 9-26-2011.

THE MARK CONSISTS OF STANDARD CHARACTERS WITHOUT CLAIM TO ANY PARTICULAR FONT, STYLE, SIZE, OR COLOR.

SN 77-273,648, FILED 9-6-2007.

JENNIFER VASQUEZ, EXAMINING ATTORNEY



David J. Kybas

Director of the United States Patent and Trademark Office

United States of America

United States Patent and Trademark Office

SIGMAX

Reg. No. 4,099,233

Registered Feb. 14, 2012

Int. Cl.: 25

TRADEMARK

PRINCIPAL REGISTER

NIPPON SIGMAX CO., LTD. (JAPAN CORPORATION)
6-8-1 NISHI-SHINJUKU
33RD FLOOR, SHINJUKU OAK TOWER
SHINJUKU-KU, TOKYO, JAPAN 163-6033

FOR: CLOTHING, NAMELY, ATHLETIC INNER SHIRT AND PANTS, ATHLETIC JERSEY, SOCKS AND STOCKINGS; FOOTWEAR, IN CLASS 25 (U.S. CLS. 22 AND 39).

FIRST USE 10-0-2011; IN COMMERCE 10-0-2011.

THE MARK CONSISTS OF STANDARD CHARACTERS WITHOUT CLAIM TO ANY PARTICULAR FONT, STYLE, SIZE, OR COLOR.

SN 77-280,375, FILED 9-14-2007.

EVELYN BRADLEY, EXAMINING ATTORNEY



David J. Kybas

Director of the United States Patent and Trademark Office

United States of America

United States Patent and Trademark Office

ROUND TABLE VIEWPOINTS

Reg. No. 4,099,234

THE MCGRAW-HILL COMPANIES, INC. (NEW YORK CORPORATION)
1221 AVENUE OF THE AMERICAS
NEW YORK, NY 10020

Registered Feb. 14, 2012

Int. Cl.: 16

FOR: PRINTED MATTER, NAMELY, A SERIES OF PRINTED ANTHOLOGIES IN THE FIELDS OF HUMANITIES, SOCIAL SCIENCES, BUSINESS, AND THE PHYSICAL SCIENCES FOR USE IN HIGHER EDUCATION, IN CLASS 16 (U.S. CLS. 2, 5, 22, 23, 29, 37, 38 AND 50).

TRADEMARK

FIRST USE 7-0-2006; IN COMMERCE 7-0-2006.

PRINCIPAL REGISTER

THE MARK CONSISTS OF STANDARD CHARACTERS WITHOUT CLAIM TO ANY PARTICULAR FONT, STYLE, SIZE, OR COLOR.

SN 77-285,712, FILED 9-21-2007.

MICHAEL TANNER, EXAMINING ATTORNEY



David J. Kyffers

Director of the United States Patent and Trademark Office

United States of America

United States Patent and Trademark Office

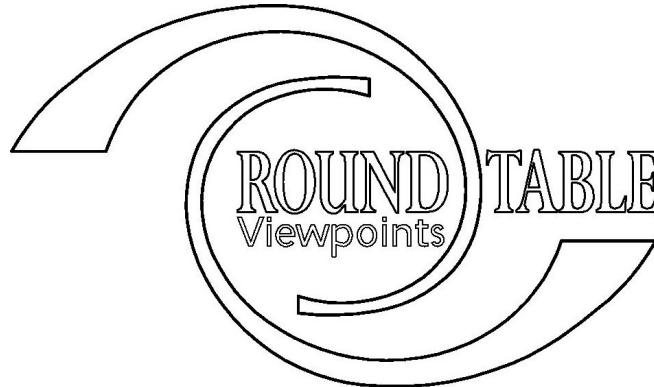

Reg. No. 4,099,235

Registered Feb. 14, 2012

Int. Cl.: 16

TRADEMARK

PRINCIPAL REGISTER

THE MCGRAW-HILL COMPANIES, INC. (NEW YORK CORPORATION)
1221 AVENUE OF THE AMERICAS
NEW YORK, NY 10020

FOR: PRINTED MATTER, NAMELY, A SERIES OF PRINTED ANTHOLOGIES IN THE FIELDS OF HUMANITIES, SOCIAL SCIENCES, BUSINESS, AND THE PHYSICAL SCIENCES FOR USE IN HIGHER EDUCATION, IN CLASS 16 (U.S. CLS. 2, 5, 22, 23, 29, 37, 38 AND 50).

FIRST USE 7-0-2006; IN COMMERCE 7-0-2006.

THE MARK CONSISTS OF THE WORDS "ROUNDTABLE" AND "VIEWPOINTS" SET WITHIN TWO INTERLOCKING CURVE DESIGNS.

SN 77-285,748, FILED 9-21-2007.

MICHAEL TANNER, EXAMINING ATTORNEY



David J. Kybas

Director of the United States Patent and Trademark Office

United States of America

United States Patent and Trademark Office



Reg. No. 4,099,236

Registered Feb. 14, 2012

**Int. Cls.: 16, 25, 28, 35,
and 41**

ATP TOUR, INC. (DELAWARE CORPORATION)
201 ATP TOUR BOULEVARD
PONTE VEDRA BEACH, FL 32082

FOR: FOLDERS; FABRIC-GIFT BAGS, IN CLASS 16 (U.S. CLS. 2, 5, 22, 23, 29, 37, 38 AND 50).

FIRST USE 4-1-2009; IN COMMERCE 4-1-2009.

TRADEMARK

FOR: CLOTHING, NAMELY, SHIRTS, SWEATSHIRTS, WARM-UP SUITS, AND SWEATERS, IN CLASS 25 (U.S. CLS. 22 AND 39).

SERVICE MARK

FIRST USE 4-1-2009; IN COMMERCE 4-1-2009.

PRINCIPAL REGISTER

FOR: TENNIS RACKETS; TENNIS RACKET ACCESSORIES, NAMELY, RACKET STRINGS, GRIPS, AND COVERS; AND TENNIS BALLS, IN CLASS 28 (U.S. CLS. 22, 23, 38 AND 50).

FIRST USE 4-1-2009; IN COMMERCE 4-1-2009.

FOR: ASSOCIATION SERVICES, NAMELY, PROMOTING RECREATIONAL TENNIS FACILITIES, IN CLASS 35 (U.S. CLS. 100, 101 AND 102).

FIRST USE 4-1-2009; IN COMMERCE 4-1-2009.

FOR: COORDINATION OF TENNIS TOURNAMENTS; PROVIDING ONLINE NONDOWNLOADABLE NEWSPAPERS IN THE FIELD OF TENNIS, IN CLASS 41 (U.S. CLS. 100, 101 AND 107).

FIRST USE 4-1-2009; IN COMMERCE 4-1-2009.

OWNER OF U.S. REG. NOS. 1,635,368, 2,837,118, AND 3,060,561.

NO CLAIM IS MADE TO THE EXCLUSIVE RIGHT TO USE "WORLD TOUR", APART FROM THE MARK AS SHOWN.

THE MARK CONSISTS OF A SILHOUETTE OF A TENNIS PLAYER HOLDING A TENNIS RACKET WITH THE TERMS "ATP WORLD TOUR".

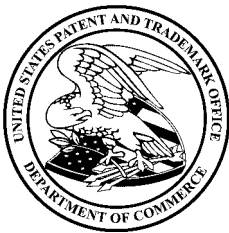

David J. Kyjars

Director of the United States Patent and Trademark Office

Reg. No. 4,099,236 SN 77-295,875, FILED 10-4-2007.

JACLYN KIDWELL WALKER, EXAMINING ATTORNEY

United States of America

United States Patent and Trademark Office

MABS

Reg. No. 4,099,237

Registered Feb. 14, 2012

Int. Cls.: 12, 16, and 40

TRADEMARK

SERVICE MARK

PRINCIPAL REGISTER

MEGGITT PLC (UNITED KINGDOM PUBLIC LIMITED COMPANY (PLC))
ATLANTIC HOUSE, AVIATION PARK WEST
CHRISTCHURCH, UNITED KINGDOM DORSETBH2

FOR: VEHICLES, NAMELY, AIRCRAFT; BRAKES FOR AIRCRAFT; BRAKING SYSTEMS AND BRAKE CONTROL SYSTEMS FOR AIRCRAFT, COMPRISED OF BRAKES, WHEEL SPEED TRANSDUCERS AND BRAKE TEMPERATURE MONITORS; AIRCRAFT WHEELS, NAMELY, LANDING GEAR WHEELS; ELECTRICALLY ACTUATED BRAKES FOR LAND VEHICLES; ELECTRICALLY ACTUATED BRAKES FOR AIRCRAFT; BRAKE LININGS FOR AIRCRAFT; BRAKE SEGMENTS FOR AIRCRAFT; BRAKE SHOES FOR AIRCRAFT; BRAKE VALVES FOR AIRCRAFT; PARTS AND FITTINGS FOR AIRCRAFT BRAKES, NAMELY, BRAKE LININGS, BRAKE SHOES, BRAKE ROTORS, BRAKE CALIPERS AND BLOCKS, BRAKE ACTUATORS, BRAKE CLUTCHES, AND BRAKE VALVES; PARTS AND FITTINGS FOR BRAKES AND BRAKING SYSTEM APPARATUS FOR AIRCRAFT, NAMELY, BRAKE LININGS, BRAKE DISKS, BRAKE SEGMENTS, BRAKE SHOES, AND BRAKE LININGS; BRAKE DISKS FOR AIRCRAFT CONTAINING CARBON-CARBON COMPOSITE MATERIALS; AIRCRAFT LANDING WHEEL BRAKES; ELECTRIC, HYDRAULIC AND MECHANICAL CONTROLS FOR AIRCRAFT BRAKES, BRAKING SYSTEMS, BRAKE CONTROL SYSTEMS, AND ANTI-SKID SYSTEMS; HYDRAULIC BRAKES FOR AIRCRAFT; HYDRAULIC BRAKE-BY-WIRE BRAKES FOR AIRCRAFT; ANALOG ELECTRICAL BRAKES FOR AIRCRAFT; DIGITAL ELECTRICAL BRAKES FOR AIRCRAFT; LANDING GEAR AND LANDING GEAR SYSTEMS FOR AIRCRAFT COMPRISED OF BRAKES AND WHEELS; WHEELS FOR AIRCRAFT, IN CLASS 12 (U.S. CLS. 19, 21, 23, 31, 35 AND 44).

FIRST USE 1-1-2011; IN COMMERCE 1-1-2011.

FOR: PAPER PUBLICATIONS, NAMELY, MANUALS FOR USE IN THE INSTALLATION AND REPAIR OF BRAKES, BRAKING SYSTEMS AND BRAKING CONTROL SYSTEMS, IN CLASS 16 (U.S. CLS. 2, 5, 22, 23, 29, 37, 38 AND 50).

FIRST USE 6-0-2009; IN COMMERCE 6-0-2009.

FOR: TECHNICAL CONSULTATION IN THE FIELD OF THE MANUFACTURE OF AIRCRAFT PARTS, NAMELY, WHEELS, BRAKES, BRAKING SYSTEMS AND BRAKE CONTROL SYSTEMS, TO THE ORDER AND SPECIFICATION OF OTHERS, IN CLASS 40 (U.S. CLS. 100, 103 AND 106).



David J. Kybas

Director of the United States Patent and Trademark Office

Reg. No. 4,099,237 FIRST USE 1-1-2011; IN COMMERCE 1-1-2011.

THE MARK CONSISTS OF STANDARD CHARACTERS WITHOUT CLAIM TO ANY PARTICULAR FONT, STYLE, SIZE, OR COLOR.

SN 77-298,350, FILED 10-8-2007.

DAVID MURRAY, EXAMINING ATTORNEY

United States of America

United States Patent and Trademark Office

PATENTLICIOSO

Reg. No. 4,099,238

LYNNE EAGAN (UNITED STATES INDIVIDUAL)
4712 ADMIRALTY WAY, #302
MARINA DEL REY, CA 90292

Registered Feb. 14, 2012

Int. Cl.: 3

FOR: LIP GLOSS, LIPSTICK AND LIP PENCILS, IN CLASS 3 (U.S. CLS. 1, 4, 6, 50, 51 AND 52).

TRADEMARK

FIRST USE 11-28-2011; IN COMMERCE 11-28-2011.

PRINCIPAL REGISTER

THE MARK CONSISTS OF STANDARD CHARACTERS WITHOUT CLAIM TO ANY PARTICULAR FONT, STYLE, SIZE, OR COLOR.

SN 77-299,299, FILED 10-9-2007.

MICHELE SWAIN, EXAMINING ATTORNEY



David J. Kybas

Director of the United States Patent and Trademark Office

United States of America

United States Patent and Trademark Office

HOSTESS {WITH THE MOSTESS}

Reg. No. 4,099,239

Registered Feb. 14, 2012

Int. Cl.: 4

TRADEMARK

PRINCIPAL REGISTER

HOSTESS WITH THE MOSTESS INC. (CALIFORNIA CORPORATION)
11624 CANDY ROSE WAY
SAN DIEGO, CA 92131

FOR: CANDLES, IN CLASS 4 (U.S. CLS. 1, 6 AND 15).

FIRST USE 12-18-2010; IN COMMERCE 12-18-2010.

THE MARK CONSISTS OF STANDARD CHARACTERS WITHOUT CLAIM TO ANY PARTICULAR FONT, STYLE, SIZE, OR COLOR.

SN 77-299,655, FILED 10-9-2007.

VIVIAN MICZNIK FIRST, EXAMINING ATTORNEY



David J. Kyffers

Director of the United States Patent and Trademark Office

United States of America

United States Patent and Trademark Office

HOSTESS {WITH THE MOSTESS}

Reg. No. 4,099,240

HOSTESS WITH THE MOSTESS INC. (CALIFORNIA CORPORATION)
11624 CANDY ROSE WAY
SAN DIEGO, CA 92131

Registered Feb. 14, 2012

Int. Cl.: 21

FOR: DISHES, NAMELY, PLATES, CUPS, BOWLS AND SERVING PLATTERS; PAPER PLATES; PAPER CUPS; CHARMS FOR ATTACHMENT TO BEVERAGE GLASSWARE FOR IDENTIFICATION PURPOSES; VASES, IN CLASS 21 (U.S. CLS. 2, 13, 23, 29, 30, 33, 40 AND 50).

TRADEMARK

PRINCIPAL REGISTER

FIRST USE 12-18-2010; IN COMMERCE 12-18-2010.

THE MARK CONSISTS OF STANDARD CHARACTERS WITHOUT CLAIM TO ANY PARTICULAR FONT, STYLE, SIZE, OR COLOR.

SN 77-299,688, FILED 10-9-2007.

VIVIAN MICZNIK FIRST, EXAMINING ATTORNEY



David J. Kybas

Director of the United States Patent and Trademark Office

United States of America

United States Patent and Trademark Office

HOSTESS {WITH THE MOSTESS}

Reg. No. 4,099,241

HOSTESS WITH THE MOSTESS INC. (CALIFORNIA CORPORATION)
11624 CANDY ROSE WAY
SAN DIEGO, CA 92131

Registered Feb. 14, 2012

Int. Cl.: 24

FOR: TEXTILE NAPKINS, IN CLASS 24 (U.S. CLS. 42 AND 50).

TRADEMARK

FIRST USE 12-18-2010; IN COMMERCE 12-18-2010.

PRINCIPAL REGISTER

THE MARK CONSISTS OF STANDARD CHARACTERS WITHOUT CLAIM TO ANY PARTICULAR FONT, STYLE, SIZE, OR COLOR.

SN 77-299,713, FILED 10-9-2007.

VIVIAN MICZNIK FIRST, EXAMINING ATTORNEY



David J. Kyffers

Director of the United States Patent and Trademark Office

United States of America

United States Patent and Trademark Office

HOSTESS {WITH THE MOSTESS}

Reg. No. 4,099,242

HOSTESS WITH THE MOSTESS INC. (CALIFORNIA CORPORATION)
11624 CANDY ROSE WAY
SAN DIEGO, CA 92131

Registered Feb. 14, 2012

Int. Cl.: 26

FOR: RIBBONS FOR GIFT WRAPPING, IN CLASS 26 (U.S. CLS. 37, 39, 40, 42 AND 50).

TRADEMARK

FIRST USE 12-18-2010; IN COMMERCE 12-18-2010.

PRINCIPAL REGISTER

THE MARK CONSISTS OF STANDARD CHARACTERS WITHOUT CLAIM TO ANY PARTICULAR FONT, STYLE, SIZE, OR COLOR.

SN 77-299,759, FILED 10-9-2007.

VIVIAN MICZNIK FIRST, EXAMINING ATTORNEY



David J. Kyffers

Director of the United States Patent and Trademark Office

United States of America

United States Patent and Trademark Office

MYSMITHVILLE

Reg. No. 4,099,243

EARLES FAMILY INC. (INDIANA CORPORATION)
1600 WEST TEMPERANCE
ELLETTSVILLE, IN 47429

Registered Feb. 14, 2012

Int. Cls.: 38 and 41

FOR: AUDIO AND VIDEO BROADCASTING SERVICES OVER THE INTERNET AND OTHER COMMUNICATIONS NETWORKS, NAMELY, ELECTRONIC TRANSMISSION OF INFORMATION, AUDIO, AND VIDEO CLIPS; PROVIDING MULTIPLE-USER ACCESS TO A GLOBAL COMPUTER INFORMATION NETWORK; PROVIDING ON-LINE FORUMS, CHAT ROOMS, LISTSERVICES AND ELECTRONIC BULLETIN BOARDS FOR TRANSMISSION OF MESSAGES AMONG COMPUTER USERS IN THE FIELD OF NEWS AND GENERAL INTEREST, IN CLASS 38 (U.S. CLS. 100, 101 AND 104).

SERVICE MARK

PRINCIPAL REGISTER

FIRST USE 3-0-2011; IN COMMERCE 3-0-2011.

FOR: EDUCATION AND ENTERTAINMENT SERVICES, NAMELY, PROVIDING A WEBSITE FEATURING AUDIO CLIPS, VIDEO CLIPS, MUSICAL PERFORMANCES, MUSICAL VIDEOS, FILM CLIPS, NEWS CLIPS, PHOTOGRAPHS, OTHER MULTIMEDIA MATERIALS, AND INFORMATION IN THE FIELDS OF NEWS AND GENERAL INTEREST; ONLINE JOURNALS, NAMELY, BLOGS FEATURING INFORMATION AND MESSAGES AMONG COMPUTER USERS IN THE FIELD OF NEWS AND GENERAL INTEREST, IN CLASS 41 (U.S. CLS. 100, 101 AND 107).

FIRST USE 3-0-2011; IN COMMERCE 3-0-2011.

THE MARK CONSISTS OF STANDARD CHARACTERS WITHOUT CLAIM TO ANY PARTICULAR FONT, STYLE, SIZE, OR COLOR.

OWNER OF U.S. REG. NOS. 2,979,998, 3,053,255, AND OTHERS.

SN 77-309,158, FILED 10-19-2007.

STEVEN JACKSON, EXAMINING ATTORNEY



David J. Kybas

Director of the United States Patent and Trademark Office

United States of America

United States Patent and Trademark Office

PSALM

Reg. No. 4,099,244

Registered Feb. 14, 2012

Int. Cl.: 28

TRADEMARK

PRINCIPAL REGISTER

TEIXEIRA, ROBERT D.S. (UNITED STATES INDIVIDUAL)
100 MORNINGSIDE DRIVE
3F
NEW YORK, NY 10027

FOR: DECK OF ILLUSTRATED CARDS USED FOR PURPOSES OF MEDITATION, HEALING AND DIVINATION, BUT NOT CONTAINING THE TEXT OF ANY PSALM, IN CLASS 28 (U.S. CLS. 22, 23, 38 AND 50).

FIRST USE 5-31-2011; IN COMMERCE 5-31-2011.

THE MARK CONSISTS OF STANDARD CHARACTERS WITHOUT CLAIM TO ANY PARTICULAR FONT, STYLE, SIZE, OR COLOR.

SN 77-313,297, FILED 10-25-2007.

JAMES STEIN, EXAMINING ATTORNEY



David J. Kybas

Director of the United States Patent and Trademark Office

United States of America

United States Patent and Trademark Office



Reg. No. 4,099,245

Registered Feb. 14, 2012

**Int. Cls.: 9, 17, 20, 22, 26,
and 42**

IRIS LTD. INC. (PENNSYLVANIA CORPORATION), DBA THE IRIS COMPANIES,
901 PARK ROAD
FLEETWOOD, PA 19522

FOR: ENCODED MAGNETIC CARDS; MAGNETIC IDENTIFYING CARDS; MAGNETICALLY
ENCODED IDENTITY CARDS, IN CLASS 9 (U.S. CLS. 21, 23, 26, 36 AND 38).

FIRST USE 12-10-2007; IN COMMERCE 12-10-2007.

TRADEMARK

FOR: LAMINATES IN THE NATURE OF A PLASTIC SHEET COATING FOR USE ON
CREDIT CARDS, IDENTIFICATION CARDS, MEMBERSHIP CARDS, DEBIT CARDS, AND
CHECK CARDS, IN CLASS 17 (U.S. CLS. 1, 5, 12, 13, 35 AND 50).

SERVICE MARK

PRINCIPAL REGISTER

FIRST USE 12-10-2007; IN COMMERCE 12-10-2007.

FOR: CLEAR PLASTIC HOLDERS FOR BADGES, IN CLASS 20 (U.S. CLS. 2, 13, 22, 25, 32
AND 50).

FIRST USE 12-10-2007; IN COMMERCE 12-10-2007.

FOR: LANYARDS FOR HOLDING BADGES, KEYS, EYEGLASSES, WINEGLASSES, IN
CLASS 22 (U.S. CLS. 1, 2, 7, 19, 22, 42 AND 50).

FIRST USE 12-10-2007; IN COMMERCE 12-10-2007.

FOR: ORNAMENTAL NOVELTY BADGES, IN CLASS 26 (U.S. CLS. 37, 39, 40, 42 AND 50).

FIRST USE 12-10-2007; IN COMMERCE 12-10-2007.

FOR: ENCODING OF MAGNETIC CARDS, IN CLASS 42 (U.S. CLS. 100 AND 101).

FIRST USE 12-10-2007; IN COMMERCE 12-10-2007.

THE STIPPLING IS FOR SHADING PURPOSES ONLY.

THE COLOR(S) BLACK, GRAY, WHITE, BLUE AND GREEN IS/ARE CLAIMED AS A
FEATURE OF THE MARK.



David J. Kybas

Director of the United States Patent and Trademark Office

Reg. No. 4,099,245 THE MARK CONSISTS OF THE TERM "IRIS" APPEARS IN GRAY WITH BLACK AND WHITE SHADOWS; THE OUTER OVAL APPEARS IN BLACK AND GRAY AND WHITE; THE BACKGROUND IN THE INNER OVAL APPEARS IN BLUE WITH CONTINENTS IN GREEN; AND THE WORDS "ID YOUR WORLD" APPEAR IN BLACK.

SN 77-329,323, FILED 11-14-2007.

CHRISIE B. KING, EXAMINING ATTORNEY

United States of America

United States Patent and Trademark Office

CLICKORDER

Reg. No. 4,099,246

IPDEV CO. (ILLINOIS CORPORATION)
414 N. ORLEANS, SUITE 501
CHICAGO, IL 60602

Registered Feb. 14, 2012

Int. Cl.: 35

FOR: COMPUTERIZED ON-LINE ORDERING SERVICES IN THE FIELD OF FREQUENTLY-ORDERED AND RE-ORDERED GENERAL MERCHANDISE, FOOD, PHARMACEUTICALS, AND PRINTER CARTRIDGES, IN CLASS 35 (U.S. CLS. 100, 101 AND 102).

SERVICE MARK

FIRST USE 1-6-2012; IN COMMERCE 1-6-2012.

PRINCIPAL REGISTER

THE MARK CONSISTS OF STANDARD CHARACTERS WITHOUT CLAIM TO ANY PARTICULAR FONT, STYLE, SIZE, OR COLOR.

SN 77-333,380, FILED 11-19-2007.

JOHN HWANG, EXAMINING ATTORNEY



David J. Kyffers

Director of the United States Patent and Trademark Office

United States of America

United States Patent and Trademark Office

My DOCTOR

Center for Life's Necessities & Health Emergencies

Reg. No. 4,099,247

MUGEMANCURO, BENSON I. (UNITED STATES INDIVIDUAL)
2812 E. SIERRA MADRE
PASADENA, CA 91107

Registered Feb. 14, 2012

Int. Cl.: 44

FOR: EMERGENCY MEDICAL RESPONSE SERVICES; INTERACTIVE MEDICAL MONITORING AND ALERT SERVICE FOR REMINDING CLIENTS OF MEDICAL INFORMATION, NAMELY, MEDICINAL DOSAGE, ALLERGIC SENSITIVITY, AND PRESCRIPTION REFILLS; MEDICAL ASSISTANCE SERVICES; MEDICAL EVALUATION SERVICES, NAMELY, FUNCTIONAL ASSESSMENT PROGRAM FOR PATIENTS RECEIVING MEDICAL REHABILITATION SERVICES FOR PURPOSES OF GUIDING TREATMENT AND ASSESSING PROGRAM EFFECTIVENESS; PHYSICIAN SERVICES; MEDICAL SERVICES, NAMELY, PROVIDING MEDICAL CARE CENTERS FOR EMERGENCY CARE, IN CLASS 44 (U.S. CLS. 100 AND 101).

SERVICE MARK

PRINCIPAL REGISTER

FIRST USE 2-1-2008; IN COMMERCE 2-1-2008.

NO CLAIM IS MADE TO THE EXCLUSIVE RIGHT TO USE "CENTER" AND "HEALTH EMERGENCIES", APART FROM THE MARK AS SHOWN.

SN 77-346,173, FILED 12-6-2007.

DANNEAN HETZEL, EXAMINING ATTORNEY



David J. Kyffers

Director of the United States Patent and Trademark Office

United States of America

United States Patent and Trademark Office

PACNET



Reg. No. 4,099,248

Registered Feb. 14, 2012

Int. Cl.: 39

SERVICE MARK

PRINCIPAL REGISTER

PACNET LIMITED (BERMUDA CORPORATION)
CLARENDON HOUSE, 2 CHURCH STREET
HAMILTON HM 11, BERMUDA

FOR: COMPUTER-BASED ELECTRONIC DATA STORAGE SERVICES; COMPUTERIZED ELECTRONIC DATA STORAGE SERVICES, COMPUTERIZED ELECTRONIC BUSINESS INFORMATION STORAGE OF ELECTRONIC FILES; ELECTRONIC STORAGE OF TECHNICAL INFORMATION IN THE FORM OF ELECTRONIC FILES, IN CLASS 39 (U.S. CLS. 100 AND 105).

FIRST USE 2-0-2011; IN COMMERCE 2-0-2011.

OWNER OF U.S. REG. NOS. 2,164,941 AND 2,778,162.

THE MARK CONSISTS OF THE WORD "PACNET" IN SPECIAL FORM WITH THREE CURVED LINES BELOW THE FINAL THREE LETTERS OF THE WORD.

SN 77-347,978, FILED 12-10-2007.

FRANK LATTUCA, EXAMINING ATTORNEY



David J. Kyffers

Director of the United States Patent and Trademark Office

United States of America
United States Patent and Trademark Office

elabs

Reg. No. 4,099,249

CABLE ELECTRONICS, INC. (TEXAS CORPORATION)
3209 WOOD DR.
GARLAND, TX 75041

Registered Feb. 14, 2012

Int. Cl.: 38

FOR: DISTRIBUTION OF ELECTRONIC CONTENT, NAMELY, AUDIO AND VIDEO DATA FILES, OVER LOCAL AREA NETWORKS, WIDE AREA NETWORKS AND THE INTERNET, IN CLASS 38 (U.S. CLS. 100, 101 AND 104).

SERVICE MARK

FIRST USE 3-9-2009; IN COMMERCE 3-9-2009.

PRINCIPAL REGISTER

OWNER OF U.S. REG. NOS. 2,405,323 AND 2,405,324.

NO CLAIM IS MADE TO THE EXCLUSIVE RIGHT TO USE "LABS", APART FROM THE MARK AS SHOWN.

THE MARK CONSISTS OF STYLIZED "C", "E" AND "LABS".

SN 77-371,046, FILED 1-14-2008.

KIMBERLY FRYE, EXAMINING ATTORNEY



David J. Kyros

Director of the United States Patent and Trademark Office

United States of America

United States Patent and Trademark Office

ERIGO

Reg. No. 4,099,250

Registered Feb. 14, 2012

Int. Cls.: 35, 36, 40, and 42

SERVICE MARK

PRINCIPAL REGISTER

ERIGO TECHNOLOGIES LLC (NEW HAMPSHIRE LIMITED LIABILITY COMPANY)
64 MAIN STREET
ENFIELD, NH 03748

FOR: BUSINESS SERVICES, NAMELY, MATCHING POTENTIAL PRIVATE AND GOVERNMENT INVESTORS WITH ENTREPRENEURS AND COMPANIES NEEDING FUNDING; ASSISTING WITH THE TRANSFER OF TECHNOLOGY FROM ONE ENTITY TO ANOTHER, NAMELY, PROVIDING RECOMMENDATIONS WITH RESPECT TO APPROPRIATE COMMERCIALIZATION STRATEGIES, IDENTIFYING TARGET COMMERCIALIZATION OPPORTUNITIES, NAMELY, MARKET IDENTIFICATION AND IDENTIFICATION OF POTENTIAL PARTNERS, LICENSEES AND COLLABORATORS, AND PROVIDING BUSINESS CONSULTATION SERVICES IN CONNECTION WITH TECHNOLOGY TRANSFER AGREEMENT FORMATION AND NEGOTIATION, TECHNOLOGY LICENSING ASSISTANCE AND PREPARING BUSINESS PLANS; ASSISTING OTHERS WITH ACQUIRING GOVERNMENT FUNDS FOR RESEARCH AND DEVELOPMENT; ASSISTING OTHERS WITH RECEIVING CONTRACTS FOR THE PURCHASE OF GOODS AND SERVICES; OVERHEAD SERVICES, NAMELY, PROVIDING ACCOUNTING, ESTIMATING CONTRACTING WORK, ASSISTING OTHERS WITH COMPLYING WITH CONTRACT REQUIREMENTS, PREPARING AND SUBMITTING PROPOSALS, QUOTES, REPORTS AND DELIVERABLES, AND PROVIDING ASSISTANCE WITH AUDITS, SECRETARIAL AND ADMINISTRATIVE SUPPORT; TECHNOLOGY INCUBATION SERVICES, NAMELY, BUSINESS CONSULTING; INCUBATION SERVICES, NAMELY, PROVIDING WORK SPACE AND OFFICE SPACE CONTAINING BUSINESS EQUIPMENT FOR START-UPS, VENTURE CAPITALISTS, AND EXISTING BUSINESSES, IN CLASS 35 (U.S. CLS. 100, 101 AND 102).

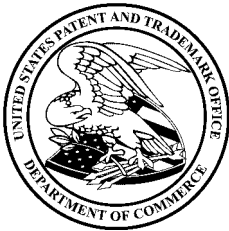

FIRST USE 8-9-2006; IN COMMERCE 8-9-2006.

FOR: PROVIDING FINANCIAL ADVICE AND CASH MANAGEMENT; DISTRIBUTING FUNDS ON BEHALF OF GOVERNMENTS TO OTHERS, IN CLASS 36 (U.S. CLS. 100, 101 AND 102).

FIRST USE 11-20-2007; IN COMMERCE 11-20-2007.

David J. Kyjars

FOR: INCUBATION SERVICES, NAMELY, PROVIDING SHOP SPACE FOR THE FABRICATION OF NEW PRODUCT PROTOTYPES FOR OTHERS, IN CLASS 40 (U.S. CLS. 100, 103 AND 106).

Reg. No. 4,099,250 FIRST USE 4-1-2010; IN COMMERCE 4-1-2010.

FOR: TECHNOLOGY CONSULTATION AND RESEARCH AND DEVELOPMENT IN THE FIELDS OF BIOMEDICAL ENGINEERING, ENERGY STORAGE, MANUFACTURING, MATERIALS, NUCLEAR ENGINEERING, POWER GENERATION, PRECISION MANUFACTURING, SOFTWARE DESIGN, SIMULATION AND MODELING, THERMAL MANAGEMENT AND TEXTILES; CONSULTING IN THE FIELD OF TECHNOLOGY DEVELOPMENT TO SMALL TECHNOLOGY COMPANIES; ASSISTING WITH THE TRANSFER OF TECHNOLOGY FROM ONE ENTITY TO ANOTHER, NAMELY, ENGINEERING CONSULTING SERVICES IN CONNECTION WITH TECHNOLOGY TRANSFER AGREEMENT FORMATION AND NEGOTIATION, TECHNOLOGY LICENSING ASSISTANCE AND PREPARING BUSINESS PLANS; INCUBATION SERVICES, NAMELY, PROVIDING LABORATORY SPACE FOR START-UPS AND EXISTING BUSINESSES, IN CLASS 42 (U.S. CLS. 100 AND 101).

FIRST USE 1-4-2006; IN COMMERCE 1-4-2006.

THE MARK CONSISTS OF STANDARD CHARACTERS WITHOUT CLAIM TO ANY PARTICULAR FONT, STYLE, SIZE, OR COLOR.

THE FOREIGN WORDING IN THE MARK TRANSLATES INTO ENGLISH AS "BUILD", "ERECT", OR "RAISE".

SN 77-377,607, FILED 1-22-2008.

WARREN L. OLANDRIA, EXAMINING ATTORNEY

United States of America

United States Patent and Trademark Office

SCARLET

Reg. No. 4,099,251

Registered Feb. 14, 2012

Int. Cl.: 9

TRADEMARK

PRINCIPAL REGISTER

RED.COM, INC. (WASHINGTON CORPORATION)
34 PARKER
IRVINE, CA 92618

FOR: DIGITAL STILL AND MOTION CAMERAS AND ACCESSORIES, SOLD INDIVIDUALLY OR AS A UNIT, COMPRISED OF, CAMERAS, DIGITAL SENSORS, CAMERA LENSES, FLASH MEMORY CARDS, ELECTRONIC MEMORIES, HARD DRIVES, VIDEO MONITORS AND FLAT PANEL DISPLAY SCREENS, ALL FOR USE IN THE CREATION, STORAGE, DELIVERY, MANIPULATION, RECORDING, PLAYBACK OR VIEWING OF VIDEO, MUSIC, GRAPHICS, PHOTOS, AUDIO, TEXT, AND MULTIMEDIA DATA; MODULAR CAMERA SYSTEMS AND ACCESSORIES, SOLD INDIVIDUALLY OR AS A UNIT, COMPRISED OF CAMERAS, CAMERA LENSES, ELECTRONIC VIEWFINDERS, PROCESSING MODULES, IMAGING MODULES, FLASH MEMORY CARDS, ELECTRONIC MEMORIES, HARD DRIVES FOR VIDEO RECORDERS, VIDEO MONITORS AND FLAT PANEL DISPLAY SCREENS, ALL FOR USE IN THE CREATION, STORAGE, DELIVERY, MANIPULATION, RECORDING, PLAYBACK OR VIEWING OF VIDEO, MUSIC, GRAPHICS, PHOTOS, AUDIO, TEXT, AND MULTIMEDIA DATA; COMPUTER PROGRAMS FOR DIGITAL STILL AND MOTION CAMERA SYSTEMS, NAMELY, COMPUTER HARDWARE AND COMPUTER SOFTWARE PROGRAMS FOR THE RECORDING, EDITING, AND PUBLICATION OF STILL IMAGE AND MOVING PICTURES, IN CLASS 9 (U.S. CLS. 21, 23, 26, 36 AND 38).

FIRST USE 11-18-2011; IN COMMERCE 11-18-2011.

THE MARK CONSISTS OF STANDARD CHARACTERS WITHOUT CLAIM TO ANY PARTICULAR FONT, STYLE, SIZE, OR COLOR.

SN 77-390,121, FILED 2-6-2008.

ELLEN B. AWRICH, EXAMINING ATTORNEY



David J. Kyros

Director of the United States Patent and Trademark Office

United States of America

United States Patent and Trademark Office

SOLAR

Reg. No. 4,099,252

THISTLE, ROBERT H. (UNITED STATES INDIVIDUAL)
29 LAKESIDE DRIVE
JOHNSTON, RI 02919

Registered Feb. 14, 2012

Int. Cl.: 30

FOR: CANDY BREATH MINTS; LIQUID CANDY DISPENSED IN A SPRAY; AND CANDY GUM, IN CLASS 30 (U.S. CL. 46).

TRADEMARK

FIRST USE 3-7-2011; IN COMMERCE 3-7-2011.

PRINCIPAL REGISTER

THE MARK CONSISTS OF STANDARD CHARACTERS WITHOUT CLAIM TO ANY PARTICULAR FONT, STYLE, SIZE, OR COLOR.

SN 77-400,307, FILED 2-19-2008.

BERNICE MIDDLETON, EXAMINING ATTORNEY



David J. Kybas

Director of the United States Patent and Trademark Office

United States of America

United States Patent and Trademark Office



The logo features the word "VETTER" in a stylized, outlined font where the letter "V" is significantly larger and has a circle above it. To the right of "VETTER" is the word "JECT" in a bold, solid black sans-serif font. A horizontal line runs above and below the text.

Reg. No. 4,099,253

Registered Feb. 14, 2012

Int. Cls.: 5 and 10

TRADEMARK

PRINCIPAL REGISTER

ARZNEIMITTEL GMBH APOTHEKER VETTER & CO. RAVENSBURG (FED REP GERMANY CORPORATION)
MARIENPLATZ 79
RAVENSBURG, FED REP GERMANY D-88212

FOR: PHARMACEUTICAL PREPARATIONS AND MEDICINE, NAMELY, ORALLY ADMIN-
ISTRABLE SOLUTIONS, INJECTABLE SOLUTIONS, SOLIDS AND SEMISOLIDS CAPABLE
OF BEING DISSOLVED IN LIQUIDS AND SOLVENTS, POWDERS IN READY-TO USE
FORM OR CAPABLE OF RECONSTITUTION, ALL FOR USE IN THE TREATMENT OF IN-
FECTIONS, CANCER, DEPRESSION, HEART DISEASE, VASCULAR DISEASE, INTESTINAL
DISORDER, LUNG AND BRONCHIAL DISFUNCTION, LIVER DISFUNCTION, ORAL AND
LARYNGEAL DISEASE, OPTICAL AND CRANIAL DISORDERS; EYEDROPS; SOLUTIONS
FOR CONTACT LENSES; PHARMACEUTICAL PREPARATIONS FOR USE IN THE
TREATMENT OF SAID DISEASE AND CONDITIONS SOLD IN PREFILLED SYRINGES;
SYRINGE COMPONENT OF SYRINGES SOLD PREFILLED WITH PHARMACEUTICAL
PREPARATION FOR USE IN THE TREATMENT OF SAID DISEASES AND CONDITIONS;
NON-IMPREGNATED COTTON SWABS FOR MEDICAL USE; COTTON SWABS IMPREG-
NATED WITH ALCOHOL, IODINE, STERILIZING AGENTS AND CLEANING SOLUTIONS
FOR MEDICAL PURPOSES; PREMOISTENED COTTON SWABS FOR MEDICAL PURPOSES;
ADHESIVE BANDAGES; SURGICAL BANDAGES; BANDAGES FOR SKIN WOUNDS, IN
CLASS 5 (U.S. CLS. 6, 18, 44, 46, 51 AND 52).

FIRST USE 3-11-1986; IN COMMERCE 3-11-1986.

FOR: MEDICAL INJECTION DEVICES, NAMELY, INJECTION SYRINGES, PEN-TYPE IN-
JECTORS, AUTOINJECTORS, DISPOSABLE AND REUSABLE SYRINGES AND SYRINGE
HOLDERS; DISPOSABLE CANNULAS, BLOOD COLLECTING VIALS FOR MEDICAL USE,
ELASTIC BANDAGES, BANDAGES FOR ANATOMICAL JOINTS, ORTHOPEDIC SUPPORT
BANDAGES AND COMPRESSION BANDAGES, IN CLASS 10 (U.S. CLS. 26, 39 AND 44).

FIRST USE 3-11-1986; IN COMMERCE 3-11-1986.

THE MARK CONSISTS OF THE TERM "VETTER-JECT". "VETTER" IS IN STYLIZED LET-
TERS WITH A CIRCLE ABOVE THE LETTER "V". "JECT" IS IN SOLID BLACK LETTERS.
A LINE APPEARS BELOW THE WORDING AND ABOVE THE WORDING TO THE RIGHT
OF THE CIRCLE.



David J. Kybas

Director of the United States Patent and Trademark Office

Reg. No. 4,099,253 SN 77-404,924, FILED 2-25-2008.

STEVEN R. FINE, EXAMINING ATTORNEY

United States of America

United States Patent and Trademark Office



Reg. No. 4,099,254

Registered Feb. 14, 2012

Int. Cls.: 5 and 10

TRADEMARK

PRINCIPAL REGISTER

ARZNEIMITTEL GMBH APOTHEKER VETTER & CO. RAVENSBURG (FED REP GERMANY CORPORATION)
MARIENPLATZ 79
RAVENSBURG, FED REP GERMANY D-88212

FOR: PHARMACEUTICAL PREPARATIONS AND MEDICINE, NAMELY, ORALLY ADMIN-ISTRABLE SOLUTIONS, INJECTABLE SOLUTIONS, SOLIDS AND SEMISOLIDS CAPABLE OF BEING DISSOLVED IN LIQUIDS AND SOLVENTS, POWDERS IN READY TO USE FORM OR CAPABLE OF RECONSTITUTION, ALL FOR USE IN THE TREATMENT OF IN-FECTIONS, CANCER, DEPRESSION, HEART DISEASE, VASCULAR DISEASE, INTESTINAL DISORDER, LUNG AND BRONCHIAL DISFUNCTION, LIVER DISFUNCTION, ORAL AND LARYNGEAL DISEASE, OPTICAL AND CRANIAL DISORDERS; PHARMACEUTICAL PREPARATIONS FOR USE IN THE TREATMENT OF SAID DISEASES AND CONDITIONS SOLD IN PREFILLED SYRINGES; SYRINGES AND SYRINGE COMPONENTS, NAMELY, DISPOSABLE INJECTION CARTRIDGES, SOLD PREFILLED WITH PHARMACEUTICAL PREPARATIONS FOR USE IN THE TREATMENT OF SAID DISEASES AND CONDITIONS; EYE DROPS; SOLUTIONS FOR CONTACT LENSES; NON-IMPREGNATED COTTON SWABS FOR MEDICAL USE; COTTON SWABS IMPREGNATED WITH ALCOHOL, IODINE, STERILIZING AGENTS AND CLEANING SOLUTIONS FOR MEDICAL PURPOSES; PREMOISTENED COTTON SWABS FOR MEDICAL PURPOSES; ADHESIVE BANDAGES; SURGICAL BANDAGES; BANDAGES FOR SKIN WOUNDS, IN CLASS 5 (U.S. CLS. 6, 18, 44, 46, 51 AND 52).

FIRST USE 3-11-1986; IN COMMERCE 3-11-1986.

FOR: MEDICAL INJECTION DEVICES, NAMELY, INJECTION SYRINGES, PEN-TYPE IN-JECTORS, AUTOINJECTORS, DISPOSABLE AND REUSABLE SYRINGES AND SYRINGE HOLDERS; DISPOSABLE CANNULAS, BLOOD COLLECTING VIALS FOR MEDICAL USE, ELASTIC BANDAGES, BANDAGES FOR ANATOMICAL JOINTS, ORTHOPEDIC SUPPORT BANDAGES AND COMPRESSION BANDAGES, IN CLASS 10 (U.S. CLS. 26, 39 AND 44).

FIRST USE 3-11-1986; IN COMMERCE 3-11-1986.

THE LINING IS A FEATURE OF THE MARK AND DOES NOT INDICATE COLOR.

THE MARK CONSISTS OF THE LETTERS "V-JECT". THE LETTER "V" IS A STYLIZED LETTER WITH A CIRCLE ABOVE IT. THE LETTERS "JECT" ARE IN SOLID BLACK. A



David J. Kyffers

Director of the United States Patent and Trademark Office

Reg. No. 4,099,254 LINE APPEARS BELOW THE LETTERS AND ABOVE THE WARDING TO THE RIGHT OF THE CIRCLE.

SN 77-405,270, FILED 2-25-2008.

STEVEN R. FINE, EXAMINING ATTORNEY

United States of America

United States Patent and Trademark Office



Reg. No. 4,099,255

JEVO, INC. (NEW YORK CORPORATION)
24 WEST 57TH STREET, SUITE 805
NEW YORK, NY 10019

Registered Feb. 14, 2012

Int. Cl.: 41

FOR: PHYSICAL FITNESS AND HEALTH CLUB SERVICES, NAMELY, PROVIDING FITNESS INSTRUCTION AND USE OF EQUIPMENT, IN CLASS 41 (U.S. CLS. 100, 101 AND 107).

SERVICE MARK

FIRST USE 2-1-2005; IN COMMERCE 2-1-2005.

PRINCIPAL REGISTER

OWNER OF U.S. REG. NO. 3,283,426.

THE MARK CONSISTS OF THE WORD "PHYSIQUE 57" IN STYLIZED LETTERING.

SN 77-408,442, FILED 2-28-2008.

BARBARA BROWN, EXAMINING ATTORNEY



David J. Kyjars

Director of the United States Patent and Trademark Office

United States of America

United States Patent and Trademark Office

LIVE IT NOW

Reg. No. 4,099,256

HOFFMAN, DAVID L. (UNITED STATES INDIVIDUAL)
30 COFFEETOWN ROAD
DILLSBURG, PA 17019

Registered Feb. 14, 2012

Int. Cl.: 25

FOR: HOODED SWEAT SHIRTS, IN CLASS 25 (U.S. CLS. 22 AND 39).

TRADEMARK

FIRST USE 10-1-2010; IN COMMERCE 10-1-2010.

PRINCIPAL REGISTER

THE MARK CONSISTS OF STANDARD CHARACTERS WITHOUT CLAIM TO ANY PARTICULAR FONT, STYLE, SIZE, OR COLOR.

SN 77-412,099, FILED 3-4-2008.

KATHERINE E. HALMEN, EXAMINING ATTORNEY



David J. Kybas

Director of the United States Patent and Trademark Office

United States of America

United States Patent and Trademark Office

ALPHA LEAGUE

Reg. No. 4,099,257

KCG IP HOLDINGS LLC (DELAWARE LIMITED LIABILITY COMPANY)
131 SOUTH DEARBORN STREET
CHICAGO, IL 60603

Registered Feb. 14, 2012

Int. Cl.: 36

FOR: FINANCIAL SERVICES, NAMELY, PROVIDING INVESTMENT MANAGEMENT SERVICES, INVESTMENT CONSULTATION AND ADVICE, INVESTMENT PORTFOLIO MANAGEMENT SERVICES, INVESTMENT BROKERAGE SERVICES, AND INVESTMENT OF FUNDS FOR OTHERS VIA A WEB PORTAL, IN CLASS 36 (U.S. CLS. 100, 101 AND 102).

SERVICE MARK

PRINCIPAL REGISTER

FIRST USE 3-0-2008; IN COMMERCE 3-0-2008.

THE MARK CONSISTS OF STANDARD CHARACTERS WITHOUT CLAIM TO ANY PARTICULAR FONT, STYLE, SIZE, OR COLOR.

NO CLAIM IS MADE TO THE EXCLUSIVE RIGHT TO USE "ALPHA", APART FROM THE MARK AS SHOWN.

SN 77-413,952, FILED 3-5-2008.

HEATHER BIDDULPH, EXAMINING ATTORNEY



David J. Kyros

Director of the United States Patent and Trademark Office

United States of America

United States Patent and Trademark Office

MAXFLI

Reg. No. 4,099,258

AMERICAN SPORTS LICENSING, INC. (DELAWARE CORPORATION)
1101 CENTRE ROAD, SUITE 339
WILMINGTON, DE 19805

Registered Feb. 14, 2012

Int. Cl.: 25

FOR: GOLF APPAREL, NAMELY, HEADWEAR, IN CLASS 25 (U.S. CLS. 22 AND 39).

TRADEMARK

FIRST USE 5-0-2008; IN COMMERCE 5-0-2008.

PRINCIPAL REGISTER

THE MARK CONSISTS OF STANDARD CHARACTERS WITHOUT CLAIM TO ANY PARTICULAR FONT, STYLE, SIZE, OR COLOR.

OWNER OF U.S. REG. NOS. 164,526, 2,718,785, AND OTHERS.

SN 77-419,884, FILED 3-12-2008.

MARY ROSSMAN, EXAMINING ATTORNEY



David J. Kyffers

Director of the United States Patent and Trademark Office

United States of America

United States Patent and Trademark Office

BETTER PROVIDER INFORMATION. RIGHT NOW.

Reg. No. 4,099,259

Registered Feb. 14, 2012

**Int. Cls.: 9, 35, 42, 44,
and 45**

TRADEMARK

SERVICE MARK

PRINCIPAL REGISTER

ENCLARITY, INC. (DELAWARE CORPORATION)
30 ENTERPRISE
SUITE 220
ALISO VIEJO, CA 92656

FOR: COMPUTER SOFTWARE FOR USE IN ADMINISTERING AND PROCESSING OF EMPLOYER AND EMPLOYEE INSURANCE AND BENEFITS; COMPUTER SOFTWARE FOR USE IN ADMINISTERING AND PROCESSING INSURANCE CARRIER SERVICES; COMPUTER SOFTWARE FOR USE IN ADMINISTERING AND PROCESSING INVOICES AND PAYMENTS TO AND FROM BENEFIT PROVIDERS AND INSURANCE COMPANIES; COMPUTER SOFTWARE FOR ADMINISTERING AND PROCESSING EMPLOYER AND EMPLOYEE INSURANCE AND BENEFITS FOR USE BY EMPLOYERS, THIRD PARTY ADMINISTRATORS, AND MEDICAL AND DENTAL SERVICE PROVIDERS, IN CLASS 9 (U.S. CLS. 21, 23, 26, 36 AND 38).

FIRST USE 11-21-2011; IN COMMERCE 11-21-2011.

FOR: DATABASE MANAGEMENT, IN CLASS 35 (U.S. CLS. 100, 101 AND 102).

FIRST USE 5-5-2008; IN COMMERCE 5-5-2008.

FOR: APPLICATION SERVICE PROVIDER (ASP) FEATURING DATA INTEGRATION SOFTWARE IN THE HEALTHCARE FIELD; APPLICATION SERVICE PROVIDER (ASP) FEATURING COMPUTER SOFTWARE FOR ADMINISTERING AND PROCESSING OF EMPLOYER AND EMPLOYEE INSURANCE AND BENEFITS, ADMINISTERING AND PROCESSING INSURANCE CARRIER SERVICES, ADMINISTERING AND PROCESSING INVOICES AND PAYMENTS TO AND FROM BENEFIT PROVIDERS AND INSURANCE COMPANIES, AND ADMINISTERING AND PROCESSING EMPLOYER AND EMPLOYEE INSURANCE AND BENEFITS FOR USE BY EMPLOYERS, THIRD PARTY ADMINISTRATORS, AND MEDICAL AND DENTAL SERVICE PROVIDERS; PROVIDING QUALITY ASSURANCE SERVICES, NAMELY, ASSESSING, MEASURING AND SCORING THE QUALITY AND ACCURACY OF DATA FILES OF HEALTHCARE MANAGEMENT ORGANIZATIONS, HEALTHCARE PROVIDERS, HEALTHCARE FACILITIES, HEALTHCARE INSTITUTIONS AND HEALTHCARE INSURERS; INFORMATION SERVICES IN THE FIELD OF HEALTHCARE DATA QUALITY ASSURANCE SERVICES; PROVIDING QUALITY ASSURANCE SERVICES, NAMELY, HEALTHCARE DATA QUALITY SCORING SERVICES; APPLICATION SERVICE PROVIDER (ASP) FEATURING COMPUTER SOFTWARE, NAMELY, AN INFORM-



David J. Kybas

Director of the United States Patent and Trademark Office

Reg. No. 4,099,259 ATION MANAGEMENT AND DATA INTEGRITY TOOL IN THE HEALTHCARE AND INSURANCE INDUSTRIES; APPLICATION SERVICE PROVIDER (ASP) FEATURING DATA INTEGRATION AND MARKET RESEARCH SOFTWARE IN THE HEALTHCARE, PHARMACEUTICAL AND INSURANCE RELATED FIELDS; APPLICATION SERVICE PROVIDER (ASP) SERVICES FEATURING COMPUTER SOFTWARE FOR SEARCHING AND RETRIEVING INFORMATION ON MEDICAL AND HEALTHCARE PROFESSIONALS, FACILITIES AND INSTITUTIONS; APPLICATION SERVICE PROVIDER (ASP) FEATURING COMPUTER SOFTWARE, NAMELY, AN INFORMATION MANAGEMENT AND DATA INTEGRITY TOOL, IN THE HEALTHCARE AND INSURANCE INDUSTRIES, IN CLASS 42 (U.S. CLS. 100 AND 101).

FIRST USE 5-5-2008; IN COMMERCE 5-5-2008.

FOR: COMPUTER SERVICES, NAMELY, PROVIDING AN ONLINE DATABASE FOR SEARCHING AND RETRIEVING MEDICAL AND HEALTH INFORMATION ON MEDICAL AND HEALTHCARE PROFESSIONALS, FACILITIES AND INSTITUTIONS, IN CLASS 44 (U.S. CLS. 100 AND 101).

FIRST USE 5-5-2008; IN COMMERCE 5-5-2008.

FOR: VERIFYING AND MONITORING THE CREDENTIALS AND OTHER DEMOGRAPHIC DATA RELATING TO DOCTORS AND OTHER MEDICAL PROFESSIONALS THROUGH THE USE OF PROPRIETARY AND NON-PROPRIETARY DATABASES, IN CLASS 45 (U.S. CLS. 100 AND 101).

FIRST USE 5-5-2008; IN COMMERCE 5-5-2008.

THE MARK CONSISTS OF STANDARD CHARACTERS WITHOUT CLAIM TO ANY PARTICULAR FONT, STYLE, SIZE, OR COLOR.

SN 77-423,473, FILED 3-17-2008.

NAKIA HENRY, EXAMINING ATTORNEY

United States of America

United States Patent and Trademark Office

ELEVANCE

Reg. No. 4,099,260

Registered Feb. 14, 2012

Int. Cl.: 10

TRADEMARK

PRINCIPAL REGISTER

MIDMARK CORPORATION (OHIO CORPORATION)
60 VISTA DRIVE
VERSAILLES, OH 45380

FOR: DENTAL CHAIRS, IN CLASS 10 (U.S. CLS. 26, 39 AND 44).

FIRST USE 7-0-2010; IN COMMERCE 7-0-2010.

THE MARK CONSISTS OF STANDARD CHARACTERS WITHOUT CLAIM TO ANY PARTICULAR FONT, STYLE, SIZE, OR COLOR.

SN 77-424,495, FILED 3-18-2008.

MICHAEL TANNER, EXAMINING ATTORNEY



David J. Kyffers

Director of the United States Patent and Trademark Office

United States of America

United States Patent and Trademark Office

HOMEGOODS. THE OFFICIAL GIFT GIVING STORE.

Reg. No. 4,099,261

HOMEGOODS, INC. (DELAWARE CORPORATION)
770 COCHITUATE ROAD
FRAMINGHAM, MA 01701

Registered Feb. 14, 2012

Int. Cl.: 35

FOR: RETAIL DEPARTMENT STORE SERVICES, IN CLASS 35 (U.S. CLS. 100, 101 AND 102).

SERVICE MARK

FIRST USE 11-7-2011; IN COMMERCE 11-7-2011.

PRINCIPAL REGISTER

THE MARK CONSISTS OF STANDARD CHARACTERS WITHOUT CLAIM TO ANY PARTICULAR FONT, STYLE, SIZE, OR COLOR.

SEC. 2(F) AS TO "HOMEGOODS".

OWNER OF U.S. REG. NOS. 1,955,706 AND 2,692,830.

SN 77-428,318, FILED 3-21-2008.

DAYNA BROWNE, EXAMINING ATTORNEY



David J. Kyffers

Director of the United States Patent and Trademark Office

United States of America
United States Patent and Trademark Office

KLP

Reg. No. 4,099,262

KARMALoop, INC. (DELAWARE CORPORATION)
334 BOYLSTON STREET, 5TH FLOOR
BOSTON, MA 02116

Registered Feb. 14, 2012

Int. Cl.: 25

FOR: CLOTHING, NAMELY, SHIRTS, T-SHIRTS, IN CLASS 25 (U.S. CLS. 22 AND 39).

TRADEMARK

FIRST USE 8-15-2007; IN COMMERCE 8-15-2007.

PRINCIPAL REGISTER

THE MARK CONSISTS OF STANDARD CHARACTERS WITHOUT CLAIM TO ANY PARTICULAR FONT, STYLE, SIZE, OR COLOR.

SN 77-432,454, FILED 3-26-2008.

KARANENDRA S. CHHINA, EXAMINING ATTORNEY



David J. Kyffers

Director of the United States Patent and Trademark Office

United States of America

United States Patent and Trademark Office

KLOTHING LIBERATION PROJECT

Reg. No. 4,099,263

KARMALoop, INC. (DELAWARE CORPORATION)
334 BOYLSTON STREET, 5TH FLOOR
BOSTON, MA 02116

Registered Feb. 14, 2012

Int. Cl.: 25

FOR: CLOTHING, NAMELY, SHIRTS, T-SHIRTS, IN CLASS 25 (U.S. CLS. 22 AND 39).

TRADEMARK

FIRST USE 8-15-2007; IN COMMERCE 8-15-2007.

PRINCIPAL REGISTER

THE MARK CONSISTS OF STANDARD CHARACTERS WITHOUT CLAIM TO ANY PARTICULAR FONT, STYLE, SIZE, OR COLOR.

SN 77-432,462, FILED 3-26-2008.

KARANENDRA S. CHHINA, EXAMINING ATTORNEY



David J. Kybas

Director of the United States Patent and Trademark Office

United States of America

United States Patent and Trademark Office

CERIDIAN

Reg. No. 4,099,264

Registered Feb. 14, 2012

Int. Cls.: 9, 35, 36, and 42

TRADEMARK

SERVICE MARK

PRINCIPAL REGISTER

CERIDIAN CORPORATION (DELAWARE CORPORATION)
3311 EAST OLD SHAKOPEE ROAD
MINNEAPOLIS, MN 55425

FOR: MAGNETICALLY ENCODED CARDS, NAMELY, FUEL CARDS, FLEET CARDS, CASH CARDS, DEBIT CARDS, STORED VALUE CARDS, PAYROLL CARDS, PURCHASING CARDS, TRAVEL AND ENTERTAINMENT CARDS, GIFT CARDS AND LOYALTY CARDS; PAYMENT AUTHORIZATION AND TRANSACTION PROCESSING TERMINALS; POINT OF SALE OR SERVICE TERMINALS; WEB ENABLED ELECTRONIC COMMERCE SYSTEMS COMPRISING COMPUTER HARDWARE AND SOFTWARE FOR ENABLING POINT OF SALE TRANSACTIONS ON A GLOBAL COMPUTER NETWORK, IN CLASS 9 (U.S. CLS. 21, 23, 26, 36 AND 38).

FIRST USE 3-23-2010; IN COMMERCE 3-23-2010.

FOR: ADMINISTERING A PROGRAM FOR ENABLING CUSTOMERS TO OBTAIN DISCOUNTS ON FUEL AT DESIGNATED MERCHANTS; ARRANGING FOR THE ACQUISITION, PAYMENT AND DELIVERY OF STATE AND FEDERAL TRUCKING PERMITS FOR TRUCKING COMPANIES; BUSINESS PROCUREMENT AND PURCHASE MANAGEMENT SERVICES, NAMELY, PRE-PURCHASE APPROVAL OF COMMERCIAL CARD TRANSACTIONS, POST-PURCHASE JUSTIFICATION AND SIGN-OFF OF TRANSACTIONS, ADJUSTMENTS TO CARD SETTINGS AND AUTOMATED ENFORCEMENT OF SPENDING POLICIES IN THE FIELD OF BUSINESS SPENDING MANAGEMENT; REGULATORY COMPLIANCE SERVICES, NAMELY, DRIVER LOG AUDIT AND FUEL TAX REPORTING, TRANSCIEVER PERMITTING SERVICES, COMMERCIAL ADMINISTRATION OF ANNUAL LICENSING OF VEHICLES AND PERSONS, ALL IN THE TRANSPORTATION INDUSTRY; ARRANGING FOR THE INVESTIGATION OF TRUCK DRIVERS TO INSURE COMPLIANCE WITH FEDERAL TRANSPORTATION LAWS; ARRANGING FOR THE INVESTIGATION AND EVALUATION OF TRUCK DRIVERS TO INSURE COMPLIANCE WITH FEDERAL TRANSPORTATION LAWS; ARRANGING FOR OTHERS TO PROVIDE PILOT CAR SERVICES IN THE NATURE OF VEHICLES TO ESCORT TRUCKS CARRYING OVERSIZED CARGO; COLLECTING AND REPORTING OF DEBIT AND CREDIT CARD TRANSACTION DATA, IN CLASS 35 (U.S. CLS. 100, 101 AND 102).



David J. Kyros

FIRST USE 3-23-2010; IN COMMERCE 3-23-2010.

Reg. No. 4,099,264 FOR: FINANCIAL SERVICES, NAMELY, ELECTRONIC PAYMENT, NAMELY, ELECTRONIC PROCESSING AND TRANSMISSION OF BILL PAYMENT DATA; ELECTRONIC FUNDS DISTRIBUTION SERVICES; CREDIT AND DEBIT CARD PAYMENT PROCESSING SERVICES; PROCESSING ELECTRONIC PAYMENT TRANSACTIONS THROUGH PRE-PAID GIFT CARDS AND CUSTOMER LOYALTY CARDS; ELECTRONIC BENEFITS TRANSFER PROCESSING SERVICES; EXTENDING CREDIT TO BUSINESSES FOR BUSINESS EXPENSES; AND MANAGEMENT OF ACCOUNTS AND RECEIVABLES, IN CLASS 36 (U.S. CLS. 100, 101 AND 102).

FIRST USE 3-23-2010; IN COMMERCE 3-23-2010.

FOR: TECHNICAL ANALYSIS, CONSULTING, DESIGN AND IMPLEMENTATION OF AUTOMATED SYSTEMS IN THE TRANSPORTATION INDUSTRY, IN CLASS 42 (U.S. CLS. 100 AND 101).

FIRST USE 3-23-2010; IN COMMERCE 3-23-2010.

THE MARK CONSISTS OF STANDARD CHARACTERS WITHOUT CLAIM TO ANY PARTICULAR FONT, STYLE, SIZE, OR COLOR.

OWNER OF U.S. REG. NOS. 1,868,786, 2,890,133, AND 3,131,234.

SN 77-438,632, FILED 4-3-2008.

JUDITH HELFMAN, EXAMINING ATTORNEY

United States of America

United States Patent and Trademark Office

METAFX

Reg. No. 4,099,265

CONNELLY, A. SCOTT (UNITED STATES INDIVIDUAL)
1137 DOLPHIN TERRACE
CORONA DEL MAR, CA 92625

Registered Feb. 14, 2012

Int. Cl.: 5

FOR: DIETARY AND NUTRITIONAL SUPPLEMENTS; DIETARY SUPPLEMENTS; DIETARY SUPPLEMENTS FOR HUMAN CONSUMPTION; MEAL REPLACEMENT AND DIETARY SUPPLEMENT DRINK MIXES; POWDERED NUTRITIONAL SUPPLEMENT DRINK MIX, IN CLASS 5 (U.S. CLS. 6, 18, 44, 46, 51 AND 52).

TRADEMARK

PRINCIPAL REGISTER

FIRST USE 10-2-2011; IN COMMERCE 11-2-2011.

THE MARK CONSISTS OF STANDARD CHARACTERS WITHOUT CLAIM TO ANY PARTICULAR FONT, STYLE, SIZE, OR COLOR.

SN 77-444,699, FILED 4-10-2008.

SUZANNE BLANE, EXAMINING ATTORNEY



David J. Kyros

Director of the United States Patent and Trademark Office

United States of America

United States Patent and Trademark Office



Reg. No. 4,099,266

Registered Feb. 14, 2012

Int. Cl.: 25

TRADEMARK

PRINCIPAL REGISTER

NEW YORK STATE DEPARTMENT OF ECONOMIC DEVELOPMENT (NEW YORK STATE AGENCY)
30 SOUTH PEARL STREET
ALBANY, NY 12245

FOR: T-SHIRTS, IN CLASS 25 (U.S. CLS. 22 AND 39).

FIRST USE 5-7-2010; IN COMMERCE 5-7-2010.

OWNER OF U.S. REG. NOS. 1,555,836, 2,431,705, AND 2,769,939.

THE COLOR(S) BLACK AND GREEN IS/ARE CLAIMED AS A FEATURE OF THE MARK.

SEC. 2(F).

THE MARK CONSISTS OF CHARACTERS IN BLACK AND A HEART IN GREEN.

SN 77-447,212, FILED 4-14-2008.

ALLISON HOLTZ, EXAMINING ATTORNEY



David J. Kybas

Director of the United States Patent and Trademark Office

United States of America

United States Patent and Trademark Office

POCKETWIZARD

Reg. No. 4,099,267

LAB PARTNERS ASSOCIATES, INC. (VERMONT CORPORATION)
21 GREGORY DRIVE
SOUTH BURLINGTON, VT 05403

Registered Feb. 14, 2012

Int. Cl.: 9

FOR: COMPUTER SOFTWARE FOR USE BY A COMPUTER IN COMMUNICATING WITH, AND CONTROLLING THE OPERATION OF, PHOTOGRAPHY EQUIPMENT; COMPUTER SOFTWARE FOR USE BY A COMPUTER IN COMMUNICATING WITH, AND CONTROLLING THE OPERATION OF, ELECTRONIC WIRELESS COMMUNICATION APPARATUS, NAMELY, TRANSMITTERS, RECEIVERS, AND TRANSCEIVERS FOR WIRELESS COMMUNICATION AND CONTROL BETWEEN EQUIPMENT USED IN THE FIELDS OF PHOTOGRAPHY AND LIGHTING; COMPUTER FIRMWARE FOR USE IN CONTROLLING THE OPERATION OF ELECTRONIC WIRELESS COMMUNICATION APPARATUS, NAMELY, TRANSMITTERS, RECEIVERS, AND TRANSCEIVERS FOR WIRELESS COMMUNICATION AND CONTROL BETWEEN EQUIPMENT USED IN THE FIELDS OF PHOTOGRAPHY AND LIGHTING, IN CLASS 9 (U.S. CLS. 21, 23, 26, 36 AND 38).

TRADEMARK

PRINCIPAL REGISTER

FIRST USE 3-31-2009; IN COMMERCE 3-31-2009.

THE MARK CONSISTS OF STANDARD CHARACTERS WITHOUT CLAIM TO ANY PARTICULAR FONT, STYLE, SIZE, OR COLOR.

OWNER OF U.S. REG. NOS. 3,367,618, 3,367,619, AND OTHERS.

SN 77-447,235, FILED 4-14-2008.

TEJBIR SINGH, EXAMINING ATTORNEY



David J. Kyros

Director of the United States Patent and Trademark Office

United States of America

United States Patent and Trademark Office

SUPPORTRIX

Reg. No. 4,099,268

Registered Feb. 14, 2012

Int. Cl.: 42

SERVICE MARK

PRINCIPAL REGISTER

SYNNEX CORPORATION (DELAWARE CORPORATION)
44201 NOBEL DRIVE
FREMONT, CA 94538

FOR: CONSULTING SERVICES IN THE FIELD OF COMPUTER HARDWARE AND COMPUTER SOFTWARE; CONSULTING SERVICES IN THE FIELD OF DIAGNOSING TECHNOLOGICAL PROBLEMS WITH CONSUMER ELECTRONICS; TECHNICAL SUPPORT SERVICES, NAMELY, TROUBLESHOOTING OF COMPUTER HARDWARE AND SOFTWARE PROBLEMS; TECHNICAL SUPPORT SERVICES, NAMELY, TROUBLESHOOTING IN THE FIELD OF DIAGNOSING TECHNOLOGICAL PROBLEMS WITH CONSUMER ELECTRONICS; TECHNICAL CONSULTING AND ASSISTANCE WITH COMPUTER-BASED INFORMATION SYSTEMS AND COMPONENTS; TECHNOLOGY CONSULTING IN THE FIELD OF CONSUMER ELECTRONICS; COMPUTER AND INFORMATION TECHNOLOGY SUPPORT SERVICES, NAMELY, HELP DESK SERVICES; TECHNICAL SUPPORT AND CONSULTING SERVICES, NAMELY, REMOTE MANAGEMENT OF COMPUTER APPLICATIONS FOR OTHERS; CONSULTING IN THE FIELD OF INFORMATION TECHNOLOGY; PROVISION OF TECHNICAL SUPPORT SERVICES, NAMELY, TROUBLESHOOTING OF COMPUTER HARDWARE AND SOFTWARE PROBLEMS, TO RESELLERS; PROVISION OF TECHNICAL INFORMATION VIA A COMPUTER AND COMMUNICATIONS NETWORK IN THE FIELD OF COMPUTERS, COMPUTER HARDWARE, COMPUTER SOFTWARE, INFORMATION TECHNOLOGY (IT), AND CONSUMER ELECTRONICS TECHNOLOGY; PROVISION OF ONLINE DATABASES FEATURING TECHNICAL SUPPORT AND SELF-HELP INFORMATION IN THE FIELD OF COMPUTERS, COMPUTER HARDWARE, COMPUTER SOFTWARE, AND INFORMATION TECHNOLOGY (IT); PROVISION OF ONLINE DATABASES FEATURING TECHNICAL SUPPORT AND SELF-HELP INFORMATION IN THE FIELD OF DIAGNOSING TECHNOLOGICAL PROBLEMS WITH CONSUMER ELECTRONICS, IN CLASS 42 (U.S. CLS. 100 AND 101).



FIRST USE 12-19-2008; IN COMMERCE 12-19-2008.

THE MARK CONSISTS OF STANDARD CHARACTERS WITHOUT CLAIM TO ANY PARTICULAR FONT, STYLE, SIZE, OR COLOR.

SN 77-449,689, FILED 4-16-2008.

KATHERINE CHANG, EXAMINING ATTORNEY

David J. Kyros

Director of the United States Patent and Trademark Office

United States of America

United States Patent and Trademark Office

HIS SAND

Reg. No. 4,099,269

KATTERHEINRICH, CAROL J. (UNITED STATES INDIVIDUAL)
11729 MOULTON NK RD.
NEW KNOXVILLE, OH 45871

Registered Feb. 14, 2012

Int. Cl.: 16

FOR: PICTURES, IN CLASS 16 (U.S. CLS. 2, 5, 22, 23, 29, 37, 38 AND 50).

TRADEMARK

FIRST USE 3-15-2009; IN COMMERCE 4-17-2010.

PRINCIPAL REGISTER

THE MARK CONSISTS OF THE WORDING "HIS SAND", WITH A CROSS DOTTING THE LETTER "I" IN THE WORD "HIS" WITH FOUR LINES CURVING FROM LEFT TO RIGHT ON THE TOP AND BOTTOM OF THE WORDS.

SN 77-452,078, FILED 4-18-2008.

CHRISTINA SOBRAL, EXAMINING ATTORNEY



David J. Kybas

Director of the United States Patent and Trademark Office

United States of America

United States Patent and Trademark Office

SOLARBRIDGE

Reg. No. 4,099,270

Registered Feb. 14, 2012

Int. Cl.: 9

TRADEMARK

PRINCIPAL REGISTER

SOLARBRIDGE TECHNOLOGIES, INC. (DELAWARE CORPORATION)
9229 WATERFORD CENTRE BLVD., SUITE 110
AUSTIN, TX 78758

FOR: INVERTERS, IN CLASS 9 (U.S. CLS. 21, 23, 26, 36 AND 38).

FIRST USE 4-30-2011; IN COMMERCE 4-30-2011.

THE MARK CONSISTS OF STANDARD CHARACTERS WITHOUT CLAIM TO ANY PARTICULAR FONT, STYLE, SIZE, OR COLOR.

SN 77-453,973, FILED 4-21-2008.

DAWN HAN, EXAMINING ATTORNEY



David J. Kybas

Director of the United States Patent and Trademark Office

United States of America

United States Patent and Trademark Office

BYERWORKS

Reg. No. 4,099,271

BYER CALIFORNIA (CALIFORNIA CORPORATION)
66 POTRERO AVENUE
SAN FRANCISCO, CA 94103

Registered Feb. 14, 2012

Int. Cl.: 25

FOR: CLOTHING, NAMELY, DRESSES, SKIRTS, BLOUSES, SKORTS, SHORTS, SHIRTS, PANTS, JACKETS, SWEATERS, VESTS AND JUMPSUITS, IN CLASS 25 (U.S. CLS. 22 AND 39).

TRADEMARK

FIRST USE 11-11-2011; IN COMMERCE 11-11-2011.

PRINCIPAL REGISTER

THE MARK CONSISTS OF STANDARD CHARACTERS WITHOUT CLAIM TO ANY PARTICULAR FONT, STYLE, SIZE, OR COLOR.

OWNER OF U.S. REG. NOS. 3,137,282, 3,294,904, AND OTHERS.

SN 77-454,006, FILED 4-21-2008.

TASNEEM HUSSAIN, EXAMINING ATTORNEY



David J. Kyffers

Director of the United States Patent and Trademark Office

United States of America

United States Patent and Trademark Office

KNEAVER

Reg. No. 4,099,272

KNEAVER CORP. (DELAWARE CORPORATION)
7653 HAWTHORNE AVENUE
LIVERMORE, CA 94550

Registered Feb. 14, 2012

Int. Cl.: 42

FOR: COMPUTER SERVICE, NAMELY, ACTING AS AN APPLICATION SERVICE PROVIDER IN THE FIELD OF KNOWLEDGE MANAGEMENT TO HOST COMPUTER APPLICATION SOFTWARE FOR CREATING SEARCHABLE DATABASES OF INFORMATION AND DATA, IN CLASS 42 (U.S. CLS. 100 AND 101).

SERVICE MARK

PRINCIPAL REGISTER

FIRST USE 9-3-2008; IN COMMERCE 4-1-2011.

THE MARK CONSISTS OF STANDARD CHARACTERS WITHOUT CLAIM TO ANY PARTICULAR FONT, STYLE, SIZE, OR COLOR.

SN 77-455,457, FILED 4-23-2008.

RUDY R. SINGLETON, EXAMINING ATTORNEY



David J. Kybas

Director of the United States Patent and Trademark Office

United States of America

United States Patent and Trademark Office

SIGNON

Reg. No. 4,099,273

MOVEON.ORG CIVIC ACTION (CALIFORNIA CORPORATION)
P.O. BOX 9218
BERKELEY, CA 94709

Registered Feb. 14, 2012

Int. Cl.: 9

FOR: SOFTWARE PROGRAM THAT ALLOWS USERS TO CREATE CAMPAIGNS AND GENERATE ELECTRONIC PETITIONS, IN CLASS 9 (U.S. CLS. 21, 23, 26, 36 AND 38).

TRADEMARK

FIRST USE 3-18-2011; IN COMMERCE 3-18-2011.

PRINCIPAL REGISTER

THE MARK CONSISTS OF STANDARD CHARACTERS WITHOUT CLAIM TO ANY PARTICULAR FONT, STYLE, SIZE, OR COLOR.

SN 77-456,306, FILED 4-23-2008.

JOHN HWANG, EXAMINING ATTORNEY



David J. Kybas

Director of the United States Patent and Trademark Office

United States of America

United States Patent and Trademark Office

Rocdiva

Reg. No. 4,099,274

MAYS, RACQUEL T (UNITED STATES INDIVIDUAL)
1237 WYNFORD WOODS SW
MARIETTA, GA 30064

Registered Feb. 14, 2012

Int. Cl.: 44

FOR: CONSULTATION SERVICES IN THE FIELD OF MAKEUP, NAMELY, ON-LINE MAKEUP CONSULTATION SERVICES AND IN-PERSON MAKEUP CONSULTATION AND APPLICATION SERVICES, IN CLASS 44 (U.S. CLS. 100 AND 101).

SERVICE MARK

FIRST USE 2-1-2009; IN COMMERCE 4-26-2009.

PRINCIPAL REGISTER

THE MARK CONSISTS OF STANDARD CHARACTERS WITHOUT CLAIM TO ANY PARTICULAR FONT, STYLE, SIZE, OR COLOR.

SN 77-456,381, FILED 4-23-2008.

KRISTIN DAHLING, EXAMINING ATTORNEY



David J. Kyjars

Director of the United States Patent and Trademark Office

United States of America
United States Patent and Trademark Office

ELECTRON

Reg. No. 4,099,275

360 DEGREES INC. (CONNECTICUT CORPORATION)
24 PRINCESS COURT
STAMFORD, CT 06903

Registered Feb. 14, 2012

Int. Cl.: 3

FOR: FRAGRANCES FOR PERSONAL USE, IN CLASS 3 (U.S. CLS. 1, 4, 6, 50, 51 AND 52).

TRADEMARK

FIRST USE 10-1-2011; IN COMMERCE 10-1-2011.

PRINCIPAL REGISTER

THE MARK CONSISTS OF STANDARD CHARACTERS WITHOUT CLAIM TO ANY PARTICULAR FONT, STYLE, SIZE, OR COLOR.

SN 77-462,839, FILED 5-1-2008.

SUNG IN, EXAMINING ATTORNEY



David J. Kyffers

Director of the United States Patent and Trademark Office

United States of America
United States Patent and Trademark Office

Dendreon

Reg. No. 4,099,276

DENDREON CORPORATION (DELAWARE CORPORATION)
3005 1ST AVENUE
SEATTLE, WA 98121

Registered Feb. 14, 2012

Int. Cl.: 5

FOR: PHARMACEUTICALS FOR USE IN THE TREATMENT OF CANCER, INFECTIOUS AND AUTOIMMUNE DISEASES, IN CLASS 5 (U.S. CLS. 6, 18, 44, 46, 51 AND 52).

TRADEMARK

FIRST USE 4-29-2010; IN COMMERCE 4-29-2010.

PRINCIPAL REGISTER

OWNER OF U.S. REG. NOS. 2,465,920 AND 2,530,065.

SN 77-463,413, FILED 5-1-2008.

GEORGE LORENZO, EXAMINING ATTORNEY



David J. Kybas

Director of the United States Patent and Trademark Office

United States of America

United States Patent and Trademark Office

THE PERFECTLY POWERFUL PEANUT

Reg. No. 4,099,277

Registered Feb. 14, 2012

Int. Cl.: 35

SERVICE MARK

PRINCIPAL REGISTER

NATIONAL PEANUT BOARD (UNITED STATES NON-CORPORATE BOARD CREATED PURSUANT TO THE PEANUT PROMOTION, RESEARCH AND INFORMATION ORDER (7 CFR PART 1216), AUTHORIZED UNDER THE COMMODITY PROMOTION, RESEARCH, AND INFORMATION ACT OF 1996 (7 USC 7401, 7411-7425))

SUITE 210
2839 PACES FERRY ROAD
ATLANTA, GA 30339

FOR: PROMOTION OF THE INTERESTS OF PEANUT PRODUCERS, IN CLASS 35 (U.S. CLS. 100, 101 AND 102).

FIRST USE 12-14-2011; IN COMMERCE 12-14-2011.

THE MARK CONSISTS OF STANDARD CHARACTERS WITHOUT CLAIM TO ANY PARTICULAR FONT, STYLE, SIZE, OR COLOR.

SN 77-464,714, FILED 5-2-2008.

JEAN IM, EXAMINING ATTORNEY



David J. Kyfos

Director of the United States Patent and Trademark Office

United States of America

United States Patent and Trademark Office

lumina sphere

Reg. No. 4,099,278

Registered Feb. 14, 2012

Int. Cl.: 41

SERVICE MARK

PRINCIPAL REGISTER

LUMINA SPHERE LLC (ARIZONA LIMITED LIABILITY COMPANY)
3655 W. ANTHEM WAY, SUITE A109-419
ANTHEM, AZ 85086

FOR: ENTERTAINMENT SERVICES, NAMELY, PROVIDING A WEB SITE FEATURING MUSICAL PERFORMANCES, MUSICAL VIDEOS, RELATED FILM CLIPS, PHOTOGRAPHS, AND OTHER MULTIMEDIA MATERIALS; ENTERTAINMENT SERVICES, NAMELY, PROVIDING A WEB SITE FEATURING PHOTOGRAPHIC, AUDIO, VIDEO AND PROSE PRESENTATIONS FEATURING ORIGINAL MUSIC, ART, SCULPTURE, POETRY, CREATIVE EXPRESSION, AND COMMENTARY; ENTERTAINMENT SERVICES, NAMELY, PROVIDING PODCASTS IN THE FIELD OF ORIGINAL MUSIC, ART, SCULPTURE, POETRY, CREATIVE EXPRESSION, AND COMMENTARY; ENTERTAINMENT IN THE NATURE OF LIVE PERFORMANCES BY A MUSICIAN AND OR MUSICIANS; ENTERTAINMENT SERVICES IN THE NATURE OF LIVE MUSICAL PERFORMANCES; ENTERTAINMENT, NAMELY, LIVE MUSIC CONCERTS, IN CLASS 41 (U.S. CLS. 100, 101 AND 107).

FIRST USE 1-7-2009; IN COMMERCE 9-30-2011.

THE MARK CONSISTS OF STANDARD CHARACTERS WITHOUT CLAIM TO ANY PARTICULAR FONT, STYLE, SIZE, OR COLOR.

SN 77-466,351, FILED 5-5-2008.

KIM MONINGHOFF, EXAMINING ATTORNEY



David J. Kyffers

Director of the United States Patent and Trademark Office

United States of America

United States Patent and Trademark Office



Reg. No. 4,099,279

Registered Feb. 14, 2012

Int. Cl.: 41

SERVICE MARK

PRINCIPAL REGISTER

LUMINA SPHERE LLC (ARIZONA LIMITED LIABILITY COMPANY)
3655 W. ANTHEM WAY, SUITE A109-419
ANTHEM, AZ 85086

FOR: ENTERTAINMENT SERVICES, NAMELY, PROVIDING A WEB SITE FEATURING MUSICAL PERFORMANCES, MUSICAL VIDEOS, RELATED FILM CLIPS, PHOTOGRAPHS, AND OTHER MULTIMEDIA MATERIALS; ENTERTAINMENT SERVICES, NAMELY, PROVIDING A WEB SITE FEATURING PHOTOGRAPHIC, AUDIO, VIDEO AND PROSE PRESENTATIONS FEATURING ORIGINAL MUSIC, ART, SCULPTURE, POETRY, CREATIVE EXPRESSION, AND COMMENTARY; ENTERTAINMENT SERVICES, NAMELY, PROVIDING PODCASTS IN THE FIELD OF ORIGINAL MUSIC, ART, SCULPTURE, POETRY, CREATIVE EXPRESSION, AND COMMENTARY; ENTERTAINMENT IN THE NATURE OF LIVE PERFORMANCES BY A MUSICIAN AND OR MUSICIANS; ENTERTAINMENT SERVICES IN THE NATURE OF LIVE MUSICAL PERFORMANCES; ENTERTAINMENT, NAMELY, LIVE MUSIC CONCERTS, IN CLASS 41 (U.S. CLS. 100, 101 AND 107).

FIRST USE 1-7-2009; IN COMMERCE 9-30-2011.

THE MARK CONSISTS OF AN EXCLAMATION MARK WITH: 1. THE TOP PORTION FORMED BY THE OUTLINE OF AN UPSIDE DOWN TEARDROP OR RAINDROP SHAPE. 2. THE BOTTOM PORTION COMPRISED OF A PARTIALLY SHADED CIRCLE - WITH THIS SHADING FORMING THE SHAPE OF A CRESCENT WITHIN THE CIRCLE.

SN 77-466,358, FILED 5-5-2008.

KIM MONINGHOFF, EXAMINING ATTORNEY



David J. Kybas

Director of the United States Patent and Trademark Office

United States of America

United States Patent and Trademark Office

SORBOTEST

Reg. No. 4,099,280

AXENS (SOCIÉTÉ ANONYME) (FRANCE SOCIÉTÉ ANONYME (SA))
89 BOULEVARD FRANKLIN ROOSEVELT
92500 RUEIL-MALMAISON, FRANCE

Registered Feb. 14, 2012

Int. Cls.: 9 and 42

FOR: APPARATUS FOR TESTING AND ANALYZING A VARIETY OF IMPURITIES AND THEIR CONCENTRATIONS FOUND IN GASES AND LIQUIDS, EITHER WATER OR HYDROCARBON BASED USING A SERIES OF SOLID ADSORBENTS, IN CLASS 9 (U.S. CLS. 21, 23, 26, 36 AND 38).

TRADEMARK

SERVICE MARK

FIRST USE 9-30-2008; IN COMMERCE 9-30-2008.

PRINCIPAL REGISTER

FOR: TESTING AND ANALYSIS OF GASES AND LIQUIDS, EITHER WATER OR HYDROCARBON BASED, USING A SERIES OF SOLID ADSORBENTS TO DETERMINE IMPURITIES AND THEIR CONCENTRATIONS, IN CLASS 42 (U.S. CLS. 100 AND 101).

FIRST USE 9-30-2008; IN COMMERCE 9-30-2008.

THE MARK CONSISTS OF STANDARD CHARACTERS WITHOUT CLAIM TO ANY PARTICULAR FONT, STYLE, SIZE, OR COLOR.

SN 77-466,563, FILED 5-6-2008.

LINDA ORNDORFF, EXAMINING ATTORNEY



David J. Kybas

Director of the United States Patent and Trademark Office

United States of America

United States Patent and Trademark Office

IMCARDIA

Reg. No. 4,099,281

Registered Feb. 14, 2012

Int. Cl.: 10

TRADEMARK

PRINCIPAL REGISTER

CORASSIST CARDIOVASCULAR LTD. (ISRAEL LIMITED LIABILITY COMPANY)
POB 12571
BEIT MERKAZIM, 32 MASKIT STREET
HERZLIYA IND. AREA, ISRAEL

FOR: MEDICAL APPARATUS, NAMELY, A DEVICE CONSISTING OF ATTACHMENT SCREWS, WHICH ARE IMPLANTED IN THE LEFT VENTRICLE (LV) WALL AND USED AS AN ANCHOR FOR THE ELASTIC ELEMENTS AND ELASTIC ELEMENTS COMPRISING METAL SPRINGS WHICH ARE ANCHORED BETWEEN NEIGHBORING ATTACHMENT SCREWS AND HARNESS ENERGY PRODUCED BY THE LV DURING SYSTOLE AND RELEASE IT DURING DIASTOLE WITHOUT THE NEED OF AN EXTERNAL POWER SOURCE OR ANY PUMPING MACHINERY, ALL FOR IMPROVING VENTRICULAR DIASTOLIC FUNCTION; MEDICAL KITS CONSISTING OF MEDIAL ELASTIC METAL SPRING ELEMENTS ASSEMBLED IN THE MIDDLE OF THE LV WALL, PERIPHERAL ELASTIC METAL SPRING ELEMENTS ASSEMBLED ON THE EDGES OF THE LV WALL, VERTICAL AND HORIZONTAL LOCATION GUIDES USED FOR VERTICAL AND HORIZONTAL POSITIONING THE DEVICE IN BETWEEN UPPER AND LOWER BOUNDARIES OF THE LV SURFACE, PAIRS OF ATTACHMENT SCREWS, WHICH ARE IMPLANTED IN THE LV WALL AND USED AS AN ANCHOR FOR THE ELASTIC ELEMENTS, AND DELIVERY TOOLS HAVING A HOLLOW OUTER TUBE AND AN INNER SHAFT, WHICH ARE USED FOR THE IMPLANTATION OF THE ATTACHMENT SCREW TO THE CORRECT DEPTH IN THE MYOCARDIAL TISSUE; MEDICAL KITS CONSISTING OF LONG MEDIAL AND PERIPHERAL ELASTIC METAL SPRING ELEMENTS WITH VARIOUS LENGTHS TO CONFORM TO HUMAN HEART ANATOMY, AND LONG HORIZONTAL GUIDE FOR THE IMPLANTATION OF THE LONG ELASTIC ELEMENTS; MEDICAL KITS COMPRISING DELIVERY TOOLS FOR IMPLANTATION OF THE ATTACHMENT SCREWS AND ELASTIC ELEMENTS BY MINIMALLY INVASIVE PROCEDURE, NAMELY, A HOLLOW TUBE WITH A JOINT AT ITS END IN WHICH THE ATTACHMENT SCREW IS POSITIONED TO ALLOW IMPLANTATION AT VARIOUS ANGLES AND A HOLLOW TUBE IN WHICH THE ELASTIC ELEMENT IS POSITIONED TO ALLOW ITS IMPLANTATION BETWEEN TWO ADJACENT ATTACHMENT SCREWS IN A MINIMALLY INVASIVE PROCEDURE, IN CLASS 10 (U.S. CLS. 26, 39 AND 44).



David J. Kyjars

Director of the United States Patent and Trademark Office

FIRST USE 5-12-2009; IN COMMERCE 5-12-2009.

THE MARK CONSISTS OF STANDARD CHARACTERS WITHOUT CLAIM TO ANY PARTICULAR FONT, STYLE, SIZE, OR COLOR.

Reg. No. 4,099,281 SN 77-467,678, FILED 5-7-2008.

GENE MACIOL, EXAMINING ATTORNEY

United States of America

United States Patent and Trademark Office

BELLE AMORE

Reg. No. 4,099,282

Registered Feb. 14, 2012

Int. Cl.: 14

TRADEMARK

PRINCIPAL REGISTER

QUALITY GOLD, INC. (OHIO CORPORATION)
500 QUALITY BLVD.
P.O. BOX 18490
FAIRFIELD, OH 45018

FOR: JEWELRY, IN CLASS 14 (U.S. CLS. 2, 27, 28 AND 50).

FIRST USE 11-11-2011; IN COMMERCE 11-11-2011.

THE MARK CONSISTS OF STANDARD CHARACTERS WITHOUT CLAIM TO ANY PARTICULAR FONT, STYLE, SIZE, OR COLOR.

THE ENGLISH TRANSLATION OF "BELLE AMORE" IN THE MARK IS "BEAUTIFUL LOVE"

SN 77-467,941, FILED 5-7-2008.

LINDA ESTRADA, EXAMINING ATTORNEY



David J. Kybas

Director of the United States Patent and Trademark Office

United States of America

United States Patent and Trademark Office

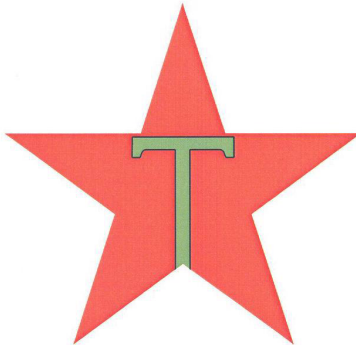

Reg. No. 4,099,283

Registered Feb. 14, 2012

Int. Cl.: 25

TRADEMARK

PRINCIPAL REGISTER

CHEVRON INTELLECTUAL PROPERTY LLC (DELAWARE LIMITED LIABILITY COMPANY)
PO BOX 6006
SAN RAMON, CA 94583

FOR: CLOTHING, NAMELY, T-SHIRTS, CAPS, HATS AND SWEATSHIRTS, IN CLASS 25 (U.S. CLS. 22 AND 39).

FIRST USE 12-15-2010; IN COMMERCE 12-15-2010.

OWNER OF U.S. REG. NOS. 150,620, 2,206,861, AND OTHERS.

THE COLOR(S) RED, BLACK AND GREEN IS/ARE CLAIMED AS A FEATURE OF THE MARK.

THE MARK CONSISTS OF A RED STAR WITH A GREEN "T" OUTLINED IN BLACK IN THE MIDDLE OF THE STAR.

SN 77-469,556, FILED 5-8-2008.

LINDA E. BLOHM, EXAMINING ATTORNEY



David J. Kyffers

Director of the United States Patent and Trademark Office

United States of America

United States Patent and Trademark Office

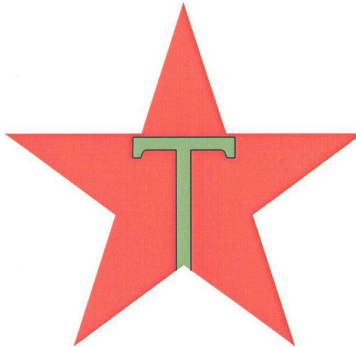

Reg. No. 4,099,284

Registered Feb. 14, 2012

Int. Cl.: 28

TRADEMARK

PRINCIPAL REGISTER

CHEVRON INTELLECTUAL PROPERTY LLC (DELAWARE LIMITED LIABILITY COMPANY)
P.O. BOX 6006
SAN RAMON, CA 94583

FOR: MODEL KITS FOR ANTIQUE DELIVERY VEHICLES, DIE-CAST CARS, AND AIRPLANES, IN CLASS 28 (U.S. CLS. 22, 23, 38 AND 50).

FIRST USE 12-15-2008; IN COMMERCE 12-15-2008.

OWNER OF U.S. REG. NOS. 150,620, 2,206,861, AND OTHERS.

THE COLOR(S) RED, BLACK AND GREEN IS/ARE CLAIMED AS A FEATURE OF THE MARK.

THE MARK CONSISTS OF A RED STAR WITH A GREEN "T" OUTLINED IN BLACK IN THE MIDDLE OF THE STAR.

SN 77-469,577, FILED 5-8-2008.

LINDA E. BLOHM, EXAMINING ATTORNEY



David J. Kyffers

Director of the United States Patent and Trademark Office

United States of America

United States Patent and Trademark Office

NATIONALGRID

Reg. No. 4,099,285

Registered Feb. 14, 2012

**Int. Cls.: 4, 9, 16, 35, 36,
37, 38, 39, 40, and 42**

TRADEMARK

SERVICE MARK

PRINCIPAL REGISTER

NATIONAL GRID ELECTRICITY TRANSMISSION PLC (UNITED KINGDOM PUBLIC LIMITED COMPANY (PLC))
1-3 STRAND
LONDON WC2N 5EH, UNITED KINGDOM

FOR: GAS, FUELS, OILS, NAMELY, NATURAL GAS, LIQUEFIED NATURAL GAS; OILS PRODUCED BY REFINING MINERAL OILS, NAMELY, GASOLINE, DIESEL FUEL, AND LIQUEFIED PETROLEUM GAS ALL IN RELATION TO THE GENERATION, SUPPLY, DISTRIBUTION AND TRANSMISSION OF ELECTRICITY, IN CLASS 4 (U.S. CLS. 1, 6 AND 15).

FIRST USE 3-31-1990; IN COMMERCE 1-3-2001.

FOR: HIGH VOLTAGE TRANSFORMERS; POWER TRANSFORMERS; ELECTRONIC AND SCIENTIFIC APPARATUS AND INSTRUMENTS, NAMELY, ELECTRIC CONDUCTORS, ELECTRIC SWITCHES, ELECTRIC TRANSFORMERS, ELECTRIC ACCUMULATORS, VOLTAGE REGULATORS, ELECTRICAL CONTROLLING DEVICES, ALL FOR TRANSMISSION AND DISTRIBUTION OF ELECTRICITY; COMPUTER PROGRAMS RELATING TO THE GENERATION, SUPPLY, DISTRIBUTION AND TRANSMISSION OF ELECTRICITY, GAS AND WATER FOR USE IN DATABASE MANAGEMENT; COMPUTER SOFTWARE FOR SIMULATION, MODELING AND ANALYSIS OF NETWORKS AND PIPELINES; COMPUTER SOFTWARE FOR USE IN FORECASTING ENERGY CONSUMPTION AND DEMAND; GAS METERS, ELECTRIC METERS; MEASURING AND SIGNALING APPARATUS AND INSTRUMENTS, NAMELY, GAS GAUGES, ELECTRIC GAUGES; FUEL DISPENSING, METERING AND STORAGE APPARATUS AND INSTRUMENTS AND SYSTEMS, NAMELY, METERED FUEL PUMPS FOR SERVICE STATIONS AND NATURAL GAS METERS; MONITORING AND SUPERVISION APPARATUS AND INSTRUMENTS, NAMELY, PROBES FOR TESTING INTEGRATED CIRCUITS, AND DIGITAL TRANSMITTERS; MAGNETICALLY ENCODED CREDIT, CHARGE AND DEBIT CARDS; BLANK SMART CARDS; ENCODED MAGNETIC CARDS; PARTS AND FITTINGS FOR ALL OF THE AFORESAID GOODS, IN CLASS 9 (U.S. CLS. 21, 23, 26, 36 AND 38).

FIRST USE 3-31-1990; IN COMMERCE 1-3-2001.

FOR: PRINTED MATTER, NAMELY, BROCHURES AND PAMPHLETS REGARDING THE TELECOMMUNICATIONS, GAS, ELECTRICITY, WATER AND OIL INDUSTRIES; PERIODICAL PUBLICATIONS, NAMELY, PRINTED PERIODICALS FEATURING INFORMATION ABOUT THE TELECOMMUNICATIONS, GAS, ELECTRICITY, WATER AND OIL INDUS-



David J. Kyjars

Director of the United States Patent and Trademark Office

Reg. No. 4,099,285 TRIES; PRINTED MANUALS FEATURING INFORMATION ABOUT THE TELECOMMUNICATIONS, GAS, ELECTRICITY, WATER AND OIL INDUSTRIES , IN CLASS 16 (U.S. CLS. 2, 5, 22, 23, 29, 37, 38 AND 50).

FIRST USE 3-31-1990; IN COMMERCE 5-17-2000.

FOR: CREDIT CARD REGISTRATION SERVICES; BUSINESS CONSULTANCY SERVICES; INDUSTRIAL CONSULTANCY SERVICES, NAMELY, ADVICE IN THE FIELD OF BUSINESS MANAGEMENT OF UTILITY, ELECTRICITY, GAS, WATER AND CONSTRUCTION INDUSTRIES; MARKETING, NAMELY, BUSINESS MARKETING AND DIRECT MARKETING FOR OTHERS; PROMOTING PUBLIC AWARENESS OF THE NEED FOR ENERGY CONSERVATION AND PROVIDING INFORMATION IN THE FIELD OF ENERGY EFFICIENCY AND ENERGY AUDITING SERVICES; POWER PLANT MANAGEMENT STUDIES, NAMELY, MARKET REPORTS AND RESEARCH STUDIES; BUSINESS MANAGEMENT OF PROJECTS RELATING TO ELECTRICITY, OIL, TELECOMMUNICATIONS AND GAS, AND CONSULTANCY SERVICES RELATED THERETO; ADVICE AND CONSULTANCY SERVICES RELATING TO ALL OF THE AFORESAID SERVICES, IN CLASS 35 (U.S. CLS. 100, 101 AND 102).

FIRST USE 3-31-1990; IN COMMERCE 5-17-2000.

FOR: BROKERAGE OF ELECTRIC AND GAS COMMODITIES; PROVISION OF LOAN AND CREDIT FACILITIES, NAMELY, CREDIT AND LOAN SERVICES; DIRECT DEBITING, NAMELY, ACCOUNTS PAYABLE DEBITING SERVICES; LEASING OF REAL PROPERTY; FINANCING OF PROJECTS; REAL ESTATE MANAGEMENT; REAL ESTATE PROCUREMENT FOR OTHERS; ADVICE AND CONSULTANCY SERVICES RELATING TO ALL OF THE AFORESAID SERVICES, IN CLASS 36 (U.S. CLS. 100, 101 AND 102).

FIRST USE 3-31-1990; IN COMMERCE 4-27-2000.

FOR: INSTALLATION, MAINTENANCE AND REPAIR OF APPARATUS AND INSTRUMENTS, NETWORKS AND SYSTEMS FOR USE IN THE SUPPLY AND DISTRIBUTION OF ELECTRICITY, GAS, WATER AND TELECOMMUNICATIONS; INSTALLATION, REPAIR, EMERGENCY SERVICING AND MAINTENANCE OF GAS, ELECTRICITY AND WATER APPLIANCES, APPARATUS AND INSTRUMENTS; LAYING, REPAIR, MAINTENANCE, REPLACEMENT AND REFURBISHMENT OF PIPELINES; PLANNING AND LAYING OUT OF POWER PLANT FACILITIES; INSTALLATION OF INDUSTRIAL DUCTWORK AND PIPING; WASTE DISPOSAL FOR OTHERS; ADVICE AND CONSULTANCY SERVICES RELATING TO ALL OF THE AFORESAID SERVICES , IN CLASS 37 (U.S. CLS. 100, 103 AND 106).

FIRST USE 3-31-1990; IN COMMERCE 4-27-2000.

FOR: NETWORK PROVIDER SERVICES, NAMELY, PROVIDING ACCESS TO TELECOMMUNICATION NETWORKS, GLOBAL COMPUTER INFORMATION NETWORKS, DIGITAL NETWORKS, WIDE AREA NETWORKS, BROAD BAND NETWORKS, OPTICAL NETWORKS, WIRELESS NETWORKS, SATELLITE NETWORKS, ELECTRONIC COMMUNICATIONS NETWORKS; PROVIDING SHARED WIRELESS AND FIBER COMMUNICATIONS TRANSMISSIONS SITES AND INFRASTRUCTURE FOR USE BY MULTIPLE BROADCASTERS AND TELECOMMUNICATIONS OPERATORS; PROVIDING ACCESS TO A DATABASE PERTAINING TO ENERGY PRODUCTION AND DISTRIBUTION, NAMELY, FUEL SOURCES, STORAGE, DISTRIBUTIONS, TRANSMISSION AND SUPPLY; ADVICE AND CONSULTANCY SERVICES RELATING TO ALL OF THE AFORESAID SERVICES, IN CLASS 38 (U.S. CLS. 100, 101 AND 104).

FIRST USE 3-31-1990; IN COMMERCE 5-1-2000.

Reg. No. 4,099,285 FOR: TRANSMISSION OF GAS THROUGH PIPELINES; ELECTRICITY DISTRIBUTION; STORAGE, DISTRIBUTION AND TRANSPORTATION OF LIQUEFIED PETROLEUM GAS; DISTRIBUTION AND SUPPLY OF ELECTRICITY AND OTHER FORMS OF ENERGY OR SOURCES OF POWER; DISTRIBUTION, SUPPLY, TRANSPORTATION AND STORAGE OF FUEL AND GAS; TRANSMISSION, SUPPLY AND DISTRIBUTION OF ELECTRICITY TO AND FROM COMMERCIAL RESIDENTIAL AND INDUSTRIAL PREMISES; PROVIDING INFORMATION IN THE FIELD OF TRANSMISSION AND DISTRIBUTION OF OIL, GAS, WATER AND ELECTRICITY; ADVICE AND CONSULTANCY SERVICES RELATING TO ALL OF THE AFORESAID SERVICES, IN CLASS 39 (U.S. CLS. 100 AND 105).

FIRST USE 3-31-1990; IN COMMERCE 4-1-2000.

FOR: GAS TREATMENT SERVICES; POWER GENERATION SERVICES; PRODUCTION OF GAS; CONSULTANCY SERVICES RELATING TO THE GENERATION OF ELECTRICITY, GAS AND WATER; ADVICE AND CONSULTANCY SERVICES RELATING TO ALL OF THE AFORESAID SERVICES, IN CLASS 40 (U.S. CLS. 100, 103 AND 106).

FIRST USE 3-31-1990; IN COMMERCE 4-1-2000.

FOR: ELECTRICITY AND NATURAL GAS SERVICES, NAMELY, METERING; MEASURING GAS CONSUMPTION; SAFETY CHECKING OF DOMESTIC APPLIANCES AND PIPEWORK; SCIENTIFIC RESEARCH, DEVELOPMENT AND ENGINEERING IN THE FIELD OF ENERGY AND THE ENVIRONMENTAL IMPACT OF ENERGY AND POWER SYSTEMS; DEVELOPMENT OF ENVIRONMENTALLY-FRIENDLY FORMS OF ENERGY AND POWER; AERIAL LASER SURVEYS; COMPUTER PROGRAMMING SERVICES; MAINTENANCE AND UPDATING OF COMPUTER SOFTWARE; DESIGN OF COMPUTER SOFTWARE AND PROGRAMMING; INSPECTION OF PIPELINES; ENGINEERING SERVICES FOR GENERATION, SUPPLY, DISTRIBUTION AND TRANSMISSION OF ELECTRICITY AND GAS; ENGINEERING SERVICES, NAMELY, ENVIRONMENTAL, GEOTECHNICAL, BIOTECHNICAL, STRUCTURAL, CIVIL AND ARCHITECTURAL; ENERGY-RELATED ENGINEERING CONSULTING SERVICES, NAMELY, EVALUATION OF ENERGY REQUIREMENTS AND PROVIDING HEATING AND POWER ENGINEERING DESIGN; ENGINEERING DESIGN; DESIGN OF GAS AND ELECTRICITY TRANSMISSION AND DISTRIBUTION NETWORKS; ADVICE AND CONSULTANCY SERVICES RELATING TO ALL OF THE AFORESAID SERVICES, IN CLASS 42 (U.S. CLS. 100 AND 101).

FIRST USE 3-31-1990; IN COMMERCE 5-17-2000.

THE MARK CONSISTS OF STANDARD CHARACTERS WITHOUT CLAIM TO ANY PARTICULAR FONT, STYLE, SIZE, OR COLOR.

SEC. 2(F).

OWNER OF U.S. REG. NOS. 2,551,591, 2,659,972, AND OTHERS.

SN 77-469,597, FILED 5-8-2008.

JAY FLOWERS, EXAMINING ATTORNEY

United States of America

United States Patent and Trademark Office



Reg. No. 4,099,286

Registered Feb. 14, 2012

Int. Cl.: 28

TRADEMARK

PRINCIPAL REGISTER

CHEVRON INTELLECTUAL PROPERTY LLC (DELAWARE LIMITED LIABILITY COMPANY)
P.O. BOX 6006
SAN RAMON, CA 94583

FOR: MODEL KITS FOR ANTIQUE DELIVERY VEHICLES, DIE-CAST CARS, AND AIRPLANES, IN CLASS 28 (U.S. CLS. 22, 23, 38 AND 50).

FIRST USE 12-15-2008; IN COMMERCE 12-15-2008.

OWNER OF U.S. REG. NOS. 150,620 AND 2,206,861.

THE COLOR(S) RED, GREEN, BLACK AND WHITE IS/ARE CLAIMED AS A FEATURE OF THE MARK.

THE MARK CONSISTS OF A RED STAR IN A WHITE CIRCLE OUTLINED IN BLACK WITH A GREEN "T" OUTLINED IN WHITE IN THE MIDDLE OF THE STAR WITH THE WORD "TEXACO" IN BLACK ACROSS THE TOP OF THE RED STAR.

SN 77-469,610, FILED 5-8-2008.

LINDA E. BLOHM, EXAMINING ATTORNEY



David J. Kyjars

Director of the United States Patent and Trademark Office

United States of America

United States Patent and Trademark Office

nationalgrid

Reg. No. 4,099,287

Registered Feb. 14, 2012

**Int. Cls.: 4, 9, 16, 35, 36,
37, 38, 39, 40, and 42**

TRADEMARK

SERVICE MARK

PRINCIPAL REGISTER

NATIONAL GRID ELECTRICITY TRANSMISSION PLC (UNITED KINGDOM PUBLIC LIMITED COMPANY (PLC))
1-3 STRAND
LONDON WC2N 5EH, UNITED KINGDOM

FOR: GAS, FUELS, OILS, NAMELY, NATURAL GAS, LIQUEFIED NATURAL GAS; OILS PRODUCED BY REFINING MINERAL OILS, NAMELY, GASOLINE, DIESEL FUEL, AND LIQUEFIED PETROLEUM GAS ALL IN RELATION TO THE GENERATION, SUPPLY, DISTRIBUTION AND TRANSMISSION OF ELECTRICITY, IN CLASS 4 (U.S. CLS. 1, 6 AND 15).

FIRST USE 7-26-2005; IN COMMERCE 7-26-2005.

FOR: HIGH VOLTAGE TRANSFORMERS; POWER TRANSFORMERS; ELECTRONIC AND SCIENTIFIC APPARATUS AND INSTRUMENTS, NAMELY, ELECTRIC CONDUCTORS, ELECTRIC SWITCHES, ELECTRIC TRANSFORMERS, ELECTRIC ACCUMULATORS, VOLTAGE REGULATORS, ELECTRICAL CONTROLLING DEVICES, ALL FOR TRANSMISSION AND DISTRIBUTION OF ELECTRICITY; COMPUTER PROGRAMS RELATING TO THE GENERATION, SUPPLY, DISTRIBUTION AND TRANSMISSION OF ELECTRICITY, GAS AND WATER FOR USE IN DATABASE MANAGEMENT; COMPUTER SOFTWARE FOR SIMULATION, MODELING AND ANALYSIS OF NETWORKS AND PIPELINES; COMPUTER SOFTWARE FOR USE IN FORECASTING ENERGY CONSUMPTION AND DEMAND; GAS METERS, ELECTRIC METERS; MEASURING AND SIGNALING APPARATUS AND INSTRUMENTS, NAMELY, GAS GAUGES, ELECTRIC GAUGES; FUEL DISPENSING, METERING AND STORAGE APPARATUS AND INSTRUMENTS AND SYSTEMS, NAMELY, METERED FUEL PUMPS FOR SERVICE STATIONS AND NATURAL GAS METERS; MONITORING AND SUPERVISION APPARATUS AND INSTRUMENTS, NAMELY, PROBES FOR TESTING INTEGRATED CIRCUITS, AND DIGITAL TRANSMITTERS; MAGNETICALLY ENCODED CREDIT, CHARGE AND DEBIT CARDS; BLANK SMART CARDS; ENCODED MAGNETIC CARDS; PARTS AND FITTINGS FOR ALL OF THE AFORESAID GOODS, IN CLASS 9 (U.S. CLS. 21, 23, 26, 36 AND 38).

FIRST USE 7-26-2005; IN COMMERCE 7-26-2005.

FOR: PRINTED MATTER, NAMELY, BROCHURES AND PAMPHLETS REGARDING THE TELECOMMUNICATIONS, GAS, ELECTRICITY, WATER AND OIL INDUSTRIES; PERIODICAL PUBLICATIONS, NAMELY, PRINTED PERIODICALS FEATURING INFORMATION ABOUT THE TELECOMMUNICATIONS, GAS, ELECTRICITY, WATER AND OIL INDUS-



David J. Kyjars

Director of the United States Patent and Trademark Office

Reg. No. 4,099,287 TRIES; PRINTED MANUALS FEATURING INFORMATION ABOUT THE TELECOMMUNICATIONS, GAS, ELECTRICITY, WATER AND OIL INDUSTRIES , IN CLASS 16 (U.S. CLS. 2, 5, 22, 23, 29, 37, 38 AND 50).

FIRST USE 7-26-2005; IN COMMERCE 7-26-2005.

FOR: CREDIT CARD REGISTRATION SERVICES; BUSINESS CONSULTANCY SERVICES; INDUSTRIAL CONSULTANCY SERVICES, NAMELY, ADVICE IN THE FIELD OF BUSINESS MANAGEMENT OF UTILITY, ELECTRICITY, GAS, WATER AND CONSTRUCTION INDUSTRIES; MARKETING, NAMELY, BUSINESS MARKETING AND DIRECT MARKETING FOR OTHERS; PROMOTING PUBLIC AWARENESS OF THE NEED FOR ENERGY CONSERVATION AND PROVIDING INFORMATION IN THE FIELD OF ENERGY EFFICIENCY AND ENERGY AUDITING SERVICES; POWER PLANT MANAGEMENT STUDIES, NAMELY, MARKET REPORTS AND RESEARCH STUDIES; BUSINESS MANAGEMENT OF PROJECTS RELATING TO ELECTRICITY, OIL, TELECOMMUNICATIONS AND GAS, AND CONSULTANCY SERVICES RELATED THERETO; ADVICE AND CONSULTANCY SERVICES RELATING TO ALL OF THE AFORESAID SERVICES, IN CLASS 35 (U.S. CLS. 100, 101 AND 102).

FIRST USE 7-26-2005; IN COMMERCE 7-26-2005.

FOR: BROKERAGE OF ELECTRIC AND GAS COMMODITIES; PROVISION OF LOAN AND CREDIT FACILITIES, NAMELY, CREDIT AND LOAN SERVICES; DIRECT DEBITING, NAMELY, ACCOUNTS PAYABLE DEBITING SERVICES; LEASING OF REAL PROPERTY; FINANCING OF PROJECTS; REAL ESTATE MANAGEMENT; REAL ESTATE PROCUREMENT FOR OTHERS; ADVICE AND CONSULTANCY SERVICES RELATING TO ALL OF THE AFORESAID SERVICES, IN CLASS 36 (U.S. CLS. 100, 101 AND 102).

FIRST USE 7-26-2005; IN COMMERCE 7-26-2005.

FOR: INSTALLATION, MAINTENANCE AND REPAIR OF APPARATUS AND INSTRUMENTS, NETWORKS AND SYSTEMS FOR USE IN THE SUPPLY AND DISTRIBUTION OF ELECTRICITY, GAS, WATER AND TELECOMMUNICATIONS; INSTALLATION, REPAIR, EMERGENCY SERVICING AND MAINTENANCE OF GAS, ELECTRICITY AND WATER APPLIANCES, APPARATUS AND INSTRUMENTS; LAYING, REPAIR, MAINTENANCE, REPLACEMENT AND REFURBISHMENT OF PIPELINES; PLANNING AND LAYING OUT OF POWER PLANT FACILITIES; INSTALLATION OF INDUSTRIAL DUCTWORK AND PIPING; WASTE DISPOSAL FOR OTHERS; ADVICE AND CONSULTANCY SERVICES RELATING TO ALL OF THE AFORESAID SERVICES , IN CLASS 37 (U.S. CLS. 100, 103 AND 106).

FIRST USE 7-26-2005; IN COMMERCE 7-26-2005.

FOR: NETWORK PROVIDER SERVICES, NAMELY, PROVIDING ACCESS TO TELECOMMUNICATION NETWORKS, GLOBAL COMPUTER INFORMATION NETWORKS, DIGITAL NETWORKS, WIDE AREA NETWORKS, BROAD BAND NETWORKS, OPTICAL NETWORKS, WIRELESS NETWORKS, SATELLITE NETWORKS, ELECTRONIC COMMUNICATIONS NETWORKS; PROVIDING SHARED WIRELESS AND FIBER COMMUNICATIONS TRANSMISSIONS SITES AND INFRASTRUCTURE FOR USE BY MULTIPLE BROADCASTERS AND TELECOMMUNICATIONS OPERATORS; PROVIDING ACCESS TO A DATABASE PERTAINING TO ENERGY PRODUCTION AND DISTRIBUTION, NAMELY, FUEL SOURCES, STORAGE, DISTRIBUTION, TRANSMISSION AND SUPPLY; ADVICE AND CONSULTANCY SERVICES RELATING TO ALL OF THE AFORESAID SERVICES, IN CLASS 38 (U.S. CLS. 100, 101 AND 104).

FIRST USE 7-26-2005; IN COMMERCE 7-26-2005.

Reg. No. 4,099,287 FOR: TRANSMISSION OF GAS THROUGH PIPELINES; ELECTRICITY DISTRIBUTION; STORAGE, DISTRIBUTION AND TRANSPORTATION OF LIQUEFIED PETROLEUM GAS; DISTRIBUTION AND SUPPLY OF ELECTRICITY AND OTHER FORMS OF ENERGY OR SOURCES OF POWER; DISTRIBUTION, SUPPLY, TRANSPORTATION AND STORAGE OF FUEL AND GAS; TRANSMISSION, SUPPLY AND DISTRIBUTION OF ELECTRICITY TO AND FROM COMMERCIAL RESIDENTIAL AND INDUSTRIAL PREMISES; PROVIDING INFORMATION IN THE FIELD OF TRANSMISSION AND DISTRIBUTION OF OIL, GAS, WATER AND ELECTRICITY; ADVICE AND CONSULTANCY SERVICES RELATING TO ALL OF THE AFORESAID SERVICES, IN CLASS 39 (U.S. CLS. 100 AND 105).

FIRST USE 7-26-2005; IN COMMERCE 7-26-2005.

FOR: GAS TREATMENT SERVICES; POWER GENERATION SERVICES; PRODUCTION OF GAS; CONSULTANCY SERVICES RELATING TO THE GENERATION OF ELECTRICITY, GAS AND WATER; ADVICE AND CONSULTANCY SERVICES RELATING TO ALL OF THE AFORESAID SERVICES, IN CLASS 40 (U.S. CLS. 100, 103 AND 106).

FIRST USE 7-26-2005; IN COMMERCE 7-26-2005.

FOR: ELECTRICITY AND NATURAL GAS SERVICES, NAMELY, METERING; MEASURING GAS CONSUMPTION; SAFETY CHECKING OF DOMESTIC APPLIANCES AND PIPEWORK; SCIENTIFIC RESEARCH, DEVELOPMENT AND ENGINEERING IN THE FIELD OF ENERGY AND THE ENVIRONMENTAL IMPACT OF ENERGY AND POWER SYSTEMS; DEVELOPMENT OF ENVIRONMENTALLY-FRIENDLY FORMS OF ENERGY AND POWER; AERIAL LASER SURVEYS; COMPUTER PROGRAMMING SERVICES; MAINTENANCE AND UPDATING OF COMPUTER SOFTWARE; DESIGN OF COMPUTER SOFTWARE AND PROGRAMMING; INSPECTION OF PIPELINES; ENGINEERING SERVICES FOR GENERATION, SUPPLY, DISTRIBUTION AND TRANSMISSION OF ELECTRICITY AND GAS; ENGINEERING SERVICES, NAMELY, ENVIRONMENTAL, GEOTECHNICAL, BIOTECHNICAL, STRUCTURAL, CIVIL AND ARCHITECTURAL; ENERGY-RELATED ENGINEERING CONSULTING SERVICES, NAMELY, EVALUATION OF ENERGY REQUIREMENTS AND PROVIDING HEATING AND POWER ENGINEERING DESIGN; ENGINEERING DESIGN; DESIGN OF GAS AND ELECTRICITY TRANSMISSION AND DISTRIBUTION NETWORKS; ADVICE AND CONSULTANCY SERVICES RELATING TO ALL OF THE AFORESAID SERVICES, IN CLASS 42 (U.S. CLS. 100 AND 101).

FIRST USE 7-26-2005; IN COMMERCE 7-26-2005.

OWNER OF U.S. REG. NOS. 2,551,591, 2,742,466, AND OTHERS.

THE COLOR(S) BLUE IS/ARE CLAIMED AS A FEATURE OF THE MARK.

SEC. 2(F).

THE COLOR BLUE IN APPEARS IN THE WORDING "NATIONALGRID".

SN 77-469,621, FILED 5-8-2008.

JAY FLOWERS, EXAMINING ATTORNEY

United States of America

United States Patent and Trademark Office

MANEKI NEKO

Reg. No. 4,099,288

Registered Feb. 14, 2012

Int. Cl.: 9

TRADEMARK

PRINCIPAL REGISTER

BRIAN T. FINN (UNITED STATES INDIVIDUAL)
APT. 2A
325 EAST 72ND STREET
NEW YORK CITY, NY 10021

FOR: GAMBLING AND GAMING MACHINES, IN CLASS 9 (U.S. CLS. 21, 23, 26, 36 AND 38).

FIRST USE 12-28-2011; IN COMMERCE 12-28-2011.

THE MARK CONSISTS OF STANDARD CHARACTERS WITHOUT CLAIM TO ANY PARTICULAR FONT, STYLE, SIZE, OR COLOR.

THE ENGLISH TRANSLATION OF "MANEKI NEKO" IN THE MARK IS BECKONING CAT.

SN 77-470,875, FILED 5-9-2008.

MICHAEL KEATING, EXAMINING ATTORNEY



David J. Kybas

Director of the United States Patent and Trademark Office

United States of America

United States Patent and Trademark Office

Suspiros

Reg. No. 4,099,289

Registered Feb. 14, 2012

Int. Cl.: 30

TRADEMARK

PRINCIPAL REGISTER

FONSECA, JOSE ARMANDO ESPARAZA (MEXICO INDIVIDUAL)
VILLA TURCA 30 VILLAS DEL MEDITERRANEO
HERMOSILLO, MEXICO 83220

FOR: CAKES, IN CLASS 30 (U.S. CL. 46).

FIRST USE 12-11-2011; IN COMMERCE 12-11-2011.

THE MARK CONSISTS OF STANDARD CHARACTERS WITHOUT CLAIM TO ANY PARTICULAR FONT, STYLE, SIZE, OR COLOR.

THE ENGLISH TRANSLATION OF THE MARK IS SIGHS.

SN 77-471,839, FILED 5-12-2008.

LINDSEY RUBIN, EXAMINING ATTORNEY



David J. Kyffers

Director of the United States Patent and Trademark Office

United States of America

United States Patent and Trademark Office

B

Reg. No. 4,099,290

Registered Feb. 14, 2012

Int. Cl.: 42

SERVICE MARK

PRINCIPAL REGISTER

THE BURGESS GROUP, L.L.C. (DELAWARE LIMITED LIABILITY COMPANY)
3RD FLOOR
1701 DUKE STREET
ALEXANDRIA, VA 22314

FOR: PROVIDING TEMPORARY USE OF ON-LINE NON-DOWNLOADABLE SOFTWARE FOR PRICING CLAIMS, ANALYZING DATA, RESEARCHING RATES AND POLICIES IN THE FIELD OF MEDICARE REIMBURSEMENT AND HEALTHCARE ECONOMICS, IN CLASS 42 (U.S. CLS. 100 AND 101).

FIRST USE 1-1-2012; IN COMMERCE 1-1-2012.

THE MARK CONSISTS OF A STYLIZED LETTER "B".

SN 77-475,292, FILED 5-15-2008.

KAREN K. BUSH, EXAMINING ATTORNEY



David J. Kyffers

Director of the United States Patent and Trademark Office

United States of America

United States Patent and Trademark Office



Reg. No. 4,099,291

PRECISION FOODS, INC. (IOWA CORPORATION)
11457 OLDE CABIN ROAD
ST. LOUIS, MO 63141

Registered Feb. 14, 2012

Int. Cls.: 1, 29, and 30

FOR: CITRIC ACID FOR HOME CANNING OF TOMATOES; FOOD GRADE CALCIUM HYDROXIDE FOR PICKLING VEGETABLES; FOOD PRESERVATIVE COMPOSITIONS, NAMELY, FRESH FRUIT PRESERVER, IN CLASS 1 (U.S. CLS. 1, 5, 6, 10, 26 AND 46).

TRADEMARK

FIRST USE 5-1-2010; IN COMMERCE 5-1-2010.

PRINCIPAL REGISTER

FOR: FRUIT PECTIN FOR MAKING HOMEMADE JAMS AND JELLIES; DRY MIXES FOR MAKING DIPS, IN CLASS 29 (U.S. CL. 46).

FIRST USE 5-1-2010; IN COMMERCE 5-1-2010.

FOR: DRY MIXES FOR MAKING HOMEMADE PICKLES, NAMELY, PICKLING SPICES; DRY MIXES FOR MAKING PICKLED VEGETABLES AND DILLED GREEN BEANS, NAMELY, PICKLING SPICES; DRY SEASONING MIXES FOR MAKING CHILI; SALT FOR PRESERVING FOOD, NAMELY, CANNING AND PICKLING SALT; PICKLING SPICES; DRY MIXES FOR MAKING PIZZA SAUCES, PASTA SAUCES, SPAGHETTI SAUCES, KETCHUP, SALSAS, CHIPOTLE SAUCES; MEAT SEASONING MIXES, IN CLASS 30 (U.S. CL. 46).

FIRST USE 12-1-2009; IN COMMERCE 12-1-2009.

OWNER OF U.S. REG. NOS. 1,104,108, 2,925,873, AND OTHERS.

THE NAME(S), PORTRAIT(S), AND/OR SIGNATURE(S) SHOWN IN THE MARK DOES NOT IDENTIFY A PARTICULAR LIVING INDIVIDUAL.

THE MARK CONSISTS OF THE WORDS "MRS. WAGES" INSIDE AN OVAL WITH THREE LEAVES CENTERED OVER THE WORDS IN THE OVAL.

SN 77-479,329, FILED 5-20-2008.

JAMES MACFARLANE, EXAMINING ATTORNEY



David J. Kyros

Director of the United States Patent and Trademark Office

United States of America

United States Patent and Trademark Office

INTERNAL FURY

Reg. No. 4,099,292

Registered Feb. 14, 2012

Int. Cl.: 25

TRADEMARK

PRINCIPAL REGISTER

DIXON, CHARLES A. (UNITED STATES INDIVIDUAL)
31Y GARDEN TERRACE
NORTH ARLINGTON, NJ 07031

FOR: CAPS; JERSEYS; BELTS; BIBS NOT OF CLOTH OR PAPER; CHILDREN'S AND INFANTS' CLOTH BIBS; CHILDREN'S CLOTH EATING BIBS; CLOTH BIBS; CLOTH BIBS FOR ADULT DINERS; CLOTH BIBS FOR USE BY SENIOR CITIZENS OR PHYSICALLY-OR MENTALLY-CHALLENGED PERSONS; CLOTH DIAPERS; CLOTHING FOR WEAR IN JUDO PRACTICES; CLOTHING FOR WEAR IN WRESTLING GAMES; CLOTHING, NAMELY, ARM WARMERS; CLOTHING, NAMELY, FOLK COSTUMES; CLOTHING, NAMELY, HAND-WARMERS; CLOTHING, NAMELY, KNEE WARMERS; CLOTHING, NAMELY, NECK TUBES; CLOTHING, NAMELY, THOBES; CLOTHING, NAMELY, WRAP-AROUNDS; CORSETS; DUSTERS; FOULARDS; HOODS; INFANT AND TODDLER ONE PIECE CLOTHING; INFANT CLOTH DIAPERS; LEATHER BELTS; MANTLES; MUFFLERS; NON-DISPOSABLE CLOTH TRAINING PANTS; PAPER HATS FOR USE AS CLOTHING ITEMS; PARTS OF CLOTHING, NAMELY, GUSSETS FOR TIGHTS, GUSSETS FOR STOCKINGS, GUSSETS FOR BATHING SUITS, GUSSETS FOR UNDERWEAR, GUSSETS FOR LEOTARDS AND GUSSETS FOR FOOTLETS; PERSPIRATION ABSORBENT UNDERWEAR CLOTHING; SHIFTS; SHORT SETS; SHOULDER WRAPS; SWADDLING CLOTHES; TIES; TOPS; TRIATHLON CLOTHING, NAMELY, TRIATHLON TIGHTS, TRIATHLON SHORTS, TRIATHLON SINGLET, TRIATHLON SHIRTS, TRIATHLON SUITS; UNDERARM CLOTHING SHIELDS; WRAPS, IN CLASS 25 (U.S. CLS. 22 AND 39).

FIRST USE 9-1-2003; IN COMMERCE 9-1-2003.

THE MARK CONSISTS OF STANDARD CHARACTERS WITHOUT CLAIM TO ANY PARTICULAR FONT, STYLE, SIZE, OR COLOR.

NO CLAIM IS MADE TO THE EXCLUSIVE RIGHT TO USE "FURY", APART FROM THE MARK AS SHOWN.

SN 77-479,704, FILED 5-20-2008.

MICHAEL SOUDERS, EXAMINING ATTORNEY



David J. Kyffers

Director of the United States Patent and Trademark Office

United States of America

United States Patent and Trademark Office

5K EVERY DAY

Reg. No. 4,099,293

PROFOOT, INC. (NEW YORK CORPORATION)
74 20TH STREET
BROOKLYN, NY 11232

Registered Feb. 14, 2012

Int. Cl.: 25

FOR: INSOLES AND NON-ORTHOTIC INSERTS FOR FOOTWEAR FOR CUSHIONING AND SUPPORTING THE FEET, IN CLASS 25 (U.S. CLS. 22 AND 39).

TRADEMARK

FIRST USE 2-28-2011; IN COMMERCE 2-28-2011.

PRINCIPAL REGISTER

THE MARK CONSISTS OF STANDARD CHARACTERS WITHOUT CLAIM TO ANY PARTICULAR FONT, STYLE, SIZE, OR COLOR.

SN 77-481,980, FILED 5-23-2008.

LESLIE RICHARDS, EXAMINING ATTORNEY



David J. Kybas

Director of the United States Patent and Trademark Office

United States of America

United States Patent and Trademark Office

Flash n Slash

Reg. No. 4,099,294

BANOM, INC. (PENNSYLVANIA CORPORATION)
BOX 687
WAYNE, PA 19087

Registered Feb. 14, 2012

Int. Cl.: 9

FOR: PROTECTIVE, CUT-RESISTANT AND ELECTRICAL ARC-RESISTANT GLOVES FOR INDUSTRIAL USE, IN CLASS 9 (U.S. CLS. 21, 23, 26, 36 AND 38).

TRADEMARK

FIRST USE 12-13-2011; IN COMMERCE 12-13-2011.

PRINCIPAL REGISTER

THE MARK CONSISTS OF STANDARD CHARACTERS WITHOUT CLAIM TO ANY PARTICULAR FONT, STYLE, SIZE, OR COLOR.

SN 77-487,740, FILED 5-30-2008.

JILL C. ALT, EXAMINING ATTORNEY



David J. Kybas

Director of the United States Patent and Trademark Office

United States of America

United States Patent and Trademark Office



Reg. No. 4,099,295

Registered Feb. 14, 2012

Int. Cls.: 5 and 32

TRADEMARK

PRINCIPAL REGISTER

SOCIETE DES PRODUITS NESTLE S.A. (SWITZERLAND SOCIÉTÉ ANONYME (SA))
CASE POSTALE 353
1800 VEVEY, SWITZERLAND

FOR: INFANT FORMULA, IN CLASS 5 (U.S. CLS. 6, 18, 44, 46, 51 AND 52).

FIRST USE 12-31-2008; IN COMMERCE 12-31-2008.

FOR: BOTTLED DRINKING WATER, IN CLASS 32 (U.S. CLS. 45, 46 AND 48).

FIRST USE 12-31-2008; IN COMMERCE 12-31-2008.

THE MARK CONSISTS OF THE IMAGE OF A BABY WRAPPED IN A BLANKET CONTAINED WITHIN A RECTANGULAR BOX.

SN 77-488,472, FILED 6-2-2008.

TRACY CROSS, EXAMINING ATTORNEY



David J. Kybas

Director of the United States Patent and Trademark Office

United States of America

United States Patent and Trademark Office

ULTIMATE FIGHTING CHAMPIONSHIP

Reg. No. 4,099,296

ZUFFA LLC (NEVADA LIMITED LIABILITY COMPANY)
2960 W. SAHARA AVENUE
LAS VEGAS, NV 89102

Registered Feb. 14, 2012

Int. Cl.: 41

FOR: PROVIDING HEALTH CLUB SERVICES, NAMELY, PROVIDING FITNESS AND EXERCISE FACILITIES, IN CLASS 41 (U.S. CLS. 100, 101 AND 107).

SERVICE MARK

FIRST USE 12-1-2009; IN COMMERCE 12-1-2009.

PRINCIPAL REGISTER

THE MARK CONSISTS OF STANDARD CHARACTERS WITHOUT CLAIM TO ANY PARTICULAR FONT, STYLE, SIZE, OR COLOR.

OWNER OF U.S. REG. NOS. 1,939,277, 3,052,007, AND OTHERS.

SN 77-490,897, FILED 6-4-2008.

DOMINICK J. SALEMI, EXAMINING ATTORNEY



David J. Kybas

Director of the United States Patent and Trademark Office

United States of America

United States Patent and Trademark Office

ADVANCE AUTO PARTS PROFESSIONAL PARTS SUPPLIER

Reg. No. 4,099,297

ADVANCE AUTO INNOVATIONS, LLC (VIRGINIA LIMITED LIABILITY COMPANY)
5008 AIRPORT ROAD
ROANOKE, VA 24012

Registered Feb. 14, 2012

Int. Cls.: 35 and 39

FOR: RETAIL AUTO AND VEHICLE PARTS AND ACCESSORIES STORE SERVICES FOR COMMERCIAL CUSTOMERS; ONLINE RETAIL AUTO AND VEHICLE PARTS AND ACCESSORIES STORE SERVICES FOR COMMERCIAL CUSTOMERS, IN CLASS 35 (U.S. CLS. 100, 101 AND 102).

SERVICE MARK

PRINCIPAL REGISTER

FIRST USE 9-26-2008; IN COMMERCE 9-26-2008.

FOR: EXPEDITED DELIVERY SERVICES TO CUSTOMERS IN THE FIELD OF AUTO AND VEHICLE PARTS AND ACCESSORIES, IN CLASS 39 (U.S. CLS. 100 AND 105).

FIRST USE 9-26-2008; IN COMMERCE 9-26-2008.

THE MARK CONSISTS OF STANDARD CHARACTERS WITHOUT CLAIM TO ANY PARTICULAR FONT, STYLE, SIZE, OR COLOR.

OWNER OF U.S. REG. NOS. 1,484,796, 1,847,137, AND OTHERS.

NO CLAIM IS MADE TO THE EXCLUSIVE RIGHT TO USE "AUTO PARTS" AND "PROFESSIONAL PARTS SUPPLIER", APART FROM THE MARK AS SHOWN.

SN 77-496,579, FILED 6-11-2008.

DAVID COLLIER, EXAMINING ATTORNEY



David J. Kypos

Director of the United States Patent and Trademark Office

United States of America

United States Patent and Trademark Office

KEEP SAFE

Reg. No. 4,099,298

BUNZL DISTRIBUTION USA, INC. (DELAWARE CORPORATION)
ONE CITY PLACE DRIVE, SUITE 200
ST. LOUIS, MO 63141

Registered Feb. 14, 2012

Int. Cl.: 9

FOR: PROTECTIVE WORK GLOVES, RESPIRATORY MASKS FOR NON-MEDICAL USE AND REFLECTIVE AND ILLUMINATED CLOTHING FOR SAFETY PURPOSES, IN CLASS 9 (U.S. CLS. 21, 23, 26, 36 AND 38).

TRADEMARK

FIRST USE 6-30-2010; IN COMMERCE 6-30-2010.

PRINCIPAL REGISTER

THE MARK CONSISTS OF STANDARD CHARACTERS WITHOUT CLAIM TO ANY PARTICULAR FONT, STYLE, SIZE, OR COLOR.

NO CLAIM IS MADE TO THE EXCLUSIVE RIGHT TO USE "SAFE", APART FROM THE MARK AS SHOWN.

SN 77-500,054, FILED 6-16-2008.

PAM WILLIS, EXAMINING ATTORNEY



David J. Kyffers

Director of the United States Patent and Trademark Office

United States of America

United States Patent and Trademark Office

VISALUS VI-NET

Reg. No. 4,099,299

Registered Feb. 14, 2012

Int. Cls.: 35 and 42

SERVICE MARK

PRINCIPAL REGISTER

VISALUS HOLDINGS LLC (DELAWARE LIMITED LIABILITY COMPANY)
2899 EAST BIG BEAVER ROAD
TROY, MI 48083

FOR: PROVIDING A WEBSITE WHERE USERS CAN POST RATINGS, REVIEWS AND RECOMMENDATIONS ON HEALTHY LIFESTYLE PRODUCTS AND SERVICES, DIET, HEALTH AND WELLNESS; PROVIDING ADVERTISING AND MARKETING SERVICES IN THE FIELD OF DIETARY AND NUTRITIONAL SUPPLEMENTS, SELF DEVELOPMENT, AND PRODUCTS PROMOTING HEALTHY LIFESTYLES, HEALTH AND WELLNESS, IN CLASS 35 (U.S. CLS. 100, 101 AND 102).

FIRST USE 6-0-2009; IN COMMERCE 11-17-2009.

FOR: PROVIDING A WEB-BASED SERVICE THAT ENABLES INDIVIDUALS TO MANAGE THE SALE AND DISTRIBUTION OF NUTRITIONAL PRODUCTS, VITAMINS, DIETARY AND NUTRITIONAL SUPPLEMENTS AND APPETITE SUPPRESSANTS, IN CLASS 42 (U.S. CLS. 100 AND 101).

FIRST USE 6-0-2009; IN COMMERCE 11-17-2009.

THE MARK CONSISTS OF STANDARD CHARACTERS WITHOUT CLAIM TO ANY PARTICULAR FONT, STYLE, SIZE, OR COLOR.

OWNER OF U.S. REG. NO. 3,312,137.

SN 77-501,815, FILED 6-18-2008.

INGRID C. EULIN, EXAMINING ATTORNEY



David J. Kyffers

Director of the United States Patent and Trademark Office

United States of America

United States Patent and Trademark Office



Reg. No. 4,099,300

Registered Feb. 14, 2012

Int. Cl.: 25

TRADEMARK

PRINCIPAL REGISTER

WOLVERINE WORLD WIDE, INC. (DELAWARE CORPORATION)
9341 COURTLAND DRIVE NE
ROCKFORD, MI 49351

FOR: CLOTHING, NAMELY, HATS, GLOVES AND BELTS, IN CLASS 25 (U.S. CLS. 22 AND 39).

FIRST USE 11-1-2010; IN COMMERCE 11-1-2010.

THE MARK CONSISTS OF A CLAW DESIGN.

SN 77-507,685, FILED 6-25-2008.

DANNEAN HETZEL, EXAMINING ATTORNEY



David J. Kyffers

Director of the United States Patent and Trademark Office

United States of America

United States Patent and Trademark Office

CANS: INFINITELY RECYCLABLE

Reg. No. 4,099,301

Registered Feb. 14, 2012

Int. Cls.: 6 and 35

TRADEMARK

SERVICE MARK

PRINCIPAL REGISTER

CAN MANUFACTURERS INSTITUTE, INC. (D.C. NON-PROFIT CORPORATION)
SUITE 1000
1730 RHODE ISLAND AVENUE, N.W.
WASHINGTON, DC 20036

FOR: ALUMINUM CANS; STEEL CANS, IN CLASS 6 (U.S. CLS. 2, 12, 13, 14, 23, 25 AND 50).

FIRST USE 11-4-2011; IN COMMERCE 11-4-2011.

FOR: PROVIDING INFORMATION ON SUSTAINABILITY OF STEEL AND ALUMINUM AND PRODUCTS MADE OF THESE MATERIALS, IN CLASS 35 (U.S. CLS. 100, 101 AND 102).

FIRST USE 8-0-2008; IN COMMERCE 8-0-2008.

THE MARK CONSISTS OF STANDARD CHARACTERS WITHOUT CLAIM TO ANY PARTICULAR FONT, STYLE, SIZE, OR COLOR.

NO CLAIM IS MADE TO THE EXCLUSIVE RIGHT TO USE "CANS" AND "RECYCLABLE", APART FROM THE MARK AS SHOWN.

SN 77-509,016, FILED 6-26-2008.

ANNE FARRELL, EXAMINING ATTORNEY



David J. Kybas

Director of the United States Patent and Trademark Office

United States of America

United States Patent and Trademark Office

MARKETFACTORY

Reg. No. 4,099,302

Registered Feb. 14, 2012

Int. Cl.: 9

TRADEMARK

PRINCIPAL REGISTER

MARKETFACTORY, INC. (DELAWARE CORPORATION)
425 BROADWAY, 3RD FLOOR
NEW YORK, NY 10013

FOR: COMPUTER SOFTWARE FOR COLLECTION, ANALYSIS, MODIFICATION, TRANSMISSION, STORAGE, SHARING, AND TRACKING OF DATA AND INFORMATION FOR USE IN THE FIELDS OF INVESTMENT IN FINANCIAL INSTRUMENTS, AND CURRENCY TRADING; COMPUTER SOFTWARE FOR USE IN CONNECTION WITH REAL-TIME TRADING, ORDER MANAGEMENT, AND ELECTRONIC ORDER ROUTING IN THE FIELDS OF INVESTMENT IN FINANCIAL INSTRUMENTS, AND CURRENCY TRADING, IN CLASS 9 (U.S. CLS. 21, 23, 26, 36 AND 38).

FIRST USE 8-24-2010; IN COMMERCE 8-24-2010.

THE MARK CONSISTS OF STANDARD CHARACTERS WITHOUT CLAIM TO ANY PARTICULAR FONT, STYLE, SIZE, OR COLOR.

SN 77-525,355, FILED 7-17-2008.

KELLY CHOE, EXAMINING ATTORNEY



David J. Kyjars

Director of the United States Patent and Trademark Office

United States of America

United States Patent and Trademark Office

health₂

Reg. No. 4,099,303

Registered Feb. 14, 2012

Int. Cl.: 32

TRADEMARK

PRINCIPAL REGISTER

HEALTH20 PRODUCTS, LLC (DELAWARE LIMITED LIABILITY COMPANY)
GALLERIA TOWER I
13355 NOEL ROAD, SUITE 1190
DALLAS, TX 75240

FOR: BOTTLED WATER, IN CLASS 32 (U.S. CLS. 45, 46 AND 48).

FIRST USE 10-5-2010; IN COMMERCE 10-5-2010.

OWNER OF U.S. REG. NO. 2,962,547.

THE COLOR(S) BLACK, BLUE, AND WHITE IS/ARE CLAIMED AS A FEATURE OF THE MARK.

THE MARK CONSISTS OF "HEALT" IN LOWERCASE BLACK FONT, A CAPITAL "H" IN BLUE FONT, A SUBSCRIPT "2" IN BLUE FONT, AND A SPHERE THAT IS SHADED BLUE AND WHITE, ALL IN A ROW.

SN 77-529,467, FILED 7-23-2008.

MAYUR VAGHANI, EXAMINING ATTORNEY



David J. Kyffers

Director of the United States Patent and Trademark Office

United States of America

United States Patent and Trademark Office

BLUESCAPE RESOURCES

Reg. No. 4,099,304

Registered Feb. 14, 2012

Int. Cl.: 35

SERVICE MARK

PRINCIPAL REGISTER

BLUESCAPE CAPITAL GROUP LLC (DELAWARE LIMITED LIABILITY COMPANY)
SUITE 200
200 CRESCENT COURT
DALLAS, TX 75201

FOR: BUSINESS MANAGEMENT SERVICES RELATING TO THE FIELD OF EXPLORATION, DRILLING, MINING, DEVELOPMENT, PRODUCTION, GATHERING, PROCESSING, REFINING, TRANSPORTATION, MARKETING, TRADING AND DISTRIBUTION OF OIL, GAS, COAL, ETHANOL AND OTHER FUELS OR NATURAL RESOURCES, IN CLASS 35 (U.S. CLS. 100, 101 AND 102).

FIRST USE 7-3-2008; IN COMMERCE 7-3-2008.

THE MARK CONSISTS OF STANDARD CHARACTERS WITHOUT CLAIM TO ANY PARTICULAR FONT, STYLE, SIZE, OR COLOR.

NO CLAIM IS MADE TO THE EXCLUSIVE RIGHT TO USE "RESOURCES", APART FROM THE MARK AS SHOWN.

SN 77-531,840, FILED 7-25-2008.

MARTHA SANTOMARTINO, EXAMINING ATTORNEY



David J. Kybas

Director of the United States Patent and Trademark Office

United States of America

United States Patent and Trademark Office

MARKETFACTORY SHERPA

Reg. No. 4,099,305

MARKETFACTORY, INC. (DELAWARE CORPORATION)
425 BROADWAY, 3RD FLOOR
NEW YORK, NY 10013

Registered Feb. 14, 2012

Int. Cl.: 9

FOR: COMPUTER SOFTWARE FOR USE IN CONNECTION WITH REAL-TIME TRADING, ORDER MANAGEMENT, AND ELECTRONIC ORDER ROUTING IN THE FIELDS OF INVESTMENT IN FINANCIAL INSTRUMENTS, AND CURRENCY TRADING, IN CLASS 9 (U.S. CLS. 21, 23, 26, 36 AND 38).

TRADEMARK

PRINCIPAL REGISTER

FIRST USE 8-24-2010; IN COMMERCE 8-24-2010.

THE MARK CONSISTS OF STANDARD CHARACTERS WITHOUT CLAIM TO ANY PARTICULAR FONT, STYLE, SIZE, OR COLOR.

SN 77-535,421, FILED 7-30-2008.

KELLY CHOE, EXAMINING ATTORNEY



David J. Kybas

Director of the United States Patent and Trademark Office

United States of America
United States Patent and Trademark Office

WHISPERER

Reg. No. 4,099,306

MARKETFACTORY, INC. (DELAWARE CORPORATION)
425 BROADWAY, 3RD FLOOR
NEW YORK, NY 10013

Registered Feb. 14, 2012

Int. Cl.: 9

FOR: COMPUTER SOFTWARE FOR COLLECTION, ANALYSIS, MODIFICATION, TRANSMISSION, STORAGE, SHARING, AND TRACKING OF DATA AND INFORMATION FOR USE IN THE FIELDS OF INVESTMENT IN FINANCIAL INSTRUMENTS, AND CURRENCY TRADING, IN CLASS 9 (U.S. CLS. 21, 23, 26, 36 AND 38).

TRADEMARK

PRINCIPAL REGISTER

FIRST USE 8-24-2010; IN COMMERCE 8-24-2010.

THE MARK CONSISTS OF STANDARD CHARACTERS WITHOUT CLAIM TO ANY PARTICULAR FONT, STYLE, SIZE, OR COLOR.

SN 77-535,425, FILED 7-30-2008.

KELLY CHOE, EXAMINING ATTORNEY



David J. Kyjars

Director of the United States Patent and Trademark Office

United States of America
United States Patent and Trademark Office

AQUA NET

Reg. No. 4,099,307

LORNAMEAD, INC. (DELAWARE CORPORATION)
175 COOPER AVENUE
TONAWANDA, NY 14150

Registered Feb. 14, 2012

Int. Cl.: 3

FOR: STYLING GELS FOR THE HAIR, IN CLASS 3 (U.S. CLS. 1, 4, 6, 50, 51 AND 52).

TRADEMARK

FIRST USE 12-1-2009; IN COMMERCE 12-1-2009.

PRINCIPAL REGISTER

THE MARK CONSISTS OF STANDARD CHARACTERS WITHOUT CLAIM TO ANY PARTICULAR FONT, STYLE, SIZE, OR COLOR.

OWNER OF U.S. REG. NO. 857,632.

SN 77-539,026, FILED 8-5-2008.

ANTHONY RINKER, EXAMINING ATTORNEY



David J. Kyffers

Director of the United States Patent and Trademark Office

United States of America

United States Patent and Trademark Office

SHARED SHELF

Reg. No. 4,099,308

Registered Feb. 14, 2012

Int. Cls.: 9 and 42

TRADEMARK

SERVICE MARK

PRINCIPAL REGISTER

ARTSTOR INC. (DELAWARE NON-PROFIT CORPORATION)
151 EAST 61ST STREET
NEW YORK, NY 10065

FOR: COMPUTER SOFTWARE PLATFORMS WHICH ALLOW SUBSCRIBERS TO STORE, MAINTAIN, ACCESS, DISPLAY AND SHARE WITH OTHER SUBSCRIBERS THEIR OWN CONTENT AND IMAGES, IN CLASS 9 (U.S. CLS. 21, 23, 26, 36 AND 38).

FIRST USE 7-0-2010; IN COMMERCE 10-25-2010.

FOR: COMPUTER SERVICES, NAMELY, INTERACTIVE HOSTING SERVICES WHICH ALLOW SUBSCRIBERS TO STORE, MAINTAIN, ACCESS, DISPLAY AND SHARE WITH OTHER SUBSCRIBERS THEIR OWN CONTENT AND IMAGES ON-LINE, IN CLASS 42 (U.S. CLS. 100 AND 101).

FIRST USE 7-0-2010; IN COMMERCE 10-25-2010.

THE MARK CONSISTS OF STANDARD CHARACTERS WITHOUT CLAIM TO ANY PARTICULAR FONT, STYLE, SIZE, OR COLOR.

NO CLAIM IS MADE TO THE EXCLUSIVE RIGHT TO USE "SHARED", APART FROM THE MARK AS SHOWN.

SN 77-539,675, FILED 8-5-2008.

SALLY SHIH, EXAMINING ATTORNEY



David J. Kyros

Director of the United States Patent and Trademark Office

United States of America

United States Patent and Trademark Office

RapidArc

Reg. No. 4,099,309

LINCOLN GLOBAL, INC. (DELAWARE CORPORATION)
17721 RAILROAD STREET
CITY OF INDUSTRY, CA 91748

Registered Feb. 14, 2012

Int. Cl.: 7

FOR: ELECTRIC ARC WELDING MACHINES, IN CLASS 7 (U.S. CLS. 13, 19, 21, 23, 31, 34 AND 35).

TRADEMARK

FIRST USE 8-5-2008; IN COMMERCE 8-5-2008.

PRINCIPAL REGISTER

THE MARK CONSISTS OF STANDARD CHARACTERS WITHOUT CLAIM TO ANY PARTICULAR FONT, STYLE, SIZE, OR COLOR.

OWNER OF U.S. REG. NO. 2,958,152.

SN 77-539,775, FILED 8-5-2008.

CAROL SPILS, EXAMINING ATTORNEY



David J. Kyfos

Director of the United States Patent and Trademark Office

United States of America

United States Patent and Trademark Office

LONGEV-A-TEA

Reg. No. 4,099,310

Registered Feb. 14, 2012

Int. Cl.: 5

TRADEMARK

PRINCIPAL REGISTER

ARLEN, MICHAEL W. (UNITED STATES INDIVIDUAL), DBA ARLEN NUTRACEUTICALS,
SUITE 200
11400 W. OLYMPIC BLVD.
LOS ANGELES, CA 900641557

FOR: POWDERED MIX FOR A VITAMIN FORTIFIED BEVERAGE, IN CLASS 5 (U.S. CLS.
6, 18, 44, 46, 51 AND 52).

FIRST USE 11-30-2011; IN COMMERCE 11-30-2011.

THE MARK CONSISTS OF STANDARD CHARACTERS WITHOUT CLAIM TO ANY PAR-
TICULAR FONT, STYLE, SIZE, OR COLOR.

SN 77-540,968, FILED 8-6-2008.

HEATHER BIDDULPH, EXAMINING ATTORNEY



David J. Kybas

Director of the United States Patent and Trademark Office

United States of America

United States Patent and Trademark Office

2 UNDER

Reg. No. 4,099,311

Registered Feb. 14, 2012

Int. Cl.: 25

TRADEMARK

PRINCIPAL REGISTER

PEI LICENSING, INC. (DELAWARE CORPORATION)
LEGAL DEPT
3000 MW 107TH AVENUE
MIAMI, FL 33172

FOR: MEN'S AND WOMEN'S CLOTHING, NAMELY, SHIRTS, SHORTS, PANTS, FLEECE VESTS, FLEECE SHIRTS, SWEATERS AND JACKETS, IN CLASS 25 (U.S. CLS. 22 AND 39).

FIRST USE 11-23-2011; IN COMMERCE 11-23-2011.

THE MARK CONSISTS OF STANDARD CHARACTERS WITHOUT CLAIM TO ANY PARTICULAR FONT, STYLE, SIZE, OR COLOR.

SN 77-542,586, FILED 8-8-2008.

KELLY CHOE, EXAMINING ATTORNEY



David J. Kyffers

Director of the United States Patent and Trademark Office

United States of America

United States Patent and Trademark Office

LITTLE MIKEY'S

Reg. No. 4,099,312

MICHAEL DOUGLAS (UNITED STATES INDIVIDUAL)
27 MAXWELL ROAD
EATONTOWN, NY 07724

Registered Feb. 14, 2012

Int. Cl.: 25

FOR: APPAREL, NAMELY, SHOES, SHIRTS, CAPS AND PANTS, IN CLASS 25 (U.S. CLS. 22 AND 39).

TRADEMARK

FIRST USE 12-16-2011; IN COMMERCE 12-16-2011.

PRINCIPAL REGISTER

THE MARK CONSISTS OF STANDARD CHARACTERS WITHOUT CLAIM TO ANY PARTICULAR FONT, STYLE, SIZE, OR COLOR.

SN 77-543,424, FILED 8-11-2008.

REBECCA EISINGER, EXAMINING ATTORNEY



David J. Kyffers

Director of the United States Patent and Trademark Office

United States of America

United States Patent and Trademark Office

TutorMing  明言网

Reg. No. 4,099,313

Registered Feb. 14, 2012

Int. Cl.: 41

SERVICE MARK

PRINCIPAL REGISTER

MUCHTALK, INC. (TAIWAN CORPORATION)
SOUTH DISTRICT
42F., NO. 758, JHONGMING S. RD.
TAICHUNG CITY 402, TAIWAN R.O.C.

FOR: ARRANGING OF SEMINARS; ART EXHIBITIONS; EDUCATIONAL SERVICES, NAMELY, DEVELOPING, ARRANGING, AND CONDUCTING EDUCATIONAL CONFERENCES AND PROGRAMS AND PROVIDING COURSES OF INSTRUCTION IN THE FIELD OF LANGUAGE; LANGUAGE INTERPRETATION; PRODUCTION OF VIDEO DISCS AND TAPES; PUBLICATION OF BOOKS; TRANSLATION, IN CLASS 41 (U.S. CLS. 100, 101 AND 107).

FIRST USE 5-22-2008; IN COMMERCE 5-22-2008.

NO CLAIM IS MADE TO THE EXCLUSIVE RIGHT TO USE THE NON-LATIN CHARACTERS THAT MEAN "UNDERSTANDING LANGUAGE WEB", APART FROM THE MARK AS SHOWN.

THE NON-LATIN CHARACTER(S) IN THE MARK TRANSLITERATE INTO "MING-YEN-WON", AND THIS MEANS "UNDERSTANDING LANGUAGE WEB" IN ENGLISH. THE NON-LATIN CHARACTERS WITHIN THE SHADED CIRCLE REPRESENT "SUN" AND "MOON", AND AS A WHOLE TRANSLITERATE INTO "MING", AND THIS MEANS "UNDERSTANDING" IN ENGLISH.

THE MARK CONSISTS OF THE WORD "TUTORMING" WITH THE LETTER "M" HAVING INNER SHADING, FOLLOWED BY A CHINESE SEAL CONSISTING OF A DESIGN OF A SHADED CIRCLE CONTAINING A CRESCENT SHAPE WITH A MIDDLE HORIZONTAL LINE AND A LETTER "D" WITH AN INTERIOR VERTICAL LINE, FOLLOWED BY THREE CHINESE CHARACTERS.

SN 77-545,877, FILED 8-13-2008.

MICHELLE DUBOIS, EXAMINING ATTORNEY



David J. Kyjars

Director of the United States Patent and Trademark Office

United States of America

United States Patent and Trademark Office

SUNGODDESS

Reg. No. 4,099,314

Registered Feb. 14, 2012

Int. Cl.: 5

TRADEMARK

PRINCIPAL REGISTER

SUNGODDESS (FLORIDA LIMITED LIABILITY COMPANY)
4737 N. OCEAN DRIVE
#216
LAUDERDALE BY THE SEA, FL 33308

FOR: DIETARY AND NUTRITIONAL SUPPLEMENTS; DIETARY BEVERAGE SUPPLEMENTS FOR HUMAN CONSUMPTION IN LIQUID AND DRY MIX FORM FOR THERAPEUTIC PURPOSES; DIETARY FOOD SUPPLEMENTS; DIETARY SUPPLEMENTS; DIETARY SUPPLEMENTS FOR HUMAN CONSUMPTION; FOOD SUPPLEMENTS; FOOD SUPPLEMENTS, NAMELY, ANTI-OXIDANTS; HERBAL SUPPLEMENTS; LIQUID NUTRITIONAL SUPPLEMENT; MEAL REPLACEMENT AND DIETARY SUPPLEMENT DRINK MIXES; MINERAL FOOD SUPPLEMENTS; MINERAL NUTRITIONAL SUPPLEMENTS; MINERAL SUPPLEMENTS; NATURAL HERBAL SUPPLEMENTS; NUTRITIONAL SUPPLEMENTS; VITAMIN AND MINERAL SUPPLEMENTS; VITAMIN SUPPLEMENTS, IN CLASS 5 (U.S. CLS. 6, 18, 44, 46, 51 AND 52).

FIRST USE 6-27-2011; IN COMMERCE 6-27-2011.

THE MARK CONSISTS OF STANDARD CHARACTERS WITHOUT CLAIM TO ANY PARTICULAR FONT, STYLE, SIZE, OR COLOR.

SN 77-546,069, FILED 8-13-2008.

LAURIE MAYES, EXAMINING ATTORNEY



David J. Kyros

Director of the United States Patent and Trademark Office

United States of America

United States Patent and Trademark Office



Reg. No. 4,099,315

Registered Feb. 14, 2012

Int. Cl.: 42

SERVICE MARK

PRINCIPAL REGISTER

ACR ELECTRONICS, INC. (FLORIDA CORPORATION)
5757 RAVENSWOOD DRIVE
FORT LAUDERDALE, FL 33312

FOR: SUBSCRIPTION BASED SERVICES PROVIDED OVER A GLOBAL COMPUTER NETWORK, NAMELY, PROVIDING A WEBSITE FEATURING TEMPORARY USE OF NON-DOWNLOADABLE SOFTWARE FOR TRACKING THE LOCATION OF A WIRELESS COMMUNICATION DEVICE, WHERE THE LOCATION OF THE WIRELESS COMMUNICATION DEVICE IS INDICATED ON A MAP DISPLAYED ON A WEB PAGE, AND FOR PROVIDING ASSISTANCE TO A USER OF THE WIRELESS DEVICE BASED ON REQUESTS COMMUNICATED BY THE USER TO THE SERVICE PROVIDER; SUBSCRIPTION BASED SERVICES PROVIDED OVER A WIRELESS COMMUNICATION SYSTEM, NAMELY, PROVIDING TEMPORARY USE OF NON-DOWNLOADABLE SOFTWARE FOR DETERMINING THE LOCATION OF A MOBILE ASSET USING A TEXT MESSAGE ENABLED WIRELESS COMMUNICATION DEVICE, AND FOR CONTROLLING FUNCTIONS OF THE MOBILE ASSET USING THE TEXT MESSAGE ENABLED WIRELESS COMMUNICATION DEVICE, IN CLASS 42 (U.S. CLS. 100 AND 101).

FIRST USE 3-30-2009; IN COMMERCE 3-30-2009.

THE MARK CONSISTS OF A CROSS AND CIRCLE DESIGN COMPRISING A CROSS ON A CIRCULAR BACKGROUND, THE CIRCULAR BACKGROUND HAVING FOUR NOTCHES SEPARATED BY 90 DEGREES ALONG ITS OUTER EDGE, THE CIRCULAR BACKGROUND SURROUNDED BY A CIRCULAR RING FORMED BY FOUR CIRCULAR SEGMENTS, AND THE WORD "SAFELIFE" IN A STYLIZED FONT POSITIONED NEXT TO THE CROSS AND CIRCLE DESIGN, AND THE WORDS "LIVE BY IT" IN A SMALLER STYLIZED FONT POSITIONED BELOW THE WORD "SAFELIFE".

SN 77-547,233, FILED 8-14-2008.

ANGELA DUONG, EXAMINING ATTORNEY



David J. Kybas

Director of the United States Patent and Trademark Office

United States of America

United States Patent and Trademark Office



Reg. No. 4,099,316

Registered Feb. 14, 2012

Int. Cl.: 45

SERVICE MARK

PRINCIPAL REGISTER

ACR ELECTRONICS, INC. (FLORIDA CORPORATION)
5757 RAVENSWOOD DRIVE
FORT LAUDERDALE, FL 33312

FOR: EMERGENCY MONITORING SERVICES, NAMELY, RECEIVING AND RESPONDING TO ALERT TRANSMISSIONS FROM EMERGENCY LOCATOR BEACON DEVICES, AND RECEIVING CALLS FROM WIRELESS COMMUNICATION DEVICES USED IN EMERGENCY SITUATIONS, AND CONTACTING EMERGENCY PERSONNEL; SECURITY SYSTEM MONITORING; ALARM SYSTEM MONITORING, IN CLASS 45 (U.S. CLS. 100 AND 101).

FIRST USE 3-30-2009; IN COMMERCE 3-30-2009.

THE MARK CONSISTS OF A CROSS AND CIRCLE DESIGN COMPRISING A CROSS ON A CIRCULAR BACKGROUND, THE CIRCULAR BACKGROUND HAVING FOUR NOTCHES SEPARATED BY 90 DEGREES ALONG ITS OUTER EDGE, THE CIRCULAR BACKGROUND SURROUNDED BY A CIRCULAR RING FORMED BY FOUR CIRCULAR SEGMENTS, AND THE WORD "SAFELIFE" IN A STYLIZED FONT POSITIONED NEXT TO THE CROSS AND CIRCLE DESIGN, AND THE WORDS "LIVE BY IT" IN A SMALLER STYLIZED FONT POSITIONED BELOW THE WORD "SAFELIFE"

SN 77-547,258, FILED 8-14-2008.

ANGELA DUONG, EXAMINING ATTORNEY



David J. Kyjars

Director of the United States Patent and Trademark Office

United States of America

United States Patent and Trademark Office

NMMLS

Reg. No. 4,099,317

Registered Feb. 14, 2012

**Int. Cls.: 35, 36, 41, and
45**

SERVICE MARK

PRINCIPAL REGISTER

STATE REGULATORY REGISTRY LLC (D.C. LIMITED LIABILITY COMPANY)
SUITE 500
1155 CONNECTICUT AVENUE, N.W.
WASHINGTON, DC 20036

FOR: ASSOCIATION SERVICES, NAMELY, PROMOTING THE INTERESTS OF FINANCIAL SERVICES COMPANIES AND PROFESSIONALS AND THEIR STATE AND FEDERAL GOVERNMENT REGULATORS; ASSOCIATION SERVICES, NAMELY, PROMOTING THE INTERESTS OF MORTGAGE INDUSTRY COMPANIES AND PROFESSIONALS AND THEIR STATE AND FEDERAL GOVERNMENT REGULATORS; PROVIDING FOR OTHERS AN ONLINE COMPUTER DATABASE OF BUSINESS INFORMATION REGARDING FINANCIAL SERVICES COMPANIES AND PROFESSIONALS AND THEIR PROFESSIONAL BACKGROUND, BUSINESS PRACTICES, CONDUCT, EMPLOYMENT, AND DISCIPLINARY STATUS; PROVIDING FOR OTHERS AN ONLINE COMPUTER DATABASE OF BUSINESS INFORMATION REGARDING MORTGAGE INDUSTRY COMPANIES AND PROFESSIONALS AND THEIR PROFESSIONAL BACKGROUND, BUSINESS PRACTICES, CONDUCT, EMPLOYMENT, AND DISCIPLINARY STATUS; PROVIDING FOR OTHERS BUSINESS INFORMATION REGARDING FINANCIAL SERVICES COMPANIES AND PROFESSIONALS AND THEIR PROFESSIONAL BACKGROUND, BUSINESS PRACTICES, CONDUCT, EMPLOYMENT, AND DISCIPLINARY STATUS IN RESPONSE TO TELEPHONE AND E-MAIL INQUIRIES; PROVIDING FOR OTHERS BUSINESS INFORMATION REGARDING MORTGAGE INDUSTRY COMPANIES AND PROFESSIONALS AND THEIR PROFESSIONAL BACKGROUND, BUSINESS PRACTICES, CONDUCT, EMPLOYMENT, AND DISCIPLINARY STATUS IN RESPONSE TO TELEPHONE AND E-MAIL INQUIRIES; PROVIDING BUSINESS ADVISORY SERVICES CONCERNING THE REGULATION OF THE FINANCIAL SERVICES INDUSTRY, NAMELY, CREATING PROPOSED RULES AND RULE CHANGES FOR OTHERS IN THE FINANCIAL SERVICES INDUSTRY TO INCREASE TRANSPARENCY; PROVIDING BUSINESS ADVISORY SERVICES CONCERNING THE REGULATION OF THE MORTGAGE INDUSTRY, NAMELY, CREATING PROPOSED RULES AND RULE CHANGES FOR OTHERS IN THE MORTGAGE INDUSTRY TO INCREASE TRANSPARENCY; PROVIDING BUSINESS ADVISORY SERVICES CONCERNING THE REGULATION OF THE FINANCIAL SERVICES INDUSTRY, NAMELY, CREATING PROPOSED RULES AND RULE CHANGES FOR STATES THAT GOVERN THE CONDUCT OF COMPANIES AND PROFESSIONALS IN THE FINANCIAL SERVICES INDUSTRY; PROVIDING BUSINESS ADVISORY SERVICES CONCERNING THE REGULATION OF THE MORTGAGE INDUSTRY, NAMELY, CREATING PROPOSED RULES AND RULE CHANGES FOR STATES THAT GOVERN THE CONDUCT OF COMPANIES AND PROFESSIONALS IN THE MORTGAGE INDUSTRY; TESTING AND EXAMINA-



David J. Kyjars

Director of the United States Patent and Trademark Office

Reg. No. 4,099,317 TION TO DETERMINE THE PROFESSIONAL COMPETENCY OF COMPANIES AND PROFESSIONALS IN THE FINANCIAL SERVICES INDUSTRY AND STATE AND FEDERAL GOVERNMENT REGULATORS OF THE FINANCIAL SERVICES INDUSTRY; TESTING AND EXAMINATION TO DETERMINE THE PROFESSIONAL COMPETENCY OF COMPANIES AND PROFESSIONALS IN THE MORTGAGE INDUSTRY AND STATE AND FEDERAL GOVERNMENT REGULATORS OF THE MORTGAGE INDUSTRY; DATA MANAGEMENT SERVICES, NAMELY, COLLECTION, AGGREGATION, AND REPORTING OF FINANCIAL SERVICES INDUSTRY DATA; DATA MANAGEMENT SERVICES, NAMELY, COLLECTION, AGGREGATION, AND REPORTING OF MORTGAGE INDUSTRY DATA; PROVIDING SERVICES TO THE FINANCIAL SERVICES INDUSTRY AND TO STATE AND FEDERAL GOVERNMENT REGULATORS OF THE FINANCIAL SERVICES INDUSTRY, NAMELY, PROVIDING AN ONLINE WEBSITE FOR STATE-REGULATED FINANCIAL SERVICES COMPANIES AND PROFESSIONALS TO APPLY FOR, AMEND, RENEW, AND SURRENDER LICENSES VIA THE INTERNET; PROVIDING SERVICES TO THE MORTGAGE INDUSTRY AND TO STATE AND FEDERAL GOVERNMENT REGULATORS OF THE MORTGAGE INDUSTRY, NAMELY, PROVIDING AN ONLINE WEBSITE FOR STATE-REGULATED MORTGAGE INDUSTRY COMPANIES AND PROFESSIONALS TO APPLY FOR, AMEND, RENEW, AND SURRENDER LICENSES VIA THE INTERNET; PROVIDING AN ONLINE COMPUTER DATABASE OF INFORMATION IN THE FIELDS OF FINANCIAL SERVICES INDUSTRY BUSINESS MANAGEMENT AND BUSINESS OPERATIONS; PROVIDING AN ONLINE COMPUTER DATABASE OF INFORMATION IN THE FIELDS OF MORTGAGE INDUSTRY BUSINESS MANAGEMENT AND BUSINESS OPERATIONS, IN CLASS 35 (U.S. CLS. 100, 101 AND 102).

FIRST USE 1-0-2008; IN COMMERCE 1-0-2008.

FOR: PROVIDING GRANTS AND FUNDING FOR RESEARCH, PROJECTS, FELLOWSHIPS, SEMINARS, SYMPOSIUMS, ROUNDTABLES, AND CLASSES, ALL IN THE FIELDS OF FINANCIAL SERVICES INDUSTRY REGULATIONS, COMPLIANCE, MANAGEMENT, AND OPERATIONS; PROVIDING GRANTS AND FUNDING FOR RESEARCH, PROJECTS, FELLOWSHIPS, SEMINARS, SYMPOSIUMS, ROUNDTABLES, AND CLASSES, ALL IN THE FIELDS OF MORTGAGE INDUSTRY REGULATIONS, COMPLIANCE, MANAGEMENT, AND OPERATIONS; PROVIDING FOR OTHERS AN ONLINE COMPUTER DATABASE OF FINANCIAL INFORMATION REGARDING FINANCIAL SERVICES COMPANIES AND PROFESSIONALS; PROVIDING FOR OTHERS AN ONLINE COMPUTER DATABASE OF FINANCIAL INFORMATION REGARDING MORTGAGE INDUSTRY COMPANIES AND PROFESSIONALS; PROVIDING FOR OTHERS FINANCIAL INFORMATION REGARDING FINANCIAL SERVICES COMPANIES AND PROFESSIONALS IN RESPONSE TO TELEPHONE AND E-MAIL INQUIRIES; PROVIDING FOR OTHERS FINANCIAL INFORMATION REGARDING MORTGAGE INDUSTRY COMPANIES AND PROFESSIONALS IN RESPONSE TO TELEPHONE AND E-MAIL INQUIRIES, IN CLASS 36 (U.S. CLS. 100, 101 AND 102).

FIRST USE 8-0-2011; IN COMMERCE 8-0-2011.

FOR: EDUCATIONAL SERVICES, NAMELY, CONDUCTING MEETINGS, SEMINARS, CONFERENCES, CLASSES, AND WORKSHOPS IN THE FIELDS OF FINANCIAL SERVICES INDUSTRY REGULATIONS, COMPLIANCE, MANAGEMENT, AND OPERATIONS, AND PROVIDING CONTINUING EDUCATION PROGRAMS FOR FINANCIAL SERVICES INDUSTRY COMPANIES AND PROFESSIONALS AND STATE AND FEDERAL GOVERNMENT REGULATORS OF THE FINANCIAL SERVICES INDUSTRY; EDUCATIONAL SERVICES, NAMELY, CONDUCTING MEETINGS, SEMINARS, CONFERENCES, CLASSES, AND WORKSHOPS IN THE FIELDS OF MORTGAGE INDUSTRY REGULATIONS, COMPLIANCE, MANAGEMENT, AND OPERATIONS, AND PROVIDING CONTINUING EDUCATION PROGRAMS FOR MORTGAGE INDUSTRY COMPANIES AND PROFESSIONALS AND STATE AND FEDERAL GOVERNMENT REGULATORS OF THE MORTGAGE INDUSTRY, IN CLASS 41 (U.S. CLS. 100, 101 AND 107).

FIRST USE 7-0-2007; IN COMMERCE 7-0-2007.

Reg. No. 4,099,317 FOR: PROVIDING AN ONLINE COMPUTER DATABASE OF INFORMATION IN THE FIELDS OF FINANCIAL SERVICES INDUSTRY REGULATIONS AND REGULATORY COMPLIANCE; PROVIDING AN ONLINE COMPUTER DATABASE OF INFORMATION IN THE FIELDS OF MORTGAGE INDUSTRY REGULATIONS AND REGULATORY COMPLIANCE, IN CLASS 45 (U.S. CLS. 100 AND 101).

FIRST USE 7-0-2007; IN COMMERCE 7-0-2007.

THE MARK CONSISTS OF STANDARD CHARACTERS WITHOUT CLAIM TO ANY PARTICULAR FONT, STYLE, SIZE, OR COLOR.

SN 77-547,965, FILED 8-15-2008.

BRIAN CALLAGHAN, EXAMINING ATTORNEY

United States of America

United States Patent and Trademark Office

RAIN 4 RENT

Reg. No. 4,099,318

WESTERN OILFIELDS SUPPLY COMPANY (DELAWARE CORPORATION)

Registered Feb. 14, 2012

3404 STATE ROAD
BAKERSFIELD, CA 93308

Int. Cls.: 6, 7, 37, 40, and 44

FOR: IRRIGATION, LIQUID FILTRATION, LIQUID MONITORING AND LIQUID HANDLING EQUIPMENT, NAMELY, METAL PIPES, AND METAL PIPE FITTINGS, IN CLASS 6 (U.S. CLS. 2, 12, 13, 14, 23, 25 AND 50).

TRADEMARK

FIRST USE 12-14-2010; IN COMMERCE 12-14-2010.

SERVICE MARK

FOR: CENTRIFUGAL AND POSITIVE DISPLACEMENT PUMPS FOR USE WITH IRRIGATION, FILTRATION, MONITORING AND LIQUID HANDLING EQUIPMENT, IN CLASS 7 (U.S. CLS. 13, 19, 21, 23, 31, 34 AND 35).

PRINCIPAL REGISTER

FIRST USE 12-22-2010; IN COMMERCE 12-22-2010.

FOR: REPAIR OF IRRIGATION, FILTRATION AND LIQUID HANDLING MACHINERY; RENTAL OF CONSTRUCTION EQUIPMENT IN THE NATURE OF PUMP SOUND BUFFER ENCLOSURES, IN CLASS 37 (U.S. CLS. 100, 103 AND 106).

FIRST USE 12-6-2011; IN COMMERCE 12-6-2011.

FOR: RENTAL OF WATER TREATMENT EQUIPMENT, NAMELY, PIPE, PUMPS, STORAGE AND TREATMENT TANKS, FILTER BOXES, SAND MEDIA, PARTICULATE AND BAG FILTERS, PIPE FITTINGS AND SPILLAGE AND SPRAY CONTAINMENT BARRIERS, RENTED AS SEPARATE COMPONENTS FOR USE IN WATER TREATMENT SYSTEMS, IN CLASS 40 (U.S. CLS. 100, 103 AND 106).

FIRST USE 12-6-2011; IN COMMERCE 12-6-2011.

FOR: RENTAL OF IRRIGATION EQUIPMENT, NAMELY, PIPE, PUMPS AND PIPE FITTINGS RENTED AS SEPARATE COMPONENTS FOR USE IN IRRIGATION SYSTEMS, IN CLASS 44 (U.S. CLS. 100 AND 101).

FIRST USE 12-6-2011; IN COMMERCE 12-6-2011.



David J. Kyros

Director of the United States Patent and Trademark Office

Reg. No. 4,099,318 THE MARK CONSISTS OF STANDARD CHARACTERS WITHOUT CLAIM TO ANY PARTICULAR FONT, STYLE, SIZE, OR COLOR.

OWNER OF U.S. REG. NOS. 886,177 AND 895,703.

SN 77-548,447, FILED 8-15-2008.

KELLY CHOE, EXAMINING ATTORNEY

United States of America

United States Patent and Trademark Office

R4R

Reg. No. 4,099,319

WESTERN OILFIELDS SUPPLY COMPANY (DELAWARE CORPORATION)

Registered Feb. 14, 2012

3404 STATE ROAD
BAKERSFIELD, CA 93308

Int. Cls.: 6, 7, 37, 40, and 44

FOR: IRRIGATION, LIQUID FILTRATION, LIQUID MONITORING AND LIQUID HANDLING EQUIPMENT, NAMELY, METAL PIPES, AND METAL PIPE FITTINGS, IN CLASS 6 (U.S. CLS. 2, 12, 13, 14, 23, 25 AND 50).

TRADEMARK

FIRST USE 12-14-2010; IN COMMERCE 12-14-2010.

SERVICE MARK

FOR: CENTRIFUGAL AND POSITIVE DISPLACEMENT PUMPS FOR USE WITH IRRIGATION, FILTRATION, MONITORING AND LIQUID HANDLING EQUIPMENT, IN CLASS 7 (U.S. CLS. 13, 19, 21, 23, 31, 34 AND 35).

PRINCIPAL REGISTER

FIRST USE 12-22-2010; IN COMMERCE 12-22-2010.

FOR: REPAIR OF IRRIGATION, FILTRATION AND LIQUID HANDLING MACHINERY; RENTAL OF CONSTRUCTION EQUIPMENT IN THE NATURE OF PUMP SOUND BUFFER ENCLOSURES, IN CLASS 37 (U.S. CLS. 100, 103 AND 106).

FIRST USE 12-6-2011; IN COMMERCE 12-6-2011.

FOR: RENTAL OF WATER TREATMENT EQUIPMENT, NAMELY, PIPE, PUMPS, STORAGE AND TREATMENT TANKS, FILTER BOXES, SAND MEDIA, PARTICULATE AND BAG FILTERS, PIPE FITTINGS AND SPILLAGE AND SPRAY CONTAINMENT BARRIERS, RENTED AS SEPARATE COMPONENTS FOR USE IN WATER TREATMENT SYSTEMS, IN CLASS 40 (U.S. CLS. 100, 103 AND 106).

FIRST USE 12-6-2011; IN COMMERCE 12-6-2011.

FOR: RENTAL OF IRRIGATION EQUIPMENT, NAMELY, PIPE, PUMPS AND PIPE FITTINGS RENTED AS SEPARATE COMPONENTS FOR USE IN IRRIGATION SYSTEMS, IN CLASS 44 (U.S. CLS. 100 AND 101).

FIRST USE 12-6-2011; IN COMMERCE 12-6-2011.



David J. Kyros

Director of the United States Patent and Trademark Office

Reg. No. 4,099,319 THE MARK CONSISTS OF STANDARD CHARACTERS WITHOUT CLAIM TO ANY PARTICULAR FONT, STYLE, SIZE, OR COLOR.

SN 77-548,515, FILED 8-15-2008.

KELLY CHOE, EXAMINING ATTORNEY

United States of America

United States Patent and Trademark Office

RFR

Reg. No. 4,099,320

WESTERN OILFIELDS SUPPLY COMPANY (DELAWARE CORPORATION)

Registered Feb. 14, 2012

3404 STATE ROAD
BAKERSFIELD, CA 93308

Int. Cls.: 6, 7, 37, 40, and 44

FOR: IRRIGATION, LIQUID FILTRATION, LIQUID MONITORING AND LIQUID HANDLING EQUIPMENT, NAMELY, METAL PIPES, AND METAL PIPE FITTINGS, IN CLASS 6 (U.S. CLS. 2, 12, 13, 14, 23, 25 AND 50).

TRADEMARK

FIRST USE 12-14-2010; IN COMMERCE 12-14-2010.

SERVICE MARK

FOR: CENTRIFUGAL AND POSITIVE DISPLACEMENT PUMPS FOR USE WITH IRRIGATION, FILTRATION, MONITORING AND LIQUID HANDLING EQUIPMENT, IN CLASS 7 (U.S. CLS. 13, 19, 21, 23, 31, 34 AND 35).

PRINCIPAL REGISTER

FIRST USE 12-22-2010; IN COMMERCE 12-22-2010.

FOR: REPAIR OF IRRIGATION, FILTRATION AND LIQUID HANDLING MACHINERY; RENTAL OF CONSTRUCTION EQUIPMENT IN THE NATURE OF PUMP SOUND BUFFER ENCLOSURES, IN CLASS 37 (U.S. CLS. 100, 103 AND 106).

FIRST USE 12-6-2011; IN COMMERCE 12-6-2011.

FOR: RENTAL OF WATER TREATMENT EQUIPMENT, NAMELY, PIPE, PUMPS, STORAGE AND TREATMENT TANKS, FILTER BOXES, SAND MEDIA, PARTICULATE AND BAG FILTERS, PIPE FITTINGS AND SPILLAGE AND SPRAY CONTAINMENT BARRIERS, RENTED AS SEPARATE COMPONENTS FOR USE IN WATER TREATMENT SYSTEMS, IN CLASS 40 (U.S. CLS. 100, 103 AND 106).

FIRST USE 12-6-2011; IN COMMERCE 12-6-2011.

FOR: RENTAL OF IRRIGATION EQUIPMENT, NAMELY, PIPE, PUMPS AND PIPE FITTINGS RENTED AS SEPARATE COMPONENTS FOR USE IN IRRIGATION SYSTEMS, IN CLASS 44 (U.S. CLS. 100 AND 101).

FIRST USE 12-6-2011; IN COMMERCE 12-6-2011.



David J. Kyros

Director of the United States Patent and Trademark Office

Reg. No. 4,099,320 THE MARK CONSISTS OF STANDARD CHARACTERS WITHOUT CLAIM TO ANY PARTICULAR FONT, STYLE, SIZE, OR COLOR.

SN 77-548,534, FILED 8-15-2008.

KELLY CHOE, EXAMINING ATTORNEY

United States of America

United States Patent and Trademark Office



Reg. No. 4,099,321

Registered Feb. 14, 2012

Int. Cls.: 35, 36, 41, and 45

SERVICE MARK

PRINCIPAL REGISTER

STATE REGULATORY REGISTRY LLC (D.C. LIMITED LIABILITY COMPANY)
SUITE 500
1155 CONNECTICUT AVENUE, N.W.
WASHINGTON, DC 20036

FOR: ASSOCIATION SERVICES, NAMELY, PROMOTING THE INTERESTS OF FINANCIAL SERVICES COMPANIES AND PROFESSIONALS AND THEIR STATE AND FEDERAL GOVERNMENT REGULATORS; ASSOCIATION SERVICES, NAMELY, PROMOTING THE INTERESTS OF MORTGAGE INDUSTRY COMPANIES AND PROFESSIONALS AND THEIR STATE AND FEDERAL GOVERNMENT REGULATORS; PROVIDING FOR OTHERS AN ONLINE COMPUTER DATABASE OF BUSINESS INFORMATION REGARDING FINANCIAL SERVICES COMPANIES AND PROFESSIONALS AND THEIR PROFESSIONAL BACKGROUND, BUSINESS PRACTICES, CONDUCT, EMPLOYMENT, AND DISCIPLINARY STATUS; PROVIDING FOR OTHERS AN ONLINE COMPUTER DATABASE OF BUSINESS INFORMATION REGARDING MORTGAGE INDUSTRY COMPANIES AND PROFESSIONALS AND THEIR PROFESSIONAL BACKGROUND, BUSINESS PRACTICES, CONDUCT, EMPLOYMENT, AND DISCIPLINARY STATUS; PROVIDING FOR OTHERS BUSINESS INFORMATION REGARDING FINANCIAL SERVICES COMPANIES AND PROFESSIONALS AND THEIR PROFESSIONAL BACKGROUND, BUSINESS PRACTICES, CONDUCT, EMPLOYMENT, AND DISCIPLINARY STATUS IN RESPONSE TO TELEPHONE AND E-MAIL INQUIRIES; PROVIDING FOR OTHERS BUSINESS INFORMATION REGARDING MORTGAGE INDUSTRY COMPANIES AND PROFESSIONALS AND THEIR PROFESSIONAL BACKGROUND, BUSINESS PRACTICES, CONDUCT, EMPLOYMENT, AND DISCIPLINARY STATUS IN RESPONSE TO TELEPHONE AND E-MAIL INQUIRIES; PROVIDING BUSINESS ADVISORY SERVICES CONCERNING THE REGULATION OF THE FINANCIAL SERVICES INDUSTRY, NAMELY, CREATING PROPOSED RULES AND RULE CHANGES FOR OTHERS IN THE FINANCIAL SERVICES INDUSTRY TO INCREASE TRANSPARENCY; PROVIDING BUSINESS ADVISORY SERVICES CONCERNING THE REGULATION OF THE MORTGAGE INDUSTRY, NAMELY, CREATING PROPOSED RULES AND RULE CHANGES FOR OTHERS IN THE MORTGAGE INDUSTRY TO INCREASE TRANSPARENCY; PROVIDING BUSINESS ADVISORY SERVICES CONCERNING THE REGULATION OF THE FINANCIAL SERVICES INDUSTRY, NAMELY, CREATING PROPOSED RULES AND RULE CHANGES FOR STATES THAT GOVERN THE CONDUCT OF COMPANIES AND PROFESSIONALS IN THE FINANCIAL SERVICES INDUSTRY; PROVIDING BUSINESS ADVISORY SERVICES CONCERNING THE REGULATION OF THE MORTGAGE INDUSTRY, NAMELY, CREATING PROPOSED RULES AND RULE CHANGES FOR STATES THAT GOVERN THE CONDUCT OF COMPANIES AND PROFESSIONALS IN THE MORTGAGE INDUSTRY; TESTING AND EXAMINA-



David J. Kyjars

Director of the United States Patent and Trademark Office

Reg. No. 4,099,321 TION TO DETERMINE THE PROFESSIONAL COMPETENCY OF COMPANIES AND PROFESSIONALS IN THE FINANCIAL SERVICES INDUSTRY AND STATE AND FEDERAL GOVERNMENT REGULATORS OF THE FINANCIAL SERVICES INDUSTRY; TESTING AND EXAMINATION TO DETERMINE THE PROFESSIONAL COMPETENCY OF COMPANIES AND PROFESSIONALS IN THE MORTGAGE INDUSTRY AND STATE AND FEDERAL GOVERNMENT REGULATORS OF THE MORTGAGE INDUSTRY; DATA MANAGEMENT SERVICES, NAMELY, COLLECTION, AGGREGATION, AND REPORTING OF FINANCIAL SERVICES INDUSTRY DATA; DATA MANAGEMENT SERVICES, NAMELY, COLLECTION, AGGREGATION, AND REPORTING OF MORTGAGE INDUSTRY DATA; PROVIDING SERVICES TO THE FINANCIAL SERVICES INDUSTRY AND TO STATE AND FEDERAL GOVERNMENT REGULATORS OF THE FINANCIAL SERVICES INDUSTRY, NAMELY, PROVIDING AN ONLINE WEBSITE FOR STATE-REGULATED FINANCIAL SERVICES COMPANIES AND PROFESSIONALS TO APPLY FOR, AMEND, RENEW, AND SURRENDER LICENSES VIA THE INTERNET; PROVIDING SERVICES TO THE MORTGAGE INDUSTRY AND TO STATE AND FEDERAL GOVERNMENT REGULATORS OF THE MORTGAGE INDUSTRY, NAMELY, PROVIDING AN ONLINE WEBSITE FOR STATE-REGULATED MORTGAGE INDUSTRY COMPANIES AND PROFESSIONALS TO APPLY FOR, AMEND, RENEW, AND SURRENDER LICENSES VIA THE INTERNET; PROVIDING AN ONLINE COMPUTER DATABASE OF INFORMATION IN THE FIELDS OF FINANCIAL SERVICES INDUSTRY BUSINESS MANAGEMENT AND BUSINESS OPERATIONS; PROVIDING AN ONLINE COMPUTER DATABASE OF INFORMATION IN THE FIELDS OF MORTGAGE INDUSTRY BUSINESS MANAGEMENT AND BUSINESS OPERATIONS, IN CLASS 35 (U.S. CLS. 100, 101 AND 102).

FIRST USE 1-0-2008; IN COMMERCE 1-0-2008.

FOR: PROVIDING GRANTS AND FUNDING FOR RESEARCH, PROJECTS, FELLOWSHIPS, SEMINARS, SYMPOSIUMS, ROUNDTABLES, AND CLASSES, ALL IN THE FIELDS OF FINANCIAL SERVICES INDUSTRY REGULATIONS, COMPLIANCE, MANAGEMENT, AND OPERATIONS; PROVIDING GRANTS AND FUNDING FOR RESEARCH, PROJECTS, FELLOWSHIPS, SEMINARS, SYMPOSIUMS, ROUNDTABLES, AND CLASSES, ALL IN THE FIELDS OF MORTGAGE INDUSTRY REGULATIONS, COMPLIANCE, MANAGEMENT, AND OPERATIONS; PROVIDING FOR OTHERS AN ONLINE COMPUTER DATABASE OF FINANCIAL INFORMATION REGARDING FINANCIAL SERVICES COMPANIES AND PROFESSIONALS; PROVIDING FOR OTHERS AN ONLINE COMPUTER DATABASE OF FINANCIAL INFORMATION REGARDING MORTGAGE INDUSTRY COMPANIES AND PROFESSIONALS; PROVIDING FOR OTHERS FINANCIAL INFORMATION REGARDING FINANCIAL SERVICES COMPANIES AND PROFESSIONALS IN RESPONSE TO TELEPHONE AND E-MAIL INQUIRIES; PROVIDING FOR OTHERS FINANCIAL INFORMATION REGARDING MORTGAGE INDUSTRY COMPANIES AND PROFESSIONALS IN RESPONSE TO TELEPHONE AND E-MAIL INQUIRIES, IN CLASS 36 (U.S. CLS. 100, 101 AND 102).

FIRST USE 8-0-2011; IN COMMERCE 8-0-2011.

FOR: EDUCATIONAL SERVICES, NAMELY, CONDUCTING MEETINGS, SEMINARS, CONFERENCES, CLASSES, AND WORKSHOPS IN THE FIELDS OF FINANCIAL SERVICES INDUSTRY REGULATIONS, COMPLIANCE, MANAGEMENT, AND OPERATIONS, AND PROVIDING CONTINUING EDUCATION PROGRAMS FOR FINANCIAL SERVICES INDUSTRY COMPANIES AND PROFESSIONALS AND STATE AND FEDERAL GOVERNMENT REGULATORS OF THE FINANCIAL SERVICES INDUSTRY; EDUCATIONAL SERVICES, NAMELY, CONDUCTING MEETINGS, SEMINARS, CONFERENCES, CLASSES, AND WORKSHOPS IN THE FIELDS OF MORTGAGE INDUSTRY REGULATIONS, COMPLIANCE, MANAGEMENT, AND OPERATIONS, AND PROVIDING CONTINUING EDUCATION PROGRAMS FOR MORTGAGE INDUSTRY COMPANIES AND PROFESSIONALS AND STATE AND FEDERAL GOVERNMENT REGULATORS OF THE MORTGAGE INDUSTRY, IN CLASS 41 (U.S. CLS. 100, 101 AND 107).

FIRST USE 1-0-2008; IN COMMERCE 1-0-2008.

Reg. No. 4,099,321 FOR: PROVIDING AN ONLINE COMPUTER DATABASE OF INFORMATION IN THE FIELDS OF FINANCIAL SERVICES INDUSTRY REGULATIONS AND REGULATORY COMPLIANCE; PROVIDING AN ONLINE COMPUTER DATABASE OF INFORMATION IN THE FIELDS OF MORTGAGE INDUSTRY REGULATIONS AND REGULATORY COMPLIANCE, IN CLASS 45 (U.S. CLS. 100 AND 101).

FIRST USE 1-0-2008; IN COMMERCE 1-0-2008.

THE MARK CONSISTS OF THE LETTERS "N", "M", "L", "S" WITH THE DESIGN OF A ROOF ABOVE THEM AND A STRAIGHT LINE BELOW THEM .

SN 77-550,298, FILED 8-19-2008.

BRIAN CALLAGHAN, EXAMINING ATTORNEY

United States of America

United States Patent and Trademark Office

WRINKLE DELETE

Reg. No. 4,099,322

AMERICEUTICALS, LLC (UNITED STATES LIMITED LIABILITY COMPANY)
5356 REYNOLDS STREET, SUITE 505
SAVANNAH, GA 31405

Registered Feb. 14, 2012

Int. Cl.: 3

FOR: ANTI-WRINKLE CREAMS; NON-MEDICATED SKIN CREAMS; SKIN LOTIONS, IN CLASS 3 (U.S. CLS. 1, 4, 6, 50, 51 AND 52).

TRADEMARK

FIRST USE 10-11-2011; IN COMMERCE 10-11-2011.

PRINCIPAL REGISTER

THE MARK CONSISTS OF STANDARD CHARACTERS WITHOUT CLAIM TO ANY PARTICULAR FONT, STYLE, SIZE, OR COLOR.

NO CLAIM IS MADE TO THE EXCLUSIVE RIGHT TO USE "WRINKLE", APART FROM THE MARK AS SHOWN.

SN 77-551,063, FILED 8-19-2008.

TEJBIR SINGH, EXAMINING ATTORNEY



David J. Kyffers

Director of the United States Patent and Trademark Office

United States of America

United States Patent and Trademark Office

SCENEdots

Reg. No. 4,099,323

MOORE, DENNIS (UNITED STATES INDIVIDUAL)
PO BOX 155
SAUNEMIN, IL 61769

Registered Feb. 14, 2012

Int. Cl.: 16

FOR: STICKERS, NAMELY, REFLECTIVE STICKERS FOR TREADPLATE AND OTHER EXTERIOR SURFACES, IN CLASS 16 (U.S. CLS. 2, 5, 22, 23, 29, 37, 38 AND 50).

TRADEMARK

FIRST USE 4-15-2010; IN COMMERCE 4-15-2010.

PRINCIPAL REGISTER

THE MARK CONSISTS OF THE WORD "SCENE" IN ALL CAPITALS IS RED, THE "D" IS IN LOWER CASE AND IS BLACK, A STYLIZED "O" IN THE FORM OF A DOT IS IN RED AND "TS" IN LOWER CASE IS BLACK. EACH LETTER HAS A WHITE OUTLINE AND A GRAY DROP SHADOW.

THE COLOR(S) RED, BLACK, WHITE, GRAY IS/ARE CLAIMED AS A FEATURE OF THE MARK.

SN 77-553,996, FILED 8-22-2008.

KRISTIN DAHLING, EXAMINING ATTORNEY



David J. Kybas

Director of the United States Patent and Trademark Office

United States of America

United States Patent and Trademark Office



Reg. No. 4,099,324

Registered Feb. 14, 2012

Int. Cl.: 43

SERVICE MARK

PRINCIPAL REGISTER

KING KONE FOOD INC. (FLORIDA CORPORATION)
290 174TH STREET
APT #1908
SUNNY ISLES BEACH, FL 33160

FOR: RESTAURANT SERVICES, IN CLASS 43 (U.S. CLS. 100 AND 101).

FIRST USE 11-21-2009; IN COMMERCE 11-21-2009.

NO CLAIM IS MADE TO THE EXCLUSIVE RIGHT TO USE "CONE" AND "HAND ROLLS", APART FROM THE MARK AS SHOWN.

THE MARK CONSISTS OF A CONE-SHAPED DESIGN CONSISTING OF TWO TRIANGLES AND A QUADRILATERAL DRAWN TOGETHER.

SN 77-560,585, FILED 9-2-2008.

STEVEN R. FINE, EXAMINING ATTORNEY



David J. Kybas

Director of the United States Patent and Trademark Office

United States of America

United States Patent and Trademark Office



Reg. No. 4,099,325

Registered Feb. 14, 2012

Int. Cls.: 16, 21, and 25

TRADEMARK

PRINCIPAL REGISTER

BENEFICENCE, INC. (COLORADO CORPORATION)
P.O. BOX 99
LIVERMORE, CO 80536

FOR: BLANK OR PARTIALLY PRINTED PAPER LABELS; BLANK OR PARTIALLY PRINTED POSTCARDS; BOOKS AND BOOKLETS IN THE FIELD OF BLESSINGS; BROCHURES ABOUT BLESSINGS; GIFT BOOKS FEATURING BLESSINGS; JOURNALS CONCERNING BLESSINGS; LEAFLETS ABOUT BLESSINGS; PAMPHLETS IN THE FIELD OF BLESSINGS; PARTIALLY PRINTED FORMS; PRINTED EMBLEMS; PRINTED MATERIALS, NAMELY, PRESS RELEASES FEATURING BLESSINGS; PRINTED PAPER LABELS; WORKBOOKS DIRECTED TO BLESSINGS; PRINTED FORMS; PRINTED INFORMATIONAL CARDS IN THE FIELD OF BLESSINGS; PRINTED INFORMATIONAL FOLDERS IN THE FIELD OF BLESSINGS; CARDS, NAMELY, NOTE CARDS CONTAINING BLESSINGS; GREETING CARDS AND POSTCARDS; BOOKMARKERS; BOOKMARKS; POSTERS, IN CLASS 16 (U.S. CLS. 2, 5, 22, 23, 29, 37, 38 AND 50).

FIRST USE 10-21-2011; IN COMMERCE 10-21-2011.

FOR: CUPS AND MUGS; GLASS MUGS; MUGS; MUGS, NOT OF PRECIOUS METAL; DRINKING GLASSES; GLASS ETCHED BY ACID, IN CLASS 21 (U.S. CLS. 2, 13, 23, 29, 30, 33, 40 AND 50).

FIRST USE 5-6-2011; IN COMMERCE 6-9-2011.

FOR: SPORTS SHIRTS; T-SHIRTS; OPEN-NECKED SHIRTS; POLO SHIRTS; SHIRTS; SHORT-SLEEVED SHIRTS; HATS; HEADGEAR, NAMELY, BASEBALL HATS, IN CLASS 25 (U.S. CLS. 22 AND 39).

FIRST USE 5-6-2011; IN COMMERCE 6-9-2011.

THE MARK CONSISTS OF A STYLIZED LETTER "B" IN THE SHAPE OF A HEART.

SN 77-562,119, FILED 9-4-2008.

STEVEN JACKSON, EXAMINING ATTORNEY



David J. Kyffers

Director of the United States Patent and Trademark Office

United States of America

United States Patent and Trademark Office

LUNCHBOX SIMPLICITY

Reg. No. 4,099,326

NEST NATURALS, INC. (DELAWARE CORPORATION)
1485 PARK AVENUE, SUITE 200
EMERYVILLE, CA 94608

Registered Feb. 14, 2012

Int. Cl.: 29

FOR: PROTEIN BASED NUTRIENT-DENSE SNACK BARS; PRESERVED, DRIED AND COOKED FRUITS AND VEGETABLES; APPLE SAUCE; FRUIT PUREES; FRUIT AND VEGETABLE BASED SNACK FOOD, IN CLASS 29 (U.S. CL. 46).

TRADEMARK

FIRST USE 10-16-2008; IN COMMERCE 10-16-2008.

PRINCIPAL REGISTER

THE MARK CONSISTS OF STANDARD CHARACTERS WITHOUT CLAIM TO ANY PARTICULAR FONT, STYLE, SIZE, OR COLOR.

NO CLAIM IS MADE TO THE EXCLUSIVE RIGHT TO USE "LUNCHBOX", APART FROM THE MARK AS SHOWN.

SN 77-568,746, FILED 9-12-2008.

CHRISTINE MARTIN, EXAMINING ATTORNEY



David J. Kybas

Director of the United States Patent and Trademark Office

United States of America

United States Patent and Trademark Office



Reg. No. 4,099,327

Registered Feb. 14, 2012

Int. Cls.: 23 and 25

TRADEMARK

PRINCIPAL REGISTER

JACQUES CARTIER CLOTHIERS, BANFF INC. (CANADA CORPORATION)
P.O. BOX 22
131A BANFF AVE.
BANFF, CANADA T0L0C0

FOR: YARNS, IN CLASS 23 (U.S. CL. 43).

FIRST USE 4-30-2008; IN COMMERCE 4-30-2008.

FOR: WEARING APPAREL FOR MEN AND WOMEN, NAMELY, SWEATERS, VESTS, COATS, PANTS, MITTENS, HATS, GLOVES, SCARVES, HEADBANDS, T-SHIRTS, SWEATSHIRTS, SOCKS, UNDERWEAR, JACKETS AND SHAWLS, IN CLASS 25 (U.S. CLS. 22 AND 39).

FIRST USE 4-30-2008; IN COMMERCE 4-30-2008.

PRIORITY CLAIMED UNDER SEC. 44(D) ON CANADA APPLICATION NO. 1403637, FILED 7-17-2008.

SEC. 2(F).

OWNER OF U.S. REG. NO. 2,622,750.

THE MARK CONSISTS OF A STYLIZED RENDERING OF THE MARK "QIVIUK".

SN 77-576,381, FILED 9-23-2008.

AISHA CLARKE, EXAMINING ATTORNEY



David J. Kybas

Director of the United States Patent and Trademark Office

United States of America

United States Patent and Trademark Office

CHIC DONOR

Reg. No. 4,099,328

CHIC DONOR, LLC. (MINNESOTA LIMITED LIABILITY COMPANY)
1518 JUDICIAL RD.

Registered Feb. 14, 2012

NORTHFIELD, MN 55057

Int. Cl.: 25

FOR: ATHLETIC APPAREL, NAMELY, SHIRTS, PANTS, JACKETS, FOOTWEAR, HATS AND CAPS, ATHLETIC UNIFORMS; DRESS SHIRTS; DRESS SUITS; DRESSING GOWNS; EVENING DRESSES; GIRDLES; HOODED SWEAT SHIRTS; JERSEYS; KNIT SHIRTS; LEATHER BELTS; LEATHER SHOES; LONG-SLEEVED SHIRTS; NIGHT SHIRTS; POLO SHIRTS; SCARVES; SHIRTS; SHOES; SKIRT SUITS; SKIRTS AND DRESSES; SLEEP SHIRTS; SLEEPING GARMENTS; SWEAT SHIRTS; T-SHIRTS; TOPS; UNDER GARMENTS; WEARABLE GARMENTS AND CLOTHING, NAMELY, SHIRTS; WEDDING DRESSES; WIND SHIRTS; WOMEN'S CEREMONIAL DRESSES; WOMEN'S SHOES; WRAPS; YOGA SHIRTS, IN CLASS 25 (U.S. CLS. 22 AND 39).

TRADEMARK

PRINCIPAL REGISTER

FIRST USE 6-14-2009; IN COMMERCE 11-30-2010.

THE MARK CONSISTS OF STANDARD CHARACTERS WITHOUT CLAIM TO ANY PARTICULAR FONT, STYLE, SIZE, OR COLOR.

SN 77-579,582, FILED 9-26-2008.

ELLEN PERKINS, EXAMINING ATTORNEY



David J. Kybas

Director of the United States Patent and Trademark Office

United States of America

United States Patent and Trademark Office

DENOVA

Reg. No. 4,099,329

MASCO CABINETRY LLC (DELAWARE LIMITED LIABILITY COMPANY)
4600 ARROWHEAD DRIVE
ANN ARBOR, MI 48105

Registered Feb. 14, 2012

Int. Cl.: 19

FOR: NONSTRUCTURAL BUILDING MATERIALS, NAMELY, ENGINEERED STONE USED
IN SURFACE APPLICATIONS, IN CLASS 19 (U.S. CLS. 1, 12, 33 AND 50).

TRADEMARK

FIRST USE 9-0-2010; IN COMMERCE 9-0-2010.

PRINCIPAL REGISTER

THE MARK CONSISTS OF STANDARD CHARACTERS WITHOUT CLAIM TO ANY PAR-
TICULAR FONT, STYLE, SIZE, OR COLOR.

"DENOVA" HAS NO MEANING IN A FOREIGN LANGUAGE.

SN 77-586,439, FILED 10-6-2008.

MELISSA VALLILLO, EXAMINING ATTORNEY



David J. Kyffers

Director of the United States Patent and Trademark Office

United States of America

United States Patent and Trademark Office

JUNEAU BIOSCIENCES

Reg. No. 4,099,330

Registered Feb. 14, 2012

Int. Cl.: 16

TRADEMARK

PRINCIPAL REGISTER

JUNEAU BIOSCIENCES, L.L.C. (UTAH LIMITED LIABILITY COMPANY)
2749 PARLEYS WAY, SUITE 210
SALT LAKE CITY, UT 84109

FOR: PRINTED MATERIALS, NAMELY, PRINTED TEACHING MATERIALS IN THE FIELD OF WOMEN'S HEALTH, PRESS RELEASES ON THE TOPIC OF WOMEN'S HEALTH, NEWSLETTERS ON THE TOPIC OF WOMEN'S HEALTH, BROCHURES AND PAMPHLETS ON THE TOPIC OF WOMEN'S HEALTH, SCHOLARLY ARTICLES IN THE FIELD OF WOMEN'S HEALTH, RESEARCH STUDIES IN THE FIELD OF WOMEN'S HEALTH, STATIONERY GOODS, NAMELY, NOTEPADS; CALENDARS; PAPER MATERIALS, NAMELY, BINDERS, NOTEBOOKS, FOLDERS, PAPER BOXES, PAPER BAGS, PAPER CONTAINERS AND BLANK WRITING JOURNALS; WRITING IMPLEMENTS, IN CLASS 16 (U.S. CLS. 2, 5, 22, 23, 29, 37, 38 AND 50).

FIRST USE 1-0-2009; IN COMMERCE 1-0-2009.

THE MARK CONSISTS OF STANDARD CHARACTERS WITHOUT CLAIM TO ANY PARTICULAR FONT, STYLE, SIZE, OR COLOR.

NO CLAIM IS MADE TO THE EXCLUSIVE RIGHT TO USE "BIOSCIENCES", APART FROM THE MARK AS SHOWN.

SN 77-587,764, FILED 10-7-2008.

JAMES STEIN, EXAMINING ATTORNEY



David J. Kyffers

Director of the United States Patent and Trademark Office

United States of America

United States Patent and Trademark Office

JUNEAU BIOSCIENCES

Reg. No. 4,099,331

JUNEAU BIOSCIENCES, L.L.C. (UTAH LIMITED LIABILITY COMPANY)

Registered Feb. 14, 2012

2749 PARLEYS WAY, SUITE 210
SALT LAKE CITY, UT 84109

Int. Cl.: 44

FOR: MEDICAL DIAGNOSTIC SERVICES, NAMELY, DIAGNOSING WOMEN'S HEALTH ISSUES; MEDICAL DIAGNOSTIC TESTING SERVICES, IN CLASS 44 (U.S. CLS. 100 AND 101).

SERVICE MARK

FIRST USE 1-0-2009; IN COMMERCE 1-0-2009.

PRINCIPAL REGISTER

THE MARK CONSISTS OF STANDARD CHARACTERS WITHOUT CLAIM TO ANY PARTICULAR FONT, STYLE, SIZE, OR COLOR.

NO CLAIM IS MADE TO THE EXCLUSIVE RIGHT TO USE "BIOSCIENCES", APART FROM THE MARK AS SHOWN.

SN 77-587,796, FILED 10-7-2008.

JAMES STEIN, EXAMINING ATTORNEY



David J. Kybas

Director of the United States Patent and Trademark Office

United States of America

United States Patent and Trademark Office

BRULERIE ST. DENIS

Reg. No. 4,099,332

VAN HOUTTE L.P. (CANADA LIMITED PARTNERSHIP)
8300, 19E AVENUE

Registered Feb. 14, 2012

MONTREAL, QUEBEC, CANADA H1Z4J8

Int. Cl.: 30

FOR: COFFEE; TEA; AND COFFEE-BASED BEVERAGES CONTAINING DAIRY PRODUCTS OR SUBSTITUTES THEREFOR, IN CLASS 30 (U.S. CL. 46).

TRADEMARK

FIRST USE 12-0-2009; IN COMMERCE 2-0-1996.

PRINCIPAL REGISTER

THE MARK CONSISTS OF STANDARD CHARACTERS WITHOUT CLAIM TO ANY PARTICULAR FONT, STYLE, SIZE, OR COLOR.

NO CLAIM IS MADE TO THE EXCLUSIVE RIGHT TO USE "BRULERIE" AS APPLIED TO INTERNATIONAL CLASSES 30 AND 43, APART FROM THE MARK AS SHOWN.

THE ENGLISH TRANSLATION OF "BRULERIE" IN THE MARK IS "COFFEE ROASTING PLANT" AND "ALCOHOL DISTILLERY".

SN 77-589,932, FILED 10-9-2008.

LESLIE RICHARDS, EXAMINING ATTORNEY



David J. Kyfos

Director of the United States Patent and Trademark Office

United States of America

United States Patent and Trademark Office



Reg. No. 4,099,333

Registered Feb. 14, 2012

Int. Cl.: 41

SERVICE MARK

PRINCIPAL REGISTER

ONE WORLD FOODS, INC. (DELAWARE CORPORATION)
811 BARTON SPRINGS ROAD, STE. 605
AUSTIN, TX 78704

FOR: ENTERTAINMENT SERVICES, NAMELY, THEATRICAL AND MUSICAL FLOOR SHOWS PROVIDED AT PERFORMANCE VENUES, MUSIC HALLS; MUSIC PRODUCTION SERVICES; LIVE MUSICAL CONCERTS; PRESENTATION OF LIVE SHOW PERFORMANCES; PROVIDING FACILITIES FOR CONCERTS AND LIVE MUSIC PERFORMANCES; ENTERTAINMENT SERVICES, NAMELY, PRODUCTION OF LIVE MUSIC PERFORMANCES, MOVIES, MUSICAL SHOWS OR PLAYS, IN CLASS 41 (U.S. CLS. 100, 101 AND 107).

FIRST USE 11-30-2006; IN COMMERCE 11-30-2006.

OWNER OF U.S. REG. NOS. 3,122,375, 3,275,845, AND OTHERS.

THE STIPLING IS FOR SHADING PURPOSES ONLY.

THE NAME(S), PORTRAIT(S), AND/OR SIGNATURE(S) SHOWN IN THE MARK DOES NOT IDENTIFY A PARTICULAR LIVING INDIVIDUAL.

THE MARK CONSISTS OF PORTRAIT OF MAN WITH THE LITERAL ELEMENT "STUBB'S" IN AN ARC ABOVE THE PORTRAIT.

SN 77-595,833, FILED 10-20-2008.

SUSAN LESLIE DUBOIS, EXAMINING ATTORNEY



David J. Kybas

Director of the United States Patent and Trademark Office

United States of America
United States Patent and Trademark Office

ngmoco:)

Reg. No. 4,099,334

NGMOCO, INC. (DELAWARE CORPORATION)
475 BRANNAN STREET, SUITE 420
SAN FRANCISCO, CA 94107

Registered Feb. 14, 2012

Int. Cls.: 9 and 41

FOR: COMPUTER APPLICATION GAME SOFTWARE FOR MOBILE PHONES AND
HANDHELD ELECTRONIC DEVICES; COMPUTER GAME PROGRAMS; COMPUTER GAME
SOFTWARE, IN CLASS 9 (U.S. CLS. 21, 23, 26, 36 AND 38).

TRADEMARK

FIRST USE 10-17-2008; IN COMMERCE 10-17-2008.

SERVICE MARK

FOR: MULTIMEDIA PUBLISHING OF COMPUTER GAME SOFTWARE FOR OTHERS, IN
CLASS 41 (U.S. CLS. 100, 101 AND 107).

PRINCIPAL REGISTER

FIRST USE 10-0-2009; IN COMMERCE 10-0-2009.

THE MARK CONSISTS OF THE STYLIZED LETTERING "NGMOCO" FOLLOWED BY A
COLON AND A CLOSE PARENTHESIS.

SN 77-597,356, FILED 10-21-2008.

DAVID HOFFMAN, EXAMINING ATTORNEY



David J. Kyffers

Director of the United States Patent and Trademark Office

United States of America

United States Patent and Trademark Office

HARD WORK WINS

Reg. No. 4,099,335

Registered Feb. 14, 2012

Int. Cl.: 25

TRADEMARK

PRINCIPAL REGISTER

JOSEPH, JEFFERSON A. (UNITED STATES INDIVIDUAL)
APT 11H
650 LENOX AVE
NEW YORK, NY 10037

FOR: ANKLETS; APRONS; ASCOTS; BASEBALL CAPS; BATH SLIPPERS; BATHING SUITS; BEACH FOOTWEAR; BEACHWEAR; BELTS; BODY SUITS; BOOTS; BOTTOMS; BOW TIES; BOXER SHORTS; BRIEFS; CAP VISORS; CAPS; CHAPS; CLIMBING BOOTS; COATS; COLLARS; CUMMERBUNDS; DENIM JACKETS; DENIMS; DRESSES; FOOTWEAR; FUR COATS; FUR HATS; FUR JACKETS; GLOVES; GOLF CAPS; GOWNS; GYM SUITS; HATS; HEAD WEAR; HIKING BOOTS; HORSE-RIDING BOOTS; HOSIERY; INFANT WEAR; JACKETS; JEANS; JOGGING PANTS; JOGGING SUITS; KNIT SHIRTS; KNITTED CAPS; LADIES' SUITS; LADIES' UNDERWEAR; LINGERIE; LONG JACKETS; LOUNGEWEAR; MITTENS; NIGHT GOWNS; NIGHT SHIRTS; OVER COATS; OVERALLS; OVERSHOES; PAJAMAS; PANTS; POLO SHIRTS; RAIN BOOTS; RAIN COATS; RAIN JACKETS; RAINWEAR; REMOVABLE COLLARS; RIDING BOOTS; RIDING COATS; RIDING GLOVES; ROBES; SCARVES; SHIRTS; SHORTS; SKIRTS; SLEEPWEAR; SLIPPERS; SOCKS; SUIT COATS; SUITS; SUSPENDERS; SWEAT PANTS; SWEAT SHIRTS; SWEAT SHORTS; SWEAT SUITS; SWEATERS; SWIM WEAR; TENNIS WEAR; TIES; TOPS; TRENCH COATS; UNDERSHIRTS; UNDERWEAR; VESTS, IN CLASS 25 (U.S. CLS. 22 AND 39).

FIRST USE 11-24-2011; IN COMMERCE 11-24-2011.

THE MARK CONSISTS OF STANDARD CHARACTERS WITHOUT CLAIM TO ANY PARTICULAR FONT, STYLE, SIZE, OR COLOR.

SN 77-598,859, FILED 10-23-2008.

TRACY CROSS, EXAMINING ATTORNEY



David J. Kyffers

Director of the United States Patent and Trademark Office

United States of America

United States Patent and Trademark Office

MEGAZINE

Reg. No. 4,099,336

SPRINGFIELD, INC. (ILLINOIS CORPORATION)
420 WEST MAIN STREET
GENESEO, IL 61254

Registered Feb. 14, 2012

Int. Cl.: 13

FOR: MAGAZINES FOR WEAPONS, IN CLASS 13 (U.S. CLS. 2 AND 9).

TRADEMARK

FIRST USE 11-0-2011; IN COMMERCE 11-0-2011.

PRINCIPAL REGISTER

THE MARK CONSISTS OF STANDARD CHARACTERS WITHOUT CLAIM TO ANY PARTICULAR FONT, STYLE, SIZE, OR COLOR.

SN 77-607,500, FILED 11-5-2008.

WANDA KAY PRICE, EXAMINING ATTORNEY



David J. Kyffers

Director of the United States Patent and Trademark Office

United States of America

United States Patent and Trademark Office



Reg. No. 4,099,337

Registered Feb. 14, 2012

Int. Cl.: 25

TRADEMARK

PRINCIPAL REGISTER

DAVIS, MARQUITA E. (UNITED STATES INDIVIDUAL), DBA PHIGUR DESIGN CO.,
6202 GATOR PLACE
CLINTON, MD 20735

FOR: A-SHIRTS; ATHLETIC APPAREL, NAMELY, SHIRTS, PANTS, JACKETS, FOOTWEAR, HATS AND CAPS, ATHLETIC UNIFORMS; CAPRI PANTS; DENIMS; DRESSES; HOODED SWEAT SHIRTS; JOGGING PANTS; KNIT SHIRTS; LONG-SLEEVED SHIRTS; LOUNGE PANTS; NIGHT SHIRTS; PANTS; SHIRTS; SHORT-SLEEVED OR LONG-SLEEVED T-SHIRTS; SHORT-SLEEVED SHIRTS; SKIRTS AND DRESSES; SLEEP SHIRTS; SWEAT PANTS; SWEAT SHIRTS; T-SHIRTS; TEE SHIRTS; WEARABLE GARMENTS AND CLOTHING, NAMELY, SHIRTS; YOGA PANTS; YOGA SHIRTS, IN CLASS 25 (U.S. CLS. 22 AND 39).

FIRST USE 1-1-2009; IN COMMERCE 1-1-2009.

THE MARK CONSISTS OF A SILHOUETTE OF A FEMALE FRAME SIMULATING A PROFILE OF THE REAR AND CHEST FORMING A "P" FOLLOWED BY THE STYLIZED LETTERS "HIG UR" WITH A DOT BETWEEN THE "G" AND "U". THE STYLIZED WORDS "EMBRACE YOURS" WITH A SHADOW EFFECT APPEAR UNDERNEATH AND TO THE RIGHT OF "PHIG UR".

SN 77-608,791, FILED 11-6-2008.

ANNE FARRELL, EXAMINING ATTORNEY



David J. Kybas

Director of the United States Patent and Trademark Office

United States of America

United States Patent and Trademark Office

O/CLAVE

Reg. No. 4,099,338

OLIVER PRODUCTS COMPANY (MICHIGAN CORPORATION)
445 SIXTH STREET NW
GRAND RAPIDS, MI 49504

Registered Feb. 14, 2012

Int. Cl.: 17

FOR: HEAT SEALABLE PLASTIC FILM USED AS AN INDUSTRIAL OR COMMERCIAL PACKING, IN CLASS 17 (U.S. CLS. 1, 5, 12, 13, 35 AND 50).

TRADEMARK

FIRST USE 2-8-2011; IN COMMERCE 2-8-2011.

PRINCIPAL REGISTER

THE MARK CONSISTS OF STANDARD CHARACTERS WITHOUT CLAIM TO ANY PARTICULAR FONT, STYLE, SIZE, OR COLOR.

SN 77-609,005, FILED 11-6-2008.

AMY C. KEAN, EXAMINING ATTORNEY



David J. Kybas

Director of the United States Patent and Trademark Office

United States of America

United States Patent and Trademark Office

CHICAGO BOOTH

The University of Chicago Booth School of Business

Reg. No. 4,099,339

UNIVERSITY OF CHICAGO, THE (ILLINOIS NOT-FOR-PROFIT CORPORATION)
5801 ELLIS AVENUE
CHICAGO, IL 60637

Registered Feb. 14, 2012

Int. Cl.: 35

FOR: PREPARING BUSINESS REPORTS, IN CLASS 35 (U.S. CLS. 100, 101 AND 102).

SERVICE MARK

FIRST USE 11-0-2008; IN COMMERCE 11-0-2008.

PRINCIPAL REGISTER

OWNER OF U.S. REG. NOS. 1,876,527 AND 2,668,437.

SEC. 2(F) AS TO "UNIVERSITY OF CHICAGO".

NO CLAIM IS MADE TO THE EXCLUSIVE RIGHT TO USE "CHICAGO" AND "SCHOOL OF BUSINESS", APART FROM THE MARK AS SHOWN.

THE MARK CONSISTS OF "CHICAGO BOOTH" TOGETHER WITH A DESIGN OF A CREST FEATURING A PHOENIX AND THE WORDS "THE UNIVERSITY OF CHICAGO BOOTH SCHOOL OF BUSINESS".

SN 77-609,380, FILED 11-6-2008.

MICHELE SWAIN, EXAMINING ATTORNEY



David J. Kyjars

Director of the United States Patent and Trademark Office

United States of America

United States Patent and Trademark Office

Because Business Moves.

Reg. No. 4,099,340

SPRING WIRELESS USA, INC. (WASHINGTON CORPORATION)
2505 - 2ND AVE., SUITE 505
SEATTLE, WA 98121

Registered Feb. 14, 2012

Int. Cls.: 35 and 42

FOR: BUSINESS CONSULTING SERVICES IN THE FIELDS OF END-TO-END E-COMMERCE, MOBILE AND WIRELESS COMMUNICATIONS, IN CLASS 35 (U.S. CLS. 100, 101 AND 102).

SERVICE MARK

FIRST USE 12-6-2011; IN COMMERCE 12-6-2011.

PRINCIPAL REGISTER

FOR: TECHNICAL CONSULTING SERVICES IN THE FIELDS OF END-TO-END E-COMMERCE, MOBILE AND WIRELESS COMMUNICATIONS, IN CLASS 42 (U.S. CLS. 100 AND 101).

FIRST USE 12-6-2011; IN COMMERCE 12-6-2011.

THE MARK CONSISTS OF STANDARD CHARACTERS WITHOUT CLAIM TO ANY PARTICULAR FONT, STYLE, SIZE, OR COLOR.

SN 77-610,212, FILED 11-7-2008.

JULIE WATSON, EXAMINING ATTORNEY



David J. Kyffers

Director of the United States Patent and Trademark Office

United States of America

United States Patent and Trademark Office

MORE FANS GO WITH VISA

Reg. No. 4,099,341

Registered Feb. 14, 2012

Int. Cl.: 36

SERVICE MARK

PRINCIPAL REGISTER

VISA INTERNATIONAL SERVICE ASSOCIATION (DELAWARE CORPORATION)
900 METRO CENTER BOULEVARD
FOSTER CITY, CA 94404

FOR: BROAD BASED FINANCIAL SERVICES, NAMELY, BANKING SERVICES, CREDIT CARD SERVICES, DEBIT CARD SERVICES; ELECTRONIC FUNDS TRANSFER, ELECTRONIC PAYMENT PROCESSING SERVICES; FINANCIAL SPONSORSHIP OF SPORTS COMPETITIONS, EVENTS, ACTIVITIES, AND GAMES; FINANCIAL SPONSORSHIP OF TEAMS PARTICIPATING IN ATHLETIC COMPETITIONS, IN CLASS 36 (U.S. CLS. 100, 101 AND 102).

FIRST USE 2-6-2011; IN COMMERCE 2-6-2011.

THE MARK CONSISTS OF STANDARD CHARACTERS WITHOUT CLAIM TO ANY PARTICULAR FONT, STYLE, SIZE, OR COLOR.

OWNER OF U.S. REG. NOS. 1,071,114, 3,357,216, AND OTHERS.

SN 77-611,363, FILED 11-10-2008.

JEFFERY COWARD, EXAMINING ATTORNEY



David J. Kyfos

Director of the United States Patent and Trademark Office

United States of America

United States Patent and Trademark Office

FAMOUSLY EFFECTIVE

Reg. No. 4,099,342

Registered Feb. 14, 2012

Int. Cl.: 35

SERVICE MARK

PRINCIPAL REGISTER

GREY GLOBAL GROUP, INC. (DELAWARE CORPORATION)
777 THIRD AVENUE
NEW YORK, NY 100171399

FOR: ADVERTISING AGENCY SERVICES, MARKETING COMMUNICATION CONSULTING SERVICES; MARKET RESEARCH SERVICES; PUBLIC RELATIONS SERVICES; DIRECT MAIL ADVERTISING SERVICES; DIRECT MARKETING SERVICES; BUSINESS MARKETING CONSULTING SERVICES; DEVELOPMENT OF MARKETING STRATEGIES AND CONCEPTS; CREATING CORPORATE AND BRAND IDENTITIES FOR OTHERS; BRAND STRATEGY CONSULTATION SERVICES IN THE FIELD OF BRAND CREATION AND DEVELOPMENT; BUSINESS RESEARCH SERVICES, NAMELY, PROVIDING ANALYSIS OF DATA IN THE FIELD OF BRAND STRATEGY; SALES PROMOTION SERVICES, NAMELY, PROMOTING THE GOODS AND SERVICES OF OTHERS, ARRANGING AND CONDUCTING PROMOTIONAL MARKETING EVENTS FOR OTHERS; MEDIA PLANNING AND PURCHASE OF ADVERTISING MEDIA SPACE AND AIRTIME FOR OTHERS; MEDIA RESEARCH SERVICES FOR MARKETING AND ADVERTISING PURPOSES; INTERNET ADVERTISING SERVICES, IN CLASS 35 (U.S. CLS. 100, 101 AND 102).

FIRST USE 7-9-2009; IN COMMERCE 10-15-2009.

THE MARK CONSISTS OF STANDARD CHARACTERS WITHOUT CLAIM TO ANY PARTICULAR FONT, STYLE, SIZE, OR COLOR.

NO CLAIM IS MADE TO THE EXCLUSIVE RIGHT TO USE "EFFECTIVE", APART FROM THE MARK AS SHOWN.

SN 77-614,811, FILED 11-14-2008.

KAREN M. STRYZ, EXAMINING ATTORNEY



David J. Kybas

Director of the United States Patent and Trademark Office

United States of America

United States Patent and Trademark Office

AVENTURA COVE PALACE

Reg. No. 4,099,343

Registered Feb. 14, 2012

Int. Cls.: 43 and 44

SERVICE MARK

PRINCIPAL REGISTER

PALACE HOLDING, S.A. DE C.V. (MEXICO CORPORATION)
HOTEL CANCUN PALACE, ZONA HOTELERA
BOULEVARD KUKULCAN, KM. 14.5
CANCUN, QUINTANA ROO, MEXICO C.P.77500

FOR: HOTEL, BAR AND RESTAURANT SERVICES; RESORT HOTELS, IN CLASS 43 (U.S. CLS. 100 AND 101).

FIRST USE 3-31-2009; IN COMMERCE 3-31-2009.

FOR: HEALTH SPA SERVICES FOR HEALTH AND WELLNESS OF THE BODY AND SPIRIT OFFERED AT A HEALTH RESORT; HEALTH SPA SERVICES, NAMELY, COSMETIC BODY CARE SERVICES, IN CLASS 44 (U.S. CLS. 100 AND 101).

FIRST USE 3-31-2009; IN COMMERCE 3-31-2009.

THE MARK CONSISTS OF STANDARD CHARACTERS WITHOUT CLAIM TO ANY PARTICULAR FONT, STYLE, SIZE, OR COLOR.

OWNER OF U.S. REG. NO. 2,660,207.

THE ENGLISH TRANSLATION OF THE WORD "AVENTURA" IN THE MARK IS "ADVENTURE".

SN 77-621,050, FILED 11-24-2008.

ALLISON SCHRODY, EXAMINING ATTORNEY



David J. Kyffers

Director of the United States Patent and Trademark Office

United States of America

United States Patent and Trademark Office

Meow Report

Reg. No. 4,099,344

STACEY SACHS (UNITED STATES INDIVIDUAL)
1167 PACIFIC AVENUE
SAN FRANCISCO, CA 94133

Registered Feb. 14, 2012

Int. Cl.: 44

FOR: PROVIDING A WEBSITE ABOUT CATS FEATURING INFORMATION AND NEWS ABOUT CAT CARE, IN CLASS 44 (U.S. CLS. 100 AND 101).

SERVICE MARK

FIRST USE 9-10-2009; IN COMMERCE 9-10-2009.

PRINCIPAL REGISTER

THE MARK CONSISTS OF STANDARD CHARACTERS WITHOUT CLAIM TO ANY PARTICULAR FONT, STYLE, SIZE, OR COLOR.

NO CLAIM IS MADE TO THE EXCLUSIVE RIGHT TO USE "REPORT", APART FROM THE MARK AS SHOWN.

SN 77-621,590, FILED 11-25-2008.

REBECCA EISINGER, EXAMINING ATTORNEY



David J. Kyffers

Director of the United States Patent and Trademark Office

United States of America

United States Patent and Trademark Office

MOM

Reg. No. 4,099,345

Registered Feb. 14, 2012

Int. Cl.: 10

TRADEMARK

PRINCIPAL REGISTER

BILLUPS-ROTHENBERG, INC. (CALIFORNIA CORPORATION)
PO BOX 977
DEL MAR, CA 920140977

FOR: OXYGEN MONITOR, IN CLASS 10 (U.S. CLS. 26, 39 AND 44).

FIRST USE 12-22-2011; IN COMMERCE 12-22-2011.

THE MARK CONSISTS OF STANDARD CHARACTERS WITHOUT CLAIM TO ANY PARTICULAR FONT, STYLE, SIZE, OR COLOR.

SN 77-621,854, FILED 11-25-2008.

KATHERINE E. HALMEN, EXAMINING ATTORNEY



David J. Kybas

Director of the United States Patent and Trademark Office

United States of America

United States Patent and Trademark Office



EASTERN

Reg. No. 4,099,346

Registered Feb. 14, 2012

Int. Cl.: 39

SERVICE MARK

PRINCIPAL REGISTER

AVIATION CAPITAL PARTNERS GROUP, LLC (DELAWARE LIMITED LIABILITY COMPANY)
306 CEDAR LANE
NEW CANAAN, CT 06840

FOR: TRANSPORTATION OF PERSONS BY AIR; AIRLINE TRANSPORTATION PASSENGER SERVICES FEATURING A FREQUENT FLYER BONUS PROGRAM; PROVIDING INFORMATION IN THE FIELD OF AIR TRAVEL AND AIR TRANSPORTATION BY ELECTRONIC MEANS, IN CLASS 39 (U.S. CLS. 100 AND 105).

FIRST USE 12-17-2010; IN COMMERCE 12-17-2010.

OWNER OF U.S. REG. NOS. 1,285,593, 1,490,543, AND OTHERS.

THE COLOR(S) BLUE AND WHITE IS/ARE CLAIMED AS A FEATURE OF THE MARK.

THE MARK CONSISTS OF THE WORD "EASTERN" SHOWN IN BLUE ALONGSIDE A WHITE STYLIZED BIRD DESIGN WITHIN A BLUE CIRCLE.

SN 77-627,469, FILED 12-5-2008.

DAVID YONTEF, EXAMINING ATTORNEY



David J. Kyffers

Director of the United States Patent and Trademark Office

United States of America

United States Patent and Trademark Office



Reg. No. 4,099,347

Registered Feb. 14, 2012

Int. Cl.: 39

SERVICE MARK

PRINCIPAL REGISTER

AVIATION CAPITAL PARTNERS GROUP, LLC (DELAWARE LIMITED LIABILITY COMPANY)
306 CEDAR LANE
NEW CANAAN, CT 06840

FOR: TRANSPORTATION OF PERSONS BY AIR; AIRLINE TRANSPORTATION PASSENGER SERVICES FEATURING A FREQUENT FLYER BONUS PROGRAM; PROVIDING INFORMATION IN THE FIELD OF AIR TRAVEL AND AIR TRANSPORTATION BY ELECTRONIC MEANS, IN CLASS 39 (U.S. CLS. 100 AND 105).

FIRST USE 12-17-2010; IN COMMERCE 12-17-2010.

OWNER OF U.S. REG. NOS. 1,467,648 AND 1,490,543.

THE COLOR(S) WHITE AND BLUE IS/ARE CLAIMED AS A FEATURE OF THE MARK.

THE MARK CONSISTS OF A WHITE STYLIZED BIRD DESIGN WITHIN A BLUE CIRCLE.

SN 77-627,477, FILED 12-5-2008.

DAVID YONTEF, EXAMINING ATTORNEY



David J. Kyffers

Director of the United States Patent and Trademark Office

United States of America

United States Patent and Trademark Office

Stimulate the Economy

Reg. No. 4,099,348

PREQUIENT (NEW JERSEY SOLE PROPRIETORSHIP)
10 HAPGOOD COURT
BOONTON, NJ 07005

Registered Feb. 14, 2012

Int. Cls.: 16 and 25

FOR: PLASTIC SHOPPING BAGS, IN CLASS 16 (U.S. CLS. 2, 5, 22, 23, 29, 37, 38 AND 50).

TRADEMARK

FIRST USE 12-28-2011; IN COMMERCE 12-28-2011.

PRINCIPAL REGISTER

FOR: SHIRTS , IN CLASS 25 (U.S. CLS. 22 AND 39).

FIRST USE 12-28-2011; IN COMMERCE 12-28-2011.

THE MARK CONSISTS OF STANDARD CHARACTERS WITHOUT CLAIM TO ANY PARTICULAR FONT, STYLE, SIZE, OR COLOR.

SN 77-627,946, FILED 12-6-2008.

MARK T. MULLEN, EXAMINING ATTORNEY



David J. Kyffers

Director of the United States Patent and Trademark Office

United States of America

United States Patent and Trademark Office

GO TAILGATING

Reg. No. 4,099,349

Registered Feb. 14, 2012

Int. Cl.: 35

SERVICE MARK

PRINCIPAL REGISTER

TIMOTHY C. GARNER (UNITED STATES INDIVIDUAL)
SUITE 340
624 HOLLY SPRINGS ROAD
HOLLY SPRINGS, NC 27540

FOR: ASSOCIATION SERVICES, NAMELY, PROMOTING THE INTERESTS OF THE TAILGATE LIFESTYLE INDUSTRY, COMPRISED OF PROVIDERS OF A WIDE VARIETY OF PUBLICATIONS, EVENTS, PRODUCTS AND SERVICES TO INDIVIDUALS AND GROUPS INTERESTED IN THE TAILGATE LIFESTYLE, IN CLASS 35 (U.S. CLS. 100, 101 AND 102).

FIRST USE 11-25-2011; IN COMMERCE 11-25-2011.

THE MARK CONSISTS OF STANDARD CHARACTERS WITHOUT CLAIM TO ANY PARTICULAR FONT, STYLE, SIZE, OR COLOR.

NO CLAIM IS MADE TO THE EXCLUSIVE RIGHT TO USE "TAILGATING", APART FROM THE MARK AS SHOWN.

SN 77-628,297, FILED 12-8-2008.

MARY CRAWFORD, EXAMINING ATTORNEY



David J. Kyffers

Director of the United States Patent and Trademark Office

United States of America

United States Patent and Trademark Office

ATTRIBUTES

Reg. No. 4,099,350

NOUVELLE SEAMLESS INTIMATES INC. (CANADA CORPORATION)

Registered Feb. 14, 2012

9500 MEILLER STREET, SUITE 400
MONTREAL, CANADA H2N2B7

Int. Cl.: 25

FOR: LINGERIE AND INTIMATE APPAREL AND FOUNDATION GARMENTS, NAMELY, UNDERWEAR, BRAS, PANTIES, GIRDLES, CAMISOLES, BODY SUITS, BRIEFS, T-SHIRTS, CROP TOPS, SUPPORT TOPS, NAMELY, BRAS AND SHIRTS, BUSTIERS, AND SLEEPWEAR AND BODYWEAR, NAMELY, SPORT BRAS, IN CLASS 25 (U.S. CLS. 22 AND 39).

TRADEMARK

PRINCIPAL REGISTER

FIRST USE 7-0-2009; IN COMMERCE 7-0-2009.

THE MARK CONSISTS OF STANDARD CHARACTERS WITHOUT CLAIM TO ANY PARTICULAR FONT, STYLE, SIZE, OR COLOR.

PRIORITY CLAIMED UNDER SEC. 44(D) ON CANADA APPLICATION NO. 1421391, FILED 12-10-2008.

SN 77-631,087, FILED 12-11-2008.

JESSICA A. POWERS, EXAMINING ATTORNEY



David J. Kypos

Director of the United States Patent and Trademark Office

United States of America

United States Patent and Trademark Office

GLIDEPATH

Reg. No. 4,099,351

Registered Feb. 14, 2012

Int. Cl.: 9

TRADEMARK

PRINCIPAL REGISTER

CIRQUE CORPORATION (UTAH CORPORATION)
SUITE A
2463 SOUTH 3850 WEST
SALT LAKE CITY, UT 84120

FOR: TOUCH AND PROXIMITY SENSING INPUT DEVICES, NAMELY, A PROXIMITY SENSITIVE TOUCHPAD DISPOSED UNDERNEATH A BEZEL OF A DISPLAY TO ENABLE INPUT OF PROXIMITY AND TOUCH GESTURES AND COMMANDS, IN CLASS 9 (U.S. CLS. 21, 23, 26, 36 AND 38).

FIRST USE 9-23-2011; IN COMMERCE 9-23-2011.

THE MARK CONSISTS OF STANDARD CHARACTERS WITHOUT CLAIM TO ANY PARTICULAR FONT, STYLE, SIZE, OR COLOR.

SN 77-635,410, FILED 12-17-2008.

SOPHIA S. KIM, EXAMINING ATTORNEY



David J. Kybas

Director of the United States Patent and Trademark Office

United States of America

United States Patent and Trademark Office

SLOW DOWN AND SAVOUR WITH ALOUETTE

Reg. No. 4,099,352

Registered Feb. 14, 2012

Int. Cl.: 29

TRADEMARK

PRINCIPAL REGISTER

BC-USA, INC. (DELAWARE CORPORATION)
300 MARTIN LUTHER KING BLVD., SUITE B
WILMINGTON, DE 19801

FOR: CHEESE, IN CLASS 29 (U.S. CL. 46).

FIRST USE 9-28-2011; IN COMMERCE 9-28-2011.

THE MARK CONSISTS OF STANDARD CHARACTERS WITHOUT CLAIM TO ANY PARTICULAR FONT, STYLE, SIZE, OR COLOR.

OWNER OF U.S. REG. NOS. 1,239,584, 2,810,549, AND OTHERS.

THE ENGLISH TRANSLATION OF "ALOUETTE" IN THE MARK IS LARK.

SN 77-641,478, FILED 12-30-2008.

COLLEEN KEARNEY, EXAMINING ATTORNEY



David J. Kyjars

Director of the United States Patent and Trademark Office

United States of America

United States Patent and Trademark Office



Reg. No. 4,099,353

TATERA, PATRICK (UNITED STATES INDIVIDUAL)
P.O. BOX 1091
TALKEETNA, AK 99676

Registered Feb. 14, 2012

Int. Cls.: 7 and 32

FOR: AERATED BEVERAGE MAKING MACHINE; AERATORS, IN CLASS 7 (U.S. CLS. 13, 19, 21, 23, 31, 34 AND 35).

TRADEMARK

FIRST USE 1-15-2011; IN COMMERCE 8-6-2011.

PRINCIPAL REGISTER

FOR: AERATED WATER; BEER; BEER WORT; BEER, ALE AND LAGER; BEER, ALE AND PORTER; BEER, ALE, LAGER, STOUT AND PORTER; BEER, ALE, LAGER, STOUT, PORTER, SHANDY; BEER-BASED COOLERS; BLACK BEER; BREWED MALT-BASED ALCOHOLIC BEVERAGE IN THE NATURE OF A BEER; COFFEE-FLAVORED BEER; COFFEE-FLAVORED SOFT DRINK; COLAS; CONCENTRATES, SYRUPS OR POWDERS USED IN THE PREPARATION OF SOFT DRINKS; EXTRACTS OF HOPS FOR MAKING BEER; FRUIT FLAVORED SOFT DRINKS; GINGER BEER; HOP EXTRACTS FOR MANUFACTURING BEER; IMITATION BEER; MALT BEER; MALT LIQUOR; NON-ALCOHOLIC BEER; PALE BEER; POP; PORTER; SELTZER WATER; SODA POPS; SODA WATER; SOFT DRINKS; SOFT DRINKS FLAVORED WITH TEA; SWEET CIDER; SYRUPS FOR MAKING SOFT DRINKS, IN CLASS 32 (U.S. CLS. 45, 46 AND 48).

FIRST USE 1-15-2011; IN COMMERCE 8-6-2011.



THE MARK CONSISTS OF A STICK-FIGURE PERSON OR HIKER, WITH A WALKING STICK HELD AT AN ANGLE PARALLEL TO HIS LEFT LEG. THE STICK-FIGURE PERSON OR HIKER HAS A CIRCLE FOR A HEAD, A CURVED BACK, CURVED, SLIGHTLY BENT RIGHT LEG, AND A STRAIGHT LEFT (BACK) LEG. THE STICK-FIGURE PERSON OR HIKER'S ARM IS STRAIGHT AND HE/SHE IS WEARING A CLEAR BEER STEIN, MUG, OR TALL GLASS AS A BACKPACK, THE HANDLE DOUBLING AS A BACKPACK STRAP AROUND THE STICK-FIGURE PERSON OR HIKER. THE BEER STEIN, MUG, OR TALL GLASS IS CLEAR WITH BUBBLES AND A FOAMY HEAD SHOWING. THERE ARE TWO RINGS AROUND THE GLASS, ONE TOWARDS THE TOP, ONE CLOSER TO THE BOTTOM OF THE GLASS.

David J. Kypos

SN 77-641,590, FILED 12-30-2008.

Director of the United States Patent and Trademark Office

BRENDAN REGAN, EXAMINING ATTORNEY

United States of America

United States Patent and Trademark Office

NOT EVEN SCARED

Reg. No. 4,099,354

NES PRODUCTIONS, INC. (ARKANSAS CORPORATION)
1071 HERON
GENTRY, AR 72734

Registered Feb. 14, 2012

Int. Cl.: 25

FOR: CLOTHING, NAMELY, SHIRTS, SHORTS, PANTS, HATS, SKIRTS, SOCKS, GLOVES, SWEATERS, AND COATS, IN CLASS 25 (U.S. CLS. 22 AND 39).

TRADEMARK

FIRST USE 12-2-2011; IN COMMERCE 12-2-2011.

PRINCIPAL REGISTER

THE MARK CONSISTS OF STANDARD CHARACTERS WITHOUT CLAIM TO ANY PARTICULAR FONT, STYLE, SIZE, OR COLOR.

SN 77-647,466, FILED 1-12-2009.

ELLEN B. AWRICH, EXAMINING ATTORNEY



David J. Kybas

Director of the United States Patent and Trademark Office

United States of America

United States Patent and Trademark Office

NEXT BEND

Reg. No. 4,099,355

TONY CRAIG (UNITED STATES INDIVIDUAL)
P.O. BOX 177

Registered Feb. 14, 2012

PILOT MOUNTAIN, NC 27041

Int. Cl.: 35

FOR: ART GALLERIES, IN CLASS 35 (U.S. CLS. 100, 101 AND 102).

SERVICE MARK

FIRST USE 12-1-2011; IN COMMERCE 12-1-2011.

PRINCIPAL REGISTER

THE MARK CONSISTS OF STANDARD CHARACTERS WITHOUT CLAIM TO ANY PARTICULAR FONT, STYLE, SIZE, OR COLOR.

SN 77-651,708, FILED 1-17-2009.

DAVID TOOLEY, EXAMINING ATTORNEY



David J. Kyffers

Director of the United States Patent and Trademark Office

United States of America

United States Patent and Trademark Office

PRIME

Reg. No. 4,099,356

Registered Feb. 14, 2012

Int. Cl.: 42

SERVICE MARK

PRINCIPAL REGISTER

PRIMESTONE (COLOMBIA CORPORATION)
AV. 9 #127B-76
BOGOTA, COLOMBIA 127B-76

FOR: INSTALLATION AND MAINTENANCE OF REVENUE MANAGEMENT COMPUTER SOFTWARE FOR BUSINESS; DESIGN AND DEVELOPMENT OF REVENUE MANAGEMENT COMPUTER SOFTWARE FOR BUSINESS, IN CLASS 42 (U.S. CLS. 100 AND 101).

FIRST USE 8-0-2011; IN COMMERCE 8-0-2011.

THE MARK CONSISTS OF STANDARD CHARACTERS WITHOUT CLAIM TO ANY PARTICULAR FONT, STYLE, SIZE, OR COLOR.

OWNER OF U.S. REG. NO. 2,772,399.

SN 77-651,914, FILED 1-19-2009.

ROSELLE HERRERA, EXAMINING ATTORNEY



David J. Kybas

Director of the United States Patent and Trademark Office

United States of America
United States Patent and Trademark Office

TSCi

Reg. No. 4,099,357

TRANSONIC COMBUSTION, LLC (CALIFORNIA LIMITED LIABILITY COMPANY)
513 CALLE SAN PABLO
CAMARILLO, CA 93012

Registered Feb. 14, 2012

Int. Cl.: 7

FOR: ENGINE PARTS, NAMELY, ELECTRONIC FUEL INJECTION MODULES; ENHANCEMENT PARTS FOR INTERNAL COMBUSTION ENGINES, NAMELY, FUEL CATALYSTS; FUEL INJECTORS, IN CLASS 7 (U.S. CLS. 13, 19, 21, 23, 31, 34 AND 35).

TRADEMARK

FIRST USE 6-6-2009; IN COMMERCE 6-6-2009.

PRINCIPAL REGISTER

THE MARK CONSISTS OF STANDARD CHARACTERS WITHOUT CLAIM TO ANY PARTICULAR FONT, STYLE, SIZE, OR COLOR.

SN 77-658,635, FILED 1-28-2009.

RONALD MCMORROW, EXAMINING ATTORNEY



David J. Kyffers

Director of the United States Patent and Trademark Office

United States of America

United States Patent and Trademark Office

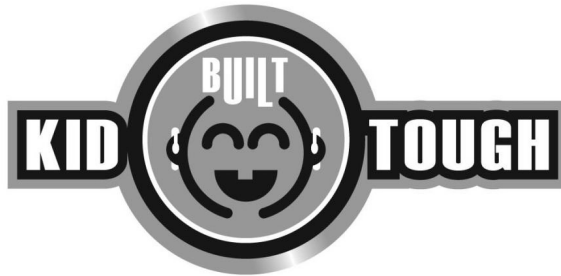

Reg. No. 4,099,358

Registered Feb. 14, 2012

Int. Cl.: 10

TRADEMARK

PRINCIPAL REGISTER

ADVANCED BIONICS, LLC (DELAWARE LIMITED LIABILITY COMPANY)
28515 WESTINGHOUSE PLACE
VALENCIA, CA 91355

FOR: MEDICAL DEVICE, NAMELY, AN EXTERNAL BEHIND-THE-EAR SPEECH PROCESSOR FOR USE WITH AN IMPLANTABLE COCHLEAR STIMULATOR; COCHLEAR IMPLANT SYSTEMS COMPRISED PRIMARILY OF IMPLANTABLE COCHLEAR STIMULATORS, IMPLANTABLE ELECTRODES, IMPLANTABLE ELECTRODE ARRAYS, HEAD PIECES, SOUND PROCESSORS, EXTERNAL PROGRAMMERS FOR COCHLEAR STIMULATORS, STIMULATOR PROGRAMMING SOFTWARE, BATTERY CHARGERS AND ELECTRIC CABLES AND TRAINING MATERIALS REGARDING THE USE AND OPERATION OF THE STIMULATORS, SOLD THEREWITH AS A UNIT, IN CLASS 10 (U.S. CLS. 26, 39 AND 44).

FIRST USE 9-26-2011; IN COMMERCE 9-26-2011.

NO CLAIM IS MADE TO THE EXCLUSIVE RIGHT TO USE "KID" , APART FROM THE MARK AS SHOWN.

THE MARK CONSISTS OF THE WORDS "KID" AND "TOUGH" IN STYLIZED LETTERING WHICH ARE SEPARATED BY A CIRCLE THAT ENCLOSES THE STYLIZED WORD "BUILT" AND AN IMAGE OF A CHILD'S HEAD WITH WEARABLE SPEECH PROCESSORS ON ITS EARS.

SN 77-658,915, FILED 1-29-2009.

JOHN SCHUYLER YARD, EXAMINING ATTORNEY



David J. Kyros

Director of the United States Patent and Trademark Office

United States of America

United States Patent and Trademark Office

GREEN BY DESIGN

Reg. No. 4,099,359

Registered Feb. 14, 2012

Int. Cls.: 35 and 41

SERVICE MARK

PRINCIPAL REGISTER

THE GABRIEL CENTER FOR SERVANT-LEADERSHIP, INC (GEORGIA CORPORATION)
123 CHURCH STREET NE, SUITE 150
MARIETTA, GA 30060

FOR: BUSINESS CONSULTING IN THE FIELDS OF PERFORMANCE MANAGEMENT, COMMUNICATIONS SOLUTIONS, HUMAN RESOURCE MANAGEMENT, AND CUSTOMER SERVICE MANAGEMENT SPECIFICALLY UTILIZING A GREEN MODEL OF LEADERSHIP DEVELOPMENT TO INCLUDE THE VALUES OF ORGANIC, SUSTAINABLE LEADERSHIP, IN CLASS 35 (U.S. CLS. 100, 101 AND 102).

FIRST USE 11-9-2011; IN COMMERCE 11-9-2011.

FOR: EDUCATIONAL SERVICES, NAMELY, CONDUCTING CLASSES, SEMINARS, CONFERENCES AND WORKSHOPS BASED ON A GREEN MODEL OF LEADERSHIP DEVELOPMENT TO INCLUDE THE VALUES OF ORGANIC, SUSTAINABLE LEADERSHIP AND DISTRIBUTING COURSE MATERIALS IN CONNECTION THEREWITH; DEVELOPING EDUCATIONAL MATERIALS FOR OTHERS BASED ON A GREEN MODEL OF LEADERSHIP DEVELOPMENT TO INCLUDE THE VALUES OF ORGANIC, SUSTAINABLE LEADERSHIP, IN CLASS 41 (U.S. CLS. 100, 101 AND 107).

FIRST USE 2-20-2009; IN COMMERCE 2-20-2009.

THE MARK CONSISTS OF STANDARD CHARACTERS WITHOUT CLAIM TO ANY PARTICULAR FONT, STYLE, SIZE, OR COLOR.

NO CLAIM IS MADE TO THE EXCLUSIVE RIGHT TO USE "GREEN", APART FROM THE MARK AS SHOWN.

SN 77-673,445, FILED 2-19-2009.

SEAN CROWLEY, EXAMINING ATTORNEY



David J. Kybas

Director of the United States Patent and Trademark Office

United States of America

United States Patent and Trademark Office

VINYLMATION

Reg. No. 4,099,360

DISNEY ENTERPRISES, INC. (DELAWARE CORPORATION)
500 SOUTH BUENA VISTA STREET
BURBANK, CA 91521

Registered Feb. 14, 2012

Int. Cl.: 18

FOR: BACKPACKS; BOOK BAGS; HANDBAGS; PURSES; TOTE BAGS, IN CLASS 18 (U.S. CLS. 1, 2, 3, 22 AND 41).

TRADEMARK

FIRST USE 6-30-2010; IN COMMERCE 6-30-2010.

PRINCIPAL REGISTER

THE MARK CONSISTS OF STANDARD CHARACTERS WITHOUT CLAIM TO ANY PARTICULAR FONT, STYLE, SIZE, OR COLOR.

SN 77-678,493, FILED 2-25-2009.

MICHAEL SOUDERS, EXAMINING ATTORNEY



David J. Kyffers

Director of the United States Patent and Trademark Office

United States of America

United States Patent and Trademark Office

VINYLMATION

Reg. No. 4,099,361

DISNEY ENTERPRISES, INC. (DELAWARE CORPORATION)
500 SOUTH BUENA VISTA STREET
BURBANK, CA 91521

Registered Feb. 14, 2012

Int. Cl.: 16

FOR: ART PRINTS; COLOR PENCILS; DIARIES; MEMO PADS; NOTE PAPER; NOTEBOOKS;
NOTEBOOK PAPER; STICKERS; WRITING PAPER, IN CLASS 16 (U.S. CLS. 2, 5, 22, 23, 29,
37, 38 AND 50).

TRADEMARK

FIRST USE 3-31-2010; IN COMMERCE 3-31-2010.

PRINCIPAL REGISTER

THE MARK CONSISTS OF STANDARD CHARACTERS WITHOUT CLAIM TO ANY PAR-
TICULAR FONT, STYLE, SIZE, OR COLOR.

SN 77-678,498, FILED 2-25-2009.

MICHAEL SOUDERS, EXAMINING ATTORNEY



David J. Kyffers

Director of the United States Patent and Trademark Office

United States of America

United States Patent and Trademark Office

VINYLMATION

Reg. No. 4,099,362

DISNEY ENTERPRISES, INC. (DELAWARE CORPORATION)
500 SOUTH BUENA VISTA STREET
BURBANK, CA 91521

Registered Feb. 14, 2012

Int. Cl.: 14

FOR: CLOCKS; JEWELRY; JEWELRY BOXES; JEWELRY CASES; KEY RINGS OF PRECIOUS METAL; NON-MONETARY COINS; WATCHES; WATCH BANDS, IN CLASS 14 (U.S. CLS. 2, 27, 28 AND 50).

TRADEMARK

FIRST USE 2-28-2010; IN COMMERCE 2-28-2010.

PRINCIPAL REGISTER

THE MARK CONSISTS OF STANDARD CHARACTERS WITHOUT CLAIM TO ANY PARTICULAR FONT, STYLE, SIZE, OR COLOR.

SN 77-678,501, FILED 2-25-2009.

MICHAEL SOUDERS, EXAMINING ATTORNEY



David J. Kyffers

Director of the United States Patent and Trademark Office

United States of America

United States Patent and Trademark Office

RED BULL

Reg. No. 4,099,363

Registered Feb. 14, 2012

Int. Cl.: 43

SERVICE MARK

PRINCIPAL REGISTER

RED BULL GMBH (AUSTRIA LIMITED LIABILITY COMPANY)
AM BRUNNEN 1
FUSCHL AM SEE, AUSTRIA A5330

FOR: RESTAURANT SERVICES, IN CLASS 43 (U.S. CLS. 100 AND 101).

FIRST USE 12-31-1998; IN COMMERCE 12-31-1998.

THE MARK CONSISTS OF STANDARD CHARACTERS WITHOUT CLAIM TO ANY PARTICULAR FONT, STYLE, SIZE, OR COLOR.

OWNER OF U.S. REG. NOS. 1,935,272, 3,561,283, AND OTHERS.

SN 77-686,056, FILED 3-8-2009.

CHRISTINE COOPER, EXAMINING ATTORNEY



David J. Kyffers

Director of the United States Patent and Trademark Office

United States of America

United States Patent and Trademark Office

VMAX

Reg. No. 4,099,364

Registered Feb. 14, 2012

Int. Cl.: 9

TRADEMARK

PRINCIPAL REGISTER

EMC CORPORATION (MASSACHUSETTS CORPORATION)
176 SOUTH STREET
HOPKINTON, MA 01748

FOR: INTELLIGENT STORAGE SYSTEMS, COMPRISING PROCESSORS, MEMORIES, OPERATING SOFTWARE, DATA STORAGE UNITS FOR STORING DATA AND SOFTWARE FOR MANAGING AND CONTROLLING DATA , IN CLASS 9 (U.S. CLS. 21, 23, 26, 36 AND 38).

FIRST USE 10-18-2011; IN COMMERCE 10-18-2011.

THE MARK CONSISTS OF STANDARD CHARACTERS WITHOUT CLAIM TO ANY PARTICULAR FONT, STYLE, SIZE, OR COLOR.

SN 77-686,585, FILED 3-9-2009.

WANDA KAY PRICE, EXAMINING ATTORNEY



David J. Kybas

Director of the United States Patent and Trademark Office

United States of America

United States Patent and Trademark Office



Reg. No. 4,099,365

Registered Feb. 14, 2012

Int. Cl.: 9

TRADEMARK

PRINCIPAL REGISTER

TRANSONIC COMBUSTION, LLC (CALIFORNIA LIMITED LIABILITY COMPANY)
513 CALLE SAN PABLO
CAMARILLO, CA 93012

FOR: COMPUTER SOFTWARE FOR OPTIMIZING FUEL INJECTION SYSTEMS, IN CLASS 9 (U.S. CLS. 21, 23, 26, 36 AND 38).

FIRST USE 3-15-2009; IN COMMERCE 3-15-2009.

THE MARK CONSISTS OF AN INCOMPLETE CIRCULAR SHAPE APPEARING IN BLACK WITH A YELLOW BOTTOM PORTION, THE SHAPE IS INTERSECTED AT THE TOP BY A GREEN POLYGON, AND ADJACENT TO THE CIRCULAR SHAPE THE WORDING "Wā-FI" APPEARS IN BLACK WITH THE LETTER "A" OVERLINED IN BLACK.

THE COLOR(S) GREEN, YELLOW AND BLACK IS/ARE CLAIMED AS A FEATURE OF THE MARK.

SN 77-686,781, FILED 3-9-2009.

RONALD MCMORROW, EXAMINING ATTORNEY



David J. Kybas

Director of the United States Patent and Trademark Office

United States of America

United States Patent and Trademark Office

PARK LA FUN

Reg. No. 4,099,366

Registered Feb. 14, 2012

Int. Cls.: 18, 25, and 35

TRADEMARK

SERVICE MARK

PRINCIPAL REGISTER

TREE STITCH DESIGN, INC. (CALIFORNIA CORPORATION)
C/O PARK LA FUN MUSIC CO.
556 SOUTH FAIR OAKS AVENUE
PASADENA, CA 91105

FOR: SMALL ACCESSORIES MADE OF IMITATION LEATHER, NAMELY, KEY CHAINS, WOMEN'S HANDBAGS, HANDBAGS, PURSES, WALLETS, IN CLASS 18 (U.S. CLS. 1, 2, 3, 22 AND 41).

FIRST USE 11-0-2011; IN COMMERCE 11-0-2011.

FOR: CLOTHING, NAMELY, T-SHIRTS, IN CLASS 25 (U.S. CLS. 22 AND 39).

FIRST USE 11-0-2011; IN COMMERCE 11-0-2011.

FOR: ONLINE RETAIL STORE SERVICES FEATURING SMALL ACCESSORIES MADE OF IMITATION LEATHER, BAGS, CLOTHING, FINE ART, PRINTS, STICKERS, IN CLASS 35 (U.S. CLS. 100, 101 AND 102).

FIRST USE 11-0-2011; IN COMMERCE 11-0-2011.

THE MARK CONSISTS OF STANDARD CHARACTERS WITHOUT CLAIM TO ANY PARTICULAR FONT, STYLE, SIZE, OR COLOR.

THE ENGLISH TRANSLATION OF "LA" IN THE MARK IS "THE".

SN 77-687,632, FILED 3-10-2009.

MARK SHINER, EXAMINING ATTORNEY



David J. Kybas

Director of the United States Patent and Trademark Office

United States of America

United States Patent and Trademark Office

XELJANZ

Reg. No. 4,099,367

PFIZER INC. (DELAWARE CORPORATION)
235 EAST 42ND STREET
NEW YORK, NY 10017

Registered Feb. 14, 2012

Int. Cl.: 5

FOR: PHARMACEUTICAL PREPARATIONS FOR THE TREATMENT OF IMMUNOLOGICAL AND INFLAMMATORY DISEASES AND DISORDERS; PHARMACEUTICAL PREPARATIONS FOR THE TREATMENT OF PAIN; PHARMACEUTICAL PREPARATIONS, NAMELY, DERMATOLOGICAL PREPARATIONS, IN CLASS 5 (U.S. CLS. 6, 18, 44, 46, 51 AND 52).

TRADEMARK

PRINCIPAL REGISTER

FIRST USE 10-20-2011; IN COMMERCE 10-20-2011.

THE MARK CONSISTS OF STANDARD CHARACTERS WITHOUT CLAIM TO ANY PARTICULAR FONT, STYLE, SIZE, OR COLOR.

SN 77-688,128, FILED 3-11-2009.

ELLEN PERKINS, EXAMINING ATTORNEY



David J. Kyffers

Director of the United States Patent and Trademark Office

United States of America

United States Patent and Trademark Office

MEI YIN

Reg. No. 4,099,368

Registered Feb. 14, 2012

Int. Cl.: 3

TRADEMARK

PRINCIPAL REGISTER

MEI CHI NATUROPATHICS, LLC (ARIZONA LIMITED LIABILITY COMPANY)
14530 E. PEAK VIEW ROAD
SCOTTSDALE, AZ 85262

FOR: BATH FOAMS; BATH GELS; BATH OILS; BATH SALTS; BODY AND BEAUTY CARE COSMETICS; BODY CREAMS; BODY EMULSIONS; BODY SCRUB; BODY WASHES; COLOGNE; CONDITIONERS; COSMETIC PREPARATIONS FOR BODY CARE; COSMETICS; EXFOLIANTS FOR SKIN AND BODY; FRAGRANCES; HAIR CARE CREAMS; HAIR CARE PREPARATIONS; LOTIONS FOR SKIN AND BODY; NON-MEDICATED BATH PREPARATIONS; NON-MEDICATED SKIN CARE PREPARATIONS; PERFUMES; SCENTED BODY SPRAY; SHAMPOOS; SKIN CLEANSERS; SKIN CREAMS; SKIN TONERS; SOAPS, IN CLASS 3 (U.S. CLS. 1, 4, 6, 50, 51 AND 52).

FIRST USE 10-27-2009; IN COMMERCE 10-1-2011.

THE MARK CONSISTS OF STANDARD CHARACTERS WITHOUT CLAIM TO ANY PARTICULAR FONT, STYLE, SIZE, OR COLOR.

THE NAME(S), PORTRAIT(S), AND/OR SIGNATURE(S) SHOWN IN THE MARK DOES NOT IDENTIFY A PARTICULAR LIVING INDIVIDUAL.

THE WORDING "MEI YIN" HAS NO MEANING IN A FOREIGN LANGUAGE.

SN 77-689,740, FILED 3-12-2009.

ELISSA GARBER KON, EXAMINING ATTORNEY



David J. Kybas

Director of the United States Patent and Trademark Office

United States of America

United States Patent and Trademark Office



Reg. No. 4,099,369

Registered Feb. 14, 2012

Int. Cls.: 25 and 28

TRADEMARK

PRINCIPAL REGISTER

TYJA CORPORATION (NEW YORK CORPORATION)
400 BURMAN BLVD.
CALVERTON, NY 11933

FOR: JERSEYS, NAMELY, UNIFORM TOPS FOR BASEBALL, SOFTBALL, SOCCER, BASKETBALL, FOOTBALL, LACROSSE, HOCKEY, VOLLEYBALL; FENCING UNIFORM TOPS AND BOTTOMS; POLO SHIRTS, NAMELY, UNIFORM TOPS FOR VOLLEYBALL, TENNIS, GOLF, BOWLING, FIELD HOCKEY, CRICKET; MIX MARTIAL ARTS UNIFORMS; KARATE UNIFORMS; TEAM POLO SHIRTS, TEAM EMBELLISHED T-SHIRTS; GRAPHIC T-SHIRTS; LONG SLEEVE T-SHIRTS; SPORTS BRAS; CHEERLEADING UNIFORM TOPS AND BOTTOMS; KNIT TOPS; LONG SLEEVE TURTLE NECK SHIRTS; LONG SLEEVE MOCK TURTLE NECK SHIRTS; TEAM EMBELLISHED SWEATSHIRTS; UNIFORM PANTS FOR BASEBALL, SOFTBALL, FOOTBALL, HOCKEY, GOLF, BOWLING AND CRICKET; UNIFORM SHORTS FOR SOFTBALL, SOCCER, BASKETBALL, LACROSSE, VOLLEYBALL AND TENNIS; SWIMSUIT BOTTOMS; SWEAT PANTS; PARACHUTE PANTS; SHORTS FOR BOXING, TRACK AND FIELD, WEIGHT LIFTING, RUNNING, BIKING AND UMPIRING; PANTS FOR CROSS TRAINING, HORSE RIDING, BIKING, SKIING/SNOWBOARDING; TEAM EMBELLISHED SWEAT PANTS; FIELD HOCKEY UNIFORM SKIRTS; WRESTLING UNIFORMS; RACING SWIMSUITS; RACING BICYCLE SUITS; THERMAL SKI SUITS; RACING RUNNING SUITS; LONG SLEEVE AND SHORT SLEEVE BATTING PRACTICE JACKETS; VARSITY LEATHER JACKETS; PONCHOS; ROBES FOR BOXERS; HORSE RIDING JACKETS; TEAM SPORT JACKETS; TEAM SPORT WINTER COATS; TRAVEL JUMPSUITS; BASKETBALL WARM UP SUITS; FLEECE SWEAT JACKETS AND SHIRTS; SKI JACKETS; WET SUITS; SKI GLOVES, LIGHTWEIGHT GLOVES; FLEECE GLOVES; FLEECE PULLOVER JACKETS; CLEATS FOR ATTACHMENT TO SPORTS SHOES FOR BASEBALL, SOFTBALL, SOCCER LACROSSE AND FOOTBALL; WRIST BANDS; SWEAT BANDS; BASEBALL BELTS; MOTORCROSS GLOVES; SNEAKERS FOR CROSS TRAINING, BASKETBALL, TENNIS, SKATEBOARDS AND RUNNING; SHOES FOR WRESTLING AND BOXING; BOOTS FOR HIKING, MOTORCROSS SKIING AND HORSE RIDING; COLD WEATHER BOOTS; SHOWER SANDALS; SOCKS, NAMELY, BASEBALL UNIFORM, SOFTBALL UNIFORM, ANKLE CUT AND SOCCER STYLE UNIFORM; BASEBALL FITTED CAPS; BASEBALL SNAP-BACK CAPS; VISORS; KNIT CAPS; GOLF HATS; ELASTIC MATERIAL HEADWEAR; SKI HATS; SWIM CAPS, BANDANAS; EAR MUFFS; HEADBANDS; BELTS FOR FOOTBALL UNIFORMS; COMPRESSION LONG AND SHORT SLEEVED TOPS; RAIN JACKETS AND PANTS, IN CLASS 25 (U.S. CLS. 22 AND 39).



David J. Kybas

Director of the United States Patent and Trademark Office

FIRST USE 12-0-2010; IN COMMERCE 1-3-2011.

Reg. No. 4,099,369 FOR: BACKPACKS FOR SOFTBALL BATS; HANGING BASEBALL/SOFTBALL BAGS; BASEBALLS; SOFTBALLS; FOOTBALLS; HOCKEY PUCKS; BASKETBALLS; VOLLEYBALLS; SOCCER BALLS; TENNIS BALLS; GOLF BALLS; LACROSSE BALLS; PERFORATED PLASTIC BALLS FOR TRAINING; RUBBER BALLS; WHEELED BASEBALL BAT BAGS; SOCCER SHIN GUARDS; WOOD BASEBALL BATS; WEIGHTS FOR BASEBALL BATS; BAGS FOR BASEBALL ROSIN; BASEBALL GLOVES; BASEBALL BATTING GLOVES; SOCCER GOALIE GLOVES; FOOTBALL RECEIVER GLOVES; METAL BASEBALL BATS; METAL SOFTBALL BATS; FACEMASKS FOR BASEBALL AND HOCKEY; MOUTH GUARDS FOR FOOTBALL; HOCKEY STICKS; LACROSSE STICKS; LACROSSE NETS; DRIVING RANGE NETS; GOLF BAGS; KNEE PADS FOR VOLLEYBALL; ATHLETIC TAPE; WATER SKIS; SNOWBOARDS; SNOW SKIS; TEES FOR FOOTBALL KICKERS; PROTECTIVE PADDING FOR PLAYING FOOTBALL LACROSSE AND HOCKEY; SOCCER NETS; BASKETBALL NETS; ATHLETIC SUPPORTERS AND PROTECTIVE ATHLETIC CUPS; PROTECTIVE WRIST GUARDS FOR ATHLETIC USE; MOUNTED BASEBALL BASES; THROW DOWN SOFTBALL BASES; PLASTIC UMPIRE CLICKER; UMPIRE POUCH AND BRUSH; SPORTS BAGS FOR CARRYING BALLS; BOWLING BALLS; CRICKET BATS; BADMINTON RACKETS; FENCING FOILS; FISHING RODS; POLO BALLS; POLO CLUBS; BOCCE BALLS; HOLLOW COMPOSITION BALLS FOR INDOOR BAT OR RACKET GAMES, TABLE GAMES AND TENNIS TYPE GAMES; PADDLES FOR INDOOR BAT OR RACKET GAMES, TABLE GAMES AND TENNIS TYPE GAMES; POOL TALLY BALLS; POOL CUES; CHALK FOR POOL STICKS; BADMINTON NETS; BOXING GLOVES; WEIGHT LIFTING GLOVES; WEIGHT LIFTING BELTS; RUGBY BALLS; SKI POLES; SNOWBOARD BINDINGS; SKATEBOARDS; HOCKEY SKATES; IN-LINE SKATES; FACE MASKS FOR FENCING; HOCKEY MASKS; UMPIRE FACE MASKS; BASEBALL BATTING TEES; BASEBALL PITCHING TRAINING NETS; BASEBALL FIELDING TRAINING GLOVES; BASEBALL CATCHERS' CHEST PROTECTORS, SHIN GUARDS AND KNEE GUARDS; BASEBALL BATTING CAGES; THUMB PROTECTORS FOR PLAYING BASEBALL; PORTABLE PRACTICE NETS FOR PLAYING BASEBALL; PORTABLE PITCHER'S MOUNDS FOR PLAYING BASEBALL; CHEERLEADING POM-POMS; TENNIS RACKETS; FIELD HOCKEY STICKS; FIELD HOCKEY BALLS; GOLF TEES; SOFTBALL AND BASEBALL TRAINING BALLS; BALLS FOR PITCHING MACHINES; EYE BLACK FOR REDUCING SUN GLARE FOR SPORTS ACTIVITIES; PINE TAR RAGS FOR USE WITH BASEBALL AND SOFTBALL BATS; BALL PITCHING MACHINES; BASEBALL BATS FOR USE IN HITTING AND FIELDING PRACTICE; BASEBALL PITCHING SCREENS; BASEBALL GLOVE LACING KITS COMPRISING LEATHER LACES, GLOVE OIL, GLOVE LACING TOOLS; PROTECTIVE WRISTBANDS FOR PLAYING SPORTS, IN CLASS 28 (U.S. CLS. 22, 23, 38 AND 50).

FIRST USE 12-0-2010; IN COMMERCE 1-3-2011.

THE MARK CONSISTS OF THE LETTERS "T" AND "J".

SN 77-694,762, FILED 3-19-2009.

ESTHER A. BORSUK, EXAMINING ATTORNEY

United States of America

United States Patent and Trademark Office

Rainbow Math

Reg. No. 4,099,370

Registered Feb. 14, 2012

Int. Cl.: 28

TRADEMARK

PRINCIPAL REGISTER

GROUCHY DOG, LLC (PENNSYLVANIA LIMITED LIABILITY COMPANY)
6694 TIPPETTS DRIVE
MERCERSBURG, PA 17236

FOR: EDUCATIONAL BOARD GAME FOR TEACHING MATH PRINCIPLES TO CHILDREN, NAMELY, COLORS, SHAPES, MATH FACTS, MONEY SKILLS AND CURRENCY, IN CLASS 28 (U.S. CLS. 22, 23, 38 AND 50).

FIRST USE 10-1-2008; IN COMMERCE 6-15-2011.

THE MARK CONSISTS OF STANDARD CHARACTERS WITHOUT CLAIM TO ANY PARTICULAR FONT, STYLE, SIZE, OR COLOR.

NO CLAIM IS MADE TO THE EXCLUSIVE RIGHT TO USE "MATH", APART FROM THE MARK AS SHOWN.

SN 77-695,523, FILED 3-20-2009.

MATTHEW KLINE, EXAMINING ATTORNEY



David J. Kypas

Director of the United States Patent and Trademark Office

United States of America

United States Patent and Trademark Office

Grouchy Dog

Reg. No. 4,099,371

GROUCHY DOG, LLC (PENNSYLVANIA LIMITED LIABILITY COMPANY)
6694 TIPPETTS DRIVE
MERCERSBURG, PA 17236

Registered Feb. 14, 2012

Int. Cl.: 28

FOR: EDUCATIONAL GAMES, NAMELY, BOARD GAMES, PARLOR GAMES, MANIPULATIVE GAMES, MANIPULATIVE PUZZLES, MULTI-DIMENSIONAL MANIPULATIVE GAMES AND MULTI-DIMENSIONAL MANIPULATIVE PUZZLES, IN CLASS 28 (U.S. CLS. 22, 23, 38 AND 50).

TRADEMARK

PRINCIPAL REGISTER

FIRST USE 7-12-2005; IN COMMERCE 6-15-2011.

THE MARK CONSISTS OF STANDARD CHARACTERS WITHOUT CLAIM TO ANY PARTICULAR FONT, STYLE, SIZE, OR COLOR.

SN 77-695,580, FILED 3-20-2009.

MATTHEW KLINE, EXAMINING ATTORNEY



David J. Kyffers

Director of the United States Patent and Trademark Office

United States of America

United States Patent and Trademark Office

LIQUID CINORHC

Reg. No. 4,099,372

GATES, CECIL SEVERIN (UNITED STATES INDIVIDUAL)
1506 SOUTH LAS VEGAS BLVD #1
LAS VEGAS, NV 89104

Registered Feb. 14, 2012

Int. Cl.: 33

FOR: ALCOHOLIC BEVERAGES, NAMELY, ALCOHOLIC MALT COOLERS, FRUIT DRINKS, ALCOHOLIC TEA-BASED BEVERAGES, WHISKY, GIN, VODKA, LIQUEURS, BRANDY, WINES, DISTILLED SPIRITS, RUM, AND BRANDY; SYRUPS FOR MAKING ALCOHOL-BASED BEVERAGES, IN CLASS 33 (U.S. CLS. 47 AND 49).

TRADEMARK

PRINCIPAL REGISTER

FIRST USE 11-11-2011; IN COMMERCE 11-11-2011.

THE MARK CONSISTS OF STANDARD CHARACTERS WITHOUT CLAIM TO ANY PARTICULAR FONT, STYLE, SIZE, OR COLOR.

NO CLAIM IS MADE TO THE EXCLUSIVE RIGHT TO USE "LIQUID", APART FROM THE MARK AS SHOWN.

THE WORDING "CINORHC" HAS NO MEANING IN A FOREIGN LANGUAGE.

SN 77-696,362, FILED 3-21-2009.

DAVID TAYLOR, EXAMINING ATTORNEY



David J. Kyfos

Director of the United States Patent and Trademark Office

United States of America

United States Patent and Trademark Office

RANGO

Reg. No. 4,099,373

PARAMOUNT PICTURES CORPORATION (DELAWARE CORPORATION)
5555 MELROSE AVENUE
HOLLYWOOD, CA 90038

Registered Feb. 14, 2012

Int. Cl.: 25

FOR: T-SHIRTS, HALLOWEEN COSTUMES AND MASKS SOLD IN CONNECTION THEREWITH, IN CLASS 25 (U.S. CLS. 22 AND 39).

TRADEMARK

FIRST USE 3-1-2011; IN COMMERCE 3-1-2011.

PRINCIPAL REGISTER

THE MARK CONSISTS OF STANDARD CHARACTERS WITHOUT CLAIM TO ANY PARTICULAR FONT, STYLE, SIZE, OR COLOR.

SN 77-697,760, FILED 3-24-2009.

CAROLYN CATALDO, EXAMINING ATTORNEY



David J. Kybas

Director of the United States Patent and Trademark Office

United States of America

United States Patent and Trademark Office

SWITCH MAGNETIC INTERCHANGE LENS SYSTEM

Reg. No. 4,099,374

Registered Feb. 14, 2012

Int. Cl.: 9

TRADEMARK

PRINCIPAL REGISTER

SWITCH VISION LLC (DELAWARE LIMITED LIABILITY COMPANY)
97 FAIRFIELD ROAD
FAIRFIELD, NJ 07004

FOR: INTERCHANGEABLE LENSES FOR EYEGLASSES, SUNGLASSES, READING GLASSES, AND CLIP-ON SUNGLASSES; SPECIFICALLY DESIGNED FRAMES FOR EYEGLASSES, SUNGLASSES, READING GLASSES, AND CLIP-ON SUNGLASSES DESIGNED TO FIT INTERCHANGEABLE LENSES; CASES FOR AFOREMENTIONED LENSES AND FRAMES, IN CLASS 9 (U.S. CLS. 21, 23, 26, 36 AND 38).

FIRST USE 5-30-2009; IN COMMERCE 5-30-2009.

THE MARK CONSISTS OF STANDARD CHARACTERS WITHOUT CLAIM TO ANY PARTICULAR FONT, STYLE, SIZE, OR COLOR.

SN 77-702,627, FILED 3-30-2009.

SEAN CROWLEY, EXAMINING ATTORNEY



David J. Kybas

Director of the United States Patent and Trademark Office

United States of America

United States Patent and Trademark Office

B  *Flawless*

Reg. No. 4,099,375

ANDERSON, LORI (UNITED STATES INDIVIDUAL)
5802 WEST RIDGECREEK DRIVE
HOUSTON, TX 77053

Registered Feb. 14, 2012

Int. Cl.: 25

FOR: T-SHIRTS, IN CLASS 25 (U.S. CLS. 22 AND 39).

TRADEMARK

FIRST USE 6-12-2009; IN COMMERCE 6-12-2009.

PRINCIPAL REGISTER

THE MARK CONSISTS OF THE WORDING "B FLAWLESS" IN STYLIZED BLACK SCRIPT FONT WITH A DESIGN OF A STYLIZED DIAMOND OUTLINED IN BLACK BETWEEN THE LETTERS "B" AND "F". THE BACKGROUND IS IN WHITE.

THE COLOR(S) BLACK AND WHITE IS/ARE CLAIMED AS A FEATURE OF THE MARK.

SN 77-703,694, FILED 3-31-2009.

STEVEN PEREZ, EXAMINING ATTORNEY



David J. Kybas

Director of the United States Patent and Trademark Office

United States of America

United States Patent and Trademark Office

LYNXPOWER

Reg. No. 4,099,376

COOPER TECHNOLOGIES COMPANY (DELAWARE CORPORATION)
600 TRAVIS, SUITE 5600
HOUSTON, TX 77002

Registered Feb. 14, 2012

Int. Cl.: 9

FOR: ELECTRIC CONNECTORS; ELECTRICAL CONNECTORS; ELECTRICAL AND ELECTRONIC CONNECTORS; ELECTRICAL POWER CONNECTORS; ELECTRIC CONNECTIONS AND CONNECTORS; PLUG CONNECTORS; PLUG-IN CONNECTORS; DECORATIVE SWITCH PLATE COVERS; ELECTRIC CURRENT SWITCHES; ELECTRIC LIGHT SWITCHES ; ELECTRIC SWITCH HOUSINGS; ELECTRIC SWITCH PLATES; ELECTRIC SWITCHES; ELECTRICAL SWITCHES; ELECTRONIC MOTION SENSITIVE SWITCHES; ELECTRONIC PROXIMITY SENSORS AND SWITCHES; ELECTRONIC TOUCH SENSITIVE SWITCHES; LIGHT SWITCHES; POWER SWITCHES; ELECTRICAL RECEPTACLES; ELECTRIC PLUGS; ELECTRICAL PLUGS; ELECTRICAL PLUGS AND SOCKETS; PLUG ADAPTORS; PLUG CONNECTORS, IN CLASS 9 (U.S. CLS. 21, 23, 26, 36 AND 38).

TRADEMARK

PRINCIPAL REGISTER

FIRST USE 4-30-2010; IN COMMERCE 4-30-2010.

THE MARK CONSISTS OF "LYNXPOWER" WITH "LYNX" IN ITALICS WITH THE "L" CAPITALIZED AND THE REMAINING LETTERS IN LOWER CASE AND "POWER" IN ALL UPPER CASE AND BOLD.

SN 77-706,714, FILED 4-3-2009.

ROBIN MITTLER, EXAMINING ATTORNEY



David J. Kybas

Director of the United States Patent and Trademark Office

United States of America

United States Patent and Trademark Office

ESP HIGH

Reg. No. 4,099,377

GUBIN, KARIN (UNITED STATES INDIVIDUAL)
6432 MASSEY ESTATES COVE
MEMPHIS, TN 38120

Registered Feb. 14, 2012

Int. Cl.: 44

FOR: PSYCHOLOGICAL COUNSELING SERVICES IN THE FIELDS OF EMOTIONAL, PHYSICAL, AND SPIRITUAL ISSUES, IN CLASS 44 (U.S. CLS. 100 AND 101).

SERVICE MARK

FIRST USE 9-30-2011; IN COMMERCE 9-30-2011.

PRINCIPAL REGISTER

THE MARK CONSISTS OF STANDARD CHARACTERS WITHOUT CLAIM TO ANY PARTICULAR FONT, STYLE, SIZE, OR COLOR.

NO CLAIM IS MADE TO THE EXCLUSIVE RIGHT TO USE "ESP", APART FROM THE MARK AS SHOWN.

SN 77-707,246, FILED 4-6-2009.

MICHAEL LITZAU, EXAMINING ATTORNEY



David J. Kybas

Director of the United States Patent and Trademark Office

United States of America

United States Patent and Trademark Office

CAR AMIGO

Reg. No. 4,099,378

GONZALEZ MORENO, JUAN ANTONIO (MEXICO INDIVIDUAL)
1347 MANUFACTURING STREET
DALLAS, TX 75207

Registered Feb. 14, 2012

Int. Cls.: 37 and 41

FOR: RESTORATION IN THE FIELD OF ANTIQUE CARS AND RACE CARS; MOTOR VEHICLE MAINTENANCE AND REPAIR, IN CLASS 37 (U.S. CLS. 100, 103 AND 106).

SERVICE MARK

FIRST USE 4-0-1996; IN COMMERCE 4-0-1996.

PRINCIPAL REGISTER

FOR: ENTERTAINMENT SERVICES, NAMELY, PARTICIPATION IN AUTOMOBILE RACES AND RELATED EXHIBITIONS AND ORGANIZING AND CONDUCTING MOTOR VEHICLE RACES, IN CLASS 41 (U.S. CLS. 100, 101 AND 107).

FIRST USE 4-0-1996; IN COMMERCE 4-0-1996.

THE MARK CONSISTS OF STANDARD CHARACTERS WITHOUT CLAIM TO ANY PARTICULAR FONT, STYLE, SIZE, OR COLOR.

NO CLAIM IS MADE TO THE EXCLUSIVE RIGHT TO USE "CAR", APART FROM THE MARK AS SHOWN.

SN 77-708,606, FILED 4-7-2009.

JAMES GRIFFIN, EXAMINING ATTORNEY



David J. Kybas

Director of the United States Patent and Trademark Office

United States of America

United States Patent and Trademark Office

ASSURE BRILLIANCE

Reg. No. 4,099,379

Registered Feb. 14, 2012

Int. Cls.: 16 and 41

TRADEMARK

SERVICE MARK

PRINCIPAL REGISTER

HYPOGUARD AMERICA LIMITED (UNITED KINGDOM COMPANY)
5198 WEST 76TH STREET
EDINA, MN 55439

FOR: PRINTED MEDICAL EDUCATION AND TRAINING MATERIALS IN THE FIELD OF DIABETES MANAGEMENT FOR CERTIFIED DIABETES EDUCATORS, PHYSICIANS, AND PATIENTS, IN CLASS 16 (U.S. CLS. 2, 5, 22, 23, 29, 37, 38 AND 50).

FIRST USE 11-0-2009; IN COMMERCE 1-0-2010.

FOR: TRAINING SERVICES IN THE FIELD OF DIABETES MANAGEMENT FOR CERTIFIED DIABETES EDUCATORS, PHYSICIANS, AND PATIENTS, IN CLASS 41 (U.S. CLS. 100, 101 AND 107).

FIRST USE 11-0-2009; IN COMMERCE 1-0-2010.

THE MARK CONSISTS OF STANDARD CHARACTERS WITHOUT CLAIM TO ANY PARTICULAR FONT, STYLE, SIZE, OR COLOR.

OWNER OF U.S. REG. NO. 2,352,631.

SN 77-709,374, FILED 4-8-2009.

SOPHIA S. KIM, EXAMINING ATTORNEY



David J. Kybas

Director of the United States Patent and Trademark Office

United States of America

United States Patent and Trademark Office

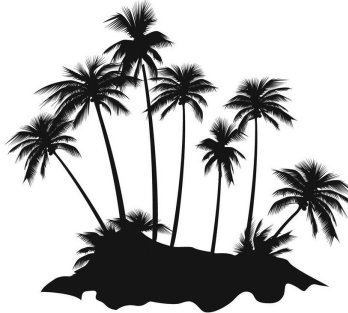

St. Somewhere

Reg. No. 4,099,380

Registered Feb. 14, 2012

Int. Cl.: 25

TRADEMARK

PRINCIPAL REGISTER

ST. SOMEWHERE CORP. (TEXAS CORPORATION)
#4 PEGUES PLACE
LONGVIEW, TX 75601

FOR: WEARING APPAREL FOR MEN AND WOMEN, NAMELY, SHIRTS, PANTS, SHORTS, SOCKS, JACKETS, DRESSES, HATS, SHOES AND BELTS, IN CLASS 25 (U.S. CLS. 22 AND 39).

FIRST USE 1-1-2011; IN COMMERCE 1-1-2011.

THE MARK CONSISTS OF STYLIZED WORDING "ST. SOMEWHERE" BENEATH A SILHOUETTE OF A SMALL ISLAND WITH PALM TREES.

SN 77-714,441, FILED 4-15-2009.

GEOFFREY FOSDICK, EXAMINING ATTORNEY



David J. Kyffers

Director of the United States Patent and Trademark Office

United States of America

United States Patent and Trademark Office

CREE 

TRUE WHITE
TECHNOLOGY

Reg. No. 4,099,381

Registered Feb. 14, 2012

Int. Cl.: 11

TRADEMARK

PRINCIPAL REGISTER

CREE, INC. (NORTH CAROLINA CORPORATION)
4600 SILICON DRIVE
DURHAM, NC 27703

FOR: LIGHT FIXTURES, IN CLASS 11 (U.S. CLS. 13, 21, 23, 31 AND 34).

FIRST USE 4-25-2010; IN COMMERCE 4-25-2010.

OWNER OF U.S. REG. NOS. 2,440,530, 2,452,761, AND 2,922,689.

NO CLAIM IS MADE TO THE EXCLUSIVE RIGHT TO USE "TRUE WHITE TECHNOLOGY", APART FROM THE MARK AS SHOWN.

THE MARK CONSISTS OF THE WORD "CREE" APPEARING ABOVE THE WORD "TRUE-WHITE" WHICH APPEARS ABOVE THE WORD "TECHNOLOGY" WHEREIN A DIAMOND-SHAPED DESIGN IS POSITIONED TO THE RIGHT OF THE TERM "CREE" AND THE TERM "TRUEWHITE" APPEARS WITHIN A RECTANGLE.

SN 77-715,667, FILED 4-16-2009.

SARA BENJAMIN, EXAMINING ATTORNEY



David J. Kyffers

Director of the United States Patent and Trademark Office

United States of America

United States Patent and Trademark Office

Just a Little

Reg. No. 4,099,382

KOI GROUP, INC. (NEVADA CORPORATION)
3565 LAS VEGAS BLVD. SOUTH #311

Registered Feb. 14, 2012

LAS VEGAS, NV 89109

Int. Cl.: 36

FOR: CHARITABLE FUNDRAISING SERVICES, IN CLASS 36 (U.S. CLS. 100, 101 AND 102).

SERVICE MARK

FIRST USE 3-18-2011; IN COMMERCE 3-18-2011.

PRINCIPAL REGISTER

THE MARK CONSISTS OF STANDARD CHARACTERS WITHOUT CLAIM TO ANY PARTICULAR FONT, STYLE, SIZE, OR COLOR.

SN 77-721,184, FILED 4-23-2009.

KATHLEEN M. VANSTON, EXAMINING ATTORNEY



David J. Kybas

Director of the United States Patent and Trademark Office

United States of America

United States Patent and Trademark Office

MIDNIGHT TREASURES

Reg. No. 4,099,383

IGT (NEVADA CORPORATION)
9295 PROTOTYPE DRIVE
RENO, NV 895218986

Registered Feb. 14, 2012

Int. Cl.: 9

FOR: GAMING MACHINES, NAMELY, DEVICES WHICH ACCEPT A WAGER, IN CLASS 9 (U.S. CLS. 21, 23, 26, 36 AND 38).

TRADEMARK

FIRST USE 10-12-2011; IN COMMERCE 10-12-2011.

PRINCIPAL REGISTER

THE MARK CONSISTS OF STANDARD CHARACTERS WITHOUT CLAIM TO ANY PARTICULAR FONT, STYLE, SIZE, OR COLOR.

SN 77-721,818, FILED 4-24-2009.

BERYL GARDNER, EXAMINING ATTORNEY



David J. Kybas

Director of the United States Patent and Trademark Office

United States of America

United States Patent and Trademark Office

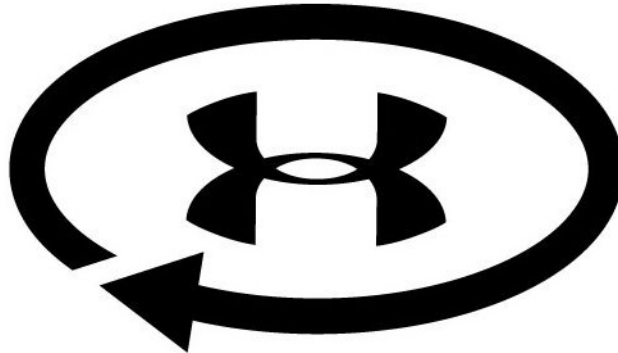

Reg. No. 4,099,384

UNDER ARMOUR, INC. (MARYLAND CORPORATION)
1020 HULL STREET
BALTIMORE, MD 21230

Registered Feb. 14, 2012

Int. Cl.: 25

FOR: THERMAL UNDERWEAR; UNDERWEAR; VESTS, IN CLASS 25 (U.S. CLS. 22 AND 39).

TRADEMARK

FIRST USE 1-0-2011; IN COMMERCE 1-0-2011.

PRINCIPAL REGISTER

OWNER OF U.S. REG. NOS. 2,727,031, 2,991,123, AND OTHERS.

THE MARK CONSISTS OF A STYLIZED LETTER "U" VERTICALLY OVERLAPPING A STYLIZED LETTER "A" SURROUNDED ENTIRELY BY AN OVAL LINE TERMINATING IN AN ARROW DESIGN.

SN 77-722,181, FILED 4-24-2009.

ANDREW RHIM, EXAMINING ATTORNEY



David J. Kybas

Director of the United States Patent and Trademark Office

United States of America

United States Patent and Trademark Office

SOLARBRIDGE
TECHNOLOGIES

Reg. No. 4,099,385

SOLARBRIDGE TECHNOLOGIES, INC. (DELAWARE CORPORATION)
9229 WATERFORD CENTRE BLVD., SUITE 110
AUSTIN, TX 78758

Registered Feb. 14, 2012

Int. Cl.: 9

FOR: INVERTERS, IN CLASS 9 (U.S. CLS. 21, 23, 26, 36 AND 38).

TRADEMARK

FIRST USE 4-30-2011; IN COMMERCE 4-30-2011.

PRINCIPAL REGISTER

NO CLAIM IS MADE TO THE EXCLUSIVE RIGHT TO USE "TECHNOLOGIES", APART FROM THE MARK AS SHOWN.

THE MARK CONSISTS OF DESIGN OF CURVY LINE ABOVE WORDS "SOLARBRIDGE TECHNOLOGIES".

SN 77-723,534, FILED 4-27-2009.

SALLY SHIH, EXAMINING ATTORNEY



David J. Kybas

Director of the United States Patent and Trademark Office

United States of America

United States Patent and Trademark Office

STARWOOD SOLAR

Reg. No. 4,099,386

Registered Feb. 14, 2012

**Int. Cls.: 35, 36, 39, and
40**

SERVICE MARK

PRINCIPAL REGISTER

STARWOOD ENERGY GROUP GLOBAL, L.L.C. (DELAWARE LIMITED LIABILITY COMPANY)
CORPORATION TRUST CENTER
1209 ORANGE STREET
WILMINGTON, DE 19801

FOR: BUSINESS MANAGEMENT AND CONSULTING SERVICES, NAMELY, ARRANGING FOR THE CREATION, CONSTRUCTION, MANAGEMENT, PROVISION, ACQUISITION, OPERATION, AND OWNERSHIP OF ENERGY COMMODITIES SUPPLY, GENERATION, TRANSPORTATION, TRANSMISSION AND DISTRIBUTION FACILITIES AND INFRASTRUCTURE; OPERATION AND MANAGEMENT OF ENERGY FACILITIES FOR OTHERS; BUSINESS SERVICES, NAMELY, FACILITIES MANAGEMENT OF TECHNICAL OPERATIONS OF ENERGY FACILITIES FOR OTHERS; BUSINESS ADMINISTRATION AND MANAGEMENT AT ENERGY PROJECTS; TAX CONSULTATION CONCERNING ENERGY COMMODITIES SUPPLY, GENERATION, TRANSPORTATION, TRANSMISSION AND DISTRIBUTION FACILITIES AND INFRASTRUCTURE; CONSULTANCY CONCERNING ECONOMIC CONSEQUENCES AND PROFITABILITY OF ENERGY PROJECTS, IN CLASS 35 (U.S. CLS. 100, 101 AND 102).

FIRST USE 11-10-2011; IN COMMERCE 11-10-2011.



FOR: ENERGY BROKERAGE SERVICES; CONSULTING SERVICES IN THE FIELD OF ENERGY BROKERAGE; ENERGY COMMODITY TRADING FOR OTHERS; ARRANGING FOR FINANCING OF ENERGY COMMODITIES; FINANCIAL RISK MANAGEMENT SERVICES IN THE FIELD OF ENERGY; FINANCING OF ENERGY PROJECTS; ARRANGING FOR FINANCING OF ENERGY COMMODITIES SUPPLY, GENERATION, TRANSPORTATION, TRANSMISSION AND DISTRIBUTION FACILITIES AND INFRASTRUCTURE; FINANCIAL RESEARCH, CONSULTING, AND FINANCIAL FORECASTING IN CONNECTION WITH ENERGY COMMODITIES SUPPLY, GENERATION, TRANSPORTATION, TRANSMISSION AND DISTRIBUTION FACILITIES AND INFRASTRUCTURE, IN CLASS 36 (U.S. CLS. 100, 101 AND 102).

FIRST USE 11-10-2011; IN COMMERCE 11-10-2011.

David J. Kyffers

Director of the United States Patent and Trademark Office

FOR: DELIVERY OF AND MAKING AVAILABLE FOR ACQUISITION POWER AND ITS BY-PRODUCTS FOR AND TO OTHERS, NAMELY, POWER AND ITS BY-PRODUCTS GENERATED FROM SOLAR ENERGY AND RELATED ENERGY SOURCES; DISTRIBUTION

Reg. No. 4,099,386 OF SOLAR ENERGY AND SOLAR POWER TO AND FROM OTHERS, IN CLASS 39 (U.S. CLS. 100 AND 105).

FIRST USE 11-10-2011; IN COMMERCE 11-10-2011.

FOR: GENERATION OF AND PRODUCTION OF ELECTRIC POWER; GENERATION OF AND PRODUCTION OF ENERGY FOR RETAIL AND WHOLESALE CUSTOMERS; ELECTRIC POWER GENERATION FROM CONVENTIONAL, SOLAR, AND ALTERNATIVE ENERGY SOURCES; ELECTRICAL UTILITY SERVICES, NAMELY, THE GENERATION OF ELECTRICITY, IN CLASS 40 (U.S. CLS. 100, 103 AND 106).

FIRST USE 11-10-2011; IN COMMERCE 11-10-2011.

THE MARK CONSISTS OF STANDARD CHARACTERS WITHOUT CLAIM TO ANY PARTICULAR FONT, STYLE, SIZE, OR COLOR.

NO CLAIM IS MADE TO THE EXCLUSIVE RIGHT TO USE "SOLAR", APART FROM THE MARK AS SHOWN.

SN 77-723,649, FILED 4-28-2009.

ROBIN MITTLER, EXAMINING ATTORNEY

United States of America

United States Patent and Trademark Office

EKOMINI

Reg. No. 4,099,387

Registered Feb. 14, 2012

Int. Cls.: 9 and 28

TRADEMARK

PRINCIPAL REGISTER

EKOMINI INC. (CANADA CORPORATION)
SUITE 200A
6250, HUTCHISON
MONTREAL, QUEBEC, CANADA H2V4C5

FOR: EDUCATIONAL AMUSEMENT APPARATUS IN THE NATURE OF AN ELECTRONIC TOY SAVINGS BANK FOR KIDS ADAPTED FOR USE WITH AN EXTERNAL DISPLAY SCREEN OR MONITOR FOR CONNECTING TO THE INTERNET TO PLAY GAMES ON THE BASICS OF PERSONAL FINANCE, IN CLASS 9 (U.S. CLS. 21, 23, 26, 36 AND 38).

FIRST USE 5-1-2009; IN COMMERCE 5-1-2009.

FOR: INTERACTIVE AND EDUCATIONAL PRODUCTS, NAMELY, ELECTRONIC TOY SAVINGS BANKS FOR KIDS, IN CLASS 28 (U.S. CLS. 22, 23, 38 AND 50).

FIRST USE 5-1-2009; IN COMMERCE 5-1-2009.

THE MARK CONSISTS OF STANDARD CHARACTERS WITHOUT CLAIM TO ANY PARTICULAR FONT, STYLE, SIZE, OR COLOR.

THE WORDING "EKOMINI" HAS NO MEANING IN A FOREIGN LANGUAGE.

SN 77-725,928, FILED 4-30-2009.

MICHELLE DUBOIS, EXAMINING ATTORNEY



David J. Kyros

Director of the United States Patent and Trademark Office

United States of America

United States Patent and Trademark Office

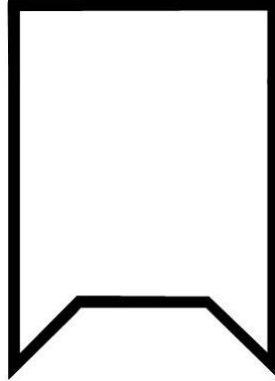

Reg. No. 4,099,388

Registered Feb. 14, 2012

Int. Cls.: 7 and 37

TRADEMARK

SERVICE MARK

PRINCIPAL REGISTER

BLACK STONE SPORTS, INC. (CANADA CORPORATION)
RR#2 1919 SETTERINGTON DRIVE
KINGSVILLE, CANADA N9Y2E5

FOR: POWER-OPERATED SKATE SHARPENING GRINDING WHEELS, NAMELY, DRESSER WHEELS AND SPINNERS , IN CLASS 7 (U.S. CLS. 13, 19, 21, 23, 31, 34 AND 35).

FIRST USE 4-30-2011; IN COMMERCE 4-30-2011.

FOR: SHARPENING SERVICES, NAMELY, ICE SKATE BLADE SHARPENING, IN CLASS 37 (U.S. CLS. 100, 103 AND 106).

FIRST USE 4-30-2011; IN COMMERCE 4-30-2011.

THE MARK CONSISTS OF A RECTANGLE WITH A TRAPEZOIDAL CUTOUT AT THE BOTTOM.

SN 77-726,982, FILED 5-1-2009.

DORITT L. CARROLL, EXAMINING ATTORNEY



David J. Kybas

Director of the United States Patent and Trademark Office

United States of America

United States Patent and Trademark Office

THE UNIVERSAL LANGUAGE OF CREATIVITY

Reg. No. 4,099,389

ADAMS, MARK (UNITED STATES INDIVIDUAL)
7630 COMANCHE DRIVE
RICHMOND, VA 23225

Registered Feb. 14, 2012

Int. Cl.: 41

FOR: EDUCATIONAL SERVICES, NAMELY, CONDUCTING WORKSHOPS, SEMINARS AND LECTURES IN THE FIELD OF PERSONAL GROWTH, PERSONAL DEVELOPMENT, SELF-HELP, SPIRITUAL GROWTH, SPIRITUAL DEVELOPMENT AND SELF-ACTUALIZATION AND DISTRIBUTION OF TRAINING MATERIAL IN CONNECTION THEREWITH; LIFE COACHING SERVICES IN THE FIELD OF PERSONAL GROWTH, PERSONAL DEVELOPMENT, SELF-HELP, SPIRITUAL GROWTH, SPIRITUAL DEVELOPMENT AND SELF-ACTUALIZATION; PERSONAL COACHING SERVICES IN THE FIELD OF PERSONAL GROWTH, PERSONAL DEVELOPMENT, SELF-HELP, SPIRITUAL GROWTH, SPIRITUAL DEVELOPMENT AND SELF-ACTUALIZATION, IN CLASS 41 (U.S. CLS. 100, 101 AND 107).

SERVICE MARK

PRINCIPAL REGISTER

FIRST USE 11-18-2011; IN COMMERCE 11-18-2011.

THE MARK CONSISTS OF STANDARD CHARACTERS WITHOUT CLAIM TO ANY PARTICULAR FONT, STYLE, SIZE, OR COLOR.

SN 77-728,063, FILED 5-4-2009.

ERIN FALK, EXAMINING ATTORNEY



David J. Kyfos

Director of the United States Patent and Trademark Office

United States of America

United States Patent and Trademark Office

DR. OZ

Reg. No. 4,099,390

Registered Feb. 14, 2012

Int. Cl.: 5

TRADEMARK

PRINCIPAL REGISTER

OZ, MEHMET C. (UNITED STATES INDIVIDUAL)
MILSTEIN 7-435
177 FORT WASHINGTON AVENUE
NEW YORK, NY 10032

FOR: MULTIVITAMIN PREPARATIONS; NUTRACEUTICALS FOR USE AS A DIETARY SUPPLEMENT; NUTRITIONAL SUPPLEMENTS; VITAMINS AND VITAMIN PREPARATIONS, IN CLASS 5 (U.S. CLS. 6, 18, 44, 46, 51 AND 52).

FIRST USE 12-6-2011; IN COMMERCE 12-6-2011.

THE MARK CONSISTS OF STANDARD CHARACTERS WITHOUT CLAIM TO ANY PARTICULAR FONT, STYLE, SIZE, OR COLOR.

THE NAME SHOWN IN THE MARK IDENTIFIES A LIVING INDIVIDUAL, NAMELY, MEHMET C. OZ, M.D., WHOSE CONSENT(S) TO REGISTER IS MADE OF RECORD.

SN 77-730,038, FILED 5-6-2009.

ALEX KEAM, EXAMINING ATTORNEY



David J. Kybas

Director of the United States Patent and Trademark Office

United States of America

United States Patent and Trademark Office

CATCHER'S MITT

Reg. No. 4,099,391

REEL FUN ENTERPRISES, LLC (LOUISIANA LIMITED LIABILITY COMPANY)
7575 JEFFERSON HWY., # 177

Registered Feb. 14, 2012

BATON ROUGE, LA 70806

Int. Cl.: 28

FOR: SPORT FISHING ACCESSORY, NAMELY, GLOVES FOR HANDLING FISH, IN CLASS 28 (U.S. CLS. 22, 23, 38 AND 50).

TRADEMARK

FIRST USE 11-8-2011; IN COMMERCE 11-8-2011.

PRINCIPAL REGISTER

THE MARK CONSISTS OF STANDARD CHARACTERS WITHOUT CLAIM TO ANY PARTICULAR FONT, STYLE, SIZE, OR COLOR.

SN 77-730,692, FILED 5-6-2009.

JILL PRATER, EXAMINING ATTORNEY



David J. Kybas

Director of the United States Patent and Trademark Office

United States of America
United States Patent and Trademark Office

ATTRAXX

Reg. No. 4,099,392

Registered Feb. 14, 2012

Int. Cl.: 28

TRADEMARK

PRINCIPAL REGISTER

MYSTIC TACKLE WORKS, INC. (DELAWARE CORPORATION)
100 ESSEZ STREET
WEST MYSTIC, CT 06388

FOR: ARTIFICIAL FISHING BAIT; ARTIFICIAL FISHING LURES; FISH ATTRACTANTS;
FISHING LURES; SCENT LURES FOR HUNTING OR FISHING, IN CLASS 28 (U.S. CLS. 22,
23, 38 AND 50).

FIRST USE 10-28-2010; IN COMMERCE 10-28-2010.

THE MARK CONSISTS OF STANDARD CHARACTERS WITHOUT CLAIM TO ANY PAR-
TICULAR FONT, STYLE, SIZE, OR COLOR.

SN 77-731,500, FILED 5-7-2009.

APRIL ROACH, EXAMINING ATTORNEY



David J. Kyffers

Director of the United States Patent and Trademark Office

United States of America
United States Patent and Trademark Office

REOLUBE

Reg. No. 4,099,393

GREAT LAKES CHEMICAL CORPORATION (DELAWARE CORPORATION)
199 BENSON ROAD
MIDDLEBURY, CT 06749

Registered Feb. 14, 2012

Int. Cl.: 4

FOR: LUBRICATING OILS AND FLUIDS FOR INDUSTRIAL PURPOSES, IN CLASS 4 (U.S. CLS. 1, 6 AND 15).

TRADEMARK

FIRST USE 12-31-2005; IN COMMERCE 12-31-2005.

PRINCIPAL REGISTER

THE MARK CONSISTS OF STANDARD CHARACTERS WITHOUT CLAIM TO ANY PARTICULAR FONT, STYLE, SIZE, OR COLOR.

OWNER OF U.S. REG. NO. 918,366.

SN 77-732,297, FILED 5-8-2009.

JAMES A. RAUEN, EXAMINING ATTORNEY



David J. Kybas

Director of the United States Patent and Trademark Office

United States of America

United States Patent and Trademark Office

CORRELATED VM

Reg. No. 4,099,394

Registered Feb. 14, 2012

Int. Cl.: 9

NETWORK SECURITY PROFESSIONALS, INC. (MINNESOTA CORPORATION), DBA
NETSPI INC.,
SUITE 670
800 WASHINGTON AVE N.
MINNEAPOLIS, MN 55401

TRADEMARK

PRINCIPAL REGISTER

FOR: COMPUTER SOFTWARE THAT AGGREGATES, ASSOCIATES AND COMPARES
COMPREHENSIVE SECURITY ASSESSMENTS AND VULNERABILITY TESTS FOR
COMPUTER NETWORKS, IN CLASS 9 (U.S. CLS. 21, 23, 26, 36 AND 38).

FIRST USE 10-26-2011; IN COMMERCE 10-26-2011.

THE MARK CONSISTS OF STANDARD CHARACTERS WITHOUT CLAIM TO ANY PAR-
TICULAR FONT, STYLE, SIZE, OR COLOR.

SN 77-732,740, FILED 5-8-2009.

MICHAEL LITZAU, EXAMINING ATTORNEY



David J. Kyffers

Director of the United States Patent and Trademark Office

United States of America

United States Patent and Trademark Office

CORRELATED VM

Reg. No. 4,099,395

Registered Feb. 14, 2012

Int. Cl.: 42

SERVICE MARK

PRINCIPAL REGISTER

NETWORK SECURITY PROFESSIONALS, INC. (MINNESOTA CORPORATION), DBA
NETSPI INC.,
SUITE 670
800 WASHINGTON AVE N.
MINNEAPOLIS, MN 55401

FOR: PROVIDING ONLINE NON-DOWNLOADABLE COMPUTER SOFTWARE THAT AGGREGATES, ASSOCIATES AND COMPARES COMPREHENSIVE SECURITY ASSESSMENTS AND VULNERABILITY TESTS FOR COMPUTER NETWORKS, IN CLASS 42 (U.S. CLS. 100 AND 101).

FIRST USE 10-11-2011; IN COMMERCE 10-11-2011.

THE MARK CONSISTS OF STANDARD CHARACTERS WITHOUT CLAIM TO ANY PARTICULAR FONT, STYLE, SIZE, OR COLOR.

SN 77-732,744, FILED 5-8-2009.

MICHAEL LITZAU, EXAMINING ATTORNEY



David J. Kyffers

Director of the United States Patent and Trademark Office

United States of America

United States Patent and Trademark Office

Beauty Gourmet

Reg. No. 4,099,396

FOTI, KRISTINE A (UNITED STATES INDIVIDUAL)

Registered Feb. 14, 2012

11 ELM COURT
COHASSET, MA 02025

Int. Cl.: 41

SERVICE MARK

PRINCIPAL REGISTER

FOR: EDUCATIONAL AND ENTERTAINMENT SERVICES, NAMELY, PROVIDING CLASSES, CONFERENCES, WORKSHOPS, TELE-SEMINARS AND SEMINARS, IN THE FIELD OF HEALTH, NUTRITION, WEIGHT-LOSS, EXERCISE, SKIN CARE, LIFESTYLE, FOOD PREPARATION AND MEAL PLANNING AND DISTRIBUTING COURSE MATERIAL IN CONNECTION THEREWITH; PUBLICATION OF BOOKS, MAGAZINES, NEWSLETTERS AND OTHER TEXTS; PRODUCTION OF SOUND AND IMAGE RECORDINGS ON SOUND AND IMAGE CARRIERS, ALL IN THE FIELD OF HEALTH, NUTRITION, WEIGHT-LOSS, EXERCISE, SKIN CARE, LIFESTYLE, FOOD PREPARATION AND MEAL PLANNING; EDUCATIONAL SERVICES, NAMELY, PROVIDING FACE-TO-FACE TEACHING, LECTURING, MENTORING, PROFESSIONAL AND LIFE COACHING, INSTRUCTION AND CONTINUOUS TRAINING, IN THE FIELDS OF HEALTH, NUTRITION, WEIGHT-LOSS, EXERCISE, SKIN CARE, LIFESTYLE, FOOD PREPARATION AND MEAL PLANNING AND THE DISTRIBUTION OF INSTRUCTIONAL MATERIALS IN CONNECTION THEREWITH; EDUCATIONAL SERVICES, PROVIDING ORAL TEACHING, LECTURING, MENTORING, PROFESSIONAL AND LIFE COACHING, INSTRUCTION AND CONTINUOUS TRAINING, IN THE FIELDS OF HEALTH, NUTRITION, WEIGHT-LOSS, EXERCISE, SKIN CARE, LIFESTYLE, FOOD PREPARATION AND MEAL PLANNING AND THE DISTRIBUTION OF INSTRUCTIONAL MATERIALS, IN CONNECTION THEREWITH; WRITING OF ARTICLES FOR PERIODICALS AND JOURNALS, OTHER THAN FOR ADVERTISING OR PUBLICITY, IN THE FIELD OF HEALTH, NUTRITION, WEIGHT-LOSS, EXERCISE SKINCARE, LIFESTYLE, FOOD PREPARATION AND MEAL PLANNING; ENTERTAINMENT SERVICES, NAMELY, PERSONAL APPEARANCES BY AN INDUSTRY EXPERT IN THE FIELD OF HEALTH, NUTRITION, WEIGHT-LOSS, EXERCISE SKINCARE, LIFESTYLE, FOOD PREPARATION AND MEAL PLANNING; CONDUCTING EDUCATION AND ENTERTAINMENT EXHIBITIONS IN THE FIELD OF HEALTH, NUTRITION, WEIGHT-LOSS, EXERCISE, SKIN CARE, LIFESTYLE, FOOD PREPARATION AND MEAL PLANNING; EDUCATIONAL AND ENTERTAINMENT SERVICES, NAMELY, A CONTINUING PROGRAM ABOUT HEALTH, NUTRITION, WEIGHT-LOSS, EXERCISE SKINCARE, LIFESTYLE, FOOD PREPARATION AND MEAL PLANNING ACCESSIBLE BY RADIO, TELEVISION, SATELLITE, AUDIO, IPTV (INTERNET PROTOCOL TELEVISION), VIDEO AND COMPUTER NETWORKS; FILM AND VIDEO PRODUCTION; EDUCATION SERVICES, NAMELY, CONDUCTING CLASSES, TUTORIALS, AND SEMINARS LIVE AND VIA AUDIO AND VIDEO STREAMING ONLINE VIA LOCAL AND GLOBAL NETWORKS, IN THE FIELDS OF HEALTH, NUTRITION,



David J. Kybas

Director of the United States Patent and Trademark Office

Reg. No. 4,099,396 WEIGHT-LOSS, EXERCISE SKINCARE, LIFESTYLE, FOOD PREPARATION AND MEAL PLANNING; EDUCATIONAL SERVICES, NAMELY, PUBLISHING AN ELECTRONIC NEWSLETTER AND ELECTRONIC MAGAZINE; PROVIDING NEWSLETTERS AND MAGAZINES VIA E-MAIL, ALL IN THE FIELD OF HEALTH, NUTRITION, WEIGHT-LOSS, EXERCISE SKINCARE, LIFESTYLE, FOOD PREPARATION AND MEAL PLANNING; ONLINE PUBLICATION OF BOOKS AND EBOOKS VIA LOCAL AND GLOBAL NETWORKS, ALL IN THE FIELD OF HEALTH, NUTRITION, WEIGHT-LOSS, EXERCISE SKINCARE, LIFESTYLE, FOOD PREPARATION AND MEAL PLANNING; EDUCATIONAL SERVICE, NAMELY, PROVIDING PODCASTS, WEBCASTS, AND BLOGS IN THE FIELD OF HEALTH, NUTRITION, WEIGHT-LOSS, EXERCISE SKINCARE, LIFESTYLE, FOOD PREPARATION AND MEAL PLANNING; EDUCATIONAL SERVICES, NAMELY, PROVIDING ONE-ON-ONE AND GROUP MENTORING, AND PROFESSIONAL COACHING IN THE FIELD OF HEALTH, NUTRITION, WEIGHT-LOSS, EXERCISE SKINCARE, LIFESTYLE, FOOD PREPARATION AND MEAL PLANNING, AND THE DISTRIBUTION OF INSTRUCTIONAL MATERIALS IN CONNECTION THEREWITH VIA A GLOBAL COMMUNICATIONS NETWORK; EDUCATIONAL SERVICES, PROVIDING AN ONLINE ARTICLE LIBRARY IN THE FIELD OF HEALTH, NUTRITION, WEIGHT-LOSS, EXERCISE SKINCARE, LIFESTYLE, FOOD PREPARATION AND MEAL PLANNING, IN CLASS 41 (U.S. CLS. 100, 101 AND 107).

FIRST USE 10-15-2011; IN COMMERCE 10-15-2011.

THE MARK CONSISTS OF STANDARD CHARACTERS WITHOUT CLAIM TO ANY PARTICULAR FONT, STYLE, SIZE, OR COLOR.

NO CLAIM IS MADE TO THE EXCLUSIVE RIGHT TO USE "BEAUTY", APART FROM THE MARK AS SHOWN.

SN 77-735,448, FILED 5-12-2009.

ANDREW LEASER, EXAMINING ATTORNEY

United States of America

United States Patent and Trademark Office

HAARFAGRE

Reg. No. 4,099,397

HAARFAGRE-30 LLC (IOWA LIMITED LIABILITY COMPANY)
PO BOX 824
PELLA, IA 50219

Registered Feb. 14, 2012

Int. Cl.: 25

FOR: CLOTHING, NAMELY, SHIRTS, HATS AND PANTS, IN CLASS 25 (U.S. CLS. 22 AND 39).

TRADEMARK

FIRST USE 11-15-2011; IN COMMERCE 11-15-2001.

PRINCIPAL REGISTER

THE MARK CONSISTS OF STANDARD CHARACTERS WITHOUT CLAIM TO ANY PARTICULAR FONT, STYLE, SIZE, OR COLOR.

THE ENGLISH TRANSLATION OF "HAARFAGRE" IN THE MARK IS UNKNOWN.

SN 77-736,004, FILED 5-13-2009.

MARGERY A. TIERNEY, EXAMINING ATTORNEY



David J. Kybas

Director of the United States Patent and Trademark Office

United States of America

United States Patent and Trademark Office

MARK 12

Reg. No. 4,099,398

Registered Feb. 14, 2012

Int. Cls.: 16 and 41

TRADEMARK

SERVICE MARK

PRINCIPAL REGISTER

K12 INC. (DELAWARE CORPORATION)
2300 CORPORATE PARK DRIVE
SUITE 200
HERNDON, VA 20171

FOR: PRINTED EDUCATIONAL AND INSTRUCTIONAL MATERIALS IN LANGUAGE ARTS AND ENGLISH IN THE PRIMARY SCHOOL CURRICULA , IN CLASS 16 (U.S. CLS. 2, 5, 22, 23, 29, 37, 38 AND 50).

FIRST USE 8-17-2009; IN COMMERCE 8-17-2009.

FOR: EDUCATIONAL SERVICES, NAMELY, PROVIDING COURSES OF INSTRUCTION AT THE PRIMARY SCHOOL LEVEL AND DISTRIBUTING COURSE MATERIAL IN CONNECTION THEREWITH; PROVIDING ON-LINE INTERACTIVE COMPUTER GAMES FOR TEACHING STUDENTS, NAMELY, PROGRAMS THAT FEATURE CONCENTRATION GAMES, VIRTUAL MANIPULATIVES, VIRTUAL REALITY WORLDS WITH AVATARS, INSTRUCTIONAL ANIMATIONS AND SIMULATIONS, INTERACTIVE STORIES WITH ANIMATION AND/OR NARRATION, AND INTERACTIVE QUIZZES THAT ARE SCORED, IN CLASS 41 (U.S. CLS. 100, 101 AND 107).

FIRST USE 10-15-2009; IN COMMERCE 10-15-2009.

THE MARK CONSISTS OF STANDARD CHARACTERS WITHOUT CLAIM TO ANY PARTICULAR FONT, STYLE, SIZE, OR COLOR.

SN 77-736,039, FILED 5-13-2009.

LESLIE RICHARDS, EXAMINING ATTORNEY



David J. Kypos

Director of the United States Patent and Trademark Office

United States of America

United States Patent and Trademark Office

ALOFT

Reg. No. 4,099,399

Registered Feb. 14, 2012

Int. Cl.: 33

TRADEMARK

PRINCIPAL REGISTER

C. MONDAVI & SONS (CALIFORNIA CORPORATION)
P.O. BOX 191
ST. HELENA, CA 94574

FOR: WINE, IN CLASS 33 (U.S. CLS. 47 AND 49).

FIRST USE 9-28-2011; IN COMMERCE 9-28-2011.

THE MARK CONSISTS OF STANDARD CHARACTERS WITHOUT CLAIM TO ANY PARTICULAR FONT, STYLE, SIZE, OR COLOR.

SN 77-736,336, FILED 5-13-2009.

MARC LEIPZIG, EXAMINING ATTORNEY



David J. Kyffers

Director of the United States Patent and Trademark Office

United States of America

United States Patent and Trademark Office

CONNECTING YOU TO SPORTS

Reg. No. 4,099,400

SPIRALEDGE, INC. (DELAWARE CORPORATION)

Registered Feb. 14, 2012

110 RIO ROBLES
SAN JOSE, CA 95134

Int. Cls.: 35, 38, and 41

FOR: PROVIDING AN ON-LINE DIRECTORY INFORMATION SERVICE FEATURING INFORMATION REGARDING SPORTS, SPORTS NEWS, SPORTING EVENTS, SPORTS RECORDS, FAMOUS ATHLETES, SPORTS FACILITIES, SPORTS TEAMS, SCHOOLS, INSTRUCTORS, TRAINERS, GENERAL INTEREST, VIRTUAL COMMUNITY, SOCIAL NETWORKING, PHOTO SHARING, AND TRANSMISSION OF PHOTOGRAPHIC IMAGES; ADVERTISING SERVICES; PROMOTING THE SERVICES OF OTHERS OVER THE INTERNET; PROVIDING AN ON-LINE SEARCHABLE DATABASE FEATURING CLASSIFIED AD LISTINGS AND EMPLOYMENT OPPORTUNITIES, IN CLASS 35 (U.S. CLS. 100, 101 AND 102).

SERVICE MARK

PRINCIPAL REGISTER

FIRST USE 6-10-2010; IN COMMERCE 6-10-2010.

FOR: PROVIDING ELECTRONIC BULLETIN BOARDS FOR TRANSMISSION OF PHOTOGRAPHIC IMAGES AND MESSAGES CONCERNING PARTICIPATORY SPORTS, AND RECREATIONAL ACTIVITIES, GENERAL INTEREST, VIRTUAL COMMUNITY, SOCIAL NETWORKING, PHOTO SHARING, IN CLASS 38 (U.S. CLS. 100, 101 AND 104).

FIRST USE 6-10-2010; IN COMMERCE 6-10-2010.



FOR: ON-LINE SEARCHABLE DATABASE FEATURING INFORMATION REGARDING SPORTS, SPORTS NEWS, SPORTING EVENTS, SPORTS RECORDS, FAMOUS ATHLETES, SPORTS FACILITIES, SPORTS TEAMS, SPORTS SCHOOLS, SPORTS INSTRUCTORS, SPORTS TRAINERS; SPORTS TRAINING SERVICES, NAMELY, PROVIDING INSTRUCTION IN THE FIELD OF PERSONAL TRAINING AND PROVIDING PERSONAL TRAINING SCHEDULES AND PROGRAMS; PROVIDING INFORMATION IN THE FIELD OF SPORTS ACTIVITIES AND RECREATIONAL ACTIVITIES, NAMELY, PROVIDING INFORMATION ABOUT HOW TO SECURE BUDDIES FOR SPORTS AND RECREATIONAL ACTIVITIES; PROVIDING ON-LINE INFORMATION REGARDING PARTICIPATORY SPORTS AND RECREATIONAL ACTIVITIES AND SPORTING EVENTS; PROVIDING ON-LINE SPORTS NEWS AND CURRENT EVENTS INFORMATION, ALONG WITH LINKS TO OTHER SPORT SITES, CONCERNING SPORTS TEAMS AND LEAGUES, RECREATIONAL ACTIVITIES, SPORTS EVENTS, AND WORKOUT FACILITIES, IN CLASS 41 (U.S. CLS. 100, 101 AND 107).

David J. Kybas

Director of the United States Patent and Trademark Office

Reg. No. 4,099,400 FIRST USE 6-10-2010; IN COMMERCE 6-10-2010.

THE MARK CONSISTS OF STANDARD CHARACTERS WITHOUT CLAIM TO ANY PARTICULAR FONT, STYLE, SIZE, OR COLOR.

SN 77-737,650, FILED 5-15-2009.

DAVID H. STINE, EXAMINING ATTORNEY

United States of America

United States Patent and Trademark Office

The Complete Connection

Reg. No. 4,099,401

MISSY ENTERPRISES, INC. (ILLINOIS CORPORATION)
420 RAMBLER COURT
STREAMWOOD, IL 60107

Registered Feb. 14, 2012

Int. Cl.: 42

FOR: COMPUTER SERVICES, NAMELY, CREATING AN ON-LINE COMMUNITY FOR USERS TO PARTICIPATE, SHARE THEIR SKILLS, RECEIVE FEEDBACK, ENGAGE IN SOCIAL NETWORKING AND IMPROVE INDIVIDUAL TALENTS, IN CLASS 42 (U.S. CLS. 100 AND 101).

SERVICE MARK

PRINCIPAL REGISTER

FIRST USE 11-1-2011; IN COMMERCE 11-1-2011.

THE MARK CONSISTS OF STANDARD CHARACTERS WITHOUT CLAIM TO ANY PARTICULAR FONT, STYLE, SIZE, OR COLOR.

SN 77-737,776, FILED 5-15-2009.

JESSICA FATHY, EXAMINING ATTORNEY



David J. Kyffers

Director of the United States Patent and Trademark Office

United States of America

United States Patent and Trademark Office

GFTIO

Reg. No. 4,099,402

Registered Feb. 14, 2012

Int. Cl.: 42

SERVICE MARK

PRINCIPAL REGISTER

MISSY ENTERPRISES, INC. (ILLINOIS CORPORATION)
420 RAMBLER COURT
STREAMWOOD, IL 60107

FOR: COMPUTER SERVICES, NAMELY, CREATING AN ON-LINE COMMUNITY FOR USERS TO PARTICIPATE IN PHILANTHROPIC ACTIVITIES AND DISCUSSIONS, COMPETITIONS, SHOWCASE THEIR SKILLS, RECEIVE FEEDBACK, FORM VIRTUAL COMMUNITIES AND ENGAGE IN SOCIAL NETWORKING, IN CLASS 42 (U.S. CLS. 100 AND 101).

FIRST USE 11-1-2011; IN COMMERCE 11-1-2011.

THE MARK CONSISTS OF STANDARD CHARACTERS WITHOUT CLAIM TO ANY PARTICULAR FONT, STYLE, SIZE, OR COLOR.

SN 77-737,793, FILED 5-15-2009.

JESSICA FATHY, EXAMINING ATTORNEY



David J. Kybas

Director of the United States Patent and Trademark Office

United States of America

United States Patent and Trademark Office

GREAT BOOK OF LIFE

Reg. No. 4,099,403

GREAT BOOK OF LIFE, LLC (WISCONSIN LIMITED LIABILITY COMPANY)
W2172 COUNTY ROAD T
DURAND, WI 54736

Registered Feb. 14, 2012

Int. Cl.: 42

FOR: PROVIDING A WEBSITE FEATURING TECHNOLOGY THAT ENABLES USERS TO COLLECT, ORGANIZE, FORMAT, EDIT, PUBLISH AND SHARE INFORMATION, IMAGES, VIDEO AND AUDIO CONCERNING A PERSON'S LIFE OR THE LIFE OF A PET, IN CLASS 42 (U.S. CLS. 100 AND 101).

SERVICE MARK

PRINCIPAL REGISTER

FIRST USE 8-1-2010; IN COMMERCE 8-1-2010.

THE MARK CONSISTS OF STANDARD CHARACTERS WITHOUT CLAIM TO ANY PARTICULAR FONT, STYLE, SIZE, OR COLOR.

SN 77-737,958, FILED 5-15-2009.

JAMES LOVELACE, EXAMINING ATTORNEY



David J. Kyffers

Director of the United States Patent and Trademark Office

United States of America

United States Patent and Trademark Office

Young & Reckless

Reg. No. 4,099,404

Registered Feb. 14, 2012

Int. Cl.: 25

TRADEMARK

PRINCIPAL REGISTER

CAUSIN DRAMA, INC. (CALIFORNIA CORPORATION)
SUITE 1200
16000 VENTURA BLVD.
ENCINO, CA 91436

FOR: CLOTHING FOR MEN, WOMEN AND CHILDREN, NAMELY, T-SHIRTS; APPAREL AND CLOTHING OF ALL TYPES FOR MEN WOMEN AND CHILDREN, NAMELY, PANTS, SHORTS, WOVEN SHIRTS, JACKETS, HOODED SWEATSHIRTS, SWEATSHIRTS, JEANS, COATS, SWEATERS AND CAPS/HATS, IN CLASS 25 (U.S. CLS. 22 AND 39).

FIRST USE 1-20-2009; IN COMMERCE 2-2-2009.

THE MARK CONSISTS OF STANDARD CHARACTERS WITHOUT CLAIM TO ANY PARTICULAR FONT, STYLE, SIZE, OR COLOR.

SN 77-738,331, FILED 5-15-2009.

JAMES GRIFFIN, EXAMINING ATTORNEY



David J. Kyffers

Director of the United States Patent and Trademark Office

United States of America

United States Patent and Trademark Office



Reg. No. 4,099,405

Registered Feb. 14, 2012

Int. Cls.: 13 and 25

TRADEMARK

PRINCIPAL REGISTER

GREENVILLE AMMO SUPPLY LLC (SOUTH CAROLINA LIMITED LIABILITY COMPANY)
4 ROBERTS HILL DRIVE
TAYLORS, SC 29687

FOR: SMALL ARMS AMMUNITION, IN CLASS 13 (U.S. CLS. 2 AND 9).

FIRST USE 5-20-2010; IN COMMERCE 5-20-2010.

FOR: BOXER SHORTS; GOLF SHIRTS; HATS; SWEAT SHIRTS; T-SHIRTS; TANK TOPS,
IN CLASS 25 (U.S. CLS. 22 AND 39).

FIRST USE 2-3-2011; IN COMMERCE 2-3-2011.

NO CLAIM IS MADE TO THE EXCLUSIVE RIGHT TO USE "GAS AMMO" IN INTERNA-
TIONAL CLASS 13, APART FROM THE MARK AS SHOWN.

THE MARK CONSISTS OF THE STYLIZED WORDS "GAS AMMO". THE WORD "GAS" IS
INSIDE AN IMAGE OF A BULLET.

SN 77-740,112, FILED 5-19-2009.

DOMINICK J. SALEMI, EXAMINING ATTORNEY



David J. Kybas

Director of the United States Patent and Trademark Office

United States of America

United States Patent and Trademark Office

VERANO

Reg. No. 4,099,406

GENERAL MOTORA LLC (DELAWARE LIMITED LIABILITY COMPANY)
300 RENAISSANCE CENTER
DETROIT, MI 482653000

Registered Feb. 14, 2012

Int. Cl.: 12

FOR: MOTOR LAND VEHICLES, NAMELY, AUTOMOBILES, SPORT UTILITY VEHICLES, TRUCKS, VANS, ENGINES THEREFOR AND STRUCTURAL PARTS THEREOF, IN CLASS 12 (U.S. CLS. 19, 21, 23, 31, 35 AND 44).

TRADEMARK

FIRST USE 11-22-2011; IN COMMERCE 11-22-2011.

PRINCIPAL REGISTER

THE MARK CONSISTS OF STANDARD CHARACTERS WITHOUT CLAIM TO ANY PARTICULAR FONT, STYLE, SIZE, OR COLOR.

THE ENGLISH TRANSLATION OF "VERANO" IN THE MARK IS "SUMMER".

SN 77-740,982, FILED 5-20-2009.

SHAILA SETTLES, EXAMINING ATTORNEY



David J. Kybas

Director of the United States Patent and Trademark Office

United States of America

United States Patent and Trademark Office

POLYSPENSION

Reg. No. 4,099,407

ROEHM MARINE, LLC (INDIANA LIMITED LIABILITY COMPANY)
6900 NELSON ROAD
FORT WAYNE, IN 46803

Registered Feb. 14, 2012

Int. Cl.: 12

FOR: SEATS FOR BOATS, IN CLASS 12 (U.S. CLS. 19, 21, 23, 31, 35 AND 44).

TRADEMARK

FIRST USE 12-1-2010; IN COMMERCE 12-1-2010.

PRINCIPAL REGISTER

THE MARK CONSISTS OF STANDARD CHARACTERS WITHOUT CLAIM TO ANY PARTICULAR FONT, STYLE, SIZE, OR COLOR.

SN 77-742,399, FILED 5-21-2009.

LOURDES AYALA, EXAMINING ATTORNEY



David J. Kyffers

Director of the United States Patent and Trademark Office

United States of America

United States Patent and Trademark Office

MONSTER HIGH

Reg. No. 4,099,408

Registered Feb. 14, 2012

Int. Cl.: 28

TRADEMARK

PRINCIPAL REGISTER

MATTEL, INC. (DELAWARE CORPORATION)
M1-1518
333 CONTINENTAL BOULEVARD
EL SEGUNDO, CA 90245

FOR: TOYS, GAMES AND PLAYTHINGS, NAMELY, DOLL PLAYSETS AND ACCESSORIES THEREFOR; TOY FIGURE PLAYSETS AND ACCESSORIES THEREFOR; TOY VEHICLES AND ACCESSORIES THEREFOR; HAND HELD UNITS FOR PLAYING ELECTRONIC GAMES OTHER THAN THOSE ADAPTED FOR USE WITH AN EXTERNAL DISPLAY SCREEN OR MONITOR; CARD GAMES; SPORTING GOODS, NAMELY, SKATEBOARDS, IN CLASS 28 (U.S. CLS. 22, 23, 38 AND 50).

FIRST USE 11-15-2011; IN COMMERCE 11-15-2011.

THE MARK CONSISTS OF STANDARD CHARACTERS WITHOUT CLAIM TO ANY PARTICULAR FONT, STYLE, SIZE, OR COLOR.

SN 77-743,282, FILED 5-22-2009.

CHARLES L. JENKINS, EXAMINING ATTORNEY



David J. Kyros

Director of the United States Patent and Trademark Office

United States of America

United States Patent and Trademark Office

i7

Reg. No. 4,099,409

Registered Feb. 14, 2012

Int. Cl.: 10

TRADEMARK

PRINCIPAL REGISTER

MEDTRONIC, INC. (MINNESOTA CORPORATION)
710 MEDTRONIC PARKWAY
MINNEAPOLIS, MN 554325604

FOR: MEDICAL DEVICES, NAMELY, REGISTRATION AND AUTOMATIC REGISTRATION DEVICES FOR USE IN IMAGE GUIDED SURGERY; TRACKING DEVICES FOR MEDICAL DEVICES AND INSTRUMENTS TO TRACK THE POSITION AND/OR ORIENTATION OF MEDICAL DEVICES AND INSTRUMENTS DURING IMAGE GUIDED SURGERY; AND PARTS AND FITTINGS THEREFOR, IN CLASS 10 (U.S. CLS. 26, 39 AND 44).

FIRST USE 3-11-2010; IN COMMERCE 3-11-2010.

THE MARK CONSISTS OF STANDARD CHARACTERS WITHOUT CLAIM TO ANY PARTICULAR FONT, STYLE, SIZE, OR COLOR.

SN 77-745,543, FILED 5-27-2009.

HOWARD B. LEVINE, EXAMINING ATTORNEY



David J. Kyjars

Director of the United States Patent and Trademark Office

United States of America

United States Patent and Trademark Office

HUNGER HELPERS

Reg. No. 4,099,410

FEEDING AMERICA (ARIZONA NON-PROFIT CORPORATION)
35 EAST WACKER DRIVE, SUITE 2000
CHICAGO, IL 60601

Registered Feb. 14, 2012

Int. Cl.: 43

FOR: CHARITABLE SERVICES, NAMELY, PROVIDING FOOD TO THE NEEDY, IN CLASS 43 (U.S. CLS. 100 AND 101).

SERVICE MARK

FIRST USE 12-29-2011; IN COMMERCE 12-29-2011.

PRINCIPAL REGISTER

THE MARK CONSISTS OF STANDARD CHARACTERS WITHOUT CLAIM TO ANY PARTICULAR FONT, STYLE, SIZE, OR COLOR.

SN 77-746,264, FILED 5-28-2009.

NELSON SNYDER, EXAMINING ATTORNEY



David J. Kybas

Director of the United States Patent and Trademark Office

United States of America

United States Patent and Trademark Office

CAN-AIR

Reg. No. 4,099,411

STEIDINGER, JOHN H. (UNITED STATES INDIVIDUAL)
1035 LAUREL DRIVE
BETHLEHEM, PA 18017

Registered Feb. 14, 2012

Int. Cl.: 21

FOR: CONTAINER INSERTS IN THE NATURE OF A PLASTIC AIR CONDUIT SPECIALLY DESIGNED TO ATTACH VERTICALLY TO THE INSIDE OF A TRASH CONTAINER THROUGH WHICH AIR PASSES FREELY FROM TOP TO BOTTOM TO RELEASE THE VACUUM THAT OTHERWISE WOULD RESTRICT THE REMOVAL OF A PLASTIC BAG FROM THE CONTAINER, IN CLASS 21 (U.S. CLS. 2, 13, 23, 29, 30, 33, 40 AND 50).

TRADEMARK

PRINCIPAL REGISTER

FIRST USE 2-12-2010; IN COMMERCE 7-26-2010.

THE MARK CONSISTS OF STANDARD CHARACTERS WITHOUT CLAIM TO ANY PARTICULAR FONT, STYLE, SIZE, OR COLOR.

SN 77-746,397, FILED 5-28-2009.

ROBIN MITTLER, EXAMINING ATTORNEY



David J. Kyffers

Director of the United States Patent and Trademark Office

United States of America

United States Patent and Trademark Office



Reg. No. 4,099,412

POLYSTRAND, INC. (COLORADO CORPORATION)
2370 AIR PARK WAY
MONTROSE, CO 81401

Registered Feb. 14, 2012

Int. Cl.: 17

FOR: PLASTIC IMPREGNATED COMPOSITE MATERIAL IN THE FORM OF REINFORCEMENT FIBERS IMPREGNATED WITH THERMOSET OR THERMOPLASTIC FOR USE IN MANUFACTURING FIBER-REINFORCED COMPOSITE STRUCTURES, IN CLASS 17 (U.S. CLS. 1, 5, 12, 13, 35 AND 50).

TRADEMARK

PRINCIPAL REGISTER

FIRST USE 3-0-2005; IN COMMERCE 3-0-2005.

OWNER OF U.S. REG. NO. 2,975,853.

THE COLOR(S) GRAY, GREEN, AND BLUE IS/ARE CLAIMED AS A FEATURE OF THE MARK.

THE MARK CONSISTS OF A SOLID GRAY LINE BREAKING OFF INTO FIVE SEPARATE LINES LAID UNDER THE WORD "POLYSTRAND" WITH THE SOLID LINE COMING THROUGH THE LETTER "D". "POLY" IS GREEN, AND "STRAND" IS BLUE.

SN 77-746,594, FILED 5-28-2009.

ELI HELLMAN, EXAMINING ATTORNEY



David J. Kybas

Director of the United States Patent and Trademark Office

United States of America

United States Patent and Trademark Office

PROSPER

Reg. No. 4,099,413

EASTMAN KODAK COMPANY (NEW JERSEY CORPORATION)
343 STATE STREET
ROCHESTER, NY 14650

Registered Feb. 14, 2012

Int. Cls.: 2 and 7

FOR: PRINTING INKS, IN CLASS 2 (U.S. CLS. 6, 11 AND 16).

TRADEMARK

FIRST USE 4-19-2011; IN COMMERCE 4-19-2011.

PRINCIPAL REGISTER

FOR: PRINTING PRESSES; PRINTING MACHINES FOR COMMERCIAL USE, IN CLASS 7
(U.S. CLS. 13, 19, 21, 23, 31, 34 AND 35).

FIRST USE 1-7-2011; IN COMMERCE 1-7-2011.

THE MARK CONSISTS OF STANDARD CHARACTERS WITHOUT CLAIM TO ANY PARTICULAR FONT, STYLE, SIZE, OR COLOR.

SN 77-747,478, FILED 5-29-2009.

ANN E. SAPPENFIELD, EXAMINING ATTORNEY



David J. Kyffers

Director of the United States Patent and Trademark Office

United States of America

United States Patent and Trademark Office



Reg. No. 4,099,414

SUGAR RIDGE BREWERY (OHIO LIMITED LIABILITY COMPANY)
1319 BROOKWOODE RD.
PERRYSBURG, OH 43551

Registered Feb. 14, 2012

Int. Cl.: 32

FOR: ALES; LAGERS, IN CLASS 32 (U.S. CLS. 45, 46 AND 48).

TRADEMARK

FIRST USE 4-11-2009; IN COMMERCE 7-15-2011.

PRINCIPAL REGISTER

NO CLAIM IS MADE TO THE EXCLUSIVE RIGHT TO USE "BREWERY" , APART FROM THE MARK AS SHOWN.

THE MARK CONSISTS OF A CIRCLE WITH A BOLD 2-HUMPED LINE DEPICTING A SUGAR RIDGE BISECTING THE CENTER OF THE CIRCLE LATERALLY. THE NAME "SUGAR RIDGE BREWERY" APPEARS BELOW THE BOLD WHITE LINE. A MOUNTAINS CAPE IS SHOWN ABOVE THE BOLD WHITE LINE. THE MARK IS ON A BLACK BACKGROUND, WHICH IS NOT A FEATURE OF THE MARK.

SN 77-747,552, FILED 5-29-2009.

MARY BOAGNI, EXAMINING ATTORNEY



David J. Kybas

Director of the United States Patent and Trademark Office

United States of America

United States Patent and Trademark Office

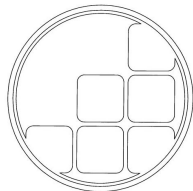

STRONGMIND

Reg. No. 4,099,415

STRONG ALLIANCE LLC (WASHINGTON LIMITED LIABILITY COMPANY)

Registered Feb. 14, 2012

P.O. BOX 362
BELLEVUE, WA 98006

Int. Cl.: 41

FOR: EDUCATION SERVICES, NAMELY, PROVIDING CURRICULUM AND TRAINING FOR CORPORATIONS, EDUCATORS AND MENTORS IN THE FIELDS OF ACADEMICS, HEALTH AND FITNESS, TEAM-BUILDING AND CHARACTER DEVELOPMENT; TUTORING SERVICES IN THE FIELD OF FUNDAMENTAL READING AND MATHEMATICS SKILLS AND HOMEWORK ASSISTANCE FOR CHILDREN; CURRICULUM DEVELOPMENT FOR CORPORATIONS, EDUCATORS, MENTORS AND STUDENTS IN THE FIELDS OF ACADEMICS, HEALTH AND FITNESS, TEAM-BUILDING AND CHARACTER DEVELOPMENT; AND DEVELOPING, ORGANIZING AND CONDUCTING SOCIAL, CULTURAL, EDUCATIONAL AND ATHLETIC PROGRAMS AND EVENTS FOR OTHERS, IN CLASS 41 (U.S. CLS. 100, 101 AND 107).

SERVICE MARK

PRINCIPAL REGISTER

FIRST USE 9-20-2010; IN COMMERCE 9-20-2010.

SN 77-747,993, FILED 5-29-2009.

KEVIN DINALLO, EXAMINING ATTORNEY



David J. Kyjars

Director of the United States Patent and Trademark Office

United States of America

United States Patent and Trademark Office

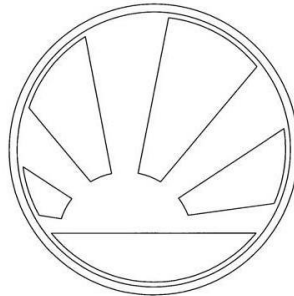

STRONGCHARACTER

Reg. No. 4,099,416

STRONG ALLIANCE LLC (WASHINGTON LIMITED LIABILITY COMPANY)

Registered Feb. 14, 2012

P.O. BOX 362
BELLEVUE, WA 98006

Int. Cl.: 41

FOR: YOUTH DEVELOPMENT SERVICES, NAMELY, CONDUCTING EDUCATIONAL PROGRAMS FOR FACILITATING GROUP TEAM-BUILDING AND CHARACTER DEVELOPMENT DISCUSSIONS AND SPEAKING ENGAGEMENTS BASED ON CHARACTER DEVELOPMENT MATERIAL; MENTORING SERVICES IN THE FIELD OF CHARACTER-BUILDING, ACADEMICS AND PHYSICAL FITNESS; CURRICULUM DEVELOPMENT FOR CORPORATIONS, EDUCATORS, MENTORS AND STUDENTS IN THE FIELDS OF ACADEMICS, HEALTH AND FITNESS, TEAM-BUILDING AND CHARACTER DEVELOPMENT; AND DEVELOPING, ORGANIZING AND CONDUCTING SOCIAL, CULTURAL, EDUCATIONAL AND ATHLETIC PROGRAMS AND EVENTS FOR OTHERS, IN CLASS 41 (U.S. CLS. 100, 101 AND 107).

SERVICE MARK

PRINCIPAL REGISTER

FIRST USE 9-20-2010; IN COMMERCE 9-20-2010.

SN 77-748,003, FILED 5-29-2009.

KEVIN DINALLO, EXAMINING ATTORNEY



David J. Kybas

Director of the United States Patent and Trademark Office

United States of America

United States Patent and Trademark Office

LINE TRAVELING CIRCUS

Reg. No. 4,099,417

K-2 CORPORATION (INDIANA CORPORATION)
4201 6TH AVENUE SOUTH
SEATTLE, WA 98108

Registered Feb. 14, 2012

Int. Cl.: 25

FOR: CLOTHING, NAMELY, SHIRTS, TEE SHIRTS, CAPS, BEANIES, HOODED SHIRTS,
IN CLASS 25 (U.S. CLS. 22 AND 39).

TRADEMARK

FIRST USE 9-1-2011; IN COMMERCE 9-1-2011.

PRINCIPAL REGISTER

THE MARK CONSISTS OF STANDARD CHARACTERS WITHOUT CLAIM TO ANY PAR-
TICULAR FONT, STYLE, SIZE, OR COLOR.

SN 77-749,964, FILED 6-2-2009.

DAVID HOFFMAN, EXAMINING ATTORNEY



David J. Kyffers

Director of the United States Patent and Trademark Office

United States of America

United States Patent and Trademark Office

iHoops

Reg. No. 4,099,418

Registered Feb. 14, 2012

Int. Cl.: 9

TRADEMARK

PRINCIPAL REGISTER

NBA PROPERTIES, INC. (NEW YORK CORPORATION)
OLYMPIC TOWER - 645 FIFTH AVENUE
NEW YORK, NY 10022

FOR: PRE-RECORDED CDROMS, AND DVDS FEATURING BASKETBALL; AUDIO RECORDINGS AND VIDEO RECORDINGS FEATURING ENTERTAINMENT AND INFORMATION IN THE FIELD OF BASKETBALL; AUDIO DISCS, VIDEO DISCS, COMPUTER LASER DISCS, PRE-RECORDED AUDIO AND VIDEO CASSETTES, PRE-RECORDED AUDIO AND VIDEO TAPES, PRE-RECORDED COMPACT DISCS, PRE-RECORDED COMPUTER LASER DISCS, ALL FEATURING ENTERTAINMENT AND INFORMATION RELATED TO BASKETBALL; COMPUTER ACCESSORIES, NAMELY, MOUSE PADS, MICE, DISC CASES, COMPUTER CARRY-ON CASES, KEYBOARD WRIST PADS, COMPUTER MONITOR CARDBOARD FRAMES, ALL RELATED TO BASKETBALL; COMPUTER PROGRAMS FOR VIEWING INFORMATION, STATISTICS OR TRIVIA ABOUT BASKETBALL; COMPUTER SOFTWARE, NAMELY, SCREEN SAVERS FEATURING BASKETBALL THEMES, COMPUTER SOFTWARE TO ACCESS AND VIEW COMPUTER WALLPAPER, COMPUTER BROWSERS, COMPUTER SKINS AND COMPUTER CURSORS; COMPUTER GAME SOFTWARE; VIDEO GAME SOFTWARE, VIDEO GAME CARTRIDGES AND VIDEO GAME MACHINES AND VIDEO GAME HAND HELD CONTROLLERS FOR USE WITH TELEVISIONS; WIRELESS TELEPHONES; RADIOS, TELEPHONES, AND CELL PHONE ACCESSORIES, NAMELY, FACE PLATES AND CELL PHONE COVERS; VIDEO MONITORS, COMPUTER MONITORS, BINOCULARS; SUNGLASSES; EYEGLASS FRAMES; EYEWEAR STRAPS AND CHAINS; EYEGLASS AND SUNGLASS CASES; MAGNETS; DISPOSABLE CAMERAS; CREDIT CARDS AND PRE-PAID TELEPHONE CALLING CARDS MAGNETICALLY ENCODED, DOWNLOADABLE VIDEO RECORDINGS, VIDEO STREAM RECORDINGS, AND AUDIO RECORDINGS IN THE FIELD OF BASKETBALL PROVIDED OVER THE INTERNET; DOWNLOADABLE COMPUTER SOFTWARE FOR VIEWING DATABASES OF INFORMATION, STATISTICAL INFORMATION, TRIVIA, POLLING INFORMATION, AND INTERACTIVE POLLING IN THE FIELD OF BASKETBALL PROVIDED OVER THE INTERNET; DOWNLOADABLE COMPUTER GAME SOFTWARE; DOWNLOADABLE VIDEO GAME PROGRAMS, INTERACTIVE VIDEO GAMES AND TRIVIA GAME SOFTWARE PROVIDED OVER THE INTERNET; DOWNLOADABLE COMPUTER SOFTWARE FOR USE AS SCREENSAVERS, WALLPAPER, BROWSERS, SKINS, AVATARS AND CURSORS OVER THE INTERNET; DOWNLOADABLE ELECTRONIC PUBLICATIONS IN THE NATURE OF MAGAZINES, NEWSLETTERS, COLORING BOOKS, GAME SCHEDULES ALL IN THE FIELD OF BASKETBALL PROVIDED OVER THE INTERNET; DOWNLOADABLE CATALOGS PROVIDED OVER THE INTERNET FEATURING AN ARRAY OF BASKETBALL-



David J. Kybas

Director of the United States Patent and Trademark Office

Reg. No. 4,099,418 THEMED PRODUCTS; DOWNLOADABLE GREETING CARDS PROVIDED OVER THE INTERNET, IN CLASS 9 (U.S. CLS. 21, 23, 26, 36 AND 38).

FIRST USE 6-30-2009; IN COMMERCE 6-30-2009.

THE MARK CONSISTS OF STANDARD CHARACTERS WITHOUT CLAIM TO ANY PARTICULAR FONT, STYLE, SIZE, OR COLOR.

SN 77-754,508, FILED 6-8-2009.

KATHLEEN LORENZO, EXAMINING ATTORNEY

United States of America

United States Patent and Trademark Office



Reg. No. 4,099,419

Registered Feb. 14, 2012

Int. Cl.: 9

TRADEMARK

PRINCIPAL REGISTER

NBA PROPERTIES, INC. (NEW YORK CORPORATION)
OLYMPIC TOWER - 645 FIFTH AVENUE
NEW YORK, NY 10022

FOR: PRE-RECORDED CDROMS, AND DVDS FEATURING BASKETBALL; AUDIO RECORDINGS AND VIDEO RECORDINGS FEATURING ENTERTAINMENT AND INFORMATION IN THE FIELD OF BASKETBALL; AUDIO DISCS, VIDEO DISCS, COMPUTER LASER DISCS, PRE-RECORDED AUDIO AND VIDEO CASSETTES, PRE-RECORDED AUDIO AND VIDEO TAPES, PRE-RECORDED COMPACT DISCS, PRE-RECORDED COMPUTER LASER DISCS, ALL FEATURING ENTERTAINMENT AND INFORMATION RELATED TO BASKETBALL; COMPUTER ACCESSORIES, NAMELY, MOUSE PADS, MICE, DISC CASES, COMPUTER CARRY-ON CASES, KEYBOARD WRIST PADS, COMPUTER MONITOR CARDBOARD FRAMES, ALL RELATED TO BASKETBALL; COMPUTER PROGRAMS FOR VIEWING INFORMATION, STATISTICS OR TRIVIA ABOUT BASKETBALL; COMPUTER SOFTWARE, NAMELY, SCREEN SAVERS FEATURING BASKETBALL THEMES, COMPUTER SOFTWARE TO ACCESS AND VIEW COMPUTER WALLPAPER, COMPUTER BROWSERS, COMPUTER SKINS AND COMPUTER CURSORS; COMPUTER GAME SOFTWARE; VIDEO GAME SOFTWARE, VIDEO GAME CARTRIDGES AND VIDEO GAME MACHINES AND VIDEO GAME HAND HELD CONTROLLERS FOR USE WITH TELEVISIONS; WIRELESS TELEPHONES; RADIOS, TELEPHONES, AND CELL PHONE ACCESSORIES, NAMELY, FACE PLATES AND CELL PHONE COVERS; VIDEO MONITORS, COMPUTER MONITORS, BINOCULARS; SUNGLASSES; EYEGLASS FRAMES; EYEWEAR STRAPS AND CHAINS; EYEGLASS AND SUNGLASS CASES; MAGNETS; DISPOSABLE CAMERAS; CREDIT CARDS AND PRE-PAID TELEPHONE CALLING CARDS MAGNETICALLY ENCODED, DOWNLOADABLE VIDEO RECORDINGS, VIDEO STREAM RECORDINGS, AND AUDIO RECORDINGS IN THE FIELD OF BASKETBALL PROVIDED OVER THE INTERNET; DOWNLOADABLE COMPUTER SOFTWARE FOR VIEWING DATABASES OF INFORMATION, STATISTICAL INFORMATION, TRIVIA, POLLING INFORMATION, AND INTERACTIVE POLLING IN THE FIELD OF BASKETBALL PROVIDED OVER THE INTERNET; DOWNLOADABLE COMPUTER GAME SOFTWARE; DOWNLOADABLE VIDEO GAME PROGRAMS, INTERACTIVE VIDEO GAMES AND TRIVIA GAME SOFTWARE PROVIDED OVER THE INTERNET; DOWNLOADABLE COMPUTER SOFTWARE FOR USE AS SCREENSAVERS, WALLPAPER, BROWSERS, SKINS, AVATARS AND CURSORS OVER THE INTERNET; DOWNLOADABLE ELECTRONIC PUBLICATIONS IN THE NATURE OF MAGAZINES, NEWSLETTERS, COLORING BOOKS, GAME SCHEDULES ALL IN THE FIELD OF BASKETBALL PROVIDED OVER THE INTERNET; DOWNLOADABLE CATALOGS PROVIDED OVER THE INTERNET FEATURING AN ARRAY OF BASKETBALL-



David J. Kybas

Director of the United States Patent and Trademark Office

Reg. No. 4,099,419 THEMED PRODUCTS; DOWNLOADABLE GREETING CARDS PROVIDED OVER THE INTERNET, IN CLASS 9 (U.S. CLS. 21, 23, 26, 36 AND 38).

FIRST USE 6-30-2009; IN COMMERCE 6-30-2009.

THE MARK CONSISTS OF THE WORD "IHOOPS" UNDER THE DEPICTION OF A BASKETBALL.

SN 77-754,606, FILED 6-8-2009.

KATHLEEN LORENZO, EXAMINING ATTORNEY

United States of America

United States Patent and Trademark Office



Reg. No. 4,099,420

Registered Feb. 14, 2012

Int. Cl.: 3

TRADEMARK

PRINCIPAL REGISTER

MSD CONSUMER CARE, INC. (DELAWARE CORPORATION)
3030 JACKSON AVENUE
MEMPHIS, TN 38151

FOR: SUN BLOCK PREPARATIONS; SUN SCREEN PREPARATIONS, IN CLASS 3 (U.S. CLS. 1, 4, 6, 50, 51 AND 52).

FIRST USE 0-0-2000; IN COMMERCE 0-0-2000.

OWNER OF U.S. REG. NOS. 693,601, 1,919,649, AND OTHERS.

THE COLOR(S) PINK, WHITE, YELLOW, BLUE, LIGHT BLUE, BROWN AND BEIGE IS/ARE CLAIMED AS A FEATURE OF THE MARK.

THE MARK CONSISTS OF A PINK AND WHITE SKY WITH BLUE AND LIGHT BLUE WATER IN THE DISTANCE AND PINK AND WHITE SAND. THERE IS A LIGHT BLUE BEACH TOWEL ON THE SAND WITH A BROWN AND WHITE TEDDY BEAR ON IT. THERE IS AN UMBRELLA ON THE SAND OUTLINED IN BROWN WITH A BROWN POLE. THE MATERIAL OF THE UMBRELLA IS BLUE AND YELLOW. THERE IS A GIRL AND DOG STANDING ON THE SAND. THE GIRL IS BEIGE WITH BLUE AND WHITE SHORTS, YELLOW HAIR, BLUE BOWS, BLUE AND WHITE EYES, AND BROWN OUTLINING. THE DOG IS BROWN WITH WHITE SHADING.

SN 77-755,994, FILED 6-10-2009.

KIM MONINGHOFF, EXAMINING ATTORNEY



David J. Kyffers

Director of the United States Patent and Trademark Office

United States of America

United States Patent and Trademark Office

OBTAIN HIGHER LEARNING

Reg. No. 4,099,421

Registered Feb. 14, 2012

Int. Cl.: 34

TRADEMARK

PRINCIPAL REGISTER

VITRICO CORPORATION (CALIFORNIA CORPORATION), DBA FIRELIGHT GLASS,
844 DOOLITTLE DRIVE
SAN LEANDRO, CA 94577

FOR: WATER PIPES FOR SMOKING, IN CLASS 34 (U.S. CLS. 2, 8, 9 AND 17).

FIRST USE 12-9-2011; IN COMMERCE 12-9-2011.

THE MARK CONSISTS OF STANDARD CHARACTERS WITHOUT CLAIM TO ANY PARTICULAR FONT, STYLE, SIZE, OR COLOR.

SN 77-756,723, FILED 6-10-2009.

GEORGE LORENZO, EXAMINING ATTORNEY



David J. Kyffers

Director of the United States Patent and Trademark Office

United States of America

United States Patent and Trademark Office

PARLEAU

Reg. No. 4,099,422

RAAB, SIMON (UNITED STATES INDIVIDUAL)
2692 SYCAMORE CANYON ROAD
SANTA BARBARA, CA 93108

Registered Feb. 14, 2012

Int. Cls.: 16 and 20

FOR: PAINTINGS, PAINTINGS IN MIXED MEDIA, IN CLASS 16 (U.S. CLS. 2, 5, 22, 23, 29, 37, 38 AND 50).

TRADEMARK

FIRST USE 8-0-2007; IN COMMERCE 11-30-2011.

PRINCIPAL REGISTER

FOR: WORKS OF ART IN MIXED MEDIA COMPOSED PRIMARILY OF POLYMERS, IN CLASS 20 (U.S. CLS. 2, 13, 22, 25, 32 AND 50).

FIRST USE 8-0-2007; IN COMMERCE 11-30-2011.

THE MARK CONSISTS OF STANDARD CHARACTERS WITHOUT CLAIM TO ANY PARTICULAR FONT, STYLE, SIZE, OR COLOR.

SN 77-760,606, FILED 6-16-2009.

MARC LEIPZIG, EXAMINING ATTORNEY



David J. Kyros

Director of the United States Patent and Trademark Office

United States of America

United States Patent and Trademark Office

DOC RHINO

Reg. No. 4,099,423

Registered Feb. 14, 2012

Int. Cl.: 10

TRADEMARK

PRINCIPAL REGISTER

RHINOSYSTEMS, INC. (OHIO CORPORATION)
SUITE 6
5399 LANCASTER DRIVE
CLEVELAND, OH 44131

FOR: NASAL IRRIGATION DEVICE, IN CLASS 10 (U.S. CLS. 26, 39 AND 44).

FIRST USE 12-9-2011; IN COMMERCE 12-9-2011.

THE MARK CONSISTS OF STANDARD CHARACTERS WITHOUT CLAIM TO ANY PARTICULAR FONT, STYLE, SIZE, OR COLOR.

SN 77-760,755, FILED 6-16-2009.

JASON TURNER, EXAMINING ATTORNEY



David J. Kybas

Director of the United States Patent and Trademark Office

United States of America

United States Patent and Trademark Office

ASD ART STYLE DESIGN LIVING

Reg. No. 4,099,424

Registered Feb. 14, 2012

Int. Cls.: 24 and 25

TRADEMARK

PRINCIPAL REGISTER

ROBERT KAUFMAN CO., INC. (CALIFORNIA CORPORATION), DBA ASD LIVING,
603-B E. UNIVERSITY DRIVE, PMB #727
CARSON, CA 90746

FOR: TOWELS, TABLE LINENS, TEXTILE NAPKINS, TEXTILE PLACE MATS, FABRIC
TABLE RUNNERS, OVEN MITTS AND POT HOLDERS, IN CLASS 24 (U.S. CLS. 42 AND
50).

FIRST USE 5-17-2009; IN COMMERCE 5-17-2009.

FOR: CLOTHING IN THE NATURE OF APRONS, CLOTH BIBS AND GLOVES; HEADWEAR,
NAMELY, HATS, IN CLASS 25 (U.S. CLS. 22 AND 39).

FIRST USE 5-10-2009; IN COMMERCE 5-10-2009.

THE MARK CONSISTS OF STANDARD CHARACTERS WITHOUT CLAIM TO ANY PAR-
TICULAR FONT, STYLE, SIZE, OR COLOR.

SN 77-763,423, FILED 6-18-2009.

BRIAN PINO, EXAMINING ATTORNEY



David J. Kyffers

Director of the United States Patent and Trademark Office

United States of America

United States Patent and Trademark Office

RICH  DAD

Reg. No. 4,099,425

CASHFLOW TECHNOLOGIES, INC. (NEVADA CORPORATION)
4330 N. CIVIC CENTER PLAZA, SUITE 101
SCOTTSDALE, AZ 85251

Registered Feb. 14, 2012

Int. Cl.: 28

FOR: BOARD GAMES AND EQUIPMENT SOLD AS A UNIT FOR PLAYING BOARD GAMES
USED FOR FINANCIAL EDUCATION, IN CLASS 28 (U.S. CLS. 22, 23, 38 AND 50).

TRADEMARK

FIRST USE 7-0-2010; IN COMMERCE 7-0-2010.

PRINCIPAL REGISTER

OWNER OF U.S. REG. NOS. 2,410,017, 2,827,787, AND OTHERS.

THE MARK CONSISTS OF THE WORD "RICH" FOLLOWED BY A QUADRILATERAL
DESIGN HAVING FOUR SECTIONS CREATED BY CURVED BANDS FOLLOWED BY THE
WORD "DAD".

SN 77-764,442, FILED 6-19-2009.

JULIE GUTTADAURO, EXAMINING ATTORNEY



David J. Kybas

Director of the United States Patent and Trademark Office

United States of America

United States Patent and Trademark Office

¡PODEMOS! Sugerencias para Mejorar la Actividad y Nutrición de los Niños

Reg. No. 4,099,426

Registered Feb. 14, 2012

Int. Cls.: 9 and 44

DEPARTMENT OF HEALTH AND HUMAN SERVICES (UNITED STATES AGENCY OF
THE UNITED STATES GOVERNMENT)
BLDG 31 RM 2B50
31 CENTER DRIVE
BETHESDA, MD 20892

TRADEMARK

SERVICE MARK

PRINCIPAL REGISTER

FOR: DOWNLOADABLE ELECTRONIC PUBLICATIONS IN THE NATURE OF MATERIALS, NAMELY, BROCHURES, TIP SHEETS AND HANDBOOKS DESIGNED TO EDUCATE AND ENCOURAGE PARENTS, CARE-GIVERS, FAMILIES, HEALTH CARE PROVIDERS AND COMMUNITY ORGANIZATIONS, NAMELY, SCHOOLS, AFTER-SCHOOL ORGANIZATIONS, BUSINESSES, WORKSITES, FAITH BASED ORGANIZATIONS, LOCAL AND STATE GOVERNMENT AGENCIES TO ASSIST CHILDREN TO MAINTAIN A HEALTHY WEIGHT THROUGH NUTRITION, EXERCISE, AND FITNESS, IN CLASS 9 (U.S. CLS. 21, 23, 26, 36 AND 38).

FIRST USE 10-0-2009; IN COMMERCE 10-0-2009.

FOR: PROVIDING EDUCATIONAL INFORMATION DESIGNED TO EDUCATE AND ENCOURAGE PARENTS, CARE-GIVERS, FAMILIES, HEALTH CARE PRACTITIONERS AND PROVIDERS, EMPLOYERS, TEACHERS, LOCAL AND STATE GOVERNMENT OFFICIALS AND COMMUNITY ORGANIZATIONS TO ASSIST CHILDREN TO MAINTAIN A HEALTHY WEIGHT THROUGH NUTRITION, EXERCISE AND FITNESS, IN CLASS 44 (U.S. CLS. 100 AND 101).

FIRST USE 10-0-2009; IN COMMERCE 10-0-2009.

THE MARK CONSISTS OF STANDARD CHARACTERS WITHOUT CLAIM TO ANY PARTICULAR FONT, STYLE, SIZE, OR COLOR.

NO CLAIM IS MADE TO THE EXCLUSIVE RIGHT TO USE "SUGERENCIAS PARA MEJORAR LA ACTIVIDAD Y NUTRICIÓN DE LOS NIÑOS", APART FROM THE MARK AS SHOWN.

THE ENGLISH TRANSLATION OF "¡PODEMOS! SUGERENCIAS PARA MEJORAR LA ACTIVIDAD Y NUTRICIÓN DE LOS NIÑOS" IN THE MARK IS "WE CAN! WAYS TO ENHANCE CHILDREN'S ACTIVITY & NUTRITION".



David J. Kyffers

Director of the United States Patent and Trademark Office

SN 77-765,898, FILED 6-23-2009.

Reg. No. 4,099,426 ELLEN BURNS, EXAMINING ATTORNEY

United States of America

United States Patent and Trademark Office

HAVAS MEDIA RADIANCE

Reg. No. 4,099,427

MEDIA PLANNING GROUP, S.A. (SPAIN SOCIEDAD ANONIMA (SA))
AVDA. DEL GENERAL PERON NO. 38, 160
MADRID, SPAIN 28020

Registered Feb. 14, 2012

Int. Cl.: 35

FOR: ADVERTISING SERVICES, BUSINESS MANAGEMENT, BUSINESS OPERATION, BUSINESS ADMINISTRATION AND OFFICE FUNCTIONS, DATA PROCESSING SERVICES, MARKETING CONSULTING, EMPLOYMENT COUNSELING AND RECRUITING, BUSINESS MARKETING SERVICES, IN CLASS 35 (U.S. CLS. 100, 101 AND 102).

SERVICE MARK

PRINCIPAL REGISTER

FIRST USE 5-5-2010; IN COMMERCE 5-5-2010.

THE MARK CONSISTS OF STANDARD CHARACTERS WITHOUT CLAIM TO ANY PARTICULAR FONT, STYLE, SIZE, OR COLOR.

NO CLAIM IS MADE TO THE EXCLUSIVE RIGHT TO USE "MEDIA", APART FROM THE MARK AS SHOWN.

SN 77-767,343, FILED 6-24-2009.

JESSICA FATHY, EXAMINING ATTORNEY



David J. Kyffers

Director of the United States Patent and Trademark Office

United States of America

United States Patent and Trademark Office

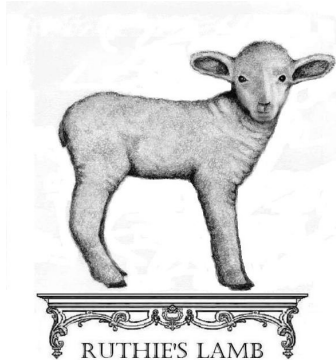

Reg. No. 4,099,428

Registered Feb. 14, 2012

Int. Cl.: 28

TRADEMARK

PRINCIPAL REGISTER

RUTHIE'S LAMB, LLC (NEW YORK LIMITED LIABILITY COMPANY)
16 TELEGRAPH STREET
BINGHAMTON, NY 13903

FOR: STUFFED TOY ANIMALS, IN CLASS 28 (U.S. CLS. 22, 23, 38 AND 50).

FIRST USE 6-6-2011; IN COMMERCE 6-6-2011.

NO CLAIM IS MADE TO THE EXCLUSIVE RIGHT TO USE "LAMB", APART FROM THE MARK AS SHOWN.

THE MARK CONSISTS OF A BLACK AND WHITE DRAWING OF A WHITE LAMB STANDING ATOP A DECORATIVE CORNICE; THE LAMB IS STANDING SIDE-ON, REAR TO THE LEFT AND HEAD TO THE RIGHT, WITH THE HEAD TURNED FACING FORWARD; THE WORDS "RUTHIE'S LAMB" APPEAR BENEATH THE CORNICE BUT WITHIN THE BOUNDARIES OF THE CORNICE FINIALS (ENDS) AS THEY EXTEND DOWNWARD.

SN 77-768,765, FILED 6-25-2009.

ANDREA HACK, EXAMINING ATTORNEY



David J. Kybas

Director of the United States Patent and Trademark Office

United States of America

United States Patent and Trademark Office

CANCER BE GLAMMED

Reg. No. 4,099,429

Registered Feb. 14, 2012

Int. Cl.: 25

TRADEMARK

PRINCIPAL REGISTER

CANCER CHIC BOUTIQUE, LLC (PENNSYLVANIA LIMITED LIABILITY COMPANY),
DBA CANCER BE GLAMMED, LLC,
5839 AYLESBORO AVENUE
PITTSBURGH, PA 15217

FOR: CLOTHING, NAMELY, CLOTHING SPORTSWEAR, NAMELY, BRAS, JACKETS, PANTS, SWEATSHIRTS, SHORTS, CAPS, HATS, SOCKS, AND GLOVES; CLOTHING ACTIVE WEAR, NAMELY, BRAS, JACKETS, PANTS, SWEATSHIRTS, SHORTS, CAPS, HATS, SOCKS, AND GLOVES; FITNESS CLOTHING, NAMELY, BRAS, JACKETS, PANTS, SWEATSHIRTS, SHORTS, CAPS, HATS, SOCKS, AND GLOVES; LINGERIE; SWIMWEAR; SLEEPWEAR; YOGA CLOTHING, NAMELY, BRAS, JACKETS, PANTS, SWEATSHIRTS, SHORTS, CAPS, HATS, SOCKS, AND GLOVES; SCARVES; SHOES; SLIPPERS, IN CLASS 25 (U.S. CLS. 22 AND 39).

FIRST USE 5-1-2011; IN COMMERCE 5-1-2011.

THE MARK CONSISTS OF STANDARD CHARACTERS WITHOUT CLAIM TO ANY PARTICULAR FONT, STYLE, SIZE, OR COLOR.

OWNER OF U.S. REG. NOS. 3,823,905 AND 4,019,946.

SN 77-768,871, FILED 6-26-2009.

MAYUR VAGHANI, EXAMINING ATTORNEY



David J. Kybas

Director of the United States Patent and Trademark Office

United States of America

United States Patent and Trademark Office



Reg. No. 4,099,430

MSD CONSUMER CARE, INC. (DELAWARE CORPORATION)
3030 JACKSON AVENUE
MEMPHIS, TN 38151

Registered Feb. 14, 2012

Int. Cl.: 3

FOR: SUN BLOCK PREPARATIONS; SUN SCREEN PREPARATIONS, IN CLASS 3 (U.S. CLS. 1, 4, 6, 50, 51 AND 52).

TRADEMARK

FIRST USE 1-0-2004; IN COMMERCE 1-0-2004.

PRINCIPAL REGISTER

OWNER OF U.S. REG. NOS. 2,230,833, 2,815,418, AND OTHERS.

THE COLOR(S) BLUE, DARK BLUE, LIGHT BLUE, WHITE, YELLOW AND ORANGE IS/ARE CLAIMED AS A FEATURE OF THE MARK.

SEC. 2(F) AS TO "SPORT".

NO CLAIM IS MADE TO THE EXCLUSIVE RIGHT TO USE "SUNBLOCK LOTION", "ULTRA SWEATPROOF", "WON'T RUN INTO EYES AND STING", "NO SLIP GRIP", "ULTRA DRY FORMULA", "WATERPROOF", "UVA", AND "UVB", APART FROM THE MARK AS SHOWN.

THE MARK CONSISTS OF A BLUE LABEL WITH TWO CURVED CORNERS AT THE TOP AND A CURVED BOTTOM. ON THE UPPER HALF OF THE LABEL IS A DARK BLUE OVAL WITH TWO DARK BLUE SWIRLS ON EITHER SIDE OF IT. OVERLAYING THE OVAL ARE TWO ORANGE AND YELLOW CURVES THAT TOGETHER FORM AN "S". THERE IS WHITE SHADING ALONG THE TOP AND BOTTOM OF THE "S". BETWEEN THE TWO SEGMENTS OF THE "S" ARE THE TERMS "COPPERTONE SPORT" IN WHITE AND "SUNBLOCK LOTION" IN BLUE. UNDERNEATH THIS ARE THREE BLUE BARS WITH A DARK BLUE OUTLINE UNDERNEATH EACH BAR. EACH BAR HAS A STRAIGHT EDGE ON THE LEFT SIDE AND A ROUNDED EDGE ON THE RIGHT SIDE. THE TERMS "ULTRA SWEATPROOF" IN YELLOW AND THE TERMS "WON'T RUN INTO EYES & STING" IN WHITE ARE ACROSS THE FIRST BAR. THE TERMS "NO SLIP GRIP ULTRA DRY FORMULA" IN WHITE ARE ACROSS THE SECOND BAR. THE TERM "WATERPROOF" IN WHITE IS ACROSS THE THIRD BAR. THERE IS A BLUE OVAL UNDERNEATH THE LOWER RIGHT PORTION OF THE THIRD BAR. THE OVAL IS DARK BLUE WITH BLUE SHADING IN THE CENTER. THE TERM "UVA" IS IN LIGHT BLUE ON THE LEFT PORTION OF THE DARK BLUE OVAL. THE TERM "UVB" IS IN LIGHT BLUE ON THE RIGHT POR-



David J. Kybas

Director of the United States Patent and Trademark Office

Reg. No. 4,099,430 TION OF THE DARK BLUE OVAL. THERE ARE LIGHT BLUE SWIRLS ON THE UPPER AND LOWER PORTIONS OF THE LABEL.

SN 77-774,506, FILED 7-6-2009.

KIM MONINGHOFF, EXAMINING ATTORNEY

United States of America

United States Patent and Trademark Office

BRIDGE DIRECT

Reg. No. 4,099,431

Registered Feb. 14, 2012

Int. Cl.: 35

SERVICE MARK

PRINCIPAL REGISTER

THE BRIDGE DIRECT, INC. (DELAWARE CORPORATION)
SUITE 2112
301 YAMATO ROAD
BOCA RATON, FL 33431

FOR: BUSINESS SERVICES, NAMELY, COMBINED STRATEGIC GOODS OR SERVICES SOURCING AND COOPERATIVE PURCHASING FOR OTHERS; WHOLESALE ORDERING SERVICES FEATURING A VARIETY OF CONSUMER GOODS OF OTHERS; BUSINESS MANAGEMENT CONSULTANCY SERVICES RELATING TO CONSUMER PRODUCT DISTRIBUTION, LOGISTICS, REVERSE LOGISTICS, SUPPLY CHAIN AND CONSUMER PRODUCT DISTRIBUTION SOLUTIONS; BUSINESS ADVISORY SERVICES RELATING TO THE SELECTION OF SOURCE SUPPLIERS FOR OTHERS IN THE FIELDS OF A WIDE VARIETY OF CONSUMER GOODS; DISTRIBUTORSHIP SERVICES IN THE FIELDS OF A WIDE VARIETY OF CONSUMER GOODS OF OTHERS, IN CLASS 35 (U.S. CLS. 100, 101 AND 102).

FIRST USE 7-0-2009; IN COMMERCE 7-0-2009.

THE MARK CONSISTS OF STANDARD CHARACTERS WITHOUT CLAIM TO ANY PARTICULAR FONT, STYLE, SIZE, OR COLOR.

NO CLAIM IS MADE TO THE EXCLUSIVE RIGHT TO USE "DIRECT", APART FROM THE MARK AS SHOWN.

SN 77-774,615, FILED 7-6-2009.

KIMBERLY PERRY, EXAMINING ATTORNEY



David J. Kyffers

Director of the United States Patent and Trademark Office

United States of America

United States Patent and Trademark Office

DIGIC

Reg. No. 4,099,432

DELTA PERFUME HOUSE, INC. (NEW YORK CORPORATION)
7304 FIFTH AVENUE, P.O. BOX 258
BROOKLYN, NY 11209

Registered Feb. 14, 2012

Int. Cl.: 3

FOR: PERFUME, IN CLASS 3 (U.S. CLS. 1, 4, 6, 50, 51 AND 52).

TRADEMARK

FIRST USE 10-0-2011; IN COMMERCE 10-0-2011.

PRINCIPAL REGISTER

THE MARK CONSISTS OF STANDARD CHARACTERS WITHOUT CLAIM TO ANY PARTICULAR FONT, STYLE, SIZE, OR COLOR.

SN 77-776,406, FILED 7-8-2009.

SANJEEV VOHRA, EXAMINING ATTORNEY



David J. Kybas

Director of the United States Patent and Trademark Office

United States of America

United States Patent and Trademark Office

Riverbend Ranch Meats

Reg. No. 4,099,433

VANDERSLOOT FARMS, INC. (IDAHO CORPORATION)
2880 N. 55TH W.

Registered Feb. 14, 2012

IDAHO FALLS, ID 83402

Int. Cl.: 29

FOR: FRESH AND FROZEN MEATS, IN CLASS 29 (U.S. CL. 46).

TRADEMARK

FIRST USE 7-1-2009; IN COMMERCE 9-1-2011.

PRINCIPAL REGISTER

THE MARK CONSISTS OF STANDARD CHARACTERS WITHOUT CLAIM TO ANY PARTICULAR FONT, STYLE, SIZE, OR COLOR.

NO CLAIM IS MADE TO THE EXCLUSIVE RIGHT TO USE "RANCH MEATS", APART FROM THE MARK AS SHOWN.

SN 77-779,296, FILED 7-13-2009.

MICHAEL WEBSTER, EXAMINING ATTORNEY



David J. Kybas

Director of the United States Patent and Trademark Office

United States of America

United States Patent and Trademark Office

Just Bad

Reg. No. 4,099,434

JUST BAD BUCKING BULLS LLC (NORTH CAROLINA LIMITED LIABILITY COMPANY)
242 JOHNSON DAIRY ROAD
MOORESVILLE, NC 28115

Registered Feb. 14, 2012

Int. Cls.: 25, 31, 41, and 44

FOR: HATS; POLO SHIRTS; SHORT-SLEEVED SHIRTS; T-SHIRTS; TEE SHIRTS; WEARABLE GARMENTS AND CLOTHING, NAMELY, SHIRTS, IN CLASS 25 (U.S. CLS. 22 AND 39).

TRADEMARK

FIRST USE 12-1-2007; IN COMMERCE 12-1-2007.

SERVICE MARK

FOR: LIVESTOCK; LIVESTOCK, NAMELY, CATTLE, IN CLASS 31 (U.S. CLS. 1 AND 46).

PRINCIPAL REGISTER

FIRST USE 5-9-2007; IN COMMERCE 5-9-2007.

FOR: ENTERTAINMENT IN THE NATURE OF COMPETITIONS IN THE FIELD OF BULL RIDING; ENTERTAINMENT IN THE NATURE OF LIVE PERFORMANCES BY BULL RIDERS; ENTERTAINMENT IN THE NATURE OF BULL RIDING GAMES; ENTERTAINMENT IN THE NATURE OF BULL RIDING TOURNAMENTS; ENTERTAINMENT SERVICES, NAMELY, ARRANGING AND CONDUCTING OF COMPETITIONS FOR BULL RIDING; ENTERTAINMENT SERVICES, NAMELY, PARTICIPATION IN BULL RIDING; ENTERTAINMENT SERVICES, NAMELY, PERSONAL APPEARANCES BY A BULL RIDER; ORGANISATION OF GAMES; ORGANISATION OF SPORTS COMPETITIONS; PROVIDING FACILITIES FOR BULL RIDING TOURNAMENTS, IN CLASS 41 (U.S. CLS. 100, 101 AND 107).

FIRST USE 5-9-2007; IN COMMERCE 5-9-2007.

FOR: BREEDING OF LIVESTOCK FOR OTHERS, NAMELY, SEEDSTOCK PRODUCERS; LEASING OF LIVESTOCK, IN CLASS 44 (U.S. CLS. 100 AND 101).

FIRST USE 5-9-2007; IN COMMERCE 5-9-2007.

THE MARK CONSISTS OF STANDARD CHARACTERS WITHOUT CLAIM TO ANY PARTICULAR FONT, STYLE, SIZE, OR COLOR.

SN 77-779,754, FILED 7-13-2009.

LINDA ORNDORFF, EXAMINING ATTORNEY



David J. Kyros

Director of the United States Patent and Trademark Office

United States of America

United States Patent and Trademark Office

EXCLUSIVE GENETICS' MILLION DOLLAR BUCKING BULL FUTURITY

Reg. No. 4,099,435

EXCLUSIVE GENETICS, LP (TEXAS LIMITED PARTNERSHIP)

Registered Feb. 14, 2012

P.O. BOX 200
ORCHARD, TX 77464

Int. Cls.: 35 and 41

FOR: ARRANGING AND CONDUCTING SALES FOR OTHERS OF LIVESTOCK IN THE NATURE OF BUCKING BULLS; ARRANGING AND CONDUCTING SALES FOR OTHERS OF LIVESTOCK IN THE NATURE OF DRAFT CHOICES FOR BUCKING BULLS, IN CLASS 35 (U.S. CLS. 100, 101 AND 102).

SERVICE MARK

PRINCIPAL REGISTER

FIRST USE 10-0-2007; IN COMMERCE 10-0-2007.

FOR: ENTERTAINMENT SERVICES IN THE FORM OF BUCKING BULL CONTESTS AND EXHIBITIONS, IN CLASS 41 (U.S. CLS. 100, 101 AND 107).

FIRST USE 10-0-2007; IN COMMERCE 10-0-2007.

THE MARK CONSISTS OF STANDARD CHARACTERS WITHOUT CLAIM TO ANY PARTICULAR FONT, STYLE, SIZE, OR COLOR.

NO CLAIM IS MADE TO THE EXCLUSIVE RIGHT TO USE "GENETICS " AND "MILLION DOLLAR BUCKING BULL FUTURITY", APART FROM THE MARK AS SHOWN.

SN 77-779,918, FILED 7-13-2009.

DAWN HAN, EXAMINING ATTORNEY



David J. Kybas

Director of the United States Patent and Trademark Office

United States of America

United States Patent and Trademark Office



Reg. No. 4,099,436

EXCLUSIVE GENETICS, LP (TEXAS LIMITED PARTNERSHIP)
P.O. BOX 200
ORCHARD, TX 77464

Registered Feb. 14, 2012

Int. Cls.: 35, 41, and 44

FOR: ARRANGING AND CONDUCTING SALES FOR OTHERS OF LIVESTOCK IN THE NATURE OF BUCKING BULLS; ARRANGING AND CONDUCTING SALES FOR OTHERS OF LIVESTOCK IN THE NATURE OF DRAFT CHOICES FOR BUCKING BULLS, IN CLASS 35 (U.S. CLS. 100, 101 AND 102).

SERVICE MARK

PRINCIPAL REGISTER

FIRST USE 10-0-2007; IN COMMERCE 10-0-2007.

FOR: ENTERTAINMENT SERVICES IN THE FORM OF BUCKING BULL CONTESTS AND EXHIBITIONS, IN CLASS 41 (U.S. CLS. 100, 101 AND 107).

FIRST USE 10-0-2007; IN COMMERCE 10-0-2007.

FOR: BUCKING BULL BREEDING SERVICES, IN CLASS 44 (U.S. CLS. 100 AND 101).

FIRST USE 10-0-2007; IN COMMERCE 10-0-2007.

THE MARK CONSISTS OF THE STYLIZED LETTERS "E" AND "G", WHERE THE "E" PARTIALLY OVERLAPS THE "G".

SN 77-779,928, FILED 7-13-2009.

DAWN HAN, EXAMINING ATTORNEY



David J. Kyjars

Director of the United States Patent and Trademark Office

United States of America
United States Patent and Trademark Office

FORTRIAS

Reg. No. 4,099,437

LEADERSHIP TEAM DEVELOPMENT, INC. (NORTH CAROLINA CORPORATION)
3209 GRESHAM LAKE ROAD, SUITE 153
RALEIGH, NC 27615

Registered Feb. 14, 2012

Int. Cl.: 25

FOR: APPAREL, NAMELY, T-SHIRTS, IN CLASS 25 (U.S. CLS. 22 AND 39).

TRADEMARK

FIRST USE 10-0-2009; IN COMMERCE 10-0-2009.

PRINCIPAL REGISTER

THE MARK CONSISTS OF STANDARD CHARACTERS WITHOUT CLAIM TO ANY PARTICULAR FONT, STYLE, SIZE, OR COLOR.

THE WORDING "FORTRIAS" HAS NO MEANING IN A FOREIGN LANGUAGE.

SN 77-781,767, FILED 7-15-2009.

KELLY CHOE, EXAMINING ATTORNEY



David J. Kybas

Director of the United States Patent and Trademark Office

United States of America

United States Patent and Trademark Office

EASY FILL

Reg. No. 4,099,438

SAECO USA INC. (MARYLAND CORPORATION)
7905 COCHRAN ROAD, SUITE 100
GLENWILLOW, OH 44139

Registered Feb. 14, 2012

Int. Cl.: 11

FOR: ELECTRIC COFFEE MACHINES, IN CLASS 11 (U.S. CLS. 13, 21, 23, 31 AND 34).

TRADEMARK

FIRST USE 9-24-2010; IN COMMERCE 9-24-2010.

PRINCIPAL REGISTER

THE MARK CONSISTS OF STANDARD CHARACTERS WITHOUT CLAIM TO ANY PARTICULAR FONT, STYLE, SIZE, OR COLOR.

SN 77-792,163, FILED 7-29-2009.

CHRISTINE MARTIN, EXAMINING ATTORNEY



David J. Kybas

Director of the United States Patent and Trademark Office

United States of America

United States Patent and Trademark Office

Have Faith
S W I M W E A R

Reg. No. 4,099,439

HAVE FAITH SWIMWEAR, LLC (DELAWARE LIMITED LIABILITY COMPANY)
P.O. BOX 2909

Registered Feb. 14, 2012

BEVERLY HILLS, CA 90213

Int. Cl.: 25

FOR: BEACH COVER-UPS, BEACH COVER UPS, BEACH FOOTWEAR, BEACH SHOES, BEACHWEAR, BELTS, BELTS MADE OUT OF CLOTH, BERMUDA SHORTS, BOARD SHORTS, BOTTOMS, CLOTHING, NAMELY, WRAP-AROUNDS, COVER UPS, FLIP FLOPS, FOOTWEAR, FOOTWEAR FOR MEN AND WOMEN, HATS, HOODS, JACKETS, JERSEYS, KNIT SHIRTS, LINGERIE, SANDALS AND BEACH SHOES, SWIMSUITS, SWIMWEAR, AND HEADGEAR, NAMELY, HEAD BANDS, HEAD SCARVES, IN CLASS 25 (U.S. CLS. 22 AND 39).

TRADEMARK

PRINCIPAL REGISTER

FIRST USE 8-1-2010; IN COMMERCE 1-13-2011.

NO CLAIM IS MADE TO THE EXCLUSIVE RIGHT TO USE "SWIM WEAR", APART FROM THE MARK AS SHOWN.

THE COLOR(S) PINK, BLACK AND WHITE IS/ARE CLAIMED AS A FEATURE OF THE MARK.

THE MARK CONSISTS OF THE WORDING "HAVE FAITH SWIM WEAR" WITH "HAVE FAITH" IN PINK AND "SWIM WEAR" IN BLACK. THE WORD "SWIM WEAR" BEING UNDERNEATH "HAVE FAITH". THE BACKGROUND OF THE LOGO IS WHITE.

SN 77-792,464, FILED 7-29-2009.

LOURDES AYALA, EXAMINING ATTORNEY



David J. Kyros

Director of the United States Patent and Trademark Office

United States of America

United States Patent and Trademark Office

Yoga Wisdom for Modern Life

Reg. No. 4,099,440

POMEDA CORPORATION (TEXAS CORPORATION)
7701 RIALTO BLVD APT 132
AUSTIN, TX 78735

Registered Feb. 14, 2012

Int. Cl.: 41

FOR: EDUCATION SERVICES, NAMELY, PROVIDING CLASSES, SEMINARS, WORKSHOPS, TRAINING IN THE FIELD OF YOGA PHILOSOPHY AND THE YOGA TRADITION, IN CLASS 41 (U.S. CLS. 100, 101 AND 107).

SERVICE MARK

FIRST USE 2-11-2004; IN COMMERCE 2-11-2004.

PRINCIPAL REGISTER

THE MARK CONSISTS OF STANDARD CHARACTERS WITHOUT CLAIM TO ANY PARTICULAR FONT, STYLE, SIZE, OR COLOR.

NO CLAIM IS MADE TO THE EXCLUSIVE RIGHT TO USE "YOGA", APART FROM THE MARK AS SHOWN.

SN 77-795,991, FILED 8-3-2009.

MATTHEW PAPPAS, EXAMINING ATTORNEY



David J. Kypas

Director of the United States Patent and Trademark Office

United States of America

United States Patent and Trademark Office

When Life Is In Jeopardy

Reg. No. 4,099,441

Registered Feb. 14, 2012

Int. Cl.: 44

SERVICE MARK

PRINCIPAL REGISTER

MARCUS, STEPHEN GARRETT (UNITED STATES INDIVIDUAL), DBA STEPHEN GARRETT
MARCUS,
1792 BELL TOWER LANE
WESTON, FL 33326

FOR: MEDICAL INFORMATION; PROVIDING A WEB SITE FEATURING MEDICAL INFORMATION, IN CLASS 44 (U.S. CLS. 100 AND 101).

FIRST USE 5-17-2011; IN COMMERCE 6-20-2011.

THE MARK CONSISTS OF STANDARD CHARACTERS WITHOUT CLAIM TO ANY PARTICULAR FONT, STYLE, SIZE, OR COLOR.

SN 77-797,089, FILED 8-4-2009.

MATTHEW KLINE, EXAMINING ATTORNEY



David J. Kybas

Director of the United States Patent and Trademark Office

United States of America

United States Patent and Trademark Office

BLAISE ENERGY

Reg. No. 4,099,442

BLAISE ENERGY, INC. (NEVADA CORPORATION)
387 15TH STREET WEST #142
DICKINSON, ND 58601

Registered Feb. 14, 2012

Int. Cls.: 9 and 35

FOR: AUTOMATED PROCESS CONTROL SYSTEM, NAMELY, MICRO-PROCESSOR BASED HARDWARE AND SOFTWARE USED TO MONITOR THE STATUS OF INDUSTRIAL PROCESSES, NAMELY, POWER GENERATION, ELECTRICAL DISTRIBUTION AND OIL AND GAS PROCESSING, IN CLASS 9 (U.S. CLS. 21, 23, 26, 36 AND 38).

TRADEMARK

SERVICE MARK

FIRST USE 11-15-2008; IN COMMERCE 5-2-2009.

PRINCIPAL REGISTER

FOR: ENERGY MANAGEMENT SERVICES, NAMELY, PROVIDING A SERVICE THAT ALLOWS CUSTOMERS TO PURCHASE ENERGY, NAMELY, ELECTRICITY, NATURAL GAS AND RENEWABLE ENERGY, AT A FIXED PRICE; MANAGING THE EXPLORATION, PRODUCTION AND OPERATIONS OF NATURAL GAS AND OIL PROPERTIES FOR OTHERS, IN CLASS 35 (U.S. CLS. 100, 101 AND 102).

FIRST USE 11-15-2008; IN COMMERCE 4-5-2009.

THE MARK CONSISTS OF STANDARD CHARACTERS WITHOUT CLAIM TO ANY PARTICULAR FONT, STYLE, SIZE, OR COLOR.

NO CLAIM IS MADE TO THE EXCLUSIVE RIGHT TO USE "ENERGY", APART FROM THE MARK AS SHOWN.

SN 77-798,244, FILED 8-6-2009.

ANDREA HACK, EXAMINING ATTORNEY



David J. Kyffers

Director of the United States Patent and Trademark Office

United States of America

United States Patent and Trademark Office

JERSEY ROCKS

Reg. No. 4,099,443

Registered Feb. 14, 2012

Int. Cl.: 25

TRADEMARK

PRINCIPAL REGISTER

LONT, JOSHUA J (UNITED STATES INDIVIDUAL)
494 ACKERSON AVENUE
WYCKOFF, NJ 07481

FOR: ATHLETIC APPAREL, NAMELY, SHIRTS, PANTS, JACKETS, FOOTWEAR, HATS AND CAPS, ATHLETIC UNIFORMS; ATHLETIC FOOTWEAR; BABY LAYETTES FOR CLOTHING; BALLOON PANTS; BEACH COVER-UPS; BEACH COVERUPS; BEACH FOOTWEAR; BEACH SHOES; BELTS; BELTS FOR CLOTHING; BELTS MADE OUT OF CLOTH; BERMUDA SHORTS; BIB SHORTS; BIBS NOT OF CLOTH OR PAPER; BIKINIS; BOARD SHORTS; BOTTOMS; BOXER SHORTS; BOXING SHORTS; BUTTON-FRONT ALOHA SHIRTS; CAMOUFLAGE PANTS; CAP VISORS; CAPRI PANTS; CAPS WITH VISORS; CARGO PANTS; CHILDREN'S AND INFANTS' CLOTH BIBS; CHILDREN'S CLOTH EATING BIBS; CLOTH BIBS; CLOTHING FOR ATHLETIC USE, NAMELY, PADDED ELBOW COMPRESSION SLEEVES; CLOTHING FOR ATHLETIC USE, NAMELY, PADDED PANTS; CLOTHING FOR ATHLETIC USE, NAMELY, PADDED SHORTS; DENIMS; DRESS SHIRTS; DRESSES THAT MAY ALSO BE USED AS TOWELS; FISHING SHIRTS; FLEECE SHORTS; FLIP FLOPS; FOOTWEAR; FOOTWEAR FOR MEN; FOOTWEAR FOR MEN AND WOMEN; FOOTWEAR FOR WOMEN; GLOVES AS CLOTHING; GOLF PANTS, SHIRTS AND SKIRTS; GOLF SHIRTS; GOLF SHORTS; GYM PANTS; GYM SHORTS; HATS; HATS FOR INFANTS, BABIES, TODDLERS AND CHILDREN; HEADBANDS FOR CLOTHING; HOODED SWEAT SHIRTS; HOODS; HUNTING PANTS; INFANT AND TODDLER ONE PIECE CLOTHING; JACKETS; JERSEYS; JOGGING PANTS; LEATHER BELTS; LEATHER PANTS; LONG-SLEEVED SHIRTS; LOUNGE PANTS; MOISTURE-WICKING SPORTS PANTS; NIGHT SHIRTS; NON-DISPOSABLE CLOTH TRAINING PANTS; NURSE PANTS; OPEN-NECKED SHIRTS; PANTIES, SHORTS AND BRIEFS; PANTS; PAPER HATS FOR USE AS CLOTHING ITEMS; PARTY HATS; PERSPIRATION ABSORBENT STRAP TO BE USED IN THE BILL OF A HAT; POLO SHIRTS; RAIN HATS; RASH GUARDS; RUGBY SHIRTS; RUGBY SHORTS; SANDALS AND BEACH SHOES; SCIENTIFIC AND TECHNOLOGICAL APPAREL, NAMELY, SHIRTS, PANTS, JACKETS, FOOTWEAR, HATS AND CAPS, UNIFORMS; SHIRTS; SHIRTS AND SHORT-SLEEVED SHIRTS; SHIRTS FOR INFANTS, BABIES, TODDLERS AND CHILDREN; SHORT SETS; SHORT TROUSERS; SHORT-SLEEVED OR LONG-SLEEVED T-SHIRTS; SHORT-SLEEVED SHIRTS; SHORTS; SKI PANTS; SLEEP SHIRTS; SLIDING SHORTS; SMALL HATS; SNOW BOARDING SUITS; SNOW PANTS; SNOW SUITS; SNOWBOARD PANTS; SPORT SHIRTS; SPORTS PANTS; SPORTS SHIRTS WITH SHORT SLEEVES; STRETCH PANTS; SUN VISORS; SWEAT PANTS; SWEAT SHIRTS; SWEAT SHORTS; SWEAT SUITS; SWIM CAPS; SWIM TRUNKS; SWIM WEAR; SWIM WEAR FOR GENTLEMEN AND LADIES; SWIMMING COSTUMES; SWIMMING TRUNKS; T-SHIRTS;



David J. Kybas

Director of the United States Patent and Trademark Office

Reg. No. 4,099,443 TEE SHIRTS; TIES; TOPS; TRACK PANTS; TRACK SUITS; TRAVEL CLOTHING CONTAINED IN A PACKAGE COMPRISING REVERSIBLE JACKETS, PANTS, SKIRTS, TOPS AND A BELT OR SCARF; TRIATHLON CLOTHING, NAMELY, TRIATHLON TIGHTS, TRIATHLON SHORTS, TRIATHLON SINGLET, TRIATHLON SHIRTS, TRIATHLON SUITS; TURTLE NECK SHIRTS; UNDERWEAR, NAMELY, BOY SHORTS; VESTED SUITS; VISORS; WALKING SHORTS; WATERPROOF JACKETS AND PANTS; WEARABLE GARMENTS AND CLOTHING, NAMELY, SHIRTS; WETSUITS; WIND PANTS; WIND SHIRTS; WOMEN'S HATS AND HOODS; WOOLLY HATS; YOGA PANTS; YOGA SHIRTS, IN CLASS 25 (U.S. CLS. 22 AND 39).

FIRST USE 3-1-2011; IN COMMERCE 3-1-2011.

THE MARK CONSISTS OF STANDARD CHARACTERS WITHOUT CLAIM TO ANY PARTICULAR FONT, STYLE, SIZE, OR COLOR.

OWNER OF U.S. REG. NO. 3,684,638.

NO CLAIM IS MADE TO THE EXCLUSIVE RIGHT TO USE "JERSEY", APART FROM THE MARK AS SHOWN.

SN 77-798,588, FILED 8-6-2009.

TAMARA FRAZIER, EXAMINING ATTORNEY

United States of America

United States Patent and Trademark Office



Reg. No. 4,099,444

Registered Feb. 14, 2012

Int. Cl.: 29

TRADEMARK

PRINCIPAL REGISTER

CLOUGHERTY PACKING, LLC (DELAWARE LIMITED LIABILITY COMPANY)
3049 E VERNON AVENUE
LOS ANGELES, CA 90058

FOR: MEAT; POULTRY; COMPOSITIONS CONTAINING MEAT FATS, IN CLASS 29 (U.S. CL. 46).

FIRST USE 7-31-2009; IN COMMERCE 9-30-2009.

OWNER OF U.S. REG. NOS. 709,414, 955,962, AND 3,322,490.

NO CLAIM IS MADE TO THE EXCLUSIVE RIGHT TO USE "SINCE 1931", APART FROM THE MARK AS SHOWN.

THE NAME(S), PORTRAIT(S), AND/OR SIGNATURE(S) SHOWN IN THE MARK DOES NOT IDENTIFY A PARTICULAR LIVING INDIVIDUAL.

THE MARK CONSISTS OF A BOX WITH A FARMER TOWARDS THE TOP OF THE BOX. THE FARMER HAS A HAT ON AND SHIRT WITH THE SLEEVES ROLLED UP. THERE IS A CROP SCENE IN THE BACKGROUND. THE BOX IS DIVIDED BY A BANNER WITH THE WORDS "FARMER JOHN" IN IT. BELOW THE BANNER ARE THE WORDS "SINCE 1931".

SN 77-800,612, FILED 8-10-2009.

JEFFREY LOOK, EXAMINING ATTORNEY



David J. Kybas

Director of the United States Patent and Trademark Office

United States of America

United States Patent and Trademark Office

Toy Closet

Reg. No. 4,099,445

Registered Feb. 14, 2012

Int. Cls.: 35 and 41

SERVICE MARK

PRINCIPAL REGISTER

TOY CLOSET FILMS LLC (NEW YORK LIMITED LIABILITY COMPANY), FORMERLY
P/S PICTURES LLC,
30 EAST 20TH STREET SUITE 406
NEW YORK, NY 10003

FOR: ADVERTISING SERVICES OF A RADIO AND TELEVISION ADVERTISING AGENCY,
IN CLASS 35 (U.S. CLS. 100, 101 AND 102).

FIRST USE 9-1-2009; IN COMMERCE 9-1-2009.

FOR: DISTRIBUTION OF MOTION PICTURE FILMS; ENTERTAINMENT AND EDUCATION-
AL SERVICES, NAMELY, PROVIDING ADVICE AND INFORMATION FOR MUSIC, VIDEO
AND FILM CONCEPT AND SCRIPT DEVELOPMENT; FILM AND VIDEO PRODUCTION
CONSULTING SERVICES; MULTIMEDIA ENTERTAINMENT SERVICES IN THE NATURE
OF RECORDING, PRODUCTION AND POST-PRODUCTION SERVICES IN THE FIELDS OF
MUSIC, VIDEO, AND FILMS, IN CLASS 41 (U.S. CLS. 100, 101 AND 107).

FIRST USE 1-1-2010; IN COMMERCE 1-1-2010.

THE MARK CONSISTS OF STANDARD CHARACTERS WITHOUT CLAIM TO ANY PAR-
TICULAR FONT, STYLE, SIZE, OR COLOR.

SN 77-802,872, FILED 8-12-2009.

MICHAEL LITZAU, EXAMINING ATTORNEY



David J. Kybas

Director of the United States Patent and Trademark Office

United States of America

United States Patent and Trademark Office

Springfield SmartRoof

Reg. No. 4,099,446

SPRINGFIELD INC. (MICHIGAN CORPORATION)

Registered Feb. 14, 2012

6509 M-37
KINGSLEY, MI 49649

Int. Cl.: 17

FOR: WEATHERIZING MEMBRANES AND VAPOR BARRIERS, IN CLASS 17 (U.S. CLS. 1, 5, 12, 13, 35 AND 50).

TRADEMARK

FIRST USE 2-9-2009; IN COMMERCE 2-9-2009.

PRINCIPAL REGISTER

THE MARK CONSISTS OF STANDARD CHARACTERS WITHOUT CLAIM TO ANY PARTICULAR FONT, STYLE, SIZE, OR COLOR.

OWNER OF U.S. REG. NOS. 3,812,117 AND 3,851,350.

SN 77-803,122, FILED 8-12-2009.

ESTHER A. BORSUK, EXAMINING ATTORNEY



David J. Kyffers

Director of the United States Patent and Trademark Office

United States of America

United States Patent and Trademark Office

Grüne Erde

Reg. No. 4,099,447

Registered Feb. 14, 2012

Int. Cls.: 3, 25, and 35

TRADEMARK

SERVICE MARK

PRINCIPAL REGISTER

GRÜNE ERDE BETEILIGUNGS GMBH (AUSTRIA GESELLSCHAFT MIT BESCHRÄNKTER HAFTUNG (GMBH))
MÜHLSDORF 12
4644 SCHARNSTEIN, AUSTRIA

FOR: SOAPS; PERFUMERY; FRAGRANCES; FRAGRANCES IN THE FORM OF OILS FOR USE IN SAUNAS AND STEAM BATHS; ESSENTIAL OILS; COSMETICS; COSMETIC PREPARATIONS; COSMETIC OILS; MAKE-UP; MAKE-UP REMOVER; MAKE-UP PENCILS; NATURAL MINERAL MAKE-UP; LIPSTICKS; LIP GLOSS; EYE SHADOWS; EYE LINER; FACE POWDER; ROUGES; MASCARAS; BEAUTY MASKS; PEELING FACIAL MASKS; SUNCARE COSMETICS, NAMELY, SUN CARE LOTIONS, NON-MEDICATED SUN CARE PREPARATIONS, AFTER-SUN GELS, AFTER-SUN MILKS, AFTER-SUN OILS, COSMETIC PREPARATIONS AGAINST SUNBURN, COSMETIC SUN TAN LOTIONS, COSMETIC SUNTAN PREPARATIONS, SUNTAN OILS FOR COSMETIC PURPOSES; ANTI-AGING CREAMS; HAIR LOTIONS; HAIR CARE PREPARATIONS; DENTIFRICES; MASSAGE OILS; INCENSE; BATH SOAPS; NON-MEDICATED BATH PREPARATIONS, BATH OILS FOR COSMETIC PURPOSES; NON-MEDICATED BATH ADDITIVES, NAMELY, BATH SALTS; NON-MEDICATED BATH ESSENCES IN THE NATURE OF ESSENTIAL OILS; NON-MEDICATED BATH PEARLS, IN CLASS 3 (U.S. CLS. 1, 4, 6, 50, 51 AND 52).

FIRST USE 5-1-2002; IN COMMERCE 5-20-2011.



FOR: BANDANAS; SCARFS; WRAPS; SHOULDER WRAPS; TIES; COLLARS; BELTS FOR CLOTHING; SWIM WEAR; BIKINIS; BATH ROBES; TRAINING SUITS; JOGGING OUTFITS; COATS; ANORAKS; CAPES; PARKAS; PONCHOS; DRESSES; GOWNS; DRESSING GOWNS; CHASUBLES; SKIRTS; SUITS; EAR MUFFS; GLOVES; HATS; CAPS; HOODS; HEADWEAR; JACKETS; BLAZERS; CARDIGANS; GILETS; JERSEYS; VESTS; BLOUSES; BLOUSONS; PULLOVERS; TWIN SETS; SWEAT SHIRTS; SWEATERS; SHIRTS; T-SHIRTS; TOPS; PA-REOS; TUNICS; TROUSERS; SHORTS; BERMUDA SHORTS; JEANS; OVERALLS; BIB OVERALLS; GAITERS; LEG WARMERS; LEGGINGS; UNDERWEAR; PANTS; BOXER SHORTS; HOSIERY; LINGERIE; BRAS; GARTERS; GARTER BELTS; NIGHTWEAR; NIGHT GOWNS; FOOTWEAR; BOOTS; SHOES; SLIPPERS; GALOSHES; FLIP FLOPS, IN CLASS 25 (U.S. CLS. 22 AND 39).

FIRST USE 3-1-2010; IN COMMERCE 5-20-2011.

David J. Kyffers

Director of the United States Patent and Trademark Office

Reg. No. 4,099,447 FOR: RETAIL SERVICES, NAMELY, RETAIL STORE SERVICES, ON-LINE RETAIL STORE SERVICES, MAIL ORDER CATALOG RETAIL SERVICES AND TELEPHONE ORDER CATALOG RETAIL SERVICES FEATURING NUTRITIONAL ADDITIVES FOR MEDICAL PURPOSES FOR USE IN FOODS AND DIETARY SUPPLEMENTS FOR HUMAN CONSUMPTION, SOAPS, PERFUMERY, FRAGRANCES, FRAGRANCES IN THE FORM OF OILS FOR USE IN SAUNAS AND STEAM BATHS, ESSENTIAL OILS, COSMETICS, COSMETIC PREPARATIONS, COSMETIC OILS, MAKE-UPS, MAKE-UP REMOVER, MAKE-UP PENCILS, NATURAL MINERAL MAKE-UP, LIPSTICKS, LIP GLOSS, EYE SHADOWS, EYE LINER, FACE POWDER, ROUGES, MASCARAS, BEAUTY MASKS, PEELING FACIAL MASKS, SUNCARE COSMETICS, ANTI-AGING CREAMS, HAIR LOTIONS, HAIR CARE PREPARATIONS, DENTIFRICES, MASSAGE OILS, INCENSE AGENTS, BATH SOAPS, COSMETIC PREPARATIONS FOR USE IN THE BATH, BATH ADDITIVES, NAMELY, BATH SALTS, BATH ESSENCES IN THE NATURE OF ESSENTIAL OILS, BATH PEARLS, MASSAGE DEVICES FOR BEAUTY CARE, MASSAGE GLOVES, COMBS, BRUSHES, NAMELY, COSMETIC BRUSHES, CLOTHES BRUSHES, MASSAGE BRUSHES, HAIR BRUSHES, PAPER BED COVERS, BED LINEN, TOWELS, WASHING MITTS, BANDANAS, SCARFS, WRAPS, SHOULDER WRAPS, TIES, COLLARS, BELTS FOR CLOTHING, SWIM WEAR, BIKINIS, BATH ROBES, TRAINING SUITS, JOGGING OUTFITS, COATS, ANORAKS, CAPES, PARKAS, PONCHOS, DRESSES, GOWNS, DRESSING GOWNS, CHASUBLES, SKIRTS, SUITS, EAR MUFFS, GLOVES, HATS, CAPS, HOODS, HEADWEAR, JACKETS, BLAZERS, CARDIGANS, GILETS, JERSEYS, VESTS, BLOUSES, BLOUSONS, PULLOVERS, TWIN SETS, SWEAT SHIRTS, SWEATERS, SHIRTS, T-SHIRTS, TOPS, PAREOS, TUNICS, TROUSERS, SHORTS, BERMUDA SHORTS, JEANS, OVERALLS, BIB OVERALLS, GAITERS, LEG WARMERS, LEGGINGS, UNDERWEAR, PANTS, BOXER SHORTS, HOSIERY, LINGERIE, BRAS, GARTERS, GARTER BELTS, NIGHTWEAR, NIGHT GOWNS, FOOTWEAR, BOOTS, SHOES, SLIPPERS, GALOSHES, FLIP FLOPS, MASSAGE MATS AND MATTING, NAMELY, FLOOR MATS FÜR USE IN MASSAGE, RUBBER MATS FOR USE IN MASSAGE, IN CLASS 35 (U.S. CLS. 100, 101 AND 102).

FIRST USE 8-26-2009; IN COMMERCE 5-20-2011.

NO CLAIM IS MADE TO THE EXCLUSIVE RIGHT TO USE "GRÜNE", APART FROM THE MARK AS SHOWN.

THE MARK CONSISTS OF THE WORDING "GRÜNE ERDE" WITH A STYLIZED TREE DESIGN BETWEEN THE TWO WORDS.

THE ENGLISH TRANSLATION OF "GRÜNE ERDE" IN THE MARK IS GREEN SOIL.

SN 77-809,495, FILED 8-20-2009.

ANDREW LEASER, EXAMINING ATTORNEY

United States of America

United States Patent and Trademark Office

BEN 10 ULTIMATE ALIEN

Reg. No. 4,099,448

Registered Feb. 14, 2012

Int. Cl.: 16

TRADEMARK

PRINCIPAL REGISTER

THE CARTOON NETWORK, INC. (DELAWARE CORPORATION)
C/O TURNER BROADCASTING SYSTEM, INC.
ONE CNN CENTER, 10N
ATLANTA, GA 30303

FOR: CHILDREN'S BOOKS; STATIONERY; WRITING IMPLEMENTS, STICKERS, POSTERS
AND CALENDARS , IN CLASS 16 (U.S. CLS. 2, 5, 22, 23, 29, 37, 38 AND 50).

FIRST USE 7-1-2011; IN COMMERCE 7-1-2011.

THE MARK CONSISTS OF STANDARD CHARACTERS WITHOUT CLAIM TO ANY PAR-
TICULAR FONT, STYLE, SIZE, OR COLOR.

OWNER OF U.S. REG. NOS. 3,080,336, 3,206,776, AND OTHERS.

SN 77-811,043, FILED 8-24-2009.

DAVID ELTON, EXAMINING ATTORNEY



David J. Kyffers

Director of the United States Patent and Trademark Office

United States of America

United States Patent and Trademark Office

BEN 10 ULTIMATE ALIEN

Reg. No. 4,099,449

Registered Feb. 14, 2012

Int. Cl.: 9

TRADEMARK

PRINCIPAL REGISTER

THE CARTOON NETWORK, INC. (DELAWARE CORPORATION)
C/O TURNER BROADCASTING SYSTEM, INC.
ONE CNN CENTER, 10N
ATLANTA, GA 30303

FOR: INTERACTIVE VIDEO GAME PROGRAMS; VIDEO GAME CARTRIDGES AND DISCS;
ELECTRONIC GAME PROGRAMS; COMPUTER GAME CARTRIDGES AND DISCS;
DOWNLOADABLE PRE-RECORDED VIDEO RECORDINGS FEATURING ENTERTAINMENT
FOR CHILDREN; AUDIO AND VIDEO RECORDINGS FEATURING ENTERTAINMENT FOR
CHILDREN, IN CLASS 9 (U.S. CLS. 21, 23, 26, 36 AND 38).

FIRST USE 1-11-2011; IN COMMERCE 1-11-2011.

THE MARK CONSISTS OF STANDARD CHARACTERS WITHOUT CLAIM TO ANY PAR-
TICULAR FONT, STYLE, SIZE, OR COLOR.

OWNER OF U.S. REG. NOS. 3,080,336, 3,206,776, AND OTHERS.

SN 77-811,046, FILED 8-24-2009.

DAVID ELTON, EXAMINING ATTORNEY



David J. Kyffers

Director of the United States Patent and Trademark Office

United States of America

United States Patent and Trademark Office



Reg. No. 4,099,450

Registered Feb. 14, 2012

Int. Cl.: 25

TRADEMARK

PRINCIPAL REGISTER

IP HOLDINGS UNLTD LLC (DELAWARE LIMITED LIABILITY COMPANY)
1450 BROADWAY
3RD FLOOR
NEW YORK, NY 10018

FOR: CLOTHING, NAMELY, SHIRTS, SWEATSHIRTS, PANTS, SHORTS, JACKETS, SOCKS, NECKTIES, HEADWEAR, FOOTWEAR, IN CLASS 25 (U.S. CLS. 22 AND 39).

FIRST USE 12-15-2009; IN COMMERCE 12-15-2009.

OWNER OF U.S. REG. NOS. 3,347,319 AND 3,661,729.

THE MARK CONSISTS OF A STYLIZED PAIR OF SCISSORS COMBINED WITH THE LOOK OF A SKULL.

SN 77-812,026, FILED 8-25-2009.

ELLEN PERKINS, EXAMINING ATTORNEY



David J. Kybas

Director of the United States Patent and Trademark Office

United States of America

United States Patent and Trademark Office

Firm-X

Reg. No. 4,099,451

Registered Feb. 14, 2012

Int. Cl.: 5

TRADEMARK

PRINCIPAL REGISTER

386 NANOTECH, INC. (FLORIDA CORPORATION)
STE 226
6860 GULFPORT BLVD
ST. PETERSBURG, FL 33707

FOR: SEXUAL STIMULANT GELS, IN CLASS 5 (U.S. CLS. 6, 18, 44, 46, 51 AND 52).

FIRST USE 11-29-2011; IN COMMERCE 11-29-2011.

THE MARK CONSISTS OF STANDARD CHARACTERS WITHOUT CLAIM TO ANY PARTICULAR FONT, STYLE, SIZE, OR COLOR.

SN 77-815,474, FILED 8-28-2009.

APRIL HESIK, EXAMINING ATTORNEY



David J. Kybas

Director of the United States Patent and Trademark Office

United States of America

United States Patent and Trademark Office

IntelliJet

Reg. No. 4,099,452

Registered Feb. 14, 2012

Int. Cl.: 9

TRADEMARK

PRINCIPAL REGISTER

PITNEY BOWES INC. (DELAWARE CORPORATION)
ONE ELMCROFT ROAD
WORLD HEADQUARTERS
STAMFORD, CT 069260700

FOR: PRINTER USED IN A MAIL PRODUCTION ENVIRONMENT, IN CLASS 9 (U.S. CLS. 21, 23, 26, 36 AND 38).

FIRST USE 9-11-2009; IN COMMERCE 9-11-2009.

THE MARK CONSISTS OF STANDARD CHARACTERS WITHOUT CLAIM TO ANY PARTICULAR FONT, STYLE, SIZE, OR COLOR.

SN 77-817,647, FILED 9-1-2009.

ELLEN B. AWRICH, EXAMINING ATTORNEY



David J. Kybas

Director of the United States Patent and Trademark Office

United States of America

United States Patent and Trademark Office

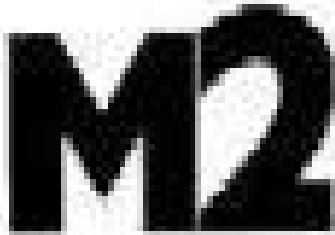

Reg. No. 4,099,453

ESPY MEDIA GROUP LIMITED (NEW ZEALAND CORPORATION)
72 COLLEGE HILL, PONSONBY
AUCKLAND 1011, NEW ZEALAND

Registered Feb. 14, 2012

Int. Cls.: 9, 16, and 41

FOR: DOWNLOADABLE ELECTRONIC PUBLICATIONS IN THE NATURE OF MAGAZINES IN THE FIELD OF MEN'S AND WOMEN'S LIFESTYLES, IN CLASS 9 (U.S. CLS. 21, 23, 26, 36 AND 38).

TRADEMARK

FIRST USE 3-31-2010; IN COMMERCE 3-31-2010.

SERVICE MARK

FOR: PRINTED MATTER AND PUBLICATIONS, NAMELY, MAGAZINES, NEWSLETTERS, ALL IN THE FIELD OF MEN'S AND WOMEN'S LIFESTYLE, IN CLASS 16 (U.S. CLS. 2, 5, 22, 23, 29, 37, 38 AND 50).

PRINCIPAL REGISTER

FIRST USE 3-31-2010; IN COMMERCE 3-31-2010.

FOR: PROVIDING NON-DOWNLOADABLE ELECTRONIC PUBLICATIONS ALL IN THE FIELD OF MEN'S AND WOMEN'S LIFESTYLE, IN CLASS 41 (U.S. CLS. 100, 101 AND 107).

FIRST USE 3-31-2010; IN COMMERCE 3-31-2010.

THE MARK CONSISTS OF THE LETTER "M" AND THE NUMBER "2" IN A STYLIZED FORMAT.

SN 77-817,917, FILED 9-1-2009.

PRISCILLA MILTON, EXAMINING ATTORNEY

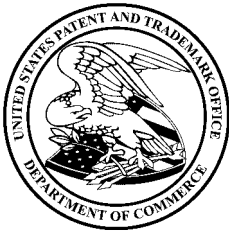

David J. Kybas

Director of the United States Patent and Trademark Office

United States of America

United States Patent and Trademark Office

VALUE CREATION CLARITY

Reg. No. 4,099,454

Registered Feb. 14, 2012

Int. Cl.: 35

SERVICE MARK

PRINCIPAL REGISTER

CENTINELA CAPITAL PARTNERS LLC (CALIFORNIA LIMITED LIABILITY COMPANY)
SUITE 390
777 SOUTH FIGUEROA STREET
LOS ANGELES, CA 90017

FOR: BUSINESS DATA ANALYSIS; ECONOMIC FORECASTING AND ANALYSIS; MARKET ANALYSIS, IN CLASS 35 (U.S. CLS. 100, 101 AND 102).

FIRST USE 9-23-2011; IN COMMERCE 9-23-2011.

THE MARK CONSISTS OF STANDARD CHARACTERS WITHOUT CLAIM TO ANY PARTICULAR FONT, STYLE, SIZE, OR COLOR.

SN 77-826,169, FILED 9-14-2009.

AMY C. KEAN, EXAMINING ATTORNEY



David J. Kappas

Director of the United States Patent and Trademark Office

United States of America

United States Patent and Trademark Office

THE ORIGINAL BRITISHERS

Reg. No. 4,099,455

Registered Feb. 14, 2012

Int. Cl.: 25

TRADEMARK

PRINCIPAL REGISTER

DNM, LLC LTD (NEW JERSEY LIMITED LIABILITY COMPANY)
SUITE 1405
1400 BROADWAY SUITE
NEW YORK, NY 10018

FOR: ATHLETIC FOOTWEAR; ATHLETIC SHOES; BOOTS; FOOTWEAR; SANDALS; SHOES;
SLIPPERS, IN CLASS 25 (U.S. CLS. 22 AND 39).

FIRST USE 9-1-2011; IN COMMERCE 9-1-2011.

THE MARK CONSISTS OF STANDARD CHARACTERS WITHOUT CLAIM TO ANY PAR-
TICULAR FONT, STYLE, SIZE, OR COLOR.

OWNER OF U.S. REG. NO. 2,977,730.

NO CLAIM IS MADE TO THE EXCLUSIVE RIGHT TO USE "ORIGINAL", APART FROM
THE MARK AS SHOWN.

SN 77-832,567, FILED 9-22-2009.

ELISSA GARBER KON, EXAMINING ATTORNEY



David J. Kyffers

Director of the United States Patent and Trademark Office

United States of America

United States Patent and Trademark Office

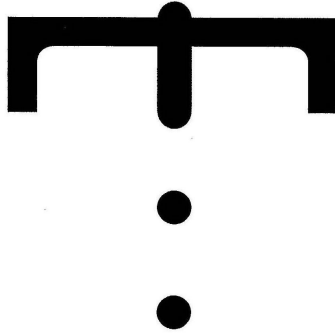

Reg. No. 4,099,456

Registered Feb. 14, 2012

Int. Cls.: 35, 39, 40, and 42

SERVICE MARK

PRINCIPAL REGISTER

TANDY BRANDS ACCESSORIES, INC. (DELAWARE CORPORATION)
SUITE A
3631 W. DAVIS ST
DALLAS, TX 75211

FOR: PRODUCT MERCHANDISING AND MARKETING FOR OTHERS IN THE FIELD OF SMALL LEATHER GOODS, BELTS, WALLETS, HANDBAGS, SPORTING GOODS, AND GIFT ACCESSORIES FOR MEN, WOMEN, AND CHILDREN, IN CLASS 35 (U.S. CLS. 100, 101 AND 102).

FIRST USE 10-27-2009; IN COMMERCE 10-27-2009.

FOR: DELIVERY AND DISTRIBUTION SERVICES, NAMELY, DELIVERY OF GOODS FOR OTHERS IN THE FIELD OF SMALL LEATHER GOODS, BELTS, WALLETS, HANDBAGS, SPORTING GOODS, AND GIFT ACCESSORIES FOR MEN, WOMEN, AND CHILDREN, IN CLASS 39 (U.S. CLS. 100 AND 105).

FIRST USE 10-27-2009; IN COMMERCE 10-27-2009.

FOR: MANUFACTURING SERVICES FOR OTHERS IN THE FIELD OF SMALL LEATHER GOODS, BELTS, WALLETS, HANDBAGS, SPORTING GOODS, AND GIFT ACCESSORIES FOR MEN, WOMEN, AND CHILDREN, IN CLASS 40 (U.S. CLS. 100, 103 AND 106).

FIRST USE 10-27-2009; IN COMMERCE 10-27-2009.

FOR: DESIGN CONSULTATION AND PRODUCT DEVELOPMENT FOR OTHERS IN THE FIELD OF SMALL LEATHER GOODS, BELTS, WALLETS, HANDBAGS, SPORTING GOODS, AND GIFT ACCESSORIES FOR MEN, WOMEN, AND CHILDREN, IN CLASS 42 (U.S. CLS. 100 AND 101).

FIRST USE 10-27-2009; IN COMMERCE 10-27-2009.

THE MARK CONSISTS OF THE STYLIZED DESIGN OF A BELT BUCKLE.

SN 77-840,351, FILED 10-2-2009.

ALLISON SCHRODY, EXAMINING ATTORNEY



David J. Kyffers

Director of the United States Patent and Trademark Office

United States of America

United States Patent and Trademark Office



Reg. No. 4,099,457

ADDERLEY, KYLE (UNITED STATES INDIVIDUAL)
103 LAKS DRIVE
MIDDLETOWN, DE 19709

Registered Feb. 14, 2012

Int. Cl.: 41

FOR: MULTIMEDIA ENTERTAINMENT SERVICES IN THE NATURE OF RECORDING, PRODUCTION AND POST-PRODUCTION SERVICES IN THE FIELDS OF MUSIC, VIDEO, AND FILMS, IN CLASS 41 (U.S. CLS. 100, 101 AND 107).

SERVICE MARK

FIRST USE 4-10-2009; IN COMMERCE 2-18-2011.

PRINCIPAL REGISTER

THE MARK CONSISTS OF A CD PLAYER THAT DISPLAYS THE STYLIZED TEXT "PABO". COMING OUT OF IT THERE IS A CD WITH THE STYLIZED TEXT "PUT-A-BEATON". TO THE LEFT THERE IS A PLAY BUTTON AND TO THE RIGHT THERE IS AN EJECT BUTTON.

SN 77-840,542, FILED 10-2-2009.

MICHAEL WIENER, EXAMINING ATTORNEY



David J. Kybas

Director of the United States Patent and Trademark Office

United States of America

United States Patent and Trademark Office

SWEET ELEGANCE

Reg. No. 4,099,458

Registered Feb. 14, 2012

Int. Cl.: 30

TRADEMARK

PRINCIPAL REGISTER

INTERNATIONAL BISCUITS & CONFECTIONS, INC. (NEW JERSEY CORPORATION)
66 N. MAIN STREET
MEDFORD, NJ 08055

FOR: SWEETS, BAKERY GOODS AND COOKIES, IN CLASS 30 (U.S. CL. 46).

FIRST USE 8-30-2010; IN COMMERCE 8-30-2010.

THE MARK CONSISTS OF STANDARD CHARACTERS WITHOUT CLAIM TO ANY PARTICULAR FONT, STYLE, SIZE, OR COLOR.

NO CLAIM IS MADE TO THE EXCLUSIVE RIGHT TO USE "SWEET", APART FROM THE MARK AS SHOWN.

SN 77-843,142, FILED 10-7-2009.

ANNE E. GUSTASON, EXAMINING ATTORNEY



David J. Kyffers

Director of the United States Patent and Trademark Office

United States of America

United States Patent and Trademark Office

OODLES OF POODLES

Reg. No. 4,099,459

IGT (NEVADA CORPORATION)
9295 PROTOTYPE DRIVE
RENO, NV 895218986

Registered Feb. 14, 2012

Int. Cl.: 9

FOR: GAMING MACHINES, NAMELY, DEVICES WHICH ACCEPT A WAGER, IN CLASS 9 (U.S. CLS. 21, 23, 26, 36 AND 38).

TRADEMARK

FIRST USE 10-26-2011; IN COMMERCE 10-26-2011.

PRINCIPAL REGISTER

THE MARK CONSISTS OF STANDARD CHARACTERS WITHOUT CLAIM TO ANY PARTICULAR FONT, STYLE, SIZE, OR COLOR.

SN 77-843,836, FILED 10-7-2009.

GEORGE LORENZO, EXAMINING ATTORNEY



David J. Kybas

Director of the United States Patent and Trademark Office

United States of America

United States Patent and Trademark Office

LAKE NONA

Reg. No. 4,099,460

LAKE NONA PROPERTY HOLDINGS, LLC (FLORIDA LIMITED LIABILITY COMPANY)
9801 LAKE NONA ROAD
ORLANDO, FL 32827

Registered Feb. 14, 2012

Int. Cl.: 41

FOR: EDUCATION SERVICES IN THE NATURE OF COURSES AT THE UNIVERSITY LEVEL; EDUCATION SERVICES IN THE NATURE OF EARLY CHILDHOOD INSTRUCTION, IN CLASS 41 (U.S. CLS. 100, 101 AND 107).

SERVICE MARK

FIRST USE 9-1-2010; IN COMMERCE 9-1-2010.

PRINCIPAL REGISTER

THE MARK CONSISTS OF STANDARD CHARACTERS WITHOUT CLAIM TO ANY PARTICULAR FONT, STYLE, SIZE, OR COLOR.

SEC. 2(F).

OWNER OF U.S. REG. NOS. 2,917,057, 3,164,463, AND 3,581,698.

SN 77-845,579, FILED 10-9-2009.

BRIAN NEVILLE, EXAMINING ATTORNEY



David J. Kyros

Director of the United States Patent and Trademark Office

United States of America

United States Patent and Trademark Office

ADVANCED NUTRITION, SENSIBLE PRICES

Reg. No. 4,099,461

Registered Feb. 14, 2012

Int. Cl.: 5

TRADEMARK

PRINCIPAL REGISTER

PBM PRODUCTS, LLC (DELAWARE LIMITED LIABILITY COMPANY)
204 NORTH MAIN STREET
GORDONSVILLE, VA 22942

FOR: INFANT FORMULA; PEDIATRIC NUTRITIONAL DRINKS FOR CHILDREN; NUTRITIONAL DRINKS FOR DIABETICS; NUTRITIONAL DRINKS, NAMELY, NUTRITIONAL SUPPLEMENTS IN BEVERAGE FORM; ANTI-DIABETIC PREPARATIONS, INCLUDING GEL FOR ASSISTING DIABETICS IN REGULATING THEIR BLOOD SUGAR, IN CLASS 5 (U.S. CLS. 6, 18, 44, 46, 51 AND 52).

FIRST USE 11-29-2011; IN COMMERCE 11-29-2011.

THE MARK CONSISTS OF STANDARD CHARACTERS WITHOUT CLAIM TO ANY PARTICULAR FONT, STYLE, SIZE, OR COLOR.

SN 77-846,643, FILED 10-12-2009.

NICHOLAS COLEMAN, EXAMINING ATTORNEY



David J. Kyffers

Director of the United States Patent and Trademark Office

United States of America

United States Patent and Trademark Office

DIRECTED SMARTSTART

Reg. No. 4,099,462

Registered Feb. 14, 2012

Int. Cl.: 9

TRADEMARK

PRINCIPAL REGISTER

DEI HEADQUARTERS, INC. (FLORIDA CORPORATION)
ATTENTION: LEGAL DEPARTMENT
ONE VIPER WAY
VISTA, CA 92081

FOR: VEHICLE TRACKING DEVICES COMPRISED OF CELLULAR RADIO MODULES, COMPUTER SOFTWARE AND COMPUTER HARDWARE, SENSORS, TRANSMITTERS, RECEIVERS AND GLOBAL POSITIONING SATELLITE RECEIVERS, ALL FOR USE IN CONNECTION WITH VEHICLE TRACKING, VEHICLE MONITORING AND ANTI-THEFT VEHICLE ALARMS, HOWEVER SPECIFICALLY EXCLUDING ELECTRONIC BREATH ACTIVATED IGNITION LOCKS, IN CLASS 9 (U.S. CLS. 21, 23, 26, 36 AND 38).

FIRST USE 10-30-2009; IN COMMERCE 10-30-2009.

THE MARK CONSISTS OF STANDARD CHARACTERS WITHOUT CLAIM TO ANY PARTICULAR FONT, STYLE, SIZE, OR COLOR.

OWNER OF U.S. REG. NOS. 2,905,106, 3,406,805, AND OTHERS.

SN 77-847,070, FILED 10-12-2009.

TARA PATE, EXAMINING ATTORNEY



David J. Kyffers

Director of the United States Patent and Trademark Office

United States of America

United States Patent and Trademark Office

SHAHIN

Reg. No. 4,099,463

IRPHANY, SHAHIN KHANAM (UNITED STATES INDIVIDUAL)
1032 EAST 42ND PLACE
LOS ANGELES, CA 90011

Registered Feb. 14, 2012

Int. Cl.: 39

FOR: AIRLINE TRANSPORTATION SERVICES, IN CLASS 39 (U.S. CLS. 100 AND 105).

SERVICE MARK

FIRST USE 10-13-2009; IN COMMERCE 11-17-2009.

PRINCIPAL REGISTER

THE MARK CONSISTS OF STANDARD CHARACTERS WITHOUT CLAIM TO ANY PARTICULAR FONT, STYLE, SIZE, OR COLOR.

SN 77-848,042, FILED 10-13-2009.

THOMAS MANOR, EXAMINING ATTORNEY



David J. Kyros

Director of the United States Patent and Trademark Office

United States of America

United States Patent and Trademark Office

VENILEX

Reg. No. 4,099,464

BREMENN IP HOLDINGS, LLC (NEVADA LIMITED LIABILITY COMPANY)
1000 EAST WILLIAM STREET, SUITE 204
CARSON CITY, NV 89701

Registered Feb. 14, 2012

Int. Cl.: 1

FOR: FORMULATION COMPRISED PRIMARILY OF BOTANICAL EXTRACTS FOR USE
IN THE MANUFACTURE OF SKIN CARE PREPARATIONS, IN CLASS 1 (U.S. CLS. 1, 5, 6,
10, 26 AND 46).

TRADEMARK

FIRST USE 5-4-2010; IN COMMERCE 5-4-2010.

PRINCIPAL REGISTER

THE MARK CONSISTS OF STANDARD CHARACTERS WITHOUT CLAIM TO ANY PAR-
TICULAR FONT, STYLE, SIZE, OR COLOR.

SN 77-850,457, FILED 10-16-2009.

CHRISTINE MARTIN, EXAMINING ATTORNEY



David J. Kyffers

Director of the United States Patent and Trademark Office

United States of America
United States Patent and Trademark Office

s  **ft**

Reg. No. 4,099,465

SOFT, LLC (ILLINOIS LIMITED LIABILITY COMPANY)
109 INGRAHAM STREET, #309
BROOKLYN, NY 11237

Registered Feb. 14, 2012

Int. Cl.: 28

FOR: CHILDREN'S TOYS AND PLAYTHINGS, NAMELY, STUFFED AND PLUSH TOYS,
IN CLASS 28 (U.S. CLS. 22, 23, 38 AND 50).

TRADEMARK

FIRST USE 9-26-2011; IN COMMERCE 9-26-2011.

PRINCIPAL REGISTER

NO CLAIM IS MADE TO THE EXCLUSIVE RIGHT TO USE "SOFT", APART FROM THE
MARK AS SHOWN.

THE MARK CONSISTS OF THE WORD "SOFT" IN LOWER CASE STANDARD FONT WITH
THE LETTER "O" IN THE WORD REPRESENTED BY AN IMAGE OF A BALL OF YARN.

SN 77-852,864, FILED 10-20-2009.

LINDA POWELL, EXAMINING ATTORNEY



David J. Kybas

Director of the United States Patent and Trademark Office

United States of America

United States Patent and Trademark Office

Lex Valu

Reg. No. 4,099,466

WARD/KRAFT, INC. (KANSAS CORPORATION)
2401 COOPER STREET
FORT SCOTT, KS 66701

Registered Feb. 14, 2012

Int. Cl.: 16

FOR: ADHESIVE LABELS, IN CLASS 16 (U.S. CLS. 2, 5, 22, 23, 29, 37, 38 AND 50).

TRADEMARK

FIRST USE 10-19-2009; IN COMMERCE 10-19-2009.

PRINCIPAL REGISTER

THE MARK CONSISTS OF STANDARD CHARACTERS WITHOUT CLAIM TO ANY PARTICULAR FONT, STYLE, SIZE, OR COLOR.

SN 77-853,190, FILED 10-20-2009.

MARC LEIPZIG, EXAMINING ATTORNEY



David J. Kyffers

Director of the United States Patent and Trademark Office

United States of America

United States Patent and Trademark Office



Reg. No. 4,099,467

Registered Feb. 14, 2012

Int. Cls.: 1, 3, 7, and 9

TRADEMARK

PRINCIPAL REGISTER

J & J TECHNOLOGY, LLC (NEVADA LIMITED LIABILITY COMPANY)
SUITE 450
ONE AMERICAN CENTER 3100 WEST END AVENUE
NASHVILLE, TN 37203

FOR: FIRE EXTINGUISHING COMPOSITIONS, FIRE EXTINGUISHING PREPARATIONS FOR USE BY CONSUMERS, FIRE DEPARTMENTS, MUNICIPALITIES AND FOR INDUSTRIAL USE, IN CLASS 1 (U.S. CLS. 1, 5, 6, 10, 26 AND 46).

FIRST USE 8-1-2010; IN COMMERCE 3-15-2011.

FOR: CRUDE OIL/PETROLEUM CLEANER USED AS A SOLUTION TO CLEAN UP CRUDE OIL ON HANDS, FABRIC, EQUIPMENT, AND MACHINERY, IN CLASS 3 (U.S. CLS. 1, 4, 6, 50, 51 AND 52).

FIRST USE 8-1-2010; IN COMMERCE 12-1-2010.

FOR: EQUIPMENT AND TOOLS, NAMELY, CANISTERS, MIST SPRAYERS, HOSES, NOZZLES, HAND PUMP CANISTERS, LARGER TANKS TO TRANSPORT LIQUIDS FOR THE DISPENSING AND APPLICATION OF PESTICIDES OR CRUDE OIL CLEAN UP SOLUTIONS; APPLICATION DEVICES, NAMELY, SPRAYER CANISTERS, HIGH PRESSURE WASHERS, NOZZLES, EXTENSION APPLICATORS TO REACH AREAS OF APPLICATION, HAND AND MACHINE CANISTER SPRAYERS AND DEVICES TO APPLY SOLUTION ALL OF THE AFOREMENTIONED FOR THE PURPOSE OF CRUDE OIL CLEAN UP PRODUCTS FOR PERSONAL USE, AND FOR USE ON LAND AND WATER; PORTABLE FLUID CONTAINED PRESSURIZED SYSTEMS COMPRISED OF BACKPACK CARRIERS, EXTENDABLE APPLICATION TOOLS AND BRUSHES TO SCRUB AND ADMINISTER SOLUTION SOLD AS A UNIT FOR APPLICATION WITH ATVS, BOATS OR PLANES, IN CLASS 7 (U.S. CLS. 13, 19, 21, 23, 31, 34 AND 35).

FIRST USE 8-15-2010; IN COMMERCE 3-1-2011.

FOR: FIRE EXTINGUISHING APPARATUS; FIRE EXTINGUISHING SYSTEMS FOR HOME, COMMERCIAL, AGRICULTURAL, VEHICULAR AND MARINE SETTINGS; FIRE EXTINGUISHING AND CLEAN UP TOOLS, NAMELY, HOSES, MIST SPRAYERS, NOZZLES, PIPE SYSTEMS COMPRISED OF TANK CANISTERS, NOZZLES, HOSES, AND EXTINGUISHERS, IN CLASS 9 (U.S. CLS. 21, 23, 26, 36 AND 38).



David J. Kybas

Director of the United States Patent and Trademark Office

Reg. No. 4,099,467 FIRST USE 8-1-2010; IN COMMERCE 3-15-2011.

OWNER OF U.S. REG. NOS. 3,663,981 AND 3,663,982.

THE COLOR(S) GREEN AND WHITE IS/ARE CLAIMED AS A FEATURE OF THE MARK.

NO CLAIM IS MADE TO THE EXCLUSIVE RIGHT TO USE "ENVIRONMENTAL", APART FROM THE MARK AS SHOWN.

THE MARK CONSISTS OF A SHADED GREEN CIRCLE, WITH A GREEN AND WHITE NUMBER ONE IN THE CENTER AND THE WORD "ENVIRONMENTAL" SUPERIMPOSED ACROSS THE NUMBER ONE, IN WHITE.

SN 77-854,195, FILED 10-21-2009.

DARRYL SPRUILL, EXAMINING ATTORNEY

United States of America

United States Patent and Trademark Office

PKI AT THE DOOR

Reg. No. 4,099,468

CODEBENCH, INC. (FLORIDA CORPORATION)
6820 LYONS TECHNOLOGY CIRCLE, SUITE 140
COCONUT CREEK, FL 33073

Registered Feb. 14, 2012

Int. Cl.: 9

FOR: COMPUTER SOFTWARE AND HARDWARE FOR VERIFYING AND VALIDATING SECURITY CREDENTIALS, IN CLASS 9 (U.S. CLS. 21, 23, 26, 36 AND 38).

TRADEMARK

FIRST USE 2-15-2011; IN COMMERCE 11-3-2011.

PRINCIPAL REGISTER

THE MARK CONSISTS OF STANDARD CHARACTERS WITHOUT CLAIM TO ANY PARTICULAR FONT, STYLE, SIZE, OR COLOR.

NO CLAIM IS MADE TO THE EXCLUSIVE RIGHT TO USE "PKI", APART FROM THE MARK AS SHOWN.

SN 77-855,181, FILED 10-22-2009.

REBECCA SMITH, EXAMINING ATTORNEY



David J. Kyffers

Director of the United States Patent and Trademark Office

United States of America

United States Patent and Trademark Office

MAKING SENSE OF BABY

Reg. No. 4,099,469

MCNEIL CONSUMER PHARMACEUTICALS CO. (NEW JERSEY PARTNERSHIP)
7050 CAMP HILL ROAD
FORT WASHINGTON, PA 19034

Registered Feb. 14, 2012

Int. Cl.: 44

FOR: PROVIDING INFORMATION IN THE FIELD OF INFANT HEALTH AND PHYSICAL DEVELOPMENT, IN CLASS 44 (U.S. CLS. 100 AND 101).

SERVICE MARK

FIRST USE 9-13-2010; IN COMMERCE 9-13-2010.

PRINCIPAL REGISTER

THE MARK CONSISTS OF STANDARD CHARACTERS WITHOUT CLAIM TO ANY PARTICULAR FONT, STYLE, SIZE, OR COLOR.

SN 77-855,820, FILED 10-23-2009.

GINA FINK, EXAMINING ATTORNEY



David J. Kybas

Director of the United States Patent and Trademark Office

United States of America

United States Patent and Trademark Office

WALL STREET RAW

Reg. No. 4,099,470

Registered Feb. 14, 2012

Int. Cl.: 16

TRADEMARK

PRINCIPAL REGISTER

TRUSTEES OF THE ZACHARY EDWARD LEIBOVIT CHILDREN'S TRUST, THE (ARIZONA TRUST)
P.O. BOX 1451
SEDONA, AZ 86339

FOR: PUBLICATIONS, NAMELY, BOOKS AND WORK BOOKS IN THE FIELDS OF FINANCIAL INFORMATION AND ADVICE, IN CLASS 16 (U.S. CLS. 2, 5, 22, 23, 29, 37, 38 AND 50).

FIRST USE 2-18-2011; IN COMMERCE 2-18-2011.

THE MARK CONSISTS OF STANDARD CHARACTERS WITHOUT CLAIM TO ANY PARTICULAR FONT, STYLE, SIZE, OR COLOR.

NO CLAIM IS MADE TO THE EXCLUSIVE RIGHT TO USE "WALL STREET", APART FROM THE MARK AS SHOWN.

SN 77-856,450, FILED 10-23-2009.

MICHAEL GAAFAR, EXAMINING ATTORNEY



David J. Kyffers

Director of the United States Patent and Trademark Office

United States of America

United States Patent and Trademark Office

WILD TRAIL

Reg. No. 4,099,471

Registered Feb. 14, 2012

Int. Cl.: 12

TRADEMARK

PRINCIPAL REGISTER

TBC TRADEMARKS, LLC (DELAWARE LIMITED LIABILITY COMPANY)
SUITE 5
2215-B RENAISSANCE DRIVE
LAS VEGAS, NV 89119

FOR: TIRES, IN CLASS 12 (U.S. CLS. 19, 21, 23, 31, 35 AND 44).

FIRST USE 9-0-2011; IN COMMERCE 9-0-2011.

THE MARK CONSISTS OF STANDARD CHARACTERS WITHOUT CLAIM TO ANY PARTICULAR FONT, STYLE, SIZE, OR COLOR.

SN 77-857,252, FILED 10-26-2009.

JASON TURNER, EXAMINING ATTORNEY



David J. Kyffers

Director of the United States Patent and Trademark Office

United States of America

United States Patent and Trademark Office

HOLLYWOOD SLASHERS

Reg. No. 4,099,472

YUDKIN, SAMUEL (UNITED STATES INDIVIDUAL)
5205 GRAND LAKE
BELLAIRE, TX 77401

Registered Feb. 14, 2012

Int. Cl.: 41

FOR: ENTERTAINMENT, NAMELY, A CONTINUING HUMAN INTEREST SHOW BROADCAST OVER TELEVISION AND THE INTERNET, IN CLASS 41 (U.S. CLS. 100, 101 AND 107).

SERVICE MARK

FIRST USE 7-1-2009; IN COMMERCE 7-1-2009.

PRINCIPAL REGISTER

THE MARK CONSISTS OF STANDARD CHARACTERS WITHOUT CLAIM TO ANY PARTICULAR FONT, STYLE, SIZE, OR COLOR.

NO CLAIM IS MADE TO THE EXCLUSIVE RIGHT TO USE "HOLLYWOOD", APART FROM THE MARK AS SHOWN.

SN 77-857,345, FILED 10-26-2009.

H. M. FISHER, EXAMINING ATTORNEY



David J. Kybas

Director of the United States Patent and Trademark Office

United States of America

United States Patent and Trademark Office

MORE FREIGHT. FEWER LOADS.
LESS IMPACT.

Reg. No. 4,099,473

DART TRANSIT COMPANY (MINNESOTA CORPORATION)
800 LONE OAK ROAD
EAGAN, MN 55121

Registered Feb. 14, 2012

Int. Cls.: 12 and 39

FOR: TRACTORS, TRAILERS AND TRACTOR-TRAILER COMBINATIONS, IN CLASS 12
(U.S. CLS. 19, 21, 23, 31, 35 AND 44).

TRADEMARK

FIRST USE 11-15-2011; IN COMMERCE 11-15-2011.

SERVICE MARK

FOR: FREIGHT TRANSPORTATION BY TRUCK, IN CLASS 39 (U.S. CLS. 100 AND 105).

PRINCIPAL REGISTER

FIRST USE 11-0-2009; IN COMMERCE 11-0-2009.

THE MARK CONSISTS OF STANDARD CHARACTERS WITHOUT CLAIM TO ANY PARTICULAR FONT, STYLE, SIZE, OR COLOR.

SN 77-857,552, FILED 10-26-2009.

PATRICIA EVANKO, EXAMINING ATTORNEY



David J. Kybas

Director of the United States Patent and Trademark Office

United States of America

United States Patent and Trademark Office

Logo
Hooks

Reg. No. 4,099,474

LOGO HOOKS, INC. (CALIFORNIA CORPORATION)
12400 VENTURA BOULEVARD, #148
STUDIO CITY, CA 91604

Registered Feb. 14, 2012

Int. Cl.: 20

FOR: NON-METAL HANGERS FOR GARMENTS AND BAGS WITH AN INFORMATION DISPLAY AREA, IN CLASS 20 (U.S. CLS. 2, 13, 22, 25, 32 AND 50).

TRADEMARK

FIRST USE 11-17-2011; IN COMMERCE 11-17-2011.

PRINCIPAL REGISTER

THE MARK CONSISTS OF THE STYLIZED WORDS "LOGO HOOKS" WITH LETTER "G" "HOOKED" INTO THE SECOND LETTER "O" OF "HOOKS".

SN 77-858,431, FILED 10-27-2009.

ESTHER A. BORSUK, EXAMINING ATTORNEY



David J. Kybas

Director of the United States Patent and Trademark Office

United States of America

United States Patent and Trademark Office

MT5

Reg. No. 4,099,475

MUL-T-LOCK LTD. (ISRAEL CORPORATION)
HA'ATZMAUT BLVD.
YAVNE, ISRAEL

Registered Feb. 14, 2012

Int. Cl.: 9

FOR: ELECTRIC, ELECTRONIC AND ELECTROMECHANICAL LOCKS AND LOCK GOODS, NAMELY, ELECTRONIC LOCK CYLINDERS, ELECTRIC STRIKING PLATES, DOOR MAGNETS, ELECTRONIC KEYS, KEY CARDS, NAMELY, ELECTRONIC OR MAGNETIC ACCESS CONTROL CARDS AND BLANK SMART CARDS, CODED TO LOCK/KEY INFORMATION SMART CARDS, AND KEY CARD READERS; ELECTRONIC OR MAGNETIC ACCESS CONTROL CARD READERS AND SMART CARD READERS; UNITS FOR PROGRAMMING LOCKS, LOCK CYLINDERS, KEYS, KEY CARDS AND KEY CARD READERS, NAMELY, COMPUTER AND COMPUTER ATTACHMENTS FOR PROGRAMMING LOCKS, LOCK CYLINDERS, KEYS, KEY CARDS, AND KEY CARD READERS; ELECTRONIC AND MAGNETIC SENSORS, NAMELY, PROXIMITY SENSORS, PRESSURE SENSORS, CONTACT SENSORS, MAGNETIC SENSORS; APPARATUS AND INSTRUMENTS FOR SIGNALING AND CHECKING, NAMELY, SENSORS FOR CHECKING AND/OR CONTROLLING PEOPLE'S MOVEMENT WITHIN, ENTRANCE TO AND EXIT FROM BUILDINGS AND THROUGH DOORS AND GATES AND/OR FOR USE WITH LOCKS; MAGNETIC AND ELECTRONIC IDENTITY CARDS; BLANK AND CODED TO LOCK/KEY INFORMATION MAGNETIC DATA CARRIERS; COMPUTER SOFTWARE, NAMELY, SOFTWARE FOR MANAGEMENT OF KEYING SYSTEMS, IN CLASS 9 (U.S. CLS. 21, 23, 26, 36 AND 38).

TRADEMARK

PRINCIPAL REGISTER

FIRST USE 1-1-2010; IN COMMERCE 1-1-2010.

THE MARK CONSISTS OF STANDARD CHARACTERS WITHOUT CLAIM TO ANY PARTICULAR FONT, STYLE, SIZE, OR COLOR.

SN 77-858,886, FILED 10-27-2009.

LINDA POWELL, EXAMINING ATTORNEY



David J. Kyros

Director of the United States Patent and Trademark Office

United States of America

United States Patent and Trademark Office

NEW MOON

Reg. No. 4,099,476

SUMMIT ENTERTAINMENT, LLC (DELAWARE LIMITED LIABILITY COMPANY)
1630 STEWART STREET, SUITE 120
SANTA MONICA, CA 90404

Registered Feb. 14, 2012

Int. Cl.: 24

FOR: BED LINENS, BLANKETS, BATH LINEN, AND PLASTIC TABLE COVERS, IN CLASS 24 (U.S. CLS. 42 AND 50).

TRADEMARK

FIRST USE 10-0-2009; IN COMMERCE 10-0-2009.

PRINCIPAL REGISTER

THE MARK CONSISTS OF STANDARD CHARACTERS WITHOUT CLAIM TO ANY PARTICULAR FONT, STYLE, SIZE, OR COLOR.

SN 77-859,381, FILED 10-28-2009.

ALLISON HOLTZ, EXAMINING ATTORNEY



David J. Kybas

Director of the United States Patent and Trademark Office

United States of America

United States Patent and Trademark Office

MERCURYWAVE

Reg. No. 4,099,477

PARK ELECTROCHEMICAL CORP. (NEW YORK CORPORATION)
48 SOUTH SERVICE ROAD, SUITE 300
MELVILLE, NY 11747

Registered Feb. 14, 2012

Int. Cls.: 6 and 24

FOR: COPPER CLAD LAMINATES FOR USE IN THE MANUFACTURE OF PRINTED CIRCUIT BOARDS, IN CLASS 6 (U.S. CLS. 2, 12, 13, 14, 23, 25 AND 50).

TRADEMARK

FIRST USE 2-26-2010; IN COMMERCE 2-26-2010.

PRINCIPAL REGISTER

FOR: FIBERGLASS FABRICS IMPREGNATED WITH RESIN FOR USE IN THE MANUFACTURE OF PRINTED CIRCUIT BOARDS AND IN ACTIVE AND PASSIVE RADIO FREQUENCY COMPONENTS, IN CLASS 24 (U.S. CLS. 42 AND 50).

FIRST USE 2-26-2010; IN COMMERCE 2-26-2010.

THE MARK CONSISTS OF STANDARD CHARACTERS WITHOUT CLAIM TO ANY PARTICULAR FONT, STYLE, SIZE, OR COLOR.

SN 77-859,404, FILED 10-28-2009.

SALLY SHIH, EXAMINING ATTORNEY



David J. Kypos

Director of the United States Patent and Trademark Office

United States of America

United States Patent and Trademark Office



Reg. No. 4,099,478

Registered Feb. 14, 2012

Int. Cl.: 9

TRADEMARK

PRINCIPAL REGISTER

ORACLE AMERICA, INC. (DELAWARE CORPORATION)
500 ORACLE PARKWAY
REDWOOD SHORES, CA 94065

FOR: COMPUTER WORKSTATIONS COMPRISING A CENTRAL PROCESSING UNIT, MEMORY, MONITOR, KEYBOARD, AND COMPUTER CURSOR CONTROL DEVICE; COMPUTER DISC DRIVES; COMPUTER DATA STORAGE DEVICES, NAMELY, BLANK HARD DRIVES, MAGNETIC TAPE DRIVES, DISK DRIVES, FLASH MEMORY DRIVES, BLANK TAPES, MEMORY CARDS, BLANK MAGNETIC DISKS, BLANK MAGNETIC TAPES AND BLANK OPTICAL DISKS, ALL FOR STORAGE OF COMPUTER DATA; COMPUTER CHIPS; COMPUTER DISK DRIVES; BLANK COMPUTER DISCS; DATA PROCESSORS; DIGITAL CAMERAS; GLOBAL POSITIONING SYSTEM TRANSMITTERS AND RECEIVERS; DVD PLAYERS; HIGH DEFINITION OPTICAL DISC PLAYERS; INTERNET TELEVISION HARDWARE, NAMELY, TELEVISION MONITORS, AND TELEVISION TRANSMITTERS; MICROPROCESSORS; SCANNERS; MAGNETIC ENCODED SMART CARD READERS; WIRELESS DATA COMMUNICATIONS HARDWARE, NAMELY, GLOBAL POSITIONING SYSTEM TRANSMITTERS AND RECEIVERS, IN CLASS 9 (U.S. CLS. 21, 23, 26, 36 AND 38).

FIRST USE 12-0-2003; IN COMMERCE 12-0-2003.

OWNER OF U.S. REG. NO. 2,277,260.

THE MARK CONSISTS OF A CUP AND SAUCER WITH STEAM RISING FROM IT.

SN 77-860,357, FILED 10-29-2009.

FRED CARL, EXAMINING ATTORNEY



David J. Kypos

Director of the United States Patent and Trademark Office

United States of America

United States Patent and Trademark Office

YUCK! ERASER

Reg. No. 4,099,479

BISELL HOMECARE, INC. (MICHIGAN CORPORATION)

Registered Feb. 14, 2012

2345 WALKER AVENUE NW
GRAND RAPIDS, MI 49544

Int. Cl.: 7

FOR: DEEP CLEANER ATTACHMENT FOR VACUUM CLEANERS AND EXTRACTORS, NAMELY, A SPOT AND STAIN EXTRACTION TOOL FOR CARPET AND UPHOLSTERY, IN CLASS 7 (U.S. CLS. 13, 19, 21, 23, 31, 34 AND 35).

TRADEMARK

FIRST USE 8-0-2010; IN COMMERCE 8-0-2010.

PRINCIPAL REGISTER

THE MARK CONSISTS OF STANDARD CHARACTERS WITHOUT CLAIM TO ANY PARTICULAR FONT, STYLE, SIZE, OR COLOR.

OWNER OF U.S. REG. NOS. 3,437,394 AND 3,464,762.

SN 77-860,387, FILED 10-29-2009.

ANDREA HACK, EXAMINING ATTORNEY



David J. Kyffers

Director of the United States Patent and Trademark Office

United States of America

United States Patent and Trademark Office

Wake Forest Health

Reg. No. 4,099,480

WAKE FOREST UNIVERSITY (NORTH CAROLINA CORPORATION)
1834 WAKE FOREST ROAD
WINSTON-SALEM, NC 27106

Registered Feb. 14, 2012

Int. Cl.: 41

FOR: EDUCATIONAL SERVICES, NAMELY, CONDUCTING CLASSES, SEMINARS, CONFERENCES, AND WORKSHOPS IN THE FIELD OF MEDICINE AND DISTRIBUTION OF COURSE MATERIALS IN CONNECTION THEREWITH, IN CLASS 41 (U.S. CLS. 100, 101 AND 107).

SERVICE MARK

PRINCIPAL REGISTER

FIRST USE 5-23-2011; IN COMMERCE 5-23-2011.

THE MARK CONSISTS OF STANDARD CHARACTERS WITHOUT CLAIM TO ANY PARTICULAR FONT, STYLE, SIZE, OR COLOR.

OWNER OF U.S. REG. NOS. 2,321,501, 2,935,341, AND OTHERS.

NO CLAIM IS MADE TO THE EXCLUSIVE RIGHT TO USE "HEALTH", APART FROM THE MARK AS SHOWN.

SN 77-860,527, FILED 10-29-2009.

KIMBERLY FRYE, EXAMINING ATTORNEY



David J. Kybas

Director of the United States Patent and Trademark Office

United States of America

United States Patent and Trademark Office

X-BOLT

Reg. No. 4,099,481

ALDILA GOLF CORP. (DELAWARE CORPORATION)
14145 DANIELSON STREET, SUITE B
POWAY, CA 92064

Registered Feb. 14, 2012

Int. Cl.: 28

FOR: ARCHERY ARROWS; ARCHERY EQUIPMENT, NAMELY, NOCKS, INSERTS, POINTS, TIPS, SHAFTS, AND FLETCHING, IN CLASS 28 (U.S. CLS. 22, 23, 38 AND 50).

TRADEMARK

FIRST USE 1-1-2011; IN COMMERCE 1-1-2011.

PRINCIPAL REGISTER

THE MARK CONSISTS OF STANDARD CHARACTERS WITHOUT CLAIM TO ANY PARTICULAR FONT, STYLE, SIZE, OR COLOR.

SN 77-862,395, FILED 11-2-2009.

AMY HELLA, EXAMINING ATTORNEY



David J. Kybas

Director of the United States Patent and Trademark Office

United States of America
United States Patent and Trademark Office

KIPG

Reg. No. 4,099,482

KERR IP GROUP, LLC (NEVADA LIMITED LIABILITY COMPANY)
P.O. BOX 18600
RENO, NV 89511

Registered Feb. 14, 2012

Int. Cl.: 45

FOR: LEGAL SERVICES, IN CLASS 45 (U.S. CLS. 100 AND 101).

SERVICE MARK

FIRST USE 1-1-2010; IN COMMERCE 10-15-2011.

PRINCIPAL REGISTER

THE MARK CONSISTS OF STANDARD CHARACTERS WITHOUT CLAIM TO ANY PARTICULAR FONT, STYLE, SIZE, OR COLOR.

SN 77-863,429, FILED 11-3-2009.

INGRID C. EULIN, EXAMINING ATTORNEY



David J. Kyffers

Director of the United States Patent and Trademark Office

United States of America

United States Patent and Trademark Office

COPPENRATH EUROPE'S BAKERY

Reg. No. 4,099,483

Registered Feb. 14, 2012

Int. Cl.: 30

TRADEMARK

PRINCIPAL REGISTER

CONDITOREI COPPENRATH & WIESE GMBH & CO. KG (FED REP GERMANY CORPORATION)
ZUM ATTERSEE 2
OSNABRÜCK, FED REP GERMANY 49076

FOR: CAKES; PASTRIES; FINE PASTRIES AND CONFECTIONERY GOODS, NAMELY, CREAM CAKES, BAKED CAKES, AND PASTRIES; EACH OF THE GOODS ALSO FROZEN, IN CLASS 30 (U.S. CL. 46).

FIRST USE 8-0-2010; IN COMMERCE 8-0-2010.

THE MARK CONSISTS OF STANDARD CHARACTERS WITHOUT CLAIM TO ANY PARTICULAR FONT, STYLE, SIZE, OR COLOR.

OWNER OF U.S. REG. NOS. 3,051,625, 3,246,416, AND OTHERS.

NO CLAIM IS MADE TO THE EXCLUSIVE RIGHT TO USE "EUROPE'S BAKERY", APART FROM THE MARK AS SHOWN.

SN 77-863,873, FILED 11-3-2009.

KATHERINE CONNOLLY, EXAMINING ATTORNEY



David J. Kybas

Director of the United States Patent and Trademark Office

United States of America

United States Patent and Trademark Office



Reg. No. 4,099,484

Registered Feb. 14, 2012

Int. Cl.: 30

TRADEMARK

PRINCIPAL REGISTER

CONDITOREI COPPENRATH & WIESE GMBH & CO. KG (FED REP GERMANY CORPORATION)
ZUM ATTERSEE 2
OSNABRÜCK, FED REP GERMANY 49076

FOR: CAKES; PASTRIES; FINE PASTRIES AND CONFECTIONERY GOODS, NAMELY, CREAM CAKES, BAKED CAKES, AND PASTRIES; EACH OF THE GOODS ALSO FROZEN, IN CLASS 30 (U.S. CL. 46).

FIRST USE 8-0-2010; IN COMMERCE 8-0-2010.

OWNER OF U.S. REG. NOS. 3,051,625, 3,246,416, AND OTHERS.

THE COLOR(S) BROWN, GOLD, RED, AND WHITE IS/ARE CLAIMED AS A FEATURE OF THE MARK.

NO CLAIM IS MADE TO THE EXCLUSIVE RIGHT TO USE "EUROPE'S BAKERY", APART FROM THE MARK AS SHOWN.

THE MARK CONSISTS OF A STYLIZED OVAL DESIGN AND THE WORDING "EUROPE'S BAKERY" IN RED APPEARING ON THE OVAL AND "COPPENRATH" IN WHITE APPEARING IN THE RED BANNER ACROSS THE CENTER OF THE MARK. THE COLOR GOLD APPEARS IN THE OVAL DESIGN, AS AN OUTLINE TO THE BANNER AND IN LINES ABOVE AND BELOW THE WORDING "COPPENRATH." THE COLOR BROWN APPEARS IN PART OF THE BORDER OF THE OVAL. WHITE APPEARS IN THE OVAL DESIGN AS WELL AS THE DESIGN ON TOP OF THE OVAL.

SN 77-863,876, FILED 11-3-2009.

KATHERINE CONNOLLY, EXAMINING ATTORNEY



David J. Kybas

Director of the United States Patent and Trademark Office

United States of America

United States Patent and Trademark Office

LOOK SLIMMER IN SECONDS

Reg. No. 4,099,485

A & H SPORTSWEAR CO., INC. (PENNSYLVANIA CORPORATION)
110 COMMERCE WAY

Registered Feb. 14, 2012

STOCKERTOWN, PA 18083

Int. Cl.: 25

FOR: APPAREL, NAMELY, JEANS, SKIRTS, TOPS, DRESSES AND SPORTSWEAR, NAMELY, TOPS, BOTTOMS, SHIRTS, BLOUSES, SKIRTS, IN CLASS 25 (U.S. CLS. 22 AND 39).

TRADEMARK

FIRST USE 9-21-2011; IN COMMERCE 9-21-2011.

PRINCIPAL REGISTER

THE MARK CONSISTS OF STANDARD CHARACTERS WITHOUT CLAIM TO ANY PARTICULAR FONT, STYLE, SIZE, OR COLOR.

OWNER OF U.S. REG. NOS. 2,121,641 AND 2,340,925.

SN 77-864,795, FILED 11-4-2009.

STEVEN R. FINE, EXAMINING ATTORNEY



David J. Kybas

Director of the United States Patent and Trademark Office

United States of America

United States Patent and Trademark Office

LOOK SLIM WITHOUT THE GYM

Reg. No. 4,099,486

A & H SPORTSWEAR CO., INC. (PENNSYLVANIA CORPORATION)
110 COMMERCE WAY
STOCKERTOWN, PA 18083

Registered Feb. 14, 2012

Int. Cl.: 25

FOR: APPAREL, NAMELY, JEANS, SKIRTS, TOPS, DRESSES AND SPORTSWEAR, NAMELY, TOPS, BOTTOMS, SHIRTS, BLOUSES, AND SKIRTS, IN CLASS 25 (U.S. CLS. 22 AND 39).

TRADEMARK

FIRST USE 10-10-2011; IN COMMERCE 10-10-2011.

PRINCIPAL REGISTER

THE MARK CONSISTS OF STANDARD CHARACTERS WITHOUT CLAIM TO ANY PARTICULAR FONT, STYLE, SIZE, OR COLOR.

OWNER OF U.S. REG. NO. 2,165,585.

SN 77-864,803, FILED 11-4-2009.

STEVEN R. FINE, EXAMINING ATTORNEY



David J. Kybas

Director of the United States Patent and Trademark Office

United States of America

United States Patent and Trademark Office

ARTRAGEOUS

Reg. No. 4,099,487

Registered Feb. 14, 2012

Int. Cl.: 25

TRADEMARK

PRINCIPAL REGISTER

SAMTEX FASHIONS LTD. (NEW YORK LIMITED LIABILITY COMPANY)
SUITE 1701
525 7TH AVENUE
NEW YORK, NY 10018

FOR: CLOTHING, NAMELY, LADIES' SKIRTS, SHIRTS, TOPS, PANTS, SHORTS, DRESSES
AND JACKETS, IN CLASS 25 (U.S. CLS. 22 AND 39).

FIRST USE 6-8-2010; IN COMMERCE 6-8-2010.

THE MARK CONSISTS OF STANDARD CHARACTERS WITHOUT CLAIM TO ANY PAR-
TICULAR FONT, STYLE, SIZE, OR COLOR.

SN 77-865,948, FILED 11-5-2009.

MICHAEL SOUDERS, EXAMINING ATTORNEY



David J. Kyffers

Director of the United States Patent and Trademark Office

United States of America

United States Patent and Trademark Office

AmericasMind

Reg. No. 4,099,488

Registered Feb. 14, 2012

Int. Cl.: 42

SERVICE MARK

PRINCIPAL REGISTER

WEST MOUNTAIN DEVELOPMENT LLC (NEW YORK LIMITED LIABILITY COMPANY)
37 ALGONQUIN DRIVE
QUEENSBURY, NY 12804

FOR: CREATING AN ON-LINE COMMUNITY FOR REGISTERED USERS TO PARTICIPATE
IN DISCUSSIONS, GET FEEDBACK FROM THEIR PEERS, FORM VIRTUAL COMMUNITIES,
AND ENGAGE IN SOCIAL NETWORKING, IN CLASS 42 (U.S. CLS. 100 AND 101).

FIRST USE 10-1-2010; IN COMMERCE 10-1-2010.

THE MARK CONSISTS OF STANDARD CHARACTERS WITHOUT CLAIM TO ANY PAR-
TICULAR FONT, STYLE, SIZE, OR COLOR.

SN 77-866,193, FILED 11-5-2009.

TAMARA FRAZIER, EXAMINING ATTORNEY



David J. Kybas

Director of the United States Patent and Trademark Office

United States of America

United States Patent and Trademark Office



Reg. No. 4,099,489

Registered Feb. 14, 2012

Int. Cl.: 3

TRADEMARK

PRINCIPAL REGISTER

LML INVESTMENTS, LLC (OHIO LIMITED LIABILITY COMPANY)
225 BUSINESS CENTER DRIVE
BLACKLICK, OH 43004

FOR: AROMATHERAPY BODY CARE PRODUCTS, NAMELY, BODY LOTION, SHOWER GEL, SHAMPOO, CONDITIONER, NON-MEDICATED LIP BALM, SOAP; BATH AND SHOWER GELS AND SALTS NOT FOR MEDICAL PURPOSES; BATH SOAPS IN LIQUID, SOLID OR GEL FORM; BEAUTY CREAMS; BEAUTY LOTIONS; COLOGNES, PERFUMES AND COSMETICS, IN CLASS 3 (U.S. CLS. 1, 4, 6, 50, 51 AND 52).

FIRST USE 2-1-2004; IN COMMERCE 11-15-2011.

OWNER OF U.S. REG. NOS. 3,041,646, 3,607,618, AND OTHERS.

NO CLAIM IS MADE TO THE EXCLUSIVE RIGHT TO USE "BRAND", APART FROM THE MARK AS SHOWN.

THE MARK CONSISTS OF THE STYLIZED TEXT "COUNTRY GIRL JEAN BRAND", WITH THE DOT OVER THE "I" IN "GIRL" REPLACED BY A STAR.

SN 77-867,894, FILED 11-9-2009.

REBECCA EISINGER, EXAMINING ATTORNEY



David J. Kybas

Director of the United States Patent and Trademark Office

United States of America

United States Patent and Trademark Office



Reg. No. 4,099,490

180 ENTERPRISES, LLC (DELAWARE LIMITED LIABILITY COMPANY)
7852 E. SANTA CATALINA DRIVE
SCOTTSDALE, AZ 85255

Registered Feb. 14, 2012

Int. Cl.: 41

FOR: ENTERTAINMENT AND EDUCATIONAL SERVICES, NAMELY, THE PRESENTATION OF SEMINARS, LECTURES, WORKSHOPS, AND CONFERENCES, AND ONGOING TELEVISION AND RADIO TALK SHOWS IN THE FIELD OF PERSONAL DEVELOPMENT ADVICE, IN CLASS 41 (U.S. CLS. 100, 101 AND 107).

SERVICE MARK

PRINCIPAL REGISTER

FIRST USE 11-10-2009; IN COMMERCE 1-25-2010.

NO CLAIM IS MADE TO THE EXCLUSIVE RIGHT TO USE "LIFE & STYLE MAKEOVERS", APART FROM THE MARK AS SHOWN.

THE COLOR(S) BLACK AND GRAY IS/ARE CLAIMED AS A FEATURE OF THE MARK.

THE MARK CONSISTS OF THREE-DIMENSIONAL NUMBERS "180" IN GRAY WITH THREE DIFFERENT IMAGES OF A WOMAN IN BLACK INSIDE THE NUMBER ZERO ABOVE THE PHRASE "LIFE & STYLE MAKEOVERS" IN BLACK LETTERS WITH A REFLECTION OF THE PHRASE IN GRAY LETTERS, THE COLOR WHITE REPRESENTS BACKGROUND, OUTLINING, SHADING, AND/OR TRANSPARENT AREAS AND ARE NOT PART OF THE MARK.

SN 77-869,931, FILED 11-11-2009.

MATTHEW KLINE, EXAMINING ATTORNEY



David J. Kappas

Director of the United States Patent and Trademark Office

United States of America

United States Patent and Trademark Office

ONE WORLD. TWO FEET.

Reg. No. 4,099,491

GREEN MARKET SERVICES COMPANY, INC. (MASSACHUSETTS CORPORATION)
1105 WEST CHESTNUT STREET
BROCKTON, MA 02301

Registered Feb. 14, 2012

Int. Cl.: 25

FOR: FOOTWEAR, IN CLASS 25 (U.S. CLS. 22 AND 39).

TRADEMARK

FIRST USE 9-0-2011; IN COMMERCE 12-1-2011.

PRINCIPAL REGISTER

THE MARK CONSISTS OF STANDARD CHARACTERS WITHOUT CLAIM TO ANY PARTICULAR FONT, STYLE, SIZE, OR COLOR.

SN 77-872,016, FILED 11-13-2009.

DAWN HAN, EXAMINING ATTORNEY



David J. Kybas

Director of the United States Patent and Trademark Office

United States of America
United States Patent and Trademark Office

 inSPIra HD

Reg. No. 4,099,492

NEUROLOGICA CORP. (MASSACHUSETTS CORPORATION)
14 ELECTRONICS AVE.
DANVERS, MA 019231011

Registered Feb. 14, 2012

Int. Cl.: 10

FOR: MEDICAL IMAGING EQUIPMENT, NAMELY, SINGLE PHOTON EMISSION COMPUTED TOMOGRAPHY (SPECT) IMAGING APPARATUS, IN CLASS 10 (U.S. CLS. 26, 39 AND 44).

TRADEMARK

FIRST USE 8-15-2011; IN COMMERCE 8-15-2011.

PRINCIPAL REGISTER

NO CLAIM IS MADE TO THE EXCLUSIVE RIGHT TO USE "HD", APART FROM THE MARK AS SHOWN.

THE MARK CONSISTS OF THE WORDING "INSPIRA HD" REPRESENTED IN STYLIZED FONT AND A BRAIN DESIGN OVER THE FIRST LETTER "I".

SN 77-872,064, FILED 11-13-2009.

WARREN L. OLANDRIA, EXAMINING ATTORNEY



David J. Kyros

Director of the United States Patent and Trademark Office

United States of America

United States Patent and Trademark Office

Sociotonia

Reg. No. 4,099,493

THE NEW UNITED STATES LLC (TENNESSEE LIMITED LIABILITY COMPANY)
2202 CHADWICK CT.

Registered Feb. 14, 2012

MOUNT JULIET, TN 37122

Int. Cl.: 25

FOR: BASEBALL CAPS; JACKETS; T-SHIRTS, IN CLASS 25 (U.S. CLS. 22 AND 39).

TRADEMARK

FIRST USE 5-9-2003; IN COMMERCE 2-19-2009.

PRINCIPAL REGISTER

THE MARK CONSISTS OF STANDARD CHARACTERS WITHOUT CLAIM TO ANY PARTICULAR FONT, STYLE, SIZE, OR COLOR.

SN 77-877,239, FILED 11-20-2009.

MICHAEL SOUDERS, EXAMINING ATTORNEY



David J. Kyros

Director of the United States Patent and Trademark Office

United States of America

United States Patent and Trademark Office

Sociotonian

Reg. No. 4,099,494

THE NEW UNITED STATES LLC (TENNESSEE LIMITED LIABILITY COMPANY)
2202 CHADWICK CT..

Registered Feb. 14, 2012

MOUNT JULIET, TN 37122

Int. Cl.: 16

FOR: BUMPER STICKERS; DECALS; PAPER BANNERS; POSTERS; PRINTED PAPER SIGNS,
IN CLASS 16 (U.S. CLS. 2, 5, 22, 23, 29, 37, 38 AND 50).

TRADEMARK

FIRST USE 5-9-2003; IN COMMERCE 2-19-2009.

PRINCIPAL REGISTER

THE MARK CONSISTS OF STANDARD CHARACTERS WITHOUT CLAIM TO ANY PAR-
TICULAR FONT, STYLE, SIZE, OR COLOR.

SN 77-877,243, FILED 11-20-2009.

MICHAEL SOUDERS, EXAMINING ATTORNEY



David J. Kyffers

Director of the United States Patent and Trademark Office

United States of America

United States Patent and Trademark Office

Sociotonians

Reg. No. 4,099,495

THE NEW UNITED STATES LLC (TENNESSEE LIMITED LIABILITY COMPANY)
2202 CHADWICK CT..

Registered Feb. 14, 2012

MOUNT JULIET, TN 37122

Int. Cl.: 16

FOR: BUMPER STICKERS; DECALS; PAPER BANNERS; POSTERS; PRINTED PAPER SIGNS,
IN CLASS 16 (U.S. CLS. 2, 5, 22, 23, 29, 37, 38 AND 50).

TRADEMARK

FIRST USE 5-9-2003; IN COMMERCE 2-19-2009.

PRINCIPAL REGISTER

THE MARK CONSISTS OF STANDARD CHARACTERS WITHOUT CLAIM TO ANY PAR-
TICULAR FONT, STYLE, SIZE, OR COLOR.

SN 77-877,245, FILED 11-20-2009.

MICHAEL SOUDERS, EXAMINING ATTORNEY



David J. Kybas

Director of the United States Patent and Trademark Office

United States of America

United States Patent and Trademark Office



Reg. No. 4,099,496

Registered Feb. 14, 2012

Int. Cl.: 35

SERVICE MARK

PRINCIPAL REGISTER

TKWS, L.L.C. (ARIZONA LIMITED LIABILITY COMPANY)
7465 E. OSBORNE ROAD
SCOTTSDALE, AZ 85251

FOR: BUSINESS CONSULTATION; BUSINESS CONSULTATION IN THE FIELD OF THE IMPORTANCE OF GIVING PRIZES, TROPHIES, PLAQUES AND OTHER AWARDS TO PARTICIPANTS AND EMPLOYEES IN BUSINESS, SCHOOL AND ATHLETIC COMPETITIONS; BUSINESS CONSULTATION SERVICES; BUSINESS MANAGEMENT CONSULTATION; BUSINESS MANAGEMENT CONSULTING; MANAGEMENT AND BUSINESS CONSULTING SERVICES IN THE FIELD OF THE IMPORTANCE OF GIVING PRIZES, TROPHIES, PLAQUES AND OTHER AWARDS TO PARTICIPANTS AND EMPLOYEES IN BUSINESS, SCHOOL AND ATHLETIC COMPETITIONS, IN CLASS 35 (U.S. CLS. 100, 101 AND 102).

FIRST USE 5-20-2010; IN COMMERCE 5-20-2010.

THE MARK CONSISTS OF THE WORDING "THE AWARDOLOGIST", WITH THREE INTERSECTING RINGS BEHIND THE WORD "AWARDOLOGIST" AND A STAR ABOVE THE "I" IN "AWARDOLOGIST".

SN 77-877,420, FILED 11-20-2009.

ROBIN MITTLER, EXAMINING ATTORNEY



David J. Kybas

Director of the United States Patent and Trademark Office

United States of America

United States Patent and Trademark Office

APPLE CINNAMON MEDLEY

Reg. No. 4,099,497

Registered Feb. 14, 2012

Int. Cl.: 4

TRADEMARK

PRINCIPAL REGISTER

RECKITT BENCKISER LLC (DELAWARE LIMITED LIABILITY COMPANY)
399 INTERPACE PARKWAY
PARSIPPANY, NJ 07054

FOR: ILLUMINANTS, NAMELY, CANDLES, FRAGRANCE SCENTED CANDLES AND SCENTED CANDLES, CANDLES FOR SCENTING OR PERFUMING THE ATMOSPHERE; TAPERS, IN CLASS 4 (U.S. CLS. 1, 6 AND 15).

FIRST USE 7-1-2010; IN COMMERCE 7-1-2010.

THE MARK CONSISTS OF STANDARD CHARACTERS WITHOUT CLAIM TO ANY PARTICULAR FONT, STYLE, SIZE, OR COLOR.

OWNER OF U.S. REG. NO. 3,550,822.

NO CLAIM IS MADE TO THE EXCLUSIVE RIGHT TO USE "APPLE CINNAMON", APART FROM THE MARK AS SHOWN.

SN 77-879,076, FILED 11-23-2009.

ANDREA K. NADELMAN, EXAMINING ATTORNEY



David J. Kyros

Director of the United States Patent and Trademark Office

United States of America
United States Patent and Trademark Office

Tanikopolis

Reg. No. 4,099,498

ALPHA MARKETING (ALABAMA LIMITED LIABILITY COMPANY)
3616 KINGSHILL ROAD
BIRMINGHAM, AL 35223

Registered Feb. 14, 2012

Int. Cl.: 35

FOR: BUSINESS ADVISORY SERVICES, CONSULTANCY AND INFORMATION, IN CLASS 35 (U.S. CLS. 100, 101 AND 102).

SERVICE MARK

FIRST USE 6-1-2010; IN COMMERCE 6-1-2011.

PRINCIPAL REGISTER

THE MARK CONSISTS OF STANDARD CHARACTERS WITHOUT CLAIM TO ANY PARTICULAR FONT, STYLE, SIZE, OR COLOR.

SN 77-880,367, FILED 11-24-2009.

ROBIN MITTLER, EXAMINING ATTORNEY



David J. Kyfos

Director of the United States Patent and Trademark Office

United States of America

United States Patent and Trademark Office



Reg. No. 4,099,499

JOHNSON GAS APPLIANCE COMPANY (IOWA CORPORATION)
520 E AVENUE NW
CEDAR RAPIDS, IA 52405

Registered Feb. 14, 2012

Int. Cl.: 11

FOR: FIREPLACES, IN CLASS 11 (U.S. CLS. 13, 21, 23, 31 AND 34).

TRADEMARK

FIRST USE 10-1-2009; IN COMMERCE 10-1-2009.

PRINCIPAL REGISTER

THE MARK CONSISTS OF THE WORD "BURNGREEN" AND DESIGN OF A SQUARE CONTAINING A FLAME.

SN 77-880,772, FILED 11-25-2009.

DAVID C. REIHNER, EXAMINING ATTORNEY



David J. Kybas

Director of the United States Patent and Trademark Office

United States of America

United States Patent and Trademark Office

Crystalvue

Reg. No. 4,099,500

Registered Feb. 14, 2012

Int. Cl.: 9

TRADEMARK

PRINCIPAL REGISTER

IPERA TECHNOLOGY, INC. (CALIFORNIA CORPORATION), AKA IPERA,
SUITE 223
1650 S AMPHLETT BLVD
SAN MATEO, CA 94402

FOR: COMMUNICATION SOFTWARE FOR PROVIDING ACCESS TO THE INTERNET; COMMUNICATIONS SOFTWARE FOR CONNECTING VIDEO STREAMING TO COMPUTERS OR MOBILE PHONES; COMPUTER HARDWARE AND COMPUTER SOFTWARE PROGRAMS FOR THE INTEGRATION OF TEXT, AUDIO, GRAPHICS, STILL IMAGES AND MOVING PICTURES INTO AN INTERACTIVE DELIVERY FOR MULTIMEDIA APPLICATIONS; COMPUTER PROCESSING SOFTWARE TO PROCESS THE IMAGE COLORS WITH THE COLOR AND INTENSITY AND INTERPRET THE RESULTS AS TENDENCIES OF THE ORGANS, GLANDS AND TISSUES ACCORDING TO THE IRIDOLOGY CHARTS; COMPUTER PROGRAMS FOR EDITING IMAGES, SOUND AND VIDEO; COMPUTER SOFTWARE FEATURING MUSICAL SOUND RECORDINGS AND MUSICAL VIDEO RECORDINGS; COMPUTER SOFTWARE FOR ORGANIZING AND VIEWING DIGITAL IMAGES AND PHOTOGRAPHS; COMPUTER SOFTWARE FOR PROCESSING DIGITAL IMAGES; COMPUTER SOFTWARE FOR VIDEO AND IMAGE ENHANCEMENT; COMPUTER SOFTWARE TO ENABLE THE TRANSMISSION OF PHOTOGRAPHS TO MOBILE TELEPHONES; COMPUTER SOFTWARE TO ENHANCE THE AUDIO-VISUAL CAPABILITIES OF MULTIMEDIA APPLICATIONS, NAMELY, FOR THE INTEGRATION OF TEXT, AUDIO, GRAPHICS, STILL IMAGES AND MOVING PICTURES; CONSUMER ELECTRONIC PRODUCTS, NAMELY, AUDIO AMPLIFIERS, AUDIO SPEAKERS, AUDIO RECEIVERS, ELECTRICAL AUDIO AND SPEAKER CABLES AND CONNECTORS, HOME THEATER SYSTEMS, AUDIO DECODERS, VIDEO DECODERS, SPEAKERS, POWER CONVERSION DEVICES, POWER CONVERTERS, AND POWER INVERTERS; DATA COMPRESSION SOFTWARE; DECODER SOFTWARE; DOWNLOADABLE SOFTWARE IN THE NATURE OF A MOBILE APPLICATION FOR INTERNET STREAMING; ELECTRONIC SCALERS FOR AUDIO AND VIDEO SIGNALS; GRAPHICAL USER INTERFACE SOFTWARE; INTERNET DIGITAL VIDEO RECORDERS; IP VIDEO SERVERS; MUSICAL VIDEO RECORDINGS; RECEIVERS FOR MOBILE PHONES; SOFTWARE FOR PROCESSING IMAGES, GRAPHICS AND TEXT; VIDEO MULTIPLEXES; VIDEO PROCESSORS; VIDEO RECEIVERS; VIDEO-TELEPHONES; DOWNLOADABLE SOFTWARE FOR DOWNLOADING VOICE, DATA AND IMAGE TRANSMISSION, NAMELY, AUDIO FILES, MULTIMEDIA FILES, TEXT FILES, E-MAILS, WRITTEN DOCUMENTS, AUDIO MATERIAL, VIDEO MATERIAL AND GAMES TO WIRELESS AND NON-WIRELESS COMMUNICATION DEVICES OVER THE AIR, IN CLASS 9 (U.S. CLS. 21, 23, 26, 36 AND 38).



David J. Kybas

Director of the United States Patent and Trademark Office

Reg. No. 4,099,500 FIRST USE 1-1-2010; IN COMMERCE 1-1-2010.

THE MARK CONSISTS OF STANDARD CHARACTERS WITHOUT CLAIM TO ANY PARTICULAR FONT, STYLE, SIZE, OR COLOR.

SN 77-881,550, FILED 11-27-2009.

LOURDES AYALA, EXAMINING ATTORNEY

United States of America

United States Patent and Trademark Office

PLUMBING PHD

Reg. No. 4,099,501

Registered Feb. 14, 2012

Int. Cls.: 16 and 41

TRADEMARK

SERVICE MARK

PRINCIPAL REGISTER

CLOCKWORK IP, LLC (DELAWARE LIMITED LIABILITY COMPANY)
SUITE 920
50 CENTRAL AVENUE
SARASOTA, FL 34236

FOR: EDUCATIONAL MATERIALS, NAMELY, WORKBOOKS, BOOKS AND PRINTED CONFERENCE MATERIALS FOR CONTRACTORS IN CONNECTION WITH THE OPERATION OF A RESIDENTIAL PLUMBING CONTRACTING BUSINESS, IN CLASS 16 (U.S. CLS. 2, 5, 22, 23, 29, 37, 38 AND 50).

FIRST USE 8-14-2009; IN COMMERCE 8-14-2009.

FOR: EDUCATIONAL SERVICES, NAMELY, DEVELOPING AND CONDUCTING SEMINARS, TUTORIALS, WORKSHOPS, AND CONFERENCES FOR CONTRACTORS IN THE FIELD OF RESIDENTIAL PLUMBING CONTRACTING, IN CLASS 41 (U.S. CLS. 100, 101 AND 107).

FIRST USE 8-14-2009; IN COMMERCE 8-14-2009.

THE MARK CONSISTS OF STANDARD CHARACTERS WITHOUT CLAIM TO ANY PARTICULAR FONT, STYLE, SIZE, OR COLOR.

NO CLAIM IS MADE TO THE EXCLUSIVE RIGHT TO USE "PLUMBING", APART FROM THE MARK AS SHOWN.

SN 77-883,017, FILED 12-1-2009.

PRISCILLA MILTON, EXAMINING ATTORNEY



David J. Kyffers

Director of the United States Patent and Trademark Office

United States of America

United States Patent and Trademark Office

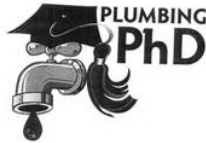

Reg. No. 4,099,502

Registered Feb. 14, 2012

Int. Cls.: 16 and 41

TRADEMARK

SERVICE MARK

PRINCIPAL REGISTER

CLOCKWORK IP, LLC (DELAWARE LIMITED LIABILITY COMPANY)
SUITE 920
50 CENTRAL AVENUE
SARASOTA, FL 34236

FOR: EDUCATIONAL MATERIALS, NAMELY, WORKBOOKS, BOOKS AND PRINTED CONFERENCE MATERIALS IN CONNECTION WITH THE OPERATION OF A RESIDENTIAL PLUMBING CONTRACTING BUSINESS, IN CLASS 16 (U.S. CLS. 2, 5, 22, 23, 29, 37, 38 AND 50).

FIRST USE 8-14-2009; IN COMMERCE 8-14-2009.

FOR: EDUCATIONAL SERVICES, NAMELY, DEVELOPING AND CONDUCTING SEMINARS, TUTORIALS, WORKSHOPS, AND CONFERENCES FOR CONTRACTORS IN THE FIELD OF RESIDENTIAL PLUMBING CONTRACTING, IN CLASS 41 (U.S. CLS. 100, 101 AND 107).

FIRST USE 8-14-2009; IN COMMERCE 8-14-2009.

NO CLAIM IS MADE TO THE EXCLUSIVE RIGHT TO USE "PLUMBING" , APART FROM THE MARK AS SHOWN.

THE MARK CONSISTS OF THE WORDS "PLUMBING PHD" SET TO THE RIGHT OF A DEPICTION OF A FAUCET WEARING A GRADUATION HAT WITH TASSEL, WITH A DROP OF WATER DRIPPING OUT OF THE FAUCET.

SN 77-883,234, FILED 12-1-2009.

PRISCILLA MILTON, EXAMINING ATTORNEY



David J. Kybas

Director of the United States Patent and Trademark Office

United States of America

United States Patent and Trademark Office



Reg. No. 4,099,503

Registered Feb. 14, 2012

Int. Cls.: 29, 30, and 43

TRADEMARK

SERVICE MARK

PRINCIPAL REGISTER

MERCHANTS GROCERY COMPANY, INC. (VIRGINIA CORPORATION)
P.O. BOX 1268
CULPEPER, VA 22701

FOR: PREPARED FOOD AND PREPACKAGED FOOD PRODUCTS FOR CONSUMPTION ON OR OFF PREMISES, NAMELY, CHICKEN, CHICKEN WINGS, PORK BARBECUE, BEEF BARBECUE, CHICKEN BARBECUE, FISH, BEEF, RIBS, PORK RIBS, GARDEN SALADS, VEGETABLE SALADS, POTATO SALADS, CHICKEN SALADS, TUNA SALADS, TACO SALADS, FRUIT SALADS, FRENCH FRIES, ONION RINGS, PICKLES; PREPARED OR PACKAGED ENTREES CONSISTING PRIMARILY OF MEAT, FISH, POULTRY OR VEGETABLES, IN CLASS 29 (U.S. CL. 46).

FIRST USE 2-11-2011; IN COMMERCE 2-11-2011.

FOR: PREPARED FOOD AND PREPACKAGED FOOD PRODUCTS FOR CONSUMPTION ON OR OFF PREMISES, NAMELY, BISCUITS, MUFFINS, SUB SANDWICHES, COLD SANDWICHES, HOT SANDWICHES, WRAP SANDWICHES, HAMBURGER SANDWICHES, CHICKEN SANDWICHES, FISH SANDWICHES, BARBECUE SANDWICHES, FRUIT COBBLERS, PIES, CHEESECAKES, CUSTARDS, DESSERT PUDDINGS, RELISH, MAYONNAISE, KETCHUP, MUSTARD; PREPARED OR PACKAGED ENTREES CONSISTING PRIMARILY OF PASTA OR RICE, IN CLASS 30 (U.S. CL. 46).

FIRST USE 2-11-2011; IN COMMERCE 2-11-2011.

FOR: FAST FOOD RESTAURANT SERVICES, IN CLASS 43 (U.S. CLS. 100 AND 101).

FIRST USE 2-11-2011; IN COMMERCE 2-11-2011.

NO CLAIM IS MADE TO THE EXCLUSIVE RIGHT TO USE "FRESH INGREDIENTS", APART FROM THE MARK AS SHOWN.

THE MARK CONSISTS OF THE STYLIZED WORD "FIXNZ" IN A RECTANGULAR BORDER WITH A SEMI-CIRCLE AT TOP CENTER OF BORDER, WITH WORDS "FRESH INGREDIENTS" ABOVE SEMI-CIRCLE, WITH LOAVES OF BREAD AND VEGETABLES, WITH A VERTICAL STRIPE DESIGN IN BACKGROUND OF RECTANGULAR BORDER.



David J. Kyros

Director of the United States Patent and Trademark Office

SN 77-884,432, FILED 12-2-2009.

Reg. No. 4,099,503 DAVID HOFFMAN, EXAMINING ATTORNEY

United States of America

United States Patent and Trademark Office

FLASH YOUR SMILE

Reg. No. 4,099,504

Registered Feb. 14, 2012

Int. Cl.: 3

TRADEMARK

PRINCIPAL REGISTER

GOSMILE, INC. (DELAWARE CORPORATION)
715 HEARST AVENUE, SUITE 300
BERKELEY, CA 94710

FOR: TOOTH WHITENING PREPARATIONS, IN CLASS 3 (U.S. CLS. 1, 4, 6, 50, 51 AND 52).

FIRST USE 8-0-2011; IN COMMERCE 8-0-2011.

THE MARK CONSISTS OF STANDARD CHARACTERS WITHOUT CLAIM TO ANY PARTICULAR FONT, STYLE, SIZE, OR COLOR.

SN 77-886,519, FILED 12-4-2009.

DOMINICK J. SALEMI, EXAMINING ATTORNEY



David J. Kybas

Director of the United States Patent and Trademark Office

United States of America

United States Patent and Trademark Office

CITY ON A HILL

Reg. No. 4,099,505

Registered Feb. 14, 2012

Int. Cl.: 36

SERVICE MARK

PRINCIPAL REGISTER

CITY ON A HILL CAPITAL LP (DELAWARE LIMITED PARTNERSHIP)
SUITE 401
711 FIFTH AVENUE
NEW YORK, NY 10022

FOR: FINANCIAL SERVICES, NAMELY, INVESTMENT ADVISORY SERVICES, INVESTMENT MANAGEMENT SERVICES AND ASSET MANAGEMENT SERVICES, IN CLASS 36 (U.S. CLS. 100, 101 AND 102).

FIRST USE 7-1-2011; IN COMMERCE 7-1-2011.

THE MARK CONSISTS OF STANDARD CHARACTERS WITHOUT CLAIM TO ANY PARTICULAR FONT, STYLE, SIZE, OR COLOR.

SN 77-887,689, FILED 12-7-2009.

KELLY BOULTON, EXAMINING ATTORNEY



David J. Kyjars

Director of the United States Patent and Trademark Office

United States of America
United States Patent and Trademark Office

ARBECY

Reg. No. 4,099,506

SIMON, JEROME (UNITED STATES INDIVIDUAL)
7949 HOLLOW PINE STREET
LAS VEGAS, NV 89143

Registered Feb. 14, 2012

Int. Cl.: 9

FOR: WIRELESS TRANSMITTERS AND RECEIVERS THAT SEND SIGNALS TO BLIND AND HANDICAPPED MUSICIANS WHICH ALLOWS THEM TO PERFORM MUSIC, IN CLASS 9 (U.S. CLS. 21, 23, 26, 36 AND 38).

TRADEMARK

FIRST USE 10-1-2009; IN COMMERCE 10-1-2010.

PRINCIPAL REGISTER

THE MARK CONSISTS OF STANDARD CHARACTERS WITHOUT CLAIM TO ANY PARTICULAR FONT, STYLE, SIZE, OR COLOR.

SN 77-889,037, FILED 12-8-2009.

ANTHONY RINKER, EXAMINING ATTORNEY



David J. Kyffers

Director of the United States Patent and Trademark Office

United States of America

United States Patent and Trademark Office

BETA SELECTED

Reg. No. 4,099,507

Registered Feb. 14, 2012

Int. Cl.: 30

TRADEMARK

PRINCIPAL REGISTER

BETA GIDA SANAYI VE TICARET ANONIM SIRKETI (TURKEY CORPORATION)
GÜLSA APARTMANI, NO: 5/A
CEMALPASA MAHALLESİ, FUZULI CADDESİ
SEYHAN - ADANA, TURKEY

FOR: TEA, ICED TEA, IN CLASS 30 (U.S. CL. 46).

FIRST USE 11-29-2011; IN COMMERCE 11-29-2011.

THE MARK CONSISTS OF STANDARD CHARACTERS WITHOUT CLAIM TO ANY PARTICULAR FONT, STYLE, SIZE, OR COLOR.

NO CLAIM IS MADE TO THE EXCLUSIVE RIGHT TO USE "SELECTED", APART FROM THE MARK AS SHOWN.

SN 77-889,787, FILED 12-9-2009.

LINDSEY RUBIN, EXAMINING ATTORNEY



David J. Kybas

Director of the United States Patent and Trademark Office

United States of America

United States Patent and Trademark Office

Amelia Earhart

Reg. No. 4,099,508

KLEPPNER, AMY (UNITED STATES INDIVIDUAL)
256 KLEPPNER ROAD
WARDSBORO, VT 05355

Registered Feb. 14, 2012

Int. Cl.: 25

FOR: CLOTHING, NAMELY, SHIRTS, PANTS, SHORTS, JACKETS, FOOTWEAR, HATS,
AND CAPS, IN CLASS 25 (U.S. CLS. 22 AND 39).

TRADEMARK

FIRST USE 9-19-1996; IN COMMERCE 8-20-2011.

PRINCIPAL REGISTER

THE MARK CONSISTS OF STANDARD CHARACTERS WITHOUT CLAIM TO ANY PAR-
TICULAR FONT, STYLE, SIZE, OR COLOR.

THE NAME "AMELIA EARHART" IDENTIFIES A DECEASED INDIVIDUAL.

SN 77-890,927, FILED 12-10-2009.

ELLEN B. AWRICH, EXAMINING ATTORNEY



David J. Kybas

Director of the United States Patent and Trademark Office

United States of America

United States Patent and Trademark Office

Amelia Earhart

Reg. No. 4,099,509

Registered Feb. 14, 2012

Int. Cl.: 16

TRADEMARK

PRINCIPAL REGISTER

KLEPPNER, AMY (UNITED STATES INDIVIDUAL)
256 KLEPPNER ROAD
WARDSBORO, VT 05355

FOR: PAPER ARTICLES, NAMELY, PAPER BAGS, POSTERS, POSTCARDS, CALENDARS, GREETING CARDS, TRADING CARDS, ART PRINTS, ART CARDS, NAMELY, CARDS FEATURING RENDERINGS OF AN ARTISTIC NATURE DEPICTING THE PERSONA ASSOCIATED WITH THE MARK, PHOTOGRAPHIC PRINTS, LITHOGRAPHIC PRINTS, BOOK COVERS, AND STATIONERY, IN CLASS 16 (U.S. CLS. 2, 5, 22, 23, 29, 37, 38 AND 50).

FIRST USE 9-19-1996; IN COMMERCE 8-18-2011.

THE MARK CONSISTS OF STANDARD CHARACTERS WITHOUT CLAIM TO ANY PARTICULAR FONT, STYLE, SIZE, OR COLOR.

THE NAME "AMELIA EARHART" IDENTIFIES A DECEASED INDIVIDUAL.

SN 77-890,943, FILED 12-10-2009.

ELLEN B. AWRICH, EXAMINING ATTORNEY



David J. Kyffers

Director of the United States Patent and Trademark Office

United States of America

United States Patent and Trademark Office



TriBion Harmonis

Reg. No. 4,099,510

Registered Feb. 14, 2012

Int. Cl.: 5

TRADEMARK

PRINCIPAL REGISTER

MERCK KGAA (FED REP GERMANY PARTNERSHIP LIMITED BY SHARES)
FRANKFURTER STR. 250
DARMSTADT, FED REP GERMANY D 64293

FOR: DIETETIC PREPARATIONS, NAMELY, DIETARY AND NUTRITIONAL SUPPLEMENTS BASED ON PROBIOTIC COMPOSITIONS; DIETETIC SUBSTANCES ADAPTED FOR MEDICAL USE, NAMELY, VITAMINS, MULTIVITAMINS, MULTIVITAMINS WITH PROBIOTICS; PHARMACEUTICAL PREPARATIONS FOR THE TREATMENT OF DEFICIENCIES OF THE IMMUNE SYSTEM, IN CLASS 5 (U.S. CLS. 6, 18, 44, 46, 51 AND 52).

FIRST USE 0-0-1999; IN COMMERCE 6-6-2011.

OWNER OF FED REP GERMANY REG. NO. 30131853, DATED 7-12-2001, RENEWED AS REG. NO. 30131853, DATED 6-1-2011, EXPIRES 5-31-2021.

OWNER OF U.S. REG. NOS. 2,806,591, 2,844,671, AND 2,869,147.

THE MARK CONSISTS OF THE STYLIZED WORDING "TRIBION HARMONIS" BELOW A DESIGN OF THREE INCOMPLETE OVERLAPPING CIRCLES OF VARYING SIZES.

THE WORDING "HARMONIS" HAS NO MEANING IN A FOREIGN LANGUAGE.

SN 77-891,316, FILED 12-11-2009.

TRICIA SONNEBORN, EXAMINING ATTORNEY



David J. Kyros

Director of the United States Patent and Trademark Office

United States of America

United States Patent and Trademark Office

S.L.I.D.E. SAVING LIVES IN DANCE EDUCATION

Reg. No. 4,099,511

HUGGINS, SAMANTHA L (UNITED STATES INDIVIDUAL)
P.O BOX 77323

Registered Feb. 14, 2012

ATLANTA, GA 30357

Int. Cl.: 41

FOR: DANCE INSTRUCTION; DANCE INSTRUCTION FOR CHILDREN; DANCE SCHOOLS; DANCE STUDIOS; EDUCATION SERVICES, NAMELY, PROVIDING DANCE CLASS AND INSTRUCTION IN THE FIELD OF DANCE. TRAINING OF DANCE INSTRUCTORS; DANCE EVENTS; ORGANIZATIONS OF DANCING EVENTS; ORGANIZING COMMUNITY FESTIVALS FEATURING A VARIETY OF ACTIVITIES, NAMELY, ART EXHIBITIONS, HERITAGE MARKETS, ETHNIC DANCES, AND THE LIKE, IN CLASS 41 (U.S. CLS. 100, 101 AND 107).

SERVICE MARK

PRINCIPAL REGISTER

FIRST USE 7-15-2010; IN COMMERCE 8-10-2010.

THE MARK CONSISTS OF STANDARD CHARACTERS WITHOUT CLAIM TO ANY PARTICULAR FONT, STYLE, SIZE, OR COLOR.

SN 77-892,034, FILED 12-11-2009.

GISELLE AGOSTO, EXAMINING ATTORNEY



David J. Kyros

Director of the United States Patent and Trademark Office

United States of America

United States Patent and Trademark Office

TIAMOND

Reg. No. 4,099,512

INNOVATIVE MEDICAL DEVICE SOLUTIONS (DELAWARE CORPORATION), AKA IMDS,
124 SOUTH 600 WEST
LOGAN, UT 84321

Registered Feb. 14, 2012

Int. Cl.: 10

FOR: IMPLANTS CONSISTING OF ARTIFICIAL MATERIALS; MEDICAL APPARATUS AND INSTRUMENTS FOR USE IN ORTHOPEDIC SURGERY; MEDICAL DEVICES, NAMELY, SPINAL IMPLANTS COMPOSED OF ARTIFICIAL MATERIALS; MEDICAL, SURGICAL AND ORTHOPAEDIC IMPLANTS MADE OF ARTIFICIAL MATERIALS; ORTHOPEDIC JOINT IMPLANTS; SURGICAL AND MEDICAL APPARATUS AND INSTRUMENTS FOR USE IN GENERAL SURGERY; SURGICAL AND MEDICAL APPARATUS AND INSTRUMENTS FOR USE IN ORTHOPEDIC SURGERY; SURGICAL APPARATUS AND INSTRUMENTS FOR USE IN ORTHOPEDIC SURGERY; SURGICAL DEVICES AND INSTRUMENTS; SURGICAL IMPLANTS COMPRISING ARTIFICIAL MATERIAL; SURGICAL INSTRUMENTS AND APPARATUS; SURGICAL INSTRUMENTS FOR USE IN ORTHOPEDIC AND SPINAL SURGERY, IN CLASS 10 (U.S. CLS. 26, 39 AND 44).

TRADEMARK

PRINCIPAL REGISTER

FIRST USE 7-5-2011; IN COMMERCE 7-5-2011.

THE MARK CONSISTS OF STANDARD CHARACTERS WITHOUT CLAIM TO ANY PARTICULAR FONT, STYLE, SIZE, OR COLOR.

SN 77-892,586, FILED 12-14-2009.

ANGELA M. MICHELI, EXAMINING ATTORNEY



David J. Kypos

Director of the United States Patent and Trademark Office

United States of America

United States Patent and Trademark Office

DGIMED ORTHO

Reg. No. 4,099,513

DGIMED ORTHO, INC. (DELAWARE CORPORATION)
SUITE 2010; 12400 WHITEWATER DRIVE
MINNETONKA, MN 55343

Registered Feb. 14, 2012

Int. Cl.: 10

FOR: MEDICAL APPARATUS AND INSTRUMENTS FOR USE IN ORTHOPEDIC SURGERY,
IN CLASS 10 (U.S. CLS. 26, 39 AND 44).

TRADEMARK

FIRST USE 7-23-2011; IN COMMERCE 7-23-2011.

PRINCIPAL REGISTER

THE MARK CONSISTS OF STANDARD CHARACTERS WITHOUT CLAIM TO ANY PARTICULAR FONT, STYLE, SIZE, OR COLOR.

NO CLAIM IS MADE TO THE EXCLUSIVE RIGHT TO USE "ORTHO", APART FROM THE MARK AS SHOWN.

SN 77-892,722, FILED 12-14-2009.

SETH A. RAPPAPORT, EXAMINING ATTORNEY



David J. Kyffers

Director of the United States Patent and Trademark Office

United States of America

United States Patent and Trademark Office

TIMATRIX

Reg. No. 4,099,514

Registered Feb. 14, 2012

Int. Cl.: 10

TRADEMARK

PRINCIPAL REGISTER

INNOVATIVE MEDICAL DEVICE SOLUTIONS (DELAWARE CORPORATION), AKA IMDS,
124 SOUTH 600 WEST
LOGAN, UT 84321

FOR: IMPLANTS CONSISTING OF ARTIFICIAL MATERIALS; ORTHOPEDIC JOINT IMPLANTS; SURGICAL AND MEDICAL APPARATUS AND INSTRUMENTS FOR USE IN GENERAL SURGERY; SURGICAL AND MEDICAL APPARATUS AND INSTRUMENTS FOR USE IN ORTHOPEDIC SURGERY; SURGICAL DEVICES AND INSTRUMENTS; SURGICAL IMPLANTS COMPRISING ARTIFICIAL MATERIAL, IN CLASS 10 (U.S. CLS. 26, 39 AND 44).

FIRST USE 7-5-2011; IN COMMERCE 7-5-2011.

THE MARK CONSISTS OF STANDARD CHARACTERS WITHOUT CLAIM TO ANY PARTICULAR FONT, STYLE, SIZE, OR COLOR.

SN 77-893,049, FILED 12-14-2009.

ANGELA M. MICHELI, EXAMINING ATTORNEY



David J. Kyffers

Director of the United States Patent and Trademark Office

United States of America

United States Patent and Trademark Office

PERFORMX

Reg. No. 4,099,515

EXTERRAN HOLDINGS INC. (DELAWARE CORPORATION)
16666 NORTHCHASE DRIVE
HOUSTON, TX 77060

Registered Feb. 14, 2012

Int. Cl.: 42

FOR: PROVIDING TEMPORARY USE OF NON-DOWNLOADABLE COMPUTER SOFTWARE FOR TRACKING AND MANAGING OF GAS COMPRESSION SERVICES OPERATIONS OVER THE INTERNET, IN CLASS 42 (U.S. CLS. 100 AND 101).

SERVICE MARK

FIRST USE 9-22-2011; IN COMMERCE 9-22-2011.

PRINCIPAL REGISTER

THE MARK CONSISTS OF STANDARD CHARACTERS WITHOUT CLAIM TO ANY PARTICULAR FONT, STYLE, SIZE, OR COLOR.

SN 77-894,768, FILED 12-16-2009.

HANNO RITTNER, EXAMINING ATTORNEY



David J. Kyffers

Director of the United States Patent and Trademark Office

United States of America

United States Patent and Trademark Office

CLEAR 2-GO

Reg. No. 4,099,516

UNIVERSITY MEDICAL PHARMACEUTICALS CORP. (CALIFORNIA CORPORATION)
88 MAXWELL
IRVINE, CA 92618

Registered Feb. 14, 2012

Int. Cl.: 5

FOR: ACNE MEDICATIONS AND ACNE TREATMENT PREPARATIONS, IN CLASS 5 (U.S. CLS. 6, 18, 44, 46, 51 AND 52).

TRADEMARK

FIRST USE 1-0-2010; IN COMMERCE 1-0-2010.

PRINCIPAL REGISTER

THE MARK CONSISTS OF STANDARD CHARACTERS WITHOUT CLAIM TO ANY PARTICULAR FONT, STYLE, SIZE, OR COLOR.

SN 77-895,178, FILED 12-16-2009.

CHRIS WELLS, EXAMINING ATTORNEY



David J. Kybas

Director of the United States Patent and Trademark Office

United States of America

United States Patent and Trademark Office

ION-POWER

Reg. No. 4,099,517

UNIVERSITY MEDICAL PHARMACEUTICALS CORP. (CALIFORNIA CORPORATION)
88 MAXWELL
IRVINE, CA 92618

Registered Feb. 14, 2012

Int. Cls.: 3 and 5

FOR: NON-MEDICATED SKIN CARE PRODUCTS, NAMELY, ANTI-WRINKLE, CLEANSING AND MOISTURIZING PATCHES WITH CREAMS, SERUMS AND/OR GELS, IN CLASS 3 (U.S. CLS. 1, 4, 6, 50, 51 AND 52).

TRADEMARK

FIRST USE 1-0-2010; IN COMMERCE 1-0-2010.

PRINCIPAL REGISTER

FOR: MEDICATED SKIN CARE PRODUCTS, NAMELY, ANTI-WRINKLE, CLEANSING AND MOISTURIZING PATCHES WITH CREAMS, SERUMS AND/OR GELS, IN CLASS 5 (U.S. CLS. 6, 18, 44, 46, 51 AND 52).

FIRST USE 1-0-2010; IN COMMERCE 1-0-2010.

THE MARK CONSISTS OF STANDARD CHARACTERS WITHOUT CLAIM TO ANY PARTICULAR FONT, STYLE, SIZE, OR COLOR.

SN 77-895,189, FILED 12-16-2009.

CHRIS WELLS, EXAMINING ATTORNEY



David J. Kybas

Director of the United States Patent and Trademark Office

United States of America

United States Patent and Trademark Office

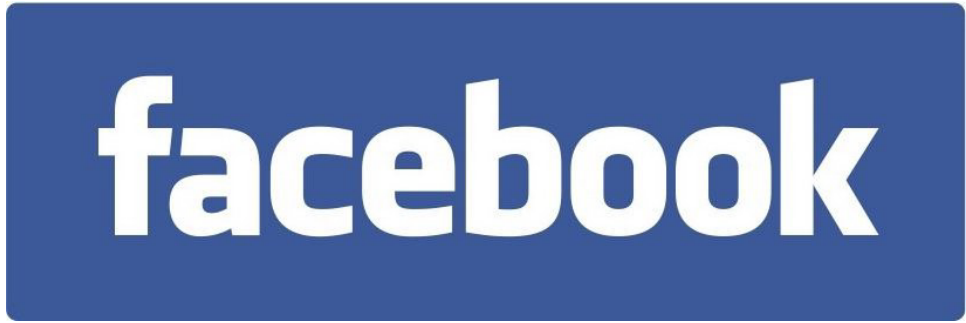

Reg. No. 4,099,518

Registered Feb. 14, 2012

Int. Cls.: 38 and 45

SERVICE MARK

PRINCIPAL REGISTER

FACEBOOK, INC. (DELAWARE CORPORATION)
1601 SOUTH CALIFORNIA AVENUE
PALO ALTO, CA 94304

FOR: PROVIDING ACCESS TO COMPUTER, ELECTRONIC AND ONLINE DATABASES; TELECOMMUNICATIONS SERVICES, NAMELY, ELECTRONIC TRANSMISSION OF DATA, MESSAGES AND INFORMATION; PROVIDING ONLINE FORUMS FOR COMMUNICATION ON TOPICS OF GENERAL INTEREST; PROVIDING ONLINE COMMUNICATIONS LINKS WHICH TRANSFER WEB SITE USERS TO OTHER LOCAL AND GLOBAL WEB PAGES; PROVIDING ACCESS TO WEB SITES FOR OTHERS HOSTED ON COMPUTER SERVERS ACCESSIBLE VIA A GLOBAL COMPUTER NETWORK; PROVIDING ACCESS TO THIRD PARTY WEB SITES BY ENABLING USERS TO LOG IN THROUGH A UNIVERSAL USERNAME AND PASSWORD VIA A GLOBAL COMPUTER NETWORK AND OTHER COMMUNICATION NETWORKS; PROVIDING ONLINE CHAT ROOMS AND ELECTRONIC BULLETIN BOARDS FOR TRANSMISSION OF MESSAGES AMONG USERS IN THE FIELD OF GENERAL INTEREST; AUDIO, TEXT AND VIDEO BROADCASTING SERVICES OVER THE INTERNET OR OTHER COMMUNICATIONS NETWORKS FEATURING THE UPLOADED, POSTED AND TAGGED AUDIO, TEXT AND VIDEO CONTENT OF OTHERS; AUDIO, TEXT AND VIDEO BROADCASTING SERVICES OVER THE INTERNET OR OTHER COMMUNICATIONS NETWORKS, NAMELY, ELECTRONICALLY TRANSMITTING AUDIO CLIPS, TEXT AND VIDEO CLIPS OF OTHERS, IN CLASS 38 (U.S. CLS. 100, 101 AND 104).

FIRST USE 8-0-2005; IN COMMERCE 8-0-2005.

FOR: IDENTIFICATION VERIFICATION SERVICES, NAMELY, PROVIDING AUTHENTICATION OF PERSONAL IDENTIFICATION INFORMATION, IN CLASS 45 (U.S. CLS. 100 AND 101).

FIRST USE 12-0-2008; IN COMMERCE 12-0-2008.

OWNER OF U.S. REG. NOS. 3,041,791, 3,734,637, AND OTHERS.

THE COLOR(S) BLUE AND WHITE IS/ARE CLAIMED AS A FEATURE OF THE MARK.

THE MARK CONSISTS OF THE WORD "FACEBOOK" IN WHITE LETTERS WITH A BLUE BACKGROUND.



David J. Kyjars

Director of the United States Patent and Trademark Office

Reg. No. 4,099,518 SN 77-896,318, FILED 12-17-2009.

JAY FLOWERS, EXAMINING ATTORNEY

United States of America

United States Patent and Trademark Office

BUCKET LIST MANAGEMENT

Reg. No. 4,099,519

Registered Feb. 14, 2012

Int. Cl.: 39

SERVICE MARK

PRINCIPAL REGISTER

TRAVEL BEYOND, INC. (MINNESOTA CORPORATION)
106 BROADWAY AVENUE
SUITE 2
WAYZATA, MN 55391

FOR: TRAVEL BOOKING AGENCIES; TRAVEL PLANNING FOR INDIVIDUALS, FAMILIES,
AND GROUPS, IN CLASS 39 (U.S. CLS. 100 AND 105).

FIRST USE 10-5-2009; IN COMMERCE 10-5-2009.

THE MARK CONSISTS OF STANDARD CHARACTERS WITHOUT CLAIM TO ANY PAR-
TICULAR FONT, STYLE, SIZE, OR COLOR.

SN 77-897,136, FILED 12-18-2009.

MARK T. MULLEN, EXAMINING ATTORNEY



David J. Kyffers

Director of the United States Patent and Trademark Office

United States of America

United States Patent and Trademark Office

ETRAQ

Reg. No. 4,099,520

CRITICARE SYSTEMS, INC. (WISCONSIN CORPORATION)
20925 CROSSROADS CIRCLE
WAUKESHA, WI 53186

Registered Feb. 14, 2012

Int. Cl.: 10

FOR: MEDICAL DEVICES AND MEDICAL PATIENT MONITORS FOR MONITORING PHYSIOLOGICAL CONDITIONS, NAMELY, OXYGEN LEVELS, CARBON DIOXIDE LEVELS, TEMPERATURE, HEART RATE AND BLOOD PRESSURE, IN CLASS 10 (U.S. CLS. 26, 39 AND 44).

TRADEMARK

PRINCIPAL REGISTER

FIRST USE 10-1-2011; IN COMMERCE 10-1-2011.

THE MARK CONSISTS OF STANDARD CHARACTERS WITHOUT CLAIM TO ANY PARTICULAR FONT, STYLE, SIZE, OR COLOR.

SN 77-897,189, FILED 12-18-2009.

KELLY BOULTON, EXAMINING ATTORNEY



David J. Kyjars

Director of the United States Patent and Trademark Office

United States of America
United States Patent and Trademark Office

BNX

Reg. No. 4,099,521

BEACON ENDOSCOPIC CORPORATION (DELAWARE CORPORATION)
2000 COMMONWEALTH AVE
NEWTON, MA 02466

Registered Feb. 14, 2012

Int. Cl.: 10

FOR: MEDICAL INSTRUMENTS FOR USE IN PERFORMING BIOPSIES OR FINE NEEDLE ASPIRATIONS; MEDICAL DEVICES, NAMELY, DEVICES FOR USE IN TREATING GASTROINTESTINAL DISEASE, IN CLASS 10 (U.S. CLS. 26, 39 AND 44).

TRADEMARK

FIRST USE 11-22-2011; IN COMMERCE 11-22-2011.

PRINCIPAL REGISTER

THE MARK CONSISTS OF STANDARD CHARACTERS WITHOUT CLAIM TO ANY PARTICULAR FONT, STYLE, SIZE, OR COLOR.

SN 77-899,363, FILED 12-22-2009.

MELISSA VALLILLO, EXAMINING ATTORNEY



David J. Kyffers

Director of the United States Patent and Trademark Office

United States of America

United States Patent and Trademark Office

SCANINN

Reg. No. 4,099,522

Registered Feb. 14, 2012

Int. Cl.: 9

TRADEMARK

PRINCIPAL REGISTER

INTELLICHECK MOBILISA, INC. (DELAWARE CORPORATION)
191 OTTO STREET
PORT TOWNSEND, WA 98368

FOR: ELECTRONIC AUTHENTICATION SYSTEMS FOR VERIFYING IDENTIFICATION DATA, NAMELY, COMPUTER HARDWARE AND SOFTWARE FOR VERIFYING PERSONAL INFORMATION FOR IDENTIFICATION PURPOSES AND COMPUTER SOFTWARE WHICH RECORDS AND REPORTS IDENTIFICATION DATA USED IN THE TRAVEL INDUSTRY, IN CLASS 9 (U.S. CLS. 21, 23, 26, 36 AND 38).

FIRST USE 2-1-2010; IN COMMERCE 2-1-2010.

THE MARK CONSISTS OF STANDARD CHARACTERS WITHOUT CLAIM TO ANY PARTICULAR FONT, STYLE, SIZE, OR COLOR.

SN 77-900,572, FILED 12-23-2009.

KELLEY WELLS, EXAMINING ATTORNEY



David J. Kyffers

Director of the United States Patent and Trademark Office

United States of America

United States Patent and Trademark Office

MAGIC PAJAMAS

Reg. No. 4,099,523

STEVEN OLSEN (UNITED STATES INDIVIDUAL)
2121 PEACE WAY
TURLOCK, CA 95382

Registered Feb. 14, 2012

Int. Cl.: 25

FOR: CLOTHING, NAMELY, PAJAMAS, ROBES, TEE-SHIRTS, PANTS, SHIRTS, SWEAT-SHIRTS, UNDERCLOTHES, IN CLASS 25 (U.S. CLS. 22 AND 39).

TRADEMARK

FIRST USE 1-31-2011; IN COMMERCE 1-31-2011.

PRINCIPAL REGISTER

THE MARK CONSISTS OF STANDARD CHARACTERS WITHOUT CLAIM TO ANY PARTICULAR FONT, STYLE, SIZE, OR COLOR.

NO CLAIM IS MADE TO THE EXCLUSIVE RIGHT TO USE "PAJAMAS", APART FROM THE MARK AS SHOWN.

SN 77-900,614, FILED 12-23-2009.

JASON TURNER, EXAMINING ATTORNEY



David J. Kyffers

Director of the United States Patent and Trademark Office

United States of America

United States Patent and Trademark Office

Petite Maison Vineyards

Reg. No. 4,099,524

Registered Feb. 14, 2012

Int. Cl.: 31

TRADEMARK

PRINCIPAL REGISTER

LENN, RONALD N. (UNITED STATES INDIVIDUAL)
86730 CENTRAL ROAD
EUGENE, OR 97402 AND

LENN, KATHLEEN M. (UNITED STATES INDIVIDUAL)
86730 CENTRAL ROAD
EUGENE, OR 97402

FOR: FRESH GRAPES FOR WINEMAKING; FRESH WINE GRAPES, IN CLASS 31 (U.S. CLS. 1 AND 46).

FIRST USE 2-1-2007; IN COMMERCE 2-1-2007.

THE MARK CONSISTS OF STANDARD CHARACTERS WITHOUT CLAIM TO ANY PARTICULAR FONT, STYLE, SIZE, OR COLOR.

NO CLAIM IS MADE TO THE EXCLUSIVE RIGHT TO USE "VINEYARDS", APART FROM THE MARK AS SHOWN.

THE ENGLISH TRANSLATION OF "PETITE MAISON" IN THE MARK IS LITTLE HOUSE.

SN 77-900,725, FILED 12-24-2009.

REGINA DRUMMOND, EXAMINING ATTORNEY



David J. Kybas

Director of the United States Patent and Trademark Office

United States of America

United States Patent and Trademark Office

ESMERALDA SYMPHONY

Reg. No. 4,099,525

ESMERALDA FARMS, INC. (FLORIDA CORPORATION)
1800 N.W. 89TH PLACE
DORAL, FL 33172

Registered Feb. 14, 2012

Int. Cl.: 31

FOR: FRESH CUT FLOWERS, NAMELY, ALSTROEMARIA VARIETIES, IN CLASS 31 (U.S. CLS. 1 AND 46).

TRADEMARK

FIRST USE 7-31-2011; IN COMMERCE 7-31-2011.

PRINCIPAL REGISTER

THE MARK CONSISTS OF STANDARD CHARACTERS WITHOUT CLAIM TO ANY PARTICULAR FONT, STYLE, SIZE, OR COLOR.

OWNER OF U.S. REG. NO. 3,650,720.

THE ENGLISH TRANSLATION OF THE WORD "ESMERALDA" IN THE MARK IS "EMERALD".

SN 77-901,214, FILED 12-28-2009.

JEFFREY LOOK, EXAMINING ATTORNEY



David J. Kybas

Director of the United States Patent and Trademark Office

United States of America

United States Patent and Trademark Office

ECRIMETOOLS.COM

Reg. No. 4,099,526

SEQUEL MEDIA & SERVICES, LLC (VIRGINIA LIMITED LIABILITY COMPANY)
3057 NUTLEY STREET, SUITE 807
FAIRFAX, VA 22031

Registered Feb. 14, 2012

**Int. Cls.: 9, 35, 42, and
45**

FOR: DOWNLOADABLE ELECTRONIC NEWSLETTERS AND ISSUE PAPERS IN THE
FIELDS OF LAW AND THE INTERNET, IN CLASS 9 (U.S. CLS. 21, 23, 26, 36 AND 38).

FIRST USE 1-25-2011; IN COMMERCE 1-25-2011.

TRADEMARK

SERVICE MARK

PRINCIPAL REGISTER

FOR: TRADEMARK, TRADE NAME AND DOMAIN NAME MONITORING SERVICES;
PROVIDING AN ONLINE DIRECTORY INFORMATION SERVICE FEATURING TELEPHONE
NUMBERS, ADDRESSES AND BUSINESS INFORMATION; ONLINE RETAIL STORE SER-
VICES FEATURING BOOKS; ADVERTISING AND DIRECTORY SERVICES, NAMELY,
PROMOTING THE SERVICES OF OTHERS BY PROVIDING A WEB PAGE FEATURING
LINKS TO THE WEBSITES OF OTHERS; PROVIDING AN ONLINE COMMERCIAL INFORM-
ATION DIRECTORY ON THE INTERNET; MARKET ANALYSIS SERVICES; PROVIDING
AN ONLINE SEARCHABLE DATABASE FEATURING BUSINESS INFORMATION ABOUT
THE RELATIONSHIPS BETWEEN SUBJECT WEBSITES, INTERNET PROTOCOL AD-
DRESSES OR DOMAIN NAMES ON THE INTERNET USED TO RESEARCH, TRACK AND
INVESTIGATE POTENTIAL OWNERSHIP OF OR AFFILIATION BETWEEN WEBSITES
THAT ARE CONNECTED BY HYPERLINKS, IN CLASS 35 (U.S. CLS. 100, 101 AND 102).

FIRST USE 1-25-2011; IN COMMERCE 1-25-2011.



FOR: PROVIDING AN ONLINE SEARCHABLE DATABASE FEATURING INFORMATION
ABOUT THE CHARACTERISTICS OF TARGETED SERVERS ON THE INTERNET, INFORM-
ATION ABOUT SHARED SERVER ARRANGEMENTS BETWEEN SUBJECT WEBSITES,
HISTORIC INFORMATION ABOUT INTERNET HOSTING ARRANGEMENTS FOR SUBJECT
WEBSITES; DATA RETRIEVAL SERVICES PERFORMED BY COMPUTER, IN CLASS 42
(U.S. CLS. 100 AND 101).

FIRST USE 1-25-2011; IN COMMERCE 1-25-2011.

David J. Kyros

Director of the United States Patent and Trademark Office

FOR: PROVIDING AN ONLINE SEARCHABLE DATABASE FEATURING LEGAL INFORM-
ATION ABOUT CASE LAW, STATUTORY LAW, TREATIES AND RELATED REGULATIONS
AND POLICY; COMPUTER SERVICES PROVIDED THROUGH A GLOBAL COMPUTER
NETWORK, NAMELY, COMPUTER-ASSISTED LEGAL RESEARCH SERVICES; COMPUTER

Reg. No. 4,099,526 SERVICES, NAMELY, PROVIDING DATABASES FEATURING LEGAL INFORMATION,
IN CLASS 45 (U.S. CLS. 100 AND 101).

FIRST USE 1-25-2011; IN COMMERCE 1-25-2011.

THE MARK CONSISTS OF STANDARD CHARACTERS WITHOUT CLAIM TO ANY PAR-
TICULAR FONT, STYLE, SIZE, OR COLOR.

SN 77-901,936, FILED 12-29-2009.

GINA HAYES, EXAMINING ATTORNEY

United States of America

United States Patent and Trademark Office



Reg. No. 4,099,527

Registered Feb. 14, 2012

Int. Cl.: 28

TRADEMARK

PRINCIPAL REGISTER

AIRBORNE DISEASE SOLUTIONS, LLC (SOUTH CAROLINA LIMITED LIABILITY COMPANY)
100 HELMSMAN WAY #214
HILTON HEAD ISLAND, SC 29928

FOR: GLOW IN THE DARK RUBBER ARCHERY AND RIFLERY TARGETS; GLOW IN THE DARK ACCESSORIES FOR USE IN ARCHERY, RIFLERY, CAMPING AND OUTDOOR SPORTS, NAMELY, TARGETS AND FINDER STRIPS, IN CLASS 28 (U.S. CLS. 22, 23, 38 AND 50).

FIRST USE 1-6-2010; IN COMMERCE 1-14-2010.

NO CLAIM IS MADE TO THE EXCLUSIVE RIGHT TO USE "GLOWERS", APART FROM THE MARK AS SHOWN.

THE COLOR(S) BLACK, YELLOW, WHITE, AND BLUE IS/ARE CLAIMED AS A FEATURE OF THE MARK.

THE MARK CONSISTS OF THE STYLIZED WORDING "GLOWERS SEEN ALL NIGHT" IN YELLOW ON A RECTANGLE WITH ROUNDED CORNERS AND THE DESIGN OF A LEAPING CAT; THE CAT IS BLACK AND OUTLINED IN YELLOW WITH YELLOW HIGHLIGHTS ON IT'S BODY; THE CATS' TEETH AND NOSE ARE WHITE; THE LINES BETWEEN THE EYES AND IN FRONT OF THE EAR ARE BLUE; THE LINES IN THE FOOT AND THE CLAWS ARE WHITE; THE RECTANGLE IS BLACK WITH A YELLOW OUTLINE INSIDE A BLACK OUTLINE.

SN 77-903,399, FILED 12-31-2009.

HOWARD B. LEVINE, EXAMINING ATTORNEY



David J. Kybas

Director of the United States Patent and Trademark Office

United States of America

United States Patent and Trademark Office

WINVISION

Reg. No. 4,099,528

Registered Feb. 14, 2012

Int. Cl.: 9

TRADEMARK

PRINCIPAL REGISTER

GALAXIA ELECTRONICS CO., LTD. (REPUBLIC OF KOREA CORPORATION)
SANGDAEWON-DONG, JUNGWON-GU, SEONGNAM
#1307, TECH-CENTER, SK TECHNOPARK 190-1,
GYEONGGI-DO, REPUBLIC OF KOREA 462-705

FOR: LIGHT EMITTING DIODE (LED) DISPLAYS, LIGHT EMITTING DIODE (LED) ELECTRONIC DISPLAY BOARDS; ELECTRONIC NOTICE BOARDS; REFLECTIVE ARTICLES FOR THE PREVENTION OF TRAFFIC ACCIDENTS, NAMELY, REFLECTIVE SAFETY BANDS TO BE WORN ON THE BODY; TRAFFIC LIGHTS; TRAFFIC LIGHT APPARATUS; LUMINOUS OR MECHANICAL ROAD SIGNS; LUMINOUS SIGNALING PANELS; MECHANICAL SIGNALING PANELS; LUMINOUS SIGNS; LUMINOUS SAFETY BEACONS; LASERS, NOT FOR MEDICAL PURPOSES; CATHODE-RAY TUBES; X-RAY TUBES NOT FOR MEDICAL PURPOSES; DISCHARGE TUBES, ELECTRIC, OTHER THAN FOR LIGHTING; DIODES; SEMI-CONDUCTORS; SILICON WAFERS; THERMISTORS; TRANSISTORS, IN CLASS 9 (U.S. CLS. 21, 23, 26, 36 AND 38).

FIRST USE 1-1-2007; IN COMMERCE 1-1-2008.

THE MARK CONSISTS OF STANDARD CHARACTERS WITHOUT CLAIM TO ANY PARTICULAR FONT, STYLE, SIZE, OR COLOR.

SN 77-904,220, FILED 1-4-2010.

JANET LEE, EXAMINING ATTORNEY



David J. Kyffers

Director of the United States Patent and Trademark Office

United States of America

United States Patent and Trademark Office

READY REACHER

Reg. No. 4,099,529

Registered Feb. 14, 2012

Int. Cl.: 8

TRADEMARK

PRINCIPAL REGISTER

ONTEL PRODUCTS CORPORATION (NEW JERSEY CORPORATION)
21 LAW DRIVE
FAIRFIELD, NJ 07004

FOR: MANUALLY OPERATED HAND HELD TOOL THAT ALLOWS AN INDIVIDUAL TO GRAB OR RETRIEVE ITEMS OUT OF NORMAL REACH, IN CLASS 8 (U.S. CLS. 23, 28 AND 44).

FIRST USE 10-16-2010; IN COMMERCE 10-16-2010.

THE MARK CONSISTS OF STANDARD CHARACTERS WITHOUT CLAIM TO ANY PARTICULAR FONT, STYLE, SIZE, OR COLOR.

NO CLAIM IS MADE TO THE EXCLUSIVE RIGHT TO USE "REACHER", APART FROM THE MARK AS SHOWN.

SN 77-905,753, FILED 1-6-2010.

KATHERINE STOIDES, EXAMINING ATTORNEY



David J. Kyros

Director of the United States Patent and Trademark Office

United States of America

United States Patent and Trademark Office

CAPTAIN CUPCAKE

Reg. No. 4,099,530

Registered Feb. 14, 2012

Int. Cl.: 30

TRADEMARK

PRINCIPAL REGISTER

HOSTESS BRANDS, INC. (DELAWARE CORPORATION)
SUITE 600
6031 CONNECTION DRIVE
IRVING, TX 75039

FOR: BAKERY GOODS, IN CLASS 30 (U.S. CL. 46).

FIRST USE 12-8-2011; IN COMMERCE 12-8-2011.

THE MARK CONSISTS OF STANDARD CHARACTERS WITHOUT CLAIM TO ANY PARTICULAR FONT, STYLE, SIZE, OR COLOR.

NO CLAIM IS MADE TO THE EXCLUSIVE RIGHT TO USE "CUPCAKE", APART FROM THE MARK AS SHOWN.

SN 77-907,727, FILED 1-8-2010.

DEZMONA MIZELLE, EXAMINING ATTORNEY



David J. Kyffers

Director of the United States Patent and Trademark Office

United States of America

United States Patent and Trademark Office

NEXDRUM

Reg. No. 4,099,531

GREIF PACKAGING LLC (DELAWARE LIMITED LIABILITY COMPANY)
425 WINTER ROAD
DELAWARE, OH 43015

Registered Feb. 14, 2012

Int. Cl.: 20

FOR: CONTAINERS NOT OF METAL FOR COMMERCIAL USE; SHIPPING CONTAINERS MADE PRINCIPALLY OF PLASTIC MATERIALS FOR COMMERCIAL USE; STORAGE DRUMS AND SHIPPING DRUMS MADE OF PLASTIC, IN CLASS 20 (U.S. CLS. 2, 13, 22, 25, 32 AND 50).

TRADEMARK

PRINCIPAL REGISTER

FIRST USE 10-0-2011; IN COMMERCE 10-0-2011.

THE MARK CONSISTS OF STANDARD CHARACTERS WITHOUT CLAIM TO ANY PARTICULAR FONT, STYLE, SIZE, OR COLOR.

SN 77-908,703, FILED 1-11-2010.

WILLIAM ROSSMAN, EXAMINING ATTORNEY



David J. Kyffers

Director of the United States Patent and Trademark Office

United States of America

United States Patent and Trademark Office

VERSATUBE

Reg. No. 4,099,532

COOK INCORPORATED (INDIANA CORPORATION)

Registered Feb. 14, 2012

P. O. BOX 489
BLOOMINGTON, IN 474020489

Int. Cl.: 10

FOR: MEDICAL DEVICE, NAMELY, A TRACHEOTOMY TUBE FOR PERCUTANEOUS PLACEMENT APPLICATIONS FOR USE WITH PERCUTANEOUS TRACHEOTOMY INTRODUCER SETS, IN CLASS 10 (U.S. CLS. 26, 39 AND 44).

TRADEMARK

FIRST USE 9-30-2010; IN COMMERCE 9-30-2010.

PRINCIPAL REGISTER

THE MARK CONSISTS OF STANDARD CHARACTERS WITHOUT CLAIM TO ANY PARTICULAR FONT, STYLE, SIZE, OR COLOR.

SN 77-910,640, FILED 1-13-2010.

ANDREA HACK, EXAMINING ATTORNEY



David J. Kyffers

Director of the United States Patent and Trademark Office

United States of America

United States Patent and Trademark Office

HABILIDAD PRIMERO CONCILLIO

Reg. No. 4,099,533

S. C. JOHNSON & SON, INC. (WISCONSIN CORPORATION)
1525 HOWE STREET
RACINE, WI 53403

Registered Feb. 14, 2012

Int. Cls.: 3, 5, and 21

FOR: ALL PURPOSE CLEANERS FOR HOUSEHOLD USE, IN CLASS 3 (U.S. CLS. 1, 4, 6, 50, 51 AND 52).

TRADEMARK

FIRST USE 9-22-2011; IN COMMERCE 9-22-2011.

PRINCIPAL REGISTER

FOR: AIR FRESHENERS, IN CLASS 5 (U.S. CLS. 6, 18, 44, 46, 51 AND 52).

FIRST USE 9-14-2011; IN COMMERCE 9-14-2011.

FOR: BATTERY OPERATED UNIT SOLD EMPTY FOR DISPENSING ALL PURPOSE CLEANER, IN CLASS 21 (U.S. CLS. 2, 13, 23, 29, 30, 33, 40 AND 50).

FIRST USE 9-22-2011; IN COMMERCE 9-22-2011.

THE MARK CONSISTS OF STANDARD CHARACTERS WITHOUT CLAIM TO ANY PARTICULAR FONT, STYLE, SIZE, OR COLOR.

OWNER OF U.S. REG. NOS. 3,584,870 AND 3,584,873.

THE ENGLISH TRANSLATION OF "HABILIDAD PRIMERO CONCILLIO" IN THE MARK IS "ABILITIES FIRST COUNCIL".

SN 77-910,870, FILED 1-13-2010.

KEVIN DINALLO, EXAMINING ATTORNEY



David J. Kybas

Director of the United States Patent and Trademark Office

United States of America
United States Patent and Trademark Office

DUCK OFF

Reg. No. 4,099,534

WILLIAMS, JOY W. (UNITED STATES INDIVIDUAL)
PO BOX 222
SURRY, VA 23883

Registered Feb. 14, 2012

Int. Cl.: 25

FOR: CLOTHING, NAMELY, SHIRTS, DRESSES, SHORTS AND PANTS; HEADWEAR;
FOOTWEAR, IN CLASS 25 (U.S. CLS. 22 AND 39).

TRADEMARK

FIRST USE 5-15-2010; IN COMMERCE 12-15-2011.

PRINCIPAL REGISTER

THE MARK CONSISTS OF STANDARD CHARACTERS WITHOUT CLAIM TO ANY PAR-
TICULAR FONT, STYLE, SIZE, OR COLOR.

SN 77-913,701, FILED 1-17-2010.

SALLY SHIH, EXAMINING ATTORNEY



David J. Kybas

Director of the United States Patent and Trademark Office

United States of America
United States Patent and Trademark Office

RAPTORQ

Reg. No. 4,099,535

Registered Feb. 14, 2012

Int. Cl.: 9

TRADEMARK

PRINCIPAL REGISTER

QUALCOMM INCORPORATED (DELAWARE CORPORATION)
TRADEMARK DEPT.
5775 MOREHOUSE DRIVE
SAN DIEGO, CA 921211714

FOR: COMPUTER HARDWARE AND SOFTWARE FOR FORWARD ERROR CORRECTION
IN THE FIELD OF NETWORK AND WIRELESS COMMUNICATION, SET-TOP BOXES AND
TELEVISION RECEIVERS, IN CLASS 9 (U.S. CLS. 21, 23, 26, 36 AND 38).

FIRST USE 1-28-2010; IN COMMERCE 1-28-2010.

THE MARK CONSISTS OF STANDARD CHARACTERS WITHOUT CLAIM TO ANY PAR-
TICULAR FONT, STYLE, SIZE, OR COLOR.

OWNER OF U.S. REG. NO. 3,507,464.

SN 77-913,942, FILED 1-18-2010.

TRACY CROSS, EXAMINING ATTORNEY



David J. Kyros

Director of the United States Patent and Trademark Office

United States of America

United States Patent and Trademark Office



Reg. No. 4,099,536

Registered Feb. 14, 2012

Int. Cl.: 41

SERVICE MARK

PRINCIPAL REGISTER

COMPETITOR GROUP, INC. (DELAWARE CORPORATION)
9477 WAPLES STREET, SUITE 150
SAN DIEGO, CA 92121

FOR: ENTERTAINMENT IN THE NATURE OF ORGANIZING A SPORTING EVENT IN THE NATURE OF A RUNNING RACE AND RELATED SPORTING AND ENTERTAINMENT EVENTS, NAMELY, ORGANIZING COMMUNITY FAIRS FEATURING VENDOR BOOTHS OF FOOD AND RACE RELATED SPORTING GOODS, AND PLANNING PARTIES AND DINNERS, IN CLASS 41 (U.S. CLS. 100, 101 AND 107).

FIRST USE 8-2-2011; IN COMMERCE 8-2-2011.

OWNER OF U.S. REG. NOS. 2,131,333, 2,530,120, AND 3,660,153.

NO CLAIM IS MADE TO THE EXCLUSIVE RIGHT TO USE "PHILADELPHIA 1/2 MARATHON", APART FROM THE MARK AS SHOWN.

THE MARK CONSISTS OF THE STYLIZED WORDS "ROCK 'N' ROLL PHILADELPHIA 1/2 MARATHON" IN THREE SEPARATE RECTANGLES AND A SEPARATE RECTANGLE CONTAINING A DESIGN, ALL SURROUNDED BY A RECTANGULAR BORDER. THE DESIGN COMPRISES A BELL SURROUNDED BY STARS.

SN 77-914,951, FILED 1-19-2010.

BRENDAN REGAN, EXAMINING ATTORNEY



David J. Kyros

Director of the United States Patent and Trademark Office

United States of America

United States Patent and Trademark Office

icandy

Reg. No. 4,099,537

KUDO, SUSAN L. (UNITED STATES INDIVIDUAL)
310 MANTUA ROAD
PACIFIC PALISADES, CA 90815

Registered Feb. 14, 2012

Int. Cl.: 9

FOR: CELL PHONE BASED COMPUTER SOFTWARE APPLICATION FOR VIEWING AND ORDERING AND PAYING FOR CANDY, IN CLASS 9 (U.S. CLS. 21, 23, 26, 36 AND 38).

TRADEMARK

FIRST USE 1-5-2011; IN COMMERCE 4-1-2011.

PRINCIPAL REGISTER

THE MARK CONSISTS OF STANDARD CHARACTERS WITHOUT CLAIM TO ANY PARTICULAR FONT, STYLE, SIZE, OR COLOR.

SN 77-916,093, FILED 1-20-2010.

MARIAM MAHMOUDI, EXAMINING ATTORNEY



David J. Kybas

Director of the United States Patent and Trademark Office

United States of America

United States Patent and Trademark Office

MEDFINANCIAL

Reg. No. 4,099,538

Registered Feb. 14, 2012

Int. Cls.: 35, 41, and 42

SERVICE MARK

PRINCIPAL REGISTER

EDFINANCIAL SERVICES, LLC (NEVADA LIMITED LIABILITY COMPANY)
298 N. SEVEN OAKS DRIVE
KNOXVILLE, TN 37922

FOR: CUSTOMER SERVICE IN THE FIELD OF HEALTH CARE; MANAGEMENT AND OPERATION OF TELEPHONE CALL CENTERS FOR OTHERS; CONSUMER SURVEY SERVICES, NAMELY, CUSTOMER SURVEY DESIGN AND IMPLEMENTATION; DEVELOPING AND PROVIDING CAMPAIGNS TO PROMOTE PUBLIC AWARENESS OF CONSUMER ISSUES IN THE FIELD OF HEALTHCARE THROUGH INCREASED CONSUMER EDUCATION, IN CLASS 35 (U.S. CLS. 100, 101 AND 102).

FIRST USE 2-25-2010; IN COMMERCE 2-25-2010.

FOR: CONSULTING SERVICES IN THE FIELD OF HEALTHCARE EDUCATION, NAMELY, IDENTIFYING EDUCATIONAL NEEDS AND DEVELOPING EDUCATION PROGRAM CONTENT FOR CONSUMERS IN THE FIELD OF HEALTHCARE, IN CLASS 41 (U.S. CLS. 100, 101 AND 107).

FIRST USE 2-25-2010; IN COMMERCE 2-25-2010.

FOR: WEB SITE DEVELOPMENT FOR OTHERS IN THE FIELD OF HEALTH CARE WEBSITES; INFORMATION TECHNOLOGY CONSULTATION FOR HEALTH CARE PROVIDERS AND CONSUMERS, IN CLASS 42 (U.S. CLS. 100 AND 101).

FIRST USE 2-25-2010; IN COMMERCE 2-25-2010.

THE MARK CONSISTS OF STANDARD CHARACTERS WITHOUT CLAIM TO ANY PARTICULAR FONT, STYLE, SIZE, OR COLOR.

SN 77-917,108, FILED 1-21-2010.

ROBIN MITTLER, EXAMINING ATTORNEY



David J. Kyffers

Director of the United States Patent and Trademark Office

United States of America

United States Patent and Trademark Office

GO TO VOICE

Reg. No. 4,099,539

Registered Feb. 14, 2012

Int. Cls.: 38 and 42

SERVICE MARK

PRINCIPAL REGISTER

GO TO VOICE, L.L.C. (GEORGIA LIMITED LIABILITY COMPANY)
1230 PEACHTREE STREET, SUITE 1075
ATLANTA, GA 30309

FOR: PROVIDING TELECOMMUNICATION CONNECTIVITY SERVICES, IN CLASS 38
(U.S. CLS. 100, 101 AND 104).

FIRST USE 6-0-2011; IN COMMERCE 6-0-2011.

FOR: PROVIDING WEB SERVICE APPLICATION PROGRAMMING INTERFACE (API)
SOFTWARE FOR USE IN BUILDING COMMUNICATION APPLICATIONS; CLOUD COM-
PUTING FEATURING HARDWARE AND SOFTWARE FOR USE IN DEVELOPING AND
PROVIDING COMMUNICATION APPLICATIONS, IN CLASS 42 (U.S. CLS. 100 AND 101).

FIRST USE 6-0-2011; IN COMMERCE 6-0-2011.

THE MARK CONSISTS OF STANDARD CHARACTERS WITHOUT CLAIM TO ANY PAR-
TICULAR FONT, STYLE, SIZE, OR COLOR.

NO CLAIM IS MADE TO THE EXCLUSIVE RIGHT TO USE "VOICE" , APART FROM THE
MARK AS SHOWN.

SN 77-920,403, FILED 1-26-2010.

KIMBERLY PERRY, EXAMINING ATTORNEY



David J. Kybas

Director of the United States Patent and Trademark Office

United States of America

United States Patent and Trademark Office

PERSONALLY YOURS

Reg. No. 4,099,540

KEMPER INDEPENDENCE INSURANCE COMPANY (ILLINOIS CORPORATION)
12926 GRAN BAY PARKWAY WEST
JACKSONVILLE, FL 32258

Registered Feb. 14, 2012

Int. Cl.: 36

FOR: INSURANCE UNDERWRITING IN THE FIELD OF PROPERTY AND CASUALTY INSURANCE, IN CLASS 36 (U.S. CLS. 100, 101 AND 102).

SERVICE MARK

FIRST USE 9-22-2011; IN COMMERCE 9-22-2011.

PRINCIPAL REGISTER

THE MARK CONSISTS OF STANDARD CHARACTERS WITHOUT CLAIM TO ANY PARTICULAR FONT, STYLE, SIZE, OR COLOR.

SN 77-921,126, FILED 1-27-2010.

JENNIFER DIXON, EXAMINING ATTORNEY



David J. Kyffers

Director of the United States Patent and Trademark Office

United States of America

United States Patent and Trademark Office

EM

Reg. No. 4,099,541

PETER SUI LUN FONG (CHINA INDIVIDUAL)
279F SOUTH ATLANTIC BLVD.
MONTEREY PARK, CA 91754

Registered Feb. 14, 2012

Int. Cl.: 28

FOR: TOYS, NAMELY, DOLLS, FASHION DOLLS, ELECTRONIC DOLLS, ANIMATED DOLLS, DOLL CLOTHING AND DOLL ACCESSORIES, IN CLASS 28 (U.S. CLS. 22, 23, 38 AND 50).

TRADEMARK

FIRST USE 1-5-2010; IN COMMERCE 2-15-2010.

PRINCIPAL REGISTER

THE MARK CONSISTS OF STANDARD CHARACTERS WITHOUT CLAIM TO ANY PARTICULAR FONT, STYLE, SIZE, OR COLOR.

SN 77-921,301, FILED 1-27-2010.

JASON TURNER, EXAMINING ATTORNEY



David J. Kybas

Director of the United States Patent and Trademark Office

United States of America

United States Patent and Trademark Office

MyTourGuide

Reg. No. 4,099,542

Registered Feb. 14, 2012

Int. Cls.: 9 and 38

TRADEMARK

SERVICE MARK

PRINCIPAL REGISTER

TRAVELBRAINS, INC. (NEW HAMPSHIRE CORPORATION)
360 ROUTE 101
UNIT 13A
BEDFORD, NH 03110

FOR: DOWNLOADABLE AUDIO, VIDEO AND GPS-RELATED FILES, RECORDINGS, AND PODCASTS ALL FEATURING AUDIO AND SPOKEN PERFORMANCES IN THE FIELD OF TRAVEL; DOWNLOADABLE ELECTRONIC PUBLICATIONS IN THE NATURE OF BOOKS, BROCHURES, FLYERS AND CALENDARS, VIA THE INTERNET AND WIRELESS DEVICES, FEATURING TRAVEL AND TOUR GUIDES; DIGITAL MEDIA, NAMELY, CD, CD-ROM, DVD AND DVD-ROM MATERIAL RELATING TO TRAVEL AND TOUR GUIDES, IN CLASS 9 (U.S. CLS. 21, 23, 26, 36 AND 38).

FIRST USE 1-1-2011; IN COMMERCE 1-1-2011.

FOR: AUDIO, VIDEO AND MULTIMEDIA BROADCASTING VIA THE INTERNET AND OTHER COMMUNICATIONS NETWORKS; TELECOMMUNICATIONS SERVICES, NAMELY, TRANSMITTING ELECTRONIC MEDIA, MULTIMEDIA CONTENT, VIDEOS, MOVIES, PICTURES, IMAGES, TEXT, PHOTOS, USER-GENERATED CONTENT, AUDIO CONTENT, AND INFORMATION REGARDING TRAVEL AND TOUR GUIDES VIA THE INTERNET AND OTHER COMMUNICATIONS NETWORKS; PROVIDING ACCESS TO INFORMATION, AUDIO, AND VIDEO VIA WEBSITES, ONLINE FORUMS, ELECTRONIC BULLETIN BOARDS, CHAT ROOMS, JOURNALS, LISTSERVS AND BLOGS FOR THE TRANSMISSION OF MESSAGES RELATING TO TRAVEL AND TOUR GUIDES, COMMENTS AND MULTIMEDIA CONTENT AMONG USERS REGARDING TRAVEL AND TOUR GUIDES VIA THE INTERNET AND OTHER COMMUNICATIONS NETWORKS; WEBCASTING SERVICES; PROVIDING COMMUNITY ON-LINE FORUMS FOR USERS CONCERNING TRAVEL AND TOUR GUIDES, IN CLASS 38 (U.S. CLS. 100, 101 AND 104).

FIRST USE 1-1-2011; IN COMMERCE 1-1-2011.

THE MARK CONSISTS OF STANDARD CHARACTERS WITHOUT CLAIM TO ANY PARTICULAR FONT, STYLE, SIZE, OR COLOR.

SN 77-922,365, FILED 1-28-2010.

BRENDAN MCCAULEY, EXAMINING ATTORNEY



David J. Kyffers

Director of the United States Patent and Trademark Office

United States of America

United States Patent and Trademark Office

TWINKLE TOES

Reg. No. 4,099,543

SKECHERS U.S.A., INC. II (DELAWARE CORPORATION)
228 MANHATTAN BEACH BLVD.
MANHATTAN BEACH, CA 90266

Registered Feb. 14, 2012

Int. Cl.: 26

FOR: HAIR ACCESSORIES, NAMELY, HAIR RIBBONS AND HAIR CLIPS, IN CLASS 26
(U.S. CLS. 37, 39, 40, 42 AND 50).

TRADEMARK

FIRST USE 12-1-2010; IN COMMERCE 12-1-2010.

PRINCIPAL REGISTER

THE MARK CONSISTS OF STANDARD CHARACTERS WITHOUT CLAIM TO ANY PARTICULAR FONT, STYLE, SIZE, OR COLOR.

OWNER OF U.S. REG. NO. 3,723,738.

SN 77-923,000, FILED 1-28-2010.

SUE LAWRENCE, EXAMINING ATTORNEY



David J. Kybas

Director of the United States Patent and Trademark Office

United States of America

United States Patent and Trademark Office

Better Back Alliance

Reg. No. 4,099,544

NUVASIVE, INC. (DELAWARE CORPORATION)
7475 LUSK BOULEVARD
SAN DIEGO, CA 92121

Registered Feb. 14, 2012

Int. Cl.: 35

FOR: PROMOTING PUBLIC AWARENESS OF ADVANCEMENTS IN THE FIELD OF SPINE SURGERY, IN CLASS 35 (U.S. CLS. 100, 101 AND 102).

SERVICE MARK

FIRST USE 1-29-2010; IN COMMERCE 1-29-2010.

PRINCIPAL REGISTER

THE MARK CONSISTS OF STANDARD CHARACTERS WITHOUT CLAIM TO ANY PARTICULAR FONT, STYLE, SIZE, OR COLOR.

NO CLAIM IS MADE TO THE EXCLUSIVE RIGHT TO USE "ALLIANCE", APART FROM THE MARK AS SHOWN.

SN 77-923,038, FILED 1-28-2010.

WILLIAM P. SHANAHAN, EXAMINING ATTORNEY



David J. Kyffers

Director of the United States Patent and Trademark Office

United States of America

United States Patent and Trademark Office

WATERMELON GREEN APPLE FREEZE

Reg. No. 4,099,545

Registered Feb. 14, 2012

Int. Cl.: 30

TRADEMARK

PRINCIPAL REGISTER

WM. WRIGLEY JR. COMPANY (DELAWARE CORPORATION)
410 NORTH MICHIGAN AVENUE
CHICAGO, IL 60611

FOR: CANDY, IN CLASS 30 (U.S. CL. 46).

FIRST USE 11-8-2010; IN COMMERCE 11-8-2010.

THE MARK CONSISTS OF STANDARD CHARACTERS WITHOUT CLAIM TO ANY PARTICULAR FONT, STYLE, SIZE, OR COLOR.

NO CLAIM IS MADE TO THE EXCLUSIVE RIGHT TO USE "WATERMELON GREEN APPLE", APART FROM THE MARK AS SHOWN.

SN 77-925,132, FILED 2-1-2010.

BERNICE MIDDLETON, EXAMINING ATTORNEY



David J. Kybas

Director of the United States Patent and Trademark Office

United States of America

United States Patent and Trademark Office

XENT

Reg. No. 4,099,546

Registered Feb. 14, 2012

Int. Cls.: 5 and 9

TRADEMARK

PRINCIPAL REGISTER

BRAINCHILD KGZ LLC (OHIO LIMITED LIABILITY COMPANY)
C/O GAMMON RAGONESI ASSOCIATES
131 WEST 33RD STREET, 16TH FLOOR
NEW YORK, NY 10001

FOR: AIR FRESHENERS, IN CLASS 5 (U.S. CLS. 6, 18, 44, 46, 51 AND 52).

FIRST USE 11-4-2011; IN COMMERCE 11-4-2011.

FOR: COMPUTER STORAGE DEVICES, NAMELY, FLASH DRIVES, IN CLASS 9 (U.S. CLS. 21, 23, 26, 36 AND 38).

FIRST USE 11-4-2011; IN COMMERCE 11-4-2011.

THE MARK CONSISTS OF STANDARD CHARACTERS WITHOUT CLAIM TO ANY PARTICULAR FONT, STYLE, SIZE, OR COLOR.

SN 77-925,298, FILED 2-1-2010.

LESLEY LAMOTHE, EXAMINING ATTORNEY



David J. Kybas

Director of the United States Patent and Trademark Office

United States of America

United States Patent and Trademark Office

SONNY THE SAFETY SEAHORSE

Reg. No. 4,099,547

SEABRIGHT HOLDINGS, INC. (DELAWARE CORPORATION)
1501 4TH AVENUE, SUITE 2600
SEATTLE, WA 98101

Registered Feb. 14, 2012

Int. Cls.: 36 and 45

FOR: PROVIDING INFORMATION AND ON-SITE CONSULTING SERVICES IN THE FIELD OF INSURANCE SERVICES IN THE NATURE OF LOSS CONTROL MANAGEMENT FOR OTHERS , IN CLASS 36 (U.S. CLS. 100, 101 AND 102).

SERVICE MARK

FIRST USE 1-1-2009; IN COMMERCE 1-1-2009.

PRINCIPAL REGISTER

FOR: PROVIDING INFORMATION AND ON-SITE CONSULTING SERVICES IN THE FIELD OF SAFETY IN THE WORKPLACE, IN CLASS 45 (U.S. CLS. 100 AND 101).

FIRST USE 1-1-2009; IN COMMERCE 1-1-2009.

THE MARK CONSISTS OF STANDARD CHARACTERS WITHOUT CLAIM TO ANY PARTICULAR FONT, STYLE, SIZE, OR COLOR.

OWNER OF U.S. REG. NOS. 2,958,304, 2,961,386, AND 2,979,104.

SN 77-925,341, FILED 2-1-2010.

TASNEEM HUSSAIN, EXAMINING ATTORNEY



David J. Kybas

Director of the United States Patent and Trademark Office

United States of America

United States Patent and Trademark Office

Fluid Nexus

Reg. No. 4,099,548

Registered Feb. 14, 2012

Int. Cl.: 9

TRADEMARK

PRINCIPAL REGISTER

NOVUS NEXUS, INC. (DELAWARE CORPORATION)
143 CADYCENTRE
#351
NORTHVILLE, MI 48167

FOR: COMPUTER SOFTWARE FOR CREATING COMPUTATIONAL FLUID DYNAMICS MODELS FROM COMPUTER AIDED DESIGN MODELS USED IN CREATING DIGITAL OR VIRTUAL COMPUTATIONAL FLUID DYNAMICS (CFD) MODELS OR VIRTUAL PROTOTYPES FOR MANUFACTURERS OF DIVERSE PRODUCTS IN ORDER TO EVALUATE THEIR ENGINEERING PERFORMANCE NOT FOR USE IN THE OIL OR GAS FIELD OR INDUSTRY, IN CLASS 9 (U.S. CLS. 21, 23, 26, 36 AND 38).

FIRST USE 12-21-2011; IN COMMERCE 12-21-2011.

THE MARK CONSISTS OF STANDARD CHARACTERS WITHOUT CLAIM TO ANY PARTICULAR FONT, STYLE, SIZE, OR COLOR.

NO CLAIM IS MADE TO THE EXCLUSIVE RIGHT TO USE "FLUID", APART FROM THE MARK AS SHOWN.

SN 77-928,395, FILED 2-4-2010.

ANGELA M. MICHELI, EXAMINING ATTORNEY



David J. Kyros

Director of the United States Patent and Trademark Office

United States of America

United States Patent and Trademark Office

HeART Touch Outreach

Reg. No. 4,099,549

HEART TOUCH OUTREACH (ILLINOIS CORPORATION)
1590 PENSTEMON COURT
GRAYSLAKE, IL 60030

Registered Feb. 14, 2012

Int. Cl.: 16

FOR: FRAMED ART PICTURES, IN CLASS 16 (U.S. CLS. 2, 5, 22, 23, 29, 37, 38 AND 50).

TRADEMARK

FIRST USE 3-4-2011; IN COMMERCE 3-4-2011.

PRINCIPAL REGISTER

THE MARK CONSISTS OF STANDARD CHARACTERS WITHOUT CLAIM TO ANY PARTICULAR FONT, STYLE, SIZE, OR COLOR.

NO CLAIM IS MADE TO THE EXCLUSIVE RIGHT TO USE "OUTREACH", APART FROM THE MARK AS SHOWN.

SN 77-929,965, FILED 2-7-2010.

CAROLYN CATALDO, EXAMINING ATTORNEY



David J. Kyffers

Director of the United States Patent and Trademark Office

United States of America

United States Patent and Trademark Office

Viridian

Reg. No. 4,099,550

Registered Feb. 14, 2012

Int. Cls.: 7 and 11

TRADEMARK

PRINCIPAL REGISTER

TACO, INC. (RHODE ISLAND CORPORATION)
1160 CRANSTON STREET
CRANSTON, RI 02920

FOR: CIRCULATOR PUMPS, IN CLASS 7 (U.S. CLS. 13, 19, 21, 23, 31, 34 AND 35).

FIRST USE 12-15-2011; IN COMMERCE 12-15-2011.

FOR: CIRCULATOR PUMPS, NAMELY, WATER PUMPS FOR USE IN HEATING AND COOLING SYSTEMS, IN CLASS 11 (U.S. CLS. 13, 21, 23, 31 AND 34).

FIRST USE 12-15-2011; IN COMMERCE 12-15-2011.

THE MARK CONSISTS OF STANDARD CHARACTERS WITHOUT CLAIM TO ANY PARTICULAR FONT, STYLE, SIZE, OR COLOR.

SN 77-934,278, FILED 2-12-2010.

STEVEN JACKSON, EXAMINING ATTORNEY



David J. Kyfos

Director of the United States Patent and Trademark Office

United States of America

United States Patent and Trademark Office

JAMES CROPPER SPECIALITY PAPERS

Reg. No. 4,099,551

JAMES CROPPER PLC (UNITED KINGDOM PUBLIC LIMITED COMPANY (PLC))
BURNESIDE MILLS, KENDAL, CUMBRIA
MANCHESTER, UNITED KINGDOM M126FZ

Registered Feb. 14, 2012

Int. Cl.: 16

FOR: PAPER AND CARDBOARD; STATIONERY; CRAFT PAPER AND CRAFT CARDBOARD,
IN CLASS 16 (U.S. CLS. 2, 5, 22, 23, 29, 37, 38 AND 50).

TRADEMARK

FIRST USE 0-0-2003; IN COMMERCE 0-0-2003.

PRINCIPAL REGISTER

THE MARK CONSISTS OF STANDARD CHARACTERS WITHOUT CLAIM TO ANY PAR-
TICULAR FONT, STYLE, SIZE, OR COLOR.

NO CLAIM IS MADE TO THE EXCLUSIVE RIGHT TO USE "SPECIALTY PAPERS", APART
FROM THE MARK AS SHOWN.

THE NAME "JAMES CROPPER" DOES NOT IDENTIFY A LIVING INDIVIDUAL.

SN 77-935,623, FILED 2-15-2010.

LINDSEY RUBIN, EXAMINING ATTORNEY



David J. Kybas

Director of the United States Patent and Trademark Office

United States of America

United States Patent and Trademark Office

RIVERLITE

Reg. No. 4,099,552

Registered Feb. 14, 2012

Int. Cl.: 19

TRADEMARK

PRINCIPAL REGISTER

BIG RIVER INDUSTRIES, INC. (GEORGIA CORPORATION)
SUITE 575
3600 MANSELL ROAD
ALPHARETTA, GA 300223107

FOR: MANUFACTURED, ROTARY KILN EXPANDED LIGHTWEIGHT AGGREGATE PRODUCTS COMPOSED OF CERAMIC MADE FROM CLAY, NAMELY, AGGREGATES FOR STRUCTURAL CONCRETE, AGGREGATES FOR CONCRETE MASONRY AND OTHER CONCRETE PRODUCTS, AGGREGATES FOR ASPHALT PAVING AND ASPHALT SURFACE TREATMENTS, AGGREGATES FOR GEOTECHNICAL FILL, AGGREGATES FOR HORTICULTURE AND SOIL AMENDMENTS, AGGREGATES FOR GREEN ROOF SOIL BLENDS, AND AGGREGATES FOR USE IN THE MANUFACTURE OF CONSTRUCTION MATERIALS AND BUILDING PRODUCTS, IN CLASS 19 (U.S. CLS. 1, 12, 33 AND 50).

FIRST USE 6-1-2011; IN COMMERCE 10-1-2011.

THE MARK CONSISTS OF STANDARD CHARACTERS WITHOUT CLAIM TO ANY PARTICULAR FONT, STYLE, SIZE, OR COLOR.

OWNER OF U.S. REG. NOS. 894,370, 1,725,706, AND 1,992,933.

SN 77-938,587, FILED 2-18-2010.

JAMES GRIFFIN, EXAMINING ATTORNEY



David J. Kyffers

Director of the United States Patent and Trademark Office

United States of America

United States Patent and Trademark Office

SWIRLCUP

Reg. No. 4,099,553

THE BARKULIS GROUP INC. (ILLINOIS CORPORATION)
P.O. BOX 704

Registered Feb. 14, 2012

LAKE BLUFF, IL 60044

Int. Cl.: 30

FOR: FROZEN YOGURT, IN CLASS 30 (U.S. CL. 46).

TRADEMARK

FIRST USE 5-31-2011; IN COMMERCE 5-31-2011.

PRINCIPAL REGISTER

THE MARK CONSISTS OF STANDARD CHARACTERS WITHOUT CLAIM TO ANY PARTICULAR FONT, STYLE, SIZE, OR COLOR.

SN 77-938,602, FILED 2-18-2010.

RENEE SERVANCE, EXAMINING ATTORNEY



David J. Kyffers

Director of the United States Patent and Trademark Office

United States of America
United States Patent and Trademark Office

ESCAPE

Reg. No. 4,099,554

PANAMA JACK INTERNATIONAL, INC. (FLORIDA CORPORATION)
230 ERNESTINE STREET
ORLANDO, FL 32801

Registered Feb. 14, 2012

Int. Cl.: 25

FOR: CLOTHING, NAMELY, HATS, CAPS, VISORS AND T-SHIRTS, IN CLASS 25 (U.S. CLS. 22 AND 39).

TRADEMARK

FIRST USE 3-0-2011; IN COMMERCE 3-0-2011.

PRINCIPAL REGISTER

THE MARK CONSISTS OF STANDARD CHARACTERS WITHOUT CLAIM TO ANY PARTICULAR FONT, STYLE, SIZE, OR COLOR.

OWNER OF U.S. REG. NOS. 3,341,080, 3,735,300, AND OTHERS.

SN 77-938,749, FILED 2-18-2010.

REBECCA POVARCHUK, EXAMINING ATTORNEY



David J. Kyffers

Director of the United States Patent and Trademark Office

United States of America

United States Patent and Trademark Office

TRUE BAN-NAG

Reg. No. 4,099,555

KARAWAY GAMING, INC. (NEVADA CORPORATION)
8797 EAST BROADWAY
TUCSON, AZ 85710

Registered Feb. 14, 2012

Int. Cl.: 41

FOR: GAMING SERVICES IN THE NATURE OF CASINO GAMING; WAGERING SERVICES,
IN CLASS 41 (U.S. CLS. 100, 101 AND 107).

SERVICE MARK

FIRST USE 7-21-2008; IN COMMERCE 7-21-2008.

PRINCIPAL REGISTER

THE MARK CONSISTS OF STANDARD CHARACTERS WITHOUT CLAIM TO ANY PAR-
TICULAR FONT, STYLE, SIZE, OR COLOR.

OWNER OF U.S. REG. NO. 3,554,751.

NO CLAIM IS MADE TO THE EXCLUSIVE RIGHT TO USE "BAN-NAG", APART FROM
THE MARK AS SHOWN.

SN 77-938,785, FILED 2-18-2010.

ALLISON HOLTZ, EXAMINING ATTORNEY



David J. Kyros

Director of the United States Patent and Trademark Office

United States of America

United States Patent and Trademark Office

Apollo

Reg. No. 4,099,556

Registered Feb. 14, 2012

Int. Cls.: 6, 7, 9, and 12

TRADEMARK

PRINCIPAL REGISTER

APOLO L.L.C. (DELAWARE LIMITED LIABILITY COMPANY), DBA APOLO L.L.C.,
16192 COASTAL HIGHWAY
LEWES, DE 19958

FOR: BOLTS OF METAL; BRANCHING PIPES OF METAL INCLUDING THOSE FROM ALLOY STEEL AND TITANIUM; CABLE CLAMPS OF METAL; CABLE JUNCTION SLEEVES OF METAL; CABLE STRETCHERS AND CINCTURE STRETCHERS OF METAL (CLAMP LINKS); COMPRESSED AIR PIPE FITTINGS OF METAL; CONTAINERS OF METAL FOR CHEMICALS, COMPRESSED GASES AND LIQUIDS; CONTAINERS OF METAL FOR COMPRESSED GAS; CONTAINERS OF METAL FOR STORAGE OF FEMININE PRODUCTS FOR HOUSEHOLD OR DOMESTIC USE; CONTAINERS OF METAL FOR TRANSPORT; COPPER INGOTS; COPPER ORES; COPPER PANELS FOR CIRCUIT BOARDS; COPPER-BASE ALLOY INGOTS; CORROSION-RESISTANT METAL OVERLAYS AND ALLOYS FOR FITTINGS, STEEL PLATES, FLANGES, PIPING COMPONENTS; DUCTS AND PIPES OF METAL FOR CENTRAL HEATING INSTALLATIONS; ELBOWS OF METAL FOR PIPES; ELBOWS OF METAL FOR PIPES INCLUDING THOSE FROM ALLOY STEEL AND TITANIUM; GALVANIZED STEEL CLIP WITH MOLDED RUBBER USED TO ATTACH DRYWALL TO WALLS OR CEILINGS; GENERAL PURPOSE METAL STORAGE CONTAINERS; HOSE HANGERS OF METAL; INDUSTRIAL METAL HOSES; INDUSTRIAL PACKAGING CONTAINERS OF METAL; JUNCTIONS OF METAL FOR PIPES INCLUDING THOSE FROM ALLOY STEEL AND TITANIUM; LOCK CYLINDERS OF METAL; LOW COPPER CARBON-STEEL SCRAPS; MAGNET WIRE, NAMELY, COPPER OR ALUMINUM WIRE COVERED WITH THIN INSULATION FOR USE IN THE MANUFACTURE OF ELECTRIC AND ELECTRONIC APPARATUS; MANUALLY OPERATED METAL VALVES; METAL AEROSOL CONTAINERS SOLD EMPTY; METAL CABLE CLIPS; METAL CABLE TRAYS USED IN BUILDING CONSTRUCTION; METAL CABLE WIRE; METAL CLAMPS; METAL CLOSURES FOR CONTAINERS; METAL CONTAINERS FOR COMPRESSED GAS OR LIQUID AIR; METAL FLUID STORAGE TANKS; METAL FUEL OIL HOSES; METAL HARDWARE, NAMELY, NUTS; METAL HOSE CLAMPS; METAL HOSE FITTINGS; METAL PIPE CLIPS; METAL PIPE COLLARS; METAL PIPE CONNECTORS; METAL PIPE COUPLINGS AND JOINTS; METAL PIPE FITTINGS; METAL PIPE MUFFS; METAL PIPES; METAL PIPES AND FITTINGS THEREFOR; METAL PIPES AND TUBES; METAL PIPES FOR LIQUID AND GAS TRANSFER; METAL PRE-RINSE, WASH DOWN SPRAY NOZZLES FOR COMMERCIAL AND INDUSTRIAL USE; METAL PULLEYS, SPRINGS AND VALVES; METAL RAMPS; SCREWS OF METAL; SMALL ITEMS OF METAL HARDWARE, NAMELY, HIGH SECURITY LOCKS AND SHEET METAL PLATES PRIMARILY FOR THE CASINO AND GAMING INDUSTRY; TUBES OF COPPER ALLOYS; TUBES OF METAL; TUBES OF NICKEL ALLOYS;



David J. Kybas

Director of the United States Patent and Trademark Office

Reg. No. 4,099,556 TUBES OF STAINLESS STEEL; UNINSULATED, NON-ELECTRIC WIRE; VALVES OF METAL OTHER THAN PARTS OF MACHINES INCLUDING THOSE FROM ALLOY STEEL AND TITANIUM, IN CLASS 6 (U.S. CLS. 2, 12, 13, 14, 23, 25 AND 50).

FIRST USE 6-28-2011; IN COMMERCE 6-28-2011.

FOR: AIR COMPRESSORS FOR VEHICLES; AIR FILTERS FOR AUTOMOBILE ENGINES; AIR FILTERS FOR MECHANICAL PURPOSES; AIR FILTERS FOR MOTORCYCLE MOTORS AND ENGINES; AIR FILTERS FOR VEHICLE MOTORS AND ENGINES; AIR TURBINES; AIR-INTAKE TUBES AND FILTERS FOR AFTER-MARKET INSTALLATION OF AUTOMOTIVE ENGINES; ALTERNATING CURRENT SERVO MOTORS; ALTERNATORS FOR LAND VEHICLES; ANTI-POLLUTION DEVICES FOR MOTORS AND ENGINES; AUTOMOBILE ENGINE VALVE COVERS; AUTOMOTIVE ENGINE BLOCKS; AUTOMOTIVE EXHAUST PIPE; AUTOMOTIVE PARTS, NAMELY, ENGINE SEALS; AUTOMOTIVE SERVICE EQUIPMENT, NAMELY, BRAKE FLUSHING MACHINES; AUXILIARY POWER UNITS FOR SUPPLYING ELECTRICAL POWER TO HEAT AND POWER GENERATORS; BALL VALVES BEING PARTS OF MACHINES; BAND BRAKES; BELTS FOR ENGINES; BELTS FOR TRANSMISSIONS OTHER THAN FOR LAND VEHICLES; BLOCK BRAKES; BLOW TORCHES, NAMELY, GAS OPERATED CUTTING TORCHES; BRAKE LININGS FOR MACHINES; BRAKES FOR MACHINES; BRUSHES AND BRUSH HOLDERS FOR USE IN ROTATING ELECTRICAL MACHINERY; BRUSHES BEING PARTS OF MOTORS, GENERATORS AND DYNAMOS; CABLES FOR LIFTS; CAMSHAFTS FOR VEHICLE ENGINES; CATALYTIC CONVERTER UNITS FOR VEHICLE EXHAUSTS; CATALYTIC CONVERTERS FOR MOTORS AND ENGINES; COMBUSTION ENGINE FUEL NOZZLES; COMPRESSORS AS PARTS OF MACHINES, MOTORS AND ENGINES; COMPUTER CONTROLLED LATHES; CYLINDERS FOR MOTORS AND ENGINES; DIESEL ENGINES FOR MACHINES; DIESEL ENGINES NOT FOR LAND VEHICLES; DIESEL-ENGINE HEATING PLUGS; DIRECT CURRENT MOTORS; DISC BRAKES FOR MACHINES; DISTRIBUTORS FOR VEHICLES; ELECTRIC MOTORS FOR MACHINES; ELECTRIC MOTORS FOR POWER TOOLS; ELECTRIC MOTORS FOR USE IN CAMERAS, NAMELY, FOR USE IN POSITIONING LENSES IN CAMERAS; ELECTRIC MOTORS, AND THEIR PARTS, NOT FOR LAND VEHICLES; ELECTRIC MOTORS, NOT FOR LAND VEHICLES; ELECTRONIC IGNITIONS FOR VEHICLES; ELECTRONICALLY AND POWER OPERATED TOOLS, NAMELY, PULLERS AND COMPONENTS THEREFOR, NUT SPLITTERS, EXTRACTORS, SEPARATORS, SPANNERS AND COIL SPRING COMPRESSORS; EMISSION REDUCTION UNITS FOR MOTORS AND ENGINES, NAMELY, CATALYTIC CONVERTERS; EMISSION REDUCTION UNITS FOR MOTORS AND ENGINES, NAMELY, EGR VALVES; EMISSION REDUCTION UNITS FOR MOTORS AND ENGINES, NAMELY, PCV VALVES; ENGINE BEARINGS; ENGINE CAMSHAFTS; ENGINE CYLINDERS FOR LAND VEHICLES; ENGINE CYLINDERS FOR VEHICLES; ENGINE INJECTORS; ENGINE MUFFLERS; ENGINE OR MOTOR MUFFLERS; ENGINE PARTS, NAMELY, CONTACT POINTS; ENGINE PARTS, NAMELY, ELECTRONIC FUEL INJECTION MODULES; ENGINE PARTS, NAMELY, OIL DIPSTICKS; ENGINE RODS; ENGINE TIMING COMPONENTS, NAMELY, CAM SPROCKETS AND CHAINS; ENGINES FOR MODEL VEHICLES; ENGINES, OTHER THAN FOR LAND VEHICLES; ENHANCEMENT PARTS FOR INTERNAL COMBUSTION ENGINES, NAMELY, FUEL CATALYSTS; EXHAUST MANIFOLD FOR ENGINES; EXHAUST PIPES FOR LAND VEHICLES; EXHAUST SILENCERS FOR ENGINES; FAN BELTS FOR MOTORS AND ENGINES; FANS FOR MACHINE ENGINES; FANS FOR MOTORS AND ENGINES; FILTER ELEMENTS FOR FUEL FILTERS; FILTER ROD MAKING MACHINES; FILTERS AND PURIFIERS FOR MACHINES, NAMELY, FILTERS AND PURIFIERS FOR REMOVING CONTAMINANTS FROM GASES USED IN THE SEMICONDUCTOR INDUSTRY; FLUID POWER COMPONENT KIT COMPRISING HOSE AND FITTINGS FOR USE IN MACHINERY; FUEL FILTERS; FUEL INJECTOR PARTS FOR LAND AND WATER VEHICLE ENGINES; FUEL PUMPS FOR LAND VEHICLES; FUEL RAILS FOR ENGINES; GAS COMPRESSORS; GAS CUTTING GUNS; GAS DIVERTERS CONSISTING OF A PUMP, STORAGE AND REFILLING TANK, PRE-HEATER, VAPORIZER, RECUPERATOR, CONDENSER AND VALVES; GAS WELDING GUNS; GAS WELDING MACHINES; GAS-OPERATED SOLDERING IRONS; GAS-OPERATED WELDING MACHINES; GASKETS FOR INTERNAL COMBUSTION ENGINES; GASOLINE ENGINES NOT FOR LAND VEHICLES;

Reg. No. 4,099,556 GEAR BOXES OTHER THAN FOR LAND VEHICLES; GEAR MOTORS NOT FOR LAND VEHICLES; GEARBOXES OTHER THAN FOR LAND VEHICLES; GENERATORS FOR LAND VEHICLES; GENERATORS OF ELECTRICITY; GLOW PLUGS FOR DIESEL ENGINES; HAND-HELD BATTERY ACTUATED HYDRAULIC CRIMP TOOL; HAND-HELD ELECTRIC-POWERED FOOD PROCESSORS; HEADERS AS PART OF VEHICLE EXHAUST SYSTEM; HEAT EXCHANGERS BEING PARTS OF ENGINES NOT FOR LAND VEHICLES; HIGH FREQUENCY MOTOR SPINDLES WITH HIGH FREQUENCY ELECTRIC CONVERTERS AND POWER SUPPLY UNITS; HOISTS THAT ARE MOUNTED ON MILITARY AND LAW ENFORCEMENT VEHICLES FOR RAISING AND LOWERING EQUIPMENT THEREON; HOSES FOR VACUUM CLEANERS; HYDRAULIC CONTROLS FOR MACHINES, MOTORS AND ENGINES; HYDRAULIC DOOR CLOSERS; HYDRAULIC DOOR OPENERS; HYDRAULIC TORQUE CONVERTERS; HYDRAULIC VALVE ACTUATORS; IGNITION DEVICES FOR MOTORS OF LAND VEHICLES; IGNITION MAGNETS FOR ENGINES; IGNITION PARTS FOR INTERNAL COMBUSTION ENGINES, NAMELY, CONDENSERS; IGNITION WIRES FOR MOTOR VEHICLES; IGNITION PARTS FOR INTERNAL COMBUSTION ENGINES, NAMELY, POINTS; INDUSTRIAL ENGINES; INTAKE AND EXHAUST AIR FLOW VANE ASSEMBLY DEVICE FOR USE IN AN INTERNAL COMBUSTION ENGINE; INTERNAL COMBUSTION ENGINE PARTS, NAMELY, HEADS; INTERNAL COMBUSTION ENGINE PARTS, NAMELY, PISTON RINGS; INTERNAL COMBUSTION ENGINE PARTS, NAMELY, PISTONS; INTERNAL COMBUSTION ENGINES FOR MACHINE OPERATION AND REPLACEMENT PARTS THEREFOR; INTERNAL COMBUSTION ENGINES FOR POWER GENERATION, OTHER THAN FOR LAND VEHICLES; INTERNAL COMBUSTION ENGINES LAND VEHICLE PARTS, NAMELY, COILS; INTERNAL COMBUSTION ENGINES LAND VEHICLE PARTS, NAMELY, DISTRIBUTOR CAPS; INTERNAL COMBUSTION ENGINES LAND VEHICLE PARTS, NAMELY, DISTRIBUTOR ROTORS; INTERNAL COMBUSTION LAND VEHICLE ENGINE PARTS, NAMELY, CONNECTING RODS; INVERTER MOTORS NOT FOR LAND VEHICLES; JET ENGINES; KICK STARTERS FOR MOTORCYCLES; MACHINE TOOLS, NAMELY, CLAMPS FOR USE IN THE PRECISION CLAMPING OF WORK PIECES; MACHINE TOOLS, NAMELY, JAWS FOR USE IN THE PRECISION CLAMPING OF WORK PIECES; MACHINE TOOLS, NAMELY, VICES FOR USE IN THE PRECISION CLAMPING OF WORK PIECES; MOTOR STARTERS; MOTORCYCLE ENGINE PARTS, NAMELY, AIR CLEANERS; OIL FILTER ADAPTERS; OIL FILTERS; OIL FILTERS FOR MECHANICAL PURPOSES; OIL FILTERS FOR MOTORS AND ENGINES; OIL PUMPS FOR LAND VEHICLES; PACKAGING MACHINES, NAMELY, LIQUID CONTAINER FILLERS; PARTS FOR COMPRESSED-AIR TOOLS, NAMELY, BRAKES, FILTERS, HOSES, PIPES, COUPLINGS VALVES, SWITCHES, COMPRESSORS, CLAMPING TOOLS AND INJECTORS; PARTS OF OILFIELD WELLHEAD MACHINES, NAMELY, GATE VALVES, BALL VALVES, CHECK VALVES, PLUG VALVES, GLOBE VALVES, CHOKE AND MANIFOLD INDUSTRIAL PUMPS, PUMP AND VALVE PARTS, PIPE FITTINGS AND FLANGES; POWER TRANSMISSION BELTS FOR MACHINES, MOTORS AND ENGINES USED IN INDUSTRIAL APPLICATIONS; POWER TRANSMISSIONS AND GEARING FOR MACHINES; POWERED TIRE CHANGER MACHINES FOR LAND VEHICLES; PRESSURE REDUCERS AS PARTS OF MACHINES; PRESSURE SWITCHES AND SENSORS FOR MONITORING, CONTROLLING, AND SWITCHING HYDRAULIC OR PNEUMATIC SYSTEMS BEING SOLD AS A UNIT WITH MANUFACTURING MACHINES; PRESSURE SWITCHES AND SENSORS FOR MONITORING, CONTROLLING, AND SWITCHING HYDRAULIC OR PNEUMATIC SYSTEMS SOLD AS AN INTEGRAL COMPONENT OF INJECTION MOLDING MACHINES; PRESSURE TRANSDUCERS AND TRANSMITTERS THAT CONVERT HYDRAULIC OR PNEUMATIC PRESSURE INTO ANALOG ELECTRICAL SIGNALS FOR MONITORING AND CONTROLLING HYDRAULIC OR PNEUMATIC SYSTEMS SOLD AS A UNIT WITH MANUFACTURING MACHINES; PRESSURE TRANSDUCERS AND TRANSMITTERS THAT CONVERT HYDRAULIC OR PNEUMATIC PRESSURE INTO ANALOG ELECTRICAL SIGNALS FOR MONITORING AND CONTROLLING HYDRAULIC OR PNEUMATIC SYSTEMS SOLD AS AN INTEGRAL COMPONENT OF INJECTION MOLDING MACHINES; PRINTING MACHINES FOR WEB PRODUCTS, PARTICULARLY WALLPAPER, FLOOR COVERINGS AND FILMS, PARTS FOR THE AFOREMENTIONED MACHINES AND LINES COMPOSED THEREOF, NAMELY, GRAVURE PRINTING LINES, SCREEN PRINTING LINES, FLEXO PRINTING LINES AND COMBINATIONS OF THE AFOREMENTIONED LINES; SERVO-DRIVES FOR

Reg. No. 4,099,556 MOTORS; SERVO-MOTORS; SERVO-VALVES; SHOCK ABSORBERS FOR MACHINES; SILENCERS AS PART OF VEHICLE EXHAUST SYSTEMS; SOFT STARTERS FOR MOTORS; VALVES BEING PARTS OF MACHINES; VALVES FOR PUMPS; VARIABLE FREQUENCY DRIVES FOR LARGE POWER APPLICATIONS IN THE OIL AND GAS, METAL, MARINE AND OTHER INDUSTRIES; VARIABLE SPEED WASH SYSTEM COMPRISED OF A VARIABLE SPEED MOTOR, PULLEY AND FLYWHEEL DRIVE SYSTEM AND SOLD AS AN INTEGRAL COMPONENT OF CLOTHES WASHING MACHINES; VEHICLE BODY AND FRAME ALIGNMENT MACHINES AND STRUCTURAL REPLACEMENT PARTS THEREFOR; VEHICLE DIP STICKS; VEHICLE ENGINE PARTS, NAMELY, CHARGE AIR COOLERS AND THEIR COMPONENT PARTS; VEHICLE ENGINE PARTS, NAMELY, CRANKCASE BREATHERS; VEHICLE ENGINE PARTS, NAMELY, INTERCOOLERS; VEHICLE ENGINE PARTS, NAMELY, OIL COOLERS; VEHICLE ENGINE PARTS, NAMELY, OIL TANK PLUGS AND CAPS; VEHICLE ENGINE PARTS, NAMELY, OIL TANKS; VEHICLE ENGINE PARTS, NAMELY, PUSH RODS; VEHICLE ENGINE PARTS, NAMELY, ROCKER ARMS; VEHICLE PARTS, NAMELY, CAM COVERS; VEHICLE PARTS, NAMELY, CARBURETORS; VEHICLE PARTS, NAMELY, ENGINE CAM PROTECTORS; VEHICLE PARTS, NAMELY, ENGINE CASES; VEHICLE PARTS, NAMELY, INTAKE MANIFOLDS; VEHICLE PARTS, NAMELY, POWER VALVE FOR CARBURETORS; VEHICLE PNEUMATIC AND HYDRAULIC COMPRESSORS; VEHICLE WASHING INSTALLATIONS; VEHICLE WASHING MACHINES; WATER PUMPS FOR LAND VEHICLES; WATER PUMPS FOR USE IN MOTORS AND ENGINES; WHEELS BEING PARTS OF MACHINES; WINCH MOTORS; WIRE-COILING MACHINES, IN CLASS 7 (U.S. CLS. 13, 19, 21, 23, 31, 34 AND 35).

FIRST USE 6-28-2011; IN COMMERCE 6-28-2011.

FOR: ACCUMULATORS AND BATTERIES; AUDIO CABLES; AUDIO EQUIPMENT FOR VEHICLES, NAMELY, STEREOs, SPEAKERS, AMPLIFIERS, EQUALIZERS, CROSSOVERS AND SPEAKER HOUSINGS; AUDIO EQUIPMENT FOR VEHICLES, NAMELY, SUBWOOFERS; AUTOMATIC ELECTRICAL DISTRIBUTION APPARATUS; AUTOMATIC INDICATORS OF LOW PRESSURE IN TIRES; AUTOMATIC INLET CONTROL VALVES FOR RECIPROCATING AIR COMPRESSORS; AUTOMATIC LIQUID-LEVEL CONTROL MACHINES AND INSTRUMENTS; AUTOMATIC NOZZLES; AUTOMATIC SWITCHING APPARATUS; AUTOMATIC TELEPHONE DIALERS; AUTOMATIC TELEPHONE EXCHANGE APPARATUS; AUTOMATIC TELEPHONE EXCHANGES; AUTOMATIC VALVES; AUTOMOTIVE MEASURING INSTRUMENTS, NAMELY, WATER TEMPERATURE GAUGES, AIR FUEL/RATIO GAUGES, BOOST GAUGES, VACUUM GAUGES AND EXHAUST GAS TEMPERATURE GAUGES; AUTOMOTIVE TESTING EQUIPMENT, NAMELY, TRANSMISSION TESTING AND BRAKE TESTING EQUIPMENT; BAGS AND CASES SPECIALLY ADAPTED FOR HOLDING OR CARRYING PORTABLE TELEPHONES AND TELEPHONE EQUIPMENT AND ACCESSORIES; BATTERIES; BATTERIES AND BATTERY CHARGERS; BATTERIES FOR LIGHTING; BATTERIES FOR POCKET LAMPS; BATTERIES FOR VEHICLES; BATTERIES, ELECTRIC; BATTERIES, ELECTRIC, FOR VEHICLES; BATTERY BOXES; BATTERY CABLES; BATTERY CASES; BATTERY CHARGE DEVICES; BATTERY CHARGERS; BATTERY PACKS; BIOMETRIC FINGERPRINT DOOR LOCK; BIOS (BASIC INPUT OUTPUT SYSTEM) COMPUTER PROGRAMS; BIOS (BASIC INPUT/OUTPUT SYSTEM) COMPUTER PROGRAM; BLANK COMPUTER DISCS; BLANK DISCS FOR COMPUTERS; BLANK FLOPPY COMPUTER DISCS; BLANK HARD COMPUTER DISCS; BLANK HARD DRIVES FOR COMPUTERS; BLANK MAGNETIC DISCS; BLANK OPTICAL DISCS; BLANK RECORDABLE OPTICAL DISC; BLANK TAPES FOR STORAGE OF COMPUTER DATA; BODY-TUBES FOR MICROSCOPES; BRAKE CONTROLLERS; BRAKE FLUID TESTERS; BRIEFCASES SPECIALLY ADAPTED FOR HOLDING LAPTOP COMPUTERS; CD DRIVES FOR COMPUTERS; CELL PHONE BATTERY CHARGERS; CELL PHONE BATTERY CHARGERS FOR USE IN VEHICLES; CELL PHONE COVERS; CELLULAR TELEPHONE APPARATUSES; CELLULAR TELEPHONES; CENTRAL PROCESSING UNIT (CPU) CLOCKS; CENTRAL PROCESSING UNIT (CPU) COOLERS; CENTRAL PROCESSING UNIT (CPU) FANS; CENTRAL PROCESSING UNITS (CPU); CHANGE-OVER SWITCHES; CHARGERS FOR BATTERIES; CHARGERS FOR ELECTRIC BATTERIES; CHILDREN'S EYE GLASSES; COMPONENTS FOR GAMING MACHINES, NAMELY, CONTROLLERS, DISPLAYS, BUTTON

Reg. No. 4,099,556 PANELS, BOLSTERS, ELECTRICAL WIRING, AND COMPUTER HARDWARE AND SOFTWARE ASSOCIATED THEREWITH; COMPUTER ACCELERATOR BOARD; COMPUTER ANTI-VIRUS SOFTWARE; COMPUTER BACKUP AND STORAGE SYSTEMS WITH MULTIPLE REMOVABLE RAID CARTRIDGES; COMPUTER BAGS; COMPUTER BASED APPARATUS FOR DESIGNING THE LAYOUT OF ELECTRONIC CIRCUITS; COMPUTER BUFFERS; COMPUTER CABLES; COMPUTER CAMERAS; COMPUTER CARD ADAPTER; COMPUTER CARRYING CASES; COMPUTER CENTRAL PROCESSING UNITS; COMPUTER CHASSIS; COMPUTER CHIPS; COMPUTER CHIPSET FOR USE IN TRANSMITTING DATA TO AND FROM A CENTRAL PROCESSING UNIT; COMPUTER COLOR PRINTER USING HEAT SENSITIVE DRY PRINTING PROCESS; COMPUTER COMMUNICATIONS SOFTWARE TO ALLOW CUSTOMERS TO ACCESS BANK ACCOUNT INFORMATION AND TRANSACT BANK BUSINESS; COMPUTER COMPONENT TESTING AND CALIBRATING EQUIPMENT; COMPUTER CONTROLS FOR THE OPERATION OF MACHINE TOOLS; COMPUTER CURSOR CONTROL DEVICES, NAMELY, COMPUTER MOUSE; COMPUTER CURSOR CONTROL DEVICES, NAMELY, DIGITIZER TABLETS; COMPUTER CURSOR CONTROL DEVICES, NAMELY, LIGHT PENS; COMPUTER CURSOR CONTROL DEVICES, NAMELY, TOUCH PADS; COMPUTER CURSOR CONTROL DEVICES, NAMELY, TRACKBALLS; COMPUTER DATABASE MANAGEMENT SOFTWARE FOR USE IN PERSONALIZING THE CONTENT OF E-MAIL COMMUNICATIONS; COMPUTER DISC DRIVES; COMPUTER DOCKING STATION; COMPUTER E-COMMERCE SOFTWARE TO ALLOW USERS TO PERFORM ELECTRONIC BUSINESS TRANSACTIONS VIA A GLOBAL COMPUTER NETWORK; COMPUTER EQUIPMENT, NAMELY, WIRELESS CARDS; COMPUTER EXPANSION BOARDS; COMPUTER FAX MODEM CARDS; COMPUTER GAME CARTRIDGES; COMPUTER GAME CARTRIDGES AND DISCS; COMPUTER GAME CASSETTES; COMPUTER GAME CONSOLES FOR USE WITH AN EXTERNAL DISPLAY SCREEN OR MONITOR; COMPUTER GAME DISCS; COMPUTER GAME EQUIPMENT, NAMELY, DISCS; COMPUTER GAME JOYSTICKS; COMPUTER GAME PROGRAMS; COMPUTER GAME PROGRAMS, CARTRIDGES, AND CASSETTES; COMPUTER GAME SOFTWARE; COMPUTER GRAPHICS BOARDS; COMPUTER GRAPHICS SOFTWARE; COMPUTER HARD DRIVE ENCLOSURES; COMPUTER HARDWARE; COMPUTER HARDWARE AND COMPUTER PERIPHERAL DEVICES; COMPUTER HARDWARE AND COMPUTER PERIPHERALS; COMPUTER HARDWARE AND COMPUTER SOFTWARE FOR RETAIL INVENTORY MANAGEMENT, SOLD AS A UNIT; COMPUTER HARDWARE AND COMPUTER SOFTWARE PROGRAMS FOR THE INTEGRATION OF TEXT, AUDIO, GRAPHICS, STILL IMAGES AND MOVING PICTURES INTO AN INTERACTIVE DELIVERY FOR MULTIMEDIA APPLICATIONS; COMPUTER HARDWARE AND PERIPHERAL DEVICES; COMPUTER HARDWARE AND PERIPHERAL DEVICES AND COMPUTER SOFTWARE FOR DATA COMMUNICATION AND TRANSLATING AND TRANSMITTING DATA SOLD THEREWITH; COMPUTER HARDWARE AND PERIPHERALS; COMPUTER HARDWARE AND PERIPHERALS THEREFOR; COMPUTER HARDWARE AND SOFTWARE FOR PROCESSING DIGITAL MUSIC FILES; COMPUTER HARDWARE AND SOFTWARE FOR SETTING UP AND CONFIGURING LOCAL AREA NETWORKS; COMPUTER HARDWARE AND SOFTWARE FOR SETTING UP AND CONFIGURING WIDE AREA NETWORKS; COMPUTER HARDWARE AND SOFTWARE SOLD AS A UNIT FOR TESTING OF EMBEDDED COMPUTER SYSTEMS; COMPUTER HARDWARE AND SOFTWARE SYSTEM FOR REMOTELY MONITORING ENVIRONMENTAL CONDITIONS AND CONTROLLING DEVICES WITHIN A BUILDING, FACILITY, GROUNDS, OR DESIGNATED SPATIAL AREA; COMPUTER HARDWARE AND SOFTWARE SYSTEM FOR TRACKING PEOPLE, OBJECTS AND PETS USING GPS DATA ON A DEVICE ON THE TRACKED PEOPLE, OBJECTS AND PETS; COMPUTER HARDWARE AND SOFTWARE USED FOR THE CONTROL OF VOICE CONTROLLED INFORMATION AND COMMUNICATION DEVICES; COMPUTER HARDWARE AND SOFTWARE, FOR USE WITH MEDICAL PATIENT MONITORING EQUIPMENT, FOR RECEIVING, PROCESSING, TRANSMITTING AND DISPLAYING DATA; COMPUTER HARDWARE FOR COMMUNICATING AUDIO, VIDEO AND DATA BETWEEN COMPUTERS VIA A GLOBAL COMPUTER NETWORK, WIDE-AREA COMPUTER NETWORKS, AND PEER-TO-PEER COMPUTER NETWORKS; COMPUTER HARDWARE FOR HIGH-SPEED PROCESSING AND STORAGE OF DATA USING MULTIPLE CPU'S; COMPUTER HARDWARE FOR IP VIDEO SURVEILLANCE; COMPUTER HARDWARE FOR TELECOMMUNICATIONS; COMPUTER

Reg. No. 4,099,556 HARDWARE FOR UPLOAD, STORAGE, RETRIEVAL, DOWNLOAD, TRANSMISSION AND DELIVERY OF DIGITAL CONTENT; COMPUTER HARDWARE FOR WIRELESS CONTENT DELIVERY; COMPUTER HARDWARE, NAMELY, FIREWALLS; COMPUTER HARDWARE, NAMELY, WIRELESS ACCESS POINT (WAP) DEVICES; COMPUTER HARDWARE, NAMELY, WIRELESS NETWORK EXTENDERS; COMPUTER HARDWARE, NAMELY, WIRELESS NETWORK REPEATERS; COMPUTER HEAT SINKS; COMPUTER INTERFACE BOARDS; COMPUTER JOYSTICKS; COMPUTER KEYBOARD CONTROLLERS; COMPUTER KEYBOARDS; COMPUTER KEYPADS; COMPUTER MEMORIES; COMPUTER MEMORY HARDWARE; COMPUTER MICE; COMPUTER MONITOR FRAMES; COMPUTER MONITORS; COMPUTER MOTHERBOARDS AND DAUGHTER BOARDS; COMPUTER MOUSE; COMPUTER MOUSE, NAMELY, TOUCHPADS; COMPUTER MOUSE, NAMELY, TRACKBALLS; COMPUTER NETWORK ADAPTERS; COMPUTER NETWORK ADAPTERS, SWITCHES, ROUTERS AND HUBS; COMPUTER NETWORK BRIDGES; COMPUTER NETWORK HUBS; COMPUTER NETWORK HUBS, SWITCHES AND ROUTERS; COMPUTER NETWORK INTERFACE DEVICES; COMPUTER NETWORK SERVER; COMPUTER NETWORK SWITCHES; COMPUTER NETWORKING HARDWARE; COMPUTER OPERATING PROGRAMS; COMPUTER OPERATING PROGRAMS AND COMPUTER OPERATING SYSTEMS; COMPUTER OPERATING PROGRAMS, RECORDED; COMPUTER OPERATING RECORDED PROGRAMS; COMPUTER OPERATING SOFTWARE; COMPUTER OPERATING SYSTEMS; COMPUTER PARALLEL PORTS; COMPUTER PERIPHERAL APPARATUS; COMPUTER PERIPHERAL DEVICES; COMPUTER PERIPHERAL EQUIPMENT; COMPUTER PERIPHERALS; COMPUTER PERIPHERALS AND PARTS THEREOF; COMPUTER PRINTER; COMPUTER PRINTERS; COMPUTER PROCESSING SOFTWARE TO PROCESS THE IMAGE COLORS WITH THE COLOR AND INTENSITY AND INTERPRET THE RESULTS AS TENDENCIES OF THE ORGANS, GLANDS AND TISSUES ACCORDING TO THE IRIDOLOGY CHARTS; COMPUTER PROGRAM FOR THE COMPILATION OF CREDIT REPORTING DATA; COMPUTER PROGRAMMES FOR DOCUMENT MANAGEMENT; COMPUTER PROGRAMS AND COMPUTER SOFTWARE FOR ELECTRONICALLY TRADING SECURITIES; COMPUTER PROGRAMS FOR CONNECTING REMOTELY TO COMPUTERS OR COMPUTER NETWORKS; COMPUTER PROGRAMS FOR EDITING IMAGES, SOUND AND VIDEO; COMPUTER PROGRAMS FOR PRE-RECORDED GAMES; COMPUTER PROGRAMS FOR SEARCHING REMOTELY FOR CONTENT ON COMPUTERS AND COMPUTER NETWORKS; COMPUTER PROGRAMS FOR SEARCHING THE CONTENTS OF COMPUTERS AND COMPUTER NETWORKS BY REMOTE CONTROL; COMPUTER PROGRAMS FOR THE ENABLING OF ACCESS OR ENTRANCE CONTROL; COMPUTER PROGRAMS FOR USE IN THE OPERATION OF NON-MEDICAL ULTRASOUND DETECTORS; COMPUTER PROGRAMS FOR USING THE INTERNET AND THE WORLD WIDE WEB; COMPUTER PROGRAMS FOR USING THE INTERNET AND THE WORLDWIDE WEB; COMPUTER PROGRAMS FOR VIDEO AND COMPUTER GAMES; COMPUTER PROGRAMS RECORDED ON DATA MEDIA (SOFTWARE) DESIGNED FOR USE IN CONSTRUCTION AND AUTOMATED MANUFACTURING (CAD/CAM); COMPUTER PROGRAMS USED FOR ELECTRONIC CASH REGISTER SYSTEMS; COMPUTER SCREEN FILTERS; COMPUTER SCREEN SAVER SOFTWARE; COMPUTER SCREENS; COMPUTER SEARCH ENGINE SOFTWARE; COMPUTER SERIAL PORTS; COMPUTER SERVERS; COMPUTER SOFTWARE AND COMPUTER HARDWARE FOR USE IN LANGUAGE LOCALIZATION, BY MEANS OF LANGUAGE TRANSLATION, SUBTITLING, DUBBING, CLOSED CAPTIONING AND TELETEXT FOR FEATURE FILMS, TELEVISION PROGRAMS, VIDEOS AND DIGITAL MEDIA IN GENERAL; COMPUTER SOFTWARE AND FIRMWARE FOR GAMES OF CHANCE ON ANY COMPUTERIZED PLATFORM, INCLUDING DEDICATED GAMING CONSOLES, VIDEO BASED SLOT MACHINES, REEL BASED SLOT MACHINES, AND VIDEO LOTTERY TERMINALS; COMPUTER SOFTWARE AND FIRMWARE FOR OPERATING SYSTEM PROGRAMS; COMPUTER SOFTWARE AND HARDWARE FOR DISSEMINATING ADVERTISING FOR OTHERS ON EMPLOYEE EARNINGS AND THIRD PARTY PAPER PAYROLL STUBS AND CHECKS AND ON ELECTRONIC PAYROLL PAYMENTS; COMPUTER SOFTWARE DEVELOPMENT TOOLS; COMPUTER SOFTWARE FEATURING MUSICAL SOUND RECORDINGS AND MUSICAL VIDEO RECORDINGS; COMPUTER SOFTWARE FOR ACCESSING INFORMATION DIRECTORIES THAT MAY BE DOWNLOADED FROM THE GLOBAL COMPUTER NETWORK; COMPUTER SOFTWARE FOR ADMINISTRATION

Reg. No. 4,099,556 OF COMPUTER LOCAL AREA NETWORKS; COMPUTER SOFTWARE FOR ADMINISTRATION OF COMPUTER NETWORKS; COMPUTER SOFTWARE FOR APPLICATION AND DATABASE INTEGRATION; COMPUTER SOFTWARE FOR COMMUNICATING WITH USERS OF HAND-HELD COMPUTERS; COMPUTER SOFTWARE FOR COMPUTER SYSTEM AND APPLICATION DEVELOPMENT, DEPLOYMENT AND MANAGEMENT; COMPUTER SOFTWARE FOR CONTROLLING AND MANAGING ACCESS SERVER APPLICATIONS; COMPUTER SOFTWARE FOR CONTROLLING AND MANAGING PATIENT MEDICAL INFORMATION; COMPUTER SOFTWARE FOR CONTROLLING SELF-SERVICE TERMINALS; COMPUTER SOFTWARE FOR CREATING AND EDITING MUSIC AND SOUNDS; COMPUTER SOFTWARE FOR CREATING SEARCHABLE DATABASES OF INFORMATION AND DATA; COMPUTER SOFTWARE FOR ENCRYPTION; COMPUTER SOFTWARE FOR INTERPRETATION OF NEURO AND BRAIN SCANS PROVIDED BY DIAGNOSTIC IMAGING EQUIPMENT; COMPUTER SOFTWARE FOR MANIPULATING DIGITAL AUDIO INFORMATION FOR USE IN AUDIO MEDIA APPLICATIONS; COMPUTER SOFTWARE FOR ORGANIZING AND VIEWING DIGITAL IMAGES AND PHOTOGRAPHS; COMPUTER SOFTWARE FOR PROCESSING DIGITAL IMAGES; COMPUTER SOFTWARE FOR PROCESSING DIGITAL MUSIC FILES; COMPUTER SOFTWARE FOR PROVIDING AN ON-LINE DATABASE IN THE FIELD OF TRANSACTION PROCESSING TO UPLOAD TRANSACTIONAL DATA, PROVIDE STATISTICAL ANALYSIS, AND PRODUCE NOTIFICATIONS AND REPORTS; COMPUTER SOFTWARE FOR PULMONARY, CARDIOVASCULAR AND EDEMA ANALYSIS FOR USE IN SMALL ANIMAL RESEARCH STUDIES; COMPUTER SOFTWARE FOR REDISTRICTING, NAMELY, AGGREGATING SMALLER GEOGRAPHICAL AREAS INTO MULTIPLE LARGER AREAS; COMPUTER SOFTWARE FOR SCIENTIFIC ANALYSIS OF GENETIC SEQUENCES; COMPUTER SOFTWARE FOR THE COLLECTION, EDITING, ORGANIZING, MODIFYING, BOOK MARKING, TRANSMISSION, STORAGE AND SHARING OF DATA AND INFORMATION; COMPUTER SOFTWARE FOR THE CREATION OF FIREWALLS; COMPUTER SOFTWARE FOR THE DATABASING, VISUALIZATION, MANIPULATION, VIRTUAL REALITY IMMERSION AND INTEGRATION OF GEOGRAPHIC INFORMATION WITH ON-LINE MEMBER COMMUNITIES; COMPUTER SOFTWARE FOR THE FIELD OF WAREHOUSING AND DISTRIBUTION, TO MANAGE TRANSACTIONAL DATA, PROVIDE STATISTICAL ANALYSIS, AND PRODUCE NOTIFICATIONS AND REPORTS; COMPUTER SOFTWARE FOR THE MANAGEMENT OF COMMERCIAL PRINTING COMPANIES IN THE FIELD OF COST ESTIMATING, PRODUCTION PLANNING, SCHEDULING PRODUCTION, BINDING, SHIPPING AND ANALYSIS OF THE PRINTING JOB; COMPUTER SOFTWARE FOR USE IN CUSTOMER RELATIONSHIP MANAGEMENT (CRM); COMPUTER SOFTWARE FOR USE IN PROGRAMMING FACSIMILE MACHINES; COMPUTER SOFTWARE FOR USE IN RELATION TO DIGITAL ANIMATION AND SPECIAL EFFECTS OF IMAGES; COMPUTER SOFTWARE FOR USE IN THE ENCRYPTION AND DECRYPTION OF DIGITAL FILES, INCLUDING AUDIO, VIDEO, TEXT, BINARY, STILL IMAGES, GRAPHICS AND MULTIMEDIA FILES; COMPUTER SOFTWARE FOR USE IN THE SAFEGUARDING OF DIGITAL FILES, INCLUDING AUDIO, VIDEO, TEXT, BINARY, STILL IMAGES, GRAPHICS AND MULTIMEDIA FILES; COMPUTER SOFTWARE FOR VISUALIZATION IN THE NATURE OF GRAPHICAL REPRESENTATION AND ANALYSIS OF SATELLITES; COMPUTER SOFTWARE FOR WIRELESS CONTENT DELIVERY; COMPUTER SOFTWARE THAT ALLOWS PEOPLE OR ORGANIZATIONS TO CREATE A VOTING EVENT, VOTE ON THE ISSUE, CHANGE THEIR VOTE AT WILL AND TRACK THE INPUT AND DISPLAY IT IN A UNIQUE GRAPHICAL WAY; COMPUTER SOFTWARE THAT ASSISTS COMPUTERS IN DEPLOYING PARALLEL APPLICATIONS AND PERFORMING PARALLEL COMPUTATIONS; COMPUTER SOFTWARE THAT PROVIDES REAL-TIME, INTEGRATED BUSINESS MANAGEMENT INTELLIGENCE BY COMBINING INFORMATION FROM VARIOUS DATABASES AND PRESENTING IT IN AN EASY-TO-UNDERSTAND USER INTERFACE; COMPUTER SOFTWARE THAT PROVIDES WEB-BASED ACCESS TO APPLICATIONS AND SERVICES THROUGH A WEB OPERATING SYSTEM OR PORTAL INTERFACE; COMPUTER SOFTWARE TO AUTOMATE DATA WAREHOUSING; COMPUTER SOFTWARE TO CONTROL AND IMPROVE COMPUTER AND AUDIO EQUIPMENT SOUND QUALITY; COMPUTER SOFTWARE TO ENABLE THE TRANSMISSION OF PHOTOGRAPHS TO MOBILE TELEPHONES; COMPUTER SOFTWARE TO ENHANCE THE AUDIO-VISUAL CAPABILITIES OF MULTIMEDIA APPLICATIONS, NAMELY, FOR THE

Reg. No. 4,099,556 INTEGRATION OF TEXT, AUDIO, GRAPHICS, STILL IMAGES AND MOVING PICTURES; COMPUTER SOFTWARE TO MAINTAIN AND OPERATE COMPUTER SYSTEM; COMPUTER SOFTWARE TO MONITOR AND CONTROL FACTORY MANUFACTURING PROCESSES; COMPUTER SOFTWARE, NAMELY, AN APPLICATION ALLOWING SALES AND FIELD SERVICE EMPLOYEES TO UPDATE AND RECEIVE DATA STORED IN AN ENTERPRISE'S COMPUTER DATABASES IN REAL TIME, USING A MOBILE DEVICE, WITH FULL TELEPHONY INTEGRATION WITH THE TELEPHONE AND/OR SOFTWARE FEATURES OF THE MOBILE DEVICE; COMPUTER SOFTWARE, NAMELY, ELECTRONIC FINANCIAL PLATFORM THAT ACCOMMODATES MULTIPLE TYPES OF PAYMENT AND DEBT TRANSACTIONS IN AN INTEGRATED MOBILE PHONE, PDA, AND WEB BASED ENVIRONMENT; COMPUTER SOFTWARE, NAMELY, GAME ENGINE SOFTWARE FOR VIDEO GAME DEVELOPMENT AND OPERATION; COMPUTER SOFTWARE, NAMELY, SOFTWARE DEVELOPMENT TOOLS FOR THE CREATION OF MOBILE INTERNET APPLICATIONS AND CLIENT INTERFACES; COMPUTER STANDS SPECIALLY DESIGNED FOR HOLDING A COMPUTER, PRINTER AND ACCESSORIES; COMPUTER STORAGE DEVICES, NAMELY, FLASH DRIVES; COMPUTER STORAGE DEVICES, NAMELY, HIGH-SPEED STORAGE SUBSYSTEMS FOR STORAGE AND BACKUP OF ELECTRONIC DATA EITHER LOCALLY OR VIA A TELECOMMUNICATIONS NETWORK; COMPUTER STYLUS; COMPUTER SWITCHES; COMPUTER TELEPHONY SOFTWARE; COMPUTER TERMINALS; COMPUTER TERMINALS, KEYBOARDS AND PRINTERS; COMPUTER TOUCHSCREENS; COMPUTER UTILITY PROGRAMS; COMPUTER WHITEBOARDS; COMPUTER-CONTROLLED ELECTRONIC APPARATUS FOR ELECTROPHYSIOLOGICAL MEASUREMENT AND TESTING OF CELLS; COMPUTER-CONTROLLED SHEET-FEEDING APPARATUS; COMPUTER-GAMING SOFTWARE; COMPUTERS; COMPUTERS; COMPUTERS AND COMPUTER HARDWARE; COMPUTERS AND COMPUTER PERIPHERALS; COMPUTERS AND INSTRUCTIONAL MANUALS SOLD AS A UNIT; COMPUTERS FOR MANAGING CONTROL DEVICES FOR AIRCRAFT; COMPUTERS FOR NETWORK MANAGEMENT; COMPUTERS FOR USE IN DATA MANAGEMENT; COMPUTERS, NAMELY, NET BOOKS; CONDUCTIVE FIBERS, NAMELY, FIBERS FOR CONDUCTING ELECTRICAL CHARGES AND STATIC ELECTRICAL CHARGES; CONDUCTIVE FIBERS, NAMELY, FLUORIDE GLASS FIBERS; CONNECTING ELECTRICAL CABLES; CONNECTION CABLES; CONNECTIONS FOR ELECTRIC LINES; CONSUMER COUPONS DOWNLOADED FROM A GLOBAL COMPUTER NETWORK; CONSUMER ELECTRONIC PRODUCTS, NAMELY, AUDIO AMPLIFIERS, AUDIO SPEAKERS, AUDIO RECEIVERS, ELECTRICAL AUDIO AND SPEAKER CABLES AND CONNECTORS, HOME THEATER SYSTEMS, AUDIO DECODERS, VIDEO DECODERS, SPEAKERS, POWER CONVERSION DEVICES, POWER CONVERTERS, AND POWER INVERTERS; CONTAINERS FOR CONTACT LENS; CONTAINERS FOR CONTACT LENSES; CONTINGENCY RESPONSE COMMUNICATION SYSTEM DESIGNED TO PROVIDE RADIO INTEROPERABILITY, STREAMING VIDEO, WIRELESS INTERNET, AND VOIP PHONE; CONTINUITY TEST APPARATUS FOR ELECTRICAL CIRCUITS; CONTRAST ENHANCEMENT FILTERS FOR ELECTRONIC DISPLAY READOUT WINDOWS; CONTROL CABINETS SPECIALLY ADAPTED FOR VEHICLE TRAFFIC CONTROL EQUIPMENT; CONTROL SYSTEM FOR THE REMOTE OBSERVATION, MANAGEMENT AND OPERATION OF CRANES, COMPRISING COMPUTERS, SOFTWARE, ELECTROMECHANICAL CONTROLS, AND VIDEO DISPLAY SCREENS; CONTROL SYSTEMS FOR AIRPORT BAGGAGE HANDLING SYSTEMS, CONSISTING OF A SINGLE OR MULTIPLE PROGRAMMABLE CONTROLLERS (PLC) WITH INPUT AND OUTPUT FEATURES FOR DIGITAL DEVICES, WITH CAPABILITY OF BEING CONNECTED TO EXTERNAL SUPERVISORY COMPUTERS; CONTROL UNITS FOR REGULATING START-UP ELECTRICAL MOTORS; CONTROL VALVES FOR REGULATING THE FLOW OF GASES AND LIQUIDS; CONVERTERS FOR ELECTRIC PLUGS; COOLANT-TEMPERATURE SENSORS; CORDLESS TELEPHONE APPARATUSES; CORDLESS TELEPHONES; CORRECTIVE GLASSES; COVER FOR AN ELECTRIC DOOR BELL THAT ATTACHES TO THE DOORBELL TO BLOCK ITS USE; COVER GLASS FOR MICROSCOPE SLIDES; COVERS FOR ELECTRIC OUTLETS; COVERS FOR TELEPHONE RECEIVERS NOT MADE OF PAPER; CREDIT CARD ENCODING MACHINES; CROSS BEAM DEPTH GAUGES; CRUISE CONTROLS FOR MOTOR VEHICLES; CRUISE CONTROLS FOR MOTORCYCLES; CUSHIONED SUPPORT BASE SPECIALLY ADAPTED TO PROP UP LAPTOP COMPUTERS; CUT-OUT SWITCHES; DAISY WHEEL

Reg. No. 4,099,556 PRINTERS; DATA ACCESS PORT FOR USE WITH ELECTRICAL CONTROL PANELS FOR CONNECTING MULTIPLE DATA AND ELECTRICAL DEVICES; DATA CARRIERS CONTAINING STORED TYPOGRAPHIC TYPEFACES; DAY AND NIGHT VISION SYSTEMS PRIMARILY COMPRISING DAY AND NIGHT SENSORS, DAY AND NIGHT CAMERAS, POWER SOURCES, COMMUNICATION MEANS, MONITORS AND OPERATING SOFTWARE; DECORATIVE AND FANCIFUL ITEMS FOR COVERING OF, AND FOR USE IN CONNECTION WITH PROTECTIVE HELMETS; DECORATIVE CHARMS FOR CELLULAR TELEPHONES; DECORATIVE COVERS FOR SATELLITE DISHES; DECORATIVE COVERS FOR SMOKE DETECTORS; DECORATIVE ORNAMENTS FOR CELLULAR TELEPHONES; DECORATIVE SWITCH PLATE COVERS; DESK OR CAR MOUNTED UNITS INCORPORATING A LOUDSPEAKER TO ALLOW A TELEPHONE HANDSET TO BE USED HANDS-FREE; DESKTOP COMPUTERS; DEVICES FOR HANDS-FREE USE OF MOBILE PHONES; DIESEL-ENGINE EXHAUST TEST INSTRUMENTS; DIFFERENTIAL SWITCHES; DIGITAL DISC DRIVES; DIGITAL ENTERTAINMENT SYSTEMS FOR WATCHING, STORING AND SHARING DIGITAL CONTENT ON A HOME COMPUTER NETWORK; DIGITAL PHOTO FRAMES FOR DISPLAYING DIGITAL PICTURES, VIDEO CLIPS AND MUSIC; DIGITAL SWITCHING SYSTEMS COMPRISED OF INTERCONNECTED ELECTROMECHANICAL AND SOLID-STATE POWER MANAGEMENT ENCLOSURES WITH STANDARD AND CUSTOM KEYPADS FOR USER REMOTE CONTROL, THE FOREGOING FOR USE ON MARINE HELMS AND LAND-BASED VEHICLE DASHBOARDS; DIGITAL TELEPHONE PLATFORMS AND SOFTWARE; DIGITAL TELEPHONE SWITCHING APPARATUS; DIGITAL TELEPHONES; DIGITAL VERSATILE DISC PLAYER; DIGITAL VIDEO DISC DRIVES; DISC MEMORIES; DISC STORAGE CONTAINERS; DISCHARGE TUBES, ELECTRIC, OTHER THAN FOR LIGHTING; DIVE COMPUTERS FOR UNDERWATER USE; DOOR CLOSERS, ELECTRIC; DOWNLOADABLE COMPUTER GAME PROGRAMS; DOWNLOADABLE COMPUTER GAME SOFTWARE VIA A GLOBAL COMPUTER NETWORK AND WIRELESS DEVICES; DOWNLOADABLE COMPUTER GRAPHICS; DOWNLOADABLE COMPUTER PROGRAMS FEATURING POSITIONABLE GAME PIECE FIGURES FOR USE IN THE FIELD OF COMPUTER GAMES; DOWNLOADABLE COMPUTER SOFTWARE IN THE FIELD OF MEMORY TRAINING ACTIVITIES SOLD AS A UNIT WITH POSITIONABLE FIGURES; DOWNLOADABLE ELECTRONIC DATA FILES AND DATABASES, NAMELY, BUSINESS AND TAX FORMS, FOR USE WITH COMPUTER SOFTWARE; DOWNLOADABLE IMAGE FILE CONTAINING ARTWORK, TEXT, AUDIO, VIDEO, GAMES AND INTERNET WEB LINKS RELATING TO SPORTING AND CULTURAL ACTIVITIES; DOWNLOADABLE RING TONES, GRAPHICS AND MUSIC VIA A GLOBAL COMPUTER NETWORK AND WIRELESS DEVICES; DRIVER IMPAIRMENT DETECTION DEVICE IN THE NATURE OF A FINGER-PRINT RECOGNITION SCANNER THAT ACTIVATES A TIMING MECHANISM TO DETERMINE THE DRIVER'S FITNESS TO DRIVE THE VEHICLE; DRY CELLS AND BATTERIES; DUCTING FOR ELECTRIC CABLES; DUST COVERS FOR COMPUTERS; EDUCATIONAL APPARATUS, NAMELY, A TRANSPARENT TANK USED AS A TEACHING AID FOR THE CHEMICAL PROCESS OF MAKING ALTERNATIVE FUELS; EGG TIMERS; ELECTRIC ACCUMULATORS; ELECTRIC ACCUMULATORS FOR VEHICLES; ELECTRIC ACTUATORS; ELECTRIC AND ELECTRONIC CIRCUITS; ELECTRIC AND ELECTRONIC VIDEO SURVEILLANCE INSTALLATIONS; ELECTRIC BATTERIES; ELECTRIC BUZZERS; ELECTRIC CABLES; ELECTRIC CABLES AND WIRES; ELECTRIC CABLES, WIRES, CONDUCTORS AND CONNECTION FITTINGS THEREFOR; ELECTRIC CAPACITORS; ELECTRIC CAPACITORS; ELECTRIC CHARGING CABLES; ELECTRIC CIGARETTE LIGHTERS FOR LAND VEHICLES; ELECTRIC CIRCUIT CLOSERS; ELECTRIC CIRCUIT OPENERS; ELECTRIC CIRCUIT SWITCHES; ELECTRIC COILS; ELECTRIC CONDUCTOR RAILS; ELECTRIC CONDUCTORS; ELECTRIC CONNECTIONS; ELECTRIC CONNECTIONS AND CONNECTORS; ELECTRIC CONNECTORS; ELECTRIC CONTACTS; ELECTRIC CONTROL PANELS; ELECTRIC CONVERTERS; ELECTRIC CORDS; ELECTRIC COUPLINGS; ELECTRIC CURRENT SWITCHES; ELECTRIC DEVICES FOR ATTRACTING AND KILLING INSECTS; ELECTRIC DIODES; ELECTRIC DISPENSER FOR SHOE COVERS; ELECTRIC DISTRIBUTION CONSOLES; ELECTRIC HAIR STRAIGHTENING IRONS; ELECTRIC HAIR-CURLERS; ELECTRIC SWITCHES; ELECTRIC TRANSFORMERS; ELECTRIC VALVE ACTUATORS; ELECTRIC VOLTAGE TRANSFORMERS; ELECTRIC WARNING LIGHT SYSTEMS; ELECTRIC

Reg. No. 4,099,556 WARNING LIGHTS; ELECTRIC WIRE AND CABLE; ELECTRIC WIRES; ELECTRIC WIRES AND CABLES; ELECTRIC, ELECTRONIC, OR ELECTROCHEMICAL OXYGEN MONITORS AND SENSORS FOR ENVIRONMENTAL USE; ELECTRICAL AND ELECTRONIC BURGLAR ALARMS; ELECTRICAL AND ELECTRONIC CONNECTORS; ELECTRICAL AND OPTICAL CABLES; ELECTRICAL APPARATUS FOR TESTING THE STATE OF OPERABILITY OF ELECTRONIC SIRENS AND PUBLIC ADDRESS SYSTEMS; ELECTRICAL CABLES; ELECTRICAL CABLES AND CORDSETS; ELECTRICAL CABLES FOR MUSICAL INSTRUMENTS; ELECTRICAL CABLES FOR USE IN CONNECTIONS; ELECTRICAL CABLES WITH INTEGRATED FITTINGS, NAMELY, CORDSETS; ELECTRICAL CELLS AND BATTERIES; ELECTRICAL CIRCUIT BOARDS; ELECTRICAL CIRCUITS FOR USE IN AMUSEMENT GAME MACHINES FOR REPRODUCING MUSIC, SPEECH AND SPECIAL EFFECTS; ELECTRICAL COMPONENTS IN THE NATURE OF ELECTRIC CONTACTORS; ELECTRICAL COMPONENTS IN THE NATURE OF PROTECTION RELAYS; ELECTRICAL CONDUCTORS; ELECTRICAL CONNECTION BOXES; ELECTRICAL CONNECTIONS; ELECTRICAL CONNECTOR HOUSINGS; ELECTRICAL CONNECTORS; ELECTRICAL CONTROLLERS; ELECTRICAL CONTROLLING DEVICES; ELECTRONIC CONTROLLERS USED TO REDUCE POWER CONSUMPTION; ELECTRONIC CONTROLS FOR GASOLINE ENGINES FOR LAND VEHICLES; ELECTRONIC DATA RELAYS FOR SENSORS; ELECTRONIC DEVICES FOR ASSISTING CARE GIVING FOR SENIORS OR PEOPLE NEEDING ASSISTANCE COMPRISED OF SENSORS FOR DETERMINING STATUS OF PERSON AND APPARATUS FOR SENDING ELECTRONIC ALERTS TO CARE GIVERS; ELECTRONIC MOTOR SWITCHES FOR SWITCHING OFF MOTORS; ELECTRONIC MOTOR VEHICLE IGNITION TUNING KITS COMPRISED OF AN ELECTRONIC CONTROL UNIT THAT MONITORS ENGINE PERFORMANCES AND DELIVERS RE-CALCULATED SENSOR VALUES TO THE ORIGINAL ENGINE CONTROL UNIT TO INCREASE ENGINE PERFORMANCE; ELECTRONIC TOUCH SENSITIVE SWITCHES; ELECTRONIC VALVES FOR CONTROLLING GAS OR FLUIDS; EYE COVERS FOR PROTECTIVE PURPOSES; EYE GLASS CASES; EYE GLASS CHAINS; EYE GLASS CORDS; EYE GLASSES; FIBER OPTIC CABLES; FIBRE-OPTIC CABLES; FIELD-GLASSES; FILTERS FOR OPTICAL DEVICES; FILTERS FOR RADIO INTERFERENCE SUPPRESSION; FILTERS FOR RESPIRATORY MASKS; FILTERS FOR USE IN LABORATORY EQUIPMENT THE BIOPHARMACEUTICAL INDUSTRY; FILTERS USED IN SCIENTIFIC AND FORENSIC APPARATUS IN DRUG DETECTION PROCESSES; FIRE ENGINES; FIRE HOSE NOZZLES; FITTED FABRIC COVER FOR A GARMENT STEAMER HEAD; FITTED PLASTIC FILMS KNOWN AS SKINS FOR COVERING AND PROVIDING A SCRATCH PROOF BARRIER OR PROTECTION FOR ELECTRONIC DEVICES, NAMELY, MP3 PLAYERS, MOBILE TELEPHONES, SMART TELEPHONES, DIGITAL CAMERAS, GLOBAL POSITIONING SYSTEMS AND PERSONAL DIGITAL ASSISTANTS; FITTED RADIO COVERS USED TO PROTECT AUTOMOBILE RADIOS; FLASH LAMPS; FLEXIBLE PVC COVERING SPECIALLY ADAPTED FOR ELECTRICAL CORDS THAT IS INFUSED WITH CITRUS TO PREVENT PET DAMAGE; GAS APPLIANCE ALARM TIMER FOR DETECTING AND ALERTING THE PRESENCE OF GAS FLOW AFTER A PRESCRIBED PERIOD OF TIME; GAS CHROMATOGRAPHY APPARATUS; GAS DETECTORS FOR DETECTING THE PRESENCE OF GAS; GAS MASKS; GAS METERS; GAS MIXERS FOR LABORATORY USE; GAS SENSORS FOR MEASURING GAS CONCENTRATION; GAS TESTING INSTRUMENTS; GATE OPERATORS POWERED BY BATTERY, ELECTRICITY OR SOLAR POWER; GATEWAY ROUTERS IN THE NATURE OF COMPUTER CONTROL HARDWARE; GLASS COVERED WITH AN ELECTRICAL CONDUCTOR; GLASS DRIERS FOR LABORATORY PURPOSES; GLASS GRADUATED SCALES; GLASS TUBES FOR SCIENTIFIC PURPOSES; GLASSES FOR SPORTS; GLOBAL POSITIONING SYSTEM (GPS) CONSISTING OF COMPUTERS, COMPUTER SOFTWARE, TRANSMITTERS, RECEIVERS, AND NETWORK INTERFACE DEVICES; GRIDS FOR BATTERIES; GUITAR CABLES; HAND-HELD DEVICE COMPRISED OF CHEMICAL AND HEAT SENSORS FOR THE DETECTION OF EXPLOSIVES; HANDHELD COMPUTERS; HANDHELD ELECTRONIC UNITS FOR ADJUSTING SOUND LEVELS IN HEARING AIDS; HANDHELD PERSONAL COMPUTERS; HDMI (HIGH-DEFINITION MULTIMEDIA INTERFACE) APPARATUS AND COMPONENT CABLES SOLD AS A UNIT; HDMI (HIGH-DEFINITION MULTIMEDIA INTERFACE) CABLES; HEADSETS FOR MOBILE TELEPHONES; HEADSETS FOR TELEPHONES; HEADSETS FOR USE WITH COMPUTERS; HEAT SINKS FOR USE IN COM-

Reg. No. 4,099,556 PUTTERS; HELMETS FOR MOTORCYCLISTS; HIGH FREQUENCY SWITCHES; HIGH PERFORMANCE COMPUTER HARDWARE WITH SPECIALIZED FEATURES FOR ENHANCED GAME PLAYING ABILITY; HIGH TENSION BATTERIES; HIGH-FREQUENCY SWITCHING POWER SUPPLIES; HOLDERS FOR COMPACT DISCS; HOLDERS FOR ELECTRIC COILS; HUMIDITY SENSOR WITH INTEGRATED DIGITAL AND ANALOG OUTPUT CIRCUITRY USED IN AUTOMOTIVE, APPLIANCE AND LIGHT INDUSTRIAL APPLICATIONS TO SENSE BOTH RELATIVE HUMIDITY AND TEMPERATURE ENVIRONMENTAL CONDITIONS; IGNITION BATTERIES; IMAGE FUSER UNITS FOR COMPUTER PRINTERS COMPRISING ELECTRO-MECHANICAL ROLLERS FOR THE PURPOSE OF TRANSFERRING TONER ONTO PAPER; IMAGE TRANSFER KITS FOR COMPUTER PRINTERS, NAMELY, KITS FORMING PARTS OF PRINTERS COMPRISING BELTS, TONER AND DRUMS FOR THE PURPOSE OF TRANSFERRING IMAGES ONTO PAPER; IN-CAR TELEPHONE HANDSET CRADLES; INDUSTRIAL CALIBRATION SENSORS; INDUSTRIAL PROCESSED CONTROL SOFTWARE FOR GENERATING COMPUTER READABLE MARKINGS FOR APPLICATION TO BOARD LUMBER; INPUT DEVICES FOR COMPUTER HARDWARE AND ELECTRONIC INSTRUMENTS, NAMELY, JOG WHEELS; INPUT DEVICES FOR COMPUTERS; INSULATED COPPER ELECTRICAL WIRE; INSULATED ELECTRICAL CONNECTORS; INTEGRATED BATTERY BACKUP SYSTEMS COMPRISING A BATTERY, AN ELECTRONIC MEASUREMENT APPARATUS FOR USE IN THE MEASUREMENT OF BATTERY HEALTH AND PERFORMANCE, AND A REMOTE COMPUTER SOFTWARE PROGRAM THAT USES THE FOREGOING DATA TO TREND, PREDICT, AND STORE DATA RELATED TO THE HEALTH OF THE BATTERY; INTERACTIVE MULTIMEDIA COMPUTER GAME PROGRAM; INTERACTIVE VIDEO GAMES OF VIRTUAL REALITY COMPRISED OF COMPUTER HARDWARE FOR USE WITH AN EXTERNAL MONITOR AND SOFTWARE; INTERFACES AND PERIPHERAL DEVICES FOR COMPUTERS; INTERFACES FOR COMPUTERS; INTERNAL COOLING FANS FOR COMPUTERS; INTEROPERABLE COMMUNICATION SYSTEM DESIGNED TO PROVIDE RADIO, STREAMING VIDEO, WIRELESS INTERNET, AND VOIP PHONE; JACKETS FOR COMPUTER DISKS; JUKE BOXES; JUMP START CABLES; JUMPER CABLES; JUNCTION SLEEVES; JUNCTION SLEEVES FOR ELECTRIC CABLES; KEYBOARD AND PRINT OUT APPARATUS FOR USE WITH COMPUTERS; KEYLESS ENTRY SYSTEM AND KEYLESS IGNITION SWITCH SYSTEM FOR AUTOMOTIVE VEHICLES COMPRISED OF A MICROPROCESSOR, ELECTRONIC SIGNAL RECEIVER, AND KEYFOB WITH ELECTRONIC SIGNAL TRANSPONDER; LABORATORY APPARATUS AND COMPUTER SYSTEMS FOR USE IN PROTEIN PURIFICATION; LABORATORY APPARATUS AND INSTRUMENTS, NAMELY, BOTTLE TOP FILTERS USED FOR THE PURIFICATION OF TISSUE CULTURE MEDIA; LABORATORY EQUIPMENT AND SUPPLIES, NAMELY, TEST TUBES; LABORATORY EQUIPMENT, NAMELY, PLASTIC, RUBBER AND ELASTOMER CLOSURES, SEALS AND STOPPERS FOR LABORATORY BOTTLES; LABORATORY FILTERS; LABORATORY STORAGE TUBES; LAN (LOCAL AREA NETWORK) ACCESS POINTS FOR CONNECTING NETWORK COMPUTER USERS; LAN (LOCAL AREA NETWORK) COMPUTER CARDS FOR CONNECTING PORTABLE COMPUTER DEVICES TO COMPUTER NETWORKS; LAPTOP COMPUTERS; LASER OBJECT DETECTORS FOR USE ON VEHICLES; LEAK DETECTING DEVICE FOR WATER SUPPLIED HOME APPLIANCES CONSISTING OF WATER SENSOR, CONTROL UNIT WITH AUDIBLE ALARM AND WATER VALVES; LENGTH MEASURING GAUGES; LENS FILTERS; LEVEL GAUGES; LEVEL INDICATORS; LEVEL INDICATORS; LEVEL MEASURING MACHINES; LEVEL SWITCHES AND LEVEL INDICATORS FOR MONITORING AND CONTROLLING LIQUIDS IN TANKS AND VESSELS; LEVEL SWITCHES FOR MONITORING AND CONTROLLING LIQUIDS IN TANKS AND VESSELS; LEVELLING RODS; LIGHT SWITCHES; LIQUID LEVEL SENSORS; LITHIUM ION BATTERIES; LITHIUM IRON PHOSPHATE BATTERIES; LITHIUM PHOSPHATE BATTERIES; LOCK-OUT VALVES AND SWITCHES FOR USE IN CARBON DIOXIDE FIRE SUPPRESSION SYSTEMS; LOW PASS INDUCTOR FILTER USED IN HIGH POWER ELECTRICAL APPLICATIONS; MAGNETIC AND ELECTROMAGNETIC COILS; MAGNETIC TAPE UNITS FOR COMPUTERS; MAGNETIC TELEPHONE WIRES; MAGNIFYING GLASSES; MAGNIFYING GLASSES THAT FIT ON THE USER'S FACE IN THE MANNER OF EYEGASSES; MAGNIFYING PEEPHOLES FOR DOORS; MARKING GAUGES FOR JOINERY PURPOSES; MEASURING APPARATUS FOR TEMPERATURE AND HUMIDITY LEVELS IN GASES AND SOLID

Reg. No. 4,099,556 SUBSTANCES; MEASURING APPARATUS, NAMELY, RAIN GAUGES; MEASURING HOSES FOR MEASURING TEMPERATURE, PRESSURE, QUANTITY AND CONCENTRATION OF FLUIDS IN HYDRAULIC OR PNEUMATIC SYSTEMS; MECHANICAL AND ELECTRONIC MEASURING MACHINES FOR IDENTIFYING AND ANALYZING STRUCTURAL DAMAGE TO VEHICLES; MEMORIES FOR USE WITH COMPUTERS; MEMORY CARDS; METAL CABINETS SPECIALLY ADAPTED TO PROTECT TELECOMMUNICATIONS EQUIPMENT IN THE NATURE OF FIBER OPTIC CABLES.; MICRO PROCESSORS; MICRO-COMPUTER; MICRO-COMPUTERS; MICRO-PROCESSORS; MICROCHIPS; MICROMETER GAUGES; MICROPHONE CABLES; MICROPROCESSOR-BASED HARDWARE SYSTEMS USED TO REDUCE POWER CONSUMPTION; MICROPROCESSORS; MICROSENSORS FOR MEASUREMENT OF PRESSURE, ACCELERATION, FORCE AND FLOW, NAMELY, SILICON PIEZORESISTIVE PRESSURE SENSORS; MINERAL INSULATED ELECTRIC CABLES; MOBILE COMPUTERS; MOBILE COMPUTING AND OPERATING PLATFORMS CONSISTING OF DATA TRANSCIEVERS, WIRELESS NETWORKS AND GATEWAYS FOR COLLECTION AND MANAGEMENT OF DATA; MOBILE TELEPHONE APPARATUS WITH BUILT-IN FACSIMILE SYSTEMS; MOBILE TELEPHONE BATTERIES; MOBILE TELEPHONES; MODEM CABLES; MODULAR TELEPHONE OUTLET; MOTOR VEHICLE TO TRAILER ELECTRICAL CONNECTORS; MOTORCYCLE CHARGER FAULT DETECTOR; MOTORCYCLE GOGGLES; MOTORCYCLE HELMETS; MOUNTING RACKS FOR COMPUTER HARDWARE; NAVIGATIONAL INSTRUMENTS FOR VEHICLES; NEOPRENE LAPTOP COVERS; NETWORK ROUTERS; NICKEL-CADMIUM STORAGE BATTERIES; PLASTIC CASES SPECIALLY ADAPTED HOLDING COMPACT DISCS, DVDS AND OTHER ELECTRONIC MEDIA; PLASTIC GUARD FOR COVERING WALL SWITCHES; PLASTIC MOLDED SUPPORT BASE SPECIALLY ADAPTED TO PROP UP LAPTOP COMPUTERS; PLASTIC ROTATING ATTACHMENT AFFIXED TO A TELEPHONE OR OTHER ELECTRONIC CORD TO PREVENT TANGLING; PLATES FOR BATTERIES; PLATES, GLASS SLIDES OR CHIPS HAVING MULTI-WELL ARRAYS THAT CAN BE USED IN CHEMICAL ANALYSIS, BIOLOGICAL ANALYSIS OR PATTERNING FOR SCIENTIFIC, LABORATORY OR MEDICAL RESEARCH USE; PLUMB LEVELS; POCKET COMPUTERS FOR NOTE-TAKING; POLLUTANT SENSORS; PORT SECURITY AND SHIPPING CONTAINER SCANNING SYSTEM COMPRISING ELECTRONIC X-RAY SCANNERS, VIDEO CAMERAS AND RECORDERS, AND GPS TRANSCIEVERS; PORTABLE TELEPHONES; POWER ADAPTERS FOR COMPUTERS; POWER CABLES; POWER FACTOR REGULATOR TO ECONOMIZE THE DELIVERY OF ELECTRICAL POWER IN THE NATURE OF A ROD CONTAINING MINERALS CONTAINED IN A PVC TUBE; POWER SWITCHES; PRE-PACKAGED KITS CONTAINING ELECTRICAL PROTECTION DEVICES IN THE NATURE OF INSULATORS, CORONA RINGS, ARMOR-RODS AND SURGE ARRESTERS AND METAL HARDWARE IN THE NATURE OF SUSPENSION CLAMPS, YOKE PLATES, ALL OF WHICH ATTACH OR CONNECT TRANSMISSION CONDUCTORS TO HIGH VOLTAGE ELECTRIC TRANSMISSION TOWERS; PRE-PAID TELEPHONE CALLING CARDS, MAGNETICALLY ENCODED; PRESSURE GAUGES; PRESSURE INDICATING PLUGS FOR VALVES; PRESSURE SENSORS; PRESSURE SWITCHES AND SENSORS FOR MONITORING, CONTROLLING, AND SWITCHING HYDRAULIC OR PNEUMATIC SYSTEMS; PRINTER CABLES; PRINTERS FOR COMPUTERS; PRINTERS FOR USE WITH COMPUTERS; PROTECTIVE COVERS AND CASES FOR CELL PHONES, LAPTOPS AND PORTABLE MEDIA PLAYERS; PROTECTIVE EAR COVERINGS; PROTECTIVE GLASSES; PROTECTIVE SHEATHS FOR FIBER OPTICAL CABLES; PROTECTIVE SLEEVES FOR LAPTOP COMPUTERS; PROXIMITY SENSORS; PUBLIC ADDRESS (PA) AND SOUND SYSTEM ACCESSORIES, NAMELY, MICROPHONE STANDS, SPEAKER STANDS, MICROPHONE CABLES, SPEAKER CABLES, SPEAKER BOXES AND SOUND MIXERS; PUBLIC TELEPHONES; RADAR OBJECT DETECTORS FOR USE ON VEHICLES; RADIO RELAY CABLES; RADIO TELEPHONES; RADIO-FREQUENCY CONTROLLED LOCKS; RADIOS AND TELEPHONES; RADIOS FOR VEHICLES; REACTORS, COILS, RETORTS AND CRACKERS FOR USE IN HIGH TEMPERATURE CHEMICAL REACTIONS; READING GLASSES; RECHARGEABLE ELECTRIC BATTERIES; RECONFIGURABLE CASINO AND LOTTERY GAMING EQUIPMENT, NAMELY, GAMING MACHINES AND OPERATIONAL COMPUTER GAME SOFTWARE THEREFOR; RECORDED COMPUTER GAME PROGRAMS; RECTIFIER TUBES; RED LED LASER POINTING DEVICES THAT CONTAIN A SUBTLE ENERGY FIELD; REED SWITCHES FOR USE WITH SECURITY

Reg. No. 4,099,556 CONTROL PANELS; RELAYS FOR RADIO AND TV STATIONS; RELEASE VALVES AND SWITCHES FOR USE IN CARBON DIOXIDE FIRE SUPPRESSION SYSTEMS; REMOTE CIRCUIT BREAKER CONTROL SWITCH OPERATORS; REMOTE CONTROL STARTERS FOR VEHICLES; REMOTE CONTROLS FOR GAS STOVES AND FIREPLACES; REMOTE CURSOR CONTROLS FOR COMPUTERS; REMOTE FUEL OIL LEVEL SENSING SYSTEM; SENSORS FOR DETERMINING POSITION, VELOCITY, ACCELERATION AND TEMPERATURE; SENSORS FOR THE DETERMINATION OF TEMPERATURES, POSITIONS AND DISTANCES; SHEATHS FOR ELECTRIC CABLES; SIMULATORS FOR DRIVING OR CONTROL OF VEHICLES; SIRENS FOR VEHICLES; SOLAR BATTERIES; TELEPHONE ANSWERING APPARATUS; TELEPHONE ANSWERING MACHINES; TELEPHONE APPARATUS; TELEPHONE APPARATUS AND RECEIVERS; TELEPHONE APPARATUS, NAMELY, INTERCOMS; TELEPHONE CALL ROUTER, FOR HOME AND OFFICE TOUCHTONE PHONES, FOR INTERNATIONAL AND LONG DISTANCE CALLS MADE FROM VARIOUS TELEPHONY PLATFORMS INCLUDING VOIP PLATFORM WITHOUT THE REQUIREMENT FOR INTERNET; TELEPHONE CALL ROUTERS; TELEPHONE CALL ROUTERS FOR LONG DISTANCE CALLS MADE THROUGH PSTN AND VOIP PLATFORMS FROM ANY TOUCHTONE PHONE WITHOUT A REQUIREMENT FOR INTERNET ACCESS; TELEPHONE CALL SCREENING AND BLOCKING DEVICE CONSISTING OF A MICROPROCESSOR THAT USES THE TELEPHONE CORD BETWEEN THE TELEPHONE AND WALL JACK FOR THE PURPOSE OF BLOCKING UNWANTED CALLS; TELEPHONE CONNECTORS; TELEPHONE EQUIPMENT, NAMELY, CALLER IDENTIFICATION BOXES; TELEPHONE HEADSETS; TELEPHONE RECEIVERS; TELEPHONE RECORDERS; TELEPHONE SETS; TELEPHONE SETS WITH SCREEN AND KEYBOARD; TELEPHONE TERMINAL; TELEPHONE TERMINALS; TELEPHONE TRANSMITTERS; TELEPHONE WIRES; TELEPHONES; VALVES FOR CONTROLLING AND REGULATING THE FLOW OF GASES OR LIQUIDS NOT BEING PARTS OF PLUMBING, HEATING, COOLING INSTALLATIONS OR MACHINES; VEHICLE BREAKDOWN WARNING LAMPS; VEHICLE BREAKDOWN WARNING TRIANGLES; VEHICLE DETECTION EQUIPMENT, NAMELY, DISPLAY MONITORS, COMPUTERS, IMAGE SENSORS, VIDEO CAMERAS, AND OPERATING SYSTEM AND APPLICATION SOFTWARE TO DETECT VEHICLE LOCATION; VEHICLE DRIVE TRAINING SIMULATORS; VEHICLE ENGINE PARTS, NAMELY, THERMOSTATS; VEHICLE LOCATING, TRACKING AND SECURITY SYSTEM COMPRISED OF AN ANTENNA AND RADIO TRANSMITTER TO BE PLACED IN A VEHICLE; VEHICLE LOCATOR AND RECOVERY DEVICE PROGRAMMED TO USE GLOBAL POSITIONING SYSTEMS (GPS) AND CELLULAR TELECOMMUNICATIONS; VEHICLE MOUNTED GPS SENSOR FOR DETERMINING THE RATE OF MOTION FOR A VEHICLE; VEHICLE RADIOS; VEHICLE SAFETY EQUIPMENT, NAMELY, AN ON-BOARD VEHICULAR SURVEILLANCE SYSTEM COMPRISED OF CAMERAS AND MONITORS FOR EXPOSING AND ELIMINATING THE BLIND SPOTS ON BOTH SIDES OF THE VEHICLE; VEHICLE SAFETY EQUIPMENT, NAMELY, BACK-UP SENSORS AND CAMERAS; VEHICLE SAFETY EQUIPMENT, NAMELY, ELECTRONIC DEER ALERTS; VEHICLE SAFETY EQUIPMENT, NAMELY, ELECTRONIC TIRE PRESSURE MONITORS; VEHICLE SAFETY EQUIPMENT, NAMELY, ELECTRONIC VIBRATION, SHOCK, MOTION, ANGLE, TEMPERATURE AND VOLTAGE MONITORS; VEHICLE TRACKING DEVICES COMPRISED OF CELLULAR RADIO MODULES, COMPUTER SOFTWARE AND COMPUTER HARDWARE, SENSORS, TRANSMITTERS, RECEIVERS AND GLOBAL POSITIONING SATELLITE RECEIVERS, ALL FOR USE IN CONNECTION WITH VEHICLE TRACKING, VEHICLE MONITORING AND ANTI-THEFT VEHICLE ALARMS; VEHICLE TRAFFIC SIGNALS; VEHICLE WHEEL ALIGNMENT MACHINES; VEHICLES BREAKDOWN WARNING LAMPS; WATER FILTER CONTROLLERS; WATER LEVEL INDICATORS, IN CLASS 9 (U.S. CLS. 21, 23, 26, 36 AND 38).

FIRST USE 6-28-2011; IN COMMERCE 6-28-2011.

FOR: ANTI-SKID CHAINS FOR VEHICLES; ANTI-SKID TEXTILE COVERS FOR TIRES; ANTI-THEFT ALARMS FOR VEHICLES; ANTI-THEFT LOCKS FOR USE ON AUTOMOBILE STEERING WHEELS; ANTITHEFT ALARMS FOR VEHICLES; AUTOMOBILE ENGINES; AUTOMOBILE SPARE WHEEL HOLDERS; AUTOMOBILE WHEEL SHIELDS; AUTOMOBILE WINDSHIELDS; AUTOMOBILES; AUTOMOTIVE ENGINE MOUNTS; AXLE BEARINGS

Reg. No. 4,099,556 FOR LAND VEHICLES; AXLE BOOT KITS FOR USE WITH LAND VEHICLES; AXLES AND CARDAN SHAFT FOR MOTOR VEHICLES; BACK-UP WARNING ALARMS FOR VEHICLES; BADGES FOR VEHICLES; BELTS FOR LAND VEHICLE TRANSMISSIONS; BOOSTER SEATS FOR USE IN VEHICLES; BRAKE AIR COMPRESSORS FOR LAND VEHICLES; BRAKE AIR CYLINDERS FOR LAND VEHICLES; BRAKE AIR VALVES FOR LAND VEHICLES; BRAKE BLOCKS FOR LAND VEHICLES; BRAKE CALIPERS FOR LAND VEHICLES; BRAKE CYLINDER REPAIR KITS, SOLD AS A UNIT FOR LAND VEHICLES; BRAKE CYLINDERS; BRAKE DISCS; BRAKE DISCS FOR MOTORCYCLES; BRAKE DISKS; BRAKE DRUMS; BRAKE DRUMS FOR LAND VEHICLES; BRAKE FACINGS; BRAKE FACINGS FOR VEHICLES; BRAKE HARDWARE FOR VEHICLES; BRAKE LINES FOR VEHICLES; BRAKE LININGS FOR LAND VEHICLES; BRAKE LININGS FOR MOTOR CARS; BRAKE PADS FOR LAND VEHICLES; BRAKE ROTORS FOR LAND VEHICLES; BRAKE SEGMENTS FOR MOTOR CARS; BRAKE SHOES FOR LAND VEHICLES; BRAKE SHOES FOR MOTOR CARS; BRAKE SYSTEMS FOR VEHICLES; BRAKES FOR LAND VEHICLES; BRAKES FOR MOTOR CARS; BRAKES FOR VEHICLES; BRAKING SYSTEMS FOR VEHICLES AND PARTS THEREOF; BUG SHIELDS AS STRUCTURAL PARTS OF VEHICLES; BURGLAR ALARMS FOR VEHICLES; CABLE CARS; CAISSONS; CAMPERS; CAPS FOR WHEEL RIMS; CARGO CARRIERS FOR VEHICLES; CARTS FOR GARDEN HOSES; CARTS, NAMELY, WHEELED, COLLAPSIBLE, CANVAS CARTS FOR TRANSPORTING AND HAULING OBJECTS; CASINGS FOR PNEUMATIC TIRES; CHASSIS FOR MOTOR VEHICLES; CHILD RESTRAINTS FOR VEHICLE SEATS; CHILD SAFETY HARNESES FOR VEHICLE SEATS; CHILDREN'S SAFETY SEATS FOR VEHICLES; CLUTCH LININGS FOR LAND VEHICLES; CLUTCHES FOR LAND VEHICLES; COACHWORK FOR MOTOR VEHICLES; COIN HOLDERS SPECIALLY ADAPTED FOR FITTING IN VEHICLES; COMBINATION CAMPING RECREATIONAL VEHICLE AND HORSE TRAILER; COMPUTER LAPTOP MOUNT SPECIALLY ADAPTED FOR USE IN VEHICLES; CONNECTING RODS FOR LAND VEHICLES OTHER THAN PARTS OF MOTORS AND ENGINES; CONVERTIBLE TOPS FOR VEHICLES; COVERS FOR BABY STROLLERS; COVERS FOR CHILDREN'S CAR SEATS; COVERS FOR VEHICLE STEERING WHEELS; CRANKCASES FOR COMPONENTS FOR MOTOR CARS (OTHER THAN FOR ENGINES); CUP HOLDERS FOR USE IN VEHICLES; CUSTOM LEATHER INTERIORS FOR VEHICLES; DIESEL ENGINES FOR LAND VEHICLES; DIESEL MOTORS FOR LAND VEHICLES; DIRECTIONAL SIGNALS FOR VEHICLES; DISC BRAKE PADS FOR VEHICLES; DOOR PANELS FOR LAND VEHICLES; GAS CAPS FOR LAND VEHICLES; GAS TANKS FOR LAND VEHICLES; GAS TANKS GROMMETS FOR LAND VEHICLES; GEAR CHANGING MECHANISMS FOR LAND AND WATER VEHICLES; GEAR LEVERS FOR BICYCLE WHEELS; GEAR WHEELS; GEARBOXES FOR LAND VEHICLES; GEARS FOR VEHICLES; GLASS WINDOWS FOR VEHICLES; GROUND EFFECT VEHICLES; GUN SHIELDS AS A STRUCTURAL PART OF A VEHICLE; GUNNER SHIELDS AS A STRUCTURAL PART OF A VEHICLE; HAND TRUCKS FOR TRANSPORTING AND POSITIONING FLAT-SHAPED OBJECTS SUCH AS ALL TYPES OF DOORS, PANELS, PARTITIONS, COUNTERTOPS, TABLE TOPS, SHEET GOODS, LADDERS, DISPLAYS, TRUSSES, GATES, FENCES; HANDLEBARS; HOLDER USED TO MOUNT A SURFBOARD TO A MOTORCYCLE; HOOD SHIELDS AS STRUCTURAL PARTS OF VEHICLES; HORNS FOR VEHICLES; HUB CAP COVERS; HUBS FOR VEHICLE WHEELS (MOTORCYCLES); HYDRAULIC CIRCUITS FOR VEHICLES; HYDRAULIC DISC BRAKES; HYDRAULIC RIM BRAKES; INNER TUBES; INTERNAL COMBUSTION ENGINES FOR LAND VEHICLES; LAND VEHICLE CONSOLE PARTS, NAMELY, WIRING HARNESES FOR CONTROL, MONITORING AND PROTECTION OF INDUSTRIAL GASOLINE AND DIESEL ENGINES; LAND VEHICLE ENGINE REBUILD KITS, SOLD AS A UNIT; LAND VEHICLE PARTS IN THE NATURE OF WIRE HARNESES, NAMELY, WIRES, TERMINALS AND CONNECTORS BUNDLED TOGETHER TO TRANSMIT ELECTRIC POWER AND SIGNALS TO ELECTRIC OR ELECTRONIC EQUIPMENT MOUNTED ON THE BODY PARTS OF AUTOMOBILES; LAND VEHICLE PARTS, NAMELY, AXLES; LAND VEHICLE PARTS, NAMELY, DIFFERENTIALS; LAND VEHICLE PARTS, NAMELY, DRIVE BELTS; LAND VEHICLE PARTS, NAMELY, DRIVE GEARS; LAND VEHICLE PARTS, NAMELY, FENDER FLARES; LAND VEHICLE PARTS, NAMELY, FENDERS; LAND VEHICLE PARTS, NAMELY, MUD GUARDS; LAND VEHICLE PARTS, NAMELY, RUNNING BOARDS; LAND VEHICLE PARTS, NAMELY, TIRE CHAINS; LAND VEHICLE PARTS, NAMELY, TIRE SNOW CHAINS; LAND VEHICLE

Reg. No. 4,099,556 PARTS, NAMELY, TRANSMISSIONS; LAND VEHICLE PARTS, NAMELY, WHEELS; LAND VEHICLE PARTS, NAMELY, WINDSHIELDS; LAND VEHICLE SUSPENSION PARTS, NAMELY, COIL SPRINGS; LAND VEHICLE SUSPENSION PARTS, NAMELY, EQUALIZERS; LAND VEHICLE SUSPENSION PARTS, NAMELY, LEAF SPRINGS; LAND VEHICLE SUSPENSION PARTS, NAMELY, TORSION/SWAY BARS; LAND VEHICLE TRANSMISSION REBUILD KITS, SOLD AS A UNIT; LAND VEHICLE TRANSMISSIONS AND REPLACEMENT PARTS THEREFOR; LAND VEHICLES; LAND VEHICLES AND STRUCTURAL PARTS THEREFOR; LANDING GEAR WHEELS; LIGHT TRUCK HARDWARE, NAMELY, MECHANISMS FOR ADAPTING RIGID LOAD BED COVERS TO THE REAR LIFT ACCESS OF TRUCKS; LUG NUTS FOR VEHICLE WHEELS; LUGGAGE CARRIERS FOR VEHICLES; LUGGAGE SPECIALLY ADAPTED FOR USE ON MOTORCYCLES; MAIN BRAKE CYLINDERS; MARINE VEHICLES, NAMELY, RUN-ABOUTS; MECHANICALLY ASSISTED SELF-CONTAINED INSERT DUMP UNITS INSTALLED IN PICK UP TRUCKS; METAL COVERS USED TO COVER AUTOMOTIVE SHOCK PARTS; METAL LOCKING DEVICE FOR TRAILER HITCH COUPLERS; METAL PARTS FOR VEHICLES, NAMELY, AUTOMOTIVE EXTERIOR AND INTERIOR METAL DECORATIVE AND PROTECTIVE TRIM; MOBILE STORAGE TANKS; MOTOR CAR DOORS; MOTOR HOMES AND STRUCTURAL VEHICLE PARTS THEREFOR; MOTOR SCOOTERS; MOTOR VEHICLE ALARM SYSTEMS; MOTOR VEHICLE BACK-UP BEEPERS; MOTOR VEHICLE POWER LOCKS; MOTOR VEHICLES, NAMELY, AUTOMOBILES, TRUCKS, VANS, SPORT UTILITY VEHICLES AND STRUCTURAL PARTS THEREFOR; MOTOR VEHICLES, NAMELY, CONCEPT MOTOR VEHICLES; MOTOR VEHICLES, NAMELY, CUSTOM HOT RODS; MOTOR VEHICLES, NAMELY, PASSENGER AUTOMOBILES, THEIR STRUCTURAL PARTS, TRIM AND BADGES; MOTORCYCLE ACCESSORIES, NAMELY, FRONT AND SIDE PLATES; MOTORCYCLE ACCESSORIES, NAMELY, GAS TANK AND RADIATOR SHROUDS; MOTORCYCLE AND AUTOMOBILE STRUCTURAL PARTS, NAMELY, SUMP GUARDS; MOTORCYCLE BAGS, NAMELY, TANK BAGS, SADDLE BAGS, Sissy BAR BAGS AND TAIL BAGS; MOTORCYCLE ENGINES; MOTORCYCLE GRIP TAPE; MOTORCYCLE KICKSTANDS; MOTORCYCLE PARTS, NAMELY, CHROMED SAFETY PADS; MOTORCYCLE PARTS, NAMELY, HEEL GUARDS; MOTORCYCLE SADDLEBAGS; MOTORCYCLE SIDECARS; MOTORCYCLE TRIKE CONVERSION KITS FOR CONVERTING A TWO-WHEELED MOTORCYCLE INTO A THREE-WHEELED MOTORCYCLE; MOTORCYCLES; MOTORCYCLES AND STRUCTURAL PARTS THEREFOR; MOTORCYCLES FOR MOTOCROSS; MOTORIZED PERSONAL MOBILITY SCOOTERS; MOTORIZED SCOOTERS; MOTORIZED VEHICLES, NAMELY, GO-CARTS; MOTORIZED VEHICLES, NAMELY, UNDERWATER DIVER PROPULSION VEHICLES; MOTORIZED, ELECTRIC-POWERED, SELF-PROPELLED, SELF-BALANCING, WHEELED PERSONAL MOBILITY TRANSPORTATION DEVICE; MOTORIZED, SELF-PROPELLED, WHEELED PERSONAL MOBILITY DEVICE, NAMELY, SCOOTERS; MOTORS AND ENGINES FOR LAND VEHICLES; MOTORS FOR AUTOMOBILES; MOTORS FOR LAND VEHICLES; MUD FLAP BRACKETS AS STRUCTURAL PARTS OF VEHICLES; MUD FLAPS FOR VEHICLES; MUDGUARDS; NON-MOTORIZED SCOOTERS; PETROL TANK CAPS FOR MOTOR CARS; PLASTIC PARTS FOR VEHICLES, NAMELY, AUTOMOTIVE EXTERIOR AND INTERIOR PLASTIC EXTRUDED DECORATIVE AND PROTECTIVE TRIM; PNEUMATIC TYRES AND INNER TUBES FOR MOTORCYCLES; POWER TRANSFER SEATS FOR VEHICLES TO PROVIDE EASIER INGRESS TO AND EGRESS FROM A VEHICLE FOR DISABLED OR MOBILITY IMPAIRED PEOPLE; POWERED WHEEL BARROWS; PUSH SCOOTERS; SCOOTERS; SEAT COVERS FOR VEHICLES; SECURITY DEVICES IN THE NATURE OF METAL OR STEEL PLATES FOR AUTOMOTIVE AFTERMARKET CAR AND TRUCK APPLICATIONS THAT ARE AFFIXED TO THE VEHICLE TO REINFORCE OR STRENGTHEN DOOR HANDLES, LATCHES AND LOCKS OR LOCK CYLINDERS; SEMI-FITTED COVERS FOR VEHICLES; SENSORS FOR LAND VEHICLES, NAMELY, ELECTRIC POWER STEERING TORQUE SENSORS, SOLD AS A COMPONENT OF THE POWER STEERING SYSTEM; SHOCK ABSORBING SPRINGS FOR MOTOR CARS; SIDE SHIELDS AS STRUCTURAL PARTS OF VEHICLES; TIRES FOR LAND VEHICLES; TIRES FOR VEHICLES; TORQUE CONVERTERS FOR LAND VEHICLES; TOW BARS FOR VEHICLES; TRAILER HITCH BALL COVERS; TRAILER HITCH COVERS; TRANSMISSION BELTS FOR LAND VEHICLES; TRANSMISSION CASES FOR LAND VEHICLES; TRANSMISSION CHAINS FOR LAND VEHICLES; TRANSMISSION MECHANISMS FOR LAND VEHICLES;

Reg. No. 4,099,556 TRANSMISSION MOUNTING PLATES FOR LAND VEHICLES; TRANSMISSION TOP COVERS FOR LAND VEHICLES; TRANSMISSIONS FOR LAND VEHICLES; TREAD USED TO RETREAD TIRES; TREADS FOR RETREADING TIRES FOR CIVIL ENGINEERING VEHICLES; TREADS FOR RETREADING TYRES FOR FORESTRY VEHICLES; TREADS FOR RETREADING TYRES FOR VEHICLES USED IN THE CIVIL ENGINEERING INDUSTRY; TRUCK AIR BRAKE HOSES; TUBULAR TIRES; TURN SIGNALS FOR VEHICLES; VALVE STEMS FOR VEHICLE TIRES; VALVES FOR VEHICLE TIRES; VEHICLE BODIES; VEHICLE CAMERA MOUNT; VEHICLE HOOD AND FENDER LOUVERS AND VENTS; VEHICLE HOODS; VEHICLE PARTS, NAMELY, BALL JOINTS; VEHICLE PARTS, NAMELY, CONSTANT VELOCITY JOINTS; VEHICLE PARTS, NAMELY, IDLER ARMS; VEHICLE PARTS, NAMELY, REARVIEW MIRRORS; VEHICLE PARTS, NAMELY, SHOCK ABSORBERS; VEHICLE PARTS, NAMELY, STEERING WHEELS; VEHICLE PARTS, NAMELY, SUN VISORS; VEHICLE PARTS, NAMELY, SUSPENSION STRUTS; VEHICLE PARTS, NAMELY, WINDSHIELD VISORS; VEHICLE PARTS, NAMELY, WINDSHIELD WIPERS; VEHICLE POWER TRAIN MECHANISM COMPRISED OF CLUTCH, TRANSMISSION, DRIVE SHAFT, AND DIFFERENTIAL; VEHICLE PROPELLERS; VEHICLE ROLL BARS; VEHICLE SEAT COVERS; VEHICLE SEAT PROTECTORS; VEHICLE SEATS; VEHICLE SIDE VIEW MIRROR COVER; VEHICLE TIRE DEFLATORS; VEHICLE TIRE VALVE STEM CAPS; VEHICLE TOW BARS; VEHICLE WHEEL RIMS; VEHICLE WHEEL RIMS AND STRUCTURAL PARTS THEREFOR; VEHICLE WHEELS; VEHICLE WINDOWS; VEHICLE-MOUNTED MOTOR VEHICLE CRASH ATTENUATORS; VEHICLES PARTS, NAMELY, FUEL FILLER PIPES BEING THE PIPE IN WHICH ONE PLACES A GASOLINE PUMP WHEN FUELING THE VEHICLE; VEHICLES, NAMELY, ELECTRONICALLY MOTORIZED SKATEBOARDS; VISCOUS GEL POLYMER SOLD AS A COMPONENT OF FINISHED CUSTOM CUSHIONED WHEEL CHAIR SEATS AND BACK CUSHIONS; WHEEL RIMS; WINDSCREEN WIPERS, IN CLASS 12 (U.S. CLS. 19, 21, 23, 31, 35 AND 44).

FIRST USE 6-28-2011; IN COMMERCE 6-28-2011.

THE MARK CONSISTS OF THE STYLIZED LETTERS "APOLO".

SN 77-939,429, FILED 2-18-2010.

WANDA KAY PRICE, EXAMINING ATTORNEY

United States of America

United States Patent and Trademark Office

NIGHT RESTORE & RECOVER COMPLEX

Reg. No. 4,099,557

MARY KAY INC. (DELAWARE CORPORATION)
16251 DALLAS PARKWAY
ADDISON, TX 75001

Registered Feb. 14, 2012

Int. Cl.: 3

FOR: COSMETICS; NON-MEDICATED SKIN CARE PREPARATIONS; SKIN CREAMS, IN CLASS 3 (U.S. CLS. 1, 4, 6, 50, 51 AND 52).

TRADEMARK

FIRST USE 8-15-2011; IN COMMERCE 8-15-2011.

PRINCIPAL REGISTER

THE MARK CONSISTS OF STANDARD CHARACTERS WITHOUT CLAIM TO ANY PARTICULAR FONT, STYLE, SIZE, OR COLOR.

NO CLAIM IS MADE TO THE EXCLUSIVE RIGHT TO USE "NIGHT RESTORE" AND "COMPLEX", APART FROM THE MARK AS SHOWN.

SN 77-942,308, FILED 2-23-2010.

KRISTIN DAHLING, EXAMINING ATTORNEY



David J. Kyffers

Director of the United States Patent and Trademark Office

United States of America

United States Patent and Trademark Office

my
SPRYCEL
(dasatinib) **support**



Reg. No. 4,099,558

BRISTOL-MYERS SQUIBB COMPANY (DELAWARE CORPORATION)
345 PARK AVENUE
NEW YORK, NY 10154

Registered Feb. 14, 2012

Int. Cls.: 16, 35, 44, and 45

FOR: PRINTED MATTER, NAMELY, BOOKLETS, BROCHURES, PAMPHLETS AND NEWSLETTERS ON THE SUBJECT OF CANCER, IN CLASS 16 (U.S. CLS. 2, 5, 22, 23, 29, 37, 38 AND 50).

TRADEMARK

FIRST USE 3-9-2010; IN COMMERCE 3-9-2010.

SERVICE MARK

FOR: ADMINISTRATION OF PATIENT REIMBURSEMENT PROGRAMS, IN CLASS 35 (U.S. CLS. 100, 101 AND 102).

PRINCIPAL REGISTER

FIRST USE 3-9-2010; IN COMMERCE 3-9-2010.

FOR: CHARITABLE SERVICES, NAMELY, PATIENT ASSISTANCE PROGRAM TO PROVIDE DRUGS AT A REDUCED COST TO LOW-INCOME PATIENTS WITHOUT PRESCRIPTION DRUG COVERAGE OR HEALTH INSURANCE COVERAGE, IN CLASS 44 (U.S. CLS. 100 AND 101).

FIRST USE 3-9-2010; IN COMMERCE 3-9-2010.

FOR: PROVIDING PERSONAL SUPPORT SERVICES FOR PATIENTS AND FAMILIES OF PATIENTS WITH CANCER, NAMELY, EMOTIONAL COUNSELING AND EMOTIONAL SUPPORT, COMPANIONSHIP, HELP WITH MEDICAL FORMS, IN CLASS 45 (U.S. CLS. 100 AND 101).

FIRST USE 3-9-2010; IN COMMERCE 3-9-2010.

OWNER OF U.S. REG. NOS. 3,114,787 AND 3,357,619.

NO CLAIM IS MADE TO THE EXCLUSIVE RIGHT TO USE "SUPPORT" AND "DASATINIB", APART FROM THE MARK AS SHOWN.

THE MARK CONSISTS OF THE WORD "MY SPRYCEL (DASATINIB) SUPPORT" AND A REPRESENTATION OF A STYLIZED TREE AND A HUMAN FIGURE.



David J. Kybas

Director of the United States Patent and Trademark Office

Reg. No. 4,099,558 SN 77-942,400, FILED 2-23-2010.

SUSAN STIGLITZ, EXAMINING ATTORNEY

United States of America

United States Patent and Trademark Office

UNAPOLOGETICALLY TEXAN

Reg. No. 4,099,559

SAN ANTONIO GOLF ASSOCIATION, INC. (TEXAS NON-PROFIT CORPORATION)
P.O. BOX 690330

Registered Feb. 14, 2012

SAN ANTONIO, TX 78269

Int. Cl.: 25

FOR: CLOTHING, NAMELY, SHIRTS AND HATS, IN CLASS 25 (U.S. CLS. 22 AND 39).

TRADEMARK

FIRST USE 3-1-2011; IN COMMERCE 3-1-2011.

PRINCIPAL REGISTER

THE MARK CONSISTS OF STANDARD CHARACTERS WITHOUT CLAIM TO ANY PARTICULAR FONT, STYLE, SIZE, OR COLOR.

SN 77-942,513, FILED 2-23-2010.

TARA PATE, EXAMINING ATTORNEY



David J. Kyffers

Director of the United States Patent and Trademark Office

United States of America

United States Patent and Trademark Office

CASHOPOLIS

Reg. No. 4,099,560

Registered Feb. 14, 2012

Int. Cls.: 9 and 41

TRADEMARK

SERVICE MARK

PRINCIPAL REGISTER

WATERLEAF LIMITED (ISLE OF MAN CORPORATION)
TOP FLOOR, 14 ATHOL STREET
DOUGLAS, ISLE OF MAN IM11JA

FOR: DOWNLOADABLE GAMING SOFTWARE USED FOR THE OPERATION OF GAMES OF CHANCE, GAMES OF SKILL AND CASINO STYLE GAMES IN LAND BASED CASINOS; GAMING MACHINES FOR LAND BASED CASINO GAMES, IN CLASS 9 (U.S. CLS. 21, 23, 26, 36 AND 38).

FIRST USE 1-12-2011; IN COMMERCE 1-12-2011.

FOR: ENTERTAINMENT SERVICES, NAMELY, PROVIDING GAMES OF CHANCE, GAMES OF SKILL AND CASINO STYLE GAMES IN LAND BASED CASINOS, IN CLASS 41 (U.S. CLS. 100, 101 AND 107).

FIRST USE 1-12-2011; IN COMMERCE 1-12-2011.

THE MARK CONSISTS OF STANDARD CHARACTERS WITHOUT CLAIM TO ANY PARTICULAR FONT, STYLE, SIZE, OR COLOR.

SN 77-942,941, FILED 2-23-2010.

ELLEN B. AWRICH, EXAMINING ATTORNEY



David J. Kyfos

Director of the United States Patent and Trademark Office

United States of America

United States Patent and Trademark Office

ASSURANT. EN SUS TÉRMINOS.

Reg. No. 4,099,561

Registered Feb. 14, 2012

Int. Cls.: 35 and 36

SERVICE MARK

PRINCIPAL REGISTER

ASSURANT, INC. (DELAWARE CORPORATION)
41ST FLOOR, ONE CHASE MANHATTAN PLAZA
NEW YORK, NY 10005

FOR: BUSINESS MANAGEMENT, CONSULTING, ADMINISTRATION, AND MARKETING SERVICES FOR OTHERS, NAMELY, FOR FINANCIAL INSTITUTIONS, AUTOMOBILE DEALERS, RETAILERS AND OTHER VENDORS OF CONSUMER AND COMMERCIAL GOODS AND SERVICES, AND FOR MANUFACTURED HOUSING VENDORS; BUSINESS MANAGEMENT FOR OTHERS, NAMELY, INSURANCE COMPANIES AND REINSURANCE COMPANIES; ADVERTISING, TELEMARKETING, SALES VOLUME TRACKING, CUSTOMER SERVICE IN THE FIELD OF INSURANCE, BUSINESS ADMINISTRATION FOR OTHERS IN THE FIELD OF INSURANCE; ADMINISTRATION OF EMERGENCY TRAVEL AND CAR RENTAL REIMBURSEMENT PROGRAMS, IN CLASS 35 (U.S. CLS. 100, 101 AND 102).

FIRST USE 5-27-2011; IN COMMERCE 5-27-2011.

FOR: INSURANCE UNDERWRITING SERVICES IN THE FIELDS OF PROPERTY, TRADITIONAL AND MANUFACTURED HOUSING HOMEOWNER'S, RENTER'S, SINGLE INTEREST, FLOOD, DISASTER AND HAZARD, CREDITOR PLACED INSURANCE, CASUALTY, HEALTH, LIFE, FUNERAL NEEDS COVERAGE, DENTAL, DISABILITY, ACCIDENTAL DEATH, DISMEMBERMENT, INVOLUNTARY UNEMPLOYMENT, CONTRACTUAL LIABILITY, SURETY, CREDIT, MORTGAGE LOAN PROTECTION, AND CREDITOR PAID INSURANCE; REINSURANCE UNDERWRITING AND REINSURANCE MANAGEMENT SERVICES FOR DISABILITY AND OTHER INSURANCE POLICIES; CREATION AND ADMINISTRATION OF PREFERRED PROVIDER, PREPAID AND DISCOUNT HEALTHCARE PLANS; ADMINISTRATION OF INSURANCE-BASED SELF-FUNDED GROUP BENEFIT PLANS; DISABILITY CLAIM ADMINISTRATION IN THE NATURE OF PROCESSING AND PAYMENT SERVICES; ADMINISTRATION OF EXTENDED WARRANTY CONTRACTS AND REPAIR AND REPLACEMENT CONTRACTS IN THE FIELDS OF CONSUMER APPLIANCES, ELECTRONICS, COMPUTERS, WIRELESS AND OTHER COMMUNICATION DEVICES, TIRES, FURNITURE, JEWELRY, MOTOR VEHICLES, NON-MOTORIZED VEHICLES, AND OTHER CONSUMER AND COMMERCIAL PRODUCTS; INSURANCE TRACKING SERVICES FOR LOAN COLLATERAL; INSURANCE ADMINISTRATION IN THE FIELD OF DEBT PROTECTION ADMINISTRATION AND SUPPLEMENTAL DEBT, IN CLASS 36 (U.S. CLS. 100, 101 AND 102).

FIRST USE 5-27-2011; IN COMMERCE 5-27-2011.



David J. Kyffers

Director of the United States Patent and Trademark Office

Reg. No. 4,099,561 THE MARK CONSISTS OF STANDARD CHARACTERS WITHOUT CLAIM TO ANY PARTICULAR FONT, STYLE, SIZE, OR COLOR.

OWNER OF U.S. REG. NOS. 2,543,367, 3,632,777, AND OTHERS.

THE ENGLISH TRANSLATION OF THE WORDS "EN SUS TÉRMINOS" IN THE MARK IS ON YOUR TERMS.

SN 77-943,700, FILED 2-24-2010.

STEVEN PEREZ, EXAMINING ATTORNEY

United States of America

United States Patent and Trademark Office

Fidelithon Systems

Reg. No. 4,099,562

Registered Feb. 14, 2012

Int. Cl.: 9

TRADEMARK

PRINCIPAL REGISTER

FIDELITHON SYSTEMS, LLC (CALIFORNIA LIMITED LIABILITY COMPANY)
111. N. MARKET STREET
SUITE 300
SAN JOSE, CA 95113

FOR: MOBILE DEVICE SOFTWARE, NAMELY, AN APPLICATION ALLOWING USERS TO UPDATE, RECEIVE AND SHARE DATA STORED IN A COMPUTER IN REAL TIME, USING A MOBILE DEVICE, WITH INTEGRATION WITH THE TELEPHONE AND/OR SOFTWARE FEATURES OF THE MOBILE DEVICE; DOWNLOADABLE SOFTWARE IN THE NATURE OF A MOBILE APPLICATION FOR DATA STORAGE, SHARING AND DEVICE TRACKING, IN CLASS 9 (U.S. CLS. 21, 23, 26, 36 AND 38).

FIRST USE 11-15-2010; IN COMMERCE 11-15-2010.

THE MARK CONSISTS OF STANDARD CHARACTERS WITHOUT CLAIM TO ANY PARTICULAR FONT, STYLE, SIZE, OR COLOR.

NO CLAIM IS MADE TO THE EXCLUSIVE RIGHT TO USE "SYSTEMS", APART FROM THE MARK AS SHOWN.

SN 77-943,737, FILED 2-24-2010.

LAURIE MAYES, EXAMINING ATTORNEY



David J. Kybas

Director of the United States Patent and Trademark Office

United States of America

United States Patent and Trademark Office

VITA PERK

Reg. No. 4,099,563

BELCHINSKY, JEREMY S. (UNITED STATES INDIVIDUAL)
10125 VERNON

Registered Feb. 14, 2012

HUNTINGTON WOODS, MI 48070

Int. Cl.: 5

FOR: NATURAL VITAMIN AND MINERAL SUPPLEMENT ADDITIVE FOR BEVERAGES INCLUDING COFFEE, IN CLASS 5 (U.S. CLS. 6, 18, 44, 46, 51 AND 52).

TRADEMARK

FIRST USE 4-15-2011; IN COMMERCE 4-15-2011.

PRINCIPAL REGISTER

THE MARK CONSISTS OF STANDARD CHARACTERS WITHOUT CLAIM TO ANY PARTICULAR FONT, STYLE, SIZE, OR COLOR.

SN 77-944,646, FILED 2-25-2010.

JASON BLAIR, EXAMINING ATTORNEY



David J. Kybas

Director of the United States Patent and Trademark Office

United States of America

United States Patent and Trademark Office



Reg. No. 4,099,564

Registered Feb. 14, 2012

Int. Cl.: 41

SERVICE MARK

PRINCIPAL REGISTER

SALISH KOOTENAI COLLEGE, INC. (MONTANA CORPORATION)
58138 US HWY 93
PABLO, MT 59855

FOR: ENTERTAINMENT SERVICES, NAMELY, ORGANIZING COLLEGE TEAM AND INDIVIDUAL SPORTS GAMES AND EXHIBITIONS; PROVIDING NEWS AND INFORMATION IN THE FIELD OF SPORTS, IN CLASS 41 (U.S. CLS. 100, 101 AND 107).

FIRST USE 1-0-2010; IN COMMERCE 2-9-2010.

THE MARK CONSISTS OF A BISON.

SN 77-945,184, FILED 2-25-2010.

ZACHARY BELLO, EXAMINING ATTORNEY



David J. Kyffers

Director of the United States Patent and Trademark Office

United States of America

United States Patent and Trademark Office

IBLEED

Reg. No. 4,099,565

Registered Feb. 14, 2012

Int. Cl.: 25

TRADEMARK

PRINCIPAL REGISTER

MARLER, DYKE LLEWYNN (UNITED STATES INDIVIDUAL), DBA IBLEED-SPORTS
APPAREL,
2820 HWY 20 E
MCDONOUGH, GA 30252

FOR: SHORT-SLEEVED OR LONG-SLEEVED T-SHIRTS, IN CLASS 25 (U.S. CLS. 22 AND 39).

FIRST USE 11-13-2010; IN COMMERCE 11-13-2010.

THE MARK CONSISTS OF STANDARD CHARACTERS WITHOUT CLAIM TO ANY PARTICULAR FONT, STYLE, SIZE, OR COLOR.

SN 77-952,640, FILED 3-7-2010.

MARY CRAWFORD, EXAMINING ATTORNEY



David J. Kybas

Director of the United States Patent and Trademark Office

United States of America
United States Patent and Trademark Office

Koheala

— A M E R I C A N —
康 琪 菜

Reg. No. 4,099,566

Registered Feb. 14, 2012

Int. Cl.: 3

TRADEMARK

PRINCIPAL REGISTER

SALIAI INTERNATIONAL HOLDING LIMITED (HONG KONG CORPORATION)
NO.C,16F.,CHINAWEAL CENTRE
414-424 JAFFE ROAD,
WANCHAI, HONG KONG

FOR: ADHESIVES FOR COSMETIC USE; ALOE VERA GEL FOR COSMETIC PURPOSES; ASTRINGENTS FOR COSMETIC PURPOSES; BEAUTY MASKS; BLEACHING PREPARATIONS FOR COSMETIC PURPOSES; BODY AND BEAUTY CARE COSMETICS; CAKES OF TOILET SOAP; CHALK FOR COSMETIC USE; CLEANER FOR COSMETIC BRUSHES; CLEANSING MILK; CLEANSING MILK FOR TOILET PURPOSES; COCOA BUTTER FOR COSMETIC PURPOSES; COLORING PREPARATIONS FOR COSMETIC PURPOSES; COMPACTS CONTAINING MAKE-UP; COSMETIC BALLS; COSMETIC CREAMS; COSMETIC MILKS; COSMETIC OILS; COSMETIC PENCILS; COSMETIC PREPARATIONS; COSMETIC PREPARATIONS FOR SLIMMING PURPOSES; COSMETICS AND MAKE-UP; DENTIFRICE; ESSENTIAL OILS; EYEBROW PENCILS; EYES MAKE-UP; FACIAL CLEANSING MILK; FACIAL MAKE-UP; FOUNDATION MAKE-UP; HAIR CARE LOTIONS; HAIR LOTIONS; LIPSTICK; MAKE-UP; MAKE-UP PREPARATIONS; MAKE-UP REMOVING LOTIONS; MAKE-UP REMOVING MILKS; MOUTH WASHES; PERFUMERIES; SKIN CLEANSING CREAM; SKIN CLEANSING LOTION; SUNSCREEN CREAMS, IN CLASS 3 (U.S. CLS. 1, 4, 6, 50, 51 AND 52).

FIRST USE 3-8-2010; IN COMMERCE 7-15-2010.

NO CLAIM IS MADE TO THE EXCLUSIVE RIGHT TO USE "AMERICAN", APART FROM THE MARK AS SHOWN.

THE NON-LATIN CHARACTERS IN THE MARK TRANSLITERATE TO "KANG QI LAI" AND THIS HAS NO MEANING IN A FOREIGN LANGUAGE.

THE MARK CONSISTS OF "KOHEALA AMERICAN" AND THREE CHINESE CHARACTERS.

THE WORDING "KOHEALA" HAS NO MEANING IN A FOREIGN LANGUAGE.

SN 77-952,721, FILED 3-8-2010.

KELLEY WELLS, EXAMINING ATTORNEY



David J. Kelley

Director of the United States Patent and Trademark Office

United States of America

United States Patent and Trademark Office

THE BEST REMEDY FOR WORKERS COMPENSATION

Reg. No. 4,099,567

WEST BEND MUTUAL INSURANCE COMPANY (WISCONSIN CORPORATION)
1900 SOUTH 18TH AVENUE
WEST BEND, WI 53095

Registered Feb. 14, 2012

Int. Cl.: 36

FOR: INSURANCE SERVICES, NAMELY, WRITING WORKERS COMPENSATION INSURANCE, IN CLASS 36 (U.S. CLS. 100, 101 AND 102).

SERVICE MARK

FIRST USE 3-10-2010; IN COMMERCE 3-10-2010.

PRINCIPAL REGISTER

THE MARK CONSISTS OF STANDARD CHARACTERS WITHOUT CLAIM TO ANY PARTICULAR FONT, STYLE, SIZE, OR COLOR.

NO CLAIM IS MADE TO THE EXCLUSIVE RIGHT TO USE "WORKERS COMPENSATION", APART FROM THE MARK AS SHOWN.

SN 77-953,474, FILED 3-8-2010.

BRIAN NEVILLE, EXAMINING ATTORNEY



David J. Kybas

Director of the United States Patent and Trademark Office

United States of America

United States Patent and Trademark Office

PREDICTABLE SUPPLY NETWORK

Reg. No. 4,099,568

Registered Feb. 14, 2012

Int. Cls.: 35 and 42

SERVICE MARK

PRINCIPAL REGISTER

TRACELINK, INC. (DELAWARE CORPORATION)
300 TRADECENTER 128
SUITE 3680
WOBURN, MA 01801

FOR: BUSINESS SERVICES, NAMELY, PROVIDING BUSINESS PROCESS INTEGRATION AND BUSINESS PROJECT PLANNING SERVICES IN THE FIELD OF MANUFACTURING AND SUPPLY CHAIN MANAGEMENT, IN CLASS 35 (U.S. CLS. 100, 101 AND 102).

FIRST USE 8-11-2010; IN COMMERCE 8-11-2010.

FOR: COMPUTER SERVICES, NAMELY, HOSTING AN ONLINE WEBSITE THAT ENABLES MANUFACTURERS, SUPPLIERS, BUSINESS PARTNERS AND CUSTOMERS TO INTEGRATE COMPUTER SYSTEMS, SHARE INFORMATION AND EXECUTE MANUFACTURING AND SUPPLY CHAIN MANAGEMENT PROCESSES; TECHNICAL SERVICES, NAMELY, PROVIDING COMPUTER SYSTEMS INTEGRATION SERVICES AND MANAGEMENT OF INFORMATION TECHNOLOGY SYSTEMS , IN CLASS 42 (U.S. CLS. 100 AND 101).

FIRST USE 8-11-2010; IN COMMERCE 8-11-2010.

THE MARK CONSISTS OF STANDARD CHARACTERS WITHOUT CLAIM TO ANY PARTICULAR FONT, STYLE, SIZE, OR COLOR.

NO CLAIM IS MADE TO THE EXCLUSIVE RIGHT TO USE "SUPPLY NETWORK", APART FROM THE MARK AS SHOWN.

SN 77-953,954, FILED 3-9-2010.

WANDA KAY PRICE, EXAMINING ATTORNEY



David J. Kyros

Director of the United States Patent and Trademark Office

United States of America

United States Patent and Trademark Office

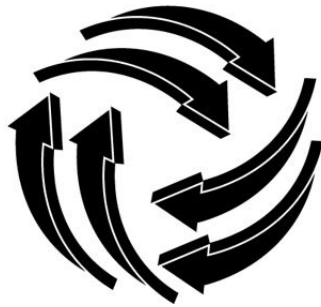

tracelink

Reg. No. 4,099,569

Registered Feb. 14, 2012

**Int. Cls.: 35, 38, 40, 41,
and 42**

SERVICE MARK

PRINCIPAL REGISTER

TRACELINK, INC. (DELAWARE CORPORATION)
300 TRADECENTER 128
SUITE 3680
WOBURN, MA 01801

FOR: BUSINESS SERVICES, NAMELY, PROVIDING ONLINE INFORMATION AND A WEBSITE FOR BUSINESS AND TECHNICAL PLANNING IN THE FIELD OF SUPPLY CHAIN MANAGEMENT; PROJECT PLANNING AND PROJECT MANAGEMENT FOR BUSINESS PURPOSES, IN CLASS 35 (U.S. CLS. 100, 101 AND 102).

FIRST USE 8-19-2009; IN COMMERCE 8-19-2009.

FOR: PROVIDING ONLINE FORUMS FOR THE TRANSMISSION OF MESSAGES AMONG COMPUTER USERS CONCERNING THE SUBJECTS OF MANUFACTURING, CONTRACT MANUFACTURING, SUPPLY CHAIN, AND SUPPLY CHAIN MANAGEMENT, IN CLASS 38 (U.S. CLS. 100, 101 AND 104).

FIRST USE 8-19-2009; IN COMMERCE 8-19-2009.

FOR: BUSINESS SERVICES, NAMELY, PROVIDING ONLINE INFORMATION AND A WEBSITE FOR BUSINESS AND TECHNICAL PLANNING IN THE FIELDS OF MANUFACTURING AND CONTRACT MANUFACTURING, IN CLASS 40 (U.S. CLS. 100, 103 AND 106).

FIRST USE 8-19-2011; IN COMMERCE 8-19-2011.

FOR: EDUCATION SERVICES, NAMELY, PROVIDING CLASSES, SEMINARS AND TRAINING IN THE FIELDS OF MANUFACTURING, CONTRACT MANUFACTURING, SUPPLY CHAIN AND SUPPLY MANAGEMENT WITH RESPECT TO BUSINESS PROCESS ALIGNMENT, BUSINESS CASE ANALYSIS AND PROGRAM PRIORITIZATION, IN CLASS 41 (U.S. CLS. 100, 101 AND 107).

FIRST USE 8-19-2011; IN COMMERCE 8-19-2011.

FOR: COMPUTER SERVICES, NAMELY, PROVIDING TEMPORARY USE OF ONLINE, NON-DOWNLOADABLE SOFTWARE FOR USE IN MANUFACTURING AND SUPPLY CHAIN MANAGEMENT; TECHNICAL SERVICES, NAMELY, PROVIDING COMPUTER SYSTEMS INTEGRATION SERVICES, COMPUTER PROJECT PLANNING, INFORMATION



David J. Kybas

Director of the United States Patent and Trademark Office

Reg. No. 4,099,569 SHARING AND COMPUTER PROJECT MANAGEMENT SERVICES IN THE FIELDS OF MANUFACTURING, CONTRACT MANUFACTURING, SUPPLY CHAIN AND SUPPLY MANAGEMENT , IN CLASS 42 (U.S. CLS. 100 AND 101).

FIRST USE 8-19-2011; IN COMMERCE 8-19-2011.

THE MARK CONSISTS OF THREE PAIRS OF STYLIZED ARROWS INDICATING CLOCK-WISE MOVEMENT IN A CIRCLE, AND THE STYLIZED WORD "TRACELINK" TO THE RIGHT.

SN 77-954,462, FILED 3-9-2010.

WANDA KAY PRICE, EXAMINING ATTORNEY

United States of America

United States Patent and Trademark Office

FROG 911

Reg. No. 4,099,570

Registered Feb. 14, 2012

**Int. Cls.: 9, 16, 20, 25,
and 42**

TRADEMARK

SERVICE MARK

PRINCIPAL REGISTER

FROG 911, LLC (DELAWARE LIMITED LIABILITY COMPANY)
211 SUN MEADOW DRIVE
GREER, SC 29650

FOR: REFLECTIVE AND ILLUMINATED CLOTHING FOR SAFETY PURPOSES; SAFETY PRODUCTS, NAMELY, REFLECTIVE PATCHES TO BE WORN ON CLOTHING; SAFETY AND IDENTIFICATION MARKINGS FOR FIRE EXTINGUISHING APPARATUS AND EMERGENCY RESPONDER APPARATUS, NAMELY, LUMINOUS SIGNS, LABELS CARRYING MAGNETICALLY, OPTICALLY, OR ELECTRONICALLY RECORDED OR ENCODED INFORMATION, SAFETY MARKERS AND GRAPHICS CARDS; SAFETY ATTIRE FOR POLICE, FIREFIGHTERS, EMERGENCY RESPONDERS, PUBLIC SAFETY AND GOVERNMENTAL PERSONNEL, NAMELY, REFLECTIVE AND ILLUMINATED CLOTHING FOR SAFETY PURPOSES, PROTECTIVE CLOTHING AND HEADGEAR, IN CLASS 9 (U.S. CLS. 21, 23, 26, 36 AND 38).

FIRST USE 5-26-2009; IN COMMERCE 5-26-2009.

FOR: SAFETY AND IDENTIFICATION MARKINGS FOR FIRE EXTINGUISHING APPARATUS AND EMERGENCY RESPONDER APPARATUS, NAMELY, PAPER AND PAPER, ADHESIVE-BACKED AND IRON-ON TRANSFERS, PAPER AND ADHESIVE-BACKED LABELS AND PRINTED VISUALS IN THE NATURE OF GRAPHICS; GRAPHIC APPLICATIONS FOR VEHICLES, BANNERS AND SIGNS, NAMELY, PLASTIC STICKERS, PAPER AND ADHESIVE-BACKED LABELS, PAPER, PLASTIC, ADHESIVE-BACKED, AND IRON-ON TRANSFERS, DECALS AND APPLIQUÉS IN THE FORM OF DECALS; AND PAPER STICKERS, PAPER AND ADHESIVE-BACKED LABELS, PAPER, PLASTIC, ADHESIVE-BACKED, AND IRON-ON TRANSFERS, DECALS AND APPLIQUÉS IN THE FORM OF DECALS; PAPER BANNERS; PRINTED PAPER SIGNS; PRINTED MATERIAL IN THE NATURE OF DECALS, PRINTED GRAPHIC APPLIQUÉS IN THE FORM OF STICKERS, PAPER AND ADHESIVE-BACKED LABELS, PAPER, PLASTIC, ADHESIVE-BACKED AND IRON-ON TRANSFERS AND DECALS FOR VEHICLES; ADHESIVE-BACKED PAPER SIGNS AND GRAPHICS IN THE FORM OF STICKERS, PAPER LABELS, PAPER, PLASTIC, ADHESIVE-BACKED AND IRON-ON TRANSFERS AND DECALS FOR VEHICLES, APPLIQUÉS IN THE FORM OF DECALS; DECALS; PRINTED ADVERTISING AND PROMOTIONAL ITEMS, NAMELY, STICKERS, PAPER AND ADHESIVE-BACKED LABELS, PAPER, PLASTIC, ADHESIVE-BACKED AND IRON-ON TRANSFERS AND DECALS, STICKERS FOR HELMETS, IN CLASS 16 (U.S. CLS. 2, 5, 22, 23, 29, 37, 38 AND 50).



David J. Kyjars

Director of the United States Patent and Trademark Office

Reg. No. 4,099,570 FIRST USE 4-4-2009; IN COMMERCE 4-4-2009.

FOR: SAFETY AND IDENTIFICATION MARKINGS FOR FIRE EXTINGUISHING APPARATUS AND EMERGENCY RESPONDER APPARATUS, NAMELY, PLASTIC SIGNS AND PLASTIC LABELS; GRAPHIC APPLICATIONS FOR VEHICLES, BANNERS, AND SIGNS, NAMELY, PLASTIC LABELS; PLASTIC LABELS; PRINTED GRAPHIC APPLIQUÉS IN THE FORM OF PLASTIC LABELS FOR VEHICLES; PRINTED ADVERTISING AND PROMOTIONAL ITEMS, NAMELY, PLASTIC LABELS FOR HELMETS, IN CLASS 20 (U.S. CLS. 2, 13, 22, 25, 32 AND 50).

FIRST USE 4-14-2009; IN COMMERCE 4-14-2009.

FOR: GOLF SHIRTS, HATS, SHIRTS, T-SHIRTS, ATHLETIC APPAREL, NAMELY, SHIRTS, PANTS, JACKETS, FOOTWEAR, HATS AND CAPS, IN CLASS 25 (U.S. CLS. 22 AND 39).

FIRST USE 6-12-2009; IN COMMERCE 6-12-2009.

FOR: CUSTOM DESIGN OF VEHICLE GRAPHICS, SAFETY RELATED ITEMS, NAMELY, REFLECTIVE AND ILLUMINATED CLOTHING FOR SAFETY PURPOSES, SAFETY PRODUCTS, NAMELY, REFLECTIVE PATCHES TO BE WORN ON CLOTHING, SAFETY AND IDENTIFICATION MARKINGS FOR FIRE EXTINGUISHING APPARATUS AND EMERGENCY RESPONDER APPARATUS, NAMELY, SIGNS, TRANSFERS LABELS, SAFETY MARKERS AND GRAPHICS, PROTECTIVE HELMETS, SAFETY ATTIRE FOR POLICE, FIREFIGHTERS, EMERGENCY RESPONDERS, PUBLIC SAFETY AND GOVERNMENTAL PERSONNEL, NAMELY, REFLECTIVE AND ILLUMINATED CLOTHING FOR SAFETY PURPOSES, PROTECTIVE CLOTHING AND HEADGEAR, GRAPHIC APPLICATIONS FOR VEHICLES, BANNERS, AND SIGNS, NAMELY, PLASTIC STICKERS, LABELS, TRANSFERS, DECALS AND APPLIQUÉS, AND PAPER STICKERS, LABELS, TRANSFERS, DECALS AND APPLIQUÉS, PAPER BANNERS, PRINTED PAPER SIGNS, PRINTED MATERIAL IN THE NATURE OF DECALS, PRINTED GRAPHIC APPLIQUÉS IN THE FORM OF STICKERS, LABELS, TRANSFERS, AND DECALS FOR VEHICLES, ADHESIVE-BACKED PAPER AND PLASTIC SIGNS AND GRAPHICS IN THE FORM OF STICKERS, LABELS, TRANSFERS, AND DECALS FOR VEHICLES, APPLIQUÉS IN THE FORM OF DECALS, DECALS, PRINTED ADVERTISING AND PROMOTIONAL ITEMS, NAMELY, STICKERS, LABELS, TRANSFERS, AND DECALS, STICKERS FOR HELMETS, VISORS, COATS, GOLF SHIRTS, HATS, JACKETS, PANTS, SHIRTS, SHOES, SUSPENDERS, SWEAT PANTS, SWEAT SHIRTS, SWEAT SUITS, SWEATERS, T-SHIRTS, VESTS, ATHLETIC APPAREL, NAMELY, SHIRTS, PANTS, JACKETS, FOOTWEAR, HATS AND CAPS, ATHLETIC UNIFORMS, BOOTS, BELTS, AND UNIFORMS AND LAW ENFORCEMENT, FIRE DEPARTMENT, PUBLIC SAFETY AND GOVERNMENTAL SERVICES RELATED MATERIALS IN THE NATURE OF REFLECTIVE AND ILLUMINATED CLOTHING FOR SAFETY PURPOSES BASED ON SELECTIONS MADE BY THE CUSTOMER AND INPUT PROVIDED BY THE CUSTOMER, IN CLASS 42 (U.S. CLS. 100 AND 101).

FIRST USE 4-4-2009; IN COMMERCE 4-4-2009.

THE MARK CONSISTS OF STANDARD CHARACTERS WITHOUT CLAIM TO ANY PARTICULAR FONT, STYLE, SIZE, OR COLOR.

NO CLAIM IS MADE TO THE EXCLUSIVE RIGHT TO USE "911", APART FROM THE MARK AS SHOWN.

SN 77-955,354, FILED 3-10-2010.

TINA BROWN, EXAMINING ATTORNEY

United States of America

United States Patent and Trademark Office

AgainstDaGrain

Reg. No. 4,099,571

REYES, DANNY (UNITED STATES INDIVIDUAL)
1 WINTHROP COURT
TENAFLY, NJ 07670

Registered Feb. 14, 2012

Int. Cls.: 41, 43, and 44

FOR: ENTERTAINMENT SERVICES IN THE NATURE OF DEVELOPMENT, CREATION, PRODUCTION AND POST-PRODUCTION SERVICES OF MULTIMEDIA ENTERTAINMENT CONTENT, IN CLASS 41 (U.S. CLS. 100, 101 AND 107).

SERVICE MARK

FIRST USE 8-30-2002; IN COMMERCE 8-30-2003.

PRINCIPAL REGISTER

FOR: RESTAURANT, IN CLASS 43 (U.S. CLS. 100 AND 101).

FIRST USE 6-1-2006; IN COMMERCE 6-1-2006.

FOR: BARBERSHOPS, IN CLASS 44 (U.S. CLS. 100 AND 101).

FIRST USE 8-30-2002; IN COMMERCE 8-30-2003.

THE MARK CONSISTS OF STANDARD CHARACTERS WITHOUT CLAIM TO ANY PARTICULAR FONT, STYLE, SIZE, OR COLOR.

SN 77-955,974, FILED 3-10-2010.

HEATHER THOMPSON, EXAMINING ATTORNEY



David J. Kyffers

Director of the United States Patent and Trademark Office

United States of America

United States Patent and Trademark Office

\$LOTCAR

Reg. No. 4,099,572

Registered Feb. 14, 2012

Int. Cl.: 9

TRADEMARK

PRINCIPAL REGISTER

DAVID BARCELOU (UNITED STATES INDIVIDUAL)
246 DANIEL WEBSTER HIGHWAY
SUITE 211
MERRIMACK, NH 03054

FOR: COMPUTERIZED GAMING EQUIPMENT, NAMELY, VIRTUAL REALITY AUTOMOTIVE RACING SIMULATORS CONNECTED TO AN INTERACTIVE NETWORK THAT ACCOMMODATE AUTOMATED MONETARY TRANSACTIONS SUCH AS THE PAYMENT OF ENTRY FEES AND THE DISBURSEMENT OF WINNINGS TO SUCCESSFUL PLAYERS OF A GAME-OF-SKILL, IN CLASS 9 (U.S. CLS. 21, 23, 26, 36 AND 38).

FIRST USE 9-28-2011; IN COMMERCE 9-28-2011.

THE MARK CONSISTS OF STANDARD CHARACTERS WITHOUT CLAIM TO ANY PARTICULAR FONT, STYLE, SIZE, OR COLOR.

SN 77-956,294, FILED 3-11-2010.

HELENE LIWINSKI, EXAMINING ATTORNEY



David J. Kybas

Director of the United States Patent and Trademark Office

United States of America

United States Patent and Trademark Office

\$LOTCAR

Reg. No. 4,099,573

Registered Feb. 14, 2012

Int. Cl.: 41

SERVICE MARK

PRINCIPAL REGISTER

DAVID BARCELOU (UNITED STATES INDIVIDUAL)
246 DANIEL WEBSTER HIGHWAY
SUITE 211
MERRIMACK, NH 03054

FOR: PROVIDING COMPUTERIZED GAMING SERVICES ON INTERACTIVE NETWORKS
IN THE NATURE OF COMPUTERIZED GAMES-OF-SKILL FEATURING AUTOMATED
MONETARY TRANSACTIONS , IN CLASS 41 (U.S. CLS. 100, 101 AND 107).

FIRST USE 9-28-2011; IN COMMERCE 9-28-2011.

THE MARK CONSISTS OF STANDARD CHARACTERS WITHOUT CLAIM TO ANY PAR-
TICULAR FONT, STYLE, SIZE, OR COLOR.

SN 77-956,295, FILED 3-11-2010.

HELENE LIWINSKI, EXAMINING ATTORNEY



David J. Kybas

Director of the United States Patent and Trademark Office

United States of America

United States Patent and Trademark Office

\$SLOT CARS\$

Reg. No. 4,099,574

Registered Feb. 14, 2012

Int. Cl.: 9

TRADEMARK

PRINCIPAL REGISTER

DAVID BARCELOU (UNITED STATES INDIVIDUAL)
246 DANIEL WEBSTER HIGHWAY
SUITE 211
MERRIMACK, NH 03054

FOR: COMPUTERIZED GAMING EQUIPMENT, NAMELY, VIRTUAL REALITY AUTOMOTIVE RACING SIMULATORS CONNECTED TO AN INTERACTIVE NETWORK THAT ACCOMMODATE AUTOMATED MONETARY TRANSACTIONS SUCH AS THE PAYMENT OF ENTRY FEES AND THE DISBURSEMENT OF WINNINGS TO SUCCESSFUL PLAYERS OF A GAME-OF-SKILL, IN CLASS 9 (U.S. CLS. 21, 23, 26, 36 AND 38).

FIRST USE 9-28-2011; IN COMMERCE 9-28-2011.

THE MARK CONSISTS OF STANDARD CHARACTERS WITHOUT CLAIM TO ANY PARTICULAR FONT, STYLE, SIZE, OR COLOR.

SN 77-956,296, FILED 3-11-2010.

HELENE LIWINSKI, EXAMINING ATTORNEY



David J. Kyros

Director of the United States Patent and Trademark Office

United States of America

United States Patent and Trademark Office

\$SLOT CARS\$

Reg. No. 4,099,575

Registered Feb. 14, 2012

Int. Cl.: 41

SERVICE MARK

PRINCIPAL REGISTER

DAVID BARCELOU (UNITED STATES INDIVIDUAL)
246 DANIEL WEBSTER HIGHWAY
SUITE 211
MERRIMACK, NH 03054

FOR: PROVIDING COMPUTERIZED GAMING SERVICES ON INTERACTIVE NETWORKS
IN THE NATURE OF COMPUTERIZED GAMES-OF-SKILL FEATURING AUTOMATED
MONETARY TRANSACTIONS , IN CLASS 41 (U.S. CLS. 100, 101 AND 107).

FIRST USE 9-28-2011; IN COMMERCE 9-28-2011.

THE MARK CONSISTS OF STANDARD CHARACTERS WITHOUT CLAIM TO ANY PAR-
TICULAR FONT, STYLE, SIZE, OR COLOR.

SN 77-956,297, FILED 3-11-2010.

HELENE LIWINSKI, EXAMINING ATTORNEY



David J. Kybas

Director of the United States Patent and Trademark Office

United States of America

United States Patent and Trademark Office

INTO THE FIRE

Reg. No. 4,099,576

Registered Feb. 14, 2012

Int. Cls.: 9, 16, and 25

TRADEMARK

PRINCIPAL REGISTER

FROG 911, LLC (DELAWARE LIMITED LIABILITY COMPANY)
211 SUN MEADOW DRIVE
GREER, SC 29650

FOR: REFLECTIVE AND ILLUMINATED CLOTHING FOR SAFETY PURPOSES; SAFETY PRODUCTS, NAMELY, REFLECTIVE PATCHES TO BE WORN ON CLOTHING; SAFETY ATTIRE FOR POLICE, FIREFIGHTERS, EMERGENCY RESPONDERS, PUBLIC SAFETY AND GOVERNMENTAL PERSONNEL, NAMELY, REFLECTIVE AND ILLUMINATED CLOTHING FOR SAFETY PURPOSES, PROTECTIVE CLOTHING AND HEADGEAR, IN CLASS 9 (U.S. CLS. 21, 23, 26, 36 AND 38).

FIRST USE 9-30-2011; IN COMMERCE 9-30-2011.

FOR: SAFETY AND IDENTIFICATION MARKINGS FOR FIRE EXTINGUISHING APPARATUS AND EMERGENCY RESPONDER APPARATUS, NAMELY, PAPER AND PAPER, ADHESIVE-BACKED AND IRON-ON TRANSFERS, PAPER AND ADHESIVE-BACKED LABELS AND PRINTED VISUALS IN THE NATURE OF GRAPHICS; GRAPHIC APPLICATIONS FOR VEHICLES, BANNERS AND SIGNS, NAMELY, PLASTIC STICKERS, PAPER AND ADHESIVE-BACKED LABELS, PAPER, PLASTIC, ADHESIVE-BACKED, AND IRON-ON TRANSFERS, DECALS AND APPLIQUÉS IN THE FORM OF DECALS; AND PAPER STICKERS, PAPER AND ADHESIVE-BACKED LABELS, PAPER, PLASTIC, ADHESIVE-BACKED, AND IRON-ON TRANSFERS, DECALS AND APPLIQUÉS IN THE FORM OF DECALS; PRINTED MATERIAL IN THE NATURE OF DECALS, PRINTED GRAPHIC APPLIQUÉS IN THE FORM OF STICKERS, PAPER AND ADHESIVE-BACKED LABELS, PAPER, PLASTIC, ADHESIVE-BACKED AND IRON-ON TRANSFERS AND DECALS FOR VEHICLES; ADHESIVE-BACKED PAPER SIGNS AND GRAPHICS IN THE FORM OF STICKERS, PAPER LABELS, PAPER, PLASTIC, ADHESIVE-BACKED AND IRON-ON TRANSFERS AND DECALS FOR VEHICLES, APPLIQUÉS IN THE FORM OF DECALS; DECALS; PRINTED ADVERTISING AND PROMOTIONAL ITEMS, NAMELY, STICKERS, PAPER AND ADHESIVE-BACKED LABELS, PAPER, PLASTIC, ADHESIVE-BACKED AND IRON-ON TRANSFERS AND DECALS, STICKERS FOR HELMETS, IN CLASS 16 (U.S. CLS. 2, 5, 22, 23, 29, 37, 38 AND 50).



David J. Kyjars

FIRST USE 5-31-2011; IN COMMERCE 5-31-2011.

Reg. No. 4,099,576 FOR: GOLF SHIRTS, HATS, SHIRTS, SWEAT SHIRTS, T-SHIRTS, ATHLETIC APPAREL, NAMELY, SHIRTS, PANTS, JACKETS, FOOTWEAR, HATS AND CAPS, IN CLASS 25 (U.S. CLS. 22 AND 39).

FIRST USE 1-31-2011; IN COMMERCE 1-31-2011.

THE MARK CONSISTS OF STANDARD CHARACTERS WITHOUT CLAIM TO ANY PARTICULAR FONT, STYLE, SIZE, OR COLOR.

NO CLAIM IS MADE TO THE EXCLUSIVE RIGHT TO USE "FIRE" , APART FROM THE MARK AS SHOWN.

SN 77-956,299, FILED 3-11-2010.

TINA BROWN, EXAMINING ATTORNEY

United States of America

United States Patent and Trademark Office

ONE U

Reg. No. 4,099,577

DAVID R. DUHAMEL (UNITED STATES INDIVIDUAL)
4307 N. 35TH STREET
ARLINGTON, VA 22207

Registered Feb. 14, 2012

Int. Cl.: 44

FOR: MEDICAL SPA SERVICES, NAMELY, MINIMALLY AND NON-INVASIVE COSMETIC THERAPIES; AND COSMETIC AND PLASTIC SURGERY, IN CLASS 44 (U.S. CLS. 100 AND 101).

SERVICE MARK

FIRST USE 1-1-2009; IN COMMERCE 1-1-2009.

PRINCIPAL REGISTER

THE MARK CONSISTS OF STANDARD CHARACTERS WITHOUT CLAIM TO ANY PARTICULAR FONT, STYLE, SIZE, OR COLOR.

SN 77-957,203, FILED 3-11-2010.

COLLEEN KEARNEY, EXAMINING ATTORNEY



David J. Kybas

Director of the United States Patent and Trademark Office

United States of America

United States Patent and Trademark Office

VINDICATED

Reg. No. 4,099,578

V2 WINE GROUP, LLC (CALIFORNIA LIMITED LIABILITY COMPANY)
567 1ST STREET E
SONOMA, CA 95476

Registered Feb. 14, 2012

Int. Cl.: 33

FOR: WINES, IN CLASS 33 (U.S. CLS. 47 AND 49).

TRADEMARK

FIRST USE 6-21-2011; IN COMMERCE 6-21-2011.

PRINCIPAL REGISTER

THE MARK CONSISTS OF STANDARD CHARACTERS WITHOUT CLAIM TO ANY PARTICULAR FONT, STYLE, SIZE, OR COLOR.

SN 77-957,296, FILED 3-12-2010.

ODESSA BIBBINS, EXAMINING ATTORNEY



David J. Kyffers

Director of the United States Patent and Trademark Office

United States of America

United States Patent and Trademark Office



Reg. No. 4,099,579

WADING RIVER PEDIATRIC DENTISTRY P.C. (NEW YORK CORPORATION)
6302 ROUTE 25A

Registered Feb. 14, 2012

WADING RIVER, NY 11792

Int. Cl.: 44

FOR: DENTISTRY, IN CLASS 44 (U.S. CLS. 100 AND 101).

SERVICE MARK

FIRST USE 10-26-2002; IN COMMERCE 10-26-2002.

PRINCIPAL REGISTER

THE MARK CONSISTS OF AN IMAGE OF A CRAYON TYPE DRAWING INSTRUMENT
DEPICTED ON A COLUMN OF A BUILDING.

SN 77-957,508, FILED 3-12-2010.

WILLIAM P. SHANAHAN, EXAMINING ATTORNEY



David J. Kyffers

Director of the United States Patent and Trademark Office

United States of America

United States Patent and Trademark Office

GASOLINA SANGRIIA

Reg. No. 4,099,580

Registered Feb. 14, 2012

Int. Cl.: 33

TRADEMARK

PRINCIPAL REGISTER

PAN AMERICAN PROPERTIES CORPORATION (PUERTO RICO CORPORATION)
9 CLAUDIA ST., AMELIA INDUSTRIAL PARK
GUAYNABO, PUERTO RICO 00968

FOR: PREPARED ALCOHOLIC COCKTAILS, IN CLASS 33 (U.S. CLS. 47 AND 49).

FIRST USE 1-10-2011; IN COMMERCE 1-10-2001.

THE MARK CONSISTS OF STANDARD CHARACTERS WITHOUT CLAIM TO ANY PARTICULAR FONT, STYLE, SIZE, OR COLOR.

OWNER OF U.S. REG. NOS. 3,181,903 AND 3,618,769.

NO CLAIM IS MADE TO THE EXCLUSIVE RIGHT TO USE "SANGRIA", APART FROM THE MARK AS SHOWN.

THE ENGLISH TRANSLATION OF "GASOLINA" IN THE MARK IS GASOLINE.

SN 77-957,758, FILED 3-12-2010.

ALLISON SCHRODY, EXAMINING ATTORNEY



David J. Kyffers

Director of the United States Patent and Trademark Office

United States of America

United States Patent and Trademark Office

AdValue

Reg. No. 4,099,581

Registered Feb. 14, 2012

Int. Cl.: 42

SERVICE MARK

PRINCIPAL REGISTER

XIUS CORP. (MASSACHUSETTS CORPORATION)
400 TRADE CENTER, SUITE 2890
WOBURN, MA 01801

FOR: APPLICATION SERVICE PROVIDER, NAMELY, PROVIDING, HOSTING, MANAGING, DEVELOPING, AND MAINTAINING APPLICATIONS, SOFTWARE, WEB SITES, AND DATABASES IN THE FIELDS OF PERSONAL PRODUCTIVITY, WIRELESS COMMUNICATION, MOBILE INFORMATION ACCESS, AND REMOTE DATA MANAGEMENT FOR WIRELESS DELIVERY OF CONTENT TO HANDHELD COMPUTERS, LAPTOPS AND MOBILE ELECTRONIC DEVICES; DESIGN AND DEVELOPMENT OF WIRELESS COMMUNICATION SYSTEMS FOR TRANSMISSION AND RECEPTION OF VOICE, DATA AND VIDEO, IN CLASS 42 (U.S. CLS. 100 AND 101).

FIRST USE 2-15-2010; IN COMMERCE 2-28-2010.

THE MARK CONSISTS OF STANDARD CHARACTERS WITHOUT CLAIM TO ANY PARTICULAR FONT, STYLE, SIZE, OR COLOR.

SN 77-957,784, FILED 3-12-2010.

MARY CRAWFORD, EXAMINING ATTORNEY



David J. Kyffers

Director of the United States Patent and Trademark Office

United States of America

United States Patent and Trademark Office

Nexus Worx

Reg. No. 4,099,582

BYERS ENGINEERING COMPANY (GEORGIA CORPORATION)
6285 BARFIELD ROAD
ATLANTA, GA 30328

Registered Feb. 14, 2012

Int. Cls.: 9 and 42

FOR: COMPUTER SOFTWARE, NAMELY, COMPUTER SOFTWARE FOR INTEGRATING CUSTOMER, NETWORK, AND GEOGRAPHIC INFORMATION SYSTEM DATA FOR PLANNING, PROVISIONING, MANAGEMENT AND MAINTENANCE OF FIBER OPTIC NETWORKS, IN CLASS 9 (U.S. CLS. 21, 23, 26, 36 AND 38).

TRADEMARK

SERVICE MARK

FIRST USE 12-7-2010; IN COMMERCE 12-7-2010.

PRINCIPAL REGISTER

FOR: PROVIDING TEMPORARY USE OF ON-LINE NON-DOWNLOADABLE COMPUTER SOFTWARE, COMPUTER SYSTEMS DESIGN CONSULTATION, AND CUSTOMIZATION OF COMPUTER SOFTWARE, ALL OF THE FOREGOING RELATING TO THE INTEGRATION OF CUSTOMER, NETWORK, AND GEOGRAPHIC INFORMATION SYSTEM DATA FOR PLANNING, PROVISIONING, MANAGEMENT AND MAINTENANCE OF UTILITIES NETWORKS, FACILITIES AND INFRASTRUCTURE, IN CLASS 42 (U.S. CLS. 100 AND 101).

FIRST USE 12-0-2009; IN COMMERCE 12-0-2009.

THE MARK CONSISTS OF STANDARD CHARACTERS WITHOUT CLAIM TO ANY PARTICULAR FONT, STYLE, SIZE, OR COLOR.

SN 77-958,488, FILED 3-14-2010.

MARGARET POWER, EXAMINING ATTORNEY



David J. Kyros

Director of the United States Patent and Trademark Office

United States of America

United States Patent and Trademark Office

TALK TO ME 123

Reg. No. 4,099,583

LDW GROUP, INC. (DELAWARE CORPORATION)

Registered Feb. 14, 2012

145 POND STREET
FRANKLIN, MA 02038

Int. Cl.: 41

FOR: ENTERTAINMENT IN THE NATURE OF LIVE PERFORMANCES BY TELEPHONE AND CHATROOM ACTORS; ENTERTAINMENT SERVICES, NAMELY, AN ON-GOING SERIES FEATURING THEMES RELATED TO ADULT ENTERTAINMENT AND ADULT TOPICS PROVIDED THROUGH WEBCASTS; ENTERTAINMENT SERVICES, NAMELY, PROVIDING A WEBSITE AT WHICH THE GENERAL PUBLIC CAN RECEIVE ADVICE FROM AN INDIVIDUAL CONCERNING RELATIONSHIPS, SUCH ADVICE BEING FOR ENTERTAINMENT PURPOSES ONLY, IN CLASS 41 (U.S. CLS. 100, 101 AND 107).

SERVICE MARK

PRINCIPAL REGISTER

FIRST USE 10-31-2011; IN COMMERCE 10-31-2011.

THE MARK CONSISTS OF STANDARD CHARACTERS WITHOUT CLAIM TO ANY PARTICULAR FONT, STYLE, SIZE, OR COLOR.

SN 77-958,724, FILED 3-15-2010.

MICHELLE DUBOIS, EXAMINING ATTORNEY



David J. Kyjars

Director of the United States Patent and Trademark Office

United States of America
United States Patent and Trademark Office

AMUSE

Reg. No. 4,099,584

Registered Feb. 14, 2012

Int. Cl.: 43

SERVICE MARK

PRINCIPAL REGISTER

HEI HOSPITALITY, LLC (DELAWARE LIMITED LIABILITY COMPANY)
101 MERRITT 7 CORPORATE PARK
1ST FLOOR
NORWALK, CT 06581

FOR: RESTAURANT, BAR AND CATERING SERVICES, IN CLASS 43 (U.S. CLS. 100 AND 101).

FIRST USE 5-0-2010; IN COMMERCE 5-0-2010.

THE MARK CONSISTS OF STANDARD CHARACTERS WITHOUT CLAIM TO ANY PARTICULAR FONT, STYLE, SIZE, OR COLOR.

SN 77-959,705, FILED 3-16-2010.

JOHN KELLY, EXAMINING ATTORNEY



David J. Kyffers

Director of the United States Patent and Trademark Office

United States of America

United States Patent and Trademark Office

MyQuick View

Reg. No. 4,099,585

Registered Feb. 14, 2012

Int. Cl.: 9

TRADEMARK

PRINCIPAL REGISTER

ADIS ADVANCED DIGITAL INFORMATION SYSTEMS LTD. (CANADA LIMITED
LIABILITY COMPANY)
2980 SUNRIDGE COURT
COQUITLAM, BC, CANADA V3E3M5

FOR: COMPUTER SOFTWARE FOR VIEWING, PRINTING, ANNOTATING, PROCESSING
AND MANAGING DIGITAL IMAGE FILES, IN CLASS 9 (U.S. CLS. 21, 23, 26, 36 AND 38).

FIRST USE 12-20-2011; IN COMMERCE 12-20-2011.

THE MARK CONSISTS OF STANDARD CHARACTERS WITHOUT CLAIM TO ANY PAR-
TICULAR FONT, STYLE, SIZE, OR COLOR.

SN 77-960,565, FILED 3-16-2010.

GINA FINK, EXAMINING ATTORNEY



David J. Kybas

Director of the United States Patent and Trademark Office

United States of America

United States Patent and Trademark Office

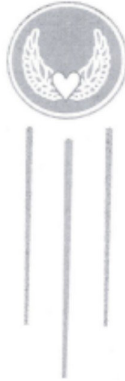

Reg. No. 4,099,586

Registered Feb. 14, 2012

Int. Cl.: 33

TRADEMARK

PRINCIPAL REGISTER

CARIBBEAN DISTILLERS CORPORATION INTERNATIONAL LIMITED (DJIBOUTI CORPORATION)
C/O AJENDRA SINGH
BRENTWOOD, CA 90049

FOR: ALCOHOLIC BEVERAGES, NAMELY, VODKA; DISTILLED SPIRITS; RUM; TEQUILA; WINE; LIQUORS, IN CLASS 33 (U.S. CLS. 47 AND 49).

FIRST USE 4-17-2010; IN COMMERCE 4-17-2010.

THE MARK CONSISTS OF A WINGED HEART WITHIN A CIRCLE WITH 3 VERTICAL LINES LOCATED BENEATH.

SN 77-962,378, FILED 3-18-2010.

HEATHER THOMPSON, EXAMINING ATTORNEY



David J. Kybas

Director of the United States Patent and Trademark Office

United States of America

United States Patent and Trademark Office



Reg. No. 4,099,587

Registered Feb. 14, 2012

Int. Cl.: 42

SERVICE MARK

PRINCIPAL REGISTER

CRAWFORD & COMPANY (GEORGIA CORPORATION)
9TH FLOOR
1001 SUMMIT BOULEVARD
ATLANTA, GA 30319

FOR: APPLICATION SERVICE PROVIDER, NAMELY, PROVIDING, HOSTING, MANAGING, DEVELOPING, RESEARCHING, ANALYZING, REPORTING, AND MAINTAINING APPLICATIONS, SOFTWARE AND DATABASES OF OTHERS IN THE FIELDS OF INSURANCE AND RISK MANAGEMENT AND DEVELOPMENT OF CUSTOMIZED SOFTWARE FOR OTHERS FOR USE IN RISK ASSESSMENT, RISK MANAGEMENT AND INSURANCE; PROVIDING TEMPORARY USE OF ON-LINE WEB-BASED NON-DOWNLOADABLE SOFTWARE FOR INSURANCE CLAIMS ADMINISTRATION, INSURANCE CLAIM MANAGEMENT, WORKER'S COMPENSATION CLAIM MANAGEMENT, RISK MANAGEMENT, AND FOR CALCULATING AND ALLOCATING COSTS AND RISKS, IN CLASS 42 (U.S. CLS. 100 AND 101).

FIRST USE 4-0-2010; IN COMMERCE 4-0-2010.

NO CLAIM IS MADE TO THE EXCLUSIVE RIGHT TO USE "RISK" AND "GROUP", APART FROM THE MARK AS SHOWN.

THE MARK CONSISTS OF AN UPSIDE DOWN HALF OPEN OVAL SHAPE THAT IS OPEN TO THE RIGHT ABOVE THE LETTERS "RSG" IN LARGE PRINT WITH THE WORDS "RISK SCIENCES GROUP" IN SMALLER PRINT DIRECTLY BENEATH.

SN 77-963,481, FILED 3-19-2010.

GRETCHEN ULRICH, EXAMINING ATTORNEY



David J. Kybas

Director of the United States Patent and Trademark Office

United States of America

United States Patent and Trademark Office

SERVEITUP

Reg. No. 4,099,588

FUSIONBRANDS INC (GEORGIA CORPORATION)

Registered Feb. 14, 2012

P.O. BOX 100
NAPLES, NY 14512

Int. Cl.: 21

FOR: BOTTLE STANDS; CAKE SUPPORTS, NAMELY, CAKE BASES; DISH STANDS; HOLDER FOR CUTTING BOARD; POT STANDS; STANDS FOR DISHES, IN CLASS 21 (U.S. CLS. 2, 13, 23, 29, 30, 33, 40 AND 50).

TRADEMARK

FIRST USE 11-23-2011; IN COMMERCE 11-23-2011.

PRINCIPAL REGISTER

THE MARK CONSISTS OF STANDARD CHARACTERS WITHOUT CLAIM TO ANY PARTICULAR FONT, STYLE, SIZE, OR COLOR.

SN 77-964,252, FILED 3-21-2010.

LANA PHAM, EXAMINING ATTORNEY



David J. Kybas

Director of the United States Patent and Trademark Office

United States of America

United States Patent and Trademark Office



Reg. No. 4,099,589

MINNESOTA VIKINGS FOOTBALL, LLC (DELAWARE LIMITED LIABILITY COMPANY)
9520 VIKING DRIVE
EDEN PRAIRIE, MN 55344

Registered Feb. 14, 2012

Int. Cls.: 9, 14, 16, 21, 25, 28, and 41

FOR: DECORATIVE MAGNETS , IN CLASS 9 (U.S. CLS. 21, 23, 26, 36 AND 38).

FIRST USE 0-0-2010; IN COMMERCE 0-0-2010.

TRADEMARK

FOR: JEWELRY PINS, IN CLASS 14 (U.S. CLS. 2, 27, 28 AND 50).

SERVICE MARK

FIRST USE 0-0-2010; IN COMMERCE 0-0-2010.

PRINCIPAL REGISTER

FOR: SERIES OF BOOKS RELATING TO FOOTBALL, NOTEPADS, STICKERS, BUMPER STICKERS, PRINTED TICKETS TO SPORTS GAMES AND EVENTS; PICTORIAL PRINTS, ART PICTURES, IN CLASS 16 (U.S. CLS. 2, 5, 22, 23, 29, 37, 38 AND 50).

FIRST USE 8-0-2010; IN COMMERCE 8-0-2010.

FOR: BEVERAGE GLASSWARE, FOAM DRINK HOLDERS, INSULATED SLEEVE HOLDERS FOR BEVERAGE CANS, IN CLASS 21 (U.S. CLS. 2, 13, 23, 29, 30, 33, 40 AND 50).

FIRST USE 0-0-2010; IN COMMERCE 0-0-2010.

FOR: MEN'S, WOMEN'S AND CHILDREN'S CLOTHING, NAMELY, HEADWEAR, T-SHIRTS, JACKETS, IN CLASS 25 (U.S. CLS. 22 AND 39).

FIRST USE 0-0-2010; IN COMMERCE 0-0-2010.

FOR: TOYS AND SPORTING GOODS, NAMELY, PLUSH TOYS, STUFFED ANIMALS, FOOTBALLS, TOY REPLICA MINIATURE FOOTBALL HELMETS, IN CLASS 28 (U.S. CLS. 22, 23, 38 AND 50).

FIRST USE 0-0-2010; IN COMMERCE 0-0-2010.

FOR: ENTERTAINMENT SERVICES, NAMELY, PRESENTATIONS IN THE NATURE OF PROFESSIONAL FOOTBALL GAMES AND EXHIBITIONS, IN CLASS 41 (U.S. CLS. 100, 101 AND 107).



David J. Kybas

Director of the United States Patent and Trademark Office

Reg. No. 4,099,589 FIRST USE 8-0-2010; IN COMMERCE 8-0-2010.

OWNER OF U.S. REG. NOS. 997,179, 2,876,746, AND 3,351,348.

NO CLAIM IS MADE TO THE EXCLUSIVE RIGHT TO USE "50", "1961" AND "2010", APART FROM THE MARK AS SHOWN.

THE MARK CONSISTS OF A DESIGN OF A VIKING SHIP AND VIKING HEAD WITH THE NUMBER "50" ON THE SHIP'S SAIL AND THE NUMBERS "1961" AND "2010" ON THE SHIP.

SN 77-964,472, FILED 3-22-2010.

SUNG IN, EXAMINING ATTORNEY

United States of America

United States Patent and Trademark Office

MEAL SENSE

Reg. No. 4,099,590

Registered Feb. 14, 2012

Int. Cl.: 43

SERVICE MARK

PRINCIPAL REGISTER

ARAMARK CORPORATION (DELAWARE CORPORATION)
29TH FLOOR
1101 MARKET STREET
PHILADELPHIA, PA 19107

FOR: RESTAURANTS; RESTAURANT SERVICES; CONTRACT FOOD SERVICES; MEAL PLAN SERVICES, NAMELY, MEAL PLANNING SERVICES IN DIGITAL AND NON-DIGITAL FORM, ACCESSIBLE THROUGH THE INTERNET AND THROUGH PAPER SUBMISSIONS; SUBSIDIZED MEAL PLAN SERVICES, NAMELY, MEAL PLANNING SERVICES IN DIGITAL AND NON-DIGITAL FORM, ACCESSIBLE THROUGH THE INTERNET AND PAPER SUBMISSIONS; MEAL PLAN SERVICES, NAMELY, PROVIDING FREE AND REDUCED COST MEALS TO OTHERS; SUBSIDIZED MEAL PLAN SERVICES, NAMELY, PROVIDING FREE AND REDUCED COST MEALS TO OTHERS, IN CLASS 43 (U.S. CLS. 100 AND 101).

FIRST USE 1-22-2010; IN COMMERCE 1-22-2010.

THE MARK CONSISTS OF STANDARD CHARACTERS WITHOUT CLAIM TO ANY PARTICULAR FONT, STYLE, SIZE, OR COLOR.

NO CLAIM IS MADE TO THE EXCLUSIVE RIGHT TO USE "MEAL", APART FROM THE MARK AS SHOWN.

SN 77-964,896, FILED 3-22-2010.

GEORGE LORENZO, EXAMINING ATTORNEY



David J. Kyros

Director of the United States Patent and Trademark Office

United States of America

United States Patent and Trademark Office

hearflex

Reg. No. 4,099,591

HEARING HEALTHCARE MANAGEMENT, INC. (OHIO CORPORATION)
3700 CORPORATE DRIVE #140
COLUMBUS, OH 43231

Registered Feb. 14, 2012

Int. Cl.: 10

FOR: HEARING AIDS, IN CLASS 10 (U.S. CLS. 26, 39 AND 44).

TRADEMARK

FIRST USE 9-9-2011; IN COMMERCE 9-9-2011.

PRINCIPAL REGISTER

THE MARK CONSISTS OF STANDARD CHARACTERS WITHOUT CLAIM TO ANY PARTICULAR FONT, STYLE, SIZE, OR COLOR.

SN 77-967,245, FILED 3-24-2010.

ALLISON HOLTZ, EXAMINING ATTORNEY



David J. Kybas

Director of the United States Patent and Trademark Office

United States of America

United States Patent and Trademark Office

WHAT DO YOU WANT TO DO BEFORE YOU DIE?

Reg. No. 4,099,592

Registered Feb. 14, 2012

Int. Cl.: 9

TRADEMARK

PRINCIPAL REGISTER

THE BURIED LIFE, INC. (CALIFORNIA CORPORATION)
C/O FULWIDER PATTON LLP
6060 CENTER DRIVE, TENTH FLOOR
LOS ANGELES, CA 90045

FOR: PRE-RECORDED VIDEODISCS FEATURING A PREVIOUSLY TELEVISED ENTERTAINMENT SERIES, IN CLASS 9 (U.S. CLS. 21, 23, 26, 36 AND 38).

FIRST USE 1-18-2010; IN COMMERCE 1-18-2010.

THE MARK CONSISTS OF STANDARD CHARACTERS WITHOUT CLAIM TO ANY PARTICULAR FONT, STYLE, SIZE, OR COLOR.

SN 77-967,864, FILED 3-24-2010.

ELIZABETH KAJUBI, EXAMINING ATTORNEY



David J. Kybas

Director of the United States Patent and Trademark Office

United States of America
United States Patent and Trademark Office

BOLT 

Reg. No. 4,099,593

Registered Feb. 14, 2012

Int. Cl.: 28

TRADEMARK

PRINCIPAL REGISTER

BOTHWELL, BRETT (UNITED STATES INDIVIDUAL), DBA BOLT SPORTS LLC,
101 WEST 75TH STREET
WWW.BOLT-SPORTS.COM
NEW YORK, NY 10023

FOR: RACKET CASES; TENNIS RACKETS; TENNIS RACQUETS, IN CLASS 28 (U.S. CLS.
22, 23, 38 AND 50).

FIRST USE 10-1-2010; IN COMMERCE 7-5-2011.

THE MARK CONSISTS OF THE WORD "BOLT" ASSOCIATED WITH AN ABSTRACT
SHAPE, THE ABSTRACT SHAPE HAS TWO CURVES ON ITS RIGHT SIDE AND A JAGGED
LINE ON ITS LEFT SIDE.

SN 77-968,519, FILED 3-25-2010.

WANDA KAY PRICE, EXAMINING ATTORNEY



David J. Kyffers

Director of the United States Patent and Trademark Office

United States of America

United States Patent and Trademark Office

MLB NETWORK RADIO

Reg. No. 4,099,594

MAJOR LEAGUE BASEBALL PROPERTIES, INC. (NEW YORK CORPORATION)
245 PARK AVENUE
NEW YORK, NY 10167

Registered Feb. 14, 2012

Int. Cl.: 41

FOR: RADIO PROGRAMMING; PROVIDING AN ON-GOING RADIO PROGRAM IN THE FIELD OF SPORTS, IN CLASS 41 (U.S. CLS. 100, 101 AND 107).

SERVICE MARK

FIRST USE 4-4-2010; IN COMMERCE 4-4-2010.

PRINCIPAL REGISTER

THE MARK CONSISTS OF STANDARD CHARACTERS WITHOUT CLAIM TO ANY PARTICULAR FONT, STYLE, SIZE, OR COLOR.

OWNER OF U.S. REG. NOS. 3,593,031, 3,680,207, AND OTHERS.

NO CLAIM IS MADE TO THE EXCLUSIVE RIGHT TO USE "NETWORK" AND "RADIO", APART FROM THE MARK AS SHOWN.

SN 77-968,540, FILED 3-25-2010.

JOSETTE BEVERLY, EXAMINING ATTORNEY



David J. Kybas

Director of the United States Patent and Trademark Office

United States of America

United States Patent and Trademark Office

ENERGYMEASURE

Reg. No. 4,099,595

Registered Feb. 14, 2012

Int. Cls.: 9 and 42

TRADEMARK

SERVICE MARK

PRINCIPAL REGISTER

CONSERVATION SERVICES GROUP, INC. (MASSACHUSETTS CORPORATION)
40 WASHINGTON STREET
WESTBOROUGH, MA 01581

FOR: COMPUTER SOFTWARE TO MANAGE ENERGY EFFICIENCY PROGRAMS AND RENEWABLE ENERGY PROGRAMS ON A UTILITY SERVICE, STATE, REGIONAL OR NATIONAL LEVEL; SOFTWARE TO TRACK PROJECTS, CUSTOMER INTERACTIONS AND CONTRACTOR ACTIVITIES, TO AGGREGATE AND REPORT RESULTS OF MULTIPLE PROJECTS BY SERVICE TERRITORY, STATE OR OTHER GEOGRAPHIC REGIONS FOR MONITORING, EVALUATION, AND VERIFICATION PURPOSES; DOWNLOADABLE COMPUTER SOFTWARE TO MANAGE ENERGY EFFICIENCY PROGRAMS AND RENEWABLE ENERGY PROGRAMS ON A UTILITY SERVICE, STATE, REGIONAL OR NATIONAL LEVEL; SOFTWARE TO TRACK PROJECTS, CUSTOMER INTERACTIONS AND CONTRACTOR ACTIVITIES, TO AGGREGATE AND REPORT RESULTS OF MULTIPLE PROJECTS BY SERVICE TERRITORY, STATE OR OTHER GEOGRAPHIC REGIONS FOR MONITORING, EVALUATION, AND VERIFICATION PURPOSES, IN CLASS 9 (U.S. CLS. 21, 23, 26, 36 AND 38).

FIRST USE 9-30-2010; IN COMMERCE 9-30-2010.

FOR: PROVIDING TEMPORARY USE OF NON-DOWNLOADABLE COMPUTER SOFTWARE TO MANAGE ENERGY EFFICIENCY PROGRAMS AND RENEWABLE ENERGY PROGRAMS ON A UTILITY SERVICE, STATE, REGIONAL OR NATIONAL LEVEL; PROVIDING TEMPORARY USE OF NON-DOWNLOADABLE COMPUTER SOFTWARE TO TRACK PROJECTS, CUSTOMER INTERACTIONS AND CONTRACTOR ACTIVITIES, TO AGGREGATE AND REPORT RESULTS OF MULTIPLE PROJECTS BY SERVICE TERRITORY, STATE OR OTHER GEOGRAPHIC REGIONS FOR MONITORING, EVALUATION, AND VERIFICATION PURPOSES, IN CLASS 42 (U.S. CLS. 100 AND 101).

FIRST USE 9-30-2010; IN COMMERCE 9-30-2010.

THE MARK CONSISTS OF STANDARD CHARACTERS WITHOUT CLAIM TO ANY PARTICULAR FONT, STYLE, SIZE, OR COLOR.

SN 77-968,719, FILED 3-25-2010.

ANNE MADDEN, EXAMINING ATTORNEY



David J. Kyffers

Director of the United States Patent and Trademark Office

United States of America

United States Patent and Trademark Office



A COMMUNITY MEDICAL CENTER EVENT

Reg. No. 4,099,596

COMMUNITY MEDICAL CENTER INC. (MONTANA CORPORATION)
2827 FORT MISSOULA ROAD
MISSOULA, MT 59804

Registered Feb. 14, 2012

Int. Cl.: 41

FOR: EDUCATION SERVICES, NAMELY, PROVIDING SEMINARS, WORKSHOPS IN THE FIELD OF CANCER, IN CLASS 41 (U.S. CLS. 100, 101 AND 107).

SERVICE MARK

FIRST USE 6-30-2010; IN COMMERCE 6-30-2010.

PRINCIPAL REGISTER

NO CLAIM IS MADE TO THE EXCLUSIVE RIGHT TO USE "A COMMUNITY MEDICAL CENTER EVENT", APART FROM THE MARK AS SHOWN.

THE MARK CONSISTS OF A PHOENIX WITH THE STYLIZED TEXT "VOICES OF HOPE A COMMUNITY MEDICAL CENTER EVENT".

SN 77-969,778, FILED 3-26-2010.

LESLEY LAMOTHE, EXAMINING ATTORNEY



David J. Kyffers

Director of the United States Patent and Trademark Office

United States of America

United States Patent and Trademark Office

ENGLOBAL VU

Reg. No. 4,099,597

Registered Feb. 14, 2012

Int. Cl.: 42

SERVICE MARK

PRINCIPAL REGISTER

ENGLOBAL CORPORATION (NEVADA CORPORATION)
SUITE 400
654 N. SAM HOUSTON PARKWAY E.
HOUSTON, TX 77060

FOR: CONSULTING SERVICES RELATED TO LAND BASED LINEAR ENGINEERING
PROJECTS, IN CLASS 42 (U.S. CLS. 100 AND 101).

FIRST USE 5-5-2010; IN COMMERCE 5-5-2010.

THE MARK CONSISTS OF STANDARD CHARACTERS WITHOUT CLAIM TO ANY PAR-
TICULAR FONT, STYLE, SIZE, OR COLOR.

OWNER OF U.S. REG. NO. 2,887,132.

SN 77-969,912, FILED 3-26-2010.

MARGARET POWER, EXAMINING ATTORNEY



David J. Kyffers

Director of the United States Patent and Trademark Office

United States of America

United States Patent and Trademark Office

CCT

Reg. No. 4,099,598

CISCO TECHNOLOGY, INC. (CALIFORNIA CORPORATION)
170 WEST TASMAN DRIVE
SAN JOSE, CA 95134

Registered Feb. 14, 2012

Int. Cl.: 42

FOR: PROVIDING TESTING FOR THE PURPOSE OF CERTIFICATION TO DETERMINE PROFESSIONAL SKILLS IN THE FIELD OF NETWORKING EQUIPMENT AND COMPUTER SYSTEMS, IN CLASS 42 (U.S. CLS. 100 AND 101).

SERVICE MARK

FIRST USE 1-31-2011; IN COMMERCE 1-31-2011.

PRINCIPAL REGISTER

THE MARK CONSISTS OF STANDARD CHARACTERS WITHOUT CLAIM TO ANY PARTICULAR FONT, STYLE, SIZE, OR COLOR.

SN 77-980,407, FILED 2-20-2010.

LAURIE MAYES, EXAMINING ATTORNEY



David J. Kyffers

Director of the United States Patent and Trademark Office

United States of America

United States Patent and Trademark Office

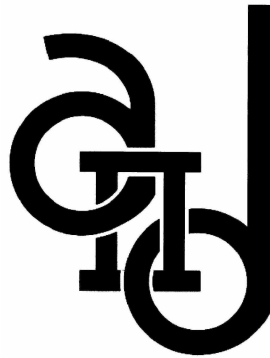

Reg. No. 4,099,599

A2D.LIGHT, INC. (CALIFORNIA CORPORATION)
1534 N. MOORPARK RD., #408
THOUSAND OAKS, CA 91360

Registered Feb. 14, 2012

Int. Cls.: 14, 18, and 35

FOR: GOODS MADE OF PRECIOUS METALS AND THEIR ALLOYS OR COATED THEREWITH, NAMELY, JEWELRY, PRECIOUS STONES, KEY RINGS, CUFF LINKS, PENDANTS, BADGES, PINS, TIE PINS, BRACELETS, MEDALLIONS, BROACHES, RINGS, AND EARRINGS, IN CLASS 14 (U.S. CLS. 2, 27, 28 AND 50).

TRADEMARK

SERVICE MARK

FIRST USE 12-1-2010; IN COMMERCE 12-4-2010.

PRINCIPAL REGISTER

FOR: LEATHER AND IMITATION LEATHER, AND GOODS MADE OF THESE MATERIALS, NAMELY, UMBRELLAS, PARASOLS AND WALKING STICKS, BAGS, COSMETIC BAGS SOLD EMPTY, WALLETS, PURSES, SUITCASES, BRIEFCASES, BACK PACKS, SHOULDER STRAPS AND BRIEFCASE-TYPE LEATHER BUSINESS FOLDERS, IN CLASS 18 (U.S. CLS. 1, 2, 3, 22 AND 41).

FIRST USE 12-1-2010; IN COMMERCE 12-31-2010.

FOR: THE BRINGING TOGETHER, FOR THE BENEFIT OF OTHERS, OF A VARIETY OF GOODS, ENABLING CUSTOMERS TO CONVENIENTLY VIEW AND PURCHASE THOSE GOODS IN THE FIELD OF JEWELRY, CONSUMER GOODS MADE OF LEATHER AND IMITATION LEATHER, CLOTHING AND CLOTHING ACCESSORIES; RETAIL STORE SERVICES, WHOLESALE OUTLET SERVICES, MAIL ORDER CATALOG SERVICES, PROVIDING HOME SHOPPING SERVICES BY MEANS OF TELEVISION, AND COMPUTERIZED ON-LINE ORDERING SERVICES, ALL IN THE FIELD OF JEWELRY, CONSUMER GOODS MADE OF LEATHER AND IMITATION LEATHER, CLOTHING AND CLOTHING ACCESSORIES, IN CLASS 35 (U.S. CLS. 100, 101 AND 102).

FIRST USE 12-1-2010; IN COMMERCE 12-1-2010.

SN 77-981,644, FILED 2-19-2009.

LESLIE RICHARDS, EXAMINING ATTORNEY



David J. Kyjars

Director of the United States Patent and Trademark Office

United States of America

United States Patent and Trademark Office

ZYBRESTAT

Reg. No. 4,099,600

Registered Feb. 14, 2012

Int. Cl.: 5

TRADEMARK

PRINCIPAL REGISTER

OXIGENE, INC. (DELAWARE CORPORATION)
701 GATEWAY BLVD
SUITE 210
SOUTH SAN FRANCISCO, CA 94080

FOR: PHARMACEUTICAL PRODUCTS FOR ONCOLOGICAL AND OPHTHALMOLOGICAL
USE, IN CLASS 5 (U.S. CLS. 6, 18, 44, 46, 51 AND 52).

FIRST USE 2-0-2011; IN COMMERCE 2-0-2011.

THE MARK CONSISTS OF STANDARD CHARACTERS WITHOUT CLAIM TO ANY PAR-
TICULAR FONT, STYLE, SIZE, OR COLOR.

SN 77-982,121, FILED 12-13-2006.

RENEE MCCRAY, EXAMINING ATTORNEY



David J. Kybas

Director of the United States Patent and Trademark Office

United States of America

United States Patent and Trademark Office

MINNIE MOUSE BOW-TIQUE

Reg. No. 4,099,601

DISNEY ENTERPRISES, INC. (DELAWARE CORPORATION)
500 SOUTH BUENA VISTA STREET
BURBANK, CA 91521

Registered Feb. 14, 2012

Int. Cl.: 28

FOR: ACTION FIGURES AND ACCESSORIES THEREFOR; DOLLS; DOLL CLOTHING;
DOLL ACCESSORIES; DOLL PLAYSETS; PLUSH TOYS; STUFFED TOYS; TALKING TOYS;
TOY ACTION FIGURES AND ACCESSORIES THEREFOR; TOY VEHICLES; TOY FIGURES,
IN CLASS 28 (U.S. CLS. 22, 23, 38 AND 50).

TRADEMARK

PRINCIPAL REGISTER

FIRST USE 2-28-2010; IN COMMERCE 2-28-2010.

THE MARK CONSISTS OF STANDARD CHARACTERS WITHOUT CLAIM TO ANY PARTICULAR FONT, STYLE, SIZE, OR COLOR.

OWNER OF U.S. REG. NOS. 3,102,338, 3,767,850, AND OTHERS.

SN 77-982,484, FILED 3-9-2010.

FONG HSU, EXAMINING ATTORNEY



David J. Kyffers

Director of the United States Patent and Trademark Office

United States of America

United States Patent and Trademark Office

DRINK THIS NOT THAT

Reg. No. 4,099,602

RODALE INC. (PENNSYLVANIA CORPORATION)
33 EAST MINOR STREET
EMMAUS, PA 180980099

Registered Feb. 14, 2012

Int. Cl.: 41

FOR: ENTERTAINMENT SERVICES IN THE NATURE OF CONTINUING TELEVISION SEGMENTS IN THE FIELD OF HEALTH, DIET AND NUTRITION, IN CLASS 41 (U.S. CLS. 100, 101 AND 107).

SERVICE MARK

FIRST USE 3-17-2011; IN COMMERCE 3-17-2011.

PRINCIPAL REGISTER

THE MARK CONSISTS OF STANDARD CHARACTERS WITHOUT CLAIM TO ANY PARTICULAR FONT, STYLE, SIZE, OR COLOR.

OWNER OF U.S. REG. NO. 3,033,225.

SN 77-982,612, FILED 1-11-2008.

BARBARA RUTLAND, EXAMINING ATTORNEY



David J. Kyffers

Director of the United States Patent and Trademark Office

United States of America

United States Patent and Trademark Office

STERLING HALL

Reg. No. 4,099,603

Registered Feb. 14, 2012

Int. Cls.: 35 and 37

SERVICE MARK

PRINCIPAL REGISTER

CHARLES G. HALL, IV (UNITED STATES INDIVIDUAL)
535 S. PLAINFIELD ROAD
SUITE A
WILLOWBROOK, IL 605277607

FOR: PROJECT MANAGEMENT SERVICES FOR OTHERS FOR BUSINESS PURPOSES IN THE FIELDS OF DEVELOPING AND CONSTRUCTING SENIOR LIVING FACILITIES AND COMMUNITIES; NEGOTIATION FOR OTHERS OF REAL ESTATE AGREEMENTS, IN CLASS 35 (U.S. CLS. 100, 101 AND 102).

FIRST USE 7-29-2011; IN COMMERCE 7-29-2011.

FOR: REAL ESTATE DEVELOPMENT IN THE FIELD OF SENIOR LIVING FACILITIES; CONSTRUCTION PROJECT MANAGEMENT SERVICES IN THE FIELDS OF DEVELOPING AND CONSTRUCTING SENIOR LIVING FACILITIES AND COMMUNITIES, IN CLASS 37 (U.S. CLS. 100, 103 AND 106).

FIRST USE 7-29-2011; IN COMMERCE 7-29-2011.

THE MARK CONSISTS OF STANDARD CHARACTERS WITHOUT CLAIM TO ANY PARTICULAR FONT, STYLE, SIZE, OR COLOR.

OWNER OF U.S. REG. NO. 2,650,526.

SN 77-982,703, FILED 2-18-2010.

RENEE SERVANCE, EXAMINING ATTORNEY



David J. Kybas

Director of the United States Patent and Trademark Office

United States of America

United States Patent and Trademark Office

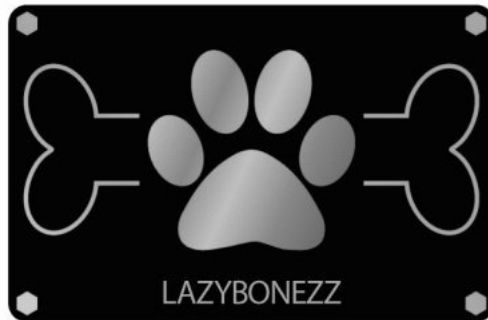

Reg. No. 4,099,604

Registered Feb. 14, 2012

Int. Cls.: 18 and 20

TRADEMARK

PRINCIPAL REGISTER

LAZY BONES PET PRODUCTS, LLC (NEW YORK LIMITED LIABILITY COMPANY)
114 WEST 26TH STREET
NEW YORK, NY 10001

FOR: ANIMAL LEASHES; COLLARS FOR PETS, IN CLASS 18 (U.S. CLS. 1, 2, 3, 22 AND 41).

FIRST USE 12-3-2011; IN COMMERCE 12-3-2011.

FOR: PET FURNITURE, IN CLASS 20 (U.S. CLS. 2, 13, 22, 25, 32 AND 50).

FIRST USE 9-13-2009; IN COMMERCE 9-13-2009.

THE MARK CONSISTS OF A PAW PRINT IN THE CENTER OF A BONE WITH THE WORDS "LAZYBONEZZ" BELOW IT.

SN 77-982,716, FILED 2-6-2009.

JESSICA A. POWERS, EXAMINING ATTORNEY



David J. Kybas

Director of the United States Patent and Trademark Office

United States of America

United States Patent and Trademark Office

H I G H G A T E H O T E L S

Reg. No. 4,099,605

Registered Feb. 14, 2012

Int. Cl.: 35

SERVICE MARK

PRINCIPAL REGISTER

HIGHGATE HOTELS, L.P. (DELAWARE LIMITED PARTNERSHIP)
SUITE 1400
545 E. JOHN CARPENTER FREEWAY
IRVING, TX 75062

FOR: HOTEL MANAGEMENT SERVICES, IN CLASS 35 (U.S. CLS. 100, 101 AND 102).

FIRST USE 7-21-2010; IN COMMERCE 7-21-2010.

NO CLAIM IS MADE TO THE EXCLUSIVE RIGHT TO USE "HOTELS", APART FROM THE MARK AS SHOWN.

THE MARK CONSISTS OF THE WORDS "HIGHGATE HOTELS" IN A STYLIZED FORMAT.

SN 77-982,743, FILED 4-15-2009.

REGINA DRUMMOND, EXAMINING ATTORNEY



David J. Kybas

Director of the United States Patent and Trademark Office

United States of America

United States Patent and Trademark Office

SWISS CARGO

Reg. No. 4,099,606

GSC TECHNOLOGIES CORPORATION (CANADA CORPORATION)
160 VANIER STREET

Registered Feb. 14, 2012

ST. JEAN, CANADA J3B3R4

Int. Cl.: 12

FOR: VEHICLE RACKS FOR BICYCLES, VEHICLE RACKS FOR SKIS, VEHICLE RACKS FOR LUGGAGE, IN CLASS 12 (U.S. CLS. 19, 21, 23, 31, 35 AND 44).

TRADEMARK

FIRST USE 3-0-2010; IN COMMERCE 3-0-2010.

PRINCIPAL REGISTER

THE MARK CONSISTS OF STANDARD CHARACTERS WITHOUT CLAIM TO ANY PARTICULAR FONT, STYLE, SIZE, OR COLOR.

OWNER OF U.S. REG. NOS. 3,610,017 AND 3,610,033.

NO CLAIM IS MADE TO THE EXCLUSIVE RIGHT TO USE "CARGO", APART FROM THE MARK AS SHOWN.

SN 77-982,744, FILED 6-29-2009.

FONG HSU, EXAMINING ATTORNEY



David J. Kybas

Director of the United States Patent and Trademark Office

United States of America

United States Patent and Trademark Office

PLAYPORTT

Reg. No. 4,099,607

TOUCHTUNES MUSIC CORPORATION (DELAWARE CORPORATION)
850 THIRD AVENUE, SUITE 11A
NEW YORK, NY 10022

Registered Feb. 14, 2012

Int. Cl.: 9

FOR: PORTABLE GAME, MUSIC, BROWSER AND ENTERTAINMENT SYSTEM, COMPRISING VIDEO TOUCH SCREEN, INTERNAL AUDIO SPEAKERS, BATTERY SUPPLY AND CHARGERS, VIDEO PROCESSOR FOR EXECUTION OF INTERACTIVE GAMES AND DATA PROCESSING PROGRAMS FOR THE COLLECTION OF FINANCIAL AND ADVERTISING INFORMATION RELATING TO THE USE OF THE SYSTEM; DIGITAL JUKEBOX INCLUDING COMPUTER HARDWARE AND SOFTWARE FOR DISTRIBUTING, SELECTING AND PLAYING AUDIO AND VIDEO MUSICAL INFORMATION; SATELLITE, WIRE, CABLE OR OPTICAL FIBER TELECOMMUNICATION NETWORK FOR REMOTE DOWNLOADING OF DIGITAL INFORMATION ON A DIGITAL TERMINAL OR DIGITAL JUKEBOX; COMPUTER HARDWARE AND SOFTWARE FOR AUDIO AND VISUAL PLAYBACK FOR KARAOKE PERFORMANCES; AUDIOVISUAL SYSTEM COMPRISING DISKS, SPEAKERS, DIGITAL SOUND BOARDS, DIGITAL TELECOMMUNICATION NETWORK, TELECOMMUNICATION BOARDS, TELECOMMUNICATION MODEM, DIGITAL JUKEBOXES, TOUCH SCREENS AND DISPLAY MONITORS; COMPUTER SOFTWARE FOR STORING, ACCESSING AND TRANSMITTING DIGITAL INFORMATION, NAMELY, MUSIC, GAMES, MANAGEMENT INFORMATION, STATISTICS, ROYALTY STATEMENTS, ADVERTISEMENTS, SOUNDS, AND VIDEO; COMPUTER PERIPHERALS, NAMELY, HAND-HELD COMPUTERS, MONITORS, JUKEBOXES, REMOTE CONTROL FOR VIDEO OR AUDIO DIGITAL JUKEBOXES, TOUCH SCREEN, MOUSE, KEYBOARDS AND COMPUTER CABLES, IN CLASS 9 (U.S. CLS. 21, 23, 26, 36 AND 38).

TRADEMARK

PRINCIPAL REGISTER



FIRST USE 10-0-2009; IN COMMERCE 10-0-2009.

THE MARK CONSISTS OF STANDARD CHARACTERS WITHOUT CLAIM TO ANY PARTICULAR FONT, STYLE, SIZE, OR COLOR.

SN 77-982,746, FILED 10-15-2008.

LINDA M. KING, EXAMINING ATTORNEY

David J. Kyffers

Director of the United States Patent and Trademark Office

United States of America

United States Patent and Trademark Office

MAGIC OF HEALTHY LIVING

Reg. No. 4,099,608

Registered Feb. 14, 2012

Int. Cl.: 29

TRADEMARK

PRINCIPAL REGISTER

DISNEY ENTERPRISES, INC. (DELAWARE CORPORATION)
500 SOUTH BUENA VISTA STREET
BURBANK, CA 91521

FOR: PROCESSED FRUITS, IN CLASS 29 (U.S. CL. 46).

FIRST USE 1-31-2011; IN COMMERCE 1-31-2011.

THE MARK CONSISTS OF STANDARD CHARACTERS WITHOUT CLAIM TO ANY PARTICULAR FONT, STYLE, SIZE, OR COLOR.

SN 77-982,771, FILED 2-5-2010.

KATHERINE CONNOLLY, EXAMINING ATTORNEY



David J. Kyffers

Director of the United States Patent and Trademark Office

United States of America
United States Patent and Trademark Office

RAPUNZEL

Reg. No. 4,099,609

DISNEY ENTERPRISES, INC. (DELAWARE CORPORATION)
500 SOUTH BUENA VISTA STREET
BURBANK, CA 91521

Registered Feb. 14, 2012

Int. Cl.: 18

FOR: ALL PURPOSE CARRYING BAGS; BOOK BAGS; TOTE BAGS, IN CLASS 18 (U.S. CLS. 1, 2, 3, 22 AND 41).

TRADEMARK

FIRST USE 11-1-2011; IN COMMERCE 11-1-2011.

PRINCIPAL REGISTER

THE MARK CONSISTS OF STANDARD CHARACTERS WITHOUT CLAIM TO ANY PARTICULAR FONT, STYLE, SIZE, OR COLOR.

SN 77-982,791, FILED 5-21-2009.

NATALIE POLZER, EXAMINING ATTORNEY



David J. Kybas

Director of the United States Patent and Trademark Office

United States of America

United States Patent and Trademark Office

Ballet Beautiful

Reg. No. 4,099,610

Registered Feb. 14, 2012

Int. Cl.: 9

TRADEMARK

PRINCIPAL REGISTER

BALLET BEAUTY LLC (DELAWARE LIMITED LIABILITY COMPANY)
NO. 9J
225 W. 106TH STREET
NEW YORK, NY 10025

FOR: PRE-RECORDED DIGITAL VIDEO DISKS FEATURING INSTRUCTIONAL DANCE TECHNIQUES FOR EXERCISE AND PHYSICAL FITNESS AND PRE-RECORDED DOWNLOADABLE VIDEOS FEATURING INSTRUCTIONAL DANCE TECHNIQUES FOR EXERCISE AND PHYSICAL FITNESS, IN CLASS 9 (U.S. CLS. 21, 23, 26, 36 AND 38).

FIRST USE 8-0-2011; IN COMMERCE 8-0-2011.

THE MARK CONSISTS OF STANDARD CHARACTERS WITHOUT CLAIM TO ANY PARTICULAR FONT, STYLE, SIZE, OR COLOR.

NO CLAIM IS MADE TO THE EXCLUSIVE RIGHT TO USE "BALLET", APART FROM THE MARK AS SHOWN.

SN 77-982,795, FILED 5-28-2009.

KATHERINE CONNOLLY, EXAMINING ATTORNEY



David J. Kyffers

Director of the United States Patent and Trademark Office

United States of America

United States Patent and Trademark Office

ENMOTION

Reg. No. 4,099,611

Registered Feb. 14, 2012

Int. Cls.: 3 and 5

TRADEMARK

PRINCIPAL REGISTER

GEORGIA-PACIFIC CONSUMER PRODUCTS LP (DELAWARE LIMITED PARTNERSHIP)
GA030-41N
133 PEACHTREE STREET NE
ATLANTA, GA 30303

FOR: SOAPS, ANTIBACTERIAL SOAP, IN CLASS 3 (U.S. CLS. 1, 4, 6, 50, 51 AND 52).

FIRST USE 6-30-2009; IN COMMERCE 6-30-2009.

FOR: ANTIBACTERIAL HANDWASH, HAND SANITIZING PREPARATIONS, IN CLASS 5 (U.S. CLS. 6, 18, 44, 46, 51 AND 52).

FIRST USE 6-30-2009; IN COMMERCE 6-30-2009.

THE MARK CONSISTS OF STANDARD CHARACTERS WITHOUT CLAIM TO ANY PARTICULAR FONT, STYLE, SIZE, OR COLOR.

OWNER OF U.S. REG. NOS. 2,664,519, 2,743,984, AND OTHERS.

SN 77-982,800, FILED 3-4-2008.

ROBIN MITTLER, EXAMINING ATTORNEY



David J. Kyffers

Director of the United States Patent and Trademark Office

United States of America

United States Patent and Trademark Office



Reg. No. 4,099,612

Registered Feb. 14, 2012

Int. Cls.: 4, 16, and 21

TRADEMARK

PRINCIPAL REGISTER

BIGELOW MERCHANDISING, LLC (DELAWARE LIMITED LIABILITY COMPANY)
THREE LIMITED PARKWAY
COLUMBUS, OH 43230

FOR: CANDLES, IN CLASS 4 (U.S. CLS. 1, 6 AND 15).

FIRST USE 12-31-2008; IN COMMERCE 12-31-2008.

FOR: CARDBOARD GIFT BOXES, GIFT WRAPPING PAPER, PAPER AND PLASTIC SHOPPING BAGS AND TISSUE PAPER, IN CLASS 16 (U.S. CLS. 2, 5, 22, 23, 29, 37, 38 AND 50).

FIRST USE 1-1-1970; IN COMMERCE 1-1-1970.

FOR: COMBS, HAIR BRUSHES, NON-ELECTRIC TOOTHBRUSHES, SHAVE BRUSHES, AND SHOE POLISHING MITTS, IN CLASS 21 (U.S. CLS. 2, 13, 23, 29, 30, 33, 40 AND 50).

FIRST USE 1-1-2009; IN COMMERCE 1-1-2009.

OWNER OF U.S. REG. NO. 3,636,961.

NO CLAIM IS MADE TO THE EXCLUSIVE RIGHT TO USE "ESTABLISHED 1838 APOTHECARIES", APART FROM THE MARK AS SHOWN.

THE NAME(S), PORTRAIT(S), AND/OR SIGNATURE(S) SHOWN IN THE MARK DOES NOT IDENTIFY A PARTICULAR LIVING INDIVIDUAL.

THE MARK CONSISTS OF THE SCRIPT WORDS "C.O. BIGELOW" ARCHED ABOVE "ESTABLISHED 1838 APOTHECARIES".

SN 77-982,821, FILED 3-26-2010.

CARYN GLASSER, EXAMINING ATTORNEY



David J. Kyjars

Director of the United States Patent and Trademark Office

United States of America

United States Patent and Trademark Office



Reg. No. 4,099,613

GSC TECHNOLOGIES CORPORATION (CANADA CORPORATION)
160 VANIER STREET
ST. JEAN, CANADA J3B3R4

Registered Feb. 14, 2012

Int. Cl.: 12

FOR: VEHICLE RACKS FOR BICYCLES, VEHICLE RACKS FOR SKIS, VEHICLE RACKS FOR LUGGAGE, IN CLASS 12 (U.S. CLS. 19, 21, 23, 31, 35 AND 44).

TRADEMARK

FIRST USE 3-0-2010; IN COMMERCE 3-0-2010.

PRINCIPAL REGISTER

OWNER OF U.S. REG. NOS. 3,610,017 AND 3,610,033.

NO CLAIM IS MADE TO THE EXCLUSIVE RIGHT TO USE "CARGO", APART FROM THE MARK AS SHOWN.

THE MARK CONSISTS OF A CROSS WITHIN AN OCTAGON PRECEDING THE WORDS "SWISS CARGO", ALL OF WHICH ARE ENCIRCLED BY A LONG OVAL.

SN 77-982,842, FILED 6-29-2009.

FONG HSU, EXAMINING ATTORNEY



David J. Kyffers

Director of the United States Patent and Trademark Office

United States of America

United States Patent and Trademark Office

SUMMIT ENTERTAINMENT RECORDS

Reg. No. 4,099,614

Registered Feb. 14, 2012

Int. Cl.: 9

TRADEMARK

PRINCIPAL REGISTER

SUMMIT ENTERTAINMENT, LLC (DELAWARE LIMITED LIABILITY COMPANY)
1630 STEWART STREET, SUITE 120
SANTA MONICA, CA 90404

FOR: MUSICAL SOUND RECORDINGS, IN CLASS 9 (U.S. CLS. 21, 23, 26, 36 AND 38).

FIRST USE 12-9-2008; IN COMMERCE 12-9-2008.

THE MARK CONSISTS OF STANDARD CHARACTERS WITHOUT CLAIM TO ANY PARTICULAR FONT, STYLE, SIZE, OR COLOR.

OWNER OF U.S. REG. NOS. 2,350,426, 3,756,889, AND OTHERS.

NO CLAIM IS MADE TO THE EXCLUSIVE RIGHT TO USE "ENTERTAINMENT RECORDS", APART FROM THE MARK AS SHOWN.

SN 77-982,846, FILED 8-18-2009.

ANDREA HACK, EXAMINING ATTORNEY



David J. Kyffers

Director of the United States Patent and Trademark Office

United States of America

United States Patent and Trademark Office

GREENBEN

Reg. No. 4,099,615

GREENBEN INC. (COLORADO CORPORATION)
4735 MONTVIEW BLVD.
DENVER, CO 80207

Registered Feb. 14, 2012

Int. Cl.: 42

FOR: PROVIDING A WEBSITE FEATURING ONLINE, NON-DOWNLOADABLE SOFTWARE TOOLS FOR THE PURPOSES OF MONITORING ENERGY USE, PROVIDING ENERGY MODELING AND PROVIDING ENERGY ASSESSMENTS, IN CLASS 42 (U.S. CLS. 100 AND 101).

SERVICE MARK

PRINCIPAL REGISTER

FIRST USE 12-30-2010; IN COMMERCE 12-30-2010.

THE MARK CONSISTS OF STANDARD CHARACTERS WITHOUT CLAIM TO ANY PARTICULAR FONT, STYLE, SIZE, OR COLOR.

SN 77-982,853, FILED 3-4-2010.

WILLIAM BRECKENFELD, EXAMINING ATTORNEY



David J. Kyffers

Director of the United States Patent and Trademark Office

United States of America

United States Patent and Trademark Office

MAKING CHANGE. MAKING SENSE.

Reg. No. 4,099,616

GREENBEN INC. (COLORADO CORPORATION)
4735 MONTVIEW BLVD.
DENVER, CO 80207

Registered Feb. 14, 2012

Int. Cl.: 42

FOR: PROVIDING A WEBSITE FEATURING ONLINE, NON-DOWNLOADABLE SOFTWARE TOOLS FOR THE PURPOSES OF MONITORING ENERGY USE, PROVIDING ENERGY MODELING AND PROVIDING ENERGY ASSESSMENTS, IN CLASS 42 (U.S. CLS. 100 AND 101).

SERVICE MARK

PRINCIPAL REGISTER

FIRST USE 12-30-2010; IN COMMERCE 12-30-2010.

THE MARK CONSISTS OF STANDARD CHARACTERS WITHOUT CLAIM TO ANY PARTICULAR FONT, STYLE, SIZE, OR COLOR.

SN 77-982,854, FILED 3-4-2010.

WILLIAM BRECKENFELD, EXAMINING ATTORNEY



David J. Kyffers

Director of the United States Patent and Trademark Office

United States of America

United States Patent and Trademark Office

NUTRA KIST

Reg. No. 4,099,617

AM CONSOLIDATED LLC (CALIFORNIA LIMITED LIABILITY COMPANY)
155 D'ARCY PARKWAY
LATHROP, CA 95330

Registered Feb. 14, 2012

Int. Cl.: 32

FOR: BOTTLED WATER; JUICES IN THE FORM OF SHELF-STABLE FRUIT AND VEGETABLE DRINKS; NON-CARBONATED SOFT DRINKS, IN CLASS 32 (U.S. CLS. 45, 46 AND 48).

TRADEMARK

FIRST USE 2-4-2011; IN COMMERCE 2-4-2011.

PRINCIPAL REGISTER

THE MARK CONSISTS OF STANDARD CHARACTERS WITHOUT CLAIM TO ANY PARTICULAR FONT, STYLE, SIZE, OR COLOR.

SN 77-982,888, FILED 10-8-2007.

REBECCA EISINGER, EXAMINING ATTORNEY



David J. Kyffers

Director of the United States Patent and Trademark Office

United States of America

United States Patent and Trademark Office

TYLER PERRY

Reg. No. 4,099,618

Registered Feb. 14, 2012

**Int. Cls.: 9, 16, 25, and
41**

TRADEMARK

SERVICE MARK

PRINCIPAL REGISTER

PERRY, TYLER (UNITED STATES INDIVIDUAL)
1801 CENTURY PARK WEST
GILBERT-LURIE, STIFFELMAN & COOK LLP
LOS ANGELES, CA 900676406

FOR: PRERECORDED AUDIO AND VIDEO DISCS AND TAPES FEATURING MUSICAL, DRAMATIC AND COMEDY PERFORMANCES, IN CLASS 9 (U.S. CLS. 21, 23, 26, 36 AND 38).

FIRST USE 12-31-2006; IN COMMERCE 12-31-2006.

FOR: PAPER AND PAPER ARTICLES, NAMELY, POSTERS, IN CLASS 16 (U.S. CLS. 2, 5, 22, 23, 29, 37, 38 AND 50).

FIRST USE 12-31-2005; IN COMMERCE 12-31-2005.

FOR: MEN'S AND WOMEN'S CLOTHING, NAMELY, SHIRTS, IN CLASS 25 (U.S. CLS. 22 AND 39).

FIRST USE 12-1-2011; IN COMMERCE 12-1-2011.

FOR: ENTERTAINMENT SERVICES, NAMELY, ARRANGING AND CONDUCTING LIVE CONCERTS AND PRODUCING TELEVISION PROGRAM AND MOTION PICTURE FILMS, ALL FEATURING MUSICAL, DRAMATIC AND COMEDY PERFORMANCES; ENTERTAINMENT SERVICES, NAMELY, TELEVISION AND MOTION PICTURE FILM PRODUCTION SERVICES, IN CLASS 41 (U.S. CLS. 100, 101 AND 107).

FIRST USE 12-31-2005; IN COMMERCE 12-31-2005.

THE MARK CONSISTS OF STANDARD CHARACTERS WITHOUT CLAIM TO ANY PARTICULAR FONT, STYLE, SIZE, OR COLOR.

THE NAME "TYLER PERRY" IDENTIFIES A LIVING INDIVIDUAL WHOSE CONSENT IS OF RECORD.

SN 78-610,205, FILED 4-15-2005.



David J. Kyjars

Director of the United States Patent and Trademark Office

Reg. No. 4,099,618 SANJEEV VOHRA, EXAMINING ATTORNEY

United States of America

United States Patent and Trademark Office



Reg. No. 4,099,619

Registered Feb. 14, 2012

Int. Cls.: 1 and 2

TRADEMARK

PRINCIPAL REGISTER

TRUE VALUE COMPANY (DELAWARE CORPORATION)
8600 WEST BRYN MAWR AVENUE
CHICAGO, IL 606313505

FOR: FERTILIZERS, IN CLASS 1 (U.S. CLS. 1, 5, 6, 10, 26 AND 46).

FIRST USE 7-29-2005; IN COMMERCE 7-29-2005.

FOR: PRUNING SEAL, NAMELY, CLEAR COATING PROTECTANT FOR TREES AND SHRUBS, IN CLASS 2 (U.S. CLS. 6, 11 AND 16).

FIRST USE 7-29-2005; IN COMMERCE 7-29-2005.

OWNER OF U.S. REG. NOS. 581,301, 3,068,261, AND OTHERS.

THE MARK CONSISTS OF THE WORDS "GREEN THUMB" UNDERLINED BY A CURVED LINE, IN A MISCELLANEOUS OVAL DESIGN WITH A LEAF DESIGN TO THE RIGHT OF THE WORDS "GREEN THUMB".

SN 78-681,340, FILED 7-29-2005.

AMY C. KEAN, EXAMINING ATTORNEY



David J. Kappas

Director of the United States Patent and Trademark Office

United States of America

United States Patent and Trademark Office

TEXT

Reg. No. 4,099,620

GROSS, JEFFERY (UNITED STATES INDIVIDUAL)
1654 N. STANLEY AVE. #3
LOS ANGELES, CA 90046

Registered Feb. 14, 2012

Int. Cls.: 9 and 41

FOR: MUSICAL SOUND RECORDINGS; MUSICAL VIDEO RECORDINGS; DOWNLOADABLE MUSICAL SOUND RECORDINGS; DOWNLOADABLE RING TONES, GRAPHICS AND MUSIC VIA A GLOBAL COMPUTER NETWORK AND WIRELESS DEVICES; DOWNLOADABLE VIDEO RECORDINGS FEATURING MUSIC; VISUAL RECORDINGS AND AUDIO VISUAL RECORDINGS FEATURING MUSIC AND ANIMATION, IN CLASS 9 (U.S. CLS. 21, 23, 26, 36 AND 38).

TRADEMARK

SERVICE MARK

PRINCIPAL REGISTER

FIRST USE 7-5-2005; IN COMMERCE 7-5-2005.

FOR: ENTERTAINMENT, NAMELY, LIVE PERFORMANCES BY A MUSICAL BAND; ENTERTAINMENT SERVICES, NAMELY, PROVIDING A WEB SITE FEATURING MUSICAL PERFORMANCES, MUSICAL VIDEOS, RELATED FILM CLIPS, PHOTOGRAPHS, AND OTHER MULTIMEDIA MATERIALS, IN CLASS 41 (U.S. CLS. 100, 101 AND 107).

FIRST USE 7-5-2005; IN COMMERCE 7-5-2005.

THE MARK CONSISTS OF STANDARD CHARACTERS WITHOUT CLAIM TO ANY PARTICULAR FONT, STYLE, SIZE, OR COLOR.

SN 78-723,588, FILED 9-29-2005.

DAYNA BROWNE, EXAMINING ATTORNEY



David J. Kyros

Director of the United States Patent and Trademark Office

United States of America

United States Patent and Trademark Office



Reg. No. 4,099,621

Registered Feb. 14, 2012

Int. Cl.: 3

TRADEMARK

PRINCIPAL REGISTER

ROYAL COUNTY OF BERKSHIRE POLO CLUB LTD. (UNITED KINGDOM CORPORATION)
NORTH STREET WINKFIELD, WINDSOR
BERKSHIRE, UNITED KINGDOM SL4 4TH

FOR: NON-MEDICATED TOILETRIES, PERFUMERY, AFTERSHAVE, CLEANING, STYLING AND STRAIGHTENING PREPARATIONS FOR THE HAIR, SHAMPOO, SOAPS, ESSENTIAL OILS, COSMETICS, HAIR LOTION, PERSONAL DEODORANTS, EAU DE TOILETTE, BODY SPRAYS, BATH OILS, BUBBLE BATH, SHOWER GEL, IN CLASS 3 (U.S. CLS. 1, 4, 6, 50, 51 AND 52).

FIRST USE 6-6-2011; IN COMMERCE 6-6-2011.

OWNER OF U.S. REG. NO. 2,525,322.

NO CLAIM IS MADE TO THE EXCLUSIVE RIGHT TO USE "ROYAL BERKSHIRE", APART FROM THE MARK AS SHOWN.

THE MARK CONSISTS OF A MAN IN POLO OUTFIT RIDING A HORSE HOLDING A POLO Mallet (STICK) VERTICALLY, WITH THE WORDING, "ROYAL BERKSHIRE" PRINTED UNDER THE HORSE AND THE WORDING, "POLO CLUB" PRINTED UNDER THIS WORDING.

SN 78-816,061, FILED 2-16-2006.

SARA BENJAMIN, EXAMINING ATTORNEY



David J. Kybas

Director of the United States Patent and Trademark Office

United States of America

United States Patent and Trademark Office

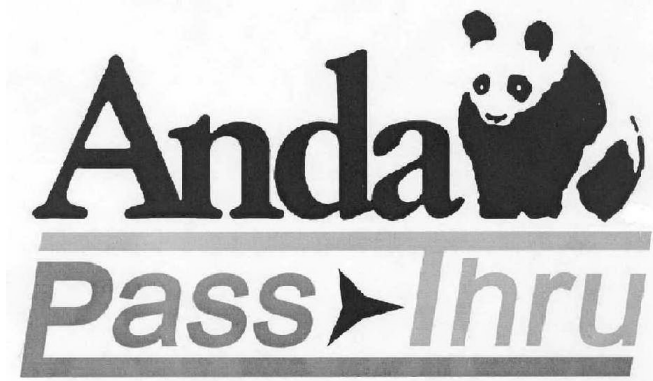

Reg. No. 4,099,622

ANDA, INC. (FLORIDA CORPORATION)
4955 ORANGE DRIVE
DAVIE, FL 33314

Registered Feb. 14, 2012

Int. Cl.: 9

FOR: COMPUTER SOFTWARE FEATURING A DATABASE FOR AUTOMATED ELECTRONIC DATA CAPTURE AND EXCHANGE OF PHARMACY ORDERS BY PHARMACEUTICAL DISTRIBUTORS, IN CLASS 9 (U.S. CLS. 21, 23, 26, 36 AND 38).

TRADEMARK

FIRST USE 1-31-2006; IN COMMERCE 1-31-2006.

PRINCIPAL REGISTER

THE TERM "ANDA" HAS NO MEANING IN A FOREIGN LANGUAGE.

SN 78-921,540, FILED 6-30-2006.

AMY C. KEAN, EXAMINING ATTORNEY



David J. Kappas

Director of the United States Patent and Trademark Office

United States of America

United States Patent and Trademark Office

DIAM

Reg. No. 4,099,623

WARSAW ORTHOPEDIC, INC. (INDIANA CORPORATION)
2500 SILVEUS CROSSING
WARSAW, IN 46581

Registered Feb. 14, 2012

Int. Cl.: 10

FOR: SURGICAL IMPLANTS COMPRISING ARTIFICIAL MATERIAL, IN CLASS 10 (U.S. CLS. 26, 39 AND 44).

TRADEMARK

FIRST USE 9-23-2006; IN COMMERCE 9-23-2009.

PRINCIPAL REGISTER

THE MARK CONSISTS OF STANDARD CHARACTERS WITHOUT CLAIM TO ANY PARTICULAR FONT, STYLE, SIZE, OR COLOR.

SN 78-973,615, FILED 9-13-2006.

MAYUR VAGHANI, EXAMINING ATTORNEY



David J. Kybas

Director of the United States Patent and Trademark Office

United States of America

United States Patent and Trademark Office

SNAKE MOUNTAIN

Reg. No. 4,099,624

Registered Feb. 14, 2012

Int. Cl.: 28

TRADEMARK

PRINCIPAL REGISTER

MATTEL, INC. (DELAWARE CORPORATION)
M1-1518
333 CONTINENTAL BOULEVARD
EL SEGUNDO, CA 90245

FOR: TOY FIGURES AND ACCESSORIES THEREFOR, IN CLASS 28 (U.S. CLS. 22, 23, 38 AND 50).

FIRST USE 12-15-2011; IN COMMERCE 12-15-2011.

THE MARK CONSISTS OF STANDARD CHARACTERS WITHOUT CLAIM TO ANY PARTICULAR FONT, STYLE, SIZE, OR COLOR.

SN 85-000,523, FILED 3-29-2010.

FRED CARL, EXAMINING ATTORNEY



David J. Kyffers

Director of the United States Patent and Trademark Office

United States of America

United States Patent and Trademark Office

TopMelt

Reg. No. 4,099,625

SURTECO USA INC. (NORTH CAROLINA CORPORATION)
7104 CESSNA DRIVE
GREENSBORO, NC 27409

Registered Feb. 14, 2012

**Int. Cls.: 1, 17, 19, and
20**

FOR: ADHESIVES AND GLUES FOR INDUSTRIAL PURPOSES; INDUSTRIAL ADHESIVES FOR USE IN COATING AND SEALING AND IN THE MANUFACTURE OF FURNITURE, IN CLASS 1 (U.S. CLS. 1, 5, 6, 10, 26 AND 46).

TRADEMARK

FIRST USE 2-0-2010; IN COMMERCE 2-0-2010.

PRINCIPAL REGISTER

FOR: PACKING AND INSULATING MATERIAL AND MATERIAL FOR FORMING SEALS, NAMELY, PAPER IMPREGNATED WITH RESIN, NAMELY, MELAMINE RESIN TO COAT SURFACES OF WOOD OR PLASTIC WORK PIECES FOR USE IN MANUFACTURING AND THE INDUSTRY; CONTINUOUS PRESSURE LAMINATE SURFACES FOR USE IN MANUFACTURING AND INDUSTRY; SEMI-FINISHED GOODS OF PLASTICS IN THE FORM OF EDGES, EDGE BANDS, WALL CONNECTOR BLOCKS FOR USE IN MANUFACTURING AND INDUSTRY; SEMI-WORKED SYNTHETIC PLASTIC AS SEMI-FINISHED PRODUCTS IN FORM OF FOILS OTHER THAN FOR PACKAGING, IN CLASS 17 (U.S. CLS. 1, 5, 12, 13, 35 AND 50).

FIRST USE 2-0-2010; IN COMMERCE 2-0-2010.



FOR: NON-METALLIC BUILDING MATERIALS, NAMELY, PROFILES OF PLASTICS FOR USE AS CONNECTORS FOR ADJACENT DRYWALL PANELS AND SKIRTING BOARDS OF PLASTIC FOR MAKING WINDOW CASEMENTS; SKIRTING BOARDS OF WOOD FOR MAKING WINDOW CASEMENTS; WOOD VENEERS, NAMELY, SURFACE DECORATIONS, NOT OF METAL, BEING FINISHED GOODS WITH A BASE OF PRINTED AND IMPREGNATED PAPERS, FOR USE IN FURNITURE BUILDING AND INTERIOR DECORATION, IN CLASS 19 (U.S. CLS. 1, 12, 33 AND 50).

FIRST USE 2-0-2010; IN COMMERCE 2-0-2010.

David J. Kyffers

FOR: FURNITURE, PARTS FOR FURNITURE, FRAMES, ALL OF THE AFOREMENTIONED OF WOOD AND SUBSTITUTES THEREFOR, OR OF PLASTICS; FURNITURE EDGES, NOT OF METAL AND NOT OF TEXTILE MATERIAL, IN CLASS 20 (U.S. CLS. 2, 13, 22, 25, 32 AND 50).

Director of the United States Patent and Trademark Office

Reg. No. 4,099,625 FIRST USE 2-0-2010; IN COMMERCE 2-0-2010.

THE MARK CONSISTS OF STANDARD CHARACTERS WITHOUT CLAIM TO ANY PARTICULAR FONT, STYLE, SIZE, OR COLOR.

SN 85-000,774, FILED 3-29-2010.

TRACY CROSS, EXAMINING ATTORNEY

United States of America

United States Patent and Trademark Office

JIMINY WICKET .COM

Reg. No. 4,099,626

Registered Feb. 14, 2012

Int. Cl.: 41

SERVICE MARK

PRINCIPAL REGISTER

CREASEY, JAMES R. (UNITED KINGDOM INDIVIDUAL)
3060 SOUTH MARION
ENGLEWOOD, CO 80113

FOR: EDUCATIONAL SERVICES, NAMELY, DEVELOPING, ARRANGING, AND CONDUCTING EDUCATIONAL CONFERENCES AND PROGRAMS AND PROVIDING COURSES OF INSTRUCTION IN THE FIELD OF EDUCATING PEOPLE OF ALL AGES AND ABILITIES TO PLAY CROQUET TO CREATE OR PROMOTE THE WELL BEING OF THOSE SUFFERING FROM AN IMPAIRMENT, AND/OR TO SUPPORT THE HOME, WORK, OR SOCIAL COMMUNITIES OF INDIVIDUALS SUFFERING FROM AN IMPAIRMENT, IN CLASS 41 (U.S. CLS. 100, 101 AND 107).

FIRST USE 4-15-2010; IN COMMERCE 4-16-2010.

THE MARK CONSISTS OF STANDARD CHARACTERS WITHOUT CLAIM TO ANY PARTICULAR FONT, STYLE, SIZE, OR COLOR.

NO CLAIM IS MADE TO THE EXCLUSIVE RIGHT TO USE ".COM" , APART FROM THE MARK AS SHOWN.

SN 85-001,415, FILED 3-29-2010.

NELSON SNYDER, EXAMINING ATTORNEY



David J. Kybas

Director of the United States Patent and Trademark Office

United States of America

United States Patent and Trademark Office

KMG - KRAV MAGA GLOBAL

Reg. No. 4,099,627

EYAL, YANILOV (ISRAEL INDIVIDUAL)

Registered Feb. 14, 2012

P.O. BOX 2956
EVEN YEHUDA, ISRAEL 40500

Int. Cl.: 25

FOR: CLOTHES, NAMELY, SHIRTS, PANTS, JACKETS, SHORTS, HATS, IN CLASS 25 (U.S. CLS. 22 AND 39).

TRADEMARK

FIRST USE 5-31-2010; IN COMMERCE 5-31-2010.

PRINCIPAL REGISTER

THE MARK CONSISTS OF STANDARD CHARACTERS WITHOUT CLAIM TO ANY PARTICULAR FONT, STYLE, SIZE, OR COLOR.

NO CLAIM IS MADE TO THE EXCLUSIVE RIGHT TO USE "KRAV MAGA GLOBAL", APART FROM THE MARK AS SHOWN.

THE ENGLISH TRANSLATION OF "KRAV MAGA" IN THE MARK IS "CONTACT COMBAT".

SN 85-002,352, FILED 3-30-2010.

DOMINICK J. SALEMI, EXAMINING ATTORNEY



David J. Kybas

Director of the United States Patent and Trademark Office

United States of America

United States Patent and Trademark Office

VARIAN MEDICAL SYSTEMS

Reg. No. 4,099,628

VARIAN MEDICAL SYSTEMS, INC. (DELAWARE CORPORATION)
3100 HANSEN WAY
PALO ALTO, CA 94304

Registered Feb. 14, 2012

**Int. Cls.: 9, 37, 41, and
42**

FOR: HIGH-ENERGY X-RAY DEVICES AND SOFTWARE SOLD THEREWITH FOR SECURITY INSPECTION AND NON-DESTRUCTIVE TESTING AND INSPECTION APPLICATIONS, IN CLASS 9 (U.S. CLS. 21, 23, 26, 36 AND 38).

TRADEMARK

FIRST USE 9-15-2000; IN COMMERCE 9-15-2000.

SERVICE MARK

FOR: REPAIR AND MAINTENANCE OF HIGH-ENERGY X-RAY APPARATUS, IN CLASS 37 (U.S. CLS. 100, 103 AND 106).

PRINCIPAL REGISTER

FIRST USE 9-15-2000; IN COMMERCE 9-15-2000.

FOR: TRAINING SERVICES IN THE FIELD OF SECURITY INSPECTION AND NON-DESTRUCTIVE TESTING AND INSPECTION, IN CLASS 41 (U.S. CLS. 100, 101 AND 107).

FIRST USE 9-15-2000; IN COMMERCE 9-15-2000.

FOR: REPAIR AND MAINTENANCE OF COMPUTER SOFTWARE FOR HIGH-ENERGY X-RAY DEVICES, IN CLASS 42 (U.S. CLS. 100 AND 101).

FIRST USE 9-15-2000; IN COMMERCE 9-15-2000.

THE MARK CONSISTS OF STANDARD CHARACTERS WITHOUT CLAIM TO ANY PARTICULAR FONT, STYLE, SIZE, OR COLOR.

NO CLAIM IS MADE TO THE EXCLUSIVE RIGHT TO USE "MEDICAL SYSTEMS", APART FROM THE MARK AS SHOWN.

SN 85-003,626, FILED 3-31-2010.

ANGELA M. MICHELI, EXAMINING ATTORNEY



David J. Kyros

Director of the United States Patent and Trademark Office

United States of America

United States Patent and Trademark Office



Reg. No. 4,099,629

Registered Feb. 14, 2012

Int. Cl.: 9

TRADEMARK

PRINCIPAL REGISTER

NCSOFT CORPORATION (REPUBLIC OF KOREA CORPORATION)
OKSAN BUILDING
157-33 SAMSUNG-DONG, GANGNAM-GU
SEOUL, REPUBLIC OF KOREA 135-090

FOR: COMPUTER GAME SOFTWARE; INTERACTIVE MULTIMEDIA COMPUTER GAME PROGRAMS; DOWNLOADABLE ELECTRONIC PUBLICATIONS IN THE NATURE OF NEWSLETTERS FEATURING ROLE-PLAYING, IN CLASS 9 (U.S. CLS. 21, 23, 26, 36 AND 38).

FIRST USE 9-0-2010; IN COMMERCE 9-0-2010.

OWNER OF U.S. REG. NOS. 2,887,785, 2,890,366, AND OTHERS.

THE MARK CONSISTS OF "GUILD WARS" AND A STYLIZED DRAGON IN THE FORM OF THE NUMBER "2".

SN 85-004,604, FILED 4-1-2010.

JERI J. FICKES, EXAMINING ATTORNEY



David J. Kyjars

Director of the United States Patent and Trademark Office

United States of America

United States Patent and Trademark Office

INTELISPEND PREPAID SOLUTIONS

Reg. No. 4,099,630

Registered Feb. 14, 2012

Int. Cls.: 9 and 35

TRADEMARK

SERVICE MARK

PRINCIPAL REGISTER

INTELISPEND PREPAID SOLUTIONS, L.L.C. (MISSOURI LIMITED LIABILITY COMPANY)
1400 S. HIGHWAY DRIVE
FENTON, MO 63099

FOR: PREPAID CARDS ISSUED TO BUSINESSES AND INDIVIDUAL CONSUMERS, NAMELY, MAGNETICALLY ENCODED REWARD CARDS AND ELECTRONICALLY READABLE REWARD CARDS; PREPAID CARDS AWARDED IN CONJUNCTION WITH EMPLOYEE, DISTRIBUTOR AND CUSTOMER REWARD AND RECOGNITION, SALES INCENTIVE, COSTS SAVINGS, LOYALTY, FREQUENCY AND AFFINITY PROGRAMS, NAMELY, MAGNETICALLY ENCODED REWARD CARDS AND ELECTRONICALLY READABLE REWARD CARDS, IN CLASS 9 (U.S. CLS. 21, 23, 26, 36 AND 38).

FIRST USE 5-17-2010; IN COMMERCE 5-17-2010.

FOR: ISSUING PREPAID CARDS; RESELLER SERVICES, NAMELY, DISTRIBUTORSHIP AND PROGRAM MANAGEMENT SERVICES IN THE FIELD OF PREPAID CARDS PURCHASED FROM FINANCIAL INSTITUTIONS FOR LOYALTY, SALES PERFORMANCE, CONSUMER PROMOTION, AND EMPLOYEE PERFORMANCE PROGRAMS; PROVIDING CUSTOMER SERVICE IN THE FIELD OF PREPAID CARDS, NAMELY, PROVIDING CARD BALANCE AND RELATED INFORMATION; PROMOTING EMPLOYEE, DISTRIBUTOR, AND CUSTOMER REWARD AND RECOGNITION, SALES INCENTIVE, COSTS SAVINGS, LOYALTY, FREQUENCY, AND AFFINITY PROGRAMS, THROUGH THE ADMINISTERING AND CONDUCTING OF INCENTIVE PROGRAMS INVOLVING THE ISSUANCE OF PREPAID CARDS, IN CLASS 35 (U.S. CLS. 100, 101 AND 102).

FIRST USE 5-17-2010; IN COMMERCE 5-17-2010.

THE MARK CONSISTS OF STANDARD CHARACTERS WITHOUT CLAIM TO ANY PARTICULAR FONT, STYLE, SIZE, OR COLOR.

NO CLAIM IS MADE TO THE EXCLUSIVE RIGHT TO USE "PREPAID SOLUTIONS", APART FROM THE MARK AS SHOWN.

SN 85-005,369, FILED 4-2-2010.

DORITT L. CARROLL, EXAMINING ATTORNEY



David J. Kyros

Director of the United States Patent and Trademark Office

United States of America

United States Patent and Trademark Office

SOMB

Reg. No. 4,099,631

Registered Feb. 14, 2012

Int. Cl.: 25

TRADEMARK

PRINCIPAL REGISTER

SOMB, LLC (CALIFORNIA LIMITED LIABILITY COMPANY)
11812 GORHAM AVENUE, PH 2
LOS ANGELES, CA 90049

FOR: ATHLETIC APPAREL, NAMELY, SHIRTS, PANTS, JACKETS, FOOTWEAR, HATS AND CAPS, ATHLETIC UNIFORMS; BOARD SHORTS; BODY SHIRTS; BOXER SHORTS; CAMOUFLAGE PANTS; CAMOUFLAGE SHIRTS; CAMOUFLAGE VESTS; CARGO PANTS; DENIMS; DRESS SHIRTS; DRESS SUITS; DRESSES; DRESSES MADE FROM SKINS; DRESSES THAT MAY ALSO BE USED AS TOWELS; DRESSING GOWNS; DRESSING GOWNS AND BATH ROBES; EVENING DRESSES; FLEECE SHORTS; FLEECE VESTS; GOLF PANTS, SHIRTS AND SKIRTS; GOLF SHIRTS; GOLF SHORTS; GYM PANTS; GYM SHORTS; HOODED SWEAT SHIRTS; JOGGING PANTS; KNIT SHIRTS; LONG SLEEVED VESTS; LONG-SLEEVED SHIRTS; LOUNGE PANTS; MEN'S AND WOMEN'S JACKETS, COATS, TROUSERS, VESTS; OPEN-NECKED SHIRTS; OVER SHIRTS; PANTIES, SHORTS AND BRIEFS; PANTS; POLO SHIRTS; RUGBY SHIRTS; RUGBY SHORTS; SCIENTIFIC AND TECHNOLOGICAL APPAREL, NAMELY, SHIRTS, PANTS, JACKETS, FOOTWEAR, HATS AND CAPS, UNIFORMS; SHIRTS; SHIRTS AND SHORT-SLEEVED SHIRTS; SHIRTS FOR INFANTS, BABIES, TODDLERS AND CHILDREN; SHIRTS FOR SUITS; SHORT SETS; SHORT TROUSERS; SHORT-SLEEVED OR LONG-SLEEVED T-SHIRTS; SHORT-SLEEVED SHIRTS; SHORTS; SKIRT SUITS; SKIRTS; SLEEP PANTS; SLEEP SHIRTS; SNOW PANTS; SPORT SHIRTS; SPORTS PANTS; SPORTS SHIRTS; SPORTS SHIRTS WITH SHORT SLEEVES; SPORTS VESTS; SWEAT PANTS; SWEAT SHIRTS; SWEAT SHORTS; T-SHIRTS; TEE SHIRTS; TRACK PANTS; TURTLE NECK SHIRTS; UNDERWEAR, NAMELY, BOY SHORTS; VESTED SUITS; VESTS; WALKING SHORTS; WATERPROOF JACKETS AND PANTS; WEARABLE GARMENTS AND CLOTHING, NAMELY, SHIRTS, IN CLASS 25 (U.S. CLS. 22 AND 39).

FIRST USE 12-1-2010; IN COMMERCE 12-1-2010.

THE MARK CONSISTS OF STANDARD CHARACTERS WITHOUT CLAIM TO ANY PARTICULAR FONT, STYLE, SIZE, OR COLOR.

SN 85-005,614, FILED 4-3-2010.

MICHAEL GAFFAR, EXAMINING ATTORNEY



David J. Kyffers

Director of the United States Patent and Trademark Office

United States of America

United States Patent and Trademark Office

GLOW-N-GROW

Reg. No. 4,099,632

Registered Feb. 14, 2012

Int. Cl.: 5

TRADEMARK

PRINCIPAL REGISTER

MIRZA, MOHAMMAD ALI (PAKISTAN INDIVIDUAL)
P.O. BOX 5652
M 35, NEW AL SAFIYA BLDG
DUBAI, UNITED ARAB EMIR. DXB5652

FOR: DIETARY AND NUTRITIONAL SUPPLEMENTS; DIETARY SUPPLEMENTS; MULTI-VITAMIN PREPARATIONS; VITAMIN AND MINERAL SUPPLEMENTS; VITAMIN SUPPLEMENTS, IN CLASS 5 (U.S. CLS. 6, 18, 44, 46, 51 AND 52).

FIRST USE 9-16-2005; IN COMMERCE 9-16-2005.

THE MARK CONSISTS OF STANDARD CHARACTERS WITHOUT CLAIM TO ANY PARTICULAR FONT, STYLE, SIZE, OR COLOR.

SN 85-005,642, FILED 4-3-2010.

LINDA M. KING, EXAMINING ATTORNEY



David J. Kyffers

Director of the United States Patent and Trademark Office

United States of America

United States Patent and Trademark Office



Reg. No. 4,099,633

Registered Feb. 14, 2012

Int. Cl.: 9

TRADEMARK

PRINCIPAL REGISTER

MOBILE COMMUNICATION TECHNOLOGIES (TEXAS LIMITED LIABILITY COMPANY)
4305 YOAKUM BOULEVARD
HOUSTON, TX 77006

FOR: CELL PHONES; DIGITAL CELLULAR PHONES; DOWNLOADABLE GRAPHICS FOR MOBILE PHONES; DOWNLOADABLE RING TONES AND GRAPHICS FOR MOBILE PHONES; MOBILE PHONES, IN CLASS 9 (U.S. CLS. 21, 23, 26, 36 AND 38).

FIRST USE 1-10-2010; IN COMMERCE 1-10-2010.

THE MARK CONSISTS OF THE WORDS "STOP TXTING" IN WHITE ON RED HEXAGON WITH WHITE BORDER WITH A BLACK EDGE AROUND THE OUTSIDE OF THE BORDER.

THE COLOR(S) BLACK, WHITE AND RED IS/ARE CLAIMED AS A FEATURE OF THE MARK.

SN 85-006,077, FILED 4-5-2010.

CAROLYN CATALDO, EXAMINING ATTORNEY



David J. Kyffers

Director of the United States Patent and Trademark Office

United States of America

United States Patent and Trademark Office

KASEY NICOLE

Reg. No. 4,099,634

RICHARD B. LEEDS, PARENT OF KASEY NICOLE LEEDS (UNITED STATES INDIVIDUAL)
7 BURRWOOD COURT
LLOYD HARBOR, NY 11724

Registered Feb. 14, 2012

Int. Cl.: 14

FOR: JEWELRY, IN CLASS 14 (U.S. CLS. 2, 27, 28 AND 50).

TRADEMARK

FIRST USE 4-30-2010; IN COMMERCE 4-30-2010.

PRINCIPAL REGISTER

THE MARK CONSISTS OF STANDARD CHARACTERS WITHOUT CLAIM TO ANY PARTICULAR FONT, STYLE, SIZE, OR COLOR.

THE NAME(S), PORTRAIT(S), AND/OR SIGNATURE(S) SHOWN IN THE MARK IDENTIFIES "KASEY NICOLE", WHOSE CONSENT(S) TO REGISTER IS MADE OF RECORD.

SN 85-006,973, FILED 4-6-2010.

BARBARA GAYNOR, EXAMINING ATTORNEY



David J. Kyffers

Director of the United States Patent and Trademark Office

United States of America

United States Patent and Trademark Office



readymade. stylish. versatile. professional.

Reg. No. 4,099,635

KIMBERLY KENNEDY, LLC (GEORGIA LIMITED LIABILITY COMPANY)
3527 SIMPSON FARM DRIVE, SE
SMYRNA, GA 300804615

Registered Feb. 14, 2012

Int. Cl.: 16

FOR: PAPER PRODUCTS, NAMELY, BLANK PAPER FOR USE IN THE MANUFACTURE OF PRINTING PAPER, INVITATIONS, STATIONERY AND ENVELOPES, IN CLASS 16 (U.S. CLS. 2, 5, 22, 23, 29, 37, 38 AND 50).

TRADEMARK

FIRST USE 11-1-2010; IN COMMERCE 11-1-2010.

PRINCIPAL REGISTER

NO CLAIM IS MADE TO THE EXCLUSIVE RIGHT TO USE "READYMADE" AND "PROFESSIONAL", APART FROM THE MARK AS SHOWN.

THE MARK CONSISTS OF THE LETTERS "RSVP" IN A CURVED ENCLOSURE WITH THE WORDS "READYMADE. STYLISH. VERSATILE. PROFESSIONAL." WRITTEN BELOW.

SN 85-007,901, FILED 4-6-2010.

TEJBIR SINGH, EXAMINING ATTORNEY



David J. Kyffers

Director of the United States Patent and Trademark Office

United States of America

United States Patent and Trademark Office

ROCOCO

Reg. No. 4,099,636

Registered Feb. 14, 2012

Int. Cl.: 3

TRADEMARK

PRINCIPAL REGISTER

INTERNATIONAL COSMETICS AND DESIGN LIMITED (UNITED KINGDOM LIMITED COMPANY (LTD.))
152-160 CITY ROAD, KEMP HOUSE, SUITE 406
LONDON, UNITED KINGDOM EC1V2NX

FOR: COSMETICS; NAIL VARNISH; NAIL VARNISH REMOVER; ARTIFICIAL FINGERNAILS; ADHESIVES FOR ARTIFICIAL NAILS; ACRYLIC FINGERNAILS; GEL FINGERNAILS; FINGERNAIL DRYING SPRAY; FINGERNAIL GROOMING PRODUCTS, NAMELY, VARNISH, GLITTER, HARDENERS, LOTIONS, CREAMS, STENCILS AND TIPS; NON-MEDICATED SKIN CARE PREPARATIONS, NAMELY, CREAMS, LOTIONS, GELS, TONERS, CLEANSERS, EXFOLIANTS AND PEELS; MAKE-UP FOR THE FACE AND BODY INCLUDING BUT NOT LIMITED TO FOUNDATION, CONCEALER, FACE AND BODY POWDER, FACE AND BODY GLITTER, BLUSHER, EYE SHADOW, EYE LINER, MASCARA, LIPSTICK, LIP GLOSS AND LIP LINER; MAKE-UP REMOVING PREPARATIONS; COMPACTS CONTAINING MAKE-UP; SOAPS FOR PERSONAL USE; ESSENTIAL OILS; SHOWER AND BATH GELS; HAIR LOTIONS, IN CLASS 3 (U.S. CLS. 1, 4, 6, 50, 51 AND 52).

FIRST USE 12-31-2007; IN COMMERCE 8-18-2009.

THE MARK CONSISTS OF STANDARD CHARACTERS WITHOUT CLAIM TO ANY PARTICULAR FONT, STYLE, SIZE, OR COLOR.

SN 85-008,619, FILED 4-7-2010.

LINDA POWELL, EXAMINING ATTORNEY



David J. Kybas

Director of the United States Patent and Trademark Office

United States of America

United States Patent and Trademark Office



Reg. No. 4,099,637

Registered Feb. 14, 2012

Int. Cl.: 35

SERVICE MARK

PRINCIPAL REGISTER

QUALCOMM LABS, INC. (CALIFORNIA CORPORATION)
5775 MOREHOUSE DRIVE
SAN DIEGO, CA 92121

FOR: ADVERTISING AND MARKETING, NAMELY, PROMOTING THE GOODS AND SERVICES OF OTHERS; DISSEMINATION OF ADVERTISING FOR OTHERS VIA AN ON-LINE COMMUNICATIONS NETWORK ON THE INTERNET; MARKETING OR ADVERTISING OR PROMOTING THE RETAIL GOODS AND SERVICES OF OTHERS TO WIRELESS OR NON-WIRELESS COMMUNICATION DEVICES; BUSINESS SERVICES FOR CONSUMERS OR OTHERS CONSISTING OF BUSINESS DATA COLLECTION OR REPORTING, IN CLASS 35 (U.S. CLS. 100, 101 AND 102).

FIRST USE 6-30-2010; IN COMMERCE 6-30-2010.

THE MARK CONSISTS OF A STYLIZED MAN DESIGN.

SN 85-010,993, FILED 4-9-2010.

BRIDGETT SMITH, EXAMINING ATTORNEY



David J. Kybas

Director of the United States Patent and Trademark Office

United States of America

United States Patent and Trademark Office

EXXACTMETHOD

Reg. No. 4,099,638

EXXOVA, INC. (GEORGIA CORPORATION)
1121 ALDERMAN DRIVE, SUITE 201
ALPHARETTA, GA 30005

Registered Feb. 14, 2012

Int. Cl.: 42

FOR: CONSULTING SERVICES IN THE FIELD OF DESIGN, SELECTION, IMPLEMENTATION AND USE OF COMPUTER SOFTWARE SYSTEMS FOR OTHERS; DATA MIGRATION SERVICES, IN CLASS 42 (U.S. CLS. 100 AND 101).

SERVICE MARK

FIRST USE 10-31-2010; IN COMMERCE 10-31-2010.

PRINCIPAL REGISTER

THE MARK CONSISTS OF STANDARD CHARACTERS WITHOUT CLAIM TO ANY PARTICULAR FONT, STYLE, SIZE, OR COLOR.

SN 85-011,754, FILED 4-12-2010.

DAYNA BROWNE, EXAMINING ATTORNEY



David J. Kyffers

Director of the United States Patent and Trademark Office

United States of America

United States Patent and Trademark Office

SUGAR FACTORY

Reg. No. 4,099,639

SUGAR FACTORY, LLC (NEVADA LIMITED LIABILITY COMPANY)
5955 EDMOND STREET
LAS VEGAS, NV 89118

Registered Feb. 14, 2012

Int. Cl.: 30

FOR: LOLLIPOPS AND PARTS AND ACCESSORIES THEREFOR, NAMELY, LOLLIPOP HEADS AND LOLLIPOP HANDLES; CANDY; CHOCOLATE; CHEWING GUM; CANDY MINTS; POPCORN; PRETZELS; BAKED GOODS, NAMELY, BAKERY GOODS, CROISSANTS, MUFFINS, COOKIES, BROWNIES, ÉCLAIRS, TARTS, MACAROONS, CUPCAKES, CAKES, PIZZAS, PANNA COTTA, BISCOTTI, PRALINES, PASTRIES, AND BREADS; CHOCOLATE COVERED NUTS AND FRUIT; CONFECTIONERY MADE PRIMARILY OF SUGAR; CONFECTIONERY MADE PRIMARILY OF CHOCOLATE; FROZEN CONFECTIONS; SNACK FOODS, NAMELY, CHOCOLATE-BASED SNACK FOODS AND SUGAR-BASED SNACK FOODS; AND GIFT BASKETS CONTAINING AN ASSORTMENT OF THE FOREGOING, IN CLASS 30 (U.S. CL. 46).

TRADEMARK

PRINCIPAL REGISTER

FIRST USE 3-3-2009; IN COMMERCE 3-3-2009.

THE MARK CONSISTS OF STANDARD CHARACTERS WITHOUT CLAIM TO ANY PARTICULAR FONT, STYLE, SIZE, OR COLOR.

OWNER OF U.S. REG. NO. 3,807,688.

NO CLAIM IS MADE TO THE EXCLUSIVE RIGHT TO USE "SUGAR", APART FROM THE MARK AS SHOWN.

SN 85-012,195, FILED 4-12-2010.

AISHA CLARKE, EXAMINING ATTORNEY



David J. Kyros

Director of the United States Patent and Trademark Office

United States of America

United States Patent and Trademark Office

* Mali Kids

Reg. No. 4,099,640

Registered Feb. 14, 2012

Int. Cls.: 14 and 25

TRADEMARK

PRINCIPAL REGISTER

THEPARERG CO., LTD. (THAILAND CORPORATION)
MUANG SAMUTSAKORN
66/2-6 MOO 4, KHOK-KRABUE
SAMUTSAKORN, THAILAND 74000

FOR: JEWELRY, IN CLASS 14 (U.S. CLS. 2, 27, 28 AND 50).

FIRST USE 1-15-2011; IN COMMERCE 1-15-2011.

FOR: CHILDREN'S CLOTHING, NAMELY, T-SHIRTS, BLOUSES, TOPS, SWEATSHIRTS, JACKETS, COATS, SWEATERS, SHIRTS, PANTS, SHORTS, SKIRTS, DRESSES, OVERALLS, HATS, SCARVES, IN CLASS 25 (U.S. CLS. 22 AND 39).

FIRST USE 8-31-2010; IN COMMERCE 8-31-2010.

NO CLAIM IS MADE TO THE EXCLUSIVE RIGHT TO USE "KIDS", APART FROM THE MARK AS SHOWN.

THE COLOR(S) BLUE AND WHITE IS/ARE CLAIMED AS A FEATURE OF THE MARK.

THE MARK CONSISTS OF THE WORDS "MALI KIDS" IN STYLIZED SCRIPT. THE SCRIPT IS BLUE AND WHITE. THERE IS A BLUE AND WHITE FLOWER TO THE LEFT OF THE WORD "MALI".

SN 85-012,980, FILED 4-13-2010.

LESLEY LAMOTHE, EXAMINING ATTORNEY



David J. Kyros

Director of the United States Patent and Trademark Office

United States of America

United States Patent and Trademark Office

ACCUCUT

Reg. No. 4,099,641

MEDIDENTA INTERNATIONAL, INC. (NEW YORK CORPORATION)

Registered Feb. 14, 2012

39-23 62ND STREET
WOODSIDE, NY 11377

Int. Cl.: 10

FOR: DENTAL INSTRUMENTS FOR USE IN CUTTING AND/OR DRILLING TEETH OR BONE, NAMELY, DRILL BITS USED IN DENTAL MOTORS TO ENABLE DENTISTS TO CUT AND/OR DRILL TEETH, IN CLASS 10 (U.S. CLS. 26, 39 AND 44).

TRADEMARK

FIRST USE 4-0-2011; IN COMMERCE 4-0-2011.

PRINCIPAL REGISTER

THE MARK CONSISTS OF STANDARD CHARACTERS WITHOUT CLAIM TO ANY PARTICULAR FONT, STYLE, SIZE, OR COLOR.

SN 85-013,169, FILED 4-13-2010.

SUNG IN, EXAMINING ATTORNEY



David J. Kyfos

Director of the United States Patent and Trademark Office

United States of America

United States Patent and Trademark Office

C4S

Reg. No. 4,099,642

TROPICAL MBC, LLC (DELAWARE LIMITED LIABILITY COMPANY)
8101 FRANKFORD AVENUE
PHILADELPHIA, PA 19136

Registered Feb. 14, 2012

Int. Cl.: 41

FOR: ENTERTAINMENT SERVICES, NAMELY, PROVIDING A WEB SITE FEATURING DOWNLOADABLE FILM CLIPS, PHOTOGRAPHS, AND OTHER MULTIMEDIA MATERIALS FEATURING ADULT ENTERTAINMENT, IN CLASS 41 (U.S. CLS. 100, 101 AND 107).

SERVICE MARK

FIRST USE 8-26-2007; IN COMMERCE 8-26-2007.

PRINCIPAL REGISTER

THE MARK CONSISTS OF STANDARD CHARACTERS WITHOUT CLAIM TO ANY PARTICULAR FONT, STYLE, SIZE, OR COLOR.

SN 85-013,460, FILED 4-14-2010.

YAT SYE, LEE, EXAMINING ATTORNEY



David J. Kyffers

Director of the United States Patent and Trademark Office

United States of America

United States Patent and Trademark Office

C4S.COM

Reg. No. 4,099,643

TROPICAL MBC, LLC (DELAWARE LIMITED LIABILITY COMPANY)
8101 FRANKFORD AVENUE
PHILADELPHIA, PA 19136

Registered Feb. 14, 2012

Int. Cl.: 41

FOR: ENTERTAINMENT SERVICES, NAMELY, PROVIDING A WEB SITE FEATURING DOWNLOADABLE FILM CLIPS, PHOTOGRAPHS, AND OTHER MULTIMEDIA MATERIALS FEATURING ADULT ENTERTAINMENT, IN CLASS 41 (U.S. CLS. 100, 101 AND 107).

SERVICE MARK

FIRST USE 4-10-2010; IN COMMERCE 4-10-2010.

PRINCIPAL REGISTER

THE MARK CONSISTS OF STANDARD CHARACTERS WITHOUT CLAIM TO ANY PARTICULAR FONT, STYLE, SIZE, OR COLOR.

SN 85-013,487, FILED 4-14-2010.

YAT SYE, LEE, EXAMINING ATTORNEY



David J. Kyffers

Director of the United States Patent and Trademark Office

United States of America

United States Patent and Trademark Office

MIM

Reg. No. 4,099,644

Registered Feb. 14, 2012

Int. Cl.: 9

TRADEMARK

PRINCIPAL REGISTER

SATTERFIELD & PONTIKES CONSTRUCTION, INC. (TEXAS CORPORATION)
11000 EQUITY DRIVE, SUITE 100
HOUSTON, TX 77041

FOR: MODEL INVENTORY MANAGEMENT SOFTWARE FOR USE IN BUILDING CONSTRUCTION, SPECIFICALLY FOR CREATING AN INVENTORY LIST OF ELEMENTS FROM A COMPUTER MODEL OF A BUILDING WITH THE MODEL CHANGING FROM A FIRST VERSION OF THE BUILDING TO A SECOND VERSION, AND FOR IDENTIFYING ELEMENTS WHICH HAVE NOT BEEN CHANGED, ELEMENTS WHICH HAVE BEEN CHANGED WITH THE CHANGE RECORDED, AND ELEMENTS DELETED FROM THE MODEL, IN CLASS 9 (U.S. CLS. 21, 23, 26, 36 AND 38).

FIRST USE 5-1-2011; IN COMMERCE 5-1-2011.

THE MARK CONSISTS OF STANDARD CHARACTERS WITHOUT CLAIM TO ANY PARTICULAR FONT, STYLE, SIZE, OR COLOR.

SN 85-016,704, FILED 4-18-2010.

STEVEN R. FINE, EXAMINING ATTORNEY



David J. Kyros

Director of the United States Patent and Trademark Office

United States of America

United States Patent and Trademark Office

SPIFTER

Reg. No. 4,099,645

4 STIR INC. (ILLINOIS CORPORATION)
261 WHITEHALL DR.
PALATINE, IL 60067

Registered Feb. 14, 2012

Int. Cl.: 8

FOR: SIFTING SPOONS, IN CLASS 8 (U.S. CLS. 23, 28 AND 44).

TRADEMARK

FIRST USE 9-1-2011; IN COMMERCE 9-1-2011.

PRINCIPAL REGISTER

THE MARK CONSISTS OF STANDARD CHARACTERS WITHOUT CLAIM TO ANY PARTICULAR FONT, STYLE, SIZE, OR COLOR.

SN 85-016,946, FILED 4-19-2010.

DEZMONA MIZELLE, EXAMINING ATTORNEY



David J. Kyffers

Director of the United States Patent and Trademark Office

United States of America

United States Patent and Trademark Office

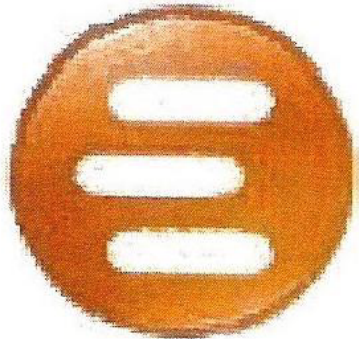

Reg. No. 4,099,646

Registered Feb. 14, 2012

**Int. Cls.: 9, 36, 38, 41,
and 42**

TRADEMARK

SERVICE MARK

PRINCIPAL REGISTER

THOMSON REUTERS (CANADA) LIMITED (CANADA CORPORATION)
SUITE 400, BAY ADELAIDE CENTRE
333 BAY STREET
TORONTO, CANADA M5H2R2

FOR: PRE-RECORDED AUDIO AND VIDEO COMPACT DISCS FEATURING FINANCIAL DATA; READ-ONLY MEMORY COMPACT DISCS FEATURING FINANCIAL DATA; COMPUTER OPERATING PROGRAMS; COMPUTER PROGRAMS FOR USE IN TRADING STOCKS AND BONDS; COMPUTER SOFTWARE FOR USE IN THE COLLECTION AND DISTRIBUTION OF DATA, FINANCIAL EXCHANGES, SHARE DEALING, STOCK DEALING, FINANCIAL TRANSACTIONS, AND FINANCIAL NEWS; BLANK MAGNETIC DATA MEDIA; BLANK OPTICAL DATA CARRIERS; BLANK MAGNETIC DISCS; MAGNETIC ENCODED CARDS; COMPUTER INTERFACE BOARDS; TELEPRINTERS; TELEVISION APPARATUS, NAMELY, TELEVISIONS, TELEVISION SCREENS; TELECOMMUNICATION APPARATUS AND INSTRUMENTS, NAMELY, FACSIMILE MACHINES; COMPUTERS; COMPUTER KEYBOARDS; COMPUTER PERIPHERAL DEVICES; PRINTERS FOR USE WITH COMPUTERS; MODEMS; COMPUTER MICE; COMPUTER TERMINALS; DOWNLOADABLE COMPUTER SOFTWARE FOR USE IN THE STOCK TRADING; AND DOWNLOADABLE ELECTRONIC PUBLICATIONS IN THE NATURE OF MAGAZINES AND NEWSLETTERS FOR USE IN THE FIELD OF STOCK TRADING; COMPUTER SOFTWARE FOR CONNECTING COMPUTERS TO LOCAL DATABASES AND/OR GLOBAL COMPUTER NETWORKS; TELECOMMUNICATIONS APPARATUS, NAMELY, MODEMS, TELEPHONES FOR CONNECTING COMPUTERS TO LOCAL DATABASES AND/OR GLOBAL COMPUTER NETWORKS; COMPUTER SOFTWARE FOR SEARCHING DATA, IN CLASS 9 (U.S. CLS. 21, 23, 26, 36 AND 38).

FIRST USE 9-14-2010; IN COMMERCE 9-14-2010.

FOR: FINANCIAL ANALYSIS; FINANCIAL CONSULTANCY; FISCAL ASSESSMENTS; STOCK EXCHANGE PRICE QUOTATIONS; ELECTRONIC FUNDS TRANSFERS; PROVIDING FINANCIAL INFORMATION ABOUT BONDS, WARRANT BONDS, COMMERCIAL SALES, AND EXCHANGE AND INVESTMENT TRUSTS; INSURANCE INFORMATION; FINANCIAL INFORMATION ABOUT THE STOCK MARKET IN THE NATURE OF ECONOMIC, MONETARY AND STOCK EXCHANGE INFORMATION, CURRENCY TRADING INFORMATION; INSURANCE AND FINANCIAL INFORMATION PROVIDED ON-LINE VIA COMPUTER DATABASES AND/OR A GLOBAL COMPUTER NETWORK; NEWS REPORTING SERVICES IN THE FIELD OF FINANCIAL NEWS, IN CLASS 36 (U.S. CLS. 100, 101 AND 102).



David J. Kybas

Director of the United States Patent and Trademark Office

Reg. No. 4,099,646 FIRST USE 9-14-2010; IN COMMERCE 9-14-2010.

FOR: PROVIDING MULTIPLE-USER ACCESS TO A GLOBAL COMPUTER INFORMATION NETWORK; PROVIDING ACCESS TO DATABASES, IN CLASS 38 (U.S. CLS. 100, 101 AND 104).

FIRST USE 9-14-2010; IN COMMERCE 9-14-2010.

FOR: PROVIDING NEWS IN THE NATURE OF CURRENT EVENT REPORTING; NEWS AGENCIES, NAMELY, GATHERING AND DISSEMINATION OF NEWS, IN CLASS 41 (U.S. CLS. 100, 101 AND 107).

FIRST USE 9-14-2010; IN COMMERCE 9-14-2010.

FOR: RENTAL OF COMPUTERS; COMPUTER SOFTWARE DESIGN FOR OTHERS; UPDATING OF COMPUTER SOFTWARE FOR OTHERS; RENTAL OF COMPUTER SOFTWARE , IN CLASS 42 (U.S. CLS. 100 AND 101).

FIRST USE 9-14-2010; IN COMMERCE 9-14-2010.

THE MARK CONSISTS OF AN ORANGE CIRCLE AND THREE WHITE HORIZONTAL BANDS WHICH REPRESENT THE DESIGN OF A LETTER "E".

THE COLOR(S) ORANGE AND WHITE IS/ARE CLAIMED AS A FEATURE OF THE MARK.

SN 85-018,543, FILED 4-20-2010.

TINA L. SNAPP, EXAMINING ATTORNEY

United States of America

United States Patent and Trademark Office

Certified Organic Diablito 100% Agave

Reg. No. 4,099,647

RAVANDI, DAVID (UNITED STATES INDIVIDUAL)
P.O. BOX 6715
BEVERLY HILLS, CA 90212

Registered Feb. 14, 2012

Int. Cl.: 33

FOR: LIQUORS MADE FROM AGAVE, NAMELY, ORGANIC MESCAL, ORGANIC TEQUILA, AND ORGANIC TEQUILA INFUSED WITH VITAMINS, IN CLASS 33 (U.S. CLS. 47 AND 49).

TRADEMARK

FIRST USE 10-1-2011; IN COMMERCE 10-3-2011.

PRINCIPAL REGISTER

THE MARK CONSISTS OF STANDARD CHARACTERS WITHOUT CLAIM TO ANY PARTICULAR FONT, STYLE, SIZE, OR COLOR.

NO CLAIM IS MADE TO THE EXCLUSIVE RIGHT TO USE "CERTIFIED ORGANIC" AND "100% AGAVE", APART FROM THE MARK AS SHOWN.

THE ENGLISH TRANSLATION OF "DIABLITO" IN THE MARK IS "LITTLE DEVIL".

SN 85-018,561, FILED 4-20-2010.

YAT SYE, LEE, EXAMINING ATTORNEY



David J. Kyffers

Director of the United States Patent and Trademark Office

United States of America

United States Patent and Trademark Office

DELTAK

Reg. No. 4,099,648

Registered Feb. 14, 2012

Int. Cls.: 35 and 41

SERVICE MARK

PRINCIPAL REGISTER

DELTAK EDU, INC. (DELAWARE CORPORATION)
SUITE 400
1415 WEST 22ND STREET
OAK BROOK, IL 60523

FOR: CONSULTING SERVICES IN THE FIELDS OF HIGHER EDUCATION ADMINISTRATION AND RECRUITMENT OF STUDENTS FOR HIGHER EDUCATION INSTITUTIONS; CONSULTING SERVICES IN THE FIELD OF HIGHER EDUCATION, NAMELY, ASSISTING COLLEGE AND UNIVERSITIES IN FINDING STUDENTS THROUGH ADVERTISING AND RECRUITMENT; HIGHER EDUCATION CONSULTING SERVICES IN THE FIELD OF STUDENT AND ALUMNI RETENTION, IN CLASS 35 (U.S. CLS. 100, 101 AND 102).

FIRST USE 3-0-2004; IN COMMERCE 3-0-2004.

FOR: CONSULTING SERVICES IN THE FIELD OF DEVELOPING CURRICULUM FOR HIGHER EDUCATION INSTITUTIONS AND FACULTY; HIGHER EDUCATION CONSULTING SERVICES, NAMELY, ASSISTING STUDENTS WITH COMPLETING THE COLLEGE AND UNIVERSITY APPLICATION PROCESS, IN CLASS 41 (U.S. CLS. 100, 101 AND 107).

FIRST USE 3-0-2004; IN COMMERCE 3-0-2004.

THE MARK CONSISTS OF STANDARD CHARACTERS WITHOUT CLAIM TO ANY PARTICULAR FONT, STYLE, SIZE, OR COLOR.

SN 85-018,894, FILED 4-20-2010.

NATALIE POLZER, EXAMINING ATTORNEY



David J. Kyffers

Director of the United States Patent and Trademark Office

United States of America

United States Patent and Trademark Office



Reg. No. 4,099,649

Registered Feb. 14, 2012

Int. Cl.: 10

TRADEMARK

PRINCIPAL REGISTER

BLUE BELT TECHNOLOGIES, INC. (PENNSYLVANIA CORPORATION)
SUITE 644
5001 BAUM BOULEVARD
PITTSBURGH, PA 15213

FOR: SURGICAL APPARATUS AND SURGICAL LOCATING APPARATUS, AND SOFTWARE PROVIDED AS A UNIT THEREWITH, FOR USE IN MUSCOSKELETAL PROCEDURES, IN CLASS 10 (U.S. CLS. 26, 39 AND 44).

FIRST USE 2-0-2009; IN COMMERCE 2-0-2009.

THE MARK CONSISTS OF MULTIPLE ARCHED LINES IN THE FORM OF A SWIRL SURROUNDING A FILLED OVAL, THE WHOLE DESIGN SUGGESTING THE LETTER "B".

SN 85-019,100, FILED 4-21-2010.

MICHELLE DUBOIS, EXAMINING ATTORNEY



David J. Kybas

Director of the United States Patent and Trademark Office

United States of America

United States Patent and Trademark Office

WEAR WITH PRIDE

Reg. No. 4,099,650

GLOBAL FASHION WORKS LLC (FLORIDA LIMITED LIABILITY COMPANY)
795 CROMWELL PARK, SUITE B
GLEN BURNIE, MD 21061

Registered Feb. 14, 2012

Int. Cl.: 25

FOR: CLOTHING, NAMELY, TOPS, BOTTOMS, HEADWEAR, FOOTWEAR, SWIMWEAR,
IN CLASS 25 (U.S. CLS. 22 AND 39).

TRADEMARK

FIRST USE 8-1-2010; IN COMMERCE 8-15-2010.

PRINCIPAL REGISTER

THE MARK CONSISTS OF STANDARD CHARACTERS WITHOUT CLAIM TO ANY PAR-
TICULAR FONT, STYLE, SIZE, OR COLOR.

SN 85-020,162, FILED 4-22-2010.

BARBARA RUTLAND, EXAMINING ATTORNEY



David J. Kyfos

Director of the United States Patent and Trademark Office

United States of America

United States Patent and Trademark Office

COLLAR SCHOLAR

Reg. No. 4,099,651

GLOBAL FASHION WORKS LLC (FLORIDA LIMITED LIABILITY COMPANY)
201 S BISCAYNE BLVD 28TH FLOOR
MIAMI, FL 33131

Registered Feb. 14, 2012

Int. Cl.: 25

FOR: CLOTHING, NAMELY, TOPS, BOTTOMS, HEADWEAR, FOOTWEAR, SWIMWEAR,
IN CLASS 25 (U.S. CLS. 22 AND 39).

TRADEMARK

FIRST USE 8-1-2010; IN COMMERCE 8-15-2010.

PRINCIPAL REGISTER

THE MARK CONSISTS OF STANDARD CHARACTERS WITHOUT CLAIM TO ANY PAR-
TICULAR FONT, STYLE, SIZE, OR COLOR.

SN 85-020,164, FILED 4-22-2010.

BARBARA RUTLAND, EXAMINING ATTORNEY



David J. Kybas

Director of the United States Patent and Trademark Office

United States of America

United States Patent and Trademark Office

TRAVETS

Reg. No. 4,099,652

Registered Feb. 14, 2012

Int. Cl.: 42

SERVICE MARK

PRINCIPAL REGISTER

CORNERSTONE INFORMATION SYSTEMS, INC. (INDIANA CORPORATION)
304 WEST KIRKWOOD
SUITE 4
BLOOMINGTON, IN 47404

FOR: SOFTWARE AS A SERVICE (SAAS) SERVICES, NAMELY, HOSTING SOFTWARE FOR USE BY OTHERS FOR USE IN VISUALIZING AND MANAGING TRAVEL-RELATED INFORMATION, IN CLASS 42 (U.S. CLS. 100 AND 101).

FIRST USE 1-13-2010; IN COMMERCE 1-13-2010.

THE MARK CONSISTS OF STANDARD CHARACTERS WITHOUT CLAIM TO ANY PARTICULAR FONT, STYLE, SIZE, OR COLOR.

SN 85-020,403, FILED 4-22-2010.

BRIAN CALLAGHAN, EXAMINING ATTORNEY



David J. Kybas

Director of the United States Patent and Trademark Office

United States of America

United States Patent and Trademark Office



Reg. No. 4,099,653

WINSTAR DISPLAY CO., LTD. (TAIWAN CORPORATION)
NO. 163, CHUNG-CHIN
TAICHUNG CITY, TAIWAN

Registered Feb. 14, 2012

Int. Cl.: 9

FOR: COMPUTER HARDWARE, LIQUID CRYSTAL DISPLAYS (LCD), LCD MONITORS, LCD PANELS, LCD LARGE-SCREEN DISPLAYS, TELEVISION MONITORS, VIDEO DISPLAY MONITORS, FLAT PANEL DISPLAY SCREENS, LIGHT EMITTING DIODE (LED) DISPLAYS, IN CLASS 9 (U.S. CLS. 21, 23, 26, 36 AND 38).

TRADEMARK

PRINCIPAL REGISTER

FIRST USE 12-0-1998; IN COMMERCE 3-20-2000.

THE MARK CONSISTS OF FIVE RED PARALLELOGRAMS WITH WHITE HIGHLIGHTS AND A PARTIAL BROWN OUTLINE, THREE OF WHICH ARE LOCATED ABOVE THE OTHER TWO, THE UPPER RIGHT TWO OF WHICH EACH HAS A TIP AT ITS LOWER LEFT CORNER.

THE COLOR(S) RED, WHITE AND BROWN IS/ARE CLAIMED AS A FEATURE OF THE MARK.

SN 85-021,127, FILED 4-22-2010.

ROBIN MITTLER, EXAMINING ATTORNEY



David J. Kybas

Director of the United States Patent and Trademark Office

United States of America

United States Patent and Trademark Office

MIGHTY-HOLD

Reg. No. 4,099,654

Registered Feb. 14, 2012

Int. Cl.: 9

TRADEMARK

PRINCIPAL REGISTER

BRIDGEPORT FITTINGS, INC. (CONNECTICUT CORPORATION)
705 LORDSHIP BOULEVARD
STRATFORD, CT 06615

FOR: ELECTRICAL FITTINGS, NAMELY, ELECTRICAL CONNECTORS, ELECTRICITY CONDUITS, ELECTRIC COUPLINGS, ELECTRICITY CONDUIT WITH INTEGRATED CABLE STRAPS, AND FITTINGS THEREFOR, NAMELY, RAINPROOF FITTINGS, ELECTRICITY CONDUIT EXPANSION FITTINGS, ELECTRICAL TRANSITION FITTINGS, ELECTRICAL GROUNDING FITTINGS, IN CLASS 9 (U.S. CLS. 21, 23, 26, 36 AND 38).

FIRST USE 9-28-2011; IN COMMERCE 9-28-2011.

THE MARK CONSISTS OF STANDARD CHARACTERS WITHOUT CLAIM TO ANY PARTICULAR FONT, STYLE, SIZE, OR COLOR.

SN 85-021,380, FILED 4-23-2010.

MAYUR VAGHANI, EXAMINING ATTORNEY



David J. Kyffers

Director of the United States Patent and Trademark Office

United States of America

United States Patent and Trademark Office

HEAVENLY RICE

Reg. No. 4,099,655

EASTWEST HOLDINGS INTERNATIONAL, INC. (NEW YORK CORPORATION)
257 CANAL ST.

Registered Feb. 14, 2012

NEW YORK, NY 10013

Int. Cl.: 30

FOR: RICE, IN CLASS 30 (U.S. CL. 46).

TRADEMARK

FIRST USE 11-23-2011; IN COMMERCE 11-23-2011.

PRINCIPAL REGISTER

THE MARK CONSISTS OF STANDARD CHARACTERS WITHOUT CLAIM TO ANY PARTICULAR FONT, STYLE, SIZE, OR COLOR.

NO CLAIM IS MADE TO THE EXCLUSIVE RIGHT TO USE "RICE", APART FROM THE MARK AS SHOWN.

SN 85-021,967, FILED 4-23-2010.

JENNY PARK, EXAMINING ATTORNEY



David J. Kyffers

Director of the United States Patent and Trademark Office

United States of America

United States Patent and Trademark Office

ZenComplete

Reg. No. 4,099,656

Registered Feb. 14, 2012

Int. Cl.: 42

SERVICE MARK

PRINCIPAL REGISTER

ZEN-BIO, INC. (NORTH CAROLINA CORPORATION)
SUITE 104
3200 CHAPEL HILL-NELSON BLVD.
RESEARCH TRIANGLE PARK, NC 27709

FOR: CUSTOM DESIGN AND DEVELOPMENT OF CHEMICAL REAGENTS AND BIOCHEMICAL ASSAYS; PHARMACEUTICAL RESEARCH SERVICES; PHARMACEUTICAL RESEARCH AND DEVELOPMENT; BIOLOGICAL RESEARCH; BIOCHEMICAL RESEARCH AND DEVELOPMENT, IN CLASS 42 (U.S. CLS. 100 AND 101).

FIRST USE 7-28-2010; IN COMMERCE 7-28-2010.

THE MARK CONSISTS OF STANDARD CHARACTERS WITHOUT CLAIM TO ANY PARTICULAR FONT, STYLE, SIZE, OR COLOR.

SN 85-023,009, FILED 4-26-2010.

ANDREW RHIM, EXAMINING ATTORNEY



David J. Kyffers

Director of the United States Patent and Trademark Office

United States of America

United States Patent and Trademark Office

SCRIPTLOCK

Reg. No. 4,099,657

RONALD S. HARMON (UNITED STATES INDIVIDUAL)
P. O. BOX 94300
ALBUQUERQUE, NM 87199 AND

Registered Feb. 14, 2012

Int. Cl.: 16

DEBBIE HARMON (UNITED STATES INDIVIDUAL)
P. O. BOX 94300
ALBUQUERQUE, NM 87199

TRADEMARK

PRINCIPAL REGISTER

FOR: PAPER GOODS AND PRINTED PAPER MATTER CONTAINING DOCUMENT SECURITY FEATURES, NAMELY, BLANK, PARTIALLY PRINTED, AND PRE-PRINTED STANDARD BUSINESS FORMS AND DOCUMENTS, AND CUSTOMIZED BUSINESS FORMS AND DOCUMENTS; BLANK, PARTIALLY PRINTED, AND PRE-PRINTED PAPER STOCK CONTAINING SAFETY, ANTI-COUNTERFEIT, AND ANTI-TAMPER FEATURES USED FOR SECURE BUSINESS FORMS, NAMELY, LABELS, DESK PADS, FORMS, VOUCHERS OF VALUE, PAPER TAGS, PAPER LABELS, PAPER INVENTORY CONTROL LABELS AND TAGS, PAPER IDENTIFICATION LABELS AND TAGS, AND PAPER DISTRIBUTION TAGS AND LABELS, AND ENVELOPES, IN CLASS 16 (U.S. CLS. 2, 5, 22, 23, 29, 37, 38 AND 50).

FIRST USE 4-19-2010; IN COMMERCE 6-11-2010.

THE MARK CONSISTS OF STANDARD CHARACTERS WITHOUT CLAIM TO ANY PARTICULAR FONT, STYLE, SIZE, OR COLOR.

SN 85-023,080, FILED 4-26-2010.

GRETCHEN ULRICH, EXAMINING ATTORNEY



David J. Kybas

Director of the United States Patent and Trademark Office

United States of America

United States Patent and Trademark Office

CHATATTACH

Reg. No. 4,099,658

CLEARONE COMMUNICATIONS (UTAH CORPORATION)

Registered Feb. 14, 2012

5225 WILEY POST WAY, SUITE 500
SALT LAKE CITY, UT 84116

Int. Cl.: 9

FOR: ELECTRONIC HARDWARE ACCESSORIES, NAMELY, SPEAKERS, SPEAKERPHONES AND MICROPHONES, CABLES, FIRMWARE AND SOFTWARE THAT ADD TWO WAY AUDIO CONFERENCING CAPABILITY TO MULTIPLE DEVICES, IN CLASS 9 (U.S. CLS. 21, 23, 26, 36 AND 38).

TRADEMARK

PRINCIPAL REGISTER

FIRST USE 9-17-2010; IN COMMERCE 9-17-2010.

THE MARK CONSISTS OF STANDARD CHARACTERS WITHOUT CLAIM TO ANY PARTICULAR FONT, STYLE, SIZE, OR COLOR.

SN 85-024,105, FILED 4-27-2010.

ANGELA DUONG, EXAMINING ATTORNEY



David J. Kyros

Director of the United States Patent and Trademark Office

United States of America

United States Patent and Trademark Office



Reg. No. 4,099,659

Registered Feb. 14, 2012

Int. Cls.: 9 and 11

TRADEMARK

PRINCIPAL REGISTER

INTERSCIENCE TECHNOLOGIES, INC (MARYLAND CORPORATION), DBA ITI GROUP,
USA,
25121 VISTA RIDGE ROAD
LAYTONSVILLE, MD 20882

FOR: LIGHT EMITTING DIODES (LEDS), IN CLASS 9 (U.S. CLS. 21, 23, 26, 36 AND 38).

FIRST USE 10-27-2011; IN COMMERCE 10-27-2011.

FOR: LED LIGHT BULBS, LED TUBE LIGHTING, AND LED LIGHTING FIXTURES, IN
CLASS 11 (U.S. CLS. 13, 21, 23, 31 AND 34).

FIRST USE 5-4-2010; IN COMMERCE 5-4-2010.

NO CLAIM IS MADE TO THE EXCLUSIVE RIGHT TO USE "TECH", APART FROM THE
MARK AS SHOWN.

THE MARK CONSISTS OF AN OBJECT COMPRISING A SPHERICAL-SHAPED MIDDLE
PORTION HAVING A PLURALITY OF CIRCLES THEREON SURROUNDED BY A THREE-
DIMENSIONAL SHAPE RESEMBLING A LOWERCASE "E". ADJACENT THE OBJECT IS
THE LETTERING "EDVA TECH" WITH "EDVA" WRITTEN IN DARK COLORED LETTERING
AND WITH "TECH" WRITTEN IN LIGHT COLORED LETTERING ON A SHADED BACK-
GROUND.

SN 85-024,399, FILED 4-27-2010.

DANIEL CAPSHAW, EXAMINING ATTORNEY



David J. Kyros

Director of the United States Patent and Trademark Office

United States of America

United States Patent and Trademark Office

eDVA Tech

Reg. No. 4,099,660

Registered Feb. 14, 2012

Int. Cls.: 9 and 11

TRADEMARK

PRINCIPAL REGISTER

INTERSCIENCE TECHNOLOGIES, INC (MARYLAND CORPORATION), DBA ITI GROUP,
USA,
25121 VISTA RIDGE ROAD
LAYTONSVILLE, MD 20882

FOR: LIGHT EMITTING DIODES (LEDS), IN CLASS 9 (U.S. CLS. 21, 23, 26, 36 AND 38).

FIRST USE 10-27-2011; IN COMMERCE 10-27-2011.

FOR: LED LIGHT BULBS, LED TUBE LIGHTING, AND LED LIGHTING FIXTURES, IN
CLASS 11 (U.S. CLS. 13, 21, 23, 31 AND 34).

FIRST USE 5-4-2010; IN COMMERCE 5-4-2010.

THE MARK CONSISTS OF STANDARD CHARACTERS WITHOUT CLAIM TO ANY PAR-
TICULAR FONT, STYLE, SIZE, OR COLOR.

NO CLAIM IS MADE TO THE EXCLUSIVE RIGHT TO USE "TECH", APART FROM THE
MARK AS SHOWN.

SN 85-024,434, FILED 4-27-2010.

DANIEL CAPSHAW, EXAMINING ATTORNEY



David J. Kyfos

Director of the United States Patent and Trademark Office

United States of America

United States Patent and Trademark Office

MINDFUL MATE

Reg. No. 4,099,661

KATHLEEN A. HALL (UNITED STATES INDIVIDUAL)
495 OWLS NEST LANE
CLARKESVILLE, GA 30523

Registered Feb. 14, 2012

Int. Cl.: 9

FOR: AUDIO AND VIDEO TAPES, DVDS, CD-ROMS, FEATURING LECTURES IN THE FIELDS OF SPIRITUAL GROWTH, DATING AND RELATIONSHIPS, HEALING AND WELLNESS, AND IDENTIFYING, OVERCOMING AND AVOIDING STRESS AND DESTRUCTIVE BEHAVIOR, IN CLASS 9 (U.S. CLS. 21, 23, 26, 36 AND 38).

TRADEMARK

PRINCIPAL REGISTER

FIRST USE 3-1-2011; IN COMMERCE 3-1-2011.

THE MARK CONSISTS OF STANDARD CHARACTERS WITHOUT CLAIM TO ANY PARTICULAR FONT, STYLE, SIZE, OR COLOR.

SN 85-024,921, FILED 4-28-2010.

JOHN DWYER, EXAMINING ATTORNEY



David J. Kyffers

Director of the United States Patent and Trademark Office

United States of America

United States Patent and Trademark Office

STEELWORX

Reg. No. 4,099,662

PACKED WAREHOUSE IMPORTS, LLC (MISSOURI LIMITED LIABILITY COMPANY)
P.O. BOX 61, 3324 JOE BALD ROAD
KIMBERLING CITY, MO 65686

Registered Feb. 14, 2012

Int. Cl.: 16

FOR: BINDERS, DESKTOP ORGANIZERS, FILE TRAYS AND HOLDERS, LETTER TRAYS, MAGAZINE FILE BOXES, DESKTOP POCKET ORGANIZERS, FILE BOXES FOR STORAGE OF BUSINESS AND PERSONAL RECORDS, IN CLASS 16 (U.S. CLS. 2, 5, 22, 23, 29, 37, 38 AND 50).

TRADEMARK

PRINCIPAL REGISTER

FIRST USE 1-0-2007; IN COMMERCE 1-0-2007.

THE MARK CONSISTS OF STANDARD CHARACTERS WITHOUT CLAIM TO ANY PARTICULAR FONT, STYLE, SIZE, OR COLOR.

SN 85-026,681, FILED 4-29-2010.

ELLEN PERKINS, EXAMINING ATTORNEY



David J. Kyffers

Director of the United States Patent and Trademark Office

United States of America

United States Patent and Trademark Office

ONGO

Reg. No. 4,099,663

Registered Feb. 14, 2012

**Int. Cls.: 9, 35, 41, and
42**

TRADEMARK

SERVICE MARK

PRINCIPAL REGISTER

ONGO, INC. (DELAWARE CORPORATION)
28023 STEVENS CREEK BLVD.
SUITE 100
CUPERTINO, CA 95014

FOR: COMPUTER AND TELECOMMUNICATIONS SOFTWARE FOR USE IN AGGREGATING AND VIEWING NEWS AND SYNDICATION FEEDS , IN CLASS 9 (U.S. CLS. 21, 23, 26, 36 AND 38).

FIRST USE 1-25-2011; IN COMMERCE 1-25-2011.

FOR: PROVIDING PERSONALIZED ONLINE INFORMATION AND NEWS IN THE FIELD OF BUSINESS; PROVIDING PERSONALIZED ONLINE NEWS AND INFORMATION IN THE FIELD OF POLITICS, IN CLASS 35 (U.S. CLS. 100, 101 AND 102).

FIRST USE 1-25-2011; IN COMMERCE 1-25-2011.

FOR: PROVIDING PERSONALIZED ONLINE NEWS AND INFORMATION IN THE FIELD OF SPORTS; PROVIDING PERSONALIZED ONLINE NEWS AND INFORMATION IN THE FIELD OF CURRENT EVENTS REPORTING; PROVIDING PERSONALIZED ONLINE INFORMATION AND NEWS IN THE FIELD OF EMPLOYMENT TRAINING; PROVIDING PERSONALIZED ONLINE NEWS AND INFORMATION IN THE FIELD OF EDUCATION; PROVIDING PERSONALIZED ONLINE NEWS AND INFORMATION IN THE FIELD OF ENTERTAINMENT, IN CLASS 41 (U.S. CLS. 100, 101 AND 107).

FIRST USE 1-25-2011; IN COMMERCE 1-25-2011.

FOR: SEARCHING AND RETRIEVING INFORMATION AND DATA RESOURCES AVAILABLE ON COMPUTER NETWORKS FOR OTHERS; PROVIDING CUSTOMIZED ONLINE WEB PAGES FEATURING USER-DEFINED INFORMATION; COMPUTER SERVICES, NAMELY, PROVIDING INTERNET SEARCH ENGINES AND CREATING INDEXES OF INFORMATION, SITES, AND OTHER RESOURCES AVAILABLE ON COMPUTER NETWORKS RELATING TO NEWS AND SYNDICATION FEEDS; PROVIDING TEMPORARY USE OF ONLINE NON DOWNLOADABLE SOFTWARE FOR SENDING AND SHARING NEWS ARTICLES VIA OPTICAL, ELECTRONIC AND WIRELESS COMMUNICATIONS NETWORKS; PROVIDING PERSONALIZED ONLINE NEWS AND INFORMATION IN THE FIELDS OF SCIENCE AND TECHNOLOGY , IN CLASS 42 (U.S. CLS. 100 AND 101).



David J. Kyffers

Director of the United States Patent and Trademark Office

Reg. No. 4,099,663 FIRST USE 1-25-2011; IN COMMERCE 1-25-2011.

THE MARK CONSISTS OF STANDARD CHARACTERS WITHOUT CLAIM TO ANY PARTICULAR FONT, STYLE, SIZE, OR COLOR.

SN 85-027,352, FILED 4-30-2010.

TRACY CROSS, EXAMINING ATTORNEY

United States of America

United States Patent and Trademark Office

ARTISTE

Reg. No. 4,099,664

Registered Feb. 14, 2012

Int. Cls.: 1 and 30

TRADEMARK

PRINCIPAL REGISTER

ARTISTE FLAVOR/ESSENCE, INC. (NEW JERSEY CORPORATION)
35B FRANKLIN TURNPIKE
WALDWICK, NJ 07463

FOR: FRAGRANCES FOR USE IN MANUFACTURING COSMETICS, SHAMPOOS, BODY WASHES, SOAPS, PERFUMES, DISHWASHING AND LAUNDRY SOAPS, AND CANDLES , IN CLASS 1 (U.S. CLS. 1, 5, 6, 10, 26 AND 46).

FIRST USE 6-30-2010; IN COMMERCE 6-30-2010.

FOR: FLAVORINGS, IN CLASS 30 (U.S. CL. 46).

FIRST USE 6-30-2010; IN COMMERCE 6-30-2010.

THE MARK CONSISTS OF STANDARD CHARACTERS WITHOUT CLAIM TO ANY PARTICULAR FONT, STYLE, SIZE, OR COLOR.

SN 85-027,355, FILED 4-30-2010.

TRACY CROSS, EXAMINING ATTORNEY



David J. Kyros

Director of the United States Patent and Trademark Office

United States of America

United States Patent and Trademark Office

CHARISMATIC ADVISOR

Reg. No. 4,099,665

Registered Feb. 14, 2012

Int. Cl.: 41

SERVICE MARK

PRINCIPAL REGISTER

THE TRUSTEE OF EATON VANCE MANAGEMENT (MASSACHUSETTS BUSINESS TRUST)
TWO INTERNATIONAL PLACE
BOSTON, MA 02110

FOR: EDUCATIONAL SERVICES, NAMELY, CONDUCTING PROGRAMS IN THE FIELD
OF FINANCIAL INVESTING FOR SECURITIES BROKER/DEALERS, IN CLASS 41 (U.S.
CLS. 100, 101 AND 107).

FIRST USE 1-5-2010; IN COMMERCE 1-11-2010.

THE MARK CONSISTS OF STANDARD CHARACTERS WITHOUT CLAIM TO ANY PAR-
TICULAR FONT, STYLE, SIZE, OR COLOR.

NO CLAIM IS MADE TO THE EXCLUSIVE RIGHT TO USE "ADVISOR", APART FROM
THE MARK AS SHOWN.

SN 85-027,556, FILED 4-30-2010.

HOWARD B. LEVINE, EXAMINING ATTORNEY



David J. Kyffers

Director of the United States Patent and Trademark Office

United States of America

United States Patent and Trademark Office

RIOT KATS BY PRISCILLA KATS

Reg. No. 4,099,666

TAYLOR, PRISCILLA (FRANCE INDIVIDUAL)

Registered Feb. 14, 2012

UNIT 1-103
3205 LOS FELIZ BLVD
LOS ANGELES, CA 90039

Int. Cl.: 25

TRADEMARK

FOR: WOMEN'S CLOTHING, NAMELY, DRESSES, GLOVES, BELTS MADE OUT OF LEATHER, BELTS MADE OUT OF CLOTH, SCARVES, LEG WARMERS, SOCKS, LEGGINGS, T-SHIRTS, TOPS, TANK TOPS, BUSTIERS, SWEATERS, VESTS, CARDIGANS, JACKETS, COATS, SKIRTS, PANTS, SHORTS, LEGGINGS, JEANS, BABYDOLL DRESSES, SLIPS, GARTER BELTS, SUSPENDERS, CORSETS, AND KNICKERS, IN CLASS 25 (U.S. CLS. 22 AND 39).

PRINCIPAL REGISTER

FIRST USE 11-29-2011; IN COMMERCE 11-29-2011.

THE MARK CONSISTS OF STANDARD CHARACTERS WITHOUT CLAIM TO ANY PARTICULAR FONT, STYLE, SIZE, OR COLOR.

THE NAME(S), PORTRAIT(S), AND/OR SIGNATURE(S) SHOWN IN THE MARK IDENTIFIES "PRISCILLA KATS", WHOSE CONSENT(S) TO REGISTER IS MADE OF RECORD.

SN 85-028,291, FILED 5-3-2010.

LINDA MICKLEBURGH, EXAMINING ATTORNEY



David J. Kybas

Director of the United States Patent and Trademark Office

United States of America

United States Patent and Trademark Office



Reg. No. 4,099,667

Registered Feb. 14, 2012

Int. Cls.: 16 and 44

TRADEMARK

SERVICE MARK

PRINCIPAL REGISTER

BOEHRINGER INGELHEIM PHARMACEUTICALS, INC. (DELAWARE CORPORATION)
P.O. BOX 368
900 RIDGEBURY ROAD
RIDGEFIELD, CT 06877

FOR: PRINTED MEDIA, NAMELY, BROCHURES, PAMPHLETS AND STICKERS ABOUT COPD, IN CLASS 16 (U.S. CLS. 2, 5, 22, 23, 29, 37, 38 AND 50).

FIRST USE 11-0-2009; IN COMMERCE 11-0-2009.

FOR: PROVIDING MEDICAL INFORMATION RELATED TO COPD AWARENESS VIA BROCHURES, PAMPHLETS, SIGNAGE, STICKERS, BOOKMARKS, BILLBOARDS, POSTERS, INTERNET, TELEVISION, VIDEO, NEWSPAPERS AND MAGAZINES, IN CLASS 44 (U.S. CLS. 100 AND 101).

FIRST USE 11-0-2009; IN COMMERCE 11-0-2009.

NO CLAIM IS MADE TO THE EXCLUSIVE RIGHT TO USE "COPD", APART FROM THE MARK AS SHOWN.

THE COLOR(S) BLUE AND WHITE IS/ARE CLAIMED AS A FEATURE OF THE MARK.

THE MARK CONSISTS OF A RECTANGLE SHAPE WITH A TRIANGLE CUT OUT IN THE UPPER LEFT SIDE, WITH A BLUE BACKGROUND AND THE WORDS: "KNOW COPD" APPEARING BELOW THE TRIANGLE CUT OUT AND TO THE RIGHT MARGIN IN WHITE LETTERS.

SN 85-028,484, FILED 5-3-2010.

AMY C. KEAN, EXAMINING ATTORNEY



David J. Kappas

Director of the United States Patent and Trademark Office

United States of America

United States Patent and Trademark Office

EAC

Reg. No. 4,099,668

Registered Feb. 14, 2012

Int. Cl.: 9

TRADEMARK

PRINCIPAL REGISTER

MICROPORE, INC. (DELAWARE CORPORATION)
350F PENCADER DRIVE
NEWARK, DE 19702

FOR: ABSORBENT CARTRIDGES FOR USE IN REBREATHING EQUIPMENT USED FOR SCUBA AND OTHER NON-MEDICAL PURPOSES, IN CLASS 9 (U.S. CLS. 21, 23, 26, 36 AND 38).

FIRST USE 5-16-2002; IN COMMERCE 5-16-2002.

THE MARK CONSISTS OF STANDARD CHARACTERS WITHOUT CLAIM TO ANY PARTICULAR FONT, STYLE, SIZE, OR COLOR.

SN 85-028,491, FILED 5-3-2010.

AMY C. KEAN, EXAMINING ATTORNEY



David J. Kyffers

Director of the United States Patent and Trademark Office

United States of America

United States Patent and Trademark Office

FRAGO

Reg. No. 4,099,669

Registered Feb. 14, 2012

Int. Cl.: 33

TRADEMARK

PRINCIPAL REGISTER

INNOVATIVE BRAND DEVELOPERS CORP. (NEW YORK CORPORATION)
42 HIGHLAND BLVD.
DIX HILLS, NY 11746

FOR: LIQUEURS, IN CLASS 33 (U.S. CLS. 47 AND 49).

FIRST USE 12-1-2011; IN COMMERCE 12-1-2011.

THE MARK CONSISTS OF STANDARD CHARACTERS WITHOUT CLAIM TO ANY PARTICULAR FONT, STYLE, SIZE, OR COLOR.

SN 85-029,219, FILED 5-3-2010.

DOUGLAS LEE, EXAMINING ATTORNEY



David J. Kyffers

Director of the United States Patent and Trademark Office

United States of America

United States Patent and Trademark Office

ZAGGO

Reg. No. 4,099,670

Registered Feb. 14, 2012

Int. Cl.: 16

TRADEMARK

PRINCIPAL REGISTER

ROBERTA CARSON (UNITED STATES INDIVIDUAL)
21 HIGH ROCK TERRACE
CHESTNUT HILL, MA 02467

FOR: KITS FOR PATIENTS, FAMILY OF PATIENTS AND NON-PROFESSIONAL CARE-GIVERS CARING FOR ELDERLY, SICK OR INJURED PATIENTS IN THE HOME OR ASSISTING WITH CARE IN A MEDICAL FACILITY, COMPRISING A GUIDE BOOK PROVIDING INFORMATION ABOUT ORGANIZATIONAL TECHNIQUES, TIPS, ADVICE AND RESOURCES FOR DEALING WITH LONG-TERM MEDICAL ISSUES AND ONGOING MEDICAL ORDEALS, A BLANK NOTEBOOK FOR USE AS A MEDICAL JOURNAL, A BUSINESS CARD CASE, AN ACCESSORY POUCH FOR SMALL PERSONAL ITEMS SUCH AS PENS, TISSUES, AND HAND SANITIZER, AND AN ACCORDION FOLDER FOR HOLDING IMPORTANT DOCUMENTS, SOLD AS A UNIT WITH A MULTI-PURPOSE CARRYING BAG, IN CLASS 16 (U.S. CLS. 2, 5, 22, 23, 29, 37, 38 AND 50).

FIRST USE 1-27-2011; IN COMMERCE 1-27-2011.

THE MARK CONSISTS OF STANDARD CHARACTERS WITHOUT CLAIM TO ANY PARTICULAR FONT, STYLE, SIZE, OR COLOR.

SN 85-029,505, FILED 5-4-2010.

JILL C. ALT, EXAMINING ATTORNEY



David J. Kyjars

Director of the United States Patent and Trademark Office

United States of America

United States Patent and Trademark Office

CLCS COMMERCIAL LINES COVERAGE SPECIALIST

Reg. No. 4,099,671

THE NATIONAL UNDERWRITER COMPANY (OHIO CORPORATION)
5081 OLYMPIC BOULEVARD
ERLANGER, KY 41018

Registered Feb. 14, 2012

Int. Cls.: 16 and 41

FOR: PRINTED MATERIALS, NAMELY, CURRICULA IN THE FIELD OF INSURANCE DESIGNATION PROGRAMS, IN CLASS 16 (U.S. CLS. 2, 5, 22, 23, 29, 37, 38 AND 50).

TRADEMARK

FIRST USE 10-0-2006; IN COMMERCE 10-0-2006.

SERVICE MARK

FOR: EDUCATIONAL SERVICES, NAMELY, PROVIDING DESIGNATION PROGRAMS IN THE NATURE OF WEB-BASED SELF-STUDY AND CLASSROOM INSTRUCTION FOR INSURANCE INDUSTRY PROFESSIONALS, AGENTS, BROKERS, ADJUSTERS, CUSTOMER SERVICE REPRESENTATIVES, UNDERWRITERS, AND SOLICITORS, IN CLASS 41 (U.S. CLS. 100, 101 AND 107).

PRINCIPAL REGISTER

FIRST USE 11-1-2011; IN COMMERCE 11-1-2011.

THE MARK CONSISTS OF STANDARD CHARACTERS WITHOUT CLAIM TO ANY PARTICULAR FONT, STYLE, SIZE, OR COLOR.

NO CLAIM IS MADE TO THE EXCLUSIVE RIGHT TO USE "COMMERCIAL LINES COVERAGE SPECIALIST", APART FROM THE MARK AS SHOWN.

SN 85-029,933, FILED 5-4-2010.

EMILY CHUO, EXAMINING ATTORNEY



David J. Kybas

Director of the United States Patent and Trademark Office

United States of America

United States Patent and Trademark Office

WORLDJJ

Reg. No. 4,099,672

MAKALUMEDIA INC. (GEORGIA CORPORATION)
3606 WOODBERRY DRIVE
DULUTH, GA 30096

Registered Feb. 14, 2012

Int. Cl.: 41

FOR: ENTERTAINMENT SERVICES, NAMELY, PROVIDING ONLINE EVENT AND COMPETITION INFORMATION ABOUT BRAZILIAN JIU-JITSU, GRAPPLING TECHNIQUES AND MIXED MARTIAL ARTS (MMA) FOR CONSUMERS, IN CLASS 41 (U.S. CLS. 100, 101 AND 107).

SERVICE MARK

PRINCIPAL REGISTER

FIRST USE 4-30-2010; IN COMMERCE 12-7-2011.

THE MARK CONSISTS OF STANDARD CHARACTERS WITHOUT CLAIM TO ANY PARTICULAR FONT, STYLE, SIZE, OR COLOR.

SN 85-030,335, FILED 5-5-2010.

ALICE BENMAMAN, EXAMINING ATTORNEY



David J. Kybas

Director of the United States Patent and Trademark Office

United States of America

United States Patent and Trademark Office

ETHICS 360

Reg. No. 4,099,673

EMPLOYMENT LAW TRAINING, INC. (DELAWARE CORPORATION)
160 PINE STREET, SUITE 200
SAN FRANCISCO, CA 94111

Registered Feb. 14, 2012

Int. Cl.: 41

FOR: EDUCATIONAL SERVICES, NAMELY, COURSES ON EMPLOYMENT AND LABOR LAW, IN CLASS 41 (U.S. CLS. 100, 101 AND 107).

SERVICE MARK

FIRST USE 5-0-2010; IN COMMERCE 5-0-2010.

PRINCIPAL REGISTER

THE MARK CONSISTS OF STANDARD CHARACTERS WITHOUT CLAIM TO ANY PARTICULAR FONT, STYLE, SIZE, OR COLOR.

NO CLAIM IS MADE TO THE EXCLUSIVE RIGHT TO USE "ETHICS", APART FROM THE MARK AS SHOWN.

SN 85-030,699, FILED 5-5-2010.

KAPIL BHANOT, EXAMINING ATTORNEY



David J. Kybas

Director of the United States Patent and Trademark Office

United States of America

United States Patent and Trademark Office

WORKPLACE HARASSMENT 360

Reg. No. 4,099,674

EMPLOYMENT LAW TRAINING, INC. (DELAWARE CORPORATION)
160 PINE STREET, SUITE 200
SAN FRANCISCO, CA 94111

Registered Feb. 14, 2012

Int. Cl.: 41

FOR: EDUCATIONAL SERVICES, NAMELY, COURSES ON EMPLOYMENT AND LABOR LAW, IN CLASS 41 (U.S. CLS. 100, 101 AND 107).

SERVICE MARK

FIRST USE 12-0-2010; IN COMMERCE 12-0-2010.

PRINCIPAL REGISTER

THE MARK CONSISTS OF STANDARD CHARACTERS WITHOUT CLAIM TO ANY PARTICULAR FONT, STYLE, SIZE, OR COLOR.

NO CLAIM IS MADE TO THE EXCLUSIVE RIGHT TO USE "WORKPLACE HARASSMENT", APART FROM THE MARK AS SHOWN.

SN 85-030,708, FILED 5-5-2010.

KAPIL BHANOT, EXAMINING ATTORNEY



David J. Kybas

Director of the United States Patent and Trademark Office

United States of America

United States Patent and Trademark Office

BE GREEN LIKE ME

Reg. No. 4,099,675

JABBERBLABBER, INC. (TENNESSEE CORPORATION)
1985 MADISON AVENUE, SUITE 7
MEMPHIS, TN 38104

Registered Feb. 14, 2012

Int. Cl.: 25

FOR: CLOTHING, NAMELY, T-SHIRTS, SWEATSHIRTS, SHIRTS, JACKETS, CAPS AND PANTS, IN CLASS 25 (U.S. CLS. 22 AND 39).

TRADEMARK

FIRST USE 3-0-2009; IN COMMERCE 3-0-2009.

PRINCIPAL REGISTER

THE MARK CONSISTS OF STANDARD CHARACTERS WITHOUT CLAIM TO ANY PARTICULAR FONT, STYLE, SIZE, OR COLOR.

SN 85-031,134, FILED 5-5-2010.

ANTHONY RINKER, EXAMINING ATTORNEY



David J. Kybas

Director of the United States Patent and Trademark Office

United States of America
United States Patent and Trademark Office

21ST

Reg. No. 4,099,676

Registered Feb. 14, 2012

Int. Cl.: 36

SERVICE MARK

PRINCIPAL REGISTER

21ST CENTURY INSURANCE AND FINANCIAL SERVICES, INC. (DELAWARE CORPORATION)
3 BEAVER VALLEY ROAD
WILMINGTON, DE 19803

FOR: INSURANCE UNDERWRITING SERVICES IN THE FIELD OF PROPERTY AND CASUALTY, AUTOMOBILE, BOAT, FLOOD, RENTERS, TOWNHOUSE, CONDOMINIUMS, HOMEOWNERS, RECREATIONAL VEHICLES, AND BUSINESS AND COMMERCIAL INSURANCE; INSURANCE ADMINISTRATION; INSURANCE CLAIMS PROCESSING, INSURANCE CLAIMS ADMINISTRATION, AND INSURANCE AGENCY SERVICES; PROVIDING INFORMATION IN INSURANCE MATTERS, IN CLASS 36 (U.S. CLS. 100, 101 AND 102).

FIRST USE 5-17-2010; IN COMMERCE 5-17-2010.

THE MARK CONSISTS OF STANDARD CHARACTERS WITHOUT CLAIM TO ANY PARTICULAR FONT, STYLE, SIZE, OR COLOR.

OWNER OF U.S. REG. NO. 3,275,078.

SN 85-031,497, FILED 5-6-2010.

JOHN WILKE, EXAMINING ATTORNEY



David J. Kybas

Director of the United States Patent and Trademark Office

United States of America

United States Patent and Trademark Office

4WRK

Reg. No. 4,099,677

OMX, INC. (NEVADA CORPORATION)
263 SHUMAN BLVD.
NAPERVILLE, IL 60563

Registered Feb. 14, 2012

Int. Cl.: 9

FOR: COMPUTER ACCESSORIES AND PERIPHERALS, NAMELY, COMPUTER PRIVACY SCREENS, IN CLASS 9 (U.S. CLS. 21, 23, 26, 36 AND 38).

TRADEMARK

FIRST USE 8-31-2010; IN COMMERCE 8-31-2010.

PRINCIPAL REGISTER

THE MARK CONSISTS OF STANDARD CHARACTERS WITHOUT CLAIM TO ANY PARTICULAR FONT, STYLE, SIZE, OR COLOR.

SN 85-031,925, FILED 5-6-2010.

CHERYL CLAYTON, EXAMINING ATTORNEY



David J. Kybas

Director of the United States Patent and Trademark Office

United States of America

United States Patent and Trademark Office



Reg. No. 4,099,678

Registered Feb. 14, 2012

Int. Cls.: 16 and 44

TRADEMARK

SERVICE MARK

PRINCIPAL REGISTER

BOEHRINGER INGELHEIM PHARMACEUTICALS, INC. (DELAWARE CORPORATION)
P.O. BOX 368
900 RIDGEBURY ROAD
RIDGEFIELD, CT 06877

FOR: PRINTED MEDIA, NAMELY, BROCHURES, PAMPHLETS AND STICKERS ABOUT COPD, IN CLASS 16 (U.S. CLS. 2, 5, 22, 23, 29, 37, 38 AND 50).

FIRST USE 11-0-2009; IN COMMERCE 11-0-2009.

FOR: PROVIDING MEDICAL INFORMATION RELATED TO COPD AWARENESS VIA BROCHURES, PAMPHLETS, SIGNAGE, STICKERS, BOOKMARKS, BILLBOARDS, POSTERS, INTERNET, TELEVISION, VIDEO, NEWSPAPERS AND MAGAZINES, IN CLASS 44 (U.S. CLS. 100 AND 101).

FIRST USE 11-0-2009; IN COMMERCE 11-0-2009.

NO CLAIM IS MADE TO THE EXCLUSIVE RIGHT TO USE "COPD", APART FROM THE MARK AS SHOWN.

THE COLOR(S) BLUE AND WHITE IS/ARE CLAIMED AS A FEATURE OF THE MARK.

THE MARK CONSISTS OF A RECTANGLE SHAPE WITH A TRIANGLE CUT OUT IN THE UPPER LEFT SIDE, WITH A BLUE BACKGROUND AND THE WORDS: "KNOW COPD" APPEARING BELOW THE TRIANGLE CUT OUT AND TO THE RIGHT MARGIN IN WHITE LETTERS; THE WORDS: "CONNECT, LEARN & BREATHE EASIER" ARE IN BLUE AND CENTERED BELOW THE WORDS: "KNOW COPD".

SN 85-032,062, FILED 5-6-2010.

AMY C. KEAN, EXAMINING ATTORNEY



David J. Kappas

Director of the United States Patent and Trademark Office

United States of America

United States Patent and Trademark Office

Connect, learn & breathe easier

Reg. No. 4,099,679

Registered Feb. 14, 2012

Int. Cls.: 16 and 44

TRADEMARK

SERVICE MARK

PRINCIPAL REGISTER

BOEHRINGER INGELHEIM PHARMACEUTICALS, INC. (DELAWARE CORPORATION)
P.O. BOX 368
900 RIDGEBURY ROAD
RIDGEFIELD, CT 06877

FOR: PRINTED MEDIA, NAMELY, BROCHURES, PAMPHLETS AND STICKERS ABOUT COPD, IN CLASS 16 (U.S. CLS. 2, 5, 22, 23, 29, 37, 38 AND 50).

FIRST USE 11-0-2009; IN COMMERCE 11-0-2009.

FOR: PROVIDING MEDICAL INFORMATION RELATED TO COPD AWARENESS VIA BROCHURES, PAMPHLETS, SIGNAGE, STICKERS, BOOKMARKS, BILLBOARDS, POSTERS, INTERNET, TELEVISION, VIDEO, NEWSPAPERS AND MAGAZINES, IN CLASS 44 (U.S. CLS. 100 AND 101).

FIRST USE 11-0-2009; IN COMMERCE 11-0-2009.

THE MARK CONSISTS OF STANDARD CHARACTERS WITHOUT CLAIM TO ANY PARTICULAR FONT, STYLE, SIZE, OR COLOR.

SN 85-032,071, FILED 5-6-2010.

AMY C. KEAN, EXAMINING ATTORNEY



David J. Kyros

Director of the United States Patent and Trademark Office

United States of America

United States Patent and Trademark Office

VELOCICHECK

Reg. No. 4,099,680

TSI INCORPORATED (MINNESOTA CORPORATION)
500 CARDIGAN ROAD
ST. PAUL, MN 55126

Registered Feb. 14, 2012

Int. Cl.: 9

FOR: AIR VELOCITY METERS, IN CLASS 9 (U.S. CLS. 21, 23, 26, 36 AND 38).

TRADEMARK

FIRST USE 5-19-1989; IN COMMERCE 5-19-1989.

PRINCIPAL REGISTER

THE MARK CONSISTS OF STANDARD CHARACTERS WITHOUT CLAIM TO ANY PARTICULAR FONT, STYLE, SIZE, OR COLOR.

OWNER OF U.S. REG. NOS. 1,530,707 AND 1,595,053.

SN 85-032,676, FILED 5-7-2010.

MATTHEW PAPPAS, EXAMINING ATTORNEY



David J. Kyffers

Director of the United States Patent and Trademark Office

United States of America

United States Patent and Trademark Office

Dorkly

Reg. No. 4,099,681

Registered Feb. 14, 2012

Int. Cl.: 41

SERVICE MARK

PRINCIPAL REGISTER

CONNECTED VENTURES, LLC (DELAWARE LIMITED LIABILITY COMPANY)
555 WEST 18TH STREET
NEW YORK, NY 10011

FOR: ENTERTAINMENT SERVICES, NAMELY, PROVIDING A WEBSITE FEATURING NON-DOWNLOADABLE FUNNY VIDEOS, HUMOR, FUNNY ARTICLES; PROVIDING LINKS TO THE WEBSITES OF OTHERS FEATURING HUMOR, FUNNY VIDEOS, AND GAMES; PROVIDING INFORMATION ABOUT GAMES, IN CLASS 41 (U.S. CLS. 100, 101 AND 107).

FIRST USE 5-25-2010; IN COMMERCE 5-25-2010.

THE MARK CONSISTS OF STANDARD CHARACTERS WITHOUT CLAIM TO ANY PARTICULAR FONT, STYLE, SIZE, OR COLOR.

SN 85-033,443, FILED 5-7-2010.

JOHN HWANG, EXAMINING ATTORNEY



David J. Kyffers

Director of the United States Patent and Trademark Office

United States of America

United States Patent and Trademark Office

CRITICAL MAIL

Reg. No. 4,099,682

Registered Feb. 14, 2012

Int. Cls.: 16, 35, and 39

TRADEMARK

SERVICE MARK

PRINCIPAL REGISTER

UNITED STATES POSTAL SERVICE (UNITED STATES INDEPENDENT ESTABLISHMENT OF THE EXECUTIVE BRANCH OF THE GOVERNMENT OF THE UNITED STATES)
475 L'ENFANT PLAZA, SW
WASHINGTON, DC 202601136

FOR: ENVELOPES AND BOXES OF CARDBOARD OR PAPER FOR SHIPPING AND PACKAGING, IN CLASS 16 (U.S. CLS. 2, 5, 22, 23, 29, 37, 38 AND 50).

FIRST USE 1-0-2011; IN COMMERCE 1-0-2011.

FOR: SORTING, HANDLING, AND RECEIVING PACKAGES AND LETTERS, IN CLASS 35 (U.S. CLS. 100, 101 AND 102).

FIRST USE 1-0-2011; IN COMMERCE 1-0-2011.

FOR: PICKUP, TRANSPORTATION AND DELIVERY OF PACKAGES AND DOCUMENTS BY VARIOUS MODES OF TRANSPORTATION, IN CLASS 39 (U.S. CLS. 100 AND 105).

FIRST USE 1-0-2011; IN COMMERCE 1-0-2011.

THE MARK CONSISTS OF STANDARD CHARACTERS WITHOUT CLAIM TO ANY PARTICULAR FONT, STYLE, SIZE, OR COLOR.

NO CLAIM IS MADE TO THE EXCLUSIVE RIGHT TO USE "MAIL", APART FROM THE MARK AS SHOWN.

SN 85-034,221, FILED 5-10-2010.

JEFFERY COWARD, EXAMINING ATTORNEY



David J. Kybas

Director of the United States Patent and Trademark Office

United States of America

United States Patent and Trademark Office



Reg. No. 4,099,683

Registered Feb. 14, 2012

Int. Cl.: 9

TRADEMARK

PRINCIPAL REGISTER

INTEL CORPORATION (DELAWARE CORPORATION)
2200 MISSION COLLEGE BOULEVARD
SANTA CLARA, CA 95052

FOR: 3D ANIMATION PROCESS TECHNOLOGY SOFTWARE FOR CREATION, PRODUCTION, RECORDING, TRANSMISSION OR REPRODUCTION OF SOUND, VIDEO, MOVIES, FILMS, ANIMATED CONTENT, GRAPHICS AND IMAGES; COMPUTER HARDWARE AND SOFTWARE FOR USE IN RELATION TO DIGITAL ANIMATION AND SPECIAL EFFECTS OF IMAGES, IN CLASS 9 (U.S. CLS. 21, 23, 26, 36 AND 38).

FIRST USE 5-21-2010; IN COMMERCE 5-21-2010.

NO CLAIM IS MADE TO THE EXCLUSIVE RIGHT TO USE "3D", APART FROM THE MARK AS SHOWN.

THE MARK CONSISTS OF A BOUNCING BALL DESIGN, WITH THE WORDING "INTRU 3D" WITHIN THE BALL AND THE WORDING "INSIDE" BELOW AND TO THE RIGHT OF THE BOUNCING BALL DESIGN.

SN 85-034,805, FILED 5-10-2010.

KATHERINE E. HALMEN, EXAMINING ATTORNEY



David J. Kyffers

Director of the United States Patent and Trademark Office

United States of America

United States Patent and Trademark Office

Don't Say No Until You Know

Reg. No. 4,099,684

NATOLI, MICHAEL E. (UNITED STATES INDIVIDUAL)
417 EAGLE POINTE LANDING DR.
EUREKA, MO 630252083

Registered Feb. 14, 2012

Int. Cls.: 13 and 25

FOR: GUNS; SHOULDER BAGS FOR GUNS; GUN HOLSTERS; NON-TELESCOPIC GUN SIGHTS; GUN PURSES; GUN BELTS; GUN CASES; AMMUNITION MAGAZINES; BULLETS , IN CLASS 13 (U.S. CLS. 2 AND 9).

TRADEMARK

FIRST USE 11-1-2010; IN COMMERCE 11-1-2010.

PRINCIPAL REGISTER

FOR: BALL CAPS; T-SHIRTS; POLO SHIRTS; GLOVES, IN CLASS 25 (U.S. CLS. 22 AND 39).

FIRST USE 11-1-2010; IN COMMERCE 11-1-2010.

THE MARK CONSISTS OF STANDARD CHARACTERS WITHOUT CLAIM TO ANY PARTICULAR FONT, STYLE, SIZE, OR COLOR.

OWNER OF U.S. REG. NO. 3,819,407.

SN 85-035,265, FILED 5-11-2010.

TRACY CROSS, EXAMINING ATTORNEY



David J. Kyffers

Director of the United States Patent and Trademark Office

United States of America

United States Patent and Trademark Office

PLAY IT ROCK

Reg. No. 4,099,685

Registered Feb. 14, 2012

Int. Cl.: 3

TRADEMARK

PRINCIPAL REGISTER

COTY GERMANY GMBH (FED REP GERMANY CORPORATION)
RHEINSTRASSE 4E
FORT MALAKOFF PARK
MAINZ, FED REP GERMANY 55116

FOR: PERFUMERY, COSMETICS, ESSENTIAL OILS, SOAPS, IN CLASS 3 (U.S. CLS. 1, 4, 6, 50, 51 AND 52).

FIRST USE 7-31-2011; IN COMMERCE 7-31-2011.

THE MARK CONSISTS OF STANDARD CHARACTERS WITHOUT CLAIM TO ANY PARTICULAR FONT, STYLE, SIZE, OR COLOR.

SN 85-036,645, FILED 5-12-2010.

TINA L. SNAPP, EXAMINING ATTORNEY



David J. Kyjars

Director of the United States Patent and Trademark Office

United States of America

United States Patent and Trademark Office



Reg. No. 4,099,686

Registered Feb. 14, 2012

Int. Cls.: 10 and 44

TRADEMARK

SERVICE MARK

PRINCIPAL REGISTER

MYRIAD GENETICS, INC. (DELAWARE CORPORATION)
320 WAKARA WAY
SALT LAKE CITY, UT 84108

FOR: SAMPLE PREPARATION DEVICE FOR MEDICAL DIAGNOSTIC USES, IN CLASS 10 (U.S. CLS. 26, 39 AND 44).

FIRST USE 5-1-2010; IN COMMERCE 5-1-2010.

FOR: MEDICAL DIAGNOSTIC TESTING, MONITORING AND REPORTING SERVICES, IN CLASS 44 (U.S. CLS. 100 AND 101).

FIRST USE 5-1-2010; IN COMMERCE 5-1-2010.

THE MARK CONSISTS OF ONE PIECE ORANGE HALF CIRCLE ON LEFT SIDE WITH INTERLOCKING GRAY HALF CIRCLE ON RIGHT SIDE WITH "PROLARIS" NAME IN GRAY LOCATED UNDERNEATH THE DESIGN, THE COLOR WHITE REPRESENTS BACKGROUND AND IS NOT CLAIMED AS A FEATURE OF THE MARK.

THE COLOR(S) ORANGE, GRAY IS/ARE CLAIMED AS A FEATURE OF THE MARK.

SN 85-036,936, FILED 5-12-2010.

KATHLEEN LORENZO, EXAMINING ATTORNEY



David J. Kyffers

Director of the United States Patent and Trademark Office

United States of America

United States Patent and Trademark Office



Reg. No. 4,099,687

Registered Feb. 14, 2012

Int. Cl.: 32

COMPAÑIA DE JARABES Y BEBIDAS GASEOSAS LA MARIPOSA, SOCIEDAD ANÓNIMA
(GUATEMALA CORPORATION)
44 CALLE 2-00, ZONA 12
GUATEMALA, GUATEMALA

FOR: MINERAL WATER, IN CLASS 32 (U.S. CLS. 45, 46 AND 48).

TRADEMARK

FIRST USE 5-7-2010; IN COMMERCE 5-7-2010.

PRINCIPAL REGISTER

NO CLAIM IS MADE TO THE EXCLUSIVE RIGHT TO USE "DESDE 1950" AND "AGUA MINERAL", APART FROM THE MARK AS SHOWN.

THE COLOR(S) BLUE AND GREY IS/ARE CLAIMED AS A FEATURE OF THE MARK.

THE MARK CONSISTS OF THE WORD "SALUTARIS" IN STYLIZED LETTERS INSIDE A SLIGHTLY SLANTED RECTANGLE WHICH APPEARS OVER A CIRCLE. IN THE UPPER AREA OF THE CIRCLE APPEAR FIVE STARS AND THE WORDING "DESDE 1950". IN THE LOWER AREA OF THE CIRCLE APPEARS THE WORDING "EL AGUA MINERAL". THE UPPER AND LOWER SIDES OF THE RECTANGLE CONTAIN A DOTTED LINE AND OUTER BORDER. THE CIRCLE ALSO CONTAINS NEAR ITS OUTER BORDER A RING FORMED BY DOTS AND A SECOND RING. THE COLOR BLUE APPEARS INSIDE THE RECTANGLE AND INSIDE THE CIRCLE. THE COLOR GREY APPEARS IN THE WORDING "DESDE 1950 SALUTARIS EL AGUA MINERAL", IN THE DOTTED LINES AND OUTER BORDERS THAT APPEAR IN THE UPPER AND LOWER SIDE OF THE RECTANGLE, IN THE STARS AND IN THE DOTTED RING AND SECOND RING THAT APPEAR INSIDE THE CIRCLE.

THE ENGLISH TRANSLATION OF "DESDE 1950 EL AGUA MINERAL" IN THE MARK IS "SINCE 1950 THE MINERAL WATER". THE WORDING "SALUTARIS" HAS NO MEANING IN A FOREIGN LANGUAGE.

SN 85-037,125, FILED 5-12-2010.

BERNICE MIDDLETON, EXAMINING ATTORNEY



David J. Kyffers

Director of the United States Patent and Trademark Office

United States of America

United States Patent and Trademark Office

Ana

Reg. No. 4,099,688

Registered Feb. 14, 2012

Int. Cl.: 9

TRADEMARK

PRINCIPAL REGISTER

INFOPOWER CORPORATION (TAIWAN CORPORATION)
NANKANG SOFTWARE PARK
3F-2, NO. 3, PARK STREET, BUILDING F
TAIPEI, TAIWAN 115

FOR: COMPUTER SOFTWARE FOR ALLOWING PEOPLE AND ORGANIZATIONS TO ACQUIRE KEY MANAGEMENT INFORMATION REQUIRED FOR MAKING EFFECTIVE DECISIONS BY ENGAGING IN COMPLEX ON-LINE ANALYTICAL PROCESSING, NAMELY, ALLOWING USERS TO EASILY CREATE, MODIFY, MANAGE, SHARE, AND COLLABORATE ON ANALYTICAL REPORTS FROM DATABASES, IN CLASS 9 (U.S. CLS. 21, 23, 26, 36 AND 38).

FIRST USE 11-1-2011; IN COMMERCE 11-1-2011.

THE MARK CONSISTS OF THE STYLIZED WORD "ANA".

SN 85-037,221, FILED 5-13-2010.

DAVID COLLIER, EXAMINING ATTORNEY



David J. Kyffers

Director of the United States Patent and Trademark Office

United States of America

United States Patent and Trademark Office

VOXEO PRISM

Reg. No. 4,099,689

VOXEO CORPORATION (DELAWARE CORPORATION)
189 S. ORANGE AVE., SUITE 2050
ORLANDO, FL 32801

Registered Feb. 14, 2012

Int. Cl.: 9

FOR: DOWNLOADABLE COMPUTER TELEPHONY SOFTWARE, IN CLASS 9 (U.S. CLS. 21, 23, 26, 36 AND 38).

TRADEMARK

FIRST USE 12-15-2010; IN COMMERCE 12-15-2010.

PRINCIPAL REGISTER

THE MARK CONSISTS OF STANDARD CHARACTERS WITHOUT CLAIM TO ANY PARTICULAR FONT, STYLE, SIZE, OR COLOR.

SN 85-037,534, FILED 5-13-2010.

LEIGH LOWRY, EXAMINING ATTORNEY



David J. Kyffers

Director of the United States Patent and Trademark Office

United States of America

United States Patent and Trademark Office

TPX

Reg. No. 4,099,690

Registered Feb. 14, 2012

Int. Cl.: 28

TRADEMARK

PRINCIPAL REGISTER

HILLERICH & BRADSBY CO. (KENTUCKY CORPORATION)
800 WEST MAIN STREET
LOUISVILLE, KY 40202

FOR: GOLF CLUBS, IN CLASS 28 (U.S. CLS. 22, 23, 38 AND 50).

FIRST USE 4-0-2011; IN COMMERCE 4-0-2011.

THE MARK CONSISTS OF STANDARD CHARACTERS WITHOUT CLAIM TO ANY PARTICULAR FONT, STYLE, SIZE, OR COLOR.

OWNER OF U.S. REG. NOS. 1,626,119, 2,845,664, AND OTHERS.

SN 85-037,729, FILED 5-13-2010.

TRICIA SONNEBORN, EXAMINING ATTORNEY



David J. Kybas

Director of the United States Patent and Trademark Office

United States of America

United States Patent and Trademark Office

DELIVERING LAYERS OF CONFIDENCE

Reg. No. 4,099,691

Registered Feb. 14, 2012

Int. Cl.: 17

TRADEMARK

PRINCIPAL REGISTER

TREDEGAR FILM PRODUCTS CORPORATION (VIRGINIA CORPORATION)
1100 BOULDERS PARKWAY
RICHMOND, VA 23225

FOR: PLASTIC SHEETS, FILMS AND LAMINATES FOR USE IN THE MANUFACTURE OF BUILDING AND CONSTRUCTION MATERIALS, CONSUMER PRODUCTS, AGRICULTURAL AND LANDSCAPING MATERIALS, LIMITED USE GARMENTS, PACKAGING MATERIALS AND FOR GENERAL INDUSTRIAL USE; SYNTHETIC RUBBER FILMS AND LAMINATES FOR USE IN THE MANUFACTURE OF CONSUMER PRODUCTS, LIMITED USE GARMENTS, PACKAGING MATERIALS AND FOR GENERAL INDUSTRIAL USE, IN CLASS 17 (U.S. CLS. 1, 5, 12, 13, 35 AND 50).

FIRST USE 9-14-2011; IN COMMERCE 10-28-2011.

THE MARK CONSISTS OF STANDARD CHARACTERS WITHOUT CLAIM TO ANY PARTICULAR FONT, STYLE, SIZE, OR COLOR.

SN 85-037,790, FILED 5-13-2010.

KATHERINE STOIDES, EXAMINING ATTORNEY



David J. Kybas

Director of the United States Patent and Trademark Office

United States of America

United States Patent and Trademark Office

ADD-A-CLOSET

Reg. No. 4,099,692

ON THE MOVE, INC. (MICHIGAN CORPORATION)
28825 IH 10 WEST
BOERNE, TX 78006

Registered Feb. 14, 2012

Int. Cl.: 20

FOR: PLASTIC BOXES, IN CLASS 20 (U.S. CLS. 2, 13, 22, 25, 32 AND 50).

TRADEMARK

FIRST USE 10-31-2011; IN COMMERCE 10-31-2011.

PRINCIPAL REGISTER

THE MARK CONSISTS OF STANDARD CHARACTERS WITHOUT CLAIM TO ANY PARTICULAR FONT, STYLE, SIZE, OR COLOR.

SN 85-038,011, FILED 5-13-2010.

JOHN KELLY, EXAMINING ATTORNEY



David J. Kybas

Director of the United States Patent and Trademark Office

United States of America

United States Patent and Trademark Office

UNIVERSITY MEDICAL PROFESSIONAL

Reg. No. 4,099,693

UNIVERSITY MEDICAL PHARMACEUTICALS CORP. (CALIFORNIA CORPORATION)
88 MAXWELL
IRVINE, CA 92618

Registered Feb. 14, 2012

Int. Cl.: 5

FOR: MEDICATED BROW AND EYE PATCHES, IN CLASS 5 (U.S. CLS. 6, 18, 44, 46, 51 AND 52).

TRADEMARK

FIRST USE 4-1-2011; IN COMMERCE 4-1-2011.

PRINCIPAL REGISTER

THE MARK CONSISTS OF STANDARD CHARACTERS WITHOUT CLAIM TO ANY PARTICULAR FONT, STYLE, SIZE, OR COLOR.

OWNER OF U.S. REG. NO. 2,012,249.

NO CLAIM IS MADE TO THE EXCLUSIVE RIGHT TO USE "MEDICAL PROFESSIONAL", APART FROM THE MARK AS SHOWN.

SN 85-038,986, FILED 5-14-2010.

DAVID COLLIER, EXAMINING ATTORNEY



David J. Kyfos

Director of the United States Patent and Trademark Office

United States of America

United States Patent and Trademark Office

BIO2

Reg. No. 4,099,694

PATTERSON, JOHN (UNITED STATES INDIVIDUAL)
912 PINE CIRCLE
WOODSTOCK, GA 30189

Registered Feb. 14, 2012

Int. Cl.: 9

FOR: CONTACT LENSES, IN CLASS 9 (U.S. CLS. 21, 23, 26, 36 AND 38).

TRADEMARK

FIRST USE 1-1-2010; IN COMMERCE 11-1-2011.

PRINCIPAL REGISTER

THE MARK CONSISTS OF STANDARD CHARACTERS WITHOUT CLAIM TO ANY PARTICULAR FONT, STYLE, SIZE, OR COLOR.

SN 85-039,246, FILED 5-14-2010.

JENNIFER DIXON, EXAMINING ATTORNEY



David J. Kyffers

Director of the United States Patent and Trademark Office

United States of America

United States Patent and Trademark Office

CAT POWER TOWER

Reg. No. 4,099,695

Registered Feb. 14, 2012

Int. Cl.: 20

TRADEMARK

PRINCIPAL REGISTER

WISER PET PRODUCTS (WISCONSIN LIMITED LIABILITY COMPANY)
SUITE E
600 OHIO STREET
OSHKOSH, WI 54902

FOR: PET FURNITURE, IN CLASS 20 (U.S. CLS. 2, 13, 22, 25, 32 AND 50).

FIRST USE 4-12-2011; IN COMMERCE 4-12-2011.

THE MARK CONSISTS OF STANDARD CHARACTERS WITHOUT CLAIM TO ANY PARTICULAR FONT, STYLE, SIZE, OR COLOR.

NO CLAIM IS MADE TO THE EXCLUSIVE RIGHT TO USE "CAT" AND "TOWER", APART FROM THE MARK AS SHOWN.

SN 85-041,908, FILED 5-18-2010.

ALLISON SCHRODY, EXAMINING ATTORNEY



David J. Kybas

Director of the United States Patent and Trademark Office

United States of America

United States Patent and Trademark Office

LUSTY

Reg. No. 4,099,696

LOUDERBACK, EDWARD (UNITED STATES INDIVIDUAL)
PMB 24025

Registered Feb. 14, 2012

SANTA BARBARA, CA 93121

Int. Cl.: 25

FOR: BASEBALL CAPS; BATHING SUITS; BEANIES; BELTS; BERETS; CHILDREN'S AND INFANT'S APPAREL, NAMELY, JUMPERS, OVERALL SLEEPWEAR, PAJAMAS, ROMPERS AND ONE-PIECE GARMENTS; CHILDREN'S HEADWEAR; COATS; FOOTWEAR; HATS; HATS FOR INFANTS, BABIES, TODDLERS AND CHILDREN; HOODED PULLOVERS; HOODED SWEAT SHIRTS; JACKETS; JOGGING OUTFITS; LONG-SLEEVED SHIRTS; PANTS; PARKAS; POLO SHIRTS; SCARVES; SHIRTS; SHIRTS FOR INFANTS, BABIES, TODDLERS AND CHILDREN; SHORT-SLEEVED OR LONG-SLEEVED T-SHIRTS; SHORTS; SOCKS; SWEAT BANDS; SWEAT JACKETS; SWEAT PANTS; SWEAT SHIRTS; SWEATERS; T-SHIRTS; TANK TOPS; TOPS; TRACK SUITS; UNDERWEAR; UNIFORMS; VESTS; WIND RESISTANT JACKETS, IN CLASS 25 (U.S. CLS. 22 AND 39).

TRADEMARK

PRINCIPAL REGISTER

FIRST USE 10-20-2010; IN COMMERCE 12-5-2011.

THE MARK CONSISTS OF STANDARD CHARACTERS WITHOUT CLAIM TO ANY PARTICULAR FONT, STYLE, SIZE, OR COLOR.

SN 85-041,927, FILED 5-18-2010.

MARK SHINER, EXAMINING ATTORNEY



David J. Kyffers

Director of the United States Patent and Trademark Office

United States of America

United States Patent and Trademark Office

MATZEL BITS!

Reg. No. 4,099,697

Registered Feb. 14, 2012

Int. Cl.: 30

TRADEMARK

PRINCIPAL REGISTER

MATZEL TOFF!, LLC (CONNECTICUT LIMITED LIABILITY COMPANY)
2 JOFRAN LANE
GREENWICH, CT 06830 AND

LEVY, ABIGAIL HENDEL (UNITED STATES INDIVIDUAL)
2 JOFRAN LANE
GREENWICH, CT 06830 AND

PHILLIP GUTTMANN (UNITED STATES INDIVIDUAL)
2-01 50TH AVENUE #6F
LONG ISLAND CITY, NY 11101

FOR: BAKERY DESSERTS, IN CLASS 30 (U.S. CL. 46).

FIRST USE 9-15-2011; IN COMMERCE 9-15-2011.

THE MARK CONSISTS OF STANDARD CHARACTERS WITHOUT CLAIM TO ANY PARTICULAR FONT, STYLE, SIZE, OR COLOR.

OWNER OF U.S. REG. NOS. 3,740,537 AND 3,740,813.

NO CLAIM IS MADE TO THE EXCLUSIVE RIGHT TO USE "BITS", APART FROM THE MARK AS SHOWN.

SN 85-042,343, FILED 5-19-2010.

TARA PATE, EXAMINING ATTORNEY



David J. Kybas

Director of the United States Patent and Trademark Office

United States of America

United States Patent and Trademark Office

HOLY MACAROON!

Reg. No. 4,099,698

Registered Feb. 14, 2012

Int. Cl.: 30

TRADEMARK

PRINCIPAL REGISTER

MATZEL TOFF!, LLC (CONNECTICUT LIMITED LIABILITY COMPANY)
2 JOFRAN LANE
GREENWICH, CT 06830 AND

LEVY, ABIGAIL HENDEL (UNITED STATES INDIVIDUAL)
2 JOFRAN LANE
GREENWICH, CT 06830 AND

PHILLIP GUTTMANN (UNITED STATES INDIVIDUAL)
2-01 50TH AVENUE #6F
LONG ISLAND CITY, NY 11101

FOR: BAKERY DESSERTS, IN CLASS 30 (U.S. CL. 46).

FIRST USE 9-15-2011; IN COMMERCE 9-15-2011.

THE MARK CONSISTS OF STANDARD CHARACTERS WITHOUT CLAIM TO ANY PARTICULAR FONT, STYLE, SIZE, OR COLOR.

NO CLAIM IS MADE TO THE EXCLUSIVE RIGHT TO USE "MACAROON", APART FROM THE MARK AS SHOWN.

SN 85-042,382, FILED 5-19-2010.

TARA PATE, EXAMINING ATTORNEY



David J. Kybas

Director of the United States Patent and Trademark Office

United States of America

United States Patent and Trademark Office

SHADES OF CELEBRATION

Reg. No. 4,099,699

FLOWER FACTORY, INC. (OHIO CORPORATION)
5655 WHIPPLE AVENUE, N. W.
NORTH CANTON, OH 447207720

Registered Feb. 14, 2012

Int. Cls.: 8, 21, and 24

FOR: PLASTIC KNIVES; PLASTIC FORKS; AND PLASTIC SPOONS, IN CLASS 8 (U.S. CLS. 23, 28 AND 44).

TRADEMARK

FIRST USE 3-11-2011; IN COMMERCE 3-11-2011.

PRINCIPAL REGISTER

FOR: PAPER PLATES; PAPER CUPS; PLASTIC PLATES; PLASTIC CUPS, IN CLASS 21 (U.S. CLS. 2, 13, 23, 29, 30, 33, 40 AND 50).

FIRST USE 3-11-2011; IN COMMERCE 3-11-2011.

FOR: PARTY ACCESSORIES, NAMELY, PLASTIC TABLECLOTHS AND PLASTIC TABLE COVERS, IN CLASS 24 (U.S. CLS. 42 AND 50).

FIRST USE 3-11-2011; IN COMMERCE 3-11-2011.

THE MARK CONSISTS OF STANDARD CHARACTERS WITHOUT CLAIM TO ANY PARTICULAR FONT, STYLE, SIZE, OR COLOR.

SN 85-043,058, FILED 5-19-2010.

SIMON TENG, EXAMINING ATTORNEY



David J. Kybas

Director of the United States Patent and Trademark Office

United States of America

United States Patent and Trademark Office

Smart TV

Reg. No. 4,099,700

SMART MEDIA, INC. (CALIFORNIA CORPORATION)
9903 SANTA MONICA BLVD., SUITE 418
BEVERLY HILLS, CA 90212

Registered Feb. 14, 2012

Int. Cl.: 38

FOR: BROADCASTING OF VIDEO AND AUDIO PROGRAMMING OVER THE INTERNET;
INTERNET BROADCASTING SERVICES; VIDEO BROADCASTING SERVICES VIA THE
INTERNET, IN CLASS 38 (U.S. CLS. 100, 101 AND 104).

SERVICE MARK

FIRST USE 9-0-2011; IN COMMERCE 9-0-2011.

PRINCIPAL REGISTER

THE MARK CONSISTS OF STANDARD CHARACTERS WITHOUT CLAIM TO ANY PAR-
TICULAR FONT, STYLE, SIZE, OR COLOR.

OWNER OF U.S. REG. NO. 2,286,864.

NO CLAIM IS MADE TO THE EXCLUSIVE RIGHT TO USE "TV", APART FROM THE MARK
AS SHOWN.

SN 85-043,149, FILED 5-19-2010.

TARAH HARDY, EXAMINING ATTORNEY



David J. Kyffers

Director of the United States Patent and Trademark Office

United States of America

United States Patent and Trademark Office

PURE

Reg. No. 4,099,701

Registered Feb. 14, 2012

Int. Cl.: 9

TRADEMARK

PRINCIPAL REGISTER

SWITCHEASY LIMITED (HONG KONG LIMITED LIABILITY COMPANY)
RM. 314, SING WIN FACTORY BLDG.
15-17 SHING YIP STREET, KWUN TONG
KOWLOON, HONG KONG

FOR: PLASTIC FILMS AND MEMBRANES ADAPTED FOR COVERING AND PROTECTING THE SURFACES OF ELECTRONIC DEVICES, NAMELY, HANDHELD PERSONAL ELECTRONIC DEVICES, NAMELY, DIGITAL MEDIA PLAYER DEVICES, PERSONAL DIGITAL ASSISTANT, HANDHELD WIRELESS DEVICES, MOBILE TELEPHONES, HANDHELD DIGITAL AUDIO AND/OR VIDEO CAPTURE DEVICES, OR DEVICES HAVING A COMBINATION OF ONE OF MORE FUNCTIONALITIES OF THE FOREGOING; FITTED PLASTIC FILMS AND MEMBRANES ADAPTED FOR COVERING AND PROTECTING THE SURFACES OF ELECTRONIC DEVICES, NAMELY, HANDHELD PERSONAL ELECTRONIC DEVICES, NAMELY, DIGITAL MEDIA PLAYER DEVICES, PERSONAL DIGITAL ASSISTANT, HANDHELD WIRELESS DEVICES, MOBILE TELEPHONES, HANDHELD DIGITAL AUDIO AND/OR VIDEO CAPTURE DEVICES, OR DEVICES HAVING A COMBINATION OF ONE OF MORE FUNCTIONALITIES OF THE FOREGOING; FITTED PLASTIC FILMS AND MEMBRANES ADAPTED FOR COVERING AND PROTECTING THE DISPLAY SCREENS OF ELECTRONIC DEVICES, NAMELY, HANDHELD PERSONAL ELECTRONIC DEVICES, NAMELY, DIGITAL MEDIA PLAYER DEVICES, PERSONAL DIGITAL ASSISTANT, HANDHELD WIRELESS DEVICES, MOBILE TELEPHONES, HANDHELD DIGITAL AUDIO AND/OR VIDEO CAPTURE DEVICES, OR DEVICES HAVING A COMBINATION OF ONE OF MORE FUNCTIONALITIES OF THE FOREGOING; PLASTIC FILMS AND MEMBRANES ADAPTED FOR COVERING AND PROVIDING A SCRATCH PROOF BARRIER OR PROTECTION FOR ELECTRONIC DEVICES, NAMELY, HANDHELD PERSONAL ELECTRONIC DEVICES, NAMELY, DIGITAL MEDIA PLAYER DEVICES, PERSONAL DIGITAL ASSISTANT, HANDHELD WIRELESS DEVICES, MOBILE TELEPHONES, HANDHELD DIGITAL AUDIO AND/OR VIDEO CAPTURE DEVICES, OR DEVICES HAVING A COMBINATION OF ONE OF MORE FUNCTIONALITIES OF THE FOREGOING, IN CLASS 9 (U.S. CLS. 21, 23, 26, 36 AND 38).



FIRST USE 7-26-2010; IN COMMERCE 7-26-2010.

David J. Kybas

THE MARK CONSISTS OF STANDARD CHARACTERS WITHOUT CLAIM TO ANY PARTICULAR FONT, STYLE, SIZE, OR COLOR.

SN 85-044,328, FILED 5-20-2010.

Reg. No. 4,099,701 LESLIE RICHARDS, EXAMINING ATTORNEY

United States of America

United States Patent and Trademark Office

HIDE-A-WAY

Reg. No. 4,099,702

MARLEN MANUFACTURING & DEVELOPMENT COMPANY (OHIO CORPORATION)
5150 RICHMOND ROAD
BEDFORD, OH 44146

Registered Feb. 14, 2012

Int. Cl.: 10

FOR: CLOSURE ARRANGEMENT FOR AN OSTOMY POUCH, NAMELY, CLOSURE CLAMPS, IN CLASS 10 (U.S. CLS. 26, 39 AND 44).

TRADEMARK

FIRST USE 6-1-2011; IN COMMERCE 6-1-2011.

PRINCIPAL REGISTER

THE MARK CONSISTS OF STANDARD CHARACTERS WITHOUT CLAIM TO ANY PARTICULAR FONT, STYLE, SIZE, OR COLOR.

SN 85-044,584, FILED 5-21-2010.

KELLY TRUSILO, EXAMINING ATTORNEY



David J. Kybas

Director of the United States Patent and Trademark Office

United States of America

United States Patent and Trademark Office



Reg. No. 4,099,703

Registered Feb. 14, 2012

Int. Cl.: 25

TRADEMARK

PRINCIPAL REGISTER

HEELING SPORTS LIMITED (TEXAS LIMITED PARTNERSHIP)
SUITE 100
3200 BELMEADE
CARROLLTON, TX 75006

FOR: FOOTWEAR, NAMELY, ATHLETIC SHOES AND APPAREL, NAMELY, T-SHIRTS
AND CAPS, IN CLASS 25 (U.S. CLS. 22 AND 39).

FIRST USE 10-31-2011; IN COMMERCE 10-31-2011.

THE MARK CONSISTS OF HUMAN-LIKE CHARACTER HAVING THE APPEARANCE OF
A MAN WITH HIS ARMS REACHING UPWARD AND LEGS SEPARATED.

SN 85-044,684, FILED 5-21-2010.

SCOTT BIBB, EXAMINING ATTORNEY



David J. Kyffers

Director of the United States Patent and Trademark Office

United States of America
United States Patent and Trademark Office

RASUREL

Reg. No. 4,099,704

LEJABY, S.A.S. (FRANCE SOCIÉTÉ PAR ACTIONS SIMPLIFIÉE (SAS))
AVENUE DU LOUP PENDU

Registered Feb. 14, 2012

RILLIEUX LA PAPE, FRANCE 69140

Int. Cl.: 25

FOR: CLOTHING, NAMELY, SWIMSUITS AND BEACH COVER UPS, IN CLASS 25 (U.S. CLS. 22 AND 39).

TRADEMARK

FIRST USE 3-17-2007; IN COMMERCE 3-17-2007.

PRINCIPAL REGISTER

THE MARK CONSISTS OF STANDARD CHARACTERS WITHOUT CLAIM TO ANY PARTICULAR FONT, STYLE, SIZE, OR COLOR.

SN 85-044,742, FILED 5-21-2010.

JACQUELINE A. LAVINE, EXAMINING ATTORNEY



David J. Kybas

Director of the United States Patent and Trademark Office

United States of America
United States Patent and Trademark Office

ADVOCACY

Reg. No. 4,099,705

Registered Feb. 14, 2012

Int. Cl.: 36

SERVICE MARK

PRINCIPAL REGISTER

ADVOCACY WEALTH MANAGEMENT SERVICES, LLC (GEORGIA LIMITED LIABILITY COMPANY)
3155 ROSWELL ROAD, SUITE 320
ATLANTA, GA 30305

FOR: STRUCTURED FINANCIAL PLANNING SERVICES; FINANCIAL CONSULTATION, NAMELY, DESIGNING FINANCIAL SOLUTIONS FOR SETTLEMENTS OF LEGAL CLAIMS THAT WORK IN CONCERT WITH STRUCTURED ANNUITIES; FINANCIAL CONSULTING SERVICES FOR ATTORNEYS, LITIGANTS, AND FINANCIAL PROFESSIONALS IN DESIGNING SETTLEMENTS OF LEGAL CLAIMS, IN CLASS 36 (U.S. CLS. 100, 101 AND 102).

FIRST USE 1-0-2007; IN COMMERCE 1-0-2011.

NO CLAIM IS MADE TO THE EXCLUSIVE RIGHT TO USE "ADVOCACY", APART FROM THE MARK AS SHOWN.

THE MARK CONSISTS OF "ADVOCACY" AND DESIGN OF A SWORD INTERSECTING THE "O".

SN 85-044,763, FILED 5-21-2010.

JASON TURNER, EXAMINING ATTORNEY



David J. Kyffers

Director of the United States Patent and Trademark Office

United States of America

United States Patent and Trademark Office



Reg. No. 4,099,706

MCANDREWS, ELIZABETH (UNITED STATES INDIVIDUAL)
47 LINCOLN AVENUE
STATEN ISLAND, NY 10306

Registered Feb. 14, 2012

Int. Cl.: 41

FOR: ON-LINE JOURNALS, NAMELY, BLOGS FEATURING RELATIONSHIP EXPERIENCES AND EVERYDAY LIFE, IN CLASS 41 (U.S. CLS. 100, 101 AND 107).

SERVICE MARK

FIRST USE 10-1-2011; IN COMMERCE 10-1-2011.

PRINCIPAL REGISTER

THE NAME "WICKED LIZZY" IDENTIFIES A LIVING INDIVIDUAL WHOSE CONSENT IS OF RECORD.

THE COLOR(S) BLACK, WHITE, GREEN, RED, LIGHT PEACH, DARK PEACH AND BLUE IS/ARE CLAIMED AS A FEATURE OF THE MARK.

THE COLOR BLACK APPEARS IN THE GIRL'S DRESS, HAIR, EYEBROWS, EYES, IN THE SHADING BELOW HER FEET AND IN THE WORDING. THE COLOR RED APPEARS IN THE GIRL'S LIPS, IN THE HEART DESIGNS, AND IN ONE OF HER BRACELETS. THE COLOR GREEN APPEARS IN THE GIRL'S EYES. THE COLORS LIGHT PEACH AND DARK PEACH APPEAR IN THE GIRL'S SKIN AND FRECKLES. THE COLOR BLUE APPEARS IN ONE OF THE GIRL'S BRACELETS.

SN 85-045,828, FILED 5-23-2010.

DORITT L. CARROLL, EXAMINING ATTORNEY



David J. Kybas

Director of the United States Patent and Trademark Office

United States of America

United States Patent and Trademark Office

MUSIC IN THE KITCHEN

Reg. No. 4,099,707

FACEMIRE, GLENDA (UNITED STATES INDIVIDUAL)
APT. A
5332 BALCONES DRIVE
AUSTIN, TX 78731

Registered Feb. 14, 2012

Int. Cl.: 16

FOR: COOK BOOKS, IN CLASS 16 (U.S. CLS. 2, 5, 22, 23, 29, 37, 38 AND 50).

TRADEMARK

FIRST USE 5-1-2009; IN COMMERCE 5-1-2009.

PRINCIPAL REGISTER

THE MARK CONSISTS OF STANDARD CHARACTERS WITHOUT CLAIM TO ANY PARTICULAR FONT, STYLE, SIZE, OR COLOR.

SN 85-046,441, FILED 5-24-2010.

DAVID COLLIER, EXAMINING ATTORNEY



David J. Kyffers

Director of the United States Patent and Trademark Office

United States of America

United States Patent and Trademark Office

WEDDENS

Reg. No. 4,099,708

AKDEMIR, EDDIE EDIP (UNITED STATES INDIVIDUAL)
82 BLOOMFIELD AVE.
PINE BROOK, NJ 07058

Registered Feb. 14, 2012

Int. Cls.: 14 and 35

FOR: JEWELRY AND IMITATION JEWELRY, IN CLASS 14 (U.S. CLS. 2, 27, 28 AND 50).

TRADEMARK

FIRST USE 11-28-2011; IN COMMERCE 11-28-2011.

SERVICE MARK

FOR: RETAIL JEWELRY STORES, IN CLASS 35 (U.S. CLS. 100, 101 AND 102).

PRINCIPAL REGISTER

FIRST USE 11-28-2011; IN COMMERCE 11-28-2011.

THE MARK CONSISTS OF STANDARD CHARACTERS WITHOUT CLAIM TO ANY PARTICULAR FONT, STYLE, SIZE, OR COLOR.

SN 85-046,880, FILED 5-25-2010.

KEVIN DINALLO, EXAMINING ATTORNEY



David J. Kyjars

Director of the United States Patent and Trademark Office

United States of America

United States Patent and Trademark Office

TOWNIE

Reg. No. 4,099,709

JOSEPH JR., FRANK P. (UNITED STATES INDIVIDUAL)
352 MAIN ST.

Registered Feb. 14, 2012

ACUSHNET, MA 02743

Int. Cl.: 43

FOR: RESTAURANT AND BAR SERVICES, IN CLASS 43 (U.S. CLS. 100 AND 101).

SERVICE MARK

FIRST USE 12-16-2011; IN COMMERCE 12-16-2011.

PRINCIPAL REGISTER

THE MARK CONSISTS OF STANDARD CHARACTERS WITHOUT CLAIM TO ANY PARTICULAR FONT, STYLE, SIZE, OR COLOR.

OWNER OF U.S. REG. NO. 3,238,812.

SN 85-047,382, FILED 5-25-2010.

CHRIS WELLS, EXAMINING ATTORNEY



David J. Kyffers

Director of the United States Patent and Trademark Office

United States of America

United States Patent and Trademark Office

MIRA QUIEN BAILA

Reg. No. 4,099,710

UNIVISION COMMUNICATIONS INC. (DELAWARE CORPORATION)
5999 CENTER DRIVE
LOS ANGELES, CA 90045

Registered Feb. 14, 2012

Int. Cl.: 41

FOR: ENTERTAINMENT SERVICES, NAMELY, AN ONGOING TELEVISION DANCE COMPETITION PROGRAM, IN CLASS 41 (U.S. CLS. 100, 101 AND 107).

SERVICE MARK

FIRST USE 9-12-2010; IN COMMERCE 9-12-2010.

PRINCIPAL REGISTER

THE MARK CONSISTS OF STANDARD CHARACTERS WITHOUT CLAIM TO ANY PARTICULAR FONT, STYLE, SIZE, OR COLOR.

NO CLAIM IS MADE TO THE EXCLUSIVE RIGHT TO USE "BAILA", APART FROM THE MARK AS SHOWN.

THE ENGLISH TRANSLATION OF "MIRA QUIEN BAILA" IN THE MARK IS LOOK WHO IS DANCING.

SN 85-047,522, FILED 5-25-2010.

BERNICE MIDDLETON, EXAMINING ATTORNEY



David J. Kyros

Director of the United States Patent and Trademark Office

United States of America

United States Patent and Trademark Office

DBTNCAA

Reg. No. 4,099,711

Registered Feb. 14, 2012

CERTIFICATION MARK

SERVICES

PRINCIPAL REGISTER

COGNITIVE AND BEHAVIORAL SPECIALTIES (MINNESOTA NON-PROFIT CORPORATION)

SUITE 135
7200 FRANCE AVENUE
EDINA, MN 55435

FOR: DIALECTICAL BEHAVIOR THERAPY (DBT) SERVICES AND DIALECTICAL BEHAVIOR THERAPY (DBT) PROGRAMS, IN CLASS B (U.S. CL. B).

FIRST USE 3-1-2011; IN COMMERCE 3-1-2011.

THE MARK CONSISTS OF STANDARD CHARACTERS WITHOUT CLAIM TO ANY PARTICULAR FONT, STYLE, SIZE, OR COLOR.

THE CERTIFICATION MARK, AS INTENDED TO BE USED BY AUTHORIZED PERSONS, IS INTENDED TO CERTIFY THAT THOSE PERSONS HAVE FULFILLED CERTAIN STANDARDS OF EDUCATION, TRAINING AND/OR PRACTICE IN THE FIELD OF DIALECTICAL BEHAVIOR THERAPY (DBT).

SN 85-047,643, FILED 5-25-2010.

DOMINICK J. SALEMI, EXAMINING ATTORNEY



David J. Kyffers

Director of the United States Patent and Trademark Office

United States of America

United States Patent and Trademark Office

Imagination
Disney STORE

Reg. No. 4,099,712

DISNEY ENTERPRISES, INC. (DELAWARE CORPORATION)
500 SOUTH BUENA VISTA STREET
BURBANK, CA 91521

Registered Feb. 14, 2012

Int. Cl.: 3

FOR: SOAP; NON-MEDICATED TOILETRIES; ROOM FRAGRANCES; FRAGRANCES, IN CLASS 3 (U.S. CLS. 1, 4, 6, 50, 51 AND 52).

TRADEMARK

FIRST USE 6-30-2011; IN COMMERCE 6-30-2011.

PRINCIPAL REGISTER

OWNER OF U.S. REG. NOS. 3,681,439, 3,758,198, AND OTHERS.

NO CLAIM IS MADE TO THE EXCLUSIVE RIGHT TO USE "STORE", APART FROM THE MARK AS SHOWN.

THE MARK CONSISTS OF THE STYLIZED WORDS "IMAGINATION DISNEY STORE".

SN 85-047,719, FILED 5-25-2010.

GIANCARLO CASTRO, EXAMINING ATTORNEY



David J. Kybas

Director of the United States Patent and Trademark Office

United States of America

United States Patent and Trademark Office



Reg. No. 4,099,713

DISNEY ENTERPRISES, INC. (DELAWARE CORPORATION)
500 SOUTH BUENA VISTA STREET
BURBANK, CA 91521

Registered Feb. 14, 2012

Int. Cl.: 3

FOR: SOAP; COSMETICS; DENTIFRICES; NON-MEDICATED TOILETRIES; ROOM FRAGRANCES; FRAGRANCES; PERFUMES, IN CLASS 3 (U.S. CLS. 1, 4, 6, 50, 51 AND 52).

TRADEMARK

FIRST USE 6-30-2011; IN COMMERCE 6-30-2011.

PRINCIPAL REGISTER

OWNER OF U.S. REG. NOS. 3,681,439, 3,758,198, AND OTHERS.

NO CLAIM IS MADE TO THE EXCLUSIVE RIGHT TO USE "STORE", APART FROM THE MARK AS SHOWN.

THE MARK CONSISTS OF THE STYLIZED WORDS "MAGIC DISNEY STORE".

SN 85-047,724, FILED 5-25-2010.

GIANCARLO CASTRO, EXAMINING ATTORNEY



David J. Kybas

Director of the United States Patent and Trademark Office

United States of America

United States Patent and Trademark Office

PRETTYSOONS

Reg. No. 4,099,714

RICHARD L. SHERMAN (UNITED STATES INDIVIDUAL)
1980 S.W. 73 AVENUE
PLANTATION, FL 33317

Registered Feb. 14, 2012

Int. Cls.: 16 and 25

FOR: STICKERS, IN CLASS 16 (U.S. CLS. 2, 5, 22, 23, 29, 37, 38 AND 50).

TRADEMARK

FIRST USE 11-15-2011; IN COMMERCE 11-18-2011.

PRINCIPAL REGISTER

FOR: CAPS; T-SHIRTS , IN CLASS 25 (U.S. CLS. 22 AND 39).

FIRST USE 11-15-2011; IN COMMERCE 11-18-2011.

THE MARK CONSISTS OF STANDARD CHARACTERS WITHOUT CLAIM TO ANY PARTICULAR FONT, STYLE, SIZE, OR COLOR.

SN 85-047,910, FILED 5-26-2010.

KATHY DE JONGE, EXAMINING ATTORNEY



David J. Kybas

Director of the United States Patent and Trademark Office

United States of America

United States Patent and Trademark Office

Vetriluxe

Reg. No. 4,099,715

MOSAICO BOUTIQUE, INC. (FLORIDA CORPORATION)
3014 N.W. 79TH AVENUE
DORAL, FL 33122

Registered Feb. 14, 2012

Int. Cl.: 21

FOR: MOSAIC ART TILES MADE OF GLASS AND CERAMIC; MOSAIC ART TILES MADE OF GLASS AND CERAMIC THAT ARE PRE-ARRANGED IN A PATTERN , IN CLASS 21 (U.S. CLS. 2, 13, 23, 29, 30, 33, 40 AND 50).

TRADEMARK

FIRST USE 3-12-2010; IN COMMERCE 3-12-2010.

PRINCIPAL REGISTER

THE MARK CONSISTS OF STYLIZED LETTERING OF THE WORD "VETRILUXE" WITH THE "X" MADE UP OF FIVE SQUARES AND A LINE ABOVE THE "X" AND ANOTHER LINE UNDER THE "X".

THE WORDING "VETRILUXE" HAS NO MEANING IN A FOREIGN LANGUAGE.

SN 85-047,992, FILED 5-26-2010.

GRETCHEN ULRICH, EXAMINING ATTORNEY



David J. Kyros

Director of the United States Patent and Trademark Office

United States of America

United States Patent and Trademark Office

PSALMIST PRAISE & WORSHIP GRAM

Reg. No. 4,099,716

MITCHELL, CARMEN (UNITED STATES INDIVIDUAL)
816 EAST RIO GRANDE STREET
PASADENA, CA 91104

Registered Feb. 14, 2012

Int. Cl.: 39

FOR: MESSAGE DELIVERY SERVICES IN THE FIELDS OF CHRISTIAN BASED SONGS
AND RELIGIOUS MESSAGES, IN CLASS 39 (U.S. CLS. 100 AND 105).

SERVICE MARK

FIRST USE 10-1-2011; IN COMMERCE 10-1-2011.

PRINCIPAL REGISTER

THE MARK CONSISTS OF STANDARD CHARACTERS WITHOUT CLAIM TO ANY PAR-
TICULAR FONT, STYLE, SIZE, OR COLOR.

SN 85-050,965, FILED 5-29-2010.

LIEF MARTIN, EXAMINING ATTORNEY



David J. Kybas

Director of the United States Patent and Trademark Office

United States of America

United States Patent and Trademark Office



Reg. No. 4,099,717

BECTON, DICKINSON AND COMPANY (NEW JERSEY CORPORATION)
1 BECTON DRIVE, MC 090
FRANKLIN LAKES, NJ 07417

Registered Feb. 14, 2012

Int. Cls.: 5 and 10

FOR: MEDICAL DIAGNOSTIC ASSAYS FOR THE DETECTION OF INFECTIOUS DISEASES, IN CLASS 5 (U.S. CLS. 6, 18, 44, 46, 51 AND 52).

TRADEMARK

FIRST USE 12-15-2011; IN COMMERCE 12-15-2011.

PRINCIPAL REGISTER

FOR: MEDICAL INSTRUMENTS FOR THE DETECTION OF INFECTIOUS DISEASES, IN CLASS 10 (U.S. CLS. 26, 39 AND 44).

FIRST USE 12-15-2011; IN COMMERCE 12-15-2011.

OWNER OF U.S. REG. NOS. 2,510,232, 2,711,880, AND OTHERS.

THE MARK CONSISTS OF A SHADED CIRCLE CONTAINING A SUNBURST DESIGN AND A PARTIAL ARC DESIGN; NEXT TO THE SHADED CIRCLE ARE THE LETTERS "BD" AND THE WORD "VERITOR".

SN 85-051,782, FILED 6-1-2010.

ALYSSA STEEL, EXAMINING ATTORNEY



David J. Kybas

Director of the United States Patent and Trademark Office

United States of America

United States Patent and Trademark Office

ORTECH

Reg. No. 4,099,718

Registered Feb. 14, 2012

Int. Cls.: 9 and 11

TRADEMARK

PRINCIPAL REGISTER

ORTECH INDUSTRIES INC. (CANADA CORPORATION)
33-13290 78TH AVENUE
SURREY, CANADA V3WOH6

FOR: DECORATIVE SWITCH PLATE COVERS; ELECTRIC JUNCTION BOXES; ELECTRIC LIGHT DIMMERS; ELECTRIC SWITCH PLATES; ELECTRICAL CONNECTOR HOUSINGS; ELECTRICAL CONNECTORS; ELECTRICAL OUTLETS; ELECTRICAL LIGHT SWITCHES; GROUND-FAULT ELECTRIC SWITCHES; ELECTRICAL LIGHTING RECEPTACLES; SCREW-ON ELECTRICAL WIRE CONNECTORS; JUNCTION BOX COVERS; ELECTRIC SWITCH PLATES; ELECTRICAL OUTLET PLATES, IN CLASS 9 (U.S. CLS. 21, 23, 26, 36 AND 38).

FIRST USE 1-0-2005; IN COMMERCE 3-0-2010.

FOR: FAUCETS; LIGHT BULBS; LIGHTING FIXTURES; SINKS; TOILET BOWLS; TOILET SEATS; TOILETS; VENTILATING EXHAUST FANS; PLUMBING FIXTURES, NAMELY, SINK TRAPS, SINK SPRAYERS, SHOWER SPRAYERS AND SHOWER MIXERS; LAMP REFLECTORS, IN CLASS 11 (U.S. CLS. 13, 21, 23, 31 AND 34).

FIRST USE 1-0-2005; IN COMMERCE 3-0-2010.

THE MARK CONSISTS OF STANDARD CHARACTERS WITHOUT CLAIM TO ANY PARTICULAR FONT, STYLE, SIZE, OR COLOR.

PRIORITY CLAIMED UNDER SEC. 44(D) ON CANADA APPLICATION NO. 1,461,764, FILED 1-7-2010.

SN 85-052,171, FILED 6-1-2010.

SAMUEL E. SHARPER JR., EXAMINING ATTORNEY



David J. Kyffers

Director of the United States Patent and Trademark Office

United States of America

United States Patent and Trademark Office

YOUR LIFE, BETTER

Reg. No. 4,099,719

RENEWMEDIA LLC (ILLINOIS LIMITED LIABILITY COMPANY)
2030 WEST BARRY AVENUE
CHICAGO, IL 60618

Registered Feb. 14, 2012

Int. Cl.: 16

FOR: GENERAL FEATURE MAGAZINES IN THE FIELD OF ADDICTION RECOVERY AND LIFE AFTER RECOVERY, IN CLASS 16 (U.S. CLS. 2, 5, 22, 23, 29, 37, 38 AND 50).

TRADEMARK

FIRST USE 9-0-2010; IN COMMERCE 9-0-2010.

PRINCIPAL REGISTER

THE MARK CONSISTS OF STANDARD CHARACTERS WITHOUT CLAIM TO ANY PARTICULAR FONT, STYLE, SIZE, OR COLOR.

SN 85-052,856, FILED 6-2-2010.

STEVEN PEREZ, EXAMINING ATTORNEY



David J. Kybas

Director of the United States Patent and Trademark Office

United States of America

United States Patent and Trademark Office

ILLUMALIGHT

Reg. No. 4,099,720

SEARS BRANDS, LLC (ILLINOIS LIMITED LIABILITY COMPANY)
3333 BEVERLY ROAD

Registered Feb. 14, 2012

HOFFMAN ESTATES, IL 60179

Int. Cl.: 7

FOR: COMPONENT FEATURE OF STAND MIXERS, NAMELY, A LIGHTING DEVICE THAT PROJECTS LIGHT INTO THE MIXING BOWL, IN CLASS 7 (U.S. CLS. 13, 19, 21, 23, 31, 34 AND 35).

TRADEMARK

FIRST USE 9-0-2011; IN COMMERCE 9-0-2011.

PRINCIPAL REGISTER

THE MARK CONSISTS OF STANDARD CHARACTERS WITHOUT CLAIM TO ANY PARTICULAR FONT, STYLE, SIZE, OR COLOR.

SN 85-053,995, FILED 6-3-2010.

KRISTINA MORRIS, EXAMINING ATTORNEY



David J. Kyffers

Director of the United States Patent and Trademark Office

United States of America

United States Patent and Trademark Office

WALMART LIFELONG LEARNING

Reg. No. 4,099,721

Registered Feb. 14, 2012

Int. Cl.: 41

SERVICE MARK

PRINCIPAL REGISTER

WAL-MART STORES, INC. (DELAWARE CORPORATION)
702 SW 8TH STREET
BENTONVILLE, AR 727160520

FOR: EDUCATIONAL SERVICES, NAMELY, CONDUCTING CLASSES AND SEMINARS IN THE FIELDS OF HIGHER EDUCATION AND DISTRIBUTION OF TRAINING MATERIALS IN CONNECTION THEREWITH; EDUCATIONAL SERVICES, NAMELY, DEVELOPING, ARRANGING, AND CONDUCTING EDUCATIONAL CONFERENCES AND PROGRAMS AND PROVIDING COURSES OF INSTRUCTION IN THE FIELD OF HIGHER EDUCATION, IN CLASS 41 (U.S. CLS. 100, 101 AND 107).

FIRST USE 6-30-2009; IN COMMERCE 6-30-2009.

THE MARK CONSISTS OF STANDARD CHARACTERS WITHOUT CLAIM TO ANY PARTICULAR FONT, STYLE, SIZE, OR COLOR.

OWNER OF U.S. REG. NOS. 909,789, 1,322,750, AND 1,783,039.

NO CLAIM IS MADE TO THE EXCLUSIVE RIGHT TO USE "LEARNING" , APART FROM THE MARK AS SHOWN.

SN 85-054,164, FILED 6-3-2010.

CAROLYN CATALDO, EXAMINING ATTORNEY



David J. Kyffers

Director of the United States Patent and Trademark Office

United States of America

United States Patent and Trademark Office

MOUNTAIN BEST

Reg. No. 4,099,722

SURRY LICENSING LLC (NEW HAMPSHIRE LIMITED LIABILITY COMPANY)
7 CORPORATE DRIVE
KEENE, NH 03431

Registered Feb. 14, 2012

Int. Cl.: 32

FOR: BEVERAGES, NAMELY, SOFT DRINKS, IN CLASS 32 (U.S. CLS. 45, 46 AND 48).

TRADEMARK

FIRST USE 12-10-2010; IN COMMERCE 12-10-2010.

PRINCIPAL REGISTER

THE MARK CONSISTS OF STANDARD CHARACTERS WITHOUT CLAIM TO ANY PARTICULAR FONT, STYLE, SIZE, OR COLOR.

NO CLAIM IS MADE TO THE EXCLUSIVE RIGHT TO USE "BEST", APART FROM THE MARK AS SHOWN.

SN 85-054,196, FILED 6-3-2010.

CARYN GLASSER, EXAMINING ATTORNEY



David J. Kyffers

Director of the United States Patent and Trademark Office

United States of America

United States Patent and Trademark Office

FOX 1440

Reg. No. 4,099,723

AIRLITE PLASTICS CO. (NEBRASKA CORPORATION)
6110 ABBOTT DR.

Registered Feb. 14, 2012

OMAHA, NE 681102805

Int. Cl.: 19

FOR: BUILDING CONSTRUCTION MATERIALS, NAMELY, NON-METAL CASTING FORMS FOR CONCRETE, IN CLASS 19 (U.S. CLS. 1, 12, 33 AND 50).

TRADEMARK

FIRST USE 7-14-2011; IN COMMERCE 7-14-2011.

PRINCIPAL REGISTER

THE MARK CONSISTS OF STANDARD CHARACTERS WITHOUT CLAIM TO ANY PARTICULAR FONT, STYLE, SIZE, OR COLOR.

OWNER OF U.S. REG. NOS. 3,320,928 AND 3,336,613.

SN 85-054,240, FILED 6-3-2010.

ANTHONY RINKER, EXAMINING ATTORNEY



David J. Kybas

Director of the United States Patent and Trademark Office

United States of America

United States Patent and Trademark Office

MCEP3S

Reg. No. 4,099,724

ZITEC, INC. (FLORIDA CORPORATION)
1031 NORTH PARTIN DRIVE
NICEVILLE, FL 32578

Registered Feb. 14, 2012

Int. Cl.: 9

FOR: POWER PROTECTIVE DEVICES, NAMELY, ELECTRICAL POWER CONDITIONERS, ELECTRICAL POWER LIMITERS FOR LIMITING AN AMOUNT OF ELECTRICAL POWER PROVIDED TO AN ELECTRICAL LOAD, ELECTRICAL POWER MANAGERS FOR MANAGING VOLTAGE, CURRENT, PHASE AND/OR FREQUENCY PROVIDED TO AN ELECTRICAL LOAD, AND ELECTRICAL SURGE SUPPRESSORS, IN CLASS 9 (U.S. CLS. 21, 23, 26, 36 AND 38).

TRADEMARK

PRINCIPAL REGISTER

FIRST USE 9-1-2011; IN COMMERCE 9-1-2011.

THE MARK CONSISTS OF STANDARD CHARACTERS WITHOUT CLAIM TO ANY PARTICULAR FONT, STYLE, SIZE, OR COLOR.

SN 85-054,855, FILED 6-4-2010.

ANNE FARRELL, EXAMINING ATTORNEY



David J. Kyffers

Director of the United States Patent and Trademark Office

United States of America

United States Patent and Trademark Office

IVANKA TRUMP

Reg. No. 4,099,725

Registered Feb. 14, 2012

Int. Cl.: 18

TRADEMARK

PRINCIPAL REGISTER

IVANKA TRUMP MARKS LLC (DELAWARE LIMITED LIABILITY COMPANY)
502 PARK AVENUE
NEW YORK, NY 10022

FOR: HANDBAGS, LUGGAGE, WALLETS, IN CLASS 18 (U.S. CLS. 1, 2, 3, 22 AND 41).

FIRST USE 2-0-2011; IN COMMERCE 2-0-2011.

THE MARK CONSISTS OF STANDARD CHARACTERS WITHOUT CLAIM TO ANY PARTICULAR FONT, STYLE, SIZE, OR COLOR.

OWNER OF U.S. REG. NOS. 3,589,236, 3,593,246, AND 3,620,026.

THE NAME "IVANKA TRUMP" IDENTIFIES A LIVING INDIVIDUAL WHOSE CONSENT IS OF RECORD.

SN 85-054,948, FILED 6-4-2010.

HEATHER BIDDULPH, EXAMINING ATTORNEY



David J. Kybas

Director of the United States Patent and Trademark Office

United States of America

United States Patent and Trademark Office

SNACK RUN

Reg. No. 4,099,726

Registered Feb. 14, 2012

Int. Cl.: 9

TRADEMARK

PRINCIPAL REGISTER

ISPIKE, LLC (NEVADA LIMITED LIABILITY COMPANY), DBA SNACK RUN,
STE. 258
7435 S. EASTERN AVENUE
LAS VEGAS, NV 89123

FOR: COMPUTER SOFTWARE FOR USE WITH WIRELESS COMMUNICATION DEVICES
FOR PLACING FOOD AND BEVERAGE ORDERS IN ARENAS, STADIUMS, AND OTHER
SPECIAL EVENT VENUES, IN CLASS 9 (U.S. CLS. 21, 23, 26, 36 AND 38).

FIRST USE 12-1-2011; IN COMMERCE 12-1-2011.

THE MARK CONSISTS OF STANDARD CHARACTERS WITHOUT CLAIM TO ANY PAR-
TICULAR FONT, STYLE, SIZE, OR COLOR.

SN 85-055,368, FILED 6-4-2010.

ALYSSA STEEL, EXAMINING ATTORNEY



David J. Kybas

Director of the United States Patent and Trademark Office

United States of America

United States Patent and Trademark Office

KRISELLE CELLARS

Reg. No. 4,099,727

K S CELLARS, LLC (OREGON LIMITED LIABILITY COMPANY)
2200 PINEGATE WAY
WHITE CITY, OR 97503

Registered Feb. 14, 2012

Int. Cl.: 33

FOR: WINE, IN CLASS 33 (U.S. CLS. 47 AND 49).

TRADEMARK

FIRST USE 10-8-2011; IN COMMERCE 10-8-2011.

PRINCIPAL REGISTER

THE MARK CONSISTS OF STANDARD CHARACTERS WITHOUT CLAIM TO ANY PARTICULAR FONT, STYLE, SIZE, OR COLOR.

NO CLAIM IS MADE TO THE EXCLUSIVE RIGHT TO USE "CELLARS", APART FROM THE MARK AS SHOWN.

SN 85-056,071, FILED 6-7-2010.

KATHERINE STOIDES, EXAMINING ATTORNEY



David J. Kyffers

Director of the United States Patent and Trademark Office

United States of America

United States Patent and Trademark Office

KOUBOO

Reg. No. 4,099,728

KOUBOO LLC (CALIFORNIA LIMITED LIABILITY COMPANY)
2770 QUEDA WAY

Registered Feb. 14, 2012

LAGUNA BEACH, CA 92651

Int. Cl.: 21

FOR: HOUSEWARES, NAMELY, TRAY, CHEESE BOARD, UTENSIL CADDY, BOTTLE CADDY, SINK CADDY, CHIP AND DIP DISH, NAPKIN HOLDER, BREAD BOX, PAPER TOWEL HOLDER; NAPKIN RING, SALAD BOWL, LAZY SUSAN; TOOTHBRUSH HOLDER, SOAP DISH, SOAP DISPENSER, LAUNDRY HAMPER FOR DOMESTIC OR HOUSEHOLD USE, MAKE-UP BRUSH HOLDER; VASE, CANDLE HOLDER; BASKETS FOR DOMESTIC USE, NOT OF METAL STORAGE BOXES INCLUDING A LID AND MADE OF WICKER, BAMBOO, RATTAN AND FIBER; INDOOR AND OUTDOOR PLANTERS, OUTDOOR CANDLE HOLDER, BIRD HOUSE, WATERING CAN; PAPER TRAY, CANDY DISH, DISHES MADE OF CERAMIC, DISHES AND BOWLS MADE OF GLASS, WINE BASKET, NOT MADE OF METAL, FOR CARRYING WINE BOTTLES, IN CLASS 21 (U.S. CLS. 2, 13, 23, 29, 30, 33, 40 AND 50).

TRADEMARK

PRINCIPAL REGISTER

FIRST USE 11-17-2011; IN COMMERCE 11-17-2011.

THE MARK CONSISTS OF STANDARD CHARACTERS WITHOUT CLAIM TO ANY PARTICULAR FONT, STYLE, SIZE, OR COLOR.

SN 85-056,122, FILED 6-7-2010.

JAMES A. RAUEN, EXAMINING ATTORNEY



David J. Kyffers

Director of the United States Patent and Trademark Office

United States of America

United States Patent and Trademark Office

OmniGen-WYC

Reg. No. 4,099,729

OMNIGEN RESEARCH, LLC (OREGON LIMITED LIABILITY COMPANY)

Registered Feb. 14, 2012

738 CORSAIR DRIVE
INDEPENDENCE, OR 97351

Int. Cl.: 5

FOR: FEED SUPPLEMENTS FOR LIVESTOCK AND COMPANION ANIMALS; MOLD INHIBITOR FOR TREATING LIVESTOCK FEED, GRAIN, AND FORAGES; NUTRITIONAL ADDITIVES FOR LIVESTOCK FEED FOR MEDICAL PURPOSES, IN CLASS 5 (U.S. CLS. 6, 18, 44, 46, 51 AND 52).

TRADEMARK

PRINCIPAL REGISTER

FIRST USE 9-1-2010; IN COMMERCE 9-1-2010.

THE MARK CONSISTS OF STANDARD CHARACTERS WITHOUT CLAIM TO ANY PARTICULAR FONT, STYLE, SIZE, OR COLOR.

SN 85-056,609, FILED 6-7-2010.

BARBARA RUTLAND, EXAMINING ATTORNEY



David J. Kyffers

Director of the United States Patent and Trademark Office

United States of America

United States Patent and Trademark Office



Reg. No. 4,099,730

Registered Feb. 14, 2012

Int. Cl.: 3

TRADEMARK

PRINCIPAL REGISTER

BAKER-JOHNSON, JENNIFER LEE (UNITED STATES INDIVIDUAL), AKA JENICA SKIN CARE,
26500 W. AGOURA RD. #102-762
CALABASAS, CA 91302 AND

JOHNSON, DEAN C. (UNITED STATES INDIVIDUAL), AKA JENICA SKIN CARE,
26500 W. AGOURA RD. #102-762
CALABASAS, CA 91302

FOR: AROMATIC BODY CARE PRODUCTS, NAMELY, BODY LOTION, SHOWER GEL, CUTICLE CREAM, SHAMPOO, CONDITIONER, NON-MEDICATED LIP BALM, SOAP, BODY POLISH, BODY AND FOOT SCRUB AND NON-MEDICATED FOOT CREAM; BEAUTY CREAMS FOR BODY CARE; BODY AND BEAUTY CARE COSMETICS; COSMETIC CREAMS FOR SKIN CARE; COSMETIC PREPARATIONS FOR BODY CARE; COSMETIC PREPARATIONS FOR SKIN RENEWAL; EXFOLIANTS FOR FACE AND BODY; LOTIONS FOR FACE AND BODY CARE; LOTIONS FOR FACE AND BODY; MOISTURIZING PREPARATIONS FOR THE SKIN; MOISTURIZING SOLUTIONS FOR THE SKIN; NAIL CARE PREPARATIONS, NAMELY, NAIL SOFTENERS; NON-MEDICATED BALMS FOR USE ON FACE AND BODY; NON-MEDICATED COSMETIC SKIN CARE PREPARATIONS CONSISTING OF ORGANIC COCONUT VIRGIN OIL AND COCONUT VIRGIN OIL; NON-MEDICATED HERBAL BODY CARE PRODUCTS, NAMELY, BODY OILS, SALVES, AND LIP BALMS; NON-MEDICATED PREPARATIONS ALL FOR THE CARE OF SKIN, HAIR AND SCALP; NON-MEDICATED SERUMS FOR USE ON FACE AND BODY; NON-MEDICATED SKIN CARE CREAMS AND LOTIONS; NON-MEDICATED SKIN CARE PREPARATIONS; NON-MEDICATED SKIN CARE PREPARATIONS, NAMELY, CREAMS, LOTIONS, GELS, TONERS, CLEANERS AND PEELS; NON-MEDICATED SKIN CREAMS; NON-MEDICATED STIMULATING LOTIONS FOR THE SKIN; NON-MEDICATED SUN CARE PREPARATIONS; PATCHES CONTAINING SUN SCREEN AND SUN BLOCK FOR USE ON THE SKIN; SKIN AND BODY TOPICAL LOTIONS, CREAMS AND OILS FOR COSMETIC USE; SKIN BRONZER; SKIN BRONZING CREAMS; SKIN CARE PREPARATION, NAMELY, BODY POLISH; SKIN CARE PREPARATIONS, NAMELY, BODY BALM; SKIN CARE PREPARATIONS, NAMELY, FRUIT ACID PEELS FOR SKIN; SKIN CARE PREPARATIONS, NAMELY, SKIN PEELS; SKIN CARE PRODUCTS, NAMELY, NON-MEDICATED SKIN SERUM; SKIN CLARIFIERS; SKIN CLEANSERS; SKIN CLEANSING CREAM; SKIN CLEANSING LOTION; SKIN CONDITIONERS; SKIN CONDITIONING CREAMS FOR COSMETIC PURPOSES; SKIN CREAM; SKIN CREAMS; SKIN CREAMS IN LIQUID AND IN SOLID FORM; SKIN CREAMS IN LIQUID AND SOLID; SKIN CREAMS IN LIQUID AND SOLID FORM; SKIN EMOLLIENTS; SKIN



David J. Kybas

Director of the United States Patent and Trademark Office

Reg. No. 4,099,730 FRESHENERS; SKIN GELS FOR ACCELERATING, ENHANCING OR EXTENDING TANS; SKIN LIGHTENERS; SKIN LIGHTENING CREAMS; SKIN LOTION; SKIN LOTIONS; SKIN MASKS; SKIN MOISTURIZER; SKIN MOISTURIZER MASKS; SKIN TONERS; SKIN WHITENING CREAMS; SKIN WHITENING PREPARATIONS; SUN CARE LOTIONS; TOPICAL SKIN SPRAYS FOR COSMETIC PURPOSES; WRINKLE REMOVING SKIN CARE PREPARATIONS, IN CLASS 3 (U.S. CLS. 1, 4, 6, 50, 51 AND 52).

FIRST USE 3-1-2008; IN COMMERCE 3-1-2008.

NO CLAIM IS MADE TO THE EXCLUSIVE RIGHT TO USE "BATH BODY SKIN" OR "LOS ANGELES, CA", APART FROM THE MARK AS SHOWN.

SN 85-056,756, FILED 6-7-2010.

MARK RADEMACHER, EXAMINING ATTORNEY

United States of America

United States Patent and Trademark Office

ZAGGOCARE

Reg. No. 4,099,731

CARSON, ROBERTA (UNITED STATES INDIVIDUAL)
21 HIGH ROCK TERRACE
CHESTNUT HILL, MA 02467

Registered Feb. 14, 2012

Int. Cl.: 16

FOR: KITS FOR PATIENTS, FAMILY OF PATIENTS AND NON-PROFESSIONAL CARE-GIVERS CARING FOR ELDERLY, SICK OR INJURED PATIENTS IN THE HOME OR ASSISTING WITH CARE IN A MEDICAL FACILITY, COMPRISING A GUIDE BOOK PROVIDING INFORMATION ABOUT ORGANIZATIONAL TECHNIQUES, TIPS, ADVICE AND RESOURCES FOR DEALING WITH LONG-TERM MEDICAL ISSUES AND ONGOING MEDICAL ORDEALS, A BLANK NOTEBOOK FOR USE AS A MEDICAL JOURNAL, A BUSINESS CARD CASE, AN ACCESSORY POUCH FOR SMALL PERSONAL ITEMS SUCH AS PENS, TISSUES, AND HAND SANITIZER, AND AN ACCORDION FOLDER FOR HOLDING IMPORTANT DOCUMENTS, SOLD AS A UNIT WITH A MULTI-PURPOSE CARRYING BAG, IN CLASS 16 (U.S. CLS. 2, 5, 22, 23, 29, 37, 38 AND 50).

TRADEMARK

PRINCIPAL REGISTER

FIRST USE 1-27-2011; IN COMMERCE 1-27-2011.

THE MARK CONSISTS OF STANDARD CHARACTERS WITHOUT CLAIM TO ANY PARTICULAR FONT, STYLE, SIZE, OR COLOR.

SN 85-057,414, FILED 6-8-2010.

JILL C. ALT, EXAMINING ATTORNEY



David J. Kybas

Director of the United States Patent and Trademark Office

United States of America

United States Patent and Trademark Office

For the Moments and Musings that Stick

Reg. No. 4,099,732

K & COMPANY LLC (DELAWARE LIMITED LIABILITY COMPANY)
2380 MCGEE SUITE #300

Registered Feb. 14, 2012

KANSAS CITY, MO 64108, MO 64108

Int. Cl.: 16

FOR: BLANK JOURNALS; CUSTOMIZABLE JOURNAL BOOKS; GLUE PENS FOR STATIONERY PURPOSES; MEMO PADS; STICKERS, IN CLASS 16 (U.S. CLS. 2, 5, 22, 23, 29, 37, 38 AND 50).

TRADEMARK

FIRST USE 5-19-2011; IN COMMERCE 5-19-2011.

PRINCIPAL REGISTER

THE MARK CONSISTS OF STANDARD CHARACTERS WITHOUT CLAIM TO ANY PARTICULAR FONT, STYLE, SIZE, OR COLOR.

SN 85-058,077, FILED 6-9-2010.

ARETHA SOMERVILLE, EXAMINING ATTORNEY



David J. Kyffers

Director of the United States Patent and Trademark Office

United States of America

United States Patent and Trademark Office



Reg. No. 4,099,733

Registered Feb. 14, 2012

Int. Cls.: 35 and 42

SERVICE MARK

PRINCIPAL REGISTER

BIZZNESSCARD LLC (ARIZONA LIMITED LIABILITY COMPANY)
15169 N. SCOTTSDALE RD., SUITE 450
SCOTTSDALE, AZ 85254

FOR: CUSTOMER LOYALTY SERVICES AND CUSTOMER CLUB SERVICES, FOR COMMERCIAL, PROMOTIONAL AND/OR ADVERTISING PURPOSES; INFORMATION SERVICES RELATING TO BUSINESS MATTERS; ON-LINE PROFESSIONAL NETWORKING SERVICES; ON-LINE TRADING SERVICES IN WHICH SELLER POSTS PRODUCTS TO BE AUCTIONED AND BIDDING IS DONE VIA THE INTERNET; OPERATING ON-LINE MARKETPLACES FOR SELLERS OF GOODS AND/OR SERVICES; PROMOTING THE GOODS AND SERVICES OF OTHERS VIA A GLOBAL COMPUTER NETWORK; PROVIDING A SEARCHABLE ON-LINE ADVERTISING WEBSITE AND GUIDE FEATURING THE GOODS AND SERVICES OF OTHER VENDORS VIA THE INTERNET; PROVIDING A SEARCHABLE ONLINE ADVERTISING GUIDE FEATURING THE GOODS AND SERVICES OF ONLINE VENDORS; PROVIDING A SEARCHABLE WEBSITE FEATURING THE GOODS AND SERVICES OF OTHER VENDORS; PROVIDING A WEB SITE AT WHICH USERS CAN OFFER GOODS FOR SALE AND BUY GOODS OFFERED BY OTHERS; PROVIDING A WEB SITE WHERE USERS CAN POST RATINGS, REVIEWS AND RECOMMENDATIONS ON PRODUCTS AND SERVICES FOR COMMERCIAL PURPOSES; PROVIDING A WEB SITE WHICH FEATURES ADVERTISEMENTS FOR THE GOODS AND SERVICES OF OTHERS ON A GLOBAL COMPUTER NETWORK; PROVIDING AN ON-LINE SEARCHABLE DATABASE FEATURING BUSINESS INFORMATION AND BUSINESS CONTACTS, IN CLASS 35 (U.S. CLS. 100, 101 AND 102).

FIRST USE 3-31-2011; IN COMMERCE 3-31-2011.

FOR: PROVIDING CUSTOMIZED ON-LINE WEB PAGES FEATURING USER-DEFINED INFORMATION, WHICH INCLUDES SEARCH ENGINES AND ON-LINE WEB LINKS TO OTHER WEB SITES, IN CLASS 42 (U.S. CLS. 100 AND 101).

FIRST USE 3-31-2011; IN COMMERCE 3-31-2011.

NO CLAIM IS MADE TO THE EXCLUSIVE RIGHT TO USE "BUSINESSCARD", APART FROM THE MARK AS SHOWN.

THE COLOR(S) BLACK, WHITE, GREEN AND GRAY IS/ARE CLAIMED AS A FEATURE OF THE MARK.



David J. Kybas

Director of the United States Patent and Trademark Office

Reg. No. 4,099,733 THE MARK CONSISTS OF A BLACK RECTANGLE WITH ROUNDED EDGES ON THE TWO BOTTOM CORNERS AND WITH THE STYLIZED WORDING "BIZZNESSCARD" INSIDE THE RECTANGLE IN GRAY. TO THE LEFT OF THE STYLIZED WORDING APPEARS AN ABSTRACT DESIGN OF EIGHT TRANSLUCENT, RECTANGULAR, OVERLAPPING BUSINESS CARDS IN THE SHAPE OF A CIRCULAR FAN AND IN VARIOUS SHADES OF WHITE, GREEN, GRAY AND BLACK.

SN 85-058,642, FILED 6-9-2010.

JENNIFER MARTIN, EXAMINING ATTORNEY

United States of America

United States Patent and Trademark Office

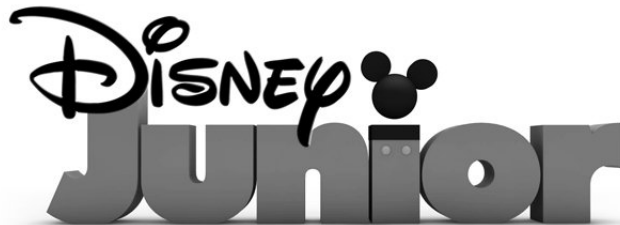

Reg. No. 4,099,734

Registered Feb. 14, 2012

Int. Cl.: 38

SERVICE MARK

PRINCIPAL REGISTER

DISNEY ENTERPRISES, INC. (DELAWARE CORPORATION)
500 SOUTH BUENA VISTA STREET
BURBANK, CA 91521

FOR: TELEVISION BROADCASTING; INTERNET BROADCASTING; CABLE TELEVISION AND SATELLITE TELEVISION BROADCASTING; COMMUNICATIONS BY COMPUTER TERMINALS; PROVIDING ON-LINE ELECTRONIC BULLETIN BOARDS, FORUMS AND DISCUSSION GROUPS FOR TRANSMISSION OF MESSAGES AMONG COMPUTER USERS THAT ARE EITHER A PART OF A SOCIAL NETWORK OF FRIENDS OR THE GENERAL PUBLIC, IN THE FIELD OF ENTERTAINMENT, IN CLASS 38 (U.S. CLS. 100, 101 AND 104).

FIRST USE 2-14-2011; IN COMMERCE 2-14-2011.

OWNER OF U.S. REG. NOS. 826,419, 3,678,843, AND OTHERS.

THE MARK CONSISTS OF THE STYLIZED WORDING "DISNEY JUNIOR" AND DESIGN. THE TERM "DISNEY" APPEARS ABOVE THE TERM "JUNIOR" AND A SILHOUETTE DESIGN OF A MOUSE'S HEAD AND EARS REPLACES THE DOT ABOVE THE LETTER "I" IN "JUNIOR". THE LETTER "I" IN "JUNIOR" ALSO HAS TWO SMALL DOTS NEAR THE TOP.

SN 85-058,888, FILED 6-9-2010.

MARLENE BELL, EXAMINING ATTORNEY



David J. Kyros

Director of the United States Patent and Trademark Office

United States of America

United States Patent and Trademark Office

GRAMPY

Reg. No. 4,099,735

GRAMPYS CHARITIES (FLORIDA CHARITABLE TRUST)
261 LEDYARD STREET
NEW LONDON, CT 06320

Registered Feb. 14, 2012

**Int. Cls.: 9, 14, 16, 18, 21,
and 25**

FOR: MOUSE PADS, IN CLASS 9 (U.S. CLS. 21, 23, 26, 36 AND 38).

FIRST USE 5-31-2010; IN COMMERCE 5-31-2010.

TRADEMARK

FOR: CLOCKS, IN CLASS 14 (U.S. CLS. 2, 27, 28 AND 50).

PRINCIPAL REGISTER

FIRST USE 5-31-2010; IN COMMERCE 5-31-2010.

FOR: CALENDARS, BLANK JOURNALS, GREETING CARDS, IN CLASS 16 (U.S. CLS. 2, 5, 22, 23, 29, 37, 38 AND 50).

FIRST USE 5-31-2010; IN COMMERCE 5-31-2010.

FOR: BACKPACKS, TOTE BAGS, GYM BAGS, IN CLASS 18 (U.S. CLS. 1, 2, 3, 22 AND 41).

FIRST USE 5-31-2010; IN COMMERCE 5-31-2010.

FOR: COFFEE MUGS, PLASTIC WATER BOTTLES SOLD EMPTY, IN CLASS 21 (U.S. CLS. 2, 13, 23, 29, 30, 33, 40 AND 50).

FIRST USE 5-31-2010; IN COMMERCE 5-31-2010.

FOR: CLOTHING, NAMELY, HATS, CAPS, APRONS, BOXER SHORTS, T-SHIRTS, LONG SLEEVE T-SHIRTS, GOLF SHIRTS, HOODED SWEATSHIRTS, SWEATSHIRTS AND GOLF WIND RESISTANT PULLOVERS, IN CLASS 25 (U.S. CLS. 22 AND 39).

FIRST USE 5-31-2010; IN COMMERCE 5-31-2010.

THE MARK CONSISTS OF STANDARD CHARACTERS WITHOUT CLAIM TO ANY PARTICULAR FONT, STYLE, SIZE, OR COLOR.

OWNER OF U.S. REG. NOS. 3,397,278 AND 3,397,279.

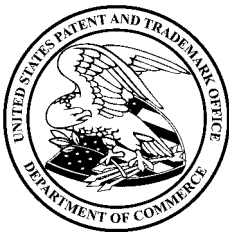

David J. Kyros

Director of the United States Patent and Trademark Office

Reg. No. 4,099,735 THE NAME "GRAMPY" DOES NOT IDENTIFY A LIVING INDIVIDUAL.

SN 85-059,416, FILED 6-10-2010.

TINA BROWN, EXAMINING ATTORNEY

United States of America

United States Patent and Trademark Office

JIFFY LUBE FLEET CARE

Reg. No. 4,099,736

JIFFY LUBE INTERNATIONAL, INC. (DELAWARE CORPORATION)
700 MILAM STREET
HOUSTON, TX 77002

Registered Feb. 14, 2012

Int. Cls.: 36 and 37

FOR: CREDIT CARD SERVICES, IN CLASS 36 (U.S. CLS. 100, 101 AND 102).

SERVICE MARK

FIRST USE 9-15-2008; IN COMMERCE 9-15-2008.

PRINCIPAL REGISTER

FOR: VEHICLE PREVENTATIVE MAINTENANCE SERVICES, NAMELY, LUBRICATING CHASSIS, CHANGING MOTOR OIL, CHANGING OIL AND AIR FILTERS, REFILLING TRANSMISSION, DIFFERENTIAL, BRAKE, POWER STEERING, RADIATOR, WINDSHIELD WASHER AND BATTERY RESERVOIRS TO PROPER FLUID LEVELS, CHANGING WINDSHIELD WIPER BLADES, INFLATING TIRES TO PROPER PRESSURE, VACUUMING INTERIORS, AND WASHING WINDOWS, IN CLASS 37 (U.S. CLS. 100, 103 AND 106).

FIRST USE 9-15-2008; IN COMMERCE 9-15-2008.

THE MARK CONSISTS OF STANDARD CHARACTERS WITHOUT CLAIM TO ANY PARTICULAR FONT, STYLE, SIZE, OR COLOR.

OWNER OF U.S. REG. NOS. 1,384,672, 3,496,989, AND OTHERS.

NO CLAIM IS MADE TO THE EXCLUSIVE RIGHT TO USE "FLEET CARE", APART FROM THE MARK AS SHOWN.

SN 85-059,554, FILED 6-10-2010.

ARETHA SOMERVILLE, EXAMINING ATTORNEY



David J. Kypos

Director of the United States Patent and Trademark Office

United States of America

United States Patent and Trademark Office

EMPERATRIZ

**i like
it!**

Reg. No. 4,099,737

Registered Feb. 14, 2012

Int. Cl.: 29

TRADEMARK

PRINCIPAL REGISTER

ALBERTO DE MIGUEL, S.A. (SPAIN CORPORATION)
CARRETERA DE ARNEDO S/N
AUTOL, LA RIOJA, SPAIN 26560

FOR: PRESERVED FISH; PRESERVED VEGETABLES, IN CLASS 29 (U.S. CL. 46).

FIRST USE 12-27-2011; IN COMMERCE 12-27-2011.

THE MARK CONSISTS OF A CROWN BELOW OF WHICH APPEARS THE WORD "EMPERATRIZ" IN STYLIZED LETTERS UNDERLINED. THE WORDING "I LIKE IT!" IN STYLIZED LETTERS APPEARS EXACTLY BENEATH THE LETTERS "TRIZ" OF THE WORD "EMPERATRIZ". THE COLOR BLACK APPEARS IN THE WORD "EMPERATRIZ" AND IN THE CROWN. THE COLOR RED APPEARS IN THE CROWN, IN THE LINE UNDERLINING THE WORD "EMPERATRIZ" AND IN THE WORDING "I LIKE IT!"

THE COLOR(S) BLACK AND RED IS/ARE CLAIMED AS A FEATURE OF THE MARK.

THE ENGLISH TRANSLATION OF "EMPERATRIZ" IN THE MARK IS "EMPRESS".

SN 85-059,934, FILED 6-10-2010.

CIMMERIAN COLEMAN, EXAMINING ATTORNEY



David J. Kybas

Director of the United States Patent and Trademark Office

United States of America

United States Patent and Trademark Office

LOYALTY

Reg. No. 4,099,738

CIARA LAROCCA (UNITED STATES INDIVIDUAL)
915 NW 1ST AV. #H2612
MIAMI, FL 33136

Registered Feb. 14, 2012

Int. Cl.: 41

FOR: ENTERTAINMENT IN THE NATURE OF LIVE PERFORMANCES BY A MUSICAL ARTIST; ENTERTAINMENT SERVICES IN THE NATURE OF LIVE MUSICAL PERFORMANCES; ENTERTAINMENT, NAMELY, LIVE MUSIC CONCERTS, IN CLASS 41 (U.S. CLS. 100, 101 AND 107).

SERVICE MARK

PRINCIPAL REGISTER

FIRST USE 9-10-2010; IN COMMERCE 9-10-2010.

THE MARK CONSISTS OF STANDARD CHARACTERS WITHOUT CLAIM TO ANY PARTICULAR FONT, STYLE, SIZE, OR COLOR.

SN 85-060,284, FILED 6-11-2010.

APRIL ROACH, EXAMINING ATTORNEY



David J. Kyffers

Director of the United States Patent and Trademark Office

United States of America

United States Patent and Trademark Office

LIVE WITHOUT REGRETS

Reg. No. 4,099,739

Registered Feb. 14, 2012

Int. Cl.: 3

TRADEMARK

PRINCIPAL REGISTER

AVON PRODUCTS, INC. (NEW YORK CORPORATION)
LEGAL DEPARTMENT, 3RD FL
777 THIRD AVENUE
NEW YORK, NY 10017

FOR: FRAGRANCES, IN CLASS 3 (U.S. CLS. 1, 4, 6, 50, 51 AND 52).

FIRST USE 8-4-2011; IN COMMERCE 8-4-2011.

THE MARK CONSISTS OF STANDARD CHARACTERS WITHOUT CLAIM TO ANY PARTICULAR FONT, STYLE, SIZE, OR COLOR.

SN 85-060,333, FILED 6-11-2010.

KEVIN CORWIN, EXAMINING ATTORNEY



David J. Kybas

Director of the United States Patent and Trademark Office

United States of America

United States Patent and Trademark Office



Reg. No. 4,099,740

AGC, LLC (DELAWARE LIMITED LIABILITY COMPANY)
ONE AMERICAN ROAD
CLEVELAND, OH 44144

Registered Feb. 14, 2012

Int. Cl.: 16

FOR: GREETING CARDS, IN CLASS 16 (U.S. CLS. 2, 5, 22, 23, 29, 37, 38 AND 50).

TRADEMARK

FIRST USE 7-31-2011; IN COMMERCE 7-31-2011.

PRINCIPAL REGISTER

OWNER OF U.S. REG. NOS. 3,006,593, 3,088,800, AND OTHERS.

THE COLOR(S) BLACK AND GRAY IS/ARE CLAIMED AS A FEATURE OF THE MARK.

THE MARK CONSISTS OF THE SMUDGED WORDS "CHEAP LAUGHS" IN BLACK AND GRAY INSIDE A SMUDGED BLACK AND GRAY RECTANGLE. THE WHITE IN THE DRAWING REPRESENTS BACKGROUND, OUTLINING, SHADING, AND/OR TRANSPARENT AREAS AND IS NOT PART OF THE MARK.

SN 85-062,106, FILED 6-14-2010.

ROBIN MITTLER, EXAMINING ATTORNEY



David J. Kyffers

Director of the United States Patent and Trademark Office

United States of America

United States Patent and Trademark Office

SUN INCOME MAXIMIZER

Reg. No. 4,099,741

SUN LIFE ASSURANCE COMPANY OF CANADA (CANADA CORPORATION)
150 KING STREET WEST, SUITE 1400

Registered Feb. 14, 2012

TORONTO, ONTARIO, CANADA M5H1J9

Int. Cl.: 36

FOR: UNDERWRITING, ISSUING AND ADMINISTRATION OF ANNUITIES, IN CLASS 36
(U.S. CLS. 100, 101 AND 102).

SERVICE MARK

FIRST USE 12-13-2010; IN COMMERCE 12-13-2010.

PRINCIPAL REGISTER

THE MARK CONSISTS OF STANDARD CHARACTERS WITHOUT CLAIM TO ANY PARTICULAR FONT, STYLE, SIZE, OR COLOR.

NO CLAIM IS MADE TO THE EXCLUSIVE RIGHT TO USE "INCOME", APART FROM THE MARK AS SHOWN.

SN 85-062,131, FILED 6-14-2010.

KATINA MISTER, EXAMINING ATTORNEY



David J. Kyffers

Director of the United States Patent and Trademark Office

United States of America

United States Patent and Trademark Office

Witchery

Reg. No. 4,099,742

WITCHERY, LLC (CALIFORNIA LIMITED LIABILITY COMPANY)
1129 GALLERON ROAD
ST. HELENA, CA 94574

Registered Feb. 14, 2012

Int. Cl.: 33

FOR: WINE AND SPIRITS, IN CLASS 33 (U.S. CLS. 47 AND 49).

TRADEMARK

FIRST USE 9-14-2011; IN COMMERCE 9-14-2011.

PRINCIPAL REGISTER

THE MARK CONSISTS OF STANDARD CHARACTERS WITHOUT CLAIM TO ANY PARTICULAR FONT, STYLE, SIZE, OR COLOR.

SN 85-062,292, FILED 6-14-2010.

ROSELLE HERRERA, EXAMINING ATTORNEY



David J. Kyffers

Director of the United States Patent and Trademark Office

United States of America

United States Patent and Trademark Office

Advocate

Reg. No. 4,099,743

CROTON WATCH CO., INC. (NEW YORK CORPORATION)
195 ANDERSON AVE.

Registered Feb. 14, 2012

MOONACHIE, NJ 07074

Int. Cl.: 14

FOR: WATCHES, IN CLASS 14 (U.S. CLS. 2, 27, 28 AND 50).

TRADEMARK

FIRST USE 10-0-2010; IN COMMERCE 10-0-2010.

PRINCIPAL REGISTER

THE MARK CONSISTS OF STANDARD CHARACTERS WITHOUT CLAIM TO ANY PARTICULAR FONT, STYLE, SIZE, OR COLOR.

SN 85-062,821, FILED 6-15-2010.

ELIZABETH KAJUBI, EXAMINING ATTORNEY



David J. Kyffers

Director of the United States Patent and Trademark Office

United States of America

United States Patent and Trademark Office



Reg. No. 4,099,744

Registered Feb. 14, 2012

Int. Cl.: 7

TRADEMARK

PRINCIPAL REGISTER

ADVANCED DRILLING TECHNOLOGIES, LLC (COLORADO CORPORATION)
529 NORTH ALBANY STREET, SUITE 1250
YUMA, CO 80759

FOR: DRILLING EQUIPMENT, NAMELY, POWER-OPERATED EQUIPMENT FOR INJECTING AND WITHDRAWING TUBING INTO AND FROM A WELLBORE, IN CLASS 7 (U.S. CLS. 13, 19, 21, 23, 31, 34 AND 35).

FIRST USE 4-25-2011; IN COMMERCE 4-25-2011.

NO CLAIM IS MADE TO THE EXCLUSIVE RIGHT TO USE "DRILLING TECHNOLOGIES", APART FROM THE MARK AS SHOWN.

THE MARK CONSISTS OF THE WORDING "ADVANCED" ON TOP OF THE WORD "DRILLING" ON TOP OF THE WORD "TECHNOLOGIES" ALL IN STYLIZED FORM AND APPEARING WITHIN A RECTANGULAR CARRIER.

SN 85-063,031, FILED 6-15-2010.

JASON TURNER, EXAMINING ATTORNEY



David J. Kybas

Director of the United States Patent and Trademark Office

United States of America

United States Patent and Trademark Office



mastermind
JAPAN



Reg. No. 4,099,745

Registered Feb. 14, 2012

Int. Cls.: 14, 18, and 25

TRADEMARK

PRINCIPAL REGISTER

HOMMA MASAOKI (JAPAN INDIVIDUAL)
KEMY COURT 101, 15-6
MINAMI-AOYAMA 6-CHOME, MINATO-KU
TOKYO 107-0062, JAPAN

FOR: KEY RINGS OF PRECIOUS METAL; ORNAMENTS OF PRECIOUS METAL OTHER THAN CUFF LINKS; CUFF LINKS; PURSES AND WALLETS OF PRECIOUS METAL; SEMI-WROUGHT PRECIOUS STONES AND THEIR IMITATIONS; UNWROUGHT PRECIOUS STONES; CLOCKS AND WATCHES, IN CLASS 14 (U.S. CLS. 2, 27, 28 AND 50).

FIRST USE 8-0-2009; IN COMMERCE 8-0-2009.

FOR: BAGS AND THE LIKE, NAMELY, ALL-PURPOSE CARRYING BAGS, ATHLETIC BAGS, SHOULDER BAGS, GLADSTONE BAGS, CARRY-ON BAGS, BOSTON BAGS, LEATHER SHOPPING BAGS, MESH SHOPPING BAGS, STRING SHOPPING BAGS, TEXTILE SHOPPING BAGS, SCHOOL BOOK BAGS, BACKPACKS, HANDBAGS, PURSES, WALLETS, KEY CASES, CREDIT CARD CASES, BUSINESS CARD CASES, COMMUTER TICKET CASES, BRIEFCASES AND FOLDING BRIEFCASES, SUITCASES, AND TRUNKS; POUCHES AND THE LIKE, NAMELY, POUCHES OF LEATHER, DRAWSTRING POUCHES, AND CHARM BAGS; UMBRELLAS AND THEIR PARTS; LEATHER STRAPS; RAWHIDES; RAW SKINS; TANNED LEATHER; FUR, IN CLASS 18 (U.S. CLS. 1, 2, 3, 22 AND 41).

FIRST USE 8-0-2009; IN COMMERCE 8-0-2009.

FOR: NON-JAPANESE STYLE OUTER CLOTHING, NAMELY, EVENING DRESSES, SUITS, SKIRTS, TROUSERS, VESTS, WAISTCOATS, OVERCOATS, TOPCOATS, MANTLES, RAINCOATS, CARDIGANS, JACKETS, ANORAKS, WIND-RESISTANT JACKETS, CHILDREN'S WEAR, NAMELY, CHILDREN'S PANTS, CHILDREN'S SWEATERS, CHILDREN'S DRESSES, CHILDREN'S SHIRTS, CHILDREN'S SKIRTS, CHILDREN'S OVERALLS, AND FORMALWEAR, NAMELY, EVENING GOWNS, TUXEDOS; COATS; SWEATERS; SHIRTS AND THE LIKE, NAMELY, TEE-SHIRTS, OPEN-NECKED SHIRTS, SPORT SHIRTS, POLO SHIRTS, SHIRTS FOR SUITS, AND BLOUSES; NIGHTWEAR; UNDERWEAR; SWIM WEAR; SWIMMING CAPS; APRONS; COLLAR PROTECTORS; SOCKS; STOCKINGS; PUTTEES; GAITERS; FUR STOLEES; SHAWLS; SCARVES; JAPANESE STYLE SOCKS (TABI); GLOVES; MITTENS; NECKTIES; NECKERCHIEFS; BANDANAS; MUFFLERS; EAR MUFFS; HEADGEAR, NAMELY, HATS AND CAPS; SUSPENDERS; WAISTBANDS; BELTS FOR



David J. Kyjars

Director of the United States Patent and Trademark Office

Reg. No. 4,099,745 CLOTHING; FOOTWEAR; MASQUERADE COSTUMES; HORSE-RIDING BOOTS, IN CLASS 25 (U.S. CLS. 22 AND 39).

FIRST USE 8-0-2009; IN COMMERCE 8-0-2009.

OWNER OF U.S. REG. NO. 3,445,351.

NO CLAIM IS MADE TO THE EXCLUSIVE RIGHT TO USE "JAPAN", APART FROM THE MARK AS SHOWN.

THE MARK CONSISTS OF THE WORDS "MASTERMIND JAPAN" IN STYLIZED TYPEFACE WHICH ARE LOCATED BETWEEN TWO DESIGN ELEMENTS WHICH DEPICT SKULLS AND CROSS BONES.

SN 85-063,226, FILED 6-15-2010.

KATHERINE STOIDES, EXAMINING ATTORNEY

United States of America

United States Patent and Trademark Office

YOWIE

Reg. No. 4,099,746

Registered Feb. 14, 2012

Int. Cl.: 42

SERVICE MARK

PRINCIPAL REGISTER

YOWIE, LLC (DELAWARE LIMITED LIABILITY COMPANY)
2716 OCEAN PARK BOULEVARD
SANTA MONICA, CA 90405

FOR: PROVIDING A WEBSITE THAT FEATURES TECHNOLOGY THAT ENABLES THE SECURE EXCHANGE OF INFORMATION BY OTHERS; PROVIDING A WEBSITE FEATURING TECHNOLOGY THAT ENABLES INTERNET USERS TO SHARE DOCUMENTS, IMAGES AND VIDEOS; PROVIDING A WEBSITE FEATURING TECHNOLOGY THAT ENABLES USERS TO ASK QUESTIONS AND RECEIVE ANSWERS; COMPUTER SERVICES, NAMELY, CREATING AN ON-LINE COMMUNITY FOR REGISTERED USERS TO PARTICIPATE IN DISCUSSIONS, GET FEEDBACK FROM THEIR PEERS, FORM VIRTUAL COMMUNITIES, AND ENGAGE IN SOCIAL NETWORKING; PROVIDING A WEBSITE THAT FEATURES TECHNOLOGY THAT ENABLES INTERNET USERS TO SIMULCAST AND SYNDICATE CONTENT TO OTHER WEBSITES; COMPUTER SERVICES, NAMELY, HOSTING ON-LINE WEB FACILITIES FOR OTHERS FOR ORGANIZING AND CONDUCTING ONLINE MEETINGS, GATHERINGS, AND INTERACTIVE DISCUSSIONS; HOSTING AN ON-LINE COMMUNITY WEB SITE FEATURING TECHNOLOGY THAT ENABLES USERS TO ASK AND SUBMIT LIVE VIDEO QUESTIONS; HOSTING OF DIGITAL CONTENT ON THE INTERNET, IN CLASS 42 (U.S. CLS. 100 AND 101).

FIRST USE 5-0-2010; IN COMMERCE 7-22-2010.

THE MARK CONSISTS OF STANDARD CHARACTERS WITHOUT CLAIM TO ANY PARTICULAR FONT, STYLE, SIZE, OR COLOR.

SN 85-063,544, FILED 6-15-2010.

KEVIN CORWIN, EXAMINING ATTORNEY



David J. Kypos

Director of the United States Patent and Trademark Office

United States of America

United States Patent and Trademark Office

FILELINE

Reg. No. 4,099,747

RETRIEVEX FINANCING CORP. (DELAWARE CORPORATION)
4 FIRST AVENUE
PEABODY, MA 01960

Registered Feb. 14, 2012

Int. Cls.: 35 and 39

FOR: ELECTRONIC MANAGEMENT AND RETRIEVAL SERVICES FOR FILES AND DOCUMENTS THAT ARE IN STORAGE, NAMELY, COMPUTERIZED FILE AND DOCUMENT MANAGEMENT SERVICES AND FILE AND DOCUMENT RETRIEVAL SERVICES FOR OTHERS; BUSINESS AND FINANCIAL RECORDS MANAGEMENT SERVICES; RECORDS MANAGEMENT SERVICES, NAMELY, DOCUMENT INDEXING FOR OTHERS; INVENTORY MANAGEMENT AND CONTROL SERVICES FOR BUSINESS AND FINANCIAL RECORDS; MAINTENANCE OF BUSINESS RECORDS, NAMELY, INVENTORY MANAGEMENT AND CONTROL SERVICES OF BUSINESS RECORDS AND BUSINESS RECORDS IN THE NATURE OF VITAL RECORDS, COMPUTER DATA, FILMS, MASTER RECORDINGS, AND ARCHIVAL MATERIALS AND RECORDS, IN CLASS 35 (U.S. CLS. 100, 101 AND 102).

SERVICE MARK

FIRST USE 6-0-2010; IN COMMERCE 6-0-2010.

PRINCIPAL REGISTER

FOR: WAREHOUSING SERVICES, NAMELY, STORAGE, DISTRIBUTION, PICK-UP, AND PACKING FOR SHIPMENT OF RECORDS AND DOCUMENTS FOR OTHERS; DOCUMENT STORAGE SERVICES; ELECTRONIC STORAGE OF FILES AND DOCUMENTS; PHYSICAL STORAGE OF ELECTRONICALLY-STORED DATA OR DOCUMENTS; STORAGE SERVICES FOR ARCHIVING DATABASES, IMAGES AND OTHER ELECTRONIC DATA; DOCUMENT DELIVERY SERVICES, IN CLASS 39 (U.S. CLS. 100 AND 105).

FIRST USE 6-0-2010; IN COMMERCE 6-0-2010.



THE MARK CONSISTS OF STANDARD CHARACTERS WITHOUT CLAIM TO ANY PARTICULAR FONT, STYLE, SIZE, OR COLOR.

SN 85-063,591, FILED 6-15-2010.

MARY ROSSMAN, EXAMINING ATTORNEY

David J. Kyros

Director of the United States Patent and Trademark Office

United States of America

United States Patent and Trademark Office

UNIVERSAL'S PHOTO CONNECT

Reg. No. 4,099,748

Registered Feb. 14, 2012

Int. Cl.: 9

TRADEMARK

PRINCIPAL REGISTER

UNIVERSAL CITY STUDIOS LLC (DELAWARE LIMITED LIABILITY COMPANY)
100 UNIVERSAL CITY PLAZA
1280/6
UNIVERSAL CITY, CA 91608

FOR: COMPUTER SOFTWARE THAT ENABLES THE STORING, RETRIEVAL, VIEWING, SHARING, ENHANCING, MANAGEMENT, DISTRIBUTING, EDITING, MANIPULATING AND PRINTING OF DIGITAL IMAGES, IN CLASS 9 (U.S. CLS. 21, 23, 26, 36 AND 38).

FIRST USE 11-17-2010; IN COMMERCE 11-17-2010.

THE MARK CONSISTS OF STANDARD CHARACTERS WITHOUT CLAIM TO ANY PARTICULAR FONT, STYLE, SIZE, OR COLOR.

NO CLAIM IS MADE TO THE EXCLUSIVE RIGHT TO USE "PHOTO", APART FROM THE MARK AS SHOWN.

SN 85-063,658, FILED 6-15-2010.

ANNE E. GUSTASON, EXAMINING ATTORNEY



David J. Kybas

Director of the United States Patent and Trademark Office

United States of America

United States Patent and Trademark Office

POWERBODY

Reg. No. 4,099,749

DELTA GALIL USA, INC. (DELAWARE CORPORATION)
150 MEADOWLAND PARKWAY
SECAUCUS, NJ 07094

Registered Feb. 14, 2012

Int. Cl.: 25

FOR: CLOTHING, NAMELY, UNDERWEAR, THERMAL UNDERWEAR, BRIEFS, BOXER BRIEFS, BOXER SHORTS, FOUNDATION GARMENTS, UNDERCLOTHES, UNDERGARMENTS, UNDERSHIRTS, AND SHAPEWEAR, NAMELY, SHIRTS, IN CLASS 25 (U.S. CLS. 22 AND 39).

TRADEMARK

PRINCIPAL REGISTER

FIRST USE 3-0-2011; IN COMMERCE 3-0-2011.

THE MARK CONSISTS OF STANDARD CHARACTERS WITHOUT CLAIM TO ANY PARTICULAR FONT, STYLE, SIZE, OR COLOR.

SN 85-063,979, FILED 6-16-2010.

MAYUR VAGHANI, EXAMINING ATTORNEY



David J. Kyffers

Director of the United States Patent and Trademark Office

United States of America

United States Patent and Trademark Office

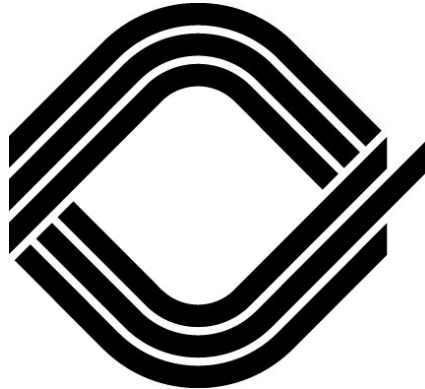

Reg. No. 4,099,750

SCENE, LLC (WASHINGTON LIMITED LIABILITY COMPANY)
538 5TH AVENUE EAST
KALISPELL, MT 59901

Registered Feb. 14, 2012

Int. Cls.: 35, 38, and 42

FOR: PROVIDING A WEBSITE FEATURING INFORMATION ABOUT THE COST AND VALUE OF INTERNET CONNECTIONS, IN CLASS 35 (U.S. CLS. 100, 101 AND 102).

SERVICE MARK

FIRST USE 5-31-2010; IN COMMERCE 5-31-2010.

PRINCIPAL REGISTER

FOR: PROVIDING INFORMATION IN THE FIELD OF INTERNET CONNECTIONS; PROVIDING INFORMATION IN THE FIELD OF INTERNET CONNECTIONS VIA THE INTERNET; PROVIDING A WEBSITE FEATURING INFORMATION ABOUT THE SPEED, QUALITY AND PERFORMANCE OF INTERNET CONNECTIONS, IN CLASS 38 (U.S. CLS. 100, 101 AND 104).

FIRST USE 5-31-2010; IN COMMERCE 5-31-2010.

FOR: PROVIDING A WEBSITE FEATURING TECHNOLOGY IN THE FORM OF NON-DOWNLOADABLE SOFTWARE THAT ENABLES USERS TO ANALYZE AND OBTAIN REPORTS ON THE SPEED, QUALITY, PERFORMANCE, COST AND VALUE OF INTERNET CONNECTIONS; APPLICATION SERVICE PROVIDER (ASP) FEATURING SOFTWARE FOR USE IN ANALYZING AND OBTAINING REPORTS ON THE SPEED, QUALITY, PERFORMANCE, COST AND VALUE OF INTERNET CONNECTIONS, IN CLASS 42 (U.S. CLS. 100 AND 101).

FIRST USE 5-31-2010; IN COMMERCE 5-31-2010.

THE MARK CONSISTS OF TWO GROUPS OF THREE CURVED LINES, ARRANGED SYMMETRICALLY ONE ABOVE THE OTHER TO FORM A SHAPE RESEMBLING A STYLIZED "O".

SN 85-063,986, FILED 6-16-2010.

GENE MACIOL, EXAMINING ATTORNEY



David J. Kyffers

Director of the United States Patent and Trademark Office

United States of America

United States Patent and Trademark Office

FRIENDSHIP IS MAGIC

Reg. No. 4,099,751

HASBRO, INC. (RHODE ISLAND CORPORATION)
1027 NEWPORT AVENUE
PAWTUCKET, RI 02862

Registered Feb. 14, 2012

Int. Cl.: 28

FOR: TOY PONIES AND ACCESSORIES FOR USE THEREWITH; PLUSH TOY ANIMALS,
IN CLASS 28 (U.S. CLS. 22, 23, 38 AND 50).

TRADEMARK

FIRST USE 8-27-2011; IN COMMERCE 8-27-2011.

PRINCIPAL REGISTER

THE MARK CONSISTS OF STANDARD CHARACTERS WITHOUT CLAIM TO ANY PAR-
TICULAR FONT, STYLE, SIZE, OR COLOR.

SN 85-064,030, FILED 6-16-2010.

WILLIAM P. SHANAHAN, EXAMINING ATTORNEY



David J. Kybas

Director of the United States Patent and Trademark Office

United States of America

United States Patent and Trademark Office

Darn Good Food

Reg. No. 4,099,752

DARN GOOD FOOD, INC. (CALIFORNIA CORPORATION)

Registered Feb. 14, 2012

3643 26TH STREET
SAN FRANCISCO, CA 94110

Int. Cl.: 35

FOR: RETAIL STORE SERVICES FEATURING FRESHLY PREPARED FOODS; WHOLESALE DISTRIBUTORSHIPS FEATURING FRESHLY PREPARED FOODS, IN CLASS 35 (U.S. CLS. 100, 101 AND 102).

SERVICE MARK

FIRST USE 5-25-2011; IN COMMERCE 5-25-2011.

PRINCIPAL REGISTER

THE MARK CONSISTS OF STANDARD CHARACTERS WITHOUT CLAIM TO ANY PARTICULAR FONT, STYLE, SIZE, OR COLOR.

NO CLAIM IS MADE TO THE EXCLUSIVE RIGHT TO USE "FOOD", APART FROM THE MARK AS SHOWN.

SN 85-064,047, FILED 6-16-2010.

AISHA SALEM, EXAMINING ATTORNEY



David J. Kybas

Director of the United States Patent and Trademark Office

United States of America

United States Patent and Trademark Office

VIIAD COMPASS

Reg. No. 4,099,753

J&H ENTERPRISES, LLC (DELAWARE LIMITED LIABILITY COMPANY)
2711 CENTERVILLE ROAD, SUITE 400
WILMINGTON, DE 19808

Registered Feb. 14, 2012

Int. Cl.: 35

FOR: HEALTH CARE ADMINISTRATION SERVICES, NAMELY, ELECTRONIC PROCESSING OF HEALTH CARE PLAN INFORMATION FOR OTHERS, IN CLASS 35 (U.S. CLS. 100, 101 AND 102).

SERVICE MARK

FIRST USE 1-0-2011; IN COMMERCE 1-0-2011.

PRINCIPAL REGISTER

THE MARK CONSISTS OF STANDARD CHARACTERS WITHOUT CLAIM TO ANY PARTICULAR FONT, STYLE, SIZE, OR COLOR.

OWNER OF U.S. REG. NO. 3,700,423.

SN 85-064,057, FILED 6-16-2010.

CURTIS FRENCH, EXAMINING ATTORNEY



David J. Kybas

Director of the United States Patent and Trademark Office

United States of America
United States Patent and Trademark Office

MIANJIA

Reg. No. 4,099,754

ICL PERFORMANCE PRODUCTS LP (DELAWARE LIMITED PARTNERSHIP)
622 EMERSON ROAD
ST. LOUIS, MO 631413141

Registered Feb. 14, 2012

Int. Cl.: 1

FOR: CHEMICALS FOR USE IN THE MANUFACTURE OF FOOD INGREDIENTS, IN CLASS 1 (U.S. CLS. 1, 5, 6, 10, 26 AND 46).

TRADEMARK

FIRST USE 7-31-2010; IN COMMERCE 7-31-2010.

PRINCIPAL REGISTER

THE MARK CONSISTS OF STANDARD CHARACTERS WITHOUT CLAIM TO ANY PARTICULAR FONT, STYLE, SIZE, OR COLOR.

THE ENGLISH TRANSLATION OF "MIANJIA" IN THE MARK IS "GOOD NOODLE".

SN 85-064,312, FILED 6-16-2010.

WANDA KAY PRICE, EXAMINING ATTORNEY



David J. Kyffers

Director of the United States Patent and Trademark Office

United States of America

United States Patent and Trademark Office

Furniture Advantage

Reg. No. 4,099,755

OFFICE ADVANTAGE, INC. (CALIFORNIA CORPORATION)
12556 KIRKHAM COURT, SUITE 1
POWAY, CA 92064

Registered Feb. 14, 2012

Int. Cl.: 35

FOR: ON-LINE RETAIL STORE SERVICES FEATURING OFFICE FURNITURE, IN CLASS 35 (U.S. CLS. 100, 101 AND 102).

SERVICE MARK

FIRST USE 12-5-2011; IN COMMERCE 12-5-2011.

PRINCIPAL REGISTER

THE MARK CONSISTS OF STANDARD CHARACTERS WITHOUT CLAIM TO ANY PARTICULAR FONT, STYLE, SIZE, OR COLOR.

NO CLAIM IS MADE TO THE EXCLUSIVE RIGHT TO USE "FURNITURE", APART FROM THE MARK AS SHOWN.

SN 85-065,481, FILED 6-17-2010.

INGRID C. EULIN, EXAMINING ATTORNEY



David J. Kyffers

Director of the United States Patent and Trademark Office

United States of America

United States Patent and Trademark Office

SMARTEMP

Reg. No. 4,099,756

Registered Feb. 14, 2012

Int. Cls.: 39 and 42

SERVICE MARK

PRINCIPAL REGISTER

APL LIMITED (DELAWARE CORPORATION)
SUITE 300
16220 NORTH SCOTTSDALE ROAD
SCOTTSDALE, AZ 85254

FOR: TRANSPORTATION AND STORAGE OF GOODS IN REFRIGERATED CONDITIONS,
IN CLASS 39 (U.S. CLS. 100 AND 105).

FIRST USE 6-8-2010; IN COMMERCE 6-8-2010.

FOR: REMOTE MONITORING OF ENVIRONMENTAL CONTROL SYSTEMS FOR SHIPPING
CONTAINERS, IN CLASS 42 (U.S. CLS. 100 AND 101).

FIRST USE 6-8-2010; IN COMMERCE 6-8-2010.

THE MARK CONSISTS OF STANDARD CHARACTERS WITHOUT CLAIM TO ANY PAR-
TICULAR FONT, STYLE, SIZE, OR COLOR.

SN 85-065,715, FILED 6-17-2010.

INGA ERVIN, EXAMINING ATTORNEY



David J. Kypos

Director of the United States Patent and Trademark Office

United States of America

United States Patent and Trademark Office

THE B.I.O. METHOD

Reg. No. 4,099,757

BLOOM, BARBARA (UNITED STATES INDIVIDUAL)
758 W. SPAIN STREET
SONOMA, CA 95476

Registered Feb. 14, 2012

Int. Cl.: 9

FOR: DIGITAL MATERIALS, NAMELY, CDS, DVDS FEATURING WELLNESS COACHING, NUTRITION, RELAXATION, AND STRETCHING; ELECTRONIC PUBLICATIONS, NAMELY, BOOKS FEATURING WELLNESS COACHING, NUTRITION, RELAXATION, AND STRETCHING RECORDED ON COMPUTER MEDIA, IN CLASS 9 (U.S. CLS. 21, 23, 26, 36 AND 38).

TRADEMARK

PRINCIPAL REGISTER

FIRST USE 11-15-2010; IN COMMERCE 11-1-2010.

THE MARK CONSISTS OF STANDARD CHARACTERS WITHOUT CLAIM TO ANY PARTICULAR FONT, STYLE, SIZE, OR COLOR.

NO CLAIM IS MADE TO THE EXCLUSIVE RIGHT TO USE "METHOD", APART FROM THE MARK AS SHOWN.

SN 85-066,255, FILED 6-18-2010.

ESTHER BELENKER, EXAMINING ATTORNEY



David J. Kyffers

Director of the United States Patent and Trademark Office

United States of America

United States Patent and Trademark Office



Reg. No. 4,099,758

Registered Feb. 14, 2012

Int. Cls.: 35 and 45

SERVICE MARK

PRINCIPAL REGISTER

THE SENATORS (RET.) FIRM, LLP (CALIFORNIA LIMITED PARTNERSHIP)
4695 MACARTHUR COURT, SUITE 370
THE SENATORS FIRM, LLP
NEWPORT BEACH, CA 92660

FOR: POLITICAL CONSULTANCY; AND COMMERCIAL LOBBYING SERVICES, IN CLASS 35 (U.S. CLS. 100, 101 AND 102).

FIRST USE 6-1-2010; IN COMMERCE 6-1-2010.

FOR: LEGAL SERVICES, IN CLASS 45 (U.S. CLS. 100 AND 101).

FIRST USE 6-1-2010; IN COMMERCE 6-1-2010.

NO CLAIM IS MADE TO THE EXCLUSIVE RIGHT TO USE "THE SENATORS (RET.) FIRM", APART FROM THE MARK AS SHOWN.

THE MARK CONSISTS OF A PARTIAL COLUMN LOGO WITH THE WORDS "THE SENATORS (RET.) FIRM" POSITIONED TO THE RIGHT OF THE LOGO.

SN 85-066,320, FILED 6-18-2010.

MARC LEIPZIG, EXAMINING ATTORNEY



David J. Kybas

Director of the United States Patent and Trademark Office

United States of America
United States Patent and Trademark Office

HONEY B

Reg. No. 4,099,759

THERESE VU (UNITED STATES INDIVIDUAL)
5045 PINDOS TRAIL
POWDER SPRINGS, GA 30127

Registered Feb. 14, 2012

Int. Cl.: 25

FOR: FOOTWEAR, NAMELY, SHOES, BOOTS, SANDALS, SLIPPERS, IN CLASS 25 (U.S. CLS. 22 AND 39).

TRADEMARK

FIRST USE 7-0-2011; IN COMMERCE 7-0-2011.

PRINCIPAL REGISTER

THE MARK CONSISTS OF STANDARD CHARACTERS WITHOUT CLAIM TO ANY PARTICULAR FONT, STYLE, SIZE, OR COLOR.

SN 85-066,345, FILED 6-18-2010.

JACQUELINE A. LAVINE, EXAMINING ATTORNEY



David J. Kybas

Director of the United States Patent and Trademark Office

United States of America

United States Patent and Trademark Office



Reg. No. 4,099,760

Registered Feb. 14, 2012

Int. Cls.: 35, 36, and 44

SERVICE MARK

PRINCIPAL REGISTER

NATIONAL CHILDHOOD CANCER FOUNDATION (CALIFORNIA NON-PROFIT CORPORATION)
440 EAST HUNTINGTON DRIVE, SUITE 400
ARCADIA, CA 91006

FOR: PROMOTING PUBLIC AWARENESS OF ISSUES RELATED TO CANCER AND THE NEED FOR EDUCATION, DIAGNOSIS, TREATMENT, AND RESEARCH IN THE FIELD OF CANCER; PUBLIC ADVOCACY TO PROMOTE AWARENESS OF ISSUES RELATED TO CANCER AND THE NEED FOR EDUCATION, DIAGNOSIS, TREATMENT, AND RESEARCH IN THE FIELD OF CANCER; ADMINISTRATION AND MANAGEMENT OF RESEARCH GRANTS; PROMOTING PUBLIC AWARENESS OF ISSUES RELATED TO CANCER AND THE NEED FOR EDUCATION, DIAGNOSIS, TREATMENT, AND RESEARCH IN THE FIELD OF CANCER BY ORGANIZING MEETINGS, CONFERENCES, RALLIES, RECEPTIONS, AND DINNERS, IN CLASS 35 (U.S. CLS. 100, 101 AND 102).

FIRST USE 10-1-2010; IN COMMERCE 10-1-2010.

FOR: CHARITABLE FUNDRAISING SERVICES; MANAGEMENT OF FUNDS FROM FEDERAL GRANTS AND PRIVATE SOURCES FOR THE BENEFIT OF CHILDHOOD CANCER RESEARCH; PROVIDING RESEARCH GRANTS TO ORGANIZATIONS IN THE FIELD OF CANCER; CHARITABLE FUND RAISING SERVICES BY MEANS OF ORGANIZING AND CONDUCTING SPORTING EVENTS AND WALKS FOR WHICH THE PROCEEDS ARE DONATED TO CHARITY; FUNDRAISING SERVICES IN THE FIELD OF CHILDHOOD CANCER BY MEANS OF ORGANIZING RECEPTIONS AND RAFFLES, IN CLASS 36 (U.S. CLS. 100, 101 AND 102).

FIRST USE 10-1-2010; IN COMMERCE 10-1-2010.

FOR: PROVIDING HEALTH INFORMATION; PROVIDING HEALTH INFORMATION IN THE FIELD OF CLINICAL TRIALS AND CANCER TREATMENT, IN CLASS 44 (U.S. CLS. 100 AND 101).

FIRST USE 10-1-2010; IN COMMERCE 10-1-2010.

OWNER OF U.S. REG. NO. 3,083,354.

THE COLOR(S) GREEN IS/ARE CLAIMED AS A FEATURE OF THE MARK.



David J. Kyjars

Director of the United States Patent and Trademark Office

Reg. No. 4,099,760 NO CLAIM IS MADE TO THE EXCLUSIVE RIGHT TO USE "CHILDREN'S CANCER", APART FROM THE MARK AS SHOWN.

THE MARK CONSISTS OF THE WORD(S) "CURESEARCH", IN DARK GREEN ("CURE") AND LIGHT GREEN ("SEARCH"), ABOVE A LINE WITH THE WORD "FOR" IN THE MIDDLE OF THE LINE IN LIGHT GREEN, WITH THE WORDS "CHILDREN'S CANCER" IN DARK GREEN BELOW THE LINE.

SN 85-068,775, FILED 6-22-2010.

CAROLINE WOOD, EXAMINING ATTORNEY

United States of America

United States Patent and Trademark Office

DIFFUSICS

Reg. No. 4,099,761

BECTON, DICKINSON AND COMPANY (NEW JERSEY CORPORATION)
1 BECTON DRIVE, MC 090
FRANKLIN LAKES, NJ 07417

Registered Feb. 14, 2012

Int. Cl.: 10

FOR: INTRAVENOUS CATHETER SYSTEM COMPRISED PRIMARILY OF CATHETERS AND MODULAR CATHETER TIP, IN CLASS 10 (U.S. CLS. 26, 39 AND 44).

TRADEMARK

FIRST USE 11-30-2011; IN COMMERCE 11-30-2011.

PRINCIPAL REGISTER

THE MARK CONSISTS OF STANDARD CHARACTERS WITHOUT CLAIM TO ANY PARTICULAR FONT, STYLE, SIZE, OR COLOR.

SN 85-069,413, FILED 6-23-2010.

ALYSSA STEEL, EXAMINING ATTORNEY



David J. Kybas

Director of the United States Patent and Trademark Office

United States of America

United States Patent and Trademark Office

ARISTA

Reg. No. 4,099,762

COOPER TECHNOLOGIES COMPANY (DELAWARE CORPORATION)
600 TRAVIS, SUITE 5600
HOUSTON, TX 77002

Registered Feb. 14, 2012

Int. Cl.: 6

FOR: METAL STRUCTURES FOR MOUNTING SOLAR PANELS, IN CLASS 6 (U.S. CLS. 2, 12, 13, 14, 23, 25 AND 50).

TRADEMARK

FIRST USE 7-13-2010; IN COMMERCE 7-13-2010.

PRINCIPAL REGISTER

THE MARK CONSISTS OF STANDARD CHARACTERS WITHOUT CLAIM TO ANY PARTICULAR FONT, STYLE, SIZE, OR COLOR.

SN 85-069,721, FILED 6-23-2010.

JAMES STEIN, EXAMINING ATTORNEY



David J. Kybas

Director of the United States Patent and Trademark Office

United States of America

United States Patent and Trademark Office

WILLIAMSBURGER

Reg. No. 4,099,763

MCPHERSON, CORY (UNITED STATES INDIVIDUAL)
342 WYTHE AVENUE
BROOKLYN, NY 11211

Registered Feb. 14, 2012

Int. Cl.: 43

FOR: RESTAURANT AND BAR SERVICES, INCLUDING RESTAURANT CARRYOUT SERVICES, IN CLASS 43 (U.S. CLS. 100 AND 101).

SERVICE MARK

FIRST USE 7-20-2008; IN COMMERCE 7-20-2008.

PRINCIPAL REGISTER

THE MARK CONSISTS OF STANDARD CHARACTERS WITHOUT CLAIM TO ANY PARTICULAR FONT, STYLE, SIZE, OR COLOR.

SN 85-071,028, FILED 6-24-2010.

LEIGH LOWRY, EXAMINING ATTORNEY



David J. Kyffers

Director of the United States Patent and Trademark Office

United States of America

United States Patent and Trademark Office



Reg. No. 4,099,764

DZIGAVA, PAATA (RUSSIAN FED. INDIVIDUAL)
2546 BATH AVENUE
BROOKLYN, NY 11214

Registered Feb. 14, 2012

Int. Cl.: 19

FOR: WOOD PRODUCTS, NAMELY, FLOOR BOARDS, FLOOR TILES, FLOOR PANELS, FLOOR TRIM, FLOOR MEDALLIONS, WALL PANELS, WALL TRIM, CEILING MEDALLIONS, CEILING PANELS, DOORS, STAIR BALUSTERS, AND STAIRS, IN CLASS 19 (U.S. CLS. 1, 12, 33 AND 50).

TRADEMARK

PRINCIPAL REGISTER

FIRST USE 8-18-2010; IN COMMERCE 8-18-2010.

NO CLAIM IS MADE TO THE EXCLUSIVE RIGHT TO USE "WOOD PRODUCTS", APART FROM THE MARK AS SHOWN.

THE MARK CONSISTS OF A SQUARE REPRESENTATION OF A WOODEN FRAME WITH GRAIN RUNNING VERTICALLY THROUGHOUT, SURROUNDING A REPRESENTATION OF A RIVER, AND THE WORDS "RIONI WOOD PRODUCTS" UNDER THE DESIGN.

SN 85-071,030, FILED 6-24-2010.

GINA HAYES, EXAMINING ATTORNEY



David J. Kyffers

Director of the United States Patent and Trademark Office

United States of America

United States Patent and Trademark Office

RIONI WOOD PRODUCTS

Reg. No. 4,099,765

DZIGAVA, PAATA (RUSSIAN FED. INDIVIDUAL)

Registered Feb. 14, 2012

2546 BATH AVENUE
BROOKLYN, NY 11214

Int. Cl.: 19

FOR: WOOD PRODUCTS, NAMELY, FLOOR BOARDS, FLOOR TILES, FLOOR PANELS, FLOOR TRIM, FLOOR MEDALLIONS, WALL PANELS, WALL TRIM, CEILING MEDALLIONS, CEILING PANELS, DOORS, STAIR BALUSTERS, AND STAIRS, IN CLASS 19 (U.S. CLS. 1, 12, 33 AND 50).

TRADEMARK

PRINCIPAL REGISTER

FIRST USE 8-18-2010; IN COMMERCE 8-18-2010.

THE MARK CONSISTS OF STANDARD CHARACTERS WITHOUT CLAIM TO ANY PARTICULAR FONT, STYLE, SIZE, OR COLOR.

NO CLAIM IS MADE TO THE EXCLUSIVE RIGHT TO USE "WOOD PRODUCTS", APART FROM THE MARK AS SHOWN.

SN 85-071,042, FILED 6-24-2010.

GINA HAYES, EXAMINING ATTORNEY



David J. Kybas

Director of the United States Patent and Trademark Office

United States of America

United States Patent and Trademark Office

GARBANZO EXTRAVAGANZO

Reg. No. 4,099,766

GOYA FOODS, INC. (DELAWARE CORPORATION)
100 SEAVIEW DRIVE
SECAUCUS, NJ 07096

Registered Feb. 14, 2012

Int. Cl.: 29

FOR: PROCESSED VEGETABLES, IN CLASS 29 (U.S. CL. 46).

FIRST USE 11-0-2011; IN COMMERCE 11-0-2011.

TRADEMARK

THE MARK CONSISTS OF STANDARD CHARACTERS WITHOUT CLAIM TO ANY PARTICULAR FONT, STYLE, SIZE, OR COLOR.

PRINCIPAL REGISTER

NO CLAIM IS MADE TO THE EXCLUSIVE RIGHT TO USE "GARBANZO", APART FROM THE MARK AS SHOWN.

THE WORDING "EXTRAVAGANZO" HAS NO MEANING IN A FOREIGN LANGUAGE.

SN 85-071,044, FILED 6-24-2010.

TASNEEM HUSSAIN, EXAMINING ATTORNEY



David J. Kybas

Director of the United States Patent and Trademark Office

United States of America

United States Patent and Trademark Office



Reg. No. 4,099,767

Registered Feb. 14, 2012

Int. Cl.: 29

TRADEMARK

PRINCIPAL REGISTER

HOFFMAN, TUCKER (UNITED STATES INDIVIDUAL)
186 WASHINGTON VALLEY ROAD
MORRISTOWN, NJ 07960

FOR: JELLIES, JAMS, IN CLASS 29 (U.S. CL. 46).

FIRST USE 10-1-2010; IN COMMERCE 10-1-2010.

THE MARK CONSISTS OF A LOON BIRD HEAD AND CHEST WITH A CIRCLE AROUND THE LOON HEAD. THE MARK ALSO CONSISTS OF THE WORDS "LOST LOON FARMS".

SN 85-071,421, FILED 6-25-2010.

MATTHEW KLINE, EXAMINING ATTORNEY



David J. Kappas

Director of the United States Patent and Trademark Office

United States of America

United States Patent and Trademark Office

Aimee M

Reg. No. 4,099,768

ELITE SUBLIMATION (CALIFORNIA CORPORATION), DBA AIMEE M. CLOTHING,
1516 E. ADAMS BL.

Registered Feb. 14, 2012

LOS ANGELES, CA 90011

Int. Cl.: 25

FOR: BATHING COSTUMES FOR WOMEN; BLOUSES; CLOTHING SHIELDS, NAMELY, PADS APPLIED TO THE UNDERARMS OF SHIRTS, BLOUSES AND SWEATERS; COATS FOR MEN AND WOMEN; CUSTOM MADE TO MEASURE SUITS FOR MEN AND WOMEN; FOOTWEAR FOR MEN AND WOMEN; FOOTWEAR FOR WOMEN; GOLF PANTS, SHIRTS AND SKIRTS; LEATHER SKIRTS; LEOTARDS AND TIGHTS FOR WOMEN, MEN AND CHILDREN OF NYLON, COTTON OR OTHER TEXTILE FIBERS; MEN'S AND WOMEN'S JACKETS, COATS, TROUSERS, VESTS; MEN'S SUITS, WOMEN'S SUITS; PLEATED SKIRTS FOR FORMAL KIMONOS (HAKAMA); SKIRT SUITS; SKIRTS; SKIRTS AND DRESSES; SUSPENDER BELTS FOR WOMEN; TRAVEL CLOTHING CONTAINED IN A PACKAGE COMPRISING REVERSIBLE JACKETS, PANTS, SKIRTS, TOPS AND A BELT OR SCARF; WOMEN'S CEREMONIAL DRESSES; WOMEN'S HATS AND HOODS; WOMEN'S SHOES; WOMEN'S TOPS, NAMELY, CAMIS; WOMEN'S UNDERWEAR, IN CLASS 25 (U.S. CLS. 22 AND 39).

TRADEMARK

PRINCIPAL REGISTER

FIRST USE 1-25-2011; IN COMMERCE 2-1-2011.

THE MARK CONSISTS OF STANDARD CHARACTERS WITHOUT CLAIM TO ANY PARTICULAR FONT, STYLE, SIZE, OR COLOR.

THE NAME(S), PORTRAIT(S), AND/OR SIGNATURE(S) SHOWN IN THE MARK DOES NOT IDENTIFY A PARTICULAR LIVING INDIVIDUAL.

SN 85-071,748, FILED 6-25-2010.

RENEE SERVANCE, EXAMINING ATTORNEY



David J. Kyros

Director of the United States Patent and Trademark Office

United States of America

United States Patent and Trademark Office



VELCRO

Reg. No. 4,099,769

VELCRO INDUSTRIES B.V. (NETHERLANDS ANTILLES LIMITED LIABILITY COMPANY)
CASTORWEG 22-24

Registered Feb. 14, 2012

CURACAO, NETHERLANDS ANTILLES

Int. Cl.: 26

FOR: FASTENERS, STRAPS AND TIES, NAMELY, SEPARABLE FASTENERS IN THE NATURE OF SNAP FASTENERS AND PRESS FASTENERS; SEPARABLE FASTENERS, NAMELY, HOOK AND LOOP-TYPE FASTENERS AND COMPONENTS THEREOF; HOOK AND LOOP FASTENING TAPE, IN CLASS 26 (U.S. CLS. 37, 39, 40, 42 AND 50).

TRADEMARK

PRINCIPAL REGISTER

FIRST USE 1-4-2011; IN COMMERCE 1-4-2011.

OWNER OF U.S. REG. NOS. 1,846,829, 2,225,651, AND OTHERS.

THE MARK CONSISTS OF THE STYLIZED WORDING "VELCRO", TO THE LEFT OF WHICH IS A CIRCULAR DESIGN WITH A STYLIZED "V" STRETCHING FROM ONE SIDE OF THE CIRCULAR DESIGN TO THE OTHER. THE STIPPLING IN THE CIRCULAR DESIGN AND THE STYLIZED "V" IS INTENDED TO INDICATE CONTRAST.

SN 85-071,771, FILED 6-25-2010.

JAMES STEIN, EXAMINING ATTORNEY



David J. Kypos

Director of the United States Patent and Trademark Office

United States of America

United States Patent and Trademark Office

AutoUSA 
POWERLISTINGS

Reg. No. 4,099,770

AUTONATION HOLDING CORP. (DELAWARE CORPORATION)
SUITE 1400
200 SW 1ST AVENUE
FT. LAUDERDALE, FL 33301

Registered Feb. 14, 2012

Int. Cl.: 35

FOR: MARKETING SERVICES, NAMELY, PROVIDING A CENTRALIZED COMPUTER DATABASE FEATURING AUTOMOBILE INVENTORY LISTING ACCESSIBLE THROUGH AN INTERNET WEBSITE AS PART OF AN AUTOMOBILE INVENTORY PROGRAM FOR MARKETING PURPOSES, IN CLASS 35 (U.S. CLS. 100, 101 AND 102).

SERVICE MARK

PRINCIPAL REGISTER

FIRST USE 6-0-2010; IN COMMERCE 6-0-2010.

OWNER OF U.S. REG. NOS. 2,935,733, 3,710,659, AND OTHERS.

THE COLOR(S) RED, BLUE, WHITE, AND GRAY IS/ARE CLAIMED AS A FEATURE OF THE MARK.

NO CLAIM IS MADE TO THE EXCLUSIVE RIGHT TO USE "AUTO USA" & "LISTINGS", APART FROM THE MARK AS SHOWN.

THE MARK CONSISTS OF THE WORDS "AUTO USA". "AUTO" IS IN RED, WHILE "USA" IS IN BLUE. NEXT TO IT IS A FIVE POINTED STAR COLORED IN RED AND BLUE AND FEATURING A WHITE CURVED LINE. BELOW THIS IS THE WORDS "POWER LISTINGS". "POWER" IS IN RED, WHILE "LISTINGS" IS IN BLUE. AT THE VERY BOTTOM IS A GRAY LINE.



SN 85-071,970, FILED 6-25-2010.

SIMON TENG, EXAMINING ATTORNEY

David J. Kybas

Director of the United States Patent and Trademark Office

United States of America

United States Patent and Trademark Office

CORE

Reg. No. 4,099,771

MCLEOD NINE (MISSOURI CORPORATION)
8830 NE 108TH STREET
KANSAS CITY, MO 64157

Registered Feb. 14, 2012

Int. Cl.: 12

FOR: HOSPITAL AND LABORATORY CARTS FEATURING DRAWER ORGANIZERS AND FIXED DISPENSERS FOR DISPENSING CONSUMABLES, NAMELY, GLOVES FOR MEDICAL USE AND ANTISEPTIC WIPES, IN CLASS 12 (U.S. CLS. 19, 21, 23, 31, 35 AND 44).

TRADEMARK

FIRST USE 7-1-2010; IN COMMERCE 7-1-2010.

PRINCIPAL REGISTER

THE MARK CONSISTS OF STANDARD CHARACTERS WITHOUT CLAIM TO ANY PARTICULAR FONT, STYLE, SIZE, OR COLOR.

SN 85-072,885, FILED 6-28-2010.

DOUGLAS LEE, EXAMINING ATTORNEY



David J. Kyfos

Director of the United States Patent and Trademark Office

United States of America

United States Patent and Trademark Office

GOLDEN CROWN

Reg. No. 4,099,772

SAM DAE ENTERPRISES, INC. (CALIFORNIA CORPORATION)
518 S. MAIN ST.,
LOS ANGELES, CA 90013

Registered Feb. 14, 2012

Int. Cl.: 18

FOR: ATTACHE CASES; BACKPACKS; BILLFOLDS; BRIEFCASES; BUSINESS CASES;
CARD WALLETS; FANNY PACKS; HANDBAGS; HANDBAGS, PURSES AND WALLETS;
LUGGAGE; STRAPS FOR HANDBAGS; STRAPS FOR LUGGAGE; SUITCASES; TRAVEL
BAGS; TRAVELING BAGS; WALLETS, IN CLASS 18 (U.S. CLS. 1, 2, 3, 22 AND 41).

TRADEMARK

PRINCIPAL REGISTER

FIRST USE 1-0-2011; IN COMMERCE 1-0-2011.

THE MARK CONSISTS OF STANDARD CHARACTERS WITHOUT CLAIM TO ANY PAR-
TICULAR FONT, STYLE, SIZE, OR COLOR.

SN 85-072,978, FILED 6-28-2010.

GISELLE AGOSTO, EXAMINING ATTORNEY



David J. Kyffers

Director of the United States Patent and Trademark Office

United States of America

United States Patent and Trademark Office

C|EWORKS

comparative • effectiveness

Reg. No. 4,099,773

UBC LATE STAGE, INC. (MISSOURI CORPORATION)
3822 SUMMIT STREET

Registered Feb. 14, 2012

KANSAS CITY, MO 64111

Int. Cl.: 42

FOR: PROVIDING ON-LINE NON-DOWNLOADABLE SOFTWARE FOR ANALYZING DISEASE OCCURRENCE AND PATIENT TREATMENT PATTERNS IN CLAIMS AND ELECTRONIC HEALTH RECORD DATA FOR THE PHARMACEUTICAL INDUSTRY, IN CLASS 42 (U.S. CLS. 100 AND 101).

SERVICE MARK

PRINCIPAL REGISTER

FIRST USE 8-20-2010; IN COMMERCE 8-20-2010.

THE MARK CONSISTS OF THE LETTERS "C" AND "E" PRESENTED IN BLUE, STYLIZED FONT THAT ARE UNDERLINED WITH A CURVED BLUE BAND. THE "C" SITS SLIGHTLY HIGHER THAN THE "E" AND THE LETTERS ARE DIVIDED BY A BLUE VERTICAL LINE. "WORKS" APPEARS IN GRAY STYLIZED FONT DIRECTLY ADJACENT TO THE "E". DIRECTLY BELOW THESE ELEMENTS ARE THE WORDS "COMPARATIVE" AND "EFFECTIVENESS" WHICH ARE SEPARATED BY A BLUE CIRCLE. "COMPARATIVE" IS PRESENTED IN GRAY STYLIZED FONT. IN THE TERM "EFFECTIVENESS", THE "EFFECTIVE" IS PRESENTED IN BLACK FONT AND "NESS" IS PRESENTED IN GRAY FONT.

THE COLOR(S) BLUE, GRAY, AND BLACK IS/ARE CLAIMED AS A FEATURE OF THE MARK.

SN 85-073,261, FILED 6-28-2010.

GRETCHEN ULRICH, EXAMINING ATTORNEY



David J. Kyjars

Director of the United States Patent and Trademark Office

United States of America

United States Patent and Trademark Office

Live your life. Be who
you are. Drink good wine
along the way.

Reg. No. 4,099,774

CELLARDOOR WINERY, INC. (MAINE CORPORATION)
367 YOUNGTOWN ROAD
LINCOLNVILLE, ME 04849

Registered Feb. 14, 2012

Int. Cls.: 21 and 25

FOR: WINE-RELATED HOUSEHOLD PRODUCTS, NAMELY, BEVERAGE GLASSWARE,
IN CLASS 21 (U.S. CLS. 2, 13, 23, 29, 30, 33, 40 AND 50).

TRADEMARK

FIRST USE 10-1-2011; IN COMMERCE 10-1-2011.

PRINCIPAL REGISTER

FOR: CLOTHING, NAMELY, T-SHIRTS, SWEATSHIRTS, HATS AND APRONS, IN CLASS
25 (U.S. CLS. 22 AND 39).

FIRST USE 10-1-2011; IN COMMERCE 10-1-2011.

THE MARK CONSISTS OF STANDARD CHARACTERS WITHOUT CLAIM TO ANY PAR-
TICULAR FONT, STYLE, SIZE, OR COLOR.

SN 85-074,541, FILED 6-30-2010.

WARREN L. OLANDRIA, EXAMINING ATTORNEY



David J. Kybas

Director of the United States Patent and Trademark Office

United States of America

United States Patent and Trademark Office

SoClutions

Reg. No. 4,099,775

Registered Feb. 14, 2012

Int. Cl.: 9

TRADEMARK

PRINCIPAL REGISTER

DATATECH, SISTEMAS DIGITALES AVANZADOS, S.L. (SPAIN CORPORATION)
165 SEMISOTANO LOCAL 1
AV. CARDENAL HERRERA ORIA,
MADRID, SPAIN 28034

FOR: INTEGRATED CIRCUITS, IN CLASS 9 (U.S. CLS. 21, 23, 26, 36 AND 38).

FIRST USE 6-1-2011; IN COMMERCE 6-1-2011.

THE MARK CONSISTS OF STANDARD CHARACTERS WITHOUT CLAIM TO ANY PARTICULAR FONT, STYLE, SIZE, OR COLOR.

SN 85-075,044, FILED 6-30-2010.

SETH A. RAPPAPORT, EXAMINING ATTORNEY



David J. Kybas

Director of the United States Patent and Trademark Office

United States of America

United States Patent and Trademark Office

TREADWELL

Reg. No. 4,099,776

ENDLESS POOLS, INC. (NEW YORK CORPORATION)
200 EAST DUTTON'S MILLS ROAD
ASTON, PA 19014

Registered Feb. 14, 2012

Int. Cl.: 28

FOR: EXERCISE EQUIPMENT, NAMELY, AQUATIC TREADMILL, ALLOWING AN INDIVIDUAL TO RUN, WALK OR JOG IN WATER IN AN UPRIGHT POSITION, FOR EXERCISE, REHABILITATION AND RECREATION, IN CLASS 28 (U.S. CLS. 22, 23, 38 AND 50).

TRADEMARK

FIRST USE 6-10-2010; IN COMMERCE 6-10-2010.

PRINCIPAL REGISTER

THE MARK CONSISTS OF STANDARD CHARACTERS WITHOUT CLAIM TO ANY PARTICULAR FONT, STYLE, SIZE, OR COLOR.

SN 85-075,096, FILED 6-30-2010.

JENNIFER VASQUEZ, EXAMINING ATTORNEY



David J. Kybas

Director of the United States Patent and Trademark Office

United States of America

United States Patent and Trademark Office

TRIGGER READY!

Reg. No. 4,099,777

LENSE ON, LLC (ARIZONA LIMITED LIABILITY COMPANY)

Registered Feb. 14, 2012

8210 E. TETHER TRAIL
SCOTTSDALE, AZ 85255

Int. Cls.: 9 and 13

FOR: MOUNTING DEVICE FOR STABILIZING CAMERAS, IN CLASS 9 (U.S. CLS. 21, 23, 26, 36 AND 38).

TRADEMARK

FIRST USE 12-5-2011; IN COMMERCE 12-5-2011.

PRINCIPAL REGISTER

FOR: MOUNTING DEVICE FOR STABILIZING FIREARMS, IN CLASS 13 (U.S. CLS. 2 AND 9).

FIRST USE 12-5-2011; IN COMMERCE 12-5-2011.

THE MARK CONSISTS OF STANDARD CHARACTERS WITHOUT CLAIM TO ANY PARTICULAR FONT, STYLE, SIZE, OR COLOR.

SN 85-075,206, FILED 6-30-2010.

PATRICIA EVANKO, EXAMINING ATTORNEY



David J. Kybas

Director of the United States Patent and Trademark Office

United States of America

United States Patent and Trademark Office

HemiCAP^{GRS}

Reg. No. 4,099,778

ARTHROSURFACE INCORPORATED (DELAWARE CORPORATION)
28 FORGE PARKWAY
FRANKLIN, MA 02038

Registered Feb. 14, 2012

Int. Cl.: 10

FOR: PROSTHETIC IMPLANTS FOR ARTICULAR RESURFACING, IN CLASS 10 (U.S. CLS. 26, 39 AND 44).

TRADEMARK

FIRST USE 4-21-2011; IN COMMERCE 4-21-2011.

PRINCIPAL REGISTER

OWNER OF U.S. REG. NO. 3,039,890.

NO CLAIM IS MADE TO THE EXCLUSIVE RIGHT TO USE "GRS", APART FROM THE MARK AS SHOWN.

THE MARK CONSISTS OF THE WORD "HEMICAP" THE LETTERS "HEMI" ARE IN LOWER CASE AND THE LETTERS "CAP" ARE IN UPPER CASE; FOLLOWED BY THE LETTERS "GRS" IN UPPER CASE AND SUPERSCRIPIT.

SN 85-076,323, FILED 7-1-2010.

LINDA E. BLOHM, EXAMINING ATTORNEY



David J. Kyffers

Director of the United States Patent and Trademark Office

United States of America

United States Patent and Trademark Office

AMBERWATCH

Reg. No. 4,099,779

VERTEX GROUP LLC (CALIFORNIA LIMITED LIABILITY COMPANY)

Registered Feb. 14, 2012

P.O. BOX 15175
NEWPORT BEACH, CA 92659

Int. Cls.: 9, 38, and 45

FOR: DOWNLOADABLE COMPUTER SOFTWARE FOR CONTROLLING AND MONITORING COMPUTER AND INTERNET USE, IN CLASS 9 (U.S. CLS. 21, 23, 26, 36 AND 38).

TRADEMARK

FIRST USE 4-20-2009; IN COMMERCE 4-20-2009.

SERVICE MARK

FOR: PROVIDING E-MAIL NOTIFICATION ALERTS REGARDING LOCATION OF CHILD PREDATOR ACTIVITY, IN CLASS 38 (U.S. CLS. 100, 101 AND 104).

PRINCIPAL REGISTER

FIRST USE 4-20-2009; IN COMMERCE 4-20-2009.

FOR: ELECTRONIC MONITORING AND TRACKING SERVICES FOR THE PURPOSE OF LOCATING CHILDREN BY USING WIRELESS COMMUNICATIONS DEVICES VIA A GLOBAL COMPUTER NETWORK, IN CLASS 45 (U.S. CLS. 100 AND 101).

FIRST USE 7-0-2010; IN COMMERCE 7-0-2010.

THE MARK CONSISTS OF STANDARD CHARACTERS WITHOUT CLAIM TO ANY PARTICULAR FONT, STYLE, SIZE, OR COLOR.

OWNER OF U.S. REG. NOS. 2,985,781, 3,511,210, AND 3,515,272.

SN 85-076,589, FILED 7-1-2010.

ALEXANDER L. POWERS, EXAMINING ATTORNEY



David J. Kyffers

Director of the United States Patent and Trademark Office

United States of America

United States Patent and Trademark Office



OPEN SOFTWARE SOLUTIONS

Reg. No. 4,099,780

Registered Feb. 14, 2012

Int. Cl.: 9

OPEN SOFTWARE SOLUTIONS, L.L.C. (IOWA LIMITED LIABILITY COMPANY), AKA
OSS OPEN SOFTWARE SOLUTIONS,
NVC SUITE 1306
331 W. 3RD ST.
DAVENPORT, IA 52801

TRADEMARK

FOR: COMPUTER SOFTWARE FOR MEDICAL OFFICE MANAGEMENT FOR ACCOUNTING
FUNCTIONS, PATIENT APPOINTMENT MANAGEMENT AND PATIENT ELECTRONIC
RECORDS MANAGEMENT, IN CLASS 9 (U.S. CLS. 21, 23, 26, 36 AND 38).

PRINCIPAL REGISTER

FIRST USE 2-1-2010; IN COMMERCE 1-1-2011.

NO CLAIM IS MADE TO THE EXCLUSIVE RIGHT TO USE "OPEN SOFTWARE SOLUTIONS",
APART FROM THE MARK AS SHOWN.

THE MARK CONSISTS OF LETTERS "OSS" POSITIONED INSIDE OVAL WITH WORDS
"OPEN SOFTWARE SOLUTIONS" UNDERNEATH OVAL.

SN 85-076,626, FILED 7-1-2010.

DAWN FELDMAN, EXAMINING ATTORNEY



David J. Kyffers

Director of the United States Patent and Trademark Office

United States of America
United States Patent and Trademark Office

HiEE

Reg. No. 4,099,781

Registered Feb. 14, 2012

Int. Cl.: 9

TRADEMARK

PRINCIPAL REGISTER

APLUS FLASH TECHNOLOGY, INC. (CALIFORNIA CORPORATION), DBA APLUS FLASH TECHNOLOGY, INC.,
1982-A ZANKER ROAD
SAN JOSE, CA 95112

FOR: COMPUTER CHIPS; COMPUTER MEMORIES; COMPUTER MEMORY HARDWARE; ELECTRONIC CHIPS FOR THE MANUFACTURER OF INTEGRATED CIRCUITS; ELECTRONIC MEMORIES; MEMORIES FOR DATA PROCESSING EQUIPMENT; MEMORIES FOR USE WITH COMPUTERS; SEMI-CONDUCTOR MEMORIES; SEMI-CONDUCTOR MEMORY UNITS, IN CLASS 9 (U.S. CLS. 21, 23, 26, 36 AND 38).

FIRST USE 11-8-2011; IN COMMERCE 11-8-2011.

THE MARK CONSISTS OF THE LETTERS "HIEE" WITH THE "I" IN LOWER CASE AND THE "H" AND "EE" IN UPPER CASE.

SN 85-077,828, FILED 7-4-2010.

ANNE FARRELL, EXAMINING ATTORNEY



David J. Kyfos

Director of the United States Patent and Trademark Office

United States of America

United States Patent and Trademark Office

Cosmicnano Technology

Reg. No. 4,099,782

SONY CORPORATION (JAPAN CORPORATION)
1-7-1 KONAN, MINATO-KU
TOKYO, JAPAN

Registered Feb. 14, 2012

Int. Cl.: 9

FOR: BLANK MAGNETIC TAPES FOR VIDEO CAMERAS AND VIDEO RECORDERS/PLAYERS, IN CLASS 9 (U.S. CLS. 21, 23, 26, 36 AND 38).

TRADEMARK

FIRST USE 6-30-2010; IN COMMERCE 6-30-2010.

PRINCIPAL REGISTER

THE MARK CONSISTS OF STANDARD CHARACTERS WITHOUT CLAIM TO ANY PARTICULAR FONT, STYLE, SIZE, OR COLOR.

NO CLAIM IS MADE TO THE EXCLUSIVE RIGHT TO USE "TECHNOLOGY", APART FROM THE MARK AS SHOWN.

SN 85-078,533, FILED 7-6-2010.

INGRID C. EULIN, EXAMINING ATTORNEY



David J. Kyffers

Director of the United States Patent and Trademark Office

United States of America

United States Patent and Trademark Office



Reg. No. 4,099,783

Registered Feb. 14, 2012

Int. Cl.: 33

TRADEMARK

PRINCIPAL REGISTER

ZIVENKO, SERGEY VIKTOROVICH (RUSSIAN FED. INDIVIDUAL)
KV.205, D.33, KUTUZOVSKY PROSPECT
MOSCOW, RUSSIAN FED. RU-121165

FOR: VODKA, IN CLASS 33 (U.S. CLS. 47 AND 49).

FIRST USE 4-0-2010; IN COMMERCE 6-0-2010.

OWNER OF U.S. REG. NOS. 2,801,797 AND 3,577,938.

THE COLOR(S) GREY, BLACK, WHITE IS/ARE CLAIMED AS A FEATURE OF THE MARK.

NO CLAIM IS MADE TO THE EXCLUSIVE RIGHT TO USE "RUSSIAN", APART FROM THE MARK AS SHOWN.

THE MARK CONSISTS OF THE WORDS "RUSSIAN WHITE GOLD" IN BLACK ON A GREY SHIELD WITH A WHITE BORDER SURROUNDED BY PARALLEL BARS IN GREY AND WHITE AND A BACKGROUND OF WHITE WITH MULTIPLE DIAMONDS IN GREY.

SN 85-078,796, FILED 7-6-2010.

FONG HSU, EXAMINING ATTORNEY



David J. Kybas

Director of the United States Patent and Trademark Office

United States of America

United States Patent and Trademark Office

READY-SEAL

Reg. No. 4,099,784

BRK BRANDS, INC. (DELAWARE CORPORATION)
3901 LIBERTY STREET ROAD
AURORA, IL 60504

Registered Feb. 14, 2012

Int. Cls.: 9 and 20

FOR: ELECTRONIC SAFES, NAMELY, FIREPROOF ELECTRONIC SAFES AND WATER-PROOF ELECTRONIC SAFES, IN CLASS 9 (U.S. CLS. 21, 23, 26, 36 AND 38).

TRADEMARK

FIRST USE 10-31-2011; IN COMMERCE 10-31-2011.

PRINCIPAL REGISTER

FOR: NON-METAL SAFES, NAMELY, FIREPROOF NON-METAL SAFES AND WATERPROOF NON-METAL SAFES, IN CLASS 20 (U.S. CLS. 2, 13, 22, 25, 32 AND 50).

FIRST USE 10-31-2011; IN COMMERCE 10-31-2011.

THE MARK CONSISTS OF STANDARD CHARACTERS WITHOUT CLAIM TO ANY PARTICULAR FONT, STYLE, SIZE, OR COLOR.

SN 85-079,328, FILED 7-7-2010.

LINDA LAVACHE, EXAMINING ATTORNEY



David J. Kybas

Director of the United States Patent and Trademark Office

United States of America

United States Patent and Trademark Office

FACECHECK

Reg. No. 4,099,785

Registered Feb. 14, 2012

Int. Cls.: 9, 35, and 36

TRADEMARK

SERVICE MARK

PRINCIPAL REGISTER

THINK COMPUTER CORPORATION (DELAWARE CORPORATION)
884 COLLEGE AVENUE
PALO ALTO, CA 94306

FOR: COMPUTER SOFTWARE, NAMELY, ELECTRONIC FINANCIAL PLATFORM THAT ACCOMMODATES MULTIPLE TYPES OF PAYMENT AND DEBT TRANSACTIONS IN AN INTEGRATED MOBILE PHONE, PDA, AND WEB BASED ENVIRONMENT; ELECTRONIC AND MAGNETIC ID CARDS FOR USE IN CONNECTION WITH PAYMENT FOR SERVICES; ELECTRONIC PAYMENT TERMINAL, IN CLASS 9 (U.S. CLS. 21, 23, 26, 36 AND 38).

FIRST USE 11-15-2010; IN COMMERCE 11-15-2010.

FOR: ADMINISTRATION OF BUSINESS PAYROLL FOR OTHERS; PAYROLL ADMINISTRATION AND MANAGEMENT SERVICES; PAYROLL PREPARATION; PAYROLL PROCESSING SERVICES; WAGE PAYROLL PREPARATION, IN CLASS 35 (U.S. CLS. 100, 101 AND 102).

FIRST USE 11-15-2010; IN COMMERCE 11-15-2010.

FOR: ELECTRONIC COMMERCE PAYMENT SERVICES, NAMELY, ESTABLISHING FUNDED ACCOUNTS USED TO PURCHASE GOODS AND SERVICES ON THE INTERNET; ELECTRONIC PAYMENT, NAMELY, ELECTRONIC PROCESSING AND TRANSMISSION OF BILL PAYMENT DATA; ELECTRONIC PROCESSING OF INSURANCE CLAIMS AND PAYMENT DATA; PAYROLL TAX DEBITING SERVICES, IN CLASS 36 (U.S. CLS. 100, 101 AND 102).

FIRST USE 11-15-2010; IN COMMERCE 11-15-2010.

THE MARK CONSISTS OF STANDARD CHARACTERS WITHOUT CLAIM TO ANY PARTICULAR FONT, STYLE, SIZE, OR COLOR.

SN 85-080,850, FILED 7-8-2010.

KAPIL BHANOT, EXAMINING ATTORNEY



David J. Kyffers

Director of the United States Patent and Trademark Office

United States of America

United States Patent and Trademark Office

PROLEVEL

Reg. No. 4,099,786

Registered Feb. 14, 2012

Int. Cl.: 41

SERVICE MARK

PRINCIPAL REGISTER

INTER-INDUSTRY CONFERENCE ON AUTO COLLISION REPAIR (ILLINOIS CORPORATION)
5125 TRILLIUM BLVD.
HOFFMAN ESTATES, IL 60192

FOR: TRAINING AND INSTRUCTION IN THE FIELDS OF AUTOMOTIVE AND AUTOMOTIVE COLLISION REPAIR AND DISTRIBUTION OF TRAINING MATERIAL IN CONNECTION THEREWITH; EDUCATIONAL TRAINING MONITORING, NAMELY, TRACKING STUDENT TRAINING; PROVIDING RECOGNITION AND INCENTIVES BY THE WAY OF AWARDING DESIGNATIONS FOR DEMONSTRATING TRAINING ACHIEVEMENT IN THE FIELDS OF AUTOMOTIVE AND AUTOMOTIVE COLLISION REPAIR, IN CLASS 41 (U.S. CLS. 100, 101 AND 107).

FIRST USE 7-0-2010; IN COMMERCE 7-0-2010.

THE MARK CONSISTS OF STANDARD CHARACTERS WITHOUT CLAIM TO ANY PARTICULAR FONT, STYLE, SIZE, OR COLOR.

SN 85-081,285, FILED 7-9-2010.

DANNEAN HETZEL, EXAMINING ATTORNEY



David J. Kyffers

Director of the United States Patent and Trademark Office

United States of America

United States Patent and Trademark Office

SOCIALPASS

Reg. No. 4,099,787

SOCIAL PASS, LLC (PENNSYLVANIA LIMITED LIABILITY COMPANY)
441 NORTH 5TH STREET FIRST FLOOR
PHILADELPHIA, PA 19123

Registered Feb. 14, 2012

Int. Cl.: 9

FOR: DOWNLOADABLE SOFTWARE IN THE NATURE OF A MOBILE APPLICATION FOR DISPLAYING, TRACKING AND SHARING A USER'S LOCATION OR PHYSICAL PRESENCE INFORMATION AND FINDING, LOCATING AND INTERACTING WITH OTHER USERS, PERSONS OR PLACES, IN CLASS 9 (U.S. CLS. 21, 23, 26, 36 AND 38).

TRADEMARK

PRINCIPAL REGISTER

FIRST USE 3-2-2011; IN COMMERCE 3-2-2011.

THE MARK CONSISTS OF STANDARD CHARACTERS WITHOUT CLAIM TO ANY PARTICULAR FONT, STYLE, SIZE, OR COLOR.

SN 85-081,519, FILED 7-9-2010.

SETH A. RAPPAPORT, EXAMINING ATTORNEY



David J. Kyffers

Director of the United States Patent and Trademark Office

United States of America

United States Patent and Trademark Office

ALGO FIRST

Reg. No. 4,099,788

Registered Feb. 14, 2012

Int. Cls.: 9, 36, and 42

TRADEMARK

SERVICE MARK

PRINCIPAL REGISTER

ALGORITHMICS TRADEMARKS LLC (DELAWARE LIMITED LIABILITY COMPANY)
CORPORATION TRUST CENTER
1209 ORANGE STREET
WILMINGTON, DE 19801

FOR: COMPUTER SOFTWARE FOR FINANCIAL RISK MANAGEMENT AND MEASUREMENT; COMPUTER SOFTWARE FOR ORGANIZING AND CONSOLIDATING FINANCIAL INFORMATION REGARDING RATINGS OF SECURITIES AND RATING THE CREDIT WORTHINESS OF BONDS AND OTHER SECURITIES; COMPUTER SOFTWARE FOR USE IN FINANCIAL ANALYSIS, CREDIT-RISK ASSESSMENT FOR COMMERCIAL LENDING AND COMMERCIAL CREDIT RISK MANAGEMENT AND MEASUREMENT; COMPUTER SOFTWARE FOR DATA WAREHOUSING IN THE FINANCIAL FIELD, NAMELY, SOFTWARE FOR ORGANISING AND OPERATING A SYSTEM FOR STORING, RETRIEVING AND MANAGING LARGE AMOUNTS OF ANY TYPE OF DATA IN THE FINANCIAL FIELD; DOWNLOADABLE SOFTWARE FOR USE IN FINANCIAL RISK MANAGEMENT AND MEASUREMENT, IN CLASS 9 (U.S. CLS. 21, 23, 26, 36 AND 38).

FIRST USE 1-31-2011; IN COMMERCE 1-31-2011.

FOR: FINANCIAL SERVICES, NAMELY, STRATEGIC FINANCIAL RISK MANAGEMENT AND MEASUREMENT; FINANCIAL CONSULTING; FINANCIAL CONSULTING CONCERNING FINANCIAL RISK MANAGEMENT AND MEASUREMENT; FINANCIAL SERVICES, NAMELY, ORGANIZING AND CONSOLIDATING FINANCIAL INFORMATION REGARDING RATINGS OF SECURITIES AND RATING THE CREDIT WORTHINESS OF BONDS AND OTHER SECURITIES; FINANCIAL SERVICES, NAMELY, FINANCIAL ANALYSIS, CREDIT-RISK ASSESSMENT FOR COMMERCIAL LENDING AND COMMERCIAL CREDIT RISK MANAGEMENT AND MEASUREMENT, IN CLASS 36 (U.S. CLS. 100, 101 AND 102).

FIRST USE 9-0-2007; IN COMMERCE 9-0-2007.

FOR: PROVIDING USE OF ONLINE NON-DOWNLOADABLE SOFTWARE FOR USE IN FINANCIAL RISK MANAGEMENT AND MEASUREMENT, IN CLASS 42 (U.S. CLS. 100 AND 101).

FIRST USE 9-0-2007; IN COMMERCE 9-0-2007.



David J. Kyffers

Director of the United States Patent and Trademark Office

Reg. No. 4,099,788 THE MARK CONSISTS OF STANDARD CHARACTERS WITHOUT CLAIM TO ANY PARTICULAR FONT, STYLE, SIZE, OR COLOR.

OWNER OF U.S. REG. NOS. 3,214,047 AND 3,311,666.

THE ENGLISH TRANSLATION OF "ALGO" IN THE MARK IS "SOMETHING".

SN 85-082,783, FILED 7-12-2010.

MELISSA VALLILLO, EXAMINING ATTORNEY

United States of America

United States Patent and Trademark Office

VIAFIELD

Reg. No. 4,099,789

PROGRESSIVE AG COOPERATIVE (IOWA CORPORATION)
207 14TH STREET, BOX 227
NORTHWOOD, IA 50459

Registered Feb. 14, 2012

Int. Cls.: 35, 36, 39, and 40

FOR: COOPERATIVE BUSINESS MANAGEMENT AND BUSINESS CONSULTATION SERVICES IN THE FIELD OF GRAIN, FEED, AGRICULTURAL PRODUCTS, AGRONOMY PRODUCTS AND ENERGY PRODUCTS; COOPERATIVE ADVERTISING SERVICES, NAMELY, CONSULTATION SERVICES IN THE DEVELOPMENT OF ADVERTISEMENTS AND SALES PROMOTIONS; DISTRIBUTORSHIP SERVICES FEATURING AGRICULTURAL PRODUCTS, GRAIN, FEED, AGRONOMY PRODUCTS AND ENERGY PRODUCTS, IN CLASS 35 (U.S. CLS. 100, 101 AND 102).

SERVICE MARK

PRINCIPAL REGISTER

FIRST USE 9-1-2010; IN COMMERCE 9-1-2010.

FOR: COMMODITY BROKERAGE SERVICES IN THE FIELD OF GRAIN, FEED, AGRICULTURAL PRODUCTS, AGRONOMY PRODUCTS AND ENERGY PRODUCTS, IN CLASS 36 (U.S. CLS. 100, 101 AND 102).

FIRST USE 9-1-2010; IN COMMERCE 9-1-2010.

FOR: WAREHOUSE STORAGE SERVICES AND TRANSPORT OF GRAIN, FEED, AGRICULTURAL PRODUCTS, AGRONOMY PRODUCTS AND ENERGY PRODUCTS, IN CLASS 39 (U.S. CLS. 100 AND 105).

FIRST USE 9-1-2010; IN COMMERCE 9-1-2010.

FOR: GRAIN PROCESSING AND MILLING SERVICES, IN CLASS 40 (U.S. CLS. 100, 103 AND 106).

FIRST USE 9-1-2010; IN COMMERCE 9-1-2010.

THE MARK CONSISTS OF STANDARD CHARACTERS WITHOUT CLAIM TO ANY PARTICULAR FONT, STYLE, SIZE, OR COLOR.

SN 85-084,414, FILED 7-14-2010.

TEJBIR SINGH, EXAMINING ATTORNEY



David J. Kyfos

Director of the United States Patent and Trademark Office

United States of America

United States Patent and Trademark Office

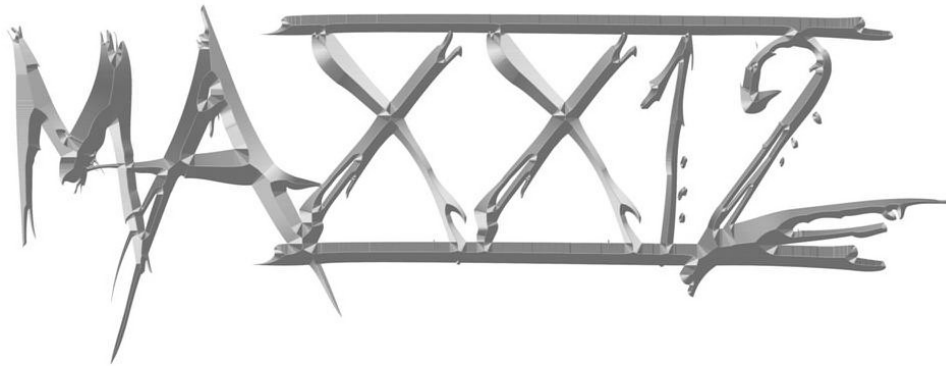

Reg. No. 4,099,790

THOMAS MICHAEL RIDDLE (UNITED STATES INDIVIDUAL)
5669 SNELL AVENUE #357
SAN JOSE, CA 95123

Registered Feb. 14, 2012

Int. Cls.: 25 and 41

FOR: CLOTHING AS MERCHANDISE AND FAN ARTICLES, NAMELY, T-SHIRTS, TOPS, SHIRTS, HATS AND CAPS, IN CLASS 25 (U.S. CLS. 22 AND 39).

TRADEMARK

FIRST USE 5-31-2010; IN COMMERCE 9-30-2010.

SERVICE MARK

FOR: ENTERTAINMENT SERVICES, NAMELY, LIVE MUSICAL CONCERTS AND CONCERT TOURS; MUSIC PUBLISHING SERVICES; MUSIC FAN CLUB SERVICES; PROVIDING AN ON-LINE COMPUTER DATABASE FEATURING PRERECORDED MUSIC, MUSICAL PERFORMANCES, MUSIC VIDEOS, MUSIC VIDEO CLIPS, MUSIC FILMS, AND MULTIMEDIA MATERIALS FEATURING MUSIC; PROVIDING AN ON-LINE COMPUTER DATABASE FEATURING ENTERTAINMENT INFORMATION ABOUT A MUSICAL BAND, NAMELY, GRAPHICS, DATA, NEWS, REVIEWS, PHOTOGRAPHS, TOUR SCHEDULES, TRAVEL SCHEDULES, MUSICAL PERFORMANCE SCHEDULES, AND SCHEDULED RELEASE DATES FOR AUDIO, VIDEO AND DIGITAL RECORDINGS, MULTI-MEDIA SOFTWARE, COLLECTIBLE GOODS AND PRINTED MATTER, IN CLASS 41 (U.S. CLS. 100, 101 AND 107).

PRINCIPAL REGISTER

FIRST USE 5-31-2010; IN COMMERCE 9-30-2010.



THE MARK CONSISTS OF "MAXX12" IN A STYLIZED FONT WITH HORIZONTAL LINING ABOVE AND BELOW THE "XX12" PORTION OF THE MARK, ALL IN SHADES OF LIGHT GRAY, MEDIUM GRAY, AND DARK GRAY

THE COLOR(S) LIGHT GRAY, MEDIUM GRAY AND DARK GRAY IS/ARE CLAIMED AS A FEATURE OF THE MARK.

SN 85-084,820, FILED 7-14-2010.

PATRICIA EVANKO, EXAMINING ATTORNEY

David J. Kybas

Director of the United States Patent and Trademark Office

United States of America

United States Patent and Trademark Office



Reg. No. 4,099,791

Registered Feb. 14, 2012

Int. Cl.: 5

TRADEMARK

PRINCIPAL REGISTER

ZHENG HONG LIMITED (BR. VIRGIN ISLANDS LIMITED COMPANY (LTD.))
P.O. BOX 957
OFFSHORE INCORPORATIONS CENTRE
ROAD TOWN, TORTOLA, BR. VIRGIN ISLANDS

FOR: TOPICAL CREAMS, BALMS AND OINTMENTS FOR THE RELIEF OF ACHES AND PAIN, IN CLASS 5 (U.S. CLS. 6, 18, 44, 46, 51 AND 52).

FIRST USE 12-31-1919; IN COMMERCE 12-31-1954.

THE MARK CONSISTS OF A CIRCULAR BORDER WITH THE DESIGN OF A TREE, GRASSLAND, A SUN AND MOUNTAINS. THE WORDS "KOONG YICK" APPEAR BESIDE THE TREE. THERE ARE TWO CHINESE CHARACTERS SHOWN BELOW THE WORDING "KOONG YICK". AND THE TWO CHINESE CHARACTERS ARE ALSO CONTAINED IN THE SUN DESIGN.

THE NON-LATIN CHARACTERS IN THE MARK TRANSLITERATE TO "KOONG YICK"

THE ENGLISH TRANSLATION OF THE WORD "KOONG YICK" IN THE MARK IS "MALE INCREASE".

SN 85-086,070, FILED 7-16-2010.

LINDA E. BLOHM, EXAMINING ATTORNEY



David J. Kybas

Director of the United States Patent and Trademark Office

United States of America

United States Patent and Trademark Office



Reg. No. 4,099,792

Registered Feb. 14, 2012

**Int. Cls.: 1, 5, 6, 11, 37,
and 42**

TRADEMARK

SERVICE MARK

PRINCIPAL REGISTER

LINDE AKTIENGESELLSCHAFT (FED REP GERMANY AKTIENGESELLSCHAFT), AKA
LINDE AG,
KLOSTERHOFSTRASSE 1
80331 MÜNCHEN/MUNICH, FED REP GERMANY

FOR: GASES AND GASES IN LIQUID OR DISSOLVED FORM FOR USE IN WELDING, BURNING, CUTTING, AS HIGH PRECISION/PURITY CALIBRATING GASES, GASES FOR USE IN SEMICONDUCTOR PRODUCTION, GASES FOR THE TREATMENT OF WATER, FOR USE IN THE FOOD INDUSTRY, AND FOR METALLURGICAL PURPOSES, NAMELY, HYDROCARBON GASES, HYDROCARBON COMPOUNDS, OXYGEN, OXYGEN CONTAINING GASES, NITROGEN, HYDROGEN, CARBON DIOXIDE, CARBON MONOXIDE, NITRIC OXIDES, AMMONIA, OZONE, HALOGENS, HALOGEN COMPOUNDS, SULFUR COMPOUNDS, ARGON, ACETYLENE AND OTHER FUEL GASES, SHIELDING GASES, ULTRA HIGH PURITY GASES, ALL RARE GASES AS WELL AS MIXTURES OF ALL AFOREMENTIONED GASES, ALL OF THE AFORESAID GASES FOR INDUSTRIAL APPLICATIONS, IN CLASS 1 (U.S. CLS. 1, 5, 6, 10, 26 AND 46).

FIRST USE 1-0-2009; IN COMMERCE 1-0-2009.

FOR: GASES AND GASES IN LIQUID OR DISSOLVED FORM FOR USE IN MEDICAL APPLICATIONS, IN CLASS 5 (U.S. CLS. 6, 18, 44, 46, 51 AND 52).

FIRST USE 1-0-2009; IN COMMERCE 1-0-2009.

FOR: INSTALLATIONS AND CONTAINERS OF METAL FOR THE STORAGE AND EVAPORATION OF LIQUEFIED GASES, NAMELY, TANKS, VESSELS, DRUMS, AND CYLINDERS FOR THE STORAGE OF LIQUEFIED GASES; GAS CYLINDERS OF METAL FOR THE STORAGE OF PRESSURIZED GAS, IN CLASS 6 (U.S. CLS. 2, 12, 13, 14, 23, 25 AND 50).

FIRST USE 1-0-2009; IN COMMERCE 1-0-2009.

FOR: DEVICES FOR HEATING, STEAM GENERATING, REFRIGERATING, DRYING, AND VENTILATING, NAMELY, APPARATUS FOR THE LIQUEFACTION AND SEPARATION OF AIR, APPARATUS FOR THE SEPARATION, PURIFICATION, SCRUBBING, AND LIQUEFACTION OF GASES, APPARATUS FOR CRACKING LIQUID AND GASEOUS HYDROCARBON MIXTURES, REACTORS FOR CHEMICAL TRANSFORMATIONS FOR THE PRODUCTION OF BASIC COMPOUNDS IN THE CHEMICAL INDUSTRY, NAMELY, OLEFINS,



David J. Kybas

Director of the United States Patent and Trademark Office

Reg. No. 4,099,792 BENZOL, NAPHTHALENE, ALCOHOL, AMMONIA, UREA, ORGANIC ACIDS; PETROCHEMICAL PROCESS AND REFINERY FURNACES; CRYOGENIC PLANTS, NAMELY, APPARATUS FOR THE PRODUCTION, APPLICATION, AND MAINTENANCE OF CRYOGENIC TEMPERATURES, NAMELY, HELIUM LIQUEFIERS; EVAPORATORS; DISTILLATION AND RECTIFICATION APPARATUS; HEAT EXCHANGERS; GAS ABSORBERS; GAS SCRUBBING COLUMNS; HYDROGEN GENERATION EQUIPMENT, NAMELY, STEAM REFORMERS; HYDROGEN GENERATORS; FOOD FREEZING APPARATUS, NAMELY, REFRIGERATORS, FREEZERS, AND COOLERS; PRESSURE REDUCERS, REGULATORS, AND VALVES OF METAL FOR USE IN GAS SUPPLY SYSTEMS; HEAT EXCHANGERS FOR THE EVAPORATION OF LIQUEFIED GASES, IN CLASS 11 (U.S. CLS. 13, 21, 23, 31 AND 34).

FIRST USE 1-0-2009; IN COMMERCE 1-0-2009.

FOR: INSTALLATION, CONSTRUCTION, REPAIR AND MAINTENANCE OF GAS, PETROCHEMICAL, CHEMICAL, PHARMACEUTICAL AND ENVIRONMENTALLY RELATED PLANTS AND APPARATUS, COOLING AND REFRIGERATING APPLIANCES, AND CRYOGENIC APPARATUS; CONSTRUCTION OF, CONSTRUCTION MANAGEMENT OF, AND SUPERVISION OF CONSTRUCTION OF INDUSTRIAL APPARATUS AND PLANTS, NAMELY, GAS, PETROCHEMICAL, CHEMICAL, PHARMACEUTICAL AND ENVIRONMENTALLY RELATED PLANTS AND APPARATUS; TECHNICAL CONSULTATION IN THE FIELD OF WELDING, IN CLASS 37 (U.S. CLS. 100, 103 AND 106).

FIRST USE 1-0-2009; IN COMMERCE 1-0-2009.

FOR: ENGINEERING SERVICES, NAMELY, DESIGN, ENGINEERING AND PLANNING OF INDUSTRIAL PLANTS, GAS PLANTS, WATER PURIFICATION AND SEWAGE DISPOSAL PLANTS, GAS SUPPLY SYSTEMS, TECHNICAL CONSULTATION IN THE FIELDS OF THE LIQUEFACTION AND SEPARATION OF GASES, AND THE PURIFICATION OF GASES, IN CLASS 42 (U.S. CLS. 100 AND 101).

FIRST USE 1-0-2009; IN COMMERCE 1-0-2009.

OWNER OF U.S. REG. NO. 3,836,594.

THE COLOR(S) WHITE AND BLUE IS/ARE CLAIMED AS A FEATURE OF THE MARK.

NO CLAIM IS MADE TO THE EXCLUSIVE RIGHT TO USE "GROUP" , APART FROM THE MARK AS SHOWN.

THE MARK CONSISTS OF THE WORDING "THE LINDE GROUP" IN WHITE IN THE UPPER LEFT CORNER OF A RECTANGLE WHICH IS COLORED DARK BLUE AND OF THE STYLIZED WORDING "LINDE" IN WHITE IN THE LOWER RIGHT CORNER OF THE RECTANGLE AND OF A WAVE-LIKE DESIGN IN LIGHTER SHADES OF BLUE EXTENDING FROM THE LEFT TO THE RIGHT SIDE OF THE MIDDLE OF THE RECTANGLE.

SN 85-087,515, FILED 7-19-2010.

MICHAEL WIENER, EXAMINING ATTORNEY

United States of America

United States Patent and Trademark Office

Pocketbook.com

Reg. No. 4,099,793

SITETOOLS, INC. (CALIFORNIA CORPORATION)

Registered Feb. 14, 2012

1726 STONER AVE #101
LOS ANGELES, CA 90025

Int. Cl.: 42

SERVICE MARK

PRINCIPAL REGISTER

FOR: APPLICATION SERVICE PROVIDER (ASP) FEATURING SOFTWARE TO ENABLE BLOGGING AND LINK BUILDING OF ELECTRONIC MEDIA AND USER GENERATED CONTENT OR INFORMATION OVER THE INTERNET OR OTHER COMMUNICATIONS NETWORK FOR USE IN WEBSITE DESIGN AND PUBLISHING; COMPUTER SERVICE, NAMELY, ACTING AS AN APPLICATION SERVICE PROVIDER IN THE FIELD OF KNOWLEDGE MANAGEMENT TO HOST COMPUTER APPLICATION SOFTWARE FOR SEARCHING AND RETRIEVING INFORMATION FROM DATABASES AND COMPUTER NETWORKS; COMPUTER SERVICE, NAMELY, ACTING AS AN APPLICATION SERVICE PROVIDER IN THE FIELD OF KNOWLEDGE MANAGEMENT TO HOST COMPUTER APPLICATION SOFTWARE FOR THE COLLECTION, EDITING, ORGANIZING, MODIFYING, BOOK MARKING, TRANSMISSION, STORAGE AND SHARING OF DATA AND INFORMATION; COMPUTER SERVICES IN THE NATURE OF CUSTOMIZED WEB PAGES FEATURING USER-DEFINED INFORMATION, PERSONAL PROFILES AND INFORMATION; PROVIDING A WEBSITE THAT GIVES USERS THE ABILITY TO CREATE CUSTOMIZED WEB PAGES FEATURING USER-DEFINED INFORMATION; PROVIDING CUSTOMIZED ON-LINE WEB PAGES FEATURING USER-DEFINED INFORMATION, WHICH INCLUDES SEARCH ENGINES AND ON-LINE WEB LINKS TO OTHER WEB SITES, IN CLASS 42 (U.S. CLS. 100 AND 101).



FIRST USE 7-23-2010; IN COMMERCE 12-10-2010.

THE MARK CONSISTS OF STANDARD CHARACTERS WITHOUT CLAIM TO ANY PARTICULAR FONT, STYLE, SIZE, OR COLOR.

SN 85-088,150, FILED 7-20-2010.

DAWN HAN, EXAMINING ATTORNEY

David J. Kyros

Director of the United States Patent and Trademark Office

United States of America

United States Patent and Trademark Office

UFC ULTIMATE INSIDER

Reg. No. 4,099,794

ZUFFA, LLC (NEVADA LIMITED LIABILITY COMPANY)
2960 W. SAHARA AVENUE
LAS VEGAS, NV 89102

Registered Feb. 14, 2012

Int. Cl.: 41

FOR: ENTERTAINMENT IN THE NATURE OF ON-GOING TELEVISION PROGRAM IN THE FIELDS OF SPORTS AND MIXED MARTIAL ARTS; ENTERTAINMENT SERVICES, NAMELY, NON-DOWNLOADABLE, PRE-RECORDED VIDEOS IN THE FIELD OF SPORTS AND MIXED MARTIAL ARTS PROVIDED VIA A GLOBAL COMPUTER NETWORK AND WIRELESS NETWORKS; AND PROVIDING A WEBSITE FEATURING INFORMATION IN THE FIELDS OF SPORTS AND MIXED MARTIAL ARTS, IN CLASS 41 (U.S. CLS. 100, 101 AND 107).

SERVICE MARK

PRINCIPAL REGISTER

FIRST USE 2-0-2011; IN COMMERCE 2-0-2011.

THE MARK CONSISTS OF STANDARD CHARACTERS WITHOUT CLAIM TO ANY PARTICULAR FONT, STYLE, SIZE, OR COLOR.

SEC. 2(F) "ULTIMATE" .

OWNER OF U.S. REG. NOS. 2,645,312, 3,052,007, AND OTHERS.

SN 85-088,560, FILED 7-20-2010.

JOHN E. MICHOS, EXAMINING ATTORNEY



David J. Kyffers

Director of the United States Patent and Trademark Office

United States of America

United States Patent and Trademark Office

UFC ^{ULTIMATE} **insider**

Reg. No. 4,099,795

ZUFFA, LLC (NEVADA LIMITED LIABILITY COMPANY)
2960 W. SAHARA AVENUE
LAS VEGAS, NV 89102

Registered Feb. 14, 2012

Int. Cl.: 41

FOR: ENTERTAINMENT IN THE NATURE OF ON-GOING TELEVISION PROGRAM IN THE FIELDS OF SPORTS AND MIXED MARTIAL ARTS; ENTERTAINMENT SERVICES, NAMELY, NON-DOWNLOADABLE, PRE-RECORDED VIDEOS IN THE FIELD OF SPORTS AND MIXED MARTIAL ARTS PROVIDED VIA A GLOBAL COMPUTER NETWORK AND WIRELESS NETWORKS; AND PROVIDING A WEBSITE FEATURING INFORMATION IN THE FIELDS OF SPORTS AND MIXED MARTIAL ARTS, IN CLASS 41 (U.S. CLS. 100, 101 AND 107).

SERVICE MARK

PRINCIPAL REGISTER

FIRST USE 2-0-2011; IN COMMERCE 2-0-2011.

OWNER OF U.S. REG. NOS. 2,645,312, 2,941,044, AND OTHERS.

SEC. 2(F) AS TO "ULTIMATE".

THE MARK CONSISTS OF THE STYLIZED TEXT "UFC" AND THE TEXT "ULTIMATE" OVER THE TEXT "INSIDER" NEXT TO "UFC". THICK LINES RUN OVER THE "ER" IN "INSIDER" AND UNDER ALL OF THE TEXT.

SN 85-088,573, FILED 7-20-2010.

JOHN E. MICHOS, EXAMINING ATTORNEY



David J. Kyffers

Director of the United States Patent and Trademark Office

United States of America

United States Patent and Trademark Office

SWEETS N TREATS

Reg. No. 4,099,796

Registered Feb. 14, 2012

Int. Cl.: 9

TRADEMARK

PRINCIPAL REGISTER

BALLY GAMING, INC. (NEVADA CORPORATION), DBA BALLY TECHNOLOGIES,
ATTN: PAMELA BOWSHER, LAW DEPT.
6601 SOUTH BERMUDA ROAD
LAS VEGAS, NV 89119

FOR: GAMING MACHINES, NAMELY, DEVICES WHICH ACCEPT A WAGER AND GAMING SOFTWARE THAT GENERATES OR DISPLAYS OUTCOMES FOR GAMING MACHINES, IN CLASS 9 (U.S. CLS. 21, 23, 26, 36 AND 38).

FIRST USE 9-30-2010; IN COMMERCE 9-30-2010.

THE MARK CONSISTS OF STANDARD CHARACTERS WITHOUT CLAIM TO ANY PARTICULAR FONT, STYLE, SIZE, OR COLOR.

SN 85-088,991, FILED 7-20-2010.

KATINA MISTER, EXAMINING ATTORNEY



David J. Kybas

Director of the United States Patent and Trademark Office

United States of America

United States Patent and Trademark Office

CRYOLC

Reg. No. 4,099,797

CRYOLOGICS, INC. (PENNSYLVANIA CORPORATION)
189 BUCK RUN RD
QUAKERTOWN, PA 18951

Registered Feb. 14, 2012

Int. Cl.: 1

FOR: CHEMICAL SOLUTION FOR THE PRESERVATION OF A MICROORGANISM, IN CLASS 1 (U.S. CLS. 1, 5, 6, 10, 26 AND 46).

TRADEMARK

FIRST USE 7-26-2011; IN COMMERCE 10-17-2011.

PRINCIPAL REGISTER

THE MARK CONSISTS OF STANDARD CHARACTERS WITHOUT CLAIM TO ANY PARTICULAR FONT, STYLE, SIZE, OR COLOR.

SN 85-089,691, FILED 7-21-2010.

KATINA MISTER, EXAMINING ATTORNEY



David J. Kybas

Director of the United States Patent and Trademark Office

United States of America

United States Patent and Trademark Office

MYPHILOSOPHYLIBRARY

Reg. No. 4,099,798

PEARSON EDUCATION, INC. (DELAWARE CORPORATION)
ONE LAKE STREET

Registered Feb. 14, 2012

UPPER SADDLE RIVER, NJ 07458

Int. Cl.: 41

FOR: PROVIDING A WEBSITE FEATURING EDUCATIONAL RESOURCES, NAMELY, NON-DOWNLOADABLE PUBLICATIONS IN THE NATURE OF DIGITAL TEXTBOOKS, PRIMARY SOURCE DOCUMENTS, SUPPLEMENTARY READING MATERIALS FOR USE IN CONNECTION WITH THE STUDY OF PHILOSOPHY, IN CLASS 41 (U.S. CLS. 100, 101 AND 107).

SERVICE MARK

PRINCIPAL REGISTER

FIRST USE 1-1-2010; IN COMMERCE 5-1-2010.

THE MARK CONSISTS OF STANDARD CHARACTERS WITHOUT CLAIM TO ANY PARTICULAR FONT, STYLE, SIZE, OR COLOR.

SN 85-090,297, FILED 7-22-2010.

MICHAEL SOUDERS, EXAMINING ATTORNEY



David J. Kybas

Director of the United States Patent and Trademark Office

United States of America

United States Patent and Trademark Office

PROlectrix

Reg. No. 4,099,799

MIDWEST TRADING GROUP INC (ILLINOIS CORPORATION)
905 S WESTWOOD AVE
ADDISON, IL 60101

Registered Feb. 14, 2012

Int. Cl.: 11

FOR: CHOCOLATE FOUNTAIN; ELECTRIC POPCORN POPPERS; ELECTRIC RICE COOKERS; ROTISseries, IN CLASS 11 (U.S. CLS. 13, 21, 23, 31 AND 34).

TRADEMARK

FIRST USE 5-5-2010; IN COMMERCE 5-5-2010.

PRINCIPAL REGISTER

SN 85-090,474, FILED 7-22-2010.

ROBIN MITTLER, EXAMINING ATTORNEY



David J. Kyffers

Director of the United States Patent and Trademark Office

United States of America

United States Patent and Trademark Office

Republic of Cake

Reg. No. 4,099,800

REPUBLIC OF CAKE, LLC (CALIFORNIA LIMITED LIABILITY COMPANY)
2 THEATRE SQUARE, SUITE 151
ORINDA, CA 94563

Registered Feb. 14, 2012

Int. Cls.: 21, 25, and 43

FOR: COFFEE MUGS, IN CLASS 21 (U.S. CLS. 2, 13, 23, 29, 30, 33, 40 AND 50).

FIRST USE 12-31-2009; IN COMMERCE 8-18-2011.

TRADEMARK

FOR: BASEBALL CAPS AND HATS; SHORT-SLEEVED OR LONG-SLEEVED T-SHIRTS,
IN CLASS 25 (U.S. CLS. 22 AND 39).

SERVICE MARK

PRINCIPAL REGISTER

FIRST USE 12-31-2009; IN COMMERCE 8-18-2011.

FOR: RESTAURANT SERVICES, NAMELY, PROVIDING OF FOOD AND BEVERAGES FOR
CONSUMPTION ON AND OFF THE PREMISES, IN CLASS 43 (U.S. CLS. 100 AND 101).

FIRST USE 12-1-2009; IN COMMERCE 10-11-2011.

THE MARK CONSISTS OF STANDARD CHARACTERS WITHOUT CLAIM TO ANY PAR-
TICULAR FONT, STYLE, SIZE, OR COLOR.

NO CLAIM IS MADE TO THE EXCLUSIVE RIGHT TO USE "CAKE", APART FROM THE
MARK AS SHOWN.

SN 85-090,999, FILED 7-22-2010.

TOBY BULLOFF, EXAMINING ATTORNEY



David J. Kyfos

Director of the United States Patent and Trademark Office

United States of America

United States Patent and Trademark Office



Reg. No. 4,099,801

Registered Feb. 14, 2012

Int. Cl.: 41

SERVICE MARK

PRINCIPAL REGISTER

TANIS, SHEIROKY (UNITED STATES INDIVIDUAL)
#B
637 MAIN ST.
AKRON, PA 17501

FOR: MULTIMEDIA ENTERTAINMENT SERVICES IN THE NATURE OF RECORDING, PRODUCTION AND POST-PRODUCTION SERVICES IN THE FIELDS OF MUSIC, VIDEO, AND FILMS, IN CLASS 41 (U.S. CLS. 100, 101 AND 107).

FIRST USE 9-24-2011; IN COMMERCE 9-24-2011.

NO CLAIM IS MADE TO THE EXCLUSIVE RIGHT TO USE "ENTERTAINMENT", APART FROM THE MARK AS SHOWN.

THE STIPPLING IS FOR SHADING PURPOSES ONLY.

THE NAME "MARTHE ELIE" DOES NOT IDENTIFY A LIVING INDIVIDUAL.

THE MARK CONSISTS OF A STYLIZED TREE BETWEEN THE TEXTS "MARTHE" AND "ELIE", AND "ENTERTAINMENT" BELOW "ELIE".

SN 85-091,146, FILED 7-22-2010.

STEVEN R. FINE, EXAMINING ATTORNEY



David J. Kybas

Director of the United States Patent and Trademark Office

United States of America

United States Patent and Trademark Office

THE LUXURY COLLECTION

Reg. No. 4,099,802

THE SHERATON LLC (DELAWARE LIMITED LIABILITY COMPANY)
ONE STARPOINT
STAMFORD, CT 06902

Registered Feb. 14, 2012

Int. Cl.: 39

FOR: ONLINE TRIP AND TRAVEL RESERVATION SERVICES, IN CLASS 39 (U.S. CLS. 100 AND 105).

SERVICE MARK

FIRST USE 2-14-1998; IN COMMERCE 2-14-1998.

PRINCIPAL REGISTER

THE MARK CONSISTS OF STANDARD CHARACTERS WITHOUT CLAIM TO ANY PARTICULAR FONT, STYLE, SIZE, OR COLOR.

SEC. 2(F).

OWNER OF U.S. REG. NOS. 2,033,783, 3,335,081, AND 3,636,970.

SN 85-092,340, FILED 7-25-2010.

AMY C. KEAN, EXAMINING ATTORNEY



David J. Kybas

Director of the United States Patent and Trademark Office

United States of America

United States Patent and Trademark Office

PAINTED WITH PASSION

Reg. No. 4,099,803

Registered Feb. 14, 2012

Int. Cls.: 18, 20, and 25

TRADEMARK

PRINCIPAL REGISTER

THE BASU GROUP, INC. (NEW JERSEY CORPORATION)
#162
2227 US HIGHWAY ONE
NORTH BRUNSWICK, NJ 08902

FOR: BACKPACKS; BELT BAGS AND HIP BAGS; BOOK BAGS; BUM BAGS; CLUTCH BAGS; CLUTCH PURSES; COSMETIC BAGS SOLD EMPTY; HANDBAGS; MESSENGER BAGS; PURSES; TOILETRY BAGS SOLD EMPTY; TOTE BAGS; TRAVEL BAGS; AND WALLETS, IN CLASS 18 (U.S. CLS. 1, 2, 3, 22 AND 41).

FIRST USE 3-3-2011; IN COMMERCE 3-3-2011.

FOR: LEATHER PICTURE FRAMES, IN CLASS 20 (U.S. CLS. 2, 13, 22, 25, 32 AND 50).

FIRST USE 7-30-2011; IN COMMERCE 7-30-2011.

FOR: BELTS FOR CLOTHING; JACKETS, IN CLASS 25 (U.S. CLS. 22 AND 39).

FIRST USE 6-15-2011; IN COMMERCE 6-15-2011.

THE MARK CONSISTS OF STANDARD CHARACTERS WITHOUT CLAIM TO ANY PARTICULAR FONT, STYLE, SIZE, OR COLOR.

SN 85-092,431, FILED 7-26-2010.

JOHN E. MICHOS, EXAMINING ATTORNEY



David J. Kyffers

Director of the United States Patent and Trademark Office

United States of America

United States Patent and Trademark Office

RETASTE YOUR YOUTH. AT 40
PROOF.

Reg. No. 4,099,804

Registered Feb. 14, 2012

Int. Cl.: 33

TRADEMARK

PRINCIPAL REGISTER

ADULT BEVERAGE COMPANY (NEVADA CORPORATION)
SUITE F
5795 SOUTH SANDHILL ROAD
LAS VEGAS, NV 89120

FOR: ALCOHOLIC BEVERAGES, NAMELY, LIQUEURS AND FLAVORED SPIRITS; FROZEN BEVERAGES CONTAINING LIQUOR AND FLAVORED SPIRITS, IN CLASS 33 (U.S. CLS. 47 AND 49).

FIRST USE 2-1-2009; IN COMMERCE 9-1-2010.

THE MARK CONSISTS OF STANDARD CHARACTERS WITHOUT CLAIM TO ANY PARTICULAR FONT, STYLE, SIZE, OR COLOR.

SN 85-093,029, FILED 7-26-2010.

TRICIA SONNEBORN, EXAMINING ATTORNEY



David J. Kyffers

Director of the United States Patent and Trademark Office

United States of America

United States Patent and Trademark Office



Reg. No. 4,099,805

Registered Feb. 14, 2012

Int. Cl.: 41

SERVICE MARK

PRINCIPAL REGISTER

UNION ENTERTAINMENT GROUP, INC. (CALIFORNIA CORPORATION)
1323 NEWBURY ROAD
THOUSAND OAKS, CA 91320

FOR: MULTIMEDIA ENTERTAINMENT SERVICES IN THE NATURE OF RECORDING, PRODUCTION AND POST-PRODUCTION SERVICES IN THE FIELDS OF MUSIC, VIDEO, AND FILMS , IN CLASS 41 (U.S. CLS. 100, 101 AND 107).

FIRST USE 3-31-2009; IN COMMERCE 10-25-2010.

THE MARK CONSISTS OF A MICROPHONE SUPPORTED BY 3 UPSIDE DOWN ARCS. BELOW THERE IS THE STYLIZED TEXT "AUDIONEST".

SN 85-094,143, FILED 7-27-2010.

JORDAN BAKER, EXAMINING ATTORNEY



David J. Kyffers

Director of the United States Patent and Trademark Office

United States of America

United States Patent and Trademark Office

PREDATOR

Reg. No. 4,099,806

INCIPIO TECHNOLOGIES, INC. (CALIFORNIA CORPORATION)
1842 BARRANCA PKWY
IRVINE, CA 92606

Registered Feb. 14, 2012

Int. Cl.: 9

FOR: PROTECTIVE CASES AND CARRYING CASES FOR PORTABLE DEVICES, NAMELY, MOBILE PHONES AND MEDIA PLAYERS, IN CLASS 9 (U.S. CLS. 21, 23, 26, 36 AND 38).

TRADEMARK

FIRST USE 9-15-2011; IN COMMERCE 9-15-2011.

PRINCIPAL REGISTER

THE MARK CONSISTS OF STANDARD CHARACTERS WITHOUT CLAIM TO ANY PARTICULAR FONT, STYLE, SIZE, OR COLOR.

SN 85-094,236, FILED 7-27-2010.

JUSTINE D. PARKER, EXAMINING ATTORNEY



David J. Kybas

Director of the United States Patent and Trademark Office

United States of America

United States Patent and Trademark Office

Solutions That Move Supply Chains

Reg. No. 4,099,807

Registered Feb. 14, 2012

Int. Cl.: 35

SERVICE MARK

PRINCIPAL REGISTER

MATERIAL HANDLING INDUSTRY (PENNSYLVANIA CORPORATION), DBA MATERIAL HANDLING INDUSTRY OF AMERICA,
SUITE 201
8720 RED OAK BLVD.
CHARLOTTE, NC 282173992

FOR: ASSOCIATION SERVICES, NAMELY, PROMOTING THE INTERESTS OF THE MATERIAL HANDLING AND LOGISTICS INDUSTRY, IN CLASS 35 (U.S. CLS. 100, 101 AND 102).

FIRST USE 7-1-2010; IN COMMERCE 9-1-2010.

THE MARK CONSISTS OF STANDARD CHARACTERS WITHOUT CLAIM TO ANY PARTICULAR FONT, STYLE, SIZE, OR COLOR.

OWNER OF U.S. REG. NOS. 3,617,376 AND 3,644,744.

SN 85-094,993, FILED 7-28-2010.

JAMES MACFARLANE, EXAMINING ATTORNEY



David J. Kyffers

Director of the United States Patent and Trademark Office

United States of America

United States Patent and Trademark Office

AUTUM

Reg. No. 4,099,808

JASON AUSTIN LLC (NEVADA LIMITED LIABILITY COMPANY)
1631 E. DESERT INN ROAD
LAS VEGAS, NV 89101

Registered Feb. 14, 2012

Int. Cls.: 9, 12, and 18

FOR: CARRYING CASES FOR MOBILE COMPUTERS, IN CLASS 9 (U.S. CLS. 21, 23, 26, 36 AND 38).

TRADEMARK

FIRST USE 2-2-2011; IN COMMERCE 2-3-2011.

PRINCIPAL REGISTER

FOR: BICYCLES, IN CLASS 12 (U.S. CLS. 19, 21, 23, 31, 35 AND 44).

FIRST USE 2-3-2011; IN COMMERCE 2-3-2011.

FOR: WALLETS, IN CLASS 18 (U.S. CLS. 1, 2, 3, 22 AND 41).

FIRST USE 2-3-2011; IN COMMERCE 2-3-2011.

THE MARK CONSISTS OF STANDARD CHARACTERS WITHOUT CLAIM TO ANY PARTICULAR FONT, STYLE, SIZE, OR COLOR.

SN 85-095,416, FILED 7-28-2010.

BARBARA A. GOLD, EXAMINING ATTORNEY



David J. Kyros

Director of the United States Patent and Trademark Office

United States of America
United States Patent and Trademark Office

MASTROS

Reg. No. 4,099,809

Registered Feb. 14, 2012

Int. Cl.: 9

TRADEMARK

PRINCIPAL REGISTER

WMS GAMING INC. (DELAWARE CORPORATION)
800 SOUTH NORTHPOINT BOULEVARD
WAUKEGAN, IL 60085

FOR: COMPONENTS FOR GAMING MACHINES THAT GENERATE OR DISPLAY WAGER OUTCOMES, NAMELY, CONTROLLERS, DISPLAYS, BUTTON PANELS, BOLSTERS, ELECTRICAL WIRING, AND COMPUTER HARDWARE AND SOFTWARE ASSOCIATED THEREWITH; GAMING MACHINES, NAMELY, DEVICES WHICH ACCEPT A WAGER; GAMING SOFTWARE THAT GENERATES OR DISPLAYS WAGER OUTCOMES OF GAMING MACHINES, IN CLASS 9 (U.S. CLS. 21, 23, 26, 36 AND 38).

FIRST USE 5-20-2011; IN COMMERCE 5-20-2011.

THE MARK CONSISTS OF STANDARD CHARACTERS WITHOUT CLAIM TO ANY PARTICULAR FONT, STYLE, SIZE, OR COLOR.

THE NAME(S), PORTRAIT(S), AND/OR SIGNATURE(S) SHOWN IN THE MARK IDENTIFIES "MICHAEL MASTROPIETRO", WHOSE CONSENT(S) TO REGISTER IS MADE OF RECORD.

SN 85-095,575, FILED 7-29-2010.

JASON BLAIR, EXAMINING ATTORNEY



David J. Kyffers

Director of the United States Patent and Trademark Office

United States of America

United States Patent and Trademark Office

HOMEFREE

Reg. No. 4,099,810

Registered Feb. 14, 2012

Int. Cls.: 35 and 39

SERVICE MARK

PRINCIPAL REGISTER

WAL-MART STORES, INC. (DELAWARE CORPORATION)
702 SW 8TH STREET
BENTONVILLE, AR 727160520

FOR: RETAIL DEPARTMENT STORE SERVICES; RETAIL STORE SERVICES FEATURING A WIDE VARIETY OF CONSUMER GOODS OF OTHERS, IN CLASS 35 (U.S. CLS. 100, 101 AND 102).

FIRST USE 10-5-2011; IN COMMERCE 10-5-2011.

FOR: TRANSPORT AND DELIVERY OF GOODS, IN CLASS 39 (U.S. CLS. 100 AND 105).

FIRST USE 10-5-2011; IN COMMERCE 10-5-2011.

THE MARK CONSISTS OF STANDARD CHARACTERS WITHOUT CLAIM TO ANY PARTICULAR FONT, STYLE, SIZE, OR COLOR.

SN 85-095,620, FILED 7-29-2010.

COLLEEN KEARNEY, EXAMINING ATTORNEY



David J. Kyros

Director of the United States Patent and Trademark Office

United States of America

United States Patent and Trademark Office



Reg. No. 4,099,811

Registered Feb. 14, 2012

Int. Cl.: 33

TRADEMARK

PRINCIPAL REGISTER

ZIVENKO, SERGEY VIKTOROVICH (RUSSIAN FED. INDIVIDUAL)
KV.205, D.33, KUTUZOVSKY PROSPECT
MOSCOW, RUSSIAN FED. RU-121165

FOR: VODKA, IN CLASS 33 (U.S. CLS. 47 AND 49).

FIRST USE 11-21-2011; IN COMMERCE 11-21-2011.

OWNER OF U.S. REG. NO. 2,801,797.

THE COLOR(S) GOLD, BLACK, RED AND WHITE IS/ARE CLAIMED AS A FEATURE OF THE MARK.

NO CLAIM IS MADE TO THE EXCLUSIVE RIGHT TO USE "RUSSIAN", APART FROM THE MARK AS SHOWN.

THE MARK CONSISTS OF A REPRESENTATION OF A BOTTLE WITH A GOLD CAP, A BLACK NECKBAND WITH A THICK AND THIN GOLD LINING TOP AND BOTTOM, THE WORDS "RUSSIAN GOLD" APPEAR IN GOLD OUTLINED IN BLACK AND A RED RIBBON BELOW IT, ALL ON A WHITE DECORATIVE BACKGROUND ETCHED OVERLAPPING OPAQUE GLASS, ALONG WITH CROSS-HATCHED ETCHING ON THE BOTTLE, A BAND OF OPAQUE GLASS WITH WHITE BANDS TOP AND BOTTOM A DECORATIVE BASE CONSISTING OF A SERIES OF PARALLEL VERTICAL LINES WITH A HORIZONTAL LINE TOP AND BOTTOM. THE BROKEN LINES IN THE DRAWING INDICATE THE PLACEMENT OF THE MARK ON THE CONTAINER FOR THE GOODS. THE SHAPE OF THE BOTTLE IS NOT CLAIMED AS A FEATURE OF THE MARK.

SN 85-095,682, FILED 7-29-2010.

ESTHER A. BORSUK, EXAMINING ATTORNEY



David J. Kyros

Director of the United States Patent and Trademark Office

United States of America

United States Patent and Trademark Office

SUGAR HIGH

Reg. No. 4,099,812

SUGAR HIGH, LLC (D.C. LIMITED LIABILITY COMPANY)
3009 CAMBRIDGE PLACE NW
WASHINGTON, DC 20007

Registered Feb. 14, 2012

Int. Cls.: 35 and 43

FOR: RETAIL BAKERY SHOPS, IN CLASS 35 (U.S. CLS. 100, 101 AND 102).

SERVICE MARK

FIRST USE 11-0-2011; IN COMMERCE 11-0-2011.

PRINCIPAL REGISTER

FOR: CAFE-RESTAURANTS , IN CLASS 43 (U.S. CLS. 100 AND 101).

FIRST USE 11-0-2011; IN COMMERCE 11-0-2011.

THE MARK CONSISTS OF STANDARD CHARACTERS WITHOUT CLAIM TO ANY PARTICULAR FONT, STYLE, SIZE, OR COLOR.

SN 85-095,694, FILED 7-29-2010.

SUE LAWRENCE, EXAMINING ATTORNEY



David J. Kybas

Director of the United States Patent and Trademark Office

United States of America
United States Patent and Trademark Office

FENNOME

Reg. No. 4,099,813

HEIRZOOM BAKERY, LLC (NEW JERSEY LIMITED LIABILITY COMPANY)
P.O. BOX 8162

Registered Feb. 14, 2012

TURNERSVILLE, NJ 08012

Int. Cl.: 30

FOR: BAKERY GOODS, IN CLASS 30 (U.S. CL. 46).

TRADEMARK

FIRST USE 11-18-2011; IN COMMERCE 11-18-2011.

PRINCIPAL REGISTER

THE MARK CONSISTS OF STANDARD CHARACTERS WITHOUT CLAIM TO ANY PARTICULAR FONT, STYLE, SIZE, OR COLOR.

SN 85-096,498, FILED 7-30-2010.

LINDA ORNDORFF, EXAMINING ATTORNEY



David J. Kybas

Director of the United States Patent and Trademark Office

United States of America

United States Patent and Trademark Office

HEIRZOOM BAKERY

Reg. No. 4,099,814

HEIRZOOM BAKERY, LLC (NEW JERSEY LIMITED LIABILITY COMPANY)
P.O. BOX 8162

Registered Feb. 14, 2012

TURNERSVILLE, NJ 08012

Int. Cl.: 30

FOR: BAKERY GOODS, IN CLASS 30 (U.S. CL. 46).

TRADEMARK

FIRST USE 11-18-2011; IN COMMERCE 11-18-2011.

PRINCIPAL REGISTER

THE MARK CONSISTS OF STANDARD CHARACTERS WITHOUT CLAIM TO ANY PARTICULAR FONT, STYLE, SIZE, OR COLOR.

NO CLAIM IS MADE TO THE EXCLUSIVE RIGHT TO USE "BAKERY", APART FROM THE MARK AS SHOWN.

SN 85-096,501, FILED 7-30-2010.

LINDA ORNDORFF, EXAMINING ATTORNEY



David J. Kyffers

Director of the United States Patent and Trademark Office

United States of America

United States Patent and Trademark Office

PlentyofPros

Reg. No. 4,099,815

MAYA, MIGUEL A. (UNITED STATES INDIVIDUAL)
89-87 218TH PLACE
NEW YORK, NY 11427

Registered Feb. 14, 2012

Int. Cl.: 35

FOR: ONLINE BUSINESS DIRECTORIES FEATURING LISTINGS OF PROFESSIONAL SERVICE PROVIDERS, IN CLASS 35 (U.S. CLS. 100, 101 AND 102).

SERVICE MARK

FIRST USE 12-15-2011; IN COMMERCE 12-15-2011.

PRINCIPAL REGISTER

THE MARK CONSISTS OF STANDARD CHARACTERS WITHOUT CLAIM TO ANY PARTICULAR FONT, STYLE, SIZE, OR COLOR.

SN 85-097,486, FILED 7-31-2010.

JOHN E. MICHOS, EXAMINING ATTORNEY



David J. Kyffers

Director of the United States Patent and Trademark Office

United States of America

United States Patent and Trademark Office

Iron is King

Reg. No. 4,099,816

ANDREW CRAWFORD (UNITED STATES INDIVIDUAL)
905 BOWEN STREET
ATLANTA, GA 30318

Registered Feb. 14, 2012

Int. Cl.: 41

FOR: ENTERTAINMENT SERVICES IN THE NATURE OF CREATION, DEVELOPMENT, AND PRODUCTION OF TELEVISION PROGRAMMING, IN CLASS 41 (U.S. CLS. 100, 101 AND 107).

SERVICE MARK

FIRST USE 6-1-2010; IN COMMERCE 9-1-2010.

PRINCIPAL REGISTER

THE MARK CONSISTS OF STANDARD CHARACTERS WITHOUT CLAIM TO ANY PARTICULAR FONT, STYLE, SIZE, OR COLOR.

NO CLAIM IS MADE TO THE EXCLUSIVE RIGHT TO USE "IRON", APART FROM THE MARK AS SHOWN.

SN 85-099,790, FILED 8-4-2010.

DOMINIC J. FERRAIUOLO, EXAMINING ATTORNEY



David J. Kyffers

Director of the United States Patent and Trademark Office

United States of America

United States Patent and Trademark Office

Cornerstone Presentations

Reg. No. 4,099,817

Registered Feb. 14, 2012

Int. Cl.: 41

SERVICE MARK

PRINCIPAL REGISTER

SANDY CHARLES MODELL (UNITED STATES INDIVIDUAL), DBA CORNERSTONE PRESENTATIONS,
1404 ELM
1404
WINTER PARK, FL 32789

FOR: EDUCATIONAL AND ENTERTAINMENT SERVICES, NAMELY, PROVIDING SPEAKING SERVICES IN THE FIELD OF BUSINESS ETHICS AND BUSINESS COMMUNICATIONS, IN CLASS 41 (U.S. CLS. 100, 101 AND 107).

FIRST USE 11-21-2011; IN COMMERCE 11-21-2011.

THE MARK CONSISTS OF STANDARD CHARACTERS WITHOUT CLAIM TO ANY PARTICULAR FONT, STYLE, SIZE, OR COLOR.

NO CLAIM IS MADE TO THE EXCLUSIVE RIGHT TO USE "PRESENTATIONS", APART FROM THE MARK AS SHOWN.

SN 85-100,018, FILED 8-4-2010.

LESLEY LAMOTHE, EXAMINING ATTORNEY



David J. Kyffers

Director of the United States Patent and Trademark Office

United States of America

United States Patent and Trademark Office



Best Value Services, LLC

Reg. No. 4,099,818

Registered Feb. 14, 2012

**Int. Cls.: 35, 36, 37, 39,
40, and 42**

SERVICE MARK

PRINCIPAL REGISTER

BEST VALUE SERVICES, LLC (KANSAS LIMITED LIABILITY COMPANY)
SUITE 608
200 WEST DOUGLAS AVE
WICHITA, KS 67202

FOR: BUSINESS SERVICES, NAMELY, FACILITIES MANAGEMENT OF TECHNICAL OPERATIONS; ACCOUNTING SERVICES; BOOKKEEPING, IN CLASS 35 (U.S. CLS. 100, 101 AND 102).

FIRST USE 9-1-2011; IN COMMERCE 9-1-2011.

FOR: REAL ESTATE SERVICE, NAMELY, RENTAL PROPERTY MANAGEMENT, IN CLASS 36 (U.S. CLS. 100, 101 AND 102).

FIRST USE 4-15-2004; IN COMMERCE 9-1-2004.

FOR: JANITORIAL SERVICES; LAUNDRY SERVICES; DRY CLEANING; BUILDING MAINTENANCE AND REPAIR; CONSTRUCTION OF BUILDINGS, IN CLASS 37 (U.S. CLS. 100, 103 AND 106).

FIRST USE 4-15-2004; IN COMMERCE 9-1-2004.

FOR: JUNK REMOVAL, IN CLASS 39 (U.S. CLS. 100 AND 105).

FIRST USE 9-1-2011; IN COMMERCE 9-1-2011.

FOR: RECYCLING, IN CLASS 40 (U.S. CLS. 100, 103 AND 106).

FIRST USE 9-1-2011; IN COMMERCE 9-1-2011.

FOR: INFORMATION TECHNOLOGY CONSULTATION, IN CLASS 42 (U.S. CLS. 100 AND 101).

FIRST USE 9-1-2011; IN COMMERCE 9-1-2011.

NO CLAIM IS MADE TO THE EXCLUSIVE RIGHT TO USE "BEST VALUE SERVICES, LLC", APART FROM THE MARK AS SHOWN.

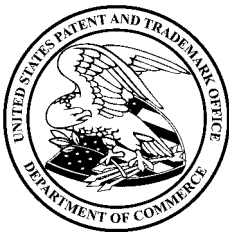

David J. Kyjars

Director of the United States Patent and Trademark Office

Reg. No. 4,099,818 THE MARK CONSISTS OF FOUR IMAGES OF INDIVIDUALS PERFORMING VARIOUS FUNCTIONS EACH WITHIN A SQUARE CARRIER. ONE IMAGE IS OF AN INDIVIDUAL PERFORMING A JANITORIAL FUNCTION, A SECOND IMAGE IS OF TWO INDIVIDUALS PERFORMING AN ADMINISTRATIVE FUNCTION, A THIRD IMAGE IS OF AN INDIVIDUAL PERFORMING A CONSTRUCTION FUNCTION, AND A FOURTH IMAGE IS OF AN INDIVIDUAL WORKING AT A COMPUTER STATION. TO THE RIGHT OF THESE IMAGES IS THE STYLIZED TEXT "BEST VALUE SERVICES, LLC".

SN 85-100,328, FILED 8-4-2010.

BARBARA RUTLAND, EXAMINING ATTORNEY

United States of America

United States Patent and Trademark Office

KONZA

Reg. No. 4,099,819

MARK MOSER (UNITED STATES INDIVIDUAL)
235 SUMMIT AVENUE
MANHATTAN, KS 66502

Registered Feb. 14, 2012

Int. Cl.: 11

FOR: SOLAR ENERGY RECEIVERS WHICH AUTOMATICALLY TRACK THE POSITION OF THE SUN, IN CLASS 11 (U.S. CLS. 13, 21, 23, 31 AND 34).

TRADEMARK

FIRST USE 11-30-2011; IN COMMERCE 11-30-2011.

PRINCIPAL REGISTER

THE MARK CONSISTS OF STANDARD CHARACTERS WITHOUT CLAIM TO ANY PARTICULAR FONT, STYLE, SIZE, OR COLOR.

SN 85-101,200, FILED 8-5-2010.

GINA HAYES, EXAMINING ATTORNEY



David J. Kyffers

Director of the United States Patent and Trademark Office

United States of America

United States Patent and Trademark Office

DESIGNED FOR VALUE

Reg. No. 4,099,820

Registered Feb. 14, 2012

Int. Cl.: 6

TRADEMARK

PRINCIPAL REGISTER

BELWITH PRODUCTS, LLC (DELAWARE LIMITED LIABILITY COMPANY), AKA HICKORY
HARDWARE,
3100 BROADWAY AVENUE SW
GRANDVILLE, MI 49418

FOR: METAL CABINET HARDWARE, NAMELY, PULLS, HANDLES AND KNOBS, COMMON
METAL DRAWER PULLS, METAL PULLS AND KNOBS FOR CABINETS, IN CLASS 6 (U.S.
CLS. 2, 12, 13, 14, 23, 25 AND 50).

FIRST USE 5-1-2011; IN COMMERCE 5-1-2011.

THE MARK CONSISTS OF STANDARD CHARACTERS WITHOUT CLAIM TO ANY PAR-
TICULAR FONT, STYLE, SIZE, OR COLOR.

SN 85-101,973, FILED 8-6-2010.

KELLEY WELLS, EXAMINING ATTORNEY



David J. Kybas

Director of the United States Patent and Trademark Office

United States of America

United States Patent and Trademark Office

Still Doing Opposite Pursuing Excellence

Reg. No. 4,099,821

KEILYN I. DAVIS (UNITED STATES INDIVIDUAL)
41 ELVA AVE

Registered Feb. 14, 2012

YOUNGSTOWN, OH 44512 AND

Int. Cl.: 9

BRAYLIN D. JONES-MCMULLEN (UNITED STATES INDIVIDUAL), AKA BRAYLIN D. JONES,

TRADEMARK

476 S RACCOON RD APT D40
AUSTINTOWN, OH 44515

PRINCIPAL REGISTER

FOR: VISUAL AND AUDIO RECORDINGS FEATURING MUSIC AND ARTISTIC PERFORMANCES, IN CLASS 9 (U.S. CLS. 21, 23, 26, 36 AND 38).

FIRST USE 1-1-2011; IN COMMERCE 3-1-2011.

THE MARK CONSISTS OF STANDARD CHARACTERS WITHOUT CLAIM TO ANY PARTICULAR FONT, STYLE, SIZE, OR COLOR.

SN 85-102,625, FILED 8-8-2010.

TASNEEM HUSSAIN, EXAMINING ATTORNEY



David J. Kyros

Director of the United States Patent and Trademark Office

United States of America

United States Patent and Trademark Office

TRQSS

Reg. No. 4,099,822

Registered Feb. 14, 2012

Int. Cl.: 12

TRADEMARK

PRINCIPAL REGISTER

TRQSS, INC. (CANADA CORPORATION)
333 BAY STREET
SUITE 2900
TORONTO, ONTARIO, CANADA M5H2T4

FOR: SECURITY HARNESS FOR VEHICLE SEATS; SAFETY BELTS FOR VEHICLE SEATS;
SEAT BELTS, IN CLASS 12 (U.S. CLS. 19, 21, 23, 31, 35 AND 44).

FIRST USE 3-1-2011; IN COMMERCE 3-1-2011.

THE MARK CONSISTS OF STANDARD CHARACTERS WITHOUT CLAIM TO ANY PAR-
TICULAR FONT, STYLE, SIZE, OR COLOR.

OWNER OF CANADA REG. NO. TMA798,657, DATED 5-26-2011, EXPIRES 5-26-2026.

SN 85-103,188, FILED 8-9-2010.

AISHA CLARKE, EXAMINING ATTORNEY



David J. Kybas

Director of the United States Patent and Trademark Office

United States of America

United States Patent and Trademark Office

SAFE-DRIVE

Reg. No. 4,099,823

Registered Feb. 14, 2012

Int. Cl.: 36

SERVICE MARK

PRINCIPAL REGISTER

SAFE-GUARD PRODUCTS INTERNATIONAL, LLC (GEORGIA LIMITED LIABILITY COMPANY)
3500 PIEDMONT ROAD, NE, SUITE 400
ATLANTA, GA 30305

FOR: PROVIDING VEHICLE SERVICES AGREEMENTS ON VEHICLES MANUFACTURED BY OTHERS FOR MECHANICAL BREAKDOWN AND SERVICING, IN CLASS 36 (U.S. CLS. 100, 101 AND 102).

FIRST USE 10-0-2010; IN COMMERCE 10-0-2010.

THE MARK CONSISTS OF STANDARD CHARACTERS WITHOUT CLAIM TO ANY PARTICULAR FONT, STYLE, SIZE, OR COLOR.

SN 85-103,852, FILED 8-10-2010.

ALEX KEAM, EXAMINING ATTORNEY



David J. Kyfos

Director of the United States Patent and Trademark Office

United States of America

United States Patent and Trademark Office

ULTRAZERO

Reg. No. 4,099,824

OXFORD & WELLS, LLC (TEXAS LIMITED LIABILITY COMPANY)
3102 MAPLE AVENUE, SUITE 450
DALLAS, TX 75201

Registered Feb. 14, 2012

Int. Cl.: 3

FOR: SHAVING CREAM AND SHAVING PREPARATIONS, IN CLASS 3 (U.S. CLS. 1, 4, 6, 50, 51 AND 52).

TRADEMARK

FIRST USE 2-21-2011; IN COMMERCE 2-21-2011.

PRINCIPAL REGISTER

THE MARK CONSISTS OF STANDARD CHARACTERS WITHOUT CLAIM TO ANY PARTICULAR FONT, STYLE, SIZE, OR COLOR.

SN 85-104,822, FILED 8-11-2010.

AMEEN IMAM, EXAMINING ATTORNEY



David J. Kybas

Director of the United States Patent and Trademark Office

United States of America

United States Patent and Trademark Office

SICKIESIZE

Reg. No. 4,099,825

HUBEN, JULIA (UNITED STATES INDIVIDUAL)
239 OAKLAND DRIVE
WILMINGTON, NC 28405

Registered Feb. 14, 2012

Int. Cl.: 18

FOR: ALL PURPOSE SPORT BAGS; BACKPACKS; BEACH BAGS; BOOK BAGS; BUM BAGS; COSMETIC BAGS SOLD EMPTY; HANDBAGS; SPORT BAGS; WALLETS, IN CLASS 18 (U.S. CLS. 1, 2, 3, 22 AND 41).

TRADEMARK

FIRST USE 1-1-2011; IN COMMERCE 1-7-2011.

PRINCIPAL REGISTER

THE MARK CONSISTS OF STANDARD CHARACTERS WITHOUT CLAIM TO ANY PARTICULAR FONT, STYLE, SIZE, OR COLOR.

SN 85-104,954, FILED 8-11-2010.

KAELIE KUNG, EXAMINING ATTORNEY



David J. Kybas

Director of the United States Patent and Trademark Office

United States of America

United States Patent and Trademark Office

K-W IGNITION

Reg. No. 4,099,826

K-W IGNITION COMPANY (ILLINOIS CORPORATION)
7727 ELM AVENUE

Registered Feb. 14, 2012

MACHESNEY PARK, IL 61115

Int. Cl.: 7

FOR: IGNITION COILS FOR FURNACES AND INTERNAL COMBUSTION ENGINES, IN CLASS 7 (U.S. CLS. 13, 19, 21, 23, 31, 34 AND 35).

TRADEMARK

FIRST USE 3-31-2010; IN COMMERCE 3-31-2010.

PRINCIPAL REGISTER

THE MARK CONSISTS OF STANDARD CHARACTERS WITHOUT CLAIM TO ANY PARTICULAR FONT, STYLE, SIZE, OR COLOR.

NO CLAIM IS MADE TO THE EXCLUSIVE RIGHT TO USE "IGNITION", APART FROM THE MARK AS SHOWN.

SN 85-105,386, FILED 8-11-2010.

YAT SYE, LEE, EXAMINING ATTORNEY



David J. Kyffers

Director of the United States Patent and Trademark Office

United States of America

United States Patent and Trademark Office



Reg. No. 4,099,827

Registered Feb. 14, 2012

Int. Cl.: 21

TRADEMARK

PRINCIPAL REGISTER

LETCHINGER, JOHN S. (UNITED STATES INDIVIDUAL)
SUITE 2800
225 WEST WACKER DRIVE
CHICAGO, IL 60606 AND

RING, THOMAS J. (UNITED STATES INDIVIDUAL)
225 WEST WACKER DRIVE, SUITE 2800
CHICAGO, IL 60606

FOR: DRINKING CONTAINER , IN CLASS 21 (U.S. CLS. 2, 13, 23, 29, 30, 33, 40 AND 50).

FIRST USE 8-13-2010; IN COMMERCE 8-13-2010.

THE MARK CONSISTS OF THE IMAGE OF A SHARK FIN ABOVE WATER WITH THE TEXT "FIN" LOCATED BELOW.

SN 85-105,481, FILED 8-11-2010.

MARC LEIPZIG, EXAMINING ATTORNEY



David J. Kybas

Director of the United States Patent and Trademark Office

United States of America

United States Patent and Trademark Office

Maasdam Pow'r Tow

Reg. No. 4,099,828

PULL'R HOLDING COMPANY, LLC (DELAWARE LIMITED LIABILITY COMPANY)
1000 GREENLEAF AVE.

Registered Feb. 14, 2012

ELK GROVE VILLAGE, IL 600075013

Int. Cl.: 12

FOR: MANUALLY OPERATED TOWING DEVICES FOR MOTOR VEHICLES, NAMELY, METAL LOCKING DEVICE FOR TRAILER HITCH COUPLERS, TRAILER HITCH BALL COVERS, TRAILER HITCH COVERS, TRAILER HITCHES AND VEHICLE TOW BARS, IN CLASS 12 (U.S. CLS. 19, 21, 23, 31, 35 AND 44).

TRADEMARK

PRINCIPAL REGISTER

FIRST USE 12-1-2011; IN COMMERCE 12-1-2011.

THE MARK CONSISTS OF STANDARD CHARACTERS WITHOUT CLAIM TO ANY PARTICULAR FONT, STYLE, SIZE, OR COLOR.

OWNER OF U.S. REG. NO. 2,606,813.

NO CLAIM IS MADE TO THE EXCLUSIVE RIGHT TO USE "TOW", APART FROM THE MARK AS SHOWN.

SN 85-105,591, FILED 8-11-2010.

ROBIN CHOSID, EXAMINING ATTORNEY



David J. Kyffers

Director of the United States Patent and Trademark Office

United States of America

United States Patent and Trademark Office



Reg. No. 4,099,829

Registered Feb. 14, 2012

Int. Cls.: 41 and 42

SERVICE MARK

PRINCIPAL REGISTER

RENSSELAER POLYTECHNIC INSTITUTE (NEW YORK CORPORATION)
3031 TROY BUILDING
110 EIGHTH STREET
TROY, NY 12180

FOR: EDUCATIONAL SERVICES, NAMELY, PROVIDING COURSES AT THE COLLEGE, GRADUATE AND PROFESSIONAL LEVELS, IN CLASS 41 (U.S. CLS. 100, 101 AND 107).

FIRST USE 12-23-2011; IN COMMERCE 12-23-2011.

FOR: TECHNOLOGICAL RESEARCH SERVICES IN THE FIELD OF SCIENCE, NAMELY, BIOLOGY, CHEMISTRY, CHEMICAL BIOLOGY, COMPUTER SCIENCE, INFORMATION TECHNOLOGY, EARTH AND ENVIRONMENTAL SCIENCE, LIGHTING, MATHEMATICAL SCIENCE, PHYSICS, APPLIED PHYSICS, ASTRONOMY, NANOTECHNOLOGY, COGNITIVE SCIENCE, PSYCHOLOGY, COMMUNICATIONS SCIENCE, ARTS AND COMMUNICATIONS SCIENCE, PHILOSOPHY, ELECTRONIC ARTS, ELECTRONIC MEDIA, GAMES AND SIMULATION, DESIGN AND INNOVATION; TECHNOLOGICAL RESEARCH SERVICES IN THE FIELD OF ENGINEERING, NAMELY, BIOMEDICAL ENGINEERING, CHEMICAL ENGINEERING, BIOLOGICAL ENGINEERING, CIVIL ENGINEERING, ENVIRONMENTAL ENGINEERING, DECISION SCIENCES AND ENGINEERING SYSTEMS, ELECTRICAL, COMPUTER AND SYSTEMS ENGINEERING, MATERIAL SCIENCE AND ENGINEERING, MECHANICAL AEROSPACE ENGINEERING, AND NUCLEAR ENGINEERING; TECHNOLOGICAL RESEARCH SERVICES IN THE FIELD OF ARCHITECTURE, NAMELY, BUILDING AND URBAN DESIGN, TECHNOLOGY AND BUILDING SCIENCE, ARCHITECTURAL LIGHTING, COMPUTATION DESIGN, AND ACOUSTICS, IN CLASS 42 (U.S. CLS. 100 AND 101).

FIRST USE 12-23-2011; IN COMMERCE 12-23-2011.

OWNER OF U.S. REG. NOS. 1,252,500, 1,261,985, AND 1,341,534.

THE COLOR(S) RED AND WHITE IS/ARE CLAIMED AS A FEATURE OF THE MARK.

THE MARK CONSISTS OF THE UPPER CASE LETTERS "RPI" IN RED ON A WHITE BACKGROUND INSIDE A RED CIRCLE.

SN 85-105,693, FILED 8-12-2010.



David J. Kyjars

Director of the United States Patent and Trademark Office

Reg. No. 4,099,829 SARA BENJAMIN, EXAMINING ATTORNEY

United States of America

United States Patent and Trademark Office

OUR BUSINESS IS YOU AND
YOUR FINANCIAL WELL-BEING

Reg. No. 4,099,830

RAYMOND JAMES FINANCIAL, INC. (FLORIDA CORPORATION)
880 CARILLON PARKWAY
ST. PETERSBURG, FL 33716

Registered Feb. 14, 2012

Int. Cl.: 36

FOR: FINANCIAL SERVICES, NAMELY, FINANCIAL PLANNING, FINANCIAL CONSULTING, ASSET MANAGEMENT AND INVESTMENT BROKERAGE SERVICES, IN CLASS 36 (U.S. CLS. 100, 101 AND 102).

SERVICE MARK

FIRST USE 4-30-2011; IN COMMERCE 4-30-2011.

PRINCIPAL REGISTER

THE MARK CONSISTS OF STANDARD CHARACTERS WITHOUT CLAIM TO ANY PARTICULAR FONT, STYLE, SIZE, OR COLOR.

SN 85-105,742, FILED 8-12-2010.

DOMINIC J. FERRAIUOLO, EXAMINING ATTORNEY



David J. Kybas

Director of the United States Patent and Trademark Office

United States of America

United States Patent and Trademark Office

SCRUBBIE DUBBIES

Reg. No. 4,099,831

BRADFORD SOAP WORKS, INC. (RHODE ISLAND CORPORATION)
200 PROVIDENCE STREET
WEST WARWICK, RI 02893

Registered Feb. 14, 2012

Int. Cl.: 21

FOR: SHOWER AND BATH CLEANSING PRODUCTS, NAMELY, BATH SPONGES, SHOWER SPONGES, MESH SPONGES, AND POUF MESH SPONGES, IN CLASS 21 (U.S. CLS. 2, 13, 23, 29, 30, 33, 40 AND 50).

TRADEMARK

FIRST USE 10-10-2011; IN COMMERCE 10-10-2011.

PRINCIPAL REGISTER

THE MARK CONSISTS OF STANDARD CHARACTERS WITHOUT CLAIM TO ANY PARTICULAR FONT, STYLE, SIZE, OR COLOR.

SN 85-105,928, FILED 8-12-2010.

KIMBERLY FRYE, EXAMINING ATTORNEY



David J. Kyffers

Director of the United States Patent and Trademark Office

United States of America

United States Patent and Trademark Office

BLACK DICE

Reg. No. 4,099,832

BLACK DICE INDUSTRIES LTD (UNITED KINGDOM LIMITED COMPANY (LTD.))
39 WATERLOO ROAD

Registered Feb. 14, 2012

LONDON NW2 7TT, UNITED KINGDOM

Int. Cl.: 14

FOR: PRECIOUS METALS AND THEIR ALLOYS; GOODS IN PRECIOUS METALS OR COATED THEREWITH, NAMELY, JEWELLERY, WATCHES, PRECIOUS STONES; HOROLOGICAL AND CHRONOMETRIC INSTRUMENTS, PARTS AND FITTINGS FOR ALL THE AFORESAID GOODS, IN CLASS 14 (U.S. CLS. 2, 27, 28 AND 50).

TRADEMARK

PRINCIPAL REGISTER

FIRST USE 0-0-2008; IN COMMERCE 0-0-2008.

THE MARK CONSISTS OF STANDARD CHARACTERS WITHOUT CLAIM TO ANY PARTICULAR FONT, STYLE, SIZE, OR COLOR.

SN 85-105,932, FILED 8-12-2010.

LESLIE RICHARDS, EXAMINING ATTORNEY



David J. Kybas

Director of the United States Patent and Trademark Office

United States of America

United States Patent and Trademark Office



Reg. No. 4,099,833

Registered Feb. 14, 2012

Int. Cls.: 39 and 42

SERVICE MARK

PRINCIPAL REGISTER

MONTEREY PENINSULA WATER MANAGEMENT DISTRICT (CALIFORNIA STATE AGENCY)
5 HARRIS COURT, BUILDING G
MONTEREY, CA 93940

FOR: WATER SUPPLY AND DISTRIBUTION SERVICES, IN CLASS 39 (U.S. CLS. 100 AND 105).

FIRST USE 7-1-2010; IN COMMERCE 8-1-2010.

FOR: HYDROLOGIC STUDY OF SURFACE AND GROUND WATER, IN CLASS 42 (U.S. CLS. 100 AND 101).

FIRST USE 7-1-2010; IN COMMERCE 8-1-2010.

NO CLAIM IS MADE TO THE EXCLUSIVE RIGHT TO USE "MONTEREY PENINSULA WATER MANAGEMENT DISTRICT", APART FROM THE MARK AS SHOWN.

THE COLOR(S) BLUE, GREEN, BLACK AND WHITE IS/ARE CLAIMED AS A FEATURE OF THE MARK.

THE MARK CONSISTS OF A WATER DROP THAT TAKES PLACE OF THE "A" IN "WATER." THE WATER DROP IS BLUE ON THE TOP, GREEN ON THE BOTTOM, WITH A WAVY WHITE SPACE IN BETWEEN. THE REST OF THE WORD "WATER" IS IN BLUE; "MONTEREY PENINSULA" AND "MANAGEMENT DISTRICT" ARE IN BLACK.

SN 85-106,349, FILED 8-12-2010.

PAUL E. FAHRENKOPF, EXAMINING ATTORNEY



David J. Kyffers

Director of the United States Patent and Trademark Office

United States of America
United States Patent and Trademark Office

DOUGH

Reg. No. 4,099,834

MALOUF MARKETING, INC. (UTAH CORPORATION), DBA MALOUF FINE LINENS,
1189 WEST 1700 NORTH #B
LOGAN, UT 84321

Registered Feb. 14, 2012

Int. Cl.: 20

FOR: MEMORY FOAM SLEEP PRODUCTS, NAMELY, PILLOWS, IN CLASS 20 (U.S. CLS.
2, 13, 22, 25, 32 AND 50).

TRADEMARK

FIRST USE 8-1-2010; IN COMMERCE 8-1-2010.

PRINCIPAL REGISTER

THE MARK CONSISTS OF STANDARD CHARACTERS WITHOUT CLAIM TO ANY PAR-
TICULAR FONT, STYLE, SIZE, OR COLOR.

SN 85-107,676, FILED 8-14-2010.

CHARISMA HAMPTON, EXAMINING ATTORNEY



David J. Kybas

Director of the United States Patent and Trademark Office

United States of America

United States Patent and Trademark Office

STACK 'N SNACK

Reg. No. 4,099,835

EVRIHOLDER PRODUCTS LLC (INDIANA LIMITED LIABILITY COMPANY)
1500 SOUTH LEWIS STREET
ANAHEIM, CA 92860

Registered Feb. 14, 2012

Int. Cl.: 21

FOR: PLASTIC PLATES, IN CLASS 21 (U.S. CLS. 2, 13, 23, 29, 30, 33, 40 AND 50).

TRADEMARK

FIRST USE 2-7-2011; IN COMMERCE 3-8-2011.

PRINCIPAL REGISTER

THE MARK CONSISTS OF STANDARD CHARACTERS WITHOUT CLAIM TO ANY PARTICULAR FONT, STYLE, SIZE, OR COLOR.

SN 85-107,706, FILED 8-14-2010.

BARNEY CHARLON, EXAMINING ATTORNEY



David J. Kyffers

Director of the United States Patent and Trademark Office

United States of America

United States Patent and Trademark Office

TRUTH CULTURE DECODER

Reg. No. 4,099,836

TRUTH CONSULTING NY INC. (NEW YORK CORPORATION)

Registered Feb. 14, 2012

306 GOLD STREET, #23A
BROOKLYN, NY 11201

Int. Cl.: 35

FOR: BRANDING SERVICES, NAMELY, CONSULTING, DEVELOPMENT, MANAGEMENT AND MARKETING OF BRANDS FOR BUSINESSES, IN CLASS 35 (U.S. CLS. 100, 101 AND 102).

SERVICE MARK

FIRST USE 4-17-2009; IN COMMERCE 4-17-2009.

PRINCIPAL REGISTER

THE MARK CONSISTS OF STANDARD CHARACTERS WITHOUT CLAIM TO ANY PARTICULAR FONT, STYLE, SIZE, OR COLOR.

SN 85-108,014, FILED 8-16-2010.

JEFF DEFORD, EXAMINING ATTORNEY



David J. Kyffers

Director of the United States Patent and Trademark Office

United States of America

United States Patent and Trademark Office

SURFA-SHIELD

Reg. No. 4,099,837

SHIELD INDUSTRIES, INC. (KANSAS CORPORATION)
P.O. BOX 687

Registered Feb. 14, 2012

HUTCHINSON, KS 675040687

Int. Cl.: 7

FOR: MACHINE PARTS, NAMELY, TILLAGE BLADES FOR CUTTING THROUGH SOIL,
IN CLASS 7 (U.S. CLS. 13, 19, 21, 23, 31, 34 AND 35).

TRADEMARK

FIRST USE 6-15-2011; IN COMMERCE 6-15-2011.

PRINCIPAL REGISTER

THE MARK CONSISTS OF STANDARD CHARACTERS WITHOUT CLAIM TO ANY PAR-
TICULAR FONT, STYLE, SIZE, OR COLOR.

SN 85-108,353, FILED 8-16-2010.

BRIAN CALLAGHAN, EXAMINING ATTORNEY



David J. Kybas

Director of the United States Patent and Trademark Office

United States of America

United States Patent and Trademark Office

OT FIT

Reg. No. 4,099,838

Registered Feb. 14, 2012

Int. Cl.: 41

SERVICE MARK

PRINCIPAL REGISTER

ULTIMATE FITNESS GROUP, LLC (DELAWARE LIMITED LIABILITY COMPANY)
1815 CORDOVA ROAD, SUITE 206
FORT LAUDERDALE, FL 33316

FOR: PROVIDING FITNESS AND EXERCISE FACILITIES; HEALTH CLUB SERVICES, NAMELY, PROVIDING INSTRUCTIONS AND EQUIPMENT IN THE FIELD OF PHYSICAL EXERCISE, IN CLASS 41 (U.S. CLS. 100, 101 AND 107).

FIRST USE 11-22-2011; IN COMMERCE 11-22-2011.

THE MARK CONSISTS OF STANDARD CHARACTERS WITHOUT CLAIM TO ANY PARTICULAR FONT, STYLE, SIZE, OR COLOR.

NO CLAIM IS MADE TO THE EXCLUSIVE RIGHT TO USE "OT", APART FROM THE MARK AS SHOWN.

SN 85-108,571, FILED 8-16-2010.

KATHERINE STOIDES, EXAMINING ATTORNEY



David J. Kyros

Director of the United States Patent and Trademark Office

United States of America

United States Patent and Trademark Office

SNACKBERRY

Reg. No. 4,099,839

Registered Feb. 14, 2012

Int. Cl.: 29

TRADEMARK

PRINCIPAL REGISTER

PETCHERSKI, MICHAEL (CANADA INDIVIDUAL)
701 DOVERCOURT ROAD
SUITE 308
TORONTO, CANADA M6H 0A1

FOR: SNACK FOODS, NAMELY, FRUIT CHIPS, FRUIT SALADS, DRIED FRUITS AND VEGETABLES; FRUIT-BASED SNACK FOOD AND NUT AND FRUIT-BASED SNACK FOOD, IN CLASS 29 (U.S. CL. 46).

FIRST USE 1-1-2010; IN COMMERCE 7-1-2011.

THE MARK CONSISTS OF STANDARD CHARACTERS WITHOUT CLAIM TO ANY PARTICULAR FONT, STYLE, SIZE, OR COLOR.

SN 85-109,922, FILED 8-18-2010.

JEFF DEFORD, EXAMINING ATTORNEY



David J. Kybas

Director of the United States Patent and Trademark Office

United States of America

United States Patent and Trademark Office

DZONE

Reg. No. 4,099,840

Registered Feb. 14, 2012

**Int. Cls.: 9, 16, 25, 35,
and 41**

TRADEMARK

SERVICE MARK

PRINCIPAL REGISTER

DZONE, INC. (NORTH CAROLINA CORPORATION)
140 PRESTON EXECUTIVE DRIVE
CARY, NC 27513

FOR: COMPUTER OPERATING SOFTWARE; COMPUTER SOFTWARE DEVELOPMENT TOOLS, IN CLASS 9 (U.S. CLS. 21, 23, 26, 36 AND 38).

FIRST USE 9-1-2011; IN COMMERCE 9-1-2011.

FOR: PRINTED EDUCATIONAL MATERIALS IN THE FIELD OF COMPUTER SOFTWARE DESIGN AND DEVELOPMENT, IN CLASS 16 (U.S. CLS. 2, 5, 22, 23, 29, 37, 38 AND 50).

FIRST USE 2-1-2006; IN COMMERCE 2-1-2006.

FOR: ATHLETIC APPAREL, NAMELY, SHIRTS, PANTS, JACKETS, FOOTWEAR, HATS AND CAPS, ATHLETIC UNIFORMS, IN CLASS 25 (U.S. CLS. 22 AND 39).

FIRST USE 2-1-2006; IN COMMERCE 2-1-2006.

FOR: ADVERTISING SERVICES, IN CLASS 35 (U.S. CLS. 100, 101 AND 102).

FIRST USE 2-1-2006; IN COMMERCE 2-1-2006.

FOR: PROVIDING ONLINE, NON-DOWNLOADABLE PUBLICATIONS, NAMELY, BLOGS IN THE FIELD OF COMPUTER SOFTWARE DESIGN AND DEVELOPMENT, IN CLASS 41 (U.S. CLS. 100, 101 AND 107).

FIRST USE 2-1-2006; IN COMMERCE 2-1-2006.

THE MARK CONSISTS OF STANDARD CHARACTERS WITHOUT CLAIM TO ANY PARTICULAR FONT, STYLE, SIZE, OR COLOR.

SN 85-110,576, FILED 8-18-2010.

LINDA LAVACHE, EXAMINING ATTORNEY



David J. Kyros

Director of the United States Patent and Trademark Office

United States of America

United States Patent and Trademark Office

WOWZAMART

Reg. No. 4,099,841

Registered Feb. 14, 2012

Int. Cl.: 35

SERVICE MARK

PRINCIPAL REGISTER

UNITED NATURAL FOODS, INC. (DELAWARE CORPORATION)
313 IRON HORSE WAY
PROVIDENCE, RI 02908

FOR: PROVIDING CONSUMER PRODUCT INFORMATION, PRODUCT CATEGORY INFORMATION, PRODUCT MERCHANDISING INFORMATION, AND PRODUCT MARKETING INFORMATION VIA THE INTERNET FOR RETAILERS OF FOOD AND BEVERAGES, NUTRITIONAL SUPPLEMENTS, PERSONAL CARE AND NON-FOOD GROCERY PRODUCTS, IN CLASS 35 (U.S. CLS. 100, 101 AND 102).

FIRST USE 10-14-2010; IN COMMERCE 10-14-2010.

THE MARK CONSISTS OF STANDARD CHARACTERS WITHOUT CLAIM TO ANY PARTICULAR FONT, STYLE, SIZE, OR COLOR.

SN 85-112,308, FILED 8-20-2010.

DAVID TAYLOR, EXAMINING ATTORNEY



David J. Kyfos

Director of the United States Patent and Trademark Office

United States of America

United States Patent and Trademark Office



Reg. No. 4,099,842

Registered Feb. 14, 2012

Int. Cl.: 19

TRADEMARK

PRINCIPAL REGISTER

GRANITIFIANDRE S.P.A. (ITALY CORPORATION)
112, VIA RADICI NORD
CASTELLARANO, ITALY 1040214

FOR: NON-METALLIC BUILDING MATERIALS, NAMELY, MARBLE, GRANITE AND STONE FOR COVERING WALLS AND FLOORS; NON-METALLIC BUILDING TILES; CERAMIC TILES; MATERIALS FOR COVERING FLOORS AND WALLS INCLUDING COVERINGS OF CERAMIC AND STONWARE, NAMELY, CERAMIC TILES AND STONE TILES FOR FLOOR AND WALL COVERING, IN CLASS 19 (U.S. CLS. 1, 12, 33 AND 50).

FIRST USE 6-30-2011; IN COMMERCE 6-30-2010.

OWNER OF U.S. REG. NO. 1,605,563.

NO CLAIM IS MADE TO THE EXCLUSIVE RIGHT TO USE "USA" AND "ARCHITECTURAL SURFACES", APART FROM THE MARK AS SHOWN.

THE MARK CONSISTS OF THE WORDS "FIANDRE" AND "USA" WRITTEN IN LARGE BLOCK CAPITAL LETTERS, BEFORE THE AFORE MENTIONED WORD THERE IS THE STYLIZED REPRESENTATION OF A LETTER "F" WRITTEN IN A CAPITAL LETTER PUT INSIDE A SLANTED SQUARE IN A CONTRASTING SHADE. BELOW THE WORDS "FIANDRE" AND "USA" ARE THE WORDS "ARCHITECTURAL" AND "SURFACES" IN SMALLER BLOCK LETTERS.

THE ENGLISH TRANSLATION OF "FIANDRE" IN THE MARK IS "FLANDERS".

SN 85-112,436, FILED 8-20-2010.

BRIAN NEVILLE, EXAMINING ATTORNEY



David J. Kyros

Director of the United States Patent and Trademark Office

United States of America

United States Patent and Trademark Office

AGAIN

Reg. No. 4,099,843

Registered Feb. 14, 2012

Int. Cl.: 25

TRADEMARK

PRINCIPAL REGISTER

AGAIN APPAREL, LLC (DELAWARE LIMITED LIABILITY COMPANY)
6260 LOOKOUT ROAD
BOULDER, CO 80301

FOR: JACKETS; PANTS; SHIRTS, IN CLASS 25 (U.S. CLS. 22 AND 39).

FIRST USE 11-30-2010; IN COMMERCE 11-30-2010.

THE MARK CONSISTS OF STANDARD CHARACTERS WITHOUT CLAIM TO ANY PARTICULAR FONT, STYLE, SIZE, OR COLOR.

SN 85-112,720, FILED 8-20-2010.

JAMES STEIN, EXAMINING ATTORNEY



David J. Kybas

Director of the United States Patent and Trademark Office

United States of America

United States Patent and Trademark Office

COACH QUOTES

Reg. No. 4,099,844

TAYLOR, ROBERT (UNITED STATES INDIVIDUAL)
705 BRAY CENTRAL DRIVE, #3301
ALLEN, TX 75013

Registered Feb. 14, 2012

Int. Cl.: 28

FOR: BALLS FOR SPORTS; FOOTBALLS, IN CLASS 28 (U.S. CLS. 22, 23, 38 AND 50).

TRADEMARK

FIRST USE 4-1-2011; IN COMMERCE 4-1-2011.

PRINCIPAL REGISTER

THE MARK CONSISTS OF STANDARD CHARACTERS WITHOUT CLAIM TO ANY PARTICULAR FONT, STYLE, SIZE, OR COLOR.

SN 85-112,997, FILED 8-22-2010.

DOMINIC FATHY, EXAMINING ATTORNEY



David J. Kyffers

Director of the United States Patent and Trademark Office

United States of America

United States Patent and Trademark Office



Reg. No. 4,099,845

Registered Feb. 14, 2012

Int. Cl.: 30

TRADEMARK

PRINCIPAL REGISTER

AMERICAN RICE, INC. (DELAWARE CORPORATION)
10700 NORTH FREEWAY
SUITE 800
HOUSTON, TX 77037

FOR: RICE, IN CLASS 30 (U.S. CL. 46).

FIRST USE 8-0-2010; IN COMMERCE 8-0-2010.

OWNER OF U.S. REG. NO. 837,239.

NO CLAIM IS MADE TO THE EXCLUSIVE RIGHT TO USE "U.S. FINEST #1 QUALITY",
APART FROM THE MARK AS SHOWN.

THE MARK CONSISTS OF AN AWARD RIBBON DESIGN WITH TWO TAILS AND THE
WORDS "U.S. FINEST QUALITY #1" IN THE CENTER.

SN 85-114,487, FILED 8-24-2010.

REGINA DRUMMOND, EXAMINING ATTORNEY



David J. Kybas

Director of the United States Patent and Trademark Office

United States of America

United States Patent and Trademark Office

ELAT

Reg. No. 4,099,846

Registered Feb. 14, 2012

Int. Cl.: 9

TRADEMARK

PRINCIPAL REGISTER

NUVANT SYSTEMS INC. (INDIANA CORPORATION)
9800 CONNECTICUT DRIVE
CROWN POINT, IN 46307

FOR: ELECTRIC CONDUCTORS, NAMELY, CHEMICALLY TREATED CARBON CLOTH FOR USE IN ELECTRO-CHEMICAL DEVICES, IN CLASS 9 (U.S. CLS. 21, 23, 26, 36 AND 38).

FIRST USE 11-4-1996; IN COMMERCE 11-4-1996.

THE MARK CONSISTS OF STANDARD CHARACTERS WITHOUT CLAIM TO ANY PARTICULAR FONT, STYLE, SIZE, OR COLOR.

THE WORDING "ELAT" HAS NO MEANING IN A FOREIGN LANGUAGE.

SN 85-114,513, FILED 8-24-2010.

MICHAEL GAAFAR, EXAMINING ATTORNEY



David J. Kybas

Director of the United States Patent and Trademark Office

United States of America

United States Patent and Trademark Office



BLUE RIBBON

Reg. No. 4,099,847

Registered Feb. 14, 2012

Int. Cl.: 30

TRADEMARK

PRINCIPAL REGISTER

AMERICAN RICE, INC. (DELAWARE CORPORATION)
10700 NORTH FREEWAY
SUITE 800
HOUSTON, TX 77037

FOR: RICE, IN CLASS 30 (U.S. CL. 46).

FIRST USE 8-0-2010; IN COMMERCE 8-0-2010.

OWNER OF U.S. REG. NOS. 106,694 AND 837,239.

NO CLAIM IS MADE TO THE EXCLUSIVE RIGHT TO USE "U.S. FINEST #1 QUALITY", APART FROM THE MARK AS SHOWN.

THE MARK CONSISTS OF AN AWARD RIBBON DESIGN WITH TWO TAILS AND THE WORDS "U.S. FINEST QUALITY #1" IN THE CENTER OF IT AND THE WORDS "BLUE RIBBON" TO THE RIGHT OF THE RIBBON DESIGN.

SN 85-114,608, FILED 8-24-2010.

REGINA DRUMMOND, EXAMINING ATTORNEY



David J. Kybas

Director of the United States Patent and Trademark Office

United States of America

United States Patent and Trademark Office

WILD HUSKIES

Reg. No. 4,099,848

Registered Feb. 14, 2012

Int. Cl.: 9

TRADEMARK

PRINCIPAL REGISTER

BALLY GAMING, INC. (NEVADA CORPORATION), DBA BALLY TECHNOLOGIES,
ATTN: PAMELA BOWSHER, LAW DEPT.
6601 SOUTH BERMUDA ROAD
LAS VEGAS, NV 89119

FOR: GAMING MACHINES, NAMELY, DEVICES WHICH ACCEPT A WAGER AND GAMING SOFTWARE THAT GENERATES OR DISPLAYS OUTCOMES FOR GAMING MACHINES, IN CLASS 9 (U.S. CLS. 21, 23, 26, 36 AND 38).

FIRST USE 1-20-2011; IN COMMERCE 1-20-2011.

THE MARK CONSISTS OF STANDARD CHARACTERS WITHOUT CLAIM TO ANY PARTICULAR FONT, STYLE, SIZE, OR COLOR.

SN 85-115,001, FILED 8-24-2010.

KATINA MISTER, EXAMINING ATTORNEY



David J. Kyffers

Director of the United States Patent and Trademark Office

United States of America

United States Patent and Trademark Office



Reg. No. 4,099,849

Registered Feb. 14, 2012

Int. Cls.: 3, 5, and 10

TRADEMARK

PRINCIPAL REGISTER

DEN-MAT HOLDINGS, LLC (DELAWARE LIMITED LIABILITY COMPANY)
2727 SKYWAY DRIVE
SANTA MARIA, CA 93455

FOR: DENTAL CLEANING AND POLISHING MATERIALS, NAMELY, LIQUIDS USED IN THE CLEANING AND POLISHING OF NATURAL AND ARTIFICIAL TEETH, IN CLASS 3 (U.S. CLS. 1, 4, 6, 50, 51 AND 52).

FIRST USE 6-0-2011; IN COMMERCE 6-0-2011.

FOR: DENTAL PREPARATIONS, NAMELY, ENAMEL SUBSTANCES FOR REPAIRING TEETH, BONDING MATERIALS, DRYING AGENTS FOR THE PURPOSES OF TOOTH REPAIR, MOLDING WAX, MATERIAL FOR REPAIRING TEETH AND FOR DENTAL CROWNS AND BRIDGES, DENTAL CEMENT, DENTAL STOPPINGS, AMALGAM AND ALLOYS FOR DENTAL PURPOSES; ETCHANTS IN THE NATURE OF SEALANTS AND ADHESIVES FOR DENTURES; DENTAL RESTORATION MATERIALS IN THE NATURE OF MATERIAL FOR REPAIRING TEETH AND FOR DENTAL CROWNS AND BRIDGES, NAMELY, TOOTH REPAIR PASTES, CEMENTS, POSTS, BASE LINERS, AND DENTAL CAPS, NAMELY, PULP CAPPERS, IN CLASS 5 (U.S. CLS. 6, 18, 44, 46, 51 AND 52).

FIRST USE 6-0-2011; IN COMMERCE 6-0-2011.

FOR: DENTAL APPARATUS, NAMELY, INTRA-ORAL LIGHT SYSTEMS FOR CURING, WHITENING, LESION DETECTION AND SOFT TISSUE MANAGEMENT; REMOVABLE PROSTHETIC, ORTHODONTIC AND COSMETIC DENTAL APPLIANCES, NAMELY, FLEXIBLE BITE GUARDS, NIGHT GUARDS, ANTIBRUXISM APPLIANCES, ORTHODONTIC APPLIANCES, FULL OR PARTIAL DENTURES, FIXED OR REMOVABLE DENTAL BRIDGES, DENTAL PLATES OF FALSE TEETH, TEMPORARY DENTAL IMPLANTS, BITE CORRECTORS, MOUTH GUARDS FOR MEDICAL PURPOSES IN THE NATURE OF SNORE GUARDS, PERIODONTAL SPLINTS, IN CLASS 10 (U.S. CLS. 26, 39 AND 44).

FIRST USE 6-0-2011; IN COMMERCE 6-0-2011.

OWNER OF U.S. REG. NO. 1,145,375.

THE COLOR(S) DARK BLUE AND LIGHT BLUE IS/ARE CLAIMED AS A FEATURE OF THE MARK.



David J. Kyjars

Director of the United States Patent and Trademark Office

Reg. No. 4,099,849 NO CLAIM IS MADE TO THE EXCLUSIVE RIGHT TO USE "DENTAL TECHNOLOGIES", APART FROM THE MARK AS SHOWN.

THE MARK CONSISTS OF THE LETTERS "DM" LIGHT BLUE AND DARK BLUE ABOVE THE WORD "DENMAT" IN DARK BLUE WITH A VERTICAL LINE IN THE COLOR LIGHT BLUE WITH THE WORDS "INNOVATIVE" "DENTAL" AND "TECHNOLOGIES" ON THREE SEPARATE LINES TO THE RIGHT IN THE COLOR DARK BLUE.

SN 85-116,589, FILED 8-26-2010.

JUSTINE D. PARKER, EXAMINING ATTORNEY

United States of America

United States Patent and Trademark Office

DUROSCOPE

Reg. No. 4,099,850

FMD, LLC (VIRGINIA LIMITED LIABILITY COMPANY)
7200 TELEGRAPH SQ DR. SUITE A
LORTON, VA 22079

Registered Feb. 14, 2012

Int. Cl.: 10

FOR: ENDOSCOPIC EQUIPMENT; RIGID AND FLEXIBLE MEDICAL ENDOSCOPES, IN CLASS 10 (U.S. CLS. 26, 39 AND 44).

TRADEMARK

FIRST USE 3-31-2011; IN COMMERCE 9-30-2011.

PRINCIPAL REGISTER

THE MARK CONSISTS OF STANDARD CHARACTERS WITHOUT CLAIM TO ANY PARTICULAR FONT, STYLE, SIZE, OR COLOR.

SN 85-117,306, FILED 8-27-2010.

EMILY CHUO, EXAMINING ATTORNEY



David J. Kybas

Director of the United States Patent and Trademark Office

United States of America

United States Patent and Trademark Office

PERFECTDRIVER.COM

Reg. No. 4,099,851

STAUFFER & STAUFFER, LLC (NEBRASKA LIMITED LIABILITY COMPANY)
5430 HEUMANN DRIVE
LINCOLN, NE 68504

Registered Feb. 14, 2012

Int. Cl.: 45

FOR: DRIVER SAFETY MONITORING SERVICES FOR PARENTS WITH TEENAGE DRIVERS WITH THE PURPOSE OF RECEIVING REPORTS CONCERNING TEENAGER DRIVING PERFORMANCE FROM OTHER DRIVERS AND NOTIFYING PARENTS OF THE OBSERVED PERFORMANCE, IN CLASS 45 (U.S. CLS. 100 AND 101).

SERVICE MARK

PRINCIPAL REGISTER

FIRST USE 10-0-2010; IN COMMERCE 10-0-2010.

THE MARK CONSISTS OF STANDARD CHARACTERS WITHOUT CLAIM TO ANY PARTICULAR FONT, STYLE, SIZE, OR COLOR.

SN 85-117,740, FILED 8-27-2010.

KELLY CHOE, EXAMINING ATTORNEY



David J. Kybas

Director of the United States Patent and Trademark Office

United States of America

United States Patent and Trademark Office

D'MAND/D'MISER

Reg. No. 4,099,852

OSCAR E. ONTIVEROS (UNITED STATES INDIVIDUAL)
4329 ALTURA AVENUE
EL PASO, TX 79903

Registered Feb. 14, 2012

Int. Cl.: 9

FOR: CONTROLLERS, NAMELY, ELECTRONIC CONTROLLERS; ELECTRONIC CONTROLLERS FOR ELECTRIC DEVICES; ELECTRONIC CONTROLLERS FOR REDUCING POWER CONSUMPTION, IN CLASS 9 (U.S. CLS. 21, 23, 26, 36 AND 38).

TRADEMARK

FIRST USE 2-1-2011; IN COMMERCE 2-1-2011.

PRINCIPAL REGISTER

THE MARK CONSISTS OF STANDARD CHARACTERS WITHOUT CLAIM TO ANY PARTICULAR FONT, STYLE, SIZE, OR COLOR.

SN 85-117,851, FILED 8-27-2010.

ANGELA DUONG, EXAMINING ATTORNEY



David J. Kyffers

Director of the United States Patent and Trademark Office

United States of America

United States Patent and Trademark Office

D'M/D'M

Reg. No. 4,099,853

OSCAR E. ONTIVEROS (UNITED STATES INDIVIDUAL)
4329 ALTURA AVENUE
EL PASO, TX 79903

Registered Feb. 14, 2012

Int. Cl.: 9

FOR: CONTROLLERS, NAMELY, ELECTRONIC CONTROLLERS; ELECTRONIC CONTROLLERS FOR ELECTRIC DEVICES; ELECTRONIC CONTROLLERS FOR REDUCING POWER CONSUMPTION, IN CLASS 9 (U.S. CLS. 21, 23, 26, 36 AND 38).

TRADEMARK

FIRST USE 3-1-2010; IN COMMERCE 3-1-2010.

PRINCIPAL REGISTER

THE MARK CONSISTS OF STANDARD CHARACTERS WITHOUT CLAIM TO ANY PARTICULAR FONT, STYLE, SIZE, OR COLOR.

SN 85-117,858, FILED 8-27-2010.

ANGELA DUONG, EXAMINING ATTORNEY



David J. Kyffers

Director of the United States Patent and Trademark Office

United States of America

United States Patent and Trademark Office

Supernova

Reg. No. 4,099,854

Registered Feb. 14, 2012

Int. Cl.: 16

TRADEMARK

PRINCIPAL REGISTER

SUPERNOVA CONSULTING GROUP, LLC (FLORIDA LIMITED LIABILITY COMPANY)
351 PILOT POINT LANE
BOCA GRANDE, FL 33921

FOR: A SERIES OF BOOKS, WRITTEN ARTICLES, HANDOUTS AND WORKSHEETS IN THE FIELD OF CAREER ADVISING, IN CLASS 16 (U.S. CLS. 2, 5, 22, 23, 29, 37, 38 AND 50).

FIRST USE 9-2-2011; IN COMMERCE 9-2-2011.

THE MARK CONSISTS OF STANDARD CHARACTERS WITHOUT CLAIM TO ANY PARTICULAR FONT, STYLE, SIZE, OR COLOR.

SN 85-118,948, FILED 8-30-2010.

MARGARET POWER, EXAMINING ATTORNEY



David J. Kybas

Director of the United States Patent and Trademark Office

United States of America

United States Patent and Trademark Office

CERTUS

Reg. No. 4,099,855

Registered Feb. 14, 2012

Int. Cl.: 10

TRADEMARK

PRINCIPAL REGISTER

NEUWAVE MEDICAL, INC. (WISCONSIN CORPORATION)
3529 ANDERSON STREET
MADISON, WI 53704

FOR: SURGICAL AND MEDICAL APPARATUS AND INSTRUMENTS, NAMELY, MEDICAL AND SURGICAL DEVICES FOR APPLYING ELECTROMAGNETIC ENERGY TO HUMAN OR ANIMAL TISSUE AND ORGANS, IN CLASS 10 (U.S. CLS. 26, 39 AND 44).

FIRST USE 11-1-2010; IN COMMERCE 11-1-2010.

THE MARK CONSISTS OF STANDARD CHARACTERS WITHOUT CLAIM TO ANY PARTICULAR FONT, STYLE, SIZE, OR COLOR.

SN 85-119,296, FILED 8-30-2010.

MARY CRAWFORD, EXAMINING ATTORNEY



David J. Kyffers

Director of the United States Patent and Trademark Office

United States of America

United States Patent and Trademark Office



Reg. No. 4,099,856

Registered Feb. 14, 2012

Int. Cl.: 29

TRADEMARK

PRINCIPAL REGISTER

CABRERA, ANTONIO RODRIGUEZ (SPAIN INDIVIDUAL)
C. PACO SANTA CRUZ N 8
UBEDA, SPAIN 23400

FOR: OLIVE OIL AND PRESERVED OLIVES, IN CLASS 29 (U.S. CL. 46).

FIRST USE 8-26-2011; IN COMMERCE 8-26-2011.

NO CLAIM IS MADE TO THE EXCLUSIVE RIGHT TO USE "ACEITE DE OLIVA", APART FROM THE MARK AS SHOWN.

THE MARK CONSISTS OF AN OLIVE TREE ABOVE A RECTANGLE CONTAINING THE WORDS "ACEITE DE OLIVA", WHICH IS ABOVE THE WORD "ELIZONDO".

THE ENGLISH TRANSLATION OF "ACEITE DE OLIVA" IN THE MARK IS "OLIVE OIL".

SN 85-120,815, FILED 9-1-2010.

TARA PATE, EXAMINING ATTORNEY



David J. Kybas

Director of the United States Patent and Trademark Office

United States of America

United States Patent and Trademark Office



Reg. No. 4,099,857

WHOLESHARE INC (DELAWARE CORPORATION)
2431 MISSION STREET
SAN FRANCISCO, CA 94110

Registered Feb. 14, 2012

Int. Cl.: 35

FOR: OPERATING ON-LINE MARKETPLACES FOR SELLERS OF GOODS AND/OR SERVICES, IN CLASS 35 (U.S. CLS. 100, 101 AND 102).

SERVICE MARK

FIRST USE 7-1-2010; IN COMMERCE 10-1-2010.

PRINCIPAL REGISTER

THE MARK CONSISTS OF THE TEXT "WHOLESHARE" WRITTEN IN A CURSIVE, HAND-DRAWN STYLE. THE LOGO IS HALF OF A NON-SPECIFIC CITRUS FRUIT (LEMON, ORANGE, GRAPEFRUIT). IT IS TILTED SLIGHTLY ON ITS SIDE AND ONE SLICE IS PARTIALLY REMOVED.

SN 85-121,327, FILED 9-1-2010.

ANGELA DUONG, EXAMINING ATTORNEY



David J. Kybas

Director of the United States Patent and Trademark Office

United States of America

United States Patent and Trademark Office

LABFX

Reg. No. 4,099,858

Registered Feb. 14, 2012

Int. Cls.: 9 and 45

TRADEMARK

SERVICE MARK

PRINCIPAL REGISTER

DRAKONTAS, LLC (NEW JERSEY LIMITED LIABILITY COMPANY)
115 EAST GLENSIDE AVENUE
SUITE #8
GLENSIDE, PA 19038

FOR: COMPUTER SOFTWARE FOR TASK GENERATION, TASK TRACKING, INFORMATION CONTRIBUTION, FORENSIC INFORMATION TOOLS, GENERATING TASKS ASSIGNMENT AND REPORTING OF INFORMATION TO ASSIST LAW ENFORCEMENT IN THE PREVENTION, INVESTIGATION, APPREHENSION, OR DETENTION OF INDIVIDUALS SUSPECTED OR CONVICTED OF OFFENSES AGAINST THE CRIMINAL LAWS AND FOR HOMELAND SECURITY, IN CLASS 9 (U.S. CLS. 21, 23, 26, 36 AND 38).

FIRST USE 9-1-2010; IN COMMERCE 9-1-2010.

FOR: PROVIDING A SECURE, WEB-BASED COMPUTERIZED SERVICE ENABLING INDIVIDUALS TO STORE AND TRANSMIT INFORMATION, INCLUDING FORENSIC TOOLS, TO ASSIST LAW ENFORCEMENT IN THE PREVENTION, INVESTIGATION, APPREHENSION, OR DETENTION OF INDIVIDUALS SUSPECTED OR CONVICTED OF OFFENSES AGAINST THE CRIMINAL LAWS AND FOR HOMELAND SECURITY, IN CLASS 45 (U.S. CLS. 100 AND 101).

FIRST USE 9-1-2010; IN COMMERCE 9-1-2010.

THE MARK CONSISTS OF STANDARD CHARACTERS WITHOUT CLAIM TO ANY PARTICULAR FONT, STYLE, SIZE, OR COLOR.

SN 85-124,302, FILED 9-7-2010.

ALYSSA STEEL, EXAMINING ATTORNEY



David J. Kybas

Director of the United States Patent and Trademark Office

United States of America

United States Patent and Trademark Office

SmartFocus

Reg. No. 4,099,859

SONOVA HOLDING AG (SWITZERLAND CORPORATION)
LAUBISRÜTISTRASSE 28
8712 STÄFA, SWITZERLAND

Registered Feb. 14, 2012

Int. Cl.: 10

FOR: HEARING AIDS AND PARTS AND FITTINGS THEREFOR, IN CLASS 10 (U.S. CLS. 26, 39 AND 44).

TRADEMARK

FIRST USE 5-0-2009; IN COMMERCE 5-0-2009.

PRINCIPAL REGISTER

THE MARK CONSISTS OF STANDARD CHARACTERS WITHOUT CLAIM TO ANY PARTICULAR FONT, STYLE, SIZE, OR COLOR.

PRIORITY CLAIMED UNDER SEC. 44(D) ON ERPN CMNTY TM OFC APPLICATION NO. 009352055, FILED 9-3-2010.

SN 85-125,263, FILED 9-8-2010.

FRANK LATTUCA, EXAMINING ATTORNEY



David J. Kybas

Director of the United States Patent and Trademark Office

United States of America

United States Patent and Trademark Office

SPREAD IT

Reg. No. 4,099,860

Registered Feb. 14, 2012

Int. Cl.: 43

SERVICE MARK

PRINCIPAL REGISTER

IMAGINATION HOLDINGS, LLC (NEVADA LIMITED LIABILITY COMPANY)
SUITE 250
3790 PARADISE ROAD
LAS VEGAS, NV 89169

FOR: HOTEL RESTAURANT, BAR AND CATERING SERVICES, IN CLASS 43 (U.S. CLS. 100 AND 101).

FIRST USE 5-15-2010; IN COMMERCE 7-1-2010.

THE MARK CONSISTS OF STANDARD CHARACTERS WITHOUT CLAIM TO ANY PARTICULAR FONT, STYLE, SIZE, OR COLOR.

SN 85-125,939, FILED 9-9-2010.

JOSETTE BEVERLY, EXAMINING ATTORNEY



David J. Kyffers

Director of the United States Patent and Trademark Office

United States of America

United States Patent and Trademark Office

HOLLYWOOD WASTE

Reg. No. 4,099,861

ARTIST SERVICES, LTD. (UNITED KINGDOM LIMITED LIABILITY COMPANY)
6 WATER LANE, KENTISH TOWN ROAD CAMDEN
LONDON, UNITED KINGDOM NW18NZ

Registered Feb. 14, 2012

Int. Cls.: 9, 35, and 41

FOR: MUSICAL SOUND AND VIDEO RECORDINGS, IN CLASS 9 (U.S. CLS. 21, 23, 26, 36 AND 38).

TRADEMARK

FIRST USE 5-17-2011; IN COMMERCE 5-17-2011.

SERVICE MARK

FOR: ONLINE RETAIL STORE SERVICES FEATURING PRE-RECORDED MUSIC, IN CLASS 35 (U.S. CLS. 100, 101 AND 102).

PRINCIPAL REGISTER

FIRST USE 9-15-2011; IN COMMERCE 9-15-2011.

FOR: PROVISION OF ONLINE INFORMATION CONCERNING MUSIC; ONLINE ENTERTAINMENT SERVICES, NAMELY, WEBCASTS IN THE FIELD OF MUSIC CONCERTS; ONLINE FAN CLUB SERVICES, IN CLASS 41 (U.S. CLS. 100, 101 AND 107).

FIRST USE 9-15-2011; IN COMMERCE 9-15-2011.

THE MARK CONSISTS OF STANDARD CHARACTERS WITHOUT CLAIM TO ANY PARTICULAR FONT, STYLE, SIZE, OR COLOR.

SN 85-126,504, FILED 9-9-2010.

ERNEST SHOSHO, EXAMINING ATTORNEY



David J. Kyros

Director of the United States Patent and Trademark Office

United States of America

United States Patent and Trademark Office

ULTRAVIN 8000

Reg. No. 4,099,862

LAMANUZZI & PANTALEO LLC (CALIFORNIA LIMITED LIABILITY COMPANY)
11767 ROAD 27 1/2

Registered Feb. 14, 2012

MADERA, CA 93637

Int. Cl.: 32

FOR: GRAPE JUICE CONCENTRATES; MIXES IN THE NATURE OF GRAPE JUICE CONCENTRATES, IN CLASS 32 (U.S. CLS. 45, 46 AND 48).

TRADEMARK

FIRST USE 3-8-2011; IN COMMERCE 3-8-2011.

PRINCIPAL REGISTER

THE MARK CONSISTS OF STANDARD CHARACTERS WITHOUT CLAIM TO ANY PARTICULAR FONT, STYLE, SIZE, OR COLOR.

SN 85-126,576, FILED 9-10-2010.

SUNG IN, EXAMINING ATTORNEY



David J. Kyfos

Director of the United States Patent and Trademark Office

United States of America

United States Patent and Trademark Office

R1

Reg. No. 4,099,863

RIDGEFIELD ONE, LLC (CONNECTICUT LIMITED LIABILITY COMPANY)
158 FLORIDA HILL ROAD
RIDGEFIELD, CT 06877

Registered Feb. 14, 2012

Int. Cl.: 35

FOR: EMPLOYMENT AGENCY SERVICES; EMPLOYMENT AGENCY SERVICES, NAMELY, FILLING THE TEMPORARY AND PERMANENT STAFFING NEEDS OF BUSINESSES; PERSONNEL RECRUITMENT SERVICES AND EMPLOYMENT AGENCIES, IN CLASS 35 (U.S. CLS. 100, 101 AND 102).

SERVICE MARK

PRINCIPAL REGISTER

FIRST USE 7-1-2011; IN COMMERCE 7-1-2011.

THE MARK CONSISTS OF STANDARD CHARACTERS WITHOUT CLAIM TO ANY PARTICULAR FONT, STYLE, SIZE, OR COLOR.

OWNER OF U.S. REG. NO. 3,893,000.

SN 85-127,906, FILED 9-13-2010.

JEFFERY COWARD, EXAMINING ATTORNEY



David J. Kybas

Director of the United States Patent and Trademark Office

United States of America

United States Patent and Trademark Office

SKINNY DIPPIN' DOGS

Reg. No. 4,099,864

IRONSIDE, JEFFREY (UNITED STATES INDIVIDUAL)
644 FOREST AVE.
OAK PARK, IL 60302 AND

Registered Feb. 14, 2012

Int. Cl.: 44

WAKAI, KATHLEEN (UNITED STATES INDIVIDUAL)
644 FOREST AVE.
OAK PARK, IL 60302

SERVICE MARK

PRINCIPAL REGISTER

FOR: ANIMAL GROOMING; ANIMAL GROOMING SERVICES; DOG GROOMING SERVICES;
DOG WALKING SERVICES; PET CARE SERVICES, NAMELY, DOG WALKING, DOG
BATHING AND NON-MEDICATED PET GROOMING; PET GROOMING SERVICES;
PROVIDING INFORMATION AND ADVICE IN THE FIELD OF PET HEALTH, IN CLASS 44
(U.S. CLS. 100 AND 101).

FIRST USE 5-1-2011; IN COMMERCE 5-1-2011.

THE MARK CONSISTS OF STANDARD CHARACTERS WITHOUT CLAIM TO ANY PAR-
TICULAR FONT, STYLE, SIZE, OR COLOR.

NO CLAIM IS MADE TO THE EXCLUSIVE RIGHT TO USE "DOGS", APART FROM THE
MARK AS SHOWN.

SN 85-129,306, FILED 9-14-2010.

INGA ERVIN, EXAMINING ATTORNEY



David J. Kybas

Director of the United States Patent and Trademark Office

United States of America

United States Patent and Trademark Office



Reg. No. 4,099,865

Registered Feb. 14, 2012

Int. Cl.: 3

TRADEMARK

PRINCIPAL REGISTER

ISLAND KINETICS, INC. (ARIZONA CORPORATION)
460 SOUTH BENSON LANE #3
CHANDLER, AZ 85224

FOR: COSMETICS, IN CLASS 3 (U.S. CLS. 1, 4, 6, 50, 51 AND 52).

FIRST USE 12-6-2011; IN COMMERCE 12-6-2011.

NO CLAIM IS MADE TO THE EXCLUSIVE RIGHT TO USE "FLOWER FRACTIONS", APART FROM THE MARK AS SHOWN.

THE COLOR(S) GREEN IS/ARE CLAIMED AS A FEATURE OF THE MARK.

THE MARK CONSISTS OF THE STYLIZED GREEN WORDING "FLOWER FRACTIONS" AND GREEN GEOMETRIC DESIGN OF MULTIPLE ROUNDED RECTANGULAR SHAPES POSITIONED AT RIGHT ANGLES TO EACH OTHER WITH A SMALL GREEN ROUNDED SQUARE ABOVE AND TO THE RIGHT OF THE LARGER DESIGN.

SN 85-129,513, FILED 9-14-2010.

BRIAN PINO, EXAMINING ATTORNEY



David J. Kyffers

Director of the United States Patent and Trademark Office

United States of America

United States Patent and Trademark Office

INNOVEX

Reg. No. 4,099,866

MASCO BATH CORPORATION (TENNESSEE CORPORATION)
540 GLEN AVENUE
MOORESTOWN, NJ 08057

Registered Feb. 14, 2012

Int. Cl.: 17

FOR: NON-METALLIC COMPOSITE POLYMERIC MATERIAL FOR USE IN THE MANUFACTURE OF BATHING AND PLUMBING FIXTURES, NAMELY, BATHTUBS, SINKS, SHOWER AND BATHTUB ENCLOSURES, IN CLASS 17 (U.S. CLS. 1, 5, 12, 13, 35 AND 50).

TRADEMARK

FIRST USE 10-29-2010; IN COMMERCE 10-29-2010.

PRINCIPAL REGISTER

THE MARK CONSISTS OF STANDARD CHARACTERS WITHOUT CLAIM TO ANY PARTICULAR FONT, STYLE, SIZE, OR COLOR.

SN 85-130,835, FILED 9-16-2010.

LESLIE RICHARDS, EXAMINING ATTORNEY



David J. Kyfos

Director of the United States Patent and Trademark Office

United States of America

United States Patent and Trademark Office

LongBow Flex

Reg. No. 4,099,867

VOJAGI, LLC/DBA VOLAGI CYCLES (CALIFORNIA CORPORATION)
374 BLODGETT STREET
COTATI, CA 949318707

Registered Feb. 14, 2012

Int. Cl.: 12

FOR: BICYCLE FRAMES; BICYCLE PARTS, NAMELY, SEAT STAY; BICYCLES; FRAMES FOR BICYCLES; RACING BICYCLES; ROAD RACING BICYCLES; STRUCTURAL PARTS OF BICYCLES, IN CLASS 12 (U.S. CLS. 19, 21, 23, 31, 35 AND 44).

TRADEMARK

FIRST USE 9-1-2010; IN COMMERCE 9-17-2010.

PRINCIPAL REGISTER

THE MARK CONSISTS OF STANDARD CHARACTERS WITHOUT CLAIM TO ANY PARTICULAR FONT, STYLE, SIZE, OR COLOR.

SN 85-132,543, FILED 9-17-2010.

JILL C. ALT, EXAMINING ATTORNEY



David J. Kyros

Director of the United States Patent and Trademark Office

United States of America

United States Patent and Trademark Office



Reg. No. 4,099,868

Registered Feb. 14, 2012

Int. Cls.: 3 and 5

TRADEMARK

PRINCIPAL REGISTER

LA FRESH (CALIFORNIA CORPORATION)
4651 SCHAEFER AVE
CHINO, CA 91710

FOR: DISPOSABLE WIPES IMPREGNATED WITH CLEANSING CHEMICALS OR COMPOUNDS FOR PET HYGIENE; PET CARE KITS COMPRISING SHAMPOO, CONDITIONER, BODY SPRAY; PET SHAMPOO, IN CLASS 3 (U.S. CLS. 1, 4, 6, 50, 51 AND 52).

FIRST USE 10-25-2010; IN COMMERCE 10-25-2010.

FOR: DISPOSABLE SANITIZING WIPES; MEDICATED GROOMING PREPARATIONS FOR PETS, NAMELY, DENTAL WIPES, EAR WIPES, AND EYE WIPES, SHAMPOO, AND CONDITIONER, IN CLASS 5 (U.S. CLS. 6, 18, 44, 46, 51 AND 52).

FIRST USE 10-25-2010; IN COMMERCE 10-25-2010.

THE MARK CONSISTS OF DESIGN OF THE WORDS "W.A.G. WASH & GO".

SN 85-133,548, FILED 9-20-2010.

GEORGE LORENZO, EXAMINING ATTORNEY



David J. Kyros

Director of the United States Patent and Trademark Office

United States of America

United States Patent and Trademark Office

DIVAS & STUDS

Reg. No. 4,099,869

Registered Feb. 14, 2012

Int. Cls.: 3, 5, and 24

TRADEMARK

PRINCIPAL REGISTER

LA FRESH (CALIFORNIA CORPORATION)
4651 SCHAEFER AVE
CHINO, CA 91710

FOR: DEODORIZERS FOR PETS; DISPOSABLE WIPES IMPREGNATED WITH CLEANSING CHEMICALS OR COMPOUNDS FOR PET HYGIENE; PET CARE KITS COMPRISING SHAMPOO, CONDITIONER, BODY SPRAY; PET FRAGRANCES; PET ODOR REMOVERS; PET SHAMPOO; PET SHAMPOO AND CONDITIONER, IN CLASS 3 (U.S. CLS. 1, 4, 6, 50, 51 AND 52).

FIRST USE 8-31-2010; IN COMMERCE 8-31-2010.

FOR: MEDICATED GROOMING PREPARATION FOR PETS, NAMELY, DENTAL MITTS; EAR WIPES; EYE WIPES; SHAMPOO; AND CONDITIONER, IN CLASS 5 (U.S. CLS. 6, 18, 44, 46, 51 AND 52).

FIRST USE 8-31-2010; IN COMMERCE 8-31-2010.

FOR: BATH MITTS; WASHING MITTS, IN CLASS 24 (U.S. CLS. 42 AND 50).

FIRST USE 8-31-2010; IN COMMERCE 8-31-2010.

THE MARK CONSISTS OF STANDARD CHARACTERS WITHOUT CLAIM TO ANY PARTICULAR FONT, STYLE, SIZE, OR COLOR.

SN 85-133,581, FILED 9-20-2010.

GEORGE LORENZO, EXAMINING ATTORNEY



David J. Kypos

Director of the United States Patent and Trademark Office

United States of America

United States Patent and Trademark Office



Reg. No. 4,099,870

Registered Feb. 14, 2012

Int. Cls.: 3, 5, and 24

TRADEMARK

PRINCIPAL REGISTER

LA FRESH (CALIFORNIA CORPORATION)
4651 SCHAEFER AVE
CHINO, CA 91710

FOR: DEODORIZERS FOR PETS; DISPOSABLE WIPES IMPREGNATED WITH CLEANSING CHEMICALS OR COMPOUNDS FOR PET HYGIENE; PET CARE KITS COMPRISING SHAMPOO, CONDITIONER, BODY SPRAY; PET FRAGRANCES; PET ODOR REMOVERS; PET SHAMPOO; PET SHAMPOO AND CONDITIONER, IN CLASS 3 (U.S. CLS. 1, 4, 6, 50, 51 AND 52).

FIRST USE 8-31-2010; IN COMMERCE 8-31-2010.

FOR: MEDICATED GROOMING PREPARATION FOR PETS, NAMELY, DENTAL MITTS, EAR WIPES, EYE WIPES, SHAMPOO, CONDITIONER, IN CLASS 5 (U.S. CLS. 6, 18, 44, 46, 51 AND 52).

FIRST USE 8-31-2010; IN COMMERCE 8-31-2010.

FOR: BATH MITTS; WASHING MITTS, IN CLASS 24 (U.S. CLS. 42 AND 50).

FIRST USE 8-31-2010; IN COMMERCE 8-31-2010.

THE MARK CONSISTS OF A ROBE HELD UP IN THE MIDDLE BY A CROWN, AND ON EACH UPPER CORNER BY A TIED TASSEL. THE WORDS "DIVAS & STUDS" ARE IN THE MIDDLE OF THE ROBE AGAINST THE BACKGROUND.

SN 85-134,331, FILED 9-21-2010.

GEORGE LORENZO, EXAMINING ATTORNEY



David J. Kyros

Director of the United States Patent and Trademark Office

United States of America

United States Patent and Trademark Office

PRESI

Reg. No. 4,099,871

Registered Feb. 14, 2012

Int. Cl.: 25

TRADEMARK

PRINCIPAL REGISTER

THE EXAMPLE FOR LEADING OUR NATION LLC (GEORGIA LIMITED LIABILITY COMPANY)
1104 LINCOLN PLACE
BROOKLYN, NY 11213

FOR: FLEECE PULLOVERS; HOODED SWEAT SHIRTS; KNIT SHIRTS; MEN'S UNDERWEAR; POLO SHIRTS; RUGBY SHIRTS; SWEATERS; SWIM WEAR, IN CLASS 25 (U.S. CLS. 22 AND 39).

FIRST USE 12-13-2011; IN COMMERCE 12-13-2011.

THE MARK CONSISTS OF STANDARD CHARACTERS WITHOUT CLAIM TO ANY PARTICULAR FONT, STYLE, SIZE, OR COLOR.

THE ENGLISH TRANSLATION OF "PRESI" IN THE MARK IS "TAKEN".

SN 85-134,876, FILED 9-21-2010.

MYRIAH HABEEB, EXAMINING ATTORNEY



David J. Kybas

Director of the United States Patent and Trademark Office

United States of America

United States Patent and Trademark Office



Reg. No. 4,099,872

Registered Feb. 14, 2012

Int. Cl.: 25

TRADEMARK

PRINCIPAL REGISTER

THE EXAMPLE FOR LEADING OUR NATION LLC (GEORGIA LIMITED LIABILITY COMPANY)
1104 LINCOLN PLACE
BROOKLYN, NY 11213

FOR: FLEECE PULLOVERS; HOODED SWEAT SHIRTS; KNIT SHIRTS; MEN'S UNDERWEAR; POLO SHIRTS; RUGBY SHIRTS; SWEATERS; SWIM WEAR, IN CLASS 25 (U.S. CLS. 22 AND 39).

FIRST USE 12-13-2011; IN COMMERCE 12-13-2011.

NO CLAIM IS MADE TO THE EXCLUSIVE RIGHT TO USE "EST 1980", APART FROM THE MARK AS SHOWN.

THE MARK CONSISTS OF A DOUBLE-LINED CIRCLE SURROUNDING A BUST OF PRESIDENT LINCOLN RESEMBLING A PENNY WITH THE WORD "PRESI" IN A LARGE FONT CURVE OVER THE HEAD OF THE BUST AND WITHIN THE CIRCLE, THE LETTERS "TFLN" TO THE LEFT SIDE OF THE BUST WITHIN THE CIRCLE IN A MEDIUM FONT, AND THE LETTERS "EST 1980" TO THE RIGHT OF THE BUST WITHIN THE CIRCLE IN A SMALLER FONT.

THE ENGLISH TRANSLATION OF "PRESI" IN THE MARK IS "TAKEN".

SN 85-134,907, FILED 9-21-2010.

MYRIAH HABEEB, EXAMINING ATTORNEY



David J. Kyjars

Director of the United States Patent and Trademark Office

United States of America

United States Patent and Trademark Office

TASTE OF THE HOLIDAYS

Reg. No. 4,099,873

Registered Feb. 14, 2012

Int. Cls.: 9 and 41

TRADEMARK

SERVICE MARK

PRINCIPAL REGISTER

MINNESOTA PUBLIC RADIO (MINNESOTA NON-PROFIT CORPORATION)
480 CEDAR STREET
ST. PAUL, MN 55101

FOR: SOUND RECORDINGS AND CDS FEATURING AUDIO PROGRAMS IN THE FIELDS OF MUSIC, COOKING, RECIPES, ENTERTAINING, INTERVIEWS, IN CLASS 9 (U.S. CLS. 21, 23, 26, 36 AND 38).

FIRST USE 11-0-2011; IN COMMERCE 11-0-2011.

FOR: EDUCATIONAL AND ENTERTAINMENT SERVICES, NAMELY, PRODUCTION AND DISTRIBUTION OF RADIO PROGRAMS TO BE BROADCAST VIA RADIO AND THE INTERNET IN THE FIELDS OF MUSIC, COOKING, RECIPES, ENTERTAINING, INTERVIEWS, HUMOR AND CULTURE; PROVIDING ONLINE INFORMATION SERVICES IN CONJUNCTION WITH EDUCATIONAL AND ENTERTAINMENT PROGRAMS, NAMELY, PROVIDING A WEBSITE THAT FEATURES MUSIC INFORMATION, ARTICLES AND AUDIO AND VIDEO PRESENTATIONS IN THE FIELDS OF MUSIC, COOKING, RECIPES, ENTERTAINING, INTERVIEWS, HUMOR AND CULTURE; PROVIDING ONLINE COLUMNS AND BLOGS IN THE FIELDS OF MUSIC, COOKING, RECIPES, ENTERTAINING, INTERVIEWS, HUMOR AND CULTURE; INTERNET RADIO SERVICES, NAMELY, PROVIDING PODCASTS IN THE FIELDS OF MUSIC, COOKING, RECIPES, ENTERTAINING, INTERVIEWS, HUMOR AND CULTURE, IN CLASS 41 (U.S. CLS. 100, 101 AND 107).

FIRST USE 12-6-2010; IN COMMERCE 12-6-2010.

THE MARK CONSISTS OF STANDARD CHARACTERS WITHOUT CLAIM TO ANY PARTICULAR FONT, STYLE, SIZE, OR COLOR.

SN 85-135,318, FILED 9-22-2010.

ANGELA M. MICHELI, EXAMINING ATTORNEY



David J. Kyffers

Director of the United States Patent and Trademark Office

United States of America

United States Patent and Trademark Office

ENVISION HOME

Reg. No. 4,099,874

SCHROEDER & TREMAYNE, INC. (MISSOURI CORPORATION)
8500 VALCOUR

Registered Feb. 14, 2012

ST. LOUIS, MO 63123

Int. Cls.: 3 and 21

FOR: WRINKLE RELEASE DRYER TOWELS, IN CLASS 3 (U.S. CLS. 1, 4, 6, 50, 51 AND 52).

FIRST USE 12-31-2010; IN COMMERCE 12-31-2010.

TRADEMARK

FOR: CLEANING MITTS OF FABRIC AND CLEANING CLOTHS, IN CLASS 21 (U.S. CLS. 2, 13, 23, 29, 30, 33, 40 AND 50).

PRINCIPAL REGISTER

FIRST USE 12-31-2010; IN COMMERCE 12-31-2010.

THE MARK CONSISTS OF STANDARD CHARACTERS WITHOUT CLAIM TO ANY PARTICULAR FONT, STYLE, SIZE, OR COLOR.

NO CLAIM IS MADE TO THE EXCLUSIVE RIGHT TO USE "HOME", APART FROM THE MARK AS SHOWN.

SN 85-135,431, FILED 9-22-2010.

ARETHA SOMERVILLE, EXAMINING ATTORNEY



David J. Kyffers

Director of the United States Patent and Trademark Office

United States of America

United States Patent and Trademark Office



Reg. No. 4,099,875

VENTURE MILLING, INC. (MARYLAND CORPORATION)
6906 ZION CHURCH ROAD
SALISBURY, MD 21804

Registered Feb. 14, 2012

Int. Cl.: 31

FOR: ANIMAL FEED, NAMELY, BLENDED BY-PASS PROTEIN FEED DEVELOPED FOR THE DAIRY FEED INGREDIENT MARKET, IN CLASS 31 (U.S. CLS. 1 AND 46).

TRADEMARK

FIRST USE 9-1-2010; IN COMMERCE 9-1-2010.

PRINCIPAL REGISTER

OWNER OF U.S. REG. NOS. 2,756,922, 2,826,135, AND 2,826,136.

NO CLAIM IS MADE TO THE EXCLUSIVE RIGHT TO USE "SELECT", APART FROM THE MARK AS SHOWN.

THE MARK CONSISTS OF THE WORD "PROVAAL" WITH THE NUMBER "2" DISPLAYED IN SUPERSCRIPT BY THE "L" AND A CIRCLE DESIGN SURROUNDING THE "P". A SWIRL DESIGN INTERSECTS THE WORD "PROVAAL2" AND SURROUNDS THE TERM "SAALECT".

SN 85-135,678, FILED 9-22-2010.

KAREN K. BUSH, EXAMINING ATTORNEY



David J. Kybas

Director of the United States Patent and Trademark Office

United States of America

United States Patent and Trademark Office

ZYA

Reg. No. 4,099,876

Registered Feb. 14, 2012

Int. Cl.: 9

TRADEMARK

PRINCIPAL REGISTER

MUSIC MASTERMIND, INC. (DELAWARE CORPORATION)
22315 MULHOLLAND HIGHWAY
CALABASAS, CA 91302

FOR: COMPUTER-GAME SOFTWARE; COMPUTER SOFTWARE FOR USE IN RECORDING, ORGANIZING, TRANSMITTING, MANIPULATING AND REVIEWING TEXT, DATA, AUDIO FILES, AND VIDEO FILES IN THE FIELDS OF ENTERTAINMENT, MUSIC AND VIDEO; ELECTRONIC GAME SOFTWARE; DOWNLOADABLE MUSIC VIA THE INTERNET OR WIRELESS DEVICES; DOWNLOADABLE ELECTRONIC GAMES AND VIDEO RECORDINGS FEATURING MUSIC; MUSIC-COMPOSITION SOFTWARE; SOUND AND VIDEO RECORDINGS FEATURING MUSIC; COMPUTER SOFTWARE FOR USE IN MUSIC EDUCATION FEATURING MUSIC INSTRUCTION, IN CLASS 9 (U.S. CLS. 21, 23, 26, 36 AND 38).

FIRST USE 9-26-2011; IN COMMERCE 9-26-2011.

THE MARK CONSISTS OF STANDARD CHARACTERS WITHOUT CLAIM TO ANY PARTICULAR FONT, STYLE, SIZE, OR COLOR.

SN 85-135,919, FILED 9-22-2010.

REBECCA SMITH, EXAMINING ATTORNEY



David J. Kyffers

Director of the United States Patent and Trademark Office

United States of America

United States Patent and Trademark Office



Reg. No. 4,099,877

Registered Feb. 14, 2012

Int. Cls.: 35 and 42

SERVICE MARK

PRINCIPAL REGISTER

EVOLVE MARKETING LLC (CALIFORNIA LIMITED LIABILITY COMPANY)
PO BOX 343
CUPERTINO, CA 95015

FOR: PROVIDING DEMAND CREATION AND LEAD GENERATION ACTIVITIES AND SERVICES, IN CLASS 35 (U.S. CLS. 100, 101 AND 102).

FIRST USE 11-3-2011; IN COMMERCE 11-3-2011.

FOR: PROVIDING TEMPORARY USE OF ON-LINE NON-DOWNLOADABLE SOFTWARE FOR USE IN ACTIVITIES RELATED TO OUTBOUND CALLING CAMPAIGNS, NAMELY, MANAGING OUTBOUND TELEPHONE CALLS, IN CLASS 42 (U.S. CLS. 100 AND 101).

FIRST USE 11-3-2011; IN COMMERCE 11-3-2011.

THE MARK CONSISTS OF AN OCTOPUS WITH LEGS IN THE SHAPE OF A TELEPHONE HANDSET.

SN 85-136,012, FILED 9-22-2010.

MYRIAH HABEEB, EXAMINING ATTORNEY



David J. Kybas

Director of the United States Patent and Trademark Office

United States of America

United States Patent and Trademark Office

THE BROADWAY

Reg. No. 4,099,878

Registered Feb. 14, 2012

Int. Cl.: 35

SERVICE MARK

PRINCIPAL REGISTER

STRATEGIC MARKS, LLC (CALIFORNIA LIMITED LIABILITY COMPANY)
25 RIDGEVIEW
IRVINE, CA 92603

FOR: RETAIL DEPARTMENT STORE AND ON-LINE RETAIL DEPARTMENT STORE SERVICES; RETAIL AND ON-LINE RETAIL CLOTHING BOUTIQUES; RETAIL AND ON-LINE RETAIL CLOTHING STORES; RETAIL AND ON-LINE RETAIL APPAREL STORES; RETAIL AND ON-LINE RETAIL STORE SERVICES FEATURING CLOTHING AND FASHION ACCESSORIES, IN CLASS 35 (U.S. CLS. 100, 101 AND 102).

FIRST USE 10-30-2011; IN COMMERCE 10-30-2011.

THE MARK CONSISTS OF STANDARD CHARACTERS WITHOUT CLAIM TO ANY PARTICULAR FONT, STYLE, SIZE, OR COLOR.

SN 85-137,191, FILED 9-24-2010.

GRETTA YAO, EXAMINING ATTORNEY



David J. Kybas

Director of the United States Patent and Trademark Office

United States of America

United States Patent and Trademark Office

ICE STORM

Reg. No. 4,099,879

Registered Feb. 14, 2012

Int. Cls.: 9 and 42

TRADEMARK

SERVICE MARK

PRINCIPAL REGISTER

LOCKHEED MARTIN CORPORATION (MARYLAND CORPORATION)
6801 ROCKLEDGE DRIVE
BETHESDA, MD 20817

FOR: COMPUTERS AND COMPUTER PERIPHERALS FOR PRESENTING VIRTUAL REALITY BY SIMULATING AND/OR PRESENTING A VISUAL, AUDITORY AND/OR TACTILE ENVIRONMENT TO A HUMAN BEING; COMPUTER HARDWARE, COMPUTER SOFTWARE, COMPUTER PERIPHERALS AND SENSORS, ALL FOR DETECTING AND/OR MONITORING PHYSICAL CONDITION AND/OR MEDICAL CONDITION OF MEDICAL PATIENT, FOR DETECTING AND/OR MONITORING LOCATION OF MEDICAL PATIENT, FOR DETECTING, MONITORING AND MEASURING VARIABLES IN MEDICAL PATIENT'S ENVIRONMENT AND COMMUNICATING PHYSICAL CONDITION, MEDICAL CONDITION, ENVIRONMENT AND LOCATION INFORMATION AND OTHER PATIENT HEALTH INFORMATION TO HEALTHCARE PROFESSIONALS, FAMILY MEMBERS AND OTHER INTERESTED THIRD PARTIES; COMPUTER HARDWARE, COMPUTER SOFTWARE, COMPUTER PERIPHERALS, AND SENSORS, ALL FOR CREATING VIRTUAL ENVIRONMENT, FOR INTERACTING WITH VIRTUAL ENVIRONMENT, FOR DETECTING, MEASURING AND RESPONDING TO FORCES AND POSITION CHANGES BY USER, FOR CAUSING FORCES APPLIED TO USER AND CAUSING POSITION CHANGES TO USER FOR USE IN TRAINING MILITARY PERSONNEL AND CIVILIAN PERSONNEL; COMPUTER HARDWARE, COMPUTER SOFTWARE, COMPUTER PERIPHERALS, AND SENSORS, ALL USED AS AN INTERFACE BETWEEN INDIVIDUAL USER AND GLOBAL OR LOCAL COMPUTER NETWORK, IN CLASS 9 (U.S. CLS. 21, 23, 26, 36 AND 38).

FIRST USE 3-15-2010; IN COMMERCE 6-16-2010.

FOR: DESIGN, DEVELOPMENT, AND MAINTENANCE OF SIMULATION SOFTWARE FOR THE PURPOSE OF MEDICAL TRAINING; COMPUTER SYSTEMS INTEGRATION SERVICES IN THE FIELD OF DESIGN, DEVELOPMENT, OPERATION AND MAINTENANCE OF SIMULATION SOFTWARE FOR THE PURPOSE OF MEDICAL TRAINING, IN CLASS 42 (U.S. CLS. 100 AND 101).

FIRST USE 3-15-2010; IN COMMERCE 6-16-2010.

THE MARK CONSISTS OF STANDARD CHARACTERS WITHOUT CLAIM TO ANY PARTICULAR FONT, STYLE, SIZE, OR COLOR.



David J. Kyjars

Director of the United States Patent and Trademark Office

Reg. No. 4,099,879 SN 85-138,780, FILED 9-27-2010.

LINDSEY RUBIN, EXAMINING ATTORNEY

United States of America

United States Patent and Trademark Office

FANGIRL

Reg. No. 4,099,880

BARR, PATRICIA M. (UNITED STATES INDIVIDUAL)
P.O. BOX 71

Registered Feb. 14, 2012

LOXAHATCHEE, FL 33470

Int. Cl.: 25

FOR: APRONS; BASEBALL CAPS AND HATS; BELTS; BLOUSES; BOARD SHORTS; BOXER SHORTS; CHILDREN'S AND INFANT'S APPAREL, NAMELY, JUMPERS, OVERALL SLEEPWEAR, PAJAMAS, ROMPERS AND ONE-PIECE GARMENTS; CHILDREN'S AND INFANTS' CLOTH BIBS; CHILDREN'S HEADWEAR; COSTUMES FOR USE IN CHILDREN'S DRESS UP PLAY; COSTUMES FOR USE IN ROLE-PLAYING GAMES; DRESSES; EAR BANDS; FLEECE BOTTOMS; FLEECE TOPS; FLIP FLOPS; GYM SHORTS; GYM SUITS; HALLOWEEN COSTUMES AND MASKS SOLD IN CONNECTION THEREWITH; HOODED PULLOVERS; HOODED SWEAT SHIRTS; JACKETS; LADIES' UNDERWEAR; NIGHT SHIRTS; PAJAMAS; SCARVES; SHIRTS AND SHORT-SLEEVED SHIRTS; SHORT-SLEEVED OR LONG-SLEEVED T-SHIRTS; SLIPPERS; SOCKS; SWEATERS; TANK TOPS; YOGA PANTS, IN CLASS 25 (U.S. CLS. 22 AND 39).

TRADEMARK

PRINCIPAL REGISTER

FIRST USE 9-22-2010; IN COMMERCE 1-25-2011.

THE MARK CONSISTS OF STANDARD CHARACTERS WITHOUT CLAIM TO ANY PARTICULAR FONT, STYLE, SIZE, OR COLOR.

SN 85-139,405, FILED 9-27-2010.

CHRISTINE MARTIN, EXAMINING ATTORNEY



David J. Kyffers

Director of the United States Patent and Trademark Office

United States of America

United States Patent and Trademark Office

PRIME Research

Reg. No. 4,099,881

PRIME RESEARCH INTERNATIONAL AG & CO KG (FED REP GERMANY PARTNERSHIP)
KAISERSTRASSE 22

Registered Feb. 14, 2012

MAINZ, FED REP GERMANY 55116

Int. Cl.: 35

FOR: COMMUNICATION RESEARCH, NAMELY, MARKETING STUDIES; MEDIA ANALYSIS, NAMELY, ADVERTISING AND MARKETING RESEARCH, IN CLASS 35 (U.S. CLS. 100, 101 AND 102).

SERVICE MARK

FIRST USE 12-31-1990; IN COMMERCE 2-29-2004.

PRINCIPAL REGISTER

THE MARK CONSISTS OF STANDARD CHARACTERS WITHOUT CLAIM TO ANY PARTICULAR FONT, STYLE, SIZE, OR COLOR.

OWNER OF U.S. REG. NO. 3,892,838.

NO CLAIM IS MADE TO THE EXCLUSIVE RIGHT TO USE "RESEARCH", APART FROM THE MARK AS SHOWN.

SN 85-139,550, FILED 9-28-2010.

AISHA SALEM, EXAMINING ATTORNEY



David J. Kyffers

Director of the United States Patent and Trademark Office

United States of America

United States Patent and Trademark Office

ilase

Reg. No. 4,099,882

BIOLASE TECHNOLOGY, INC. (DELAWARE CORPORATION)
4 CROMWELL
IRVINE, CA 92618

Registered Feb. 14, 2012

Int. Cl.: 10

FOR: DENTAL INSTRUMENTS FOR USE IN ORAL AND JOINT THERAPEUTIC TREATMENT OF SKIN, NERVE AND MUSCLE TISSUES; DENTAL INSTRUMENTS, NAMELY, ORAL IRRIGATORS, DENTAL DEVICES FOR ROOT CANAL PROCEDURES IN THE NATURE OF ROOT CANAL THERAPY INSTRUMENTS USED TO SHAVE THE INSIDE OF A ROOT CANAL AND DENTAL ROOT FILES USED IN ROOT CANAL DENTAL PROCEDURES, DENTAL HAND PIECES, ELECTROMAGNETIC ENERGY EMITTING DEVICES FOR DENTAL AND MEDICAL USE IN THE NATURE OF LASERS FOR DENTAL AND MEDICAL USE AND STRUCTURAL COMPONENT PARTS THEREFOR; ELECTRONIC AESTHETIC SKIN TREATMENT DEVICES USING LIGHT EMITTING DIODES, NAMELY, INFRARED, RED, ORANGE, YELLOW, GREEN, AND BLUE WAVELENGTHS FOR GENERATING LIGHT RAYS; ELECTRONIC LIGHT THERAPY APPARATUS FOR THE SKIN; ELECTRONIC STIMULATOR FOR ORAL AND JOINT TREATMENT OF SKIN, NERVE AND MUSCLE TISSUES; LASERS FOR MEDICAL PURPOSES; LASERS FOR MEDICAL USE; LASERS FOR SURGICAL AND MEDICAL USE; LASERS FOR THE COSMETIC TREATMENT OF THE FACE AND SKIN; LIGHT EMITTING DEVICES, NAMELY, LAMPS AND LED DEVICES FOR TREATMENT OF A VARIETY OF SKIN CONDITIONS; LIGHT EMITTING DIODE (LED) APPARATUS FOR LIGHTING, INCORPORATED INTO MEDICAL INSTRUMENTS; MEDICAL AND SURGICAL LAPAROSCOPES; MEDICAL APPARATUS AND INSTRUMENTS FOR USE IN SURGERY, IN CLASS 10 (U.S. CLS. 26, 39 AND 44).

TRADEMARK

PRINCIPAL REGISTER



FIRST USE 2-28-2010; IN COMMERCE 3-31-2010.

OWNER OF U.S. REG. NOS. 2,535,143, 3,454,749, AND OTHERS.

THE MARK CONSISTS OF ONE WORD "ILASE" ALL IN ITALICS, WITH THE "I" BEING LOWERCASE, THE "L" BEING CAPITALIZED, AND "ASE" BEING LOWERCASE.

SN 85-140,266, FILED 9-28-2010.

DAVID YONTEF, EXAMINING ATTORNEY

David J. Kyffers

Director of the United States Patent and Trademark Office

United States of America

United States Patent and Trademark Office

paradise found

Reg. No. 4,099,883

Registered Feb. 14, 2012

Int. Cl.: 29

TRADEMARK

PRINCIPAL REGISTER

PEELED INC. (DELAWARE CORPORATION), DBA PEELED SNACKS,
530 3RD AVENUE SUITE 2R
BROOKLYN, NY 11215

FOR: DRIED FRUITS, IN CLASS 29 (U.S. CL. 46).

FIRST USE 12-30-2010; IN COMMERCE 12-30-2010.

THE MARK CONSISTS OF STYLIZED LETTERS FOR "P", "A", "R", "A", "D", "I", "S", "E",
"F", "O", "U", "N", "D".

SN 85-140,980, FILED 9-29-2010.

SHAUNIA CARLYLE, EXAMINING ATTORNEY



David J. Kyffers

Director of the United States Patent and Trademark Office

United States of America

United States Patent and Trademark Office

CHANDEL'ART

Reg. No. 4,099,884

DRAGON CLAW U.S.A. INC. (CALIFORNIA CORPORATION)
16033 ARROW HIGHWAY
IRWINDALE, CA 91706

Registered Feb. 14, 2012

Int. Cl.: 11

FOR: CHANDELIERS, IN CLASS 11 (U.S. CLS. 13, 21, 23, 31 AND 34).

TRADEMARK

FIRST USE 7-0-2010; IN COMMERCE 7-0-2010.

PRINCIPAL REGISTER

THE MARK CONSISTS OF STANDARD CHARACTERS WITHOUT CLAIM TO ANY PARTICULAR FONT, STYLE, SIZE, OR COLOR.

SN 85-141,460, FILED 9-29-2010.

APRIL ROACH, EXAMINING ATTORNEY



David J. Kyffers

Director of the United States Patent and Trademark Office

United States of America

United States Patent and Trademark Office

GIANT EAGLE SLENDER SANDWICH BUNS

Reg. No. 4,099,885

Registered Feb. 14, 2012

Int. Cl.: 30

TRADEMARK

PRINCIPAL REGISTER

PHOENIX INTANGIBLES HOLDING COMPANY (DELAWARE CORPORATION)
TWO GREENVILLE CROSSING
4005 KENNETT PIKE, SUITE 220
GREENVILLE, DE 19807

FOR: BAKERY PRODUCTS, IN CLASS 30 (U.S. CL. 46).

FIRST USE 11-0-2010; IN COMMERCE 11-0-2010.

THE MARK CONSISTS OF STANDARD CHARACTERS WITHOUT CLAIM TO ANY PARTICULAR FONT, STYLE, SIZE, OR COLOR.

OWNER OF U.S. REG. NOS. 3,140,176, 3,729,689, AND OTHERS.

NO CLAIM IS MADE TO THE EXCLUSIVE RIGHT TO USE "SLENDER SANDWICH BUNS", APART FROM THE MARK AS SHOWN.

SN 85-141,741, FILED 9-30-2010.

SHAUNIA CARLYLE, EXAMINING ATTORNEY



David J. Kybas

Director of the United States Patent and Trademark Office

United States of America

United States Patent and Trademark Office

THE 90-DAY NOVEL

Reg. No. 4,099,886

WATT, ALAN (CANADA INDIVIDUAL)
1242 KENISTON AVENUE
LOS ANGELES, CA 90019

Registered Feb. 14, 2012

Int. Cls.: 16 and 41

FOR: BOOKS IN THE FIELD OF WRITING AND MOTIVATION, IN CLASS 16 (U.S. CLS. 2, 5, 22, 23, 29, 37, 38 AND 50).

TRADEMARK

FIRST USE 10-9-2010; IN COMMERCE 10-16-2010.

SERVICE MARK

FOR: EDUCATIONAL SERVICES, NAMELY, PROVIDING CLASSES, SEMINARS, WORKSHOPS IN THE FIELD OF WRITING AND MOTIVATION, IN CLASS 41 (U.S. CLS. 100, 101 AND 107).

PRINCIPAL REGISTER

FIRST USE 11-30-2007; IN COMMERCE 8-31-2008.

THE MARK CONSISTS OF STANDARD CHARACTERS WITHOUT CLAIM TO ANY PARTICULAR FONT, STYLE, SIZE, OR COLOR.

NO CLAIM IS MADE TO THE EXCLUSIVE RIGHT TO USE "NOVEL", APART FROM THE MARK AS SHOWN.

SN 85-141,785, FILED 9-30-2010.

FRED CARL, EXAMINING ATTORNEY



David J. Kybas

Director of the United States Patent and Trademark Office

United States of America

United States Patent and Trademark Office

House Research Institute

Reg. No. 4,099,887

HOUSE RESEARCH INSTITUTE (CALIFORNIA CORPORATION)
2100 WEST THIRD STREET
LOS ANGELES, CA 90057

Registered Feb. 14, 2012

Int. Cl.: 42

FOR: MEDICAL RESEARCH; SCIENTIFIC INVESTIGATIONS FOR MEDICAL PURPOSES;
SCIENTIFIC RESEARCH, IN CLASS 42 (U.S. CLS. 100 AND 101).

SERVICE MARK

FIRST USE 1-0-2011; IN COMMERCE 1-0-2011.

PRINCIPAL REGISTER

THE MARK CONSISTS OF STANDARD CHARACTERS WITHOUT CLAIM TO ANY PARTICULAR FONT, STYLE, SIZE, OR COLOR.

OWNER OF U.S. REG. NO. 3,142,194.

NO CLAIM IS MADE TO THE EXCLUSIVE RIGHT TO USE "RESEARCH INSTITUTE", APART FROM THE MARK AS SHOWN.

SN 85-141,931, FILED 9-30-2010.

MARGERY A. TIERNEY, EXAMINING ATTORNEY



David J. Kybas

Director of the United States Patent and Trademark Office

United States of America

United States Patent and Trademark Office

GILLIAM

Reg. No. 4,099,888

Registered Feb. 14, 2012

Int. Cl.: 30

TRADEMARK

PRINCIPAL REGISTER

QUALITY CANDY COMPANY, INC. (CALIFORNIA CORPORATION)
1420 JET STREAM DRIVE, SUITE 110
HENDERSON, NV 89052

FOR: CANDY, IN CLASS 30 (U.S. CL. 46).

FIRST USE 7-1-1998; IN COMMERCE 7-1-1998.

THE MARK CONSISTS OF STANDARD CHARACTERS WITHOUT CLAIM TO ANY PARTICULAR FONT, STYLE, SIZE, OR COLOR.

OWNER OF U.S. REG. NO. 1,766,088.

SN 85-142,038, FILED 9-30-2010.

CIMMERIAN COLEMAN, EXAMINING ATTORNEY



David J. Kyffers

Director of the United States Patent and Trademark Office

United States of America
United States Patent and Trademark Office

Gilliam

Reg. No. 4,099,889

QUALITY CANDY COMPANY, INC. (CALIFORNIA CORPORATION)
1420 JET STREAM DRIVE, SUITE 110
HENDERSON, NV 89052

Registered Feb. 14, 2012

Int. Cl.: 30

FOR: CANDY, IN CLASS 30 (U.S. CL. 46).

TRADEMARK

FIRST USE 3-30-2003; IN COMMERCE 3-30-2003.

PRINCIPAL REGISTER

OWNER OF U.S. REG. NO. 1,766,088.

THE MARK CONSISTS OF THE WORD "GILLIAM" IN LOWER CASE STYLIZED FORM.

SN 85-142,059, FILED 9-30-2010.

CIMMERIAN COLEMAN, EXAMINING ATTORNEY



David J. Kyffers

Director of the United States Patent and Trademark Office

United States of America

United States Patent and Trademark Office

ASSURANCESELECT 7

Reg. No. 4,099,890

GREAT AMERICAN LIFE INSURANCE COMPANY (OHIO CORPORATION)
525 VINE STREET, 7TH FLOOR
CINCINNATI, OH 45202

Registered Feb. 14, 2012

Int. Cl.: 36

FOR: ANNUITY UNDERWRITING, EXCLUDING PRENEED AND HEALTHCARE ANNUITIES, IN CLASS 36 (U.S. CLS. 100, 101 AND 102).

SERVICE MARK

FIRST USE 5-2-2011; IN COMMERCE 5-2-2011.

PRINCIPAL REGISTER

THE MARK CONSISTS OF STANDARD CHARACTERS WITHOUT CLAIM TO ANY PARTICULAR FONT, STYLE, SIZE, OR COLOR.

SN 85-144,264, FILED 10-4-2010.

GRETTA YAO, EXAMINING ATTORNEY



David J. Kybas

Director of the United States Patent and Trademark Office

United States of America

United States Patent and Trademark Office



Reg. No. 4,099,891

Registered Feb. 14, 2012

Int. Cl.: 43

SERVICE MARK

PRINCIPAL REGISTER

BUTTERBEE'S FRANCHISE SYSTEMS LLC (OHIO LIMITED LIABILITY COMPANY)
112 HAMMERSTONE WAY
MT. ORAB, OH 45154

FOR: BAR AND RESTAURANT SERVICES, IN CLASS 43 (U.S. CLS. 100 AND 101).

FIRST USE 7-17-2006; IN COMMERCE 7-17-2006.

OWNER OF U.S. REG. NO. 3,887,900.

NO CLAIM IS MADE TO THE EXCLUSIVE RIGHT TO USE "AMERICAN GRILLE", APART FROM THE MARK AS SHOWN.

THE MARK CONSISTS OF THE WORD "BUTTERBEE'S" ACROSS AN OVAL WHICH ALSO CONTAINS AMERICAN "GRILLE" AND STARS.

SN 85-145,425, FILED 10-5-2010.

GINA HAYES, EXAMINING ATTORNEY



David J. Kybas

Director of the United States Patent and Trademark Office

United States of America

United States Patent and Trademark Office

GARRISON BROTHERS TEXAS' FIRST AND OLDEST LEGAL WHISKEY DISTILLERY

Reg. No. 4,099,892

LONE STAR DISTILLERY, LLC (TEXAS LIMITED LIABILITY COMPANY)
P.O. BOX 5932
AUSTIN, TX 78763

Registered Feb. 14, 2012

Int. Cl.: 33

FOR: WHISKEY, IN CLASS 33 (U.S. CLS. 47 AND 49).

TRADEMARK

FIRST USE 10-12-2011; IN COMMERCE 10-12-2011.

PRINCIPAL REGISTER

THE MARK CONSISTS OF STANDARD CHARACTERS WITHOUT CLAIM TO ANY PARTICULAR FONT, STYLE, SIZE, OR COLOR.

OWNER OF U.S. REG. NO. 3,790,736.

NO CLAIM IS MADE TO THE EXCLUSIVE RIGHT TO USE "TEXAS' FIRST AND OLDEST LEGAL WHISKEY DISTILLERY", APART FROM THE MARK AS SHOWN.

SN 85-145,702, FILED 10-5-2010.

DAVID HOFFMAN, EXAMINING ATTORNEY



David J. Kyffers

Director of the United States Patent and Trademark Office

United States of America

United States Patent and Trademark Office

CORSAGE BUDDY

Reg. No. 4,099,893

VICKIE KATNIK (UNITED STATES INDIVIDUAL)
1401 FOOTHILL BOULEVARD
NORTH TUSTIN, CA 92705

Registered Feb. 14, 2012

Int. Cl.: 26

FOR: FASTENERS FOR ATTACHING A FLOWER TO AN ARTICLE OF CLOTHING, NAMELY, FLOWER FASTENERS, IN CLASS 26 (U.S. CLS. 37, 39, 40, 42 AND 50).

TRADEMARK

FIRST USE 11-10-2011; IN COMMERCE 11-10-2011.

PRINCIPAL REGISTER

THE MARK CONSISTS OF STANDARD CHARACTERS WITHOUT CLAIM TO ANY PARTICULAR FONT, STYLE, SIZE, OR COLOR.

OWNER OF U.S. REG. NO. 3,558,153.

NO CLAIM IS MADE TO THE EXCLUSIVE RIGHT TO USE "CORSAGE", APART FROM THE MARK AS SHOWN.

SN 85-145,729, FILED 10-5-2010.

AMY ALFIERI, EXAMINING ATTORNEY



David J. Kybas

Director of the United States Patent and Trademark Office

United States of America

United States Patent and Trademark Office

estate planning for busy people

Reg. No. 4,099,894

BUSY WILLS, INC. (CALIFORNIA CORPORATION)
11641 VALLEY SPRING, #302
STUDIO CITY, CA 91604

Registered Feb. 14, 2012

Int. Cl.: 45

FOR: LEGAL SERVICES, IN CLASS 45 (U.S. CLS. 100 AND 101).

SERVICE MARK

FIRST USE 10-15-2010; IN COMMERCE 1-5-2011.

PRINCIPAL REGISTER

THE MARK CONSISTS OF STANDARD CHARACTERS WITHOUT CLAIM TO ANY PARTICULAR FONT, STYLE, SIZE, OR COLOR.

NO CLAIM IS MADE TO THE EXCLUSIVE RIGHT TO USE "ESTATE PLANNING", APART FROM THE MARK AS SHOWN.

SN 85-146,157, FILED 10-6-2010.

ELISSA GARBER KON, EXAMINING ATTORNEY



David J. Kyffers

Director of the United States Patent and Trademark Office

United States of America

United States Patent and Trademark Office



Reg. No. 4,099,895

Registered Feb. 14, 2012

Int. Cl.: 11

TRADEMARK

PRINCIPAL REGISTER

PARTY ON!, INC (CALIFORNIA CORPORATION)
P.O. BOX 814
ESCONDIDO, CA 92033

FOR: STERILIZING APPARATUS FEATURING A GERMICIDAL LIGHT FOR STORING ORAL HYGIENE PRODUCTS FOR BATHROOM USE, IN CLASS 11 (U.S. CLS. 13, 21, 23, 31 AND 34).

FIRST USE 11-1-2011; IN COMMERCE 12-1-2011.

NO CLAIM IS MADE TO THE EXCLUSIVE RIGHT TO USE "ORAL HYGIENE", APART FROM THE MARK AS SHOWN.

THE COLOR(S) YELLOW, BLACK AND WHITE IS/ARE CLAIMED AS A FEATURE OF THE MARK.

THE MARK CONSISTS OF A YELLOW AND WHITE HOUSE WITH A BLACK TOOTHBRUSH PEAKING OUT OF AN OPEN DOOR. THE WORDING "OH-HO ORAL HYGIENE HIDEOUT" IN THE COLOR BLACK APPEARS TO THE RIGHT OF THE HOUSE DESIGN, WITH A BLACK ELECTRIC CORD APPEARING BENEATH THE WORDING.

SN 85-146,730, FILED 10-6-2010.

ANDREW RHIM, EXAMINING ATTORNEY



David J. Kybas

Director of the United States Patent and Trademark Office

United States of America

United States Patent and Trademark Office

pocketswole

Reg. No. 4,099,896

Registered Feb. 14, 2012

Int. Cl.: 28

TRADEMARK

PRINCIPAL REGISTER

KHONGDY, THITSADY (UNITED STATES INDIVIDUAL)
#6
537 BROAD ST.
MERIDEN, CT 06450

FOR: BALL BEARINGS FOR SKATEBOARDS; SKATEBOARD WHEELS; SKATEBOARDS,
IN CLASS 28 (U.S. CLS. 22, 23, 38 AND 50).

FIRST USE 9-1-2011; IN COMMERCE 9-1-2011.

THE MARK CONSISTS OF STANDARD CHARACTERS WITHOUT CLAIM TO ANY PAR-
TICULAR FONT, STYLE, SIZE, OR COLOR.

SN 85-146,846, FILED 10-6-2010.

DAVID TAYLOR, EXAMINING ATTORNEY



David J. Kyfos

Director of the United States Patent and Trademark Office

United States of America

United States Patent and Trademark Office

VEE WINDOW

Reg. No. 4,099,897

Registered Feb. 14, 2012

Int. Cl.: 12

TRADEMARK

PRINCIPAL REGISTER

BAE SYSTEMS LAND & ARMAMENTS L.P. (DELAWARE LIMITED PARTNERSHIP)
SUITE 700
1525 WILSON BOULEVARD
ARLINGTON, VA 22209

FOR: VEHICLE WINDOWS, IN CLASS 12 (U.S. CLS. 19, 21, 23, 31, 35 AND 44).

FIRST USE 8-29-2007; IN COMMERCE 8-29-2007.

THE MARK CONSISTS OF STANDARD CHARACTERS WITHOUT CLAIM TO ANY PARTICULAR FONT, STYLE, SIZE, OR COLOR.

NO CLAIM IS MADE TO THE EXCLUSIVE RIGHT TO USE "WINDOW", APART FROM THE MARK AS SHOWN.

SN 85-147,163, FILED 10-7-2010.

EMILY CHUO, EXAMINING ATTORNEY



David J. Kybas

Director of the United States Patent and Trademark Office

United States of America

United States Patent and Trademark Office

SHOULDER SAVER

Reg. No. 4,099,898

BROWNING (UTAH CORPORATION)
ONE BROWNING PLACE
MORGAN, UT 84050

Registered Feb. 14, 2012

Int. Cl.: 25

FOR: CAMOUFLAGE SHIRTS; HUNTING SHIRTS, IN CLASS 25 (U.S. CLS. 22 AND 39).

TRADEMARK

FIRST USE 2-1-2011; IN COMMERCE 2-15-2011.

PRINCIPAL REGISTER

THE MARK CONSISTS OF STANDARD CHARACTERS WITHOUT CLAIM TO ANY PARTICULAR FONT, STYLE, SIZE, OR COLOR.

NO CLAIM IS MADE TO THE EXCLUSIVE RIGHT TO USE "SHOULDER", APART FROM THE MARK AS SHOWN.

SN 85-147,265, FILED 10-7-2010.

AISHA SALEM, EXAMINING ATTORNEY



David J. Kyffers

Director of the United States Patent and Trademark Office

United States of America

United States Patent and Trademark Office

MOD THIS

Reg. No. 4,099,899

Registered Feb. 14, 2012

Int. Cls.: 38 and 41

SERVICE MARK

PRINCIPAL REGISTER

THE MUSICIAN NETWORK LLC (KANSAS LIMITED LIABILITY COMPANY), AKA THE MUSICIAN NETWORK,
#357
7111 W 151ST ST
OVERLAND PARK, KS 66223

FOR: VIDEO BROADCASTING SERVICES OVER THE INTERNET OR OTHER COMMUNICATIONS NETWORK, NAMELY, ELECTRONICALLY TRANSMITTING VIDEO CLIPS, IN CLASS 38 (U.S. CLS. 100, 101 AND 104).

FIRST USE 10-18-2010; IN COMMERCE 10-18-2010.

FOR: ENTERTAINMENT SERVICES, NAMELY, AN ON-GOING SERIES FEATURING THE MODIFICATION OF MUSIC EQUIPMENT PROVIDED THROUGH WEBCASTS OVER THE INTERNET, IN CLASS 41 (U.S. CLS. 100, 101 AND 107).

FIRST USE 10-18-2010; IN COMMERCE 10-18-2010.

THE MARK CONSISTS OF STANDARD CHARACTERS WITHOUT CLAIM TO ANY PARTICULAR FONT, STYLE, SIZE, OR COLOR.

NO CLAIM IS MADE TO THE EXCLUSIVE RIGHT TO USE "MOD", APART FROM THE MARK AS SHOWN.

SN 85-147,396, FILED 10-7-2010.

MICHAEL GAAFAR, EXAMINING ATTORNEY



David J. Kyffers

Director of the United States Patent and Trademark Office

United States of America

United States Patent and Trademark Office

Tribalve Herbs Superfoods & Vital Nutrients

Reg. No. 4,099,900

HAYES-COOK, ASA (UNITED STATES INDIVIDUAL)
3915 SHERWOOD FOREST DR
TRAVERSE CITY, MI 49686

Registered Feb. 14, 2012

Int. Cl.: 35

FOR: RETAIL STORE SERVICES FEATURING HEALTH PRODUCTS, NAMELY, HERBS, NUTRITIONAL SUPPLEMENTS AND FOOD SUPPLEMENTS, IN CLASS 35 (U.S. CLS. 100, 101 AND 102).

SERVICE MARK

FIRST USE 8-1-2010; IN COMMERCE 9-10-2010.

PRINCIPAL REGISTER

THE MARK CONSISTS OF STANDARD CHARACTERS WITHOUT CLAIM TO ANY PARTICULAR FONT, STYLE, SIZE, OR COLOR.

NO CLAIM IS MADE TO THE EXCLUSIVE RIGHT TO USE "HERBS SUPERFOODS & VITAL NUTRIENTS", APART FROM THE MARK AS SHOWN.

SN 85-147,941, FILED 10-7-2010.

SETH A. RAPPAPORT, EXAMINING ATTORNEY



David J. Kyffers

Director of the United States Patent and Trademark Office

United States of America

United States Patent and Trademark Office

WILLOWDALE FINANCIAL PARTNERS

Reg. No. 4,099,901

WILLOWDALE FINANCIAL PARTNERS, LLC (VIRGINIA LIMITED LIABILITY COMPANY)
5765-F BURKE CENTRE PARKWAY, #313
BURKE, VA 220152233

Registered Feb. 14, 2012

Int. Cl.: 36

FOR: FINANCIAL ADVISORY AND CONSULTANCY SERVICES, IN CLASS 36 (U.S. CLS. 100, 101 AND 102).

SERVICE MARK

FIRST USE 9-14-2010; IN COMMERCE 9-14-2010.

PRINCIPAL REGISTER

THE MARK CONSISTS OF STANDARD CHARACTERS WITHOUT CLAIM TO ANY PARTICULAR FONT, STYLE, SIZE, OR COLOR.

NO CLAIM IS MADE TO THE EXCLUSIVE RIGHT TO USE 'FINANCIAL PARTNERS', APART FROM THE MARK AS SHOWN.

SN 85-148,213, FILED 10-8-2010.

WON TEAK OH, EXAMINING ATTORNEY



David J. Kyffers

Director of the United States Patent and Trademark Office

United States of America

United States Patent and Trademark Office



Reg. No. 4,099,902

Registered Feb. 14, 2012

Int. Cl.: 5

TRADEMARK

PRINCIPAL REGISTER

CARENET USA INC. (CALIFORNIA CORPORATION)
6294 PEACH AVE
CORONA, CA 92880

FOR: FOOD SUPPLEMENTS, IN CLASS 5 (U.S. CLS. 6, 18, 44, 46, 51 AND 52).

FIRST USE 3-1-2001; IN COMMERCE 6-1-2001.

NO CLAIM IS MADE TO THE EXCLUSIVE RIGHT TO USE "US" AND THE NON-LATIN CHARACTERS THAT TRANSLITERATE TO "US", APART FROM THE MARK AS SHOWN.

THE NON-LATIN CHARACTERS IN THE MARK TRANSLITERATE TO "MAI GUAO SHR KAE" AND THIS MEANS "US TIME" IN ENGLISH.

THE MARK CONSISTS OF THE TERM "US" NEXT TO DESIGN OF THREE STARS ON THE STYLIZED TERM "TIME" ALL ABOVE THE WORDING "US TIME" IN FOUR CHINESE CHARACTERS.

THE ENGLISH TRANSLATION OF THE CHINESE CHARACTERS IN THE MARK IS "US TIME".

SN 85-148,903, FILED 10-8-2010.

SALLY SHIH, EXAMINING ATTORNEY



David J. Kybas

Director of the United States Patent and Trademark Office

United States of America

United States Patent and Trademark Office

FAMA SECRETO DE EXITO

Reg. No. 4,099,903

Registered Feb. 14, 2012

Int. Cl.: 16

TRADEMARK

PRINCIPAL REGISTER

MUNIZ, ILEANA (UNITED STATES INDIVIDUAL)
SUITE 123
247 SW 8 ST
MIAMI, FL 33130

FOR: MAGAZINES, NAMELY, SPANISH MAGAZINES IN THE FIELD OF COMMUNICATIONS, ENTERTAINMENT, FASHION, CULTURE AND ART, IN CLASS 16 (U.S. CLS. 2, 5, 22, 23, 29, 37, 38 AND 50).

FIRST USE 1-11-1997; IN COMMERCE 1-11-1997.

THE MARK CONSISTS OF STANDARD CHARACTERS WITHOUT CLAIM TO ANY PARTICULAR FONT, STYLE, SIZE, OR COLOR.

THE ENGLISH TRANSLATION OF "FAMA SECRETO DE EXITO" IN THE MARK IS "SECRET FAME OF FORMER".

SN 85-148,971, FILED 10-9-2010.

WARREN L. OLANDRIA, EXAMINING ATTORNEY



David J. Kyffers

Director of the United States Patent and Trademark Office

United States of America

United States Patent and Trademark Office

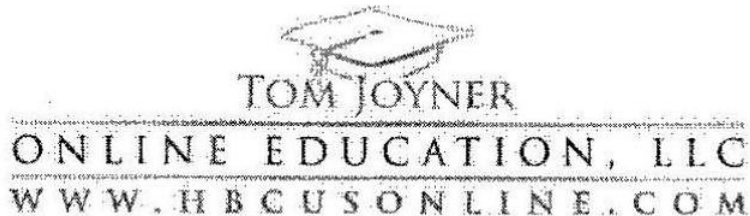

Reg. No. 4,099,904

Registered Feb. 14, 2012

Int. Cl.: 35

SERVICE MARK

PRINCIPAL REGISTER

TOM JOYNER ONLINE EDUCATION, LLC (TEXAS LIMITED LIABILITY COMPANY)
SUITE 930
13760 NOEL ROAD
DALLAS, TX 75240

FOR: CONSULTING SERVICES IN THE FIELD OF HIGHER EDUCATION ADMINISTRATION; MARKETING SERVICES FOR ONLINE DEGREE PROGRAMS, CERTIFICATES, CERTIFICATIONS, PREFERRED LICENSES; RECRUITMENT OF STUDENTS FOR ENROLLMENT IN ONLINE DEGREE PROGRAMS AT HIGHER EDUCATION INSTITUTIONS, IN CLASS 35 (U.S. CLS. 100, 101 AND 102).

FIRST USE 8-0-2010; IN COMMERCE 8-0-2010.

NO CLAIM IS MADE TO THE EXCLUSIVE RIGHT TO USE "ONLINE EDUCATION, LLC" AND "WWW.HBCUSONLINE.COM", APART FROM THE MARK AS SHOWN.

THE NAME(S), PORTRAIT(S), AND/OR SIGNATURE(S) SHOWN IN THE MARK IDENTIFIES "TOM JOYNER", WHOSE CONSENT(S) TO REGISTER IS MADE OF RECORD.

THE MARK CONSISTS OF A SQUARE ACADEMIC CAP WITH THE WORDS "TOM JOYNER" IN STYLIZED LETTERS BELOW IT, THE WORDS "ONLINE EDUCATION, LLC" IN STYLIZED LETTERS BETWEEN TWO LINES AND THE WORDS "WWW.HBCUSONLINE.COM" BELOW THE BOTTOM LINE.

SN 85-149,648, FILED 10-11-2010.

TOBY BULLOFF, EXAMINING ATTORNEY



David J. Kybas

Director of the United States Patent and Trademark Office

United States of America

United States Patent and Trademark Office

BRACESLOTTERY.COM

Reg. No. 4,099,905

ORTHODONTIA LLC (MISSOURI LIMITED LIABILITY COMPANY)

Registered Feb. 14, 2012

6946 LEEDALE
ST. LOUIS, MO 63121

Int. Cl.: 35

FOR: PROVIDING AN ON-LINE COMMERCIAL INFORMATION DIRECTORY ON THE INTERNET IN THE FIELD OF ORTHODONTIA; PROVIDING A WEBSITE FEATURING PHYSICIAN REFERRALS IN THE FIELD OF ORTHODONTIA, IN CLASS 35 (U.S. CLS. 100, 101 AND 102).

SERVICE MARK

PRINCIPAL REGISTER

FIRST USE 11-5-2011; IN COMMERCE 11-5-2011.

THE MARK CONSISTS OF STANDARD CHARACTERS WITHOUT CLAIM TO ANY PARTICULAR FONT, STYLE, SIZE, OR COLOR.

SN 85-149,729, FILED 10-11-2010.

MICHAEL TANNER, EXAMINING ATTORNEY



David J. Kyffers

Director of the United States Patent and Trademark Office

United States of America

United States Patent and Trademark Office

HMMQP

Reg. No. 4,099,906

Registered Feb. 14, 2012

Int. Cl.: 35

SERVICE MARK

PRINCIPAL REGISTER

IASIS HEALTHCARE CORPORATION (DELAWARE CORPORATION)
DOVER CENTER, BUILDING E
117 SEABOARD LANE
FRANKLIN, TN 370672855

FOR: HEALTHCARE BUSINESS AND MANAGEMENT CONSULTING SERVICES, NAMELY, ESTABLISHING AND DEVELOPING BEST PRACTICES AND QUALITY CONTROL MECHANISMS TO IMPROVE CLINICAL OPERATIONS AND PROMOTE THE QUALITY AND SAFETY OF HEALTHCARE PROVIDERS, IN CLASS 35 (U.S. CLS. 100, 101 AND 102).

FIRST USE 10-22-2008; IN COMMERCE 10-22-2008.

THE MARK CONSISTS OF STANDARD CHARACTERS WITHOUT CLAIM TO ANY PARTICULAR FONT, STYLE, SIZE, OR COLOR.

SN 85-150,330, FILED 10-12-2010.

DORITT L. CARROLL, EXAMINING ATTORNEY



David J. Kyjars

Director of the United States Patent and Trademark Office

United States of America

United States Patent and Trademark Office



Reg. No. 4,099,907

SILVER BRACELETS, INC. (NEVADA CORPORATION)
6052 TURKEY LAKE ROAD
ORLANDO, FL 32712

Registered Feb. 14, 2012

Int. Cl.: 43

FOR: RESTAURANT SERVICES, NAMELY, TAKE-OUT FOOD SERVICES PROVIDED BY A GROUP OF INDIVIDUAL QUICK-SERVICE ESTABLISHMENTS SHARING A COMMON SEATING AREA, IN CLASS 43 (U.S. CLS. 100 AND 101).

SERVICE MARK

FIRST USE 10-28-2011; IN COMMERCE 10-28-2011.

PRINCIPAL REGISTER

THE MARK CONSISTS OF A SOLID UNDER CAPITALIZED LETTER "E" WHICH INCLUDES A SOLID HORIZONTAL CROSS BAR WHICH INCLUDES THE WORDS "EARL'S COURT" IN ALL CAPITALIZED LETTERS.

SN 85-150,916, FILED 10-12-2010.

MARK T. MULLEN, EXAMINING ATTORNEY



David J. Kybas

Director of the United States Patent and Trademark Office

United States of America

United States Patent and Trademark Office

WASP

Reg. No. 4,099,908

ATLAS BOLT & SCREW COMPANY LLC (DELAWARE LIMITED LIABILITY COMPANY)
1628 TROY ROAD
ASHLAND, OH 44805

Registered Feb. 14, 2012

Int. Cl.: 6

FOR: METAL FASTENERS, NAMELY, THREADED FASTENERS, IN CLASS 6 (U.S. CLS. 2, 12, 13, 14, 23, 25 AND 50).

TRADEMARK

FIRST USE 2-1-2011; IN COMMERCE 2-1-2011.

PRINCIPAL REGISTER

THE MARK CONSISTS OF STANDARD CHARACTERS WITHOUT CLAIM TO ANY PARTICULAR FONT, STYLE, SIZE, OR COLOR.

SN 85-151,470, FILED 10-13-2010.

ELIZABETH HUGHITT, EXAMINING ATTORNEY



David J. Kyffers

Director of the United States Patent and Trademark Office

United States of America

United States Patent and Trademark Office

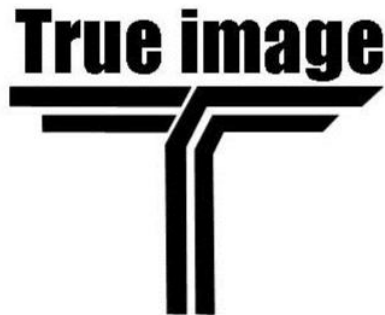

Reg. No. 4,099,909

Registered Feb. 14, 2012

Int. Cl.: 25

TRADEMARK

PRINCIPAL REGISTER

KEVIN LANE (UNITED STATES INDIVIDUAL)
8750 HELIX VISTA DRIVE, UNIT B
SPRING VALLEY, CA 91977

FOR: CAPS; JERSEYS; PANTS; SHIRTS; SHORTS; SWEAT PANTS; SWEAT SHIRTS; SWEAT SHORTS; SWIMWEAR; T-SHIRTS; TOPS; TRACK PANTS; WALKING SHORTS, IN CLASS 25 (U.S. CLS. 22 AND 39).

FIRST USE 11-17-2011; IN COMMERCE 11-17-2011.

THE MARK CONSISTS OF THE WORDS "TRUE IMAGE" ALONG THE TOP MEMBER OF A STYLIZED "T".

SN 85-151,528, FILED 10-13-2010.

MICHAEL WEBSTER, EXAMINING ATTORNEY



David J. Kyffers

Director of the United States Patent and Trademark Office

United States of America

United States Patent and Trademark Office

PINPOINT Rx

Reg. No. 4,099,910

Registered Feb. 14, 2012

Int. Cl.: 9

OPTOPO, INC. (DELAWARE CORPORATION), DBA CENTICE CORPORATION (CENTICE CORP.),
SUITE 1000
215 SOUTHPORT DRIVE
MORRISVILLE, NC 27560

TRADEMARK

FOR: SCIENTIFIC APPARATUS, NAMELY, SPECTROMETERS AND PARTS AND FITTINGS THEREFOR, IN CLASS 9 (U.S. CLS. 21, 23, 26, 36 AND 38).

PRINCIPAL REGISTER

FIRST USE 1-9-2011; IN COMMERCE 1-9-2011.

THE MARK CONSISTS OF STANDARD CHARACTERS WITHOUT CLAIM TO ANY PARTICULAR FONT, STYLE, SIZE, OR COLOR.

NO CLAIM IS MADE TO THE EXCLUSIVE RIGHT TO USE "RX", APART FROM THE MARK AS SHOWN.

SN 85-152,179, FILED 10-13-2010.

Laurie Mayes, Examining Attorney



David J. Kyffers

Director of the United States Patent and Trademark Office

United States of America

United States Patent and Trademark Office

MAGNASHAVE

Reg. No. 4,099,911

GHERMAN, RICHARD JOEL (UNITED STATES INDIVIDUAL)
POST OFFICE BOX 1312
PEBBLE BEACH, CA 939531312

Registered Feb. 14, 2012

Int. Cl.: 8

FOR: HAND TOOLS, NAMELY, KNIFE SHARPENERS; HAND-OPERATED SHARPENING TOOLS AND INSTRUMENTS; MANUALLY-OPERATED RAZOR BLADE SHARPENERS, IN CLASS 8 (U.S. CLS. 23, 28 AND 44).

TRADEMARK

FIRST USE 3-10-2006; IN COMMERCE 5-23-2011.

PRINCIPAL REGISTER

THE MARK CONSISTS OF STANDARD CHARACTERS WITHOUT CLAIM TO ANY PARTICULAR FONT, STYLE, SIZE, OR COLOR.

OWNER OF U.S. REG. NOS. 3,713,452 AND 3,778,708.

SN 85-153,185, FILED 10-14-2010.

ANDREW RHIM, EXAMINING ATTORNEY



David J. Kybas

Director of the United States Patent and Trademark Office

United States of America

United States Patent and Trademark Office

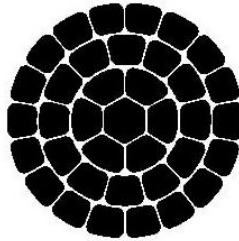

STABILOY

Reg. No. 4,099,912

Registered Feb. 14, 2012

Int. Cl.: 9

TRADEMARK

PRINCIPAL REGISTER

ALCAN PRODUCTS CORPORATION (TEXAS CORPORATION)
8770 WEST BRYN MAWR AVENUE
CHICAGO, IL 60631

FOR: ELECTRIC WIRE AND CABLE, IN CLASS 9 (U.S. CLS. 21, 23, 26, 36 AND 38).

FIRST USE 4-0-1994; IN COMMERCE 4-0-1994.

OWNER OF U.S. REG. NOS. 983,205 AND 1,099,249.

THE MARK CONSISTS OF UNIQUE CIRCULAR DESIGN COMPRISED GEOMETRIC FIGURES ABOVE THE WORDING "STABILOY".

SN 85-153,321, FILED 10-15-2010.

ANGELA DUONG, EXAMINING ATTORNEY



David J. Kyffers

Director of the United States Patent and Trademark Office

United States of America

United States Patent and Trademark Office

MONACO VESTA

Reg. No. 4,099,913

Registered Feb. 14, 2012

Int. Cl.: 12

TRADEMARK

PRINCIPAL REGISTER

INTERNATIONAL TRUCK INTELLECTUAL PROPERTY COMPANY, LLC (ILLINOIS
LIMITED LIABILITY COMPANY)
4201 WINFIELD ROAD
WARRENVILLE, IL 60555

FOR: MOTOR HOMES, IN CLASS 12 (U.S. CLS. 19, 21, 23, 31, 35 AND 44).

FIRST USE 11-19-2010; IN COMMERCE 11-19-2010.

THE MARK CONSISTS OF STANDARD CHARACTERS WITHOUT CLAIM TO ANY PARTICULAR FONT, STYLE, SIZE, OR COLOR.

SN 85-153,635, FILED 10-15-2010.

KEVON CHISOLM, EXAMINING ATTORNEY



David J. Kyffers

Director of the United States Patent and Trademark Office

United States of America

United States Patent and Trademark Office

NEW AWAKENINGS

Reg. No. 4,099,914

BOWLER, WOSSENE (UNITED STATES INDIVIDUAL)
913 SUMMIT WAY

Registered Feb. 14, 2012

LAGUNA BEACH, CA 92561

Int. Cl.: 30

FOR: GROUND COFFEE BEANS, IN CLASS 30 (U.S. CL. 46).

TRADEMARK

FIRST USE 2-13-2011; IN COMMERCE 2-13-2011.

PRINCIPAL REGISTER

THE MARK CONSISTS OF STANDARD CHARACTERS WITHOUT CLAIM TO ANY PARTICULAR FONT, STYLE, SIZE, OR COLOR.

SN 85-153,668, FILED 10-15-2010.

ANTHONY RINKER, EXAMINING ATTORNEY



David J. Kybas

Director of the United States Patent and Trademark Office

United States of America

United States Patent and Trademark Office

A CLEAR DIRECTION FOR THE FUTURE

Reg. No. 4,099,915

GT EXHAUST, INC. (NEBRASKA CORPORATION)

Registered Feb. 14, 2012

4121 NW 37TH STREET
LINCOLN, NE 68524

Int. Cl.: 7

FOR: EXHAUST MANIFOLDS FOR ENGINES; EXHAUST SILENCERS FOR ENGINES; EXHAUST ACCESSORIES FOR ENGINES, NAMELY, CORRUGATED FLEX CONNECTORS FOR CONNECTING THE EXHAUST TO THE ENGINE, WYE CONNECTORS USED TO CONNECT EXHAUST USED WITH DUAL OUTLET ENGINES, EXHAUST THIMBLES USED TO PROVIDE SEPARATION BETWEEN THE EXHAUST PIPE AND THE WALLS AND CEILING, AND OUTLET EXTENSIONS USED TO EXTEND AN EXHAUST PIPE; THERMAL INSULATING WRAPS FOR ENGINES SOLD AS AN INTEGRAL PART OF ENGINES; ENGINE PARTS, NAMELY, THREE-WAY, OXIDATION AND DIESEL OXIDATION CATALYSTS; DIESEL FUEL PARTICULATE FILTERS, IN CLASS 7 (U.S. CLS. 13, 19, 21, 23, 31, 34 AND 35).

TRADEMARK

PRINCIPAL REGISTER

FIRST USE 3-0-2009; IN COMMERCE 3-0-2009.

THE MARK CONSISTS OF STANDARD CHARACTERS WITHOUT CLAIM TO ANY PARTICULAR FONT, STYLE, SIZE, OR COLOR.

SN 85-153,682, FILED 10-15-2010.

CHERYL CLAYTON, EXAMINING ATTORNEY



David J. Kyros

Director of the United States Patent and Trademark Office

United States of America

United States Patent and Trademark Office

IMPETUS

Reg. No. 4,099,916

Registered Feb. 14, 2012

Int. Cl.: 35

SERVICE MARK

PRINCIPAL REGISTER

TIERRA BONALDI (UNITED STATES INDIVIDUAL)
45 WINTER STREET
RENO, NV 89503

FOR: ADVERTISING AND MARKETING; ADVERTISING, MARKETING AND PROMOTIONAL SERVICES RELATED TO ALL INDUSTRIES FOR THE PURPOSE OF FACILITATING NETWORKING AND SOCIALIZING OPPORTUNITIES FOR BUSINESS PURPOSES; ADVICE IN THE FIELD OF BUSINESS MANAGEMENT AND MARKETING; BUSINESS MARKETING CONSULTING SERVICES; DIRECT MARKETING; MARKETING CONSULTING; ON-LINE ADVERTISING AND MARKETING SERVICES; PROMOTING, ADVERTISING AND MARKETING OF THE ON-LINE WEB SITES OF OTHERS; PROMOTION, ADVERTISING AND MARKETING OF ON-LINE WEBSITES, IN CLASS 35 (U.S. CLS. 100, 101 AND 102).

FIRST USE 11-5-2010; IN COMMERCE 11-5-2010.

THE MARK CONSISTS OF STANDARD CHARACTERS WITHOUT CLAIM TO ANY PARTICULAR FONT, STYLE, SIZE, OR COLOR.

SN 85-153,707, FILED 10-15-2010.

RUDY R. SINGLETON, EXAMINING ATTORNEY



David J. Kyfos

Director of the United States Patent and Trademark Office

United States of America

United States Patent and Trademark Office

THE VALUED ASSET

Reg. No. 4,099,917

E. BUCKLEY BARLOW (UNITED STATES INDIVIDUAL)
3372 BRUCE STREET
SALT LAKE CITY, UT 84124

Registered Feb. 14, 2012

Int. Cl.: 41

FOR: EDUCATIONAL SERVICES, NAMELY, CONDUCTING CLASSES, SEMINARS, CONFERENCES AND WORKSHOPS IN THE FIELDS OF BUSINESS AND PERSONAL DEVELOPMENT AND DISTRIBUTION OF TRAINING MATERIALS IN CONNECTION THEREWITH, IN CLASS 41 (U.S. CLS. 100, 101 AND 107).

SERVICE MARK

PRINCIPAL REGISTER

FIRST USE 7-3-2009; IN COMMERCE 9-5-2010.

THE MARK CONSISTS OF STANDARD CHARACTERS WITHOUT CLAIM TO ANY PARTICULAR FONT, STYLE, SIZE, OR COLOR.

SN 85-153,833, FILED 10-15-2010.

JANICE KIM, EXAMINING ATTORNEY



David J. Kybas

Director of the United States Patent and Trademark Office

United States of America

United States Patent and Trademark Office

MONACO
Vesta

Reg. No. 4,099,918

Registered Feb. 14, 2012

Int. Cl.: 12

TRADEMARK

PRINCIPAL REGISTER

INTERNATIONAL TRUCK INTELLECTUAL PROPERTY COMPANY, LLC (ILLINOIS
LIMITED LIABILITY COMPANY)
4201 WINFIELD ROAD
WARRENVILLE, IL 60555

FOR: MOTOR HOMES, IN CLASS 12 (U.S. CLS. 19, 21, 23, 31, 35 AND 44).

FIRST USE 11-19-2010; IN COMMERCE 11-19-2010.

THE MARK CONSISTS OF THE WORDS "MONACO VESTA" WITH THE "V" IN "VESTA"
DESIGNED WITH THREE LINES ON THE LEFT SIDE WITH EACH LINE GETTING A LITTLE
SHORTER IN LENGTH AND THE TOP LINE BEING THE LONGEST.

SN 85-154,049, FILED 10-15-2010.

KEVON CHISOLM, EXAMINING ATTORNEY



David J. Kyffers

Director of the United States Patent and Trademark Office

United States of America

United States Patent and Trademark Office

SURFAIR360

Reg. No. 4,099,919

FOSTER, BILL G. (UNITED STATES INDIVIDUAL), DBA SURFAIR360,
548 BLUEBIRD CANYON
LAGUNA BEACH, CA 92651

Registered Feb. 14, 2012

Int. Cl.: 28

FOR: PLASTIC STRAP SYSTEM ESPECIALLY DESIGNED FOR SURFBOARDS COMPRISED
PRIMARILY OF A STRAP AFFIXED TO THE SURFBOARD WITH EPOXY ALLOWING THE
SURFER TO DO FREESTYLE TRICKS WHILE KEEPING THE SURFBOARD UNDER
HIM/HER, IN CLASS 28 (U.S. CLS. 22, 23, 38 AND 50).

TRADEMARK

PRINCIPAL REGISTER

FIRST USE 12-6-2011; IN COMMERCE 12-6-2011.

THE MARK CONSISTS OF STANDARD CHARACTERS WITHOUT CLAIM TO ANY PAR-
TICULAR FONT, STYLE, SIZE, OR COLOR.

SN 85-154,064, FILED 10-15-2010.

TINA L. SNAPP, EXAMINING ATTORNEY



David J. Kyffers

Director of the United States Patent and Trademark Office

United States of America

United States Patent and Trademark Office

musXpand

Reg. No. 4,099,920

Registered Feb. 14, 2012

Int. Cls.: 9, 35, 41, and 42

TRADEMARK

SERVICE MARK

PRINCIPAL REGISTER

HILGER, PHILIPPE H. (FRANCE INDIVIDUAL)
227 WATERLEIGH DR
VANCOUVER, BC, CANADA V5X4T2

FOR: AUDIO AND VIDEO RECORDINGS FEATURING MUSIC AND ARTISTIC PERFORMANCES; COMPUTER SOFTWARE FEATURING MUSICAL SOUND RECORDINGS AND MUSICAL VIDEO RECORDINGS; COMPUTER SOFTWARE FOR PROCESSING DIGITAL MUSIC FILES; DIGITAL MUSIC DOWNLOADABLE FROM THE INTERNET; DOWNLOADABLE MP3 FILES, MP3 RECORDINGS, ON-LINE DISCUSSION BOARDS, WEBCASTS, WEBINARS AND PODCASTS FEATURING MUSIC, AUDIO BOOKS IN THE FIELD OF MUSIC, AND NEWS BROADCASTS; DOWNLOADABLE MUSICAL SOUND RECORDINGS; DOWNLOADABLE RING TONES, GRAPHICS AND MUSIC VIA A GLOBAL COMPUTER NETWORK AND WIRELESS DEVICES; DOWNLOADABLE VIDEO RECORDINGS FEATURING MUSIC; MUSICAL SOUND RECORDINGS; MUSICAL VIDEO RECORDINGS; SERIES OF MUSICAL SOUND RECORDINGS; SOUND RECORDINGS FEATURING MUSIC; VIDEO RECORDINGS FEATURING MUSIC; VISUAL RECORDINGS AND AUDIOVISUAL RECORDINGS FEATURING MUSIC AND ANIMATION, IN CLASS 9 (U.S. CLS. 21, 23, 26, 36 AND 38).

FIRST USE 5-20-2011; IN COMMERCE 5-20-2011.

FOR: BUSINESS CONSULTING, BUSINESS MANAGEMENT AND PROVIDING INFORMATION IN THE MUSIC BUSINESS FIELD; ON-LINE RETAIL STORE SERVICES FEATURING DOWNLOADABLE PRE-RECORDED MUSIC AND VIDEO; ON-LINE WHOLESALE AND RETAIL STORE SERVICES FEATURING DOWNLOADABLE SOUND, MUSIC, IMAGE, VIDEO AND GAME FILES; PERSONAL MANAGEMENT SERVICES FOR MUSICAL PERFORMERS, IN CLASS 35 (U.S. CLS. 100, 101 AND 102).

FIRST USE 5-20-2011; IN COMMERCE 5-20-2011.

FOR: ENTERTAINMENT IN THE NATURE OF VISUAL AND AUDIO PERFORMANCES BY MUSICAL ARTISTS AND BANDS; ENTERTAINMENT INFORMATION SERVICES, NAMELY, PROVIDING INFORMATION AND NEWS RELEASES ABOUT A MUSICAL ARTIST; ENTERTAINMENT SERVICES, NAMELY, PROVIDING NONDOWNLOADABLE PRERECORDED MUSIC, INFORMATION IN THE FIELD OF MUSIC, AND COMMENTARY AND ARTICLES ABOUT MUSIC, ALL ON-LINE VIA A GLOBAL COMPUTER NETWORK; ENTERTAINMENT SERVICES, NAMELY, PROVIDING ON-LINE REVIEWS OF MUSIC;



David J. Kybas

Director of the United States Patent and Trademark Office

Reg. No. 4,099,920 PROVIDING A WEBSITE FEATURING INFORMATION IN THE FIELD OF MUSIC AND ENTERTAINMENT; PROVIDING A WEBSITE FOR ENTERTAINMENT PURPOSES WHERE USERS CAN VIEW AND POST PICTURES, VIDEOS AND RECORDINGS FEATURING MUSICAL ARTISTS AND BANDS; PROVIDING AN INTERNET WEBSITE PORTAL IN THE FIELD OF MUSIC; PROVISION OF INFORMATION RELATING TO MUSIC, IN CLASS 41 (U.S. CLS. 100, 101 AND 107).

FIRST USE 5-20-2011; IN COMMERCE 5-20-2011.

FOR: COMPUTER SERVICES, NAMELY, DIGITAL FORMATTING AND COMPRESSION OF MUSIC AND IMAGES, NAMELY, PROCESSING OF DIGITAL MUSIC AND VIDEO IMAGES INTO DOWNLOADABLE PRODUCTS; COMPUTER SERVICES, NAMELY, HOSTING ON-LINE WEB FACILITIES FOR OTHERS TO SHOWCASE SONGWRITING AND MUSICAL TALENTS AND FOR FACILITATING AND CONDUCTING ONLINE CONNECTIONS, COLLABORATIONS, AND INTERACTIVE DISCUSSIONS ABOUT SONGWRITING AND MUSIC; PROVIDING A WEBSITE ALLOWING USERS TO UPLOAD AND DOWNLOAD MUSIC; PROVIDING A WEBSITE FEATURING TECHNOLOGY THAT ENABLES USERS TO UPLOAD AND DOWNLOAD MUSIC RELATED RECORDINGS, IN CLASS 42 (U.S. CLS. 100 AND 101).

FIRST USE 5-20-2011; IN COMMERCE 5-20-2011.

THE MARK CONSISTS OF A STYLIZED WRITING OF THE WORD "MUSXPAND" OUTLINED IN BLACK WITH ALL LOWERCASE LETTERS EXCEPT THE LETTER "X" IN UPPERCASE, WITH A COLOR GRADIENT FROM PURPLE IN THE TOP LEFT CORNER OF THE DESIGN TO RED IN THE BOTTOM RIGHT CORNER, THROUGH GREEN IN THE CENTRAL PART.

THE COLOR(S) PURPLE, GREEN, RED AND BLACK IS/ARE CLAIMED AS A FEATURE OF THE MARK.

SN 85-154,533, FILED 10-17-2010.

ARETHA SOMERVILLE, EXAMINING ATTORNEY

United States of America

United States Patent and Trademark Office

JUST OUT WORK 'EM

Reg. No. 4,099,921

SMT ENTERPRISES, INC. (CALIFORNIA CORPORATION), DBA STREET MADE,
320 NORTH 10TH ST.
SACRAMENTO, CA 95811

Registered Feb. 14, 2012

Int. Cls.: 25 and 41

FOR: APPAREL, NAMELY, SHIRTS, SWEATSHIRTS, JACKETS AND HATS, IN CLASS 25
(U.S. CLS. 22 AND 39).

TRADEMARK

FIRST USE 12-0-2010; IN COMMERCE 12-0-2010.

SERVICE MARK

FOR: ENTERTAINMENT AND EDUCATIONAL SERVICES, NAMELY, PROVIDING NEWS
AND INFORMATION ABOUT SPORTS AND ENTERTAINMENT; ORGANIZING AND
CONDUCTING MUSIC EVENTS AND SPORTS EVENTS IN THE FIELD OF MIXED MARTIAL
ARTS, IN CLASS 41 (U.S. CLS. 100, 101 AND 107).

PRINCIPAL REGISTER

FIRST USE 12-0-2010; IN COMMERCE 12-0-2010.

THE MARK CONSISTS OF STANDARD CHARACTERS WITHOUT CLAIM TO ANY PAR-
TICULAR FONT, STYLE, SIZE, OR COLOR.

SN 85-154,772, FILED 10-18-2010.

REBECCA POVARCHUK, EXAMINING ATTORNEY



David J. Kybas

Director of the United States Patent and Trademark Office

United States of America

United States Patent and Trademark Office



Reg. No. 4,099,922

PERATA, LINDA (UNITED STATES INDIVIDUAL)
170 COUNTRYSIDE CIRCLE
PARK CITY, UT 84098

Registered Feb. 14, 2012

Int. Cl.: 42

FOR: HOSTING AN ON-LINE COMMUNITY WEB SITE FEATURING SUPPORT FOR LYME AND MORGELLONS DISEASE, IN CLASS 42 (U.S. CLS. 100 AND 101).

SERVICE MARK

FIRST USE 4-21-2007; IN COMMERCE 4-21-2007.

PRINCIPAL REGISTER

NO CLAIM IS MADE TO THE EXCLUSIVE RIGHT TO USE "MORGELLONS", APART FROM THE MARK AS SHOWN.

THE COLOR(S) PINK, ORANGE, SILVER, AND BLACK IS/ARE CLAIMED AS A FEATURE OF THE MARK.

THE MARK CONSISTS OF A PINK AND ORANGE ECHINACEA FLOWER AND THE STYLIZED WORDS "MORGELLONS SANCTUM" IN SILVER WITH BLACK OUTLINES.

SN 85-154,845, FILED 10-18-2010.

APRIL HESIK, EXAMINING ATTORNEY



David J. Kyffers

Director of the United States Patent and Trademark Office

United States of America

United States Patent and Trademark Office

ELITEMP

Reg. No. 4,099,923

SANOMEDICS DEVELOPMENT CORPORATION (FLORIDA CORPORATION)
80 SW 8TH STREET, SUITE 2180
MIAMI, FL 33130

Registered Feb. 14, 2012

Int. Cl.: 10

FOR: THERMOMETERS FOR MEDICAL PURPOSES, IN CLASS 10 (U.S. CLS. 26, 39 AND 44).

TRADEMARK

FIRST USE 9-23-2011; IN COMMERCE 9-23-2011.

PRINCIPAL REGISTER

THE MARK CONSISTS OF STANDARD CHARACTERS WITHOUT CLAIM TO ANY PARTICULAR FONT, STYLE, SIZE, OR COLOR.

SN 85-154,921, FILED 10-18-2010.

MARK RADEMACHER, EXAMINING ATTORNEY



David J. Kyfos

Director of the United States Patent and Trademark Office

United States of America

United States Patent and Trademark Office

SAFEKEEPERS

Reg. No. 4,099,924

DEBRA W. FINKEL (UNITED STATES INDIVIDUAL)
62A WALNUT PARK
NEWTON, MA 02458

Registered Feb. 14, 2012

Int. Cl.: 21

FOR: HOUSEHOLD CONTAINERS FOR FOODS, IN CLASS 21 (U.S. CLS. 2, 13, 23, 29, 30, 33, 40 AND 50).

TRADEMARK

FIRST USE 3-1-2011; IN COMMERCE 3-1-2011.

PRINCIPAL REGISTER

THE MARK CONSISTS OF STANDARD CHARACTERS WITHOUT CLAIM TO ANY PARTICULAR FONT, STYLE, SIZE, OR COLOR.

SN 85-155,621, FILED 10-19-2010.

LOURDES AYALA, EXAMINING ATTORNEY



David J. Kybas

Director of the United States Patent and Trademark Office

United States of America

United States Patent and Trademark Office

MELI

Reg. No. 4,099,925

Registered Feb. 14, 2012

Int. Cl.: 41

SERVICE MARK

PRINCIPAL REGISTER

CHILDREN'S LITERACY INITIATIVE (PENNSYLVANIA CORPORATION)
2314 MARKET STREET
PHILADELPHIA, PA 19103

FOR: LITERACY TRAINING SERVICES; EDUCATIONAL SERVICES, NAMELY, CONDUCTING AND ORGANIZING CLASSES, SEMINARS, CONFERENCES AND WORKSHOPS IN THE FIELD OF CHILDREN'S LITERACY, AS WELL AS THE DISTRIBUTION OF COURSE MATERIALS IN CONNECTION THEREWITH, IN CLASS 41 (U.S. CLS. 100, 101 AND 107).

FIRST USE 2-1-2010; IN COMMERCE 10-1-2010.

THE MARK CONSISTS OF STANDARD CHARACTERS WITHOUT CLAIM TO ANY PARTICULAR FONT, STYLE, SIZE, OR COLOR.

SN 85-155,770, FILED 10-19-2010.

DAVID TAYLOR, EXAMINING ATTORNEY



David J. Kyffers

Director of the United States Patent and Trademark Office

United States of America

United States Patent and Trademark Office

BLACK OPS

Reg. No. 4,099,926

ULTIMATE SCUBA ADVENTURES (PENNSYLVANIA SOLE PROPRIETORSHIP)
641 PAINTER STREET
MEDIA, PA 19063

Registered Feb. 14, 2012

Int. Cl.: 41

FOR: SCUBA DIVING TRAINING AND EDUCATION SERVICES, NAMELY, CLASSES, SEMINARS AND WORKSHOPS IN THE FIELD OF SCUBA DIVING, IN CLASS 41 (U.S. CLS. 100, 101 AND 107).

SERVICE MARK

FIRST USE 2-28-2011; IN COMMERCE 2-28-2011.

PRINCIPAL REGISTER

THE MARK CONSISTS OF STANDARD CHARACTERS WITHOUT CLAIM TO ANY PARTICULAR FONT, STYLE, SIZE, OR COLOR.

SN 85-155,996, FILED 10-19-2010.

AMEEN IMAM, EXAMINING ATTORNEY



David J. Kyffers

Director of the United States Patent and Trademark Office

United States of America

United States Patent and Trademark Office

CONFORMA 3000

Reg. No. 4,099,927

OPTIVUS PROTON THERAPY, INC. (CALIFORNIA CORPORATION)
1475 S. VICTORIA CT.

Registered Feb. 14, 2012

SAN BERNARDINO, CA 92408

Int. Cl.: 10

FOR: MEDICAL PRODUCTS, NAMELY, PROTON BEAM TREATMENT EQUIPMENT CONSISTING OF PROTON BEAM ACCELERATORS, PROTON BEAM TRANSPORTS, PROTON BEAM CONTROLLERS, AND PROTON BEAM TREATMENT STATIONS CONSISTING OF GANTRIES, TREATMENT NOZZLES AND PATIENT ALIGNMENT SYSTEMS; AND MONITORING SYSTEMS FOR RADIATION THERAPY USED IN HEALTH CARE FACILITIES, NAMELY, PROTON DOSE MONITORS, IN CLASS 10 (U.S. CLS. 26, 39 AND 44).

TRADEMARK

PRINCIPAL REGISTER

FIRST USE 8-25-2010; IN COMMERCE 1-13-2011.

THE MARK CONSISTS OF STANDARD CHARACTERS WITHOUT CLAIM TO ANY PARTICULAR FONT, STYLE, SIZE, OR COLOR.

SN 85-156,045, FILED 10-19-2010.

ELLEN PERKINS, EXAMINING ATTORNEY



David J. Kybas

Director of the United States Patent and Trademark Office

United States of America

United States Patent and Trademark Office

BLAST

Reg. No. 4,099,928

AMERICAN BILTRITE INC. (DELAWARE CORPORATION)
57 RIVER STREET
WELLESLEY HILLS, MA 02481

Registered Feb. 14, 2012

Int. Cl.: 27

FOR: BULLET RESISTANT RUBBER SURFACE COVERINGS, NAMELY, FLOOR AND WALL COVERINGS, IN CLASS 27 (U.S. CLS. 19, 20, 37, 42 AND 50).

TRADEMARK

FIRST USE 3-2-2011; IN COMMERCE 3-2-2011.

PRINCIPAL REGISTER

THE MARK CONSISTS OF STANDARD CHARACTERS WITHOUT CLAIM TO ANY PARTICULAR FONT, STYLE, SIZE, OR COLOR.

SN 85-156,121, FILED 10-19-2010.

PAM WILLIS, EXAMINING ATTORNEY



David J. Kybas

Director of the United States Patent and Trademark Office

United States of America

United States Patent and Trademark Office

THUH

Reg. No. 4,099,929

Registered Feb. 14, 2012

Int. Cl.: 9

PREMIER ASSISTIVE TECHNOLOGY, INC. (MICHIGAN CORPORATION), DBA PREMIER LITERACY,
SUITE 205
1309 N. WILLIAM ST.
JOLIET, IL 60435

TRADEMARK

PRINCIPAL REGISTER

FOR: ENVIRONMENTAL MONITORING SYSTEM COMPRISED OF METERS AND SENSORS THAT MEASURE PRESSURE, HUMIDITY, TEMPERATURE AND INCLUDES ALARM AND REPORTING FUNCTIONS; WIRELESS CONTROLLER TO MONITOR AND CONTROL THE FUNCTIONING OF OTHER ELECTRONIC DEVICES, IN CLASS 9 (U.S. CLS. 21, 23, 26, 36 AND 38).

FIRST USE 5-1-2011; IN COMMERCE 8-15-2011.

THE MARK CONSISTS OF STANDARD CHARACTERS WITHOUT CLAIM TO ANY PARTICULAR FONT, STYLE, SIZE, OR COLOR.

SN 85-156,386, FILED 10-19-2010.

MARGARET POWER, EXAMINING ATTORNEY



David J. Kyros

Director of the United States Patent and Trademark Office

United States of America

United States Patent and Trademark Office

HOTEL OKURA

Reg. No. 4,099,930

HOTEL OKURA CO., LTD. (JAPAN CORPORATION)
2-10-4, TORANOMON, MINATO-KU
TOKYO, JAPAN

Registered Feb. 14, 2012

Int. Cl.: 43

FOR: HOTELS; PROVIDING TEMPORARY ACCOMMODATION; PROVIDING CONFERENCE ROOMS; PROVIDING FOOD AND DRINK, IN CLASS 43 (U.S. CLS. 100 AND 101).

SERVICE MARK

FIRST USE 5-20-1962; IN COMMERCE 11-26-2011.

PRINCIPAL REGISTER

THE MARK CONSISTS OF STANDARD CHARACTERS WITHOUT CLAIM TO ANY PARTICULAR FONT, STYLE, SIZE, OR COLOR.

OWNER OF U.S. REG. NO. 1,992,434.

NO CLAIM IS MADE TO THE EXCLUSIVE RIGHT TO USE "HOTEL", APART FROM THE MARK AS SHOWN.

SN 85-156,658, FILED 10-20-2010.

ALICE BENMAMAN, EXAMINING ATTORNEY



David J. Kyffers

Director of the United States Patent and Trademark Office

United States of America

United States Patent and Trademark Office

SABA

Reg. No. 4,099,931

SCA HYGIENE PRODUCTS AB (SWEDEN CORPORATION)
SE-405 03

Registered Feb. 14, 2012

GOTEBORG, SWEDEN

Int. Cl.: 5

FOR: SANITARY TOWELS, PANTYLINERS, SANITARY NAPKINS, IN CLASS 5 (U.S. CLS. 6, 18, 44, 46, 51 AND 52).

TRADEMARK

FIRST USE 0-0-1981; IN COMMERCE 8-26-2011.

PRINCIPAL REGISTER

THE MARK CONSISTS OF STANDARD CHARACTERS WITHOUT CLAIM TO ANY PARTICULAR FONT, STYLE, SIZE, OR COLOR.

SN 85-156,776, FILED 10-20-2010.

LESLEY LAMOTHE, EXAMINING ATTORNEY



David J. Kybas

Director of the United States Patent and Trademark Office

United States of America

United States Patent and Trademark Office

35 MAPLE STREET

Reg. No. 4,099,932

Registered Feb. 14, 2012

Int. Cl.: 33

TRADEMARK

PRINCIPAL REGISTER

THE OTHER GUYS, INC. (CALIFORNIA CORPORATION)
35 MAPLE STREET
SONOMA, CA 95476

FOR: DISTILLED SPIRITS, IN CLASS 33 (U.S. CLS. 47 AND 49).

FIRST USE 8-0-2011; IN COMMERCE 8-0-2011.

THE MARK CONSISTS OF STANDARD CHARACTERS WITHOUT CLAIM TO ANY PARTICULAR FONT, STYLE, SIZE, OR COLOR.

SN 85-156,963, FILED 10-20-2010.

B. PARADEWELAI, EXAMINING ATTORNEY



David J. Kyffers

Director of the United States Patent and Trademark Office

United States of America

United States Patent and Trademark Office



Hotel Okura

Reg. No. 4,099,933

HOTEL OKURA CO., LTD. (JAPAN CORPORATION)
2-10-4, TORANOMON, MINATO-KU
TOKYO, JAPAN

Registered Feb. 14, 2012

Int. Cl.: 43

FOR: HOTELS; PROVIDING TEMPORARY ACCOMMODATION; PROVIDING CONFERENCE ROOMS; PROVIDING FOOD AND DRINK, IN CLASS 43 (U.S. CLS. 100 AND 101).

SERVICE MARK

FIRST USE 5-20-1992; IN COMMERCE 11-26-2011.

PRINCIPAL REGISTER

OWNER OF U.S. REG. NO. 1,992,434.

NO CLAIM IS MADE TO THE EXCLUSIVE RIGHT TO USE "HOTEL", APART FROM THE MARK AS SHOWN.

THE MARK CONSISTS OF A STYLIZED FLOWER BLOSSOM OVER THE WORDS "HOTEL OKURA" IN STYLIZED LETTERING.

SN 85-157,051, FILED 10-20-2010.

ALICE BENMAMAN, EXAMINING ATTORNEY



David J. Kybas

Director of the United States Patent and Trademark Office

United States of America

United States Patent and Trademark Office



Reg. No. 4,099,934

Registered Feb. 14, 2012

Int. Cl.: 25

TRADEMARK

PRINCIPAL REGISTER

SESSOMS, DE'ANGELO (UNITED STATES INDIVIDUAL)
2093 CORSICA WAY SW
MARIETTA, GA 30008

FOR: BATHING SUITS; COATS; DRESSES; HATS; HOODED SWEATSHIRTS; PANTS; POLO SHIRTS; SHIRTS; SHOES; SHORTS; SOCKS; SWEATSHIRTS; T-SHIRTS; UNDERWEAR, IN CLASS 25 (U.S. CLS. 22 AND 39).

FIRST USE 6-21-2011; IN COMMERCE 6-21-2011.

THE MARK CONSISTS OF A SMILEY FACE DESIGN HOLDING UP ITS ARMS IN A SHRUG POSE.

SN 85-157,134, FILED 10-20-2010.

LINDA M. KING, EXAMINING ATTORNEY



David J. Kybas

Director of the United States Patent and Trademark Office

United States of America

United States Patent and Trademark Office

DEADWOOD MOUNTAIN GRAND

Reg. No. 4,099,935

TENEXCOTA, LLC (SOUTH DAKOTA LIMITED LIABILITY COMPANY)
440 MOUNT RUSHMORE ROAD
RAPID CITY, SD 57701

Registered Feb. 14, 2012

Int. Cls.: 41 and 43

FOR: CASINO GAMING ENTERTAINMENT SERVICES, IN CLASS 41 (U.S. CLS. 100, 101 AND 107).

SERVICE MARK

FIRST USE 5-6-2010; IN COMMERCE 5-10-2010.

PRINCIPAL REGISTER

FOR: HOTEL AND RESTAURANT SERVICES, IN CLASS 43 (U.S. CLS. 100 AND 101).

FIRST USE 5-6-2010; IN COMMERCE 5-10-2010.

THE MARK CONSISTS OF STANDARD CHARACTERS WITHOUT CLAIM TO ANY PARTICULAR FONT, STYLE, SIZE, OR COLOR.

NO CLAIM IS MADE TO THE EXCLUSIVE RIGHT TO USE "DEADWOOD", APART FROM THE MARK AS SHOWN.

SN 85-157,237, FILED 10-20-2010.

FLORENTINA BLANDU, EXAMINING ATTORNEY



David J. Kybas

Director of the United States Patent and Trademark Office

United States of America

United States Patent and Trademark Office

EGT

Reg. No. 4,099,936

INTERNATIONAL BUSINESS GROUP INC. (NEVADA CORPORATION)
5348 VEGAS DRIVE
LAS VEGAS, NV 89108

Registered Feb. 14, 2012

Int. Cl.: 35

SERVICE MARK

PRINCIPAL REGISTER

FOR: ADMINISTRATION OF A CONSUMER LOYALTY PROGRAM TO PROMOTE RESTAURANT SERVICES AND RETAIL SERVICES OF OTHERS; ADMINISTRATION OF A DISCOUNT PROGRAM FOR ENABLING PARTICIPANTS TO OBTAIN DISCOUNTS ON GOODS AND SERVICES THROUGH USE OF A DISCOUNT MEMBERSHIP CARD; ADMINISTRATION OF A DISCOUNT PROGRAM FOR ENABLING PARTICIPANTS TO OBTAIN DISCOUNTS ON THE COST OF SERVICES OR RECEIVE IMPROVED SERVICES THROUGH USE OF A MEMBERSHIP CARD; ADMINISTRATION OF A PROGRAM FOR ENABLING PARTICIPANTS TO OBTAIN DISCOUNTS ON GOODS AND RECEIVE IMPROVED SERVICES; ADMINISTRATION OF A PROGRAM FOR ENABLING PARTICIPANTS TO OBTAIN DISCOUNTS ON PRODUCTS AND SERVICES; ADMINISTRATION OF A PROGRAM FOR ENABLING PARTICIPANTS TO OBTAIN DISCOUNTS ON THE COST OF SERVICES OR RECEIVE IMPROVED SERVICES; CUSTOMER LOYALTY SERVICES AND CUSTOMER CLUB SERVICES, FOR COMMERCIAL, PROMOTIONAL AND/OR ADVERTISING PURPOSES; MEMBERSHIP CLUB SERVICES PROVIDING DISCOUNTS AND PROCESSING REBATES FOR THE SERVICES OF OTHERS; ONLINE SERVICE FOR CONNECTING SOCIAL NETWORK USERS WITH RETAILERS FOR THE PURPOSE OF FACILITATING DISCOUNTED PURCHASES; PROMOTING THE GOODS AND SERVICES OF OTHERS BY MEANS OF THE ISSUANCE OF LOYALTY REWARDS CARDS; PROMOTING THE GOODS AND SERVICES OF OTHERS THROUGH THE DISTRIBUTION OF DISCOUNT CARDS; PROMOTING THE SALE OF GOODS AND SERVICES OF OTHERS BY AWARDING PURCHASE POINTS FOR CREDIT CARD USE; PROVIDING INCENTIVE AWARD PROGRAMS FOR CUSTOMERS AND EMPLOYEES THROUGH THE DISTRIBUTION OF PREPAID STORED VALUE CARDS FOR THE PURPOSE OF PROMOTING AND REWARDING LOYALTY; SALES PROMOTION FOR OTHERS PROVIDED THROUGH THE DISTRIBUTION AND THE ADMINISTRATION OF PRIVILEGED USER CARDS, IN CLASS 35 (U.S. CLS. 100, 101 AND 102).



FIRST USE 10-31-2010; IN COMMERCE 10-31-2010.

David J. Kyros

THE MARK CONSISTS OF STANDARD CHARACTERS WITHOUT CLAIM TO ANY PARTICULAR FONT, STYLE, SIZE, OR COLOR.

Director of the United States Patent and Trademark Office

SN 85-157,609, FILED 10-20-2010.

Reg. No. 4,099,936 GINA FINK, EXAMINING ATTORNEY

United States of America

United States Patent and Trademark Office

NO PRESSURE, NO OBLIGATION

Reg. No. 4,099,937

YOU FIT, INC. (FLORIDA CORPORATION)

Registered Feb. 14, 2012

6161 9TH AVE. NORTH
ST. PETERSBURG, FL 33710

Int. Cl.: 41

FOR: HEALTH CLUB SERVICES, NAMELY, PROVIDING INSTRUCTION, FACILITIES, AND EQUIPMENT IN THE FIELD OF PHYSICAL EXERCISE, IN CLASS 41 (U.S. CLS. 100, 101 AND 107).

SERVICE MARK

FIRST USE 10-21-2010; IN COMMERCE 10-21-2010.

PRINCIPAL REGISTER

THE MARK CONSISTS OF STANDARD CHARACTERS WITHOUT CLAIM TO ANY PARTICULAR FONT, STYLE, SIZE, OR COLOR.

SN 85-157,611, FILED 10-20-2010.

MELISSA VALLILLO, EXAMINING ATTORNEY



David J. Kyffers

Director of the United States Patent and Trademark Office

United States of America

United States Patent and Trademark Office

MATHEW BRUNO

Reg. No. 4,099,938

A & M BRUNO INVESTMENTS, L.P. (CALIFORNIA LIMITED PARTNERSHIP)
P. O. BOX 1530
TURLOCK, CA 95381

Registered Feb. 14, 2012

Int. Cl.: 33

FOR: WINES, IN CLASS 33 (U.S. CLS. 47 AND 49).

TRADEMARK

FIRST USE 9-1-2011; IN COMMERCE 9-1-2011.

PRINCIPAL REGISTER

THE MARK CONSISTS OF STANDARD CHARACTERS WITHOUT CLAIM TO ANY PARTICULAR FONT, STYLE, SIZE, OR COLOR.

THE NAME(S), PORTRAIT(S), AND/OR SIGNATURE(S) SHOWN IN THE MARK IDENTIFIES "MATHEW BRUNO", WHOSE CONSENT(S) TO REGISTER IS MADE OF RECORD.

SN 85-159,606, FILED 10-22-2010.

ERNEST SHOSHO, EXAMINING ATTORNEY



David J. Kyffers

Director of the United States Patent and Trademark Office

United States of America

United States Patent and Trademark Office

IEIS

Reg. No. 4,099,939

RAPHA MEDIA INC. (NEW YORK CORPORATION)
87-11 116TH STREET
RICHMOND HILL, NY 11418

Registered Feb. 14, 2012

Int. Cl.: 38

FOR: NEWS AGENCY SERVICES, NAMELY, ELECTRONIC TRANSMISSION OF DIGITAL MEDIA CONTENT FOR OTHERS AND TRANSMISSION OF LIVE NEWS, INFORMATION, ENTERTAINMENT EVENTS AND SPORTS EVENTS OVER DIGITAL NETWORKS, THE INTERNET AND SATELLITE NETWORKS, IN CLASS 38 (U.S. CLS. 100, 101 AND 104).

SERVICE MARK

PRINCIPAL REGISTER

FIRST USE 10-22-2011; IN COMMERCE 10-22-2011.

THE MARK CONSISTS OF STANDARD CHARACTERS WITHOUT CLAIM TO ANY PARTICULAR FONT, STYLE, SIZE, OR COLOR.

SN 85-160,102, FILED 10-25-2010.

YAT SYE, LEE, EXAMINING ATTORNEY



David J. Kybas

Director of the United States Patent and Trademark Office

United States of America

United States Patent and Trademark Office

THE NOWHERE BAND

Reg. No. 4,099,940

Registered Feb. 14, 2012

Int. Cls.: 25 and 41

TRADEMARK

SERVICE MARK

PRINCIPAL REGISTER

RADFORD, DAVID (UNITED STATES INDIVIDUAL)
3340 ROYALSTON AVENUE
FORT MYERS, FL 33916

FOR: CLOTHING, NAMELY, SHIRTS, HATS, IN CLASS 25 (U.S. CLS. 22 AND 39).

FIRST USE 8-15-2010; IN COMMERCE 8-15-2010.

FOR: ENTERTAINMENT, NAMELY, LIVE MUSIC CONCERTS; ENTERTAINMENT SERVICES IN THE NATURE OF LIVE MUSICAL PERFORMANCES, IN CLASS 41 (U.S. CLS. 100, 101 AND 107).

FIRST USE 8-15-2010; IN COMMERCE 8-15-2010.

NO CLAIM IS MADE TO THE EXCLUSIVE RIGHT TO USE "BAND", APART FROM THE MARK AS SHOWN.

THE MARK CONSISTS OF THE STYLIZED WORDS "THE NOWHERE BAND".

SN 85-160,135, FILED 10-25-2010.

KELLY TRUSILO, EXAMINING ATTORNEY



David J. Kybas

Director of the United States Patent and Trademark Office

United States of America

United States Patent and Trademark Office

MAGIC BUTTON

Reg. No. 4,099,941

Registered Feb. 14, 2012

Int. Cl.: 26

TRADEMARK

PRINCIPAL REGISTER

GLORIA INTERNATIONAL INC. (CANADA CORPORATION)
622, DE LA NOUE STREET
VERDUN, CANADA H3E1W1

FOR: CLOTHING ACCESSORY, NAMELY, A BUTTON REPLACEMENT WHICH ALLOWS ITS USER TO INCREASE THE SIZE OF ITS CLOTHES, MORE PARTICULARLY THE SIZE OF ITS SHIRT, BLOUSE OR POLO SHIRT COLLAR, THE SIZE OF ITS SHIRT OR BLOUSE CUFFS OR THE WAIST SIZE OF ITS PANTS OR SKIRT, IN CLASS 26 (U.S. CLS. 37, 39, 40, 42 AND 50).

FIRST USE 1-1-2011; IN COMMERCE 1-1-2011.

THE MARK CONSISTS OF STANDARD CHARACTERS WITHOUT CLAIM TO ANY PARTICULAR FONT, STYLE, SIZE, OR COLOR.

NO CLAIM IS MADE TO THE EXCLUSIVE RIGHT TO USE "BUTTON", APART FROM THE MARK AS SHOWN.

SN 85-160,779, FILED 10-25-2010.

DORITT L. CARROLL, EXAMINING ATTORNEY



David J. Kybas

Director of the United States Patent and Trademark Office

United States of America

United States Patent and Trademark Office

Stiffness Matters

Reg. No. 4,099,942

Registered Feb. 14, 2012

Int. Cl.: 9

TRADEMARK

PRINCIPAL REGISTER

MATRIGEN LLC (CALIFORNIA LIMITED LIABILITY COMPANY)
2500 EAST IMPERIAL HWY
#201-343
BREA, CA 92821

FOR: PLATES, GLASS SLIDES OR CHIPS HAVING MULTI-WELL ARRAYS THAT CAN BE USED IN CHEMICAL ANALYSIS, BIOLOGICAL ANALYSIS OR PATTERNING FOR SCIENTIFIC, LABORATORY OR MEDICAL RESEARCH USE, IN CLASS 9 (U.S. CLS. 21, 23, 26, 36 AND 38).

FIRST USE 4-9-2011; IN COMMERCE 10-4-2011.

THE MARK CONSISTS OF STANDARD CHARACTERS WITHOUT CLAIM TO ANY PARTICULAR FONT, STYLE, SIZE, OR COLOR.

SN 85-160,807, FILED 10-25-2010.

ALLISON HOLTZ, EXAMINING ATTORNEY



David J. Kyjars

Director of the United States Patent and Trademark Office

United States of America

United States Patent and Trademark Office

BREATHEZEN

Reg. No. 4,099,943

DR. JAMES ZINREICH (UNITED STATES INDIVIDUAL)
10 STREAM COURT
OWENS MILLS, MD 21117

Registered Feb. 14, 2012

Int. Cl.: 5

FOR: NASAL SPRAY PREPARATIONS FOR NASAL AND PARANASAL SINUSES FOR THE PURPOSE OF IMPROVING AIRFLOW; NASAL RINSE PREPARATIONS FOR NASAL AND PARANASAL SINUSES FOR THE PURPOSE OF IMPROVING AIRFLOW, IN CLASS 5 (U.S. CLS. 6, 18, 44, 46, 51 AND 52).

TRADEMARK

PRINCIPAL REGISTER

FIRST USE 8-17-2011; IN COMMERCE 8-17-2011.

THE MARK CONSISTS OF STANDARD CHARACTERS WITHOUT CLAIM TO ANY PARTICULAR FONT, STYLE, SIZE, OR COLOR.

SN 85-161,139, FILED 10-26-2010.

MICHAEL SOUDERS, EXAMINING ATTORNEY



David J. Kybas

Director of the United States Patent and Trademark Office

United States of America

United States Patent and Trademark Office

CERNO SOLUTIONS

Reg. No. 4,099,944

CERNO SOLUTIONS, LLC (DELAWARE LIMITED LIABILITY COMPANY)
2711 N. HASKELL AVENUE, SUITE 2150
DALLAS, TX 75204

Registered Feb. 14, 2012

Int. Cl.: 36

FOR: DEBT COLLECTION, IN CLASS 36 (U.S. CLS. 100, 101 AND 102).

SERVICE MARK

FIRST USE 8-0-2010; IN COMMERCE 8-0-2010.

PRINCIPAL REGISTER

THE MARK CONSISTS OF STANDARD CHARACTERS WITHOUT CLAIM TO ANY PARTICULAR FONT, STYLE, SIZE, OR COLOR.

SN 85-161,290, FILED 10-26-2010.

RONALD AIKENS, EXAMINING ATTORNEY



David J. Kyffers

Director of the United States Patent and Trademark Office

United States of America

United States Patent and Trademark Office

ZARKANA

Reg. No. 4,099,945

CREATIONS MEANDRES INC. (CANADA CORPORATION)

Registered Feb. 14, 2012

8400 SECOND AVENUE
MONTREAL, QUEBEC, CANADA H1Z4M6

Int. Cl.: 41

FOR: ENTERTAINMENT SERVICES, NAMELY, CONCEPTION, CREATION, PRODUCTION, AND PRESENTATION OF THEATRICAL PERFORMANCES; CONCEPTION, CREATION, PRODUCTION, DISTRIBUTION AND PRESENTATION OF AUDIO-VISUAL WORKS; PRODUCTION OF MULTIMEDIA THEATRICAL PERFORMANCES, IN CLASS 41 (U.S. CLS. 100, 101 AND 107).

SERVICE MARK

PRINCIPAL REGISTER

FIRST USE 11-9-2010; IN COMMERCE 11-9-2010.

THE MARK CONSISTS OF STANDARD CHARACTERS WITHOUT CLAIM TO ANY PARTICULAR FONT, STYLE, SIZE, OR COLOR.

THE WORDING "ZARKANA" HAS NO MEANING IN A FOREIGN LANGUAGE.

SN 85-161,485, FILED 10-26-2010.

CHRIS WELLS, EXAMINING ATTORNEY



David J. Kybas

Director of the United States Patent and Trademark Office

United States of America
United States Patent and Trademark Office

CROSSLINK

Reg. No. 4,099,946

UNIVERSAL COOPERATIVES, INC. (MINNESOTA CORPORATION)
1300 CORPORATE CENTER CURVE
EAGAN, MN 55121

Registered Feb. 14, 2012

Int. Cl.: 1

FOR: AGRICULTURAL ADJUVANTS FOR USE WITH HERBICIDES, INSECTICIDES, AND PESTICIDES, IN CLASS 1 (U.S. CLS. 1, 5, 6, 10, 26 AND 46).

TRADEMARK

FIRST USE 7-21-2011; IN COMMERCE 7-21-2011.

PRINCIPAL REGISTER

THE MARK CONSISTS OF STANDARD CHARACTERS WITHOUT CLAIM TO ANY PARTICULAR FONT, STYLE, SIZE, OR COLOR.

SN 85-161,809, FILED 10-26-2010.

BILL DAWE, EXAMINING ATTORNEY



David J. Kyffers

Director of the United States Patent and Trademark Office

United States of America

United States Patent and Trademark Office

Big City

Reg. No. 4,099,947

Registered Feb. 14, 2012

Int. Cl.: 25

TRADEMARK

PRINCIPAL REGISTER

DAMON LAMONT INC. (TEXAS CORPORATION)
102
607 FILLMORE
VICTORIA, TX 77901

FOR: CLOTHING, NAMELY, DRESSES, COATS, SHORTS, SHIRTS, DRESS SHIRTS, PANTS, DRESS PANTS, JEANS, SWEATERS, JACKETS, SUITS, TUXEDOS, DINNER JACKETS, T-SHIRTS, BLOUSES, KNIT TOPS, VESTS, WIND RESISTANT JACKETS, SWEAT SHIRTS, SWEAT PANTS, SKI JACKETS, BELTS, GLOVES, SCARVES, PAJAMAS, ROBES, UNDERWEAR, UNDERSHIRTS, HEADWEAR, TIES, CAPS, AND HATS, IN CLASS 25 (U.S. CLS. 22 AND 39).

FIRST USE 1-1-2007; IN COMMERCE 1-1-2007.

THE MARK CONSISTS OF STANDARD CHARACTERS WITHOUT CLAIM TO ANY PARTICULAR FONT, STYLE, SIZE, OR COLOR.

SN 85-161,860, FILED 10-26-2010.

JANICE L. MCMORROW, EXAMINING ATTORNEY



David J. Kyffers

Director of the United States Patent and Trademark Office

United States of America

United States Patent and Trademark Office

SAFE GRIP SPLINE

Reg. No. 4,099,948

MARIAK INDUSTRIES, INC. (CALIFORNIA CORPORATION)
575 W. MANVILLE STREET
RANCHO DOMINGUEZ, CA 90220

Registered Feb. 14, 2012

Int. Cl.: 19

FOR: NON-METAL WINDOW ROLLER SHADE COMPONENTS, NAMELY, A CONNECTOR FOR SHADE FABRICS, IN CLASS 19 (U.S. CLS. 1, 12, 33 AND 50).

TRADEMARK

FIRST USE 1-0-2007; IN COMMERCE 1-0-2007.

PRINCIPAL REGISTER

THE MARK CONSISTS OF STANDARD CHARACTERS WITHOUT CLAIM TO ANY PARTICULAR FONT, STYLE, SIZE, OR COLOR.

NO CLAIM IS MADE TO THE EXCLUSIVE RIGHT TO USE "SPLINE", APART FROM THE MARK AS SHOWN.

SN 85-161,907, FILED 10-26-2010.

PATRICIA EVANKO, EXAMINING ATTORNEY



David J. Kybas

Director of the United States Patent and Trademark Office

United States of America

United States Patent and Trademark Office

MAX-ROLL TUBE

Reg. No. 4,099,949

MARIAK INDUSTRIES, INC. (CALIFORNIA CORPORATION)
575 W. MANVILLE STREET
RANCHO DOMINGUEZ, CA 90220

Registered Feb. 14, 2012

Int. Cl.: 20

FOR: NON-METAL WINDOW ROLLER SHADE COMPONENTS, NAMELY, A TUBE FOR CONNECTING SHADE FABRICS, IN CLASS 20 (U.S. CLS. 2, 13, 22, 25, 32 AND 50).

TRADEMARK

FIRST USE 1-0-2007; IN COMMERCE 1-0-2007.

PRINCIPAL REGISTER

THE MARK CONSISTS OF STANDARD CHARACTERS WITHOUT CLAIM TO ANY PARTICULAR FONT, STYLE, SIZE, OR COLOR.

NO CLAIM IS MADE TO THE EXCLUSIVE RIGHT TO USE "TUBE", APART FROM THE MARK AS SHOWN.

SN 85-161,909, FILED 10-26-2010.

PATRICIA EVANKO, EXAMINING ATTORNEY



David J. Kybas

Director of the United States Patent and Trademark Office

United States of America

United States Patent and Trademark Office

PLATINUM CLUTCH

Reg. No. 4,099,950

Registered Feb. 14, 2012

Int. Cl.: 20

TRADEMARK

PRINCIPAL REGISTER

MARIAK INDUSTRIES, INC. (CALIFORNIA CORPORATION)
575 W. MANVILLE STREET
RANCHO DOMINGUEZ, CA 90220

FOR: NON-METAL WINDOW ROLLER SHADE COMPONENTS, NAMELY, A CLUTCH MECHANISM FOR RETRACTING AND RELEASING ROLLER SHADES, IN CLASS 20 (U.S. CLS. 2, 13, 22, 25, 32 AND 50).

FIRST USE 11-0-2010; IN COMMERCE 11-0-2010.

THE MARK CONSISTS OF STANDARD CHARACTERS WITHOUT CLAIM TO ANY PARTICULAR FONT, STYLE, SIZE, OR COLOR.

NO CLAIM IS MADE TO THE EXCLUSIVE RIGHT TO USE "CLUTCH", APART FROM THE MARK AS SHOWN.

SN 85-161,914, FILED 10-26-2010.

PATRICIA EVANKO, EXAMINING ATTORNEY



David J. Kybas

Director of the United States Patent and Trademark Office

United States of America

United States Patent and Trademark Office

InSight PCB

Reg. No. 4,099,951

FRONTLINE PCB SOLUTIONS LTD (ISRAEL CORPORATION)

Registered Feb. 14, 2012

P.O.B. 680
YAVNE, ISRAEL 81106

Int. Cl.: 9

FOR: COMPUTER SOFTWARE FOR PROVIDING COMPREHENSIVE AND AUTOMATIC ANALYSIS OF CUSTOMER'S PRODUCT INFORMATION AND GENERATING REPORTS THAT MAY BE USED FOR PRODUCT COSTING, SALE PRICE QUOTATION AND ENGINEERING DECISIONS, IN CLASS 9 (U.S. CLS. 21, 23, 26, 36 AND 38).

TRADEMARK

PRINCIPAL REGISTER

FIRST USE 11-2-2011; IN COMMERCE 11-2-2011.

THE MARK CONSISTS OF STANDARD CHARACTERS WITHOUT CLAIM TO ANY PARTICULAR FONT, STYLE, SIZE, OR COLOR.

NO CLAIM IS MADE TO THE EXCLUSIVE RIGHT TO USE "PCB", APART FROM THE MARK AS SHOWN.

SN 85-162,011, FILED 10-27-2010.

CURTIS FRENCH, EXAMINING ATTORNEY



David J. Kypos

Director of the United States Patent and Trademark Office

United States of America

United States Patent and Trademark Office



Reg. No. 4,099,952

Registered Feb. 14, 2012

Int. Cl.: 21

TRADEMARK

PRINCIPAL REGISTER

NATIONAL TOWELETTE CO., INC. (NEW JERSEY CORPORATION)
1726 WOODHAVEN DRIVE
BENSALEM, PA 19020

FOR: NON-WOVEN TEXTILE WIPES NOT ALREADY IMPREGNATED WITH DISINFECTING AND SANITIZING CHEMICALS OR COMPOUNDS, IN CLASS 21 (U.S. CLS. 2, 13, 23, 29, 30, 33, 40 AND 50).

FIRST USE 8-1-2010; IN COMMERCE 11-10-2011.

NO CLAIM IS MADE TO THE EXCLUSIVE RIGHT TO USE "WIPES" AND "FLEXIBLE", APART FROM THE MARK AS SHOWN.

THE MARK CONSISTS OF THREE LINES, THE FIRST LINE CONTAINS THE WORD "FLEX"; THE SECOND LINE, INDENTED, CONTAINS THE WORD "WIPES"; THE THIRD LINE CONTAINS THE WORDS "FLEXIBLE LIQUID EXPRESS". TO THE RIGHT OF THE LITERAL ELEMENTS IS AN IMAGE OF A LIQUID DROP FALLING INTO STYLIZED LIQUID.

SN 85-162,029, FILED 10-27-2010.

JOHN WILKE, EXAMINING ATTORNEY



David J. Kybas

Director of the United States Patent and Trademark Office

United States of America

United States Patent and Trademark Office



Reg. No. 4,099,953

MIDMARK CORPORATION (OHIO CORPORATION)
60 VISTA DRIVE
VERSAILLES, OH 45380

Registered Feb. 14, 2012

Int. Cl.: 10

FOR: A PATIENT-CONTROLLED HEAT AND MASSAGE FUNCTION IN DENTAL CHAIRS,
IN CLASS 10 (U.S. CLS. 26, 39 AND 44).

TRADEMARK

FIRST USE 7-0-2010; IN COMMERCE 7-0-2010.

PRINCIPAL REGISTER

OWNER OF U.S. REG. NO. 3,877,850.

THE MARK CONSISTS OF THE TERM "SERENESCAPE" IMPOSED ON A RECTANGULAR
BACKGROUND WITH A WAVE FORM POSITIONED ABOVE "SERENESCAPE".

SN 85-162,347, FILED 10-27-2010.

AMY ALFIERI, EXAMINING ATTORNEY



David J. Kybas

Director of the United States Patent and Trademark Office

United States of America

United States Patent and Trademark Office

Pacidoodle

Reg. No. 4,099,954

NOBLE, LORRI (UNITED STATES INDIVIDUAL)
280 HARROGATE SPRINGS ROAD
WETUMPKA, AL 36093

Registered Feb. 14, 2012

Int. Cl.: 10

FOR: PACIFIERS FOR BABIES WITH BABY'S NAME PERMANENTLY ENGRAVED ON
PACIFIER, IN CLASS 10 (U.S. CLS. 26, 39 AND 44).

TRADEMARK

FIRST USE 3-25-2010; IN COMMERCE 11-5-2010.

PRINCIPAL REGISTER

THE MARK CONSISTS OF STANDARD CHARACTERS WITHOUT CLAIM TO ANY PAR-
TICULAR FONT, STYLE, SIZE, OR COLOR.

SN 85-162,453, FILED 10-27-2010.

GEORGE LORENZO, EXAMINING ATTORNEY



David J. Kybas

Director of the United States Patent and Trademark Office

United States of America

United States Patent and Trademark Office

AUDINGO

Reg. No. 4,099,955

ENACOMM, INC. (OKLAHOMA CORPORATION)

Registered Feb. 14, 2012

7424 OAK SHORES DRIVE
AUSTIN, TX 78730

Int. Cl.: 38

SERVICE MARK

PRINCIPAL REGISTER

FOR: COMMUNICATION SERVICES, NAMELY, USER-SCHEDULED TRANSMISSION OF NOTIFICATIONS, NAMELY, VOICE, AUDIO, AND DATA BY TELECOMMUNICATIONS NETWORKS, WIRELESS COMMUNICATION NETWORKS, AND DATA NETWORKS, INCLUDING TRANSMISSION OF PRE-RECORDED VOICE MESSAGES FOR PRESENTATION AS NOTIFICATIONS OR ALERTS FOR WAKEUP CALLS AND OTHER USER-SCHEDULED NOTIFICATIONS; BROADCASTING SERVICES, NAMELY, TRANSMISSION OF ADVERTISING PROGRAMS AND MEDIA ADVERTISING COMMUNICATIONS IN CONJUNCTION WITH USER-SCHEDULED TRANSMISSION OF VOICE, AUDIO, AND DATA VIA TELECOMMUNICATIONS NETWORKS AND WIRELESS COMMUNICATION NETWORKS, AND DIGITAL DATA NETWORKS; TELECOMMUNICATIONS SERVICES, NAMELY, PROVIDING ONLINE FACILITIES FOR REAL-TIME OR NEAR REAL-TIME INTERACTION BETWEEN AND AMONG USERS OF COMPUTERS, MOBILE AND HANDHELD COMPUTERS, AND WIRED AND WIRELESS COMMUNICATION DEVICES CONCERNING TOPICS OF GENERAL INTEREST; ELECTRONIC TRANSMISSION OF MESSAGES, NAMELY, ENABLING INDIVIDUALS TO SEND AND RECEIVE MESSAGES VIA VOICE MESSAGES, E-MAIL, INSTANT MESSAGING OR A WEB SITE ON THE INTERNET, IN CLASS 38 (U.S. CLS. 100, 101 AND 104).

FIRST USE 5-6-2011; IN COMMERCE 5-6-2011.

THE MARK CONSISTS OF STANDARD CHARACTERS WITHOUT CLAIM TO ANY PARTICULAR FONT, STYLE, SIZE, OR COLOR.

SN 85-163,150, FILED 10-27-2010.

JASON TURNER, EXAMINING ATTORNEY



David J. Kypos

Director of the United States Patent and Trademark Office

United States of America

United States Patent and Trademark Office



Reg. No. 4,099,956

ENACOMM, INC. (OKLAHOMA CORPORATION)

Registered Feb. 14, 2012

7424 OAK SHORES DRIVE
AUSTIN, TX 78730

Int. Cl.: 38

SERVICE MARK

PRINCIPAL REGISTER

FOR: COMMUNICATION SERVICES, NAMELY, USER-SCHEDULED TRANSMISSION OF NOTIFICATIONS, NAMELY, VOICE, AUDIO, AND DATA BY TELECOMMUNICATIONS NETWORKS, WIRELESS COMMUNICATION NETWORKS, AND DATA NETWORKS, INCLUDING TRANSMISSION OF PRE-RECORDED VOICE MESSAGES FOR PRESENTATION AS NOTIFICATIONS OR ALERTS FOR WAKEUP CALLS AND OTHER USER-SCHEDULED NOTIFICATIONS; BROADCASTING SERVICES, NAMELY, TRANSMISSION OF ADVERTISING PROGRAMS AND MEDIA ADVERTISING COMMUNICATIONS IN CONJUNCTION WITH USER-SCHEDULED TRANSMISSION OF VOICE, AUDIO, AND DATA VIA TELECOMMUNICATIONS NETWORKS AND WIRELESS COMMUNICATION NETWORKS, AND DIGITAL DATA NETWORKS; TELECOMMUNICATIONS SERVICES, NAMELY, PROVIDING ONLINE FACILITIES FOR REAL-TIME OR NEAR REAL-TIME INTERACTION BETWEEN AND AMONG USERS OF COMPUTERS, MOBILE AND HANDHELD COMPUTERS, AND WIRED AND WIRELESS COMMUNICATION DEVICES CONCERNING TOPICS OF GENERAL INTEREST; ELECTRONIC TRANSMISSION OF MESSAGES, NAMELY, ENABLING INDIVIDUALS TO SEND AND RECEIVE MESSAGES VIA VOICE MESSAGES, E-MAIL, INSTANT MESSAGING OR A WEB SITE ON THE INTERNET, IN CLASS 38 (U.S. CLS. 100, 101 AND 104).

FIRST USE 5-6-2011; IN COMMERCE 5-6-2011.



THE MARK CONSISTS OF THE WORDS "AUDINGO" IN A STYLIZED MODERNA FONT IN GRADATIONS OF THE COLOR GREEN, AND NEXT TO THE WORD IS A SUBSTANTIALLY SPHERICAL, SILVER OBJECT WITH SILVER FEET. THE SPHERICAL OBJECT INCLUDES A GREEN PLAY BUTTON IN THE CENTER AND GREEN FORWARD AND BACK SELECTION BUTTONS ON THE LEFT AND RIGHT SIDES. THE BUTTONS ARE IN GRADATIONS OF THE COLOR GREEN, AND THE SPHERICAL OBJECT IS IN GRADATIONS OF THE COLOR SILVER. GREEN EAR PHONES EXTEND OVER THE TOP OF THE SPHERICAL OBJECT AND ADJACENT TO THE FORWARD AND BACK SELECTION BUTTONS. THE SPHERICAL OBJECT IS TILTED SLIGHTLY TOWARD THE WORD AND ELEVATED ABOVE A SURFACE, CASTING A SILVER SHADOW ON THE SURFACE.

THE COLOR(S) GREEN AND SILVER IS/ARE CLAIMED AS A FEATURE OF THE MARK.

David J. Kybas

Director of the United States Patent and Trademark Office

Reg. No. 4,099,956 SN 85-163,152, FILED 10-27-2010.

JASON TURNER, EXAMINING ATTORNEY

United States of America

United States Patent and Trademark Office



Reg. No. 4,099,957

Registered Feb. 14, 2012

Int. Cl.: 38

SERVICE MARK

PRINCIPAL REGISTER

ENACOMM, INC. (OKLAHOMA CORPORATION)
7424 OAK SHORES DRIVE
AUSTIN, TX 78730

FOR: COMMUNICATION SERVICES, NAMELY, USER-SCHEDULED TRANSMISSION OF NOTIFICATIONS, NAMELY, VOICE, AUDIO, AND DATA BY TELECOMMUNICATIONS NETWORKS, WIRELESS COMMUNICATION NETWORKS, AND DATA NETWORKS, INCLUDING TRANSMISSION OF PRE-RECORDED VOICE MESSAGES FOR PRESENTATION AS NOTIFICATIONS OR ALERTS FOR WAKEUP CALLS AND OTHER USER-SCHEDULED NOTIFICATIONS; BROADCASTING SERVICES, NAMELY, TRANSMISSION OF ADVERTISING PROGRAMS AND MEDIA ADVERTISING COMMUNICATIONS IN CONJUNCTION WITH USER-SCHEDULED TRANSMISSION OF VOICE, AUDIO, AND DATA VIA TELECOMMUNICATIONS NETWORKS AND WIRELESS COMMUNICATION NETWORKS, AND DIGITAL DATA NETWORKS; TELECOMMUNICATIONS SERVICES, NAMELY, PROVIDING ONLINE FACILITIES FOR REAL-TIME OR NEAR REAL-TIME INTERACTION BETWEEN AND AMONG USERS OF COMPUTERS, MOBILE AND HANDHELD COMPUTERS, AND WIRED AND WIRELESS COMMUNICATION DEVICES CONCERNING TOPICS OF GENERAL INTEREST; ELECTRONIC TRANSMISSION OF MESSAGES, NAMELY, ENABLING INDIVIDUALS TO SEND AND RECEIVE MESSAGES VIA VOICE MESSAGES, E-MAIL, INSTANT MESSAGING OR A WEB SITE ON THE INTERNET, IN CLASS 38 (U.S. CLS. 100, 101 AND 104).

FIRST USE 5-6-2011; IN COMMERCE 5-6-2011.



THE MARK CONSISTS OF A SUBSTANTIALLY SPHERICAL, SILVER OBJECT WITH SILVER FEET. THE SPHERICAL OBJECT INCLUDES A GREEN PLAY BUTTON IN THE CENTER AND GREEN FORWARD AND BACK SELECTION BUTTONS ON THE LEFT AND RIGHT SIDES. THE BUTTONS ARE IN GRADATIONS OF THE COLOR GREEN, AND THE SPHERICAL OBJECT IS IN GRADATIONS OF THE COLOR SILVER. GREEN EAR PHONES EXTEND OVER THE TOP OF THE SPHERICAL OBJECT AND ADJACENT TO THE FORWARD AND BACK SELECTION BUTTONS. THE SPHERICAL OBJECT IS TILTED SLIGHTLY TO THE LEFT AND ELEVATED ABOVE A SURFACE, CASTING A SILVER SHADOW ON THE SURFACE.

David J. Kybas

THE COLOR(S) GREEN AND SILVER IS/ARE CLAIMED AS A FEATURE OF THE MARK.

Director of the United States Patent and Trademark Office

SN 85-163,153, FILED 10-27-2010.

Reg. No. 4,099,957 JASON TURNER, EXAMINING ATTORNEY

United States of America

United States Patent and Trademark Office

EVOLUTION

Reg. No. 4,099,958

NIAGARA THERMAL PRODUCTS LLC (NEW YORK LIMITED LIABILITY COMPANY)
3315 HASELEY DRIVE
NIAGARA FALLS, NY 14304

Registered Feb. 14, 2012

Int. Cls.: 11 and 42

FOR: HEAT EXCHANGERS IN THE NATURE OF COLD PLATES FOR USE IN COOLING SYSTEMS, SOLD SEPARATELY, IN CLASS 11 (U.S. CLS. 13, 21, 23, 31 AND 34).

TRADEMARK

FIRST USE 3-12-2011; IN COMMERCE 6-5-2011.

SERVICE MARK

FOR: CUSTOM DESIGN AND ENGINEERING OF COLD PLATES FOR USE IN COOLING SYSTEMS, IN CLASS 42 (U.S. CLS. 100 AND 101).

PRINCIPAL REGISTER

FIRST USE 3-12-2011; IN COMMERCE 6-5-2011.

THE MARK CONSISTS OF STANDARD CHARACTERS WITHOUT CLAIM TO ANY PARTICULAR FONT, STYLE, SIZE, OR COLOR.

SN 85-163,314, FILED 10-28-2010.

APRIL HESIK, EXAMINING ATTORNEY



David J. Kyros

Director of the United States Patent and Trademark Office

United States of America

United States Patent and Trademark Office

LIFE PEAK

Reg. No. 4,099,959

LIFEPEAK LLC (CALIFORNIA LIMITED LIABILITY COMPANY)
20562 CRESCENT BAY DRIVE
LAKE FOREST, CA 92630

Registered Feb. 14, 2012

Int. Cl.: 5

FOR: ANTIBACTERIAL HAND LOTIONS; HAND-SANITIZING PREPARATIONS; SPRAY
SANITIZER FOR PERSONAL USE, IN CLASS 5 (U.S. CLS. 6, 18, 44, 46, 51 AND 52).

TRADEMARK

FIRST USE 3-18-2011; IN COMMERCE 3-18-2011.

PRINCIPAL REGISTER

THE MARK CONSISTS OF STANDARD CHARACTERS WITHOUT CLAIM TO ANY PAR-
TICULAR FONT, STYLE, SIZE, OR COLOR.

SN 85-163,806, FILED 10-28-2010.

WILLIAM BRECKENFELD, EXAMINING ATTORNEY



David J. Kyfos

Director of the United States Patent and Trademark Office

United States of America

United States Patent and Trademark Office



Reg. No. 4,099,960

LIFEPEAK LLC (CALIFORNIA LIMITED LIABILITY COMPANY)
20562 CRESCENT BAY DRIVE
LAKE FOREST, CA 92630

Registered Feb. 14, 2012

Int. Cl.: 5

FOR: ANTIBACTERIAL HAND LOTIONS; HAND-SANITIZING PREPARATIONS; SPRAY
SANITIZER FOR PERSONAL USE, IN CLASS 5 (U.S. CLS. 6, 18, 44, 46, 51 AND 52).

TRADEMARK

FIRST USE 3-18-2011; IN COMMERCE 3-18-2011.

PRINCIPAL REGISTER

THE MARK CONSISTS OF A LIQUID DROP WITH THE WORDS "LIFE" AND "PEAK" HO-
RIZONTALLY STACKED TO THE RIGHT.

SN 85-163,830, FILED 10-28-2010.

WILLIAM BRECKENFELD, EXAMINING ATTORNEY



David J. Kyfos

Director of the United States Patent and Trademark Office

United States of America

United States Patent and Trademark Office

SASSY INTERNATIONAL

Reg. No. 4,099,961

GADHIA, SHEETAL (UNITED STATES INDIVIDUAL)

Registered Feb. 14, 2012

74-02 43RD AVENUE
ELMHURST, NY 11373

Int. Cl.: 25

FOR: CLOTHING PRODUCTS, NAMELY, EMBROIDERED SHIRTS, PANTS AND TUNICS FOR MEN AND WOMEN, SCARVES, HEADWEAR AND FOOTWEAR, IN CLASS 25 (U.S. CLS. 22 AND 39).

TRADEMARK

FIRST USE 11-11-2011; IN COMMERCE 11-11-2011.

PRINCIPAL REGISTER

THE MARK CONSISTS OF STANDARD CHARACTERS WITHOUT CLAIM TO ANY PARTICULAR FONT, STYLE, SIZE, OR COLOR.

NO CLAIM IS MADE TO THE EXCLUSIVE RIGHT TO USE "INTERNATIONAL", APART FROM THE MARK AS SHOWN.

SN 85-164,333, FILED 10-29-2010.

SCOTT BIBB, EXAMINING ATTORNEY



David J. Kyffers

Director of the United States Patent and Trademark Office

United States of America

United States Patent and Trademark Office

WE2ME

Reg. No. 4,099,962

Registered Feb. 14, 2012

Int. Cl.: 42

SERVICE MARK

PRINCIPAL REGISTER

TOPITZ DESIGN STUDIO LLC (NEW JERSEY LIMITED LIABILITY COMPANY)
7 PROSPECT ST, UNIT 810
MORRISTOWN, NJ 07960

FOR: COLOR ANALYSIS FOR PURPOSES OF INTERIOR DESIGN; DESIGN OF INTERIOR DECOR; INTERIOR DECORATING; INTERIOR DESIGN SERVICES; INTERIOR STYLING SERVICES , IN CLASS 42 (U.S. CLS. 100 AND 101).

FIRST USE 9-0-2011; IN COMMERCE 9-0-2011.

THE MARK CONSISTS OF STANDARD CHARACTERS WITHOUT CLAIM TO ANY PARTICULAR FONT, STYLE, SIZE, OR COLOR.

SN 85-164,408, FILED 10-29-2010.

SUSAN STIGLITZ, EXAMINING ATTORNEY



David J. Kyffers

Director of the United States Patent and Trademark Office

United States of America

United States Patent and Trademark Office

BASYS PROCESSING

Reg. No. 4,099,963

Registered Feb. 14, 2012

Int. Cl.: 36

SERVICE MARK

PRINCIPAL REGISTER

BASYS PROCESSING, INC. (KANSAS CORPORATION), DBA BASYS PROCESSING, INC.,
8450 NIEMAN ROAD
LENEXA, KS 66214

FOR: CHECK PROCESSING; CREDIT CARD PAYMENT PROCESSING SERVICES; CREDIT
CARD TRANSACTION PROCESSING SERVICES, IN CLASS 36 (U.S. CLS. 100, 101 AND
102).

FIRST USE 10-29-2010; IN COMMERCE 10-29-2010.

THE MARK CONSISTS OF STANDARD CHARACTERS WITHOUT CLAIM TO ANY PAR-
TICULAR FONT, STYLE, SIZE, OR COLOR.

NO CLAIM IS MADE TO THE EXCLUSIVE RIGHT TO USE "PROCESSING, INC.", APART
FROM THE MARK AS SHOWN.

SN 85-164,522, FILED 10-29-2010.

TASHIA BUNCH, EXAMINING ATTORNEY



David J. Kybas

Director of the United States Patent and Trademark Office

United States of America

United States Patent and Trademark Office



Reg. No. 4,099,964

Registered Feb. 14, 2012

Int. Cl.: 5

TRADEMARK

PRINCIPAL REGISTER

SABINSA CORPORATION (NEW JERSEY CORPORATION)
20 LAKE DRIVE
EAST WINDSOR, NJ 08520

FOR: STANDARDIZED EXTRACT FROM BLACK PEPPER OR LONG PEPPER CONTAINING PIPERINE FORMULATED WITH NUTRITIONAL ITEMS FOR USE AS A DIETARY SUPPLEMENT, IN CLASS 5 (U.S. CLS. 6, 18, 44, 46, 51 AND 52).

FIRST USE 11-1-2010; IN COMMERCE 11-1-2010.

OWNER OF U.S. REG. NO. 1,976,029.

THE COLOR(S) GREEN, BLACK AND LIGHT BROWN IS/ARE CLAIMED AS A FEATURE OF THE MARK.

THE MARK CONSISTS OF REPRESENTATION OF A POD IN GREEN COLOR WITH SIX GRAINS OF BLACK PEPPER AND STYLIZED LETTERS "BIOPERINE" IN LIGHT BROWN COLOR FONT.

SN 85-164,726, FILED 10-29-2010.

EMILY CHUO, EXAMINING ATTORNEY



David J. Kyjars

Director of the United States Patent and Trademark Office

United States of America
United States Patent and Trademark Office

ForsLean



Reg. No. 4,099,965

Registered Feb. 14, 2012

Int. Cl.: 5

TRADEMARK

PRINCIPAL REGISTER

SABINSA CORPORATION (NEW JERSEY CORPORATION)
20 LAKE DRIVE
EAST WINDSOR, NJ 08520

FOR: NATURAL EXTRACT OF COLEUS FORSKOHLII ROOT SOLD AS AN ESSENTIAL INGREDIENT OF DIETARY SUPPLEMENTS, IN CLASS 5 (U.S. CLS. 6, 18, 44, 46, 51 AND 52).

FIRST USE 11-1-2010; IN COMMERCE 11-1-2010.

OWNER OF U.S. REG. NOS. 2,452,105 AND 3,806,859.

THE COLOR(S) BLACK WHITE AND GREEN IS/ARE CLAIMED AS A FEATURE OF THE MARK.

THE MARK CONSISTS OF STYLIZED BOLDDED LETTERS "FORSLEAN" IN BLACK FONT ON A WHITE BACKGROUND UNDERLINED WITH A BLACK LINE CARRYING A LEAF MOTIF WITH 4 LEAFLETS IN THE CENTER IN GREEN COLOR WITH WHITE PETIOLES THAT MEET IN THE CENTER OF THE MOTIF.

SN 85-164,775, FILED 10-29-2010.

EMILY CHUO, EXAMINING ATTORNEY



David J. Kybas

Director of the United States Patent and Trademark Office

United States of America
United States Patent and Trademark Office

GRINGO

Reg. No. 4,099,966

NADARED (CALIFORNIA CORPORATION), DBA NADARED LTD,
P.O. BOX 1603
LA JOLLA, CA 92038

Registered Feb. 14, 2012

Int. Cl.: 33

FOR: DISTILLED SPIRITS; DISTILLED SPIRITS COMPRISED OF TEQUILA; SPIRITS, IN CLASS 33 (U.S. CLS. 47 AND 49).

TRADEMARK

FIRST USE 4-10-2010; IN COMMERCE 12-1-2011.

PRINCIPAL REGISTER

THE MARK CONSISTS OF STANDARD CHARACTERS WITHOUT CLAIM TO ANY PARTICULAR FONT, STYLE, SIZE, OR COLOR.

THE ENGLISH TRANSLATION OF "GRINGO" IN THE MARK IS "FOREIGNER".

SN 85-164,869, FILED 10-29-2010.

SKYE YOUNG, EXAMINING ATTORNEY



David J. Kyffers

Director of the United States Patent and Trademark Office

United States of America

United States Patent and Trademark Office

PetraPayz

Reg. No. 4,099,967

PETRAPAYZ, LLC (MICHIGAN LIMITED LIABILITY COMPANY)
316 MORRIS AVENUE, SUITE 500
MUSKEGON, MI 49440

Registered Feb. 14, 2012

Int. Cl.: 35

FOR: PAYROLL PROCESSING SERVICES, IN CLASS 35 (U.S. CLS. 100, 101 AND 102).

SERVICE MARK

FIRST USE 11-30-2010; IN COMMERCE 11-30-2010.

PRINCIPAL REGISTER

THE MARK CONSISTS OF STANDARD CHARACTERS WITHOUT CLAIM TO ANY PARTICULAR FONT, STYLE, SIZE, OR COLOR.

SN 85-164,877, FILED 10-29-2010.

MICHAEL WEBSTER, EXAMINING ATTORNEY



David J. Kyffers

Director of the United States Patent and Trademark Office

United States of America

United States Patent and Trademark Office



Reg. No. 4,099,968

SABINSA CORPORATION (NEW JERSEY CORPORATION)
20 LAKE DRIVE
EAST WINDSOR, NJ 08520

Registered Feb. 14, 2012

Int. Cl.: 5

FOR: DIETARY SUPPLEMENT, IN CLASS 5 (U.S. CLS. 6, 18, 44, 46, 51 AND 52).

TRADEMARK

FIRST USE 11-1-2010; IN COMMERCE 11-1-2010.

PRINCIPAL REGISTER

OWNER OF U.S. REG. NO. 3,047,029.

THE COLOR(S) GOLDEN YELLOW, WHITE AND BLUE IS/ARE CLAIMED AS A FEATURE OF THE MARK.

THE MARK CONSISTS OF AN OVAL SHAPE IN GOLDEN YELLOW COLOR WITH A STYLIZED DEPICTION OF A HUMAN FIGURE IN WHITE COLOR AND THE WORDING "LEANGARD" IN BLUE FONT WITH "L" AND "G" IN UPPER CASE AND THE REMAINING LETTERS IN LOWER CASE.

SN 85-164,881, FILED 10-29-2010.

EMILY CHUO, EXAMINING ATTORNEY



David J. Kyffers

Director of the United States Patent and Trademark Office

United States of America

United States Patent and Trademark Office



Reg. No. 4,099,969

SABINSA CORPORATION (NEW JERSEY CORPORATION)
20 LAKE DRIVE
EAST WINDSOR, NJ 08520

Registered Feb. 14, 2012

Int. Cl.: 5

FOR: DIETARY SUPPLEMENTS, IN CLASS 5 (U.S. CLS. 6, 18, 44, 46, 51 AND 52).

TRADEMARK

FIRST USE 11-1-2010; IN COMMERCE 11-1-2010.

PRINCIPAL REGISTER

OWNER OF U.S. REG. NO. 3,446,135.

THE COLOR(S) GREEN, RED AND PURPLE IS/ARE CLAIMED AS A FEATURE OF THE MARK.

THE MARK CONSISTS OF STYLIZED PARTIAL CONCENTRIC HOOPS IN GREEN COLOR ENCLOSING A HEART SHAPE IN RED COLOR AND THE WORD "RESVENOX" IN BOLDED PURPLE FONT UNDERSCORED WITH A RED LINE.

SN 85-164,907, FILED 10-29-2010.

EMILY CHUO, EXAMINING ATTORNEY



David J. Kyffers

Director of the United States Patent and Trademark Office

United States of America

United States Patent and Trademark Office



Reg. No. 4,099,970

SABINSA CORPORATION (NEW JERSEY CORPORATION)
20 LAKE DRIVE
EAST WINDSOR, NJ 08520

Registered Feb. 14, 2012

Int. Cl.: 3

FOR: ULTRAPURE TETRAHYDROCURCUMIN IN THE NATURE OF A PLANT EXTRACT FOR USE AS A COMPONENT IN COSMETICS, IN CLASS 3 (U.S. CLS. 1, 4, 6, 50, 51 AND 52).

TRADEMARK

FIRST USE 11-1-2010; IN COMMERCE 11-1-2010.

PRINCIPAL REGISTER

OWNER OF U.S. REG. NO. 3,283,502.

THE COLOR(S) ORANGE-BROWN AND WHITE IS/ARE CLAIMED AS A FEATURE OF THE MARK.

THE MARK CONSISTS OF STYLIZED ITALICIZED LETTERS "SABIWHITE" WITH "S" AND "W" IN UPPER CASE AND THE REMAINING LETTERS IN LOWER CASE IN ORANGE-BROWN COLOR FONT APPEAR WITHIN AN OVAL SHAPE THAT IS ENCASED IN AN ORANGE BROWN DOUBLE LINED BORDER AND PARTIALLY COLORED IN ORANGE-BROWN COLOR AND PARTLY IN WHITE COLOR.

SN 85-164,928, FILED 10-29-2010.

EMILY CHUO, EXAMINING ATTORNEY



David J. Kyros

Director of the United States Patent and Trademark Office

United States of America

United States Patent and Trademark Office



Reg. No. 4,099,971

SABINSA CORPORATION (NEW JERSEY CORPORATION)
20 LAKE DRIVE
EAST WINDSOR, NJ 08520

Registered Feb. 14, 2012

Int. Cl.: 5

FOR: NON-PRESCRIPTION DIETARY SUPPLEMENTS CONTAINING SELENIUM, IN CLASS 5 (U.S. CLS. 6, 18, 44, 46, 51 AND 52).

TRADEMARK

FIRST USE 11-1-2010; IN COMMERCE 11-1-2010.

PRINCIPAL REGISTER

OWNER OF U.S. REG. NO. 2,285,054.

THE COLOR(S) TAN AND BROWNISH-RED IS/ARE CLAIMED AS A FEATURE OF THE MARK.

NO CLAIM IS MADE TO THE EXCLUSIVE RIGHT TO USE "SELENIUM", APART FROM THE MARK AS SHOWN.

THE MARK CONSISTS OF THE WORDING "SELENIUM SELECT" WITH THE LETTERS "S" AND "LECT" IN UPPER CASE AND THE REMAINING LETTERS IN LOWER CASE APPEARING WITHIN A CAPSULE SHAPE COLORED HALF IN TAN COLOR AND THE OTHER HALF IN BROWNISH-RED COLOR. THE WORD "SELENIUM" IS IN A BROWNISH-RED FONT WITHIN THE TAN AREA AND THE WORD "SELECT" IS IN A TAN COLORED FONT WITHIN THE BROWNISH-RED AREA. THE CAPSULE IS ENCLOSED WITHIN THREE CONCENTRIC STYLIZED BRACKETS, TWO OUTER BRACKETS ARE IN BROWNISH-RED AND THE INNER BRACKET IN TAN.



SN 85-164,955, FILED 10-29-2010.

EMILY CHUO, EXAMINING ATTORNEY

David J. Kyjars

Director of the United States Patent and Trademark Office

United States of America

United States Patent and Trademark Office

CISCO PRIME

Reg. No. 4,099,972

CISCO TECHNOLOGY, INC. (CALIFORNIA CORPORATION)
170 WEST TASMAN DRIVE
SAN JOSE, CA 95134

Registered Feb. 14, 2012

Int. Cl.: 9

FOR: COMPUTER SOFTWARE AND HARDWARE FOR NETWORK MANAGEMENT, IN CLASS 9 (U.S. CLS. 21, 23, 26, 36 AND 38).

TRADEMARK

FIRST USE 5-31-2011; IN COMMERCE 5-31-2011.

PRINCIPAL REGISTER

THE MARK CONSISTS OF STANDARD CHARACTERS WITHOUT CLAIM TO ANY PARTICULAR FONT, STYLE, SIZE, OR COLOR.

OWNER OF U.S. REG. NOS. 2,498,746, 3,759,451, AND OTHERS.

SN 85-165,260, FILED 10-29-2010.

JAMES GRIFFIN, EXAMINING ATTORNEY



David J. Kyffers

Director of the United States Patent and Trademark Office

United States of America

United States Patent and Trademark Office

IVANKA TRUMP

Reg. No. 4,099,973

IVANKA TRUMP MARKS LLC (DELAWARE LIMITED LIABILITY COMPANY)
502 PARK AVENUE
NEW YORK, NY 10022

Registered Feb. 14, 2012

Int. Cl.: 25

FOR: COATS, JACKETS, RAINWEAR, IN CLASS 25 (U.S. CLS. 22 AND 39).

TRADEMARK

FIRST USE 8-25-2011; IN COMMERCE 8-25-2011.

PRINCIPAL REGISTER

THE MARK CONSISTS OF STANDARD CHARACTERS WITHOUT CLAIM TO ANY PARTICULAR FONT, STYLE, SIZE, OR COLOR.

OWNER OF U.S. REG. NOS. 3,589,236, 3,593,246, AND 3,620,026.

THE NAME "IVANKA TRUMP" IDENTIFIES A LIVING INDIVIDUAL WHOSE CONSENT IS OF RECORD.

SN 85-166,241, FILED 11-1-2010.

THEODORE MCBRIDE, EXAMINING ATTORNEY



David J. Kybas

Director of the United States Patent and Trademark Office

United States of America

United States Patent and Trademark Office

I V A N K A  T R U M P

Reg. No. 4,099,974

IVANKA TRUMP MARKS LLC (DELAWARE LIMITED LIABILITY COMPANY)
502 PARK AVENUE
NEW YORK, NY 10022

Registered Feb. 14, 2012

Int. Cl.: 25

FOR: COATS, JACKETS, RAINWEAR, IN CLASS 25 (U.S. CLS. 22 AND 39).

TRADEMARK

FIRST USE 8-25-2011; IN COMMERCE 8-25-2011.

PRINCIPAL REGISTER

OWNER OF U.S. REG. NOS. 3,589,236, 3,593,246, AND 3,620,026.

THE COLOR(S) RED AND BLACK IS/ARE CLAIMED AS A FEATURE OF THE MARK.

THE NAME "IVANKA TRUMP" IDENTIFIES A LIVING INDIVIDUAL WHOSE CONSENT IS OF RECORD.

THE MARK CONSISTS OF THE WORDS "IVANKA TRUMP" IN A STYLIZED BLACK FONT AND THE BLACK STYLIZED LETTERS "IT" APPEARING IN AN OVAL IN BACKGROUND COLOR WITH A RED INNER OUTLINE AND BLACK OUTER OUTLINE.

SN 85-166,246, FILED 11-1-2010.

THEODORE MCBRIDE, EXAMINING ATTORNEY



David J. Kybas

Director of the United States Patent and Trademark Office

United States of America

United States Patent and Trademark Office

BUZZKILL

Reg. No. 4,099,975

Registered Feb. 14, 2012

Int. Cl.: 35

SERVICE MARK

PRINCIPAL REGISTER

DRUG-FREE ACTION ALLIANCE (OHIO NON-PROFIT CORPORATION)
6185 HUNTLEY ROAD, SUITE H
COLUMBUS, OH 43229

FOR: PROMOTING PUBLIC AWARENESS OF THE HEALTH, SAFETY AND LEGAL ISSUES ARISING FROM CONSUMPTION OF ALCOHOLIC BEVERAGES BY THOSE UNDER LEGAL DRINKING AGE; PROMOTING PUBLIC AWARENESS OF THE HEALTH, SAFETY AND LEGAL ISSUES ARISING WHEN INDIVIDUALS OF LEGAL DRINKING AGE PERMIT POSSESSION OR CONSUMPTION OF ALCOHOLIC BEVERAGES BY OTHERS UNDER LEGAL DRINKING AGE, IN CLASS 35 (U.S. CLS. 100, 101 AND 102).

FIRST USE 8-9-2011; IN COMMERCE 8-9-2011.

THE MARK CONSISTS OF STANDARD CHARACTERS WITHOUT CLAIM TO ANY PARTICULAR FONT, STYLE, SIZE, OR COLOR.

SN 85-166,300, FILED 11-1-2010.

GIANCARLO CASTRO, EXAMINING ATTORNEY



David J. Kyffers

Director of the United States Patent and Trademark Office

United States of America

United States Patent and Trademark Office

INWAP

Reg. No. 4,099,976

VDOPIA, INC. (DELAWARE CORPORATION)
2051 JUNCTION AVENUE #218
SAN JOSE, CA 95131

Registered Feb. 14, 2012

Int. Cl.: 35

FOR: ADVERTISING AND ADVERTISEMENT SERVICES; DISSEMINATION OF ADVERTISING FOR OTHERS VIA A GLOBAL COMPUTER NETWORK; PROVIDING ADVERTISEMENTS VIA MOBILE PHONE NETWORKS THAT CONNECT ADVERTISERS WITH MOBILE PHONE PUBLISHERS, IN CLASS 35 (U.S. CLS. 100, 101 AND 102).

SERVICE MARK

PRINCIPAL REGISTER

FIRST USE 9-0-2010; IN COMMERCE 9-0-2010.

THE MARK CONSISTS OF STANDARD CHARACTERS WITHOUT CLAIM TO ANY PARTICULAR FONT, STYLE, SIZE, OR COLOR.

SN 85-166,591, FILED 11-1-2010.

ALLISON HOLTZ, EXAMINING ATTORNEY



David J. Kyffers

Director of the United States Patent and Trademark Office

United States of America

United States Patent and Trademark Office

PREWAP

Reg. No. 4,099,977

VDOPIA, INC. (DELAWARE CORPORATION)
2051 JUNCTION AVENUE #218
SAN JOSE, CA 95131

Registered Feb. 14, 2012

Int. Cl.: 35

FOR: ADVERTISING AND ADVERTISEMENT SERVICES; DISSEMINATION OF ADVERTISING FOR OTHERS VIA A GLOBAL COMPUTER NETWORK; PROVIDING ADVERTISEMENTS VIA MOBILE PHONE NETWORKS THAT CONNECT ADVERTISERS WITH MOBILE PHONE PUBLISHERS, IN CLASS 35 (U.S. CLS. 100, 101 AND 102).

SERVICE MARK

PRINCIPAL REGISTER

FIRST USE 9-0-2010; IN COMMERCE 9-0-2010.

THE MARK CONSISTS OF STANDARD CHARACTERS WITHOUT CLAIM TO ANY PARTICULAR FONT, STYLE, SIZE, OR COLOR.

SN 85-166,595, FILED 11-1-2010.

ALLISON HOLTZ, EXAMINING ATTORNEY



David J. Kybas

Director of the United States Patent and Trademark Office

United States of America

United States Patent and Trademark Office

PLAYER SUPREME

Reg. No. 4,099,978

NEFOUSE ENTERPRISES, INC. (MICHIGAN CORPORATION), DBA JP LANN COMPANIES,
4320 DELEMERE COURT
ROYAL OAK, MI 48073

Registered Feb. 14, 2012

Int. Cl.: 28

FOR: GOLF CLUBS, GOLF CLUB BAGS, GOLF CLUB COVERS, GOLF BALL MARKERS,
DIVOT REPAIR TOOLS FOR GOLFERS, GOLF BALL RETRIEVER, GOLF ACCESSORY
POUCHES, NON-MOTORIZED GOLF CARTS AND ORGANIZER BAGS FOR SPORTING
EQUIPMENT, IN CLASS 28 (U.S. CLS. 22, 23, 38 AND 50).

TRADEMARK

PRINCIPAL REGISTER

FIRST USE 4-0-2011; IN COMMERCE 4-0-2011.

THE MARK CONSISTS OF STANDARD CHARACTERS WITHOUT CLAIM TO ANY PAR-
TICULAR FONT, STYLE, SIZE, OR COLOR.

SN 85-166,802, FILED 11-2-2010.

VERNA BETH RIRIE, EXAMINING ATTORNEY



David J. Kyffers

Director of the United States Patent and Trademark Office

United States of America

United States Patent and Trademark Office

CAIU A NOITE

Reg. No. 4,099,979

INTERCONTINENTAL PACKAGING CO. (MINNESOTA CORPORATION)
1999 SHEPARD ROAD
ST. PAUL, MN 55116

Registered Feb. 14, 2012

Int. Cl.: 33

FOR: WINES, IN CLASS 33 (U.S. CLS. 47 AND 49).

TRADEMARK

FIRST USE 12-1-2010; IN COMMERCE 6-1-2011.

PRINCIPAL REGISTER

THE MARK CONSISTS OF STANDARD CHARACTERS WITHOUT CLAIM TO ANY PARTICULAR FONT, STYLE, SIZE, OR COLOR.

THE ENGLISH TRANSLATION OF "CAIU A NOITE" IN THE MARK IS "NIGHT FALL."

SN 85-166,948, FILED 11-2-2010.

RENEE SERVANCE, EXAMINING ATTORNEY



David J. Kyffers

Director of the United States Patent and Trademark Office

United States of America

United States Patent and Trademark Office

Thuh Company

Reg. No. 4,099,980

Registered Feb. 14, 2012

Int. Cl.: 9

PREMIER ASSISTIVE TECHNOLOGY, INC. (MICHIGAN CORPORATION), DBA PREMIER LITERACY,
SUITE 205
1309 N. WILLIAM ST.
JOLIET, IL 60435

TRADEMARK

PRINCIPAL REGISTER

FOR: ENVIRONMENTAL MONITORING SYSTEM COMPRISED OF METERS AND SENSORS THAT MEASURE PRESSURE, HUMIDITY, TEMPERATURE AND INCLUDES ALARM AND REPORTING FUNCTIONS; WIRELESS CONTROLLER TO MONITOR AND CONTROL THE FUNCTIONING OF OTHER ELECTRONIC DEVICES, IN CLASS 9 (U.S. CLS. 21, 23, 26, 36 AND 38).

FIRST USE 5-1-2011; IN COMMERCE 8-15-2011.

THE MARK CONSISTS OF STANDARD CHARACTERS WITHOUT CLAIM TO ANY PARTICULAR FONT, STYLE, SIZE, OR COLOR.

NO CLAIM IS MADE TO THE EXCLUSIVE RIGHT TO USE "COMPANY", APART FROM THE MARK AS SHOWN.

SN 85-167,195, FILED 11-2-2010.

MARGARET POWER, EXAMINING ATTORNEY



David J. Kyjars

Director of the United States Patent and Trademark Office

United States of America

United States Patent and Trademark Office



Reg. No. 4,099,981

Registered Feb. 14, 2012

Int. Cl.: 43

SERVICE MARK

PRINCIPAL REGISTER

GOVINDA CORPORATION (GEORGIA CORPORATION)
246 HWY 49 NORTH
BYRON, GA 31008

FOR: AGENCY SERVICES FOR THE RESERVATION OF TEMPORARY ACCOMMODATION;
HOTEL AND MOTEL SERVICES; PROVIDING CONFERENCE ROOMS; RENTAL OF ROOMS
AS TEMPORARY LIVING ACCOMMODATIONS; RENTAL OF ROOMS FOR SOCIAL
FUNCTIONS, IN CLASS 43 (U.S. CLS. 100 AND 101).

FIRST USE 8-1-2011; IN COMMERCE 8-1-2011.

THE MARK CONSISTS OF AN ENCIRCLED STYLIZED "H".

SN 85-167,358, FILED 11-2-2010.

MARK RADEMACHER, EXAMINING ATTORNEY



David J. Kyffers

Director of the United States Patent and Trademark Office

United States of America

United States Patent and Trademark Office

FURRY COUTURE

Reg. No. 4,099,982

Registered Feb. 14, 2012

**Int. Cls.: 3, 14, 18, and
20**

ARGENTOSC (NEW YORK CORPORATION)
SUITE 2201
1407 BROADWAY
NEW YORK, NY 10018

FOR: COSMETICS, NAMELY, SHAMPOOS, IN CLASS 3 (U.S. CLS. 1, 4, 6, 50, 51 AND 52).

FIRST USE 2-2-2011; IN COMMERCE 2-2-2011.

TRADEMARK

FOR: JEWELRY PRODUCTS, NAMELY, COATED PRECIOUS METALS AND ALLOYS AND DOG NECKLACES, IN CLASS 14 (U.S. CLS. 2, 27, 28 AND 50).

PRINCIPAL REGISTER

FIRST USE 2-2-2011; IN COMMERCE 2-2-2011.

FOR: LEATHER PRODUCTS, NAMELY, DOG COLLARS AND LEASHES, IN CLASS 18 (U.S. CLS. 1, 2, 3, 22 AND 41).

FIRST USE 2-2-2011; IN COMMERCE 2-2-2011.

FOR: FURNITURE, NAMELY, BEDS FOR PETS, IN CLASS 20 (U.S. CLS. 2, 13, 22, 25, 32 AND 50).

FIRST USE 2-2-2011; IN COMMERCE 2-2-2011.

THE MARK CONSISTS OF STANDARD CHARACTERS WITHOUT CLAIM TO ANY PARTICULAR FONT, STYLE, SIZE, OR COLOR.

NO CLAIM IS MADE TO THE EXCLUSIVE RIGHT TO USE "COUTURE", APART FROM THE MARK AS SHOWN.

SN 85-167,688, FILED 11-3-2010.

GINA HAYES, EXAMINING ATTORNEY



David J. Kyffers

Director of the United States Patent and Trademark Office

United States of America

United States Patent and Trademark Office

StarFix

Reg. No. 4,099,983

ICC IND. COM. EXP. IMP. LTDA (BRAZIL LTDA OF BRAZIL)
AV. BRIG. FARIA LIMA, 1768
SAO PAULO, BRAZIL

Registered Feb. 14, 2012

Int. Cl.: 31

FOR: ANIMAL FEED INGREDIENTS, NAMELY, YEAST-BASED MYCOTOXINS BINDER FOR USE AS AN ADDITIVE IN ANIMAL FEED PRODUCTION, IN CLASS 31 (U.S. CLS. 1 AND 46).

TRADEMARK

FIRST USE 6-1-2008; IN COMMERCE 6-1-2008.

PRINCIPAL REGISTER

THE MARK CONSISTS OF THE STYLIZED WORDS "STARFIX" WHEREIN THE LETTERS "STARF" ARE DARK BROWN, THE LETTER "I" IS RED, AND THE LETTER "X" IS LIGHT BROWN; THE LETTERS "I" AND "X" ARE CONNECTED BY CRISSCROSSING RED LINES.

THE COLOR(S) DARK AND LIGHT BROWN AND RED IS/ARE CLAIMED AS A FEATURE OF THE MARK.

SN 85-167,703, FILED 11-3-2010.

TRICIA SONNEBORN, EXAMINING ATTORNEY



David J. Kybas

Director of the United States Patent and Trademark Office

United States of America

United States Patent and Trademark Office

TOP SQUASH

Reg. No. 4,099,984

O&R PRODUCE FARMS (NEW YORK CORPORATION)
234 MOUNT EVE ROAD
GOSHEN, NY 10924

Registered Feb. 14, 2012

Int. Cl.: 31

FOR: AGRICULTURAL PRODUCTS, NAMELY, FRESH SQUASH, IN CLASS 31 (U.S. CLS. 1 AND 46).

TRADEMARK

FIRST USE 1-1-2010; IN COMMERCE 9-1-2010.

PRINCIPAL REGISTER

THE MARK CONSISTS OF STANDARD CHARACTERS WITHOUT CLAIM TO ANY PARTICULAR FONT, STYLE, SIZE, OR COLOR.

NO CLAIM IS MADE TO THE EXCLUSIVE RIGHT TO USE "SQUASH", APART FROM THE MARK AS SHOWN.

SN 85-167,724, FILED 11-3-2010.

GINA HAYES, EXAMINING ATTORNEY



David J. Kyffers

Director of the United States Patent and Trademark Office

United States of America

United States Patent and Trademark Office

BrainyQuote

Reg. No. 4,099,985

XPLORE, INC. (DELAWARE CORPORATION)
4409 KNIGHTSBRIDGE DRIVE
MCKINNEY, TX 75070

Registered Feb. 14, 2012

Int. Cl.: 41

FOR: PROVIDING AN ONLINE COMPUTER DATABASE IN THE FIELDS OF EDUCATION AND ENTERTAINMENT FEATURING FAMOUS QUOTATIONS, IN CLASS 41 (U.S. CLS. 100, 101 AND 107).

SERVICE MARK

FIRST USE 7-1-2001; IN COMMERCE 7-1-2011.

PRINCIPAL REGISTER

THE MARK CONSISTS OF STANDARD CHARACTERS WITHOUT CLAIM TO ANY PARTICULAR FONT, STYLE, SIZE, OR COLOR.

SN 85-167,954, FILED 11-3-2010.

CURTIS FRENCH, EXAMINING ATTORNEY



David J. Kybas

Director of the United States Patent and Trademark Office

United States of America

United States Patent and Trademark Office

ISO'VEN

Reg. No. 4,099,986

CARL R. SPADARO (UNITED STATES INDIVIDUAL)
6899 PHILLIPS INDUSTRIAL BLVD.
JACKSONVILLE, FL 32256

Registered Feb. 14, 2012

Int. Cl.: 11

FOR: BAKING OVENS, IN CLASS 11 (U.S. CLS. 13, 21, 23, 31 AND 34).

TRADEMARK

FIRST USE 6-0-2011; IN COMMERCE 6-0-2011.

PRINCIPAL REGISTER

THE MARK CONSISTS OF STANDARD CHARACTERS WITHOUT CLAIM TO ANY PARTICULAR FONT, STYLE, SIZE, OR COLOR.

SN 85-168,373, FILED 11-3-2010.

CAROL SPILS, EXAMINING ATTORNEY



David J. Kybas

Director of the United States Patent and Trademark Office

United States of America

United States Patent and Trademark Office



Reg. No. 4,099,987

CARL R. SPADARO (UNITED STATES INDIVIDUAL)
6899 PHILLIPS INDUSTRIAL BLVD.
JACKSONVILLE, FL 32256

Registered Feb. 14, 2012

Int. Cl.: 11

FOR: BAKING OVENS, IN CLASS 11 (U.S. CLS. 13, 21, 23, 31 AND 34).

TRADEMARK

FIRST USE 6-0-2011; IN COMMERCE 6-0-2011.

PRINCIPAL REGISTER

THE MARK CONSISTS OF THE WORD "ISO'VEN" WITH THE LETTER "O" IN RED AND THE REMAINING LETTERS IN BLACK, THE LETTER "O" BEING LOCATED ON A BROWN PIZZA SPATULA.

THE COLOR(S) RED, BLACK AND BROWN IS/ARE CLAIMED AS A FEATURE OF THE MARK.

SN 85-168,418, FILED 11-3-2010.

CAROL SPILS, EXAMINING ATTORNEY



David J. Kyffers

Director of the United States Patent and Trademark Office

United States of America

United States Patent and Trademark Office

MY PREFERRED WORLD

Reg. No. 4,099,988

Registered Feb. 14, 2012

Int. Cl.: 43

SERVICE MARK

PRINCIPAL REGISTER

PREFERRED HOTEL GROUP, INC. (DELAWARE CORPORATION)
311 S. WACKER DR., SUITE 1900
CHICAGO, IL 60606

FOR: HOTEL SERVICES; RESORT HOTEL SERVICES; ACCOMMODATION RESERVATION SERVICES; PROVISION OF HOTEL ACCOMMODATION; PROVISION OF HOTEL VENUES FOR MEETINGS AND CONFERENCES; PROVIDING ADVICE AND INFORMATION TO TOURISTS AND TRAVELERS ON HOTEL DESTINATIONS; HOTEL RESERVATION AND BOOKING SERVICES, IN CLASS 43 (U.S. CLS. 100 AND 101).

FIRST USE 12-20-2010; IN COMMERCE 12-20-2010.

THE MARK CONSISTS OF STANDARD CHARACTERS WITHOUT CLAIM TO ANY PARTICULAR FONT, STYLE, SIZE, OR COLOR.

OWNER OF U.S. REG. NOS. 1,419,160, 3,439,372, AND OTHERS.

SN 85-168,427, FILED 11-3-2010.

KEVIN DINALLO, EXAMINING ATTORNEY



David J. Kybas

Director of the United States Patent and Trademark Office

United States of America

United States Patent and Trademark Office

PZ

Reg. No. 4,099,989

Registered Feb. 14, 2012

Int. Cl.: 14

TRADEMARK

PRINCIPAL REGISTER

PAZ CREATIONS LTD. (ISRAEL CORPORATION)
5 SHAUL AVIGUR STREET
TEL AVIV, ISRAEL

FOR: JEWELRY, IN CLASS 14 (U.S. CLS. 2, 27, 28 AND 50).

FIRST USE 9-1-2010; IN COMMERCE 9-1-2010.

THE MARK CONSISTS OF STANDARD CHARACTERS WITHOUT CLAIM TO ANY PARTICULAR FONT, STYLE, SIZE, OR COLOR.

SN 85-168,641, FILED 11-3-2010.

DAVID HOFFMAN, EXAMINING ATTORNEY



David J. Kyffers

Director of the United States Patent and Trademark Office

United States of America

United States Patent and Trademark Office

BABY GOGGLES

Reg. No. 4,099,990

MIKAEL HAVLUCIYAN (UNITED STATES INDIVIDUAL)
3275 5TH AVE., NO. 501
SAN DIEGO, CA 92103

Registered Feb. 14, 2012

Int. Cl.: 9

FOR: SOFTWARE FOR APPLYING VARIOUS FILTERS TO A DIGITAL CAMERA TO DISTORT THE IMAGES SEEN THROUGH THE CAMERA, IN CLASS 9 (U.S. CLS. 21, 23, 26, 36 AND 38).

TRADEMARK

FIRST USE 2-25-2011; IN COMMERCE 2-25-2011.

PRINCIPAL REGISTER

THE MARK CONSISTS OF STANDARD CHARACTERS WITHOUT CLAIM TO ANY PARTICULAR FONT, STYLE, SIZE, OR COLOR.

SN 85-168,745, FILED 11-4-2010.

MEGHAN REINHART, EXAMINING ATTORNEY



David J. Kyffers

Director of the United States Patent and Trademark Office

United States of America

United States Patent and Trademark Office

BELLA BAMBBA

Reg. No. 4,099,991

BENEFIT COSMETICS LLC (DELAWARE LIMITED LIABILITY COMPANY)
225 BUSH STREET, 20TH FLOOR
SAN FRANCISCO, CA 94104

Registered Feb. 14, 2012

Int. Cl.: 3

FOR: COSMETICS; FACE POWDER, IN CLASS 3 (U.S. CLS. 1, 4, 6, 50, 51 AND 52).

FIRST USE 12-0-2010; IN COMMERCE 1-0-2011.

TRADEMARK

THE MARK CONSISTS OF STANDARD CHARACTERS WITHOUT CLAIM TO ANY PARTICULAR FONT, STYLE, SIZE, OR COLOR.

PRINCIPAL REGISTER

THE NAME SHOWN IN THE MARK DOES NOT IDENTIFY A PARTICULAR LIVING INDIVIDUAL.

THE ENGLISH TRANSLATION OF "BELLA" IN THE MARK IS "BEAUTIFUL".

SN 85-169,267, FILED 11-4-2010.

MARY ROSSMAN, EXAMINING ATTORNEY



David J. Kyffers

Director of the United States Patent and Trademark Office

United States of America

United States Patent and Trademark Office

TWO WHEELS - ONE LOVE

Reg. No. 4,099,992

DALLAIRE, PATRICK STEVEN (UNITED STATES INDIVIDUAL)
3244 NE 62ND AVENUE
PORTLAND, OR 97213

Registered Feb. 14, 2012

Int. Cl.: 25

FOR: CAMISOLES; HEADGEAR, NAMELY, HATS, CAPS, BEANIES; HOODED SWEAT-SHIRTS; JACKETS; JERSEYS; LEATHER BELTS; SHORT-SLEEVED OR LONG-SLEEVED T-SHIRTS; SWEATSHIRTS; T-SHIRTS, IN CLASS 25 (U.S. CLS. 22 AND 39).

TRADEMARK

FIRST USE 8-15-2011; IN COMMERCE 8-15-2011.

PRINCIPAL REGISTER

THE MARK CONSISTS OF STANDARD CHARACTERS WITHOUT CLAIM TO ANY PARTICULAR FONT, STYLE, SIZE, OR COLOR.

SN 85-169,323, FILED 11-4-2010.

JEFFERY COWARD, EXAMINING ATTORNEY



David J. Kybas

Director of the United States Patent and Trademark Office

United States of America

United States Patent and Trademark Office

LINAGARD

Reg. No. 4,099,993

Registered Feb. 14, 2012

Int. Cl.: 17

TRADEMARK

PRINCIPAL REGISTER

LINATEX LIMITED (ENGLAND COMPANY)
WILKINSON HOUSE
GALWAY ROAD, BLACKBUSHE BUSINESS PARK
YATELEY, HAMPSHIRE, UNITED KINGDOM GU466GE

FOR: LININGS, SLEEVES, CASINGS, PANELS, SCREENS, HOSES, SHEETS AND COATINGS
MADE OF NATURAL RUBBER AND NATURAL AND SYNTHETIC RUBBER BLENDS FOR
PROTECTING PARTS OF MACHINERY, VALVES, TRANSMISSION BELTS, TANKS, PUMPS,
IMPELLERS, HOSES AND PIPES, IN CLASS 17 (U.S. CLS. 1, 5, 12, 13, 35 AND 50).

FIRST USE 12-31-1994; IN COMMERCE 1-1-1998.

THE MARK CONSISTS OF STANDARD CHARACTERS WITHOUT CLAIM TO ANY PAR-
TICULAR FONT, STYLE, SIZE, OR COLOR.

SN 85-169,742, FILED 11-4-2010.

MICHELE SWAIN, EXAMINING ATTORNEY



David J. Kyffers

Director of the United States Patent and Trademark Office

United States of America

United States Patent and Trademark Office

OFFICIAL B

Reg. No. 4,099,994

Registered Feb. 14, 2012

Int. Cl.: 41

SERVICE MARK

PRINCIPAL REGISTER

JOHNSON, BRYAN (UNITED STATES INDIVIDUAL)
#H306
412 E. NOVAK LN
KENT, WA 98032

FOR: ENTERTAINMENT IN THE NATURE OF VISUAL AND AUDIO PERFORMANCES BY A HIP HOP ARTIST; ENTERTAINMENT SERVICES IN THE NATURE OF LIVE MUSICAL PERFORMANCES, IN CLASS 41 (U.S. CLS. 100, 101 AND 107).

FIRST USE 9-0-2010; IN COMMERCE 9-0-2010.

THE MARK CONSISTS OF STANDARD CHARACTERS WITHOUT CLAIM TO ANY PARTICULAR FONT, STYLE, SIZE, OR COLOR.

THE NAME(S), PORTRAIT(S), AND/OR SIGNATURE(S) SHOWN IN THE MARK IDENTIFIES BRYAN JOHNSON, WHOSE CONSENT(S) TO REGISTER IS MADE OF RECORD.

SN 85-170,019, FILED 11-5-2010.

GILBERT SWIFT, EXAMINING ATTORNEY



David J. Kybas

Director of the United States Patent and Trademark Office

United States of America

United States Patent and Trademark Office

RELATIONSHIP CARE

Reg. No. 4,099,995

Registered Feb. 14, 2012

Int. Cl.: 35

SERVICE MARK

PRINCIPAL REGISTER

AMERICAN EXPRESS MARKETING & DEVELOPMENT CORP. (DELAWARE CORPORATION)
200 VESEY STREET
NEW YORK, NY 10285

FOR: CUSTOMER SERVICE IN THE FIELD OF FINANCIAL AND TRAVEL SERVICES, IN CLASS 35 (U.S. CLS. 100, 101 AND 102).

FIRST USE 8-16-2011; IN COMMERCE 8-16-2011.

THE MARK CONSISTS OF STANDARD CHARACTERS WITHOUT CLAIM TO ANY PARTICULAR FONT, STYLE, SIZE, OR COLOR.

SN 85-171,276, FILED 11-8-2010.

ALICE BENMAMAN, EXAMINING ATTORNEY



David J. Kybas

Director of the United States Patent and Trademark Office

United States of America

United States Patent and Trademark Office



Reg. No. 4,099,996

CELGENE CORPORATION (DELAWARE CORPORATION)
86 MORRIS AVENUE
SUMMIT, NJ 07901

Registered Feb. 14, 2012

Int. Cl.: 42

FOR: MEDICAL AND SCIENTIFIC RESEARCH, INCLUDING CONDUCTING CLINICAL TRIALS; CONDUCTING CLINICAL TRIALS ON THE SAFETY AND EFFECTIVENESS OF POMALIDOMIDE; CONDUCTING CLINICAL TRIALS ON THE SAFETY AND EFFECTIVENESS OF A DRUG FOR MYELOFIBROSIS, IN CLASS 42 (U.S. CLS. 100 AND 101).

SERVICE MARK

PRINCIPAL REGISTER

FIRST USE 7-15-2010; IN COMMERCE 7-15-2010.

THE MARK CONSISTS OF BLUE AND RED CIRCLE WITH THE WORD "RESUME" IN DARK BLUE LETTERING.

THE COLOR(S) BLUE AND RED IS/ARE CLAIMED AS A FEATURE OF THE MARK.

SN 85-171,756, FILED 11-8-2010.

DOUGLAS LEE, EXAMINING ATTORNEY



David J. Kyjars

Director of the United States Patent and Trademark Office

United States of America

United States Patent and Trademark Office

SYNC, SHARE, PLAY

Reg. No. 4,099,997

Registered Feb. 14, 2012

Int. Cl.: 42

SERVICE MARK

PRINCIPAL REGISTER

SMRTV, INC. (DELAWARE CORPORATION)
22ND FLOOR
10100 SANTA MONICA BLVD.
LOS ANGELES, CA 90067

FOR: COMPUTER SERVICES, NAMELY, CREATING AN ON-LINE COMMUNITY FOR REGISTERED USERS TO PARTICIPATE IN DISCUSSIONS, GET FEEDBACK FROM THEIR PEERS, FORM VIRTUAL COMMUNITIES, AND ENGAGE IN SOCIAL NETWORKING FEATURING TOPICS IN THE FIELD OF INTERACTIVE TELEVISION, IN CLASS 42 (U.S. CLS. 100 AND 101).

FIRST USE 10-11-2011; IN COMMERCE 10-11-2011.

THE MARK CONSISTS OF STANDARD CHARACTERS WITHOUT CLAIM TO ANY PARTICULAR FONT, STYLE, SIZE, OR COLOR.

SN 85-172,866, FILED 11-9-2010.

WILLIAM P. SHANAHAN, EXAMINING ATTORNEY



David J. Kyros

Director of the United States Patent and Trademark Office

United States of America

United States Patent and Trademark Office

VEDA BARS

Reg. No. 4,099,998

CARPENTER, RUSSELL (GREAT BRITAIN INDIVIDUAL)
1668 LEVI LANE
SANTA ROSA, CA 95403

Registered Feb. 14, 2012

Int. Cl.: 5

FOR: NUTRITIONAL AND DIETARY SUPPLEMENTS FORMED AND PACKAGED AS BARS, IN CLASS 5 (U.S. CLS. 6, 18, 44, 46, 51 AND 52).

TRADEMARK

FIRST USE 4-12-2011; IN COMMERCE 5-1-2011.

PRINCIPAL REGISTER

THE MARK CONSISTS OF STANDARD CHARACTERS WITHOUT CLAIM TO ANY PARTICULAR FONT, STYLE, SIZE, OR COLOR.

NO CLAIM IS MADE TO THE EXCLUSIVE RIGHT TO USE "BARS", APART FROM THE MARK AS SHOWN.

SN 85-172,937, FILED 11-9-2010.

MICHAEL ENGEL, EXAMINING ATTORNEY



David J. Kyros

Director of the United States Patent and Trademark Office

United States of America

United States Patent and Trademark Office

A50

Reg. No. 4,099,999

Registered Feb. 14, 2012

Int. Cl.: 5

TRADEMARK

PRINCIPAL REGISTER

BRAIN PHARMA, INC. (FLORIDA CORPORATION), DBA BPI,
3149 SW 42ND STREET #200
HOLLYWOOD, FL 33312

FOR: DIETARY AND NUTRITIONAL SUPPLEMENTS; DIETARY AND NUTRITIONAL SUPPLEMENTS FOR INCREASING STRENGTH AND LEAN BODY MASS; NON-PRESCRIPTION DIETARY AND NUTRITIONAL SUPPLEMENTS SOLD IN VITAMIN AND NUTRITION SHOPS AND ONLINE STORES FEATURING OVER-THE-COUNTER NUTRITIONAL SUPPLEMENTS, IN CLASS 5 (U.S. CLS. 6, 18, 44, 46, 51 AND 52).

FIRST USE 1-14-2011; IN COMMERCE 1-14-2011.

THE MARK CONSISTS OF STANDARD CHARACTERS WITHOUT CLAIM TO ANY PARTICULAR FONT, STYLE, SIZE, OR COLOR.

SN 85-173,285, FILED 11-10-2010.

DAVID I, EXAMINING ATTORNEY



David J. Kyfos

Director of the United States Patent and Trademark Office

United States of America

United States Patent and Trademark Office

THE BACC ROOM

Reg. No. 4,100,000

Registered Feb. 14, 2012

Int. Cl.: 41

SERVICE MARK

PRINCIPAL REGISTER

THE MAJESTIC STAR CASINO, LLC (INDIANA LIMITED LIABILITY COMPANY)
ONE BUFFINGTON HARBOR DRIVE
GARY, IN 46406

FOR: CASINO SERVICES, IN CLASS 41 (U.S. CLS. 100, 101 AND 107).

FIRST USE 12-14-2010; IN COMMERCE 12-14-2010.

THE MARK CONSISTS OF STANDARD CHARACTERS WITHOUT CLAIM TO ANY PARTICULAR FONT, STYLE, SIZE, OR COLOR.

SN 85-173,708, FILED 11-10-2010.

GINA FINK, EXAMINING ATTORNEY



David J. Kybas

Director of the United States Patent and Trademark Office

United States of America

United States Patent and Trademark Office

PINEBANK ASSET MANAGEMENT

Reg. No. 4,100,001

PINEBANK ASSET MANAGEMENT, L.P. (DELAWARE LIMITED PARTNERSHIP)
100 PARK AVENUE, 32ND FLOOR
NEW YORK, NY 10017

Registered Feb. 14, 2012

Int. Cl.: 36

FOR: FINANCIAL SERVICES, NAMELY, FINANCIAL FUNDS MANAGEMENT, IN CLASS 36 (U.S. CLS. 100, 101 AND 102).

SERVICE MARK

FIRST USE 3-0-2011; IN COMMERCE 9-0-2011.

PRINCIPAL REGISTER

THE MARK CONSISTS OF STANDARD CHARACTERS WITHOUT CLAIM TO ANY PARTICULAR FONT, STYLE, SIZE, OR COLOR.

NO CLAIM IS MADE TO THE EXCLUSIVE RIGHT TO USE "ASSET MANAGEMENT", APART FROM THE MARK AS SHOWN.

SN 85-174,210, FILED 11-11-2010.

DAVID TOOLEY, EXAMINING ATTORNEY



David J. Kyffers

Director of the United States Patent and Trademark Office

United States of America

United States Patent and Trademark Office

METALGUARD

Reg. No. 4,100,002

TRACEDETECT, INC. (DELAWARE CORPORATION)
180 NORTH CANAL STREET
SEATTLE, WA 98103

Registered Feb. 14, 2012

Int. Cl.: 9

FOR: INSTRUMENTS FOR ANALYSIS FOR THE IDENTIFICATION AND QUANTIFICATION OF METALS; ELECTRODES FOR ANALYSIS FOR THE IDENTIFICATION AND QUANTIFICATION OF METALS; COMPUTER SOFTWARE FOR ANALYSIS FOR THE IDENTIFICATION AND QUANTIFICATION OF METALS, IN CLASS 9 (U.S. CLS. 21, 23, 26, 36 AND 38).

TRADEMARK

PRINCIPAL REGISTER

FIRST USE 6-0-2009; IN COMMERCE 6-0-2009.

THE MARK CONSISTS OF STANDARD CHARACTERS WITHOUT CLAIM TO ANY PARTICULAR FONT, STYLE, SIZE, OR COLOR.

SN 85-174,353, FILED 11-11-2010.

ANN E. SAPPENFIELD, EXAMINING ATTORNEY



David J. Kyffers

Director of the United States Patent and Trademark Office

United States of America

United States Patent and Trademark Office



Reg. No. 4,100,003

Registered Feb. 14, 2012

Int. Cl.: 42

SERVICE MARK

PRINCIPAL REGISTER

CASHIDO CORPORATION (TAIWAN CORPORATION)
NO.8, KEXI 1ST RD.
ZHUNAN SCIENCE PARK, ZHUNAN TOWNSHIP
MIAOLI COUNTY, 350, TAIWAN

FOR: CHEMICAL ANALYSIS; BACTERIOLOGICAL RESEARCH; CHEMICAL RESEARCH;
ARCHITECTURAL CONSULTATION; CONSTRUCTION DRAFTING; TECHNICAL CON-
SULTANCY IN THE FIELD OF ENVIRONMENTAL PROTECTION; RESEARCH IN THE
FIELD OF ENVIRONMENTAL PROTECTION; INDUSTRIAL DESIGN; UNDERWATER
EXPLORATION; URBAN PLANNING, IN CLASS 42 (U.S. CLS. 100 AND 101).

FIRST USE 7-23-2009; IN COMMERCE 4-6-2010.

THE MARK CONSISTS OF A BALL LIKE CONTOUR OVERLAYING A LOWER PORTION
OF A LEAF LIKE CONTOUR, ALL ABOVE THE STYLIZED WORD "CASHIDO".

SN 85-174,736, FILED 11-11-2010.

FLORENTINA BLANDU, EXAMINING ATTORNEY



David J. Kyffers

Director of the United States Patent and Trademark Office

United States of America

United States Patent and Trademark Office

SlimActin

Reg. No. 4,100,004

LIFE FACTOR RESEARCH LLC (NEW MEXICO LIMITED LIABILITY COMPANY)
56145 VILLAGE DRIVE
LA QUINTA, CA 92253

Registered Feb. 14, 2012

Int. Cl.: 5

FOR: DIETARY AND NUTRITIONAL SUPPLEMENTS USED FOR WEIGHT LOSS, IN CLASS 5 (U.S. CLS. 6, 18, 44, 46, 51 AND 52).

TRADEMARK

FIRST USE 1-15-2008; IN COMMERCE 1-15-2008.

PRINCIPAL REGISTER

THE MARK CONSISTS OF STANDARD CHARACTERS WITHOUT CLAIM TO ANY PARTICULAR FONT, STYLE, SIZE, OR COLOR.

SN 85-175,603, FILED 11-12-2010.

SAMUEL E. SHARPER JR., EXAMINING ATTORNEY



David J. Kyffers

Director of the United States Patent and Trademark Office

United States of America

United States Patent and Trademark Office

ProEsta

Reg. No. 4,100,005

LIFE FACTOR RESEARCH LLC (NEW MEXICO LIMITED LIABILITY COMPANY)
56145 VILLAGE DRIVE
LA QUINTA, CA 92253

Registered Feb. 14, 2012

Int. Cl.: 5

FOR: DIETARY SUPPLEMENTS, IN CLASS 5 (U.S. CLS. 6, 18, 44, 46, 51 AND 52).

TRADEMARK

FIRST USE 1-15-2008; IN COMMERCE 1-15-2008.

PRINCIPAL REGISTER

THE MARK CONSISTS OF STANDARD CHARACTERS WITHOUT CLAIM TO ANY PARTICULAR FONT, STYLE, SIZE, OR COLOR.

SN 85-175,720, FILED 11-12-2010.

SAMUEL E. SHARPER JR., EXAMINING ATTORNEY



David J. Kybas

Director of the United States Patent and Trademark Office

United States of America

United States Patent and Trademark Office

AllerServe

Reg. No. 4,100,006

ALLERSERVE LLC (MARYLAND LIMITED LIABILITY COMPANY)
P.O. BOX 727

Registered Feb. 14, 2012

ELLCOTT CITY, MD 21041

Int. Cl.: 35

FOR: BUSINESS CONSULTATION IN THE FIELD OF PROPER HANDLING OF FOODS FOR BUSINESS SERVING PEOPLE WITH FOOD ALLERGIES, IN CLASS 35 (U.S. CLS. 100, 101 AND 102).

SERVICE MARK

FIRST USE 10-1-2011; IN COMMERCE 11-29-2011.

PRINCIPAL REGISTER

THE MARK CONSISTS OF STANDARD CHARACTERS WITHOUT CLAIM TO ANY PARTICULAR FONT, STYLE, SIZE, OR COLOR.

SN 85-175,895, FILED 11-12-2010.

THEODORE MCBRIDE, EXAMINING ATTORNEY



David J. Kybas

Director of the United States Patent and Trademark Office

United States of America

United States Patent and Trademark Office

ECHO NINER

Reg. No. 4,100,007

TAE, SANG HO (UNITED STATES INDIVIDUAL)
26235 CORONA DR.

Registered Feb. 14, 2012

HELENDALE, CA 92342

Int. Cl.: 9

FOR: BAGS FOR CAMERAS AND PHOTOGRAPHIC EQUIPMENT, IN CLASS 9 (U.S. CLS. 21, 23, 26, 36 AND 38).

TRADEMARK

FIRST USE 7-26-2011; IN COMMERCE 7-26-2011.

PRINCIPAL REGISTER

THE MARK CONSISTS OF STANDARD CHARACTERS WITHOUT CLAIM TO ANY PARTICULAR FONT, STYLE, SIZE, OR COLOR.

SN 85-175,903, FILED 11-12-2010.

NATALIE POLZER, EXAMINING ATTORNEY



David J. Kybas

Director of the United States Patent and Trademark Office

United States of America

United States Patent and Trademark Office

HER ROYAL HIGHNESS

Reg. No. 4,100,008

HRH WINES (CALIFORNIA PARTNERSHIP)

Registered Feb. 14, 2012

19201 SONOMA HWY #255
SONOMA, CA 95476

Int. Cl.: 33

FOR: WINE, IN CLASS 33 (U.S. CLS. 47 AND 49).

TRADEMARK

FIRST USE 11-5-2011; IN COMMERCE 11-5-2011.

PRINCIPAL REGISTER

THE MARK CONSISTS OF STANDARD CHARACTERS WITHOUT CLAIM TO ANY PARTICULAR FONT, STYLE, SIZE, OR COLOR.

SN 85-175,943, FILED 11-12-2010.

MICHELE SWAIN, EXAMINING ATTORNEY



David J. Kybas

Director of the United States Patent and Trademark Office

United States of America

United States Patent and Trademark Office

HCGBOXCOMPLETE

Reg. No. 4,100,009

HCG NORTHWEST LLC (NEVADA LIMITED LIABILITY COMPANY)
13010 159TH ST E
PUYALLUP, WA 98374

Registered Feb. 14, 2012

Int. Cl.: 16

FOR: WEIGHT LOSS PROGRAM KITS CONSISTING PRIMARILY OF PRINTED COOK-BOOKS, WORKBOOKS AND PLANNERS ON WEIGHT LOSS AND DIETING, AND ALSO INCLUDING HOMEOPATHIC DIETARY SUPPLEMENTS CONTAINING HUMAN CHORIONIC GONADOTROPIN, PRE-RECORDED CDS FEATURING INFORMATION ON MAINTAINING WEIGHT LOSS AND PRE-RECORDED DVDS FEATURING INSTRUCTIONAL INFORMATION ON WEIGHT LOSS PROGRAM AND MEAL PLAN, ALL SOLD AS A UNIT, IN CLASS 16 (U.S. CLS. 2, 5, 22, 23, 29, 37, 38 AND 50).

TRADEMARK

PRINCIPAL REGISTER

FIRST USE 11-5-2010; IN COMMERCE 4-26-2011.

THE MARK CONSISTS OF STANDARD CHARACTERS WITHOUT CLAIM TO ANY PARTICULAR FONT, STYLE, SIZE, OR COLOR.

SN 85-176,933, FILED 11-15-2010.

KATHERINE STOIDES, EXAMINING ATTORNEY



David J. Kyros

Director of the United States Patent and Trademark Office

United States of America

United States Patent and Trademark Office

ATHLETE 4 EVER

Reg. No. 4,100,010

WHITMYER, GREGORY (UNITED STATES INDIVIDUAL)
10331 RED PINE PL
WALDORF, MD 20601

Registered Feb. 14, 2012

Int. Cl.: 25

FOR: CLOTHING AND SPORTSWEAR, NAMELY, T-SHIRTS, SWEATSHIRTS, SHIRTS, SWEATERS, TOPS, PANTS, SWEATPANTS, BOTTOMS, JACKETS, COATS, CAPS, HATS, HEADWEAR, SOCKS, UNDERWEAR, LINGERIE, SHOES, SCARVES, MITTENS, GLOVES, SLEEPWEAR, BEACHWEAR, DRESSES, SKIRTS, UNIFORMS, SHORTS, BELTS, EAR MUFFS, WRISTBANDS, AND HEADBANDS, IN CLASS 25 (U.S. CLS. 22 AND 39).

TRADEMARK

PRINCIPAL REGISTER

FIRST USE 11-1-2010; IN COMMERCE 11-1-2010.

THE MARK CONSISTS OF STANDARD CHARACTERS WITHOUT CLAIM TO ANY PARTICULAR FONT, STYLE, SIZE, OR COLOR.

NO CLAIM IS MADE TO THE EXCLUSIVE RIGHT TO USE "ATHLETE", APART FROM THE MARK AS SHOWN.

SN 85-177,406, FILED 11-16-2010.

SEAN CROWLEY, EXAMINING ATTORNEY



David J. Kyffers

Director of the United States Patent and Trademark Office

United States of America

United States Patent and Trademark Office

LIVE AT THE RYMAN

Reg. No. 4,100,011

GAYLORD ENTERTAINMENT COMPANY (DELAWARE CORPORATION)
ONE GAYLORD DRIVE
NASHVILLE, TN 37214

Registered Feb. 14, 2012

Int. Cl.: 41

FOR: ENTERTAINMENT SERVICES, NAMELY, LIVE MUSIC CONCERTS, IN CLASS 41
(U.S. CLS. 100, 101 AND 107).

SERVICE MARK

FIRST USE 12-6-2011; IN COMMERCE 12-6-2011.

PRINCIPAL REGISTER

THE MARK CONSISTS OF STANDARD CHARACTERS WITHOUT CLAIM TO ANY PARTICULAR FONT, STYLE, SIZE, OR COLOR.

OWNER OF U.S. REG. NOS. 1,867,250, 2,221,888, AND OTHERS.

NO CLAIM IS MADE TO THE EXCLUSIVE RIGHT TO USE "LIVE", APART FROM THE MARK AS SHOWN.

SN 85-177,808, FILED 11-16-2010.

MARY CRAWFORD, EXAMINING ATTORNEY



David J. Kybas

Director of the United States Patent and Trademark Office

United States of America

United States Patent and Trademark Office

buncee

Reg. No. 4,100,012

BUNCEE LLC (NEW YORK LIMITED LIABILITY COMPANY)
P.O. BOX 824

Registered Feb. 14, 2012

MATTITUCK, NY 11952

Int. Cls.: 9 and 45

FOR: COMPUTER SOFTWARE FOR ENABLING AND PROVIDING AN INTERNET BASED SERVICE THAT ALLOWS USERS TO SHARE MEDIA AND COMMUNICATE ACROSS A SOCIAL NETWORK, IN CLASS 9 (U.S. CLS. 21, 23, 26, 36 AND 38).

TRADEMARK

FIRST USE 1-25-2011; IN COMMERCE 1-25-2011.

SERVICE MARK

FOR: PROVIDING AN INTERACTIVE SOCIAL NETWORKING WEBSITE ALLOWING USERS TO SHARE MEDIA AND COMMUNICATE, FOR ENTERTAINMENT PURPOSES, IN CLASS 45 (U.S. CLS. 100 AND 101).

PRINCIPAL REGISTER

FIRST USE 2-1-2011; IN COMMERCE 2-1-2011.

THE MARK CONSISTS OF THE STYLIZED TERM "BUNCEE" HAVING A TEARDROP AT THE END THEREOF.

SN 85-177,813, FILED 11-16-2010.

WENDY JUN, EXAMINING ATTORNEY



David J. Kyros

Director of the United States Patent and Trademark Office

United States of America

United States Patent and Trademark Office

NIKOLE KRYSTAL

Reg. No. 4,100,013

HERNANDEZ FASHIONS, INC. (TEXAS CORPORATION)
615 S. EL PASO STREET
EL PASO, TX 79901

Registered Feb. 14, 2012

Int. Cl.: 25

FOR: CLOTHING, NAMELY, JEANS, BLOUSES, JACKETS, SWEAT SHIRTS, SWEAT PANTS, TEE-SHIRTS, CAPS, SHORTS, AND COATS, IN CLASS 25 (U.S. CLS. 22 AND 39).

TRADEMARK

FIRST USE 12-1-2011; IN COMMERCE 12-1-2011.

PRINCIPAL REGISTER

THE MARK CONSISTS OF STANDARD CHARACTERS WITHOUT CLAIM TO ANY PARTICULAR FONT, STYLE, SIZE, OR COLOR.

THE NAME "NIKOLE KRYSTAL" DOES NOT IDENTIFY A LIVING INDIVIDUAL.

SN 85-177,830, FILED 11-16-2010.

MELISSA VALLILLO, EXAMINING ATTORNEY



David J. Kyffers

Director of the United States Patent and Trademark Office

United States of America

United States Patent and Trademark Office

ARGANMAGIC

Reg. No. 4,100,014

JOCOTT BRANDS, INC. (CALIFORNIA CORPORATION)
16217 KITTRIDGE STREET
VAN NUYS, CA 91406

Registered Feb. 14, 2012

Int. Cl.: 3

FOR: NON-MEDICATED PREPARATIONS ALL FOR THE CARE OF SKIN, HAIR AND SCALP, IN CLASS 3 (U.S. CLS. 1, 4, 6, 50, 51 AND 52).

TRADEMARK

FIRST USE 11-26-2010; IN COMMERCE 11-26-2010.

PRINCIPAL REGISTER

THE MARK CONSISTS OF STANDARD CHARACTERS WITHOUT CLAIM TO ANY PARTICULAR FONT, STYLE, SIZE, OR COLOR.

SN 85-177,942, FILED 11-16-2010.

FRED CARL, EXAMINING ATTORNEY



David J. Kyfos

Director of the United States Patent and Trademark Office

United States of America

United States Patent and Trademark Office



Reg. No. 4,100,015

Registered Feb. 14, 2012

Int. Cl.: 36

SERVICE MARK

PRINCIPAL REGISTER

SPRINGLEAF FINANCE, INC. (INDIANA CORPORATION)
601 N.W. SECOND STREET
EVANSVILLE, IN 47708

FOR: CONSUMER LENDING SERVICES; INSURANCE UNDERWRITING IN THE FIELD OF LIFE, ACCIDENTAL DEATH AND DISMEMBERMENT, DISABILITY AND CREDIT INSURANCE, IN CLASS 36 (U.S. CLS. 100, 101 AND 102).

FIRST USE 1-17-2011; IN COMMERCE 2-4-2011.

THE MARK CONSISTS OF AN IMAGE OF A LEAF.

SN 85-178,130, FILED 11-16-2010.

NAKIA HENRY, EXAMINING ATTORNEY



David J. Kyffers

Director of the United States Patent and Trademark Office

United States of America

United States Patent and Trademark Office

HEALTH CORNER

Reg. No. 4,100,016

WALGREEN CO. (ILLINOIS CORPORATION)
200 WILMOT ROAD
DEERFIELD, IL 60015

Registered Feb. 14, 2012

Int. Cl.: 44

FOR: INTERNET-BASED HEALTH CARE INFORMATION SERVICES, IN CLASS 44 (U.S. CLS. 100 AND 101).

SERVICE MARK

FIRST USE 7-31-2006; IN COMMERCE 7-31-2006.

PRINCIPAL REGISTER

THE MARK CONSISTS OF STANDARD CHARACTERS WITHOUT CLAIM TO ANY PARTICULAR FONT, STYLE, SIZE, OR COLOR.

OWNER OF U.S. REG. NOS. 2,944,628 AND 3,349,078.

NO CLAIM IS MADE TO THE EXCLUSIVE RIGHT TO USE "HEALTH", APART FROM THE MARK AS SHOWN.

SN 85-178,638, FILED 11-17-2010.

ALICE BENMAMAN, EXAMINING ATTORNEY



David J. Kyjars

Director of the United States Patent and Trademark Office

United States of America

United States Patent and Trademark Office

TUMMY CALM

Reg. No. 4,100,017

TJL ENTERPRISES, INC. (CALIFORNIA CORPORATION)
156 GRANADA AVENUE
LONG BEACH, CA 90803

Registered Feb. 14, 2012

Int. Cl.: 5

FOR: HOMEOPATHIC MEDICINE FOR DIGESTIVE UPSET, IN CLASS 5 (U.S. CLS. 6, 18, 44, 46, 51 AND 52).

TRADEMARK

FIRST USE 11-14-2011; IN COMMERCE 11-14-2011.

PRINCIPAL REGISTER

THE MARK CONSISTS OF STANDARD CHARACTERS WITHOUT CLAIM TO ANY PARTICULAR FONT, STYLE, SIZE, OR COLOR.

NO CLAIM IS MADE TO THE EXCLUSIVE RIGHT TO USE "TUMMY", APART FROM THE MARK AS SHOWN.

SN 85-179,174, FILED 11-17-2010.

CAROLINE WOOD, EXAMINING ATTORNEY



David J. Kyffers

Director of the United States Patent and Trademark Office

United States of America

United States Patent and Trademark Office

BEAMER

Reg. No. 4,100,018

DISCOUNT TOBACCO PRODUCTS, INC. (MICHIGAN CORPORATION)
30313 KINGSWAY DRIVE
FARMINGTON HILLS, MI 48331

Registered Feb. 14, 2012

Int. Cl.: 34

FOR: TOBACCO SUBSTITUTES, NAMELY, HERBAL MOLASSES, IN CLASS 34 (U.S. CLS. 2, 8, 9 AND 17).

TRADEMARK

FIRST USE 1-8-2011; IN COMMERCE 1-20-2011.

PRINCIPAL REGISTER

THE MARK CONSISTS OF STANDARD CHARACTERS WITHOUT CLAIM TO ANY PARTICULAR FONT, STYLE, SIZE, OR COLOR.

SN 85-179,522, FILED 11-17-2010.

JOHN WILKE, EXAMINING ATTORNEY



David J. Kybas

Director of the United States Patent and Trademark Office

United States of America

United States Patent and Trademark Office

The Kinky Girls

Reg. No. 4,100,019

TRUDY N. MINOR (UNITED STATES INDIVIDUAL)

Registered Feb. 14, 2012

8506 N. MATTOX #RK16
KANSAS CITY, MO 64154

Int. Cl.: 25

FOR: CLOTHING, NAMELY, SHIRTS, FT-SHIRTS, TANK TOPS, SWEAT SHIRTS, HOODED SWEAT SHIRTS, PANTS, SWEAT PANTS, PAJAMA PANTS, WORK-OUT PANTS, SHORTS, APRONS, SCARVES, HATS, JACKETS, DRESSES, SKIRTS, UNDER GARMENTS, SOCKS, HEADBANDS, IN CLASS 25 (U.S. CLS. 22 AND 39).

TRADEMARK

PRINCIPAL REGISTER

FIRST USE 10-1-2009; IN COMMERCE 7-30-2011.

THE MARK CONSISTS OF STANDARD CHARACTERS WITHOUT CLAIM TO ANY PARTICULAR FONT, STYLE, SIZE, OR COLOR.

NO CLAIM IS MADE TO THE EXCLUSIVE RIGHT TO USE "GIRLS", APART FROM THE MARK AS SHOWN.

SN 85-179,795, FILED 11-18-2010.

BERNICE MIDDLETON, EXAMINING ATTORNEY



David J. Kyffers

Director of the United States Patent and Trademark Office

United States of America

United States Patent and Trademark Office

ENVIRANIZED

Reg. No. 4,100,020

Registered Feb. 14, 2012

Int. Cl.: 4

TRADEMARK

PRINCIPAL REGISTER

ENVIRACARBON INC (FLORIDA CORPORATION)
SUITE 804
3245 S. ATLANTIC AVE.
DAYTONA BEACH SHORES, FL 32118

FOR: FUELS; SOLID FUELS, IN CLASS 4 (U.S. CLS. 1, 6 AND 15).

FIRST USE 10-0-2011; IN COMMERCE 10-0-2011.

THE MARK CONSISTS OF STANDARD CHARACTERS WITHOUT CLAIM TO ANY PARTICULAR FONT, STYLE, SIZE, OR COLOR.

SN 85-180,265, FILED 11-18-2010.

GENE MACIOL, EXAMINING ATTORNEY



David J. Kyffers

Director of the United States Patent and Trademark Office

United States of America

United States Patent and Trademark Office

Tri blocks

Reg. No. 4,100,021

Registered Feb. 14, 2012

Int. Cl.: 28

TRADEMARK

PRINCIPAL REGISTER

JUNIOR LEARNING INCORPORATED (CALIFORNIA CORPORATION), DBA JUNIOR LEARNING INCORPORATED,
19744 BEACH BOULEVARD, SUITE 389
HUNTINGTON BEACH, CA 92648

FOR: BLOCKS SOLD AS AN INTEGRAL COMPONENT OF EQUIPMENT SOLD AS A UNIT FOR PLAYING AN EDUCATIONAL WORD BUILDING GAME, IN CLASS 28 (U.S. CLS. 22, 23, 38 AND 50).

FIRST USE 3-1-2011; IN COMMERCE 11-10-2011.

THE MARK CONSISTS OF STANDARD CHARACTERS WITHOUT CLAIM TO ANY PARTICULAR FONT, STYLE, SIZE, OR COLOR.

NO CLAIM IS MADE TO THE EXCLUSIVE RIGHT TO USE "BLOCKS", APART FROM THE MARK AS SHOWN.

SN 85-180,349, FILED 11-18-2010.

MICHELLE DUBOIS, EXAMINING ATTORNEY



David J. Kyffers

Director of the United States Patent and Trademark Office

United States of America

United States Patent and Trademark Office

Vira-Flu Ultra

Reg. No. 4,100,022

PROMESA DISTRIBUTORS INC. (NORTH CAROLINA CORPORATION)

Registered Feb. 14, 2012

5160 INDIANA AVE. STE. A
WINSTON SALEM, NC 27106

Int. Cl.: 5

FOR: ANTI-COUGH DROPS; COUGH DROPS; COUGH EXPECTORANTS; COUGH LOZENGES; COUGH SYRUPS; COUGH TREATMENT PREPARATIONS, IN CLASS 5 (U.S. CLS. 6, 18, 44, 46, 51 AND 52).

TRADEMARK

FIRST USE 11-30-2011; IN COMMERCE 11-30-2011.

PRINCIPAL REGISTER

THE MARK CONSISTS OF STANDARD CHARACTERS WITHOUT CLAIM TO ANY PARTICULAR FONT, STYLE, SIZE, OR COLOR.

SN 85-180,398, FILED 11-18-2010.

ELI HELLMAN, EXAMINING ATTORNEY



David J. Kyfos

Director of the United States Patent and Trademark Office

United States of America

United States Patent and Trademark Office

GREAT MUSIC WAS RECORDED ON VINYL

Reg. No. 4,100,023

Registered Feb. 14, 2012

Int. Cl.: 25

TRADEMARK

PRINCIPAL REGISTER

MCCULLOUGH, CHERYL (UNITED STATES INDIVIDUAL)
#252
9420 RESEDA BLVD.
NORTHRIDGE, CA 91324

FOR: T-SHIRTS, SWEATSHIRTS, JACKETS, BASEBALL HATS, CAPS, TANK TOPS, JEANS, OVERALLS, SHIRTS, LEATHER JACKETS, SWEATPANTS, JOGGING SUITS, WRISTBANDS, HEADBANDS, BELTS, HALTER TOPS, PAJAMAS, PANTIES, SCARVES, SWIMSUITS, SHAWLS, SLIPPERS, SHOWER CAPS, SKIRTS, SNEAKERS, SOCKS, SHOES, SHORTS, CHILDREN'S AND INFANT'S APPAREL, NAMELY, JUMPERS, OVERALL SLEEPWEAR, PAJAMAS, ROMPERS AND ONE-PIECE GARMENTS, IN CLASS 25 (U.S. CLS. 22 AND 39).

FIRST USE 8-26-2011; IN COMMERCE 8-26-2011.

THE MARK CONSISTS OF STANDARD CHARACTERS WITHOUT CLAIM TO ANY PARTICULAR FONT, STYLE, SIZE, OR COLOR.

SN 85-180,614, FILED 11-18-2010.

MICHELE SWAIN, EXAMINING ATTORNEY



David J. Kyjars

Director of the United States Patent and Trademark Office

United States of America

United States Patent and Trademark Office

MAN-SMART

Reg. No. 4,100,024

M-S NETSOURCE LTD., LLC (VIRGINIA LIMITED LIABILITY COMPANY)
8210 CRESTWOOD HEIGHTS DRIVE, #125
MCLEAN, VA 22102

Registered Feb. 14, 2012

Int. Cl.: 45

FOR: PROVIDING A WEBSITE FEATURING INFORMATION AND ADVICE IN THE FIELD OF PERSONAL RELATIONSHIPS, IN CLASS 45 (U.S. CLS. 100 AND 101).

SERVICE MARK

FIRST USE 6-26-2010; IN COMMERCE 6-26-2010.

PRINCIPAL REGISTER

THE MARK CONSISTS OF STANDARD CHARACTERS WITHOUT CLAIM TO ANY PARTICULAR FONT, STYLE, SIZE, OR COLOR.

SN 85-180,836, FILED 11-19-2010.

JULIE WATSON, EXAMINING ATTORNEY



David J. Kybas

Director of the United States Patent and Trademark Office

United States of America

United States Patent and Trademark Office

A YEAR OF A MILLION MOMENTS

Reg. No. 4,100,025

TWENTIETH CENTURY FOX FILM CORPORATION (DELAWARE CORPORATION)
10201 WEST PICO BOULEVARD
LOS ANGELES, CA 90035

Registered Feb. 14, 2012

Int. Cl.: 41

FOR: PROVIDING ON-LINE INFORMATION IN THE FIELD OF MOTION PICTURE FILM AND VIDEO ENTERTAINMENT VIA THE INTERNET; ENTERTAINMENT SERVICES, NAMELY, PROVIDING ON-LINE COMPUTER GAMES, IN CLASS 41 (U.S. CLS. 100, 101 AND 107).

SERVICE MARK

PRINCIPAL REGISTER

FIRST USE 1-1-2011; IN COMMERCE 1-1-2011.

THE MARK CONSISTS OF STANDARD CHARACTERS WITHOUT CLAIM TO ANY PARTICULAR FONT, STYLE, SIZE, OR COLOR.

SN 85-181,234, FILED 11-19-2010.

ALICIA COLLINS, EXAMINING ATTORNEY



David J. Kyffers

Director of the United States Patent and Trademark Office

United States of America

United States Patent and Trademark Office

KomeMas

Reg. No. 4,100,026

PROMESA DISTRIBUTORS INC. (NORTH CAROLINA CORPORATION)
5160 INDIANA AVE. STE. A
WINSTON SALEM, NC 27106

Registered Feb. 14, 2012

Int. Cl.: 5

FOR: LIQUID VITAMIN SUPPLEMENTS; MULTI-VITAMIN PREPARATIONS; MULTIVITAMIN PREPARATIONS; VITAMIN AND MINERAL SUPPLEMENTS; VITAMIN B PREPARATIONS; VITAMIN C PREPARATIONS; VITAMIN D PREPARATIONS, IN CLASS 5 (U.S. CLS. 6, 18, 44, 46, 51 AND 52).

TRADEMARK

PRINCIPAL REGISTER

FIRST USE 11-30-2011; IN COMMERCE 11-30-2011.

THE MARK CONSISTS OF STANDARD CHARACTERS WITHOUT CLAIM TO ANY PARTICULAR FONT, STYLE, SIZE, OR COLOR.

SN 85-181,258, FILED 11-19-2010.

ELI HELLMAN, EXAMINING ATTORNEY



David J. Kypos

Director of the United States Patent and Trademark Office

United States of America

United States Patent and Trademark Office

FOR FRESHNESS YOU CAN SEE,
THINK FISHER

Reg. No. 4,100,027

JOHN B. SANFILIPPO & SON, INC. (DELAWARE CORPORATION)
1703 N. RANDALL ROAD
ELGIN, IL 601237820

Registered Feb. 14, 2012

Int. Cl.: 29

FOR: NUTS, SHELLED, ROASTED AND/OR FLAVORED, IN CLASS 29 (U.S. CL. 46).

TRADEMARK

FIRST USE 12-14-2010; IN COMMERCE 12-14-2010.

PRINCIPAL REGISTER

THE MARK CONSISTS OF STANDARD CHARACTERS WITHOUT CLAIM TO ANY PARTICULAR FONT, STYLE, SIZE, OR COLOR.

SN 85-181,439, FILED 11-19-2010.

ANN E. SAPPENFIELD, EXAMINING ATTORNEY



David J. Kyffers

Director of the United States Patent and Trademark Office

United States of America
United States Patent and Trademark Office

FragFarmer

Reg. No. 4,100,028

CAAMANO, ERIC (UNITED STATES INDIVIDUAL)
145 W. FOREST AVE
ARCADIA, CA 91006

Registered Feb. 14, 2012

Int. Cl.: 31

FOR: LIVE CORAL FRAGMENTS AND WHOLE CORAL COLONIES, IN CLASS 31 (U.S. CLS. 1 AND 46).

TRADEMARK

FIRST USE 12-8-2003; IN COMMERCE 12-8-2003.

PRINCIPAL REGISTER

THE MARK CONSISTS OF STANDARD CHARACTERS WITHOUT CLAIM TO ANY PARTICULAR FONT, STYLE, SIZE, OR COLOR.

SN 85-181,520, FILED 11-19-2010.

HOWARD SMIGA, EXAMINING ATTORNEY



David J. Kyffers

Director of the United States Patent and Trademark Office

United States of America

United States Patent and Trademark Office

Scribes STAT

Reg. No. 4,100,029

SCRIBES STAT, LLC (OREGON LIMITED LIABILITY COMPANY)
1750 SW SKYLINE BLVD. STE 220
LAKE OSWEGO, OR 97221

Registered Feb. 14, 2012

Int. Cl.: 35

FOR: MEDICAL TRANSCRIPTION SERVICES; TEMPORARY AND PERMANENT EMPLOYEE AGENCY SERVICES FOR MEDICAL TRANSCRIPTION SERVICES; RECORDS MANAGEMENT SERVICES, NAMELY, DOCUMENT INDEXING FOR OTHERS, IN CLASS 35 (U.S. CLS. 100, 101 AND 102).

SERVICE MARK

PRINCIPAL REGISTER

FIRST USE 11-30-2009; IN COMMERCE 11-30-2009.

THE MARK CONSISTS OF STANDARD CHARACTERS WITHOUT CLAIM TO ANY PARTICULAR FONT, STYLE, SIZE, OR COLOR.

NO CLAIM IS MADE TO THE EXCLUSIVE RIGHT TO USE "SCRIBES", APART FROM THE MARK AS SHOWN.

SN 85-181,655, FILED 11-19-2010.

STEVEN JACKSON, EXAMINING ATTORNEY



David J. Kyffers

Director of the United States Patent and Trademark Office

United States of America

United States Patent and Trademark Office

MEI SHAN TANG

Reg. No. 4,100,030

PRIZEMART LIMITED (HONG KONG LIMITED COMPANY (LTD.))
68 WANG LUNG ST.

Registered Feb. 14, 2012

10/F TSUEN WAN INTERNATIONAL CENTRE
TSUEN WAN, NT, HONG KONG

Int. Cl.: 5

FOR: HERBAL SUPPLEMENTS, IN CLASS 5 (U.S. CLS. 6, 18, 44, 46, 51 AND 52).

TRADEMARK

FIRST USE 11-1-2011; IN COMMERCE 11-1-2011.

PRINCIPAL REGISTER

THE MARK CONSISTS OF STANDARD CHARACTERS WITHOUT CLAIM TO ANY PARTICULAR FONT, STYLE, SIZE, OR COLOR.

THE ENGLISH TRANSLATION OF "MEI SHAN TANG" IN THE MARK IS HOUSE OF BEAUTY AND KINDNESS.

SN 85-183,103, FILED 11-23-2010.

ERIN FALK, EXAMINING ATTORNEY



David J. Kybas

Director of the United States Patent and Trademark Office

United States of America

United States Patent and Trademark Office

BECAUSE OF HER

Reg. No. 4,100,031

CARELLE LTD (NEW YORK CORPORATION)
2 WEST 46TH STREET
NEW YORK, NY 10036

Registered Feb. 14, 2012

Int. Cl.: 14

FOR: JEWELRY, IN CLASS 14 (U.S. CLS. 2, 27, 28 AND 50).

TRADEMARK

FIRST USE 5-31-2011; IN COMMERCE 5-31-2011.

PRINCIPAL REGISTER

THE MARK CONSISTS OF STANDARD CHARACTERS WITHOUT CLAIM TO ANY PARTICULAR FONT, STYLE, SIZE, OR COLOR.

SN 85-183,158, FILED 11-23-2010.

LINDA E. BLOHM, EXAMINING ATTORNEY



David J. Kybas

Director of the United States Patent and Trademark Office

United States of America

United States Patent and Trademark Office

VCA ADVANCED VETERINARY CARE CENTER

Reg. No. 4,100,032

VICAR OPERATING, INC. (DELAWARE CORPORATION)
12401 WEST OLYMPIC BOULEVARD
LOS ANGELES, CA 900641022

Registered Feb. 14, 2012

Int. Cl.: 44

FOR: ANIMAL HOSPITAL SERVICES, IN CLASS 44 (U.S. CLS. 100 AND 101).

SERVICE MARK

FIRST USE 11-29-2011; IN COMMERCE 11-29-2011.

PRINCIPAL REGISTER

THE MARK CONSISTS OF STANDARD CHARACTERS WITHOUT CLAIM TO ANY PARTICULAR FONT, STYLE, SIZE, OR COLOR.

OWNER OF U.S. REG. NOS. 2,847,530, 3,708,234, AND OTHERS.

NO CLAIM IS MADE TO THE EXCLUSIVE RIGHT TO USE "ADVANCED VETERINARY CARE CENTER", APART FROM THE MARK AS SHOWN.

SN 85-183,382, FILED 11-23-2010.

EVELYN BRADLEY, EXAMINING ATTORNEY



David J. Kyffers

Director of the United States Patent and Trademark Office

United States of America

United States Patent and Trademark Office

EVERY SHOT COUNTS

Reg. No. 4,100,033

Registered Feb. 14, 2012

Int. Cl.: 28

TRADEMARK

PRINCIPAL REGISTER

AIRBORNE ATHLETICS, INC. (MINNESOTA CORPORATION)
1800 EAST CLIFF ROAD
SUITE 11A
BURNSVILLE, MN 55337

FOR: BASKETBALL RETURN DEVICES, IN CLASS 28 (U.S. CLS. 22, 23, 38 AND 50).

FIRST USE 9-2-2011; IN COMMERCE 9-6-2011.

THE MARK CONSISTS OF STANDARD CHARACTERS WITHOUT CLAIM TO ANY PARTICULAR FONT, STYLE, SIZE, OR COLOR.

SN 85-184,111, FILED 11-23-2010.

DOMINICK J. SALEMI, EXAMINING ATTORNEY



David J. Kyffers

Director of the United States Patent and Trademark Office

United States of America

United States Patent and Trademark Office

BIG TIME GANGSTA

Reg. No. 4,100,034

GLU MOBILE INC. (DELAWARE CORPORATION)
45 FREMONT STREET, SUITE 2800
SAN FRANCISCO, CA 94105

Registered Feb. 14, 2012

Int. Cls.: 9 and 41

FOR: COMPUTER GAME SOFTWARE; ELECTRONIC GAME SOFTWARE; ELECTRONIC GAME SOFTWARE FOR CELLULAR TELEPHONES; ELECTRONIC GAME SOFTWARE FOR HANDHELD ELECTRONIC DEVICES; ELECTRONIC GAME SOFTWARE FOR WIRELESS DEVICES; DOWNLOADABLE ELECTRONIC GAME SOFTWARE FOR SOCIAL NETWORKING APPLICATIONS AND USE ON SOCIAL NETWORKING WEBSITES, IN CLASS 9 (U.S. CLS. 21, 23, 26, 36 AND 38).

TRADEMARK

SERVICE MARK

PRINCIPAL REGISTER

FIRST USE 3-31-2011; IN COMMERCE 3-31-2011.

FOR: ENTERTAINMENT SERVICES, NAMELY, PROVIDING ON-LINE COMPUTER GAMES; MULTIMEDIA PUBLISHING OF GAMES; PROVIDING A COMPUTER GAME FOR USE NETWORK-WIDE BY NETWORK USERS; PROVIDING INFORMATION ON-LINE RELATING TO COMPUTER GAMES AND COMPUTER ENHANCEMENTS FOR GAMES, IN CLASS 41 (U.S. CLS. 100, 101 AND 107).

FIRST USE 3-31-2011; IN COMMERCE 3-31-2011.

THE MARK CONSISTS OF STANDARD CHARACTERS WITHOUT CLAIM TO ANY PARTICULAR FONT, STYLE, SIZE, OR COLOR.

SN 85-184,202, FILED 11-23-2010.

KATHERINE STOIDES, EXAMINING ATTORNEY



David J. Kyros

Director of the United States Patent and Trademark Office

United States of America

United States Patent and Trademark Office

CONTRACT KILLER

Reg. No. 4,100,035

GLU MOBILE INC. (DELAWARE CORPORATION)
45 FREMONT STREET, SUITE 2800
SAN FRANCISCO, CA 94105

Registered Feb. 14, 2012

Int. Cls.: 9 and 41

FOR: COMPUTER GAME SOFTWARE; ELECTRONIC GAME SOFTWARE; ELECTRONIC GAME SOFTWARE FOR CELLULAR TELEPHONES; ELECTRONIC GAME SOFTWARE FOR HANDHELD ELECTRONIC DEVICES; ELECTRONIC GAME SOFTWARE FOR WIRELESS DEVICES; DOWNLOADABLE ELECTRONIC GAME SOFTWARE FOR SOCIAL NETWORKING APPLICATIONS AND USE ON SOCIAL NETWORKING WEBSITES, IN CLASS 9 (U.S. CLS. 21, 23, 26, 36 AND 38).

TRADEMARK

SERVICE MARK

PRINCIPAL REGISTER

FIRST USE 3-24-2011; IN COMMERCE 3-24-2011.

FOR: ENTERTAINMENT SERVICES, NAMELY, PROVIDING ON-LINE COMPUTER GAMES; MULTIMEDIA PUBLISHING OF GAMES; PROVIDING A COMPUTER GAME FOR USE NETWORK-WIDE BY NETWORK USERS; PROVIDING INFORMATION ON-LINE RELATING TO COMPUTER GAMES AND COMPUTER ENHANCEMENTS FOR GAMES, IN CLASS 41 (U.S. CLS. 100, 101 AND 107).

FIRST USE 3-24-2011; IN COMMERCE 3-24-2011.

THE MARK CONSISTS OF STANDARD CHARACTERS WITHOUT CLAIM TO ANY PARTICULAR FONT, STYLE, SIZE, OR COLOR.

SN 85-184,204, FILED 11-23-2010.

KATHERINE STOIDES, EXAMINING ATTORNEY



David J. Kyros

Director of the United States Patent and Trademark Office

United States of America

United States Patent and Trademark Office

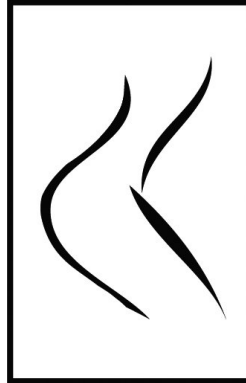

Reg. No. 4,100,036

HCG NORTHWEST LLC (NEVADA LIMITED LIABILITY COMPANY)
13010 159TH ST E
PUYALLUP, WA 98374

Registered Feb. 14, 2012

Int. Cl.: 16

FOR: WEIGHT LOSS PROGRAM KITS CONSISTING PRIMARILY OF PRINTED COOK-BOOKS, WORKBOOKS AND PLANNERS, ON WEIGHT LOSS AND DIETING, AND ALSO INCLUDING HOMEOPATHIC DIETARY SUPPLEMENTS, CDS, AND DVDS, IN CLASS 16 (U.S. CLS. 2, 5, 22, 23, 29, 37, 38 AND 50).

TRADEMARK

PRINCIPAL REGISTER

FIRST USE 11-5-2010; IN COMMERCE 4-26-2011.

THE MARK CONSISTS OF THE STYLIZED SIDE VIEW OF THE MIDSECTION TORSO PORTION OF A FEMALE FIGURE WITHIN A RECTANGULAR BORDER.

SN 85-184,552, FILED 11-24-2010.

KATHERINE STOIDES, EXAMINING ATTORNEY



David J. Kyffers

Director of the United States Patent and Trademark Office

United States of America

United States Patent and Trademark Office

gobounce

Reg. No. 4,100,037

Registered Feb. 14, 2012

Int. Cls.: 39 and 43

SERVICE MARK

PRINCIPAL REGISTER

HOPE NEWMAN PROVOST (UNITED STATES INDIVIDUAL)
425 EAST 13TH STREET, #6C
NEW YORK, NY 10009

FOR: TRAVEL AGENCY SERVICES, NAMELY, MAKING RESERVATIONS AND BOOKINGS FOR TRANSPORTATION AND PROVIDING INFORMATION AND REVIEWS CONCERNING TRAVEL BY MEANS OF A COMPUTER NETWORK AND GLOBAL COMMUNICATIONS NETWORKS; TRAVEL AND TOUR INFORMATION SERVICES, NAMELY, PROVIDING INFORMATION ABOUT VACATION DESTINATIONS; TRAVEL AND TOUR TICKET RESERVATION SERVICES; MAKING RESERVATIONS FOR TRAVEL ACTIVITIES, NAMELY, FOR TOURS, TRAVEL TO EVENTS AND TRAVEL TO ATTRACTIONS, IN CLASS 39 (U.S. CLS. 100 AND 105).

FIRST USE 11-1-2011; IN COMMERCE 11-1-2011.

FOR: TRAVEL AGENCY SERVICES, NAMELY, MAKING RESERVATIONS AND BOOKINGS FOR TEMPORARY LODGING AND RESTAURANTS AND MEALS, IN CLASS 43 (U.S. CLS. 100 AND 101).

FIRST USE 11-1-2011; IN COMMERCE 11-1-2011.

THE MARK CONSISTS OF STANDARD CHARACTERS WITHOUT CLAIM TO ANY PARTICULAR FONT, STYLE, SIZE, OR COLOR.

SN 85-184,685, FILED 11-24-2010.

JOHN GARTNER, EXAMINING ATTORNEY



David J. Kybas

Director of the United States Patent and Trademark Office

United States of America

United States Patent and Trademark Office

HENRY LIQUID TAPE

Reg. No. 4,100,038

THE W.W. HENRY COMPANY L.P. (CALIFORNIA LIMITED PARTNERSHIP)
400 ARDEX DRIVE
ALIQUIPPA, PA 15001

Registered Feb. 14, 2012

Int. Cl.: 1

FOR: ADHESIVES FOR FLOOR COVERINGS, IN CLASS 1 (U.S. CLS. 1, 5, 6, 10, 26 AND 46).

TRADEMARK

FIRST USE 1-0-2011; IN COMMERCE 1-0-2011.

PRINCIPAL REGISTER

THE MARK CONSISTS OF STANDARD CHARACTERS WITHOUT CLAIM TO ANY PARTICULAR FONT, STYLE, SIZE, OR COLOR.

OWNER OF U.S. REG. NOS. 1,064,754, 2,726,870, AND OTHERS.

NO CLAIM IS MADE TO THE EXCLUSIVE RIGHT TO USE "LIQUID TAPE", APART FROM THE MARK AS SHOWN.

SN 85-184,770, FILED 11-24-2010.

MARY ROSSMAN, EXAMINING ATTORNEY



David J. Kybas

Director of the United States Patent and Trademark Office

United States of America

United States Patent and Trademark Office

NATURAL ELEMENTS

Reg. No. 4,100,039

HUNTER DOUGLAS INC. (DELAWARE CORPORATION)
1 BLUE HILL PLAZA
PEARL RIVER, NY 10965

Registered Feb. 14, 2012

Int. Cl.: 20

FOR: WINDOW BLINDS; WINDOW SHADES, IN CLASS 20 (U.S. CLS. 2, 13, 22, 25, 32 AND 50).

TRADEMARK

FIRST USE 3-23-2011; IN COMMERCE 3-23-2011.

PRINCIPAL REGISTER

THE MARK CONSISTS OF STANDARD CHARACTERS WITHOUT CLAIM TO ANY PARTICULAR FONT, STYLE, SIZE, OR COLOR.

SN 85-184,957, FILED 11-24-2010.

MARGERY A. TIERNEY, EXAMINING ATTORNEY



David J. Kybas

Director of the United States Patent and Trademark Office

United States of America
United States Patent and Trademark Office

RIVERSTONE

Reg. No. 4,100,040

HUNTER DOUGLAS INC. (DELAWARE CORPORATION)

Registered Feb. 14, 2012

1 BLUE HILL PLAZA
PEARL RIVER, NY 10965

Int. Cl.: 20

FOR: WINDOW BLINDS; WINDOW SHADES, IN CLASS 20 (U.S. CLS. 2, 13, 22, 25, 32 AND 50).

TRADEMARK

FIRST USE 3-23-2011; IN COMMERCE 3-23-2011.

PRINCIPAL REGISTER

THE MARK CONSISTS OF STANDARD CHARACTERS WITHOUT CLAIM TO ANY PARTICULAR FONT, STYLE, SIZE, OR COLOR.

SN 85-184,968, FILED 11-24-2010.

MARGERY A. TIERNEY, EXAMINING ATTORNEY



David J. Kybas

Director of the United States Patent and Trademark Office

United States of America

United States Patent and Trademark Office

VALLEY VIEW CASINO CENTER

Reg. No. 4,100,041

SAN PASQUAL CASINO DEVELOPMENT GROUP INC. (CALIFORNIA CORPORATION)
16300 NYEMII PASS ROAD
VALLEY CENTER, CA 92082

Registered Feb. 14, 2012

Int. Cl.: 43

FOR: ARENA SERVICES, NAMELY, PROVIDING FACILITIES FOR SPORTS, CONCERTS, CONVENTIONS, EXHIBITIONS, SPORTING EVENTS, POLITICAL AND RELIGIOUS RALLIES, SOCIAL FUNCTIONS, AND RECREATIONAL ACTIVITIES, IN CLASS 43 (U.S. CLS. 100 AND 101).

SERVICE MARK

PRINCIPAL REGISTER

FIRST USE 12-0-2010; IN COMMERCE 12-0-2010.

THE MARK CONSISTS OF STANDARD CHARACTERS WITHOUT CLAIM TO ANY PARTICULAR FONT, STYLE, SIZE, OR COLOR.

OWNER OF U.S. REG. NOS. 3,542,867, 3,857,074, AND 3,857,075.

NO CLAIM IS MADE TO THE EXCLUSIVE RIGHT TO USE "CASINO CENTER", APART FROM THE MARK AS SHOWN.

SN 85-184,977, FILED 11-24-2010.

JACLYN KIDWELL WALKER, EXAMINING ATTORNEY



David J. Kyros

Director of the United States Patent and Trademark Office

United States of America

United States Patent and Trademark Office

VALLEY VIEW CASINO CENTER

Reg. No. 4,100,042

SAN PASQUAL CASINO DEVELOPMENT GROUP INC. (CALIFORNIA CORPORATION)
16300 NYEMII PASS ROAD
VALLEY CENTER, CA 92082

Registered Feb. 14, 2012

Int. Cl.: 35

FOR: CONCESSION STANDS FEATURING FOOD, SOUVENIRS AND GENERAL CONSUMER GOODS, IN CLASS 35 (U.S. CLS. 100, 101 AND 102).

SERVICE MARK

FIRST USE 12-0-2010; IN COMMERCE 12-0-2010.

PRINCIPAL REGISTER

THE MARK CONSISTS OF STANDARD CHARACTERS WITHOUT CLAIM TO ANY PARTICULAR FONT, STYLE, SIZE, OR COLOR.

OWNER OF U.S. REG. NOS. 3,542,867, 3,857,074, AND 3,857,075.

NO CLAIM IS MADE TO THE EXCLUSIVE RIGHT TO USE "CASINO CENTER", APART FROM THE MARK AS SHOWN.

SN 85-185,000, FILED 11-24-2010.

JACLYN KIDWELL WALKER, EXAMINING ATTORNEY



David J. Kyffers

Director of the United States Patent and Trademark Office

United States of America

United States Patent and Trademark Office

REVOLUTION WEB

Reg. No. 4,100,043

REVOLUTION FLYERS INC. (FLORIDA CORPORATION)

Registered Feb. 14, 2012

399 E. SHERIDAN ST #410
DANIA BEACH, FL 33004

Int. Cl.: 42

FOR: CREATION, DESIGN, DEVELOPMENT AND MAINTENANCE OF WEB SITES FOR OTHERS; COMPUTER SERVICES, NAMELY, SEARCH ENGINE OPTIMIZATION; GRAPHIC DESIGN, IN CLASS 42 (U.S. CLS. 100 AND 101).

SERVICE MARK

FIRST USE 11-25-2010; IN COMMERCE 11-25-2010.

PRINCIPAL REGISTER

THE MARK CONSISTS OF STANDARD CHARACTERS WITHOUT CLAIM TO ANY PARTICULAR FONT, STYLE, SIZE, OR COLOR.

NO CLAIM IS MADE TO THE EXCLUSIVE RIGHT TO USE "WEB", APART FROM THE MARK AS SHOWN.

SN 85-185,241, FILED 11-25-2010.

C. DIONNE CLYBURN, EXAMINING ATTORNEY



David J. Kyffers

Director of the United States Patent and Trademark Office

United States of America

United States Patent and Trademark Office

Glux

Reg. No. 4,100,044

Registered Feb. 14, 2012

Int. Cl.: 9

TRADEMARK

PRINCIPAL REGISTER

GLUX AC-TECH (BEIJING) CO., LTD. (CHINA LIMITED COMPANY (LTD.))
A-306, 89 XISANHUAN NORTH ROAD
HAIDIAN DISTRICT
BEIJING, 100089, CHINA

FOR: ELECTRIC LIGHT DIMMERS; ELECTRONIC INDICATOR BOARDS; ELECTRONIC NOTICE BOARDS; INDICATOR LIGHTS; LIGHTING CONTROLS; LUMINOUS POINTERS; LUMINOUS SIGNS; MECHANICAL SIGNS; NEON SIGNS; RADIO TRANSMITTERS AND RECEIVERS FOR REMOTE CONTROLS, RADIO CONTROLS, IN CLASS 9 (U.S. CLS. 21, 23, 26, 36 AND 38).

FIRST USE 11-25-2005; IN COMMERCE 4-10-2011.

THE MARK CONSISTS OF STANDARD CHARACTERS WITHOUT CLAIM TO ANY PARTICULAR FONT, STYLE, SIZE, OR COLOR.

THE WORDING "GLUX" HAS NO MEANING IN A FOREIGN LANGUAGE.

SN 85-185,371, FILED 11-26-2010.

KELLY CHOE, EXAMINING ATTORNEY



David J. Kyjars

Director of the United States Patent and Trademark Office

United States of America

United States Patent and Trademark Office

Glux

Reg. No. 4,100,045

Registered Feb. 14, 2012

Int. Cl.: 11

TRADEMARK

PRINCIPAL REGISTER

GLUX AC-TECH (BEIJING) CO., LTD. (CHINA LIMITED COMPANY (LTD.))
A-306, 89 XISANHUAN NORTH ROAD
HAIDIAN DISTRICT
BEIJING, 100089, CHINA

FOR: AIR CONDITIONING APPARATUS; BATHS, BATHTUBS, WHIRLPOOL BATHS AND BATH INSTALLATIONS; FILTERS FOR DRINKING WATER; HEATING INSTALLATIONS; HEATING UNITS FOR INDUSTRIAL PURPOSES; HOT PLATES; LAMPS; LIGHTING FIXTURES; LIGHTS FOR VEHICLES; REFRIGERATORS, IN CLASS 11 (U.S. CLS. 13, 21, 23, 31 AND 34).

FIRST USE 11-25-2005; IN COMMERCE 4-10-2011.

THE MARK CONSISTS OF STANDARD CHARACTERS WITHOUT CLAIM TO ANY PARTICULAR FONT, STYLE, SIZE, OR COLOR.

THE WORDING "GLUX" HAS NO MEANING IN A FOREIGN LANGUAGE.

SN 85-185,373, FILED 11-26-2010.

KELLY CHOE, EXAMINING ATTORNEY



David J. Kybas

Director of the United States Patent and Trademark Office

United States of America

United States Patent and Trademark Office

FROMBIES

Reg. No. 4,100,046

TRALY (U.S.A.) INC. (FLORIDA CORPORATION)
899 APPLEBY STREET
BOCA RATON, FL 33487

Registered Feb. 14, 2012

Int. Cl.: 16

FOR: ART PRINTS, PRINTED MATERIALS, NAMELY, POSTERS, COMIC BOOKS, IN CLASS 16 (U.S. CLS. 2, 5, 22, 23, 29, 37, 38 AND 50).

TRADEMARK

FIRST USE 10-14-2011; IN COMMERCE 10-14-2011.

PRINCIPAL REGISTER

THE MARK CONSISTS OF STANDARD CHARACTERS WITHOUT CLAIM TO ANY PARTICULAR FONT, STYLE, SIZE, OR COLOR.

SN 85-185,776, FILED 11-28-2010.

KRISTINA MORRIS, EXAMINING ATTORNEY



David J. Kybas

Director of the United States Patent and Trademark Office

United States of America

United States Patent and Trademark Office

Infliction of Pain

Reg. No. 4,100,047

Registered Feb. 14, 2012

Int. Cl.: 25

TRADEMARK

PRINCIPAL REGISTER

BRIAN EDWARD RUSSELL (UNITED STATES INDIVIDUAL), DBA INFLICTION OF PAIN,
7812 ROBERTA DRIVE
PLANO, TX 75025

FOR: ATHLETIC APPAREL, NAMELY, SHIRTS, PANTS, JACKETS, FOOTWEAR, HATS AND CAPS, ATHLETIC UNIFORMS; BUTTON DOWN SHIRTS; CAMOUFLAGE SHIRTS; CLOTHING FOR ATHLETIC USE, NAMELY, PADDED SHIRTS; COLLARED SHIRTS; FISHING SHIRTS; HOODED SWEAT SHIRTS; LONG-SLEEVED SHIRTS; POLO SHIRTS; SHIRTS AND SHORT-SLEEVED SHIRTS; SHIRTS FOR INFANTS, BABIES, TODDLERS AND CHILDREN; SHORT-SLEEVED SHIRTS; SPORT SHIRTS; SPORTS SHIRTS; T-SHIRTS; TEE SHIRTS; WEARABLE GARMENTS AND CLOTHING, NAMELY, SHIRTS, IN CLASS 25 (U.S. CLS. 22 AND 39).

FIRST USE 3-1-2011; IN COMMERCE 11-30-2011.

THE MARK CONSISTS OF STANDARD CHARACTERS WITHOUT CLAIM TO ANY PARTICULAR FONT, STYLE, SIZE, OR COLOR.

SN 85-185,793, FILED 11-28-2010.

KELLY BOULTON, EXAMINING ATTORNEY



David J. Kypos

Director of the United States Patent and Trademark Office

United States of America

United States Patent and Trademark Office

GREAT EAGLE RETURNS

Reg. No. 4,100,048

Registered Feb. 14, 2012

Int. Cl.: 9

TRADEMARK

PRINCIPAL REGISTER

WMS GAMING INC. (DELAWARE CORPORATION)
800 SOUTH NORTHPOINT BOULEVARD
WAUKEGAN, IL 60085

FOR: COMPONENTS FOR GAMING MACHINES THAT GENERATE OR DISPLAY WAGER OUTCOMES, NAMELY, CONTROLLERS, DISPLAYS, BUTTON PANELS, BOLSTERS, ELECTRICAL WIRING, AND COMPUTER HARDWARE AND SOFTWARE ASSOCIATED THEREWITH; GAMING MACHINES, NAMELY, DEVICES WHICH ACCEPT A WAGER; GAMING SOFTWARE THAT GENERATES OR DISPLAYS WAGER OUTCOMES OF GAMING MACHINES, IN CLASS 9 (U.S. CLS. 21, 23, 26, 36 AND 38).

FIRST USE 3-25-2011; IN COMMERCE 3-25-2011.

THE MARK CONSISTS OF STANDARD CHARACTERS WITHOUT CLAIM TO ANY PARTICULAR FONT, STYLE, SIZE, OR COLOR.

OWNER OF U.S. REG. NO. 3,270,308.

SN 85-185,894, FILED 11-29-2010.

TOBY BULLOFF, EXAMINING ATTORNEY



David J. Kyffers

Director of the United States Patent and Trademark Office

United States of America

United States Patent and Trademark Office



Reg. No. 4,100,049

Registered Feb. 14, 2012

Int. Cl.: 25

TRADEMARK

PRINCIPAL REGISTER

ANAHEIM DUCKS HOCKEY CLUB, LLC (CALIFORNIA LIMITED LIABILITY COMPANY)
2695 EAST KATELLA AVENUE
ANAHEIM, CA 92806

FOR: CLOTHING, NAMELY, BANDANAS, BEACH COVER-UPS, BELTS, BOXER SHORTS, CAPS, CLOTH BIBS, COATS, DRESSES, FOOTWEAR, EAR MUFFS, GLOVES, HATS, HEADBANDS, JACKETS, JERSEYS, MITTENS, NIGHTSHIRTS, PAJAMAS, PANTS, RAIN COATS, RAIN WEAR, ROBES, SCARVES, SHIRTS, SHORTS, SKIRTS, SOCKS, SUITS, SUN VISORS, SWEATERS, SWEAT PANTS, SWEATSHIRTS, SWIMSUITS, SWIM TRUNKS, T-SHIRTS, TIES, TOQUES, UNDERWEAR, VESTS, WARM-UP SUITS AND WRISTBANDS, IN CLASS 25 (U.S. CLS. 22 AND 39).

FIRST USE 11-23-2010; IN COMMERCE 11-23-2010.

OWNER OF U.S. REG. NOS. 1,990,290, 3,321,727, AND OTHERS.

NO CLAIM IS MADE TO THE EXCLUSIVE RIGHT TO USE "ANAHEIM" , APART FROM THE MARK AS SHOWN.

THE MARK CONSISTS OF THE WORDS "ANAHEIM DUCKS" SURROUNDING A DUCK MASK WITH CROSSED HOCKEY STICKS.

SN 85-186,306, FILED 11-29-2010.

TAMARA FRAZIER, EXAMINING ATTORNEY



David J. Kyjars

Director of the United States Patent and Trademark Office

United States of America

United States Patent and Trademark Office



Reg. No. 4,100,050

ANAHEIM DUCKS HOCKEY CLUB, LLC (CALIFORNIA LIMITED LIABILITY COMPANY)
2695 EAST KATELLA AVENUE
ANAHEIM, CA 92806

Registered Feb. 14, 2012

Int. Cl.: 41

FOR: ENTERTAINMENT SERVICES, NAMELY, ICE HOCKEY EXHIBITIONS, IN CLASS 41 (U.S. CLS. 100, 101 AND 107).

SERVICE MARK

FIRST USE 11-23-2010; IN COMMERCE 11-23-2010.

PRINCIPAL REGISTER

OWNER OF U.S. REG. NOS. 1,853,330, 3,321,728, AND OTHERS.

NO CLAIM IS MADE TO THE EXCLUSIVE RIGHT TO USE "ANAHEIM", APART FROM THE MARK AS SHOWN.

THE MARK CONSISTS OF THE WORDS "ANAHEIM DUCKS" SURROUNDING A DUCK MASK WITH CROSSED HOCKEY STICKS.

SN 85-186,318, FILED 11-29-2010.

TAMARA FRAZIER, EXAMINING ATTORNEY



David J. Kybas

Director of the United States Patent and Trademark Office

United States of America

United States Patent and Trademark Office

MONSTER BLOCKS

Reg. No. 4,100,051

J & O PLASTICS, INC. (OHIO CORPORATION)
12475 SHEETS ROAD
RITTMAN, OH 44270

Registered Feb. 14, 2012

Int. Cl.: 28

FOR: TOYS, NAMELY, CONSTRUCTION BLOCKS, IN CLASS 28 (U.S. CLS. 22, 23, 38 AND 50).

TRADEMARK

FIRST USE 6-1-2011; IN COMMERCE 6-1-2011.

PRINCIPAL REGISTER

THE MARK CONSISTS OF STANDARD CHARACTERS WITHOUT CLAIM TO ANY PARTICULAR FONT, STYLE, SIZE, OR COLOR.

NO CLAIM IS MADE TO THE EXCLUSIVE RIGHT TO USE "BLOCKS", APART FROM THE MARK AS SHOWN.

SN 85-186,928, FILED 11-30-2010.

KIMBERLY FRYE, EXAMINING ATTORNEY



David J. Kyffers

Director of the United States Patent and Trademark Office

United States of America

United States Patent and Trademark Office

STINKY FEET

Reg. No. 4,100,052

BOB'S SPACE RACERS, INC. (FLORIDA CORPORATION)
427 15TH STREET

Registered Feb. 14, 2012

DAYTONA BEACH, FL 32117

Int. Cl.: 28

FOR: ARCADE GAME MACHINES FOR TEAM PLAY; ARCADE GAMES; ARCADE-TYPE ELECTRONIC VIDEO GAMES; COIN-OPERATED AMUSEMENT MACHINES, IN CLASS 28 (U.S. CLS. 22, 23, 38 AND 50).

TRADEMARK

FIRST USE 11-16-2010; IN COMMERCE 11-16-2010.

PRINCIPAL REGISTER

THE MARK CONSISTS OF STANDARD CHARACTERS WITHOUT CLAIM TO ANY PARTICULAR FONT, STYLE, SIZE, OR COLOR.

SN 85-187,428, FILED 11-30-2010.

VERNA BETH RIRIE, EXAMINING ATTORNEY



David J. Kyros

Director of the United States Patent and Trademark Office

United States of America

United States Patent and Trademark Office

HEALARIUM

Reg. No. 4,100,053

Registered Feb. 14, 2012

Int. Cl.: 9

TRADEMARK

PRINCIPAL REGISTER

HEALARIUM INC (DELAWARE CORPORATION)
HERCULES PLAZA, SUITE 5100, 1313 MARKET
C/O PHS CORPORATE SERVICES, INC
WILMINGTON, DE 19801

FOR: COMPUTER SOFTWARE PLATFORMS FOR PERSONAL HEALTH MANAGEMENT, NAMELY, DATA INTERPRETATION, HEALTH RECOMMENDATIONS, MONITORING ADHERENCE TO HEALTH RECOMMENDATION AND TRACKING PROGRESS OF HEALTH INDICATORS, IN CLASS 9 (U.S. CLS. 21, 23, 26, 36 AND 38).

FIRST USE 1-26-2011; IN COMMERCE 1-26-2011.

THE MARK CONSISTS OF STANDARD CHARACTERS WITHOUT CLAIM TO ANY PARTICULAR FONT, STYLE, SIZE, OR COLOR.

SN 85-187,890, FILED 12-1-2010.

SHAUNIA CARLYLE, EXAMINING ATTORNEY



David J. Kyffers

Director of the United States Patent and Trademark Office

United States of America

United States Patent and Trademark Office

HEALTHIES

Reg. No. 4,100,054

Registered Feb. 14, 2012

Int. Cl.: 9

TRADEMARK

PRINCIPAL REGISTER

HEALARIUM INC (DELAWARE CORPORATION)
HERCULES PLAZA, SUITE 5100, 1313 MARKET
C/O PHS CORPORATE SERVICES, INC
WILMINGTON, DE 19801

FOR: A FEATURE OF SOFTWARE, NAMELY, COMPUTER SOFTWARE PLATFORMS FOR THE PURPOSE OF INCENTIVIZE INDIVIDUALS OR GROUPS TO RECOGNIZE EXCELLENCE AND DISTINGUISH HEALTH ACHIEVEMENT AND FOR ADHERENCE TO HEALTHY BEHAVIOR THROUGH THE ISSUANCE OF CREDITS, IN CLASS 9 (U.S. CLS. 21, 23, 26, 36 AND 38).

FIRST USE 1-26-2011; IN COMMERCE 1-26-2011.

THE MARK CONSISTS OF STANDARD CHARACTERS WITHOUT CLAIM TO ANY PARTICULAR FONT, STYLE, SIZE, OR COLOR.

SN 85-187,891, FILED 12-1-2010.

SHAUNIA CARLYLE, EXAMINING ATTORNEY



David J. Kyffers

Director of the United States Patent and Trademark Office

United States of America

United States Patent and Trademark Office

SLEEP NOW

Reg. No. 4,100,055

MILLER & STONE GROUP, INC. (CONNECTICUT CORPORATION)
16 WATERBURY RD.
PROSPECT, CT 06712

Registered Feb. 14, 2012

Int. Cl.: 5

FOR: DIETARY AND NUTRITIONAL SUPPLEMENTS, IN CLASS 5 (U.S. CLS. 6, 18, 44, 46, 51 AND 52).

TRADEMARK

FIRST USE 4-15-2011; IN COMMERCE 4-15-2011.

PRINCIPAL REGISTER

THE MARK CONSISTS OF STANDARD CHARACTERS WITHOUT CLAIM TO ANY PARTICULAR FONT, STYLE, SIZE, OR COLOR.

NO CLAIM IS MADE TO THE EXCLUSIVE RIGHT TO USE "SLEEP", APART FROM THE MARK AS SHOWN.

SN 85-188,258, FILED 12-1-2010.

CHRISTINE MARTIN, EXAMINING ATTORNEY



David J. Kybas

Director of the United States Patent and Trademark Office

United States of America

United States Patent and Trademark Office

INSTALL 360

Reg. No. 4,100,056

BUSH INDUSTRIES, INC. (DELAWARE CORPORATION)
ONE MASON DRIVE, P.O. BOX 460
JAMESTOWN, NY 147020460

Registered Feb. 14, 2012

Int. Cls.: 37 and 39

FOR: FURNITURE INSTALLATION, IN CLASS 37 (U.S. CLS. 100, 103 AND 106).

SERVICE MARK

FIRST USE 1-0-2011; IN COMMERCE 1-0-2011.

PRINCIPAL REGISTER

FOR: DELIVERY OF FURNITURE , IN CLASS 39 (U.S. CLS. 100 AND 105).

FIRST USE 1-0-2011; IN COMMERCE 1-0-2011.

THE MARK CONSISTS OF STANDARD CHARACTERS WITHOUT CLAIM TO ANY PARTICULAR FONT, STYLE, SIZE, OR COLOR.

NO CLAIM IS MADE TO THE EXCLUSIVE RIGHT TO USE "INSTALL", APART FROM THE MARK AS SHOWN.

SN 85-188,265, FILED 12-1-2010.

LINDA LAVACHE, EXAMINING ATTORNEY



David J. Kyffers

Director of the United States Patent and Trademark Office

United States of America

United States Patent and Trademark Office

SIMPLEAN

Reg. No. 4,100,057

GENERAL ELECTRIC COMPANY (NEW YORK CORPORATION)
1 RIVER ROAD

Registered Feb. 14, 2012

SCHENECTADY, NY 12345

Int. Cls.: 35 and 41

FOR: BUSINESS INFORMATION IN THE FIELD OF PROVIDING ASSISTANCE TO EMPLOYEES IN IMPROVING PROCESSES; BUSINESS SERVICES, NAMELY, FORMULATION OF BEST PRACTICES FOR IMPROVING PROCESSES, IN CLASS 35 (U.S. CLS. 100, 101 AND 102).

SERVICE MARK

PRINCIPAL REGISTER

FIRST USE 7-29-2011; IN COMMERCE 7-29-2011.

FOR: TRAINING SERVICES IN THE FIELD OF BUSINESS PROCESS IMPROVEMENT, IN CLASS 41 (U.S. CLS. 100, 101 AND 107).

FIRST USE 7-29-2011; IN COMMERCE 7-29-2011.

THE MARK CONSISTS OF STANDARD CHARACTERS WITHOUT CLAIM TO ANY PARTICULAR FONT, STYLE, SIZE, OR COLOR.

SN 85-188,466, FILED 12-1-2010.

DAVID I, EXAMINING ATTORNEY



David J. Kyfos

Director of the United States Patent and Trademark Office

United States of America

United States Patent and Trademark Office

SANDCASTLE

Reg. No. 4,100,058

Registered Feb. 14, 2012

Int. Cl.: 6

TRADEMARK

PRINCIPAL REGISTER

HALLIBURTON ENERGY SERVICES, INC. (DELAWARE CORPORATION)
1-B-121
2601 BELTLINE ROAD
CARROLLTON, TX 75006

FOR: OIL AND GAS WELL EQUIPMENT, NAMELY, A VERTICAL STORAGE SYSTEM CONSISTING PRIMARILY OF METAL STORAGE TANKS FOR STORING PROPPANT MATERIAL AND FEATURING PORTABLE STORAGE BINS AND TRAILERS, IN CLASS 6 (U.S. CLS. 2, 12, 13, 14, 23, 25 AND 50).

FIRST USE 12-7-2009; IN COMMERCE 11-29-2011.

THE MARK CONSISTS OF STANDARD CHARACTERS WITHOUT CLAIM TO ANY PARTICULAR FONT, STYLE, SIZE, OR COLOR.

OWNER OF U.S. REG. NOS. 2,612,682, 2,974,259, AND 3,158,069.

SN 85-188,522, FILED 12-1-2010.

DAVID TOOLEY, EXAMINING ATTORNEY



David J. Kypos

Director of the United States Patent and Trademark Office

United States of America

United States Patent and Trademark Office



Reg. No. 4,100,059

T & C FOOTWEAR CORP. (CALIFORNIA CORPORATION)
21858 GARCIA LANE,
CITY OF INDUSTRY, CA 91787

Registered Feb. 14, 2012

Int. Cl.: 25

FOR: FOOTWEAR, WOMEN'S FOOTWEAR, MEN'S FOOTWEAR, CHILDREN'S FOOTWEAR,
TODDLER'S FOOTWEAR, BABIES FOOTWEAR, IN CLASS 25 (U.S. CLS. 22 AND 39).

TRADEMARK

FIRST USE 11-18-2011; IN COMMERCE 11-18-2011.

PRINCIPAL REGISTER

THE MARK CONSISTS OF STYLIZED WORD "NVY" WITH CURVED LINE AROUND IT.

SN 85-188,802, FILED 12-1-2010.

JAY FLOWERS, EXAMINING ATTORNEY



David J. Kyffers

Director of the United States Patent and Trademark Office

United States of America

United States Patent and Trademark Office

THE HEARTS AND MINDS OF RETIREMENT CONSUMERS

Reg. No. 4,100,060

ING NORTH AMERICA INSURANCE CORPORATION (DELAWARE CORPORATION)
5780 POWERS FERRY ROAD
ATLANTA, GA 30327

Registered Feb. 14, 2012

Int. Cl.: 36

FOR: FINANCIAL SERVICES, NAMELY, RETIREMENT PLANNING SERVICES; FINANCIAL PLANNING; FINANCIAL INVESTMENTS; RESEARCH RELATED TO FINANCE, RETIREMENT, SAVINGS ATTITUDES, RETIREMENT SAVINGS BEHAVIORS AND INVESTMENT BEHAVIORS, IN CLASS 36 (U.S. CLS. 100, 101 AND 102).

SERVICE MARK

PRINCIPAL REGISTER

FIRST USE 4-4-2011; IN COMMERCE 4-4-2011.

THE MARK CONSISTS OF STANDARD CHARACTERS WITHOUT CLAIM TO ANY PARTICULAR FONT, STYLE, SIZE, OR COLOR.

SN 85-188,903, FILED 12-2-2010.

ELLEN PERKINS, EXAMINING ATTORNEY



David J. Kyffers

Director of the United States Patent and Trademark Office

United States of America

United States Patent and Trademark Office

LIFE EQUALS

Reg. No. 4,100,061

URBANUS VICTUS, L.L.C. (MISSOURI LIMITED LIABILITY COMPANY)
3300 CHARLOTTE

Registered Feb. 14, 2012

KANSAS CITY, MO 64109

Int. Cl.: 5

FOR: DIETARY AND NUTRITIONAL SUPPLEMENTS; DIETARY AND NUTRITIONAL SUPPLEMENTS CONTAINING, NAMELY, SODIUM ASCORBATE, CALCIUM ASCORBATE, FISH OIL, HERBS, MEDICINAL ROOTS, AND BERRIES; DIETARY AND NUTRITIONAL SUPPLEMENTS FOR ENDURANCE SPORTS; DIETARY SUPPLEMENTS; DIETARY SUPPLEMENTS FOR HUMAN CONSUMPTION; DIETARY SUPPLEMENTS ALSO CONTAINING ELDERBERRY, MAGNESIUM STEARATE, ACAI BERRY, GUARANA, FISH OIL; DIETARY SUPPLEMENTS FOR HUMANS, CHILDREN, TEENAGERS, ADULTS, PREGNANT WOMEN, TREATING NAUSEA, TREATING FATIGUE, TREATING COLD SYMPTOMS, TREATING LACK OF FOCUS, TREATING UNDERNUTRITION; HERBAL SUPPLEMENTS; MINERAL NUTRITIONAL SUPPLEMENTS; MINERAL SUPPLEMENTS; NATURAL HERBAL SUPPLEMENTS; NUTRITIONAL SUPPLEMENTS; NUTRITIONAL SUPPLEMENTS FOR BOOSTING ENERGY, INCREASING FOCUS, SLEEPING AID, IMMUNE SYSTEM HEALTH, LONGEVITY, HERBAL BLEND, DAILY MULTIVITAMIN REQUIREMENTS, RECOVERY, PRE-WORKOUT, ENDURANCE TRAINING, STRENGTH TRAINING, REPLENISHMENT, DETOXIFICATION; VITAMIN AND MINERAL SUPPLEMENTS; VITAMIN SUPPLEMENTS, IN CLASS 5 (U.S. CLS. 6, 18, 44, 46, 51 AND 52).

TRADEMARK

PRINCIPAL REGISTER

FIRST USE 1-27-2011; IN COMMERCE 1-27-2011.

THE MARK CONSISTS OF STANDARD CHARACTERS WITHOUT CLAIM TO ANY PARTICULAR FONT, STYLE, SIZE, OR COLOR.

SN 85-188,954, FILED 12-2-2010.

MICHAEL KEATING, EXAMINING ATTORNEY



David J. Kyros

Director of the United States Patent and Trademark Office

United States of America

United States Patent and Trademark Office

HEALTH CORNER

Reg. No. 4,100,062

WALGREEN CO. (ILLINOIS CORPORATION)
200 WILMOT ROAD
DEERFIELD, IL 60015

Registered Feb. 14, 2012

Int. Cl.: 41

FOR: PROVIDING COMMUNITY OUTREACH EDUCATIONAL SERVICES, NAMELY, PRESENTATIONS IN THE FIELD OF HEALTH CARE, IN CLASS 41 (U.S. CLS. 100, 101 AND 107).

SERVICE MARK

FIRST USE 4-7-2011; IN COMMERCE 4-7-2011.

PRINCIPAL REGISTER

THE MARK CONSISTS OF STANDARD CHARACTERS WITHOUT CLAIM TO ANY PARTICULAR FONT, STYLE, SIZE, OR COLOR.

OWNER OF U.S. REG. NOS. 2,944,628 AND 3,349,078.

NO CLAIM IS MADE TO THE EXCLUSIVE RIGHT TO USE "HEALTH", APART FROM THE MARK AS SHOWN.

SN 85-189,164, FILED 12-2-2010.

ALICE BENMAMAN, EXAMINING ATTORNEY



David J. Kyffers

Director of the United States Patent and Trademark Office

United States of America

United States Patent and Trademark Office

DOLLARMANIA

Reg. No. 4,100,063

Registered Feb. 14, 2012

Int. Cl.: 43

SERVICE MARK

PRINCIPAL REGISTER

MARK LICENCY INTERNACIONAL S.L. (SPAIN LIMITED LIABILITY COMPANY)
AVDA. DE EUROPA, 19 - EDIFICIO 2
PLANTA 3, OFICINA AB, POZUELO DE ALARCÓN
MADRID, SPAIN 28224

FOR: RESTAURANT SERVICES, IN CLASS 43 (U.S. CLS. 100 AND 101).

FIRST USE 2-2-2011; IN COMMERCE 2-2-2011.

THE MARK CONSISTS OF STANDARD CHARACTERS WITHOUT CLAIM TO ANY PARTICULAR FONT, STYLE, SIZE, OR COLOR.

SN 85-189,313, FILED 12-2-2010.

DAWN HAN, EXAMINING ATTORNEY



David J. Kyffers

Director of the United States Patent and Trademark Office

United States of America

United States Patent and Trademark Office

OURBIZPOST

Reg. No. 4,100,064

Registered Feb. 14, 2012

Int. Cl.: 35

SERVICE MARK

PRINCIPAL REGISTER

OURBIZPOST LTD. (CANADA CORPORATION)
2 BLOOR STREET EAST
SUITE 3500
TORONTO, CANADA M4W1A8

FOR: CLASSIFIED ADVERTISING SERVICES; PROVIDING AN INTERNET WEB SITE FOR CLASSIFIED ADVERTISING RELEVANT TO BUSINESS AND INDUSTRY; PROVIDING AN ON-LINE SEARCHABLE DATABASE FEATURING CLASSIFIED AD LISTINGS AND EMPLOYMENT OPPORTUNITIES; PROVIDING A WEB SITE WHERE USERS CAN POST ITEMS AND SERVICES FOR SALE THROUGH ON-LINE CLASSIFIED ADVERTISEMENTS; PROVIDING AN INTERNET WEB SITE FOR CLASSIFIED ADVERTISING FOR OTHERS TO BUY, LEASE AND SELL GOODS, BUY AND SELL BUSINESSES, LEASE AND OFFER REAL ESTATE AND OFFICE SPACE, AND OFFER AND OBTAIN SERVICES AND EMPLOYMENT; ADVERTISING AND DIRECTORY SERVICES, NAMELY, PROMOTING THE SERVICES OF OTHERS BY PROVIDING A WEB PAGE FEATURING LINKS TO THE WEBSITES OF OTHERS; DISSEMINATION OF ADVERTISING FOR OTHERS VIA AN INTERNET WEB SITE; ON-LINE BUSINESS NETWORKING SERVICES, IN CLASS 35 (U.S. CLS. 100, 101 AND 102).

FIRST USE 10-1-2010; IN COMMERCE 10-1-2010.

THE MARK CONSISTS OF STANDARD CHARACTERS WITHOUT CLAIM TO ANY PARTICULAR FONT, STYLE, SIZE, OR COLOR.

PRIORITY CLAIMED UNDER SEC. 44(D) ON CANADA APPLICATION NO. 1505460, FILED 11-25-2010.

SN 85-191,350, FILED 12-6-2010.

GINA FINK, EXAMINING ATTORNEY



David J. Kyjars

Director of the United States Patent and Trademark Office

United States of America

United States Patent and Trademark Office

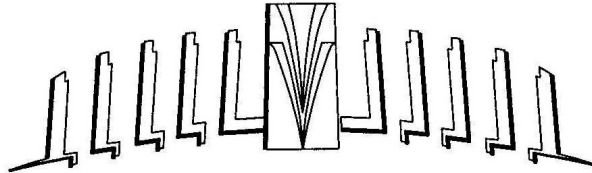

Center

Reg. No. 4,100,065

SAN PASQUAL CASINO DEVELOPMENT GROUP INC. (CALIFORNIA CORPORATION)
16300 NYEMII PASS ROAD
VALLEY CENTER, CA 92082

Registered Feb. 14, 2012

Int. Cl.: 35

FOR: CONCESSION STANDS FEATURING FOOD, SOUVENIRS AND GENERAL CONSUMER GOODS, IN CLASS 35 (U.S. CLS. 100, 101 AND 102).

SERVICE MARK

FIRST USE 12-0-2010; IN COMMERCE 12-0-2010.

PRINCIPAL REGISTER

NO CLAIM IS MADE TO THE EXCLUSIVE RIGHT TO USE "CENTER", APART FROM THE MARK AS SHOWN.

THE MARK CONSISTS OF THE STYLIZED DESIGN OF A SERIES OF 5 RECTANGLES, A CENTER RECTANGLE WITH A STYLIZED FOUNTAIN, AND 5 ADDITIONAL STYLIZED RECTANGLES WITH THE STYLIZED WORDING "CENTER" APPEARING DIRECTLY UNDERNEATH.

SN 85-192,517, FILED 12-7-2010.

JACLYN KIDWELL WALKER, EXAMINING ATTORNEY



David J. Kybas

Director of the United States Patent and Trademark Office

United States of America

United States Patent and Trademark Office

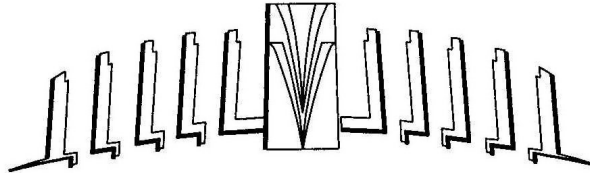

Center

Reg. No. 4,100,066

Registered Feb. 14, 2012

Int. Cl.: 43

SERVICE MARK

PRINCIPAL REGISTER

SAN PASQUAL CASINO DEVELOPMENT GROUP INC. (CALIFORNIA CORPORATION)
16300 NYEMII PASS ROAD
VALLEY CENTER, CA 92082

FOR: ARENA SERVICES, NAMELY, PROVIDING FACILITIES FOR SPORTS, CONCERTS, CONVENTIONS, EXHIBITIONS, SPORTING EVENTS, POLITICAL AND RELIGIOUS RALLIES, SOCIAL FUNCTIONS, AND RECREATIONAL ACTIVITIES, IN CLASS 43 (U.S. CLS. 100 AND 101).

FIRST USE 12-0-2010; IN COMMERCE 12-0-2010.

NO CLAIM IS MADE TO THE EXCLUSIVE RIGHT TO USE "CENTER", APART FROM THE MARK AS SHOWN.

THE MARK CONSISTS OF A STYLIZED SERIES OF 5 RECTANGLES, A CENTER RECTANGLE WITH A STYLIZED FOUNTAIN, AND 5 ADDITIONAL STYLIZED RECTANGLES WITH THE STYLIZED WORDING "CENTER" APPEARING DIRECTLY UNDERNEATH.

SN 85-192,542, FILED 12-7-2010.

JACLYN KIDWELL WALKER, EXAMINING ATTORNEY



David J. Kybas

Director of the United States Patent and Trademark Office

United States of America

United States Patent and Trademark Office

StriVectin-TL

Reg. No. 4,100,067

Registered Feb. 14, 2012

Int. Cl.: 3

TRADEMARK

PRINCIPAL REGISTER

STRIVECTIN OPERATING COMPANY, INC. (DELAWARE CORPORATION)
599 WEST PUTNAM AVE
GREENWICH, CT 06830

FOR: COSMETICS, IN CLASS 3 (U.S. CLS. 1, 4, 6, 50, 51 AND 52).

FIRST USE 8-1-2011; IN COMMERCE 8-1-2011.

THE MARK CONSISTS OF STANDARD CHARACTERS WITHOUT CLAIM TO ANY PARTICULAR FONT, STYLE, SIZE, OR COLOR.

OWNER OF U.S. REG. NOS. 3,175,013, 3,292,055, AND 3,292,056.

SN 85-192,848, FILED 12-8-2010.

AMY KERTGATE, EXAMINING ATTORNEY



David J. Kyffers

Director of the United States Patent and Trademark Office

United States of America

United States Patent and Trademark Office

NTSF: SD: SUV::

Reg. No. 4,100,068

THE CARTOON NETWORK, INC. (DELAWARE CORPORATION)
1050 TECHWOOD DRIVE, NW
ATLANTA, GA 30318

Registered Feb. 14, 2012

Int. Cl.: 41

FOR: ENTERTAINMENT SERVICES, NAMELY, PROVISION OF ONGOING MULTIMEDIA PROGRAMS IN THE FIELD OF COMEDY, ACTION AND ADVENTURE DISTRIBUTED VIA VARIOUS PLATFORMS ACROSS MULTIPLE FORMS OF TRANSMISSION MEDIA, IN CLASS 41 (U.S. CLS. 100, 101 AND 107).

SERVICE MARK

PRINCIPAL REGISTER

FIRST USE 7-22-2011; IN COMMERCE 7-22-2011.

THE MARK CONSISTS OF STANDARD CHARACTERS WITHOUT CLAIM TO ANY PARTICULAR FONT, STYLE, SIZE, OR COLOR.

SN 85-193,182, FILED 12-8-2010.

FRED CARL, EXAMINING ATTORNEY



David J. Kyffers

Director of the United States Patent and Trademark Office

United States of America

United States Patent and Trademark Office

THE MAGIC TAP

Reg. No. 4,100,069

Registered Feb. 14, 2012

Int. Cl.: 21

IDEASTREAM CONSUMER PRODUCTS, LLC (DELAWARE LIMITED LIABILITY COMPANY)
812 HURON ROAD
SUITE 390
CLEVELAND, OH 44115

TRADEMARK

PRINCIPAL REGISTER

FOR: MANUALLY ACTUATED PUMP DISPENSERS FOR ATTACHMENT TO CONTAINERS FOR USE IN DISPENSING LIQUIDS, IN CLASS 21 (U.S. CLS. 2, 13, 23, 29, 30, 33, 40 AND 50).

FIRST USE 11-11-2011; IN COMMERCE 11-11-2011.

THE MARK CONSISTS OF STANDARD CHARACTERS WITHOUT CLAIM TO ANY PARTICULAR FONT, STYLE, SIZE, OR COLOR.

NO CLAIM IS MADE TO THE EXCLUSIVE RIGHT TO USE "TAP", APART FROM THE MARK AS SHOWN.

SN 85-193,336, FILED 12-8-2010.

JULIE GUTTADAURO, EXAMINING ATTORNEY



David J. Kyffers

Director of the United States Patent and Trademark Office

United States of America

United States Patent and Trademark Office

FORWARD CARE

Reg. No. 4,100,070

Registered Feb. 14, 2012

Int. Cl.: 36

SERVICE MARK

PRINCIPAL REGISTER

CHRYSLER GROUP LLC (DELAWARE LIMITED LIABILITY COMPANY)
CIMS 485-13-32
1000 CHRYSLER DRIVE
AUBURN HILLS, MI 48326

FOR: PROVIDING EXTENDED WARRANTIES ON MOTOR VEHICLES; EXTENDED WARRANTY SERVICES, NAMELY, MOTOR VEHICLE MAINTENANCE SERVICE CONTRACTS, IN CLASS 36 (U.S. CLS. 100, 101 AND 102).

FIRST USE 3-0-2011; IN COMMERCE 3-0-2011.

THE MARK CONSISTS OF STANDARD CHARACTERS WITHOUT CLAIM TO ANY PARTICULAR FONT, STYLE, SIZE, OR COLOR.

NO CLAIM IS MADE TO THE EXCLUSIVE RIGHT TO USE "CARE", APART FROM THE MARK AS SHOWN.

SN 85-193,352, FILED 12-8-2010.

KIM MONINGHOFF, EXAMINING ATTORNEY



David J. Kyffers

Director of the United States Patent and Trademark Office

United States of America

United States Patent and Trademark Office

M.O. Kingz Ent.

Reg. No. 4,100,071

GIVANS, JEREMY TIBERIAS (UNITED STATES INDIVIDUAL)
12000 FLEMING APT. 106
HOUSTON, TX 77013

Registered Feb. 14, 2012

Int. Cl.: 41

FOR: ENTERTAINMENT SERVICES IN THE NATURE OF RECORDING, PRODUCTION AND POST-PRODUCTION SERVICES IN THE FIELD OF MUSIC, IN CLASS 41 (U.S. CLS. 100, 101 AND 107).

SERVICE MARK

FIRST USE 8-1-2011; IN COMMERCE 8-1-2011.

PRINCIPAL REGISTER

THE MARK CONSISTS OF STANDARD CHARACTERS WITHOUT CLAIM TO ANY PARTICULAR FONT, STYLE, SIZE, OR COLOR.

NO CLAIM IS MADE TO THE EXCLUSIVE RIGHT TO USE "ENT.", APART FROM THE MARK AS SHOWN.

SN 85-193,749, FILED 12-8-2010.

PAUL E. FAHRENKOPF, EXAMINING ATTORNEY



David J. Kyffers

Director of the United States Patent and Trademark Office

United States of America

United States Patent and Trademark Office

Movement Of Kingz Entertainment

Reg. No. 4,100,072

GIVANS, JEREMY TIBERIAS (UNITED STATES INDIVIDUAL)
12000 FLEMING APT. 106
HOUSTON, TX 77013

Registered Feb. 14, 2012

Int. Cl.: 41

FOR: ENTERTAINMENT SERVICES IN THE NATURE OF RECORDING, PRODUCTION AND POST-PRODUCTION SERVICES IN THE FIELD OF MUSIC, IN CLASS 41 (U.S. CLS. 100, 101 AND 107).

SERVICE MARK

FIRST USE 8-1-2011; IN COMMERCE 8-1-2011.

PRINCIPAL REGISTER

THE MARK CONSISTS OF STANDARD CHARACTERS WITHOUT CLAIM TO ANY PARTICULAR FONT, STYLE, SIZE, OR COLOR.

NO CLAIM IS MADE TO THE EXCLUSIVE RIGHT TO USE "ENTERTAINMENT", APART FROM THE MARK AS SHOWN.

SN 85-193,751, FILED 12-8-2010.

PAUL E. FAHRENKOPF, EXAMINING ATTORNEY



David J. Kyfos

Director of the United States Patent and Trademark Office

United States of America
United States Patent and Trademark Office

LACTO

Reg. No. 4,100,073

BOHAGER HOLDINGS, LLC (FLORIDA LIMITED LIABILITY COMPANY)
1341 RAZORBILL LANE
PUNTA GORDA, FL 33983

Registered Feb. 14, 2012

Int. Cl.: 5

FOR: ENZYME FOOD SUPPLEMENTS; ENZYMES FOR MEDICAL PURPOSES; NUTRITIONAL SUPPLEMENTS, IN CLASS 5 (U.S. CLS. 6, 18, 44, 46, 51 AND 52).

TRADEMARK

FIRST USE 2-12-2004; IN COMMERCE 2-12-2004.

PRINCIPAL REGISTER

THE MARK CONSISTS OF STANDARD CHARACTERS WITHOUT CLAIM TO ANY PARTICULAR FONT, STYLE, SIZE, OR COLOR.

SN 85-194,038, FILED 12-9-2010.

JAMES GRIFFIN, EXAMINING ATTORNEY



David J. Kyffers

Director of the United States Patent and Trademark Office

United States of America

United States Patent and Trademark Office

The Stress Code

Reg. No. 4,100,074

HURWITZ, WENDY (UNITED STATES INDIVIDUAL)
PO BOX 440 ANSONIA STATION
NEW YORK, NY 10023

Registered Feb. 14, 2012

Int. Cl.: 41

FOR: CONDUCTING WORKSHOPS AND SEMINARS IN PERSONAL AWARENESS, IN CLASS 41 (U.S. CLS. 100, 101 AND 107).

SERVICE MARK

FIRST USE 12-1-2011; IN COMMERCE 12-1-2011.

PRINCIPAL REGISTER

THE MARK CONSISTS OF STANDARD CHARACTERS WITHOUT CLAIM TO ANY PARTICULAR FONT, STYLE, SIZE, OR COLOR.

NO CLAIM IS MADE TO THE EXCLUSIVE RIGHT TO USE "STRESS", APART FROM THE MARK AS SHOWN.

SN 85-194,190, FILED 12-9-2010.

KATHRYN COWARD, EXAMINING ATTORNEY



David J. Kybas

Director of the United States Patent and Trademark Office

United States of America

United States Patent and Trademark Office

M2Z

Reg. No. 4,100,075

WASTE MANAGEMENT, INC. (DELAWARE CORPORATION)
1001 FANNIN STREET - SUITE 4000
HOUSTON, TX 77002

Registered Feb. 14, 2012

**Int. Cls.: 9, 11, 14, 16, 18,
20, 21, and 24**

FOR: TIRE GAUGES, NAMELY, TIRE PRESSURE GAUGES , IN CLASS 9 (U.S. CLS. 21, 23, 26, 36 AND 38).

FIRST USE 7-16-2002; IN COMMERCE 7-16-2002.

TRADEMARK

FOR: FLASHLIGHTS; POCKET LIGHTS, NAMELY, POCKET SEARCH LIGHTS, IN CLASS 11 (U.S. CLS. 13, 21, 23, 31 AND 34).

PRINCIPAL REGISTER

FIRST USE 7-16-2002; IN COMMERCE 7-16-2002.

FOR: JEWELRY; WATCHES; TIE TACS; PENDANTS; KEY CHAINS OF PRECIOUS METAL; TROPHIES OF PRECIOUS METAL; MEDALS FOR USE AS AWARDS, IN CLASS 14 (U.S. CLS. 2, 27, 28 AND 50).

FIRST USE 11-30-2001; IN COMMERCE 11-30-2001.

FOR: BLANK JOURNALS; DOCUMENT PORTFOLIOS; NOTE PADS; PAPER FLAGS AND BANNERS; PRINTED AWARDS; WRITING PENS; PENCILS; STICKERS; COASTERS MADE OF PAPER, IN CLASS 16 (U.S. CLS. 2, 5, 22, 23, 29, 37, 38 AND 50).

FIRST USE 3-4-2004; IN COMMERCE 3-4-2004.

FOR: LEATHER KEY CHAINS; BRIEFCASE TYPE PORTFOLIOS; TOTE AND SPORT BAGS, IN CLASS 18 (U.S. CLS. 1, 2, 3, 22 AND 41).

FIRST USE 2-22-2005; IN COMMERCE 2-22-2005.

FOR: PICTURE FRAMES; PLASTIC FLAGS AND BANNERS; NON-METAL TROPHIES; PLASTIC KEY CHAINS , IN CLASS 20 (U.S. CLS. 2, 13, 22, 25, 32 AND 50).

FIRST USE 10-24-2003; IN COMMERCE 10-24-2003.



David J. Kybas

Director of the United States Patent and Trademark Office

Reg. No. 4,100,075 FOR: DRINKWEAR, NAMELY, CUPS, TRAVEL MUGS, PLASTIC AND ALUMINUM WATER BOTTLES SOLD EMPTY, AND COFFEE MUGS; INSULATED SLEEVE HOLDERS FOR BEVERAGE CANS; COASTERS NOT OF PAPER AND NOT BEING TABLE LINEN, IN CLASS 21 (U.S. CLS. 2, 13, 23, 29, 30, 33, 40 AND 50).

FIRST USE 11-29-2001; IN COMMERCE 11-29-2001.

FOR: FLAGS AND BANNERS OF TEXTILE; CLOTH COASTERS , IN CLASS 24 (U.S. CLS. 42 AND 50).

FIRST USE 2-3-2005; IN COMMERCE 2-3-2005.

THE MARK CONSISTS OF STANDARD CHARACTERS WITHOUT CLAIM TO ANY PARTICULAR FONT, STYLE, SIZE, OR COLOR.

OWNER OF U.S. REG. NOS. 3,583,670, 3,779,499, AND 3,908,303.

SN 85-194,215, FILED 12-9-2010.

MATTHEW EINSTEIN, EXAMINING ATTORNEY

United States of America

United States Patent and Trademark Office

MAXBALANCED

Reg. No. 4,100,076

CAPSTONE INVESTMENT FINANCIAL GROUP, INC. (COLORADO CORPORATION)
615 N. NEVADA AVE
COLORADO SPRINGS, CO 80903

Registered Feb. 14, 2012

Int. Cl.: 36

FOR: INVESTMENT ADVISORY SERVICES; FUND INVESTMENT CONSULTATION; INVESTMENT OF FUNDS FOR OTHERS; MUTUAL FUND DISTRIBUTION; MUTUAL FUND INVESTMENT; MUTUAL FUNDS AND CAPITAL INVESTMENT; FINANCIAL SERVICES, NAMELY, INVESTMENT ADVICE, INVESTMENT MANAGEMENT, INVESTMENT CONSULTATION AND INVESTMENT OF FUNDS FOR OTHERS, INCLUDING PRIVATE AND PUBLIC EQUITY AND DEBT INVESTMENT SERVICES; AND PROVIDING INFORMATION AND ADVICE IN THE FIELD OF FINANCE, FINANCIAL INVESTMENTS, FINANCIAL VALUATIONS, AND THE FINANCIAL ASPECTS OF RETIREMENT, IN CLASS 36 (U.S. CLS. 100, 101 AND 102).

SERVICE MARK

PRINCIPAL REGISTER

FIRST USE 1-16-2011; IN COMMERCE 1-16-2011.

THE MARK CONSISTS OF STANDARD CHARACTERS WITHOUT CLAIM TO ANY PARTICULAR FONT, STYLE, SIZE, OR COLOR.

SN 85-194,804, FILED 12-10-2010.

LIEF MARTIN, EXAMINING ATTORNEY



David J. Kyfos

Director of the United States Patent and Trademark Office

United States of America

United States Patent and Trademark Office

AFFINITY BUSINESS FIRST

Reg. No. 4,100,077

Registered Feb. 14, 2012

Int. Cl.: 36

SERVICE MARK

PRINCIPAL REGISTER

AFFINITY FEDERAL CREDIT UNION (UNITED STATES FEDERALLY CHARTERED CREDIT UNION)
73 MOUNTAIN VIEW BOULEVARD
BASKING RIDGE, NJ 07920

FOR: CREDIT CARD SERVICES, IN CLASS 36 (U.S. CLS. 100, 101 AND 102).

FIRST USE 11-12-2010; IN COMMERCE 11-12-2010.

THE MARK CONSISTS OF STANDARD CHARACTERS WITHOUT CLAIM TO ANY PARTICULAR FONT, STYLE, SIZE, OR COLOR.

NO CLAIM IS MADE TO THE EXCLUSIVE RIGHT TO USE "BUSINESS", APART FROM THE MARK AS SHOWN.

SN 85-195,430, FILED 12-10-2010.

ROBIN MITTLER, EXAMINING ATTORNEY



David J. Kybas

Director of the United States Patent and Trademark Office

United States of America

United States Patent and Trademark Office

TORRENT

Reg. No. 4,100,078

SAGE MANUFACTURING CORPORATION (WASHINGTON CORPORATION)
8500 NORTHEAST DAY ROAD
BAINBRIDGE ISLAND, WA 98110

Registered Feb. 14, 2012

Int. Cl.: 28

FOR: FISHING RODS, IN CLASS 28 (U.S. CLS. 22, 23, 38 AND 50).

TRADEMARK

FIRST USE 6-1-2011; IN COMMERCE 6-1-2011.

PRINCIPAL REGISTER

THE MARK CONSISTS OF STANDARD CHARACTERS WITHOUT CLAIM TO ANY PARTICULAR FONT, STYLE, SIZE, OR COLOR.

SN 85-195,670, FILED 12-10-2010.

DEIRDRE ROBERTSON, EXAMINING ATTORNEY



David J. Kybas

Director of the United States Patent and Trademark Office

United States of America

United States Patent and Trademark Office

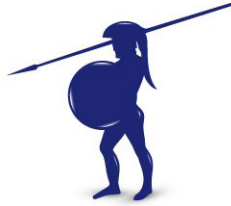

MACICA

Reg. No. 4,100,079

Registered Feb. 14, 2012

Int. Cl.: 36

SERVICE MARK

PRINCIPAL REGISTER

MACICA, LLC. (TEXAS LIMITED LIABILITY COMPANY)
PO BOX 242456
LITTLE ROCK, AR 72223

FOR: ARRANGING OF LEASES AND RENTAL AGREEMENTS FOR REAL ESTATE; ASSESSMENT AND MANAGEMENT OF REAL ESTATE; LEASE OF REAL ESTATE; LEASING OF REAL ESTATE; REAL ESTATE ACQUISITION SERVICES; REAL ESTATE EQUITY SHARING, NAMELY, MANAGING AND ARRANGING FOR CO-OWNERSHIP OF REAL ESTATE; REAL ESTATE MANAGEMENT SERVICES; REAL ESTATE RENTAL SERVICES, NAMELY, RENTAL OF RESIDENTIAL HOUSING; REAL ESTATE SERVICE, NAMELY, RENTAL PROPERTY MANAGEMENT; REAL ESTATE SERVICES, NAMELY, PROPERTY MANAGEMENT SERVICES FOR CONDOMINIUM ASSOCIATIONS, HOMEOWNER ASSOCIATIONS AND APARTMENT BUILDINGS, IN CLASS 36 (U.S. CLS. 100, 101 AND 102).

FIRST USE 1-1-2011; IN COMMERCE 11-9-2011.

THE MARK CONSISTS OF A SPARTAN HOPLITE SOLDIER WITH SPEAR AND SHIELD AND THE WORD "MACICA" UNDERNEATH WRITTEN IN A GREEK STYLE FONT, ALL IN BLUE WITH WHITE DETAILING.

THE COLOR(S) BLUE AND WHITE IS/ARE CLAIMED AS A FEATURE OF THE MARK.

THE ENGLISH TRANSLATION OF THE WORD "MACICA" IN THE MARK IS "CATKIN".

SN 85-196,032, FILED 12-12-2010.

CYNTHIA TRIPI, EXAMINING ATTORNEY



David J. Kybas

Director of the United States Patent and Trademark Office

United States of America
United States Patent and Trademark Office

TINYPASS

Reg. No. 4,100,080

Registered Feb. 14, 2012

Int. Cls.: 36 and 42

SERVICE MARK

PRINCIPAL REGISTER

TINYPASS LLC (DELAWARE LIMITED LIABILITY COMPANY)
105 HUDSON STREET
SUITE 401
NEW YORK, NY 10013

FOR: PROVIDING ELECTRONIC PROCESSING OF ELECTRONIC PAYMENTS AND CREDIT CARD TRANSACTIONS VIA A GLOBAL COMPUTER NETWORK, IN CLASS 36 (U.S. CLS. 100, 101 AND 102).

FIRST USE 1-6-2011; IN COMMERCE 1-6-2011.

FOR: SOFTWARE AS A SERVICE (SAAS) SERVICES FEATURING SOFTWARE FOR USE IN PROCESSING AND FACILITATING ELECTRONIC PAYMENTS AND CREDIT CARD TRANSACTIONS VIA A GLOBAL COMPUTER NETWORK; APPLICATION SERVICE PROVIDER (ASP) FEATURING SOFTWARE AND APPLICATION PROGRAMMING INTERFACE SOFTWARE (API) FOR USE IN PROCESSING AND FACILITATING ELECTRONIC PAYMENTS AND CREDIT CARD TRANSACTIONS VIA A GLOBAL COMPUTER NETWORK; SOFTWARE AS A SERVICE (SAAS) SERVICES FEATURING SOFTWARE FOR USE IN MANAGING ACCESS TO DIGITAL MEDIA CONTENT; APPLICATION SERVICE PROVIDER (ASP) FEATURING SOFTWARE FOR USE IN MANAGING ACCESS TO DIGITAL MEDIA CONTENT, IN CLASS 42 (U.S. CLS. 100 AND 101).

FIRST USE 1-6-2011; IN COMMERCE 1-6-2011.

THE MARK CONSISTS OF STANDARD CHARACTERS WITHOUT CLAIM TO ANY PARTICULAR FONT, STYLE, SIZE, OR COLOR.

SN 85-196,288, FILED 12-13-2010.

MICHAEL TANNER, EXAMINING ATTORNEY



David J. Kybas

Director of the United States Patent and Trademark Office

United States of America

United States Patent and Trademark Office

FlexD

Reg. No. 4,100,081

STERIS CORPORATION (OHIO CORPORATION)
5960 HEISLEY ROAD
MENTOR, OH 44060

Registered Feb. 14, 2012

Int. Cl.: 1

FOR: CHEMICALS FOR USE IN THE DECONTAMINATION OF POLLUTED SITES, IN CLASS 1 (U.S. CLS. 1, 5, 6, 10, 26 AND 46).

TRADEMARK

FIRST USE 9-2-2010; IN COMMERCE 9-2-2010.

PRINCIPAL REGISTER

THE MARK CONSISTS OF STANDARD CHARACTERS WITHOUT CLAIM TO ANY PARTICULAR FONT, STYLE, SIZE, OR COLOR.

SN 85-196,508, FILED 12-13-2010.

ALICE BENMAMAN, EXAMINING ATTORNEY



David J. Kybas

Director of the United States Patent and Trademark Office

United States of America

United States Patent and Trademark Office

Huge Clouds, Amazing Taste!

Reg. No. 4,100,082

DISCOUNT TOBACCO PRODUCTS, INC. (MICHIGAN CORPORATION)
30313 KINGSWAY DRIVE
FARMINGTON HILLS, MI 48331

Registered Feb. 14, 2012

Int. Cl.: 34

FOR: TOBACCO SUBSTITUTES, NAMELY, HERBAL MOLASSES, IN CLASS 34 (U.S. CLS. 2, 8, 9 AND 17).

TRADEMARK

FIRST USE 1-8-2011; IN COMMERCE 1-20-2011.

PRINCIPAL REGISTER

THE MARK CONSISTS OF STANDARD CHARACTERS WITHOUT CLAIM TO ANY PARTICULAR FONT, STYLE, SIZE, OR COLOR.

SN 85-198,325, FILED 12-15-2010.

JOHN WILKE, EXAMINING ATTORNEY



David J. Kyffers

Director of the United States Patent and Trademark Office

United States of America

United States Patent and Trademark Office



Reg. No. 4,100,083

Registered Feb. 14, 2012

Int. Cl.: 32

TRADEMARK

PRINCIPAL REGISTER

J. ANDRES ZAPATA (UNITED STATES INDIVIDUAL)
649 E. NAPLES ST.
CHULA VISTA, CA 91911

FOR: NON-ALCOHOLIC COCKTAIL MIXES; NON-ALCOHOLIC FRUIT EXTRACTS USED IN THE PREPARATION OF BEVERAGES; PREPARED ENTREES CONSISTING OF FRUIT DRINKS AND FRUIT JUICES, FRUIT-BASED BEVERAGES, NON-ALCOHOLIC BEVERAGES CONTAINING FRUIT JUICES, NON-ALCOHOLIC FRUIT EXTRACTS USED IN THE PREPARATION OF BEVERAGES, NON-ALCOHOLIC FRUIT JUICE BEVERAGES, VEGETABLE JUICES, VEGETABLE-FRUIT JUICES AND SMOOTHIES, IN CLASS 32 (U.S. CLS. 45, 46 AND 48).

FIRST USE 3-8-2011; IN COMMERCE 3-21-2011.

NO CLAIM IS MADE TO THE EXCLUSIVE RIGHT TO USE "CASA" OR "EST. 2010", APART FROM THE MARK AS SHOWN.

THE MARK CONSISTS OF A STYLIZED REPRESENTATION OF AN AGAVE PLANT WITH A SILHOUETTE OF A SINGLE DROP SET ABOVE IT. THE COMBINED OUTLINE OF THE SINGLE DROP AND THE AGAVE PLANT FORM A LARGER DROP. THE WORDS "CASA ZG" APPEAR INSIDE THE LEAVES OF THE AGAVE PLANT, WHERE THE WORD "CASA" IS LOCATED ABOVE THE LETTERS "ZG" AND LOCATED UNDERNEATH THESE IS THE TERM "EST. 2010". ENCLOSED WITHIN THE LOWER LEAVES OF THE AGAVE PLANT IS A STYLIZED OVAL FORM AND WITHIN IT IS A SMALLER STYLIZED OVAL FORM.

THE ENGLISH TRANSLATION OF "CASA" IN THE MARK IS "HOUSE".

SN 85-198,497, FILED 12-15-2010.

KIM MONINGHOFF, EXAMINING ATTORNEY



David J. Kybas

Director of the United States Patent and Trademark Office

United States of America

United States Patent and Trademark Office

MEMOMAX

Reg. No. 4,100,084

Registered Feb. 14, 2012

Int. Cl.: 9

TRADEMARK

PRINCIPAL REGISTER

OTAVIO LACERDA (BRAZIL INDIVIDUAL)
CASA 6
R. ELISEU TEIXEIRA DE CAMARGO, 571
CAMPINAS, BRAZIL SP13101-6

FOR: ELECTRONIC GAMES DOWNLOADABLE THROUGH THE INTERNET AND PLAYABLE BY ONE OR MORE PLAYERS ON MOBILE ELECTRONIC PLATFORMS, IN CLASS 9 (U.S. CLS. 21, 23, 26, 36 AND 38).

FIRST USE 10-29-2011; IN COMMERCE 10-29-2011.

THE MARK CONSISTS OF STANDARD CHARACTERS WITHOUT CLAIM TO ANY PARTICULAR FONT, STYLE, SIZE, OR COLOR.

SN 85-198,517, FILED 12-15-2010.

JANET LEE, EXAMINING ATTORNEY



David J. Kybas

Director of the United States Patent and Trademark Office

United States of America

United States Patent and Trademark Office

Good Karma = Great Life

Reg. No. 4,100,085

AMAZING KARMA, LLC (CALIFORNIA LIMITED LIABILITY COMPANY)
10061 RIVERSIDE DR. - #324
TOLUCA LAKE, CA 91602

Registered Feb. 14, 2012

Int. Cl.: 45

FOR: PROVIDING A WEBSITE THAT ENCOURAGE AND ACKNOWLEDGES RANDOM ACTS OF KINDNESS AND COURTESY, IN CLASS 45 (U.S. CLS. 100 AND 101).

SERVICE MARK

FIRST USE 10-1-2010; IN COMMERCE 10-1-2010.

PRINCIPAL REGISTER

THE MARK CONSISTS OF STANDARD CHARACTERS WITHOUT CLAIM TO ANY PARTICULAR FONT, STYLE, SIZE, OR COLOR.

SN 85-198,622, FILED 12-15-2010.

CAROLINE WOOD, EXAMINING ATTORNEY



David J. Kybas

Director of the United States Patent and Trademark Office

United States of America

United States Patent and Trademark Office

RATESPECIAL

Reg. No. 4,100,086

Registered Feb. 14, 2012

Int. Cl.: 35

SERVICE MARK

PRINCIPAL REGISTER

RATESPECIAL LLC (CALIFORNIA LIMITED LIABILITY COMPANY)
35 NORTH ARROYO PARKWAY, SUITE 250
PASADENA, CA 91103

FOR: ADVERTISING AND DIRECTORY SERVICES, NAMELY, PROMOTING THE SERVICES OF OTHERS BY PROVIDING A WEB PAGE FEATURING LINKS TO THE WEBSITES OF OTHERS; MARKETING SERVICES, NAMELY, PROVIDING INFORMATIONAL WEB PAGES DESIGNED TO GENERATE SALES TRAFFIC VIA HYPERLINKS TO OTHER WEB SITES; ONLINE ADVERTISING AND PROMOTIONAL SERVICES, IN CLASS 35 (U.S. CLS. 100, 101 AND 102).

FIRST USE 7-0-2008; IN COMMERCE 7-0-2008.

THE MARK CONSISTS OF STANDARD CHARACTERS WITHOUT CLAIM TO ANY PARTICULAR FONT, STYLE, SIZE, OR COLOR.

SN 85-199,036, FILED 12-15-2010.

ANN E. SAPPENFIELD, EXAMINING ATTORNEY



David J. Kyros

Director of the United States Patent and Trademark Office

United States of America

United States Patent and Trademark Office

ELIMINATE THE HATE

Reg. No. 4,100,087

Registered Feb. 14, 2012

Int. Cl.: 35

SERVICE MARK

PRINCIPAL REGISTER

TNA ENTERTAINMENT, LLC (DELAWARE LIMITED LIABILITY COMPANY)
SUITE 1001
4100 SPRING VALLEY ROAD
DALLAS, TX 75244

FOR: PROMOTING PUBLIC AWARENESS OF BULLYING, IN CLASS 35 (U.S. CLS. 100, 101 AND 102).

FIRST USE 11-9-2010; IN COMMERCE 11-9-2010.

THE MARK CONSISTS OF STANDARD CHARACTERS WITHOUT CLAIM TO ANY PARTICULAR FONT, STYLE, SIZE, OR COLOR.

SN 85-199,340, FILED 12-16-2010.

JOHN DWYER, EXAMINING ATTORNEY



David J. Kybas

Director of the United States Patent and Trademark Office

United States of America

United States Patent and Trademark Office

SING-A-MA-JIGS! DUETS

Reg. No. 4,100,088

Registered Feb. 14, 2012

Int. Cl.: 28

TRADEMARK

PRINCIPAL REGISTER

MATTEL, INC. (DELAWARE CORPORATION)
M1-1518
333 CONTINENTAL BOULEVARD
EL SEGUNDO, CA 90245

FOR: PLUSH TOYS AND ACCESSORIES THEREFOR, IN CLASS 28 (U.S. CLS. 22, 23, 38 AND 50).

FIRST USE 11-14-2011; IN COMMERCE 11-14-2011.

THE MARK CONSISTS OF STANDARD CHARACTERS WITHOUT CLAIM TO ANY PARTICULAR FONT, STYLE, SIZE, OR COLOR.

SN 85-199,914, FILED 12-16-2010.

TAMARA FRAZIER, EXAMINING ATTORNEY



David J. Kyjars

Director of the United States Patent and Trademark Office

United States of America

United States Patent and Trademark Office

TIMESHEASY

Reg. No. 4,100,089

EASY SOFTWARE SOLUTIONS, LLC (VIRGINIA LIMITED LIABILITY COMPANY)
4510 COX ROAD, SUITE 109
GLEN ALLEN, VA 23060

Registered Feb. 14, 2012

Int. Cl.: 42

FOR: PROVIDING TEMPORARY USE OF ONLINE, NON-DOWNLOADABLE SOFTWARE FOR TIME MANAGEMENT; APPLICATION SERVICE PROVIDER FEATURING SOFTWARE FOR USE IN THE FIELD OF BUSINESS MANAGEMENT, NAMELY, ACCOUNTING, TRANSACTION PROCESSING, BUSINESS PROCESS, IN THE FIELD OF TIME MANAGEMENT; PROVIDING TEMPORARY USE OF ONLINE NON-DOWNLOADABLE COMPUTER SOFTWARE FOR FINANCIAL PLANNING, DATABASE MANAGEMENT, DATA AGGREGATION AND REPORTING, AND ONLINE BACKUP OF ELECTRONIC FILES; PROVIDING TEMPORARY USE OF ONLINE, NON-DOWNLOADABLE SOFTWARE FOR EMPLOYEE AND CONTRACTOR TIME MANAGEMENT, IN CLASS 42 (U.S. CLS. 100 AND 101).

SERVICE MARK

PRINCIPAL REGISTER

FIRST USE 12-1-2010; IN COMMERCE 12-1-2010.

THE MARK CONSISTS OF STANDARD CHARACTERS WITHOUT CLAIM TO ANY PARTICULAR FONT, STYLE, SIZE, OR COLOR.

SN 85-200,593, FILED 12-17-2010.

RONALD AIKENS, EXAMINING ATTORNEY



David J. Kyros

Director of the United States Patent and Trademark Office

United States of America

United States Patent and Trademark Office

Hear Your Brand

Reg. No. 4,100,090

DIGITAT CONCEPTS LLC (GEORGIA LIMITED LIABILITY COMPANY)
POB 212034

Registered Feb. 14, 2012

WEST PALM BEACH, FL 33421

Int. Cl.: 9

FOR: ELECTRONIC PRODUCTS, NAMELY, BOOM BOXES, AUDIO SPEAKERS, RADIOS, HEADPHONES, EARPHONES, CD PLAYERS, DVD PLAYERS, MP3 PLAYERS AND PORTABLE MEDIA PLAYERS, IN CLASS 9 (U.S. CLS. 21, 23, 26, 36 AND 38).

TRADEMARK

FIRST USE 1-18-2011; IN COMMERCE 3-18-2011.

PRINCIPAL REGISTER

THE MARK CONSISTS OF STANDARD CHARACTERS WITHOUT CLAIM TO ANY PARTICULAR FONT, STYLE, SIZE, OR COLOR.

SN 85-201,223, FILED 12-18-2010.

LESLEY LAMOTHE, EXAMINING ATTORNEY



David J. Kyros

Director of the United States Patent and Trademark Office

United States of America

United States Patent and Trademark Office

Z-GUARD

Reg. No. 4,100,091

MEDLINE INDUSTRIES, INC. (ILLINOIS CORPORATION)
ONE MEDLINE PLACE
MUNDELEIN, IL 60060

Registered Feb. 14, 2012

Int. Cl.: 5

FOR: MEDICATED SKIN PROTECTANT, IN CLASS 5 (U.S. CLS. 6, 18, 44, 46, 51 AND 52).

TRADEMARK

FIRST USE 8-0-2011; IN COMMERCE 8-0-2011.

PRINCIPAL REGISTER

THE MARK CONSISTS OF STANDARD CHARACTERS WITHOUT CLAIM TO ANY PARTICULAR FONT, STYLE, SIZE, OR COLOR.

SN 85-201,891, FILED 12-20-2010.

MICHAEL KEATING, EXAMINING ATTORNEY



David J. Kybas

Director of the United States Patent and Trademark Office

United States of America

United States Patent and Trademark Office

LIFEPLAST

Reg. No. 4,100,092

WOODGRAIN MILLWORK, INC. (OREGON CORPORATION)
300 NW 16TH STREET
FRUITLAND, ID 83619

Registered Feb. 14, 2012

Int. Cls.: 6 and 19

FOR: METAL STRUCTURAL DOOR FRAMES AND PARTS THEREFOR, IN CLASS 6 (U.S. CLS. 2, 12, 13, 14, 23, 25 AND 50).

TRADEMARK

FIRST USE 6-15-2010; IN COMMERCE 6-15-2010.

PRINCIPAL REGISTER

FOR: NON-METAL STRUCTURAL DOOR FRAMES AND PARTS THEREFOR, IN CLASS 19 (U.S. CLS. 1, 12, 33 AND 50).

FIRST USE 6-15-2010; IN COMMERCE 6-15-2010.

THE MARK CONSISTS OF STANDARD CHARACTERS WITHOUT CLAIM TO ANY PARTICULAR FONT, STYLE, SIZE, OR COLOR.

SN 85-202,076, FILED 12-20-2010.

JOHN DALIER, EXAMINING ATTORNEY



David J. Kybas

Director of the United States Patent and Trademark Office

United States of America
United States Patent and Trademark Office

PACKHARD

Reg. No. 4,100,093

CHEMPORT, INC. (TEXAS CORPORATION), DBA CORPORATION,
1530 GOODYEAR, SUITE C
EL PASO, TX 79936

Registered Feb. 14, 2012

Int. Cl.: 1

FOR: FERTILIZERS FOR AGRICULTURAL USE, IN CLASS 1 (U.S. CLS. 1, 5, 6, 10, 26 AND 46).

TRADEMARK

FIRST USE 1-1-1993; IN COMMERCE 1-1-1993.

PRINCIPAL REGISTER

THE MARK CONSISTS OF STANDARD CHARACTERS WITHOUT CLAIM TO ANY PARTICULAR FONT, STYLE, SIZE, OR COLOR.

SN 85-202,288, FILED 12-20-2010.

HELENE LIWINSKI, EXAMINING ATTORNEY



David J. Kybas

Director of the United States Patent and Trademark Office

United States of America
United States Patent and Trademark Office

HALCYON

Reg. No. 4,100,094

HALCYON HOME HEALTH, LLC (DELAWARE LIMITED LIABILITY COMPANY)
2928 HABERSHAM RD NW
ATLANTA, GA 30305

Registered Feb. 14, 2012

Int. Cl.: 44

FOR: MEDICAL SERVICES PROVIDED WITHIN NURSING CARE FACILITIES, ASSISTED LIVING FACILITIES, HOSPICE FACILITIES AND HOME HOSPICE CARE; PROVIDING MEDICAL FACILITIES FOR NURSING CARE, ASSISTED LIVING, HOSPICE CARE AND HOME HOSPICE CARE, IN CLASS 44 (U.S. CLS. 100 AND 101).

SERVICE MARK

PRINCIPAL REGISTER

FIRST USE 2-1-2011; IN COMMERCE 2-1-2011.

THE MARK CONSISTS OF STANDARD CHARACTERS WITHOUT CLAIM TO ANY PARTICULAR FONT, STYLE, SIZE, OR COLOR.

SN 85-203,561, FILED 12-22-2010.

BARBARA RUTLAND, EXAMINING ATTORNEY



David J. Kyfos

Director of the United States Patent and Trademark Office

United States of America

United States Patent and Trademark Office

AFFINITY PURE REWARDS

Reg. No. 4,100,095

Registered Feb. 14, 2012

Int. Cl.: 36

SERVICE MARK

PRINCIPAL REGISTER

AFFINITY FEDERAL CREDIT UNION (UNITED STATES FEDERALLY CHARTERED CREDIT UNION)
73 MOUNTAIN VIEW BOULEVARD
BASKING RIDGE, NJ 07920

FOR: CREDIT CARD SERVICES, IN CLASS 36 (U.S. CLS. 100, 101 AND 102).

FIRST USE 10-26-2010; IN COMMERCE 10-26-2010.

THE MARK CONSISTS OF STANDARD CHARACTERS WITHOUT CLAIM TO ANY PARTICULAR FONT, STYLE, SIZE, OR COLOR.

NO CLAIM IS MADE TO THE EXCLUSIVE RIGHT TO USE "REWARDS", APART FROM THE MARK AS SHOWN.

SN 85-204,853, FILED 12-23-2010.

ROBIN MITTLER, EXAMINING ATTORNEY



David J. Kyffers

Director of the United States Patent and Trademark Office

United States of America

United States Patent and Trademark Office



Reg. No. 4,100,096

Registered Feb. 14, 2012

Int. Cl.: 6

TRADEMARK

PRINCIPAL REGISTER

TORNADO TECH, LLC (OKLAHOMA LIMITED LIABILITY COMPANY)
1212 WEST LIBERTY
PONCA CITY, OK 74602

FOR: METAL STORM SHELTERS, IN CLASS 6 (U.S. CLS. 2, 12, 13, 14, 23, 25 AND 50).

FIRST USE 3-30-2011; IN COMMERCE 3-30-2011.

NO CLAIM IS MADE TO THE EXCLUSIVE RIGHT TO USE "TORNADO SHELTERS", APART FROM THE MARK AS SHOWN.

THE COLOR(S) RED, BLACK, GREY AND WHITE IS/ARE CLAIMED AS A FEATURE OF THE MARK.

THE MARK CONSISTS OF A GREY, BLACK AND WHITE CYCLONE BEHIND A LARGE RED "T" OUTLINED IN BLACK, WHICH COMPRISES THE FIRST LETTER IN THE WORDS "TORNADO" ABOVE "TECH", BOTH WORDS COMPRISED OF BLACK LETTERING OUTLINED IN RED OTHER THAN THE LARGE RED "T", AND THE BLACK WORDS "TORNADO SHELTERS" THEREUNDER.

SN 85-205,230, FILED 12-23-2010.

AMY HELLA, EXAMINING ATTORNEY



David J. Kyffers

Director of the United States Patent and Trademark Office

United States of America

United States Patent and Trademark Office

BOSTON DANDY

Reg. No. 4,100,097

NEW SEED, INC. (DELAWARE CORPORATION)
1220 N MARKET, SUITE 806
WILMINGTON, DE 19801

Registered Feb. 14, 2012

Int. Cl.: 1

FOR: ACTIVE CHEMICAL INGREDIENTS FOR USE IN THE MANUFACTURE OF ANTI-CANCER DRUGS; ACTIVE CHEMICAL INGREDIENTS FOR USE IN THE MANUFACTURE OF PHARMACEUTICALS FOR TREATING INFLAMMATORY, KIDNEY, VIRAL, METABOLIC, ENDOCRINE, MUSCULOSKELETAL, CARDIOVASCULAR, CARDIOPULMONARY, RESPIRATORY, NEUROLOGICAL, GASTROINTESTINAL, HORMONAL, DERMATOLOGICAL, GENITOURINARY, SEXUAL DYSFUNCTION, HEPATOLOGICAL, OPHTHALMIC, PSYCHIATRIC AND IMMUNE SYSTEM RELATED DISEASES AND DISORDERS; ANTIOXIDANTS AND PROTEINS USED IN THE MANUFACTURE OF COSMETICS, BEVERAGES, FOOD PRODUCTS AND FOOD SUPPLEMENTS; BIOCHEMICALS FOR IN VITRO AND IN VIVO SCIENTIFIC USE; BIOCHEMICALS, NAMELY, POLYPEPTIDES FOR IN VITRO RESEARCH USE, IN CLASS 1 (U.S. CLS. 1, 5, 6, 10, 26 AND 46).

TRADEMARK

PRINCIPAL REGISTER

FIRST USE 8-12-2011; IN COMMERCE 9-15-2011.

THE MARK CONSISTS OF STANDARD CHARACTERS WITHOUT CLAIM TO ANY PARTICULAR FONT, STYLE, SIZE, OR COLOR.

NO CLAIM IS MADE TO THE EXCLUSIVE RIGHT TO USE "BOSTON", APART FROM THE MARK AS SHOWN.

SN 85-205,631, FILED 12-25-2010.

ALICIA COLLINS, EXAMINING ATTORNEY



David J. Kyros

Director of the United States Patent and Trademark Office

United States of America

United States Patent and Trademark Office

CELEBIPAWS

Reg. No. 4,100,098

Registered Feb. 14, 2012

Int. Cl.: 14

TRADEMARK

PRINCIPAL REGISTER

MICHELLE HARDING (UNITED STATES INDIVIDUAL)
1 GEORGE STREET
WEST MILFORD, NJ 07480

FOR: PET JEWELRY, IN CLASS 14 (U.S. CLS. 2, 27, 28 AND 50).

FIRST USE 11-25-2011; IN COMMERCE 11-25-2011.

THE MARK CONSISTS OF STANDARD CHARACTERS WITHOUT CLAIM TO ANY PARTICULAR FONT, STYLE, SIZE, OR COLOR.

SN 85-206,544, FILED 12-28-2010.

SANJEEV VOHRA, EXAMINING ATTORNEY



David J. Kybas

Director of the United States Patent and Trademark Office

United States of America

United States Patent and Trademark Office

The Link You've Been Missing

Reg. No. 4,100,099

Registered Feb. 14, 2012

Int. Cl.: 29

TRADEMARK

PRINCIPAL REGISTER

SASSY LADY FOODS, INC. (TENNESSEE CORPORATION)
1138 N. GERMANTOWN PKWY, STE. 101, #225
CORDOVA, TN 380165872

FOR: SAUSAGES, IN CLASS 29 (U.S. CL. 46).

FIRST USE 9-1-2011; IN COMMERCE 9-3-2011.

THE MARK CONSISTS OF STANDARD CHARACTERS WITHOUT CLAIM TO ANY PARTICULAR FONT, STYLE, SIZE, OR COLOR.

SN 85-207,933, FILED 12-30-2010.

GEORGE LORENZO, EXAMINING ATTORNEY



David J. Kybas

Director of the United States Patent and Trademark Office

United States of America

United States Patent and Trademark Office

No Debt Club

Reg. No. 4,100,100

Registered Feb. 14, 2012

Int. Cl.: 45

SERVICE MARK

PRINCIPAL REGISTER

TRUNNELL & SELLERS, P.C. (COLORADO CORPORATION)
SOUTH TOWER, SUITE 2800
600 17TH STREET
DENVER, CO 80202

FOR: LEGAL SERVICES, IN CLASS 45 (U.S. CLS. 100 AND 101).

FIRST USE 9-1-2011; IN COMMERCE 9-1-2011.

THE MARK CONSISTS OF STANDARD CHARACTERS WITHOUT CLAIM TO ANY PARTICULAR FONT, STYLE, SIZE, OR COLOR.

SN 85-208,216, FILED 12-30-2010.

ANGELA M. MICHELI, EXAMINING ATTORNEY



David J. Kybas

Director of the United States Patent and Trademark Office

United States of America

United States Patent and Trademark Office

Kohort

Reg. No. 4,100,101

KOHORT.COM INC. (DELAWARE CORPORATION)
156A CHURCH ST.
BURLINGTON, VT 05401

Registered Feb. 14, 2012

Int. Cl.: 42

FOR: COMPUTER SERVICES, NAMELY, CREATING AN ON-LINE COMMUNITY FOR REGISTERED USERS TO PARTICIPATE IN DISCUSSIONS, GET FEEDBACK FROM THEIR PEERS, FORM VIRTUAL COMMUNITIES, AND ENGAGE IN SOCIAL NETWORKING, IN CLASS 42 (U.S. CLS. 100 AND 101).

SERVICE MARK

PRINCIPAL REGISTER

FIRST USE 10-15-2011; IN COMMERCE 10-15-2011.

THE MARK CONSISTS OF STANDARD CHARACTERS WITHOUT CLAIM TO ANY PARTICULAR FONT, STYLE, SIZE, OR COLOR.

SN 85-208,239, FILED 12-30-2010.

ANGELA M. MICHELLI, EXAMINING ATTORNEY



David J. Kyjars

Director of the United States Patent and Trademark Office

United States of America

United States Patent and Trademark Office

Thinner Band

Reg. No. 4,100,102

DE MARCO, ANTHONY F. (UNITED STATES INDIVIDUAL)
39 SHERIDAN AVENUE
PATERSON, NJ 07502

Registered Feb. 14, 2012

Int. Cl.: 9

FOR: SERIES OF PRERECORDED COMPACT DISCS FEATURING HYPNOSIS, NAMELY, FOR WEIGHT LOSS AND WEIGHT MANAGEMENT, SELF HYPNOSIS, SELF CONFIDENCE, SELF IMPROVEMENT, STRESS, ANXIETY, SELF ESTEEM, AND SUCCESS, IN CLASS 9 (U.S. CLS. 21, 23, 26, 36 AND 38).

TRADEMARK

PRINCIPAL REGISTER

FIRST USE 5-21-2011; IN COMMERCE 8-15-2011.

THE MARK CONSISTS OF STANDARD CHARACTERS WITHOUT CLAIM TO ANY PARTICULAR FONT, STYLE, SIZE, OR COLOR.

SN 85-208,582, FILED 12-31-2010.

INGA ERVIN, EXAMINING ATTORNEY



David J. Kyffers

Director of the United States Patent and Trademark Office

United States of America

United States Patent and Trademark Office

Thinner Band Hypnosis

Reg. No. 4,100,103

DE MARCO, ANTHONY F. (UNITED STATES INDIVIDUAL)
39 SHERIDAN AVENUE
PATERSON, NJ 07502

Registered Feb. 14, 2012

Int. Cl.: 44

FOR: HYPNOSIS SERVICES, NAMELY, PROVIDING WEIGHT LOSS AND WEIGHT MANAGEMENT PROGRAM SERVICES, INCLUDING INSTRUCTION IN SELF HYPNOSIS, SELF CONFIDENCE, SELF IMPROVEMENT, STRESS, ANXIETY, SELF ESTEEM AND SUCCESS, IN CLASS 44 (U.S. CLS. 100 AND 101).

SERVICE MARK

PRINCIPAL REGISTER

FIRST USE 5-21-2011; IN COMMERCE 8-15-2011.

THE MARK CONSISTS OF STANDARD CHARACTERS WITHOUT CLAIM TO ANY PARTICULAR FONT, STYLE, SIZE, OR COLOR.

NO CLAIM IS MADE TO THE EXCLUSIVE RIGHT TO USE "HYPNOSIS", APART FROM THE MARK AS SHOWN.

SN 85-208,638, FILED 12-31-2010.

INGA ERVIN, EXAMINING ATTORNEY



David J. Kyros

Director of the United States Patent and Trademark Office

United States of America

United States Patent and Trademark Office



Reg. No. 4,100,104

Registered Feb. 14, 2012

Int. Cl.: 5

TRADEMARK

PRINCIPAL REGISTER

REGENERON PHARMACEUTICALS, INC. (NEW YORK CORPORATION)
777 OLD SAW MILL RIVER ROAD
TARRYTOWN, NY 10591

FOR: PHARMACEUTICAL PREPARATIONS, NAMELY, OPHTHALMICS; PHARMACEUTICAL PREPARATIONS FOR THE TREATMENT OF OPHTHALMIC DISEASES AND CONDITIONS, IN CLASS 5 (U.S. CLS. 6, 18, 44, 46, 51 AND 52).

FIRST USE 11-21-2011; IN COMMERCE 11-21-2011.

THE MARK CONSISTS OF THE WORD "EYLEA" AND AN EYE DESIGN TO THE LEFT OF THE WORD "EYLEA". THE WORD "EYLEA" IS IN THE COLOR DARK BLUE. WITH RESPECT TO THE EYE DESIGN, THERE ARE TWO THICK CRESCENT SHAPES FACING EACH OTHER ON THE LEFT AND THE RIGHT. THE CRESCENT SHAPE ON THE LEFT IS THE COLOR DARK BLUE. THE CRESCENT SHAPE ON THE RIGHT IS THE COLOR YELLOW. IN BETWEEN THE TWO CRESCENT SHAPES ARE A SERIES OF LIGHT BLUE SQUARES WITH A DARK BLUE CIRCLE IN THE MIDDLE.

THE COLOR(S) DARK BLUE, LIGHT BLUE, AND YELLOW IS/ARE CLAIMED AS A FEATURE OF THE MARK.

SN 85-209,921, FILED 1-4-2011.

GEORGE LORENZO, EXAMINING ATTORNEY



David J. Kyjars

Director of the United States Patent and Trademark Office

United States of America

United States Patent and Trademark Office

LASH SECRETS

Reg. No. 4,100,105

PACIFIC WORLD CORPORATION (CALIFORNIA CORPORATION)
25800 COMMERCENTRE DRIVE
LAKE FOREST, CA 926308803

Registered Feb. 14, 2012

Int. Cl.: 3

FOR: ADHESIVES FOR AFFIXING FALSE EYELASHES; ARTIFICIAL EYELASHES, IN CLASS 3 (U.S. CLS. 1, 4, 6, 50, 51 AND 52).

TRADEMARK

FIRST USE 8-15-2011; IN COMMERCE 8-15-2011.

PRINCIPAL REGISTER

THE MARK CONSISTS OF STANDARD CHARACTERS WITHOUT CLAIM TO ANY PARTICULAR FONT, STYLE, SIZE, OR COLOR.

NO CLAIM IS MADE TO THE EXCLUSIVE RIGHT TO USE "LASH", APART FROM THE MARK AS SHOWN.

SN 85-210,572, FILED 1-5-2011.

HOWARD SMIGA, EXAMINING ATTORNEY



David J. Kyffers

Director of the United States Patent and Trademark Office

United States of America

United States Patent and Trademark Office

Snap it right every time!

Reg. No. 4,100,106

SNAPANTS, LLC (FLORIDA LIMITED LIABILITY COMPANY)
13835 SW 41ST ST.
DAVIE, FL 33330

Registered Feb. 14, 2012

Int. Cl.: 25

FOR: CHILDREN'S CLOTHING, NAMELY, ROMPERS FEATURING SPECIAL COLORED-CODED SNAP-ON FASTENERS, IN CLASS 25 (U.S. CLS. 22 AND 39).

TRADEMARK

FIRST USE 3-23-2011; IN COMMERCE 7-1-2011.

PRINCIPAL REGISTER

THE MARK CONSISTS OF STANDARD CHARACTERS WITHOUT CLAIM TO ANY PARTICULAR FONT, STYLE, SIZE, OR COLOR.

SN 85-210,715, FILED 1-5-2011.

SIMON TENG, EXAMINING ATTORNEY



David J. Kybas

Director of the United States Patent and Trademark Office

United States of America

United States Patent and Trademark Office

LIP PRINCESS

Reg. No. 4,100,107

Registered Feb. 14, 2012

Int. Cl.: 10

TRADEMARK

PRINCIPAL REGISTER

PERTH ONLINE MARKETING PTY LTD. (AUSTRALIA LIMITED COMPANY (LTD.))
ST. GEORGES TERRACE
PO BOX 5618
PERTH, WA, AUSTRALIA 6831

FOR: HAND OPERATED PLUMPING DEVICE BY WHICH THE USER MAY TEMPORARILY ENHANCE THE SIZE OF THE USER'S LIPS FOR COSMETIC PURPOSES, NAMELY, VACUUM PUMP, IN CLASS 10 (U.S. CLS. 26, 39 AND 44).

FIRST USE 1-0-2011; IN COMMERCE 1-0-2011.

THE MARK CONSISTS OF STANDARD CHARACTERS WITHOUT CLAIM TO ANY PARTICULAR FONT, STYLE, SIZE, OR COLOR.

NO CLAIM IS MADE TO THE EXCLUSIVE RIGHT TO USE "LIP", APART FROM THE MARK AS SHOWN.

SN 85-213,389, FILED 1-7-2011.

APRIL ROACH, EXAMINING ATTORNEY



David J. Kyffers

Director of the United States Patent and Trademark Office

United States of America

United States Patent and Trademark Office

Skin Perfect
[Image Wellness]

Reg. No. 4,100,108

SKIN PERFECT, LLC (OHIO LIMITED LIABILITY COMPANY)
2117 POLARIS PARKWAY
COLUMBUS, OH 43240

Registered Feb. 14, 2012

Int. Cl.: 44

FOR: COSMETIC SKIN CARE SERVICES, IN CLASS 44 (U.S. CLS. 100 AND 101).

SERVICE MARK

FIRST USE 10-20-2010; IN COMMERCE 10-20-2010.

PRINCIPAL REGISTER

NO CLAIM IS MADE TO THE EXCLUSIVE RIGHT TO USE "SKIN" AND "WELLNESS", APART FROM THE MARK AS SHOWN.

THE MARK CONSISTS OF THE WORDS "IMAGE WELLNESS" IN BRACKETS BELOW THE WORDS SKIN PERFECT.

SN 85-215,075, FILED 1-11-2011.

WILLIAM BRECKENFELD, EXAMINING ATTORNEY



David J. Kybas

Director of the United States Patent and Trademark Office

United States of America

United States Patent and Trademark Office



Reg. No. 4,100,109

Registered Feb. 14, 2012

Int. Cl.: 9

TRADEMARK

PRINCIPAL REGISTER

FKA DISTRIBUTING CO. (MICHIGAN CORPORATION), DBA HOMEDICS, INC.,
3000 PONTIAC TRAIL
COMMERCE TOWNSHIP, MI 48390

FOR: CARRYING CASES, NAMELY, LUGGAGE, BRIEFCASES, TOTES, BACKPACKS, PROTECTIVE SLEEVES, FOLIOS, POUCHES AND MESSENGER BAGS ADAPTED TO HOLD, CARRY AND CHARGE PORTABLE ELECTRONIC DEVICES AND RELATED ACCESSORIES; BATTERIES, BATTERY CHARGERS AND ADAPTERS FOR CONNECTING TO POWER SUPPLIES AND PORTABLE ELECTRONIC DEVICES, IN CLASS 9 (U.S. CLS. 21, 23, 26, 36 AND 38).

FIRST USE 12-1-2010; IN COMMERCE 12-1-2010.

THE MARK CONSISTS OF A ROUNDED SQUARE CONTAINING A STYLIZED 'P' WITH THE WORD "POWERBAG" BELOW. THE COLOR WHITE IN THE DRAWING IS USED TO SHOW BACKGROUND AND IS NOT A FEATURE OF THE MARK.

SN 85-215,581, FILED 1-12-2011.

KAPIL BHANOT, EXAMINING ATTORNEY



David J. Kybas

Director of the United States Patent and Trademark Office

United States of America

United States Patent and Trademark Office

GAS UP & GO

Reg. No. 4,100,110

Registered Feb. 14, 2012

Int. Cl.: 28

TRADEMARK

PRINCIPAL REGISTER

MATTEL, INC. (DELAWARE CORPORATION)
M1-1518
333 CONTINENTAL BOULEVARD
EL SEGUNDO, CA 90245

FOR: TOY VEHICLES AND ACCESSORIES THEREFOR, IN CLASS 28 (U.S. CLS. 22, 23, 38 AND 50).

FIRST USE 6-20-2011; IN COMMERCE 6-20-2011.

THE MARK CONSISTS OF STANDARD CHARACTERS WITHOUT CLAIM TO ANY PARTICULAR FONT, STYLE, SIZE, OR COLOR.

SN 85-215,673, FILED 1-12-2011.

HENRY S. ZAK, EXAMINING ATTORNEY



David J. Kyffers

Director of the United States Patent and Trademark Office

United States of America

United States Patent and Trademark Office

ADVENTURE FRIENDS

Reg. No. 4,100,111

Registered Feb. 14, 2012

Int. Cl.: 28

TRADEMARK

PRINCIPAL REGISTER

MATTEL, INC. (DELAWARE CORPORATION)
M1-1518
333 CONTINENTAL BOULEVARD
EL SEGUNDO, CA 90245

FOR: DOLLS, DOLL CLOTHING AND DOLL ACCESSORIES, IN CLASS 28 (U.S. CLS. 22, 23, 38 AND 50).

FIRST USE 12-1-2011; IN COMMERCE 12-1-2011.

THE MARK CONSISTS OF STANDARD CHARACTERS WITHOUT CLAIM TO ANY PARTICULAR FONT, STYLE, SIZE, OR COLOR.

SN 85-215,693, FILED 1-12-2011.

HENRY S. ZAK, EXAMINING ATTORNEY



David J. Kyffers

Director of the United States Patent and Trademark Office

United States of America

United States Patent and Trademark Office

YOGURFIT

Reg. No. 4,100,112

PICO PLATA AVV, LIMITED (ST.KITTS-NEVIS LIMITED LIABILITY COMPANY)
355 ALHAMBRA CIRCLE, SUITE 801
CORAL GABLES, FL 33134

Registered Feb. 14, 2012

Int. Cl.: 25

FOR: SPORT-STYLE CLOTHING, NAMELY, T-SHIRTS, POLOS, SWEATSHIRTS, JACKETS, SWEATPANTS, SHORTS, SKIRTS, HATS AND CAPS; JEANS; PAJAMAS , IN CLASS 25 (U.S. CLS. 22 AND 39).

TRADEMARK

FIRST USE 6-1-2011; IN COMMERCE 6-1-2011.

PRINCIPAL REGISTER

THE MARK CONSISTS OF STANDARD CHARACTERS WITHOUT CLAIM TO ANY PARTICULAR FONT, STYLE, SIZE, OR COLOR.

SN 85-216,088, FILED 1-12-2011.

SUZANNE BLANE, EXAMINING ATTORNEY



David J. Kyffers

Director of the United States Patent and Trademark Office

United States of America

United States Patent and Trademark Office



CHEKHUP

Reg. No. 4,100,113

Registered Feb. 14, 2012

Int. Cl.: 30

TRADEMARK

PRINCIPAL REGISTER

CHEK HUP SDN. BHD. (CO. NO. 242599-U) (MALAYSIA CORPORATION)
SD 2567-D, LOT NO. 34144
2 1/2 MILES, JALAN JELAPANG
30020 IPOH, PERAK, MALAYSIA

FOR: COFFEE AND COFFEE PRODUCTS, NAMELY, ARTIFICIAL COFFEE, COFFEE BASED BEVERAGES, COFFEE BEANS, COFFEE SUBSTITUTES; INSTANT COFFEE; MIXES IN THE NATURE OF CONCENTRATES OR SYRUPS OR POWDERS USED IN THE PREPARATION OF COFFEE BASED BEVERAGES; COFFEE FLAVORED SYRUP USED IN MAKING FOOD BEVERAGES, COFFEE BEVERAGES WITH MILK; COCOA AND COCOA PRODUCTS, NAMELY, COCOA POWDER, COCOA BASED BEVERAGES, COCOA BEVERAGES WITH MILK; CHOCOLATE FOOD BEVERAGES NOT BEING DAIRY-BASED OR VEGETABLE BASED, CHOCOLATE FLAVORED SYRUPS; TEA; SUGAR, IN CLASS 30 (U.S. CL. 46).

FIRST USE 1-0-2011; IN COMMERCE 1-0-2011.

OWNER OF U.S. REG. NOS. 3,171,268 AND 3,244,033.

THE MARK CONSISTS OF AN IMAGE OF A RABBIT PUSHING A WHEELBARROW FILLED WITH SPHERICAL OBJECTS, WHICH IS TO THE LEFT OF THE WORD "CHEKHUP".

SN 85-216,648, FILED 1-13-2011.

KATHERINE CHANG, EXAMINING ATTORNEY



David J. Kybas

Director of the United States Patent and Trademark Office

United States of America

United States Patent and Trademark Office

PREDICTABILITY CALIBRATION

Reg. No. 4,100,114

WESTNEY CONSULTING GROUP, INC. (TEXAS CORPORATION)
2200 WEST LOOP S #500
HOUSTON, TX 770273545

Registered Feb. 14, 2012

Int. Cls.: 35 and 36

FOR: BUSINESS RISK AND DECISION ANALYSIS AND BUSINESS CONSULTATION REGARDING ENGINEERING AND CONSTRUCTION PROJECTS IN THE OIL AND GAS, POWER GENERATION, MINING AND MINERALS, CHEMICALS MANUFACTURING AND PHARMACEUTICALS INDUSTRIES, IN CLASS 35 (U.S. CLS. 100, 101 AND 102).

SERVICE MARK

PRINCIPAL REGISTER

FIRST USE 4-7-2010; IN COMMERCE 4-7-2010.

FOR: FINANCIAL RISK AND DECISION ANALYSIS AND FINANCIAL CONSULTATION REGARDING ENGINEERING AND CONSTRUCTION PROJECTS IN THE OIL AND GAS, POWER GENERATION, MINING AND MINERALS, CHEMICALS MANUFACTURING AND PHARMACEUTICALS INDUSTRIES, IN CLASS 36 (U.S. CLS. 100, 101 AND 102).

FIRST USE 4-7-2010; IN COMMERCE 4-7-2010.

THE MARK CONSISTS OF STANDARD CHARACTERS WITHOUT CLAIM TO ANY PARTICULAR FONT, STYLE, SIZE, OR COLOR.

NO CLAIM IS MADE TO THE EXCLUSIVE RIGHT TO USE "PREDICTABILITY", APART FROM THE MARK AS SHOWN.

SN 85-217,111, FILED 1-13-2011.

JACLYN KIDWELL WALKER, EXAMINING ATTORNEY



David J. Kyffers

Director of the United States Patent and Trademark Office

United States of America

United States Patent and Trademark Office



LAUREATE

BIOPHARMA

Reg. No. 4,100,115

LAUREATE BIOPHARMACEUTICAL SERVICES, INC. (DELAWARE CORPORATION)
201 COLLEGE ROAD EAST
PRINCETON, NJ 08540

Registered Feb. 14, 2012

Int. Cls.: 40 and 42

FOR: CUSTOM MANUFACTURE OF PHARMACEUTICAL DRUGS FOR OTHERS, IN CLASS 40 (U.S. CLS. 100, 103 AND 106).

SERVICE MARK

FIRST USE 1-31-2011; IN COMMERCE 1-31-2011.

PRINCIPAL REGISTER

FOR: PHARMACEUTICAL DRUG DEVELOPMENT SERVICES FOR OTHERS, IN CLASS 42 (U.S. CLS. 100 AND 101).

FIRST USE 1-31-2011; IN COMMERCE 1-31-2011.

OWNER OF U.S. REG. NOS. 2,909,928 AND 3,024,054.

NO CLAIM IS MADE TO THE EXCLUSIVE RIGHT TO USE "BIOPHARMA", APART FROM THE MARK AS SHOWN.

THE MARK CONSISTS OF A DESIGN OF A LAUREL WREATH, BENEATH WHICH IS PRINTED THE WORD "LAUREATE" IN STYLIZED CAPITAL LETTERS; BELOW THAT IS A HORIZONTAL LINE AND THE WORD "BIOPHARMA" IN A DIFFERENT, SMALLER FONT.

SN 85-218,162, FILED 1-14-2011.

VERNA BETH RIRIE, EXAMINING ATTORNEY



David J. Kybas

Director of the United States Patent and Trademark Office

United States of America

United States Patent and Trademark Office

LAUREATE BIOPHARMA

Reg. No. 4,100,116

LAUREATE BIOPHARMACEUTICAL SERVICES, INC. (DELAWARE CORPORATION)
201 COLLEGE ROAD EAST
PRINCETON, NJ 08540

Registered Feb. 14, 2012

Int. Cls.: 40 and 42

FOR: CUSTOM MANUFACTURE OF PHARMACEUTICAL DRUGS FOR OTHERS, IN CLASS 40 (U.S. CLS. 100, 103 AND 106).

SERVICE MARK

FIRST USE 1-31-2011; IN COMMERCE 1-31-2011.

PRINCIPAL REGISTER

FOR: PHARMACEUTICAL DRUG DEVELOPMENT SERVICES FOR OTHERS, IN CLASS 42 (U.S. CLS. 100 AND 101).

FIRST USE 1-31-2011; IN COMMERCE 1-31-2011.

THE MARK CONSISTS OF STANDARD CHARACTERS WITHOUT CLAIM TO ANY PARTICULAR FONT, STYLE, SIZE, OR COLOR.

OWNER OF U.S. REG. NOS. 2,909,928 AND 3,024,054.

NO CLAIM IS MADE TO THE EXCLUSIVE RIGHT TO USE "BIOPHARMA", APART FROM THE MARK AS SHOWN.

SN 85-218,170, FILED 1-14-2011.

VERNA BETH RIRIE, EXAMINING ATTORNEY



David J. Kyffers

Director of the United States Patent and Trademark Office

United States of America

United States Patent and Trademark Office

COAT OF SILENCE

Reg. No. 4,100,117

VERTETEK CORPORATION (ILLINOIS CORPORATION)
14590 PARK PLACE
HOMER GLEN, IL 60491

Registered Feb. 14, 2012

Int. Cls.: 2 and 17

FOR: PAINTS, IN CLASS 2 (U.S. CLS. 6, 11 AND 16).

TRADEMARK

FIRST USE 5-0-2011; IN COMMERCE 5-0-2011.

PRINCIPAL REGISTER

FOR: SOUNDPROOFING COATINGS IN THE NATURE OF PAINT , IN CLASS 17 (U.S. CLS. 1, 5, 12, 13, 35 AND 50).

FIRST USE 5-0-2011; IN COMMERCE 5-0-2011.

THE MARK CONSISTS OF STANDARD CHARACTERS WITHOUT CLAIM TO ANY PARTICULAR FONT, STYLE, SIZE, OR COLOR.

SN 85-218,988, FILED 1-17-2011.

NANCY CLARKE, EXAMINING ATTORNEY



David J. Kybas

Director of the United States Patent and Trademark Office

United States of America
United States Patent and Trademark Office

JUBULANI

Reg. No. 4,100,118

Registered Feb. 14, 2012

Int. Cl.: 25

TRADEMARK

PRINCIPAL REGISTER

J.B.S. LTD. (NEW YORK CORPORATION)
17TH FLOOR
1400 BROADWAY
NEW YORK, NY 10018

FOR: CLOTHING, NAMELY, WOMEN'S DRESSES, PANTS, SKIRTS, TOPS, JACKETS, SHAWLS; DRESS SETS, NAMELY, JACKETS AND DRESSES, IN CLASS 25 (U.S. CLS. 22 AND 39).

FIRST USE 3-0-2011; IN COMMERCE 3-0-2011.

THE MARK CONSISTS OF STANDARD CHARACTERS WITHOUT CLAIM TO ANY PARTICULAR FONT, STYLE, SIZE, OR COLOR.

SN 85-219,905, FILED 1-18-2011.

LAURIE MAYES, EXAMINING ATTORNEY



David J. Kyros

Director of the United States Patent and Trademark Office

United States of America

United States Patent and Trademark Office

SMART FRIENDS BOWLING

Reg. No. 4,100,119

Registered Feb. 14, 2012

Int. Cl.: 28

TRADEMARK

PRINCIPAL REGISTER

VTECH ELECTRONICS NORTH AMERICA, LLC (DELAWARE LIMITED LIABILITY COMPANY)
1155 DUNDEE ROAD
ARLINGTON HEIGHTS, IL 60004

FOR: CHILDREN'S MULTIPLE ACTIVITY TOYS; ELECTRONIC EDUCATIONAL GAME MACHINES FOR CHILDREN; ELECTRONIC LEARNING TOYS, IN CLASS 28 (U.S. CLS. 22, 23, 38 AND 50).

FIRST USE 5-2-2011; IN COMMERCE 5-2-2011.

THE MARK CONSISTS OF STANDARD CHARACTERS WITHOUT CLAIM TO ANY PARTICULAR FONT, STYLE, SIZE, OR COLOR.

NO CLAIM IS MADE TO THE EXCLUSIVE RIGHT TO USE "BOWLING", APART FROM THE MARK AS SHOWN.

SN 85-220,607, FILED 1-19-2011.

JEFF DEFORD, EXAMINING ATTORNEY



David J. Kyffers

Director of the United States Patent and Trademark Office

United States of America

United States Patent and Trademark Office

HTC SENSATION

Reg. No. 4,100,120

Registered Feb. 14, 2012

Int. Cl.: 9

TRADEMARK

PRINCIPAL REGISTER

HTC CORPORATION (TAIWAN CORPORATION)
NO. 23, XINGHUA ROAD
TAOYUAN CITY, TAIWAN

FOR: COMPUTER HARDWARE AND SOFTWARE FOR ENABLING, OPERATING, ENHANCING, CUSTOMIZING, UPDATING AND MANAGING MOBILE, PORTABLE, SMART, VOICE-OVER-INTERNET-PROTOCOL, AND WIRELESS DEVICES; USER INTERFACE SOFTWARE; COMPUTER HARDWARE AND SOFTWARE FOR DELIVERING, ENABLING, CREATING, ENHANCING, CUSTOMIZING, UPDATING, AND MANAGING USER INTERFACING, TELECOMMUNICATIONS AND TELECOMMUNICATIONS SERVICES; COMPUTER HARDWARE AND SOFTWARE FOR TRANSMITTING AND RECEIVING VOICE, IMAGE, DATA, AUDIO, VIDEO AND MULTIMEDIA CONTENT; WIRELESS MODEMS; ACCESSORIES FOR THE ABOVE GOODS, NAMELY, HEADSETS, HEADSETS WITH WIRELESS TRANSMISSION FUNCTION, CONNECTION CABLES, IN-CAR TELEPHONE HANDSET CRADLES, IN-CAR MOUNTS AND FACE PLATES FOR MOBILE PHONES, SMARTPHONES, CELLULAR PHONES AND PERSONAL DIGITAL ASSISTANTS, REPLACEMENT PARTS THEREFOR, BATTERIES, BATTERY CHARGER ADAPTORS, BATTERY CHARGERS, CASES, POUCHES SPECIFICALLY ADAPTED FOR CARRYING MOBILE PHONES, SMARTPHONES, CELLULAR PHONES AND PERSONAL DIGITAL ASSISTANTS, IN-VEHICLE BATTERY CHARGERS AND IN-VEHICLE HOLDERS, IN CLASS 9 (U.S. CLS. 21, 23, 26, 36 AND 38).

FIRST USE 6-15-2011; IN COMMERCE 6-15-2011.

THE MARK CONSISTS OF STANDARD CHARACTERS WITHOUT CLAIM TO ANY PARTICULAR FONT, STYLE, SIZE, OR COLOR.

OWNER OF U.S. REG. NOS. 3,584,880, 3,819,603, AND 3,890,684.

SN 85-221,275, FILED 1-19-2011.

DANNEAN HETZEL, EXAMINING ATTORNEY



David J. Kyffers

Director of the United States Patent and Trademark Office

United States of America

United States Patent and Trademark Office

HTC SENSATION

Reg. No. 4,100,121

Registered Feb. 14, 2012

Int. Cl.: 9

TRADEMARK

PRINCIPAL REGISTER

HTC CORPORATION (TAIWAN CORPORATION)
NO. 23, XINGHUA ROAD
TAOYUAN CITY, TAIWAN

FOR: MOBILE PHONES, SMARTPHONES, CELLULAR PHONES AND PERSONAL DIGITAL ASSISTANTS AND WIRELESS HANDHELD DIGITAL ELECTRONIC DEVICES FOR COMMUNICATING, RECORDING, ORGANIZING, TRANSMITTING, MANIPULATING, STORING, AND REVIEWING TEXT, DATA, IMAGE, AND AUDIO FILES, IN CLASS 9 (U.S. CLS. 21, 23, 26, 36 AND 38).

FIRST USE 6-15-2011; IN COMMERCE 6-15-2011.

THE MARK CONSISTS OF STANDARD CHARACTERS WITHOUT CLAIM TO ANY PARTICULAR FONT, STYLE, SIZE, OR COLOR.

OWNER OF U.S. REG. NOS. 3,584,880, 3,819,603, AND 3,890,684.

SN 85-221,280, FILED 1-19-2011.

DANNEAN HETZEL, EXAMINING ATTORNEY



David J. Kybas

Director of the United States Patent and Trademark Office

United States of America

United States Patent and Trademark Office

COMBAT MEDIC

Reg. No. 4,100,122

Registered Feb. 14, 2012

Int. Cl.: 28

TRADEMARK

PRINCIPAL REGISTER

MATTEL, INC. (DELAWARE CORPORATION)
M1-1518
333 CONTINENTAL BOULEVARD
EL SEGUNDO, CA 90245

FOR: TOY VEHICLES AND ACCESSORIES THEREFOR, IN CLASS 28 (U.S. CLS. 22, 23, 38 AND 50).

FIRST USE 12-1-2011; IN COMMERCE 12-1-2011.

THE MARK CONSISTS OF STANDARD CHARACTERS WITHOUT CLAIM TO ANY PARTICULAR FONT, STYLE, SIZE, OR COLOR.

SN 85-221,550, FILED 1-19-2011.

REBECCA EISINGER, EXAMINING ATTORNEY



David J. Kybas

Director of the United States Patent and Trademark Office

United States of America
United States Patent and Trademark Office

CITYBUG

Reg. No. 4,100,123

Registered Feb. 14, 2012

Int. Cl.: 12

TRADEMARK

PRINCIPAL REGISTER

J.D COMPONENTS CO., LTD. (TAIWAN CORPORATION)
SHOU SHUI HSIANG
NO. 80, NAN DEE LANE, SHAN HSI VILL.
CHANG HUA HSIEN, TAIWAN

FOR: VEHICLES, NAMELY, ELECTRIC CARS, ELECTRIC MOTORCYCLES, MOTORIZED AND NON-MOTORIZED SCOOTERS FOR PERSONAL TRANSPORTATION AND PERSONAL AMUSEMENT; MOTORIZED AND NON-MOTORIZED BICYCLES FOR PERSONAL TRANSPORTATION; MOTORIZED AND NON-MOTORIZED TRICYCLES FOR PERSONAL TRANSPORTATION AND PERSONAL AMUSEMENT, AND ACCESSORIES FOR THE ABOVE MENTIONED GOODS, NAMELY, FRAMES, HANDLEBARS, HANDLE BAR STEMS, SADDLES, PEDALS, KICKSTANDS, WHEEL RIMS, SEAT POSTS, SEAT POST CLAMPS, HANDLE BAR ENDS, AND QUICK RELEASE BRAKES, IN CLASS 12 (U.S. CLS. 19, 21, 23, 31, 35 AND 44).

FIRST USE 3-16-2011; IN COMMERCE 11-30-2011.

OWNER OF U.S. REG. NOS. 2,603,402 AND 2,941,175.

THE MARK CONSISTS OF A STYLIZED WORD FOR "CITYBUG"; THERE IS NO SPACE BETWEEN THE LETTERS "T" AND "Y".

SN 85-223,417, FILED 1-21-2011.

KRISTIN CARLSON, EXAMINING ATTORNEY



David J. Kybas

Director of the United States Patent and Trademark Office

United States of America

United States Patent and Trademark Office

SENSIBLES

Reg. No. 4,100,124

HUHTAMAKI, INC. (KANSAS CORPORATION)
9201 PACKAGING DRIVE
DESOTO, KS 66018

Registered Feb. 14, 2012

Int. Cl.: 21

FOR: DISPOSABLE PAPER PLATES, IN CLASS 21 (U.S. CLS. 2, 13, 23, 29, 30, 33, 40 AND 50).

TRADEMARK

FIRST USE 9-1-2011; IN COMMERCE 9-1-2011.

PRINCIPAL REGISTER

THE MARK CONSISTS OF STANDARD CHARACTERS WITHOUT CLAIM TO ANY PARTICULAR FONT, STYLE, SIZE, OR COLOR.

SN 85-223,557, FILED 1-21-2011.

LINDA M. KING, EXAMINING ATTORNEY



David J. Kyffers

Director of the United States Patent and Trademark Office

United States of America

United States Patent and Trademark Office



Reg. No. 4,100,125

SUPERPUMPER, INC. (NORTH DAKOTA CORPORATION)
100 27TH ST. NE
MINOT, ND 58703

Registered Feb. 14, 2012

Int. Cls.: 35 and 37

FOR: RETAIL CONVENIENCE STORE SERVICES, IN CLASS 35 (U.S. CLS. 100, 101 AND 102).

SERVICE MARK

FIRST USE 1-19-2011; IN COMMERCE 1-19-2011.

PRINCIPAL REGISTER

FOR: VEHICLE SERVICE STATION SERVICES, IN CLASS 37 (U.S. CLS. 100, 103 AND 106).

FIRST USE 1-19-2011; IN COMMERCE 1-19-2011.

OWNER OF U.S. REG. NOS. 1,611,556, 2,805,415, AND OTHERS.

NO CLAIM IS MADE TO THE EXCLUSIVE RIGHT TO USE "STATIONS", APART FROM THE MARK AS SHOWN.

THE MARK CONSISTS OF A CAPED CHARACTER FORMED BY A GAS STATION PUMP TO THE LEFT OF THE TERM "SPF STATIONS". THE NOZZLE AND HOSE FROM THE PUMP ARE ENCIRCLING THE TERMS "SPF STATIONS". THE CHARACTER IS POINTING TO STARS TO THE LEFT OF THE GAS PUMP NOZZLE. THERE IS A DROP OF GASOLINE COMING OUT OF THE NOZZLE.

SN 85-225,117, FILED 1-25-2011.

JOHN GARTNER, EXAMINING ATTORNEY



David J. Kybas

Director of the United States Patent and Trademark Office

United States of America

United States Patent and Trademark Office

HETOK

Reg. No. 4,100,126

Registered Feb. 14, 2012

Int. Cl.: 8

TRADEMARK

PRINCIPAL REGISTER

CHEWREN INDUSTRY CO., LTD. (TAIWAN CORPORATION)
TA-LI INDUSTRIAL PARK
NO. 128, 11TH ROAD, TA-LI DISTRICT
TAICHUNG CITY, TAIWAN

FOR: HAND TOOLS AND HAND TOOL ACCESSORIES, NAMELY, MANUALLY OPERATED SCREWDRIVERS, SOCKETS, WRENCHES, RATCHET WRENCHES, BITS FOR HAND DRILLS, HOLLOWING BITS FOR HAND DRILLS, PERFORATING TOOLS, TONGS, DRILL HOLDERS, DRILLS, HAMMERS, RATCHETS, SAWS, SPANNERS, PLIERS, NIPPERS, SCISSORS AND DRILLS, COMBINATION WRENCHES, TUBE CUTTERS, HEAVY-DUTY PRYBARS, BRANDING HAND TOOLS, BRANDING IRONS, IN CLASS 8 (U.S. CLS. 23, 28 AND 44).

FIRST USE 1-26-2011; IN COMMERCE 1-26-2011.

THE MARK CONSISTS OF STANDARD CHARACTERS WITHOUT CLAIM TO ANY PARTICULAR FONT, STYLE, SIZE, OR COLOR.

THE WORDING "HETOK" HAS NO MEANING IN A FOREIGN LANGUAGE.

SN 85-226,477, FILED 1-26-2011.

LINDA LAVACHE, EXAMINING ATTORNEY



David J. Kypos

Director of the United States Patent and Trademark Office

United States of America

United States Patent and Trademark Office

PLAY NOW

Reg. No. 4,100,127

DAVIS, LOCKE (UNITED STATES INDIVIDUAL)
2116 MCCALLIE AVENUE
CHATTANOOGA, TN 374043118

Registered Feb. 14, 2012

Int. Cl.: 10

FOR: MEDICAL DEVICES, NAMELY, ANKLE FOOT ORTHOSES, IN CLASS 10 (U.S. CLS. 26, 39 AND 44).

TRADEMARK

FIRST USE 8-5-2011; IN COMMERCE 8-5-2011.

PRINCIPAL REGISTER

THE MARK CONSISTS OF STANDARD CHARACTERS WITHOUT CLAIM TO ANY PARTICULAR FONT, STYLE, SIZE, OR COLOR.

SN 85-226,685, FILED 1-26-2011.

ELLEN BURNS, EXAMINING ATTORNEY



David J. Kyffers

Director of the United States Patent and Trademark Office

United States of America

United States Patent and Trademark Office

PLAYNOW

Reg. No. 4,100,128

DAVIS, LOCKE (UNITED STATES INDIVIDUAL)
2116 MCCALLIE AVENUE
CHATTANOOGA, TN 374043118

Registered Feb. 14, 2012

Int. Cl.: 10

FOR: MEDICAL DEVICES, NAMELY, ANKLE FOOT ORTHOSES, IN CLASS 10 (U.S. CLS. 26, 39 AND 44).

TRADEMARK

FIRST USE 8-5-2011; IN COMMERCE 8-5-2011.

PRINCIPAL REGISTER

THE MARK CONSISTS OF STANDARD CHARACTERS WITHOUT CLAIM TO ANY PARTICULAR FONT, STYLE, SIZE, OR COLOR.

SN 85-226,742, FILED 1-26-2011.

ELLEN BURNS, EXAMINING ATTORNEY



David J. Kybas

Director of the United States Patent and Trademark Office

United States of America

United States Patent and Trademark Office



Reg. No. 4,100,129

Registered Feb. 14, 2012

Int. Cl.: 44

SERVICE MARK

PRINCIPAL REGISTER

BIANCO, PAT (UNITED STATES INDIVIDUAL)
331 INDIAN TRAIN DRIVE
FRANKLIN LAKES, NJ 07417 AND

QUINN, JOHN C. (UNITED STATES INDIVIDUAL)
437 HARRISTOWN RD.
GLEN ROCK, NJ 07452

FOR: WELLNESS AND HEALTH-RELATED CONSULTING SERVICES, FEATURING CONSULTATION IN THE AREAS OF PREVENTATIVE MEDICINE AND THE ROLE OF NUTRITION, NUTRACEUTICALS, HORMONE REPLACEMENT THERAPY, BIOIDENTICAL HORMONE REPLACEMENT THERAPY, AND FITNESS IN A HEALTHY LIFESTYLE, IN CLASS 44 (U.S. CLS. 100 AND 101).

FIRST USE 11-15-2011; IN COMMERCE 11-15-2011.

NO CLAIM IS MADE TO THE EXCLUSIVE RIGHT TO USE "HEALTH MANAGEMENT, LLC", APART FROM THE MARK AS SHOWN.

THE COLOR(S) PURPLE, LIGHT PURPLE, DARK PURPLE, BLACK AND WHITE IS/ARE CLAIMED AS A FEATURE OF THE MARK.

THE MARK CONSISTS OF A BLACK SQUARE AND WITHIN THE BLACK SQUARE A FIRST PARTIAL PURPLE ELLIPSE WITH THE WORD "PRESCIENCE" IN WHITE LETTERS WITHIN THE FIRST PARTIAL PURPLE ELLIPSE, A WHITE PARTIAL ELLIPSE, A SECOND PARTIAL PURPLE ELLIPSE, A LIGHT PURPLE PARTIAL ELLIPSE, A THIRD PARTIAL PURPLE ELLIPSE, A DARK PURPLE PARTIAL ELLIPSE, A FOURTH PARTIAL PURPLE ELLIPSE, AND ON THE OUTSIDE BOTTOM PORTION OF THE BLACK SQUARE THE WORDS "HEALTH MANAGEMENT, LLC." IN PURPLE LETTERING.

SN 85-226,864, FILED 1-26-2011.

MARC LEIPZIG, EXAMINING ATTORNEY



David J. Kyffers

Director of the United States Patent and Trademark Office

United States of America

United States Patent and Trademark Office

Stuck here on purpose.

Reg. No. 4,100,130

SUITE P INC. (NORTH CAROLINA CORPORATION)

Registered Feb. 14, 2012

P.O. BOX 7100
KILL DEVIL HILLS, NC 27948

Int. Cl.: 16

FOR: GENERAL FEATURE MAGAZINE IN THE FIELD OF COASTAL LIFESTYLE, IN CLASS 16 (U.S. CLS. 2, 5, 22, 23, 29, 37, 38 AND 50).

TRADEMARK

FIRST USE 5-1-2011; IN COMMERCE 9-1-2011.

PRINCIPAL REGISTER

THE MARK CONSISTS OF STANDARD CHARACTERS WITHOUT CLAIM TO ANY PARTICULAR FONT, STYLE, SIZE, OR COLOR.

SN 85-226,934, FILED 1-26-2011.

SIMON TENG, EXAMINING ATTORNEY



David J. Kybas

Director of the United States Patent and Trademark Office

United States of America

United States Patent and Trademark Office

FOREVERMARK CABINETRY

Reg. No. 4,100,131

SHEK, JOANNA (UNITED STATES INDIVIDUAL)
13 STEPHENVILLE PARKWAY
EDISON, NJ 08820

Registered Feb. 14, 2012

Int. Cl.: 20

FOR: CABINETS, IN CLASS 20 (U.S. CLS. 2, 13, 22, 25, 32 AND 50).

TRADEMARK

FIRST USE 1-26-2011; IN COMMERCE 1-26-2011.

PRINCIPAL REGISTER

THE MARK CONSISTS OF STANDARD CHARACTERS WITHOUT CLAIM TO ANY PARTICULAR FONT, STYLE, SIZE, OR COLOR.

NO CLAIM IS MADE TO THE EXCLUSIVE RIGHT TO USE "CABINETRY", APART FROM THE MARK AS SHOWN.

SN 85-227,295, FILED 1-27-2011.

ANDREA HACK, EXAMINING ATTORNEY



David J. Kyffers

Director of the United States Patent and Trademark Office

United States of America

United States Patent and Trademark Office

CARE & LEARN TEDDY

Reg. No. 4,100,132

Registered Feb. 14, 2012

Int. Cl.: 28

TRADEMARK

PRINCIPAL REGISTER

VTECH ELECTRONICS NORTH AMERICA, LLC (DELAWARE LIMITED LIABILITY COMPANY)
1155 DUNDEE ROAD
ARLINGTON HEIGHTS, IL 60004

FOR: ELECTRONIC LEARNING TOYS; INFANT DEVELOPMENT TOYS; INFANT TOYS; MUSICAL TOYS; STUFFED AND PLUSH TOYS, IN CLASS 28 (U.S. CLS. 22, 23, 38 AND 50).

FIRST USE 4-28-2011; IN COMMERCE 4-28-2011.

THE MARK CONSISTS OF STANDARD CHARACTERS WITHOUT CLAIM TO ANY PARTICULAR FONT, STYLE, SIZE, OR COLOR.

NO CLAIM IS MADE TO THE EXCLUSIVE RIGHT TO USE "TEDDY", APART FROM THE MARK AS SHOWN.

SN 85-227,765, FILED 1-27-2011.

JEFF DEFORD, EXAMINING ATTORNEY



David J. Kybas

Director of the United States Patent and Trademark Office

United States of America

United States Patent and Trademark Office

BLUE CLEANING

Reg. No. 4,100,133

Registered Feb. 14, 2012

Int. Cl.: 37

SERVICE MARK

PRINCIPAL REGISTER

ARAMARK CORPORATION (DELAWARE CORPORATION)
29TH FLOOR
1101 MARKET STREET
PHILADELPHIA, PA 19107

FOR: JANITORIAL SERVICES, CUSTODIAL SERVICES, NAMELY, CLEANING OF BUILDINGS, AND BUILDING MAINTENANCE SERVICE, IN CLASS 37 (U.S. CLS. 100, 103 AND 106).

FIRST USE 4-22-2011; IN COMMERCE 4-22-2011.

THE MARK CONSISTS OF STANDARD CHARACTERS WITHOUT CLAIM TO ANY PARTICULAR FONT, STYLE, SIZE, OR COLOR.

NO CLAIM IS MADE TO THE EXCLUSIVE RIGHT TO USE "CLEANING", APART FROM THE MARK AS SHOWN.

SN 85-227,941, FILED 1-27-2011.

BARBARA BROWN, EXAMINING ATTORNEY



David J. Kybas

Director of the United States Patent and Trademark Office

United States of America

United States Patent and Trademark Office

SIZZLING STONE KOREAN BISTRO

Reg. No. 4,100,134

SVC INVESTMENTS, INC. (CALIFORNIA CORPORATION)
1468 ZEPHYR AVE.
HAYWARD, CA 94544

Registered Feb. 14, 2012

Int. Cl.: 43

FOR: RESTAURANT SERVICES FEATURING ASIAN CUISINE, IN CLASS 43 (U.S. CLS. 100 AND 101).

SERVICE MARK

FIRST USE 11-12-2011; IN COMMERCE 11-12-2011.

PRINCIPAL REGISTER

THE MARK CONSISTS OF STANDARD CHARACTERS WITHOUT CLAIM TO ANY PARTICULAR FONT, STYLE, SIZE, OR COLOR.

NO CLAIM IS MADE TO THE EXCLUSIVE RIGHT TO USE "KOREAN BISTRO", APART FROM THE MARK AS SHOWN.

SN 85-228,932, FILED 1-28-2011.

DAVID HOFFMAN, EXAMINING ATTORNEY



David J. Kyfos

Director of the United States Patent and Trademark Office

United States of America

United States Patent and Trademark Office

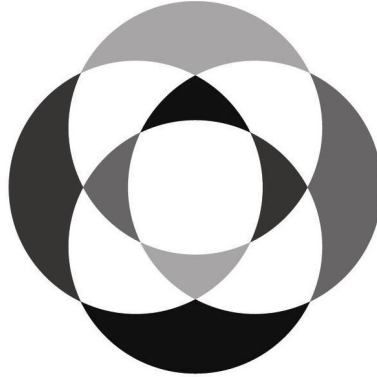

Reg. No. 4,100,135

Registered Feb. 14, 2012

Int. Cls.: 9 and 38

TRADEMARK

SERVICE MARK

PRINCIPAL REGISTER

GREATCALL, INC. (DELAWARE CORPORATION)
12680 HIGH BLUFF DRIVE, SUITE 310
SAN DIEGO, CA 92130

FOR: CELLULAR TELEPHONES, BATTERIES FOR CELLULAR TELEPHONES, CARRYING CASES SPECIALLY ADAPTED FOR CELLULAR PHONES AND EQUIPMENT THEREFOR, TRAVEL AND DESKTOP CHARGERS FOR BATTERIES FOR CELLULAR TELEPHONES, HANDS-FREE CELLULAR PHONES, SPEAKER PHONES, HANDS-FREE CAR KITS FOR CELLULAR TELEPHONES COMPRISED PRIMARILY OF A MICROPHONE, EXTERNAL AUDIO SPEAKER, POWER CABLES, TELEPHONE HANDSET CRADLE, AND MOUNTING BRACKETS, IN CLASS 9 (U.S. CLS. 21, 23, 26, 36 AND 38).

FIRST USE 9-12-2010; IN COMMERCE 9-12-2010.

FOR: TELECOMMUNICATIONS SERVICES, NAMELY, CELLULAR TELEPHONE SERVICES, LONG-DISTANCE TELEPHONE COMMUNICATION SERVICES, ELECTRONIC VOICE AND DATA TRANSMISSION SERVICES, AND PROVIDING SPECIALIZED TELEPHONE COMMUNICATION SERVICES FEATURING CUSTOM CALLING FEATURES AND TELEPHONE CALLING PLANS, IN CLASS 38 (U.S. CLS. 100, 101 AND 104).

FIRST USE 9-12-2010; IN COMMERCE 9-12-2010.

THE MARK CONSISTS OF ADJOINING SHAPES COMBINED TO FORM A CIRCLE ENCOMPASSING A SMALLER SQUARE WITHIN THAT CIRCLE.

SN 85-229,305, FILED 1-28-2011.

ELIZABETH HUGHITT, EXAMINING ATTORNEY



David J. Kybas

Director of the United States Patent and Trademark Office

United States of America

United States Patent and Trademark Office

INNOTAB

Reg. No. 4,100,136

Registered Feb. 14, 2012

Int. Cls.: 9 and 28

TRADEMARK

PRINCIPAL REGISTER

VTECH ELECTRONICS NORTH AMERICA, LLC (DELAWARE LIMITED LIABILITY COMPANY)
1155 DUNDEE ROAD
ARLINGTON HEIGHTS, IL 60004

FOR: CHILDREN'S EDUCATIONAL SOFTWARE; COMPUTER GAME PROGRAMS; COMPUTER GAME SOFTWARE; COMPUTERS; TABLET COMPUTER, IN CLASS 9 (U.S. CLS. 21, 23, 26, 36 AND 38).

FIRST USE 9-6-2011; IN COMMERCE 9-6-2011.

FOR: ELECTRONIC EDUCATIONAL GAME MACHINES FOR CHILDREN; ELECTRONIC GAMES FOR THE TEACHING OF CHILDREN; ELECTRONIC LEARNING TOYS; HAND HELD UNITS FOR PLAYING ELECTRONIC GAMES OTHER THAN THOSE ADAPTED FOR USE WITH AN EXTERNAL DISPLAY SCREEN OR MONITOR, IN CLASS 28 (U.S. CLS. 22, 23, 38 AND 50).

FIRST USE 9-6-2011; IN COMMERCE 9-6-2011.

THE MARK CONSISTS OF STANDARD CHARACTERS WITHOUT CLAIM TO ANY PARTICULAR FONT, STYLE, SIZE, OR COLOR.

SN 85-229,474, FILED 1-29-2011.

JEFF DEFORD, EXAMINING ATTORNEY



David J. Kybas

Director of the United States Patent and Trademark Office

United States of America

United States Patent and Trademark Office

AFFLICTION

Reg. No. 4,100,137

AFFLICTION HOLDINGS LLC (CALIFORNIA LIMITED LIABILITY COMPANY)
1799 APOLLO COURT
SEAL BEACH, CA 90740

Registered Feb. 14, 2012

Int. Cls.: 25 and 26

FOR: BELTS, WRISTBANDS, WRIST BANDS, HEADGEAR, NAMELY, HATS, CAPS, BEANIES, AND VISORS, IN CLASS 25 (U.S. CLS. 22 AND 39).

TRADEMARK

FIRST USE 1-1-2006; IN COMMERCE 1-1-2006.

PRINCIPAL REGISTER

FOR: BELT BUCKLES, IN CLASS 26 (U.S. CLS. 37, 39, 40, 42 AND 50).

FIRST USE 1-1-2006; IN COMMERCE 1-1-2006.

THE MARK CONSISTS OF STANDARD CHARACTERS WITHOUT CLAIM TO ANY PARTICULAR FONT, STYLE, SIZE, OR COLOR.

OWNER OF U.S. REG. NOS. 3,109,069, 3,773,491, AND OTHERS.

SN 85-229,616, FILED 1-30-2011.

WENDY JUN, EXAMINING ATTORNEY



David J. Kyffers

Director of the United States Patent and Trademark Office

United States of America

United States Patent and Trademark Office

★ EAT BECAUSE ★

WOODSTOCK

★ IT'S GOOD! ★

Reg. No. 4,100,138

Registered Feb. 14, 2012

Int. Cl.: 4

TRADEMARK

PRINCIPAL REGISTER

UNITED NATURAL FOODS, INC. (DELAWARE CORPORATION)
313 IRON HORSE WAY
PROVIDENCE, RI 02908

FOR: CHARCOAL, IN CLASS 4 (U.S. CLS. 1, 6 AND 15).

FIRST USE 5-0-2011; IN COMMERCE 5-0-2011.

OWNER OF U.S. REG. NO. 1,487,657.

THE MARK CONSISTS OF THE WORDING "EAT BECAUSE" BETWEEN TWO ASTERISKS ABOVE THE WORD "WOODSTOCK" AND THE WORDING "IT'S GOOD!" BETWEEN TWO ASTERISKS BELOW THE WORD "WOODSTOCK".

SN 85-230,668, FILED 1-31-2011.

ELIZABETH KAJUBI, EXAMINING ATTORNEY



David J. Kyffers

Director of the United States Patent and Trademark Office

United States of America

United States Patent and Trademark Office

WOODSTOCK

Reg. No. 4,100,139

Registered Feb. 14, 2012

Int. Cl.: 4

TRADEMARK

PRINCIPAL REGISTER

UNITED NATURAL FOODS, INC. (DELAWARE CORPORATION)
313 IRON HORSE WAY
PROVIDENCE, RI 02908

FOR: CHARCOAL, IN CLASS 4 (U.S. CLS. 1, 6 AND 15).

FIRST USE 5-0-2011; IN COMMERCE 5-0-2011.

THE MARK CONSISTS OF STANDARD CHARACTERS WITHOUT CLAIM TO ANY PARTICULAR FONT, STYLE, SIZE, OR COLOR.

OWNER OF U.S. REG. NOS. 1,487,657, 3,458,482, AND 3,619,430.

SN 85-230,671, FILED 1-31-2011.

ELIZABETH KAJUBI, EXAMINING ATTORNEY



David J. Kyffers

Director of the United States Patent and Trademark Office

United States of America

United States Patent and Trademark Office

PermaFlat

Reg. No. 4,100,140

Registered Feb. 14, 2012

Int. Cl.: 16

TRADEMARK

PRINCIPAL REGISTER

DACASSO LIMITED, INC. (FLORIDA CORPORATION)
2350 NW 71ST PLACE SUITE B
GAINESVILLE, FL 32653

FOR: DESK BLOTTERS, IN CLASS 16 (U.S. CLS. 2, 5, 22, 23, 29, 37, 38 AND 50).

FIRST USE 5-31-2011; IN COMMERCE 5-31-2011.

THE MARK CONSISTS OF STANDARD CHARACTERS WITHOUT CLAIM TO ANY PARTICULAR FONT, STYLE, SIZE, OR COLOR.

SN 85-230,738, FILED 1-31-2011.

NAPOLEON SHARMA, EXAMINING ATTORNEY



David J. Kyffers

Director of the United States Patent and Trademark Office

United States of America

United States Patent and Trademark Office

TOWHEAD SALSA

Reg. No. 4,100,141

KUHLMAN, KIRK (UNITED STATES INDIVIDUAL)
1848 COUNTY ROAD 1198
TUTTLE, OK 73089

Registered Feb. 14, 2012

Int. Cl.: 30

FOR: FOOD CONDIMENT CONSISTING PRIMARILY OF KETCHUP AND SALSA; SALSA;
TOMATO-BASED SALSA, IN CLASS 30 (U.S. CL. 46).

TRADEMARK

FIRST USE 10-15-2011; IN COMMERCE 11-5-2011.

PRINCIPAL REGISTER

THE MARK CONSISTS OF STANDARD CHARACTERS WITHOUT CLAIM TO ANY PARTICULAR FONT, STYLE, SIZE, OR COLOR.

NO CLAIM IS MADE TO THE EXCLUSIVE RIGHT TO USE "SALSA", APART FROM THE MARK AS SHOWN.

SN 85-231,347, FILED 2-1-2011.

BRIAN CALLAGHAN, EXAMINING ATTORNEY



David J. Kyffers

Director of the United States Patent and Trademark Office

United States of America

United States Patent and Trademark Office



contributing to life

Reg. No. 4,100,142

Registered Feb. 14, 2012

Int. Cl.: 41

SERVICE MARK

PRINCIPAL REGISTER

FLOYD JR, CARL ANTHONY (UNITED STATES INDIVIDUAL)
900 HARGROVE ROAD APT. 50
TUSCALOOSA, AL 35401

FOR: ARRANGING AND CONDUCTING EDUCATIONAL CONFERENCES; CAREER COUNSELING; CHARITABLE SERVICES, NAMELY, PROVIDING ARTS AND CRAFTS AND EDUCATIONAL MATERIALS IN THE NATURE OF RECYCLED MANUFACTURING BY-PRODUCTS TO NEEDY AND UNDERPRIVILEGED CHILDREN; CHILDREN'S EDUCATIONAL SERVICES, NAMELY, PROVIDING ACADEMIC PERFORMANCE EVALUATION, GUIDANCE AND MONITORING FOR CHILDREN PRE-KINDERGARTEN THROUGH GRADE 12 VIA THE INTERNET; COMPUTER EDUCATION TRAINING; CONSULTATION IN THE FIELD OF K-12 EDUCATIONAL SYSTEMS; EDUCATION SERVICES IN THE NATURE OF COURSES AT THE UNIVERSITY LEVEL; EDUCATION SERVICES, NAMELY, ONE-ON-ONE MENTORING IN THE FIELDS OF MUSIC, ART, DANCE, LIFE SKILLS AND LEADERSHIP DEVELOPMENT, GOAL SETTING, AND ENTREPRENEURSHIP.; EDUCATION SERVICES, NAMELY, PRE-KINDERGARTEN THROUGH 12TH GRADE CLASSROOM INSTRUCTION, VOCATIONAL INSTRUCTION, MENTORING, TUTORING, CLASSES, SEMINARS AND WORKSHOPS FOR INDIVIDUALS WITH AUTISM AND OTHER DEVELOPMENTAL DISORDERS; EDUCATION SERVICES, NAMELY, PROVIDING CLASSES, SEMINARS, WORKSHOPS, TUTORING, AND MENTORING IN THE FIELD OF MIDDLE AND HIGH SCHOOL REFORM; EDUCATION SERVICES, NAMELY, PROVIDING HANDS-ON OPPORTUNITIES FOR CHILDREN IN THE FIELD OF INTUITIVE ENGINEERING THROUGH LIVE, BROADCAST, AND ON-LINE CLASSES, SEMINARS, WORKSHOPS, TRAINING AND CURRICULUM DEVELOPMENT FOR CHILDREN, PARENTS AND EDUCATORS; EDUCATION SERVICES, NAMELY, PROVIDING MENTORING, TUTORING, CLASSES, SEMINARS AND WORKSHOPS IN THE FIELD OF MUSIC, ART, DANCE, LIFE SKILLS AND LEADERSHIP DEVELOPMENT, GOAL SETTING, AND ENTREPRENEURSHIP.; EDUCATIONAL AND ENTERTAINMENT SERVICES, NAMELY, PROVIDING A VOLUNTEER PROGRAM FEATURING RECREATIONAL ACTIVITIES, LITERACY TRAINING, ART EVENTS, AND SPORTING EVENTS FOR CHILDREN IN FOSTER CARE; EDUCATIONAL AND ENTERTAINMENT SERVICES, NAMELY, PROVIDING MOTIVATIONAL AND EDUCATIONAL SPEAKERS; EDUCATIONAL AND ENTERTAINMENT SERVICES, NAMELY, PROVIDING MOTIVATIONAL AND EDUCATIONAL SPEAKERS IN THE FIELD OF SELF- AND PERSONAL IMPROVEMENT; EDUCATIONAL COUNSELING SERVICES TO ASSIST STUDENTS IN PLANNING AND PREPARING FOR FURTHER EDUCATION; EDUCATIONAL COURSE MONITORING, NAMELY, TRACKING STUDENT PERFORMANCE; EDUCATIONAL SERVICES IN THE NATURE OF CHARTER SCHOOLS; EDUCATIONAL SERVICES, NAMELY,



David J. Kybas

Director of the United States Patent and Trademark Office

Reg. No. 4,100,142 A LEARNING AND INNOVATION CENTER FEATURING FULLY CUSTOMIZED LEADERSHIP, MOTIVATIONAL, EDUCATIONAL, AND BRAINSTORMING TRAINING; EDUCATIONAL SERVICES, NAMELY, CONDUCTING CHESS CLASSES BY MEANS OF A CHESS CLUB; EDUCATIONAL SERVICES, NAMELY, CONDUCTING SEMINARS, LECTURES, TELESEMINARS, TELECLASSES, AND WORKSHOPS IN PERSONAL AWARENESS; EDUCATIONAL SERVICES, NAMELY, DEVELOPING AND CONDUCTING TRAINING COURSES AND DISTRIBUTION OF TRAINING MATERIALS IN CONNECTION THEREWITH FOR SUBJECT MATTERS AS REQUESTED BY CUSTOMERS; EDUCATIONAL SERVICES, NAMELY, DEVELOPING AND CONDUCTING WORKOUTS, WORKSHOPS, PRESENTATIONS, RETREATS, AND PERSONAL TRAINING IN RIGHT-BRAIN FITNESS; EDUCATIONAL SERVICES, NAMELY, PROVIDING A READING PROGRAM DESIGNED TO MOTIVATE CHILDREN TO READ; ENCOURAGING AMATEUR SPORTS AND PHYSICAL EDUCATION BY ORGANIZING, SANCTIONING, CONDUCTING, REGULATING AND GOVERNING AMATEUR ATHLETIC PROGRAMS AND ACTIVITIES; ENTERTAINMENT AND EDUCATION SERVICES IN THE NATURE OF LIVE DANCE AND MUSICAL PERFORMANCES; ENTERTAINMENT AND EDUCATION SERVICES, NAMELY, PROVIDING RECOGNITION AND INCENTIVES BY WAY OF CELEBRATIONS AND AWARDS TO GIRLS FROM UNDERSERVED COMMUNITIES WHO HAVE COMPLETED THEIR HIGH SCHOOL CAREERS SUCCESSFULLY AND WHO ARE GOING ON TO COLLEGE; ENTERTAINMENT AND EDUCATIONAL SERVICES, NAMELY, PROVIDING A WEBSITE THAT DISPLAYS VARIOUS REQUESTS, REVIEWS, RECOMMENDATIONS, RANKINGS, TRACKINGS, VOTES, AND INFORMATION RELATING TO UNCREATED, UNRELEASED, NEW, SPECIAL, POPULAR, AND RARE PRODUCTS, SERVICES, AND EVENTS IN THE FIELDS OF POP CULTURE, ENTERTAINMENT, EDUCATION, AND SPORTS, ALL EXCLUSIVELY FOR NON-BUSINESS AND NON-COMMERCIAL TRANSACTIONS AND PURPOSES; ENTERTAINMENT AND EDUCATIONAL SERVICES, NAMELY, PROVIDING ADVICE AND INFORMATION FOR MUSIC, VIDEO AND FILM CONCEPT AND SCRIPT DEVELOPMENT; INFORMATION ABOUT EDUCATION; INFORMATION IN THE FIELD OF PARENTING CONCERNING EDUCATION OF CHILDREN; ORGANIZATION OF EXHIBITIONS FOR CULTURAL OR EDUCATIONAL PURPOSES; PHYSICAL EDUCATION; PHYSICAL EDUCATION SERVICES; PROVIDING AFTER SCHOOL EDUCATIONAL PROGRAMS FOR CHILDREN IN GRADES 3-8 AND PLAY FACILITIES FOR CHILDREN; PROVIDING FACILITIES FOR MOVIES, SHOWS, PLAYS, MUSIC OR EDUCATIONAL TRAINING; PROVIDING INFORMATION IN THE FIELD OF LITERACY, READING, SIGN LANGUAGE, EDUCATION, TRAINING, EARLY CHILDHOOD INSTRUCTION AND TUTORING RELATED TO HEARING AND SPEECH DISABILITIES VIA THE INTERNET, IN CLASS 41 (U.S. CLS. 100, 101 AND 107).

FIRST USE 9-30-2010; IN COMMERCE 9-30-2010.

THE MARK CONSISTS OF WHITE BACKGROUND WITH TWO BLACK ARROWS POINTING INWARD AT A GOLD STAR IN THE MIDDLE.

THE COLOR(S) BLACK, WHITE, AND GOLD IS/ARE CLAIMED AS A FEATURE OF THE MARK.

SN 85-231,874, FILED 2-1-2011.

JAY FLOWERS, EXAMINING ATTORNEY

United States of America

United States Patent and Trademark Office



Reg. No. 4,100,143

MANUEL TORRES (UNITED STATES INDIVIDUAL), DBA SWINGLOW,
250 STERN DR.

Registered Feb. 14, 2012

EL PASO, TX 79932

Int. Cl.: 35

FOR: ON-LINE RETAIL STORE SERVICES FEATURING A WIDE VARIETY OF CONSUMER GOODS OF OTHERS; ON-LINE RETAIL STORE SERVICES FEATURING CLOTHING, GOLF ACCESSORIES; ON-LINE WHOLESALE AND RETAIL STORE SERVICES FEATURING CLOTHING, GOLF ACCESSORIES; RETAIL STORE AND ON-LINE RETAIL STORE SERVICES FEATURING CLOTHING, GOLF ACCESSORIES; RETAIL STORE SERVICES FEATURING CLOTHING, GOLF ACCESSORIES; WHOLESALE AND RETAIL STORE SERVICES AND ON-LINE RETAIL AND WHOLESALE STORE SERVICES FEATURING CLOTHING, GOLF ACCESSORIES, IN CLASS 35 (U.S. CLS. 100, 101 AND 102).

SERVICE MARK

PRINCIPAL REGISTER

FIRST USE 4-22-2011; IN COMMERCE 4-22-2011.

THE MARK CONSISTS OF A GOLFER WITH A BLUE BODY, A GREEN SWING PATH, RED "SWIN" LETTERS, BLUE "GLOW" AND "SHOW SOME STYLE" LETTERS.

THE COLOR(S) BLUE, GREEN, AND RED IS/ARE CLAIMED AS A FEATURE OF THE MARK.

SN 85-232,856, FILED 2-3-2011.

JANICE L. MCMORROW, EXAMINING ATTORNEY



David J. Kybas

Director of the United States Patent and Trademark Office

United States of America

United States Patent and Trademark Office

APEX OVER 70 YEARS OF QUALITY

Reg. No. 4,100,144

TEKNOR APEX COMPANY (DELAWARE CORPORATION)
505 CENTRAL AVE.

Registered Feb. 14, 2012

PAWTUCKET, RI 02861

Int. Cl.: 17

FOR: GARDEN HOSES; WATERING HOSES, IN CLASS 17 (U.S. CLS. 1, 5, 12, 13, 35 AND 50).

TRADEMARK

FIRST USE 9-30-2011; IN COMMERCE 9-30-2011.

PRINCIPAL REGISTER

THE MARK CONSISTS OF STANDARD CHARACTERS WITHOUT CLAIM TO ANY PARTICULAR FONT, STYLE, SIZE, OR COLOR.

OWNER OF U.S. REG. NOS. 1,633,203 AND 3,496,603.

SN 85-232,911, FILED 2-3-2011.

PAM WILLIS, EXAMINING ATTORNEY



David J. Kyffers

Director of the United States Patent and Trademark Office

United States of America

United States Patent and Trademark Office

 URComfort

Reg. No. 4,100,145

TROPITONE FURNITURE CO., INC. (FLORIDA CORPORATION)

Registered Feb. 14, 2012

5 MARCONI
IRVINE, CA 92618

Int. Cl.: 20

FOR: FURNITURE; INDOOR AND OUTDOOR SEATING FURNITURE, IN CLASS 20 (U.S. CLS. 2, 13, 22, 25, 32 AND 50).

TRADEMARK

FIRST USE 11-2-2011; IN COMMERCE 11-2-2011.

PRINCIPAL REGISTER

THE MARK CONSISTS OF A CURVED LINE ANGELES UPWARDS AT BOTH ENDS WITH A CIRCLE ABOVE THE LINE AND THE TERM "URCOMFORT" TO THE RIGHT OF THE LINE.

SN 85-233,194, FILED 2-3-2011.

TOBY BULLOFF, EXAMINING ATTORNEY



David J. Kyffers

Director of the United States Patent and Trademark Office

United States of America

United States Patent and Trademark Office



Reg. No. 4,100,146

Registered Feb. 14, 2012

Int. Cl.: 28

TRADEMARK

PRINCIPAL REGISTER

RGA DESIGN, ENTRETENIMENTO E PUBLICIDADE LTDA.-EPP (BRAZIL LIMITED LIABILITY COMPANY)
SALA 01, CIDADE UNIVERSITARIA
RUA EURICO WARDERLEIDEMORAESCARVALHO 231
CAMPINAS/SP, BRAZIL

FOR: CARD GAMES; PLAYING CARDS, IN CLASS 28 (U.S. CLS. 22, 23, 38 AND 50).

FIRST USE 7-2-2009; IN COMMERCE 7-7-2010.

NO CLAIM IS MADE TO THE EXCLUSIVE RIGHT TO USE "BEERCARDS", APART FROM THE MARK AS SHOWN.

THE MARK CONSISTS OF THE LETTERS "BC" IN STYLIZED FONT AND THREE STYLIZED RENDERINGS OF BARRELS WITHIN A SHIELD DESIGN FEATURING AN OPEN CROWN AT THE TOP AND FOUR GEOMETRIC SCROLL DESIGNS ON THE SIDES ALL ABOVE THE STYLIZED WORDS "BEERCARDS".

SN 85-233,298, FILED 2-3-2011.

DAVID YONTEF, EXAMINING ATTORNEY



David J. Kyfos

Director of the United States Patent and Trademark Office

United States of America

United States Patent and Trademark Office

THE NEW WAY TO DO ENERGY

Reg. No. 4,100,147

Registered Feb. 14, 2012

Int. Cl.: 5

TRADEMARK

PRINCIPAL REGISTER

PUREBRANDS, LLC (DELAWARE LIMITED LIABILITY COMPANY)
1040 HOLLAND DRIVE
BOCA RATON, FL 33487

FOR: DISSOLVABLE ORAL STRIPS CONTAINING NUTRIENTS FOR CENTRAL NERVOUS SYSTEM STIMULATION, VITAMIN SUPPLEMENTS, AND ANALGESICS, IN CLASS 5 (U.S. CLS. 6, 18, 44, 46, 51 AND 52).

FIRST USE 5-27-2011; IN COMMERCE 5-27-2011.

THE MARK CONSISTS OF STANDARD CHARACTERS WITHOUT CLAIM TO ANY PARTICULAR FONT, STYLE, SIZE, OR COLOR.

SN 85-233,519, FILED 2-3-2011.

TAMARA FRAZIER, EXAMINING ATTORNEY



David J. Kybas

Director of the United States Patent and Trademark Office

United States of America

United States Patent and Trademark Office

CALIFIRE GRILL

Reg. No. 4,100,148

Registered Feb. 14, 2012

Int. Cl.: 43

SERVICE MARK

PRINCIPAL REGISTER

PAMJAT, INC. (CALIFORNIA CORPORATION)
C/O BUCHALTER NEMER
1000 WILSHIRE BLVD., SUITE 1500
LOS ANGELES, CA 90017

FOR: BAR SERVICES; RESTAURANT SERVICES, IN CLASS 43 (U.S. CLS. 100 AND 101).

FIRST USE 11-15-2011; IN COMMERCE 11-15-2011.

THE MARK CONSISTS OF STANDARD CHARACTERS WITHOUT CLAIM TO ANY PARTICULAR FONT, STYLE, SIZE, OR COLOR.

NO CLAIM IS MADE TO THE EXCLUSIVE RIGHT TO USE "GRILL", APART FROM THE MARK AS SHOWN.

SN 85-234,264, FILED 2-4-2011.

FLORENTINA BLANDU, EXAMINING ATTORNEY



David J. Kyffers

Director of the United States Patent and Trademark Office

United States of America

United States Patent and Trademark Office

GEMTECH

Reg. No. 4,100,149

Registered Feb. 14, 2012

Int. Cl.: 42

SERVICE MARK

PRINCIPAL REGISTER

GEMACO INC. (MISSOURI CORPORATION)
2925 NORTH 7 HIGHWAY
BLUE SPRINGS, MO 64013

FOR: CUSTOM DESIGN OF PLASTIC COMPONENT PARTS FOR OTHERS; DESIGN OF CUSTOM MOLDS AND TOOLING FOR THE MANUFACTURE OF PLASTIC PARTS AND PRODUCTS, BUT NOT INCLUDING NETWORK CARDS, NETWORK HUBS, NETWORK ROUTERS, NETWORK RESIDENTIAL GATEWAYS, NETWORK BRIDGES, HIGH-WAVE ANTENNAS, COMMUNICATION SERVERS, COMMUNICATION APPARATUS, COMPUTER INTERFACE ELECTRIC DRIVING APPARATUS, ELECTRIC CAMERAS, VIDEO CONFERENCE EQUIPMENT, VIDEO PHONES, RADIO TRANSMITTER-RECEIVERS, RADIO RECEIVERS, RADIO TRANSMITTERS, MICROPHONES, HIGH-WAVE BOOSTERS, VIDEO TRANSMITTER-RECEIVERS, SIGNAL BOOSTERS, SIGNAL TRANSDUCERS, INFRARED EXAMINED SENSORS, SATELLITE ANTENNAS, VIDEO COMMUNICATION DEVICES, CONVERSION DEMODULATORS, DRAWING MACHINE CONTROLLER CARDS, COMPUTER SCANNERS, IN CLASS 42 (U.S. CLS. 100 AND 101).

FIRST USE 1-13-2011; IN COMMERCE 1-13-2011.

THE MARK CONSISTS OF STANDARD CHARACTERS WITHOUT CLAIM TO ANY PARTICULAR FONT, STYLE, SIZE, OR COLOR.

SN 85-234,645, FILED 2-4-2011.

SUSAN RICHARDS, EXAMINING ATTORNEY



David J. Kyffers

Director of the United States Patent and Trademark Office

United States of America

United States Patent and Trademark Office

EQUITEIN

Reg. No. 4,100,150

TECHMIX, LLC (MINNESOTA LIMITED LIABILITY COMPANY)
740 BOWMAN STREET
STEWART, MN 55385

Registered Feb. 14, 2012

Int. Cl.: 5

FOR: ANIMAL FEED SUPPLEMENTS, IN CLASS 5 (U.S. CLS. 6, 18, 44, 46, 51 AND 52).

TRADEMARK

FIRST USE 11-11-2011; IN COMMERCE 11-11-2011.

PRINCIPAL REGISTER

THE MARK CONSISTS OF STANDARD CHARACTERS WITHOUT CLAIM TO ANY PARTICULAR FONT, STYLE, SIZE, OR COLOR.

SN 85-235,005, FILED 2-5-2011.

NAPOLEON SHARMA, EXAMINING ATTORNEY



David J. Kyffers

Director of the United States Patent and Trademark Office

United States of America

United States Patent and Trademark Office



Reg. No. 4,100,151

Registered Feb. 14, 2012

Int. Cls.: 3 and 44

TRADEMARK

SERVICE MARK

PRINCIPAL REGISTER

MARSHAS M2 MAKEUP LLC (FLORIDA LIMITED LIABILITY COMPANY), DBA MARSHAS MAKEUP,
1311 NW 170 TERRACE
MIAMI, FL 33169

FOR: CLEANER FOR COSMETIC BRUSHES; COMPACTS CONTAINING MAKE-UP; COSMETICS AND MAKE-UP; EYE MAKE-UP; EYE MAKE-UP REMOVER; FACIAL MAKE-UP; FOUNDATION MAKE-UP; MAKE-UP; MAKE-UP KITS COMPRISED OF LIP STICK, FOUNDATION, EYE SHADOW, LIP GLOSS, BLUSH, EYE LINER, LIP LINER, BRONZER, CONCEALER, EYE LASHES, HIGHLIGHTERS; MAKE-UP REMOVER, IN CLASS 3 (U.S. CLS. 1, 4, 6, 50, 51 AND 52).

FIRST USE 10-31-2011; IN COMMERCE 11-2-2011.

FOR: SERVICES OF A MAKE-UP ARTIST, IN CLASS 44 (U.S. CLS. 100 AND 101).

FIRST USE 10-31-2011; IN COMMERCE 11-2-2011.

NO CLAIM IS MADE TO THE EXCLUSIVE RIGHT TO USE "MAKEUP", APART FROM THE MARK AS SHOWN.

THE MARK CONSISTS OF THE STYLIZED LETTER "M" WITH A HEART DESIGN COMING OFF OF THE FIRST STEM OF THE LETTER "M" AND WITH A STYLIZED NUMBER "2" AS A SUPERSCRIT TO THE LETTER "M". BELOW THE "M2" IS THE STYLIZED WORDING "MARSHA'S MAKEUP" AND BELOW THAT IS THE STYLIZED WORDING "UNCONDITIONAL LOVE UNDENIABLE BEAUTY". THERE ARE CIRCLES AND SWIRLS AND STARS BEHIND THE "M2" PORTION OF THE MARK IN THE BACKGROUND.

SN 85-235,051, FILED 2-5-2011.

KELLEY WELLS, EXAMINING ATTORNEY



David J. Kybas

Director of the United States Patent and Trademark Office

United States of America

United States Patent and Trademark Office

JEEP ARCTIC

Reg. No. 4,100,152

Registered Feb. 14, 2012

Int. Cl.: 12

TRADEMARK

PRINCIPAL REGISTER

CHRYSLER GROUP LLC (DELAWARE LIMITED LIABILITY COMPANY)
CIMS 485-13-32
1000 CHRYSLER GROUP LLC
AUBURN HILLS, MI 48326

FOR: MOTOR VEHICLES, NAMELY, PASSENGER AUTOMOBILES, THEIR STRUCTURAL PARTS, TRIM AND BADGES, IN CLASS 12 (U.S. CLS. 19, 21, 23, 31, 35 AND 44).

FIRST USE 10-0-2011; IN COMMERCE 10-0-2011.

THE MARK CONSISTS OF STANDARD CHARACTERS WITHOUT CLAIM TO ANY PARTICULAR FONT, STYLE, SIZE, OR COLOR.

OWNER OF U.S. REG. NOS. 820,237, 3,382,692, AND OTHERS.

SN 85-235,318, FILED 2-7-2011.

TARA PATE, EXAMINING ATTORNEY



David J. Kybas

Director of the United States Patent and Trademark Office

United States of America

United States Patent and Trademark Office

HOT BOOTIES

Reg. No. 4,100,153

Registered Feb. 14, 2012

Int. Cl.: 25

TRADEMARK

PRINCIPAL REGISTER

NATURES PILLOWS, INC. (PENNSYLVANIA CORPORATION)
2607 INTERPLEX DRIVE
TREVOSE, PA 19053

FOR: SLIPPERS, IN CLASS 25 (U.S. CLS. 22 AND 39).

FIRST USE 3-2-2011; IN COMMERCE 3-2-2011.

THE MARK CONSISTS OF STANDARD CHARACTERS WITHOUT CLAIM TO ANY PARTICULAR FONT, STYLE, SIZE, OR COLOR.

SN 85-235,407, FILED 2-7-2011.

ROSELLE HERRERA, EXAMINING ATTORNEY



David J. Kyffers

Director of the United States Patent and Trademark Office

United States of America

United States Patent and Trademark Office

ALERT CIRCLE

Reg. No. 4,100,154

I GRACE CO., INC. (NEW YORK CORPORATION)
403 EAST 91ST STREET
NEW YORK, NY 10128

Registered Feb. 14, 2012

**Int. Cls.: 35, 36, 37, 41,
and 45**

FOR: ESTIMATING CONTRACTING WORK; SCHEDULING OF HOME REPAIR AND RENOVATION APPOINTMENTS IN THE FIELDS OF RESIDENTIAL CONSTRUCTION; EMPLOYMENT HIRING SERVICES IN THE FIELD OF HOUSEHOLD STAFF; COST CONTAINMENT IN THE FIELD OF RESIDENTIAL PROPERTY MANAGEMENT; ENERGY USAGE MANAGEMENT IN THE FIELD OF RESIDENTIAL PROPERTY MANAGEMENT, IN CLASS 35 (U.S. CLS. 100, 101 AND 102).

SERVICE MARK

PRINCIPAL REGISTER

FIRST USE 3-0-2011; IN COMMERCE 3-0-2011.

FOR: FINANCIAL MANAGEMENT SERVICES, NAMELY, BUDGET PLANNING SERVICES IN THE FIELD OF RESIDENTIAL PRE-CONSTRUCTION; FINANCIAL MANAGEMENT SERVICES, NAMELY, HOUSEHOLD OPERATING BUDGET CREATION AND MANAGEMENT, FINANCIAL PLANNING AND FINANCIAL ANALYSIS SERVICES, NAMELY, CAPITAL EXPENDITURE PLANNING AND ANALYSIS IN THE FIELD OF RESIDENTIAL PRE-CONSTRUCTION; BILL PAYMENT SERVICES IN THE FIELD OF RESIDENTIAL PROPERTY MANAGEMENT; POST-LOSS ESTIMATING IN THE FIELD OF RESIDENTIAL PROPERTY MANAGEMENT, NAMELY, CONDUCTING APPRAISALS FOR INSURANCE CLAIMS OF REAL ESTATE; CLAIMS RESOLUTION ASSISTANCE IN THE FIELD OF RESIDENTIAL PROPERTY MANAGEMENT, NAMELY, INSURANCE CLAIMS PROCESSING, IN CLASS 36 (U.S. CLS. 100, 101 AND 102).

FIRST USE 3-0-2011; IN COMMERCE 3-0-2011.

FOR: RESIDENTIAL CONSTRUCTION SERVICES, NAMELY, CONSTRUCTION MANAGEMENT, SERVING AS GENERAL CONTRACTOR FOR RESIDENTIAL CONSTRUCTION PROJECTS, NAMELY, COORDINATING AND OVERSEEING THE WORK OF SUB-CONTRACTORS PROVIDING FRAMING, PAINTING, ELECTRICAL, HEATING AND AIR CONDITIONING, FOUNDATION AND OTHER CONSTRUCTION SERVICES, SERVING AS OWNER'S REPRESENTATIVE FOR RESIDENTIAL CONSTRUCTION PROJECTS, NAMELY, ACTING AS THE ON SITE REPRESENTATIVE OF THE BUILDING OWNER TO OVERSEE THE WORK OF GENERAL AND SUB CONTRACTORS AND ARCHITECTS; HISTORIC BUILDING RESTORATIONS; RESIDENTIAL REAL ESTATE MAINTENANCE SERVICES,



David J. Kyffers

Director of the United States Patent and Trademark Office

Reg. No. 4,100,154 NAMELY, PROVIDING, SUPERVISING, AND OVERSEEING PREVENTIVE MAINTENANCE AND REPAIR PROJECTS, IN CLASS 37 (U.S. CLS. 100, 103 AND 106).

FIRST USE 3-0-2011; IN COMMERCE 3-0-2011.

FOR: TRAINING IN THE FIELD OF RESIDENTIAL PROPERTY MANAGEMENT; DEVELOPING EDUCATIONAL MANUALS FOR OTHERS IN THE FIELD OF RESIDENTIAL PROPERTY MANAGEMENT , IN CLASS 41 (U.S. CLS. 100, 101 AND 107).

FIRST USE 3-0-2011; IN COMMERCE 3-0-2011.

FOR: ZONING AND ENTITLEMENT STUDY SERVICES, NAMELY, REVIEWING STANDARDS AND PRACTICES TO ASSURE COMPLIANCE WITH ZONING LAWS AND REGULATIONS IN THE FIELD OF RESIDENTIAL PRE-CONSTRUCTION; LEGAL SERVICES, NAMELY, CONTRACT NEGOTIATION SERVICES FOR HOUSEHOLD SERVICE PROVIDERS; SECURITY CONSULTANCY IN THE FIELD OF RESIDENTIAL PROPERTY MANAGEMENT, NAMELY, CONDUCTING SAFETY AND LOSS PREVENTION ANALYSES, IN CLASS 45 (U.S. CLS. 100 AND 101).

FIRST USE 3-0-2011; IN COMMERCE 3-0-2011.

THE MARK CONSISTS OF STANDARD CHARACTERS WITHOUT CLAIM TO ANY PARTICULAR FONT, STYLE, SIZE, OR COLOR.

SN 85-237,062, FILED 2-8-2011.

ELLEN B. AWRICH, EXAMINING ATTORNEY

United States of America

United States Patent and Trademark Office

SOMERSET

Reg. No. 4,100,155

LOGAN OUTDOOR PRODUCTS LLC (UTAH LIMITED LIABILITY COMPANY)
P.O. BOX 4057

Registered Feb. 14, 2012

LOGAN, UT 843234057

Int. Cl.: 11

FOR: GAS GRILLS, IN CLASS 11 (U.S. CLS. 13, 21, 23, 31 AND 34).

TRADEMARK

FIRST USE 5-31-2011; IN COMMERCE 5-31-2011.

PRINCIPAL REGISTER

THE MARK CONSISTS OF STANDARD CHARACTERS WITHOUT CLAIM TO ANY PARTICULAR FONT, STYLE, SIZE, OR COLOR.

SN 85-237,740, FILED 2-9-2011.

KATHRYN COWARD, EXAMINING ATTORNEY



David J. Kyffers

Director of the United States Patent and Trademark Office

United States of America

United States Patent and Trademark Office

TWINKLE & LEARN TAMBOURINE

Reg. No. 4,100,156

Registered Feb. 14, 2012

Int. Cl.: 28

TRADEMARK

PRINCIPAL REGISTER

VTECH ELECTRONICS NORTH AMERICA, LLC (DELAWARE LIMITED LIABILITY COMPANY)
1155 DUNDEE ROAD
ARLINGTON HEIGHTS, IL 60004

FOR: CHILDREN'S MULTIPLE ACTIVITY TOYS; ELECTRONIC LEARNING TOYS; INFANT DEVELOPMENT TOYS; INFANT TOYS; MUSICAL TOYS, IN CLASS 28 (U.S. CLS. 22, 23, 38 AND 50).

FIRST USE 5-18-2011; IN COMMERCE 5-18-2011.

THE MARK CONSISTS OF STANDARD CHARACTERS WITHOUT CLAIM TO ANY PARTICULAR FONT, STYLE, SIZE, OR COLOR.

NO CLAIM IS MADE TO THE EXCLUSIVE RIGHT TO USE "TAMBOURINE", APART FROM THE MARK AS SHOWN.

SN 85-238,519, FILED 2-10-2011.

JEFF DEFORD, EXAMINING ATTORNEY



David J. Kyffers

Director of the United States Patent and Trademark Office

United States of America
United States Patent and Trademark Office

BIODREAM

Reg. No. 4,100,157

WINMAX GROUP INC. (CALIFORNIA CORPORATION)
15450 E. VALLEY BLVD.

Registered Feb. 14, 2012

CITY OF INDUSTRY, CA 91746

Int. Cl.: 5

FOR: HEALTH FOOD SUPPLEMENTS; VITAMINS, IN CLASS 5 (U.S. CLS. 6, 18, 44, 46, 51 AND 52).

TRADEMARK

FIRST USE 12-10-2010; IN COMMERCE 12-10-2010.

PRINCIPAL REGISTER

THE MARK CONSISTS OF STANDARD CHARACTERS WITHOUT CLAIM TO ANY PARTICULAR FONT, STYLE, SIZE, OR COLOR.

SN 85-238,559, FILED 2-10-2011.

ANN E. SAPPENFIELD, EXAMINING ATTORNEY



David J. Kybas

Director of the United States Patent and Trademark Office

United States of America

United States Patent and Trademark Office

BOOT BOSS

Reg. No. 4,100,158

PAMELA L. CASEY (UNITED STATES INDIVIDUAL)
2698 W. PENICK POINTE LANE
MERIDIAN, ID 83646

Registered Feb. 14, 2012

Int. Cl.: 25

FOR: PANT LEG GARTER, IN CLASS 25 (U.S. CLS. 22 AND 39).

TRADEMARK

FIRST USE 7-29-2011; IN COMMERCE 7-29-2011.

PRINCIPAL REGISTER

THE MARK CONSISTS OF STANDARD CHARACTERS WITHOUT CLAIM TO ANY PARTICULAR FONT, STYLE, SIZE, OR COLOR.

NO CLAIM IS MADE TO THE EXCLUSIVE RIGHT TO USE "BOOT", APART FROM THE MARK AS SHOWN.

SN 85-239,083, FILED 2-10-2011.

GENE MACIOL, EXAMINING ATTORNEY



David J. Kyffers

Director of the United States Patent and Trademark Office

United States of America

United States Patent and Trademark Office



Reg. No. 4,100,159

QIU YAO LIANG (CHINA INDIVIDUAL)
NO. 115, MA LI XI NEW DISTRICT
GUAN LAN, SHENZHEN, CHINA

Registered Feb. 14, 2012

Int. Cl.: 9

FOR: GLOVES FOR PROTECTION AGAINST ACCIDENTS; GOGGLES FOR SPORTS; KNEE PADS FOR WORKERS; PERSONAL SECURITY ALARMS; PROTECTIVE HELMETS; PROTECTIVE HELMETS FOR SPORTS; SAFETY RESTRAINTS; SPECTACLES; SUNGLASSES, IN CLASS 9 (U.S. CLS. 21, 23, 26, 36 AND 38).

TRADEMARK

PRINCIPAL REGISTER

FIRST USE 1-4-2006; IN COMMERCE 1-1-2011.

THE MARK CONSISTS OF THE STYLIZED WORD GUB.

SN 85-239,515, FILED 2-10-2011.

MARK SPARACINO, EXAMINING ATTORNEY



David J. Kybas

Director of the United States Patent and Trademark Office

United States of America

United States Patent and Trademark Office

LAPLACE

Reg. No. 4,100,160

Registered Feb. 14, 2012

Int. Cl.: 9

TRADEMARK

PRINCIPAL REGISTER

QIU YAO LIANG (CHINA INDIVIDUAL)
NO. 115, MA LI XI NEW DISTRICT
GUAN LAN, SHENZHEN, CHINA

FOR: GLOVES FOR PROTECTION AGAINST ACCIDENTS; GOGGLES FOR SPORTS; KNEE PADS FOR WORKERS; PERSONAL SECURITY ALARMS; PROTECTIVE HELMETS; PROTECTIVE HELMETS FOR SPORTS; SAFETY RESTRAINTS; SPECTACLES; SUNGLASSES, IN CLASS 9 (U.S. CLS. 21, 23, 26, 36 AND 38).

FIRST USE 11-22-2010; IN COMMERCE 1-1-2011.

THE MARK CONSISTS OF THE STYLIZED WORD "LAPLACE".

SN 85-239,536, FILED 2-10-2011.

MARK SPARACINO, EXAMINING ATTORNEY



David J. Kyros

Director of the United States Patent and Trademark Office

United States of America

United States Patent and Trademark Office



Reg. No. 4,100,161

Registered Feb. 14, 2012

Int. Cls.: 35 and 41

SERVICE MARK

PRINCIPAL REGISTER

NETWORK OF EXECUTIVE WOMEN, INC. (MARYLAND NON-STOCK CORPORATION)
C/O ACCENTURE
161 N. CLARK STREET
CHICAGO, IL 60601

FOR: ASSOCIATION SERVICES, NAMELY, PROMOTING THE INTERESTS OF WOMEN IN THE FOOD, BEVERAGE, CONSUMER PRODUCTS AND RETAIL INDUSTRIES, IN CLASS 35 (U.S. CLS. 100, 101 AND 102).

FIRST USE 5-29-2009; IN COMMERCE 5-29-2009.

FOR: EDUCATIONAL SERVICES, NAMELY, CONDUCTING CLASSES, SEMINARS, CONFERENCES AND WORKSHOPS IN THE FIELD OF WOMEN IN THE FOOD, BEVERAGE, CONSUMER PRODUCTS AND RETAIL INDUSTRIES; AND DISTRIBUTION OF COURSE MATERIALS IN CONNECTION THEREWITH; PROVIDING ON-LINE NEWSLETTERS IN THE FIELD OF WOMEN IN THE FOOD, BEVERAGE, CONSUMER PRODUCTS AND RETAIL INDUSTRIES, IN CLASS 41 (U.S. CLS. 100, 101 AND 107).

FIRST USE 5-29-2009; IN COMMERCE 5-29-2009.

THE MARK CONSISTS OF EIGHT TRIANGLES ARRANGED BY DECREASING SIZE, FORMING A SEMICIRCLE WITH AN OFF-CENTER RADIAL POINT.

SN 85-241,329, FILED 2-14-2011.

ALICE BENMAMAN, EXAMINING ATTORNEY



David J. Kybas

Director of the United States Patent and Trademark Office

United States of America

United States Patent and Trademark Office



Reg. No. 4,100,162

Registered Feb. 14, 2012

Int. Cls.: 35 and 41

SERVICE MARK

PRINCIPAL REGISTER

NETWORK OF EXECUTIVE WOMEN, INC. (MARYLAND NON-STOCK CORPORATION)
C/O ACCENTURE
161 N. CLARK STREET
CHICAGO, IL 60601

FOR: ASSOCIATION SERVICES, NAMELY, PROMOTING THE INTERESTS OF WOMEN IN THE FOOD, BEVERAGE, CONSUMER PRODUCTS AND RETAIL INDUSTRIES, IN CLASS 35 (U.S. CLS. 100, 101 AND 102).

FIRST USE 5-29-2009; IN COMMERCE 5-29-2009.

FOR: EDUCATIONAL SERVICES, NAMELY, CONDUCTING CLASSES, SEMINARS, CONFERENCES AND WORKSHOPS IN THE FIELD OF WOMEN IN THE FOOD, BEVERAGE, CONSUMER PRODUCTS AND RETAIL INDUSTRIES; AND DISTRIBUTION OF COURSE MATERIALS IN CONNECTION THEREWITH; PROVIDING ON-LINE NEWSLETTERS IN THE FIELD OF WOMEN IN THE FOOD, BEVERAGE, CONSUMER PRODUCTS AND RETAIL INDUSTRIES, IN CLASS 41 (U.S. CLS. 100, 101 AND 107).

FIRST USE 5-29-2009; IN COMMERCE 5-29-2009.

THE MARK CONSISTS OF THE FOLLOWING: EIGHT TRIANGLES ARRANGED BY DECREASING SIZE, FORMING A SEMICIRCLE WITH AN OFF-CENTER RADIAL POINT, WITH THE TOP TRIANGLE IN TURQUOISE, THEN RED, BROWN, PURPLE, BLUE, DARK GRAY, GOLD AND THE LAST ONE IN ORANGE.

THE COLOR(S) TURQUOISE, RED, BROWN, PURPLE, BLUE, DARK GRAY, GOLD AND ORANGE IS/ARE CLAIMED AS A FEATURE OF THE MARK.

SN 85-241,364, FILED 2-14-2011.

ALICE BENMAMAN, EXAMINING ATTORNEY



David J. Kybas

Director of the United States Patent and Trademark Office

United States of America

United States Patent and Trademark Office

AJAX SPARKLING CLEAN

Reg. No. 4,100,163

Registered Feb. 14, 2012

Int. Cl.: 3

TRADEMARK

PRINCIPAL REGISTER

COLGATE-PALMOLIVE COMPANY (DELAWARE CORPORATION)
300 PARK AVENUE
NEW YORK, NY 10022

FOR: ALL PURPOSE CLEANER, IN CLASS 3 (U.S. CLS. 1, 4, 6, 50, 51 AND 52).

FIRST USE 6-3-2011; IN COMMERCE 6-3-2011.

THE MARK CONSISTS OF STANDARD CHARACTERS WITHOUT CLAIM TO ANY PARTICULAR FONT, STYLE, SIZE, OR COLOR.

OWNER OF U.S. REG. NOS. 427,106, 2,425,188, AND OTHERS.

NO CLAIM IS MADE TO THE EXCLUSIVE RIGHT TO USE "SPARKLING CLEAN", APART FROM THE MARK AS SHOWN.

SN 85-241,505, FILED 2-14-2011.

MARK SHINER, EXAMINING ATTORNEY



David J. Kyffers

Director of the United States Patent and Trademark Office

United States of America

United States Patent and Trademark Office

RESERVA DEL SOL

Reg. No. 4,100,164

Registered Feb. 14, 2012

Int. Cl.: 33

TRADEMARK

PRINCIPAL REGISTER

MIGUEL TORRES, S.A. (SPAIN CORPORATION)
MIQUEL TORRES I CARBÓ 6
08720- VILAFRANCA DEL PENEDÈS
(BARCELONA), SPAIN

FOR: WINE, IN CLASS 33 (U.S. CLS. 47 AND 49).

FIRST USE 7-12-2011; IN COMMERCE 7-12-2011.

THE MARK CONSISTS OF STANDARD CHARACTERS WITHOUT CLAIM TO ANY PARTICULAR FONT, STYLE, SIZE, OR COLOR.

OWNER OF U.S. REG. NO. 3,571,530.

NO CLAIM IS MADE TO THE EXCLUSIVE RIGHT TO USE "RESERVA", APART FROM THE MARK AS SHOWN.

THE ENGLISH TRANSLATION OF "RESERVA DEL SOL" IN THE MARK IS "RESERVE OF THE SUN".

SN 85-241,532, FILED 2-14-2011.

KIM MONINGHOFF, EXAMINING ATTORNEY



David J. Kybas

Director of the United States Patent and Trademark Office

United States of America

United States Patent and Trademark Office

Unaffiliated

Reg. No. 4,100,165

WANLASS, ANTHONY (UNITED STATES INDIVIDUAL)
1156 ALAMEDA STREET
GLENDALE, CA 91201 AND

Registered Feb. 14, 2012

Int. Cl.: 25

HAUETER, CHRIS (UNITED STATES INDIVIDUAL)
1156 ALAMEDA STREET
GLENDALE, CA 91201

TRADEMARK

PRINCIPAL REGISTER

FOR: BELTS; BIKINIS; HATS; KIMONOS; RASH GUARDS; SHIRTS; SHOES; SHORTS;
SWEATPANTS; UNDERGARMENTS, IN CLASS 25 (U.S. CLS. 22 AND 39).

FIRST USE 11-12-2011; IN COMMERCE 11-12-2011.

THE MARK CONSISTS OF STANDARD CHARACTERS WITHOUT CLAIM TO ANY PARTICULAR FONT, STYLE, SIZE, OR COLOR.

SN 85-242,032, FILED 2-14-2011.

RON FAIRBANKS, EXAMINING ATTORNEY



David J. Kyffers

Director of the United States Patent and Trademark Office

United States of America

United States Patent and Trademark Office

HOME DEFENSE CENTER

Reg. No. 4,100,166

Registered Feb. 14, 2012

Int. Cl.: 6

TRADEMARK

PRINCIPAL REGISTER

JOHN D. BRUSH & CO., INC. (NEW YORK CORPORATION), DBA SENTRY SAFE,
900 LINDEN AVENUE
ROCHESTER, NY 14625

FOR: SECURITY SAFES MADE PRINCIPALLY OF METAL, IN CLASS 6 (U.S. CLS. 2, 12,
13, 14, 23, 25 AND 50).

FIRST USE 1-0-2011; IN COMMERCE 8-0-2011.

THE MARK CONSISTS OF STANDARD CHARACTERS WITHOUT CLAIM TO ANY PAR-
TICULAR FONT, STYLE, SIZE, OR COLOR.

SN 85-242,589, FILED 2-15-2011.

BILL DAWE, EXAMINING ATTORNEY



David J. Kyfos

Director of the United States Patent and Trademark Office

United States of America

United States Patent and Trademark Office

madd

Reg. No. 4,100,167

Registered Feb. 14, 2012

Int. Cl.: 45

SERVICE MARK

PRINCIPAL REGISTER

MOTHERS AGAINST DRUNK DRIVING (D.C. NON-PROFIT CORPORATION)
SUITE 700
511 E. JOHN CARPENTER FREEWAY
IRVING, TX 75062

FOR: PROVIDING PERSONAL SUPPORT SERVICES FOR VICTIMS OF DRUNK DRIVING AND THEIR FAMILIES AND FRIENDS, NAMELY, COMPANIONSHIP, HELP WITH LEGAL, FINANCIAL AND MEDICAL FORMS, COUNSELING AND EMOTIONAL SUPPORT, IN CLASS 45 (U.S. CLS. 100 AND 101).

FIRST USE 4-12-2011; IN COMMERCE 4-12-2011.

OWNER OF U.S. REG. NOS. 1,250,706, 3,100,555, AND OTHERS.

THE MARK CONSISTS OF THE LITERAL ELEMENT "MADD" IN LOWERCASE LETTERS.

SN 85-243,625, FILED 2-16-2011.

LINDA M. KING, EXAMINING ATTORNEY



David J. Kyffers

Director of the United States Patent and Trademark Office

United States of America

United States Patent and Trademark Office

ERISP

Reg. No. 4,100,168

INVESTMENT ADVISORY, LLC (PENNSYLVANIA LIMITED LIABILITY COMPANY)
3093 WELLS RD.

Registered Feb. 14, 2012

MALVERN, PA 19355

Int. Cl.: 36

FOR: INVESTMENT AND INSURANCE CONSULTANCY SERVICES; PROVIDING DEFINED BENEFIT PLAN FINANCIAL CONSULTING AND INSURANCE BROKERAGE , IN CLASS 36 (U.S. CLS. 100, 101 AND 102).

SERVICE MARK

FIRST USE 3-1-2011; IN COMMERCE 5-1-2011.

PRINCIPAL REGISTER

THE MARK CONSISTS OF STANDARD CHARACTERS WITHOUT CLAIM TO ANY PARTICULAR FONT, STYLE, SIZE, OR COLOR.

SN 85-244,101, FILED 2-16-2011.

TARA PATE, EXAMINING ATTORNEY



David J. Kybas

Director of the United States Patent and Trademark Office

United States of America

United States Patent and Trademark Office

100YSS

Reg. No. 4,100,169

Registered Feb. 14, 2012

Int. Cl.: 42

SERVICE MARK

PRINCIPAL REGISTER

DEFENSE ADVANCED RESEARCH PROJECTS AGENCY (UNITED STATES FEDERAL AGENCY)

GENERAL COUNSEL
3701 NORTH FAIRFAX DRIVE
ARLINGTON, VA 222031704

FOR: SCIENTIFIC AND TECHNOLOGICAL SERVICES, NAMELY, RESEARCH AND DEVELOPMENT, AND PROVIDING WEBSITES FEATURING TECHNOLOGY INFORMATION, ALL IN THE FIELD OF SPACE FLIGHT, IN CLASS 42 (U.S. CLS. 100 AND 101).

FIRST USE 6-15-2011; IN COMMERCE 6-15-2011.

THE MARK CONSISTS OF STANDARD CHARACTERS WITHOUT CLAIM TO ANY PARTICULAR FONT, STYLE, SIZE, OR COLOR.

SN 85-244,174, FILED 2-16-2011.

ANDREW LEASER, EXAMINING ATTORNEY



David J. Kybas

Director of the United States Patent and Trademark Office

United States of America

United States Patent and Trademark Office

PIGMA CALLIGRAPHER

Reg. No. 4,100,170

Registered Feb. 14, 2012

Int. Cl.: 16

TRADEMARK

PRINCIPAL REGISTER

SAKURA COLOR PRODUCTS CORPORATION (JAPAN CORPORATION)
10-17, NAKAMICHI 1-CHOME, HIGASHINARI-KU
OSAKA-SHI, OSAKA-FU, JAPAN 537-0025

FOR: WRITING INSTRUMENTS, IN CLASS 16 (U.S. CLS. 2, 5, 22, 23, 29, 37, 38 AND 50).

FIRST USE 5-12-2011; IN COMMERCE 7-21-2011.

THE MARK CONSISTS OF STANDARD CHARACTERS WITHOUT CLAIM TO ANY PARTICULAR FONT, STYLE, SIZE, OR COLOR.

OWNER OF U.S. REG. NOS. 1,278,932 AND 3,504,058.

NO CLAIM IS MADE TO THE EXCLUSIVE RIGHT TO USE "CALLIGRAPHER", APART FROM THE MARK AS SHOWN.

SN 85-245,074, FILED 2-17-2011.

GINA HAYES, EXAMINING ATTORNEY



David J. Kyffers

Director of the United States Patent and Trademark Office

United States of America

United States Patent and Trademark Office

WHOOOP ASS

Reg. No. 4,100,171

O.T.PARK, LLC (WEST VIRGINIA LIMITED LIABILITY COMPANY)
2805 MCCORKLE AVENUE
ST. ALBANS, WV 25177

Registered Feb. 14, 2012

Int. Cl.: 20

FOR: NON-METAL FASTENERS, NAMELY, ORNAMENTAL AND DECORATIVE ATTACHMENTS FOR DRAWSTRINGS AND ITEMS CONTAINING LACES SUCH AS OUTERWEAR, SHOES, AND MEN'S, WOMEN'S AND CHILDREN'S CLOTHING, NAMELY, HOODED SWEATSHIRTS, IN CLASS 20 (U.S. CLS. 2, 13, 22, 25, 32 AND 50).

TRADEMARK

PRINCIPAL REGISTER

FIRST USE 11-10-2011; IN COMMERCE 11-10-2011.

THE MARK CONSISTS OF STANDARD CHARACTERS WITHOUT CLAIM TO ANY PARTICULAR FONT, STYLE, SIZE, OR COLOR.

SN 85-245,217, FILED 2-17-2011.

PAM WILLIS, EXAMINING ATTORNEY



David J. Kyffers

Director of the United States Patent and Trademark Office

United States of America

United States Patent and Trademark Office

BRILLIANT CREATIONS

Reg. No. 4,100,172

Registered Feb. 14, 2012

Int. Cls.: 9 and 28

TRADEMARK

PRINCIPAL REGISTER

VTECH ELECTRONICS NORTH AMERICA, LLC (DELAWARE LIMITED LIABILITY COMPANY)
1155 DUNDEE ROAD
ARLINGTON HEIGHTS, IL 60004

FOR: CHILDREN'S EDUCATIONAL SOFTWARE; COMPUTER PERIPHERALS; COMPUTERS; NOTEBOOK AND LAPTOP COMPUTERS , IN CLASS 9 (U.S. CLS. 21, 23, 26, 36 AND 38).

FIRST USE 6-3-2011; IN COMMERCE 6-3-2011.

FOR: ELECTRONIC EDUCATIONAL GAME MACHINES FOR CHILDREN; ELECTRONIC LEARNING TOYS, IN CLASS 28 (U.S. CLS. 22, 23, 38 AND 50).

FIRST USE 6-3-2011; IN COMMERCE 6-3-2011.

THE MARK CONSISTS OF STANDARD CHARACTERS WITHOUT CLAIM TO ANY PARTICULAR FONT, STYLE, SIZE, OR COLOR.

SN 85-245,582, FILED 2-18-2011.

JEFF DEFORD, EXAMINING ATTORNEY



David J. Kyfos

Director of the United States Patent and Trademark Office

United States of America

United States Patent and Trademark Office

GROW & DISCOVER MUSIC STUDIO

Reg. No. 4,100,173

Registered Feb. 14, 2012

Int. Cl.: 28

TRADEMARK

PRINCIPAL REGISTER

VTECH ELECTRONICS NORTH AMERICA, LLC (DELAWARE LIMITED LIABILITY COMPANY)
1155 DUNDEE ROAD
ARLINGTON HEIGHTS, IL 60004

FOR: CHILDREN'S MULTIPLE ACTIVITY TOYS; ELECTRONIC EDUCATIONAL GAME MACHINES FOR CHILDREN; ELECTRONIC LEARNING TOYS; INFANT DEVELOPMENT TOYS; INFANT TOYS; MUSICAL TOYS; TOY PIANOS, IN CLASS 28 (U.S. CLS. 22, 23, 38 AND 50).

FIRST USE 5-23-2011; IN COMMERCE 5-23-2011.

THE MARK CONSISTS OF STANDARD CHARACTERS WITHOUT CLAIM TO ANY PARTICULAR FONT, STYLE, SIZE, OR COLOR.

NO CLAIM IS MADE TO THE EXCLUSIVE RIGHT TO USE "MUSIC", APART FROM THE MARK AS SHOWN.

SN 85-245,585, FILED 2-18-2011.

REGINA DRUMMOND, EXAMINING ATTORNEY



David J. Kyffers

Director of the United States Patent and Trademark Office

United States of America

United States Patent and Trademark Office

SING & SOAR BUTTERFLY

Reg. No. 4,100,174

Registered Feb. 14, 2012

Int. Cl.: 28

TRADEMARK

PRINCIPAL REGISTER

VTECH ELECTRONICS NORTH AMERICA, LLC (DELAWARE LIMITED LIABILITY COMPANY)
1155 DUNDEE ROAD
ARLINGTON HEIGHTS, IL 60004

FOR: BABY MULTIPLE ACTIVITY TOYS; ELECTRONIC LEARNING TOYS; INFANT DEVELOPMENT TOYS; INFANT TOYS; MUSICAL TOYS, IN CLASS 28 (U.S. CLS. 22, 23, 38 AND 50).

FIRST USE 5-18-2011; IN COMMERCE 5-18-2011.

THE MARK CONSISTS OF STANDARD CHARACTERS WITHOUT CLAIM TO ANY PARTICULAR FONT, STYLE, SIZE, OR COLOR.

NO CLAIM IS MADE TO THE EXCLUSIVE RIGHT TO USE "BUTTERFLY", APART FROM THE MARK AS SHOWN.

SN 85-245,588, FILED 2-18-2011.

REGINA DRUMMOND, EXAMINING ATTORNEY



David J. Kyffers

Director of the United States Patent and Trademark Office

United States of America

United States Patent and Trademark Office



Reg. No. 4,100,175

SHEK, JOANNA (UNITED STATES INDIVIDUAL)
13 STEPHENVILLE PARKWAY
EDISON, NJ 08820

Registered Feb. 14, 2012

Int. Cl.: 20

FOR: KITCHEN CABINETS; BATHROOM VANITIES, IN CLASS 20 (U.S. CLS. 2, 13, 22, 25, 32 AND 50).

TRADEMARK

FIRST USE 1-26-2011; IN COMMERCE 1-26-2011.

PRINCIPAL REGISTER

NO CLAIM IS MADE TO THE EXCLUSIVE RIGHT TO USE "CABINETRY", APART FROM THE MARK AS SHOWN.

THE MARK CONSISTS OF THE WORDS "FOREVERMARK CABINETRY" ABOVE A HORIZONTAL BAR BELOW WHICH APPEARS THE WORD "CABINETRY". TO THE RIGHT OF THE WORDING APPEARS AN IMAGE OF A TREE.

SN 85-245,605, FILED 2-18-2011.

ANDREA HACK, EXAMINING ATTORNEY



David J. Kybas

Director of the United States Patent and Trademark Office

United States of America

United States Patent and Trademark Office

Nail Creations Appealing While Healing

Reg. No. 4,100,176

Registered Feb. 14, 2012

Int. Cl.: 3

TRADEMARK

PRINCIPAL REGISTER

BARILE, MARIA (UNITED STATES INDIVIDUAL)
31900 NORTH MARGINAL ROAD
WILLOWICK, OH 44095

FOR: NAIL REPAIR PRODUCTS, NAMELY, NAIL WRAPS; FINGERNAIL AND TOENAIL EMBELLISHMENTS; NON-MEDICATED NAIL CARE PRODUCTS, NAMELY, A PROTECTIVE ADHESIVE WITH A FOAM PADDING AFFIXED TO THE CENTER OF THE ADHESIVE WHICH IS PLACED OVER A FINGER OR TOE DUE TO A FUNGUS OR NAIL INJURY, IN CLASS 3 (U.S. CLS. 1, 4, 6, 50, 51 AND 52).

FIRST USE 10-21-2011; IN COMMERCE 10-21-2011.

THE MARK CONSISTS OF STANDARD CHARACTERS WITHOUT CLAIM TO ANY PARTICULAR FONT, STYLE, SIZE, OR COLOR.

NO CLAIM IS MADE TO THE EXCLUSIVE RIGHT TO USE "NAIL", APART FROM THE MARK AS SHOWN.

SN 85-246,229, FILED 2-18-2011.

COLLEEN KEARNEY, EXAMINING ATTORNEY



David J. Kyfos

Director of the United States Patent and Trademark Office

United States of America

United States Patent and Trademark Office



Reg. No. 4,100,177

MARS, INCORPORATED (DELAWARE CORPORATION)
6885 ELM STREET
MCLEAN, VA 221013883

Registered Feb. 14, 2012

Int. Cl.: 31

FOR: PET FOOD, IN CLASS 31 (U.S. CLS. 1 AND 46).

TRADEMARK

FIRST USE 5-23-2011; IN COMMERCE 5-23-2011.

PRINCIPAL REGISTER

THE MARK CONSISTS OF THE WORD "CRAVE" IN WHITE ON TOP OF RED SOLID CIRCLES OF VARYING SIZES AND SURROUNDED BY RED, PINK, YELLOW AND ORANGE SOLID CIRCLES OF VARYING SIZES.

THE COLOR(S) RED, PINK, YELLOW, ORANGE AND WHITE IS/ARE CLAIMED AS A FEATURE OF THE MARK.

SN 85-246,456, FILED 2-18-2011.

AISHA SALEM, EXAMINING ATTORNEY



David J. Kybas

Director of the United States Patent and Trademark Office

United States of America

United States Patent and Trademark Office

THE BEHAVIORAL ARCHITECTS

Reg. No. 4,100,178

HOLLINGWORTH, CRAWFORD (UNITED STATES INDIVIDUAL)
96 BANBURY ROAD

Registered Feb. 14, 2012

OXFORD, OXFORDSHIRE, UNITED KINGDOM OX26JT

Int. Cl.: 35

FOR: MARKET RESEARCH; MARKETING CONSULTING, IN CLASS 35 (U.S. CLS. 100, 101 AND 102).

SERVICE MARK

FIRST USE 11-29-2011; IN COMMERCE 11-29-2011.

PRINCIPAL REGISTER

THE MARK CONSISTS OF STANDARD CHARACTERS WITHOUT CLAIM TO ANY PARTICULAR FONT, STYLE, SIZE, OR COLOR.

NO CLAIM IS MADE TO THE EXCLUSIVE RIGHT TO USE "BEHAVIORAL", APART FROM THE MARK AS SHOWN.

SN 85-246,881, FILED 2-19-2011.

CAROLINE WOOD, EXAMINING ATTORNEY



David J. Kyffers

Director of the United States Patent and Trademark Office

United States of America

United States Patent and Trademark Office

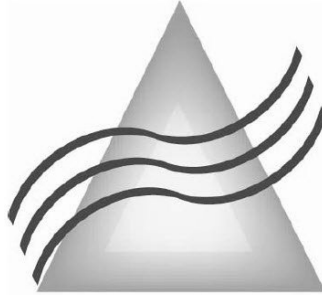

Reg. No. 4,100,179

Registered Feb. 14, 2012

Int. Cls.: 39 and 40

SERVICE MARK

PRINCIPAL REGISTER

GOLDEN PASS LNG TERMINAL LLC (DELAWARE LIMITED LIABILITY COMPANY)
THREE ALLEN CENTER, SUITE 800
333 CLAY STREET
HOUSTON, TX 77002

FOR: STORAGE AND TRANSPORTATION OF FUELS; TRANSPORT BY PIPELINE, IN CLASS 39 (U.S. CLS. 100 AND 105).

FIRST USE 3-14-2011; IN COMMERCE 3-14-2011.

FOR: NATURAL GAS LIQUEFACTION AND GASIFICATION SERVICES, IN CLASS 40 (U.S. CLS. 100, 103 AND 106).

FIRST USE 3-14-2011; IN COMMERCE 3-14-2011.

THE MARK CONSISTS OF A TRIANGLE WITH THREE PARALLEL WAVY LINES RUNNING HORIZONTALLY ACROSS THE MIDDLE OF THE TRIANGLE.

SN 85-247,297, FILED 2-21-2011.

MARGARET POWER, EXAMINING ATTORNEY



David J. Kyffers

Director of the United States Patent and Trademark Office

United States of America

United States Patent and Trademark Office

Voter's Friend

Reg. No. 4,100,180

VOTER'S FRIEND LLC (DELAWARE LIMITED LIABILITY COMPANY)

Registered Feb. 14, 2012

108 E. 4TH STREET, #13
NEW YORK, NY 10003

Int. Cl.: 35

FOR: PROVIDING INFORMATION REGARDING POLITICAL ISSUES, KNOWING HOW TO VOTE AND KNOWING HOW TO REGISTER TO VOTE, IN CLASS 35 (U.S. CLS. 100, 101 AND 102).

SERVICE MARK

FIRST USE 12-1-2011; IN COMMERCE 12-1-2011.

PRINCIPAL REGISTER

THE MARK CONSISTS OF STANDARD CHARACTERS WITHOUT CLAIM TO ANY PARTICULAR FONT, STYLE, SIZE, OR COLOR.

NO CLAIM IS MADE TO THE EXCLUSIVE RIGHT TO USE "VOTER'S", APART FROM THE MARK AS SHOWN.

SN 85-248,447, FILED 2-22-2011.

RAUL CORDOVA, EXAMINING ATTORNEY



David J. Kybas

Director of the United States Patent and Trademark Office

United States of America

United States Patent and Trademark Office

IcyBlue

Reg. No. 4,100,181

Registered Feb. 14, 2012

Int. Cl.: 24

TRADEMARK

PRINCIPAL REGISTER

ICYBLUE, LLC (FLORIDA LIMITED LIABILITY COMPANY)
222 SEASPRAY AVENUE
PALM BEACH, FL 33480

FOR: FABRIC COMPRISED OF BAMBOO AND COTTON FIBERS THAT CONTAIN CHEMICAL AND NATURAL SUBSTANCES THAT SELF-COOLS ON ACTIVATION FOR LOCALIZED COLD THERAPY OF THE HUMAN BODY, NOT FOR MEDICAL USE, IN CLASS 24 (U.S. CLS. 42 AND 50).

FIRST USE 2-22-2011; IN COMMERCE 5-17-2011.

THE MARK CONSISTS OF STANDARD CHARACTERS WITHOUT CLAIM TO ANY PARTICULAR FONT, STYLE, SIZE, OR COLOR.

SN 85-248,664, FILED 2-22-2011.

CHRISTOPHER BUONGIORNO, EXAMINING ATTORNEY



David J. Kybas

Director of the United States Patent and Trademark Office

United States of America

United States Patent and Trademark Office



Reg. No. 4,100,182

Registered Feb. 14, 2012

Int. Cl.: 9

TRADEMARK

PRINCIPAL REGISTER

FOWNES BROTHERS & CO. INC. (NEW YORK CORPORATION)
16 E 34TH STREET
NEW YORK, NY 10016

FOR: HEADPHONES FOR PORTABLE SOUND DEVICES INCORPORATING AN EARMUFF INTO THE DESIGN FOR PROTECTION AGAINST THE COLD, IN CLASS 9 (U.S. CLS. 21, 23, 26, 36 AND 38).

FIRST USE 8-23-2011; IN COMMERCE 8-23-2011.

THE MARK CONSISTS OF A STYLIZED PAIR OF HEADPHONES POSITIONED WITHIN A FIRST CIRCLE, THE HEADPHONES SURROUNDING A SECOND CONCENTRIC CIRCLE HAVING A THIRD PARTIALLY BROKEN CONCENTRIC CIRCLE POSITIONED THEREIN, THE SECOND CIRCLE HAVING A BAR ALIGNED WITH THE BREAK IN THE THIRD CIRCLE, THE BAR EXTENDING ALONG A RADIUS OF THE CONCENTRIC CIRCLES AND TERMINATING IN A SECOND PERPENDICULAR BAR WITHIN THE FIRST CIRCLE, THE FIRST CIRCLE ADDITIONALLY BEING SURROUNDED BY A FOURTH CONCENTRIC CIRCLE.

SN 85-249,392, FILED 2-23-2011.

GINA FINK, EXAMINING ATTORNEY



David J. Kyffers

Director of the United States Patent and Trademark Office

United States of America

United States Patent and Trademark Office



Reg. No. 4,100,183

Registered Feb. 14, 2012

Int. Cls.: 20 and 24

TRADEMARK

PRINCIPAL REGISTER

CHING MEI PAPER CO., LTD. (TAIWAN CORPORATION)
8F., NO. 50, SECTION 3, ROOSEVELT ROAD
TAIPEI, TAIWAN

FOR: FURNITURE; BULLETIN BOARDS; STORAGE BASKETS; NON-METAL STORAGE BOXES; PACKAGING MATERIALS, NAMELY, PLASTIC STORAGE BOXES; CARDBOARD STORAGE BOXES; HAT RACKS; HAT AND COAT STANDS; MAGAZINE RACKS; AND SHOE RACKS, IN CLASS 20 (U.S. CLS. 2, 13, 22, 25, 32 AND 50).

FIRST USE 1-5-2011; IN COMMERCE 6-9-2011.

FOR: WOVEN FABRICS, BED AND TABLE COVERS, BED SHEETS, PILLOW CASES, QUILTS, BEDSPREADS AND CURTAINS, IN CLASS 24 (U.S. CLS. 42 AND 50).

FIRST USE 1-5-2011; IN COMMERCE 6-9-2011.

NO CLAIM IS MADE TO THE EXCLUSIVE RIGHT TO USE "PAPER", APART FROM THE MARK AS SHOWN.

THE MARK CONSISTS OF HORIZONTAL BARS WITH SAME LENGTH COMPRISING A SQUARE ON THE LEFT HAND SIDE OF THE WORDING "PAPER CASA".

THE ENGLISH TRANSLATION OF "CASA" IN THE MARK IS HOUSE.

SN 85-251,057, FILED 2-24-2011.

BRIAN NEVILLE, EXAMINING ATTORNEY



David J. Kybas

Director of the United States Patent and Trademark Office

United States of America

United States Patent and Trademark Office

LEE BROS.

Reg. No. 4,100,184

Registered Feb. 14, 2012

Int. Cls.: 11 and 21

TRADEMARK

PRINCIPAL REGISTER

MARTENS MAXWELL INC. (SOUTH CAROLINA CORPORATION)
STE. 1-C
62 BROAD STREET
CHARLESTON, SC 29401

FOR: ELECTRIC ROSTERS; BARBECUE SMOKERS AND ELECTRIC COFFEE BREWERS,
IN CLASS 11 (U.S. CLS. 13, 21, 23, 31 AND 34).

FIRST USE 3-25-2011; IN COMMERCE 3-25-2011.

FOR: COOKING POTS AND PANS; COOKING STEAMERS; CUTTING BOARDS; SERVING
SPOONS; SERVING LADLES; SKILLETS; COFFEE PITCHERS; NON-ELECTRIC CANNING
SETS COMPRISED OF CHROME JAR RACKS, COLANDERS, BLANCHERS WITH LIDS,
BLANCHER INSERTS, JAR LIFTERS, LID LIFTERS, KITCHEN TONGS, JAR WRENCHES
AND JAR FUNNELS, IN CLASS 21 (U.S. CLS. 2, 13, 23, 29, 30, 33, 40 AND 50).

FIRST USE 3-25-2011; IN COMMERCE 3-25-2011.

THE MARK CONSISTS OF STANDARD CHARACTERS WITHOUT CLAIM TO ANY PAR-
TICULAR FONT, STYLE, SIZE, OR COLOR.

NO CLAIM IS MADE TO THE EXCLUSIVE RIGHT TO USE "BROS.", APART FROM THE
MARK AS SHOWN.

SN 85-251,073, FILED 2-24-2011.

CHRISTINA SOBRAL, EXAMINING ATTORNEY



David J. Kypos

Director of the United States Patent and Trademark Office

United States of America

United States Patent and Trademark Office

Pheodol

Reg. No. 4,100,185

Registered Feb. 14, 2012

Int. Cl.: 5

TRADEMARK

PRINCIPAL REGISTER

GOLDEN BIOTECHNOLOGY CORPORATION (TAIWAN CORPORATION)
10F, NO. 9, LANE 3, SEC. 1
TAIPEI COUNTY 2514, TAIWAN

FOR: ADJUVANTS FOR MEDICAL PURPOSES; ANTIALLERGIC MEDICINES; ANTI-CANCER PREPARATIONS; MEDICINAL HERBAL EXTRACTS FOR MEDICAL PURPOSES; PHARMACEUTICAL AND MEDICINAL PREPARATIONS AND SUBSTANCES FOR THE PREVENTION AND TREATMENT OF DISORDERS OF THE NERVOUS SYSTEM, THE IMMUNE SYSTEM, THE CARDIO-VASCULAR SYSTEM, THE METABOLIC SYSTEM, THE RESPIRATORY SYSTEM, THE MUSCULO-SKELETAL SYSTEM, THE GENITOURINARY SYSTEM, FOR THE TREATMENT OF INFLAMMATORY DISORDERS, OCULAR DISORDERS, OR BONE DISEASES, FOR USE IN DERMATOLOGY, ONCOLOGY, HEMATOLOGY AND OPHTHALMOLOGY AND FOR GASTROENTEROLOGICAL DISORDERS OR LIVER AILMENTS; PHARMACEUTICAL AND MEDICINAL PREPARATIONS FOR THE TREATMENT OF BRAIN DISEASES OR DISORDERS AND AUTOIMMUNE DISEASES OR DISORDERS; DIETARY AND NUTRITIONAL SUPPLEMENTS FOR MEDICAL USE; DIETARY SUPPLEMENTS FOR TREATING FATIGUE OR LIVER SUPPORT; ANIMAL FEED ADDITIVE FOR USE AS A NUTRITIONAL SUPPLEMENT FOR MEDICAL PURPOSES; DIETARY SUPPLEMENTS FOR HUMAN CONSUMPTION OR FOR ANIMALS; NUTRITIONAL ADDITIVES FOR MEDICAL PURPOSES FOR USE IN FOODS FOR HUMAN CONSUMPTION OR FOR ANIMALS; ANIMAL FEED SUPPLEMENTS; DIETARY PET SUPPLEMENTS IN THE FORM OF PET TREATS; FUNGI PREPARATIONS FOR MEDICAL OR VETERINARY USE FOR TREATING DISORDERS OF THE NERVOUS SYSTEM, THE IMMUNE SYSTEM, THE CARDIO-VASCULAR SYSTEM, THE METABOLIC SYSTEM, THE RESPIRATORY SYSTEM, THE MUSCULO-SKELETAL SYSTEM, THE GENITOURINARY SYSTEM, FOR THE TREATMENT OF INFLAMMATORY DISORDERS, OCULAR DISORDERS, BRAIN DISEASES OR DISORDERS, AUTOIMMUNE DISEASES OR DISORDERS, OR BONE DISEASES, FOR USE IN DERMATOLOGY, ONCOLOGY, HEMATOLOGY AND OPHTHALMOLOGY AND FOR GASTROENTEROLOGICAL DISORDERS OR LIVER AILMENTS; PHARMACEUTICAL PREPARATIONS AND SUBSTANCES FOR VETERINARY PURPOSES FOR TREATING DISORDERS OF THE NERVOUS SYSTEM, THE IMMUNE SYSTEM, THE CARDIO-VASCULAR SYSTEM, THE METABOLIC SYSTEM, THE RESPIRATORY SYSTEM, THE MUSCULO-SKELETAL SYSTEM, THE GENITOURINARY SYSTEM, FOR THE TREATMENT OF INFLAMMATORY DISORDERS, OCULAR DISORDERS, BRAIN DISEASES OR DISORDERS, AUTOIMMUNE DISEASES OR DISORDERS, OR BONE DISEASES, FOR USE IN DERMATOLOGY, ONCOLOGY, HEMATOLOGY AND OPHTHALMOLOGY AND FOR GASTROENTEROLOGICAL DISORDERS OR LIVER AILMENTS; CHEMICAL PREPARATIONS FOR



David J. Kybas

Director of the United States Patent and Trademark Office

Reg. No. 4,100,185 MEDICINAL PURPOSES FOR TREATING DISORDERS OF THE NERVOUS SYSTEM, THE IMMUNE SYSTEM, THE CARDIO-VASCULAR SYSTEM, THE METABOLIC SYSTEM, THE RESPIRATORY SYSTEM, THE MUSCULO-SKELETAL SYSTEM, THE GENITOURINARY SYSTEM, FOR THE TREATMENT OF INFLAMMATORY DISORDERS, OCULAR DISORDERS, BRAIN DISEASES OR DISORDERS, AUTOIMMUNE DISEASES OR DISORDERS, OR BONE DISEASES, FOR USE IN DERMATOLOGY, ONCOLOGY, HEMATOLOGY AND OPHTHALMOLOGY AND FOR GASTROENTEROLOGICAL DISORDERS OR LIVER AILMENTS; CARDIOVASCULAR PHARMACEUTICALS; CARDIOVASCULAR TREATMENT PREPARATIONS; PHARMACEUTICALS PREPARATIONS FOR THE TREATMENT OF KIDNEY DISEASES, IN CLASS 5 (U.S. CLS. 6, 18, 44, 46, 51 AND 52).

FIRST USE 2-25-2011; IN COMMERCE 7-19-2011.

THE MARK CONSISTS OF STANDARD CHARACTERS WITHOUT CLAIM TO ANY PARTICULAR FONT, STYLE, SIZE, OR COLOR.

SN 85-251,681, FILED 2-25-2011.

KAREN K. BUSH, EXAMINING ATTORNEY

United States of America

United States Patent and Trademark Office

AmeriCrush

Reg. No. 4,100,186

Registered Feb. 14, 2012

Int. Cl.: 25

TRADEMARK

PRINCIPAL REGISTER

AMERICAN MONSTER TRUCK PROMOTIONS, LLC (FLORIDA LIMITED LIABILITY COMPANY)
4375 S. HWY. 441
OKEECHOBEE, FL 34974

FOR: HATS; SHIRTS, IN CLASS 25 (U.S. CLS. 22 AND 39).

FIRST USE 6-18-2011; IN COMMERCE 6-18-2011.

THE MARK CONSISTS OF STANDARD CHARACTERS WITHOUT CLAIM TO ANY PARTICULAR FONT, STYLE, SIZE, OR COLOR.

SN 85-253,078, FILED 2-28-2011.

JOHN GARTNER, EXAMINING ATTORNEY



David J. Kybas

Director of the United States Patent and Trademark Office

United States of America

United States Patent and Trademark Office



Reg. No. 4,100,187

Registered Feb. 14, 2012

Int. Cl.: 31

TRADEMARK

PRINCIPAL REGISTER

PORTERVILLE CITRUS, INC. (CALIFORNIA CORPORATION)
9289 CLEMENS ROAD
TERRA BELLA, CA 93270

FOR: FRESH ORANGES, IN CLASS 31 (U.S. CLS. 1 AND 46).

FIRST USE 3-8-2011; IN COMMERCE 3-8-2011.

NO CLAIM IS MADE TO THE EXCLUSIVE RIGHT TO USE "BARNFIELD, POWELL, PACKED BY PORTERVILLE CITRUS INC. TERRA BELLA, CA 93270, PREMIUM CALIFORNIA CITRUS, SUMMER NAVEL ORANGES, CALIFORNIA 888 888", APART FROM THE MARK AS SHOWN.

THE COLOR(S) RED, GREEN, ORANGE AND BLUE IS/ARE CLAIMED AS A FEATURE OF THE MARK.

THE MARK CONSISTS OF A COUNTRY ROAD ON WHICH AN OLD RED PICKUP TRUCK IS CARRYING THREE BLUE COLORED BUCKETS OF ORANGES WITH GREEN LEAVES ON A BLUE ROAD. ON THE DRIVER-SIDE DOOR IS THE WORDING "PACKED BY PORTERVILLE CITRUS INC. TERRA BELLA, CA 93270" IN WHITE AND BLUE LETTERING. AT THE REAR OF THE TRUCK IS A WHITE LICENSE PLATE WITH THE WORDING "CALIFORNIA" IN RED LETTERING, AND "888 888" IN BLUE LETTERING. ON THE OPPOSITE SIDE OF THE TRUCK ARE TWO GREEN STREET SIGNS WITH THE WORDING "BARNFIELD" AND "POWELL" IN WHITE LETTERING. IN THE FOREGROUND, ON THE BOTTOM-LEFT, IS THE WORDING "PREMIUM CALIFORNIA CITRUS", IN WHITE LETTERING OVER A SMALL ORANGE BACKGROUND, AND ON THE BOTTOM-RIGHT, "SUMMER NAVEL ORANGES", IN BLUE LETTERING OVER A SMALL WHITE BACKGROUND. BEHIND THE TRUCK IS AN ORCHARD OF ORANGE TREES WITH GREEN LEAVES AND OUTLINED IN BLUE, SURROUNDING A RED BARN WITH A BLUE ROOF AND A BLUE SILO, SITTING ON BLUE AND GREEN STRIPED GRASS. ABOVE THE ORCHARD IS A HORIZON OF BLUE AND WHITE SUN RAYS.

SN 85-253,647, FILED 2-28-2011.

ANGELA DUONG, EXAMINING ATTORNEY



David J. Kappas

Director of the United States Patent and Trademark Office

United States of America

United States Patent and Trademark Office

SUN LIFE SELECT ACCESS

Reg. No. 4,100,188

SUN LIFE ASSURANCE COMPANY OF CANADA (CANADA CORPORATION)
150 KING STREET WEST, SUITE 1400

Registered Feb. 14, 2012

TORONTO, ONTARIO, CANADA M5H1J9

Int. Cl.: 35

FOR: PROVIDING SALES AND ADMINISTRATIVE SUPPORT SERVICES TO AGENTS SELLING FINANCIAL AND INSURANCE SERVICES, IN CLASS 35 (U.S. CLS. 100, 101 AND 102).

SERVICE MARK

FIRST USE 2-7-2011; IN COMMERCE 2-7-2011.

PRINCIPAL REGISTER

THE MARK CONSISTS OF STANDARD CHARACTERS WITHOUT CLAIM TO ANY PARTICULAR FONT, STYLE, SIZE, OR COLOR.

SN 85-253,654, FILED 2-28-2011.

TOBY BULLOFF, EXAMINING ATTORNEY



David J. Kyjars

Director of the United States Patent and Trademark Office

United States of America
United States Patent and Trademark Office

PROBLITZ

Reg. No. 4,100,189

PROTEAM, INC. (IDAHO CORPORATION)
5118 N. SAWYER AVENUE
BOISE, ID 83714

Registered Feb. 14, 2012

Int. Cl.: 11

FOR: ELECTRIC APPARATUS FOR DRYING HARD FLOORS, CARPETS, WALLS, AND CEILINGS, NAMELY, AIR MOVERS, IN CLASS 11 (U.S. CLS. 13, 21, 23, 31 AND 34).

TRADEMARK

FIRST USE 7-29-2011; IN COMMERCE 7-29-2011.

PRINCIPAL REGISTER

THE MARK CONSISTS OF STANDARD CHARACTERS WITHOUT CLAIM TO ANY PARTICULAR FONT, STYLE, SIZE, OR COLOR.

SN 85-254,269, FILED 3-1-2011.

WILLIAM P. SHANAHAN, EXAMINING ATTORNEY



David J. Kybas

Director of the United States Patent and Trademark Office

United States of America
United States Patent and Trademark Office

ECORICE

Reg. No. 4,100,190

Registered Feb. 14, 2012

Int. Cl.: 35

SERVICE MARK

PRINCIPAL REGISTER

LINDSAY CORPORATION (DELAWARE CORPORATION)
2222 NORTH 111TH STREET
OMAHA, NE 68164

FOR: PROMOTING PUBLIC AWARENESS OF THE USE OF CENTER PIVOT AND LATERAL MOVE IRRIGATION SYSTEMS IN CONNECTION WITH GROWING AND IRRIGATING RICE, IN CLASS 35 (U.S. CLS. 100, 101 AND 102).

FIRST USE 8-17-2011; IN COMMERCE 8-17-2011.

THE MARK CONSISTS OF STANDARD CHARACTERS WITHOUT CLAIM TO ANY PARTICULAR FONT, STYLE, SIZE, OR COLOR.

SN 85-254,326, FILED 3-1-2011.

CHRISTINA SOBRAL, EXAMINING ATTORNEY



David J. Kyros

Director of the United States Patent and Trademark Office

United States of America

United States Patent and Trademark Office

infotxt

Reg. No. 4,100,191

Registered Feb. 14, 2012

Int. Cl.: 42

SERVICE MARK

PRINCIPAL REGISTER

INFOTXT CORPORATION (CALIFORNIA CORPORATION)
228 HAMILTON COURT, 2ND FLOOR
PALO ALTO, CA 94301

FOR: PROVIDING A WEBSITE FEATURING NON-DOWNLOADABLE SOFTWARE FOR BROADCASTING TEXT MESSAGES TO THE DESIGNATED RECIPIENTS FOR OTHERS, IN CLASS 42 (U.S. CLS. 100 AND 101).

FIRST USE 7-20-2011; IN COMMERCE 7-20-2011.

THE MARK CONSISTS OF STANDARD CHARACTERS WITHOUT CLAIM TO ANY PARTICULAR FONT, STYLE, SIZE, OR COLOR.

SN 85-254,442, FILED 3-1-2011.

SETH A. RAPPAPORT, EXAMINING ATTORNEY



David J. Kyffers

Director of the United States Patent and Trademark Office

United States of America

United States Patent and Trademark Office

GARDEN BUGS 2-IN-1 MAGIC MOBILE

Reg. No. 4,100,192

Registered Feb. 14, 2012

Int. Cl.: 28

TRADEMARK

PRINCIPAL REGISTER

VTECH ELECTRONICS NORTH AMERICA, LLC (DELAWARE LIMITED LIABILITY
COMPANY)
1155 DUNDEE ROAD
ARLINGTON HEIGHTS, IL 60004

FOR: BABY MULTIPLE ACTIVITY TOYS; ELECTRONIC LEARNING TOYS; INFANT DE-
VELOPMENT TOYS; INFANT TOYS; INFANT'S RATTLES; MUSICAL TOYS; PLUSH TOYS;
TOY MOBILES, IN CLASS 28 (U.S. CLS. 22, 23, 38 AND 50).

FIRST USE 5-19-2011; IN COMMERCE 5-19-2011.

THE MARK CONSISTS OF STANDARD CHARACTERS WITHOUT CLAIM TO ANY PAR-
TICULAR FONT, STYLE, SIZE, OR COLOR.

NO CLAIM IS MADE TO THE EXCLUSIVE RIGHT TO USE "2-IN-1" AND "MOBILE", APART
FROM THE MARK AS SHOWN.

SN 85-255,230, FILED 3-2-2011.

REGINA DRUMMOND, EXAMINING ATTORNEY



David J. Kybas

Director of the United States Patent and Trademark Office

United States of America

United States Patent and Trademark Office

TALK & GO FARM RATTLE

Reg. No. 4,100,193

Registered Feb. 14, 2012

Int. Cl.: 28

TRADEMARK

PRINCIPAL REGISTER

VTECH ELECTRONICS NORTH AMERICA, LLC (DELAWARE LIMITED LIABILITY COMPANY)
1155 DUNDEE ROAD
ARLINGTON HEIGHTS, IL 60004

FOR: BABY RATTLES; ELECTRONIC LEARNING TOYS; INFANT DEVELOPMENT TOYS; INFANT TOYS; MUSICAL TOYS, IN CLASS 28 (U.S. CLS. 22, 23, 38 AND 50).

FIRST USE 5-19-2011; IN COMMERCE 5-19-2011.

THE MARK CONSISTS OF STANDARD CHARACTERS WITHOUT CLAIM TO ANY PARTICULAR FONT, STYLE, SIZE, OR COLOR.

NO CLAIM IS MADE TO THE EXCLUSIVE RIGHT TO USE "RATTLE", APART FROM THE MARK AS SHOWN.

SN 85-255,239, FILED 3-2-2011.

REGINA DRUMMOND, EXAMINING ATTORNEY



David J. Kyjars

Director of the United States Patent and Trademark Office

United States of America

United States Patent and Trademark Office



Reg. No. 4,100,194

Registered Feb. 14, 2012

Int. Cl.: 42

SERVICE MARK

PRINCIPAL REGISTER

SURVEY & BALLOT SYSTEMS, INC. (MINNESOTA CORPORATION)
7653 ANAGRAM DRIVE
EDEN PRAIRIE, MN 55344

FOR: PROVIDING TEMPORARY USE OF NON-DOWNLOADABLE SOFTWARE FOR CONDUCTING ELECTIONS AND MANAGING AND ADMINISTERING THE VOTING PROCESS, IN CLASS 42 (U.S. CLS. 100 AND 101).

FIRST USE 11-15-2011; IN COMMERCE 11-15-2011.

OWNER OF U.S. REG. NO. 2,898,201.

THE MARK CONSISTS OF THE WORD "MY" INSIDE A SHADED QUOTATION MARK FOLLOWED BY THE TERM "DIRECTVOTE".

SN 85-256,211, FILED 3-2-2011.

CHARLES L. JENKINS, EXAMINING ATTORNEY



David J. Kyros

Director of the United States Patent and Trademark Office

United States of America

United States Patent and Trademark Office

PEDRO INFANTE

Reg. No. 4,100,195

Registered Feb. 14, 2012

Int. Cl.: 33

TRADEMARK

PRINCIPAL REGISTER

COMERCIALIZADORA DE TEQUILA, FRANQUICIAS Y MECHANDISE LIBRA, S.A. DE
C.V. (MEXICO CORPORATION)

447
XOCHICALCO
DISTRITO FEDERAL, MEXICO 03020

FOR: ALCOHOLIC BEVERAGES EXCEPT BEERS; ALCOHOLIC BEVERAGES, NAMELY,
TEQUILA; ALCOHOLIC MIXED BEVERAGES EXCEPT BEERS, IN CLASS 33 (U.S. CLS.
47 AND 49).

FIRST USE 12-6-2011; IN COMMERCE 12-6-2011.

THE MARK CONSISTS OF STANDARD CHARACTERS WITHOUT CLAIM TO ANY PAR-
TICULAR FONT, STYLE, SIZE, OR COLOR.

THE NAME(S), PORTRAIT(S), AND/OR SIGNATURE(S) SHOWN IN THE MARK DOES NOT
IDENTIFY A PARTICULAR LIVING INDIVIDUAL.

SN 85-256,220, FILED 3-2-2011.

DAWN HAN, EXAMINING ATTORNEY



David J. Kyffers

Director of the United States Patent and Trademark Office

United States of America

United States Patent and Trademark Office

PRINCESS AND THE POTTY

Reg. No. 4,100,196

Registered Feb. 14, 2012

Int. Cl.: 28

TRADEMARK

PRINCIPAL REGISTER

MATTEL, INC. (DELAWARE CORPORATION)
M1-1518
333 CONTINENTAL BOULEVARD
EL SEGUNDO, CA 90245

FOR: DOLLS, DOLL CLOTHING AND DOLL ACCESSORIES, IN CLASS 28 (U.S. CLS. 22, 23, 38 AND 50).

FIRST USE 11-21-2011; IN COMMERCE 11-21-2011.

THE MARK CONSISTS OF STANDARD CHARACTERS WITHOUT CLAIM TO ANY PARTICULAR FONT, STYLE, SIZE, OR COLOR.

SN 85-256,751, FILED 3-3-2011.

RON FAIRBANKS, EXAMINING ATTORNEY



David J. Kyffers

Director of the United States Patent and Trademark Office

United States of America

United States Patent and Trademark Office

PERFECT PAIRS

Reg. No. 4,100,197

POWER PRODUCTS, LLC (MICHIGAN LIMITED LIABILITY COMPANY)
2254 E. HIGHLAND RD
HIGHLAND, MI 48356

Registered Feb. 14, 2012

Int. Cl.: 29

FOR: BLANCHED NUTS; FLAVORED NUTS; PREPARED NUTS; PROCESSED NUTS;
ROASTED NUTS; SEASONED NUTS; SHELLED NUTS, IN CLASS 29 (U.S. CL. 46).

TRADEMARK

FIRST USE 10-18-2011; IN COMMERCE 10-18-2011.

PRINCIPAL REGISTER

THE MARK CONSISTS OF STANDARD CHARACTERS WITHOUT CLAIM TO ANY PARTICULAR FONT, STYLE, SIZE, OR COLOR.

SN 85-257,883, FILED 3-4-2011.

KATINA MISTER, EXAMINING ATTORNEY



David J. Kybas

Director of the United States Patent and Trademark Office

United States of America

United States Patent and Trademark Office

AGUA ENERVIVA

Reg. No. 4,100,198

AGUA ENERVIVA, INC. (CONNECTICUT CORPORATION)

Registered Feb. 14, 2012

P.O. BOX 31232
GREENWICH, CT 06831

Int. Cl.: 32

FOR: NON-ALCOHOLIC BEVERAGES, NAMELY, DRINKING WATER, FLAVORED DRINKING WATER AND CAFFEINE-ENHANCED DRINKING WATER, IN CLASS 32 (U.S. CLS. 45, 46 AND 48).

TRADEMARK

FIRST USE 8-2-2011; IN COMMERCE 8-24-2011.

PRINCIPAL REGISTER

THE MARK CONSISTS OF STANDARD CHARACTERS WITHOUT CLAIM TO ANY PARTICULAR FONT, STYLE, SIZE, OR COLOR.

NO CLAIM IS MADE TO THE EXCLUSIVE RIGHT TO USE "AGUA", APART FROM THE MARK AS SHOWN.

THE ENGLISH TRANSLATION OF "AGUA" IN THE MARK IS WATER. THE WORDING "ENERVIVA" HAS NO MEANING IN A FOREIGN LANGUAGE.

SN 85-258,856, FILED 3-5-2011.

JENNIFER MARTIN, EXAMINING ATTORNEY



David J. Kyros

Director of the United States Patent and Trademark Office

United States of America

United States Patent and Trademark Office

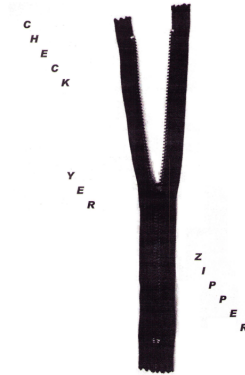

Reg. No. 4,100,199

Registered Feb. 14, 2012

Int. Cl.: 16

TRADEMARK

PRINCIPAL REGISTER

FRIEDRICH, DUANE J. (UNITED STATES INDIVIDUAL)
17 CANYON VIEW DR
MISSOULA, MT 59802

FOR: PRINTED MATERIAL IN THE NATURE OF DECALS FOR MAINTENANCE SERVICE AND APPOINTMENT REMINDERS, IN CLASS 16 (U.S. CLS. 2, 5, 22, 23, 29, 37, 38 AND 50).

FIRST USE 6-30-2011; IN COMMERCE 6-30-2011.

THE MARK CONSISTS OF THE WORDS "CHECK YER ZIPPER" RUNNING DIAGONALLY. IN BETWEEN "YER" AND "ZIPPER" IS A PICTURE OF A ZIPPER ZIPPED ABOUT HALF-WAY FORMING THE LETTER "Y".

SN 85-258,975, FILED 3-5-2011.

SIMON TENG, EXAMINING ATTORNEY



David J. Kybas

Director of the United States Patent and Trademark Office

United States of America

United States Patent and Trademark Office

JITTO

Reg. No. 4,100,200

Registered Feb. 14, 2012

Int. Cl.: 10

TRADEMARK

PRINCIPAL REGISTER

JITTO INTERNATIONAL CO., LTD. (TAIWAN CORPORATION)
10F, NO. 109, SEC. 6, MIN-CHIUAN E. ROAD
TAIPEI 114, TAIWAN

FOR: SUPPORTERS FOR MEDICAL PURPOSES; SUPPORTS FOR GENERAL MEDICAL USE; BLOOD PRESSURE MEASURING APPARATUS; BLOOD PRESSURE MONITORS; HEALTH MONITORING DEVICES, NAMELY, BLOOD PRESSURE MONITORS, THERMOMETERS AND PEDOMETERS; MEDICAL APPARATUS, NAMELY, RESPIRATORY EQUIPMENT AND MONITORS THEREFOR; ERGOMETERS FOR MEDICAL TESTING PURPOSES; RESPIRATION MONITORS; MEDICAL VENTILATOR TUBING AND TUBING CONNECTORS; PROBES FOR MEDICAL PURPOSES; PORTABLE MEDICAL DEVICES USED FOR BREATHING EXERCISES, NAMELY, PORTABLE DEVICES USED FOR ENDOGENOUS BREATHING EXERCISES AND FOR RESPIRATORY MUSCLE TRAINING; MEDICAL APPARATUS, NAMELY, CONTINUOUS POSITIVE AIRWAY PRESSURE (CPAP) DEVICES; PATIENT BREATHING SYSTEM COMPRISING A BREATHING CIRCUIT, CONNECTORS TO PATIENT, VENTILATOR, SCAVENGER, FRESH GAS DELIVERY CIRCUIT AND CARBON DIOXIDE ABSORBER; NEBULIZERS FOR RESPIRATION THERAPY; HUMIDIFICATION APPARATUS FOR MEDICAL PURPOSE, IN CLASS 10 (U.S. CLS. 26, 39 AND 44).

FIRST USE 12-6-2010; IN COMMERCE 12-6-2010.

THE MARK CONSISTS OF THE LETTERS "JITTO" ADJACENT A MISCELLANEOUS ARCUATE DESIGN HAVING AN OVAL CONTOUR ADJACENT THE MISCELLANEOUS DESIGN.

SN 85-259,774, FILED 3-7-2011.

ALLISON SCHRODY, EXAMINING ATTORNEY



David J. Kyros

Director of the United States Patent and Trademark Office

United States of America

United States Patent and Trademark Office

park*lane
JEWELRY | SINCE 1955

Reg. No. 4,100,201

JEWELS BY PARK LANE, INC. (ILLINOIS CORPORATION)
100 EAST COMMERCE DRIVE
SCHAUMBURG, IL 60173

Registered Feb. 14, 2012

Int. Cls.: 14 and 35

FOR: JEWELRY AND WATCHES, IN CLASS 14 (U.S. CLS. 2, 27, 28 AND 50).

TRADEMARK

FIRST USE 2-0-2011; IN COMMERCE 2-0-2011.

SERVICE MARK

FOR: ADVICE AND CONSULTATION SERVICES IN CONNECTION WITH THE SALE OF JEWELRY, WATCHES, AND ACCESSORIES THROUGH PRE-ORGANIZED SOCIAL GATHERINGS, IN CLASS 35 (U.S. CLS. 100, 101 AND 102).

PRINCIPAL REGISTER

FIRST USE 2-0-2011; IN COMMERCE 2-0-2011.

OWNER OF U.S. REG. NOS. 1,478,630, 3,452,796, AND OTHERS.

NO CLAIM IS MADE TO THE EXCLUSIVE RIGHT TO USE "JEWELRY" OR "SINCE 1955", APART FROM THE MARK AS SHOWN.

SN 85-260,064, FILED 3-7-2011.

MARK RADEMACHER, EXAMINING ATTORNEY



David J. Kyros

Director of the United States Patent and Trademark Office

United States of America

United States Patent and Trademark Office

I AM...LOVED

Reg. No. 4,100,202

MCKAY, JENNIFER (UNITED STATES INDIVIDUAL)
17041 BOLLINGER DRIVE
PACIFIC PALISADES, CA 90272

Registered Feb. 14, 2012

Int. Cl.: 4

FOR: CANDLES, IN CLASS 4 (U.S. CLS. 1, 6 AND 15).

TRADEMARK

FIRST USE 12-15-2010; IN COMMERCE 12-15-2010.

PRINCIPAL REGISTER

THE MARK CONSISTS OF STANDARD CHARACTERS WITHOUT CLAIM TO ANY PARTICULAR FONT, STYLE, SIZE, OR COLOR.

SN 85-260,253, FILED 3-7-2011.

MATTHEW MCDOWELL, EXAMINING ATTORNEY



David J. Kyffers

Director of the United States Patent and Trademark Office

United States of America

United States Patent and Trademark Office

I AM...LUCKY

Reg. No. 4,100,203

Registered Feb. 14, 2012

Int. Cls.: 4 and 16

TRADEMARK

PRINCIPAL REGISTER

MCKAY, JENNIFER (UNITED STATES INDIVIDUAL)
17041 BOLLINGER DRIVE
PACIFIC PALISADES, CA 90272

FOR: CANDLES, IN CLASS 4 (U.S. CLS. 1, 6 AND 15).

FIRST USE 12-15-2010; IN COMMERCE 12-15-2010.

FOR: PENCILS, PENS, PAPER STATIONERY AND NOTEPADS, IN CLASS 16 (U.S. CLS. 2, 5, 22, 23, 29, 37, 38 AND 50).

FIRST USE 12-15-2010; IN COMMERCE 12-15-2010.

THE MARK CONSISTS OF STANDARD CHARACTERS WITHOUT CLAIM TO ANY PARTICULAR FONT, STYLE, SIZE, OR COLOR.

SN 85-260,265, FILED 3-7-2011.

MATTHEW MCDOWELL, EXAMINING ATTORNEY



David J. Kybas

Director of the United States Patent and Trademark Office

United States of America

United States Patent and Trademark Office



Reg. No. 4,100,204

AHOLD LICENSING SARL (SWITZERLAND LIMITED LIABILITY COMPANY)
2 RUE JEAN-PETITOT
GENEVA, SWITZERLAND 1204

Registered Feb. 14, 2012

Int. Cl.: 21

FOR: ABRASIVE PADS FOR KITCHEN OR DOMESTIC PURPOSES; DISPOSABLE TABLE PLATES; PLASTIC CUPS, IN CLASS 21 (U.S. CLS. 2, 13, 23, 29, 30, 33, 40 AND 50).

TRADEMARK

FIRST USE 7-0-2011; IN COMMERCE 7-0-2011.

PRINCIPAL REGISTER

OWNER OF U.S. REG. NOS. 2,871,579, 3,411,740, AND OTHERS.

SEC. 2(F) AS TO "GUARANTEED VALUE".

THE MARK CONSISTS OF A SCISSORS DESIGN WITH A DASHED LINE EXTENDING TO THE RIGHT OF THE SCISSORS. THE WORD "GUARANTEED" APPEARS ABOVE THE LINE AND THE WORD "VALUE" APPEARS BELOW THE LINE.

SN 85-260,924, FILED 3-8-2011.

BRIDGETT SMITH, EXAMINING ATTORNEY



David J. Kybas

Director of the United States Patent and Trademark Office

United States of America

United States Patent and Trademark Office

BEAUTIFUL FEMALE

Reg. No. 4,100,205

EDMOND L. CARTER III (UNITED STATES INDIVIDUAL)
817 UNION

Registered Feb. 14, 2012

LINDEN, NJ 07036

Int. Cl.: 25

FOR: UNDERGARMENTS, BOOTS, PANTS, SKIRTS, SHIRTS, HATS, GLOVES, SOCKS, SCARVES, SWIM WEAR, JACKETS, COATS, SNEAKERS, DRESSES, HEADBANDS, SWEATSHIRTS, HOODED SWEATSHIRTS, SHOES, TEE SHIRTS, SPORTS BRAS, BRAS, THONGS, TIGHTS, SWEAT PANTS, SKORTS, SHORTS, CAPRI PANTS, STOCKINGS, PJAMAS, LINGERIE, JEANS, IN CLASS 25 (U.S. CLS. 22 AND 39).

TRADEMARK

PRINCIPAL REGISTER

FIRST USE 12-5-2011; IN COMMERCE 12-5-2011.

THE MARK CONSISTS OF STANDARD CHARACTERS WITHOUT CLAIM TO ANY PARTICULAR FONT, STYLE, SIZE, OR COLOR.

NO CLAIM IS MADE TO THE EXCLUSIVE RIGHT TO USE "FEMALE", APART FROM THE MARK AS SHOWN.

SN 85-265,361, FILED 3-12-2011.

AMY C. KEAN, EXAMINING ATTORNEY



David J. Kyffers

Director of the United States Patent and Trademark Office

United States of America

United States Patent and Trademark Office

NAUGHTY BITES

Reg. No. 4,100,206

KAREN BRANDELL (UNITED STATES INDIVIDUAL)
833 MILL RACE POINT
LONGWOOD, FL 32750

Registered Feb. 14, 2012

Int. Cl.: 29

FOR: SNACK MIX CONSISTING PRIMARILY OF PROCESSED NUTS, PRETZELS AND
POPCORN, IN CLASS 29 (U.S. CL. 46).

TRADEMARK

FIRST USE 11-1-2011; IN COMMERCE 11-1-2011.

PRINCIPAL REGISTER

THE MARK CONSISTS OF STANDARD CHARACTERS WITHOUT CLAIM TO ANY PAR-
TICULAR FONT, STYLE, SIZE, OR COLOR.

NO CLAIM IS MADE TO THE EXCLUSIVE RIGHT TO USE "BITES", APART FROM THE
MARK AS SHOWN.

SN 85-265,997, FILED 3-14-2011.

KEVIN CORWIN, EXAMINING ATTORNEY



David J. Kybas

Director of the United States Patent and Trademark Office

United States of America

United States Patent and Trademark Office



Reg. No. 4,100,207

GLASS, KEVIN (UNITED STATES INDIVIDUAL)
9 CHARLOTTE RD.

Registered Feb. 14, 2012

MARBLEHEAD, MA 01945

Int. Cl.: 42

FOR: ELECTRONIC LEGAL DISCOVERY CONSULTING SERVICES, IN CLASS 42 (U.S. CLS. 100 AND 101).

SERVICE MARK

FIRST USE 6-0-2011; IN COMMERCE 6-0-2011.

PRINCIPAL REGISTER

THE MARK CONSISTS OF A YELLOW HAYSTACK WITH BLACK SHADING; A BLACK MAGNIFYING GLASS IS ON THE HAYSTACK REVEALING BLACK COMPUTER CODE CONSISTING OF THE NUMBERS "1" AND "0" ON A WHITE BACKGROUND; BELOW THE HAYSTACK IS THE WORD "HAYSTACKID" IN BLACK STYLIZED FONT.

THE COLOR(S) YELLOW, BLACK AND WHITE IS/ARE CLAIMED AS A FEATURE OF THE MARK.

SN 85-267,117, FILED 3-15-2011.

DAVID COLLIER, EXAMINING ATTORNEY



David J. Kyros

Director of the United States Patent and Trademark Office

United States of America

United States Patent and Trademark Office

MIDNIGHT DIAMONDS

Reg. No. 4,100,208

Registered Feb. 14, 2012

Int. Cl.: 9

TRADEMARK

PRINCIPAL REGISTER

BALLY GAMING, INC. (NEVADA CORPORATION), DBA BALLY TECHNOLOGIES,
ATT: LEGAL DEPARTMENT
6601 SOUTH BERMUDA ROAD
LAS VEGAS, NV 89119

FOR: GAMING MACHINES, NAMELY, DEVICES WHICH ACCEPT A WAGER AND GAMING SOFTWARE THAT GENERATES OR DISPLAYS OUTCOMES FOR GAMING MACHINES, IN CLASS 9 (U.S. CLS. 21, 23, 26, 36 AND 38).

FIRST USE 9-22-2011; IN COMMERCE 9-22-2011.

THE MARK CONSISTS OF STANDARD CHARACTERS WITHOUT CLAIM TO ANY PARTICULAR FONT, STYLE, SIZE, OR COLOR.

SN 85-267,309, FILED 3-15-2011.

WENDY GOODMAN, EXAMINING ATTORNEY



David J. Kybas

Director of the United States Patent and Trademark Office

United States of America

United States Patent and Trademark Office

KATARA

Reg. No. 4,100,209

NEWFREY LLC (DELAWARE LIMITED LIABILITY COMPANY)
1207 DRUMMOND PLAZA
NEWARK, DE 19711

Registered Feb. 14, 2012

Int. Cl.: 6

FOR: METAL HARDWARE, NAMELY, DOOR KNOBS, DOOR LEVERS AND LEVER SETS, DOOR HANDLES AND HANDLE SETS, DOOR HINGES AND LATCHES, LOCKS, DEAD-BOLTS, KEYS AND KEY BLANKS, IN CLASS 6 (U.S. CLS. 2, 12, 13, 14, 23, 25 AND 50).

TRADEMARK

FIRST USE 4-4-2011; IN COMMERCE 4-4-2011.

PRINCIPAL REGISTER

THE MARK CONSISTS OF STANDARD CHARACTERS WITHOUT CLAIM TO ANY PARTICULAR FONT, STYLE, SIZE, OR COLOR.

SN 85-267,475, FILED 3-15-2011.

BRENDAN MCCAULEY, EXAMINING ATTORNEY



David J. Kyffers

Director of the United States Patent and Trademark Office

United States of America

United States Patent and Trademark Office

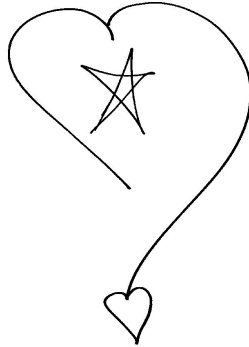

Reg. No. 4,100,210

Registered Feb. 14, 2012

Int. Cls.: 16 and 25

TRADEMARK

PRINCIPAL REGISTER

POLIAKOFF, STEPHANIE (UNITED STATES INDIVIDUAL)
4988 CHARLTON LANE
CHARLOTTE, NC 28210

FOR: JOURNALS FOR GRATITUDE FEATURING INSPIRATIONAL MESSAGES AND BLANK PAGES FOR LISTING ITEMS OF GRATITUDE; BLANK WRITING JOURNALS , IN CLASS 16 (U.S. CLS. 2, 5, 22, 23, 29, 37, 38 AND 50).

FIRST USE 10-1-1991; IN COMMERCE 1-1-2011.

FOR: CLOTHING, NAMELY, T-SHIRTS, IN CLASS 25 (U.S. CLS. 22 AND 39).

FIRST USE 10-1-1991; IN COMMERCE 1-1-2011.

THE MARK CONSISTS OF A HEART WITH A STAR DIRECTLY IN THE CENTER WITH A SMALLER HEART LAUNCHED OFF THE BOTTOM OF THE LARGER HEART. THERE IS A STAR IN THE MIDDLE.

SN 85-270,758, FILED 3-18-2011.

MARIA-VICTORIA SUAREZ, EXAMINING ATTORNEY



David J. Kybas

Director of the United States Patent and Trademark Office

United States of America

United States Patent and Trademark Office

Vinni
X

Reg. No. 4,100,211

Registered Feb. 14, 2012

Int. Cl.: 25

TRADEMARK

PRINCIPAL REGISTER

HERRERA, GUTIERREZ, MEYERS, AND CIA, LTDA (NICARAGUA LIMITED LIABILITY COMPANY)
VILLA SANDINO GRUPO C 369
GRANADA, NICARAGUA

FOR: CHILDREN'S CLOTHING FOR BOYS RANGING FROM AGE NEWBORN TO EIGHT YEARS OF AGE, NAMELY, SHIRTS, PANTS, SHORTS, VESTS, TIES, SUIT SETS, JUMPERS, AND HATS, IN CLASS 25 (U.S. CLS. 22 AND 39).

FIRST USE 8-15-2010; IN COMMERCE 8-15-2010.

THE MARK CONSISTS OF CROSSED STRAIGHT LINES AND TWO PARABOLAS FORMING A BOW TIE LIKE PATTERN BELOW THE WORD "VINNI".

SN 85-271,913, FILED 3-21-2011.

ANNE MADDEN, EXAMINING ATTORNEY



David J. Kyffers

Director of the United States Patent and Trademark Office

United States of America

United States Patent and Trademark Office

TRUE NORTH

Reg. No. 4,100,212

COREFILING SARL (LUXEMBOURG SOCIÉTÉ À RESPONSABILITÉ LIMITÉE (SARL))
PARC D'ACTIVITÉS 75

Registered Feb. 14, 2012

CAPELLEN, L-8308, LUXEMBOURG

Int. Cl.: 9

FOR: COMPUTER SOFTWARE, NAMELY, SOFTWARE TO PREPARE, READ OR REVIEW
EXTENSIBLE BUSINESS REPORTING LANGUAGE OR INLINE EXTENSIBLE BUSINESS
REPORTING LANGUAGE, IN CLASS 9 (U.S. CLS. 21, 23, 26, 36 AND 38).

TRADEMARK

FIRST USE 11-5-2004; IN COMMERCE 11-5-2004.

PRINCIPAL REGISTER

THE MARK CONSISTS OF STANDARD CHARACTERS WITHOUT CLAIM TO ANY PAR-
TICULAR FONT, STYLE, SIZE, OR COLOR.

SN 85-273,587, FILED 3-22-2011.

JUDITH HELFMAN, EXAMINING ATTORNEY



David J. Kyros

Director of the United States Patent and Trademark Office

United States of America

United States Patent and Trademark Office

YETI

Reg. No. 4,100,213

Registered Feb. 14, 2012

Int. Cl.: 9

TRADEMARK

PRINCIPAL REGISTER

COREFILING SARL (LUXEMBOURG SOCIÉTÉ À RESPONSABILITÉ LIMITÉE (SARL))
PARC D'ACTIVITÉS 75
CAPELLEN, L-8308, LUXEMBOURG

FOR: COMPUTER SOFTWARE, NAMELY, SOFTWARE TO PREPARE, READ OR REVIEW
EXTENSIBLE BUSINESS REPORTING LANGUAGE OR INLINE EXTENSIBLE BUSINESS
REPORTING LANGUAGE, IN CLASS 9 (U.S. CLS. 21, 23, 26, 36 AND 38).

FIRST USE 6-20-2008; IN COMMERCE 6-20-2008.

THE MARK CONSISTS OF STANDARD CHARACTERS WITHOUT CLAIM TO ANY PAR-
TICULAR FONT, STYLE, SIZE, OR COLOR.

SN 85-273,591, FILED 3-22-2011.

JUDITH HELFMAN, EXAMINING ATTORNEY



David J. Kybas

Director of the United States Patent and Trademark Office

United States of America

United States Patent and Trademark Office

SPHINX

Reg. No. 4,100,214

Registered Feb. 14, 2012

Int. Cl.: 9

TRADEMARK

PRINCIPAL REGISTER

COREFILING SARL (LUXEMBOURG SOCIÉTÉ À RESPONSABILITÉ LIMITÉE (SARL))
PARC D'ACTIVITÉS 75
CAPELLEN, L-8308, LUXEMBOURG

FOR: COMPUTER SOFTWARE, NAMELY, SOFTWARE TO PREPARE, READ OR REVIEW
EXTENSIBLE BUSINESS REPORTING LANGUAGE OR INLINE EXTENSIBLE BUSINESS
REPORTING LANGUAGE, IN CLASS 9 (U.S. CLS. 21, 23, 26, 36 AND 38).

FIRST USE 3-24-2010; IN COMMERCE 3-24-2010.

THE MARK CONSISTS OF STANDARD CHARACTERS WITHOUT CLAIM TO ANY PAR-
TICULAR FONT, STYLE, SIZE, OR COLOR.

SN 85-273,603, FILED 3-22-2011.

JUDITH HELFMAN, EXAMINING ATTORNEY



David J. Kyros

Director of the United States Patent and Trademark Office

United States of America

United States Patent and Trademark Office



Reg. No. 4,100,215

Registered Feb. 14, 2012

Int. Cls.: 35 and 43

SERVICE MARK

PRINCIPAL REGISTER

100 WATT DISTRIBUTION LLC (ARIZONA LIMITED LIABILITY COMPANY)
77 W CHICAGO STREET, SUITE 9
CHANDLER, AZ 85225

FOR: RESTAURANT FRANCHISING, NAMELY, OFFERING BUSINESS MANAGEMENT ASSISTANCE IN THE ESTABLISHMENT AND/OR OPERATION OF RESTAURANTS , IN CLASS 35 (U.S. CLS. 100, 101 AND 102).

FIRST USE 7-1-2011; IN COMMERCE 11-11-2011.

FOR: RESTAURANT, BAR AND CATERING SERVICES, IN CLASS 43 (U.S. CLS. 100 AND 101).

FIRST USE 7-1-2011; IN COMMERCE 11-11-2011.

NO CLAIM IS MADE TO THE EXCLUSIVE RIGHT TO USE "IRISH" AND "PUBLIC HOUSE", APART FROM THE MARK AS SHOWN.

THE COLOR(S) DARK RED, BLACK GOLD AND WHITE IS/ARE CLAIMED AS A FEATURE OF THE MARK.

THE MARK CONSISTS OF A BLACK RECTANGLE OUTLINED IN GOLD WITH A DARK RED ELONGATED RECTANGLE OUTLINED IN BLACK SUPERIMPOSED OVER THE CENTER OF THE BLACK RECTANGLE, INSIDE THE DARK RED RECTANGLE APPEARS THE WORDING "IRISH REPUBLIC" IN LARGE WHITE LETTERS WITH BLACK BORDERS, IN THE CENTER OF THE LOWER PORTION OF THE BLACK RECTANGLE AND BELOW THE RED RECTANGLE APPEARS THE WORDING "PUBLIC HOUSE" IN GOLD LETTERS AND ABOVE SUPERIMPOSED IN THE CENTER TOP OF THE TWO RECTANGLES IS A BLACK CREST WITH GOLD BORDER CONTAINING A RAMPANT RED LION.

SN 85-274,024, FILED 3-22-2011.

JEFF DEFORD, EXAMINING ATTORNEY



David J. Kyffers

Director of the United States Patent and Trademark Office

United States of America

United States Patent and Trademark Office

You're good to go

Reg. No. 4,100,216

Registered Feb. 14, 2012

Int. Cl.: 4

TRADEMARK

PRINCIPAL REGISTER

PARMAN ENERGY CORPORATION (TENNESSEE CORPORATION), AKA WILLIAMS
LUBRICATION EQUIPMENT SALES AND SERVICE,
7101 COCKRILL BEND BOULEVARD
NASHVILLE, TN 372090907

FOR: PETROLEUM, IN CLASS 4 (U.S. CLS. 1, 6 AND 15).

FIRST USE 7-1-2011; IN COMMERCE 8-1-2011.

THE MARK CONSISTS OF STANDARD CHARACTERS WITHOUT CLAIM TO ANY PARTICULAR FONT, STYLE, SIZE, OR COLOR.

SN 85-276,042, FILED 3-24-2011.

CHERYL CLAYTON, EXAMINING ATTORNEY



David J. Kybas

Director of the United States Patent and Trademark Office

United States of America

United States Patent and Trademark Office



Reg. No. 4,100,217

Registered Feb. 14, 2012

Int. Cl.: 10

TRADEMARK

PRINCIPAL REGISTER

HMD BIOMEDICAL INC. (TAIWAN CORPORATION)
NO.181, MINSHENG ST.
XINPU TOWNSHIP
HSINCHU COUNTY 305, TAIWAN

FOR: BLOOD ANALYZER FOR MEDICAL DIAGNOSTIC USE; SYRINGE NEEDLES FOR MEDICAL USE; GLUCOSE ANALYZERS, NAMELY, BLOOD GLUCOSE METERS; ELECTRIC BLOOD PRESSURE METERS; MEDICAL INSTRUMENTS FOR MONITORING BLOOD GLUCOSE LEVELS AND OTHER VITAL SIGNS; LANCETS; LANCING DEVICES FOR MEDICAL USE; BLOOD GLUCOSE METERS, IN CLASS 10 (U.S. CLS. 26, 39 AND 44).

FIRST USE 1-27-2011; IN COMMERCE 1-27-2011.

THE MARK CONSISTS OF A PAIR OF OVERLAPPING ARCUATE ARROWHEAD LIKE CONTOURS WITH THE LETTERS "GL" IMPRINTED THEREON, ALL ADJACENT THE LETTERS "GOODLIFE".

SN 85-277,770, FILED 3-26-2011.

APRIL HESIK, EXAMINING ATTORNEY



David J. Kybas

Director of the United States Patent and Trademark Office

United States of America

United States Patent and Trademark Office

SPEAL

Reg. No. 4,100,218

Registered Feb. 14, 2012

Int. Cl.: 35

SERVICE MARK

PRINCIPAL REGISTER

TOPOINTC.COM, INC. (CALIFORNIA CORPORATION)
4900 CALIFORNIA AVE., TOWER B-210
BAKERSFIELD, CA 93309

FOR: PROMOTING THE GOODS AND SERVICES OF OTHERS VIA A GLOBAL COMPUTER NETWORK BY PROVIDING A WEB SITE AT WHICH A USER CAN CREATE AN ACCOUNT THROUGH WHICH SPECIAL OFFERS ARE MADE TO INDIVIDUALS WHO PROMOTE THE GOODS OR SERVICES OF THE USER; INCENTIVE AWARD PROGRAMS TO PROMOTE THE SALE OF PRODUCTS AND SERVICES OF OTHERS, IN CLASS 35 (U.S. CLS. 100, 101 AND 102).

FIRST USE 6-1-2011; IN COMMERCE 6-1-2011.

THE MARK CONSISTS OF STANDARD CHARACTERS WITHOUT CLAIM TO ANY PARTICULAR FONT, STYLE, SIZE, OR COLOR.

SN 85-278,097, FILED 3-27-2011.

HOWARD SMIGA, EXAMINING ATTORNEY



David J. Kyffers

Director of the United States Patent and Trademark Office

United States of America

United States Patent and Trademark Office

Definitions Skincare

Reg. No. 4,100,219

TAG KAREN CEDER (UNITED STATES INDIVIDUAL)
81 LANEWOOD AVENUE
FRAMINGHAM, MA 01701

Registered Feb. 14, 2012

Int. Cl.: 3

FOR: COSMETIC PREPARATIONS FOR BODY CARE; COSMETIC PREPARATIONS FOR SKIN CARE; COSMETIC PREPARATIONS FOR SLIMMING PURPOSES; COSMETICS AND COSMETIC PREPARATIONS; COSMETICS AND MAKE-UP, IN CLASS 3 (U.S. CLS. 1, 4, 6, 50, 51 AND 52).

TRADEMARK

PRINCIPAL REGISTER

FIRST USE 12-1-2011; IN COMMERCE 12-8-2011.

THE MARK CONSISTS OF STANDARD CHARACTERS WITHOUT CLAIM TO ANY PARTICULAR FONT, STYLE, SIZE, OR COLOR.

NO CLAIM IS MADE TO THE EXCLUSIVE RIGHT TO USE "SKINCARE", APART FROM THE MARK AS SHOWN.

SN 85-278,904, FILED 3-28-2011.

JASON TURNER, EXAMINING ATTORNEY



David J. Kyffers

Director of the United States Patent and Trademark Office

United States of America

United States Patent and Trademark Office



Reg. No. 4,100,220

Registered Feb. 14, 2012

Int. Cl.: 25

TRADEMARK

PRINCIPAL REGISTER

CHEROKEE INC. (DELAWARE CORPORATION)
5990 SEPULVEDA BLVD., SUITE 600
SHERMAN OAKS, CA 91411

FOR: BRAS; CAPS; FOOTWEAR; HATS; JACKETS; PANTS; SHIRTS; SHORTS; SOCKS;
SWEATPANTS; SWEATSHIRTS; T-SHIRTS; TANK TOPS; VISORS; WARM-UP SUITS, IN
CLASS 25 (U.S. CLS. 22 AND 39).

FIRST USE 8-0-2011; IN COMMERCE 8-0-2011.

OWNER OF U.S. REG. NOS. 1,834,699, 2,556,514, AND OTHERS.

THE MARK CONSISTS OF THE WORDS "SIDE" AND "OUT" WITH A GRID DESIGN ABOVE
THE WORDS AND A TRIANGLE BEHIND THE UPPER RIGHT PORTION OF THE GRID.

SN 85-279,035, FILED 3-28-2011.

MICHAEL WEBSTER, EXAMINING ATTORNEY



David J. Kybas

Director of the United States Patent and Trademark Office

United States of America

United States Patent and Trademark Office

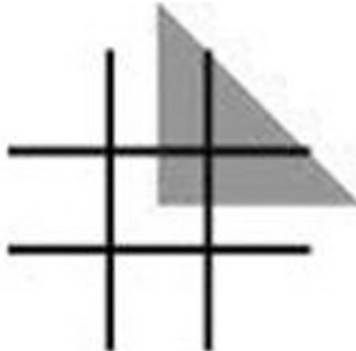

Reg. No. 4,100,221

Registered Feb. 14, 2012

Int. Cl.: 25

TRADEMARK

PRINCIPAL REGISTER

CHEROKEE INC. (DELAWARE CORPORATION)
5990 SEPULVEDA BLVD., SUITE 600
SHERMAN OAKS, CA 91411

FOR: BRAS; CAPS; FOOTWEAR; HATS; JACKETS; PANTS; SHIRTS; SHORTS; SOCKS;
SWEATPANTS; SWEATSHIRTS; T-SHIRTS; TANK TOPS; VISORS; WARM-UP SUITS, IN
CLASS 25 (U.S. CLS. 22 AND 39).

FIRST USE 8-0-2011; IN COMMERCE 8-0-2011.

THE MARK CONSISTS OF A GRID DESIGN AND A TRIANGLE BEHIND THE UPPER RIGHT
PORTION OF THE GRID.

SN 85-279,042, FILED 3-28-2011.

MICHAEL WEBSTER, EXAMINING ATTORNEY



David J. Kyffers

Director of the United States Patent and Trademark Office

United States of America

United States Patent and Trademark Office

VAZISUBANI

Reg. No. 4,100,222

Registered Feb. 14, 2012

CERTIFICATION MARK

GOODS

PRINCIPAL REGISTER

NATIONAL INTELLECTUAL PROPERTY CENTER OF GEORGIA - SAKPATENTI (REP OF GEORGIA GOVERNMENT AGENCY)
30 RUSTAVELI AVE.
0108 TBILISI, REP OF GEORGIA

FOR: WINE, IN CLASS A (U.S. CL. A).

FIRST USE 1-1-1970; IN COMMERCE 1-1-1998.

THE MARK CONSISTS OF STANDARD CHARACTERS WITHOUT CLAIM TO ANY PARTICULAR FONT, STYLE, SIZE, OR COLOR.

THE CERTIFICATION MARK, AS INTENDED TO BE USED BY AUTHORIZED PERSONS, IS INTENDED TO CERTIFY THAT THE GOODS HAVE BEEN PRODUCED IN ACCORDANCE WITH PRODUCTION STANDARDS ESTABLISHED BY THE CERTIFIER AND THAT THE GOODS EMANATE FROM A SPECIFIC GEOGRAPHIC REGION, NAMELY, THE ZONE OF VAZISUBANI WHICH INCLUDES THE VILLAGES OF VAZISUBANI, KALAUARI, SHASHIANI AND VACHNADZIANI, AND OTHER LOCATIONS SPECIFIED IN THE STANDARDS, IN GEORGIA.

SN 85-280,095, FILED 3-29-2011.

MARK SHINER, EXAMINING ATTORNEY



David J. Kyffers

Director of the United States Patent and Trademark Office

United States of America

United States Patent and Trademark Office

ORAL DETECT

Reg. No. 4,100,223

PREMIER BIOTECH (MINNESOTA CORPORATION)
6630 LAKEWAY DR.
CHANHASSEN, MN 55317

Registered Feb. 14, 2012

Int. Cl.: 10

FOR: MEDICAL DIAGNOSTIC INSTRUMENTS FOR THE ANALYSIS OF BODY FLUIDS,
IN CLASS 10 (U.S. CLS. 26, 39 AND 44).

TRADEMARK

FIRST USE 8-8-2011; IN COMMERCE 8-8-2011.

PRINCIPAL REGISTER

THE MARK CONSISTS OF STANDARD CHARACTERS WITHOUT CLAIM TO ANY PAR-
TICULAR FONT, STYLE, SIZE, OR COLOR.

NO CLAIM IS MADE TO THE EXCLUSIVE RIGHT TO USE "ORAL", APART FROM THE
MARK AS SHOWN.

SN 85-281,059, FILED 3-30-2011.

ANN E. SAPPENFIELD, EXAMINING ATTORNEY



David J. Kyffers

Director of the United States Patent and Trademark Office

United States of America

United States Patent and Trademark Office



Reg. No. 4,100,224

PSS WORLD MEDICAL, INC. (FLORIDA CORPORATION)
4345 SOUTHPOINT BOULEVARD
JACKSONVILLE, FL 32216

Registered Feb. 14, 2012

Int. Cl.: 35

FOR: BUSINESS CONSULTING SERVICES IN THE FIELD OF CLINICAL LABORATORIES,
IN CLASS 35 (U.S. CLS. 100, 101 AND 102).

SERVICE MARK

FIRST USE 3-0-2011; IN COMMERCE 3-0-2011.

PRINCIPAL REGISTER

OWNER OF U.S. REG. NOS. 1,528,735 AND 3,392,847.

NO CLAIM IS MADE TO THE EXCLUSIVE RIGHT TO USE "LABORATORY CONSULTING",
APART FROM THE MARK AS SHOWN.

THE MARK CONSISTS OF A LABORATORY FLASK DESIGN INSIDE AN UNDERLINED
ROUNDED SQUARE CARRIER, AND TO THE RIGHT APPEARS THE PARTIALLY UNDER-
LINED WORDING "MEDSOL", AND BENEATH APPEARS THE WORDING "LABORATORY
CONSULTING BY PSS".

SN 85-284,068, FILED 4-1-2011.

APRIL HESIK, EXAMINING ATTORNEY



David J. Kyffers

Director of the United States Patent and Trademark Office

United States of America

United States Patent and Trademark Office

KENT PLACE SCHOOL

Reg. No. 4,100,225

KENT PLACE SCHOOL (NEW JERSEY NON-PROFIT ORGANIZATION)
42 NORWOOD AVENUE
SUMMIT, NJ 07902

Registered Feb. 14, 2012

Int. Cls.: 25, 36, and 41

FOR: CLOTHING, NAMELY, HATS, T-SHIRTS, SWEATSHIRTS, SWEATPANTS, SHORTS, JACKETS, AND SWEATERS, IN CLASS 25 (U.S. CLS. 22 AND 39).

TRADEMARK

FIRST USE 6-0-2008; IN COMMERCE 6-0-2008.

SERVICE MARK

FOR: CHARITABLE FUND RAISING SERVICES, IN CLASS 36 (U.S. CLS. 100, 101 AND 102).

PRINCIPAL REGISTER

FIRST USE 0-0-1987; IN COMMERCE 0-0-1987.

FOR: EDUCATIONAL SERVICES, NAMELY, PROVIDING COURSES OF INSTRUCTION AT THE PRIMARY AND SECONDARY (K-12) LEVEL AND DISTRIBUTION OF COURSE MATERIAL IN CONNECTION THEREWITH, IN CLASS 41 (U.S. CLS. 100, 101 AND 107).

FIRST USE 0-0-1894; IN COMMERCE 0-0-1894.

THE MARK CONSISTS OF STANDARD CHARACTERS WITHOUT CLAIM TO ANY PARTICULAR FONT, STYLE, SIZE, OR COLOR.

NO CLAIM IS MADE TO THE EXCLUSIVE RIGHT TO USE "SCHOOL", APART FROM THE MARK AS SHOWN.

SN 85-284,138, FILED 4-1-2011.

STEVEN JACKSON, EXAMINING ATTORNEY



David J. Kypos

Director of the United States Patent and Trademark Office

United States of America

United States Patent and Trademark Office

SLEEP GEEK

Reg. No. 4,100,226

L&P PROPERTY MANAGEMENT COMPANY (DELAWARE CORPORATION)
4095 FIRESTONE BOULEVARD
SOUTH GATE, CA 90280

Registered Feb. 14, 2012

Int. Cl.: 41

FOR: ENTERTAINMENT SERVICES, NAMELY, CONDUCTING ONLINE CONTESTS OR GAMES RELATING TO THE FURNITURE AND BEDDING INDUSTRY, IN CLASS 41 (U.S. CLS. 100, 101 AND 107).

SERVICE MARK

FIRST USE 5-31-2011; IN COMMERCE 5-31-2011.

PRINCIPAL REGISTER

THE MARK CONSISTS OF STANDARD CHARACTERS WITHOUT CLAIM TO ANY PARTICULAR FONT, STYLE, SIZE, OR COLOR.

NO CLAIM IS MADE TO THE EXCLUSIVE RIGHT TO USE "SLEEP", APART FROM THE MARK AS SHOWN.

SN 85-285,264, FILED 4-4-2011.

KATHERINE STOIDES, EXAMINING ATTORNEY



David J. Kyros

Director of the United States Patent and Trademark Office

United States of America

United States Patent and Trademark Office

THE POWER BEHIND THE BUSINESS

Reg. No. 4,100,227

PDUS DIRECT, LLC (NEVADA LIMITED LIABILITY COMPANY)
1040 SANDHILL DRIVE
RENO, NV 89521

Registered Feb. 14, 2012

Int. Cl.: 9

FOR: ELECTRICAL POWER DISTRIBUTION SYSTEMS, NAMELY, POWER STRIPS AND ELECTRICAL POWER DISTRIBUTION UNITS FOR LOCAL AND REMOTE ELECTRICAL POWER MANAGEMENT, POWER MONITORING, AND ENVIRONMENTAL MONITORING; ELECTRIC CORDS, SHIELDS, AND ELECTRICAL CONNECTORS FOR ELECTRICAL POWER DISTRIBUTION SYSTEMS; SOFTWARE FOR USE IN CONTROLLING POWER DISTRIBUTION SYSTEMS, IN CLASS 9 (U.S. CLS. 21, 23, 26, 36 AND 38).

TRADEMARK

PRINCIPAL REGISTER

FIRST USE 7-31-2011; IN COMMERCE 7-31-2011.

THE MARK CONSISTS OF STANDARD CHARACTERS WITHOUT CLAIM TO ANY PARTICULAR FONT, STYLE, SIZE, OR COLOR.

SN 85-285,291, FILED 4-4-2011.

ELIZABETH KAJUBI, EXAMINING ATTORNEY



David J. Kyffers

Director of the United States Patent and Trademark Office

United States of America

United States Patent and Trademark Office

ThermoCan

Reg. No. 4,100,228

Registered Feb. 14, 2012

Int. Cl.: 10

TRADEMARK

PRINCIPAL REGISTER

S.L.P. SCIENTIFIC LABORATORY PRODUCTS LTD. (ISRAEL LIMITED LIABILITY COMPANY)
62 ANILEVITCH ST.
TEL-AVIV, ISRAEL 67060

FOR: MEDICAL APPARATUS FOR DIAGNOSING OR TREATING RESPIRATORY CONDITIONS, IN CLASS 10 (U.S. CLS. 26, 39 AND 44).

FIRST USE 6-20-2011; IN COMMERCE 10-1-2011.

THE MARK CONSISTS OF STANDARD CHARACTERS WITHOUT CLAIM TO ANY PARTICULAR FONT, STYLE, SIZE, OR COLOR.

SN 85-287,350, FILED 4-6-2011.

JESSICA A. POWERS, EXAMINING ATTORNEY



David J. Kybas

Director of the United States Patent and Trademark Office

United States of America

United States Patent and Trademark Office

Docket Direct

Reg. No. 4,100,229

AMERICAN LEGALNET, INC. (CALIFORNIA CORPORATION)

Registered Feb. 14, 2012

16501 VENTURA BLVD., SUITE 615
ENCINO, CA 91436

Int. Cl.: 42

FOR: PROVIDING TEMPORARY USE OF ON-LINE NON-DOWNLOADABLE SOFTWARE FOR CREATING, ORGANIZING, MANAGING, RECEIVING, TRACKING, AND SCHEDULING COURT FILINGS AND BUSINESS FORMS, IN CLASS 42 (U.S. CLS. 100 AND 101).

SERVICE MARK

FIRST USE 4-6-2011; IN COMMERCE 8-18-2011.

PRINCIPAL REGISTER

THE MARK CONSISTS OF STANDARD CHARACTERS WITHOUT CLAIM TO ANY PARTICULAR FONT, STYLE, SIZE, OR COLOR.

NO CLAIM IS MADE TO THE EXCLUSIVE RIGHT TO USE "DOCKET", APART FROM THE MARK AS SHOWN.

SN 85-288,181, FILED 4-6-2011.

ELLEN PERKINS, EXAMINING ATTORNEY



David J. Kyffers

Director of the United States Patent and Trademark Office

United States of America

United States Patent and Trademark Office



Reg. No. 4,100,230

CHIPOTLE MEXICAN GRILL, INC. (DELAWARE CORPORATION)
1401 WYNKOOP STREET, SUITE 500
DENVER, CO 80202

Registered Feb. 14, 2012

Int. Cl.: 43

FOR: RESTAURANT SERVICES; TAKE-OUT RESTAURANT SERVICES, IN CLASS 43 (U.S. CLS. 100 AND 101).

SERVICE MARK

FIRST USE 9-15-2011; IN COMMERCE 9-15-2011.

PRINCIPAL REGISTER

THE MARK CONSISTS OF THE WORD "SHOPHOUSE" TO THE RIGHT OF A STYLIZED DESIGN OF A FLOWER WITH THREE PETALS ABOVE A BOWL, ALL IN THE COLOR ORANGE.

THE COLOR(S) ORANGE IS/ARE CLAIMED AS A FEATURE OF THE MARK.

SN 85-288,275, FILED 4-6-2011.

VERNA BETH RIRIE, EXAMINING ATTORNEY



David J. Kyffers

Director of the United States Patent and Trademark Office

United States of America

United States Patent and Trademark Office



Reg. No. 4,100,231

Registered Feb. 14, 2012

Int. Cl.: 43

SERVICE MARK

PRINCIPAL REGISTER

INDEPENDENT OWNERS COOPERATIVE, LLC (DELAWARE LIMITED LIABILITY COMPANY)
500 U.S. ROUTE ONE
FREEPORT, ME 04032

FOR: RESTAURANT AND BAR SERVICES, IN CLASS 43 (U.S. CLS. 100 AND 101).

FIRST USE 6-30-2011; IN COMMERCE 6-30-2011.

OWNER OF U.S. REG. NOS. 927,498, 3,866,900, AND OTHERS.

NO CLAIM IS MADE TO THE EXCLUSIVE RIGHT TO USE "SPORTS GRILLE", APART FROM THE MARK AS SHOWN.

THE MARK CONSISTS OF THE WORDING "GROUND ROUND" IN FANCIFUL SCRIPT WITHIN CONCENTRIC CIRCLES. CENTERED BELOW THE WORDING "GROUND ROUND" ARE THE TERMS "SPORTS GRILLE" WITHIN A STYLIZED BANNER DESIGN THAT OVERLAYS THE CONCENTRIC CIRCLES.

SN 85-289,781, FILED 4-8-2011.

GENE MACIOL, EXAMINING ATTORNEY



David J. Kyffers

Director of the United States Patent and Trademark Office

United States of America

United States Patent and Trademark Office



Reg. No. 4,100,232

Registered Feb. 14, 2012

Int. Cls.: 3 and 16

TRADEMARK

PRINCIPAL REGISTER

VIOLENT LIPS, LLC (CALIFORNIA LIMITED LIABILITY COMPANY)
C/O SCHALL & ASSOCIATES
16255 VENTURA BLVD. #1106
ENCINO, CA 91436

FOR: COSMETICS AND MAKE-UP, IN CLASS 3 (U.S. CLS. 1, 4, 6, 50, 51 AND 52).

FIRST USE 4-15-2011; IN COMMERCE 4-15-2011.

FOR: PRINTED PATTERNS, IN CLASS 16 (U.S. CLS. 2, 5, 22, 23, 29, 37, 38 AND 50).

FIRST USE 4-15-2011; IN COMMERCE 4-15-2011.

NO CLAIM IS MADE TO THE EXCLUSIVE RIGHT TO USE "LIPS", APART FROM THE MARK AS SHOWN.

THE MARK CONSISTS OF THE WORDING "VIOLENT LIPS" IN A STYLIZED FONT NEXT TO A PAIR OF LIPS WITH FLUID DRIPPING FROM THEM.

SN 85-292,188, FILED 4-11-2011.

ANNE E. GUSTASON, EXAMINING ATTORNEY



David J. Kybas

Director of the United States Patent and Trademark Office

United States of America

United States Patent and Trademark Office

CAGE CADDY

Reg. No. 4,100,233

WIZARD SPORTS EQUIPMENT, INC. (CALIFORNIA CORPORATION)
4883 EAST LA PALMA AVE. UNIT 504
ANAHEIM, CA 92807

Registered Feb. 14, 2012

Int. Cl.: 28

FOR: BAG FOR HOLDING SOFTBALL OR BASEBALL BAT, IN CLASS 28 (U.S. CLS. 22, 23, 38 AND 50).

TRADEMARK

FIRST USE 1-5-2011; IN COMMERCE 1-5-2011.

PRINCIPAL REGISTER

THE MARK CONSISTS OF STANDARD CHARACTERS WITHOUT CLAIM TO ANY PARTICULAR FONT, STYLE, SIZE, OR COLOR.

NO CLAIM IS MADE TO THE EXCLUSIVE RIGHT TO USE "CADDY", APART FROM THE MARK AS SHOWN.

SN 85-292,428, FILED 4-12-2011.

REBECCA SMITH, EXAMINING ATTORNEY



David J. Kyffers

Director of the United States Patent and Trademark Office

United States of America

United States Patent and Trademark Office

The logo for "Energy Plus" is displayed in a large, bold, sans-serif font. The letters are white with a thick black outline, set against a dark gray rectangular background.

Reg. No. 4,100,234

Registered Feb. 14, 2012

Int. Cl.: 30

TRADEMARK

PRINCIPAL REGISTER

ANDRE PROST, INC. (DELAWARE CORPORATION)
680 MIDDLESEX TURNPIKE
OLD SAYBROOK, CT 06475

FOR: CANDY, IN CLASS 30 (U.S. CL. 46).

FIRST USE 6-6-2011; IN COMMERCE 6-6-2011.

OWNER OF U.S. REG. NO. 1,696,339.

THE MARK CONSISTS OF THE STYLIZED WORDS "ENERGYPLUS" IN A RELATIVELY LIGHTER SHADE WITH A RELATIVELY DARKER BACKGROUND/BORDER.

SN 85-292,469, FILED 4-12-2011.

EMILY CARLSEN, EXAMINING ATTORNEY



David J. Kybas

Director of the United States Patent and Trademark Office

United States of America

United States Patent and Trademark Office

HONEES ENERGYPLUS

Reg. No. 4,100,235

Registered Feb. 14, 2012

Int. Cl.: 30

TRADEMARK

PRINCIPAL REGISTER

ANDRE PROST, INC. (DELAWARE CORPORATION)
680 MIDDLESEX TURNPIKE
OLD SAYBROOK, CT 06475

FOR: CANDY, IN CLASS 30 (U.S. CL. 46).

FIRST USE 6-6-2011; IN COMMERCE 6-6-2011.

THE MARK CONSISTS OF STANDARD CHARACTERS WITHOUT CLAIM TO ANY PARTICULAR FONT, STYLE, SIZE, OR COLOR.

OWNER OF U.S. REG. NO. 1,696,339.

SN 85-292,474, FILED 4-12-2011.

EMILY CARLSEN, EXAMINING ATTORNEY



David J. Kyffers

Director of the United States Patent and Trademark Office

United States of America

United States Patent and Trademark Office



PARAMOUNT

SETTLEMENT PLANNING

Reg. No. 4,100,236

Registered Feb. 14, 2012

Int. Cl.: 36

SERVICE MARK

PRINCIPAL REGISTER

PARAMOUNT SETTLEMENT PLANNING, LLC (NEW YORK LIMITED LIABILITY COMPANY)
3686 SENECA ST.
WEST SENECA, NY 14224

FOR: FINANCIAL SERVICES, NAMELY, PROVIDING FINANCIAL PLANNING AND FINANCIAL ANALYSIS IN CONNECTION WITH THE SETTLEMENT OF LEGAL CLAIMS, STRUCTURED SETTLEMENTS, AND STRUCTURED INSTALLMENT SALES; FINANCIAL CONSULTING SERVICES IN THE FIELD OF STRUCTURED SETTLEMENTS; INSURANCE BROKERAGE SERVICES IN THE FIELD OF STRUCTURED SETTLEMENTS, IN CLASS 36 (U.S. CLS. 100, 101 AND 102).

FIRST USE 10-31-2011; IN COMMERCE 10-31-2011.

NO CLAIM IS MADE TO THE EXCLUSIVE RIGHT TO USE "SETTLEMENT PLANNING", APART FROM THE MARK AS SHOWN.

THE MARK CONSISTS OF THE CAPITAL LETTER "P" WITHIN A DIAMOND SHAPE, ABOVE THE WORD "PARAMOUNT", ABOVE A HORIZONTAL LINE, ABOVE THE WORDS "SETTLEMENT PLANNING".

SN 85-292,543, FILED 4-12-2011.

JULIE GUTTADAURO, EXAMINING ATTORNEY



David J. Kybas

Director of the United States Patent and Trademark Office

United States of America

United States Patent and Trademark Office

CULTURE OF CARING

Reg. No. 4,100,237

FRIEDLANDER GROUP, INC. (NEW YORK CORPORATION)
2500 WESTCHESTER AVENUE, SUITE 400A
PURCHASE, NY 10577

Registered Feb. 14, 2012

Int. Cl.: 36

FOR: PROVIDING INFORMATION IN THE FIELD OF WORKERS' COMPENSATION, IN CLASS 36 (U.S. CLS. 100, 101 AND 102).

SERVICE MARK

FIRST USE 11-0-2011; IN COMMERCE 11-0-2011.

PRINCIPAL REGISTER

THE MARK CONSISTS OF STANDARD CHARACTERS WITHOUT CLAIM TO ANY PARTICULAR FONT, STYLE, SIZE, OR COLOR.

SN 85-292,593, FILED 4-12-2011.

JASON BLAIR, EXAMINING ATTORNEY



David J. Kybas

Director of the United States Patent and Trademark Office

United States of America

United States Patent and Trademark Office

MICHAEL DOMINICK'S LINCOLN AVENUE PRIME STEAKHOUSE

Reg. No. 4,100,238

DPM MANAGEMENT, INC. (ARIZONA CORPORATION)

Registered Feb. 14, 2012

16641 N 90TH ST
SCOTTSDALE, AZ 85260

Int. Cl.: 43

FOR: STEAKHOUSE RESTAURANT SERVICES, IN CLASS 43 (U.S. CLS. 100 AND 101).

SERVICE MARK

FIRST USE 10-6-2011; IN COMMERCE 10-6-2011.

PRINCIPAL REGISTER

THE MARK CONSISTS OF STANDARD CHARACTERS WITHOUT CLAIM TO ANY PARTICULAR FONT, STYLE, SIZE, OR COLOR.

NO CLAIM IS MADE TO THE EXCLUSIVE RIGHT TO USE "PRIME STEAKHOUSE", APART FROM THE MARK AS SHOWN.

THE NAME(S), PORTRAIT(S), AND/OR SIGNATURE(S) SHOWN IN THE MARK DOES NOT IDENTIFY A PARTICULAR LIVING INDIVIDUAL.

SN 85-293,361, FILED 4-12-2011.

MICHAEL WEBSTER, EXAMINING ATTORNEY



David J. Kybas

Director of the United States Patent and Trademark Office

United States of America

United States Patent and Trademark Office

DustRam

Reg. No. 4,100,239

Registered Feb. 14, 2012

Int. Cl.: 7

TRADEMARK

PRINCIPAL REGISTER

SKITTER & SQUIRT ADVENTURES, LLC (MONTANA LIMITED LIABILITY COMPANY)
PO BOX 2790
MISSOULA, MT 59806

FOR: AIR POWERED TOOLS, NAMELY, CHIPPING HAMMERS AND DEMOLITION HAMMERS; POWER OPERATED TOOLS, NAMELY, DRILL HAMMERS; POWER TOOL PARTS, NAMELY, CHIPPING HAMMER AND DEMOLITION HAMMER VACUUM ATTACHMENTS; POWER TOOLS, NAMELY, HAMMER DRIVERS; SUCTION NOZZLES FOR VACUUM CLEANERS, IN CLASS 7 (U.S. CLS. 13, 19, 21, 23, 31, 34 AND 35).

FIRST USE 9-26-2011; IN COMMERCE 9-26-2011.

THE MARK CONSISTS OF STANDARD CHARACTERS WITHOUT CLAIM TO ANY PARTICULAR FONT, STYLE, SIZE, OR COLOR.

SN 85-294,619, FILED 4-13-2011.

EMILY CHUO, EXAMINING ATTORNEY



David J. Kyffers

Director of the United States Patent and Trademark Office

United States of America

United States Patent and Trademark Office

BAR NONE, THE BEST RALLY IN TEXAS

Reg. No. 4,100,240

BIKERS ADULT RALLY, L.L.C. (TEXAS LIMITED LIABILITY COMPANY)
962 POETRY ROAD

Registered Feb. 14, 2012

ROYSE CITY, TX 75189

Int. Cl.: 41

FOR: ENTERTAINMENT SERVICES, NAMELY, ORGANIZING AND CONDUCTING MOTORCYCLE EXHIBITION AND RALLIES, IN CLASS 41 (U.S. CLS. 100, 101 AND 107).

SERVICE MARK

FIRST USE 11-15-2011; IN COMMERCE 11-15-2011.

PRINCIPAL REGISTER

THE MARK CONSISTS OF STANDARD CHARACTERS WITHOUT CLAIM TO ANY PARTICULAR FONT, STYLE, SIZE, OR COLOR.

SN 85-295,178, FILED 4-14-2011.

KAPIL BHANOT, EXAMINING ATTORNEY



David J. Kyffers

Director of the United States Patent and Trademark Office

United States of America

United States Patent and Trademark Office

EXPECT THE UNEXPECTED

Reg. No. 4,100,241

BIKERS ADULT RALLY, L.L.C. (TEXAS LIMITED LIABILITY COMPANY)
962 POETRY ROAD

Registered Feb. 14, 2012

ROYSE CITY, TX 75189

Int. Cl.: 41

FOR: ENTERTAINMENT SERVICES, NAMELY, ORGANIZING AND CONDUCTING MOTORCYCLE EXHIBITION AND RALLIES, IN CLASS 41 (U.S. CLS. 100, 101 AND 107).

SERVICE MARK

FIRST USE 11-15-2011; IN COMMERCE 11-15-2011.

PRINCIPAL REGISTER

THE MARK CONSISTS OF STANDARD CHARACTERS WITHOUT CLAIM TO ANY PARTICULAR FONT, STYLE, SIZE, OR COLOR.

SN 85-295,203, FILED 4-14-2011.

KAPIL BHANOT, EXAMINING ATTORNEY



David J. Kyffers

Director of the United States Patent and Trademark Office

United States of America

United States Patent and Trademark Office

MAKE + PRINT

Reg. No. 4,100,242

Registered Feb. 14, 2012

Int. Cl.: 16

TRADEMARK

PRINCIPAL REGISTER

STICKERYOU INC. (CANADA CORPORATION)
525 ADELAID STREET, SUITE 402
TORONTO, ONTARIO, CANADA M5V1T6

FOR: CUSTOM STICKERS; CUSTOM DECALS; PRINTED MATTER, NAMELY, CUSTOM VINYL STATIC CLING SHEETS FOR AFFIXATION IN WINDOWS AND WINDSHIELDS; CUSTOM REMOVABLE TATTOOS; CUSTOM TEMPORARY TATTOOS; CUSTOM IRON ON TRANSFERS; LABEL PAPER; CUSTOM LABELS, NAMELY, ADDRESS LABELS, ADHESIVE LABELS, PAPER LABELS; PRINTED NOVELTY WINE LABELS, PRINTED PAPER LABELS, PRINTED WINE LABELS, PRINTED BEER BOTTLE LABELS, SHIPPING LABELS, BLANK PAPER LABELS FOR COMPACT DISCS, ADHESIVE LABELS FOR IDENTIFICATION, ADHESIVE LABELS FOR FOOD JARS, BLANK PAPER LABELS OF VARYING SHAPES, NAMELY, CIRCLES, SQUARES, STARS, AND HEARTS, IN CLASS 16 (U.S. CLS. 2, 5, 22, 23, 29, 37, 38 AND 50).

FIRST USE 9-1-2011; IN COMMERCE 9-1-2011.

THE MARK CONSISTS OF STANDARD CHARACTERS WITHOUT CLAIM TO ANY PARTICULAR FONT, STYLE, SIZE, OR COLOR.

SN 85-295,354, FILED 4-14-2011.

RON FAIRBANKS, EXAMINING ATTORNEY



David J. Kyros

Director of the United States Patent and Trademark Office

United States of America

United States Patent and Trademark Office

IntelliFlora

Reg. No. 4,100,243

VETS PLUS, INC. (WISCONSIN CORPORATION)
303 RED CEDAR STREET
MENOMONIE, WI 54751

Registered Feb. 14, 2012

Int. Cl.: 5

FOR: ANIMAL HEALTH SUPPLEMENT, NAMELY, DIETARY AND NUTRITIONAL SUPPLEMENT, IN CLASS 5 (U.S. CLS. 6, 18, 44, 46, 51 AND 52).

TRADEMARK

FIRST USE 4-11-2011; IN COMMERCE 6-16-2011.

PRINCIPAL REGISTER

THE MARK CONSISTS OF STANDARD CHARACTERS WITHOUT CLAIM TO ANY PARTICULAR FONT, STYLE, SIZE, OR COLOR.

SN 85-295,999, FILED 4-15-2011.

TOBY BULLOFF, EXAMINING ATTORNEY



David J. Kybas

Director of the United States Patent and Trademark Office

United States of America

United States Patent and Trademark Office

GKube

Reg. No. 4,100,244

Registered Feb. 14, 2012

Int. Cl.: 35

SERVICE MARK

PRINCIPAL REGISTER

GKUBE, LLC (DELAWARE LIMITED LIABILITY COMPANY)
1565 CRYSTAL PASS
ALLEN, TX 75002

FOR: AUCTION MANAGEMENT SERVICES PROVIDED TO OTHERS OVER AN ON-LINE WEB SITE ACCESSED THROUGH A GLOBAL COMPUTER NETWORK; ON-LINE AUCTION SERVICES, IN CLASS 35 (U.S. CLS. 100, 101 AND 102).

FIRST USE 8-15-2011; IN COMMERCE 11-12-2011.

THE MARK CONSISTS OF STANDARD CHARACTERS WITHOUT CLAIM TO ANY PARTICULAR FONT, STYLE, SIZE, OR COLOR.

SN 85-296,154, FILED 4-15-2011.

FRED CARL, EXAMINING ATTORNEY



David J. Kybas

Director of the United States Patent and Trademark Office

United States of America

United States Patent and Trademark Office

INDUSTRY SPEAKS

Reg. No. 4,100,245

Registered Feb. 14, 2012

Int. Cls.: 35 and 38

SERVICE MARK

PRINCIPAL REGISTER

COMPTON, KAREN (UNITED STATES INDIVIDUAL), DBA A3K CONSULTING,
3443 BROOKHILL STREET
GLENDALE, CA 91214

FOR: PROVIDING AN INTERACTIVE WEBSITE WITH BUSINESS INFORMATION AND RESOURCES RELATED TO THE FIELDS OF ARCHITECTURE, ENGINEERING AND CONSTRUCTION; PROVIDING REFERRALS IN THE FIELDS OF ARCHITECTURE, ENGINEERING AND CONSTRUCTION; PROVIDING RATINGS SERVICES FOR PROFESSIONALS IN THE FIELDS OF ARCHITECTURE, ENGINEERING AND CONSTRUCTION FOR COMMERCIAL SERVICES; PROVIDING A WEBSITE WHERE USERS CAN POST RATINGS, REVIEWS AND RECOMMENDATIONS ON PRODUCTS AND SERVICES FOR COMMERCIAL SERVICES, IN CLASS 35 (U.S. CLS. 100, 101 AND 102).

FIRST USE 9-22-2011; IN COMMERCE 9-22-2011.

FOR: PROVIDING ON-LINE CHAT ROOMS AND ELECTRONIC BULLETIN BOARDS FOR TRANSMISSION OF MESSAGES AMONG USERS IN THE FIELD OF ARCHITECTURE, ENGINEERING AND CONSTRUCTION, IN CLASS 38 (U.S. CLS. 100, 101 AND 104).

FIRST USE 9-22-2011; IN COMMERCE 9-22-2011.

THE MARK CONSISTS OF STANDARD CHARACTERS WITHOUT CLAIM TO ANY PARTICULAR FONT, STYLE, SIZE, OR COLOR.

NO CLAIM IS MADE TO THE EXCLUSIVE RIGHT TO USE "INDUSTRY", APART FROM THE MARK AS SHOWN.

SN 85-296,250, FILED 4-15-2011.

TOBY BULLOFF, EXAMINING ATTORNEY



David J. Kyffers

Director of the United States Patent and Trademark Office

United States of America

United States Patent and Trademark Office



Reg. No. 4,100,246

DIVILIO, JAMES (UNITED STATES INDIVIDUAL)
10 HARNESS ROAD
SAINT JAMES, NY 11780

Registered Feb. 14, 2012

Int. Cl.: 43

FOR: RESTAURANT AND BAR SERVICES; TAKE-OUT RESTAURANT SERVICES, IN CLASS 43 (U.S. CLS. 100 AND 101).

SERVICE MARK

FIRST USE 8-15-2011; IN COMMERCE 8-15-2011.

PRINCIPAL REGISTER

NO CLAIM IS MADE TO THE EXCLUSIVE RIGHT TO USE "FRESH", APART FROM THE MARK AS SHOWN.

THE COLOR(S) RED, ORANGE, YELLOW AND GREEN IS/ARE CLAIMED AS A FEATURE OF THE MARK.

THE MARK CONSISTS OF THE WORDS "CABO FRESH" WITH "CABO" IN RED AND "FRESH" IN GREEN, WITH A RED SWIRL AND RED, ORANGE, YELLOW AND GREEN RAYS ABOVE THE WORDS.

THE ENGLISH TRANSLATION OF "CABO" IN THE MARK IS "CAPE".

SN 85-297,358, FILED 4-18-2011.

ALICE BENMAMAN, EXAMINING ATTORNEY



David J. Kybas

Director of the United States Patent and Trademark Office

United States of America

United States Patent and Trademark Office

WE KEEP 'EM MOVIN'

Reg. No. 4,100,247

SYRVET, INC. (IOWA CORPORATION)

Registered Feb. 14, 2012

955 SE OLSON DR.
WAUKEE, IA 50263

Int. Cl.: 35

FOR: RETAIL STORE SERVICES FEATURING VETERINARY PRODUCTS ACCESSIBLE ON-LINE AND BY TELEPHONE, FACSIMILE AND MAIL ORDER, IN CLASS 35 (U.S. CLS. 100, 101 AND 102).

SERVICE MARK

FIRST USE 8-25-2011; IN COMMERCE 8-25-2011.

PRINCIPAL REGISTER

THE MARK CONSISTS OF STANDARD CHARACTERS WITHOUT CLAIM TO ANY PARTICULAR FONT, STYLE, SIZE, OR COLOR.

SN 85-297,596, FILED 4-18-2011.

COURTNEY ALVAREZ, EXAMINING ATTORNEY



David J. Kyffers

Director of the United States Patent and Trademark Office

United States of America

United States Patent and Trademark Office

Watts Power

Reg. No. 4,100,248

DIRECT 2U WHOLESALE LLC (FLORIDA LIMITED LIABILITY COMPANY)
P.O. BOX 673
LUTZ, FL 33549

Registered Feb. 14, 2012

Int. Cl.: 3

FOR: TOOTH WHITENING PREPARATIONS, IN CLASS 3 (U.S. CLS. 1, 4, 6, 50, 51 AND 52).

TRADEMARK

FIRST USE 12-15-2009; IN COMMERCE 12-15-2009.

PRINCIPAL REGISTER

THE MARK CONSISTS OF STANDARD CHARACTERS WITHOUT CLAIM TO ANY PARTICULAR FONT, STYLE, SIZE, OR COLOR.

SN 85-297,981, FILED 4-18-2011.

MATTHEW EINSTEIN, EXAMINING ATTORNEY



David J. Kyffers

Director of the United States Patent and Trademark Office

United States of America

United States Patent and Trademark Office

CHOOSEAFAMILY.COM

Reg. No. 4,100,249

CHOOSEAFAMILY.COM INC (NEW YORK CORPORATION)
38-11 DITMARS BLVD #715
ASTORIA, NY 11105

Registered Feb. 14, 2012

Int. Cl.: 45

FOR: INTERNET BASED SOCIAL AND PERSONAL INTRODUCTION AND NETWORKING SERVICES, IN CLASS 45 (U.S. CLS. 100 AND 101).

SERVICE MARK

FIRST USE 7-1-2007; IN COMMERCE 11-14-2011.

PRINCIPAL REGISTER

THE MARK CONSISTS OF STANDARD CHARACTERS WITHOUT CLAIM TO ANY PARTICULAR FONT, STYLE, SIZE, OR COLOR.

SN 85-298,447, FILED 4-19-2011.

RONALD MCMORROW, EXAMINING ATTORNEY



David J. Kybas

Director of the United States Patent and Trademark Office

United States of America

United States Patent and Trademark Office

LONGHAND

Reg. No. 4,100,250

Registered Feb. 14, 2012

Int. Cl.: 33

TRADEMARK

PRINCIPAL REGISTER

PLATA WINE PARTNERS, LLC (CALIFORNIA LIMITED LIABILITY COMPANY)
855 BORDEAUX WAY SUITE 100
NAPA, CA 94558

FOR: ALCOHOLIC BEVERAGES EXCEPT BEERS, IN CLASS 33 (U.S. CLS. 47 AND 49).

FIRST USE 10-11-2011; IN COMMERCE 10-11-2011.

THE MARK CONSISTS OF STANDARD CHARACTERS WITHOUT CLAIM TO ANY PARTICULAR FONT, STYLE, SIZE, OR COLOR.

SN 85-298,696, FILED 4-19-2011.

GIANCARLO CASTRO, EXAMINING ATTORNEY



David J. Kyffers

Director of the United States Patent and Trademark Office

United States of America

United States Patent and Trademark Office

M+M
CREATIVE
STUDIO

Reg. No. 4,100,251

Registered Feb. 14, 2012

Int. Cl.: 42

SERVICE MARK

PRINCIPAL REGISTER

MM CREATIVE STUDIO INC. (CALIFORNIA CORPORATION)
#88
369 S. DOHENY DR.
BEVERLY HILLS, CA 90211

FOR: ARCHITECTURAL DESIGN, IN CLASS 42 (U.S. CLS. 100 AND 101).

FIRST USE 6-1-2010; IN COMMERCE 7-25-2011.

NO CLAIM IS MADE TO THE EXCLUSIVE RIGHT TO USE "CREATIVE STUDIO", APART FROM THE MARK AS SHOWN.

THE MARK CONSISTS OF THE WORDS "M+M CREATIVE STUDIO" WHERE "M+M" IS STACKED ON TOP IN A LARGER FONT, "CREATIVE" IS BELOW IN A MEDIUM FONT, AND "STUDIO" IS BELOW THAT IN A SMALL FONT.

SN 85-299,203, FILED 4-19-2011.

JASON BLAIR, EXAMINING ATTORNEY



David J. Kybas

Director of the United States Patent and Trademark Office

United States of America

United States Patent and Trademark Office



Reg. No. 4,100,252

WHAT YOU CAN DO, LLC (TEXAS LIMITED LIABILITY COMPANY)
1701 N. MARKET ST.
DALLAS, TX 75208

Registered Feb. 14, 2012

Int. Cl.: 36

FOR: PROVIDING FUNDRAISING SERVICES FOR OTHERS VIA A GLOBAL COMPUTER NETWORK, IN CLASS 36 (U.S. CLS. 100, 101 AND 102).

SERVICE MARK

FIRST USE 6-1-2011; IN COMMERCE 6-1-2011.

PRINCIPAL REGISTER

THE MARK CONSISTS OF THE WORD "DO" ABOVE A SMILE, BOTH INSIDE A CIRCLE CREATING A FACE WHERE THE CIRCULAR ELEMENTS OF THE LETTERS "D" AND "O" APPEAR AS THE EYES OF THE FACE.

SN 85-299,617, FILED 4-20-2011.

YAT SYE, LEE, EXAMINING ATTORNEY



David J. Kyffers

Director of the United States Patent and Trademark Office

United States of America

United States Patent and Trademark Office

PORCH AT SCHENLEY

Reg. No. 4,100,253

Registered Feb. 14, 2012

Int. Cl.: 43

SERVICE MARK

PRINCIPAL REGISTER

EPR HOLDINGS, INC. (DELAWARE CORPORATION)
801 WEST STREET, 2ND FLOOR
WILMINGTON, DE 19801

FOR: RESTAURANT SERVICES, IN CLASS 43 (U.S. CLS. 100 AND 101).

FIRST USE 11-14-2011; IN COMMERCE 11-14-2011.

THE MARK CONSISTS OF STANDARD CHARACTERS WITHOUT CLAIM TO ANY PARTICULAR FONT, STYLE, SIZE, OR COLOR.

NO CLAIM IS MADE TO THE EXCLUSIVE RIGHT TO USE "AT SCHENLEY", APART FROM THE MARK AS SHOWN.

SN 85-299,944, FILED 4-20-2011.

TINA MAI, EXAMINING ATTORNEY



David J. Kyffers

Director of the United States Patent and Trademark Office

United States of America

United States Patent and Trademark Office

City Greens

Reg. No. 4,100,254

Registered Feb. 14, 2012

Int. Cl.: 43

SERVICE MARK

PRINCIPAL REGISTER

CITY GREENS, LLC (LOUISIANA LIMITED LIABILITY COMPANY)
SUITE 2450
1250 POYDRAS STREET
NEW ORLEANS, LA 70113

FOR: RESTAURANT SERVICES, IN CLASS 43 (U.S. CLS. 100 AND 101).

FIRST USE 5-15-2011; IN COMMERCE 5-15-2011.

THE MARK CONSISTS OF STANDARD CHARACTERS WITHOUT CLAIM TO ANY PARTICULAR FONT, STYLE, SIZE, OR COLOR.

NO CLAIM IS MADE TO THE EXCLUSIVE RIGHT TO USE "GREENS", APART FROM THE MARK AS SHOWN.

SN 85-300,492, FILED 4-20-2011.

ANDREW LEASER, EXAMINING ATTORNEY



David J. Kyffers

Director of the United States Patent and Trademark Office

United States of America

United States Patent and Trademark Office



Reg. No. 4,100,255

Registered Feb. 14, 2012

Int. Cl.: 42

SERVICE MARK

PRINCIPAL REGISTER

GOTGRIPE, INC. (DELAWARE CORPORATION)
27 EVANS DR.
SIMSBURY, CT 06070

FOR: COMPUTER SERVICES, NAMELY, CREATING AN ON-LINE COMMUNITY FOR REGISTERED USERS TO FORM VIRTUAL COMMUNITIES, GET FEEDBACK FROM THEIR PEERS, ENGAGE IN SOCIAL NETWORKING AND DISCUSSION TO EXPRESS, DISCUSS, AND SOLVE GRIEVANCES, IN CLASS 42 (U.S. CLS. 100 AND 101).

FIRST USE 4-6-2011; IN COMMERCE 4-6-2011.

NO CLAIM IS MADE TO THE EXCLUSIVE RIGHT TO USE "GRIPE", APART FROM THE MARK AS SHOWN.

THE MARK CONSISTS OF THE WORDING "GOT GRIPE" IN STYLIZED OUTLINED LETTERS WITH A MOUTH AS THE "O" IN "GOT", ALL ON TOP OF A STAR PATTERN.

SN 85-301,770, FILED 4-21-2011.

EMILY CHUO, EXAMINING ATTORNEY



David J. Kybas

Director of the United States Patent and Trademark Office

United States of America

United States Patent and Trademark Office

JUICYNISTA

Reg. No. 4,100,256

IPPOLITO, ALESSANDRO (UNITED STATES INDIVIDUAL)
111 RIDGEDALE ROAD
TEMPLE TERRACE, FL 33617

Registered Feb. 14, 2012

Int. Cl.: 21

FOR: LEMON SQUEEZERS; NON-ELECTRIC FRUIT SQUEEZERS; NON-ELECTRIC JUICERS,
IN CLASS 21 (U.S. CLS. 2, 13, 23, 29, 30, 33, 40 AND 50).

TRADEMARK

FIRST USE 12-4-2011; IN COMMERCE 12-4-2011.

PRINCIPAL REGISTER

THE MARK CONSISTS OF STANDARD CHARACTERS WITHOUT CLAIM TO ANY PAR-
TICULAR FONT, STYLE, SIZE, OR COLOR.

SN 85-302,913, FILED 4-23-2011.

GEORGE LORENZO, EXAMINING ATTORNEY



David J. Kyros

Director of the United States Patent and Trademark Office

United States of America

United States Patent and Trademark Office

TESTIMONY

Reg. No. 4,100,257

Registered Feb. 14, 2012

Int. Cl.: 3

TRADEMARK

PRINCIPAL REGISTER

I AM A DREAMER LLC (MISSOURI LIMITED LIABILITY COMPANY), DBA LEVI
EMMANUEL,
12500 MANCHESTER AVE
GRANDVIEW, MO 64030

FOR: AFTER SHAVE LOTIONS; AFTER-SHAVE LOTIONS; AFTER-SUN LOTIONS; AGE
RETARDANT LOTION; AROMATIC BODY CARE PRODUCTS, NAMELY, BODY LOTION,
SHOWER GEL, CUTICLE CREAM, SHAMPOO, CONDITIONER, NON-MEDICATED LIP
BALM, SOAP, BODY POLISH, BODY AND FOOT SCRUB AND NON-MEDICATED FOOT
CREAM; BABY LOTION; BATH LOTION; BATHING LOTIONS; BEAUTY CREAMS FOR
BODY CARE; BEAUTY LOTIONS; BODY AND BEAUTY CARE COSMETICS; BODY ART
PENS; BODY BUTTER; BODY CRAYONS; BODY CREAM; BODY CREAM SOAP; BODY
CREAMS; BODY DEODORANT IN PILL FORM; BODY DEODORANTS; BODY EMULSIONS;
BODY GLITTER; BODY LOTION; BODY LOTIONS; BODY MASK CREAM; BODY MASK
LOTION; BODY MASK POWDER; BODY MASKS; BODY MILK; BODY MILKS; BODY OIL;
BODY OILS; BODY POWDER; BODY SCRUB; BODY SPLASH; BODY SPRAY USED AS A
PERSONAL DEODORANT AND AS FRAGRANCE; BODY SPRAYS; BODY SPRAYS,
NAMELY, WATER IN ATOMIZED CONTAINERS USED TO PRODUCE A COOLING EFFECT;
BODY WASH; COLOGNES, PERFUMES AND COSMETICS; COSMETIC BATH SALTS;
COSMETIC CREAMS; COSMETIC CREAMS FOR SKIN CARE; COSMETIC MASKS; COS-
METIC MASSAGE CREAMS; COSMETIC NOURISHING CREAMS; COSMETIC OLIVE OIL
FOR THE FACE AND BODY; COSMETIC PREPARATIONS FOR BODY CARE; COSMETIC
PREPARATIONS, NAMELY, FIRING LOTIONS; COSMETIC SKIN FRESHENERS; COS-
METIC SUN MILK LOTIONS; COSMETIC SUNTAN LOTIONS; COSMETICS IN GENERAL,
INCLUDING PERFUMES; COSMETICS IN THE FORM OF MILKS, LOTIONS AND EMUL-
SIONS; COTTON BALLS FOR COSMETIC PURPOSES; COTTON BUDS FOR COSMETIC
PURPOSES; DECORATIVE TRANSFERS AND SKIN JEWELS FOR COSMETIC PURPOSES;
DEODORANTS FOR BODY CARE; DISINFECTING PERFUMED SOAPS; EAU DE PERFUME;
ESSENTIAL OILS AS PERFUME FOR LAUNDRY PURPOSES; EYE LOTIONS; FACE AND
BODY BEAUTY CREAMS; FACE AND BODY CREAMS; FACE AND BODY GLITTER; FACE
AND BODY LOTIONS; FACE AND BODY MILK; FACE CREAMS FOR COSMETIC USE;
FACE MILK AND LOTIONS; FACIAL LOTION; HAIR CARE LOTIONS; HAIR LOTION;
HAIR LOTIONS; HAIR WAVING LOTION; HAND LOTIONS; LIQUID PERFUMES; LIQUID
SOAPS FOR HANDS, FACE AND BODY; LOTIONS FOR BEARDS; LOTIONS FOR CEL-
LULITE REDUCTION; LOTIONS FOR COSMETIC PURPOSES; LOTIONS FOR FACE AND
BODY CARE; LOTIONS FOR STRENGTHENING THE NAILS; MAKE-UP FOR THE FACE
AND BODY; MAKE-UP PREPARATIONS FOR THE FACE AND BODY; MAKE-UP REMOV-



David J. Kyppas

Director of the United States Patent and Trademark Office

Reg. No. 4,100,257 ING LOTIONS; MAKE-UP REMOVING MILK, GEL, LOTIONS AND CREAMS; MASSAGE LOTIONS; NON-MEDICATED DIAPER RASH OINTMENTS AND LOTIONS; NON-MEDICATED HERBAL BODY CARE PRODUCTS, NAMELY, BODY OILS, SALVES, AND LIP BALMS; OILS FOR PERFUMES AND SCENTS; PERFUME; PERFUME OILS; PERFUME OILS FOR THE MANUFACTURE OF COSMETIC PREPARATIONS; PERFUMED CREAMS; PERFUMED EXTRACTS FOR TISSUES AND PERFUMES; PERFUMED PASTE; PERFUMED POWDER; PERFUMED POWDERS; PERFUMED SOAP; PERFUMED SOAPS; PERFUMED TALCUM POWDER; PERFUMES; PERFUMES AND COLOGNES; PERFUMES AND TOILET WATERS; PERFUMES FOR INDUSTRIAL PURPOSES; PERFUMES IN SOLID FORM; PERFUMES, AFTERSHAVES AND COLOGNES; PERFUMES, EAU DE COLOGNES AND AFTERSHAVES; PERFUMES, EAUX DE COLOGNE AND AFTERSHAVES; PERFUMING SACHETS; SACHETS FOR PERFUMING LINEN; SCENTED BODY SPRAY; SHAVING LOTION; SHAVING LOTIONS; SKIN AND BODY TOPICAL LOTIONS, CREAMS AND OILS FOR COSMETIC USE; SKIN CLEANSING LOTION; SKIN LOTION; SUN-BLOCK LOTIONS; SUN-TANNING OILS AND LOTIONS, IN CLASS 3 (U.S. CLS. 1, 4, 6, 50, 51 AND 52).

FIRST USE 5-17-2011; IN COMMERCE 6-17-2011.

THE MARK CONSISTS OF STANDARD CHARACTERS WITHOUT CLAIM TO ANY PARTICULAR FONT, STYLE, SIZE, OR COLOR.

SN 85-303,040, FILED 4-23-2011.

TINA BROWN, EXAMINING ATTORNEY

United States of America

United States Patent and Trademark Office

PETROCORE

Reg. No. 4,100,258

Registered Feb. 14, 2012

Int. Cls.: 9 and 41

TRADEMARK

SERVICE MARK

PRINCIPAL REGISTER

PETROSKILLS, LLC (OKLAHOMA LIMITED LIABILITY COMPANY)
2930 SOUTH YALE AVENUE
TULSA, OK 741146252

FOR: ONLINE DATABASES FEATURING DOWNLOADABLE ELECTRONIC PUBLICATIONS IN THE NATURE OF COURSE MANUALS IN THE FIELDS OF GEOLOGY, GEOPHYSICS, PETROPHYSICS, WELL CONSTRUCTION, PRODUCTION ENGINEERING, RESERVOIR ENGINEERING, ECONOMICS AND MANAGEMENT, ENVIRONMENTAL TECHNOLOGY, AND PRODUCTION FACILITIES DESIGN, OPERATION AND MAINTENANCE, WHICH COULD BE SEARCHED AND OBTAINED ONLINE, IN CLASS 9 (U.S. CLS. 21, 23, 26, 36 AND 38).

FIRST USE 5-15-2011; IN COMMERCE 5-15-2011.

FOR: PROVIDING AN ONLINE SEARCHABLE DATABASE FEATURING INFORMATION ABOUT EDUCATIONAL OPPORTUNITIES, NAMELY, PROVIDING A SEARCHABLE DATABASE FEATURING INFORMATION ABOUT EDUCATIONAL CLASSES AND SEMINARS IN THE FIELDS OF GEOLOGY, GEOPHYSICS, PETROPHYSICS, WELL CONSTRUCTION, PRODUCTION ENGINEERING, RESERVOIR ENGINEERING, ECONOMICS AND MANAGEMENT, ENVIRONMENTAL TECHNOLOGY, AND PRODUCTION FACILITIES DESIGN, OPERATION AND MAINTENANCE, WHICH COULD BE SEARCHED AND OBTAINED ONLINE; ONLINE LIBRARIES, NAMELY, PROVIDING ONLINE ELECTRONIC LIBRARY SERVICES WHICH FEATURE TRAINING COURSE MANUALS AND CATALOGS IN THE FIELDS OF GEOLOGY, GEOPHYSICS, PETROPHYSICS, WELL CONSTRUCTION, PRODUCTION ENGINEERING, RESERVOIR ENGINEERING, ECONOMICS AND MANAGEMENT, ENVIRONMENTAL TECHNOLOGY, AND PRODUCTION FACILITIES DESIGN, OPERATION AND MAINTENANCE; AND EDUCATIONAL SERVICES, NAMELY, CONDUCTING INTERNET-BASED CLASSES AND INTERNET-BASED INTERACTIVE ONLINE TRAINING IN THE FIELDS OF GEOLOGY, GEOPHYSICS, PETROPHYSICS, WELL CONSTRUCTION, PRODUCTION ENGINEERING, RESERVOIR ENGINEERING, ECONOMICS AND MANAGEMENT, ENVIRONMENTAL TECHNOLOGY, AND PRODUCTION FACILITIES DESIGN, OPERATION AND MAINTENANCE, IN CLASS 41 (U.S. CLS. 100, 101 AND 107).

FIRST USE 5-15-2011; IN COMMERCE 5-15-2011.

THE MARK CONSISTS OF STANDARD CHARACTERS WITHOUT CLAIM TO ANY PARTICULAR FONT, STYLE, SIZE, OR COLOR.



David J. Kyffers

Director of the United States Patent and Trademark Office

Reg. No. 4,100,258 SN 85-303,511, FILED 4-25-2011.

MATTHEW KLINE, EXAMINING ATTORNEY

United States of America

United States Patent and Trademark Office

First in Health

Reg. No. 4,100,259

Registered Feb. 14, 2012

Int. Cl.: 35

SERVICE MARK

PRINCIPAL REGISTER

NORTH CAROLINA COMMUNITY CARE, INC. (NORTH CAROLINA CORPORATION)
SUITE 200
2300 REXWOODS BLVD
RALEIGH, NC 27607

FOR: CONSULTING SERVICES, NAMELY, TO EMPLOYERS, COMMUNITY ORGANIZATIONS, BROKERS AND BENEFICIARIES, RELATED TO CONSUMER INFORMATION REGARDING HEALTH CARE PLAN OPTIONS, PRODUCTS AND PROGRAMS IN THE FIELD OF MANAGED CARE AND STATE AND FEDERAL MEDICAL CARE PROGRAMS, IN CLASS 35 (U.S. CLS. 100, 101 AND 102).

FIRST USE 4-1-2011; IN COMMERCE 7-25-2011.

THE MARK CONSISTS OF STANDARD CHARACTERS WITHOUT CLAIM TO ANY PARTICULAR FONT, STYLE, SIZE, OR COLOR.

NO CLAIM IS MADE TO THE EXCLUSIVE RIGHT TO USE "HEALTH", APART FROM THE MARK AS SHOWN.

SN 85-303,518, FILED 4-25-2011.

MICHAEL SOUDERS, EXAMINING ATTORNEY



David J. Kybas

Director of the United States Patent and Trademark Office

United States of America

United States Patent and Trademark Office

Nice guys win at the end.

Reg. No. 4,100,260

NGUYEN, MAI-TRANG THI (UNITED STATES INDIVIDUAL)

Registered Feb. 14, 2012

12
4135 CESAR CHAVEZ
SAN FRANCISCO, CA 94131

Int. Cl.: 25

FOR: HATS; SCARVES; T-SHIRTS, IN CLASS 25 (U.S. CLS. 22 AND 39).

TRADEMARK

FIRST USE 4-20-2011; IN COMMERCE 4-20-2011.

PRINCIPAL REGISTER

THE MARK CONSISTS OF STANDARD CHARACTERS WITHOUT CLAIM TO ANY PARTICULAR FONT, STYLE, SIZE, OR COLOR.

SN 85-306,486, FILED 4-27-2011.

THEODORE MCBRIDE, EXAMINING ATTORNEY



David J. Kybas

Director of the United States Patent and Trademark Office

United States of America

United States Patent and Trademark Office

Health & Wellness Consumer Journey

Reg. No. 4,100,261

Registered Feb. 14, 2012

Int. Cl.: 35

SERVICE MARK

PRINCIPAL REGISTER

CATALINA MARKETING CORPORATION (DELAWARE CORPORATION)
200 CARILLON PARKWAY
ST PETERSBURG, FL 33716

FOR: PROMOTING THE SALE OF GOODS AND SERVICES OF HEALTH-RELATED COMPANIES, MANAGED CARE ORGANIZATIONS, MEDICAL EDUCATION COMPANIES, HEALTH CLUBS, PHARMACEUTICAL COMPANIES AND RETAIL STORES FEATURING HEALTH-RELATED GOODS VIA PRINT AND ELECTRONIC MEDIA IN ACCORDANCE WITH A HEALTH CONSUMER BEHAVIOR MODIFICATION MODEL CREATED BY A HEALTHCARE PROVIDER; COMPILATION OF DATA FOR HEALTH-RELATED COMPANIES TO ANALYZE PATIENT BEHAVIOR AND PURCHASE PATTERNS, IN CLASS 35 (U.S. CLS. 100, 101 AND 102).

FIRST USE 10-21-2011; IN COMMERCE 10-21-2011.

THE MARK CONSISTS OF STANDARD CHARACTERS WITHOUT CLAIM TO ANY PARTICULAR FONT, STYLE, SIZE, OR COLOR.

NO CLAIM IS MADE TO THE EXCLUSIVE RIGHT TO USE "HEALTH & WELLNESS CONSUMER", APART FROM THE MARK AS SHOWN.

SN 85-306,708, FILED 4-27-2011.

JENNIFER DIXON, EXAMINING ATTORNEY



David J. Kypos

Director of the United States Patent and Trademark Office

United States of America

United States Patent and Trademark Office

BBQ on the GO!

Reg. No. 4,100,262

AKERUE INDUSTRIES, LLC (ILLINOIS LIMITED LIABILITY COMPANY)
90 MCMILLEN ROAD
ANTIOCH, IL 60002

Registered Feb. 14, 2012

Int. Cl.: 11

FOR: BARBECUE GRILLS, IN CLASS 11 (U.S. CLS. 13, 21, 23, 31 AND 34).

TRADEMARK

FIRST USE 7-1-2011; IN COMMERCE 7-1-2011.

PRINCIPAL REGISTER

THE MARK CONSISTS OF STANDARD CHARACTERS WITHOUT CLAIM TO ANY PARTICULAR FONT, STYLE, SIZE, OR COLOR.

NO CLAIM IS MADE TO THE EXCLUSIVE RIGHT TO USE "BBQ", APART FROM THE MARK AS SHOWN.

SN 85-307,477, FILED 4-28-2011.

CHERYL CLAYTON, EXAMINING ATTORNEY



David J. Kyffers

Director of the United States Patent and Trademark Office

United States of America

United States Patent and Trademark Office



Reg. No. 4,100,263

FRISKY-NINETEEN LLC (FLORIDA LIMITED LIABILITY COMPANY)
383 NE 2ND AVENUE
HALLANDALE, FL 33009

Registered Feb. 14, 2012

Int. Cl.: 25

FOR: FOOTWEAR, IN CLASS 25 (U.S. CLS. 22 AND 39).

TRADEMARK

FIRST USE 3-31-2011; IN COMMERCE 3-31-2011.

PRINCIPAL REGISTER

THE MARK CONSISTS OF THE TERM "FOOTSTEPS" APPEARING ABOVE TWO FOOTPRINTS, WITH THE HEEL OF THE FOOTPRINTS APPEARING CLOSEST TO THE TERM "FOOTSTEPS", ABOVE THE WORDING "ONE STEP AHEAD...".

SN 85-307,501, FILED 4-28-2011.

BRENDAN REGAN, EXAMINING ATTORNEY



David J. Kybas

Director of the United States Patent and Trademark Office

United States of America

United States Patent and Trademark Office

SolarNOC

Reg. No. 4,100,264

Registered Feb. 14, 2012

Int. Cl.: 42

SERVICE MARK

PRINCIPAL REGISTER

LOCUS ENERGY (NEW YORK LIMITED LIABILITY COMPANY)
#1100
1375 BROADWAY
NEW YORK, NY 10018

FOR: PROVIDING TEMPORARY USE OF ON-LINE NONDOWNLOADABLE SOFTWARE AND APPLICATIONS FOR DISPLAYING GRAPHS, CHARTS, AGGREGATE INFORMATION, AND PERFORMANCE INDICATORS, IN CLASS 42 (U.S. CLS. 100 AND 101).

FIRST USE 10-1-2011; IN COMMERCE 10-1-2011.

THE MARK CONSISTS OF STANDARD CHARACTERS WITHOUT CLAIM TO ANY PARTICULAR FONT, STYLE, SIZE, OR COLOR.

SN 85-308,059, FILED 4-29-2011.

DAVID HOFFMAN, EXAMINING ATTORNEY



David J. Kyffers

Director of the United States Patent and Trademark Office

United States of America

United States Patent and Trademark Office

SWEEPSHOT

Reg. No. 4,100,265

T-MOBILE USA, INC. (DELAWARE CORPORATION)
12920 S.E. 38TH STREET
BELLEVUE, WA 98006

Registered Feb. 14, 2012

Int. Cl.: 9

FOR: FEATURE OF WIRELESS HANDHELD TELECOMMUNICATIONS DEVICE IN THE NATURE OF SOFTWARE THAT ENABLES THE CAPTURING, CREATING, AND EDITING OF DIGITAL PHOTOGRAPHS AND IMAGES , IN CLASS 9 (U.S. CLS. 21, 23, 26, 36 AND 38).

TRADEMARK

PRINCIPAL REGISTER

FIRST USE 7-27-2011; IN COMMERCE 7-27-2011.

THE MARK CONSISTS OF STANDARD CHARACTERS WITHOUT CLAIM TO ANY PARTICULAR FONT, STYLE, SIZE, OR COLOR.

SN 85-308,330, FILED 4-29-2011.

TRACY FLETCHER, EXAMINING ATTORNEY



David J. Kyffers

Director of the United States Patent and Trademark Office

United States of America

United States Patent and Trademark Office

AFFINITY

Reg. No. 4,100,266

Registered Feb. 14, 2012

Int. Cl.: 9

TRADEMARK

PRINCIPAL REGISTER

KITH CONSUMER PRODUCT INC. (CALIFORNIA CORPORATION)
13975 CENTRAL AVE.
SUITE A
CHINO, CA 91710

FOR: TELEVISION SETS; HOME THEATRE SYSTEMS COMPRISING DVD PLAYERS, OPTICAL DISC PLAYERS, AUDIO AMPLIFIERS, AUDIO SPEAKERS, VIDEO PROJECTORS; AUDIO ELECTRONIC COMPONENTS, NAMELY, SURROUND SOUND SYSTEMS; INTERNET RADIOS; PORTABLE MEDIA PLAYERS; AUDIO RECEIVERS AND VIDEO RECEIVERS; CABLES FOR THE TRANSMISSION OF SOUNDS AND IMAGES; ANTENNAS FOR TELEVISION, FOR RADIO; DIGITAL AUDIO AND VIDEO RECORDERS AND PLAYERS; SET-TOP BOXES; PROGRAMMABLE DIGITAL TELEVISION RECORDERS; VIDEO MONITORS; LIQUID CRYSTAL DISPLAY (LCD) MONITORS; INTERNET DIGITAL VIDEO RECORDERS; REMOTE CONTROL UNITS FOR TELEVISION SETS, FOR DVD PLAYERS, FOR OPTICAL DISC PLAYERS, IN CLASS 9 (U.S. CLS. 21, 23, 26, 36 AND 38).

FIRST USE 10-24-2011; IN COMMERCE 10-24-2011.

THE MARK CONSISTS OF THE WORD "AFFINITY" AND A STYLIZED UNDERLINE SITUATED SLIGHTLY BELOW THE WORD. THE UNDERLINE EXTENDS FROM THE BOTTOM LEFT SIDE OF THE LETTER "A" TO THE MIDDLE OF THE LETTER "Y". THE UNDERLINE VARIES IN WIDTH, BEING THICKEST IN THE CENTER AND GRADUALLY TAPERING TO POINTS AT BOTH ENDS.

SN 85-308,760, FILED 4-29-2011.

LEIGH CAROLINE CASE, EXAMINING ATTORNEY



David J. Kyfos

Director of the United States Patent and Trademark Office

United States of America

United States Patent and Trademark Office

FAMILY PAINT

Reg. No. 4,100,267

ARCSOFT, INC. (CALIFORNIA CORPORATION)
46601 FREMONT BLVD
FREMONT, CA 94538

Registered Feb. 14, 2012

Int. Cl.: 9

FOR: COMPUTER SOFTWARE FOR CREATING, AUTHORING, VIEWING, ORGANIZING, EDITING AND SHARING DIGITAL PHOTOGRAPHS AND IMAGES, AUDIOS, VIDEOS, 3D IMAGES AND OBJECTS, AND MULTIMEDIA WORKS , IN CLASS 9 (U.S. CLS. 21, 23, 26, 36 AND 38).

TRADEMARK

PRINCIPAL REGISTER

FIRST USE 1-22-2011; IN COMMERCE 3-25-2011.

THE MARK CONSISTS OF STANDARD CHARACTERS WITHOUT CLAIM TO ANY PARTICULAR FONT, STYLE, SIZE, OR COLOR.

SN 85-308,885, FILED 4-29-2011.

SUZANNE BLANE, EXAMINING ATTORNEY



David J. Kyffers

Director of the United States Patent and Trademark Office

United States of America

United States Patent and Trademark Office



Reg. No. 4,100,268

Registered Feb. 14, 2012

Int. Cl.: 33

TRADEMARK

PRINCIPAL REGISTER

BELL, TYLER (UNITED STATES INDIVIDUAL)
PO BOX 6497
MONTGOMERY, AL 36106

FOR: WINES, IN CLASS 33 (U.S. CLS. 47 AND 49).

FIRST USE 9-1-2011; IN COMMERCE 10-1-2011.

THE MARK CONSISTS OF THE STYLIZED WORD "MIXTAPE" INSIDE AN OUTLINE DESIGN OF A CASSETTE TAPE.

SN 85-308,913, FILED 4-29-2011.

JEFFREY LOOK, EXAMINING ATTORNEY



David J. Kybas

Director of the United States Patent and Trademark Office

United States of America

United States Patent and Trademark Office

COMBIPLUS

Reg. No. 4,100,269

VISSMANN WERKE GMBH & CO KG (FED REP GERMANY GMBH & CO. KG)
VISSMANNSTRABE 1

Registered Feb. 14, 2012

ALLENDORF, FED REP GERMANY 35108

Int. Cl.: 11

FOR: PUMPING AND HEAT TRANSFER STATION FOR HYDRONIC HEATING SYSTEMS FOR RESIDENTIAL AND COMMERCIAL BUILDINGS, IN CLASS 11 (U.S. CLS. 13, 21, 23, 31 AND 34).

TRADEMARK

FIRST USE 8-30-2011; IN COMMERCE 8-30-2011.

PRINCIPAL REGISTER

THE MARK CONSISTS OF STANDARD CHARACTERS WITHOUT CLAIM TO ANY PARTICULAR FONT, STYLE, SIZE, OR COLOR.

SN 85-309,434, FILED 5-2-2011.

MARIA-VICTORIA SUAREZ, EXAMINING ATTORNEY



David J. Kyffers

Director of the United States Patent and Trademark Office

United States of America

United States Patent and Trademark Office

FIG IT! LIVE IT! SHARE IT!

Reg. No. 4,100,270

SUZANNE FLOREK, INC. (ILLINOIS CORPORATION)
3907 WOODLAND AVENUE
WESTERN SPRINGS, IL 60558

Registered Feb. 14, 2012

Int. Cl.: 43

FOR: PROVIDING A WEBSITE FEATURING A SEARCHABLE DATABASE OF RECIPES, FOOD-RELATED PHOTOGRAPHS AND COOKING INFORMATION, IN CLASS 43 (U.S. CLS. 100 AND 101).

SERVICE MARK

FIRST USE 7-13-2011; IN COMMERCE 7-13-2011.

PRINCIPAL REGISTER

THE MARK CONSISTS OF STANDARD CHARACTERS WITHOUT CLAIM TO ANY PARTICULAR FONT, STYLE, SIZE, OR COLOR.

SN 85-309,825, FILED 5-2-2011.

MARK SHINER, EXAMINING ATTORNEY



David J. Kyffers

Director of the United States Patent and Trademark Office

United States of America

United States Patent and Trademark Office

SUPERSTORE SHUFFLE

Reg. No. 4,100,271

PROGRESSIVE CASUALTY INSURANCE COMPANY (OHIO CORPORATION)
6300 WILSON MILLS ROAD

Registered Feb. 14, 2012

MAYFIELD VILLAGE, OH 44143

Int. Cl.: 41

FOR: ENTERTAINMENT SERVICES, NAMELY, PROVIDING AN INSURANCE-THEMED ON-LINE COMPUTER GAME, IN CLASS 41 (U.S. CLS. 100, 101 AND 107).

SERVICE MARK

FIRST USE 11-11-2011; IN COMMERCE 11-11-2011.

PRINCIPAL REGISTER

THE MARK CONSISTS OF STANDARD CHARACTERS WITHOUT CLAIM TO ANY PARTICULAR FONT, STYLE, SIZE, OR COLOR.

SN 85-309,837, FILED 5-2-2011.

SOPHIA S. KIM, EXAMINING ATTORNEY



David J. Kybas

Director of the United States Patent and Trademark Office

United States of America

United States Patent and Trademark Office

GOGGLE EYES

Reg. No. 4,100,272

GOLAD ADAR (NETHERLANDS INDIVIDUAL)
SCHERENENKWEG 16

Registered Feb. 14, 2012

HATTEM, NETHERLANDS 8051KH

Int. Cl.: 28

FOR: BOARD GAMES; CARD GAMES; PARTY GAMES, IN CLASS 28 (U.S. CLS. 22, 23, 38 AND 50).

TRADEMARK

FIRST USE 9-4-2011; IN COMMERCE 11-18-2011.

PRINCIPAL REGISTER

THE MARK CONSISTS OF STANDARD CHARACTERS WITHOUT CLAIM TO ANY PARTICULAR FONT, STYLE, SIZE, OR COLOR.

SN 85-310,590, FILED 5-3-2011.

EDWARD NELSON, EXAMINING ATTORNEY



David J. Kybas

Director of the United States Patent and Trademark Office

United States of America

United States Patent and Trademark Office

SAFE-T-SIDE

Reg. No. 4,100,273

Registered Feb. 14, 2012

Int. Cl.: 20

TRADEMARK

PRINCIPAL REGISTER

EXCELLIGENCE LEARNING CORPORATION (CALIFORNIA CORPORATION), DBA
ANGELES,
2 LOWER RAGSDALE DR., SUITE 200
MONTEREY, CA 93940

FOR: CRIBS, IN CLASS 20 (U.S. CLS. 2, 13, 22, 25, 32 AND 50).

FIRST USE 7-26-2011; IN COMMERCE 7-26-2011.

THE MARK CONSISTS OF STANDARD CHARACTERS WITHOUT CLAIM TO ANY PARTICULAR FONT, STYLE, SIZE, OR COLOR.

SN 85-310,891, FILED 5-3-2011.

MARK RADEMACHER, EXAMINING ATTORNEY



David J. Kybas

Director of the United States Patent and Trademark Office

United States of America

United States Patent and Trademark Office



Reg. No. 4,100,274

AZIZ, ABDUL (UNITED STATES INDIVIDUAL), DBA LA CASH AND CARRY,
1126 S. SANTA FE AVE.
LOS ANGELES, CA 90021

Registered Feb. 14, 2012

Int. Cl.: 3

FOR: INCENSE; INCENSE STICKS, IN CLASS 3 (U.S. CLS. 1, 4, 6, 50, 51 AND 52).

TRADEMARK

FIRST USE 10-1-2011; IN COMMERCE 10-1-2011.

PRINCIPAL REGISTER

NO CLAIM IS MADE TO THE EXCLUSIVE RIGHT TO USE "NAGCHAMPA", APART FROM THE MARK AS SHOWN.

THE MARK CONSISTS OF STYLIZED WORDS OF "BOMBAY NAGCHAMPA" IN AN OVAL CIRCLE.

THE ENGLISH TRANSLATION OF "NAGCHAMPA" IN THE MARK IS INDIAN FRAGRANCE.

SN 85-311,462, FILED 5-3-2011.

SAMUEL E. SHARPER JR., EXAMINING ATTORNEY



David J. Kyros

Director of the United States Patent and Trademark Office

United States of America

United States Patent and Trademark Office

SUPER_{5X}

Reg. No. 4,100,275

AZIZ, ABDUL (UNITED STATES INDIVIDUAL), DBA LA CASH AND CARRY,
1126 S. SANTA FE AVE.

Registered Feb. 14, 2012

LOS ANGELES, CA 90021

Int. Cl.: 4

FOR: BUTANE FUEL; BUTANE GAS CARTRIDGES SOLD FILLED; CANISTERS CONTAIN-
ING BUTANE FUEL, IN CLASS 4 (U.S. CLS. 1, 6 AND 15).

TRADEMARK

FIRST USE 10-1-2011; IN COMMERCE 10-1-2011.

PRINCIPAL REGISTER

NO CLAIM IS MADE TO THE EXCLUSIVE RIGHT TO USE "SUPER", APART FROM THE
MARK AS SHOWN.

THE MARK CONSISTS OF STYLIZED WORDS OF "SUPER 5X".

SN 85-311,471, FILED 5-3-2011.

SAMUEL E. SHARPER JR., EXAMINING ATTORNEY



David J. Kyfos

Director of the United States Patent and Trademark Office

United States of America

United States Patent and Trademark Office

THE LEADER IN PORK SOLUTIONS

Reg. No. 4,100,276

CLEMENS FOOD GROUP, LLC (PENNSYLVANIA LIMITED LIABILITY COMPANY)
2700 CLEMENS ROAD
HATFIELD, PA 19440

Registered Feb. 14, 2012

Int. Cl.: 35

FOR: WHOLESALE DISTRIBUTORSHIPS FEATURING FOODS, IN CLASS 35 (U.S. CLS. 100, 101 AND 102).

SERVICE MARK

FIRST USE 5-0-2011; IN COMMERCE 5-0-2011.

PRINCIPAL REGISTER

THE MARK CONSISTS OF STANDARD CHARACTERS WITHOUT CLAIM TO ANY PARTICULAR FONT, STYLE, SIZE, OR COLOR.

NO CLAIM IS MADE TO THE EXCLUSIVE RIGHT TO USE "PORK", APART FROM THE MARK AS SHOWN.

SN 85-311,701, FILED 5-4-2011.

CHRISTINA SOBRAL, EXAMINING ATTORNEY



David J. Kyffers

Director of the United States Patent and Trademark Office

United States of America

United States Patent and Trademark Office

CAMBRIA CUSTOM COLLECTION

Reg. No. 4,100,277

MSG MARKETING, INC. (ILLINOIS CORPORATION)
469 S. SPRING RD.
ELMHURST, IL 60126

Registered Feb. 14, 2012

Int. Cl.: 20

FOR: DRAPERY HARDWARE, NAMELY, TRAVERSE RODS, POLES, CURTAIN HOOKS, CURTAIN RODS AND FINIALS, IN CLASS 20 (U.S. CLS. 2, 13, 22, 25, 32 AND 50).

TRADEMARK

FIRST USE 12-1-2011; IN COMMERCE 12-1-2011.

PRINCIPAL REGISTER

THE MARK CONSISTS OF STANDARD CHARACTERS WITHOUT CLAIM TO ANY PARTICULAR FONT, STYLE, SIZE, OR COLOR.

OWNER OF U.S. REG. NOS. 3,091,437, 3,930,774, AND OTHERS.

NO CLAIM IS MADE TO THE EXCLUSIVE RIGHT TO USE "CUSTOM COLLECTION", APART FROM THE MARK AS SHOWN.

SN 85-312,209, FILED 5-4-2011.

DOUGLAS LEE, EXAMINING ATTORNEY



David J. Kyfos

Director of the United States Patent and Trademark Office

United States of America

United States Patent and Trademark Office

EPONME

Reg. No. 4,100,278

MT-EMZ, LLC (MONTANA LIMITED LIABILITY COMPANY)
1084 HARMONY COURT
KALISPELL, MT 59901

Registered Feb. 14, 2012

Int. Cl.: 35

FOR: ON-LINE RETAIL STORE SERVICES FEATURING SOCIAL COUPONS AND GIFT CARDS FOR OTHERS; PROMOTIONAL SERVICES, NAMELY, PROMOTING THE GOODS OF OTHERS BY MEANS OF PROVIDING ONLINE COUPONS, IN CLASS 35 (U.S. CLS. 100, 101 AND 102).

SERVICE MARK

PRINCIPAL REGISTER

FIRST USE 8-15-2011; IN COMMERCE 8-15-2011.

THE MARK CONSISTS OF STANDARD CHARACTERS WITHOUT CLAIM TO ANY PARTICULAR FONT, STYLE, SIZE, OR COLOR.

SN 85-312,605, FILED 5-4-2011.

KAREN BRACEY, EXAMINING ATTORNEY



David J. Kyffers

Director of the United States Patent and Trademark Office

United States of America

United States Patent and Trademark Office

pluscast

Reg. No. 4,100,279

Registered Feb. 14, 2012

Int. Cl.: 1

TRADEMARK

PRINCIPAL REGISTER

SOLIDSCAPE, INC. (DELAWARE CORPORATION)
316 DANIEL WEBSTER HIGHWAY
MERRIMACK, NH 03054

FOR: CHEMICAL USED IN 3-D MODEL MAKING, IN CLASS 1 (U.S. CLS. 1, 5, 6, 10, 26 AND 46).

FIRST USE 6-8-2011; IN COMMERCE 6-14-2011.

THE MARK CONSISTS OF STANDARD CHARACTERS WITHOUT CLAIM TO ANY PARTICULAR FONT, STYLE, SIZE, OR COLOR.

SN 85-313,148, FILED 5-5-2011.

JEFF DEFORD, EXAMINING ATTORNEY



David J. Kybas

Director of the United States Patent and Trademark Office

United States of America

United States Patent and Trademark Office

CHUGOPOLY

Reg. No. 4,100,280

DIETZ, ALEXANDER J (UNITED STATES INDIVIDUAL)
222 W. RIDGEPOINT
FRESNO, CA 93711

Registered Feb. 14, 2012

Int. Cl.: 28

FOR: BOARD GAMES, IN CLASS 28 (U.S. CLS. 22, 23, 38 AND 50).

TRADEMARK

FIRST USE 5-1-2011; IN COMMERCE 8-28-2011.

PRINCIPAL REGISTER

THE MARK CONSISTS OF STANDARD CHARACTERS WITHOUT CLAIM TO ANY PARTICULAR FONT, STYLE, SIZE, OR COLOR.

SN 85-315,135, FILED 5-7-2011.

LINDA ORNDORFF, EXAMINING ATTORNEY



David J. Kyffers

Director of the United States Patent and Trademark Office

United States of America

United States Patent and Trademark Office



Reg. No. 4,100,281

BEYOND VISION, INC. (FLORIDA CORPORATION)
2201 NW 102 PL #1
MIAMI, FL 33172

Registered Feb. 14, 2012

Int. Cl.: 9

FOR: EYEWEAR, IN CLASS 9 (U.S. CLS. 21, 23, 26, 36 AND 38).

TRADEMARK

FIRST USE 10-19-2011; IN COMMERCE 10-19-2011.

PRINCIPAL REGISTER

THE MARK CONSISTS OF THE DESIGN OF A LETTER "M", WITH A HORIZONTAL LINE APPEARING BEHIND THE LETTER.

SN 85-315,974, FILED 5-9-2011.

GEORGE LORENZO, EXAMINING ATTORNEY



David J. Kyffers

Director of the United States Patent and Trademark Office

United States of America

United States Patent and Trademark Office

ALL THE TASTE NONE OF THE WASTE

Reg. No. 4,100,282

Registered Feb. 14, 2012

Int. Cl.: 29

TRADEMARK

PRINCIPAL REGISTER

SF INVESTMENTS, INC. (DELAWARE CORPORATION)
BAYNARD BUILDING, STE. 103
3411 SILVERSIDE ROAD
WILMINGTON, DE 19810

FOR: MEAT, IN CLASS 29 (U.S. CL. 46).

FIRST USE 8-31-2011; IN COMMERCE 8-31-2011.

THE MARK CONSISTS OF STANDARD CHARACTERS WITHOUT CLAIM TO ANY PARTICULAR FONT, STYLE, SIZE, OR COLOR.

SN 85-318,395, FILED 5-11-2011.

KAREN BRACEY, EXAMINING ATTORNEY



David J. Kyffers

Director of the United States Patent and Trademark Office

United States of America
United States Patent and Trademark Office

PolyTough1

Reg. No. 4,100,283

POLYPIPE, INC. (TEXAS CORPORATION)
2406 N. I-35
GAINESVILLE, TX 76241

Registered Feb. 14, 2012

Int. Cl.: 17

FOR: NON-METAL BIMODAL FLEXIBLE PIPES USED FOR GAS DISTRIBUTION, IN CLASS 17 (U.S. CLS. 1, 5, 12, 13, 35 AND 50).

TRADEMARK

FIRST USE 9-0-2011; IN COMMERCE 9-0-2011.

PRINCIPAL REGISTER

THE MARK CONSISTS OF STANDARD CHARACTERS WITHOUT CLAIM TO ANY PARTICULAR FONT, STYLE, SIZE, OR COLOR.

SN 85-318,439, FILED 5-11-2011.

BARNEY CHARLON, EXAMINING ATTORNEY



David J. Kyffers

Director of the United States Patent and Trademark Office

United States of America

United States Patent and Trademark Office

The Greatest Hits on Earth - Live!

Reg. No. 4,100,284

Registered Feb. 14, 2012

Int. Cl.: 41

SERVICE MARK

PRINCIPAL REGISTER

FOREVER MUSIC PRODUCTIONS, LLC (NEW HAMPSHIRE LIMITED LIABILITY COMPANY)
50 NASHUA ROAD SUITE # 200
LONDONDERRY, NH 03053

FOR: ENTERTAINMENT, NAMELY, LIVE PERFORMANCES BY A MUSICAL BAND; ENTERTAINMENT SERVICES, NAMELY, PROVIDING A WEBSITE FEATURING NON-DOWNLOADABLE PHOTOGRAPHIC, AUDIO, AND VIDEO PRESENTATIONS ALL IN THE FIELD OF MUSIC, IN CLASS 41 (U.S. CLS. 100, 101 AND 107).

FIRST USE 8-13-2011; IN COMMERCE 8-13-2011.

THE MARK CONSISTS OF STANDARD CHARACTERS WITHOUT CLAIM TO ANY PARTICULAR FONT, STYLE, SIZE, OR COLOR.

NO CLAIM IS MADE TO THE EXCLUSIVE RIGHT TO USE "LIVE", APART FROM THE MARK AS SHOWN.

SN 85-318,528, FILED 5-11-2011.

GRETCHEN ULRICH, EXAMINING ATTORNEY



David J. Kyffers

Director of the United States Patent and Trademark Office

United States of America

United States Patent and Trademark Office

get to a better State

Reg. No. 4,100,285

Registered Feb. 14, 2012

Int. Cl.: 36

SERVICE MARK

PRINCIPAL REGISTER

STATE FARM MUTUAL AUTOMOBILE INSURANCE COMPANY (ILLINOIS CORPORATION)

A3
ONE STATE FARM PLAZA
BLOOMINGTON, IL 61701

FOR: INSURANCE UNDERWRITING SERVICES IN THE FIELDS OF AUTO, HOME, HEALTH, LIFE, AND FIRE; PROVIDING BANKING SERVICES; MUTUAL FUND INVESTMENTS; FINANCIAL ANALYSIS AND CONSULTATION, IN CLASS 36 (U.S. CLS. 100, 101 AND 102).

FIRST USE 6-13-2011; IN COMMERCE 6-13-2011.

THE MARK CONSISTS OF STANDARD CHARACTERS WITHOUT CLAIM TO ANY PARTICULAR FONT, STYLE, SIZE, OR COLOR.

SN 85-318,843, FILED 5-12-2011.

ELISSA GARBER KON, EXAMINING ATTORNEY



David J. Kyjars

Director of the United States Patent and Trademark Office

United States of America

United States Patent and Trademark Office

mejora tu Estado

Reg. No. 4,100,286

Registered Feb. 14, 2012

Int. Cl.: 36

SERVICE MARK

PRINCIPAL REGISTER

STATE FARM MUTUAL AUTOMOBILE INSURANCE COMPANY (ILLINOIS CORPORATION)

A3
ONE STATE FARM PLAZA
BLOOMINGTON, IL 61710

FOR: INSURANCE UNDERWRITING SERVICES IN THE FIELDS OF AUTO, HOME, HEALTH, LIFE, AND FIRE; PROVIDING BANKING SERVICES; MUTUAL FUND INVESTMENTS; FINANCIAL ANALYSIS AND CONSULTATION, IN CLASS 36 (U.S. CLS. 100, 101 AND 102).

FIRST USE 6-13-2011; IN COMMERCE 6-13-2011.

THE MARK CONSISTS OF STANDARD CHARACTERS WITHOUT CLAIM TO ANY PARTICULAR FONT, STYLE, SIZE, OR COLOR.

THE ENGLISH TRANSLATION OF "MEJORA TU ESTADO" IN THE MARK IS IMPROVING YOUR STATUS.

SN 85-318,909, FILED 5-12-2011.

ELISSA GARBER KON, EXAMINING ATTORNEY



David J. Kyffers

Director of the United States Patent and Trademark Office

United States of America

United States Patent and Trademark Office

DOC 360

Reg. No. 4,100,287

WIS-PAK, INC. (WISCONSIN CORPORATION)
860 WEST STREET
WATERTOWN, WI 53094

Registered Feb. 14, 2012

Int. Cl.: 32

FOR: SOFT DRINKS AND SYRUPS AND CONCENTRATES FOR MAKING THE SAME, IN CLASS 32 (U.S. CLS. 45, 46 AND 48).

TRADEMARK

FIRST USE 8-1-2011; IN COMMERCE 8-1-2011.

PRINCIPAL REGISTER

THE MARK CONSISTS OF STANDARD CHARACTERS WITHOUT CLAIM TO ANY PARTICULAR FONT, STYLE, SIZE, OR COLOR.

SN 85-322,521, FILED 5-17-2011.

DOMINICK J. SALEMI, EXAMINING ATTORNEY



David J. Kyffers

Director of the United States Patent and Trademark Office

United States of America

United States Patent and Trademark Office

SNAP IT. SEND IT. YOU
COULD WIN IT.

Reg. No. 4,100,288

PEPSICO, INC. (NORTH CAROLINA CORPORATION)
700 ANDERSON HILL ROAD
PURCHASE, NY 10577

Registered Feb. 14, 2012

Int. Cl.: 32

FOR: SOFT DRINKS, IN CLASS 32 (U.S. CLS. 45, 46 AND 48).

TRADEMARK

FIRST USE 9-4-2011; IN COMMERCE 9-4-2011.

PRINCIPAL REGISTER

THE MARK CONSISTS OF STANDARD CHARACTERS WITHOUT CLAIM TO ANY PARTICULAR FONT, STYLE, SIZE, OR COLOR.

SN 85-330,664, FILED 5-26-2011.

MATTHEW EINSTEIN, EXAMINING ATTORNEY



David J. Kybas

Director of the United States Patent and Trademark Office

United States of America

United States Patent and Trademark Office

VIALOCAL

Reg. No. 4,100,289

Registered Feb. 14, 2012

Int. Cl.: 35

SERVICE MARK

PRINCIPAL REGISTER

ST. JACQUES, INC. (NEW JERSEY CORPORATION)
60 WASHINGTON STREET, SUITE 203
MORRISTOWN, NJ 07960

FOR: ADVERTISING AND MARKETING; ADVERTISING AND MARKETING SERVICES, NAMELY, PROMOTING THE GOODS AND SERVICES OF SMALL BUSINESSES, IN CLASS 35 (U.S. CLS. 100, 101 AND 102).

FIRST USE 6-1-2011; IN COMMERCE 6-1-2011.

THE MARK CONSISTS OF STANDARD CHARACTERS WITHOUT CLAIM TO ANY PARTICULAR FONT, STYLE, SIZE, OR COLOR.

SN 85-340,037, FILED 6-7-2011.

IRA J. GOODSaid, EXAMINING ATTORNEY



David J. Kyffers

Director of the United States Patent and Trademark Office

United States of America

United States Patent and Trademark Office

Fight Republic

Reg. No. 4,100,290

CAESARS LICENSE COMPANY, LLC (NEVADA LIMITED LIABILITY COMPANY)
ONE CAESARS PALACE DRIVE
LAS VEGAS, NV 89109

Registered Feb. 14, 2012

Int. Cl.: 41

FOR: ENTERTAINMENT SERVICES IN THE NATURE OF LIVE MIXED MARTIAL ARTS (MMA) EVENTS, IN CLASS 41 (U.S. CLS. 100, 101 AND 107).

SERVICE MARK

FIRST USE 7-8-2011; IN COMMERCE 7-8-2011.

PRINCIPAL REGISTER

THE MARK CONSISTS OF STANDARD CHARACTERS WITHOUT CLAIM TO ANY PARTICULAR FONT, STYLE, SIZE, OR COLOR.

NO CLAIM IS MADE TO THE EXCLUSIVE RIGHT TO USE "FIGHT", APART FROM THE MARK AS SHOWN.

SN 85-346,117, FILED 6-14-2011.

INGRID C. EULIN, EXAMINING ATTORNEY



David J. Kybas

Director of the United States Patent and Trademark Office

United States of America

United States Patent and Trademark Office

STESSO

Reg. No. 4,100,291

Registered Feb. 14, 2012

Int. Cl.: 33

TRADEMARK

PRINCIPAL REGISTER

WINERY EXCHANGE, INC. (CALIFORNIA CORPORATION)
GENEVIEVE BURCH
500 REDWOOD BLVD., SUITE 200
NOVATO, CA 94947

FOR: ALCOHOLIC BEVERAGES EXCEPT BEERS, IN CLASS 33 (U.S. CLS. 47 AND 49).

FIRST USE 9-0-2011; IN COMMERCE 9-0-2011.

THE MARK CONSISTS OF STANDARD CHARACTERS WITHOUT CLAIM TO ANY PARTICULAR FONT, STYLE, SIZE, OR COLOR.

THE ENGLISH TRANSLATION OF "STESSO" IN THE MARK IS SAME.

SN 85-356,916, FILED 6-27-2011.

CARRIE GENOVESE, EXAMINING ATTORNEY



David J. Kyffers

Director of the United States Patent and Trademark Office

United States of America

United States Patent and Trademark Office

SHENANDOAH VALLEY BRAND

Reg. No. 4,100,292

Registered Feb. 14, 2012

Int. Cl.: 30

TRADEMARK

PRINCIPAL REGISTER

ALPENGLOW BEVERAGE CO. (VIRGINIA CORPORATION)
C/O STEPTOE & JOHNSON PLLC
400 WHITE OAKS BLVD.
BRIDGEPORT, WV 26330

FOR: SALAD DRESSING, IN CLASS 30 (U.S. CL. 46).

FIRST USE 12-2-2011; IN COMMERCE 12-2-2011.

THE MARK CONSISTS OF STANDARD CHARACTERS WITHOUT CLAIM TO ANY PARTICULAR FONT, STYLE, SIZE, OR COLOR.

NO CLAIM IS MADE TO THE EXCLUSIVE RIGHT TO USE "BRAND", APART FROM THE MARK AS SHOWN.

SN 85-360,925, FILED 6-30-2011.

KELLEY WELLS, EXAMINING ATTORNEY



David J. Kybas

Director of the United States Patent and Trademark Office

United States of America

United States Patent and Trademark Office

Nice guy wins at the end

Reg. No. 4,100,293

NGUYEN, MAI-TRANG THI (UNITED STATES INDIVIDUAL)

Registered Feb. 14, 2012

#12
4135 CESAR CHAVEZ
SAN FRANCISCO, CA 94131

Int. Cl.: 25

FOR: HATS; SCARVES; T-SHIRTS, IN CLASS 25 (U.S. CLS. 22 AND 39).

TRADEMARK

FIRST USE 4-20-2011; IN COMMERCE 4-20-2011.

PRINCIPAL REGISTER

THE MARK CONSISTS OF STANDARD CHARACTERS WITHOUT CLAIM TO ANY PARTICULAR FONT, STYLE, SIZE, OR COLOR.

SN 85-370,678, FILED 7-13-2011.

THEODORE MCBRIDE, EXAMINING ATTORNEY



David J. Kyffers

Director of the United States Patent and Trademark Office

United States of America

United States Patent and Trademark Office

*Petit
Trousseau*

Reg. No. 4,100,294

Registered Feb. 14, 2012

Int. Cl.: 25

TRADEMARK

PRINCIPAL REGISTER

ELIZABETH H. LEFKOVITS (UNITED STATES INDIVIDUAL)
4600 OLD LEEDS ROAD
BIRMINGHAM, AL 35213

FOR: BABY BIBS NOT OF PAPER, BABY BODYSUITS, BLAZERS, BONNETS, CAPS; CHILDREN'S AND INFANT'S APPAREL, NAMELY, JUMPERS, OVERALL SLEEPWEAR, PAJAMAS, ROMPERS AND ONE-PIECE GARMENTS; COATS, DRESSES, FOOTIES, GOWNS, HATS, INFANT AND TODDLER ONE PIECE CLOTHING, JACKETS, PANTS, RAIN HATS, SHIRTS, SHORTALLS, SHORTS, SKIRTS, SPORT COATS, SUITS, SWEATERS, AND TIES, IN CLASS 25 (U.S. CLS. 22 AND 39).

FIRST USE 6-1-2010; IN COMMERCE 10-1-2010.

NO CLAIM IS MADE TO THE EXCLUSIVE RIGHT TO USE "TROUSSEAU", APART FROM THE MARK AS SHOWN.

THE MARK CONSISTS OF THE WORDS "PETIT TROUSSEAU" IN A STYLIZED FONT.

THE ENGLISH TRANSLATION OF "PETIT" IN THE MARK IS SMALL.

SN 85-975,920, FILED 7-27-2010.

ANNE MADDEN, EXAMINING ATTORNEY



David J. Kyros

Director of the United States Patent and Trademark Office

United States of America

United States Patent and Trademark Office

CAMPING MAMA

Reg. No. 4,100,295

Registered Feb. 14, 2012

Int. Cls.: 9 and 28

TRADEMARK

PRINCIPAL REGISTER

COOKING MAMA LIMITED (CHINA CORPORATION)
ROOM 501, 5F 113 ARGYLE STREET, MONGKOK
KOWLOON, HONG KONG, CHINA

FOR: ACCESSORIES FOR CONSUMER GAME CONSOLES ADAPTED FOR USE WITH AN EXTERNAL DISPLAY SCREEN OR MONITOR, NAMELY, VIDEO GAME SOFTWARE, VIDEO GAME CARTRIDGES, VIDEO GAME DISCS, IN CLASS 9 (U.S. CLS. 21, 23, 26, 36 AND 38).

FIRST USE 9-6-2011; IN COMMERCE 9-6-2011.

FOR: HAND-HELD GAMES WITH LIQUID CRYSTAL DISPLAYS, IN CLASS 28 (U.S. CLS. 22, 23, 38 AND 50).

FIRST USE 9-6-2011; IN COMMERCE 9-6-2011.

THE MARK CONSISTS OF STANDARD CHARACTERS WITHOUT CLAIM TO ANY PARTICULAR FONT, STYLE, SIZE, OR COLOR.

SN 85-975,937, FILED 10-22-2010.

RONALD AIKENS, EXAMINING ATTORNEY



David J. Kyfos

Director of the United States Patent and Trademark Office

United States of America

United States Patent and Trademark Office



Reg. No. 4,100,296

Registered Feb. 14, 2012

Int. Cls.: 9 and 38

TRADEMARK

SERVICE MARK

PRINCIPAL REGISTER

VONAGE MARKETING LLC (DELAWARE LIMITED LIABILITY COMPANY)
23 MAIN STREET
HOLMDEL, NJ 07733

FOR: COMPUTER TELEPHONY SOFTWARE, NAMELY, SOFTWARE APPLICATIONS FOR ESTABLISHING AND PERFORMING PHONE CALLS, OVER A VARIETY OF NETWORKS IN THE NATURE OF THE INTERNET; DOWNLOADABLE SOFTWARE FOR USE WITH WIRELESS TELECOMMUNICATIONS DEVICES TO PROVIDE WIRELESS TRANSMISSION OF E-MAIL, TEXT, VOICE, STILL IMAGES, INFORMATION, DATA AND OTHER CONTENT VIA THE INTERNET AND VIA WIRELESS LOCAL AREA NETWORK DEVICES; COMPUTER AND TELECOMMUNICATIONS NETWORK HUBS, SWITCHES AND ROUTERS; COMPUTER HARDWARE AND COMMUNICATIONS SOFTWARE FOR USE IN CONNECTING TELECOMMUNICATIONS EQUIPMENT, TELEPHONES, COMPUTERS, WIRED AND WIRELESS COMPUTER NETWORKS; COMPUTER SOFTWARE AND HARDWARE FOR PROVIDING TRANSMISSION AND EXCHANGE OF VOICE, DATA, IMAGES AND GRAPHICS IN THE FIELDS OF TELECOMMUNICATIONS; HARDWARE FOR TELECOMMUNICATIONS FOR CONNECTING DEVICES VIA IN-HOME PHONE AND ELECTRICAL WIRING, NAMELY, COMPUTER NETWORK HUBS, COMPUTER SWITCHES AND COMPUTER ROUTERS DESIGNED TO PROVIDE IN-HOME VOICE OVER INTERNET PROTOCOL (VOIP) COMMUNICATIONS, IN CLASS 9 (U.S. CLS. 21, 23, 26, 36 AND 38).

FIRST USE 8-3-2011; IN COMMERCE 8-3-2011.

FOR: TELEPHONY COMMUNICATIONS SERVICES, IN CLASS 38 (U.S. CLS. 100, 101 AND 104).

FIRST USE 8-3-2011; IN COMMERCE 8-3-2011.

OWNER OF U.S. REG. NOS. 2,614,773, 3,740,428, AND OTHERS.

THE MARK CONSISTS OF CLOCK EVIDENCING QUARTER HOUR OVER THE WORLD MAP AND A TELEPHONE RECEIVER OVER THE CLOCK WITH THE WORDS "VONAGE" UNDER THE CLOCK.

SN 85-975,987, FILED 4-29-2011.

VERNA BETH RIRIE, EXAMINING ATTORNEY



David J. Kyffers

Director of the United States Patent and Trademark Office

United States of America

United States Patent and Trademark Office



Reg. No. 4,100,297

Registered Feb. 14, 2012

Int. Cls.: 9 and 38

TRADEMARK

SERVICE MARK

PRINCIPAL REGISTER

VONAGE MARKETING LLC (DELAWARE LIMITED LIABILITY COMPANY)
23 MAIN STREET
HOLMDEL, NJ 07733

FOR: COMPUTER TELEPHONY SOFTWARE, NAMELY, SOFTWARE APPLICATIONS FOR ESTABLISHING AND PERFORMING PHONE CALLS, OVER A VARIETY OF NETWORKS IN THE NATURE OF THE INTERNET; DOWNLOADABLE SOFTWARE FOR USE WITH WIRELESS TELECOMMUNICATIONS DEVICES TO PROVIDE WIRELESS TRANSMISSION OF E-MAIL, TEXT, VOICE, STILL IMAGES, INFORMATION, DATA AND OTHER CONTENT VIA THE INTERNET AND VIA WIRELESS LOCAL AREA NETWORK DEVICES; COMPUTER AND TELECOMMUNICATIONS NETWORK HUBS, SWITCHES AND ROUTERS; COMPUTER HARDWARE AND COMMUNICATIONS SOFTWARE FOR USE IN CONNECTING TELECOMMUNICATIONS EQUIPMENT, TELEPHONES, COMPUTERS, WIRED AND WIRELESS COMPUTER NETWORKS; COMPUTER SOFTWARE AND HARDWARE FOR PROVIDING TRANSMISSION AND EXCHANGE OF VOICE, DATA, IMAGES AND GRAPHICS IN THE FIELDS OF TELECOMMUNICATIONS; HARDWARE FOR TELECOMMUNICATIONS FOR CONNECTING DEVICES VIA IN-HOME PHONE AND ELECTRICAL WIRING, NAMELY, COMPUTER NETWORK HUBS, COMPUTER SWITCHES AND COMPUTER ROUTERS DESIGNED TO PROVIDE IN-HOME VOICE OVER INTERNET PROTOCOL (VOIP) COMMUNICATIONS, IN CLASS 9 (U.S. CLS. 21, 23, 26, 36 AND 38).

FIRST USE 7-27-2011; IN COMMERCE 7-27-2011.

FOR: TELEPHONY COMMUNICATIONS SERVICES, IN CLASS 38 (U.S. CLS. 100, 101 AND 104).

FIRST USE 7-27-2011; IN COMMERCE 7-27-2011.

OWNER OF U.S. REG. NOS. 2,614,773, 3,740,428, AND OTHERS.

THE MARK CONSISTS OF A TELEPHONE RECEIVER WITH A CONTINUOUS WAVE-LIKE DESIGN COMPRISED OF REPEATING DESIGNS OF A SOLID DOT INSIDE A STYLIZED "V", BOTH RIGHT SIDE UP AND UPSIDE DOWN EMANATING FROM EAR PIECE PORTION OF TELEPHONE RECEIVER OVER THE WORLD MAP WITH THE WORDS "VONAGE" UNDER THE TELEPHONE RECEIVER.



David J. Kyffers

Director of the United States Patent and Trademark Office

SN 85-975,988, FILED 6-8-2011.

Reg. No. 4,100,297 VERNA BETH RIRIE, EXAMINING ATTORNEY

United States of America

United States Patent and Trademark Office

SPRUCE IT UP!

Reg. No. 4,100,298

Registered Feb. 14, 2012

Int. Cls.: 4 and 5

TRADEMARK

PRINCIPAL REGISTER

S. C. JOHNSON & SON, INC. (WISCONSIN CORPORATION)
1525 HOWE STREET
RACINE, WI 53403

FOR: CANDLES, IN CLASS 4 (U.S. CLS. 1, 6 AND 15).

FIRST USE 10-27-2011; IN COMMERCE 10-27-2011.

FOR: AIR FRESHENERS, IN CLASS 5 (U.S. CLS. 6, 18, 44, 46, 51 AND 52).

FIRST USE 9-14-2011; IN COMMERCE 9-14-2011.

THE MARK CONSISTS OF STANDARD CHARACTERS WITHOUT CLAIM TO ANY PARTICULAR FONT, STYLE, SIZE, OR COLOR.

SN 85-975,991, FILED 11-5-2010.

DAVID I, EXAMINING ATTORNEY



David J. Kyfos

Director of the United States Patent and Trademark Office

United States of America

United States Patent and Trademark Office

¡ADÓRNALO!

Reg. No. 4,100,299

Registered Feb. 14, 2012

Int. Cls.: 4 and 5

TRADEMARK

PRINCIPAL REGISTER

S. C. JOHNSON & SON, INC. (WISCONSIN CORPORATION)
1525 HOWE STREET
RACINE, WI 53403

FOR: CANDLES, IN CLASS 4 (U.S. CLS. 1, 6 AND 15).

FIRST USE 10-27-2011; IN COMMERCE 10-27-2011.

FOR: AIR FRESHENERS, IN CLASS 5 (U.S. CLS. 6, 18, 44, 46, 51 AND 52).

FIRST USE 9-14-2011; IN COMMERCE 9-14-2011.

THE MARK CONSISTS OF STANDARD CHARACTERS WITHOUT CLAIM TO ANY PARTICULAR FONT, STYLE, SIZE, OR COLOR.

THE ENGLISH TRANSLATION OF "¡ADÓRNALO!" IN THE MARK IS DECORATE!.

SN 85-975,992, FILED 11-8-2010.

DAVID I, EXAMINING ATTORNEY



David J. Kyfos

Director of the United States Patent and Trademark Office

United States of America

United States Patent and Trademark Office

PUBLIC

Reg. No. 4,100,300

Registered Feb. 14, 2012

Int. Cl.: 43

SERVICE MARK

PRINCIPAL REGISTER

IAN SCHRAGER COMPANY (DELAWARE LIMITED LIABILITY COMPANY)
818 GREENWICH STREET
NEW YORK, NY 10014

FOR: HOTEL SERVICES, IN CLASS 43 (U.S. CLS. 100 AND 101).

FIRST USE 9-12-2011; IN COMMERCE 9-12-2011.

THE MARK CONSISTS OF STANDARD CHARACTERS WITHOUT CLAIM TO ANY PARTICULAR FONT, STYLE, SIZE, OR COLOR.

SN 85-976,017, FILED 12-7-2010.

KATINA MISTER, EXAMINING ATTORNEY



David J. Kybas

Director of the United States Patent and Trademark Office

United States of America

United States Patent and Trademark Office

Save an Alien

Reg. No. 4,100,301

PLAYTIKA LTD. (ISRAEL LIMITED COMPANY (LTD.))
16 GERSHON ST.
TEL AVIV, ISRAEL 37017

Registered Feb. 14, 2012

Int. Cl.: 41

FOR: ENTERTAINMENT SERVICES, NAMELY, PROVIDING ON-LINE COMPUTER GAMES AND GAME APPLICATIONS, ENHANCEMENTS WITHIN ONLINE COMPUTER GAMES, AND GAME APPLICATIONS WITHIN ONLINE COMPUTER GAMES; PROVIDING ONLINE REVIEWS OF COMPUTER GAMES, AND PROVIDING OF INFORMATION RELATING TO COMPUTER GAMES; PROVIDING AN INTERNET WEBSITE PORTAL IN THE FIELD OF COMPUTER GAMES AND GAMING; ENTERTAINMENT SERVICES, NAMELY, PROVIDING VIRTUAL ENVIRONMENTS IN WHICH USERS CAN INTERACT THROUGH SOCIAL GAMES FOR RECREATIONAL, LEISURE OR ENTERTAINMENT PURPOSES, IN CLASS 41 (U.S. CLS. 100, 101 AND 107).

SERVICE MARK

PRINCIPAL REGISTER

FIRST USE 3-17-2011; IN COMMERCE 3-17-2011.

THE MARK CONSISTS OF STANDARD CHARACTERS WITHOUT CLAIM TO ANY PARTICULAR FONT, STYLE, SIZE, OR COLOR.

SN 85-976,028, FILED 5-13-2011.

JASON BLAIR, EXAMINING ATTORNEY



David J. Kyffers

Director of the United States Patent and Trademark Office

United States of America

United States Patent and Trademark Office

GLOVEWORKS

Reg. No. 4,100,302

AMMEX CORPORATION (WASHINGTON CORPORATION)

Registered Feb. 14, 2012

P.O. BOX 88047
TUKWILA, WA 98138

Int. Cl.: 21

FOR: LATEX, NITRILE AND VINYL GLOVES FOR HOUSEHOLD, FOOD SERVICE AND GENERAL USE, IN CLASS 21 (U.S. CLS. 2, 13, 23, 29, 30, 33, 40 AND 50).

TRADEMARK

FIRST USE 11-1-2011; IN COMMERCE 11-1-2011.

PRINCIPAL REGISTER

THE MARK CONSISTS OF STANDARD CHARACTERS WITHOUT CLAIM TO ANY PARTICULAR FONT, STYLE, SIZE, OR COLOR.

OWNER OF U.S. REG. NOS. 2,775,169 AND 2,775,170.

SN 85-976,046, FILED 12-8-2010.

LAURIE MAYES, EXAMINING ATTORNEY



David J. Kyffers

Director of the United States Patent and Trademark Office

United States of America

United States Patent and Trademark Office

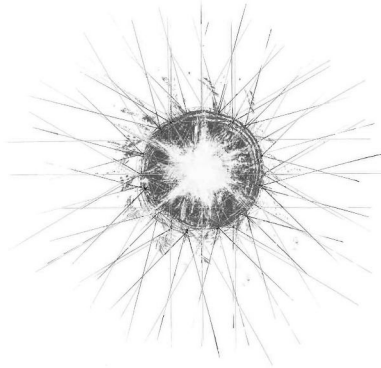

Reg. No. 4,100,303

Registered Feb. 14, 2012

Int. Cls.: 9 and 16

TRADEMARK

PRINCIPAL REGISTER

MAKING GOOD LLC (DELAWARE LIMITED LIABILITY COMPANY)
1366 OAK CREEK CANYON
MONTECITO, CA 93108

FOR: CINEMATOGRAPHIC FILMS FEATURING MUSIC AND DOCUMENTARIES, DRAMAS, COMEDIES, AND CARTOONS ON SELF-IMPROVEMENT, SELF-HELP, PERSONAL GROWTH, INSPIRATIONAL, AND CHILDREN'S TOPICS; DOWNLOADABLE ELECTRONIC AUDIO FILES, VIDEO FILES, MULTIMEDIA FILES, TEXT FILES, AND PUBLICATIONS, NAMELY, BOOKS RECORDED ON COMPUTER MEDIA, FEATURING MUSIC AND DOCUMENTARIES, DRAMAS, COMEDIES, AND CARTOONS ON SELF-IMPROVEMENT, SELF-HELP, PERSONAL GROWTH, INSPIRATIONAL, AND CHILDREN'S TOPICS; DIGITAL RECORDING, NAMELY, PRE-RECORDED DVDS, HIGH-DEFINITION DVDS, CDS, AND INTERACTIVE CD-ROMS, FEATURING BOOKS, MUSIC AND DOCUMENTARIES, DRAMAS, COMEDIES AND CARTOONS ON SELF-IMPROVEMENT, SELF-HELP, PERSONAL GROWTH, INSPIRATIONAL, AND CHILDREN'S TOPICS; LASER-READABLE AND OPTICAL DISCS, FEATURING BOOKS, MUSIC AND DOCUMENTARIES, DRAMAS, COMEDIES AND CARTOONS ON SELF-IMPROVEMENT, SELF-HELP, PERSONAL GROWTH, INSPIRATIONAL, AND CHILDREN'S TOPICS; MAGNETIC AND ELECTRONIC RECORDINGS, NAMELY, FLOPPY DISCS, COMPUTER HARD DRIVES, COMPUTER SOLID STATE DRIVES AND VIDEOCASSETTE TAPES, FEATURING BOOKS, MUSIC AND DOCUMENTARIES, DRAMAS, COMEDIES, AND CARTOONS ON SELF-IMPROVEMENT, SELF-HELP, PERSONAL GROWTH, INSPIRATIONAL, AND CHILDREN'S TOPICS; MAGNETO-OPTICAL RECORDINGS, NAMELY, PRE-RECORDED DVDS AND COMPACT DISCS, FEATURING BOOKS, MUSIC AND DOCUMENTARIES, DRAMAS, COMEDIES AND CARTOONS ON SELF-IMPROVEMENT, SELF-HELP, PERSONAL GROWTH, INSPIRATIONAL, AND CHILDREN'S TOPICS; PRE-RECORDED FLASH MEMORY CARDS, FEATURING BOOKS, MUSIC AND DOCUMENTARIES, DRAMAS, COMEDIES, AND CARTOONS ON SELF-IMPROVEMENT, SELF-HELP, PERSONAL GROWTH, INSPIRATIONAL, AND CHILDREN'S TOPICS; AUDIO-VISUAL TEACHING APPARATUS, NAMELY, EDUCATIONAL SOFTWARE FOR CHILDREN AND ADULTS, FEATURING PERSONAL GROWTH, SELF-IMPROVEMENT, SELF-HELP, INSPIRATIONAL, AND CHILDREN'S TOPICS; ELECTRONIC GAME PROGRAMS; INTERACTIVE VIDEO GAME PROGRAMS ADAPTED FOR USE WITH TELEVISION DISPLAYS; COMPUTER SOFTWARE FOR USE IN COMPUTER GAMES AND ELECTRONIC GAMES; COMPUTER PROGRAMS, NAMELY, DIGITAL GAME PROGRAMS ADAPTED FOR USE WITH TELEVISION DISPLAYS; ELECTRONIC GAME SOFTWARE FOR MOBILE PHONES; COMPACT DISCS, VIDEO DISCS, AND LASER DISCS ALL FEATURING BOOKS, MUSIC AND DOCUMENTARIES, DRAMAS, COMEDIES AND CARTOONS ON SELF-IMPROVE-



David J. Kybas

Director of the United States Patent and Trademark Office

Reg. No. 4,100,303 MENT, SELF-HELP, PERSONAL GROWTH, INSPIRATIONAL, AND CHILDREN'S TOPICS; APPLICATION COMPUTER SOFTWARE PROGRAMS FOR PERSONAL AND HANDHELD MOBILE DEVICES TO CONTAIN BOOKS, MUSIC AND DOCUMENTARIES, DRAMAS, COMEDIES, AND CARTOONS ON SELF-IMPROVEMENT, SELF-HELP, PERSONAL GROWTH, INSPIRATIONAL, AND CHILDREN'S TOPICS, IN CLASS 9 (U.S. CLS. 21, 23, 26, 36 AND 38).

FIRST USE 9-28-2010; IN COMMERCE 9-28-2010.

FOR: PRINTED MATTER AND PUBLICATIONS, NAMELY, BOOKS, MAGAZINES, NEWSLETTERS, PERIODICALS, JOURNALS, MANUALS, CATALOGUES, PAMPHLETS, LEAFLETS, AND PRINTED INSTRUCTIONAL AND TEACHING MATERIALS, COMIC BOOKS, GRAPHIC NOVELS, CALENDARS, GREETING CARDS, STATIONERY, NOTE PADS, NOTE CARDS, POSTERS, BOOK COVERS, AND BOOK MARKS, ALL FEATURING ARTWORK AND ARTICLES, INTERVIEWS, REFERENCES, AND QUOTATIONS ON SELF-HELP, SELF-IMPROVEMENT, PERSONAL GROWTH, INSPIRATIONAL, AND CHILDREN'S TOPICS, IN CLASS 16 (U.S. CLS. 2, 5, 22, 23, 29, 37, 38 AND 50).

FIRST USE 8-17-2000; IN COMMERCE 8-17-2000.

THE MARK CONSISTS OF A STYLIZED REPRESENTATION OF AN IMAGE OF A PARTIALLY SHADED SUN WITH AN UNSHADED CENTER, WITH BEAMING RAYS OF SUNSHINE EMANATING FROM THE SUN.

SN 85-976,053, FILED 7-1-2010.

ODESSA BIBBINS, EXAMINING ATTORNEY

United States of America

United States Patent and Trademark Office

BRUC ENTERTAINMENT

Reg. No. 4,100,304

CURB, MIKE (UNITED STATES INDIVIDUAL)
47 MUSIC SQUARE EAST
NASHVILLE, TN 37203

Registered Feb. 14, 2012

Int. Cl.: 16

FOR: PHOTOGRAPHIC PRINTS; PRINTED BOOKLETS IN THE FIELD OF MUSIC TO BE INSERTED IN COMPACT DISCS; MAGAZINES, NAMELY, IN THE FIELD OF ENTERTAINMENT AND MUSIC; POSTERS; STICKERS, IN CLASS 16 (U.S. CLS. 2, 5, 22, 23, 29, 37, 38 AND 50).

TRADEMARK

PRINCIPAL REGISTER

FIRST USE 10-10-2010; IN COMMERCE 10-10-2010.

THE MARK CONSISTS OF STANDARD CHARACTERS WITHOUT CLAIM TO ANY PARTICULAR FONT, STYLE, SIZE, OR COLOR.

OWNER OF U.S. REG. NO. 3,656,037.

NO CLAIM IS MADE TO THE EXCLUSIVE RIGHT TO USE "ENTERTAINMENT", APART FROM THE MARK AS SHOWN.

SN 85-976,059, FILED 11-23-2010.

DOUGLAS LEE, EXAMINING ATTORNEY



David J. Kybas

Director of the United States Patent and Trademark Office

United States of America

United States Patent and Trademark Office

Ghosts of Jupiter

Reg. No. 4,100,305

Registered Feb. 14, 2012

Int. Cl.: 41

SERVICE MARK

PRINCIPAL REGISTER

WILSON, NATE (UNITED STATES INDIVIDUAL)
763 BROADWAY, APT 1
SOMERVILLE, MA 02144

FOR: ENTERTAINMENT IN THE NATURE OF A LIVE MUSICAL PERFORMER, MUSICAL BAND OR MUSICAL GROUP, ENTERTAINMENT IN THE NATURE OF LIVE PERFORMANCES BY A MUSICAL ARTIST, MUSICAL GROUP OR MUSICAL BAND, ENTERTAINMENT IN THE NATURE OF VISUAL AND AUDIO PERFORMANCES BY A MUSICAL ARTIST, MUSICAL GROUP AND MUSICAL BAND; ENTERTAINMENT, NAMELY, LIVE MUSIC CONCERTS; ENTERTAINMENT, NAMELY, PERSONAL APPEARANCES BY A MUSICIAN, MUSICAL GROUP OR MUSICAL BAND; ENTERTAINMENT SERVICES, NAMELY, PROVIDING A WEB SITE FEATURING NONDOWNLOADABLE MUSICAL PERFORMANCES, MUSICAL VIDEOS, RELATED FILM CLIPS, PHOTOGRAPHS, AND OTHER MULTIMEDIA MATERIALS FEATURING MUSIC; ENTERTAINMENT SERVICES, NAMELY, PROVIDING NONDOWNLOADABLE PRERECORDED MUSIC, INFORMATION IN THE FIELD OF MUSIC, COMMENTARY AND ARTICLES ABOUT MUSIC, ALL ONLINE VIA A GLOBAL COMPUTER NETWORK, ENTERTAINMENT IN THE NATURE OF TRAVELING MUSICAL CONCERT TOURS; ENTERTAINMENT SERVICES, NAMELY, PROVIDING NONDOWNLOADABLE PRE-RECORDED MUSIC VIA COMPUTER, IN CLASS 41 (U.S. CLS. 100, 101 AND 107).

FIRST USE 11-4-2011; IN COMMERCE 11-4-2011.

THE MARK CONSISTS OF STANDARD CHARACTERS WITHOUT CLAIM TO ANY PARTICULAR FONT, STYLE, SIZE, OR COLOR.

SN 85-976,061, FILED 10-1-2010.

WILLIAM VERHOSEK, EXAMINING ATTORNEY



David J. Kypos

Director of the United States Patent and Trademark Office

United States of America

United States Patent and Trademark Office

110%

Reg. No. 4,100,306

RECOVER GEAR, LLC (DELAWARE LIMITED LIABILITY COMPANY)
822 A1A NORTH, S. 200

Registered Feb. 14, 2012

POINTE VEDRA BEACH, FL 32082

Int. Cl.: 25

FOR: PANTS; SHIRTS; SHORTS; SOCKS, IN CLASS 25 (U.S. CLS. 22 AND 39).

TRADEMARK

FIRST USE 7-16-2010; IN COMMERCE 7-16-2010.

PRINCIPAL REGISTER

THE MARK CONSISTS OF STANDARD CHARACTERS WITHOUT CLAIM TO ANY PARTICULAR FONT, STYLE, SIZE, OR COLOR.

SN 85-976,089, FILED 11-3-2010.

GIANCARLO CASTRO, EXAMINING ATTORNEY



David J. Kyffers

Director of the United States Patent and Trademark Office

United States of America

United States Patent and Trademark Office

LIVING
the GIFT



Reg. No. 4,100,307

JACOB BERRY MINISTRIES, INC. (OKLAHOMA CORPORATION)
1902 G NORTHWEST
MIAMI, OK 74354

Registered Feb. 14, 2012

Int. Cl.: 9

FOR: DIGITAL MEDIA, NAMELY, PRE-RECORDED DVDS, CDS, PRE-RECORDED FLASH DRIVES, AND DOWNLOADABLE AUDIO AND VIDEO RECORDINGS FEATURING AND PROMOTING EVANGELISTIC CHRISTIAN MINISTRY, NAMELY, SERMONS, SPEECHES, TALKS AND MUSIC, IN CLASS 9 (U.S. CLS. 21, 23, 26, 36 AND 38).

TRADEMARK

PRINCIPAL REGISTER

FIRST USE 5-30-2011; IN COMMERCE 5-30-2011.

THE MARK CONSISTS OF THE WORDS "LIVING THE GIFT" IN BLACK WITH A STYLIZED DOVE OUTLINED IN BLACK HOLDING A RED RIBBON ON THE RIGHT SIDE THEREOF.

THE COLOR(S) BLACK AND RED IS/ARE CLAIMED AS A FEATURE OF THE MARK.

SN 85-976,096, FILED 12-29-2010.

CHRIS WELLS, EXAMINING ATTORNEY



David J. Kybas

Director of the United States Patent and Trademark Office

United States of America

United States Patent and Trademark Office

WILD BILL'S

Reg. No. 4,100,308

MAZIN G. SAMONA (UNITED STATES INDIVIDUAL)
1238 ANDERSON COURT
CLAWSON, MI 48017

Registered Feb. 14, 2012

Int. Cl.: 35

FOR: RETAIL STORE SERVICES FEATURING SMOKERS' ARTICLES, IN CLASS 35 (U.S. CLS. 100, 101 AND 102).

SERVICE MARK

FIRST USE 10-31-2011; IN COMMERCE 10-31-2011.

PRINCIPAL REGISTER

THE MARK CONSISTS OF STANDARD CHARACTERS WITHOUT CLAIM TO ANY PARTICULAR FONT, STYLE, SIZE, OR COLOR.

SN 85-976,105, FILED 5-3-2011.

JUDITH HELFMAN, EXAMINING ATTORNEY



David J. Kybas

Director of the United States Patent and Trademark Office

United States of America

United States Patent and Trademark Office

WILD BILL'S TOBACCO

Reg. No. 4,100,309

Registered Feb. 14, 2012

Int. Cl.: 35

SERVICE MARK

PRINCIPAL REGISTER

MAZIN G. SAMONA (UNITED STATES INDIVIDUAL)
SUITE 205
154 SOUTH OLD WOODWARD AVENUE
BIRMINGHAM, MI 48009

FOR: RETAIL STORE SERVICES FEATURING SMOKERS' ARTICLES, IN CLASS 35 (U.S. CLS. 100, 101 AND 102).

FIRST USE 10-31-2011; IN COMMERCE 10-31-2011.

THE MARK CONSISTS OF STANDARD CHARACTERS WITHOUT CLAIM TO ANY PARTICULAR FONT, STYLE, SIZE, OR COLOR.

NO CLAIM IS MADE TO THE EXCLUSIVE RIGHT TO USE "TOBACCO", APART FROM THE MARK AS SHOWN.

SN 85-976,114, FILED 5-3-2011.

JUDITH HELFMAN, EXAMINING ATTORNEY



David J. Kyffers

Director of the United States Patent and Trademark Office

United States of America

United States Patent and Trademark Office

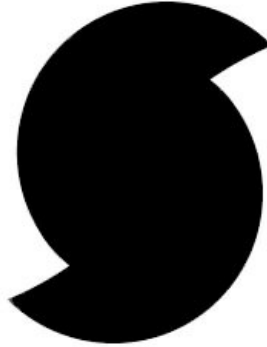

Reg. No. 4,100,310

SOUNDHOUND, INC. (DELAWARE CORPORATION)
1731 TECHNOLOGY DRIVE, SUITE 700
SAN JOSE, CA 95110

Registered Feb. 14, 2012

Int. Cls.: 9, 35, and 38

FOR: COMPUTER SEARCH ENGINE SOFTWARE; COMPUTER SOFTWARE FOR USE IN SEARCHING VIA TEXT, SOUND, SPEECH, AND MUSICAL QUERIES; COMPUTER SOFTWARE FOR USE IN RECOGNIZING AND IDENTIFYING SOUND, SPEECH, AND MUSIC BY COMPARING INPUT SAMPLES WITH KNOWN SAMPLES; COMPUTER SOFTWARE FOR DISPLAY OF TEXT, GRAPHICS, AND LYRICS, IN CLASS 9 (U.S. CLS. 21, 23, 26, 36 AND 38).

TRADEMARK

SERVICE MARK

PRINCIPAL REGISTER

FIRST USE 4-0-2010; IN COMMERCE 4-0-2010.

FOR: ONLINE RETAIL STORE SERVICES IN THE FIELD OF ENTERTAINMENT FEATURING LINKS FOR PURCHASING MUSICAL WORKS, DOWNLOADABLE RINGTONES, PRE-RECORDED AUDIO AND AUDIOVISUAL WORKS; ADVERTISING SERVICES, NAMELY, PROVIDING ADVERTISING SPACE ON WEB SITES AND ON MOBILE APPLICATIONS ACCESSIBLE VIA THE GLOBAL COMPUTER NETWORK AND VIA TELECOMMUNICATION NETWORKS; PROMOTING THE GOODS AND SERVICES OF OTHERS VIA A GLOBAL COMPUTER NETWORK AND VIA TELECOMMUNICATION NETWORKS, IN CLASS 35 (U.S. CLS. 100, 101 AND 102).

FIRST USE 4-0-2010; IN COMMERCE 4-0-2010.

FOR: ELECTRONIC TRANSMISSION OF STREAMED AND DOWNLOADABLE AUDIO AND VIDEO FILES, AND TEXT FILES, VIA COMPUTERS AND OTHER COMMUNICATIONS NETWORKS; DELIVERY OF MESSAGES BY ELECTRONIC TRANSMISSION, IN CLASS 38 (U.S. CLS. 100, 101 AND 104).

FIRST USE 4-0-2010; IN COMMERCE 4-0-2010.

THE MARK CONSISTS OF A STYLIZED "S".

SN 85-976,115, FILED 4-8-2010.

MICHAEL SOUDERS, EXAMINING ATTORNEY



David J. Kyros

Director of the United States Patent and Trademark Office

United States of America

United States Patent and Trademark Office

NURTURED BY NATURE

Reg. No. 4,100,311

VALOR BRANDS, INC. (GEORGIA CORPORATION)
3159 ROYAL DRIVE, SUITE 360
ALPHARETTA, GA 30022

Registered Feb. 14, 2012

Int. Cl.: 3

FOR: BABY WIPES; PRE-MOISTENED BABY WIPES, IN CLASS 3 (U.S. CLS. 1, 4, 6, 50, 51 AND 52).

TRADEMARK

FIRST USE 12-21-2011; IN COMMERCE 12-21-2011.

PRINCIPAL REGISTER

THE MARK CONSISTS OF STANDARD CHARACTERS WITHOUT CLAIM TO ANY PARTICULAR FONT, STYLE, SIZE, OR COLOR.

OWNER OF U.S. REG. NO. 3,814,955.

SN 85-976,116, FILED 5-17-2010.

SALLY SHIH, EXAMINING ATTORNEY



David J. Kyffers

Director of the United States Patent and Trademark Office

United States of America

United States Patent and Trademark Office

CROOKED HUMAN

Reg. No. 4,100,312

CROOKED HUMAN, INC. (CALIFORNIA CORPORATION)

Registered Feb. 14, 2012

12230 EL CAMINO REAL, SUITE 130
SAN DIEGO, CA 92130

Int. Cls.: 25 and 35

FOR: APPAREL, NAMELY, T-SHIRTS, SHIRTS, SHORTS, PANTS, SWEATSHIRTS, SWEATPANTS, JACKETS, HATS, VISORS, SHOES, SANDALS, UNDERWEAR, SOCKS, AND BELTS, IN CLASS 25 (U.S. CLS. 22 AND 39).

TRADEMARK

FIRST USE 3-16-2011; IN COMMERCE 3-16-2011.

SERVICE MARK

PRINCIPAL REGISTER

FOR: RETAIL, WHOLESALE AND ONLINE RETAIL AND WHOLESALE STORE SERVICES FEATURING EXERCISE EQUIPMENT, BOOKS, CDS, DVDS, FOOTWEAR AND APPAREL, VIDEO GAMES AND SOFTWARE, IN CLASS 35 (U.S. CLS. 100, 101 AND 102).

FIRST USE 3-16-2011; IN COMMERCE 3-16-2011.

THE MARK CONSISTS OF STANDARD CHARACTERS WITHOUT CLAIM TO ANY PARTICULAR FONT, STYLE, SIZE, OR COLOR.

SN 85-976,124, FILED 1-27-2011.

BARBARA GAYNOR, EXAMINING ATTORNEY



David J. Kybas

Director of the United States Patent and Trademark Office

United States of America

United States Patent and Trademark Office

FONDERIE 47

Reg. No. 4,100,313

Registered Feb. 14, 2012

Int. Cl.: 14

TRADEMARK

PRINCIPAL REGISTER

THUM, PETER (UNITED STATES INDIVIDUAL)
31 UNION SQUARE WEST, 6D
NEW YORK, NY 10003

FOR: JEWELRY; WATCHES, IN CLASS 14 (U.S. CLS. 2, 27, 28 AND 50).

FIRST USE 9-30-2011; IN COMMERCE 9-30-2011.

THE MARK CONSISTS OF STANDARD CHARACTERS WITHOUT CLAIM TO ANY PARTICULAR FONT, STYLE, SIZE, OR COLOR.

THE ENGLISH TRANSLATION OF "FONDERIE" IN THE MARK IS "FOUNDRY".

SN 85-976,146, FILED 4-28-2010.

APRIL HESIK, EXAMINING ATTORNEY



David J. Kyffers

Director of the United States Patent and Trademark Office

United States of America

United States Patent and Trademark Office

DOTCOMS FOR MOMS

Reg. No. 4,100,314

LIMETIME INC. (DELAWARE CORPORATION)
4322 FRANKLIN AVE.
LOS ANGELES, CA 90027

Registered Feb. 14, 2012

Int. Cls.: 35, 41, and 44

FOR: PROVIDING AN INTERNET PORTAL WEBSITE FOR PARENTS IN THE FIELD OF SHOPPING FOR CHILD-FRIENDLY PRODUCTS, IN CLASS 35 (U.S. CLS. 100, 101 AND 102).

SERVICE MARK

FIRST USE 2-12-2010; IN COMMERCE 11-5-2010.

SUPPLEMENTAL REGISTER

FOR: PROVIDING AN INTERNET INFORMATIONAL WEBSITE FOR PARENTS IN THE FIELD OF ENTERTAINMENT AND FAMILY FRIENDLY ACTIVITIES AND EVENTS, IN CLASS 41 (U.S. CLS. 100, 101 AND 107).

FIRST USE 2-12-2010; IN COMMERCE 11-5-2010.

FOR: PROVIDING AN INTERNET INFORMATIONAL WEBSITE FOR PARENTS IN THE FIELD OF BEAUTY AND HEALTH AND FITNESS, IN CLASS 44 (U.S. CLS. 100 AND 101).

FIRST USE 2-12-2010; IN COMMERCE 11-5-2010.

THE MARK CONSISTS OF STANDARD CHARACTERS WITHOUT CLAIM TO ANY PARTICULAR FONT, STYLE, SIZE, OR COLOR.

SER. NO. 76-701,512, FILED P.R. 2-12-2010; AM. S.R. 11-19-2010.

INGA ERVIN, EXAMINING ATTORNEY



David J. Kyffers

Director of the United States Patent and Trademark Office

United States of America

United States Patent and Trademark Office

CALI MADE

Reg. No. 4,100,315

Registered Feb. 14, 2012

Int. Cl.: 25

TRADEMARK

SUPPLEMENTAL REGISTER

STEPHEN CHRISTOPHER JAPPE (UNITED STATES INDIVIDUAL), DBA CALIMADE
CLOTHING,
4360 E. MAIN ST. #423
VENTURA, CA 930038279

FOR: CLOTHING, NAMELY, SHIRTS, JACKETS, CAPS; APPAREL, NAMELY, T-SHIRTS,
JACKETS, SHIRTS, CAPS AND HATS, IN CLASS 25 (U.S. CLS. 22 AND 39).

FIRST USE 9-25-2008; IN COMMERCE 9-25-2008.

THE MARK CONSISTS OF STANDARD CHARACTERS WITHOUT CLAIM TO ANY PAR-
TICULAR FONT, STYLE, SIZE, OR COLOR.

SER. NO. 76-705,900, FILED P.R. 1-3-2011; AM. S.R. 12-6-2011.

MAYUR VAGHANI, EXAMINING ATTORNEY



David J. Kyros

Director of the United States Patent and Trademark Office

United States of America

United States Patent and Trademark Office

DoseMonitor

Reg. No. 4,100,316

Registered Feb. 14, 2012

Int. Cl.: 9

TRADEMARK

SUPPLEMENTAL REGISTER

PHS TECHNOLOGIES GROUP, LLC (ARIZONA LIMITED LIABILITY COMPANY)
32531 NORTH SCOTTSDALE RD., STE. 105-282
SCOTTSDALE, AZ 85266

FOR: COMPUTER SOFTWARE FOR USE IN CALCULATING, ASSESSING AND REPORTING THE RADIATION EXPOSURE LEVELS OF HEALTH CARE PATIENTS FROM IONIZING RADIATION SOURCES AND PROCEDURES, IN CLASS 9 (U.S. CLS. 21, 23, 26, 36 AND 38).

FIRST USE 4-15-2010; IN COMMERCE 7-1-2010.

THE MARK CONSISTS OF STANDARD CHARACTERS WITHOUT CLAIM TO ANY PARTICULAR FONT, STYLE, SIZE, OR COLOR.

SER. NO. 76-708,561, FILED P.R. 8-1-2011; AM. S.R. 12-20-2011.

DOMINIC J. FERRAIUOLO, EXAMINING ATTORNEY



David J. Kyffers

Director of the United States Patent and Trademark Office

United States of America

United States Patent and Trademark Office



*"My Strength... My Hope
My Inspiration... My Cause"*

Reg. No. 4,100,317

CAUSE SPORTSWEAR, LLC (MINNESOTA LIMITED LIABILITY COMPANY)
21250 SYCAMORE STREET NW
CEDAR, MN 55011

Registered Feb. 14, 2012

Int. Cl.: 25

FOR: WEARING APPAREL AND CLOTHING, NAMELY, SHIRTS, T-SHIRTS, SWEATSHIRTS;
HEADGEAR, NAMELY, HATS AND CAPS, IN CLASS 25 (U.S. CLS. 22 AND 39).

TRADEMARK

FIRST USE 10-0-2010; IN COMMERCE 10-0-2010.

SUPPLEMENTAL REGISTER

SER. NO. 77-570,173, FILED P.R. 9-15-2008; AM. S.R. 11-28-2011.

KATHLEEN LORENZO, EXAMINING ATTORNEY



David J. Kybas

Director of the United States Patent and Trademark Office

United States of America

United States Patent and Trademark Office

RENEWABLE FOREST PROJECT

Reg. No. 4,100,318

IRVING TISSUE CORPORATION (CANADA CORPORATION)
100 MIDLAND DRIVE
DIEPPE, CANADA E1A6X4

Registered Feb. 14, 2012

Int. Cl.: 35

FOR: ASSOCIATION SERVICES, NAMELY, PROMOTING THE INTERESTS OF THE FOREST, PAPER AND WOOD PRODUCTS INDUSTRY, AND PROMOTING PUBLIC AWARENESS OF ENVIRONMENTAL ISSUES AND INITIATIVES IN THE FOREST, PAPER AND WOOD PRODUCTS INDUSTRY, IN CLASS 35 (U.S. CLS. 100, 101 AND 102).

SERVICE MARK

SUPPLEMENTAL REGISTER FIRST USE 12-28-2009; IN COMMERCE 12-28-2009.

THE MARK CONSISTS OF STANDARD CHARACTERS WITHOUT CLAIM TO ANY PARTICULAR FONT, STYLE, SIZE, OR COLOR.

PRIORITY CLAIMED UNDER SEC. 44(D) ON CANADA APPLICATION NO. 1419199, FILED 11-21-2008, REG. NO. TMA811,220, DATED 11-7-2011, EXPIRES 11-7-2026.

SER. NO. 77-623,679, FILED P.R. 12-1-2008; AM. S.R. 3-12-2010.

ZHALEH DELANEY, EXAMINING ATTORNEY



David J. Kyros

Director of the United States Patent and Trademark Office

United States of America

United States Patent and Trademark Office

THE BLACK SERIES

Reg. No. 4,100,319

MERCHSOURCE, LLC (CALIFORNIA LIMITED LIABILITY COMPANY)
19517 PAULING

Registered Feb. 14, 2012

FOOTHILL RANCH, CA 92610

Int. Cl.: 21

FOR: SOAP DISPENSERS, IN CLASS 21 (U.S. CLS. 2, 13, 23, 29, 30, 33, 40 AND 50).

TRADEMARK

FIRST USE 10-31-2009; IN COMMERCE 10-31-2009.

SUPPLEMENTAL REGISTER

THE MARK CONSISTS OF STANDARD CHARACTERS WITHOUT CLAIM TO ANY PARTICULAR FONT, STYLE, SIZE, OR COLOR.

SER. NO. 77-713,815, FILED P.R. 4-14-2009; AM. S.R. 7-25-2011.

AISHA SALEM, EXAMINING ATTORNEY



David J. Kyffers

Director of the United States Patent and Trademark Office

United States of America

United States Patent and Trademark Office

nursing mothers express
their love

Reg. No. 4,100,320

RODRIGUEZ, CURTIS V. (UNITED STATES INDIVIDUAL)
5820 COMANCHE DRIVE
SAN JOSE, CA 95123

Registered Feb. 14, 2012

Int. Cl.: 25

FOR: ATHLETIC APPAREL, NAMELY, SHIRTS, PANTS, JACKETS, FOOTWEAR, HATS AND CAPS, ATHLETIC UNIFORMS; HATS; SHORT-SLEEVED OR LONG-SLEEVED T-SHIRTS; T-SHIRTS; TEE SHIRTS, IN CLASS 25 (U.S. CLS. 22 AND 39).

TRADEMARK

FIRST USE 12-25-2011; IN COMMERCE 12-25-2011.

SUPPLEMENTAL REGISTER

THE MARK CONSISTS OF STANDARD CHARACTERS WITHOUT CLAIM TO ANY PARTICULAR FONT, STYLE, SIZE, OR COLOR.

SER. NO. 77-749,829, FILED P.R. 6-2-2009; AM. S.R. 1-6-2012.

ELLEN B. AWRICH, EXAMINING ATTORNEY



David J. Kyros

Director of the United States Patent and Trademark Office

United States of America

United States Patent and Trademark Office

RE-FLEX

Reg. No. 4,100,321

SAYRE ENTERPRISES, INC. (DELAWARE CORPORATION)
2522 BEECH AVE.

Registered Feb. 14, 2012

BUENA VISTA, VA 24416

Int. Cl.: 9

FOR: REFLECTIVE SAFETY PRODUCTS, NAMELY, REFLECTIVE VESTS, VINYL BELTS, SASHES, ARM BANDS, WRIST BANDS, ANKLE BANDS, HELMET BANDS, ID HOLDERS, SUSPENDERS, HEADBANDS, AND GLOVES, IN CLASS 9 (U.S. CLS. 21, 23, 26, 36 AND 38).

TRADEMARK

SUPPLEMENTAL REGISTER

FIRST USE 10-5-1991; IN COMMERCE 10-5-1991.

THE MARK CONSISTS OF STANDARD CHARACTERS WITHOUT CLAIM TO ANY PARTICULAR FONT, STYLE, SIZE, OR COLOR.

SER. NO. 77-790,862, FILED P.R. 7-28-2009; AM. S.R. 11-15-2011.

EVELYN BRADLEY, EXAMINING ATTORNEY



David J. Kyjars

Director of the United States Patent and Trademark Office

United States of America

United States Patent and Trademark Office

SWAG CODES

Reg. No. 4,100,322

PRODEGE, LLC (CALIFORNIA LIMITED LIABILITY COMPANY)
2108 VAIL AVENUE

Registered Feb. 14, 2012 REDONDO BEACH, CA 90278

Int. Cl.: 35

FOR: ADVERTISING AND PROMOTIONAL SERVICES, NAMELY, PROMOTING THE SALES OF GOODS AND SERVICES OF OTHERS THROUGH PLACEMENT OF ADVERTISEMENT AND PROMOTIONAL DISPLAYS ON GLOBAL COMPUTER NETWORK BROWSER SOFTWARE; PROMOTING THE GOODS AND SERVICES OF OTHERS BY MEANS OF ON-LINE SWEEPSTAKES PROGRAMS; PROMOTING THE SALES OF GOODS AND SERVICES OF OTHERS THROUGH THE ONLINE DISTRIBUTION OF PROMOTIONAL CONTESTS VIA A GLOBAL COMPUTER NETWORK; PROMOTION ADMINISTRATION SERVICES FOR OTHERS, NAMELY, ADVERTISING AND PROMOTING SWEEPSTAKES AND CONTESTS FOR ADVERTISING PURPOSES; FULFILLMENT AND WINNER NOTIFICATION SERVICES FOR SWEEPSTAKES AND CONTESTS CONDUCTED FOR ADVERTISING PURPOSES; ISSUING GIFT CERTIFICATES AND REDEEMABLE COUPONS WHICH MAY BE REDEEMED OR USED FOR GOODS OR SERVICES, SUCH CERTIFICATES AND COUPONS HAVING BEEN AWARDED OR EARNED AS PART OF A SEARCH ENGINE SWEEPSTAKES AND FOR SEARCHES, PURCHASES, REFERRAL OF FRIENDS, AND OTHER ACTIVITIES; CONSUMER LOYALTY SERVICES FOR COMMERCIAL, PROMOTIONAL AND/OR ADVERTISING PURPOSES, NAMELY, ADMINISTRATION OF A FREQUENT USER PROGRAM THAT ALLOWS MEMBERS TO REDEEM POINTS OR AWARDS FOR GOODS AND/OR SERVICES, IN CLASS 35 (U.S. CLS. 100, 101 AND 102).

SERVICE MARK

SUPPLEMENTAL REGISTER

FIRST USE 5-18-2008; IN COMMERCE 5-18-2008.

THE MARK CONSISTS OF STANDARD CHARACTERS WITHOUT CLAIM TO ANY PARTICULAR FONT, STYLE, SIZE, OR COLOR.

SER. NO. 77-795,515, FILED P.R. 8-3-2009; AM. S.R. 5-12-2010.

KATHERINE CHANG, EXAMINING ATTORNEY



David J. Kypos

Director of the United States Patent and Trademark Office

United States of America

United States Patent and Trademark Office

CLOUDCAMP

Reg. No. 4,100,323

ENOMALY INC. (CANADA CORPORATION)

Registered Feb. 14, 2012

300 THE EAST MALL, SUITE 102
ETOBICOKE, ONTARIO, CANADA M9B6B7

Int. Cls.: 16, 25, and 41

FOR: CONFERENCE MATERIALS AND EDUCATIONAL MATERIALS IN PRINT FORM, NAMELY, COURSE WORKBOOKS, MANUALS, NEWSLETTERS, BROCHURES, MAGAZINES, JOURNALS, REPORTS AND PAMPHLETS, ALL IN THE FIELD OF CLOUD COMPUTING AND INFORMATION TECHNOLOGY; CONFERENCE MERCHANDISE, NAMELY, PENS, NOTE PADS, IN CLASS 16 (U.S. CLS. 2, 5, 22, 23, 29, 37, 38 AND 50).

TRADEMARK

SERVICE MARK

FOR: CONFERENCE MERCHANDISE, NAMELY, CAPS AND T-SHIRTS, IN CLASS 25 (U.S. CLS. 22 AND 39).

SUPPLEMENTAL REGISTER

FOR: EDUCATIONAL SERVICES, NAMELY, ARRANGING, ORGANIZING, CONDUCTING AND PROVIDING CONFERENCES AND SEMINARS RELATING TO CLOUD COMPUTING AND INFORMATION TECHNOLOGY; CONFERENCE MATERIALS AND EDUCATIONAL MATERIALS IN NON-DOWNLOADABLE ELECTRONIC FORM, NAMELY, COURSE WORKBOOKS, MANUALS, NEWSLETTERS, BROCHURES, MAGAZINES, JOURNALS, REPORTS AND PAMPHLETS, ALL IN THE FIELD OF CLOUD COMPUTING AND INFORMATION TECHNOLOGY, IN CLASS 41 (U.S. CLS. 100, 101 AND 107).

THE MARK CONSISTS OF STANDARD CHARACTERS WITHOUT CLAIM TO ANY PARTICULAR FONT, STYLE, SIZE, OR COLOR.

OWNER OF CANADA REG. NO. TMA774788, DATED 8-17-2010, EXPIRES 8-17-2025.

SER. NO. 77-810,253, FILED P.R. 8-21-2009; AM. S.R. 12-19-2011.

PRISCILLA MILTON, EXAMINING ATTORNEY



David J. Kypos

Director of the United States Patent and Trademark Office

United States of America

United States Patent and Trademark Office

HOLY SCHMITT

Reg. No. 4,100,324

OWEN JONATHAN SCHMITT (UNITED STATES INDIVIDUAL)
122 E WAYNE AVE
ALDAN, PA 19018

Registered Feb. 14, 2012

Int. Cl.: 25

FOR: SHIRTS, IN CLASS 25 (U.S. CLS. 22 AND 39).

TRADEMARK

FIRST USE 10-1-2010; IN COMMERCE 10-1-2010.

SUPPLEMENTAL REGISTER

THE MARK CONSISTS OF STANDARD CHARACTERS WITHOUT CLAIM TO ANY PARTICULAR FONT, STYLE, SIZE, OR COLOR.

SER. NO. 77-867,108, FILED P.R. 11-6-2009; AM. S.R. 12-29-2011.

JAMES STEIN, EXAMINING ATTORNEY



David J. Kyffers

Director of the United States Patent and Trademark Office

United States of America

United States Patent and Trademark Office

SCHMITT HAPPENS

Reg. No. 4,100,325

OWEN JONATHAN SCHMITT (UNITED STATES INDIVIDUAL)
122 E. WAYNE AVE
ALDAN, PA 19018

Registered Feb. 14, 2012

Int. Cl.: 25

FOR: SHIRTS, IN CLASS 25 (U.S. CLS. 22 AND 39).

TRADEMARK

FIRST USE 10-1-2010; IN COMMERCE 10-1-2010.

SUPPLEMENTAL REGISTER

THE MARK CONSISTS OF STANDARD CHARACTERS WITHOUT CLAIM TO ANY PARTICULAR FONT, STYLE, SIZE, OR COLOR.

SER. NO. 77-867,121, FILED P.R. 11-6-2009; AM. S.R. 12-29-2011.

JAMES STEIN, EXAMINING ATTORNEY



David J. Kybas

Director of the United States Patent and Trademark Office

United States of America

United States Patent and Trademark Office

A.R.T.

Reg. No. 4,100,326

Registered Feb. 14, 2012

Int. Cl.: 40

SERVICE MARK

SUPPLEMENTAL REGISTER

POINT.360 (CALIFORNIA CORPORATION)
2777 NORTH ONTARIO STREET
BURBANK, CA 91504

FOR: DIGITAL RESTORATION AND ENHANCEMENT OF ARCHIVED STILL AND NON-STILL IMAGES; DIGITAL RESTORATION AND ENHANCEMENT OF ARCHIVED STILL AND NON-STILL IMAGES TO IMPROVE RESOLUTION; AND DIGITAL RESTORATION AND ENHANCEMENT OF ARCHIVED STILL AND NON-STILL IMAGES TO REMOVE UNDESIRE COMPONENTS, NAMELY, GRAININESS AND NOISE, IN CLASS 40 (U.S. CLS. 100, 103 AND 106).

FIRST USE 10-2-2009; IN COMMERCE 10-2-2009.

THE MARK CONSISTS OF STANDARD CHARACTERS WITHOUT CLAIM TO ANY PARTICULAR FONT, STYLE, SIZE, OR COLOR.

SER. NO. 77-891,524, FILED P.R. 12-11-2009; AM. S.R. 12-5-2011.

WENDY GOODMAN, EXAMINING ATTORNEY



David J. Kyffers

Director of the United States Patent and Trademark Office

United States of America

United States Patent and Trademark Office

LIVEIMAGING

Reg. No. 4,100,327

SYNAPSENSE CORPORATION (DELAWARE CORPORATION)
2365 IRON POINT ROAD, #100
FOLSOM, CA 95630

Registered Feb. 14, 2012

Int. Cl.: 9

FOR: COMPUTER SOFTWARE FOR ENVIRONMENTAL SENSOR OUTPUT MONITORING IN THE FIELD OF ENVIRONMENTAL CONTROLS, IN CLASS 9 (U.S. CLS. 21, 23, 26, 36 AND 38).

TRADEMARK

FIRST USE 3-0-2008; IN COMMERCE 3-0-2008.

SUPPLEMENTAL REGISTER

THE MARK CONSISTS OF STANDARD CHARACTERS WITHOUT CLAIM TO ANY PARTICULAR FONT, STYLE, SIZE, OR COLOR.

SER. NO. 77-912,727, FILED P.R. 1-15-2010; AM. S.R. 12-8-2011.

ROBERT C. CLARK JR., EXAMINING ATTORNEY



David J. Kyffers

Director of the United States Patent and Trademark Office

United States of America

United States Patent and Trademark Office

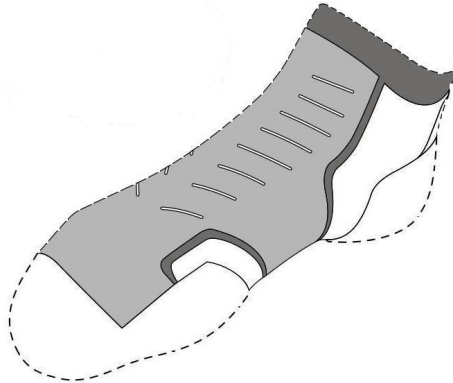

Reg. No. 4,100,328

Registered Feb. 14, 2012

Int. Cl.: 25

TRADEMARK

SUPPLEMENTAL REGISTER

THRONEBURG, JAMES L. (UNITED STATES INDIVIDUAL)
2210 NEWTON DRIVE; P.O. BOX 5399
STATESVILLE, NC 286875399

FOR: MEN'S, WOMEN'S AND CHILDREN'S SOCKS, IN CLASS 25 (U.S. CLS. 22 AND 39).

FIRST USE 1-1-2009; IN COMMERCE 1-1-2009.

THE STIPPLING IS FOR SHADING PURPOSES ONLY.

THE MARK CONSISTS OF A THREE-DIMENSIONAL CONFIGURATION OF A SPECIFIC DESIGN FEATURE USED ON SOCKS AND ON PACKAGING FOR THE SOCKS. THE DESIGN FEATURES A COLORED BAND THAT ENCIRCLES THE OPEN NECK PORTION OF THE SOCK, EXTENDS DOWNWARD ALONG THE TOP OF THE SOCK TO THE BEGINNING OF THE TOE AREA, AND AT THE ARCH AREA EXTENDS AS A BAND AROUND THE ENTIRE INSTEP PORTION OF THE SOCK. FURTHER, ON THE ARCH OF THE SOCK ARE TWO ROWS OF ASYMMETRIC LINES FORMING A CHEVRON PATTERN. NO CLAIM IS MADE TO THE SOCK ITSELF, WHICH IS INDICATED IN BROKEN LINES.

SER. NO. 77-928,263, FILED P.R. 2-4-2010; AM. S.R. 11-28-2011.

MICHELE SWAIN, EXAMINING ATTORNEY



David J. Kyffers

Director of the United States Patent and Trademark Office

United States of America

United States Patent and Trademark Office

Grasslands Road

Reg. No. 4,100,329

AMSCAN INC. (NEW YORK CORPORATION)
80 GRASSLANDS ROAD
ELSFORD, NY 10523

Registered Feb. 14, 2012

Int. Cls.: 19 and 20

FOR: FIGURINES OF CLAY, STONE, CONCRETE, MARBLE; ENGRAVED AND CUT STONE PLAQUES; CAST STONE GARDEN AND HOUSEHOLD ORNAMENTS; AND NON-PRECIOUS STONES FOR GARDEN OR ORNAMENTAL USE, IN CLASS 19 (U.S. CLS. 1, 12, 33 AND 50).

TRADEMARK

SUPPLEMENTAL REGISTER FIRST USE 2-1-2010; IN COMMERCE 2-1-2010.

FOR: FIGURINES OF PLASTER, PLASTIC, POLYMER AND WOOD, IN CLASS 20 (U.S. CLS. 2, 13, 22, 25, 32 AND 50).

FIRST USE 2-1-2010; IN COMMERCE 2-1-2010.

THE MARK CONSISTS OF STANDARD CHARACTERS WITHOUT CLAIM TO ANY PARTICULAR FONT, STYLE, SIZE, OR COLOR.

SER. NO. 77-948,150, FILED 3-2-2010.

AMY C. KEAN, EXAMINING ATTORNEY



David J. Kybas

Director of the United States Patent and Trademark Office

United States of America

United States Patent and Trademark Office

Buck i Wild

Reg. No. 4,100,330

DOZIER, PATRICE G. (UNITED STATES INDIVIDUAL)
1340 HENNESSY TERRACE
SANDY SPRING, MD 20860

Registered Feb. 14, 2012

Int. Cl.: 25

FOR: T-SHIRTS; SHORT-SLEEVED OR LONG-SLEEVED T-SHIRTS, IN CLASS 25 (U.S. CLS. 22 AND 39).

TRADEMARK

FIRST USE 10-1-2007; IN COMMERCE 10-10-2007.

SUPPLEMENTAL REGISTER

THE MARK CONSISTS OF STANDARD CHARACTERS WITHOUT CLAIM TO ANY PARTICULAR FONT, STYLE, SIZE, OR COLOR.

SER. NO. 77-982,094, FILED P.R. 10-2-2007; AM. S.R. 12-28-2011.

KIMBERLY FRYE, EXAMINING ATTORNEY



David J. Kyffers

Director of the United States Patent and Trademark Office

United States of America

United States Patent and Trademark Office

HOMETOWN HOTTIES

Reg. No. 4,100,331

DENNIS PUBLISHING, INC. (NEW YORK CORPORATION)
1040 AVENUE OF THE AMERICAS
NEW YORK, NY 10018

Registered Feb. 14, 2012

Int. Cl.: 16

FOR: MAGAZINES, NAMELY, SECTIONS OF MAGAZINES FEATURING PHOTOGRAPHS AND BIOGRAPHICAL ARTICLES AND STORIES ABOUT WOMEN, IN CLASS 16 (U.S. CLS. 2, 5, 22, 23, 29, 37, 38 AND 50).

TRADEMARK

FIRST USE 1-1-2010; IN COMMERCE 1-1-2010.

SUPPLEMENTAL REGISTER

OWNER OF U.S. REG. NO. 2,786,595.

SER. NO. 78-981,509, FILED P.R. 10-20-2003; AM. S.R. 11-17-2011.

LINDA POWELL, EXAMINING ATTORNEY



David J. Kybas

Director of the United States Patent and Trademark Office

United States of America

United States Patent and Trademark Office

TUNNEL SHUTTERS

Reg. No. 4,100,332

BRANDLEY, ARI (UNITED STATES INDIVIDUAL)
1397 MOORE RD.

Registered Feb. 14, 2012

NEWNAN, GA 30263

Int. Cl.: 7

FOR: AGRICULTURAL MACHINES, NAMELY, MANUAL OR MACHINE-ADJUSTABLE SHUTTERS, AERATORS, AND BELLOWS, ALL UTILIZED FOR THE CONTROL OF AIR-FLOW AND VENTILATION IN POULTRY HOUSES , IN CLASS 7 (U.S. CLS. 13, 19, 21, 23, 31, 34 AND 35).

TRADEMARK

SUPPLEMENTAL REGISTER FIRST USE 6-15-2010; IN COMMERCE 1-2-2011.

THE MARK CONSISTS OF STANDARD CHARACTERS WITHOUT CLAIM TO ANY PARTICULAR FONT, STYLE, SIZE, OR COLOR.

NO CLAIM IS MADE TO THE EXCLUSIVE RIGHT TO USE "SHUTTERS", APART FROM THE MARK AS SHOWN.

SER. NO. 85-025,442, FILED P.R. 4-28-2010; AM. S.R. 11-19-2011.

MICHAEL ENGEL, EXAMINING ATTORNEY



David J. Kyfos

Director of the United States Patent and Trademark Office

United States of America

United States Patent and Trademark Office

Ribbonwick

Reg. No. 4,100,333

SMITH MOUNTAIN INDUSTRIES, INC. (VIRGINIA CORPORATION)
1000 DILLARD DRIVE
FOREST, VA 24551

Registered Feb. 14, 2012

Int. Cl.: 4

FOR: CANDLES, IN CLASS 4 (U.S. CLS. 1, 6 AND 15).

TRADEMARK

FIRST USE 1-7-2009; IN COMMERCE 1-7-2009.

SUPPLEMENTAL REGISTER

THE MARK CONSISTS OF STANDARD CHARACTERS WITHOUT CLAIM TO ANY PARTICULAR FONT, STYLE, SIZE, OR COLOR.

SER. NO. 85-079,961, FILED 7-8-2010.

THOMAS MANOR, EXAMINING ATTORNEY



David J. Kyfos

Director of the United States Patent and Trademark Office

United States of America

United States Patent and Trademark Office



Reg. No. 4,100,334

Registered Feb. 14, 2012

Int. Cl.: 41

SERVICE MARK

SUPPLEMENTAL REGISTER

KUNYAR INSTITUTE, THE (DELAWARE CORPORATION)
65 WALNUT STREET
STE 301
WELLESLEY, MA 02481

FOR: NEWSLETTERS IN THE FIELD OF WELLNESS; EDUCATIONAL SERVICES, NAMELY, PROVIDING LIVE AND ONLINE PROGRAMS, CLASSES, AND SEMINARS, IN THE FIELDS OF HEALTH AND WELLNESS, FOR PROFESSIONALS AND LAY-PEOPLE, TO INCLUDE CONTINUING MEDICAL EDUCATION, AND PRINTABLE MATERIALS IN HARD COPY OR ELECTRONIC FORMAT ON THE SAME TOPICS DISTRIBUTED THEREWITH, IN CLASS 41 (U.S. CLS. 100, 101 AND 107).

FIRST USE 11-22-2011; IN COMMERCE 11-22-2011.

NO CLAIM IS MADE TO THE EXCLUSIVE RIGHT TO USE "HEALTH", APART FROM THE MARK AS SHOWN.

THE MARK CONSISTS OF AN IMAGE OF A SHIELD WITH THE WORDING "THE LIBRARY OF HEALTH" CENTERED INSIDE THE SHIELD.

SER. NO. 85-088,620, FILED P.R. 7-20-2010; AM. S.R. 11-25-2011.

ANDREA K. NADELMAN, EXAMINING ATTORNEY



David J. Kybas

Director of the United States Patent and Trademark Office

United States of America

United States Patent and Trademark Office

HAWGER IN TRAINING

Reg. No. 4,100,335

Registered Feb. 14, 2012

Int. Cl.: 25

TRADEMARK

SUPPLEMENTAL REGISTER

SOCIAL FABRIC, LLC (ALABAMA LIMITED LIABILITY COMPANY)
3215 GLASGOW CIRCLE
BIRMINGHAM, AL 35203

FOR: FOOTWEAR; HEADWEAR; PANTS; SHIRTS, IN CLASS 25 (U.S. CLS. 22 AND 39).

FIRST USE 7-24-2010; IN COMMERCE 7-24-2010.

THE MARK CONSISTS OF STANDARD CHARACTERS WITHOUT CLAIM TO ANY PARTICULAR FONT, STYLE, SIZE, OR COLOR.

SER. NO. 85-088,939, FILED P.R. 7-20-2010; AM. S.R. 12-19-2011.

MICHELLE DUBOIS, EXAMINING ATTORNEY



David J. Kyffers

Director of the United States Patent and Trademark Office

United States of America

United States Patent and Trademark Office



Reg. No. 4,100,336

Registered Feb. 14, 2012

Int. Cl.: 25

TRADEMARK

SUPPLEMENTAL REGISTER

CHU, KIEN C (UNITED STATES INDIVIDUAL)
4B
87 JORALEMON ST.
BROOKLYN, NY 11201

FOR: CAMISOLES, TANK-TOPS, TUNICS, CARDIGANS, CLOAKS, COATS, DRESSES, JACKETS, LEGGINGS, LOUNGE WEAR, PANTS, PONCHOS, SHAWLS, SERAPE, SKIRTS, STRETCH PANTS, STOLES, SHORTS, YOGA PANTS, YOGA SHIRTS, IN CLASS 25 (U.S. CLS. 22 AND 39).

FIRST USE 3-5-2010; IN COMMERCE 7-15-2010.

THE MARK CONSISTS OF 3 KNOTS ON A CORD CREATED BY 2 KNOTS ON EACH ENDS AND ONE KNOT IN BETWEEN.

SER. NO. 85-090,033, FILED P.R. 7-21-2010; AM. S.R. 1-6-2012.

NAAKWAMA ANKRAH, EXAMINING ATTORNEY



David J. Kyffers

Director of the United States Patent and Trademark Office

United States of America

United States Patent and Trademark Office

PRODUKT GLAS

Reg. No. 4,100,337

PRODUKT GLAS, INC. (ALABAMA CORPORATION)

Registered Feb. 14, 2012

STE D4
HUNTSVILLE, AL 35801

Int. Cl.: 35

FOR: RESELLER SERVICES, NAMELY, DISTRIBUTORSHIP SERVICES IN THE FIELD OF GLASS SYSTEM OFFICE FRONTS, STORE FRONTS, SLIDING AND SWING DOORS, AND CUSTOM APPLICATIONS, IN CLASS 35 (U.S. CLS. 100, 101 AND 102).

SERVICE MARK

FIRST USE 7-31-2010; IN COMMERCE 12-12-2011.

SUPPLEMENTAL REGISTER

THE MARK CONSISTS OF STANDARD CHARACTERS WITHOUT CLAIM TO ANY PARTICULAR FONT, STYLE, SIZE, OR COLOR.

THE ENGLISH TRANSLATION OF "PRODUKT GLAS" IN THE MARK IS "PRODUCT GLASS".

SER. NO. 85-091,979, FILED P.R. 7-23-2010; AM. S.R. 12-16-2011.

SANI KHOURI, EXAMINING ATTORNEY



David J. Kyros

Director of the United States Patent and Trademark Office

United States of America

United States Patent and Trademark Office

vitamin milk

Reg. No. 4,100,338

Registered Feb. 14, 2012

Int. Cl.: 29

TRADEMARK

SUPPLEMENTAL REGISTER

WHITE III, LEON, TIMOTHY (UNITED STATES INDIVIDUAL)
1233 LIBERTY PKWY NW
ATLANTA, GA 30318

FOR: ACIDOPHILUS MILK; ALGAE FOOD BEVERAGES, NAMELY, SEAWEED DRINKS; BEVERAGES CONSISTING PRINCIPALLY OF MILK; BEVERAGES HAVING A MILK BASE; BEVERAGES MADE FROM YOGHURT; CHOCOLATE MILK; COCONUT MILK POWDER; CONDENSED MILK; COWS' MILK; CREAMERS FOR BEVERAGES; DAIRY PRODUCTS EXCLUDING ICE CREAM, ICE MILK AND FROZEN YOGURT; DAIRY-BASED BEVERAGES; DAIRY-BASED CHOCOLATE FOOD BEVERAGES; DAIRY-BASED FOOD BEVERAGES; DAIRY-BASED POWDERS FOR MAKING DAIRY-BASED FOOD BEVERAGES AND SHAKES; DAIRY-BASED SNACK FOODS EXCLUDING ICE CREAM, ICE MILK AND FROZEN YOGURT; DRIED MILK FOR FOOD; DRIED MILK POWDER; EVAPORATED MILK; FERMENTED MILK; FOOD ADDITIVES IN THE NATURE OF FAT ACIDS MADE FROM MEAT, FISH, FRUITS, VEGETABLES, EGGS, MILK AND EDIBLE OILS AND FATS; FRUIT-BASED FOOD BEVERAGE; GOAT MILK; HALF AND HALF; HEMP MILK USED AS A MILK SUBSTITUTE; MILK; MILK BASED BEVERAGES CONTAINING FRUIT JUICE; MILK BEVERAGES CONTAINING FRUITS; MILK BEVERAGES WITH HIGH MILK CONTENT; MILK CURD; MILK DRINKS CONTAINING FRUITS; MILK POWDER; MILK POWDER FOR NUTRITIONAL PURPOSES; MILK PRODUCTS EXCLUDING ICE CREAM, ICE MILK AND FROZEN YOGURT; MILK PROTEIN; MILK PROTEINS; MILK-BASED BEVERAGE CONTAINING COFFEE; MILK-BASED BEVERAGES CONTAINING MILK CONCENTRATES, VEGETABLE OIL AND ADDED NUTRIENTS; MILK-BASED BEVERAGES WITH CHOCOLATE; MILK-BASED BEVERAGES WITH HIGH MILK CONTENT; MILK-BASED ENERGY DRINKS; NUT-BASED MILK; PEANUT-BASED FOOD BEVERAGES; POWDERED MILK; POWDERED MILK FOR FOOD PURPOSES; RICE MILK FOR USE AS A MILK SUBSTITUTE; SHEEP MILK; SOY-BASED FOOD BEVERAGE USED AS A MILK SUBSTITUTE; SOYA MILK; SOYBEAN MILK; STRAWBERRY MILK; VANILLA MILK; VEGETABLE-BASED CHOCOLATE FOOD BEVERAGES; VEGETABLE-BASED FOOD BEVERAGES; YOGURT-BASED BEVERAGES, IN CLASS 29 (U.S. CL. 46).



FIRST USE 1-1-2009; IN COMMERCE 1-1-2009.

David J. Kyros

THE MARK CONSISTS OF STANDARD CHARACTERS WITHOUT CLAIM TO ANY PARTICULAR FONT, STYLE, SIZE, OR COLOR.

Reg. No. 4,100,338 NO CLAIM IS MADE TO THE EXCLUSIVE RIGHT TO USE "MILK", APART FROM THE MARK AS SHOWN.

SER. NO. 85-095,573, FILED P.R. 7-29-2010; AM. S.R. 3-21-2011.

KEVON CHISOLM, EXAMINING ATTORNEY

United States of America

United States Patent and Trademark Office

THEWOODLANDSTEAPARTY

Reg. No. 4,100,339

Registered Feb. 14, 2012

Int. Cl.: 41

SERVICE MARK

SUPPLEMENTAL REGISTER

NORTH HOUSTON TEA PARTY PATRIOTS, INC. (TEXAS CORPORATION)
SUITE 205
26710 I-45 NORTH,
OAK RIDGE NORTH, TX 77386

FOR: EDUCATION AND ENTERTAINMENT SERVICES, NAMELY, PROVIDING COMMUNITY EDUCATION VIA PUBLIC LECTURES AND CONFERENCES REGARDING THE CORE CONSERVATIVE VALUES OF UPHOLDING THE CONSTITUTION, LIMITED GOVERNMENT, FISCAL RESPONSIBILITY AND FREE MARKETS, IN CLASS 41 (U.S. CLS. 100, 101 AND 107).

FIRST USE 4-15-2009; IN COMMERCE 4-15-2009.

THE MARK CONSISTS OF STANDARD CHARACTERS WITHOUT CLAIM TO ANY PARTICULAR FONT, STYLE, SIZE, OR COLOR.

SER. NO. 85-125,541, FILED P.R. 9-9-2010; AM. S.R. 5-7-2011.

KATHRYN COWARD, EXAMINING ATTORNEY



David J. Kyffers

Director of the United States Patent and Trademark Office

United States of America

United States Patent and Trademark Office

The Photodiarist

Reg. No. 4,100,340

Registered Feb. 14, 2012

Int. Cl.: 41

SERVICE MARK

SUPPLEMENTAL REGISTER

PHOTO-L, LLC (DELAWARE LIMITED LIABILITY COMPANY)
SUITE 400
2711 CENTERVILLE ROAD
WILMINGTON, DE 19808

FOR: ON-LINE JOURNALS, NAMELY, BLOGS FEATURING PHOTOGRAPHY AND ART,
IN CLASS 41 (U.S. CLS. 100, 101 AND 107).

FIRST USE 8-22-2009; IN COMMERCE 8-22-2009.

THE MARK CONSISTS OF STANDARD CHARACTERS WITHOUT CLAIM TO ANY PAR-
TICULAR FONT, STYLE, SIZE, OR COLOR.

SER. NO. 85-130,362, FILED P.R. 9-15-2010; AM. S.R. 12-15-2011.

REBECCA POVARCHUK, EXAMINING ATTORNEY



David J. Kybas

Director of the United States Patent and Trademark Office

United States of America

United States Patent and Trademark Office

INTERNATIONAL PRESCHOOL CURRICULUM

Reg. No. 4,100,341

CLARENTER LLC (FLORIDA LIMITED LIABILITY COMPANY)
2200 NE 33RD AVE APT 9B
FORT LAUDERDALE, FL 33305

Registered Feb. 14, 2012

Int. Cl.: 41

FOR: EDUCATIONAL SERVICES, NAMELY, DEVELOPING CURRICULUM FOR OTHERS
IN THE FIELD OF PRESCHOOL EDUCATION, IN CLASS 41 (U.S. CLS. 100, 101 AND 107).

SERVICE MARK

FIRST USE 5-31-2010; IN COMMERCE 5-31-2010.

SUPPLEMENTAL REGISTER

THE MARK CONSISTS OF STANDARD CHARACTERS WITHOUT CLAIM TO ANY PAR-
TICULAR FONT, STYLE, SIZE, OR COLOR.

NO CLAIM IS MADE TO THE EXCLUSIVE RIGHT TO USE "PRESCHOOL", APART FROM
THE MARK AS SHOWN.

SER. NO. 85-133,072, FILED P.R. 9-20-2010; AM. S.R. 6-18-2011.

ROSELLE HERRERA, EXAMINING ATTORNEY



David J. Kybas

Director of the United States Patent and Trademark Office

United States of America

United States Patent and Trademark Office

EYEZZ

Reg. No. 4,100,342

Registered Feb. 14, 2012

Int. Cl.: 3

VICTORIA PRINCIPAL PRODUCTIONS, INC. (CALIFORNIA CORPORATION)
C/O SUSSMAN & ASSOCIATES
1222 16TH AVENUE SOUTH, 3RD FLOOR
NASHVILLE, TN 37212

FOR: COSMETICS, IN CLASS 3 (U.S. CLS. 1, 4, 6, 50, 51 AND 52).

TRADEMARK

FIRST USE 9-0-2011; IN COMMERCE 9-0-2011.

SUPPLEMENTAL REGISTER

THE MARK CONSISTS OF STANDARD CHARACTERS WITHOUT CLAIM TO ANY PARTICULAR FONT, STYLE, SIZE, OR COLOR.

OWNER OF U.S. REG. NOS. 3,241,585, 3,241,587, AND OTHERS.

SER. NO. 85-146,788, FILED P.R. 10-6-2010; AM. S.R. 12-16-2011.

DAVID TAYLOR, EXAMINING ATTORNEY



David J. Kyfos

Director of the United States Patent and Trademark Office

United States of America

United States Patent and Trademark Office

POCKET LAUNCHER

Reg. No. 4,100,343

PAUL K. GUILLOW, INC. (MASSACHUSETTS CORPORATION)
40 NEW SALEM ST.
WAKEFIELD, MA 01880

Registered Feb. 14, 2012

Int. Cl.: 28

FOR: TOY AIRCRAFT, IN CLASS 28 (U.S. CLS. 22, 23, 38 AND 50).

TRADEMARK

FIRST USE 8-1-2011; IN COMMERCE 10-25-2011.

SUPPLEMENTAL REGISTER

THE MARK CONSISTS OF STANDARD CHARACTERS WITHOUT CLAIM TO ANY PARTICULAR FONT, STYLE, SIZE, OR COLOR.

SER. NO. 85-152,408, FILED P.R. 10-14-2010; AM. S.R. 12-2-2011.

MICHAEL TANNER, EXAMINING ATTORNEY



David J. Kyffers

Director of the United States Patent and Trademark Office

United States of America

United States Patent and Trademark Office

Silicon Valley Stainless

Reg. No. 4,100,344

JENSEN, KEVIN J. (UNITED STATES INDIVIDUAL)

Registered Feb. 14, 2012

P.O. BOX 6161
ALAMEDA, CA 94501

Int. Cl.: 10

TRADEMARK

SUPPLEMENTAL REGISTER

FOR: BLUNT CURETTES; DRILLING JIGS FOR SURGICAL AND DENTAL APPLICATIONS; ELECTRIC SCALPELS; ELECTRO-SURGICAL MOTORS BEING PART OF SURGICAL AND MEDICAL APPARATUS AND INSTRUMENTS FOR USE IN GENERAL SURGERY; HEAD-LIGHT LENS MODULES FOR MEDICAL AND SURGICAL USE; KNIVES FOR SURGICAL PURPOSES; LASERS FOR SURGICAL AND MEDICAL USE; MEDICAL AND SURGICAL APPARATUS AND INSTRUMENTS, NAMELY, DEVICES USED IN ORTHOPEDIC SURGERY TO POSITION SURGICAL INSTRUMENTS, IMPLANTS AND/OR PATIENTS' LIMBS; MEDICAL AND SURGICAL APPARATUS AND INSTRUMENTS, NAMELY, ORTHOPEDIC FIXATION DEVICE USED IN ORTHOPEDIC TRANSPLANT AND/OR IMPLANT SURGERY; MEDICAL AND SURGICAL APPARATUS AND INSTRUMENTS, NAMELY, VERTEBRAL OSTEOSYNTHESIS STAPLE-SHAPED APPARATUS AND INSTRUMENTS; MEDICAL AND SURGICAL CUTTERS FOR CUTTING HUMAN OR ANIMAL TISSUE AND ORGANS; MEDICAL AND SURGICAL KNIVES AND CUTTERS FOR CUTTING HUMAN OR ANIMAL TISSUE AND ORGANS; MEDICAL AND SURGICAL KNIVES FOR CUTTING HUMAN OR ANIMAL TISSUE AND ORGANS; MEDICAL AND SURGICAL LAPAROSCOPES; MEDICAL AND SURGICAL LAPAROSCOPES AND CATHETERS; MEDICAL DEVICE AND SURGICAL INSTRUMENT FOR USE IN DIAGNOSIS AND SURGERY OF THE GASTRO-INTESTINAL TRACT; MEDICAL DEVICES, NAMELY, SURGICAL DEVICES THAT FACILITATE THE IDENTIFICATION, SEPARATION OR ABLATION OF BIOLOGIC TISSUES; MEDICAL TRAYS FOR SURGERY; MEDICAL, SURGICAL AND ORTHOPAEDIC IMPLANTS MADE OF ARTIFICIAL MATERIALS; ROBOTIC ARMS FOR SURGICAL PURPOSES; SURGICAL AND MEDICAL APPARATUS AND INSTRUMENTS FOR USE IN GENERAL SURGERY; SURGICAL AND MEDICAL APPARATUS AND INSTRUMENTS FOR USE IN ORTHOPEDIC SURGERY; SURGICAL AND MEDICAL APPARATUS AND INSTRUMENTS FOR USE IN VETERINARY SURGERY; SURGICAL APPARATUS AND INSTRUMENTS FOR MEDICAL, DENTAL OR VETERINARY USE; SURGICAL APPARATUS AND INSTRUMENTS FOR USE IN OPHTHALMIC SURGERY; SURGICAL APPARATUS AND INSTRUMENTS FOR USE IN ORTHOPEDIC SURGERY; SURGICAL APPARATUS FOR USE IN OPHTHALMIC SURGERY; SURGICAL BLADES; SURGICAL CLIPS; SURGICAL COMPRESSORS; SURGICAL CUTLERY; SURGICAL DEVICES AND INSTRUMENTS; SURGICAL FORCEPS; SURGICAL INSTRUMENTS AND APPARATUS; SURGICAL INSTRUMENTS FOR FITTING HIP JOINT IMPLANTS AND THEIR PARTS; SURGICAL INSTRUMENTS FOR USE IN OPHTHALMIC SURGERY; SURGICAL INSTRUMENTS FOR USE IN ORTHOPEDIC AND SPINAL SURGERY;



David J. Kyros

Director of the United States Patent and Trademark Office

Reg. No. 4,100,344 SURGICAL INSTRUMENTS FOR USE IN GENERAL SURGERY; SURGICAL KNIVES; SURGICAL LAMPS; SURGICAL MESH; SURGICAL PERFORATORS; SURGICAL PLIERS; SURGICAL RETRACTORS; SURGICAL ROBOTS; SURGICAL SAWS; SURGICAL SCISSORS; SURGICAL SKIN HOOKS; SURGICAL SKIN STAPLERS; SURGICAL STAPLE REMOVERS; SURGICAL STAPLERS; SURGICAL STAPLES; SURGICAL SUTURES; SURGICAL AND MEDICAL APPARATUS AND INSTRUMENTS FOR USE IN SURGERY, IN CLASS 10 (U.S. CLS. 26, 39 AND 44).

FIRST USE 6-15-2010; IN COMMERCE 6-15-2010.

THE MARK CONSISTS OF STANDARD CHARACTERS WITHOUT CLAIM TO ANY PARTICULAR FONT, STYLE, SIZE, OR COLOR.

NO CLAIM IS MADE TO THE EXCLUSIVE RIGHT TO USE "STAINLESS", APART FROM THE MARK AS SHOWN.

SER. NO. 85-153,258, FILED P.R. 10-14-2010; AM. S.R. 10-25-2011.

CHARLES L. JENKINS, EXAMINING ATTORNEY

United States of America

United States Patent and Trademark Office

Kiddie Catch-All

Reg. No. 4,100,345

ARNOLD, ALETHA (UNITED STATES INDIVIDUAL)
213 BERRYWOOD DRIVE
SMYRNA, TN 37167 AND

Registered Feb. 14, 2012

Int. Cl.: 12

ARNOLD, BETTYE (UNITED STATES INDIVIDUAL)
213 BERRYWOOD DRIVE
SMYRNA, TN 37167

TRADEMARK

SUPPLEMENTAL REGISTER

FOR: MESH STORAGE BAGS WITH INJECTION MOLDED PLASTIC TOPS WHICH ARE SPECIALLY ADAPTED FOR FITTING ON CHILDREN'S CAR SEATS FOR STORING TOYS, CUPS, BOOKS AND OTHER ITEMS A CHILD MIGHT WANT WHILE IN THE CAR SEAT, IN CLASS 12 (U.S. CLS. 19, 21, 23, 31, 35 AND 44).

FIRST USE 11-1-2010; IN COMMERCE 11-1-2010.

THE MARK CONSISTS OF STANDARD CHARACTERS WITHOUT CLAIM TO ANY PARTICULAR FONT, STYLE, SIZE, OR COLOR.

NO CLAIM IS MADE TO THE EXCLUSIVE RIGHT TO USE "CATCH ALL", APART FROM THE MARK AS SHOWN.

SER. NO. 85-157,830, FILED P.R. 10-21-2010; AM. S.R. 12-19-2011.

DANIEL CAPSHAW, EXAMINING ATTORNEY



David J. Kyros

Director of the United States Patent and Trademark Office

United States of America

United States Patent and Trademark Office

DNA Guide

Reg. No. 4,100,346

Registered Feb. 14, 2012

Int. Cl.: 9

TRADEMARK

SUPPLEMENTAL REGISTER

DNA GUIDE, INC. (DELAWARE CORPORATION)
#2
7575 BATELY CT.
SEBASTOPOL, CA 95472

FOR: COMPUTER SOFTWARE PLATFORMS FOR MANAGING ACCESS AND/OR INFORMATION FOR GENETIC DATA, IN CLASS 9 (U.S. CLS. 21, 23, 26, 36 AND 38).

FIRST USE 10-19-1999; IN COMMERCE 10-5-2009.

THE MARK CONSISTS OF STANDARD CHARACTERS WITHOUT CLAIM TO ANY PARTICULAR FONT, STYLE, SIZE, OR COLOR.

NO CLAIM IS MADE TO THE EXCLUSIVE RIGHT TO USE "GUIDE", APART FROM THE MARK AS SHOWN.

SER. NO. 85-169,437, FILED P.R. 11-4-2010; AM. S.R. 11-16-2011.

COURTNEY ALVAREZ, EXAMINING ATTORNEY



David J. Kyffers

Director of the United States Patent and Trademark Office

United States of America

United States Patent and Trademark Office

Monologando

Reg. No. 4,100,347

MENDOZA, MANUEL (VENEZUELA INDIVIDUAL)
1855 SW 81ST LANE

Registered Feb. 14, 2012

DAVIE, FL 33324

Int. Cl.: 41

FOR: ENTERTAINMENT IN THE NATURE OF THEATRE PRODUCTIONS, IN CLASS 41
(U.S. CLS. 100, 101 AND 107).

SERVICE MARK

FIRST USE 3-0-2010; IN COMMERCE 3-0-2010.

SUPPLEMENTAL REGISTER

THE MARK CONSISTS OF STANDARD CHARACTERS WITHOUT CLAIM TO ANY PARTICULAR FONT, STYLE, SIZE, OR COLOR.

THE ENGLISH TRANSLATION OF "MONOLOGANDO" IN THE MARK IS "MONOLOGING".

SER. NO. 85-174,083, FILED P.R. 11-10-2010; AM. S.R. 8-26-2011.

RON FAIRBANKS, EXAMINING ATTORNEY



David J. Kybas

Director of the United States Patent and Trademark Office

United States of America

United States Patent and Trademark Office

PORTFOLIOREVUE

Reg. No. 4,100,348

CREDIT MANAGEMENT SOLUTIONS, INC. (DELAWARE CORPORATION)
6640 ELI WHITNEY DRIVE
COLUMBIA, MD 21046

Registered Feb. 14, 2012

Int. Cl.: 42

FOR: PROVIDING AN ONLINE NON-DOWNLOADABLE INTERNET-BASED SYSTEM APPLICATION FEATURING TECHNOLOGY ENABLING USERS TO ANALYZE LOAN PORTFOLIOS TO EVALUATE CREDIT RISK AND THE UNDERLYING COLLATERAL VALUE, IN CLASS 42 (U.S. CLS. 100 AND 101).

SERVICE MARK

SUPPLEMENTAL REGISTER FIRST USE 4-6-2011; IN COMMERCE 4-6-2011.

THE MARK CONSISTS OF STANDARD CHARACTERS WITHOUT CLAIM TO ANY PARTICULAR FONT, STYLE, SIZE, OR COLOR.

SER. NO. 85-175,512, FILED P.R. 11-12-2010; AM. S.R. 12-9-2011.

DORITT L. CARROLL, EXAMINING ATTORNEY



David J. Kybas

Director of the United States Patent and Trademark Office

United States of America

United States Patent and Trademark Office

FRESH PIZZA FAST.

Reg. No. 4,100,349

PIZZA INN, INC. (MISSOURI CORPORATION)
3551 PLANO PARKWAY
THE COLONY, TX 75056

Registered Feb. 14, 2012

Int. Cl.: 43

FOR: RESTAURANT SERVICES; CARRY-OUT RESTAURANT SERVICES, IN CLASS 43
(U.S. CLS. 100 AND 101).

SERVICE MARK

FIRST USE 6-3-2011; IN COMMERCE 6-3-2011.

SUPPLEMENTAL REGISTER

THE MARK CONSISTS OF STANDARD CHARACTERS WITHOUT CLAIM TO ANY PARTICULAR FONT, STYLE, SIZE, OR COLOR.

NO CLAIM IS MADE TO THE EXCLUSIVE RIGHT TO USE "PIZZA", APART FROM THE MARK AS SHOWN.

SER. NO. 85-175,600, FILED P.R. 11-12-2010; AM. S.R. 1-11-2012.

KATHLEEN LORENZO, EXAMINING ATTORNEY



David J. Kybas

Director of the United States Patent and Trademark Office

United States of America

United States Patent and Trademark Office

SOUS VIDE COMMERCIAL

Reg. No. 4,100,350

PRESTON INDUSTRIES, INC. (ILLINOIS CORPORATION)
6600 WEST TOUHY AVENUE
NILES, IL 60714

Registered Feb. 14, 2012

Int. Cl.: 11

FOR: COOKING EQUIPMENT, NAMELY, CONSTANT TEMPERATURE CIRCULATORS, IMMERSION CIRCULATORS AND THERMAL CIRCULATORS, IN CLASS 11 (U.S. CLS. 13, 21, 23, 31 AND 34).

TRADEMARK

FIRST USE 9-10-2010; IN COMMERCE 9-10-2010.

SUPPLEMENTAL REGISTER

THE MARK CONSISTS OF STANDARD CHARACTERS WITHOUT CLAIM TO ANY PARTICULAR FONT, STYLE, SIZE, OR COLOR.

SER. NO. 85-187,029, FILED P.R. 11-30-2010; AM. S.R. 12-15-2011.

ANN E. SAPPENFIELD, EXAMINING ATTORNEY



David J. Kybas

Director of the United States Patent and Trademark Office

United States of America

United States Patent and Trademark Office

Sustainability Entrepreneurs

Reg. No. 4,100,351

BEN-ELI, MICHAEL URI (UNITED STATES INDIVIDUAL)
444 EAST 86 STREET APT 36B
NEW YORK, NY 10028

Registered Feb. 14, 2012

Int. Cls.: 35 and 41

FOR: BUSINESS STRATEGY DEVELOPMENT RELATING TO SUSTAINABLE DEVELOPMENT PERFORMANCE, IN CLASS 35 (U.S. CLS. 100, 101 AND 102).

SERVICE MARK

FIRST USE 3-28-2008; IN COMMERCE 3-28-2008.

SUPPLEMENTAL REGISTER

FOR: TRAINING IN THE FIELD OF SUSTAINABILITY PRACTICES, TECHNOLOGIES, AND STRATEGIES; EDUCATIONAL SERVICES, NAMELY, PROVIDING SEMINARS, CLASSES AND WORKSHOPS IN THE FIELD OF SUSTAINABILITY PRACTICES, TECHNOLOGIES, AND STRATEGIES, IN CLASS 41 (U.S. CLS. 100, 101 AND 107).

FIRST USE 3-28-2008; IN COMMERCE 3-28-2008.

THE MARK CONSISTS OF STANDARD CHARACTERS WITHOUT CLAIM TO ANY PARTICULAR FONT, STYLE, SIZE, OR COLOR.

OWNER OF U.S. REG. NO. 3,604,298.

SER. NO. 85-193,060, FILED P.R. 12-8-2010; AM. S.R. 12-23-2011.

TINA BROWN, EXAMINING ATTORNEY



David J. Kybas

Director of the United States Patent and Trademark Office

United States of America

United States Patent and Trademark Office

FLASHING FIREWORKS

Reg. No. 4,100,352

FLASHING FIREWORKS.COM, INC. (NEBRASKA CORPORATION)
7820 L STREET
OMAHA, NE 68127

Registered Feb. 14, 2012

Int. Cl.: 13

FOR: DETONATING FIREWORKS; FIREWORK FOUNTAINS; FIREWORKS; FIREWORKS;
FIREWORKS BODIES; FIREWORKS IN SHELL FORMS; FIREWORKS, NAMELY, SPARK-
LERS, IN CLASS 13 (U.S. CLS. 2 AND 9).

TRADEMARK

FIRST USE 4-1-2009; IN COMMERCE 4-1-2009.

SUPPLEMENTAL REGISTER

THE MARK CONSISTS OF STANDARD CHARACTERS WITHOUT CLAIM TO ANY PAR-
TICULAR FONT, STYLE, SIZE, OR COLOR.

NO CLAIM IS MADE TO THE EXCLUSIVE RIGHT TO USE "FIREWORKS", APART FROM
THE MARK AS SHOWN.

SER. NO. 85-205,793, FILED P.R. 12-27-2010; AM. S.R. 12-16-2011.

DAVID TAYLOR, EXAMINING ATTORNEY



David J. Kyffers

Director of the United States Patent and Trademark Office

United States of America

United States Patent and Trademark Office

The Baking Tube

Reg. No. 4,100,353

LEASURE, PEARL (UNITED STATES INDIVIDUAL)
P.O. BOX 743

Registered Feb. 14, 2012

MIDDLEBURG, FL 32050

Int. Cl.: 21

FOR: BAKEWARE, NAMELY, SILICONE TUBES FOR USE IN BAKING FOODS, IN CLASS 21 (U.S. CLS. 2, 13, 23, 29, 30, 33, 40 AND 50).

TRADEMARK

FIRST USE 12-29-2010; IN COMMERCE 12-29-2010.

SUPPLEMENTAL REGISTER

THE MARK CONSISTS OF STANDARD CHARACTERS WITHOUT CLAIM TO ANY PARTICULAR FONT, STYLE, SIZE, OR COLOR.

SER. NO. 85-206,310, FILED P.R. 12-28-2010; AM. S.R. 12-16-2011.

TINA BROWN, EXAMINING ATTORNEY



David J. Kyffers

Director of the United States Patent and Trademark Office

United States of America

United States Patent and Trademark Office

TOTALLY AGAVE. TOTALLY
SMOOTH.

Reg. No. 4,100,354

AGAVE VENTURES LLC (DELAWARE LIMITED LIABILITY COMPANY)
1064 LORETTO ROAD
BARDSTOWN, KY 40004

Registered Feb. 14, 2012

Int. Cl.: 33

FOR: TEQUILA, IN CLASS 33 (U.S. CLS. 47 AND 49).

TRADEMARK

FIRST USE 3-1-2011; IN COMMERCE 3-1-2011.

SUPPLEMENTAL REGISTER

THE MARK CONSISTS OF STANDARD CHARACTERS WITHOUT CLAIM TO ANY PARTICULAR FONT, STYLE, SIZE, OR COLOR.

SER. NO. 85-211,553, FILED P.R. 1-6-2011; AM. S.R. 12-13-2011.

STEVEN JACKSON, EXAMINING ATTORNEY



David J. Kybas

Director of the United States Patent and Trademark Office

United States of America

United States Patent and Trademark Office

COMMUNITIES OF WELLNESS

Reg. No. 4,100,355

CHRISTIAN, LORI (UNITED STATES INDIVIDUAL)
27629 CHAGRIN BLVD., SUITE #103
BEACHWOOD, OH 44122

Registered Feb. 14, 2012

Int. Cl.: 35

FOR: MARKETING SERVICES, NAMELY, PROMOTING THE HEALTHCARE PROVIDER SERVICES OF OTHERS USING CONSUMER REFERRALS, IN CLASS 35 (U.S. CLS. 100, 101 AND 102).

SERVICE MARK

FIRST USE 5-31-2011; IN COMMERCE 5-31-2011.

SUPPLEMENTAL REGISTER

THE MARK CONSISTS OF STANDARD CHARACTERS WITHOUT CLAIM TO ANY PARTICULAR FONT, STYLE, SIZE, OR COLOR.

SER. NO. 85-220,217, FILED P.R. 1-18-2011; AM. S.R. 1-10-2012.

MICHAEL GAAFAR, EXAMINING ATTORNEY



David J. Kyffers

Director of the United States Patent and Trademark Office

United States of America

United States Patent and Trademark Office

Official Ambassador of Aviation

Reg. No. 4,100,356

KIDDIE HAWK AIR ACADEMY (COLORADO CORPORATION)
26 W DRY CREEK CIRCLE, SUITE 600
LITTLETON, CO 80120

Registered Feb. 14, 2012

Int. Cl.: 41

FOR: EDUCATIONAL SERVICES, NAMELY, PROVIDING INCENTIVES TO PEOPLE TO DEMONSTRATE EXCELLENCE IN THE FIELD OF AVIATION, IN CLASS 41 (U.S. CLS. 100, 101 AND 107).

SERVICE MARK

FIRST USE 12-31-2003; IN COMMERCE 12-31-2006.

SUPPLEMENTAL REGISTER

THE MARK CONSISTS OF STANDARD CHARACTERS WITHOUT CLAIM TO ANY PARTICULAR FONT, STYLE, SIZE, OR COLOR.

SER. NO. 85-220,522, FILED 1-18-2011.

ELLEN B. AWRICH, EXAMINING ATTORNEY



David J. Kyffers

Director of the United States Patent and Trademark Office

United States of America

United States Patent and Trademark Office

GOLDBERG

DIAMONDS & JEWELRY

Reg. No. 4,100,357

Registered Feb. 14, 2012

Int. Cl.: 35

SERVICE MARK

SUPPLEMENTAL REGISTER

HERBERT GOLDBERG COMPANY, INC. (TEXAS CORPORATION)
SUITE 250
14951 DALLAS PARKWAY
DALLAS, TX 75254

FOR: WHOLESALE AND RETAIL STORE SERVICES FEATURING JEWELRY AND DIAMOND JEWELRY, IN CLASS 35 (U.S. CLS. 100, 101 AND 102).

FIRST USE 8-1-2011, THE MARK WAS FIRST USED ANYWHERE IN A DIFFERENT FORM OTHER THAN THAT SOUGHT TO BE REGISTERED AT LEAST AS EARLY AS 00/00/1970.; IN COMMERCE 8-1-2011, THE MARK WAS FIRST USED IN COMMERCE IN A DIFFERENT FORM OTHER THAN THAT SOUGHT TO BE REGISTERED AT LEAST AS EARLY AS 00/00/1970..

NO CLAIM IS MADE TO THE EXCLUSIVE RIGHT TO USE "DIAMONDS & JEWELRY", APART FROM THE MARK AS SHOWN.

THE MARK CONSISTS OF THE WORD "GOLDBERG" WITH A SHADOW DESIGN, THE WORDS "DIAMONDS & JEWELRY", AND A BLURRED HORIZONTAL LINE AT THE LEFT SIDE UNDER "GOL" IN "GOLDBERG".

SER. NO. 85-226,451, FILED P.R. 1-26-2011; AM. S.R. 11-28-2011.

TEJBIR SINGH, EXAMINING ATTORNEY



David J. Kypos

Director of the United States Patent and Trademark Office

United States of America

United States Patent and Trademark Office

Micro Transfer

Reg. No. 4,100,358

JACAR SYSTEMS LLC (MICHIGAN LIMITED LIABILITY COMPANY)
10321 ARNOLD RD.

Registered Feb. 14, 2012

FAIR HAVEN, MI 480231006

Int. Cl.: 7

FOR: AUTOMATED MACHINERY USED TO MOVE PARTS IN A SHEET METAL STAMPING APPLICATION, IN CLASS 7 (U.S. CLS. 13, 19, 21, 23, 31, 34 AND 35).

TRADEMARK

FIRST USE 7-17-2008; IN COMMERCE 7-17-2008.

SUPPLEMENTAL REGISTER

THE MARK CONSISTS OF STANDARD CHARACTERS WITHOUT CLAIM TO ANY PARTICULAR FONT, STYLE, SIZE, OR COLOR.

SER. NO. 85-229,323, FILED P.R. 1-28-2011; AM. S.R. 12-19-2011.

REBECCA GILBERT, EXAMINING ATTORNEY



David J. Kyffers

Director of the United States Patent and Trademark Office

United States of America

United States Patent and Trademark Office

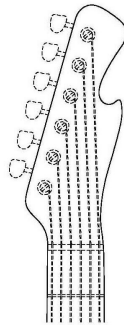

Reg. No. 4,100,359

LOWE, BRAD (FLORIDA SOLE PROPRIETORSHIP), DBA LOWE CUSTOM GUITARS,
3150 PHOENIX AVE.
OLDSMAR, FL 34677

Registered Feb. 14, 2012

Int. Cl.: 15

FOR: MUSICAL INSTRUMENTS, NAMELY, GUITARS, IN CLASS 15 (U.S. CLS. 2, 21 AND 36).

TRADEMARK

FIRST USE 4-20-2011; IN COMMERCE 4-20-2011.

SUPPLEMENTAL REGISTER

THE MARK CONSISTS OF A PRODUCT CONFIGURATION FOR GUITARS CONSISTING OF A TWO DIMENSIONAL BASS GUITAR HEADSTOCK OUTLINE FEATURING A GENERALLY STRAIGHT SIDE ON THE LEFT AND A RIGHT SIDE SHAPED TO EVOKE THE LIKENESS OF A BOTTLE OPENER. THE DOTTED LINES ARE NOT PART OF THE MARK AND SERVE ONLY TO SHOW THE POSITION OR PLACEMENT OF THE MARK.

SER. NO. 85-237,520, FILED P.R. 2-9-2011; AM. S.R. 11-17-2011.

TRACY WHITTAKER-BROWN, EXAMINING ATTORNEY



David J. Kybas

Director of the United States Patent and Trademark Office

United States of America

United States Patent and Trademark Office

CAPITAL IMPACT

Reg. No. 4,100,360

EMERGING MARKETS PRIVATE EQUITY ASSOCIATION (DELAWARE CORPORATION)
1055 THOMAS JEFFERSON ST NW, SUITE 650
WASHINGTON, DC 20007

Registered Feb. 14, 2012

Int. Cl.: 41

FOR: INVESTMENT INDUSTRY CONFERENCES AND DISTANCE LEARNING PROGRAMS
OFFERED VIA WEBCAST IN THE FIELD OF INVESTMENT, FINANCE AND ECONOMIC
DEVELOPMENT, IN CLASS 41 (U.S. CLS. 100, 101 AND 107).

SERVICE MARK

FIRST USE 10-0-2011; IN COMMERCE 10-0-2011.

SUPPLEMENTAL REGISTER

THE MARK CONSISTS OF STANDARD CHARACTERS WITHOUT CLAIM TO ANY PAR-
TICULAR FONT, STYLE, SIZE, OR COLOR.

SER. NO. 85-240,368, FILED P.R. 2-11-2011; AM. S.R. 11-17-2011.

TOBY BULLOFF, EXAMINING ATTORNEY



David J. Kyffers

Director of the United States Patent and Trademark Office

United States of America

United States Patent and Trademark Office

VERTICALCLOUD

Reg. No. 4,100,361

CLOUDCOR, INC. (CANADA CORPORATION), AKA CLOUDCOR,
1155 NORTH SERVICE ROAD WEST, UNIT 11
OAKVILLE, CANADA L6M3E3

Registered Feb. 14, 2012

Int. Cl.: 41

FOR: PROVIDING INFORMATION, NEWS AND COMMENTARY IN THE FIELD OF CURRENT EVENTS RELATING TO CLOUD COMPUTING AND BUSINESS VIA AN INTERNET WEBSITE PORTAL, PRINTED AND ELECTRONIC MEDIA, IN CLASS 41 (U.S. CLS. 100, 101 AND 107).

SERVICE MARK

SUPPLEMENTAL REGISTER FIRST USE 7-10-2010; IN COMMERCE 11-11-2010.

THE MARK CONSISTS OF STANDARD CHARACTERS WITHOUT CLAIM TO ANY PARTICULAR FONT, STYLE, SIZE, OR COLOR.

SER. NO. 85-240,598, FILED P.R. 2-11-2011; AM. S.R. 10-20-2011.

JASON BLAIR, EXAMINING ATTORNEY



David J. Kyffers

Director of the United States Patent and Trademark Office

United States of America

United States Patent and Trademark Office

Vegas Strip

Reg. No. 4,100,362

GARY A. PALLINO (UNITED STATES INDIVIDUAL)

Registered Feb. 14, 2012

5675 W. ROCHELLE AVE. #101
LAS VEGAS, NV 89103

Int. Cl.: 18

FOR: BACKPACKS; BACKPACKS WITH ROLLING WHEELS; BRIEFCASE-TYPE PORTFOLIOS; BRIEFCASES AND ATTACHE CASES; HANDBAGS; HANDBAGS FOR LADIES; HANDBAGS FOR MEN; HANDBAGS, PURSES; PURSES AND WALLETS; PURSES NOT MADE OF PRECIOUS METAL; TRAVEL BAGS; TRAVEL CASES; TRAVELLING CASES OF LEATHER; TRUNKS AND SUITCASES; LUGGAGE AND TRUNKS, LUGGAGE. WALLETS; WALLETS AND WALLET INSERTS; WALLETS INCLUDING CARD HOLDERS; WALLETS MADE OF LEATHER OR OTHER MATERIALS; WALLETS WITH CARD COMPARTMENTS; WALLETS, NOT OF PRECIOUS METAL, IN CLASS 18 (U.S. CLS. 1, 2, 3, 22 AND 41).

TRADEMARK

SUPPLEMENTAL REGISTER

FIRST USE 11-3-2011; IN COMMERCE 11-3-2011.

THE MARK CONSISTS OF STANDARD CHARACTERS WITHOUT CLAIM TO ANY PARTICULAR FONT, STYLE, SIZE, OR COLOR.

OWNER OF U.S. REG. NOS. 3,930,205 AND 4,032,908.

SER. NO. 85-241,003, FILED P.R. 2-13-2011; AM. S.R. 11-9-2011.

JENNY PARK, EXAMINING ATTORNEY



David J. Kybas

Director of the United States Patent and Trademark Office

United States of America

United States Patent and Trademark Office

WATERWAY

Reg. No. 4,100,363

ARCHANGEL ANCIENT TREE ARCHIVE (MICHIGAN CORPORATION)
400 CASS ST.

Registered Feb. 14, 2012

TRAVERSE CITY, MI 49684

Int. Cl.: 31

FOR: LIVING TREES, IN CLASS 31 (U.S. CLS. 1 AND 46).

TRADEMARK

FIRST USE 1-19-2011; IN COMMERCE 1-19-2011.

SUPPLEMENTAL REGISTER

THE MARK CONSISTS OF STANDARD CHARACTERS WITHOUT CLAIM TO ANY PARTICULAR FONT, STYLE, SIZE, OR COLOR.

SER. NO. 85-243,451, FILED P.R. 2-16-2011; AM. S.R. 12-15-2011.

ANTHONY RINKER, EXAMINING ATTORNEY



David J. Kybas

Director of the United States Patent and Trademark Office

United States of America

United States Patent and Trademark Office

CELIAC AWARENESS PROGRAM

Reg. No. 4,100,364

Registered Feb. 14, 2012

Int. Cls.: 16 and 41

TRADEMARK

SERVICE MARK

SUPPLEMENTAL REGISTER

CELIAC SPRUE ASSOCIATION/UNITED STATES OF AMERICA, INC. (NEBRASKA
NON-PROFIT CORPORATION)
P.O. BOX 31700
OMAHA, NE 68131

FOR: LITERATURE AND WRITTEN MATERIALS, NAMELY, NEWSLETTERS, INFORMATIONAL AND EDUCATIONAL WRITTEN PAMPHLETS, BROCHURES, HANDBOOKS, CATALOGS IN THE FIELD OF PRODUCTS FOR PATIENTS WITH CELIAC SPRUE DISEASE AND GLUTEN-INDUCED SENSITIVITIES, INCLUDING, BUT NOT LIMITED TO, DERMATITIS HERPETIFORMIS; COOKBOOKS, BOOKLETS, LEAFLETS, INFORMATIONAL FLYERS, WALLET-SIZED INFORMATIONAL CARDS, POSTERS, INFORMATIONAL SHEETS, RESEARCH MONOGRAPHS, JOURNALS AND JOURNAL REPRINTS, CHARTS, DIAGRAMS, AND ADHESIVE-BACKED STICKERS, ALL RELATING TO CELIAC SPRUE DISEASE AND GLUTEN-INDUCED SENSITIVITIES, INCLUDING, BUT NOT LIMITED TO, DERMATITIS HERPETIFORMIS; KITS COMPRISING OF ONE OR MORE OF THE FOREGOING MATERIALS; AND BOOKS, PERIODICALS AND OTHER INFORMATIONAL DOCUMENTS, ALL RELATING TO CELIAC SPRUE DISEASE AND GLUTEN-INDUCED SENSITIVITIES, INCLUDING, BUT NOT LIMITED TO, DERMATITIS HERPETIFORMIS, IN CLASS 16 (U.S. CLS. 2, 5, 22, 23, 29, 37, 38 AND 50).

FIRST USE 1-31-2010; IN COMMERCE 1-31-2010.



FOR: EDUCATIONAL AND TRAINING SERVICES, NAMELY, CONDUCTING SEMINARS, COURSES, CONFERENCES, LECTURES, WORKSHOPS RELATING TO CELIAC SPRUE DISEASE AND GLUTEN-INDUCED SENSITIVITIES, INCLUDING, BUT NOT LIMITED TO, DERMATITIS HERPETIFORMIS AND CONDUCTING COLLABORATIVE MEETINGS WITH PHYSICIANS, MEDICAL TECHNICIANS AND OTHERS IN THE SCIENTIFIC COMMUNITY TO DISCUSS, LEARN AND EVALUATE MEDICAL RESEARCH AND OTHER MEDICAL ADVANCES RELATING TO CELIAC SPRUE DISEASE AND GLUTEN-INDUCED SENSITIVITIES, INCLUDING, BUT NOT LIMITED TO, DERMATITIS HERPETIFORMIS, IN CLASS 41 (U.S. CLS. 100, 101 AND 107).

FIRST USE 1-31-2010; IN COMMERCE 1-31-2010.

David J. Kyffers

THE MARK CONSISTS OF STANDARD CHARACTERS WITHOUT CLAIM TO ANY PARTICULAR FONT, STYLE, SIZE, OR COLOR.

Reg. No. 4,100,364 SER. NO. 85-247,085, FILED P.R. 2-20-2011; AM. S.R. 11-23-2011.

SUNG IN, EXAMINING ATTORNEY

United States of America

United States Patent and Trademark Office

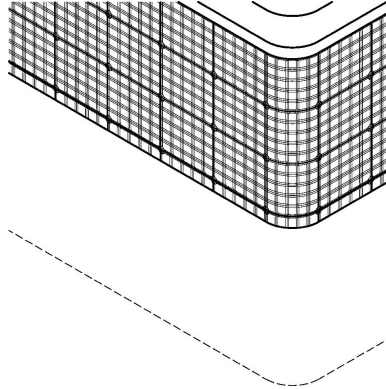

Reg. No. 4,100,365

Registered Feb. 14, 2012

Int. Cl.: 20

TRADEMARK

SUPPLEMENTAL REGISTER

E. S. KLUFT & COMPANY, LLC (CALIFORNIA LIMITED LIABILITY COMPANY)
11096 JERSEY BOULEVARD, SUITE 101
RANCHO CUCAMONGA, CA 91730

FOR: MATTRESSES, IN CLASS 20 (U.S. CLS. 2, 13, 22, 25, 32 AND 50).

FIRST USE 11-30-2010; IN COMMERCE 11-30-2010.

THE MARK CONSISTS OF A PLAID DESIGN LOCATED ON AND COVERING THE ENTIRE PERIMETER OF THE SIDE BORDER OF A MATTRESS, THE PLAID DESIGN COMPRISING A REPEAT PATTERN NO LARGER THAN APPROXIMATELY 1 TO 1.6 INCHES IN BOTH ITS HORIZONTAL AND VERTICAL DIMENSIONS. THE MATTER SHOWN IN DOTTED LINES IS NOT PART OF THE MARK BUT MERELY SERVES TO SHOW THE PLACEMENT OF THE MARK ON THE GOODS.

SER. NO. 85-249,997, FILED P.R. 2-23-2011; AM. S.R. 12-1-2011.

KIMBERLY FRYE, EXAMINING ATTORNEY



David J. Kybas

Director of the United States Patent and Trademark Office

United States of America

United States Patent and Trademark Office

Vegas Strip

Reg. No. 4,100,366

GARY A. PALLINO (UNITED STATES INDIVIDUAL)

Registered Feb. 14, 2012

5675 W. ROCHELLE AVE. #101
LAS VEGAS, NV 89103

Int. Cl.: 3

FOR: COLOGNE; COLOGNE WATER; COLOGNES, COSMETIC ROUGES, LIPSTICK; LIPSTICK CASES; LIPSTICK HOLDERS; LIPSTICKS; PERFUMES; PERFUMES AND COLOGNES; PERFUMES AND TOILET WATERS; PERFUMES AS COSMETICS; PERFUMES, EAU DE COLOGNES AND AFTERSHAVES; PERFUME; PERFUME OILS, IN CLASS 3 (U.S. CLS. 1, 4, 6, 50, 51 AND 52).

TRADEMARK

SUPPLEMENTAL REGISTER

FIRST USE 10-5-2011; IN COMMERCE 10-5-2011.

THE MARK CONSISTS OF STANDARD CHARACTERS WITHOUT CLAIM TO ANY PARTICULAR FONT, STYLE, SIZE, OR COLOR.

OWNER OF U.S. REG. NOS. 3,930,205 AND 4,032,908.

SER. NO. 85-252,729, FILED P.R. 2-27-2011; AM. S.R. 11-9-2011.

JENNY PARK, EXAMINING ATTORNEY



David J. Kybas

Director of the United States Patent and Trademark Office

United States of America

United States Patent and Trademark Office



Reg. No. 4,100,367

CALAS, LENI (UNITED STATES INDIVIDUAL)
22-43 35TH ST
ASTORIA, NY 11105

Registered Feb. 14, 2012

Int. Cl.: 41

FOR: EDUCATION AND ENTERTAINMENT SERVICES, NAMELY,, ONLINE JOURNALS, NAMELY, BLOGS FEATURING AN ONLINE RESOURCE GUIDE FOR PARENTS AND CAREGIVERS OF YOUNG CHILDREN, CONSISTING OF REVIEWS OF CHILD-FRIENDLY BUSINESSES AND GOODS, EVENTS CALENDARS, PARENTING STYLES AND STORIES, ENTERTAINMENT, MUSIC, THE ARTS, CULTURE, CONCEPTION, ADOPTION, FOSTER CARE, FERTILITY, PREGNANCY AND FETAL DEVELOPMENT, BIRTHING, PARENTING, CHILD CARE, PHYSICAL AND EMOTIONAL CHILD DEVELOPMENT, CHILDREN'S EDUCATION, CHILDREN'S FITNESS, CHILD SAFETY, CHILDREN'S HEALTH, LIFESTYLES AND NUTRITION, INTERACTIVE ENTERTAINMENT WITH PARENTS AND CHILDREN AND INFORMATION OF INTEREST TO SPECIFIC GEOGRAPHIC AREAS; PROVIDING NEWSLETTERS IN THE FIELD OF PARENTING AND/OR AND CARING FOR YOUNG CHILDREN, CONSISTING OF REVIEWS OF CHILD-FRIENDLY BUSINESSES AND GOODS, EVENTS CALENDARS, PARENTING STYLES AND STORIES, ENTERTAINMENT, MUSIC, THE ARTS, CULTURE, CONCEPTION, ADOPTION, FOSTER CARE, FERTILITY, PREGNANCY AND FETAL DEVELOPMENT, BIRTHING, PARENTING, CHILD CARE, PHYSICAL AND EMOTIONAL CHILD DEVELOPMENT, CHILDREN'S EDUCATION, CHILDREN'S FITNESS, CHILD SAFETY, CHILDREN'S HEALTH, LIFESTYLES AND NUTRITION, INTERACTIVE ENTERTAINMENT WITH PARENTS AND CHILDREN AND INFORMATION OF INTEREST TO SPECIFIC GEOGRAPHIC AREAS, VIA E-MAIL, IN CLASS 41 (U.S. CLS. 100, 101 AND 107).

SERVICE MARK

SUPPLEMENTAL REGISTER



FIRST USE 3-1-2011; IN COMMERCE 5-22-2011.

THE MARK CONSISTS OF THE WORDING "MAMAS" IN WHITE INSIDE A PINK CIRCLE.

THE COLOR(S) PINK AND WHITE IS/ARE CLAIMED AS A FEATURE OF THE MARK.

SER. NO. 85-254,132, FILED P.R. 3-1-2011; AM. S.R. 11-17-2011.

David J. Kypos

STEVEN R. FINE, EXAMINING ATTORNEY

United States of America

United States Patent and Trademark Office

INFRASTRUCTURE-AT-RISK

Reg. No. 4,100,368

THE A STAR GROUP, INC (NEW YORK CORPORATION)
154 READE STREET, 2ND FLOOR
NEW YORK, NY 10013

Registered Feb. 14, 2012

Int. Cl.: 42

FOR: PROVIDING ON-LINE NON-DOWNLOADABLE SOFTWARE FOR USE IN THE FIELD OF RISK MANAGEMENT INCLUDING ANALYSIS, VALUATION AND RISK MANAGEMENT OF INFRASTRUCTURE AND ASSETS , IN CLASS 42 (U.S. CLS. 100 AND 101).

SERVICE MARK

FIRST USE 11-1-2010; IN COMMERCE 11-1-2010.

SUPPLEMENTAL REGISTER

THE MARK CONSISTS OF STANDARD CHARACTERS WITHOUT CLAIM TO ANY PARTICULAR FONT, STYLE, SIZE, OR COLOR.

SER. NO. 85-254,154, FILED P.R. 3-1-2011; AM. S.R. 12-16-2011.

SAIMA MAKHDOOM, EXAMINING ATTORNEY



David J. Kyffers

Director of the United States Patent and Trademark Office

United States of America

United States Patent and Trademark Office

DIGITAL W8

Reg. No. 4,100,369

Registered Feb. 14, 2012

Int. Cl.: 42

COMPLIANCE TECHNOLOGIES INTERNATIONAL, LLP (DELAWARE LIMITED LIABILITY PARTNERSHIP)
SUITE 403
200 BRICKSTONE SQUARE
ANDOVER, MA 01810

SERVICE MARK

SUPPLEMENTAL REGISTER

FOR: APPLICATION SERVICE PROVIDER (ASP) FEATURING SOFTWARE FOR USE IN COMPLYING WITH TAX REGULATIONS FOR NON-UNITED STATES CITIZENS, IN CLASS 42 (U.S. CLS. 100 AND 101).

FIRST USE 11-30-2010; IN COMMERCE 11-30-2010.

THE MARK CONSISTS OF STANDARD CHARACTERS WITHOUT CLAIM TO ANY PARTICULAR FONT, STYLE, SIZE, OR COLOR.

NO CLAIM IS MADE TO THE EXCLUSIVE RIGHT TO USE "W8", APART FROM THE MARK AS SHOWN.

SER. NO. 85-254,577, FILED P.R. 3-1-2011; AM. S.R. 12-1-2011.

MICHAEL SOUDERS, EXAMINING ATTORNEY



David J. Kybas

Director of the United States Patent and Trademark Office

United States of America

United States Patent and Trademark Office

THE CLOUD COMPUTING EVENT OF THE YEAR

Reg. No. 4,100,370

SALESFORCE.COM, INC. (DELAWARE CORPORATION)

Registered Feb. 14, 2012

THE LANDMARK @ ONE MARKET ST., STE. 300
SAN FRANCISCO, CA 94105

Int. Cl.: 41

FOR: EDUCATIONAL SERVICES, NAMELY, CONDUCTING SEMINARS, CONFERENCES, WORKSHOPS, AND COMPUTER APPLICATION TRAINING IN THE FIELDS OF MARKETING, PROMOTION, SALES, CUSTOMER INFORMATION, CUSTOMER RELATIONSHIP MANAGEMENT, SALES SUPPORT AND EMPLOYEE EFFICIENCY, AND DISTRIBUTING COURSE MATERIALS IN CONNECTION THEREWITH, IN CLASS 41 (U.S. CLS. 100, 101 AND 107).

SERVICE MARK

SUPPLEMENTAL REGISTER

FIRST USE 11-17-2009; IN COMMERCE 11-17-2009.

THE MARK CONSISTS OF STANDARD CHARACTERS WITHOUT CLAIM TO ANY PARTICULAR FONT, STYLE, SIZE, OR COLOR.

SER. NO. 85-256,149, FILED P.R. 3-2-2011; AM. S.R. 11-21-2011.

Laurie Mayes, Examining Attorney



David J. Kybas

Director of the United States Patent and Trademark Office

United States of America

United States Patent and Trademark Office

EMS MEDIA SERVICES

Reg. No. 4,100,371

Registered Feb. 14, 2012

Int. Cl.: 35

SERVICE MARK

SUPPLEMENTAL REGISTER

WISCONSIN EMERGENCY MEDICAL TECHNICIANS ASSOCIATION, INC. (WISCONSIN CORPORATION), DBA WISCONSIN EMS ASSOCIATION,
26422 OAKRIDGE DRIVE
WIND LAKE, WI 53195

FOR: ADVERTISING AND MARKETING CONSULTANCY; ADVERTISING VIA ELECTRONIC MEDIA AND SPECIFICALLY THE INTERNET; BUSINESS CONSULTING SERVICES, NAMELY, PROVIDING ASSISTANCE IN DEVELOPMENT OF BUSINESS STRATEGIES AND CREATIVE IDEATION; CONCEPT AND BRAND DEVELOPMENT IN THE EMERGENCY MEDICAL SERVICES FIELD; CREATIVE MARKETING DESIGN SERVICES; PROVIDING ADVERTISING SERVICES, IN CLASS 35 (U.S. CLS. 100, 101 AND 102).

FIRST USE 10-30-2010; IN COMMERCE 12-6-2011.

THE MARK CONSISTS OF STANDARD CHARACTERS WITHOUT CLAIM TO ANY PARTICULAR FONT, STYLE, SIZE, OR COLOR.

NO CLAIM IS MADE TO THE EXCLUSIVE RIGHT TO USE "SERVICES", APART FROM THE MARK AS SHOWN.

SER. NO. 85-256,241, FILED P.R. 3-2-2011; AM. S.R. 12-6-2011.

ESTHER A. BORSUK, EXAMINING ATTORNEY



David J. Kybas

Director of the United States Patent and Trademark Office

United States of America

United States Patent and Trademark Office

COFFEE FOR WATER

Reg. No. 4,100,372

TAVANGAR, JAHAN (UNITED STATES INDIVIDUAL)
1879 COVERED BRIDGE ROAD
MALVERN, PA 19355

Registered Feb. 14, 2012

Int. Cl.: 30

FOR: COFFEE, IN CLASS 30 (U.S. CL. 46).

TRADEMARK

FIRST USE 3-0-2011; IN COMMERCE 3-0-2011.

SUPPLEMENTAL REGISTER

THE MARK CONSISTS OF STANDARD CHARACTERS WITHOUT CLAIM TO ANY PARTICULAR FONT, STYLE, SIZE, OR COLOR.

NO CLAIM IS MADE TO THE EXCLUSIVE RIGHT TO USE "COFFEE", APART FROM THE MARK AS SHOWN.

SER. NO. 85-256,445, FILED P.R. 3-3-2011; AM. S.R. 12-13-2011.

JOHN KELLY, EXAMINING ATTORNEY



David J. Kyffers

Director of the United States Patent and Trademark Office

United States of America

United States Patent and Trademark Office

Remote Station

Reg. No. 4,100,373

STEVE KLEIN (UNITED STATES INDIVIDUAL)
10960 VENTURA BOULEVARD
STUDIO CITY, CA 91604

Registered Feb. 14, 2012

Int. Cl.: 9

FOR: VIDEO EDITING AND STORAGE MANAGEMENT EQUIPMENT, NAMELY, COMPUTER HARDWARE AND SOFTWARE FOR EDITING IMAGES, SOUND AND VIDEO, IN CLASS 9 (U.S. CLS. 21, 23, 26, 36 AND 38).

TRADEMARK

FIRST USE 3-26-2009; IN COMMERCE 3-26-2009.

SUPPLEMENTAL REGISTER

THE MARK CONSISTS OF STANDARD CHARACTERS WITHOUT CLAIM TO ANY PARTICULAR FONT, STYLE, SIZE, OR COLOR.

SER. NO. 85-256,866, FILED P.R. 3-3-2011; AM. S.R. 11-25-2011.

SUSAN STIGLITZ, EXAMINING ATTORNEY



David J. Kyffers

Director of the United States Patent and Trademark Office

United States of America

United States Patent and Trademark Office

SUVAL CONSULTANTS

Reg. No. 4,100,374

BECKERMAN, HELAINE (UNITED STATES INDIVIDUAL)
12 PADDOCK ROAD

Registered Feb. 14, 2012

WHITE PLAINS, NY 10605

Int. Cl.: 35

FOR: BUSINESS CONSULTATION AND ADVISORY SERVICES, IN CLASS 35 (U.S. CLS. 100, 101 AND 102).

SERVICE MARK

FIRST USE 4-4-2011; IN COMMERCE 4-4-2011.

SUPPLEMENTAL REGISTER

THE MARK CONSISTS OF STANDARD CHARACTERS WITHOUT CLAIM TO ANY PARTICULAR FONT, STYLE, SIZE, OR COLOR.

NO CLAIM IS MADE TO THE EXCLUSIVE RIGHT TO USE "CONSULTANTS", APART FROM THE MARK AS SHOWN.

SER. NO. 85-258,014, FILED P.R. 3-4-2011; AM. S.R. 12-13-2011.

BRIAN CALLAGHAN, EXAMINING ATTORNEY



David J. Kybas

Director of the United States Patent and Trademark Office

United States of America

United States Patent and Trademark Office

Smart Prep

Reg. No. 4,100,375

HORIZON TECHNOLOGY, INC. (NEW HAMPSHIRE CORPORATION)
45 NORTHWESTERN DR.
SALEM, NH 03079

Registered Feb. 14, 2012

Int. Cl.: 9

FOR: SCIENTIFIC INSTRUMENTS, NAMELY, ELECTRO-MECHANICAL SAMPLE EXTRACTION SYSTEM COMPRISED OF A SYRINGE PUMP, SELECTOR VALVE, SOLENOID VALVE, AND STEPPER MOTOR FOR EXTRACTING CHEMICALS FROM LIQUID MATERIALS FOR TESTING FOR THE PRESENCE OF ORGANIC AND INORGANIC COMPOUNDS, NOT FOR MEDICAL OR CLINICAL USE, IN CLASS 9 (U.S. CLS. 21, 23, 26, 36 AND 38).

TRADEMARK

SUPPLEMENTAL REGISTER

FIRST USE 8-14-2011; IN COMMERCE 8-14-2011.

THE MARK CONSISTS OF STANDARD CHARACTERS WITHOUT CLAIM TO ANY PARTICULAR FONT, STYLE, SIZE, OR COLOR.

SER. NO. 85-261,886, FILED P.R. 3-9-2011; AM. S.R. 11-21-2011.

PAULA MAHONEY, EXAMINING ATTORNEY



David J. Kyffers

Director of the United States Patent and Trademark Office

United States of America

United States Patent and Trademark Office

PROGRESSIVE BUSINESS ALLIANCE OF AMERICA

Reg. No. 4,100,376

PROGRESSIVE BUSINESS ALLIANCE OF AMERICA, INC. (WISCONSIN CORPORATION)
W3846 CROWN ROAD
CAMBRIA, WI 53923

Registered Feb. 14, 2012

Int. Cl.: 35

FOR: POLITICAL ACTION COMMITTEE SERVICES, NAMELY, PROMOTING THE INTERESTS OF BUSINESSES THAT PURSUE AND IMPLEMENT POLICIES THAT FAVOR OR PROMOTE GOOD JOBS AND WAGES FOR EMPLOYEES AND THEIR FAMILIES, ENVIRONMENTAL STEWARDSHIP AND PROTECTION OF OUR NATURAL RESOURCES AND NATURAL HERITAGE, IN THE FIELD OF POLITICS; BUSINESS NETWORKING, IN CLASS 35 (U.S. CLS. 100, 101 AND 102).

SERVICE MARK

SUPPLEMENTAL REGISTER

FIRST USE 4-1-2011; IN COMMERCE 4-1-2011.

THE MARK CONSISTS OF STANDARD CHARACTERS WITHOUT CLAIM TO ANY PARTICULAR FONT, STYLE, SIZE, OR COLOR.

NO CLAIM IS MADE TO THE EXCLUSIVE RIGHT TO USE "BUSINESS ALLIANCE", APART FROM THE MARK AS SHOWN.

SER. NO. 85-262,516, FILED P.R. 3-9-2011; AM. S.R. 12-5-2011.

MATTHEW MCDOWELL, EXAMINING ATTORNEY



David J. Kybas

Director of the United States Patent and Trademark Office

United States of America

United States Patent and Trademark Office

GREAT HAIR

Reg. No. 4,100,377

BOUIE, LTD (TENNESSEE PARTNERSHIP), DBA KMB SALON,
125 ETOWAH TRACE
FAYETTEVILLE, GA 30214

Registered Feb. 14, 2012

Int. Cl.: 3

FOR: HAIR CARE PREPARATIONS; HAIR CLEANING PREPARATIONS; HAIR STYLING PREPARATIONS, IN CLASS 3 (U.S. CLS. 1, 4, 6, 50, 51 AND 52).

TRADEMARK

FIRST USE 2-7-2011; IN COMMERCE 2-7-2011.

SUPPLEMENTAL REGISTER

THE MARK CONSISTS OF STANDARD CHARACTERS WITHOUT CLAIM TO ANY PARTICULAR FONT, STYLE, SIZE, OR COLOR.

NO CLAIM IS MADE TO THE EXCLUSIVE RIGHT TO USE "HAIR", APART FROM THE MARK AS SHOWN.

SER. NO. 85-262,909, FILED P.R. 3-10-2011; AM. S.R. 12-12-2011.

CHRISIE B. KING, EXAMINING ATTORNEY



David J. Kyffers

Director of the United States Patent and Trademark Office

United States of America

United States Patent and Trademark Office

GREENSCENTS

Reg. No. 4,100,378

R.L. WILLIAMS COMPANY (NORTH CAROLINA CORPORATION)
103 NORTH MCLIN CREEK ROAD
CONOVER, NC 28613

Registered Feb. 14, 2012

Int. Cl.: 5

FOR: AIR FRESHENERS, IN CLASS 5 (U.S. CLS. 6, 18, 44, 46, 51 AND 52).

TRADEMARK

FIRST USE 2-1-2008; IN COMMERCE 2-1-2008.

SUPPLEMENTAL REGISTER

THE MARK CONSISTS OF STANDARD CHARACTERS WITHOUT CLAIM TO ANY PARTICULAR FONT, STYLE, SIZE, OR COLOR.

SER. NO. 85-263,564, FILED P.R. 3-10-2011; AM. S.R. 12-15-2011.

AMY HELLA, EXAMINING ATTORNEY



David J. Kyffers

Director of the United States Patent and Trademark Office

United States of America

United States Patent and Trademark Office

High Intensity Pilates

Reg. No. 4,100,379

CRIVELLO, CHRISTINE (UNITED STATES INDIVIDUAL)
3408 MANHATTAN AVE
MANHATTAN BEACH, CA 90266

Registered Feb. 14, 2012

Int. Cl.: 41

FOR: PHYSICAL FITNESS STUDIO SERVICES, NAMELY, PROVIDING EXERCISE CLASSES, BODY SCULPTING CLASSES, AND GROUP FITNESS CLASSES, IN CLASS 41 (U.S. CLS. 100, 101 AND 107).

SERVICE MARK

FIRST USE 2-1-2011; IN COMMERCE 2-1-2011.

SUPPLEMENTAL REGISTER

THE MARK CONSISTS OF STANDARD CHARACTERS WITHOUT CLAIM TO ANY PARTICULAR FONT, STYLE, SIZE, OR COLOR.

NO CLAIM IS MADE TO THE EXCLUSIVE RIGHT TO USE "PILATES", APART FROM THE MARK AS SHOWN.

SER. NO. 85-263,864, FILED P.R. 3-10-2011; AM. S.R. 12-9-2011.

WILLIAM BRECKENFELD, EXAMINING ATTORNEY



David J. Kybas

Director of the United States Patent and Trademark Office

United States of America

United States Patent and Trademark Office

C.O.D. DIRECT

Reg. No. 4,100,380

UNITED PARCEL SERVICE OF AMERICA, INC. (DELAWARE CORPORATION)
55 GLENLAKE PARKWAY
ATLANTA, GA 30328

Registered Feb. 14, 2012

Int. Cl.: 36

FOR: ELECTRONIC PAYMENT, NAMELY, ELECTRONIC PROCESSING AND TRANSMISSION OF BILL PAYMENT DATA, IN CLASS 36 (U.S. CLS. 100, 101 AND 102).

SERVICE MARK

FIRST USE 8-31-2004; IN COMMERCE 8-31-2004.

SUPPLEMENTAL REGISTER

THE MARK CONSISTS OF STANDARD CHARACTERS WITHOUT CLAIM TO ANY PARTICULAR FONT, STYLE, SIZE, OR COLOR.

NO CLAIM IS MADE TO THE EXCLUSIVE RIGHT TO USE "C.O.D.", APART FROM THE MARK AS SHOWN.

SER. NO. 85-263,870, FILED P.R. 3-10-2011; AM. S.R. 12-14-2011.

GIANCARLO CASTRO, EXAMINING ATTORNEY



David J. Kyffers

Director of the United States Patent and Trademark Office

United States of America

United States Patent and Trademark Office

Chia Water

Reg. No. 4,100,381

Registered Feb. 14, 2012

Int. Cl.: 32

TRADEMARK

SUPPLEMENTAL REGISTER

GRUPO LIAG S.A. DE C.V. (MEXICO SOCIEDAD ANONIMA (SA DE CV)))
AV. LOPEZ DE LEGASPI NO. 589, ZONA INDUS
GUADALAJARA, 44940, MEXICO

FOR: BOTTLED DRINKING WATER CONTAINING CHIA; CONCENTRATES FOR MAKING FRUIT DRINKS CONTAINING CHIA; DRINKING WATER WITH VITAMINS CONTAINING CHIA; ESSENCES FOR MAKING FLAVORED MINERAL WATER CONTAINING CHIA; FLAVORED BOTTLED WATER CONTAINING CHIA; FLAVORED ENHANCED WATER CONTAINING CHIA; FLAVORED MINERAL WATER CONTAINING CHIA; FRUIT FLAVORED DRINKS CONTAINING CHIA; MINERAL WATER CONTAINING CHIA; PREPARATIONS FOR MAKING BEVERAGES, NAMELY, THOSE DERIVED FROM THE CHIA SEED; SYRUPS FOR MAKING FRUIT-FLAVORED DRINKS CONTAINING CHIA, IN CLASS 32 (U.S. CLS. 45, 46 AND 48).

FIRST USE 6-15-2011; IN COMMERCE 6-15-2011.

THE MARK CONSISTS OF STANDARD CHARACTERS WITHOUT CLAIM TO ANY PARTICULAR FONT, STYLE, SIZE, OR COLOR.

NO CLAIM IS MADE TO THE EXCLUSIVE RIGHT TO USE "WATER", APART FROM THE MARK AS SHOWN.

SER. NO. 85-267,898, FILED P.R. 3-15-2011; AM. S.R. 12-16-2011.

JENNIFER MARTIN, EXAMINING ATTORNEY



David J. Kyros

Director of the United States Patent and Trademark Office

United States of America

United States Patent and Trademark Office

HIRE A LOCAL

Reg. No. 4,100,382

HIRE A LOCAL PTY. LTD. (AUSTRALIA PRIVATE LIMITED COMPANY)
3/3 OCEAN STREET
WOOLLAHRA, AUSTRALIA

Registered Feb. 14, 2012

Int. Cl.: 35

FOR: PROVIDING A WEBSITE FOR JOB SEARCH, WORKER PROFILES AND JOB ADVERTISEMENT LISTING SERVICES, IN CLASS 35 (U.S. CLS. 100, 101 AND 102).

SERVICE MARK

FIRST USE 1-25-2011; IN COMMERCE 2-16-2011.

SUPPLEMENTAL REGISTER

THE MARK CONSISTS OF STANDARD CHARACTERS WITHOUT CLAIM TO ANY PARTICULAR FONT, STYLE, SIZE, OR COLOR.

SER. NO. 85-270,063, FILED P.R. 3-17-2011; AM. S.R. 12-19-2011.

ELIZABETH KAJUBI, EXAMINING ATTORNEY



David J. Kyffers

Director of the United States Patent and Trademark Office

United States of America

United States Patent and Trademark Office

ORGASM SHOT

Reg. No. 4,100,383

Registered Feb. 14, 2012

Int. Cl.: 44

SERVICE MARK

SUPPLEMENTAL REGISTER

CHARLES E. RUNELS, JR. (UNITED STATES INDIVIDUAL), DBA STUDIO MEDICINE,
52 SOUTH SECTION ST., SUITE A
FAIRHOPE, AL 36532

FOR: NON-INVASIVE COSMETIC MEDICAL PROCEDURE NAMELY, THE INJECTION OF BLOOD-DERIVED GROWTH FACTORS INCLUDING PLATELET RICH FIBRIN MATRIX WITHIN THE GSPOT, CLITORIS, AND/OR OTHER VAGINAL STRUCTURES TO REJUVENATE THE TISSUE AND FACILITATE THE FEMALE ORGASM, IN CLASS 44 (U.S. CLS. 100 AND 101).

FIRST USE 3-18-2011; IN COMMERCE 3-18-2011.

THE MARK CONSISTS OF STANDARD CHARACTERS WITHOUT CLAIM TO ANY PARTICULAR FONT, STYLE, SIZE, OR COLOR.

NO CLAIM IS MADE TO THE EXCLUSIVE RIGHT TO USE "SHOT", APART FROM THE MARK AS SHOWN.

SER. NO. 85-270,547, FILED P.R. 3-18-2011; AM. S.R. 11-30-2011.

GRETTA YAO, EXAMINING ATTORNEY



David J. Kyros

Director of the United States Patent and Trademark Office

United States of America

United States Patent and Trademark Office

CHINA BISTRO EXPRESS

Reg. No. 4,100,384

CHINA BISTRO LLC (FLORIDA LIMITED LIABILITY COMPANY)
3925 SW 53 COURT
FORT LAUDERDALE, FL 33312

Registered Feb. 14, 2012

Int. Cl.: 43

FOR: RESTAURANT AND CATERING SERVICES, IN CLASS 43 (U.S. CLS. 100 AND 101).

SERVICE MARK

FIRST USE 1-4-2010; IN COMMERCE 3-1-2011.

SUPPLEMENTAL REGISTER

THE MARK CONSISTS OF STANDARD CHARACTERS WITHOUT CLAIM TO ANY PARTICULAR FONT, STYLE, SIZE, OR COLOR.

SER. NO. 85-272,977, FILED P.R. 3-22-2011; AM. S.R. 12-16-2011.

DANNEAN HETZEL, EXAMINING ATTORNEY



David J. Kyffers

Director of the United States Patent and Trademark Office

United States of America

United States Patent and Trademark Office

Unified Content

Reg. No. 4,100,385

ZL TECHNOLOGIES, INC. (CALIFORNIA CORPORATION), FORMERLY ZIPLIP INC.,
2000 CONCOURSE DRIVE
SAN JOSE, CA 95131

Registered Feb. 14, 2012

Int. Cl.: 9

FOR: COMPUTER SOFTWARE FOR CREATING SEARCHABLE DATABASES OF INFORMATION AND DATA, IN CLASS 9 (U.S. CLS. 21, 23, 26, 36 AND 38).

TRADEMARK

FIRST USE 4-1-2010; IN COMMERCE 4-15-2010.

SUPPLEMENTAL REGISTER

THE MARK CONSISTS OF STANDARD CHARACTERS WITHOUT CLAIM TO ANY PARTICULAR FONT, STYLE, SIZE, OR COLOR.

OWNER OF U.S. REG. NO. 3,910,498.

SER. NO. 85-275,767, FILED P.R. 3-24-2011; AM. S.R. 12-1-2011.

DAWN HAN, EXAMINING ATTORNEY



David J. Kyffers

Director of the United States Patent and Trademark Office

United States of America

United States Patent and Trademark Office

Return-to-Center

Reg. No. 4,100,386

MAILBOX POST SOLUTIONS AND MORE, LLC (OHIO LIMITED LIABILITY COMPANY)
12026 BLACK ROAD
MARYSVILLE, OH 43040

Registered Feb. 14, 2012

Int. Cl.: 6

FOR: ROTATING METAL POST FOR SUPPORT OF MAILBOXES, IN CLASS 6 (U.S. CLS. 2, 12, 13, 14, 23, 25 AND 50).

TRADEMARK

FIRST USE 8-1-2009; IN COMMERCE 8-1-2009.

SUPPLEMENTAL REGISTER

THE MARK CONSISTS OF STANDARD CHARACTERS WITHOUT CLAIM TO ANY PARTICULAR FONT, STYLE, SIZE, OR COLOR.

SER. NO. 85-279,990, FILED P.R. 3-29-2011; AM. S.R. 12-18-2011.

TINA BROWN, EXAMINING ATTORNEY



David J. Kyffers

Director of the United States Patent and Trademark Office

United States of America
United States Patent and Trademark Office

SOBRECITOS

Reg. No. 4,100,387

ACH FOOD COMPANIES, INC. (DELAWARE CORPORATION)
7171 GOODLETT FARMS PARKWAY
CORDOVA, TN 38016

Registered Feb. 14, 2012

Int. Cl.: 29

FOR: INSTANT SOUPS IN POWDER FORM, IN CLASS 29 (U.S. CL. 46).

FIRST USE 12-7-2011; IN COMMERCE 12-7-2011.

TRADEMARK

THE MARK CONSISTS OF STANDARD CHARACTERS WITHOUT CLAIM TO ANY PARTICULAR FONT, STYLE, SIZE, OR COLOR.

SUPPLEMENTAL REGISTER

THE ENGLISH TRANSLATION OF "SOBRECITOS" IN THE MARK IS "SACHETS".

SER. NO. 85-291,555, FILED P.R. 4-11-2011; AM. S.R. 12-19-2011.

ELLEN B. AWRICH, EXAMINING ATTORNEY



David J. Kyros

Director of the United States Patent and Trademark Office

United States of America

United States Patent and Trademark Office

panoramic
full visual system

Reg. No. 4,100,388

DUO INDUSTRIE (FRANCE SOCIÉTÉ PAR ACTIONS SIMPLIFIÉE (SAS))
344, RUE DU JARDIN COLARD

Registered Feb. 14, 2012

LANSARGUES, FRANCE F-34130

Int. Cls.: 6, 20, and 24

FOR: REINFORCING MATERIALS OF METAL FOR BUILDING; NON-ELECTRIC CABLES AND WIRE OF COMMON METAL; SECTIONS OF METAL FOR METALLIC TRANSPORTABLE BUILDINGS, NAMELY, WALL PANELS; NON-LUMINOUS AND NON-MECHANICAL BUILDING MATERIALS OF METAL IN THE NATURE OF WALL PANELS FOR FURNITURE OR FOR PARTS OF FURNITURE FOR EXHIBITION STANDS; TRANSPORTABLE BUILDINGS OF METAL; PRE-FABRICATED BUILDINGS OF METAL, IN CLASS 6 (U.S. CLS. 2, 12, 13, 14, 23, 25 AND 50).

TRADEMARK

FOR: FURNITURE; PARTS FOR FURNITURE; PICTURE FRAMES; FURNITURE FOR EXHIBITION STANDS MADE FROM PIPES AND TUBES OF ALUMINUM AND JUNCTIONS OF PLASTIC, SUCH AS TABLES; COUNTERS; CABINETS FOR USE AS FURNITURE; CHESTS OF DRAWERS; SHELVES; SHOWCASES; ADVERTISEMENT BOARDS IN THE NATURE OF DISPLAY BOARDS; DISPLAY STANDS FOR POINTS OF SALE, SIGNBOARDS MADE OF PLASTIC, IN CLASS 20 (U.S. CLS. 2, 13, 22, 25, 32 AND 50).

SUPPLEMENTAL REGISTER

FOR: PRINTED POSTERS MADE PRIMARILY OF FABRIC AND PLASTIC; CLOTH BANNERS; ELASTIC WOVEN MATERIAL FOR USE AS FABRIC AND PRINTED POSTERS; LOOSE COVERS FOR FURNITURE, COVERINGS OF PLASTIC FOR FURNITURE, UNFITTED FURNITURE COVERINGS OF TEXTILE, WALL HANGINGS OF TEXTILE, IN CLASS 24 (U.S. CLS. 42 AND 50).



PRIORITY CLAIMED UNDER SEC. 44(D) ON ERPN CMNTY TM OFC APPLICATION NO. 9448705, FILED 10-15-2010, REG. NO. 9448705, DATED 3-25-2011, EXPIRES 3-25-2021.

THE MARK CONSISTS OF THE TERM "PANORAMIC" IN STYLIZED FONT LOCATED ABOVE THE TERMS "FULL VISUAL SYSTEM" IN STYLIZED FONT.

SER. NO. 85-296,636, FILED P.R. 4-15-2011; AM. S.R. 12-19-2011.

EMILY CARLSEN, EXAMINING ATTORNEY

David J. Kyffers

Director of the United States Patent and Trademark Office

United States of America

United States Patent and Trademark Office

DIABETES WHAT TO EAT

Reg. No. 4,100,389

MEREDITH CORPORATION (IOWA CORPORATION)
1716 LOCUST STREET
DES MOINES, IA 50309

Registered Feb. 14, 2012

Int. Cl.: 16

FOR: PUBLICATIONS, NAMELY, MAGAZINES AND BOOKS PROVIDING ARTICLES, INFORMATION AND RECIPES DESIGNED FOR CONSUMERS WITH DIABETES , IN CLASS 16 (U.S. CLS. 2, 5, 22, 23, 29, 37, 38 AND 50).

TRADEMARK

FIRST USE 3-30-2010; IN COMMERCE 3-30-2010.

SUPPLEMENTAL REGISTER

THE MARK CONSISTS OF STANDARD CHARACTERS WITHOUT CLAIM TO ANY PARTICULAR FONT, STYLE, SIZE, OR COLOR.

SER. NO. 85-296,769, FILED P.R. 4-15-2011; AM. S.R. 12-16-2011.

NAAKWAMA ANKRAH, EXAMINING ATTORNEY



David J. Kyffers

Director of the United States Patent and Trademark Office

United States of America

United States Patent and Trademark Office

PAID AS YOU GO

Reg. No. 4,100,390

MERCURY STUDIO LLC (MICHIGAN LIMITED LIABILITY COMPANY)
24075 ROANOKE

Registered Feb. 14, 2012

OAK PARK, MI 48237

Int. Cl.: 35

FOR: ADVERTISING, INCLUDING PROMOTION RELATING TO THE SALE OF ARTICLES AND SERVICES FOR THIRD PARTIES BY THE TRANSMISSION OF ADVERTISING MATERIAL AND THE DISSEMINATION OF ADVERTISING MESSAGES ON COMPUTER NETWORKS; DISSEMINATION OF ADVERTISING FOR OTHERS VIA PUBLIC AND PRIVATE WIRELESS NETWORKS FOR DISPLAY ON MOBILE DEVICES; MARKETING, ADVERTISING, AND PROMOTING THE RETAIL GOODS AND SERVICES OF OTHERS TO WIRELESS ELECTRONIC DEVICES, IN CLASS 35 (U.S. CLS. 100, 101 AND 102).

SERVICE MARK

SUPPLEMENTAL REGISTER

FIRST USE 2-0-2011; IN COMMERCE 2-0-2011.

THE MARK CONSISTS OF STANDARD CHARACTERS WITHOUT CLAIM TO ANY PARTICULAR FONT, STYLE, SIZE, OR COLOR.

SER. NO. 85-298,233, FILED P.R. 4-18-2011; AM. S.R. 12-13-2011.

RUSS HERMAN, EXAMINING ATTORNEY



David J. Kyffers

Director of the United States Patent and Trademark Office

United States of America

United States Patent and Trademark Office

American Group

Reg. No. 4,100,391

AMERICAN GROUP, LLC (ARIZONA LIMITED LIABILITY COMPANY)

Registered Feb. 14, 2012

75 W. BASELINE RD. #19
GILBERT, AZ 85233

Int. Cl.: 35

FOR: TRANSPORTATION LOGISTICS SERVICES, NAMELY, ARRANGING THE TRANSPORTATION OF GOODS FOR OTHERS; TRANSPORTATION LOGISTICS SERVICES, NAMELY, PLANNING AND SCHEDULING SHIPMENTS FOR USERS OF TRANSPORTATION SERVICES, IN CLASS 35 (U.S. CLS. 100, 101 AND 102).

SERVICE MARK

SUPPLEMENTAL REGISTER FIRST USE 12-1-2006; IN COMMERCE 12-1-2006.

THE MARK CONSISTS OF STANDARD CHARACTERS WITHOUT CLAIM TO ANY PARTICULAR FONT, STYLE, SIZE, OR COLOR.

NO CLAIM IS MADE TO THE EXCLUSIVE RIGHT TO USE "GROUP", APART FROM THE MARK AS SHOWN.

SER. NO. 85-300,008, FILED P.R. 4-20-2011; AM. S.R. 12-2-2011.

MARK SPARACINO, EXAMINING ATTORNEY



David J. Kyfos

Director of the United States Patent and Trademark Office

United States of America

United States Patent and Trademark Office

HAWAIIAN PORTRAITS

Reg. No. 4,100,392

Registered Feb. 14, 2012

Int. Cl.: 41

SERVICE MARK

SUPPLEMENTAL REGISTER

MVP HAWAII LLC (TEXAS LIMITED LIABILITY COMPANY), DBA HAWAIIAN PORTRAITS,
PO BOX 601719
DALLAS, TX 75360

FOR: PHOTOGRAPHY SERVICES, IN CLASS 41 (U.S. CLS. 100, 101 AND 107).

FIRST USE 4-1-2011; IN COMMERCE 4-1-2011.

THE MARK CONSISTS OF STANDARD CHARACTERS WITHOUT CLAIM TO ANY PARTICULAR FONT, STYLE, SIZE, OR COLOR.

NO CLAIM IS MADE TO THE EXCLUSIVE RIGHT TO USE "PORTRAITS", APART FROM THE MARK AS SHOWN.

SER. NO. 85-301,248, FILED P.R. 4-21-2011; AM. S.R. 1-5-2012.

MARTHA FROMM, EXAMINING ATTORNEY



David J. Kyffers

Director of the United States Patent and Trademark Office

United States of America

United States Patent and Trademark Office

INTELLIGENT CROSS SELL

Reg. No. 4,100,393

CBS INTERACTIVE INC. (DELAWARE CORPORATION)

Registered Feb. 14, 2012

51 WEST 52ND STREET
NEW YORK, NY 10019

Int. Cls.: 35 and 42

FOR: PROMOTING THE GOODS AND SERVICES OF ONLINE MERCHANTS TO INDIVIDUALS VIA A GLOBAL COMPUTER NETWORK ON THE INTERNET BY MEANS OF PROVIDING AND OPERATING LINKS TO RECOMMENDATIONS FOR OTHER PRODUCTS AND SERVICES; PROMOTING THE GOODS AND SERVICES OF ONLINE BUSINESSES THROUGH ONLINE ORDERING AND CATALOGUING OF THOSE GOODS AND SERVICES; BUSINESS CONSULTATION, IN CLASS 35 (U.S. CLS. 100, 101 AND 102).

SERVICE MARK

SUPPLEMENTAL REGISTER

FIRST USE 12-31-2007; IN COMMERCE 12-31-2007.

FOR: COMPUTER SERVICES, NAMELY, PROVIDING INFORMATION, SOFTWARE AND RELATED TECHNOLOGY AND INTERFACES THAT FACILITATE THE SUGGESTIVE AND PERSONALIZED ELECTRONIC MARKETING, SALE AND RECOMMENDATION OF GOODS AND SERVICES OF ONLINE MERCHANTS TO INDIVIDUALS VIA THE GLOBAL COMPUTER NETWORK; COMPUTER SERVICES VIA WEB INTERFACE FOR ONLINE BUSINESSES FOR THE PURPOSE OF CONNECTING INDIVIDUALS WITH INFORMATION AND MATCHING CUSTOMERS WITH PRODUCTS BY PROVIDING RESEARCH, RETRIEVAL, AUTOMATIC CLASSIFICATION AND CONTENT ORGANIZATION SERVICES AND RECOMMENDATION CAPABILITIES, FILTERING, VIEWING AND CONVERSION CAPABILITIES; APPLICATION SERVICE PROVIDER FEATURING SOFTWARE FOR USE IN DATA MINING AND RECOMMENDATION SYSTEMS BASED ON USER-DEFINED INFORMATION, RATINGS OF PRODUCTS AND SERVICES, PERSONAL PROFILE, AND OTHER INFORMATION; COMPUTER SERVICES, NAMELY, PROVIDING ENTERPRISE-LEVEL ON-LINE NON-DOWNLOADABLE SOFTWARE AND LINE-OF-BUSINESS ON-LINE NON-DOWNLOADABLE SOFTWARE FOR USE AS A DECISION ENGINE THAT WORKS TO GENERATE ALTERNATIVE RECOMMENDATIONS FOR PRODUCTS AND SERVICES ACROSS AN ENTERPRISE, IN THE FIELD OF E-COMMERCE, IN CLASS 42 (U.S. CLS. 100 AND 101).



FIRST USE 0-0-2007; IN COMMERCE 0-0-2007.

David J. Kyffers

THE MARK CONSISTS OF STANDARD CHARACTERS WITHOUT CLAIM TO ANY PARTICULAR FONT, STYLE, SIZE, OR COLOR.

Director of the United States Patent and Trademark Office

SER. NO. 85-303,839, FILED P.R. 4-25-2011; AM. S.R. 12-20-2011.

Reg. No. 4,100,393 INGA ERVIN, EXAMINING ATTORNEY

United States of America

United States Patent and Trademark Office

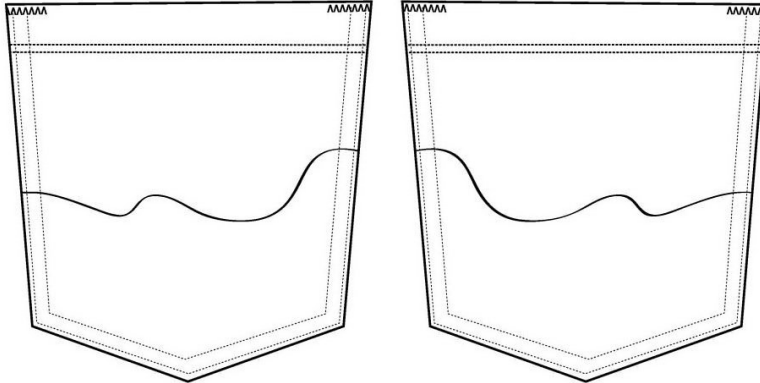

Reg. No. 4,100,394

Registered Feb. 14, 2012

Int. Cl.: 25

TRADEMARK

SUPPLEMENTAL REGISTER

MEIJER, INC. (MICHIGAN CORPORATION)
2929 WALKER AVE., NW
GRAND RAPIDS, MI 49544

FOR: DENIMS, IN CLASS 25 (U.S. CLS. 22 AND 39).

FIRST USE 10-20-2011; IN COMMERCE 10-20-2011.

THE MARK CONSISTS OF A STYLIZED STITCHING AS IT APPEARS ACROSS TWO SIDE-BY-SIDE POCKETS. THE DOTTED LINES SURROUNDING THE MARK REPRESENT THE SHAPE OF THE POCKETS AND ARE NOT CLAIMED AS A FEATURE OF THE MARK.

SER. NO. 85-305,586, FILED P.R. 4-27-2011; AM. S.R. 11-22-2011.

ALICE BENMAMAN, EXAMINING ATTORNEY



David J. Kybas

Director of the United States Patent and Trademark Office

United States of America

United States Patent and Trademark Office



Reg. No. 4,100,395

BALORU S.A. (ECUADOR SOCIEDAD ANONIMA (SA))
KM. 16 1/2 VIA DAULE
GUAYAQUIL, ECUADOR

Registered Feb. 14, 2012

Int. Cl.: 32

FOR: SOFT DRINKS, IN CLASS 32 (U.S. CLS. 45, 46 AND 48).

FIRST USE 0-0-2008; IN COMMERCE 0-0-2008.

TRADEMARK

NO CLAIM IS MADE TO THE EXCLUSIVE RIGHT TO USE "DESDE 1952", APART FROM THE MARK AS SHOWN.

SUPPLEMENTAL REGISTER

THE MARK CONSISTS OF THE PHRASE "LA ORIGINAL DESDE 1952", WITH ALL LETTERING IN UPPER CASE, APPEARING IN THE CENTER OF A RINGED OVAL.

THE ENGLISH TRANSLATION OF "LA ORIGINAL DESDE" IN THE MARK IS "THE ORIGINAL SINCE".

SER. NO. 85-306,901, FILED P.R. 4-28-2011; AM. S.R. 12-16-2011.

ANNE E. GUSTASON, EXAMINING ATTORNEY



David J. Kyffers

Director of the United States Patent and Trademark Office

United States of America

United States Patent and Trademark Office

LA ORIGINAL DESDE 1952

Reg. No. 4,100,396

BALORU S.A. (ECUADOR SOCIEDAD ANONIMA (SA))
KM. 16 1/2 VIA DAULE
GUAYAQUIL, ECUADOR

Registered Feb. 14, 2012

Int. Cl.: 32

FOR: SOFT DRINKS, IN CLASS 32 (U.S. CLS. 45, 46 AND 48).

TRADEMARK

FIRST USE 0-0-2008; IN COMMERCE 0-0-2008.

SUPPLEMENTAL REGISTER

THE MARK CONSISTS OF STANDARD CHARACTERS WITHOUT CLAIM TO ANY PARTICULAR FONT, STYLE, SIZE, OR COLOR.

NO CLAIM IS MADE TO THE EXCLUSIVE RIGHT TO USE "DESDE 1952", APART FROM THE MARK AS SHOWN.

THE ENGLISH TRANSLATION OF "LA ORIGINAL DESDE" IN THE MARK IS "THE ORIGINAL SINCE".

SER. NO. 85-306,986, FILED P.R. 4-28-2011; AM. S.R. 12-16-2011.

ANNE E. GUSTASON, EXAMINING ATTORNEY



David J. Kyfos

Director of the United States Patent and Trademark Office

United States of America

United States Patent and Trademark Office

GREEN IS A BEAUTIFUL THING.

Reg. No. 4,100,397

PENNSYLVANIA STATE EMPLOYEES CREDIT UNION (PENNSYLVANIA CORPORATION)
ONE CREDIT UNION PLACE
HARRISBURG, PA 17110

Registered Feb. 14, 2012

Int. Cl.: 36

FOR: CREDIT UNION SERVICES, IN CLASS 36 (U.S. CLS. 100, 101 AND 102).

SERVICE MARK

FIRST USE 1-22-2009; IN COMMERCE 1-22-2009.

SUPPLEMENTAL REGISTER

THE MARK CONSISTS OF STANDARD CHARACTERS WITHOUT CLAIM TO ANY PARTICULAR FONT, STYLE, SIZE, OR COLOR.

SER. NO. 85-307,514, FILED P.R. 4-28-2011; AM. S.R. 12-19-2011.

RENEE MCCRAY, EXAMINING ATTORNEY



David J. Kybas

Director of the United States Patent and Trademark Office

United States of America

United States Patent and Trademark Office

COOPERSTOWN COFFEE

Reg. No. 4,100,398

DANIELS, JOHN (UNITED STATES INDIVIDUAL)

Registered Feb. 14, 2012

NO. 2-D
150 WEST 47TH STREET
NEW YORK, NY 10036

Int. Cl.: 30

FOR: COFFEE; COFFEE BEANS; GROUND COFFEE BEANS, IN CLASS 30 (U.S. CL. 46).

TRADEMARK

FIRST USE 10-1-2010; IN COMMERCE 10-28-2011.

SUPPLEMENTAL REGISTER

THE MARK CONSISTS OF STANDARD CHARACTERS WITHOUT CLAIM TO ANY PARTICULAR FONT, STYLE, SIZE, OR COLOR.

NO CLAIM IS MADE TO THE EXCLUSIVE RIGHT TO USE "COFFEE", APART FROM THE MARK AS SHOWN.

SER. NO. 85-308,477, FILED P.R. 4-29-2011; AM. S.R. 1-10-2012.

EMILY CHUO, EXAMINING ATTORNEY



David J. Kybas

Director of the United States Patent and Trademark Office

United States of America

United States Patent and Trademark Office

SOCIALMEDIA.ORG

Reg. No. 4,100,399

Registered Feb. 14, 2012

Int. Cls.: 16 and 41

TRADEMARK

SERVICE MARK

SUPPLEMENTAL REGISTER

GASPEDAL LLC (ILLINOIS LIMITED LIABILITY COMPANY)
333 W. NORTH AVE, STE. 500
CHICAGO, IL 60610

FOR: NEWSLETTERS, PRINTED SEMINAR NOTES, BROCHURES, AND PAMPHLETS, ALL IN THE FIELD OF BUSINESS OPERATIONS AND BUSINESS CONSULTATION, IN CLASS 16 (U.S. CLS. 2, 5, 22, 23, 29, 37, 38 AND 50).

FIRST USE 5-12-2010; IN COMMERCE 5-12-2010.

FOR: CONDUCTING WORKSHOPS, SEMINARS AND EDUCATIONAL EVENTS, NAMELY, IN-PERSON AND ONLINE EDUCATIONAL CONFERENCES AND FORUMS IN THE FIELD OF BUSINESS OPERATIONS AND BUSINESS CONSULTATION; PROVIDING ON-LINE NEWSLETTERS IN THE FIELD OF BUSINESS OPERATIONS AND BUSINESS CONSULTATION, IN CLASS 41 (U.S. CLS. 100, 101 AND 107).

FIRST USE 2-2-2011; IN COMMERCE 2-2-2011.

THE MARK CONSISTS OF STANDARD CHARACTERS WITHOUT CLAIM TO ANY PARTICULAR FONT, STYLE, SIZE, OR COLOR.

SER. NO. 85-310,130, FILED P.R. 5-2-2011; AM. S.R. 11-30-2011.

EVELYN BRADLEY, EXAMINING ATTORNEY



David J. Kyffers

Director of the United States Patent and Trademark Office

United States of America

United States Patent and Trademark Office



Reg. No. 4,100,400

Registered Feb. 14, 2012

Int. Cls.: 16 and 41

TRADEMARK

SERVICE MARK

SUPPLEMENTAL REGISTER

GASPEDAL LLC (ILLINOIS LIMITED LIABILITY COMPANY)
333 W. NORTH AVE, STE. 500
CHICAGO, IL 60610

FOR: NEWSLETTERS, PRINTED SEMINAR NOTES, BROCHURES, AND PAMPHLETS, ALL IN THE FIELD OF BUSINESS OPERATIONS AND BUSINESS CONSULTATION, IN CLASS 16 (U.S. CLS. 2, 5, 22, 23, 29, 37, 38 AND 50).

FIRST USE 3-23-2011; IN COMMERCE 3-23-2011.

FOR: CONDUCTING WORKSHOPS, SEMINARS AND EDUCATIONAL EVENTS, NAMELY, IN-PERSON AND ONLINE EDUCATIONAL CONFERENCES AND FORUMS IN THE FIELD OF BUSINESS OPERATIONS AND BUSINESS CONSULTATION; PROVIDING ON-LINE NEWSLETTERS IN THE FIELD OF BUSINESS OPERATIONS AND BUSINESS CONSULTATION, IN CLASS 41 (U.S. CLS. 100, 101 AND 107).

FIRST USE 2-2-2011; IN COMMERCE 2-2-2011.

THE MARK CONSISTS OF THE WORDS "SOCIALMEDIA.ORG" IN A SHADED CIRCLE, WITHIN ANOTHER CIRCLE.

SER. NO. 85-310,137, FILED P.R. 5-2-2011; AM. S.R. 11-30-2011.

EVELYN BRADLEY, EXAMINING ATTORNEY



David J. Kybas

Director of the United States Patent and Trademark Office

United States of America

United States Patent and Trademark Office

LENS BAND

Reg. No. 4,100,401

Registered Feb. 14, 2012

Int. Cl.: 9

TRADEMARK

SUPPLEMENTAL REGISTER

ARI K. LEE (UNITED STATES INDIVIDUAL), DBA LENS BAND,
SUITE #102-560
8550 W. DESERT INN ROAD
LAS VEGAS, NV 89117

FOR: SILICONE/RUBBER BAND USED AROUND THE BARREL OF SLR CAMERA LENS,
TO HOLD ZOOM ADJUSTMENT RING IN PLACE, IN CLASS 9 (U.S. CLS. 21, 23, 26, 36 AND
38).

FIRST USE 10-1-2010; IN COMMERCE 10-1-2010.

THE MARK CONSISTS OF STANDARD CHARACTERS WITHOUT CLAIM TO ANY PAR-
TICULAR FONT, STYLE, SIZE, OR COLOR.

NO CLAIM IS MADE TO THE EXCLUSIVE RIGHT TO USE "BAND", APART FROM THE
MARK AS SHOWN.

SER. NO. 85-318,496, FILED P.R. 5-11-2011; AM. S.R. 12-10-2011.

JANET LEE, EXAMINING ATTORNEY



David J. Kyffers

Director of the United States Patent and Trademark Office

United States of America

United States Patent and Trademark Office

Attorney OnDemand

Reg. No. 4,100,402

CESPEDES, ERNESTO, FELIPE (UNITED STATES INDIVIDUAL)
23200 CAMINO DEL MAR #707

Registered Feb. 14, 2012

BOCA RATON, FL 33433

Int. Cl.: 45

FOR: PROVIDING LEGAL SERVICES ONLINE AND IN PERSON, IN CLASS 45 (U.S. CLS. 100 AND 101).

SERVICE MARK

FIRST USE 4-29-2011; IN COMMERCE 4-29-2011.

SUPPLEMENTAL REGISTER

THE MARK CONSISTS OF STANDARD CHARACTERS WITHOUT CLAIM TO ANY PARTICULAR FONT, STYLE, SIZE, OR COLOR.

NO CLAIM IS MADE TO THE EXCLUSIVE RIGHT TO USE "ATTORNEY", APART FROM THE MARK AS SHOWN.

SER. NO. 85-320,547, FILED P.R. 5-13-2011; AM. S.R. 10-7-2011.

KAPIL BHANOT, EXAMINING ATTORNEY



David J. Kybas

Director of the United States Patent and Trademark Office

United States of America

United States Patent and Trademark Office

pupchips

Reg. No. 4,100,403

PUPCHIPS, LLC (NEVADA LIMITED LIABILITY COMPANY)
3726 S LAS VEGAS BLVD 1810
LAS VEGAS, NV 89109

Registered Feb. 14, 2012

Int. Cl.: 31

FOR: PET FOOD; PET TREATS, IN CLASS 31 (U.S. CLS. 1 AND 46).

TRADEMARK

FIRST USE 4-9-2011; IN COMMERCE 4-13-2011.

SUPPLEMENTAL REGISTER

THE MARK CONSISTS OF STANDARD CHARACTERS WITHOUT CLAIM TO ANY PARTICULAR FONT, STYLE, SIZE, OR COLOR.

SER. NO. 85-322,317, FILED P.R. 5-16-2011; AM. S.R. 11-29-2011.

LESLEY LAMOTHE, EXAMINING ATTORNEY



David J. Kybas

Director of the United States Patent and Trademark Office

United States of America

United States Patent and Trademark Office

NATIONAL PROM QUEEN SCHOLARSHIP ORGANIZATION

Reg. No. 4,100,404

LIVE YOUR DREAM, INC. (TENNESSEE CORPORATION)
7902 PELLEAUX ROAD
KNOXVILLE, TN 37938

Registered Feb. 14, 2012

Int. Cl.: 41

FOR: ARRANGING OF CONTESTS, IN CLASS 41 (U.S. CLS. 100, 101 AND 107).

SERVICE MARK

FIRST USE 5-11-2011; IN COMMERCE 5-11-2011.

SUPPLEMENTAL REGISTER

THE MARK CONSISTS OF STANDARD CHARACTERS WITHOUT CLAIM TO ANY PARTICULAR FONT, STYLE, SIZE, OR COLOR.

SER. NO. 85-323,020, FILED P.R. 5-17-2011; AM. S.R. 11-30-2011.

NAKIA HENRY, EXAMINING ATTORNEY



David J. Kyfos

Director of the United States Patent and Trademark Office

United States of America

United States Patent and Trademark Office

TOTAL RETURN METHODOLOGY

Reg. No. 4,100,405

Registered Feb. 14, 2012

Int. Cls.: 35 and 42

SERVICE MARK

SUPPLEMENTAL REGISTER

MOTIONPOINT CORPORATION (FLORIDA CORPORATION)
SUITE 14
4661 JOHNSON ROAD
COCONUT CREEK, FL 33073

FOR: BUSINESS CONSULTATION IN THE FIELD OF BUSINESS ASPECTS RELATED TO IMPROVING THE PERFORMANCE OF A WEBSITE IN MULTIPLE GEOGRAPHIC MARKETS, IN CLASS 35 (U.S. CLS. 100, 101 AND 102).

FIRST USE 3-16-2011; IN COMMERCE 5-12-2011.

FOR: PROVIDING TEMPORARY USE OF A WEB-BASED SOFTWARE APPLICATION FOR IMPROVING THE PERFORMANCE OF A WEBSITE IN MULTIPLE GEOGRAPHIC MARKETS; PROVIDING TEMPORARY USE OF ON-LINE NON-DOWNLOADABLE SOFTWARE FOR IMPROVING THE PERFORMANCE OF A WEBSITE IN MULTIPLE GEOGRAPHIC MARKETS, IN CLASS 42 (U.S. CLS. 100 AND 101).

FIRST USE 3-16-2011; IN COMMERCE 5-12-2011.

THE MARK CONSISTS OF STANDARD CHARACTERS WITHOUT CLAIM TO ANY PARTICULAR FONT, STYLE, SIZE, OR COLOR.

SER. NO. 85-325,056, FILED P.R. 5-19-2011; AM. S.R. 12-15-2011.

KATHERINE E. HALMEN, EXAMINING ATTORNEY



David J. Kybas

Director of the United States Patent and Trademark Office

United States of America
United States Patent and Trademark Office



Reg. No. 4,100,406

TNB STORE (TEXAS SOLE PROPRIETORSHIP)
7106 TAOS DRIVE
CORPUS CHRISTI, TX 78413

Registered Feb. 14, 2012

Int. Cl.: 25

FOR: BASEBALL CAPS; T-SHIRTS, IN CLASS 25 (U.S. CLS. 22 AND 39).

TRADEMARK

FIRST USE 9-0-2009; IN COMMERCE 9-0-2009.

SUPPLEMENTAL REGISTER

THE MARK CONSISTS OF THE WORDING "TRUST NO BITCH" IN STYLIZED FONT. THE CHARACTERS "TNB" ARE IN A LARGER FONT, WITHIN THE CHARACTER "T" IS THE WORDING "RUST", WITHIN THE CHARACTER "N" IS THE CHARACTER "O" AND WITHIN THE CHARACTER "B" IS THE WORDING "ITCH".

SER. NO. 85-335,033, FILED P.R. 6-1-2011; AM. S.R. 10-5-2011.

SUSAN RICHARDS, EXAMINING ATTORNEY



David J. Kybas

Director of the United States Patent and Trademark Office

United States of America

United States Patent and Trademark Office

SOLAR BUTTERFLY

Reg. No. 4,100,407

Registered Feb. 14, 2012

Int. Cl.: 28

TRADEMARK

SUPPLEMENTAL REGISTER

FASCINATIONS, INC. (WASHINGTON CORPORATION)
SUITE 100
19224 DES MOINES WAY S.
SEATTLE, WA 98148

FOR: SOLAR-POWERED MECHANICAL NOVELTY TOYS, IN CLASS 28 (U.S. CLS. 22, 23, 38 AND 50).

FIRST USE 1-30-2011; IN COMMERCE 1-30-2011.

THE MARK CONSISTS OF STANDARD CHARACTERS WITHOUT CLAIM TO ANY PARTICULAR FONT, STYLE, SIZE, OR COLOR.

NO CLAIM IS MADE TO THE EXCLUSIVE RIGHT TO USE "SOLAR", APART FROM THE MARK AS SHOWN.

SER. NO. 85-339,072, FILED P.R. 6-6-2011; AM. S.R. 12-8-2011.

LINDA M. KING, EXAMINING ATTORNEY



David J. Kyffers

Director of the United States Patent and Trademark Office

United States of America

United States Patent and Trademark Office

Rhythmgravity Aerobics

Reg. No. 4,100,408

Registered Feb. 14, 2012

Int. Cl.: 35

SERVICE MARK

SUPPLEMENTAL REGISTER

BREEZE, NEVADA (UNITED STATES INDIVIDUAL), DBA QUEEN OF HOOKS MUSIC,
2125 FAIR OAKS BLVD., UNIT C4
2125 FAIR OAKS AVE
SACRAMENTO, CA 95825

FOR: RETAIL STORE AND ONLINE RETAIL STORE SERVICES FEATURING MUSICAL FITNESS PROGRAM CD'S AND DVD'S FEATURING INSTRUCTIONAL SONGS IN THE NATURE OF PROLONGED RHYTHM AEROBICS AND USED IN THE EXERCISE PROGRAM RHYTHMCARDIO WHICH USES GRAVITY AND BODY WEIGHT IN CONJUNCTION WITH CONSISTENT FITNESS RHYTHMS, WITH THE AFOREMENTIONED RHYTHMCARDIO PROGRAM BEING A FEATURE OF THE NEVADA BREEZE FITNESSGRAVITY MUSICAL FITNESS PROGRAM, IN CLASS 35 (U.S. CLS. 100, 101 AND 102).

FIRST USE 5-1-2010; IN COMMERCE 6-2-2011.

THE MARK CONSISTS OF STANDARD CHARACTERS WITHOUT CLAIM TO ANY PARTICULAR FONT, STYLE, SIZE, OR COLOR.

NO CLAIM IS MADE TO THE EXCLUSIVE RIGHT TO USE "AEROBICS", APART FROM THE MARK AS SHOWN.

SER. NO. 85-339,099, FILED P.R. 6-6-2011; AM. S.R. 12-6-2011.

MELISSA VALLILLO, EXAMINING ATTORNEY



David J. Kybas

Director of the United States Patent and Trademark Office

United States of America

United States Patent and Trademark Office

RhythmCardio's

Reg. No. 4,100,409

Registered Feb. 14, 2012

Int. Cl.: 35

SERVICE MARK

SUPPLEMENTAL REGISTER

BREEZE, NEVADA (UNITED STATES INDIVIDUAL), DBA QUEEN OF HOOKS MUSIC,
2125 FAIR OAKS BLVD.
UNIT C4
SACRAMENTO, CA 95825

FOR: RETAIL STORE AND ONLINE RETAIL STORE SERVICES FEATURING A VARIETY OF AUDIO CD'S AND VIDEO DVD'S FEATURING FITNESS AND AEROBICS INSTRUCTION BY THE NEVADA BREEZE FITNESSGRAVITY MUSICAL FITNESS PROGRAM FEATURING RHYTHMIC CARDIO EXERCISES USING PROLONGED RHYTHM IN STRENGTHENING CORE AND IMPROVING BALANCE, IN CLASS 35 (U.S. CLS. 100, 101 AND 102).

FIRST USE 5-1-2010; IN COMMERCE 11-28-2010.

THE MARK CONSISTS OF STANDARD CHARACTERS WITHOUT CLAIM TO ANY PARTICULAR FONT, STYLE, SIZE, OR COLOR.

SER. NO. 85-339,344, FILED P.R. 6-6-2011; AM. S.R. 12-6-2011.

MELISSA VALLILLO, EXAMINING ATTORNEY



David J. Kyffers

Director of the United States Patent and Trademark Office

United States of America

United States Patent and Trademark Office

TOTAL BUSINESS LEAN

Reg. No. 4,100,410

WRIGHT SOLUTIONS LTD. (TEXAS LIMITED PARTNERSHIP)
522 S KIRBY ST.

Registered Feb. 14, 2012

PILOT POINT, TX 76258

Int. Cl.: 35

FOR: BUSINESS MANAGEMENT CONSULTANCY AND ADVISORY SERVICES, IN CLASS 35 (U.S. CLS. 100, 101 AND 102).

SERVICE MARK

FIRST USE 6-2-2011; IN COMMERCE 6-2-2011.

SUPPLEMENTAL REGISTER

THE MARK CONSISTS OF STANDARD CHARACTERS WITHOUT CLAIM TO ANY PARTICULAR FONT, STYLE, SIZE, OR COLOR.

NO CLAIM IS MADE TO THE EXCLUSIVE RIGHT TO USE "BUSINESS", APART FROM THE MARK AS SHOWN.

SER. NO. 85-341,117, FILED P.R. 6-8-2011; AM. S.R. 12-12-2011.

MARCIE MILONE, EXAMINING ATTORNEY



David J. Kybas

Director of the United States Patent and Trademark Office

United States of America

United States Patent and Trademark Office

CHUCK BOWL

Reg. No. 4,100,411

CC INVESTMENTS LLC (COLORADO LIMITED LIABILITY COMPANY)
PO BOX 2300

Registered Feb. 14, 2012

GRAND JUNCTION, CO 81502

Int. Cl.: 29

FOR: STEAK STRIPS WITH VARIOUS TOPPINGS FOR CONSUMPTION ON OR OFF PREMISES, IN CLASS 29 (U.S. CL. 46).

TRADEMARK

FIRST USE 5-4-2011; IN COMMERCE 5-4-2011.

SUPPLEMENTAL REGISTER

THE MARK CONSISTS OF STANDARD CHARACTERS WITHOUT CLAIM TO ANY PARTICULAR FONT, STYLE, SIZE, OR COLOR.

NO CLAIM IS MADE TO THE EXCLUSIVE RIGHT TO USE "CHUCK", APART FROM THE MARK AS SHOWN.

SER. NO. 85-346,619, FILED P.R. 6-15-2011; AM. S.R. 11-29-2011.

ANGELA M. MICHELI, EXAMINING ATTORNEY



David J. Kyffers

Director of the United States Patent and Trademark Office

United States of America

United States Patent and Trademark Office

CALIFORNIA VALLEY CELLARS

Reg. No. 4,100,412

ALAN PWELON, CHAN (HONG KONG INDIVIDUAL)
SUITE 2211, PARK IN COMMERCIAL CENTRE
MONGKOK, HONG KONG

Registered Feb. 14, 2012

Int. Cl.: 33

FOR: RED WINES; WHITE WINES, IN CLASS 33 (U.S. CLS. 47 AND 49).

FIRST USE 11-2-2011; IN COMMERCE 11-2-2011.

TRADEMARK

THE MARK CONSISTS OF STANDARD CHARACTERS WITHOUT CLAIM TO ANY PARTICULAR FONT, STYLE, SIZE, OR COLOR.

SUPPLEMENTAL REGISTER

NO CLAIM IS MADE TO THE EXCLUSIVE RIGHT TO USE "CELLARS", APART FROM THE MARK AS SHOWN.

SER. NO. 85-347,980, FILED 6-16-2011.

TASHIA BUNCH, EXAMINING ATTORNEY



David J. Kyffers

Director of the United States Patent and Trademark Office

United States of America

United States Patent and Trademark Office

HOUSTON LGBT PRIDE CELEBRATION

Reg. No. 4,100,413

PRIDE HOUSTON, INC. (TEXAS CORPORATION)

Registered Feb. 14, 2012

P. O. BOX 66071
HOUSTON, TX 772666071

Int. Cl.: 35

FOR: PROMOTING PUBLIC AWARENESS OF THE NEED FOR DIVERSITY AND EQUAL RIGHTS IN OUR COMMUNITY AS WELL AS TO COMMEMORATE AND CELEBRATE THE HISTORY OF THE GAY AND LESBIAN COMMUNITY, IN CLASS 35 (U.S. CLS. 100, 101 AND 102).

SERVICE MARK

SUPPLEMENTAL REGISTER FIRST USE 9-1-2009; IN COMMERCE 9-1-2009.

THE MARK CONSISTS OF STANDARD CHARACTERS WITHOUT CLAIM TO ANY PARTICULAR FONT, STYLE, SIZE, OR COLOR.

NO CLAIM IS MADE TO THE EXCLUSIVE RIGHT TO USE "LGBT PRIDE CELEBRATION", APART FROM THE MARK AS SHOWN.

SER. NO. 85-353,743, FILED P.R. 6-23-2011; AM. S.R. 12-28-2011.

GIANCARLO CASTRO, EXAMINING ATTORNEY



David J. Kyffers

Director of the United States Patent and Trademark Office

United States of America

United States Patent and Trademark Office

Vinyl Coating Solutions

Reg. No. 4,100,414

VINYL COATING SOLUTIONS (CALIFORNIA CORPORATION)
9701 LURLINE AVE., SUITE C
CHATSWORTH, CA 91311

Registered Feb. 14, 2012

Int. Cl.: 37

FOR: HOUSE PAINTING; PAINTING; PAINTING AND APPLYING COATINGS TO BUILDING INTERIORS AND BUILDING EXTERIORS; PAINTING AND VARNISHING; PAINTING CONTRACTOR SERVICES; PAINTING IN THE FIELD OF HOUSES, IN CLASS 37 (U.S. CLS. 100, 103 AND 106).

SERVICE MARK

SUPPLEMENTAL REGISTER FIRST USE 5-10-2011; IN COMMERCE 5-10-2011.

THE MARK CONSISTS OF STANDARD CHARACTERS WITHOUT CLAIM TO ANY PARTICULAR FONT, STYLE, SIZE, OR COLOR.

SER. NO. 85-354,104, FILED P.R. 6-23-2011; AM. S.R. 12-15-2011.

DANNEAN HETZEL, EXAMINING ATTORNEY



David J. Kyffers

Director of the United States Patent and Trademark Office

United States of America

United States Patent and Trademark Office

Cloud Intelligence

Reg. No. 4,100,415

Registered Feb. 14, 2012

Int. Cl.: 35

SERVICE MARK

SUPPLEMENTAL REGISTER

DATAIUM, LLC (TENNESSEE LIMITED LIABILITY COMPANY)
WWW.DATAIUM.COM
2525 PERIMETER PLACE DRIVE SUITE 105
NASHVILLE, TN 37214

FOR: BUSINESS MANAGEMENT CONSULTING WITH RELATION TO STRATEGY, MARKETING, SALES, OPERATION, PRODUCT DESIGN PARTICULARLY SPECIALIZING IN THE USE OF ANALYTIC AND STATISTIC MODELS FOR THE UNDERSTANDING AND PREDICTING OF CONSUMERS, BUSINESSES, AND MARKET TRENDS AND ACTIONS; BUSINESS MONITORING AND CONSULTING SERVICES, NAMELY, TRACKING WEB SITES AND APPLICATIONS OF OTHERS TO PROVIDE STRATEGY, INSIGHT, MARKETING, SALES, OPERATION, PRODUCT DESIGN, PARTICULARLY SPECIALIZING IN THE USE OF ANALYTIC AND STATISTIC MODELS FOR THE UNDERSTANDING AND PREDICTING OF CONSUMERS, BUSINESSES, AND MARKET TRENDS AND ACTIONS; CONSUMER STRATEGY BUSINESS CONSULTING IN THE FIELDS OF MARKETING, SALES, OPERATION, AND PRODUCT DESIGN PARTICULARLY SPECIALIZING IN THE USE OF ANALYTIC MODELS FOR THE UNDERSTANDING AND PREDICTING OF CONSUMER, BUSINESS, AND RETAIL MARKET TRENDS AND ACTIONS, IN CLASS 35 (U.S. CLS. 100, 101 AND 102).

FIRST USE 6-24-2011; IN COMMERCE 6-24-2011.

THE MARK CONSISTS OF STANDARD CHARACTERS WITHOUT CLAIM TO ANY PARTICULAR FONT, STYLE, SIZE, OR COLOR.

NO CLAIM IS MADE TO THE EXCLUSIVE RIGHT TO USE "CLOUD" , APART FROM THE MARK AS SHOWN.

SER. NO. 85-355,231, FILED P.R. 6-24-2011; AM. S.R. 12-7-2011.

TEJBIR SINGH, EXAMINING ATTORNEY



David J. Kyffers

Director of the United States Patent and Trademark Office

United States of America

United States Patent and Trademark Office

FRESH ALL DAY

Reg. No. 4,100,416

TRI STAR SERVICES, LLC (TENNESSEE LIMITED LIABILITY COMPANY)
1740 ED TEMPLE BOULEVARD
NASHVILLE, TN 372081850

Registered Feb. 14, 2012

Int. Cl.: 35

FOR: RETAIL CONVENIENCE STORES, IN CLASS 35 (U.S. CLS. 100, 101 AND 102).

SERVICE MARK

FIRST USE 8-3-2011; IN COMMERCE 8-3-2011.

SUPPLEMENTAL REGISTER

THE MARK CONSISTS OF STANDARD CHARACTERS WITHOUT CLAIM TO ANY PARTICULAR FONT, STYLE, SIZE, OR COLOR.

SER. NO. 85-364,472, FILED P.R. 7-6-2011; AM. S.R. 12-8-2011.

AMY HELLA, EXAMINING ATTORNEY



David J. Kyffers

Director of the United States Patent and Trademark Office

United States of America

United States Patent and Trademark Office

The Innovator Awards

Reg. No. 4,100,417

Registered Feb. 14, 2012

Int. Cl.: 41

SERVICE MARK

SUPPLEMENTAL REGISTER

PICHINSON, MARTIN (UNITED STATES INDIVIDUAL)
BUILDING A
1100 LA AVENIDA STREET
MOUNTAIN VIEW, CA 94043

FOR: PROVIDING RECOGNITION AND INCENTIVES BY THE WAY OF AWARDS TO DEMONSTRATE EXCELLENCE IN THE FIELD OF BUSINESS, VENTURE CAPITALISM, AND TECHNOLOGY , IN CLASS 41 (U.S. CLS. 100, 101 AND 107).

FIRST USE 1-1-2010; IN COMMERCE 1-1-2010.

THE MARK CONSISTS OF STANDARD CHARACTERS WITHOUT CLAIM TO ANY PARTICULAR FONT, STYLE, SIZE, OR COLOR.

NO CLAIM IS MADE TO THE EXCLUSIVE RIGHT TO USE "AWARDS", APART FROM THE MARK AS SHOWN.

SER. NO. 85-367,203, FILED P.R. 7-9-2011; AM. S.R. 12-23-2011.

VERNA BETH RIRIE, EXAMINING ATTORNEY



David J. Kybas

Director of the United States Patent and Trademark Office

United States of America

United States Patent and Trademark Office

Organ Remapping

Reg. No. 4,100,418

JAUDY, DR. GILBERT (UNITED STATES INDIVIDUAL)
42-620 CAROLINE CT. STE 103
PALM DESERT, CA 92211

Registered Feb. 14, 2012

Int. Cl.: 41

FOR: EDUCATION SERVICES, NAMELY, PROVIDING SEMINARS IN THE FIELD OF HEALTH CARE, IN CLASS 41 (U.S. CLS. 100, 101 AND 107).

SERVICE MARK

FIRST USE 2-16-2011; IN COMMERCE 2-16-2011.

SUPPLEMENTAL REGISTER

THE MARK CONSISTS OF STANDARD CHARACTERS WITHOUT CLAIM TO ANY PARTICULAR FONT, STYLE, SIZE, OR COLOR.

SER. NO. 85-370,720, FILED P.R. 7-13-2011; AM. S.R. 12-12-2011.

MICHELE SWAIN, EXAMINING ATTORNEY



David J. Kyfos

Director of the United States Patent and Trademark Office

United States of America

United States Patent and Trademark Office

ANTWERP DIAMONDS (USA)

Reg. No. 4,100,419

Registered Feb. 14, 2012

Int. Cl.: 14

TRADEMARK

SUPPLEMENTAL REGISTER

INCENTIVES FOREVER, INC. (TEXAS CORPORATION)
SUITE 250
14951 DALLAS PKWY.
DALLAS, TX 75254

FOR: DIAMOND JEWELRY FEATURING ANTWERP DIAMONDS, IN CLASS 14 (U.S. CLS. 2, 27, 28 AND 50).

FIRST USE 9-0-2003; IN COMMERCE 9-0-2003.

THE MARK CONSISTS OF STANDARD CHARACTERS WITHOUT CLAIM TO ANY PARTICULAR FONT, STYLE, SIZE, OR COLOR.

NO CLAIM IS MADE TO THE EXCLUSIVE RIGHT TO USE "ANTWERP DIAMONDS", APART FROM THE MARK AS SHOWN.

SER. NO. 85-372,231, FILED 7-15-2011.

EDWARD FENNESSY, EXAMINING ATTORNEY



David J. Kyfos

Director of the United States Patent and Trademark Office

United States of America

United States Patent and Trademark Office

Starkweather Umbrellas

Reg. No. 4,100,420

Registered Feb. 14, 2012

Int. Cl.: 18

STARKWEATHER'S DIVERSIFIED PRODUCTS LLC (NEW YORK LIMITED LIABILITY COMPANY)
UNIT 1D
120 N 7 ST
BROOKLYN, NY 11249

TRADEMARK

FOR: METAL PARTS OF UMBRELLAS; PARASOLS; UMBRELLA HANDLES; UMBRELLAS; UMBRELLAS AND PARASOLS; UMBRELLAS AND THEIR PARTS, IN CLASS 18 (U.S. CLS. 1, 2, 3, 22 AND 41).

SUPPLEMENTAL REGISTER

FIRST USE 10-1-2010; IN COMMERCE 10-1-2010.

THE MARK CONSISTS OF STANDARD CHARACTERS WITHOUT CLAIM TO ANY PARTICULAR FONT, STYLE, SIZE, OR COLOR.

NO CLAIM IS MADE TO THE EXCLUSIVE RIGHT TO USE "UMBRELLAS", APART FROM THE MARK AS SHOWN.

SER. NO. 85-373,129, FILED P.R. 7-16-2011; AM. S.R. 12-7-2011.

ZACHARY BELLO, EXAMINING ATTORNEY



David J. Kyffers

Director of the United States Patent and Trademark Office

United States of America

United States Patent and Trademark Office

INTERACTIVE PORTFOLIO

Reg. No. 4,100,421

ROMANO, STARR (UNITED STATES INDIVIDUAL)
46887 ANTIOCH PLACE
STERLING, VA 20164

Registered Feb. 14, 2012

Int. Cl.: 35

FOR: PROVIDING AN ON-LINE SEARCHABLE DATABASE OF RESUMES AND VIRTUAL INTERVIEWS FEATURING EMPLOYMENT OPPORTUNITIES AND CONTENT ABOUT EMPLOYMENT; PROVIDING NETWORKING OPPORTUNITIES FOR INDIVIDUALS SEEKING EMPLOYMENT; PROVIDING ON-LINE EMPLOYMENT PLACEMENT SERVICES, NAMELY, MATCHING RESUMES AND POTENTIAL EMPLOYERS VIA A GLOBAL COMPUTER NETWORK; CAREER MANAGEMENT SERVICES, NAMELY, PROVIDING EMPLOYMENT SERVICES, IN CLASS 35 (U.S. CLS. 100, 101 AND 102).

SERVICE MARK

SUPPLEMENTAL REGISTER

FIRST USE 7-1-2011; IN COMMERCE 10-1-2011.

THE MARK CONSISTS OF STANDARD CHARACTERS WITHOUT CLAIM TO ANY PARTICULAR FONT, STYLE, SIZE, OR COLOR.

NO CLAIM IS MADE TO THE EXCLUSIVE RIGHT TO USE "INTERACTIVE", APART FROM THE MARK AS SHOWN.

SER. NO. 85-380,163, FILED P.R. 7-25-2011; AM. S.R. 12-15-2011.

ODESSA BIBBINS, EXAMINING ATTORNEY



David J. Kyffers

Director of the United States Patent and Trademark Office

United States of America

United States Patent and Trademark Office

FRAC KING

Reg. No. 4,100,422

OILFIELD SURPLUS LLC (LOUISIANA LIMITED LIABILITY COMPANY)
3718 WEST PINHOOK ROAD
BROUSSARD, LA 70518

Registered Feb. 14, 2012

Int. Cl.: 7

FOR: METAL OIL FIELD FRAC HEAD USED FOR PUMPING FRAC MATERIAL INTO OIL WELLS, IN CLASS 7 (U.S. CLS. 13, 19, 21, 23, 31, 34 AND 35).

TRADEMARK

FIRST USE 9-1-2009; IN COMMERCE 9-1-2009.

SUPPLEMENTAL REGISTER

THE MARK CONSISTS OF STANDARD CHARACTERS WITHOUT CLAIM TO ANY PARTICULAR FONT, STYLE, SIZE, OR COLOR.

SER. NO. 85-380,591, FILED P.R. 7-26-2011; AM. S.R. 12-3-2011.

NAKIA HENRY, EXAMINING ATTORNEY



David J. Kyffers

Director of the United States Patent and Trademark Office

United States of America

United States Patent and Trademark Office

SwissSTIM

Reg. No. 4,100,423

VALMED, S.A. (SWITZERLAND CORPORATION)
AVENUE DU TOURBILLON 34
SION 1950 VALAIS, SWITZERLAND

Registered Feb. 14, 2012

Int. Cl.: 10

FOR: ELECTROMEDICAL REHABILITATIVE AND PAIN MANAGEMENT PRODUCTS FOR CLINICAL AND HOME USE, NAMELY, ELECTRICAL NERVE AND MUSCLE STIMULATORS, ULTRASONIC STIMULATORS, MAGNET THERAPY STIMULATORS AND LASER THERAPY STIMULATORS, IN CLASS 10 (U.S. CLS. 26, 39 AND 44).

TRADEMARK

SUPPLEMENTAL REGISTER FIRST USE 6-7-2006; IN COMMERCE 6-7-2006.

THE MARK CONSISTS OF STANDARD CHARACTERS WITHOUT CLAIM TO ANY PARTICULAR FONT, STYLE, SIZE, OR COLOR.

SER. NO. 85-382,363, FILED 7-27-2011.

MICHAEL LITZAU, EXAMINING ATTORNEY



David J. Kyffers

Director of the United States Patent and Trademark Office

United States of America

United States Patent and Trademark Office

Competent Care Management

Reg. No. 4,100,424

COMPETENT CARE MANAGEMENT, INC. (NORTH CAROLINA CORPORATION)
1490 PATTERSON GROVE RD.

Registered Feb. 14, 2012

RAMSEUR, NC 27316

Int. Cl.: 45

FOR: CASE MANAGEMENT SERVICES, NAMELY, THE COORDINATION OF NECESSARY MEDICAL SERVICES, VOCATIONAL ISSUES AND EDUCATIONAL SERVICES FOR PERSONS INJURED AT WORK, IN CLASS 45 (U.S. CLS. 100 AND 101).

SERVICE MARK

FIRST USE 7-15-2010; IN COMMERCE 8-1-2010.

SUPPLEMENTAL REGISTER

THE MARK CONSISTS OF STANDARD CHARACTERS WITHOUT CLAIM TO ANY PARTICULAR FONT, STYLE, SIZE, OR COLOR.

NO CLAIM IS MADE TO THE EXCLUSIVE RIGHT TO USE "MANAGEMENT", APART FROM THE MARK AS SHOWN.

SER. NO. 85-391,485, FILED P.R. 8-6-2011; AM. S.R. 12-7-2011.

JEFFREY LOOK, EXAMINING ATTORNEY



David J. Kybas

Director of the United States Patent and Trademark Office

United States of America

United States Patent and Trademark Office

NAUTICALALARM

Reg. No. 4,100,425

Registered Feb. 14, 2012

Int. Cl.: 9

TRADEMARK

SUPPLEMENTAL REGISTER

SECURICOM CORPORATION (FLORIDA CORPORATION)
8440 SW 38TH STREET
APT 2
MIAMI, FL 33155

FOR: MARINE ELECTRONIC SECURITY, VIDEO SURVEILLANCE, AND ALARM SYSTEM COMPRISED OF A CPU AND VIDEO CAMERAS, MOTION DETECTORS, WATER DETECTORS, BURGLAR AND INTRUSION DETECTORS, FIRE DETECTORS, ALL INTEGRATED WITH SECURITY, SMOKE, FIRE, WATER, BURGLAR ALARMS AND COMMUNICATIONS SYSTEMS; INSTALLATION, REPAIR AND MAINTENANCE OF SECURITY SYSTEMS AND SMOKE, WATER, BURGLAR AND FIRE ALARMS FOR THE MARINE INDUSTRY; REMOTE MONITORING OF SECURITY AND ALARM SYSTEMS; REMOTE MONITORING OF MARINE ELECTRICAL SYSTEMS, IN CLASS 9 (U.S. CLS. 21, 23, 26, 36 AND 38).

FIRST USE 7-0-2011; IN COMMERCE 7-0-2011.

THE MARK CONSISTS OF STANDARD CHARACTERS WITHOUT CLAIM TO ANY PARTICULAR FONT, STYLE, SIZE, OR COLOR.

SER. NO. 85-395,310, FILED P.R. 8-11-2011; AM. S.R. 12-15-2011.

DOMINICK J. SALEMI, EXAMINING ATTORNEY



David J. Kyffers

Director of the United States Patent and Trademark Office

United States of America

United States Patent and Trademark Office

SUTTON HOUSE

Reg. No. 4,100,426

Registered Feb. 14, 2012

Int. Cl.: 43

SERVICE MARK

SUPPLEMENTAL REGISTER

SKIVVER PROPERTIES, LLC (NORTH CAROLINA LIMITED LIABILITY COMPANY), DBA
SUTTON HOUSE,
5237 MURRAYHILL ROAD
CHARLOTTE, NC 28210

FOR: BAR SERVICES; RESTAURANT SERVICES, NAMELY, PROVIDING OF FOOD AND
BEVERAGES FOR CONSUMPTION ON AND OFF THE PREMISES, IN CLASS 43 (U.S. CLS.
100 AND 101).

FIRST USE 4-1-2011; IN COMMERCE 4-1-2011.

THE MARK CONSISTS OF STANDARD CHARACTERS WITHOUT CLAIM TO ANY PAR-
TICULAR FONT, STYLE, SIZE, OR COLOR.

NO CLAIM IS MADE TO THE EXCLUSIVE RIGHT TO USE "HOUSE", APART FROM THE
MARK AS SHOWN.

SER. NO. 85-395,614, FILED P.R. 8-11-2011; AM. S.R. 12-15-2011.

MAUREEN DALL, EXAMINING ATTORNEY



David J. Kybas

Director of the United States Patent and Trademark Office

United States of America

United States Patent and Trademark Office



Reg. No. 4,100,427

MCGAFFNEY, HOWARD (UNITED STATES INDIVIDUAL)
172 GARGONZA COURT
SAINT AUGUSTINE, FL 32084

Registered Feb. 14, 2012

Int. Cl.: 25

FOR: BIKINIS; HATS; HOODED SWEATSHIRTS; RASH GUARDS; SHIRTS; SHORTS;
SWEATSHIRTS; SWIM SUITS; WET SUITS, IN CLASS 25 (U.S. CLS. 22 AND 39).

TRADEMARK

FIRST USE 7-13-2011; IN COMMERCE 7-13-2011.

SUPPLEMENTAL REGISTER

THE MARK CONSISTS OF THE STYLIZED TEXT "SURFBILLY" IN WHICH THE LETTER S IS IN THE SHAPE OF A SHARK. THE LETTERS "B" AND "Y" HAVE LONG TAILS WITH SMALL BARBS (TEETH). THE TAIL OF THE LETTER "B" EXTENDS UPWARD AND CURVES ABOVE THE TEXT. THE ENTIRE TEXT "SURFBILLY" HAS BARBS (TEETH) LOCATED ON THE FRONT WITH RANDOM PLACEMENT.

SER. NO. 85-397,757, FILED P.R. 8-15-2011; AM. S.R. 12-20-2011.

STEVEN R. FINE, EXAMINING ATTORNEY



David J. Kybas

Director of the United States Patent and Trademark Office

United States of America

United States Patent and Trademark Office

R.O.P. KIT

Reg. No. 4,100,428

R.O.P. KITS INTERNATIONAL (TEXAS CORPORATION)

Registered Feb. 14, 2012

PO BOX 972981
EL PASO, TX 79997

Int. Cl.: 10

FOR: SURGICAL EYE CARE KITS COMPOSED OF SYRINGES, FORCEPS, INFANT EYE SPECULUM, PROBE, DRAPE CLOTH AND DROPPER, IN CLASS 10 (U.S. CLS. 26, 39 AND 44).

TRADEMARK

FIRST USE 10-31-2011; IN COMMERCE 10-31-2011.

SUPPLEMENTAL REGISTER

THE MARK CONSISTS OF STANDARD CHARACTERS WITHOUT CLAIM TO ANY PARTICULAR FONT, STYLE, SIZE, OR COLOR.

NO CLAIM IS MADE TO THE EXCLUSIVE RIGHT TO USE "KIT", APART FROM THE MARK AS SHOWN.

SER. NO. 85-398,278, FILED P.R. 8-15-2011; AM. S.R. 1-5-2012.

JOHN HWANG, EXAMINING ATTORNEY



David J. Kybas

Director of the United States Patent and Trademark Office

United States of America

United States Patent and Trademark Office

STOUCH LIGHTING

Reg. No. 4,100,429

STOUCH LIGHTING, INC. (PENNSYLVANIA CORPORATION)
525 TURNER INDUSTRIAL WAY
ASTON, PA 19014

Registered Feb. 14, 2012

Int. Cl.: 37

FOR: TECHNICAL CONSULTATION SERVICES, NAMELY, PERTAINING TO THE INSTALLATION AND MAINTENANCE OF COMMERCIAL AND RESIDENTIAL OF LIGHTING APPARATUS, LIGHTING INSTRUMENTS AND LIGHTING SYSTEMS, IN CLASS 37 (U.S. CLS. 100, 103 AND 106).

SERVICE MARK

SUPPLEMENTAL REGISTER FIRST USE 1-19-2009; IN COMMERCE 1-19-2009.

THE MARK CONSISTS OF STANDARD CHARACTERS WITHOUT CLAIM TO ANY PARTICULAR FONT, STYLE, SIZE, OR COLOR.

NO CLAIM IS MADE TO THE EXCLUSIVE RIGHT TO USE "LIGHTING", APART FROM THE MARK AS SHOWN.

SER. NO. 85-398,881, FILED P.R. 8-16-2011; AM. S.R. 12-9-2011.

JEFFREY LOOK, EXAMINING ATTORNEY



David J. Kyffers

Director of the United States Patent and Trademark Office

United States of America

United States Patent and Trademark Office

PolicePrivacy

Reg. No. 4,100,430

Registered Feb. 14, 2012

Int. Cl.: 45

SERVICE MARK

SUPPLEMENTAL REGISTER

POLICEPRIVACY.COM,LLC (NEVADA LIMITED LIABILITY COMPANY)
SUITE D403
28562 OSO PKWY
RANCHO SANTA MARGARITA, CA 92688

FOR: PROVIDING A WEB SITE FEATURING INFORMATION ON THE DEVELOPMENT OF PRIVACY, SECURITY AND DATA GOVERNANCE LAW, IN CLASS 45 (U.S. CLS. 100 AND 101).

FIRST USE 11-1-2006; IN COMMERCE 11-30-2006.

THE MARK CONSISTS OF STANDARD CHARACTERS WITHOUT CLAIM TO ANY PARTICULAR FONT, STYLE, SIZE, OR COLOR.

SER. NO. 85-399,747, FILED P.R. 8-17-2011; AM. S.R. 12-9-2011.

DAVID YONTEF, EXAMINING ATTORNEY



David J. Kyffers

Director of the United States Patent and Trademark Office

United States of America
United States Patent and Trademark Office

DROIDDB

Reg. No. 4,100,431

SYWARE, INC. (MASSACHUSETTS CORPORATION)
P.O. BOX 425091
CAMBRIDGE, MA 02142

Registered Feb. 14, 2012

Int. Cl.: 9

FOR: COMPUTER SOFTWARE FOR USE IN DEVELOPING OTHER SOFTWARE TO MANAGE BUSINESS DATA ON HANDHELD ELECTRONIC DEVICES, CELL PHONES, OR ON COMPUTER DESKTOP OPERATING SYSTEMS, IN CLASS 9 (U.S. CLS. 21, 23, 26, 36 AND 38).

TRADEMARK

SUPPLEMENTAL REGISTER FIRST USE 2-19-2011; IN COMMERCE 8-22-2011.

THE MARK CONSISTS OF STANDARD CHARACTERS WITHOUT CLAIM TO ANY PARTICULAR FONT, STYLE, SIZE, OR COLOR.

SER. NO. 85-403,376, FILED 8-22-2011.

BERYL GARDNER, EXAMINING ATTORNEY



David J. Kybas

Director of the United States Patent and Trademark Office

United States of America

United States Patent and Trademark Office

Life Sustaining Management and Alternatives Program

Reg. No. 4,100,432

ROSENBERG, MARK (UNITED STATES INDIVIDUAL)
38 NORTH RIDGE ROAD
DENVER, NJ 07834

Registered Feb. 14, 2012

Int. Cl.: 44

FOR: PALLIATIVE CARE SERVICES, IN CLASS 44 (U.S. CLS. 100 AND 101).

SERVICE MARK

FIRST USE 1-1-2010; IN COMMERCE 1-1-2010.

SUPPLEMENTAL REGISTER

THE MARK CONSISTS OF STANDARD CHARACTERS WITHOUT CLAIM TO ANY PARTICULAR FONT, STYLE, SIZE, OR COLOR.

NO CLAIM IS MADE TO THE EXCLUSIVE RIGHT TO USE "PROGRAM", APART FROM THE MARK AS SHOWN.

SER. NO. 85-404,653, FILED P.R. 8-23-2011; AM. S.R. 12-20-2011.

HEATHER THOMPSON, EXAMINING ATTORNEY



David J. Kybas

Director of the United States Patent and Trademark Office

United States of America

United States Patent and Trademark Office

THE TATTOO LEARNING CENTER

Reg. No. 4,100,433

Registered Feb. 14, 2012

Int. Cl.: 41

SERVICE MARK

SUPPLEMENTAL REGISTER

THE TATTOO LEARNING CENTER, LLC (MASSACHUSETTS LIMITED LIABILITY COMPANY)
PO BOX 106
ALTAMONT, NY 12009

FOR: EDUCATION SERVICES, NAMELY, PROVIDING CLASSES IN THE FIELD OF DESIGN AND APPLICATION OF PERMANENT BODY ART, IN CLASS 41 (U.S. CLS. 100, 101 AND 107).

FIRST USE 1-1-2009; IN COMMERCE 1-1-2009.

THE MARK CONSISTS OF STANDARD CHARACTERS WITHOUT CLAIM TO ANY PARTICULAR FONT, STYLE, SIZE, OR COLOR.

NO CLAIM IS MADE TO THE EXCLUSIVE RIGHT TO USE "LEARNING CENTER", APART FROM THE MARK AS SHOWN.

SER. NO. 85-404,915, FILED P.R. 8-23-2011; AM. S.R. 12-13-2011.

SUSAN RICHARDS, EXAMINING ATTORNEY



David J. Kybas

Director of the United States Patent and Trademark Office

United States of America

United States Patent and Trademark Office

BEVERLY HILLS CHESS CLUB

Reg. No. 4,100,434

Registered Feb. 14, 2012

Int. Cls.: 28 and 41

BEVERLY HILLS CHESS CLUB, INC. (CALIFORNIA CORPORATION)
SUITE 210
8950 W. OLYMPIC BLVD.,
BEVERLY HILLS, CA 90211

FOR: CHESS SETS; CHESSBOARDS, IN CLASS 28 (U.S. CLS. 22, 23, 38 AND 50).

TRADEMARK

FIRST USE 10-1-2009; IN COMMERCE 10-1-2009.

SERVICE MARK

SUPPLEMENTAL REGISTER

FOR: ARRANGING OF CONTESTS; CONDUCTING AFTER SCHOOL TUTORING PROGRAMS; CONSULTATION IN THE FIELD OF K-12 EDUCATIONAL SYSTEMS; EDUCATION SERVICES IN THE NATURE OF EARLY CHILDHOOD INSTRUCTION; EDUCATION SERVICES, NAMELY, ONE-ON-ONE MENTORING IN THE FIELD OF CHESS; EDUCATION SERVICES, NAMELY, PROVIDING TUTORING IN THE FIELD OF CHESS; EDUCATION SERVICES, NAMELY, PROVIDING CLASSES, CAMPS, SEMINARS, AFTER SCHOOL PROGRAMS, TOURNAMENTS AND TUTORING IN THE FIELD OF CHESS; EDUCATIONAL AND ENTERTAINMENT SERVICES FOR CHILDREN, NAMELY, PROVIDING INTERACTIVE PLAY AREAS, INSTRUCTIONAL CLASSES IN THE FIELD OF CHESS AND SOCIAL GATHERINGS FOR CHILDREN; EDUCATIONAL SERVICES, NAMELY, CONDUCTING CHESS CLASSES BY MEANS OF A CHESS CLUB; EDUCATIONAL SERVICES, NAMELY, CONDUCTING CLASSES, SEMINARS, CONFERENCES, WORKSHOPS, RETREATS, CAMPS AND FIELD TRIPS IN THE FIELD OF CHESS AND DISTRIBUTION OF TRAINING MATERIAL IN CONNECTION THEREWITH; EDUCATIONAL SERVICES, NAMELY, DEVELOPING CURRICULUM FOR EDUCATORS; RESEARCH IN THE FIELD OF EDUCATION, IN CLASS 41 (U.S. CLS. 100, 101 AND 107).

FIRST USE 7-15-2009; IN COMMERCE 7-15-2009.

THE MARK CONSISTS OF STANDARD CHARACTERS WITHOUT CLAIM TO ANY PARTICULAR FONT, STYLE, SIZE, OR COLOR.

NO CLAIM IS MADE TO THE EXCLUSIVE RIGHT TO USE "CHESS CLUB", APART FROM THE MARK AS SHOWN.

SER. NO. 85-405,208, FILED P.R. 8-23-2011; AM. S.R. 12-19-2011.

JASON BLAIR, EXAMINING ATTORNEY



David J. Kyros

Director of the United States Patent and Trademark Office

United States of America

United States Patent and Trademark Office

CollegeSearchEngine.net

Reg. No. 4,100,435

GRAGG ADVERTISING (MISSOURI CORPORATION)

Registered Feb. 14, 2012

450 EAST 4TH ST., STE 100
KANSAS CITY, MO 64106

Int. Cl.: 35

FOR: PROVIDING ONLINE LEAD GENERATION ADVERTISING AND PROMOTIONAL SERVICES; PROVIDING A SEARCHABLE ONLINE ADVERTISING WEBSITE AND INFORMATIONAL GUIDE FEATURING THE GOODS AND SERVICES OF OTHER VENDORS VIA THE INTERNET IN THE FIELDS OF HIGHER EDUCATION AND STUDENT RECRUITMENT TO SCHOOLS OF HIGHER EDUCATION, IN CLASS 35 (U.S. CLS. 100, 101 AND 102).

SERVICE MARK

SUPPLEMENTAL REGISTER

FIRST USE 3-5-2007; IN COMMERCE 3-5-2007.

THE MARK CONSISTS OF STANDARD CHARACTERS WITHOUT CLAIM TO ANY PARTICULAR FONT, STYLE, SIZE, OR COLOR.

SER. NO. 85-405,765, FILED P.R. 8-24-2011; AM. S.R. 12-15-2011.

JUDITH HELFMAN, EXAMINING ATTORNEY



David J. Kybas

Director of the United States Patent and Trademark Office

United States of America

United States Patent and Trademark Office

GREENEST CLASSROOM

Reg. No. 4,100,436

MALT-O-MEAL COMPANY (MINNESOTA CORPORATION)
2700 IDS CENTER, 80 SOUTH EIGHTH STREET
MINNEAPOLIS, MN 55402

Registered Feb. 14, 2012

Int. Cl.: 41

FOR: CONTESTS AND INCENTIVE AWARD PROGRAMS TO ENCOURAGE STUDENTS, PARENTS AND EDUCATORS TO SET UP AND ACHIEVE GOALS IN SUSTAINABILITY AND REDUCTION OF WASTE OF RESOURCES IN THE FIELD OF EDUCATION, IN CLASS 41 (U.S. CLS. 100, 101 AND 107).

SERVICE MARK

SUPPLEMENTAL REGISTER FIRST USE 4-1-2011; IN COMMERCE 4-1-2011.

THE MARK CONSISTS OF STANDARD CHARACTERS WITHOUT CLAIM TO ANY PARTICULAR FONT, STYLE, SIZE, OR COLOR.

SER. NO. 85-406,906, FILED P.R. 8-25-2011; AM. S.R. 8-25-2011.

JENNY PARK, EXAMINING ATTORNEY



David J. Kyffers

Director of the United States Patent and Trademark Office

United States of America

United States Patent and Trademark Office

GREENEST CLASSROOM CONTEST

Reg. No. 4,100,437

MALT-O-MEAL COMPANY (MINNESOTA CORPORATION)
2700 IDS CENTER, 80 SOUTH EIGHTH STREET
MINNEAPOLIS, MN 55402

Registered Feb. 14, 2012

Int. Cl.: 41

FOR: CONTESTS AND INCENTIVE AWARD PROGRAMS TO ENCOURAGE STUDENTS, PARENTS AND EDUCATORS TO SET UP AND ACHIEVE GOALS IN SUSTAINABILITY AND REDUCTION OF WASTE OF RESOURCES IN THE FIELD OF EDUCATION, IN CLASS 41 (U.S. CLS. 100, 101 AND 107).

SERVICE MARK

SUPPLEMENTAL REGISTER FIRST USE 4-1-2011; IN COMMERCE 4-1-2011.

THE MARK CONSISTS OF STANDARD CHARACTERS WITHOUT CLAIM TO ANY PARTICULAR FONT, STYLE, SIZE, OR COLOR.

NO CLAIM IS MADE TO THE EXCLUSIVE RIGHT TO USE "CONTEST", APART FROM THE MARK AS SHOWN.

SER. NO. 85-406,911, FILED P.R. 8-25-2011; AM. S.R. 8-25-2011.

JENNY PARK, EXAMINING ATTORNEY



David J. Kyffers

Director of the United States Patent and Trademark Office

United States of America

United States Patent and Trademark Office

Consignment Mommies

Reg. No. 4,100,438

FREEMAN, CHRISTAN (UNITED STATES INDIVIDUAL)
4007 HENDERSON ROAD
GREENSBORO, NC 27410

Registered Feb. 14, 2012

Int. Cl.: 35

FOR: PROVIDING AN ON-LINE DIRECTORY INFORMATION SERVICE FEATURING INFORMATION REGARDING CONSIGNMENT SALES AND STORES, IN CLASS 35 (U.S. CLS. 100, 101 AND 102).

SERVICE MARK

FIRST USE 8-1-2009; IN COMMERCE 2-1-2010.

SUPPLEMENTAL REGISTER

THE MARK CONSISTS OF STANDARD CHARACTERS WITHOUT CLAIM TO ANY PARTICULAR FONT, STYLE, SIZE, OR COLOR.

NO CLAIM IS MADE TO THE EXCLUSIVE RIGHT TO USE "CONSIGNMENT", APART FROM THE MARK AS SHOWN.

SER. NO. 85-407,048, FILED P.R. 8-25-2011; AM. S.R. 12-16-2011.

JESSICA FATHY, EXAMINING ATTORNEY



David J. Kyffers

Director of the United States Patent and Trademark Office

United States of America

United States Patent and Trademark Office

Beautiful Badass

Reg. No. 4,100,439

SHANKS, NIA (UNITED STATES INDIVIDUAL)
PO BOX 7544

Registered Feb. 14, 2012

PADUCAH, KY 42002

Int. Cl.: 25

FOR: BEANIES; CAPS; HATS; HOODED SWEATSHIRTS; JACKETS; LONG-SLEEVED SHIRTS; PANTS; SHORTS; SWEATSHIRTS; T-SHIRTS; TANK TOPS, IN CLASS 25 (U.S. CLS. 22 AND 39).

TRADEMARK

FIRST USE 8-10-2010; IN COMMERCE 6-17-2011.

SUPPLEMENTAL REGISTER

THE MARK CONSISTS OF STANDARD CHARACTERS WITHOUT CLAIM TO ANY PARTICULAR FONT, STYLE, SIZE, OR COLOR.

SER. NO. 85-408,621, FILED P.R. 8-26-2011; AM. S.R. 8-26-2011.

MATTHEW MCDOWELL, EXAMINING ATTORNEY



David J. Kyros

Director of the United States Patent and Trademark Office

United States of America

United States Patent and Trademark Office

Love Kush

Reg. No. 4,100,440

STEVE LOPEZ (UNITED STATES INDIVIDUAL)
973 DENNSTEDT PL APT C
EL CAJON, CA 92020

Registered Feb. 14, 2012

Int. Cl.: 25

FOR: HATS; HOODED SWEATSHIRTS; JACKETS; PANTS; SHIRTS; SHORT-SLEEVED OR LONG-SLEEVED T-SHIRTS; SHORTS; SWEATERS; SWEATSHIRTS; T-SHIRTS, IN CLASS 25 (U.S. CLS. 22 AND 39).

TRADEMARK

FIRST USE 5-29-2011; IN COMMERCE 6-7-2011.

SUPPLEMENTAL REGISTER

THE MARK CONSISTS OF STANDARD CHARACTERS WITHOUT CLAIM TO ANY PARTICULAR FONT, STYLE, SIZE, OR COLOR.

SER. NO. 85-408,744, FILED P.R. 8-26-2011; AM. S.R. 8-26-2011.

ROBIN CHOSID, EXAMINING ATTORNEY



David J. Kyffers

Director of the United States Patent and Trademark Office

United States of America

United States Patent and Trademark Office

CONFETTI LIGHTS

Reg. No. 4,100,441

B.J. ALAN COMPANY (OHIO CORPORATION)
555 MARTIN LUTHER KING, JR. BLVD.
YOUNGSTOWN, OH 445021102

Registered Feb. 14, 2012

Int. Cl.: 13

FOR: FIREWORKS, IN CLASS 13 (U.S. CLS. 2 AND 9).

TRADEMARK

FIRST USE 3-26-2010; IN COMMERCE 3-26-2010.

SUPPLEMENTAL REGISTER

THE MARK CONSISTS OF STANDARD CHARACTERS WITHOUT CLAIM TO ANY PARTICULAR FONT, STYLE, SIZE, OR COLOR.

SER. NO. 85-410,225, FILED 8-30-2011.

BRENDAN REGAN, EXAMINING ATTORNEY



David J. Kybas

Director of the United States Patent and Trademark Office

United States of America

United States Patent and Trademark Office

EMERALD COAST MARTIAL ARTS ACADEMY

Reg. No. 4,100,442

EMERALD COAST MARTIAL ARTS (FLORIDA LIMITED LIABILITY COMPANY)

Registered Feb. 14, 2012

A
85 BEAL PKWY
FT. WALTON BEACH, FL 32548

Int. Cl.: 41

FOR: MARTIAL ARTS INSTRUCTION, IN CLASS 41 (U.S. CLS. 100, 101 AND 107).

SERVICE MARK

FIRST USE 1-5-2005; IN COMMERCE 1-5-2005.

SUPPLEMENTAL REGISTER

THE MARK CONSISTS OF STANDARD CHARACTERS WITHOUT CLAIM TO ANY PARTICULAR FONT, STYLE, SIZE, OR COLOR.

NO CLAIM IS MADE TO THE EXCLUSIVE RIGHT TO USE "MARTIAL ARTS ACADEMY", APART FROM THE MARK AS SHOWN.

SER. NO. 85-413,368, FILED P.R. 9-1-2011; AM. S.R. 12-19-2011.

JENNIFER MARTIN, EXAMINING ATTORNEY



David J. Kybas

Director of the United States Patent and Trademark Office

United States of America

United States Patent and Trademark Office

CarrierRate.com

Reg. No. 4,100,443

GLOBALTRANZ ENTERPRISES, INC. (DELAWARE CORPORATION)

Registered Feb. 14, 2012

5415 E. HIGH STREET, BLDG A-9, #460
PHOENIX, AZ 85023

Int. Cl.: 42

FOR: PROVIDING TEMPORARY USE OF NON-DOWNLOADABLE COMPUTER SOFTWARE FOR PREPARING SHIPPING DOCUMENTS AND FOR TRACKING FREIGHT OVER COMPUTER NETWORKS, INTRANETS AND THE INTERNET, IN CLASS 42 (U.S. CLS. 100 AND 101).

SERVICE MARK

SUPPLEMENTAL REGISTER FIRST USE 3-20-2005; IN COMMERCE 3-20-2005.

THE MARK CONSISTS OF STANDARD CHARACTERS WITHOUT CLAIM TO ANY PARTICULAR FONT, STYLE, SIZE, OR COLOR.

SER. NO. 85-414,659, FILED P.R. 9-2-2011; AM. S.R. 12-20-2011.

KATHRYN COWARD, EXAMINING ATTORNEY



David J. Kybas

Director of the United States Patent and Trademark Office

United States of America

United States Patent and Trademark Office

RISK 24/7

Reg. No. 4,100,444

RISK STRATEGIES LLC (ILLINOIS LIMITED LIABILITY COMPANY)
517 W US HWY 50
O'FALLON, IL 62269

Registered Feb. 14, 2012

Int. Cl.: 36

FOR: INSURANCE AGENCY AND BROKERAGE, IN CLASS 36 (U.S. CLS. 100, 101 AND 102).

SERVICE MARK

FIRST USE 9-1-2011; IN COMMERCE 9-1-2011.

SUPPLEMENTAL REGISTER

THE MARK CONSISTS OF STANDARD CHARACTERS WITHOUT CLAIM TO ANY PARTICULAR FONT, STYLE, SIZE, OR COLOR.

SER. NO. 85-414,920, FILED P.R. 9-4-2011; AM. S.R. 12-21-2011.

DAVID YONTEF, EXAMINING ATTORNEY



David J. Kybas

Director of the United States Patent and Trademark Office

United States of America

United States Patent and Trademark Office

RESULTS

Reg. No. 4,100,445

INNOVATION FOR RESULTS, LLC (OREGON LIMITED LIABILITY COMPANY)
915 OAK STREET, SUITE 300
EUGENE, OR 97401

Registered Feb. 14, 2012

Int. Cl.: 42

FOR: PROVIDING WEB-BASED NON-DOWNLOADABLE SOFTWARE FOR CREATING DATABASES OF PATIENT CHART INFORMATION IN THE FIELD OF BEHAVIORAL CLINICAL HEALTH , IN CLASS 42 (U.S. CLS. 100 AND 101).

SERVICE MARK

FIRST USE 11-28-2005; IN COMMERCE 11-28-2005.

SUPPLEMENTAL REGISTER

THE MARK CONSISTS OF STANDARD CHARACTERS WITHOUT CLAIM TO ANY PARTICULAR FONT, STYLE, SIZE, OR COLOR.

SER. NO. 85-416,764, FILED P.R. 9-7-2011; AM. S.R. 12-27-2011.

MICHAEL LITZAU, EXAMINING ATTORNEY



David J. Kyffers

Director of the United States Patent and Trademark Office

United States of America

United States Patent and Trademark Office

Los Angeles Oktoberfest

Reg. No. 4,100,446

BARCELONA ENTERPRISES (CALIFORNIA CORPORATION)

Registered Feb. 14, 2012

4230 STANSBURY AVENUE #101
SHERMAN OAKS, CA 91423

Int. Cl.: 41

FOR: CONDUCTING ENTERTAINMENT EXHIBITIONS IN THE NATURE OF BEER FESTIVALS, IN CLASS 41 (U.S. CLS. 100, 101 AND 107).

SERVICE MARK

FIRST USE 6-1-2009; IN COMMERCE 6-27-2009.

SUPPLEMENTAL REGISTER

THE MARK CONSISTS OF STANDARD CHARACTERS WITHOUT CLAIM TO ANY PARTICULAR FONT, STYLE, SIZE, OR COLOR.

NO CLAIM IS MADE TO THE EXCLUSIVE RIGHT TO USE "OKTOBERFEST", APART FROM THE MARK AS SHOWN.

SER. NO. 85-421,929, FILED P.R. 9-13-2011; AM. S.R. 12-29-2011.

TARAH HARDY, EXAMINING ATTORNEY



David J. Kybas

Director of the United States Patent and Trademark Office

United States of America

United States Patent and Trademark Office

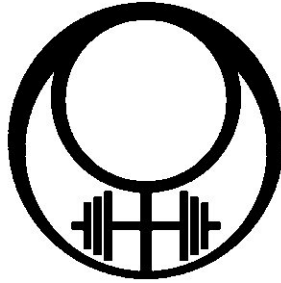

Reg. No. 4,100,447

SHANKS, NIA (UNITED STATES INDIVIDUAL)
P.O. BOX 7544

Registered Feb. 14, 2012

PADUCAH, KY 42002

Int. Cl.: 25

FOR: BEANIES; CAPS; HATS; HOODED SWEATSHIRTS; LONG-SLEEVED SHIRTS; PANTS; SHORTS; SOCKS; T-SHIRTS; TANK TOPS, IN CLASS 25 (U.S. CLS. 22 AND 39).

TRADEMARK

FIRST USE 5-1-2011; IN COMMERCE 5-1-2011.

SUPPLEMENTAL REGISTER

THE MARK CONSISTS OF A FEMALE SYMBOL WITH A BARBELL, SURROUNDED BY AN OUTER CIRCLE.

SER. NO. 85-461,282, FILED P.R. 11-1-2011; AM. S.R. 11-1-2011.

MATTHEW MCDOWELL, EXAMINING ATTORNEY



David J. Kyros

Director of the United States Patent and Trademark Office

United States of America

United States Patent and Trademark Office

Lift Like a Girl

Reg. No. 4,100,448

SHANKS, NIA (UNITED STATES INDIVIDUAL)
PO BOX 7544

Registered Feb. 14, 2012

PADUCAH, KY 42002

Int. Cl.: 25

FOR: CLOTHING, NAMELY, T-SHIRTS, TANK TOPS, LONG SLEEVE SHIRTS, HOODED SWEATSHIRTS, ZIP UP HOODED SWEATSHIRTS, HATS, CAPS, BEANIES, PANTS, SHORTS, AND SOCKS, IN CLASS 25 (U.S. CLS. 22 AND 39).

TRADEMARK

FIRST USE 5-1-2011; IN COMMERCE 6-1-2011.

SUPPLEMENTAL REGISTER

THE MARK CONSISTS OF STANDARD CHARACTERS WITHOUT CLAIM TO ANY PARTICULAR FONT, STYLE, SIZE, OR COLOR.

SER. NO. 85-471,245, FILED P.R. 11-13-2011; AM. S.R. 11-13-2011.

MATTHEW MCDOWELL, EXAMINING ATTORNEY



David J. Kyros

Director of the United States Patent and Trademark Office